

ASM 180 TD/TD+

ASM 181 TD+

Helium Leak Detector



User's Manual



FOR SALES AND SERVICE PLEASE CALL:

PTB SALES T : 866.332.0500
F : 626.334.2151
www.ptbsales.com

DATE SERVICED: _____



[View our inventory](#)

A very wide range of helium leak detectors

You have just purchased an ALCATEL leak detector.

This product is part of a very wide range of products resulting from 30 years of experience.

The applications of helium leak testing are extremely varied ranging from high-tech installation maintenance to high-speed testing of industrial products.



Each product of the ALCATEL detector range is designed to meet the specific needs of each application:

- unit portability;
- high sensitivity;
- pumping capacity;
- pumping type;
- automation and integration in an industrial process.

Integrable or turnkey solutions for automated leak testing



France

Alcatel Vacuum Technology - France
98, avenue de Brogny - BP 2069
74009 ANNECY Cedex
Tel : (33) 4 50 65 77 77
Fax : (33) 4 50 65 77 89

Germany

Alcatel HOCHVAKUUMTECHNIK GmbH
Am Kreuzeck 10
D - 97877 WERTHEIM
Tel : (49) 9342 9610-0
Fax : (49) 9342 9610-30

Italy

Alcatel Vacuum Systems S.p.A
Via Trento, 30
20059 VIMERCATE (MI)
Tel : (39) 39 686 3855
Fax : (39) 39 667 125

Japan

Alcatel ITS JAPAN
High Vacuum Technology Division
Ebisu MT Building 5 Floor
15-7, Higashi 3-Chome
Shibuya-ku, TOKYO 150-0011
Tel : (81) 3 5468 1621
Fax : (81) 3 5468 1603

Korea

Alcatel Vacuum Technology Korea
5th Floor, Sunghyun B/D
10-5, Karak-Dong, Songpa-ku
Seoul, SOUTH KOREA
Tel : (82) 2 409 6277
Fax : (82) 2 409 6279

United Kingdom

Alcatel Vacuum Technology (U.K.) Ltd.
10 Lancaster Court - Coronation Road
HIGH-WYCOMBE, HP 12 3TD
Tel : (44) 1 494 448 444
Fax : (44) 1 494 448 222

USA

Alcatel Vacuum Products
67 Sharp Street
HINGHAM, MA. 02043
Tel : (1) 781 331 - 4200
Fax : (1) 781 331 - 4230

High Vacuum Technology



User's Manual ASM 180 TD/TD+ - ASM 181 TD+

Introduction	■ The ASM 180 series.	■ A 10
	■ ASM 180 TD Detector operating principle	■ A 20
	■ ASM 180 TD+ - ASM 181 TD+	
	Detector operating principle	■ A 21
	■ Analyzer cell operating principle.	■ A 30
	■ Testing methods	■ A 40
	■ Operator interface	■ A 50
	■ Options	■ A 60
	■ Accessories	■ A 70
	■ Technical characteristics	■ A 80
	■ Dimensions	■ A 90
Installation	■ Precautions and unpacking.	■ B 10
	■ Controlling the detector with the I/O interface	■ B 20
	■ Controlling the detector with a micro-computer (RS232)	■ B 30
	■ Connecting an external printer	■ B 40
	■ Connecting a neutral gas purge (ASM 180TD only)	■ B 50
	■ Connecting the leak detector to the installation via the hardware interface	■ B 60
	■ Before starting up the detector	■ B 70

Contents

User's Manual

ASM 180 TD/TD+ - ASM 181 TD+

Operation	■ Starting up the detector	■ C 10
	■ Detector operation	■ C 20
	■ Detector autocalibration	■ C 30
	■ Switching off the detector	■ C 40
	■ Alphanumeric Control and Display Panel (ACDP) operation.	■ C 50
	■ Configuring the unit according to the gas to be detected	■ C 60
	■ Use of the "I" gas line option ASM 180 TD/TD+ only	■ C 70
Maintenance	■ Table of preventive maintenance intervals	■ D 10
Troubleshooting	■ General troubleshooting guide	■ D 20
	■ Problem with the roughing pump.	■ D 30
	■ No display	■ D 40
	■ Problem with the secondary pump.	■ D 50
	■ Spectro fault	■ D 60
	■ Inlet pressure problem	■ D 70
	■ Cycle start faults.	■ D 80
	■ Faults at end of autocalibration.	■ D 90
	■ Faults in sniffer mode	■ D 100
	■ Helium measurement problem	■ D 110
	■ I/O interface problem.	■ D 120

User's Manual ASM 180 TD/TD+ - ASM 181 TD+

Maintenance	■ Analyzer cell maintenance	■ E 10
Sheets	■ Greasing the hybrid turbomolecular pump	■ E 20
	■ Greasing the molecular drag pump	■ E 30
	■ Replacement / Recalibration of the detector internal calibrated leak	■ E 40
	■ Autocalibration of the detector with an external calibrated leak	■ E 50
	■ MD4E membrane pump maintenance	■ E 60
	■ CP20 Partial maintenance	■ E 70
	■ I/O interface board fuse replacement	■ E 80
Components	■ Preventive maintenance components delivered with the detector	■ F 10
	■ Monitoring and display	■ F 20
	■ Power and electrical supply	■ F 30
	■ Automatism and electronic circuits	■ F 40
	■ Measurement	■ F 50
	■ Pumping	■ F 60
	■ Valves	■ F 70
	■ Pipes	■ F 80
	■ Connections and seals	■ F 90
	■ Cover	■ F 100
	■ Options and accessories	■ F 110
	■ Components summary	■ F 120
Appendix	■ View of the operator interface	■ G 10
	■ Recording curve	■ G 20

MANUAL REFERENCE : 104435

EDITION : 04 - September 97

User's Manual

ASM 180 TD/TD+ - ASM 181 TD+

Introduction

■ The ASM 180 series	■ A 10
■ ASM 180 TD Detector operating principle	■ A 20
■ ASM 180 TD+ - ASM 181 TD+	
Detector operating principle	■ A 21
■ Analyzer cell operating principle	■ A 30
■ Testing methods	■ A 40
■ Operator interface	■ A 50
■ Options	■ A 60
■ Accessories	■ A 70
■ Technical characteristics	■ A 80
■ Dimensions	■ A 90

The ASM 180 series

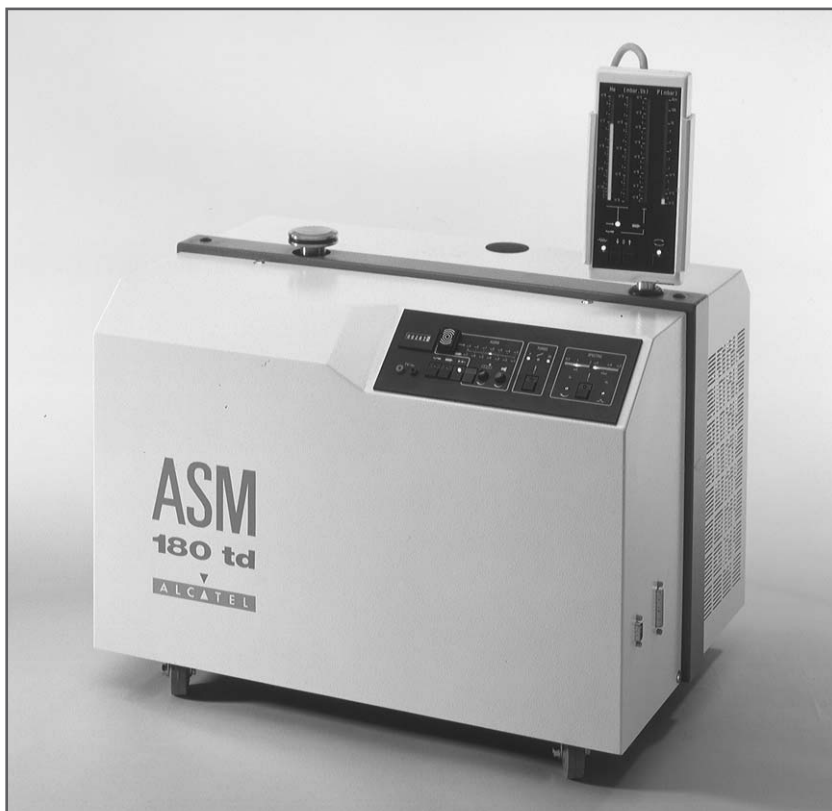

The main characteristics of this series of products are :

- very high sensitivity (2×10^{-11} mbar.l/s) ;
- a range of pumping capacities to meet different requirements ;
- sturdy design adapted to severe industrial environments ;
- user-friendly.



The ASM 180 series

includes different models :

- compact detectors (180) ;
- console detectors with work surface (181) ;
- conventional detectors equipped with oil sealed vacuum pumps ;
- oil-free ("D") dry detectors.

The ASM 180 series

The versions according the detector types:

PUMPING	COMPACT VERSION	CONSOLE VERSION
Standard: 1 Rotary vane pump PPM 2021 1 Hybrid pump PTM 5154	ASM 180 T	ASM 181 T
Enhanced conventionnal roughing: 2 Rotary vane pumps PPM 2021 1 Hybrid pump PTM 5154		ASM 181 T with 40 m ³ /h roughing option
2 Rotary vane pumps PPM 2021 1 Turbomolecular pump ATP 100 1 Hybrid pump PTM 5154		ASM 181 T2
Dry: 1 Primary membrane pump Type MD4E 1 Molecular drag pump MDP 5011 1 Hybrid pump PTM 5154	ASM 180 TD	
Dry +: 1 Dry pump Type CP20 1 Molecular drag pump MDP 5011 1 Hybrid pump PTM 5154	ASM 180 TD+	ASM 181 TD+
Enhanced dry roughing: 2 Dry pump Type CP20 1 Molecular drag pump MDP 5011 1 Hybrid pump PTM 5154		ASM 181 TD+ with 50 m ³ /h roughing option
1 Dry pump Type CP20 1 Molecular drag pump MDP 5011 1 Turbomolecular pump ATP 100 1 Hybrid pump PTM 5154		ASM 181 T2 D+

ASM 180 TD

Detector operating principle

Vacuum circuit

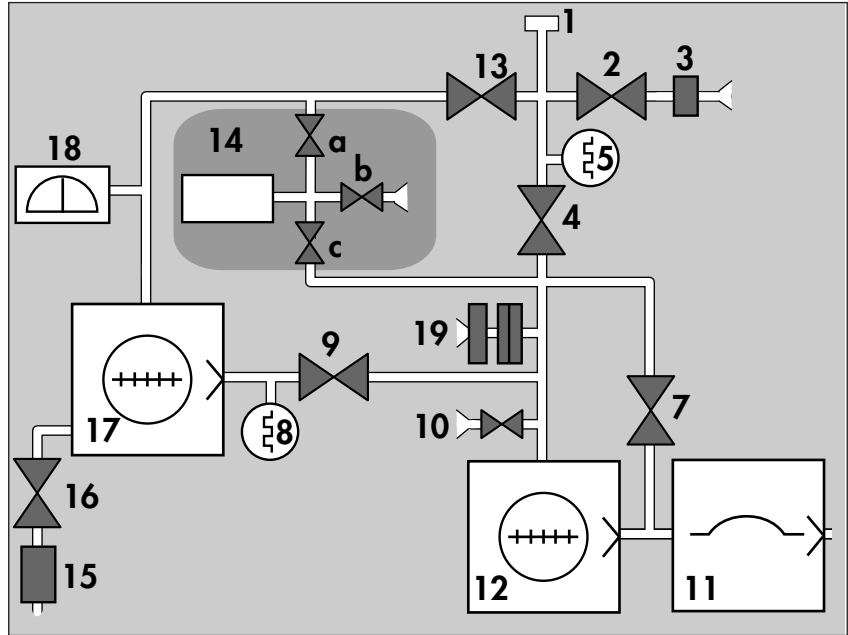

- | | |
|-----------------------------------|-------------------------------------------|
| 1. Detector inlet port | 12. Roughing molecular drag pump (MDP) |
| 2. Inlet vent valve | 13. Detection valve |
| 3. Vent filter connector | 14. Calibrated leak module |
| 4. Roughing valve | 15. Connector for long distance sniffer |
| 5. Inlet pressure gauge (PI3C) | 16. Sniffer valve |
| 7. By-pass valve | 17. Hybrid turbomolecular pump (PTM 5154) |
| 8. Exhaust pressure gauge (PI1) | 18. Analyzer cell |
| 9. Exhaust valve | 19. Connector for inert gas purge |
| 10. Roughing pump vent valve | |
| 11. Roughing membrane pump (MD4E) | |

Pumping capacities 4 m³/h roughing (membrane pump MD4E)
 + 10 l/s (molecular drag pump MDP).
 Helium pumping speed at inlet port : 4.4 l/s.

Test capacities Short test cycle.
 Quick response time.
 Autocalibration with integrated calibrated leak.

ASM 180 TD

Detector operating principle

Note: Only operational parts are represented.

Operation in vacuum test mode: 3 stages

1a Primary roughing

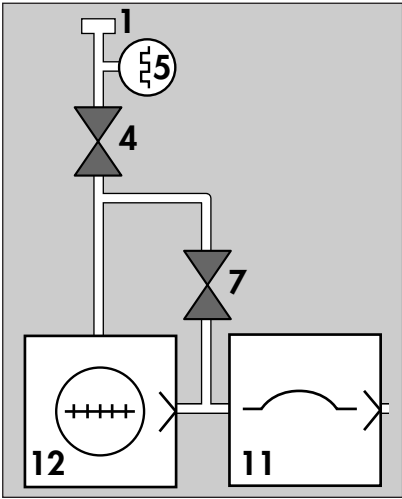

1b Molecular roughing

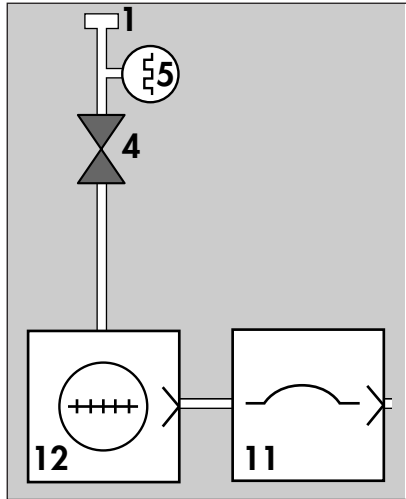

Note: Valve 7 closes at about 6 mbar.

2 Gross leak test mode (GL)

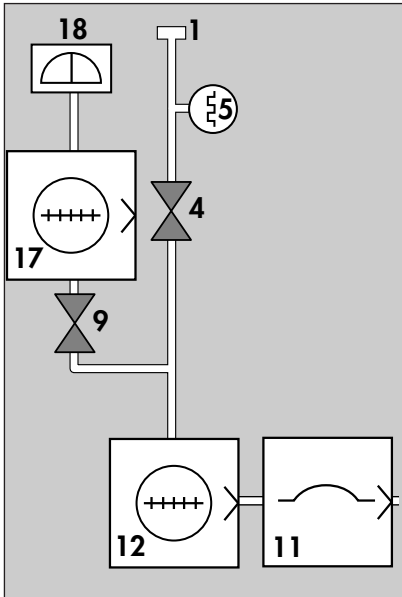

3 Fine leak test mode (FL)

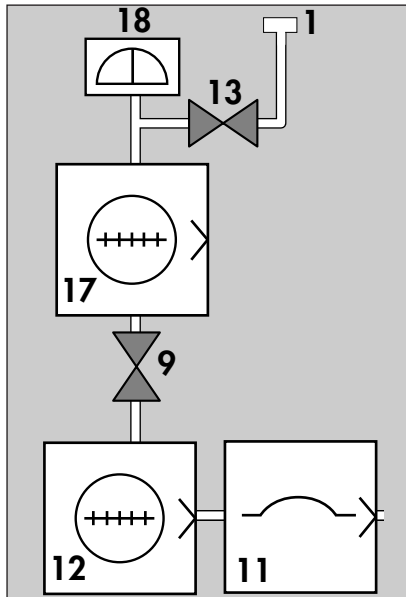

Edition 03 - May 97

ASM 180 TD

Detector operating principle

Operation in sniffing mode (LDS)

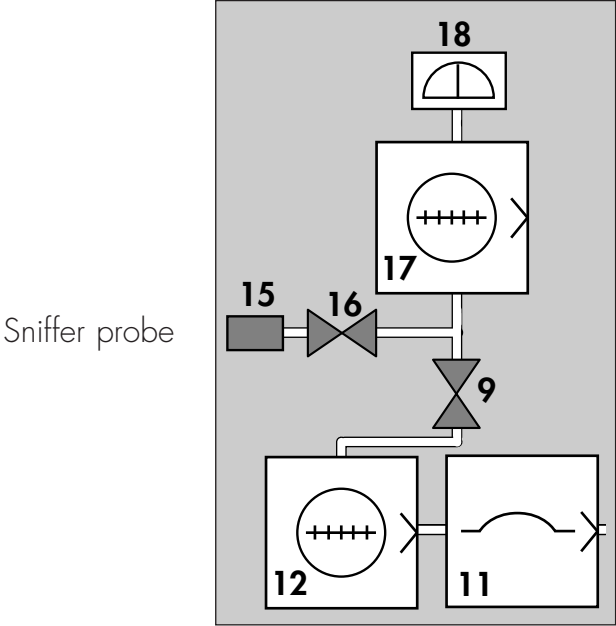

ASM 180 TD

Detector operating principle

Operation in internal calibration mode

1 Roughing of calibrated leak

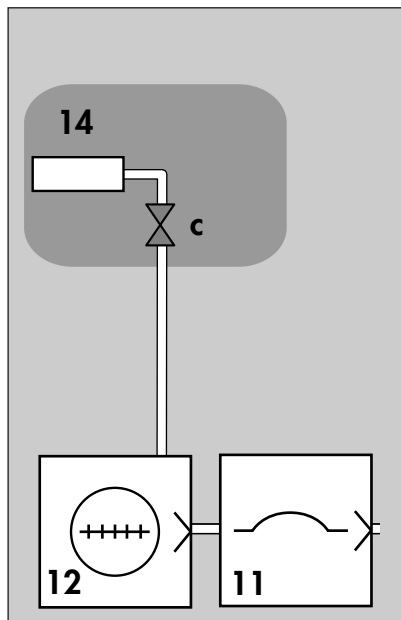

2 Calibration

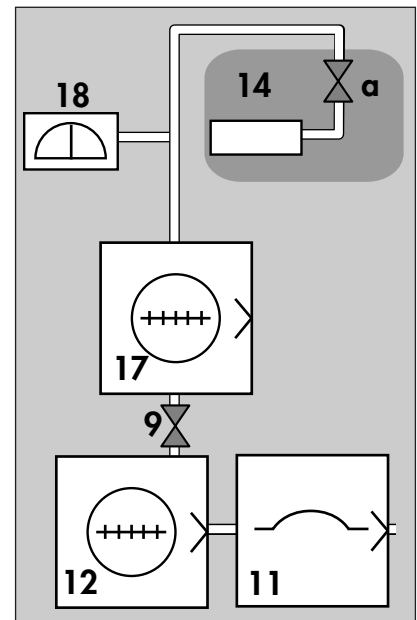

3 Venting of calibrated leak

The leak is returned to atmospheric pressure

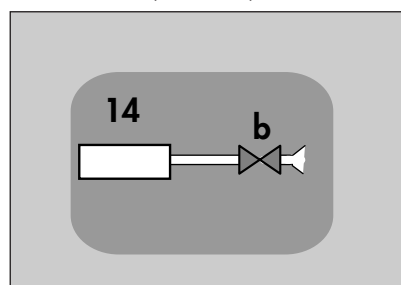

ASM 180 TD+ - ASM 181 TD+ Detector operating principle

Vacuum circuit

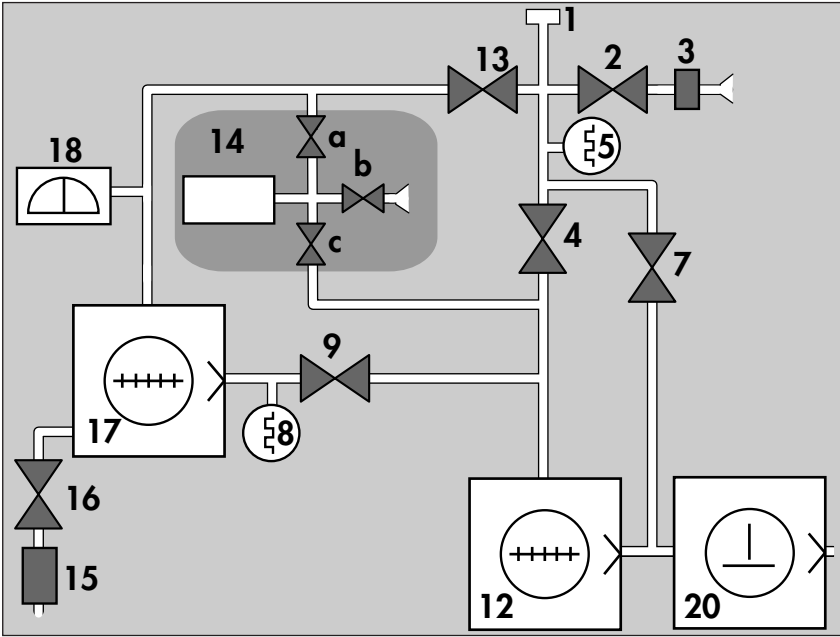

- | | |
|----------------------------------------|-------------------------------------------|
| 1. Detector inlet port | 13. Detection valve |
| 2. Inlet vent valve | 14. Calibrated leak module |
| 3. Vent filter connector | 15. Connector for long distance sniffer |
| 4. Roughing valve | 16. Sniffer valve |
| 5. Inlet pressure gauge (PI3C) | 17. Hybrid turbomolecular pump (PTM 5154) |
| 7. By-pass valve | 18. Analyzer cell |
| 8. Exhaust pressure gauge (PI1) | 19. Exhaust valve |
| 9. Exhaust valve | 20. Dry primary roughing pump (CP20) |
| 12. Roughing molecular drag pump (MDP) | |

Pumping capacities

25 m³/h (15 cfm) roughing (dry primary pump CP20)
+ 10 l/s (molecular drag pump MDP).
Helium pumping speed at inlet port: 4.4 l/s.

Test capacities

Short test cycle.
Quick response time.
Autocalibration with integrated calibrated leak.

ASM 180 TD+ - ASM 181 TD+ Detector operating principle

Note: Only operational parts are represented.

Operation in vacuum test mode: 3 stages

1 Primary roughing

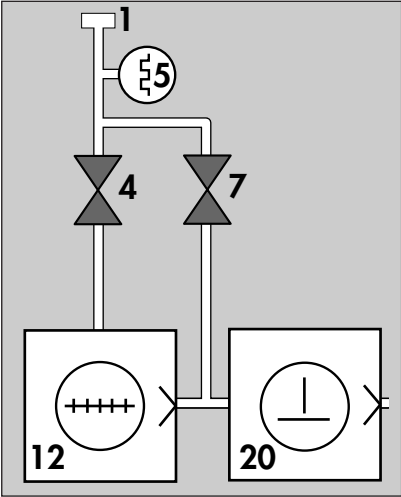

2a Gross leak test mode (GL)
1 mbar < Inlet Pressure < 6 mbar

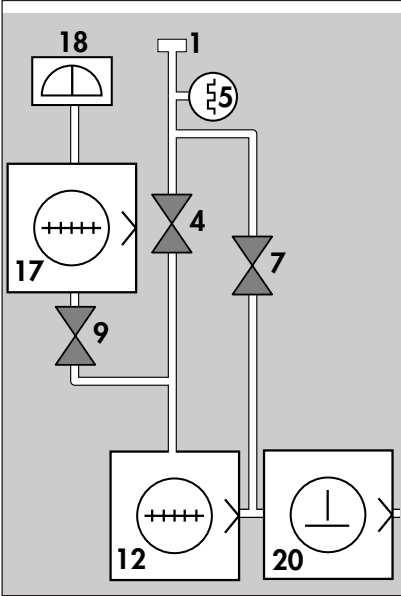

2b Gross leak test mode (FL)
Inlet Pressure ≤ 6 mbar

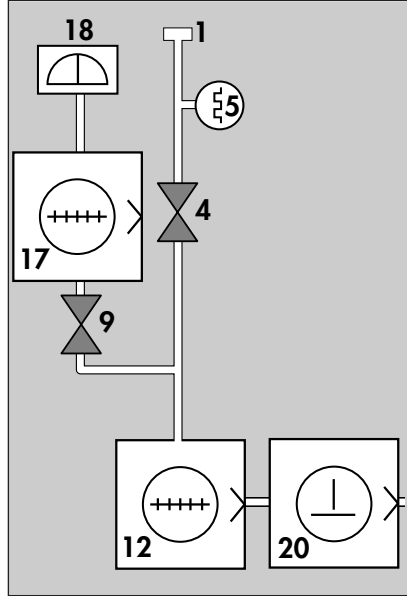

Edition 04 - September 97

ASM 180 TD+ - ASM 181 TD+ Detector operating principle

**Operation in vacuum test mode:
3 stages
(continued)**

3 Fine leak test mode (FL)

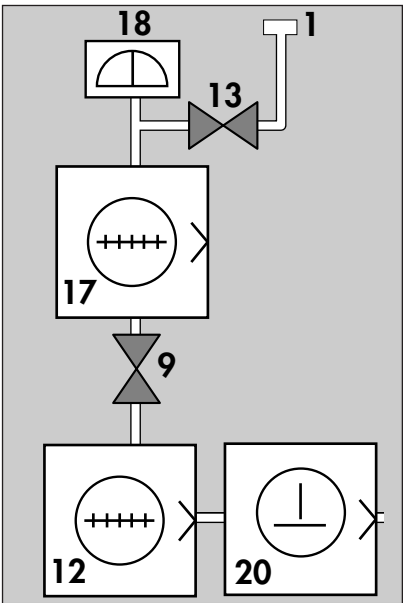

Operation in sniffing mode (LDS)

Sniffer probe

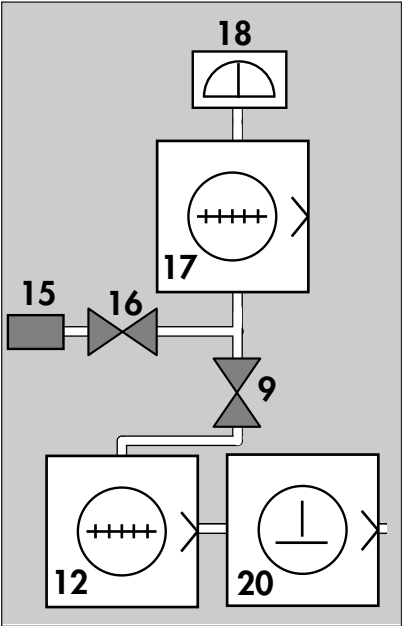

ASM 180 TD+ - ASM 181 TD+ Detector operating principle

Operation in internal calibration mode

1 Roughing of calibrated leak

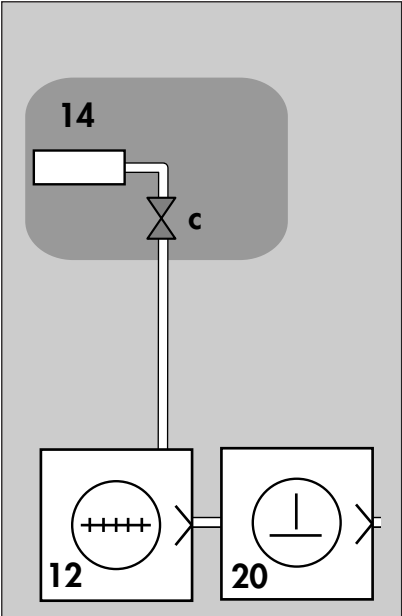

2 Calibration

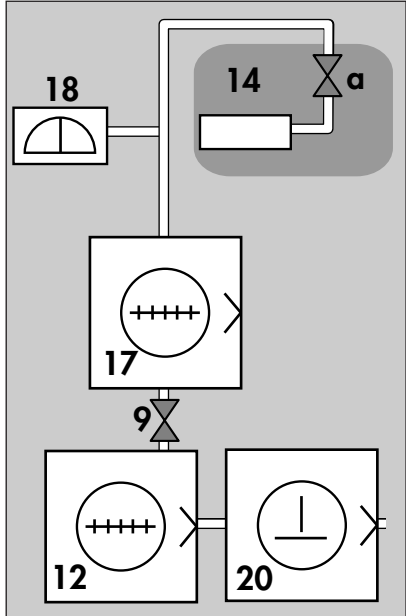

3 Venting of calibrated leak

The leak is returned to atmospheric pressure

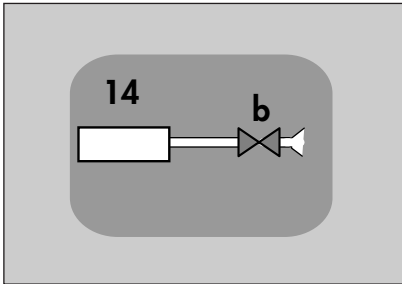

Analyzer cell operating principle

Cell principle The mass spectrometry **analyzer cell** is used for helium partial pressure measurements.

Magnetic deflection spectrometry The molecules of the gas being analyzed are bombarded by an electron beam from a heated tungsten **filament (1)** in an **ionization chamber (3)**. A large proportion of the molecules are transformed into ions. These ionized particles are accelerated by an electrical field: the acceleration voltage. A magnetic field deflects the ion beam by a radius proportional to the mass of the ions. The **acceleration voltage** directs the Helium ions to the **target** at the entrance of an amplifier, an electron multiplier based system, **developed and patented by ALCATEL**.

Leak flow rate The stream of Helium ions is proportional to the partial pressure of helium in the installation and its measurement is used to find the value of the flow rate of the detected leak.

Vacuum operation It is essential for the total pressure in the analyzer cell to be less than 10^{-4} mbar so that the paths of the electrons and ions are not disturbed by residual molecules.

Separation of He ions from "noise" In order to separate the helium ions from the "noise" due to "dispersed ions", a **"braking electrode" (6)**, placed in front of the target, eliminates secondary, low-energy ions.

Total pressure The top of the cell contains an auxiliary electrode which collects ions that have a higher mass than that of helium. This electrode, the **triode electrode (4)**, is used to measure the total pressure inside the analyzer.

Analyzer cell operating principle

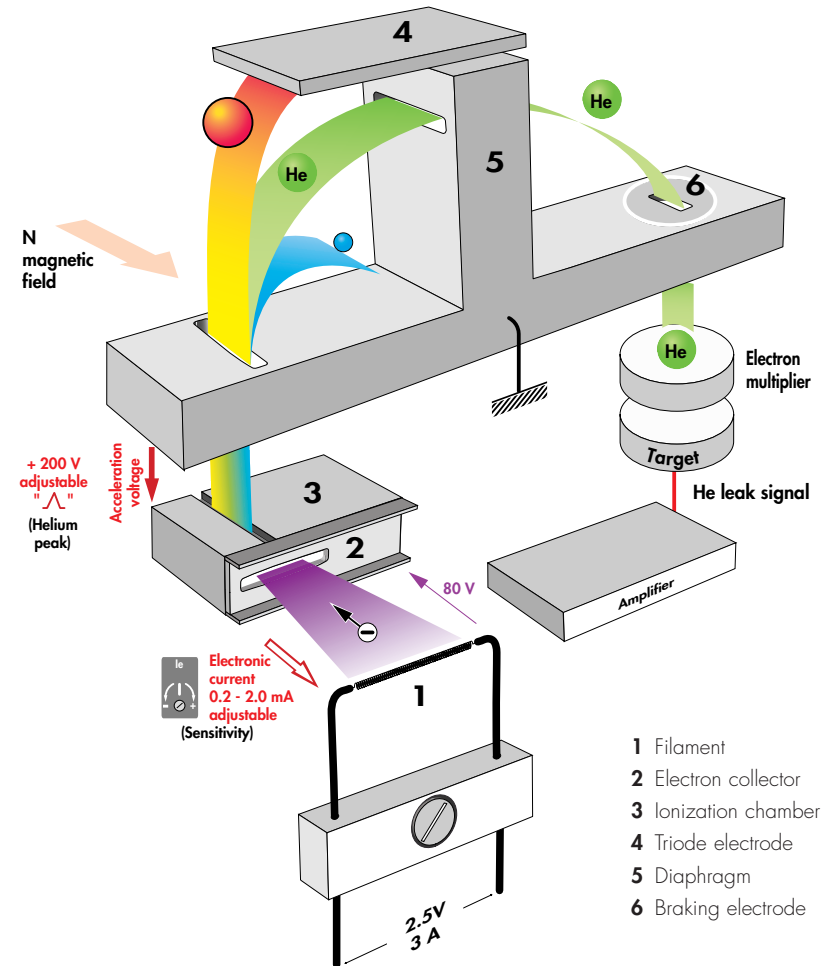

- 1 Filament
- 2 Electron collector
- 3 Ionization chamber
- 4 Triode electrode
- 5 Diaphragm
- 6 Braking electrode

➔ Electron beam

● "Heavy" ions

● He Helium ions

● "Light" ions

Testing methods

Leak detection is used to detect micro-openings, porosities, etc. in test parts. The detection of these passages involves the use of a light gas, which is capable of infiltrating the smallest passages quickly: **Helium**.

The detector samples and measures the helium flow rate entering the test part via the leak(s).

The testing method is selected according to the test part and the measurement accuracy required:

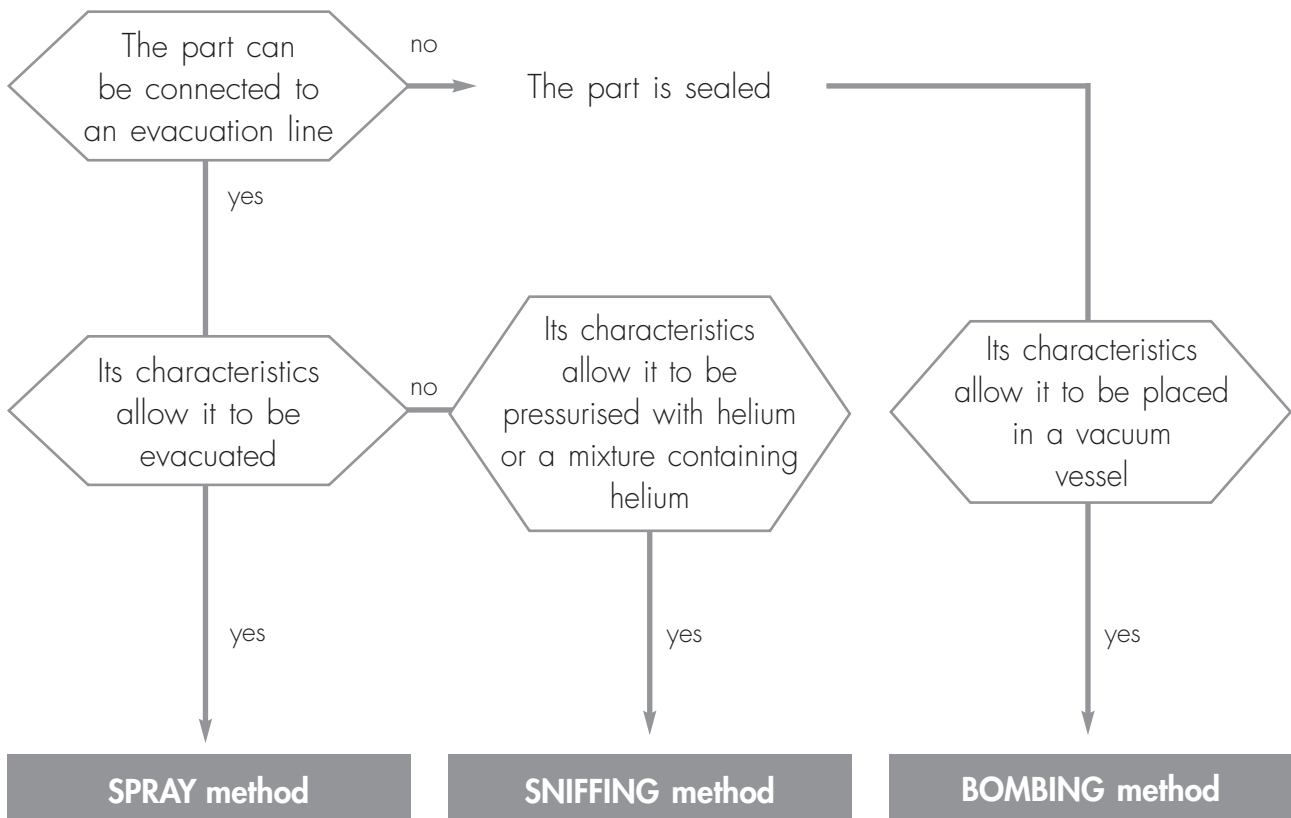

Leak rate measurement from 10^{-10} to 10^{-1} mbar and possibility of locating the leak

Minimum detectable leak of 10^{-6} mbar and possibility of locating the leak

Leak not located

Edition 03 - May 97

Testing methods

Spray method

This involves removing air from the test part, connecting it to the analyzer and then spraying helium over the outer surface.

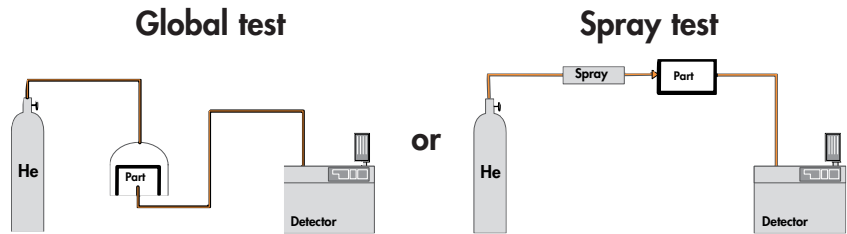

The part is placed under a cover, into which helium is injected.

Areas liable to leak are sprayed with helium.

The leak cannot be located.

The leak can be located.

The detector measures the flow of helium penetrating the part.

Response time

When spraying starts, the leak signal is not displayed instantaneously on the analyzer:

there is a response time which depends on the volume V being tested and the helium pumping speed S of the system at the opening of the part, according to the following relation:

$$T = \frac{V}{S} \quad (T \text{ in seconds, } V \text{ in litres, } S \text{ in l/s})$$

T is the time required for the signal to reach 63 % of the final value.

Testing methods

Sniffer method

The test part is pressurized with helium. The detector, via an LDS (Long Distance Sniffer) probe, collects the helium escaping from the part.

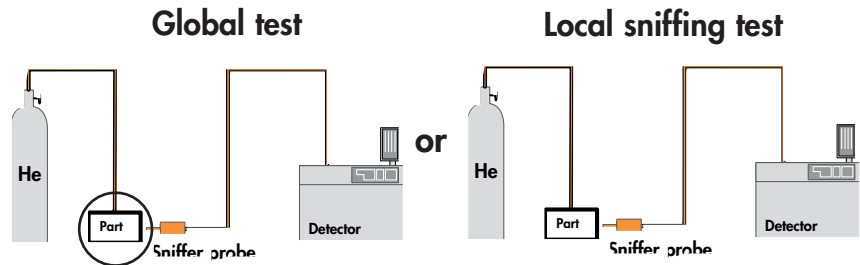

The part is placed under a cover containing a sniffer probe.

The leak cannot be located.

The helium from the leak accumulates over time inside the cover. The detector measures the concentration.

The sniffer probe is moved over areas likely to contain leaks.

The leak can be located.

The signal supplied by the analyzer is not a direct measurement of the leak. The sniffer probe only collects part of the helium escaping from the part depending on the distance separating the leak from the tip of the probe.

Testing methods

Bombing method

This method is used for sealed objects that cannot be connected directly to the detector (semiconductors, waterproof watches, etc.).

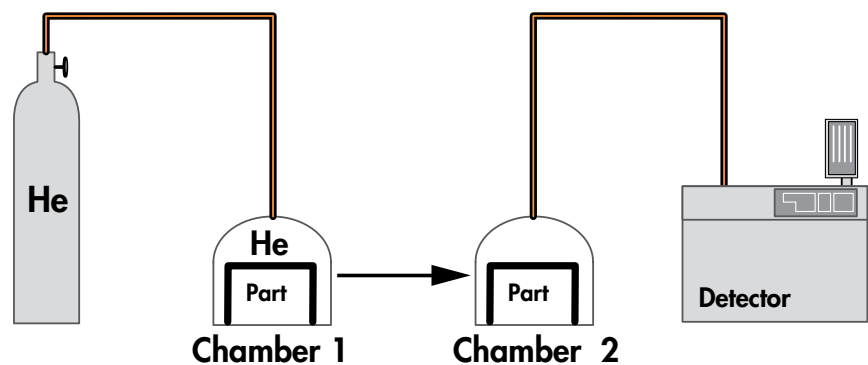

The part is placed in a vessel containing pressurised helium.

The helium penetrates the part if it has a leak.

The part is then removed from the vessel and placed in another vacuum vessel which is connected to the detector. The helium escapes from the part through the leak and produces a signal.

This signal is not a direct measurement of the leak as the helium pressure inside the part is difficult to determine. It depends on the pressurisation time, pressurisation pressure, internal volume of the part, dwell time before vacuum test and size of the leak.

Operator interface

CONTROL PANEL

The **counter** operates when the unit is switched on

Detector **pumping** system status display. (details on **C 10**)

Detection parameters (analyzer cell)

electronic ionization current display

cell pressure

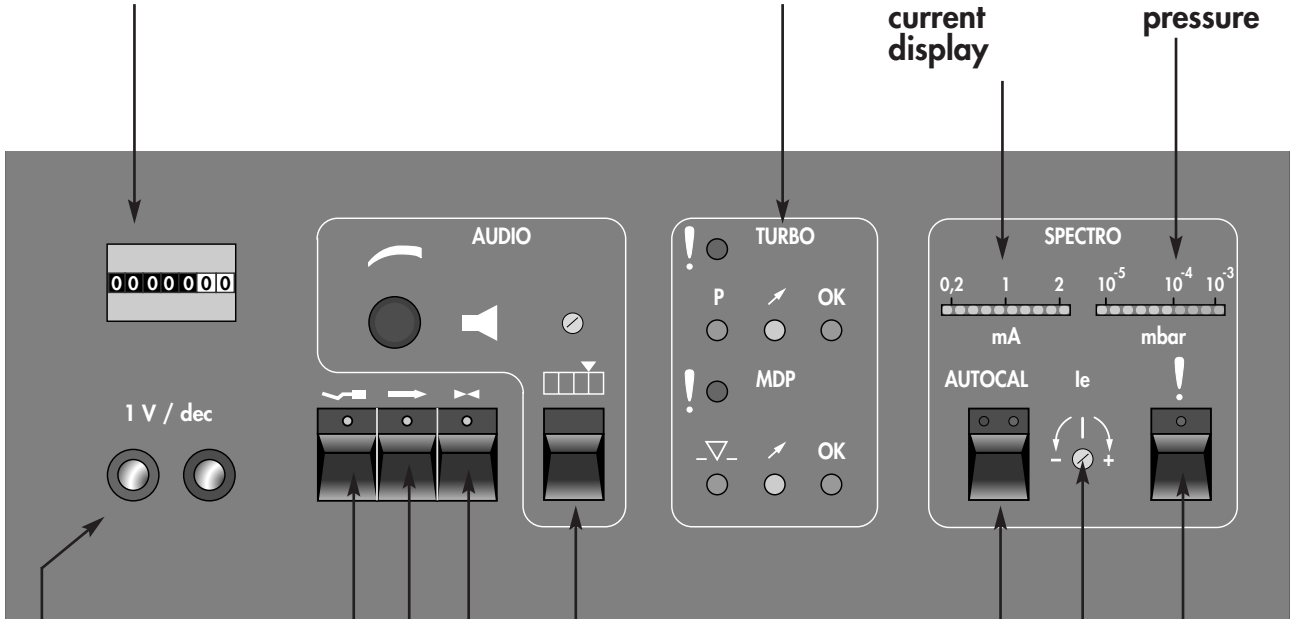

Analog output to record the leak signal (details on **C 20**)

Alarm **setpoint and volume control** setting (details on **C 20**)

Detector autocalibration start-up

Emission current fine adjustment

Filament reset

Mode selection

Sniffer (LDS)
Gross leak
Automatic inlet vent

Edition 03 - May 97

Operator interface

REMOTE CONTROL UNIT

Leak flow (Helium signal) display

Measurement scale in **Fine leak** mode

Measurement scale in **Gross leak** or LDS mode

Detector inlet pressure display

Test mode
Gross leak
Fine leak
LDS

Filament
ON / OFF

Cycle
ON / OFF

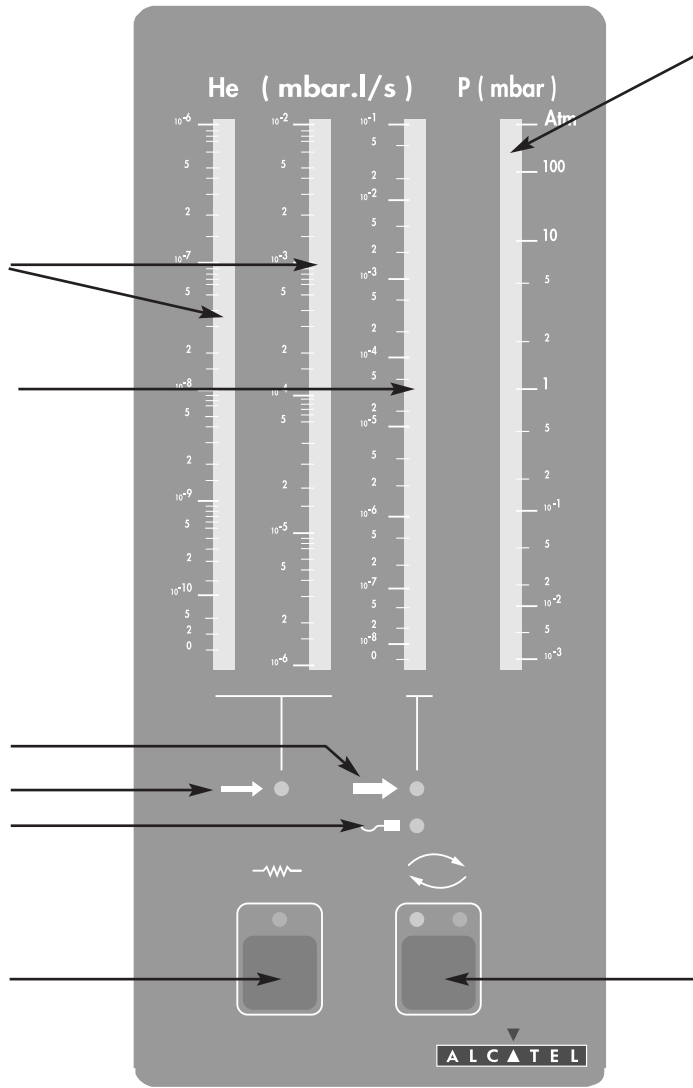

Factory options

Metal seals These reduce the Helium background noise.

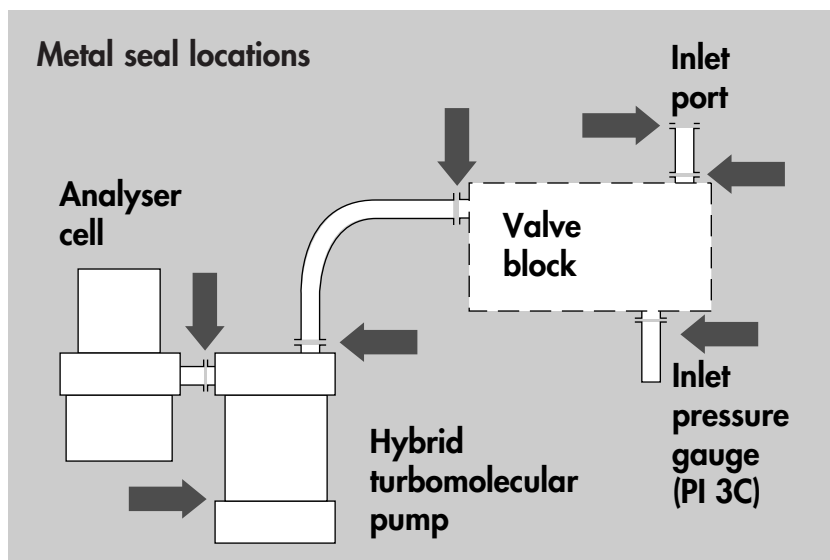

Elastomer cell seal Used for easier maintenance operations on the analysis cell (mass spectrometer).

This seal replaces the lead seal and can be reused.

Spare elastomer seal part number: **102823**.



In the event of a high helium concentration in the room in which the test is being conducted, the use of this type of seal may generate an increase in the residual signal of the unit.

Control panel protection

A Plexiglas cover equipped with a key is used to lock the access to the detector setting parameters for non-qualified operators.

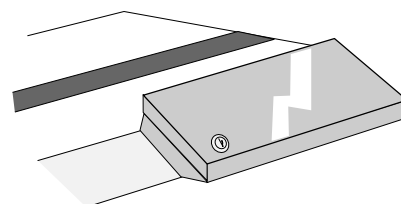

3 masses For use of one of the three following tracer gases: Helium 4, Helium 3 or Hydrogen 2.

Factory options

Alphanumeric Control and Display Panel (ACDP)

Designed for industrial control, it is used to:

- display the measurement in digital form,
- automate the unit test cycle,
- sort tested parts and
- print the test results on an optional external printer.

It consists of:

- A user interface mounted on the front panel of the detector
- an RS232 interface at the rear used to connect an external printer.

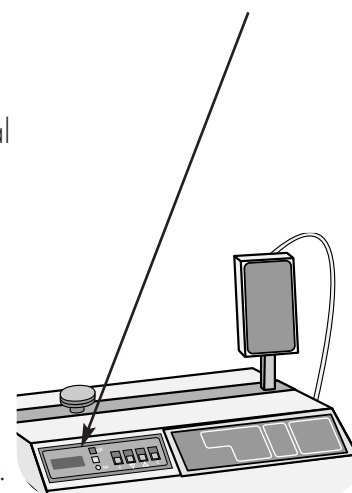
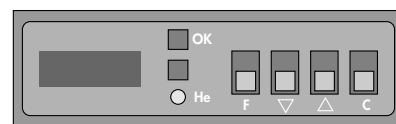

Automatic test chamber

This option includes the ACDP option.

This is used for the automatic bombing testing of small components.

When the chamber cover is closed, the test cycle is initiated, via a contact.

Three aluminium alloy models are available:

- a hemispheric chamber, diam. 72 mm, depth 31 mm;
- a cylindrical chamber, maximum diam. 85 mm and maximum depth 68 mm;
- a cylindrical chamber, maximum diam. 160 mm and maximum depth 200 mm.

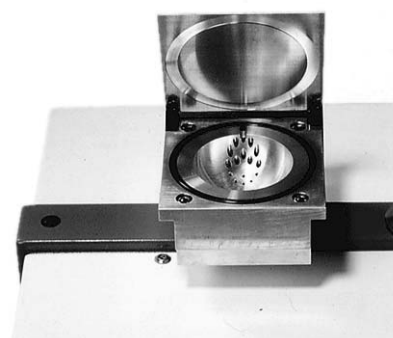

Factory options

Remote control unit with different cable lengths

Remote control unit with

- a **7 m (21 feet)** cable instead of 3.5 m (11 feet) or,
- a **25 m (76 feet)** cable instead of 3.5 m (11 feet).

Stainless steel cover (UCT) (for compact versions)

Designed for use of the unit in clean rooms ("Ultra Clean Technology"). The front and rear covers and frame are made of stainless steel.

An adapter can be attached to the side of the unit for connection to an exhaust system: diameter 100 mm (Part No.: **102867** - proposed as accessories).



Test of gas line ("I") (for compact versions)

Used to perform spray testing on long lines (typical diameter: 1/4"), with a reduced response time due to the transfer of the helium by a carrier gas injected in viscous flow.



In this case, the detector is equipped with an additional 1/4" VCR connector specific to this option and a luminous button to activate the function.

Factory options

50 m³/h roughing (for console version)

In order to reduce the roughing time when testing large volumes, a second CP 20 rotary vane pump can be added to the roughing system.

Vacuum circuit of the ASM 181 TD+ equipped with the 50 m³/h (2x15cfm) roughing option :

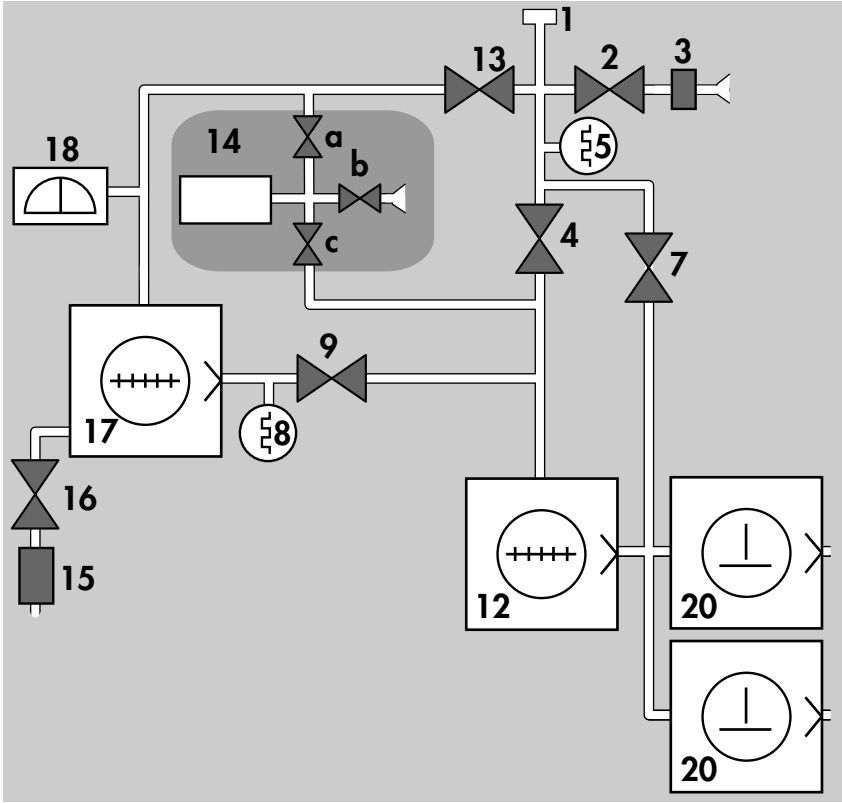

Apart from the roughing capacity and the weight (185 kg/406 lb with the option), the characteristics and the use of the leak detector remain the same.

Accessories

ALSTAT statistical software kit

To be used when the detector is connected to a PC-compatible computer.

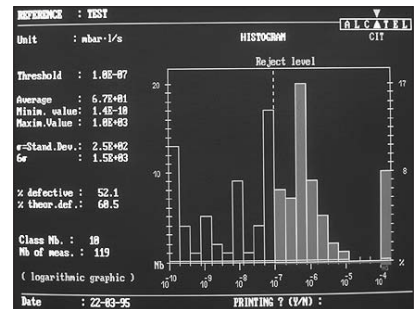

Part No.: **785911**

Cart (for compact versions)



Part No.: **072654**

Long Distance Sniffer (LDS) probe

This is used for long distance sniffing (tube length=5m).



Part No.: **072301**

Spray probe

Helium spray probe (less tubing).

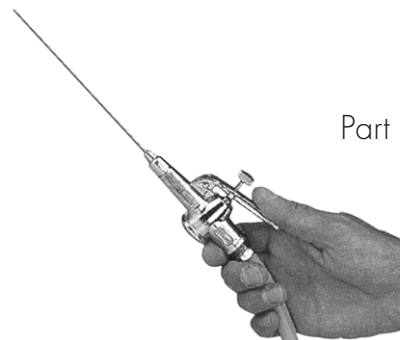

Part No.: **083465**

Accessories

Exhaust line / adapter (for compact versions)

Stainless steel cover option required.

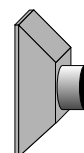

Part No.: **102867**

Cycle control pedal

This is connected to the I/O interface and frees the operator's hands. The test cycle is initiated by pressing on the pedal.

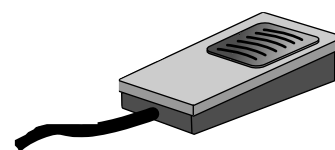

Part No.: **100913**

Printer

The unit equipped with the ACDP option can issue test tickets and autocalibration reports to guarantee measurement traceability.

Refer to the **B 40** and **C 50** section concerning the use of the ACDP option.

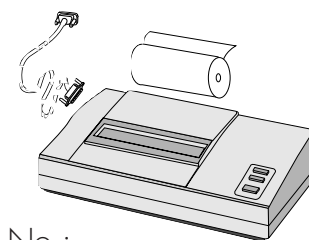

Part No.:
 120V - 60Hz : **103593**
 100V - 50/60Hz : **103594**
 220V - 50Hz : **102873**

Connection components

- St. steel flexible hose L 250 mm - DN 40
- St. steel flexible hose L 500 mm - DN 40
- St. steel flexible hose L 1000 mm - DN 40
- St. steel symmetrical T - DN 40
- St. steel symmetrical cross - DN 40
- St. steel reducing nipple DN40 / DN25
- St. steel centering ring with viton seal DN 40

- Part No. **068373**
- 068374**
- 068375**
- 068564**
- 068571**
- 068253**
- 068230**

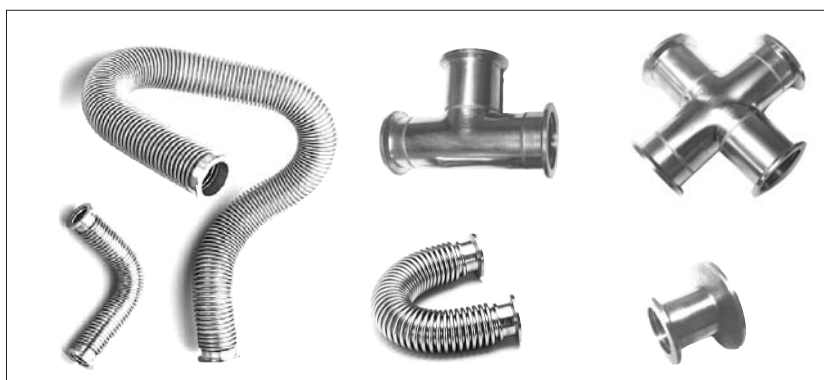

For any other accessories, contact our sales department.

Technical characteristics

	ASM 180 TD	ASM 180 TD+	ASM 181 TD+	
	Standard	Standard	Standard	with 50 m ³ /h roughing option
Roughing (primary) pump	4 m ³ /h (2.4 cfm) + 10 l/s	25 m ³ /h (15 cfm) + 10 l/s	25 m ³ /h (15 cfm) + 10 l/s	2 x 25 m ³ /h (2 x 15 cfm) + 10 l/s
Hybrid turbomolecular pump (air)	130 l/s			
Measurement range	2.10 ⁻¹¹ to 10 ⁻¹ mbar.l/s			
Electronic response time	< 0.1 s			
8 decade log recording output	1 V/dec.			
Setpoint setting - Fine leak	10 ⁻¹¹ to 10 ⁻² mbar.l/s			
Setpoint setting - Gross leak	10 ⁻⁸ to 10 ⁻¹ mbar.l/s			
Inlet pressure display	10 ³ to 10 ⁻³ mbar			
Triode pressure display (Spectro)	10 ⁻⁵ to 10 ⁻³ mbar			
Emission current display	0.2 to 2 mA			
Cell sensitivity	3.10 ⁻⁴ A/mbar			
He pumping speed at detector inlet port	4.4 l/s			
Air pumping speed at spectrometer	110 l/s			
He pumping speed at spectrometer	30 l/s			
TMP exhaust pressure safety limit	6 mbar			
Start-up time	3 min			
Cycle time, inlet port blanked off (GL - FL mode)	2 - 4 s			
Power voltage	100, 115, 200, 220, 230, 240 V			
Power frequency	50/60 Hz single-phase			
Power consumption	1.2 kVA	1.5 kVA	1.6 kVA	2.4 kVA
Ambient operating temperature	10 to 40 °C			
Weight	73 kg (160lb)	96 kg (210lb)	155 kg (340lb)	185 kg (406lb)
Noise level (at 1m; alarm not operational)	54 dB	65 dB	65 dB	67 dB
Inert gas purge:	absolute pressure	1.4±0.1 bar abs.		
	flow rate	1.10 ⁻² mbar.l/s		
		No Purge		
		No Purge		

Dimensions (mm/inch)

ASM 180 TD

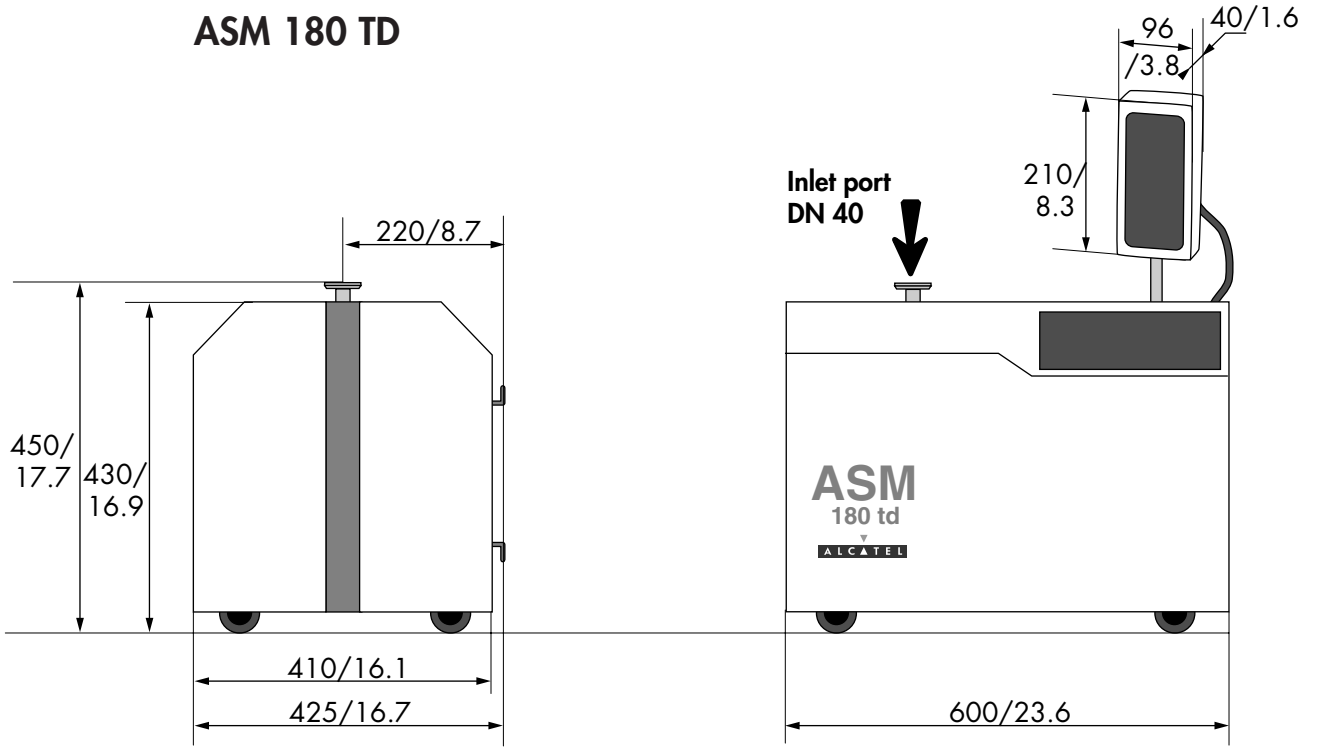

ASM 180 TD+

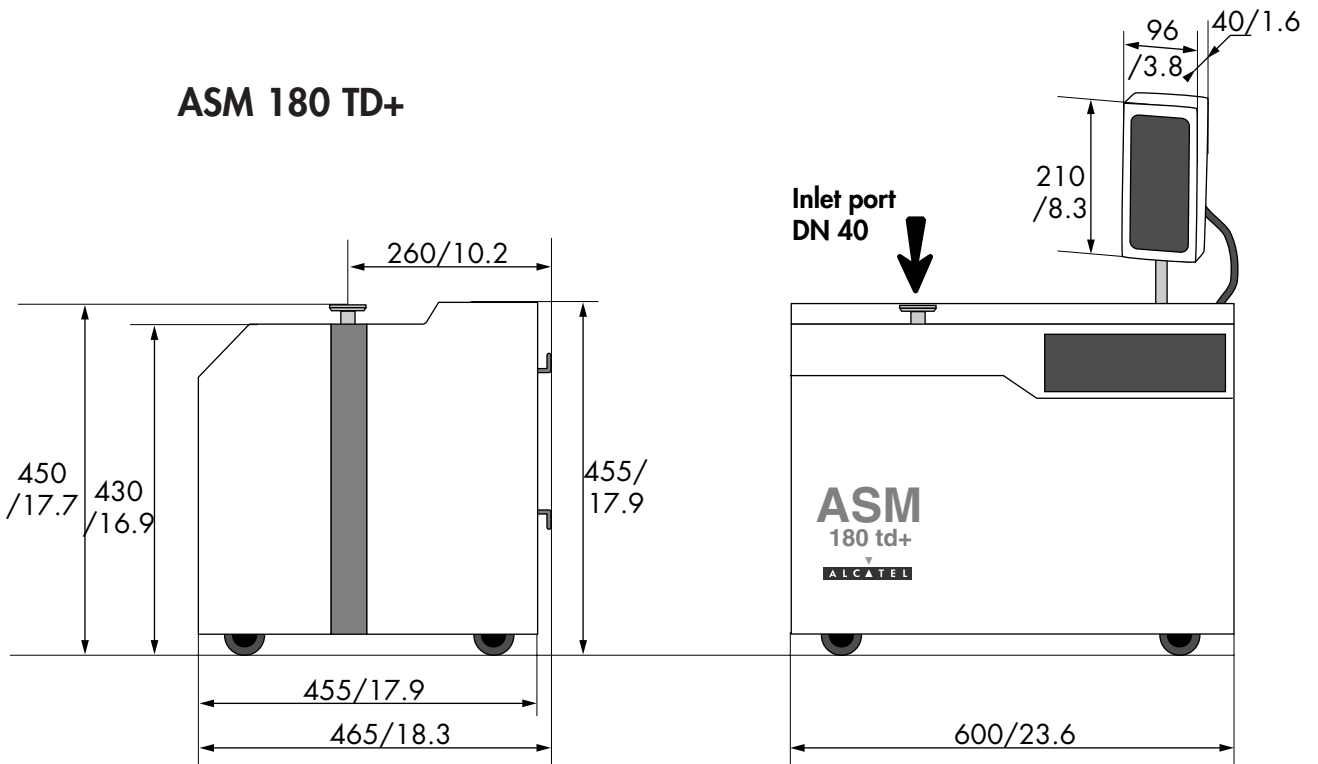

Dimensions (mm/inch)

ASM 181 TD+

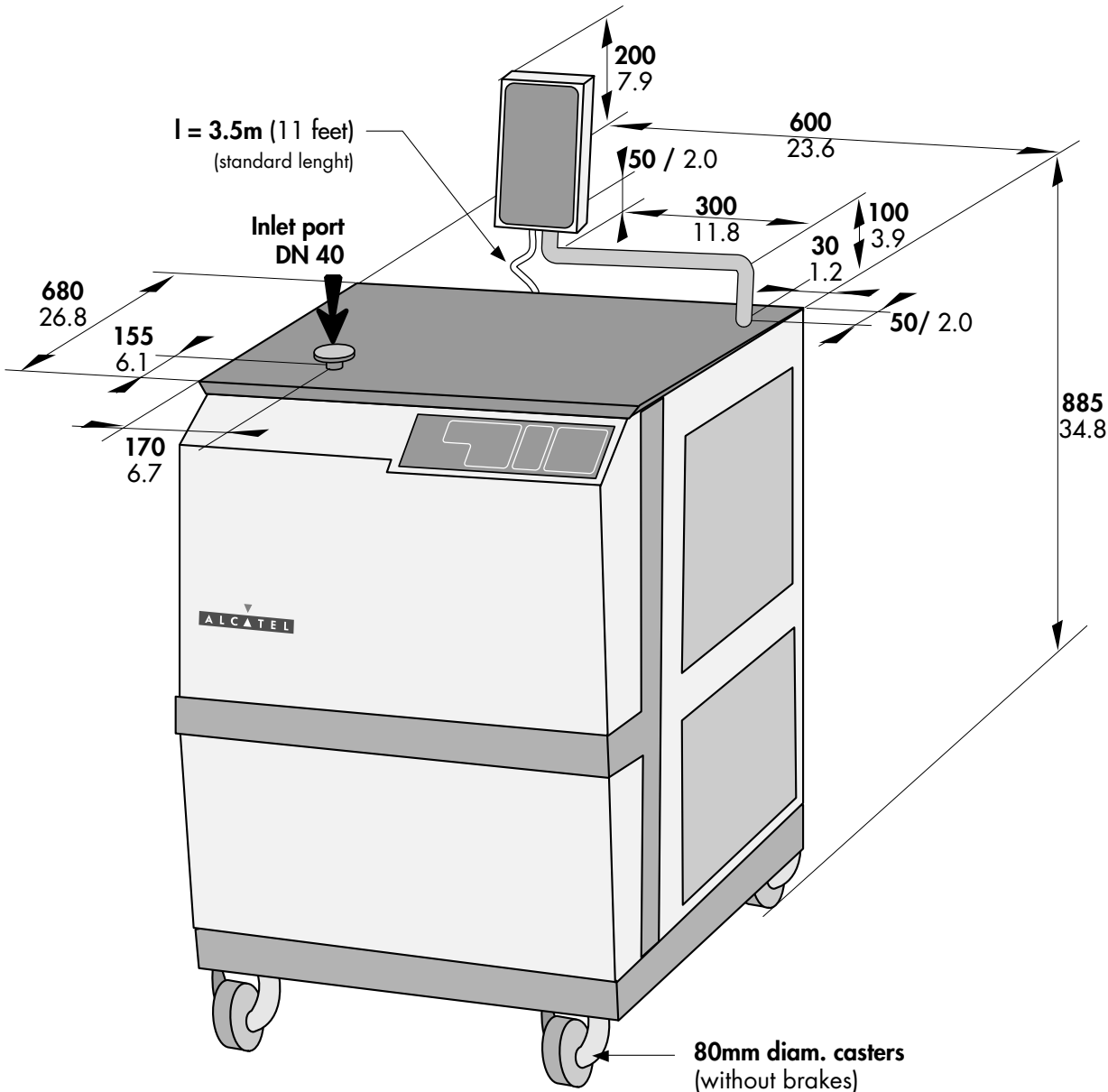

Edition 04 - September 97

User's Manual ASM 180 TD/TD+ - ASM 181 TD+

Installation

- Precautions and unpacking ■ **B 10**
- Controlling the detector with the I/O interface ■ **B 20**
- Controlling the detector with
a micro-computer (RS232) ■ **B 30**
- Connecting an external printer ■ **B 40**
- Connecting a neutral gas purge (ASM 180TD only). ■ **B 50**
- Connecting the leak detector to the installation
via the hardware interface ■ **B 60**
- Before starting up the detector ■ **B 70**

Precautions and unpacking



Before switching on the unit, the user should read the safety instructions supplied with the detector and be sure to follow them.

Unpacking

When the equipment is received, unpack it carefully: do not discard the packaging until you have made sure that the unit has not been damaged during transport.

The following are supplied with your unit:

- an instruction manual
- a maintenance kit
- the calibration certificate of the internal calibrated leak.

(If one of these parts is missing, contact ALCATEL immediately).

Check the **packaging tilt indicator** of the detector.

Before opening, check the **name of the model** and the **serial number**.



After opening, check the colour of the **hydrating bags** packed in the detector casing.
(red in the event of humidity)

Precautions and unpacking

Handling the leak detector with a hoist and slings

ASM 180 compact version

Two lifting rings are supplied with the leak detector. Plugs are also supplied to replace the rings during normal use of leak detector.



ASM 181 console version

Four lifting rings are supplied with the leak detector. They must be located on the upper part of the leak detector frame after having removed the work surface of the leak detector (fixed by one screw on each side).

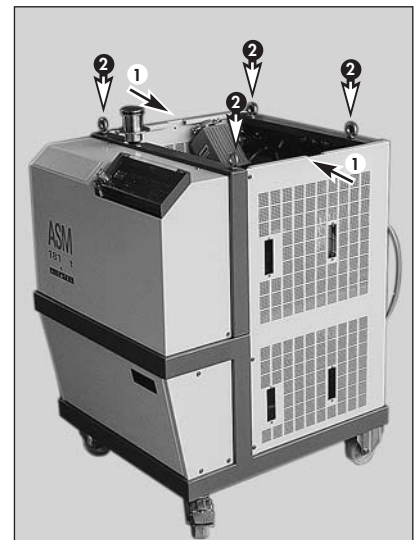

- 1 - Work surface fixing screws
- 2 - Location of the lifting rings

In the event of any damage, contact the shipper and, if necessary, notify ALCATEL.

Precautions and unpacking

Storage For prolonged storage, factors such as temperature, humidity, saline atmosphere, etc. may damage the detector elements. In this case, it may have operating problems. Before starting up after storage for over six months, it is recommended to change all the seals (contact customer service).

The seal kits must be kept away from heat and light (direct sunlight and ultraviolet light) in order to prevent hardening of the elastomers.

Installation The performances of the detector (pumping speed, accuracy and reliability) depend on:

- the ambient temperature;
- the vacuum connections;
- the frequency and quality of maintenance;
- the helium calibration.

Position the unit so there is no possible risk of the unit falling or tilting.

Controlling the detector with the I/O interface

This makes it possible to control the detector using a PLC.

Connect the jumper plug if the I/O interface is not used

In the absence of external control, the jumper plug supplied with the detector must be kept in place in order to use the operator interface (contacts 23-24 connected):

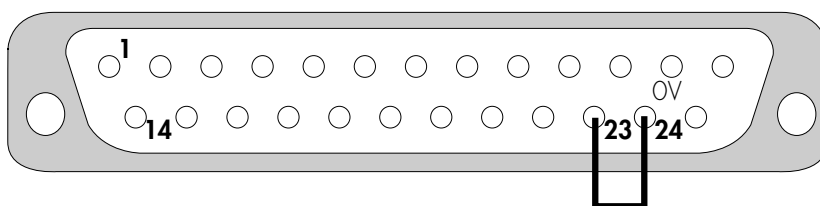

Prepare the connector wiring

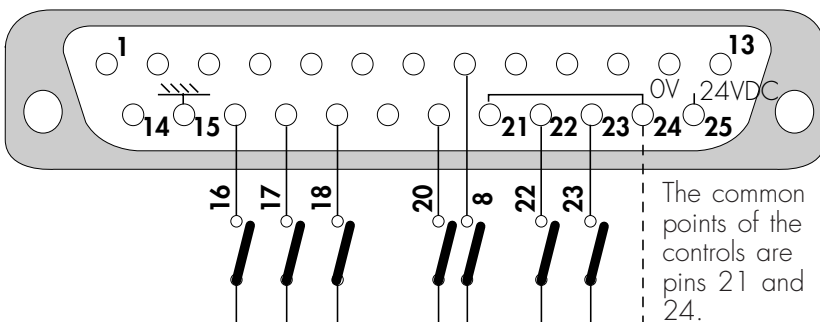

The common points of the controls are pins 21 and 24.

It is recommended to use a shielded cable which is grounded on the connector cap.

The controls (inputs)

23 Interface	Contact open: the detector is controlled by the I/O interface, the operator can not access the keys  on the control panel or the filament key on the remote control unit. Contact closed: the unit is controlled by the operator interface.
22 Calibration	Falling edge: Autocalibration sequence start
8 Cycle	Falling edge: Cycle start
20 Filament	Closed: Filament on
18 GL mode	Closed: Gross Leak mode selection
17 LDS mode	Closed: LDS mode selection
16 Inlet vent	Closed: Automatic vent mode selection

Note: if contacts 22 and 8 are kept closed to ground, the "cycle" and "autocal" keys on the operator interface are inactive.

Controlling the detector with the I/O interface

The signals (outputs)

Dry contacts:

Direct current:

60V - 60W or 2A max

Alternative current:

40V - 125VA or 2A max

Recorder output

Contact closed

1 - 2	Sniffer mode (LDS)
3 - 4	Gross Leak mode
5 - 6	Fine Leak mode
7 - 9	Cycle in progress
10 - 11	Filament on
12 - 13	Helium signal > Reject setpoint
19 - 15	Analog output 0 - 10 VDC (inlet pressure)
14 - 15	0 - 8 VDC analogue output (Helium signal)

Note:

15	Internal ground
24	Common (external ground)
21	Common (external ground)

Controlling the detector with a micro-computer (RS 232)

The RS232 interface is used to control the detector with a micro-computer.

Preparing the RS 232 link cable

Use a Sub D9 pin, female connector.

Pins used

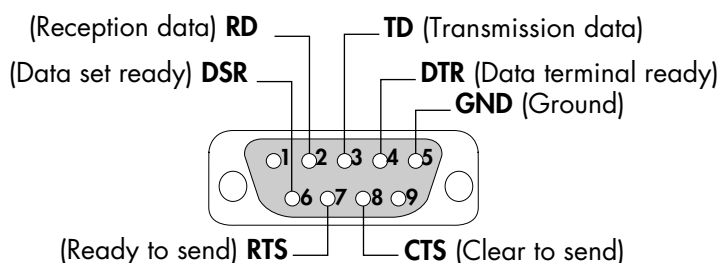

Connection cable

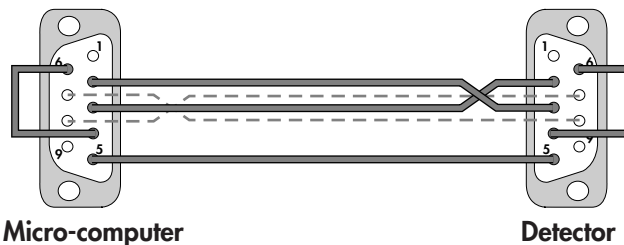

(---- 7 and 8 Connections are necessary only if RTS and CTS are used in a software created by the user)

Connecting the detector to a micro-computer

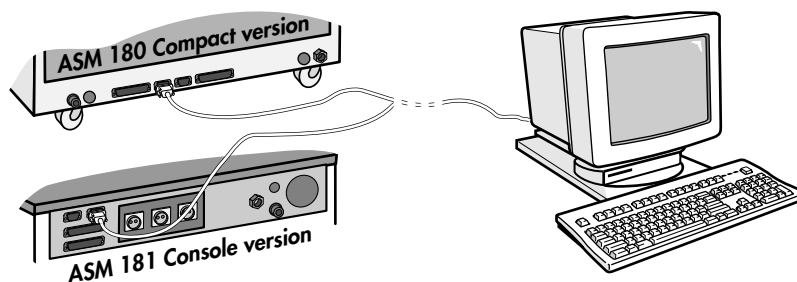

Controlling the detector with a micro-computer (RS 232)

RS 232 transmission parameters

At the first start-up, the user will find the default configuration:

- Transmission speed: **9600 baud**
- Data length: **8 bits**
- Parity: **NONE**
- Stop bit: **1**

The transmission speed can be modified by modifying the S6 switches of the main board in the detector.

Speed (Baud)	Switch			
	1	2	3	4
110	off	off	off	nu
150	on	off	off	nu
300	off	on	off	nu
1200	off	off	on	nu
1800	on	off	on	nu
2400	on	on	off	nu
4800	off	on	on	nu
9600	on	on	on	nu

nu = pin not used

Main board

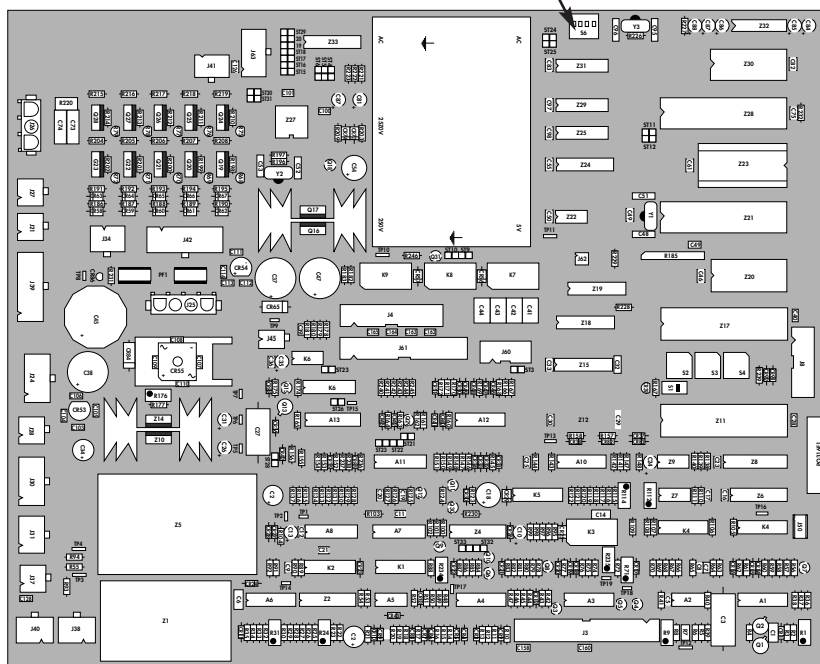

Board located inside the detector front cover

Controlling the detector with a micro-computer (RS 232)

Users of PC type micro-computers can communicate easily with the detector using the **Terminal** program in **Windows**.

Data exchange protocol

Three protocols are proposed for communications:

■ Hardware (local mode)

The detector sends a continuous data stream reflecting its status in the form of a string of 50 <CR> characters.

e.g.: **CYCLE OFF / FILAMENT ON <CR>**
FL TEST 1.2 E-8 <CR>

■ Software (remote mode)

This protocol is adapted to the use of the ALSTAT software (Optional). There is no continuous emission. The detector answers the requests sent from the terminal.

■ Printer (Printer mode)*

This protocol allows to connect a printer directly to the RS 232 interface. The detector sends test-, default-, autocalibration- and auto zero-tickets.

Note: During the detector start-up process, the RS 232 interface sends data regarding the EPROM edition (L0040 index /).

* Factory default configuration.

Controlling the detector with a micro-computer (RS 232)

Protocol selection

The selection of the protocol is made from the micro-computer with following commands:

"L"	Local	Hardware protocol
"R"	Remote	Software protocol
"P"	Printer	Printer protocol

Common protocol commands



Language selection

"F"	French
"E"	English
"D"	German

List the commands

"space"

Commands

	"A"	Cell autocalibration start
	"C"	Test cycle start under vacuum
	"B"	LDS test cycle start
	"S"	Test cycle stop (vacuum or LDS)
	«U»	GL mode selection, same as key 
	«u»	GL mode selection cancelled
	«V»	Air vent, same as key 
	«v»	No air vent
	«T»	Manual adjustment of helium peak ON
	«t»	Manual adjustment of helium peak OFF
	«Q»	Manual adjustment of emission current ON
	«q»	Manual adjustment of emission current OFF
ASCII Code 05	"ctrl E"	Switches the filament on/off
09	"ctrl I"	Returns to the factory default configuration values of emission current and helium peak calibration
26	"ctrl Z"	Returns to the default zero value (helium signal)
	"+"	Increase selected parameter
	"-"	Decrease selected parameter
	=DA dd mm yy<CR>	Adjustment of date
	=TI hh mn ss<CR>	Adjustment of time
	=STB xx<CR>	Timer for CP 20 stand-by mode (reduced rotational speed): 01 to 60 min (default value is 01 min)

Controlling the detector with a micro-computer (RS 232)

Software (Remote) mode The detector sends back the requested data:

ASCII Code 06 "ctrl F" The detector sends back its status in code form:

A <CR>	Detector not in Cycle
R <CR>	Detector in roughing phase or the filament is off
T 1.0E-7 <CR>	Detector in FL test mode, it sends back the measured helium signal
TG 1.0E-7 <CR>	Detector in GL test mode, it sends back the measured helium signal

Printer mode The detector sends tickets:

	Test ticket:	Sniffing test ticket:
	<pre> MANUAL CYCLE C=Elapsed time (H.M:S) S=Signal (mbar.1/s) CYCLE START: 13 NOV. 1996 10.48:13 C=00.00:00 S=4.4E-10 GL MODE: C=00.00:06 S=4.4E-10 FL MODE: C=00.00:07 S=7.8E-07 STOP CYCLE: C=00.00:12 S=1.5E-09 ALCATEL ASM180 series LEAK RATE: 1.5E-9 UNITS: mbar.1/s 13 NOV. 1996 10.48:25 </pre>	<pre> MANUAL CYCLE C=Elapsed time (H.M:S) S=Signal (mbar.1/s) LDS START: 13 NOV. 1996 10.48:29 C=00.00:00 S=3.6E-10 STOP LDS: C=00.00:13 S=2.3E-05 ALCATEL ASM180 series LDS LEAK RATE: 1.5E-9 UNITS: mbar.1/s 13 NOV. 1996 10.48:42 </pre>
<p>Residual helium signal when cycle is started →</p> <p>Elapsed time for GL crossover →</p> <p>Elapsed time for FL crossover →</p> <p>Helium signal before switching to FL mode →</p> <p>Cycle duration →</p> <p>Helium signal at the end of the cycle →</p>		
	Autozero ticket:	Autocalibration ticket:
	<pre> ALCATEL ASM180 series ELECTRICAL ZERO O.K. 13 NOV. 1996 10.47:59 </pre>	<pre> ALCATEL ASM180 series CALIBRATION COMPLETED Calibrated leak value 7.7E-08 mbar.1/s 13 NOV. 1996 10.47:34 </pre>

Controlling the detector with a micro-computer (RS 232)

Printer mode
(continued)

Default ticket:

```
DEFAULT CODE: 200
13 NOV. 1996
10.49:06
```

List of defaults

*3 digit code = FAMILY code (1) + DEFAULT code (2)

0 INIT DEFECTS*****

- * 011 *RAM test defect
- * 012 *Real time clock defect
- * 013 *EPROM Checksum defect

1 RS232 COMMAND DEFECTS*****

- * 100 *Time Out Expired
- * 101 *Unknown command
- * 102 *Uncomplete command line
- * 103 *Invalid character

2 SPECTRO DEFECTS*****

- * 200 *Spectro parameter Unit
- * 201 *Incompatible reference leak value
- * 202 *Background level too high
- * 204 *Helium Peak Adjustment defect
- * 205 *Emission current adjustment limit exceeded
- * 206 *Calibration Interrupted
- * 208 *Electronic Zero Init
- * 209 *Filament emission defect
- * 210 *Triode (spectro) pressure safety activated
- * 211 *Amplifier Zero adjustment Init

3 PUMPING SYSTEM DEFECTS*****

- * 301 *Exhaust pressure > 10 mbar
- * 302 *TMP in acceleration mode
- * 303 *TMP defect
- * 304 *LDS flow too high
- * 305 *LDS probe clogged

Controlling the detector with a micro-computer (RS 232)

Example of communication with a PC

Terminal operation under Window 3.11.

As soon as the connections are done and the Terminal function opened under Window, the main two parameters to be configured are Emulation and communication.

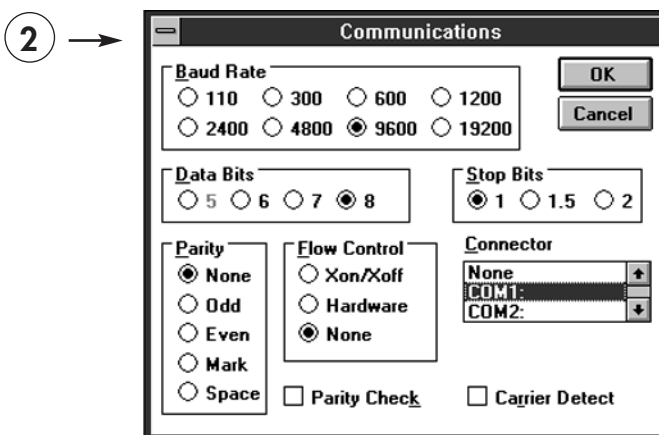
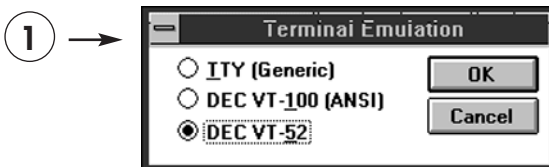
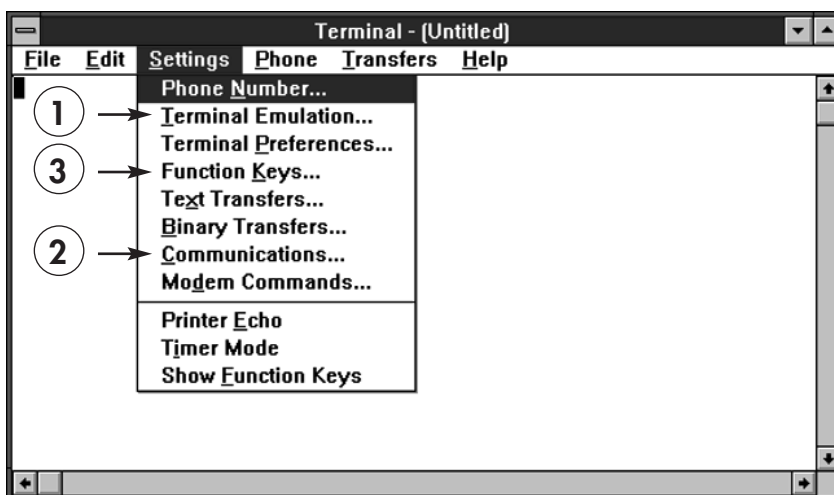

Controlling the detector with a micro-computer (RS 232)

Function keys may be programmed to allow to send commands to the detector without the use of the keyboard, as shown in the following example.

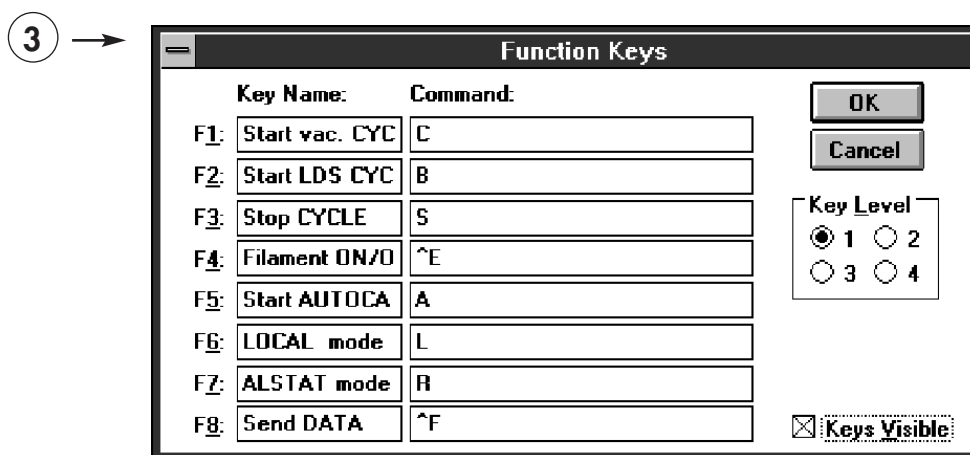

Then, communication can be settled.

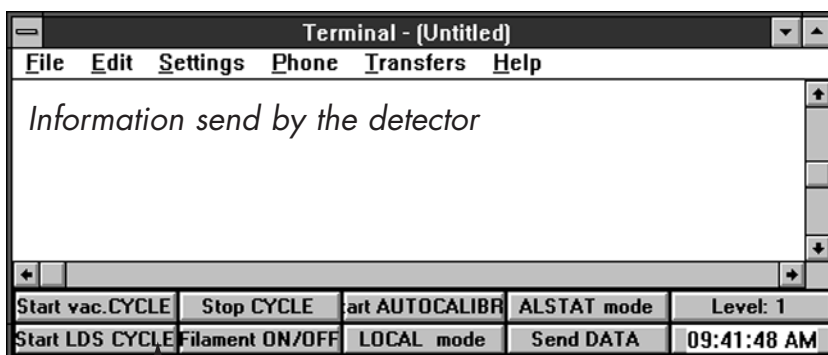

Function keys

Connecting an external printer (ACDP option required)

Purpose The ACDP option (see **A 60**) is used to connect an external printer directly to the detector and print test tickets, calibration tickets or test parameter readings stored inside the detector (see **C 50**).

This type of function guarantees the traceability of leak testing operations.

Type Any printer equipped with an **RS232C type serial link** is suitable. It should have a minimum **buffer memory of 2K**. The tickets printed using the ACDP option contain a maximum of 25 characters per line. The external printer should get electrical power from a source external to the detector.

Interface configuration

- Transmission speed: **9600 baud**
- Data length: **8 bits**
- Parity: **NONE**
- Stop bit: **1**

Pin used:

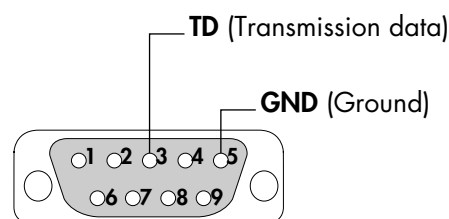

Detector male connector

Connecting an external printer (ACDP option required)

Connecting the printer

The connection is made directly to the printer RS232 interface port.
(Interface port only valid with the ACDP option).

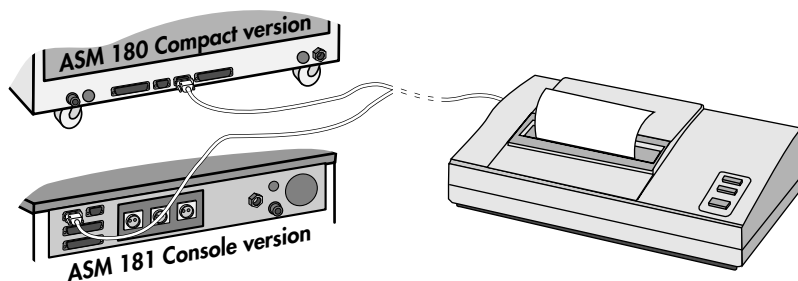

External printer option

When a detector is ordered, Alcatel offers an **"external printer"** which includes:

- the "ACDP" option (Alphanumeric Control and Display Panel),
- a thermal printer (with 112 mm wide paper and electrical power supply adapter);
- the detector / printer connection cable.

Connecting configuration

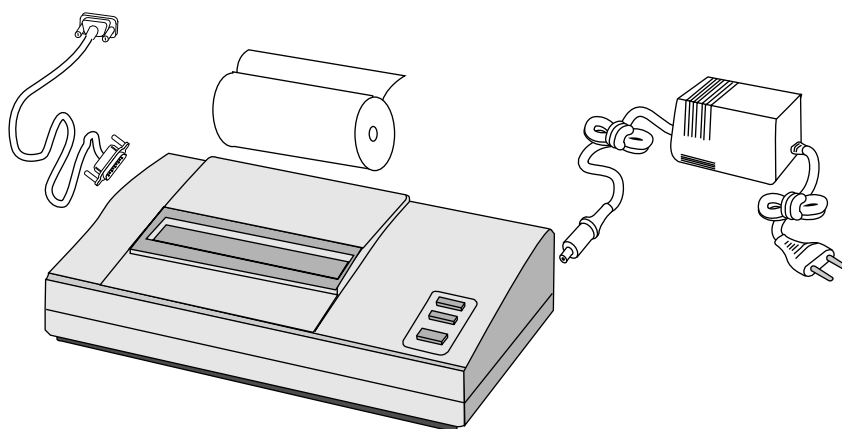
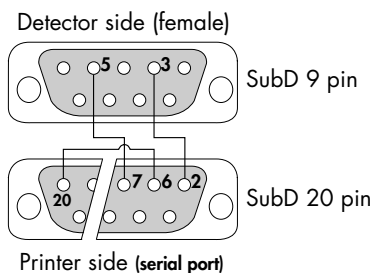

Printer offered:
SEIKO - DPU 414 40 B printer
Thermal paper - SEIKO TP 411-28CL
width 112mm, reel diameter 48mm.

Connecting an external printer (ACDP option required)

Connecting a PC micro-computer to the RS 232 printer interface

The connection of a PC micro-computer allows to customize the reference of the parts to be tested under of the control of the ACDP option (*see C50*).

Wiring and transmission are done in the same way as for standard RS 232 link (*see B30*).

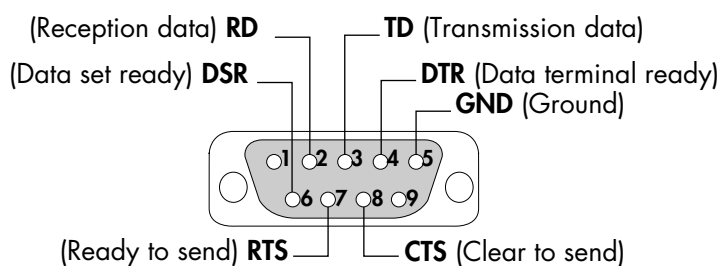
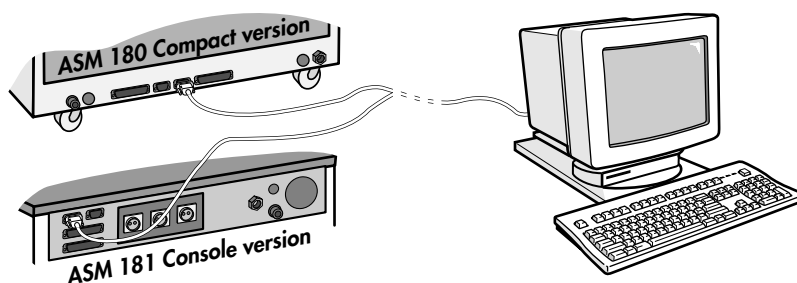

Connecting cable

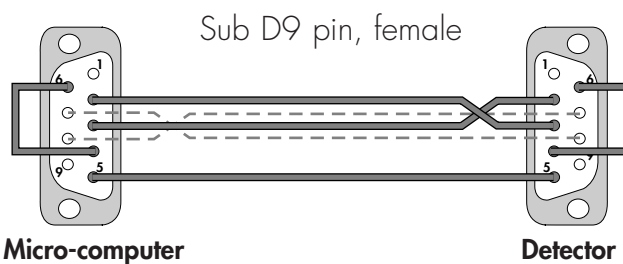

(---7 and 8 Connections are necessary only if RTS and LTS are used in a software created by user)

Link configuration

Speed: 9600 bands
 Data length: 8 bits
 Parity: None
 Stop bit: 1

Connecting an external printer (ACDP option required)

Example of customized reference of the tested part via ACDP option (see procedure in C50)

- Connect the PC to RS 232 printer interface as explained above.
- Set the Terminal function under Window (*see B30*).
- As soon as the ACDP panel proposes the choice of a part: (Basic part modification menu *see C50, page 17*).
- Send from the PC "CTRL D" and then the 16 characters to identify the part (*see C50, page 18*).

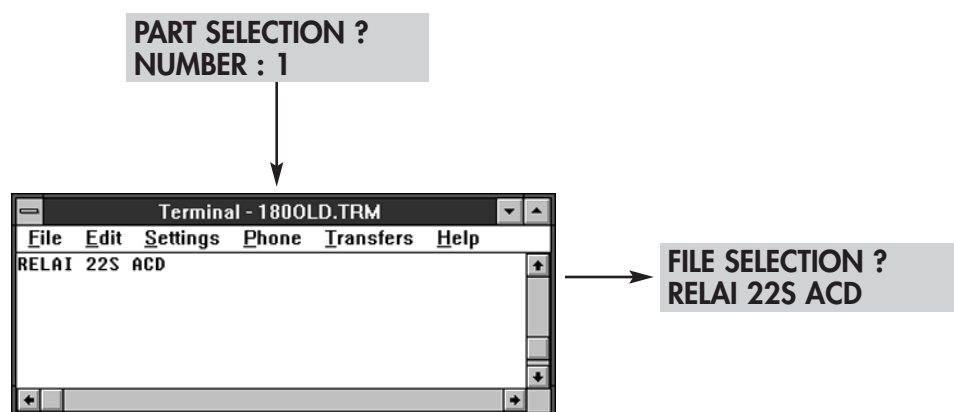

Example of the acquisition on a PC of a test result controlled by the ACDP option (Copy of test ticket)

- PC connected to RS 232 printer interface : See on **C50** for the operating mode of ACDP option.

At the end of an automatic test

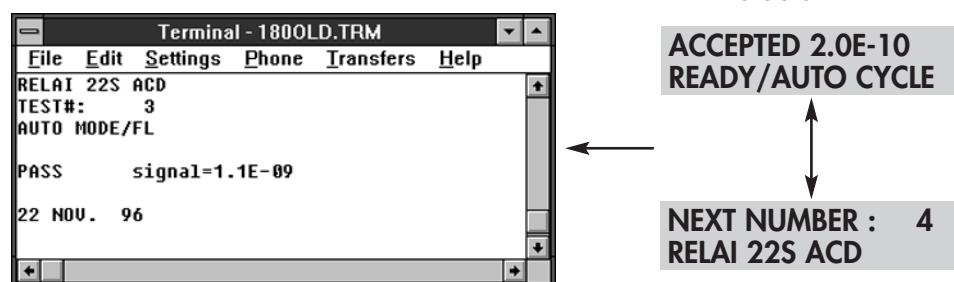

Connecting a neutral gas purge (ASM 180 TD only)

- Use**
- Used to accelerate the cleanup of the helium background noise after detecting a significant leak.
 - Make high sensitivity testing easier due to the reduction and stabilization of the helium background noise.

Neutral gas supply The neutral gas supplied must have a helium concentration less than or equal to 1 ppm.
Supply pressure: 1.4 ± 0.1 bar (absolute) (≈ 20 psia).

Connection A quick connector is located to the left at the rear of the detector near the LDS connector. The corresponding male connector (to be fitted on the gas inlet tube) is supplied in a plastic bag with the detector.

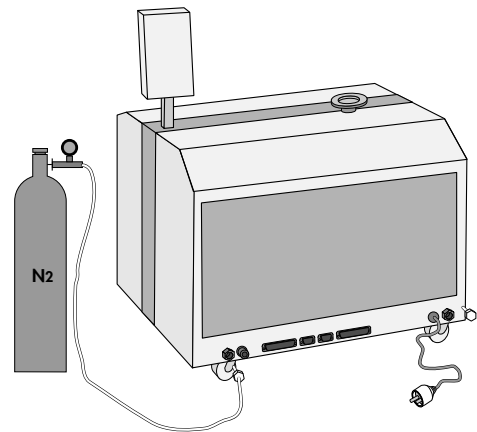

Note The neutral gas purge connector is different than the inlet hole connector. The latter can also be connected to a neutral gas source to purge the inlet and anything connected to it at the end of a cycle. The supply pressure of the gas for the inlet vent must be atmospheric pressure $1,0^{+0,2}_{+0}$ atm absolute (≈ 14 psia).

Connecting the leak detector to the installation via the hardware interface

1 Connect the remote control unit (Sub D 25 pts plug)

2 Connect the I/O interface

(see B 20)

! The I/O interface connector should never be connected or disconnected with the unit on.

! If the detector is not controlled by the I/O interface: the jumper plug must be connected. If the detector is controlled by the I/O interface, install the interface cable to the Sub D 25 pin connector on the detector.

3 Connect the RS232

(see B 30)

If the detector is to be connected to a micro-computer, connect the cabled RS232.

4 Connect an external printer

(see B 40)

(ACDP option required see A 60)
Connect the printer output using an RS232 cable.

5 Connect the LDS probe

(quick connector)

6 Connect to atmospheric pressure

When a neutral gas is used, the filter is unscrewed and replaced by the connection to the selected gas supply source.
1/4" BSP connector - Pressure : $1.0^{+0.2}_{-0}$ atm absolute

7 Connect the inert gas purge

(quick connector - ASM 180 TD only)
The helium concentration of neutral gas must be ≤ 1 ppm.
Pressure: $1,4 \pm 0,1$ bar absolute (≈ 20 psia).

8 Connect the unit to the main power

! Check that the voltage marked on the unit identification plate corresponds to that of the electrical source.

Power consumption ASM 180 TD 1.2 kVA
. ASM 180 TD+ 1.5 kVA

Fuse Voltage 200-220-240 V 3.15AT
Voltage 100-115 V 6.30AT

ASM 180 TD/TD+ compact versions

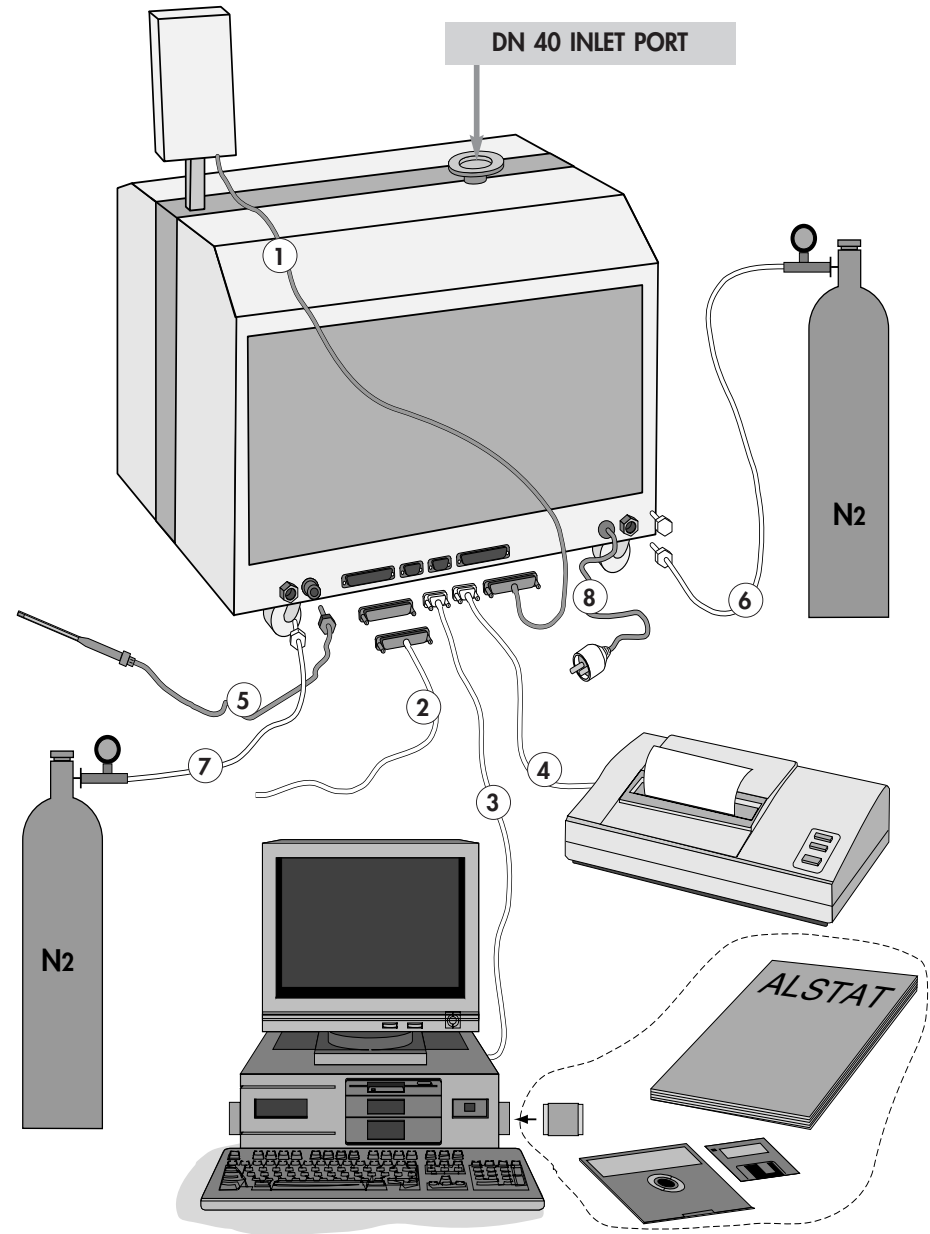

Connecting the leak detector to the installation via the hardware interface

ASM 181 TD+ console version

1 Connect the remote control unit

2 Connect the I/O interface
(see B 20)

! The I/O interface connector should never be connected or disconnected with the unit on.

! If the detector is not controlled by the I/O interface: the jumper plug must be connected. If the detector is controlled by the I/O interface, install the interface cable to the Sub D 25 pin connector on the detector.

3 Connect the RS232
(see B 30)

If the detector is to be connected to a micro-computer, connect the cabled RS232.

4 Connect an external printer (see B 40)

(ACDP option required see A 60)
Connect the printer output using an RS232 cable.

5 Connect the LDS probe

(quick connector)

6 Connect to atmospheric pressure

When a neutral gas is used, the filter is unscrewed and replaced by the connection to the selected gas supply source.
1/4" BSP connector - Pressure : $1.0^{+0.2}_{+0}$ atm absolute

7 Connect accessories

Additional plugs : 3 power plugs allow to connect accessories such as recorders, gauges,...
(Maximum current: 4A; Specific 4A Fuses provided).

8 Connect the unit to the main power

! Check that the voltage marked on the unit identification plate corresponds to that of the electrical source.

Power consumption1.6 kVA

Fuse Voltage 200-220-240 V3.15AT

Voltage 100-115 V.....6.30AT

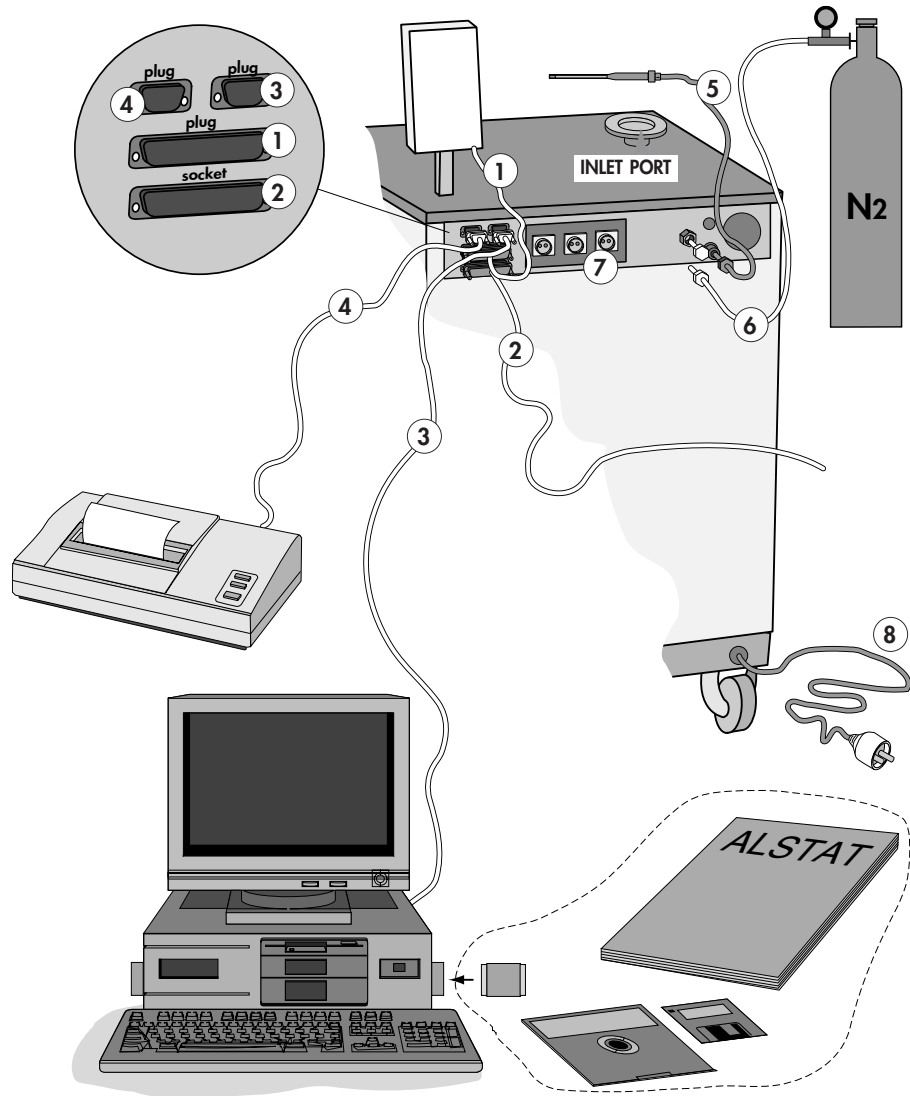

Before starting up the detector

Check that the jumper plug is present

If the detector is not controlled by **the I/O interface**: the jumper plug supplied with the unit must be connected at the rear of the unit.

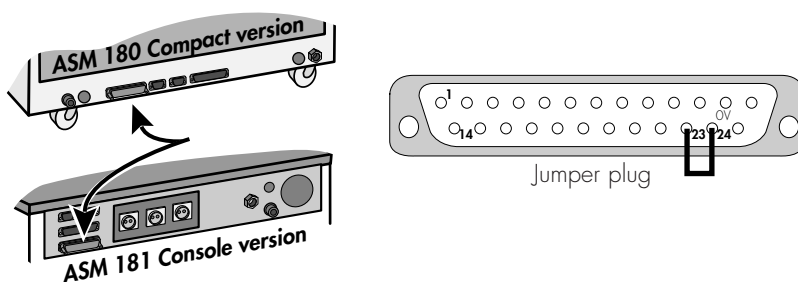

Without the jumper plug, the unit will not operate.



The jumper plug must be connected or disconnected **with the power off.**

User's Manual

ASM 180 TD/TD+ - ASM 181 TD+

Operation

■ Starting up the detector	■ C 10
■ Detector operation.	■ C 20
■ Detector autocalibration	■ C 30
■ Switching off the detector.	■ C 40
■ Alphanumeric Control and Display Panel (ACDP) operation	■ C 50
■ Configuring the unit according to the gas to be detected	■ C 60
■ Use of the "I" gas line option ASM 180 TD/TD+ only.	■ C 70

Starting up the detector

In G 10, the user will find a view of the operator interface. It can be used to identify the operational parts of the control panel and remote control unit.



Before starting up the detector, check that the I/O plug connector is present (see sheet B 70).

Power-up

Set the circuit breaker switch to **I**

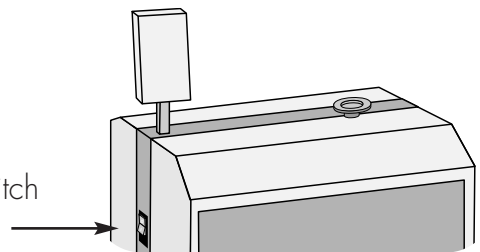

The roughing pump is started.

The cycle control button green indicator light flashes. (around 20s.)

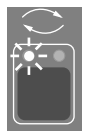

Once the primary pressure (MD4E or CP20) threshold has been reached, the by-pass valve opens, the indicator light comes on and **the molecular roughing (MDP)** is started.



The molecular pump is in the acceleration phase.

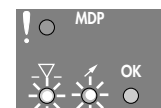

When the by-pass pressure threshold is detected, the valve closes.



The molecular pump reaches its nominal rotational speed in 2 to 3 min.



Starting up the detector

Once the exhaust pressure threshold has been reached (after approximately 25 s), the P indicator light comes on and the **secondary pump (TMP)** is started.



The secondary pump is in the acceleration phase.

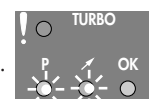

It reaches its nominal rotational speed in 2 to 3 min.



The filament on phase is started.

The filament key indicator light flashes for approx. 8 seconds and becomes steady once the filament is emitting.



The panel then displays the filament current and the pressure in the analyzer cell.

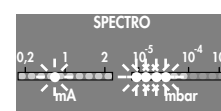

The detector **checks the cell calibration.**

The autocalibration key red indicator light flashes for a few seconds

(see autocalibration sheet C 30 for details).



If no problems are encountered, the unit is considered to be calibrated: the green indicator light comes on.



The detector is ready to be used.

The cycle control is enabled when the green indicator light on the cycle control key comes on. (the autocalibration is validated)



Detector operation

In G 10, the user will find a view of the operator interface. It can be used to identify the operational parts of the control panel and remote control unit.

The following pages contain:

Working in vacuum test mode	Pages 1, 2
Working in Gross Leak mode	Page 2
Working in sniffer mode	Page 3
Setting the audio alarm setpoint	Page 4
Saving the filament	Page 5
Inlet port venting at the end of the test	Page 5
Recording the Helium signal	Page 5

Working in vacuum test mode



Make sure that the parts can withstand the difference in internal/external pressure to which they are subjected.

Connect the test part

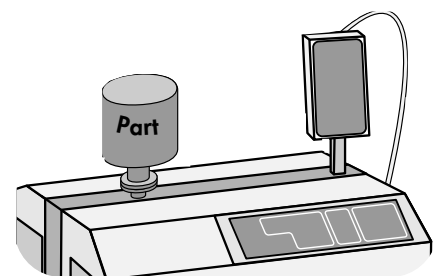

Detector operation

Starting up evacuation of the line and the part

Start a cycle by pressing on the key



The pressure drop is shown on the display unit.

According to the characteristics of the test part and therefore the pressure reached, the unit is placed in gross leak or fine leak test mode.

Gross Leak mode:
 $6 \text{ mbar} > P > 2 \cdot 10^{-2} \text{ mbar}$

Fine Leak mode:
 $P < 2 \cdot 10^{-2} \text{ mbar}$

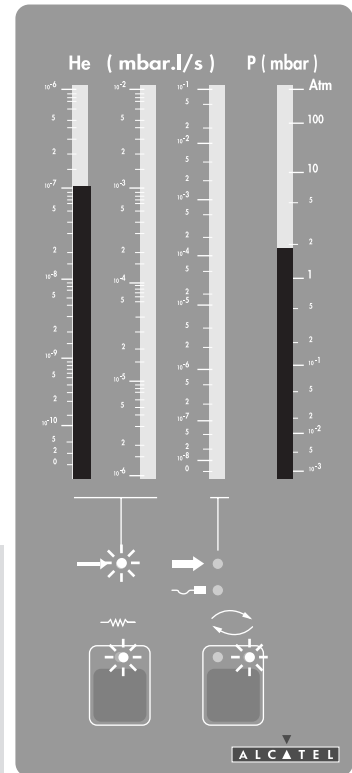

Note: The filament must be lit for a cycle to be started.

Working in Gross Leak mode

It is possible to preset the gross leak mode by pressing the key



It is sometimes preferable to work in **Gross Leak** mode, in order to reduce cycle times.

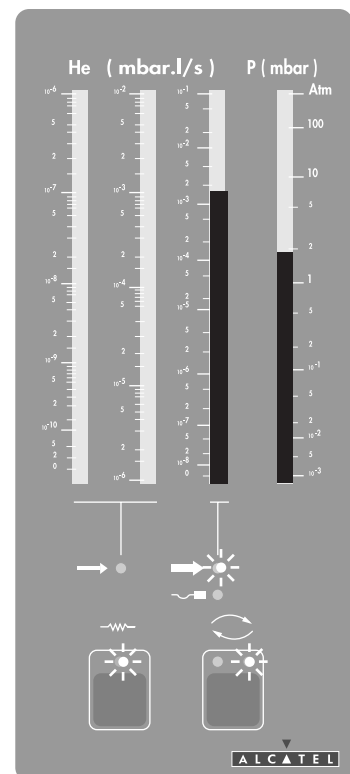

Detector operation

Working in Sniffer mode (LDS)

Select the LDS function.



Connect the probe to the quick connector.

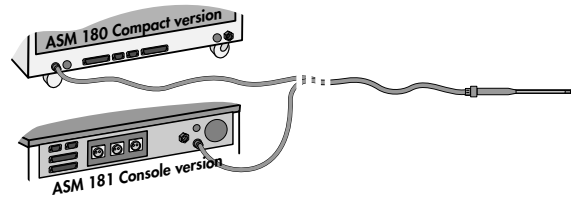

The filament emission goes off for a few seconds during the probe roughing phase.

The test is operational when the emission presence indicator light is lit.



The sniffer test mode indicator light is lit on the unit.

The measured helium flow signal is shown on the gross leak measurement display.

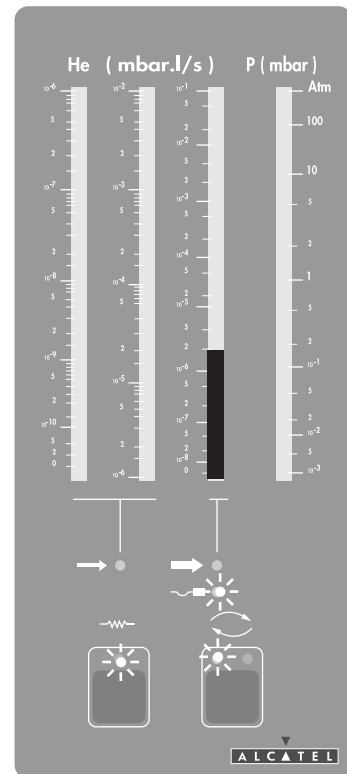

Check the probe operation

When the LDS probe is placed in the ambient air, the He signal displayed is approximately $5 \cdot 10^{-6}$ to $1 \cdot 10^{-5}$ (equivalent to the natural concentration of helium in the air).

Check that the helium signal decreases when the probe hole is blocked with your finger.

Measured flow = concentration

Given the detector configuration, the measured flow corresponds to the helium concentration.

e.g.: Display of $5 \cdot 10^{-6}$ corresponds to a measured leak of $5 \cdot 10^{-6}$ mbar.l/s of He. and to a measured He concentration of $5 \cdot 10^{-6}$ or 5ppm.

LDS mode specificities

The inlet pressure displayed on the remote control unit does not affect operation (it is an independent circuit: see **A 20**).

The cycle key  is not used.

Detector operation

Audio alarm (90 dB)

The audio alarm is triggered when the leak rate is greater than the reject setpoint. The frequency of the audio signal depends on the leak rate measured by the unit (the higher the rate, the higher the signal frequency).

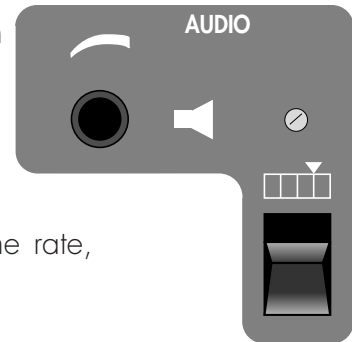

Display the alarm setpoint by pressing



The threshold is then shown on the measurement displays (Gross leak or Fine leak depending on the test mode used)

Set the audio alarm setpoint

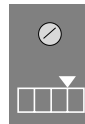

Adjust the setpoint using a screwdriver to turn the potentiometer.

Release the key.

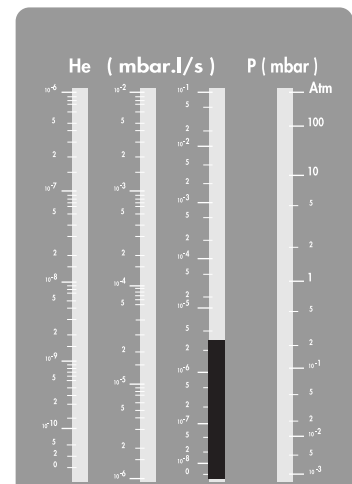

Adjust the audio volume



Adjust the audio signal volume with the Audio section knob. When this knob is at the minimum position ("0" position), the audio signal is cut off.

Detector operation

Saving the filament

Press the key on the remote control unit.



To save the filament, it is possible to switch it off when it is not to be used for a period of time.

The indicator light then goes off*.

The filament is switched on again by pressing on the key a second time. The indicator light flashes for approximately 8 s before lighting up, the filament is now operating.



*Note: The filament can only be switched off when the detector is in test mode.

Enable the inlet vent

When the inlet vent indicator light is lit, at the end of the cycle, the inlet vent valve is open.



Disable the inlet vent

press



It is possible to disable the opening of this valve by releasing the key. The indicator light goes out. This function is important to prevent the installation from returning to atmospheric pressure by mistake.

Record the helium signal

This output supplies a voltage of 0 to 8V. (see recording curve in **G 20**)
The response curve is logarithmic (1 volt per decade).



Detector autocalibration

Purpose of autocalibration

Used to ensure that:

- the detector analyzer cell detects the helium properly (test of the Helium ion path so that they reach their target: see **A 30** Analyzer cell principle)
- the Helium leak value displayed corresponds to the real value.

Autocalibration system

The detector uses an internal calibrated leak equipped with a temperature-dependent compensation system. The value of the leak is approximately 1×10^{-7} mbar.l/s. Electrovalves are used to connect the calibrated leak to the analyzer cell.

The electrovalves are controlled and the two calibration parameters are set entirely automatically by pressing the **AUTOCAL** button.

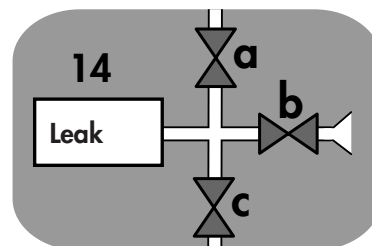

Autocal circuit layout

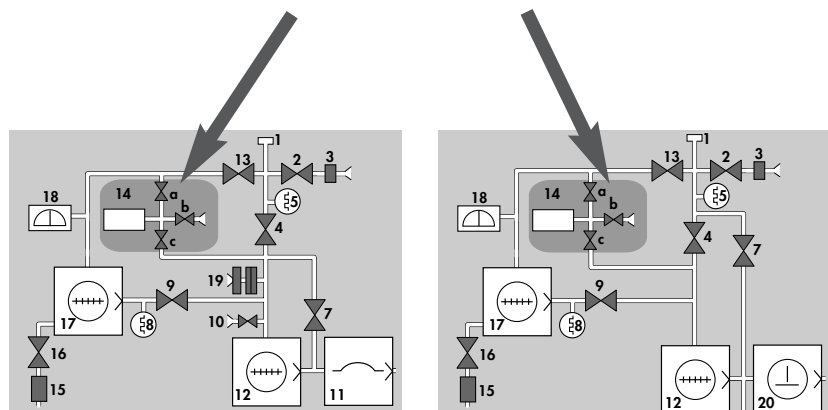

ASM 180 TD

ASM 180 TD+
ASM 181 TD+

Detector autocalibration

Running an autocalibration

1 At start-up

At detector start-up, as soon as the analyzer cell (spectro) is operational, an autocalibration is performed automatically.

2 During operation

During operation, the calibration is checked as follows:

Electrical zero check



- Switch off the filament (indicator light off);
- check that the helium signal on the fine leak display is at "0" (3 to 4 bars of the bargraph);
- if this is not the case, perform an electrical reset by pressing the **AUTOCAL** key

The red indicator light flashes for a moment.

In the event of failure (the red indicator light remains lit), contact customer service.



Autocalibration

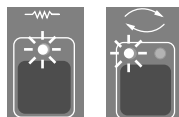

- Check that the detector is not in test mode and that the **AUTOCAL** indicator light is lit; green indicator of the cycle key lit.

- Press the **AUTOCAL** key

The red indicator light flashes;

The Helium signal oscillates and stabilizes on the fine leak bargraph.

The green indicator light comes on to indicate that the autocalibration has been completed.

(see details of the autocalibration cycle in para. 4).



- It is recommended to run an autocalibration after 1 hour of operation and then on a regular basis (once every day).
- In the majority of applications, autocalibration is used to make sure that the detector analyzer cell is operating correctly.

Detector autocalibration

3 Calibration range Use of an external leak

If very accurate leak measurement is required in a measurement range other than 1.10^{-8} - 1.10^{-6} , it is recommended to use an **external calibrated leak, the value of which is close to the required value:**

- Run an autocalibration as shown in section 2

- Once the autocalibration has been completed and validated, connect the external calibrated leak to the detector inlet port and run a test cycle with the  key,

- Wait a few minutes for the Helium signal to stabilize,

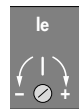
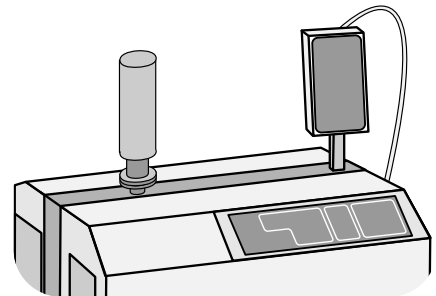

- Adjust the displayed Helium signal value manually as a function of the external calibrated leak using the filament current fine adjustment potentiometer.

Remember to take into account the effect of the temperature on the value of the external calibrated leak in accordance with the information given on the label. In the event of problems, contact customer service.

Detector autocalibration

4 Autocalibration procedure

Throughout the autocalibration cycle, the "autocal" key red indicator light flashes.

- **Residual check.**
- **Autocalibration circuit roughing.**
- **Connection with the analyzer cell.**

The Helium signal measurement is displayed.

- **Comparison of the measured signal with the calibrated leak value** after waiting a few seconds for the signal to stabilize.

If the difference is less than 10 %, the autocalibration is stopped and validated.

If the difference is greater than 10 %, the autocalibration is continued.

- **Helium peak detection.** The automatic control system varies the acceleration voltage in the analyzer cell (see **A 30**). This varies the path of the Helium ions until the maximum Helium signal is obtained. The Helium signal display oscillates during this stage.

- **Sensitivity adjustment.**

The filament current in the analyzer cell (see **A 30**) is automatically adjusted so that the detector displays a correct leak value (internal calibrated leak value corrected as a function of temperature).

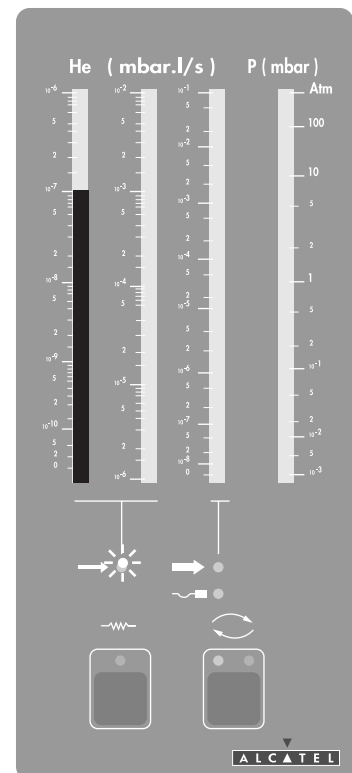

Stages 6 and 7 can be performed several times if necessary, until the correct display is obtained.

Detector autocalibration

5 In the event of a calibration fault

• End of cycle.

The sequence has been performed correctly, the detector is calibrated in Fine Leak mode, the green indicator light comes on.

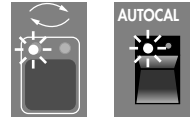

If a fault is encountered, the sequence is stopped and the red indicator light comes on.

Faults which stop the autocalibration sequence are:

- zero impossible
- background signal too high
- sensitivity adjustment impossible
- voluntary stop by operator.



If the current cycle is stopped voluntarily, this is considered as a fault.

Following a fault, the calibration parameters stored previously are restored.

The "autocal" key red indicator light remains continuously lit, a defect ticket is emitted on the RS232 interface in printer mode (**see B 30**).

The "cycle" key green indicator light is lit.

The unit can still be used.

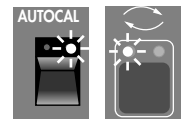

After an initial autocalibration fault signal, it is recommended to run a second autocalibration.

A repeated calibration fault is an indication that the cell is "polluted" and requires maintenance.

Internal calibrated leak service life

An internal calibrated leak can deliver helium for years. In order to guarantee the reliability of measurements, in most applications, ALCATEL recommends recalibration of the internal calibrated leak at least every two years. The value of the leak decreases over time according to a ratio indicated on the internal calibrated leak label and on the calibration certificate (e.g. 2 % every year).

The calibrated leak is recalibrated in approved centers, using reference leaks : **see E 40** for the internal calibrated leak replacement procedure.

Switching off the detector

The unit can be switched off at any time by setting the circuit breaker switch to 0.

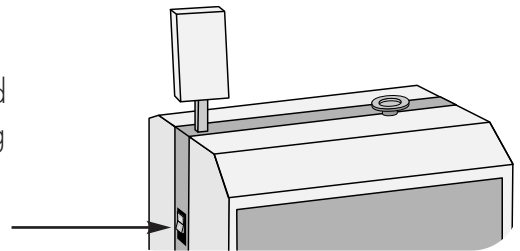

To keep the connection lines clean, it is recommended to leave them under vacuum when the detector is shut off.

To maintain vacuum, the inlet vent key must be off.



Alphanumeric Control and Display Panel (ACDP) operation

Contents

The present instructions only apply to units which are equipped with the ACDP option.

Purpose of the ACDP option	page 2
Use of the configuration keys	page 3
Start-up	page 4
Access to the various configuration menus	page 5
- Manual mode	} Main menu
- Automatic mode	
Working in manual mode - Vacuum test	page 7
- Start a cycle	
- Stop a cycle	
Working in manual mode - LDS test	page 8
- Start a test	
- Stop the test	
Operations available during the manual test cycle	page 9
- Display the elapsed time	
- Print the current measurement	
- Switch off the filament	
- Switch on the filament	
- Example of test ticket in manual mode	
Working in automatic mode (Vacuum test only)	page 12
- Start an auto test	
- Result messages at end of auto test	
- Error messages at end of auto test	
- Examples of auto test tickets	
Part modification menu	page 15
- Purpose of part modification menu	
- Automatic test parameters	
- Basic part modification menu	
- Test part selection change	
- Test part reference customization (via RS 232)	
- Automatic test parameter modification	
- Time and date modification	
Unit autocalibration	page 21
Monitoring of the audio signal with the ACDP	page 22
Default unit configuration	page 24
- Internal switches	
- Automatic test parameters - Setting ranges	
Summary functional diagram (A3)	page 26
View of ACDP panel (A3)	page 27

Alphanumeric Control and Display Panel (ACDP) operation

Purpose of the ACDP option

This option is intended for **industrial inspection**.

It is used to:

- display messages concerning the status of the detector;
- display the measurement in digital form;
- configure and control the unit in two operating modes (manual or automatic);
- print inspection tickets using an external printer connected to the associated interface (see **B 40**).
- To monitor the audio signal according to the selected configuration

Manual operation

- The operator retains control of the test cycle start and stop using the cycle key  or the **C** key on the ACDP.
- The Red and Green indicator lights (rejected part / accepted part) come on according to the value of the Helium signal in relation to the programmed manual reject level.
- The choice of test mode (gross leak, fine leak or sniffer) is up to the user.
- The detector can be used as if it did not include this option (see standard detector operation in **C 20**).
- The audio signal is working on a FIXED or FLOATING mode, according to the selected configuration.

Automatic operation

- The test cycle is automated according to the programmable test parameters.
- It is possible to program up to 10 references of different parts each with its own test parameters.
- At the end of each automatic cycle, the test result is displayed, the part is sorted as "Accepted" or "rejected" according to the programmed reject level.
- An audio signal could be activated, according to the result of the test and the selected configuration.



The ACDP panel operating instructions are given in the following pages. We advise you to read them carefully in order to become familiar with its operation.

At the end of C 50 (pages 26 and 27), the user will find a view of the front panel of the option and a flow chart showing all the available functions.

Alphanumeric Control and Display Panel (ACDP) operation

Use of the configuration keys

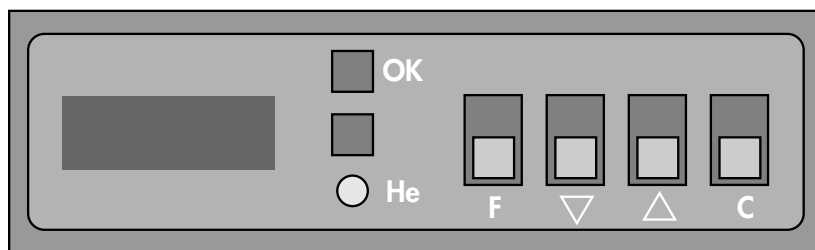

F This key is used to validate the selections made and to access the various configuration menus. It is activated in the basic display (see **page 4**).

▼ ▲ These keys are used to select a response or adjust values. They are activated whenever the display shows a "?". To adjust values such as reject level, hold down the **▼** or **▲** keys to scroll through the figures more quickly.

C This key allows to start a test cycle in manual or automatic mode. It also allows to stop the test cycle in manual mode. It is activated when the display shows READY/AUTO CYCLE or READY/MAN CYCLE. Note: The cycle key of the remote control unit  has priority over the control panel keys. This key remains activated whatever the display. This note is valid for all the commands of the standard detector (control panel and remote control).

Alphanumeric Control and Display Panel (ACDP) operation

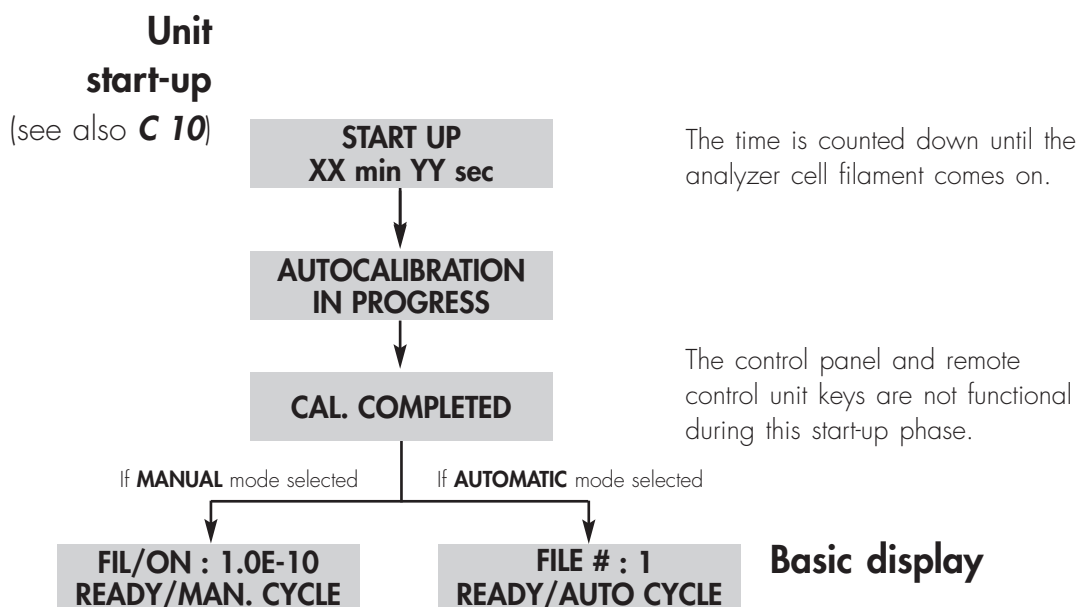

Basic display

The basic display gives information which depends on the operating mode (automatic or manual) in which the detector was previously configured.

Using the basic display, the user can:

- start a test cycle ( or **C** key);
- access the various configuration menus;
Pressing only the **F** key makes it possible to return to the basic display without modifying any configuration parameters.)
- perform an autocalibration.

See the following pages for further details.

Alphanumeric Control and Display Panel (ACDP) operation

Access to the various configuration menus

(Main menu)

MANUAL Mode

Automatic mode
overleaf

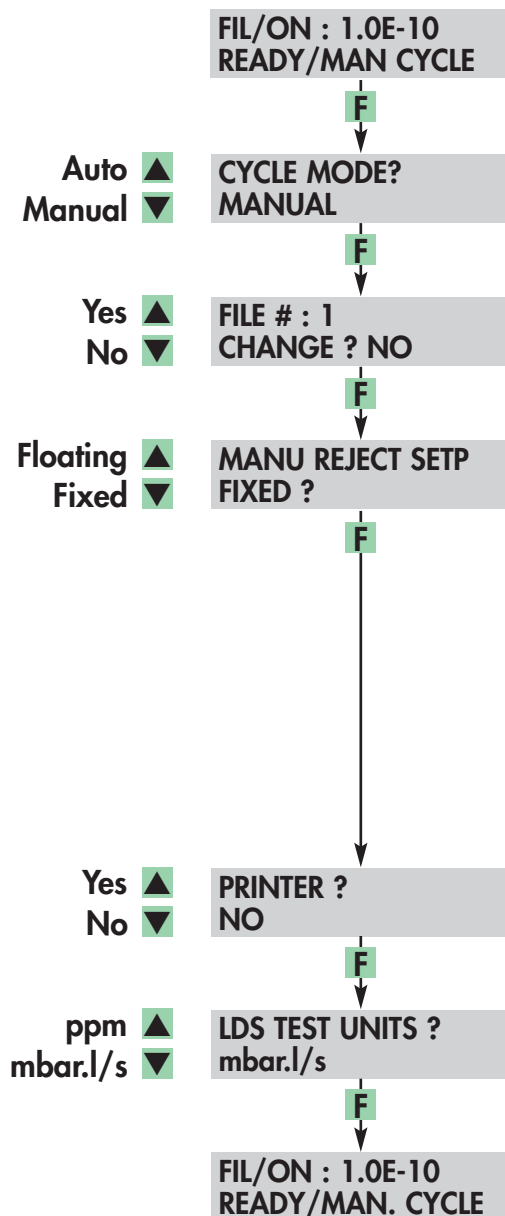

Basic display

▲ ▼ are used to change operating mode.

▲ **Yes** : is used to access to part modification basic menu (see **page 15**)

The manual reject setpoint monitors :

- the switching of the Red light indicator of ACDP panel (in relation to the fixed reject setpoint only),
- the emission of an audio signal (when controlled by ADCP),
- The closing of the reject setpoint contact on I/O interface (see **B 20**) when the helium signal value is greater than the setpoint (for further details on Fixed/Floating, see **page 22**).

Enable or disable the printer interface in Manual mode.

Selection of the measurement unit in sniffer mode.

Return to the basic display (Manual mode).

Alphanumeric Control and Display Panel (ACDP) operation

Main menu (continued)

Manual mode
overleaf

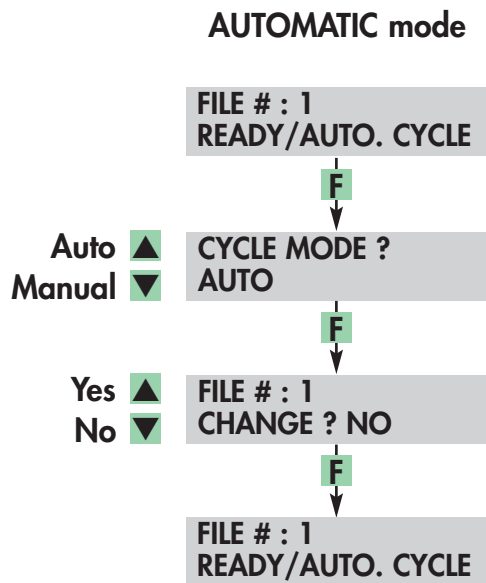

Basic display

▲ ▼ are used to change operating mode

▲ **Yes:** is used to access the basic part modification menu (see **page 15**)

Return to the basic display (automatic mode).

Alphanumeric Control and Display Panel (ACDP) operation

Working in manual mode Vacuum test

Start a cycle **C** or 

Stop the cycle **C** or 

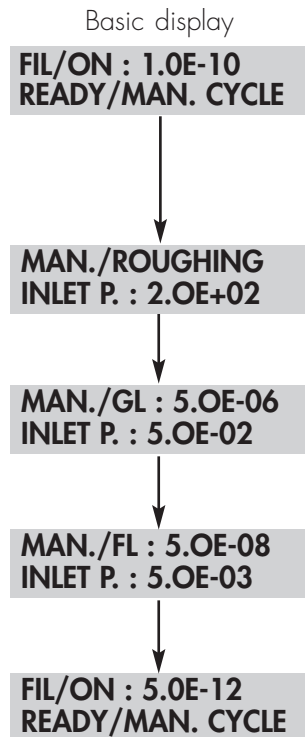

Indicates alternately:
- filament status, Helium signal,
- selected part reference,
- manual cycle standby message.

The test part is roughed down.

The test part is connected to the
Gross leak measurement system.

The test part is connected to the
Fine leak measurement system.

Return to the basic display.

Note: in manual mode, the normal detector controls are entirely available (see **C 20**).

See **page 9** for the available operations during a Manual cycle test.

Alphanumeric Control and Display Panel (ACDP) operation

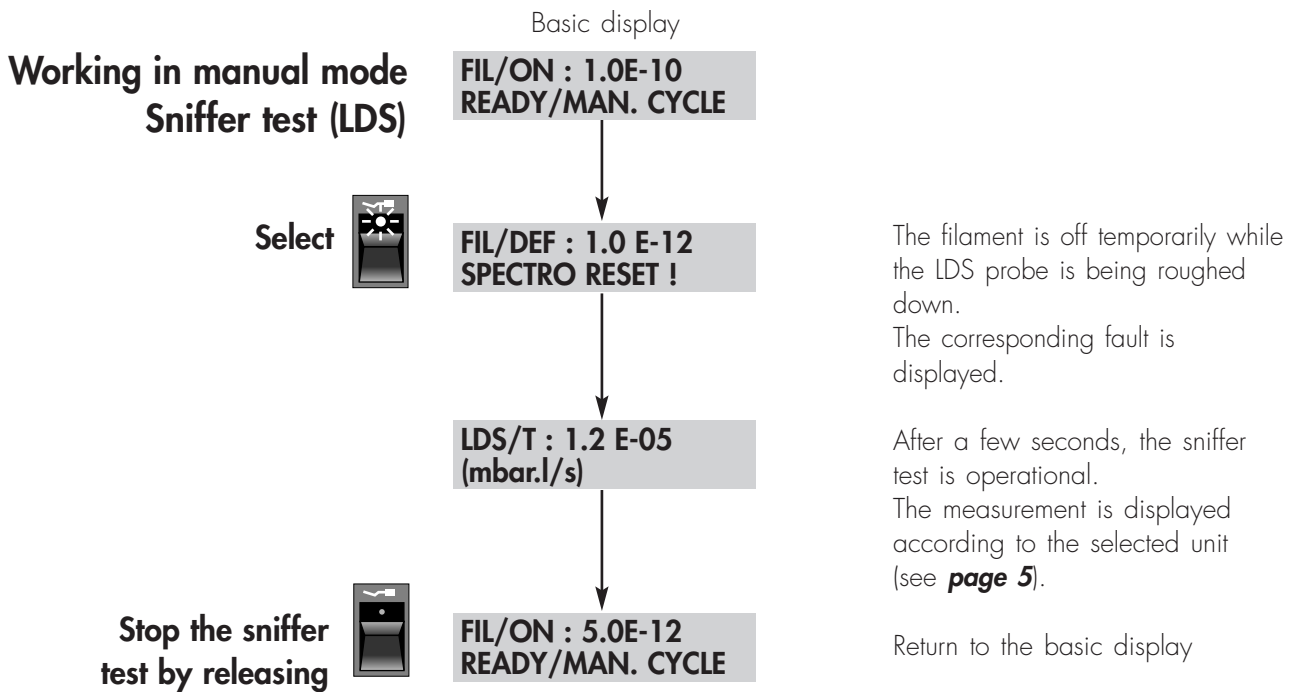

See **page 9** for the available operations during a Manual cycle test.

Alphanumeric Control and Display Panel (ACDP) operation

Operations available during manual mode test cycle

Display the time elapsed since start of cycle

Press ▼ or ▲

Manual test basic display

MAN./FL : 1.0 E-09
INLET P. : 1.0 E-03

MAN./FL : 1.0 E-09
CHRONO : 27S

Timer: time elapsed since start of cycle.

Print the current measurement

Press ▼ and ▲ simultaneously

MAN./FL : 1.0 E-09
CHRONO : 37S

Instantaneous print-out of ticket if the external printer is connected to the printer interface (see **B40**) and activated (see **page 5**) (sample print-out see **page 10**)

Switch off the filament

(see **C20**)

Press 

FIL/DEF. : 1.0 E-12
SPECTRO RESET !

Vacuum test only.
The filament indicator light goes off.



Switch on the filament

(see **C20**)

Press 

MAN./FL : 1.0 E-09
INLET P. : 1.0 E-03

Vacuum test only
The filament indicator light is lit after a few seconds.



Modify the FIXED manual reject setpoint :

Press on **F**.

Adjust the displayed setpoint with the key ▼ and ▲.

Press on **F** to valid and to return to display during the manual cycle test.

MAN./FL : 1.0 E-09
REJECT ? : 1.0 E-08

F

Only if FIXED reject is selected and when leak detector is in test mode.

The FIXED setpoint is memorised until next modification. It is active whichever the test status (GL-FL or LDS).

Return to manual test basic display

Alphanumeric Control and Display Panel (ACDP) operation

Ticket printing examples (manual mode)

Vacuum test ticket

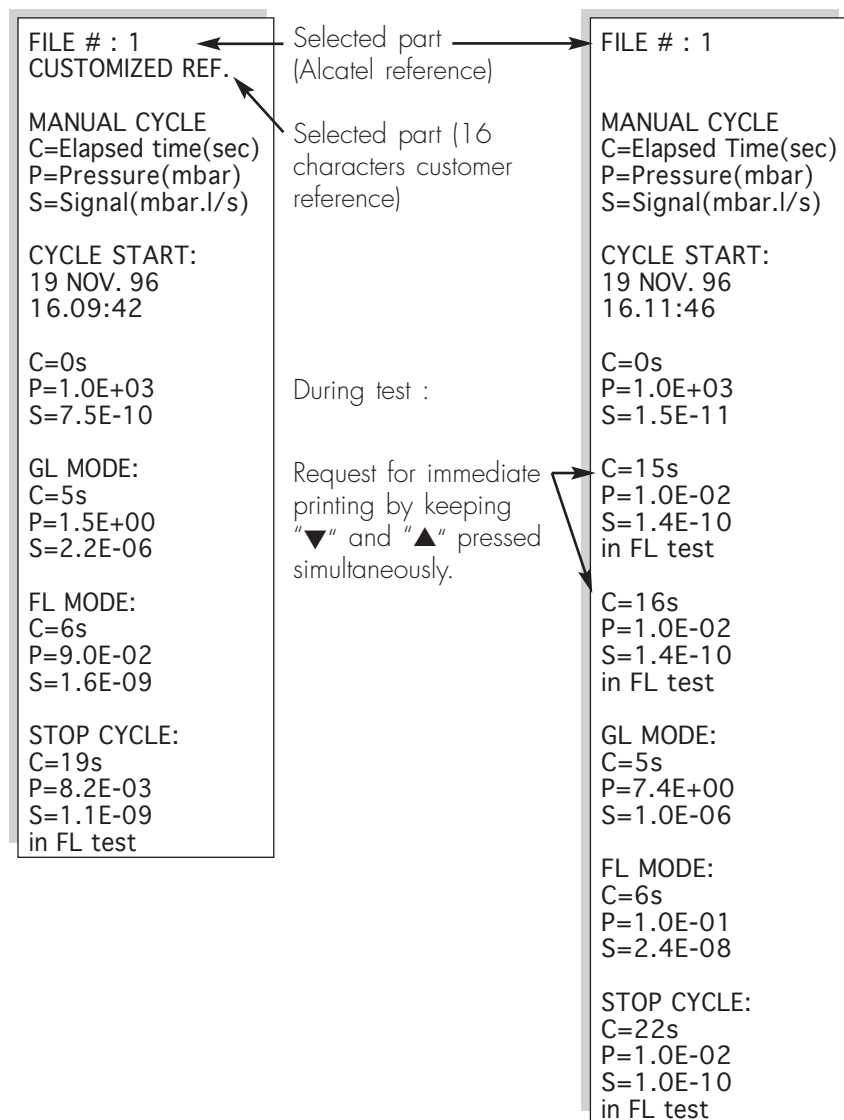

N.B. : A minimum of 1 second is required between two immediate printings.

Alphanumeric Control and Display Panel (ACDP) operation

Sniffer ticket

<pre> FILE # : 1 CUSTOMIZED REF. MANUAL CYCLE C=Elapsed time(sec) P=Pressure(mbar) S=Signal(mbar.l/s) CYCLE START: 3 FEB. 95 8.53:39 C=0s P=1.0E+03 S=1.0E-12 C=14s P=1.0E+03 S=1.0E+03 in LDS test C=41s P=1.0E+03 S=8.5E-07 in LDS test STOP CYCLE: C=59s P=1.0E+03 S=9.5E+02 in LDS test </pre>	<p>← Selected part</p> <p>← Customer reference</p> <p>← Measurement unit (ppm or mbar.l/s)</p> <p>← Intermediate measurement (requested by keeping "▼" and "▲" pressed simultaneously)</p> <p>← Intermediate measurement with long distance sniffer blocked</p>
--------------------------------------------------------------------------------------------------------------------------------------------------------------------------------------------------------------------------------------------------------------------------------------------------------------------------	--------------------------------------------------------------------------------------------------------------------------------------------------------------------------------------------------------------------------------------------------------------------------------------

Alphanumeric Control and Display Panel (ACDP) operation

Working in automatic mode Vacuum test

Start a test **C** or 

Basic display

**FILE # : 1
READY/AUTO. CYCLE**

Indicates alternately:
- Previous test result (see **page 13**),
- Auto cycle standby message,
- Next test No.,
- Selected part reference.

**AUTO/ROUGHING
...S**



Roughing time count down

**AUTO/FL : 1.8E-10
...S**



Test time count down

If SERIAL Nr and ticket test and printer are selected.

If Nr TEST is selected

 **SERIAL # ? :**
 **23**

F

Selection of Serial Nr or Test Nr in part modification menu: **page 19**.
At the end of each validated test, a serial number for the tested part, incremented by one over the previous one, is proposed. Possibility to manually modify it with the  and  key. Systematic validation by key **F**.
Note: if a cycle is started using the key  before validation, this cycle is stopped and is not taken in account.

Display of the test result

Return to the basic display. The test number (TEST Nr) or Serial number (SERIAL Nr) is incremented for the next test. The display of the result, the possible emission of an audio signal and the printing of a test ticket depend on the programmed test parameters for the selected part (see part modification menu : **page 15**).

Alphanumeric Control and Display Panel (ACDP) operation

Result message and audio signals at end of automatic test

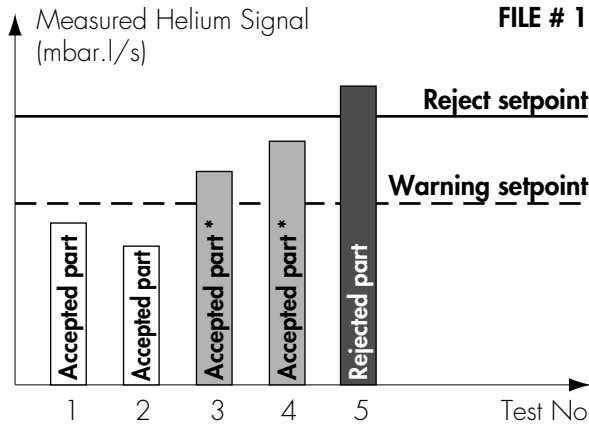

(see page 15)

Audio signal Test result display

None

PASS : 2.0E-10

The measured Helium signal is less than the Reject level and the Warning level.

None

PASS* : 3.0E-9

The measured Helium signal is less than the Reject level but greater than the Warning level. (WL < Measured S < RL)

Fixed signal

FAIL : 1.0E-06

The measured Helium signal is greater than the Reject level.

Fixed signal

FAIL ROUGHING

Switching to test mode is not possible within the roughing time (part refused for very gross leak)

Error message at end of unvalidated automatic test

**RETEST ! DEF. # 11
READY/AUTO CYCLE**

The test has not been validated; the cycle is interrupted. The test is not counted.

Two fixed audio signals

DEF. code X	Explanation
6	FIL OFF in roughing
7	FIL OFF in test
9	CYCLE OFF in roughing
10	CYCLE OFF in test
11	Pressure RISE in test

Alphanumeric Control and Display Panel (ACDP) operation

Ticket printing examples (AUTO mode)

Parameters ticket

<p>FILE # : 1 CUSTOMER reference S=level (mbar.l/s) T=timer (sec) S rejected : 2.8E-09 S alarm :9.9E-10 T roughing : 9 T test : 6 PRINTER ON number: TEST # 26JUNE 96</p>	<p>FILE # : 2 S=level (mbar.l/s) T=timer (sec) S rejected : 1.0E-08 S alarm :8.0E-09 T roughing : 10 T test : 7 PRINTER ON number: SERIAL # 26JUNE 96</p>	<p>Selected part Customer reference</p> <p>Test ticket to be printed Test reference</p>
-------------------------------------------------------------------------------------------------------------------------------------------------------------------------------------------------------------------------------------------------------------------------------------------------------------	--------------------------------------------------------------------------------------------------------------------------------------------------------------------------------------------------------------------------------------------------------------------------------	-------------------------------------------------------------------------------------------------------------------

Test ticket

<p>CUSTOMER reference TEST Nr : 5 AUTO MODE /FL PASS signal = 9.0E-10 26JUNE 96 16.6:37</p>	<p>FILE # : 2 SERIAL Nr : 3826 AUTO MODE /FL PASS signal = 7.2E-09 26JUNE 96 15.18:20</p>
--------------------------------------------------------------------------------------------------------------------------------------------------------------	------------------------------------------------------------------------------------------------------------------------------------------------------------

Accepted part

<p>CUSTOMER reference TEST Nr : 6 AUTO MODE /FL PASS signal = 1.5E-09 Warning level exceeded 26JUNE 96 16.10:08</p>	<p>TEST Nr automatically incremented</p>
---------------------------------------------------------------------------------------------------------------------------------------------------------------------------------------------------	------------------------------------------

Accepted part with warning level

<p>Modifiable and validated SERIAL Nr at the end of each test</p>	<p>FILE # : 2 SERIAL Nr : 4217 AUTO MODE FAIL signal = 3.2E-06 26JUNE 96 15.20:31</p>
-------------------------------------------------------------------	--------------------------------------------------------------------------------------------------------------------------------------------------------

Rejected part

<p>CUSTOMER reference TEST Nr : 7 AUTO MODE/ FAIL T. Roughing 26JUNE 96 16.12:05</p>

Rejected part on account of roughing timer

Alphanumeric Control and Display Panel (ACDP) operation

Purpose of the part modification menu

This menu is used to:

- set up the automatic test parameters for 10 part references memorized as file # 1 to 10,
- select the part to be tested among the 10 memorized,
- modify and check the date and time which are displayed and printed on the control tickets.

File

As indicated above, 10 part references can be memorized with their associated automatic test parameters. Access to these files is allowed whichever test mode of the detector (AUTO or MANUAL) has been selected. An eleventh reference called FILE BYPASS, available in the MANUAL mode only, allows to reduce the number of menus displayed because it has no automatic test parameter. 16 alphanumeric characters introduced by connecting the detector to a (PC) microcomputer allow to customize the 10 part references (see **page 18**).

Automatic test parameters

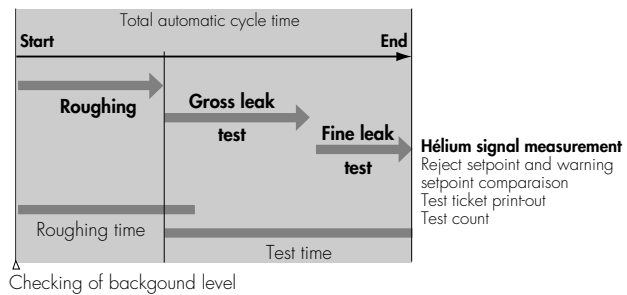

Background setpoint

If the Helium signal, when not in a cycle and at the time the cycle start is activated, is greater than the "background setpoint", the test cycle is cancelled and an empty cycle is requested to "clean" the detector (optional, selected with a switch inside the detector; see **page 24**).

The background setpoint can be useful for high sensitivity tests (reject setpoint in the 10^{-9} to 10^{-10} mbar.l/s range).

Roughing time

If the detector has not changed to test mode after the "roughing time", the cycle is stopped and the part rejected for Gross Leak.

Alphanumeric Control and Display Panel (ACDP) operation

Test time When the detector is changed to test mode, the "test time" is counted down. After the test time, the Helium signal is measured (instantaneously) and the result analysed according to the next parameters.

Test ticket A test ticket is printed if a printer is connected (see **B 40**) and if this parameter is activated.

Test reference When automatic tests are performed for a selected part reference, each individual test is identified by a number called TEST REFERENCE. Two kinds of test references are available:
 TEST Nr : test number automatically incremented after each cycle.
 SERIAL Nr : serial number incremented after each cycle but manually modifiable and validated at the end of each test (see **page 12**).

Helium signal measurement

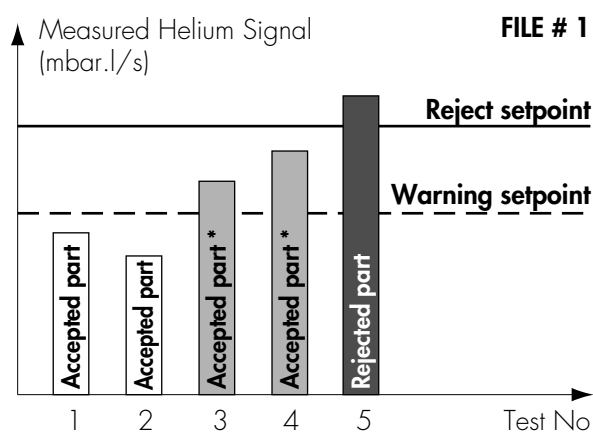

Reject setpoint If the "measured Helium signal" is \geq Reject setpoint, the part is rejected.

Warning setpoint If the "measured Helium signal" is \geq Warning setpoint and $<$ Reject setpoint, the part is accepted but a warning* signals that the measurement is approaching the Reject level.

If the "measured Helium signal" is $<$ Warning setpoint, the part is accepted.

Note: The test parameters can be programmed independently for the 10 different file # available.

Alphanumeric Control and Display Panel (ACDP) operation

Basic part modification menu

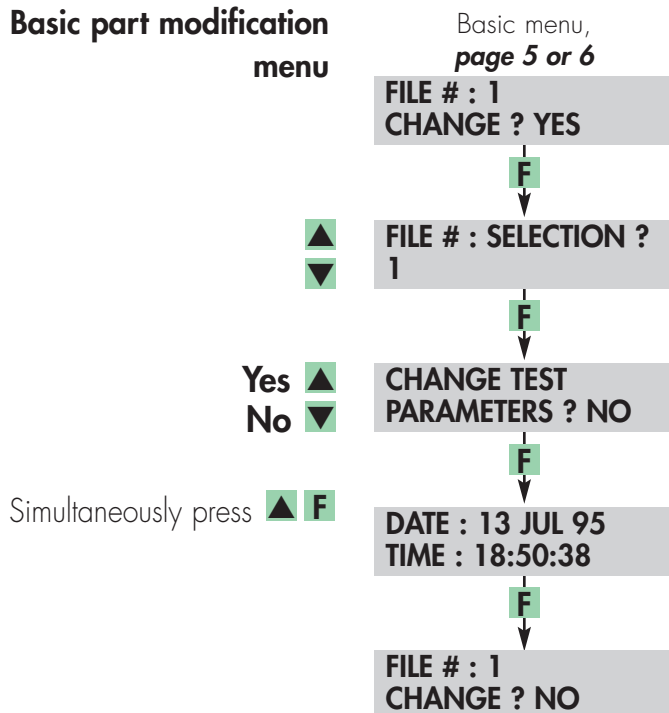

10 parts in automatic and 10 parts + 1 "file by-pass" in manual mode can be defined (**page 18**)

▲ **Yes**: used to modify the part parameters (**page 19**)

Is used to modify the date and time (**page 20**)

Return to the main menu

Alphanumeric Control and Display Panel (ACDP) operation

Selected part change

Select the part using the keys ▲ and ▼

Example ▲

Part reference customization

From the PC, send "CTRL D" (decimal code "4")

Send 16 characters defining the reference assigned to the part

Delete the customized reference, send "CTRL N" (decimal code "14")

Delete all the customized references, send "CTRL O" (decimal code "15")

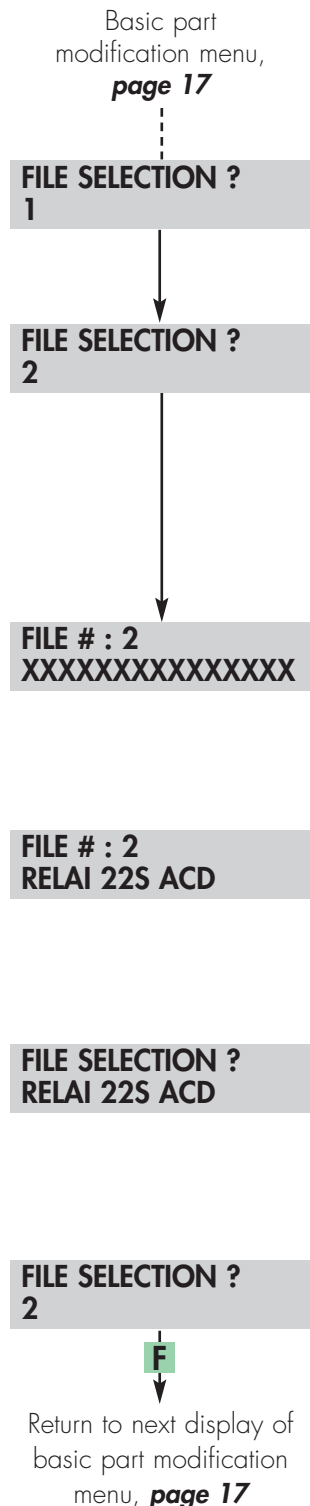

It is possible to select 10 different test parts each with its own test parameters. When the manual test mode is activated, it is possible to select an 11th imaginary "file by-pass" part, without any parameters, specifically for the manual test: only the manual reject setpoint is taken into account (see **page 5**).

Function only possible if the detector is connected to a micro-computer (PC) in terminal emulation through the RS ACDP interface (**B 40**).

E.g.: Relai 22S ACD
In the event of an error, repeat CTRL D.

Alphanumeric Control and Display Panel (ACDP) operation

Part parameter modification

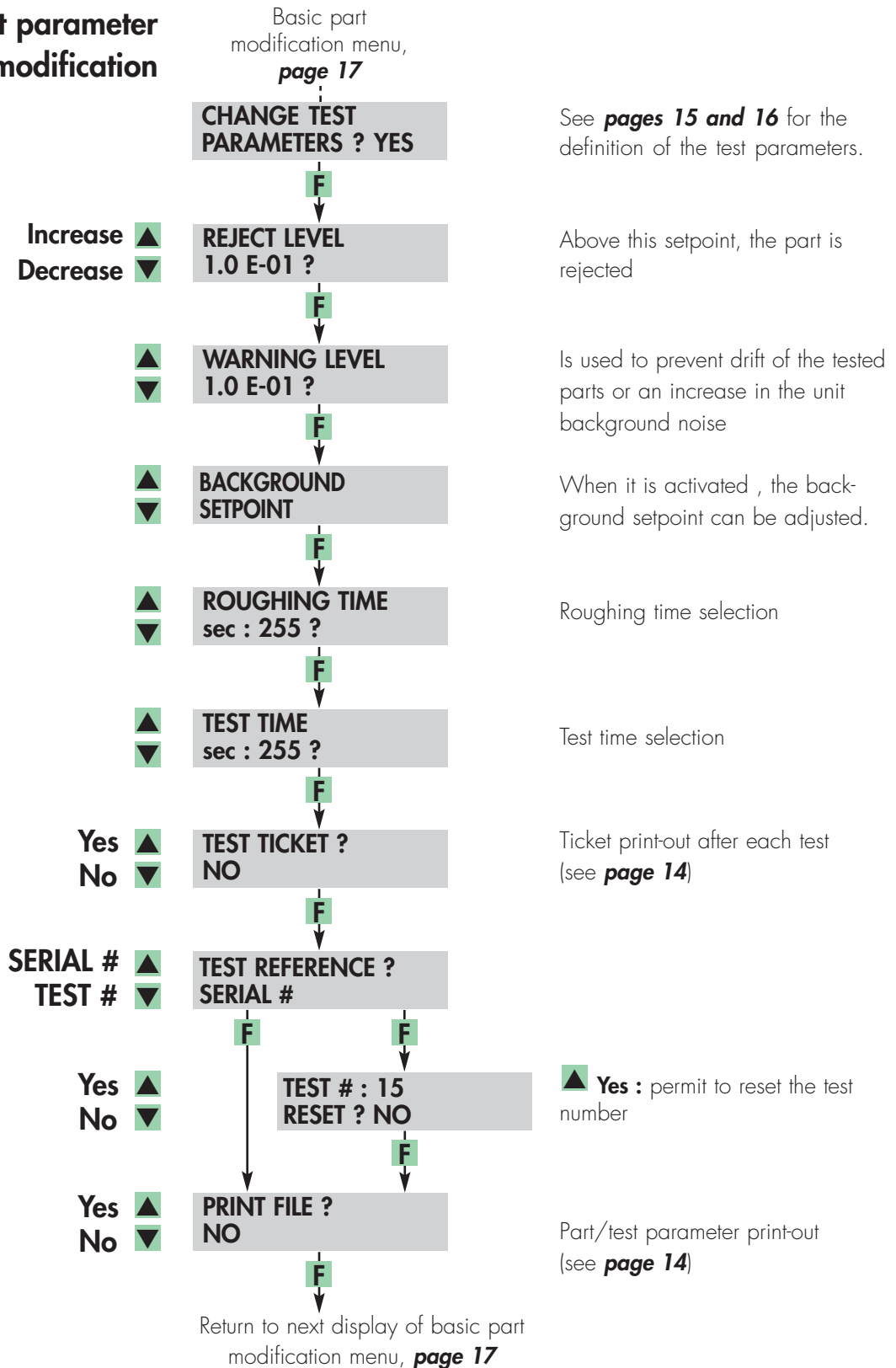

Alphanumeric Control and Display Panel (ACDP) operation

Date and time modification

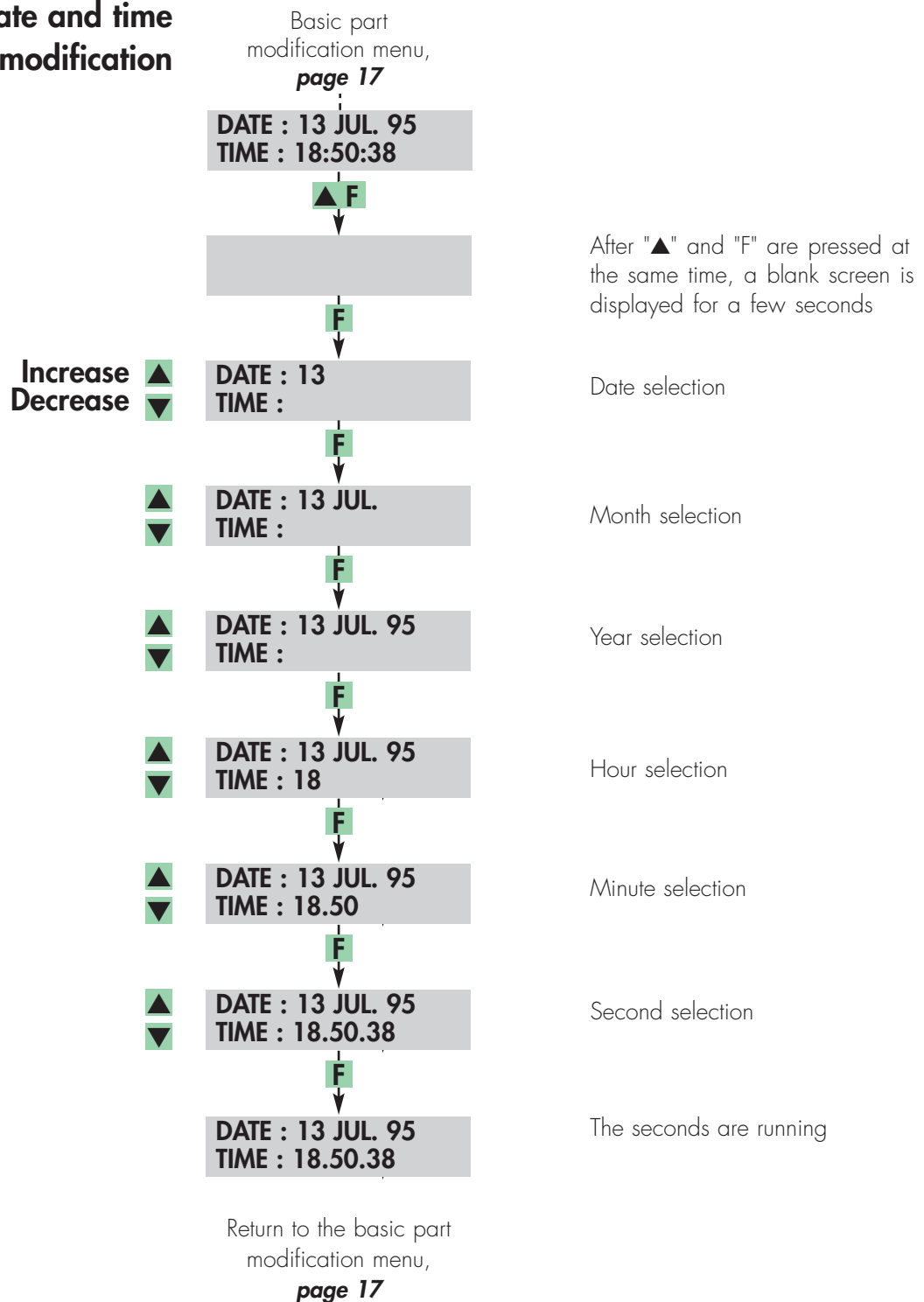

Alphanumeric Control and Display Panel (ACDP) operation

Detector autocalibration

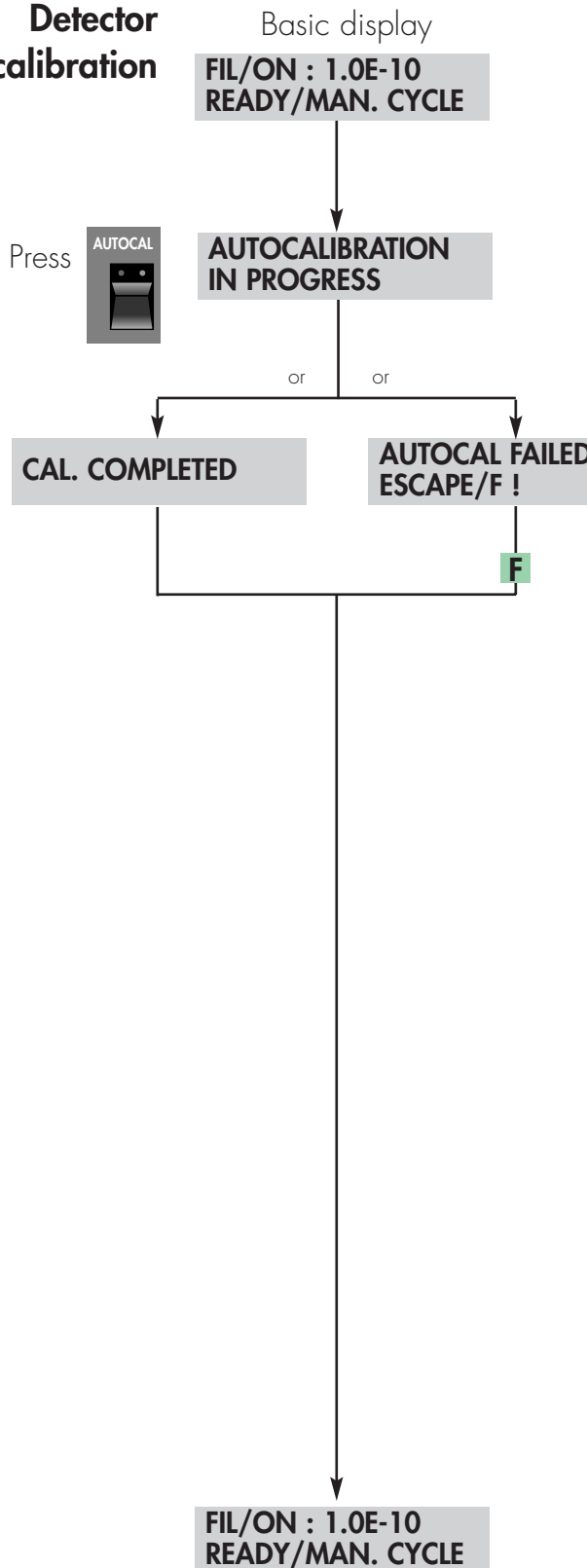

To be taken in account by the ACDP, the autocalibration has to be started from basic display

Autocalibration cycle started (see C 30).
Note : electrical auto-reset is not taken in account by ACDP

Display of result. In case of fault, 2 audio signals are emitted

Autocalibration ticket print-out if printer connected (see B 40)

examples of tickets :

```

    AUTOCALIBRATION REPORT
    STARTED :
    13 DEC. 95
    9.13:5
    COMPLETED :
    13 DEC. 95
    9.13:40
    DETECTOR STARTED
    13 DEC. 95
    8.05:30
    END OF AUTOCAL REPORT
  
```

```

    AUTOCALIBRATION REPORT
    STARTED :
    13 DEC. 95
    9.13:48
    FAILED:
    13 DEC. 95
    9.13:51
    DETECTOR STARTED
    13 DEC. 95
    8.05:30
    END OF AUTOCAL REPORT
  
```

Return to the basic display

Alphanumeric Control and Display Panel (ACDP) operation

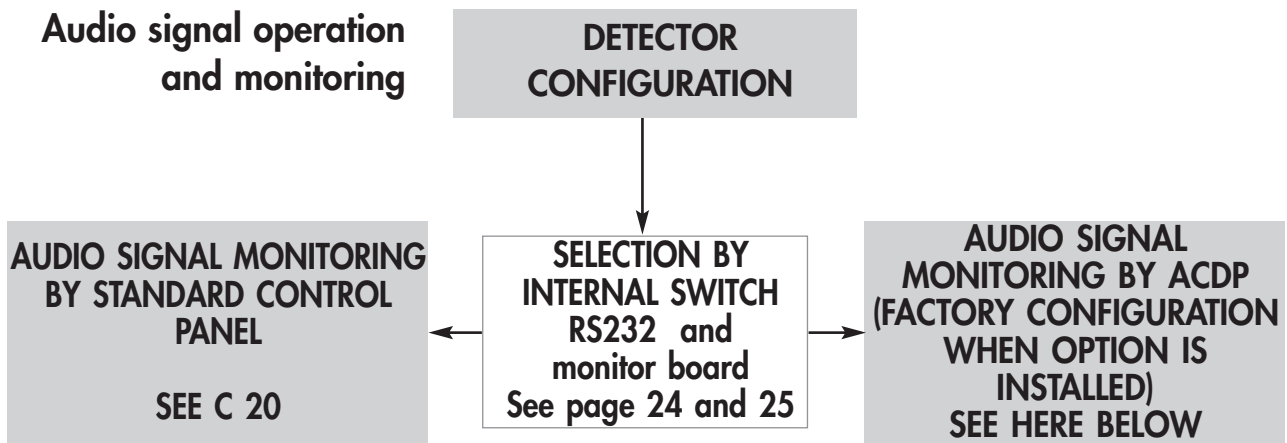

Adjust the audio volume



- The audio signal volume is adjusted with the knob located in the AUDIO section of the standard control panel. When this knob is at the minimum position ("0"), the audio signal is cut off. This button is the only one to be activated in the AUDIO section of the standard control panel.

End of AUTOMATIC test

- An audio signal is emitted for a short time, with a fixed frequency, when the tested part is REFUSED.
- Two audio signals are emitted for a short time, with a fixed high frequency, when the part has to be retested because of a fault.

End of AUTOCALIBRATION

- Two audio signals are emitted for a short time, with a fixed high frequency, when autocalibration failed.

During MANUAL test

- Two operation modes are available according to the type of MANUAL REJECT SETPOINT selected in the main menu (see **page 5**): FIXED or FLOATING reject setpoint.

FIXED reject setpoint

- An audio signal is emitted when the Helium signal is higher than the setpoint. The frequency of the audio signal depends on the value of the Helium signal (the higher the helium signal, the higher the audio signal frequency). The fixed reject setpoint can be modified while the leak detector is in manual test mode using key F (**see page 9**). This operation mode allows an accurate audio leak detection based on the fixed reject setpoint.

Alphanumeric Control and Display Panel (ACDP) operation

FLOATING reject setpoint

- A modulated audio signal is AUTOMATICALLY emitted according to the Helium signal fluctuations. When the Helium signal increases, the audio signal switches on.

There is no manual setting in this operation mode.

This operation mode provides a useful audio assistance for pin pointing leaks when using the sniffing or spray method.

Note : To quickly shut down an audio signal which is hindering (in case of increasing background level), the choice can be :

- set the volume to "0".
- switch off and then on the filament (see **page 9**),
- briefly expose the detector to a helium source in order to higher up the audio signal frequency and then let it lower down until it stops.

Alphanumeric Control and Display Panel (ACDP) operation

Test parameters

Parameters	Setting range	Default configuration
Reject setpoint	$1.0 \cdot 10^{-10}$ to $1.0 \cdot 10^{-1}$	$5 \cdot 10^{-8}$
Alarm setpoint	$1.0 \cdot 10^{-10}$ to $1.0 \cdot 10^{-1}$	$1 \cdot 10^{-8}$
Background setpoint	$1.0 \cdot 10^{-11}$ to $1.0 \cdot 10^{-6}$	$1 \cdot 10^{-8}$
Roughing time	1 to 255 s	9 s
Test time	1 to 255 s	6 s
Test ticket	YES - NO	YES
Test reference	SERIAL Nr - TEST Nr	TEST Nr
TEST Nr	0 - 65535	0
SERIAL Nr	0 - 65535	0
MAN. Reject setpoint	FIXED - FLOATING	FIXED
FIXED manual setpoint	$1.0 \cdot 10^{-11}$ to $1.0 \cdot 10^{-1}$	$5 \cdot 10^{-8}$
FLOAT. manual setpoint	FL: $2.0 \cdot 10^{-10}$ to $1.0 \cdot 10^{-2}$	(Automatic)
FLOAT. manual setpoint	GL: $2.0 \cdot 10^{-8}$ to $1.0 \cdot 10^{-1}$	(Automatic)
MANUAL test Ticket	YES - NO	NO
LDS measurement	mbar.l/s or ppm	mbar.l/s

Note : The default parameters are valid for part reference 1, the values of the parameters are at random for parts 2 to 10.

Supervisor board

The four following straps allow to configure the audio signal monitoring

	ST 21	ST 22	ST 23	ST 26
Standard audio signal control (1*)	ON	OFF	ON	ON
ACDP audio signal control (2*)	OFF	ON	OFF	OFF

* Factory configuration for detectors without ACDP option (1) and (2) with ACDP option.

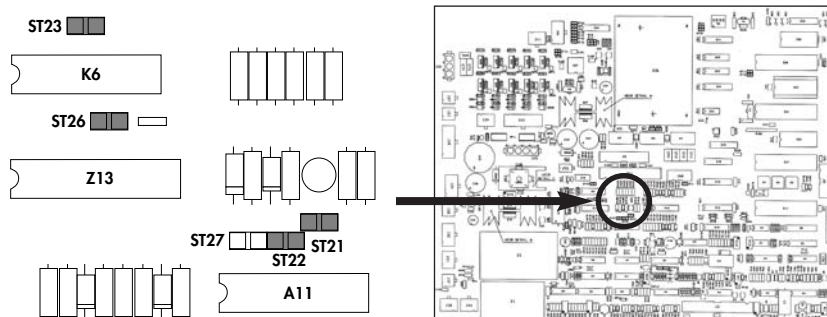

Alphanumeric Control and Display Panel (ACDP) operation

General screen flow chart

The purpose of this sheet is to give a guide for the use of the option's menus.

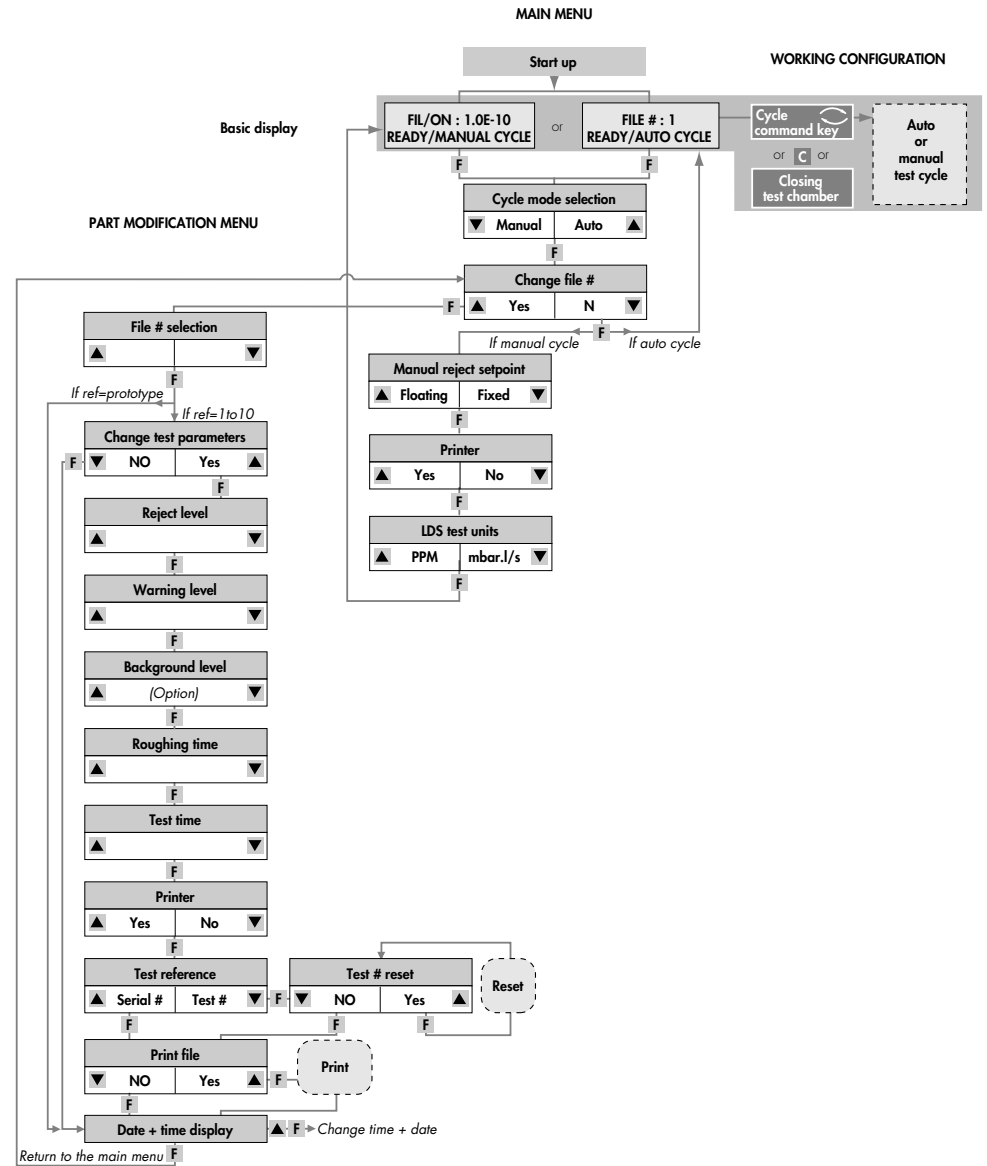

Alphanumeric Control and Display Panel (ACDP) operation

View of the ACDP panel The purpose of this sheet is to show the key or the part of the display in action during use of the option.

ACDP PANEL

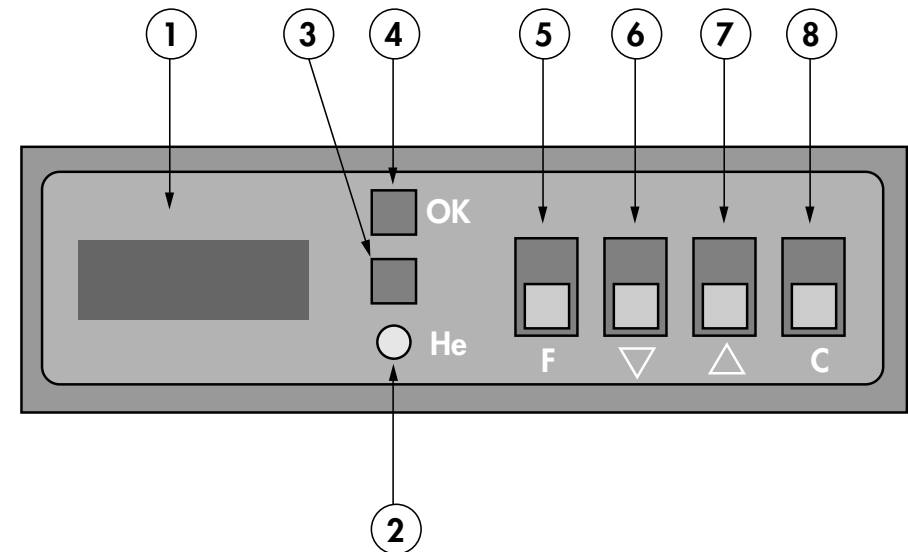

- 1 **LCD display**
2 x 16 character lines
- 2 **Yellow indicator light** signalling the activation of the autocalibration process
- 3 **Red indicator light** (part rejected)
- 4 **Green indicator light** (part accepted)
- 5 **F key** used to access the various functions
- 6 **Shift down key ▼** } used to modify parameters
- 7 **Shift up key ▲** }
- 8 **C key:** cycle control

Configuring the unit according to the gas to be detected

The following instructions only apply to units which are equipped with the "3 Mass" option and for a change of tracer gas.

Introduction to the unit

The unit equipped with the "3 Mass" option does not have any external differences in relation to the standard unit. The modifications are inside the unit (analysis cell magnet and electronic supervisor board).

The functions are the same as the standard detector.

The tracer gases which can be used

Gas	Atomic mass
Helium 4	4
Helium 3	3
Hydrogen	2

Alcatel does not supply a calibrated internal leak in Helium 3 and Hydrogen. The calibration is made with an external calibrated leak.

Initialize the acceleration voltage as a function of the mass to be detected

While the unit is switched off, open the front cover of the unit and tilt it forwards to access the **supervisor board**.

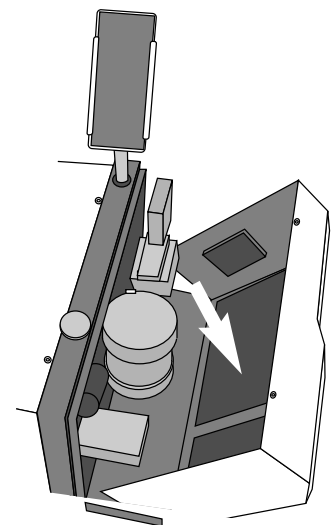

Configuring the unit according to the gas to be detected

Configure the switch S1

If the detection can be performed on Helium 3 or Hydrogen, set the **switch S1 to ON** (external autocalibration).

If the detection must be performed on Helium 4, the **switch S1** can, if required, be set to **OFF** (autocalibration with an internal calibrated leak) or **ON** (external autocalibration).

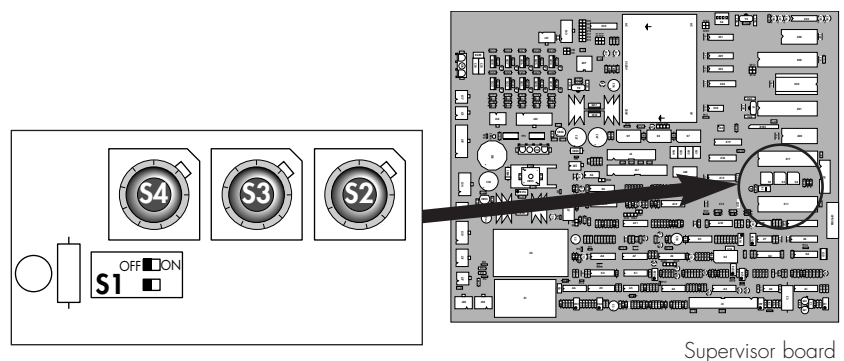

Switch on the detector while resetting the autocalibration parameters

Set the circuit breaker switch to **I**.

While the green cycle key  indicator light is flashing (first seconds of the commissioning cycle), press the autocal key **AUTOCAL**.

If the cycle key indicator light stops flashing before you press the autocal key **AUTOCAL**, switch off the unit and repeat the operation.

The red autocal key indicator light comes on.



Configuring the unit according to the gas to be detected

Initialize the acceleration voltage

Place a voltmeter between terminal **TP7** (ground) and terminal **TP3** (acceleration voltage).
(Voltmeter rating ≥ 400 V=.)

Using a screwdriver, adjust the potentiometer **R31** to adjust the voltage as a function of the tracer gas used:

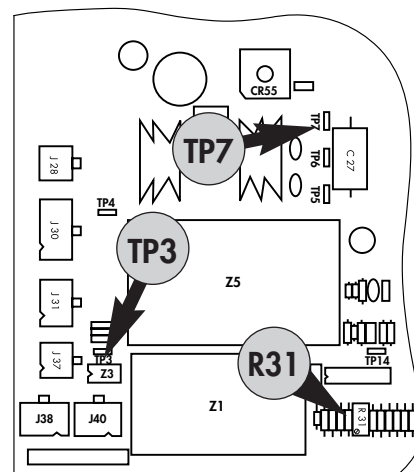

Right side of the supervisor board

Tracer gas	Mass	Acceleration voltage
Helium 4	4	150 ± 2 V
Helium 3	3	198 ± 2 V
Hydrogen	2	290 ± 2 V

Switch off the detector

Set the circuit breaker switch to **0**.

Autocalibrate the detector

For mass 2 or 3 detection:

autocalibration is performed only with an external calibrated leak: refer to section **E 50 Autocalibration with external calibrated leak**.

For helium 4 detection (standard):

- to perform autocalibration with a calibrated leak inside the detector, it is necessary to proceed as for a newly installed leak: refer to section **E 40 Replacement/recalibration of the detector internal calibrated leak**;

- to perform autocalibration with an external calibrated leak: refer to section **E 50 Autocalibration with external calibrated leak**.

Use of the "I" gas line option For ASM 180 TD and ASM 180 TD+

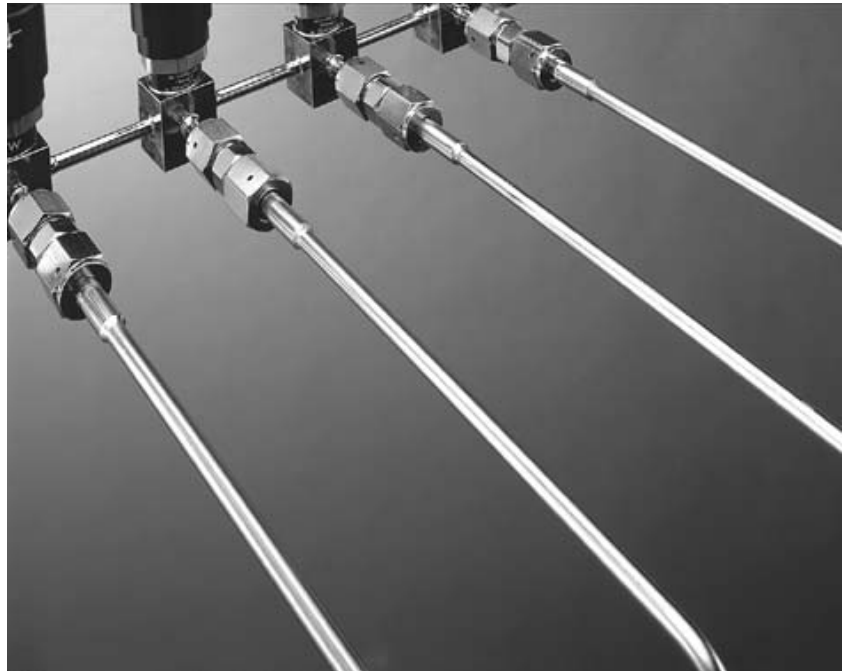

Contents	Purpose of the "I" option	page 1
	Operating principle	page 2
	Choice of carrier gas	page 4
	Installation preparation	page 5
	Installation connection	page 6
	Test procedure	page 8
	In the event of a problem	page 11

Purpose of the option

Used to perform spray testing on long lines (typical diameter: 1/4"), with a reduced response time due to the transfer of the helium by a carrier gas injected in the viscous state.

This option allows the unit to detect leaks of the order of 10^{-9} mbar.l/s in a considerably reduced time in relation to the conventional vacuum test.

The test is thus quicker and more reliable.

Use of the "I" gas line option For ASM 180 TD and ASM 180 TD+

Operating principle

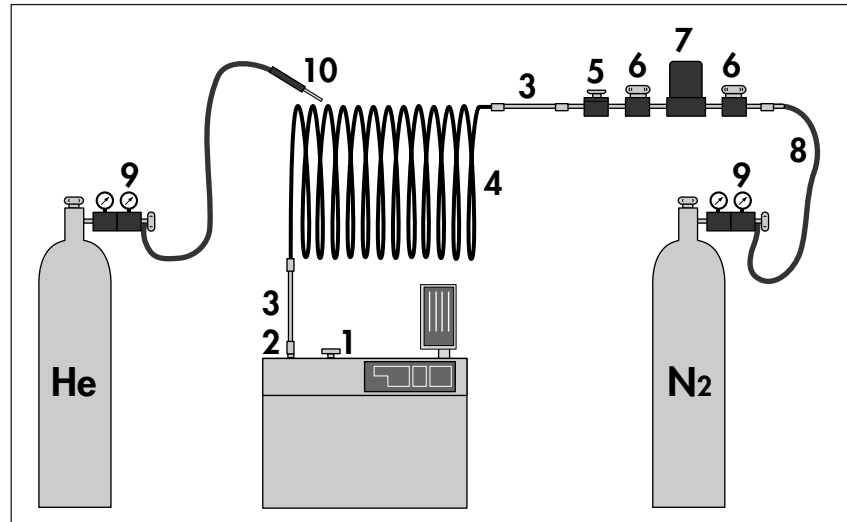

- | | |
|-------------------------------------------|-------------------------------------------|
| 1. Detector inlet port | 6. Manual valve |
| 2. Gas line inlet port
(VCR connector) | 7. Mass flow controller (N ₂) |
| 3. St. steel flexible connector | 8. Flexible connector |
| 4. Rigid line under test | 9. Pressure controller |
| 5. Reference leak | 10. Helium spray |

Test principle

The detector is connected at the 1/4 VRC connection to one end of the line under test.

The carrier gas is injected at the other end of the line.

The line is pumped by the detector and the carrier gas is injected to obtain a laminar flow (a few mbar absolute pressure).

Helium is sprayed around the line.

In the event of a leak, the helium which enters the line is "transported" to the detector by the carrier gas.

The sensitivity of the test depends on the helium content of the carrier gas (which must be as low as possible).

Use of the "I" gas line option For ASM 180 TD and ASM 180 TD+

Choice of carrier gas

- the most commonly used carrier gas is **nitrogen**.
- In order to be able to identify leaks of approximately 10^{-9} mbar.l/s, the carrier gas must have a helium content which is less than a few ppb (10^{-9}).
- If "0.999 999 999 concentration" nitrogen is considered too expensive, nitrogen obtained from a tank or a source of liquid nitrogen can be used.
- Any gas free of helium can be used as a carrier gas (e.g. l'Argon).
However, for safety reasons, the method is not applicable to process gases which are toxic, reactive, explosive or flammable. In addition, the detector is not designed to pump chemically reactive gases.

Use of the "I" gas line option For ASM 180 TD and ASM 180 TD+

Installation preparation

Equipment required (in addition to the detector)

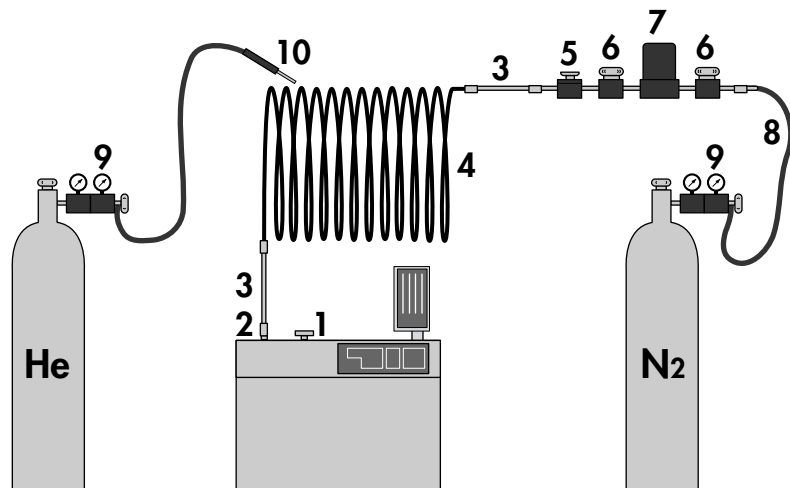

Flexible connection components (3)

E.g.: flexible stainless steel tubes of a diameter not greater than 10 mm so as not to increase the response time and connection accessories compatible with the installation under test.

Helium spray equipment (10)

E.g.: helium cylinder with pressure relief valve, tube and spray gun.

Carrier gas source (8)

E.g.: helium-"free" nitrogen cylinder and pressure relief valve. This source must be compatible with the cleanliness or purity requirements within the installation at the time of the test.

A carrier gas flow adjustment device (7)

The quickest method to adjust the gas flow is the mass flow controller (Mass Flow Controller).

As an alternative, a manual micro-flow valve (DN16) can be used.

According to usual connection procedures, stop valves (6) and filters may be inserted.

A reference leak (5)

used to "calibrate" the installation (response time for the furthest point from the detector, ratio of actual leak / helium signal read on the detector). ALCATEL offers reference leaks specially designed for this application (without reservoir, with 1/4" VCR connectors).

Different values of leaks are available (mbar.l/s):

1×10^{-9} (Part No. **103371**), 1×10^{-8} (Part No. **103372**),
 1×10^{-7} (Part No. **103373**), 1×10^{-5} (Part No. **103374**).

Use of the "I" gas line option For ASM 180 TD and ASM 180 TD+

Installation connection

Principle

- The detector DN40 inlet port **(1)** must be blocked.
- Connect the gas line under test **(4)** to the detector's 1/4" VCR connector **(2)** via flexible connection components **(3)**.
- Connect the reference leak **(5)**.
- Connect the carrier gas flow control accessories composed of a mass flow controller **(7)** or manual micro-flow rate valve and stop valves **(6)** if necessary.
- Connect the carrier gas source via a flexible tube **(8)**.

Precautions

- A laminar flow must be maintained in the entire line under test to obtain the expected result: the response time is increased if a significant volume is between the carrier gas supply and the detector.
- It is advisable to place the detector as close to the zone liable to leak as possible.
- Purge the injection system with the carrier gas in order to eliminate the air.
- It is better to stop the "gas line test" function in case of autocalibration

Note: It is not necessary to connect a neutral gas purge to the detector: the carrier gas acts in the same way as the purge.

Use of the "I" gas line option For ASM 180 TD and ASM 180 TD+

Multiple line test

Shut off the line under test as much as possible with the valves and fittings available.

The zone under test is limited to the line through which the carried gas flows to the detector.

It is therefore necessary to prevent the flow of carrier gas through the lines not under test, using the valves V1, V2, and V3.

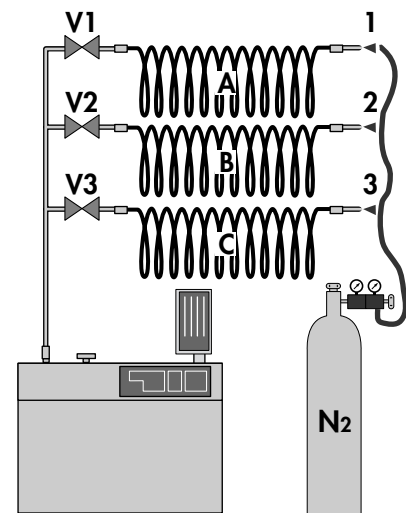

To test the line,	open,	close,	connect
A	V1	V2 and V3	1
B	V2	V1 and V3	2
C	V3	V2 and V1	3

Use of the "I" gas line option For ASM 180 TD and ASM 180 TD+

Test procedure

The connections are made according to the recommendations on page 7.

Close the carrier gas supply

Close the valves (6 and 9).

Start up the detector



Make sure that the DN40 inlet port is blocked. Activate the atmospheric pressure key .

Activate the "gas line test" function

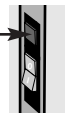

Press the yellow button above the ON switch.

Run a cycle



Wait until the detector enters "Fine Leak" mode and the analyzer cell pressure is sufficiently low (for example, no more than 3 green indicator lights on).

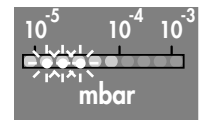

Initially, the helium background noise increases briefly and then decreases and becomes stable.

Note: The inlet pressure displayed on the remote control unit is not the pressure at the gas line (circuit separated by a membrane inside the detector: see detector mimic diagram). It is the pressure at the level of the DN40 inlet port. However, this pressure varies as a function of the pressure in the gas line.

Use of the "I" gas line option For ASM 180 TD and ASM 180 TD+

Inject the carrier gas

Gradually open the carrier gas supply until the maximum flow allowed is obtained.

The detector must remain in Fine Leak test mode.

The inlet pressure and the cell pressure increase as the carrier gas flow increases.

If the detector switches to Gross Leak mode, reduce the carrier gas flow.

The length of time it takes for the pressure to stabilize in the gas line depends on the length of the gas line.

If a mass flow controller (7) is used, the maximum carrier gas flow can be defined quickly before connection to the installation, by connecting the injection system directly to the detector.

The maximum flow is of the order of 40 to 60 SCCM or 0.6 to 1 atm.cm³/s for the ASM 180TDI.

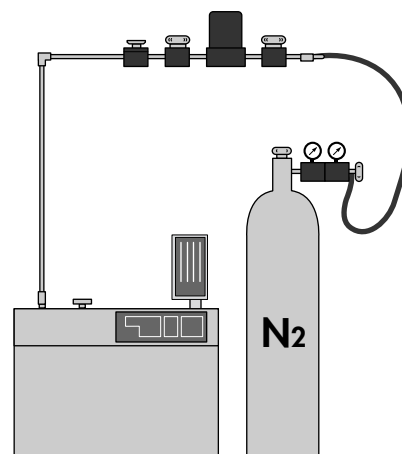

Use of the "I" gas line option For ASM 180 TD and ASM 180 TD+

Calibrate the installation

Spray the reference leak (5) for a defined period (e.g. 5 seconds).

Note:

- the time required to obtain a signal on the detector (any leak on the gas line will give a response \leq this reference time).
- the ratio read on the detector

$$\frac{\text{Reference leak value}}{\text{Helium signal value}}$$

(this ratio depends on the detector and the carrier gas flow. Value: between 10 and 20).

Test the installation

Spray the various test points and according to the reference time defined above, wait to go to the next point. It is recommended to start on the detector side and to test progressively by moving further away (increasing response times).

Stop the test

Close the carrier gas injection. Stop the test cycle by pressing .

Deactivate the «gas line test» mode

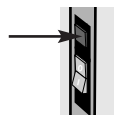

Deactivate the "gas line test" mode by pressing the yellow button.

Switch off the detector

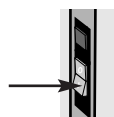

Set the circuit breaker switch to 0.

In the event of problems when using the "I" gas line test option

SYMPTOM	CAUSE	REMEDY
<p>The detector does not switch to Fine Leak mode for example, after 5 min for a 1/4" line, length ≤ 100 m</p>	<p>Gross Leak on installation</p>	<p>Inject the carrier gas (40 SCCM) and test the installation (page 10). The leaks at the connections or the line are displayed on the GL measurement scale if the detector is in GL mode, or Inlet Pressure display if the detector is in roughing mode.</p>
<p>The helium background noise does not decrease for example, the helium signal remains at the 10^{-7} scale (The minimum detectable leak is limited to the value of the helium background noise.)</p>	<p>The carrier gas contains a significant helium concentration</p>	<ul style="list-style-type: none"> • Vary the carrier gas flow while remaining in FL mode. If the helium signal rises with the carrier gas flow, the carrier gas contains helium. • Purge the carrier gas injection system again to remove any possible trace of residual air. If the problem persists, the test can be performed in the background noise limit or change the carrier gas.
	<p>NO</p>	
	<p>Gross Leak on installation</p>	<p>Vary the carrier gas flow while remaining in FL mode. If the helium signal rises or remains practically constant when the carrier gas flow falls, there is a gross leak on the installation.. Test the installation (page 10).</p>

User's Manual

ASM 180 TD/TD+ - ASM 181 TD+

Maintenance

■ Table of preventive maintenance intervals	■ D 10
■ General troubleshooting guide	■ D 20
■ Problem with the roughing pump	■ D 30
■ No display	■ D 40
■ Problem with the secondary pump	■ D 50
■ Spectro fault	■ D 60
■ Inlet pressure problem	■ D 70
■ Cycle start faults	■ D 80
■ Faults at end of autocalibration	■ D 90
■ Faults in sniffer mode	■ D 100
■ Helium measurement problem	■ D 110
■ I/O interface problem	■ D 120

Table of preventive maintenance intervals

FREQUENCY*	MAINTENANCE OPERATIONS TO BE PERFORMED				SEE SHEET
		ASM 180 TD	ASM 180 TD+	ASM 181 TD+	
4000 H	<p>Clean the vacuum lines, the valves and the gauges with alcohol - Dust the electronic boards and the fan. Clean the analyzer cell with alcohol* - Replace the filament and the electron collector - Replace the 2 special seals on the analyzer cell and the VHS preamplifier.</p> <p><i>* This cleaning may also be necessary if there is general contamination which creates insulating surface deposits.</i></p>	■	■	■	E 10
5000 H	<p>Check and clean the MD4E membrane pump - Replace the membrane</p>	■			E 60
8000 H	Re-grease the TMP 5154 hybrid pump.	■	■	■	E 20
	Re-grease the MDP 5011 pump.	■	■	■	E 30
	Check the electronics - Calibrate...	■	■	■	Call customer service
	Calibrate the pressure gauges.	■	■	■	Call customer service
	Adjustments - Calibration - Replace the long distance sniffer filter if necessary.	■	■	■	Call customer service
10000 H	Partial maintenance CP 20 pump		■	■	E 70
24000 H	Replace the ball bearings and the seals of the TMP 5154 Hybrid Pump.	■	■	■	Call customer service
	Replace the ball bearings and the seals of the MDP 5011 Molecular Drag Pump.	■	■	■	Call customer service
	Complete maintenance CP 20 Pump.		■	■	Call customer service
Every 2 years	Recalibration of internal calibrated leak.	■	■	■	E 40

*Service intervals : The service intervals given are for applications and work rates which conform to the normal operating conditions. If the machine is operating under more difficult conditions they can be shortened.

General troubleshooting guide



These checks must be performed with the detector isolated from all installations and supplied with the correct electrical power.





It is assumed that the connection and the electrical continuities have been checked beforehand.

Note: the troubleshooting guide follows a chronological order and a methodology which is the result of the experience of Alcatel CIT Customer Service. It is therefore recommended to follow this order so as to locate faults effectively.

Symptoms (detector inlet port blanked off)

Problems at start-up

The roughing pump does not start (no noise)	D - 30
The by-pass indicator light does not come on	D - 30
The MDP fault indicator light is on	D - 30
No display on the control panel MDP part	D - 30
No display on the remote control and the control panel	D - 40
The TURBO "P" indicator light does not come on after 2 min	D - 50
The TURBO "⚡" acceleration indicator light does not come on	D - 50
The TURBO "!" fault indicator light is on	D - 50
The  filament on indicator light does not come on	D - 60
The  filament on indicator light is flashing	D - 60
The "!" "spectro" alarm indicator light comes on	D - 60
No inlet pressure display (P(mbar) display)	D - 70
Autocalibration failed	D - 90

General troubleshooting guide

Symptoms (detector inlet port blanked off)

Problems during vacuum test cycle

The cycle key is disabled 	D - 80
No pressure drop at start of cycle (P(mbar) display)	D - 70
Inlet pressure > 1 mbar	D - 70
No change to FL mode ($P < 2 \times 10^{-2}$ mbar)	D - 110
Low sensitivity	D - 110
High background noise	D - 110
CP 20 pump has stopped during cycle (ASM 180 TD+/181 TD+).	D - 30

Problems during LDS test cycle

The  LDS indicator light does not come on	D - 100
The LDS helium signal $< 5 \times 10^{-6}$ mbar.l/s	D - 100
"Spectro" indicator lights off, filament off	D - 100

Autocalibration problems

Electrical zero check failed (filament off)	D - 90
Autocalibration failed (filament on)	D - 90

Problems on I/O interface board

No 24V on the jumper plug	D - 120
---------------------------	---------

Problem with the roughing pump

SYMPTOM	CAUSE	REMEDY
<p>No noise from the MD4E (ASM 180 TD)</p>	<p>Circuit breaker switch</p> <ul style="list-style-type: none"> • Difference in voltage between input and output. • impossible to keep in position 1. 	<p>Contact customer service</p>
	<p>NO</p> <p>Pump motor does not rotate</p>	<p>Contact customer service</p>
	<p>NO</p>	<p>Contact customer service</p>
<p>No noise from the CP20 (ASM 180 TD+) (ASM 181 TD+)</p>	<p>Problem on CP20 electrical module</p>	<p>Contact customer service</p>
	<p>NO</p> <p>CP20 pump overheating</p>	<p>Check the cooling system</p>
	<p>NO</p>	<p>Contact customer service</p>

Problem with the roughing pump

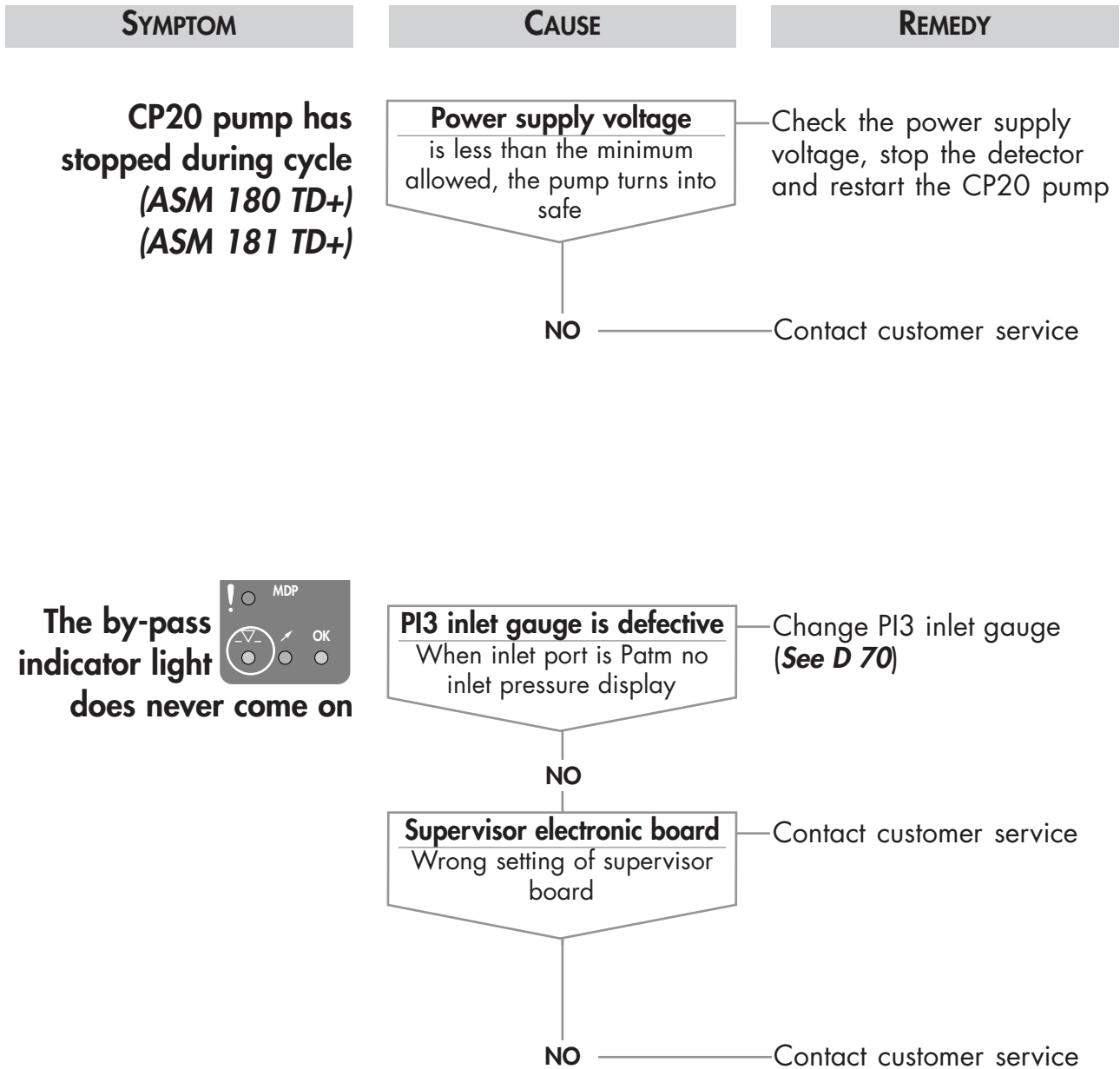

Problem with the roughing pump

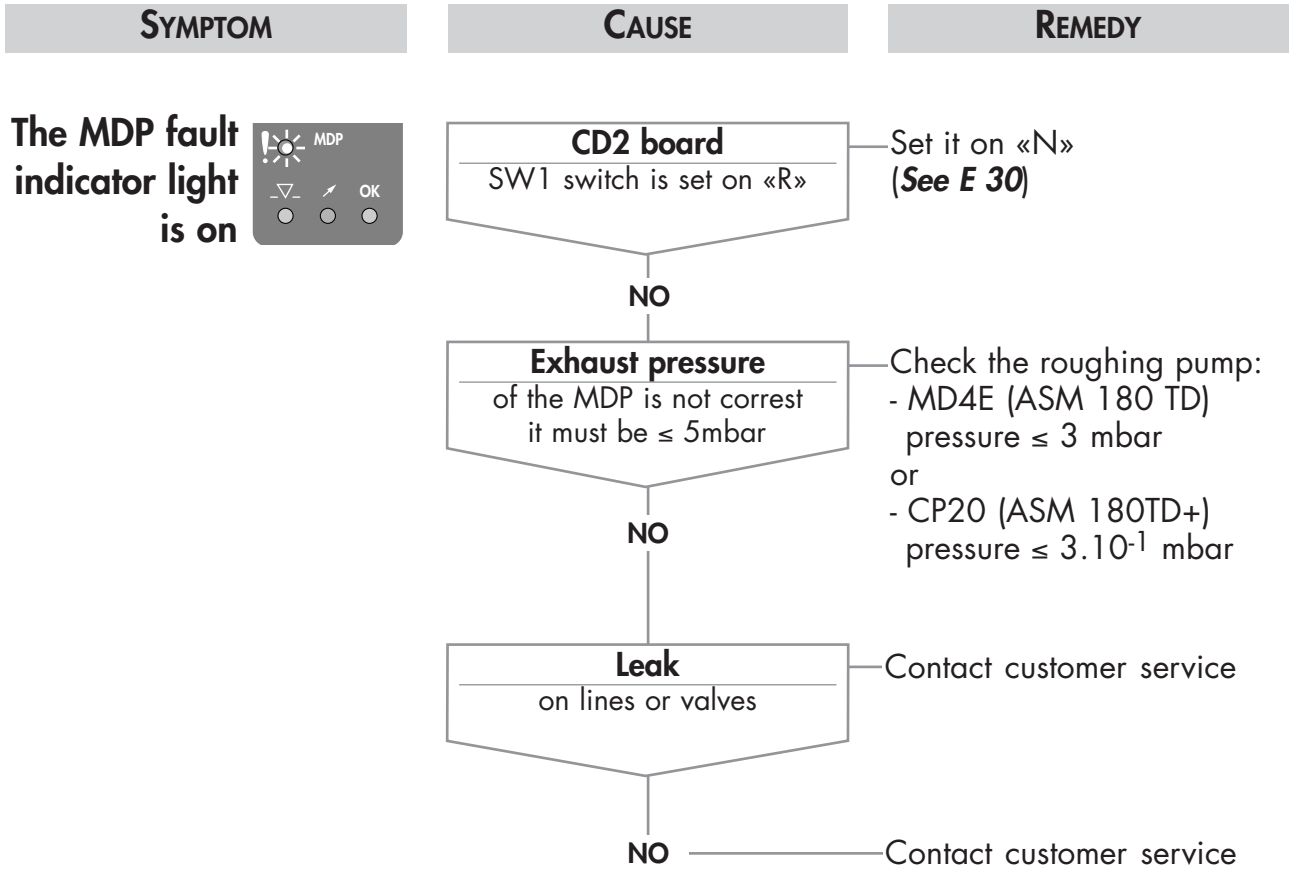

 At cycle start, it is normal for the MDP 5011 rotational speed to slow temporarily.

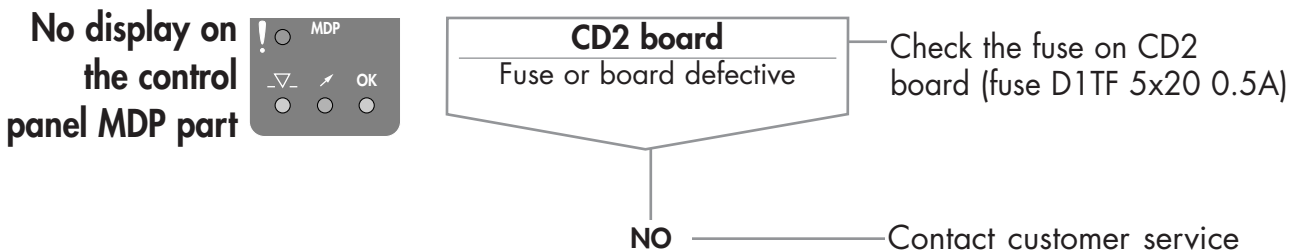

No display

SYMPTOM	CAUSE	REMEDY
<p>No display on the remote control and the front control panel (but the primary pump starts on)</p>	<p>Main fuse is out of order</p> <p>NO</p>	<p>Change the fuse located under the main switch (See F 30)</p> <p>Contact customer service</p>

Problem with the secondary pump

SYMPTOM	CAUSE	REMEDY
---------	-------	--------



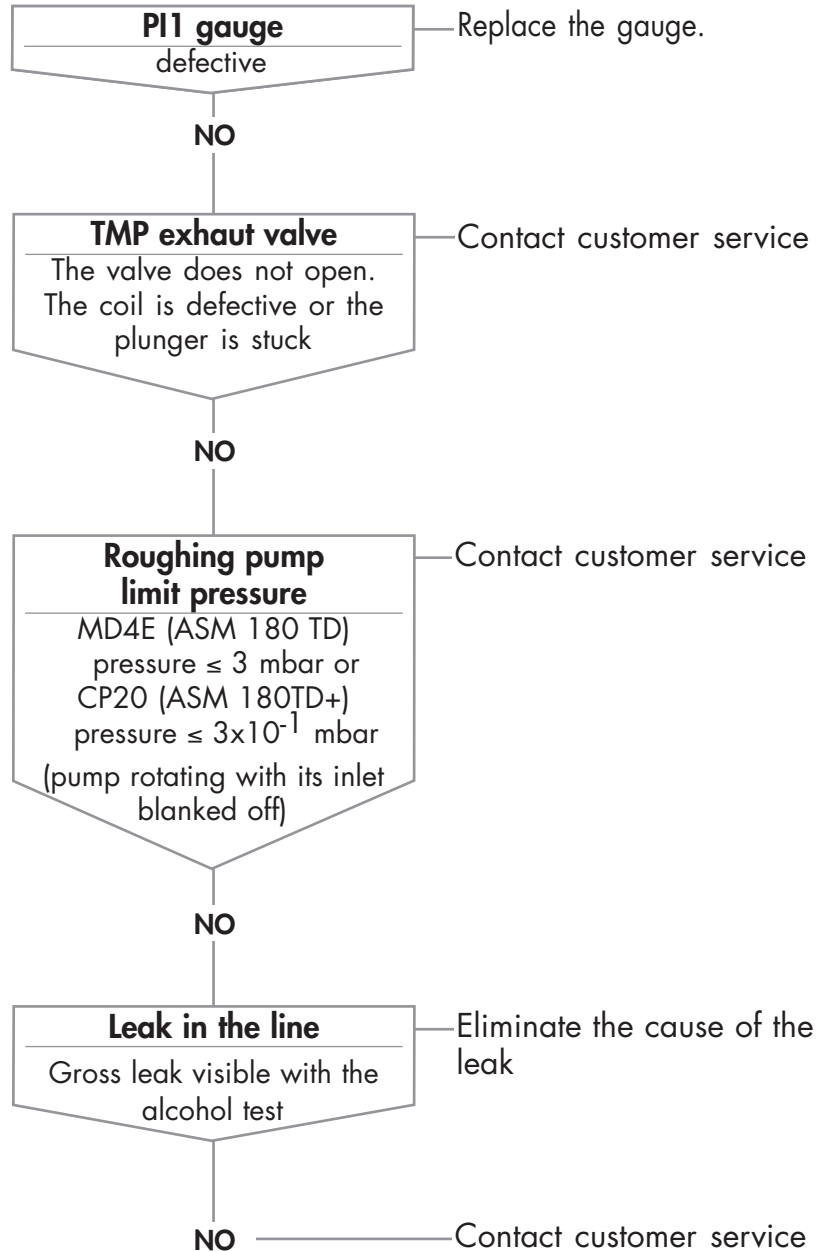

The P indicator light does not come on after more than 2 min

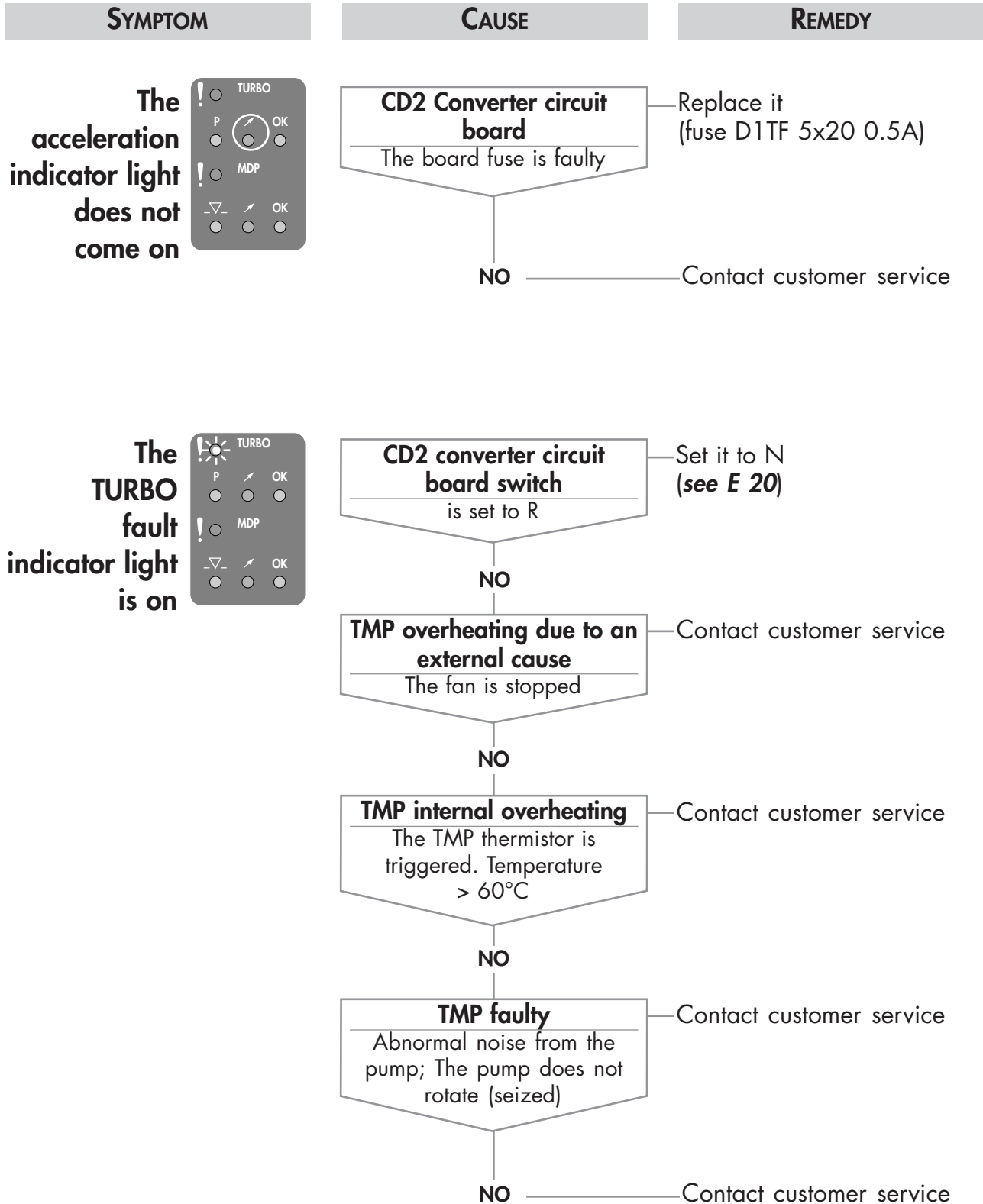

Problem with the secondary pump

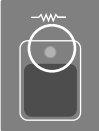

Spectro fault

SYMPTOM	CAUSE	REMEDY
<p>The filament indicator light does not come on </p>	<p>Filament key  in OFF position</p> <p>NO</p> <p>I/O jumper plug This is not connected to the rear of the detector</p> <p>NO</p>	<p>Press filament key  once to ON position</p> <p>Switch off the detector and connect the I/O jumper plug. Start up again (see B 70)</p> <p>Contact customer service</p>
<p>The filament indicator light is flashing </p>	<p>Filament On the cell JAEGER connector, open circuit between pins 1 and 5</p> <p>NO</p> <p>Short-circuit in the cell On the cell JAEGER connector, conductivity between 6 and the other pins of the connector</p> <p>NO</p>	<p>Replace the filament (see E 10)</p> <p>Eliminate the short-circuit; check conductivity between pins 1 and 5 of the Jaeger connector (see E 10)</p> <p>Contact customer service</p>
<p>The "spectro" alarm indicator light comes on </p>	<p>Spectro pressure > 10^{-4} mbar</p> <p>NO</p> <p>Analyzer cell Gross leak visible with the alcohol test</p> <p>NO</p>	<p>Wait for a few seconds until the vacuum improves in the cell and reset the filament</p> <p>Eliminate the leak (check particularly the seal of the analyzer cell)</p> <p>Contact customer service</p>

Inlet pressure problem

SYMPTOM	CAUSE	REMEDY
---------	-------	--------

No inlet pressure display

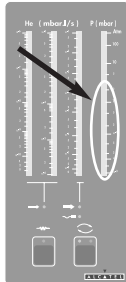

PI3 gauge
is defective

Replace the PI3 inlet pressure gauge

NO

Contact customer service

No pressure drop at start of a cycle







Fuse on the P0318 board
is defective

Replace the fuse (fuse 250V 5x20 T1.25A) (see F 40)

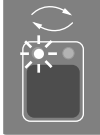
NO

Contact customer service

Cycle start faults



SYMPTOM	CAUSE	REMEDY
<p>The cycle key is disabled (green indicator light on)</p> 	<p>Filament off  filament key indicator light is off</p> <p>NO</p> <p>LDS mode selected  LDS key indicator is ON</p> <p>NO</p>	<p>Press the  filament key, the indicator light comes on. Otherwise, <i>see D 60</i>.</p> <p>Release the  LDS key to switch to vacuum test mode</p> <p>Contact customer service</p>
<p>The cycle key is disabled (indicator lights off)</p> 	<p>I/O plug connector This is not connected to the rear of the detector</p> <p>NO</p>	<p>Switch off the detector and connect the I/O plug connector. Start up again (<i>see B 70</i>)</p> <p>Contact customer service</p>

Note:

The cycle key green indicator light only indicates that autocalibration is validated. The fact that the indicator light is off does not inhibit the use of the cycle key.

Faults at end of autocalibration



Note: if a printer or a micro-computer is connected to the RS232 interface (configured in printer mode), a default ticket is emitted which provides diagnostic assistance (*see B 30*).

SYMPTOM	CAUSE	REMEDY
<p>Electrical zero check failed (filament off): red autocal indicator light on</p> 	<p>Preamplifier Helium signal displayed on the FL ramp too high</p> <p>NO</p>	<p>Contact customer service</p> <p>Contact customer service</p>
<p>Autocal failed (filament on): red autocal filament on</p> 	<p>Autocalibration system configuration</p> <ul style="list-style-type: none"> • Incorrect position of switch S1 and status of indicator light CR1 • Incorrect thumbwheel values <ul style="list-style-type: none"> • Temperature sensor disconnected <p>NO</p> <p>Sensitivity fault</p> <ul style="list-style-type: none"> • Long autocal cycle • Spectro filament current red during autocal cycle <p>NO</p>	<p>Correct the faults inside the detector (<i>see E 40</i>)</p> <ul style="list-style-type: none"> • Check the consistency of the display with an external calibrated leak. If the calibration is accurate enough it may be possible to continue using the detector if necessary. • Perform maintenance on the cell (<i>see E 10</i>).
	<p><i>see page 2/2</i></p>	

Faults at end of autocalibration

SYMPTOME	CAUSE	REMEDY
	<p>Helium background fault</p> <ul style="list-style-type: none"> • Autocal cycle interrupted • High background out of test (relative to internal calibrated leak). <p>NO</p> <p>Peak fault</p> <ul style="list-style-type: none"> • weak or non-existent "oscillations" of the helium signal during the autocal cycle <p>NO</p>	<p>— Check the consistency of the display with an external calibrated leak. If the calibration is accurate enough it may be possible to continue using the detector if necessary.</p> <ul style="list-style-type: none"> • Perform maintenance on the cell (see E 10). <p>— Check the consistency of the display with an external calibrated leak. If the calibration is accurate enough it may be possible to continue using the detector if necessary.</p> <ul style="list-style-type: none"> • Perform maintenance on the cell (see E 10) <p>— Contact customer service</p>

Faults in sniffer mode

SYMPTOM	CAUSE	REMEDY
<p>The  indicator light on the remote control unit does not come on. LDS key engaged</p>	<p>Circuit breaker switch The  cycle key yellow indicator light is on or the FL ramp is on.</p>	<p>Press the  key to stop the current cycle. The LDS is started up in a few seconds.</p>
	<p>NO</p>	<p>Contact customer service</p>
<p>The LDS helium signal is less than 5×10^{-6} mbar l/s (LDS probe in ambient air)</p>	<p>LDS probe filter blocked</p> <ul style="list-style-type: none"> • Blocking the end of the LDS probe with your finger has little effect on the helium signal. • Changing complete probe corrects problem. 	<p>Change the LDS probe filter. (see F 110)</p>
	<p>NO</p>	
	<p>LDS tube pinched or blocked</p> <ul style="list-style-type: none"> • Blocking the end of the LDS probe with your finger has little effect on the helium signal. • Changing complete probe corrects problem. 	<p>Contact customer service</p>
	<p>NO</p>	<p>Contact customer service</p>
<p>Spectro indicator lights off No He display Filament off</p>	<p>Hole in LDS tube</p> <ul style="list-style-type: none"> • Normal operation can be restored when the probe is disconnected. • Changing complete probe corrects problem. 	<p>Recondition</p>
	<p>NO</p>	<p>Contact customer service</p>

Helium measurement problem

SYMPTOM	CAUSE	REMEDY
<p>No change to Fine Leak mode $P < 2 \cdot 10^{-2} \text{mbar}$</p>	<p>GL key engaged The indicator light is on</p>	<p>Release the key</p>
	<p>NO</p>	<p>Contact customer service</p>
<p>Low sensitivity</p>	<p>High triode gauge pressure Analyzer cell degassing time too short</p>	<p>Wait for a spectro pressure $< 10^{-4} \text{ mbar}$</p>
	<p>NO</p>	<p>Clean and recondition (<i>see E 10</i>)</p>
	<p>Cell contamination The cell is dirty</p>	<p>Contact customer service</p>

Helium measurement problem

SYMPTOM	CAUSE	REMEDY
High background noise	Leak inside the detector Leak visible during a Helium leak check.	Eliminate the leak
	NO	
	Vacuum line contamination The lines are dirty or greasy	Clean with alcohol or replace them if necessary
	NO	
	High triode gauge pressure Analyzer cell degassing time too short	Wait for a spectro pressure < 10^{-4} mbar
	NO	
Cell contamination The cell is dirty and polluted	Clean and recondition (<i>see E 10</i>)	
NO		
Ultimate pressure of MD4E or CP20 The dry roughing pump is defective	Contact customer service	
NO		
	Contact customer service	

I/O interface problem

SYMPTOM	CAUSE	REMEDY
<p>No 24V on the I/O jumper plug pins 24-25</p>	<p>I/O interface board fuse defective</p>	<p>Change the fuse (see E 80)</p>
	<p>NO</p> <p>ST1 and ST2 straps incorrectly positionned on the I/O interface board regarding 24V function</p>	<p>Set up correct configuration (see E 80)</p>

Maintenance sheets

■ Analyzer cell maintenance	■ E 10
■ Greasing the hybrid turbomolecular pump	■ E 20
■ Greasing the molecular drag pump	■ E 30
■ Replacement / Recalibration of the detector internal calibrated leak	■ E 40
■ Autocalibration of the detector with an external calibrated leak	■ E 50
■ MD4E membrane pump maintenance	■ E 60
■ CP20 Partial maintenance	■ E 70
■ I/O interface board fuse replacement	■ E 80

Analyzer cell maintenance

The frequency of preventive maintenance is listed in D 10.

Components :	P/N
Filament	053146
Electron collector (pack of 5).....	068842
Special seal wire (10 meter roll).....	083478

Tools : **Maintenance kit (see F 10)**

Special precautions



Disconnect the detector from the main power.



The VHS amplifier and the analyzer cell are very sensitive to any form of contamination and particularly to dust.

When assembling, to avoid gettering due to dust or finger prints, you are advised to work :

- in a clean room,
- on lent free paper,
- with unpowered vinyl gloves (clean room gloves),
- to dust each part with filtered dry air,
- to block all the openings in the vacuum lines and the VHS preamplifier.



Every time the VHS preamplifier and the analyzer cell are disassembled, their special seals must be replaced.

Analyzer cell maintenance

Dismantle the VHS amplifier

- Disconnect electrically the VHS amplifier and the spectro cell (2 connectors).
- Remove VHS amplifier from the cell by unscrewing the 2 cHc screws using the $\varnothing 6$ allen wrench supplied in the maintenance case.

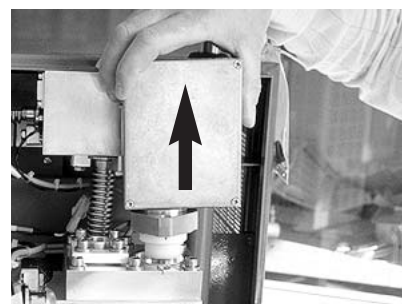

- Position carefully (head down) the VHS amplifier on a clean support (dust free).
- It is advisable to keep the electron multiplier of the VHS lying down during all the removal in order to protect it from the dust.

Prepare the new special metal seal

Prepare special metal seal for the analyzer cell using the seal former (see **F 10 item 8**) or use an elastomer seal (optional) (see **F 110**).

The ends of the seal must only cross once (no twist).

Check that the ends cross near one of the six screws holes, one end on either side of hole. Place the prepared seal on a flat surface protected from contamination.

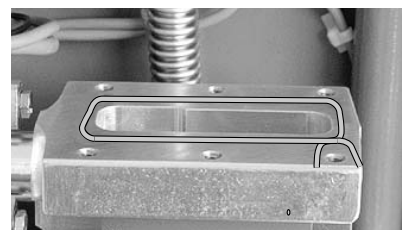

Analyzer cell maintenance

Cleaning the base of the cell

Unscrew the 6 screws and carefully extract the flange from the body (pull directly upwards).

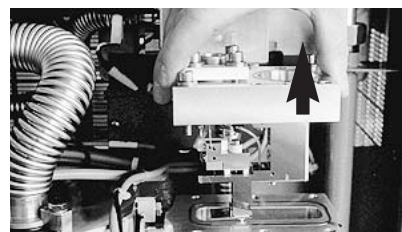

There may be traces of metallic deposits in the internal duct in the cell base **(2)** to the right of the filament, in which case clean off with abrasive paper (180 grade). Vacuum out any residue and complete the cleaning with alcohol.

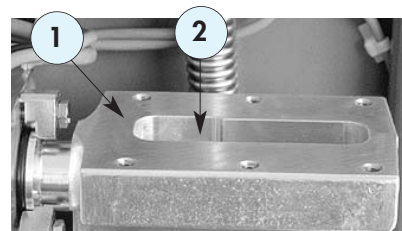

Clean the special metal seal channel with alcohol **(1)**.

Block the opening immediately with the seal former.

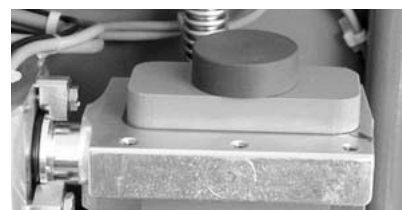

Analyzer cell maintenance

Removing the filament

Remove the filament by unscrewing the retaining screw and loosening the 2 connection screws.

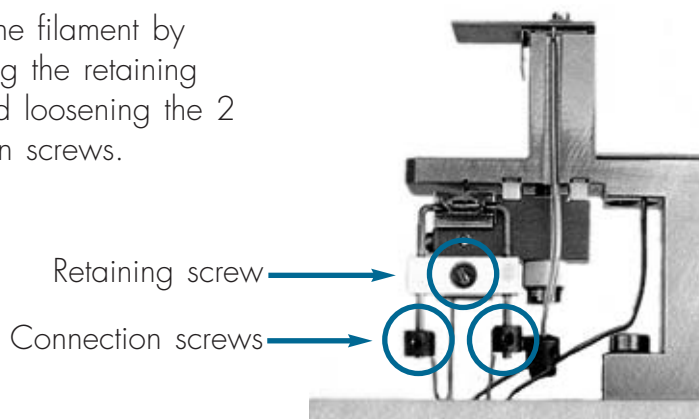

Removing the electron collector

Remove the retaining screws.

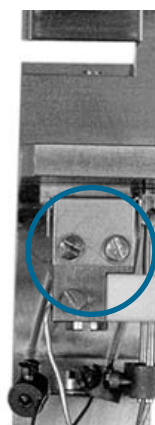

Replacing the filament and the electron collector

Install the electron collector (**1**) on the ionization chamber by partially tightening the two screws.

Install a new filament (**2**) by inserting the two wires into the connectors (do not tighten the latter)

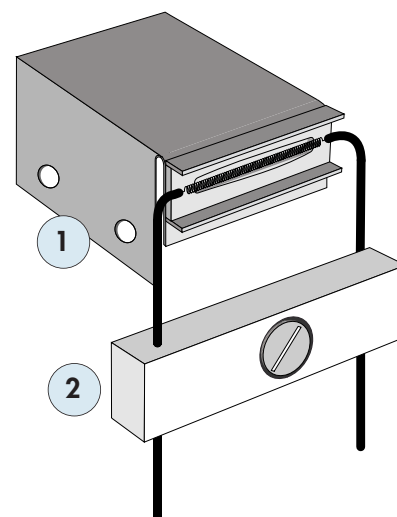

Analyzer cell maintenance



The correct condition and adjustment of these components are determining factors in maintaining the specifications of the detector.

Adjusting the components

The insulator is perfectly seated on the two faces of the support.
The filament is centered in the electron collector (the same number of turns on each side of the collector opening - the **X** dimension in the front view diagram).
Continue to adjust the collector so that the filament is vertically centered in the collector opening and is parallel to the opening (the **Y** dimension in the front view diagram).

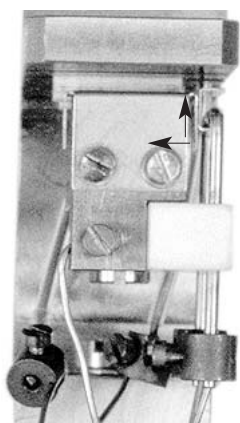

Tighten the 2 collector retaining screws completely.

If necessary, fine adjust the parallelism between the axis of the filament and the axis of the collector oblong opening by adjusting the squareness of the collector (Work on the area marked  in the diagram).

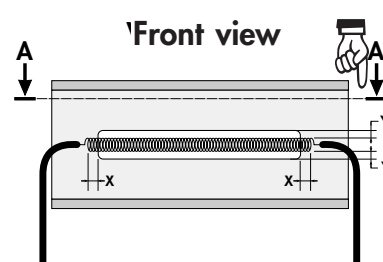

Check that the filament is correctly aligned on the axis indicated by the section **AA** in the diagram. If necessary, adjust one of the branches of the filament's two conductors located above the insulator to correct this alignment.

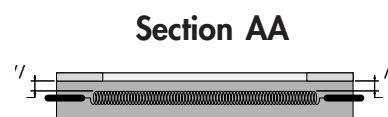

Tighten the filament electrical connections.

Analyzer cell maintenance

Installing the analyzer cell metal seal

Place the metal seal in the cell body seal seat. Check that the point where the 2 ends of the seal cross is located near a retaining screw, which one end on either side (or use an elastomer seal)

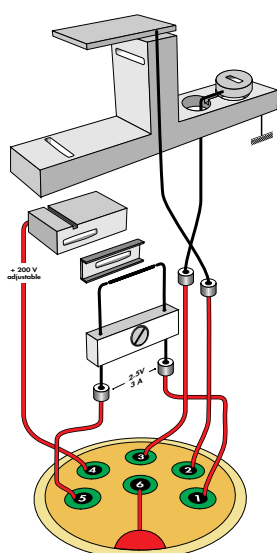

Electrical connections JAEGER connector

- 1 Filament
- 2 Triode electrode
- 3 Braking electrode
- 4 Ionisation chamber
- 5 Filament
- 6 Ground

Check that no electrical conductor is located outside the area delimited by the guide piece. Install the cell, taking care to lower it into the duct without touching the sides. Install the 6 screws with their respective washers.

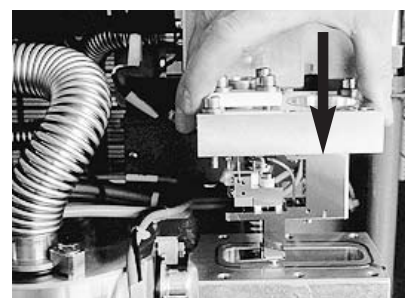

Tighten the 6 screws, in the sequence shown at right to a torque of **0.8 m.daN**.

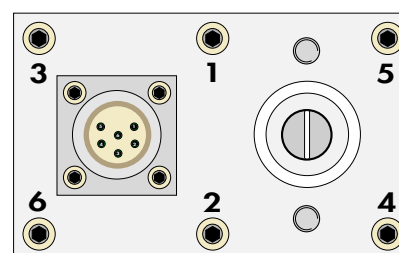

Analyzer cell maintenance

Re-installing the VHS preamplifier

Prepare the metal seal for the preamplifier using the seal former. Install the seal and center it in the cell flange seal seat placing the point where the two ends cross near a retaining screw, one on either side.

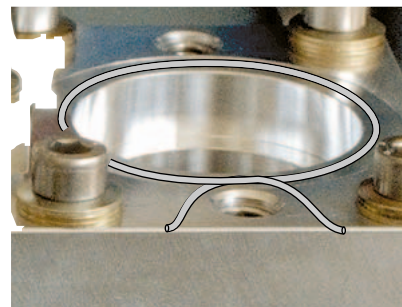

Position the VHS preamplifier carefully on the cell.. Tighten the 2 screws progressively and alternately.
Torque : 1 m. daN.

Connect the VHS preamplifier to the cell electrically (2 connectors).

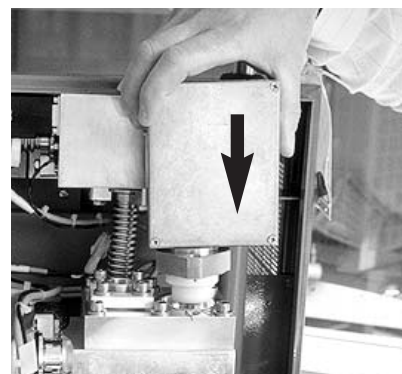

Analyzer cell maintenance

Check the flanges for leaks

The detector must be on for a few minutes before leak

SYMPTOM AND CAUSE

REMEDY

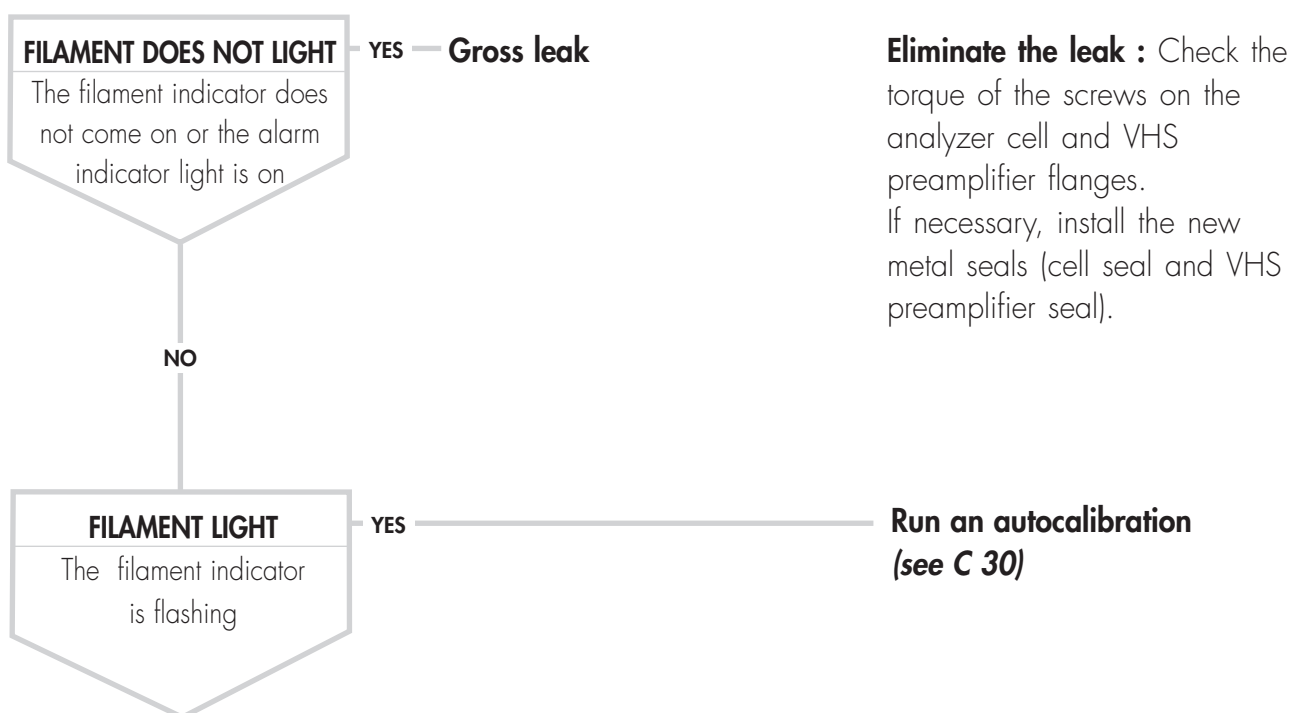

Spray helium to leak check the flanges of the analyzer cell and preamplifier. Eliminate any leaks as describe above.

Greasing the hybrid turbomolecular pump PTM 5154



The frequency of preventive maintenance is listed in D 10.

Components :	P/N
Grease syringe	056993

Accessing the bearings

Remove the rear cap from the pump (4 allen head screws). This cap is directly accessible from underneath the leak detector.

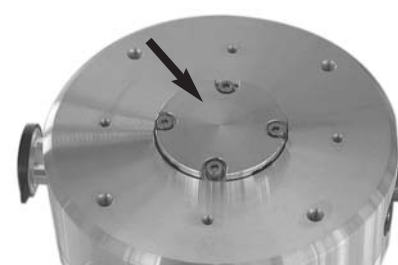

Using the grease syringe

The grease syringe is equipped with a black clip **(A)** and a red clip **(B)**.

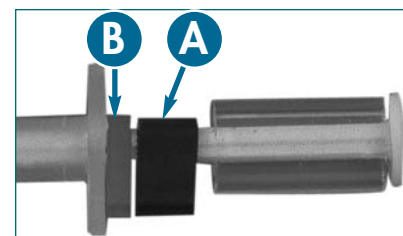

These clips are used as stops to control the amount of grease injected into the bearing.

Greasing the front bearing

Remove black clip **(A)**. Push the grease syringe in through the screw hole **(1)** until it comes up against a stop. Inject grease pushing in the plunger until it stops at clip **B**.

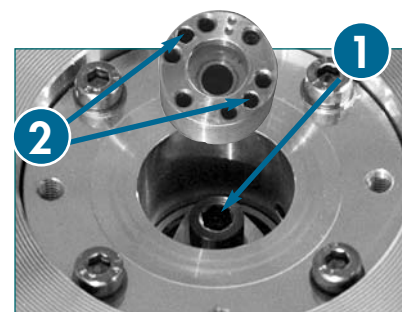

Greasing the rear bearing

Remove the red clip **B** and distribute the grease between the injection points (smooth holes directly opposite each other : 2).

Greasing the hybrid turbomolecular pump PTM 5154



Distributing the grease in the bearings

Set the SW1 switch on the CD2 board to the break-in **(R)** position and run the detector for 10 minutes with it in this position. Then reset SW1 to its normal **(N)** position.

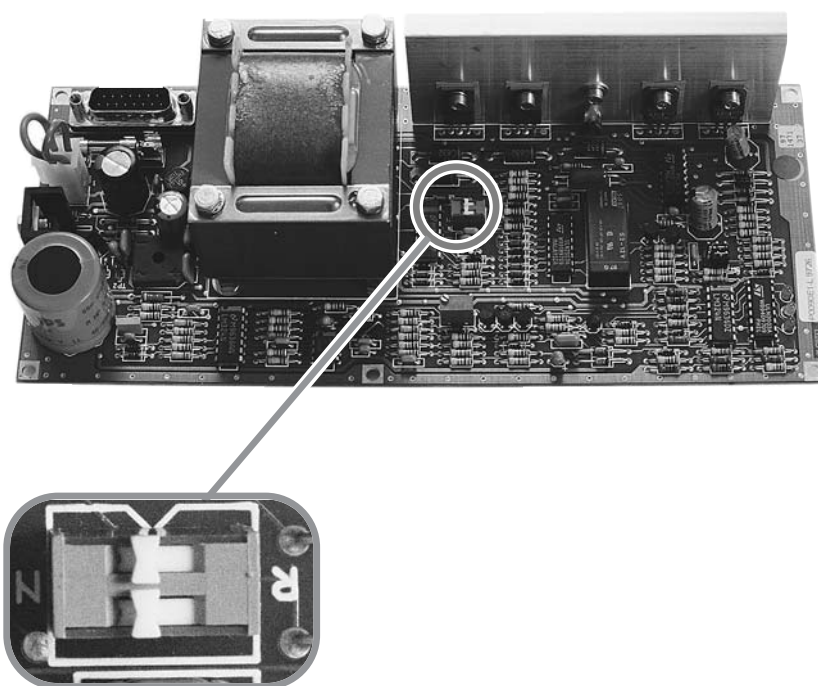

SW1 switch :
R : Running-in
N : Normal

Greasing the molecular drag pump MDP 5011



The frequencies of preventive maintenance are listed in D 10.

Components :	P/N
Grease syringe	056993

Accessing the bearings

Remove the clips and use the extractor to take out the plug (see **F10 item 3**). Once the extractor is in place, pull it vertically.



Using the grease syringe

The grease syringe is equipped with a black clip **(A)** and a red clip **(B)**.

These clips are used as stops to control the amount of grease injected into the bearing.

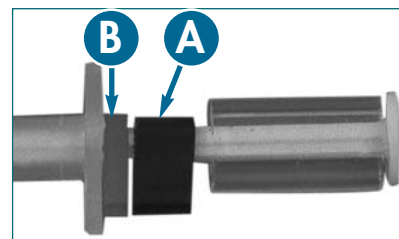

Greasing the front bearing

Remove black clip **(A)**
Push the grease syringe in through the screw hole **(1)** until it comes up against a stop. Inject grease pushing in the plunger until it stops at clip **B**.

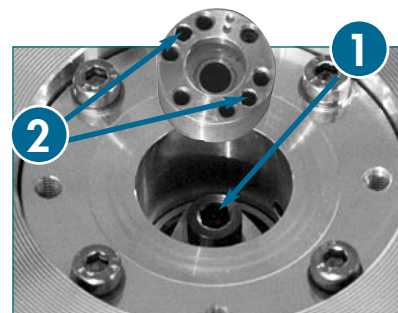

Greasing the rear bearing

Remove the red clip **B** and distribute the grease between the injection points (smooth holes directly opposite each other : 2).

Greasing the molecular drag pump MDP 5011



Distributing the grease in the bearings

Set the SW1 switch on the CD2 board located in the rear cover to the break-in **(R)** position and run the detector for 10 minutes with it in this position. Then reset SW1 to its normal **(N)** position.

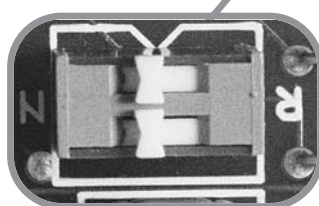
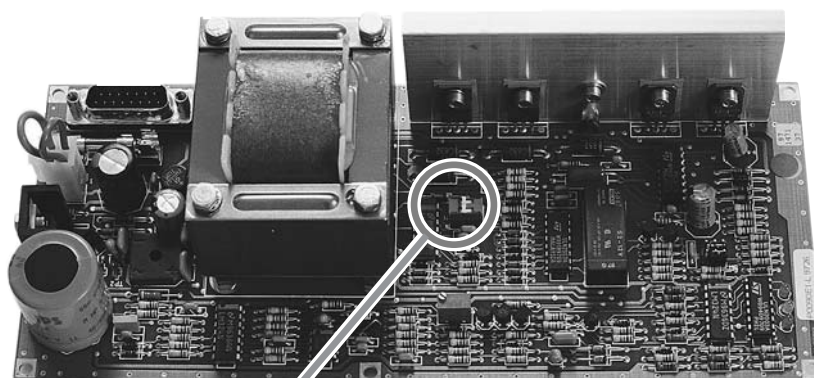

SW1 switch :
R : Running-in
N : Normal

Replacement / Recalibration of the detector internal calibrated leak

The frequency of preventive maintenance is listed in D 10.

Components : P/N

Internal calibrated leak 101302

Purpose of the calibrated internal leak

It enables the auto-calibration of the detector. Autocalibration is triggered at start-up or when the **AUTOCAL** button is pressed on the control panel (see **C 30**).

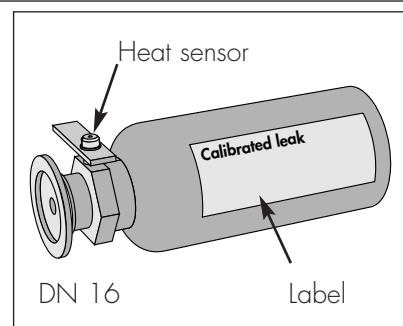

Frequency of internal leak "recalibration"

In order to ensure the reliability of the helium test, ALCATEL recommends to "recalibrating" the internal calibrated leak at least every 2 years (from the calibration date marked on the leak label and its calibration certificate).

How to recalibrate the internal leak

Recalibration is generally performed using a comparative method with a reference standard. This work can only be performed in ALCATEL or other approved service centers. For this, therefore it is necessary to remove the internal calibrated leak from the detector.

Removal of the internal calibrated leak

- Switch off the detector and disconnect it from the main power.
- Open the front cover of the detector (attached with 4 screws).
- Disconnect the heat sensor connector (3-pin connector).
- Disconnect the DN 16 flange and remove the calibrated leak.

Caution: Do not separate the heat sensor from the calibrated leak.

Replacement / Recalibration of the detector internal calibrated leak

Installation of a new internal calibrated leak

A "recalibrated" leak is returned to you with:

- a new value,
- a calibration certificate.

To install this new calibrated internal leak:

- Switch off the detector and unplug it from the main power.
- Install the leak:
 - DN 16 connector,
 - heat sensor.

Before the front cover is closed, the new value of the leak must be entered.

Entering the new internal calibrated leak value

This is carried out using the three thumbwheels located on the **supervisor board** placed in the front cover.

- Set, on the thumbwheels, the helium value of the calibrated leak at 20°C (marked on the leak label) as in the following example:
 $1.5 \cdot 10^{-7}$ mbar.l/s or
 1.5×10^{-7} atm.cm³/s

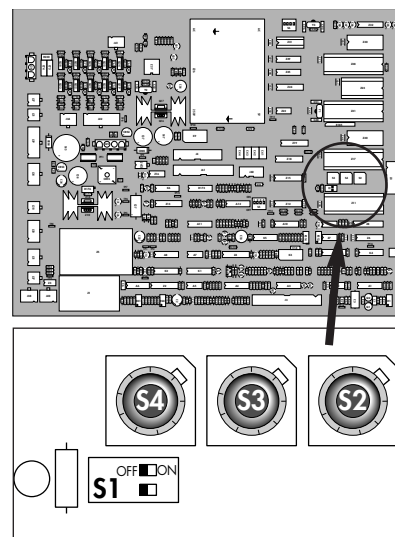

Set: S4 to 1; S3 to 5; S2 to 7

The internal calibrated leak value must be between 1.0E-8 and 8.0E-6 mbar.l/s.

- Check that the switch S1 is set to OFF (adjacent red indicator light off, internal autocalibration enabled).

Replacement / Recalibration of the detector internal calibrated leak

- Close the front cover (4 screws).
- Connect the detector to the main power.
- Switch it on: an autocalibration is performed automatically at the end of the start-up sequence.

It is recommended to repeat an autocalibration after 1 hour of operation when the temperature has stabilized inside the unit.

Intensive use of the detector

In the case of intensive use of the detector, it is recommended to have a spare internal calibrated leak.
If this is not possible, the detector can still be used and auto-calibrated using an external calibrated leak (**see E 50**).

Autocalibration of the detector with an external calibrated leak

Disconnecting the detector

Turn off the detector and unplug it from the main power. Open the front cover.

Correcting the value of the external calibrated leak

It is recommended to correct this value as a function of the ambient temperature (the leak is assumed to have a stable temperature) and the time elapsed since its calibration date (marked on the leak label).

E.g.:

External calibrated leak of 1.1×10^{-7} mbar.l/s helium at 20°C - calibrated 1st February 1994 - Ambient temperature 25°C - Temperature coefficient + 3 % per °C. - Annual loss 2 %

The leak value to be entered on 1st February 1995 is:

Value at 20°C	Temperature correction	Time correction	Value at 25°C
$1,1 \times 10^{-7}$	$\times \left(1 + \frac{3}{100} \times 5\right)$	$\times \left(1 - \frac{2}{100} \times 1\right)$	$= 1,2 \times 10^{-7}$
	↓ 3% ↓ 25°C - 20°C	↓ 2% ↓ year	

The value of the external calibrated leak entered must be between 1.0×10^{-8} and 8.0×10^{-6} inclusive.

Autocalibration of the detector with an external calibrated leak

Entering the external calibrated leak value

This value is entered on the thumbwheels

S2, S3, S4 located on the **supervisor board**.

- Set, on the thumbwheels, the helium value of the corrected calibrated leak

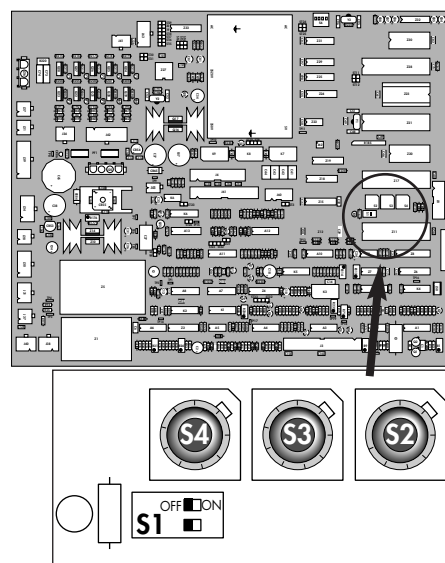

Set as example : S4 to 1; S3 to 2; S2 to 7
for a value of 1.2×10^{-7} mbar.l/s

Set the switch S1 on the main board to ON. The adjacent red indicator light comes on, in the external autocalibration position.

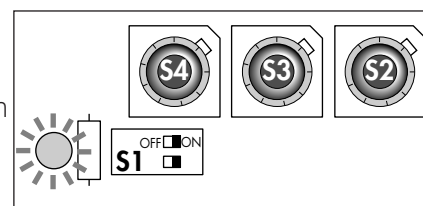

In this position:

- the internal autocalibration (in particular the control of the internal autocalibration system valves) is disabled.
- the automatic internal autocalibration is no longer performed at detector start-up.
- Only the external autocalibration is authorized : it is started by pressing the **AUTOCAL** key, with the detector in test mode (see next pages).

Autocalibration of the detector with an external calibrated leak

Switching on the detector again

Close the detector cover.
Connect the detector to the main power.
Switch on the detector.

Running a test

Connect the external calibrated leak directly to the detector inlet (if it is equipped with a valve, the valve should be open).



Start a test cycle.
Allow the signal to stabilize for a few minutes.

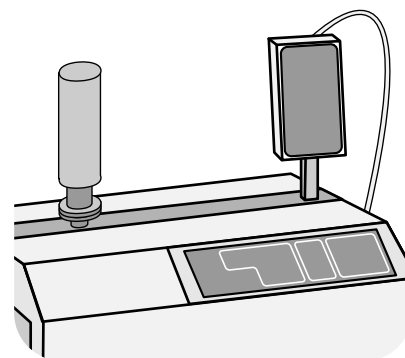

Note: external autocalibration can be performed either in GL or FL mode provided that the residual helium signal of the detector (background noise) is at least one decade less than the corrected value of the external calibrated leak. Internal autocalibration is performed systematically in FL mode (internal calibrated leak of approximately 1×10^{-7} mbar.l/s maximum).

Autocalibration of the detector with an external calibrated leak

Running the calibration



When the helium signal has stabilized in test mode, press the **AUTOCAL** key on the control panel.

The red indicator light comes on and flashes: the external autocalibration is performed.



The result appears on the key indicator lights in the same way as for an internal autocalibration (**see C 30**).

If the autocalibration fails, the red indicator light of the **AUTOCAL** key comes on, the previously saved settings are retained and the use of the detector is not disabled.

When the external autocalibration is completed, the test cycle can be interrupted and the external leak removed. The detector is ready for use.



If the internal calibrated leak will be removed for a long period of time, it is recommended to replace it with a DN 16 blank off to prevent dust from entering the lines.

Note: To return to the internal autocalibration, simply set Switch S1 on the monitor board to OFF and enter the value of the internal calibrated leak (at 20°C) on the thumbwheels S2, S3 and S4 (**see E 40**)

MD4E membrane pump maintenance



The frequency of the preventive maintenance tasks is listed in section D 10.



Components :	P/N
Membrane kit	062968

A membrane kit is included in the maintenance kit supplied with the detector (*see F 10*).

Tools required:



10 , **17**  and **20mm**  thin spanner,
Phillips screwdriver ,
5mm allen wrench .

Remove the membrane pump from the detector

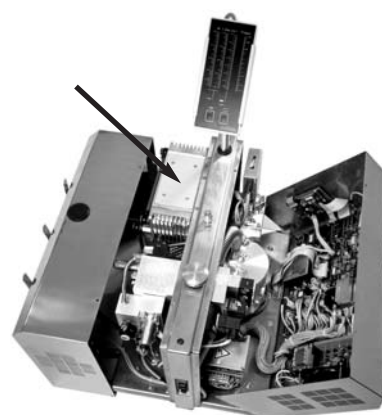
- Switch off the detector and disconnect from the main power.
-  Open the rear cover.
- Disconnect the membrane pump inlet port.
- Disconnect the power supply cable.
-  Unfasten the 3 nuts (2 fixing feet and 1 angle bracket) which secure it on the frame and remove the pump.



Open the intake chamber

-   Unfasten the connectors (1) between the pumping stages.

Position the pump vertically.

-  Remove the 4 CHC screws (2) and remove the cover from the casing.

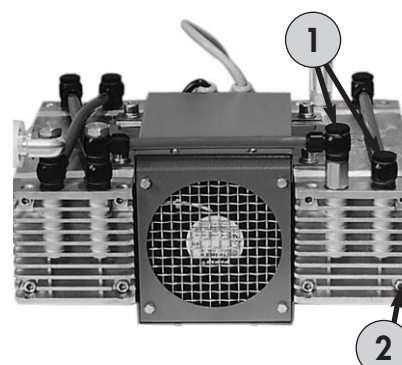

MD4E membrane pump maintenance



The intake chamber components

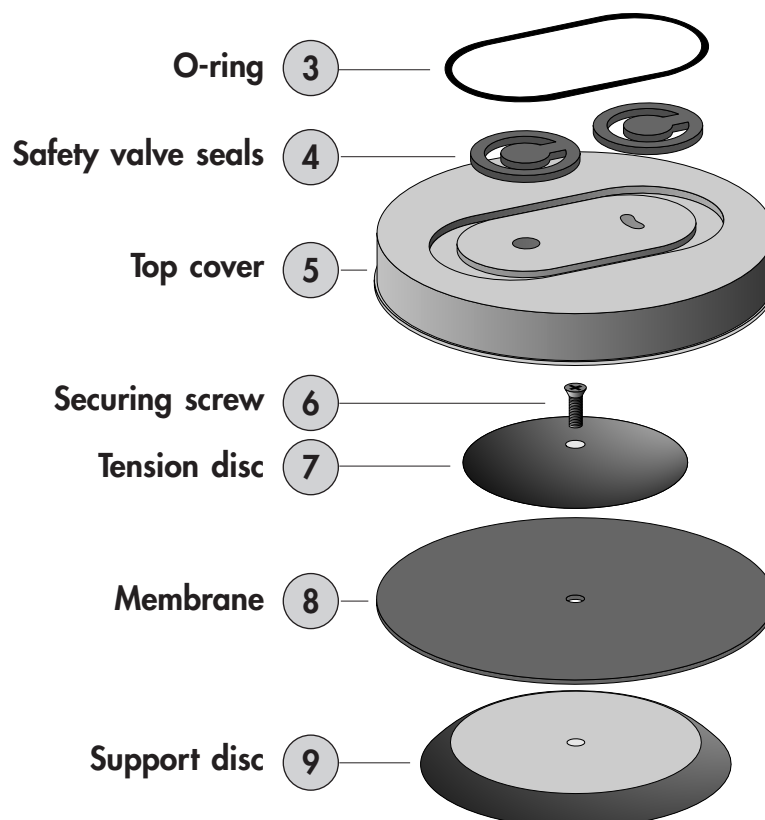

Dismantle the intake chamber

Remove the O-ring (3). Mark the position of the safety valve seals (4) and remove them.

Remove the top cover (5): if necessary, use the hole on the edge of the part.

Clean the soiled parts with alcohol or a solvent.



Reassemble the intake chamber

Put the top cover in place. Position the safety valve seals as shown above. Close the chamber.

If the membrane is damaged, replace it (page 3).

MD4E membrane pump maintenance



Change the membrane

Access the membrane

 Remove the securing screw (6) (attached screw). Remove the tension disc (7) using, if necessary, a tool (screwdriver, allen wrench) to detach the disc from the membrane.

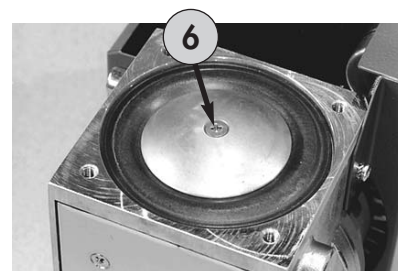

Remove the membrane (8) using a seal plate if necessary.

Clean the bearing surfaces and the support disc (9).

Install a new membrane

Put a new membrane in place.
On top of it, position the tension disc.
Pour a drop of low thread braking fluid (loctite) on the screw threads and secure the disc.

Reassemble the intake chamber

see page 2.

Repeat the operation on the other 3 intake chambers

Check that the pump is operating correctly

The pump itself must reach a limit pressure ≤ 3 mbar.

If necessary, plan a gross leak test (with alcohol).

Partial maintenance of the CP 20 pump

The frequency of the preventive maintenance tasks is listed in section D 10.

Components : P/N

Partial maintenance kit 103499
including:

- **Ball bearing 6001 CP** (per 2)
- **O'ring 200 02700 G2 T47501 FPM72**
(inlet side ball bearing) (per 2)
- **O'ring 300 09600 G2 T47501 FPM72** (stator)
- **Grease tube D101 ultrathermique 200**
- **Plastic box "caubere" 6532** (rectangular)

Tools required :

Allen wrench Ø 3mm  , 4mm  and 5mm  ,
Open end wrench or ring spanner Ø 10  ,
Phillips screwdriver .

Partial maintenance of the CP 20 pump

Access to the CP 20 pump

On the ASM 180 TD+, the dismantling of the pump from the frame is not necessary to perform a partial maintenance.

Disconnect the detector power supply from mains (safety precaution).

ASM 180 TD+ :

5 Open the rear cover unscrewing the 4 fixing screws (hinge system provided).

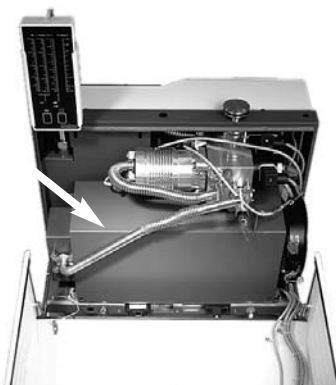

ASM 181 TD+ :

5 Remove the side cover unscrewing the fixing screws.

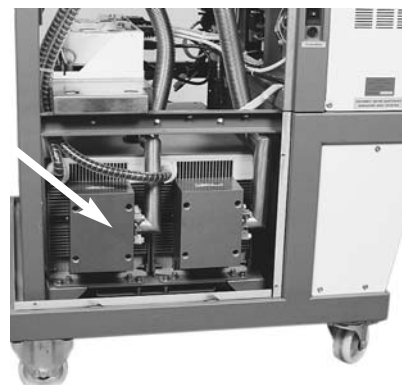

10 Disconnect the DN 25 pumping line near the CP 20 pump.

Partial maintenance of the CP 20 pump

Disassembly

5

■ Disassemble the intake stator by removing its 4 attachment screws (1).

■ Remove the O-ring (2) and the 2 bearing O-rings (3) on the intake stator.

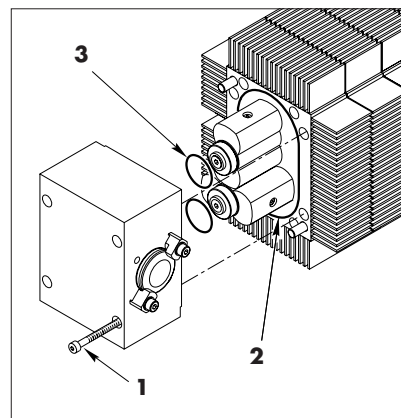

3

■ Remove the 2 screws (4) at the end of the shafts followed by the 2 washers (5) and extract the 2 bearings (6).

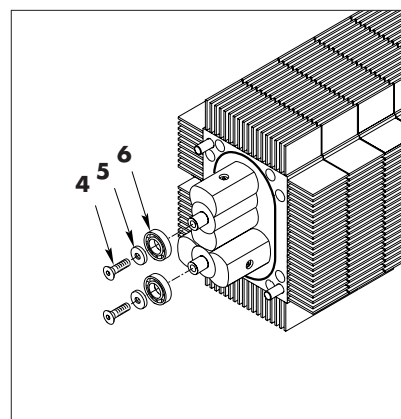

Reassembly

4

■ Clean the shaft ends.

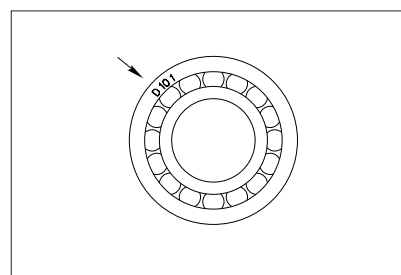

■ Check the D101 mark on the new bearings. Fit them with the mark facing outwards, secure using the washers (5) and M5-12 FHc (allen head) screws (4).

■ Clean and lightly grease the new O-rings and the bearing housings on the intake stator, fit 2 seals (3).

■ Clean the groove of the O-ring on the pump body and fit a new seal (2).

5

■ Position the intake stator on the pump body and secure it using 4 M6-70 CHc (allen head) screws (1).

I/O interface board fuse replacement

Fuse specifications:

T 1.25A - 250V 5 x 20 mm

Purpose of the interface board

It controls the I/O interface which is used to link the detector to an external control system.

On ASM 180 TD and ASM 180 TD+, it is located in the bottom part of the detector, protected by a stainless steel cover.
On ASM 181 TD+, it is located on the rear inside the frame.

Accessing the interface board

ASM 180 TD and ASM 180 TD+:

- Switch off the detector and disconnect all the connectors at the rear.
- Remove the rear cover and unfasten the 3 attachment screws of the stainless steel bottom cover located at the same level as the interface connectors on the frame.
- Open the front cover and unfasten the 4th screw located near the hybrid turbomolecular pump (oblong hole on the frame).
- At the bottom part of the detector, release the I/O interface board and the stainless steel protective cover on which it is attached.

ASM 181 TD+:

- Remove the rear and side cover.
- The I/O board is accessible at the rear inside of the frame near the Sub-D connectors.

24 V output

- A 24 V DC output is provided on this board (pins 24 and 25 of the I/O interface)
- This output can or cannot be selected using straps located on this board (ST1 and ST2).
- If these straps are present, the 24 V output is available on the pins 24 and 25 of J3.
- If there are no straps, an external power supply (coming from an automatic control system for example) should be provided (**see B 20**).

I/O interface board fuse replacement

 In case of the use of the detector with the jumper plug, ST1 and ST2 have to be present

Change the fuse

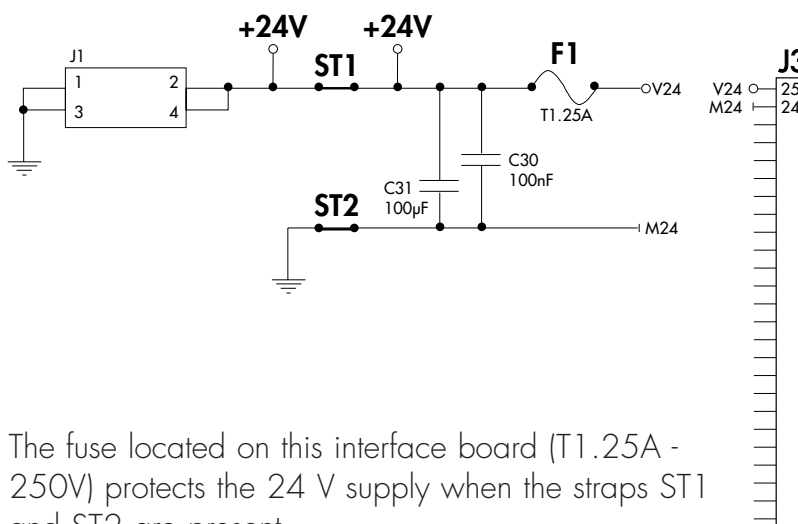

The fuse located on this interface board (T1.25A - 250V) protects the 24 V supply when the straps ST1 and ST2 are present.

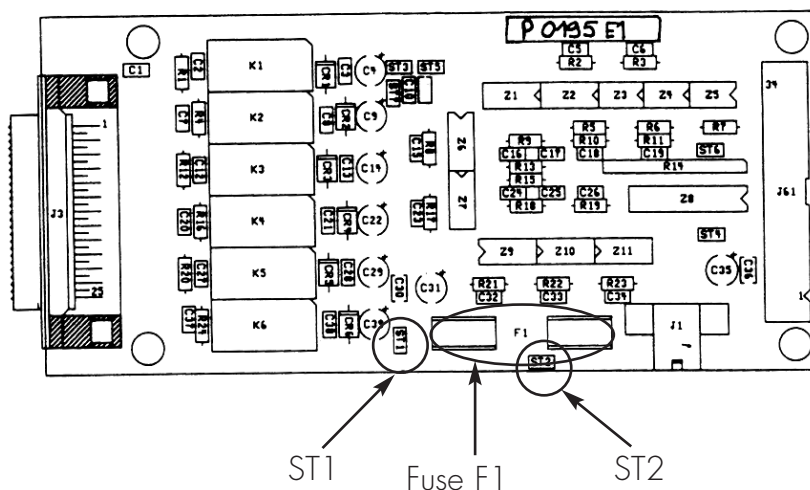

Maintenance components

■ Preventive maintenance components delivered with the detector	■ F 10
■ Monitoring and display	■ F 20
■ Power and electrical supply	■ F 30
■ Automatism and electronic circuits	■ F 40
■ Measurement	■ F 50
■ Pumping	■ F 60
■ Valves	■ F 70
■ Pipes	■ F 80
■ Connections and seals	■ F 90
■ Cover	■ F 100
■ Options and accessories	■ F 110
■ Components summary	■ F 120

Preventive maintenance components delivered with the detector

Maintenance kit delivered with the detector

ASM 180 TD
ASM 180 TDi

P/N : 090201

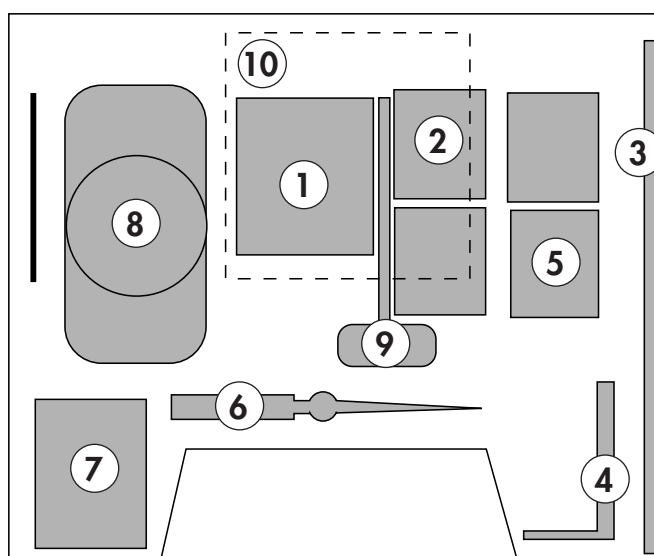

Item	Description	Quantity
1	Filament assembly	1
2	Tube including: Collector	1 5
	Stainless steel screw CS M2x4	1
3	Screw CHC M4x80	1
4	Allen wrench 5 mm	1
5	P11 spare gauge	1
6	Screwdriver	1
7	Tube including: Aluminium gasket	1 1
	Lead gasket (L=1 m)	1
	Fuse slow/blow 5x20 0.5A	1
	Fuse slow/blow D1TD 5x20 1.25A	2
	Fuse slow/blow D1TD 5x20 3.15A	1
	Fuse slow/blow D1TD 5x20 6.3A	1
	Fuse slow/blow D1TD 5x20 10A	1
8	Block - Seal former	1
9	Straight FACOM 5 & 6 mm Allen keys	2
10	Membrane kit	1

Preventive maintenance components delivered with the detector

Maintenance kit delivered with the detector

**ASM 180 TD+
ASM 180 TD+i
ASM 181 TD+**

P/N : 104434

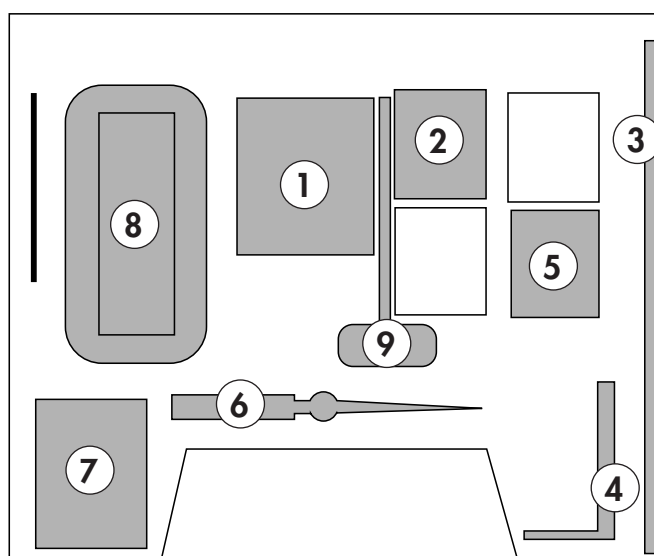

Item	Description	Quantity
1	Filament assembly	1
2	Tube including:	1
	Collector	5
	Stainless steel screw CS M2x4	1
3	Screw CHC M4x80	1
4	Allen wrench 5 mm	1
5	PI1 spare gauge	1
6	Screwdriver	1
7	Tube including:	1
	Aluminium gasket	1
	Lead gasket (L = 1 m)	1
	Fuse slow/blow 5x20 0.5A	2
	Fuse slow/blow 5x20 1.25A	2
	Fuse slow/blow 5x20 3.15A	1
	Fuse slow/blow 5x20 5x20 6.3A	1
	Fuse slow/blow 5x20 5x20 10A	1
8	Block - Seal former	1
9	Straight FACOM 5 & 6 mm Allen keys	2

Monitoring and display*

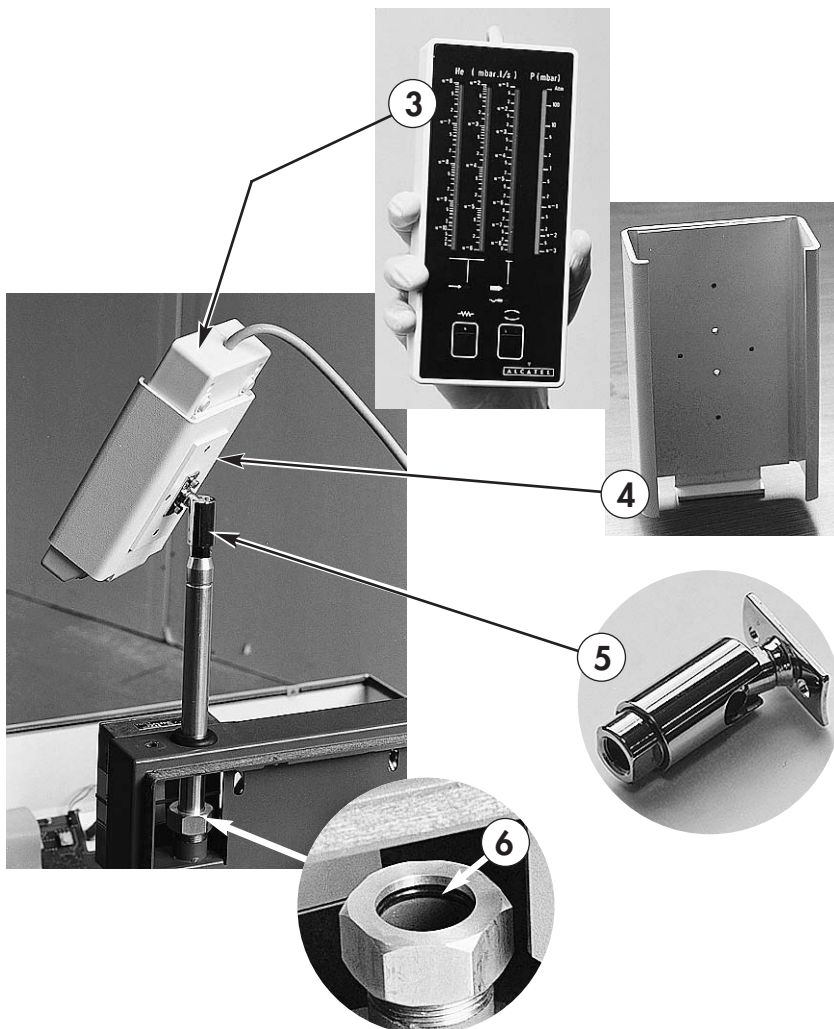

Item	Description	P/N
1	Remote control unit	101299
2	Elapsed time counter	037861
3	Remote control unit . . . 3.5 m	101496
	or remote control unit . . 7 m	104286
	or remote control unit . . 25 m	104287
4	Holder	090211
5	Ball and socket joint	090172
6	Clamping O-ring	082116

* Applies to ASM 180 TD and ASM 180 TD+

Power and electrical supply

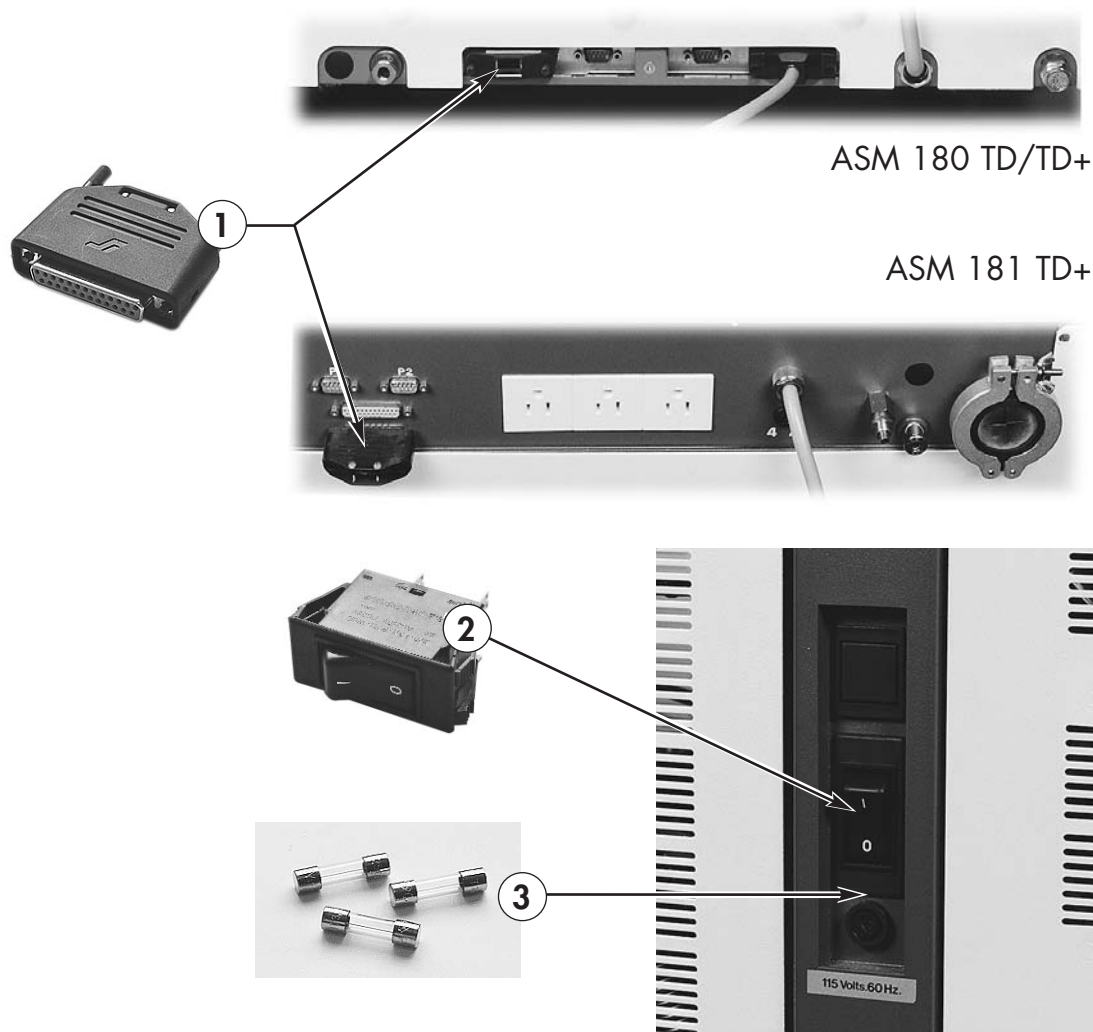

Item	Description	P/N
1	Jumper plug (Sub D 25 pins)	101824
2	Breaker switch:	
	100/115V : 8A (180TD)	101779
	200/220/240V : 4A (180TD)	101781
	100/115V : 16A (180TD+ - 181TD+)	101780
	200/220/240V : 8A (180TD+ - 181TD+)	101779
3	Fuse:	
	100/115V : T6.3A (180TD/TD+ 181TD+)	060855
	200/220/115V : T3.15A (180TD/TD+ 181TD+)	060860

Automatism and electronic circuits

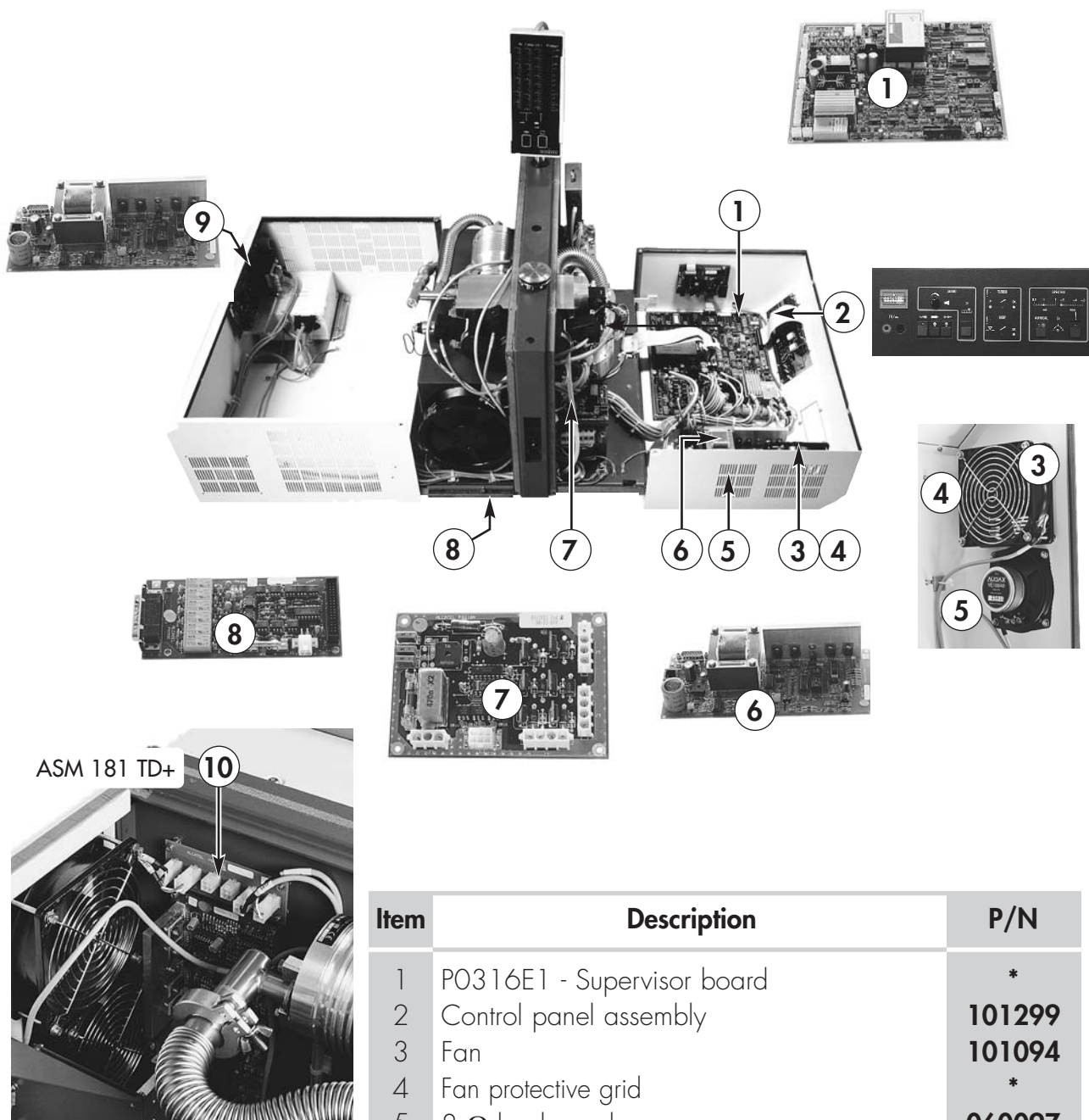

Item	Description	P/N
1	P0316E1 - Supervisor board	*
2	Control panel assembly	101299
3	Fan	101094
4	Fan protective grid	*
5	8 Ω loud speaker	060097
6	P0090 - CD2/TMP5154 power supply board	072402
7	P0318 - Booster board	104153
8	P0195 - I/O Interface board	101404
9	P0090 - CD2/MDP5011 power supply board	072402
10	P0191E1 - Distribution board (ASM 181 TD+)	100436

* Contact customer service

Measurement

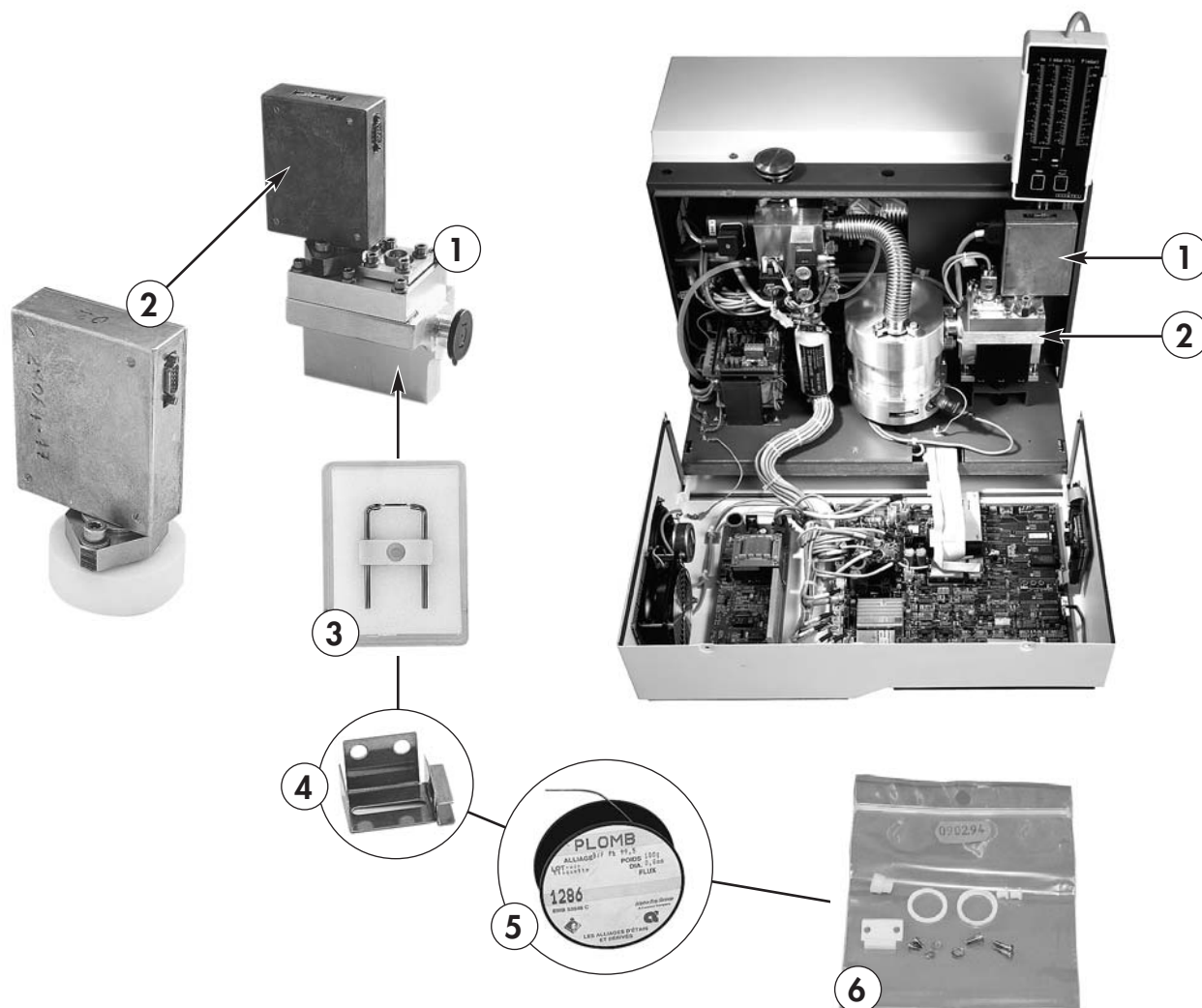

Item	Description	P/N
1	Complete VHS analyser cell with lead seal (without magnet)	072493
2	Electron multiplier amplifier (VHS)	072494
3	Filament	053146
4	Electron collector (set of 5)	068842
5	Lead gasket (10 meter)	083478
6	Accessories kit (analyzer cell)	090294

Measurement

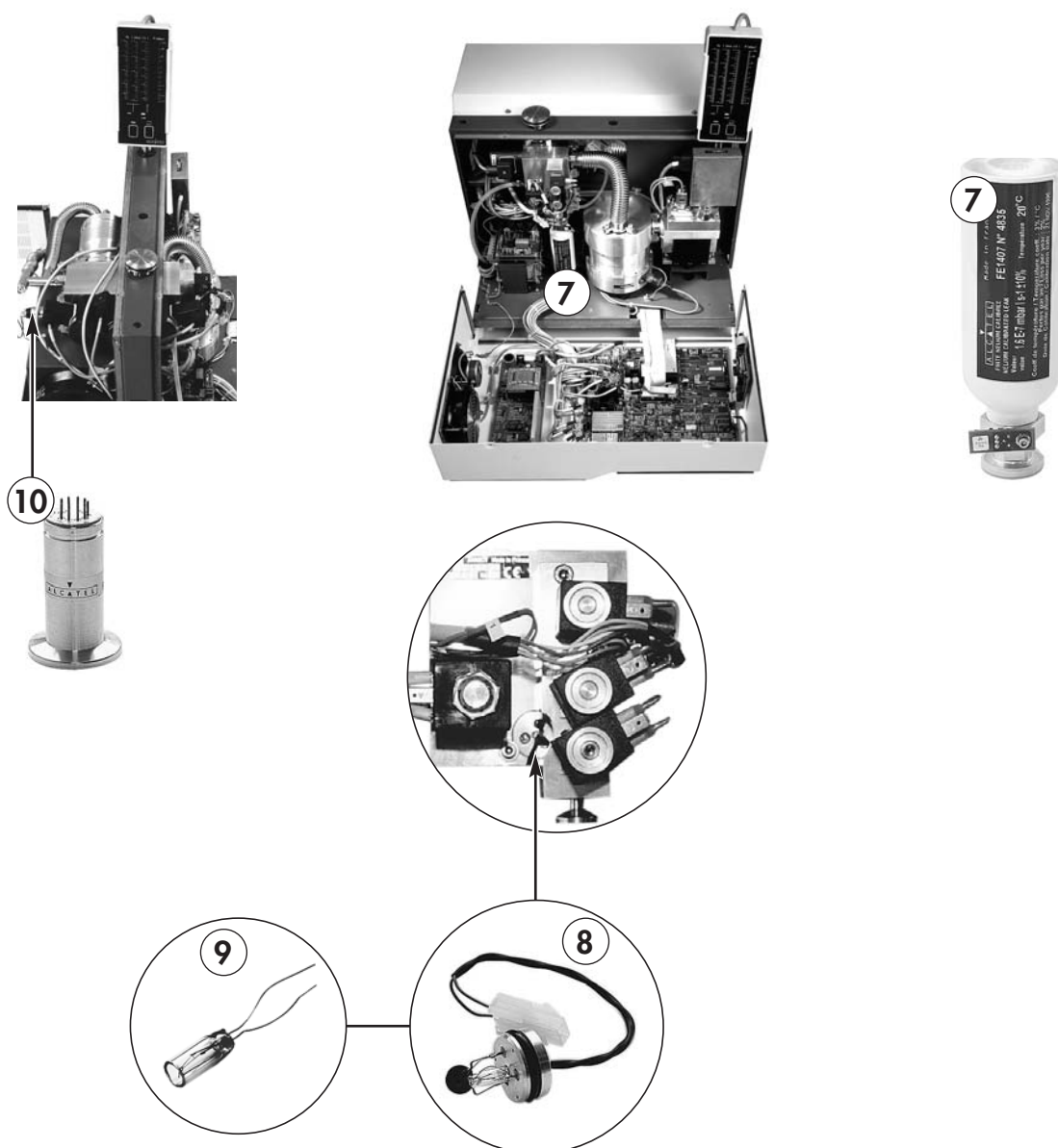

Item	Description	P/N
7	Calibrated leak Fe 1407 with thermal probe	101302
8	Aluminium PI1 gauge	795706
9	Spare filament for PI1 (set of 5)	068835
10	Aluminium PI3C gauge	786434

Pumping

MD4E membrane pump

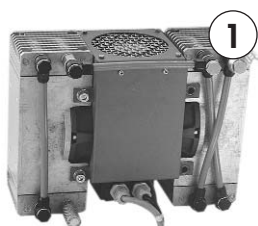

ASM 180 TD

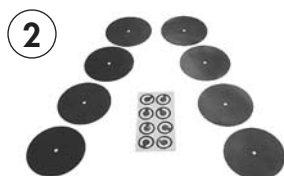
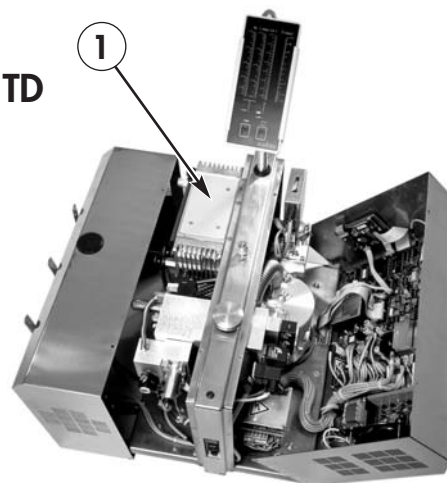

3a

3b

Item	Description	P/N
1	MD4E membrane pump:	
	100 V - 50/60 HZ	062980
	220/240 V - 50/60 HZ	062981
	120 V - 50/60 HZ	062982
	200 V - 50/60 HZ	062984
2	Seals kit for MD4E membrane pump	062968
3	a: MD4E Shock absorber (per unit)	101554
	b: MD4E Shock absorber (per unit)	101555

Pumping

CP20 pump



ASM 180 TD+

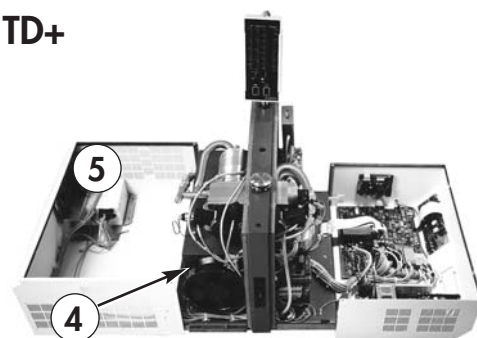

ASM 181 TD+

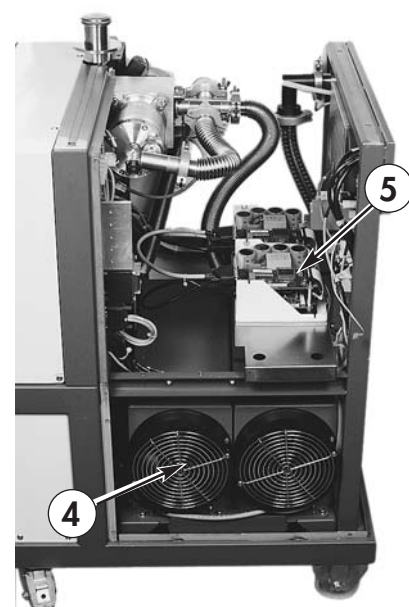

Item	Description	P/N
4	CP 20 pump	*
5	CP 20 pump controller.	*
-	Partial maintenance kit CP 20 including: 2 ball bearings 6001 CP 2 O-rings 2 x Ø 27 1 O-ring 3 x Ø 96 1 grease tube 10 g 1 plastic box	103499

Edition 04 - September 97

Pumping

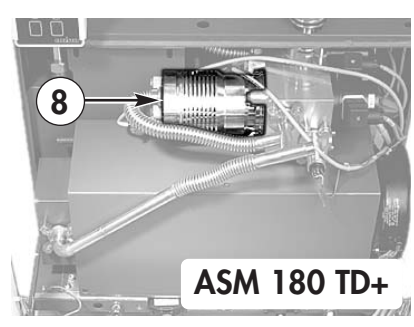
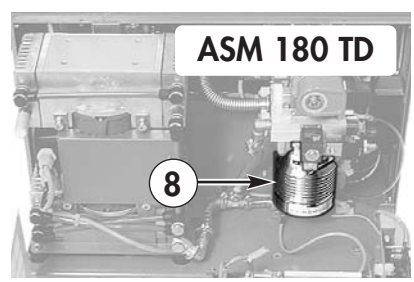
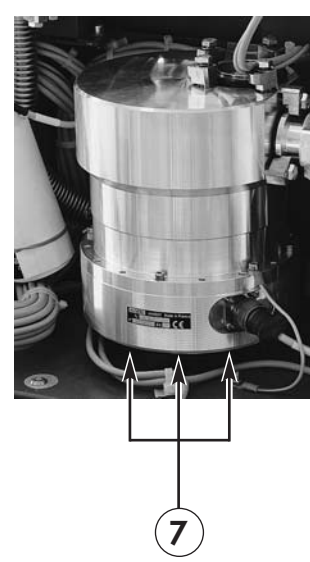
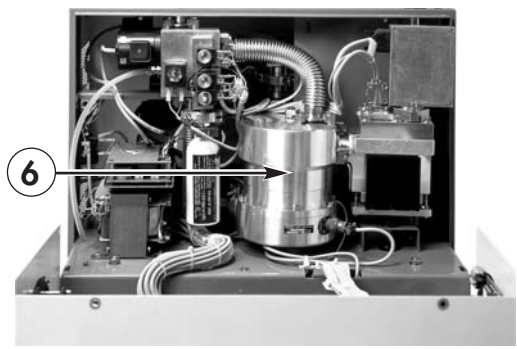

Item	Description	P/N
6	TMP 5154 - Standard seal	798023
7	TMP 5154 - Shock absorber	055232
8	MDP 5011	795600
9	Greasing syringe for TMP 5154 and MDP 5011	056993

Valves

ASM 180 TD

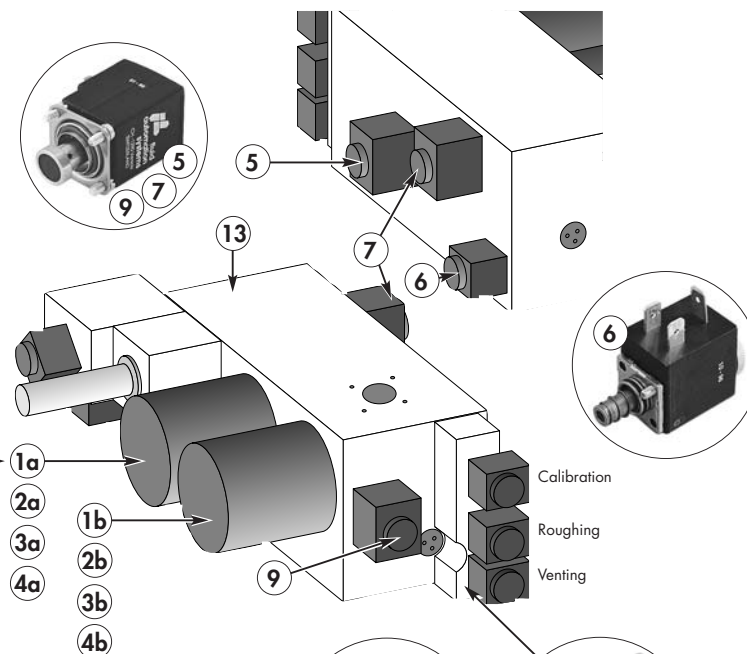
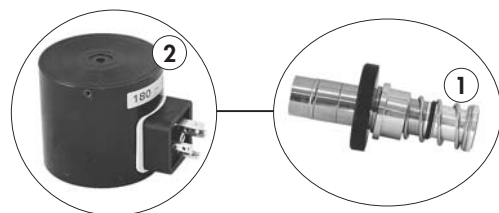
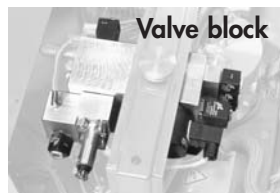

Item	Description	P/N
a	Roughing valve	
b	Detection valve	
1	VAT NW 25 valve operator	*
2	VAT 180-260V valve coil	*
3	Seal kit for VAT valve (not pictured)	*
4	Grease tube (10g) for VAT valve (not pictured)	*
5	Bacosol 24V DC 23W valve (exhaust)	104655
6	Minisol valve 2/2 NO 24V DC (roughing system vent) (with coil)	101304
7	Bacosol 24V DC 23W valve (by-pass)	104655
8	Calibration block	100973
9	Bacosol 24V DC 23W valve (air inlet)	104655
10	Minisol valve 2/2 NF (LDS) (without coil)	038101
11	Coil for 24V DC minisol valve	067040
12	Vickers silencer	075990
13	Valve block ASM 180 TD (not equipped)	*

* Contact customer service



LDS valve
(connected to the TMP rear)

Valves

ASM 180 TD+
ASM 181 TD+

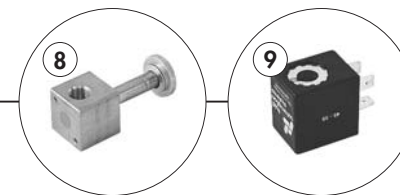
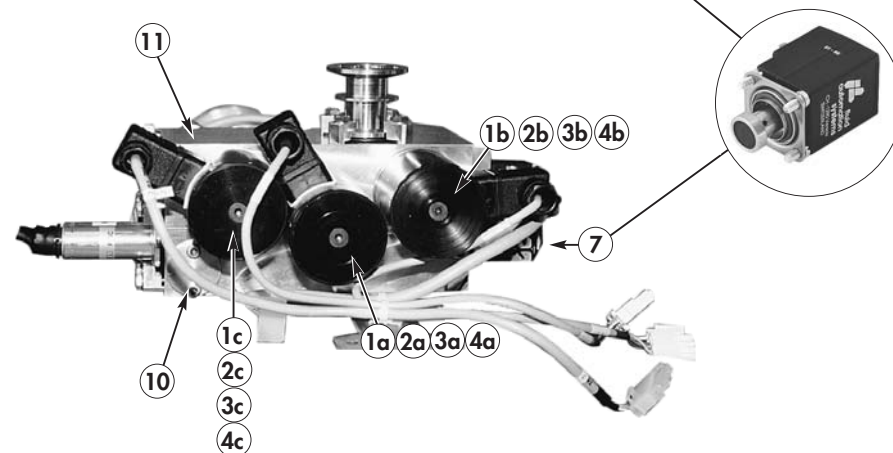
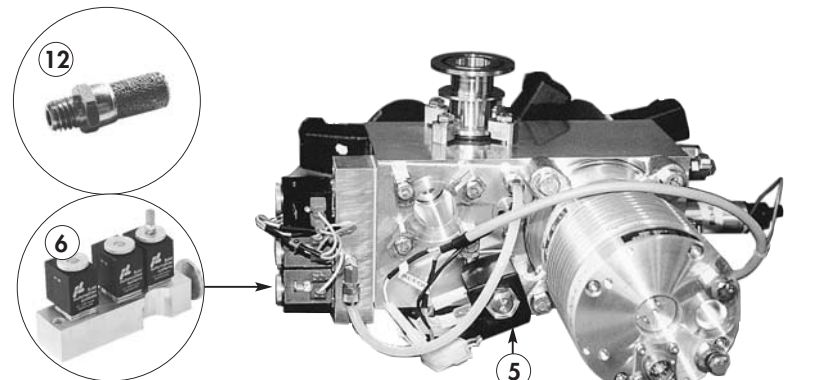
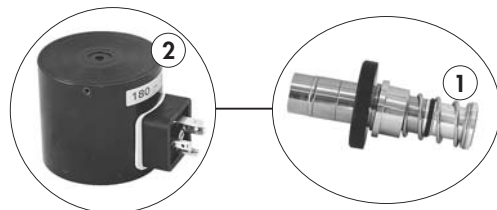
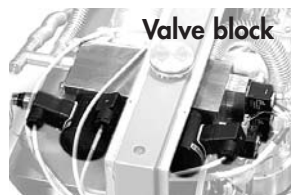

Item	Description	P/N
a	Roughing valve	
b	Detection valve	
c	By-pass valve	
1	VAT NW 25 valve operator	*
2	VAT 180-260V valve coil	*
3	Seal kit for VAT valve <i>(not pictured)</i>	*
4	Grease tube (10g) for VAT valve <i>(not pictured)</i>	*
5	Bacosol 24V DC 23W valve (exhaust)	104655
6	Calibration block	100973
7	Bacosol 24V DC 23W valve (air inlet)	104655
8	Minisol valve 2/2 NF (LDS) (without coil)	038101
9	Coil for 24V DC minisol valve	067040
10	Non injection TD+ plug	104426
11	Valve block ASM 180 TD+ (not equipped)	*
12	Vickers silencer	075990

* Contact customer service

LDS valve
(connected to the TMP rear)

Pipes



Item	Description	P/N
1	Inlet filter NW 25 (without seal)	072857
2	Diaphragm NW 25 (without seal)	*
3	Silencer 1/4	101552
4	Inlet adaptor NW 25-NW40 - 180 TD+	*
	Inlet adaptor NW 25-NW40 - 180 TD	*
5	Rilsan tube Ø 6	*
6	PVC tube 4 x 2	*
7	Flexible tube NW 16 (length 250 mm)	068369
8	Stainless steel tube NW 25/NW 40	101539
9	CP 20 pipe	*
10	CP 20 pipe plug	*

* Contact customer service

Connections and Seals

Seals



Item	Description	P/N
1	O-ring NW 16	079237
	O-ring NW 25	079238
	O-ring (block valve blank off) (16.9 x Ø2.7)	082113
	O-ring NW 40	082129
	O-ring NW 63	082140
	Calibration block O-ring (8 x Ø1.9)	082195

Cover



Item	Description	P/N
1	Lifting ring (per unit)	076192
2	Stopper for frame (per unit)	075940
3	Heyco stopper (per unit)	082922
4	ASM 180 Compact version wheel (per unit) (pivoting)	101816
5	ASM 181 Consol version wheel (per unit): Rear wheel (fixed)	101528
6	Front wheel (pivoting with brake)	101529

Options and accessories

Metal seals

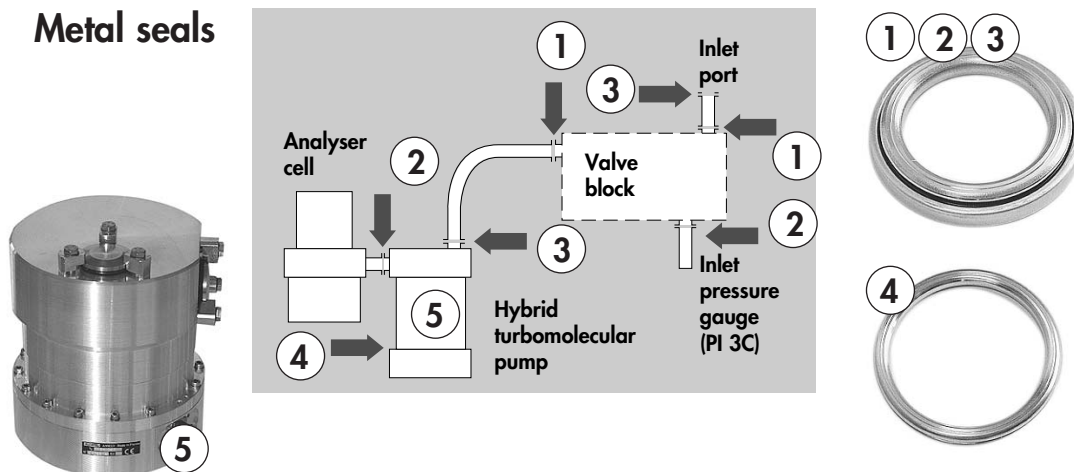

Cell elastomer seal

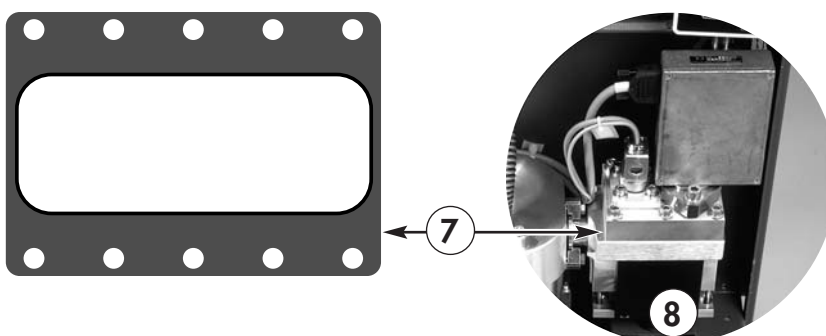

Item	Description	P/N
1	Seal NW 25 helicoflex	100745
2	Seal NW 25 helicoflex (with colaret)	079934
3	Seal NW 40 helicoflex	101492
4	Seal DI 128.7 helicoflex (for TMP 5154)	079089
5	TMP 5154 NW 40 metal	798024
6	Seals kit for TMP 5154 metal	*
7	Cell elastomer seal	102823
8	Complete analyzer cell VHS with elastomer seal (without magnet)	*

* Contact customer service

Options and accessories

Control panel protection

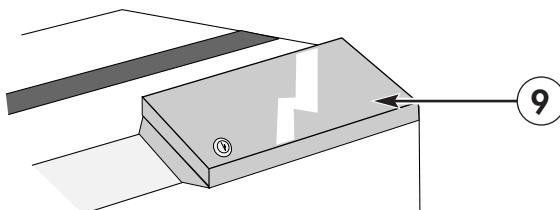

Alphanumeric Control and Display Panel (ACDP)

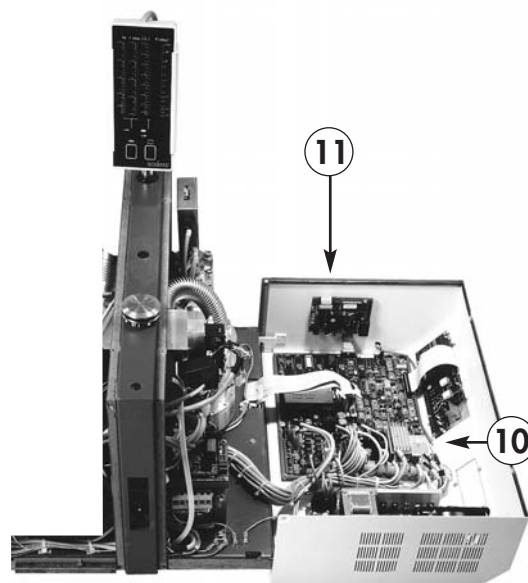
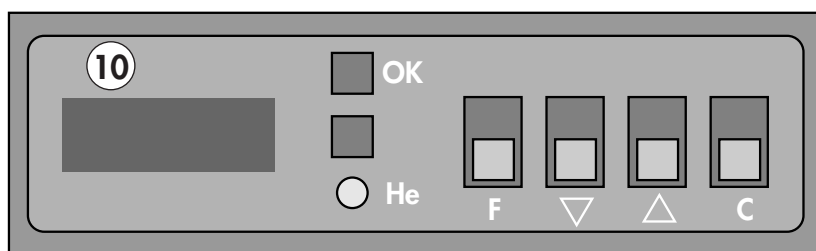

Item	Description	P/N
9	Protective cover of control panel	100348
10	ACDP control assembly	*
11	RS 232 board for ACDP	*

* Contact customer service

Options and accessories

«I» option

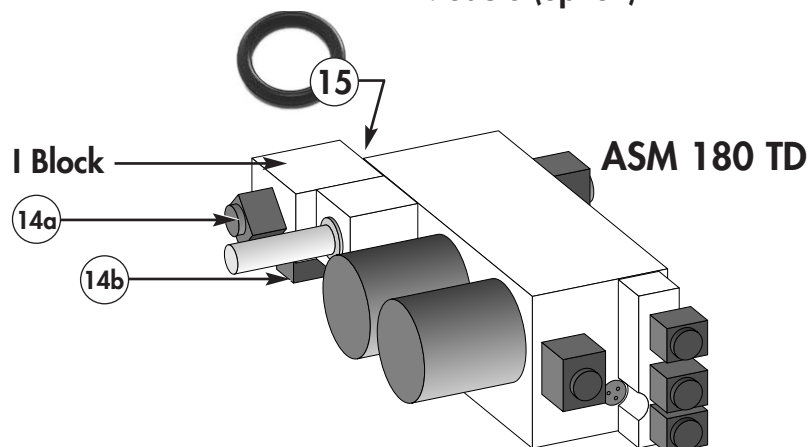
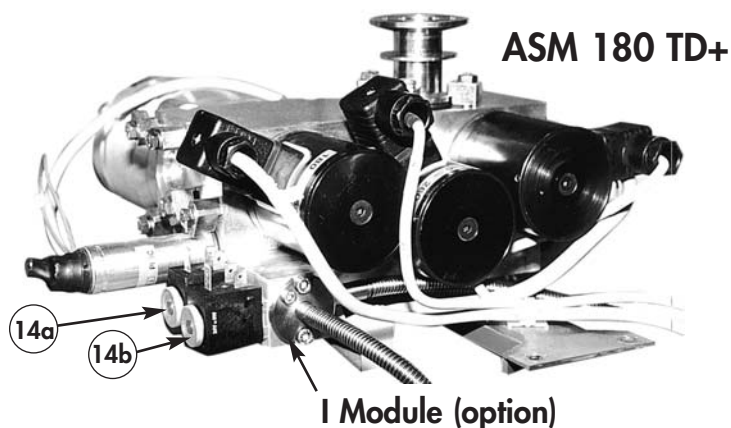
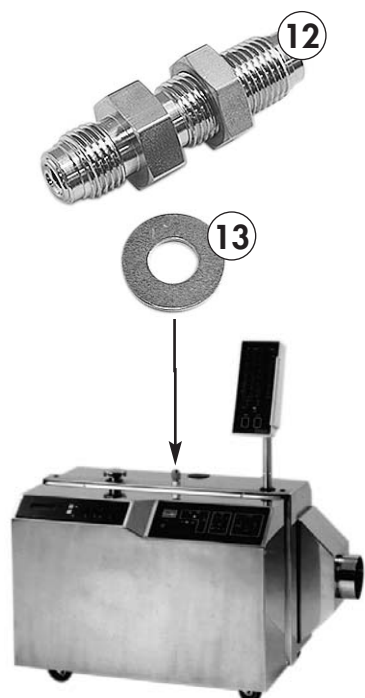

Item	Description	P/N
12	VCR Cajon connector	101583
13	Metal seal Cajon for «I» option	101584
a	Injection valve	
b	Roughing valve	
14	Minisol valve 2/2 NF for «I» option (with coil)	101303
15	TDI, TD+I Block O-ring	082111
-	«I» option switch (not pictured)	102826
-	529C 24V bulb for «I» option switch (not pictured)	102827

Options and accessories

LDS probe

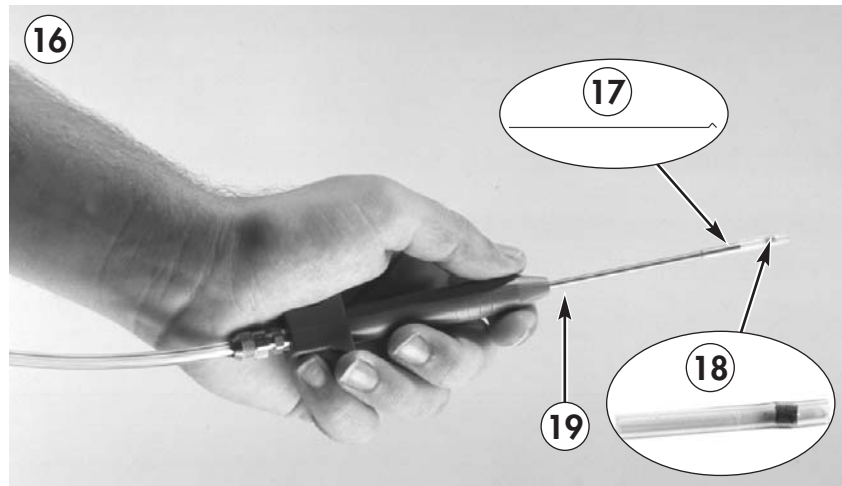

Spray gun

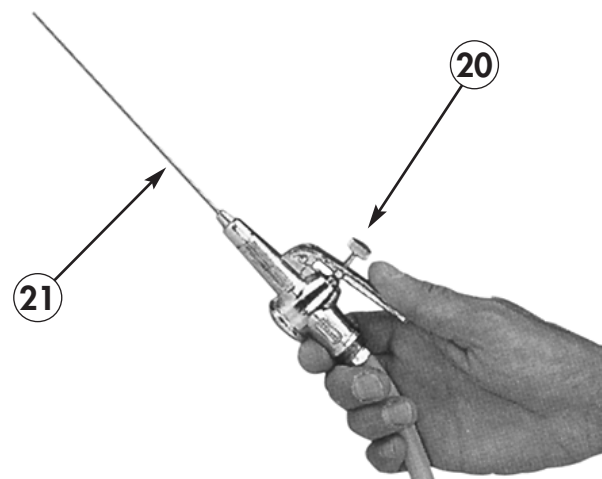

3 masses magnet



Item	Description	P/N
16	LDS probe (5 meter tube)	072301
17	LDS spare needle	072606
18	LDS spare filter (set of 5)	068843
19	LDS spare metal tube	067838
20	Spray gun	083465
21	Spray gun spare nozzle	083446
22	3 Masses magnet	*

* Contact customer service

Components summary

	Description	P/N
Maintenance kit delivered with the detector (F10)	Maintenance kit ASM 180 TD	090201
	Maintenance kit ASM 180 TD+	104434
Monitoring and display (F20)	Ball and socket joint	090172
	Clamping O-ring	082116
	Elapsed time counter	037861
	Holder	090211
	Remote control unit	101298
	Remote control unit 3.5 m	101496
	or remote control unit 7 m	104286
	or remote control unit 25 m	104287
Power and electrical supply (F30)	Breaker switch:	
	100/115V : 8A (180TD)	101779
	200/220/240V : 4A (180TD)	101781
	100/115V : 16A (180TD+ - 181TD+)	101780
	200/220/240V : 8A (180TD+ - 181TD+)	101779
	Fuse:	
	100/115V : T3,15A (180TD/TD+ - 181TD+)	060855
200/220/115V : T6,3A (180TD/TD+ - 181TD+)	060860	
	Jumper plug (Sub D 25 pins)	101824
Automatism and electronic circuits (F40)	8 Ω loud speaker	060097
	Control panel assembly	101299
	Fan	101094
	Fan protective grid	056067
	P0090 - CD2/MDP 5011 power supply board	072402
	P0090 - CD2/TMP 5154 power supply board	072402
	P0191E1 - Distribution board (ASM 181TD+)	100436
	P0195 - I/O Interface board	101404
	P0316E1 - Supervisor board	*
	P0318 - Booster board	104153

* Contact customer service

Components summary

	Description	P/N
Measurement (F50)	Accessories kit (analyzer cell)	090294
	Aluminium PI1 gauge	795706
	Aluminium PI3C gauge	786434
	Calibrated leak Fe1407 with thermal probe	101302
	Complete VHS analyzer cell with lead seal (without magnet)	072493
	Electron collector (set of 5)	068842
	Electron multiplier amplifier (VHS)	072494
	Filament	053146
	Lead gasket (10 meter)	083478
	Spare filament for PI1 (set of 5)	068835
	Pumping (F60)	CP 20 pump
CP 20 pump controller		*
Greasing syringe for TMP 5154 and MDP 5011		056993
MD4E membrane pump:		
100 V - 50/60 HZ		062980
220/240 V - 50/60 HZ		062981
120 V - 50/60 HZ		062982
200 V - 50/60 HZ		062984
MDP 5011		795600
MD4E Shock absorber (type a per unit)		101554
MD4E Shock absorber (type b per unit)		101555
Partial maintenance kit CP 20 including:		103499
2 ball bearings 6001 CP		
1 grease tube 10 g		
2 O-rings 2 x Ø 27		
1 O-ring 3 x Ø 96		
1 plastic box		
Seals kit for MD4E membrane pump	062968	
TMP 5154 - Standard seal	798023	
TMP 5154 - Shock absorber	055232	

* Contact customer service

Components summary

	Description	P/N
Valves (F70)	Bacosol 24V DC 23W valve (air inlet)	104655
	Bacosol 24V DC 23W valve (by-pass)	104655
	Bacosol 24V DC 23W valve (exhaust)	104655
	Calibration block	100973
	Coil for 24V DC minisol valve	067040
	Minisol valve 2/2 NC (LDS) (without coil)	038101
	Minisol valve 2/2 NO 24V DC (roughing system vent) (with coil)	101304
	Non injection TD+ plug	104426
	Roughing valve (a)	
	Detection valve (b)	
	By-pass valve (c)	
	Grease tube (10g) for VAT valve (not pictured)	*
	Seal kit for VAT valve (not pictured)	*
	VAT 180/260V valve coil	*
	VAT NW 25 valve operator	*
	Valve block ASM 180 TD (not equipped)	*
	Valve block ASM 180 TD+ (not equipped)	*
Vickers silencer	075990	
Pipes (F80)	CP 20 pipe	*
	CP 20 pipe plug	*
	Diaphragm NW 25 (without seal)	*
	Flexible tube NW 16 (length 250 mm)	068369
	Inlet adaptor NW 25-NW40 - 180 TD	*
	Inlet adaptor NW 25-NW40 - 180 TD+	*
	Inlet filter NW 25 (without seal)	072857
	PVC tube 4 x 2	*
	Rilsan tube Ø 6	*
	Silencer 1/4	101552
	Stainless steel tube NW 25/NW 40	101539
Connections and Seals (F90)	Calibration block O-ring (8 x Ø1.9)	082195
	O-ring (block valve blank off) (16.9 x Ø2.7)	082113
	O-ring NW 16	079237
	O-ring NW 25	079238
	O-ring NW 40	082129
	O-ring NW 63	082140

* Contact customer service

Components summary

	Description	P/N
Cover (F100)	Heyco stopper (per unit)	082922
	Lifting ring (per unit)	076192
	Stopper for frame (per unit)	075940
	ASM 180 TD/TD+ wheel (per unit) (pivoting)	101816
	ASM 181 TD+ wheel (per unit):	
	Rear wheel (fixed)	101528
	Front wheel (pivoting with brake)	101529
Options and accessories (F110)	ACDP control assembly	*
	529C 24V bulb for «I» option switch <i>(not pictured)</i>	102827
	Cell elastomer seal	102823
	Complete analyzer cell VHS with elastomer seal (without magnet)	*
	«I» Option switch <i>(not pictured)</i>	102826
	LDS spare filter (set of 5)	068843
	LDS spare needle	072606
	LDS probe (5 meter tube)	072301
	LDS spare metal tube	067838
	3 Masses magnet	*
	Metal seal cajon for «I» option	101584
	Minisol valve 2/2 NF (with coil) for Injection valve for «I» option (a) Roughing valve for «I» option (b)	101303
	Protective cover of control panel	100348
	RS 232 board for ACDP	*
	Seal NW 25 helicoflex	100745
	Seal NW 25 helicoflex (with colaret)	079934
	Seal NW 40 helicoflex	101492
	Seal DI 128.7 helicoflex (for TMP 5154)	079089
	Seals kit for TMP 5154 metal	*
	Spray gun	083465
	Spray gun spare nozzle	083446
	TDI, TD+I Block O-ring	082111
	TMP 5154 NW 40 metal	798024
VCR Cajon connector	101583	

* Contact customer service

Appendix

■ View of the operator interface.	■ G 10
■ Recording curve	■ G 20

G 10

View of the operator interface

The purpose of this sheet is to identify the activated keys or parts of the operator interface while the detector is in operation.

CONTROL PANEL

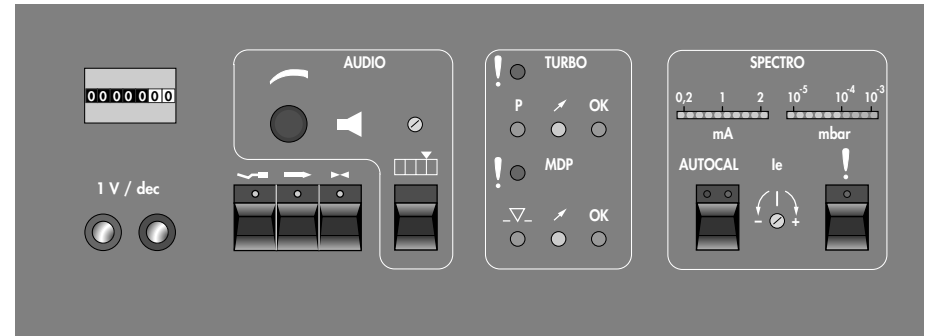

REMOTE CONTROL UNIT

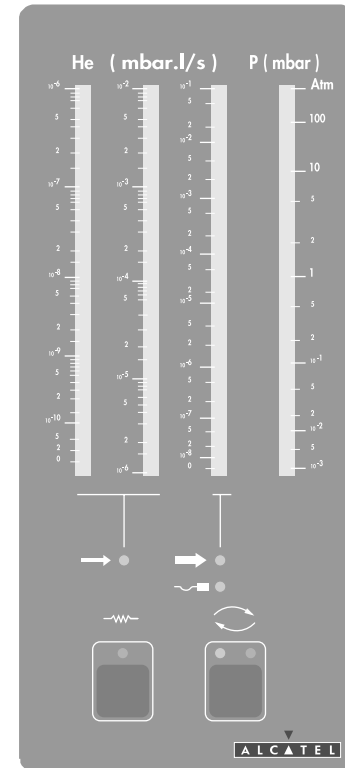

Recording curve



The purpose of this sheet is to show the logarithmic response curve of the analogue output located on the control panel

Analog output chart

Volts	Signal He FL	Signal He GL
0,10	3,07E-12	3,07E-10
0,15	1,12E-11	1,12E-09
0,20	2,08E-11	2,08E-09
0,25	3,20E-11	3,20E-09
0,30	4,51E-11	4,51E-09
0,35	6,03E-11	6,03E-09
0,40	7,80E-11	7,80E-09
0,45	9,84E-11	9,84E-09
0,50	1,22E-10	1,22E-08
0,55	1,49E-10	1,49E-08
0,60	1,80E-10	1,80E-08
0,65	2,16E-10	2,16E-08
0,70	2,57E-10	2,57E-08
0,75	3,04E-10	3,04E-08
0,80	3,57E-10	3,57E-08
0,85	4,18E-10	4,18E-08
0,90	4,88E-10	4,88E-08
0,95	5,67E-10	5,67E-08
1,00	6,56E-10	6,56E-08
1,05	7,58E-10	7,58E-08
1,10	8,74E-10	8,74E-08
1,15	1,00E-09	1,00E-07
1,20	1,15E-09	1,15E-07
1,25	1,32E-09	1,32E-07
1,30	1,51E-09	1,51E-07
1,35	1,73E-09	1,73E-07
1,40	1,97E-09	1,97E-07
1,45	2,25E-09	2,25E-07
1,50	2,56E-09	2,56E-07
1,55	2,91E-09	2,91E-07
1,60	3,30E-09	3,30E-07
1,65	3,75E-09	3,75E-07
1,70	4,25E-09	4,25E-07
1,75	4,82E-09	4,82E-07
1,80	5,46E-09	5,46E-07
1,85	6,18E-09	6,18E-07
1,90	6,99E-09	6,99E-07
1,95	7,91E-09	7,91E-07
2,00	8,93E-09	8,93E-07
2,05	1,01E-08	1,01E-06
2,10	1,14E-08	1,14E-06
2,15	1,29E-08	1,29E-06
2,20	1,45E-08	1,45E-06

Volts	Signal He FL	Signal He GL
2,25	1,64E-08	1,64E-06
2,30	1,85E-08	1,85E-06
2,35	2,08E-08	2,08E-06
2,40	2,35E-08	2,35E-06
2,45	2,64E-08	2,64E-06
2,50	2,98E-08	2,98E-06
2,55	3,35E-08	3,35E-06
2,60	3,77E-08	3,77E-06
2,65	4,25E-08	4,25E-06
2,70	4,78E-08	4,78E-06
2,75	5,38E-08	5,38E-06
2,80	6,05E-08	6,05E-06
2,85	6,81E-08	6,81E-06
2,90	7,66E-08	7,66E-06
2,95	8,61E-08	8,61E-06
3,00	9,68E-08	9,68E-06
3,05	1,09E-07	1,09E-05
3,10	1,22E-07	1,22E-05
3,15	1,38E-07	1,38E-05
3,20	1,55E-07	1,55E-05
3,25	1,74E-07	1,74E-05
3,30	1,95E-07	1,95E-05
3,35	2,19E-07	2,19E-05
3,40	2,46E-07	2,46E-05
3,45	2,77E-07	2,77E-05
3,50	3,11E-07	3,11E-05
3,55	3,49E-07	3,49E-05
3,60	3,92E-07	3,92E-05
3,65	4,40E-07	4,40E-05
3,70	4,95E-07	4,95E-05
3,75	5,55E-07	5,55E-05
3,80	6,24E-07	6,24E-05
3,85	7,00E-07	7,00E-05
3,90	7,86E-07	7,86E-05
3,95	8,83E-07	8,83E-05
4,00	9,91E-07	9,91E-05
4,05	1,11E-06	1,11E-04
4,10	1,25E-06	1,25E-04
4,15	1,40E-06	1,40E-04
4,20	1,57E-06	1,57E-04
4,25	1,77E-06	1,77E-04
4,30	1,98E-06	1,98E-04
4,35	2,23E-06	2,23E-04

Volts	Signal He FL	Signal He GL
4,40	2,50E-06	2,50E-04
4,45	2,81E-06	2,81E-04
4,50	3,15E-06	3,15E-04
4,55	3,53E-06	3,53E-04
4,60	3,97E-06	3,97E-04
4,65	4,45E-06	4,45E-04
4,70	5,00E-06	5,00E-04
4,75	5,61E-06	5,61E-04
4,80	6,29E-06	6,29E-04
4,85	7,06E-06	7,06E-04
4,90	7,93E-06	7,93E-04
4,95	8,89E-06	8,89E-04
5,00	9,98E-06	9,98E-04
5,10	1,26E-05	1,26E-03
5,20	1,58E-05	1,58E-03
5,30	1,99E-05	1,99E-03
5,40	2,51E-05	2,51E-03
5,50	3,16E-05	3,16E-03
5,60	3,98E-05	3,98E-03
5,70	5,01E-05	5,01E-03
5,80	6,31E-05	6,31E-03
5,90	7,94E-05	7,94E-03
6,00	1,00E-04	1,00E-02
6,10	1,26E-04	1,26E-02
6,20	1,58E-04	1,58E-02
6,30	2,00E-04	2,00E-02
6,40	2,51E-04	2,51E-02
6,50	3,16E-04	3,16E-02
6,60	3,98E-04	3,98E-02
6,70	5,01E-04	5,01E-02
6,80	6,31E-04	6,31E-02
6,90	7,94E-04	7,94E-02
7,00	1,00E-03	1,00E-01
7,10	1,26E-03	1,26E-01
7,20	1,58E-03	1,58E-01
7,30	2,00E-03	2,00E-01
7,40	2,51E-03	2,51E-01
7,50	3,16E-03	3,16E-01
7,60	3,98E-03	3,98E-01
7,70	5,01E-03	5,01E-01
7,80	6,31E-03	6,31E-01
7,90	7,94E-03	7,94E-01
8,00	1,00E-02	1,00E+00

He signal (mbar.l/s)

