

ASync Sharing Unit

TABLE OF CONTENTS

SECTION 1 - DESCRIPTION	2
SECTION 2 - SPECIFICATIONS	5
SECTION 3 - INSTALLATION	7
SECTION 4 - FRONT PANEL CONTROLS AND INDICATORS	9
SECTION 5 - NETWORK MANAGEMENT PORT	10
SECTION 6 - INTERFACE SIGNALS AND CABLING	14
SECTION 7 - TROUBLESHOOTING	19
SECTION 8 - WARRANTY	20

Data Comm for Business, Inc.
807 Pioneer Street
Champaign, IL 61820
217-352-3207

August 22, 2001
Firmware Version: 1.3

8500088

1. DESCRIPTION

The DCB Async Sharing Unit (ASU) shares a single port with 4, 8, 16, 24 or 32 others. Data received on the network composite is broadcast to all the other ports. The ASU makes it easy to share async polling networks. The ASU can be used with terminal devices, with multipoint modems, point-to-point modems, with DSU's, over ISDN or over frame relay. The ASU is the ideal product for this requirement. It supports async port speeds up to 38.4 kbps for the 8 thru 32 port units, and up to 115.2 kbps for the 4 port unit.

One method of selecting ports is using terminal RTS. In RTS/CTS control mode, the ASU scans all port RTS inputs and stops scanning when a HIGH signal is detected. When a terminal asserts RTS, the RTS signal is passed from the port to the network composite. On the network composite, the RTS lead is passed out to the modem. The modem Clear to Send (CTS) response is passed back to the terminal that asserted RTS. The terminal will send data upon receiving CTS. After the terminal completes its transmission and lowers RTS, the scanning resumes. In the RTS/CTS control mode, data from a port is discarded if RTS is not asserted.

The anti-streaming timer option for the ASU blocks transmission from a port if that port holds RTS on for more than 8 seconds. This is useful in systems that experience "hung" ports due to terminal RTS or modem DCD staying on in error. Turning RTS off and back on or a reset of the ASU will reset the anti-streaming timer.

The COMBINER mode of the ASU is perfect for polled systems that do not have RTS/CTS control. For example, many RTUs used in SCADA and other control system environments are implemented with just three RS232 leads, transmit data, receive data and signal ground. The ASU may be used at the host end of a system, where the multiple ports are connected to line drivers, modems, DSUs, etc, and where the Carrier Detect (DCD) signal is constantly on, rather than switched. In COMBINER mode, the RTS and TXD inputs from all ports are combined on the composite RTS and TXD outputs.

In BACKUP mode the ASU scans the device ports for RTS. If RTS is high on any device port, a data channel is opened between the Composite and the Device port. To connect the ASU to the backup modem, an RJ45 line cord and the DCB Async Modem adapter, part number 9802018 is used. With this cable modem DCD is wired to the ASU port RTS input. When the backup link is established, a path is opened between the host computer and the remote device served by that modem.

To make the host modem behave properly, the ASU sends out an initialization command string. This command string puts the modem in answer mode, insures that modem DCD follows the call progress and insures that the RS232 interface speed is correct. The command string is sent by the ASU as soon as the ASU is put into Backup mode. Once in Backup mode, the ASU also sends out the string after the ASU is powered on and after the ASU is reset.

The ASU can be used at the remote locations where the network composite port connects to a modem, ISDN TA or DSU. The ASU can also be used at the host end of a network to share one host port with many modems, ISDN TAs or DSUs.

For tail circuit applications, the ASU has a DCD to RxD holdoff. A timer can be set that insures DCD is asserted a minimum of x milliseconds before receive data is sent to the ports. The value can be set from 1 to 500 ms. The DCD to RxD holdoff option must be enabled before the delay value can be set. Tail circuit applications include tail circuit modems or radios.

Some features of the ASU include:

- Shares one asynchronous port with 4, 8, 16, 24 or 32 other ports
- Async RS-232 interface up to 115.2 kbps
- Broadcasts from one port to many or concentrates many ports to one port
- Backup mode for easy circuit protection
- Control sharing with RTS/CTS
- Anti-streaming option
- Use for financial, traffic, SCADA networks
- Monitor functions allow network management port user to monitor transmit or receive of any data port.
- Field upgradeable from 8 to 32 ports.
- Power supplies available for 12 VDC, 24 VDC, 48 VDC, 120 VAC, and 240 VAC.
- Rack mount options available.

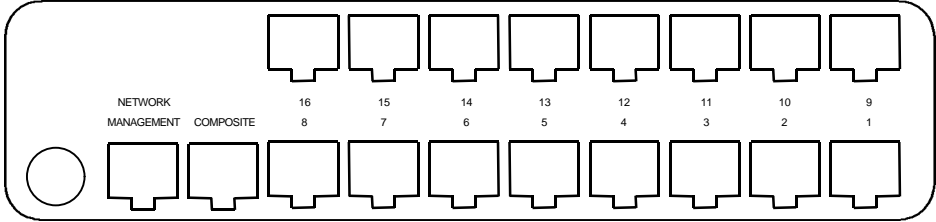
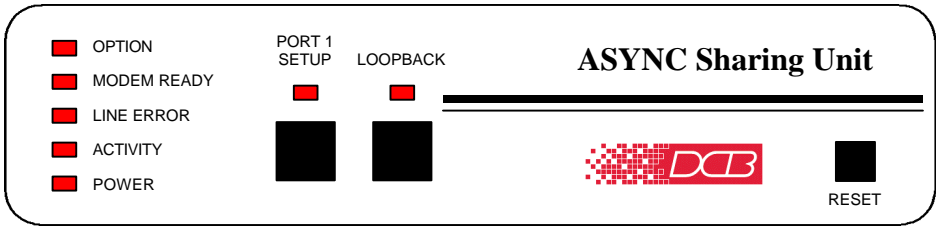

ASU, 16 Channel Unit

2. SPECIFICATIONS

2.1 General

2.1.1 Device Ports

Speed

Asynchronous only

1200, 2400, 4800, 9600, 19,200 or 38,400 bps (57,600 and 115,200 available on 4 port unit)

Data Format

10 bits/character, 1 start, 1 stop, 8 data

Interface

CCITT V.24, RS-232D, implemented in RJ-45, 8 position connectors. (RS-561 standard physical pin-out used on RJ-45 connectors)

Buffer

28K circular

2.1.2 Composite Port

Full Duplex

Speed

Asynchronous only

1200, 2400, 4800, 9600, 19,200 or 38,400 bps (57,600 and 115,200 available on 4 port unit)

Interface

RS-232D, implemented in RJ-45, 8 position connector

2.1.3 Network Management Port Commands

Show Configuration

Change Port Configuration

Show / Change ID

Activity Counters

Zero Activity Counters

Test Tools

Network Loop

Monitor Port Tx

Monitor Port Rx

NMP Parity

Reset ASU

Type

Repeat Last Command

Disconnect NMP

2.2 Environmental

Operation: 0 to 65° C, 10 to 85% relative humidity

Storage: -40 to 85° C, 10 to 85% relative humidity

2.3 Physical / Electrical

10¼" W x 9¾" D x 2½" H – 4, 8 and 16 channel units

10¼" W x 9¾" D x 4¼" H – 24 and 32 channel units

120 VAC external power supply

30 watts, .25 amps

Optional 12 VDC, 24VDC, 48VDC, or 240VAC power supply available

2.4 Other Specifications

Operating Modes

RTS/CTS

Combiner

Backup

Front Panel Indicators

Power

Activity

Line Error

Modem Ready

Option

Port 1 Setup

Loopback

Front Panel Switches

Loopback

Port 1 Setup

Reset

3. INSTALLATION

3.1 Unpacking

Remove the ASU from the shipping container and examine it carefully for external damage. If shipping damage is apparent, notify the shipper immediately.

The following accessories are included with each ASU:

- external power supply
- manual
- warranty, maintenance contract and repair information
- Modem to Composite cable (black) for connecting the ASU to an external modem
- Network Management Port cable (green) for connecting the ASU network management port to an asynchronous terminal or PC for configuration

3.2 Setup

All ports must be configured to match the speed of the attached devices. This is done using the network management port CP command. (see Section 5). The desired mode of operation is also set using this command.

3.3 Using Leased Line Modems

In this section, a reference to modem includes modems, digital radios or DSU/CSUs for leased line installations.

Connect the modems to the phone line and power ON the modems. Confirm the presence of carrier at each modem. If carrier is not detected at both ends, recheck the option settings. If carrier is still not present, check the cable from the telephone line to the modem. If everything is correct and still no carrier call the manufacturer of the modem or contact the telephone company for assistance.

Connect the ASU composite port to the modem. A two foot RJ45 to DB-25 male cable connects the composite port of the ASU (the RJ45 connector second from the left when viewed from the rear) to the data port of the modem (usually a DB-25 female connector). See Section 6 for cabling information.

Connect the ASU to power.

Power, Activity and Modem Ready indicators on the front panel of the ASU should be. (See Section 4).

3.4 Cabling

Cabling between the ASU and terminal devices is a common source of installation problems. The ASU must have data from attached terminal devices, as an input on Position 6 of the RJ45 connector. Data from the ASU to any attached equipment will be transmitted on position 5 of the RJ45 connector. See paragraph 6.1 for position location on the RJ45 connector.

See Section 6 to determine the correct cables for your application.

3.5 Resetting Factory Defaults

The factory default settings for the ASU ports are as follows:

Port Rate	9600
Mode	RTS/CTS
Anti-Streaming	ON

To reset the unit to factory defaults use the !R command from the network management port or perform the following steps using the front panel switches:

1. Depress and hold the PORT 1 SETUP switch while depressing the RESET switch.
2. Be sure to continue to hold the Port 1 Setup switch until its LED has gone OFF and returned ON.
3. Release and depress the Port 1 Setup switch again to return management control to the network management port.
4. All settings should now be at the factory defaults. Use the SC (Show Configuration) command to check the settings.

4. FRONT PANEL CONTROLS AND INDICATORS

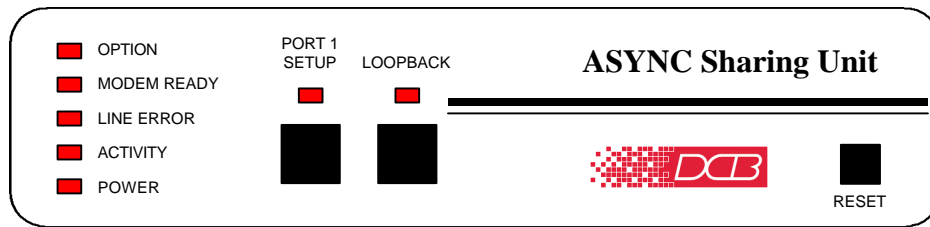

4.1 Switches

Port 1 Setup – Maps the network management port commands to device port 1. When Port 1 Setup is active, the indicator is on.

Loopback – Initiates a bi-directional composite port loopback. The loopback is active when the indicator is on.

Reset – Performs a hardware reset of the unit.

4.2 Indicators

POWER – ON when the ASU is connected to power.

ACTIVITY – ON when RTS is high on any device port.

LINE ERROR – flashes when a data error is detected.

MODEM READY – ON if Data Carrier Detect is present from the composite link device.

OPTION – always ON.

PORT 1 SETUP – ON when the network management port functions have been mapped to device port 1 by depressing the front panel switch. To return these functions to the network management port, depress the front panel switch again.

LOOPBACK – ON when the bidirectional composite loopback has been activated by depressing the front panel switch. To return to normal operation, depress the front panel switch again.

5. NETWORK MANAGEMENT PORT

5.1 Introduction

The Network Management port (NMP) is used to configure the ASU for proper operation. This connection must be used to configure the unit.

5.2 Connections and Setup

Connection to the NMP is made either through a port on the rear of the unit or by using Port 1 Setup.

5.2.1 Port 1 Setup

The easiest way to access the NMP functions is by using a terminal connected to port 1 of the unit. A switch located on the front panel performs this function. See paragraph 4.1 for information.

5.2.2 Dedicated Terminal or PC

The NMP functions are also available through a port on the rear of the unit labeled Network Management Port. To connect a dedicated terminal to this port, use the green cable provided and the appropriate adapter for either a terminal or PC. Set the terminal device for 9600 bps, 8 data bits, no parity and one stop bit.

5.2.3 Dedicated Modem

For remote access to NMP functions, a dial-up modem may be connected to the Network Management Port. You must fix the DTE interface speed of the modem at 9600 bps, 8 data bits, no parity and one stop bit. Refer to your modem manual for appropriate setup procedures. Use the appropriate cable from paragraph 6.3.5 for connection.

5.3 Using the Network Management port

To activate the NMP, press the ENTER key. When you see **AT YOUR COMMAND >>**, the NMP is active and ready for your commands. Type H <Enter> to display the command set.

5.4 Commands

5.4.1 Help (H or ?)

<u>COMMAND</u>		<u>PARAGRAPH</u>
Show: Config	SC	5.4.2
Change: Port Config	CP	5.4.3
Set ID	ID	5.4.4
Activity Counters/Zero	AC/Z	5.4.5
Test Tools	TT	5.4.9
Type	TY	5.4.6
Repeat Last Command	*	5.4.7
Disconnect NMP	BYE	5.4.8

This Help screen shows the choice of commands available. The commands allow you to display the selected options (Show configuration), configure the unit (Configure ports and Set ID), and perform many different diagnostic functions such as monitor data, show activity and other useful tests.

5.4.2 Show Configuration

The Show Config (SC) command shows the current port rate and operational mode settings. Use this command to verify proper unit configuration.

5.4.3 Change Port Configuration

The Change Port Config (CP) command sets the port rate, and operational mode of the ASU. If RTS/CTS mode is selected, an anti-streaming option is available. The factory default setting is 9600, RTS/CTS mode with anti-streaming on. Anti-streaming disables any port that leaves RTS on for more than 8 seconds. The port becomes active again after RTS turns off. If DCD to RxD holdoff is enabled, the timer can be set from 1 to 500 ms. The default is disabled.

5.4.4 Set ID

The Set ID (ID) command allows you to set or change the unit identifier. IDs can be a maximum of 15 characters in length. Pressing <Enter> with no entry will leave the ID unchanged.

5.4.5 Activity Counts / Zero

The Activity Counts (AC) command shows transmit and receive data statistics for all ports. The data are presented in terms of characters sent and received by the network and each device port. Error counts are also shown. A range of ports may be included with this command to reduce the number of ports displayed.

NOTE

This command allows port numbers or port number ranges to be included on the command line. When port numbers are included, the syntax is as follows:

(Command)1	Port 1
(Command)1,2,6	Ports 1, 2 & 6
(Command)1 2 6	Ports 1, 2 & 6
(Command)2-6	Ports 2 thru 6
(Command)1,5-8	Ports 1 and 5 thru 8

The Z command is used to zero the counters so that current activity can be monitored.

5.4.6 Type

The Type (TY) command displays information about the ASU including firmware version, number of ports and unit ID.

5.4.7 Repeat Last Command

To repeat the last command, simply press the * key. This is handy for repeating screens of constantly changing data.

5.4.8 Disconnect NMP

The BYE command toggles the RTS output from the Network Management port. This is used to disconnect equipment such as dial-up modems or the DCB Access Switch.

5.4.9 Test Tools

The Test Tools (TT) menu summarizes the test and troubleshooting commands. These commands are listed separately to reduce the clutter in the main help list, but are always available from the command prompt.

<u>COMMAND</u>		<u>PARAGRAPH</u>
Network Loop/Quit	NL/QNL	5.4.10
Monitor Port Tx	MT#	5.4.11
Monitor Port Rx	MR#	5.4.11
NMP Parity	P	5.4.12
Reset ASU	RESET	5.4.13

5.4.10 Network Loopback

The Network Loopback (NL) command enables a bi-directional loopback of the composite port. Use the QNL command to disable the loopback.

5.4.11 Monitor Port TX or RX

The Monitor Port TX (MT#) command monitors data transmitted from the selected port to the composite port. The Monitor Port RX (MR#) command monitors data received by the selected port from the composite port. A port number must be included on the command line.

When port monitor is active, two ESC characters are needed to end the test.

5.4.12 NMP Parity

The NMP Parity command (P) sets the parity for the network management port. The factory default is SPACE (8,N,1).

5.4.13 Reset ASU

The Reset ASU (RESET) command performs a reset of the unit.

6. INTERFACE SIGNALS AND CABLING

6.1 Connector Location and Pin Reference

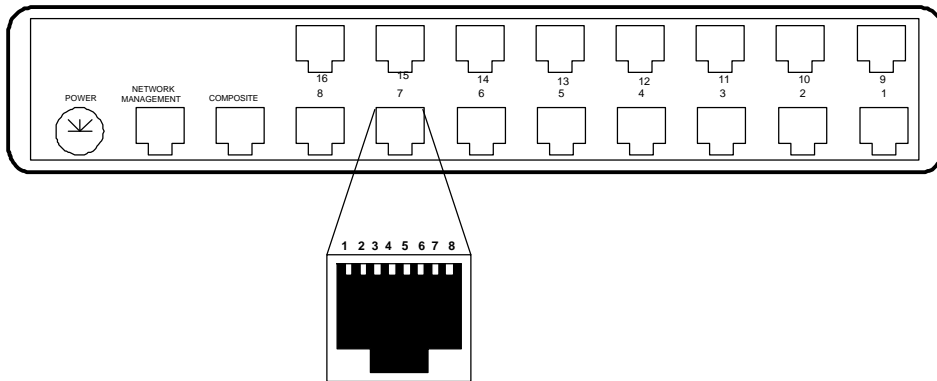

Rear Panel and RJ-45 Jack

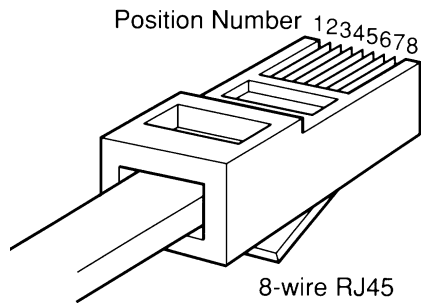

RJ-45 Plug Positions

6.2 Port Interface

6.2.1 Composite Port (RJ-45)

<u>Pin</u>	<u>Signal</u>	<u>In/Out</u>
1	Not Used	
2	Not Used	
3	Data Carrier Detect	IN
4	Signal Ground	
5	Transmit Data	OUT
6	Receive Data	IN
7	Request to Send	OUT
8	Clear to Send	IN

6.2.2 Device Ports (RJ-45)

<u>Pin</u>	<u>Signal</u>	<u>In/Out</u>
1	Data Set Ready	OUT
2	Data Carrier Detect	OUT
3	Busy	IN
4	Signal Ground	
5	Receive Data	OUT
6	Transmit Data	IN
7	Clear to Send	OUT
8	Request to Send	IN

6.2.3 Network Management Port (RJ-45)

<u>Pin</u>	<u>Signal</u>	<u>In/Out</u>
1	Not Used	
2	Not Used	
3	Data Carrier Detect	IN
4	Signal Ground	
5	Transmit Data	OUT
6	Receive Data	IN
7	Request to Send	OUT
8	Clear to Send	IN

6.3 Cables

6.3.1 Composite Port to Modem

A two foot composite to modem cable is included with each unit. The configuration is as follows:

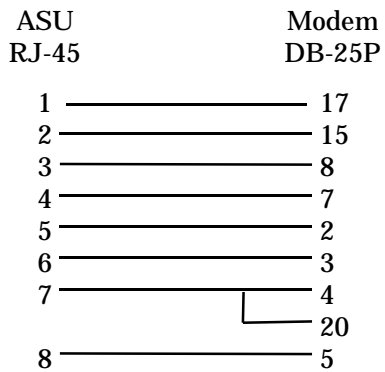

6.3.2 Composite Port to DTE Device or PC Com Port

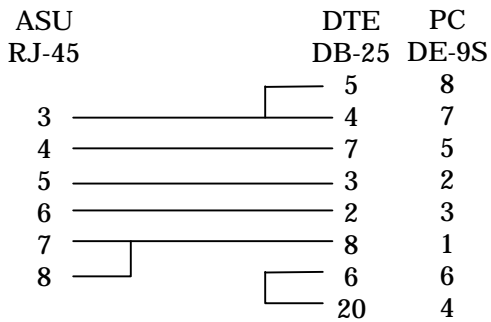

6.3.3 Device Port to DTE Device

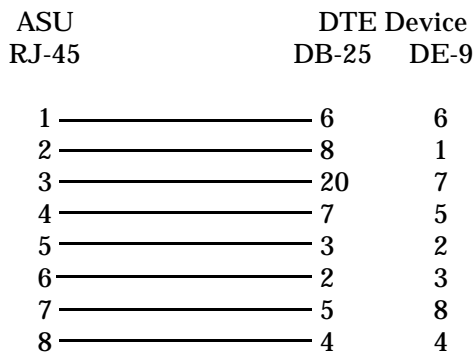

6.3.4 Device Port to Modem

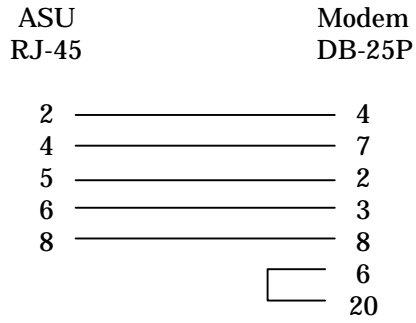

6.3.5 Device Port to Dial Backup Modem (9802018)

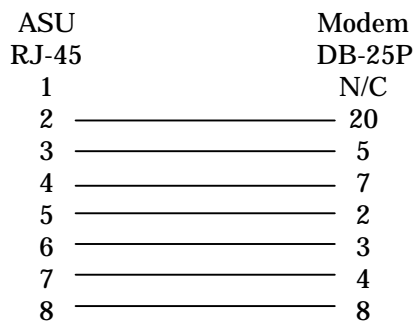

6.3.6 Device Port to Host BPF for backup (9500023)

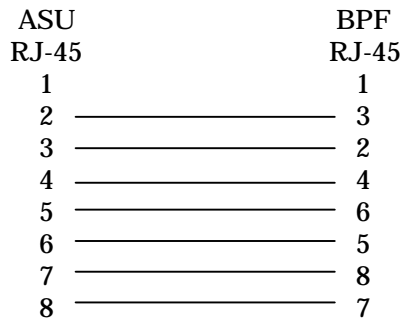

6.3.7 Network Management Port

To a TERMINAL

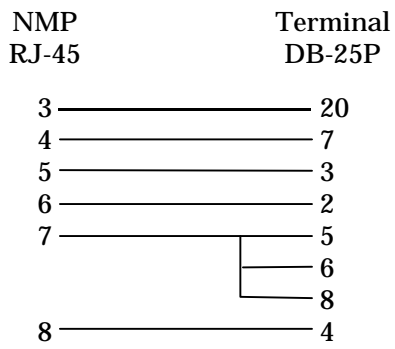

To a PC using terminal emulation

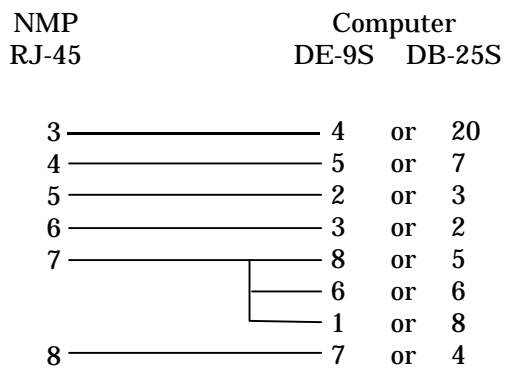

To a dial-up MODEM for remote access

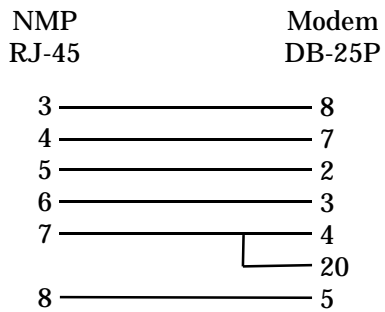

7. TROUBLESHOOTING

7.1 General Approach

When troubleshooting problems, a rational plan can save you many hours of frustration. The following is a brief outline of standard troubleshooting procedures.

1. Gather the facts to determine the exact nature of the problem.
2. Draw a picture of the system showing the equipment at both the host and remote ends and the phone lines or in-house wiring. Use this as a reference to note your observations, test steps and test results. A picture keeps you focused and often saves duplicate effort.
3. Record the front panel indications before changing anything. This is an important part of fact gathering
4. If you change anything, change only one thing at a time.
5. Use the built-in test functions, especially the loopback tests and record your results.

7.2 Installation Troubleshooting, Terminals

Terminal problems typically fall into two categories:

1. The terminal or printer gets no data
2. The terminal or printer gets "garbage" data

When a terminal gets no data, check to see the cables are wired properly.

If the terminal gets "garbage" data, check the port speed of the ASU and the terminal to make sure they match.

7.3 Assistance

If you need assistance troubleshooting your system, contact DCB customer support at (217) 352-3207 between 8:00 am and 5:00 pm central time Monday through Friday.

8. WARRANTY

DCB products are warranted to be free of defects in materials and workmanship for two years. Data Comm for Business will repair or replace any equipment proven to be defective within the warranty period. All warranty work is F.O.B. Champaign, IL. This warranty is exclusive of abuse, misuse, accidental damage, acts of God or consequential damages, etc. DCB liability shall not exceed the original purchase price.

All equipment returned for warranty repair must be accompanied by a Returned Material Authorization (RMA) number. To receive an RMA number, call (217) 352-3207 between the hours of 8 AM and 5 PM central time. Equipment must be shipped prepaid to DCB and will be returned at DCB's expense.

Data Comm for Business, Inc.
807 Pioneer Street
Champaign, IL 61820

Tel (217) 352-3207
Fax (217) 352-0350
Email support@dcbnet.com