



**Time Tested • Time Proven**





# The ROADMASTER difference

- 'Hands-on' design and manufacturing  
ROADMASTER doesn't outsource. All of our core products are designed, engineered and manufactured at our plant in Vancouver, Washington, with virtually every process done under the same roof.

To us, "made in the U.S.A." means just that — we didn't just assemble it; we made it.

The reason for hands-on manufacturing is simple: quality. Quality starts on the inside, and when you control the process, you control the quality. The way we see it, "quality first" is the reason more ROADMASTER towing products are on the road today than any other brand.

- The most stringent testing in the industry  
ROADMASTER was the first towing products manufacturer to use computerized testing — as well as "real world" physical testing — to ensure structural integrity, longevity and the safety of your family.

Front cover photo  
courtesy of [thervgeeks.com](http://thervgeeks.com)

## Contents

Tow bars .....	2-5
All-Terrain™ tow bars .....	2
Sterling™ All-Terrain .....	3
Falcon 2™ .....	4
StowMaster™ .....	5
Tow bar mounting brackets .....	6-7
Supplemental braking .....	8-16
Even Brake® .....	10-11
9700 .....	11
InvisiBrake® .....	12-13
BrakeMaster™ .....	14
Accessories .....	15-16
Combo Kits .....	17
Protection and storage .....	18-19
Safety cables .....	20
Electrical .....	21-23
Tow bar covers and padlocks .....	24
Towing accessories .....	25
Tow bar adaptors .....	26
Pins and clips .....	27
Hitch accessories .....	28-30
Tow dollies .....	30-31
Wheel Masters .....	32-35
Suspension Solutions .....	36-39
Anti-sway bars .....	38-39
Care and cleaning .....	40



## A true American manufacturer

Others assemble parts from who knows where.  
ROADMASTER starts with raw steel and ends with the finest tow bars on the planet.

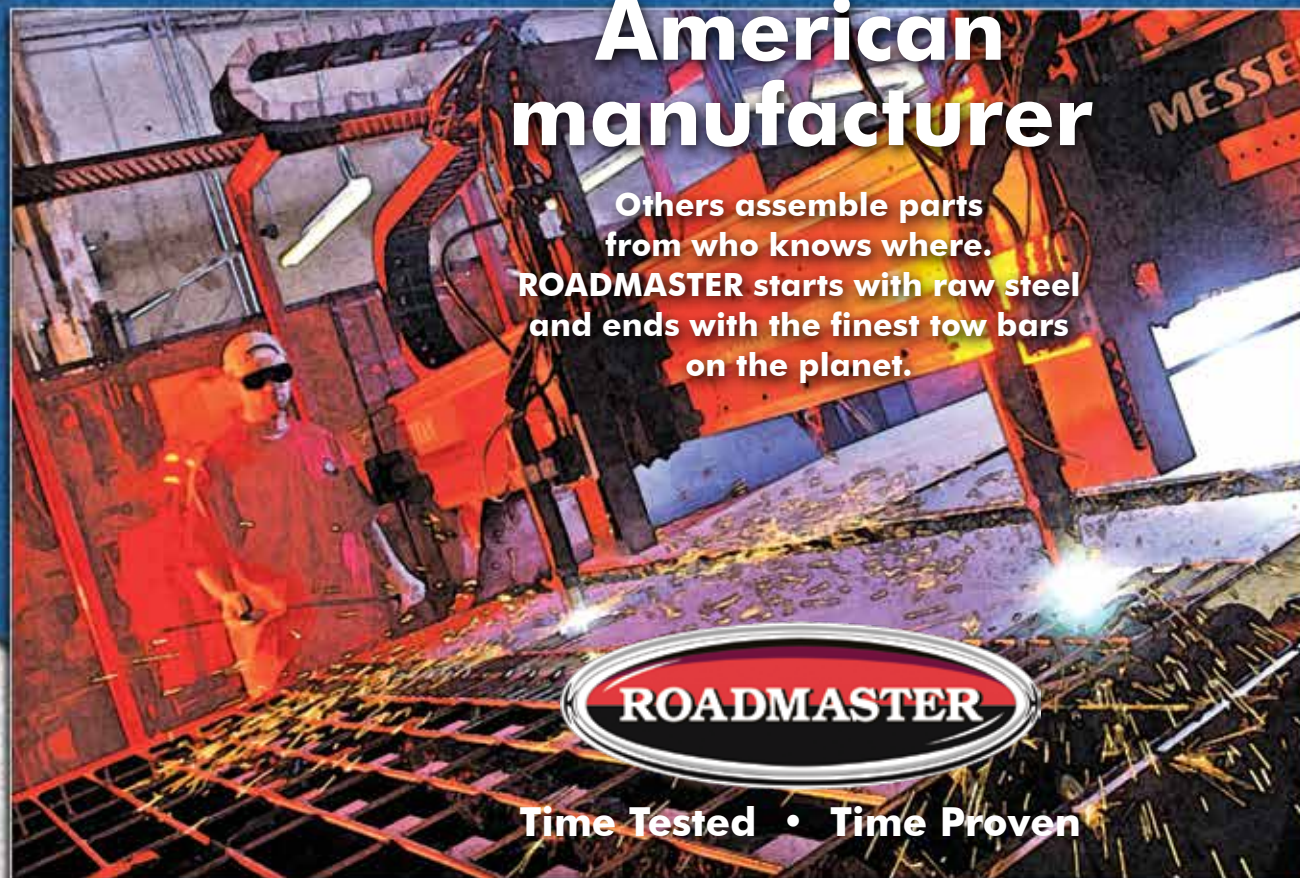

Time Tested • Time Proven

above: a plasma cutter sections tow bar mounting bracket parts at ROADMASTER's Vancouver, Washington plant.



# The basics of towing...

## What to know **before** you tow.

There are four major components to any towing system — the tow bar, the mounting bracket, supplemental brakes and towing accessories.

ROADMASTER offers a wide range of product choices within each category. Each one has been designed, tested and manufactured to make every aspect of your towing experience safe and pleasurable.

**Important** — Before towing any vehicle, consult your owner's manual to be sure your vehicle can be towed with all four wheels on the ground without damage to the transmission. Some vehicles can be towed as is, but others may require a transmission lube pump system or driveshaft disconnect. Both products are reliable, time-proven accessories that protect your vehicle's transmission during towing.

### Step 1

#### Select a tow bar

If you select the tow bar method of towing, you must choose either a motorhome-mounted tow bar or a car-mounted tow bar.

#### Motorhome-mounted...

Motorhome-mounted tow bars insert into the two-inch motorhome receiver and can be stored on the back of the motorhome.



Motorhome-mounted bars are preferred because they never have to be lifted off the front of the towed vehicle and you always have a built-in spot for storage on your motorhome.

#### ...or car-mounted?

Car-mounted tow bars are mounted and stored on the front of your towed vehicle.



Designed for simplicity and ease of use, they can be detached and lifted off the vehicle for storage in a trunk or cargo bin.

### Step 2

#### Mounting bracket

Regardless of the type of tow bar you choose, a tow bar mounting bracket will be required. It's custom-designed to fit your specific tow vehicle and bolts to the vehicle's frame to provide an attachment point for the tow bar.



#### Question — tow bar...

A tow bar is by far the most common method of towing. It allows for the quickest connection to the motorhome; plus it's lightweight, easy to handle and simple to store.



#### ...or tow dolly?

A tow dolly is ideal for those who want to tow multiple vehicles without installing a tow bar or mounting bracket on each one. Plus, a transmission lube pump system is not necessary for vehicles with front wheel drive automatic transmissions because the front wheels are off the ground.



### Step 3

#### Supplemental brakes

Supplemental brakes are required in most states, and for an excellent reason — the laws of physics. At highway speeds or during a panic stop, the inertia of a towed vehicle's weight significantly increases stopping distance.

Oftentimes, the difference between a severe accident and a close call is just a few feet. Supplemental braking systems are designed to stop the towed vehicle-motorhome combination in about the same distance as the motorhome alone.

There are four ROADMASTER systems to choose from, offering you the widest choice of any manufacturer.



### Step 4

#### Safety equipment and accessories

Required by law in almost every state, safety cables (A) attach to both your towed vehicle and your motorhome as a secondary security device.

Your towed vehicle must also be wired for functioning turn signals and taillights while in tow. A Universal Wiring Kit with diodes (B) safely connects the two vehicles' electronics. A power cord (C) is necessary to conduct the lighting signals from the motorhome to the towed vehicle.

These items can be purchased separately or you can purchase a Combo Kit similar to the one shown here, which also includes a tow bar cover (D) and other common accessories, matched to your ROADMASTER tow bar (kit contents vary).



## Tow Bars

# Length, strength, stability

Since day one,  
the longest arms  
in the industry for  
superior stability



For decades Roadmaster has made tow bars that are the easiest to use and release in the industry. We also have been making tow bars with the longest arms on the market giving you the most stability available and the most space between your car and RV for tighter turns. For the tow bars with the longest list of features and the highest level of craftsmanship and quality, look no further than Roadmaster, the industry leader in tow bar technology.

**Need help choosing a tow bar?  
Call our experts at 800-669-9690.**

# ALL-TERRAIN™

U.S. patent numbers  
6,619,686  
6,957,824

Non-binding tow bars  
with the patented Freedom Latch,  
storage latch and built-in channel guides



## Freedom Latch™ non-binding technology

No more binding! (or skinned knuckles, or “#%?#^@?#!”)

A patented cam design inside the Freedom Latch transforms linear motion into rotary motion at a 400-to-1 ratio — five pounds of force against the latch equals 2,000 pounds of force against the lock. So you'll never have to straighten and align your towed vehicle to release the tow bar — Freedom Latches release at any angle or bind. First time, every time.

After all, who's on vacation here — you, or your tow bar?

## Falcon All-Terrain

*Our best-selling tow bar. Simple. Durable. Time-tested. Proven.*

**522 Falcon All-Terrain tow bar** — 6,000-pound GVWR capacity  
Motorhome-mounted tow bar — weighs 38 pounds

**9243-1 Falcon All-Terrain Combo Kit\*** with straight safety cables and power cord

**9243-2 Falcon All-Terrain Combo Kit\*** with coiled safety cables and power cord

## BlackHawk™ 2 All-Terrain

*For heavy-duty, hard-core, serious towers.*

**422 BlackHawk 2 All-Terrain tow bar** — 10,000-pound GVWR capacity  
Motorhome-mounted tow bar — weighs 42 pounds

**9243-3 BlackHawk 2 All-Terrain Combo Kit\***

\* Contains the accessories you need, matched to your All-Terrain tow bar — see page 17.

## Exclusive features

- **Patented one-step storage latch**  
Fold the tow bar toward the motorhome and it will “click,” automatically locking in place.
- **Built-in channel guides**  
Both the safety cables and the power cord are routed through the built-in channel guides for protection against damage or dragging, and for a clean, uncluttered look.
- **Solid stainless steel inner arms**  
For smooth, trouble-free operation and easy maintenance. Stainless steel looks better, lasts longer and prevents corrosion that binds — Roadmaster tow bars are the most rust-free in the industry.
- **Largest hook-up radius**  
No wasted time lining up your towed vehicle! You can't say this about many things in life but connecting Roadmaster tow bars is just like horseshoes — “close” is good enough.
- **Metal-flake powder-coat finish**  
This finish exceeds all 500-hour salt spray, extreme weather and high-impact standards.



# World's Strongest Aluminum Tow Bar!

*For those who simply want the best*



**New!**  
Now with  
**8,000-pound  
capacity!**

The Sterling All-Terrain was designed, tested and manufactured to the highest standards. The Sterling All-Terrain weighs just 35 pounds, yet pulls up to four tons. Steel and stainless steel at every critical point ensure superior strength and structural integrity.

A unique eggshell design distributes pressure throughout the tow bar, making the Sterling All-Terrain the world's strongest aluminum tow bar. The Sterling All-Terrain is easy to connect, and its stainless steel inner arms telescope, center and automatically lock as you pull away. Once you've reached your destination, a unique storage lock secures the Sterling All-Terrain in its stored position.

The Sterling All-Terrain comes complete with safety cables and power cord. Both are routed through a center channel for added safety, convenience and a clean, uncluttered appearance.

Beyond its many performance features, the Sterling All-Terrain is aesthetically pleasing — its powder-coated finish and sleek design complement your coach and your car. As well they should — the Sterling All-Terrain exemplifies ROADMASTER's highest standards, as well as yours.

- Freedom Latch™ — disconnects first time, every time
- Includes safety cables and power cord
- Urethane bushings eliminate metal-on-metal friction for a smoother ride
- Solid stainless steel inner arms — for smooth, trouble-free operation
- Built-in channel guides — support and protect the safety cables and power cord
- Storage latch — fold the tow bar and it automatically locks in place
- EZ Hook safety cables — for quick connect and disconnect
- Stainless steel metal-flake powder-coat finish

**Includes the safety cables and the power cord**  
Includes 8,000-pound GVWR capacity EZ Hook safety cables and a 6-wire power cord.



Includes "easy on, easy off" EZ Hook™ safety cables

## Sterling All-Terrain

- 576 Sterling All-Terrain tow bar**  
8,000-pound weight capacity motorhome-mounted tow bar — weighs 35 pounds with safety cables and a 6-wire power cord with one 6-wire plug (attached) and one 7-wire plug
- 9284-2 Sterling All-Terrain Combo Kit** (the accessories you need, matched to your Sterling All-Terrain tow bar — see page 17)



# Tow Bars



## 6,000 pound weight capacity motorhome-mounted tow bar

- The use of stainless steel in virtually every moving component allows for smooth, trouble-free operation and prevents corrosion that binds.
- Autowlok locking mechanism — allows both tow bar arms to extend or retract for a quick connection. Then, as you drive away, the arms self-center and automatically lock.
- A patented latching mechanism ensures secure, easy storage on the back of your motorhome.
- One-person quick connect and disconnect — thanks to ROADMASTER's self-supporting "quick-disconnects," one person can easily connect or disconnect the Falcon 2 in seconds.
- Full-length, steel crossbar reinforced for maximum support and safety
- A lustrous, high-tech powder coat finish for maximum durability



## Falcon 2

- 520** Falcon 2 tow bar — weighs 37 pounds
- 525** Falcon 2 tow bar (fits Blue Ox brackets) — weighs 37 pounds
- 055-3** Falcon 2 tow bar cover
- 9243-1** Falcon 2 Combo Kit\* with straight safety cables and power cord
- 9243-2** Falcon 2 Combo Kit\* with coiled safety cables and power cord
- 066** Release tool — aids in unlocking tow bar arms when bound — not necessary with any All-Terrain tow bar

\* Contains the accessories you need, matched to your Falcon 2 tow bar — see page 17.



Time Tested • Time Proven



## Autowlok™ System

Stainless steel arms and Autowlok System for smoother and easier hookups and disconnects.

## Falcon 2 stowed

In the folded position, the Falcon 2 conveniently stores out of the way on the back of your motorhome. A tow bar cover (sold separately) keeps your tow bar clean.



U.S. patent number 7,004,490

## Patented Storage Latch

The patented Storage Latch makes storing the Falcon 2 tow bar a snap! Simply fold the tow bar toward the motorhome and it will "click," automatically locking in place.

## Quick-disconnects

One person can easily connect or disconnect the Falcon 2 in seconds.



# STOWMASTER™

America's Best-Selling Car-Mounted Tow Bar



## 6,000-pound weight capacity car-mounted tow bar

- Stainless steel in virtually every moving component for smooth, trouble-free operation.
- Autowlok locking mechanism — allows both tow bar arms to extend or retract for a quick connection. Then, as you drive away, the arms self-center and automatically lock.
- Full-length safety cross-bar — a full-length angle iron brace is integrated into the rear of the bar for maximum support.
- Self-lubricating nylon bushings eliminate friction between the inner and outer arms.
- Other tow bars use steel on steel.
- Plug-welded arms — steel plugs seal both ends of the tow bar, preventing corrosion from moisture and debris.
- A lustrous, high-tech powder coat finish for maximum durability.



StowMaster mounts on the towed vehicle and can be easily removed in seconds!

*Note: the StowMaster tow bar will not fit MX, MS or EZ5 style brackets.*



### Autowlok™ System

The Autowlok System makes StowMaster an easy, one-person hookup and disconnect!

### Full-length safety strap

Although you may never need it, it's nice to know that ROADMASTER has built a safety strap into the StowMaster that will prevent the separation of the tow bar in the unlikely event the primary lock should not function. Peace of mind built right in.

- 501** StowMaster tow bar with 2" coupler — weighs 48 pounds
- 504** StowMaster tow bar with 2-5/16" coupler (special order only)
- 581** StowMaster tow bar with 2½" pintle ring — weighs 48 pounds
- 583** StowMaster tow bar with 3" pintle ring (special order only)
- 9252** StowMaster Combo Kit\*
- 052-3** StowMaster tow bar cover

\* Contains the accessories you need, matched to your StowMaster tow bar — see page 17.

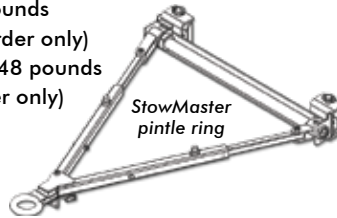

## TRACKER™

The safest, strongest, easiest, most durable, trouble-free, 5,000-pound rated, A-frame tow bar manufactured...  
**BAR NONE!**

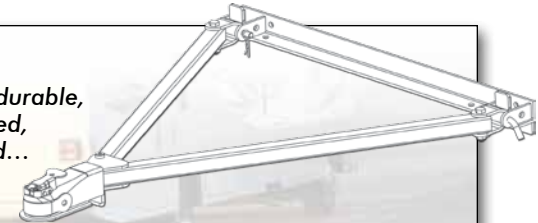

- 020** Tracker tow bar — weighs 20 pounds  
Fits standard 2" ball

*Note: an optional set of quick-disconnects (part number 201) is necessary to remove the front extensions. Tracker will not fit MX, MS or EZ5 brackets.*

## At-a-glance tow bar features

Tow Bar	Feature											Type of Mount		Capacity
	Freedom Latch™	Autowlok™ Latch	Quick-Disconnect System	Pinless Storage Latch	Built-in Cable Guide	Multi-Axis Swivel Control	Solid Stainless Steel Inner Arms	Made from	Made in the U.S.A.	Powder-Coated Finish	Computer-Designed and -Tested	Motorhome-Mounted	Vehicle-Mounted	
Sterling All-Terrain	X		X	X	X	X	X	aluminum	X	X	X	X		8,000
Falcon All-Terrain	X		X	X	X	X	X	steel	X	X	X	X		6,000
BlackHawk 2 All-Terrain	X		X	X	X	X	X	steel	X	X	X	X		10,000
Falcon 2		X	X	X		X	X	steel	X	X	X	X		6,000
StowMaster 501 (with coupler)		X	X				X	steel	X	X	X		X	6,000
StowMaster 581 (with pintle ring)		X	X				X	steel	X	X	X		X	6,000
Tracker								steel	X	X	X		X	5,000

# Tow Bar Mounting Brackets

## Why *our* brackets are the strongest, safest and easiest to use...

- **A better design** — our brackets are integrated into the frame and undercarriage of the vehicle, connecting to existing holes and fasteners wherever possible, for a quick, easy installation by your local professional.
- **Easier installation** — our brackets are 30 percent quicker to install, on average, than other brands — there are fewer components to unbolt or remove and fewer holes to drill.
- **Computer-tested** — every bracket design is subjected to computer-simulated “Finite Element Analysis” (see below) to ensure structural integrity and maximum strength.
- **Custom fit** — every mounting bracket is custom-made to fit a specific vehicle or range of vehicles.
- **We have the bracket for your car** — we have more than

1,200 different brackets available (far more than any other company) — which fit nearly every vehicle made during the last 25 years.

- **Baked-on finish** — every bracket is powder coated. In this process, charged particles of pigment are baked into the surface of the bracket. They fuse to the metal to form a lustrous, uniform and extremely durable finish.

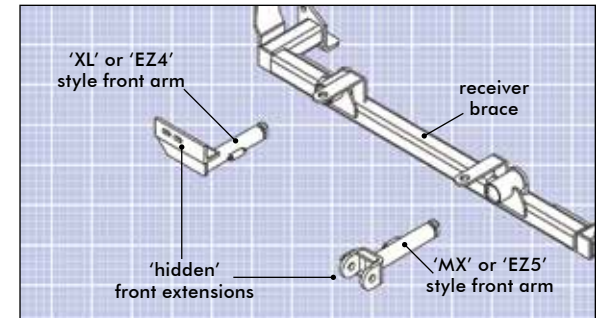

An engineering drawing shows the ‘hidden’ front extensions (see page 7) and a portion of the receiver brace, which is attached behind the fascia. Every ROADMASTER mounting bracket is a custom design. This one fits the 2013-2016 Ford Flex.

## What is ‘FEA?’

ROADMASTER’s computerized testing method is called “FEA,” which stands for “Finite Element Analysis.”

If that sounds complicated, that’s because it is — FEA is the same method NASA engineers use to test their new designs. The automotive and biomedical industries, among others, also use finite element analysis.

Every FEA design is displayed as a full-scale, three-dimensional object, which engineers can rotate and study on the screen as they apply thousands of pounds of force across the load-bearing components. Stress

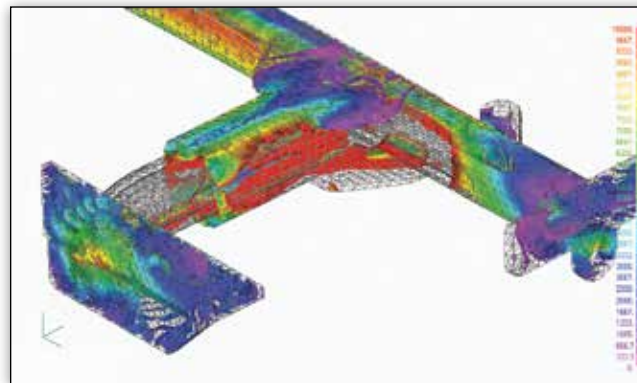

A screen capture image of one facet of FEA testing for a tow bar mounting bracket.

in the steel is pinpointed and the design is manipulated to remove it.

The result is an optimized design, in both materials and components, which has been tested and verified at maximum linear strain — the strongest, safest and easiest-to-use brackets in the industry.

ROADMASTER was the first towing products manufacturer to use computerized stress testing — as well as “real world” physical testing — on our tow bars and mounting brackets to ensure structural integrity, longevity and the safety of your family.



# 'Hidden' Mounting Brackets



Now you see 'em...

...Now you don't!

Since the 1990s, ROADMASTER mounting brackets have been manufactured with front arms which are easily removed when the vehicle isn't being towed — Now you see 'em...now you don't!

**No unsightly steel hanging off the front of your car!**



Made in the U.S.A.

**Do we have a mounting bracket for your car, truck or SUV?**

More than likely.

- Call us (800-669-9690) or
- visit [www.roadmasterinc.com](http://www.roadmasterinc.com).



Front arms attached and removed

## Direct-Connect style

This style allows you to connect your tow bar directly to the mounting bracket, eliminating the need for a crossbar. This is our easiest system to connect and disconnect. If you're using a motorhome-mounted tow bar, this is the bracket you should choose.

*Note: the Direct-Connect style will not accommodate a Guardian™ rock shield, Tow Defender 4700, Stowaway or EZ Hook™ safety cables (like those included with the Sterling tow bar). Use the Crossbar style (shown at bottom) for these items.*

*pictured: a Direct-Connect style EZ5 Twistlock™ mounting bracket*

# Which bracket style is right for you?

## Crossbar style

This style allows you to use our utility mounting platform with a crossbar for flexibility in accessorizing and customizing your towing system with a Guardian rock shield, Tow Defender or Stowaway. If you're using a Sterling All-Terrain or a vehicle-mounted tow bar, you'll need this style of bracket.

*pictured: a Crossbar style EZ4 Twistlock™ mounting bracket*

*\* Crossbar and quick-disconnects included with tow bar or sold separately*

# Supplemental Braking Systems



## Why do you need a supplemental braking system? Here are five reasons...

### 1. Safety first! Supplemental brakes...

- ...take the load off the motorhome. When the motorhome and towed vehicle brake in tandem, it takes significantly less time and distance to come to a controlled stop.
- ...relieve stress on the tow bar and the mounting brackets — a panic stop without supplemental brakes is a leading cause of tow system failure.
- ...reduce the chance of a catastrophic brake failure at the motorhome as a result of sustained braking.

**2. It's required** — According to the American Automobile Association, most states — plus many Canadian provinces — now require supplemental brakes if the towed weight exceeds 3,000 pounds (see page 9).

**3. Chassis warranty** — Workhorse/Chevrolet will void your chassis warranty if you tow more than 1,000 pounds without supplemental brakes; Ford stipulates 1,500 pounds.

**4. Wear and tear** — Because they aren't braking for two vehicles, your motorhome brakes last longer.

**5. It just makes good sense** — Every other trailer on the road today — fifth wheels, travel trailers, boat trailers or semi-trailers — has its own braking system. When you're towing two or three extra tons, shouldn't you have a supplemental braking system to stop it?

**Need help choosing a supplemental braking system?  
Call our experts at 800-669-9690.**

## Which system is right for me?

**A 'direct' system?** — **BrakeMaster** is recommended if you don't frequently change motorhomes or towed vehicles. Because it connects directly to the motorhome's braking system, the initial installation is longer than a portable system. But once installed, it's a truly trouble-free and easy-to-use braking system.

**A 'set-it-and-forget-it' system?** — **InvisiBrake** is recommended if you like convenience above all else and plan on keeping your towed vehicle for the foreseeable future. InvisiBrake is not a portable system, but the major components can be easily removed and installed in a new towed vehicle.

**Or a portable?** — **Even Brake** and the **9700** are recommended if you change towed vehicles or motorhomes often. Both are portable systems, with no installed components in the motorhome except for a dashboard monitor. Initial installation time is approximately one hour, depending on the vehicles.

**Even Brake** is a sophisticated system with proportional braking; the **9700** is a basic system which applies a pre-set braking pressure.



**BrakeMaster™**  
Proportional braking system



**InvisiBrake®**  
'Set-it-and-forget-it' braking system



**Even Brake®**  
Portable proportional braking system



**9700**  
Portable pre-set braking system

### All systems...

- ...will bring your towed vehicle into compliance with U.S. and Canadian requirements.
- ...include an emergency break away system, to stop your towed vehicle should it ever separate from the motorhome.
- ...work in virtually any towed vehicle with power brakes.
- ...work in virtually any motorhome.
- ...greatly decrease your stopping distance, helping you avoid the danger and hassle of accidents.



Time Tested • Time Proven



# Weight limits for towing without supplemental brakes







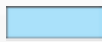

## It's required!

The states in **red** require supplemental brakes if the towed weight exceeds 3,000 pounds.

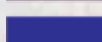

The color key for the other states, as well as state-by-state weight limits, is listed below.

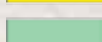
### SPECIFIC WEIGHT LIMITS — UNITED STATES

If the towed weight exceeds the following, a supplemental braking device is required.

	1,000 pounds (New York)
	1,500 pounds (Cal., ID, NV)
	2,000 pounds (Mississippi)
	3,000 pounds (28 states & DC)
	4,000 pounds (NC, RI, DE)
	4,500 pounds (Texas)
	5,000 pounds (Alaska)
	10,000 pounds (Massachusetts)
	15,000 pounds (Michigan)

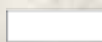
### OTHER CATEGORIES

	Must stop within a specified distance
	Not stated or no requirement
	Supplemental brakes always required

### KEY

- 'A' Must stop within a specified distance
- 'B' Not stated or no requirement
- 'C' Supplemental brakes always required

*Important! Every reasonable effort was made to verify the accuracy of this information; however, ROADMASTER, Inc. does not warrant its accuracy and disclaims all liability for any claims or damages which may result from errors or omissions.*

Source:  
American Automobile Association Digest of Motor Laws  
as viewed at [www.drivinglaws.aaa.com](http://www.drivinglaws.aaa.com) (October, 2016)

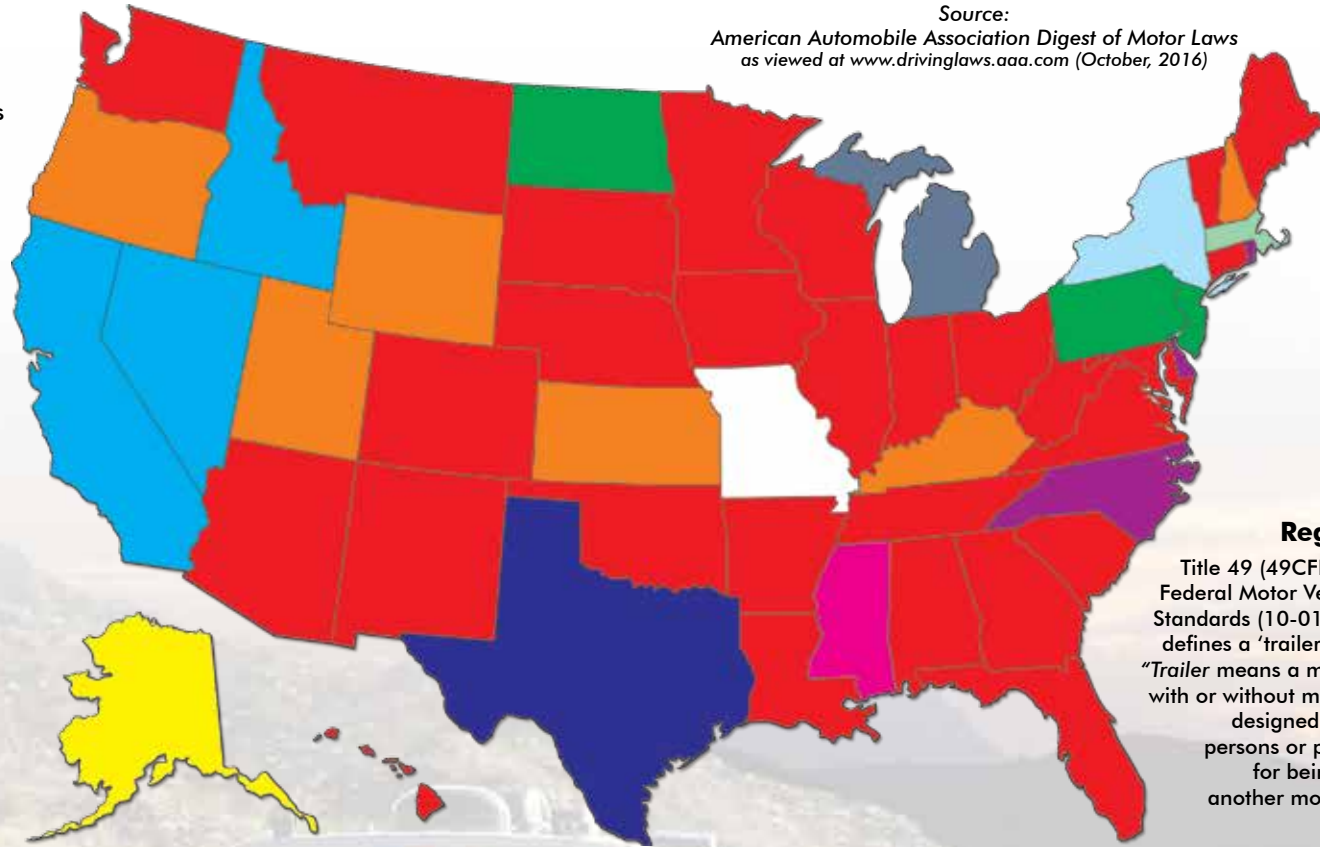

### Federal Regulations

Title 49 (49CFR571) of the Federal Motor Vehicle Safety Standards (10-01-08 edition) defines a 'trailer' as follows: "Trailer means a motor vehicle with or without motive power, designed for carrying persons or property and for being drawn by another motor vehicle."

### United States

STATE	WEIGHT LIMIT IN POUNDS OR OTHER RESTRICTION (SEE 'KEY')
Alabama	3,000
Alaska	5,000
Arizona	3,000
Arkansas	3,000
California	1,500
Colorado	3,000
Connecticut	3,000
Delaware	4,000
District of Columbia	3,000
Florida	3,000
Georgia	3,000
Hawaii	3,000
Idaho	1,500
Illinois	3,000
Indiana	3,000
Iowa	3,000
Kansas	'A'

STATE	WEIGHT LIMIT IN POUNDS OR OTHER RESTRICTION (SEE 'KEY')
Kentucky	'A'
Louisiana	3,000
Maine	3,000
Maryland	3,000
Massachusetts	10,000
Michigan	15,000
Minnesota	3,000
Mississippi	2,000
Missouri	'B'
Montana	3,000
Nebraska	3,000
Nevada	1,500
New Hampshire	'A'
New Jersey	'C'
New Mexico	3,000
New York	1,000
North Carolina	4,000

STATE	WEIGHT LIMIT IN POUNDS OR OTHER RESTRICTION (SEE 'KEY')
North Dakota	'C'
Ohio	3,000
Oklahoma	3,000
Oregon	'A'
Pennsylvania	'C'
Rhode Island	4,000
South Carolina	3,000
South Dakota	3,000
Tennessee	3,000
Texas	4,500
Utah	'A'
Vermont	3,000
Virginia	3,000
Washington	3,000
West Virginia	3,000
Wisconsin	3,000
Wyoming	'A'

### Canada

PROVINCE/TERRITORY	WEIGHT LIMIT IN POUNDS OR OTHER RESTRICTION (SEE 'KEY')
Alberta	2,000
British Columbia	4,400
Manitoba	'A'
New Brunswick	3,000
Newfoundland	'A'
Northwest Territories	'C'
Nova Scotia	4,000
Nunavut	'A'
Ontario	3,000
Prince Edward Island	3,300
Quebec	2,860
Saskatchewan	3,000
Yukon Territory	2,000

# Portable Proportional Braking

## **EVEN BRAKE<sup>®</sup>**

### **Portable Proportional Braking System**

#### **Even Brake...Even Safer.**

Even Brake is the ultimate portable, proportional towed vehicle braking system. It automatically increases or decreases braking pressure in direct proportion to the motorhome. In other words, it brakes evenly — at the same time, and at the same intensity, as you brake the motorhome.

Proportional braking is a distinct advantage over 'on-or-off' systems, which brake at one preset level, no matter how hard the motorhome stops. Even Brake delivers full emergency braking when you need it, and won't cause excessive brake wear when you don't.

Nobody brakes the same way every time — and neither does Even Brake.



**9400 Even Brake portable proportional braking system**



#### **Even Brake's monitor gives you complete, continuous braking information — at a glance.**

Even Brake stays in constant communication with the motorhome, and with you. It reports any braking activity or a change in system status to a wireless monitor in the motorhome.



The monitor **shows** you —

- An LED display across the top of the monitor illuminates when Even Brake is applying the brakes or if there is any change in the braking system. The LED display is a quick, visual reference — a green, yellow or red light.
- Simultaneously, an LCD text message directly below the LED explains the current braking condition, in complete detail.

The monitor **tells** you —

- In addition to the LED display and the LCD text message, an audio tone will alert you to an emergency braking condition.



# EVEN BRAKE<sup>®</sup>

## Exclusive Features

- **Full-time proportional braking** — proportional braking is even braking — your towed vehicle's brakes respond to your motorhome's brakes, at the same time and intensity.
- **Constant self-diagnostic testing** — Even Brake monitors its own performance constantly, and any change in system status is transmitted to the motorhome monitor. Even Brake is the only supplemental braking system that checks itself, so you don't have to — a glance at the monitor assures you that Even Brake is fully operational.
- **'Power Save' low battery protection** — Even Brake warns you of a low battery in the towed vehicle with LED and LCD alerts at the motorhome monitor, giving you time to recharge the battery. If the battery voltage drops too low, Even Brake goes into sleep mode, while retaining emergency braking power.
- **'Terrain-Sensing Logic'** — Even Brake adjusts to uphill or downhill grades and to rough terrain by automatically leveling itself. Because it's always level, Even Brake always brakes with maximum efficiency.

## Additional Features

- **Automatic brake protection** — the monitor alerts you after an extended period of continuous braking, then Even Brake releases braking pressure, avoiding excessive wear on the towed vehicle's brakes.
- **Easily adjusts to individual braking preferences** — adjust braking force and sensitivity at the touch of a button.
- **On-board memory** — even when unplugged, Even Brake will remember your adjustment settings and will automatically level itself.
- **Completely portable** — easily transfers from vehicle to vehicle without expensive labor fees; connects and disconnects in seconds.
- **Automatically delivers maximum braking pressure in an emergency or a break away situation** — Even Brake works the most when you need it the most.
- **Small and lightweight** — fits in virtually all vehicles, with plenty of "elbow room" under the steering wheel and dash.
- **High-capacity air compressor** — recovers quicker — ready for the next stop nearly twice as fast as other systems.
- **Includes an emergency break away system**
- **Adjustable brake pedal clamp** — fits brake pedals that other systems can't.
- **Adjustable monitor lights** — bright for daytime driving; dimmer switch allows the monitor lights to be dimmed for nighttime driving.
- **Four independently adjustable feet** — for a stable platform in vehicles with uneven floors.

**9400** Even Brake portable proportional braking system

# Portable Pre-set Braking

## Efficient, effective...and **EASY!**

The 9700 is a preset system with three braking preferences — light, **medium** or **heavy** braking. Or, the 9700 may be set to activate only in an emergency break away.

The 9700 uses the electrical connections already in place on your towed vehicle (the towed vehicle's electrical harness) to brake when you brake the motorhome — the same electrical signal that activates the towed vehicle's brake lights also activates the 9700.

## 9700 Features

- Three braking pressure presets: light, medium or heavy
  - Or, the 9700 may be set to activate only in a break away
- Activates only when the motorhome's brake lights illuminate — no false braking!
- Connects and disconnects from the towed vehicle in just a minute or two
- Includes an LED motorhome monitor for a visual reference of braking activity
- Includes an emergency break away system
  - The 9700 automatically delivers maximum braking pressure in a break away.
- Automatically protects the towed vehicle's brakes
  - The 9700 releases braking pressure after an extended period of braking, then activates the next time the motorhome's brakes are applied.
  - Audible alert at motorhome indicates extended braking.
- Easily transfers from one towed vehicle to another, without expensive labor fees. (Initial installation is typically under an hour, depending on the vehicles.)
- Recovers quicker — the 9700 is ready for the next stop nearly twice as fast as other systems with smaller air compressors.
- Includes an emergency break away system
- Adjustable brake pedal clamp — fits brake pedals that other systems can't
- Does not accumulate water in the reservoir tank, unlike other systems — no puddles on the carpet!
- Four independently adjustable feet — for a stable platform in vehicles with uneven floors
- Meets U.S. and Canadian braking requirements

**9700** 9700 portable braking system



**9700**  
ROADMASTER  
PORTABLE BRAKING SYSTEM



# A revolutionary innovation in supplemental braking — nothing.

**Z**ip. Zero. Zilch. Nothing. Nada. Nil.

That's what you have to do to connect and disconnect InvisiBrake. There's nothing to take in and out of your towed vehicle and there's nothing to push, pull, set, adjust, activate or deactivate.

What could be easier than nothing at all?

patent pending



# INVISI BRAKE®

## What is InvisiBrake®?

InvisiBrake is a fully-automatic supplemental braking system that uses the electrical connections already in place on your towed vehicle (the towed vehicle's electrical harness) to brake when you brake the motorhome — the same electrical signal that activates the towed vehicle's brake lights also activates InvisiBrake.

## Features

- **Out of sight**  
InvisiBrake is so small (8¾" x 8¾" x 2¾") it can usually be mounted under the driver's seat, under the rear seat, behind interior panels or in the trunk, without sacrificing any of the vehicle's usable space.
- **Set-it-and-forget-it braking**  
Once it's installed, InvisiBrake just works. There's nothing for you to remember — not even an 'on' switch — just plug in the umbilical cord like you always do and you're ready to go!
- **Charges your battery while towing**  
InvisiBrake connects directly to the towed vehicle's battery and trickle-charges the battery during towing — InvisiBrake will never drain the battery.
- **Two-stage motorhome monitor**  
InvisiBrake includes an LED monitor for a visual reference of braking activity; an audible alert at the motorhome will warn you if the brakes have been on for too long.
- **Activates only when the motorhome's brake lights illuminate** — no false braking!
- **Energizes your power brakes** — most braking systems work on a 'dead' brake pedal. InvisiBrake energizes your power brakes so that you have the same power braking system while towing as you do while driving.
- **Works in virtually any towed vehicle with vacuum-powered brakes** — including hybrids and those with full-time ('active') power braking systems.
- **Includes an emergency break away system**
- **Easily adjusts to individual braking preferences** — braking pressure is adjustable from five to 100 psi.
- **Meets U.S. and Canadian braking requirements**

**8700** InvisiBrake supplemental braking system



# Set-It-and-Forget-It Braking

Simple. Reliable. Made to last.

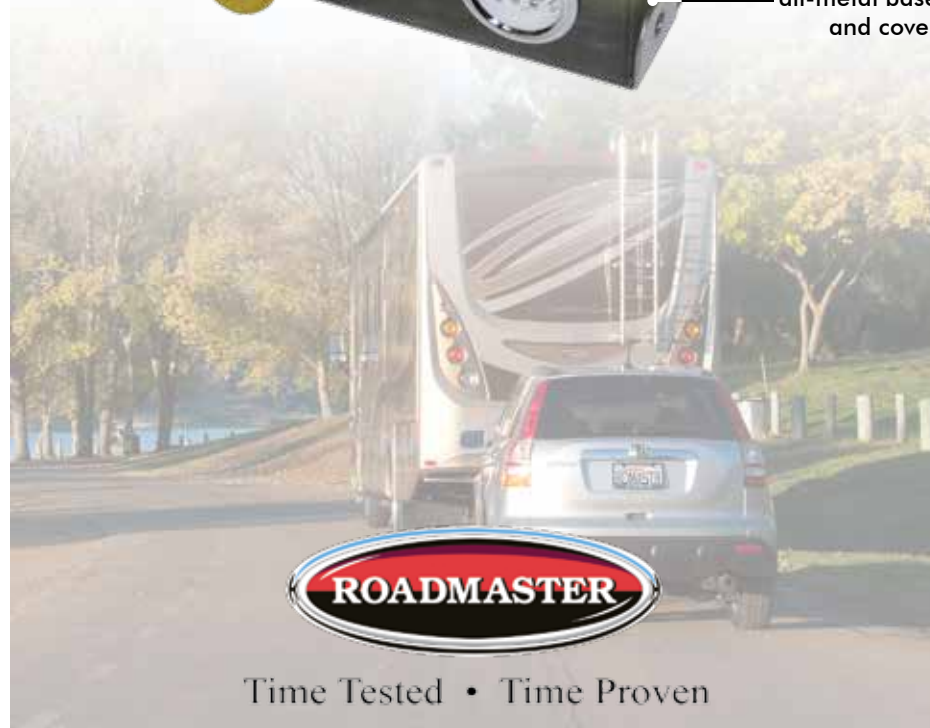
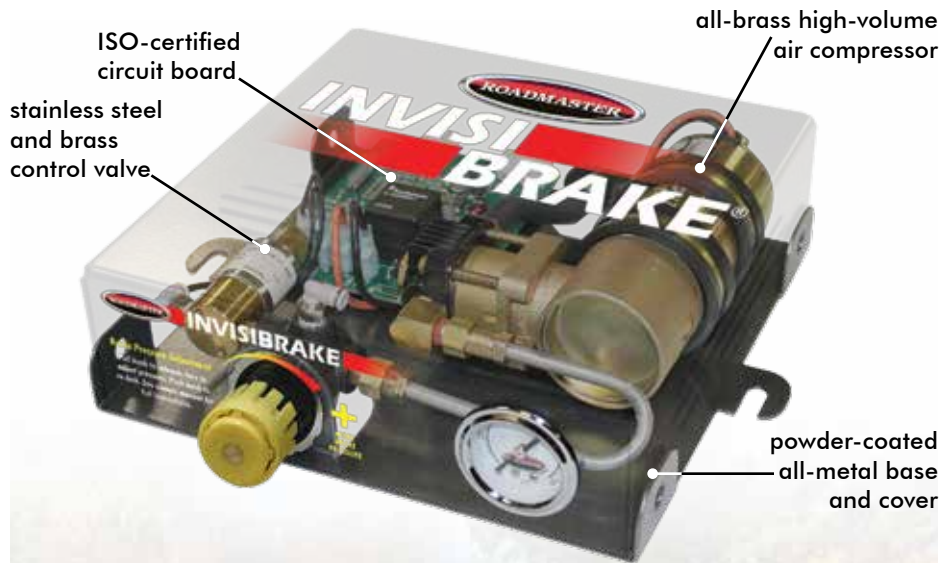

## Why is InvisiBrake better?

- **Nothing** to put in or take out to tow or drive.
- **Hidden from view** — As the name implies, InvisiBrake is hidden once installed. There's no unsightly equipment to see in your car.
- **Simple operation** — works intuitively. No fuss, no hassle.
- **Charges your battery** — trickle-charges the battery while towing. Never drains your towed vehicle's battery.
- **Power brakes** — InvisiBrake engages the power braking system, giving you the same power brakes whether towing or driving.
- **Safety is standard** — includes a break away system and a monitor alarm.



## How does InvisiBrake work?

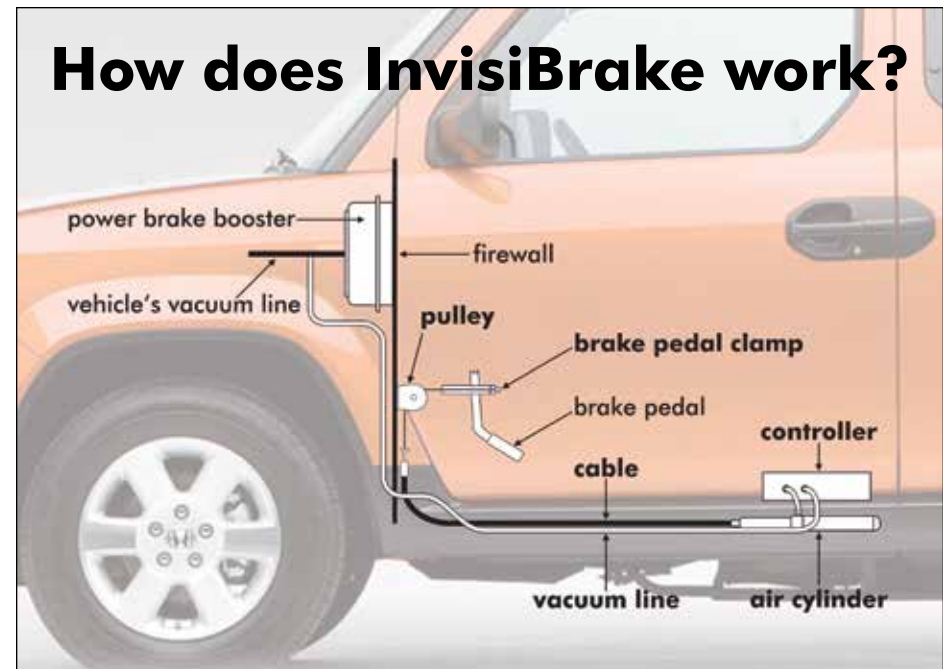

1. The controller receives a braking signal from the motorhome.
2. The vacuum created by the controller activates the power brakes.
3. The air cylinder pulls a cable that applies the brakes.

# 'Direct' Proportional Braking

## by ROADMASTER™ **BRAKEMASTER™**

PROPORTIONATE TOWED CAR BRAKING SYSTEM

### What is BrakeMaster?

BrakeMaster is ROADMASTER's 'direct' proportional braking system. It connects directly to the motorhome's air or hydraulic braking system for rock-solid, reliable braking — brake line pressure in the motorhome controls the brakes in the towed vehicle.

Because it connects directly to what powers your motorhome's brakes, BrakeMaster is a truly proportional, truly synchronized braking system — however you brake the motorhome, BrakeMaster automatically applies the same pressure. Every time.

Connects and disconnects from the towed vehicle in under a minute, without any tools, adjustments or settings — attach the brake pedal adaptor (see BrakeMaster Accessories on the next page), quick-connect the air hose, and you're ready to tow.

Weighs just 3¾ pounds and measures 17 inches in length — stores almost anywhere.



### BrakeMaster...

- ...works in virtually any motorhome.
- ...works in virtually any towed vehicle with power brakes.
- ...easily disconnects from the brake pedal — from towed car to road car in seconds!
- ...includes a break away emergency braking system.
- ...meets U.S. and Canadian braking requirements.

There's a BrakeMaster for all three types of motorhome brakes...

- 9060** BrakeMaster with BrakeAway for motorhomes with hydraulic brakes
- 9100** BrakeMaster for motorhomes with air or air over hydraulic brakes
- 9160** BrakeMaster with BrakeAway for motorhomes with air or air over hydraulic brakes
- 104** Air cylinder storage bag (for all three BrakeMasters)
- 8600** BrakeAway emergency braking system (included with 9060 and 9160)

Included with BrakeMaster models 9060 and 9160, the BrakeAway towed vehicle emergency braking system works in conjunction with your BrakeMaster to bring your towed vehicle to a controlled stop should it ever separate from your motorhome.

The BrakeAway is available separately but you must have an installed BrakeMaster system for it to function.

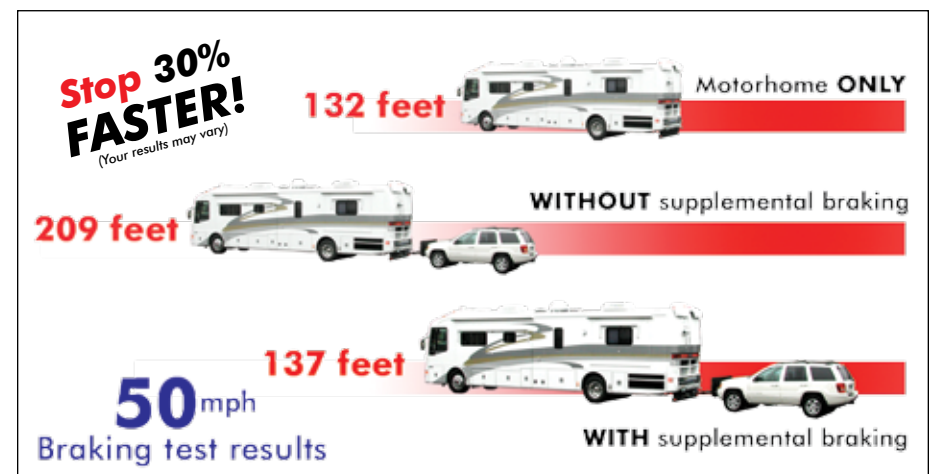



# BrakeMaster Accessories



## Seat adaptors — 88XXX

Provide a vehicle-specific mounting location to pin the BrakeMaster. Available for most vehicles; required on some applications. Visit [www.roadmasterinc.com](http://www.roadmasterinc.com) to see if one is available or required for your vehicle.

## Second vehicle kits

**98100/98160** — If you switch BrakeMaster between two vehicles, install the 98100 or the 98160 in the second vehicle. Both kits contain monitor wiring, air lines and installation hardware; the 98160 also includes a BrakeAway.

## Second motorhome kits

**98200/98300** — If you change motorhomes, install these components in the motorhome. The 98200 is for motorhomes with air or air over hydraulic brakes; the 98300 is for motorhomes with hydraulic brakes.

## 900002 Brake Pressure Reducer

With the Brake Pressure Reducer, you can install BrakeMaster in a hybrid, a Hummer H3 or in any vehicle with a full-time ('active') power braking system — reduced air pressure eliminates over-braking issues.

Works in any supplemental braking system which uses pressurized air to brake the towed vehicle.

## Metric-to-Standard Brake Line Tees

Use these tees to install the BrakeMaster 9060 proportioning valve in motorhomes with metric brake lines.

**7923** for 10 millimeter brake lines. Fits virtually all metric brake lines for this application.

**7921** for 12 millimeter brake lines



## 104 Air cylinder storage bag

Protect your air cylinder when you're not towing. The storage bag is made of marine-grade vinyl, with a Velcro closure, and has two carrying straps.

Approximate size: 26" w x 7½" h

## 921004-88

### 88-inch patch cord

If you're using a drop hitch, receiver extension or any accessory which extends the length of the towing system, use this patch cord. It's 12 inches longer than the standard BrakeMaster patch cord (part number 921004).



Brake Pressure Reducer



7923 Brake Line Tee

# Accessories for InvisiBrake, Even Brake and the 9700



**9332**  
12-volt outlet kit  
four-foot cord

**9331**  
12-volt extension cord  
six-foot cord



**9330** 12-volt 'Y' adaptor



## Second vehicle kits

### 98800 For the 9700

If you switch the 9700 between two vehicles, install this break away system, and monitor and brake light signal wiring, in the second vehicle.

### 98400 For Even Brake

If you switch Even Brake between two vehicles, install this break away system, ICX transmitter and Brake-Lite Relay in the second vehicle.

### 98700 For InvisiBrake reinstallation

(note: InvisiBrake is not designed to be switched between two vehicles.)

If you replace your towed vehicle, you can transfer the InvisiBrake controller and air cylinder to the new vehicle with these components.

## Second motorhome kit

### 98850 For InvisiBrake and the 9700

If you change motorhomes, install these components in the motorhome.

## InvisiBrake pulley mounting bracket

### 8700-PBC

If there is no flat surface to mount the InvisiBrake pulley due to curves, recesses or obstructions in the firewall, use this optional bracket.

## Air cylinder shaft and foot extensions

For Even Brake and the 9700

### 9336/9336-3 Air cylinder shaft extensions

Extends the reach of the air cylinder shaft by either 1½ inches (part number 9336) or by 3½ inches (part number 9336-3).

### 9337/9337-4 Foot extensions

Allows the 9700 or Even Brake to sit up to one inch higher in the vehicle. Available singly (part number 9337) or in a four-pack (part number 9337-4).

# Accessories for All Roadmaster Braking Systems (BrakeMaster, Even Brake, InvisiBrake and the 9700)



## 8603 Break away cable

A self-supporting, coiled design provides lift off the road surface while still allowing plenty of slack for cornering. Extends to eight feet and conveniently retracts for storage. Ideal for virtually any break away system.

## Why do I need a Brake-Lite Relay?

### What does the Brake-Lite Relay do?

It stops the brake lights from functioning until the vehicle is started. This prevents the towed vehicle's brake signal from overriding the motorhome's turn signal.

When you tow without the Brake-Lite Relay, your towed vehicle's brake lights **alone** will work fine. Your turn signals **alone** will work fine. But if you're braking **and** turning, the brake light from the towed vehicle will override the turn signal from the motorhome and drivers behind you will be unaware you're about to turn.

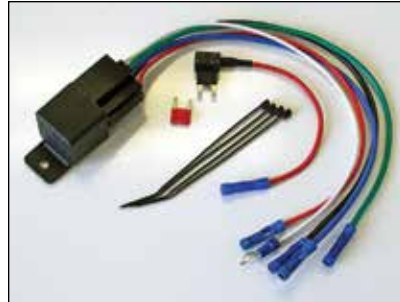

### Do you need a Brake-Lite Relay?

You only need a Brake-Lite Relay if you're installing a supplemental towed vehicle braking system that pushes or pulls the brake pedal.

Exceptions –

- With the engine off, step on your brakes. If the brake lights do not illuminate, you do **not** need a Brake-Lite Relay.
- If you're using magnetic tow lights or a bulb and socket wiring kit, you do **not** need a Brake-Lite Relay.
- If both your motorhome and towed vehicle are wired for separate brake and turn signals, you do **not** need a Brake-Lite Relay.



*Note: many newer vehicles have a 'sleep mode' which shuts down most electronics, including the brake lights, when the engine is turned off. However, this sleep mode isn't instantaneous — it takes a certain amount of time to kick in. Until that happens, your vehicle's brake lights will override the turn signal during towing.*

*To avoid this you can either: a) install a Brake-Lite Relay; b) wire the vehicle so that the turn signals function while towing; c) install a bulb and socket kit; or d) wait for the sleep mode to activate before towing. The option you choose is a function of what works best for your particular towing combination.*

## 88400 Brake-Lite Relay

Comes standard with Even Brake®.

- Wiring and components included
- Easy-to-follow instructions



break away switch  
break away pin and ring

## 650898 Break away switch, pin and ring 200200-20 Break away pin and ring

Our replacement break away switch has a sealed, corrosion-resistant ABS housing and metal contact points.

The replacement break away pin is attached to a plated steel ring and comes with a water-resistant O-ring seal.

## Why do we make stop light switches?

For your peace of mind.

ROADMASTER uses the stop light switch to connect InvisiBrake, BrakeMaster, Even Brake and 9700 motorhome monitors directly to the towed vehicle's brake light, so you always know when the brake pedal is depressed and released. It's simple — brake light on: monitor on; brake light off: monitor off.

If any particular vehicle's stop light switch doesn't work when it's being towed, we make one for it that does.

Other manufacturers' motorhome monitors are connected to the supplemental braking system. They only tell you when the supplemental braking system is on or off.



That's an important distinction, and here's why:

Say the braking system is positioned too far forward, so it's riding on the brake pedal. Every ROADMASTER monitor will accurately indicate continuous braking, notifying you of a problem before you even drive away. But motorhome monitors that are connected to the supplemental braking system will have nothing to report. That would likely result in brake damage.



## Here's how to tell if you need a stop light switch...

If the brake lights don't work with your towed vehicle's ignition key turned to the "tow" position, you need a stop light switch.

ROADMASTER manufactures stop light switch kits for most popular towed vehicles; check online at [www.roadmasterinc.com](http://www.roadmasterinc.com) for the most current list.

**Stop light switch kits** — 751XXX





Time Tested • Time Proven



shown: 9243-1

### Your Combo Kit includes a seven-wire plug

Why? Because most motorhomes are now equipped with seven-wire sockets. The plug is already attached to one end of the power cord, which will simplify the installation for the majority of our customers. (Since the Sterling All-Terrain comes with a power cord, the Sterling All-Terrain Combo Kit does not include one.)

# Combo Kits

**Tow bars, you've met your match.**  
Combo Kits contain the accessories you need, matched to your ROADMASTER tow bar.

Each Combo Kit contains:

- Electrical components —
  - A wiring kit with four Hy-Power diodes
  - A straight or Flexo-Coil™ power cord to connect electricity between the vehicles, with a 7-wire plug for the motorhome (attached) and a plug and socket for the towed vehicle  
(Since the Sterling All-Terrain tow bar comes with a power cord, the Sterling All-Terrain Combo Kit does not include one.)
  - A bracket to mount the power cord socket
- A pair of safety cables rated at 6,000-, 8,000- or 10,000-pound GVWR capacity, depending on the model you choose — see below  
(Since the Sterling All-Terrain tow bar comes with safety cables, the Sterling All-Terrain Combo Kit does not include them.)
- Two or three (9252) case-hardened steel padlocks (keyed alike) — for added security
- A marine-grade vinyl cover (see page 24) to protect your tow bar
- A marine-grade vinyl storage bag (see below) — for all your towing accessories

### Combo Kits

#### 9284-2 Sterling All-Terrain

Does not include safety cables or power cord

#### 9252 StowMaster and StowMaster All-Terrain — 6,000-pound capacity

With coiled safety cables and coiled power cord

#### 9243-1 Falcon 2 and Falcon All-Terrain — 8,000-pound capacity

With straight safety cables and straight power cord

#### 9243-2 Falcon 2 and Falcon All-Terrain — 6,000-pound capacity

With coiled safety cables and coiled power cord

#### 9243-3 BlackHawk 2 All-Terrain — 10,000-pound capacity

With coiled safety cables and straight power cord

### ROADMASTER tow bag

Keep your towing accessories in one place and keep dirt and grime out of your car or motorhome. A great way to store safety cables, the power cord and other small accessories. Made from marine-grade vinyl, with a Velcro closure.

#### 056 Tow bag

(approximate size: 10" w x 14" h)



# Protection and Storage



**Protects your towed vehicle and RV against dings and rock chips.**



Made in the U.S.A.

**T**he Guardian is crafted from rotationally-molded, high-impact polyethylene to absorb the impact of rocks, gravel and road debris — instead of ricocheting it back at the motorhome.

The Guardian can be attached and removed in seconds, and fits all ROADMASTER tow bars equipped with quick-disconnects (Note: MX, MS and EZ5 brackets will not accommodate the Guardian). Can also be used with a tow dolly to help protect your towed vehicle by using Guardian bracket part number 2000-8 (see page 31).

If you tow more than one vehicle, the second vehicle kit has all the mounting hardware necessary to swap the Guardian from one vehicle to another.

- 4000 Guardian rock shield**
- 2000-8 Guardian adaptor for tow dollies**
- 4000-1 Second vehicle kit**

**For maximum protection, use a Guardian and a Tow Defender** (see page 19).

Motorhomes kick up rocks, gravel and road debris, but so does oncoming traffic. A Tow Defender/Guardian combination protects your towed vehicle's finish, headlights and windshield against damage from both lanes.

## Guardian storage system

The 4000-10 Stowaway slides over your tow bar's stinger or ball mount to convert the rear of your motorhome into a storage area for your Guardian rock shield. A center cut-out affords quick and easy access to most motorhome electrical components.

In addition to these features, the 4000-40 Stowaway has a drop-down collar with a pull-pin design that allows you to easily remove the Stowaway for access to the rear diesel compartment.

With a set of optional quick-disconnects (part number 222, page 25), both Stowaways will also store either a StowMaster tow bar or a ROADMASTER quick-disconnect crossbar.

- 4000-10 Stowaway**
- 4000-40 Stowaway with rear RV access**



shown: Stowaway 4000-40



## RoadWing™ removable mud flap system

RoadWing's 'anti-sail' design keeps the mud flaps down, where they can stay on the job — double-bolt attachment points hold the system in place and grooved interior channels deflect rocks, gravel and road debris down and away from your towed vehicle or trailer.

The RoadWing fits most 2" hitch receivers. It slides over your ball mount or tow bar stinger and is easily attached with set bolts, or just as easily detached. The 24" x 24" flaps can be trimmed to fit nearly any vehicle.

The four models below fit vehicles from full-size trucks to buses, motorhomes and trucks with dual tires.

- 4400**      **77-inch** – fits full-size trucks
- 4400-73**    **73-inch** – fits SUVs and midsize trucks
- 4400-69**    **69-inch** – fits mini-pickups and small SUVs
- 4400-102**   **expandable** from 91" to 102" for motorhomes, buses and trucks with dual tires
- 200345-00**   **one replacement mud flap** (24" x 24") for the 4400, 4400-73 or the 4400-69
- 200345-36**   **one replacement mud flap** (24" x 36") for the 4400-102



for 2" hitch receivers



Hitch or ball mount not included



Gas struts automatically compress for cornering.

## A bumper-to-bumper blanket of protection!

The Tow Defender's all-weather, heavy-duty screen deflects rocks, gravel and road debris down and away, protecting your towed vehicle's finish, headlights and windshield against chips and dings. The vinyl-coated mesh lets air through, keeping it low and over the road.

Fully extended, both Tow Defenders offer 20 square feet of protection, and are held in place with shock-absorbing gas struts.

Once you've reached your destination, roll up the Tow Defender, snap the elastic straps around each end and store it against the motorhome.

- Quick installation and release
- Lightweight and compact — weighs just 14½ pounds, and rolls up to four inches in diameter
- Powder-coated steel supports and heavy-duty gas struts for maximum durability, support and cornering flexibility
- Reinforced seams and gussets for added longevity

**4700 Tow Defender** — fits all ROADMASTER tow bars with quick-disconnect release systems (does not fit MX, MS or EZ5 brackets)

**4750 Tow Defender** — fits Blue Ox tow bars with Blue Ox brackets, Demco tow bars with Demco brackets and all motorhome-mounted ROADMASTER tow bars

# Safety Cables

Both EZ Hook and Standard safety cables have drop-forged steel hooks and spring-loaded clasps for maximum strength and security.



straight cables (645)



coiled cables (643)

## Standard safety cables

Our aircraft-type, galvanized steel safety cables are continuously tested to ROADMASTER's exacting standards. Each comes fitted with heavy-duty, drop-forged steel hooks with spring-loaded latches. Vinyl coating prevents the safety cables from scratching or chipping the tow bar.

An additional benefit of coiled cables is that they conveniently contract for storage.

Each kit contains two cables, snap hooks and two quick links. Rated at either 6,000-, 8,000- or 10,000-pound capacity, depending on the model you choose.

- 643**    **68" 6,000-pound GVWR capacity single hook coiled** — 1 pair  
The 68-inch length fits most towing combinations.
- 643-2**    **68" 6,000-pound GVWR capacity double hook coiled** — 1 pair
- 645-76**    **76" 8,000-pound GVWR capacity single hook straight** — 1 pair  
The 76-inch length is for towing combinations with accessories that extend the distance between the motorhome and the towed vehicle.
- 645**    **64" 8,000-pound GVWR capacity single hook straight** — 1 pair
- 646**    **64" 8,000-pound GVWR capacity double hook straight** — 1 pair

10,000-pound capacity — part number 653



- 653**    **80" 10,000-pound GVWR capacity double hook coiled** — 1 pair  
The 80-inch length fits most towing combinations, including those with accessories that extend the length of the towing system.

## EZ Hook™ safety cables

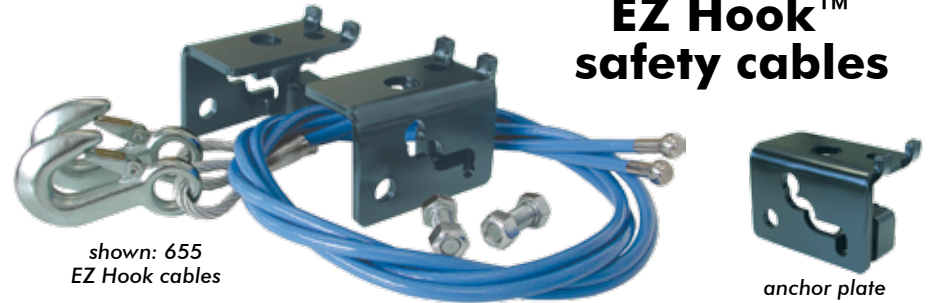

shown: 655 EZ Hook cables

anchor plate

EZ Hook safety cables are faster to connect than other cables. They have all the features of our standard cables with the addition of a unique attachment system — a stainless steel ball at the end of the cable latches into a slotted anchor plate. **Only for ROADMASTER mounting brackets with quick-disconnect systems.**



### 8,000-pound GVWR capacity

- 655**    **1 pair EZ Hook 68" safety cables with anchor plates** —  
The 68" length fits most towing combinations.
- 655-68**    **1 pair EZ Hook 68" safety cables** (without anchor plates)
- 910650-68**    **1 replacement EZ Hook 68" safety cable** (cable only)
- 655-64**    **1 pair EZ Hook 64" safety cables** (without anchor plates) —  
The 64" length is for towing combinations with a shorter distance between the motorhome and the towed vehicle.
- 910650**    **1 replacement EZ Hook 64" safety cable** (cable only)
- 655-76**    **1 pair EZ Hook 76" safety cables** (without anchor plates) —  
The 76" length is for towing combinations with accessories that extend the distance between the motorhome and the towed vehicle.
- 910650-76**    **1 replacement EZ Hook 76" safety cable** (cable only)
- 910653**    **1 pair EZ Hook safety cable anchor plates**

## Safety cable extensions

Extensions (or longer safety cables, see above) may be necessary for use with accessories which extend the length of the towing system. These extensions are also used as bracket safety cables. Each pair includes a pair of quick links. (Single replacement extensions are also available — see page 27.)

### 8,000-pound GVWR capacity

- |                          |                            |
|--------------------------|----------------------------|
| <b>910646-8</b> ..... 8" | <b>910646-16</b> ..... 16" |
| <b>910646-10</b> ... 10" | <b>910646-17</b> ..... 17" |
| <b>910646-12</b> ... 12" | <b>910646-18</b> ..... 18" |
| <b>910646-13</b> ... 13" | <b>910646-19</b> ..... 19" |
| <b>910646-14</b> ... 14" | <b>910646-20</b> ..... 20" |
| <b>910646-15</b> ... 15" | <b>910646-22</b> ..... 22" |



Shown: 8" 8,000-pound GVWR capacity



# Towed vehicle wiring kits

**B**y law, a towed vehicle's turn signals, running lights and brake lights must mimic the motorhome's. There are three ways to accomplish that:

- 1) a wiring kit with diodes;
- 2) a wiring kit with bulbs and sockets; and
- 3) magnetic tow lights.

Whichever one you choose, we have a kit with all the necessary components.

## Universal and economy towed vehicle wiring kits

shown: 154  
Universal kit



These kits use a system of diodes to connect your towed vehicle's turn signals, running lights and brake signals to your motorhome's. Diodes prevent electrical feedback and protect both vehicles' electrical systems.

The Universal wiring kit includes:

- Four Hy-Power™ diodes
- A 27-foot length of 4-wire electrical cord with 4-wire flat connectors
- Three feet of split wire loom
- A six-foot power cord with 4-wire flat connectors (connects electricity between the two vehicles)
- A ring terminal
- Wire connectors
- Cable ties
- Step-by-step instructions

**154 Universal wiring kit**

**152 Economy wiring kit**

Similar to the 154 Universal wiring kit but bulk packed and without the 4-wire plugs or six-foot power cord



## 'All-in-one' towed vehicle wiring kits

shown: 15267  
wiring kit



Complete diode wiring kits for the two most popular towing combinations. They have everything in the Economy wiring kit (described to the left), plus a Flexo-Coil™ power cord (described on the next page).

**15247** For 4- to 7-wire towing combinations

**15267** For 6- to 7-wire towing combinations



## Magnetic towed vehicle wiring kits

Magnetic tow lights are the quick and easy way to connect your towed vehicle's electrical system to your motorhome's. A self-contained system, which requires no splicing into the towed vehicle's electrical system.

- Fits all vehicles
- Magnets hold lights securely
- Heavy-duty vinyl casing for maximum wire protection
- Meets DOT standards
- Includes plugs, sockets and wire harness
- Wiring cable length: 29 feet

**2100 Deluxe magnetic tow lights**

with case, anti-scratch pads and 4-wire cable harness

**2120 Standard magnetic tow lights**

with 4-wire flat plugs and harness



## Bulb & socket towed vehicle wiring kits

A major advantage of a bulb and socket kit is that it bypasses the towed vehicle's electrical system, which eliminates the concern of interacting with any vehicle electronics, or voiding the vehicle manufacturer's warranty.

*Note: the towed vehicle's taillights must have room for an extra socket and bulb inside the lens housing. To see if a bulb and socket will fit in your vehicle, visit [www.roadmasterinc.com](http://www.roadmasterinc.com).*

### LED bulb and socket kit

shown: 152-LED  
wiring kit



LEDs have significant safety and appearance advantages over incandescent bulbs — they're brighter, they activate faster and they last longer. Another advantage is that LEDs draw significantly less amperage and are therefore less of a strain on the electrical system.

This complete kit contains a 27-foot wiring harness, butt connectors, two LED bulbs, two sockets, zip ties, ring terminals, split loom and installation instructions.

**152-LED Bulb and socket kit with LED bulbs**

**152-2** 2-pack of LED bulbs and sockets only

**152-50** 2-pack of LED bulbs only

### Incandescent bulb and socket kit

This economical option has the same components as the LED bulb and socket kit (above), but with incandescent bulbs.

**155** Bulb and socket kit

**155-2** One pair of bulbs and sockets only

**155-10** 10-pack of bulbs and sockets only

# Electrical

## Hy-Power™ diodes

Diodes are used to tie into the towed vehicle's brake light, running light and turn signal wiring, and connect it to the motorhome.

Diodes permit electrical current to flow in only one direction — from the motorhome to the towed vehicle's taillights — preventing electrical feedback and the damage it can cause to both vehicles' electronics.

If you're using a diode, why not use the best? Hy-Power diodes have a heavy-duty aluminum heat sink, and each diode is protected against the elements — all components are housed inside an epoxy-sealed aluminum case.

Four-pack required for most vehicles. Includes detailed wiring instructions.

- 790** one Hy-Power diode    **792** two Hy-Power diodes  
**793** three Hy-Power diodes    **794** four Hy-Power diodes  
**790-25** 25-pack Hy-Power diodes (bulk pack)



## Park Light diode

**Problem** — Electrical damage can occur to the towed vehicle if its headlights are turned on while still connected to the motorhome.

**Solution** — Use a Park Light diode to stop any interaction between the two park light systems, preventing electrical feedback and electrical damage.

Note: the Park Light diode will not replace Hy-Power diodes (see above).

- 690** Park Light diode



## Brite-Lite™ 3-to-2 converter

**If you have this** — the motorhome has separate brake and turn signal lights; the towed vehicle has combined brake and turn signal lights.

**You need this** — the Brite-Lite converter connects a vehicle with a separate brake and turn signal system to a vehicle with a combined brake and turn system, while delivering more current to the towed vehicle's brake and turn signal lights for brighter illumination.

- 732** Brite-Lite 3-to-2 wiring converter

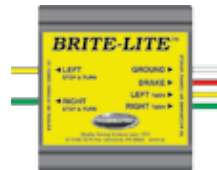

## Flexo-Coil™ and straight power cords

Whatever electrical system you choose, you'll need a cord to connect electricity between the towed vehicle and the motorhome.

ROADMASTER's power cords are the best — the wires are water-, oil- and chemical-resistant, and the plugs are injected with silicone to prevent corrosion.



1466

## Flexo-Coil power cord kits

Flexo-Coil cords expand to more than eight feet and conveniently contract for storage.

For tow bars without cable channel guides

- 164** 4-wire Flexo-Coil cord kit with plugs and sockets  
**1644** 4-wire Flexo-Coil cord kit with plugs, sockets and socket bracket  
**146** 6-wire Flexo-Coil cord kit with plugs and sockets  
**1466** 6-wire Flexo-Coil cord kit with plugs, sockets and socket bracket  
**164-7** 7- to 4-wire Flexo-Coil cord kit with plugs, socket and socket bracket  
**146-7** 7- to 6-wire Flexo-Coil cord kit with plugs, socket and socket bracket

## Straight cord power cord kits

For tow bars with cable channel guides (All-Terrain)

- 98164** 4-wire straight cord kit with plugs and sockets  
**98146** 6-wire straight cord kit with plugs and sockets  
**98164-7** 7- to 4-wire straight cord kit with plugs, socket and socket bracket  
**98146-7** 7- to 6-wire straight cord kit with plugs, socket and socket bracket



98146-7

## Bulk power cord components

- 1064-B** Blue 4-wire Flexo-Coil cord without plugs  
**1046-R** Red 6-wire Flexo-Coil cord without plugs  
**1047-B3** 4-wire Flexo-Coil cord with one 4-wire plug and one 7-wire plug  
**1067-R3** 6-wire Flexo-Coil cord with one 6-wire plug and one 7-wire plug  
**650814** Straight blue power cord with one 7-wire plug (installed) and one 4-wire plug (not installed)  
**650816-7** Straight red power cord with one 7-wire plug (installed) and one 6-wire plug (not installed)  
**910030-2** 4-wire plug    **910030-8** 6-wire plug    **9338-77** 7-wire plug  
**910030-1** 4-wire socket    **910030-7** 6-wire socket    **9338-70** 7-wire socket

## Heavy-duty electrical socket brackets

These brackets are made of thick steel — not lightweight sheet metal. They hold the towed vehicle's electrical socket firmly in place, making it easy to plug and unplug the power cord. Both straight and 90° angled brackets fit most electrical sockets, and can be either welded or bolted in place. Black powder coat finish.

- 910030** straight bracket  
**910030-5** bracket with 90° bend



910030-5



## Never disconnect the battery cable to tow!

Eliminate the inconvenience and danger of pulling your battery cable with these battery disconnects. After the initial installation, your vehicle can be towed and then driven without any further adjustment to the battery — ever!

Battery disconnects are ideal for anyone towing a vehicle which must be towed with the battery cable disconnected.

Both battery disconnects...

- ...work on virtually all 12-volt batteries.
- ...are pre-assembled for easy installation.
- ...provide a positive current source for break away systems or other accessories which must be connected to the battery.



766 Remote  
Battery Disconnect

### 766 Remote Battery Disconnect

- Activates with a remote switch usually located inside the towed vehicle's passenger compartment.

### 765 Automatic Battery Disconnect

- Fully automatic 'connect-it-and-forget-it' operation
- Marine-grade solenoid with 200-amp constant duty and 600-amp surge
- Constantly charges the battery (up to full capacity) during towing.
- The motorhome's headlight switch turns the Automatic Battery Disconnect on and off.

Note: not for use with diesel engine vehicles. To see which vehicles can use the battery disconnects, visit [www.roadmasterinc.com](http://www.roadmasterinc.com).



## No more dead battery!

These simple, easy-to-install charge line kits help maintain the vehicle's battery charge while in tow, supplying up to 15 amps of current. They also extend battery life by providing a constant maintenance charge (without overcharging the battery) during towing. Installation hardware is included.

- Heavy-duty 14-gauge (156-25) and 12-gauge (156-75) wire
- Includes a thermal circuit breaker — no need to hunt down a blown fuse

**156-25 Towed vehicle charge line kit**

**156-75 Motorhome charge line kit**

## Don't do the Fuse Limbo...



...Just flip  
a switch!

# FUSEMASTER

How about if you never had to spend another minute with your face on the floor mat, gazing up into a black void, hunting for a minuscule piece of plastic playing hide and seek?

You don't have to.

FuseMaster eliminates the necessity of having to remove a fuse for towing, then having to reinsert it for driving. After it's installed, you simply flip a switch to accomplish the same task.

There are several FuseMasters which, collectively, fit most vehicles which must have fuses removed for towing. To determine the FuseMaster you need, call ROADMASTER (800-669-9690) or click the 'Vehicle Specific Info' tab at [www.roadmasterinc.com](http://www.roadmasterinc.com).

### Pulling a Honda CR-V fuse is "...a real PITA."

"Honda did not give much thought to the location of this fuse. I could not pull it with their fuse puller, ended up using a long needle nose pliers. To re-install the fuse is a real feat — you can't see what you're doing because your hand blocks your view. The hassle of pulling and re-installing the fuse is a real PITA."

— Joe Shigouri, West Jordan, Utah

# Tow Bar and Crossbar Covers

These tow bar and quick-disconnect crossbar covers are made of heavy-duty marine-grade black vinyl, hand-crafted at the ROADMASTER plant for a custom fit.

The quick-disconnect crossbar cover is designed to cover the car-side brackets and crossbar when the tow bar is disconnected.

Proudly displaying the ROADMASTER logo, each



105 crossbar cover

of these 'car wash safe' covers will help keep your tow bar, brackets and quick-disconnect crossbar free of dirt and road grime when not in use, ensuring smooth and easy tow bar operation.



055-3 motorhome-mounted tow bar cover



052-3 StowMaster and StowMaster All-Terrain tow bar cover

- 105** quick-disconnect crossbar cover
- 055-3** for ROADMASTER motorhome-mounted tow bars
- 052-3** for the StowMaster and StowMaster All-Terrain tow bars



## LubeMaster™ silicone spray

LubeMaster is the ideal lubricant for tow bars, awning arms, window tracks, folding steps or for hundreds of other applications around the home and RV.

It's a dry silicone, which does not attract dirt or road grime that can cause binding.

Meets Volatile Organic Compound (VOC) standards.

**747 LubeMaster**

# Tow Bar Padlocks

Don't spend your time worrying about a stranger or kids unlatching or removing your safety pins. Replace them with padlocks and peace of mind. Padlocks discourage theft and tampering and protect against accidental release.

Hardened steel shackle, double ball locking mechanism, and solid brass tumblers and components.



Quick-disconnect padlock

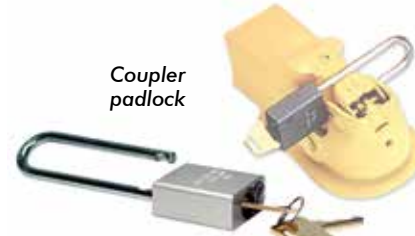

Coupler padlock



Receiver hitch lock

- 301** Quick-disconnect padlock
- 302** 2-pack quick-disconnect padlocks (keyed alike)
- 303** 2-pack quick-disconnect padlocks and 1 coupler padlock (keyed alike)
- 308** 4-pack quick-disconnect padlocks (keyed alike)
- 304** 1 receiver hitch lock and 2-pack quick-disconnect locks
- 305** Coupler padlock
- 315** Receiver hitch lock
- 316** 2-pack receiver hitch locks (keyed alike)

## Tow Bar Cleaner

A fast-acting, environmentally-friendly solution that makes cleaning your tow bar a breeze. Removes dirt and build-up, penetrating into blind holes and between adjacent surfaces. Melts away road film, diesel exhaust, bugs, tar, grease and grime, dirt and debris.

Biodegradable, non-toxic, contains no petroleum distillates or phosphates.

Designed for tow bars but works wonders on any surface that's hard to clean.



**9932 Tow Bar Cleaner** 22 oz. spray





### EZ Twistlock™ receiver inserts

Designed for ROADMASTER EZ Twistlock series brackets, these heavy-duty rubber caps help keep out dirt, gravel and grime when your Twistlock bracket extensions are removed.

Each insert is stamped with the ROADMASTER name and will give your towed vehicle that finished look.

**210 1 pair** — fits 1½" inner diameter tubes, including EZ4 and EZ5 brackets

**212 1 pair** — fits 1¼" inner diameter tubes, including EZ2 brackets



### XL™ receiver inserts

Designed for ROADMASTER XL series brackets, these heavy gauge steel caps help keep out dirt, gravel and grime when your XL bracket extensions are removed.

Each insert is stamped with the ROADMASTER name and will give your towed vehicle that finished look. They fit all 1½" tubes.

**200-5 1 pair XL receiver inserts**



### Safety cable guide

Helps prevent the safety cables and power cord from being crushed or damaged, either between the coupler and the ball or between the ball mount and the road.

Nickel plated; mounts directly underneath the hitch ball.

For car-mounted tow bars or for any towing application that uses a ball mount.

**669 Safety cable guide**

## Towing Accessories



5" x 12"

### "Car-in-tow" signs

Printed in black on yellow plastic. Required by law in many states.

Rear window suction cups included. Will not fade or warp.

**440** "This is a towed car"

**660** "Car in tow and ready to go!"

**770-2 two-sided** — "Vehicle in tow" and "I go where I'm towed to"

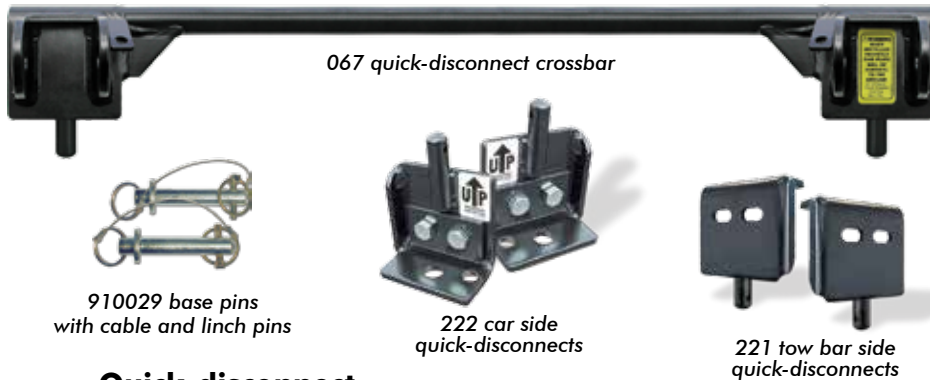

067 quick-disconnect crossbar

910029 base pins with cable and linch pins

222 car side quick-disconnects

221 tow bar side quick-disconnects

### Quick-disconnect base assembly

The 910021-00 base assembly components are shown above; the 067 crossbar is available separately.

**910021-00 Complete assembly** —

067 crossbar

222 car side quick-disconnects

910029 base pins (see page 27)

**067 Quick-disconnect crossbar only**

### Quick-disconnects

The connection points in ROADMASTER's exclusive quick-disconnect ('QD') system, available in full and half sets.

**201 1 full set quick-disconnects**

a pair of tow bar side QDs and a pair of car side QDs

**221 tow bar side QDs only**

**222 car side QDs only**

## Quick-Disconnect Accessories



### Safety cable anchors for quick-disconnects

A quick and secure connection point at your towed vehicle, the safety cable anchors are manufactured from ¼-inch laser-cut steel plate and come with a powder-coated, gloss black finish. The anchors bolt onto all mounting brackets with ROADMASTER quick-disconnects.

Two safety cable anchors per set.

**910648 Safety cable anchors**

### Quick-disconnect covers

Give your towed vehicle that finished look, and protect your knees. These covers fit over all car-side quick-disconnects when not towing. Made of high-impact, rotationally-molded plastic that is fade- and crack-resistant.

**202 1 pair quick-disconnect covers**

# Tow Bar Adaptors

## To adapt other manufacturers' tow bars to ROADMASTER brackets...

### 025

Adapts Reese, Valley, Eaz-Lift, Draw-Tite and Husky car-mounted tow bars to ROADMASTER brackets (see notes 1 and 2).

**032** and **033** adapt motorhome-mounted Blue Ox tow bars (Acclaim, Adventurer, Aladdin, Alexxa, Alpha, Allure, Ambassador, Avail, Aventa, Aventa II, Aventa LX, Kar Bar), as well as Blue Ox "A frame" tow bars (with one- or three-pronged attachments) to ROADMASTER brackets. They also adapt Demco Commander, Dominator, Aluminator, Excalibar, Excalibar II and Kwik-Tow tow bars to ROADMASTER brackets.

**032** — Allows you to disconnect the adaptor bar and the removable front bracket arms (see note 2). The Guardian rock guard (see page 18) will work with this adaptor.

**033** — The adaptor is permanently bolted to the mounting bracket (see notes 1 and 2).

**037** — Adapts Blue Ox Rangefinder II or Rangefinder III to ROADMASTER brackets (see note 2). The Guardian rock guard (see page 18) will work with this adaptor.

**038** — Adapts Duncan Towmatic II, Karbar and EazAligner 2000 car-mounted tow bars to ROADMASTER brackets (see notes 1 and 2).

Adaptor components shown in white

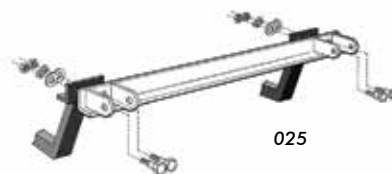

025

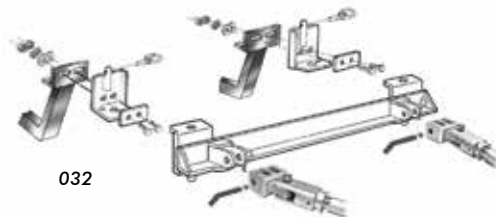

032



033

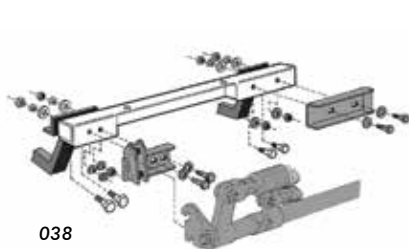

038

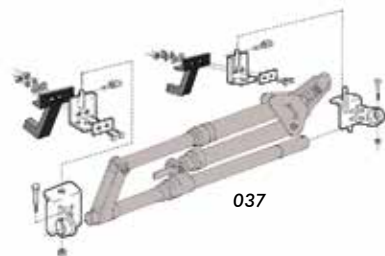

037

**Note 1:** in order to remove the front extensions on ROADMASTER XL or EZ Twistlock brackets, you will need quick-disconnects (part number 201; see page 25) in addition to the adaptor.

**Note 2:** this adaptor does not fit MX, MS or EZ5 brackets.

(Tow bars and mounting brackets are not included with adaptor bars.)

## To adapt ROADMASTER tow bars to other manufacturers' brackets...

**031** — Adapts these tow bars to Blue Ox brackets: Falcon; Falcon All-Terrain; BlackHawk; BlackHawk All-Terrain (with serial numbers up to 16,500); Sterling (with serial numbers up to 14,500).

**031-5** — Adapts these tow bars to Blue Ox brackets: BlackHawk All-Terrain (with serial numbers above 16,500) and Sterling (with serial numbers above 14,500). Includes collar.



**034** — Adapts these tow bars to Demco brackets: Falcon; Falcon All-Terrain; BlackHawk; BlackHawk All-Terrain (with serial numbers up to 16,500); Sterling (with serial numbers up to 14,500).

**034-5** — Adapts these tow bars to Demco brackets: BlackHawk All-Terrain (with serial numbers above 16,500) and Sterling (with serial numbers above 14,500). Includes collar.



## To adapt ROADMASTER tow bars to off-road bumpers...



**035** and **035-1** — connect ROADMASTER motorhome-mounted tow bars to the bumper mounts. The bumper mounts can have either a 7/8" or a 1" diameter hole.

**035** — for bumper mounts that are 3/4" thick

**035-1** — for bumper mounts that are 1" thick

**910044** — hitch pin for 035 and 035-1

*Note: before using these adaptors, confirm that the bumper manufacturer has approved the bumper for flat towing.*





# Hitch Accessories

The leading cause of tow system failure is an "out of level" tow bar — when the tow bar is at an upward or downward slope. Many of the accessories in this section will allow you to connect your tow bar at a safe, level height.

*Note: longer safety cables or safety cable extensions may be necessary for any accessory which extends the length of the towing system (see pages 20 and 27).*

## High-Low Hitch Receiver Adaptors

Level the RV hitch to the tow bar with one of these adaptors. The shanks can be turned up or down to level the towing system.

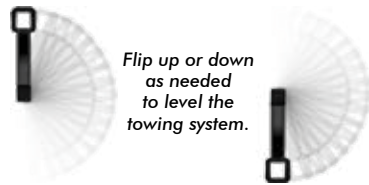

### For 2-inch receiver hitches

The 07 series adaptors have a 6,000-pound GVWR and a 200-pound maximum tongue weight. The 048 series adaptors have a solid-steel shank, allowing a 10,000-pound capacity and 400-pound maximum tongue weight.

Fit nearly all two-inch receiver hitches.

In two-, four-, six-, eight- and 10-inch sizes.

model	size	weight capacity in pounds
<b>048-2</b>	2"	10,000
<b>072</b>	2"	6,000
<b>048-4</b>	4"	10,000
<b>070</b>	4"	6,000
<b>048-6</b>	6"	10,000
<b>076</b>	6"	6,000
<b>048-8</b>	8"	10,000
<b>048-10</b>	10"	10,000



Shown: 048-8  
Also available in 2", 4", 6" and 10" sizes.

### 2½-inch to 2-inch high-low adaptors

It's an adaptor and a drop hitch! These adaptors attach to 2½-inch receivers and accept a 2-inch insert. Great for tow bars, bike carriers, cargo trays and any other hitch-mounted accessory.

10,000-pound capacity; 400-pound maximum tongue weight; fit nearly all 2½" receiver hitches.

model	size	weight capacity in pounds
<b>058-4</b>	4"	10,000
<b>058-6</b>	6"	10,000
<b>058-8</b>	8"	10,000
<b>058-10</b>	10"	10,000



Shown: 058-6  
Also available in 4", 8" and 10" sizes.

## Is your towing system within the Safe Zone?

Three inches above or below level is the 'Safe Zone' for motorhome-mounted tow bars. Car-mounted tow bars must be approximately level.

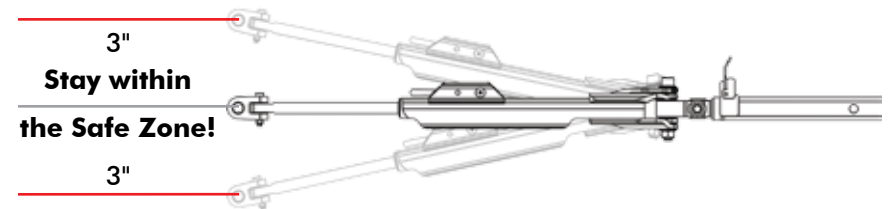

It's easy to bring an out-of-level tow bar into the 'Safe Zone.' Use one of ROADMASTER's hitch accessories to raise or lower the motorhome hitch receiver or tow bar stinger.

## Hitch Receiver Extensions — 6,000-pound capacity

The hitch receiver extensions provide 7½ and 12 inches, for those towing systems which need a little more reach.

Rated at 6,000 pounds capacity and 200-pound maximum tongue weight.

- 071-75** 7½" hitch receiver extension
- 071** 12" hitch receiver extension



7½" and 12" sizes

## Anti-rattle Hitch Receiver Extension — 10,000-pound capacity

This 7½" hitch extension has a solid steel shank, allowing a 10,000-pound capacity and a 400-pound tongue weight.

A threaded hitch pin hole and bolt eliminate the rattle, wander and sway associated with other hitch extensions.

- 071-1075** 7½" hitch receiver extension



with threaded hitch pin hole and bolt



## Quiet Hitch™

Quiet Hitch stops sway and wander before it begins by eliminating any free play between the receiver and the tow bar (or bike rack, ball mount or whatever you insert) for a solid, seamless connection. Consistent pressure keeps your towing combination tracking straight through crosswinds, curves and sudden maneuvers — all with considerably less effort on your part.

Quiet Hitch also reduces tire wear, as well as wear and tear on the hitch and the receiver, by eliminating free play.

Especially effective on towing combinations with multiple hitch extensions; also reduces noisy rattle caused by bike racks or hitch accessories.

All three Quiet Hitches (see below) bolt on in seconds.

**061 Quiet Hitch for 2" hitch receivers**

**062 Quiet Hitch for 2½" hitch receivers**

**061-125 Quiet Hitch for 1¼" hitch receivers**  
(The receiver must have a ring or collar around it for Quiet Hitch to attach.)

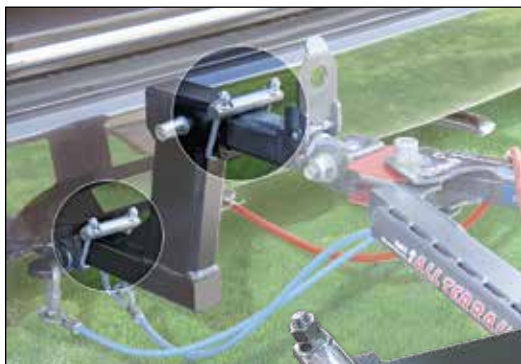

061 Quiet Hitch

### What do our customers say?

"I've been using your Quiet Hitch on my Suburban hitch now for almost a year. Very nice product! I trailer our various boats about 60,000 miles per year fishing bass tournaments and taping our 'Real Fishing' TV series. It's so nice to keep the rattle out of the hitch assembly. In fact I just bought two more in Florida last week for two other of our tow vehicles."

— Bob Izumi, Burlington, Ontario

### Dual Hitch Receiver

With this dual-purpose hitch receiver, you can add a bike carrier or other hitch accessory to the rear of your motorhome.

- Fits most 2" hitch receivers
- Solid steel construction
- Computer-designed and -tested
- Powder coated for maximum durability
- 10,000-pound capacity; 400-pound maximum tongue weight

U.S. patent number  
5,884,930

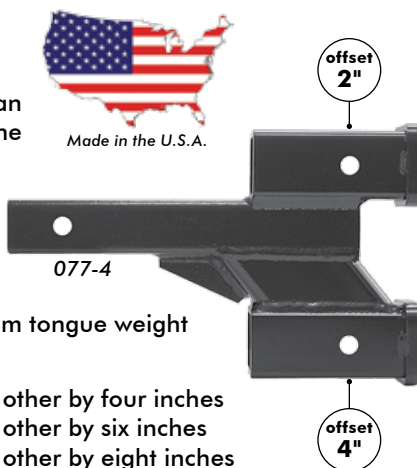

077-4

**077-2** Both receivers offset by two inches

**077-4** One receiver offset by two inches, the other by four inches

**077-6** One receiver offset by two inches, the other by six inches

**077-8** One receiver offset by two inches, the other by eight inches

**077-10** One receiver offset by two inches, the other by 10 inches

## A spare tire carrier for your motorhome! Spare yourself!



U.S. patent number  
8,720,760

When it comes to a flat tire, "I hope it won't happen to me" isn't much of a contingency plan. But that's all most motorhome owners have to work with. Because most motorhomes don't carry a spare.

So spare yourself and get a spare tire carrier — before Murphy's Law kicks in and you find out just how long it can take to find a spare tire 30 miles north of Phoenix. On a Sunday. And how much you're going to pay for it.

ROADMASTER's spare tire carrier is the proactive approach to a flat tire —

- With a ready-to-go spare, Roadside Assistance can get you back on the road quickly.
- Carrying your own spare allows you to control the cost.
- You have a place to put your spare, without taking up any valuable cargo space.
- Comes with a two-inch receiver hitch for a tow bar, hitch rack or other hitch-mounted accessory.
- The carrier can be lowered to either side for engine access or ladder clearance.
- Powder coated for durability and corrosion resistance
- Bolts into the receiver to help prevent rattle

### Specifications

- For 16", 16.5", 19.5", 22.5", 24" and 24.5" wheels
- 10,000-pound maximum capacity
- 400-pound maximum tongue weight
- Mounts in a standard 2-inch receiver hitch

### 195225 Spare Tire Carrier

(Motorhome spare tire covers are available through special order.)

A patented hinge mechanism makes raising or lowering the spare easy.



# Hitch Accessories

## Rollaway™

Prevents the hitch from digging and dragging on the pavement. Made for heavy-duty applications. Front load design accommodates hitches that other rollers won't fit. Solid steel roller won't fail like plastic or rubber rollers.

Fits most two-inch hitch receivers; works with or without a ball mount.

**050 Rollaway**



Includes the hitch pin and clip

## Adjustable Ball Mount

An adjustable ball mount that spans 16 inches of vertical height in one-inch increments. The shank can be turned up or down, for low or high ground clearance.

The maximum rise is seven inches; the maximum drop is nine inches.

Only for towing a car behind a motorhome — not for use with any type of trailer.

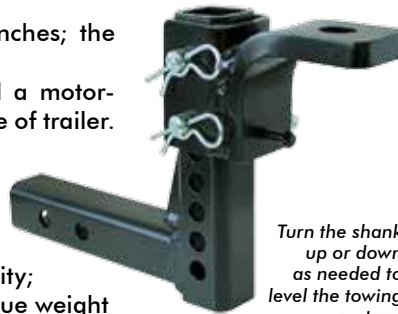

Turn the shank up or down as needed to level the towing system.

**880 Adjustable Ball Mount**

6,000-pound GVWR capacity;  
200-pound maximum tongue weight

## Roller Hitches

Drop extension for car-mounted tow bars. Use a Roller Hitch in 4" through 10" drops to level the RV hitch to the tow bar.

- The solid-steel roller prevents scraping and dragging.
- Fits all square tube hitch receivers with two-inch inner diameters.
- 5,000-pound GVWR capacity; 200-pound tongue weight maximum

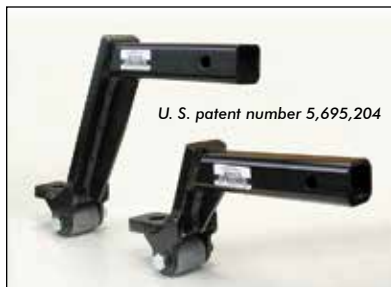

U. S. patent number 5,695,204

Shown: 10-inch and four-inch Roller Hitches. Also available in six- and eight-inch sizes.

**051-4**     **4" Roller Hitch**  
**051-8**     **8" Roller Hitch**

**051-6**     **6" Roller Hitch**  
**051-10**    **10" Roller Hitch**

# Adjustable Tow Dollies

## RoadMaster™

**2000-1 adjustable tow dolly**

U. S. patent number 6,164,897



### Features

- Axles can be adjusted out to a maximum of 101½ inches, or in to a minimum of 93½ inches.
- Slideable 'Easy-load' ramps —
  - Slideable ramps quickly adjust to tow virtually any car weighing up to 4,250 pounds.
  - Unique TrueGrip laser-cut tread pattern provides positive traction in both directions for safe loading and unloading
- Accu-Lube™ hubs — easily repack the wheel bearings with a grease gun
- Built-in electric brakes for safer stops
- Ramps, axle and deck are powder coated for maximum durability and corrosion resistance
- Conveniently located bed tilt release — eliminates crawling under car to tilt bed
- Dual pin bed latch — bed cannot tilt even if one pin fails
- Heavy-duty trailer tires — increase safety when towing heavier vehicles
- Complete with adjustable TieDown™ straps (fit most tires from 12 to 16 inches) and ratchets
- Locking storage trays — for TieDown straps and miscellaneous equipment. One key fits both trays.

### Specifications

Overall length: 136"  
Overall width —  
Narrow axle position: 93.5"  
Wide axle position: 101.5"  
Weight: 620 pounds  
Maximum vehicle weight:  
4,250 pounds  
Tires: ST205-75 R14 radials  
Maximum tread width —  
Ramps narrow position: 68"  
Ramps wide position: 76"  
Trailer ball size: 2"

Self-steering wheels with stabilizers allow the dolly to track the motorhome without cutting corners.



**2000-1 RoadMaster tow dolly**



## Accessories for both dollies

- 200330-80** Spare tire and wheel for both tow dollies
- 2100** Deluxe magnetic tow lights for both dollies
- 2120** Standard magnetic tow lights for both dollies
- 2110** Tie down ratchet (one — for both dollies)



### TieDown™ straps

- 2114** TieDown strap (one — for both dollies) — fits most 14" tires
- 2115** TieDown strap (one — for both dollies) — fits most 15" tires
- 2150** Adjustable TieDown strap (one — for both dollies) — fits most 12"-16" tires

## Add functionality and protection with a spare tire carrier and a Guardian carrier.

### 2000-7 Spare tire carrier for tow dolly (spare tire not included)

Mount your spare tire and wheel on your tow dolly using this heavy-duty steel, powder-coated mounting bracket. Bolts on and off in seconds.



### 2000-8 Guardian carrier for tow dolly (Guardian not included)

Add the protection of our Guardian with this mounting bracket. Helps protect your towed vehicle against damage from rocks and road debris. The all-steel, powder-coated bracket bolts on and off in seconds.

# Roadmaster

Tow Dolly model  
**RM3477**  
part number 2050-1

## The economical adjustable!

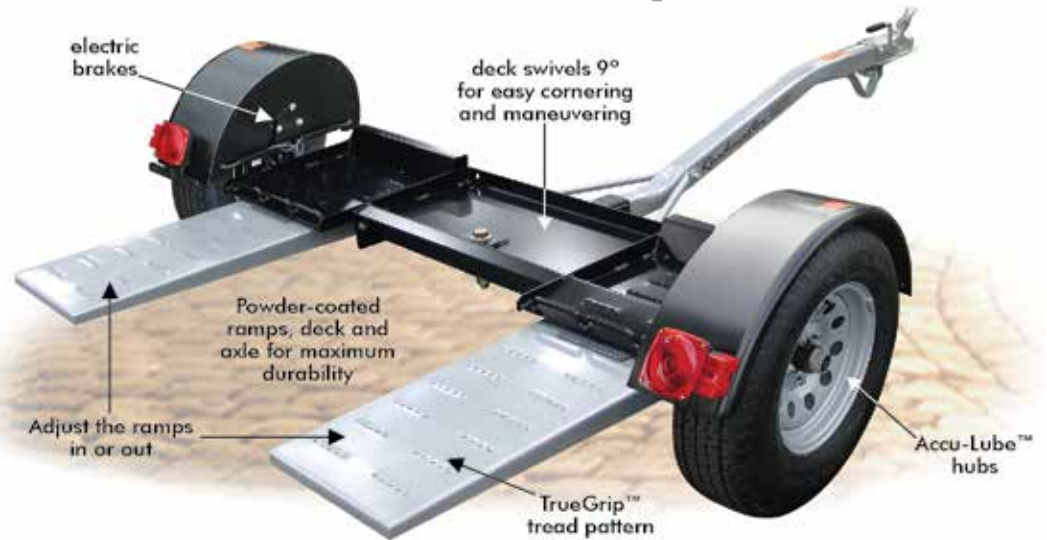

### Features

- Slideable 'Easy-load' ramps —
- Slideable ramps quickly adjust your dolly to tow virtually any car weighing up to 4,250 pounds.
- Unique TrueGrip laser-cut tread pattern provides positive traction in both directions for safe loading and unloading
- Accu-Lube™ hubs — easily repack the wheel bearings with a grease gun
- Built-in electric brakes for safer stops
- Deck swivels 9° for easy cornering and maneuvering
- Ramps, axle and deck are powder coated for maximum durability
- Complete with adjustable TieDown straps (fit most tires from 12 to 16 inches) and ratchets

- Easy assembly (average assembly time: one to two hours)

### Specifications

Minimum tire width: 34" inside to inside  
 Maximum tire width: 77" outside to outside  
 Overall length: 121"  
 Overall width: 102"  
 Height at fenders: 29"  
 Weight — empty: 545 pounds  
 Tires: ST205-75 R14 radials  
 Maximum weight of towed vehicle: 4,250 pounds  
 Trailer ball size: 2"

**2050-1 Tow dolly model RM3477**

**Need help choosing a tow dolly? Call our experts at 800-669-9690.**

# Dual Tire Inflators

Dual tires out of sight? Out of reach? Out of air?

## Safe travel begins with safe tires.

- On average, one out of every four vehicles on the road today is being driven with under-inflated tires.
- A tire can lose up to half its pressure without appearing to be under-inflated.
- Tires can lose one to two psi per month in normal conditions.
- Driving with under-inflated tires is the number one cause of tire wear and catastrophic blowouts.



Easy to install, the inflation hoses attach to your existing valve stem (no need to remove your valve core) allowing you to inflate and equalize your tires in seconds!  
A typical dual tire inflator kit includes:

- four stainless steel hoses with quadruple-crimped plated brass fittings
- mounting brackets
- retaining nuts
- valve caps
- all attachment hardware

### Wheel cover-mount dual inflators



- 8208 Wheel cover-mount stainless steel 4-hose kit** for 16" to 19½" dual wheels, with 45° extenders for front tires
- 82082 Wheel cover-mount airless 4-hose kit** for 16" to 19½" dual wheels, with 45° extenders for front tires
- 8008 Wheel cover-mount two-ply rubber 4-hose kit** for 16" to 19½" dual wheels, with 45° extenders for front tires

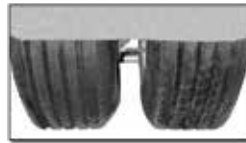

The tire on the left is dangerously low, yet to the naked eye, looks the same as the full tire on the right.

### Hand hole-mount dual inflators



- 8009 Hand hole-mount stainless steel 2-hose kit** for 16" to 19½" inner dual wheels
- 80092 Hand hole-mount airless 2-hose kit** for 16" to 19½" inner dual wheels
- 8007 Hand hole-mount two-ply rubber 2-hose kit** for 16" to 19½" inner dual wheels



**WHEEL MASTERS™**

## Checking and inflating tires is as easy as 1, 2, 3!

- 1) Determine your mounting system: hub-mount; hand-hole mount; or wheel cover mount.
- 2) Determine which style fits your budget: rubber two-ply; stainless steel; or airless stainless steel.
- 3) Determine how many hoses you need: two-hose kit (inner dual wheels only); or four-hose kit (both inner and outer wheels).



### Hub-mount dual inflators



- 8001 Hub-mount stainless steel 4-hose kit** for 16" to 19½" wheels
- 8002 Hub-mount stainless steel 2-hose kit** for 16" to 22½" inner dual wheels
- 8004 Hub-mount stainless steel 4-hose kit** for 22½" wheels
- 8005 Hub-mount stainless steel 2-hose kit** for 22½" inner dual wheels
- 8110A Hub-mount stainless steel 4-hose kit** for 22½" aluminum wheels
- 80012 Hub-mount airless 4-hose kit** for 16" to 19½" wheels
- 80022 Hub-mount airless 2-hose kit** for 16" to 19½" inner dual wheels
- 8003 Hub-mount two-ply rubber 4-hose kit** for 16" to 19½" wheels
- 8006 Hub-mount two-ply rubber 2-hose kit** for 16" to 19½" inner dual wheels



# Valve stem support, valve extenders and lug nut covers

## Rubber valve stem support

Does your 16" wheel have a rubber valve stem? Rubber may be insufficient to support an aftermarket air extension hose or extender. Easy to install, the valve stem support clips to the wheel and attaches to the factory valve stem — no tools required.

The bracket supports and strengthens the valve stem against the extra weight and rotation force while in motion.

For all 16" wheels with rubber valve stems.

**8029VS Rubber valve stem support**



## Dual tire valve extenders

Enjoy easy access to your hard-to-reach valve stems with these durable, nickel-plated brass valve extenders. They make checking and inflating your dual tires easy. Available in straight, 45°, 90°, 135° and 180° sets.

### Straight valve extenders

Sets include two straight extenders and two caps.

**80292 2" straight valve extender**

**80293 3" straight valve extender**

**80294 4" straight valve extender**

### 45° valve extender

Angled for easy access.

Set includes two 45° extenders and two caps.

**8029 45° valve extender**

### 90° valve extender

Angled for easy access.

Set includes two 90° extenders and two caps.

**802990 90° valve extender**

### 135° valve extender

Angled for easy access.

Set includes two 135° extenders and two caps.

**8029135 135° valve extender**

### 180° valve extender

Angled for easy access.

Set includes two 180° extenders and two caps.

**8029180 180° valve extender**

**GOT AIR?**

## Custom lug nut covers

Dress up your plain wheels or replace lost lug nut covers with stainless steel lug nut covers. Designed to stay rust- and corrosion-free for years.

Each cover fits snugly over your existing lug nuts and stays in place even in the toughest conditions.



**8010 GM/Chevrolet 1" lug nut covers** — stainless steel, eight-pack

**8011 Ford 1-1/16" lug nut covers** — stainless steel, eight-pack

**8012 1½" truck lug nut covers** — stainless steel, six-pack

**8019 Ford 7/8" lug nut covers** — stainless steel, eight-pack

**9003-4 Snap-in four-prong lug nut covers for wheel covers** — four-pack

**9003-5 Snap-in four-prong lug nut covers for wheel covers** — five-pack

**9005-6 Lug nut covers for 22½" hub piloted wheels (33mm)** — stainless steel, six pack

## Universal lug nut cover pliers

Remove and install your lug nut covers quickly with these universal lug nut cover pliers. The rubber-coated handles provide a non-slip grip and their 9" length makes it easy to reach down into deep dish wheels. Made of heavy gauge steel for durability and strength.

**8211 Universal lug nut cover pliers**



## Valve stem end caps

These sturdy valve stem caps look great, plus they don't rust, providing you with years of detailed beauty. They also assist in maintaining proper tire air pressure.

**8030 Valve stem end caps** — six-pack



# Stainless steel wheel covers, tire pressure gauges

## Stainless steel wheel covers

These low-profile, aerodynamically-designed covers will look great for years thanks to their stainless steel construction. The 16" and 16½" models have an easy-to-install, snap-in retention system; the 19½" models include a hardware retention system. Both retention systems hold tight, keeping your cover centered on the wheel and preventing wobble.



## Wheel Masters wheel covers

with one-year limited warranty

PART NUMBER	SIZE	APPLICATION
3160B0.....	16"	all (no Budd or split rim 8-lug)
3165B0.....	16½"	all (no Budd or split rim 8-lug)
3165BB0.....	16½"	all chassis Budd rims/hardware included, 8-lug
319580.....	19½"	Ford 8-lug (no split rims)/hardware included
3195B0.....	19½"	all (no 8-lug or split rim)/hardware included, 10-lug

Note: Wheel Masters kits have four wheel covers each.

## Namsco wheel covers

PART NUMBER	SIZE	APPLICATION	QUANTITY
7160B0.....	16"	all (no Budd or split rims)/hardware not required, 8-lug	4
7160B1.....	16"	all (no Budd or split rims)/hardware not required, 8-lug	1
7165B0.....	16½"	all (no Budd or split rims)/hardware not required, 8-lug	4
7165B1.....	16½"	all (no Budd or split rims)/hardware not required, 8-lug	1
7165BB0.....	16½"	Budd rims all chassis/hardware included, 8-lug	4
7165SP0.....	16½"	Sprinter vehicles/hardware included, 8-lug	4
719580.....	19½"	Ford 8-lug (no split rims)/hardware included	4
719581.....	19½"	One single front — Ford 8-lug front (no split rims)/hardware included	1
719583.....	19½"	One single rear — Ford 8-lug rear (no split rims)/hardware included	1
7195B0.....	19½"	all (no 8-lug or split rims)/hardware included, 10-lug	4
7195B1.....	19½"	One single front — all — front (no 8-lug or split rims)/hardware included, 10-lug	1
7195B3.....	19½"	One single rear — all — rear (no 8-lug or split rims)/hardware included, 10-lug	1
7140.....		hardware kit for 7165BB0 and 7195B0	1
7142.....		hardware kit for 7165SP0	1
7140F.....		hardware kit for 719580	1
9130.....		3-prong center cap for all Namsco wheel covers	1
9003-4.....		4-prong snap-in lug nut cover for wheel covers	4

**Free!**

A dual tire inflation hose kit (part number 8008, see page 32) is included with all Wheel Masters wheel cover kits. (Offer does not apply to Namsco wheel covers.)

## Tire pressure gauges

Proper air pressure is an integral part of a safe road adventure and boosts your gas mileage. These professional-quality, easy-to-read gauges are designed to help you get to your next stop safe and sound while saving you money.

### Deluxe tire pressure gauge

- For trucks and RVs
- High ANSI grade B accuracy
- Shock resistant
- Convenient pressure release button
- Measures from 10 to 160 pounds
- Easy-to-read dial
- Protective case

**8216 Deluxe tire pressure gauge**



8216



8200-00

### Universal tire pressure gauge

- Measures from 10 to 120 pounds
- Holds pressure after you disconnect it so you can bring the gauge up to read it
- Tread depth indicator
- No-slip rubber grip
- Convenient 'quick release' pressure release button
- Easy-to-read dial
- Protective case
- Swivel head

**8200-00 Universal tire pressure gauge**

### Long dual foot tire pressure gauge

- For trucks and RVs
- Measures from 10 to 150 pounds
- For all valve stem applications

**8216-4 Long dual foot tire pressure gauge**



8216-4 length: 11½"

### 90° tire pressure gauge

Can't reach your valve stem because of those small hand holes? This 90° bend gauge allows you access to those hard-to-reach areas to properly check tire pressure.

- Durable stainless steel construction
- Easy-to-read indicator
- Measures in two-pound increments from 10 to 160 psi.

**8216-5 90° tire pressure gauge**



8216-5 length: 11½"

### Short dual foot tire pressure gauge

- Measures from 10 to 120 psi
- For all valve stem applications
- Spring pocket clip

**8216-6 Short dual foot tire pressure gauge**

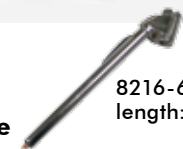

8216-6 length: 6"



# Mirrors and trailer levels



**WHEEL MASTERS™**

*Innovative solutions for performance, safety and beauty*

## Vision Plus™ portable side view mirrors

Mount these portable mirrors quickly and easily on the door or fender of your tow vehicle. Each mirror extends up to 17" so you can see to back up and monitor how your trailer is tracking.

Adjustable-length nylon strap and non-scratch hooks at the top and bottom of the door or fender hold the 9½" long x 6¾" wide x 2½" deep stainless steel mirror heads securely in place.

The mirrors are powder coated for durability and good looks; rubber padding helps control vibration and prevent scratching.

- 6500** Vision Plus mirror (shown), two-pack
- 6510** Vision Plus 5" round convex wide-angle mirror
- 6600** Eagle Vision 7" square mirror
- 6800** Wide angle spot mirror, 3¼" x 3¼"



## Level Master™ trailer levels

These giant all-in-one RV levels provide visual side-to-side and front-to-rear leveling assistance for trailers, fifth wheels and motorhomes.

Both can be viewed from the driver's seat to help locate the best level location for parking your RV. Each mark on the side-to-side scale indicates one inch of blocking.

The front-to-rear scale is adjustable and can be easily viewed while operating your tongue jack.

The leveling bars are encased in UV-resistant plastic — no leaking or rusting sometimes associated with other levels.

Both levels come with instructions to easily install them on your trailer or motorhome. The Level Master bracket (part number 6700BK; see below) can be used with either level.

- 6700** Level Master — 11" x 2¾" all-in-one level — metal housing
- 6780** Level Master with 6700BK bracket
- 67200** Level Master 2 — 10¾" x 2-7/8" all-in-one level — UV-resistant plastic housing



Level Master 2 without bracket



Level Master with bracket

### Level Master bracket

Adds flexibility to the installation of the Level Master 6700 or 67200 (above) on pin box surfaces that are 25° to 90°.

- Heavy-duty plastic
- Mounting hardware included
- Easy to mount
- Adjustable to fit your needs
- Fits most fifth wheel pin boxes

**6700BK** Level Master bracket



Fits most fifth wheel pin boxes  
For both Level Masters (above)

# Suspension Solutions



We're the suspension experts.

Motorhome manufacturers make your RV “livable.”  
We help make your motorhome “drivable.”

Very few people would say they bought their motorhome (or truck, van or SUV) for the suspension. For most of us, the suspension is out of sight and out of mind — even though your driving performance, safety and comfort are all riding on those components.

The primary benefits of ROADMASTER suspension components are:

- Anti-sway bars — virtually eliminate ‘body roll’ (the vehicle rolls from side to side, especially during cornering). Anti-sway bars stabilize the vehicle, which keeps it level through crosswinds, as well as dramatically improving overall handling.
- Steering stabilizers — front tire blow out protection. Stabilizers also automatically compensate for oversteer caused by pot holes, rut tracks and other unfavorable road conditions.
- Trac bars — drastically reduce ‘wander’ (the steering feels loose, making it difficult to keep the vehicle in a straight line).

## Do you need a custom suspension component?

Every “yes” to the following questions is a “yes” for an anti-sway bar, a steering stabilizer and/or a trac bar...

- Does the vehicle “roll” when cornering?
- Does driving for an extended period of time leave you physically exhausted?
- Is your rig all over the road — can’t keep it between the lines?
- Would you lose control if one of the front tires blew out?
- Does the steering wheel have a mind of its own?
- Do passing trucks and crosswinds rock your vehicle back and forth?
- Is driving a ‘white knuckle’ experience?

## Which component is right for you?

ROADMASTER designs, engineers and manufactures anti-sway bars, steering stabilizers and trac bars. They work in concert with the other components of your suspension system to add stability and control.

The chart on this page identifies the primary benefits of aftermarket suspension products. Each one has value — for a specific application. Use the chart to make an informed, educated decision about what aftermarket suspension product(s) will enhance your vehicle’s stability, handling and maneuverability.

	Shock Absorbers	Air Bags	RSS Anti-Sway Bar	Bell Crank	Davis TruTrac Bar	Generic Steering Dampener	Reflex Steering Stabilizer
<b>Bouncing</b>	X						
<b>‘Porpoising’ (up and down movement)</b>	X						
<b>Rough Ride</b>	X	X					
<b>Sway (‘body roll’)</b>			X				
<b>Soft Steering</b>			X	X	X	X	X
<b>Wind Buffeting (crosswinds, wind gusts and passing 18-wheelers)</b>			X		X		X
<b>Wander</b>				X	X		X
<b>Rut Tracking</b>					X		X
<b>Blow Out Protection</b>						X	X
<b>Load Leveling</b>		X					





# REFLEX™

## Steering Stabilizers

**R**eflex steering stabilizers are a safety feature for Class A and C motorhomes, SUVs, vans and emergency vehicles. Tempered steel springs, which are attached to the tie rods and undercarriage, automatically compensate for oversteer caused by pot holes, rut tracks and other unfavorable road conditions, as well as crosswinds and passing 18-wheelers.

The springs react instantaneously to bring the vehicle back to center.



### Reflex helps you handle...

- **Front tire blow out** — when you blow out a front tire, your vehicle will make an abrupt turn toward that tire, causing you to veer into oncoming traffic or off the road. The stabilizer reacts instantaneously to bring the vehicle back to center.
- **Crosswinds and passing traffic** — works to keep your steering centered and prevents oversteering to help control your vehicle more effectively.
- **Road fatigue** — helps you stop fighting the steering wheel for control. The stabilizer keeps the steering wheel centered — not you.
- **Rut tracking** — ruts cause you to oversteer. With the Reflex steering stabilizer on board, your reactions become easier, eliminating overcompensation when steering out of a rut.
- **Rut edging** — when your tire drops off the edge of the pavement, it can startle even the most careful driver. The Reflex steering stabilizer keeps you going straight — helping you control the vehicle until you're back on the road.
- **Pot holes and debris** — with the Reflex steering stabilizer in place, the motorhome will stay straight and go in the direction you want, even when you bounce through a pot hole or other dangerous road condition.

### What do our customers say?

"I had a Reflex steering stabilizer installed, and the difference was night and day — my class C motorhome handles like a sports car. The stabilizer keeps the steering centered, no matter what the road throws at me. Ruts, bumps and hairpin curves are no problem. My steering wheel doesn't belong to potholes any more. It belongs to me."

— Jerry Miller, Portland, Oregon

**To see if a Reflex steering stabilizer is available for your vehicle** call us (800-669-9690) or visit [www.roadmasterinc.com](http://www.roadmasterinc.com).

# Stabilizers and Trac Bars

RSS suspension products are vehicle-specific. To find the stabilizer or TruTrac bar for your vehicle, visit [www.roadmasterinc.com](http://www.roadmasterinc.com) or call 800-669-9690.

## Davis TruTrac™

**Does your motorhome vibrate from side to side?**

**Are 'wandering,' 'rut tracking' and 'lazy steering' a problem?**

**Tired and fatigued trying to keep in line going down the road?**



Davis TruTrac bars link the chassis to the front axle, eliminating excessive axle side play, without affecting normal up-and-down suspension travel. The result is precise, predictable handling. The benefits are an immediate improvement in both vehicle performance and safety, as well as increased driver comfort — more positive control means less driver fatigue.

Each TruTrac bar comes complete with all mounting hardware, and installs using pre-drilled factory holes — no drilling or welding required. They will not interfere with original equipment or affect any factory warranty.

Davis TruTrac bars are available for Ford F53 chassis (V8 and V10), all Workhorse motorhome chassis (W16, W18, W20, W22 and W24) and Kodiak 45/5500 chassis. They use polyurethane bushings for maximum stability and longevity.

### What do our customers say?

"My F53 chassis would vibrate so bad that it shook the whole motorhome. The only way to stop the vibration was to slow down to 20 mph — which almost got me rear-ended twice. Finally my wife told me, 'I'm not riding in that motorhome any more.'

A mechanic told me about Davis TruTrac bars. I had one installed and the vibrations stopped immediately. I drove that motorhome for another 150,000 miles (with my wife back on board) and it was solid as a rock.

Buying that Davis TruTrac bar was the best move I ever made."  
— John Kielty, Reno, Nevada

# Anti-Sway Bars

## Why fight it?

Does your suspension have the best of you?...beat you down?...control you?

Driving your RV should be an enjoyable experience. And it can be. Adding a set of RSS anti-sway bars to your suspension has an immediate effect on stability and cornering control.



Does your motorhome (or SUV, pickup truck or van) handle like the Queen Mary? Does it pitch and roll with every gust of wind or passing semi, or list to port or starboard on the curves, or waddle over speed bumps, railroad tracks and driveways?

Well, it shouldn't. As a matter of fact, motorhomes can be made to handle just like what they are — motor vehicles — with two aftermarket upgrades.

Upgrading your shock absorbers will control up and down motion. But the best shocks in the world won't affect side to side motion (the "Queen Mary effect," commonly called "body roll" or "sway") by one iota.

### The solution to sway is in the suspension.

Adding a set of custom anti-sway bars to your suspension system will have the same effect on sway as a good set of shocks has on up and down motion — there's an immediate improvement in stability and tracking, especially on the curves.

For many motorhome owners, this is an empowering experience. What was beyond their control, just yesterday, is suddenly within it — cornering with confidence, quicker maneuvering and a remarkably level ride over uneven terrain — all without launching the dishes out of the cupboard.

And even after eight or 10 hours at the wheel they arrive fresh, instead of fatigued, which means they can start enjoying the Grand Canyon, the Grand Tetons or the grandkids right away.



typical anti-sway bar kit components  
(kits vary)



## Ours



## Theirs

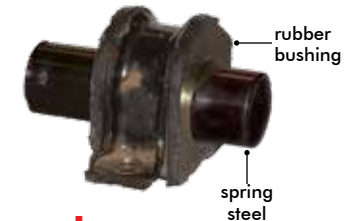

### A better anti-sway bar.

RSS anti-sway bars are built to offer significantly more resistance to sway than stock bars...

- **Bigger is better** — RSS anti-sway bars have a thicker diameter than stock bars (often, a quarter to three-eighths of an inch more). Each incremental increase in diameter has an exponential effect on performance — on average, torsional roll stiffness is increased by 30 percent with every 1/8" increase in diameter. In plain English — RSS anti-sway bars offer up to 90 percent more resistance to sway.
- **A high-grade alloy** — RSS anti-sway bars are made of 4140 "chromoly" steel (a chrome and molybdenum alloy) which is considerably stronger and more durable than the standard spring steel (a 1020 grade) used in many stock anti-sway bars.
- **A better pivot point** — RSS anti-sway bars have polyurethane bushings, which, unlike the rubber used in stock bushings, is impervious to gas, oil and ozone corrosion, is more resistant to abrasion, and doesn't buckle under heavier load weights.



# Anti-Sway Bars

## About RSS anti-sway bars...

RSS currently manufactures more than 150 different anti-sway bars for large vehicles such as pickup trucks, vans and SUVs, and on up to full-size motorhomes. Whether you're driving a Ford F350 or a 40-foot Class A motorhome, we make an anti-sway bar for you.



And chances are, the next ambulance or rescue vehicle you see will have an RSS anti-sway bar — RSS anti-sway bars make it safer and easier to drive an emergency vehicle at high speeds, and they also hold it level, so that both patient and paramedic are on a more stable platform.

Which means that throughout the country, you'll find a wide variety of vehicles already equipped with RSS anti-sway bars.

Each RSS anti-sway bar is designed as a custom fit, for a specific chassis. RSS engineering designs take into consideration chassis and axle manufacturers' specifications (your warranty will not be affected), and to avoid any interaction or conflict between the anti-sway bar and popular accessory add-ons, whether or not they're presently on your vehicle.

RSS suspension products are vehicle-specific. To find the anti-sway bar for your vehicle: visit [www.roadmasterinc.com](http://www.roadmasterinc.com) or call 800-669-9690.

## RSS anti-sway bars are designed to fit specific...

- ...class A motorhomes
- ...class C motorhomes
- ...sport utility vehicles
- ...trucks and vans



## RSS anti-sway bar benefits

• **Safety** — body roll forces more weight to the outside tires, reducing traction. An anti-sway bar distributes the weight evenly over all the wheels. With more rubber on the road, the vehicle is more stable and responsive.

Sway can force the driver into a series of oversteer reactions, especially during cornering. Compensating for sway at the steering wheel is dangerous at any speed.

• **Comfort** — constantly having to correct for sway is not only dangerous, it's also physically exhausting. RSS anti-sway bars virtually eliminate sway caused by crosswinds and weight shift. So even after hours at the wheel, the driver arrives fresh, instead of fatigued.

## What do our customers say?

"I noticed a difference as soon as I stepped into the motorhome — there was no rocking movement. During a recent trip we encountered substantial crosswinds. With the RSS anti-sway bar, I estimate our motorhome's sway was reduced by 90%. We don't feel anything now when a tractor trailer blows by us. I'm 100% satisfied — everyone should experience the benefit of this product."

— Johnny Singleton, Myrtle Beach, South Carolina

"After installing the (anti-sway) bar, the truck handles like a Ferrari! Unbelievable how this has changed the unfavorable handling characteristics into a finely-tuned, very user-friendly vehicle with exceptional road manners. After the installation, I test-drove doing hard swerves...like being on rails! I highly recommend adding these to your chassis."

— Carl Sommer, Fort Wayne, Indiana

"...These products WORK and are worth every penny. To have peace of mind and feel in control of your coach is a fantastic feeling."

— Dwayne Guida, Loxley, Alabama

# Care and Cleaning



## LubeMaster™ silicone spray

LubeMaster is the ideal lubricant for tow bars, awning arms, window tracks, folding steps or for hundreds of other applications around the home and RV.

It's a dry silicone, which doesn't attract dirt or road grime that can cause binding.

Meets Volatile Organic Compound (VOC) standards.

**747 LubeMaster**

## Tow Bar Cleaner

A fast-acting, environmentally-friendly solution that makes cleaning your tow bar a breeze. Removes dirt and grime build-up, penetrating into blind holes and between adjacent surfaces. Melts away road film, diesel exhaust, bugs, tar, grease and grime, dirt and debris.

Biodegradable, non-toxic, contains no phosphates or petroleum distillates.

Designed for tow bars but works wonders on any surface that's hard to clean.

**9932 Tow Bar Cleaner**  
22 oz. spray



## Voom™ RV

The newest cleaning technology in Voom RV allows you to use only one cleaner for all of your RV's cleaning and maintenance. From top to bottom, front to rear, inside and out, Voom RV is the only cleaner you will ever need.

Voom RV is an all-purpose cleaner that's safe for all surfaces not harmed by water. And it's safe for the planet — Voom RV is biodegradable and contains no petroleum distillates. Great for around the home, too!

**Exterior uses:** aluminum; awnings; black streaks; chrome; bug stains; painted surfaces; rubber; rubber roofs; screens; tar; wheels and more! **Interior uses:** appliances; carpets; counter tops; fiberglass; grease; hard water stains; mold and mildew; pet stains; spot cleaning; tubs; toilets; upholstery.

**9911 Voom RV** 32 oz. spray  
**9910 Voom RV** 1 gallon  
**9955 Voom RV** 55-gallon drum

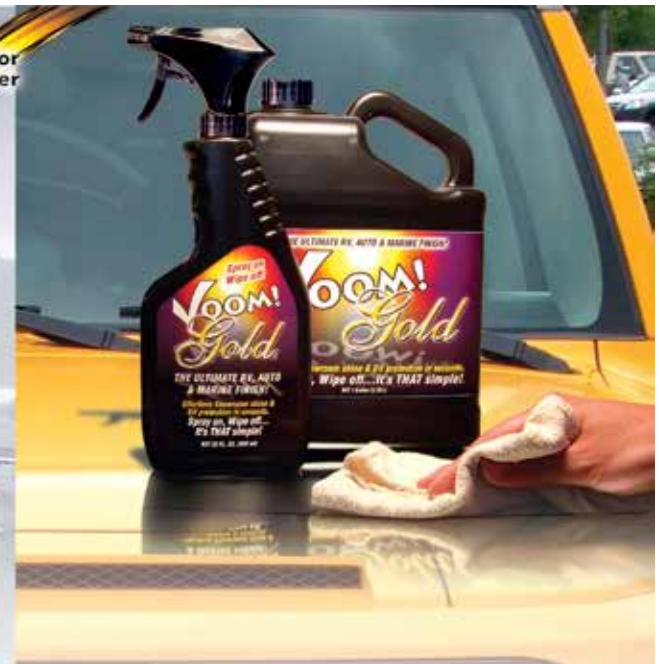

**A beautiful shine and great UV protection**

## Voom™ Gold

Effortless showroom shine and UV protection in seconds — uniquely formulated Voom Gold produces a microfine UV- and chemical-resistant film, creating a deep, rich luster that will deepen with each application, protecting surfaces from further oxidation or deterioration. Spray on, wipe off — it's that simple!

Perfect for both smooth and textured surfaces, vinyl, rubber, plastic and fiberglass. Renews and protects all exterior surfaces from further oxidation and deterioration. Contains no acrylic polymers that yellow and crack. Shine lasts for months and deepens with every application.

**9941 Voom Gold** 22 oz. spray  
**9940 Voom Gold** 1 gallon



Made in the U.S.A.





Time Tested • Time Proven



Photo courtesy of GoRving.com

## Glossary of towing terms

**binding** — When the tow bar is difficult to detach because of excessive pressure, the tow bar is said to be “bound.” All-Terrain tow bars (see pages 2 and 3) have a patented latching mechanism which virtually eliminates this problem.

**car-mounted** — a tow bar designed to be mounted and stored on the towed vehicle.

**curb weight** — the total weight of a vehicle and all necessary fluids (water, coolant, oil and a full tank of gas) when not loaded with either passengers or cargo.

**diode** — Diodes allow the towed vehicle’s brake and turn signal lights to mimic the motorhome’s (which is required by law) without damaging the towed vehicle’s electrical system. They allow current to flow in only one direction, eliminating electrical feedback, which could damage the towed vehicle’s wiring, fuses or other electrical components.

**Gross Vehicle Weight Rating** (or “GVWR”) — how much weight a vehicle is designed to carry. The GVWR includes the net weight of the vehicle, plus the weight of passengers, fuel, cargo and any additional accessories. GVWR is a safety standard used to prevent overloading.

**hitch** (or “receiver hitch”) — the two-inch receiver on the back of the motorhome where your tow bar connects.

**motorhome-mounted** — a tow bar designed to be mounted and stored on the motorhome.

**mounting bracket** (a.k.a. “bracket”) — connects the towed vehicle to the tow bar. All mounting brackets are bolted to the subframe of the towed vehicle.

**proportional braking** — A supplemental braking system which brakes at the same time and intensity as the motorhome is called “proportional.” There are two proportional systems in this catalog — a direct system (BrakeMaster) and a portable system (Even Brake).

**removable bracket arms** — All tow bar mounting brackets have arms which extend out from the vehicle. ROADMASTER’s ‘hidden’ brackets (see page 7) have arms that can be easily removed, making the bracket virtually invisible.

**quick-disconnects** — the connection point between the tow bar and the tow bar mounting brackets. These components allow the tow bar to be quickly connected and disconnected. There is one quick-disconnect (“QD”) for the driver’s side and one for the passenger side. Quick-disconnects also allow for the mounting of accessories such as the Guardian.

**quick links** — used to attach the safety cables. They look like one link in a chain, and have a nut which can be threaded up or down to open or close the link.

**safety cables** — Required by law, safety cables connect the towed vehicle to the towing vehicle. They are a secondary safety device to hold the vehicles together if the towing system separates for any reason.

**stinger** — the part of a tow bar that inserts into the motorhome’s receiver hitch. A hitch pin and clip secure the tow bar to the motorhome.

**supplemental braking** — an independent braking system that brakes the towed vehicle in tandem with the motorhome.





"After installing the Reflex stabilizer bars, the truck handles like a Ferrari! Unbelievable how this has changed the unfavorable handling characteristics into a finely-tuned, very user-friendly vehicle with exceptional road manners.

After the installation I test-drove, doing hard swerves... like being on rails!"

— Carl Sommer, Fort Wayne, Indiana

"I swerved to avoid a collision with a truck in the wrong lane, and veered off the road into the brush. I could see my Ford Explorer in the motorhome's rear view camera, whipping back and forth. I thought for sure it was going to roll on its side. I know a little about physics, and I was amazed that your Falcon 2 tow bar held it in place. You folks make a damn good product."

— Walt Leutwyler, Dallas, Texas

"With your easy-to-follow instructions I had no trouble at all installing your tow bar mounting bracket on my Nissan Versa. The installation was perfect. I can't say enough about the quality of the product, the excellent hardware package, and again, the excellent instructions. I wouldn't have attempted the installation without your instructions."

— Monty Kelley, Modesto, California

(Visit [www.roadmasterinc.com/products/testimonials](http://www.roadmasterinc.com/products/testimonials) to see what dozens of other customers have said about our products.)



Time Tested • Time Proven

ROADMASTER, Inc. • 6110 NE 127th Ave.  
Vancouver, Washington 98682 • 800-669-9690  
fax (360) 735-9300 • [roadmasterinc.com](http://roadmasterinc.com)

TM & © 1999-2016 ROADMASTER, Inc. All rights reserved 10/16 853079-12  
All illustrations and specifications contained in this catalog are based on the latest information available at the time of publication.  
ROADMASTER, Inc. reserves the right to make changes at any time, without notice, in material, specifications and models, or to discontinue models.