PeopleSoft Enterprise Student Financials 9.0 PeopleBook

March 2010

Copyright © 1988, 2010, Oracle and/or its affiliates. All rights reserved.

Trademark Notice

Oracle is a registered trademark of Oracle Corporation and/or its affiliates. Other names may be trademarks of their respective owners.

License Restrictions Warranty/Consequential Damages Disclaimer

This software and related documentation are provided under a license agreement containing restrictions on use and disclosure and are protected by intellectual property laws. Except as expressly permitted in your license agreement or allowed by law, you may not use, copy, reproduce, translate, broadcast, modify, license, transmit, distribute, exhibit, perform, publish or display any part, in any form, or by any means. Reverse engineering, disassembly, or decompilation of this software, unless required by law for interoperability, is prohibited.

Warranty Disclaimer

The information contained herein is subject to change without notice and is not warranted to be error-free. If you find any errors, please report them to us in writing.

Restricted Rights Notice

If this software or related documentation is delivered to the U.S. Government or anyone licensing it on behalf of the U.S. Government, the following notice is applicable:

U.S. GOVERNMENT RIGHTS

Programs, software, databases, and related documentation and technical data delivered to U.S. Government customers are "commercial computer software" or "commercial technical data" pursuant to the applicable Federal Acquisition Regulation and agency-specific supplemental regulations. As such, the use, duplication, disclosure, modification, and adaptation shall be subject to the restrictions and license terms set forth in the applicable Government contract, and, to the extent applicable by the terms of the Government contract, the additional rights set forth in FAR 52.227-19, Commercial Computer Software License (December 2007). Oracle USA, Inc., 500 Oracle Parkway, Redwood City, CA 94065.

Hazardous Applications Notice

This software is developed for general use in a variety of information management applications. It is not developed or intended for use in any inherently dangerous applications, including applications which may create a risk of personal injury. If you use this software in dangerous applications, then you shall be responsible to take all appropriate fail-safe, backup, redundancy and other measures to ensure the safe use of this software. Oracle Corporation and its affiliates disclaim any liability for any damages caused by use of this software in dangerous applications.

Third Party Content, Products, and Services Disclaimer

This software and documentation may provide access to or information on content, products and services from third parties. Oracle Corporation and its affiliates are not responsible for and expressly disclaim all warranties of any kind with respect to third party content, products and services. Oracle Corporation and its affiliates will not be responsible for any loss, costs, or damages incurred due to your access to or use of third party content, products or services.

Contents

Preface

PeopleSoft Enterprise Student Financials Preface	xxix
PeopleSoft Products	xxix
PeopleSoft Enterprise Campus Solutions Application Fundamentals	xxix
PeopleBook Structure	xxix
PeopleBooks and the Online PeopleSoft Library	xxxii

Chapter 1

Getting Started with PeopleSoft Enterprise Student Financials	1
PeopleSoft Enterprise Student Financials Overview	1
PeopleSoft Student Financials Business Processes	2
PeopleSoft Student Financials Integrations	2
PeopleSoft Enterprise Student Financials Implementation	3

Chapter 2

Completing Student Financials General Setup	5
Understanding Student Financials General Setup	5
Setting Up Installation Parameters and Keywords	5
Understanding Installation Parameters	6
Understanding Global Invoicing	6
Pages Used to Set Up Installation Parameters and Keywords	7
Defining Number Sequence Start Points, Maximum Row Settings, and ChartField Edit Options	7
Defining Payment by Invoice	11
Defining Keyword Edit Tables and a Null Due Date	11
Defining Commit Levels	15
Defining Keywords	16
Reviewing Valid Records and Fields	17
Pages Used to Review Valid Records and Fields	17
Reviewing Valid Records	17
Reviewing Valid Fields	18
Setting Up Business Units	19
Understanding Business Units	19
Pages Used to Set Up Business Units	20

Defining Basic Business Unit Parameters	21
Defining Additional Business Unit Parameters	22
Defining Posting Parameters	24
Defining Committal and Approval Options	28
Defining Collection Rules	30
Defining Basic Refunding Rules	30
Defining Refund Approval Parameters	30
Defining Default Payroll Parameters	30
Defining Auto-Numbering Sequences	31
(CAN)(AUS)(NZL) Defining Tax Parameters for Students from Canada, Australia, and New Zealand	32
Setting Up Tax Authorities and Tax Codes	34
Understanding Tax Authorities and Tax Codes	34
Pages Used to Set Up Tax Authorities and Tax Codes	35
Defining Tax Authorities	35
Specifying VAT Rebates for Tax Authorities	36
Defining Tax Codes	36
Setting Up Aging Sets	37
Page Used to Set Up Aging Sets	37
Defining Aging Sets	37
Setting Up Payment Application Rules	39
Understanding Payment Application Rules	39
Pages Used to Set Up Payment Application Rules	40
Creating a Charge Priority List and Linking It to an Item Type Tree	40
Defining Charge Priority List Rules	41
Defining Payment Overall Priorities	47
Setting Up Account Types	51
Pages Used to Set Up Account Types	51
Setting Up Account Types	52
Setting Up Accounting Dates	54
Page Used to Set Up Accounting Dates	54
Page Used to Set Up Accounting Dates	55
Setting Up Item Types and Item Type Groups	55
Understanding Item Types and Item Type Groups	56
Pages Used to Set Up Item Types and Item Type Groups	57
Defining Basic Item Type Attributes	58
Defining Transaction Amount and Tax Form Parameters for Item Types	62
Defining Miscellaneous Parameters for Item Types	64
Defining External Awards	67
Defining Item Type Posting Restrictions	68
Linking Account Types to an Item Type	69
Mapping Item Types to General Ledger Accounts	70
Defining Item Type Groups	76
Setting Up Service Indicator Sets	77
Understanding Service Indicator Sets	77

Pages Used to Set Up Service Indicator Sets	78
Defining Service Indicator Set Details	78
Defining Eligible Academic Careers for Service Indicator Sets	80
Setting Up a Default Academic Term	81
Page Used to Set Up a Default Academic Term	81
Defining Default Academic Terms	81

Chapter 3

Setting Up ePayment Processing	83
Understanding ePayment Processing	83
Setting Up Credit Card Types	83
Page Used to Set Up Credit Card Types	84
Defining Accepted Credit Card Types	84
Re-encrypting Credit Card, Bank Account Numbers, Security Code Data, and Security Key	84
Understanding Encryption	85
Understanding Re-encryption	85
Pages Used to Re-Encrypt and Convert Data	87
Regenerating the Encryption Key	87
Converting Data to Use a Regenerated Encryption Key	88
Setting Up Payment Merchants	90
Page Used to Set Up Payment Merchants	91
Defining Electronic Payment Merchants	91
Testing Payment and Hosted Payment Transactions	96
Page Used to Test Payment and Hosted Payment Transactions	96
Testing ePayment and Hosted Payment Transactions	97
Setting Up SF Merchants	100
Understanding SF Merchants	100
Page Used to Set Up SF Merchants	101
Defining ePayment Processing Parameters	101
Setting Up Institution Sets	106
Setting Up Item Types for ePayment	107
Setting Up Self-Service Options	107

Chapter 4

Setting Up GL Interface Processing	109
Understanding GL Interface Processing Setup	109
GL Interface Processing Using PeopleSoft General Ledger or Oracle General Ledger	110
GL Interface Processing Using a Third-Party or Legacy General Ledger System	112
Loading Setup Data Using PeopleSoft Application Messaging	112
Reviewing Setup Table Data for PeopleSoft Financials	117

Understanding Table Setup Data	117
Pages Used to Review Setup Table Data	117
Linking Student Financials Business Units to PeopleSoft General Ledger Units	118
Setting Up HRMS for Oracle Financials	118
Setting Up the Ledger Fields Table	119
Understanding the Ledger Fields Table Setup	119
Page Used to Set Up the Ledger Fields Table	119
Defining Ledger Fields	119
Synchronizing Oracle GL Segments	120
Mapping General Ledger Business Units to Oracle General Ledger	120
Pages Used to Map General Ledger Business Units to Oracle General Ledger	121
Mapping GL Business Units to Oracle GL	121
Mapping Transaction Classification to Oracle GL Journal Categories	123
Synchronizing ChartField Values	125
Page Used to Synchronize ChartField Values	125
Synchronizing ChartField Values	125
(Optional) Creating ChartField SpeedType Keys	127
Understanding ChartField SpeedType Keys	127
Page Used to Create ChartField SpeedType Keys	127
Defining ChartField SpeedTypes	127
(Optional) Activating ChartField Validation Options	130
Assigning Charts of Accounts	130
Validating ChartFields	130
Understanding ChartFields Validation	131
Page Used to Validate ChartFields	131
Identifying Invalid ChartFields	131
Setting Up Integration with PeopleSoft Financials and Oracle Financials	132
Pages Used to Set Up Integration with PeopleSoft Financials and Oracle Financials	132
Defining Batch Publish Rules for GL Messaging	133
Defining Batch Programs for GL Messaging	134
Setting Up Business Unit Synchronization for PeopleSoft Financials	134
Synchronizing Student Financials Business Unit Data with PeopleSoft Financials	135
Copying ChartField Information for Item Types from One Term to Another	137
Page Used to Copy ChartField Information for Item Types from One Term to Another	137
Running the GL Term Copy Process	137

Chapter 5

Setting Up Tuition Controls, Criteria, Equations, and Waivers	139
Understanding Tuition Controls, Criteria, Equations, and Waivers	139
Creating Billing and Due Date Calendars	139
Page Used to Create Billing and Due Date Calendars	140
Defining Billing and Due Date Calendars	140

Setting Up Adjustment Calendars	142
Understanding Adjustment Calendars	142
Pages Used to Set Up Adjustment Calendars	143
Defining Adjustment Calendars	143
Defining Administrative Fees for Adjustment Periods	145
Calculating the Term Fee by Term and Adjusting by Term Scenarios	147
Establishing Tuition Calculation Controls	150
Pages Used to Establish Tuition Calculation Controls	151
Specifying Tuition Calculation Parameters	151
Establishing Restrictions on Automatic Tuition Calculation	153
Selecting Errors and Warnings	154
Defining Variables for Criteria and Equations	155
Understanding Equation Variables	155
Pages Used to Define Variables for Criteria and Equations	155
Defining Character Variables	156
Defining Numeric Variables	156
Defining Yes/No Flags	157
Establishing Criteria for Tuition Groups and Fee Triggers	158
Understanding Tuition Group and Fee Trigger Criteria	158
Pages Used to Establish Criteria for Tuition Groups and Fee Triggers	159
Defining Criteria Codes and Criteria Types	159
Defining Criteria Details	160
Using Equation Engine to Define Tuition Calculation Equations	161
Understanding Global Variables	162
Page Used to Define Tuition Calculation Equations	163
Viewing Delivered Equations	163
Viewing Equation Information	164
Using Equation Engine in Student Financials Tuition Calculation	168
Using Student Financials Undergraduate Selection Equation	169
Defining Waivers and Waiver Groups	171
Pages Used to Define Waivers and Waiver Groups	171
Defining Waivers	171
Defining Waiver Groups	173
Creating Course Lists	174
Page Used to Create Course Lists	174
Defining Course Lists	174
Chapter 6	
Setting Up Fees and Tuition Groups	177
Setting Up Fee Classes	177
Page Used to Set Up Fee Classes	178
Defining Minimum and Maximum Fees	178

Understanding Minimum and Maximum Fees	178
Pages Used to Define Minimum and Maximum Fees	178
Defining Minimum and Maximum Fees for Billing Careers and Academic Years	179
Defining Minimum and Maximum Fees for Terms and Sessions	180
Defining Minimum and Maximum Fees for Admit Terms	181
Setting Up Application Fees	181
Understanding Application Fees	181
Pages Used to Set Up Application Fees	182
Defining Application Fees	182
Defining Application Fee Item Types	183
Defining Application Sub Fees	185
Setting Up Deposit Fees and Deposit Due Dates	186
Pages Used to Set Up Deposit Fees and Deposit Due Dates	186
Defining Deposit Fees	187
Defining Deposit Fee Due Dates	188
Defining Status Changes Resulting from Deposits	189
Setting Up Term Fee Codes	190
Understanding Term Fee Codes	190
Pages Used to Set Up Term Fee Codes	191
Defining Term Fee Codes	191
Defining Term and Session Fees	193
Defining Term Sub Fee Codes	195
Defining Term Sub Fees	198
Defining Tuition Residency Minimums and Maximums	202
Copying Term Fees to Subsequent Terms	203
Setting Up Course Fees and Class Fees	204
Understanding Course Fees and Class Fees	205
Pages Used to Set Up Course Fees and Class Fees	206
Setting Up Rate Tables for Course Fees	207
Defining Course Fees	209
Defining Course Sub Fees	210
Defining Modal Course Fees	212
Defining Modal Course Sub Fees	213
Defining Class Fees	213
Defining Class Sub Fees	214
Defining Modal Class Fees	216
Defining Modal Class Sub Fees	217
Rolling Over Course and Class Fees to Future Terms	217
Defining Optional Fees	218
Pages Used to Define Optional Fees	218
Defining Optional Fee Codes	219
Defining Optional Fee Values	219
Linking Optional Fees to Terms	220
Defining Optional Fee Amounts	221
Setting Up Transaction Fees	222

Page Used to Set Up Transaction Fees	223
Defining Transaction Fees	223
Setting Up Course List Fees	224
Page Used to Set Up Course List Fees	224
Defining Course List Fees	225
Setting Up Tuition Groups	227
Understanding Tuition Groups	228
Pages Used to Set Up Tuition Groups	228
Defining Tuition Groups	229
Linking Adjustment Codes to Tuition Groups	230
Linking Criteria to Tuition Groups	231
Linking Term Fees to Tuition Groups	232
Linking a Waiver Code to a Single Term Fee Within a Tuition Group	233
Linking Course Lists to Tuition Groups	234
Linking Waiver Codes to Tuition Groups	234
Reviewing Established Tuition Group Priorities	235

Chapter 7

Setting Up Refunding	237
Prerequisites	237
Setting Up Your Business Unit to Refund Customers	238
Pages Used to Set Up Your Business Unit to Refund Customers	238
Defining Basic Refunding Rules	238
Defining Refund Approval Parameters	241
Defining Default Payroll Interface Parameters	242
Setting Default Withholding Amounts for Payroll Refunds	243
Setting Up Accounts Payable Options	243
Pages Used to Set Up Accounts Payable Options	243
Setting Up an AP Business Unit	243
Defining AP Set Controls for Vendors	245
Setting Up Payroll Refund Options	246
Creating Job Data for Payroll Refunds	246
Pages Used to Create Job Data	247
Creating Job Data for Payroll Refunds	247
Creating Job Data in Batch	248
Creating T4A Tax Job Data	249
Setting Up Direct Deposit for Students	249
Designating Sponsors	249
Pages Used to Designate Sponsors	250
Designating Sponsors for Individual Students	250
Designating Sponsors for Organizations	251

Chapter 8

Setting Up Payment Plans	253
Common Elements Used in This Chapter	253
Setting Up Deferral Contracts	253
Pages Used to Set Up Deferral Contracts	254
Defining Basic Deferral Contract Parameters	254
Defining Deferral Contract Administrative Fees	256
Defining Deferral Contract Eligible Charges and Maximum Amounts	257
Setting Up Payment Plan Contracts	259
Pages Used to Set Up Payment Plan Contracts	259
Defining Basic Payment Plan Contract Parameters	259
Defining Payment Plan Type, Eligible Charges, and Time Frame	262
Defining Payment Plan Item Types	265
Defining Self Service Options	267
Defining Payment Plan Administrative Fees	269
Setting Up Third-Party Contracts	270
Pages Used to Set Up Third-Party Contracts	271
Defining Basic Third-Party Contract Parameters	271
Defining Third-Party Contract Item Types	274
Defining Third-Party Charge Transfers	276
Setting Up Collection Agreements	277
Pages Used to Set Up Collection Agreements	278
Defining Basic Collection Agreement Parameters	278
Defining Collection Agreement Administrative Fees	280

Chapter 9

Setting Up Billing	283
Setting Up Billing Messages	283
Understanding Billing Messages	283
Pages Used to Set Up Billing Messages	284
Defining Billing Messages	284
Linking Billing Messages to Item Types	285
Linking Billing Messages to Aging Sets	285
Linking Billing Messages to Business Units	286
Linking Billing Messages to Students	286
Linking Billing Messages to Corporations	286
Setting Up Invoice Layouts	286
Understanding XML Publisher	287
Pages Used to Set Up Invoice Layouts	287

Defining and Maintaining Reports	288
View Sample XML For Report Definition	289
Print Invoices From The Run Control Page	289
Defining Invoice Layout Information	291
Defining Invoice Layout Sorting and Summarization	292
Setting Up Invoice ID Number Generation	295
Page Used to Set Up Invoice ID Number Generation	295
Defining Invoice Number Generation	295
Setting Up Billing Scan Lines	296
Page Used to Set Up Bill Scan Lines	296
Defining Billing Scan Lines	296
Setting Up Billing Types	298
Page Used to Define Billing Types	298
Setting Up Billing Standard Requests	298
Pages Used to Set Up Billing Standard Requests	299
Defining General Selections	300
Define Additional General Selections	302
Defining Communication Information	304
Defining Academic Selections	305
Defining Additional Academic Selections	307
Selecting Billing Messages	307
Selecting Student Groups	308
Select Enrollment Blocks	309
Selecting Account Types	310
Defining Corporation Information	311

Chapter 10

Setting Up Cashiering	313
Defining a Cashiering Office	313
Pages Used to Define a Cashiering Office	313
Defining the Basic Cashiering Office Parameters	314
Defining the Transaction Setup of a Cashiering Office	316
Setting Up Valid Registers and Cashiers	320
Pages Used to Set Up Valid Registers and Cashiers	320
Defining Valid Registers	320
Defining Valid Cashiers	321
Setting Up Target Keys	323
Pages Used to Set Up Target Keys	323
Defining Target Keys	323
Linking Tax Authorities to Target Keys	326
Setting Up Tender Keys	327
Pages Used to Set Up Tender Keys	328

Defining Tender Keys	328
Specifying Cashiers for Tender Keys	331
Setting Up for Processing Credit Cards	331
Setting Up Void Reasons	332
Page Used to Set Up Void Reasons	332
Setting Up Receipt Messages	332
Pages Used to Set Up Receipt Messages	332
Creating Receipt Messages Linked to Cashiering Offices	333
Creating Receipt Messages Linked to Target Keys	333
Creating Receipt Messages Linked to Tender Keys	334
Modifying Cashiering Receipt Forms	335
Pages Used to Modify Cashiering Receipt Forms	335
Preparing Image Files for Uploading	336
Uploading Image Files	337
Setting Up Form Image Text	337
Using Form Editor to Change a Receipt Title and Add an Image	338

Chapter 11

Setting Up Receivables Maintenance	341
Defining Origins and Group Types	341
Understanding Origins and Group Types	341
Pages Used to Define Origins and Group Types	342
Defining Origins	342
Defining Group Types	343
Setting Up Late Fees	344
Pages Used to Set Up Late Fees	345
Setting Up Basic Late Fee Parameters	345
Setting Up Aging Category Information for Late Fees	348
Defining Late Fee Maximums and Due Dates	349
Specifying Academic Programs for Late Fees	351
Setting Up Late Fees - Billing	353
Understanding Late Fees Billing	353
Page Used to Set Up Late Fees - Billing	353
Set up Late Fees - Billing Parameters	353
Setting Up External File Layouts	355
Understanding External File Layouts	355
Pages Used to Set Up External File Layouts	356
Defining Basic File Layout Parameters	356
Defining Field Positions and Lengths	357
Defining Locations and Lengths of Control Data	358
Setting Up Item Reasons	359
Page Used to Set Up Item Reasons	359

Setting Up Payroll Deduction	359
Understanding Payroll Deduction	359
Pages Used to Set Up Payroll Deduction	360
Defining Payroll Deduction Codes	360
Defining Payroll Deduction Relationships	361
Assigning Payroll Deduction Codes to Payment Plans	361

Chapter 12

Setting Up Receivables Collection	363
Prerequisites	363
Setting Up Business Units for Collections	363
Pages Used to Set Up Business Units for Collections	364
Defining Collection Rules for Business Units	364
Setting Up Collectors	366
Page Used to Set Up Collectors	366
Defining Collectors	366
Setting Up Collection Criteria	367
Pages Used to Set Up Collection Criteria	367
Setting Up Student Collection Criteria	367
Setting Up Organization Collection Criteria	369
Defining Reason In and Reason Out Codes	369
Pages Used to Define Reason In and Reason Out Codes	370
Creating Follow-Up Actions	370
Page Used to Create Follow-Up Actions	370
Setting Up Collection Letter Templates	370
Page Used to Set Up Collection Letter Templates	371
Defining Collection Letter Templates	371

Chapter 13

Setting Up Tax Form Production	375
Common Element Used in This Chapter	375
Setting Up 1098-T Tax Form Production	375
Understanding 1098-T Tax Form Production Setup	375
Pages Used to Set Up 1098-T Tax Form Production	376
Setting Up a TIN	376
Setting Up Valid Citizenship Statuses	378
Setting Up T2202A Tax Form Production	379
Setting Up T4A Tax Form Production	379

Chapter 14

Processing ePayment Transactions 381

Understanding ePayment Transactions 381

Processing ePayment Service Requests 382

 Pages Used to Process ePayment Service Requests 382

 Processing Submitted Credit Card Transactions 383

 Processing Submitted eCheck Transactions 385

 Purging Security Code Data 385

Reviewing and Canceling Self-Service ePayment Transactions 386

 Page Used to Review and Cancel Self-Service ePayment Transactions 387

 Viewing and Canceling Self-Service Credit Card Transactions 387

Processing Refunds for ePayments 391

 Pages Used to Process Refunds for ePayments 392

 Creating Online Student Refunds 392

 Running the ePayment Refunds Process 392

Reviewing ePayment Transactions 392

 Pages Used to Review ePayment Transactions 393

 Defining Selection Criteria for Reviewing ePayment Transactions 393

 Reviewing ePayment Transaction Details 396

Reviewing Self-Service Agreements 398

 Page Used to Review Self-Service Agreements 399

 Reviewing Self-Service Agreements 399

Chapter 15

Using GL Interface Processing 403

Understanding GL Interface Processing 403

Running the Chartfield Audit Report 406

 Understanding the Chartfield Audit Report 406

 Page Used to Run the Chartfield Audit Report 409

 Running the Chartfield Audit Report 409

Creating Accounting Entries 411

 Understanding Accounting Entry Creation 411

 Pages Used to Create Accounting Entries 414

 Creating Accounting Entries Using the GL Interface Process 414

 Creating Accounting Entries Using the Cashiering GL Interface Process 415

Reviewing GL Interface Information 416

 Pages Used to Review GL Interface Information 416

 Reviewing GL Interface Run History 417

 Reviewing Accounting Line Information 417

Reviewing Batch Publish Control Records	420
Using the Back Out GL Interface Process	421
Page Used to Run the Back Out GL Interface Process	421
Running the Back Out GL Interface Process	421
Sending Accounting Entries to the General Ledger	422
Page Used to Send Accounting Entries to the General Ledger	423
Publishing Accounting Line Information	423

Chapter 16

Calculating Tuition and Fees	425
Calculating Tuition for a Single Student	425
Pages Used to Calculate Tuition for a Single Student	425
Calculating a Student's Tuition	426
Calculating Tuition for Multiple Students	427
Pages Used to Calculate Tuition for Multiple Students	427
Calculating Tuition in Batch	428
Locking In a Minimum Tuition Amount	430
Page Used to Lock In a Minimum Tuition Amount	430
Locking In Tuition	430
Recalculating Tuition and Fees After Enrollment Cancellation	431
Page Used to Recalculate Tuition and Fees After Enrollment Cancellation	431
Recalculating Tuition and Fees After Enrollment Cancellation	431
Changing, Calculating, and Posting Optional Fees	432
Pages Used to Change, Calculate, and Post Optional Fees	432
Calculating Optional Fees for an Individual Student	433
Overriding Optional Fees After the No Change Date	434

Chapter 17

Refunding Customers	435
Understanding Refunds	435
Refunding Methods	436
Refunding Processes	436
Refunding Recipients	436
Refunding Formats	436
Refunding Process Flow	437
Creating Batch Refunds	439
Pages Used to Create Batch Refunds	440
Defining General Parameters	441
Selecting Academic Programs	442
Selecting Account Types and Terms	443

Selecting Item Types	444
Creating Online Refunds	444
Pages Used to Create Online Refunds	445
Creating Student Refunds	445
Creating Organization Refunds	448
Creating Student Refunds with an Extra Amount	449
Specifying the Account and Term Associated with an Extra Refunded Amount	451
Creating Online Refunds for a Sponsor	451
Approving Refunds	453
Pages Used to Approve Refunds	453
Routing Batch Refunds to Worklists	453
Approving Refunds	454
Completing Batch Payroll Refunds	455
Pages Used to Complete Batch Payroll Refunds	455
Creating Job Data by Batch	456
Requesting a Payroll Interface	456
Creating and Loading Paysheets	456
Calculating Refunds	457
Confirming Refunds	457
Distributing Payroll Refunds Through Direct Deposit	457
Page Used to Distribute Payroll Refunds Through Direct Deposit	458
Running the Create Direct Deposit File Process	458
Printing Checks and Direct Deposit Advice Slips	458
Pages Used to Print Checks and Direct Deposit Advice Slips	458
Running the Refund Check and Advice Slip Printing Processes	459
Completing AP Refunds	459
Understanding AP Refund Completion	459
Page Used to Complete AP Refunds	460
Running the AP Refund Process	460
Distributing Refunds to ePayment Accounts	461
Understanding ePayment Refunds	461
Pages Used to Distribute ePayment Refunds	462
Distributing Refunds for ePayment Transactions	462
Distributing Refunds for Other Credit Card Transactions	462
Canceling Refunds	463
Pages Used to Cancel Refunds	463
Canceling Student Refunds	463
Canceling Organization Refunds	464
Reversing Refunds	464
Understanding Refund Reversals	464
Pages Used to Reverse Refunds	465
Reversing Student Refunds by ID	465
Reversing Student Refunds by Date	466
Reversing Organization Refunds by ID	467
Reversing Organization Refunds by Date	467

Reversing Refunds Within Payroll for North America	467
Renumbering Refund Checks for Reprinting	467
Page Used to Renumber Refund Checks for Reprinting	468
Renumbering Checks	468
Deleting Paysheets	468
Page Used to Delete Paysheets	469
Deleting Paysheets	469
Viewing Refund Information in Student Financials	469
Pages Used to View Refund Information	469

Chapter 18

Administering Payment Plans	471
Understanding Payment Plans	471
Common Elements Used in This Chapter	471
Understanding Payment Plans	471
Linking Students to Deferral Contracts	473
Pages Used to Link Students to Deferral Contracts	473
Defining Student-Specific Details for a Deferral Contract	473
Administering Payment Plan Contracts	474
Pages Used to Administer Payment Plan Contracts	475
Confirming and Modifying Payment Plan Contract Parameters for an Individual Student	475
Confirming and Modifying Additional Payment Plan Contract Parameters for an Individual Student	476
Recalculating Payment Plan Contracts	478
Administering Third-Party Contracts	479
Page Used to Administer Third-Party Contracts	479
Linking Students to Third-Party Contracts	479
Recalculating Third-Party Contracts	481
Enrolling Multiple Students in a Payment Plan or Third-Party Contract	482
Pages Used to Enroll Multiple Students in a Payment Plan or Third-Party Contract	482
Defining Enrollment for Multiple Students	482
Reviewing Results by Contract	484
Processing Mass Contract Assignments	485
Processing Mass Cancellations	486
Using Inquire Contract Assignments	488

Chapter 19

Billing Customers	489
Understanding Customer Billing	489
Completing Billing Requests	489

Understanding Billing Requests	490
Pages Used to Complete Billing Requests	492
Specifying Basic Student Billing Request Parameters	492
Specifying Bill Terms and Print Options for Student Billing Requests	494
Specifying Basic Corporate Billing Request Parameters	497
Specifying Bill Terms and Print Options for Student Billing Requests	498
Billing Specific Charges for Individual Students	498
Pages Used to Bill Specific Charges for Individual Students	499
Viewing Pending To Bill Items	499
Creating Individual Bills for Students	500
Viewing the Student Invoice Summary Pages	502
Processing Billing Requests	504
Pages Used to Process Billing Requests	505
Processing Student Billing Requests	505
Processing Corporate Billing Requests	506
Printing Invoices	506
Pages Used to Print Invoices	506
Printing Student Invoices Using Form Based Extract Bill	507
Printing Corporate Invoices Using Form Based Extract Bill	509
Printing Student Invoices Using an SQR or XML Publisher	510
Printing Corporate Invoices Using an SQR or XML Publisher	511
Printing Student Invoices Using Crystal	511
Printing Corporate Invoices Using Crystal	512
Canceling Bills	513
Pages Used to Cancel a Bill	513
Canceling Bills	514
Viewing Billing Information	515
Pages Used to View Billing Information	515
Reviewing Student Billing History	516
Viewing Details for Student Bill Items	517

Chapter 20

Cashiering	519
Understanding Cashiering	519
Common Elements Used in This Chapter	519
Cashiering	520
Opening a Cashiering Office for a Business Day	520
Pages Used to Open a Cashiering Office for a Business Day	520
Opening a Cashiering Office	520
Opening Valid Registers	522
Opening Valid Cashiers	523
Processing Cashiering Transactions	524

Understanding Cashiering Transactions	524
Pages Used to Process Cashiering Transactions	526
Accepting Student Payments	527
Allocating Student Payments to Specific Charges	534
Accepting Corporate Payments	534
Allocating Corporate Payments to Sponsored Charges	536
Creating Third-Party Tracking Information for Corporate Payments	537
Creating Department Receipts	537
Cashing Checks	539
Processing Interim Deposits	542
Replenishing Cash	543
Selecting Exchange Rates for Cashiering Transactions Processed with Foreign Currency	544
Entering Check Information for Cashiering Transactions	545
Entering Credit Card Information for Cashiering Transactions	546
Posting Delayed Receipts	548
Page Used to Post Delayed Receipts	548
Posting Delayed Payment Receipts	548
Processing the Cashiering GL Interface	549
Voiding Receipts	549
Understanding Receipt Voiding	549
Pages Used to Void Receipts	550
Voiding Receipts Using Security	550
Voiding Receipts Without Using Security	550
Reviewing Details for Individual Receipts	551
Page Used to Review Details for Individual Receipts	552
Reviewing and Printing Individual Receipts	552
Reviewing Receipt and Tender Activity	553
Understanding Receipt and Tender Activity Review	553
Pages Used to Review Receipt and Tender Activity	553
Reviewing Receipts by Business Date	554
Reviewing Payment Activity for an Organization	555
Reviewing Payment and Check Cashing Activity for a Student	556
Reviewing Tender Activity by Cashier	557
Reviewing Tender Activity by Register	558
Reviewing Receipt Tender Flow	559
Reviewing Totals by Deposit ID	561
Page Used to Review Totals by Deposit ID	561
Reviewing Cashiering Office Balance Totals by Deposit ID	561
Closing a Cashiering Office for a Business Day	562
Pages Used to Close a Cashiering Office for a Business Day	563
Closing Registers	563
Closing Cashiers	564
Closing a Cashiering Office	565
Reopening a Cashiering Office for a Closed Business Day	566
Pages Used to Reopen a Cashiering Office for a Closed Business Day	566

Reopening the Office	566
Reopening Registers	567
Reopening Cashiers	568

Chapter 21

Maintaining Receivables	571
Common Elements Used in This Chapter	571
Entering Groups of Transactions	573
Understanding Group Data Entry	573
Pages Used to Enter Groups of Transactions	573
Defining Source Information and Control Totals for Group Transactions	574
Adding Transactions to a Group Entry	576
Entering Transactions from an External Source	579
Page Used to Enter Transactions from an External Source	580
Loading External Files	580
Processing Payroll Deductions	581
Prerequisites	581
Pages Used to Process Payroll Deductions	582
Selecting Payroll Deduction Records	582
Reviewing Results of Payroll Deduction Record Selection	584
Creating Payroll Deduction Groups	585
Reviewing and Revising Group Data Entries Before Posting	586
Pages Used to Review and Revise Group Data Entries Before Posting	586
Reviewing Suspended Transactions from a Data Group	587
Reviewing and Updating Details About a Specific Data Group Transaction	587
Posting Group Data Entries	587
Pages Used to Post Group Data Entries	588
Running the Group Post Process	588
Posting Transactions for Individual Students and Organizations	589
Pages Used to Post Transactions for Individual Students and Organizations	589
Posting Transactions for Individual Students	590
Posting Transactions for Individual Organizations	592
Consolidating and Reviewing Transactions for Individual Students and Organizations	592
Pages Used to Consolidate and Review Transactions for Individual Students and Organizations	593
Viewing Account Information Within the Maintain Receivables Feature	593
Pages Used to View Account Information Within the Maintain Receivables Feature	593
Viewing Payment by Invoice Information Within the Maintain Receivables Feature	594
Pages Used to View Payment by Invoice Information Within the Maintain Receivables Feature	594
Viewing Items by Invoice	594
Viewing Corp Items by Invoice	595
Updating Payment Invoice ID	596
Updating Corp Payment ID	597

Managing Disputed Charges	597
Understanding Disputed Charges	597
Pages Used to Manage Disputed Charges	598
Entering Dispute Information	598
Reversing Payments and Charges	600
Pages Used to Reverse Payments and Charges	600
Reversing Payments	601
Reversing Charges	601
Reversing Groups of Transactions	602
Processing Payroll Deduction Reversals	603
Applying Payments	603
Pages Used to Apply Payments	603
Running the Payment Applier Process	603
Writing Off Charges and Account Balances	604
Understanding Write-offs	605
Pages Used to Write Off Charges and Account Balances	605
Creating Write-offs for Individual Students	606
Creating Write-offs for Individual Organizations	607
Selecting Accounts to Write Off for Individual Students and Organizations	607
Selecting Items to Write Off for Individual Students and Organizations	608
Processing Batch Write-offs	608
Reversing Write-offs for Students	610
Reversing Write-offs for Organizations	611
Processing Enrollment Deposits	611
Pages Used to Process Enrollment Deposits	611
Defining Basic Parameters for Enrollment Deposit Processing	612
Selecting Academic Programs and Waiver Forms (Student Permissions) for the Enrollment Deposit Process	613
Processing Late Fees	614
Pages Used to Process Late Fees	615
Calculating and Posting Late Fees	615
Processing Late Fees Using the Billing Request Number	617
Pages Used to Process Late Fees Using the Billing Request Number	617
Processing Late Fees - Billing	618
Processing Enrollment Cancellation	619
Understanding Enrollment Cancellation	620
Pages Used to Process Enrollment Cancellation	620
Defining Student Selection Criteria for Enrollment Cancellation	620
Defining Charges, Offset Payments, Cancellation Options, and Service Indicators for Enrollment Cancellation	625
Validating Tables	626
Page Used to Validate Tables	626
Running the Table Validation Process	627

Chapter 22

Maintaining Customers 633

Understanding the Maintain Customers Feature 633

Understanding the Maintain Customers Feature 633

Managing Student Permissions 634

 Understanding Student Permissions 634

 Pages Used to Manage Student Permissions 634

 Creating Student Permission Forms to Apply Restricted Credits 635

 Attaching Student Permission Forms to Student Records 635

 Attaching Student Permission Forms to Charge Priority Lists 636

Processing and Reviewing Customer Credit History 637

 Pages Used to Process and Review Customer Credit History 637

 Processing Customer Credit History 637

Chapter 23

Collecting Receivables 643

Understanding Receivables Collection 643

 Prerequisites 643

 Common Element Used in This Chapter 643

 Receivables Collection 644

Assigning Collection Items to Collectors and Worklists 644

 Pages Used to Assign Collection Items to Collectors and Worklists 644

 Assigning Collection Items to Collectors 644

 Assigning Collection Items to Worklists 646

Working Collection Items 646

 Understanding Collection Items 646

 Pages Used to Work Collection Items 647

 Viewing Demographic Information and Collection Items 648

 Selecting Collection Letter Templates 650

 Recording Collection Steps and Follow-Up Actions for Collection Items 651

Updating Collection Letter Information 654

 Pages Used to Update Collection Letter Information 654

Processing Collection Letters 655

 Page Used to Process Collection Letters 655

Adding to a Collector's Queue Without Using Worklists 655

 Pages Used to Add to a Collector's Queue Without Using Worklists 655

 Manually Adding Students To Collections Without Using The Workflow Process 656

 Manually Adding Corporations To Collections Without Using The Workflow Process 656

Viewing Customers or Corporations That Are in Collection 657

Pages Used to View Customers or Corporations That Are in Collection	657
Viewing Customers in Collection	657
Viewing Corporations in Collection	658

Chapter 24

Producing Tax Forms and Receipt Information	659
Understanding Tax Form and Receipt Production	659
Common Elements Used in This Chapter	659
Tax Form Production	659
Understanding Receipt Information Generation	660
Producing and Filing 1098-T Tax Forms	661
Prerequisites	662
Pages Used to Produce and File 1098-T Tax Forms	662
Generating 1098-T Data	663
Reviewing 1098-T Messages	665
Reviewing and Overriding 1098-T Data	665
Validating and Auditing 1098-T Data	671
Printing 1098-T Forms and Creating Transmission Files	672
Producing T2202A Tax Forms	675
Prerequisite	675
Pages Used to Produce T2202A Tax Forms	675
Generating T2202A Data	676
Reviewing and Editing T2202A Data	677
Printing T2202A Tax Information on Preprinted Forms	678
Printing T2202A Tax Information Using File Extract	679
Producing T4A Tax Forms	679
Prerequisites	680
Pages Used to Produce T4A Tax Forms	680
Creating POI Job Data for T4A	680
Generating T4A Data	681
Reviewing T4A Tax Forms	682
Generating Income Tax and Donation Receipt Information	683
Pages Used to Generate Income Tax and Donation Receipt Information	683
Generating Income Tax Receipt Information	683
Generating Donation Receipt Information	683

Chapter 25

Setting Up and Using International Health Coverage	685
Understanding International Health Coverage	685
IHC Process Flow	685

Purchasing	687
Reporting and Paying	687
Refunding	687
Setting Up the IHC Feature	688
Pages Used to Set Up IHC	688
Setting Up Provider Information	689
Setting Up Provider Coverage Plans and Rates	690
Setting Up IHC Item Types	691
Setting Up IHC Contact Information	691
Maintaining Student Information and Creating Schedules	692
Pages Used Maintain Student Information	692
Maintaining Student Health Coverage Information	692
Creating Schedules	697
Generating IHC Letters	698
Page Used to Generate Letters	699
Generating Letters to Students	699

Chapter 26

(NLD) Using the Banking Interface	703
Understanding the Banking Interface for the Netherlands	703
Setting Up the Banking Interface	703
Pages Used to Set Up the Banking Interface	704
Setting Up Account Information for Business Units	704
Setting Up Bank Account Numbers for Students	706
Setting Up Default Values for VERWINFO or Clieop03 Files	708
Billing Students Using OLA or VERWINFO	710
Understanding Billing Students Using OLA or VERWINFO	710
Pages Used to Bill Students Using OLA or VERWINFO	711
Posting Student Transactions	711
Printing OLA Forms	711
Loading VERWINFO Files	712
Processing Payments	713
Using the Clieop03 Process	713
Understanding the Clieop03 Process	714
Prerequisites	714
Page Used for the Clieop03 Process	714
Creating Clieop03 Files	714

Chapter 27

(AUS) Setting Up and Using Australian Loan Processing	717
--	------------

Understanding Loan Processing for Australian Higher Education	717
HECS-HELP	717
Tuition Calculation for HECS	720
FEE-HELP	721
OS-HELP	721
Preparing for Setting Up HELP	721
Setting Up Australian Loan Defaults	722
Pages Used to Set Up Australian Loan Defaults	722
Defining Liability Statuses	723
Defining HECS HELP Loan Defaults	725
Defining FEE HELP Loan Defaults	725
Defining OS HELP Loan Defaults	726
Defining Status Change Rule Loan Defaults	727
Setting Up HECS Fee Codes	728
Setting Up HECS Band Fees	728
Linking Band Fees to Tuition Groups	730
Excluding HECS Classes	731
Reviewing HECS Results and Running the HECS Reconciliation	732
Pages Used to Review HECS Results and Run the HECS Reconciliation	733
Reviewing HECS Results	733
Reconciling HECS on the Census Date	734
Creating and Updating FEE-HELP Loans	735
Understanding FEE-HELP Loans	735
Pages Used to Create and Update FEE-HELP Loans	736
Creating and Updating FEE-HELP Loans	736
Updating Statuses for FEE HELP Determinations	737
Creating and Updating OS-HELP Loans	741
Page Used to Create and Update OS-HELP Loans	742
Maintaining OS-HELP Loans	742
Creating Commonwealth Assistance Notices	743
Page Used to Create Commonwealth Assistance Notices	743
Creating or Updating Commonwealth Assistance Notices	743

Chapter 28

(NZL) StudyLink Processing	745
Understanding StudyLink	745
Setting Up StudyLink Functionality	745
Pages Used to Set Up StudyLink Functionality	746
Defining StudyLink Institution Defaults	746
Defining the Institution ID	748
Defining StudyLink Posting Parameters	750
Processing VOS Requests and Responses	751

Pages Used to Process VOS Requests and Responses	751
Requesting VOS Information	751
Initiating VOS Responses	752
Maintaining StudyLink Loan Information	753
Understanding Maintaining StudyLink Loan Information	753
Pages Used to Maintain StudyLink Loan Information	754
Creating Payment Schedules	754
Processing Batch Refunds	755
Creating Student Reports	756

Chapter 29

(NZL) New Zealand Qualification Authority Fees	757
Understanding NZQA Fees	757
Setting Up NZQA Fee Information	757
Page Used to Set Up NZQA Fees	758
Setting Up Valid Records	759
Setting Up Valid Fields	759
Setting Up Fee Triggers	760
Setting Up Term Fee Codes	762
Setting Up Term Fees	763
Viewing Term Sub Fee Codes	765
Setting Up Term Sub Fees	766
Setting Up Per Credit Charges	768

Appendix A

Delivered Workflows for Student Financials	771
Delivered Workflows for Student Financials	771
Corporate Collection Worklist	771
Customer Collection Worklist	772
Department Receipt Approval	773
Group Posting Approval	773
Refund Approval	774

Appendix B

Student Financials Global Invoicing Reminder Letters	775
Defining and Issuing Reminder Letters	775
Pages Used to Define and Issue Reminder Letters	775
Defining Communication Data Source	777

Defining Invoice Reminder Letter Properties	779
Defining Template Properties	780
Defining Output Properties	781
Defining Bursting Properties	782
Setting Up Standard Letter	782
Defining Comm Key	783
Defining Event 3C Groups	784
Defining Event Definition	785
Defining 3C Engine Parameters	785
Defining Manage Duplicate Assignment	786
Reviewing the Generated Communication	787
Running Communication Generation Process	788
Setting Up Process Parameters	789
Reviewing Communication	790
Appendix C	
PeopleSoft Student Financials Reports	793
PeopleSoft Student Financials Reports: A to Z	793
Crystal and SQR Reports	793
Setup Table Crystal Reports	802
Index	807

PeopleSoft Enterprise Student Financials Preface

This preface discusses:

- PeopleSoft Products.
- PeopleSoft Enterprise Campus Solutions Application Fundamentals.
- PeopleBook structure.

PeopleSoft Products

This PeopleBook refers to the following PeopleSoft product: PeopleSoft Enterprise Student Financials.

PeopleSoft Enterprise Campus Solutions Application Fundamentals

Additional, essential information describing the setup and design of your system appears in two companion volumes of documentation called *PeopleSoft Enterprise Campus Solutions 9.0 Application Fundamentals PeopleBook* and *PeopleSoft Enterprise Campus Community Fundamentals 9.0 PeopleBook*. Each PeopleSoft product line has its own version of this documentation.

Note. One or more pages in Student Financials operate in deferred processing mode. Deferred processing is described in the preface in the *PeopleSoft Enterprise Campus Solutions 9.0 Application Fundamentals PeopleBook*.

See Also

PeopleSoft Enterprise Campus Solutions 9.0 Application Fundamentals PeopleBook, "PeopleSoft Enterprise Campus Solutions Preface"

PeopleSoft Enterprise Campus Community 9.0 Fundamentals PeopleBook, "PeopleSoft Enterprise Campus Community Preface"

PeopleBook Structure

PeopleSoft PeopleBooks follow a common structure. By understanding this structure, you can use this PeopleBook more efficiently.

The PeopleBooks structure conveys a task-based hierarchy of information. Each chapter describes a process that is required to set up or use the application. Chapter sections describe each task in the process. Subsections within a section describe a single step in the process task.

Some PeopleBooks may also be divided into parts. PeopleBook parts can group together similar implementation or business process chapters within an application or group together two or more applications that integrate into one overall business solution. When a book is divided into parts, each part is divided into chapters.

The following table provides the order and descriptions of chapters in a PeopleBook:

Chapters	Description
Preface	<p>This is the chapter you're reading now. It explains:</p> <ul style="list-style-type: none"> • How to use the Application Fundamentals book. • How PeopleBooks are structured. • Common elements used in the PeopleBook, if necessary.
Getting Started With...	<p>This chapter discusses product implementation guidelines. It explains:</p> <ul style="list-style-type: none"> • The business processes documented within the book. • Integrations between the product and other products. • A high-level overview of how our documentation maps to the overall implementation process; it doesn't offer step-by-step guidance on how to perform an actual implementation.
Navigation	<p>(Optional) Some PeopleSoft applications provide custom navigation pages that contain groupings of folders that support a specific business process, task, or user role. When an application contains custom navigation pages, this chapter provides basic navigation information for these pages.</p> <p>Note. Not all applications have delivered custom navigation pages.</p>
Understanding...	<p>(Optional) This is an introductory chapter that broadly explains the product and the functionality within the product.</p>

Chapters	Description
Setup and Implementation	<p>This can be one or more chapters. These chapters contain documentation to assist you in setting up and implementing the product. For example, if functionality X is part of a product, this chapter would be devoted to explaining how to set up functionality X, not necessarily how to use functionality X. You would look to the corresponding business process chapter to learn how to use the functionality.</p> <p>Note. Sometimes a small amount of business process information is included in a setup chapter if the amount of business process documentation is insufficient to create a separate section in the book.</p>
Business Process	<p>This can be one or more chapters. These chapters contain documentation that addresses specific business processes with each chapter generally devoted to a specific functional area. For example, if functionality X is part of a product, this chapter would be devoted to explain how the functionality works, not necessarily how to set up functionality X. You would look to the corresponding setup and implementation chapter to learn how to set up the functionality.</p> <p>Note. Sometimes a small amount of setup and implementation information is included in a business process chapter if the amount of setup and implementation documentation is insufficient to create a separate chapter in the book.</p>
Appendixes	<p>(Optional) If the book requires it, one or more appendixes might be included in the book. Appendixes contain information that is considered supplemental to the primary documentation.</p>
Delivered Workflow Appendix	<p>(Optional) The delivered workflow appendix describes all of the workflows that are delivered for the application.</p> <p>Note. Not all applications have delivered workflows.</p>
Reports Appendix	<p>(Optional) This appendix contains an abbreviated list of all of the product's reports. The detailed documentation on the use of these reports is usually included in the related business process chapter.</p>

PeopleBooks and the Online PeopleSoft Library

A companion PeopleBook called PeopleBooks and the Online PeopleSoft Library contains general information, including:

- Understanding the PeopleSoft online library and related documentation.
- How to send PeopleSoft documentation comments and suggestions to Oracle.
- How to access hosted PeopleBooks, downloadable HTML PeopleBooks, and downloadable PDF PeopleBooks as well as documentation updates.
- Understanding PeopleBook structure.
- Typographical conventions and visual cues used in PeopleBooks.
- ISO country codes and currency codes.
- PeopleBooks that are common across multiple applications.
- Common elements used in PeopleBooks.
- Navigating the PeopleBooks interface and searching the PeopleSoft online library.
- Displaying and printing screen shots and graphics in PeopleBooks.
- How to manage the PeopleSoft online library including full-text searching and configuring a reverse proxy server.
- Understanding documentation integration and how to integrate customized documentation into the library.
- Glossary of useful PeopleSoft terms that are used in PeopleBooks.

You can find this companion PeopleBook in your PeopleSoft online library.

Chapter 1

Getting Started with PeopleSoft Enterprise Student Financials

This chapter provides an overview of PeopleSoft Enterprise Student Financials and discusses:

- PeopleSoft Enterprise Student Financials business processes.
- PeopleSoft Enterprise Student Financials integrations.
- PeopleSoft Enterprise Student Financials implementation.

PeopleSoft Enterprise Student Financials Overview

Student Financials is a tool for higher education institutions to manage student receivables, billing, collections, and cashiering. Using Student Financials, both staff and students can quickly find and use the financial information they need to make critical decisions. Student Financials receives information from virtually all areas of PeopleSoft Enterprise Campus Solutions. With this application, you can:

- Calculate fees and tuition.
- Maintain customer account information.
- Create bills.
- Establish payment plans.
- Refund tuition and fees.
- Perform cashiering.
- Process collections.
- Interact with your general ledger system.
- Set up and print tax forms.

PeopleSoft Student Financials Business Processes

Student Financials enables you to manage and calculate student financial information for your institution. With it you can calculate tuition and fees, bill customers, and issue refunds. It provides functionality enabling you to set up payment plans for students and implement an automated collections process. It integrates with your general ledger to properly track and allocate your institution's debits and credits. Student Financials provides built-in tax reporting functionality for both the U.S. (1098-T) and Canada (T2202A, T4A, Donation Receipts, and Tax Receipts). It supports and automates third-party processing by providing a seamless link to the payment posting process, enabling you to process both split payments, directed payments, or both online.

PeopleSoft Student Financials Integrations

Student Financials integrates with these applications:

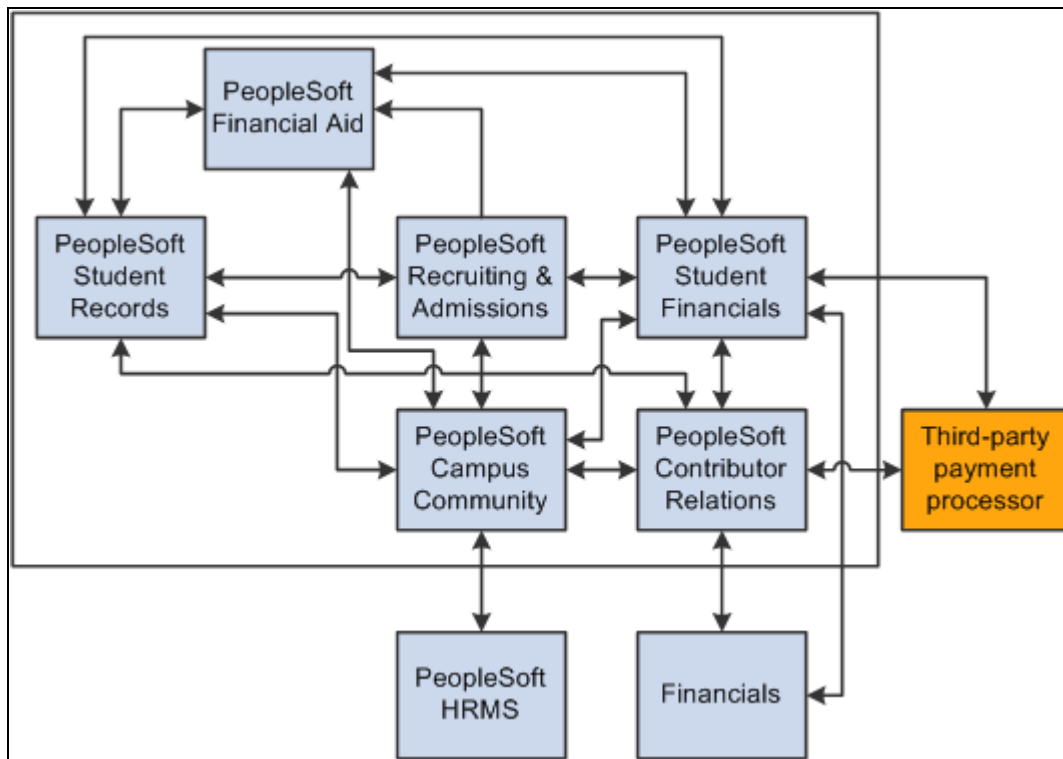

PeopleSoft Student Financials integrations

We discuss integration considerations in the implementation chapter in this PeopleBook. Supplemental information about third-party application integrations is located on the My Oracle Support website.

PeopleSoft Enterprise Student Financials Implementation

PeopleSoft Setup Manager enables you to generate a list of setup tasks for your organization based on the features that you are implementing. The setup tasks include the components that you must set up, listed in the order in which you must enter data into the component tables, and links to the corresponding PeopleBook documentation.

Student Financials also provides component interfaces to help you load data from your existing system into Student Financials tables. Use the Excel to Component Interface utility with the component interfaces to populate the tables.

This table lists all of the components that have setup component interfaces:

Component	Component Interface	References
CLASS_FEE_PANEL	SSF_CLASS_FEE_PANEL_GBL	See Chapter 6, "Setting Up Fees and Tuition Groups," Setting Up Course Fees and Class Fees , page 204.
CLST_FEE_PANEL	SSF_CLST_FEE_PANEL_GBL	See Chapter 6, "Setting Up Fees and Tuition Groups," Setting Up Course Fees and Class Fees , page 204.
ITEM_TYPE_PANEL	SSF_ITEM_TYPE_PANEL_GBL	See Chapter 2, "Completing Student Financials General Setup," Setting Up Item Types and Item Type Groups , page 55.

This section lists tasks that you should complete as part of setting up your PeopleSoft Student Financials system.

- Complete the general setup of your Student Financials system. This setup is required before you can set up any of the features that are delivered with Student Financials. During this step you define the most basic elements of the Student Financials system including tableset IDs, SF installation parameters, item types, the 1098-T TIN table, and account types.
- Define how your Student Financials system interacts with your general ledger. The required steps of this implementation task depend on whether your institution interacts with PeopleSoft General Ledger, Oracle General Ledger, or a third party general ledger application.
- Set up application fee and enrollment deposit processing.
- Define payment processing parameters including payment item types and charge priority.
- If your institution has satellite departments or auxiliary services, such as Housing, Library, and Parking, that will need to interact with Student Financials, you will likely need to set up the External File Load feature.
- Decide how your institution calculates tuition and set up the appropriate components.
- Set up the parameters for the Billing feature.

- If your institution chooses to use the Cashiering feature that is delivered with Student Financials, you must define cashiering offices, valid registers and cashiers, tender keys, and target keys.
- Determine whether your institution issues refunds through accounts payable or payroll, and set up your system accordingly.
- Define payment plans for your institution. Student Financials delivers functionality for several different types of payment plans.
- In conjunction with the 3Cs setup, define your collections process.
- Coordinate with the financial aid staff to set up item types for financial aid disbursement.

Other Sources of Information

In the planning phase of your implementation, take advantage of all PeopleSoft sources of information, including the installation guides, data models, business process maps, and troubleshooting guidelines.

See Also

PeopleSoft Enterprise Campus Community 9.0 Fundamentals PeopleBook, "PeopleSoft Enterprise Campus Community Preface"

PeopleTools PeopleBook: PeopleSoft Component Interfaces

Enterprise PeopleTools PeopleBook: PeopleSoft Setup Manager

Chapter 2

Completing Student Financials General Setup

This chapter provides an overview of PeopleSoft Student Financials general setup and discusses how to:

- Set up installation parameters and keywords.
- Review valid records and fields.
- Set up business units.
- Set up tax authorities and tax codes.
- Set up aging sets.
- Set up payment application rules.
- Set up account types.
- Set up accounting dates.
- Set up item types and item type groups.
- Set up service indicator sets.
- Set up a default academic term.

Understanding Student Financials General Setup

A substantial amount of setup is required before you can use. The setup described in this chapter establishes the framework for everything that follows. Take enough time and resources now to build a strong foundation, which you can add to later. You do much of this setup once, and modify it rarely, if ever. You use other parts repeatedly as the system expands and changes.

Be aware that PeopleSoft Campus Solutions is an integrated system and coordination between departments and applications is essential to the success of your implementation.

Setting Up Installation Parameters and Keywords

To set up installation parameters and keywords, use the Student Fin Installation component (INSTALLATION_SF) and the Keywords component (KEYWORDS).

This section provides overviews of installation parameters and key words and global invoicing and discusses how to:

- Define number sequence start points, maximum row settings, and ChartField edit options.
- Define payment by invoice.
- Define keyword edit tables and a null due date.
- Define commit levels.
- Define keywords.

Understanding Installation Parameters

Installation parameters define how Student Financials looks and performs. You specify how the system:

- Numbers certain elements.
- Displays results for various functions.
- Determines the frequency for committing work to the database.

You can change most of these settings at any time without any negative impact. In fact, you should experiment with your settings to strike the proper performance balance. PeopleSoft software provides default settings for many of these parameters, but review them to make sure that they work well for your institution.

Keywords

Key words enable you to quickly locate item types within a long list of possibilities. For example, you might have dozens of payment item types, but only a handful that are related to scholarships. By defining Scholarship as one of your key words and associating it with the select few item types, it will be much easier to locating just the item type you need will be much easier. You can define up to three keywords per item type. Key words are associated with edit tables, and you must select the appropriate edit table to use for each key word.

Note. Because Student Financials, Financial Aid, and Contributor Relations all use keywords, we recommend Student Financials, Financial Aid, and Contributor Relations staff work together to define a keyword standard for your institution.

Understanding Global Invoicing

Many institutions, especially those outside the United States, are required to bill and collect payments from students using an invoice model rather than the standard statements typically used in the United States. Campus Solutions enables such global institutions to invoice for student receivables.

Global invoicing enables institutions to:

- Link charges to a specific invoice with a unique invoice number. Subsequent invoices include only new activity and do not include any prior balance.

- Send a reminder letter rather than include unpaid charges in another invoice if a student does not pay an invoice.
- Allow students to make a payment against a specific invoice rather than against the overall account. Any charge or payment priorities are applied only within the context of the specific invoice.
- Create a specific credit invoice that references the original invoice if charges are reversed after being invoiced.
- Refund excess payments or a credit balance from an invoice to the student unless the student authorizes the institution to apply that credit to a different invoice.
- Pass charges to the General Ledger only after they have been invoiced.

Campus Solutions offers institutions the flexibility to use its global invoicing functionality or to use billing statements.

An option in the Student Financials installation setup enables the global invoicing functionality. Institutions can also define banking information for inclusion on the invoice as necessary.

Pages Used to Set Up Installation Parameters and Keywords

<i>Page Name</i>	<i>Definition Name</i>	<i>Navigation</i>	<i>Usage</i>
SF Installation	INSTALLATION_SF	Set Up SACR, Install, Student Fin Installation, SF Installation	Define number sequence start points, maximum row settings, ChartField edit options, and financial system setup.
Populate Items by Invoice	SSF_RUNCTL_EURO_BI	Set Up SACR, Product Related, Student Financials, Charges and Payments, Populate Items by Invoice	Define payment by invoice.
SF Installation 2	INSTALLATION_SF2	Set Up SACR, Install, Student Fin Installation, SF Installation 2	Define keyword edit tables, invoice/payment processing, and a null due date.
SF Installation 3	INSTALLATION_SF3	Set Up SACR, Install, Student Fin Installation, SF Installation 3	Define commit levels.
Keywords	KEYWORD_TBL	Set Up SACR, Product Related, Student Financials, Item Types, Keywords	Define keywords.

Defining Number Sequence Start Points, Maximum Row Settings, and ChartField Edit Options

Access the SF Installation page (Set Up SACR, Install, Student Fin Installation, SF Installation).

SF Installation		SF Installation 2		SF Installation 3	
Process Group:	<input type="text"/>	Last Batch ID:	<input type="text" value="41"/>		
		Last Origin ID:	<input type="text" value="18"/>		
Maximum Row Settings					
Application Fees:	<input type="text" value="25"/>	Deposit Fees:	<input type="text" value="25"/>		
Tuition Calculation:	<input type="text" value="25"/>	Tuition Calculation Messages:	<input type="text" value="25"/>		
Late Fees:	<input type="text" value="25"/>	Cashiering Receipts:	<input type="text" value="25"/>		
Group Post:	<input type="text" value="100"/>	Refunds:	<input type="text" value="50"/>		
Financial System					
<input type="radio"/> Enterprise Financials		<input checked="" type="radio"/> Oracle Financials		<input type="radio"/> Others	
ChartField Display Options					
Abbreviated Display Delimiter:	<input type="text" value="*"/>	<input type="checkbox"/> Display External Chartfield			
ChartField Edit Options					
<input type="checkbox"/> Combinations Table Edit	<input checked="" type="checkbox"/> Real-Time Validation Edit	<input type="checkbox"/> Ledger Table Edit			
<input type="checkbox"/> Required Fields Edit	<input type="checkbox"/> Journal Set Edit				

SF Installation page

Process Group

Enter a value for the process group. The system uses the process group in conjunction with GL Combination processes.

Last Batch ID

Each batch transaction is assigned an ID number. This field displays the last ID number assigned to a batch. To start your numbering sequence at a particular point, enter a number here. Otherwise, the system continues to increment subsequent batch transactions from the number shown.

Last Origin ID

Use origin IDs to track the source of batch transactions (for example, receipts from the housing or parking offices). This field displays the last ID number that was assigned to an origin definition. To start your numbering sequence at a particular point, enter a number here. Otherwise, the system continues to increment subsequent origin definitions from the number shown.

Maximum Row Settings Group Box

For each field in this group box, enter the maximum rows of results that you want to display on a page at one time.

Financial System

Use this group box to select the financial system that you want to use: Enterprise Financials, Oracle Financials, or Others.

The selection and functioning of the options in this group box depends on the General Ledger check box selection on the HRMS Installation Table (Setup HRMS, Install, Installation Table).

If the General Ledger check box is selected in HRMS:

- The Enterprise Financials option is selected by default and is read-only.
- The Oracle Financials and Others options are not available for selection.

If the General Ledger check box is cleared in HRMS:

- The Enterprise Financials option is selected by default and is available for selection.
- The Oracle Financials option is available for selection.
- The Others option is available for selection.

ChartField Display Options

Abbreviated Display Delimiter This field is used to distinguish individual ChartFields to be added, updated or viewed as a string on setup pages. Select a delimiter that is not a letter, number or special character used to define any of the ChartField values. For example, if the character '-' is used within the ChartField value 23-1103, do not use the '-' character as the delimiter. If 'A' is used within the ChartField value such as TRAINING, do not use 'A' as the delimiter.

Display External Chartfield This field is available only if the General Ledger check box is cleared in HRMS and the Others option is selected in the Financial System group box.

ChartField Edit Options

ChartFields represent organizational or reporting structures and are used to facilitate the journaling of accounting entries. You can use dynamic ChartFields to customize certain display characteristics (such as order, visibility, labels) of the standard set of ChartFields. Selecting one of the first four options ensures that the Student Financials Departmental Receipt is created with a required ChartField.

Combinations Table Edit Evaluates the ChartField combination to determine whether it exists in the PS_VALID_COMBO_TBL.

If you select the Combinations Table Edit check box, you cannot select the Real-Time Validation Edit check box.

If you select Oracle Financials in the Financial System group box, this check box is cleared by default.

Note. The Combinations Table Edit option is not supported for Oracle Financials.

Real-Time Validation Edit	<p>Evaluates the ChartField combination using the Synchronous Message COMBO_CF_EDIT_REQUEST with Student Financials.</p> <p>If you select the Real-Time Validation Edit check box, you cannot select the Combinations Table Edit check box.</p> <p>If you select Oracle Financials in the Financial System group box, this check box is selected by default.</p> <hr/> <p>Note. The Real-Time Validation Edit option is supported for Oracle Financials and you should select this option if you select Oracle Financials as the financial system. When you set up chartfield combinations, a web service performs real time validation of the chartfield combinations against the Oracle GL combinations.</p> <hr/>
Ledger Table Edit	<p>The LED_FLDS_SF_TBL is used to store required ChartFields for a specified ledger. Required ChartFields are examined for values, and edit errors occur when required values do not exist in the specified ChartFields.</p> <p>If you select Oracle Financials in the Financial System group box, this check box is cleared by default.</p> <hr/> <p>Note. The Ledger Table Edit option is not supported for Oracle Financials.</p> <hr/>
Required Fields Edit	<p>Checks for values in all fields defined in the Required Fields secondary page.</p>
Journal Set Edit	<p>Evaluates individual sets of ChartFields (journal sets) to make sure that percent totals equal 100 and that ledger values remain the same for ChartFields of the same journal set. Selecting this check box also ensures that debit and credit journal set entries are properly balanced.</p>
Use External ChartFields	<p>This check box appears only if you clear the General Ledger check box in HRMS, select Others as the Financial System on the SF Installation page, and restart the application server.</p>

See CS90 to EBS GL Integration Developer's Reference Guide. The guide is posted to My Oracle Support.

See Also

[Chapter 11, "Setting Up Receivables Maintenance," Defining Origins and Group Types, page 341](#)

[Chapter 4, "Setting Up GL Interface Processing," Understanding GL Interface Processing Setup, page 109](#)

[Chapter 17, "Refunding Customers," Understanding Refunds, page 435](#)

PeopleSoft Enterprise HRMS 9.0 Application Fundamentals PeopleBook, "Setting Up and Working with ChartFields and ChartField Combinations" Populating HRMS with Valid ChartField Combinations

Defining Payment by Invoice

Access the Populate Items by Invoice page (Set Up SACR, Product Related, Student Financials, Charges and Payments, Populate Items by Invoice).

Populate Items by Invoice

Run Control ID: 1155257880 [Report Manager](#) [Process Monitor](#) Run

*Pre-conversion Invoice ID:

Populate Items by Invoice page

You can define your business requirements based on country requirements and business model needs.

This enables you to associate charges to individual invoices, create credit invoices, and produce reminder letters. On the payment side, you can run online posting, Cashiering, and batch processes to apply payments to specific invoices.

Run the Populate Item Invoice process to initialize the apply payments by invoice functionality.

This process creates rows in SSF_ITEM_INV that are required to apply payments by invoice. Before running this process, run billing for any transaction that has not yet been billed.

After the process is run, the installation Apply Payments by Invoice check box is selected on the SF Installation 2 page. If you decide at a later time to not apply payments by invoice, the user can clear the check box.

***Pre-conversion Invoice ID** The pre-conversion invoice ID can be any value and does not need to be defined in the Billing Invoice setup, for example, invconv2006.

Run Click to initiate the process.

Defining Keyword Edit Tables and a Null Due Date

Access the SF Installation 2 page (Set Up SACR, Install, Student Fin Installation, SF Installation 2).

SF Installation		SF Installation 2		SF Installation 3	
Edit Table					
Key Word:		KEYWORD1_VW			
Key Word 2:		KEYWORD2_VW			
Key Word 3:		KEYWORD3_VW			
Invoice/Payment Processing					
<input type="checkbox"/>	Apply Payments by Invoice	Pre-conversion Invoice ID:			
Encryption					
Decryption Profile ID		CS_CREDIT_CARD_DECRYPT			
Encryption Profile ID		CS_CREDIT_CARD_ENCRYPT			
<input checked="" type="checkbox"/>	Self Service Payment Profile				
Null Due Date:		01/01/2500			

SF Installation 2 page

Applying Payment by Invoice

Global institutions may have the requirement to assign payments to a specific invoice and not to individual charges.

Campus Solutions allows institutions to select whether to associate payments with a specific invoice or with individual charges. Global Invoicing will associate charges with individual invoices. When payments are received, they are paid against an invoice number and the payment is applied to the charges associated with that invoice. If an overpayment of an invoice number exists, a refund can be generated. A student can make a prepayment prior to any charges invoiced in order to hold his or her place in class. Such a prepayment is not part of the invoice. When tuition calculation is run and charges are incurred, and a bill is generated with the unique invoice number, the prepayment is applied to that invoice. Future bills show only the unpaid amount of the invoice, not an accumulation of charges and payments. If a waiver exists for a student's payment, the waiver appears on the invoice.

Applying payments by invoice involves:

- Invoicing
 - Generate an invoice with unique invoice numbers for charges.
 - Associate invoice numbers with items on the invoice.
 - Create a credit invoice for overpayments.
 - Create a credit invoice for credit balances based on charge reversals while referencing the original invoice.
 - Create invoices in batch as well as on line.
 - View and reprint any individual invoice using original invoice data.
 - Store student bank information (similar to payment profile information but accessible administratively) for student or the legally responsible party.
 - Invoices with a payment voucher which include can line (OCR-B font) that can incorporate the institution's bank information as well as the student's bank information, invoice number, and amount due.
- Payment Processing
 - Payments applied against a specific invoice. If a credit balance remains from a specific invoice, it can manually be applied to another invoice or the student can request a refund.
 - Payments are accepted and applied using payment files from banks or clearinghouses.
 - Prepayments are applied when an invoice is generated
- Reminders and Collections
 - Reminders can be generated for open invoices after a due date has passed using the Campus Community Comm Gen process. Reminder letters include original invoice amount, any payments, remaining unpaid balance, and the number of days passed due.
 - Institutions define a minimum balance as selection criteria when sending reminder letters.
 - All reminders are tracked at the student level for each invoice.

Edit Table

Key Word Select an edit table to use for your first level Key Word values.

Key Word 2 Select an edit table to use for your Key Word 2 values.

Key Word 3 Select an edit table to use for your Key Word 3 values.

Invoice Payment Processing

You cannot set the Apply Payments by Invoice check box. You must instead run the Populate Item Invoice process.

After the process is run, the installation check box, Apply Payments by Invoice, is selected.

If you decide at a later time to not apply payments by invoice, you can clear the check box.

Encryption

Set default profile IDs.

PeopleTools Pluggable Cryptography framework provides the delivered profiles of TRIPLE DES ENC B64 and TRIPLE DES DEC B64.

PeopleSoft Enterprise Campus Solutions has enhanced the PeopleTools profiles specifically for Campus Solutions re-encryption.

Profiles specify multiple user-defined steps applying various algorithms and keys to the data in a specified order and supporting various encryption standards and third-party encryption libraries.

The decrypt profile must be the same profile and have the same keys that are used to encrypt the data as it is. The encryption profile must contain the new keys and algorithm to which you are converting. Therefore, when using the delivered Campus Solutions profiles, you must change the key value on the Algorithm Keyset page for the encrypt profile and associated algorithm before running the conversion process. After running the conversion, you must modify the decrypt profile to include the new key.

Decryption Profile ID The predefined, enhanced profile that is delivered for Campus Solution is CS_CREDIT_CARD_DECRYPT.

Encryption Profile ID The predefined, enhanced profile that is delivered for Campus Solution is CS_CREDIT_CARD_ENCRYPT.

This encryption profile is used in the storage of credit card, bank account numbers, Security Code data, and Security Key.

The profile is used by both Student Financials and Contributor Relations.

See *PeopleSoft Enterprise Student Financials 9.0*, Setting Up ePayment Processing, Re-encrypting Credit Card, Bank Account Numbers, Security Code Data, and Security Key

See Chapter 14, "Processing ePayment Transactions," Purging Security Code Data, page 385.

Self Service Payment Profile

Self Service Payment Profile

The check box is selected by default. When the check box is selected, existing self-service payment profiles are retained and students can create and save new profiles.

Clear the check box to prevent students from creating and saving new payment profiles and from using existing profiles in Self Service.

Note. Clearing the check box does not automatically delete existing payment profiles. The check box is therefore not cleared by default, because you might have existing profiles in your system.

Note also that clearing the check box does not automatically prevent students from creating and maintaining profiles.

Use the following instructions to delete existing profiles and ensure that students cannot create and maintain payment profiles.

After you clear the check box, you must:

1. Run the SSF_PPROFDEL process to delete existing payment profiles: PeopleTools, Process Scheduler, System Process Requests. Click Run, select Purge SF Payment Profiles, and click OK.
2. Remove security for the Payment Profile (SS_SF_ACCT_PROFILE) component by removing the component from all permission lists.

If you clear the check box and take these steps, the default behavior in Self Service will be to *not* create or save payment profiles.

If you forget to remove security for the Payment Profile component and the Self Service Payment Profile check box is cleared, students will still be able to create new and maintain existing payment profiles.

This information appears in a warning message when you clear the Self Service Payment Profile check box and click Save.

Null Due Date

Enter a date that you want the system to use when no other form of due date is specified. Charges with a null due date appear as future charges. You should select a date well into the future. This date appears on the Total Due Charges page of the self-service portion of Student Financials.

Defining Commit Levels

Access the SF Installation 3 page (Set Up SACR, Install, Student Fin Installation, SF Installation 3).

The screenshot shows a web interface for 'SF Installation 3'. It features a 'Commit Level' section with four sub-sections: 'Application Fee', 'Deposit Fee', 'Late Fee', and '1098-T Data'. Each sub-section contains three radio button options: 'Commit After Each Item' (which is selected), 'Commit At The End', and 'Use Commit Level'. To the right of the 'Use Commit Level' option is an empty text input field.

SF Installation 3 page

Application Fee, Deposit Fee, Late Fee, and 1098–T Data Commit Level Group Boxes

The selections that you make in the following fields control how often the system commits batched application, deposit, 1098–T, and late fee transactions to the database.

- Commit After Each Item** Select to commit each transaction when it is processed. The advantage to this selection is that the commitment process does not affect access to your database.
- Commit At The End** Select this option to commit all the transactions contained in the batch being processed at the conclusion of that batch's process. The advantage to this selection is that processing itself is more efficient. The disadvantage is that when transactions are being committed, other processing involving that database may be affected until commitment is complete.
- Use Commit Level** Select to commit a specified number of transactions during processing. For example, if you enter 50 in the Use Commit Level field, when the transactions are saved the system commits blocks of fifty transactions until the batch is complete. At the end of a batch process, the system commits all remaining transactions even if the number of transactions is less than the number in the Commit Level field.

Defining Keywords

Access the Keywords page (Set Up SACR, Product Related, Student Financials, Item Types, Keywords).

Keywords			
SetID:	PSUNV	Keyword:	SCHOLARSHP
*Keyword Status:	Active		
*Description:	Scholarship Funds		
*Short Description:	SCHOLARSHF		
*Keyword Nbr:	Keyword 1		

Keywords page

Keyword Nbr (keyword number) Select the keyword number for this keyword. Each keyword is associated with an edit table that is set up in SF Installation.

Reviewing Valid Records and Fields

To set up records and fields, use the Valid Records component (VALID_RECORD_SF) and the Valid Fields component (VALID_FIELDS).

Student Financials makes certain valid records (tables) and fields available for users to review. You can modify these records and fields, but it is not advised. This section discusses how to:

- Review valid records.
- Review valid fields.

Pages Used to Review Valid Records and Fields

Page Name	Definition Name	Navigation	Usage
Valid Records	SEL_VALID_RECS	Set Up SACR, Product Related, Student Financials, Valid Records	Review valid records.
Valid Fields	SEL_VALID_VARS	Set Up SACR, Product Related, Student Financials, Valid Fields	Review valid fields.

Reviewing Valid Records

Access the Valid Records page (Set Up SACR, Product Related, Student Financials, Valid Records).

Valid Records

SetID: MODEL

Find | View All First 1-8 of 15 Last

*Record (Table) Name	Description	Expand/Collapse
ACAD_PROG	Student Academic Program	+ -
ACAD_SUBPLAN	Student Academic Subplan Table	+ -
CRSE_CATALOG	Course Catalog Data	+ -
DERIVED_SF	Derived - Student Financials	+ -
EXTERNAL_SYSTEM	External System ID's	+ -
PERS_DTUSA_SBR	Personal Data Subrecord - USA	+ -
PERS_INST_REL	Institutional Relationship	+ -
RESIDENCY_OFF	Official Residency Data	+ -

Valid Records page

Record (Table) Name The record (table) name used in the tuition calculation setup appears when you open the page. Because this information is delivered with the system, be careful whenever you plan to make changes to it.

Reviewing Valid Fields

Access the Valid Fields page (Set Up SACR, Product Related, Student Financials, Valid Fields).

Valid Fields

SetID: MODEL

Find | View 100 First 1-3 of 106 Last

*Record:	ACAD_SUBPLAN	*Description:	Academic Sub-Plan	+ -
Field:	ACAD_SUB_PLAN	Edit Table:	ACAD_SUBPLAN_W 40	
*Record:	DERIVED_SF	*Description:	Age - Begin of Term	+ -
Field:	AGE_BOT	Edit Table:	70	
*Record:	DERIVED_SF	*Description:	Age - End of Term	+ -
Field:	AGE_EOT	Edit Table:	71	

Valid Fields page

Record This field displays the record name. The system provides the default selection for this field.

Description	This field displays the record description. The system provides the default selection for this field.
Field	This field displays the field name. The system provides the default selection for this field.
Edit Table	This field displays the edit table associated with the record. The system provides the default selection for this field.

Setting Up Business Units

To set up business units, use the SF Business Unit component (BUSINESS_UNIT_SF).

This section provides an overview of business units and discusses how to:

- Define basic business unit parameters.
- Define additional business unit parameters.
- Define posting parameters.
- Define committal and approval options.
- Define collection rules.
- Define basic refunding rules.
- Define refund approval parameters.
- Define default payroll interface parameters.
- Define auto-numbering sequences.
- Define tax parameters for students from Canada, Australia, and New Zealand (includes Tax Calculation Options).

Understanding Business Units

The SF business unit is the framework that controls all processing within the Student Financials application. Each business unit can have its own set of business rules. For example, you might have different campuses that operate independently from each other financially. By setting up different business units, you can define just what you need. You must set up at least one business unit.

Pages Used to Set Up Business Units

<i>Page Name</i>	<i>Definition Name</i>	<i>Navigation</i>	<i>Usage</i>
General 1	BUS_UNIT_TBL_SF	Set Up SACR, Product Related, Student Financials, SF Business Unit, General 1	Define basic business unit parameters.
General 2	BUS_UNIT_TBL_SF2	Set Up SACR, Product Related, Student Financials, SF Business Unit, General 2	Define additional business unit parameters.
Posting Setup	BUS_UNIT_TBL_SF14	Set Up SACR, Product Related, Student Financials, SF Business Unit, Posting Setup	Define posting parameters.
Commit Options	BUS_UNIT_TBL_SF10	Set Up SACR, Product Related, Student Financials, SF Business Unit, Commit Options	Define committal and approval options.
Collections	BUS_UNIT_TBL_SF7	Set Up SACR, Product Related, Student Financials, SF Business Unit, Collections	Define collection rules.
Refund Setup	BUS_UNIT_TBL_SF3	Set Up SACR, Product Related, Student Financials, SF Business Unit, Refund Setup	Define basic refunding rules.
Refund Approval	BUS_UNIT_TBL_SF20	Set Up SACR, Product Related, Student Financials, SF Business Unit, Refund Approval	Define refund approval parameters.
Payroll Defaults	BUS_UNIT_TBL_SF4	Set Up SACR, Product Related, Student Financials, SF Business Unit, Payroll Defaults	Define default payroll parameters. Use PeopleSoft Payroll for North America to process refunds.
Counters	BUS_UNIT_TBL_SF8	Set Up SACR, Product Related, Student Financials, SF Business Unit, Counters	Define auto-numbering sequences.
Canadian/ANZ Taxes	BUS_UNIT_TBL_SF19	Set Up SACR, Product Related, Student Financials, SF Business Unit, Canadian/ANZ Taxes	Define tax parameters for students from Canada, Australia, and New Zealand and tax calculation options.

Defining Basic Business Unit Parameters

Access the General 1 page (Set Up SACR, Product Related, Student Financials, SF Business Unit, General 1).

General 1		General 2	Posting Setup	Commit Options	Collections	Refund Setup	Refund Approval
Business Unit:	PSUNV						
*Description:	PeopleSoft University Bursar						
Short Description:	PSU						
*Base Currency:	USD		US Dollar				
Exchange Rate Type:	OFFIC		Official Rate				
*Academic Institution:	PSUNV		PeopleSoft University				
Campus:	MAIN		Main				
Location:	PSCSHCDA		Hacienda				
General Ledger Unit:	EGVBU		Educ & Govt/State				
Accounting Method:	A		Accrual Accounting				
AP Business Unit:	US001		USA Operations				

General 1 page

Base Currency	Confirm or select the base currency that you want this business unit to use. The default value is the base currency selected for the institution under Set Up HRMS, Install, Installation Table, HRMS Options. You can override the base currency for each business unit.
Exchange Rate Type	Select the exchange rate type that you use to convert other currency types to the base currency. The exchange rate type is necessary for the posting of charges. <hr/> Note. You define exchange rate types on the Currency Rate Type page (same navigation as above). <hr/>
Academic Institution	Identify the academic institution that contains the SF business unit.
Campus	Enter the appropriate campus for the SF business unit.
Location	Enter the appropriate location for the SF business unit.
General Ledger Unit	If your institution uses PeopleSoft Financials, select the general ledger unit that receives information from the SF business unit. Otherwise, leave this field blank.
Accounting Method	Select your institution's accounting method: <i>Accrual</i> , <i>Cash</i> , or <i>Modified Cash</i> accounting.

AP Business Unit

Select the business unit with which your system interacts when processing refunds through the accounts payable department.

Defining Additional Business Unit Parameters

Access the General 2 page (Set Up SACR, Product Related, Student Financials, SF Business Unit, General 2).

The screenshot shows the 'General 2' configuration page for Business Unit PSUNV (PeopleSoft University Bursar). The page includes the following settings:

- Display Ethnicity Online
- Display Campus ID Online
- Display National ID Online
- Late Fee Option: Late Fee - Past Due/Aging
- Address Usage Billing: SLCT ORD 1 (Home, Mailing, Permanent, Work)
- Name Usage: NAME_PREF (Preferred Name)
- Term / Classes Cancel Reason: CANC (Class Cancelled)
- Aging Set: STD (STD Aging Set)
- Service Indicator Set: STD (Standard)
- Service Impact: NOCH (NO SI added thru Cred History)
- Tuition Calc Required Default: No
- Maintain GL Interface History
- Calc Tuition after Grade Post
- Load Criteria Table
- Accept Self-Service Payments

Buttons at the bottom: Save, Return to Search, Notify, Previous tab, Next tab, Add, Update/Display.

General 2 page

Display Ethnicity Online Select this option if you want the student's ethnicity to appear on the Academic Information page.

Display Campus ID Online Select this option if you want the campus ID to appear on the Academic Information page. The campus ID identifies the campus, not the student.

Display National ID Online Select this option if you want the student's national ID (for example, social security number) to appear on the Academic Information page.

Late Fee Option	<p>Select one of two Late Fee - Billing methods: Late Fees - Bill Request Nbr or Late Fees - Past Due/Aging.</p> <p>Late Fees run control pages use this option to verify that the correct process is used before processing.</p> <p>You can use two distinct processes to calculate late fees. One method is based on the account aging or the due date. The other method is based on a billing request number using the amount billed as a basis.</p>
Address Usage Billing	Select a default address usage type to use when you generate customer bills.
Name Usage	Select a default name usage type.
Term/Class Cancel Reason	Select a term/class cancellation code that you want to use as the default reason when you run the Term/Class Cancellation process.
Aging Set	Select the aging set that the system uses by default for the Assign Collector process.
Service Indicator Set	Select the service indicator set to use. This service indicator set must include all service indicators that you want to use for credit history processing.
Service Impact	Select the service impact to use to stop a service indicator from being placed by the credit history process. This is a default value that will be used when credit history is called from the self-service pages.
Tuition Calc Required Default (tuition calculation required default)	<p>Select <i>Yes</i> if you want the Tuition Calc Required flag set automatically when a student is activated in a term. Use this option if you want tuition to be calculated on Anticipated Units.</p> <p>Select <i>No</i> if you do not want the Tuition Calc Required flag set automatically when a student is activated in a term. Use this option if you want tuition fees calculated only after enrollment activity (Bill Units).</p>
Maintain GL Interface History	Select this option if you want the system to maintain general ledger interface history. This selection is required for you to use the Back Out GL Interface functionality.
Calc Tuition after Grade Post (calculate tuition after grade post)	<p>Select this option if you want the Tuition Calc Required flag to be set to Yes whenever student grades are posted or changed through the Grade Roster page.</p> <hr/> <p>Note. This check box does not affect the Tuition Calc Required flag being set to Yes when grades are posted or changed through the Enrollment pages.</p> <hr/>
Load Criteria Table	<p>Select this option if you want the criteria tables (for example, Career, Program, Fee Triggers, and so on) to be loaded into working storage at the beginning of the Tuition Calculation process. If you are using a large number of waiver criteria, fee triggers, and criteria for tuition groups, selecting this option can improve Tuition Calculation process performance.</p> <hr/> <p>Note. If more than 1000 total criteria values exist, this option must not be selected. Working storage is currently limited to 1000 maximum values.</p> <hr/>

Accept Self-Service Payments

Select this option if you want to allow students to make payments over the web using ePayments. This selection is limited to this SF business unit. This SF business unit must also be attached to an institution set that enables self-service payments. Unless self-service payments are enabled for both the SF business unit and the institution set, students will have access to only one of the self-service pages (Account Inquiry).

See *PeopleSoft Enterprise Campus Self Service 9.0 PeopleBook*, "Setting Up Student Financials Self Service."

Defining Posting Parameters

Access the Posting Setup page (Set Up SACR, Product Related, Student Financials, SF Business Unit, Posting Setup).

General 1		General 2		Posting Setup		Commit Options		Collections		Refund Setup		Refund Approval		▶	
Business Unit:		PSUNV				PeopleSoft University Bursar									
QUICK_POST_TBL Purge Control															
Origin ID:		00010		Housing Office											
Group Type:		Q		Quick Post Transaction											
Credit Processing															
Item Tree Name:		ITEM_SECURITY													
Default Term Control:		Use SF Term Default				<input checked="" type="checkbox"/> Move Initial Payment									
Excess Payment Account:		MIS		Miscellaneous Fees		<input checked="" type="checkbox"/> Move Initial Waiver									
Excess Waiver Account:						<input checked="" type="checkbox"/> Move Initial Financial Aid									
Excess FA Account:		TUT		Tuition		<input checked="" type="checkbox"/> Disbursement Date Item									
Reference Number Posting Usage															
<input type="checkbox"/> Ref Debit Item Flag				<input type="checkbox"/> Ref Item Payment Flag				<input checked="" type="checkbox"/> Ref Excess Payment Flag							

Posting Setup page

Default Term Control Select a value on which to base the term.

The values are:

- *Latest Enrollment Term.* Select if you want the default term to be based on the maximum term from STDNT_CAR_TERM where the eligible to enroll check box is on. If that does not return a term, then the default term will be based on the term value defined in the SF Term Default setup.
- *Most Current Enrollment Term* Select if you want the default term based on the term from STDNT_CAR_TERM with a begin date of less than equal to the current date. If that does not return a term, then the default term will be based on the term from STDNT_CAR_TERM where the end date is greater than or equal to the current date. If this does not return a term, then the default term will be based on the term value defined in the SF Term Default setup.

QUICK_POST_TBL Purge Control

Student Post (Quick Post) and Corp Post transactions are recorded in the Quick Post table. These entries can be consolidated into posting groups using the Purge QUICK_POST_TBL process. The options in this group box create entries in the Group Control record that enable you to easily track Student Post transactions.

Origin ID Select the origin ID that you want the system to use when consolidating transactions into posting groups.

Group Type Select the group type that you want the system to use when consolidating transactions into posting groups.

Credit Processing

Set the conditions that you want the system to use when credits (payments) are posted on an account.

Item Tree Name Select the name of the item type tree that contains all of the item types that you use for transactions. This tree also controls item type security.

Default Term Control Select how you want to determine the term that the system uses as the default if a charge or payment is entered without specifying a term.

Note. Values for this field are delivered with your system as translate values. Do not modify these values in any way. Any modifications to these values require a substantial programming effort.

Warning! Your selection of a default term control can affect how payments are processed. When either of the enrollment term selections are used, the actual term value may vary from student to student. The actual term value used becomes the value of the current term for payment processing.

Values are:

Last Enrollment Term: Select if you want the default term to be based on the student's most recent completed term of enrollment.

Most Current Enrollment Term: Select if you want the default term to be based on the student's most recent term of enrollment, whether completed or not.

Use SF Term Default: Select if you want the default term to be based on the term value that you defined in SF Term Default setup.

Move Initial Payment Select to move all payments in excess of charges to the account specified for excess payments. If the option is not selected, excess payments show as a credit balance on the charge account.

Excess Payment Account Select a default account that you want to use for payments that are received in excess of charges.

Move Initial Waiver Select to move all waivers in excess of charges to the account specified for excess waivers. If this option is not selected, excess waivers show as a credit balance on the charge account.

Excess Waiver Account Select a default account that you want to use for waivers that are posted to an account in advance of charges. This feature can also be used as an option for waivers that are posted in excess of charges.

Warning! Waivers should rarely, if ever, be applied to a student's account other than through the tuition calculation process. Waivers posted using the Student Post or Group Post processes may not be able to be adjusted properly.

Move Initial Financial Aid Select to move all financial aid payments in excess of eligible charges to the account specified for excess financial aid. If this option is not selected, excess financial aid payments show as a credit balance on the charge account.

Excess FA Account (excess financial aid account) Select a default account that you want to use for financial aid that is posted to an account in excess of eligible charges.

Disbursement Date Item Select if you want the system to display each disbursement of a financial aid award in a single term (same item type) as a separate line item on a student's account. Also, selecting this option enables the system to identify specific disbursements in the event that an adjustment is required.

For example, if a direct loan requires more than one disbursement in one term, selecting this check box identifies each disbursement with a unique date causing the system to recognize each as a separate entry.

Clear this option to have all disbursements in a term roll into one line item.

Note. After you begin posting financial aid awards, you should not change this setting.

Warning! Financial aid disbursement does not correctly reverse disbursements when multiple disbursements exist within a term and you do not select the Disbursement Date Item check box. This can occur, for example, if multiple disbursements are in a single term and one or more of them is reduced. If you use batch disbursement to post the new disbursement amount, the posting process reverses the entire disbursement total for the term and then reposts only one of the disbursements in the term. In PeopleSoft Financial Aid, the disbursements look like they have been disbursed properly, but in Student Financials only one of the disbursements is properly posted, so the two applications are out of sync. If you use online disbursement to update the newly reduced disbursement amount, the same problem occurs. The online disbursement process reverses the entire award amount for the term and posts only the new reduced single disbursement amount.

Reference Number Posting Usage

This group box provides additional options for the posting of debits and payments.

Ref Debit Item Flag (reference debit item flag) Select to have the option of associating a reference number with charge items. For example, you could use a parking ticket number as a reference on a parking fine charge. Each charge item with a reference number is displayed separately on the Charge Detail page.

Ref Item Payment Flag (reference item payment flag) Select to have the option of associating a payment with a particular charge by using the reference number. For example, if you use a parking ticket number as a reference number on a parking fine charge, you can use that same ticket number to tie the payment to the specific charge.

Note. The Ref Debit Item Flag check box must be selected for you to use the Ref Item Payment Flag option.

Ref Excess Payment Flag (reference excess payment flag) Select this option to have payments made in excess of a particular charge applied to other charges with the same reference ID.

Note. The Move Initial Payment check box must be selected for you to use the Ref Excess Payment Flag.

See Also

Chapter 11, "Setting Up Receivables Maintenance," page 341

Chapter 21, "Maintaining Receivables," Consolidating and Reviewing Transactions for Individual Students and Organizations, page 592

Chapter 2, "Completing Student Financials General Setup," Setting Up Payment Application Rules, page 39

Defining Committal and Approval Options

Access the Commit Options page (Set Up SACR, Product Related, Student Financials, SF Business Unit, Commit Options).

General 1		General 2		Posting Setup		Commit Options		Collections		Refund Setup		Refund Approval		▶	
Business Unit:		PSUNV				PeopleSoft University Bursar									
Group Posting															
Commit Option															
<input type="radio"/> Commit Every Transaction		<input type="radio"/> Commit At the End		<input checked="" type="radio"/> Commit Level		<input type="text" value="100"/>									
Group Approval Role:		<input type="text" value="CS - Group Approver"/>				🔍									
Unbalanced Group Approval Role:		<input type="text" value="CS - Group Approver UB"/>				🔍									
GL Posting															
Commit Option															
<input checked="" type="radio"/> Commit Every Item		<input type="radio"/> Commit at the End		<input type="radio"/> Commit Level		<input type="text"/>									
GL Max Error Before Stopping:		<input type="text"/>													
Billing Commit Option															
<input checked="" type="radio"/> Commit Every Transaction		<input type="radio"/> Commit at the End		<input type="radio"/> Commit Level		<input type="text"/>									
Credit History Commit Option															
<input type="radio"/> Commit Every Transaction		<input type="radio"/> Commit at the End		<input checked="" type="radio"/> Commit Level		<input type="text" value="100"/>									

Commit Options page

Important! The selections that you make in this page have a specific effect on processing. Consult your IT staff and system administrators to determine the optimum selections for your processing needs.

Group Posting

Set the levels at which group post transactions are committed to the database.

Commit Every Transaction	Select to commit each transaction when it is processed.
Commit At the End	Select to commit all the transactions that are contained in the batch being processed at the conclusion of that batch process.
Commit Level	Select to commit a specified number of transactions during background processing. For example, if you enter <i>100</i> in the Commit Level field, when you run a batch process the system processes 100 transactions and then commits them to the database until the batch is complete. At the end of a batch process, the system commits all remaining transactions even if the number of transactions is less than the number in the Commit Level field.
Group Approval Role	Select the role of the person or persons who can approve the group.
Unbalanced Group Approval Role	Select the role of the person or persons who can approve an out-of-balance group.

GL Posting

Set the levels at which general ledger transactions are committed to the database.

Commit Every Item	Select to commit each transaction when it is processed.
Commit at the End	Select to commit all the transactions that are contained in the batch being processed at the conclusion of that batch process.
Commit Level	Select to commit a set number of transactions during background processing.
GL Max Error Before Stopping (general ledger maximum error before stopping)	Enter the maximum number of errors that you want the system to allow before stopping transaction processing.

Billing Commit Option

Set the levels at which billing transactions are committed to the database.

Commit Every Transaction	Select to commit each transaction when it is processed.
Commit at the End	Select to commit all the transactions that are contained in the batch being processed at the conclusion of that batch's process.
Commit Level	Select to commit a set number of transactions during background processing. Enter a commit level in the field to the right of this option.

Credit History Commit Option

Set the levels at which Credit History process transactions are committed to the database.

The functionality of Credit History commit options is similar to other commit options on this page.

See Also

Enterprise PeopleTools PeopleBook: Workflow Technology

Defining Collection Rules

Define the rules governing how your business unit handles receivables collection.

See Also

Chapter 12, "Setting Up Receivables Collection," page 363

Defining Basic Refunding Rules

Specify the business unit rules governing how the system handles refunds.

See Also

Chapter 7, "Setting Up Refunding," Setting Up Your Business Unit to Refund Customers, page 238

Defining Refund Approval Parameters

Set refund approval levels for student and organization refunds.

See Also

Chapter 7, "Setting Up Refunding," Setting Up Your Business Unit to Refund Customers, page 238

Defining Default Payroll Parameters

Establish default parameters for refunds created using PeopleSoft Payroll for North America.

See Also

PeopleSoft Enterprise Payroll for North America 9.0 PeopleBook, "Setting Up the Payroll Process"

Defining Auto-Numbering Sequences

Access the Counters page (Set Up SACR, Product Related, Student Financials, SF Business Unit, Counters).

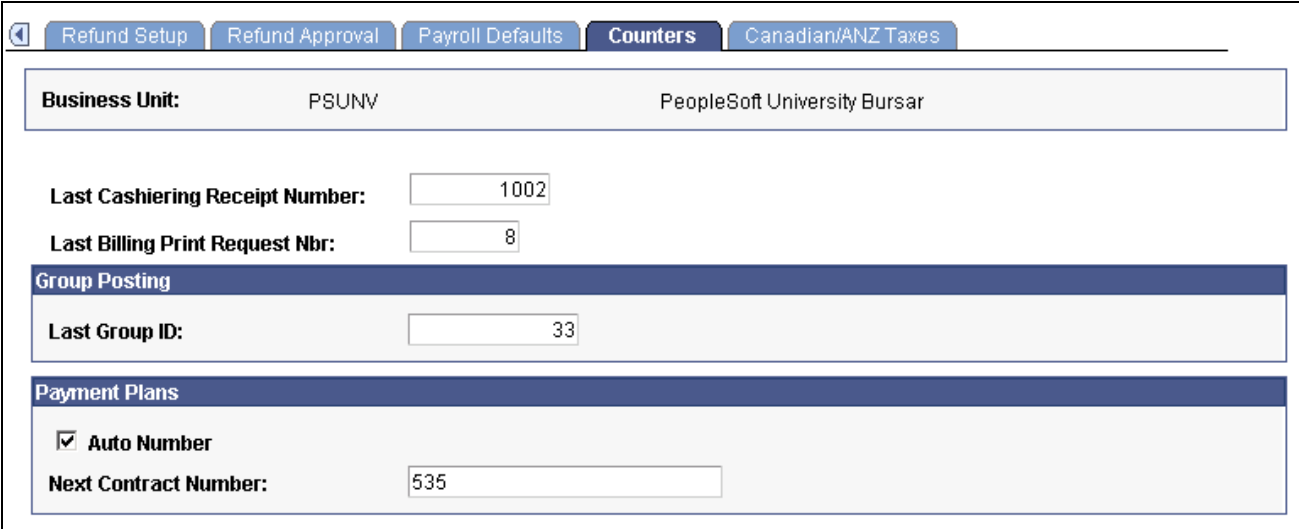

The screenshot shows the 'Counters' page in the PeopleSoft University Bursar system. The page is divided into several sections:

- Business Unit:** PSUNV, PeopleSoft University Bursar
- Last Cashiering Receipt Number:** 1002
- Last Billing Print Request Nbr:** 8
- Group Posting:** Last Group ID: 33
- Payment Plans:**
 - Auto Number
 - Next Contract Number:** 535

Counters page

With the exception of payment plans, the counter number fields on this page automatically display the last number used. You can specify a number with which you would like the sequence numbering to begin. For example, if you want cashiering receipt numbers to begin at 1,000, enter the number 999 in the Last Cashiering Receipt Number field. The system automatically assigns the number 1,000 to the first receipt produced and increments all receipts by 1 thereafter.

Last Cashiering Receipt Number If you want to change the starting point of the numbering sequence for cashiering receipts, enter a number that is one less than the number that you want to begin with.

Last Billing Print Request Nbr (last billing print request number) If you want to change the starting point of the numbering sequence for billing requests, enter a number that is one less than the number that you want to begin with.

Group Posting

Last Group ID If you want to change the starting point of the numbering sequence for posting group ID numbers, enter a number that is one less than the number that you want to begin with.

Payment Plans

Auto Number Select if you want the system to automatically generate sequential contract numbers for payment plan contracts.

Next Contract Number If you want to change the starting point of the numbering sequence for payment plan contract numbers, enter the contract number that you want to begin with.
 Unlike the previous counters, the Next Contract Number field displays the next number in the sequence.

(CAN)(AUS)(NZL) Defining Tax Parameters for Students from Canada, Australia, and New Zealand

Access the Canadian/ANZ Taxes page (Set Up SACR, Product Related, Student Financials, SF Business Unit, Canadian/ANZ Taxes).

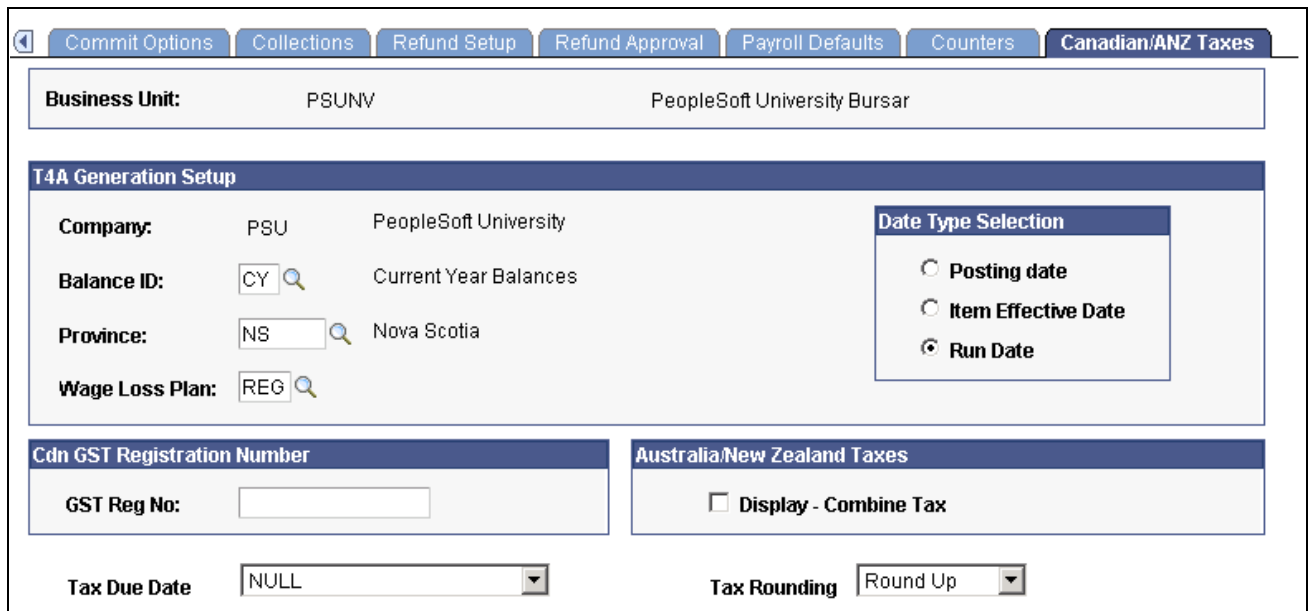

The screenshot displays the 'Canadian/ANZ Taxes' configuration page. At the top, navigation tabs include 'Commit Options', 'Collections', 'Refund Setup', 'Refund Approval', 'Payroll Defaults', 'Counters', and 'Canadian/ANZ Taxes'. The 'Business Unit' is set to 'PSUNV' (PeopleSoft University Bursar). The 'T4A Generation Setup' section contains the following fields: 'Company' (PSU - PeopleSoft University), 'Balance ID' (CY - Current Year Balances), 'Province' (NS - Nova Scotia), and 'Wage Loss Plan' (REG). A 'Date Type Selection' box is present with three radio buttons: 'Posting date', 'Item Effective Date', and 'Run Date' (which is selected). Below this, there are two sub-sections: 'Cdn GST Registration Number' with a 'GST Reg No' field, and 'Australia/New Zealand Taxes' with a 'Display - Combine Tax' checkbox. At the bottom, 'Tax Due Date' is set to 'NULL' and 'Tax Rounding' is set to 'Round Up'.

Canadian/ANZ Taxes page

T4A Generation Setup

Canadian students are required to report all scholarship income. The T4A report is generated for the student's use.

The following fields define the setup that is needed to transfer information from the Student Financials application to the PeopleSoft Payroll for North America application for the processing and generation of T4A reports. Consult your payroll staff to determine the proper selections for the following options.

Company Enter the company that generates the report. This is used to aggregate student income balances in payroll.

Balance ID Enter the balance ID. This selection controls the period of time covered by the report.

Province Enter the province where scholarship income is received.

Wage Loss Plan Enter a wage loss plan. Wage loss plans are set up in Set Up HRMS, Product Related, Payroll for North America, Canadian Taxes, Wage Loss Plan Table.

Date Type Selection

In this group box, select the type of date that you want to use to govern selection of items to be included in the T4A report. The system uses the date type selection in conjunction with the balance ID to control which transactions it includes in the report.

Posting Date Select to use the item posting date to govern transaction selection.

Item Effective Date Select to use the item effective date to govern transaction selection.

Run Date Select to use the item run date to govern transaction selection.

Note. Use only when the T4A Generation process is run within the same calendar or tax year as the transactions.

Cdn GST Registration Number

Enter the GST Reg No (Goods and Services Tax registration number) that is assigned to this business unit. The system uses this value for any receipts and invoices that are specifically designed to include the GST registration number when GST is assessed.

Australia/New Zealand Taxes

Display – Combine Tax Select to display transactions with tax included (summed). The default setting (check box cleared) displays taxes as a separate line item.

Tax Due Date Select a Tax Due Date option to control when taxes that are associated with charges are considered due. Options are:

Charge Due Date: Select to make taxes due on the same date as the corresponding charge.

Charge Effective Date: Select to make taxes due on the date that the corresponding charge becomes effective. This date may be different from the due date of the charge.

Null: Select if you do not want the system to automatically assign a due date. This setting leaves open the option of assigning a due date at a later point (for example, through the Billing process). This is the default setting.

Posting Date: Select to make tax charges due immediately on the date that the corresponding charge is posted.

Tax Rounding

This option controls how taxes are adjusted at the half-cent point. Different taxing authorities have different rules for how adjustments must be made. Determine the requirements for your institution before selecting an option. Rounding affects only tax amounts that are calculated to the exact half-cent point. Options are:

No Rounding: Select to truncate the calculated tax amount to the full-cent value. This option effectively eliminates any fraction of a cent. For example, 3.769 USD would be truncated to 3.76 USD. Fractions will never be rounded up.

Round Down: Select if you want taxes that calculate to the half-cent point or less to be reduced to the nearest full-cent value. For example, 3.765 USD would be reduced to 3.76 USD.

Round Up: Select if you want taxes that calculate to the half-cent point or more to be increased to the nearest full-cent value. For example, 3.765 USD would be increased to 3.77 USD.

Note. Student Financials rounds based on the third decimal place of a number.

Setting Up Tax Authorities and Tax Codes

To set up tax authorities and tax codes, use the Tax Authorities component (TAX_AUTHORITY) and the Tax Codes component (TAX_CODE_VAT).

This section provides an overview of tax authorities and tax codes and discusses how to:

- Define tax authorities.
- Specify VAT rebates for tax authorities.
- Define tax codes.

Understanding Tax Authorities and Tax Codes

Your institution may be under the jurisdiction of one or more tax authorities that require you to charge taxes for certain transactions. To process tax charges, you must define one or more tax authority codes.

Tax codes are used to link taxes to charge item types. Each tax code must include at least one tax authority, but can include more than one if your institution is subject to more than one taxing authority. For example, you may need to charge students both state and local sales taxes for books. By setting up a tax code that combines the two authorities, you can charge both taxes.

Pages Used to Set Up Tax Authorities and Tax Codes

Page Name	Definition Name	Navigation	Usage
Tax Authority	TAX_AUTHORITY	Set Up SACR, Product Related, Student Financials, Charges and Payments, Tax Authorities, Tax Authority	Define tax authorities.
Tax Authorities - Rebate	TAX_AUTHORITY_PSB	Set Up SACR, Product Related, Student Financials, Charges and Payments, Tax Authorities, Rebate	Specify VAT rebates for tax authorities.
Tax Authorities - Summary	TAX_AUTHORITY_VAT	Set Up SACR, Product Related, Student Financials, Charges and Payments, Tax Authorities, Summary	Review tax authority parameters.
Tax Codes	TAX_CODE_VAT	Set Up SACR, Product Related, Student Financials, Charges and Payments, Tax Codes	Define tax codes using one or more tax authorities.

Defining Tax Authorities

Access the Tax Authority page (Set Up SACR, Product Related, Student Financials, Charges and Payments, Tax Authorities, Tax Authority).

Tax Authority		Rebate	Summary
SetID:	PSUNV	Authority:	TX1
*Description:	GST Tax		
*Short Description:	GST Tax	Tax Code Type:	S
Effective Date:	01/01/2002	*Status:	Active
Percent:	8.000	Account Type:	<input type="text"/>
Same Account:	<input checked="" type="checkbox"/>	*Item Type:	801000000000 GST Tax
Service Impact:	<input type="text"/>		

Tax Authority page

Tax Code Type Select a tax code type of S (sales tax) or V (value added tax).

- Percent** Set the default percentage of tax that the authority assesses.
- Same Account and Acct Type (account type)** Select the Same Account check box if you want the tax assessed to appear in the same account as its associated charge. If you clear the check box, you can select a different account type in the Acct Type field.
- Item Type** Select the item type that you have defined for transactions from this tax authority.
- Service Impact** Select the service impact that exempts customers from this taxation.

Specifying VAT Rebates for Tax Authorities

Access the Tax Authorities - Rebate page (Set Up SACR, Product Related, Student Financials, Charges and Payments, Tax Authorities, Rebate).

The screenshot shows the 'Tax Authorities - Rebate' page with the following details:

- SetID:** PSUNV
- Authority:** TX1
- Description:** GST Tax
- Short Description:** GST Tax
- Vat Public Service Body Type** table:

*VAT PSB Type	Rebate Rate
Public Colleges	3.00

Tax Authorities - Rebate page

VAT PSB Type (value added tax public service body type) and **Rebate Rate** If applicable, select the value added tax public service body type and enter a rebate rate.

Defining Tax Codes

Access the Tax Codes page (Set Up SACR, Product Related, Student Financials, Charges and Payments, Tax Codes).

Tax Codes

SetID: PSUNV **Tax Code:** TUITAX **Tax Code Percent:** 16.000

***Description:**

***Short Description:**

Long Description:

Consolidate Same Item Type

*Authority	Percent	+ -
TX1 <input type="text" value="GST Tax"/>	8.000	+ -
TX2 <input type="text" value="PST Tax"/>	8.000	+ -

Tax Codes page

Consolidate Same Item Type If you are creating a code that combines two or more different tax authorities, you can select this check box to consolidate the tax transactions that make up the code into the same item type during posting. Otherwise, the system creates each transaction on an account as individual entries.

Authority Select the tax authority that you want to attach to the tax code.

Percentage The default percentage appears to the right of each authority that you add.

Setting Up Aging Sets

To set up aging sets, use the Aging Set component (AGING_TABLE).

An aging set is a complete set of aging categories that defines how your system ages your accounts. You can define multiple aging sets to be used for different types of customers. For example, you might want to age student accounts differently than you do organization accounts.

Page Used to Set Up Aging Sets

Page Name	Definition Name	Navigation	Usage
Aging Set	AGING_TABLE	Set Up SACR, Product Related, Student Financials, Collections, Aging Set	Define aging sets.

Defining Aging Sets

Access the Aging Set page (Set Up SACR, Product Related, Student Financials, Collections, Aging Set).

Aging Set

SetID: PSUNV Aging ID: CHC

Find First 1 of 1 Last

*Effective Date: 01/01/1900 Status: Active

Description: Credit History and Collections

Short Description: CredHist

*Basis Date: Current Due Date

Dispute Aging: Categorize Category: 06

Aging Category				
*Aging Category	Short Desc	Start Days	End Days	Summary Category
01	Future Aging Cat	Future Agi	-9999	Future Due
02	Current Charges	Current	0	Current Due
03	16-45	16-45	16	Past Due
04	46-60	46-60	46	Past Due
05	61-90	61-90	61	Past Due
06	91-120	91-120	91	
07	Dispute Charge	Dispute Ch	0	Dispute Due
96	120+	120+	121	Past Due

Aging Set page

Basis Date

Select the basis date that you want to use when a charge is assigned to an aging category. Options are: *Actual Billing Date*, *Billing Date*, *Current Due Date*, and *Original Due Date*. For External Organization accounts, the two valid basis dates are *Actual Billing Date* and *Original Due Date*.

Dispute Aging

In the Dispute Aging and Category fields, define how you want to categorize any charges in dispute.

Values are:

Age Normal: Select to age disputed charges like any other charge. When you select this option, disputed charges can still show up as being past due and can trigger collection actions.

Categorize: Select if you want disputed charges to be distinguished as a unique category. When you select this option, the Category field becomes active.

Ignore: Select if you want the system to overlook disputed charges. When you select this option, the system does not distinguish disputed charges as a unique category and does not age them like other charges. In addition, disputed charges do not trigger collection actions.

Category

Enter the category value that you want to use for disputed charges.

Aging Category

Enter an aging category value that you want to use to distinguish each time range. In the field to the right, enter a description of the particular category.

Start Days and End Days	Enter the beginning and ending points of the aging category. For example, if charges that are up to thirty days old are considered current, enter <i>0</i> in the Start Days field and <i>30</i> in the End Days field. The beginning and ending points of the range are controlled by the basis date.
Summ (summary)	Select a code to identify the late charge category. Values are <i>C</i> (current due), <i>D</i> (dispute due), <i>F</i> (future due), <i>O</i> (other), or <i>P</i> (past due).

Setting Up Payment Application Rules

To set up payment application rules, use the Charge Priority List component (CHARGE_PRIORITY) and the Payment Overall Priority component (OVERALL_PRIORITY).

This section provides an overview of payment application rules and discusses how to:

- Create a charge priority list and link it to an item type tree.
- Define charge priority list rules.
- Define payment overall priorities.

Understanding Payment Application Rules

Your institution probably has rules about how payments are to be applied to charges on student accounts. You may want tuition to always be paid first, or you may want the oldest charges paid first. In addition, many rules apply to financial aid. Regardless of your institution's specific rules, you want Student Financials to automatically apply them, eliminating the need to make immediate decisions about each payment.

Obviously, defining one set of rules that works for every situation is difficult. To meet all of your needs, you should carefully plan and define several sets of rules. You must understand how these rule sets work separately and with each other, and how they work with other parts of the system.

To make setup as flexible, yet precise, as possible, the system uses a combination of charge priority list and payment overall priority rules that are attached to payment item types. These very specific payment processing definitions are also affected by the default term, business unit posting rules, and priority values defined for payment item types.

Student Financials provides flexible payment processing capabilities, but setup requires considerable thought. While complex, the process is logical and accommodates most payment application schemes. Plan well and take the time to test your setup extensively.

Before you start setting up your charge priority list and payment overall priority rules, be sure to check your item type tree setup. Because your charge priority definition depends on your item type tree, the tree must be set up correctly. For example, all item types that are related to tuition should be grouped together under a tree node named *Tuition*. The same applies to housing and parking item types. Your actual item type tree setup may use different terminology, but the structure must include nodes similar to these examples. Also, make sure that the same item type number has not been included in more than one tree node.

Charge Priority List Rules

Defining charge priority rules is the first step in determining how the system applies a payment. You define exactly what charges are eligible for payment under a particular rule set. You also define whether payments can be applied to charges from various time periods and you can establish a priority order for allowed charges.

Charge priority lists depend on item type trees to identify which charge items are qualified for the particular type of payment. Because charge priority list details are defined at the tree node level, you can make payment restrictions as broad or narrow as you want.

Payment Overall Priority Rules

Payment overall priority rules define the order of payment allocation when payments do not fully cover all eligible charges. You have two options when defining payment overall priority rules. Either your payment overall priority can act as a tiebreaker, or it can pay all eligible charges equally.

See Also

Enterprise PeopleTools PeopleBook: Tree Manager

Pages Used to Set Up Payment Application Rules

Page Name	Definition Name	Navigation	Usage
Charge Priority List	ITEM_CHRG_TYP_PRTY	Set Up SACR, Product Related, Student Financials, Charges and Payments, Charge Priority List	Create a charge priority list and link it to an item type tree.
Charge Priority List - Details	ITEM_CHRG_TYP_PRT2	Set Up SACR, Product Related, Student Financials, Charges and Payments, Charge Priority List, Details	Define charge priority list rules.
Payment Overall Priority	PAY_PRIOR_ALL	Set Up SACR, Product Related, Student Financials, Charges and Payments, Payment Overall Priority	Define payment overall priorities.

Creating a Charge Priority List and Linking It to an Item Type Tree

Access the Charge Priority List page (Set Up SACR, Product Related, Student Financials, Charges and Payments, Charge Priority List).

Charge Priority List | **Details**

SetID: PSUNV **Charge Priority List:** TUTFIRST

Find | View All First 1 of 1 Last

***Effective Date:** 01/01/1900 ***Status:** Active

***Description:**

***Short Description:**

Long Description:

***Tree Name:**

Charge Priority List page

Tree Name Select the name of the item type tree that includes all item types to be paid under this charge priority list.

Defining Charge Priority List Rules

Access the Charge Priority List - Details page (Set Up SACR, Product Related, Student Financials, Charges and Payments, Charge Priority List, Details).

Charge Priority List | **Details**

SetID: PSUNV **Charge Priority List:** TUTFIRST

Find First 1 of 1 Last

Effective Date: 01/01/1900 **Status:** Active

Permission Form: Apply to SF charges **Use Aid Year**

Find | View All First 1 of 5 Last

***Tree Node** ***Priority:**

Current Term: **Amount:** USD

Prior Term: **Amount:**

Prior Year: **Amount:**

Future Term: **Amount:**

Charge Priority List - Details page

Self service student permissions can be used for a student to grant permission.

Permission Form	<p>Select a permission form if you want one to apply. A permission form is a type of advance permission that the system uses with item types that have payment application restrictions. When you select a permission form, the system applies the charge priority definition only if the permission form has been attached to the student.</p> <p>Permission forms are commonly used with financial aid payment. For example, if a particular type of financial aid award restricts payments to the current term charges unless permission is given by the student to pay prior term charges, then a permission form can grant that permission. The permission form must be attached to the charge priority list definition that is set to <i>Permission</i> for the prior term.</p>
Use Aid Year	<p>Select to use the financial aid year for the charge priority list. When the flag is off (cleared), current functionality applies and the academic year is used.</p>
Tree Node	<p>Select allowable charges by entering the appropriate tree nodes. The system applies payments only to charge item types that fall in the range of the tree node.</p> <hr/> <p>Warning! If you want to use the pay proportionate % tax functionality that is available in Payment Overall Priority setup (see the following field description), the tax item type must not be included within the range of allowable charges. If it is included within the range, the system treats it as any other eligible charge and it does not distinguish it as unique.</p> <hr/>
Priority	<p>Assign a priority level for each tree node that is used to define allowable charges. The system uses this priority value only when you select <i>Charge Tree Node</i> as one of the Sort Payment Field values in your Payment Overall Priority setup. A priority of 1 is higher than a priority of 2.</p>

Current Term

Select a value to control whether payments can be applied to charges for the current term. Four values are available for this field:

Yes: Select this value if you want the system to apply payments with no restrictions to charges in this time period.

No: Select this value if you do not want the system to apply payments to any charges in this time period.

Neg. Perm: (negative permission) Select this value if you want the system to apply payments as necessary to charges in this time period, unless the student expressly prevents it. Student permissions can be used in conjunction with negative permission.

Permission: Select this value if you want the system to require specific permission before applying payments to charges in this time period. Student permissions can be used in conjunction with permission needed.

Note. The definition of the Current Term value is determined by the value of the payment term. If no term is specified, the value of the payment term is determined by the Default Term Control value in the SF Business Unit component. Three options are available for default term control: Use SF Default Term, Use Last Enrollment Term, and Use Current Enrollment Term. When you use SF Default Term, the value of the payment term is the same as that of the SF default term. If you use either Last Enrollment Term or Current Enrollment Term as the default term control, the value of the payment term varies by the enrollment history of the student against whose account the payment is being applied.

Prior Term

Select a value to control whether and how payments can be applied to charges for the prior term. The four values for this field are the same as those defined for the Current Term field.

The prior term is the academic term that immediately precedes the current term. The actual determination of the prior term is based on the value that is used for the current term. Values are:

Use Aid Year OFF: All terms prior to the current term within the academic year only.

Use Aid Year ON: All terms prior to the current term within the current aid year only.

Prior Year

Select a value to control whether and how payments are applied to charges for the prior year. The four values for this field are the same as those defined for the Current Term field.

Use Aid Year OFF: All terms prior to the current academic year.

Use Aid Year ON: All terms prior to the current term that are in the aid year immediately prior to the current aid year.

Future Term

Select a value to control whether and how payments can be applied to charges for any future terms. The four values for this field are the same as those defined for the Current Term field.

A future term is an academic term that comes after the current term. The actual determination of a future term is based on the value that is used for the current term.

Use Aid Year flag OFF: A future term is an academic term that comes after the current term. The actual determination of a future term is based on the value that is used for current term.

Use Aid Year flag ON: All terms after the current term within the current aid year.

Amount

Enter the maximum amount that can be applied to the corresponding period. If no limitation exists for this payment, leave the amount field blank on all platforms except for DB2. If the amount is left blank on a DB2 platform, it functions as if it is zero and does not allow any amounts to be paid by the payment. On DB2 platforms only, you must complete the amount field with all 9s (a value of 999,999,999.00) to allow for no limitation. The field is formatted for 12.2 number entries.

Example of a Charge Priority List Selection

Charge priority setup can be confusing, and small differences can sometimes yield surprising results. It is not possible to provide examples of all scenarios, but the following examples present two common outcomes.

Remember that any charge that is qualified for payment by the charge priority selection is considered equal and can be paid according to the rules of the definition. This is why tax item types must be excluded from the range of allowable charges if you want to pay them proportionate to the payment against the charge. If they were included within the range of allowable charges, the tax could be paid in full, or not at all, regardless of the amount paid on the associated charge.

Using our sample charges, and a charge priority list allowing charges from the Tuition, Housing, Miscellaneous, and Parking tree nodes, examine the following two scenarios and see how minor changes can affect payment application. In each case, the SF Business Unit Default Term Control is set to use the value *Last Enrollment Term*. For purposes of this example, assume that the student's last completed term of enrollment is Fall, 2000 and no term is specified with the payment (causing the system to use the SF Business Unit Default Term Control value—this point is important to understanding these examples).

Sample Charges

<i>Transaction Type</i>	<i>Tree Node</i>	<i>Term</i>	<i>Charge Amount</i>	<i>Due Date</i>
Tuition Charge	Tuition	Fall, 1999	500.00 USD	October 15, 1999
Housing Charge	Housing	Fall, 1999	1,000.00 USD	October 30, 1999
Phone Charge	Other	Fall, 1999	100.00 USD	October 30, 1999

Transaction Type	Tree Node	Term	Charge Amount	Due Date
Tuition Charge	Tuition	Spring, 2000	2,000.00 USD	February 15, 2000
Tuition Charge	Tuition	Fall, 2000	2,000.00 USD	October 5, 2000
Housing Charge	Housing	Fall, 2000	700.00 USD	October 5, 2000
Misc. Charge	Miscellaneous	Fall, 2000	75.00 USD	October 1, 2000
Housing Charge	Housing	Fall, 2000	200.00 USD	February 1, 2001 2
Tuition Charge	Tuition	Spring, 2001	1,800.00 USD	January 15, 2001
Housing Charge	Housing	Spring, 2001	1,050.00 USD	February 5, 2001
Misc. Charge	Miscellaneous	Spring, 2001	50.00 USD	February 5, 2001

Selected Charges—Scenario One

When the student makes a payment to the account, the charge priority list rules allow the following charges to be selected as eligible for payment:

Transaction Type	Tree Node	Term	Charge Amount	Due Date
Tuition Charge	Tuition	Fall, 1999	500.00 USD	10/15/99
Housing Charge	Housing	Fall, 1999	1,000.00 USD	10/30/99
Tuition Charge	Tuition	Spring, 2000	2,000.00 USD	2/15/00
Tuition Charge	Tuition	Fall, 2000	2,000.00 USD	10/5/00
Housing Charge	Housing	Fall, 2000	700.00 USD	10/5/00
Misc. Charge	Miscellaneous	Fall, 2000	75.00 USD	10/1/00
Housing Charge	Housing	Fall, 2000	200.00 USD	2/1/01

Transaction Type	Tree Node	Term	Charge Amount	Due Date
Tuition Charge	Tuition	Spring, 2001	1,800.00 USD	1/15/01
Housing Charge	Housing	Spring, 2001	1,050.00 USD	2/5/01
Misc. Charge	Miscellaneous	Spring, 2001	50.00 USD	2/5/01

Comparing the two tables, you can see that the only item not included in the set of eligible charges is the phone charge. The reason for this is that the charge priority list example given previously allows payments for charges from four tree nodes: Tuition, Housing, Miscellaneous, and Parking. The Phone charge is under the tree node of Other and, therefore, is not considered an eligible charge. Also, because payments can be applied to all time periods (current term, prior term, prior year, and future term), the system can include all active charges.

Selected Charges—Scenario Two

If you use a different charge priority setup that excludes payments for a future term on each of the allowable charge nodes, the results are considerably different:

Transaction Type	Tree Node	Term	Charge Amount	Due Date
Tuition Charge	Tuition	Fall, 1999	500.00 USD	10/15/99
Housing Charge	Housing	Fall, 1999	1,000.00 USD	10/30/99
Tuition Charge	Tuition	Spring, 2000	2,000.00 USD	2/15/00
Tuition Charge	Tuition	Fall, 2000	2,000.00 USD	10/5/00
Housing Charge	Housing	Fall, 2000	700.00 USD	10/5/00
Misc. Charge	Miscellaneous	Fall, 2000	75.00 USD	10/1/00
Housing Charge	Housing	Fall, 2000	200.00 USD	2/1/01

In this case, the system does not include charges for Spring, 2001 because they are associated with a future term. This is because you established the current term as the last enrollment term when you defined your default term control. In this case, the last enrollment term is Fall, 2000. If you change the Default Term Control value to *Use SF Default Term*, the system will once again include all charges because the current term will be Spring, 2001.

In summary, your charge priority definitions determine what charges are eligible for payment. This determination is made by limiting payments to charge item types that meet specific criteria that are related to tree nodes and time periods.

See Also

[Chapter 22, "Maintaining Customers," Managing Student Permissions, page 634](#)

[Chapter 2, "Completing Student Financials General Setup," Defining Posting Parameters, page 24](#)

Defining Payment Overall Priorities

Access the Payment Overall Priority page (Set Up SACR, Product Related, Student Financials, Charges and Payments, Payment Overall Priority).

Payment Overall Priority

SetID: PSUNV Payment Overall Priority: EURO

Find | View All First 1 of 1 Last

*Effective Date: 01/01/1900 *Status: Active

Description: European Invoicing Short Description: EuroInvoic

Allocation Method: By Oldest First Pay Proportionate % Tax:

Charge Sort

Sort 1: Oldest Invoice Date

Sort 2: Term, Oldest First

Sort 3:

Sort 4:

Payment Overall Priority page

Allocation Method

Select an allocation method:

By Oldest First: Select if you want to use sort payment fields to sort the eligible charges. If you select this option, the last sort is to order the eligible charges by the oldest item number first.

Equal Percentages: Select if you want to pay an equal portion of each eligible charge. If you elect to pay by equal percentages, the sort payment fields are not used.

Pay Proportionate % Tax Select if you want all taxes associated with a particular charge to be paid proportionate to the payment against the charge. Payment of taxes follows the same payment priority as the associated charge.

Note. For pay proportionate % tax functionality to work, the tax item type cannot be included as an allowable charge in the charge priority setup. Make sure that the tax item type is not included within the range of any of the tree nodes that are selected as allowable charges.

Charge Sort

You can define up to four charge sort criteria. Remember that all sort rules defined for Payment Overall Priority apply only to charges already selected by the Charge Priority rules. For example, if your Charge Priority rules are set up to select charges for current and future terms only, and your Payment Overall Priority rules are set up to sort by *Term, Oldest First*, the term that is defined as current will be the oldest term available.

Sort 1 Sort 2 Sort 3 and Sort 4 A number of possible values exist for each sort field:

Academic Year: Select to sort active charges by academic year, beginning with active charges from the earliest year.

Academic Year, Current First: Select to sort active charges by the academic year, using the current academic year first. After the system selects eligible charges for the current academic year, it sorts the remaining charges by academic year from the oldest to the most recent.

Charge Tree Node: Select to sort active charges by the priority value of the charge tree nodes that are established in the charge priority list definition being used.

Item Charge Due Date: Select to sort active charges by charge due date, beginning with the active charge with the earliest due date.

Term, Current First: Select to sort active charges by term, using the current term first. You determine the definition of the current term using the Default Term Control field on the Posting Setup page of the SF Business Unit component. Therefore, it is not necessarily the chronological current term. After the system selects eligible charges for the current term, it sorts the remaining charges by term from the oldest to the most recent.

Term, Oldest First: Select to sort active charges by terms, using the oldest term first.

Term, Payment Term First: Select to sort active charges by terms, using the term for which the payment applies first. If no term is specified with the payment, the system uses the SF default term. After the system selects eligible charges for the payment term, it sorts the remaining charges by term from the oldest to the most recent.

Oldest Invoice Date: Select if you want the posting to gather the charges by invoice. This value is available only if the Apply Payments by Invoice flag is selected on the SF Installation setup.

Example of How Payment Overall Priority Sorts Eligible Charges

Using our sample set of charges, look at how charge priority and payment overall priority rules work together to control payment application. Suppose that a student makes a payment of 8,000.00 USD against his or her account. Consider the following two setup scenarios to understand how differently payments are applied.

Sample Charges

Transaction Type	Tree Node	Term	Charge Amount	Due Date
Tuition Charge	Tuition	Fall, 1999	500.00 USD	10/15/99
Housing Charge	Housing	Fall, 1999	1,000.00 USD	10/30/99
Phone Charge	Other	Fall, 1999	100.00 USD	10/30/99
Tuition Charge	Tuition	Spring, 2000	2,000.00 USD	2/15/00
Tuition Charge	Tuition	Fall, 2000	2,000.00 USD	10/5/00
Housing Charge	Housing	Fall, 2000	700.00 USD	10/5/00
Misc. Charge	Miscellaneous	Fall, 2000	75.00 USD	10/1/00
Housing Charge	Housing	Fall, 2000	200.00 USD	2/1/01
Tuition Charge	Tuition	Spring, 2001	1,800.00 USD	1/15/01
Housing Charge	Housing	Spring, 2001	1,050.00 USD	2/5/01
Misc. Charge	Miscellaneous	Spring, 2001	50.00 USD	2/5/01

In the previous section on setting up a charge priority list, the setup example shown selects charges using four Item Type Tree nodes (Tuition, Housing, Miscellaneous, and Parking) and allows payments to be applied in all time periods. Using this rule set, the system selects all of the charges on the student's account as eligible, with the exception of the phone charge.

Selected and Sorted Charges—Scenario One

Using the Payment Overall Priority setup shown previously (eligible charges sorted first by due date, then by charge tree node), the system sorts the eligible charges in this way:

Transaction Type	Tree Node	Term	Charge Amount	Due Date
Tuition Charge	Tuition	Fall, 1999	500.00 USD	10/15/99
Housing Charge	Housing	Fall, 1999	1,000.00 USD	10/30/99
Tuition Charge	Tuition	Spring, 2000	2,000.00 USD	2/15/00
Misc. Charge	Miscellaneous	Fall, 2000	75.00 USD	10/1/00
Tuition Charge	Tuition	Fall, 2000	2,000.00 USD	10/5/00
Housing Charge	Housing	Fall, 2000	700.00 USD	10/5/00
Tuition Charge	Tuition	Spring, 2001	1,800.00 USD	1/15/01
Housing Charge	Housing	Fall, 2000	200.00 USD	2/1/01
Housing Charge	Housing	Spring, 2001	1,050.00 USD	2/5/01
Misc. Charge	Miscellaneous	Spring, 2001	50.00 USD	2/5/01

In this example, all charges with due dates through 10/5/00 will be paid in full and 1,725.00 USD will be applied to the Spring, 2001 Tuition charge due 1/15/01. Because not enough money exists to pay all charges in full, the system applies the payment to the charges in order of the due date.

Also, note that two charges are due 10/5/00 and also two are due on 2/5/01. The system sorted these charges in order of their charge tree node priority. Recall that in the charge priority setup, the Tuition node is given a priority of 1, Housing a priority of 2, and Miscellaneous and Parking a priority of 3.

Selected and Sorted Charges—Scenario Two

If you use a payment overall priority that reverses the order of the sort payment fields (charge tree node first and charge due date second), the results are very different. In this case, the system sorts the eligible charges in the following way:

Transaction Type	Tree Node	Term	Charge Amount	Due Date
Tuition Charge	Tuition	Fall, 1999	500.00 USD	10/15/99
Tuition Charge	Tuition	Spring, 2000	2,000.00 USD	2/15/00

<i>Transaction Type</i>	<i>Tree Node</i>	<i>Term</i>	<i>Charge Amount</i>	<i>Due Date</i>
Tuition Charge	Tuition	Fall, 2000	2,000.00 USD	10/5/00
Tuition Charge	Tuition	Spring, 2001	1,800.00 USD	1/15/01
Housing Charge	Housing	Fall, 1999	1,000.00 USD	10/30/99
Housing Charge	Housing	Fall, 2000	700.00 USD	10/5/00
Housing Charge	Housing	Fall, 2000	200.00 USD	2/1/01
Housing Charge	Housing	Spring, 2001	1,050.00 USD	2/5/01
Misc. Charge	Miscellaneous	Fall, 2000	75.00 USD	10/1/00
Misc. Charge	Miscellaneous	Spring, 2001	50.00 USD	2/5/01

The system pays in full all Tuition charges and those Housing charges through the October 5, 2000 due date. This is because the system sorts charges first by charge tree node and second by the charge due date.

In summary, your Payment Overall Priority definition determines how the system sorts eligible charges (selected by your corresponding charge priority definition) to allocate payment.

Setting Up Account Types

To set up account types, use the SF Account Types component (ACCT_TYPE_SF).

Account types classify item types into usable account groupings. Differentiating charges into multiple accounts enables flexibility in billing and assessing late fees. For example, creating a separate account type for housing enables you to bill and assess late fees for housing charges differently than you do for tuition charges.

Pages Used to Set Up Account Types

<i>Page Name</i>	<i>Definition Name</i>	<i>Navigation</i>	<i>Usage</i>
Account Types	ACCT_TYPE_SF	Set Up SACR, Product Related, Student Financials, Item Types, SF Account Types, Account Types	Set up account types.

Setting Up Account Types

Access the Account Types page (Set Up SACR, Product Related, Student Financials, Item Types, SF Account Types, Account Types).

Account Types

SetID: PSUNV **Account Type:** TUT

***Description:**

Short Description:

***Account Nbr Prefix:** **Account Per Term**

Late Fee Code: % and \$\$/serv ind

Ext Org Late Fee Code: % and \$\$/serv ind

<input type="checkbox"/> Primary Account	<input type="checkbox"/> View Unappld Pymt Credit Hist	<input type="checkbox"/> Include Pre-Pay
<input type="checkbox"/> Move Excess FA	<input type="checkbox"/> Exclude From Aging Total	<input type="checkbox"/> Balance Forward
<input type="checkbox"/> Move Exc Pmt	<input checked="" type="checkbox"/> Late Fee Account	<input type="checkbox"/> Include in Class Cancellation
<input type="checkbox"/> Move Exc Waiver	<input checked="" type="checkbox"/> Include in Balance	<input type="checkbox"/> Payment Plan Account
<input type="checkbox"/> Include Billing	<input type="checkbox"/> Include Transfers	<input checked="" type="checkbox"/> Ext Org Late Fee Account

Account Types page

Account Nbr Prefix (account number prefix) Enter an account number prefix that appears as part of the charge description on account display pages. For example, charges with the account number prefix TUTION would appear as *TUTION001*.

Account Per Term Select to maintain a distinction between charges by term. If you do not select this option, all charges are placed in a single account.

Late Fee Code This code is used with the late fee process based on aging, past due accounts, or both. Enter a late fee code to control the application of late fees to student charges in this account type. This selection does not apply late fees to external organization charges. This does not pertain to the Late Fees - Billing process.

Ext Org Late Fee Code (external organization late fee code) This code is used with the late fee process based on aging, past due accounts, or both. Enter an external organization late fee code to control the application of late fees to external organization charges in this account type. This selection does not apply late fees to student charges. This does not pertain to the Late Fees - Billing process.

Primary Account Select to establish this account as primary. Only one account type can be designated as the primary account.

View Unappld Pymt Credit Hist (view unapplied payment credit history)	Select if you want unapplied payments to offset eligible charges. For example, a student has a tuition charge of 5,000 USD that is 90 days past due and an unapplied payment of 1,000 USD that is in the student's account. If you clear the check box, Credit History shows 5,000 USD as 90 days past and –1,000 USD as current. If you select the check box, Credit History shows 4,000 USD as 90 days past due.
Include Pre-Pay	Reserved for future use.
Move Excess FA (move excess financial aid)	Select to have excess financial aid moved into the FA Excess account that is defined on the SF business unit. For example, a student owes 1,000 USD in tuition and receives 1,000 USD in financial aid but later drops a class and overall charges are reduced to 750 USD. If the check box is selected, the excess 250 USD is moved from the Tuition account to the FA Excess account that is specified on the SF business unit. If the check box is cleared, the excess remains in the Tuition account as a credit.
<hr/>	
Note. When you select this option, you must also select the Move Initial Financial Aid option on the SF Business Unit, Posting setup page.	
<hr/>	
Exclude from Aging Total	Select to prevent this account from aging and being included in the collection process.
Balance Forward	Reserved for future use.
Move Exc Pmt (move excess payment)	Select to move an excess payment into the Payment Excess account that is defined on the Posting setup page in the SF Business Unit component. For example, a student receives a parking ticket for 200 USD that is subsequently paid with a 200 USD check. The student then launches an appeal and the ticket is reduced to 150 USD. If the check box is selected, the excess 50 USD is moved from the Parking account to the Payment Excess account defined on the SF business unit. If the check box is cleared, the excess 50 USD remains in the Parking account as a credit.
<hr/>	
Note. When you select this option, you must also select the Move Initial Payment option on the SF Business Unit, Posting setup page.	
<hr/>	
Late Fee Account	This amount is used with the late fee process based on aging, past due accounts, or both. Select to designate the account as the recipient of all late fees. When you select this option, you must also enter a late fee code. This does not pertain to the Late Fees - Billing process.
Include In Class Cancellation	Select to include this account when determining whether a student's enrollment will be canceled due to nonpayment of fees. If the check box is cleared, this account will not be included in calculations. For example, you might want to include charges in the tuition account but exclude charges in a miscellaneous account.

Move Exc Waiver (move excess waiver) Select to move an excess waiver payment into the Excess Waiver account type that is defined on the SF business unit. For example, a student owes 1,000 USD in tuition and receives a 1,000 USD tuition waiver but later drops a class that reduces the overall charge to 750 USD. If the check box is selected, the excess 250 USD moves from the Tuition account to the Excess Waiver account specified on the SF business unit. If the check box is cleared, the excess 250 USD remains in the Tuition account as a credit.

Note. When you select this option, you must also select the Move Initial Waiver option on the SF Business Unit, Posting setup page.

Include in Balance Select to include the account in the student's account balance. If this check box is cleared, the account is excluded from the student's balance.

Payment Plan Account Select if the account is to be used as a payment plan account.

Note. If you select this check box, do not select a late fee code. This does not pertain to the Late Fees - Billing process.

Include Billing Reserved for future use.

Include Transfers Reserved for future use.

Ext Org Late Fee Account (external organization late fee account) This is account used with the late fee process based on aging, past due accounts, or both. Select to attach a late fee to the account. When you select this option, you must also enter an external organization and late fee code. This does not pertain to the Late Fees - Billing process.

See Also

[Chapter 18, "Administering Payment Plans," page 471](#)

Setting Up Accounting Dates

This section discusses how to set up accounting dates.

Page Used to Set Up Accounting Dates

<i>Page Name</i>	<i>Definition Name</i>	<i>Navigation</i>	<i>Usage</i>
Accounting Dates	SSF_ACCTG_DT_DEFN	Set up SACR, Product Related, Student Financials, Item Types, Accounting Dates, Accounting Dates	Set up accounting dates for a term or a combination of term and session.

Page Used to Set Up Accounting Dates

Access the Accounting Dates page (Set up SACR, Product Related, Student Financials, Item Types, Accounting Dates, Accounting Dates).

Accounting Dates

SetID: PSUNV

Accounting Date ID: AD1

***Description:**

***Status:** ▼

Accounting Dates					
Term	Session	*Accounting Date			
0600	▼	03/24/2008	31	+	-
0600	Regular Academic Session ▼	03/27/2008	31	+	-
0620	Regular Academic Session ▼	03/28/2009	31	+	-
0620	Twelve Week ▼	04/24/2009	31	+	-
0620	Open Entry/Open Exit ▼	05/31/2009	31	+	-

Accounting Dates page

Use this page to maintain accounting date IDs and accounting dates for each term or combination of term and session.

All IDs that you set up on this page and that have an active status are available in the Accounting Date ID field on the Initial Setup page. On that page you can assign an ID to an item type to designate the specific date to be used for transactions.

See [Chapter 2, "Completing Student Financials General Setup," Accounting Date Options, page 59.](#)

Accounting Date Enter a date to be used to stamp Accounting Date (ACCOUNTING_DT) in Accounting Line (SF_ACCTG_LN) transactions.

You can set up an accounting date for a term or a combination of term and session.

Setting Up Item Types and Item Type Groups

To set up item types and item type groups, use the Item Types component (ITEM_TYPE_PANEL) and the Item Type Groups component (ITEM_GROUPINGS).

This section provides an overview of item types and item type groups and discusses how to:

- Define basic item type attributes.
- Define transaction amount and tax form parameters for item types.
- Define miscellaneous parameters for item types.
- Define external awards.
- Define item type posting restrictions.
- Link account types to an item type.
- Map item types to general ledger accounts.
- Define item type groups.

Understanding Item Types and Item Type Groups

Item types are the basic work unit of the Student Financials application. Each item type defines and describes a unique action. During the setup of your item types, you differentiate between charges and credits and define how and where each can be applied. You also group them by classification and determine how your system uses them to transfer student account information to your general ledger.

Many functions in the Student Financials application also use item type trees. You need to understand how item type trees are organized and used.

Note. Virtually everything you do within Student Financials involves item types (the exception being certain transactions in cashiering). Because of this, planning your item type setup is very important. Make sure that you create enough item types to represent every unique transaction. Also, establish a numbering scheme that enables you to group similar charges and credits. This helps you later when you define item type security and facilitates creating groups of item types for other setup procedures such as defining waivers, charge priority lists, and payment plans. Use the sample data that is provided with the system as an example.

Item Type Groups

Use item type groups to combine ranges of item types using multiple item type tree nodes. Item type groups limit the application of credits to desired charge items only. For example, if you have a waiver attached to a tuition group, you can use an item grouping to limit the application of the waiver to only tuition and housing, rather than to all fees.

See Also

Enterprise PeopleTools PeopleBook: Tree Manager

Pages Used to Set Up Item Types and Item Type Groups

<i>Page Name</i>	<i>Definition Name</i>	<i>Navigation</i>	<i>Usage</i>
Initial Setup	ITEM_TYPE_TBL	Set Up SACR, Product Related, Student Financials, Item Types, Item Types, Initial Setup	Define basic item type attributes.
Amount Edits	ITEM_TYPE_TBL4	Set Up SACR, Product Related, Student Financials, Item Types, Item Types, Amount Edits	Define transaction amount and tax form parameters for item types.
Miscellaneous	ITEM_TYPE_TBL2	Set Up SACR, Product Related, Student Financials, Item Types, Item Types, Miscellaneous	Define miscellaneous parameters for item types.
External Awards	SSF_EAITMTYPE_TBL	Set Up SACR, Product Related, Student Financials, Item Types, Item Types, External Awards	Define the financial aid external award type, source, and program code attributes for SF payments to be considered as external awards.
Posting Restrictions	ITEM_TYPE_TBL3	Set Up SACR, Product Related, Student Financials, Item Types, Item Types, Posting Restrictions	Define item type posting restrictions.
Account Types	ITEM_ACCT_TYPE	Set Up SACR, Product Related, Student Financials, Item Types, Item Types, Account Types	Link account types to an item type.
GL Interface	GL_INTERFACE	Set Up SACR, Product Related, Student Financials, Item Types, Item Types, GL Interface	Map item types to general ledger accounts.
AP ChartFields	SSF_CF_WRKGRID_SEC	Click the Jrnl Set ChartFields link on the GL Interface page.	Define item type GL interface parameters for AP distribution.
Write-off ChartFields	SSF_CF_WRKGRID_SEC	Click the Write-off ChartFields link on the Item Interface page.	Define item type GL interface parameters for write-offs.
Journal Set ChartFields	SSF_CF_WRKGRID_SEC	Click the Jrnl Set ChartFields link on the GL Interface page.	Define item type GL interface parameters for a journal set.

Page Name	Definition Name	Navigation	Usage
Deferred ChartFields	SSF_CF_WRKGRID_SEC	Click the Deferred ChartFields link on the GL Interface page.	Define item type GL interface parameters for a deferred revenue account.
Item Type Groups	ITEM_GROUP_TBL	Set Up SACR, Product Related, Student Financials, Item Types, Item Type Groups	Define item type groups.

Defining Basic Item Type Attributes

Access the Initial Setup page (Set Up SACR, Product Related, Student Financials, Item Types, Item Types, Initial Setup).

Initial Setup page

Keywords Select up to three keywords that you want to link to the item type.

Tuition Deposit Select if the item type is for a tuition deposit. This check box is active only when the Deposit item type classification is selected.

GL Interface Required If you select this check box, you must complete the GL Interface page of this component to save the item type. You must define both a debit and credit side for the item type, the GL Pct (general ledger percent) must add up to 100 percent for all accounts on each side, and all of the required fields on the GL Interface page must be populated. If you select this check box, the Course Class Specific check box and Accounting Date Options group box also become available.

See [Chapter 2, "Completing Student Financials General Setup," Mapping Item Types to General Ledger Accounts, page 70.](#)

Course Class Specific Select if you want to override the GL Interface defined for this item type and use one that is defined specifically for certain courses or classes. When you select this check box, the GL Interface defined for the item type is overridden if you define an interface at the course or class level only and select the Track Class Pricing check box on the related term fee setup.

For example, if you want tuition revenue from certain math classes credited to a special account rather than the normal tuition account, set up a unique item type using the Course Class Specific option.

Note. GL Interfaces specific to a course or class are defined on the Student Records GL Interface page in either the Course Catalog component or the Class Schedule component.

Accounting Date Options

The Accounting Date Options group box is available only when the GL Interface Required check box is selected.

Accounting Date Control

Select the accounting date of the item type. Transactions in Accounting Line (SF_ACCTG_LN) are stamped with the accounting date.

Values are:

Accounting Date:

Select this value to use the accounting date that is set up on the Accounting Dates page.

When you select *Accounting Date* here, you must then select a value in the Accounting Date ID field, to associate it with the item type. The date that is used in Accounting Line transactions is the date that is set up for the term or a combination of term and session for that ID on the Accounting Dates page.

Item Effective Date: Select to use the effective date of the transaction (item) as the accounting date.

Maximum (Accounting Dt, Run Dt):

Select this value to use the date that is the greater of these two dates—the accounting date (see the definition of the *Accounting Date* value) and the run date, which is the GL Interface process date.

Maximum (Term Start Dt, Run Dt): Select to make the system use the more recent of term start date or run date as the accounting date. This option is useful to prevent complications resulting from accounting periods that have already been closed.

Run Date: Select to use the GL Interface process date as the accounting date. This is the default value for this field.

Term Start Date: Select to use the beginning of the term as the accounting date. For example, suppose students at your institution register for fall term courses in the spring, but you want the system to put the tuition income from those registrations into a fall accounting period. By selecting term start date as your accounting date control and specifying the fall term on your tuition transaction, the system posts the charges to the fall period.

Warning! Selecting *Term Start Date* in the Accounting Date Control field could cause transactions to be backdated into an already closed accounting period. Select this option with caution.

Accounting Date ID

This field is available and required only when the value in the Accounting Date Control field is *Accounting Date* or *Maximum (Accounting Dt, Run Dt)*.

All IDs that are set up on the Accounting Dates page and have an active status are available values in this field.

Use this field to assign an accounting date ID to an item type to designate the specific date to be used for Accounting Line transactions.

See [Chapter 2, "Completing Student Financials General Setup," Setting Up Accounting Dates, page 54.](#)

Classification

Select the appropriate classification for this item type. Your choice determines the fields that are available to you on the Miscellaneous Edits page, and indicates to the system whether the item type is a charge or credit entry.

Application Fee	Select if you are defining an item type used for an application fee. Application Fee transactions result in a charge on the student's account.
Billing	Reserved for future use.
Charge	Select if you are defining a charge item type. Charge transactions result in a charge on the student's account and, depending on your GL setup, may create a receivable.
Contributor Relations	Select if you are defining a contributor relations item type. Typically, the Contributor Relations staff define contributor relations item types.
Deposit	Select if you are defining a deposit item type. If the deposit classification is selected, a Tuition Deposit check box is also activated. If this item type is used for a tuition deposit, both the Deposit classification and the Tuition Deposit check box must be selected. Deposit and Tuition Deposit transactions result in a credit on the student's account.
Financial Aid	Select if you are defining a financial aid item type. Financial Aid transactions result in a credit (payment) on the student's account. <hr/> Note. Financial Aid item types also require definition in the Financial Aid application. <hr/>
GL Interface Only	Reserved for future use.
Interest	Select if you are defining an item type for interest charges for payment plans. Interest transactions result in a charge on the student's account.
Payment	Select if you are defining a payment item type. Payment transactions result in a credit (payment) on the student's account.
Pay Plan Credit	Reserved for future use.
Pre-Paid Tuition	Reserved for future use.
Transfers	Reserved for future use.
Refund	Select if you are defining an item type used for an overpayment refund. Refund transactions result in a charge on the student's account.

- Waiver** Select if you are defining an item type used for waivers.
Waiver transactions result in a credit (payment) on the student's account.
- Withholding** Select if you are defining an item type for tax withholding.
Withholding transactions result in a charge on the student's account.
- Write-off** Select if you are defining an item type used for bad debt write-off.
Write-off transactions result in a credit on the student's account.

See Also

PeopleSoft Enterprise Contributor Relations 9.0 PeopleBook, "Setting Up Commitment Management," Completing Item Type Initial Setup

PeopleSoft Enterprise Financial Aid 9.0 PeopleBook, "Setting Up Packaging Basics," Defining Financial Aid Item Types

Defining Transaction Amount and Tax Form Parameters for Item Types

Access the Amount Edits page (Set Up SACR, Product Related, Student Financials, Item Types, Item Types, Amount Edits).

Initial Setup		Amount Edits		Miscellaneous		External Awards		Posting Restrictions		Account Types		GL Interface	
SetID: PSUNV				Item Type: 000000000260 Math Lab Fee									
Find View All First 1 of 1 Last													
Effective Date: 01/01/1900		Status: Active		Minimum Transaction Amount: 0.00		*Currency: USD		*Maximum Transaction Amount: 9,999,999.00		Default Amount: 0.00			
T4A Setup													
<input type="checkbox"/> T4A Eligible													
T2202A Setup													
<input type="checkbox"/> T2202A Eligible <input type="checkbox"/> T2202A Offset													
1098-T Setup													
<input checked="" type="checkbox"/> 1098-T Eligible													

Amount Edits page

Min Transaction Amount (minimum transaction amount) and Max Transaction Amount (maximum transaction amount)	Select the optional minimum and maximum amounts for each transaction using this item type. The system uses these amounts as edits for group posting.
Base Currency	The base currency selected by your institution is supplied automatically to the Base Currency field. You can override this field.
Default Amount	You can enter a default amount for your item types to streamline data entry. This is particularly useful when you are entering a charge or payment for something with a fixed cost (for example, a parking permit). You can override this default amount whenever necessary. The default amount must be greater than or equal to the minimum transaction amount.

T4 Setup

This group box pertains to the form that is required by the Canadian government to report certain scholarships and other financial aid that must be counted as income.

T4 processing in Student Financials is a payroll interface. You can use Student Financials or Financial Aid to process income scholarships and have the scholarship income reported to the federal government through the standard payroll T4 process.

Note. If your institution does not use PeopleSoft Payroll for North America, you can run the SF Generate T4 Data process (SFGENT4) and use the output from the file generated by this process to create an interface with your payroll system.

T4A Eligible	Select the T4A Income check box and enter a corresponding wage loss plan on the CDN/ANZ Taxes page (in the SF business unit component) to indicate that this item type is considered income per the T4 definition (and, therefore, needs to be reported as income). A process in tax reporting generates the payroll interface that is necessary to generate a T4 transaction as an interface to the payroll system.
---------------------	--

Note. Wage loss plans are set up in Set Up HRMS, Product Related, Payroll for North America, Canadian Taxes, Wage Loss Plan Table.

T2202A Setup

This group box pertains to the form that is required by the Canadian government to report eligible educational expenses for Canadian students.

T2202A Eligible	Select if this item is an eligible educational expense.
------------------------	---

T22202A Offset	Select if this item is to be used to offset eligible educational expenses. For example, waivers may reduce the total fees paid by the student and would, therefore, be considered an offset.
-----------------------	--

1098-T Setup

This group box pertains to the form that is required by the U.S. government to report eligible educational expenses for U.S. students.

1098-T Eligible Select if this item is an eligible educational expense.

Defining Miscellaneous Parameters for Item Types

Access the Miscellaneous page (Set Up SACR, Product Related, Student Financials, Item Types, Item Types, Miscellaneous).

Miscellaneous page

Note. Not all fields shown in the example are available for all item type classifications. And other fields may be available that are not shown. The following list defines all fields that are used with all item type classifications.

Charge Priority List	<p>Select the charge priority list that you want to use to control which charges are eligible for payment with this item type.</p> <p>If you are selecting a charge priority list for an ePayment item type, the value that you select here affects the charges that are eligible for self-service payment on the Payment Information, Charge Information, and Payment Allocation pages.</p> <p>This field is used with Deposit, Financial Aid, Payment, Pre-Paid Tuition, and Waiver item type classifications.</p> <hr/> <p>Note. You can leave this field blank if you want charge priority lists to be ignored for this item type. If you do so, excess payments appear as unapplied payments, potentially available for refund to the student. For example, if this item type is a Financial Aid stipend that a student uses to pay for living expenses, but not available for tuition and mandatory fees, you could leave this field blank. Any stipend is then reflected as an excess payment and may be given to the student as a refund for living expenses.</p> <hr/> <p>Warning! Do not change this setting after transactions have been posted. Create a new item type with a new charge priority list.</p> <hr/>
Payment Overall Priority	<p>Select the payment overall priority definition that you want to use to control the order in which payments are applied to eligible charges using this item type.</p> <p>This field is used with Deposit, Financial Aid, Payment, Pre-Paid Tuition, and Waiver item type classifications.</p> <hr/> <p>Warning! Do not change this setting after transactions have been posted. Create a new item type with a new payment overall priority.</p> <hr/>
Adjustment Calendar	Reserved for future use.
Days to Encumber	<p>If you want to encumber payments for a period of time before making them available for a refund, enter the number of days in this field.</p> <p>The number that you enter in this field establishes how many business days must pass before a refund can be made. For example, if you entered the number <i>10</i> in this field, ten working days would have to pass before a customer could receive a payment refund (the student could receive a refund on the eleventh day).</p> <p>This field is used with Payment item type classifications.</p>
Payment Terms	Reserved for future use.
NRA Taxable Credit (nonresident alien taxable credit) and Earnings Code	<p>Select if this item type is considered taxable income for nonresident aliens. When you select this option, the Earnings Code field becomes active and you can identify the item type with its corresponding payroll earnings code.</p> <p>This field is used with Financial Aid, Payment, and Waiver item type classifications.</p>

NRA Offset Charge (nonresident alien offset charge) and Earnings Code	<p>Select if this item type can offset (reduce) tax liability for nonresident aliens. When you select this option, the Earnings Code field becomes active and you can identify the item type with its corresponding payroll earnings code. This field is not shown on the sample page.</p> <p>This field is used with Application Fee, Billing, Charge, GL Interface Only, Interest, and Withholding item type classifications.</p>
Tax Code	<p>Select a tax code for charges that are taxable. For example, purchases that are made at a campus bookstore might be subject to state taxes, local sales taxes, or both. This field is not shown on the sample page.</p> <p>This field is used with Charge, GL Interface Only, Refund and Withholding item type classifications.</p>
Earnings Code Non Taxable	<p>Enter an earnings code to be used with nontaxable payments.</p> <p>This field is used with Deposit, Financial Aid, Payment, Pre-Paid Tuition, Refund, and Waiver item type classifications.</p>
Earnings Code	<p>If you process refunds through payroll, choose the appropriate earnings code.</p> <p>This field is used with all item type classifications except Write-off.</p>
Tender Specific	<p>Select if you want to specify the form of tender to use with this item type. For example, if you set up an item type to be used for credit card payments, you should select this check box and specify the desired tender form in the Tender Category field. The Tender Category field appears when you select this option.</p> <p>This field is used with Deposit and Payment item type classifications.</p>
Tender Category	<p>Select the tender category that you want to use with a tender specific charge.</p>
Refundable Indicator	<p>Select if you want payments against the charge to be eligible for refunding.</p> <p>This field is used with Deposit, Financial Aid, Payment, and Pre-Paid Tuition item type classifications.</p>
Taxable	<p>If you use PeopleSoft Payroll for North America, the system automatically selects and uses this option. Clear the check box if the item type is not taxable under any circumstance, or your institution does not use Payroll for North America.</p> <p>This field is used with Deposit, Financial Aid, Payment, and Pre-Paid Tuition item type classifications.</p>
Payment Priority Flag	<p>Select to assign a priority ranking to this payment. When you select this check box, the Priority field is activated. If you do not select this option, the system ignores values in the Priority field and the payment has the lowest priority ranking (999).</p> <p>This field is used with Deposit, Financial Aid, Payment, and Waiver item type classifications.</p>

Warning! Do not change this setting after transactions have been posted. Create a new item type with the Payment Priority Flag check box cleared.

Priority

Enter a priority value.

Payment priority is used to cause payment swapping whereby payments with a higher priority can actually displace lower-priority payments. For example, you might want financial aid payments to be applied to tuition charges whenever possible, leaving the student with less out-of-pocket expenses. And rules that are associated with certain types of financial aid might require that institutional waivers be applied ahead of the aid. In this case, the institutional waivers should have a higher priority value (1 being the highest priority value and 999 being the lowest) than the financial aid, and the financial aid should have a higher priority value than a cash payment.

With payment swapping, waivers and financial aid payments (in the previous example) can be applied after a cash payment has been made and the cash payment is swapped out, or displaced by the higher priority payments. Assuming that the total payments exceed the amount of the charge resulting in an overpayment, the cash payment would then be eligible for refund to the student.

This field is used with Deposit, Financial Aid, Payment, and Waiver item type classifications.

Pick Up Receivable from Charge

Select to credit receivables based on the specific charge being paid by the payment. This selection is used in GL processing.

This field is used with Deposit, Financial Aid, Payment, and Waiver item type classifications.

Match Charge Write-Offs

Select to match write-off entries to the original charges. You must also complete the Write-Off page for each charge item type and term for which you want to match charges to write-offs on the GL Interface. This field is not shown on the sample page.

If this check box is cleared, write-offs will be routed to the generic receivables account that is set up in the write-off item type.

This field is used only with the Write-off item type classification.

Defining External Awards

Access the External Awards page (Set Up SACR, Product Related, Student Financials, Item Types, Item Types, External Awards).

External Awards page

Use this page to define the financial aid external award type, source, and program code.

To define an external award, complete the financial aid setup that defines the general external award attributes, then set the way your institution mapping strategy will represent a student's financial payment will be represented on a Financial Aid Award package. Once this is completed, complete the External Award Cross Reference setup in Financial Aid which will maps the award attributes to a financial aid item type. Finally, complete the External Award page on the Student Financials item type setup to complete the mapping of payments to a Financial Aid award.

The Student Financials External Awards process uses the cross-reference mapping and external award attributes mapped on the Student Financials item type setup to determine which Student Financials payments to process and report as external award transactions.

See Also

[Isfa] Setting Up External Awards

[Isfa] Managing External Award Reporting

Defining Item Type Posting Restrictions

Access the Posting Restrictions page (Set Up SACR, Product Related, Student Financials, Item Types, Item Types, Posting Restrictions).

Initial Setup	Amount Edits	Miscellaneous	External Awards	Posting Restrictions	Account Types	GL Interface
SetID:	PSUNV	Item Type:	000000000260 Math Lab Fee			
Find View All First ◀ 1 of 1 ▶ Last						
Effective Date:	01/01/1900	Status:	Active			
Item Effdt Edits						
*Days in the Past:	<input type="text" value="99,999"/>	*Days in the Future:	<input type="text" value="99,999"/>			
Due Date Edits						
*Days in the Past:	<input type="text" value="99,999"/>	*Days in the Future:	<input type="text" value="99,999"/>			
<input type="checkbox"/> Term Enroll Req for Posting						

Posting Restrictions page

Item Effdt Edits (item effective date edits)

Days in the Past and Days in the Future Enter the number of days in the past and the number of days in the future that an item can be effective-dated.

Due Date Edits

Days in the Past and Days in the Future Enter the number of days in the past and the number of days in the future that a due date can be set.

Appropriate Term Enroll Req for Posting
(appropriate term enroll required for posting) Select if you want the system to make sure the student is enrolled in the appropriate term before posting the charge. If the student is not enrolled, the charge is left with the status *unposted*. Use this feature to avoid posting charges that have a high probability of being canceled.

Linking Account Types to an Item Type

Access the Account Types page (Set Up SACR, Product Related, Student Financials, Item Types, Item Types, Account Types).

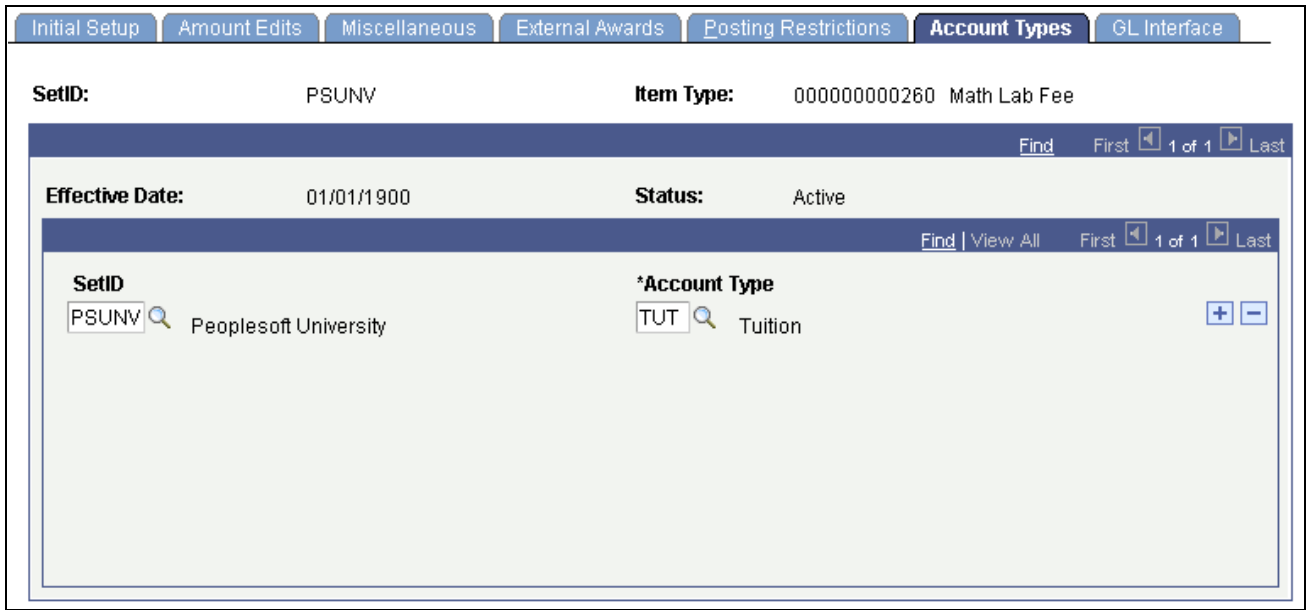

Account Types page

SetID

Enter the setID that includes both the account type and the item type.

Warning! You can have item types and account types duplicated in more than one setID, but this is not recommended. Exercise caution that you do not specify a setID that is incorrect for the item type that you are defining.

Account Type

Enter an account type that you want to associate with the item type. Account types provide information for prompting when you are performing data entry.

Mapping Item Types to General Ledger Accounts

Access the GL Interface page (Set Up SACR, Product Related, Student Financials, Item Types, Item Types, GL Interface).

GL Interface page

Note. If you select the GL Interface Required check box on the Initial Setup page, you must complete this page to save the item type.

Copy GL Interface

Click to copy a GL Interface setup from a previous term.

Note. Although the GL Interface definition is designated for a specific term, it is also effective-dated. Therefore, you need not perform the copy function if no changes are made to your setup.

Item Type GL Entry Setup - Term

Term	Select a term if you have a term-specific general ledger. If you do not enter a term, you must enter <i>0000</i> as a placeholder.
Session	Select a session if you want to limit the GL Interface definition to a specific academic session.

Item Type GL Entry Setup - Effective Date

Effective Date and Status Enter the effective date and the status for the interface.

AP ChartFields Click to access the AP ChartFields page, where you can enter chart of accounts information to define a liability account—typically a holding account. The link is not available if this is a Contributor Relations item type.

Use this link if you use the PeopleSoft Accounts Payable interface to create refund checks for students, external organizations, or both.

Select a predefined SpeedType definition to populate the ChartFields.

Click the Copy button to copy ChartField values into a temporary variable. Click the Paste button to paste the copied ChartField values from the temporary variable into another ChartField page. Note that if one of the check boxes in the ChartField Edit Options group box on the SF Installation page is selected, then a check mark button appears next to the Copy and Paste buttons. Click the check mark to validate the ChartField combination. This button does not start journal set edits.

Writeoff ChartFields Click to access the Writeoff ChartFields page, where you can enter chart of accounts information to define an account for write-offs. You must define a unique account for each charge that you want the system to match.

Select a predefined SpeedType definition to populate the ChartFields.

Click the Copy button to copy ChartField values into a temporary variable. Click the Paste button to paste the copied ChartField values from the temporary variable into another ChartField page. Note that one of the check boxes in the ChartField Edit Options group box on the SF Installation page is selected, then a check mark button appears next to the Copy and Paste buttons. Click the check mark to validate the ChartField combination. This button does not start journal set edits.

Item Type GL Entry Setup - Journal Sets

Each GL Interface definition requires at least one debit and one credit entry. Each debit entry and each credit entry can be split into multiple entries for distribution to your general ledger, but you must make sure that each side (debit and credit) totals 100 percent.

Jrnl Set (journal set) Enter the journal set that is used by your institution. You can use multiple journal sets. This enables you to generate a set of balanced entries into your journals. Using multiple journal sets also enables you to set journals for multiple ledgers, for example, budget or actuals.

Use the copy icon to copy the setup for the row, which can then be pasted to the new or any proceeding row.

Timing Select the appropriate timing for sending the charge to the general ledger. You can select either *Assessment*, which sends the charge when it is incurred, *Satisfaction*, which sends the charge when the offset is posted, or *Billed*, which sends the charge or waiver when it has been billed.

DB/CR(debit/credit) Select either *Debit* or *Credit* for the DB/CR field. You must set up one debit and one credit for each item type.

Note. For charge classifications, the debit side represents accounts receivable and the credit side represents revenue.

Next to the Jrnl Set field, there are copy and paste icons. Use the copy icon to copy the setup for the row, which can then be pasted to the new, or any proceeding row.

To input all areas for the ChartFields, abbreviated display fields have been added. The number of delimiters displayed is based on the number of ChartFields. The abbreviated display fields are used to view the ChartField set up as a string, add or update the ChartField string. All ChartField edits set up on the SF Installation page are adhered to within the display field.

Splitting a Transaction Between Multiple GL Accounts

The General Ledger Percent (GL Pct), Priority, Priority Amount, and Account Limit fields are used to split a debit or credit across multiple GL accounts.

GL Pct (general ledger percent) Enter an optional percentage of the transaction that you want posted to the GL account.

Priority Enter the posting priority for either the GL percent or priority amount. The lower the number, the higher the priority.

Priority Amt (priority amount) Enter an optional priority amount that you want distributed to a GL account. If you specify a priority amount, the amount specified will be distributed to the GL account definition with the highest priority. The remaining balance will be distributed to the remaining GL accounts as defined.

Account Limit Enter a maximum monetary amount that you want to distribute to the specified GL account. For example, if you set the GL Pct field to 25 percent and the Account Limit field to 100 USD, 25 percent of a debit or credit up to a maximum of 100 USD will be distributed to the specified GL account.

Defer Revenue - Until and Deferred Date

Select the Defer Revenue - Until check box on the revenue (credit) side of your ChartField setup and specify a date. Then click the Deferred ChartFields link to access the Deferred GL Interface page, where you can define GL Interface parameters for a deferred revenue account.

If you indicate that a particular item type needs to defer revenue, the system prompts you for liability account information and the deferred date. The system uses the liability account until the date that you have indicated for that item type. The system does not automatically generate the entry for moving the deferred revenue from the liability account to the realized revenue. When this date passes, you must move the revenue into the general ledger.

Select a predefined SpeedType definition to populate the ChartFields.

Click the Copy button to copy ChartField values into a temporary variable. Click the Paste button to paste the copied ChartField values from the temporary variable into another ChartField page. Note that if one of the check boxes in the ChartField Edit Options group box on the SF Installation page is selected, then a check mark button appears next to the Copy and Paste buttons. Click the check mark to validate the ChartField combination. This button does not start journal set edits.

Deferred ChartFields

This link becomes available only if you check the Defer Revenue - Until check box above. Click this link to access the Deferred GL Interface page, where you can define GL Interface parameters for a deferred revenue account.

Select a predefined SpeedType definition to populate the ChartFields.

Click the Copy button to copy ChartField values into a temporary variable. Click the Paste button to paste the copied ChartField values from the temporary variable into another ChartField page. Note that if one of the check boxes in the ChartField Edit Options group box on the SF Installation page is selected, then a check mark button appears next to the Copy and Paste buttons. Click the check mark to validate the ChartField combination. This button does not start journal set edits.

Journal Set ChartFields

Click this link to access the Journal Set ChartFields page, where you can define the parameters for the journal set.

Dynamic Organization

If you select this optional check box, the system allocates the appropriate revenue based on the subject area of the classes in which a student is enrolled. In the PeopleSoft Student Records system, subject areas map to academic organizations, and academic organizations map to financial organizations. Consequently, the system enables you to map subject areas to financial organizations. By using these constructs with the dynamic organization capabilities, you can distribute revenue based on a student's course load using the organizational ChartField.

Note. The dynamic organization feature uses billing units. When making adjustments, the system reallocates based on the number of billing units. It does not use the adjustment calendar to determine how much remains allocated to the organization. It reallocates 100 percent of the funds.





Deferred Dynamic Org Select to have the system defer the appropriate revenue based on the subject area of the classes in which a student is enrolled. This capability enables you to defer revenue based on a student's course load using the organizational ChartField.

Journal Set ChartFields Page

Access the Journal Set ChartFields page (Click the Jrnl Set ChartFields link on the GL Interface page).

Journal Set ChartFields

GL Business Unit:  SpeedType:

Ledger:    

Account:  Product Revenue

Department:  Executive Branch

Project/Grant: 

Product: 

Fund Code:  ACCT_CD

Program Code: 

Class Field: 

Affiliate: 

Operating Unit: 

Alternate Account: 

Budget Reference: 

Chartfield 1: 

Chartfield 2: 

Chartfield 3: 

Journal Set ChartFields page

Note. You must run the Sync Chartfield Values process before you use this page.

See [Chapter 4, "Setting Up GL Interface Processing," Synchronizing ChartField Values, page 125.](#)

Use this page to define the parameters for the journal set.

Select a predefined SpeedType definition to populate the ChartFields.

Click the Copy button to copy ChartField values into a temporary variable.

Click the Paste button to paste the copied ChartField values from the temporary variable into another ChartField page.

If one of the check boxes in the ChartField Edit Options group box on the SF Installation page is selected, a Validate check mark icon appears next to the Copy and Paste buttons. Click the Validate icon to validate the ChartField combination. This icon does not start journal set edits. If you do not click the Validate icon, validation is still performed when you save the Item Types component.

For Oracle Financials, the Real-Time Validation Edit option should be selected on the SF Installation page. Click the Validate icon to perform real time validation of the entered combination with Oracle GL. If you do not click the Validate icon, real time validation is still performed when you save the Item Types component.

Integration with Oracle Financials

The Journal Set ChartFields page appears and functions differently if Oracle Financials is selected in the Financial System group box on the SF Installation page:

- If you select a GL business unit that has not been mapped on the Chartfield Mapping page, you receive an error message.
- The Ledger field does not appear.
- The 2 Affiliate Intra (Intra Unit), Project/Grant, and Affiliate chartfields are not supported and these should be made inactive on the HRMS Standard Chartfield Configuration page.
- The prompt table associated with the chartfields displays valid segment values based on the mapping on the ChartFields Mapping page.

See [Chapter 2, "Completing Student Financials General Setup," Defining Number Sequence Start Points, Maximum Row Settings, and ChartField Edit Options, page 7.](#)

See [Chapter 4, "Setting Up GL Interface Processing," Mapping General Ledger Business Units to Oracle General Ledger, page 120.](#)

See CS90 to EBS GL Integration Developer's Reference Guide. The guide is posted to My Oracle Support.

Defining Item Type Groups

Access the Item Type Groups page (Set Up SACR, Product Related, Student Financials, Item Types, Item Type Groups).

Item Type Groups

SetID: PSUNV Group: TUI&HOUFEE

Find First 1 of 1 Last

*Effective Date: 01/01/1998 *Status: Active

*Description: Tuition & Housing

*Short Description: TutHou

Long Description:

*TableSet: PSUNV

*Tree Name: ITEM_SECURITY

*Tree Node		
HOUSING		+ -
TUITION		+ -

Item Type Groups page

TableSet Select the setID that includes the item type tree that you want to use.

Tree Name Select the tree name of an item type tree that includes all of the tree nodes that you want to include in your item type group.

Tree Node Select a tree node that you want to include in your item type group

Setting Up Service Indicator Sets

To set up service indicator sets, use the Service Indicator Sets component (SERVICE_IND_SETUP).

This section provides an overview of service indicator sets and discusses how to:

- Define service indicator set details.
- Define eligible academic careers for service indicator sets.

Understanding Service Indicator Sets

Service indicator sets enable you to automatically attach service indicators to student accounts by running the Credit History process. When you define service indicator sets, you link a service indicator to an aging category and minimum amount combination. When you run the Credit History process, the system applies the linked service indicator to any student or external organization with an overdue balance that falls within the specified aging category and is over the minimum amount. In addition, if the linked service indicator is already applied to an account and the overdue balance is paid off, the next time you run the Credit History process, the system removes the service indicator.

See Also

Chapter 22, "Maintaining Customers," Processing and Reviewing Customer Credit History, page 637

PeopleSoft Enterprise Campus Community 9.0 Fundamentals PeopleBook, "Setting Up Service Indicators," Setting Up Service Indicator Codes and Reasons

Pages Used to Set Up Service Indicator Sets

<i>Page Name</i>	<i>Definition Name</i>	<i>Navigation</i>	<i>Usage</i>
Service Indicator	SRVC_IND_SF_TBL	Set Up SACR, Product Related, Student Financials, Collections, Service Indicator Sets, Service Indicator	Create service indicator sets and define descriptive information for them.
Service Indicator - Details	SRVC_IND_SF	Set Up SACR, Product Related, Student Financials, Collections, Service Indicator Sets, Service Indicator, Details	Define service indicator set details.
Service Indicator - Career Setup	SRVC_IND_SF_C	Set Up SACR, Product Related, Student Financials, Collections, Service Indicator Sets, Service Indicator, Career Setup	Define eligible academic careers for service indicator sets.

Defining Service Indicator Set Details

Access the Service Indicator - Details page (Set Up SACR, Product Related, Student Financials, Collections, Service Indicator Sets, Service Indicator, Details).

The screenshot displays the 'Service Indicator - Details' page. At the top, there are tabs for 'Service Indicator', 'Details', and 'Career Setup'. Below the tabs, the 'Business Unit' is 'PSUNV PeopleSoft University Bursar' and the 'Service Indicator Set' is 'STD Standard'. The 'Effective Date' is '01/01/1998' and the 'Status' is 'Active'. The 'Severity' field contains the value '1'. The 'Aging Category' is '96 120+'. The 'Aging Set' is 'STD STD Aging Set'. The 'Service Indicator Cd' is 'SF1 Student Financial 1'. The 'Service Ind Reason' is 'NOPAY Not Paid'. The 'Contact ID' is 'SF0009'. The 'Department' is 'ADMISSIONS Admissions Office'. On the right side, there is a 'Min Amt' field with the value '100.00' and three checked checkboxes: 'Use Records', 'Use Admissions', and 'No Career'.

Service Indicator - Details page

- Severity** Enter the alphanumeric code established by your institution to indicate the severity of the service indicator.
- Aging Set** Select the aging set containing the aging category to which you are linking a service indicator.
- Aging Category** Select the aging category that triggers the application of the service indicator to student accounts.
- Min Amt** (minimum amount) Define the minimum amount that triggers the application of the service indicator to student accounts.
- Service Indicator Cd** (service indicator code) Select a service indicator code from your established list. This code is linked to a service impact that controls what actions the system takes related to the service indicator.
- Service Ind Reason Cd** (service indicator reason code) Select a service indicator reason code from your established list. This code explains why this service indicator is being applied.
- Contact ID** Select the ID number of a specific person with the department responsible for this service indicator set.
- Department** Select the department that is responsible for this service indicator set. This is the department that the student must contact to clear the associated service indicator.

Academic Career Controls

The check boxes in this group box control where the system searches to confirm that the student is active in an academic career before applying a service indicator. At least one check box must be selected, but you can select all three. You must select the No Career check box for external organizations.

- Use Records** Select if you want the system to verify that the student's academic career matches the one that you establish on the Service Indicator Career Setup page.

- Use Admissions** Select to have the system verify that the student's admissions career matches the one that you established on the Service Indicator Career Setup page. This verification takes place after the academic career verification. The system performs this verification only after it performs the verification in Student Records and cannot find a match.

- No Career** Select if you want the system to process the student only if no admissions career or academic career is associated with the student, regardless of whether you selected the Use Records check box or the Use Admissions check box. Selecting this check box indicates to the system that you want a service indicator placed even if the student is not activated in Student Records or PeopleSoft Student Admissions. This must be selected for external organizations.

Defining Eligible Academic Careers for Service Indicator Sets

Access the Service Indicator - Career Setup page (Set Up SACR, Product Related, Student Financials, Collections, Service Indicator Sets, Service Indicator, Career Setup).

The screenshot displays the 'Service Indicator - Career Setup' page. At the top, there are tabs for 'Service Indicator', 'Details', and 'Career Setup'. Below the tabs, the following information is shown:

- Business Unit:** PSUNV PeopleSoft University Bursar
- Service Indicator Set:** STD Standard

Below this information are three nested table-like structures, each with a 'Find', 'First', and 'Last' navigation bar:

- Table 1:**
 - Effective Date:** 01/01/1998
 - Status:** Active
- Table 2:**
 - Severity:** 1
- Table 3:**
 - *Academic Career:** Undergraduate (dropdown menu)

Service Indicator - Career Setup page

Academic Career

Select the academic career to which the associated service indicator can be applied.

Note. If you did not select the No Career check box on the Service Indicator - Details page, you must be sure to specify the career for all appropriate rows and severity levels.

Setting Up a Default Academic Term

To set up a default academic term, use the SF Term Default component (DFLT_TERM_TBL).

A default term value simplifies data entry. Typically, changing the default term value at the beginning of each term is most beneficial. Using effective dating functionality, you can predefine default term values in advance and have them automatically change on the first day of the term.

Page Used to Set Up a Default Academic Term

Page Name	Definition Name	Navigation	Usage
Term Default	DFLT_TERM_TBL	Set Up SACR, Product Related, Student Financials, Charges and Payments, SF Term Default, Term Default	Define default academic terms.

Defining Default Academic Terms

Access the Term Default page (Set Up SACR, Product Related, Student Financials, Charges and Payments, SF Term Default, Term Default).

Term Default

Business Unit: PSUNV PeopleSoft University Bursar

Find | View All First 1 of 23 Last

<p>*Effective Date: 03/26/2005 </p> <p>*Term: 0542 2005 Spring Qtr</p> <p>*Term Begin Date: 03/26/2005 </p> <p>*Academic Year: 2005</p> <p>Antic Aid Term From: 0532 2004 Fall Qtr</p>	<p>*Status: Active </p> <p>*Term Ending Date: 06/17/2005 </p> <p>Antic Aid Term To: 0542 2005 Spring Qtr</p>
---	--

Term Default page

Effective Date	Enter the effective date for the SF term that you are identifying.
Status	Select the status for this term default.
Term	Enter the default academic term.
Term Beginning Date and Term Ending Date	Enter the term beginning date and the term ending date.
Academic Year	Enter the academic year to which the term belongs.
Antic Aid Term From (anticipated aid term from)	Enter the value of the first (beginning) term that you want considered for anticipated financial aid (aid awarded but not disbursed).
Antic Aid Term To (anticipated aid term to)	Enter the value of the last (ending) term that you want considered for anticipated financial aid.

Chapter 3

Setting Up ePayment Processing

This chapter includes an overview of ePayment processing and discusses how to:

- Set up credit card types.
- Re-encrypt credit card, bank account numbers, Security Code data, and Security Key.
- Set up Payment merchants.
- Test Payment and Hosted Payment Transactions.
- Set up Student Financials merchants.
- Set up institution sets.
- Set up item types for an ePayment transaction.
- Set up self-service options.

Understanding ePayment Processing

Student Financials enables your institution to receive payments for charges by eCheck or credit card through cashiering (credit card only) and over the web using self-service functionality (credit card and eCheck). The rules that your institution defines for authorizing and capturing ePayment transactions as well as for processing ePayment credits are established when you set up your payment merchant, SF merchant, and SF institution set parameters.

Setting Up Credit Card Types

To set up credit card types, use the Credit Card Type component (CREDIT_CARD_TYPE).

Your institution must have contracts with credit card providers (such as VISA or Master Card) to be able to accept payments using their cards. To prevent users from attempting to record payments using unauthorized cards, you must define the credit card types accepted by your institution.

This section discusses how to define accepted credit card types.

Page Used to Set Up Credit Card Types

Page Name	Definition Name	Navigation	Usage
Credit Card Type	CREDIT_CARD_TYPE	Set Up SACR, Product Related, Student Financials, Credit Card Type	Define accepted credit card types.

Defining Accepted Credit Card Types

Access the Credit Card Type page (Set Up SACR, Product Related, Student Financials, Credit Card Type).

Credit Card Type

SetID: PSUNV **Credit Card Type:** VI

***Description:**

Short Description:

Date Format

MM/DD/YYYY

MM/YYYY

Credit Card Type page

Date Format

Select an expiration date format.

MM/DD/YYYY Select to include the month, day, and year in the expiration date format.

MM/YYYY Select to include only the month and year in the expiration date format.

Re-encrypting Credit Card, Bank Account Numbers, Security Code Data, and Security Key

To replace a known or suspected compromised encryption key, regenerate the encryption key and convert existing credit card, bank account numbers, and Security Code data using the new key. Periodic key changes can be essential to your institution's encryption key management.

This section provides overviews of encryption and re-encryption and discusses how to:

- Regenerate the encryption key.
- Convert data to use a regenerated encryption key.

Understanding Encryption

PeopleSoft Enterprise Campus Solutions encryption uses PeopleTools Pluggable Cryptography, which is an advanced security framework that provides a security model for applications to encrypt credit card data.

Pluggable Cryptography enables you to secure critical PeopleSoft data and communicate securely with other businesses. It enables you to extend and improve cryptographic support for your data in PeopleTools, giving you strong cryptography with the flexibility to change and grow, by incrementally acquiring stronger and more diverse algorithms for encrypting data. In PeopleTools, pluggable cryptography capability is provided by PeopleSoft pluggable encryption technology (PET).

By using the Tools Pluggable Cryptography for strong encryption/decryption, the system encrypts data using 3DES algorithms and 168-bit encryption keys.

To replace a known or suspected compromised key, regenerate the encryption key and convert existing credit card, bank account numbers, and Security Code data using the new key. Periodic key changes can be essential to your institution's encryption key management.

This section provides an overview of how to regenerate the encryption key and convert credit card, bank account numbers, and Security Code data using the new key.

Understanding Re-encryption

When you change the encryption key at any time after the initial conversion, you must also re-encrypt all of your credit card, bank account numbers, and Security Code data using that key. Predefined encrypt and decrypt profiles are delivered for Campus Solutions re-encryption. These profiles specify multiple user-defined steps applying various algorithms and keys to the data in a specified order and supporting various encryption standards and third-party encryption libraries.

Use the following parameters for Campus Solutions re-encryption.

Parameter	Value
Encrypt Profile ID	<i>CS_CREDIT_CARD_ENCRYPT</i>
Algorithm ID (encrypt)	<i>3des_ks168_cbc_encrypt</i>
Keyset ID	<i>CSCreditCard</i>
Decrypt Profile ID	<i>CS_CREDIT_CARD_DECRYPT</i>
Algorithm ID (decrypt)	<i>3des_ks168_cbc_decrypt</i>

Note. You can create your own profiles or modify the delivered ones. However, we do not recommend it. If you do, you must be very careful to use the appropriate values for whatever you create or modify.

To change the credit card encryption key and re-encrypt the data, do the following:

1. Navigate to the Generate Encryption Key page (Set Up SACR, Common Definitions, Encryption, Generate Encryption Key).
2. Click the Generate Random Key button to generate a new random hexadecimal encryption key.

Clicking this button generates a new, random hexadecimal encryption key. You can modify this key. However, you must format it as a 24-byte string in hexadecimal notation. The first two characters must be *0x*, and the remainder must be exactly 48 characters consisting of a combination of numeric digits and the lowercase letters *a* through *f*.

3. Copy the regenerated encryption key.
4. Navigate to the Algorithm page (PeopleTools, Security, Encryption, Algorithm Keyset) for the encrypt algorithm ID and keyset ID (*3des_ks168_cbc_encrypt* and *CSCredi Card*).
5. Paste the regenerated encryption key value in the Key Value field, replacing the previous value, and save the page.
6. Navigate to the Convert Encryption page (Set Up SACR, Common Definitions, Encryption, Convert Encryption).
7. Confirm that the encrypt and decrypt profile IDs are correct, then click the Run button to start the conversion process.

The Credit Card Conversion process converts each field in the grid. If the process fails for any reason, the process can be restarted in the standard way and the process picks up where it left off. If the process cannot be restarted, the process can be run from the beginning and it automatically bypasses fields that have already been processed.

Warning! You must complete steps 1-7 to encrypt and run the conversion process prior to completing the next steps, which set up decryption.

8. Navigate back to the Algorithm page (PeopleTools, Security, Encryption, Algorithm Keyset) for the decrypt algorithm ID and keyset ID (*3des_ks168_cbc_decrypt* and *CSCreditCard*).
9. Paste the regenerated encryption key value in the Key Value field, replacing the previous value, and save the page.

See Also

PeopleSoft Enterprise PeopleTools PeopleBook: Security Administration, "Securing Data with Pluggable Cryptography"

[Chapter 2, "Completing Student Financials General Setup," Defining Keyword Edit Tables and a Null Due Date, page 11](#)

[Chapter 14, "Processing ePayment Transactions," page 381](#)

Pages Used to Re-Encrypt and Convert Data

<i>Page Name</i>	<i>Definition Name</i>	<i>Navigation</i>	<i>Usage</i>
Generate Encryption Key	SSF_CC_ENCRYPT_KEY	Set Up SACR, Common Definitions, Encryption, Generate Encryption Key	Use this utility to change the key used to encrypt credit card, bank account numbers, Security Code data, and Security Key. Note. When you change the key, you must also run the conversion utility to re-encrypt credit card numbers using the new encryption key. Never change the key without also running the conversion.
Convert Encryption	SSF_CC_RUN_CNVRT	Set Up SACR, Common Definitions, Encryption, Convert Encryption	Perform conversion of credit card numbers to use a regenerated credit card encryption key.
Algorithm Keyset	CRYPT_KEYSET	PeopleTools, Security, Encryption, Algorithm Keyset	Copy the regenerated key to the key value field on this page for the encrypt profile prior to running the conversion process. After running the conversion process, copy the regenerated key to the key value field on this page for the decrypt profile.
Process Scheduler	PRCSRQSTDLG	Click the Run button on the Convert Encryption page.	Run the SSF_CC_CNVRT conversion process to convert existing credit card data using the regenerated credit card encryption key.

Regenerating the Encryption Key

Access the Generate Encryption Key page (Set Up SACR, Common Definitions, Encryption, Generate Encryption Key).

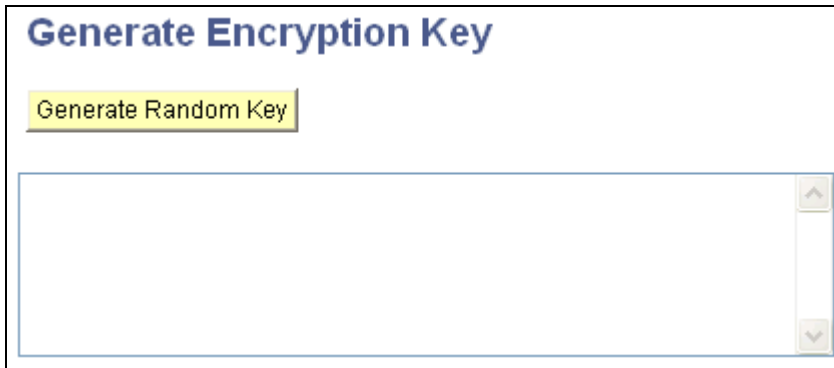

Generate Encryption Key

Generate Random Key

Generate Encryption Key page

Generate Random Key Click to have the system generate a random key in the format needed by the encryption algorithms used for credit card encryption and decryption profiles.

Converting Data to Use a Regenerated Encryption Key

Access the Convert Encryption page (Set Up SACR, Common Definitions, Encryption, Convert Encryption).

Convert Encryption

Run Control ID: PS [Report Manager](#) [Process Monitor](#) Run

Decryption Profile ID CS_CREDIT_CARD_DECRYPT ▼

Encryption Profile ID CS_CREDIT_CARD_ENCRYPT ▼

Record (Table) Name	Field Name	Crypt Action	+	-
ADM_APPL_TENDER	CR_CARD_NBR	Decrypt, then Encrypt	+	-
ADM_APPL_TENDER	SSF_BNK_ACCT_NUM	Decrypt, then Encrypt	+	-
AV_EP_ADJ_GIFT	AV_CR_CARD_NBR	Decrypt, then Encrypt	+	-
AV_EP_ADJ_MBR	AV_CR_CARD_NBR	Decrypt, then Encrypt	+	-
AV_EP_GIFT_DTL	AV_CR_CARD_NBR	Decrypt, then Encrypt	+	-
AV_EP_MBR_DTL	AV_CR_CARD_NBR	Decrypt, then Encrypt	+	-
AV_EP_TRANS_LOG	AV_CR_CARD_NBR	Decrypt, then Encrypt	+	-
AV_INVLV_G_HDR	AV_CR_CARD_NBR	Decrypt, then Encrypt	+	-
CSH_OFF_RCPT_T	CR_CARD_NBR	Decrypt, then Encrypt	+	-
CSH_OFF_RCPT_T	SSF_BNK_ACCT_NUM	Decrypt, then Encrypt	+	-
GROUP_LINE	CREDIT_CARD_NBR	Decrypt, then Encrypt	+	-
GROUP_LINE	SSF_BNK_ACCT_NUM	Decrypt, then Encrypt	+	-
PAYMENT_TBL	CREDIT_CARD_NBR	Decrypt, then Encrypt	+	-
PAYMENT_TBL	SSF_BNK_ACCT_NUM	Decrypt, then Encrypt	+	-
QUICK_POST_TBL	CREDIT_CARD_NBR	Decrypt, then Encrypt	+	-
QUICK_POST_TBL	SSF_BNK_ACCT_NUM	Decrypt, then Encrypt	+	-
REFUND_CC_INFO	CREDIT_CARD_NBR	Decrypt, then Encrypt	+	-
REFUND_CHECK	SSF_BNK_ACCT_NUM	Decrypt, then Encrypt	+	-
SF_ACCT_PROFILE	CR_CARD_NBR	Decrypt, then Encrypt	+	-
SF_ACCT_PROFILE	SSF_BNK_ACCT_NUM	Decrypt, then Encrypt	+	-
SF_PAYMENT	CR_CARD_NBR	Decrypt, then Encrypt	+	-
SF_PAYMENT	SSF_BNK_ACCT_NUM	Decrypt, then Encrypt	+	-
SF_PAYMENT_LOG	CR_CARD_NBR	Decrypt, then Encrypt	+	-
SF_PAYMENT_LOG	SSF_BNK_ACCT_NUM	Decrypt, then Encrypt	+	-
SSF_PAYMENT_CWV	SSF_CWV_NUM	Decrypt, then Encrypt	+	-
SCC_MERCHANT	SCC_EPAY_SEC_KEY	Decrypt, then Encrypt	+	-
AV_EP_PMT_CWV	AV_CWV_NUM	Decrypt, then Encrypt	+	-

Convert Encryption page

Decryption Profile ID and Encryption Profile ID

Default profile IDs are set on the SF Installation 2 page (Set Up SACR, Install, Student Fin Installation, SF Installation 2).

PeopleTools Pluggable Cryptography framework provides the delivered profiles of *TRIPLE DES ENC B64* and *TRIPLE DES DEC B64*.

PeopleSoft Enterprise Campus Solutions has enhanced the PeopleTools profiles specifically for Campus Solutions re-encryption. The predefined, enhanced profiles delivered for Campus Solution are *CS_CREDIT_CARD_DECRYPT* and *CS_CREDIT_CARD_ENCRYPT*.

Profiles specify multiple user-defined steps applying various algorithms and keys to the data in a specified order and supporting various encryption standards and third-party encryption libraries.

The decrypt profile must be the same profile and have the same keys used to encrypt the data as it is. The encryption profile must contain the new keys and algorithm to which you are converting. Therefore, when using the delivered CS profiles, you must change the key value on the Algorithm Keyset page for the encrypt profile and associated algorithm, before running the conversion process. After running the conversion, you must modify the decrypt profile to include the new key.

Crypt Action

Decrypt, then Encrypt is the action set to occur when you run the Credit Card Conversion process. The process first decrypts the credit card, account numbers, and Security Code data using the old algorithm and keys, and then encrypts it with the new set of algorithm and keys.

Setting Up Payment Merchants

A flexible interface supports the processing of credit card and eCheck transactions. The interface uses a flexible adapter-based model to support the transmission of electronic payment transactions. You can use either the Integration Broker-based interface or the Business Interlinks interface to send electronic payment transactions to third party payment processors. The Integration Broker interface provides Security Code support but the Business Interlinks interface does not.

Warning! Before you read this section, refer to the Setting Up Adapters chapter in the Application Fundamentals PeopleBook for information about the Adapter Type Table and Adapter Table components. The components are used to define the adapters that are used in electronic payment and hosted payment processing.

See *PeopleSoft Enterprise Campus Solutions 9.0 Application Fundamentals PeopleBook*, "Setting Up Adapters."

To set up Payment merchants, use the Payment Merchant (SCC_MERCHANT) component.

This section discusses how to define Payment merchants.

Page Used to Set Up Payment Merchants

Page Name	Definition Name	Navigation	Usage
Payment Merchant	SCC_MERCHANT	Set Up SACR, Common Definitions, Electronic Payments, Payment Merchant, Payment Merchant	Define electronic payment merchants.

Defining Electronic Payment Merchants

Access the Payment Merchant page (Set Up SACR, Common Definitions, Electronic Payments, Payment Merchant, Payment Merchant).

Payment Merchant

Merchant Setup ID: HostedPaySiteCC

***Description:**

***Status:** ▼

***Service Provider:** ▼

***3rd Party Merchant ID:** **Hosted Payment Provider**

Hosted Payment Setup

Adapter: 🔍

Browser Requirements Message:

To proceed with your payment, you need to enable cookies and javascript in your browser. If you are unsure how to enable these, please click on the Browser Requirements link below.

Browser Requirements Detail:

How to Enable Cookies:

Microsoft Internet Explorer 6 or later Choose Tools -- Internet Options. Click the Privacy tab

Payment Merchant page (1 of 2)

Electronic Payment Setup

Service Operation:

Adapter: **Security Key Required**

Supported Transactions

Value	Description		
91 <input type="button" value="Q"/>	Get Token (HPay)	+	-
92 <input type="button" value="Q"/>	Authorize Only (HPay)	+	-
93 <input type="button" value="Q"/>	Credit Only (HPay)	+	-

Electronic Check

Verification Level:

Settlement Method:

ACH Class:

Credit Card

Address Verification Flag:

Additional Setup Options

Process Server:

IP Override:

Payment Merchant page (2 of 2)

Service Provider Select a service provider: *Cybersource, TouchNet, or Unsupported.*
 This field is informational only.

3rd party Merchant ID Enter the merchant name.

Hosted Payment Provider Select this check box to identify the payment merchant as a hosted payment provider.

If you select this check box:

- The Hosted Payment Setup group box becomes available.
- The Security Code Supported check box in the Credit Card group box is not available, because that control is established (as well as collected) at the hosted payment (third party) site.

See [Chapter 14, "Processing ePayment Transactions," Understanding ePayment Transactions, page 381.](#)

Hosted Payment Setup

This group box is available only if the Hosted Payment Provider check box is selected.

Adapter	Select the adapter to be used by the hosted payment merchant to process hosted payment transactions.
Browser Requirements Message and Browser Requirements Detail	Enter a browser-related message, or browser-related detail about browser requirements, that an application can display to a user before the user is transferred to the third party hosted site.
Browser Requirements Message	For schools that use hosted payment, the message that you enter here appears on the Make a Payment - Confirm Payment page if the Display Browser Message check box is selected on the Electronic Payments (Institution Set) setup page.
Browser Requirements Detail	For schools that use hosted payment, the detail that you provide here appears when students click the Browser Requirements link on the Make a Payment - Confirm Payment page if the Display Browser Message check box is selected on the Electronic Payments (Institution Set) setup page. See <i>PeopleSoft Enterprise Campus Self Service 9.0 PeopleBook</i> , "Setting Up Student Financials Self Service," Defining Self-Service ePayments for Institution Sets.

Electronic Payment Setup

Service Operation	Select the service operation to be used by the adapter when processing the electronic or hosted payment transaction request. This field is required only if you use the Integration Broker based adapter (SCC_INT_BROKER).
Adapter	Select the adapter to be used by this merchant to process electronic payment transactions using the electronic payment interface.
Insert All Transactions	Click this button to insert all transactions into the Supported Transactions group box.
Security Key Required	Use this check box to indicate that a special security token or password is needed to process transactions. If you select this check box, the Security Key Setup group box becomes available.

Security Key Setup

This group box is available only if you select the Security Key Required check box.

Key	This field contains the security token or password that might be required by a third party payment processor. This field is encrypted using the encryption profiles from the SF Installation table.
------------	---

Supported Transactions

The following services are available for the ePayment API. Check with your third party provider for a list of supported services.

Value Select a value for the supported transactions.

Credit Card transactions:

- *1: Authorize Only*
- *2: Authorize and Bill*
- *3: Bill Only*
- *4: Credit Only*

eCheck transactions:

- *5: Make Payment*
- *6: Apply Credit*

Hosted transactions:

- *91: Get Token*
- *92: Authorize Only*
- *93: Credit Only*

Electronic Check

Verification Level Select the level of verification that the system uses for eCheck payments.

If a valid value is not entered on the transaction request, the value that you select here is used.

Validation: Select to test the format and bank routing number of each eCheck payment and to compare the transaction information to the check-processing partner's internal negative file.

Verification: Select to perform all validation steps and to compare each transaction's information with an external negative file to identify accounts that have a history of bad checks or that were closed for cause.

Note. Validation and verification are optional. Neither process checks the status or the existence of an account nor do they guarantee that funds are available.

Settlement Method

Select the default method that the system uses to deliver settlements to and from your students' banks.

If a valid value is not entered on the transaction request, the value that you select here is used.

Automated Clearing House: Select to deposit U.S. and Canadian transactions using the Automated Clearing House (ACH) or the Canadian Payment Association.

Facsimile draft: Select to deposit transactions as facsimile drafts. Use this method when the issuing bank is not an ACH member.

Best possible: Select to deposit transactions through the ACH system unless the student's bank is not an ACH participant, in which case, the system creates a facsimile draft and deposits it.

ACH Class

Select the default value for ACH Class data element used by eCheck transactions. If a valid value is not entered on the transaction request, the value that you select here is used.

The values are:

1. *ARC* (Accounts Receivable Entries): Checks received by a merchant through mail or drop box and presented as a HYPERLINK "http://www.nationalach.com" ACH entry.
2. *POP* (Point-of-Purchase): A check presented in-person to a merchant for purchase is presented as a HYPERLINK "http://www.nationalach.com" ACH entry instead of a physical check.
3. *TEL* (Telephone Initiated-Entry) Verbal authorization by telephone to issue a HYPERLINK "http://www.nationalach.com" ACH entry such as checks by phone.
4. *WEB* (Web Initiated-Entry): Electronic authorization through the Internet to create a HYPERLINK "http://www.nationalach.com" ACH .

Credit Card**Security Code Supported**

Select this check box to indicate that the merchant supports the sending of Security Code values.

You must clear this check box for merchants using Business Interlink based integration technology.

Because the Security Code is captured at the third party site for hosted payment transactions, this check box is not available for hosted payment providers—that is, where the Hosted Payment Provider check box is selected.

See [Chapter 14, "Processing ePayment Transactions," page 381](#).

Address Verification Flag This field controls whether the system verifies the credit card billing address during credit card processing. The options are *Address Verification Off* and *Address Verification On*.

Note. If you select *Address Verification On* and the address given does not match, authorization is declined, but the credit card funds are set aside.

If a valid value is not entered on the transaction request, the value that you select here is used for credit card transactions.

This field also appears on the SF Merchants page.

Additional Setup Options

Process Server This field holds the location of the Process Server used by the Business Interlink based credit card and eCheck transactions. This field is only relevant if you are using the Business Interlinks and the Business Interlink adapter (SCC_BUS_INTERLINK).

IP Override This field is used by the credit card and eCheck business interlinks and is passed through the ip_address input property. This field is also used as a default ip address for transactions processed by the Integration Broker based adapter for electronic payment transactions that require this field.

See Electronic Payment Integration Developer's Reference Guide. The guide is posted to My Oracle Support.

See Also

PeopleSoft Enterprise Student Financials 9.0 PeopleBook, Processing ePayment Transactions

Testing Payment and Hosted Payment Transactions

The Electronic Payment Test component allows testing of ePayment and hosted payment transactions. This page also serves as a run control page for the batch testing component (SCC_EPAY_TST – Epayment Batch Test).

Page Used to Test Payment and Hosted Payment Transactions

Page Name	Definition Name	Navigation	Usage
Electronic Payment Test	SCC_EPAYMENT_TEST	Set Up SACR, Common Definitions, Electronic Payments, Electronic Payment Test	Test ePayment and hosted payment transactions.

Testing ePayment and Hosted Payment Transactions

Access the Electronic Payment Test page (Set Up SACR, Common Definitions, Electronic Payments, Electronic Payment Test).

Electronic Payment Test		Post to Hosted Payment URL	Submit
Run Control ID: BILLING	Report Manager	Process Monitor	Run
Merchant Options			
Merchant Setup ID:	<input type="text" value="HostedPaySiteCC"/>	<input checked="" type="checkbox"/> Hosted Payment Provider	
3rd Party Merchant ID:	35		
Adapter ID:	SCC_INT_BROKER		
Adapter Class:	SCC_EPAYMENT:ADAPTERS:IntegrationBrokerAdapter		
Service Operation:	SCC_UPAY_SYNC		
ACH Class:	POP		
Testing Options			
Trans. Type:	<input type="text"/>	Review Transaction	
Payment Amount:	<input type="text" value="100.00"/> USD	Application:	TEST
Merchant Ref ID:	<input type="text" value="e1ee2624-6108-11de-b941-b38d2f063e00"/>		
Transaction Response			
Result Code:	0		
Original Result Code:	100		
Decision:	SUCCESS		
Status Message:	Transaction was successful.		
Authorization Code:	888888	2009-06-24-14.49.39.	
AVS Code:	X		
CV Result:	M		
Transaction Ref:	61373837TWATK6JO		
Request ID:	2458801789370008401927		

Electronic Payment Test page (1 of 3)

Request Token:	Ahj/7wSRcpV1gEicYfAOIkGzFm3ZuGbepXg1JbaVPTaJO5YnIC m0SdyxOdIHTIEevDJbpgFrLIC4E5EKIXWASJxh8A4AjRHV	
Session ID:		
Return Message:	Transaction was successful.	
ECheck Account Information		
Reference Nbr:	000000000001	
First Name:	Joe	
Last Name:	Smith	
Bank Account Type:	Checking	
Bank ID:	<input type="text"/> 121042882	
Account Number:	<input type="text"/> 4100	Check #: <input type="text"/>
Agreement Number:	<input type="text"/>	Agreement Date: <input type="text"/>
IP Address:	<input type="text"/>	
Agreement Text:	<input type="text"/>	
Credit Card Information		
Enter the information requested exactly as it appears on your credit card.		
Credit Card First Name:	Joe	
Credit Card Last Name:	Smith	
Credit Card Type:	Visa Card	
Card Number:	<input type="text"/> 4111-1111-1111-1111	
Security Code:	1111	
Card Expiration Month:	<input type="text"/> 10 / <input type="text"/> 2010 (ex: 01 / 2010)	

Electronic Payment Test page (2 of 3)

Address/Billing Information

The billing address you specify must match your credit card company's records.

Address Line 1: 15821 Ventura Blvd

City: Encino

State: CA

Country: USA

Postal Code: 91346

Email Address: js@ps.com

Telephone: 818/922-2275

Electronic Payment Test page (3 of 3)

Post to Hosted Payment URL Click this button to cause a redirect to the third party URL where a sample payment can be made. The third party site should redirect you back to this page after the payment is made. You can then authorize the payment by using the Trans. Type field to select the *Authorize Only (92)* transaction.

Note. The Session ID field should be updated after you select either *Authorize Only (92)* or *Credit Only (93)* transaction.

This button is available only for payment merchants who are hosted payment providers.

Submit Click this button to submit the transaction using the Electronic Payment API.

Run Click this button to run the batch electronic payment test program. This program tests credit card and eCheck transactions (Authorize and Credit) to make sure that these transactions function correctly in a batch environment (this is more relevant when using the Business Interlink adapter).

Merchant Options

Merchant Setup ID Select a Merchant Setup ID. Values are defined in the Payment Merchant setup component (Set Up SACR, Common Definitions, Electronic Payments, Payment Merchant, Payment Merchant).

Note. The remaining fields in this section are informational only and appear based on the setup in the Payment Merchant setup component and the Adapter Type Table and Adapter Table setup components.

Testing Options

Trans. Type (transaction type)	Select the type of transaction to be processed. The valid values for this field are defined in the Supported Transactions section of the Payment Merchant setup page (Set Up SACR, Common Definitions, Electronic Payments, Payment Merchant, Payment Merchant).
Merchant Ref ID	Enter a value that uniquely identifies the transaction that is sent to the third party processor. If this field is left blank it is programmatically populated with a uniquely generated ID.

Transaction Response

This section of the page contains the results of the transaction request. The fields all appear based on properties of the Transaction Response class that is returned from the Electronic Payment Manager class.

See Also

[Chapter 3, "Setting Up ePayment Processing," Setting Up Payment Merchants, page 90](#)

Setting Up SF Merchants

To set up SF merchants, use the SF Merchants (MERCHANT_TBL) component.

This section provides an overview of SF merchants and discusses how to define ePayment processing parameters.

Understanding SF Merchants

An SF merchant (student financials merchant) is an entity within the Student Financials application that enables you to set up unique credit card and eCheck processing rules for different departments in your institution. You can use an SF merchant to set up credit card and eCheck processing for cashiering offices and student self-service functions. The SF merchant definition provides information needed by the ePayment service provider and defines what services it performs and what customer information the system displays on the payment page.

To process credit cards and eChecks in Student Financials, you must establish at least two SF merchant definitions—one for credit card support and one for eCheck support. If you have different processing rules for credit card processing in the cashiering office than you do in student self service, then you will need to establish multiple credit card SF merchants to handle these different processing rules.

Page Used to Set Up SF Merchants

<i>Page Name</i>	<i>Definition Name</i>	<i>Navigation</i>	<i>Usage</i>
SF Merchants	MERCHANT_TBL	Set Up SACR, Common Definitions, Self Service, Student Financials, SF Merchants	Define ePayment processing parameters. Used for cashiering offices and student self service.

Defining ePayment Processing Parameters

Access the SF Merchants page (Set Up SACR, Common Definitions, Self Service, Student Financials, SF Merchants).

SF Merchants

SF Merchant ID: ECHKRCARD

Description:

Process Option:

Payment Merchant:

Hosted Payment Provider

Security Code Supported

Batch Transmission Error:

Credit Card

Real-Time Authorization Real-Time Capture Real-Time Credit

Perform Check Risk Service **Check Risk Threshold:**

Check Digit Edit

Security Code Required

Address Verification Flag:

Self Service Options

Convenience Fee Option:

Convenience Fee Amount:

Convenience Fee Percentage:

Minimum Payment Amount:

Maximum Payment Amount:

Default Options

Contact Type:

Address Usage:

Type of Name:

Phone Type:

Email ID: **Default Email**

SF Merchants page

Process Option

Select the type of transaction that is governed by the SF Merchant rules that you are defining: *Credit Card* or *Electronic Check*.

Payment Merchant	<p>Enter the Payment Merchant that you wish to use for this SF Merchant. The ID can be shared by several SF Merchant definitions.</p> <hr/> <p>Note. If you intend to process both credit card and eCheck self-service transactions, you must set up two SF merchants, one with a process option of <i>Credit Card</i> and one with a process option of <i>Electronic Check</i>.</p> <hr/>
Hosted Payment Provider	<p>If the payment merchant that you select on this page is a hosted payment provider and you selected the Hosted Payment Provider check box on the Payment Merchant page, the check box on this page appears selected and unavailable for edit.</p> <p>If the payment merchant that you select on this page is not a hosted payment merchant, the Hosted Payment Provider check box appears on this page but is cleared and is not available for edit.</p>
Security Code Supported	<p>If you select the Security Code Supported check box on the Payment Merchant page to indicate that the merchant supports the sending of Security Code values, the check box on this page appears selected and unavailable for edit.</p> <p>This check box does not appear for hosted payment providers.</p>
Batch Transmission Error	<p>Enter the maximum number of batch transmission errors that you want the system to allow before canceling the batch transmission.</p>
Credit Card	
<p>This group box appears if you select <i>Credit Card</i> in the Process Option field. Use it to enter credit card-specific processing parameters. Check with your third party provider for a list of supported services.</p>	
Real-Time Authorization	<p>Select to authorize credit card transactions in real time, actually reserving or setting aside credit card funds. If you clear this check box, you must authorize credit card transactions in batch mode. When you select this check box, the Real-Time Capture check box becomes available.</p> <p>For hosted payment providers, this check box is selected and is not available for edit.</p>
Real-Time Capture	<p>Select to capture credit card transactions in real time, actually transferring funds to your institution as the transaction takes place. If you clear this check box, you must capture credit card transactions in batch mode.</p> <p>For hosted payment providers, this check box is selected and is not available for edit.</p>
Real-Time Credit	<p>Select to credit in real time when you void credit card payments originating from cashiering offices.</p> <hr/> <p>Note. Do not select this check box for self-service transactions because you can only process credits for self-service transactions in batch.</p> <hr/>

- Perform Check Risk Service** Select to perform a risk assessment at the time of authorization. The risk assessment is an estimation of the veracity of the transaction. Factors such as improper address, too many transactions, or transactions dispersed geographically increase the risk of fraud.
- This check box is not available for hosted payment providers.
- Check Digit Edit** Select to verify the check digit of the credit card number being used prior to processing the transaction. If the check digit is incorrect, the customer receives an error message and is asked to correct the credit card number entered.
- This check box is not available for hosted payment providers.
- Check Risk Threshold** Enter an amount above which the credit card processing merchant is alerted to the possibility of fraud. When a transaction is processed, the credit card processing vendor returns a risk assessment. The check risk threshold is the allowable risk that a school is willing to assume for a given transaction.
- This check box is not available for hosted payment providers.
- Security Code Required** This check box is available only for credit card merchants.
- The check box does not appear if the merchant is a hosted payment provider.
- If you select this check box, the Security Code field is available as a required field on all pages that accept credit card transactions—Cashiering, Make a Payment, and Purchase Miscellaneous Items.
- The Security Code field does not appear on any inquiry pages.
-
- Note.** The Security Code is supported only if you use the Integration Broker interface for credit card processing. Do not select the check box if you use Business Interlinks.
-
- Address Verification Flag** This field controls whether the system verifies the credit card billing address during credit card processing. The options are *Address Verification Off* and *Address Verification On*.
-
- Note.** If you select *Address Verification On* and the address given does not match, authorization will be declined, but the credit card funds will be set aside.
-
- This field appears on this page and the Payment Merchant page.
- Electronic Check**
- This group box appears if you select *Electronic Check* in the Process Option field. Use it to enter eCheck-specific processing parameters. Check with your third party provider for a list of supported services.
- Real-Time Debit** Select to process eCheck transactions in real time. If you clear this check box, you must run the eCheck Processing process to debit eCheck payments in batch.

Authentication Method or Shared Secret

For Integration Broker and Business Interlinks, the field appears as Authentication Method.

Define how the system authenticates eCheck payments. If you select *Birthdate*, *PIN*, or *National ID Number*, students must enter the required information to authenticate an eCheck payment. If you select *No Authentication*, students can submit eCheck payments without authentication.

You define a student's birthdate, national ID number, or PIN in PeopleSoft Campus Community. The system always uses a student's primary national ID number for authentication purposes.

For Hosted Payment, the field appears as Shared Secret.

When the third party payment provider authenticates the student on their site, they use the Shared Secret provided by Campus Solutions to verify the student. Valid values are *PIN* and *Birthdate*.

Note. Students should not use dashes when entering the national ID number.

See *PeopleSoft Enterprise Campus Community 9.0 Fundamentals PeopleBook*, "Managing Personal Identification Data," Entering PINs.

See *PeopleSoft Enterprise Campus Community 9.0 Fundamentals PeopleBook*, "Adding a Person to Your Campus Solutions Database."

See *PeopleSoft Enterprise Campus Community 9.0 Fundamentals PeopleBook*, "Managing Biographical Information."

Self Service Options

Convenience Fee Option Select one of the following options if you want to charge students a fee for each ePayment transaction.

Fixed Amount: Select to charge a fixed convenience fee for each ePayment transaction.

Percentage: Select to make the convenience fee equal a percentage of the ePayment transaction.

Note. In most cases, the ePayment convenience fee is posted wherever the payment is applied. For example, if a payment is allocated to charges across multiple business units, the convenience fee is based on the total payment, but is distributed proportionately across the business units. If the payment is not allocated across business units but is directed to charges in one business unit, the convenience fee will be posted in the same business unit. If a payment is not manually allocated, the convenience fee is directed to the business unit with the highest priority.

Convenience Fee Amount

If you want to charge a fixed convenience fee amount, specify the amount as currency. (For example, using U.S. Dollars as the base currency, an entry of *1.50* results in a surcharge of 1.50 USD per transaction).

Convenience Fee Percentage	If you want to charge a percentage convenience fee, specify the percentage as a number greater than zero. In the previous example, the entry 5.5 results in a surcharge of 5.5 percent per transaction.
Minimum Payment Amount	Set the minimum amount that a student can pay during a single ePayment transaction.
Maximum Payment Amount	Set the maximum amount that a student can pay during a single ePayment transaction.

Default Options

Items in this group box relate to customer information that the system displays on the Make a Payment page for self-service transactions, and the Tender Details page for cashiering transactions.

Contact Type	Select the contact type representing the address for an External Org ID.
Address Usage	Select the address usage type that you want to use to display default customer addresses on the payment page.
Default Email	ePayment processing vendors require an email address to process transactions. Select this check box to use the default email address entered in the Email ID field rather than requiring students to enter one. When you select this check box, the Email Address field does not appear on the Make a Payment self-service page.
Type of Name	Select the default name type that the system uses to look up and display the customer name on the Make a Payment page.
Phone Type	ePayment processing vendors require a phone number to process transactions over the web. Select the default phone type that the system uses to look up and display the customer phone number on the Make a Payment page.
Email ID	Enter the default generic email address that the system uses for all credit card transactions when you select the Default Email check box.

See Electronic Payment Integration Developer's Reference Guide. The guide is posted to My Oracle Support.

See Also

[Chapter 14, "Processing ePayment Transactions," page 381](#)

Setting Up Institution Sets

You use institution sets to define basic institution set parameters and to set up ePayment rules for institution sets. This setup is done in Campus Self Service.

See *PeopleSoft Enterprise Campus Self Service 9.0 PeopleBook*, "Setting Up Student Financials Self Service," Setting Up Institution Sets.

Setting Up Item Types for ePayment

To enable eCheck and credit card processing, you must define miscellaneous parameters for item types. The system uses the following attributes from the credit card or eCheck Item Type, Miscellaneous page:

- Charge Priority List (during posting of the ePayment transaction).
- Payment Overall Priority (during posting of the ePayment transaction).
- Tender Specific and Tender Specify Category (eCheck or credit card; this value controls what will be displayed on SF Institution Set 2 page for an eCheck item type or a credit card item type).

See Also

Chapter 2, "Completing Student Financials General Setup," Setting Up Item Types and Item Type Groups, page 55

Setting Up Self-Service Options

You can use self-service options to define business unit labels for self-service payment pages. The values you enter here are used in the View By column headings on self-service pages.

See *PeopleSoft Enterprise Campus Self Service 9.0 PeopleBook*, "Setting Up Student Financials Self Service," Setting Up Self-Service Options.

Chapter 4

Setting Up GL Interface Processing

This chapter provides an overview of General Ledger (GL) interface processing setup and discusses how to:

- Load setup data using PeopleSoft Application Messaging.
- Review setup table data for PeopleSoft Financials.
- Link Student Financials business units to PeopleSoft General Ledger units.
- Set up HRMS for Oracle Financials.
- Set up the Ledger Fields table.
- Synchronize Oracle GL Segments.
- Map General Ledger business units to Oracle General Ledger.
- Synchronize ChartField values.
- (Optional) Create ChartField speed type keys.
- (Optional) Activate ChartField validation options.
- Assign charts of accounts.
- Validate ChartFields.
- Set up integration with PeopleSoft Financials and Oracle Financials.
- Copy ChartField information for item types from one term to another.

Understanding GL Interface Processing Setup

This section discusses:

- GL Interface processing using PeopleSoft General Ledger or Oracle General Ledger.
- GL Interface processing using a third-party or legacy general ledger system.

Note. When customers license PeopleSoft Campus Solutions, they receive a limited use license for Human Resources, Benefits Administration, and Payroll for North America.

GL Interface Processing Using PeopleSoft General Ledger or Oracle General Ledger

Most of the setup that is needed to transfer information between the Student Financials application and the PeopleSoft General Ledger or Oracle General Ledger applications is done within General Ledger and then transferred to Student Financials. Throughout the setup process, you should work closely with staff who coordinate the General Ledger application. They will help you define your setup tables and tell you what information is necessary for the GL Interface process.

If the system interacts with PeopleSoft or Oracle Financials, it uses application messaging to share accounting line information with the PeopleSoft or Oracle General Ledger.

GL Messaging

During the GL Messaging process, Student Financials delivers these queues and messages to the PeopleSoft Financials database:

<i>Message Queue</i>	<i>Message</i>	<i>Description</i>
STUDENT_ADMIN_ACCOUNTING	STUDENT_FIN_ACCTG_LINE	Notifies the message broker that new SF_ACCTG_LN records are ready to be retrieved by PeopleSoft Financials and, after journal generation, retrieves the updated SF_ACCTG_LN records into Student Financials.
HR_SETUP	BUS_UNIT_SF_FULLSYNC	Sends the BUS_UNIT, DESCR, and DESCRSHORT rows in the BUS_UNIT_TBL_SF to PeopleSoft Financials to seed its BUS_UNIT_TBL_SF.
HR_SETUP	BUS_UNIT_SF_SYNC	Sends new Student Financials business units or updates when the DESCR field or DESCRSHORT field is changed.

During the GL Messaging process, Student Financials delivers these queues and messages to the Oracle Financials database:

<i>Message Queue</i>	<i>Message</i>	<i>Description</i>
STUDENT_ADMIN_ACCOUNTING	STUDENT_FIN_ACCTG_LINE	Notifies the message broker that new SF_ACCTG_LN records are ready to be retrieved by Oracle Financials.

<i>Message Queue</i>	<i>Message</i>	<i>Description</i>
SSF_GL_INT	SSF_GL_SEGMENT_FULLSYNC	Fetches all available active ledgers, segments from Oracle GL and inserts the data into PS_SSF_EB_SEGMENTS record.
SSF_GL_INT	SSF_GL_SEGMENT_VAL_REQ SSF_GL_SEGMENT_VAL_RESP	Full/partial sync of segment values. This inserts/updates the chartfield prompt tables based on mappings from SSF_EB_GLB_U_LED.
SSF_GL_INT	SSF_CF_COMBO_RT_VLD_REQ SSF_CF_COMBO_RT_VLD_RESP	Performs realtime validation of entered chartfield combination against the combinations table in Oracle GL.
SSF_GL_INT	SSF_ACCTG_LINE_TRFM_EBGL	This is a transformation program used by the batch publish utility. This maps and inserts data from SF_ACCTG_LN and AV_ACCTG_LN into the GL_INTERFACE table in Oracle GL.
SSF_GL_INT	SSF_GL_ACCTG_LINE_SYNC	This message receives the non-rowset based message, validates and parses the message, and updates the journal related fields in one of the SF_ACCTG_LN and AV_ACCTG_LN tables.

The PeopleSoft system delivers a default node of PSFT_HR. If you change this default, you must reconfigure the message channel. However, regardless of whether you change the message node, you must configure it by inserting the proper URL.

Note. An easy way to determine where messaging starts and ends is to name the publishing node with the name of the database to which it publishes or from which it publishes.

In the PeopleSoft Financials database, message definition, queue, and message node naming must match the naming that is used in the Student Financials database.

PeopleSoft Financials subscribes to the published messages in the Student Financials database, takes the accounting lines into the SF_ACCTG_LN table, and runs those lines through Journal Generator to create journal entries. PeopleSoft Financials then publishes the updated accounting lines, Student Financials subscribes to these lines, and then the data that is published by PeopleSoft Financials updates the Student Financials SF_ACCTG_LN table.

In addition, you must select the Display External ChartField check box on the SF Installation Table.

For information about messaging for Oracle Financials:

See CS90 to EBS GL Integration Developer's Reference Guide. The guide is posted to My Oracle Support.

GL Interface Processing Using a Third-Party or Legacy General Ledger System

Student Financials provides an extra field for you to use to enter chart of accounts data on your item types, course or class fees, and cashiering tenders or targets. You can use the existing PeopleSoft-delivered ChartFields (ACCOUNT, DEPTID, and so on) to enter your chart of accounts information.

Alternatively, Student Financials provides a 50-character field called External GL Chart Field (field name EXT_GL_CHARTFLD) that you can use to enter chart of accounts data. To enable this field, you must signify to the system that you are *not using* PeopleSoft or Oracle General Ledger. To indicate that you are not using PeopleSoft or Oracle General Ledger, clear the General Ledger check box on the Installation Table page and select Others as the financial system on the SF Installation page. After you clear this check box and complete setup on the SF Installation page, pages that usually display the PeopleSoft-delivered ChartFields for data entry display instead—or, in some instances, also—the External GL ChartField field.

Using the External GL Chart Field does have some limitations. The system does not perform any editing against this field. In addition, the ChartField validation process does not check the contents of the External GL Chart Field to ensure that you have supplied valid chart of accounts information for each item type, course/class fee, and cashiering tender/target.

Even if you are not using PeopleSoft General Ledger, you must populate the GL setup tables (except the ChartField definition tables) before you can use the GL Interface or Cashiering GL Interface processes.

See Also

PeopleSoft Enterprise Campus Solutions 9.0 Application Fundamentals PeopleBook, "Reviewing Installation Setup and System Defaults"

[Chapter 2, "Completing Student Financials General Setup," Defining Number Sequence Start Points, Maximum Row Settings, and ChartField Edit Options, page 7](#)

Loading Setup Data Using PeopleSoft Application Messaging

If your system interacts with PeopleSoft or Oracle Financials, it shares accounting messaging directly through PeopleSoft Application Messaging.

This table lists all PeopleSoft Financials published messages to which Student Financials subscribes in order to load ChartFields:

<i>Message Name</i>	<i>Channel</i>	<i>Pub/Sub Node</i>	<i>Records</i>
BUD_REF_CF_FULLSY NC	ENTERPRISE_SETUP	PSFT_EP (FIN)/PSFT_HR (CS)	BUD_REF_TBL

Message Name	Channel	Pub/Sub Node	Records
BUD_REF_CF_SYNC	ENTERPRISE_SETUP	PSFT_EP (FIN)/PSFT_HR (CS)	BUD_REF_TBL
CHARTFIELD1_FULLSYNC	ENTERPRISE_SETUP	PSFT_EP (FIN)/PSFT_HR (CS)	CHARTFIELD1_TBL
CHARTFIELD1_SYNC	ENTERPRISE_SETUP	PSFT_EP (FIN)/PSFT_HR (CS)	CHARTFIELD1_TBL
CHARTFIELD2_FULLSYNC	ENTERPRISE_SETUP	PSFT_EP (FIN)/PSFT_HR (CS)	CHARTFIELD2_TBL
CHARTFIELD2_SYNC	ENTERPRISE_SETUP	PSFT_EP (FIN)/PSFT_HR (CS)	CHARTFIELD2_TBL
CHARTFIELD3_SYNC	ENTERPRISE_SETUP	PSFT_EP (FIN)/PSFT_HR (CS)	CHARTFIELD3_TBL
CHARTFIELD3_FULLSYNC	ENTERPRISE_SETUP	PSFT_EP (FIN)/PSFT_HR (CS)	CHARTFIELD3_TBL
CLASS_CF_SYNC	ENTERPRISE_SETUP	PSFT_EP (FIN)/PSFT_HR (CS)	CLASS_CF_TBL
CLASS_CF_FULLSYNC	ENTERPRISE_SETUP	PSFT_EP (FIN)/PSFT_HR (CS)	CLASS_CF_TBL
DEPT_FULLSYNC	ENTERPRISE_SETUP	PSFT_EP (FIN)/PSFT_HR (CS)	DEPT_TBL
DEPT_SYNC	ENTERPRISE_SETUP	PSFT_EP (FIN)/PSFT_HR (CS)	DEPT_TBL
FUND_LOAD	ENTERPRISE_SETUP	PSFT_EP (FIN)/PSFT_HR (CS)	FUND_TBL
FUND_CF_SYNC	ENTERPRISE_SETUP	PSFT_EP (FIN)/PSFT_HR (CS)	FUND_TBL
PROGRAM_CF_FULLSYNC	ENTERPRISE_SETUP	PSFT_EP (FIN)/PSFT_HR (CS)	PROGRAM_TBL

Message Name	Channel	Pub/Sub Node	Records
OPER_UNIT_CF_FULL SYNC	ENTERPRISE_SETUP	PSFT_EP (FIN)/PSFT_HR (CS)	OPER_UNIT_TBL
OPER_UNIT_CF_SYNC	ENTERPRISE_SETUP	PSFT_EP (FIN)/PSFT_HR (CS)	OPER_UNIT_TBL
PRODUCT_CHARTFIE LD_FULLSYNC	ENTERPRISE_SETUP	PSFT_EP (FIN)/PSFT_HR (CS)	PRODUCT_TBL
PRODUCT_CHARTFIE LD_SYNC	ENTERPRISE_SETUP	PSFT_EP (FIN)/PSFT_HR (CS)	PRODUCT_TBL
PROGRAM_CF_SYNC	ENTERPRISE_SETUP	PSFT_EP (FIN)/PSFT_HR (CS)	PROGRAM_TBL
HR_ACCT_CD_LOAD	ENTERPRISE_SETUP	PSFT_EP (FIN)/PSFT_HR (CS)	ACCT_CD_TBL
BUS_UNIT_FS_FULLS YNC	ENTERPRISE_SETUP	PSFT_EP (FIN)/PSFT_HR (CS)	BUS_UNIT_TBL_FS
BUS_UNIT_FS_SYNC	ENTERPRISE_SETUP	PSFT_EP (FIN)/PSFT_HR (CS)	BUS_UNIT_TBL_FS
ACCOUNT_CHARTFIE LD_FULLSYNC	GL_SETUP	PSFT_EP (FIN)/PSFT_HR (CS)	GL_ACCOUNT_TBL
ACCOUNT_CHARTFIE LD_SYNC	GL_SETUP	PSFT_EP (FIN)/PSFT_HR (CS)	GL_ACCOUNT_TBL
LEDGER_DEFN_FULL SYNC	GL_SETUP	PSFT_EP (FIN)/PSFT_HR (CS)	LED_DEFN_TBL
LEDGER_DEFN_SYNC	GL_SETUP	PSFT_EP (FIN)/PSFT_HR (CS)	LED_DEFN_TBL
BUS_UNIT_GL_FULLS YNC	GL_SETUP	PSFT_EP (FIN)/PSFT_HR (CS)	BUS_UNIT_TBL_GL
BUS_UNIT_GL_SYNC	GL_SETUP	PSFT_EP (FIN)/PSFT_HR (CS)	BUS_UNIT_TBL_GL

Message Name	Channel	Pub/Sub Node	Records
BUS_UNIT_SF_FULLSYNC	HR_SETUP	PSFT_EP (FIN)/PSFT_HR (CS)	BUS_UNIT_TBL_SF
BUS_UNIT_SF_SYNC	HR_SETUP	PSFT_EP (FIN)/PSFT_HR (CS)	BUS_UNIT_TBL_SF
JOURNAL_GEN_APPL_ID_FULLSYNC	JOURNAL_GENERATOR	PSFT_EP (FIN)/PSFT_HR (CS)	JRNLGEN_APPL_ID
JOURNAL_GENERATOR_APPL_ID_SYNC	JOURNAL_GENERATOR	PSFT_EP (FIN)/PSFT_HR (CS)	JRNLGEN_APPL_ID
PROJECT_FULLSYNC	PROJECTS_SETUP	PSFT_EP (FIN)/PSFT_HR (CS)	PROJECT
PROJECT_SYNC	PROJECTS_SETUP	PSFT_EP (FIN)/PSFT_HR (CS)	PROJECT

This table lists the messages that are required to integrate with Oracle Financials:

Message Name	Channel	Pub/Sub Node	Records/Comments
SSF_GL_SEGMENT_FULLSYNC	SSF_GL_INT	~~ANY~~/PSFT_HR (CS)	SSF_EB_SEGMENTS
SSF_GL_SEGMENT_VAL_REQ	SSF_GL_INT	PSFT_HR (CS) /WSDL_NODE	Request message for Chartfield values synchronization.

<i>Message Name</i>	<i>Channel</i>	<i>Pub/Sub Node</i>	<i>Records/Comments</i>
SSF_GL_SEGMENT_VAL_RE SP	SSF_GL_INT	~~ANY~~/PSFT_HR (CS)	<ul style="list-style-type: none"> • GL_ACCOUNT_TBL • DEPT_TBL • PRODUCT_TBL • FUND_TBL • PROGRAM_TBL • CLASS_CF_TBL • OPER_UNIT_TBL • ALTACCT_TBL • BUD_REF_TBL • CHARTFIELD1_TBL • CHARTFIELD2_TBL • CHARTFIELD3_TBL
SSF_CF_COMBO_RTVLD_RE Q	SSF_GL_INT	PSFT_HR (CS) /WSDL_NODE	Transformation message for real time Chartfield combination validation request.
SSF_CF_COMBO_RTVLD_RE SP	SSF_GL_INT	~~ANY~~/PSFT_HR (CS)	Transformation message for real time Chartfield combination validation response.
SSF_ACCTG_LINE_TRFM_E BGL	SSF_GL_INT	PSFT_HR (CS) /WSDL_NODE	Transformation message for Batch Publish.
SSF_GL_ACCTG_LINE_SYN C	SSF_GL_INT	~~ANY~~/PSFT_HR (CS)	SF_ACCTG_LN, AV_ACCTG_LN

See Also

PeopleSoft Enterprise General Ledger PeopleBook, "Integrating and Transferring Information Among Applications," and "Integrating PeopleSoft General Ledger with PeopleSoft Applications"

Enterprise PeopleTools 8.45 PeopleBook: PeopleSoft Integration Broker

CS90 to EBS GL Integration Developer's Reference Guide. The guide is posted to My Oracle Support.

Reviewing Setup Table Data for PeopleSoft Financials

This section provides an overview of setup table data and lists the pages used to review setup table data.

Note. This section applies to integration with PeopleSoft Financials only.

Understanding Table Setup Data

After you load all of the setup tables that support the GL Interface, you can use a variety of components to review the setup data for accuracy.

The PeopleSoft Student Financials application recognizes three types of business units: the SF (student financials) business unit, the AP (accounts payable) business unit, and the GL (general ledger) business unit. You define GL business units in PeopleSoft General Ledger and load them through an integration point. The Business Unit GL component enables you to review the GL business unit definition.

You define the journal generator templates in PeopleSoft General Ledger and load them through an integration point. The Journal Generator templates define the valid template IDs that the GL Interface process assigns to each accounting entry that it creates. Each accounting entry must have a valid journal generator template ID for it to be properly recorded in PeopleSoft General Ledger.

Note. Most of the fields on the Journal Generator Template - Defaults and Journal Generator Template - Summarization pages are used only by the PeopleSoft General Ledger system during journal generation processing.

Pages Used to Review Setup Table Data

<i>Page Name</i>	<i>Definition Name</i>	<i>Navigation</i>	<i>Usage</i>
Business Unit GL - Definition	BUS_UNIT_TBL_GL1	Set Up HRMS, Product Related, Payroll for North America, GL Interface, Review GL Business Units, Definition	View attributes assigned to your GL business unit.
Currency Options	BUS_UNIT_TBL_GL2	Set Up HRMS, Product Related, Payroll for North America, GL Interface, Review GL Business Units, Currency Options	View currency option settings from your GL business unit.
Journal Generator Templates - Defaults	JRNL_GEN_DEFAULTS	Set Up HRMS, Product Related, Payroll for North America, GL Interface, Review Journal Generator Tmpl, Defaults	View the journal generator template ID that is used by the GL Interface process. Other fields on this page are used only in PeopleSoft General Ledger by the journal generator process.

<i>Page Name</i>	<i>Definition Name</i>	<i>Navigation</i>	<i>Usage</i>
Journal Generator Templates - Summarization	JRNL_GEN_SUM	Set Up HRMS, Product Related, Payroll for North America, GL Interface, Review Journal Generator Tmpl, Defaults	View summarization parameters that the PeopleSoft General Ledger Journal Generator process uses.
Detail Calendar	DETAIL_CALENDAR1	Set Up HRMS, Product Related, Payroll for North America, GL Interface, Review Detail Calendar	View fiscal years and accounting periods from PeopleSoft General Ledger.

Linking Student Financials Business Units to PeopleSoft General Ledger Units

This section applies to integration with PeopleSoft Financials only.

After reviewing your PeopleSoft general ledger setup data, you must associate each Student Financials business unit to a PeopleSoft General Ledger unit using the General Ledger Unit field on the General 1 page.

See Also

[Chapter 2, "Completing Student Financials General Setup," Defining Basic Business Unit Parameters, page 21](#)

Setting Up HRMS for Oracle Financials

For integration with Oracle Financials, the General Ledger check box must be cleared on the HRMS Installation Table (Setup HRMS, Install, Installation Table).

Use the Business Unit GL - Definition page (Set Up HRMS, Product Related, Payroll for North America, GL Interface, Review GL Business Units, Definition) to create and maintain GL business units. These business units are mapped to Oracle Ledger, Operating Unit, and Legal Entity using the Chartfields Mapping page—more information about this page is provided later in the chapter.

For more information, refer to the User Task Flow diagram in the Using GL Interface Processing chapter.

See Also

[Chapter 15, "Using GL Interface Processing," Understanding GL Interface Processing, page 403](#)

[Chapter 2, "Completing Student Financials General Setup," Defining Number Sequence Start Points, Maximum Row Settings, and ChartField Edit Options, page 7](#)

[Chapter 4, "Setting Up GL Interface Processing," Mapping General Ledger Business Units to Oracle General Ledger, page 120](#)

CS90 to EBS GL Integration Developer's Reference Guide. The guide is posted to My Oracle Support.

Setting Up the Ledger Fields Table

To set up the ledger fields table, use the Ledger Fields Table component (SF_LED_FLDS_TBL).

This section provides an overview of setting up the ledger fields table and discusses how to define ledger fields.

Note. This page is not used for integration with Oracle Financials.

If you select Oracle Financials as the financial system, you must manually remove the Ledger Fields Table page from the menu navigation by changing the Permission Lists. You should create a custom permission list to hide the menu navigation to this component.

Understanding the Ledger Fields Table Setup

When you define an item type GL Interface, you specify the ledger to which account information is transferred. The Ledger Fields Table defines the fields that are available. Not all available ChartFields are needed to convey the accounting information. To prevent entering data into an incorrect ChartField, define only the values that you need. The business unit, account, and ledger fields are always required for the GL Interface definition and do not need to be added to the Ledger Fields Table.

Page Used to Set Up the Ledger Fields Table

<i>Page Name</i>	<i>Definition Name</i>	<i>Navigation</i>	<i>Usage</i>
Ledger Fields Table	SF_LED_FLDS_TBL	Set Up SACR, Product Related, Student Financials, General Ledger Interface, Ledger Fields Table	Define ledger fields.

Defining Ledger Fields

Access the Ledger Fields Table page (Set Up SACR, Product Related, Student Financials, General Ledger Interface, Ledger Fields Table).

Ledger Fields Table				
SetID: SHARE		Ledger: LOCAL		
*ChartField		Description		
1	DEPTID	Department	+	-
2	FUND_CODE	Fund Code	+	-
3	PROGRAM_CODE	Program Code	+	-

Ledger Fields Table page

This page is not available if Oracle Financials is selected in the Financial System group box on the SF Installation page.

ChartField Select the database field name that represents a valid ChartField.

Synchronizing Oracle GL Segments

Integration Broker messaging brings all available Segment details—Segment Name, Segment Description, Segment ID and Ledger ID—from Oracle GL and stores them in the SSF_EB_SEGMENTS record in Student Financials.

You use the data that is available as a result of this process to complete the chartfields to segments mapping on the Chartfields Mapping page.

Warning! Synchronizing Oracle GL segments is essential for integration with Oracle Financials.

No delivered process or Campus Solutions component is available for this synchronization.

The Synchronize Oracle GL Segments web service is a Consulting solution only.

See CS90 to EBS GL Integration Developer's Reference Guide. The guide is posted to My Oracle Support.

The Integration Broker Message is successful only if Oracle Financials is selected in the Financial System group box on the SF Installation page.

See [Chapter 2, "Completing Student Financials General Setup," Defining Number Sequence Start Points, Maximum Row Settings, and ChartField Edit Options, page 7.](#)

Mapping General Ledger Business Units to Oracle General Ledger

This section discusses how to:

- Map GL business units to Oracle GL.

- Map transaction classifications to Oracle GL journal categories.

See CS90 to EBS GL Integration Developer's Reference Guide. The guide is posted to My Oracle Support.

Pages Used to Map General Ledger Business Units to Oracle General Ledger

<i>Page Name</i>	<i>Definition Name</i>	<i>Navigation</i>	<i>Usage</i>
ChartFields Mapping	SSF_EB_CF_SEG_MAP	Setup SACR, Product Related, Student Financials, General Ledger Interface, Map GL BU to Oracle GL, Chartfields Mapping	Map GL business units to Oracle Financials ledger, legal entity, and operating unit. Map chartfields to segments.
Journal Details Mapping	SSF_EB_ITM_JRN_MAP	Setup SACR, Product Related, Student Financials, General Ledger Interface, Map GL BU to Oracle GL, Journal Details Mapping	Map transaction classification to Oracle GL journal category.

Mapping GL Business Units to Oracle GL

Access the Chartfields Mapping page (Setup SACR, Product Related, Student Financials, General Ledger Interface, Map GL BU to Oracle GL, Chartfields Mapping)

ChartFields Mapping
Journal Details Mapping

GL Business Unit: US001 US001 NEW YORK OPERATIONS

GL BU to Oracle Ledger Mapping

*Ledger: *Operating Unit:

*Legal Entity: *Created By:

ChartFields to Segments [Customize](#) | [Find](#) | [View All](#) |

First 1-12 of 12 Last

	ChartFields	Segment Name	Segment Description
1	Account	SEGMENT3 <input type="button" value="Q"/>	Account
2	Department	SEGMENT2 <input type="button" value="Q"/>	Department
3	Product	SEGMENT5 <input type="button" value="Q"/>	Product
4	Fund Code	SEGMENT4 <input type="button" value="Q"/>	Sub-Account
5	Program Code	<input type="text"/> <input type="button" value="Q"/>	
6	Class Field	<input type="text"/> <input type="button" value="Q"/>	
7	Operating Unit	SEGMENT1 <input type="button" value="Q"/>	Company
8	Alternate Account	<input type="text"/> <input type="button" value="Q"/>	
9	Budget Reference	<input type="text"/> <input type="button" value="Q"/>	
10	Chartfield 1	<input type="text"/> <input type="button" value="Q"/>	
11	Chartfield 2	<input type="text"/> <input type="button" value="Q"/>	
12	Chartfield 3	<input type="text"/> <input type="button" value="Q"/>	

ChartFields Mapping page

To use this page, ensure that you have selected the Oracle Financials check box in the Financial System group box on the SF Installation page.

Note. The synchronization of Oracle GL Segments must be performed before you map chartfields to segments on this page.

GL BU to Oracle Ledger Mapping

You must enter a value in the Ledger, Legal Entity, and Operating Unit fields because in Oracle Financials, the chart of account consists of Ledger, Legal Entity, and Operating Unit.

The values in the Ledger field are available after you run the Synchronize Oracle GL Segments web service.

The Legal Entity and Operating Unit fields are not validated in Student Financials at this time, but must be valid values in Oracle Financials (available from the department that sets up Oracle GL).

You must enter a value in the Created By field because when transactions from Accounting Line are pushed to the GL Interface, a Created By value is required. The value must be numeric.

ChartFields to Segments

The chartfields that appear in this group box are the active chartfields on the HRMS Standard Chartfield Configuration page (Set up HRMS, Common Definitions, ChartField Configuration, Standard ChartField Configuration). This list of chartfields here is the same as the list on the Journal Set ChartFields page.

The 2 Affiliate Intra (Intra Unit), Project/Grant, and Affiliate chartfields are not supported and will not be available—ensure that these values are inactive on the Standard Chartfield Configuration page.

Note. You must map each chartfield to a segment name. If you do not, when you click Save, an error message appears and the page is not saved: *All available segments must be mapped to chartfields.*

Also, you must map each chartfield to a distinct segment name. If you do not, when you click Save, an error message appears and the page is not saved: *Segment is mapped to more than one chartfield.*

Mapping Transaction Classification to Oracle GL Journal Categories

Access the Journal Details Mapping page (Setup SACR, Product Related, Student Financials, General Ledger Interface, Map GL BU to Oracle GL, Journal Details Mapping).

ChartFields Mapping
Journal Details Mapping

GL Business Unit: US001 US001 NEW YORK OPERATIONS

Journal Source:

Transaction Classification to Journal Category
Customize | Find | View All |
First Last

	Transaction Classification	Journal Category
1	Application Fee	Others
2	Billing Only	Others
3	Cashiering	Other
4	Charge	Charges
5	Contributor Relations	Other
6	Deposit	Deposits
7	Financial Aid	Aid
8	GL Interface Only	Others
9	Interest	Others
10	Pay Plan Credit	Credits
11	Payment	Credits
12	Pre-Paid Tuition	Others
13	Refund	Credits
14	Transfers	Others
15	Waiver	Waiver
16	Withholding	Others
17	Write-off	Waiver

Journal Details Mapping page

To use this page, ensure that you have selected the Oracle Financials check box in the Financial System group box on the SF Installation page.

The Journal Source field is used to identify the source of financial transactions in Oracle GL. The value that you enter here is passed to the GL_INTERFACE in Oracle GL. This value must exist as a valid source in Oracle GL. The journaling process in Oracle GL validates this value during import and fails to import details if the source is invalid. Oracle GL provides a facility to correct such entries and re-import.

Transaction Classification to Journal Category

The list of Transaction Classification values on this page is the same as the list of values that are available in the Item Type Code field on the Item Types (Search) page (Set Up SACR, Product Related, Student Financials, Item Types, Item Types).

The Journal Category value is used to identify the category of financial transactions in Oracle GL. This value must exist as a valid category in Oracle GL. The journaling process in Oracle GL validates this value during import. Errors are logged and Oracle GL provides a facility to correct the entries and re-import.

Map a journal category for Cashiering to ensure that cashiering entries are transferred to Oracle GL.

You should map each transaction classification to a journal category—you must map at least one journal category to be able to save the page. If you leave a journal category blank, you receive a warning message when you save the page and a value of *Others* is entered in the Journal Category field.

Synchronizing ChartField Values

The Synchronize Chartfield Values component is used for integration with Oracle Financials only.

Use the Synchronize Segment Values (SSF_SYNSEGVL) batch process to insert/update segment values into appropriate ChartField prompt tables based on the values that you mapped in the ChartFields to Segments group box on the ChartFields Mapping page.

Note. Synchronization of Oracle GL segments must be performed and chartfields must be mapped to segments before you run the Synchronize Segment Values process.

See [Chapter 2, "Completing Student Financials General Setup," ChartField Display Options, page 9.](#)

See CS90 to EBS GL Integration Developer's Reference Guide. The guide is posted to My Oracle Support.

Page Used to Synchronize ChartField Values

<i>Page Name</i>	<i>Definition Name</i>	<i>Navigation</i>	<i>Usage</i>
Synchronize Chartfield Values	SSF_RUNCTL_CFSYNC	Setup SACR, Product Related, Student Financials, General Ledger Interface, Synchronize Chartfield Values, Synchronize Chartfield Values	Insert/update segment values into appropriate ChartField prompt tables based on the ChartFields to Segments mapping.

Synchronizing ChartField Values

Access the Synchronize Chartfield Values page (Setup SACR, Product Related, Student Financials, General Ledger Interface, Synchronize Chartfield Values, Synchronize Chartfield Values).

Synchronize Chartfield Values page

Note. To use this batch process, ensure that you have selected the Oracle Financials check box in the Financial System group box on the SF Installation page.

Refresh Options

Partial

This option is selected by default. Use this option to run an incremental update of the prompt tables. Student Financials data is updated only if there has been a change to Oracle GL data since the last time that the process was run.

Full

Select this option to run a complete refresh of the prompt tables.

You would usually select this option for first time installation only.

Note. If you select the Full option, all prompt tables except the Department Chartfield (DEPT_TBL) prompt table are truncated and existing data is purged before the full synchronization happens.

The Department Chartfield prompt table is not truncated. Unlike other chartfield prompt tables that are truncated based on an inactive status of chartfields on the HRMS Standard Chartfield Configuration page, new values are added to the Department Chartfield table and the existing values remain intact.

When you click Run:

1. Ledger details associated with the GL Business Unit are retrieved based on the setup on the ChartFields Mapping page.
2. SetID and Segment details for the specified GL Business Unit are retrieved from the Chartfields to Segments Mapping table— this information is required to insert data into the ChartField prompt tables.

3. A Web Service call to Oracle GL is made with the Ledger and Segment details.

The SSF_GL_SEGMENT_VAL_SYNC message is invoked for both Partial and Full options. For the Partial option, the business unit that is selected on this page is used and the related setID and segment details are retrieved from the mapping setup. For the Full option, all business units that are mapped to Oracle GL in the mapping setup are used.

4. Returned data is inserted into the appropriate prompt tables along with the derived SetID and Effective Date is updated with the LAST_UPDATE_DATE from Oracle Financials.

See CS90 to EBS GL Integration Developer's Reference Guide. The guide is posted to My Oracle Support.

(Optional) Creating ChartField SpeedType Keys

To set up ChartField speed type keys, use the SpeedTypes component (SPEEDTYPE).

This section provides an overview of Chartfield SpeedType Keys and discuss how to define ChartField SpeedTypes Keys.

Understanding ChartField SpeedType Keys

Often you will want to enter the same combination of ChartField values repeatedly. By creating shortcut keys called SpeedTypes for these frequently used combinations of ChartFields, you can reduce data entry time and increase data entry accuracy. Using a SpeedType key that you define, you can enter one alphanumeric code that automatically enters all of its defined ChartField values.

Page Used to Create ChartField SpeedType Keys

<i>Page Name</i>	<i>Definition Name</i>	<i>Navigation</i>	<i>Usage</i>
SpeedTypes	SPEEDTYPE	Set Up SACR, Product Related, Student Financials, General Ledger Interface, SpeedTypes	Define ChartField SpeedTypes.

Defining ChartField SpeedTypes

Access the SpeedTypes page (Set Up SACR, Product Related, Student Financials, General Ledger Interface, SpeedTypes).

SpeedType Data	
SetID:	SHARE
SpeedType Key:	100000
Description:	<input type="text" value="ACCT_CD"/>
Type of SpeedType:	Universal (All Operators)
ChartField Values	
Statistics Code:	<input type="text"/>
Currency:	<input type="text"/>
GL Business Unit:	<input type="text"/>
Ledger:	<input type="text"/>
<input type="checkbox"/> Bypass Edits	
Account:	<input type="text" value="5001"/>
Department:	<input type="text" value="114"/>
Project/Grant:	<input type="text" value="TRAINING"/>
Product:	<input type="text"/>
Fund Code:	<input type="text"/>
Program Code:	<input type="text"/>
Class Field:	<input type="text"/>
Affiliate:	<input type="text"/>
Operating Unit:	<input type="text"/>
Alternate Account:	<input type="text"/>
Budget Reference:	<input type="text"/>
Chartfield 1:	<input type="text"/>
Chartfield 2:	<input type="text"/>
Chartfield 3:	<input type="text"/>

SpeedTypes page

The type of SpeedType depends on what you select for the User ID and Primary Permission List fields. The type of SpeedType is then displayed at the top of the SpeedTypes page.

Type of SpeedType	<p>Select the type of speed type to restrict the key to a particular operator or class. Values are:</p> <p><i>One Operator:</i> Only the operator specified in the dialog box can use this key combination. When you select this option, the User field becomes available and the Prim Perm List (primary permission list) field becomes unavailable.</p> <p><i>One Operator Class:</i> Only the operator class specified in the dialog box can use this key combination. When you select this option, the Prim Perm List field becomes available for use and the User field becomes unavailable.</p> <p><i>Universal (All Operators):</i> All operators are authorized to use this combination. When this option is selected, both the User and Prim Perm List fields become unavailable.</p>
Statistics Code	Optionally, enter a statistics code to record information used for statistical analysis. The PeopleSoft General Ledger staff defines statistics codes.
Currency	The system automatically populates this field with your institution's base currency value. You can override this value to change the currency code.
Bypass Edits	<p>Select to bypass the edits when setting up SpeedTypes. Bypassing the edits enables you to set up an incomplete SpeedType. For example, you could leave the Fund field blank, and cashiers could enter the appropriate fund during department receipt creation.</p> <hr/> <p>Note. The functionality of the Bypass Edits check box is relevant only if you select the Combinations Table Edit check box on the SF Installation page. When you select the Combinations Table Edit check box, the system processes department receipts only if cashiers select the correct ChartFields.</p> <hr/> <p>See Chapter 2, "Completing Student Financials General Setup," Setting Up Installation Parameters and Keywords, page 5.</p>
Copy and Paste	If you are entering multiple SpeedTypes, you can select your ChartFields, copy and paste them into the next SpeedType that you create, and then revise individual ChartFields.

Integration with Oracle Financials

The SpeedTypes page appears differently if Oracle Financials is selected in the Financial System group box on the SF Installation page:

- The Ledger field is not available.
- The Validate icon is available to validate the combination entered. Click the icon to trigger real time validation of the entered combination with Oracle GL.
- The Bypass Edits check box is cleared by default.
- ChartField prompt tables display valid values based on the Chartfields to Segments mapping on the ChartFields Mapping page and the values populated from Oracle GL for each segment into respective prompt tables.

- The 2 Affiliate Intra (Intra Unit), Project/Grant, and Affiliate chartfields are not supported and should be made inactive on the HRMS Standard Chartfield Configuration page.

See [Chapter 2, "Completing Student Financials General Setup," ChartField Display Options, page 9.](#)

See Also

[Chapter 2, "Completing Student Financials General Setup," Setting Up Business Units, page 19](#)

(Optional) Activating ChartField Validation Options

ChartFields in Student Financials can be dynamically displayed, and they depend on the ChartField setup in PeopleSoft Enterprise Human Resources Management (HRMS).

See *PeopleSoft Enterprise Student Financials 9.0 PeopleBook, "Completing Student Financials General Setup" Defining Number Sequence Start Points, Maximum Row Settings and ChartField Edit Options, Defining Dynamic ChartFields*

See *PeopleSoft Enterprise Student Financials 9.0 PeopleBook, Completing Student Financials General Setup, Setting Up Item Types and Item Type Groups*

See *PeopleSoft Enterprise HRMS 9.0 Application Fundamentals PeopleBook, "Setting Up and Working with ChartFields and ChartField Combinations" Populating HRMS with Valid ChartField Combinations*

Assigning Charts of Accounts

You can assign a chart of accounts (ChartFields) to item types, course and class fees (if you use course and class fees), and cashiering setup (if you use the Cashiering feature).

See Also

[Chapter 2, "Completing Student Financials General Setup," Setting Up Item Types and Item Type Groups, page 55](#)

[Chapter 5, "Setting Up Tuition Controls, Criteria, Equations, and Waivers," Establishing Criteria for Tuition Groups and Fee Triggers, page 158](#)

[Chapter 10, "Setting Up Cashiering," page 313](#)

Validating ChartFields

This section provides an overview of chartfield validation and discusses how to identify invalid chartfields.

This section applies to integration with PeopleSoft Financials only.

To identify invalid chartfield combinations,

See [Chapter 15, "Using GL Interface Processing," Running the Chartfield Audit Report, page 406.](#)

Understanding ChartFields Validation

Student Financials provides several methods for ensuring that the chartfields that you enter on item types, course and class fees, and Cashiering tender keys and target keys are valid. When you create these elements, PeopleCode programs on the GL Interface pages validate the chartfields that you enter against the setup data that you loaded from PeopleSoft General Ledger. Because your General Ledger staff can change chartfields over time, inactivating them or even perhaps deleting them, Student Financials provides a process that validates chartfields on item types, course and class fees, and cashiering tenders and targets. The ChartField Validation process produces a report that identifies item types, course and class fees, and cashiering setup that contain invalid chartfields.

Page Used to Validate ChartFields

<i>Page Name</i>	<i>Definition Name</i>	<i>Navigation</i>	<i>Usage</i>
Chartfield Validation	RUNCTL_SFGLVAL1	Set Up SACR, Product Related, Student Financials, General Ledger Interface, Chart Field Validation, Chartfield Validation	Identify invalid ChartFields in Student Financials.

Identifying Invalid ChartFields

Access the Chartfield Validation page (Set Up SACR, Product Related, Student Financials, General Ledger Interface, Chart Field Validation, Chartfield Validation).

Chartfield Validation

Run Control ID: PRINT_RECEIPT [Report Manager](#) [Process Monitor](#) Run

***Business Unit:**

***As Of Date:**

***Effective Status Option:**

***Term:**

Chartfield Validation page

Business Unit	Select the Student Financials business unit for which you want to validate ChartField information.
As of Date	Because ChartField values can change as you synchronize with the PeopleSoft Financials application, you must specify a date on which you want to run the verification.
Effective Status Option	Status options are: <i>Active Status Only:</i> Select to validate ChartField definitions for item types with a status of <i>Active</i> . <i>Active and Inactive Status:</i> Select to validate ChartField definitions on all item types regardless of status.
Term	Select the term that you want to verify.

Setting Up Integration with PeopleSoft Financials and Oracle Financials

This section discusses how to:

- Define batch publish rules for GL messaging.
- Define batch programs for GL messaging.
- Set up business unit synchronization for PeopleSoft Financials.
- Synchronize Student Financials business unit data with PeopleSoft Financials.

Pages Used to Set Up Integration with PeopleSoft Financials and Oracle Financials

<i>Page Name</i>	<i>Definition Name</i>	<i>Navigation</i>	<i>Usage</i>
Batch Publish Rules	EO_MSGPUBBATCH	Enterprise Components, Integration Definitions, Batch Publish Rules	Define batch publish rules for GL messaging.
Batch Programs	EO_MSGBATPGM	Enterprise Components, Integration Definitions, Batch Publish Rules, Batch Programs	Define batch programs for GL messaging.
Full Table Publish Rules	EO_MSGPUBFULL	Enterprise Components, Integration Definitions, Full Data Publish Rules, Full Table Publish Rules	Set up business unit synchronization for PeopleSoft Financials.

Page Name	Definition Name	Navigation	Usage
Full Data Publish	EO_FULLDATAPUB	Enterprise Components, Integration Definitions, Initiate Processes, Full Data Publish	Synchronize Student Financials business unit data with PeopleSoft Financials.

Defining Batch Publish Rules for GL Messaging

Access the Batch Publish Rules page (Enterprise Components, Integration Definitions, Batch Publish Rules).

The screenshot displays the 'Batch Publish Rules' configuration page. At the top, there are tabs for 'Batch Publish Rules', 'Record Mapping', and 'Batch Programs'. The 'Message Name' is 'STUDENT_FIN_ACCTG_LINE' and the 'Description' is 'SF_ACCTG_LN Message'. Below this is a 'Publish Rule Definition' section with a search bar and navigation controls. The 'Publish Rule ID' is 'STUDENT_FIN_ACCTG_LINE', the 'Description' is 'SF_ACCTG_LN Message', and the 'Status' is 'Active'. There are fields for 'Chunking Rule ID' and 'Alternate Chunk'. Below these are two sections: 'Message Options' with checked boxes for 'Create Message Header' and 'Create Message Trailer', and 'Output Format' with radio buttons for 'Message', 'Flat File', and 'Flat File with Control Record', where 'Message' is selected.

Batch Publish Rules page

To define batch publish rules:

1. Enter *STUDENT_FIN_ACCTG_LINE* in the Publish Rule ID field.
2. Select *Active* in the Status field.
3. For PeopleSoft Financials 8.4 integration, select the Create Message Header and Create Message Trailer check boxes.

For integration with PeopleSoft Financials version 8.8 onwards, clear both check boxes.

For Oracle Financials integration, clear both check boxes.

Defining Batch Programs for GL Messaging

Access the Batch Programs page (Enterprise Components, Integration Definitions, Batch Publish Rules, Batch Programs).

Batch Programs page

1. Select *STUDENT_FIN_ACCTG_LINE* as the message name.
2. Enter the process names *SFDPTREC* (Cashiering GL Interface process) and *SFPGLINT* (GL Interface process), which EOP_PUBLISHM picks up when publishing accounting lines to PeopleSoft Financials or Oracle Financials.

If you do not select these process, the messages will not be created when EOP_PUBLISHM runs.

Setting Up Business Unit Synchronization for PeopleSoft Financials

This section applies to integration with PeopleSoft Financials only.

Access the Full Table Publish Rules page (Enterprise Components, Integration Definitions, Full Data Publish Rules, Full Table Publish Rules).

Full Table Publish Rules		Record Mapping	Languages
Message Name: BUS_UNIT_SF_FULLSYNC			
Description: Bus Unit SF Full Sync			
Publish Rule Definition Find View All First 1 of 1 Last			
*Publish Rule ID:	BUS_UNIT_SF_FULLSYNC		+ -
*Description:	BUS_UNIT_SF_FULLSYNC Pub Rule		
*Status:	Active		
Chunking Rule ID:	<input type="text"/>		
Alternate Chunk	<input type="text"/>		
Table:	<input type="text"/>		
Message Options		Output Format	
<input checked="" type="checkbox"/> Create Message Header		<input type="radio"/> Message	
<input checked="" type="checkbox"/> Create Message Trailer		<input type="radio"/> Flat File	
		<input type="radio"/> Flat File with Control Record	

Full Table Publish Rules page

To set up business unit synchronization:

1. Enter *BUS_UNIT_SF_FULLSYNC* in the Publish Rule ID field.

This rule publishes three fields (Business Unit, Description, Short Description) for all rows on the table to PeopleSoft Financials.

2. Select *Active* in the Status field.
3. Select the Create Message Header and Create Message Trailer check boxes.

Note. You must synchronize all Student Financials business units before you run any GL processes by running *BUS_UNIT_SF_FULLSYNC* full table publish once. Thereafter, the system manages additions or changes through messaging in the SF Business Unit component (*BUSINESS_UNIT_SF*).

Synchronizing Student Financials Business Unit Data with PeopleSoft Financials

This section applies to integration with PeopleSoft Financials only.

Access the Full Data Publish page (Enterprise Components, Integration Definitions, Initiate Processes, Full Data Publish).

Full Data Publish

Run Control ID: PRINT_RECEIPT [Report Manager](#) [Process Monitor](#) **Run**

Process Request Find | View All First 1 of 1 Last

*Request ID: BUFSYNC

Description: SF BU FullSync

Process Frequency

Once Always Don't Run

Parameters

*Message Name: BUS_UNIT_SF_FULLSYNC Bus Unit SF Full Sync

Full Data Publish page

To synchronize business units:

1. Enter a request ID and description.
2. Select the Once option in the Process Frequency group box.

Note. You can rerun this process without harming your system if the PeopleSoft Financials database becomes unsynchronized or corrupt.

3. Select *BUS_UNIT_SF_FULLSYNC* in the Message Name field.
4. Click Run.

After the process runs, the system keeps business units synchronized by triggering a message to the PeopleSoft Financials database whenever you change information in the Description field or the Short Description field on the General 1 page of the SF Business Unit component. In addition, the system triggers a message to PeopleSoft Financials whenever you add a new business unit.

Note. The queue HR_SETUP enables one-way messaging and data publishing. To use this channel, you must configure the message node information by inserting the proper URL. PeopleSoft Financials must subscribe to these Student Financials published messages to keep its database up to date.

See Also

PeopleSoft Enterprise General Ledger PeopleBook, "Integrating PeopleSoft General Ledger with PeopleSoft Applications"

Copying ChartField Information for Item Types from One Term to Another

This section discusses how to run the GL Term Copy process.

Page Used to Copy ChartField Information for Item Types from One Term to Another

Page Name	Definition Name	Navigation	Usage
GL Term Copy	RUNCTL_SFGL_FEE	Set Up SACR, Product Related, Student Financials, General Ledger Interface, Copy Term, GL Term Copy	Run the GL Term Copy process.

Running the GL Term Copy Process

Access the GL Term Copy page (Set Up SACR, Product Related, Student Financials, General Ledger Interface, Copy Term, GL Term Copy).

GL Term Copy

Run Control ID: EM [Report Manager](#) [Process Monitor](#) Run

Parameters

SetID: <input type="text" value="PSUNV"/>	To Date: <input type="text" value="10/05/2006"/>
From Term: <input type="text" value="0570"/> 2006 Fall	To Term: <input type="text" value="0580"/> 2007 Spring
From Session: <input type="text" value=""/>	To Session: <input type="text" value=""/>

Select Item Types for Copy

<input type="checkbox"/> Application Fee	<input checked="" type="checkbox"/> Billing Only	<input type="checkbox"/> Original Charge	<input type="checkbox"/> Deposit
<input type="checkbox"/> Financial Aid	<input type="checkbox"/> Withholding	<input checked="" type="checkbox"/> Interest	<input checked="" type="checkbox"/> Payment
<input type="checkbox"/> Refund	<input type="checkbox"/> Waiver	<input type="checkbox"/> Pay Plan Credit	<input type="checkbox"/> Writeoff

GL Term Copy page

Parameters

From Term and To Term

Select the term from which you are copying item type ChartField information and the term that you are copying it to.

- From Session and To Session** Select the session from which you are copying item type ChartField information and the session that you are copying it to.
- To Date** Select the effective date to be used for the copy.

Check One or More Item Types for Copy

In this group box, select the classification of item types for which you want to copy ChartField information.

When you run the GL Term Copy process, it copies all of the ChartField information for all item types within the classification that you select. This process functions even if you previously copied ChartField information for an individual item type using the Copy GL Interface button on the GL Interface page of the Item Types component.

Chapter 5

Setting Up Tuition Controls, Criteria, Equations, and Waivers

This chapter provides an overview of tuition controls, criteria, equations, and waivers and discusses how to:

- Create billing and due date calendars.
- Set up adjustment calendars.
- Establish tuition calculation controls.
- Define variables for criteria and equations.
- Establish criteria for tuition groups and fee triggers.
- Use Equation Engine to define tuition calculation equations.
- Define waivers and waiver groups.
- Create course lists.

Understanding Tuition Controls, Criteria, Equations, and Waivers

Controls, criteria, and waivers determine when the system calculates tuition and for whom. They define how much money the system returns if a student drops a class or withdraws. They also establish for whom tuition should be waived and for what reason. Equation Engine replaces the equation processor previously used in Campus Solutions applications. Equation Engine performs complicated calculations that can help you select students for inclusion in a group or determine a fee for a unique situation.

Creating Billing and Due Date Calendars

To set up billing and due date calendars, use the Billing and Due Calendars component (DUE_DATE_PANEL).

Billing and due date calendars are associated with tuition calculation and are used to determine the percentage of specific fees due to be paid by a particular time. Because a due date calendar is required for the setup of fees, you must define at least one billing and due date calendar for your institution. You can also define additional billing and due date calendars as needed to meet the requirements of your business processes.

When creating your billing and due date calendar, you can specify that the payment of a fee is due in full at a particular date, or you can create a payment schedule. For example, you can define a billing and due date calendar that indicates that your application fee is due in full at the time that an application is filed and create another billing and due date calendar for installment payments for your tuition fees. You can also design the system so that a due date for a fee is designated at the time that you create a bill or post a charge.

Page Used to Create Billing and Due Date Calendars

Page Name	Definition Name	Navigation	Usage
Billing and Due Calendars	DUE_DATE_TABLE	Set Up SACR, Product Related, Student Financials, Tuition and Fees, Billing and Due Calendars	Define billing and due date calendars.

Defining Billing and Due Date Calendars

Access the Billing and Due Calendars page (Set Up SACR, Product Related, Student Financials, Tuition and Fees, Billing and Due Calendars).

Billing and Due Calendars

SetID: PSUNV
Due Date Code: STD
***Description:** **Short Description:**
***Pivot Date:** Copy Billing and Due Calendar

Find | View All First 1 of 25 Last

***Term:** 2005 Spring **Session:**

Find | View All First 1-4 of 4 Last

From Day	To Day	*Due %	*Due Date Calc	Days	*Billing Date Calc	Days	
<input type="text" value="-9999"/>	<input type="text" value="-60"/>	<input type="text" value="50.00"/>	<input type="text" value="Days from Pivot Date"/>	<input type="text" value="-45"/>	<input type="text" value="Days from Due Date"/>	<input type="text" value="-30"/>	+ -
<input type="text" value="-9999"/>	<input type="text" value="-60"/>	<input type="text" value="50.00"/>	<input type="text" value="Days from Pivot Date"/>	<input type="text" value="-15"/>	<input type="text" value="No Date Calculated"/>	<input type="text" value="0"/>	+ -
<input type="text" value="-59"/>	<input type="text" value="9999"/>	<input type="text" value="50.00"/>	<input type="text" value="Days from Run Date"/>	<input type="text" value="10"/>	<input type="text" value="Days from Due Date"/>	<input type="text" value="-15"/>	+ -
<input type="text" value="-59"/>	<input type="text" value="9999"/>	<input type="text" value="50.00"/>	<input type="text" value="Days from Run Date"/>	<input type="text" value="25"/>	<input type="text" value="No Date Calculated"/>	<input type="text" value="0"/>	+ -

Billing and Due Calendars page

Pivot Date	<p>Select a pivot date for this calendar. Student Financials uses the pivot date as the starting place to calculate due dates or billing dates. The system counts the billing dates and due dates—either back in time or forward in time—from the pivot date that you select.</p> <hr/> <p>Warning! Values for this field are delivered with your system as translate values. Do not modify these values in any way. Any modifications to these values requires a substantial programming effort.</p> <hr/> <p>Select from:</p> <p><i>Admit Term Start Date:</i> Select to use as the pivot date the first day of the term that the student is admitted. This option pertains to application fee processing only.</p> <p><i>Application Date:</i> Select to use as the pivot date the date that the application is filed. This option pertains to application fee processing only.</p> <p><i>Class Start Date:</i> Select to use as the pivot date the first day of the class.</p> <p><i>Session Start Date:</i> Select to use as the pivot date the first day of the session.</p> <p><i>Term Start Date:</i> Select to use as the pivot date the first day of the term.</p>
Copy Billing and Due Calendar	Click to copy this billing and due calendar to a new term or session.
Term	Enter the term for this billing and due calendar.
Session	If you are defining a billing and due calendar for a session within a term, or you want to use the session start date as the pivot date, specify the session.
From Day and To Day	Enter the first and last day that you assess fees. Express the number of days before the pivot date as a negative number, and the number of days after the pivot date as a positive number.
Due % (due percent)	Define the percentage of the fee that's due for the respective assessment period.
Due Date Calc (due date calculation)	<p>Use this field to determine how the system calculates the due date for a given fee assessment period. Select from:</p> <p><i>Days from Pivot Date:</i> Select to calculate the due date based on the pivot date.</p> <p><i>Days from Run Date:</i> Select to calculate the due date based on the day that you assessed fees.</p> <p><i>No Date Calculated:</i> Select to disable the calculation of a due date.</p>
Days	<p>Enter the number of days from the pivot date or run date that the fees are due. Enter a negative number to indicate days before the respective date; enter a positive number to indicate days after the respective date. If you select <i>No Date Calculated</i> in the Due Date Calc field, the Days field becomes unavailable.</p>

Billing Date Calc (billing date calculation)	<p>Use this field to determine how the system calculates the billing date for a given fee assessment period. Select from:</p> <p><i>Days from Due Date:</i> Select to calculate the billing date based on the calculated due date.</p> <p><i>Days from Pivot Date:</i> Select to calculate the billing date based on the pivot date.</p> <p><i>Days from Run Date:</i> Select to calculate the billing date based on the day that you assessed fees.</p> <p><i>No Date Calculated:</i> Select to disable the calculation of a billing date.</p>
Days	<p>Enter the number of days from the due date, pivot date, or run date that the system produces a bill. Enter a negative number to indicate days before the respective date; enter a positive number to indicate days after the respective date. If you select <i>No Date Calculated</i> in the Billing Date Calc field, the Days field becomes unavailable.</p>

Setting Up Adjustment Calendars

To set up adjustment calendars, use the Adjustment Calendars component (ADJ_TERM_PANEL).

This section provides an overview of adjustment calendars and discusses how to:

- Define adjustment calendars.
- Define administrative fees for adjustment periods.
- Calculate the Term Fee by Term and Adjust by Term Scenarios

Understanding Adjustment Calendars

Adjustment calendars determine the refund schedules that you apply to the members of a tuition group. These calendars govern how the system adjusts term and class level fees when a student withdraws or drops a class. The system uses the number of days that a term or class has been in session or the class attendance percentage to determine the percentage of refund due. The system calculates these figures using date and time stamps located in the STDNT_ENRL table. State government, an agency, the federal government, or your institution can mandate refund schedules. The pro rata refund is applied to first-time students who withdraw. Federal regulations require you to use the refund table that is best for the student.

The logic for term fee calculations and adjustments for each student is:

- The student enrollment record contains all the add and drop transactions. When a student adds or drops a class, the Tuition Calculation process records various fields from the enrolment records in a temporary table. The temporary table references the add and drop dates as the transaction date.
- When a student drops a class, the Tuition Calculation process calculates the drop costs by comparing the amount before the drop to the amount after the drop. Tuition Calculation then applies the appropriate adjustment calendar percentage.

See Also

PeopleSoft Enterprise Student Records 9.0 PeopleBook, "Processing Class Enrollment Transactions," Understanding Class Enrollment Processing

Pages Used to Set Up Adjustment Calendars

Page Name	Definition Name	Navigation	Usage
Adjustment Calendars	ADJ_TERM_TABLE	Set Up SACR, Product Related, Student Financials, Tuition and Fees, Adjustment Calendars	Define adjustment calendars.
Administrative Fee Setup	ADMIN_FEE_SP	Click the Administrative Fee Setup link on the Adjustment Calendars page.	Define administrative fee for adjustment periods.

Defining Adjustment Calendars

Access the Adjustment Calendars page (Set Up SACR, Product Related, Student Financials, Tuition and Fees, Adjustment Calendars).

Adjustment Calendars

SetID: PSUNV Adjustment Code: STD

*Description: Standard Adjustment

*Adjustment Option: By Term Start Date

*Adjust Reason: Class Cancelled [Copy Adjustment Calendar](#) Term Withdrawal Set Default

*Term: 0540 2005 Spr Session:

Day From	To	Percent From	To	Meeting From	To	Refund Percent	
-9999	0	0.000	0.000	0	0	100.00	Administrative Fee Setup + -
1	5	0.000	0.000	0	0	90.00	Administrative Fee Setup + -
6	10	0.000	0.000	0	0	80.00	Administrative Fee Setup + -
11	20	0.000	0.000	0	0	50.00	Administrative Fee Setup + -

Adjustment Calendars page

Note. Most types of financial aid have specific fee adjustment requirements. Consult your financial aid staff to determine adjustment calendar requirements.

Description	Enter a description to identify this adjustment calendar.
Adjustment Option	<p>Select the adjustment option for this adjustment calendar. Values are:</p> <p><i>By Census Date:</i> Select to adjust fees based on the census date. Use only for Higher Education Contribution Scheme (HECS) calculation. This adjustment option is not available for term fees.</p> <p><i>By Class Length %</i> (by class length percentage): Select to adjust fees based on the number of days that have passed out of the total number of class days scheduled. For example, if a class is scheduled to run for 13 weeks, and a student drops the class at the end of the second week, the student would have attended slightly over 15 percent of the class length.</p> <p><i>By Class Meeting %</i> (by class meeting percentage): Select to adjust fees based on the number of class meetings attended out of the total number of scheduled class meetings.</p> <p><i>By Class Meetings</i> Select to adjust fees based on the number of class meetings attended regardless of the total number of meetings scheduled.</p> <p><i>By Class Start Date:</i> Select to adjust fees based on the number of days that have passed from the class start date.</p> <p><i>By Session Start Date:</i> Select to adjust fees based on the number of days that have passed from the first day of the session.</p> <p><i>By Term Start Date:</i> Select to adjust fees based on the number of days that have passed from the first day of the term.</p>
Adjust Reason (adjustment reason)	<p>Select the adjustment reason code. You might adjust fees differently depending on the reason that the student drops or withdraws. For example, you might give a full refund to a student who has to drop for reasons beyond his control. The adjust reason is a short explanation of the difference.</p> <hr/> <p>Note. If you want to select an adjustment reason for a term withdrawal, you must first select the Term Withdrawal check box.</p> <hr/>
Term Withdrawal	Select if this adjustment code is to be used for term withdrawal. Do not select this check box if the adjust reason is for dropped classes.
Copy Adjustment Calendar	Click to copy an adjustment calendar from one term to another.
Set Default	Select to designate an adjust reason as the default reason for both term withdrawal and dropping a class. Both term withdrawal and class drop must have one adjustment calendar defined as the default.
Term and Session	Enter the appropriate term and session information for each adjust reason.

Day From and To	<p>If you select the adjustment options <i>By Class Start Date</i>, <i>By Term Start Date</i>, or <i>By Session Start Date</i>, enter the beginning (Day From) and ending point (Day To) of the time period. For both of these fields, express the number of days before the start date defined in the Adjustment Option field as a negative number.</p> <p>For example, if you want a student to receive a full refund from any time before the start of a term to the day before the start of a term, enter -9999 in the From Day field and -1 in the To Day field.</p>
Percent From and To	<p>If you select the adjustment options <i>By Class Length %</i> or <i>By Class Meeting %</i>, enter a beginning (Percent From) and ending point (Percent To) of the range. Percent values cannot be expressed as negative numbers.</p> <p>For example, if you want students to receive a full refund if they drop any time before attending at least 10 percent of the class, enter 0% in the Percent From field and 9.999% in the Percent To field.</p>
Meeting From and Meeting To	<p>If you select the adjustment option <i>By Class Meetings</i>, enter a beginning (Meeting From) and ending (Meeting To) class session.</p> <p>For example, if you want students to receive a full refund if they drop any time before attending the third class session, enter 0 in the Meeting From field and 2 in the Meeting To field.</p>
Refund Percent	<p>Enter the percent of fees charged that you want the student to receive as a refund.</p>
Administrative Fee Setup	<p>Click to define any administrative fees that are associated with the adjustment period.</p> <hr/> <p>Note. Administrative fees for withdrawal can be defined for each refund range row. You can set up an administrative fee for cancellation only on the first row and only if the refund percent is 100 percent.</p> <hr/>

Defining Administrative Fees for Adjustment Periods

Access the Administrative Fee Setup page (click the Administrative Fee Setup link on the Adjustment Calendars page).

Adjustment Calendars

Administrative Fee Setup

Due Date Code: Standard **Currency:** USD

Withdrawal

Flat Fee:

Percentage:

Maximum Amount:

Account Type: Miscellaneous Fees

Item Type: Transaction Fee-Drop Class

Cancellation

Flat Fee:

Account Type: Miscellaneous Fees

Item Type: Transaction Fee-Drop Class

Administrative Fee Setup page

Due Date Code Select the due date code (billing and due calendar) that you want to use for the administrative fee.

Withdrawal Group Box

Flat Fee If you want to charge a student a specific amount for withdrawing from school or for canceling enrollment in classes, enter the amount in the Flat Fee fields. This option can be used alone or in conjunction with a percentage fee.

Percentage If you want to charge students a percentage of their tuition and fees when they withdraw from school, enter that percentage in this field. This option can be used alone or in conjunction with a flat fee. This option applies to withdrawal only.

Maximum Amount If you want to put a limit on the total administrative fees that can be charged to students who withdraw from school, enter a maximum amount in this field. This option applies to withdrawal only.

Account Type Select an account type for the administrative fee.

Item Type Select the item type that you have set up for administrative fee charges.

Cancellation

Flat Fee If you want to charge a student a specific amount for withdrawing from school or for canceling enrollment in classes, enter the amount in the Flat Fee fields. This option can be used alone or in conjunction with a percentage fee.

Account Type Select an account type for the administrative fee.

Item Type Select the item type that you have set up for administrative fee charges.

See Also

[Chapter 2, "Completing Student Financials General Setup," Setting Up Account Types, page 51](#)

[Chapter 2, "Completing Student Financials General Setup," Setting Up Item Types and Item Type Groups, page 55](#)

Calculating the Term Fee by Term and Adjusting by Term Scenarios

The following scenarios describe how the system calculates the term fees after a student initially enrolls in four classes and then:

- Drops one class.
- Adds an additional class.
- Drops two classes on the same day, with the same reason.
- Drops two classes on the same day, with two different reasons.

The term fee is assessed through an equation and is charged by term and adjusted by term. Refer to the section [Using Equation Engine to Define Tuition Calculation Equations](#) to see the sample equation, SFTDTFTRMTRM (Charge by Term, Adjust by Term).

Scenario 1: On January 1, 2007 the student enrolled in four classes at 100 per unit. Each class is three billing units; therefore, the total billing units equals 12 and the total amount equals 1200.00 USD, as shown in the following examples:

<i>Class_nbr</i>	<i>Stdnt_enrl_status</i>	<i>Enrl_add_dt</i>	<i>Trans_date</i>	<i>Enrol_actn_rsn_last</i>
1001	E	01/01/2007	N/A	N/A
1022	E	01/01/2007	N/A	N/A
1003	E	01/01/2007	N/A	N/A
1004	E	0/01/2007	N/A	N/A

The following table lists the transaction in the Tuition Calculation temporary table after initial enrollment:

Transaction Date	Amount	Difference	Drop Date	Reason	Refund %	Drop Cost
01/01/2007	1200.00	N/A	N/A	N/A	/AN	N/A

Student Balance is 1200.00

Scenario 2: On January 1, 2007 the student initially enrolled in four classes. Then on January 2, 2007 the student drops one class:

Class_nbr	Stdnt_enrl_status	Enrl_add_dt	Trans_date	Enrol_actn_reason_l ast
1001	D	01/01/2007	01/02/2007	SDRP
1002	E	01/01/2007	N/A	N/A
1003	E	01/01/2007	N/A	N/A
1004	E	01/01/2007	N/A	N/A

The following table lists the transactions in the Tuition Calculation temporary table after initial enrollment and dropping one class:

Transaction Date	Amount	Difference	Drop Date	Reason	Refund %	Drop Cost
01/0/2007	1200.00	N/A	N/A	N/A	N/A	N/A
01/02/2007	900.00	300.00	01/02/2007	SDRP	80%	300* (100% — 80%) = 60

Student balance: $900.00 + 60.00 = 960.00$

Scenario 3: On January 3, 2007 the student initially enrolled in four classes. On January 2, 2007 the student dropped a class and then on January 3, 2007 the student adds an additional class:

Class_nbr	Stdnt_enrl_status	Enrl_add_dt	Trans_date	Enrol_actn_ran_last
1011	D	01/01/2007	01/02/2007	SDRP
1002	E	01/01/2007	N/A	N/A
1003	E	01/01/2007	N/A	N/A
1004	E	01/01/2007	N/A	N/A
1005	E	01/03/2007	N/A	N/A

The following table lists the transactions in the Tuition Calculation temporary table after initial enrollment and dropping one class and adding one class:

Transaction Date	Amount	Difference	Drop Date	Reason	Refund %	Drop Cost
01/0/2007	1200.00	N/A	N/A	N/A	N/A	N/A
01/02/2007	900.00	300.00	01/02/2007	SDRP	80%	300* (100% — 80%) = 60
01/03/2007	1200.00	N/A	N/A	N/A	N/A	N/A

Note. In this example, the drop cost of 1200.00 on January 3, 2007 is not calculated on an added class.

Student balance: 1200.00 + 60.00 = 1260

Scenario 4; On January 1, 2007 the student initially enrolled in four classes. Then on January 2, 2007 the student drops two classes with the same reason, on the same day.

Class_nbr	Stdnt_enrl_status	Enrl_add_dt	Trans_date	Enrol_actn_ran_last
1011	D	01/01/2007	01/02/2007	SDRP
1002	D	01/01/2007	01/02/2007	SDRP
1003	E	01/01/2007	N/A	N/A
1004	E	01/01/2007	N/A	N/A

The following table lists the transactions in the Tuition Calculation temporary table after the initial enrollment and dropping of two classes with the same reason, on the same day.

Transaction Date	Amount	Difference	Drop Date	Reason	Refund %	Drop Cost
01/0/2007	1200.00	N/A	N/A	N/A	N/A	N/A
01/02/2007	900.00	600.00	01/02/2007	SDRP	80%	600 (100% — 80%) = 120.00

Student balance: 600.00 + 120.00 = 720.00

Scenario 5: On January 1, 2007 the student initially enrolled in four classes. Then on January 2, 2007 the student drops two classes with two different reasons:

Class_nbr	Stdnt_enrl_status	Enrl_add_dt	Trans_date	Enrol_actn_ran_last
1011	D	01/01/2007	01/02/2007	SDRP
1002	D	01/01/2007	01/02/2007	CANC
1003	E	01/01/2007	N/A	N/A

<i>Class_nbr</i>	<i>Stdnt_enrl_status</i>	<i>Enrl_add_dt</i>	<i>Trans_date</i>	<i>Enrol_actn_ran_last</i>
1004	E	01/01/2007	N/A	N/A

The following table lists the transactions in the Tuition Calculation temporary table after the initial enrollment and dropping of two classes with two different reasons, on the same day.

<i>Transaction Date</i>	<i>Amount</i>	<i>Difference</i>	<i>Drop Date</i>	<i>Reason</i>	<i>Refund %</i>	<i>Drop Cost</i>
01/0/2007	1200.00	N/A	N/A	N/A	N/A	N/A
01/02/2007	900.00*	300.00	01/02/2007	CANC	90%	300* (100% — 90%) = 30.00
01/02/2007	600.00	300.00	01/02/2007	SDRP	80%	\$600 (100% — 80%) = 60.00

Student Balance: 600.00 + 30.00 + 60.00 = 690.00

When a student drops two classes with two different reasons on the same day, the temporary table is inserted alphabetically by reason and each class is calculated separately. The first amount is calculated by only noting that one class has been canceled. The second amount is calculated by using the second class that has been dropped by the student.

If the adjustment calendar is by session start date, the session code is taken into account similarly to the reason.

During withdrawal processing, the student's enrollment record, for enrolled classes, will have the drop date equal the last attendance date. Therefore, the transaction date will be the last attendance date.

Establishing Tuition Calculation Controls

To set up tuition calculation controls, use the Tuition Calculation Controls component (CALC_CNTRNL_PANEL).

Tuition calculation controls determine the academic careers that are eligible for tuition and fee calculation each term.

This section discusses how to:

- Specify tuition calculation parameters.
- Establish restrictions on automatic tuition calculation.
- Select errors and warnings.

Pages Used to Establish Tuition Calculation Controls

Page Name	Definition Name	Navigation	Usage
Tuition Calculation Controls	CALC_CNTL_TABLE	Set Up SACR, Product Related, Student Financials, Tuition and Fees, Tuition Calculation Controls	Specify tuition calculation parameters for academic careers by term.
Refund Calculation Controls	CALC_ON_REFUND_CTL	Set Up SACR, Product Related, Student Financials, Tuition and Fees, Tuition Calculation Controls, Refund Calculation Controls	Establish restrictions on automatic tuition calculation.
Display Error/Warning Controls	DISP_ERR_CNTL	Set Up SACR, Product Related, Student Financials, Tuition and Fees, Tuition Calculation Controls, Display Error/Warning Controls	Select errors and warnings for tuition calculation.

Specifying Tuition Calculation Parameters

Access the Tuition Calculation Controls page (Set Up SACR, Product Related, Student Financials, Tuition and Fees, Tuition Calculation Controls).

Tuition Calculation Controls page

Note. You must establish tuition controls for each active academic career for each term.

Academic Career Select the academic career for your tuition calculation controls.

Tuition Calculation Controls for Terms

Term Select the term to which these controls apply.

Term Wash Period The term wash period indicates the number of days that a student can drop and add classes of equal value (wash) without penalty. This is not the same as a drop/add period in which students are allowed to make any changes. The term wash period typically extends beyond the normal drop/add period to accommodate students who must make changes to their enrollment.

For example: a student enrolls in Chemistry 101 and determines, after two weeks in class, that he or she is too advanced for the introductory level class. If the term wash period is at least 14 days, the student can switch to Chemistry 201 without penalty.

Note. The dropped and added classes do not need to match exactly as long as the total amount of tuition and related fees is equal. For example, a student can drop one four-credit course and replace it with two two-credit courses as long as the total tuition and fee charges do not change.

Transaction Wash Period Enter a number of days for a transaction wash period. The transaction wash period allows students a period of time in which to complete a *wash* transaction. That is, the student does not need to drop and add the wash classes at the same time. Rather, as long as the replacement class or classes are added within the transaction wash period, no penalty is incurred. If the drop and add take place *outside* both the term wash and transaction wash periods, the student is charged the prorated amount of the dropped class and the full amount of the added class.

Auto Calculate Tuition Select to automatically calculate tuition whenever you inquire on a student's (automatically calculate tuition) account. This feature enables you to see the most up-to-date tuition information without having to run a separate tuition calculation.

Auto Calculate Self Service

Select to automatically calculate tuition for a particular term in self service. If you select the check box, a student using self service can see the most up-to-date tuition information without you having to run a separate tuition calculation.

In self service, the system calculates tuition when a student accesses the Account Inquiry or the Make a Payment component. The system does not automatically calculate tuition when a student accesses the Student Center. In addition, tuition calculation is never invoked from the Student Services Center or Student Services Center (Student).

Note. This option impacts only self service, in contrast to the Auto Calculate Tuition option that impacts only the administrative module. You can choose to enable automatic tuition calculation for self service, administrative module, or both.

The check box is cleared by default.

Note. In addition to selecting this check box, you must also select automatic self service tuition calculation elsewhere in the system, for tuition calculation to be invoked in self service. You must select the check box here for automatic self service tuition calculation to have effect for a particular term.

See *PeopleSoft Enterprise Campus Self Service 9.0 PeopleBook*, "Setting Up Student Financials Self Service," Defining Basic Institution Set Parameters.

Auto Calculate Waivers (automatically calculate waivers)

Select to automatically calculate student waivers whenever tuition is calculated. If you select this option, Student Financials calculates a student's tuition first, and then automatically applies all tuition waivers against the student's final tuition amount. If you do not select this option, the system does *not* calculate or post tuition waivers, so you must calculate and post waivers in background processing.

Tuition Calculation Controls for Sessions**Session**

Enter a session if you want your tuition calculation controls to apply to specific sessions within the term. If you leave this field blank, the controls apply to all sessions in the term.

Session Wash Period

If you choose to apply tuition calculation controls by the session, you must enter a session wash period value. The session wash period works the same as a term wash period.

Establishing Restrictions on Automatic Tuition Calculation

Access the Refund Calculation Controls page (Set Up SACR, Product Related, Student Financials, Tuition and Fees, Tuition Calculation Controls, Refund Calculation Controls).

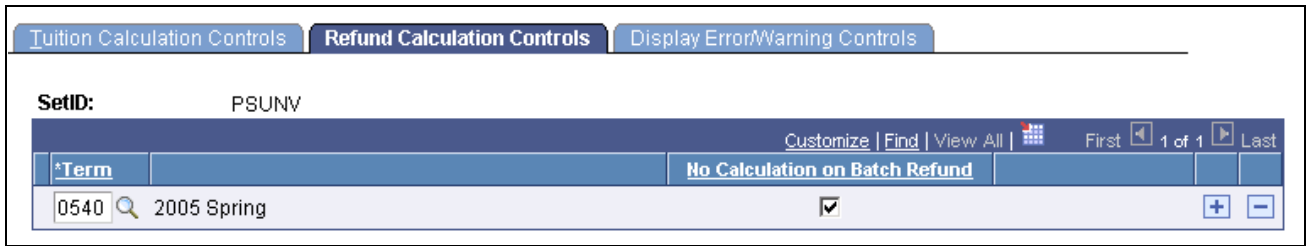

Refund Calculation Controls page

Term Enter the term for which the refund calculation control applies.

No Calculation on Batch Refund Select if you do not want the system to automatically calculate tuition when batch refund processing is run.

Selecting Errors and Warnings

Access the Display Error/Warning Controls page (Set Up SACR, Product Related, Student Financials, Tuition and Fees, Tuition Calculation Controls, Display Error/Warning Controls).



Display Error/Warning Controls page

The default setting is ON to display warnings and messages. If you do not have a row for the term with these controls cleared, you will continue to receive errors and warnings. Insert a row for every term in which you want to clear warnings and messages.

If an equation contains the equation keyword *Message*, or the equation produces an error, the message is written to the Tuition Calc log file.

Note. The equation keyword Message may affect performance and should be used primarily in your test environment to verify the results of the equation.

Term	Select the term for the error and warning controls that you are defining.
Include Status of Warning	Select to have warning messages appear in CALC_ERROR. If you do not select this check box, warnings do not appear.
Include Status of Message	Select to have messages appear in CALC_ERROR. If you do not select this check box, messages do not appear.
Display in Log File	Select during your installation process when you want to review log file information. This feature is typically disabled after installation and testing has been completed.

Defining Variables for Criteria and Equations

To set up variables for criteria and equations, use the Equation Variables component (STDNT_EQUTN_VARS).

This section provides an overview of equation variables and discusses how to:

- Define character variables.
- Define numeric variables.
- Define yes/no flags.

Understanding Equation Variables

Equation variables are user-defined variables that you can use to classify students when no standard system values are available. For example, you might need to calculate a fee for students involved in summer internship programs. You could define one or more variables to use to identify the students and calculate the appropriate fees.

Pages Used to Define Variables for Criteria and Equations

<i>Page Name</i>	<i>Definition Name</i>	<i>Navigation</i>	<i>Usage</i>
Char Variables (character variables)	STDNT_EQUTIN_CHAR	Student Financials, Tuition and Fees, Equation Variables, Char Variables	Define character variables.
Num Variables (numeric variables)	STDNT_EQUTN_NUM	Student Financials, Tuition and Fees, Equation Variables, Num Variables	Define numeric variables.

Page Name	Definition Name	Navigation	Usage
Y/N Flags (yes/no flags)	STDNT_EQUTN_FLAG	Student Financials, Tuition and Fees, Equation Variables, Y/N Flags	Define yes/no variables.

Defining Character Variables

Access the Char Variables page (Student Financials, Tuition and Fees, Equation Variables, Char Variables).

Char Variables page

Term Select the term for which you want the variables to apply.

Var Char1 (variable characters 1) through **Var Char10** (variable characters 10) You can attach up to 10 character variables to the student, using the Var Char1 through Var Char10 fields. Save the page, and the system links the character variables that you specified to the student. The character variables no longer apply when the term that you selected ends.

Defining Numeric Variables

Access the Num Variables page (Student Financials, Tuition and Fees, Equation Variables, Num Variables).

Char Variables		Num Variables		Y/N Flags	
Sally Dewey			SFTRN016		
Find View All First ◀ 1 of 1 ▶ Last					
Billing Career:	GRAD	Graduate			
Institution:	PSUNV	PeopleSoft University			
Find View All First ◀ 1 of 1 ▶ Last					
Term:	0530	2004 Fall			
Numeric Variables					
Var Num1:	<input type="text" value="2.60"/>	Var Num6:	<input type="text"/>		
Var Num2:	<input type="text" value="9.0"/>	Var Num7:	<input type="text"/>		
Var Num3:	<input type="text"/>	Var Num8:	<input type="text"/>		
Var Num4:	<input type="text"/>	Var Num9:	<input type="text"/>		
Var Num5:	<input type="text"/>	Var Num10:	<input type="text"/>		

Num Variables page

Term

Select the term for which you want the variables to apply.

Var Num1 (variable number 1) through **Var Num10** (variable number 10)

Attach up to 10 numeric variables to the student, using these fields. Save the page, and the system links the variables that you specified to the student. The numeric variables no longer apply when the term that you selected ends.

Defining Yes/No Flags

Access the Y/N Flags page (Student Financials, Tuition and Fees, Equation Variables, Y/N Flags).

Sally Dewey SFTRN016

Find | View All First 1 of 1 Last

Billing Career: GRAD Graduate

Institution: PSUNV PeopleSoft University

Find | View All First 1 of 1 Last

Term: 0530 2004 Fall

Yes / No Flags

<input checked="" type="checkbox"/> User Variable Y/N Flag #1	<input type="checkbox"/> User Variable Y/N Flag #6
<input type="checkbox"/> User Variable Y/N Flag #2	<input checked="" type="checkbox"/> User Variable Y/N Flag #7
<input type="checkbox"/> User Variable Y/N Flag #3	<input type="checkbox"/> User Variable Y/N Flag #8
<input type="checkbox"/> User Variable Y/N Flag #4	<input type="checkbox"/> User Variable Y/N Flag #9
<input type="checkbox"/> User Variable Y/N Flag #5	<input checked="" type="checkbox"/> User Variable Y/N Flag #10

Y/N Flags page

Term Select the term for which you want the variables to apply.

User Variable Y/N Flag #1 (user variable yes/no flag number 1) through **User Variable Y/N Flag #10** (user variable yes/no flag number 10) You can select up to 10 Y/N flags per student, using the User Variable Y/N Flag #1 through User Variable Y/N Flag #10 check boxes. Save the page, and the system links the variables that you specified to the student.

Establishing Criteria for Tuition Groups and Fee Triggers

To set up criteria for tuition groups and fee triggers, use the Criteria component (SEL_CRITERIA_PANEL).

This section provides an overview of tuition group and fee trigger criteria and discusses how to:

- Define criteria codes and criteria types.
- Define criteria details.

Understanding Tuition Group and Fee Trigger Criteria

Criteria are essentially questions that can be answered *yes* or *no*. In PeopleSoft Enterprise Student Financials, use criteria to compare one or more variable values to a student's academic situation to determine whether an action should be triggered (for example, applying a waiver to fees), or in which tuition group the student should be included.

The Criteria component is a flexible means of identifying and classifying students. Criteria can be as simple as a single variable (for example, is the student a sophomore) or extremely complex involving multiple variables. Whenever you create a criteria definition, test it thoroughly to make sure it produces the exact results that you expect.

Trigger criteria and tuition group criteria cannot be used interchangeably. You can, however, create one of each using the same detail setup.

Pages Used to Establish Criteria for Tuition Groups and Fee Triggers

Page Name	Definition Name	Navigation	Usage
Criteria	SEL_CRITERIA_TABLE	Set Up SACR, Product Related, Student Financials, Tuition and Fees, Criteria	Define criteria codes and criteria types.
Criteria Details	SEL_CRITER_TABLE	Set Up SACR, Product Related, Student Financials, Tuition and Fees, Criteria, Criteria Details	Define criteria details.

Defining Criteria Codes and Criteria Types

Access the Criteria page (Set Up SACR, Product Related, Student Financials, Tuition and Fees, Criteria).

The screenshot shows the 'Criteria' page in a software application. At the top, there are two tabs: 'Criteria' (selected) and 'Criteria Details'. Below the tabs, the 'Business Unit' is set to 'PSUNV' and the 'Criteria' is set to 'HONORS'. A search bar at the top right contains 'Find | View All' and navigation buttons for 'First', '1 of 1', and 'Last'. The main form area contains several fields:

- *Effective Date:** A date picker set to 01/01/2005.
- *Status:** A dropdown menu set to 'Active'.
- *Description:** A text input field containing 'Honors Waiver'.
- Long Description:** A larger text area containing 'Honors Waiver'.
- *Criteria Type:** A dropdown menu set to 'Trigger Criteria'.

Criteria page

Criteria Type

Select one of two criteria types. The two types cannot be used interchangeably. Select from:

Trigger Criteria: Select to define a criterion that triggers an event.

Tuition Group Criteria: Select to define a criterion that links a student to a tuition group.

Defining Criteria Details

Access the Criteria Details page (Set Up SACR, Product Related, Student Financials, Tuition and Fees, Criteria, Criteria Details).

The screenshot shows the 'Criteria Details' page with the following information:

- Business Unit:** PSUNV
- Criteria:** HONORS Honors Waiver
- Effective Date:** 01/01/2005
- Status:** Active
- *Description:** Student Group
- List Detail Values Below:** (Empty)
- How Specified:**
 - Selected Detail Values
 - Selected Tree Nodes
- Tree Information:**
 - TableSet: (Empty)
 - Tree Name: (Empty)
 - Level Name: (Empty)
- Operator:** = Equal To
- Value / Node:** HONR

Criteria Details page

Description

Select a variable related to a student's characteristics for a particular term.

Note. Student Financials provides system variables that cover most needs. In addition, 30 user-defined variables are available to use. Using these user-defined variables is more difficult because you must know the definition of each variable position.

How Specified

Selected Detail Values

Select to match the variable with a specific value.

Selected Tree Nodes

Select to match the variable using any value within a tree node. When you select this option, the fields in the Tree Information group box become available.

TableSet, Tree Name, and Level Name

Select the tableset, tree name, and a level name on the tree if the tree has strictly enforced levels. After specifying this information, enter a node or nodes to assist in specifying the student group.

Operator

Define the function that the system performs against the value.

Relational Operators

<	Less than
<=	Less than or equal to
>	Greater than
>=	Greater than or equal to
<>	Not equal to
BLK (blank)	The field value is blank
BTW (between)	The field value is between A and B
NBL (not blank)	The field value is not blank

Value/Node

If you select Selected Detail Values in the How Specified group box, enter an explicit variable value. The system edits it against a prompt table if one exists, or the system edits it for valid dates, numbers, and string lengths.

If you chose Selected Tree Nodes in the How Specified group box, specify a tree node in the Node field.

A tree node is a collection of values that is aggregated under a single node. It is a quick way to specify numerous values. A tree must have the same criteria as its detail value.

See Also

[Chapter 5, "Setting Up Tuition Controls, Criteria, Equations, and Waivers," Defining Variables for Criteria and Equations, page 155](#)

Using Equation Engine to Define Tuition Calculation Equations

The Equation Engine is a powerful tool that enables you to develop a variety of formulas. In Student Financials, equations are used to identify a student's enrollment status, calculate and assign fees, and calculate tuition. This section provides an overview of global variables and discusses how to:

- View delivered equations.

- View equation information.
- Use Equation Engine in Student Financials tuition calculation.
- Student Financials undergraduate selection equation.

See Also

PeopleSoft Enterprise Campus Solutions 9.0 Application Fundamentals PeopleBook, "Working with Equation Engine"

Understanding Global Variables

The following SF global variables are now available to calculate: adjustments, course fees, course list fees, and class fees. The new global variables use fields from the Tuition Calculation temporary table, which originates from the STDNT_ENRL_ or CLASS_TBL.

The SF global variables are:

- A_amount
- A_select (yes/no flag)
- Acad_career (academic career)
- Billing_career
- Business_unit
- Class_nbr
- Crse_id (course id)
- Enrol_actn_rsn_last (enrollment action reason last)
- Emplid
- Institution
- Session_code
- Stdnt_car_nbr (Student Career Number)
- STRM (Term)
- Trans_date
- Trans_time

Page Used to Define Tuition Calculation Equations

<i>Page Name</i>	<i>Definition Name</i>	<i>Navigation</i>	<i>Usage</i>
Equation Editor	EQUATION_EDITOR	Set Up SACR, Common Definitions, Equation Engine, Equation Editor	View delivered equations.

Viewing Delivered Equations

Access the Equation Editor page (Set Up SACR, Common Definitions, Equation Engine, Equation Editor).

Equation Editor
 Enter any information you have and click Search. Leave fields blank for a list of a

Find an Existing Value **Add a New Value**

Equation Id Auth Class: PUBLIC

Equation Name: begins with

Description: begins with

Include History Correct History Case Sensitive

Search **Clear** [Basic Search](#)  [Save Search Criteria](#)

Search Results

View All First 1-22 of 22 Last

Equation Name	Description	Data Type Description
SFPPSPPL	Pop Sel Pmt Plan Contract Sel	Demonstration Data
SFPPSPPLTPC	Pop Sel Pmt Plan Contract Sel	Demonstration Data
SFTDBILLUNIT	Billing Units	Demonstration Data
SFTDCLASSNBR	Charge by Class Number	Demonstration Data
SFTDCLSEL	Class Select	Demonstration Data
SFTDCLSTRM	TF Charge by Class Adj by Trm	Demonstration Data
SFTDCLSWVR	Class Waiver	Demonstration Data
SFTDCOURSEID	Charge by Course ID	Demonstration Data
SFTDCSSTDYFE	Case Study Fees	Demonstration Data
SFTDMDLABRAT	Medical School Laboratory Fees	Demonstration Data
SFTDMDSCUIT	Medical School Tuition	Demonstration Data
SFTDMDSPECLT	Medical Speciality	Demonstration Data
SFTDMDTESTSC	Medical School Test Scores	Demonstration Data
SFTDRSRCHFEE	Research Project Fees	Demonstration Data
SFTDTFSECLS	TF Charge by Sess Adj by Class	Demonstration Data
SFTDTFSESTRM	TF Chrg by Sess Adj by Trm/Ses	Demonstration Data
SFTDTFTRMCLS	TF Charge by Term Adj by Class	Demonstration Data
SFTDTFTRMSES	TF Charge by Term Adj by Sess	Demonstration Data
SFTDTFTRMTRM	TF Charge by Term Adj by Term	Demonstration Data
SFTDUGRAD	Undergraduate	Demonstration Data
SFTDUGRDAMT	SF UGRD Pay Amount	Demonstration Data
SFTDUGRDSEL	SF UGRD Select	Demonstration Data

Equation Editor page

You can view any equation listed on this page.

Viewing Equation Information

Access the SFTDTFTRMTRM equation on the Equation Editor page. (Set Up SACR, Common Definitions, Equation Engine, Equation Editor).

Equation Editor

Equation Name SFTDTFTRMTRM

Equation Table Find | View All First 1 of 1 Last

*Eff Date 01/01/1900 Active Enable Preview Results

Short Desc TF TRM TRM *Descr TF Charge by Term Adj by Term

Compile Status Successfully Parsed

Equation Edit Function

Equation Detail Find | View 18 First 1-100 of 103 Last

Sel	Line	Keyword	Operand Type	Operand	Comment:
<input type="checkbox"/>	1	Skip			TF Charge by Terr + -
<input type="checkbox"/>	2	Message	String	Running SFTDTFTRMTRM	+ -
<input type="checkbox"/>	3	End Message			+ -
<input type="checkbox"/>	4	Assign	Local Variable	FOUND_STDNT_CAR_TERM	+ -
<input type="checkbox"/>	5		Number	0.00000	+ -
<input type="checkbox"/>	6	End Assign			+ -
<input type="checkbox"/>	7	Find First	Local Variable	FOUND_STDNT_CAR_TERM	+ -
<input type="checkbox"/>	8		Table	STDNT_CAR_TERM	+ -
<input type="checkbox"/>	9		Keyed Global Equal	EMPLID	+ -
<input type="checkbox"/>	10		Keyed Global Equal	ACAD_CAREER	+ -
<input type="checkbox"/>	11		Keyed Global Equal	INSTITUTION	+ -
<input type="checkbox"/>	12		Keyed Global Equal	STRM	+ -
<input type="checkbox"/>	13	End Find			+ -
<input type="checkbox"/>	14	If			+ -

Equation Editor page (1 of 4)

<input type="checkbox"/>	15	Local Variable	FOUND_STDNT_CAR_TERM	<input type="text"/>	<input type="button" value="+"/>	<input type="button" value="-"/>
<input type="checkbox"/>	16	Then		<input type="text"/>	<input type="button" value="+"/>	<input type="button" value="-"/>
<input checked="" type="checkbox"/>	17	Assign	Local Variable	FOUND_STDNT_ENRL	<input type="text"/>	<input type="button" value="+"/>
<input type="checkbox"/>	18	Number		0.00000	<input type="text"/>	<input type="button" value="+"/>
<input type="checkbox"/>	19	End Assign		<input type="text"/>	<input type="button" value="+"/>	<input type="button" value="-"/>
<input checked="" type="checkbox"/>	20	Assign	Local Variable	CLASS_NBR	<input type="text"/>	<input type="button" value="+"/>
<input type="checkbox"/>	21	Number		0.00000	<input type="text"/>	<input type="button" value="+"/>
<input type="checkbox"/>	22	End Assign		<input type="text"/>	<input type="button" value="+"/>	<input type="button" value="-"/>
<input checked="" type="checkbox"/>	23	Find First	Local Variable	FOUND_STDNT_ENRL	<input type="text"/>	<input type="button" value="+"/>
<input type="checkbox"/>	24	Table		STDNT_ENRL	<input type="text"/>	<input type="button" value="+"/>
<input type="checkbox"/>	25	Keyed Global Equal		EMPLID	<input type="text"/>	<input type="button" value="+"/>
<input type="checkbox"/>	26	Keyed Global Equal		ACAD_CAREER	<input type="text"/>	<input type="button" value="+"/>
<input type="checkbox"/>	27	Keyed Global Equal		INSTITUTION	<input type="text"/>	<input type="button" value="+"/>
<input type="checkbox"/>	28	Keyed Global Equal		STRM	<input type="text"/>	<input type="button" value="+"/>
<input type="checkbox"/>	29	Keyed Local Greater Equal		CLASS_NBR	<input type="text"/>	<input type="button" value="+"/>
<input type="checkbox"/>	30	End Find		<input type="text"/>	<input type="button" value="+"/>	<input type="button" value="-"/>
<input checked="" type="checkbox"/>	31	Assign	Global Variable	A_AMOUNT	<input type="text"/>	<input type="button" value="+"/>
<input type="checkbox"/>	32	Number		0.00000	<input type="text"/>	<input type="button" value="+"/>
<input type="checkbox"/>	33	End Assign		<input type="text"/>	<input type="button" value="+"/>	<input type="button" value="-"/>
<input checked="" type="checkbox"/>	34	Loop		<input type="text"/>	<input type="button" value="+"/>	<input type="button" value="-"/>
<input checked="" type="checkbox"/>	35	If		<input type="text"/>	<input type="button" value="+"/>	<input type="button" value="-"/>
<input type="checkbox"/>	36	Not		<input type="text"/>	<input type="button" value="+"/>	<input type="button" value="-"/>
<input type="checkbox"/>	37	Local Variable		FOUND_STDNT_ENRL	<input type="text"/>	<input type="button" value="+"/>
<input type="checkbox"/>	38	Then		<input type="text"/>	<input type="button" value="+"/>	<input type="button" value="-"/>
<input type="checkbox"/>	39	Exit Loop		<input type="text"/>	<input type="button" value="+"/>	<input type="button" value="-"/>
<input type="checkbox"/>	40	End If		<input type="text"/>	<input type="button" value="+"/>	<input type="button" value="-"/>
<input checked="" type="checkbox"/>	41	If		<input type="text"/>	<input type="button" value="+"/>	<input type="button" value="-"/>
<input checked="" type="checkbox"/>	42	(<input type="text"/>	<input type="button" value="+"/>	<input type="button" value="-"/>
<input type="checkbox"/>	43	Table		STDNT_ENRL	<input type="text"/>	<input type="button" value="+"/>
<input type="checkbox"/>	44	Field		STDNT_ENRL_STATUS	<input type="text"/>	<input type="button" value="+"/>
<input type="checkbox"/>	45	=		<input type="text"/>	<input type="button" value="+"/>	<input type="button" value="-"/>
<input type="checkbox"/>	46	Prompted Value		E	<input type="text"/>	<input type="button" value="+"/>
<input type="checkbox"/>	47	And		<input type="text"/>	<input type="button" value="+"/>	<input type="button" value="-"/>

Equation Editor page (2 of 4)

48	(
49		Table	STDNT_CAR_TERM						
50		Field	LAST_DATE_ATTENDED						
51	=								
52		String							
53	Or								
54		Global Variable	ENRL_DROP_DT						
55	<								
56		Table	STDNT_CAR_TERM						
57		Field	LAST_DATE_ATTENDED						
58)								
59)								
60	Or								
61	(
62		Global Variable	ENRL_DROP_DT						
63	<								
64		Table	STDNT_ENRL						
65		Field	ENRL_DROP_DT						
66)								
67	Or								
68	(
69		Global Variable	ENRL_DROP_DT						
70	=								
71		Table	STDNT_ENRL						
72		Field	ENRL_DROP_DT						
73	And								
74		Global Variable	ENRL_ACTN_RSN_LAST						
75	<>								
76		Table	STDNT_CAR_TERM						
77		Field	WITHDRAW_REASON						
78	And								

Equation Editor page (3 of 4)

<input type="checkbox"/>	79	Global Variable	ENRL_ACTN_RSN_LAST		
<input type="checkbox"/>	80	<			
<input type="checkbox"/>	81	Table	STDNT_ENRL		
<input type="checkbox"/>	82	Field	ENRL_ACTN_RSN_LAST		
<input type="checkbox"/>	83)			
<input type="checkbox"/>	84	Then			
▼ <input type="checkbox"/>	85	Assign	Global Variable	A_AMOUNT	
<input type="checkbox"/>	86		Global Variable	A_AMOUNT	
<input type="checkbox"/>	87	+			
<input type="checkbox"/>	88	Number		100.00000	
<input type="checkbox"/>	89	*			
<input type="checkbox"/>	90	Table	STDNT_ENRL		
<input type="checkbox"/>	91	Field	UNT_BILLING		
<input type="checkbox"/>	92	End Assign			
<input type="checkbox"/>	93	End If			
▼ <input type="checkbox"/>	94	Find Next	Local Variable	FOUND_STDNT_ENRL	
<input type="checkbox"/>	95		Table	STDNT_ENRL	
<input type="checkbox"/>	96	End Find			
<input type="checkbox"/>	97	End Loop			
<input type="checkbox"/>	98	End If			
▼ <input type="checkbox"/>	99	Assign	Global Variable	A_AMOUNT	
<input type="checkbox"/>	100		Global Variable	A_AMOUNT	
<input type="checkbox"/>	101	+			
<input type="checkbox"/>	102	Number		300.00000	
<input type="checkbox"/>	103	End Assign			

Equation Editor page (4 of 4)

This sample equation calculates the term fee by term, adjust by term. To determine the enrolled classes on a specific date, tuition calculation looks at the temporary table and, for each row, the equation is called and it compares the global variables from the temporary table to the student's enrollment. Refer to Understanding the Adjustment Calendar section for logic for the term fee and adjustment calculation for each student.

See Also

PeopleSoft Enterprise Campus Solutions 9.0 Application Fundamentals PeopleBook, "Working with Equation Engine"

Using Equation Engine in Student Financials Tuition Calculation

Access the SFTDUGRDAMT equation on the Equation Editor page.

Equation Editor

Equation Name SFTDUGRDAMT

Equation Table Find | View All | First 1 of 1 Last

'Eff Date: 01/01/1900 Active Enable Preview Results

Short Desc: SFUGRDAMT 'Descr: SF UGRD Pay Amount

Compile Status: Not Yet Compiled

Equation Edit Function:

Equation Detail Find | View All | First 1-18 of 20 Last

Sel	Line	Keyword	Operand Type	Operand	Comment:
<input type="checkbox"/>	1	Assign	Local Variable	FOUND_STD_CAR_TERM	<input type="text"/>
<input type="checkbox"/>	2		Number	0.00000	<input type="text"/>
<input type="checkbox"/>	3	End Assign			<input type="text"/>
<input type="checkbox"/>	4	Assign	Local Variable	ACAD_CAREER	<input type="text"/>
<input type="checkbox"/>	5		String	UGRD	<input type="text"/>
<input type="checkbox"/>	6	End Assign			<input type="text"/>
<input type="checkbox"/>	7	Find First	Local Variable	FOUND_STD_CAR_TERM	<input type="text"/>
<input type="checkbox"/>	8		Table	STDNT_CAR_TERM	<input type="text"/>
<input type="checkbox"/>	9		Keyed Global Equal	EMPLID	<input type="text"/>
<input type="checkbox"/>	10		Keyed Local Equal	ACAD_CAREER	<input type="text"/>
<input type="checkbox"/>	11		Keyed Global Equal	INSTITUTION	<input type="text"/>
<input type="checkbox"/>	12		Keyed Global Equal	STRM	<input type="text"/>
<input type="checkbox"/>	13	End Find			<input type="text"/>
<input type="checkbox"/>	14	If			<input type="text"/>
<input type="checkbox"/>	15		Local Variable	FOUND_STD_CAR_TERM	<input type="text"/>
<input type="checkbox"/>	16	Then			<input type="text"/>
<input type="checkbox"/>	17	Assign	Global Variable	A_AMOUNT	<input type="text"/>
<input type="checkbox"/>	18		Number	234.56000	<input type="text"/>

Application Prompts Customize | Find | View All | First 1 of 1 Last

*Application Prompt ID	
1	Stdnt Fin Tuition Amount Eqtns

Parameters Customize | Find | View All | First 1 of 1 Last

Global	Type	Description
1		

Equation Editor page (SFTDUGRDAMT)

This equation uses the *Stdnt Fin Tuit Amount Limited* application prompt ID. The equation looks at a student's career number, determines whether the student is an undergraduate, and then assigns a monetary amount.

Using Student Financials Undergraduate Selection Equation

Access the SFTDUGRDSEL equation on the Equation Editor page (Set Up SACR, Common Definitions, Equation Engine, Equation Editor).

Equation Editor

Equation Name SFTDUGRDSEL

Equation Table Find | View All First 1 of 1 Last

'Eff Date: 01/01/1900 Active Enable Preview Results

Short Desc: SFUGRDSEL *Desc: SF UGRD Select

Compile Status: Not Yet Compiled

Equation Edit Function:

Equation Detail Find | View All First 1-18 of 20 Last

Sel	Line	Keyword	Operand Type	Operand	Comment:
<input type="checkbox"/>	1	Assign	Local Variable	FOUND_STD_CAR_TERM	<input type="text"/>
<input type="checkbox"/>	2		Number	0.00000	<input type="text"/>
<input type="checkbox"/>	3	End Assign			<input type="text"/>
<input type="checkbox"/>	4	Assign	Local Variable	ACAD_CAREER	<input type="text"/>
<input type="checkbox"/>	5		String	UGRD	<input type="text"/>
<input type="checkbox"/>	6	End Assign			<input type="text"/>
<input type="checkbox"/>	7	Find First	Local Variable	FOUND_STD_CAR_TERM	<input type="text"/>
<input type="checkbox"/>	8		Table	STDNT_CAR_TERM	<input type="text"/>
<input type="checkbox"/>	9		Keyed Global Equal	EMPLID	<input type="text"/>
<input type="checkbox"/>	10		Keyed Local Equal	ACAD_CAREER	<input type="text"/>
<input type="checkbox"/>	11		Keyed Global Equal	INSTITUTION	<input type="text"/>
<input type="checkbox"/>	12		Keyed Global Equal	STRM	<input type="text"/>
<input type="checkbox"/>	13	End Find			<input type="text"/>
<input type="checkbox"/>	14	If			<input type="text"/>
<input type="checkbox"/>	15		Local Variable	FOUND_STD_CAR_TERM	<input type="text"/>
<input type="checkbox"/>	16	Then			<input type="text"/>
<input type="checkbox"/>	17	Assign	Global Variable	A_SELECT	<input type="text"/>
<input type="checkbox"/>	18		String	YES	<input type="text"/>

Application Prompts Customize | Find | View All First 1 of 1 Last

*Application Prompt ID	
1	Stdnt Fin Tuition Select Eqtns

Parameters Customize | Find | View All First 1 of 1 Last

Global	Type	Description
1		

Equation Editor page (SFTDUGRDSEL)

This equation selects students based on their undergraduate status.

See Also

PeopleSoft Enterprise Campus Solutions 9.0 Application Fundamentals PeopleBook, "Working with Equation Engine"

Defining Waivers and Waiver Groups

To set up waivers and waiver groups, use the Waivers component (WAIVER_PANEL) and the Waiver Groups component (WAIVER_GROUP_PANEL).

Waivers provide a convenient, consistent, and easily maintainable way of waiving or reducing tuition or fees for students who meet specific criteria. Waiver groups enable you to attach one or more waivers directly to class, course, and course list fees.

This section discusses how to:

- Define waivers.
- Define waiver groups.

Pages Used to Define Waivers and Waiver Groups

<i>Page Name</i>	<i>Definition Name</i>	<i>Navigation</i>	<i>Usage</i>
Waivers	WAIVER_TABLE	Set Up SACR, Product Related, Student Financials, Tuition and Fees, Waivers	Define waivers.
Waiver Groups	WAIVER_GROUP_TABLE	Set Up SACR, Product Related, Student Financials, Course and Class Fees, Waiver Groups	Define waiver groups.

Defining Waivers

Access the Waivers page (Set Up SACR, Product Related, Student Financials, Tuition and Fees, Waivers).

Waivers

SetID: PSUNV **Waiver Code:** HNR50

***Description:** Honors Waivers 50%

Long Description: Honors Waivers 50%

Find | View All First 1 of 1 Last

***Effective Date:** 01/01/1999 ***Status:** Active

***Account Type:** TUT Tuition

***Item Type:** 350000000020 Waiver Priority 20

***Criteria:** Use Criteria Use Equation
 HONORS Honors Waiver

Adjust Until Date: 12/31/2005 **Use Excess Account:**

Waive Percentage: 50.00 **Item Type Group:** TUITION Tuition

Amount/Unit: **Flat Amount:**

Waiver Offset: **Maximum Amount:** 9,999,999.00 USD

Waive Tax: **Increase Waiver for Tax:**

Tax Waiver Account Type: TUT Tuition

Tax Waiver Item Type: 350000000020 Waiver Priority 20

Waivers page

- Criteria** Select the criteria to use to determine the student's eligibility for a waiver.
 - Adjust Until Date** Define the last day that a waiver can be granted to a student who meets the criteria.
 - Use Excess Account** Select to move any excess waiver amounts to the account defined for excesses.
 - Waive Percentage** If only a percentage of a fee is to be waived, enter that percentage in this field.
 - Item Type Group** Select an item type group if you want the option of attaching the waiver to a tuition group. When a waiver is attached to a tuition group, an item type group is necessary to limit which fees are affected. If the waiver is attached to a term fee, class, course, or course list fee, the program does not consider the item type group because the waiver is attached at a more specific level.
-
- Note.** The Item Type Group field is available only if Waiver Percentage or Waiver Offset is selected as the method of calculating the waiver.
-
- Amount/Unit** If the waiver is based on the amount of units in a student's course load, enter the per unit amount.
 - Flat Amount** You can waive a flat amount for students who meet the criteria. If you select this option, do not complete the Waive Percentage and Waiver Offset fields.

Waiver Offset	Enter an amount the students potentially pay themselves. For example, you might waive all tuition fees for employees, but want them to pay at least 100 USD. Enter <i>100</i> in this field, and the system reduces the calculated waiver by 100 USD.
	Note. Waiver Offset cannot be used in conjunction with the Waive Percentage, Amount/Unit, or Flat Amount option. You can use Waiver Offset with the Maximum Amount option to limit the total amount of the waiver. Also, if the waiver is attached to a tuition group, the Item Type Group field must be populated.
Maximum Amount	Enter the maximum amount that can be waived for a student.
Waive Tax	Select to control whether the waiver adjusts taxes that are associated with a charge. Selecting this option does not increase the amount of the waiver, but distributes it proportionately across the charge and tax. When you select this option, the Tax Waiver Account Type and Tax Waiver Item Type fields become available.
Increase Waiver for Tax	Select to add the amount of the tax to the waiver. When selected, this option can cause the total waiver to exceed the maximum amount limits.
Tax Waiver Account Type	Enter an account type for the waived tax. The default value is the same as for the waiver account type, but you can override it.
Tax Waiver Item Type	Enter an item type for the waived tax. The default value is the same as for the waiver item type, but you can override it.

Defining Waiver Groups

Access the Waiver Groups page (Set Up SACR, Product Related, Student Financials, Course and Class Fees, Waiver Groups).

Waiver Groups

SetID: PSUNV **Waiver Group:** EQUATN_GRP

***Description:**

***Effective Date:** ***Status:** + -

Customize | Find | View All | First Last

*Waiver Code	Description	+ -
FG1	First Generation Waiver #1	+ -
HNR50	Honors Waivers 50%	+ -

Waiver Groups page

Waiver Code Add a waiver to the waiver group.

Creating Course Lists

To set up course lists, use the Course Lists component (CRSE_LIST_PANEL).

Course lists represent a group of linked courses. You can assign a course fee to a course list rather than attaching the fee to specific courses. Course lists can also be used with third-party contracts to control what courses are covered by the sponsor contract.

Page Used to Create Course Lists

<i>Page Name</i>	<i>Definition Name</i>	<i>Navigation</i>	<i>Usage</i>
Course Lists	CRSE_LIST_SF	Set Up SACR, Product Related, Student Financials, Course and Class Fees, Course Lists	Define course lists.

Defining Course Lists

Access the Course Lists page (Set Up SACR, Product Related, Student Financials, Course and Class Fees, Course Lists).

Course Lists

SetID: PSUNV **Course List:** 000000008

Find | View All First 1 of 1 Last

***Effective Date:** 06/01/1998 ***Status:** Active

***Description:** Math Course for TP Contract

Short Description: Math Crse

Long Description: Math Course for TP Contract

Find | View 1 First 1-2 of 2 Last

***Sequence Number:** 1 **Wildcard Indicator**

Institution: PSUNV PeopleSoft University

Academic Group: LBART College of Liberal Arts

Subject: MATH Mathematics

***Sequence Number:** 2 **Wildcard Indicator**

Course ID: 001061 Elementary Accounting

Course Lists page

Note. The effective date of the course list cannot precede the effective date of the course catalog from which you select courses.

- Sequence Number** Enter a sequence number for the class. Sequence numbers are important for writing course information to the table and cannot be duplicated. The sequence number does not affect the payment order.
- Wildcard Indicator** Select if you are creating a list of courses with like characteristics. When you select this option, the Institution, Acad Group, and Subject fields replace the Course ID field.
- Institution** Select the appropriate institution. This field is available only if the WildCard Indicator check box is selected.
- Academic Group** Select the academic group in which the courses reside. This field is available only if the WildCard Indicator check box is selected.
- Subject** Select the subject area for the courses. This field is available only if the WildCard Indicator check box is selected.
- Course ID** To create a course list using one or more specific courses, enter a course ID.

Chapter 6

Setting Up Fees and Tuition Groups

You charge fees to students for everything from application to graduation. You define each of those fees and establish rules for how they will be applied and to whom. Tuition groups enable you to assess fees to large groups of students who share attributes.

This chapter discusses how to:

- Set up fee classes.
- Define minimum and maximum fees.
- Set up application fees.
- Set up deposit fees and deposit due dates.
- Set up term fee codes.
- Set up course fees and class fees.
- Define optional fees.
- Set up transaction fees.
- Set up course list fees.
- Set up tuition groups.

Setting Up Fee Classes

To set up fee classes, use the Fee Classes component (FEE_CLASS).

You use fee classes for reporting purposes and grouping fees. For example, you might have a variety of item types that you want to organize under the fee class of Mandatory Tuition and Fees. That way, you can produce a report that shows all mandatory fee item types. Fee class codes are required for term fee setup.

Page Used to Set Up Fee Classes

<i>Page Name</i>	<i>Definition Name</i>	<i>Navigation</i>	<i>Usage</i>
Fee Classes	FEE_CLASS_TBL	Set Up SACR, Product Related, Student Financials, Tuition and Fees, Fee Classes	Set up fee classes.

Defining Minimum and Maximum Fees

To set up minimum and maximum fees, use the Minimum / Maximum Fees component (MIN_MAX_FEE_PANEL).

This section provides an overview of minimum and maximum fees and discusses how to:

- Define minimum and maximum fees for billing careers and academic years.
- Define minimum and maximum fees for terms and sessions.
- Define minimum and maximum fees for admit terms.

Understanding Minimum and Maximum Fees

You can define a minimum and maximum range for all of your fees and charges. You can set fee ranges for sessions, terms, academic years, and billing careers so that they build off one another. Be sure to define enough minimum/maximum fee codes to meet all your needs. For example, a minimum/maximum fee code for application fees might require a career limit of 100 USD while a code for term fees might require a career limit of 60,000 USD.

Pages Used to Define Minimum and Maximum Fees

<i>Page Name</i>	<i>Definition Name</i>	<i>Navigation</i>	<i>Usage</i>
Minimum/Maximum Fees 1	MIN_MAX_FEE	Set Up SACR, Product Related, Student Financials, Tuition and Fees, Minimum / Maximum Fees, Minimum/Maximum Fees 1	Define minimum and maximum fees for billing careers and academic years.
Minimum/Maximum Fees 2	MIN_MAX_FEE_2	Set Up SACR, Product Related, Student Financials, Tuition and Fees, Minimum / Maximum Fees, Minimum / Maximum Fees 2	Define minimum and maximum fees for terms and sessions.

Page Name	Definition Name	Navigation	Usage
Minimum/Maximum Fees 3	MAX_FEE_ADM_TERM	Set Up SACR, Product Related, Student Financials, Tuition and Fees, Minimum / Maximum Fees, Minimum / Maximum Fees 3	Define minimum and maximum fees for admit terms.

Defining Minimum and Maximum Fees for Billing Careers and Academic Years

Access the Minimum/Maximum Fees 1 page (Set Up SACR, Product Related, Student Financials, Tuition and Fees, Minimum / Maximum Fees, Minimum/Maximum Fees 1).

Minimum / Maximum Fees 1		Minimum / Maximum Fees 2		Minimum / Maximum Fees 3	
SetID:	PSUNV	Fee Code:	ACTFEE		
*Description:	Student Activity Fee				
Billing Career Minimum / Maximum Find View All First 1 of 1 Last					
*Institution:	PSUNV PeopleSoft University	*Career:	UGRD Undergraduate		
Minimum Amount:	56,000.00	Maximum Amount:	95,000.00	USD	
Maximum Tuition	5,000.000				
Residency:					
Academic Year Minimum / Maximum Find View All First 1 of 1 Last					
*Academic Year:	2004				
Minimum Amount:	13,500.00	Maximum Amount:	21,000.00	USD	

Minimum/Maximum Fees 1 page

Billing Career Minimum/Maximum

The system, by default, sets the student's billing career to the academic career in the student's career term record. The tuition calculation process uses the student's billing career to calculate the student's tuition.

If the student is active in more than one academic career in the same term, you might want to consolidate tuition calculation and billing under a single academic career. If so, then point the billing career for all of the student's career term records to the same academic career. For example, a student might be enrolled in a term as both a graduate student and an undergraduate student. If you wanted to consolidate tuition calculation to just the undergraduate career, you would select undergraduate as the billing career for both the student's undergraduate term record and graduate term record.

If you decide to use a single billing career for all of a student's academic careers within a term, note that to perform a term or session withdrawal, the student must be enrolled in at least one class within the academic career that you select as the student's billing career. Otherwise, the term withdrawal and session withdrawal processes halt processing and instruct you to change the student's billing career to an academic career in which the student has enrollments for the term.

- Institution** Enter the institution that includes the career that you are defining.
- Minimum Amount and Maximum Amount** Enter the minimum and the maximum amount to charge for the billing career.
- Maximum Tuition Residency** Enter the maximum tuition residency for this career. This number represents the level of tuition residency, not the monetary amount that is charged.

Academic Year Minimum/Maximum

Enter an academic year and specify its minimum and maximum fees.

See Also

[Chapter 6, "Setting Up Fees and Tuition Groups," Defining Tuition Residency Minimums and Maximums, page 202](#)

Defining Minimum and Maximum Fees for Terms and Sessions

Access the Minimum/Maximum Fees 2 page (Set Up SACR, Product Related, Student Financials, Tuition and Fees, Minimum / Maximum Fees, Minimum/Maximum Fees 2).

Minimum / Maximum Fees 1		Minimum / Maximum Fees 2		Minimum / Maximum Fees 3	
SetID:	PSUNV	Fee Code:	ACTFEE	Student Activity Fee	
Term Minimum / Maximum				Find View All First 1 of 1 Last	
*Term:		Minimum Amount		Maximum Amount	
0530 2004 Fall		6,750.00		10,500.00	USD
Session Minimum / Maximum				Customize Find View All First 1 of 1 Last	
*Session		Minimum Amount		Maximum Amount	
Regular Academic Session		6,750.00		10,500.00	USD

Minimum/Maximum Fees 2 page

Term Minimum/Maximum

Enter an academic term and its minimum and maximum fees.

Session Minimum/Maximum

Enter an academic session and its minimum and maximum fees.

Defining Minimum and Maximum Fees for Admit Terms

Access the Minimum/Maximum Fees 3 page (Set Up SACR, Product Related, Student Financials, Tuition and Fees, Minimum / Maximum Fees, Minimum/Maximum Fees 3).

Minimum / Maximum Fees 1		Minimum / Maximum Fees 2		Minimum / Maximum Fees 3	
SetID:	PSUNV	Fee Code:	ACTFEE	Student Activity Fee	
Admit Term Maximum		Customize Find View All First 1 of 1 Last			
*Admit Term	Maximum Amount				
0530	2004 Fall	10,500.00	USD		

Minimum/Maximum Fees 3 page

Enter an admit term and its maximum amount.

Setting Up Application Fees

To set up application fees, use the Application Fees component (APPLICATION_FEES).

This section provides an overview of application fees and discusses how to:

- Define application fees.
- Define application fee item types.
- Define application sub fees.

Understanding Application Fees

You must define the rules that your institution uses to assess application fees. Each application fee code that you define represents one or more individual fee charges (sub fees).

A one-to-one relationship exists between an application fee and an application center. You can define only one application fee for an application center. However, an application fee can have multiple sub fees. For example, you could charge different sub fees based on a student's admit type. Then, each admit type (for example, new students, transfer students, or readmitted students) would have its own application sub fee.

Each application fee code requires the definition of one or more sub fees that make up the charge. You can set up sub fees so that they are cumulative or mutually exclusive. You can also define a combination of cumulative and mutually exclusive fees. For example, you can define an application fee code with two sub fees: one sub fee charges students a fee of 50 USD to apply over the web and another sub fee charges students a fee of 75 USD to apply through the mail. While students can apply using both methods, it is unlikely that they would do so.

See Also

PeopleSoft Enterprise Recruiting and Admissions 9.0 PeopleBook, "Building Your Recruiting Structure," Setting Up Application Processing Centers

Pages Used to Set Up Application Fees

Page Name	Definition Name	Navigation	Usage
Application Fees	APP_FEE_TABLE	Set Up SACR, Product Related, Student Financials, Admission Fees, Application Fees	Define application fees.
Application Fee Item Types	APP_FEE_TBL_S1	Click the Application Fee Item Types link on the Application Fees page.	Define application fee item types.
Application Sub Fees	APP_SUBFEE_TABLE	Set Up SACR, Product Related, Student Financials, Admission Fees, Application Fees, Application Sub Fees	Define application sub fees.

Defining Application Fees

Access the Application Fees page (Set Up SACR, Product Related, Student Financials, Admission Fees, Application Fees, Application Sub-Fees).

Application Fees
Application Sub Fees

SetID: PSUNV **Fee Code:** APP2

***Description:**

***Fee Class:** Copy Application Fee

Find | View All
First 1 of 6 Last

Effective Term: + -

***Maximum Amount:** USD

Minimum/Maximum Fee Code:

Post to SF from App [Application Fee Item Types](#)

Update App from SF

Update App Fee Status From:

Application Fees page

Fee Class	Select a fee class. Fee Class is a descriptive field that is used for reporting purposes only.
Copy Application Fee	Click to copy an application fee and its sub fees from one term to the next.
Effective Term	Select a term for the application fee. You must define an application fee for each term.
Maximum Amount	Enter the maximum fee amount, including all sub fees, for a single application.
Minimum/Maximum Fee Code	Select an optional minimum/maximum fee code.
Post to SF from App (post to Student Financials from application)	Select to post the application fee to Student Financials as it is created. Do not post the application fee to the student's account when the payment is recorded. When you select this option, the Application Fee Item Types link appears. Click it to open the Application Fee Item Types page. The first time that you select the check box, the page opens automatically.
Update App from SF (update application from Student Financials)	Select this option to automatically update the student's application status from Student Financials. When you select this option, the Update Application Fee Status from and to fields appear.
Update Application Fee Status from and to	Select the status that you want the system to change from and to. The options for both fields are <i>Pending</i> , <i>Received</i> , and <i>Waived</i> .

Note. If the student's original status is different than the option you select, the system does not change it. Consult with your admissions staff to determine the correct settings.

See Also

[Chapter 6, "Setting Up Fees and Tuition Groups," Defining Minimum and Maximum Fees, page 178](#)

Defining Application Fee Item Types

Access the Application Fee Item Types page (click the Application Fee Item Types link on the Application Fees page).

Application Fees

Application Fee Item Types

Account to Post: Application Fees

Charge Item Type: Undergraduate Application Fee

Paid Item Type: Payment - All terms

Waiver Item Type: Application Waiver

Due Date Code:

Track Payment Method

*Tender Category	*Item Type		
Credit Card	310000000300	Credit Card - Application Cent	+ -
Check	300000000002	Check	+ -
Cash	300000000001	Cash Payment	+ -

Application Fee Item Types page

- Account To Post** Enter the account type that you created for application fees.

- Charge Item Type** Enter the charge item type that you created for application fees. If you want to bill the student and post only the charge and not the payment, leave the Paid Item Type and Waive Item Type fields blank.

- Paid Item Type** Enter the payment item type that you created for application fees.

- Waiver Item Type** Enter the waiver item type that you created for waiving application fees.

- Due Date Code** Select a code that determines when the application fee is due.

Note. The billing and due calendar must be set up with a pivot date of application date for a due date code to be available.

- Track Payment Method** Select to track the tender that is used to pay this fee for reconciliation purposes. This option is designed for real-time application processing where students walk in with their applications and have them processed at that time. When this option is selected, the Tender Category and Item Type fields become available.

- Tender Category and Item Type** Attach a tender category and item type. If you elect to track the payment method, you must attach the tender category and item type for each type of tender that you want to accept. If you do not include a specific tender category, it cannot be accepted in payment for application fees under this application fee code. Using multiple tender categories also enables students to pay their application fees with a combination of tenders.

Defining Application Sub Fees

Access the Application Sub Fees page (Set Up SACR, Product Related, Student Financials, Admission Fees, Application Fees, Application Sub Fees).

The screenshot displays the 'Application Sub Fees' configuration page. At the top, there are tabs for 'Application Fees' and 'Application Sub Fees'. The main form is organized into several sections:

- Header:** SetID: PSUNV, Fee Code: APP2 Undergraduate Application Fees. Navigation: Find | View All, First 1 of 6 Last.
- Effective Term:** 0505 2003 Fall, Max Amt: 135.00 USD.
- Sub Fees Section:**
 - *Sub Fee Code: APP2
 - *Calculation Option: All Matching Rows
 - *Maximum Amount: 20.00 USD
 - Checkboxes: Career Specific, Program Specific, Plan Specific, Sub-Plan Specific, Campus Specific, Appl Method Specific, Fee Type Specific, Admit Type Specific.
- Bottom Section:**
 - Institution: PSUNV (PSU)
 - Academic Program: LAU (Lib Arts)
 - Sub-Plan: (empty)
 - Application Method: Web Appl
 - Admit Type: FYR (First-Year)
 - Career: UGRD (Undergrad)
 - Academic Plan: BIOLBS (Biol BS)
 - Campus: MAIN (Main)
 - Fee Type: Standard
 - Flat Amount: 20.00 USD

Application Sub Fees page

Sub Fee Code Enter a code for the sub fee.

Calculation Option Select a calculation option. Values are:

All Matching Rows: Select to sum multiple sub fees that match the student's characteristics. For example, if you defined a sub fee of 60 USD for undergraduate students that submitted applications using the web and a sub fee of 40 USD for international undergraduate student applications, the system would charge 100 USD to students who meet both of these conditions.

Most Descriptive Row: Select to charge students the sub fee that most closely matches the application that they submitted. For example, if you charge a sub fee of 55 USD for undergraduate applications that were submitted by a service, and a 60 USD sub fee for undergraduate applications that were submitted using the internet, an undergraduate student that submitted an application using the internet would be charged 60 USD. The most descriptive row option works best for sub fees, such as the one in this example, that are mutually exclusive, as in this example. The system charges the first application sub fee that it recognizes. No way is available to prioritize which fee is charged.

Maximum Amount

Enter the maximum amount for this sub fee.

Note. The maximum amount of the sub fee cannot exceed the maximum amount of the application fee.

Sub Fees

Use the check boxes on this page to select the criteria for the system to use when calculating the sub fee. When you select a check box, a corresponding field becomes available in the lower part of the page. Use this field to select a specific value for the calculation criterion. The fewer criteria that you select, the more broadly the system applies the fee.

Setting Up Deposit Fees and Deposit Due Dates

To set up deposit fees and deposit due dates, use the Deposit Fees component (DEPOSIT_FEES).

Some institutions require a deposit fee from accepted applicants to reserve space in an academic program.

This section discusses how to:

- Define deposit fees.
- Define deposit fee due dates.
- Define status changes resulting from deposits.

Pages Used to Set Up Deposit Fees and Deposit Due Dates

<i>Page Name</i>	<i>Definition Name</i>	<i>Navigation</i>	<i>Usage</i>
Deposit Fees	DEP_FEE_TABLE	Set Up SACR, Product Related, Student Financials, Admission Fees, Deposit Fees	Define deposit fees.
Deposit Due Dates	DEP_DUE_DT_TABLE	Set Up SACR, Product Related, Student Financials, Admission Fees, Deposit Fees, Deposit Due Dates	Define deposit fee due dates.
Status Update	DEP_DUE_DT_SP	Click the Status Update link on the Deposit Due Dates page.	Define status changes resulting from deposits.

Defining Deposit Fees

Access the Deposit Fees page (Set Up SACR, Product Related, Student Financials, Admission Fees, Deposit Fees, Deposit Due Dates).

The screenshot shows the 'Deposit Fees' page with the following details:

- SetID:** PSUNV
- Deposit Fee Code:** STD
- *Status:** Active
- *Description:** Standard Deposit Fees
- Short Description:** Standard
- *Multiple Deposit:** All Programs Deposit
- *Admit Term:** 0540 (2005 Spring)
- *Institution:** PSUNV (PeopleSoft University)
- *Career:** BUSN (Graduate Business)
- Program:** MBA (Masters of Business Admin)
- Deposit Amount:** 750.00 USD
- No Deposit Required

Deposit Fees page

Delete Deposit Fee Click to delete the deposit fee code.

Copy Deposit Fee Click to copy the deposit fee to a new term.

Multiple Deposits Specify how to calculate deposits for students who are enrolled in more than one program.

All Programs Deposit: Select to charge students a deposit fee for each program into which they are admitted.

First Program In: Select to calculate a deposit fee for the First Program *per* application number. If one application exists, and the student is admitted to multiple programs on that application, one deposit is calculated (as long as the admit rows are processed sequentially) for the first program to which the student is admitted. If more than one application exists, and the student is admitted to multiple programs on those applications, then a deposit is calculated for the first program admitted on *each* application.

Admit Term Enter the admit term to which the deposit fee applies.

Specifying Deposit Fees by Institution, Career, and Program

Select the institution, academic career, and academic program to which the deposit fee applies along with the deposit amount.

No Deposit Required

Select to exclude the deposit fee all together. For example, if your institution recruits undergraduate Fine Arts students and admits them without requiring any deposit, define a row and select the option. If you specify a deposit amount of zero, a zero charge appears on the student's account. If you select this check box, no charge appears at all.

Defining Deposit Fee Due Dates

Access the Deposit Due Dates page (Set Up SACR, Product Related, Student Financials, Admission Fees, Deposit Fees, Deposit Due Dates).

Deposit Due Dates page

- Pivot Date** Select either *Admit Date* or *Application Date* as the pivot date that determines the starting point for calculating the deposit fee due date.
- From Date and To Date** Enter the range of admission dates to which the deposit fee due date applies.
- Use** Select either *Due Days* or *Due Date* for calculating the due date. The corresponding field becomes available.
- Due Days** Enter the number of days after the pivot date that a deposit fee is due.
- Due Date** Enter the specific deposit fee due date.
- Due % (due percentage)** Enter the percentage of the deposit that is due. You must define enough rows to total 100 percent.

Update Application from SF (update application from Student Financials)

Select to automatically update the student's academic program status when you post the deposit fee.

Status Update

If you select the Update Application from SF option, you must specify how students' program statuses are updated. Click this link to access the Status Update page.

Defining Status Changes Resulting from Deposits

Access the Status Update page (click the Status Update link on the Deposit Due Dates page).

Status Update page

Previous Status Enter the academic program status of the students prior to posting a deposit fee.

New

Status Enter the academic program status that the system assigns to students when it posts their deposit fees.

Program Action Enter the program action that initiates the status change.

Action Reason Enter the reason for the program action that you select.

Create Student Select to automatically matriculate students into an academic program upon receipt of the deposit.

Bill for Deposit Select to generate a bill for any remaining deposit balance.

Setting Up Term Fee Codes

To set up term fee codes, use the Term Fees component (TERM_FEE_PANEL) and the Copy Term Fees component (RUN_SFCPTMFE).

This section provides an overview of term fee codes and discusses how to:

- Define term fee codes.
- Define term and session fees.
- Define term sub fee codes.
- Define term sub fees.
- Define tuition residency minimums and maximums.
- Copy term fees to subsequent terms.

Understanding Term Fee Codes

Term fee codes are the most generalized method of establishing rates for tuition and fees. Each term fee code comprises one or more term fee definitions. Each term fee definition comprises one or more term sub fee codes. And each term sub fee code comprises one or more term sub fees. This multilevel structure provides flexibility and convenience.

By using different fee triggers and calculation methods at the lower levels, one term fee code can control how tuition is calculated for a wide range of unique student situations. Another term fee code can do the same for room and board combinations. Take the time to learn how term fee codes work and how you can use them to solve your most complex tuition calculation needs.

Term Sub Fee Codes

You can define one or more sub fee codes for a given term fee. Sub fee codes provide flexibility in how you show charges on an account, how you calculate charges, and how you print charges on a bill. For example, if your institution prefers to show just the *bottom line* charge for tuition and fees rather than the detail of these fees, you can use sub fees to define all the fees that compose a tuition and fees charge, and one charge appears on an account. If your institution prefers to show the detail of each charge that composes tuition and fees, you can create individual term fees for each of these charges and break down tuition and fees into detail on an account.

Term Fee Copying

After you define your term fees for one term, you can copy those same fees forward to subsequent terms. This enables you to set term fees at the start of each term; you do not have to redefine your term fee schedule with each new term, which reduces data entry time.

Pages Used to Set Up Term Fee Codes

<i>Page Name</i>	<i>Definition Name</i>	<i>Navigation</i>	<i>Usage</i>
Term Fee Codes	TERM_FEE_CD_TABLE	Set Up SACR, Product Related, Student Financials, Tuition and Fees, Term Fees, Term Fee Codes	Define term fee codes.
Term Fees	TERM_FEE_TABLE	Set Up SACR, Product Related, Student Financials, Tuition and Fees, Term Fees	Define term and session fees.
Term Sub Fee Codes	TERM_SF_CODE_TABLE	Set Up SACR, Product Related, Student Financials, Tuition and Fees, Term Fees, Term Sub Fee Codes	Define term sub fee codes.
Term Sub Fees	TERM_SUBFEE_TABLE	Set Up SACR, Product Related, Student Financials, Tuition and Fees, Term Fees, Term Sub Fees	Define term sub fees.
Term Fee Residency	TERM_FEE_RES_TABLE	Set Up SACR, Product Related, Student Financials, Tuition and Fees, Term Fees, Term Fee Residency	Define tuition residency minimum and maximum amounts.
Copy Term Fees	RUNCTL_SFCPTMFE	Set Up SACR, Product Related, Student Financials, Tuition and Fees, Copy Term Fees	Copy term fees to subsequent terms.

Defining Term Fee Codes

Access the Term Fee Codes page (Set Up SACR, Product Related, Student Financials, Tuition and Fees, Term Fees, Term Fee Codes).

Term Fee Codes		Term Fees	Term Sub Fee Codes	Term Sub Fees	Term Fee Residency
SetID:	PSUNV	Fee Code:	UNDGRD	Delete Term Fee	
*Status:	Active				
*Description:	Undergraduate Term Fees				
Long Description:	Undergraduate Term Fees				
*Charge By:	Term				
*Use:	Bill Units	<input checked="" type="checkbox"/> Use Anticipated Units if enrollment exists			
*Fee Class:	MAN Tuition and Mandatory Fees				

Term Fee Codes page

Delete Term Fee

Click to delete the term fee.

Note. You cannot delete a term fee that is in use by an active tuition group.

Charge By

Specify how the fee code calculates fees. Values are:

Class: Select to reflect charges for the particular term fee that is relative to each class in the student's account information. The system automatically makes available the information that is necessary to use course lists with third-party contracts.

Session: Select to sum charges for all classes that are taken within a particular session in the student's account information. If you select this option and want to use course lists with third-party contracts, you must also enable Track Class Pricing (on the Term Fees page).

Term: Select to sum charges for all classes that are taken with a particular term in the student's account information. If you select this option and want to use course lists with third-party contracts, you must also enable Track Class Pricing (on the Term Fees page).

Use

Select the basis for calculating the fee. Values are:

Anti Units (anticipated units): Select to calculate fees based on the number of units in which students typically enroll within a certain academic program. For example, if Fine Arts freshmen are expected to enroll in 15 units, the system calculates the fee on that basis for all freshmen.

Bill Units: Select to charge fees based on the actual number of units in which the student is enrolled versus anticipated units.

Use Anticipated Units if enrollment exists

Select to calculate fees based on anticipated units even if actual enrollment information is available. If you do not select this check box and you are calculating fees using anticipated units, the system uses actual enrollment information when it is available.

Fee Class Select a fee class to use for reporting purposes.

See Also

[Chapter 6, "Setting Up Fees and Tuition Groups," Setting Up Course List Fees, page 224](#)

[Chapter 18, "Administering Payment Plans," Administering Third-Party Contracts, page 479](#)

Defining Term and Session Fees

Access the Term Fees page (Set Up SACR, Product Related, Student Financials, Tuition and Fees, Term Fees).

Term Fee Codes | **Term Fees** | Term Sub Fee Codes | Term Sub Fees | Term Fee Residency

SetID: PSUNV Fee Code: UNDGRD Undergraduate Term Fees Copy Term Fee

Term / Session Find | View All | First 1 of 9 Last

*Term: 0570 2006 Fall Session: + -

*Account Type: TUT Tuition

*Item Type: 100000000004 Tuition

Anticipated Item Type:

Fee Trigger: Use Criteria Use Equation

UGRD Undergraduate

*Adjustment Code: STD Standard Adjustment

*Due Date Code: STD Standard

Minimum/Maximum Fee Code:

Minimum Amount: 0.00 Maximum Amount: 9,999,999.00 USD

Anticipated Stop Date:

Charge for Wait Listed Class Track Class pricing

Exclude Classes w/ HECS Status

Term Fees page

Copy Term Fee Click to copy the term fee to a new term.

Term Select the term to which the term fee applies.

Session If you defined the term fee code to charge by session on the Term Fee Codes page, select the session to which the term fee applies.

Account Type and Item Type Select an account type and item type for the term fee.

Anticipated Item Type	<p>If the system calculates the term fee code using anticipated units, this field is required. Select a different item type from the one you selected in the Item Type field to distinguish between charges that are based on anticipated enrollment and charges that are based on actual enrollment.</p> <hr/> <p>Note. If you set up multiple terms, ensure that you specify an anticipated item type for each term.</p> <hr/>
Fee Trigger	<p>To select an optional fee trigger that limits the application of the term fee to specific students, click either the Use Criteria option or the Use Equation option, and then select the predefined criteria or equation from the lookup.</p> <p>See <i>PeopleSoft Enterprise Campus Solutions 9.0 Application Fundamentals PeopleBook</i>, "Working with Equation Engine."</p>
Adjustment Code	<p>Enter the adjustment code (calendar) that governs this fee. This code determines the refund amount for students who drop classes.</p> <hr/> <p>Note. This adjustment code is used only for class drops. The adjustment code for withdrawal is attached to the tuition group.</p> <hr/>
Due Date Code	Select a due date code (calendar) to define when the fee is due and payable.
Minimum/Maximum Fee Code	Enter an optional minimum/maximum fee code to assign predefined limits to the term fee.
Minimum Amount	Enter a minimum charge amount that is unique to this term fee.
Maximum Amount	Enter a maximum charge amount that is unique to this term fee.
Anticipated Stop Date	This field becomes available when the system calculates fees using anticipated units. Enter a date after which the system no longer uses anticipated units. At this point, the system calculates the term fee using actual enrollment (billing) units. If the student has not enrolled in classes by the date specified, the system calculates fees using zero units. If so defined, minimum charges could still apply.
Charge for Wait Listed Class	Select to charge the term fee for students who are on a waiting list for a class.

Track Class Pricing Select to track revenue on a class-specific basis, thereby allocating revenue to specific departments. For example, a student pays a term fee of 2,000.00 USD and is enrolled in four classes of equal units: Physics 150, Calculus 31, Art 111, and Philosophy 101. Breaking down the fee by class yields revenue of 500.00 USD per class. Using revenue tracking by class, you can allocate the revenue from Physics 150 to the Physics Department, the revenue from Calculus 31 to the Math Department, the revenue from Art 111 to the Art Department, and the revenue from Philosophy 101 to the College of Liberal Arts.

Note. To accurately track revenue by class, you must set up your item types and classes appropriately in addition to selecting this check box.

See *PeopleSoft Enterprise Student Records 9.0 PeopleBook*, "Managing the Schedule of Classes."

Exclude Classes w/HECS Status(exclude classes with Higher Education Contribution Scheme status)(AUS) Select this option so that students are not charged twice for the same class if they are under multiple loan programs.

See Also

[Chapter 5, "Setting Up Tuition Controls, Criteria, Equations, and Waivers," Establishing Criteria for Tuition Groups and Fee Triggers, page 158](#)

[Chapter 6, "Setting Up Fees and Tuition Groups," Defining Minimum and Maximum Fees, page 178](#)

Defining Term Sub Fee Codes

Access the Term Sub Fee Codes page (Set Up SACR, Product Related, Student Financials, Tuition and Fees, Term Fees, Term Sub Fee Codes).

Term Sub Fee Codes page

Track Sub Fees Select to break down charges by the individual sub fees within the sub fee code . When the check box is cleared, the system sums all sub fee charges.

Sub Fee Code Enter the sub fee code that you are defining.

Calculation Option 1 and Calculation Option 2

To charge students the maximum fees, set the Calculation Option 1 field to *All Matching Rows* and the Calculation Option 2 field to *Against All Enrollment Units*. To charge students the minimum fees, set the Calculation Option 1 field to *Most Descriptive Row* and the Calculation Option 2 field to *Against Meet Criteria Units*.

Warning! Values for these fields are delivered with your system as translate values. Do not modify these values in any way. Any modifications to these values will require a substantial programming effort.

Calculation Option 1 This option determines who is charged a term sub fee. Values are:

All Matching Rows: The system assesses the term sub fee against all criteria that match the check box selections that you select at the bottom of the page: Career Specific, Group Specific, Subject Specific, Campus Specific, Location Specific, and Instruction Specific. This is the default value.

Most Descriptive Row: The system charges the term sub fee for criteria that most closely match the check box options that you select at the bottom of this page. If you selected the *Most Descriptive Row* value for Calculation Option 1, select the appropriate specific option: Career Specific, Group Specific, Subject Specific, Campus Specific, Location Specific, or Instruction Mode Specific.

Calculation Option 2 Determines how the system calculates the term sub fee. Values are:

Against All Enrollment Units: The system charges the students (identified in the Calculation Option 1 field) the term sub fee against all the units in their class load. This is the default value.

Against Meet Criteria Units: The system charges the students the term sub fee against only the courses they are taking that match the criteria that was selected in Calculation Option 1.

Minimum Amount Set an optional minimum amount for the term sub fee.

Maximum Amount Set an optional maximum amount for the term sub fee.

Matching Criteria

If you select *Most Descriptive Row for Calc Option 1*, or *Against Meet Criteria Units in Calc Option 2*, or both, you must define the specific criteria that the courses must match. The following check boxes enable you to control the application of term sub fees by specifying class characteristics. For example, you might have a class for which you charge 350.00 USD per unit if it is taught in a classroom by a professor, and 275.00 USD per unit if the class is an independent study using videotaped lectures. By selecting the Instruction Mode Specific check box, you can define two term sub fees under a single sub fee code. For students taking the class with a professor, the system charges 350.00 USD per unit. For students taking the class as an independent study, the system charges 275.00 USD.

Career Specific Select to match classes by academic career.

Group Specific Select to match classes by academic group.

Subject Specific Select to match classes by academic subject area.

Campus Specific Select to match classes by campus.

Location Specific Select to match classes by class location specification.

Instruction Mode Specific Select to match classes by instruction mode.

Program Specific If Program Specific is selected, the Term Sub Fees page allows the user to select the academic program that this fee is intended for.

(AUS) Cohort Year Specific Select to specify the cohort year on the Term Sub Fees page.

Note. The Cohort Year field is available on this page only if the institution has selected the Australia functionality in their academic structure. The value in the Institution field is used to determine whether the Australia functionality was selected in the academic structure (not the setID).

Defining Term Sub Fees

Access the Term Sub Fees page (Set Up SACR, Product Related, Student Financials, Tuition and Fees, Term Fees, Term Sub Fees).

Term Sub Fees page

Audit Rate Specified and Audit Calculated Separately

Two options determine how the system assesses charges for audited classes: Audit Rate Specified and Audit Calculated Separately.

Audit Rate Specified Select to use a special rate for audited classes. If you select this option, the tuition calculation process uses the audit rate that you have defined. If the check box is cleared, the system applies regular rates to audited classes.

When you select this check box, the Amount/Unit (Audit) and Flat Amount (Audit) fields become available.

Audit Calculated Separately Select to calculate audited classes separately from graded classes. If you select this check box, the system charges students only the audit rate for the class. If you clear this check box, and you select the Audit Rate Specified check box, the system charges students the audit rate in addition to the regular term fee.

Term Sub Fee Calculation Specifications

Use the following fields to more narrowly target the application of the fee. The fewer fields that you define, the more broadly the system applies the fee. These fields are available only if the corresponding options are selected on the Term Sub Fee Codes page.

Institution	Select the institution that uses the term sub fee.
Career	If you selected the Career Specific check box on the Term Sub Fee Codes page, select an academic career.
Academic Group	If you selected the Group Specific check box on the Term Sub Fee Codes page, select an academic group.
Subject	If you selected the Subject Specific check box on the Term Sub Fee Codes page, select an academic subject area.
Campus	If you selected the Campus Specific check box on the Term Sub Fee Codes page, select a campus.
Location	If you selected the Location Specific check box on the Term Sub Fee Codes page, select a location.
Mode	If you selected the Instruction Mode Specific check box on the Term Sub Fee Codes page, select a mode.
Academic Program	If you selected the Program Specific check box on the Term Sub Fee Codes page, select an academic program. This is the academic program on the student's enrollment and not the student's primary academic program.
(AUS) Cohort Year	If the Cohort Year Specific check box was selected on the Term Sub Fee Codes page, then you can specify the cohort year here.

Note. This field is available on this page only if the institution has selected the Australia functionality in their academic structure. The value in the Institution field is used to determine whether the Australia functionality was selected in the academic structure (not the setID).

Fee Specifications

Using the following fields, you can control exactly how much to charge for the term sub fee. Fees can be based on academic units, a flat fee, a per-unit surcharge, a flat fee surcharge, or a combination of all four. The amounts that you enter are not independent of each other. Rather, they are summed. For example, if you establish an amount per unit of 250 USD and a flat amount of 300 USD, the system charges a student taking 15 units 4,050 USD (3,750 + 300 USD). If you specify an audit rate, the system also adds fees for audited to the total.

Unit From and To	Use the Unit From and To fields to define the range of units that are eligible for the term sub fee. The system does not charge the term sub fee for the number of units less than the number in the Units From field and greater than the number in the To field. Make sure that you set the range to cover all possibilities.
	Note. If the unit from value is set to zero, the system can calculate fees for students who are active in a term but not enrolled for classes. To prevent an incorrect calculation, set the unit from amount no lower than <i>0.10</i> .
Fee Amt Equation (fee amount equation)	Enter an optional equation that you have defined to calculate fees. Equations are an alternative method of calculating fees. If your fee structure is very complex, equations might be more efficient, because they can reduce term fee maintenance.
Amount/Unit	Enter the amount to charge per unit.
Flat Amount	Enter a flat amount to charge, regardless of the units taken.
Amount/Unit(Audit)	Enter the amount to charge per unit for audited classes.
Flat Amount(Audit)	Enter a flat amount to charge for audited classes, regardless of units taken.
Surcharge Effective Unit	To include a surcharge when students enroll for more than a specified number of academic units, enter the threshold number in this field. For example, to apply a surcharge to students who are enrolled in more than 15 units, enter <i>15</i> .
Amount/Unit (Surcharge) (amount per unit surcharge)	Enter a per unit surcharge for overload units.
Flat Amount (Surcharge)	Enter a flat amount charge for overload units.

Setting Up a Multitiered Tuition Term Sub Fee

Setting up a multitiered tuition fee schedule is easy using additional term sub fee definitions. In the following example, three term sub fees are defined to charge tuition for three different ranges of academic units:

- Students who take up to 12 units are charged a flat amount of 1,200 USD, plus 250 USD per unit (12 units = 4,200 USD).
- Students who take up to 15 units are charged a flat amount of 1,200 USD, plus 250 USD for the first 12 units, plus 225 USD per unit for the additional units (15 units = 4,875 USD).
- Students who take over 15 units are charged a flat amount of 1,200 USD plus 250 USD per unit for the first 12 units, plus 225 USD per unit for the next 3 units, plus 200 USD for each unit over 15.

Term Fee Codes		Term Fees		Term Sub Fee Codes		Term Sub Fees		Term Fee Residency	
SetID:	PSUNV	Fee Code:	SAMPLE Sample Term Fee Code						
Term / Session		Find View All First 1 of 1 Last							
Term:	2003 Fall	Session:							
<input checked="" type="checkbox"/> Audit Rate specified		<input checked="" type="checkbox"/> Audit calculated separately							
Sub Fees		Find View All First 1 of 1 Last							
Sub Fee Code:		SAMPLE							
		Find View 1 First 1-3 of 3 Last							
Institution:	PSUNV PSU	Career:	<input type="text"/>						
Academic Group:	<input type="text"/>	Subject:	<input type="text"/>						
Campus:	<input type="text"/>	Location:	<input type="text"/>						
Mode:	<input type="text"/>								
Unit From:	<input type="text"/> 0.10	To:	<input type="text"/> 12.00	Fee Amt Equation: <input type="text"/>					
Amount/Unit:	<input type="text"/> 250.00			Flat Amount:		<input type="text"/> 1,200.00			
Amount/Unit (Audit):	<input type="text"/> 125.00			Flat Amount (Audit):		<input type="text"/> 0.00			
Surcharge Effective Unit:	<input type="text"/> 0.00								
Amount/Unit (Surcharge):	<input type="text"/> 0.00			Flat Amount (Surcharge):		<input type="text"/> 0.00 USD			

Term Sub Fees page (1 of 2)

Institution:	PSUNV <input type="text"/> PSU	Career:	<input type="text"/>	<input type="button" value="+"/> <input type="button" value="-"/>
Academic Group:	<input type="text"/>	Subject:	<input type="text"/>	
Campus:	<input type="text"/>	Location:	<input type="text"/>	
Mode:	<input type="text"/>			
Unit From:	12.10 To: 15.00	Fee Amt Equation:	<input type="text"/>	<input type="button" value="Q"/>
Amount/Unit:	225.00	Flat Amount:	<input type="text"/> 0.00	
Amount/Unit (Audit):	<input type="text"/> 0.00	Flat Amount (Audit):	<input type="text"/> 0.00	
Surcharge Effective Unit:	<input type="text"/> 0.00			
Amount/Unit (Surcharge):	<input type="text"/> 0.00	Flat Amount (Surcharge):	<input type="text"/> 0.00	USD

Institution:	PSUNV <input type="text"/> PSU	Career:	<input type="text"/>	<input type="button" value="+"/> <input type="button" value="-"/>
Academic Group:	<input type="text"/>	Subject:	<input type="text"/>	
Campus:	<input type="text"/>	Location:	<input type="text"/>	
Mode:	<input type="text"/>			
Unit From:	15.10 To: 999.99	Fee Amt Equation:	<input type="text"/>	<input type="button" value="Q"/>
Amount/Unit:	200.00	Flat Amount:	<input type="text"/> 0.00	
Amount/Unit (Audit):	<input type="text"/> 0.00	Flat Amount (Audit):	<input type="text"/> 0.00	
Surcharge Effective Unit:	<input type="text"/> 0.00			
Amount/Unit (Surcharge):	<input type="text"/> 0.00	Flat Amount (Surcharge):	<input type="text"/> 0.00	USD

Term Sub Fees page (2 of 2)

Defining Tuition Residency Minimums and Maximums

Access the Term Fee Residency page (Set Up SACR, Product Related, Student Financials, Tuition and Fees, Term Fees, Term Fee Residency).

Term Fee Codes	Term Fees	Term Sub Fee Codes	Term Sub Fees	Term Fee Residency
SetID:	PSUNV	Fee Code:	UNDGRDUndergraduate Term Fees	
Term / Session		Find View All First 1 of 9 Last		
Term:	2006 Fall	Session:	Customize Find View All First 1-3 of 3 Last	
*Minimum Amount	*Maximum Amount	Tuition Residency		
<input type="text"/> 2,700.00	<input type="text"/> 3,499.99	<input type="text"/> 0.500	USD	<input type="button" value="+"/> <input type="button" value="-"/>
<input type="text"/> 3,500.00	<input type="text"/> 4,199.99	<input type="text"/> 0.500	USD	<input type="button" value="+"/> <input type="button" value="-"/>
<input type="text"/> 4,200.00	<input type="text"/> 99,999.00	<input type="text"/> 1.000	USD	<input type="button" value="+"/> <input type="button" value="-"/>

Term Fee Residency page

Minimum Amount and Maximum Amount Enter the minimum and maximum amounts that a student pays to reach each level of tuition residency.

Tuition Residency

If your institution has programs in which students do not have to pay for more than a specified number of terms at full-time equivalency rates, you can use tuition residency to automatically cap the fees. For example, you might offer a professional education program that can be completed with seven terms of full-time work. To attract students, you advertise a seven-term course of study for a specified amount of money. Enrolling students are placed in cohort groups, attend a structured series of classes, and pay a flat amount per term. Over the course of seven terms, some students inevitably will have scheduling conflicts with one or more classes and they will have to take them out of sequence. To accommodate these students, you allow them to take the classes the next time that they are offered at no additional charge. By using tuition residency functionality, you can automatically ensure that the students pay the full tuition and that the system does not accidentally charge them for the delayed classes.

See Also

[Chapter 6, "Setting Up Fees and Tuition Groups," Defining Minimum and Maximum Fees, page 178](#)

[Chapter 6, "Setting Up Fees and Tuition Groups," Setting Up Tuition Groups, page 227](#)

Copying Term Fees to Subsequent Terms

Access the Copy Term Fees page (Set Up SACR, Product Related, Student Financials, Tuition and Fees, Copy Term Fees).

Copy Term Fees

Run Control ID: 1 [Report Manager](#) [Process Monitor](#) Run

Parameters			
Copy Options:	Copy One Term Fee		
SetID:	PSUNV		
From Fee Code:	TF1	To Fee Code:	
From Term:	0530 2004 Fall	To Term:	0550 2005 Fall
From Session:		To Session:	

Copy Term Fees page

Copy Options	Select the copy options that you want to use: <hr/> Warning! Values for this field are delivered with your system as translate values. Do not modify these values in any way. Any modifications to these values will require a substantial programming effort. <hr/> <i>Copy All Term Fees:</i> Copies all the term fees in the source term to the target term. <i>Copy One Term Fee:</i> Enables you to copy a specific fee from one term to another or to rename a term fee definition within the same term. When you select this option, the From Fee Code and To Fee Code fields become available for use.
SetID	Select the setID to which the term fees are linked.
From Fee Code	Select the source fee code from the required From Fee Code field.
To Fee Code	Enter the name of the fee code in the To Fee Code field. To copy the fee code to a new term, you can use the same name. To rename the fee code definition, enter the new name.
From Term and To Term	Select the source term in the From Term field. Select the target term in the To Term field.
From Session and To Session	Use the From Session field to identify any session that is held in the source term whose fee schedule you are copying. Use the To Session field to identify any session target term for which you want to use the copied fee schedule. <hr/> Warning! Values for these fields are delivered with your system as translate values. Do not modify these values in any way. Any modifications to these values will require a substantial programming effort. <hr/>

Setting Up Course Fees and Class Fees

To set up course fees and class fees, use the Rate Tables for Course Fees component (CRSE_RATE_PANEL), the Course Fees component (CRSE_FEE_PANEL), the Course Fees Modal component (CRSE_FEE_MODAL), the Class Fees component (CLASS_FEE_PANEL), and the Class / Course Fees Rollover component (RUNCTL_FEE_RLVR).

This section provides an overview of course and class fees, and discusses how to:

- Set up rate tables for course fees.
- Define course fees.
- Define course sub fees.
- Define modal course fees.
- Define modal course sub fees.

- Define class fees.
- Define class sub fees.
- Define modal class fees.
- Define modal class sub fees.
- Roll over course and class fees to future terms.

Understanding Course Fees and Class Fees

After term fees, course fees and class fees are the most generalized method of establishing rates for fees.

Rate Tables for Course Fees

Use course rate IDs to add student characteristics to a course fee. Using a course rate ID with a course fee enables you to charge students with different characteristics at different rates. For example, you could charge an undergraduate chemistry student one fee for a lab, and an undergraduate humanities student a different fee for the same lab.

Note. Course rate IDs are not a replacement for course fees. Rather, they work in conjunction with a course fee definition.

Course Fees

Course fees provide additional flexibility in assessing fees. For example, you can define extra fees for courses with labs or studio sections. You could also override the term fees calculation rules for a particular course and charge a different fee altogether.

Note. If only one instance of the course exists, the course fee acts as the class fee. However, if a difference exists between a course fee and a class fee, the class fee overrides the course fee.

Class Fees

A class is a particular instance of a course. Courses are identified at the catalog level, and classes are identified through the class schedule. If the course fee is different from the fee charged for a class offered in that course, the class fee overrides the course fee.

Modal Course Fees and Class Fees

The Course Fees Modal component enables student records personnel to define course fees when accessing the Course Catalog component within PeopleSoft Student Records.

The Class Fees Modal component enables student records personnel to define class fees when accessing the Schedule New Course or Schedule of Classes components within PeopleSoft Student Records.

See Also

PeopleSoft Enterprise Student Records 9.0 PeopleBook, "Setting Up the Course Catalog," Creating Course Offerings

PeopleSoft Enterprise Student Records 9.0 PeopleBook, "Managing the Schedule of Classes"

Pages Used to Set Up Course Fees and Class Fees

Page Name	Definition Name	Navigation	Usage
Rate Tables for Course Fees	CRSE_RATE_TABLE	Set Up SACR, Product Related, Student Financials, Course and Class Fees, Rate Tables for Course Fees	Set up rate tables for course fees.
Course Fees	CRSE_FEE_TABLE	Set Up SACR, Product Related, Student Financials, Course and Class Fees, Course Fees	Define course fees.
Course Sub Fees	CRSE_SUBFEE_TABLE	Set Up SACR, Product Related, Student Financials, Course and Class Fees, Course Sub Fees	Define course sub fees.
Course Fees Modal	CRSE_FEE_TBL_MDL	Set Up SACR, Product Related, Student Financials, Course and Class Fees, Course Fees Modal	Define modal course fees.
Course Sub Fees Modal	CRSE_SUBFEE_TBL_MD	Set Up SACR, Product Related, Student Financials, Course and Class Fees, Course Sub Fees Modal	Define modal course sub fees.
Class Fees	CLASS_FEE_TABLE	Set Up SACR, Product Related, Student Financials, Course and Class Fees, Class Fees	Define class fees.
Class Sub Fees	CLASS_SUBFEE_TABLE	Set Up SACR, Product Related, Student Financials, Course and Class Fees, Class Sub Fees	Define class sub fees.
Class Fees Modal	CLASS_FEE_TBL_MDL	Set Up SACR, Product Related, Student Financials, Course and Class Fees, Class Fees Modal	Define modal class fees.

Page Name	Definition Name	Navigation	Usage
Class Sub Fees Modal	CLASS_SUBFEE_MDL	Set Up SACR, Product Related, Student Financials, Course and Class Fees, Class Sub Fees Modal	Define modal class sub fees.
Class / Course Fees Rollover	RUNCTL_FEE_RLVR	Set Up SACR, Product Related, Student Financials, Course and Class Fees, Class / Course Fees Rollover	Roll over course and class fees to future terms.

Setting Up Rate Tables for Course Fees

Access the Rate Tables for Course Fees page (Set Up SACR, Product Related, Student Financials, Course and Class Fees, Rate Tables for Course Fees).

Rate Tables for Course Fees

SetID: PSUNV **Course Rate ID:** CNCRT1

Find | View All First 1 of 1 Last

***Effective Date:** 01/01/1900 ***Status:** Active

***Description:** **Short Description:**

Career Specific **Group Specific**
 Program Specific **Plan Specific**
 Cohort Year Specific **Audit Rate specified**

Find | View All First 1 of 3 Last

Institution: PSUNV PeopleSoft University

Career: GRAD Graduate

Academic Group: FA College of Fine Arts

Academic Program: GFAU Graduate Fine Arts Programs

Academic Plan:

Cohort Year:

Fee Amt Equation:

Amount/Unit: **Flat Amount:**

Amount/Unit (Audit): **Flat Amount (Audit):** USD

Rate Tables for Course Fees page

Career Specific Select to match classes by academic career.

Group Specific Select this option to match classes by academic group.

Program Specific	Select to match classes by academic program.
Plan Specific	Select to match classes by academic plan.
(AUS) Cohort Year Specific	Select to match classes by cohort year.
Audit Rate Specified	Select to define a unique rate for audited courses. If this check box is cleared, students auditing the course are charged the regular rate.
Institution	Enter the academic institution.

Student Characteristics

The following fields describe characteristics of the student, not the course. By inserting additional rows with different combinations of characteristics, you can charge a different rate for the same course. These fields are all optional. To have the fee apply to all students within an institution, leave all of the student characteristics fields blank.

Institution	Select the institution that uses the term sub fee.
Career	If you selected the Career Specific check box, select an academic career.
Academic Group	If you selected the Group Specific check box, select an academic group.
Academic Program	If you selected the Program Specific check box, select an academic program. This is the academic program on the student's enrollment and not the student's primary academic program.
Cohort Year	If the Cohort Year Specific check box was selected, then you can specify the cohort year here.
Academic Plan	Enter the academic plan to which you want the fee to apply.

Fee Calculation Parameters

Using the following fields, you can control how much the system charges for the course fee. Fees can be charged based on academic units, a flat fee, or a combination of the two. Amounts that you enter are not independent of each other. Rather, they are summed.

Fee Amt Equation	Select an optional equation. Equations can be used for more complex selections than is possible using the student characteristics.
Amount/Unit	Enter the amount to charge per unit.
Flat Amount	Enter a flat amount to charge regardless of units taken.
Amount/Unit (Audit)	Enter the amount to charge per unit for audited classes.

Flat Amount (Audit) Enter a flat amount to charge for audited classes regardless of units taken.

See Also

PeopleSoft Enterprise Campus Solutions 9.0 Application Fundamentals PeopleBook, "Working with Equation Engine"

Defining Course Fees

Access the Course Fees page (Set Up SACR, Product Related, Student Financials, Course and Class Fees, Course Fees, Course Sub Fees).

The screenshot shows the 'Course Fees' page with the following details:

- Course Fees** / **Course Sub Fees** tabs
- SetID:** PSUNV
- Course ID:** 007274 Intro to Political Theory
- Component:** LEC Lecture
- Institution:** PSUNV PeopleSoft University
- Campus:** [Blank]
- Location:** [Blank]
- Copy Course Fee** button
- Term / Session:** 0450 2001 Fall
- *Term:** 0450 2001 Fall
- Session:** Open Entry/Open Exit
- *Charge Method:** Always
- Charge for Wait Listed Class
- Include in Pro-rata
- Include in other Withdrawal

Course Fees page

- Component** If more than one component of the course exists, select the component for which you want to define the fee. Otherwise, leave this field blank.
- Institution** Enter the institution to which the course belongs. If the fee is assessed regardless of the institution, leave this field blank.
- Campus** Enter the campus to which the course belongs. If the fee is assessed regardless of the campus, leave this field blank.
- Location** Enter the location to which the course belongs. If the fee is assessed regardless of the location, you can leave this field blank.
- Copy Course Fee** Select this option to copy a definition from one term to another.

Term/Session

Term	Select the term in which the fee is charged.
Session	If applicable, select the session in which the fee is charged.
Charge Method	Define the charge method. Values are: <i>Always:</i> If you select this value, the fee is charged in addition to term fees. For example, the lab fee would be charged in addition to the course's term fee (tuition). <i>Not included in term tuition:</i> If you select this value, the course fee is charged in addition to term fees. However, class units will be excluded from the term fee calculation.
Charge for Wait Listed Class	Select this option if the course fee is to be charged to a wait listed student.
Include in Pro-rata	Select this option if this course fee is included in pro rata refund calculations.
Include in Other Withdrawal	Select this option to include this fee in other withdrawal calculations. This selection is optional.

Defining Course Sub Fees

Access the Course Sub Fees page (Set Up SACR, Product Related, Student Financials, Course and Class Fees, Course Sub Fees).

Course Fees		Course Sub Fees	
SetID:	PSUNV	Course ID:	007274 Intro to Political Theory
Find View All First 1 of 1 Last			
Component:	LEC	Institution:	PSUNV
Campus:		Location:	
Find View All First 1 of 1 Last			
Term / Session	2001 Fall	Session:	OEE
<input type="checkbox"/> Audit Rate specified			
Find View All First 1 of 6 Last			
*Account Type:	TUT Tuition		
*Item Type:	170000000021 Course Fee - Term Start		
Fee Trigger:	<input checked="" type="radio"/> Use Criteria <input type="radio"/> Use Equation		
Course Rate ID:		Fee Amt Equation:	
Amount/Unit:	60.00	Flat Amount:	20.00
Amount/Unit (Audit):	0.00	Flat Amount (Audit):	0.00
Minimum Amount:	0.00	Maximum Amount:	0.00 USD
*Adjustment Code:	OEETMSTR OEE by Term Start Date	*Due Date Code:	OEE Open Entry/Open Exit
Waiver Group:			
<input type="checkbox"/> Exclude HECS Students			

Course Sub Fees page

Audit Rate Specified Select to define a unique rate for audited courses. If you clear this check box, students that audit the course are charged the regular rate.

Account Type Select the account type to which you want to post the course fee.

Item Type Select the item type to which you want the course fee posted.

Fee Trigger To apply the course fee to certain students only, select either the Use Criteria option or the Use Equation option, and then select the predefined criteria or equation from the lookup. If you leave this field blank, all students who take the course are charged the fee.

See PeopleSoft Enterprise Campus Solutions 9.0 Application Fundamentals PeopleBook, "Working with Equation Engine."

Course Rate ID Enter an optional course rate ID to control the application of the course fee using student characteristics. If you enter a course rate ID, the Equation, Amount/Unit, and Flat Amount fields become unavailable.

Fee Calculation Parameters

Using the following fields, you can control how much the system charges for the course fee. Fees can be charged based on academic units, a flat fee, or a combination of the two. Amounts that you enter are not independent of each other. Rather, they are summed.

Fee Amt Equation (fee amount equation)	Select an optional equation. Use equations for more complex selections than are possible using the student characteristics.
Amount/Unit	Enter the amount to charge per unit.
Flat Amount	Enter a flat amount to charge regardless of units taken.
Amount/Unit (Audit)	Enter the amount to charge per unit for audited classes.
Flat Amount (Audit)	Enter a flat amount to charge for audited classes regardless of units taken.
Minimum Amount	Enter an optional minimum amount for the course sub fee.
Maximum Amount	Enter an optional maximum amount for the course sub fee.
Adjustment Code	Select the adjustment code (calendar) to associate with this course sub fee.
Due Date Code	Select the due date code (calendar) to associate with this course sub fee.
Waiver Group	Select an optional waiver group that can offset course sub fee charges.
Exclude HECS Students Contribution Scheme students)(AUS)	Select this option so that students are not charged twice for the same class if they exclude Higher Education are under multiple loan programs.

See Also

Chapter 5, "Setting Up Tuition Controls, Criteria, Equations, and Waivers," Establishing Criteria for Tuition Groups and Fee Triggers, page 158

PeopleSoft Enterprise Campus Solutions 9.0 Application Fundamentals PeopleBook, "Working with Equation Engine"

Chapter 5, "Setting Up Tuition Controls, Criteria, Equations, and Waivers," Setting Up Adjustment Calendars, page 142

Chapter 5, "Setting Up Tuition Controls, Criteria, Equations, and Waivers," Creating Billing and Due Date Calendars, page 139

Chapter 5, "Setting Up Tuition Controls, Criteria, Equations, and Waivers," Defining Waivers and Waiver Groups, page 171

Defining Modal Course Fees

Access the Course Fee Modal page (Set Up SACR, Product Related, Student Financials, Course and Class Fees, Course Fees Modal).

This page is identical to the Course Fees page.

See Also

[Chapter 6, "Setting Up Fees and Tuition Groups," Defining Course Fees, page 209](#)

Defining Modal Course Sub Fees

Access the Course Sub Fees Modal page (Set Up SACR, Product Related, Student Financials, Course and Class Fees, Course Sub Fees Modal).

This page is identical to the Course Sub Fees page.

See Also

[Chapter 6, "Setting Up Fees and Tuition Groups," Defining Course Sub Fees, page 210](#)

Defining Class Fees

Access the Class Fees page (Set Up SACR, Product Related, Student Financials, Course and Class Fees, Class Fees).

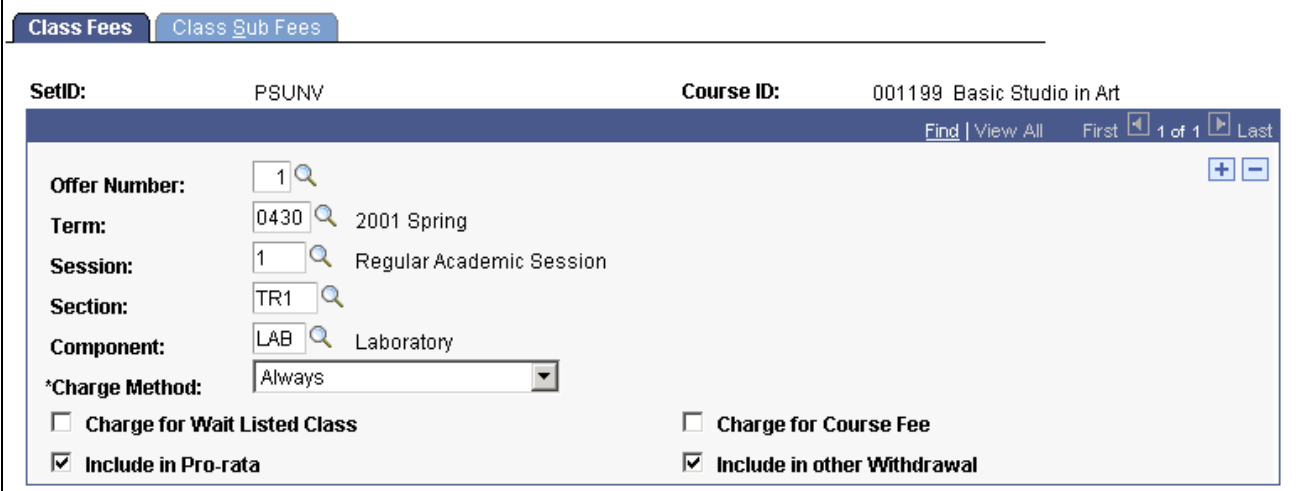

Class Fees | **Class Sub Fees**

SetID: PSUNV **Course ID:** 001199 Basic Studio in Art

Find | View All First 1 of 1 Last

Offer Number: 1

Term: 0430 2001 Spring

Session: 1 Regular Academic Session

Section: TR1

Component: LAB Laboratory

***Charge Method:** Always

Charge for Wait Listed Class Charge for Course Fee

Include in Pro-rata Include in other Withdrawal

Class Fees page

- Offer Number** Enter the offer number of the class.
- Term** Enter the term for which the class is offered.
- Session** If the class is offered in more than one session in the term, enter the session number.
- Section** If the class is offered in more than one section, enter a section number.

Component	If more than one component is offered for the class, and the class charge should apply to a specific component, select the component.
Charge Method	Define the charge method. Values are: <i>Always:</i> The fee is charged in addition to term fees. For example, the lab fee would be charged in addition to the class term fee (tuition). <i>Not included in term tuition:</i> The class is excluded from the term fee calculation and the class fee becomes the total charge for the class.
Charge for Wait Listed Class	Select this option if the class fee is to be charged to a wait listed student.
Charge for Course Fee	Select this option if you want to charge course fees in addition to class fees. If you do not select this check box, class fee definitions override course fee definitions for the same class.
Include in Pro-rata	Select this option if this class fee is included in pro rata refund calculations.
Include in other Withdrawal	Select this option to include this fee in other withdrawal calculations. This selection is optional.

Defining Class Sub Fees

Access the Class Sub Fees page (Set Up SACR, Product Related, Student Financials, Course and Class Fees, Class Sub Fees).

Class Fees		Class Sub Fees	
SetID:	PSUNV	Course ID:	007274 Intro to Political Theory
Find View All First 1 of 1 Last			
Offer Number:	1	Term:	2001 Fall
Class Section:		Session:	OEE
<input type="checkbox"/> Audit Rate specified			
Sub Fees		Find View All First 1 of 6 Last	
*Account Type:	TUT Tuition		
*Item Type:	170000000011 Class Fee - Term Start		
Fee Trigger:	<input checked="" type="radio"/> Use Criteria <input type="radio"/> Use Equation		
Course Rate ID:		Fee Amt Equation:	
Amount/Unit:	30.00	Flat Amount:	10.00
Amount/Unit (Audit):	0.00	Flat Amount (Audit):	0.00
Minimum Amount:	0.00	Maximum Amount:	0.00 USD
*Adjustment Code:	OEE by Term Start Date	*Due Date Code:	OEE Open Entry/Open Exit
Waiver Group:			
<input type="checkbox"/> Exclude HECS Students			

Class Sub Fees page

Audit Rate Specified Select to define a unique rate for audited classes. If the check box is cleared, students auditing the class are charged the regular rate.

Account Type Select the account type to which you want the class fee posted.

Item Type Select the item type to which you want the class fee posted.

Fee Trigger To apply the class fee to specific students, select either the Use Criteria option or the Use Equation option, and then select the predefined criteria or equation from the lookup. If you leave the field blank, the system charges the fee to all students who take the class.

See *PeopleSoft Enterprise Campus Solutions 9.0 Application Fundamentals PeopleBook*, "Working with Equation Engine."

Course Rate ID Enter an optional course rate ID to control the application of the class fee using student characteristics. If you enter a course rate ID, the Equation, Amount/Unit, and Flat Amount fields become unavailable.

Fee Calculation Parameters

Using the following fields, you can control exactly how much the system charges for the class fee. Fees can be charged based on academic units, a flat fee, or a combination of the two. Amounts that you enter are not independent of each other. Rather, they are summed.

Fee Amt Equation	Select an optional equation. You can use equations for more complex selections than are possible using the student characteristics.
Amount/Unit	Enter the amount that you want to charge per unit.
Flat Amount	Enter a flat amount that you want to charge, regardless of units taken.
Amount/Unit (Audit)	Enter the amount that you want to charge per unit for audited classes.
Flat Amount (Audit)	Enter a flat amount that you want to charge for audited classes regardless of units taken.
Minimum Amount	Enter an optional minimum amount for the class sub fee.
Maximum Amount	Enter an optional maximum amount for the class sub fee.
Adjustment Code	Select the adjustment code (calendar) to associate with this class sub fee.
Due Date Code	Select the due date code (calendar) to associate with this class sub fee.
Waiver Group	Select an optional waiver group that can offset class sub fee charges.
Exclude HECS Students (exclude Higher Education Contribution Scheme students)(AUS)	Select this option so that students are not charged twice for the same class if they are under multiple loan programs.

See Also

Chapter 5, "Setting Up Tuition Controls, Criteria, Equations, and Waivers," Establishing Criteria for Tuition Groups and Fee Triggers, page 158

PeopleSoft Enterprise Campus Solutions 9.0 Application Fundamentals PeopleBook, "Working with Equation Engine"

Chapter 5, "Setting Up Tuition Controls, Criteria, Equations, and Waivers," Setting Up Adjustment Calendars, page 142

Chapter 5, "Setting Up Tuition Controls, Criteria, Equations, and Waivers," Creating Billing and Due Date Calendars, page 139

Chapter 5, "Setting Up Tuition Controls, Criteria, Equations, and Waivers," Defining Waivers and Waiver Groups, page 171

Defining Modal Class Fees

Access the Class Fees Modal page (Set Up SACR, Product Related, Student Financials, Course and Class Fees, Class Fees Modal).

This page is identical to the Class Fees page.

See Also

Chapter 6, "Setting Up Fees and Tuition Groups," Defining Class Fees, page 213

Defining Modal Class Sub Fees

Access the Class Sub Fees Modal page (Set Up SACR, Product Related, Student Financials, Course and Class Fees, Class Sub Fees Modal).

This page is identical to the Class Sub Fees page.

See Also

Chapter 6, "Setting Up Fees and Tuition Groups," Defining Class Sub Fees, page 214

Rolling Over Course and Class Fees to Future Terms

Access the Class / Course Fees Rollover page (Set Up SACR, Product Related, Student Financials, Course and Class Fees, Class / Course Fees Rollover).

Class / Course Fees Rollover

Run Control ID: 1 [Report Manager](#) [Process Monitor](#) Run

Parameters			
*SetID:	<input type="text" value="PSUNV"/>	Class Fees:	<input checked="" type="checkbox"/>
*From Term:	<input type="text" value="0487"/> 2003 Spring	Course Fees:	<input type="checkbox"/>
*To Term:	<input type="text" value="0505"/> 2003 Fall	Course List Fees:	<input type="checkbox"/>
Override Existing Setup:	<input type="checkbox"/>		

Class / Course Fees Rollover page

From Term and To Term Enter the term from which you are copying fee information and the term to which you are copying it.

Override Existing Setup If the term that you specify in the To Term field has existing fee information, the process does not overwrite it unless you select this check box. If you select this check box, the process replaces the existing fee information with the fee information from the term specified in the From Term field.

Class Fees, Course Fees, and Course List Fees Select the types of fee information that you want to roll over.

Note. Reversing this process is not possible after you run it.

Defining Optional Fees

To set up optional fees, use the Optional Fees component (OPT_FEE_TABLE).

Your institution may have several fees that apply to many, but not all, students. For example, many students might need to purchase a parking sticker. By setting up a parking sticker fee as an optional fee, students can choose to purchase a parking sticker at the time of registration.

Institutions can use Self Service Miscellaneous Purchases to allow students to select in self service.

See *Setting Up Self Service Student Financials*, *Setting Up Miscellaneous Fees* for setup information.

See *PeopleSoft Enterprise Campus Self Service 9.0 PeopleBook*, "Setting Up Student Financials Self Service," *Setting Up Miscellaneous Fees*.

This section discusses how to:

- Define optional fee codes.
- Define optional fee values.
- Link optional fees to terms.
- Define optional fee amounts.

Pages Used to Define Optional Fees

<i>Page Name</i>	<i>Definition Name</i>	<i>Navigation</i>	<i>Usage</i>
Optional Fees	OPT_FEE_TABLE	Set Up SACR, Product Related, Student Financials, Optional Fees, Optional Fees	Define optional fee codes.
Values	OPT_FEE_VAL	Set Up SACR, Product Related, Student Financials, Optional Fees, Optional Fees, Values	Define optional fee values.
Optional Fees - Term	OPT_FEE_TERM	Set Up SACR, Product Related, Student Financials, Optional Fees, Optional Fees - Terms	Link optional fees to terms.
Optional Fees per Term	OPT_FEE_TERM_VAL	Set Up SACR, Product Related, Student Financials, Optional Fees, Optional Fees per Term	Define optional fee amounts.

Defining Optional Fee Codes

Access the Optional Fees page (Set Up SACR, Product Related, Student Financials, Optional Fees, Optional Fees).

The screenshot displays the 'Optional Fees' page with the following details:

- SetID:** PSUNV
- Fee Code:** PRKING
- *Effective Date:** 01/01/1900
- *Status:** Active
- *Description:** Parking
- *Short Description:** Parking
- Long Description:** (Empty text area)
- *Academic Career:** Graduate Business, Continuing Education, Semester Credit
- Buttons:** Add all Careers, +, -

Optional Fees page

Add all Careers Click to apply the optional fee to all active academic careers in the institution. If you add all careers, the Academic Career field becomes unavailable.

Academic Career Enter the specific careers to which the system applies the optional fee.

Defining Optional Fee Values

Access the Values page (Set Up SACR, Product Related, Student Financials, Optional Fees, Optional Fees, Values).

Optional Fees		Values	
SetID:	PSUNV	Fee Code:	PRKING Parking
		Find View All First 1 of 1 Last	
Effective Date:	01/01/1900	Status:	Active
		Customize Find View All First 1-2 of 2 Last	
*Valid Value	*Description	Short Description	Initial Value
NOPARK	No Parking Sticker	No Parking	<input checked="" type="checkbox"/>
PRKING	Parking Sticker	Parking St	<input type="checkbox"/>

Values page

Valid Value Define the valid value for the optional fee. This is the value that is attached to an optional fee per term definition.

Description Provide a description for the optional fee.

Short Desc(short description) Provide a short description for the optional fee.

Initial Value Select to make a valid value the default value.
 Select the Init Value (initial value) check box as the default fee to be charged. In this example, the default value *NOPARK* means that the system does not charge an optional parking sticker fee to a student unless *PRKING* is manually selected during tuition calculation.

Linking Optional Fees to Terms

Access the Optional Fees - Term page (Set Up SACR, Product Related, Student Financials, Optional Fees, Optional Fees - Terms).

Optional Fees - Term

SetID: PSUNV

Fee Code: PRKING Parking

Find | View All First 1 of 2 Last

*Term:	0505	2003 Fall	
*Account Type:	PAR	Parking Fees	
*Item Type:	2000000000002	Parking Stickers	
*Due Date Code:	STD	Standard	
Start Date:	04/01/2003		
Stop Date:	08/31/2003		
No Change Date:	08/31/2003		

One Fee for All Careers

Optional Fees - Term page

- Term** Select the term in which the fee is charged.
- Account Type** Enter the account type for the fee.
- Item Type** Select the item type to which the system posts the optional term fee.
- Due Date Code** Select the due date code (billing and due calendar).
- Start Date** Enter an optional start date to specify the first day that the optional fee can be selected.
- Stop Date** Enter an optional stop date to specify the last day that the optional fee can be selected. The Optional Fees for a Student Related page functionality cannot be used to calculate or link students to an optional fee after this date. However, if changes are necessary, you can use the Optional Fees Override page.
- No Change Date** Enter an optional no change date after which enrollment changes do not affect the amount of optional fees charged.
- One Fee for All Careers** Select to charge students one fee regardless of the number of billing careers to which they are associated. If you clear this check box, the system charges students who are associated with more than one billing career once for each career.

Defining Optional Fee Amounts

Access the Optional Fees per Term page (Set Up SACR, Product Related, Student Financials, Optional Fees, Optional Fees per Term).

Optional Fees per Term

SetID: PSUNV
 Fee Code: PRKING Parking
 Term: 0505 2003 Fall

Copy Optional Fee

*Academic Load: Full-Time

*Effective Date: 01/01/2003 *Status: Active

Value		Amount/Unit	Flat Amount	Maximum Amount	Initial Value
NOPARK	No Parking Sticker	0.00	0.00	99,999.00 USD	<input checked="" type="checkbox"/>
PRKING	Parking Sticker	0.00	75.00	99,999.00 USD	<input type="checkbox"/>

Optional Fees per Term page

Academic Load Select an academic load as a criterion for the optional fee.

Optional Fee Parameters

Value Displays the fee code values and descriptions.

Amount/Unit Enter the amount to charge per enrollment unit.

Flat Amount Enter a flat amount to charge regardless of units taken.

Maximum Amount Enter a maximum amount to charge any one student for this optional fee.

Initial Value Select to define a valid value as the default value of the optional fee. The system automatically selects the check box next to the default value that you specified in the Values page, but you can override the selection for a particular term.

Copy Optional Fee Click to copy an optional fee definition from one term to another.

Note. If you have specified start, stop, and no change dates on the Optional Fee - Term page, you might need to adjust the dates.

Setting Up Transaction Fees

To set up transaction fees, use the Transaction Fees component (TRANSACTION_FEES).

Transaction fees are additional fees that are charged to students in the event of an enrollment transaction such as the addition or dropping of a class. You set up transaction fees by term with an effective date for each term.

Page Used to Set Up Transaction Fees

Page Name	Definition Name	Navigation	Usage
Transaction Fees	TRANS_FEE_TABLE	Set Up SACR, Product Related, Student Financials, Tuition and Fees, Transaction Fees	Define transaction fees.

Defining Transaction Fees

Access the Transaction Fees page (Set Up SACR, Product Related, Student Financials, Tuition and Fees, Transaction Fees).

Transaction Fees

SetID: PSUNV **Trans Fee Code:** TRANFEES

***Description:** Copy Transaction Fee

Term / Session Find | View All First 1 of 1 Last

***Term:** 2004 Fall **Session:** + -

***Effective Date:** + - ***Status:** + -

Transaction	Amount	Account Type	Item Type	Graded Only	Charge Withdraw
<input checked="" type="checkbox"/> Initial Enrollment	<input type="text" value="250.00"/> USD	<input type="text" value="MIS"/> Misc	<input type="text" value="120000000000"/> Transaction Fee-Initial Enroll		
<input checked="" type="checkbox"/> Add Fee	<input type="text" value="32.00"/>	<input type="text" value="MIS"/> Misc	<input type="text" value="120000000001"/> Transaction Fees-Add Class	<input type="checkbox"/>	
<input checked="" type="checkbox"/> Drop Fee	<input type="text" value="28.00"/>	<input type="text" value="MIS"/> Misc	<input type="text" value="120000000002"/> Transaction Fee-Drop Class	<input checked="" type="checkbox"/>	<input checked="" type="checkbox"/>
<input checked="" type="checkbox"/> Add Wait List	<input type="text" value="10.00"/>	<input type="text" value="MIS"/> Misc	<input type="text" value="120000000003"/> Transaction Fee-Add Wait List	<input type="checkbox"/>	
<input checked="" type="checkbox"/> Drop Wait List	<input type="text" value="5.00"/>	<input type="text" value="MIS"/> Misc	<input type="text" value="120000000004"/> Transaction Fees-Drop Wait Lis	<input type="checkbox"/>	

Minimum/Maximum Fee Code: Min/Max Fees for MM1 - SF

***Due Date Code:** Standard

Transaction Fees page

Copy Transaction Fee Click to copy a transaction fee definition from one term to another. You will likely need to change the effective date when you use this button so that the transaction fee definition becomes active on the appropriate day of the additional term for which you are copying the fee.

- Term** Enter the term for which you want the transaction fee to apply.
- Session** To apply the transaction fee to more than one session within the term, specify the session.

Transaction Fee Definitions

- Transaction** Select the check box by the transaction fee that you want to define (Initial Enrollment, Add Fee, Drop Fee, Add Wait List, or Drop Wait List).
- Amount** Enter the amount of the transaction fee.
- Account Type** Select the account type to which you want the transaction fee to post.
- Item Type** Select the item type that you have defined for the transaction fee.
- Graded Only** Select to apply the transaction fee to graded classes only. If this check box is cleared, the transaction fee applies to audited and graded classes. This option is not available for initial enrollment transaction fees.
- Charge Withdraw** Select to charge the transaction fee when a student withdraws from school. This option is available with drop fee transaction charges only. If the check box is cleared, drop fee transaction charges are not applied when a student withdraws.
- Minimum/Maximum Fee Code** Select an optional minimum/maximum fee code to apply to these transaction fees.
- Due Date Code** Select the due date code (billing and due calendar) that governs the transaction fee.

Setting Up Course List Fees

To set up course list fees, use the Course List Fees component (CLST_FEE_PANEL).

Establish fees for all courses within a given course list.

Page Used to Set Up Course List Fees

<i>Page Name</i>	<i>Definition Name</i>	<i>Navigation</i>	<i>Usage</i>
Course List Fees	CLST_FEE_TABLE	Set Up SACR, Product Related, Student Financials, Course and Class Fees, Course List Fees	Define course list fees.

Defining Course List Fees

Access the Course List Fees page (Set Up SACR, Product Related, Student Financials, Course and Class Fees, Course List Fees).

Course List Fees

SetID: PSUNV **Course List:** 000000007 Course List#7

[Copy Course List Fee](#)

Term / Session Find | View All First 1 of 2 Last

*Term: 0450 2001 Fall Charge for Wait Listed Class

Session: Open Entry/Open Exit Audit Rate specified

*Charge Method: Always Include in Pro-rata

Include in other Withdrawal

Sub Fees Find | View All First 1 of 6 Last

*Account Type: TUT Tuition

*Item Type: 170000000031 Crse List Fee - Term Start

Fee Trigger: Use Criteria Use Equation

Course Rate ID:

Amount/Unit: 90.00 Fee Amt Equation:

Amount/Unit (Audit): 0.00 Flat Amount: 30.00

Minimum Amount: 0.00 Flat Amount (Audit): 0.00

Maximum Amount: 0.00 USD

*Adjustment Code: OEETMSTR OEE by Term Start Date *Due Date Code: OEE Open Entry/Open Exit

Waiver Group:

Exclude HECS Students

Course List Fees page

Copy Course List Fee Click to copy a course list fee definition from one term to another.

Term Enter the term in which the fee is charged.

Session Select the session in which the fee is charged.

Charge Method Select the charge method. Values are:

Always: The fee is charged in addition to term fees.

Not included in term tuition: The course is excluded from the term fee calculation and the course fee becomes the total cost of the class.

Charge for Wait Listed Class Select to charge the course fee to a wait listed student.

Audit Rate Specified Select to define a unique rate for audited courses. If you clear this check box, the system charges the regular rate to students auditing the course.

Include in Pro-rata	Select to include the course fee in pro rata refund calculations.
Include in Other Withdrawal	Select to include this fee in other withdrawal calculations. This selection is optional.

Course List Sub Fees

Account Type	Enter the account type to which you want the course list fee posted.
Item Type	Enter the item type to which you want the course list fee posted.
Fee Trigger	To apply the course list fee to specific students, select either the Use Criteria option or the Use Equation option, and then select the predefined criteria or equation from the lookup. If you leave this field blank, the system charges the fee to all students who take the courses. <i>See PeopleSoft Enterprise Campus Solutions 9.0 Application Fundamentals PeopleBook, "Working with Equation Engine."</i>
Course Rate ID	Enter an optional course rate ID to control the application of the course list fee using student characteristics. This field is available only if the Equation field is blank and the Amount/Unit and Flat Amount fields have a value of 0.00. You define course rate IDs using the Rate Tables for Course Fees page.

Fee Calculation Parameters

Using the following fields, you can control exactly how much the system charges for the course fee. Fees can be charged based on academic units, a flat fee, or a combination of the two. Amounts that you enter are not independent of each other. Rather, they are summed.

Fee Amt Equation (fee amount equation)	Enter an optional equation.
Amount/Unit	Enter the amount charge per unit.
Flat Amount	Enter a flat amount to charge regardless of units taken.
Amount/Unit (Audit)	Enter the amount to charge per unit for audited classes.
Flat Amount (Audit)	Enter a flat amount to charge for audited classes regardless of units taken.
Minimum Amount	Enter an optional minimum amount for the course list sub fee.
Maximum Amount	Enter an optional maximum amount for the course list sub fee.
Adjustment Code	Enter the adjustment code (calendar) to associate with this course list sub fee.
Due Date Code	Enter the due date code (calendar) to associate with this course list sub fee.

Waiver Group

Enter an optional waiver group that can offset course list sub fee charges.

Warning! If the wildcard feature was used when the course list was set up, the waiver group will apply to anyone who meets the waiver criteria and is enrolled in any of the subjects covered by the course list.

(AUS) Exclude HECS Students (exclude Higher Education Contribution Scheme students) Select so that students are not charged twice for the same class if they are under multiple loan programs.

See Also

[Chapter 5, "Setting Up Tuition Controls, Criteria, Equations, and Waivers," Establishing Criteria for Tuition Groups and Fee Triggers, page 158](#)

[Chapter 5, "Setting Up Tuition Controls, Criteria, Equations, and Waivers," Setting Up Adjustment Calendars, page 142](#)

[Chapter 6, "Setting Up Fees and Tuition Groups," Setting Up Course Fees and Class Fees, page 204](#)

PeopleSoft Enterprise Campus Solutions 9.0 Application Fundamentals PeopleBook, "Working with Equation Engine"

[Chapter 5, "Setting Up Tuition Controls, Criteria, Equations, and Waivers," Defining Waivers and Waiver Groups, page 171](#)

[Chapter 5, "Setting Up Tuition Controls, Criteria, Equations, and Waivers," Creating Billing and Due Date Calendars, page 139](#)

Setting Up Tuition Groups

To set up tuition groups, use the Tuition Groups component (SEL_GROUP_PANEL).

This section provides an overview of tuition groups and discusses how to:

- Define tuition groups.
- Link adjustment codes to tuition groups.
- Link criteria to tuition groups.
- Link term fee codes to tuition groups.
- Link a waiver code to a single term fee within a tuition group.
- Link course lists to tuition groups.
- Link waiver codes to tuition groups.
- Review established tuition group priorities.

Understanding Tuition Groups

Tuition groups enable you to combine large groups of students who are charged, generally, the same set of fees under the same rules. Within the tuition group definition, you use adjustment codes, term fee, course list, and waiver definitions to fine-tune charges and adjustments (refund rules) so that students receive the correct charges for their unique situations. Because so much flexibility is in the components that compose the tuition group, you can define relatively few tuition groups to control all tuition calculations. Students might be assigned to a tuition group as they are activated for a term or be automatically assigned to the correct group using criteria that you have defined when tuition is calculated. You can also override the system-assigned tuition group on an individual student basis.

Pages Used to Set Up Tuition Groups

<i>Page Name</i>	<i>Definition Name</i>	<i>Navigation</i>	<i>Usage</i>
Tuition Groups - Definition	SEL_GROUP_TABLE	Set Up SACR, Product Related, Student Financials, Tuition and Fees, Tuition Groups, Definition	Define tuition groups.
Tuition Groups - Adjustment Codes	SEL_GROUP_ADJ_CODE	Set Up SACR, Product Related, Student Financials, Tuition and Fees, Tuition Groups, Adjustment Codes	Link adjustment codes to tuition groups.
Tuition Groups - Criteria	GROUP_CRITR_TABLE	Set Up SACR, Product Related, Student Financials, Tuition and Fees, Tuition Groups, Criteria	Link criteria to tuition groups.
Tuition Groups - Term Fees	GROUP_FEE_TABLE	Set Up SACR, Product Related, Student Financials, Tuition and Fees, Tuition Groups, Term Fees	Link term fees to tuition groups.
Term Fee Waivers	GRP_FEE_WAIVER	Click the Waivers link on the Tuition Groups - Term Fees page.	Link a waiver code to a single term fee within a tuition group.
Tuition Groups - Course Lists	GROUP_CLST_TABLE	Set Up SACR, Product Related, Student Financials, Tuition and Fees, Tuition Groups, Course Lists	Link course lists to tuition groups.
Tuition Groups - Waivers	GRP_WAIVER_TABLE	Set Up SACR, Product Related, Student Financials, Tuition and Fees, Tuition Groups, Waivers	Link waiver codes to tuition groups.

Page Name	Definition Name	Navigation	Usage
Tuition Group Priority	SEL_GROUP_PRIORITY	Set Up SACR, Product Related, Student Financials, Tuition and Fees, Tuition Group Priority	Review established tuition group priorities.

Defining Tuition Groups

Access the Tuition Groups - Definition page (Set Up SACR, Product Related, Student Financials, Tuition and Fees, Tuition Groups, Definition).

The screenshot displays the 'Definition' tab of the Tuition Groups - Definition page. The Business Unit is set to PSUNV and the Tuition Group is TG1. The Effective Date is 09/03/2003 and the Status is Active. The Description is Tuition Group #1, the Short Description is TG1, and the Long Description is Tuition Group #1. The Priority is 30 and the Transaction Fee Code is TRANFEES. The Tuition Calculation Group checkbox is checked, while the Fin Aid Calculation Group and Lock In Flag checkboxes are unchecked.

Tuition Groups - Definition page

- Priority** If a group of students cannot be categorized into one tuition group, you must define the preferred tuition group with a higher priority. For example, if your institution offers a combined JD/MBA program, students could be assigned to one of three tuition groups (JD, MBA, or JD/MBA). By setting a higher priority (lower number) for the JD/MBA group, you ensure that students are charged appropriately.
- Transaction Fee Code** Select an optional transaction fee code.
- Tuition Calculation Group** Clear this check box if you do not want to use this tuition group for actual tuition calculation.
- Fin Aid Calculation Group** (financial aid calculation group) Select to enable this definition to be used for calculating projected fees for financial aid budgets.

Lock In Flag Select to lock in a minimum amount of tuition for the group at a specified point in the term.

See Also

Chapter 6, "Setting Up Fees and Tuition Groups," Setting Up Transaction Fees, page 222

Linking Adjustment Codes to Tuition Groups

Access the Tuition Groups - Adjustment Codes page (Set Up SACR, Product Related, Student Financials, Tuition and Fees, Tuition Groups, Adjustment Codes).

Definition		Adjustment Codes		Criteria		Term Fees		Course Lists		Waivers	
Business Unit:	PSUNV	Tuition Group:	TG1								
Find View All First 1 of 1 Last											
Effective Date:	09/03/2003	Status:	Active								
	Adjustment Code	Description	Service Ind	Reason:							
Pro-rata:	PRORATA	Prorata	<input type="checkbox"/>	<input type="checkbox"/>							
Accrediting Agency:	AGENCY	Agency	<input type="checkbox"/>	<input type="checkbox"/>							
State:	STATE	State	<input type="checkbox"/>	<input type="checkbox"/>							
Federal Refund:	FEDERAL	Federal	<input type="checkbox"/>	<input type="checkbox"/>							
Institution:	INSTITUT	Institutional	<input type="checkbox"/>	<input type="checkbox"/>							
Non-SFA Institution:	NSFAINST	Non-SFA Institutional	<input type="checkbox"/>	<input type="checkbox"/>							
Non-SFA 1st Time Institution:	1STCAR	First Career	<input type="checkbox"/>	<input type="checkbox"/>							
Non-SFA 1st Time Career:	1STINST	1st Time Institution	<input type="checkbox"/>	<input type="checkbox"/>							
Default Service Ind / Reason:			<input type="checkbox"/>	<input type="checkbox"/>							

Tuition Groups - Adjustment Codes page

Select adjustment codes to determine the refund schedules for members of a tuition group. Some refund schedules are mandated by a state government or agency, or by the federal government. Your institution can also devise and apply its own refund schedule. Federal regulations require that refunds for students that receive federal financial aid be calculated using the refund table most advantageous to the student.

Pro-rata Enter the adjustment code that you have defined for pro rata refund calculations. The pro rata refund is applied to first-time students who withdraw.

Accrediting Agency Enter the adjustment code that you have defined to meet the refund requirements of your accrediting agency for students who withdraw.

State Enter the adjustment code that you have defined to meet your state refund requirements agency for students who withdraw.

Federal Refund	Enter the adjustment code that you have defined to meet federal refund requirements for students who withdraw.
Institution	Enter the adjustment code that you have defined for your institution for students who withdraw. This is the adjustment code that the system uses if no other schedules supersede it.
Non-SFA Institution (nonfederal student financial aid institution)	Enter the adjustment code that you have defined for students who withdraw but do not receive any federal financial aid.
Non-SFA 1st Time Institution	Enter the adjustment code that you have defined for students who withdraw but do not receive any federal financial aid and are attending your institution for the first time (first term).
Non-SFA 1st Time Career	Enter the non-SFA 1st time career schedule that your institution applies by career for students who are first-time students, who do not receive any federal financial aid, and who withdraw.
Service Ind (service indicator)	Enter an optional service indicator code to apply to the student upon his or her withdrawal. Upon the student's withdrawal, if the reason in the term history/withdrawal component is the same as the reason that you set on the Tuition Group Adjustment code page, the service indicator is set for the student
Reason	Enter an optional service indicator reason.
Default Service Ind/Reason (default service indicator and reason)	Enter an optional service indicator and reason to use as default values.

See Also

[Chapter 5, "Setting Up Tuition Controls, Criteria, Equations, and Waivers," Setting Up Adjustment Calendars, page 142](#)

Linking Criteria to Tuition Groups

Access the Tuition Groups - Criteria page (Set Up SACR, Product Related, Student Financials, Tuition and Fees, Tuition Groups, Criteria).

Tuition Groups - Criteria page

Criteria Select the criteria to select students for inclusion in the tuition group. You must attach at least one criteria code.

Priority When you use more than one criteria code, connect them with an OR operator and provide a priority rating.

Linking Term Fees to Tuition Groups

Access the Tuition Groups - Term Fees page (Set Up SACR, Product Related, Student Financials, Tuition and Fees, Tuition Groups, Term Fees).

Tuition Groups - Term Fees page

Fee Code Enter the term fee code that you want to link to this tuition group. You must link at least one term fee code, but you can add as many term fee codes as necessary to cover fees for all members of the tuition group.

Description The term fee description appears in this field.

Include in Pro-rata Calc (include in pro rata calculation) Select to include the term fee in a pro rata refund calculation in the event that the student withdraws.

Include in Withdrawal Calc (include in withdrawal calculation)

Select to include the term fee in a withdrawal calculation if that the student withdraws.

Select this check box when tuition calculation adjustments for a withdrawal require different calendars and calculations for specific term fees.

If you select this check box, the tuition calculation adjustment process for withdrawals uses the applicable adjustment calendar that is designated on the Tuition Groups - Adjustment Codes page.

If you clear this check box, the tuition calculation adjustment process for withdrawals uses the adjustment calendar that is defined on the Term Fees - Term Fees page for this specific term fee.

Selecting this check box does not override an adjustment reason in PeopleSoft Student Records. Nor does it exempt a fee from the withdrawal adjustment calculation.

To use the adjustment calendar that is associated with the term fee when you are adjusting tuition on a withdrawal, be sure to create a row for withdrawal in the setup of the adjustment calendar that you have specified on your term fee.

See [Chapter 6, "Setting Up Fees and Tuition Groups," Defining Term and Session Fees, page 193.](#)

Lock In Calc (lock in calculation)

Select to lock in charges for this term fee at a specified point in the term. This option is available only if the Lock in Calc check box has been selected on the Definition page.

Residency Calc (residency calculation)

Select to include the term fee in tuition residency calculation.

Waivers

Click to define waivers that are specific to one term fee.

See Also

[Chapter 6, "Setting Up Fees and Tuition Groups," Setting Up Term Fee Codes, page 190](#)

Linking a Waiver Code to a Single Term Fee Within a Tuition Group

Access the Term Fee Waivers page (click the Waivers link on the Tuition Groups - Term Fees page).

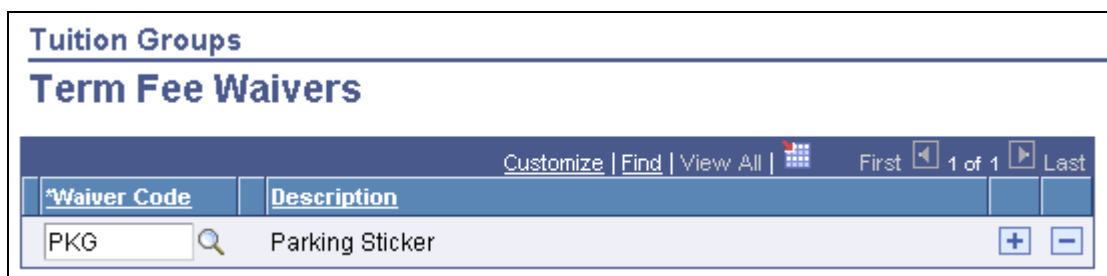

Tuition Groups - Term Fee Waivers page

Waiver Code Select the waiver code to apply to the term fee to waive charges. Waivers that are attached at this level apply only to the specific term fee and not to the tuition group as a whole.

Linking Course Lists to Tuition Groups

Access the Tuition Groups - Course Lists page (Set Up SACR, Product Related, Student Financials, Tuition and Fees, Tuition Groups, Course Lists).

*Course List	Description	Include in Pro-rata Calc	Include in Withdrawal Calc
000000002	Course List #2	<input checked="" type="checkbox"/>	<input checked="" type="checkbox"/>

Tuition Groups - Course Lists page

Course List Enter the course list that you are linking to the tuition group.

Include in Pro-rata Calc Select if you want the course list fees included in any pro-rata calculation. (include in pro rata calculation)

Include In Withdrawal Calc Select if you want the course list fees included in any withdrawal calculations for this tuition group. (include in withdrawal calculation)

See Also

[Chapter 6, "Setting Up Fees and Tuition Groups," Setting Up Course List Fees, page 224](#)

Linking Waiver Codes to Tuition Groups

Access the Tuition Groups - Waivers page (Set Up SACR, Product Related, Student Financials, Tuition and Fees, Tuition Groups, Waivers).

Definition	Adjustment Codes	Criteria	Term Fees	Course Lists	Waivers
Business Unit:	PSUNV	Tuition Group:	TG1		
Find View All First 1 of 1 Last					
Effective Date:	09/03/2003	Status:	Active		
Customize Find View All First 1-2 of 2 Last					
Waiver Code	Description				
FG1	First Generation Waiver #1	+ -			
HNR1	Honors #1 Waiver	+ -			

Tuition Groups - Waivers page

Waiver Code Select the waiver code to link to the tuition group. Waiver codes that are linked at this level apply to all term fees that are attached to the tuition group.

See Also

[Chapter 5, "Setting Up Tuition Controls, Criteria, Equations, and Waivers," Defining Waivers and Waiver Groups, page 171](#)

Reviewing Established Tuition Group Priorities

Access the Tuition Group Priority page (Set Up SACR, Product Related, Student Financials, Tuition and Fees, Tuition Group Priority).

The Tuition Group Priority page lists all tuition groups that are defined for your institution, provides a description of the tuition groups, and displays their priority. Use this page to confirm that potentially competing tuition group definitions have the correct priority ratings.

Chapter 7

Setting Up Refunding

This chapter lists prerequisites and discusses how to:

- Set up your business unit to refund customers.
- Set up accounts payable (AP) options.
- Set up payroll refund options.
- Create job data for payroll refunds.
- Set up direct deposits for students.
- Designate sponsors.

See Also

[Chapter 17, "Refunding Customers," Understanding Refunds, page 435](#)

Prerequisites

To process refunds, first create refund item types. An item type defines how the item is applied to a student or corporate account within Student Financials. Use the SF Item Type component to define refund item types.

If you use the accounts payable method to create and distribute refunds, your accounts payable department must set up their system to recognize students and corporations as vendors to distribute refund checks to them.

If you use the payroll method to create and distribute refunds, your payroll department must use PeopleSoft Enterprise Payroll for North America to create a refund company that employs your students. This enables your payroll department to issue refund checks to students as if they were paychecks. Most of the setup for payroll refunds occurs in Payroll for North America. In addition to company and job data, you need to set up pay groups, run IDs, and direct deposits for students. Finally, node definitions (for the HRMS node) need to be set up for any batch processing.

See Also

Chapter 2, "Completing Student Financials General Setup," Setting Up Item Types and Item Type Groups, page 55

Enterprise PeopleTools PeopleBook: Internet Technology, Configuring the Portal Environment

PeopleSoft Enterprise Payroll for North America 9.0 PeopleBook, "Administering Interfaces with PeopleSoft HRMS and PeopleSoft Enterprise Expenses," Administering the Interface with Student Financials

Setting Up Your Business Unit to Refund Customers

This section discusses how to:

- Define basic refunding rules.
- Define refund approval parameters.
- Define default payroll interface parameters.
- Set default withholding amounts for payroll refunds.

Pages Used to Set Up Your Business Unit to Refund Customers

<i>Page Name</i>	<i>Definition Name</i>	<i>Navigation</i>	<i>Usage</i>
Refund Setup	BUS_UNIT_TBL_SF3	Set Up SACR, Product Related, Student Financials, SF Business Unit, Refund Setup	Define the rules governing how your business unit handles refunds.
Refund Approval	BUS_UNIT_TBL_SF20	Set Up SACR, Product Related, Student Financials, SF Business Unit, Refund Approval	Define refund approval levels.
Payroll Defaults	BUS_UNIT_TBL_SF4	Set Up SACR, Product Related, Student Financials, SF Business Unit, Payroll Defaults	Create default parameters for refunds that use the payroll interface.

Defining Basic Refunding Rules

Access the Refund Setup page (Set Up SACR, Product Related, Student Financials, SF Business Unit, Refund Setup).

General 1	General 2	Posting Setup	Commit Options	Collections	Refund Setup	Refund Approval	Payroll Defaults	Counters
Business Unit:		PSUNV		PeopleSoft University Bursar				
Refund Method:	A/P	<input checked="" type="checkbox"/> Allow Changes in Refund Method						
Refund Service Impact:	REFND	Refund	<input type="checkbox"/> Refund Debit Balances					
Ext Org Contact Type:	CEO	Chief Executive Officer						
Number of Days Between Refunds								
Batch Financial Aid Only:	10	Batch Both FA and Non FA:	12					
Batch Non Financial Aid Only:	11	Online Refunds:	13					
Amount Controls								
Minimum Refund:	25.00	Maximum Refund:	5,000.00					
Sponsored Recipient Controls								
Individual Threshold Amount				Corp Threshold Amount				
Individual Sponsor:	25.00	Individual Sponsor:	100.00					
Organization Sponsor:	50.00	Organization Sponsor:	200.00					

Refund Setup page

Refund Method

Values are:

A/P: Create the refund in Student Financials and have your accounts payable department produce and distribute the checks.

Other: Create the refund in Student Financials and produce a check using a third-party application.

Payroll: Use PeopleSoft Payroll for North America to create refunds and produce checks. You can use this option for individual refunds only, not for refunds to an organization.

Allow Changes in Refund Method

Select to enable a user to switch between the AP, Other, and Payroll methods when processing online refunds. If you clear this check box, the user can use only the refund method specified for the SF Business Unit.

Refund Service Impact

Select the value to use to prevent or deny a refund.

Refund Debit Balances

Select to create refunds that exceed the available credit balance. For example, if a student has charges of 9,000 USD and an unapplied credit of 10,000 USD from a fellowship award, the system allows a refund of the excess unapplied credit even though the student's account technically has a debit balance.

Ext Org Contact Type (external organization contact type)

Select the external organization contact type for processing batch refunds for external organizations.

Number of Days Between Refunds

Define the minimum number of days between the times refunds can be processed for a particular customer.

Note. These restrictions prevent refunds processed in batch mode, but produce only warning messages for online refunds.

Batch Financial Aid Only Enter the minimum number of days between batch-produced refunds of excess financial-aid credits. This setting restricts refunds of financial aid item type credits only and does not affect batch-produced refunds of nonfinancial-aid credits.

Note. Use this setting to specify a different interval between refunds for financial aid and nonfinancial-aid credits only.

Batch both FA and Non FA (batch both financial aid and nonfinancial aid) Enter the minimum number of days between batch-produced refunds of all excess credits. Use this setting to process financial-aid and nonfinancial-aid credits the same way.

Batch Non Financial Aid Only Enter the minimum number of days between batch-produced refunds of excess nonfinancial-aid credits. This setting restricts nonfinancial-aid credits only and does not affect batch-produced refunds of financial aid item type credits.

Note. Use this setting to specify a different interval between refunds for nonfinancial-aid and financial aid credits only.

Online Refunds Enter the minimum number of days between online-produced refunds of all excess credits.

Note. Because online refunds are usually produced for extraordinary reasons, this setting results in a warning message when you attempt to process refunds more frequently than the specified number of days. It does not prevent you from processing the refund.

Amount Controls Group Box

Minimum Refund Enter an amount below which you do not want to produce refunds in batch mode. Refunds below this amount can be processed online. You receive a warning message, but you can override it.

Maximum Refund Enter an amount above which you do not want to produce refunds. You cannot override this amount.

Sponsored Recipient Controls

Sponsored recipient controls refer to the threshold below which student refunds are paid directly to the sponsored student or organization rather than to the sponsor. For example, if the individual sponsor threshold amount is established at 25.00 USD and a sponsored student has a refundable credit balance of 20.00 USD, the refund is paid to the student rather than to a sponsor. Sponsors can be either individuals or organizations.

Individual Threshold Amount

Individual Sponsor and Organization Sponsor Enter a monetary amount (threshold) below which student refunds are not paid to an individual or an organization sponsor.

Corp Threshold Amount

Individual Sponsor and Organization Sponsor Enter a monetary amount (threshold) below which refunds to an organization are not paid to an individual or an organization sponsor.

Defining Refund Approval Parameters

Access the Refund Approval page (Set Up SACR, Product Related, Student Financials, SF Business Unit, Refund Approval).

General 1	General 2	Posting Setup	Commit Options	Collections	Refund Setup	Refund Approval
Business Unit:		PSUNV	PeopleSoft University Bursar			
Individual						
<input checked="" type="checkbox"/> Activate On-line Approvals			<input checked="" type="checkbox"/> Activate Batch Approvals			
<input checked="" type="checkbox"/> Level 1 Role:	CS - First Level Refund App	<input checked="" type="checkbox"/> Approval 1 Amt:	500.00			
<input checked="" type="checkbox"/> Level 2 Role:	CS - Second Level Refund	<input checked="" type="checkbox"/> Approval 2 Amt:	1,000.00			
<input checked="" type="checkbox"/> Level 3 Role:	CS - Supervisor Refund App	<input checked="" type="checkbox"/> Approval 3 Amt:	2,000.00			
Organization						
<input checked="" type="checkbox"/> Activate On-line Approvals						
<input checked="" type="checkbox"/> Level 1 Role:	CS - First Level Refund App	<input checked="" type="checkbox"/> Approval 1 Amt:	500.00			
<input checked="" type="checkbox"/> Level 2 Role:	CS - Second Level Refund	<input checked="" type="checkbox"/> Approval 2 Amt:	1,000.00			
<input checked="" type="checkbox"/> Level 3 Role:	CS - Supervisor Refund App	<input checked="" type="checkbox"/> Approval 3 Amt:	2,000.00			

Refund Approval page

Refund approval controls determine whether approval is required before a refund can be issued. If approval is required, refund requests are routed to the appropriate approver's worklist.

Approval amounts define a range. For example, if the approval 1 amount is set at 500 USD, the approval 2 amount is set at 1,000 USD, and the approval 3 amount is set at 2,000 USD, all refunds under 500 USD do not require approval. All refunds between 500 USD and 999 USD require only level 1 approval, and so on.

Individual

Activate Online Approvals and Activate Batch Approvals Select to require approval of online or batch refunds. If you activate approvals, you must establish roles and approval amounts.

Level 1 Role, Level 2 Role, and Level 3 Role Select the appropriate role for each level of approval.

Approval 1 Amt (approval 1 amount),
Approval 2 Amt (approval 2 amount), and
Approval 3 Amt (approval 3 amount) Enter the refund amount for which the system requires each level of approval.

Organization

Establish approval parameters for corporate refunds. The fields in this group box are identical to those in the Individual group box, except that batch approvals do not apply for organization refunds.

Defining Default Payroll Interface Parameters

Access the Payroll Defaults page (Set Up SACR, Product Related, Student Financials, SF Business Unit, Payroll Defaults).

Business Unit:	PSUNV	PeopleSoft University Bursar
Business Unit for HRMS:	PSUNV	PeopleSoft University
Company:	PSU	PeopleSoft University
Pay Group:	PS1	Student Refunds
Department:	PRESIDENT	Office of the President
Job Code:	PS0001	Student Refunds
Position Number:	90000001	

Payroll Defaults page

Note. Before entering data on this page, consult your institution's payroll staff to determine the correct settings. Use PeopleSoft Payroll for North America to set up and process payroll refunds.

Business Unit for HRMS (business unit for human resources management system) Select the business unit that PeopleSoft Payroll for North America uses to identify the refund company.

Company Select the company code that has been designated for individual refunds.

Setting Default Withholding Amounts for Payroll Refunds

Default withholding amounts, as well as Federal, State, and company tax tables, are set up in PeopleSoft Payroll for North America.

See Also

PeopleSoft Enterprise Payroll for North America 9.0 PeopleBook, "Maintaining Payroll Data"

Setting Up Accounts Payable Options

To set up accounts payable options, use the AP Business Unit component (BUS_UNIT_AP) and the AP Set Controls - Vendor component (SF_AP_VNDR_OPTIONS).

This section discusses how to:

- Set up an AP business unit.
- Define AP set controls for vendors.

Pages Used to Set Up Accounts Payable Options

<i>Page Name</i>	<i>Definition Name</i>	<i>Navigation</i>	<i>Usage</i>
AP Business Unit Options	BUS_UNIT_TBL_AP	Set Up SACR, Product Related, Student Financials, Refunds, AP Business Unit	Establish AP interface and voucher numbering parameters.
AP Set Controls - Vendor	SF_AP_VNDR_OPTIONS	Set Up SACR, Product Related, Student Financials, Refunds, AP Set Controls - Vendor	Define vendor information.

Setting Up an AP Business Unit

Access the AP Business Unit Options page (Set Up SACR, Product Related, Student Financials, Refunds, AP Business Unit).

AP Business Unit Options			
Business Unit:	STATE		
Description:	State	Short Desc:	State
Vendor Set ID:	STATE	AP User ID:	VP1
		Voucher Origin:	EDI
Voucher Numbering			
Voucher Sequencing By:	Automatic Sequencing	Voucher Prefix:	
Last Voucher Number:	5500		
Voucher Group Numbering			
<input checked="" type="checkbox"/> Control Group Numbering		Group ID Last Used:	

AP Business Unit Options page

AP business unit options control how Student Financials creates vendor and voucher file definitions. These definitions are used for transfer to PeopleSoft Enterprise Payables to create refund payments.

Note. The AP business unit options that you define on this page should match PeopleSoft Payables definitions.

AP User ID The Student Financials application refunding process populates each voucher it creates with the AP user ID that you specify here. This ID must exist in PeopleSoft Financials.

Voucher Origin The Student Financials application refunding process populates each voucher it creates with the voucher origin that you specify here. This origin value must exist in PeopleSoft Payables.

Voucher Numbering

Voucher Sequencing By Select how voucher numbers are assigned. Values are:

Automatic Sequencing: Assign voucher numbers starting with the number that you specify in the Last Voucher Number field.

Use SF Refund# as Voucher#: Assign voucher numbers using the SF refund ID number.

Voucher Prefix Enter an optional two-character voucher prefix to enable accounts payable staff to easily identify vouchers that originate in Student Financials. Voucher IDs are eight characters long. If you enter a prefix, a six-digit number is attached to create the voucher ID. For example, if you use the prefix SF, the refunding process will create the voucher ID SF000001.

Last Voucher Number Displays the last voucher number used. You can override this value to establish a new starting point for numbering.

Voucher Group Numbering

Control Group Numbering	Select to assign a control group ID to each voucher that the Student Financials refunding process creates. If control group numbering is selected, the Group ID Last Used field is updated every time you run the refund process. (All of the vouchers created from one refund process run share a common group ID number.)
Group ID Last Used	Displays the last group ID when the Control Group Numbering check box is selected.

Defining AP Set Controls for Vendors

Access the AP Set Controls - Vendor page (Set Up SACR, Product Related, Student Financials, Refunds, AP Set Controls - Vendor).

AP Set Controls - Vendor

Vendor Set ID: SHARE

AP Set Controls - Vendor	
Vendor ID Prefix:	<input type="text" value="SU"/>
Last Vendor ID:	<input type="text" value="550010"/>
Vendor Pay Group:	<input type="text"/>
Vendor Classification:	<input type="text" value="Supplier"/>

AP Set Controls Vendor page

Note. AP set controls insert information into vouchers that are produced for refunds using PeopleSoft Payables. Consult your account payables staff to determine the proper settings.

Vendor ID Prefix	Enter an optional vendor ID prefix to be used with all vendor ID numbers. This prefix should describe the entity producing the voucher transactions. When you add a vendor ID prefix, the prefix replaces the first two characters of the vendor ID number.
Last Vendor ID	Displays the last vendor ID used by the system. Insert a new value to specify a starting point for new vouchers.
Vendor Pay Group	Enter an optional two-character vendor pay group code. This code can be used during payment processing to cause Pay Cycle Manager to pay only vouchers originating in Student Financials.

Vendor Classification Select the value to use for the `VENDOR_CLASS` in the `VENOR_SYNC` message for the AP Interface process for refunding. Values are *Attorney*, *Employee*, *HRMS*, and *Supplier*. The default value is *Supplier*.

See Also

PeopleSoft Enterprise Payables 8.9 PeopleBook, "Entering and Processing Vouchers Online," General Voucher Entry Information

PeopleSoft Enterprise Payables 9.0 PeopleBook, "Establishing Pay Cycles"

Setting Up Payroll Refund Options

Use PeopleSoft Payroll for North America to create and distribute refunds using the payroll method. A number of setup steps are included on the Payroll side, including generating a calendar, which designates pay period end dates that the Payroll system uses when generating refund checks. Most of the time you will create a calendar for every possible day of a given year. That way, whenever you want to create a payroll refund, a pay period end date has already been designated. You can also create calendars for specific days on an as-needed basis. Be sure to select the Off Cycle check box when creating calendars for Student Financials.

You will also use PeopleSoft Payroll for North America to create pay groups, pay run IDs, balance IDs and so on.

For refunding students through Payroll, Student Financials recommends the following settings in HRMS:

If the student is assigned to an existing Benefit Record Assign Primary Job, select *Make New Job Primary*.

If the Primary Job terminates, select *Re-Assign Primary Job Highest Active Job*.

See *PeopleSoft Enterprise Human Resources 9.0 PeopleBook: Manage Base Benefits, "Setting Up Additional Base Benefits Features," Setting Up Multiple Jobs*

See *PeopleSoft Enterprise Payroll for North America 9.0 PeopleBook: "Administering Interfaces with PeopleSoft HRMS and PeopleSoft Enterprise Expenses," Administering the Interface with Student Financials*

Creating Job Data for Payroll Refunds

To set up job data for payroll refunds, use the Create Student Job Data component (`SSF_POIJOB_TEST`) and the Request Student Job Data component (`SSF_RUN_POIJOB`).

This section discusses how to:

- Create job data for payroll refunds.
- Create job data in batch.
- Create T4A tax job data.

See Also

Chapter 7, "Setting Up Refunding," Setting Up Your Business Unit to Refund Customers, page 238

Pages Used to Create Job Data

<i>Page Name</i>	<i>Definition Name</i>	<i>Navigation</i>	<i>Usage</i>
Request Student Job Data	SSF_POIJOB_TEST	Student Financials, Refunds, Create Student Job Data, Request Student Job Data	Create a student job record.
Request Student Job Data	SSF_RUN_POIJOB	Student Financials, Refunds, Process Batch Refunds, Request Student Job Data	Create student job data in batch.

Creating Job Data for Payroll Refunds

Access the Request Student Job Data page (Student Financials, Refunds, Create Student Job Data, Request Student Job Data).

Request Student Job Data

Business Unit: PSUNV PeopleSoft University Bursar Create POI Job

Parameters

Business Unit for HRMS: PSUNV PeopleSoft University

Department: PRESIDENT **Job Code:** PS0001 **Company:** PSU **Pay Group:** PS1

EmplID: Mitchell,Cameron

Process EFFDT: **Empl Rcd#:** 0 [Student Job Data](#)

Service Return Messages Customize | Find | First 1 of 1 Last

Request Student Job Data page (single student)

Processing Options

The fields that appear on this page depend on your processing population selection.

Processing Population	<p>Values are:</p> <p><i>Refund Batch</i>: Enables you to select a specific refund batch ID.</p> <p><i>Refund Students</i>: Creates job data for all students with a pending refund.</p> <p><i>Student List</i>: Click the Student List link to enter individual IDs.</p> <p><i>T4A Students</i>: Creates job (tax) records for students receiving a T4A (Canadian tax form).</p>
Batch ID	This field appears only if you select Student List for the processing population. Select the student IDs that you want to process.
Student List	This link appears only if you select Refund Batch for the processing population.
Commit Frequency	<p>Enter a number for records committed to the database. Select this option to commit a specified number of transactions during background processing. For example, if you enter 100 in the Commit Frequency field, when you run a batch process the system processes 100 transactions and then commits them to the database until the batch is complete. At the end of a batch process, the system commits all remaining transactions even if the number of transactions is less than the number in the Commit Frequency field.</p> <p>See Chapter 2, "Completing Student Financials General Setup," Defining Commit Levels, page 15.</p>
Confirm Job Data Created	Select to create a record in the message log of the process monitor for every job record created.
Empl Rcd# (employee record number)	After the process is complete, Empl Rcd# is populated with a value of <i>0</i> for the primary job record. A secondary job will have a value of <i>1</i> . You might have a secondary job if you have a multi-institution environment and a student is enrolled in two institutions (and is receiving refunds from both of them).
Student Job Data	Click to access the Workforce Administration, Job Information, Job Data component.
Service Return Messages	Any messages, if problems occur, appear here.
Create POI Job	Click to create job data for the selected student.

Creating Job Data in Batch

Access the Request Student Job Data page (Student Financials, Refunds, Process Batch Refunds, Request Student Job Data).

Request Student Job Data

Run Control ID: BATCH_REFUNDS [Report Manager](#) [Process Monitor](#) Run

*Business Unit: PeopleSoft University Bursar

Job Effective Date: 11/03/2004

Processing Options

*Processing Population: Batch ID:

Commit Frequency: Confirm Job Data Created

Request Student Job Data page (batch)

The processing options on this page are identical to those on the previous page.

Creating T4A Tax Job Data

You may need to create T4A tax records for students.

See [Chapter 24, "Producing Tax Forms and Receipt Information," Creating POI Job Data for T4A, page 680.](#)

Setting Up Direct Deposit for Students

If you use the payroll refund method and you want to distribute refunds through direct deposit, you must first set up direct deposit for each applicable student (for U.S. or Canadian students).

You set up direct deposits in PeopleSoft Payroll for North America.

See *PeopleSoft Enterprise Payroll for North America, Maintaining Payroll Data, "Setting Up Direct Deposits"*

Designating Sponsors

Sometimes students and organizations with a negative account balance have sponsors that should be the refund recipient. You must designate a sponsor for those sponsored students and corporations.

This section discusses how to:

- Designate sponsors for individual students.
- Designate sponsors for organizations.

Pages Used to Designate Sponsors

Page Name	Definition Name	Navigation	Usage
Individual Sponsor	REFUND_CUSTOMER_ID	Student Financials, Refunds, Designate Sponsor	Designate a sponsor for each credit on the student's account.
Corp Sponsor (corporate sponsor)	REFUND_ORG_SPONSOR	Student Financials, Refunds, Designate Corporate Sponsor	Designate a sponsor for each credit on the organization's account.

Designating Sponsors for Individual Students

Access the Individual Sponsor page (Student Financials, Refunds, Designate Sponsor, Individual Sponsor).

Individual Sponsor

Business Unit: PSUNV

ID: Layton,Jack

Individual Sponsor
Find First 1 of 1 Last

Item Type: Cash Payment	Term: 2001 Spring	
Account: MISFEES001-	Item Amt: -2,000.00	Balance: -2,000.00
Sponsor ID: <input type="text"/>		
Sponsor Org ID <input type="text"/>	Org Contact: <input type="text"/>	

Individual Sponsor page

ID Enter the ID of the student for whom you want to designate one or more sponsors.

Individual Sponsor

Sponsor ID If the sponsor that you are designating is an individual, select the ID of the individual. When you select a value in this field, the Sponsor Org ID and Org Contact fields become unavailable.

Sponsor Org ID (sponsor organization ID) If the sponsor that you are designating is an external organization, select the ID of the organization. When you select a value in this field, the Sponsor ID field becomes unavailable.

Org Contact (organization contact) If you select an organization in the Sponsor Org ID field, select the contact for that organization.

Designating Sponsors for Organizations

Access the Corp Sponsor page (Student Financials, Refunds, Designate Corporate Sponsor).

With the exception of the External Org ID (external organization ID) field, the fields on this page are identical to those on the Individual Sponsor page.

External Org ID Enter the ID of the external organization for which you want to designate one or more sponsors.

See Also

[Chapter 7, "Setting Up Refunding," Designating Sponsors, page 249](#)

Chapter 8

Setting Up Payment Plans

This chapter lists common elements and discusses how to:

- Set up deferral contracts.
- Set up payment plan contracts.
- Set up third-party contracts.
- Set up collection agreements.

Common Elements Used in This Chapter

Status

Enter the status of the contract. Values are:

Active: Select to make the contract available for use.

Cancelled: Select to cancel the contract.

Hold: Select to prevent new students from being added to the contract, but not to discontinue its use completely.

Inactive: Select to discontinue use of the contract.

Billing Cycle

Select the billing cycle for the payment plan. Values are:

Bi-Monthly: Select to bill students every other month.

Monthly: Select to bill students each month.

One Time: Select to bill students only once.

User Selected: Select to specify billing and due dates rather than having the system generate the schedules.

Weekly: Select to bill students weekly.

Setting Up Deferral Contracts

To set up deferral contracts, use the Create Deferral Contract component (DEFERRAL_CONTRACT).

This section discusses how to:

- Define basic deferral contract parameters.

- Define deferral contract administrative fees.
- Define deferral contract eligible charges and maximum amounts.

Pages Used to Set Up Deferral Contracts

<i>Page Name</i>	<i>Definition Name</i>	<i>Navigation</i>	<i>Usage</i>
Deferral Contract	DEFER_CONTRACT	Student Financials, Payment Plans, Create Deferral Contract, Deferral Contract	Define basic deferral contract parameters.
Deferral Contract Fee	DEFER_CONTRACT_FEE	Student Financials, Payment Plans, Create Deferral Contract, Deferral Contract Fee	Define deferral contract administrative fees.
Deferral Contract Charges	DEFER_CONTRACT	Student Financials, Payment Plans, Create Deferral Contract, Deferral Contract Charges	Define deferral contract eligible charges and maximum amounts.

Defining Basic Deferral Contract Parameters

Access the Deferral Contract page (Student Financials, Payment Plans, Create Deferral Contract, Deferral Contract).

Deferral Contract page

- Term** Select the term to which the contract applies.
- Tree Name** Select the item type tree name that includes the charge item types that you cover under this plan.
- Student Max** (student maximum) Enter the maximum amount that you want to allow any one student to defer under the contract. Be sure to set this amount high enough to meet your needs. The system does not defer eligible charges that cause the deferred amount to exceed the student maximum. For example, if the student maximum is 10,000 USD and the system already deferred 8,500 USD, it rejects a new eligible charge of 2,000 USD because the total exceeds the defined maximum.
- From Date and To Date** Set the date range for the deferral contract. The system defers only eligible charges that are posted to the student's account within this range.
- Due Date/Days and Bill Date/Days** Set the time unit to use to calculate the payment's due date and bill date. Options are:
Due Date: If you select this option, the Defer Date field becomes available.
Due Days: If you select this option, the Defer Days field becomes available.
- Defer Days** If you select *Due Days* in the Due Date/Days and Bill Date/Days fields, enter the number of days from the transaction's effective date that the system defers the due date and bill date.

Defer Date

If you select *Due Date* in the Due Date/Days field, set the date that the payment is due and the date that you want it billed regardless of the charge effective date.

Copy Contracts

Click the Copy button to copy an existing deferral contract as the basis of a new deferral contract. You can copy all contract setup information except for term and date information.

Access the Copy Contract page (click the Copy button on the Deferral Contract page).

Copy Contract page

New Contract Number

Enter a new number for the copied contract.

If auto numbering is enabled on the SF Business Unit Payment Plan Contract Set Up page, NEXT is automatically assigned as the new contract number. You can change the contract number.

Description

Enter a description for the copied contract.

Copy All Values

Select to copy all other related contract information from the previous contract.

Enter the desired information and click Save. You are returned to the Deferral Contract page, where you can modify the new contract information as desired.

Defining Deferral Contract Administrative Fees

Access the Deferral Contract Fee page (Student Financials, Payment Plans, Create Deferral Contract, Deferral Contract Fee).

Deferral Contract	Deferral Contract Fee	Deferral Contract Charges	
Business Unit:	PSUNV	Contract Number: 522	
Assessment Fee:	<input type="text" value="55.00"/> USD		
Account Type:	<input type="text" value="PPL"/> Pay Plan		
Assess Item Type:	<input type="text" value="110000000000"/> Administrative Fees		
Due Date/Days		Bill Date/Days	
Use:	<input type="text" value="Due Date"/>	Use:	<input type="text" value="Due Date"/>
Due after Days:	<input type="text"/>	Days:	<input type="text"/>
Due Date:	<input type="text" value="03/15/2001"/>	Date:	<input type="text" value="03/07/2001"/>

Deferral Contract Fee page

Assessment Fee Enter the amount of the administrative fee that you want to charge for this contract.

Account Type Enter the account type designated for payment plans.

Assess Item Type Enter the item type of the assessment fee.

Due Date/Days and Bill Date/Days

Define the parameters for calculating the due date for the assessment fee.

Use Select how you want to calculate the due date and bill date for the assessment fee. Values are:

Due Date: Select to specify a specific date for the assessment fee to be due and billed. When you select this option, the Due Date field becomes available.

Due Days: Select to make the assessment fee due and billed a certain number of days after it is assessed. When you select this option, the Due after Days field becomes available.

Due after Days In both the Due Date/Days and Bill Date/Days group boxes, enter the number of days after the system posts the assessment fee that it becomes due and is billed.

Due Date In both the Due Date/Days and Bill Date/Days group boxes, enter the actual date that you want the assessment fee due and billed.

Defining Deferral Contract Eligible Charges and Maximum Amounts

Access the Deferral Contract Charges page (Student Financials, Payment Plans, Create Deferral Contract, Deferral Contract Charges).

Deferral Contract
Deferral Contract Fee
Deferral Contract Charges

Business Unit: PSUNV **Contract Number:** 522

Offset Charge Info

Item Type Group:

Term From: **Term To:**

Find | View All
First
1-2 of 2
Last

*Line#	*Tree Node	*Max Amount	
1	TUITION	5,000.00	USD + -
2	HOUSING	5,000.00	USD + -

Deferral Contract Charges page

Offset Charge Info

Fields in this group box are not available for deferral contracts.

Eligible Charge Parameters

Line# (line number) This field is automatically populated as you add new charge nodes.

Tree Node Select the item type tree node to designate charges that are covered under this contract.

Max Amount (maximum amount) Enter the maximum amount that can be deferred under the corresponding tree node. Be sure to set this amount high enough to meet your needs. Eligible charges are selected for deferment on an individual basis and the sum of charges within the node must not exceed the maximum amount.

For example, using the previous setup, suppose that a student has tuition charges of 1,500 USD and 3,800 USD, and a housing charge of 4,900 USD. Because the total of the tuition charges exceeds the maximum amount of 5,000 USD, the system defers only one of the tuition charges. The housing charge is within the maximum amount limit and the combined total of the single tuition charge and housing charge does not exceed the student maximum amount, allowing both to be deferred.

Setting Up Payment Plan Contracts

To set up payment plan contracts, use the Create Payment Plan component (TP_PAYMENT_PLAN).

This section discusses how to:

- Define basic payment plan contract parameters.
- Define payment plan type, eligible charges, and time frame.
- Define payment plan item types.
- Define self-service options.
- Define payment plan administrative fees.

Pages Used to Set Up Payment Plan Contracts

<i>Page Name</i>	<i>Definition Name</i>	<i>Navigation</i>	<i>Usage</i>
Payment Plan 1	TP_PAYMENT_PLAN	Student Financials, Payment Plans, Create Payment Plan, Payment Plan 1	Define basic payment plan contract parameters.
Payment Plan 2	TP_PAYMENT_PLAN3	Student Financials, Payment Plans, Create Payment Plan, Payment Plan 2	Define payment plan type, eligible charges, and time frame.
Payment Plan Item Type	TP_PAYMENT_PLN2	Student Financials, Payment Plans, Create Payment Plan, Payment Plan Item Type	Define payment plan item types.
Self Service Options	SSF_TP_PMT_PLAN4	Student Financials, Payment Plans, Create Payment Plan, Self Service Options	Define self-service options.
Payment Plan Fee	TP_CONTRACT_ASSESS	Student Financials, Payment Plans, Create Payment Plan, Payment Plan Fee	Define payment plan administrative fees.

Defining Basic Payment Plan Contract Parameters

Access the Payment Plan 1 page (Student Financials, Payment Plans, Create Payment Plan, Payment Plan 1).

Payment Plan 1	Payment Plan 2	Payment Plan Item Type	Self Service Options	Payment Plan Fee
Business Unit:	PSUNV	Contract Number:	533	<input type="button" value="Copy"/>
Description:	Calculated PPL	Short Description:	Calculated	
Long Description:	Bundle 11			
Pay Plan Type:	Credit Original Account	Status:	Active	
Total Budget Amt:	10,000.00 USD	First Bill Date:	11/19/2001	
Payment Due Days:	5	Number Of Payments:	2	
Term:	0430 2001 Spring	Last Date:	12/31/2002	
Billing Cycle:	Monthly	Service Impact:		
Plan Type:				
Payroll Deduction:				
<input type="button" value="Save"/> <input type="button" value="Return to Search"/> <input type="button" value="Previous in List"/> <input type="button" value="Next in List"/> <input type="button" value="Notify"/> <input type="button" value="Refresh"/> <input type="button" value="Add"/> <input type="button" value="Update/Display"/>				
Payment Plan 1 Payment Plan 2 Payment Plan Item Type Self Service Options Payment Plan Fee				

Payment Plan 1 page

Description

Enter a description. This will also appear in Self Service Enroll in a Payment Plan.

Pay Plan Type

Define how the system credits payments made to this plan. Values are:

Credit the Original Account: Select to credit all eligible charges and create a new payment plan charge.

Create Billing Entries: This option should not be used with any of the three payment plans.

Status

Specify whether the payment plan contract is active or inactive. You can change the status of a contract to *Inactive* regardless of the status of any students that are associated with it.

Note. You should change the contract status to *Inactive* on any calculated payment plans for previous terms. This enhances performance because of the way the system automatically recalculates active contracts. An active contract is one for which both the contract and student status have a value of *Active*, and the last date of the contract is greater than the current system date. When the system recalculates contracts for a student, it evaluates all active contracts for that student. You do not need to set the student status to *Inactive* to receive this performance benefit as long as you have set the appropriate contract status to *Inactive*.

Total Budget Amt (total budget amount)	<p>This should be defined in conjunction with all eligible charges. Enter the maximum amount of installment payments that a student can make through the payment plan account. Carefully consider all eligible charges when you establish this figure to make sure that it is high enough to cover all the intended costs.</p> <p>For lump sum plans, the total budget amount becomes the default lump sum amount. You can adjust this amount for each student who is linked to the plan.</p>
First Bill Date	<p>Set the date on which you generate the first bill for the payment plan. The system uses the first bill date and the billing cycle to set the billing dates for the duration of the payment plan. You can override this setting for each student who is linked to the plan.</p> <hr/> <p>Note. The billing program does not acknowledge the payment plan until on or after the first bill date specified. For example, if your first bill date is set for November 16 and you run your billing process on the 15th, the system does not process Payment Plan billing until the next run.</p> <hr/>
Payment Due Days	Enter the number of days after the bill date that the payment is due.
Number of Payments	Enter the number of payments (installments) that students must make to pay off the plan. The system uses the information in this field as the default value. You can override the number of payments for each student who is linked to the plan.
Term	<p>This field is required for calculated payment plans. Enter the term that the system posts on the payment plan credit and the installments.</p> <p>This field is optional for existing and lump-sum payment plans.</p>
Last Date	Enter the last date that charges can be added or adjusted and still be picked up by the plan.
Service Impact	<p>Enter the service impact that would prevent enrollment into the payment plan.</p> <p>This prevents enrollment into the payment plan through Batch Assignment, Assign Page, and Self Service.</p>
Plan Type	Select the value of the HR plan type that applies to the payroll deduction code.
Payroll Deduction	<p>Enter the code of the payroll deduction that applies to the payment plan account.</p> <hr/> <p>Note. Assigning a payroll deduction code to a payment plan is necessary only if you plan to restrict payroll deductions to apply to payment plan accounts.</p> <hr/>

Copy Contracts

Click the Copy button to copy an existing payment plan contract as the basis of a new payment plan contract. You can copy all contract setup information except for term and date information.

Access the Copy Contract page (click the Copy button on the Payment Plan 1 page).

Copy Contract	
Business Unit:	PSUNV PeopleSoft University Bursar
Contract Number:	532 User Defined
New Contract Information	
New Contract Number:	<input type="text" value="NEXT"/>
Description:	<input type="text" value="Next Payment Plan Contract"/>
<input type="checkbox"/> Copy All Values	
<input type="button" value="Next"/> <input type="button" value="Cancel"/>	

Copy Contract page

New Contract Number Enter a new number for the copied contract.

If auto numbering is enabled on the SF Business Unit payment plan contract set up page, NEXT is automatically assigned as the new contract number. You can change the contract number.

Description Enter a description for the copied contract.

Copy All Values Select to copy all other related contract information from the previous contract.

Enter the desired information and click Save. You are returned to the Payment Plan 1 page, where you can modify the new contract information as desired.

See Also

[Chapter 11, "Setting Up Receivables Maintenance," Setting Up Payroll Deduction, page 359](#)

Defining Payment Plan Type, Eligible Charges, and Time Frame

Access the Payment Plan 2 page (Student Financials, Payment Plans, Create Payment Plan, Payment Plan 2).

Payment Plan 1	Payment Plan 2	Payment Plan Item Type	Self Service Options	Payment Plan Fee
Business Unit:	PSUNV	Contract Number:	533	
*Plan Type:	Calculated			
Maximum Amount:	10,000.00 USD	Lump Sum Amount:	USD	
Item Type Group:	TUITION	Offset Item Type Group:	FINAID	
Term	Charge Date	Anticipated Aid Term/Date		
From: 0430 2001 Sprng	Add: 08/01/2001	From: 0430 2001 Sprng		
To: 0430 2001 Sprng	Adjust: 12/31/2010	To: 0430 2001 Sprng		
Offset Term	Charge Offset Date	Anticipated Aid Date:		
From: 0430 2001 Sprng	Add: 08/01/2001	Anticipated Aid Date: 12/31/2001		
To: 0430 2001 Sprng	Adjust: 12/31/2010			
		<input checked="" type="checkbox"/> Calculate Real Time		
Save	Return to Search	Previous in List	Next in List	Notify
		Refresh	Add	Update/Display
Payment Plan 1 Payment Plan 2 Payment Plan Item Type Self Service Options Payment Plan Fee				

Payment Plan 2 page

Plan Type

Select the plan type from the following values:

Calculated: Select to determine which charges to include based on the rules that you define on this page. If you use this option, each time that you calculate or recalculate the payment plan, the system picks up all eligible charges and adds them to the plan balance. You can also use the Calculate Real Time option to have the contract recalculated each time an eligible change occurs in the student's account. This is available for Self Service Enroll in a Payment Plan.

Existing: Select to manually choose which charges to include in each student's payment plan at the time you add the student to the plan.

Note. When you choose *Existing*, the rest of the fields (with the exception of Calculate Real Time) become unavailable.

Lump Sum: Select to create a payment plan for a fixed amount. This is the most basic type of plan and is useful for students who do not expect any changes to occur in their accounts and know how much they need to finance. This is available for Self Service Enroll in a Payment Plan.

Note. When you select the Lump Sum option, the Lump Sum Amount field becomes available and all other fields on the page become unavailable.

Maximum Amount

The maximum amount is set by default from the total budget amount and can be overridden, if needed. This field is available with calculated payment plans only.

Lump Sum Amount Enter the lump sum amount that you want the contract to cover. The default value for this field is the total budget amount that is established on the Payment Plan 1 page. You can override this value, but you cannot exceed the total budget amount limit. This field is available with lump sum payment plans only.

Item Type Group Select the item type group that includes all of the charges to be included in the payment plan. This field is available with calculated payment plans only.

Offset Item Type Group Select the offset item type group that includes payments, financial aid, or both that the system uses to offset charges and thereby reduce the amount of the payment plan. This field is available with calculated payment plans only.

Term and Offset Term

In these group boxes, enter the range of terms for which the system includes charges and offsetting credits in the payment plan. These fields are available with calculated payment plans only.

Charge Date and Charge Offset Date

In these group boxes, specify when charges and offsetting credits can be added to or adjusted in the payment plan. These fields are available with calculated payment plans only.

Add Enter the earliest date to include charges, offsetting credits, or both in the payment plan.

Adjust Enter the last date on which you can adjust the payment plan for new charges or a reduction in charges, offsetting credits or both.

Anticipated Aid Term/Date

Enter the range of terms for which the system considers anticipated aid. These fields are available for the calculated payment plan, but not required.

From and To Enter the earliest term and latest term for which the system considers anticipated aid.

Anticipated Aid Date Enter the date that the system uses to determine whether anticipated aid is eligible. If this date is less than the current system date, the system disregards anticipated aid when it calculates the payment plan contract.

Calculate Real Time Check Box

Calculate Real Time Select to automatically calculate payment plan charges whenever a change is made to eligible charges. This option affects all students who are associated with the plan, but you can override it at the student level. If you do not select this option, you must calculate payment plan agreements in batch mode.

Defining Payment Plan Item Types

Access the Payment Plan Item Type page (Student Financials, Payment Plans, Create Payment Plan, Payment Plan Item Type).

Payment Plan 1	Payment Plan 2	Payment Plan Item Type	Self Service Options	Payment Plan Fee
Business Unit:	PSUNV	Contract Number:	533	
Adjustment Option:	Adjust Equally			
Extra Payments Option:				
Account Type:	PPL		Payment Plan	
Charge Item Type:	1800000000002		Student Tuition & Fees	
Billing Item Type:				
Payment Item Type:	3600000000001		Move to Payment Plan	
<div style="display: flex; justify-content: space-between; align-items: center;"> <div> Save Return to Search Previous in List Next in List Notify Refresh </div> <div> Add Update/Display </div> </div>				
Payment Plan 1 Payment Plan 2 Payment Plan Item Type Self Service Options Payment Plan Fee				

Payment Plan Item Type page

Adjustment Option Enter how the system distributes changes to payment plan installments. See Increasing Payment Plan Contract Installments and Decreasing Payment Plan Contract Installments below for detailed information about this field and its values.

Extra Payments Option Specify how the system applies payments that exceed the amount billed. Values are:

All Bills: Select to reduce the amount due in equal portions across all remaining bills.

First Bill: Select to reduce the amount of the next bill by the amount of the excess payment. If the excess is greater than the amount of the next bill, the system applies it to remaining bills in the order due.

Last Bill: Select to apply the excess amounts to the final bill of the contract.

Account Type Enter the account type that you have defined for the plan.

Charge Item Type	Enter the charge item type. This creates the installment charges on the payment plan account.
	Note. If this field is not available, change the payment plan type on the Payment Plan 1 page to <i>Credit Original Account</i> .
Billing Item Type	This field is not available for use with this type of payment plan. If the field is available, change the payment plan type on the Payment Plan 1 page to <i>Credit Original Account</i> .
Payment Item Type	Enter the payment item type to use to credit the tuition and fees covered by the payment plan.
	Note. If this field is not available, change the payment plan type on the Payment Plan 1 page to <i>Credit Original Account</i> .

Note. How you set up the account types and item types that you use with your payment plans significantly affects the way the plan works. How you define your account types determines how charges and payments appear on the student's account. Item type setup controls how charges and payments are applied. Test your setup using different configurations to determine what works best for your situation.

Increasing Payment Plan Contract Installments

Anytime you add a new eligible charge to a payment plan contract or decrease a payment offset for a contract, the amount of the payment plan contract increases. When this happens, the system must distribute this increase to one or all of the payment plan contract installments.

For calculated payment plan contracts, the Adjustment Option field value determines how the system distributes increases to installments. Values are:

- *Adjust Equally:* Distributes increases equally among the unbilled installments.
- *Adjust Last:* Adds increases to the last unbilled installment.
- *Adjust First:* Adds increases to the first unbilled installment.
- *Do Not Adjust:* Does not allow increases.

Note. If all installments have been billed, you cannot increase the payment plan contract, regardless of the adjustment option. In addition, these adjustment options apply only if you have billed at least one installment. If no billing has occurred, the system adjusts equally by default.

For existing payment plan contracts, when you click the Calculate button, the system distributes increases equally among all installments. This happens regardless of the selected adjustment option or whether you have billed any installments. You can use the Payment Distribution page to manually update the installment amounts before posting.

Decreasing Payment Plan Contract Installments

Anytime you reverse or reduce an eligible charge from a payment plan contract or increase a payment offset for a contract, the amount of the payment plan contract decreases. When this happens, the system must distribute this decrease to the payment plan contract installments. Student Financials does not allow payment plan credits to have an unapplied balance. This means that unlike payment plan contract increases, payment plan contract decreases cannot be prevented. Even if all of the payment plan contract installments have been billed, or the payment plan is inactive, or the last adjustment date has passed, the system must adjust the installments whenever a payment plan contract amount decreases.

Similar to payment plan increases, the Adjustment Option field value determines how the system distributes decreases to installments. Because an individual installment can never be less than 0.00, however, the adjustment option rules don't always apply in exactly the same way that they do with payment plan contract increases. When the total amount of a payment plan contract decrease is greater than the amount of each individual installment, the adjustment option provides a starting point for the system to apply decreases. Values are:

- *Adjust First*: Adjusts installments in ascending item number order.
- *Adjust Last*: Adjusts installments in descending item number order.
- *Do Not Adjust*: Adjusts installments in descending item number order.
- *Adjust Equally*: Divides the adjustment amount equally across all installments.

If no unbilled installments exist for a payment plan contract decrease, or the total of the unbilled installments is less than the total decrease, the system adjusts installments in the following order using the starting point that is designated by the adjustment option:

1. Unbilled and unpaid installments.
2. Unbilled and paid installments.
3. Billed and unpaid installments.
4. Billed and paid installments.

For example, a payment plan contract with an adjustment option of *Adjust Last* has two unbilled installments of 200.00 USD each and undergoes a decrease of 500.00 USD. The system cannot apply the entire decrease to the last unbilled installment because that would bring the installment to an amount that is less than 0.00 USD, so it subtracts 200.00 USD from the last unbilled installment, and with the remaining 300.00 USD moves to the next to last unbilled installment. Again, it can apply only 200.00 USD to the installment, leaving an unapplied balance of 100.00 USD. The system subtracts this unapplied balance to one of the billed installments according to the order given previously.

See Also

[Chapter 2, "Completing Student Financials General Setup," page 5](#)

Defining Self Service Options

Access the Self Service Options page (Student Financials, Payment Plans, Payment Plan, Create, Self Service Options).

Payment Plan 1	Payment Plan 2	Payment Plan Item Type	Self Service Options	Payment Plan Fee
Business Unit:	PSUNV	Contract Number:	SS_TRANS_F	
<input checked="" type="checkbox"/> Allow Self Service Enrollment		Plan Type:	Lump Sum	
Self Service Description:	<div style="border: 1px solid gray; padding: 5px;"> Enroll in early Housing billing installments for Spring 2006. You may adjust the number of installments or the installment amount. </div>			
Self Service Start Date:	01/01/2006	Self Service End Date:	02/01/2006	
Conditions at Plan Enrollment				
Student Group:	<input type="text"/>			
<input checked="" type="checkbox"/> Limit Plan to Existing Charges	Minimum Amount:	<input type="text" value="100.00"/>		
<input checked="" type="checkbox"/> Allow Change in Amount				
<input checked="" type="checkbox"/> Allow Change in Installments				

Self Service Options page

This self-service component enables students to link their charges to a specified payment plan. Only the calculated and lump sum payment plans are available for the self-service enrollment in a Payment Plan functionality.

If the student wants to revoke permission, this can be done only by the administrator, not by means of self service by the student.

Allow Self Service Enrollment Select to enable self-service enrollment in the payment plan.

Self Service Description Enter a useful summary of the payment plan that the system displays to the student.

Self Service Start Date and Self Service End Date Enter a start and end date for self-service enrollment. The system performs an edit to check that the billing date is equal to or later than the self service end date.

Conditions at Plan Enrollment

Student Group Enter a value to limit self-service enrollment to a specific group of students.

Limit Plan to Existing Charges Select to allow the student to link only the eligible charges to the payment plan at the time of payment plan enrollment.

Any additional transactions do not affect the payment plan amount. If you do not select this option, the payment plan maximum amount defaults to the contract amount and the system can move any future eligible transactions to the payment plan.

Allow Change in Amount

Select to allow the student to change the contract amount to less than the payment plan maximum amount or less than the existing charges but greater than the minimum amount.

If you do not select this option and you have selected the Limit Plan to Existing Charges option, the plan amount is either the maximum amount or the eligible charges.

Allow Change in Installments

Select to allow the student to change the number of installments.

Minimum Amount

Indicate a minimum amount for the payment plan.

If you have selected the Limit Plan to Existing Charges option or the Allow Change In Amount option, you must enter an amount greater than zero.

Defining Payment Plan Administrative Fees

Access the Payment Plan Fee page (Student Financials, Payment Plans, Create Payment Plan, Payment Plan Fee).

Payment Plan 1	Payment Plan 2	Payment Plan Item Type	Self Service Options	Payment Plan Fee
Business Unit:	PSUNV	Contract Number:	533	
Type of Assessment:	Payment Plan Fee			
Payment Plan Fee:	57.00	USD		
Percentage of Payment Plan:				
Monthly Interest Rate:				
Assessment Fee Split:	Add to first payment			
Assessment Item Type:	110000000000	Administrative Fees		
Save	Return to Search	Previous in List	Next in List	Notify
		Refresh	Add	Update/Display
Payment Plan 1 Payment Plan 2 Payment Plan Item Type Self Service Options Payment Plan Fee				

Payment Plan Fee page

Type of Assessment	<p>Select the type of assessment. You can leave this field blank if you do not want to assess a fee. When you leave the field blank, all of the other fields on the page become unavailable. If the majority of the students who are associated with this payment plan should be assessed a fee, select one of the following options. When linking each student to the payment plan, you can waive the fee on an individual basis.</p> <p><i>Monthly Interest Rate:</i> Select to charge interest that is calculated monthly against the outstanding balance in the plan. When you select this option, you must also set a monthly interest rate.</p> <hr/> <p>Note. This option is not available with calculated payment plans.</p> <hr/> <p><i>Payment Plan Fee:</i> Select to assess a fixed amount fee. If you select this option, the Payment Plan Fee, Assessment Fee Split, and the Assessment Item Type fields become available.</p> <p><i>Percentage of Payment Plan:</i> Select to assess a fee based on a percentage of the plan's initial balance. If you select this option, the Percentage of Payment Plan, Assessment Fee Split, and the Assessment Item Type fields become available.</p>
Payment Plan Fee	Enter an optional flat-amount payment-plan fee if your institution assesses a flat fee for payment plans. This field is available only if you select <i>Payment Plan Fee</i> in the Type of Assessment field.
Percentage of Payment Plan	Enter the percent amount that you want the system to use when you select <i>Percentage of Payment Plan</i> in the Type of Assessment field.
Monthly Interest Rate	Enter a monthly interest rate that you want to charge when you select <i>Monthly Interest Rate</i> in the Type of Assessment field.
Assessment Fee Split	<p>Select how you want to split the assessment fee. This field is available only if you select <i>Payment Plan Fee</i> or <i>Percentage of Payment Plan</i> in the Type of Assessment field.</p> <p><i>Add to first installment:</i> Select to apply the entire assessment fee to the first payment of the contract.</p> <p><i>Add to last installment:</i> Select to apply the entire assessment fee to the last payment of the contract.</p> <p><i>Split over all installments:</i> Select to divide and apply the assessment fee equally over all payments.</p>
Assessment Item Type	Enter the item type that you want to use for the assessment fee.

Setting Up Third-Party Contracts

To set up third-party contracts, use the Create Third Party Contract component (TP_CONTRACT).

This section discusses how to:

- Define basic third-party contract parameters.

- Define third-party contract item types.
- Define third-party contract transfer parameters.

Pages Used to Set Up Third-Party Contracts

<i>Page Name</i>	<i>Definition Name</i>	<i>Navigation</i>	<i>Usage</i>
Third Party Contract	TP_CONTRACT	Student Financials, Payment Plans, Create Third Party Contract, Third Party Contract	Define basic third-party contract parameters.
Third Party Item Types	TP_CONTRACT_ITEM	Student Financials, Payment Plans, Create Third Party Contract, Third Party Item Types	Define third-party contract item types.
Third Party Charges	TP_CONTRACT_CHRG	Student Financials, Payment Plans, Create Third Party Contract, Third Party Charges	Define third-party contract transfer parameters.

Defining Basic Third-Party Contract Parameters

Access the Third Party Contract page (Student Financials, Payment Plans, Create Third Party Contract, Third Party Contract).

Third Party Contract		Third Party Item Types		Third Party Charges	
Business Unit:	PSUNV	Contract Number:	WITH TAX		
Description:	N/A	Short Description:	H.S.	<input type="button" value="Copy"/>	
Long Description:	Alta High School with Tax				
External Org ID:	000010004	Alta High School			
Status:	Active	Contract Priority:	400		
Contact Type:	TPC Third Party Contract				
Ext. Contract:					
Contract Max:	50,000.00 USD	Student Max:	5,000.00 USD		
Charge Tree:	ITEM_SECURITY	Last Date:	08/31/2010		
Delivery Code:					
Service Impact:					
<input type="button" value="Save"/> <input type="button" value="Return to Search"/> <input type="button" value="Previous in List"/> <input type="button" value="Next in List"/> <input type="button" value="Notify"/> <input type="button" value="Refresh"/> <input type="button" value="Add"/> <input type="button" value="Update/Display"/>					
Third Party Contract Third Party Item Types Third Party Charges					

Third Party Contract page

- Description** Enter a description for the third-party contract. This field is required.

- External Org ID** (external organization ID) Enter the ID for the contract sponsor.

- Contract Priority** Enter a contract priority value if a student is linked to more than one third-party contract. This establishes an order for the contracts to apply.

- Contact Type** Select the type for the contact person at the organization. You define the contact type at the same time you define the organization ID.

- Ext. Contract** (external contract) Enter the sponsor's contract number in this field. This value can be used as a reference number.

- Contract Max** (contract maximum) Enter a contract maximum amount. This is the maximum monetary amount that the sponsor provides for all sponsored students combined. This amount cannot be adjusted after students are linked to a contract.

- Student Max** (student maximum) Enter a student maximum amount. This is the maximum amount that the sponsor provides for any one sponsored student. This amount cannot be adjusted after students are linked to a contract.

- Charge Tree** Enter the charge tree (item type tree) that you want to use to define which charges the contract covers.

- Last Date** Enter the last date that charges can be adjusted. This date cannot be adjusted after students are linked to a contract.

Delivery Code and Requisition Nbr
(delivery code and requisition number)

Enter a delivery code, a requisition number, or both if provided by the sponsor. These values can be used as reference numbers.

Service Impact

Enter the service impact that would prevent enrollment into the third-party contract, through individual assignment or batch assignment.

Copy Contracts

Click the Copy button to copy an existing third-party contract as the basis of a new third-party contract. You can copy all contract setup information except for term and date information.

Access the Copy Contract page.

Copy Contract

Business Unit: PSUNV PeopleSoft University Bursar

Contract Number: LAST DATE EXP Last Date Expired

New Contract Information

New Contract Number: NEXT

Description: Next Third Party Contract

Copy All Values

Next Cancel

Copy Contract page

New Contract Number Enter a new number for the copied contract.

If auto numbering is enabled on the SF Business Unit Payment Plan Contract Set Up page, NEXT is automatically assigned as the new contract number. You can change the contract number.

Description Enter a description for the copied contract.

Copy All Values Select to copy all other related contract information from the previous contract.

Enter the desired information and click Save. You are returned to the Third Party Contract page, where you can modify the new contract information as desired.

Defining Third-Party Contract Item Types

Access the Third Party Item Types page (Student Financials, Payment Plans, Create Third Party Contract, Third Party Item Types).

Third Party Contract		Third Party Item Types		Third Party Charges	
Business Unit:	PSUNV	Contract Number:	525		
Account Type:	TPC		TPC		
Charge Item Type:	1000000000008		Sponsored Tuition & Fees		
Discount Item Type:	<input type="text"/>				
Credit Account Type:	TUT		Tuition		
Credit Item Type:	3800000000002		Deferred to Third Party		
Contract Type:	Specific Course List	Date Type:	Course List		
Term:	0430		2001 Spring		
Start Date:	<input type="text"/>	Academic Year:	<input type="text"/>		
End Date:	<input type="text"/>	End Date:	<input type="text"/>		
Course List:	000000009		Course List for TP Contracts		

Third Party Item Types page

Account Type Enter the account type for third-party contract charges.

Charge Item Type Enter the item type for third-party contract charges that will appear on the corporate account and invoice.

Discount Item Type If you want to allow discounts to third-party contract sponsors, enter the item type that you have set up to credit against eligible charges. For example, if you have a local corporation that provides tuition sponsorship for dozens of employees each year, you can offer them a discount.

This item type number is the default value for all discounts that are associated with this contract, but you can override and specify a different item type for each eligible node.

This is not recommended for use on a date range contract.

Credit Account Type Enter the account type that the system uses for credits to the customer's account.

Credit Item Type Enter the item type that the system uses for credits to the customer.

Contract Type

Select from the following values:

Specific Course: Reserved for future use.

Specific Course List: Select to apply the contract to a specific list of courses. When you select this option, the Term and Course List fields become available.

Note. If you are using term fees and your third-party contract is set up with a course list, then the applicable term fee must have Track Class Pricing enabled.

Specific Term: Select to apply the contract to charges that are assessed to the student within a specific term. When you select this option, the Term field becomes available.

Note. You cannot enter an offset item group if you use this option.

Specific Year or Period: Select to apply the contract to charges that are assessed to the student within a particular academic year or specified period of time. When you select this option, the Academic Year, Start Date, and End Date fields become available.

This is not recommended for use on a date range contract.

Date Type

When you have entered *Specific Year or Period* in the Contract Type field, you must also set the time period to which the third-party contract applies. Values are:

Academic Year: Select to apply the contract to apply to a full academic year. If you select this option, the Academic Year field becomes available.

Course List: This option is not available.

Date Range: If you select this option, the Start Date and End Date fields become available. Enter the start date and end date to specify the date range to which the contract applies.

Term Year: This option is not available.

Term

Enter the academic term to which the contract applies.

Academic Year

Enter the academic year to which the contract applies.

Start Date and End Date

Enter a start date and end date for the period for which the contract applies.

Course List

Enter the course list to which the contract applies. This course list applies to all students who are attached to the contract, but you can override it at the student level if necessary.

Note. When using a course list with a third-party contract, particular setup issues related to term fees exist.

See Also

[Chapter 2, "Completing Student Financials General Setup," page 5](#)

[Chapter 6, "Setting Up Fees and Tuition Groups," Setting Up Tuition Groups, page 227](#)

[Chapter 6, "Setting Up Fees and Tuition Groups," Setting Up Term Fee Codes, page 190](#)

Defining Third-Party Charge Transfers

Access the Third Party Charges page (Student Financials, Payment Plans, Create Third Party Contract, Third Party Charges).

Third Party Charges page

Offset Charge Info

Item Type Group

Enter an item type group that the system uses to offset charges that are covered by the contract. For example, you can apply all financial aid to the student's account before transferring eligible charges to the sponsor.

Note. If your school uses the Payment Priority check box in the setup of these item types, you may not want to define any offset charge item type groups. The preferred method is to use this option.

Term From and Term To

Enter a term range for offsetting charges. You can limit the range to just one term by entering it in both fields.

Eligible Charges

Line# (line number)	This field is automatically populated as you add new charge nodes.
Tree Node	Enter a tree node from the item type tree that includes all charge item types that you want to cover with the third-party contract.
Max Amount (maximum amount)	Define a maximum amount that you can apply to pay off the charges belonging to the corresponding tree node.
Charge % (charge percentage)	Enter the percentage of the eligible charge that the system transfers to the sponsor. This percentage amount is limited by the maximum amount. For example, if the student has eligible tuition charges of 8,000 USD and a sponsor has agreed to pay 50 percent of the charges up to a maximum amount of 3,000 USD, the system transfers only 3,000 USD to the sponsor.
Charge Item Type	Enter the charge item type that the system uses to apply charges to the sponsor's account.
Discount % (discount percentage)	If you want to give a discount to the third-party contract sponsor, enter a discount percentage in this field. <hr/> Note. Discounts are intended to move a portion of a charge to a sponsor account and a portion of a charge to a discount account. At no time should 100 percent of the charges be moved to the discount account. Waive the fee to facilitate this type of transaction. <hr/>
Discount Item Type	The value in this field is set by default from the discount item type selection that you made on the Third Party Item Types setup page. You can override this value for each eligible charge.
Include Tax	Select to transfer all tax charges that are associated with an eligible charge to the sponsor. When you select this check box, the Tax Item Type field becomes available.
Tax Item Type	Enter the item type that applies tax charges to the sponsor's account.

Setting Up Collection Agreements

To set up collection agreements, use the Collection Agreement component (COLL_AGREEMENT).

This section discusses how to:

- Define basic collection agreement parameters.
- Define collection agreement administrative fees.

Note. You can set up a collection agreement only for a customer whose account includes items in the collection process.

See Also

Chapter 23, "Collecting Receivables," page 643

Pages Used to Set Up Collection Agreements

<i>Page Name</i>	<i>Definition Name</i>	<i>Navigation</i>	<i>Usage</i>
Collection Agreement	COLL_AGREEMENT	Student Financials, Collections, Collection Agreement	Define basic collection agreement parameters.
Collection Agreement Assess	TP_CONTRACT_ASSESS	Student Financials, Collections, Collection Agreement, Collection Agreement Assess	Define collection agreement administrative fees.
Payment Distribution	TP_PPLN_QCK_POST	Student Financials, Collections, Collection Agreement, Payment Distribution	Confirm collection agreement payment schedules.

Defining Basic Collection Agreement Parameters

Access the Collection Agreement page (Student Financials, Collections, Collection Agreement).

Collection Agreement		Collection Agreement Assess		Payment Distribution	
Business Unit:	PSUNV	Contract Number:	535	<input type="button" value="Calculate"/>	
ID:	SFCC0001 Isabel Shields				
First Bill Date:	09/15/2006 <input type="button" value="B1"/>	Billing Cycle:	Monthly <input type="button" value="Post"/>		
Payments:	3	Pay Plan Type:	Credit Original Account <input type="button" value="Post"/>		
Amount:	1,000.00	Account Type:	PPL		
Reference Number:		Due after Days:	10		
Adjustment Option:	Do Not Adjust <input type="button" value="Post"/>				
Status:	Active <input type="button" value="Post"/>				
		Item Type:	180000000002	Student Tuition & Fees	
		Pay Item Type:	300000000002	Check	

Find View All First <input type="button" value="Left"/> 1 of 1 <input type="button" value="Right"/> Last						
<input type="checkbox"/>	Acct Nbr	Item Term	Item Type	Item Amount	Balance	Rev
<input type="checkbox"/>	TUITION001	2006 Fall	Tuition	1,000.00	1,000.00	

Collection Agreement page

First Bill Date

Select the date that you generate the first bill for the collection agreement. The system uses the first bill date and the billing cycle to set the billing dates for the duration of the collection agreement.

Note. The billing program does not acknowledge the collection agreement until on or after the first bill date specified. For example, if your first bill date is set for November 16 and you run your billing process on the 15th, the system does not process the collection agreement billing until the next run.

Payments

Enter the number of payments that students must make to pay off the collection agreement.

Pay Plan Type

Use this field to define how the system credits payments that are made to this collection agreement. Values are:

Credit the Original Account: Select to credit all eligible charges and create a new collection agreement charge.

Create Billing Entries: Do not use this option with this type of plan.

Amount

Displays the amount of past due debt to be covered by the collection agreement after you select the check box next to a line item in the bottom scroll area of the page.

Account Type

Enter the account type that is defined for the agreement.

Reference Number

Enter an optional reference number for each student on a particular contract. The reference number entry is for information only.

Due after Days	Enter the number of days after the bill date that the payment is due.
Adjustment Option	Select an adjustment option. Values are: <i>Adjust Equally:</i> Select to apply adjustments that are made to the collection agreement equally across all remaining payments. <i>Adjust First Bill:</i> Select to apply adjustments that are made to the collection agreement to the plan's next bill. <i>Adjust Last Bill:</i> Select to apply adjustments that are made to the collection agreement to the plan's final bill. <i>Do not Adjust:</i> Select to prevent any adjustment from being made to the collection agreement.
Item Type	Enter the item type that creates the charge the student is paying off.
Pay Item Type	Enter the pay item type to use to pay off the past due charges that are covered by the collection agreement.

Calculating and Posting the Collection Agreement

Before calculating and posting the collection agreement, you should complete the Collection Agreement Contract Assessment page. After completing this page, return to the collection agreement page to calculate and post the collection agreement.

Calculate	Click to calculate the amount of the collections agreement charges.
Post	Click to post the collection agreement charges. After the agreement is posted, the word <i>Paid</i> appears to the left of all items that are included in the agreement.
Rev (reverse)	After you post the collection agreement, this check box becomes available. Select it and repost the collection agreement to reverse the agreement and return the student's account to the original state.
Display Error/Warning	Click to view error messages, warning messages, or both.

Defining Collection Agreement Administrative Fees

Access the Collection Agreement Assess page (Student Financials, Collections, Collection Agreement, Collection Agreement Assess).

Collection Agreement	Collection Agreement Assess	Payment Distribution
Business Unit:	PSUNV	Contract Number: 535
Type of Assessment:	Payment Plan Fee	
Payment Plan Fee:	100.00	USD
Percentage of Payment Plan:		
Monthly Interest Rate:		
Assessment Fee Split:	Split over all payments	
Assessment Item Type:	110000000000	Administrative Fees

Collection Agreement Assess page

- Type of Assessment** Select the type of assessment. You can leave this field blank if you do not want to assess a fee. When you leave the field blank, all of the other fields on the page become unavailable. If you want to assess a fee, select one of the following options:
- Monthly Interest Rate:* Select to charge interest that is calculated monthly against the outstanding balance in the plan. When you select this option, you must also set a monthly interest rate.
- Payment Plan Fee:* Select to assess a fixed amount fee. If you select this option, the Payment Plan Fee, Assessment Fee Split, and Assessment Item Type fields become available.
- Percentage of Payment Plan:* Select to assess a fee based on a percentage of the plan's initial balance. If you select this option, the Percentage of Payment Plan, Assessment Fee Split, and Assessment Item Type fields become available.
- Payment Plan Fee** Enter the payment plan fee dollar amount. You can enter this amount as a flat amount only, not as a percentage or interest rate.
- Assessment Fee Split** Determine the assessment fee split. Values are:
- Add to first payment:* Select to apply the entire assessment fee to the first payment of the contract.
- Add to last payment:* Select to apply the entire assessment fee to the last payment of the contract.
- Split over all payments:* Select to divide and apply the assessment fee equally over all payments.
- Percentage of Payment Plan** Enter the percentage of payment plan amount that you want the system to use when you select *Percentage of Payment Plan* in the Type of Assessment field.
- Monthly Interest Rate** Enter a monthly interest rate to charge when you select *Monthly Interest Rate* in the Type of Assessment field.
- Assessment Item Type** Select the item type that you want to use for the assessment fee.

Chapter 9

Setting Up Billing

This chapter discusses how to:

- Set up billing messages.
- Set up invoice layouts.
- Set up invoice ID number generation.
- Set up billing scan lines.
- Set up billing types.
- Set up billing standard requests.

Setting Up Billing Messages

To set up billing messages, use the Message Categories component (BI_MSG_CAT_TBL), the Item Type Message component (BI_BILL_MSG_ITM), the Customer Message component (BI_BILL_MSG_CUS), the Business Unit Message component (BI_BILL_MSG_ALL), the Aging Set Messages component (BI_BILL_MSG_AGE), the Corporation Messages component (BI_BILL_MSG_ORG), and the Billing Messages component (BI_BILL_MSG_TBL).

This section provides an overview of billing messages and discusses how to:

- Define billing messages.
- Link billing messages to item types.
- Link billing messages to aging sets.
- Link billing messages to business units.
- Link billing messages to students.
- Link billing messages to organizations.

Understanding Billing Messages

You can create and organize the messages that appear on your bills by defining message categories and billing messages.

Message categories enable you to track and organize billing messages that relate to one type of action or account. You must link all your billing messages to a message category.

After you have defined message categories, you create the messages that appear on your bills. Your messages can alert students of past due payments, warn them of potential fines or penalties, or inform them how their bills are calculated.

You link each message to an item type, an aging set, a business unit, a student, or a corporation. When you link the messages to these elements, the system determines which messages appear on each bill depending on to whom the bill is issued and to what the bill pertains.

Pages Used to Set Up Billing Messages

<i>Page Name</i>	<i>Definition Name</i>	<i>Navigation</i>	<i>Usage</i>
Message Categories	BI_MSG_CAT_TBL	Set Up SACR, Product Related, Student Financials, Billing, Message Categories	Define message categories.
Item Type Messages	BI_BILL_MSG_ITM	Set Up SACR, Product Related, Student Financials, Billing, Item Type Message	Link billing messages to item types.
Customer Messages	BI_BILL_MSG_CUS	Set Up SACR, Product Related, Student Financials, Billing, Customer Message	Link billing messages to students.
Business Unit Messages	BI_BILL_MSG_ALL	Set Up SACR, Product Related, Student Financials, Billing, Business Unit Message	Link billing messages to business units.
Aging Set Messages	BI_BILL_MSG_AGE	Set Up SACR, Product Related, Student Financials, Billing, Aging Set Messages	Link billing messages to aging sets.
Corporation Messages	BI_BILL_MSG_ORG	Set Up SACR, Product Related, Student Financials, Billing, Corporation Messages	Link billing messages to organizations.
Billing Messages	BI_BILL_MSG_TBL	Set Up SACR, Product Related, Student Financials, Billing, Billing Messages	Define billing messages.

Defining Billing Messages

Access the Billing Messages page (Set Up SACR, Product Related, Student Financials, Billing, Billing Messages).

Billing Messages page

Message Category Select a category with which to associate this message.

Keywords Enter keywords to use when searching for this message.

Message Text Enter the message to print on the bill. Remember that you link billing messages to item types, aging sets, business units, students, and corporations. Make the text of the message specific to whichever one that you plan to link it to.

Linking Billing Messages to Item Types

Access the Item Type Messages page (Set Up SACR, Product Related, Student Financials, Billing, Item Type Message).

Message Number Select the number of the billing message to link to the item type range.

When you generate a bill with charges or payments associated with the specified item type, the message linked to that item type appears on the bill. For example, if you create a billing message explaining how you calculate tuition, you can attach this message to all the tuition item types. When the system generates a bill with a charge against a tuition item type, the message explaining how you calculate tuition appears on the bill.

Linking Billing Messages to Aging Sets

Access the Aging Set Messages page (Set Up SACR, Product Related, Student Financials, Billing, Aging Set Messages).

Message Number Select the number of the billing message to link to the aging set and aging category.

When you generate a bill for a customer whose payment is late, the system selects the message to appear on the bill based on the number of days the payment is past due.

Note. You can attach only one message per aging category. The message associated with the oldest charge on a customer's account is the one that appears on the customer's bill.

Linking Billing Messages to Business Units

Access the Business Unit Messages page (Set Up SACR, Product Related, Student Financials, Billing, Business Unit Message).

Message Number Select the number of the billing message to link to the business unit.

Messages linked to a business unit appear on all bills generated by that business unit.

Linking Billing Messages to Students

Access the Customer Messages page (Set Up SACR, Product Related, Student Financials, Billing, Customer Message).

Message Number Select the number of the billing message to link to the student.

When you generate bills for the student, the billing messages you linked appear on the bill.

Linking Billing Messages to Corporations

Access the Corporation Messages page (Set Up SACR, Product Related, Student Financials, Billing, Corporation Messages).

Message Number Select the number of the billing message to link to the organization.

When you generate bills for the organization, the billing messages that you linked appear on the bill.

Setting Up Invoice Layouts

To set up invoice layouts, use the Invoice Layout component (BI_INV_LAYOUT).

An invoice layout is a set of parameters that determine how the system formats the invoices that you print. Because you may require different formats for different types of invoices, you can create many different invoice layouts.

This section discusses how to:

- Define and maintain reports.
- View sample XML for report definition.
- Print invoices from the run control page.
- Define invoice layout information.
- Define invoice layout sorting and summarization.

Understanding XML Publisher

Institutions may use XML Publisher, 3C Engine, and Communication Generation to print a variety of communications or letters, for example, generated invoices. Schools which use global invoicing can use any of the three to print reminder letters. Additional setups are often required if an institution uses XML Publisher.

Student Financials provides four templates to print invoices. They illustrate how an institution may present invoice data to students and external organizations. The templates can be customized to accommodate specific requirements.

The following billing templates are provided:

- *Template SSF_INVOICE_OI* can be used for standard External Organization Invoicing
- *Template SSF_INVOICE_OEI* can be used for Global External Organization Invoicing and includes logic for Credit Invoicing.
- *Template SSF_INVOICE_SI* can be used for standard Student Invoicing.
- *Template SSF_INVOICE_SEI* can be used for Global Student Invoicing and includes logic for Credit Invoicing.

Templates are designed to work with existing Invoice options as defined on the Invoice Layout setup page where you can associate XML Pub Reports and templates to specific Invoice Layouts.

Pages Used to Set Up Invoice Layouts

Page Name	Definition Name	Navigation	Usage
Report Definition	SSF_PRNT_INV	Reporting Tools, XML Publisher. Setup, Report Definition, Definition	Define and maintain reports.
Data Source	PSXPDATASRC	Reporting Tools, XML Publisher, Data Source	View sample XML for report definition.

Page Name	Definition Name	Navigation	Usage
Student Invoice Other	RUN_CNTL_PBILL	Student Financials, Bill Customers, Student Bills, Print Invoice	Print invoices from the run control page.
Invoice Layout One	BI_INV_LAYOUT	Set Up SACR, Product Related, Student Financials, Billing, Invoice Layout, Invoice Layout One	Define invoice layout information.
Invoice Layout Two	BI_INV_LAYOUT2	Set Up SACR, Product Related, Student Financials, Billing, Invoice Layout, Invoice Layout Two	Define invoice layout sorting and summarization.

Defining and Maintaining Reports

Access the Report Definition page (Reporting Tools, XML Publisher. Setup, Report Definition, Definition).

Definition	Template	Output	Security	Bursting
Report Name: SSF_PRNT_INV				
Data Source				
Data Source Type: Rowset				
Data Source ID: SSF_INVOICE_DEMO1				
Data Source Description: SSF Invoice for XMLPublisher				
Report Properties				
Report Description: <input type="text" value="Print Invoices"/>				
*Report Status: <input type="text" value="Active"/>				
*Report Category ID: <input type="text" value="ALLUSER"/> All PeopleSoft User				
Object Owner ID: <input type="text" value="Student Financials"/>				
Template Type: <input type="radio"/> PDF <input checked="" type="radio"/> RTF <input type="radio"/> eText <input type="radio"/> XSL				
Days Before Purge: <input type="text" value="1"/>				
Registered Date/Time: 01/28/2006 3:45:49PM Registered By: PS				
Updated Date/Time: 10/03/2006 10:58:34AM Updated By: PS				
Download: Data Schema Sample Data				

Report Definition page

Use the XML Publisher Report Definition page to define and maintain reports. The Student Financials templates reside under the XML Publisher report definition SSF_PRNT_INV.

View Sample XML For Report Definition

Access the Data Source page (Reporting Tools, XML Publisher, Data Source).

Data Source			
Data Source Type:	Rowset		
Data Source ID:	SSF_INVOICE_DEMO1		
Data Source Properties			
Description:	<input type="text" value="SSF Invoice for XMLPublisher"/>	<input checked="" type="checkbox"/> Active	
Object Owner ID:	<input type="text" value="Student Financials"/>		
Registered Date/Time:	01/25/06 9:40:45AM	Registered By:	PS
Last Update Date/Time:	09/27/06 8:05:55AM	Updated By:	PPLSOFT
Related Files			
File Type	File	Upload File	
Sample Data File	SSF_PRINT_INV.xml	Upload	
Schema File	SSF_PRINT_INV.xsd	Upload	

Data Source page

Use the Data Source page to view sample XML for your report definition. This enables you to review the data contained in the extract in detail. Use the data source ID from the Report Definition page.

Print Invoices From The Run Control Page

Access the Student Invoice Other page (Student Financials, Bill Customers, Student Bills, Print Invoice, Student Invoice Other).

Student Invoice Other

Run Control ID: BILLING [Report Manager](#) [Process Monitor](#) Run

Print Options

*Business Unit: PeopleSoft University Bursar Output XML Data:

Print Invoice by: Output Chunk Size:

ID:

Invoice Number:

Override Bill Request

Override Bill Request Layout

Invoice Layout:

Aid Term From: Aid Term To:

Address Usage:

Print Schedule of Classes Term:

Override Address Info Address not required Use Email Address Print Zero Bill

XML Output Directory:

Student Invoice Other page

XML can also be generated when printing invoices from the run control page by setting Output XML Data to either *Yes* or *Only Output XML Data*. The second option does not produce an invoice but does produce the related XML data, which is helpful when making modifications to the provided templates.

Note. The XML Output Directory should be populated with the target directory location. The process automatically generates a file name for the XML.

Output XML Data

- Select *No* to create no XML output.
- Select *Yes* to generate invoices and XML output.
- Select *Output Only XML Data* to generate output XML data without invoices.

Output Chunk Size

Use this field to determine the size of the data chunks passed to XML Publisher. If it is set to zero, no chunking occurs.

Chunking determines how many invoices are in one file. For example, if you set Output Chunk Size to 200, 200 invoices are placed in each file output. In this example if you process 1,000 invoices and set Output Chunk Size to 200, five PDF files are produced, each containing 200 invoices.

You can output directly to the printer and not create any files. In this case, chunking only controls the size of the chunks of data that are passed to XML Publisher. Chunking should still be used even if you output directly to the printer.

XML Output Directory Enter the directory path for the XML output. This field is not available when you select not to output XML data.

Defining Invoice Layout Information

Access the Invoice Layout One page (Set Up SACR, Product Related, Student Financials, Billing, Invoice Layout, Invoice Layout One).

Invoice Layout One		Invoice Layout Two	
SetID:	PSUNV	Invoice Layout ID:	REMIND
User ID:	SAMPLE		04/07/2006 2:18:17PM
*Status:	Active		
Description:	Reminder		
Short Desc:	Reminder		
Location Code:	PSCSHCDA	Hacienda	
	<input type="checkbox"/>	Anticipated Aid Detail	
	<input type="checkbox"/>	Include Anticipated Aid Total	
*Term Summary:	Current Term Only		
XML Publisher Related			
Report Definition ID:	SSF_PRNT_INV	Print Invoices	
Template ID:	SSF_INVOICE_SE1	European Student Invoice	
	<input type="checkbox"/>	Extract Bank Information	

Invoice Layout One page

Location Code Enter the location where invoice recipients must mail their payments.

Anticipated Aid Detail and Include Anticipated Aid Total Select to print, on the invoice, a detailed summary and the total amount of the financial aid that you expect the student to receive. If you do not select either of these options, no anticipated financial aid information appears on the invoice.

- Term Summary** Select the terms for which information appears in the term summary section of the invoice:
- All Terms:* Displays information for past, current, and future terms.
 - Current and Future Only:* Displays information regarding only current and future terms.
 - Current Term Only:* Displays information regarding the current term only.
 - Future Only:* Displays information regarding future terms only.

XML Publisher Related

Complete this section only if you are using XML Publisher

- Report Definition ID** Enter the desired report definition ID.
- Template ID** Enter the desired template ID.
- Extract Bank Information** Select this check box if the student's banking information should be included in the XML Publisher extract.

Defining Invoice Layout Sorting and Summarization

Access the Invoice Layout Two page (Set Up SACR, Product Related, Student Financials, Billing, Invoice Layout, Invoice Layout Two).

Invoice Layout One		Invoice Layout Two	
SetID:	PSUNV	Invoice Layout ID:	TF2
		Tuition&Fees Layout#2	
Bill Sort Fields		Transaction Sort	
*Sort 1:	Zip Code	Sort 1:	Academic Year
Sort 2:	Student ID	Sort 2:	Term
Sort 3:		Sort 3:	
Sort 4:		Sort 4:	
Summarization Fields		<input checked="" type="checkbox"/> Subtotal	
Summ 1:			
Summ 2:			

Invoice Layout Two page

Bill Sort Fields

Determine the sort order of the invoices in a given billing run. The sort order that you choose here determines the order in which the system prints the invoices. You do not have to enter a value in all four sort fields. In the preceding example, invoices are sorted first by postal code, then by student ID.

Sort 1, Sort 2, Sort 3, and Sort 4

Select the sort order of your invoices:

Academic Level: Sorts by the academic level of the student (such as freshman, sophomore, junior, or senior).

Academic Load: Sorts by the academic course load of the student (such as part-time or full-time load).

Academic Program: Sorts by the academic program of the student (such as liberal arts).

Campus: Sorts by the campus of the institution that the student attends.

Corporation ID: Sorts by the unique ID (organization ID) of the external corporation associated with each bill.

Country: Sorts by the country of residence of the student associated with each bill.

Invoice Number: Sorts by the system-generated invoice number assigned to each bill.

Name: Sorts by the name of the student associated with each bill.

Student Enrollment Block: Sorts by the Enrollment Block associated to the ID.

ID: Sorts by the unique ID of the student associated with each bill.

Total Amount Due: Sorts by the total dollar amount due for each bill.

Tuition Residency: Sorts by the tuition residency of the student (for example, in-state or out-of-state tuition) in effect at the time that the system generates the bill.

Zip Code: Sorts by the postal code of the student associated with each bill.

Note. You cannot sort by both invoice number and ID. The system will not give you an error message

Transaction Sort

Determine how transaction details are sorted on an individual invoice. You do not have to enter a value in all four sort fields.

**Sort 1, Sort 2, Sort 3,
and Sort 4**

Select how to sort transaction details on your invoices:

Academic Year: Sorts by the academic year associated with each transaction.

Account Number: Sorts by the account number of each transaction.

Amount: Sorts by the dollar amount of each transaction.

Due Date: Sorts by the due date of each transaction.

Item Description: Sorts by the description of the item type for each transaction.

Item Number All: Sorts by the item number that the system assigns to each transaction during posting.

Session: Sorts by the academic session associated with each transaction.

Student ID (Third Party): Sorts a sponsoring organization's bills by the unique student ID associated with each third-party transaction.

Student Name (Third Party): Sorts a sponsoring organization's bills by the student name associated with each third-party transaction.

Term: Sorts by the academic term associated with each transaction.

Transaction Date: Sorts by the date on which each transaction occurred.

Subtotal

Becomes available if you enter a value in the Sort 1 field. Select to print a subtotal of the transactions on the invoice.

Summarization Fields

You can summarize billing information on your printed invoices rather than printing all the billing details. Use this group box to select the fields by which you want to summarize. When you summarize, the printed invoice no longer shows transaction detail.

Summ 1 (summary 1) and **Summ 2** (summary 2) Select how to summarize billing information on your printed invoices:

Account Number: Summarizes by the account number and account term.

Item Description: Summarizes by the item type description.

Item Nbr - Refund/Payment Only (item number - refund/payment only): Summarizes refunds and payments by item number only. Transaction details for other transactions still appear according to the sort order selected in the Transaction Sort Fields group box.

Item Number All: Summarizes by the item number that the system assigns to each transaction during posting.

Item Type Code: Summarizes by the item type code or classification.

Item Type: Summarizes by item type.

Student ID (Third Party): Summarizes a sponsoring organization's bills by the unique student ID associated with each third-party transaction.

Student Name (Third Party): Summarizes a sponsoring organization's bills by the student name associated with each third-party transaction.

Setting Up Invoice ID Number Generation

To set up invoice ID number generation, use the Invoice ID Number component (INVOICE_NUMBER).

Each bill that you create must have a unique invoice ID number associated with it. You define how the system generates each invoice ID number. The invoice number consists of three parts that combine text with system-generated number sequences. Each part can consist of no more than 10 characters and no fewer than 2 characters. The maximum length of the entire invoice ID is 22 characters. This section discusses how to define invoice number generation.

Page Used to Set Up Invoice ID Number Generation

Page Name	Definition Name	Navigation	Usage
Invoice ID Number	BI_IVC_NUM	Set Up SACR, Product Related, Student Financials, Billing, Invoice ID Number	Define invoice number generation.

Defining Invoice Number Generation

Access the Invoice ID Number page (Set Up SACR, Product Related, Student Financials, Billing, Invoice ID Number)

Invoice ID Number

Invoice ID Number: FEES

Description: **Status:**

Example Invoice

0000000121FALL98LNS

0000000121	<input type="radio"/> Text <input type="text"/>	Part 1 Sequence Length:	<input type="text" value="10"/>
	<input checked="" type="radio"/> Auto Sequenced	Part 1 Next Sequence Number:	<input type="text" value="0000000121"/>
<hr/>			
FALL98	<input checked="" type="radio"/> Text <input type="text" value="FALL98"/>	Part 2 Sequence Length:	<input type="text" value="6"/>
	<input type="radio"/> Auto Sequenced	Part 2 Next Sequence number:	<input type="text"/>
<hr/>			
LNS	<input checked="" type="radio"/> Text <input type="text" value="LNS"/>	Part 3 Sequence Length:	<input type="text" value="6"/>
	<input type="radio"/> Auto Sequenced	Part 3 Next Sequence Number:	<input type="text"/>

Invoice ID Number page

- Example Invoice** Displays how your invoice IDs appear using the parameters that you select.
- Text** Select to enter specific text for the segment. The Part 1 Sequence Length, Part 2 Sequence Length, or Part 3 Sequence Length field of the segment becomes available, depending on which segment you are defining.
- Auto Sequenced** Select to make the segment a number automatically sequenced by the system. The Part 1 Next Sequence Number, Part 2 Next Sequence Number, or Part 3 Next Sequence Number field becomes available, depending on which segment that you are defining.
- Part 1 Sequence Length, Part 2 Sequence Length, and Part 3 Sequence Length** If you selected the Text option for a segment, enter characters to appear on the bill along with the length of the segment. If the length is greater than the number of characters that you enter, the system puts a number of spaces in the segment equal to the difference between the length and the number of characters entered.
- Part 1 Next Sequence Number, Part 2 Next Sequence Number, and Part 3 Next Sequence Number** If you selected the Auto Sequenced option for a segment, use these fields to set the next number to appear on a bill. When you press TAB to move out of the field, the system fills the remainder of the field with zeros so that the total length is 10. This number appears in the segment of the first ID generated by the system using this invoice ID generation scheme. The auto-sequenced segment of each ID generated after the first is one higher than the previous. For example, if you enter 0000001 in the Part 1 Next Sequence Number field, the first segment of the first invoice ID is 0000001. The first segment of the second invoice ID is 0000002, and so on.

Setting Up Billing Scan Lines

To set up billings scan lines, use the Billing Scan Line component (BI_SCAN_LINE).

Create a bill scan line if your bank requires it to track transactions. Communicate with your bank to obtain specifications on how to construct your bill scan line. This section discusses how to define bill scan lines.

Page Used to Set Up Bill Scan Lines

<i>Page Name</i>	<i>Definition Name</i>	<i>Navigation</i>	<i>Usage</i>
Billing Scan Line	BI_SCAN_LINE	Set Up SACR, Product Related, Student Financials, Billing, Billing Scan Line	Define bill scan lines.

Defining Billing Scan Lines

Access the Billing Scan Line page (Set Up SACR, Product Related, Student Financials, Billing, Billing Scan Line).

Billing Scan Line

Scan Line: BT1

*Description: Billing Test 1 Status: Active

		Find	First	1-3 of 3	Last
<input type="radio"/> Field	<input type="text"/>				
<input checked="" type="radio"/> Text	TESTBILL				
<input type="radio"/> Sequence Number	<input type="text"/>	Length:	<input type="text" value="8"/>		
<hr/>					
<input type="radio"/> Field	<input type="text"/>				
<input type="radio"/> Text	<input type="text"/>				
<input checked="" type="radio"/> Sequence Number	<input type="text" value="2"/>	Length:	<input type="text" value="5"/>		
<hr/>					
<input checked="" type="radio"/> Field	A <input type="text"/> Amount Due				
<input type="radio"/> Text	<input type="text"/>				
<input type="radio"/> Sequence Number	<input type="text"/>	Length:	<input type="text" value="15"/>		

Billing Scan Line page

The bill scan line is a single line of no more than 60 characters of both text and numbers. You add it to a bill using the General Selections 2 page of the Billing Standard Request component. Each segment consists of a field, a piece of text, or a sequence number.

Field If you select the Field option, select the field that you want to use: *A* (amount due), *B* (business unit), *D* (invoice due date), *E* (employee ID), *I* (invoice date), *N* (invoice number), *O* (external org field), and *P* (postal code).

Text If you select the Text option, use the adjacent field to enter text to include in the bill scan line.

Sequence Number If you select the Sequence Number option, enter the number in the adjacent field. This number appears in the segment of the first bill scan line generated by the system using this bill scan line generation scheme. The automatically-sequenced segment of each bill scan line generated after the first is one higher than the previous. For example, if you enter *0000001*, the Sequence Number segment of the first bill scan line is *0000001*. The segment of the second bill scan line is *0000002*, and so on.

Length

If you select the Field option, the system automatically populates the Length field according to the option that you choose. This field is then unavailable for editing.

If you select the Text option, the system automatically populates the Length field with the number of characters that you entered in the Text field. You can override this number with a greater number.

If you select the Sequence Number option, the system automatically populates the Length field with the number 10. You can override this number.

Setting Up Billing Types

To set up billing types, use the Billing Type component (BI_TYPE_TBL).

When you set up your billing standard request, the system requires that you select a billing type for the request. The system uses billing types to distinguish bills when determining prior invoice amount and the last billing date for students or corporations. This section lists the page used to define billing types.

Page Used to Define Billing Types

<i>Page Name</i>	<i>Definition Name</i>	<i>Navigation</i>	<i>Usage</i>
Billing Type	BI_TYPE_TBL	Set Up SACR, Product Related, Student Financials, Billing, Billing Type	Define billing types.

Setting Up Billing Standard Requests

To set up billing standard requests, use the Billing Standard Request component (BI_STD_REQ_TBL).

This section discusses how to:

- Define general selections.
- Define additional general selections.
- Define communication information.
- Define academic selections.
- Define additional academic selections.
- Select billing messages.
- Select student groups.
- Select enrollment blocks.

- Select account types.
- Define corporate information.

A billing standard request is a set of parameters that determine how the system identifies and bills groups of customers. After you set these parameters, you can use them repeatedly.

Pages Used to Set Up Billing Standard Requests

<i>Page Name</i>	<i>Definition Name</i>	<i>Navigation</i>	<i>Usage</i>
General Selections	BI_STD_REQ_TBL	Set Up SACR, Product Related, Student Financials, Billing, Billing Standard Request, General Selections	Define general selections.
General Selection 2	BI_STD_REQ_ALL6	Set Up SACR, Product Related, Student Financials, Billing, Billing Standard Request, General Selection 2	Define additional general selections.
Communication Info (communication information)	BI_STD_REQ_ALL4	Set Up SACR, Product Related, Student Financials, Billing, Billing Standard Request, Communication Info	Define communication information.
Academic Selections	BI_STD_REQ_ALL1	Set Up SACR, Product Related, Student Financials, Billing, Billing Standard Request, Academic Selections	Define academic selections.
Academic Selections 2	BI_CAN_REQ_ALL1A	Set Up SACR, Product Related, Student Financials, Billing, Billing Standard Request, Academic Selections 2	Define additional academic selections.
Billing Standard Request - Messages	BI_STD_REQ_ALL2	Set Up SACR, Product Related, Student Financials, Billing, Billing Standard Request, Messages	Select billing messages.
Student Groups	BI_STD_REQ_ALL7	Set Up SACR, Product Related, Student Financials, Billing, Billing Standard Request, Student Groups	Select student groups.
Enrollment Blocks	SSF_STD_REQ_ERLBLK	Set Up SACR, Product Related, Student Financials, Billing, Billing Standard Request, Enrollment Blocks	Select enrollment blocks.

Page Name	Definition Name	Navigation	Usage
Account Selections	BI_STD_REQ_ALL3	Set Up SACR, Product Related, Student Financials, Billing, Billing Standard Request, Account Selections	Select the account types.
Corporation Info (corporation information)	BI_STD_REQ_ALL5	Set Up SACR, Product Related, Student Financials, Billing, Billing Standard Request, Corporation Info	Define corporate information.

Defining General Selections

Access the General Selections page (Set Up SACR, Product Related, Student Financials, Billing, Billing Standard Request, General Selections).

General Selections page

Type of Request

Student

Select to create billing requests for students and individual customers. All fields on the page become available.

Organization

Select to create billing requests for external organizations. The fields in the Last Name Selection group box become unavailable. You must use the Last Name Selection group box on the Corporation Info page instead.

Last Name Selection

From and To Define a range of students for which the system generates bills based on the students' last names. For example, to generate a bill for all students with last names starting with the letter *A* through the letter *C*, enter *A* in the From field and *C* in the To field. Leave these fields blank to generate bills for all students who meet the criteria that you set in this component.

Balance Selection

The two fields in this group box work together to generate bills for customers based on credit and debit balances.

Minimum Credit Balance Enter the credit balance above which you generate a bill. Enter the minimum credit balance as a negative number.

Minimum Debit Balance Enter the debit balance above which you generate a bill. Enter the minimum debit balance as a positive number.

To create a bill for all students regardless of account balances, leave the Minimum Credit Balance and Minimum Debit Balance fields set to *0.00*.

Transaction Selection

Added After and Added Until Filter the charges and payments included in the bill based on the date they posted. Only charges and payments posted after the date entered in the Added After field are included in the bill. Only charges and payments posted before or on the date entered in the Added Until field are included in the bill. To include all charges and payments, leave these fields blank.

Miscellaneous Selection

To bill all customers, leave all fields and options in this group box empty.

Select Billing by Invoice Select this to indicate Select Billing by Invoice. This is only displayed when the institution has indicated Apply Payments by Invoice on the SF Installation setup.

Zero Bill Handling Specify how the system processes bills for zero amounts:

Ignore Zero Bills: Ignores zero amounts. Be careful when using this value. The system looks for a net amount due and does not process bills when a credit balance in one account offsets a balance due in another account.

Create Zero Bills: Generates bills for zero amounts.

Update Zero Bills: Sets flags indicating that the account has been billed, but does not generate a bill. The next time that you run the billing process, the system ignores flagged zero amounts, thereby increasing performance.

Not Billed Since

Enter a date here to bill only those customers who you have not billed since that date. For example, if the date in the Not Billed Since field is *10/1/2005*, and you run the billing process on 10/15/2005, the system generates bills for students who it billed before 10/1/2005 or who it has not billed at all. The system does not bill students who it billed on 10/1/2005 or between 10/1/2005 and 10/15/2005.

If you select a value in this field, it overrides any conflicting selection criteria that you define.

Define Additional General Selections

Access the General Selection 2 page (Set Up SACR, Product Related, Student Financials, Billing, Billing Standard Request, General Selection 2).

General Selection 2 page

Invoice Option

Create Invoices

Select so that your invoices do not reference the amount of the previous invoice. For example, suppose that you bill a student for tuition charges of 500.00 USD and housing charges of 2,000.00 USD, for a total of 2,500.00 USD on 10/1/2005. On 10/15/2005, a 75.00 USD miscellaneous charge posts to the student's account before the original bill is paid. If you generate another bill on 10/15/2005, it lists only the new invoice amount of 75.00 USD and details only the miscellaneous charge.

When selected, the system generates bills for accounts with new activity only.

Create Account Statements

Select to generate account statements rather than invoices. The details that appear on the account statement depend on the value that you select in the Prior Invoice Calc Option (prior invoice calculation option) field, which is available only if you select the Create Account Statements option.

When selected, the system generates bills even for accounts with no new activity. However, the system does not allow you to generate a bill more than once per day for an account with no new activity.

Note. Create Credit Invoices

If your institution selected Apply Payments by Invoice on the SF Installation 2 page of the SF Installation component, Create Credit Invoices will display in the Invoice Option group box in place of Create Account Statements.

Select Create Credit Invoices to create a credit invoice based on charge reversals.

Prior Invoice Calc Option (prior invoice calculation option)

Determine the details to appear on account statements:

Use Previous Invoice Amount: Account statements reference the amount of the previous invoice and indicate the previous invoice ID on new bills. For example, suppose that you bill a student for tuition charges of 500.00 USD and housing charges of 2,000.00 USD, for a total of 2,500.00 USD on 10/1/2005. On 10/15/2005, a 75.00 USD miscellaneous charge posts to the student's account before the original bill is paid. If you generate another bill on 10/15/2005, it lists a prior invoice amount of 2,500.00 USD and the corresponding invoice ID, along with the new invoice amount of 75.00 USD that details only the miscellaneous charge.

Account Balance Method: Account statements reference the amount of the previous invoice but do not indicate the previous invoice ID on new bills. For example, suppose that you bill a student for tuition charges of 500.00 USD and housing charges of 2,000.00 USD, for a total of 2,500.00 USD on 10/1/2005. On 10/15/2005, a 75.00 USD miscellaneous charge posts to the student's account before the original bill is paid. If you generate another bill on 10/15/2005, it lists a prior invoice amount of 2,500.00 USD, along with the new invoice amount of 75.00 USD that details only the miscellaneous charge.

Campus Select

Institution

Select an institution. The system generates bills for students who attend the selected institution only.

Campus

Select a campus. The system generates bills for those students on the selected campus only. You must select an institution before you select a campus.

Remaining Fields

Invoice ID Number

Select the user-defined invoice ID number generation scheme that you want to use to assign unique invoice ID numbers to each bill.

- Bill Scan Line Definition** If your bank requires bill scan lines, select the bill scan line generation scheme that you want to use to attach a bill scan line to each bill.

- Service Impact** (Optional) Attach a service impact to the billing standard request. You normally use this field to attach a service impact that excludes from billing those students or corporations with a service indicator associated with the selected service impact.

- Print Schedule of Classes** Select to print the student's enrollment summary on your invoices. This field is not available if you select the Corporation option in the Type of Request group box on the General Selections page.

Defining Communication Information

Access the Communication Info page (Set Up SACR, Product Related, Student Financials, Billing, Billing Standard Request, Communication Info).

The screenshot displays the 'Communication Info' page with the following details:

- General Selections:** General Selections 2, Communication Info, Academic Selections, Academic Selections 2
- SetID:** PSUNV
- Billing ID:** BIL1
- Eff Date:** 01/01/1900
- Status:** Active
- Create Communication Records**
- Academic Institution:** PSUNV (PeopleSoft University)
- Administrative Function:** SFBI (Student Financials Billing)
- Communication Category:** FEES (Tuition & Fees)
- Communication Context:** BILL (Bill)
- Additional Bill Communication:**
 - Bill Comm Flag**
 - Letter Code:** [Empty field]

Communication Info page

- Create Communication Records** Select to create a communication record during the bill generation process.

- Academic Institution** Enter the academic institution to which the communication record applies.

- Administrative Function** Enter *SFBI*.

- Communication Category** Enter the type of communication record to create.

Communication Context Within the communication category that you select, choose the context of the communication record to create.

Additional Bill Communication

Bill Comm Flag (bill communication flag) Select to produce a duplicate bill for the parent or guardian of each student affected by the billing standard request when you run the billing process. The system uses the parent or guardian that you specify on the Relationships page within PeopleSoft Campus Community. The Letter Code field becomes available.

Letter Code If applicable, enter one or more letter codes. The system matches these against any letter codes specified for the communication recipient on the Relationships page within Campus Community.

See Also

PeopleSoft Enterprise Campus Community 9.0 Fundamentals PeopleBook, "Setting Up Administrative Functions"

PeopleSoft Enterprise Campus Community 9.0 Fundamentals PeopleBook, "Managing Communications"

PeopleSoft Enterprise Campus Community 9.0 Fundamentals PeopleBook, "Managing Biographical Information," Managing Relationships Data

Defining Academic Selections

Access the Academic Selections page (Set Up SACR, Product Related, Student Financials, Billing, Billing Standard Request, Academic Selections).

Academic Selections page

All Careers Select to generate a bill for all students regardless of academic career. The Academic Institution, Career, Academic Program, Academic Plan, Academic Program Status, and Admissions Program Status fields become unavailable.

Use Records Select to filter billed students based on academic program status. The Academic Program Status field becomes available.

Use Admissions Select to filter billed students based on admissions program status. The Admissions Program Status field becomes available. You can select this check box in addition to the Use Records check box. However, if you select both check boxes, the system checks academic program status first during the billing process to determine whether it should bill a student. It only uses admissions program status if a student has no academic program status.

Academic Career

Select the academic institution, career, academic program, and academic plan to bill.

Academic Program Status

Select the academic program status to bill. To generate bills based on academic program status, you must select at least one academic career and academic program on this page.

Admissions Program Status

Select the admissions program status to bill.

Defining Additional Academic Selections

Access the Academic Selections 2 page (Set Up SACR, Product Related, Student Financials, Billing, Billing Standard Request, Academic Selections 2).

The screenshot displays the 'Academic Selections 2' page with the following fields and values:

Field	Value
SetID:	PSUNV
Billing ID:	BIL1
Effective Date:	01/01/1900
Academic Institution:	PSUNV PeopleSoft University
Academic Group:	PSUNV PeopleSoft University
Tuition Residency:	IS In State
Form of Study:	Class Enrollment
Academic Plan Type:	Honors
Academic Load:	Enrolled Full-Time
Approved Academic Load:	Full-Time
Academic Level - Term Start:	10 Freshman
Academic Level - Projected:	20 Sophomore

Academic Selections 2 page

Select a value for any of eight academic categories to filter your billing process.

Note. The billing process acknowledges the selection criteria on this page only if you select a Bill By option of *Bill Range* when creating your billing request.

Selecting Billing Messages

Access the Billing Standard Request - Messages page (Set Up SACR, Product Related, Student Financials, Billing, Billing Standard Request, Messages).

Academic Selections 2 | **Messages** | Student Groups | Enrollment Blocks | Account Selections | Corporation Info

SetID: PSUNV Billing ID: BIL10

Find | View All First 1 of 1 Last

Eff Date: 01/01/1900 Status: Active

Messages Find First 1-3 of 3 Last

*Message Number	Message Text:
1	Fees are due and payable upon receipt of this invoice.
30	If Library Fines are not paid, your library privileges will be revoked.
60	If you have questions regarding charges or payments, please phone the Bursar's Office at (777) 555-1212.

Billing Standard Request - Messages page

Message Number Enter the message number associated with the text that you want to appear on your bills. Remember that any business unit messages that you create appear on the bill, in addition to the messages that you select here.

Selecting Student Groups

Access the Student Groups page (Set Up SACR, Product Related, Student Financials, Billing, Billing Standard Request, Student Groups).

Student Groups page

All Groups Select to generate bills for all student groups. The Institution and Student Group fields become unavailable.

Current Table Entries Only Select to create bills and invoices only for students that are currently in the student groups that you specify in the Student Groups group box. The system excludes any students with a future-dated active status in a student group.

Student Groups

Select the institution and student group to bill.

See Also

PeopleSoft Enterprise Recruiting and Admissions 9.0 PeopleBook, "Setting Up Prospects"

Select Enrollment Blocks

Access the Enrollment Blocks page (Set Up SACR, Product Related, Student Financials, Billing, Billing Standard Request, Enrollment Blocks).

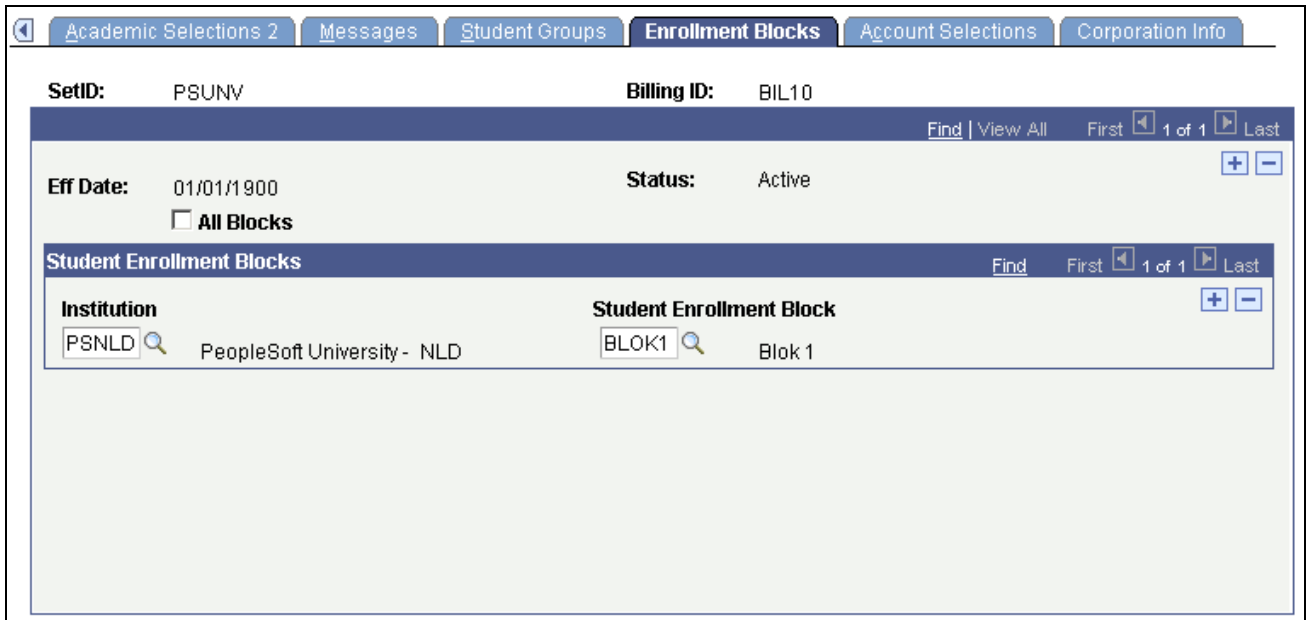

Enrollment Blocks page

All Blocks Select to restrict processing to all enrollment blocks

Student Enrollment Blocks

Restrict processing to specific enrollment blocks

Selecting Account Types

Access the Account Selections page (Set Up SACR, Product Related, Student Financials, Billing, Billing Standard Request, Account Selections).

SetID: PSUNV **Billing ID:** EUROFARMST
 Find | View All First 1 of 1 Last
Eff Date: 01/01/1900 **Status:** Active
 All Accounts

Account Types		Find	First	1-3 of 3	Last
*Account Type	TUT	Tuition			
	HOU	Housing			
	PPL	Payment Plan			

Account Selections page

You can determine by account type what charges and credits are included on an invoice.

An invoice is created for all unbilled activity on the account and through the account type or item type setup you can select what is included or excluded from the invoice.

All Accounts Select to bill all account types.

Account Type Enter the specific account types to include in an invoice, for example, tuition, housing, or payment plan.

Account Types

If you do not select the All Accounts check box, select a specific account type to bill.

Defining Corporation Information

Access the Corporation Info page (Set Up SACR, Product Related, Student Financials, Billing, Billing Standard Request, Corporation Info).

The screenshot shows a web-based interface for 'Corporation Info'. At the top, there are several tabs: 'Academic Selections 2', 'Messages', 'Student Groups', 'Enrollment Blocks', 'Account Selections', and 'Corporation Info'. Below the tabs, the 'SetID' is 'PSUNV' and the 'Billing ID' is 'BIL10'. A navigation bar includes 'Find | View All', 'First', '1 of 1', and 'Last'. The 'Eff Date' is '01/01/1900' and the 'Status' is 'Active'. A 'Description Selection' box contains two input fields: 'Corporation From:' and 'Corporation To:'. Below this is a 'Contact Type:' dropdown menu.

Corporation Info page

Corporation From and Corporation To

Enter an alphabetical range of corporations to bill. Leave these fields blank to generate bills for all corporations that meet the criteria that you set in this component.

Contact Type

To address corporate bills to a specific position (such as chief financial officer), select the type of contact.

Chapter 10

Setting Up Cashiering

This chapter discusses how to:

- Define a cashiering office.
- Set up valid registers and cashiers.
- Set up target keys.
- Set up tender keys.
- Set up for processing credit cards.
- Set up void reasons.
- Set up receipt messages.
- Modify cashiering receipt forms.

Defining a Cashiering Office

To set up a cashiering office, use the Cashiering Offices component (CASHIERING_OFFICES).

Before you can run your cashiering process, you must first define the characteristics of your cashiering office. Your institution may have multiple cashiering offices, located on or off campus. Different cashiering offices often serve different roles in your institution. The Cashiering feature provides the flexibility to define different cashiering offices, each with its own set of cashiering rules and requirements.

This section discusses how to:

- Define the basic cashiering office parameters.
- Define the transaction setup of a cashiering office.

Pages Used to Define a Cashiering Office

<i>Page Name</i>	<i>Definition Name</i>	<i>Navigation</i>	<i>Usage</i>
Cashiering Offices	CSH_OFF_TABLE	Set Up SACR, Product Related, Student Financials, Cashiering, Cashiering Offices	Define the basic parameters of the cashiering office.

Page Name	Definition Name	Navigation	Usage
Transaction Setup	CSH_OFF_TABLE2	Set Up SACR, Product Related, Student Financials, Cashiering, Cashiering Offices, Transaction Setup	Define the way in which your cashiering office handles and posts transactions.
Over GL Entry	CSH_OFF_TBL_OVER	Set Up SACR, Product Related, Student Financials, Cashiering, Cashiering Offices, Over GL Entry	Define the general ledger chart of accounts to which you record any cash overages for your cashiering office. The chart of accounts that you define on this page provides the credit side of the GL entry.
Short GL Entry	CSH_OFF_TBL_SHORT	Set Up SACR, Product Related, Student Financials, Cashiering, Cashiering Offices, Short GL Entry	Define the general ledger chart of accounts to which you record any cash shortages for your cashiering office. The chart of accounts that you define on this page provides the debit side of the GL entry.

Defining the Basic Cashiering Office Parameters

Access the Cashiering Offices page (Set Up SACR, Product Related, Student Financials, Cashiering, Cashiering Offices).

Cashiering Offices		Transaction Setup	
Business Unit:	PSUNV	Cashier's Office:	WALNUTCR
*Description:	Walnut Creek Cashier's Office		
*Short Description:	Walnut Crk		
Long Description:	Walnut Creek Cashier's Office		
*Campus:	WALCR	Walnut Creek Campus	
*Location:	WALNUT		
*Base Currency:	USD	US Dollar	
*Balance By:	Cashier	Change Due Tender:	CASH
Retrieval Limit:			
Print Product:	Crystal	<input checked="" type="checkbox"/> Use Forms Engine For Receipts	
<input type="checkbox"/> GL Interface Required			
Over GL Entry:	*****		
Short GL Entry:	*****		
Close Office Edits			
<input checked="" type="checkbox"/> Posted Close Required		<input checked="" type="checkbox"/> Approved Close Required	

Cashiering Offices page

- Campus** Enter the campus on which the cashiering office is located.
- Location** Enter the specific location of the cashiering office.
- Base Currency** Enter the base currency that the cashiering office uses when processing transactions. All transactions in the office are set to this currency by default. The default value for this field is the default currency of your business unit.
- Balance By** Select the method to use to balance the cashiering office. Select from the following values:
- Cashier:* Select this value to balance receipts of each cashier against the cash drawer. With this method, a cashier can use any open register, but no one else can use his individual cash drawer. Therefore, balancing by cashier is the more secure option. It enables you to track errors and outages to specific cashiers.
- Register:* Select this value to balance the receipts of each register against the cash drawer. With this method, any number of valid cashiers can use the cash drawer in a register during a given business day.
- Change Due Tender** Enter the tender key that you want to designate for change due. This is the type of tender that the office uses to give change to customers. You define the tender keys available in this field using the Tender Keys component.

Retrieval Limit	Enter the number of business days the system retrieves when you open, reopen, or close the cashiering office. This is an optional field. Use it to enhance system performance.
	<hr/> Note. If you do not enter a value, the system displays all past business days when opening, closing, or reopening a cashiering office. This slows system performance significantly. <hr/>
Print Product	Select to print receipts. If you want to print receipts automatically using the Create Receipt button on the six receipt generation pages, you must select a print product. You can print receipts using <i>Crystal</i> .
Use Forms Engine for Receipts	Select to use Forms Engine to print student payment, corporate payment, department, and check cashing receipts. Clear to use the specified Print Product to print your receipts. If you select this check box, it is necessary to specify printers for your valid registers before you can print receipts using Forms Engine.
Over GL Entry (over general ledger entry)	Click this link to access the Over GL Entry page or enter the ChartField values in the display field . Select the ChartField values that correspond to the general ledger account into which you record your cashiering overages.
Short GL Entry (short general ledger entry)	Click this link to access the Short GL Entry page or enter the ChartField values in the display field. Select the ChartField values that correspond to the general ledger account into which you record your cashiering shortages.
GL Interface Required (general ledger interface required)	If you select this check box, the system requires you to run the Cashiering GL Interface process before closing the cashiering office.
 Close Office Edits	
	Use the Close Office Edits group box to specify the requirements that your office must meet before you can close it.
Posted Close Required	If you select this check box, the system requires you to post all receipts before closing the cashiering office. This requirement takes effect only if you select the <i>Delay posting</i> or <i>Group Post</i> options in the Posting field of the Transaction Setup page.
Approved Close Required	If you select this check box, the system requires you to approve all pending department receipts before closing the cashiering office. This requirement takes effect only if you select the Dept Receipt Approval Required check box on the Transaction Setup page.

Defining the Transaction Setup of a Cashiering Office

Access the Transaction Setup page (Set Up SACR, Product Related, Student Financials, Cashiering, Cashiering Offices, Transaction Setup).

Cashiering Offices		Transaction Setup	
Business Unit:	PSUNV	Cashier's Office:	WALNUTCR
SF Merchant ID:	CASH_HP	<input type="checkbox"/> Realtime Transaction Override	
Merchant Setup ID:	HostedPaySiteCC	<input checked="" type="checkbox"/> Hosted Payment Provider	
Void Receipts			
'Direct Reports:	Student Financials Data	<input type="checkbox"/> Transfer after void	
Post Receipts			
'Posting:	No posting delay	Origin ID:	00014 Cashiering
Group Type:	X Receipts	<input type="checkbox"/> Post Unprocessed Authorization	
Check Cashing Target:	CHECKFEE		
Check Cashing Fee:	0.50	Check Cashing Maximum:	<input type="text"/>
<input type="checkbox"/> Dept Receipt Approval Required			

Transaction Setup

Note. If you select the Realtime Transaction Override check box, you must authorize and capture your cashiering credit card transactions using the batch process.

The value in Merchant Setup ID field and the selection of the Hosted Payment Provider check box are based on the setup of those fields on the Payment Merchant page.

See [Chapter 3, "Setting Up ePayment Processing," Setting Up Payment Merchants, page 90.](#)

See Electronic Payment Integration Developer's Reference Guide. The guide is posted to My Oracle Support.

If the payment merchant is set up for hosted payment transactions, the Realtime Transaction Override and Post Unprocessed Authorization check boxes are cleared and not available for edit.

The Realtime Transaction Override check box applies to Business Interlink and Integration Broker transactions. It allows the cashier office to override the Real-Time Authorization selection on the SF Merchant page in case the Cashier Office is experiencing multiple timeouts. The transactions are then not authorized online but in batch.

For information about the Post Unprocessed Authorization check box, see the Post Receipts section of documentation.

Void Receipts

Use this group box to define how the system voids receipts.

Direct Reports

Enter the appropriate value for your institution to determine the rules the system uses to establish supervisory relationships for the process of voiding receipts.

Student Financials Data: Select this value to establish supervisory relationships of cashiers on the Valid Cashiers page.

Human Resources Data: Select this value to have Student Financials use the employment data for each cashier defined in PeopleSoft Human Resources to determine supervisory relationships.

Transfer after void

Select this check box if, upon voiding a receipt, you want the system to transfer you automatically to the page where the receipt was created. For example, after voiding a student payment, the system automatically takes you to the Student Payment page if you selected this option.

Post Receipts

Use this group box to define how the system posts student payments and corporate payments.

Posting

Use this field to select when the system posts student and corporate payment receipts. Valid values are:

No posting delay: If you select this value, the system posts receipts immediately to student and corporate accounts from the Student Payment and Corporate Payment pages when you click the Create Receipt button. The advantage of this method is that the system updates account balances as you create payment receipts.

Delay posting: If you select this value, the system does not post receipts to student or corporate accounts when you click the Create Receipt button on the Student Payment and Corporate Payment pages. Instead, you post delayed student and corporate payment receipts using the Post Receipts page.

By delaying posting, you can enhance system performance during receipt creation, especially if you have a large number of cashiers using the system. Using the Post Receipts page, you can post receipts at any time during the day, when it puts less demand on the system.

Group Post: If you select this value, the system does not post receipts when you click the Create Receipt button on the Student Payment and Corporate Payment pages. Instead, the system places each receipt that you create into a single posting group for the business day. To post receipts for a group, use the Posting Groups page in the Maintain Receivables feature. Like the *Delay posting* method, the *Group Post* method enables you to enhance system performance during peak demand. However, using the *Group Post* method, you post all receipts at the end of the day by running one batch process. Therefore, the system does not update your student or corporate accounts as often.

Origin ID and Group Type

If you selected *Group Post* in the Posting field, enter the origin ID and group type of the posting group in which your cashiering office places student and corporate payment receipts.

Post Unprocessed Authorizations

Note. If the payment merchant is set up for hosted payment transactions, this check box is cleared and not available for edit.

If you select this check box, the system posts credit card transactions even if it has not processed the authorizations of those transactions. If you clear this check box, the system posts only transactions for which you have processed authorizations.

This option is useful when intermittent timeouts of the authorization process occur. This enables the system to save or post the transactions normally regardless of the timeout. However, if this situation occurs, you must remember to authorize your credit card transactions using the batch process in the Maintain Receivables feature.

Note. You should define a group type and origin ID in Maintain Receivables specifically for cashiering receipts so that you can more readily identify and isolate these posting groups.

Setting Check Cashing Rules

- | | |
|------------------------------|---|
| Check Cashing Target | Enter the target key associated with the check-cashing fee item type. Define the check cashing fee target key using the Target Keys component. Define the amount of the check-cashing fee in the Check Cashing Fee field. This is not a required field. |
| Check Cashing Fee | Enter the amount that you want to charge customers when they use this cashiering office to cash checks. |
| Check Cashing Maximum | Enter the maximum check amount that you want to allow customers to cash at your cashiering office. |

Setting Department Receipt Approval

- | | |
|--|---|
| Dept Receipt Approval Required (department receipt approval required) | Select this check box to implement the workflow approval process for all department receipts generated by this cashiering office. When you select this check box, the Cashier Approval Rolefield becomes available. |
| Cashier Approval Role | Enter the role of the person who approves department receipts generated by your cashiering office. A person with the cashier approval role must approve all department receipts before you post them to the general ledger.

If you select the Approved Close Required check box on the Cashiering Offices page, the person with the cashier approval role must approve all department receipts before you close the cashiering office. |

See Also

[Chapter 3, "Setting Up ePayment Processing," Setting Up SF Merchants, page 100](#)

[Chapter 14, "Processing ePayment Transactions," page 381](#)

[Chapter 21, "Maintaining Receivables," page 571](#)

Setting Up Valid Registers and Cashiers

To set up valid registers and cashiers, use the Valid Registers component (REGISTERS) and the Valid Cashiers component (CASHIERS).

This section discusses how to:

- Define valid registers.
- Define valid cashiers.

Pages Used to Set Up Valid Registers and Cashiers

<i>Page Name</i>	<i>Definition Name</i>	<i>Navigation</i>	<i>Usage</i>
Valid Registers	CSH_OFF_REGISTERS	Set Up SACR, Product Related, Student Financials, Cashiering, Valid Registers	Define valid registers.
Valid Cashiers	CSH_OFF_CASHIER	Set Up SACR, Product Related, Student Financials, Cashiering, Valid Cashiers	Define valid cashiers.

Defining Valid Registers

Access the Valid Registers page (Set Up SACR, Product Related, Student Financials, Cashiering, Valid Registers).

Valid Registers

Business Unit: PSUNV **Cashier's Office:** WALNUTCR Walnut Creek Cashier's Office

Find First ◀ 1-3 of 3 ▶ Last

*Register	Print Receipt Automatically				Server Destination Printer	+ -
	Student Payment	Corporate Payment	Department Receipt	Cash Check		
REG01	<input type="checkbox"/>	<input type="checkbox"/>	<input type="checkbox"/>	<input type="checkbox"/>		+ -
REG02	<input type="checkbox"/>	<input type="checkbox"/>	<input type="checkbox"/>	<input type="checkbox"/>		+ -
REG03	<input type="checkbox"/>	<input type="checkbox"/>	<input type="checkbox"/>	<input type="checkbox"/>		+ -

Valid Registers page

Register Enter the alphanumeric code that you use to identify the register.

Setting Up Receipts to Print Automatically

Select the check boxes under the Print Receipt Automatically heading to determine which types of receipts print automatically when each valid register creates them. The system recognizes the selections made in these check boxes only if you choose to balance by register in the setup of your cashiering office. You can choose to print receipts automatically for Student Payment, Corporate Payment, Department Receipt, and Cash Check receipts. For each valid register set to print automatically, use the Forms Engine Printer field to specify the printer to which Forms Engine generates the receipt.

Defining Valid Cashiers

Access the Valid Cashiers page (Set Up SACR, Product Related, Student Financials, Cashiering, Valid Cashiers).

Valid Cashiers

Business Unit: PSUNV **Cashier's Office:** WALNUTCR Walnut Creek Cashier's Office

Cashier: PS Delete Cashier

Supervisor
 Approval Required Switch
 Department Only Cashier

Supervisor Operator ID:

Print Receipt Automatically

Student Payment
 Corporate Payment
 Department Receipt
 Cash Check

Valid Cash Registers Find First 1 of 1 Last

Valid Cashiers page

- Delete Cashier** Click to delete the cashier from the cashiering office.
- Supervisor** Select to give the cashier the ability to void receipts. A cashier designated as a supervisor can void his or her own receipts and the receipts of any other cashier that directly reports to him or her.
- Approval Required Switch** Select to implement the workflow approval process for any department receipts processed by the cashier.
- Department Only Cashier** Select to designate the cashier as one who can process only department receipts and does not have an open cash drawer. When you select this check box, the system automatically selects the Approval Required check box and makes it unavailable.
- Supervisor Operator ID** This field is available only if you select *Student Financials Data* in the Direct Reports field of the Transaction Setup page. Enter an ID to indicate the supervisor to whom the cashier directly reports. The supervisor assigned to this cashier can view and void the cashier's receipts.

Print Receipt Automatically

Use the Print Receipt Automatically group box to determine which types of receipts print automatically when the valid cashier creates them. The system recognizes the selections made in these check boxes only if you choose balance by cashier in the setup of your cashiering office. You can choose to print receipts automatically for Student Payment, Corporate Payment, Department Receipt, and Cash Check receipts.

Valid Cash Registers

In the Valid Cash Registers scroll area, enter the codes of the valid registers that you want the cashier to be able to use.

Setting Up Target Keys

To set up target keys, use the Target Keys component (TARGET_KEYS).

Target keys indicate which charges receive credit for a given transaction. A cashier must specify a target key for all transactions except department receipts, cash replenishments, and interim deposits. You can also enter ChartField information for target keys.

This section discusses how to:

- Define target keys.
- Link tax authorities to target keys.

Pages Used to Set Up Target Keys

<i>Page Name</i>	<i>Definition Name</i>	<i>Navigation</i>	<i>Usage</i>
Target Keys - Definition	TARGET_KEY_TABLE	Set Up SACR, Product Related, Student Financials, Cashiering, Target Keys, Definition	Define a target key.
Target Key ChartFields	SSF_CF_WRKGRID_SEC	Click the Target GL Entry link on the Definition page.	Define a chart of accounts for a target key. Define the general ledger chart of accounts to which you record any cashiering transactions associated with the target key that you are defining.
Target Keys - Tax Authority	TARGET_KEY_TAX	Set Up SACR, Product Related, Student Financials, Cashiering, Target Keys, Tax Authority	Link tax authorities to target keys. Attach tax authorities to your target key. This enables you to assess tax on certain cashiering transactions with this target key.

Defining Target Keys

Access the Target Keys - Definition page (Set Up SACR, Product Related, Student Financials, Cashiering, Target Keys, Definition).

Definition		Tax Authority	
Business Unit:	PSUNV		
Target Key:	ALL		
Find View All First 1 of 1 Last			
Effective Date:	01/01/1900	Status:	Active
Description:	All Charges Not to GL		
Short Description:	All -No GL		
Long Description:	All charges not to general ledger Using a item type of tender = credit card.		
Default Amount:	500.00	USD	
Minimum Amount:	0.00		
Maximum Amount:	2,000.00		
<input type="checkbox"/> GL Interface Required			
Target GL Entry:	*****		
<input checked="" type="checkbox"/> Post			
Posting Parameters			
Account Type:	OTH	Other Fees	
<input type="checkbox"/> Restrict Payment to Account			
<input checked="" type="checkbox"/> Use Excess Account	MIS	Miscellaneous Fees	
<input type="checkbox"/> Apply Payments by Invoice			
Item Type:	310000000400	Credit Card - Cashiering Pmts	
Charge Priority:	ALL	Any Charge	

Target Keys – Definition page

Default Amount Enter an optional default amount for the target. For example, if tuition charges are typically 5,000 USD, then for the tuition target key, you can enter 5,000 USD as a default amount to reduce the amount of data entry required at the time of payment.

Minimum Amount Enter the minimum amount allowed for the target key per transaction.

Maximum Amount Enter the maximum amount allowed for the target key per transaction.

GL Interface Required, Target GL Entry and Copy and Paste buttons Select to include transactions for this target key when you run the cashiering GL interface process.

Click the Target GL Entry link to specify ChartFields or enter ChateField values. Enter the ChartField values that correspond to the general ledger account into which you record transaction information associated with the target key. The chart of accounts that you define on this page provides the credit side of the GL entry.

For a cashiering receipt to properly interface with your general ledger system, both the target key and the tender key associated with the receipt must have the GL Interface Required check box selected.

You can also specify a SpeedType on this page. To specify the Speed Type, click the link and enter the SpeedType that you have already set up.

For ease of use, after entering your ChartFields, click the Copy button to copy them to a clipboard. You can go to any other field and use the Paste button to paste.

Be careful when selecting this check box because if the item type associated with the target key also has this check box selected, the regular GL interface process will pick up any transactions associated with the target key that you are defining. The cashiering GL interface process is intended to be used to send transactions to your general ledger that do not post to student or corporate accounts. Usually, you do not want these nonpostable transactions to be picked up by the regular GL interface process. Therefore, you normally do not want to select the GL Interface Required check box for the target key unless it is to be used for transactions that do not post to an account.

Post Select to post student payments or corporate payments associated with this target key. The system selects this check box by default.

If you select this check box, you cannot attach a tax authority to the target key. This is because when you attach a tax authority to a target key, the system assesses a tax to any cashiering transactions associated with that target key. Postable targets post against charges on a student or corporate account. The system already assesses any necessary taxes to a charge when it posts to an account. Therefore, if a tax authority were attached to a postable target key, when you used the target key for a cashiering transaction, the system would assess tax to the target even though the charge it would post against had already been taxed. This would cause the payer of the charge to be taxed twice for the same charge.

Posting Parameters

Determine how the system posts transactions associated with the target key.

Account Type If you are defining target keys for student or corporate payments, enter the account type the target affects. The account type determines the account to which the payment posts.

Restrict Payment to Account	Select to post each payment in its entirety to the account that you set in the Account Type field. The system credits any excess payments to the account that you selected, thereby creating a credit balance that can be applied to new charges or refunded later. If you select this check box, the Use Excess Account check box and its accompanying field become unavailable.
Use Excess Account	<p>If you do not select Restrict Payment to Account check box, you can select this check box. When you select this check box and do not specify a specific account in its accompanying field, the system credits excess payments to the default payment excess account that you defined during the setup of your Student Financials business unit.</p> <p>Use the edit box to the right of this check box to enter a specific excess account to which the system credits any excess payments to this target key.</p>
Apply Payments by Invoice	Select this check box to restrict payments to an invoice. The check box displays only if your institution indicated on the SF Installation 2 page that it will apply payments by invoice.
Item Type	If you are defining a target key for payments that post to student or corporate accounts, enter the payment item type that appears on the account when you use this target key.
Charge Priority	The system automatically populates this field with the charge priority of the item type that you entered. However, you can use this field to override the payment allocation rules for payments to this target. The charge priority determines how the system applies payments to charges.

Linking Tax Authorities to Target Keys

Access the Target Keys - Tax Authority page (Set Up SACR, Product Related, Student Financials, Cashiering, Target Keys, Tax Authority).

The screenshot displays the 'Tax Authority' definition page. At the top, there are two tabs: 'Definition' and 'Tax Authority'. Below the tabs, the following information is displayed:

- Business Unit:** PSUNV
- Target Key:** TUITION
- Eff Date:** 01/01/2000
- Status:** Active

Below this information, there are two search bars with magnifying glass icons:

- *Tax Authority** (with a search icon)
- *Target Key** (with a search icon)

To the right of these search bars is a **Tax Percent** field. The interface also includes navigation controls such as 'Find | View All', 'First', '1 of 1', and 'Last'.

Target Keys - Tax Authority page

Tax Authority Enter tax authorities to attach to the target key. When you enter a tax authority, the system automatically populates the Tax Percent field with the appropriate percentage.

Target Key Enter the target key of the tax that the system adds to transactions conducted using the target key that you are defining. Whenever you process payments to the target key, the system adds the attached tax target key automatically, thereby charging the customer the appropriate tax.

Tax Percent The system populates this field with the appropriate percentage when you entered a value in the Tax Authority field.

Note. If you attach a tax authority to the target key and you select the Post check box on the Definition page, the system does not allow you to save the target key.

See Also

Chapter 2, "Completing Student Financials General Setup," [Setting Up Tax Authorities and Tax Codes](#), page 34

Setting Up Tender Keys

To set up tender keys, use the Tender Keys component (TENDER_KEYS).

Tender keys represent the types of tender your office can accept. Examples of tender include cash, checks, and credit cards. You can also enter ChartField information for tender keys, overages, and shortages.

This section discusses how to:

- Define tender keys.
- Specify cashiers for tender keys.

Pages Used to Set Up Tender Keys

<i>Page Name</i>	<i>Definition Name</i>	<i>Navigation</i>	<i>Usage</i>
Tender Key	TENDER_KEY_TABLE	Set Up SACR, Product Related, Student Financials, Cashiering, Tender Keys, Tender Key	Define tender keys.
Tender Key GL	SSF_CF_WRKGRID_SEC	Click the GL Entry link on the Tender Key page.	Define charts of accounts for tender keys.
Tender Key Over GL	SSF_CF_WRKGRID_SEC	Click the Over GL Entry link on the Tender Key page.	Define charts of accounts for overages.
Tender Key Short GL	SSF_CF_WRKGRID_SEC	Click the Short GL Entry link on the Tender Key page.	Define charts of accounts for shortages.
Tender Key Valid Cashiers	TENDER_CSHR_TABLE	Set Up SACR, Product Related, Student Financials, Cashiering, Tender Keys, Tender Key Valid Cashiers	Specify cashiers for tender keys.

Defining Tender Keys

Access the Tender Key page (Set Up SACR, Product Related, Student Financials, Cashiering, Tender Keys, Tender Key).

Tender Key		Tender Key Valid Cashiers	
Business Unit:	PSUNV	Tender Key:	CASH-8.4
		Find View All First 1 of 1 Last	
*Effective Date:	01/01/2001	*Status:	Active
*Description:	Cash		
*Short Description:	Cash		
Long Description:	Cash		
*Tender Category:	Cash	Accounts Receivable - Other	
<input checked="" type="checkbox"/> Change Allowed			
Service Impact:	<input type="text"/>		
	Minimum Amount		Maximum Amount
Transaction Amount:	<input type="text" value="0.01"/> USD		<input type="text" value="20,000.00"/> USD
Out Amount:	<input type="text" value="-0.01"/>		<input type="text" value="-1,000.00"/>
Drawer Warning Amount:	<input type="text" value="200.00"/>		<input type="text" value="7,500.00"/>
Drawer Error Amount:	<input type="text" value="50.00"/>		<input type="text" value="5,000.00"/>
<input checked="" type="checkbox"/> GL Interface Required	GL Entry	Over GL Entry	Short GL Entry

Tender Key page

Tender Category

Select the appropriate category for the tender that you are defining. When a cashier enters a tender key during a cashiering transaction, this tender category tells the system which tender details must be entered before the cashier can successfully conduct the transaction.

Change Allowed

Select this check box if you want the cashier to be able to give change for a transaction using this tender key.

Service Impact

Enter a service impact code to affect how the system processes transactions using this tender. For example, if this field contains a negative service impact for checks, the system will not permit any students to tender checks as payment if the service indicators on their accounts are associated with the negative service impact.

Transaction Amount

Enter the minimum and maximum amounts of this tender that your cashiers can accept per transaction.

Out Amount

Enter the minimum and maximum amounts of this tender that your cashiers can dispense per transaction as change due.

Drawer Warning Amount

Enter the minimum and maximum amounts of this tender that your drawers can contain before the system generates a warning message.

When you create a receipt that causes the amount of this tender remaining in the cashier's drawer to be equal to or less than the minimum amount, the system generates a warning message signaling you to perform a cash replenishment.

When you create a receipt that causes the amount of this tender in the cashier's drawer to exceed the maximum amount, the system generates a warning message signaling you to perform an interim deposit.

Drawer Error Amount

Enter the minimum and maximum amounts of this tender that your drawers can contain before the system generates an error message.

When you attempt to create a receipt that causes the amount of this tender in the cashier's drawer to be equal to or less than the minimum amount, the system generates an error message signaling you to perform a cash replenishment and does not process the receipt.

When you attempt to create a receipt that causes the amount of this tender in the cashier's drawer to equal or exceed the maximum amount, the system generates an error message signaling you to perform an interim deposit and does not process the receipt.

Note. You determine the maximum amount that the cashiering office can dispense when cashing a check in the Cashiering Offices page.

GL Interface Required
(general ledger interface required)

If you select the GL Interface Required check box, any transactions associated with this tender key must interface with the general ledger, and you must enter ChartField information on the GL Entry, Over GL Entry, and Short GL Entry pages of this component.

For a cashiering receipt to properly interface with the general ledger system, both the target key and the tender key associated with the receipt must have the GL Interface Required check box selected.

GL Entry (general ledger entry)

Click the GL Entry link to enter in the display field the ChartField values that correspond to the general ledger account into which you record any cashiering transactions associated with the tender key that you are defining. The chart of accounts that you define on this page provides the debit side of the GL entry.

You can also specify a SpeedType on this page. To specify the Speed Type, click this link or one of the preceding links and enter the SpeedType that you have already set up.

For ease of use, after entering your ChartFields values, click the Copy button to copy them to a clipboard. You can go to any other field and use the Paste button to paste.

Over GL Entry (over general ledger entry)

Click the Over GL Entry link to enter in the display field the ChartField values that correspond to the general ledger account into which you record any overages when a cashier or register does not balance for the tender that you are defining. The chart of accounts that you define on this page provides the debit side of the GL entry.

Short GL Entry (short general ledger entry)

Click the Short GL Entry link to enter in the display field the ChartField values that correspond to the general ledger account into which you record any short amounts when a cashier or register does not balance for the tender that you are defining. The chart of accounts that you define on this page provides the credit side of the GL entry.

Specifying Cashiers for Tender Keys

Access the Tender Key Valid Cashiers page (Set Up SACR, Product Related, Student Financials, Cashiering, Tender Keys, Tender Key Valid Cashiers).

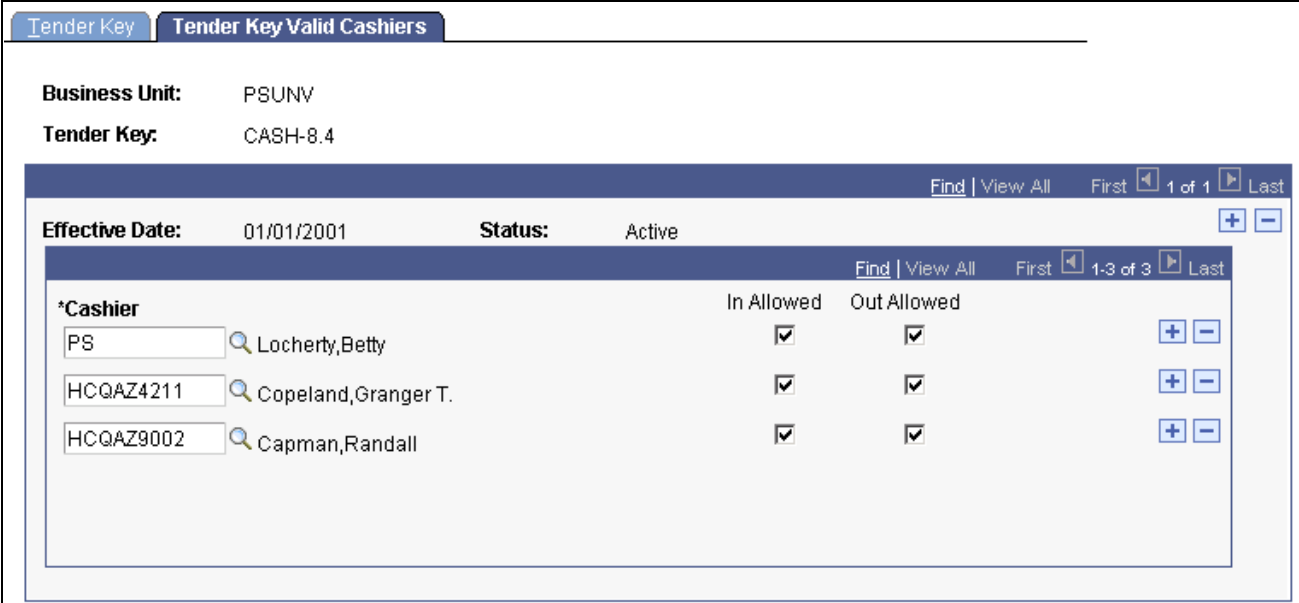

*Cashier	In Allowed	Out Allowed
PS Locherty, Betty	<input checked="" type="checkbox"/>	<input checked="" type="checkbox"/>
HCQAZ4211 Copeland, Granger T.	<input checked="" type="checkbox"/>	<input checked="" type="checkbox"/>
HCQAZ9002 Capman, Randall	<input checked="" type="checkbox"/>	<input checked="" type="checkbox"/>

Tender Key Valid Cashiers page

Cashier

Enter cashiers that can process transactions using the tender key.

In Allowed and Out Allowed

Select to determine if a cashier can take the tender in or give the tender out. For example, if you select only the In Allowed check box for a cashier when you define the cash tender key, the cashier can only take in cash. The cashier cannot give cash to a customer in a check cashing transaction or as change. A cashier with neither check box selected can not perform any transactions with this tender.

Setting Up for Processing Credit Cards

You use the SF Merchant page to set up the parameters that the cashiering system uses when processing credit cards.

See [Chapter 3, "Setting Up ePayment Processing," Setting Up SF Merchants, page 100.](#)

Setting Up Void Reasons

To set up void reasons, use the Void Reasons component (VOID_REASONS).

Void reasons provide brief explanations for voided cashiering receipts. They provide background information for auditors and staff. This section lists the page used to set up void reasons.

Page Used to Set Up Void Reasons

<i>Page Name</i>	<i>Definition Name</i>	<i>Navigation</i>	<i>Usage</i>
Void Reasons	CO_VOID_REASON_TBL	Set Up SACR, Product Related, Student Financials, Cashiering, Void Reasons	Create void reasons.

Setting Up Receipt Messages

To set up receipt messages, use the Receipt Print Messages component (MESSAGES).

This section discusses how to:

- Create receipt messages linked to cashiering offices.
- Create receipt messages linked to target keys.
- Create receipt messages linked to tender keys.

Pages Used to Set Up Receipt Messages

<i>Page Name</i>	<i>Definition Name</i>	<i>Navigation</i>	<i>Usage</i>
Cashier Office Messages	CSH_MSG_BD	Set Up SACR, Product Related, Student Financials, Cashiering, Receipt Print Messages, Cashier Office Messages	Create receipt messages linked to cashiering offices.
Target Messages	CSH_MSG_TG	Set Up SACR, Product Related, Student Financials, Cashiering, Receipt Print Messages, Target Messages	Create receipt messages linked to target keys.
Tender Messages	CSH_MSG_TN	Set Up SACR, Product Related, Student Financials, Cashiering, Receipt Print Messages, Tender Messages	Create receipt messages linked to tender keys.

Creating Receipt Messages Linked to Cashiering Offices

Access the Cashier Office Messages page (Set Up SACR, Product Related, Student Financials, Cashiering, Receipt Print Messages, Cashier Office Messages).

Cashier Office Messages page

Message Enter the message that you want to appear on all receipts printed by this cashier office.

Long Message Enter an optional, more detailed message.

Creating Receipt Messages Linked to Target Keys

Access the Target Messages page (Set Up SACR, Product Related, Student Financials, Cashiering, Receipt Print Messages, Target Messages).

The screenshot shows the 'Target Messages' page. At the top, there are three tabs: 'Cashier Office Messages', 'Target Messages' (selected), and 'Tender Messages'. Below the tabs, the page displays the following information:

- Business Unit:** PSUNV
- Cashier's Office:** MAIN
- Main Cashiering Office-7.5 Int**
- 'Target Key:** CHECKFEE
- 'Effective Date:** 01/01/1900
- Status:** Active
- Message:** Check Cashing Fee Message
- Long Message:** Check Cashing Fee Message

Target Messages page

- Target Key** Enter the target key to which you want to link the message.
- Message** Enter a message to appear on all receipts associated with the target key.
- Long Message** Enter an optional, more detailed message.

Creating Receipt Messages Linked to Tender Keys

Access the Tender Messages page (Set Up SACR, Product Related, Student Financials, Cashiering, Receipt Print Messages, Tender Messages).

The screenshot shows the 'Tender Messages' page. At the top, there are three tabs: 'Cashier Office Messages', 'Target Messages', and 'Tender Messages' (selected). Below the tabs, the page displays the following information:

- Business Unit:** PSUNV
- Cashier's Office:** MAIN
- Main Cashiering Office-7.5 Int**
- 'Tender Key:** CASHIN
- 'Effective Date:** 01/01/1900
- Status:** Active
- Message:** Cash In Message
- Long Message:** Cash In Message

Tender Messages page

- Tender Key** Enter the tender key to which you want to link the message.

Message	Enter a message to appear on all receipts associated with the tender key.
Long Message	Enter an optional, more detailed message.

Modifying Cashiering Receipt Forms

To set up cashiering receipt forms, use the Upload EPS Image File component (FE_UPIMG_RUNCTL), the Form Image Text component (FE_IMAGE_TEXT), and the Form Editor component (FORM_EDITOR).

There are some simple modifications that you can make to the delivered Forms Engine cashiering receipts. For example, you can have your institution's logo appear on your receipts.

This section discusses how to:

- Prepare image files for uploading.
- Upload image files.
- Set up form image text.
- Use Form Editor to change a receipt title and add an image.

Pages Used to Modify Cashiering Receipt Forms

<i>Page Name</i>	<i>Definition Name</i>	<i>Navigation</i>	<i>Usage</i>
Upload EPS Image File	FE_UPIMG_RUNCTL	Set Up SACR, Common Definitions, Forms Engine, Process, Upload EPS Image File	Upload image files.
Form Image Text	FE_IMAGE_TEXT	Set Up SACR, Common Definitions, Forms Engine, Setup, Form Image Text	Set up form image text.
Form Editor	FORM_EDITOR	Set Up SACR, Common Definitions, Forms Engine, Setup, Form Editor	Change a receipt title and add an image.
Form Text Attributes	FORM_TEXT	Click the Edit Field Attributes link for a form row with a form field type of Text.	Specify form text attributes.
Form Image Attributes	FORM_IMAGE	Click the Edit Field Attributes link for a form row with a form field type of Image.	Specify form image attributes.

Preparing Image Files for Uploading

Before you upload an image file to your database, there are some steps you must take to prepare the file. The required steps differ depending on whether the image is cached or noncached.

Preparing a Cached Image for Uploading

If an image is cached, Forms Engine does not resend it for each page on which it is printed. Preparing a cached image for uploading requires some knowledge of PostScript. You must:

1. Create a plain text file with an .eps (Encapsulated PostScript) extension.
See the sample file fe_flower1.eps in the data directory of your ps_home for an example.
2. Edit this PostScript file with a plain text editor to display the graphic image.
Only edit the contents between the first "begin" and the last "end," noninclusive.
3. Test print the image. To do so:
 - a. Copy the EPS file to a temp file.
 - b. Delete everything before the first "begin" inclusive.
 - c. Delete everything after the last "end" inclusive.
 - d. Insert a line at the top that reads "40 40 translate" to move the image to within the page margins.
 - e. Insert a line at the bottom that reads "showpage."
 - f. Copy the temp file to a PostScript printer.

Preparing a Noncached Image for Uploading

If an image is noncached, Forms Engine resends it for each page on which it is printed. Preparing a noncached image for uploading does not require knowledge of PostScript. You must:

1. Open and display the image using a graphical display or editing program.
2. Create a graphic image that is the size of a page.
This image will be a background image for the receipt, so place it within a white background.
3. Print the image to a PostScript printer, but when the print dialog box appears, select the Print to file check box.
4. When the Print to file dialog box appears, place the file into a temp directory.

5. Make the following edits to the file:
 - a. Remove the "showpage" command near the end of the file.
 - b. Remove all lines with "@PDL" in them.
 - c. Remove all lines with "%Pages" in them.
 - d. Remove all lines with "%Page" in them.
 - e. Remove the "%EOF" line near the end of the file.

Uploading Image Files

Access the Upload EPS Image File page (Set Up SACR, Common Definitions, Forms Engine, Process, Upload EPS Image File).

Run Control ID:	PS	Report Manager Process Monitor Run
*URL:	<input type="text" value="MYFTP"/>	
File Transfer ID:	<input type="text" value="Pat"/>	
Operator Password (Encrypted):	<input type="text" value="*****"/>	
Confirm Password:	<input type="text" value="*****"/>	
*Unique System Filename:	<input type="text" value="fe_flower1.eps"/>	
*Remote File Name:	<input type="text" value="pub/fe_flower.eps"/>	
*Form Image Name:	<input type="text" value="FE_FLOWER1"/>	

Upload EPS Image File page

Enter the required information and run the process to upload the image to an FTP server.

Setting Up Form Image Text

Access the Form Image Text Viewer page (Set Up SACR, Common Definitions, Forms Engine, Setup, Form Image Text).

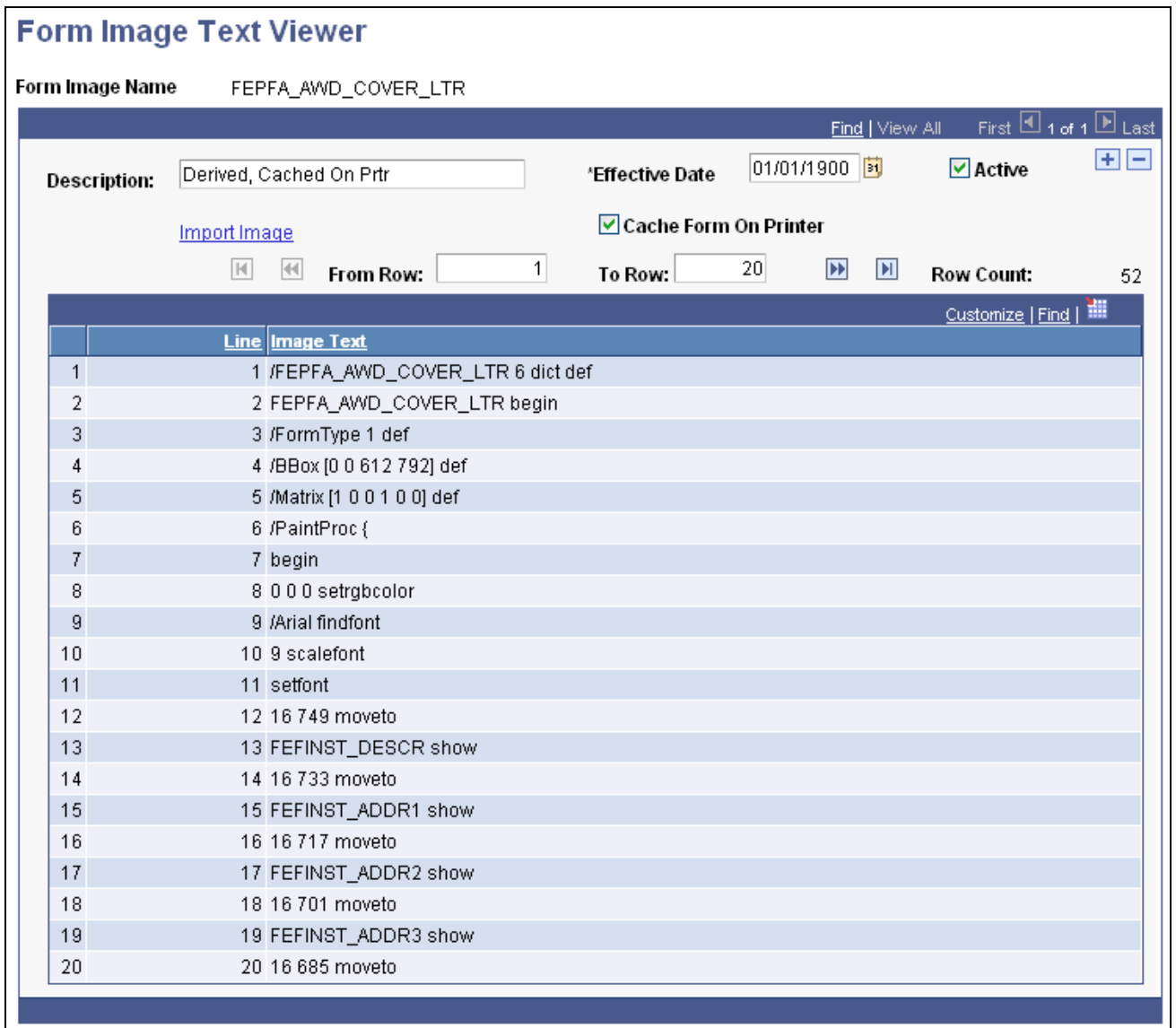

Form Image Text Viewer page

Description Enter a description for the image.

Cache Form On Printer Select if the image is cached. Clear if the image is noncached.

Using Form Editor to Change a Receipt Title and Add an Image

Access the Form Editor page (Set Up SACR, Common Definitions, Forms Engine, Setup, Form Editor).

Form Editor

Form: SF_CSH_RCPT_PRT4

Form Table Find | View All First 1 of 1 Last

'Effective Date: 01/01/1900 Active

'Description: Dept Receipt for non GL 'Width: 792 'Height: 612

Preview [Import Page](#) Source: Page Def Rel Page: SF_CSH_RCPT_PRT4 Last Import: 10/23/2006 7:00PM

Set Page Device

Background Color

Red: 1.0000000 Green: 1.0000000 Blue: 1.0000000 Image:

Form Field Names Customize | Find | View 100 First 1-3 of 131 Last

	*Form Field Name	Sample Text		
1	ADDR_LINE1	?	<input type="text"/>	<input type="button" value="+"/> <input type="button" value="-"/>
2	ADDR_LINE2	?	<input type="text"/>	<input type="button" value="+"/> <input type="button" value="-"/>
3	ADDR_LINE3	?	<input type="text"/>	<input type="button" value="+"/> <input type="button" value="-"/>

Form Details Customize | Find | View 100 First 1-5 of 148 Last

	Fldno	Form Field Type	Edit Field Attributes		
1	1	Data Field	Edit Field Attributes	<input type="button" value="+"/>	<input type="button" value="-"/>
2	2	Data Field	Edit Field Attributes	<input type="button" value="+"/>	<input type="button" value="-"/>
3	3	Data Field	Edit Field Attributes	<input type="button" value="+"/>	<input type="button" value="-"/>
4	4	Data Field	Edit Field Attributes	<input type="button" value="+"/>	<input type="button" value="-"/>
5	5	Data Field	Edit Field Attributes	<input type="button" value="+"/>	<input type="button" value="-"/>

Form Editor page

Changing a Receipt Title

To change a receipt title:

1. Scroll to the row with a Fldno (field number) of 12.
2. Click the Edit Field Attributes link to open the Form Text Attributes page.
3. Edit the title in the Form Text field.
4. Click OK and save your changes to the form.

Adding a Cachable Image to a Receipt

To add a cachable image to a receipt:

1. Insert a row in the field number grid.
2. Entered a form field type of *Image*.
3. Click the Edit Field Attributes link to open the Form Image Attributes page.
4. Locate and select the desired image.

5. Specify a start position.

X is the horizontal distance from the left side of the page, in units of 1/72 of an inch. Y is the vertical distance from the bottom of the page, in units of 1/72 of an inch. For example, if X is 504 and Y is 684, the start position would be 1.5 inches from the upper right corner of an 8.5-inch by 11-inch page.

6. Specify a scaling factor.

For example, if the unscaled image is roughly 3 inches square, use an X and Y scaling factor of 0.3 so that the image comes out as one square inch.

7. Click OK and save your changes to the form.

Adding a Noncachable Image to a Receipt

To add a noncachable image to a receipt:

1. Enter the name of the image in the Image field.
2. Save your changes to the form.

Chapter 11

Setting Up Receivables Maintenance

This chapter discusses how to:

- Define origins and group types.
- Set up late fees.
- Set up late fees - billing.
- Set up external file layouts.
- Set up item reasons.
- Set up payroll deduction.

Defining Origins and Group Types

To define origins and group types, use the Origin Table component (ORIGIN_TABLE) and the Group Type Table component (GROUP_TYPE).

This section provides an overview of origins and group types and discusses how to:

- Define origins.
- Define group types.

Understanding Origins and Group Types

Before you can perform group data entry using the Maintain Receivables feature, you must define origins and group types.

Origins

Origins represent sources of charges or payments that are used during group posting. You can also apply security at the origin level. This security limits the number of users who can view and update the transactions with which an origin is associated. You can also use the description that you define for an origin as criteria for selecting groups during group data entry.

Group Types

Group types represent sets of frequently posted receivables such as financial aid, housing charges, and lock box payments. You can use the description of a group type as criteria for selecting groups for viewing during group data entry.

Pages Used to Define Origins and Group Types

Page Name	Definition Name	Navigation	Usage
Origin Table	ORIGIN_TABLE1	Set Up SACR, Product Related, Student Financials, Charges and Payments, Origin Table	Define origins.
Group Type Table	GROUP_TYPE_TABLE	Set Up SACR, Product Related, Student Financials, Charges and Payments, Group Type Table	Define group types.

Defining Origins

Access the Origin Table page (Set Up SACR, Product Related, Student Financials, Charges and Payments, Origin Table).

Origin Table

SetID: PSUNV **Origin ID:** 00008

Find | View All First ◀ 1 of 1 ▶ Last

***Effective Date:** 01/01/1900 B1 ***Status:** Active + -

***Description:**

***Short Description:**

***Origin Method:**

***Currency:** 🔍

***Origin Type:**

Approval Prior to Posting

Approval on Update

Origin Table page

Origin Method	<p>Indicate the origin method of the transactions (how the transactions were entered into the system). Values are:</p> <p><i>External:</i> Select this option if the transactions were entered into the system using an external file load from a source such as a third-party housing or parking system.</p> <p><i>LockBox:</i> Select this option if the transactions were entered into the system using an external file load from a lock box source.</p> <p><i>Online:</i> Select this option if the transactions were entered into the system manually using the Group Entry component.</p>
Currency	<p>Select the type of currency that is used by this origin. The default value is the base currency that you specified in your SF Business Unit setup.</p>
Origin Type	<p>Select the origin type that describes the source of the transactions. Values are:</p> <p><i>Department:</i> The origin is a department within your institution.</p> <p><i>Individual:</i> The origin is an individual either from your institution or external to it.</p> <p><i>Org (organization):</i> The origin is an organization from within your institution or external to it. An example of an organization from within your institution is a theater box office.</p> <p><i>System:</i> The origin is another computer system organization from within your institution or external to it.</p>
Approval Prior to Posting	<p>Select to require approval before posting transactions from this origin.</p>
Approval on Update	<p>Select to require approval before updating any transactions in this origin.</p>

Defining Group Types

Access the Group Type Table page (Set Up SACR, Product Related, Student Financials, Charges and Payments, Group Type Table).

Group Type Table

SetID: PSUNV

Group Type: H

Find | View All First ◀ 1 of 1 ▶ Last

Effective Date:

Status: ▼

Description:

Short Description:

Create New Charge Item

Group Type Table page

Group Type Enter the one-character code that you want to use for the group type you are creating.

Create New Charge Item Select to create a unique item for each charge transaction in the group. Clearing the check box allows the charge items to be consolidated by common_ID, item type, and term.

This field appears (shaded) on the External Files run control page, the Create Group Data Entries page, and the Create Group Corp Data Entries page.

Setting Up Late Fees

To set up late fees, use the Late Fees component (LATE_FEE_TABLE).

Student Financials enables you to create late fees that the system assesses when it identifies past due charges. This section discusses how to:

- Set up basic late fee parameters.
- Set up aging category information for late fees.
- Define late fee maximums and due dates.
- Specify academic programs for late fees.

Pages Used to Set Up Late Fees

<i>Page Name</i>	<i>Definition Name</i>	<i>Navigation</i>	<i>Usage</i>
Late Fees Setup 1	LATE_FEE_TABLE1	Set Up SACR, Product Related, Student Financials, Charges and Payments, Late Fees, Late Fees Setup 1	Set up basic late fee parameters.
Late Fees Setup 2	LATE_FEE_TABLE2	Set Up SACR, Product Related, Student Financials, Charges and Payments, Late Fees, Late Fees Setup 2	Set up aging category information for late fees.
Late Fees Setup 3	LATE_FEE_TABLE3	Set Up SACR, Product Related, Student Financials, Charges and Payments, Late Fees, Late Fees Setup 3	Define late fee maximums and due dates.
Late Fees Setup 4	LATE_FEE_TABLE4	Set Up SACR, Product Related, Student Financials, Charges and Payments, Late Fees, Late Fees Setup 4	Specify academic programs for late fees.

Setting Up Basic Late Fee Parameters

Access the Late Fees Setup 1 page (Set Up SACR, Product Related, Student Financials, Charges and Payments, Late Fees, Late Fees Setup 1).

Late Fees Setup 1		Late Fees Setup 2		Late Fees Setup 3		Late Fees Setup 4	
SetID:	PSUNV	Late Fee Code:	EXTORG				
*Description:	% and \$\$/serv ind						
Use Aging Category:	<input type="checkbox"/>	Item Type Group:	<input type="text"/>				
Service Impact:	NLF	Grace Period:	5				
*Charge By:	Months	Months Between Charges:	1				
Find First 1 of 1 Last							
*Late Fee Scheme:	ALLPRG	*ID Switch:	Ext Org ID				
*Item Type:	8000000000001	Late fees					
Find View All First 1 of 1 Last							
*Effective Date:	01/01/1998	*Status:	Active				
Amount Past Due:	10.00	Minimum Due:	10.00				
Init Aging %:	25.000	Init Flat Amount:	25.00				
Percent:	20.000	Flat Amount:	20.00 USD				

Late Fees Setup 1 page

Use Aging Category

Select this check box if you want to use the credit history process to assess late fees for all overdue charges for a Student Financials Account. Aging category definitions are entered in the Late Fees Setup 2 page.

When this check box is selected, the following fields become unavailable: Item Type Group, Grace Period, Amount Past Due, Minimum Due, Init Aging % (initial aging percentage), Init Flat Amount (initial flat amount), Percent, and Flat Amount.

Item Type Group

Select an item type group if you want to assess late fees for specific charges only.

Service Impact

To exempt a student or external organization from a particular late fee, enter the service impact code that you defined for exemptions.

Grace Period

Enter the grace period that you want to allow the student before the system assesses a late fee. The value in this field becomes zero by default if you do not enter a grace period value.

Charge By

Select a charge-by value to represent the frequency that you charge late fees.

Warning! Values for this field are delivered with your system as translate values. Do not modify these values in any way. Any modifications to these values will require a substantial programming effort. Values are:

Months: Select to assess late fees on a monthly basis regardless of the number of days in the month.

Days: Select to specify an interval based on a set number of days.

Months Between Charges and Days Between Charges

The label of this field depends on the value that you select in the Charge By field. If you select *Month*, the Months Between Charges label appears. If you select *Days*, the Days Between Charges label appears.

Enter the months or days between charges to specify how often late fees are charged. For example, if you charge late fees every month, enter *1* in this field. If you charge late fees every other month, enter *2*.

Late Fee Scheme

Enter a description for a late fee scheme. Late fee schemes enable you to set up multiple rules for a single late fee. For example, you can enter different academic program load rules, academic load rules, or both. You must define at least one late fee scheme.

ID Switch

Select an ID switch for this late fee scheme. The ID switch is used to specify whether a particular late fee scheme is for a student ID or an external organization ID.

Warning! Values for this field are delivered with your system as translate values. Do not modify these values in any way. Any modifications to these values will require a substantial programming effort.

Item Type

Select an item type to attach to this late fee scheme. The system posts late fees to this item type.

Assessing Late Fees When Not Using Aging Category

If you do not assess late fees using an aging category, use the following fields to establish what fees the system assesses. You can assess late fees as a percentage of the late charge or as a flat amount. You can also use a combination of these methods.

Amount Past Due

Enter an amount past due for this late fee. This is the minimum amount that a charge must be past due before the system assesses a late fee.

Minimum Due

Enter a minimum due amount for this late fee. This is the minimum payment that must be made to prevent further late charges.

Init Aging % (initial aging percentage)

Enter a percentage value in this field that you want to charge as the initial late fee assessment.

Note. If you do not enter a value in this field, then the system does not charge an initial percentage for the first late fee. The value in this field can be the same as the one that you enter in the Percent field.

Init Flat Amount (initial flat amount)

Enter a flat amount charge in this field that you want to charge as the initial late fee assessment.

Note. If you do not enter a value in this field, then the system does not charge an initial flat amount for the first late fee. The value in this field can be the same as the one that you enter in the Flat Amount field.

Percent Enter a percentage value in this field that you want to charge for all late fee assessments after the initial assessment.

Flat Amount Enter an amount in this field that you want to charge for all late fee assessments after the initial assessment.

Setting Up Aging Category Information for Late Fees

Access the Late Fees Setup 2 page (Set Up SACR, Product Related, Student Financials, Charges and Payments, Late Fees, Late Fees Setup 2).

The screenshot displays the 'Late Fees Setup 2' page with the following details:

- SetID:** PSUNV
- Late Fee Code:** EXTORG % and \$\$/serv ind
- Aging Set:** [Empty field]
- Scheme:** ALLPRG
- Effective Date:** 01/01/1998
- Status:** Active
- *Flat Amt Calc:** Use Oldest
- *Percent Calc:** Sum Categories
- Table Columns:** Aging Category, Past Due, Percent, Flat Amount, Min Due
- Currency:** USD

Late Fees Setup 2 page

Note. Enter information on this page only if you select the Use Aging Category check box on the Late Fees Setup 1 page. If the Use Aging Category check box is not selected, these fields will be unavailable.

Aging Set Enter the aging set for this late fee.

Flat Amt Calc (flat amount calculation)

Select to calculate late fees using flat amounts. Values are:

Use Oldest: Select to calculate late fees based on the flat amount of the oldest charge only.

Sum Categories: Select to calculate late fees by applying the flat amount for each charge.

Percent Calc (percent calculation) Select to calculate late fees based on the percentage of outstanding charges. Values are:

Use Oldest: Select to calculate late fees based on the sum of the outstanding charges multiplied by the percentage that is associated with the oldest charge.

Sum Categories: Select to calculate late fees by multiplying each outstanding charge by its associated percentage and summing the total.

Note. You can use a combination of the *Use Oldest* and *Sum Categories* values or the same value in both the Flat Amt Calc and Percent Calc fields. The values that you select indicate the manner in which the system calculates the rules that you define for each of your aging categories.

Defining Aging Category Rules for the Late Fee Scheme

You can assess late fees as a percentage of the late charge, or as a flat amount. You can also use a combination of these methods.

Past Due Enter the minimum amount past due that makes a student or external organization subject to late fees.

Percent and Flat Amount Enter the percent, flat amount, or both of late fees that the system assesses.

Min Due (minimum due) Enter the minimum due for the minimum late fee due.

See Also

[Chapter 2, "Completing Student Financials General Setup," Setting Up Aging Sets, page 37](#)

Defining Late Fee Maximums and Due Dates

Access the Late Fees Setup 3 page (Set Up SACR, Product Related, Student Financials, Charges and Payments, Late Fees, Late Fees Setup 3).

Late Fees Setup 1		Late Fees Setup 2		Late Fees Setup 3		Late Fees Setup 4	
SetID:	PSUNV	Late Fee Code:	EXTORG % and \$\$/serv ind				
		Find First 1 of 1 Last					
Scheme:	ALLPRG						
		Find View All First 1 of 1 Last					
Effective Date:	01/01/1998	Status:	Active				
<input checked="" type="checkbox"/> Exclude Disputed Items		<input type="checkbox"/> Exclude Credit Items					
<input type="checkbox"/> Exclude Small Items		Item Min:		USD			
<input type="checkbox"/> New Item Nbr		<input type="checkbox"/> CAP Fees					
<input type="checkbox"/> Apply Anticipated Aid		Eff Term:		Nbr of Days:			
Maximum Late Fees							
*Yearly:	999,999,999.99	*Nbr:	999	*Year Start:	01/01	*Year Stop:	12/31
*Term:	999,999,999.99	*Nbr:	999				
*Monthly:	999,999,999.99	*Nbr:	999				
Due Info.							
*Due Date:	Days from Effective Date	Due Days:	5				

Late Fees Setup 3 page

Note. If you selected the Use Aging Category option on the Late Fees Setup 1 page, all check boxes except Apply Anticipated Aid are unavailable.

- Exclude Disputed Items** Select to exclude items that are being disputed from late fee charges.
- Exclude Credit Items** Select to disregard items with a credit balance from calculation of late fee charges.
- Exclude Small Items and Item Min** (item minimum) Select to exclude items below a certain threshold from late fee charges. In the Item Min field, enter the accompanying item minimum to establish the threshold.
- New Item Nbr** (new item number) Select to identify each assessed late fee separately on a student's account. For example, if your institution charged late fees in May, June, and July, you will see three separate entries for late fees. If you clear this option, all late fees appear as one entry on the student's account (although you can drill down to see the assessment detail).
- CAP Fees** (capitalize fees) Select to add late fees to the total balance due (capitalize). When late fees are capitalized, they become subject to late fees and interest.
- Apply Anticipated Aid** Select if you want to reduce the amount of overdue charges by anticipated financial aid.
- Eff Term** (effective term) and **Nbr of Days** (number of days) Enter the effective term of the anticipated aid and the number of days from the award date that you continue to consider anticipated aid as a reduction to charge of days)

Maximum Late Fees

- Yearly, Term, and Monthly** On a yearly, term, and monthly basis, enter the maximum monetary amount that you want to collect in late fees. In the Nbr field, enter the maximum number of months, terms, or years for which you want to collect late fees.
- Year Start and Year Stop** If you enter a maximum amount in the Yearly field, enter the month and day for the year start and year stop that defines your institution's time span.

Due Info (due information)

- Due Date** Select a due date option to establish the payment due date for late charges.
-
- Warning!** Values for this field are delivered with your system as translate values. Do not modify these values in any way. Any modifications to these values will require a substantial programming effort. Values are:
-
- Days from Posted Date:* Select this option if you want late fees to be due a specified number of days after they are posted to the account.
- Days from Effective Date:* Select this option if you want the late fees to be due a specified number of days after the effective date of the late fees charge.
- Null Value:* Select this option if you want to use the *Null Due Date* value that you established in SF Installation setup. Using this option enables you to set a due date during the billing process.
- Due Days** Enter the number of days after the due date that you want late fee charges to be due.
-
- Note.** This field is not available if you select *Null Value* in the Due Date field.
-

Specifying Academic Programs for Late Fees

Access the Late Fees Setup 4 page (Set Up SACR, Product Related, Student Financials, Charges and Payments, Late Fees, Late Fees Setup 4).

Late Fees Setup 4 page

All Programs Select to have students in all academic programs included in the calculation for a late fee scheme. If you select this option, the Institution, Acad Prog (academic program), All Acad Loads (all academic loads), and Acad Load (academic load) fields become unavailable.

Blank Program Select if a late fee scheme applies to a nonstudent without an academic program, such as a faculty member who is not enrolled in your institution as a student.

Note. A late fee scheme can apply to both students and nonstudents, so you may have a late fee scheme for which you select both All Programs and Blank Program.

Late Fee Schemes for Individual Programs

If you do not select the All Programs check box, you must indicate which academic programs are included in the late fee scheme. At least one academic program must be defined.

Institution Enter an institution for this late fee scheme.

Acad Prog (academic program) Enter an academic program for this late fee scheme.

All Acad Loads (all academic loads) Select to have all academic loads included in this late fee scheme. If you select this option, the Acad Load field becomes unavailable.

Acad Load (academic load) Select an academic load for this late fee scheme.

Setting Up Late Fees - Billing

This section provides an overview of late fees – billing and discusses how to defining Late Fees - Billing Parameters.

Understanding Late Fees Billing

To supplement the Late Fees process, Campus Solutions offers an alternative Late Fees calculation process

While Late Fees uses past-due amounts, aging categories, or both to calculate late fees, Late Fees - Billing compares the amount due from a specified billing record with the amount of payments or credits on the account. If the payments or credits are less than the amount due, the student is assessed a late fee.

Late Fees - Billing enables you to:

- Define which payments or credits are considered in the calculation, using Item Type Group.
- Define a threshold amount for which, the account is not assessed the late fee if the unpaid balance is less than this threshold.

Note. You must select either the Late Fees method or the Late Fee — Billing method, but not both, at the Business Unit level as the method for calculating and processing late fees.

Page Used to Set Up Late Fees - Billing

<i>Page Name</i>	<i>Definition Name</i>	<i>Navigation</i>	<i>Usage</i>
Late Fees - Billing	SSF_LATE_FEE_CD	Set Up SACR, Product Related, Student Financials, Charges and Payments, Late Fees, Late Fees — Billing	Set up parameters for late fees - billing.

Set up Late Fees - Billing Parameters

Access the Late Fees - Billing page (Set Up SACR, Product Related, Student Financials, Charges and Payments, Late Fees, Late Fees - Billing).

Late Fees - Billing

SetID: PSUNV **Late Fee Code:** BLFORG

Description: Late Fee Billing -Organization

Late Fee Run Minimum: 50.00 **Maximum:** 150.00

Late Fee Period Maximum: 750.00 **Period From Date:** 01/01/2005

Service Impact:

Account Type: OTH Other Fees

Late Fee Item Type: 800000000001 Late fees

Offset Group: LTFEEOFF Exclude Charge Reversals

Late Fee Rules						
	From Amount	To Amount	Late Fee Flat Amount	Late Fee Percentage		
1	100.00	3000.00	50.00		+	-
2	3000.01	6000.00	75.00		+	-
3	6000.01	9000.00	100.00		+	-

Late Fees - Billing page.

Late Fee Run Minimum Enter a minimum balance for the run.

Maximum Enter a maximum balance for the run.

Late Fee Period Maximum Enter a maximum late fee amount for the period.

Period From Date **Note.** Indicate the from date to be used for determining previously assessed late fees (part of period maximum calculation).

Service Impact Enter a positive service impact to prevent late fee assessment

Account Type Indicate the account type to be used to post the late fee.

Late Fee Item Type Indicate the item type to be used to post the late fee.

Offset Group Enter the offset item group to be used to identify credits that should be applied for processing.

Exclude Charge Reversals Select to indicate whether reversals should be included when the system is determining the charge adjustments. These are charge reversals from charges that have already been billed.

Late Fee Rules

From Amount	Identify a minimum amount for the range.
To Amount	Identify a maximum amount for the range.
Late Fee Flat Amount	Optionally, indicate a flat amount for the late fee. You must have at least the flat amount or the percentage set up.
Late Fee Percentage	Optionally, indicate a percentage amount for the late fee.

Setting Up External File Layouts

To set up external file layouts, use the External File Layouts component (BANK_INPUT_FILE).

This section provides an overview of external file layouts and discusses how to:

- Define basic file layout parameters.
- Define field positions and lengths.
- Define locations and lengths of control data.

Understanding External File Layouts

Student Financials enables you to import charge and payment information from outside sources. For example, many institutions have housing and parking management applications from third-party vendors. Or you may use a lock box service to receive and record payments. This information is imported into the Student Financials application using a file transfer process.

Field Positions and Lengths

Each piece of information in an external file is defined by a starting character position and a field length. Certain types of data (for example date fields) do not require a length definition because they have a fixed length. Consult the data provider to determine the correct definition.

Control Data

You must also set the location and length of the control data. This information is loaded into the Group Control Information. It is used to compare what the data source indicates they have sent to what was actually received, loaded, and posted. Control data also includes the origin code and the currency code. Control data may be located in the file header or trailer.

Pages Used to Set Up External File Layouts

<i>Page Name</i>	<i>Definition Name</i>	<i>Navigation</i>	<i>Usage</i>
Record Types	BNK_RCN_INP_LAY1	Set Up SACR, Product Related, Student Financials, External File Layouts, Record Types	Define basic file layout parameters.
Field Details 1	BNK_RCN_INP_LAY4	Set Up SACR, Product Related, Student Financials, External File Layouts, Record Types, Field Details 1	Define the first set of field positions and lengths.
Field Details 2	BNK_RCN_INP_LAY5	Set Up SACR, Product Related, Student Financials, External File Layouts, Record Types, Field Details 2	Define the second set of field positions and lengths.
Field Details 3	BNK_RCN_INP_LAY6	Set Up SACR, Product Related, Student Financials, External File Layouts, Record Types, Field Details 3	Define the third set of field positions and lengths.
Control Totals	BNK_RCN_INP_LAY2	Set Up SACR, Product Related, Student Financials, External File Layouts, Record Types, Control Totals	Defining locations and lengths of control data.

Defining Basic File Layout Parameters

Access the Record Types page (Set Up SACR, Product Related, Student Financials, External File Layouts, Record Types).

Record Types page

Use Header Flag and Use Trailer Flag Select to indicate to the system to look for information in the header position, trailer position, or both.

Trailer Enter any specific information that you want included in the file trailer.

Defining Field Positions and Lengths

Access the Field Details 1 page (Set Up SACR, Product Related, Student Financials, External File Layouts, Record Types, Field Details 1).

Use	Field	Start	Length	Format	Default	Date	Prefix
✓	Customer ID	1	9	Student Gp	NO		
✓	Amount	10	15				
✓	Item Type	35	12				
<input type="checkbox"/>	Reference Nbr						
✓	Accounting Date	26	8	MMDDCCYY			
<input type="checkbox"/>	Due Date						
<input type="checkbox"/>	Billing Date						
✓	Account Type				HOU		

Field Details 1 page

Note. Use the Field Details 2 page and the Field Details 3 page to define positions and lengths for additional fields.

- Use** To activate a field, select the Use check box next to it. The Customer ID, Amount, and Item Type fields are required.
- Start and Length** Enter the start position and length for any applicable fields.
- Format** Enter the format for any applicable fields.
- Default** Enter the default for any applicable fields.
- Prefix** Enter a prefix value if one is required.

Defining Locations and Lengths of Control Data

Access the Control Totals page (Set Up SACR, Product Related, Student Financials, External File Layouts, Record Types, Control Totals).

Record Types | Field Details 1 | Field Details 2 | Field Details 3 | **Control Totals**

SetID: PSUNV **Layout ID:** HOUSING1 Housing

Control Field Use				
Use	Field	Start	Length	Default
<input checked="" type="checkbox"/>	Control Count	1	4	
<input checked="" type="checkbox"/>	Control Amount	8	12	
	Origin:			00010 🔍
	Currency Code:			USD 🔍

Control Field Location

Header

Trailer

Control Totals page

- Use** To activate a field, select the Use check box next to it.
 - Start and Length** Enter the start position and length for any applicable fields.
 - Default** Enter the default for any applicable fields.
- Control Field Location**
- Header or Trailer** Select either header or trailer to indicate where control values can be found.

Setting Up Item Reasons

To set up item reasons, use the Item Reasons component (ITEM_REASONS).

Item reasons provide brief explanations for payment and charge reversals. They provide background information to auditors and staff.

Page Used to Set Up Item Reasons

<i>Page Name</i>	<i>Definition Name</i>	<i>Navigation</i>	<i>Usage</i>
Item Reasons	LINE_REASON_TBL	Set Up SACR, Product Related, Student Financials, Charges and Payments, Item Reasons	Set up item reasons.

Setting Up Payroll Deduction

To set up payroll deduction, use the Identify SA Deduction Codes component (SSF_SA_DED_TBL), the Create Deduction Relationship component (SF_PAYDED_RELATION), and the Create Payment Plans component (TP_PAYMENT_PLAN).

This section provides an overview of payroll deduction and discusses how to:

- Define payroll deduction codes.
- Define payroll deduction relationships.
- Assign payroll deduction codes to payment plans.

Understanding Payroll Deduction

Student Financials enables university employees to pay tuition, fees, and other educational expenses through payroll deductions. For applicable employees, PeopleSoft Payroll for North America calculates the payroll deductions to be used to pay student charges. Student Financials then takes those payroll deductions and applies them as payments to the appropriate student accounts. You also can restrict the payroll deduction payment to a payment plan account. In addition, this new feature enables you to apply payroll deductions from one employee to the account of a student with a different ID. This allows, for example, a university employee, who has a dependent who attends that same university, to have deductions from his paycheck apply to his dependent's student account.

Note. Close coordination between your PeopleSoft Payroll for North America and Student Financials staff is crucial to properly process payroll deductions.

Pages Used to Set Up Payroll Deduction

Page Name	Definition Name	Navigation	Usage
SA Payroll Deduction Codes	SSF_SA_DED_TBL	Student Financials, Charges and Payments, Payroll Deduction Processing, Identify SA Deduction Codes, SA Payroll Deduction Codes	Define payroll deduction codes.
Payroll Deduction Relationship	SF_PAYDED_REL	Student Financials, Charges and Payments, Payroll Deduction Processing, Create Deduction Relationship, Payroll Deduction Relationship	Define payroll deduction relationships.
Payment Plan 1	TP_PAYMENT_PLAN	Student Financials, Payment Plans, Create Payment Plan	Assigning payroll deduction codes to payment plans

Defining Payroll Deduction Codes

Access the SA Payroll Deduction Codes page (Student Financials, Charges and Payments, Payroll Deduction Processing, Identify SA Deduction Codes, SA Payroll Deduction Codes).

SA Payroll Deduction Codes page

These are payroll deduction codes that PeopleSoft Payroll for North America uses to deduct funds to be applied to student charges in Student Financials.

Plan Type Enter the value of the plan type that applies to the payroll deduction code.

Deduction Code Enter the appropriate deduction code.

See Also

PeopleSoft Payroll for North America PeopleBook, "Defining Deductions"

Defining Payroll Deduction Relationships

Access the Payroll Deduction Relationship page (Student Financials, Charges and Payments, Payroll Deduction Processing, Create Deduction Relationship, Payroll Deduction Relationship).

Payroll Deduction Relationship

Julia Wrench FA0800

#	*Plan Type	*Deduction Code	Description	*Related ID	Expiration Date			
1	25	B25-01	Dependent Life	FA0711	Vigor,Lamii D	10/09/2005	BT	+ -

Payroll Deduction Relationship page

Defining payroll deduction relationships for an employee, specifying the recipients of the employee's payroll deductions is optional.

The page displays the ID of the employee whose pay is being deducted. The name of the employee appears to the left.

Deduction Code Enter the code of the payroll deduction that the system applies to the recipient.

Related ID Enter the ID of the student whom you want to receive the deducted funds.

Expiration Date Enter the date after which deducted funds no longer apply to the account of the student selected in the Related ID field. After this date, the system applies any payroll deductions to the account of the employee whose pay is being deducted.

Note. You can define only one related ID per deduction code. Defining a payroll deduction relationship is necessary only to apply a deduction to someone other than the employee receiving the payroll deduction. If an employee's payroll deduction is to be applied to his or her own student account, do not complete this page for that employee.

Assigning Payroll Deduction Codes to Payment Plans

Access the Payment Plan 1 page (Student Financials, Payment Plans, Create Payment Plan). In the Payroll Deduction field, enter the code of the payroll deduction that applies to the payment plan account.

Note. Assigning a payroll deduction code to a payment plan is necessary only if you plan to restrict payroll deductions to apply to payment plan accounts. In addition, you must be sure that you select the Use Payment Plan check box when you run the Payroll Deduction Group Create process to restrict payroll deductions to apply to payment plan accounts.

See Also

Chapter 8, "Setting Up Payment Plans," Defining Basic Payment Plan Contract Parameters, page 259

Chapter 12

Setting Up Receivables Collection

This chapter lists prerequisites and discusses how to:

- Set up business units for collections.
- Set up collectors.
- Set up collection criteria.
- Define reason in and reason out codes.
- Create follow-up actions.
- Set up collection letter templates.

Prerequisites

Before you set up and run your collection process, you must:

1. Make sure PeopleSoft Workflow is set up properly to handle your collection process.
2. Set up the 3Cs for collection purposes. Although the 3Cs are part of the PeopleSoft Campus Community application, all of the pages that are necessary to set up the 3Cs for collection purposes can be accessed through the Collect Receivables menu in Student Financials.

See Also

Enterprise PeopleTools PeopleBook: Using PeopleSoft Applications, Using Workflow

PeopleSoft Enterprise Campus Community 9.0 Fundamentals PeopleBook, "Understanding the 3Cs — Communications, Checklists, and Comments"

Setting Up Business Units for Collections

You establish the collection parameters of your business unit using the Collections page of the SF Business Unit component (BUSINESS_UNIT_SF). This page specifies the rules that the Assign Collector process uses to determine whether it should bring past due charges into or out of the collection process. In addition, you use this page to determine whether the system assigns collection responsibilities by role or by user ID.

Pages Used to Set Up Business Units for Collections

Page Name	Definition Name	Navigation	Usage
Collections	BUS_UNIT_TBL_SF7	Set Up SACR, Product Related, Student Financials, SF Business Unit, Collections	Define collection rules for business units.

Defining Collection Rules for Business Units

Access the Collections page (Set Up SACR, Product Related, Student Financials, SF Business Unit, Collections).

Collections page

Collector Type

Assign the collector type by role or by user ID. Values are:

Collector Assigned by User ID: Select to assign collection responsibilities to specific individuals.

Collector Assigned by Role: Select to assign collection responsibilities to everyone assigned a particular role.

Past Due Amount

Enter a minimum past-due amount to assign to collections for student accounts. By setting this minimum, you can focus your collection efforts on those accounts that are most cost-effective to recover.

Past Due Category

Select a category to define the minimum amount of time that an amount must be past due before it is assigned for collection.

Past Due Amount Org (past due amount organization)	Enter a minimum past-due amount to assign to collections for organization accounts.
Past Due Category Org (past due category organization)	Select a category that establishes the minimum amount of time that an amount must be past due before it is assigned for collection.
Exit Due Amount	Enter the exit due amount with the corresponding exit due category for individuals (for example, students). If the past-due amount falls below the exit due amount within the exit due category (time period), the account is automatically removed from the collections process.
Exit Due Category	The exit due category, in conjunction with the exit due amount, controls the removal of an account from collections. For example, if the past-due balance of an account falls below the specified exit due amount, but the length of time the account has been past due is beyond the range of the exit due category, the account will remain in collection. This selection is limited to accounts of individuals.
Exit Due Amount Org (exit due amount organization)	Enter the exit due amount with the corresponding exit due category for organizations. If the past-due amount falls below the exit due amount within the exit due category (time period), the account is automatically removed from the collections process.
Exit Due Category Org (exit due category organization)	The exit due category, in conjunction with the exit due amount, controls the removal of an account from collections. For example, if the past-due balance of an account falls below the specified exit due amount, but the length of time that the account has been past due is beyond the range of the exit due category, the account will remain in collection. This selection is limited to organization accounts.
Write Off Service Indicator	Select a write-off service indicator to use if a collection balance is written off. This service indicator code is automatically applied to all customer accounts that you write off, and the service limitations that you define for this code are applied to the customer.
NSF Line Reason (insufficient funds line reason)	Select the NSF line reason code that you want to use when a check is returned for insufficient funds. When a check is returned, it is reversed using the Payment Reversal process and marked with the NSF Line Reason code. If you select the NSF check box on the Collection Criteria page, the system uses this code to assign returned checks to your collectors who are responsible for recovering checks that are returned for insufficient funds.

See Also

PeopleSoft Enterprise Campus Community 9.0 Fundamentals PeopleBook, "Understanding the 3Cs — Communications, Checklists, and Comments"

Chapter 12, "Setting Up Receivables Collection," Setting Up Collectors, page 366

Enterprise PeopleTools PeopleBook: Workflow Technology, Defining Roles and Users

Setting Up Collectors

To set up collectors, use the Collector component (COLLECTOR_SF).

Before you can start assigning past due items for collection, you must establish collectors within the system.

Page Used to Set Up Collectors

Page Name	Definition Name	Navigation	Usage
Collector	COLLECTOR_SF	Set Up SACR, Product Related, Student Financials, Collections, Collector	Define collectors.

Defining Collectors

Access the Collector page (Set Up SACR, Product Related, Student Financials, Collections, Collector).

Collector

Business Unit: PSUNV PeopleSoft University Bursar **Collector Type:** User ID

User ID: PS Locherty, Betty

Collector Details Find First 1 of 1 Last

*Effective Date: 01/01/1900 *Status as of Effective Date: Active

Role Name: CS - Collector A

*Type of Name: Preferred

*Location Code: PSCSWAL2 Walnut Creek Center

Collector page

Role Name If your business unit assigns collection responsibilities by role rather than by user ID, select a collector role.

Type of Name Select the type of name that the system uses when referring to this collector.

Location Code Enter the code that is associated with the location where the collector is based.

Setting Up Collection Criteria

To set up collection criteria, use the Collection Criteria component (COLL_CRITER_SF) and the Corporate Collection Criteria component (COLL_CRITER_ORG).

You must set up collection criteria for each collector user ID or role to which you assign collection items. The collection criteria that you establish act as filters that assign collection items to the appropriate collector when you run the Assign Collector process.

This section discusses how to:

- Set up student collection criteria.
- Set up organization collection criteria.

Pages Used to Set Up Collection Criteria

<i>Page Name</i>	<i>Definition Name</i>	<i>Navigation</i>	<i>Usage</i>
Collection Criteria	COLL_CRITER_SF	Set Up SACR, Product Related, Student Financials, Collections, Collection Criteria	Set up student collection criteria.
Corporate Collection Criteria (corporation collection criteria)	COLL_CRITER_ORG	Set Up SACR, Product Related, Student Financials, Collections, Corporate Collection Criteria	Set up organization collection criteria.

Setting Up Student Collection Criteria

Access the Collection Criteria page (Set Up SACR, Product Related, Student Financials, Collections, Collection Criteria).

Collection Criteria page

User ID or Role Name Select a user ID or role name. The label of the field changes depending on your business unit setup. If you assign collection items by user ID, the User ID field appears. If you assign collection items by role, the Role Name field appears.

Catch All Collector Select to assign to this collector any collection items that did not meet any other collector's criteria.

Amount Past Due Select to assign collection items to this collector only if they meet the minimum past-due amount that you enter in the field that appears to the right of the check box when you select it.

Past Due Catg (past-due category) Select to assign collection items to this collector only if they belong to the aging category that you enter in the field that appears to the right of the check box when you select it.

Last Name, From, and To Select to assign collection items to this collector only for students who fall within the range of last names that you specify in the From and To fields that appear to the right of the check box when you select it.

NSF (non-sufficient funds) Select to assign to this collector only those collection items that are associated with students who have this item reason attached to their accounts.

Template and Code Select the Template check box to attach a particular collections letter template to any collection items that are assigned to this when you run the Assign Collector process. In the Code field that appears to the right of the selected check box, select the code of the appropriate collection letter template.

Academic Program Select to assign to this collector only those collection items within the academic programs that you specify in the Academic Programs scroll area. This scroll area appears only if you select the Academic Programs check box.

Note. The system assigns collections to the first collector who meets the defined criteria. When assigning a collection item, the system reviews the criteria by sequence number starting with the lowest number. Therefore, you should create the criteria with the higher monetary amounts first. This will ensure that the high monetary collections are assigned to the collector who can best handle them. For example, suppose that you establish collection criteria with a sequence number of 1 with an amount past due of 100.00 and a past due category of 03 (30–60 days past due). The system would assign to the collector linked to these criteria all collection items of 100.00 USD and above that were 30–60 days past due. A collector linked to collection criteria with a minimum past due amount that is greater than 100.00 USD for the same past due dates, but with a higher sequence number, would not be assigned any collections.

Setting Up Organization Collection Criteria

Access the Corporate Collection Criteria page (Set Up SACR, Product Related, Student Financials, Collections, Corporate Collection Criteria).

Except for the Description check box and the lack of the Academic Program check box, this page is identical to the Collection Criteria page.

Description Select to assign collection items to this collector only for organizations that fall within the range of names that you specify in the From and To fields that appear to the right of the check box when you select it.

See Also

[Chapter 12, "Setting Up Receivables Collection," Setting Up Collection Criteria, page 367](#)

Defining Reason In and Reason Out Codes

To set up reason in and reason out codes, use the Reason In component (REASON_IN_SF) and the Reason Out component (REASON_OUT_SF).

The Assign Collector process brings past-due items into the collections system and moves reconciled items out of the collections system. When you move an item into or out of the system, you can track the movement using reason in and reason out codes.

Pages Used to Define Reason In and Reason Out Codes

<i>Page Name</i>	<i>Definition Name</i>	<i>Navigation</i>	<i>Usage</i>
Reason In	REASON_IN_SF	Set Up SACR, Product Related, Student Financials, Collections, Reason In	Set up reason in codes that identify why the system moved an item into collections.
Reason Out	REASON_OUT_SF	Set Up SACR, Product Related, Student Financials, Collections, Reason Out	Set up reason out codes that identify why the system moved an item out of collections.

Creating Follow-Up Actions

To set up follow-up actions, use the Follow-Up Table component (FOLLOW_UP).

Part of the collection process involves following up on past due items that remain in the collection system. The Collect Receivables feature enables you to create follow-up action codes that record the steps that you intend to take to resolve a collection item.

Page Used to Create Follow-Up Actions

<i>Page Name</i>	<i>Definition Name</i>	<i>Navigation</i>	<i>Usage</i>
Follow Up Table	FOLLOWUP_TBL	Set Up SACR, Product Related, Student Financials, Collections, Follow-Up Table	Define follow-up action codes.

Setting Up Collection Letter Templates

To set up collection letter templates, use the Collection Letter Template component (COLL_LTRTMP_TABLE).

The Collect Receivables feature enables you to create a template for the dunning letters that you automatically generate to send to students with past-due charges on their accounts. In addition, this template enables you to set a schedule for sending different dunning letters to students depending on how long their past-due charges have been in the collections system.

Page Used to Set Up Collection Letter Templates

Page Name	Definition Name	Navigation	Usage
Collections Letter Template	COLL_LTRTMP_TABLE	Set Up SACR, Product Related, Student Financials, Collections, Collection Letter Template, Collection Letter Template	Define collection letter templates.

Defining Collection Letter Templates

Access the Collections Letter Template page (Set Up SACR, Product Related, Student Financials, Collections, Collection Letter Template, Collection Letter Template).

Collections Letter Template

SetID: PSUNV **Template Code:** DUNNINGLTR

Find First 1 of 1 Last

***Effective Date:** 01/01/1900 ***Status:** Active

***Description:** Dunning Letters **Short Description:** Dun Ltrs

Long Description:

***Checklist:** Other ***Mailing Code:** Day of Month

Address Usage: SLCT ORD 1 **Type of Name:** Preferred

Service Impact: CENR Block All Enrollment Actvty

Dunning Letter Details Find | View All First 1 of 3 Last

Nbr	*Function	*Category	*Context	Day of the Month
	*Letter Code	*Method	Department	
1	SFCO Collection	PDACCT PDA	PDA-01 PDA-01	1
	D01 Dunning Letter #1	Letter	STDNT SERV	

Collections Letter Template page

Checklist Select the type of checklist with which you want to associate this collections letter template.

Mailing Code	<p>Select the method that the system uses to determine the schedule for sending out the different dunning letters that you attach to the template.</p> <p>If you select <i>Day of Month</i>, the corresponding field that appears in the Dunning Letter Details group box is Day of the Month. When you select this mailing code, the system sends dunning letters according to the day of the month in which you run the Collections Dunning Letter process.</p> <p>If you select <i>Days in Collection</i>, the corresponding field that appears in the Dunning Letter Details group box is Days in Collection. When you select this mailing code, the system sends dunning letters according to how long a collections item that is associated with this letter template has been in the collections system.</p>
Address Usage	Enter the method that the system uses to determine the addresses to which it sends dunning letters.
Type of Name	Select the type of name that the system uses when addressing the dunning letters.
Service Impact	Enter the service impact that the system attaches to students when it sends dunning letters to them using this template.

Dunning Letter Details

Specify details for each dunning letter that is attached to the template.

Nbr (number)	Indicates the number of the dunning letter with respect to all the dunning letters that you attach to the template.
Function	Enter the administrative function that you want to associate with the dunning letter.
Category	Enter the communication category that you want to associate with this dunning letter.
Context	Enter the communication context that you want to associate with the dunning letter.
Day of the Month	<p>The system compares the number that you enter in this field to the day of the month on which you run the Collections Dunning Letter process to determine whether a dunning letter should be sent for any collections item associated with the collections letter template.</p> <p>For example, suppose that you enter <i>15</i> in this field and run the Collections Dunning Letter process on 07/18/2005. Because the day that you ran the process is on or after the value in the Day of the Month field, the system would determine that a dunning letter should be sent for any collections items associated with this collections letter template.</p>

Days in Collections	When you run the Collections Dunning Letter process, the system generates a dunning letter for any collections items that are associated with this collections letter template that have been in the collections system for a number of days equal to or greater than the number that you enter in this field.
Letter Code	Enter the code of the standard letter that you want to associate with this dunning letter.
Method	Enter the method of communication for the dunning letter.
Department	Enter the department that is associated with the dunning letter.

Insert rows to associate additional dunning letters with the collections letter template. In this way, you can create a schedule for sending out multiple dunning letters. For example, suppose that you attach three different dunning letters to the collections letter template with values of *1*, *15*, and *30* in the Day of the Month field. If you run the Collections Dunning Letter process on 07/18/2005, the system knows to generate the first and second dunning letter for associated collections items based on the schedule that you set up here.

See Also

PeopleSoft Enterprise Campus Community 9.0 Fundamentals PeopleBook, "Managing Checklists"

Chapter 13

Setting Up Tax Form Production

This chapter lists common elements and discusses how to:

- Set up 1098-T tax form production.
- Set up T2202A tax form production.
- Set up T4A tax form production.

Common Element Used in This Chapter

Calendar Year	For the purposes of tax reports, the calendar year represents the tax year for which you are reporting.
----------------------	---

Setting Up 1098-T Tax Form Production

To set up 1098-T tax form production, use the 1098-T TIN Table component (SF_1098_INST).

This section provides an overview of 1098-T tax form production setup and discusses how to:

- Set up a taxpayer identification number (TIN).
- Set up valid citizenship statuses.

Understanding 1098-T Tax Form Production Setup

To set up Student Financials for 1098-T generation, you must:

1. Set up a TIN under which your institution files 1098-T tax information to the IRS.

While many institutions may only designate one TIN per business unit, Student Financials enables you to set up one TIN to file 1098-T information for multiple business units.

2. Designate item types as qualified tuition and related expenses.

For the Student Financials system to determine whether a student is to receive a 1098-T form, it looks for any item types on the student's account that you have designated as qualified tuition and related expenses. A check box on the Amount Edits setup page enables you to identify item types as qualified tuition and related expenses.

See Also

Chapter 2, "Completing Student Financials General Setup," Setting Up Item Types and Item Type Groups, page 55

Pages Used to Set Up 1098-T Tax Form Production

Page Name	Definition Name	Navigation	Usage
1098-T TIN Detail	SF_1098_INST	Set Up SACR, Product Related, Student Financials, Taxes, 1098-T TIN Table	Set up a TIN.
1098-T Citizenship	SF_1098_INST_CIT	Set Up SACR, Product Related, Student Financials, Taxes, 1098-T TIN Table, 1098-T Citizenship	Set up valid citizenship statuses.
1098-T Institution Address	SF_1098_INSTAD_SEC	Click the 1098-T Institution Address link on the 1098-TIN page.	Enter the address associated with the TIN that you are defining.

Setting Up a TIN

Access the 1098-T TIN Detail page (Set Up SACR, Product Related, Student Financials, Taxes, 1098-T TIN Table, 1098-T TIN Detail).

1098-T TIN Detail page

You set up TINs each year.

Copy TIN Setup	Click to copy the TIN setup data from a previous year into the TIN that you are creating. When you click this button, the system prompts you to enter the calendar year from which to copy setup data.
1098-T Institution Address	Click this link to access the 1098-T Institution Address page, where you can enter the address information associated with this TIN.
Address Usage	Select the logic that the system uses to select the student address that prints on each 1098-T form.
Name Usage	Enter the logic that the system uses to select the student name that prints on each 1098-T form.
Contact Name	Enter the name of the primary contact associated with the TIN.
Contact Phone	Enter the telephone number of the primary contact associated with the TIN.
Name Control	Enter the first four characters of the description of the institution associated with the TIN. Disregard the word <i>the</i> when it is the first word of the description unless the name has only two words.
Transmission Code	To file 1098-T tax forms with the Internal Revenue Service (IRS) electronically, you must first file IRS Form 4419, Application for Filing Information Return Magnetically/Electronically. If the IRS accepts your application to file electronically, you are assigned a five-character alphanumeric Transmitter Control code. Enter this code in the Transmission Code field.
Last Filing Year	Select if this is the last year that you are using this TIN to file 1098-T forms with the IRS.
Reporting Method Changed	Select this check box if you have changed your method of reporting (payments received or amounts billed) from the previous year.

Business Unit Detail

Select the business units that you want to include under the TIN.

Business Unit	Enter the business unit for which you want to report 1098-T data under this TIN. When you exit this field, the system populates the Institution field with the institution that is associated with the business unit that you select.
Institution	Enter the institution that is associated with the business unit that you select. If you already selected a business unit, the system automatically populates this field with the correct institution.

FinAid Group (financial aid group) Enter the item type group to use to identify items that are related to financial aid. The system uses this group to calculate the value of Box 4 on the 1098-T form.

Note. The financial aid item type group should contain only scholarships, grants, and fellowship item types.

Third Party Group Enter the item type group to use to identify items that are related to third-party billing arrangements. The system uses this group to determine whether students are eligible to receive 1098-T forms.

1098-T Self Service

Select the self-service options that you want to include under the TIN.

Set up the report template each year when the new TIN record is created.

Display 1098-T Self Service Select to enable students to see a given year on the Selection page. Selecting the check box causes the TIN for this calendar year to appear in self service.

Clear this check box to restrict this tax year from appearing in self service.

Use the Report Definition field to identify the associated XML Publisher template.

Display Box Amount Select to enable students to access the details for each box amount that appears on the View 1098-T page in Student Financials self-service. Box amounts are the numbered and named boxes on the 1098-T form that contain amounts such as Payments Received.

This check box is only available when the Display 1098-T Self Service check box is selected.

Use Electronic Statements Use this setting in batch to decide whether a paper copy should be printed. This setting is also used online to decide whether to show the consent message/button in self service.

Selecting this check box means that the student can consent to receive the 1098-T form electronically (online using self service) rather than receiving a printed copy. The student must consent to receive the 1098-T electronically; otherwise, the form continues to be printed by means of the batch process and mailed to the student.

Use the Template Definition field to identify the associated XML Publisher template.

Setting Up Valid Citizenship Statuses

Access the 1098-T Citizenship page (Set Up SACR, Product Related, Student Financials, Taxes, 1098-T TIN Table, 1098-T Citizenship).

1098-T TIN Detail		1098-T Citizenship	
Federal TIN:	951223331	Calendar Year:	2006
Copy TIN Setup			
Valid Citizenship Statuses			
Customize Find View All First 1-3 of 3 Last			
	*Citizenship Status	Description	
1	1 <input type="text"/>	Native	+ -
2	2 <input type="text"/>	Naturalized	+ -
3	3 <input type="text"/>	Alien Permanent	+ -

1098-T Citizenship page

Set up valid citizenship statuses so that a 1098-T is produced only for those statuses listed.

Setting Up T2202A Tax Form Production

To set up Student Financials for T2202A data generation, you must designate item types as T2202A eligible tuition and offsets. For Student Financials to calculate tuition amounts for each T2202A form, it totals the amounts of any item types on the student's account that you designated as T2202A eligible. In addition, you must identify any waivers that offset T2202A eligible tuition so that the system accurately calculates the tuition amount that appears on your T2202A forms. Check boxes on the Amount Edits setup page enable you to identify item types as T2202A eligible tuition or as T2202A offsets.

See Also

[Chapter 2, "Completing Student Financials General Setup," Setting Up Item Types and Item Type Groups, page 55](#)

Setting Up T4A Tax Form Production

This section discusses how to set up the T4A tax form production. To set up Student Financials for T4A data generation, you must:

1. Designate item types as T4A income.

To determine whether to generate T4A data for a student, Student Financials looks for any item types on the student's account that are designated as T4A income. A check box and associated field on the Amount Edits setup page enable you to identify item types that count as T4A income. The Wage Loss Plan has been moved to the Canadian/ANZ Taxes page of the SF Business Unit component. In addition, on the Miscellaneous page, you must select an earnings code to classify the type of the T4A income.

2. Define your T4A generation processing parameters on the Canadian/ANZ Taxes page of the SF Business Unit component.

See Also

Chapter 2, "Completing Student Financials General Setup," Setting Up Item Types and Item Type Groups, page 55

Chapter 2, "Completing Student Financials General Setup," Setting Up Business Units, page 19

Chapter 14

Processing ePayment Transactions

This chapter provides an overview of ePayment transactions and discusses how to:

- Process ePayment service requests.
- Review and cancel self-service ePayment transactions.
- Process refunds for ePayments.
- Review ePayment transactions.
- Review self-service agreements

Understanding ePayment Transactions

PeopleSoft Student Financials enables your institution to receive payments for charges by eCheck or credit card through cashiering and over the web using self-service functionality. The rules that your institution defines for accepting, verifying, and authorizing transactions are established when you set up your Student Financials (SF) merchant and SF institution set.

After a credit card transaction takes place, the following steps occur during the completion of a transaction:

1. Through real time or batch authorization, your system transfers the credit card number and payment request to the payment provider.
2. The payment provider routes the transaction to the merchant bank and then to the credit card company.
3. The credit card provider routes the payment request to the bank that issued the card, if applicable.
4. The bank or credit card company authorizes or declines the transaction, transfers the result back to the credit card provider, then transfers the result back to you.
5. Your system generates a capture request in real time or in batch. It routes the capture request to the issuing bank and the bank approves the money to be routed to the merchant account.

When the student submits an electronic check payment:

1. The transaction is transmitted to the school's payment provider.
2. The payment provider forwards the bank account number and routing number to the corresponding payment processor.
3. The payment processor validates the transaction and transmits the result back to the payment provider.
4. The payment provider forwards the results back to the PeopleSoft system.

5. The results of the transaction are presented back to the student.

The check is subsequently submitted by the payment provider for settlement to the ACS System.

See Also

[Chapter 3, "Setting Up ePayment Processing," Setting Up SF Merchants, page 100](#)

[Chapter 20, "Cashiering," page 519](#)

Electronic Payment Integration Developer's Reference Guide. The guide is posted to My Oracle Support.

Processing ePayment Service Requests

Student Financials provides a batch process that authorizes, captures, and credits submitted credit card transactions, or debits and credits eCheck transactions.

This section discusses how to:

- Process submitted credit card transactions.
- Process submitted eCheck transactions.
- Purge Security Code data.

Pages Used to Process ePayment Service Requests

<i>Page Name</i>	<i>Definition Name</i>	<i>Navigation</i>	<i>Usage</i>
Credit Card Processing	RUNCTL_SFPCRCARD	Student Financials, Charges and Payments, Electronic Transactions, Electronic Payments, Process Credit Cards, Credit Card Processing	Process submitted credit card transactions.
eCheck Processing	RUNCTL_SFPECHECK	Student Financials, Charges and Payments, Electronic Transactions, Electronic Payments, Process Electronic Check, eCheck Processing	Process submitted eCheck transactions.
Security Code Purge Process	SCC_RUN_CVPURGE	Student Financials, Charges and Payments, Electronic Transactions, Electronic Payments, Security Code Purge, Security Code Purge Process	Purge Security Code data.

Processing Submitted Credit Card Transactions

Access the Credit Card Processing page (Student Financials, Charges and Payments, Electronic Transactions, Electronic Payments, Process Credit Cards, Credit Card Processing).

Credit Card Processing

Run Control ID: PS [Report Manager](#) [Process Monitor](#) Run

SF Merchant ID: All SF credit card centers

Service Request

Authorize and Capture
 Capture
 Credit

Credit Card Transaction Source

All
 Admissions Academic Institution: Application Center:
 Cashiering Business Unit: Cashier's Office:
 Self Service Institution Set:

Re-Post Self Service Errors

Credit Card Processing page

SF Merchant ID (Student Financials merchant ID) Select the ID of the SF merchant whose transactions you want to process.

Service Request

Hosted transactions cannot be authorized or captured in batch.

The Real-Time Authorization and Real-Time Capture check boxes on the SF Merchants page are selected by default and are not available for edit for hosted payment providers.

See: PeopleSoft Enterprise Student Financials 9.0 PeopleBooks, Processing ePayment Transactions, Processing ePayment Service Requests

Authorize and Capture Select to authorize and capture any credit card transactions that have not yet been authorized for the SF merchant ID selected. If you set up your SF merchant ID to not authorize or capture in real time, you must run the batch process with this check box selected to authorize and capture your credit card transactions.

Capture	Select to capture any credit card transactions that have been authorized, but not captured. If you set up your SF merchant ID to authorize in real time, but not to capture in real time, you must run the batch process with this check box selected to capture your credit card transactions.
	<hr/>
	Note. Even if you authorize credit card transactions in real time, you might have connection errors with your credit card processing vendor. When this happens, your transactions fail and remain unauthorized. Therefore, you eventually need to run the batch process with the Authorize and Capture check box selected to process those failed transactions.
	<hr/>
Credit	Select to credit the credit card accounts of students whose credit card transactions have been refunded, voided, or reversed.
	<hr/>
	Note. If you intend to process credits originating from a refund using the batch process, be sure that you have already run the Process ePayment Refunds process (SFPCCBAT). It generates the student refund credits that you send to the web credit card processing vendor using the Credit Card Processing batch process.
	<hr/>

Credit Card Transaction Source

All	Select to process credit card transactions from all sources using the same SF merchant ID.
Admissions	Select to process credit card transactions in order to view historical Admissions data. You must also specify an academic institution and application center.
Application Center	In order to view historical Application Center data, select an application center for the processing of admissions deposits.
Cashiering	Select to process credit card transactions from cashiering offices. You must also specify a business unit and cashier's office.
Self Service	Select to process credit card transactions from self-service sources.

Other Fields

Re-Post Self Service Errors	Select to post any transactions that previously failed to post due to setup or system errors.
------------------------------------	---

To create a file log or troubleshoot batch credit card transactions, use Application Designer: Open the Business Interlink (CREDITCARD_TRANSACTION), click on the Input tab, and change the default value of Trace to Y.

See Also

[Chapter 17, "Refunding Customers," page 435](#)

Processing Submitted eCheck Transactions

Access the eCheck Processing page (Student Financials, Charges and Payments, Electronic Payments, Process Electronic Check, eCheck Processing).

eCheck Processing

Run Control ID: PS [Report Manager](#) [Process Monitor](#) Run

SF Merchant ID: SS Hosted Payment echeck Merch

Service Request

Debit
 Credit

Institution Set: PeopleSoft University

Re-Post Self Service Errors

eCheck Processing page

Debit	Select to debit any eCheck transactions that have not yet been debited for the SF merchant ID selected. This is not applicable for hosted payment transactions.
Credit	Select to credit the eCheck accounts of students whose eCheck transactions have been refunded, voided, or reversed.
Institution Set	Select the institution set for which you are processing eCheck transactions.
Re-Post Self Service Errors	Select to post any transactions that previously failed to post due to setup or system errors.

To create a file log or troubleshoot batch eCheck transactions, use Application Designer: Open the Business Interlink (ECHECK_TRANSACTION), click on the Input tab, and change the default value of Trace to Y.

Purging Security Code Data

Access the Security Code Purge Process page (Student Financials, Charges and Payments, Electronic Transactions, Electronic Payments, Security Code Purge, Security Code Purge Process).

Security Code Purge Process			
Run Control ID: PURGE	Report Manager	Process Monitor	<input type="button" value="Run"/>
Purge Interval			
Days: <input type="text" value="000"/>	Hours: <input type="text" value="072"/>	Minutes: <input type="text" value="000"/>	Purge Cutoff Date Time:
Number of Records Purged: 0000000000	Last Run Date Time:		

Security Code Purge Process page

The Security Code that is located on credit cards is a security feature for *card not present* transactions such as Internet transactions. The Security Code is sent to the issuing bank at the time of authorization. The merchant can stop the transaction if the Security Code is invalid.

The Security Code is supported only if you use the Integration Broker based interface for processing credit card transactions. Collecting the Security Code at the time of the ePayment transaction can lower your transaction costs.

Payment Application Best Practices require software vendors to delete Security Code data stored in any tables after the transaction is completed. Security Code data is stored encrypted in the SSF_PAYMENT_CVV table. The row is retained only as long as authorization is pending.

In real time transactions, the Security Code record is deleted immediately after submission and transmission of authorization and/or capture transaction.

For batch authorizations, a lag time can exist between the submission of a self-service or administrative transaction and the authorization of the transaction.

The Security Code Purge process is intended as a fail-safe measure to ensure that the Security code is either processed or purged from the system in a reasonable amount of time.

See [Chapter 3, "Setting Up ePayment Processing," page 83](#).

See [Electronic Payment Integration Developer's Reference Guide](#). The guide is posted to My Oracle Support.

Reviewing and Canceling Self-Service ePayment Transactions

Student Financials enables you to review and cancel submitted payments that are not yet authorized or posted to the student account.

This section discusses how to view self-service credit card transactions.

Page Used to Review and Cancel Self-Service ePayment Transactions

<i>Page Name</i>	<i>Definition Name</i>	<i>Navigation</i>	<i>Usage</i>
Maintain ePayment Transaction	SF_PAYMENT_MAINT1	Student Financials, Charges and Payments, Electronic Transactions, Electronic Payments, Maintain ePayment Transaction	View and cancel self-service credit card transactions.

Viewing and Canceling Self-Service Credit Card Transactions

Access the Maintain ePayment Transaction page (Student Financials, Charges and Payments, Electronic Transactions, Electronic Payments, Maintain ePayment Transaction)

Maintain ePayment Transaction

Reference Nbr:	000000000065	ID:	SFEK00051
	Odelia,Susan H		<input type="button" value="Cancel"/>
Sequence number:	1		
Institution Set:	EC PSUNV University		
Amount:	230.500 USD		
Payment Status:	Payment Submitted		
Posting Status:	Pending		
Transaction Requested:			
Source:	Payment		
Process Instance:			
Reversal Status:		Reversal Indicator:	
Last Change Date:	11/16/2009 6:45:53PM	User ID:	SSS_SFEK00051

Authorization Information

Authorization Datetime:			
Request ID:			
Authorization Code:		AVS Code:	
Authorization Reply:		Date:	
Transaction Reference Nbr:			

Posting Message

Business Unit:	
Message Set Number:	
Message Number:	
Error or Warning Flag:	

Maintain ePayment Transaction page (1 of 2)

Payment Information	
First Name:	Susan
Last Name:	Odelia
Credit Card Type:	Visa Card
Credit Card Number:	4111111111111111 Last Four Digits: 1111
Expiration Date:	10 2010
Email Address:	ps@ps.com
Telephone:	292/292-2929
Billing Address	
Country:	United States
Address:	123 Main Street Lee, CA 94587 Alameda

Maintain ePayment Transaction page (2 of 2)

Reference Nbr (reference number) Displays the unique reference number that the system assigns to each credit card transaction.

ID Displays the ID of the student who made the credit card transaction.

Posting Status Indicates whether the Student Financials system successfully posted each transaction. Values are:

Errors: The transaction encountered errors during posting.

Pending: The system has not yet posted the transaction.

Successful: The system successfully posted the transaction.

Source Indicates where the transaction originated. Values are:

Application Center: The transaction originated from an admissions office application center.

Cashiering: The transaction originated from a cashiering office.

Payment: The transaction originated from the self-service Make a Payment page.

Refund: The transaction originated from the Student Financials Refund process.

Reversal: The transaction originated from the Payment Reversals page.

Reversal Status If you reversed the transaction, this field Indicates whether the system successfully processed the reversal. Values are:

Errors: The system encountered errors during the reversal.

Successful: The system successfully reversed the transaction.

Cancel Click to cancel this transaction.

Note. The Cancel button is available only for transactions that are not posted and authorized.

Authorization Information

Information appears in this group box when a self-service credit card transaction has been authorized.

Credit Card Authorization DTTM Displays the date and time that the credit card processing vendor authorized the credit card transaction.

(credit card authorization date and time)

Credit Card Request ID Displays the unique ID that the credit card processing vendor assigns to each transaction.

Credit Card Authorization Code Displays the unique authorization code sent by the bank to the credit card processing vendor.

Date Displays the original date of the credit card transaction.

Authorization Reply Displays the authorization reply code that was received from the credit card processing vendor for each transaction.

Credit Card AVS Return Code (credit card address verification system code)	<p>Displays the address verification code that the credit card processing vendor sends to the Student Financials system. The code indicates whether the address that was sent with the transaction matches the credit card company's records. If you set the system not to perform address verification for a transaction, the AVS Code column is blank for that transaction.</p> <p>Values are:</p> <p><i>X</i> (Exact): The address and the 9-digit zip code match.</p> <p><i>Y</i> (Yes): The address and the 5-digit zip code match.</p> <p><i>A</i> (Address): The address matches, but the 5-digit zip code does not.</p> <p><i>W</i> (Whole zip): The address does not match, but the 9-digit zip code does.</p> <p><i>Z</i> (Zip): The address does not match, but the 5-digit zip code does.</p> <p><i>N</i> (No): Neither the address nor the zip code match.</p> <p><i>U</i> (Unavailable): Information is unavailable or the card-issuing bank does not support AVS.</p> <p><i>S</i> (Unsupported): The card-issuing bank does not support AVS.</p> <p><i>R</i> (Retry): The system of the card-issuing bank is unavailable.</p> <p><i>E</i> (Edit Error): The transaction is ineligible for AVS or an edit error occurred.</p>
---	---

Posting Message

Information appears in this group box when a self-service credit card transaction has been posted.

Business Unit	Displays the description of the business unit within which the transactions were processed.
Message Set Number and Message Number	If any errors occurred or warnings were issued during the processing of this transaction, use the message set number and the message number to locate the message explaining what happened.
Error or Warning Flag	Indicates whether the system encountered any errors or generated any warning messages when it posted the transaction.

Processing Refunds for ePayments

This section discusses how to:

- Create online student refunds.
- Run the ePayment Refunds process.

Pages Used to Process Refunds for ePayments

<i>Page Name</i>	<i>Definition Name</i>	<i>Navigation</i>	<i>Usage</i>
Student Refund	REFUND_SF	Student Financials, Refunds, Student Refund	Create an online refund for a student.
ePayment Refunds	RUNCTL_SFPCCBAT	Student Financials, Refunds, Electronic Payment Refunds, Process ePayment Refunds	Generate refund credits in preparation of transmission to your third-party ePayment processor.
Review Refund Messages	REFUND_CC_MSGS	Student Financials, Refunds, Electronic Payment Refunds, Review Refund Messages	Review ePayment refund messages.
Batch ePayment Refund Details	RUN_SF862	Student Financials, Refunds, Electronic Payment Refunds, Batch ePayment Refund Details	Review batch ePayment refund messages.

Creating Online Student Refunds

Access the Student Refund page (Student Financials, Refunds, Student Refund).

See Also

[Chapter 17, "Refunding Customers," Creating Student Refunds, page 445](#)

Running the ePayment Refunds Process

Access the Process ePayment Refunds page (Student Financials, Refunds, Electronic Payment Refunds, Process ePayment Refunds)

See Also

[Chapter 17, "Refunding Customers," Distributing Refunds to ePayment Accounts, page 461](#)

Reviewing ePayment Transactions

This section discusses how to:

- Define selection criteria for reviewing ePayment transactions.

- Review ePayment transaction details.

Pages Used to Review ePayment Transactions

<i>Page Name</i>	<i>Definition Name</i>	<i>Navigation</i>	<i>Usage</i>
Selection Criteria	SF_PAYMENT_TRANS1	<ul style="list-style-type: none"> • Student Financials, Charges and Payments, Electronic Transactions, Electronic Payments, Review Transaction Log, Selection Criteria • Student Financials, Charges and Payments, Electronic Payments, Review Pending Transactions, Selection Criteria 	Define selection criteria for reviewing specific ePayment transactions.
Transaction Detail	SF_PAYMENT_TRANS3	<ul style="list-style-type: none"> • Student Financials, Charges and Payments, Electronic Transactions, Electronic Payments, Review Transaction Log, Transaction Detail • Student Financials, Charges and Payments, Electronic Transactions, Electronic Payments, Review Pending Transactions, Transaction Detail 	Review ePayment transaction details.
Pending Transaction Detail	SF_PAYMENT_INQ1	Click a reference number link on the Transaction Detail page.	View detailed information about a pending ePayment transaction.
Totals	SF_PAYMENT_TRANS2	Student Financials, Charges and Payments, Electronic Transactions, Electronic Payments, Review Transaction Log, Totals	Review counts and monetary totals of processed ePayment transactions.

Defining Selection Criteria for Reviewing ePayment Transactions

Access the Selection Criteria page (Student Financials, Charges and Payments, Electronic Transactions, Electronic Payments, Review Transaction Log, Selection Criteria).

Selection Criteria		Totals	Transaction Detail
SF Merchant ID:	EPMTCRCRD	ePayment Credit Card	
Totals			
Total Debit:		0.000	
Total Credit:		0.000	
Total:		0.000	
Filter Options			
<input type="radio"/> Specific	Reference Nbr:	<input type="text"/>	<input type="button" value="Search"/>
<input type="radio"/> ID	ID Type:	Person <input type="button" value="v"/>	ID: <input type="text"/> <input type="button" value="m"/>
<input checked="" type="radio"/> Range	From:	11/04/2009 <input type="button" value="B"/>	To: 11/04/2009 <input type="button" value="B"/>
Range Criteria			
Transaction Requested:	Auth/Capt <input type="button" value="v"/>	Batch ID:	<input type="text"/> <input type="button" value="m"/>
Tran Status:	Success <input type="button" value="v"/>	Process Instance:	<input type="text"/> <input type="button" value="m"/>
Posting Status:	Success <input type="button" value="v"/>	Reversal Status:	<input type="button" value="v"/>
Credit Card Type:	Visa Card <input type="button" value="v"/>		
Transaction Source Information			
<input checked="" type="radio"/> All			
<input type="radio"/> Cashiering	Business Unit:	<input type="text"/> <input type="button" value="m"/>	
	Cashier's Office:	<input type="text"/> <input type="button" value="m"/>	
	Receipt Number:	<input type="text"/>	
<input type="radio"/> Admissions	Academic Institution:	<input type="text"/> <input type="button" value="m"/>	
	Application Center:	<input type="text"/> <input type="button" value="m"/>	
	Application Nbr:	<input type="text"/>	
<input type="radio"/> Self Service	Institution Set:	<input type="text"/> <input type="button" value="m"/>	

Selection Criteria page

Depending on the SF merchant ID that you select, the transaction detail displays values for credit cards or eChecks.

Note. If you access this page through the Transaction Log component, a Totals group box appears at the top of this page displaying the total debit and total credit, and a Totals page appears.

Filter Options

Specific and Reference Nbr (reference number)	Select the Specific option to retrieve transaction information for one specific transaction by entering its reference number.
ID	Select to retrieve transaction information related to one person or organization
ID Type	Specify whether the ID for which you want to retrieve transaction information is a person or organization.
<hr/>	
	Note. <i>Org</i> is valid only for corporate payments made through cashiering.
<hr/>	
ID	Select the ID of the student or organization whose transactions you want to view.
Range	Select to retrieve all transaction information from the sources specified in the Transaction Source Information group box.

Transaction Source Information

All	Select to retrieve transactions from all sources using the same SF merchant ID.
<hr/>	
	Note. This selection displays all transactions for the SF merchant ID without regard for security display restrictions.
<hr/>	
Cashiering	Select to retrieve transactions from all cashiering offices.
Business Unit	Select to narrow the selection of transactions to cashier's offices that are attached to a specific business unit.
Cashier's Office	Select to narrow the selection of transactions to a specific office.
Receipt Number	Select transaction information from one specific receipt.
Admissions	Select to retrieve transactions in order to view historical Admissions data.
Academic Institution	Select to narrow the selection of transactions to admissions offices that are part of a specific academic institution.
Application Center	In order to view historical Application Center data, select to narrow the selection of transactions to a particular application center.
Self Service	Select to retrieve transactions from self-service sources.
Institution Set	Select to narrow the selection only to self-service transactions from a specific institution set.

Other Fields and Elements

- Credit Card Type** Select the type of credit card used in the transactions that you want to view.

- Batch ID** When you run the Process ePayment Refunds process, the system assigns a batch ID to all the credit card transactions that are affected by the process. Specify a batch ID to retrieve information about all the transactions with that particular batch ID.

- Transaction Requested** Use this field to filter the retrieved transaction information by the type of transaction requested. Four types of transaction requests are available:
 - Authorize:* Request for authorization of a credit card payment.
 - Auth/Capt:* Request for authorization and capture of a credit card payment.
 - Credit:* Request for an amount to be credited (refunded) to a credit card account.
 - Capture:* Request for capture of a credit card payment.

- Search** Click to select all credit card transactions that meet your selection criteria. The system displays this information on the Transaction Detail page.

Reviewing ePayment Transaction Details

Access the Transaction Detail page (Student Financials, Charges and Payments, Electronic Transactions, Electronic Payments, Review Transaction Log, Transaction Detail).

Selection Criteria		Transaction Detail								
SF Merchant ID:		EPMTCRCRD			ePayment Credit Card					
Customize Find View All First 1-2 of 2 Last										
General		Refund	Self-Service	Cashiering	Admissions					
Reference Nbr	Seq	Auth Date	ID	Amount	Transaction Requested	Auth Code	Last Four Digit	Credit Card Type	Source	
1	000000000024	0		SR13265	1,003.000		1111	Visa	Payment	
2	000000000023	0		SR13265	60.000		1111	Visa	Payment	

Transaction Detail page

Note. Multiple views of this page are available when you click the tabs in the scroll area. This section documents elements common to all views first.

Common Page Information

Reference Nbr (reference number) Lists the unique reference number that the system assigns to each credit card transaction. Click the Reference Nbr link to access the Pending Transaction Detail page, where you can review detailed information about the transaction.

Seq (sequence) Lists the sequence number that the system assigns to every activity for a given transaction reference number.

Note. A sequence number of zero means that submitted transactions are pending (no processing has taken place by the credit card vendor).

Date Lists the original date of each transaction.

ID Lists the ID of the student or external organization who made each transaction.

Amount Lists the monetary amount of each transaction.

General Tab

Type Lists the type of transaction requested. A blank value in this field indicates that the transaction is awaiting background processing.

Auth Code (authorization code) Lists the unique authorization code that was sent by the bank to the credit card processing vendor.

Card Nbr (card number) Lists the last four digits of the credit card number that was used for each transaction.

Card Type Lists the type of credit card that was used for each transaction.

Source Indicates where the transaction originated.

Refund Tab

Batch ID When you run the Process ePayment Refunds process, the system assigns a batch ID to all the credit card transactions affected by the process. This heading lists the batch ID that is assigned to each transaction.

Unit Lists the business unit that processed each refund.

Refund Nbr (refund number) Lists the unique number that the system assigns to each refund transaction.

Line Lists the refund line number.

Self-Service Tab

Institution Set Lists the institution set within which the transactions were processed.

Business Unit Lists the business unit within which the transactions were processed.

Err/Warn (error/warning)	Lists whether a warning was issued or an error occurred.
Posted	Lists the posting date for each transaction.
Posting Status	Lists whether the Student Financials system successfully posted each transaction. Values are: <i>Errors:</i> Errors occurred during posting. <i>Pending:</i> The system has not yet posted the transactions. <i>Successful:</i> The system successfully posted the transactions.

Cashiering Tab

Unit	Lists the business unit associated with the cashiering office that performed the transactions.
Cashier's Office	Lists the cashier's office from which the transaction originated.
Register	Lists the register within the cashier's office from which the transaction originated.
Receipt Nbr (receipt number)	Lists the receipt number of the transaction.
Line	Lists the receipt line number.
User	Lists the user or process that initiated the transaction. In the case of refunds that necessitate a credit, it lists SFCCBAT, which is the Process ePayment Refunds process.
ID Type	Lists the ID type of the person or organization for whom the transaction applies.

Admissions Tab

Institution	Lists the academic institution from which the transaction originated.
Application Center	Lists the application center from which the transaction originated.
Appl Nbr (application number)	Lists the application number for which the payment was made.

Reviewing Self-Service Agreements

This section discusses how to review self-service agreements.

An inquiry page is added for the administrative user to review the various self-service agreements that the student has signed.

The self-service features require that requirements agreements include electronic (eCheck) Make a Payment Transactions, 1098-T, Payment Plan Enrollment, and Student Permissions.

Page Used to Review Self-Service Agreements

Page Name	Definition Name	Navigation	Usage
Review Self Service Agreements	SSF_AGREE_INQ	Student Financials, Charges and Payment, Electronic Transactions, Review Self Service Agreements	View self-service agreements text and authentication.

Reviewing Self-Service Agreements

Access the Review Self Service Agreements page (Student Financials, Charges and Payment, Electronic Transactions, Review Self Service Agreements)

Review Self Service Agreements

ID:
ID Type:

Agreement Number:
Agreement Type:

From Date:
To Date:

Customize Find View All <input type="button" value="📄"/> First 1-4 of 4 <input type="button" value="📄"/> Last					
Details		Text		Authentication	
ID	Agreement Number	Agreement Status	User ID	Agreement Type	Agreement Date
SFPP00050	0000000000001	Accepted	SSS_SFPP00050	Payment Plan Enrollment	01/17/2007
SFPP00050	0000000000002	Accepted	SSS_SFPP00050	Student Permission	01/17/2007
SFPP00050	0000000000003	Accepted	SSS_SFPP00050	1098-T Consent	01/17/2007
SFPP00050	0000000000004	Accepted	SSS_SFPP00050	Electronic Check	01/17/2007

Review Self Service Agreements page

ID Enter the student or organization ID.

ID Type Select *Person* or *Organization*.

Agreement Number Enter the agreement number that is automatically assigned when the agreement is transacted during the self-service activity.

Agreement Type Select an agreement type. Values are *1098_T*, *Electronic Check*, *Payment Plan Enrollment*, and *Student Permission*. To include all agreement types, leave this field blank.

FromandTo Enter the date of the processed agreements.

Search Click to display the search results in the Details, Text and Authentication pages.

Details

Agreement Status Displays the status of the agreement. Values are *Accepted* and *Revoked*.

Text

Select the Text tab.

Review Self Service Agreements

ID: 
ID Type:

Agreement Number:
Agreement Type:

From Date: 
To Date: 

Customize | Find | View All |  First  1-4 of 4  Last

Details		
Text		
Authentication		
ID	Agreement Number	Agreement Text
SFPP00050	000000000001	I agree to the installment schedule listed above. If I default on any installments, I understand that full amount may be due immediately and a hold will be placed on my account.
SFPP00050	000000000002	Permission to apply Title IV financial aid funds to all charges appearing on the account.
SFPP00050	000000000003	I agree to receive my 1098-T Tax form electronically through on-line access. Clicking the 'Yes, I have read the agreement' checkbox means you will no longer receive the 1098-T form via US mail. Click the Submit push button to always access your 1098-T on-line. Click the Cancel push button to return to the 1098-T Year selection.
SFPP00050	000000000004	I hereby authorize the University to initiate debit entries to my Depository, according to the terms above, and for my Depository to debit the same to such account. In the event that this electronic payment is returned for 'NSF' or 'Non-Sufficient Funds', I understand that a return fee of \$30.00 will be applied to my account.

Review Self Service Agreements page: Text tab

Agreement Text

Displays the text that the student agreed to when performing the self-service activity.

Note. The text in this field varies according to the agreement type used by the student.

Authentication

Select the Authentication tab.

Review Self Service Agreements

ID:
***ID Type:**

Agreement Number:
Agreement Type:

From Date:
To Date:

Customize | Find | View All | First 1-4 of 4 Last

Details			Text			Authentication <input type="button" value="🔍"/>		
ID	Agreement Number	Authentication Method						
SFPP00050	0000000000001	No Auth						
SFPP00050	0000000000002	No Auth						
SFPP00050	0000000000003	No Auth						
SFPP00050	0000000000004	NID						

Review Self Service Agreements page: Authentication tab

Authentication Method Displays the method by which the student authenticated his or her identity. Values are *NID* (national id), *Birthdate*, *PIN* (personal identification number) and *No Auth*(no authentication).

Chapter 15

Using GL Interface Processing

This chapter provides an overview of GL Interface processing and discusses how to:

- Run the Chartfield Audit report.
- Create accounting entries.
- Review GL Interface information.
- Use the Back Out GL Interface process.
- Send accounting entries to the general ledger.

Understanding GL Interface Processing

The PeopleSoft Student Financials General Ledger Interface (GL Interface) records the effect of Student Financials transactions (for example, charges, payments, and cash receipts) against a general ledger chart of accounts.

A chart of accounts represents how an organization gathers, stores, combines, and uses financial information in its operations. For example, an organization may want to track student receivables, third-party receivables, payments, financial aid disbursements, cash receipts, or refunds disbursed for the balance sheet and other financial statement reporting requirements.

Student Financials integrates with PeopleSoft General Ledger and Oracle General Ledger. The Student Financials GL Interface:

- Loads setup information from the PeopleSoft General Ledger or Oracle General Ledger application that is used in the creation of accounting information.
- Validates the chart of accounts (ChartFields) on various Student Financials setup tables against data from PeopleSoft General Ledger or Oracle General Ledger to ensure that Student Financials reflects an institution's current chart of accounts.

For Oracle General Ledger, validation is always real-time.

- Creates and sends accounting information to an institution's general ledger, enabling the institution's accounting office to track revenue, expenses, receivables, and liabilities.

Accounting office staff should perform the majority of the setup that is required to record information in the general ledger. This chapter focuses on how to process and review the information that is transferred to the general ledger.

For integration with PeopleSoft Financials, before you run the GL Interface, you can run the Chartfield Audit report to review the existing chartfield setup and ensure that the chartfield combinations are still valid as on a specific GL Run Date.

You can run the GL Interface at any appropriate interval. When you define an item type, a course in a course catalog, a class, or tender keys and target keys in your cashiering office, you complete a GL Interface-related page. The GL Interface and Cashiering GL interface processes use the information that you enter on these GL Interface-related pages to create accounting entries. You transfer these accounting entries to the PeopleSoft General Ledger application using Application Messaging—a feature of PeopleTools Integration Technology. After you transfer the accounting entries to the PeopleSoft General Ledger database, your PeopleSoft General Ledger staff creates the journal entries and posts the information to the general ledger.

Here is a user task flow for integration with Oracle Financials:

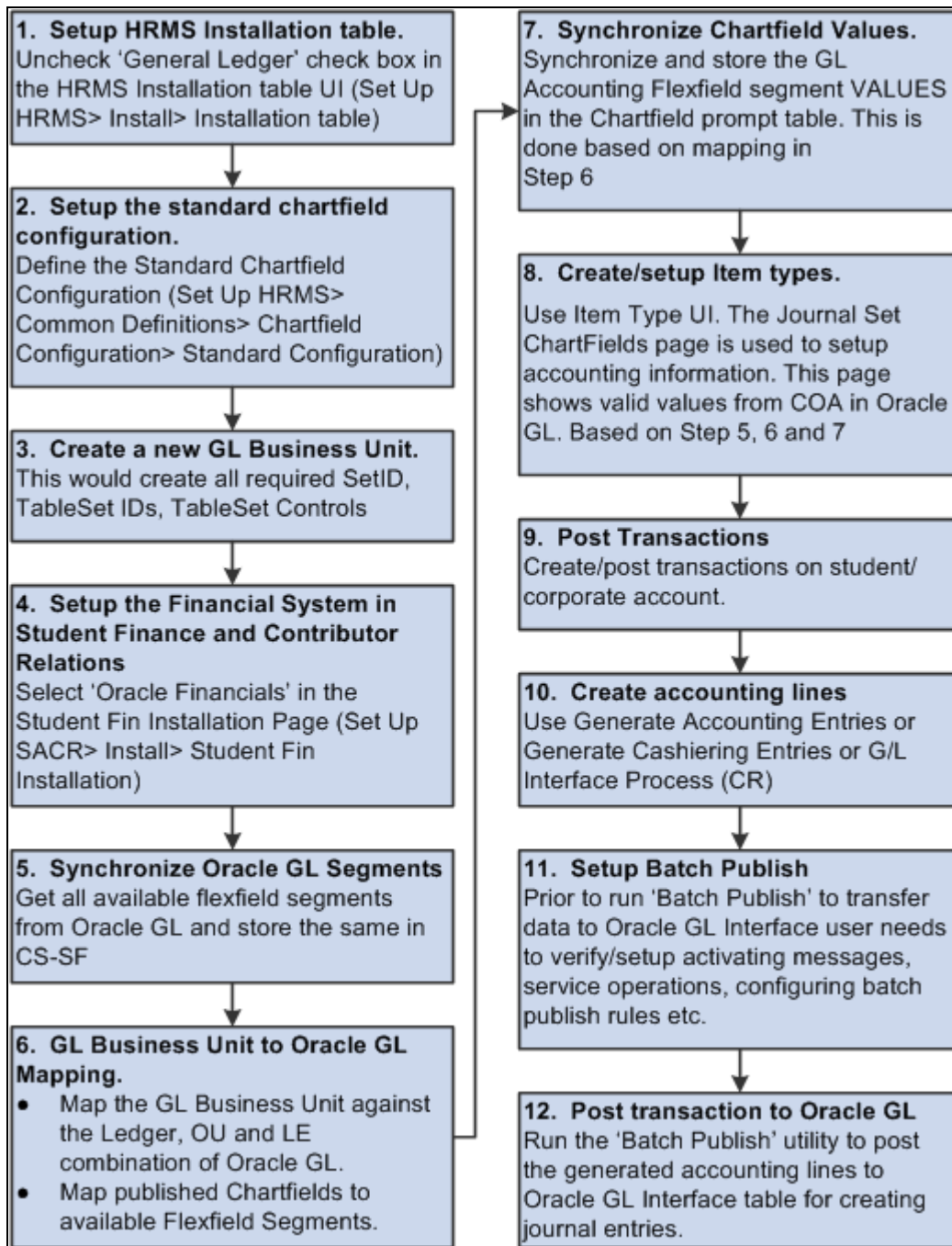

User task flow for integration with Oracle Financials

See [Chapter 2, "Completing Student Financials General Setup,"](#) [Defining Number Sequence Start Points,](#) [Maximum Row Settings,](#) and [ChartField Edit Options,](#) page 7.

See CS90 to EBS GL Integration Developer's Reference Guide. The guide is posted to My Oracle Support.

See Also

PeopleSoft Enterprise General Ledger PeopleBook

Running the Chartfield Audit Report

This section provides an overview of the Chartfield Audit report and discusses how to run the report.

Note. The Chartfield Audit Report page is not used in integration with Oracle Financials.

If Oracle Financials is selected in the Financial System group box on the SF Installation page, you must manually remove the Chartfield Audit Report page from the menu navigation by changing the Permission Lists. You should create a custom permission list to hide the menu navigation to this component.

See [Chapter 2, "Completing Student Financials General Setup," Defining Number Sequence Start Points, Maximum Row Settings, and ChartField Edit Options, page 7.](#)

Understanding the Chartfield Audit Report

The Chartfield Audit report reviews the existing chartfield setup and identifies invalid chartfield combinations. The report provides details of invalid chartfield combinations that are intended for reporting to GL, that is, those for which the GL Interface Required check box is selected on the related setup pages.

Before you run the GL Interface process, run the Chartfield Audit report and manually correct invalid combinations. You therefore avoid invalid transactions being interfaced to the GL.

The Chartfield Audit Report uses the setup that you specify on the SF Installation page.

See [Chapter 2, "Completing Student Financials General Setup," Defining Number Sequence Start Points, Maximum Row Settings, and ChartField Edit Options, page 7.](#)

Note. You can review the accounting line information after you run the Generate Accounting Lines batch process and you can verify the status of the transactions after you run the Batch Publish process. The chartfield combination *cannot* be edited or corrected in ACCOUNTING LINE (SF_ACCTG_LN).

Parameters

Chartfields can be set up on item types, course catalog, class schedule, cashiering target and tender keys, and the cashiering office. All these areas must therefore be included in the audit. The records that are used to find chartfield combinations are:

- ITEM_TYPE_TBL
- GL_INT_DT_TBL
- GL_INTERFACE
- CRSE_OFFER
- CRSE_OFFER_GL
- CLASS_TBL
- CLASS_TBL_GL

- TENDER_KEY_TBL
- TARGET_KEY_TBL
- CSH_OFF_TBL
- TERM_VAL_TBL

Here is the process flow for validating chartfield combinations:

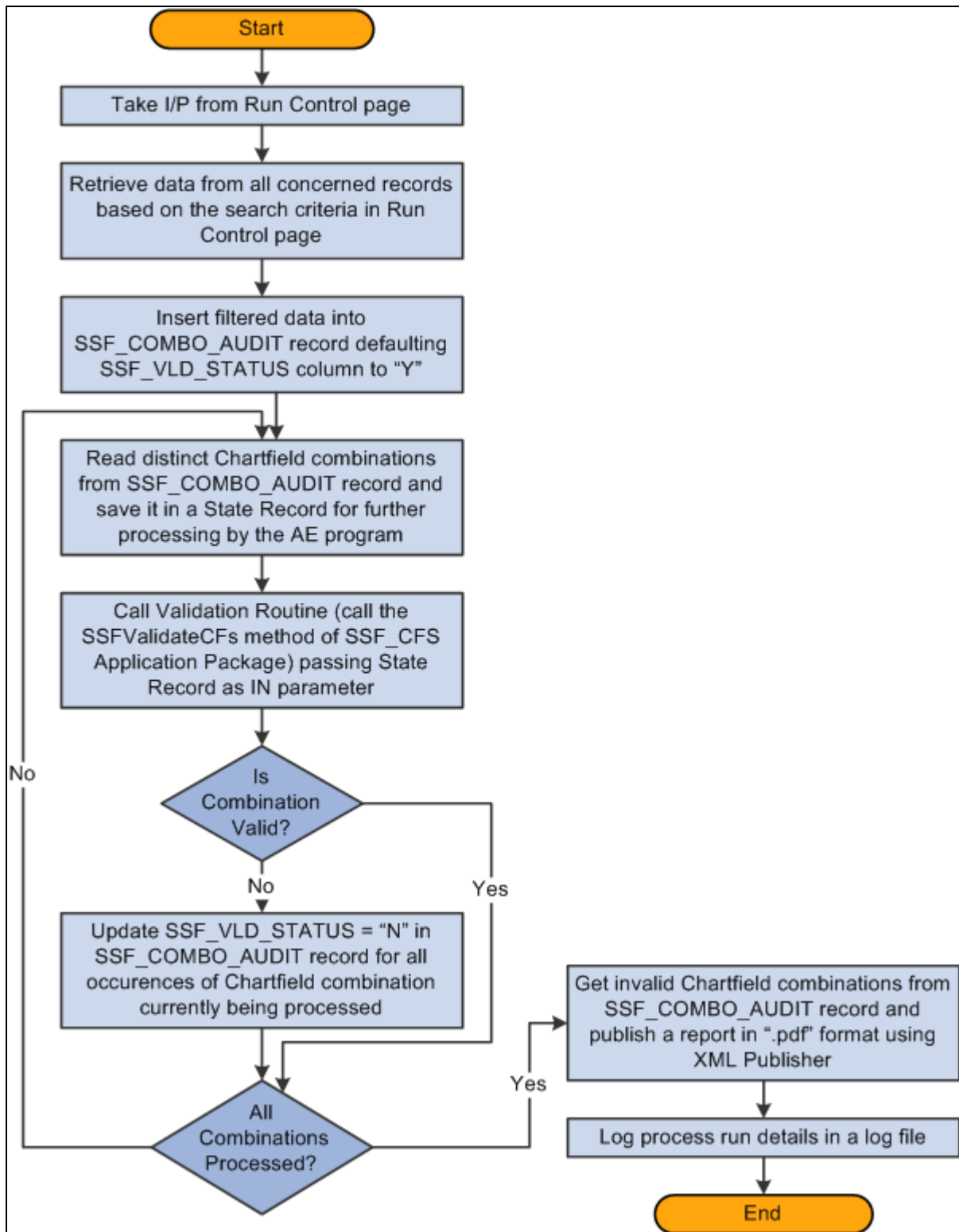

Process flow for validating chartfield combinations

Page Used to Run the Chartfield Audit Report

<i>Page Name</i>	<i>Definition Name</i>	<i>Navigation</i>	<i>Usage</i>
Chartfield Audit Report	SSF_CF_AUDT_RUN	Student Financials, GL Interface, Chartfield Audit Report, Chartfield Audit Report	Identify invalid chartfield combinations.

Running the Chartfield Audit Report

Access the Chartfield Audit Report page (Student Financials, GL Interface, Chartfield Audit Report, Chartfield Audit Report).

Chartfield Audit Report	
Run Control ID: CF Audit Report	Report Manager Process Monitor Run
Selection Criteria	
'Business Unit:	<input type="text" value="PSUNV"/> PeopleSoft University Bursar
'GL Run Date:	<input type="text" value="05/31/2009"/>
'Term From:	<input type="text" value="0330"/> 1998 Fall
'Term To:	<input type="text" value="0620"/> 2009 Spring
Validate Options	
<input checked="" type="checkbox"/> Item Type Setup <input checked="" type="checkbox"/> Course Catalog Setup <input checked="" type="checkbox"/> Schedule of Classes Setup <input checked="" type="checkbox"/> Cashiering Office Setup	
Item Type Setup	
SetID:	PSUNV PeopleSoft University
Group:	<input type="text" value="ALL"/> All Item Types
From:	<input type="text" value="0000000000001"/>
To:	<input type="text" value="0020000000000"/>
Course Catalog Setup	
'Institution:	<input type="text" value="PSUNV"/> PeopleSoft University
Campus:	<input type="text"/>
Schedule of Classes Setup	
'Institution:	<input type="text" value="PSUNV"/> PeopleSoft University
Campus:	<input type="text"/>
Academic Career:	<input type="text"/>
Cashiering Office Setup	
'Business Unit:	<input type="text" value="PSUNV"/> PeopleSoft University Bursar
Cashier's Office:	<input type="text"/>
Report Layout	
Report Definition ID:	<input type="text"/>
Template ID:	<input type="text"/>

Chartfield Audit Report page

You must enter a value in the Business Unit, GL Run Date, Term From and Term To fields.

GL Run Date Enter the date on which you expect to run the GL Interface process. You can enter a future, but not a past, date. The current date appears by default.

Term To Enter a value that is equal to or greater than the value in the Term From field.

Validate Options

In the Validate Options group box, select a check box to indicate that you want to include a particular area in the audit.

When you select a check box, a related group box with selection parameters becomes available. For example, the Item Type Setup group box is available only if you select the Item Type Setup check box.

Item Type Setup

In the Item Type Setup group box, if you enter a value in the Group field, the From and To fields are not available for entry.

Cashiering Office Setup

The value in the Business Unit field in the Cashiering office Setup group box is used to report invalid chartfield combinations from Cashiering Office as well as Target and Tender Key setup.

Viewing the Report

When you click Run, an Application Engine program is initiated. A PDF report is produced using XML Publisher.

The report lists only the chartfields that have invalid combinations. If you select an area to be audited and no invalids are found for the combination, a *No Invalids found* message appears for that area on the report. If you select an area to be audited and no data is found for the combination, a *No Data found* message appears for that area on the report.

Creating Accounting Entries

This section provides an overview of accounting entry creation and discusses how to:

- Create accounting entries using the GL Interface process.
- Create accounting entries using the Cashiering GL Interface process.

Understanding Accounting Entry Creation

Financial transaction activity from the PeopleSoft Student Financials application must be transferred to the general ledger so that your accounting office can track revenue, expenses, receivables, and liabilities that are created in Student Financials. The GL Interface creates accounting lines to accomplish this.

If your system integrates with PeopleSoft or Oracle Financials, it publishes accounting lines directly to the general ledger through PeopleSoft Application Messaging. A unique Cashiering GL Interface process exists for cash receipts for cashiering transactions.

Note. In this section, the term *accounting entry* refers to a single debit or credit entry destined for the general ledger. Accounting entries contain four primary elements: an accounting date, ChartField (chart of accounts) information, a currency code, and either a positive or negative monetary amount. The GL Interface creates accounting entries and stores them in the PS_SF_ACCTG_LN table. The terms *accounting entry* and *accounting line* are synonymous and are used interchangeably in this document.

GL Interface Process

The GL Interface process creates accounting lines for all types of transaction activity in the Student Financials application.

Note. The GL Interface process creates accounting lines for all Student Financials transactions except cash receipts that are accepted through the Cashiering feature. Run the Cashiering GL Interface process to create entries for cash receipts that are accepted through the Cashiering feature.

This diagram illustrates how the PeopleSoft Financials GL Interface process creates accounting lines for Student Financials transactions:

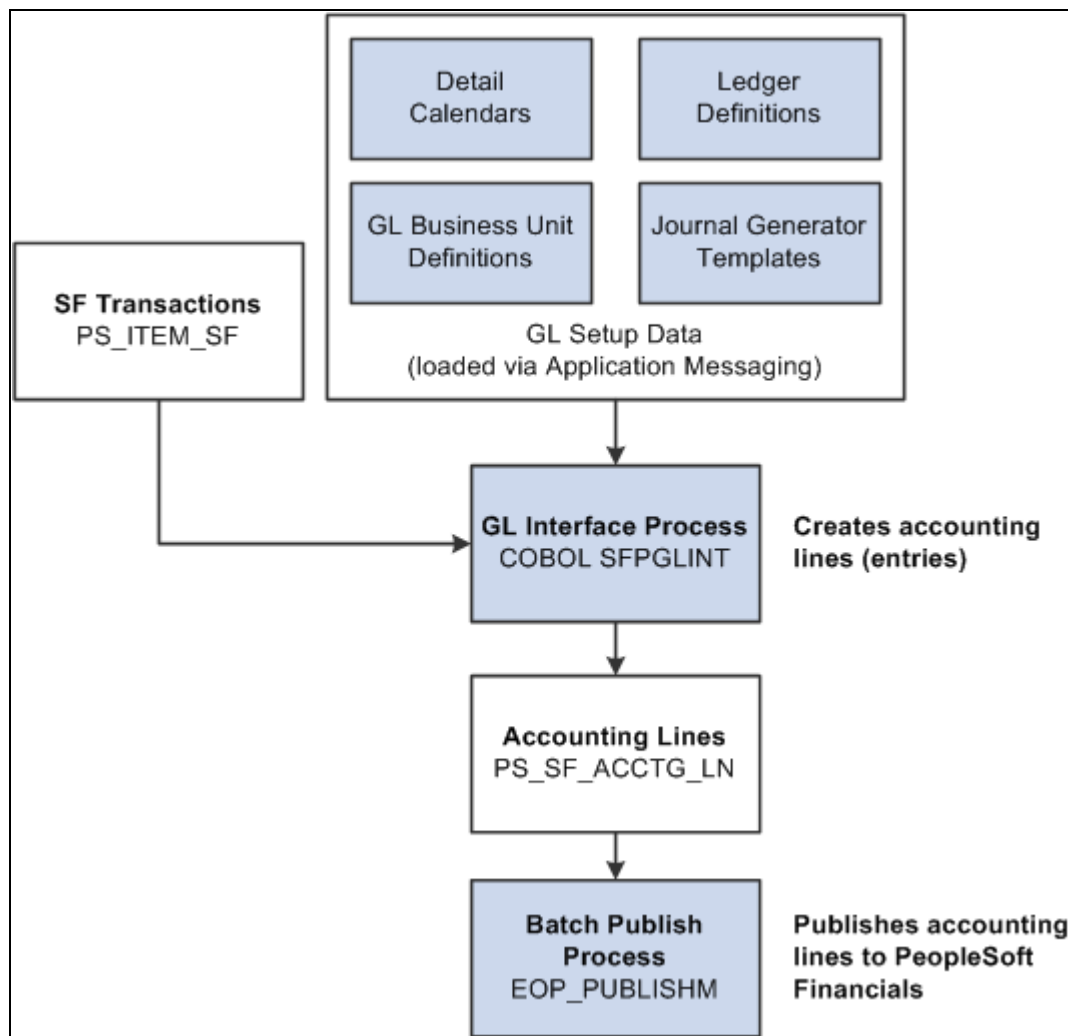

GL Interface process with PeopleSoft Financials integration

This diagram illustrates how the Oracle Financials GL Interface process creates accounting lines for Student Financials transactions:

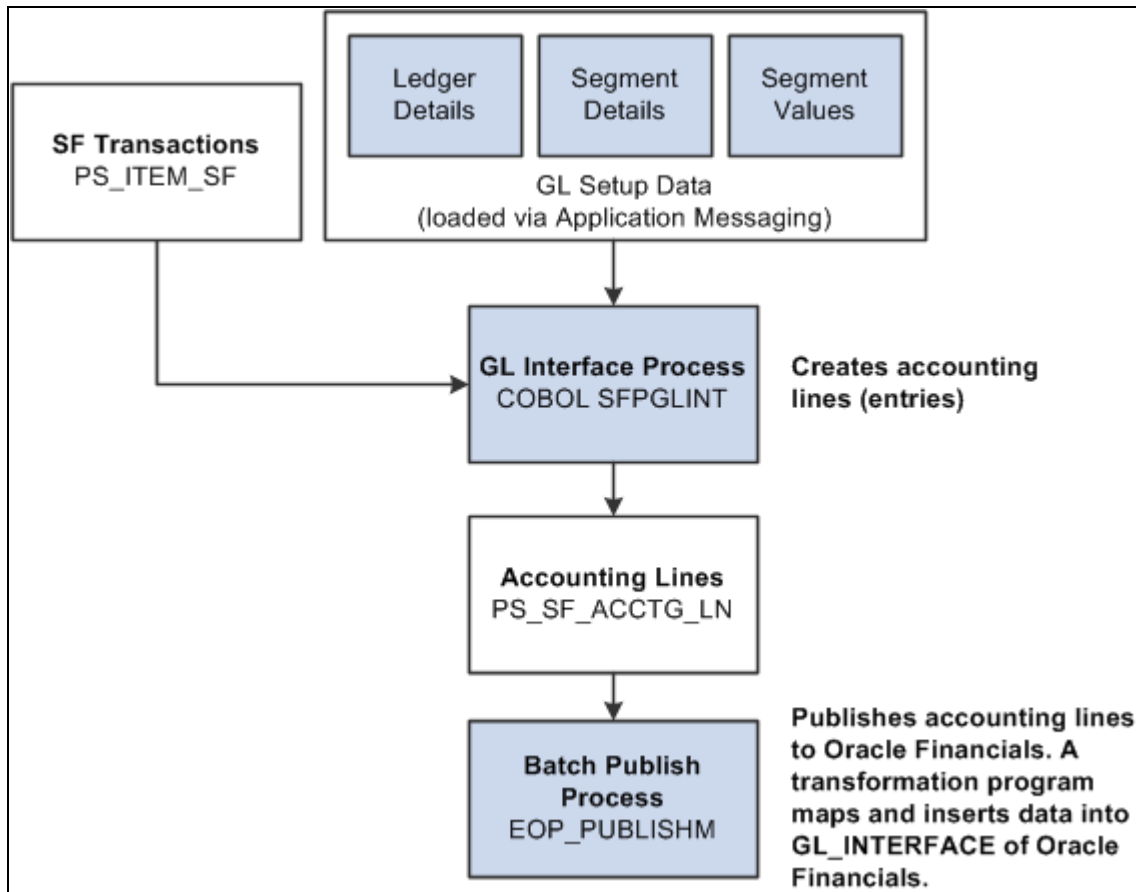

GL Interface process with Oracle Financials integration

If you interact with PeopleSoft or Oracle Financials, the system uses application messaging to share accounting line information with PeopleSoft or Oracle General Ledger.

Cashiering GL Interface Process

The Cashiering GL Interface process creates accounting lines for cash receipts, cash drawer overages, and cash drawer shortages from cashiering.

The Cashiering GL Interface process is the same as illustrated in the previous section, except that SF Transactions: PS_ITEM_SF is replaced with Cashiering:

- Cash Drawer Shortages
- Cash Drawer Overages
- Cash Receipts

Reviewing GL Interface Results

After running the GL Interface or Cashiering GL Interface process, you can confirm the success of the run and check details of accounting line entries before you send them to the general ledger.

You cannot use the Back Out GL Interface process to reverse cashiering entries sent to the general ledger, so you must correct any mistakes before running the Batch Publish process for cashiering entries.

Pages Used to Create Accounting Entries

Page Name	Definition Name	Navigation	Usage
Generate Accounting Entries	RUNCTL_SFGL01	Student Financials, GL Interface, Generate Accounting Entries	Create accounting entries using the GL Interface process.
Cashiering GL Interface	RUNCTL_SF_DEPTRCPT	Student Financials, GL Interface, Generate Cashiering Entries	Create accounting entries using the cashiering GL Interface process.
Review GL Messages	SF_GL_INT_MSG	Student Financials, GL Interface, Review GL Messages	View messages resulting from the GL Interface process.
Cashiering GL Interface	CSH_OFF_GL_INT	Student Financials, GL Interface, Review Cashiering Entries	View the results of the Cashiering GL Interface process.
Cashiering GL Interface Messages	CSH_GL_DTL_SP	Click the GL Run Error Detail link on the Cashiering GL Interface page. If multiple batches have been run, select the batch ID for the batch you want to review.	Review messages resulting from the Cashiering GL Interface process.

Creating Accounting Entries Using the GL Interface Process

Access the Generate Accounting Entries page (Student Financials, GL Interface, Generate Accounting Entries).

Generate Accounting Entries

Run Control ID: Print_Receipt [Report Manager](#) [Process Monitor](#) Run

Required Parameters

Business Unit: PeopleSoft University Bursar [Manual Batch Publish](#)

Journal Template: Commit Accting Template

Term: 2005 Spring

Generate Accounting Entries page

Business Unit	Enter the business unit of the account activity that you are transferring to your institution's general ledger.
Journal Template	Enter the journal template that you want to use to create the transactions. This field is not available if Oracle Financials is selected in the Financial System group box on the SF Installation page.
Term	The system selects all GL records that are less than or equal to the term code you select here.
Manual Batch Publish	Click to access the Batch Publish page. This link appears if your system interacts with PeopleSoft Financials or Oracle Financials.
Run	Click to access the Process Scheduler Request page. If your system interacts with PeopleSoft Financials or Oracle Financials, select the check box next to the SF GL Interface - Acct Lines (SFPGLINT) process.

Note. The GL Interface process does not populate the Budget Period ChartField on each accounting line. Instead, when accounting entries from Student Financials are loaded into General Ledger, the General Ledger assigns the proper budget period to them.

Creating Accounting Entries Using the Cashiering GL Interface Process

Access the Cashiering GL Interface page (Student Financials, GL Interface, Generate Cashiering Entries).

Cashiering GL Interface

Run Control ID: GL_Cashiering [Report Manager](#) [Process Monitor](#) Run

Parameters	
Business Unit: PSUNV <input type="text"/>	PeopleSoft University Bursar Manual Batch Publish
Cashier's Office: ROSEWOOD <input type="text"/>	Rosewood Cashiering Office
Business Date: 09/30/2004 <input type="text"/>	
Journal Template: PTMPLT <input type="text"/>	Commit Accting Template

Cashiering GL Interface page

Note. If Oracle Financials is selected in the Financial System group box on the SF Installation page, ensure that Cashiering is mapped to a journal category on the Journal Details Mapping page (Setup SACR, Product Related, Student Financials, General Ledger Interface, Journal Details Mapping).

See [Chapter 2, "Completing Student Financials General Setup," Defining Number Sequence Start Points, Maximum Row Settings, and ChartField Edit Options, page 7.](#)

See [Chapter 4, "Setting Up GL Interface Processing," Mapping General Ledger Business Units to Oracle General Ledger, page 120.](#)

Business Unit	Enter the business unit for the account activity that you are transferring to your institution's general ledger.
Cashier's Office	Enter the cashiering office for the account activity that you are transferring to your institution's general ledger.
Business Date	Enter the business date of the cashiering office transactions that you are transferring to your institution's general ledger.
Journal Template	Enter the journal template that you want to use to create the transactions. This field does not appear if Oracle Financials is selected in the Financial System group box on the SF Installation page.
Manual Batch Publish	Click to access the Batch Publish page. This link appears if your system interacts with PeopleSoft Financials or Oracle Financials.
Run	Click to access the Process Scheduler Request page. If your system interacts with PeopleSoft Financials or Oracle Financials, select the check box next to the SF Cashiering GL Interface (SFDPTREC) process.

Reviewing GL Interface Information

This section discusses how to:

- Review GL Interface run history.
- Review accounting line information.
- Review batch publish control records.

Pages Used to Review GL Interface Information

<i>Page Name</i>	<i>Definition Name</i>	<i>Navigation</i>	<i>Usage</i>
Review GL History	SF_GL_RUN_HISTORY	Student Financials, GL Interface, Review GL History	Review GL Interface run history resulting from the GL Interface, Cashiering GL Interface, and Back Out processes.

Page Name	Definition Name	Navigation	Usage
Accounting Line	SF_GL_ACCTG_INQ2	Student Financials, GL Interface, Review Accounting Lines, Accounting Line	Review accounting line information created by the GL Interface and Cashiering GL Interface processes.
SF Accounting Line Detail	SF_GL_ACCTG_DTL	Click a Detail link on the Main tab of the Accounting Line page.	Review detailed accounting line information.
Review GL Integration Data	SF_GL_INT_BATCHPRM	Student Financials, GL Interface, Review GL Integration Data	Review batch publish control records.

Reviewing GL Interface Run History

Access the Review GL History page (Student Financials, GL Interface, Review GL History).

Review GL History					
Business Unit: PSUNV					
Customize Find View All First 1-2 of 2 Last					
	GL Posting Date Time	Process Instance	Status	NBR Recs	Manually Complete Back Out
1	01/26/2005 1:39:26PM	1194	GL Interface Completed	62	<input type="checkbox"/>
2	01/26/2005 1:55:57PM	1197	Back Out Completed	20	<input type="checkbox"/>

Review GL History page

Manually Complete Back Out

If the Back Out process fails before setting the status to *Backout Successful*, then this check box becomes available. Select the check box to manually complete the failed Back Out process.

Reviewing Accounting Line Information

Access the Accounting Line page (Student Financials, GL Interface, Review Accounting Lines, Accounting Line).

Accounting Line

Business Unit: PSUNV PeopleSoft University Bursar

Search Criteria

Student ID
 Receipt Number

Ext Org
 Run Date and Sequence Number

Search Criteria - Chart Fields

Chart Fields
 GL Business Unit:
 Ledger:

Account:
Department:
Project/Grant:
Product:
Fund Code:
Program Code:
Class Field:
Affiliate:
Operating Unit:
Alternate Account:
Budget Reference:
Chartfield 1:
Chartfield 2:
Chartfield 3:

Accounting Line page (1 of 2)

SF Accounting Line

[View Accounting Line Records](#)

SF Accounting Lines Customize | Find | View All | First 1 of 1 Last

Line	Status	Line Date	Accounting Date	Period	Year	Journal	Currency

Accounting Line page (2 of 2)

Search Criteria

Use the options in this group box to select the fields that you want to use to search for an accounting line. Enter a particular field value as the search criteria.

Student ID	Select to view the accounting lines for a single person. Select an ID in the field to the right.
Receipt Number	Select to view the accounting lines that are related to a single receipt. Select the receipt number in the field on the right.
Ext Org (external organization)	Select to view the accounting lines for a single external organization. Select the external organization in the field to the right.
Run Date and Sequence Number	Select to view the accounting lines for a specific GL Interface process instance. Select the date and enter the sequence number in the fields to the right.

Search Criteria - ChartFields

Select the ChartFields option to view the accounting lines that are related to specific ChartField values. If you select this option, you must select one or more ChartField values.

Ext Chart (external GL ChartField)	If you are using a third-party or legacy General Ledger application, enter the external chart of accounts information for which you want to search. If you use this option, the search returns only accounting lines containing the specific chart of accounts information that you supply.
---	---

If Oracle Financials is selected in the Financial System group box on the SF Installation page:

- The Ledger field is not available.
- ChartField prompt tables display valid values based on the Chartfields to Segments mapping on the ChartFields Mapping page and the values populated from Oracle GL for each segment into respective prompt tables.
- The 2 Affiliate Intra (Intra Unit), Project/Grant, and Affiliate chartfields are not supported and should be made inactive on the HRMS Standard Chartfield Configuration page.

See [Chapter 2, "Completing Student Financials General Setup," Defining Number Sequence Start Points, Maximum Row Settings, and ChartField Edit Options, page 7.](#)

See [Chapter 4, "Setting Up GL Interface Processing," Mapping General Ledger Business Units to Oracle General Ledger, page 120.](#)

SF Accounting Line

After selecting your search criteria, click the View Accounting Line Records button to display accounting line information in the four tabs located in this group box.

SF Accounting Lines

This scroll area displays the results of your search.

The Main tab displays general accounting line information. Click the Detail link next to an accounting line to access the SF Accounting Line Detail page, where you can view all fields for the accounting line record.

The fields on the Journal Info tab display the information that is published to PeopleSoft or Oracle Financials. This page also contains the GL journal line number, journal ID, and line date, which are supplied from the data that is returned to Student Financials through the STUDENT_SF_ACCTG_LINE subscription message after the journals are generated in PeopleSoft Financials. For Oracle Financials, the return data from General Ledger is populated using the message SSF_GL_ACCTG_LINE_SYNC.

If Oracle Financials is selected in the Financial System group box on the SF Installation page, the 2 Affiliate Intra (Intra Unit), Project/Grant, and Affiliate chartfields are not supported and should be made inactive on the HRMS Standard Chartfield Configuration page.

See [Chapter 2, "Completing Student Financials General Setup," ChartField Display Options, page 9.](#)

Reviewing Batch Publish Control Records

Access the Review GL Integration Data page (Student Financials, GL Interface, Review GL Integration Data).

Review GL Integration Data page

Selection Criteria - Batch Pub

Enter values for the batch publish records that you want to view in the Process Instance field or the Process Status field. Click the Search button to display these records in the Batch Publish Control Record (PeopleSoft Financials or Oracle Financials integration) scroll area.

Batch Publish Control Record (PeopleSoft Financials or Oracle Financials Integration)

This scroll area displays general information about the selected batch publish control records. Select the View check box next to a batch publish control record to view its related accounting lines in the SF Accounting Lines scroll area.

SF Accounting Line

Click the View Accounting Line Records button to display accounting lines that are associated with the batch publish control record next to which you selected the View check box. If you want to display accounting lines for a specific process instance regardless of the batch publish control record, select the Use Process Instance check box and enter the desired process instance in the field to the right of the check box.

SF Accounting Lines

This scroll area is identical to the SF Accounting Line scroll area on the Accounting Line page.

If Oracle Financials is selected in the Financial System group box on the SF Installation page, the 2 Affiliate Intra (Intra Unit), Project/Grant, and Affiliate chartfields are not supported and should be made inactive on the HRMS Standard Chartfield Configuration page.

See [Chapter 2, "Completing Student Financials General Setup," ChartField Display Options, page 9.](#)

Using the Back Out GL Interface Process

The Back Out GL Interface process enables you to reverse the most recent run of the GL Interface process. When you run the Back Out GL Interface process, it effectively deletes the accounting lines created in the Accounting Line table PS_SF_ACCTG_LN for the most recent process instance and resets the corresponding rows in PS_ITEM_SF as not having been processed by the GL Interface. The back out process makes enables you to correct errors before information is sent to the general ledger.

Page Used to Run the Back Out GL Interface Process

<i>Page Name</i>	<i>Definition Name</i>	<i>Navigation</i>	<i>Usage</i>
Back Out GL Interface	RUNCTL_SFPGLBCK	Student Financials, GL Interface, Reverse GL Interface	Run the Back Out GL Interface process.

Running the Back Out GL Interface Process

Access the Back Out GL Interface page (Student Financials, GL Interface, Reverse GL Interface).

Back Out GL Interface

Run Control ID: Rev_GL [Report Manager](#) [Process Monitor](#) Run

Business Unit:

GL Run to be Processed	
GL Posting Date Time:	09/30/2004 5:11:17PM
Process Instance:	185
GL Run Status:	GL Interface Completed

Back Out GL Interface page

Business Unit Enter the business for which you want to run the back out process.

This process to deletes accounting lines created in error.

If you need to reverse an earlier run of the GL Interface process, you can return to the Back Out GL Interface page and run the process again. Continue to run the process until you have backed out all of the entries that you need to correct.

After the back out process finishes, you can enter any correcting transactions in Student Financials. Then rerun the GL Interface process to create new accounting lines for the transactions.

Note. The Back Out GL Interface process does not back out accounting lines that are created by the Cashiering GL Interface process.

Warning! Use caution when running the Back Out GL Interface process because backing out accounting entries from Student Financials that have already been posted in PeopleSoft or Oracle General Ledger would lead to out-of-balance conditions between Student Financials and PeopleSoft or Oracle General Ledger. Run the Back Out GL Interface process only if you are sure that the accounting lines have not already been transferred to PeopleSoft or Oracle General Ledger. If the accounting lines have been transferred to PeopleSoft or Oracle General Ledger and you proceed with the Back Out GL Interface process, you must manually reverse the corresponding entries in PeopleSoft or Oracle General Ledger.

Sending Accounting Entries to the General Ledger

This section discusses how to publish accounting line information.

Page Used to Send Accounting Entries to the General Ledger

Page Name	Definition Name	Navigation	Usage
Batch Publish	EO_BATCHPUB	Enterprise Components, Integration Definitions, Initiate Processes, Batch Publish	Publish accounting line information.

Publishing Accounting Line Information

Access the Batch Publish page (Enterprise Components, Integration Definitions, Initiate Processes, Batch Publish).

Batch Publish

Run Control ID: Batch_Pub [Report Manager](#) [Process Monitor](#) **Run**

Process Request Find | View All First 1 of 1 Last

*Request ID: 1

Description: Batch Publish_SF_ACCTG_LN

Process Frequency

Once Always Don't Run

Parameters

*Process Name: SFGLINT GL Interface

Batch Publish page

To run the Batch Publish process:

1. Enter a request ID and description for the process.
2. Select the Always option in the Process Frequency group box.
3. Enter *SFGLINT* in the Process Name field.

Enter *SFDPTRC* if you are using the Cashiering GL Interface process.

4. Click the Run button to initiate the Manual Batch Publish (EOP_PUBLISHM) process.

The Manual Batch Publish process:

1. Selects accounting lines based on three criteria: process or job instance, process name, and process status.

2. Collects accounting line entries that are generated by the GL Interface process (SFPGLINT) and publishes them to the PeopleSoft or Oracle Financials database.

Interface with Oracle Financials

Two types of interfaces with Oracle Financials are required: Outbound and Inbound

- **Outbound:** The same batch publish process that is used for PeopleSoft Financials is used to transfer accounting line transactions from Student Financials (SF_ACCTG_LN) to the Oracle General Ledger interface. Transformation program logic maps data from SF_ACCTG_LN to the GL_INTERFACE of Oracle GL.
- **Inbound:** When the journaling process in Oracle GL is complete, a message and transformation program is used to send journal related information back to Student Financials (SF) and to update SF_ACCTG_LN with the following details – Journal ID, Journal Date, Journal Line, Journal Line Status and Journal Line Date.

See CS90 to EBS GL Integration Developer's Reference Guide. The guide is posted to My Oracle Support.

Chapter 16

Calculating Tuition and Fees

This chapter discusses how to:

- Calculate tuition for a single student.
- Calculate tuition for multiple students.
- Lock in a minimum tuition amount.
- Recalculate tuition and fees after enrollment cancellation.
- Change, calculate, and post optional fees.

Calculating Tuition for a Single Student

Calculate tuition for a single student when you need to see immediate results.

Pages Used to Calculate Tuition for a Single Student

<i>Page Name</i>	<i>Definition Name</i>	<i>Navigation</i>	<i>Usage</i>
Tuition Calculation	STDNT_TUITION_CALC	Student Financials, Tuition and Fees, Tuition Calculation	Calculate a student's tuition.
Tuition and Fees	TUITION_CALC_SP	Click the Display Tuition and Fees link on the Tuition Calculation page.	Review calculated fees for a single student.
Fees After Calculation	TUITION_CALC_TBL	Student Financials, Tuition and Fees, Review Fees After Calculation	Review calculated fees for a single student.
Calculation Messages	STDNT_TUITION_CALC	Click the Display Errors/Warnings link on the Tuition Calculation page.	Review messages generated during tuition calculation for a single student.
Fee Calculation Messages	TUIT_CALC_MESSAGES	Student Financials, Tuition and Fees, Review Calculation Messages, Fee Calculation Messages	Review messages generated during tuition calculation for a single student.

Calculating a Student's Tuition

Access the Tuition Calculation page (Student Financials, Tuition and Fees, Tuition Calculation).

Tuition Calculation

Sally Dewey ID: SFTRN016

[Academic Information](#) [Display Student's Accounts](#)

View All First 1 of 1 Last

Academic Career: Graduate

Find | View All First 1 of 2 Last

Academic Institution: PeopleSoft University	Business Unit: PeopleSoft University Bursar
Term: 2005 Spr Semester	Billing Career: Graduate
Primary Program: Graduate Fine Arts Programs	Campus: Main Hacienda Campus
Override Billing Units: <input type="checkbox"/>	Projected Bill Units: <input type="text"/>
Override Init Enrl Fee: <input type="checkbox"/>	Override Init Add Fee: <input type="checkbox"/>
Tuition Residency: <input type="text" value="0.000"/>	Tuition Group:
Override Tuition Group: <input type="text"/>	Tuition Calc Date Time:
Tuition Calc Required: <input type="checkbox"/>	

Calculate Tuition and Fees
[Display Tuition and Fees](#)
[Display Errors / Warnings](#)

Tuition Calculation page

Academic Information Click to access the Academic Information page.

Display Student's Accounts Click to access the Student Accounts page.

Note. If you review the student's account before calculating tuition, information might not be available.

Override Billing Units Select to calculate tuition based on anticipated units.

Projected Billing Units If you set billing units as a part of tuition calculation, the system displays the number of the student's projected billing units. You can edit this field.

Override Init Enrl Fee Select to override an initial enrollment fee.
(override initial enrollment fee)

Override Init Add Fee Select to override an initial add fee.
(override initial add fee)

Tuition Residency This field displays the tuition residency that is calculated for the student. You can override the value and calculate it again to post the changed amount.

Override Tuition Group	Enter a tuition group other than the one to which the student is already assigned. When you calculate the student's tuition using this page, the system uses the tuition group that you enter in this field instead of the previously assigned group.
Tuition Group	Until tuition and fees have been calculated at least once, this field is blank. After calculation, the field displays the tuition group into which the student was placed upon calculation.
Tuition Calc Required (tuition calculation required)	The system selects this check box when changes have been made to the student's enrollment or other attributes (such as placement in a student group) that require an initial or new calculation of tuition and fees.
Tuition Calc Date Time (tuition calculation date time)	The system displays the date and time that tuition was last calculated.
Display Tuition and Fees	Click to access the Tuition and Fees page, where you can review charges for tuition and fees that have been calculated and charged to the student's account.
Display Errors/Warnings	Click to access the Calculation Messages page, where you can review all messages associated with tuition and fees calculation for the student. This field is available only if the corresponding selections have been made on the Display Errors/Warning Controls page in the Tuition Calculation Controls component (CALC_CNTL_TABLE).

See Also

[Chapter 6, "Setting Up Fees and Tuition Groups," Setting Up Transaction Fees, page 222](#)

[Chapter 5, "Setting Up Tuition Controls, Criteria, Equations, and Waivers," Establishing Tuition Calculation Controls, page 150](#)

Calculating Tuition for Multiple Students

You can calculate tuition for multiple students using a batch process. You can define this process so that it automatically calculates tuition at times when processing demands are low.

Pages Used to Calculate Tuition for Multiple Students

<i>Page Name</i>	<i>Definition Name</i>	<i>Navigation</i>	<i>Usage</i>
Tuition for Multiple Students	RUNCTL_SFPBCALC	Student Financials, Tuition and Fees, Calculate Batch Tuition, Calculate Tuition, Tuition for Multiple Students	Calculate tuition in batch.

Page Name	Definition Name	Navigation	Usage
Fees After Calculation (Batch)	TUIT_CALC_B_PANEL	Student Financials, Tuition and Fees, Calculate Batch Tuition, Review Fees After Calculation, Fees After Calculation (Batch)	Review fees after batch tuition calculation.
Fee Calculation Messages (Batch)	CALC_MSG_B_PANEL	Student Financials, Tuition and Fees, Calculate Batch Tuition, View Fee Calculation Messages, Fee Calc Messages (Batch)	Review messages resulting from batch tuition calculation.

Calculating Tuition in Batch

Access the Tuition for Multiple Students page (Student Financials, Tuition and Fees, Calculate Batch Tuition, Calculate Tuition, Tuition for Multiple Students).

Tuition for Multiple Students

Run Control ID: DOC [Report Manager](#) [Process Monitor](#) Run

Parameters

Batch ID: 000000000276 [Display Details](#)

*Business Unit: PeopleSoft University Bursar [Display Messages](#)

Run Option:

Select Option:

Academic Career [Customize](#) | [Find](#) | [View All](#) | First 1 of 1 Last

Undergraduate + -

Term [Customize](#) | [Find](#) | [View All](#) | First 1 of 1 Last

2005 Spring + -

Academic Program [Customize](#) | [Find](#) | [View All](#) | First 1 of 1 Last

Liberal Arts Undergraduate + -

Tuition for Multiple Students page

Business Unit Enter the business unit for which you are calculating the tuition.

Run Option

Enter the appropriate run option:

Warning! Values for this field are delivered with your system as translate values. Do not modify these values in any way. Any modifications to these values require a substantial programming effort.

Values are:

Calc and Post Tuition, Waivers: (calculate and post tuition, waivers): Calculates and posts tuition and fee waivers for all students who meet the criteria that you select on this page.

Calculate Tuition only: Calculates but *does not post* tuition for all students who meet the criteria that you select on this page. This option does not calculate or post waivers.

Calculate Waivers only: Calculates but *does not post* waivers for all students who meet the criteria that you select on this page. This option does not calculate or post tuition.

Calculate and Post Tuition: Calculates and posts tuition only for all students who meet the criteria that you select on this page.

Calculate and Post Waivers: Calculates and posts fee waivers only for all students who meet the criteria that you select on this page.

Post Tuition only: Posts tuition that you have already calculated.

Post Waivers only: Posts waivers that you have already calculated.

Select Option

Select how students should be selected for tuition calculation.

Warning! Values for this field are delivered with your system as translate values. Do not modify these values in any way. Any modifications to these values require a substantial programming effort.

Values are:

All students: Calculates tuition for all students, regardless of when their tuition was last calculated.

Required Only: Calculates tuition for students who meet the criteria in the page and for whom the tuition calculation required check box is set to *yes*.

Display Details

Click to review the Fees After Calculation (Batch) page.

Display Messages

Click to review the Fee Calculation Messages (Batch) page.

Academic Career

Enter an optional academic career for which you want to calculate tuition and fees. Leave this field blank to calculate tuition for all careers that are limited by your run option, and select option settings.

Term

Enter the term for which you want to calculate tuition and fees.

Academic Program Enter an optional academic program for which you want to calculate tuition and fees. Leave this field blank to calculate tuition and fees for all eligible students in all academic programs that are limited by your run option, and select option settings.

Locking In a Minimum Tuition Amount

The Lock In Tuition Amount process enables you to charge students a minimum lock in amount for a fee, regardless of when they drop a class, the number of classes that they drop, or whether fees increase.

Page Used to Lock In a Minimum Tuition Amount

Page Name	Definition Name	Navigation	Usage
Lock In Tuition Amount	RUNCTL_LCK_IN_TUIT	Student Financials, Tuition and Fees, Process Tuition Lock In, Lock In Tuition Amount	Lock in a minimum tuition amount.

Locking In Tuition

Access the Lock in Tuition Amount page (Student Financials, Tuition and Fees, Process Tuition Lock In, Lock In Tuition Amount).

Lock In Tuition Amount page

Business Unit Enter the business unit for which you are processing the tuition lock.

Term Enter the term being locked.

Report Only	Select to see the effect of the lock without processing it.
Tuition Group	Enter the tuition group that you want to process.

Recalculating Tuition and Fees After Enrollment Cancellation

When the system selects students during the Enrollment Cancellation process for nonpayment of fees, you must recalculate tuition and fees for those students.

See Also

[Chapter 21, "Maintaining Receivables," Processing Enrollment Cancellation, page 619](#)

Page Used to Recalculate Tuition and Fees After Enrollment Cancellation

<i>Page Name</i>	<i>Definition Name</i>	<i>Navigation</i>	<i>Usage</i>
Recalc for Cancellation (recalculate for cancellation)	RUNCTL_SFPCCALC	Student Financials, Tuition and Fees, Calculate Batch Tuition, Calculate After Cancellation, Recalc for Cancellation	Recalculate tuition and fees after enrollment cancellation.

Recalculating Tuition and Fees After Enrollment Cancellation

Access the Recalc for Cancellation page Student Financials, Tuition and Fees, Calculate Batch Tuition, Calculate After Cancellation, Recalc for Cancellation).

Recalc for Cancellation

Run Control ID: DOC [Report Manager](#) [Process Monitor](#) Run

Parameters

Batch ID: 000000000276 [Display Messages](#)

Term/Session Cancellation	Class Cancellation
Find View All First ◀ 1 of 1 ▶ Last Request ID: <input style="width: 80%;" type="text" value="0000001030"/> <input type="button" value="🔍"/> <input type="button" value="+"/> <input type="button" value="-"/>	Find View All First ◀ 1 of 1 ▶ Last Request ID: <input style="width: 80%;" type="text" value="0000001503"/> <input type="button" value="🔍"/> <input type="button" value="+"/> <input type="button" value="-"/>

Recalc for Cancellation page

Request ID (request identifier) Enter a request ID for term or session cancellations, class cancellations, or both.

Changing, Calculating, and Posting Optional Fees

This section discusses how to:

- Calculate optional fees for an individual student.
- Override optional fees after the no change date.

Pages Used to Change, Calculate, and Post Optional Fees

Page Name	Definition Name	Navigation	Usage
Optional Fees for a Student	OPT_FEE_STDNT	Student Financials, Tuition and Fees, Assign Optional Fees, Optional Fees for a Student	Calculate optional fees for an individual student.
Optional Fees	OPT_FEE_STDNT_S	Click the Display Optional Fees link on the Optional Fees for a Student page.	Review a student's optional fees.

Page Name	Definition Name	Navigation	Usage
Optional Fees Override	OPT_FEE_OVERRIDE	Student Financials, Tuition and Fees, Override Optional Fees, Optional Fees Override	Override optional fees after the no change date.

Calculating Optional Fees for an Individual Student

Access the Optional Fees for a Student page (Student Financials, Tuition and Fees, Assign Optional Fees, Optional Fees for a Student).

Optional Fees for a Student

Maria Lourdes
ID: SFEK00056

[Academic Information](#)
Calculate Tuition and Fees

Institution: PSUNV PeopleSoft University [Display Optional Fees](#)

Term: 2004 Fall [Student Accounts](#)

Career	Fee Code	*Valid Value	Amount/Unit	Flat Amount	Maximum Amount	Date Time	User ID
		<input type="text"/>	0.00	0.00	0.00	10/04/2004 1:35:08PM	PS

[Customize](#) | [Find](#) | [View All](#) | [First](#) | 1 of 1 | [Last](#)

Optional Fees for a Student page

- Career** Displays the student's academic career.
- Fee Code** Displays the fee code of each optional fee that is attached to the student.
- Valid Value** Enter a value for each fee code. The system displays the default value that you defined on the Optional Fees per Term page. You can override this value. After you select the value, the system displays the amount of the fee in the appropriate field (Amount/Unit or Flat Amount).
- Amount/Unit** If the optional fee is based on the number of units in which the student is enrolled, the system displays the total monetary amount in this field.
- Flat Amount** If the optional fee is a flat charge, the system displays the total dollar amount in this field.
- Maximum Amount** Displays the maximum amount that you defined for the fee on the Optional Fees per Term page.
- Date Time** Displays the date and time that the optional fee was calculated.
- User ID** Indicates who entered the charge.
- Academic Information** Click to display the student's enrollment status.

Calculate Tuition and Fees Click to calculate and post tuition and fees for the student, including optional fees.

Note. After you have saved any changes that you make to a student's optional fees, any tuition calculation process takes the changes into account. That is, you do not need to calculate tuition from this page.

Display Optional Fees Click to display all optional fees that were charged after calculation.

Student Accounts Click to review a summary of the student's entire account and verify that the system correctly posted the optional fees.

Overriding Optional Fees After the No Change Date

Access the Optional Fees Override page (Student Financials, Tuition and Fees, Override Optional Fees, Optional Fees Override).

This page is identical to the Optional Fees for a Student page.

See Also

[Chapter 16, "Calculating Tuition and Fees," Calculating Optional Fees for an Individual Student, page 433](#)

Chapter 17

Refunding Customers

This chapter provides an overview of refunds and discusses how to:

- Create batch refunds.
- Create online refunds.
- Approve refunds.
- Complete batch payroll refunds.
- Complete online payroll refunds.
- Distribute payroll refunds through direct deposit.
- Print checks and direct deposit advice slips.
- Complete accounts payable (AP) refunds.
- Distribute refunds to ePayment accounts.
- Cancel refunds.
- Reverse refunds.
- Renumber refund checks for reprinting.
- Delete paysheets.
- View refunding information.

Understanding Refunds

This section discusses:

- Refund methods.
- Refund processes.
- Refund recipients.
- Refund format.
- Refund process flow.

Refunding Methods

You can use three refunding methods to create and distribute refunds:

- Payroll.

The payroll method involves creating and distributing refunds using PeopleSoft Enterprise Payroll for North America that treats your students like employees. The payroll method can only create and distribute student refunds, not organization refunds.

- Accounts payable.

The accounts payable method involves creating and distributing refunds through an interface with PeopleSoft Enterprise Payables.

- Other.

The other method is a catchall method used by institutions that create and distribute refunds through an interface with an application other than Payroll for North America or Payables.

Refunding Processes

You can use two types of processes to create and distribute refunds:

- Online.

Processing a refund online involves creating and distributing a refund for one recipient in real time.

- Batch.

Processing refunds in batch involves creating and distributing refunds for one or more recipients on a scheduled basis using a batch process.

Refunding Recipients

Two types of recipients can receive refunds: students and organizations. In Student Financials, the recipient refers to the type of account being refunded and does not necessarily indicate the person or organization that actually receives the refund. For example, a student withdraws from a class and is due to receive a refund. However, a nonstudent sponsor originally paid the student's tuition fees and should therefore receive the refunded money. Although the sponsor receives the actual refund, it is still considered a student refund in terms of how you create and distribute it.

Refunding Formats

You can use several types of formats to distribute refunds:

- Check.

Using the check format, you refund customers by sending them a check for the refund amount.

- Credit card.

Using the credit card format, you directly refund a customer's credit card for the refund amount.

- Electronic check.

Using the electronic check format, you directly refund a customer's eCheck account for the refund amount.

- Direct deposit.

Using the direct deposit format, you automatically deposit the refund amount into a predetermined direct deposit account. The direct deposit format is an option only if you use the payroll method to create refunds.

Refunding Process Flow

The following diagrams display the decisions and processes involved with creating and distributing payroll and AP refunds.

Payroll Refund Processing

The following diagram outlines payroll refund processing:

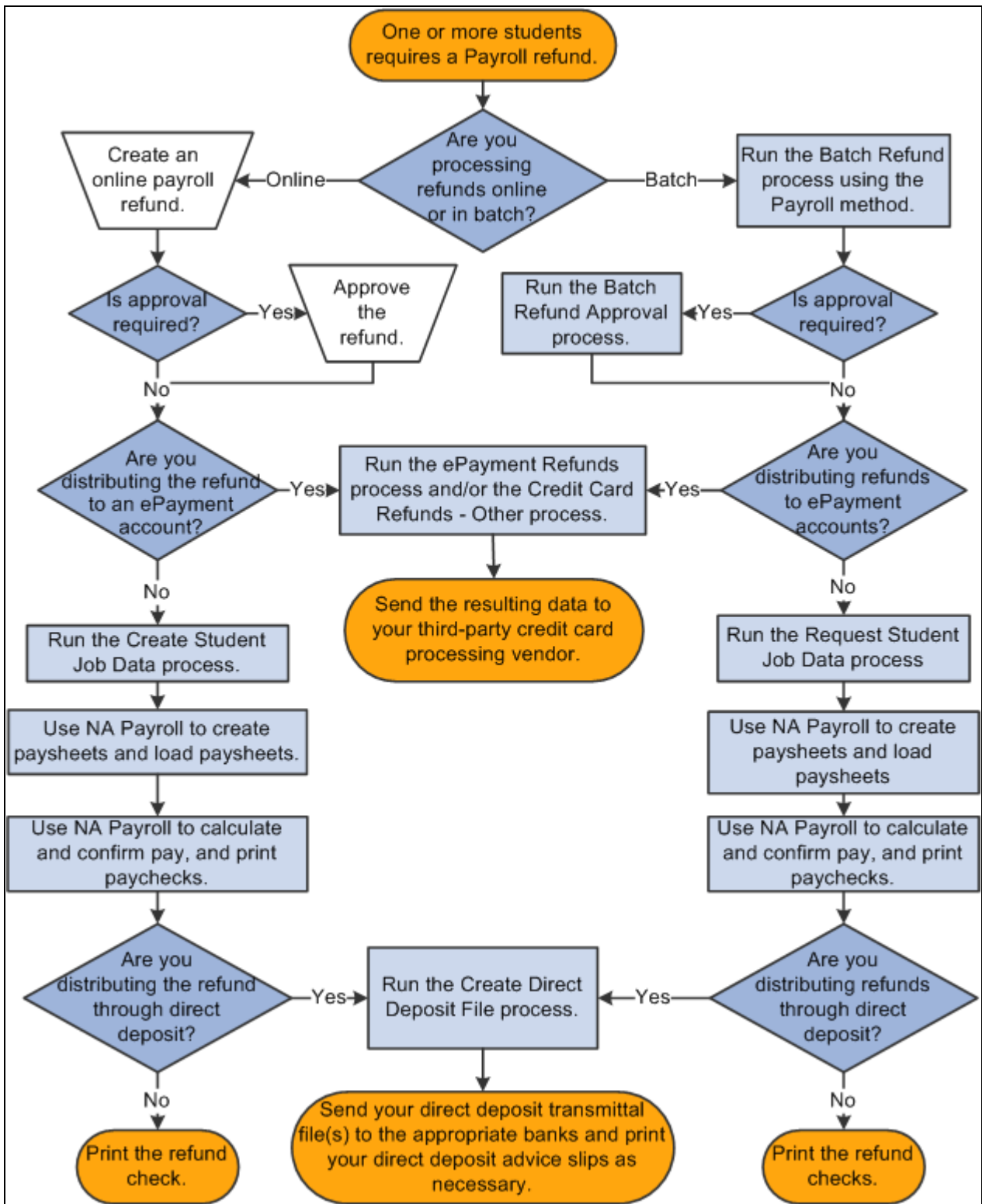

Payroll refund process flow

AP Refund Processing

The following diagram outlines AP refund processing:

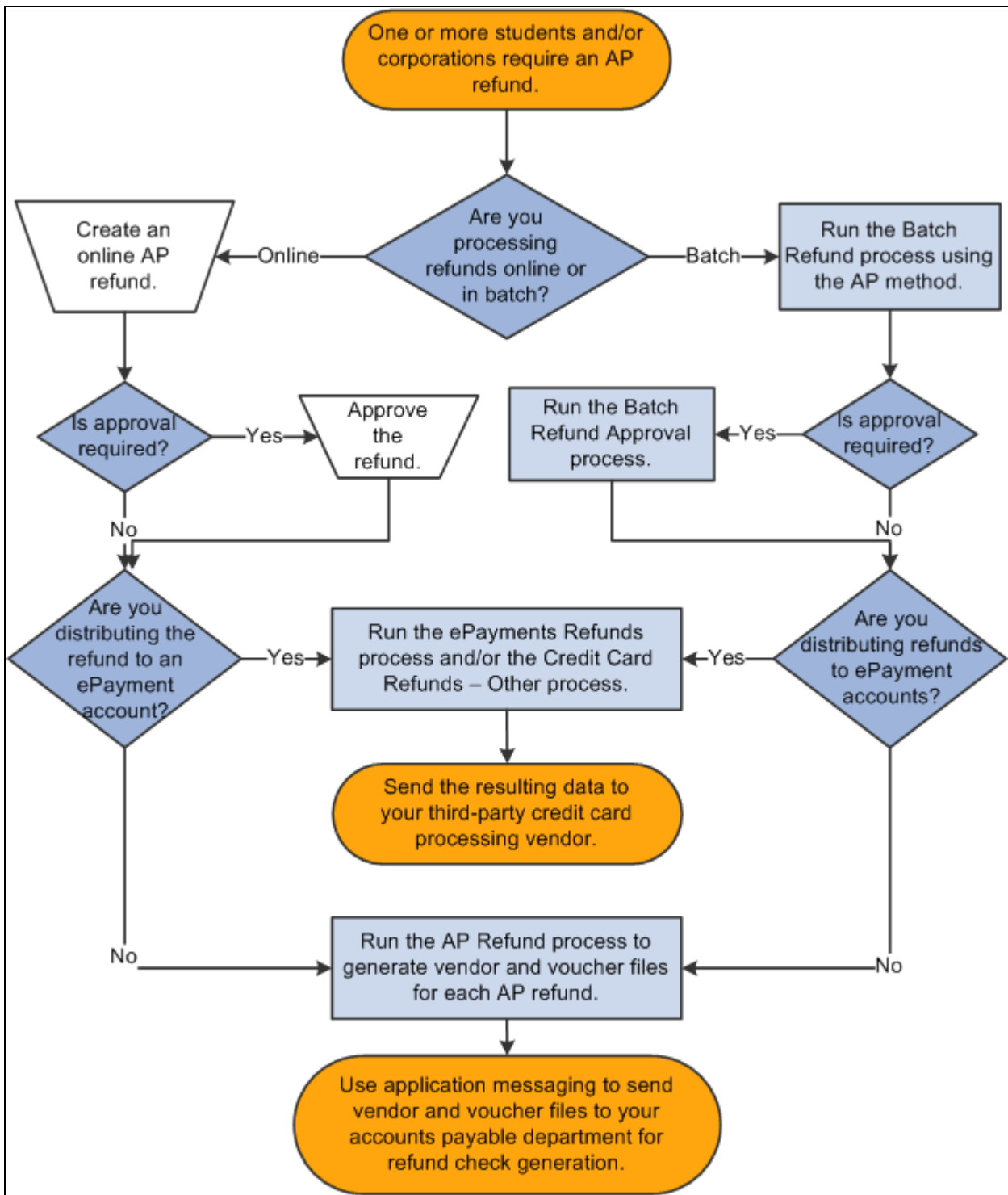

AP refund process flow

Creating Batch Refunds

This section discusses how to:

- Define general parameters.
- Select academic programs.
- Select account types and terms.
- Select item types.

Note. You cannot refund unsettled credit card payments using the Batch Refund (SFPREFND) process. The process ignores any unsettled credit card payments.

See Also

Chapter 14, "Processing ePayment Transactions," page 381

Pages Used to Create Batch Refunds

<i>Page Name</i>	<i>Definition Name</i>	<i>Navigation</i>	<i>Usage</i>
Batch Refund	RUNCTL_SFPREFND	Student Financials, Refunds, Process Batch Refunds, Create Refunds, Batch Refund	Define general parameters of the Batch Refund process.
Academic Programs	RUNCTL_SFPREFND_2	Student Financials, Refunds, Process Batch Refunds, Academic Programs	Specify academic programs to include in the batch refund process.
Accounts/Terms	RUNCTL_SFPREFND_3	Student Financials, Refunds, Process Batch Refunds, Accounts / Terms	Select account types and academic terms to include in the batch refund process.
Item Types	RUNCTL_SFPREFND_4	Student Financials, Refunds, Process Batch Refunds, Item Types	Select item types to include in the batch refund process.
Batch Refund Lines	REFUND_LINES	Student Financials, Refunds, Process Batch Refunds, Review Batch Refunds	View results of the Batch Refund process.
Review Batch Messages	REFUND_MESSAGES	Student Financials, Refunds, Process Batch Refunds, Review Batch Messages	View warnings or errors generated during the Batch Refund process.

Defining General Parameters

Access the Batch Refund page (Student Financials, Refunds, Process Batch Refunds, Create Refunds, Batch Refund).

Batch Refund		Academic Programs	Accounts / Terms	Item Types
Run Control ID:	PS	Report Manager	Process Monitor	Run
Required Parameters				
Batch ID:	000000000007	Check Batch Refunds	Batch Refund Messages	
Business Unit:	PSUNV	PeopleSoft University Bursar		
Refund Method:	Accounts Payable			
Run Option 1:	Individual and Organization	<input checked="" type="checkbox"/> Report Only		
Run Option 2:	Both Financial Aid and Non FA	<input type="checkbox"/> Calc Tuition if Required		
Sponsor Refund Option:	No Sponsor			
Refund Item Type:	500000000001			
Address Usage:	SLCT ORD 2	Mailing, Work, Dorm, Home		
Ext Org Contact Type:	CEO	Chief Executive Officer		
Refund Service Impact:	REFND	Student Refund Check		

Batch Refund page

- Batch ID** Displays the unique ID assigned after you save your batch refund parameters.
- Check Batch Refunds** After you run the process, click to access the Batch Refund Lines page and view created refunds.
- Batch Refund Messages** After you run the process, click to access the Review Batch Messages page and view warnings or errors that the system encountered during the process.
- Refund Method** Displays the refund method that you selected on the Refund Setup page of the SF Business Unit component (BUSINESS_UNIT_SF).
- Run Option 1** Select the type of recipients to create refunds for. Values are: *Individual Only*, *Organization Only*, or *Individual and Organization*.
- Run Option 2** Select the types of credits to create refunds for. You can create refunds for financial aid credits (credits with an item type classification of Financial Aid), nonfinancial aid credits (credits with an item type classification other than Financial Aid), or both.
- Report Only** Select to generate a report listing what refunds the system would create. When selected, the process does not actually create the refunds listed in the report.

- Calc Tuition if Required** (calculate tuition if required) Select to calculate tuition for students who have not already had their tuition calculated or who need tuition recalculated.
- Sponsor Refund Option** Select whether you want to include sponsors in the process, and if so, what types of sponsors.
- Refund Item Type** Select the item type to assign to the refunds that the Batch Refund process creates.
- Address Usage** Enter how the system chooses the proper address for each refund.
- External Org Contact Type** (external organization contact type) Displays the contact type that you specified on the Refund Setup page of the SF Business Unit component. The system uses this contact type to determine the recipient of any organization refunds generated by the batch process.
- Refund Service Impact** Displays the refund service impact that you specified on the Refund Setup page of the SF Business Unit component. The system uses this service impact during the batch process to identify any students who should be prevented from receiving a refund.

Selecting Academic Programs

Access the Academic Programs page (Student Financials, Refunds, Process Batch Refunds, Academic Programs).

The screenshot shows the 'Academic Programs' page. At the top, there are navigation tabs: 'Batch Refund', 'Academic Programs', 'Accounts / Terms', and 'Item Types'. Below the tabs, there is a 'Run Control ID: PS' and buttons for 'Report Manager', 'Process Monitor', and 'Run'. A 'Required Parameters' section contains 'Batch ID: 000000000007' and links for 'Check Batch Refunds' and 'Batch Refund Messages'. There is a checkbox for 'All Programs'. The main section is titled 'Academic Programs' and shows a search for 'LAU' (Liberal Arts Undergraduate). Below that is a 'Program Status' table with one entry: 'AC' (Active in Program).

Academic Programs page

Required Parameters

All Programs Select to include all academic programs in the batch process.

Academic Programs

This group box is available only if you clear the All Programs check box.

Academic Program Select the academic program to include in the process.

Program Status

All Statuses Expand this scroll area to select academic program statuses to include in the batch refund process. The system creates refunds only for those students with the statuses you select. Alternatively, you can click the All Statuses button to populate all the statuses in the grid. This should be used with caution because statuses included are Deceased, Dismissed, and other statuses for which you may not want refunds processed. You can click the button and then delete the status rows that you do not want included for refund processing.

Selecting Account Types and Terms

Access the Accounts/Terms page (Student Financials, Refunds, Process Batch Refunds, Accounts / Terms).

The screenshot shows the 'Accounts / Terms' page of a web application. At the top, there is a navigation bar with four tabs: 'Batch Refund', 'Academic Programs', 'Accounts / Terms' (which is the active tab), and 'Item Types'. Below the navigation bar, the page displays 'Run Control ID: PS' on the left and a yellow 'Run' button on the right. In the center, there are two blue links: 'Report Manager' and 'Process Monitor'. Below these links is a section titled 'Required Parameters' with a dark blue header. Inside this section, there is a 'Batch ID: 000000000007' field. Below the Batch ID, there are two checked checkboxes: 'All Accounts' and 'All Terms'. To the right of the 'All Accounts' checkbox, there are two blue links: 'Check Batch Refunds' and 'Batch Refund Messages'.

Accounts/Terms pag

All Accounts and All Terms

Select to include all account types and academic terms in the batch refund process. If you clear either check box and click Refresh, a scroll area appears. Add the accounts and terms to process.

Selecting Item Types

Access the Item Types page (Student Financials, Refunds, Process Batch Refunds, Item Types).

Batch Refund | Academic Programs | Accounts / Terms | **Item Types**

Run Control ID: PS [Report Manager](#) [Process Monitor](#) [Run](#)

Required Parameters

Batch ID: 000000000007 [Check Batch Refunds](#) [Batch Refund Messages](#)

All Item Types

*Item Type From		*Item Type To	
300000000001	Cash Payment	300000000001	Cash Payment

Item Types page

All Item Types

Select to include all item types in the batch refund process. If you clear the check box, use the Item Type From and Item Type To fields to define the range of item types to include in the batch refund process.

Creating Online Refunds

This section discusses how to:

- Create student refunds.
- Create organization refunds.
- Create student refunds with an extra amount.
- Specify the account and term associated with an extra refunded amount.
- Create online refunds for a sponsor.

Pages Used to Create Online Refunds

<i>Page Name</i>	<i>Definition Name</i>	<i>Navigation</i>	<i>Usage</i>
Student Refund	REFUND_SF	Student Financials, Refunds, Student Refund	Create an online refund for a student.
Academic Information	SF_STUDENT_SP	Click the Academic Information link on the Student Refund page.	View enrollment and personal information for a given student.
Student Accounts	ACCOUNT_SF_SP	Click the Student Accounts link on the Student Refund page.	View account activity information for a given student.
Corporate Refund	REFUND_ORG_SF	Student Financials, Refunds, Corporate Refund	Create an online refund for an organization. You can use this page in conjunction with the A/P refund method only.
Corp Accounts	ACCOUNT_ORG_SF_SP	Click the Get Account link on the Corporate Refund page.	View account activity for a given corporation.
Refund with Extra Amount	REFUND_SF	Student Financials, Refunds, Refund with Extra Amount	Create a refund for an amount greater than the refundable balance.
Extra Refund Amount	EXTRA_REFUND_AMT	Click the Extra Amount Info link on the Refund with Extra Amount page	Specify account and term information associated with the extra amount refunded.
Online Refund Other	REFUND_SF_OLD	Student Financials, Refunds, Online Refund Other	Create a refund for a designated sponsor.

Creating Student Refunds

Access the Student Refund page (Student Financials, Refunds, Student Refund).

Note. If you pay multiple targets by the same transaction, each target appears as a separate line item on the Student Refund page. When you refund multiple targets from the same transaction, however, the system combines the targets into a single refund. For example, if you are refunding a student 750.00 USD for tuition and 125.00 USD for housing, and both targets were part of the same credit card payment, the system combines the target refunds into a single credit card refund of 875.00 USD. It does not issue two separate refunds to the same credit card.

See [Chapter 20, "Cashiering," Accepting Student Payments, page 527.](#)

Refund Amount The system automatically enters the total amount of the line item in this field. To include only a portion of the line item in the refund, decrease the amount.

Format Select the format to distribute the refund. Values are:

A (automatic check): Select if you have an interface to a specific check-writing application.

C (credit card): Select to directly refund the student's credit card. This value is selected by default for all refunds originating from credit card payments.

D (direct deposit): Select to distribute the refund to the student's checking or savings account through direct deposit. If you have set up the student for direct deposit using the Direct Deposit page and the line item does not have a credit card payment item type, the Format field is set by default to *D* for every refund line item.

E (electronic check): Select to directly refund the student's eCheck account. This value is selected by default for all refunds originating from eCheck payments.

P (paper check): Select to distribute the refund by using a check generated according to the refund method that you selected.

Note. You can change a default format of *C* or *E* to *A* or *P*. If you do this, the system processes the refund so that you can generate a paper check instead of directly crediting the student's credit card or eCheck account. If you change the format to *A* or *P* for more than one ePayment transaction, the system combines the transactions into one lump refund so that you issue only one check to the student. You cannot change a default format of *A* or *P* to *C* or *E*.

Address Type Select the type of address that you want printed on the check.

Note. You can only refund one ePayment at a time using the Student Refund page. Even if there are multiple ePayments on a student's account, you can select only one at a time. In addition, the system does not allow you to post a refund for eCheck payments that have not been debited or credit card payments that have not been settled. If you click the Post Refund button after selecting a refund for an ePayment that has not been debited/settled, you receive an error message.

Student Refund Buttons and Links

Post Refund	<p>Click to post the refund to the student's account. If you selected <i>Payroll</i> in the Refund Method field, the Produce Check link becomes available when you click this button.</p> <p>If you set up your business unit to require refund approval, the system alerts you to the approval requirement when you click Post Refund.</p>
Produce Check	<p>If you are creating the refund using the payroll refund method, click to create the payroll interface for the refund. This link opens the Produce Student Refund Check page (SSF_REF_STU_CNTRL).</p> <hr/> <p>Note. For refunds using the payroll method, the Create Student Job Data step must be completed before moving onto the Produce Student Refund Check. (You need to run the Create Student Job Data process if a student has never had a refund before and there is no "employee" data.) The Produce Check is the first process for interfacing to payroll. Once there, you enter the pay period end date and click Process Check. That step creates the paysheet data. A paysheet serves as a repository for the data required for Payroll for North America to calculate a refund. After creating the paysheet, (click Process Check) the system populates the paysheet data. The Print Check button appears, enabling you to print a check (or direct deposit advice) on your printer.</p> <hr/>
Calculate Tuition	<p>Click to calculate tuition for the selected student. This button is available only if you selected the Auto Calculate Tuition check box on the Tuition Calculation Controls page, there is a term listed for any of the refunds listed, and tuition is required.</p>
View Refund Check	<p>Expand this group box to view a simulation of a refund check for the amount that you are refunding.</p>
See Also	<p><u>Chapter 14, "Processing ePayment Transactions," page 381</u></p>

Creating Organization Refunds

Access the Corporate Refund page (Student Financials, Refunds, Corporate Refund).

Corporate Refund

Business Unit: PSUNV

External Org ID: RICHLIERFOUNDATION

Balance: -200.00 [Get Account](#)

Refund Selection							
	Account Number	Term	Item Type	Item Amount	Balance	Refund Amount	
<input checked="" type="checkbox"/>	MISFEES001-2001 Sprng		Check	-50.00	-50.00	50.000	USD
<input checked="" type="checkbox"/>	MISFEES001-2001 Sprng		Check	-150.00	-150.00	150.000	USD

Refund Item Type: Refund **Location Nbr:**

View Refund Check

Pay:	Two Hundred and 0/100	Date:	01/19/2005
Name:	RICHLIERFOUNDATION 25612 Ventura Blvd Suite 360 Studio City CA 90231		200.00

Corporate Refund page

External Org ID(external organization ID) Enter the ID of the organization for which you want to create a refund. organization ID)

Get Account Click to access the Corp Accounts secondary page.

Location Nbr (location number) Enter the organization's location number to determine the address to print on the check. The address associated with the location number appears at the bottom of the page, to the right of any image that you have inserted.

The remaining fields on this page are identical to their counterparts on the Student Refund page.

See Also

[Chapter 17, "Refunding Customers," Creating Student Refunds, page 445](#)

Creating Student Refunds with an Extra Amount

Access the Refund with Extra Amount page (Student Financials, Refunds, Refund with Extra Amount).

Refund with Extra Amount

Business Unit: PSUNV

ID: Jackson,Jezebel

Balance: -100.00 **Anticipated Aid:**

[Academic Information](#) [Student Accounts](#) **Refund Method:**

Refund Selection									
	Account Number	Term	Item Type	Item Amount	Item Balance	Refund Amount		Format	
<input checked="" type="checkbox"/>	MISFEES001-2000 Sum		Payment-Cash	-100.00	-100.00	100.000	USD	A	

Refund Item Type: Refund **Post Refund**

Address Type: **Format:** **Extra Amount:** [Extra Refund Info](#)

View Refund Check

Pay:	Two Hundred and 0/100	Date:	01/19/2005
Name:	Jackson,Jezebel		200.00
	879 Victoria St Los Angeles CA 90231		

Refund with Extra Amount page

Use this page to create a refund for more than the refundable balance or in the absence of a refundable balance. For example, you can disburse anticipated aid to a student before the actual receipt of funds. The refund becomes a charge on the student's account that is later credited when your institution actually receives the financial aid.

Note. You cannot use the Refund with Extra Amount page to create a refund for an organization.

With the exception of the following fields, this page is the same as the Student Refund page.

- Method** Enter the format to distribute any extra amount added to the refund.
- Extra Amount** Enter the extra amount that you are adding to the refund.
- Extra Refund Info** Click to access the Extra Refund Amount page.

Note. You can create a refund for more than the refundable balance only if you select the Refund Debit Balances check box on the Refund Setup page. If you do not select this check box, you can create a refund for an extra amount, but not for an extra amount and a credit at the same time.

See Also

[Chapter 7, "Setting Up Refunding," Setting Up Your Business Unit to Refund Customers, page 238](#)

[Chapter 17, "Refunding Customers," Creating Student Refunds, page 445](#)

Specifying the Account and Term Associated with an Extra Refunded Amount

Access the Extra Refund Amount page (click the Extra Amount Info link on the Refund with Extra Amount page).

Extra Account Nbr Specify the account to charge the extra refund amount to.
(extra account number)

Extra Account Term If the account that you select in the Extra Account Nbr field is set up by term, select a term.

Extra Item Term Enter the academic term to assign to the extra refunded amount.

Creating Online Refunds for a Sponsor



Access the Online Refund Other page (Student Financials, Refunds, Online Refund Other).



Online Refund Other

Business Unit: PSUNV

ID: Duncan, Marla

For ID: **Balance:** -20.00 **Anticipated Aid:**

[Academic Information](#) [Get Account](#) **Refund Method:**   

Refund Selection							
Account Number	Short Description	Description	Item Amount	Balance	Refund Amount	Format	
<input checked="" type="checkbox"/> MISFEES001-2001 Sprng		Check	-20.00	-20.00	<input type="text" value="20.00"/>	A	 

Refund Item Type: Refund **Post Refund**

Address: **Format:** **Extra Amount:**

View Refund Check

Pay:	Twenty and 0/100	Date:	10/22/2004
Name:	Marla Duncan 7687 Coldwater Canyon Sherman Oaks CA 90231		20.00

Online Refund Other page

If you have designated an individual as a sponsor for credits on a student's account, use the Online Refund Other page to create refunds for those credits, to be distributed to the sponsor.

Note. You can create a refund for a sponsor only if you have associated the sponsor with a student using the Designate Individual Sponsor page.

With the exception of the following fields, this page is the same as the Refund with Extra Amount page.

ID Enter the ID of the sponsor for whom you are creating a refund. If the sponsor that you select sponsors only one student, the ID of that student appears in the For ID field.

For ID If the sponsor that you select in the ID field sponsors more than one student, select the student whose refund you are creating.

See Also

[Chapter 17, "Refunding Customers," Creating Student Refunds with an Extra Amount, page 449](#)

Approving Refunds

Depending on your business unit setup, a refund might require approval by up to three separate approvers. When approval is required, you cannot create a paysheet for a refund (payroll method only), complete a refund, or print a refund until it has been approved. This section discusses how to:

- Route batch refunds to worklists.
- Approve refunds.

Pages Used to Approve Refunds

<i>Page Name</i>	<i>Definition Name</i>	<i>Navigation</i>	<i>Usage</i>
Batch Refund Approval	RUNCTL_RFND_APPR	Student Financials, Refunds, Approve Refunds, Process Refund Approval, Process Refund Approval	Route batch refunds requiring approval to appropriate worklists.
Refund Approval	REFUND_SF_APPR	From the worklist, click a refund requiring approval.	Approve refunds.
Refund Approvals	REFUND_SF_APPR_INQ	Student Financials, Refunds, Approve Refunds, Verify Student Approvals	View the progress of a student refund requiring approval.
Corp Refund Approval	REFUND_ORG_APP_INQ	Student Financials, Refunds, Approve Refunds, Verify Corporate Approvals, Corp Refund Approval	View the progress of an organization refund requiring approval.

Routing Batch Refunds to Worklists

Access the Batch Refund Approval page (Student Financials, Refunds, Approve Refunds, Process Refund Approval, Process Refund Approval).

Before batch refunds can be approved, they must be routed to worklists.

Business Unit Select the business unit of the batch refunds to approve.

Refund Batch ID Enter the batch ID of the group of refunds to approve.

See Also

Chapter 17, "Refunding Customers," Viewing Refund Information in Student Financials, page 469

Completing Batch Payroll Refunds

This section discusses how to:

- Create job data by batch.
- Request a payroll interface.
- Create and load paysheets.
- Calculate refunds.
- Confirm refunds.

Pages Used to Complete Batch Payroll Refunds

<i>Page Name</i>	<i>Definition Name</i>	<i>Navigation</i>	<i>Usage</i>
Request Student Job Data	SSF_RUN_POIJOB	Student Financials, Refunds, Process Batch Refunds, Request Student Job Data	Create student job data in batch.
Request Payroll Interface	SSF_RUN_PAYINTFC	Student Financials, Refunds, Process Batch Refunds, Request Payroll Interface	The Request Payroll Interface page acts in the same way as the Produce Check link on the individual refund page. Instead of taking you to the Produce Student Refund Check page, it does essentially the same thing for a refund batch.
Load Paysheet Transactions	RUNCTL_PSHUP	Payroll for North America, Payroll Processing USA, Create and Load Paysheets, Load Paysheet Transactions	Create and load paysheets using Payroll for North America.
Pay Calculation	RUNCTL_PAY_CALC	Payroll for North America, Payroll Processing USA, Produce Payroll, Calculate Pay	Calculate using Payroll for North America.

Page Name	Definition Name	Navigation	Usage
Refund Confirmation	RUNCTL_PAY_CONF	Payroll for North America, Payroll Processing USA, Produce Payroll, Confirm Pay	Confirm using Payroll for North America.

Creating Job Data by Batch

Access the Request Student Job Data page (Student Financials, Refunds, Process Batch Refunds, Request Student Job Data).

See Also

[Chapter 7, "Setting Up Refunding," Creating Job Data for Payroll Refunds, page 246](#)

Requesting a Payroll Interface

Access the Request Payroll Interface page (Student Financials, Refunds, Process Batch Refunds, Request Payroll Interface).

Request Payroll Interface

Run Control ID: BATCH_REFUNDS [Report Manager](#) [Process Monitor](#)

Required Parameters

*Business Unit:

Batch ID:

*Pay Period End Date:

Request Payroll Interface page

Batch ID Select the batch ID of the refunds you want to process.

Pay Period End Date Select the pay period end date.

Creating and Loading Paysheets

Access the Refund Paysheet Creation page.

You must create a paysheet for each batch refund created using the payroll refund method. Payroll for North America uses these paysheets to calculate refund checks.

See *PeopleSoft Enterprise Payroll for North America 9.0 PeopleBook, "Working with Paysheets"*

Calculating Refunds

Access the Refund Calculation page.

See Also

PeopleSoft Enterprise Payroll for North America 9.0 PeopleBook, "Calculating Pay"

Confirming Refunds

Access the Refund Confirmation page .(Payroll for North America, Payroll Processing USA, Produce Payroll, Confirm Pay, Refund Confirmation).

After you have completed your refund calculations, run the Refund Confirmation (PSPCNFRM) process to finalize refund earnings, create check records, and update period-to-date earnings balances within Payroll for North America.

See Also

PeopleSoft Enterprise Payroll for North America 9.0 PeopleBook, "Confirming Pay"

Distributing Payroll Refunds Through Direct Deposit

If you created any batch or online refunds with a direct deposit format, you must create a transmittal file with all the information that your institution must provide to student banks, so that the refunds can be transferred directly into the students' bank accounts. This section discusses how to run the Create Direct Deposit File process.

Note. The system includes a student's direct deposit refund in the transmittal file only if you set up the student's direct deposit parameters using the Direct Deposit or Direct Deposit Canada pages (through Payroll for North America).

See Also

Chapter 7, "Setting Up Refunding," Setting Up Direct Deposit for Students, page 249

Page Used to Distribute Payroll Refunds Through Direct Deposit

<i>Page Name</i>	<i>Definition Name</i>	<i>Navigation</i>	<i>Usage</i>
Direct Deposit Create File	RUNCTL_DDP001	Payroll for North America, Payroll Processing USA, Create Direct Deposits, Create Direct Deposit File, Direct Deposit Create File	Create an electronic transmittal file to transfer refunds directly into a student's bank account.

Running the Create Direct Deposit File Process

Access the Direct Deposit Create File page (Payroll for North America, Payroll Processing USA, Create Direct Deposits, Create Direct Deposit File, Direct Deposit Create File).

See Also

PeopleSoft Enterprise Payroll for North America 9.0 PeopleBook, "Working with Checks and Direct Deposit"

Printing Checks and Direct Deposit Advice Slips

Payroll for North America provides reports that enable you to print out refund checks or direct deposit advice slips for a given pay end date. This section discusses how to run the Refund Check and Advice Slip Printing processes.

Pages Used to Print Checks and Direct Deposit Advice Slips

<i>Page Name</i>	<i>Definition Name</i>	<i>Navigation</i>	<i>Usage</i>
Refund Check Print	RUNCTL_CHK_ADV1	Payroll for North America, Payroll Processing USA, Produce Checks, Print Checks, Refund Check Print	Print confirmed payroll refund checks for U.S. students.
Refund Cheque Print	RUNCTL_CHK_ADV1	Payroll for North America, Payroll Processing CAN, Produce Cheques, Print Cheques	Print confirmed payroll refund checks for Canadian students.
DDP Advice Print	RUNCTL_CHK_ADV1	Payroll for North America, Payroll Processing USA, Create Direct Deposits, Print Advice Forms	Print direct deposit advice slips for U.S. students.

Page Name	Definition Name	Navigation	Usage
DDP Advice Print Canada	RUNCTL_CHK_ADV1	Payroll for North America, Payroll Processing CAN, Create Direct Deposits, Print Advice Forms	Print direct deposit advice slips for Canadian students.

Running the Refund Check and Advice Slip Printing Processes

Access the Refund Check Print Payroll for North America, Payroll Processing USA, Produce Checks, Print Checks, Refund Check Print, DDP Advice Print Payroll for North America, Payroll Processing USA, Create Direct Deposits, Print Advice Forms, DDP Advice Print). or DDP Advice Print Canada (Payroll for North America, Payroll Processing CAN, Create Direct Deposits, Print Advice Forms)page.

Note. The Refund Cheque Print, DDP Advice Print, and DDP Advice Print Canada pages are identical to the Refund Check Print page except for the page labels, checks, and advice slips that they generate.

See *PeopleSoft Enterprise Payroll for North America 9.0 PeopleBook*, "Working with Checks and Direct Deposit"

Completing AP Refunds

This section provides an overview of AP refund completion and discusses how to run the AP Refund process.

See Also

PeopleSoft Enterprise Payables 9.0 PeopleBook

Understanding AP Refund Completion

When you create refunds using the accounts payable method, you must interface with PeopleSoft Payables to complete your refunds. If your system interfaces with PeopleSoft Financials the AP Refund process publishes messages to which PeopleSoft Payables subscribes through PeopleSoft Application Messaging.

AP Refund Messaging

The following diagram illustrates how AP refund messages travel between Student Financials and PeopleSoft Financials

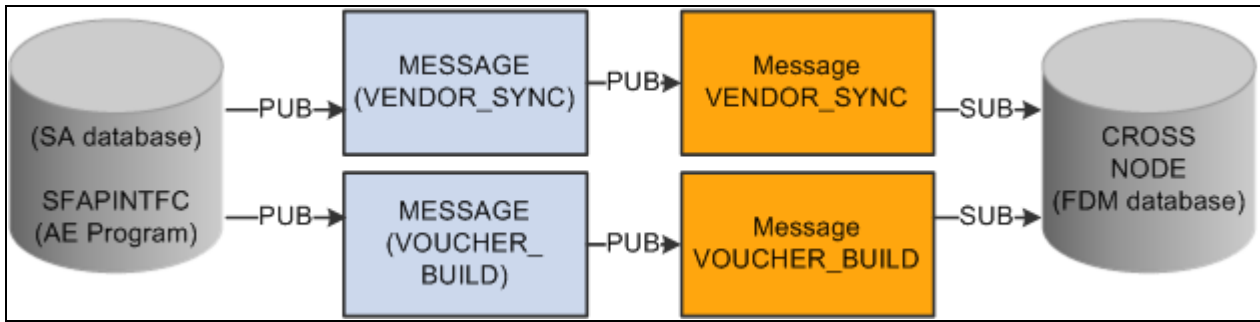

Student Financials to PeopleSoft Financials AP refund messaging process

During the AP refund messaging process, Student Financials delivers two queues and two messages to the PeopleSoft Financials database:

<i>Message Channel</i>	<i>Message</i>	<i>Description</i>
VENDOR	VENDOR_SYNC	Publishes all vendor information (address, location, and contact) in a message to the PeopleSoft Financials database, one vendor at a time. Also allows changes to vendor data to be published iteratively.
VOUCHER	VOUCHER_BUILD	Sends voucher header, line, and distribution information in the message to be processed by PeopleSoft Payables. The system populates staging tables with the message data. The Voucher Build (AP_VCHRBLD) process then processes these staging tables.

Page Used to Complete AP Refunds

<i>Page Name</i>	<i>Definition Name</i>	<i>Navigation</i>	<i>Usage</i>
Create Vendors and Vouchers	RUNCTL_AP_REFUND	Student Financials, Refunds, AP Refunding, Create Vendors and Vouchers	Run the AP Refund process to create vendor and voucher files or publish vendor and voucher information.

Running the AP Refund Process

Access the Create Vendors and Vouchers page (Student Financials, Refunds, AP Refunding, Create Vendors and Vouchers).

Create Vendors and Vouchers

Run Control ID: AP_Refunds [Report Manager](#) [Process Monitor](#) Run

Parameters

Business Unit: PeopleSoft University Bursar

Run Option: **Generate Report**

Create Vendors and Vouchers page

Run Option Select the type of recipient for whom you are running the process. Values are: *Individual Only*, *Organization Only*, or *Individual and Organization*.

Generate Report Select to generate a report that lists details of the AP Refund process.

Run Click to access the Process Scheduler page.

If your system integrates with PeopleSoft Financials, select the check box next to the SF to Payables Interface (SF_AP_INTFC) process. This process looks at AP setup data and refund data to build and generate messages. It publishes a message for each vendor that it creates or changes, and it also publishes one single message containing all processed vouchers. In addition, if a student or corporate address changes in Student Financials, the system sends a message to PeopleSoft Payables indicating the change. PeopleSoft Payables subscribes to this message and updates the corresponding vendor address accordingly.

Distributing Refunds to ePayment Accounts

This section provides an overview of ePayment refunds and discusses how to:

- Distribute refunds for ePayment transactions.
- Distribute refunds for other credit card transactions.

See Also

[Chapter 14, "Processing ePayment Transactions," Processing Refunds for ePayments, page 391](#)

Understanding ePayment Refunds

Student Financials handles refunds to credit cards and eChecks (ePayments) differently than check and direct deposit refunds.

When you refund ePayments using the Batch Refund process, the system creates a separate refund for each credit card payment, even if there are multiple credit card payments on one student's account. The system rolls any cash or check credits on the student's account into one lump sum refund that is separate from any credit card refunds.

In addition, unlike refunds created using the check or direct deposit format, you do not use your Payroll for North America or Payables interface to complete the refunds. The system ignores ePayment refunds when you run the Refund Sheet Creation, Refund Calculation, Refund Confirmation, and AP Refunds batch processes. Instead, you run ePayment-specific batch processes that enable you to interface with your third-party credit card vendor to directly refund student ePayments.

Pages Used to Distribute ePayment Refunds

<i>Page Name</i>	<i>Definition Name</i>	<i>Navigation</i>	<i>Usage</i>
ePayment Refunds	RUNCTL_SFPCCBAT	Student Financials, Refunds, Electronic Payment Refunds, Process ePayment Refunds, ePayment Refunds	Generate refund credits in preparation of transmission to your third-party ePayment processor.
Credit Card Refund - Other	RUNCTL_CC_REFUND	Student Financials, Refunds, Electronic Payment Refunds, Other Credit Card Refunds, Credit Card Refund - Other	Generate a flat file logging refunds of credit card payments that did not occur over the web or through your cashiering office.

Distributing Refunds for ePayment Transactions

Access the ePayment Refunds page (Student Financials, Refunds, Electronic Payment Refunds, Process ePayment Refunds, ePayment Refunds).

The ePayment Refunds page (SFPCCBAT) process logs any refunded web credit card payments for a given business unit and generates the credits that you send to your third-party credit card processing vendor. Run this process prior to running the Credit Card Processing (SF_CRCRD) process.

See Also

[Chapter 14, "Processing ePayment Transactions," page 381](#)

Distributing Refunds for Other Credit Card Transactions

Access the Credit Card Refunds - Other page (Student Financials, Refunds, Electronic Payment Refunds, Other Credit Card Refunds, Credit Card Refund - Other).

The Credit Card Refund - Other (SFCCRFND) process enables you to generate a flat file that logs refunds of credit card payments that did not occur over the web or through your cashiering office (such as credit card payments made using the Student Post page). Send this flat file to your third-party credit card processing vendor for reconciliation. To reconcile your refunds in a timely manner, run this process nightly.

Note. You might need to modify the flat file that this process generates to meet the needs of your credit card processing vendor.

CC Interface File (credit card interface file) Enter the location to store the flat file.

Report Only Select to generate a text file along with the flat file, so you can see the results of the process.

Canceling Refunds

If the system generates an error during the posting of a refund, you cannot continue processing the refund, and you cannot reverse it because the posting process did not finish. You must cancel the refund and post it again. This section discusses how to:

- Cancel student refunds.
- Cancel organization refunds.

Note. You may never have to use the cancellation pages. They are designed solely as a safety measure for quick recovery.

Pages Used to Cancel Refunds

<i>Page Name</i>	<i>Definition Name</i>	<i>Navigation</i>	<i>Usage</i>
Student Refund Cancellation	REFUND_HDR_CAN_SF	Student Financials, Refunds, Reverse and Cancel Refunds, Cancel Student Refund, Student Refund Cancellation	Cancel a student refund and begin again if you encounter a problem during the posting process.
Corp Refund Cancellation	REFUND_ORG_CAN_SF	Student Financials, Refunds, Reverse and Cancel Refunds, Cancel Corporate Refund, Corp Refund Cancellation	Cancel an organization refund and begin again if you encounter a problem during the posting process.

Canceling Student Refunds

Access the Student Refund Cancellation page (Student Financials, Refunds, Reverse and Cancel Refunds, Cancel Student Refund, Student Refund Cancellation).

Cancel Select this check box next to the refund to cancel. When you save the page, the system cancels each selected refund and makes the Cancel check box unavailable.

Canceling Organization Refunds

Access the Corp Refund Cancellation page (Student Financials, Refunds, Reverse and Cancel Refunds, Cancel Corporate Refund, Corp Refund Cancellation).

This page is identical to the Student Refund Cancellation page.

See Also

[Chapter 17, "Refunding Customers," Canceling Refunds, page 463](#)

Reversing Refunds

This section provides an overview of refund reversals and discusses how to:

- Reverse student refunds by ID.
- Reverse student refunds by date.
- Reverse organization refunds by ID.
- Reverse organization refunds by date.
- Reverse refunds within Payroll for North America.

Understanding Refund Reversals

First, you reverse the refund within Student Financials, effectively unposting the refund from the recipient's account.

Next, if you originally created the reversed refund using the payroll method, you run a process that reverses the associated refund check within Payroll for North America. If you reverse a direct deposit refund for which you have already created a transmittal file, the system includes the reversal in the next transmittal file that you create.

If you originally created the reversed refund using the accounts payable method, you must notify your accounts payable department so they can reverse the associated refund record within PeopleSoft Payables.

Credit card refund reversals are possible only during certain stages of the refunding process. You can reverse a credit card refund after its original creation and after you run the ePayment Refunds process. When reversing a credit card refund, you need only reverse it within Student Financials. However, after you submit the credit to the third-party credit card processing vendor, you can no longer reverse the credit card refund.

See Also

PeopleSoft Enterprise Payroll for North America 9.0 PeopleBook, "Working with Checks and Direct Deposit"

Pages Used to Reverse Refunds

Page Name	Definition Name	Navigation	Usage
Student Refunds by ID	REFUND_REV_STU_SF	Student Financials, Refunds, Reverse and Cancel Refunds, Student Refunds by ID	Reverse refunds for a specific student.
Student Refunds by Date	REFUND_REVERSE_SF	Student Financials, Refunds, Reverse and Cancel Refunds, Student Refunds by Date	Reverse student refunds for a specific date.
Corporate Refunds by ID	REFUND_REV_ORG	Student Financials, Refunds, Reverse and Cancel Refunds, Corporate Refunds by ID	Reverse refunds for a specific organization.
Corporate Refunds by Date	REFUND_REV_ORG_SF	Student Financials, Refunds, Reverse and Cancel Refunds, Corporate Refunds by Date	Reverse organization refunds for a specific organization.
Refund Check Reversal	RUNCTL_PAY_REV	<ul style="list-style-type: none"> • Payroll for North America, Payroll Processing USF, Reverse/Adjust Paychecks • Payroll for North America, Payroll Processing CAN, Reverse/Adjust Paycheques • Payroll for North America, Payroll Processing USA, Reverse/Adjust Paychecks 	Reverse a check within Payroll for North America.

Reversing Student Refunds by ID

Access the Student Refunds by ID page (Student Financials, Refunds, Reverse and Cancel Refunds, Student Refunds by ID).

Student Refunds by ID			
Business Unit:	PSUNV	PeopleSoft University Bursar	
ID	SFEK00047	Poncil,Karen M	Academic Information
Refund Information			
Find First 1-2 of 2 Last			
Refund Date:	05/06/2003 11:20:50AM	Refund Amount:	200.00
Address:	123 Main Street Lee CA	Status:	Posted
		Last Updated:	LS
	Check / Voucher Info	Refund Detail	<input type="button" value="Reverse"/>
Refund Date:	05/06/2003 11:22:32AM	Refund Amount:	100.00
Address:	123 Main Street Lee CA	Status:	Posted
		Last Updated:	LS
	Refund Detail		<input type="button" value="Reverse"/>

Student Refunds by ID page

Academic Information Click to access the Academic Information page.

Status The values that appear on this page are *AP Interface Created*, *Credit Pending*, *Confirmed*, *Declined*, *Posted*, and *Interfaced to Payroll*.

Check/Voucher Info Click to view information regarding the check or voucher associated with this refund. If you completed this refund using the Payroll for North America interface, this link accesses the Detail Check Information page. If you completed this refund using the PeopleSoft Payables interface, this link accesses the Detail Refund AP Information page.

Refund Detail Click to access the Detail Refund Information by Student page.

Reverse Click this button next to the refund that you want to reverse.

Reversing Student Refunds by Date

Access the Student Refunds by Date page (Student Financials, Refunds, Reverse and Cancel Refunds, Student Refunds by Date).

Aside from displaying refunds by date instead of student ID, this page is identical to the Student Refunds by ID page.

See Also

[Chapter 17, "Refunding Customers," Reversing Student Refunds by ID, page 465](#)

Reversing Organization Refunds by ID

Access the Corporate Refunds by ID page (Student Financials, Refunds, Reverse and Cancel Refunds, Corporate Refunds by ID).

Aside from displaying organization refunds instead of student refunds, this page is identical to the Student Refunds By ID page.

See Also

Chapter 17, "Refunding Customers," Reversing Student Refunds by ID, page 465

Reversing Organization Refunds by Date

Access the Corporate Refunds by Date page (Student Financials, Refunds, Reverse and Cancel Refunds, Corporate Refunds by Date).

Aside from displaying organization refunds by date instead of by ID, this page is identical to the Student Refunds By ID page.

See Also

Chapter 17, "Refunding Customers," Reversing Student Refunds by ID, page 465

Reversing Refunds Within Payroll for North America

Access the Paycheck Reversal/Adjustment page.

Note. If a refund calendar is not set up as off-cycle, you may encounter processing problems.

Renumbering Refund Checks for Reprinting

During your refunding process, you may have to reprint a range of checks. For example, if a group of physical checks were damaged during printing, you would need to renumber the checks stored in the system to match the replacement checks that you actually issue. This section discusses how to renumber checks.

Page Used to Renumber Refund Checks for Reprinting

<i>Page Name</i>	<i>Definition Name</i>	<i>Navigation</i>	<i>Usage</i>
Refund Check Reprint	RUNCTL_PAY_REPRINT	<ul style="list-style-type: none"> Payroll for North America, Payroll Processing USA, Produce Checks, Reprint Checks Payroll for North America, Payroll Processing CAN, Produce Cheques, Reprint Cheques Payroll for North America, Payroll Processing USF, Produce Checks, Reprint Checks. 	Renumber checks for reprinting.

Renumbering Checks

Access the Refund Check Reprint page (Payroll for North America, Payroll Processing USA, Produce Checks, Reprint Checks, Refund Check Reprint).

See Also

PeopleSoft Enterprise Payroll for North America 9.0 PeopleBook, "Working with Checks and Direct Deposit"

Deleting Paysheets

While generating refund checks using Payroll for North America, you may encounter problems during the paysheet creation or refund calculation steps. This results in an uncalculated refund check or an incomplete paysheet, both of which cannot be completed. You must delete the paysheet and start the process over again. This section discusses how to delete paysheets.

Page Used to Delete Paysheets

<i>Page Name</i>	<i>Definition Name</i>	<i>Navigation</i>	<i>Usage</i>
Refund Unsheet	RUNCTL_PAY_USHT_SF	Payroll for North America, Payroll Processing USA, Update Paysheets, Pay Unsheet, Refund Unsheet	Delete paysheets.

Deleting Paysheets

Access the Refund Unsheet page (Payroll for North America, Payroll Processing USA, Update Paysheets, Pay Unsheet, Refund Unsheet).

The options in the Payroll Cycle group box are unavailable.

See Also

PeopleSoft Enterprise Payroll for North America 9.0 PeopleBook, "Working with Paysheets"

Viewing Refund Information in Student Financials

Throughout your refunding process, you may want to view information about the refunds that you are creating and distributing. The following table lists information for Student Financials. Other reports are available in Payroll for North America. This section lists the pages used to view refund information.

Pages Used to View Refund Information

<i>Page Name</i>	<i>Definition Name</i>	<i>Navigation</i>	<i>Usage</i>
Review Student by ID	REFUND_INQ_STU_SF	Student Financials, Refunds, Review Student by ID	View information regarding the selected student's refunds.
Detail Refund Check Information	PAY_CHECK_SECON_SF	Click the Check/Voucher Info (check/voucher information) link on various pages within the Refunding feature.	Review details about the check associated with a payroll refund.
Detail Refund AP Information	VOUCHER_SECON_SF	Click the Check/Voucher Info (check/voucher information) link on various pages within the Refunding feature.	Review details about the voucher associated with an AP refund.

Page Name	Definition Name	Navigation	Usage
Detail Refund Information By Student	REFUND_INQ_DETAIL	Click the Refund Detail link from various pages within the Refunding feature.	Review information about a student refund.
Review Student by Date	REFUND_INQUIRY_SF	Student Financials, Refunds, Review Student by Date	View information regarding student refunds created on a specific date.
Ind Sponsor Refunds By ID (individual sponsor refunds by ID)	REF_IND_SP_INQ_ID	Student Financials, Refunds, Review Sponsor Refunds by ID	View information regarding an individual sponsor's refunds.
Ind Sponsor Refunds By Date (individual sponsor refunds by date)	REF_IND_SP_INQ_DT	Student Financials, Refunds, Review Sponsor Refunds by Date	View information regarding individual sponsor refunds created on a specific date.
Corp Refunds By ID (corporation refunds by ID)	REFUND_INQ_O_ID_SF	Student Financials, Refunds, Review Corporate Refunds by ID	View information regarding a specific organization's refunds.
Corp Refunds By Date (corporation refunds by date)	REFUND_INQ_O_DT_SF	Student Financials, Refunds, View Corporate Refunds by Date	View information regarding organization refunds created on a specific date.
Corp Sponsor Refunds by ID (corporation sponsor refunds by ID)	REF_ORG_SP_INQ_ID	Student Financials, Refunds, Review Corporate Sponsor by ID	View information regarding the refunds of a specific organization sponsor.
Corp Sponsor Refunds by Date (corporation sponsor refunds by date)	REF_ORG_SP_INQ_DT	Student Financials, Refunds, View Corporate Sponsor by Date	View information regarding the organization sponsor refunds created on a specific date.
Refund Address	REFUND_ADDR	Click the Get Address link on the Batch Refund Lines page.	View address information for a refund recipient.

Chapter 18

Administering Payment Plans

This chapter provides an overview of payment plans and discusses how to:

- Link students to deferral contracts.
- Administer payment plan contracts.
- Administer third-party contracts.
- Enroll multiple students in a payment plan or third-party contract.

Understanding Payment Plans

This section lists common elements and provides an overview of payment plans.

Common Elements Used in This Chapter

Reference Number	Enter an optional reference number for each student on a particular contract. The reference number entry is for information purposes only and does not appear on the student's charges.
Status	This field displays the current status of the contract. Values are: <i>Active:</i> Select to make the contract available for use. This is the default value for this field until the student has been linked to the contract by posting. After the student has been linked to the contract, the other options become available. <i>Cancelled:</i> Select to remove the student from the contract. <i>Hold:</i> Select to prevent new transfers from the plan account but not to discontinue its use completely. <i>Inactive:</i> Select to discontinue use of the contract. <i>Not Posted:</i> Indicates that a new or changed contract has not been posted.

Understanding Payment Plans

Using Student Financials, you can create and maintain these types of payment agreements for students with diverse financial needs or responsibilities:

- Deferral contract
- Payment plan
- Third-party contract
- Collection agreement

Deferral Contracts

Deferral contracts are designed for students who, for whatever reason, need to defer payment of charges for a short period of time. Deferral contracts extend the charge due date for eligible charges. You can link multiple students to one deferral contract definition, or you can create individual contracts to accommodate each student's unique needs.

Payment Plans

Payment plans enable you to offer students the flexibility of paying their education expenses over a period of time rather than in one lump sum. Student Financials provides several choices for you to create and process student payment plans. The three types of payment plans are calculated, existing, and lump sum. These types differ from the deferral contract in that the deferral contract only adjusts the due and billing dates. The calculated and existing payment plans defined in this section actually credit the eligible charges.

- The calculated payment plan enables you to use item type groups to define eligible charges. Also, the calculated payment plan can use the Offset Charges feature. Adjustments to student charges can affect this payment plan. This payment plan may be available through self-service.
- The existing payment plan enables you to manually select individual charges that may be eligible for the payment plan. Adjustments to the student charges can affect this payment plan.
- The lump sum payment plan uses the Charge Priority List feature to determine which charges can be paid by the initial lump sum payment. The initial lump sum payment will be posted to the payment plan account type. Adjustments to the student charges will not have an effect on this payment plan. This payment plan may be available through self-service.

Third-Party Contracts

Third-party contracts are credit agreements between your institution and a third-party sponsor—typically, corporations or government agencies. The third party agrees to sponsor one or more students and pays all or part of their tuition, fees, or expenses. The sponsor establishes all parameters regarding what portion of which expenses it pays.

When a student is linked to a third-party contract, a credit is applied to the student's account, the *receivable* is moved from the student's account to the sponsor's account, and the student's sponsor is sent a bill. This contract type is especially beneficial for students in a retraining program or an employee education program who may not have the cash to pay the tuition and fees in advance and then seek reimbursement. If the sponsoring organization does not pay, the temporary credit is reversed and the student is liable for the payment.

Collection Agreements

Often, when a student or external organization agrees to repay a past due debt, they are unable to pay the full balance in one lump sum. Use a collection agreement to set up and maintain a payment schedule, produce billing entries, and track receipt of payments.

See Also

[Chapter 8, "Setting Up Payment Plans," page 253](#)

Linking Students to Deferral Contracts

When you link a student to deferral contracts, you specify certain parameters that are specific to the student you are linking.

This section discusses how to define student-specific details for a deferral contract.

Pages Used to Link Students to Deferral Contracts

<i>Page Name</i>	<i>Definition Name</i>	<i>Navigation</i>	<i>Usage</i>
Defer Student	DEFER_STUDENT	Student Financials, Payment Plans, Assign Deferral Contract, Defer Student	Define student-specific details for a deferral contract.
Deferred Charges	ITEM_LINE_DEFER_SP	Click the Deferred Charges link on the Student Defer page.	View all active charges in the student's account and confirm that eligible charges have been deferred to the correct due date.
Defer Student Charges	DEFER_STDNT_LINE	Student Financials, Payment Plans, Assign Deferral Contract, Defer Student Charges	Confirm the deferral contract calculation results.

Defining Student-Specific Details for a Deferral Contract

Access the Defer Student page (Student Financials, Payment Plans, Assign Deferral Contract, Defer Student).

Defer Student		Defer Student Charges	
Business Unit:	PSUNV	Contract Number:	536
ID	SFPP00002 Brown,Charles	<input type="button" value="Calculate"/>	Deferred Charges
		<input type="button" value="Post"/>	Display Error/Warning
Contract Details			
Term:	2005 Spr		60.00
Assessment Fee:	<input type="text" value="60.00"/> USD		60.00
Status	<input type="text" value="Active"/>		
Student Max:	<input type="text" value="5,000.00"/> USD		
Reference Number:	<input type="text"/>		
	<input type="checkbox"/> Waive Fee		

Defer Student page

- Calculate** Click to calculate charges to be deferred. After calculating the contract but before posting it, look at the Defer Student Charges page to confirm which charges the system selected for deferral.
- Post** Click to defer charges.
- Deferred Charges** After posting, click to confirm that the charges have been deferred to the correct dates.
- Display Errors/Warnings** Click to see errors and warning messages.
- Assessment Fee** The default amount in this field is the fee that you specified during the setup of the deferral contract. Use this field to override the default amount.
- Student Max** (student maximum) The default value for this field is the maximum amount that you specified during the setup of the deferral contract. You can override this amount.
- Waive Fee** Select to waive the student's assessment fee.

Administering Payment Plan Contracts

This section discusses how to:

- Confirm and modify payment plan contract parameters for an individual student.
- Confirm and modify additional payment plan contract parameters for an individual student.
- Recalculate payment plan contracts.

Pages Used to Administer Payment Plan Contracts

<i>Page Name</i>	<i>Definition Name</i>	<i>Navigation</i>	<i>Usage</i>
Payment Plan 1	PAY_PLAN_SF_1	Student Financials, Payment Plans, Assign Payment Plan, Payment Plan 1	Confirm and modify payment plan contract parameters for an individual student.
Payment Plan 2	PAY_PLAN_SF	Student Financials, Payment Plans, Assign Payment Plan, Payment Plan 2	Confirm and modify additional payment plan contract parameters for an individual student.
Payment Distribution	TP_PPLN_QCK_POST	Student Financials, Payment Plans, Assign Payment Plan, Payment Distribution	Review the payment schedule, charge amounts, billing dates, and due dates for the payment plan. You can adjust the billing dates and installment amounts on this page.
Recalc Payment Plan	RUNCTL_PMTPLNRECAL	Student Financials, Payment Plans, Recalculate Payment Plan, Recalc Payment Plan	Recalculate payment plan contracts.

Confirming and Modifying Payment Plan Contract Parameters for an Individual Student

Access the Payment Plan 1 page (Student Financials, Payment Plans, Assign Payment Plan, Payment Plan 1).

Payment Plan 1		Payment Plan 2		Payment Distribution	
Business Unit:	PSUNV	Contract Number:	532		
ID:	SFPP00010 Casey,Ryan	Plan Type:	Existing		
Maximum Amount:	<input type="text"/> USD	Lump Sum Amount:	<input type="text"/> USD		
Item Type Group:	<input type="text"/>	Offset Item Type Group:	<input type="text"/>		
Term		Charge Date		Anticipated Aid Term/Date	
From:	<input type="text"/>	Add:	<input type="text"/>	From:	<input type="text"/>
To:	<input type="text"/>	Adjust:	<input type="text"/>	To:	<input type="text"/>
Offset Term		Charge Offset Date		Anticipated Aid Date:	
From:	<input type="text"/>	Add:	<input type="text"/>	<input type="text"/>	
To:	<input type="text"/>	Adjust:	<input type="text"/>		
<input type="checkbox"/> Calculate Real Time					
Save		Return to Search		Previous in List	
		Next in List		Notify	
		Refresh		Add	
				Update/Display	
Payment Plan 1 Payment Plan 2 Payment Distribution					

Payment Plan 1 page

All of the values that appear in the fields on this page are default values from the contract setup pages. You can override values in any fields that are available, but you cannot exceed the limits established when you set up the contract. Not all fields are available with all types of contracts.

See Also

[Chapter 8, "Setting Up Payment Plans," Setting Up Payment Plan Contracts, page 259](#)

Confirming and Modifying Additional Payment Plan Contract Parameters for an Individual Student

Access the Payment Plan 2 page (Student Financials, Payment Plans, Assign Payment Plan, Payment Plan 2).

Payment Plan 1	Payment Plan 2	Payment Distribution			
Business Unit:	PSUNV	Contract Number: 532			
ID:	SFPP00009 Carman,Mark	Plan Type: Existing Calculate			
First Bill Date:	11/05/2001 31	Billing Cycle: User Selected Post			
Payments:	3	Pay Plan Type: Credit Original Account Display Error/Warning			
Amount:	862.00 USD	Account Type: PPL			
Reference Number:		Due after Days: 1 <input checked="" type="checkbox"/> Waive Fee			
Adjustment Option:	Adjust Last Bill	Item Type: 180000000002 Student Tuition & Fees			
Status:	Active	Pay Item Type: 360000000001 Move to Payment Plan			
Plan Type					
Payroll Deduction:					
Find View 2 First 1-3 of 3 Last					
Account Number	Item Term	Item Type	Item Amount	Balance	Reverse
Paid TUITION001	1998 Fall	Course Fees	60.00	0.00 USD	<input type="checkbox"/>
Paid TUITION001	1998 Fall	Course Fees	102.00	0.00	<input type="checkbox"/>
Paid TUITION001	1998 Fall	Tuition	700.00	0.00	<input type="checkbox"/>

Payment Plan 2 page

**First Bill Date,
Payments, and
Adjustment Option**

The values that appear in each of these fields are set by default from the payment plan contract setup. You can override these values.

Status

The value that appears in this field is set by default from the payment plan contract setup. You can override this value to make the student *Active*, *Inactive*, or *Cancelled*. After you set the student status to *Cancelled*, you can later reactivate the payment plan contract for the student by changing the student status back to *Active*.

For calculated payment plan contracts, the system distributes the charges equally across all unbilled installments, regardless of the selected adjustment option, when you reactivate a calculated payment plan contract for a student. Subsequent adjustments to a reactivated plan follow the rules of the plan's adjustment option.

For both calculated and existing payment plan contracts, the system charges any designated assessment fee upon reactivation.

For existing payment plan contracts, the system allows additional charges for students with a status of *Active* if the associated contract has a status of *Inactive*.

**Plan Type, Billing Cycle,
Pay Plan Type, Account
Type, Due after Days,
Item Type, and Pay Item
Type**

The values that appear in each of these fields are set by default from the payment plan contract setup. The values are for information only and cannot be changed.

Amount For calculated and lump sum payment plans, the value that appears in this field is set by default from the Maximum Amount field or the Lump Sum Amount field, respectively, on the Payment Plan 1 page. For the existing type payment plans, the value of the selected charges after calculation appears in this field.

Waive Fee If an administrative fee was initially defined in the payment plan setup, then you can waive the fee. Select this check box if you want to waive the fee for individual students.

Eligible Charges

When you add a student to an existing type payment plan, all eligible charges appear at the bottom of the page. Select one or more charges to include in the payment plan.

Calculate Click to create the payment plan agreement. The payment plan agreement consists of all scheduled payments and plan fees. This button is unavailable if the student status is *Inactive*.

After you click this button, you can review and adjust billing dates and installment amounts on the Payment Distribution page.

Post Click to post each of the scheduled payments and plan fees to the student's account.

Recalculating Payment Plan Contracts

Access the Recalc Payment Plan page (Student Financials, Payment Plans, Recalculate Payment Plan, Recalc Payment Plan).

The screenshot shows the 'Recalc Payment Plan' interface. At the top, there is a title 'Recalc Payment Plan' and a 'Run Control ID: 1'. Navigation links for 'Report Manager' and 'Process Monitor' are present, along with a yellow 'Run' button. Below this is a 'Parameters' section. The 'Business Unit' is set to 'PSUNV' with a search icon and the text 'PeopleSoft University Bursar'. A table-like area contains search filters for 'Contract Number From' and 'Contract Number To', both set to '515'. There are also search icons and '+' '-' buttons for these fields. At the top right of this area, there are navigation controls: 'Find | View All', 'First', '1 of 1', and 'Last'.

Recalc Payment Plan page

Contract Number From and Contract Number To Enter contract numbers. You can recalculate one contract or a range of contracts. To calculate just one, enter the same number in both fields. To recalculate a range of contracts, enter the first and last contract numbers in the range.

You should recalculate payment plan contracts on a regular basis until the adjustment date has passed so that your payment plan balances are up-to-date and reflect adjustments to the student's charges.

Note. The Payment Plan Recalculation (SFPPLNCL) process recalculates only payment plans of the calculated type.

Administering Third-Party Contracts

This section discusses how to:

- Link students to third-party contracts.
- Recalculate third-party contracts.

Page Used to Administer Third-Party Contracts

<i>Page Name</i>	<i>Definition Name</i>	<i>Navigation</i>	<i>Usage</i>
Third Party Contract	TP_STUDENT	Student Financials, Payment Plans, Assign Third Party Contract	Link students to third-party contracts.
Recalc Third Party Contracts (recalculate third-party contracts)	RUNCTL_TPICAL	Student Financials, Payment Plans, ReCalc Third Party Contracts	Recalculate third-party contracts.

Linking Students to Third-Party Contracts

Access the Third Party Contract page (Student Financials, Payment Plans, Assign Third Party Contract).

Third Party Contract

Business Unit: PSUNV	Contract Number: SPRING - BILL
External Org ID: SFBO0001	Status: Active
Date Type: Date Range	Contract Maximum: 100,000.00 USD
Term:	Acad Year:
Start Date: 11/01/2001	End Date: 05/31/2002

Find | View All First 1 of 1 Last

*ID	Student Max	Status	Priority
Reference Number <input type="text" value="SF0027"/> <input type="button" value="🔍"/> Martin,Gene <input style="width: 100%;" type="text"/>	Course List <input type="text" value="5,000.00"/> USD <input type="button" value="🔍"/> <input style="width: 100%;" type="text"/>	<input type="text" value="Not Posted"/>	<input type="text" value="999999"/> <input type="button" value="Post"/> <input type="button" value="+"/> <input type="button" value="-"/>

[Corp Accounts](#)

Third Party Contract page

- ID** Enter the ID of the student that you are linking to the third-party contract.
- Student Max** (student maximum) The amount that you specified during the third-party contract setup appears by default in this field. You can decrease the amount.
- Priority** If a student is linked to more than one third-party contract, you may want the contracts to apply in a preferred order. Enter a priority value to determine the order in which the contracts apply. The default priority value is 999999. The lower the number, the higher the priority.

Course List Confirm the default course list that is attached to the third-party contract or override the selection with a different list. If you override the default selection, the list applies only to the individual student being linked to the contract. If the contract was not set up with the Specific Course List option, it cannot be added on this page.

Note. To use a course list with a third-party contract, you must consider the setup issues that are related to term fees.

- Post** Click to link the student to the third-party contract.
- Find** Click to access the Explorer User prompt. Use the Explorer User prompt to enter a student's ID to quickly locate his or her record in the third-party contract.
- Corp Accounts** (corporation accounts) Click to access the Corp Accounts page, where you can review account details for the sponsor of this third-party contract.

See Also

[Chapter 6, "Setting Up Fees and Tuition Groups," Setting Up Course List Fees, page 224](#)

[Chapter 6, "Setting Up Fees and Tuition Groups," Setting Up Term Fee Codes, page 190](#)

Recalculating Third-Party Contracts

Access the Recalc Third Party Contracts page (Student Financials, Payment Plans, ReCalc Third Party Contracts).

Recalc Third Party Contracts page

Contract Number From and **Contract Number To** You can recalculate one contract or several contracts in a range. To recalculate only one contract, enter the contract number in the Contract Number From field. The same number appears in the Contract Number To field by default. To recalculate a range of contracts, enter the first contract number of the range in the Contract Number From field and the last in the range in the Contract Number To field.

You should periodically use the Third Party Recalculation (SFPTPPRC) process to recalculate third-party contracts until the end of the adjustment period for third-party contracts (last date, as established on the Third Party Contract setup page) to make sure all adjustments to charges are recognized.

Enrolling Multiple Students in a Payment Plan or Third-Party Contract

This section discusses how to:

- Define enrollment for multiple students in a payment plan or third-party contract.
- Review results by contract.
- Process mass contract assignments.
- Process mass cancellations.
- Use inquire contract assignments.

Pages Used to Enroll Multiple Students in a Payment Plan or Third-Party Contract

<i>Page Name</i>	<i>Definition Name</i>	<i>Navigation</i>	<i>Usage</i>
Mass Contract Select	SSF_RUNCTL_PS_TPC	Student Financials, Payment Plans, Mass Contract Select	Define enrollment for multiple students.
Review Results by Contract	SSF_PS_PPL_REVIEW	Student Financials, Payment Plans, Review Results by Contract	View results by contract for payment plans and for third-party contracts.
Recalc Payment Plan	RUNCTL_PMTPLNRECAL	Student Financials, Payment Plans, Assign and Recalc, Recalc Payment Plan	Link students to or cancel a student's link to a contract.
Inquire Contract Assignments	SSF_TP_PPL_INQUIRY	Student Financials, Payment Plans, Inquire Contract Assignments	View all students linked to a payment plan.

Defining Enrollment for Multiple Students

Access the Mass Contract Select page (Student Financials, Payment Plans, Mass Contract Select).

Mass Contract Select

Run Control ID: SF [Report Manager](#) [Process Monitor](#) Run

Population Selection

Selection Tool ▼

Query Name 🔍 [Launch Query Manager](#) [Preview Selection Results](#)

Default Values

Business Unit 🔍 PeopleSoft University Bursar

Contract Number 🔍 Calculated with Antic Aid

Reference Nbr

Contract Status ▼

[Review Results by Contract](#)

Save Notify
Add Update/Display

Mass Contract Select page

Use this page to run a predefined query, run an equation engine, or load a flat file to identify the population for a specific contract. Also define initial default values that will be associated with each employee ID.

Population selection is a method for selecting the IDs to process for a specific transaction. The Population Selection group box is a standard group box that appears on run control pages when the Population Selection process is available or required for the transaction. Selection tools are available based on the selection tools that your institution selected in the setup of the Population Selection process for the application process and on your user security. Fields in the group box appear based on the selection tool that you select. The fields act the same from within the group box no matter what run control page you are on or what transaction you are processing.

If your institution uses a specific selection tool (PS Query, Equation Engine, or external file) to identify IDs for a specific transaction, you must use it.

Click the Run button to run the query and populate a staging table with the selected employee IDs and the default values. A log file will contain all records that did not populate the staging table because of a service impact or because the student is already associated with the contract number.

Population Selection

Selection Tool Select *PS Query*, *Equation Engine*, or an external file.

Query Name Enter the appropriate query.

Default Values

Contract Number Enter the appropriate contract number.

Reference Nbr (reference number) Provide a reference number. This field is optional.

Contract Status Select a status of *Active* or *Cancel*.

Click the Review Results by Contract link to view the results of the query along with the default values.

Reviewing Results by Contract

The Review Results by Contract page will vary depending on the type of contract selected.

Review Results by Contract for a Payment Plan

Access the Review Results by Contract page (Student Financials, Payment Plans, Review Results by Contract).

Review Results by Contract

Business Unit: PSUNV PeopleSoft University Bursar

Contract Number: 530 Calculated with Antic Aid

	*ID	Plan Amount	Reference Number	Status		
<input type="checkbox"/>	0002 <input type="text"/>	1,600.00	<input type="text"/>	Active	<input type="button" value="+"/>	<input type="button" value="-"/>
<input type="checkbox"/>	0010 <input type="text"/>	1,600.00	<input type="text"/>	Active	<input type="button" value="+"/>	<input type="button" value="-"/>

[Select All](#) [Clear All](#)
[Assign and Recalc](#)

Review Results by Contract page

You can use the Review Results by Contract page for data entry. When you initially access the page, one row is populated with default values, but the ID field is blank. Enter the ID.

You can also update the Plan Amount, Reference Number, and Status fields.

Click the Add (+) button to enter the number of rows desired for additional data entry.

After clicking Apply, delete individual rows or use the Select All button to select all rows and then click Delete. This action removes the rows from the staging table. The Clear All link removes all the Select flags, if needed.

After entering the necessary data in all rows, click Apply.

Review Results by Contract for a Third-Party Contract

Access the Review Results by Contract page (Student Financials, Payment Plans, Review Results by Contract).

Review Results by Contract

Business Unit: PSUNV PeopleSoft University Bursar

Contract Number: WITH TAX N/A

	*ID	Student Max	Course List	Reference Number	Status		
<input type="checkbox"/>	0002	5,000.00			Active	+..	-
<input type="checkbox"/>	0003	5,000.00			Active	+..	-

[Select All](#) [Clear All](#) Delete [Assign and Recalc](#)

OK Cancel Apply

Review Results by Contract page

The Third Party Contract data entry page is similar to that used for Payment Plan, except that a Student Max column replaces the Plan Amount column on the Payment Plan page. The Third Party Contract data entry page also includes an additional Course List column.

Processing Mass Contract Assignments

Use this batch process to link students to a contract.

You can link students to a contract or cancel students from a contract. A contract from and to range is used to identify contracts for processing. The process scheduler contains two processes, Assign Contract and Recalc, which enable you to either select the Assign Contract process for the new mass batch or select the current functionality to recalculate the contract. After the Assign Contract process finishes successfully, the respective records in the staging table are deleted. Use the Assign Contract process to either activate or cancel your selected population from the contract.

Access the Recalc Payment Plan page (Student Financials, Payment Plans, Assign and Recalc, Recalc Payment Plan).

Recalc Payment Plan

Run Control ID: SFRE8010401 [Report Manager](#) [Process Monitor](#) **Run**

Parameters

Business Unit: PeopleSoft University Bursar

Find | View All First 1 of 1 Last

Contract Number From: Contract Number To: + -

Save **Return to Search** **Notify** **Add** **Update/Display**

Recalc Payment Plan page

Contract Number From Enter the first contract number to be included in the batch process.

Contract Number To Enter the final contract number to be included in the batch process.

Processing Mass Cancellations

Access the Mass Contract Select page (Student Financials, Payment Plans, Mass Contract Select).

Mass Contract Select

Run Control ID: SF [Report Manager](#) [Process Monitor](#) Run

Population Selection

Selection Tool: ▼

Query Name: 🔍 [Launch Query Manager](#) [Preview Selection Results](#)

Default Values

Business Unit: 🔍 PeopleSoft University Bursar

Contract Number: 🔍 Payment Plan

Reference Nbr:

Contract Status: ▼

[Review Results by Contract](#)

Save
Notify

+ Add
Update/Display

Mass Contract Select page

Use this batch process to cancel students to the contract.

This page is used to remove all students from a contract. This function is especially useful to cancel all students from a third-party contract.

Use one of the Population Selection process methods to identify all students within a contract, and then select *Cancelled* in the Status field located within the Default Values group box.

Review the selected records using the Review Results by Contract page, and then use the Assign and Recalc process to proceed with the mass cancellation. The students are canceled from the contract, installments are reversed, and the original charges are reinstated.

Population Selection

Selection Tool Select *PS Query*, *Equation Engine*, or *External File*.

Query Name Enter the appropriate query, equation engine, or file path and name.

Default Values

Contract Number Enter the appropriate contract number.

Contract Status Select or cancel a status.

Click the Review Results by Contract link to view the results of the query along with the default values.

Using Inquire Contract Assignments

Access the Inquire Contract Assignments page (Student Financials, Payment Plans, Inquire Contract Assignments).

Inquire Contract Assignments

Business Unit: PSUNV PeopleSoft University Bursar
Contract Number: 534 Payment Plan

ID	Name	Plan Amount	Number Of Payments	Status	Self Service Agreement Number
SFPP00016	Smith,Pat	4,100.00	5	Active	
SFPP00017	Anderson,Patricia	4,100.00	5	Active	
SFPP00018	Johnson,Pat	4,100.00	5	Active	
SFPP00019	Hanson,Patricia	4,100.00	5	Active	

Return to Search
Previous in List
Next in List

Inquire Contract Assignments page

Use the Inquire Contract Assignments page to view all students linked to a payment plan.

Chapter 19

Billing Customers

This chapter provides an overview of customer billing and discusses how to:

- Complete billing requests.
- Bill specific charges for individual students.
- Process billing requests.
- Print invoices.
- Cancel bills.
- View billing information.

Understanding Customer Billing

You must submit a clear and accurate bill to every customer. The PeopleSoft Student Financials Billing feature offers you great flexibility when generating these bills. You can create a single bill for one customer, or you can create a batch of bills for several customers at once. You determine the messages that appear on your bills. To save time, you can establish a billing standard request that enables you to repeatedly create bills with the same parameters. You can print your bills using Form Based Extract Bill, Crystal, or a Student Financials Structured Query Report (SQR) and XML Publisher.

Note. Although the terms *bill* and *invoice* are technically synonymous, a distinction exists between the two terms in the context of the Student Financials application. Throughout this chapter, the term *bill* refers to a set of billing data for a student or a corporation that resides in the database. When the system prints a bill, the resulting paper document is an *invoice*.

Credit Invoices pertain to Oracle's global invoicing functionality and are invoices that document reductions in charges that have been previously invoiced. *Credit Invoices* are used to notify the student that a prior invoice has changed and a lesser amount is now requested from the student, a payment has a credit balance, or both.

Remember these conventions to avoid any confusion while reading the Billing Customers chapter.

See [Chapter 9, "Setting Up Billing," page 283](#).

Completing Billing Requests

This section provides an overview of billing requests and discusses how to:

- Specify basic student billing request parameters.
- Specify bill terms and print options for student billing requests.
- Specify basic corporate billing request parameters.
- Specify bill terms and print options for student billing requests.

Understanding Billing Requests

Use the Billing Request component (BI_REQUEST) to set the parameters that the billing process uses to determine the type of bills generated. To complete a billing request, you must use the following two pages. Versions of both of these pages are included in the Student Billing Request (BI_REQUEST) and the Corp. Billing Request (BI_REQUEST_ORG) components.

- Billing Request 1
- Billing Request 2

On the Billing Request 1 page, you create the set of parameters that the billing process uses to generate bills. On the Billing Request 2 page, you create printing parameters that populate the printing process pages. In addition, the Billing Request 2 page enables you to print invoices for single students with the click of a button, without using a separate process to generate the bill and print the invoice.

Bill By Options for Student Billing Requests

Oracle delivers three bill by options for your use when creating new billing requests. Selecting a bill by option is required for each billing request that you create. The options are *Bill One ID*, *Bill Range*, and *Bill All Not Yet Billed*. The bill by option that you select specifies whether the billing process bills one specific student, all students meeting the criteria of the billing standard request that you select, or only those students for whom you have not already generated bills. The option that you choose also determines which selection criteria from the billing standard request that the system uses when generating bills.

This table lists the selection criteria that the system applies to the bill generation process according to the option that you select:

Selection Criteria	Bill All Not Yet Billed	Bill Range	Bill One ID
Last Name	X	X	Does not apply
Account Type	X	X	X
Account Term	X	X	X
Not Billed Since	X	X	Does not apply
Transaction Date	X	X	X

Selection Criteria	Bill All Not Yet Billed	Bill Range	Bill One ID
Service Impact	X	X	Does not apply
Career/Program/Plan	Does not apply	X	Does not apply
Campus	Does not apply	X	Does not apply
Student Groups	Does not apply	X	Does not apply

Bill By Options for Corporate Billing Requests

Just as with student billing requests, when you create a new corporate billing request, you must select a bill by option. For corporate billing requests, four options are available: *Bill One Ext Org ID* (bill one external organization ID), *Bill Range*, *Bill Per Contract(s)*, and *Bill All Not Yet Billed*. The bill by option that you select specifies whether the billing process bills one specific corporation, all corporations meeting the criteria of the billing standard request that you select, corporations associated with specific third-party contracts, or only those corporations for whom you have not already generated bills. The option that you choose also determines which selection criteria from the billing standard request that the system uses when generating bills.

This table lists the selection criteria that the system applies to the bill generation process according to the option that you select:

Selection Criteria	Bill All Not Yet Billed	Bill Range	Bill One Ext Org ID	Bill Per Contract(s)
Name	X	X		X
Account Type	X	X	X	X
Account Term	X	X	X	X
Not Billed Since	X	X		X
Service Impact	X	X		
Transaction Date	X	X	X	X

Pages Used to Complete Billing Requests

<i>Page Name</i>	<i>Definition Name</i>	<i>Navigation</i>	<i>Usage</i>
Billing Request 1	BI_REQUEST	Student Financials, Bill Customers, Student Bills, Create Billing Request, Billing Request 1	Specify basic student billing request parameters.
Billing Request 2	BI_REQUEST_ID	Student Financials, Bill Customers, Student Bills, Create Billing Request, Billing Request 2	Specify bill terms and print options for student billing requests.
Corp Billing Request - Billing Request 1	BI_REQUEST_ORG	Student Financials, Bill Customers, Corporate Bills, Create Billing Request, Billing Request 1	Specify basic corporate billing request parameters.
Corp Billing Request - Billing Request 2	BI_REQUEST_TWO	Student Financials, Bill Customers, Corporate Bills, Create Billing Request, Billing Request 2	Specify bill terms and print options for student billing requests.
Error Bill Message	BI_BILL_ERR_SEC_PN	Click the Error Info link from the preceding various pages.	View information regarding any errors that the system encountered while processing the bill.
Warning Bill Message	BI_BILL_WAR_SEC_PN	Click the Warning Info link from the preceding pages.	View information regarding any warnings that the system encountered while processing the bill.

Specifying Basic Student Billing Request Parameters

Access the Billing Request 1 page (Student Financials, Bill Customers, Student Bills, Create Billing Request, Billing Request 1).

Billing Request 1		Billing Request 2	
Business Unit:	PSUNV PeopleSoft University Bursar	Billing Request Nbr:	999999999 PS
Bill By Option:	Bill One ID	Due Date/Days	
*Billing ID:	<input type="text" value="BIL1"/>	Enter a Due Date or Due Days	
*Invoice Date:	<input type="text" value="09/03/2004"/>	Due Date:	<input type="text"/>
ID:	<input type="text" value="SF0009"/> Jeppsen, Tim	Due Days:	<input type="text" value="14"/>
Item Due Info			
		Customize Find View All	First 1 of 1 Last
*Term	Description	Due Date	Due Days
0540	2005 Spring	<input type="text" value="02/15/2005"/>	<input type="text"/>
Invoice Range			
Start:			End:

Billing Request 1 page

Billing ID Enter the ID of the billing standard request that you want to link to this billing request.

Invoice Date Enter the date that you want to establish as the date of the invoice creation. The system can use this date to determine when generated bills are due. The system automatically populates the field with the current system date, but you can override this date.

ID If you are creating a billing request for a single student, select the unique ID of the student in this field. This field is available only if you select the *Bill One ID* option when creating the request. Be sure that the student whom you select matches the criteria of the billing standard request that you select.

Calculate Tuition If you are creating a billing request for one student ID, click this button to calculate tuition for that student. This button is available only if you select the Auto Calculate Tuition check box on the Tuition Calculation Controls page, and the student whose name that you select in the ID field requires tuition calculation.

Due Date/Days

Set a default due date for all the charges included in the bill that do not already have a due date.

Due Date Enter the specific due date that you want to assign to charges without a due date when you create the bill.

Due Days You can set the default due date as a function of the date that you generate the bill. Enter the number of days that the system adds to the invoice date to determine a due date.

Item Due Info

Set a default due date for term-specific charges that do not already have a due date. You can use the fields in this group box in conjunction with the fields in the Due Date/Days group box. For example, using the Due Date field in the Due Date/Days group box, you set a due date of 10/31/2005 for all charges included in the bill. However, suppose that you want charges from a previous term to be due sooner. In this case, you can use the fields in the Item Due Info (item due information) group box to establish a separate due date for charges in that specific term. The system assigns the default due date of 10/31/2005 to any charges falling outside that term.

Term	Select the specific term with the charges to which you want to assign a due date.
Due Date	Enter the specific due date that you want to assign to charges without a due date when you create the bill.
Due Days	You can also set the default due date as a function of the date that you generate the bill. Enter the number of due days that the system adds to the invoice date to determine a due date.

Note. The Due Date and Due Days fields are mutually exclusive. If you enter a value in both fields, the system will keep only the most recently added value after you refresh the page.

Invoice Range

Start and End	If you run the billing process by clicking the Generate Invoice button on the Billing Request 2 page, the system displays the first invoice generated during the process in the Start field and the last invoice generated during the process in the End field.
----------------------	---

Specifying Bill Terms and Print Options for Student Billing Requests

Access the Billing Request 2 page (Student Financials, Bill Customers, Student Bills, Create Billing Request, Billing Request 2).

Billing Request 1		Billing Request 2	
Business Unit:	PSUNV PeopleSoft University Bursar	Billing Request Nbr:	13 PS
Bill Term			
Bill Term:	One Term	From Term:	0550 2005 Fall
Print Options		To:	
Invoice Layout:	TF1 Tuition&Fees Layout #1	Aid Term From:	0550 2005 Fall
Output Format:	Form Based Extract Bill	To:	0560 2006 Spring
<input type="radio"/> Generate Invoice <input type="radio"/> Generate & Print Bill		<input checked="" type="checkbox"/> Print Schedule of Classes	
Address Usage:	SLCT ORD 1 Home, Mailing, Permanent, Work	for Term:	0550 2005 Fall
Output File Directory:		Bill File:	
<input type="checkbox"/> Override Address Info		<input type="checkbox"/> Address not required	
<input type="checkbox"/> Use Email Address		<input type="checkbox"/> Print Zero Bill	
Generate Invoice			
Information Messages & Errors			

Billing Request 2 page

Bill Term

Bill Term

Select the term or terms for which you want to generate bills. Valid values are:

All Terms: Select to bill students for all terms.

One Term: Select to bill students for one specific term. If you select this option, you must select a term in the From Term field.

Term Range: Select to bill students for a specific range of terms. If you select this option, you must select terms in the From Term and To fields.

From Term and To

If you enter *One Term* in the Bill Term field, enter the term for which you want to bill in the From Term field.

If you enter *Term Range* in the Bill Term field, enter the beginning term of the range in the From Term field and the ending term of the range in the To field.

Print Options

Invoice Layout

Enter the invoice layout to print invoices.

Output Format

Select the method to print invoices using the Generate Invoice button. Four valid printing output methods are available: *Crystal Bill*, *Other Bill (SQR)*, *XML Publisher*, and *Form Based Extract Bill*.

Aid Term From and To

Set the range of terms to print anticipated financial aid detail on the invoices. Enter the beginning term of the range in the Aid Term From field and the ending term of the range in the To field. These fields are required if you select either the Anticipated Aid Detail check box or the Include Anticipated Aid Total check box for the invoice layout that you select in the Invoice Layout field.

Generate Invoice	Select to generate and store the bill, but not print an invoice when you click the Generate Invoice button. This is the default option if you select the <i>Bill All Not Yet Billed</i> value or the <i>Bill Range</i> value when you access the component.
Generate & Print Bill	Select to generate a bill and print an invoice when you click the Generate Invoice button. Remember that this field is available only if you select the <i>Bill One ID</i> option when you access the BI_REQUEST component.
Print Schedule of Classes for Term	Select to print the student's enrollment summary when you print invoices. If you select the Print Schedule of Classes check box, use this field to select the academic term that includes the enrollment summary that you want to print on your invoices.
Address Usage	Enter the logic that the system uses to select the address printed on the bills.
Output File Directory	Enter the directory path to which the process stores the bills that it generates. Specifying an output file directory is necessary only when you are printing invoices using the value <i>Form Based Extract Bill</i> . If this field is left blank, output will go to the Report Repository.
Override Address Info (override address information)	This check box affects only the printing of invoices that the system already generated. If you select this check box, the system ignores the address that is already associated with the bills and selects addresses to print according to the order selected in the Address Usage field.
Address not required	Select to print invoices even if the process finds no address.
Use Email Address	Reserved for future use.
Print Zero Bill	Select to print zero balance bills. The system creates only zero balance bills if you select <i>Create Zero Bills</i> in the Zero Bill Handling field on the General Selections page for the selected billing standard request.
Generate Invoice	Click to run the billing process manually and generate bills. If you select the <i>Bill One ID</i> value when creating the request and select the Generate & Print Bill option, the system prints an invoice for the specified student.

Information Messages & Errors

This group box displays messages indicating the success of the bill generation process after you click the Generate Invoice button.

Invoice Generated This message appears when the process generates bills successfully.

Error Info (error information)

If an error occurs when you run the billing process, this link appears in the Information Messages & Errors group box. Click the link to open the Error Bill Message page, where you can view detailed information about the nature of the error.

Warning Info (warning information)

If a *warning* situation occurs when you try to run the billing process, this link appears in the Information Messages & Errors group box. Click the link to open the Warning Bill Message page, where you can view detailed information about the nature of the warning.

Note. Although you can generate bills for a range of students using the Generate Invoice button in combination with the Generate Invoice option in the Print Choice group box, the Generate Invoice button is intended only for generating and printing an individual bill for a student. You should process bills for a range of students using the Bill Request process page. If you use the same run control ID to process your billing request and print your invoices, some of the values that you set in the Billing Request 2 page are supplied by default to their respective fields in the printing process page that you use. The values can be supplied from the following fields: Invoice Layout, Print Schedule of Classes for Term, Aid Term From, To, Address Usage, Output File Directory, Bill File, Override Address Info, Address not required, Use Email Address, Address, and Print Zero Bill.

Specifying Basic Corporate Billing Request Parameters

Access the Corp Billing Request - Billing Request 1 page Student Financials, Bill Customers, Corporate Bills, Create Billing Request, Billing Request 1.

The screenshot shows the 'Billing Request 1' page with the following details:

- Business Unit:** PSUNV PeopleSoft University Bursar
- Billing Request Nbr:** 999999999 PS
- Bill By Option:** Bill Range
- *Billing ID:** CRP_IN_CR Corp Create Inv, Create Zero
- *Invoice Date:** 10/13/2004
- External Org ID:** (empty field)
- Due Date/Days:** Enter a Due Date or Due Days. **Due Date:** 11/15/2004. **Due Days:** (empty field)
- Third Party Contract Table:**

*Contract Number	Description
- Item Due Info Table:**

*Term	Description	Due Date	Due Days
0530	2004 Fall		
- Invoice Range:**

Start: _____ **End:** _____

Corp Bill Request - Billing Request 1 page

Except for the External Org ID, Invoice per Student, and Contract Number fields, this page is identical to the Billing Request 1 page.

External Org ID (external organization ID) If you want to create a bill for a single organization, select the unique ID of the organization. This field is available only if you select the Bill One Ext Org ID (bill one external organization ID) option when you create the request. Be sure that the corporation that you select matches the criteria of the billing standard request (Billing ID) that you select.

Invoice per Student This check box appears only if you select the *Bill Per Contract(s)* value when you create the request. If you select the Invoice per Student check box, the billing process generates a separate corporate bill for each student associated with the contract that you select in the Contract Number field.

For example, if the contract that you choose has ten students associated with it, then the system would generate ten separate bills for the corporation associated with the contract. If you do not select the Invoice per Student check box, the system generates one corporate bill per contract regardless of the number of students attached to the contract.

Third Party Contract

Contract Number Select the number of the contract that is associated with the corporation that you want to bill. You can select multiple contracts by inserting additional rows.

See Also

[Chapter 19, "Billing Customers," Specifying Basic Student Billing Request Parameters, page 492](#)

Specifying Bill Terms and Print Options for Student Billing Requests

Access the Corp Billing Request - Billing Request 2 page Student Financials, Bill Customers, Corporate Bills, Create Billing Request, Billing Request 2.

This page is identical to the Billing Request 2 page.

See Also

[Chapter 19, "Billing Customers," Specifying Basic Corporate Billing Request Parameters, page 497](#)

Billing Specific Charges for Individual Students

Student Financials enables you to create an individual bill for a student for only some of the charges on the account. In addition, you can review pending billing items and an invoice summary when you are done.

This section discusses how to:

- View pending to bill items.
- Create individual bills for students.
- View the Student Invoice Summary pages.

Pages Used to Bill Specific Charges for Individual Students

<i>Page Name</i>	<i>Definition Name</i>	<i>Navigation</i>	<i>Usage</i>
Pending To Bill Items	SSF_BI_CUR_ACCOUNT	Student Financials, Bill Customers, Student Bills, Pending to Bill Items	Viewing pending to bill items.
Identify Student Charges	BI_BILL_SELECT	Student Financials, Bill Customers, Student Bills, Identify Student Charges	Create individual bills for students.
Prior Billing	BI_BILL_HEADER_SP	Click the Get Prior Billing link on the Bill Select page.	View information regarding past billing for the student.
Billing Detail	BI_BILL_DETAIL_SP	Click the Get Billing Detail Lines link on the Prior Billing page.	View detail of bills appearing on the Prior Billing page.
Student Invoice Summary	SSF_BI_INV_MAIN	Student Financials, Bill Customers, Student Bills, Student Invoice Summary	Lists all invoices for a student.
Invoice Header	SSF_BI_INV_HDR	Click the link on the Student Invoice Summary page.	View student invoice information.
Invoice Career	SSF_BILL_CAREER	Click the Invoice Career link on the Invoice Header page	Displays academic information for a student.
Invoice Detail	SSF_BILL_DETAIL	Click the Invoice Detail link on the Invoice Header page	Lists the individual charges and payments for this invoice.
Invoice Messages	SSF_BILL_MESSAGES	Click the Invoice Messages link on the Invoice Header page	Displays any messaging on invoices.

Viewing Pending To Bill Items

Access the Pending To Bill Items page (Student Financials, Bill Customers, Student Bills, Pending to Bill Items).

Pending To Bill Items			
Business Unit:	PSUNV PeopleSoft University Bursar		
Name:	Terry Chastain	ID:	SFTRN025
Account Balance:	2,700.00		
Account Detail			
Item Description	Item Term	Date Posted	Amount
Administrative Fees	0518	01/13/2005	100.00
Parking Stickers	0518	01/13/2005	100.00
Housing	0518	01/13/2005	2,000.00
Meal Plan-21	0518	01/13/2005	500.00

Pending To Bill Items page

This page displays charges that have not been billed for a specific student. After you run the billing process, the pending items no longer appear on this page.

Account Balance The total amount shown is not the total amount due for a student. Amounts that were billed prior to this summary might exist.

Creating Individual Bills for Students

Access the Identify Student Charges page (Student Financials, Bill Customers, Student Bills, Identify Student Charges).

Identify Student Charges

Business Unit: PSUNV PeopleSoft University Bursar

*ID: Stewing,Russell [Get Prior Billing](#)

*Address Type:

*Billing ID: 06Student Billing

Bill Scan Line: **Total Billed:** 0.00

Due Date/Days

Due Date:

Due Days:

Account Info					Find	First	3 of 6	Last
Account Nbr	Account Term	Item Type	Item Amount	Balance	Billed Amt			
TUITION001	2004 Fall	Technology Fee						

Details							Find	First	1-2 of 2	Last
Line #	Posted	Item Effective Date	Billing Date	Due Date	Due Amt	Line Amt				
<input type="checkbox"/> 1	04/12/2005	04/12/2005		04/12/2005	75.00	75.00				
<input type="checkbox"/> 2	04/12/2005	04/12/2005		Due Date	-75.00	-75.00				

Identify Student Charges page

- ID** Enter the unique ID of the student whom you want to bill.
- Address Type** Enter the address that you want to use when creating the bill.
- Billing ID** Enter the ID of the billing standard request that you want to use to generate the bill.
- Bill Scan Line** Enter a bill scan line if your bank requires it.
- Due Date** Enter the default due date that you want to assign to charges without a due date when you create the bill.
- Due Days** You can also set the default due date as a function of the date on which you generate the bill. Enter the number of due days that the system adds to the day that you generate the bill to determine a due date.

The page displays a list of line items in the two group boxes at the bottom of the page. Select the check box next to each line item that you want to include in the student's bill.

After you save your configured individual bill, you can review the individual bill and print it using the specified print option.

- Get Prior Billing** Click to access the Prior Billing page.

Viewing the Student Invoice Summary Pages

Access the Student Invoice Summary page (Student Financials, Bill Customers, Student Bills, Student Invoice Summary).

Student Invoice			
Student Invoice Summary			
Patricia Anderson		SFPP00017	
PeopleSoft University Bursar			
Invoice Date	Invoice Number	Status	Invoice Amount
08/05/2002	HD 0000000080TST	Initiated	895.00

Student Invoice Summary page

This page lists all invoices for a specific student with the most recent invoice listed first.

Invoice Number Click to view the details of the invoice on the Invoice Header page.

Student Invoice			
Invoice Header			
Patricia Anderson		SFPP00017	
PeopleSoft University Bursar			
Invoice Number:	HD 0000000080TST	Billing Request Nbr:	6
Invoice Date:	08/05/2002	Invoice Balance:	895.00
Prior Invoice ID:		Prior Invoice Amount:	0.00
Invoice Type:	Regular	Total Billed:	895.00
Billing Status:	Initiated	Due Date:	08/10/2002
Address Type:	BILL	Bill Date and Time:	08/05/2002 12:28:15PM
 Billing Address			
Invoice Career		Invoice Detail	
Invoice Messages		Return	

Invoice Header page

The Invoice Header page displays more detail about this invoice.

Billing Status This field will indicate *Initiated* or *Cancelled*.

Billing Address Click the arrow button to display or hide the student's address information.

Invoice Career, Invoice Detail, and Invoice Messages These links provide the same information as Invoice Info Student Information pages, and are displayed next.

Student Invoice	
Invoice Career	
Patricia Anderson	SFPP00017
PeopleSoft University Bursar	
Invoice Number: HD 0000000080TST	
Billing Request Nbr: 6	
Academic Info	Academic Info 2
Academic Career: UGRD Undergraduate	Academic Career:
Academic Program: LAU Liberal Arts Undergraduate	Academic Program:
Academic Plan: UNDECL-Undeclared Undergraduate	Academic Plan:
Proj Level: 10 Freshman	Proj Level:
Academic Info 3	Miscellaneous
Academic Career:	Academic Load: Enrolled Full-Time
Academic Program:	Tuition Residency:
Academic Plan:	Campus:
Proj Level:	Bill Date and Time: 08/05/2002 12:28:15PM

Invoice Career page

Student Invoice					
Invoice Details					
Patricia Anderson			SFPP00017		
PeopleSoft University Bursar					
Invoice Number:		HD 0000000080TST	Billing Request Nbr:		6
Details					
Customize Find View All  First <input type="button" value="◀"/> 1-11 of 11 <input type="button" value="▶"/> Last					
Item Description	Term	Date Posted	Due Date	Line Amount	
Tuition	2002 Fall	08/05/2002	08/15/2002	750.00	
Tuition	2002 Fall	08/05/2002	08/30/2002	750.00	
Rent	2002 Fall	08/05/2002	08/15/2002	1,300.00	
Rent	2002 Fall	08/05/2002	08/30/2002	1,300.00	
Move to Payment Plan	2002 Fall	08/05/2002	08/10/2002	0.00	
Student Tuition & Fees	2002 Fall	08/05/2002	08/10/2002	0.00	
Student Tuition & Fees	2002 Fall	08/05/2002	08/10/2002	520.00	
Student Tuition & Fees	2002 Fall	08/05/2002	08/10/2002	300.00	
Administrative Fees	2002 Fall	08/05/2002	08/10/2002	75.00	
Move to Payment Plan	2002 Fall	08/05/2002	08/10/2002	-2,600.00	
Move to Payment Plan	2002 Fall	08/05/2002	08/10/2002	-1,500.00	

Invoice Details page

Student Invoice					
Invoice Messages					
Patricia Anderson			SFPP00017		
PeopleSoft University Bursar					
Invoice Number:		HD 0000000080TST	Billing Request Nbr:		6
Messages					
1	Fees are due and payable upon receipt of this invoice.				
70	Business Hours are 8:00 a.m.-4:30 p.m.				

Invoice Messages page

Processing Billing Requests

This section discusses how to:

- Process student billing requests.
- Process corporate billing requests.

Pages Used to Process Billing Requests

Page Name	Definition Name	Navigation	Usage
Generate Invoice	RUNCTL_SFPBILLNG2	Student Financials, Bill Customers, Student Bills, Generate Invoice	Process student billing requests.
Generate Invoice	RUNCTL_SFPBILLNG3	Student Financials, Bill Customers, Corporate Bills, Generate Invoice	Process corporate billing requests.

Processing Student Billing Requests

Access the Generate Invoice page (Student Financials, Bill Customers, Student Bills, Generate Invoice).

Generate Invoice

Run Control ID: BillingRequest [Report Manager](#) [Process Monitor](#) Run

Bill Indicator

- Bill All
- Invoice Range
- Customer ID

*Business Unit: PeopleSoft University Bursar

Billing Request Nbr:

ID:

Address Usage:

Billing ID:

Invoice Date:

Print By

Invoice Layout:

Form Based Crystal Other

Print Choice

Generate Invoice

Generate & Print Bill

Due Date/Days

Due Date:

Due Days:

Class Schedule

Print

Term:

Item Due Info Find | View All First 1 of 1 Last

Term: Due Date: Due Days:

Generate Invoice page (student)

Business Unit

Enter the business unit for which you are generating bills.

Billing Request Nbr
(billing request number)

Enter the number of the billing request that you want to use to generate your bills.

The system populates the remaining fields on the page with the data from the billing request that you choose in the Business Request Nbr field.

Note. If you want the system to populate the printing process pages with the printing parameters of the billing request that you are processing, you must use the same run control ID for printing that you use for processing the billing request.

See Also

Chapter 19, "Billing Customers," Completing Billing Requests, page 489

Processing Corporate Billing Requests

Access the Generate Invoice page (corporate) (Student Financials, Bill Customers, Corporate Bills, Generate Invoice).

This page is identical to the Generate Invoice page (student).

See Also

Chapter 19, "Billing Customers," Processing Student Billing Requests, page 505

Printing Invoices

This section discusses how to:

- Print student invoices using Form Based Extract Bill.
- Print corporate invoices using Form Based Extract Bill.
- Print student invoices using an SQR.
- Print corporate invoices using an SQR or XML Publisher.
- Print student invoices using Crystal.
- Print corporate invoices using Crystal.

You can print your bills using Form Based Extract Bill, Crystal, or a Student Financials Structured Query Report and XML Publisher.

Pages Used to Print Invoices

<i>Page Name</i>	<i>Definition Name</i>	<i>Navigation</i>	<i>Usage</i>
Student Invoice Extract	RUN_CNTL_PBILL	Student Financials, Bill Customers, Student Bills, Produce Extract File, Student Invoice Extract	Print student invoices using Form Based Extract Bill.
Corporation Invoice Extract	RUN_CTNL_PBILL_ORG	Student Financials, Bill Customers, Corporate Bills, Produce Extract File, Corporation Invoice Extract	Print corporate invoices using Form Based Extract Bill.

Print By Select one of these values:

Customer ID: Print an invoice for a single student. When you select this option, the ID and Invoice Number fields become available.

Invoice Date: Print all student invoices with the same invoice date. When you select this option, the Invoice Date field becomes available.

Request #: (request number) Print all student invoices with a specific billing request number. When you select this option, the Billing Request Nbr (billing request number) field becomes available.

Invoice Range: Print a range of student invoices according to their invoice numbers. When you select this option, the Start and End fields become available.

ID Enter the unique ID of the student for whom you want to print an invoice.

Billing Request Nbr
(billing request number) Enter the billing request number for which you want to print invoices. When you select a request number, the printing parameters from the associated billing request are supplied to the respective fields on this page.

Invoice Date Enter the invoice date of the invoices that you want to print.

Invoice Number Select the specific invoice number that you want to print. Select an ID first to limit the valid invoice ID values to those of the student for whom you want to print an invoice. Note that when you select the Invoice Range option in the Print By group box, the label for this field changes from Invoice Number to Start.

Start Enter the invoice ID at the beginning of the invoice range. Note that when you select the Customer ID option in the Print By group box, the label for this field changes from Start to Invoice ID.

End Enter the invoice ID at the end of the invoice range.

The following fields are populated by default with the values set in the billing request if the run control ID that you use to print is the same as the one that you use to process the billing request. They also are populated by default with the values set in the billing request if you select Request # in the Print By group box and specify a billing request number.

Invoice Layout Enter the invoice layout to format the printed invoices.

Override Bill Request Layout If you select the Print By option of Invoice Range or Invoice Date, and the invoices included use different invoice layouts, you receive a warning message when you run the process that reads *Bills may be printed with different layouts*. If you select the Override Bill Request Layout check box, you do not receive the warning message. Instead, the system uses the layout selected in the Invoice Layout field for all invoices for the specified invoice range or date.

Aid Term From and Aid Term To	Enter the beginning and ending terms for the term range. The term range determines for which terms the anticipated financial aid appears on the bills.
	<hr/> Note. If you do not select either the Anticipated Aid Detail check box or the Include Anticipated Aid Total check box for the invoice layout that you selected, the Aid Term From and Aid Term To fields are not available. <hr/>
Output File Directory	Enter the path of the directory to which the system sends the extract file. Form Based Extract Bill uses this file to print the invoices.
Bill File	Enter the name of the file that the system generates.
Address Usage	Enter the logic that the system uses to select the address printed on the bills.
Override Address Info (override address information)	This check box affects only the printing of bills that the system already generated. If you select this check box, the process ignores the address that is already associated with the bills and selects addresses to print according to the order that is selected in the Address Usage field.
Address Not Required	Select this check box to print bills even if the process finds no address.
Use Email Address	Select if you send invoices by email.
Print Zero Bill	Select to print zero balance bills.
Class Schedule	
Print	Select to print the student enrollment summary when you print invoices.
Term	If you select the Print check box, enter the term of the enrollment summary that you want to print on your invoices.

Printing Corporate Invoices Using Form Based Extract Bill

Access the Corporation Invoice Extract page (Student Financials, Bill Customers, Corporate Bills, Produce Extract File, Corporation Invoice Extract).

Corporation Invoice Extract

Run Control ID: BILLING [Report Manager](#) [Process Monitor](#) Run

Print By

Corp ID

Invoice Date

Request #

Invoice Range

***Business Unit:** PeopleSoft University Bursar

External Org ID:

Billing Request Nbr:

Invoice Date:

Start: Start **End:** End

Invoice Layout: Tuition&Fees Layout #7 **Override Bill Request Layout**

Output File Directory: **Bill File:**

Override Address Info

Use Email Address

Address not required

Print Zero Bill

Corporation Invoice Extract page

Except for the Corp ID and External Org ID (external organization ID) fields, this page is identical to the Student Invoice Extract page.

Corp ID (corporation ID) Select to print an invoice for a single corporation. When you select this option, the Corp ID and Invoice ID (invoice ID) fields become available.

External Org ID (external organization ID) Enter the unique ID of the corporation for which you want to print an invoice.

Printing Student Invoices Using an SQR or XML Publisher

Access the Student Invoice Other page (Student Financials, Bill Customers, Student Bills, Print Invoice, Student Invoice Other).

Student Invoice Other

Run Control ID: BILLING [Report Manager](#) [Process Monitor](#) Run

Print Options

*Business Unit: PeopleSoft University Bursar Output XML Data:

Print Invoice by: Output Chunk Size:

ID:

Invoice Number:

Override Bill Request

Override Bill Request Layout

Invoice Layout:

Aid Term From: Aid Term To:

Address Usage:

Print Schedule of Classes Term:

Override Address Info Address not required Use Email Address Print Zero Bill

XML Output Directory:

Student Invoice Other page

Except for the absence of the Output File Directory and Bill File fields, and the addition of XML Publisher fields, this page is identical to the Student Invoice Extract page.

Printing Corporate Invoices Using an SQR or XML Publisher

Access the Corporation Invoice Other page (Student Financials, Bill Customers, Corporate Bills, Print Invoice, Corporation Invoice Other).

Except for the absence of the Output File Directory and Bill File fields, and the addition of XML Publisher fields, this page is identical to the Corporation Invoice Form Based Extract Bill page.

Printing Student Invoices Using Crystal

Access the Student Invoice Crystal page (Student Financials, Bill Customers, Student Bills, Print Invoice Crystal, Student Invoice Crystal).

Student Invoice Crystal page

Parameters

Business Unit Enter the business unit for which you are printing the invoice.

ID Enter the ID of the student whose invoice you want to print.

Invoice Number Enter the unique ID number of the invoice that you want to print.

Anticipated Aid

Aid Term From and Aid Term To Enter the beginning and end terms for the term range. The term range determines for which terms the anticipated financial aid appears on the bills.

Note. When using Crystal to print invoices, you can print only one invoice at a time.

Printing Corporate Invoices Using Crystal

Access the Corporation Invoice Crystal page (Student Financials, Bill Customers, Corporate Bills, Print Invoice Crystal, Corporation Invoice Crystal).

Corporation Invoice Crystal

Run Control ID: BILLING [Report Manager](#) [Process Monitor](#) Run

Parameters

Business Unit:	<input type="text" value="PSUNV"/>	PeopleSoft University Bursar
External Org ID:	<input type="text" value="000010011"/>	Ironwood High School
Invoice Number:	<input type="text"/>	

Corporation Invoice Crystal page

Parameters

- Business Unit** Enter the business unit for which you are printing the invoice.
- External Org ID** Enter the ID of the corporation with an invoice that you want to print.
(external organization ID)
- Invoice Number** Enter the unique ID number of the invoice that you want to print.

Note. When using Crystal to print invoices, you can print only one invoice at a time.

Canceling Bills

If you encounter problems during your billing process, Student Financials enables you to cancel bills so that you can rerun the billing process correctly.

This section discusses how to run the Billing Cancellation process.

Pages Used to Cancel a Bill

<i>Page Name</i>	<i>Definition Name</i>	<i>Navigation</i>	<i>Usage</i>
Bill Cancellation	SF_BICANC	Student Financials, Bill Customers, Cancel Invoice, Bill Cancellation	Run the Billing Cancellation process.
Bill Cancellation	BI_CANC_INQ	Student Financials, Bill Customers, Review Invoice Cancellation, Bill Cancellation	View the results of the Bill Cancellation process.

Canceling Bills

Access the Bill Cancellation page (Student Financials, Bill Customers, Cancel Invoice, Bill Cancellation).

Bill Cancellation

Run Control ID: BILLING [Report Manager](#) [Process Monitor](#) Run

Business Unit:

***Run Option:**

Billing Request Nbr:

ID: Hornberger,Lena

External Org ID:

Invoice Number:

***Bill Cancellation Log Option:**

Bill Cancellation page

Run Option

This field determines whether the process cancels an entire group of bills or an individual bill. Values are:

Bill Request Nbr (bill request number): Select to cancel a bill associated with a specific bill request number. When you select this value, the Billing Request Nbr (billing request number) field becomes available and the Invoice Number, ID, and External Org ID fields become unavailable.

Invoice ID: Select to cancel a bill associated with a specific invoice ID. When you select this value, the Billing Request Nbr field becomes unavailable and the Invoice Number, ID, and External Org ID fields become available.

Note. The system allows you to cancel only the most recently generated bill. This means that to cancel an old bill, you must first cancel every bill that you generated after it.

Billing Request Nbr
(billing request number)

When you enter the *Bill Request Nbr* option in the Run Option field, the system automatically populates this field with the billing request number of the last bill that you generated.

ID

Enter the unique ID of the student whose bill you want to cancel.

External Org ID
(external organization ID)

Enter the unique ID of the organization for which you want to cancel a bill.

Invoice Number Enter the invoice ID assigned to the individual bill that you want to cancel. When you select the *Invoice Number* value in the Run Option field and select an ID or external organization ID, the system automatically populates the Invoice Number field with the invoice number of the last bill that you generated for that ID.

Billing Cancellation Log Option The option that you select in this field determines what type of information the system displays on the Bill Cancellation inquiry page. We recommend that you select *Log All Activity* so that you can see all of the results of the Bill Cancellation process in the inquiry page. Values are:

Log All Activity: Select to display both failed and successful cancellation attempts for the chosen bill request number or invoice ID.

Log Failed Cancels Only: Select to display only failed cancellation attempts for the chosen bill request number or invoice ID.

Log Successful Cancels Only: Select to display only successful cancellation attempts for the chosen bill request number or invoice ID.

None: Select to display only the bill cancellation number that is generated by the system.

For each bill affected by the process, the system sets the status to *Cancelled*. In addition, if the system originally set due dates on any of the bills cancelled by the Bill Cancellation process, it resets those due dates to *Null*.

Viewing Billing Information

Several tools are available to use in Student Financials to view the billing activity for a customer's account.



Pages Used to View Billing Information

<i>Page Name</i>	<i>Definition Name</i>	<i>Navigation</i>	<i>Usage</i>
Invoice Info Student	BI_BILL_HEADER	Student Financials, Bill Customers, Student Bills, Review Invoice, Invoice Info Student	Review student billing history.
Billing Address Info (billing address information)	BI_BILL_HDR_SEC_PN	Click the Address Info link on the Invoice Info Student page.	View the address information that is associated with a student bill.
Bill Career	BILL_CAREER	Student Financials, Bill Customers, Student Bills, Review Invoice, Bill Career	Review the academic information that is associated with a student bill.

Page Name	Definition Name	Navigation	Usage
Bill Detail	BILL_DETAIL_1	Student Financials, Bill Customers, Student Bills, Review Invoice, Bill Detail	View details regarding all the items that are included in a student bill.
Bill Messages	BILL_MESSAGES_SCPN	Student Financials, Bill Customers, Student Bills, Review Invoice, Bill Messages	View any messages that are associated with a student bill.
Invoice Info Corp. (invoice information corporation)	BI_BILL_HEADER_ORG	Student Financials, Bill Customers, Corporate Bills, Review Invoice, Invoice Info Corp	Review an overview of corporate billing history.
Invoice Info. Corp - Bill Detail (invoice information corporation - bill detail)	BILL_DETAIL	Student Financials, Bill Customers, Corporate Bills, Review Invoice, Bill Detail	View details regarding all the items that are included in a corporate bill.
Academic Information	BILL_DETAIL_SP	Click the Bill Header - Detail link on the Invoice Info. Corp. - Bill Detail page.	View academic information regarding the student who is associated with the third-party contract.
Invoice Info. Corp - Bill Messages (invoice information corporation - bill messages)	BILL_MESSAGES_SCPN	Student Financials, Bill Customers, Corporate Bills, Review Invoice, Bill Messages	View any messages that are associated with a corporate bill.
Invoice Printing	BI_IVC_PRT_RQST	Student Financials, Bill Customers, Review Printed Invoice	View information regarding specific printing processes.

Reviewing Student Billing History

Access the Invoice Info Student page (Student Financials, Bill Customers, Student Bills, Review Invoice, Invoice Info Student).



Invoice Info Student		Bill Career	Bill Detail	Bill Messages
Business Unit:	PSUNV PeopleSoft University Bursar	Billing Request Nbr:		40
Name:	Campbell,Jezebel	ID:		SFEUC0001
Invoice Number:	CRDITINVOICE0000000000 <input checked="" type="checkbox"/> Credit Invoice	Prior Invoice Amount:		0.00
Prior Invoice ID:		Total Billed:		-8,200.00
Invoice Type:	Cred Bill	Due Date:		08/18/2006
Billing Status:	Initiated	  		
Address Type:	BILL			
Address:	Address Info			
Error / Warning				

Invoice Info Student page

The Credit Invoice indicator is visible if the invoice is a credit invoice.

Viewing Details for Student Bill Items

Access the Bill Detail page (Student Financials, Bill Customers, Student Bills, Review Invoice, Bill Detail).

Invoice Info Student		Bill Career	Bill Detail	Bill Messages	
Business Unit:	PSUNV PeopleSoft University Bursar	Billing Request Nbr:		40	
Name:	Campbell,Jezebel	ID:		SFEUC0001	
Invoice Type:	Credit Invoice				
Details Customize Find View All  First 1-6 of 6 Last					
Item Type	Item Term	Date Posted	Due Date	Effective	Line Amount
Tuition	2005 Fall	08/15/2006	08/18/2006	08/15/2006	-1,500.00
Rent	2005 Fall	08/15/2006	08/18/2006	08/15/2006	-2,600.00
European Mystery Foundation	2006 Spring	08/15/2006	08/18/2006	08/15/2006	-4,000.00
European Mystery Foundation	2006 Spring	08/15/2006	08/18/2006	08/15/2006	4,000.00
European Merit Scholarship	2005 Fall	08/15/2006	08/18/2006	08/15/2006	-2,600.00
European Merit Scholarship	2005 Fall	08/15/2006	08/18/2006	08/15/2006	-1,500.00
Related Invoices Customize Find  First 1-2 of 2 Last					
Related Invoice ID	Item Description	Related Amount	Req Nbr	Bill Date and Time	
EUCASHFALL050000000000	Tuition	-1500.00	14	03/31/2006 8:40:04AM	
EUCASHFALL050000000000	Rent	-2600.00	14	03/31/2006 8:40:04AM	

Bill Detail page

View details regarding all the items included in a student bill.

Related Invoices

Related Invoice ID appears only if the invoice is a credit invoice. The Related Invoice ID link opens the same page for the related invoice ID in a new window.

Chapter 20

Cashiering

This chapter provides an overview of cashiering and discusses how to:

- Open a cashiering office for a business day.
- Process cashiering transactions.
- Post delayed receipts.
- Process the cashiering GL interface.
- Void receipts.
- Review details for individual receipts.
- Review receipt and tender activity.
- Review totals by deposit ID.
- Close a cashiering office for a business day.
- Reopen a cashiering office for a closed business day.

Understanding Cashiering

This section lists common elements and provides an overview of cashiering.

Common Elements Used in This Chapter



Click to view the first group of receipts.



Click to view the previous group of receipts.



Click to view the next group of receipts.



Click to view the last group of receipts.

Ref Nbr (reference number)

Enter a reference number to help organize and track your transactions. This is not a required field.

Cashiering

On a daily basis, the cashiering office collects and tracks a large number of transactions when students and other customers pay tuition, library fines, and fees. With the Student Financials cashiering program, you can perform a variety of transactions quickly, securely, and accurately. The inquiry and report features of the system support your audit trails for maintaining integrity in the system. In addition, the system enables you to design how each transaction interacts with the general ledger.

Opening a Cashiering Office for a Business Day

This section discusses how to:

- Open a cashiering office.
- Open valid registers.
- Open valid cashiers.

Pages Used to Open a Cashiering Office for a Business Day

<i>Page Name</i>	<i>Definition Name</i>	<i>Navigation</i>	<i>Usage</i>
Open Cashier Offices	CSH_OPEN_OFFICE	Student Financials, Cashiering, Cash Management, Open Offices, Open Cashier Offices	Open a cashiering office.
Open Registers	CSH_OPEN_REGISTER	Student Financials, Cashiering, Cash Management, Open Offices, Open Registers	Open valid registers.
Open Cashiers	CSH_OPEN_CASHIER	Student Financials, Cashiering, Cash Management, Open Offices, Open Cashiers	Open valid cashiers.

Opening a Cashiering Office

Access the Open Cashier Offices page (Student Financials, Cashiering, Cash Management, Open Offices, Open Cashier Offices).

Open Cashier Offices		Open Registers	Open Cashiers		
Business Unit:	PSUNV				
Cashier's Office:	WALNUTCR	Walnut Creek Cashier's Office			
Current Business Date:	<input type="text" value="10/09/2009"/>	<input type="button" value="Open Cashier Office"/>	<input type="button" value="Copy Registers and Cashiers"/>		
Find View All First ◀ 1-7 of 9 ▶ Last					
Business Date	Opened By	Open Datetime	Closed By	Close Datetime	Last Sequence
10/09/2009	PS	10/09/2009 8:05:17AM			3
10/06/2009	PS	10/06/2009 11:33:20AM	PS	10/07/2009 10:33:50AM	6
10/04/2009	PS	10/02/2009 10:08:06AM	PS	10/02/2009 10:25:45AM	7
10/03/2009	PS	10/01/2009 12:25:42PM	PS	10/02/2009 10:07:51AM	4
10/02/2009	PS	09/30/2009 2:09:37PM	PS	10/01/2009 11:26:54AM	5
10/01/2009	PS	10/01/2009 12:04:46PM	PS	10/01/2009 12:23:39PM	7
09/30/2009	PS	09/30/2009 9:05:52AM	PS	09/30/2009 12:27:09PM	10

Open Cashier Offices page

Current Business Date Enter the business date for which you want to open the cashiering office. The default value for the field is the system date.

Business Date This heading displays business dates on which you opened the cashiering office. The system displays all of the business dates on which you opened the cashiering office unless you select a retrieval limit on the Cashiering Offices page during the setup of your cashiering office. For example, if you specify a retrieval limit of 5 for your cashiering office, the Business Date heading displays only the last five dates on which you opened the cashiering office.

Open Cashier Office Click to open the cashiering office. When you click this button, the Current Business Date field becomes unavailable.

Copy Registers and Cashiers After you open the cashiering office, you can click this button to copy information regarding the cashiers and registers from one business date to another. If you routinely use the same registers and cashiers from day to day, this button saves you the time and effort involved in having to manually select and open the registers and cashiers on the Open Registers and Open Cashiers pages.

Note. If you do not specify a retrieval limit for your cashiering office during setup, the Business Date heading displays all business dates on which you opened the cashiering office. Eventually, this list of dates will become so long that it can degrade system performance when you open the Open Cashier Offices page.

See Also

[Chapter 10, "Setting Up Cashiering," Defining a Cashiering Office, page 313](#)

Opening Valid Registers

Access the Open Registers page (Student Financials, Cashiering, Cash Management, Open Offices, Open Registers).

Open Registers page

Register Enter the register that you want to open for the business day. If you click the Copy Registers and Cashiers button on the Open Cashier Offices page, the system automatically selects and opens registers from the copied business day.

Open Select to open the register for the business day. After you select this check box, it becomes unavailable. If you click the Copy Registers and Cashiers button on the Open Cashier Offices page, the system automatically selects this check box for each copied register.

Tender Key Enter a tender key to indicate the type of tender that you want the register to be able to use in its transactions. If you click the Copy Registers and Cashiers button on the Open Cashier Offices page, the system automatically inserts the tender keys for each copied register.

Deposit ID(deposit identifier) This is an optional field to help you track your deposits. Enter the actual bank deposit ID in this field for each tender key. If you are not balancing by register, this field is unavailable.

Opening Balance Enter an opening balance for each tender key. If you are not balancing by register, this field is unavailable.

Opening Valid Cashiers

Access the Open Cashiers page (Student Financials, Cashiering, Cash Management, Open Offices, Open Cashiers).

Open Cashier Offices | Open Registers | **Open Cashiers**

Business Unit: PSUNV
Cashier's Office: WALNUTCR Walnut Creek Cashier's Office

Find | View All First 1 of 9 Last

Business Date: 10/09/2009

Find | View All First 1 of 1 Last

*Cashier: PS Register: REG01 Open

Tender Key	Deposit ID	Opening Balance	
CASH-NO GL Cash - Not to GL			USD
CC - NO GL Credit Card - Not to GL			USD
CHECK-NOGL Check - Not to GL			USD

Open Cashiers page

- Cashier** Enter the ID for the cashier that you want to open. If you click the Copy Registers and Cashiers button on the Open Cashier Offices page, the system automatically selects cashiers from the copied business day.
- Register** Enter the register that you want this cashier to use. Only registers that you open on the Open Registers page are available to select. If you click the Copy Registers and Cashiers button on the Open Cashier Offices page, the system automatically selects registers from the copied business day.
- Open** Select to open this cashier for the business day. After you select this check box, it becomes unavailable. Even if you click the Copy Registers and Cashiers button on the Open Cashier Offices page, you must still select this check box manually to open the cashier.
- Tender Key** Enter a tender key to indicate the type of tender that you want the cashier to be able to use in its transactions. Only the tender keys that you assigned to the selected open register are available to select. In addition, you must have assigned the cashier to the tender key that you are selecting when you set up the tender key. If you click the Copy Registers and Cashiers button on the Open Cashier Offices page, the system automatically inserts the tender keys for each copied cashier.

Deposit ID (deposit identifier)	This is an optional field to help you track your deposits. Enter the actual bank deposit ID in this field for each tender key. If you do not balance by cashier, this field is unavailable.
Opening Balance	If you are balancing by cashier, enter an opening balance for each tender key. If you do not balance by cashier, this field is unavailable.

Processing Cashiering Transactions

This section provides an overview of cashiering transactions, lists common elements, and discusses how to:

- Accept student payments.
- Allocate student payments to specific charges.
- Accept corporate payments.
- Allocate corporate payments to sponsored charges.
- Create third-party tracking information for corporate payments.
- Create department receipts.
- Cash checks.
- Process interim deposits.
- Replenish cash.
- Select exchange rates for cashiering transactions processed with foreign currency.
- Enter check information for cashiering transactions.
- Enter credit card information for cashiering transactions.

Understanding Cashiering Transactions

Using the Cashiering feature of Student Financials, you can process six types of cashiering transactions.

<i>Type of Transaction</i>	<i>Description</i>
Student Payment	A payment tendered by a student. Typically, the system posts a student payment to the student's account. However, a student payment can also represent the purchase of an item (such as books or supplies). In this case, the system may not necessarily post the payment to the student's account.

<i>Type of Transaction</i>	<i>Description</i>
Corporate Payment	A payment tendered by an external organization. The system posts a corporate payment to the organization's account.
Department Receipt	A transfer of funds through the cashiering office to a department's general ledger account. Institutions often have offices or departments (such as the housing office, the bookstore, and the athletics office) that take in money on a daily basis or only at certain times of the year. These departments often deposit their funds through the cashiering office to record their accounting information in the institution's general ledger.
Cash Check	An exchange of cash for a check tendered by a customer.
Interim Deposit	A withdrawal of funds from the cashier's drawer to be deposited in the bank during the business day, while the cashier is still open. Most cashiering offices set limits on how much money they want their cashiers' drawers to have in them. The Cashiering feature enables you to set this limit on a tender-specific basis on the Tender Key page. When one of your cashiers' drawers reaches the set limit, you must take tender out of the drawer so that you can deposit it in the bank.
Cash Replenishment	An addition of funds to a cashier's drawer during the business day, while the cashier is still open, so that the drawer does not run out of money.

Every time that you process one of these transactions, the Cashiering feature creates a receipt in the system. These receipts enable you to track and organize your cashiering transactions.

Note. Both Student Payments and Corporate Payments support hosted payment transactions.

See: Student Financials 9.0 PeopleBook, Setting Up ePayment Processing

See: Student Financials 9.0 PeopleBook, Setting Up Cashiering, Defining the Transaction Setup of a Cashiering Office

See Electronic Payment Integration Developer's Reference Guide. The guide is posted to My Oracle Support.

Pages Used to Process Cashiering Transactions

<i>Page Name</i>	<i>Definition Name</i>	<i>Navigation</i>	<i>Usage</i>
Student Payments	CSH_OFF_PMNT	Student Financials, Cashiering, Post Student Payments, Student Payments	Accept student payments in hosted and non-hosted payment modes.
Select Charges To Pay	CSH_O_SPLITPAY_SEC	Click the Select Charges to Pay link on the Student Payments page or the Corporate Payments page.	Allocate student payments to specific charges.
Corporate Payments	CSH_OFF_ORG_PMNT	Student Financials, Cashiering, Post Corporate Payments	Accept corporate payments in hosted and non-hosted modes.
Select Students to Pay	QUICK_CSH_EMP_SEC	Click the Select Students to Pay link on the Corporate Payments page.	Allocate corporate payments to sponsored charges.
Third Party Info (third-party information)	ORG_CSH_3PARTYINF	Click the Third Party Info link on the Corporate Payments page.	Create third-party tracking information for corporate payments.
Department Receipts	CSH_OFF_DEPT	Student Financials, Cashiering, Collect Department Receipts	Create department receipts.
Cash Checks	CSH_OFF_CASH_CHECK	Student Financials, Cashiering, Cash Checks	Cash checks.
Interim Deposits	CSH_OFF_DEPOSIT	Student Financials, Cashiering, Cash Management, Make Interim Deposits, Interim Deposits	Process interim deposits.
Cash Replenishment	CSH_OFF_REPLENISH	Student Financials, Cashiering, Cash Management, Replenish Cash, Cash Replenishment	Create a cash replenishment when adding funds to a cashiering drawer.
Currency Conversion	QUICK_POST_CURR_SP	Click the Currency Detail link on the Student Payments page, the Corporate Payments page, the Department Receipts page, or the Cash Checks page.	Select exchange rates for cashiering transactions processed with foreign currency.

Page Name	Definition Name	Navigation	Usage
Check Information	CSH_OFF_CHK_PMT_SP	Click the Tender Details link on the Student Payments page, the Corporate Payments page, the Department Receipts page, or the Cash Checks page. This link accesses the Check Information page only if you select a check tender in the Tender field.	Enter check information for cashiering transactions. Some of these details appear on the receipt for tracking and auditing purposes.
Credit Card Information	CSH_OFF_CC_PMT_SEC	Click the Tender Details link on the Student Payments page, the Corporate Payments page, or the Department Receipts page. This link accesses the Credit Card Information page only if you select a credit card tender in the Tender field of the respective page and only for non-hosted payments.	Enter credit card information for cashiering transactions for non-hosted payments using Business Interlink or Integration Broker, but not for hosted payments. Some of these details appear on the receipt for tracking and auditing purposes. For the Department Receipt, the credit card information is only stored. It is not processed by the third party vendor. The credit card authorization for the Department Receipt must be done outside of Campus Solutions.

Accepting Student Payments

Access the Student Payments page (Student Financials, Cashiering, Post Student Payments, Student Payments).

Student Payments

Unit:	PSUNV	Office:	Walnut Creek Cashier's Office	Business Date:	10/09/2009
Register:	REG01	Cashier:	PS		

ID:	SFTP00013	Shepard, Abigail	
Balance	397.01	Anticipated Aid:	0.00
Select Charges to Pay			

Ref Nbr:	<input type="text"/>	Create Receipt	New Transaction
Target:	750.00	Tax:	0.00
Tender:	750.00	Change:	0.00

Target Detail Find First 1 of 1 Last

Target:	<input type="text" value="TUT-NONGL"/>	Tut - NoGL	Amount:	<input type="text" value="750.00"/> USD
Term:	<input type="text" value="0630"/>	Invoice ID:	<input type="text"/>	

Tender Detail Find First 1 of 1 Last

*Tender:	<input type="text" value="CC - NO GL"/>	CC - No GL	Amount:	<input type="text" value="750.00"/> USD Currency Detail
Deposit ID:	<input type="text"/>	Tender Details		

Go to: [Academic Information](#) [Student Accounts](#)

Student Payments page

You can process credit card payments on the Student Payments page using hosted payment or non-hosted payment mode, depending on your setup.

See: Student Financials 9.0 PeopleBook, Setting Up ePayment Processing

See: Student Financials 9.0 PeopleBook, Setting Up Cashiering, Defining the Transaction Setup of a Cashiering Office

See Electronic Payment Integration Developer's Reference Guide. The guide is posted to My Oracle Support.

The following documentation about the Student Payments page is based on non-hosted payment mode. For information about hosted payment mode, see the Hosted Payment subsection later within this section of documentation.

Select Charges to Pay Click to access the Select Charges to Pay page, where you can specify to which charges to apply the payment to. You can pay only charges that are associated with the target key that you select in the Target Detail group box. If you select more than one target key in the Target Detail group box, the Select Charges to Pay page is not available. If you select *Apply Payments by Invoice* on the SF Installation 2 page, the Select Charges to Pay link cannot be used.

Note. The Target, Tax, Tender, and Change fields display the correct totals only after you click the Refresh button. If you make a change to any of the fields in the Target Detail group box or the Tender Detail group box, you must click the Refresh button for those changes to register in the display fields.

Target Detail

Target

Enter a target key for the student payment. You define target keys using the Target Keys component (TARGET_KEYS).

If the target key that you select is associated with a tax authority, the system automatically inserts an additional target key for the tax. This is the secondary target key that you designated for the tax authority when you assigned the tax authority to the primary target key during target key setup.

Note. *Restrict payment by invoice*

If your institution specifies that it will apply payments by invoice, you can restrict payments to an invoice. When the target key is associated with an invoice cash or check payment, the cashier can restrict or select an invoice for which the payment is applied. The Restricted by Invoice label appears if Apply Payments by Invoice is selected on the SF Installation 2 page and the Cashier Target key is defined as Post.

Amount

Enter the target amount. The system populates this field automatically if you specify a default amount when you define the selected target key. If necessary, you can override the target amount to match the amount that the student tenders for payment.

If the system automatically inserts a tax target key, it supplies the appropriate target amount.

Term

Enter the term to be associated with this payment. This defines the current term to be used in the payment allocation rules. If this field is left blank, the term will be derived from the option selected on the SF Business Unit>Posting Setup>Default Term Control field.

Tender Detail

You can create student payments with both cash and check tenders, but credit card tender payments must be processed separately from other tenders. For example, a student has charges for tuition, books, and housing in the amount of 1,465 USD. The student pays 1,000 USD by credit card, 400 USD by check, and 65 USD by cash. Using two tender types, you can combine the check and cash payments into a single student payment for 465 USD, but you must create a separate student payment for the 1,000 USD credit card payment. This is necessary because when the system applies a student payment made with a credit card, it associates the payment with a payment reference number that it uses for processing. This reference number is particularly important when you are issuing refunds for credit card payments.

See [Chapter 17, "Refunding Customers," Creating Student Refunds, page 445.](#)

See [Chapter 17, "Refunding Customers," Distributing Refunds to ePayment Accounts, page 461.](#)

Tender	<p>This information applies if you use non-hosted payment mode.</p> <p>Select a value to identify the method of payment that the student is using. If you enter check or credit card, the Check Information page or Credit Card Information page appear automatically.</p> <p>You can also access these pages by clicking the Tender Details link.</p> <hr/> <p>Note. For information about the hosted payment process, refer to the Hosted Payment section.</p> <hr/>
Amount	<p>Enter the amount tendered. If you selected a target key with a default amount, the system automatically supplies that default tender amount. In addition, if you click the Refresh button or the Create Receipt button without entering a tender amount, the system automatically populates this field with the amount that you specified for the target. If the currency tendered is not the base currency that you selected during the setup of your cashiering office, select the correct currency in the field to the right of the Amount field.</p>
Currency Detail	<p>If the student tenders foreign currency for the payment, click this link to access the Currency Conversion page, where you select the method that the system uses to convert the currency.</p>
Deposit ID	<p>If you assigned a deposit ID to the selected tender key when you opened the cashiering office, it appears in this field.</p>
Tender Details	<p>This information applies if you use non-hosted mode.</p> <p>If you select a check tender as the tender key, click this link to access the Check Information page, where you enter specific information about the check tendered.</p> <p>If you select a credit card tender as the tender key, click this link to access the Credit Card Information page, where you enter specific information about the credit card used.</p> <p>For information about these pages refer to the <i>Entering Credit Card Information for Cashiering Transactions</i> and <i>Entering Credit Card Information for Cashiering Transactions</i> later in this chapter.</p> <p>Some of the tender details that you enter appear on your receipts for tracking and auditing purposes.</p> <hr/> <p>Note. For information about the hosted payment process, refer to the Hosted Payment section.</p> <hr/>
Message	<p>When you create a receipt for a credit card payment and you authorize the payment in real time, the Message field displays the status of the transaction.</p>
<i>Using the Go to Links</i>	
Academic Information	<p>Click to access the Academic Information page, where you can view a student's personal and academic information.</p>

Student Account	Click to access the Customer Accounts page, where you can view a student's account information.
View Anticipated Aid	Click to access the Anticipated Aid Details page, where you can view details about the financial aid that the student is anticipated to receive. This link appears on the page only if the student has anticipated financial aid.

Using the Student Payment Buttons

Calculate Tuition	Click to calculate tuition for the student making the payment. This button is available only if you select the Auto Calculate Tuition check box on the Tuition Calculation Controls page.
--------------------------	---

Create Receipt, Print Receipt, and Create and Print Receipt

Note. For information about the hosted payment process, refer to the Hosted Payment section.

The label and functionality of this button changes according to the automatic receipt printing setup of your valid cashiers and valid registers.

If you are not printing automatically, the label of this button is Create Receipt. Click it to create a receipt for the student payment. If you set up your cashiering office for no posting delay, the system posts the payment. Depending on the setup of the SF merchant ID assigned to your cashiering office, this button may also trigger the authorization and capture of any student payments that are made with a credit card.

When you click the Create Receipt button, the label changes to Print Receipt. Click it to print the receipt using Forms Engine. Forms Engine generates the receipt and sends it to the appropriate printer as specified on the Valid Registers page.

If you are printing automatically, the label of this button is Create and Print Receipt. Click it to simultaneously create the receipt and print it using Forms Engine.

Note. If your institution specifies that it will apply payments by invoice, the Receipt Detail page will indicate an invoice number.

Note. If you select *Delay posting* or *Group Post* in the Posting field during the setup of your cashiering office, the system does not post the student payment when you click the Create Receipt button. You must post your payments using the Post Receipts page if you selected *Delay posting* or the Group Posting page if you selected *Group Post*.

Note. If you do not select the Use Forms Engine for Receipts check box on the Cashiering Offices page, click the Print Receipt button or the Create and Print Receipt button to create a printable receipt using the specified print product (Crystal or other print method). In this case, you must navigate to Report Manager to view and print the receipt.

New Transaction After you create a receipt, click to return to the Student Payments dialog page to process another student payment.

Declined Credit Card

In non-hosted payment mode, if a credit card is declined, the Create Receipt button label becomes the Re-create Receipt button. You cannot make changes to the tender type—in the Tender Detail group box, the Tender field is not available for edit and the Add and Delete row buttons are not available. You have 2 options:

- Click the New Transaction button to create a new receipt.
- Change the credit card details by selecting the Tender Details link, and then clicking the Re-create Receipt button from the receipt page.

For information about hosted payment mode, refer to the Hosted Payment section.

Hosted Payment

Tender For hosted payments, when you select credit card as the tender, the Credit Card Information page does not appear. Instead, you should ensure that the receipt is complete and then click on the Tender Details link to access the third party hosted site and enter credit card details. Clicking the Tender Details link causes the receipt details to be validated and invokes the ePayment API using the SF_PMT_REF_NBR as the merchant reference. The API retrieves the Cashier payment details using Cashiering application classes, and transfers control to the third party host. Alternatively, you can click the Create Receipt button to start the same processing.

Input credit card details on the third party hosted site page.

Fields that appear on the third party page might be configurable, depending on the level of customization that the third party allows.

If you click Cancel, you are taken back to the Receipt page on which a message appears advising that the payment has been cancelled. The receipt cannot be used and you must start a new transaction.

If you click Continue you return to the Student Payments page where you can authorize payment. Click the Authorize and Print button to change the SF_PAYMENT status to Submitted and invoke the ePayment API to authorize the payment. The authorization results, credit card type, and last 4 digits of the credit card are saved in the SF_PAYMENT record and the Receipt record.

Student Payments					
Unit:	PSUNV	Office:	Walnut Creek Cashier's Office	Business Date:	10/09/2009
Register:	REG01	Cashier:	PS	Receipt Nbr:	1091
ID:	SFTP00013	Shepard, Abigail			
Balance	397.01	Ref Nbr:			
Target:	750.00	Tax:	0.00	Tender:	750.00
				Change:	0.00
Click on Authorize Payment to complete this transaction. This transaction will not be completed until Authorization has occurred.					
<input type="button" value="Authorize and Print"/>			<input type="button" value="New Transaction"/>		

Student Payments page — Authorize Transactions

If the authorization is successful, the Receipt page appears:

Student Payments					
Unit:	PSUNV	Office:	Walnut Creek Cashier's Office	Business Date:	10/09/2009
Register:	REG01	Cashier:	PS	Receipt Nbr:	1091
ID:	SFTP00013	Shepard, Abigail			
Balance	-352.99	Ref Nbr:			
Target:	750.00	Tax:	0.00	Tender:	750.00
				Change:	0.00
Transaction was successful. Authorization Code: 112610					
<input type="button" value="Print Receipt"/>			<input type="button" value="New Transaction"/>		

Student Payments page — Receipt

If the credit card is declined, the Student Payments page appears with a message: *Transaction was declined.*

New Transaction

If you click this button, you are taken to the Student Post search page, with the assumption that a new receipt will be created. A new SF_PAYMENT record is created with the receipt number and an Initiated status.

Allocating Student Payments to Specific Charges

Access the Select Charges To Pay page (click the Select Charges to Pay link on the Student Payments page or the Corporate Payments page).

Select Charges to Pay

Select Charges To Pay

Total Pay Amount: 0.00

Item Type	Term	Item Amt	Balance	Pay Amount
Tuition	2004 Fall	2,350.00	1,500.00	<input type="text" value="100.00"/>
SingleRoom	2004 Fall	2,000.00	1,900.00	<input type="text" value="100.00"/>
Student ID	2004 Fall	25.00	25.00	<input type="text" value="0.00"/>
Parking St	2004 Fall	125.00	125.00	<input type="text" value="0.00"/>

Select Charges To Pay page

Pay Amount Enter the amount that you want to pay toward the item on the student's account. Remember that you can select only charges associated with the target key that you select in the Target Detail group box on the Student Payments page or the Corporate Payments page. This field is unavailable for all other items on a student's account.

After you select your charges to pay and click the OK button, the fields in the Target Details group box on the Student Payment page become unavailable.

Accepting Corporate Payments

Access the Corporate Payments page (Student Financials, Cashiering, Post Corporate Payments).

Corporate Payments			
Unit:	PSUNV	Office:	European Cashier Office
Register:	EUR01	Cashier:	PS
		Business Date:	08/21/2006
Org ID:	000010003	Union High School	
Balance	-105.00	Select Charges to Pay	Select Students to Pay
		Third Party Info	
Ref Nbr:	<input type="text"/>	Create Receipt	New Transaction
Target:	0.00	Tax:	0.00
Tender:	0.00	Difference:	0.00
Target Detail			
Find First 1 of 1 Last			
Target:	<input type="text" value="INV_CHECK"/>	INV_CHECK	Amount: <input type="text"/> USD
Term:	<input type="text"/>	Restricted to Invoice	Invoice ID: <input type="text"/>
Tender Detail			
Find First 1 of 1 Last			
*Tender:	<input type="text"/>	Amount: <input type="text"/> USD	Currency Detail
Deposit ID:	<input type="text"/>	Tender Details	
Go to:	Corp Accounts		

Corporate Payments page.

You can process credit card payments on the Corporate Payments page using hosted payment or non-hosted payment mode, depending on your setup.

See: Student Financials 9.0 PeopleBook, Setting Up ePayment Processing

See: Student Financials 9.0 PeopleBook, Setting Up Cashiering, Defining the Transaction Setup of a Cashiering Office

The following documentation about the Corporate Payments page is based on non-hosted payment mode. For information about hosted payment mode, see the Hosted Payment section in the Student Payments page documentation.

With the exception of the following three links, this page is identical to the Student Payments page.

Note. The following links cannot be used if the institution uses Apply Payments by Invoice.

- | | |
|---|--|
| Select Students to Pay | Click to access the Select Students to Pay page, where you can specify the sponsored charges to which the system applies the corporate payment. |
| Third Party Info (third-party information) | Click to access the Third Party Info page, where you can enter tracking information if your corporate payment is associated with a third-party contract. |
| Corp Account (corporate account) | Click to access the Corporate Accounts page, where you can view the account information of a corporation. |

Note. *Restrict payment by invoice.*

If your institution specifies that it will apply payments by invoice, you can restrict payments to an invoice. When the target key is associated with an invoice cash or check payment, the cashier can restrict or select an invoice for which the payment is applied. The Restricted by Invoice label appears if Apply Payments by Invoice is selected on the SF Installation 2 page and the Cashier Target key is defined as Post.

See Also

Chapter 20, "Cashiering," Accepting Student Payments, page 527

Allocating Corporate Payments to Sponsored Charges

Access the Select Students Pay page (click the Select Students to Pay link on the Corporate Payments page).

Select Students to Pay page

ID	Enter the ID of the student whose charges the organization wants to pay. Only students included in the organization's third-party contract are available in the pick list.
All Terms	Select to apply the corporate payment to every term in which the sponsored student has a charge. If you select this check box, you cannot select a specific pay term.
Pay Term	If you do not select the All Terms check box, use this field to apply the corporate payment to sponsored student charges that are associated with only one specific term.
Total	This field displays the total amount of the sponsored student's charges to which the system can apply the corporate payment.
EmplID Org Detail (employee ID organization detail)	Click to access the Item Information page, where you can view the specific sponsored charges of the selected student.

Creating Third-Party Tracking Information for Corporate Payments

Access the Third Party Info page (click the Third Party Info link on the Corporate Payments page).

Third Party Info

Contract Number:

Contract ID:

Third Party Info page

Contract Number Enter the number of the third-party contract that you want to associate with this corporate payment.

Contract ID Enter the student ID of the third-party contract member that you want to associate with the corporate payment.

Creating Department Receipts

Access the Department Receipts page (Student Financials, Cashiering, Collect Department Receipts).

Department Receipts

Unit: PSUNV **Office:** Main Cashiering Office-7.5 Int **Business Date:** 03/22/1999
Register: REG2 **Cashier:** PS

Receipt Status: Not Posted

Target Total: 100.00 **Total Tax:** 0.00 **Tender Total:** 100.00

Reference Nbr:

Target Detail Find | View All First ◀ 1 of 1 ▶ Last

Amount: USD **Tax Authority:**

SpeedType: **ChartFields:**

Tender Detail Find | View All First ◀ 1 of 1 ▶ Last

***Tender:** Cash **Amount:** [Currency Detail](#)

Deposit ID: [Tender Details](#)

Department Receipts page

Note. If your institution does not use PeopleSoft General Ledger or Oracle General Ledger, the Ext GL Chartfield (external general ledger ChartField) field appears in the Target Detail group box instead of the standard ChartFields.

Receipt Status The system displays the status of the department receipt in this field. Before you click the Create Receipt button, this field displays the *Not Posted* value. After you click the Create Receipt button, the value changes to *Processed* if approval of the department receipt is not required. If approval is required, the value changes to *Pending* when you click the Create Receipt button.

ChartFields Click this link to select the chart of accounts to which your department receipt posts or enter the ChartField values in the display field.

Target Detail

Instead of specifying a target key as you do for student and corporate payments, you must select the chart of accounts to which your department receipt posts. In addition, if tax is associated with the department receipt, you must manually add a target row for the tax and specify its tax authority. For example, if you were processing a department receipt for 550 USD, of which 50 USD were tax, you would enter two target rows. The first nontax target row would be for 500 USD. The second tax target row would be for 50 USD.

Tax Authority Enter the tax authority that is associated with the amount of tax that you are including in the department receipt. You select a tax authority for the tax target row only.

Amount Enter the monetary amount for the target.

ChartFields Click to select the chart of accounts to which your department receipt posts. Click the SpeedType field to enter a SpeedType, which is a predefined set of ChartFields for a department your cashiering office works with regularly. After you enter the SpeedType, the system automatically populates the appropriate general ledger fields.

Tender Detail

Tender Enter the type of tender being used for the department receipt.

Amount Enter the amount of tender for the department receipt.

Currency Detail If the department receipt involves foreign currency, click this link to access the Currency Conversion page, where you select the method that the system uses to convert the currency.

Deposit ID If you assigned a deposit ID to the selected tender key when you opened the cashiering office, it appears in this field.

Tender Details

If you enter a check tender as the tender key, click this link to access the Check Information page where you enter specific information about the check tendered.

If you select a credit card tender as the tender key, click this link to access the Credit Card Information page, where you enter specific information about the credit card used.

For the Department Receipt, the credit card information is only stored. It is not processed by the third party vendor. The credit card authorization for the Department Receipt must be done outside of Campus Solutions.

Using the Department Receipt Buttons**Create Receipt, Print Receipt and Create and Print Receipt**

The label and functionality of this button changes according to the automatic receipt printing setup of your valid cashiers and valid registers.

If you are not printing automatically, the label of this button is Create Receipt. Click it to create a department receipt.

When you click the Create Receipt button, the label changes to Print Receipt. Click it to print the receipt using Forms Engine. Forms Engine generates the receipt and sends it to the appropriate printer as specified on the Valid Registers page.

If you are printing automatically, the label of this button is Create and Print Receipt. Click it to simultaneously create the receipt and print it using Forms Engine.

Note. If you do not select the Use Forms Engine for Receipts check box on the Cashiering Offices page, click the Print Receipt button or the Create and Print Receipt button to create a printable receipt using the specified print product (Crystal or other print method). In this case, you must navigate to Report Manager to view and print the receipt.

New Transaction

After you create a receipt, click this button to return to the Department Receipts dialog page so that you can process another department receipt.

See Also

[Chapter 2, "Completing Student Financials General Setup," Setting Up Tax Authorities and Tax Codes, page 34](#)

[Chapter 4, "Setting Up GL Interface Processing," \(Optional\) Creating ChartField SpeedType Keys, page 127](#)

Cashing Checks

Access the Cash Checks page (Student Financials, Cashiering, Cash Checks).

Cash Checks

Unit:	PSUNV	Office:	Walnut Creek Cashier's Office	Business Date:	09/24/2004
Register:	REG01	Cashier:	PS		

ID:	SFCA00017	Yoshimura, Peg A			
Balance:	4,750.00	Anticipated Aid:	2,500.00		

Ref Nbr:	<input type="text"/>	Create and Print Receipt	New Transaction		
-----------------	----------------------	--	---------------------------------	--	--

Target:	0.50	Tax:	0.00	Tender:	0.00	Pay Out Amt:	0.00
----------------	------	-------------	------	----------------	------	---------------------	------

Target Detail Find First 1 of 1 Last

Target:	Check Cashing Fee	Amount:	<input type="text" value="0.50"/>	USD
----------------	-------------------	----------------	-----------------------------------	-----

Tender Detail Find First 1-2 of 2 Last

*Tender:	<input type="text" value="CHECK-NOGL"/>	Check-NoGL	Amount:	<input type="text" value="50.00"/>	USD	Currency Detail
Deposit ID:	<input type="text" value="123"/>	Tender Details				

*Tender:	<input type="text" value="CASH-NO GL"/>	Cash-No GL	Amount:	<input type="text"/>	USD	Currency Detail
Tender Details						

Go to: [Academic Information](#) [Student Accounts](#) [View Anticipated Aid](#)

Cash Checks page

Note. The Target, Tax, Tender, and Pay Out Amt fields display the correct totals only after you click the Refresh button. If you make a change to any of the fields in the Target Detail group box or the Tender Detail group box, you must click the Refresh button for those changes to register in the display fields.

Target Detail

Target The system automatically selects the Check Cashing Fee target key. If you set up your check-cashing target key to tax the check-cashing fee, the system automatically inserts an additional target key for the tax.

Amount The system populates this field automatically with the check-cashing fee that you specified for the cashiering office. The cashier can override the default check-cashing fee.

If the system automatically inserts a tax target key, it supplies the appropriate target amount.

540

Copyright © 1988, 2010, Oracle and/or its affiliates. All Rights Reserved.

Tender Detail

Tender	Enter a check tender. If you press Tab to move out of this field, the system accesses the Check Information page.
Amount	Enter the amount of the check being cashed. If the currency tendered is not the base currency that you selected during the setup of your cashiering office, select the correct currency in the field to the right of the Amt field.
Currency Detail	If the student tenders foreign currency for the payment, click this link to access the Currency Conversion page, where you select the method that the system uses to convert the currency.
Deposit ID	If you assigned a deposit ID to the check tender key when you opened the cashiering office, it appears in this field.
Tender Details	Click to access the Check Information page, where you enter specific information about the check tendered.

Using the Go to Links

Student Accounts	Click to access the Student Accounts page, where you can view a student's account information.
Academic Information	Click to access the Student Personal Information page, where you can view a student's personal and academic information.
View Anticipated Aid	Click to access the Anticipated Aid Details page, where you can view details about the financial aid the student is anticipated to receive. This link appears on the page only if the student has anticipated financial aid.

Using the Cash Check Buttons

Create Receipt, Print Receipt and Create and Print Receipt

The label and functionality of this button changes according to the automatic receipt printing setup of your valid cashiers and valid registers.

If you are not printing automatically, the label of this button is Create Receipt. Click it to create a receipt for the cashed check.

When you click the Create Receipt button, the label changes to Print Receipt. Click it to print the receipt using Forms Engine. Forms Engine generates the receipt to the appropriate printer as specified on the Valid Registers page.

If you are printing automatically, the label of this button is Create and Print Receipt. Click it to simultaneously create the receipt and print it using Forms Engine.

Note. If you do not select the Use Forms Engine for Receipts check box on the Cashiering Offices page, click the Print Receipt or Create and Print Receipt button to create a printable receipt using the specified print product (Crystal or other print method). In this case, you must navigate to Report Manager to view and print the receipt.

New Transaction

After you create a receipt, click to return to the Cash Checks dialog page to cash another check.

Processing Interim Deposits

Access the Interim Deposits page (Student Financials, Cashiering, Cash Management, Make Interim Deposits, Interim Deposits).

Interim Deposits

Unit: PSUNV **Office:** Walnut Creek Cashier's Office **Business Date:** 09/24/2004
Register: REG01 **Cashier:** PS

Ref Nbr: [Create Receipt](#) [New Transaction](#)

Tender Total: -1,000.00

Tender Detail			
*Tender	Item Amount	Deposit ID	
CASH-NO GL <input style="width: 50px;" type="text"/> <small>Cash - Not to GL</small>	-1,000.00 <input style="width: 50px;" type="text"/> <small>USD</small> Currency Detail	123 <input style="width: 50px;" type="text"/>	Find First 1 of 1 Last

Interim Deposits page

Tender Detail

Tender

Enter the type of tender that you are removing from the drawer.

Item Amount	Enter the amount of tender that you are removing from the drawer. Remember that because you are removing tender from the drawer, you must enter a negative value in this field.
Currency Detail	If you are removing foreign currency from the drawer, click this link to access the Currency Conversion page, where you select the method that the system uses to convert the currency.
Deposit ID	If you assigned a deposit ID to the selected tender key when you opened the cashiering office, it appears in this field.

Using the Interim Deposit Buttons

Create Receipt	Click to create a receipt for the interim deposit. When you click the Create Receipt button, it becomes unavailable and the Print Receipt button appears.
Print Receipt	Click to create a report of the receipt that you just created. This button appears only after you click the Create Receipt button.

Note. You must use the Report Manager to view the report created when you click the Print Receipt button.

New Transaction	After you have created a receipt, click this button to return to the Interim Deposits dialog page so that you can process another interim deposit.
------------------------	--

Replenishing Cash

Access the Cash Replenishment page (Student Financials, Cashiering, Cash Management, Replenish Cash, Cash Replenishment).

Cash Replenishment

Unit: PSUNV	Office: Walnut Creek Cashier's Office	Business Date: 09/24/2004
Register: REG01	Cashier: PS	

Ref Nbr: <input style="width: 90%;" type="text"/>	Create Receipt	New Transaction
---	--------------------------------	---------------------------------

Tender Total: 2,500.00

Tender Detail		Find	First	1 of 1	Last
*Tender:	CASH-NO GL <input style="width: 80%;" type="text"/>	Cash - Not to GL	Amount:	2,500.00	USD

Cash Replenishment page

Tender Detail

Tender	Enter the tender key that you have set up for cash payments.
Amount	Enter the amount of cash that you are adding to the drawer.

Using the Cash Replenishment Buttons

Create Receipt	Click to create a receipt for the cash replenishment. When you click the Create Receipt button, it becomes unavailable and the Print Receipt button appears.
Print Receipt	Click to create a report of the receipt that you just created. This button appears only after you click the Create Receipt button.

Note. You must use the Report Manager to view the report created when you click the Print Receipt button.

New Transaction	After you create a receipt, click to return to the Cash Replenishment dialog page so that you can process another cash replenishment.
------------------------	---

Selecting Exchange Rates for Cashiering Transactions Processed with Foreign Currency

Access the Currency Conversion page (click the Currency Detail link on the Student Payments page, the Corporate Payments page, the Department Receipts page, or the Cash Checks page).

Currency Conversion

Exchange Rate Type: 

Exchange Rate: 0.78698710

Item Amount: 750.00 CAD

Converted Item Amount: 590.24 USD

Currency Conversion page

Exchange Rate Type	Enter the type of exchange rate that you want the system to use to convert the foreign currency.
Item Amount	This field displays the amount of foreign currency that is tendered to the cashier.

Converted Item Amount This field displays the amount after the system converts the foreign currency to your base currency.

Entering Check Information for Cashiering Transactions

Access the Check Information page (click the Tender Details link on the Student Payments page, the Corporate Payments page, the Department Receipts page, or the Cash Checks page).

Check Information

Check Nbr:	<input style="width: 60%;" type="text" value="1126"/>
Account Number:	<input style="width: 60%;" type="text" value="123456"/>
Bank Account Type:	<input style="width: 20px;" type="text" value="C"/> <input style="width: 300px;" type="text" value="Checking"/>
Bank Account Holder Name:	<input style="width: 90%;" type="text"/>
Federal Reserve Bank ID:	<input style="width: 80%;" type="text"/>
Third Party Check Name:	<input style="width: 90%;" type="text"/>
Bank Tracer Nbr:	<input style="width: 90%;" type="text"/>

Check Information page

Check Nbr (check number)	Enter the check number as printed on the check.
Account Number	Enter the customer's bank account number.
Bank Account Type	Enter the type of account, <i>C</i> (checking) or <i>S</i> (savings).
Bank Account Holder Name	Enter the name of the person on the account.
Federal Reserve Bank ID	If you know the Federal Reserve Bank ID of the bank issuing the check, enter it here.
Third Party Check Name	This field is available only if the tender category of the tender that you select on the Student Payments page is <i>Third Party Check</i> . Use this field to enter the name of the third party making the payment on the student's behalf.
Bank Tracer Nbr (bank tracer number)	Enter any information in this optional field to track or characterize the transaction.

Note. All of the fields on the Check Information page are optional and enable you to more easily track your check information. Some of the field values appear on your printed receipts.

Entering Credit Card Information for Cashiering Transactions

This section applies only if you use non-hosted payment mode.

Access the Credit Card Information page (click the Tender Details link on the Student Payments page, the Corporate Payments page, or the Department Receipts page).

Access the Credit Card Information page.

Credit Card Information

Card Type:  Visa Card

Card Number:

Expiration:

Security Code:

First Name:

Last Name:

Billing Information

Country:  United States

Address: [Edit Address](#)

Email Address:

Telephone:

Authorization Information

Credit Card Status: Pending Authorization

Credit Card Information page

Card Type Enter the type of credit card used for the transaction. This field is required.

Card Number	Enter the credit card number as it appears on the credit card. This field is required.
	<hr/> Note. Credit card numbers do not appear on the printed receipts. <hr/>
Expiration	Enter the expiration date of the credit card. This field is required.
Security Code	Enter the Security Code that is located on the credit card. The Security Code is a security feature for "card not present" transactions such as Internet transactions. The Security Code field is available if the Security Code Required check box is selected on the SF Merchants page.
	<hr/> Note. Security Code is supported for hosted payment mode and Integration Broker. It is not supported through Business Interlink. <hr/>
	See Chapter 3, "Setting Up ePayment Processing," Setting Up SF Merchants, page 100.
First Name	Enter the first name of the credit card holder as it appears on the credit card. If you accessed the Credit Card Information page from the Student Payment page, the default value for this field is the first name of the student making the payment. This field is required.
Last Name	Enter the last name of the credit card holder as it appears on the credit card. If you accessed the Credit Card Information page from the Student Payment page, the default value for this field is the first name of the student making the payment. This field is required.
Bank Tracer Nbr (bank tracer number)	Enter any information in this optional field to track or characterize the transaction.

Billing Information

Enter the billing information of the student or organization making the payment.

Note. If you use the third-party vendor business interlink for credit card processing of student payments, you must enter an email address and telephone number. Also, if the SF merchant ID associated with your cashiering office requires address verification, the billing address that you enter here must match the billing address recorded for the credit card; otherwise, the transaction will be denied.

Authorization Information

This group box displays the authorization details received from the third-party credit card processing vendor. Prior to a user authorizing the payment, the only field appearing in this group box is the Credit Card Status (credit card authorization status) field. After you authorize the transaction, the system displays the Reference Nbr (reference number), Authorization Reply, Auth Code (authorization code), Auth DTTM (authorization datetime), and Request ID fields.

See Also

Chapter 3, "Setting Up ePayment Processing," Setting Up Credit Card Types, page 83

Posting Delayed Receipts

If you select the Delay posting option during the setup of your cashiering office, you must use the Post Receipts page to select and post your payment receipts periodically throughout the day.

See Also

Chapter 10, "Setting Up Cashiering," Defining a Cashiering Office, page 313

Page Used to Post Delayed Receipts

Page Name	Definition Name	Navigation	Usage
Post Receipts	CSH_POST_RCPT	Student Financials, Cashiering, Post Receipts	Post delayed payment receipts.

Posting Delayed Payment Receipts

Access the Post Receipts page (Student Financials, Cashiering, Post Receipts).

Post Receipts

Business Unit: PSUNV **Business Date:** 09/24/2004
Cashier's Office: WALNUTCR Walnut Creek Cashier's Office

First Receipt Seq Nbr: 9 **Last Receipt Seq Nbr:** 20
Total Number of Receipts: 2 **Seq** 9 **to** 20

Unposted Receipts									
	Seq Nbr	Receipt Number	Register	Cashier	Total Amount	Trans Date	Time	Trans Type	ID
Post	9	1011	REG01	PS	100.00	09/24/2004	7:08:04PM	Student Payment	SFCA00017
Post	20	1022	REG01	PS	750.00	09/27/2004	1:07:29PM	Student Payment	SFCA00017

Post Receipts page

Posting Receipts

Post Click next to the unposted receipt that you want to post. When you click the button, the system posts the receipt and makes the button unavailable.

Processing the Cashiering GL Interface

You must process the cashiering GL (general ledger) interface to send to your GL any cashiering transactions that are not posted to a student or corporate account. You can send department receipts to the GL only through the cashiering GL interface process. However, if you process any transactions using nonpostable target keys but still need to send them to your GL, you must do so using the cashiering GL interface process. The system sends cashiering transactions using postable target keys to the GL using the regular GL interface process as long as you set up the item types that are associated with the applicable target keys to go to the general ledger. Use caution with target key and item type setup to ensure the following results:

- The system sends all necessary transactions to the GL through either one of the two GL interface processes.
- The system does not send transactions to the GL twice.

Furthermore, you can only send cashiering overage and shortage GL entries using the cashiering GL interface process. And if you select the GL Interface Required check box during the setup of your cashiering office, you must run the cashiering GL interface before you can close your cashiering office.

See Also

[Chapter 2, "Completing Student Financials General Setup," Setting Up Item Types and Item Type Groups, page 55](#)

[Chapter 10, "Setting Up Cashiering," Setting Up Target Keys, page 323](#)

Voiding Receipts

This section provides an overview of receipt voiding and discusses how to:

- Void receipts using security.
- Void receipts without using security.

Understanding Receipt Voiding

A processed or even a posted receipt may become invalid. A cashier could make a mistake when creating a receipt, a student's check could bounce, or an organization could stop payment on a check. In these cases, the Cashiering feature enables you to void a receipt.

Note. You can void receipts only for an open business day. If you want to void a receipt for a past business day, you must reopen the cashiering office for that business day.

Pages Used to Void Receipts

<i>Page Name</i>	<i>Definition Name</i>	<i>Navigation</i>	<i>Usage</i>
Void Receipts	CSH_VOID_SECURE	Student Financials, Cashiering, Cash Management, Void Receipts - Cashier	Using either SF or HR security, void the receipts created by you or any cashier who directly reports to you.
Void Receipts - All	CSH_VOID_RCPT	Student Financials, Cashiering, Cash Management, Void Receipts- All	Bypassing SF or HR security, void any receipts that are created on a given business day.

Voiding Receipts Using Security

Access the Void Receipts page (Student Financials, Cashiering, Cash Management, Void Receipts - Cashier).

This page is identical to the Void Receipts - All page.

This page is intended for use by the majority of your institution's cashiering staff when voiding receipts. It is a secure page in that it permits you to void only receipts that you, the user, generated. If you are a supervisor, the page also enables you to void the receipts of any cashiers that directly report to you.

Void

Click next to the receipt that you want to void. When you click the button, the system requires you to select a void reason. After you select a void reason, the system voids the receipt, makes the Void button unavailable, and displays the Void Code representing the void reason that you selected.

When you void a corporate or student payment receipt, the system reverses any payments that were posted to the respective corporate or student account. In addition, it may issue a credit to any credit card payments depending on the status of the credit card transaction.

If the Cashier's office is set to Group Post, the credit is issued to the third party vendor but you must adjust the transaction on the student's account or corporation's account.

If the SF Merchant is set up for real time credits, then dependent on the third party vendor, the credit is sent automatically to the vendor when the receipt is voided. If the SF Merchant is not set up for real time credits, the batch job must be run.

Voiding Receipts Without Using Security

Access the Void Receipts - All page (Student Financials, Cashiering, Cash Management, Void Receipts- All).

This page represents an alternate receipt-voiding method that bypasses your security. Very few people at your institution should have access to this page. It is intended only for individuals that oversee all of your institution's cashiering activities such as a Vice Chancellor or a Chief Financial Officer. The page enables you to void any receipt created for an open business day.

Void Receipts - All

Business Unit: PSUNV **Business Date:** 09/24/2004
Cashier's Office: WALNUTCR Walnut Creek Cashier's Office

First Receipt Seq Nbr: 1 **Last Receipt Seq Nbr:** 20
Total Number of Receipts: 20 ◀ ◀ Seq 1 to 20 ▶ ▶

Void Code	GL Run	Status	Receipt Number	Register	Cashier	Total Amount	Time	Trans Type	ID
Void	N	Delayed	1022	REG01	PS	750.00	1:07:29PM	Stdnt Pymt	SFCA00017
Void	N	Posted	1015	REG01	PS	250.00	7:36:13PM	Stdnt Pymt	SFCA00020
Void	N	Posted	1016	REG01	PS	100.00	7:45:12PM	Stdnt Pymt	SFCA00018
Void	N	Posted	1013	REG01	PS	100.00	7:34:08PM	Stdnt Pymt	SFCA00018
Void	N	Posted	1014	REG01	PS	150.00	7:35:22PM	Stdnt Pymt	SFCA00019
Void	N	Posted	1019	REG01	PS	500.00	11:25:15AM	Stdnt Pymt	SFCA00001
Void	N	Posted	1020	REG01	PS	500.00	12:00:29PM	Corp Pymt	000010065
Void	N	Posted	1017	REG01	PS	175.00	7:45:57PM	Stdnt Pymt	SFCA00019
Void	N	Posted	1018	REG01	PS	100.00	7:46:48PM	Stdnt Pymt	SFCA00020

Void Receipts - All page

See Also

[Chapter 20, "Cashiering," Voiding Receipts Using Security, page 550](#)

Reviewing Details for Individual Receipts

This section discusses how to review and print individual receipts.

Page Used to Review Details for Individual Receipts

<i>Page Name</i>	<i>Definition Name</i>	<i>Navigation</i>	<i>Usage</i>
Cash Check Detail Corporate Payment Detail Cash Replenishment Detail Department Receipt Detail Interim Deposit Detail Student Payment Detail	CSH_RCPT_DETAIL	<ul style="list-style-type: none"> • Student Financials, Cashiering, Review Check Cashing • Student Financials, Cashiering, Review Corporate Payments • Student Financials, Cashiering, Cash Management, Review Replenishment • Student Financials, Cashiering, Review Department Receipts • Student Financials, Cashiering, Cash Management, Interim Deposit Detail • Student Financials, Cashiering, Review Student Payments 	Review information regarding a specific receipt.

Reviewing and Printing Individual Receipts

Access the Cash Check Detail (Student Financials, Cashiering, Review Check Cashing), Corporate Payment Detail (Student Financials, Cashiering, Review Corporate Payments), Cash Replenishment Detail (Student Financials, Cashiering, Cash Management, Review Replenishment), Department Receipt Detail (Student Financials, Cashiering, Review Department Receipts), Interim Deposit Detail (Student Financials, Cashiering, Cash Management, Interim Deposit Detail), or Student Payment Detail page Student Financials, Cashiering, Review Student Payments) page. The page label, fields, and group boxes that appear on the inquiry page depend on the component that you use to access it.

Print Receipt

If you select the Use Forms Engine for Receipts check box on the Cashiering Offices page, click to print the receipt using Forms Engine. Forms Engine generates the receipt and sends it to the appropriate printer as specified on the Valid Registers page.

If you do not select the Use Forms Engine for Receipts check box on the Cashiering Offices page, or you click the Print Receipt button from the Cash Replenishment Detail or Interim Deposit Detail page, the system initiates the process of creating a printable receipt using the specified print application. In this case, you must navigate to Report Manager to view and print the receipt.

See Also

Chapter 20, "Cashiering," Processing Cashiering Transactions, page 524

Reviewing Receipt and Tender Activity

This section provides an overview of receipt and tender activity review and discusses how to:

- Review receipts by business date.
- Review payment activity for an organization.
- Review payment and check cashing activity for a student.
- Review tender activity by cashier.
- Review tender activity by register.
- Review receipt tender flow.

Understanding Receipt and Tender Activity Review

While the receipt detail pages (such as Student Payment Detail and Corporate Payment Detail) display useful information regarding individual receipts, they provide information only for one receipt at a time. Student Financials provides several pages enabling you to view your cashiering office's receipt activity as a whole.

In addition, Student Financials enables you to view cashiering activity by the type of tender used. For example, you might want to know how much cash your office brought in on a given day as opposed to how much revenue it received in checks.

Tender Flow

The Cashiering feature also enables you to review information regarding how tender flowed in and out of the cashiering office on a given business day. You can view the tender flow for a certain cashier, register, or tender type.

Pages Used to Review Receipt and Tender Activity

<i>Page Name</i>	<i>Definition Name</i>	<i>Navigation</i>	<i>Usage</i>
Receipts By Business Date	CSH_RCPT_BY_DATE2	Student Financials, Cashiering, Balance by Business Day, Review Receipts By Date	Review receipts by business date.

Page Name	Definition Name	Navigation	Usage
Corporate Receipts	CSH_RCPT_EXT_ORG	Student Financials, Cashiering, Review Corporate Receipts	Review payment activity for an organization.
Student Receipts	CSH_RCPT_EMPLID	Student Financials, Cashiering, Review Student Receipts	Review payment and check cashing activity for a student.
Tender By Cashier	CSH_TENDER_BY_CASH	Student Financials, Cashiering, Balance by Business Day, Review Tender By Cashier	Review tender activity by cashier.
Tender By Register	CSH_TENDER_BY_REG	Student Financials, Cashiering, Balance by Business Day, Review Tender By Register	Review tender activity by register.
Currencies by Tender	CURR_BY_TENDER_SP	Click the Currency Detail link on the Tender By Cashier or Tender By Register page.	View how much each type of currency contributed to the tender total and how the system converted the type of currency.
Receipt Tender Flow	CSH_OFF_TENDER_FLW	Student Financials, Cashiering, Balance by Business Day, Review Receipt Tender Flow	Review receipt tender flow.

Reviewing Receipts by Business Date

Access the Receipts By Business Date page (Student Financials, Cashiering, Balance by Business Day, Review Receipts By Date).

Receipts By Business Date

Business Unit: PSUNV **Office:** HACIENDA Hacienda Cashiering Office

Business Date: 05/05/2003 **Cashier:** LS **Register:** HAC01 **Trans Type:** All **Approval Status:**

Sort By: Date # (Asc) **Search**

First Receipt Seq Nbr: 1 **Last Receipt Seq Nbr:** 2

Total Number of Receipts: 2 **Seq** 1 **to** 2

Seq Nbr	Cashier	Register	Transaction Type	Transaction Date	Transaction Time	Total	Short Name	Receipt Nbr			
1	LS	HAC01	Stdnt Pymt	05/05/2003	11:52:43AM	150.00	Cancelled	1001			
2	LS	HAC01	Stdnt Pymt	05/05/2003	11:56:06AM	150.00	Posted	1002			

Receipts By Business Date page

- Business Date** Enter the business date for which you want to view receipt activity.
- Cashier** Use this field to filter the receipts displayed for a specific cashier.
- Register** Use this field to filter the receipts displayed for a specific register.
- Trans Type (transaction type)** Use this field to filter the receipts displayed by transaction type. You can select all transaction types, or you can view only *Cash Check* (cash checks), *Cash Repl* (cash replenishments), *Corp Pymt* (corporate payments), *Dept Rcpt* (department receipts), *Interim Deposits* (interim deposits), or *Stdnt Pymt* (student payments) transactions.
- Receipt Status** Use this field to filter the receipts displayed by status. Values are *Approved*, *Cancelled*, *Delayed*, *Denied*, *Group Post*, *Not Posted*, *Pending*, *Posted*, *Processed*, *Unprocessed*, and *Voided*.
- Sort By** Use this field to sort the displayed receipts. You can sort them by cashier, date, receipt status, register, total, transaction date and time, or transaction type. You can sort by all of these criteria in either ascending or descending order.
- Search** Click to filter and sort the displayed receipts by the criteria that you select in the Cashier, Register, Trans Type, and Sort By fields.

Reviewing Payment Activity for an Organization

Access the Corporate Receipts page (Student Financials, Cashiering, Review Corporate Receipts).

Corporate Receipts

Business Unit: PSUNV **Office:** WALNUTCR Walnut Creek Cashier's Office

External Org ID: Bechtel Corp

[Find](#) | [View All](#) First 1-2 of 2 Last

Business Date	Seq Nbr	Cashier	Register	Trans Date	Time	Approval Status	Total	Receipt Nbr
09/24/2004	7	PS	REG01	09/24/2004	6:19:41PM	Posted	750.00	1009
09/24/2004	8	PS	REG01	09/24/2004	6:39:38PM	Posted	500.00	1010

Corporate Receipts page

External Org ID Enter the ID of the corporation whose receipts you want to view.

Search Click the Search button to display the receipts for the selected corporation.

Receipt Nbr (receipt number) This heading lists the system-assigned receipt number for each receipt. Click a receipt number to access the Corporate Payment Detail page, where you can view more detailed information about the corporate payment receipt.













Reviewing Payment and Check Cashing Activity for a Student

Access the Student Receipts page (Student Financials, Cashiering, Review Student Receipts).

Student Receipts

Business Unit: PSUNV **Office:** WALNUTCR Walnut Creek Cashier's Office

ID:  Chappell,Thomas [Academic Information](#)

Business Date	Seq Nbr	Cashier	Register	Trans Date	Time	Tran Type	Total	Approval Status	Receipt Nbr	
09/24/2004	17	PS	REG01	09/27/2004	11:25:15AM	Stdnt Pymt	500.00	Posted	1019	  
09/24/2004	1	PS	REG01	09/24/2004	4:23:52PM	Stdnt Pymt	750.00	Posted	1003	  
09/24/2004	5	PS	REG01	09/24/2004	5:28:49PM	Cash Check	0.50	Processed	1007	  
09/24/2004	6	PS	REG01	09/24/2004	6:00:48PM	Stdnt Pymt	200.00	Posted	1008	  

Student Receipts page

ID Enter the ID of the student whose receipts you want to review.

Search Click the Search button to display the receipts for the selected student.

Receipt Nbr (receipt number) This heading lists the system-assigned receipt number for each receipt. Click a receipt number to access the Student Payment Detail page or the Cash Check Detail page, depending on the transaction type, where you can view more detailed information about the receipt.

Reviewing Tender Activity by Cashier

Access the Tender By Cashier page (Student Financials, Cashiering, Balance by Business Day, Review Tender By Cashier)

Tender By Cashier

Business Unit: PSUNV **Office:** Walnut Creek Cashier's Office

Cashier Office Date: **Total Balance:** 6,526.00

Total by Tender Key Find First ◀ 1-3 of 3 ▶ Last

Tender Key	Tender Total Amount
Cash - Not to GL	3,791.00
Credit Card - Not to GL	425.00
Check - Not to GL	2,310.00

Detail by Cashier Find | View 1 First ◀ 1-3 of 3 ▶ Last

Cashier:	APPR1	Total:	0.00
<hr/>			
Cashier:	PS	Total:	6,526.00
	CASH-NO GL		3,791.00
	CC - NO GL		425.00
	CHECK-NOGL		2,310.00
<hr/>			
Cashier:	PSSA	Total:	0.00

Tender By Cashier page

Cashier Office Date Enter the business date of the tender activity that you want to view.

Search Click to retrieve the tender activity information for the selected business date.

Currency Detail Click to access the Currencies by Tender page, where you can view a breakdown of each currency type that the cashiering office received, its converted amount, and how it contributed to the total balance for the tender key.

Reviewing Tender Activity by Register

Access the Tender By Register page (Student Financials, Cashiering, Balance by Business Day, Review Tender By Register).

Tender By Register

Business Unit: PSUNV **Office:** Walnut Creek Cashier's Office

Cashier Office Date:  **Total Balance:** 6,526.00

Total by Tender Key		Find	First	1-3 of 3	Last
Tender Key	Tender Total Amount				
Cash - Not to GL	3,791.00				
Credit Card - Not to GL	425.00				
Check - Not to GL	2,310.00				

Detail by Register		Find	View All	First	1 of 2	Last
Register:	REG01	Total:		6,526.00		
	CASH-NO GL			3,791.00		
	CC - NO GL			425.00		
	CHECK-NOGL			2,310.00		

Tender By Register page

Cashier Office Date Enter the business date of the tender activity that you want to view.

Search Click to retrieve the tender activity information for the selected business date.

Currency Detail Click to access the Currencies by Tender page, where you can view a breakdown of each currency type that the cashiering office received, its converted amount, and how it contributed to the total balance for the tender key.

Reviewing Receipt Tender Flow

Access the Receipt Tender Flow page (Student Financials, Cashiering, Balance by Business Day, Review Receipt Tender Flow).

Receipt Tender Flow									
Business Unit:		PSUNV		Office:		WALNUTCR Walnut Creek Cashier's Office			
Business Date		Cashier		Tender		Register			
09/24/2004									
<input checked="" type="checkbox"/> Include in Totals		Opening Balance		3,500.00		Search			
Find View All First 1-7 of 22 Last									
Seq Nbr	Cashier	Register	Trans Date	Time	Tender	Amount	Total	Rcpt Status	Receipt Nbr
1	PS	REG01	09/24/2004	4:23:52PM	CHECK-NOGL	750.00	4,250.00	Posted	1003
2	PS	REG01	09/24/2004	4:25:00PM	CASH-NOGL	100.00	4,350.00	Processed	1004
3	PS	REG01	09/24/2004	5:24:23PM	CHECK-NOGL	10.00	4,360.00	Processed	1005
3	PS	REG01	09/24/2004	5:24:23PM	CASH-NOGL	-9.50	4,350.50	Processed	1005
4	PS	REG01	09/24/2004	5:28:03PM	CASH-NOGL	2,000.00	6,350.50	Processed	1006
5	PS	REG01	09/24/2004	5:28:49PM	CHECK-NOGL	50.00	6,400.50	Processed	1007
5	PS	REG01	09/24/2004	5:28:49PM	CASH-NOGL	-49.50	6,351.00	Processed	1007
Over/Short:						-7,401.00	2,625.00		

Receipt Tender Flow page

Business Date Enter the business date for which you want to view tender flow.

Cashier To view tender flow for a specific cashier, select the cashier.

Tender To view tender flow of a specific tender key, select the tender key.

Register To view tender flow for a specific register, select the register.

Include in Totals Select to add the opening balance of the cashiering office to the tender in and out activity to come up with a system-generated closing balance.

Opening Balance After you click the Search button, this field displays the total of all of the opening balances that you specified for your cashiers or registers when you opened the cashiering office.

Note. If you select a specific cashier or register in the Cashier field or the Register field, the Opening Balance field reflects the opening balance for only the selected cashier or register.

Search Click to display all of the receipts that meet the criteria that you select in the Business Date, Cashier, Tender, and Register fields.

Receipt Nbr (receipt number)	This heading lists the system-assigned receipt number for each receipt. If you click the receipt number for a receipt, the system accesses the appropriate detail page to view complete information about the receipt. For example, if you click the receipt number for a student payment, the system accesses the Student Payment Detail page.
Over/Short	The system calculates any overage or shortage by comparing the actual closing balance entered on the Close Cashier page to the system-generated closing balance, which appears to the right of the Over/Short field. If an overage or shortage exists, you should inquire on specific tenders to narrow down the cause.

Reviewing Totals by Deposit ID

When you open your cashiers and registers using the Open Registers and Open Cashiers pages, you can designate a deposit ID for each type of tender that you select for a cashier or register. If you use the optional Deposit ID field to track your cashiering transactions, you can view your totals by deposit ID.

In addition, when you use the Student Post, Corp Post, Group Data Entry, or Group Corp Data Entry components to post payments, you can assign a deposit ID to each posting. The Totals By Deposit page enables you to see totals for these payments in addition to the totals associated with cashiering transactions. This is useful if you reconcile all of your bank deposits through your cashiering office.

See Also

[Chapter 20, "Cashiering," Opening Valid Registers, page 522](#)

[Chapter 20, "Cashiering," Opening Valid Cashiers, page 523](#)

[Chapter 21, "Maintaining Receivables," page 571](#)

Page Used to Review Totals by Deposit ID

<i>Page Name</i>	<i>Definition Name</i>	<i>Navigation</i>	<i>Usage</i>
Totals By Deposit ID	CSH_RCPT_DEPOSITID	Student Financials, Cashiering, Balance by Business Day, Review Totals by Deposit ID	Review cashiering office balance totals by deposit ID.

Reviewing Cashiering Office Balance Totals by Deposit ID

Access the Totals By Deposit ID page (Student Financials, Cashiering, Balance by Business Day, Review Totals by Deposit ID).

Totals By Deposit ID

Business Unit: PSUNV **Cashier's Office:** Walnut Creek Cashier's Office

Deposit ID:

	Cashiering	Non Cashiering	Total
Posted:	1,875.00	0.00	3,125.00
Unposted:	1,250.00		1,250.00
			1,875.00

Business Date	ID	Org ID	Register	Cashier	Trans Date	Description	Receipt Number	Status	Rev	Total
09/24/2004	SFCA00018		REG01	PS	09/24/2004		1013	Posted		100.00
09/24/2004	SFCA00019		REG01	PS	09/24/2004		1014	Posted		150.00
09/24/2004	SFCA00020		REG01	PS	09/24/2004		1015	Posted		250.00
09/24/2004	SFCA00018		REG01	PS	09/24/2004		1016	Posted		100.00
09/24/2004	SFCA00019		REG01	PS	09/24/2004		1017	Posted		175.00
09/24/2004	SFCA00020		REG01	PS	09/24/2004		1018	Posted		100.00
09/24/2004	SFCA00001		REG01	PS	09/27/2004		1019	Posted		500.00
09/24/2004		000010065	REG01	PS	09/27/2004		1020	Posted		500.00
09/24/2004			REG01	PS	09/27/2004		1021	Processed		500.00
09/24/2004	SFCA00017		REG01	PS	09/27/2004		1022	Delayed		750.00

Totals By Deposit ID page

Deposit ID Enter the deposit ID for which you want to view totals.

Search Click to display all of the payments that are associated with the selected deposit ID.

Closing a Cashiering Office for a Business Day

This section discusses how to:

- Close registers.
- Close cashiers.
- Close a cashiering office.

Pages Used to Close a Cashiering Office for a Business Day

Page Name	Definition Name	Navigation	Usage
Close Registers	CSH_CLOSE_REGISTER	Student Financials, Cashiering, Cash Management, Close Offices, Close Cashier Offices	Close registers.
Close Cashier	CSH_CLOSE_CASHIER	Student Financials, Cashiering, Cash Management, Close Offices, Close Cashier Offices	Close cashiers.
Close Offices	CSH_CLOSE_OFFICE	Student Financials, Cashiering, Cash Management, Close Offices, Close Cashier Offices	Close a cashiering office.

Closing Registers

Access the Close Registers page (Student Financials, Cashiering, Cash Management, Close Offices, Close Cashier Offices).

Close Registers page

- Close** Select to close the register. When you select this check box, the system makes it unavailable. If you have multiple open registers, be sure to close them all because you cannot close the cashiering office for a given business day until you close all of its open registers.
- Closing Balance** If you are balancing by register, enter the closing balance for each type of tender used during the business day.
- Over/Short Amount** When you enter a closing balance for a tender, the system calculates and displays the amount of any overage or shortage under this heading. If you processed any foreign-currency transactions during the business day, the tender for each currency appears so that you can record a closing balance.

Closing Cashiers

Access the Close Cashier page (Student Financials, Cashiering, Cash Management, Close Offices, Close Cashier Offices).

The screenshot shows the 'Close Cashier' page with the following details:

- Navigation:** Close Registers, Close Cashier (selected), Close Offices
- Business Unit:** PSUNV
- Cashier's Office:** WALNUTCR Walnut Creek Cashier's Office
- Business Date:** 10/18/2004
- Cashier:** PS Close

	Closing Balance		Over/Short Amt
Cash - Not to GL	<input type="text"/>	USD	-100.00
Credit Card - Not to GL	<input type="text"/>	USD	-89.00
Check - Not to GL	<input type="text"/>	USD	-150.00

Close Cashier page

- Close** Select to close the cashier. When you select this check box, the system makes it unavailable. If you have multiple open cashiers, be sure to close them all, because you cannot close the cashiering office for a given business day until you close all of its open cashiers.
- Closing Balance** If you are balancing by cashier, enter the closing balance for each type of tender used during the business day.

Over/Short Amount When you enter a closing balance for a tender, the system calculates and displays the amount of any overage or shortage under this heading. If you processed any foreign-currency transactions during the business day, the tender for each currency appears so that you can record a closing balance.

Closing a Cashiering Office

Access the Close Offices page (Student Financials, Cashiering, Cash Management, Close Offices, Close Cashier Offices).

Close Registers Close Cashier **Close Offices**

Business Unit: PSUNV
Cashier's Office: WALNUTCR Walnut Creek Cashier's Office
Current Business Date: 10/18/2004 Close

Find View All First 1 of 2 Last		
Business Date	Closed By	Close Datetime
10/18/2004		

Close Offices page

Close Click to close the cashiering office. When you click this button, the system populates the Closed By and Datetime fields, recording who closed the cashiering office and when it was closed.

Note. During the setup of your cashiering office, you determine the closing requirements of your office. If you have not met these requirements when you click the Close button, you will receive an error message telling you what you must do before you can close your cashiering office.

See Also

Chapter 10, "Setting Up Cashiering," Defining the Basic Cashiering Office Parameters, page 314

Reopening a Cashiering Office for a Closed Business Day

Situations may occur that require you to reopen a cashiering office for a business day that you have already closed. For example, to void a receipt from a closed business day, you must reopen your cashiering office for that business day.

Note. After performing the transaction that required the reopening of the cashiering office, be sure to close it again.

This section discusses how to:

- Reopen a cashiering office.
- Reopen registers.
- Reopen cashiers.

Pages Used to Reopen a Cashiering Office for a Closed Business Day

<i>Page Name</i>	<i>Definition Name</i>	<i>Navigation</i>	<i>Usage</i>
Reopen Office	CSH_REOPEN_OFFICE	Student Financials, Cashiering, Cash Management, Reopen Offices, Reopen Office	Reopen a cashiering office for a previously closed business date.
Reopen Register	CSH_OPEN_REGISTER	Student Financials, Cashiering, Cash Management, Reopen Offices, Reopen Register	Reopen registers for a previously closed business day.
Reopen Cashier	CSH_OPEN_CASHIER	Student Financials, Cashiering, Cash Management, Reopen Offices, Reopen Cashier	Reopen cashiers for a previously closed business day.

Reopening the Office

Access the Reopen Office page (Student Financials, Cashiering, Cash Management, Reopen Offices, Reopen Office).

Reopen Office		Reopen Register		Reopen Cashier	
Business Unit:	PSUNV				
Cashier's Office:	WALNUTCR	Walnut Creek Cashier's Office			
Current Business Date:	<input type="text" value="09/24/2004"/>	<input type="button" value="Reopen Cashier Office"/>			
Find View All First ◀ 1-2 of 2 ▶ Last					
Business Date	Opened By	Open Datetime	Closed By	Close Datetime	Last Sequence
09/24/2004	PS	09/24/2004 7:43:55PM			20
03/22/1999	PSSA	03/22/1999 2:11:04PM			0

Reopen Office page

Current Business Date Enter the business date for which you want to reopen the cashiering office.

Business Date This heading displays business dates for which you opened the cashiering office. The system displays all of the business dates on which you opened the cashiering office unless you select a retrieval limit on the Cashiering Offices page during the setup of your cashiering office. For example, if you specify a retrieval limit of 5 for your cashiering office, the Business Date heading displays only the last five dates on which you opened the cashiering office.

Note. If you do not specify a retrieval limit for your cashiering office during setup, the Business Date heading displays all business dates on which you opened the cashiering office. In time, this list of dates will become so long that it can degrade system performance when you open the Open Cashier Offices page.

Reopen Cashier Office Click to reopen the cashiering office. When you click this button, the Current Business Date field becomes unavailable.

Reopening Registers

Access the Reopen Register page (Student Financials, Cashiering, Cash Management, Reopen Offices, Reopen Register).

Reopen Office | **Reopen Register** | Reopen Cashier

Business Unit: PSUNV
Cashier's Office: WALNUTCR Walnut Creek Cashier's Office

Business Date: 03/22/1999

*Register: REG01 Open

*Tender Key		Deposit ID	Opening Balance		
CASH	Cash - 7.5 Integration			USD	+ -
CHECK	Check - 7.5 Integration			USD	+ -
CREDITCARD	Credit Card			USD	+ -

Reopen Register page

Register Enter the register that you want to reopen for the business day. The system automatically selects the registers from the business day for which you are reopening the cashiering office.

Open Select to reopen this register for the business day. After you select the check box, it becomes unavailable.

Tender Key Each tender key that you assigned to the register when you originally opened the office appears automatically.

Deposit ID The deposit IDs that you assigned to each tender key appear automatically.

Opening Balance If you balance by register, enter an opening balance for each tender key.

Reopening Cashiers

Access the Reopen Cashier page (Student Financials, Cashiering, Cash Management, Reopen Offices, Reopen Cashier).

Reopen Office Reopen Register **Reopen Cashier**

Business Unit: PSUNV
Cashier's Office: WALNUTCR Walnut Creek Cashier's Office

Find | View All First 1 of 1 Last

Business Date: 03/22/1999

Find | View All First 2 of 2 Last

*Cashier: PSSA Register: REG01 Open

Find First 1-3 of 3 Last

*Tender Key		Deposit ID	Opening Balance		
CASH	Cash - 7.5 Integration		1,000.00	USD	
CHECK	Check - 7.5 Integration			USD	
CREDITCARD	Credit Card			USD	

Reopen Cashier page

- Cashier** The system automatically selects the cashiers from the business day for which you are reopening the cashiering office.
- Register** The register that you originally assigned to this cashier when you first opened the office automatically appears.
- Open** Select to reopen the cashier for the business day.
- Tender Key** Each tender key that you assigned to the cashier when you originally opened the office appears automatically.
- Deposit ID** The deposit IDs that you assigned to each tender key appear automatically.
- Opening Balance** If you balance by cashier, enter an opening balance for each tender key.

Chapter 21

Maintaining Receivables

This chapter lists common elements and discusses how to:

- Enter groups of transactions.
- Enter transactions from an external source.
- Process payroll deductions.
- Review and revise group data entries before posting.
- Post group data entries.
- Post transactions for individual students and organizations.
- Consolidate and review transactions for individual students and organizations.
- View account information within the Maintain Receivables feature.
- View payment by invoice information within the Maintain Receivables feature.
- Manage disputed charges.
- Reverse payments and charges.
- Apply payments.
- Write off charges and account balances.
- Process enrollment deposits.
- Process late fees.
- Process late fees – billing.
- Process enrollment cancellation.
- Validate tables.

Common Elements Used in This Chapter



Click to view the first group of transactions.



Click to view the previous group of transactions.



Click to view the next group of transactions.



Click to view the last group of transactions.

Account Nbr (account number)	This field displays the account number that is assigned by the Student Financials application to the line item.
Acct Term (accounting term)	This field displays the accounting term that is assigned by the Student Financials application to the line item.
Anticipated Aid	This field displays financial aid that was awarded to the student but not yet disbursed.
Balance	This field displays the positive or negative balance of any active account.
Billing Date	This field displays billing dates that are specified for charges.
Business Unit	This field displays the business unit of the transactions.
Contract ID	This field displays the student ID or IDs that are associated with a third-party contract sponsored by the corporation for which you are viewing account information.
Contract Number	This field displays the contract number of any third-party contracts that are sponsored by the corporation for which you are viewing account information.
Descr (description)	This field displays the description of the item type.
Due Amount	This field displays the amount that is due on a charge and is displayed in conjunction with the Due Date field.
Due Date	This field displays the date on which a charge is due.
Effective Date	This field displays the item effective date of the transaction.
Item Amount	This field displays the amount of the transaction item.
Item Balance	This field displays the remaining balance of the item.
Item Type	This field displays the item type number.
Line Seq Nbr (line sequence number)	This field displays the sequence number of transactions that involve multiple item lines.
Name	This field displays the name of the student that is associated with a third-party contract for which a sponsor is being charged.
Net Award	This field displays the student's anticipated financial aid.
Posted Date & Time	This field displays the date and time that a transaction was posted.

Term This field displays the term of the transaction.

Entering Groups of Transactions

This section provides an overview of group data entry and discusses how to:

- Define source information and control totals for group transactions.
- Add transactions to a group entry.

Understanding Group Data Entry

PeopleSoft Student Financials enables you to post transactions for a group of students or organizations, which enables you to quickly and easily post many receivables without having to post and approve each one individually. Student Financial Cashiering Office application has the option to create Group Data entries. In addition, charges and payments from external sources can be loaded through the SF External File Load process, and these transactions populate the Group Data Entry tables.

To enter groups of transactions for students and organizations, access the pages using the Group Data Entry and Group Corp Data Entry components, respectively. To approve groups of transactions, use the same two pages, but access them from the worklist.

Pages Used to Enter Groups of Transactions

<i>Page Name</i>	<i>Definition Name</i>	<i>Navigation</i>	<i>Usage</i>
Group Entry	GROUP_ENT_ONE	Student Financials, Charges and Payments, Group Processing, Create Group Data Entries, Group Entry Student Financials, Charges and Payments, Group Processing, Create Group Corp Data Entries, Group Corp Entry	Define source information and control totals for group transactions.
Group Line Entry	GROUP_LINE_CNTRL	Student Financials, Charges and Payments, Group Processing, Create Transactions, Group Line Entry Student Financials, Charges and Payments, Group Processing, Create Corporate Transactions, Group Corp Line Entry	Add transactions to a group entry.

Defining Source Information and Control Totals for Group Transactions

Access the Group Entry page (Student Financials, Charges and Payments, Group Processing, Create Group Data Entries, Group Entry).

Group Entry		Group Line Entry	
Business Unit:	PSUNV	Group ID:	000000000000034
*Group Type:	H Housing	*Accounting Date:	10/13/2004
*Origin ID:	00010 Housing	*Received:	10/13/2004
Original Group ID:		*Entry Date:	10/13/2004
Control Totals		Operator:	PS
Balance Group:	<input type="checkbox"/>	Assign To:	Approval Information
Control Total:	0.00 USD 0	Display Option	
Entered Total:	10,500.00 5	Range in DB:	1 to 5
Difference:	-10,500.00 -5	Display:	1 to 5
Posted Total:	10,500.00 10/13/2004 5	Total in DB:	5
Effective Status			
Edit Status:	Edited	Posting Status:	Complete
Deposit Balance:	Not Balan	Process Instance:	
*Posting Action:	Posted		

Group Entry page

Note. The system uses all of the information on this page as group control information and does not post it to student or corporate accounts.

- Group Type** Enter the group type that describes the transactions.
- Accounting Date** Enter the accounting date for the transactions. The default value is the current system date, but you can change it if necessary.
- Origin ID** Enter an origin ID to indicate the source of the transactions. Depending on the origin ID, approval for the transactions might be required. SF Security can be placed on this field to allow individual sources (origins) to access only their groups of transactions.
- Received** Enter the date on which your office received payment or charge transactions.
- Original Group ID** This field is populated after the Reverse Groups process runs. The Reverse Group process creates a new group ID representing the transactions that were reversed, and this field will reference the original group ID.
- Entry Date** Enter the date that you are entering the transactions.

Operator This field displays the ID of the user who is entering transactions.

Assign To Reserved for future use.

Note. For groups requiring approval, the Approval Information link appears following the Assign To field. This link gives you the Original Approver ID, Approved At Date/Time Stamp, Last Approver ID, and Approved At Date/Time Stamp data. This link does not replace the Assign To field, it just provides further information about the content of the field.

Control Totals

Balance Group Select this option to require that the group be in balance before the system posts it. To determine whether a group is balanced, the system compares the number of transactions and amounts to information in the control totals fields.

Control Total Enter the monetary sum of the transactions in the group in the Control Total field and enter the total number of transactions in the group in the unlabeled field to the right. For example, if you are entering a group of checks that was received from students, enter the total monetary value of the checks in the Control Total field and the number of checks (count) in the unlabeled field. If the external file load process is used and the external file setup defines control totals, these fields are populated through the file load process.

Entered Total These fields display the monetary amount of all transactions that are entered in the batch and the count of the entries.

Difference These fields display the difference between the entered totals and the control totals.

Posted Total These fields display the monetary total, posting date, and count of the entries after the batch is posted.

Display Option

The display option enables you to view multiple rows. The number of transaction rows that are *chunked* (viewable at one time) is controlled by the maximum row settings selection in the SF Installation setup.

Range in DB This field displays the range of sequence numbers within the group ID.

Display This field displays the range of sequence numbers that is currently displayed. The display range is the viewable "chunk."

Total in DB This field displays the total number of transactions within the group ID.

Effective Status**Edit Status**

This field displays whether the batch has been edited.

Deposit Balance

This field displays whether the batch is balanced. You must select the Balance Group check box and the batch must balance for this field to display *Balanced*.

Posting Action

Select one of these values:

Available for Posting: If no approval is required, the field contains this value.

Do Not Post: If you are approving this posting group, select this option to hold the group for further review.

Posted: Indicates that the group has been posted.

Waiting for Approval: If approval is required, the field contains this value.

Posting Status

This field displays the posting status. Possible values for this field are *Balance, Complete, Error, Incomplete, Not Posted,* and *Reversed*.

Process Instance

This field displays the process instance number assigned by the process scheduler. This field is only populated if the posting job is not successful. To post a corrected group, you must remove the process instance number using the Reset Process Instance button on the Group Post Run Control page.

Adding Transactions to a Group Entry

Access the Group Line Entry page (Student Financials, Charges and Payments, Group Processing, Create Transactions, Group Line Entry).

Group Entry		Group Line Entry	
Business Unit:	PSUNV	Group ID:	0000000000000033
Find View All First 1 of 4 Last			
Line Nbr:	1	Mark For Delete + -	
ID:	SFEK00048	Poncil,Michael N	
Balance:	5,489.00		
Account Type:	TUT	Tuition	
Item Type:	3000000000002	Check	
Amount:	1,000.00 USD	Charge Priority:	ALL
Term:	0487	Service Indicator:	<input type="checkbox"/>
Ref Nbr:	<input type="text"/>	<input type="checkbox"/> Use Excess Account	<input type="checkbox"/>
		<input checked="" type="checkbox"/> Restrict Payment to Account	
		<input type="checkbox"/> Restrict to Invoice	<input type="text"/>
Payment Information		Dates	
Payment ID:	<input type="text"/>	Item Effective Date:	05/06/2003
Pay Method:	Check	Due Date:	<input type="text"/>
Payment Details			
Academic Information	Application Information	Tender Details	

Group Line Entry page

Line Nbr (line number) This field displays the line number of the current entry. This field increments as each new entry line is added.

ID Enter the ID for the student that you are adding to the group.

Balance This field displays the current balance of the student's account.

Account Type Select the account type of the new entry. The description of the account type appears to the right of the field.

Note. Specifying an account type for a payment transaction is optional.

Item Type Select the item type of the new entry. The description of the item type appears to the right of the field.

Warning! We strongly advise that you do *not* enter refund item types through Group Post. If you enter a refund item type through Group Post, the Refund Table is not updated. If you try to reverse the refund item type through the Group Reversal process, the reversal process tries to reverse all items with the same refund number. Refund item types that are posted through Group Post have a refund number of zero because they are not true refunds. Posting reverses all items on the account with a refund number of zero, that is, all items on the account that are not refunds.

Charge Priority	The charge priority list that is attached to the selected item type (credit item types only) appears in this field. You may override this value.
Amount	Enter the item (charge or payment) amount of the transaction.
Use Excess Account	Select to direct payment amounts in excess of the charge to another account. Enter the target account in the field to the right.
Restrict Payment to Account	Select to keep the entire amount of the payment in the account. Selecting this option prevents an excess payment from being transferred to an excess payment account.
Restrict to Invoice	If your institution specifies that it will apply payments by invoice, you can restrict payments to an invoice.
Term	Enter the term for which you want to post this transaction.
Ref Nbr (reference number)	Enter an optional reference number to track the transaction.
Service Indicator	If this transaction is a write-off, the system populates the write-off service indicator code.

Payment Information

Payment ID	Enter a payment ID in this field to reverse a payment. When you exit the field, the system populates the remaining fields on the page with the original payment information.
Pay Method	If the payment item type is set up to be tender-specific, the tender value appears in this field. If the field is not populated, you may select a payment method (tender).

Dates

Item Effective Date	Enter the date on which the transaction becomes active. The default value is the current date.
Due Date	Enter an optional due date for charge transactions. If you leave this field blank, the billing program populates the field in the student's account.

Mark For Delete	Click to select a particular row on the group entry page of the non-posted group for deletion. <hr/> Note. This button only appears for non-posted rows on the Create Transaction page and when the posting status value is <i>Not Complete</i> . When you click the button, the label changes to Unmark for Delete. You can post the group and this transaction will not be posted, but you will still have a record of it as part of the group for audit or reconciliation purposes. You can later correct the item, click Unmark for Delete, and repost the group. <hr/>
Currency Detail	Click to access the Currency Conversion page, where you can change the exchange rate type on payment item types if you changed the default currency code.
Payment Details	Click to access the Payment Details page, where you can review details about the payment that was made. You can review the details about the payment for a payment item type, but typically, when you post a payment, you would use this page to enter data to which the payment should apply. For example, posting a payment toward payment plans, you could enter the specific contract number or post a payment for a specific career or class if you only want the payment to go towards one career or a particular class.
Academic Information	Click to access the Academic Information page, where you can review the student's enrollment information.
Application Information	Click to access the Application Information page, where you can review the student's application status.
Tender Details	Click to access the Check Information page, where you can enter details about a payment by check. When entering a specific item type that is attached to a particular tender type (check or credit card), this page appears so that you can enter specific tender details. Otherwise, click the link to view the tender details.

Entering Transactions from an External Source

Many institutions receive transaction information from external sources, such as third-party housing and parking applications, and lock box services. Loading external files enables you to maintain your receivables with transactions created by sources both outside and inside your institution.

This section discusses how to load external files.

Page Used to Enter Transactions from an External Source

Page Name	Definition Name	Navigation	Usage
External Files	RUNCTL_SFGPLOAD	Student Financial, Charges and Payments, Group Processing, External Files	Load external files.

Loading External Files

Access the External Files page (Student Financial, Charges and Payments, Group Processing, External Files).

External Files

Run Control ID: 1 [Report Manager](#) [Process Monitor](#) Run

Parameters

Business Unit: PeopleSoft University Bursar **Report Only**

File Name:

File Directory:

Group Type:

Layout ID:

Balance the Group

External Files page

Parameters

- Business Unit** Enter the business unit that uses the file.
- File Name** Enter the name of the data file. Do not include the file extension. The extension on data files must always be *.dat*.
- File Directory** Enter the file directory where the file was stored.
- Group Type** Enter the appropriate group type for the data source.
- Layout ID** Enter the layout ID that you defined for the type of file that is being loaded.
- Balance the Group** If you select this check box, the Balance Group check box is selected when you access the Group Entry page.

Report Only Select this option to generate a report to review the contents of the file after the file is loaded into Group Data Entry.

See Also

Chapter 11, "Setting Up Receivables Maintenance," Setting Up External File Layouts, page 355

Processing Payroll Deductions

This section lists prerequisites for payroll deduction processing and discusses how to:

1. Select payroll deduction records.
2. Review results of payroll deduction record selection.
3. Create payroll deduction groups.

See Also

Chapter 11, "Setting Up Receivables Maintenance," Understanding Payroll Deduction, page 359

Prerequisites

Before Student Financials can retrieve deduction information from PeopleSoft Payroll for North America, your payroll department must calculate payroll deductions as part of its normal payroll process. The system stores payroll deduction records in the PS_PAY_DEDUCTION table.

Note. Consult your Payroll for North America staff for more information about how they calculate payroll deductions for employees.

See Also

PeopleSoft Enterprise Payroll for North America 9.0 PeopleBook, "Defining Deductions"

Pages Used to Process Payroll Deductions

<i>Page Name</i>	<i>Definition Name</i>	<i>Navigation</i>	<i>Usage</i>
Select SA Payroll Deduction	RUNCTL_PAYINIT_SF1	Student Financials, Charges and Payments, Payroll Deduction Processing, Process SA Payroll Deduction, Select SA Payroll Deduction	Select PeopleSoft Enterprise Student Administration payroll deduction records.
SA Payroll Deduction Summary	SF_PAYDED_SUMMARY	Student Financials, Charges and Payments, Payroll Deduction Processing, Review Deduction Transactions, SA Payroll Deduction Summary	Review results of payroll deduction record selection for an individual employee.
Payroll Deduction Group Creation	RUNCTL_SFPAYDED	Student Financials, Charges and Payment, Payroll Deduction Processing, Create Deduction Transactions, Payroll Deduction Group Creation	Create payroll deduction groups.

Selecting Payroll Deduction Records

Access the Select SA Payroll Deduction page (Student Financials, Charges and Payments, Payroll Deduction Processing, Process SA Payroll Deduction, Select SA Payroll Deduction).

Select SA Payroll Deduction

Run Control ID: 1 [Report Manager](#) [Process Monitor](#) Run

Process Request Parameter(s)

<p>On-Cycle Run</p> <p>Pay Run ID: <input style="width: 100%;" type="text"/></p>	or	<p>Off-Cycle Pay Calendar</p> <p>Company: <input style="width: 50%;" type="text" value="GBI"/> <input type="text" value="GBI"/></p> <p>Pay Group: <input style="width: 50%;" type="text" value="KC1"/> <input type="text" value="Cdn Weekly"/></p> <p>Pay End Date: <input style="width: 50%;" type="text" value="12/19/1999"/></p> <p>Process: Page #: <input style="width: 50%;" type="text"/> <input type="text"/> Thru: <input style="width: 50%;" type="text"/> <input type="text"/></p>
---	----	--

Payroll Cycle

On-Cycle
 Off-Cycle
 Both

Select SA Payroll Deduction page

On-Cycle Run

To select payroll deduction records that result from normal, scheduled payroll processing, select a Pay Run ID. Each Pay Run ID represents a single batch payroll process.

Off-Cycle Pay Calendar

To select payroll deduction records that result from manually issued or on-demand checks, select a specific pay calendar record using the Company, Pay Group, Pay End Date, Page #, and Thru fields.

Payroll Cycle

Consult your Payroll for North America staff for more information about the best method for running the process.

On-Cycle Select to have the process review only on-cycle payroll transactions.

Off-Cycle Select to have the process review only off-cycle payroll transactions.

Both Select to have the process review both on- and off-cycle payroll transactions.

Running the Select Payroll Deduction Process

When you run the Select Payroll Deduction (SFPAYDED) process, the system scans the PS_PAY_DEDUCTION table in Payroll for North America for any payroll deduction records with the deduction codes that you designated to use with Student Financials. If these records were not already selected in a previous process run, the system moves them to the PS_PAY_DED_PROC staging table.

Note. To run this process properly, you must have a working knowledge of Payroll for North America functionality. Consult your payroll staff for more information about how to define the parameters of this process and when to run it.

Reviewing Results of Payroll Deduction Record Selection

Access the SA Payroll Deduction Summary page (Student Financials, Charges and Payments, Payroll Deduction Processing, Review Deduction Transactions, SA Payroll Deduction Summary).

SA Payroll Deduction Summary								
Ana Jante			Z1009					
Check Date	Paycheck Number	Plan Type	Deduction Code	Current Deduction	Business Unit	Group ID	Target ID	Group Detail
03/05/1999	100913	Vision	ZVIS1	10.00	PSUNV	0000000000000037	Z1009	Line Nbr 2
03/05/1999	100914	Vision	ZVIS1	10.00	PSUNV	0000000000000037	Z1009	Line Nbr 3
04/05/1999	101023	Vision	ZVIS1	10.00	PSUNV	0000000000000038	SFPO00019	Line Nbr 1
04/05/1999	101024	Vision	ZVIS1	10.00	PSUNV	0000000000000038	SFPO00019	Line Nbr 2

SA Payroll Deduction Summary page

- Check Date** The issue date of the paycheck from which the system made the deduction.
- Paycheck Number** The unique number of the paycheck.
- Deduction Code** The PeopleSoft Student Administration payroll deduction code that is associated with the deduction.
- Current Deduction** The monetary amount of the deduction.
- Business Unit** The business unit to which the system applied the deduction.
- Group ID** The ID of the group transaction in which the system included the deduction.
- Target ID** The student ID associated with the account that the system credited with the deduction.
- Group Detail** Click to access the Group Line Entry page. From this page, you can review details about the group transaction that was used to post the deduction to a student account.

Note. If you have not yet added a deduction record to a group transaction using the Payroll Deduction Group Create (SF_PAY_DED) process, the Business Unit, Group ID, Target ID, and Group Detail fields are blank for that record. To reconcile deduction records that have not been processed into the group post tables, create a query that checks the PS_PAY_DED_PROC table for blank values in BUSINESS_UNIT, GROUP_ID_SF, EMPLID_RELATED, and where PROCESS_FLAG = N.

Creating Payroll Deduction Groups

Access the Payroll Deduction Group Creation page (Student Financials, Charges and Payment, Payroll Deduction Processing, Create Deduction Transactions, Payroll Deduction Group Creation).

Payroll Deduction Group Creation

Run Control ID: PAY_GROUP_CREATE [Report Manager](#) [Process Monitor](#) Run

Parameters

*Business Unit: PeopleSoft University Bursar Use Payment Plan

*Origin ID: Cashiering Office

*Group Type:

Term: 2002 Fall

Deduction code selection Customize | Find | First 1-2 of 2 Last

#	*Plan Type	*Deduction Code	Description	*Item Type	Payment
1	<input type="text" value="00"/>	<input type="text" value="B00-23"/>	Parking	<input type="text" value="300000000001"/>	Cash Payment + -
2	<input type="text" value="14"/>	<input type="text" value="ZVIS1"/>	EBenefits Vis Deduct 1	<input type="text" value="300000000024"/>	Payment-TUT/HOU + -

Payroll Deduction Group Creation page

Parameters

Enter the Business Unit, Origin ID, Group Type, and Term values that the system assigns to the group transaction you are creating. If you are restricting payroll deductions to pay payment plan contract charges, select the Use Payment Plan check box.

Deduction code selection

Plan Type Select the benefit plan type to restrict the selection of available deduction codes.

Deduction Code Select the deduction codes of the payroll deduction records that you are adding to a posting group.

Item Type For each deduction code that you add to a posting group, select the payment item type that the system uses when posting the associated deductions to student accounts.

Run Click to run the Payroll Deduction Group Create (SF_PAY_DED) process.

The process creates a group transaction for any payroll deductions in the PS_PAY_DED_PROC staging table that match the run control criteria and were not included in a previous posting group. If you do not select the Use Payment Plan check box, the system ignores the payment plan contract information that is associated with accounts receiving deduction funds. If you select the Use Payment Plan check box and you assigned deduction codes to the appropriate payment plan contracts, then for any students who are linked to those contracts, the system includes contract information in the group line entry.

On the Group Entry page, the Payroll Deduction Group Create (SF_PAY_DED) process sets the posting action of the created group to *Available for Posting*. On the Group Line Entry page, the Payroll Deduction Group Create (SF_PAY_DED) process selects the Restrict Payment to Account check box for students who are linked to an eligible payment plan contract. On the Payment Details page, the Payroll Deduction Group Create process populates the Contract # field for group line entries that are restricted to payment plan accounts.

Note. The system applies payroll deductions to payment plan accounts only if you assign deduction codes to the appropriate payment plan contracts and if you select the Use Payment Plan check box when running the Payroll Deduction Group Create (SF_PAY_DED) process. You can also use the charge priority list to restrict your payroll deduction payments to specific charges.

Reviewing and Revising Group Data Entries Before Posting

The Group Data Entry and External File Load processes put saved transaction data into a suspended status until the group is actually posted. The Suspended Group Post component enables you to view and revise transaction entries for individual transactions.

This section discusses how to:

- Review suspended transactions from a data group.
- Review and update details about a specific data group transaction.

Pages Used to Review and Revise Group Data Entries Before Posting

<i>Page Name</i>	<i>Definition Name</i>	<i>Navigation</i>	<i>Usage</i>
Suspended Group Post	GROUP_POST_SUSPEND	Student Financials, Charges and Payments, Group Processing, Review Suspended Transactions, Suspended Group Post	Review suspended transactions from a data group.
Group Post Details	GROUP_POST_INFO_SP	Click the Group Post Details link on the Suspended Group Post page.	Review details about a suspended posting group.

Page Name	Definition Name	Navigation	Usage
Group Line Details	GRPLINE_SUSP_SP	Click the Line Details link on the Suspended Group Post page.	Review and update details about a specific data group transaction.

Reviewing Suspended Transactions from a Data Group

Access the Suspended Group Post page (Student Financials, Charges and Payments, Group Processing, Review Suspended Transactions, Suspended Group Post).

Group Post Details	Click to access the Group Post Details page.
Acad Info (academic information)	Click to access the Academic Information page, where you can view the student's enrollment information.
Line Details	Click to access the Group Line Details page.

Reviewing and Updating Details About a Specific Data Group Transaction

Access the Group Line Details page (click the Line Details link on the Suspended Group Post page).

Update	Click this button to access the Group Line Entry page and update the transaction information. Alternatively, you can correct or update group lines from Student Financials, Charges and Payments, Group Processing, Correct Transactions or Student Financials, Charges and Payments, Group Processing, Correct Corporate Transactions.
---------------	---

See Also

[Chapter 21, "Maintaining Receivables," Adding Transactions to a Group Entry, page 576](#)

Posting Group Data Entries

This section discusses how to run the Group Post process.

After you correct entries in the group, you must save the group and then post it to update the affected accounts.

Pages Used to Post Group Data Entries

Page Name	Definition Name	Navigation	Usage
Post Transactions	RUNCTL_SFPGRPST	Student Financials, Charges and Payments, Group Processing, Post Transactions	Run the Group Post process.
Review Transactions	GROUP_SUMM_VW	Student Financials, Charges and Payments, Group Processing, Review Transactions	Review group entry information after it is posted.

Running the Group Post Process

Access the Post Transactions page (Student Financials, Charges and Payments, Group Processing, Post Transactions).

Post Transactions

Run Control ID: 1 [Report Manager](#) [Process Monitor](#) Run

Parameters

Business Unit:	<input type="text" value="PSUNV"/>	PeopleSoft University Bursar
Group Type:	<input type="text" value="H"/>	Housing
Starting Group ID:	<input type="text" value="0000000000000041"/>	
Ending Group ID:	<input type="text" value="0000000000000044"/>	
Operator ID:	<input type="text" value="PS"/>	
Assign Group OperID:	<input type="text" value="PS"/>	Reset Process Instance

Post Transactions page

Parameters

- Business Unit** Select the business unit to which the group is associated.
- Group Type** Select the group type to which the group ID is associated.
- Starting Group ID and Ending Group ID** Select the starting group ID and the ending group ID. The system generates these IDs when you complete the Group Data Entry pages.
- Operator ID** Optionally, select the user ID of the person posting the group.

Assign Group OperID (assign group operator ID) Optionally, select and assign a user to the group.

Reset Process Instance Click to delete a process instance number from a posting group that failed.

Run Click to access the Process Scheduler Request page. You can run two processes: Group Posting Common ID Create (SFPGRPDR) and Group Posting Process (SFPGRPST).

The Group Posting Common ID Create (SFPGRPDR) process is an optional process that evaluates all pending groups to find new IDs that do not yet have a row in the SF_COMMON_ID table. When the system encounters a new ID, it inserts a row into SF_COMMON_ID, which eliminates the need for the posting process to perform this function before posting pending transactions to an account. This process is especially useful during certain times of the year, such as the beginning of a term or the beginning of an academic year, when you have large groups with new IDs that have not undergone the posting process. If you run the Group Posting Common ID Create (SFPGRPDR) process before you run the Group Posting (SFPGRPST) process, the posting process is faster because it has fewer records to process.

The Group Posting Process (SFPGRPST) posts group transactions and inserts rows into SF_COMMON_ID for new IDs if you do not run the Group Posting Common ID Create (SFPGRPDR) process first.

Posting Transactions for Individual Students and Organizations

Student Financials enables you to process online transactions for students and organizations without entering control information or running a batch process. This section discusses how to:

- Post transactions for individual students.
- Post transactions for individual organizations.

Pages Used to Post Transactions for Individual Students and Organizations

<i>Page Name</i>	<i>Definition Name</i>	<i>Navigation</i>	<i>Usage</i>
Student Post	GRP_QUICK_POST	Student Financials, Charges and Payments, Post Student Transaction, Student Post	Post transactions for individual students.
Select Charges to Pay	QUICK_SPLITPAY_SEC	Click the Select Charges to Pay link on the Student Post page.	Specify the charges to which the system applies a student payment.
Payment Details	QUICK_POST_SECPAN	Click the Payment Details link on the Student Post page.	Add specific information to the payment record.

Page Name	Definition Name	Navigation	Usage
Corp Post	ORG_QUICK_POST	Student Financials, Charges and Payments, Post Corporation Transaction, Corp Post	Post transactions for individual organizations.
Select Students to Pay	QUICK_EMPLIPAY_SEC	Click the Select Students to Pay link on the Corp Post page.	Specify the sponsored student charges to which the system applies the corporate payment.
Third Party Information	ORG_THIRD_PARTYINF	Click the Third Party Information link on the Corp Post page.	Specify third-party contract information.

Posting Transactions for Individual Students

Access the Student Post page (Student Financials, Charges and Payments, Post Student Transaction, Student Post)

Student Post

Business Unit: PeopleSoft University Bursar

ID: SFEURO0031 Main, Marcus

Balance: 7,679.00 **Anticipated Aid:** 0.00

Account Type: Tuition [New Transaction](#) [Post](#)

Item Type: 300000005000 European - Cash

Amount: USD [Currency Detail](#) [Select Charges to Pay](#)

Term:

Reference Number:

Item Effective Date: 08/24/2006

Due Date:

Charge Priority: ALL Any Charge **Pay Method:** Cash [Tender Details](#)

Use Exc Acct MIS

Restrict Payment to Account

Restrict to Invoice

[Student Accounts](#) [Academic Information](#) [Payment Details](#)

Student Post page

New Transaction Click to enter a new transaction.

Post	Click to post the entered transaction.
Amount	Enter the item amount. Click the Currency Detail link to specify the exchange rate.
Term	Enter the term for which you want to post this transaction.
Reference Number	Enter an optional reference number to track the transaction.
Posted Date	After the transaction posts, the date it was posted appears in this field.
Item Effective Date	Enter the date on which the transaction becomes active. The default is the current date.
Due Date	Optionally, enter a due date if the transaction is a charge.
Charge Priority	For all credit item types, this field displays the charge priority list that is associated with the item type. If necessary, you may override this value.
Pay Method	If the payment item type is set up as tender-specific, then the tender category appears in this field. If the field is not populated, select a value from the list. Click the Tender Details button to add specific information, such as check number and bank information.
Payment ID	This field is used only when reversing a payment. Enter the payment ID number of the transaction to be reversed. When you exit the field, the page is completed with the original transaction information.
Use Exc Acct (use excess account)	Select the Exc Acct check box to route payments in excess of a charge or account balance to a designated excess account. When the check box is selected, enter the excess account type in the field to the right.
Restrict Payment to Account	Select to restrict the entire amount of the payment to the specified account type. Selecting this option prevents excess payments from being transferred to an excess payment account.
Restrict to Invoice	Select to restrict payment to an invoice. This option is only available if an institution elected to apply payments by invoice on the SF Installation page.
Select Charges to Pay	Click this link to access the Select Charges to Pay page.
Pay Amount	From the Select Charges to Pay page, specify the amount of the total payment that you want to apply against this charge. The specified amounts must total 100 percent of the payment.
Student Accounts	Click this link to access the Student Accounts page.
Academic Information	Click this link to access the Academic Information page.
Payment Details	Click this link to access the Payment Details page.

Posting Transactions for Individual Organizations

Access the Corp Post page (Student Financials, Charges and Payments, Post Corporation Transaction, Corp Post).

With the exception of the following links, this page is the same as the Student Post page.

Select Students to Pay Click this link to access the Select Students to Pay page.

Corp Accounts Click this link to access the Corp Accounts page.

Third Party Information Click this link to access the Third Party Information page.

See Also

[Chapter 21, "Maintaining Receivables," Posting Transactions for Individual Students, page 590](#)

Consolidating and Reviewing Transactions for Individual Students and Organizations

This section lists the pages used to consolidate and reviewing transactions for individual students and organizations.

Note. Single transactions that are created using the Student Post and Corp Post components are stored in the QUICK_POST_TBL (quick post table). This table can become very large. The Purge QUICK_POST_TBL process consolidates these transactions into two posting groups, one for student transactions and one for corporate transactions. It then empties the table. After these transactions are consolidated into posting groups, they can be easily tracked and audited.

Note. Define the origin ID and group type that the system uses to consolidate transactions into posting groups on the Posting Setup page.

See Also

[Chapter 2, "Completing Student Financials General Setup," Defining Posting Parameters, page 24](#)

Pages Used to Consolidate and Review Transactions for Individual Students and Organizations

<i>Page Name</i>	<i>Definition Name</i>	<i>Navigation</i>	<i>Usage</i>
Purge Posting Table	RUN_CNTL_SFBKPOST	Student Financials, Charges and Payments, Group Processing, Purge Posting Table	Run the Purge QUICK_POST_TBL process.
Posting Information	QUICK_POST_ACTIVIT	Student Financials, Charges and Payments, Group Processing, Review Posting Information, Posting Information	Review transactions that were consolidated by the Purge QUICK_POST_TBL process.

Viewing Account Information Within the Maintain Receivables Feature

This section lists the pages used to view account information within the Maintain Receivables feature.

Pages Used to View Account Information Within the Maintain Receivables Feature

<i>Page Name</i>	<i>Definition Name</i>	<i>Navigation</i>	<i>Usage</i>
Item View	ITEM_SF	Student Financials, View Item, Item View	Review item activity for student accounts.
Corp Item View	ITEM_ORG_SF	Student Financials, View Corporate Item, Corp Item View	Review item activity for organization accounts.
Item Line View	ITEM_LINE_SF	Student Financials, View Item Line, Item Line View	Review information about each line item in a student account.
Item Line Corp View	ITEM_LINE_ORG_SF	Student Financials, View Corporate Item Line, Item Line Corp View	Review charges to a corporate account by the account type that is affected.
Item Due View	ITEM_DUE_SF	Student Financials, View Item Due, Item Due View	Review detailed information about due line items in a student account.

<i>Page Name</i>	<i>Definition Name</i>	<i>Navigation</i>	<i>Usage</i>
Corp Item Due View	ITEM_DUE_ORG_SF	Student Financials, View Corporate Item Due, Corp Item Due View	Review detailed information about due line items in an organization account.

Viewing Payment by Invoice Information Within the Maintain Receivables Feature

The Maintain Receivables application provides a variety of ways to inquire on payment by invoice information at various levels of detail.

Note. This section is only valid for institutions that apply payments by invoice.

Pages Used to View Payment by Invoice Information Within the Maintain Receivables Feature

<i>Page Name</i>	<i>Definition Name</i>	<i>Navigation</i>	<i>Usage</i>
View Items by Invoice	SSF_VW_ITEM_INV	Student Financials, Charges and Payments, Payments by Invoice, View Items by Invoice	View a summary of student items by invoice.
View Corp Items by Invoice	SSF_VW_ITEMORG_INV	Student Financials, Charges and Payments, Payments by Invoice, View Corp Items by Invoice	View a summary of corporate items by invoice.
Update Payment Invoice ID	SSF_PMT_INVOICE	Student Financials, Charges and Payments, Payments by Invoice, Update Payment Invoice ID	Update the invoice ID for payments restricted to invoices.
Update Corp Payment Invoice ID	SSF_ORGPMT_INVOICE	Student Financials, Charges and Payments, Payments by Invoice, Update Corp Payment Invoice	Update the invoice ID of corporate payments.

Viewing Items by Invoice

Access the View Items by Invoice page (Student Financials, Charges and Payments, Payments by Invoice, View Items by Invoice).

View Items by Invoice

Business Unit: PSUNV
 Main, Marcus **ID:** SFEURO0031 [Academic Information](#)
Balance: 7,679.00 [Student Accounts](#) **Anticipated Aid:** 0.00 [View Anticipated Aid](#)

Due Amount by Invoice					
Customize Find View All First ◀ 1-2 of 2 ▶ Last					
Invoice Number	Invoice Date	Invoiced Amount	Due Amount	Applied Amount	Invoice Balance
EUROFARM056000000000009	05/15/2006	4,602.00	4,602.00	1,125.00	3,477.00
EUROFARM056000000000005	05/15/2006	4,202.00	4,202.00		4,202.00

Due Amount by Item Invoice						
Customize Find View All First ◀ 1-3 of 6 ▶ Last						
Invoice		Item				
Item Description	Invoice Number	Invoice Date	Invoiced Amount	Due Amount	Applied Amount	Charge Balance
Course Fees	EUROFARM056000000000009	05/15/2006	102.00	102.00		102.00
Tuition	EUROFARM056000000000009	05/15/2006	1,500.00	1,500.00	1,125.00	375.00
Rent	EUROFARM056000000000009	05/15/2006	3,000.00	3,000.00		3,000.00

View Items by Invoice page

If payments are not restricted to invoice, then payments may be applied to charges that are not invoiced. In addition, the system displays both student and corporate payments that were received and posted towards an invoice. Only invoices with an invoice balance of more than \$0.00 appear.

View items by invoice number.

Viewing Corp Items by Invoice

Access the View Corp Items by Invoice page (Student Financials, Charges and Payments, Payments by Invoice, View Corp Items by Invoice).

View Corp Items by Invoice

Business Unit: PSUNV
External Org ID: 000010003 Union High School
Balance: -105.00 [Corp Accounts](#)

Due Amount by Invoice					
Invoice Number	Invoice Date	Invoiced Amount	Due Amount	Applied Amount	Charge Balance
PRECONVERSION	12/31/2005	3,095.00	3,095.00		3,095.00

Due Amount by Item Invoice							
Invoice	Item	Invoice Number	Invoice Date	Invoiced Amount	Due Amount	Applied Amount	Charge Balance
	Parking Stickers	PRECONVERSION	12/31/2005	150.00	150.00		150.00
	Single Room	PRECONVERSION	12/31/2005	900.00	900.00		900.00
	Book Fees	PRECONVERSION	12/31/2005	95.00	95.00		95.00

View Corp Items by Invoice page

View a summary of corporate items by invoice number.

Updating Payment Invoice ID

Access the Update Payment Invoice ID page (Student Financials, Charges and Payments, Payments by Invoice, Update Payment Invoice ID).

Update Payment Invoice ID

Business Unit: PSUNV

ID: Main, Marcus

Account Balance: 0.00 **Anticipated Aid:** 0.00

Payment ID Nbr	Payment Amount	Date Posted	Term	Invoice Number
				<input type="text"/>

Update Payment Invoice ID page

Use this page to designate an unapplied payment towards an invoice:

1. Select the invoice ID to which the payment is to be applied.
2. Click Save.

3. Run the Payment Applier process for the student.

The Payment Applier process applies the credit to the invoice. Payments restricted to a specific invoice cannot be designated to pay another invoice; however, they can be refunded.

Updating Corp Payment ID

Access the Update Corp Payment Invoice page (Student Financials, Charges and Payments, Payments by Invoice, Update Corp Payment Invoice).

Update Corp Payment Invoice page

Managing Disputed Charges

This section provides an overview of disputed charges and discusses how to enter dispute information.

Understanding Disputed Charges

When a student or organization disputes charges, the disputed charge is designated as a line entry on the Review Credit History page (depending on how Dispute Aging is set up in the Aging Set). When you have resolved the dispute, the customer can pay the charge, you can remove the disputed amount from the item, or you can move the charge to a write-off account

You would follow these steps to dispute a charge:

1. Access the Change Item Line (for students) or Change Corp Item Line (for organizations) page to display a list of accounts for a student or organization.
2. Click the Account Details link next to the account that contains the disputed charge to access the Change Item Line - Account Summary (for students) or Change Corp Item Line - Account Summary (for organizations) page.

These pages display all charges that are associated with the selected account.

3. Click the Item Details link next to the disputed charge to access the Change Item Line - Line Detail Update (for students) or Change Corp Item Line - Line Detail Update (for organizations) page.

4. Enter dispute information for the charge and click the Save button.

Pages Used to Manage Disputed Charges

<i>Page Name</i>	<i>Definition Name</i>	<i>Navigation</i>	<i>Usage</i>
Change Item Line	ACCOUNT_SF	Student Financials, Collection, Adjustments, Change Item Line	Select an account that contains a disputed charge for a student.
Change Item Line - Account Summary	CHG_ITEM_LINE_SP	Click the Account Details link on the Change Item Line page.	Select a disputed charge for a student.
Change Item Line - Line Detail Update	ITEM_LINE_SF_SP_UP	Click the Item Details link on the Account Summary page.	Enter dispute information for a student.
Change Corp Item Line	ACCOUNT_ORG_SF	Student Financials, Collections, Adjustments, Change Corporate Item Line, Change Corp Item Line	Select an account containing a disputed charge for an organization.
Change Item Line - Account Summary	CHG_ORG_ITM_LN_SP	Click the Account Details link on the Change Item Line page.	Select a disputed charge for an organization.
Change Item Line - Line Detail Update	ITEM_LNE_ORGSF_UP	Click the Item Details link on the Change Item Line - Account Summary page.	Enter dispute information for an organization.

Entering Dispute Information

Access the Change Item Line - Line Detail Update (click the Item Details link on the Account Summary page).

Line Detail Update

Damage Charge **Item Nbr:** 000000000015652 **Item Type:** 700000000005

Ref Nbr:

Item Amount: 200.00

Details Find | View All First 1 of 1 Last

Nbr	Effective Dt	Due Dt	Dispute Dt	Dispute Amount	Encum Dt	Amount Encumbered
	Item Term	Line Action	Line Reason	Description:		
1	08/02/1998 <input type="text"/>	08/02/1998 <input type="text"/>	08/25/2003 <input type="text"/>	125.00 <input type="text"/>	10/07/2004 <input type="text"/>	125.00 <input type="text"/>
	0330 <input type="text"/>	GRP <input type="text"/>	<input type="text"/>	Damage Charge <input type="text"/>		

Payments paying this Charge Find | View All First 1 of 1 Last

Description	Account Nbr	Term	Date	Amount
Non-taxable				
				0.00

Non-taxable Find | View All First 1 of 1 Last

Item Type	Account Nbr	Term	Item Amt	Balance
				0.00

Line Detail Update page

- Ref Nbr** (reference number) Enter the reference number that you are using to track the disputed receivable.
- Nbr Effective Dt** (number effective date) This field is set by default to the current system date.
- Due Dt** (due date) Enter the due date of the charge.
- Dispute Dt** (dispute date) Enter the date that the student or organization disputed the charge.
- Dispute Amount** Enter the amount of the dispute.
- Encum Dt** (encumbrance date) Enter the encumbrance date from which you want the disputed amount of the payment held.
- Amount Encumbered** Enter the dollar amount of the student's account that the dispute encumbers in this field.
- Item Term** This field displays the term to which the system posted the charge.
- Line Action** Enter the line action.

- Line Reason** Enter a line reason code that specifies the reason for the dispute.
- Description** The description is set by default to the description of the original transaction.

Reversing Payments and Charges

This section discusses how to:

- Reverse payments.
- Reverse charges.
- Reverse groups of transactions.
- Process payroll deduction reversals.

Pages Used to Reverse Payments and Charges

<i>Page Name</i>	<i>Definition Name</i>	<i>Navigation</i>	<i>Usage</i>
Payment Reversal	PMT_REVERSAL	Student Financials, Charges and Payments, Reversals, Reverse Payment, Payment Reversal	Reverse student payments.
Payment Reversal - Payment Detail	PAYMENT_DTL_SP	Click the Payment Detail link on the Payment Reversal page.	Review details about a student payment before reversing it.
Payment Corp Reversal	PMT_ORG_REVERSAL	Student Financials, Charges and Payments, Reversals, Reverse Corporate Payment, Payment Corp Reversal	Reverse corporate payments.
Payment Corp Reversal - Payment Detail (payment corporate reversal - payment detail)	PAYMENT_DTL_ORG_SP	Click the link next to a payment on the Payment Corp Reversal page.	Review details about a corporate payment before reversing it.
Charge Reversal	ACCOUNT_SF	Student Financials, Charges and Payments, Reversals, Reverse Charge, Charge Reversal	Select a student account containing a charge you want to reverse.
Charge Reversal - Charge Detail	CHARGE_REV_SP	Click the Account Details link on the Charge Reversal page.	Reverse student charges.

Page Name	Definition Name	Navigation	Usage
Reverse Corporate Charge - Charge Reversal	ACCOUNT_ORG_SF	Student Financials, Charges and Payments, Reversals, Reverse Corporate Charge	Select a corporate account containing a charge you want to reverse.
Reverse Corporate Charge - Charge Detail	CHARGE_REV_ORG_SP	Click the Account Details link on the Reverse Corporate Charge - Charge Reversal page.	Reverse corporate charges.
Reversal Detail	LINE_REASON_SF_SP	Click the Reverse button on the Payment Reversal, Payment Corp Reversal, Charge Reversal, or Reverse Corporate Charge - Charge Reversal page.	Enter optional reversal information after reversing a payment or charge.
Group Reversal	RUNCTL_SFRVRGRP	Student Financials, Charges and Payments, Group Processing, Reverse Groups, Group Reversal	Reverse groups of transactions.

Reversing Payments

Access the Payment Reversal (for students) (Student Financials (Student Financials, Charges and Payments, Reversals, Reverse Payment, Payment Reversal), Charges and Payments, Reversals, Reverse Payment) or Payment Corp Reversal (for organizations) page.

1. Enter search criteria and click the Search button to display the desired payments.
2. Click the Reverse button next to a payment to access the Reversal Detail page.
3. Enter optional reversal information (such as Item Effective Date, Description, and Reason Code) on the Reversal Detail page and click the OK button to complete the payment reversal.

Reversing Charges

Access the Charge Reversal (for students) (Student Financials (Student Financials, Charges and Payments, Reversals, Reverse Charge, Charge Reversal), Charges and Payments, Reversals, Reverse Charge) or Charge Corp Reversal - Charge Reversal (for organizations) page.

1. Click the Account Details link next to the account that contains the charge you want to reverse.
 This link accesses the Charge Reversal - Charge Detail (for students) or Charge Corp Reversal - Charge Detail (for organizations) page, which displays all charges that are associated with the selected account.
2. Click the Reverse button next to a charge to access the Reversal Detail page.
3. Enter optional reversal information (such as Item Effective Date, Description, and Reason Code) on the Reversal Detail page and click the OK button to complete the charge reversal.

Reversing Groups of Transactions

Access the Group Reversal page (Student Financials, Charges and Payments, Group Processing, Reverse Group, Group Reversal).

Group Reversal

Run Control ID: 1 [Report Manager](#) [Process Monitor](#) Run

Parameters

Business Unit:	<input type="text" value="PSUNV"/>	PeopleSoft University Bursar	<input checked="" type="checkbox"/> Include Detail
Group ID:	<input type="text" value="000000000000029"/>		
Description:	<input type="text" value="Reversals for Bursar Test"/>		
Bank Tracer Nbr:	<input type="text"/>		
Item Effective Date:	<input type="text"/>		
*Due Date Option:	<input type="text" value="Old Due Dt"/>		

Group Reversal page

Parameters

- Include Detail** Select this option to generate a detailed report of the transactions reversed when you run the process.
- Group ID** Enter the unique ID of the group of transactions that you want to reverse.
- Description** Enter an optional description for the group reversal. This description appears next to the item type on the Group Line Entry page.
- Bank Tracer Nbr** (bank tracer number) Enter a number for tracking purposes. This field is optional.
- Item Effective Date** Enter the effective date that the system assigns to the reversed transactions.
- Due Date Option** Select an option to determine how the system calculates due dates for the reversed transactions.

New Due Dt (new due date): Select this option to enter a new due date that the system assigns to the reversed transactions.

Null: The system assigns a null value to the due date of the reversed transactions and assigns new due dates during the billing process.

Old Due Dt (old due date): The system assigns the original due date of the reversed transaction.

Processing Payroll Deduction Reversals

When Payroll for North America reverses a previous payroll deduction, the resulting deduction is a negative amount. Student Financials cannot link the negative deduction amount to the originally posted deduction. The system selects these negative deductions through the Select Payroll Deduction (SFPAYDED) process. However, when you run the Payroll Deduction Group Create (SF_PAY_DED) process on negative deductions, the system enters them into the posting tables as a group with a Posting Action of *Do Not Post* and a Posting Status of *Errors*. Because you cannot post these negative deductions using the normal method, you must manually resolve the affected student accounts.

Note. If the Payroll Deduction Group Create (SF_PAY_DED) process encounters both negative and positive deductions, it creates two separate posting groups, one for the negative deductions and one for the positive deductions.

Applying Payments

You can run the Payment Applier process to allocate unapplied payments to eligible charges that are still owing. The process applies payments to both student and corporate accounts. Payment swapping might occur if a priority payment is applied.

Pages Used to Apply Payments

<i>Page Name</i>	<i>Definition Name</i>	<i>Navigation</i>	<i>Usage</i>
Payment Applier	RUNCTL_PMTWKUP	Student Financials, Charges and Payments, Apply Payment. Payment Applier	Run the Payment Applier process.
Payment Shuffle	ITEM_SF_XREF	Student Financials, Charges and Payments, Payment Shuffle	Identify remaining unapplied payments after running the Payment Applier process.

Running the Payment Applier Process

Access the Payment Applier page (Student Financials, Charges and Payments, Apply Payment. Payment Applier).

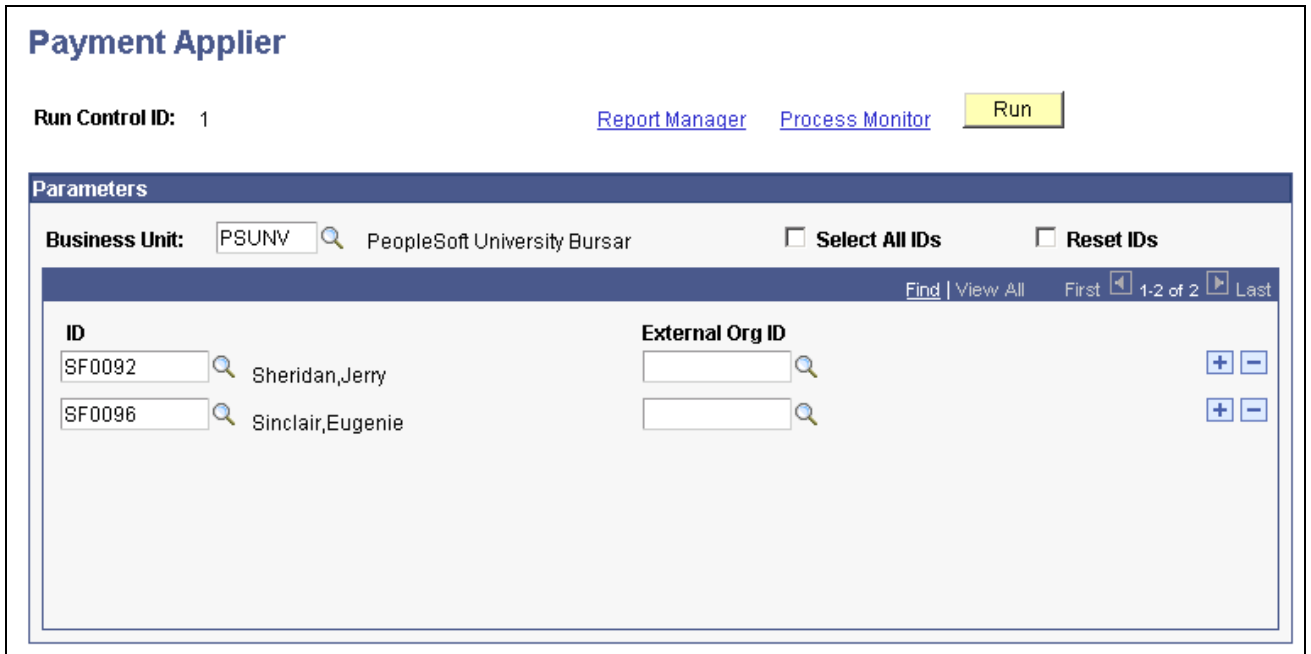

Payment Applier page

Business Unit Enter the business unit for which you want to run the Payment Applier process.

Select All IDs Select to run the Payment Applier process for all student and corporate IDs.

Reset IDs When you select this option, all applied payments are unapplied. Then, all payments are applied to their eligible charges as if for the first time, following payment allocation rules. All payments are applied in priority order.

Note. The Payment Applier process does not reset payments if the account is a payment plan or if the account has write-off or refund transactions.

ID or External Org ID If you do not select the Select All IDs check box, enter ID numbers for the students or organizations to which you want payments applied.

Note. When running the process for individual IDs, you cannot include both students and organizations at the same time.

Writing Off Charges and Account Balances

This section provides an overview of write-offs and discusses how to:

- Create write-offs for individual students.
- Create write-offs for individual organizations.
- Select accounts to write off for individual students and organizations.

- Select items to write off for individual students and organizations.
- Process batch write-offs.
- Reverse write-offs for students.
- Reverse write-offs for organizations.

Understanding Write-offs

If a receivable becomes impossible to collect, you can write off the receivable by moving the charge within your general ledger from your receivable or collections account to your write-off account. The system adds the write-off service indicator to the customer's account and applies the restrictions that you defined for write-off customers.

If you process a write-off by mistake, or if a customer agrees to pay a debt that you already wrote off, Student Financials enables you to reverse the write-off.

Pages Used to Write Off Charges and Account Balances

<i>Page Name</i>	<i>Definition Name</i>	<i>Navigation</i>	<i>Usage</i>
Student Writeoff	WRITEOFF_QCK_POST	Student Financials, Collections, Write Offs, Post Student Write-off, Student Writeoff	Create write-offs for individual students.
Corp Writeoff	WRITEOFF_ORG_POST	Student Financials, Collections, Write Offs, Post Corporate Writeoff, Corp Writeoff	Create write-offs for individual organizations.
Accounts To Writeoff	WRITEOFF_ACCT_SP	Select the Writeoff Accounts option or click the Accounts to Writeoff link on the Student Writeoff page.	Select accounts to write off for individual students and organizations.
Items To Writeoff	WRITEOFF_ITEMS_SP	Select the Writeoff Items option and click the Items to Writeoff link on the Student Writeoff page.	Select items to write off for individual students and organizations.
Write Offs	RUNCTL_WRITE_OFF	Student Financials, Collections, Write Offs, Run Write-off Process, Write Offs	Process batch write-offs.
Writeoff Reversal	WRITEOFF_REVERSAL	Student Financials, Collections, Write Offs, Reverse Student Writeoff, Writeoff Reversal	Reverse write-offs for students.

Page Name	Definition Name	Navigation	Usage
Writeoff Corp Reversal	WRITEOFF_ORG_REVER	Student Financials, Collections, Write Offs, Reverse Corporate Writeoff, Writeoff Corp Reversal	Reverse write-offs for organizations.
Writeoff Detail	WRITEOFF_DTL_SP	Click the Writeoff Detail link on the Writeoff Reversal or Writeoff Corp Reversal page.	Review information about a write-off.

Creating Write-offs for Individual Students

Access the Student Writeoff page (Student Financials, Collections, Write Offs, Post Student Write-off, Student Writeoff).

Student Writeoff page

ID Select the ID of the student whose receivables you are writing off.

Balance This field displays the total balance of the customer's account.

Anticipated Aid This field displays the amount of financial aid that was awarded to the student but not yet disbursed.

Writeoff

Select a write-off method.

Writeoff Balance Select this option to write off the entire amount shown in the Balance field.

Writeoff Account(s)	When you select this option, the Accounts to Writeoff link becomes available.
Writeoff Item(s)	When you select this option, the Items to Writeoff link becomes available.
Srv Ind Cd (service indicator code)	Select the service indicator code that sets the desired limitations on transactions for customers whose accounts you have written off.
Student Accounts and Academic Information	Click the Student Accounts link to see the View Customer Accounts page. Click the Academic Information link to view academic plan and enrollment information.
 Item Information	
Item Type	Select the item type that you are using for your write-off account. The description of the item type appears in the field to the right.
Item Amount	The amount of the transaction that you are writing off appears next to the term you select.
Term	Enter a term for the write-off.
Reference Nbr (reference number)	Enter the reference number that you use to track your write-offs.
Item Effective Date	Enter the effective date of the item.
Payment Details	Click this link to review further details about the write-off.

Creating Write-offs for Individual Organizations

Access the Corp Writeoff page (Student Financials, Collections, Write Offs, Post Corporate Writeoff, Corp Writeoff).

This page is identical to the Student Writeoff page.

See Also

Chapter 21, "Maintaining Receivables," Creating Write-offs for Individual Students, page 606

Selecting Accounts to Write Off for Individual Students and Organizations

Access the Accounts To Writeoff page (Select the Writeoff Accounts option or click the Accounts to Writeoff link on the Student Writeoff page).

Accounts To Writeoff						
Find View All First 1-3 of 3 Last						
Account Type	Account Number	Balance	Date Opened			
Housing	HOUSING001 - 2000 Sprng	2,500.00	02/01/2000	Active		<input checked="" type="checkbox"/>
Parking Fe	PRKFEEES001 -	300.00	02/01/2000	Active		<input type="checkbox"/>
Tuition	TUITION001 - 2000 Sprng	6,125.00	02/01/2000	Active		<input type="checkbox"/>

Accounts To Writeoff page

Select the check box next to the accounts that you want to write off.

Selecting Items to Write Off for Individual Students and Organizations

Access the Items To Writeoff page (Select the Writeoff Items option and click the Items to Writeoff link on the Student Writeoff page).

Items To Writeoff					
Find View All First 1-4 of 9 Last					
Item Type	Term	Item Amt	Balance		
Parking St	1998 Fall	125.00	125.00		<input type="checkbox"/>
Parking St	1999 Sprng	125.00	125.00		<input type="checkbox"/>
Parking St	1999 Sumr	125.00	125.00		<input type="checkbox"/>
MealPln-14	1998 Fall	500.00	500.00		<input type="checkbox"/>

Items To Writeoff page

Select the check box next to the items you want to write off.

Processing Batch Write-offs

Access the Write Offs page (Student Financials, Collections, Write Offs, Run Write-off Process, Write Offs).

Write Offs

Run Control ID: Writeoffs [Report Manager](#) [Process Monitor](#) Run

Parameters

Select By:

By ID By External Org ID

Business Unit: PeopleSoft University Bursar

Aging Set: **Aging Category:** 120+

Past Due Amount: **Last Activity Date:**

Item Type Writeoff: Writeoff

Service Indicator Cd: All Services Hold Report Only

Group

Group Type: **Origin ID:** HovenBank

Write Offs page

- By ID** Select this option to execute this process for individuals.
- By External Org ID** (by external organization ID) Select this option to execute this process for organizations.
- Business Unit** Select the business unit for the write-offs that you are processing.
- Aging Set and Aging Category** Enter the aging set and the appropriate aging category to select the overdue amounts. For example, if you select the *STD* (standard) aging set and the code of 96 for the 120+ day aging category, transactions for individuals or organizations that match the criteria for the *STD* aging set and are more than 120 days past due are selected to be written off.
- Past Due Amount and Last Activity Date** Enter the past due amount criteria for the aging category and the last activity date to further refine your selection.
- Item Type Writeoff** Select the item type that your institution uses for write-offs.
- Service Indicator Cd** (service indicator code) Select the appropriate service indicator code to place a hold on an individual after you write off charges.

Note. Service indicators cannot be applied to organizations that use the Student Financials application.

Report Only Select this option to produce a report of individuals who are selected for write-off before you continue with the process.

Group Type and Origin ID To perform the write-off, you must create a posting group that consists of all amounts to be written off. Select the group type and origin ID to use when creating your posting group. These fields are used for security purposes. You should use a group type and origin type with limited access.

Running this process creates a posting group. Make note of the posting group ID because you should review the posting group before you post it. After you are satisfied with the posting group, post it using the Group Post process.

See Also

Chapter 21, "Maintaining Receivables," Posting Group Data Entries, page 587

Reversing Write-offs for Students

Access the Writeoff Reversal page (Student Financials, Collections, Write Offs, Reverse Student Writeoff, Writeoff Reversal).

Writeoff Reversal

Business Unit: PSUNV

ID: King, Raymond **Term:**

Balance: 0.00 **Anticipated Aid:** 0.00 ⊘

Description	Short Description	Post Date	Amount	Balance	Rev	
Writeoff	1998 Fall	10/13/2004	2,303.470	0.00	N	Writeoff Detail <input type="button" value="Reverse"/>

[Find](#) | [View All](#) | First 1 of 1 Last

[Student Accounts](#) [Academic Information](#)

Writeoff Reversal page

ID Enter the ID of the student for whom you want to reverse the write-off.

Term Enter the term for which you want the write off reversal to apply.

Description This field displays the description of the write-off item type.

Term	This field displays the term of the original charge.
Post Date	This field displays the date the write-off was posted.
Amount	This field displays the amount of the write-off.
Balance	This field displays the balance of each transaction.
Rev (reversed)	This field displays the write-off reversal status. When the reversal is complete, the <i>N</i> changes to a <i>Y</i> to indicate that you successfully reversed the write-off.
Reverse	Click this button next to the write-off that you want to reverse.
Writeoff Detail	Click this link to access the Writeoff Detail page.

Reversing Write-offs for Organizations

Access the Writeoff Corp Reversal page (Student Financials, Collections, Write Offs, Reverse Corporate Writeoff, Writeoff Corp Reversal).

This page is identical to the Writeoff Reversal page.

See Also

[Chapter 21, "Maintaining Receivables," Reversing Write-offs for Students, page 610](#)

Processing Enrollment Deposits

The Enrollment Deposit process enables you to restrict services by automatically placing a service indicator on student records if the respective students do not pay the required enrollment deposits. This process also automatically releases service indicators upon receipt of enrollment deposits.

This section discusses how to:

- Define basic parameters for the Enrollment Deposit process.
- Select academic programs and waiver forms for the Enrollment Deposit process.

Pages Used to Process Enrollment Deposits

<i>Page Name</i>	<i>Definition Name</i>	<i>Navigation</i>	<i>Usage</i>
Enroll Deposit	RUNCTL_ENRL_DPST	Student Financials, Charges and Payments, Enrollment Deposits, Enroll Deposit	Define basic parameters for the Enrollment Deposit process.

Page Name	Definition Name	Navigation	Usage
Enroll Deposit2	RUNCTL_ENRL_DPST2	Student Financials, Charges and Payments, Enrollment Deposits, Enroll Deposit2	Select academic programs and waiver forms for the Enrollment Deposit process.

Defining Basic Parameters for Enrollment Deposit Processing

Access the Enroll Deposit page (Student Financials, Charges and Payments, Enrollment Deposits, Enroll Deposit).

Enroll Deposit page

Business Unit Select the business unit for which you are processing enrollment deposits.

Term Select the term for which you are processing enrollment deposits.

Item Type Group Select the item type group that you are using for enrollment deposits.

Amount Enter the amount of the enrollment deposit. The amount is the monetary amount of a single deposit.

Service Indicators

Set Srvc Ind (set service indicator) Select this option to set service indicator codes.

Rel Srvc Ind (release service indicators) Select this option to release the service indicator codes that have been applied to student's accounts.

Srv Ind Cd (service indicator code)	Select the service indicator code that you want to apply.
Srvc Reason (service reason), Contact , and Srvc Impact (service impact)	Select the service reason code that is attached to the service indicator code, the contact, and the service impact code.

Letter Generation

Using the 3Cs functionality, you can automatically generate letters to students.

Gen Letter (generate letter) and Letter Code	When you select the Gen Letter option, use the Letter Code field to identify the letter that the system generates.
Function, Category, and Context	Select the desired function, category, and context.

See Also

PeopleSoft Enterprise Campus Community 9.0 Fundamentals PeopleBook, "Understanding the 3Cs — Communications, Checklists, and Comments"

Selecting Academic Programs and Waiver Forms (Student Permissions) for the Enrollment Deposit Process

Access the Enroll Deposit2 page (Student Financials, Charges and Payments, Enrollment Deposits, Enroll Deposit2).

Enroll Deposit2 page

All Programs To evaluate enrollment deposits for all academic programs, select this option. This selection makes the Academic Program fields unavailable.

Academic Program Select the academic program whose deposits you want to process.

Permission Form Select a permission form (Student Permissions) that allows financial aid monies to pay the enrollment fee for students who have been granted permission.

Processing Late Fees

The Late Fee process enables you to calculate late fees for all students and organizations that are past due on their accounts.

See Also

Chapter 11, "Setting Up Receivables Maintenance," Setting Up Late Fees, page 344

Pages Used to Process Late Fees

<i>Page Name</i>	<i>Definition Name</i>	<i>Navigation</i>	<i>Usage</i>
Late Fees	RUNCTL_SFPLATFE	Student Financials, Charges and Payments, Late Fees, Late Fees Processing, Late Fees	Calculate and post late fees.
Late Fees	LATE_FEE_TBL	Student Financials, Charges and Payments, Late Fees, Review Student Late Fees, Late Fees	Review late fees for students.
Late Fee Details	LATE_FEE_DTL_EMP	Click the Details link on the Late Fees page: Late Fees 2 tab.	Review details about a student late fee.
Late Fee Messages	LATE_FEE_MESSAGES	Student Financials, Charges and Payments, Late Fees, Review Late Fee Messages, Late Fee Messages	Review errors and warnings generated during the processing of student late fees.
Corp Late Fees	LATE_FEE_ORG	Student Financials, Charges and Payments, Late Fees, Review Corp Late Fees, Corp Late Fees	Review late fees for organizations.
Corp Late Fees - Late Fees Details	LATE_FEE_ORG	Click the Details link on the Corp Late Fees - Late Fees 2 tab.	Review details about a corporate late fee.
Corp Late Fee Messages	LATE_FEE_ORG_MSG	Student Financials, Charges and Payments, Late Fees, Review Corp Late Fee Messages	Review errors or warnings generated during the processing of corporate late fees.

Calculating and Posting Late Fees

Access the Late Fees page (Student Financials, Charges and Payments, Late Fees, Late Fees Processing, Late Fees).

Late Fees page

Batch ID This field displays the batch ID that the system assigns when it runs the process.

Report Only Select this option to produce a report without posting the late fee.

Run Options Select from these values:

All External Organizations: Enables you to process late fees for external corporate customers. If you select this run option, the ID and External Org ID fields become unavailable and the From ID and To ID fields become available. These fields enable you to specify a range of external organizations against which to process late fees. These fields are not required. If you leave them blank, the system processes late fees for all external organizations.

Single External Organization: Enables you to process late fees that are incurred by a single corporate customer. If you select this run option, the External Org ID field becomes available and the ID, From ID, and To ID fields become unavailable.

Single Student: This is the default value. It enables you to process a late fee for one individual. If you select this run option, the ID field becomes available and the External Org ID, From ID, and To ID fields become unavailable.

All Students: Enables you to process late fees for all students. If you select this run option, the ID and External Org ID fields become unavailable and the From ID and To ID fields become available. These fields enable you to specify a range of students against which to process late fees. These fields are not required. If you leave them blank, the system processes late fees for all students.

Business Unit Select the business unit for which you are processing late fees.

ID If applicable, select the ID of the student for which you are processing late fees. This field becomes available when you select the *Single Student* run option.

From ID	If applicable, select the beginning ID of your range. This field is only applicable if you process a range of either students or corporations when using the respective run options <i>All Students</i> or <i>All External Organizations</i> .
To ID	If applicable, select the ending ID of your range. This field is only applicable if you process a range of either students or corporations when using the respective run options <i>All Students</i> or <i>All External Organizations</i> .
External Org ID (external organization ID)	If applicable, select the ID of the organization for which you are processing late fees.
Late Fee Code	Select the late fee code for the fee schedule that you are applying.
Display Late Fees	Click the Display Late Fees link to access the Display Late Fees page, where you can review the accounts that were processed in this run.
Display Errors/Warnings	Click the Display Errors/Warnings link to access the Late Fee Messages page, where you can view errors or warnings that you encountered during this run.

Processing Late Fees Using the Billing Request Number

An alternative Late Fees process starts with the amount due from a specified billing request number and nets any payments or credits received on the account since the billing date. If the payments or credits are less than the amount due, the student is assessed a late fee.

Pages Used to Process Late Fees Using the Billing Request Number

<i>Page Name</i>	<i>Definition Name</i>	<i>Navigation</i>	<i>Usage</i>
Late Fees – Billing	RUNCTL_SFPBLTFE	Student Financials, Charges and Payments, Late Fees, Late Fees Processing – Billing, Late Fees–Billing	Process late fees using the Billing Request number.
Late Fees – Billing	SSF_LTFEE_TBL	Student Financials, Charges and Payments, Late Fees, Review Late Fees – Billing, Late Fees – Billing	Review student late fees – billing for students.
Late Fee Messages	LATE_FEE_MESSAGES	Student Financials, Charges and Payments, Late Fees, Review Late Fee Messages	Review any errors or warnings generated during the processing of student late fees.

Page Name	Definition Name	Navigation	Usage
Review Corp Late Fees - Billing (corporation late fees)	SSF_LTFEE_ORGG	Student Financials, Charges and Payments, Late Fees, Review Corp Late Fees – Bill (corporation late fees)	Review late fees for organizations.
Corp Late Fee Messages (corporation late fee messages)	LATE_FEE_ORG_MSG	Student Financials, Charges and Payments, Late Fees, Review Corp Late Fee Messages	Review any errors or warnings generated during the processing of corporate late fees.

Processing Late Fees - Billing

Access the Late Fees - Billing page (Student Financials, Charges and Payments, Late Fees, Late Fees Processing – Billing, Late Fees–Billing)

Late Fees - Billing

Run Control ID: 1151604329 [Report Manager](#) [Process Monitor](#) Run

Parameters

Batch ID: Report Only

Business Unit: PeopleSoft University Bursar [Display Late Fees](#) [Display Errors / Warnings](#)

Billing Request Nbr: **Type of Request:**

Bill Date and Time: **Due Date:**

Late Fee Code: **Posting Term:**

Payment Date Range

From: **To:**

Late Fee Maximum Date Range

From: **To:**

Include Anticipated Aid? Maximum Aid Term:

Late Fees - Billing page.

Parameters

- Report Only** Select if the process is Report Only mode.
- Business Unit** Select the business unit to be used for identifying the students, organizations, or both to be processed.
- Display Late Fees** Select to access the Display Late Fees page, where you can review the accounts that were processed in this run.

Display Errors / Warnings	Select to access the Late Fee Messages page, where you can view any errors or warnings that you encountered during this run.
Billing Request Nbr (billing request number)	Enter the number to be used for identifying the students, organizations, or both to be processed.
Emplid/External Org Id (employee ID/external organization ID)	Enter a single student or organization for processing.
Late Fee Code	Select a value.
Posting Term	Select the term in which the late fee will be posted.
Include Anticipated Aid?	Select to include anticipated aid.
Maximum Aid Term	Enter a maximum aid term for the process.
Run	Click to run the Late Fees - Billing process.

Payment Date Range

From	Enter a start date for the payment date range.
To	Enter an end date for the payment date range.

Late Fee Maximum Date Range

From	This value is provided by default from the late fee code setup.
To	Enter an end date for the late fee maximum date range.

Processing Enrollment Cancellation

This section provides an overview of enrollment cancellation and discusses how to:

- Define student selection criteria for enrollment cancellation.
- Define charges, offset payments, cancellation options, and service indicators for enrollment cancellation.

Understanding Enrollment Cancellation

The Enrollment Cancellation process selects students for enrollment cancellation when they are past due on their fee payments. You can set up the system to cancel individual classes within a term, individual classes within a session, the entire term, or the entire session for students who meet the past due requirements that you define. You can apply enrollment cancellation criteria to all students in your institution or only to students in specific tuition groups or academic programs. You have the flexibility to define enrollment cancellation rules that meet the specific needs of your institution.

The Enrollment Cancellation process in the Student Financials application selects only students for cancellation. The actual cancellation process is completed in PeopleSoft Student Records using the Student Records Term Withdrawal process (SRPCWDPR).

See Also

PeopleSoft Enterprise Student Records 9.0 PeopleBook

Pages Used to Process Enrollment Cancellation

Page Name	Definition Name	Navigation	Usage
Enrollment Cancellation 1	RUNCTL_SFPCLCAN	Student Financials, Tuition and Fees, Cancellation, Cancel Enrollment, Enrollment Cancellation 1	Define student selection criteria for enrollment cancellation.
Enrollment Cancellation 2	RUNCTL_SFPCLCAN2	Student Financials, Tuition and Fees, Cancellation, Cancel Enrollment, Enrollment Cancellation 2	Define charges, offset payments, cancellation options, and service indicators for enrollment cancellation.
Enrollment Cancellation	CANC_TERM_CLASS	Student Financials, Tuition and Fees, Cancellation, Review Enrollment Cancellation, Enrollment Cancellation	Review results of the Enrollment Cancellation process.
Enrollment Cancellation Messages	CANC_MESSAGES	Student Financials, Tuition and Fees, Cancellation, Review Cancellation Messages	Review messages generated by the Enrollment Cancellation process.

Defining Student Selection Criteria for Enrollment Cancellation

Access the Enrollment Cancellation 1 page (Student Financials, Tuition and Fees, Cancellation, Cancel Enrollment, Enrollment Cancellation 1).

Enrollment Cancellation 1		Enrollment Cancellation 2	
Run Control ID:	1	Report Manager	Process Monitor
Batch ID:	999999999999	<input type="checkbox"/> Report Only	Run
*Business Unit:	PSUNV	Display Cancellation	Display Cancellation Messages
Cancellation Type <input type="radio"/> Term Cancellation <input type="radio"/> Session Cancellation <input checked="" type="radio"/> Class by Class Within Term <input type="radio"/> Class by Class Within Session Term: 0522 2004 Sum Session:		Selection Criteria <input type="radio"/> All <input type="radio"/> Tuition Group <input checked="" type="radio"/> Academic Program Tuition Group: Find First 1 of 1 Last Acad Prog: Find First 1-2 of 2 Last LAU FAU	
		Aging Criteria <input type="radio"/> By Date <input checked="" type="radio"/> By Days	
Past Due			
Initial Amount:	600.00	Subsequent Amount:	0.00 USD

Enrollment Cancellation 1 page

- Business Unit** Select the business unit for the students that you are reviewing.
- Report Only** Select to view which students are eligible for cancellation without completing the process. The results of the report are available when you click the Display Cancellation link.
- Display Cancellation** Click to view cancellation results. It does not matter whether the Report Only check box is selected. The system displays results for the Class Cancellation process you have run.
- Display Cancellation Messages** Click to view enrollment cancellation warning and error messages.

Cancellation Type

Define which enrollments are canceled by running the process. The cancellation type works in conjunction with the Cancel Completed Classes and Cancel Classes With Grades check boxes on the Enrollment Cancellation 2 page to determine what type of request the Enrollment Cancellation process generates for a student.

Term Cancellation

Select to cancel all the classes that a student is taking for a term.

If you select this option and you also select the Cancel Completed Classes check box, Cancel Classes With Grades check box, or both, then the Enrollment Cancellation process generates a term cancellation request for each selected student.

If you select this option, you do not select the Cancel Completed Classes or the Cancel Classes With Grades check boxes, and a student has either completed a class or has a graded class, then the Enrollment Cancellation process generates an enrollment request with an action of drop, instead of a term cancellation request, for the student's uncompleted and ungraded classes.

If you select this option, you do not select the Cancel Completed Classes or the Cancel Classes With Grades check boxes, and the student has no completed or graded classes, then the Enrollment Cancellation process generates a term cancellation request.

Session Cancellation

Select to cancel all the classes that a student is taking for a session.

If you select this option and you select the Cancel Completed Classes check box, the Cancel Classes With Grades check box, or both, then the Enrollment Cancellation process generates a session cancellation request for each selected student.

If you select this option, you do not select the Cancel Completed Classes or the Cancel Classes With Grades check boxes, and a student has either completed a class or has a graded class, then the Enrollment Cancellation process generates an enrollment request with an action of drop, instead of a session cancellation request, for the student's uncompleted and ungraded classes.

If you select this option, you do not select the Cancel Completed Classes or the Cancel Classes With Grades check boxes, and the student has no completed or graded classes, then the Enrollment Cancellation process generates a session cancellation request.

Class by Class Within Term

Select to cancel individual classes within a term.

If you select this option and you select the Cancel Completed Classes check box, the Cancel Classes With Grades check box, or both, then the Enrollment Cancellation process generates an enrollment request with an action of drop. The system drops each class in the term, one by one, until the past due amount is less than the Subsequent Amount that you specify. If the request results in all classes being dropped for a student, then the process generates a term cancellation request.

If you select this option, you do not select the Cancel Completed Classes or the Cancel Classes With Grades check boxes, and a student has either completed a class or has a graded class, then the Enrollment Cancellation process generates an enrollment request with an action of drop for the student's uncompleted and ungraded classes. The system drops each class, one by one, until the past due amount is less than the Subsequent Amount.

If you select this option, you do not select the Cancel Completed Classes or the Cancel Classes With Grades check boxes, and the student has no completed or graded classes, then the Enrollment Cancellation process generates an enrollment request with an action of drop. The system drops each class, one by one, until the past due amount is less than the Subsequent Amount. If the request results in all classes being dropped for a student, then the process generates a term cancellation request.

Class by Class Within Session

Select to cancel individual classes within a session.

If you select this option and you select the Cancel Completed Classes check box, the Cancel Classes With Grades check box, or both, then the Enrollment Cancellation process generates an enrollment request with an action of drop. The system drops each class in the session, one by one, until the past due amount is less than the Subsequent Amount that you specify. If the request results in all classes being dropped for a student, then the process generates a session cancellation request.

If you select this option, you do not select the Cancel Completed Classes or the Cancel Classes With Grades check boxes, and a student has either completed a class or has a graded class, then the Enrollment Cancellation process generates an enrollment request with an action of drop for the student's uncompleted and ungraded classes. The system drops each class, one by one, until the past due amount is less than the Subsequent Amount.

If you select this option, you do not select the Cancel Completed Classes or the Cancel Classes With Grades check boxes, and the student has no completed or graded classes, then the Enrollment Cancellation process generates an enrollment request with an action of drop. The system drops each class, one by one, until the past due amount is less than the Subsequent Amount. If the request results in all classes being dropped for a student, then the process generates a session cancellation request.

Term

Enter the term for which you are canceling enrollments. This field is required.

Session

Enter the session for which you are canceling enrollments if you are using either session option.

Selection Criteria

Select which students you want to review for enrollment cancellation processing.

All	Select to review all students in the business unit who meet the criteria that you specify. If you select this option, the Tuition Group and Academic Program fields are not available.
Tuition Group	Select n to review students within a specific tuition group.
Academic Program	Select to review students within a specific academic program.

Aging Criteria

By Date	Select and enter a date to indicate that any student with a past due amount on the specified payment date should be selected for enrollment cancellation.
By Days	Select and enter the number of days to indicate that any student with a past due amount for the number of days specified should be selected for enrollment cancellation.

Past Due

Initial Amount	Enter the initial past due amount that places a student in the enrollment cancellation process. Students with past due amounts that are lower than the initial amount are not selected.
Subsequent Amount	This field is available only when the Class by Class Within Term or Class by Class Within Session option is selected. The system uses this information to automatically cancel classes one by one until the past due amount is less than the subsequent amount.

Example of the Class by Class Cancellation Process with Subsequent Amount

A student enrolls in four classes at a cost of 300 USD per class, but pays only 300 USD. For enrollment cancellation purposes, the initial amount is 600 USD and the subsequent amount is 350 USD. The system selects the student as eligible for enrollment cancellation because the past due amount is 900 USD, which exceeds the specified initial amount. The first class that is cancelled lowers the past due amount to 600 USD. Because this figure is still higher than the subsequent amount (350 USD), the system cancels a second class, which brings the past due amount to 300 USD. Because this figure is lower than the subsequent amount specified, no more classes are cancelled.

Defining Charges, Offset Payments, Cancellation Options, and Service Indicators for Enrollment Cancellation

Access the Enrollment Cancellation 2 page (Student Financials, Tuition and Fees, Cancellation, Cancel Enrollment, Enrollment Cancellation 2).

Enrollment Cancellation 1		Enrollment Cancellation 2	
Run Control ID:	BILLING	Report Manager	Process Monitor <input type="button" value="Run"/>
Batch ID:	999999999999	Display Cancellation	
Business Unit:	PSUNV	Display Cancellation Messages	
Item Group Selection			
Charges:	Item Group	From / To Term	
	TUITION <input type="text"/>	0505 <input type="text"/>	0505 <input type="text"/>
<input checked="" type="checkbox"/> Unapplied Payments	TUIT&FEES <input type="text"/>	0505 <input type="text"/>	0505 <input type="text"/>
<input checked="" type="checkbox"/> Unapplied Financial Aid	FINAID <input type="text"/>	0505 <input type="text"/>	0505 <input type="text"/>
<input checked="" type="checkbox"/> Anticipated Aid		0505 <input type="text"/>	0505 <input type="text"/>
Options			
<input checked="" type="checkbox"/> Cancel Completed Classes	<input checked="" type="checkbox"/> Cancel Classes With Grades	<input checked="" type="checkbox"/> Eligible to Enroll	
Service Impact			
Service Impact:	BILLS <input type="text"/>	No Bill	

Enrollment Cancellation 2 page

Display Cancellation Click to access the Enrollment Cancellation page, where you can review details about students with cancelled enrollment.

Display Cancellation Messages Click to access the Enrollment Canc Messages page, where you can review cancellation messages.

Item Group Selection

Item Group Select the appropriate item group to indicate the specific charges to be included in the past due amount.

From/To Term Enter the From/To Term range for picking up the charges.

Unapplied Payments, Unapplied Financial Aid, Anticipated Aid To reduce charges by certain types of unapplied payments, unapplied financial aid, or anticipated aid, select the option and then enter the appropriate item group and the from/to term range for picking up these credits.

Options

- Cancel Completed Classes** Select this option to cancel classes that have been completed but not graded. The system will not cancel any classes for which the student has received grades.

- Cancel Classes With Grades** If grades have been entered, and you want to include graded classes in the cancellation process, select this option to cancel classes with grades.

- Eligible to Enroll** If you select this check box, the Enrollment Cancellation process selects the Eligible to Enroll check box on the Term Activation page for students selected by the process. If you do not select this check box, the Enrollment Cancellation process clears the Eligible to Enroll check box on the Term Activation page for students that were selected by the process.

Service Impact

- Service Impact** Enter a service impact to exclude students from the enrollment cancellation process. Those students with the service indicator are not selected for the enrollment cancellation process.

A service impact, once set, is not in effect for all terms after that time. It must be reset every term *or* set for the generic term 0000. No *effective term* is associated with a service impact. A service impact set at one institution will not be respected by other institutions.

See Also

PeopleSoft Enterprise Student Records 9.0 PeopleBook, "Managing Student Programs, Plans, and Subplans"

Validating Tables

The Table Validation process is a powerful tool that enables you to report on and correct referential integrity errors within Student Financials tables. These errors can occur as a result of setup errors, changes to setup after data is partially processed, or your own modified programs that insert or update Student Financials tables.

Page Used to Validate Tables

Page Name	Definition Name	Navigation	Usage
Table Validation	RUN_CNTL_SFTBLVAL	Student Financials, Charges and Payments, Validate Tables, Table Validation	Run the Table Validation process.

Running the Table Validation Process

Access the Table Validation page (Student Financials, Charges and Payments, Validate Tables, Table Validation).

Table Validation

Run Control ID: Table_Val [Report Manager](#) [Process Monitor](#) Run

Select Option <input checked="" type="radio"/> All IDs <input type="radio"/> One ID <input type="radio"/> ID Range	Run Option <input type="checkbox"/> Update	Business Unit Business Unit: <input type="text" value="PSUNV"/> <input type="button" value=""/> PeopleSoft University Bursar															
ID Option <input type="text" value="Individual and Organization"/>																	
Detail Options <table style="width: 100%; border: none;"> <tr> <td><input type="checkbox"/> Student Account Balance</td> <td><input type="checkbox"/> Applied Amount</td> <td><input type="checkbox"/> Cross Reference Effective Date</td> </tr> <tr> <td><input type="checkbox"/> Corporation Account Balance</td> <td><input type="checkbox"/> Balance Amount</td> <td><input type="checkbox"/> Cross Reference Payment ID</td> </tr> <tr> <td><input type="checkbox"/> Item Amount</td> <td><input type="checkbox"/> Cross Reference CommonID Table</td> <td><input type="checkbox"/> Cross Reference Contract Nbr</td> </tr> <tr> <td><input type="checkbox"/> Payment Amount</td> <td><input type="checkbox"/> Cross Reference CommonID Field</td> <td></td> </tr> <tr> <td><input type="checkbox"/> Refund Amount</td> <td><input type="checkbox"/> Cross Reference Item Amount</td> <td></td> </tr> </table>			<input type="checkbox"/> Student Account Balance	<input type="checkbox"/> Applied Amount	<input type="checkbox"/> Cross Reference Effective Date	<input type="checkbox"/> Corporation Account Balance	<input type="checkbox"/> Balance Amount	<input type="checkbox"/> Cross Reference Payment ID	<input type="checkbox"/> Item Amount	<input type="checkbox"/> Cross Reference CommonID Table	<input type="checkbox"/> Cross Reference Contract Nbr	<input type="checkbox"/> Payment Amount	<input type="checkbox"/> Cross Reference CommonID Field		<input type="checkbox"/> Refund Amount	<input type="checkbox"/> Cross Reference Item Amount	
<input type="checkbox"/> Student Account Balance	<input type="checkbox"/> Applied Amount	<input type="checkbox"/> Cross Reference Effective Date															
<input type="checkbox"/> Corporation Account Balance	<input type="checkbox"/> Balance Amount	<input type="checkbox"/> Cross Reference Payment ID															
<input type="checkbox"/> Item Amount	<input type="checkbox"/> Cross Reference CommonID Table	<input type="checkbox"/> Cross Reference Contract Nbr															
<input type="checkbox"/> Payment Amount	<input type="checkbox"/> Cross Reference CommonID Field																
<input type="checkbox"/> Refund Amount	<input type="checkbox"/> Cross Reference Item Amount																
Item Due Info <input type="checkbox"/> Item Due Date <input type="checkbox"/> Initial Run	Commit Option <input checked="" type="radio"/> Commit At the End <input type="radio"/> Commit Level																

Table Validation page

Select Option

- All IDs** Select to run the process against all accounts in the system. If *Individual and Organization* is selected as the ID Option, All IDs is the required Select Option.
- One ID** Select to run the process against a single individual or corporate account.
- ID Range** Select to process a range of either individual or corporate accounts.

Run Option

- Update** Select to correct data errors when they are detected. Clear this check box to produce reports only. If you select this check box, the process still produces reports.

Note. When you run the Table Validation process, you have the option of selecting as many reports and updates as you want. In update mode, data dependencies and processing must occur in the order that the options appear on the page.

ID Option**ID Option**

Individual and Organization: Select to process all accounts in the system. If you select this option, the Select Option is limited to All IDs, and the Start and End fields are hidden.

Individual Only: Select to process only individual accounts. If you select this option, all Select Options are available.

Organization Only: Select to process only external organization accounts. If you select this option, all Select Options are available.

From ID

This field is available when either One ID or ID Range is selected as the Select Option and is labeled appropriate to the ID Option selection.

To ID

This field is available when ID Range is selected as the Select Option and the label is associated with the appropriate ID Option selection.

Detail Options

In the Detail Options group box, select the reports or updates that you want to process. If the Update run option is not selected, the process produces a report that identifies referential data integrity discrepancies, but it does not change any data. If you select the Update run option, discrepancies are corrected as indicated in each description.

Student Account Balance

Select to compare the account balance from the ACCOUNT_SF table with the sum of the item amounts from the ITEM_SF table. If the amounts are different, the system uses the sum of the item amounts to update the account balance.

Corporation Account Balance

Select to compare the account balance from the ACCOUNT_ORG_SF table with the sum of the item amounts from the ITEM_SF table. If the amounts are different, the system uses the sum of the item amounts to update the account balance.

Item Amount

Select to compare the item amount from the ITEM_SF table with the sum of the line amounts from the ITEM_LINE_SF table. If the amounts are different, the system uses the sum of the line amounts to update the item amount.

Payment Amount

Select to compare the payment amounts from the PAYMENT_TBL table with the sum of the item amounts for each payment from the ITEM_SF table. If the amounts are different, the system uses the sum of the item amounts to update the payment amount.

Refund Amount

Select to compare the refund amount from the REFUND_HDR table with the item amount from the ITEM_SF table. If the amounts are different, the system uses the item amount to update the refund amount.

Applied Amount

Select to compare the sum of the cross reference amounts from the ITEM_XREF table with the applied amount from the ITEM_SF table. If the amounts are different, the system uses the cross-reference amount to update the applied amount.

Balance Amount

Select to compare the sum of the cross-reference amount from the ITEM_XREF table with the net value of the item amount, minus the item balance from the ITEM_SF table. If the amounts are different, the system subtracts the sum of the cross-reference amount from the item amount and uses the result to update the item balance.

Cross Reference CommonID Table

Select the Cross Reference CommonID Table check box and run the process.

The report performs the following cross checks:

- For every student with an account that is defined in ACCOUNT_SF and for every organization with an account that is defined in ACCOUNT_ORG_SF, the report verifies that a row exists in the SF_COMMON_ID table. If a row does not exist in the SF_COMMON_ID table and you run the report in update mode, the system inserts a row for the student or organization ID into SF_COMMON_ID.
- For every person or organization, the report verifies for each COMMON_ID that the maximum item number that is recorded in the ITEM_SF table matches the field ITEM_NBR_LAST stored in the SF_COMMON_ID table. When you run the report in update mode, if the ITEM_NBR_LAST in the SF_COMMON_ID table does not match the highest ITEM_NBR for a given student or organization in ITEM_SF, the program updates the field ITEM_NBR_LAST to match the highest ITEM_NBR in ITEM_SF for that student or organization.
- For every person or organization, the report verifies for each COMMON_ID that the maximum payment ID number recorded in the PAYMENT_TBL matches the field PAYMENT_ID_LAST stored in the SF_COMMON_ID table. When you run the report in update mode, if the PAYMENT_ID_LAST in the SF_COMMON_ID table does not match the highest PAYMENT_ID_NBR for a given student or organization in PAYMENT_TBL, the program updates the field PAYMENT_ID_LAST to match the highest PAYMENT_ID_NBR in PAYMENT_TBL for that student or organization.

The report lists any discrepancies found.

Note. Due to its intensive table analysis of the core SF transaction tables and possible updates to SF_COMMON_ID, you should run the Cross Reference CommonID Table report in update mode only on a limited basis and only while it has exclusive access to the system. Do not run other Student Financials processes while this report is running.

**Cross Reference
CommonID Field**

Select the Cross Reference CommonID Field check box and run the process.

The report cross checks COMMON_ID and SA_ID_TYPE against the fields EMPLID and EXT_ORG_ID in the following tables:

- ITEM_SF
- ITEM_LINE_SF
- PAYMENT_TBL
- ITEM_DUE_SF

For each table, the system reports errors when the following conditions occur:

1. Both EMPLID and EXT_ORG_ID are populated.
2. Neither EMPLID nor EXT_ORG_ID is populated.
3. The SF_COMMON_ID.SA_ID_TYPE = P (person) and the EMPLID has a value that is not the same value in COMMON_ID.
4. The SF_COMMON_ID.SA_ID_TYPE = O (organization) and the EXT_ORG_ID have values that are not the same value in COMMON_ID.

Note. Even if you run the report in update mode, the system does not update the EMPLID, EXT_ORG_ID, COMMON_ID, and SA_ID_TYPE fields to prevent an inadvertent change to these ID fields. You must identify the correct values and make a manual correction in all relevant tables.

**Cross Reference Item
Amount**

Select to compare the sum of the cross-reference amounts from the ITEM_XREF table with the item amount from the ITEM_SF table. If the item amount is less than this sum, the values in the ITEM_XREF table are set to zero and the errors are reported. To correct the errors, the payments must be backed out and then reapplied. Each payment can be backed out manually or by running the Applied Amount and Balance Amount reports *after* running this report. Exception: If the item is linked to a contract, the system does not set the values in the ITEM_XREF table to zero. To correct the errors, the contracts must be cancelled, the update process must be run again to zero the ITEM_XREF values, and the contracts must be reapplied.

**Cross Reference
Effective Date**

Select to find any missing effective dates in the ITEM_XREF table to the item effective date in the ITEM_SF table. If dates are missing, the system uses the item effective date from ITEM_SF to update the effective date.

**Cross Reference
Payment ID**

Select to find any missing payment ID numbers from the ITEM_XREF table with the payment ID number from the ITEM_SF table. If the numbers are different, the system uses the payment ID number from ITEM_SF to update the payment ID number in ITEM_XREF.

**Cross Reference
Contract Nbr** (cross
reference contract
number)

Select to validate the contract number in the ITEM_XREF table. If the item number contract is populated but the contract number is blank, the system uses the contract number from the TP_STUDENT table to update the ITEM_XREF table.

Item Due Info

Item Due Date	Select to find due date discrepancies in the ITEM_DUE_SF table. The program compares this due date with the due date from the ITEM_LINE_SF table. If the dates are different, the system uses the due date from ITEM_LINE_SF to calculate the appropriate value and update the ITEM_DUE_SF due date.
Initial Run	Select in conjunction with the Item Due Date option to delete all due date values from the ITEM_DUE_SF table before recalculating them. This option only has an effect if the report is run in update mode.
<hr/>	
Note. The Item Due Date and Initial Run fields must always be considered together.	
<hr/>	

Commit Option

Commit At the End	Select to commit changes only at the end of processing. This option applies only to the Item Due Date option.
Commit Level	Select to specify a commit level. When you select this option, you are required to specify a value in the box that appears to the right. The program commits changes to the table after each 100 IDs have been processed.
<hr/>	
Note. This option applies only to the Item Due Date option.	
<hr/>	

You can use the Operator ID and Date Time Stamp columns to find out who last performed an update or insert operation on the following tables and when the operation was last performed

- ITEM_SF
- ITEM_LINE_SF
- PAYMENT_TBL
- ITEM_DUE_SF
- ACCOUNT_SF
- ACCOUNT_ORG_SF
- ITEM_XREF
- BI_BILL_HEADER
- BI_BILLING_LINE
- SF_ACCTG_LN

You will need to use a query tool to find out the Operator ID and Date Time Stamp column values.

Chapter 22

Maintaining Customers

This chapter provides an overview of the Maintain Customers feature and discusses how to:

- Manage student permissions.
- Process and review customer credit history.

Understanding the Maintain Customers Feature

The Maintain Customers feature provides components that enable you to maintain, view, and report some student data within PeopleSoft Student Financials without having to access the PeopleSoft Campus Community application. The Maintain Customers feature has these components:

- Address Maintenance
- Electronic Addresses
- Relations with Institution
- Residency Data
- Service Indicator Data
- Active Service Indicators
- Address Search
- Address Listing

Understanding the Maintain Customers Feature

For more information:

See Also

PeopleSoft Enterprise Campus Community 9.0 Fundamentals PeopleBook

Managing Student Permissions

This section provides an overview of student permissions and discusses how to:

1. Create student permission forms to apply restricted credits.
2. Attach student permission forms to student records.
3. Attach student permission forms to charge priority lists.

Understanding Student Permissions

Certain types of credits to a student's account are restricted as to what types of charges they can be applied to as well as what term or terms, by Aid Year versus by Academic Year. For example, the Department of Education requires authorization from a student before applying Title IV financial aid to a student's account for charges other than allowable charges, which are tuition, mandatory fees, and contracted housing and board. Additionally, some scholarships pay charges for a specific term. Student permissions, which are granted by the student, allow this money to pay charges incurred from other terms.

Institutions that use an automated system to manage student finances can create student permissions that are a record of standing permissions from students to apply restricted credits.

Note. If you attach student permissions to a charge priority, you can define the terms for which permission is required for application of payment.

Pages Used to Manage Student Permissions

<i>Page Name</i>	<i>Definition Name</i>	<i>Navigation</i>	<i>Usage</i>
Permission Form	WAIVER_FORM_TABLE	Set Up SACR, Product Related, Student Financials, Charges and Payments, Student Permission Forms, Permission Form	Create permission form for applying restricted credits.
Assign Student Permissions	STDNT_WAIVER_FORM	Student Financials, Charges and Payments, Assign Student Permissions	Assign permission to apply restricted credits.
Details	ITEM_CHRG_TYP_PRT2	Set Up SACR, Product Related, Student Financials, Charges and Payments, Charge Priority List, Details	Attach permission forms to charge priority lists.

Creating Student Permission Forms to Apply Restricted Credits

Access the Permission Form page (Set Up SACR, Product Related, Student Financials, Charges and Payments, Student Permission Forms, Permission Form).

Permission Form

SetID: PSUNV
Permission Form: FA_ALL

Find | View All First 1 of 1 Last

***Effective Date:** 01/01/2007 ***Status:** Active

***Description:** Financial Aid Permissions

***Short Description:** FA_ALL

Long Description: Self Service Financial Aid Permissions

Enable for Self Service

Permission Form page

Enable for Self Service Select the check box to identify permission waivers as eligible for use in student self-service.

Attaching Student Permission Forms to Student Records

Access the Assign Student Permissions page (Student Financials, Charges and Payments, Assign Student Permissions).

Assign Student Permissions

Institution: PSUNV PeopleSoft University

ID: FASP0008 Kirk, Dani R

***Permission Form:** FA_ALL Financial Aid Permission

***Effective Date:** 10/19/2006 ***Status:** Active

Long Description: Permission to apply Title IV financial aid funds to all charges appearing on the account.

Last Updated: FASP0008

Date/Time: 10/19/06 3:30:20PM **Originated from Self-Service**

Assign Student Permissions page

Permission Form Enter the permission form that you want to attach to the student's record.

Originated from Self-Service This check box is selected by default when the permission form is initiated via the self-service application.

For each Permission (Waiver) level 2 added in the Effective Date section, the Oprid and the Process Date/Time fields are modified to indicate who performed the update.

Attaching Student Permission Forms to Charge Priority Lists

Access the Details page (Set Up SACR, Product Related, Student Financials, Charges and Payments, Charge Priority List, Details).

Attach Student Permission forms to charge priority lists during the setup of your charge priority list rules.

See Also

Chapter 2, "Completing Student Financials General Setup," Defining Charge Priority List Rules, page 41

Processing and Reviewing Customer Credit History

The Credit History process assigns outstanding charges for one or more students or organizations to aging categories of a particular aging set. After the charges are assigned to aging sets, you can use the Collect Receivables feature to begin the collection process.

See Also

[Chapter 2, "Completing Student Financials General Setup," Setting Up Aging Sets, page 37](#)

Pages Used to Process and Review Customer Credit History

<i>Page Name</i>	<i>Definition Name</i>	<i>Navigation</i>	<i>Usage</i>
Credit History	RUNCTL_CREHIST	Student Financials, Collections, Credit History, Process Credit History, Credit History	Process customer credit history.
Credit History	CREDIT_HIST_LIST	Student Financials, Collections, Credit History, Review Credit History	Review the aging history of a student's account.
Corporation Credit History	CREDIT_HIST_LIST_O	Student Financials, Collections, Credit History, Review Corp Credit History, Corporation Credit History	Review the aging history of an organization's account.

Processing Customer Credit History

Access the Credit History page (Student Financials, Collections, Credit History, Process Credit History, Credit History).

Credit History

Run Control ID: [Report Manager](#) [Process Monitor](#) Run

Select Option	Processing Options										
<input type="radio"/> All IDs <input type="radio"/> One ID <input type="radio"/> ID Range <input type="radio"/> Last Activity Date <input checked="" type="radio"/> Temp Table	Business Unit: <input type="text" value="PSUNV"/> <input type="button" value="Q"/> PeopleSoft University Bursar Aging Set: <input type="text" value="STD"/> <input type="button" value="Q"/> STD Aging Set ID Switch: <input type="button" value="By Emplid"/> <input type="button" value="v"/> Temp Table ID: <input type="text"/> <input type="button" value="Q"/>										
Temp Table Build Options											
<table border="1" style="width: 100%; border-collapse: collapse;"> <thead> <tr style="background-color: #2e5496; color: white;"> <th style="width: 50%;">Last Activity Date Options</th> <th style="width: 50%;">Process Only</th> </tr> </thead> <tbody> <tr> <td><input checked="" type="radio"/> Use This Date <input type="text" value="03/30/2009"/> <input type="button" value="Q"/></td> <td><input type="radio"/> Last Activity</td> </tr> <tr> <td><input type="radio"/> Use Last Run Date</td> <td><input checked="" type="radio"/> Last Activity and Age History <input checked="" type="checkbox"/> Include Max Aged History</td> </tr> <tr> <td><input type="radio"/> Use Run Date Minus (days) <input type="text" value="1"/></td> <td><input type="radio"/> To Release Service Indicators</td> </tr> </tbody> </table>	Last Activity Date Options	Process Only	<input checked="" type="radio"/> Use This Date <input type="text" value="03/30/2009"/> <input type="button" value="Q"/>	<input type="radio"/> Last Activity	<input type="radio"/> Use Last Run Date	<input checked="" type="radio"/> Last Activity and Age History <input checked="" type="checkbox"/> Include Max Aged History	<input type="radio"/> Use Run Date Minus (days) <input type="text" value="1"/>	<input type="radio"/> To Release Service Indicators	<table border="1" style="width: 100%; border-collapse: collapse;"> <thead> <tr style="background-color: #2e5496; color: white;"> <th>Population Selection</th> </tr> </thead> <tbody> <tr> <td><input type="checkbox"/> Population Selection</td> </tr> </tbody> </table>	Population Selection	<input type="checkbox"/> Population Selection
Last Activity Date Options	Process Only										
<input checked="" type="radio"/> Use This Date <input type="text" value="03/30/2009"/> <input type="button" value="Q"/>	<input type="radio"/> Last Activity										
<input type="radio"/> Use Last Run Date	<input checked="" type="radio"/> Last Activity and Age History <input checked="" type="checkbox"/> Include Max Aged History										
<input type="radio"/> Use Run Date Minus (days) <input type="text" value="1"/>	<input type="radio"/> To Release Service Indicators										
Population Selection											
<input type="checkbox"/> Population Selection											
<table border="1" style="width: 100%; border-collapse: collapse;"> <thead> <tr style="background-color: #2e5496; color: white;"> <th>Service Indicator</th> </tr> </thead> <tbody> <tr> <td><input checked="" type="checkbox"/> Service Indicator Update</td> </tr> <tr> <td>Service Indicator Set: <input type="text" value="STD"/> <input type="button" value="Q"/> Standard</td> </tr> <tr> <td>Placed Person ID: <input type="text"/> <input type="button" value="Q"/></td> </tr> <tr> <td>Exclude Service Impact: <input type="text"/> <input type="button" value="Q"/></td> </tr> </tbody> </table>	Service Indicator	<input checked="" type="checkbox"/> Service Indicator Update	Service Indicator Set: <input type="text" value="STD"/> <input type="button" value="Q"/> Standard	Placed Person ID: <input type="text"/> <input type="button" value="Q"/>	Exclude Service Impact: <input type="text"/> <input type="button" value="Q"/>	<table border="1" style="width: 100%; border-collapse: collapse;"> <thead> <tr style="background-color: #2e5496; color: white;"> <th>Back Date</th> </tr> </thead> <tbody> <tr> <td><input type="checkbox"/> Back Date Flag</td> </tr> <tr> <td>Back Date: <input type="text"/></td> </tr> </tbody> </table>	Back Date	<input type="checkbox"/> Back Date Flag	Back Date: <input type="text"/>		
Service Indicator											
<input checked="" type="checkbox"/> Service Indicator Update											
Service Indicator Set: <input type="text" value="STD"/> <input type="button" value="Q"/> Standard											
Placed Person ID: <input type="text"/> <input type="button" value="Q"/>											
Exclude Service Impact: <input type="text"/> <input type="button" value="Q"/>											
Back Date											
<input type="checkbox"/> Back Date Flag											
Back Date: <input type="text"/>											

Credit History page

Select Option

All IDs

Select to run the Credit History process for all students or organizations with outstanding charges in the database.

One ID

Select to run the Credit History process for a single student or external organization. When you select this option, the ID field or the External Org ID field appears, depending on the value that you select in the ID Switch field.

ID Range

Select to run the Credit History process for a range of students or external organizations. When you select this option, the Start EmplID and End EmplID fields or the Start Ext Org ID (start external organization ID) and End Ext Org ID (end external organization ID) fields appear, depending on the value that you select in the ID Switch field.

Last Activity Date

Select to run Credit History process for only those students or external organizations that have had activity on their accounts since a given date. When you select this option, the Last Activity Date field appears.

Temp Table Select this option to have the system insert records into the temp table for credit history processing. When you select this option, the Temp Table ID field and the Last Activity Date Options, Process Only, and Population Selection group boxes appear. You can use these group boxes to determine which records should be inserted into the temp table for credit history processing.

Processing Options

Aging Set Enter the aging set containing the aging categories to which you want to assign outstanding charges.

ID Switch Choose whether the Credit History process includes students or organizations. Select the *By Emplid* (by employee ID) value to run the process for students or the *By Org ID* (by organization ID) value to run the process for organizations.

ID Select the identification number of the student for whom you are running the Credit History process.

External Org ID (external organization ID) Select the identification number of the organization for which you are running the Credit History process.

Start ID and End ID Use these fields to set a range of students for which you want to run the Credit History process.

Start Ext Org ID and End Ext Org ID Use these fields to set a range of organizations for which you want to run the Credit History process.

Last Activity Date Enter the date on or after which activity must have occurred in a student or corporate account to be included in the Credit History process.

Temp Table ID Select the temp table into which the system inserts records for credit history processing.

Last Activity Date Options

Use this group box to specify how the system should determine the Last Activity Date for the temp table option. Use this group box in conjunction with the Process Only group box.

Use This Date Enter the date the system uses as the Last Activity Date. For example, if you enter January 10 2009, only activities that have occurred on or after January 10 2009 in a student or corporate account are included in the Credit History process.

Use Last Run Date Select to have the system use the date when the Credit History process last ran as the Last Activity Date. To find out the last run date, the system looks at records with the same Operator ID and Run Control ID as the current run. If the last run date record is not available, the system sets the Last Activity Date as one day prior to the current run date. For example, if you run the Credit History process on January 10 2009 and the system does not find any last run record, the system uses January 09 2009 as the Last Activity Date.

Use Run Date Minus (days) Enter the number of days that the system should subtract from the current run date to calculate the Last Activity Date. For example, if you enter 2 in this field and the process is run on January 10 2009, the system uses January 08 2009 as the Last Activity Date.

Process Only

Use this group box in conjunction with the Last Activity Date Options group box for the Temp Table option.

Last Activity Select to run the process for students or organizations that have activities occurring on or after the Last Activity Date. For example, if you have selected this option and entered January 10 2009 in the Use This Date field, only activities that have occurred on or after January 10 2009 in a student or corporate account are included in the Credit History process.

Last Activity and Age History Select to run the process for students or organizations that have activities occurring on or after the Last Activity Date.

By selecting this option, the process includes the existing non-zero credit history records in the temporary table for processing. These records are included to ensure that the correct aging category is applied (an existing entry moves from a past due aging category to another, for example, from past due 31-60 to past due 61 -90).

The Last Activity and Age History selection excludes the accounts in the maximum aging category, if no activity has occurred since the last activity date specified. These accounts cannot age beyond the maximum aging category. To reduce the population selected for the credit history process and improve performance, the accounts are therefore not selected. Removing a service indicator does not constitute an activity.

To Release Service Indicators Select to run the process for students or organizations that have activities occurring on or after the Last Activity Date. By selecting this option, the process also determines whether the selected activities have service indicators which need to be released. The process uses the options you have set up in the Service Indicator Set group box to determine which service indicators need to be considered.

Include Max Aged History If service indicators have been manually removed for any accounts in this category, the accounts will not be included in the credit history process and a service indicator will not be placed on the account again.

If you select the Include Max Aged History check box, the accounts in the maximum aging category are included in the temp table and are processed in the credit history process.

Population Selection

Use this group box if you want to use a Population Selection tool for the temp table option. You can select only PS Query or External File as the selection tool. For information about Population Selection, see the Campus Community Fundamentals PeopleBook.

Service Indicator

Service Indicator Update	Select to post a service indicator to the accounts. When you select this check box, the Service Indicator Set, Placed Person ID, and Exclude Service Impact fields appear in the group box.
Service Indicator Set	Enter the set of rules that you want to use for the service indicator.
Placed Person ID	Enter the identification number of the person who is assigning the service indicator.
Exclude Service Impact	Enter the value that restricts a service indicator from being applied through the Credit History process.

Back Date

Back Date Flag	Select this check box if you want to recalculate credit history for a previous date. If you select this option, the Back Date field appears in the group box.
Back Date	Enter the previous date for which you want to run the Credit History process. <hr/> Note. When running this option, the system will create two records: one record for today's date (effective date) and one record for the back-dated effective date record. <hr/>

Chapter 23

Collecting Receivables

This chapter provides an overview of receivables collection and discusses how to:

- Assign collection items to collectors and worklists.
- Work collection items.
- Update collection letter information.
- Process collection letters.
- Add to a collector's queue without using worklists.
- View customers and corporations that are in collection.

Understanding Receivables Collection

This section lists prerequisites and common elements and provides an overview of receivables collection.

Prerequisites

Before you can move items into or out of the collection system, you must run the Credit History (RUNCTL_CREHIST) process to determine the aging categories in which past due items belong.

See Also

[Chapter 22, "Maintaining Customers," Processing and Reviewing Customer Credit History, page 637](#)

Common Element Used in This Chapter

Collection ID (collection identifier) A system-assigned ID for a given collection item.

Receivables Collection

The Collect Receivables feature provides early intervention for past-due accounts. The feature interacts with PeopleSoft Workflow to assign collections items to the worklist of specific users. In addition, the feature interacts with the 3Cs (communications, comments, and checklists) from Campus Community to generate automated collection (dunning) letters. All the information that is needed to manage the collections cycle is compiled in one location and can be reviewed and updated by collectors and supervisors.

Assigning Collection Items to Collectors and Worklists

This section discusses how to:

- Assign collection items to collectors.
- Assign collection items to worklists.

Pages Used to Assign Collection Items to Collectors and Worklists

<i>Page Name</i>	<i>Definition Name</i>	<i>Navigation</i>	<i>Usage</i>
Process Collections	RUNCTL_COLLECT_SF	Student Financials, Collections, Process Collections	Assign collection items to collectors.
Assign Collections Worklist	RUNCTL_COLLECT	<ul style="list-style-type: none"> • Student Financials, Collections, Assign Customers to Worklist, Assign Collections Worklist • Student Financials, Collections, Assign Corporation to Worklist, Assign Collections Worklist 	Assign collection items to worklist.

Assigning Collection Items to Collectors

Access the Process Collections page (Student Financials, Collections, Process Collections).

Process Collections

Run Control ID: Coll_Agreement [Report Manager](#) [Process Monitor](#) Run

Business Unit	Option
Business Unit: <input type="text" value="PSUNV"/> PeopleSoft University Bursar	ID Switch: <input type="text" value="By Emplid"/> <input type="checkbox"/> Report Only

Parameters	
Reason In: <input type="text" value="PDA"/> Past Due Account	Reason Out: <input type="text" value="PRO"/> Promise to Pay
Aging Set: STD Aging Set	
Past Due Amount: 500.00	Past Due Category: 30-60
Past Due Amount Org: 1,000.00	Past Due Category Org: 30-60
Exit Due Amount: 250.00	Exit Due Category: 30-60
Exit Due Amount Org: 500.00	Exit Due Category Org: 30-60

Process Collections page

Option

ID Switch

Select whether to assign collection items for students or for organizations. The two valid values for this field are *By Emplid* and *By Org ID*.

Report Only

The Assign Collector process normally generates a report of the collection items that it assigns to collectors. If you want to generate the report of what assignments the system will make without actually making them, select this check box.

Parameters

Reason In

Enter the reason in code that the system attaches to each item that the Assign Collector process moves into the collection system.

Reason Out

Enter the reason out code that the system attaches to each item that the Assign Collector process moves out of the collection system.

The Assign Collector (SFCOLLEC) process assigns each receivable that is eligible for collection to a collector based on the collection criteria that you established during your collections setup. It creates new collection records for items moved into collections for the first time. In addition, it updates the collection records for items that have been resolved or modified since the last time the process was run.

See Also

Chapter 2, "Completing Student Financials General Setup," Setting Up Business Units, page 19

Assigning Collection Items to Worklists

Access the Assign Collections Worklist page (Student Financials, Collections, Assign Customers to Worklist, Assign Collections Worklist).

The Collections (SSF_ASGNWORK) process (if you assign collection items by user ID) or the Collections Role SSF_ASGNWORK process (if you assign collection items by role) routes collection items to the worklist of the appropriate collector.

Note. If you access this page using the Assign Org Worklist component, you can choose to run the Process Org Collections process (if you assign collection items by user ID) or the Process Org Role Collections process (if you assign collection items by role) when you click Run. These processes route organization collection items to worklists rather than student collection items.

Working Collection Items

This section provides an overview of collection items and discusses how to:

- View demographic information and collection items.
- Select collection letter templates for collection items.
- Record collection steps and follow-up actions for collection items.

Understanding Collection Items

After you assign collection items to the appropriate worklists, your collectors can begin working each item.

Working Student Collection Items

Collectors and supervisors use the Demographic Information and Collection Information pages to work student collection items. You can access these pages using three different components:

- Customer Conversations

Collectors normally use the Customer Conversations component to manually create a collection record for a past-due item without running the Assign Collector process.

- Customer Conversations Wrklst (customer conversations worklist)

This is the most common component that collectors use to work student collection items. It is also the most secure method for working collection items because collectors can access this component only through their personal worklists.

- Customer Conversations Update

This component is the least secure of the three. It is intended for users in a supervisory position who check and update the work of the collectors at your institution. Using this component, a supervisor can access any collection item that is associated with a given business unit.

Working Corporate Collection Items

Collectors and supervisors use the Demographic Information and Cust Conv Coll (customer conversation collection) pages to work corporate collection items. You can access these pages using three different components:

- **Org Customer Conversations (organization customer conversations)**
Collectors use this component to work corporate collection items in the same way that they use the Customer Conversations component to work student collection items.
- **Org Customer Convers Wrklst (organization customer conversations worklist)**
Collectors use this component to work corporate collection items in the same way that they use the Customer Conversations Wrklst component to work student collection items.
- **Org Customer Convers Update (organization customer conversations update)**
Collectors use this component to work corporate collection items in the same way that they use the Customer Conversations Update component to work student collection items.

Pages Used to Work Collection Items

<i>Page Name</i>	<i>Definition Name</i>	<i>Navigation</i>	<i>Usage</i>
Demographic Information	CUST_CONV	Student Financials, Collections, Collection Effort, Begin Customer Collection, Demographic Information	View demographic information and collection items for a student.
Demographic Information	CUST_CONV_ORG	Student Financials, Collections, Collection Effort, Begin Corporate Collection, Demographic Information	View demographic information and collection items for an organization.
Collections Dunning Letter	COLL_DUNN_LTR_SP	Click the Dunning Letter Info (dunning letter information) link on the Demographic Information page.	Select collection letter templates for item types.
Credit History	CRED_HIST_LST_SP	Click the Get Credit History link on the Demographic Information page.	Review the credit history of the student whose collection records you are working.
Credit History	CRED_HIST_LST_SP_O	Click the Get Credit History link on the Org Customer Convers Wrklst - Demographic Information page	Review the credit history of the organization for which you are working collection records.

Page Name	Definition Name	Navigation	Usage
Collection Information	CUST_CONV_COLL	Student Financials, Collections, Collection Effort, Begin Customer Collection, Collection Information	Record collection steps and follow-up actions for collection items.
Communication	COMM_SF_SP	Click the Get Communication link on the Collection Information page.	View information about communication records that you created for the collection item.
Checklist	PERS_CHKLST_SF_SP	Click the Get Checklist link on the Collection Information page.	View information about checklist records that you created for the collection item.
Comments	CMNT_SF_SP	Click the Get Comment link on the Collection Information page.	View information about comment records that you created for the collection item.

Viewing Demographic Information and Collection Items

Access the Demographic Information page (Student Financials, Collections, Collection Effort, Begin Customer Collection, Demographic Information).

Demographic Information		Collection Information	
Business Unit:	PSUNV	PeopleSoft University Bursar	
ID:	<input type="text" value="BFCH00031"/>	Chui,Robert K	
Reason In:	<input type="text" value="PDA"/>	Past Due Account	
Collection ID:	2	Account Total:	500.00
		Dunning Letter Info	
		Get Credit History	
Account Info			
		Find View All	First <input type="button" value="◀"/> 1 of 1 <input type="button" value="▶"/> Last
Account Nbr	Term	Status	Balance
OTHFEES001		Active	500.00
Address Info			
		Find View All	First <input type="button" value="◀"/> 1 of 1 <input type="button" value="▶"/> Last
Address Type	HOME		
Address 1	22626 Lewis Street		
Address 2			
Address 3			
City	Encino		
State	CA	Postal Code	91436
		Country	USA
Phone Info			
		Find	First <input type="button" value="◀"/> 1 of 1 <input type="button" value="▶"/> Last
<input type="checkbox"/>			

Demographic Information page

ID Displays the ID of the student whose collection items you are working. The name of the student appears to the right of this field.

If you access this page from the Customer Conversations component or the Customer Conversations Update component, use this field to select the student whose collection items you want to work.

Dunning Letter Info (dunning letter information) Click to access the Collections Dunning Letter secondary page.

Reason In Displays the reason in code that is associated with the collection record. If you are using this page to manually create a collection record, use this field to select a reason in code for the collection record.

Get Credit History Click to access the Credit History secondary page.

Phone Info

This scroll area displays all of the phone numbers that are associated with the student. If you select the check box next to one of the phone numbers, the selected phone number appears in the Phone field on the Collection Information page.

Selecting Collection Letter Templates

Access the Collections Dunning Letter page (click the Dunning Letter Info link on the Demographic Information page).

Collections Dunning Letter

Template Code:	<input type="text" value="DUNNINGLTR"/>		Dunning Letters
Address Usage:	<input type="text" value="SLCT ORD 1"/>		Home, Mailing, Permanent, Work
Service Impact:	<input type="text" value="CENR"/>		Block All Enrollment Actvty
Template Assign Date:	<input type="text" value="10/05/2004"/>		
Type of Name:	<input type="text" value="Preferred"/>		
Mailing Code:	Day of Month		
Template Status:	Initial		

Dunning Letter Details	Find View All	First	1 of 3	Last
Sequence Number:	1			
*Administrative Function:	<input type="text" value="SFCO"/>		Student Financials Collections	
*Communication Category:	<input type="text" value="COLL"/>		Collections Past Due	
*Communication Context:	<input type="text" value="SFIN"/>		Student Financials	
Day of the Month:	<input type="text" value="1"/>			
*Communication Method:	<input type="text" value="Letter"/>			
*Letter Code:	<input type="text"/>			
Start Date:	<input type="text"/>			
Department	<input type="text" value="STDNT SERV"/>			
Mail Status:	Pending		DateTime:	

Collections Dunning Letter page

Template Code Enter the code of the collection letter template that you want to attach to the collection record.

Template Assign Date Enter the date on which you assigned the template to this collection record.

Template Status	Displays the status of the collection letter template.
Date Time	Displays the date and time that the Collections Dunning Letter process creates a communication record for a letter.
Mail Status	Displays the status of the individual collection letter.

Note. If you attached a collection letter template to the collection criteria of the collector who is responsible for the collection items, the system enters this information automatically when you run Process Collections.

See Also

[Chapter 12, "Setting Up Receivables Collection," Setting Up Collection Letter Templates, page 370](#)

Recording Collection Steps and Follow-Up Actions for Collection Items

Access the Collection Information page (Student Financials, Collections, Collection Effort, Begin Customer Collection, Collection Information).

Demographic Information		Collection Information	
Business Unit:	PSUNV	PeopleSoft University Bursar	
ID:	FA0146	Chesnek,Cooper	
Collection Activity Find View All First 1 of 1 Last			
Collection ID:	1	Activity:	1
Follow Up Action:	PHONECALL	Phone Call	
User ID:	PS		
Next Review User ID:	SSF_APPR1		
Next Review Date:	03/01/2005		
Communication			
Letter Code:	DUN	Standard	Date/Time: 10/05/2004 1:56:19PM Get Communication
Checklist			
Promise Date:	10/15/2004	Date/Time: 10/05/2004 1:56:19PM	Get Checklist
Cash Forecast:	1000.00		
Comments			
Category:	COLL	Collection	Date/Time: 10/05/2004 1:56:19PM Get Comment
Comment:			

Collection Information page

Note. The Cust Conv Coll (customer conversation collection) page is identical to this page.

Follow Up Action	Enter any follow-up actions that are required for the collection record.
User ID	Enter the user ID of the collector who worked this item.
Next Review Date	Enter the date on which this collection record must be worked again if it hasn't yet been resolved.
Next Review User ID	Enter the user ID of the collector who is assigned to review the collection record next.
Action Date/Time	Indicates the date and time that a collector last entered information for this collection record on this page.
Communication Date Time	Indicates the date and time that a collector last modified the information in the Communication group box.

Checklist Date Time	Indicates the date and time that a collector last modified the information in the Checklist group box.
Comment Date Time	Indicates the date and time that a collector last modified the information in the Comments group box.
Phone	If you select the check box next to one of the phone numbers displayed on the Demographic Information page, that phone number appears here.

Communication

Use this group box to record communication activity that you perform for this collection record that lies outside of the automated letter generation process.

Letter Code	Enter the letter code of the letter that you sent.
Get Communication	Click to access the Communication page, where you can view information about any communications that are associated with the collection item that you are working.

Checklist

Use this group box to record any checklist activity that you perform for this collection record.

Promise Date	Enter the date by which the student promised to make a payment toward a collection item.
Cash Forecast	Enter the amount of money that the student promised to pay.
Get Checklist	Click to access the Checklist page, where you can view information about any checklists that are associated with the collection item that you are working.

Comments

Use this group box to record any comment activity that you perform for this collection record.

Category	Enter a category for the comment.
Comment	Enter a comment.
Get Comment	Click to access the Comments page, where you can view information about any comments that are associated with the collection item that you are working.

See Also

PeopleSoft Enterprise Campus Community 9.0 Fundamentals PeopleBook, "Managing Communications"

PeopleSoft Enterprise Campus Community 9.0 Fundamentals PeopleBook, "Managing Comments"

PeopleSoft Enterprise Campus Community 9.0 Fundamentals PeopleBook, "Managing Checklists"

Updating Collection Letter Information

At some point during the collection process, you may need to review and update the status of a collection letter template that is assigned to a student collection record. Two pages are available for this purpose, one for student collection letters and one for corporate collection letters. Both pages have identical functionality.

Note. You cannot modify the Template Assign Date field or the Template Code field on either of these pages.

See Also

[Chapter 23, "Collecting Receivables," Selecting Collection Letter Templates, page 650](#)

[Chapter 12, "Setting Up Receivables Collection," Setting Up Collection Letter Templates, page 370](#)

Pages Used to Update Collection Letter Information

Page Name	Definition Name	Navigation	Usage
Collections Dunning Letter	COLL_DUNNING_LTR	Student Financials, Collections, Letter Generation, Dunning Letter Content, Collections Dunning Letter	Review and update the collection letter information for a given student collection record.
Collections Dunning Letter	COLL_DUNNING_O_LTR	Student Financials, Collections, Letter Generation, Corporate Dunning Letter, Collections Dunning Letter	Review and update the collection letter information for a given corporate collection record.

Processing Collection Letters

The Collect Receivables feature enables you to generate automated collection letters to send to customers with past-due items. Based on the collection letter templates that you assign to your collection records, the Collections Dunning Letter process determines which letters to send and creates a communication record for them in PeopleSoft Campus Community. Your Campus Community personnel use these communication records to run a letter generation process to generate the letters. In addition, for every letter requiring generation, the process updates its mail status in Student Financials to *Sent*. The process updates the template status of any affected collection letter template to *Complete*.

See Also

PeopleSoft Enterprise Campus Community 9.0 Fundamentals PeopleBook, "Managing Communications"

Page Used to Process Collection Letters

<i>Page Name</i>	<i>Definition Name</i>	<i>Navigation</i>	<i>Usage</i>
Collections Dunning Letter	RUNCTL_SFBU	Student Financials, Collections, Letter Generation, Generate Dunning Letters, Collection Dunning Letter	Run the process that determines what collection letters need to be generated and sent to customers.

Adding to a Collector's Queue Without Using Worklists

This section discusses how to:

- Manually add students to collections.
- Manually add corporations to collections.

Pages Used to Add to a Collector's Queue Without Using Worklists

<i>Page Name</i>	<i>Definition Name</i>	<i>Navigation</i>	<i>Usage</i>
Collection Placement	SSF_ASGN_COLLECTN	Student Financials, Collections, Put Customers in Collection, Collection Placement	Manually add students to collections without using the workflow process.

Page Name	Definition Name	Navigation	Usage
Collection Placement	SSF_ASGN_COLL_ORG	Student Financials, Collections, Put Corporations in Collection, Collection Placement	Manually add corporations to collections without using the workflow process.

Manually Adding Students To Collections Without Using The Workflow Process

Access the Collection Placement page (Student Financials, Collections, Put Customers in Collection, Collection Placement).

Collection Placement

Business Unit: PSUNV PeopleSoft University Bursar

Collector Type: Collector Assigned by User ID

Place Customers into Collections							Customize Find	First 1-3 of 3 Last
ID	Reason In	Collector Assigned	Collector Role	Role Name	Account Total			
SFCH00029	PDA	PS	CS - Collector A	CS - Collector A	1,250.00			
SFCH00030	PDA	PS	CS - Collector A	CS - Collector A	1,250.00			
SFCH00031	PDA	PS	CS - Collector A	CS - Collector A	1,750.00			

Collection Placement page

The Collection Placement page enables you to assign collectors to students or corporations. However, you must run the Credit History process first, which uses aging categories against students or corporations to determine who should be placed in collection

ID Enter the student whom you want to add to collections.

Reason In Enter the reason that the student is in collection.

Collector Assigned Enter the collector.

Manually Adding Corporations To Collections Without Using The Workflow Process

Access the Collection Placement page (Student Financials, Collections, Put Corporations in Collection). This page is identical to the page for customers.

Viewing Customers or Corporations That Are in Collection

This section discusses how to:

- View customers in collection.
- View corporations in collection.

Pages Used to View Customers or Corporations That Are in Collection

Page Name	Definition Name	Navigation	Usage
Collector Queue	SSF_COLLECTOR_INQ	<ul style="list-style-type: none"> • Student Financials, Collections, Collection Effort, View Customer Collector Queue, Collector Queue • Student Financials, Collections, Collection Effort, View Corporate Collector Queue, Collector Queue 	View collection activity for a student or corporation by collector queue, enabling you to view what is currently in a collector's queue.

Viewing Customers in Collection

Access the Collector Queue page (Student Financials, Collections, Collection Effort, View Customer Collector Queue, Collector Queue).

Collector Queue

Business Unit: PSUNV PeopleSoft University Bursar

User ID: PS

Role Name: CS - Collector A

ID	Name	Collection ID	Status
SFPP0001	Christopher,William	1	Initial
SFCH00029	Ballard,Adam L	2	Initial
SFCH00030	Cardenas,Joseph J	3	Initial
SFCH00031	Chui,Robert K	4	Initial

Collector Queue page

Collection ID and **Status** Click to either link to view the Demographic Information page.

Viewing Corporations in Collection

Access the Collector Queue page (Student Financials, Collections, Collection Effort, View Corporate Collector Queue, Collector Queue). This page is identical to the page for customers.

Chapter 24

Producing Tax Forms and Receipt Information

This chapter provides overviews of tax form and receipt production and receipt information generation and discusses how to:

- Produce and file 1098-T tax forms.
- Produce T2202A tax forms.
- Produce T4A tax forms.
- Generate income tax and donation receipt information.

Understanding Tax Form and Receipt Production

This section lists common elements and discusses tax form production.

Common Elements Used in This Chapter

Calendar Year	For the purposes of tax reports, the calendar year represents the tax year for which you are reporting.
TIN (taxpayer identification number)	The number under which an institution files 1098-T tax information.

Tax Form Production

PeopleSoft Student Financials provides tools that you can use when managing your tax data and generating tax reports. The Manage Tax Reporting feature enables you to process data and generate reports using one Internal Revenue Service (IRS) tax form and two Canada Customs and Revenue Agency (CCRA) tax forms:

- 1098-T: An IRS form that reports tuition and related expenses for a student to use to claim an educational tax credit.
- T2202A: A CCRA form that reports tuition and related expenses for a student to use to claim an educational tax credit.
- T4A data: A CCRA form that reports all scholarship-related income for a student.

1098-T Tax Forms

The Taxpayer Relief Act of 1997 allows taxpayers to claim educational credits for some higher education expenses. Institutions that receive qualified tuition and related expenses from or on behalf of a student are required to furnish each eligible student with an IRS Form 1098-T, Tuition Statement. The information on the form helps determine whether a student, or the person who can claim the student as a dependent, can claim an income tax credit for the Hope Scholarship Credit or Lifetime Learning Credit. In addition, for every 1098-T provided to an eligible student, your institution must also file a 1098-T with the IRS. PeopleSoft Student Financials enables your institution to print your 1098-T forms for mailing to students and to transmit your 1098-T data electronically to the IRS.

Self-Service 1098-T Forms (United States)

Institutions based in the United States are required annually to issue IRS Form 1098-T to students so that they can report tuition and fee amounts on their tax returns. PeopleSoft Campus Solutions enables students to display and print their completed 1098-T forms in PDF format using self-service. This functionality supports institutions and their efforts to reduce costs and streamline administrative processes. Use Oracle's XML Publisher tool to create the PDF document.

Institutions can control the appearance of completed forms using the 1098-T TIN Detail setup page.

When 1098-T forms are generated and printed, the student can access a summary of the information from the completed 1098-T form. The student can then print the completed form in PDF format.

The student is required to provide consent and an eSignature before accessing the completed form.

(CAN) T2202A Tax Forms

Canadian taxpayers can claim tuition and education amounts as tax credits that reduce the amount of federal income tax they pay. For students to determine whether they are eligible for these tax credits, Canadian institutions must provide each of them with a Form T2202A. This form details the eligible tuition fees and education amounts that a student can claim for a given tax year.

(CAN) T4A Tax Forms

The CCRA requires that taxpayers report scholarship-related income. To comply with this requirement, Canadian institutions must provide each eligible student with a T4A slip detailing any scholarship-related income. Then, the student is responsible for reporting this income to the federal government.

Student Financials, in conjunction with PeopleSoft Payroll for North America, enables your institution to produce and print T4A forms. Using Student Financials, you can identify which students have items on their accounts that are T4A reportable and report these taxable items to your payroll department through an interface with PeopleSoft Payroll for North America. Your payroll department then uses processes within PeopleSoft Payroll for North America to produce T4A slips for the applicable students.

Understanding Receipt Information Generation

This section discusses generating income tax receipts and donation receipts.

Income Tax Receipt Information Generation

Canada allows students who are enrolled in non-degree continuing education courses to claim income tax credits for tuition fees. For these students to take advantage of this credit, they must receive an income tax receipt from their respective university listing the following information:

- GST (goods and services tax) registration number of the university.
- Student ID.
- Term in which the student was enrolled in the course.
- Course title.
- Course number.
- Period (date and time) during which the course was covered.
- Location (facility and room number).
- Student name.
- Student address.
- Assessed fee.
- Assessed GST, along with an indication of any tax exemptions.
- Tax credit portion.
- Date issued.
- Payment method.

Donation Receipt Information Generation

Universities often receive donations from students and third-party organizations. When this occurs, the university is responsible to provide a receipt listing the following information:

- GST registration number of the university.
- Date that the university received the donation.
- Date that the university issued the receipt.
- Name of the student or third-party organization.
- Address of the student or third-party organization.

Producing and Filing 1098-T Tax Forms

This section lists prerequisites and discusses how to:

- Generate 1098-T data.

- Review 1098–T messages.
- Review and override 1098-T data.
- Validate and audit 1098-T data.
- Print 1098-T forms and create electronic transmission files.

Prerequisites

Before you begin generating and transmitting 1098-T information, you must complete these setup tasks in your PeopleSoft Student Financials system:

1. Set up a TIN under which your institution files 1098-T tax information to the IRS.
2. Determine which of your item types to designate as qualified tuition and related expenses.

See Also

[Chapter 13, "Setting Up Tax Form Production," Setting Up a TIN, page 376](#)

[Chapter 2, "Completing Student Financials General Setup," Setting Up Item Types and Item Type Groups, page 55](#)

Pages Used to Produce and File 1098-T Tax Forms

<i>Page Name</i>	<i>Definition Name</i>	<i>Navigation</i>	<i>Usage</i>
Generate 1098-T	RUNCTL_SF_SFP1098P	Student Financials, Taxes, Generate 1098-T	Generate 1098-T data.
Review 1098–T Messages	SSF_1098T_INQ	Student Financials, Taxes, Review 1098–T Messages, Review 1098–T Messages	Review 1098–T messages.
1098-T Data	SF_1098_DTL	Student Financials, Taxes, Edit 1098-T Data, 1098-T Data Student Financials, Taxes, Review 1098–T Data, 1098–T Data	Edit or review 1098-T data by student.
1098-T Student Address	SF_1098_STUADDR_PB	Click the Student Address link on the 1098-T Data page.	View the address of the student whose 1098-T data you are reviewing or overriding.

Page Name	Definition Name	Navigation	Usage
1098-T Audit Report	RUNCTL_SF_SF1098VP	Student Financials, Taxes, Tax Reports, 1098-T Audit Report	Validate and audit 1098-T data.
1098-T Print	RUNCTL_SF_SF1098RP	Student Financials, Taxes, Tax Reports, 1098-T Form Print, 1098-T Print	Print 1098-T forms and create electronic transmission files.
1098-T File Info	SF_1098_FILE_PB	Click the File Parameters link on the 1098-T Print page.	Enter the file path and file name of the electronic file that you want to create and send to the IRS.

Generating 1098-T Data

Access the Generate 1098-T page (Student Financials, Taxes, Generate 1098-T, Generate 1098-T).

Generate 1098–T page

Control Information

Student Override

Clear to generate data for all applicable students who fall under the federal TIN and calendar year that you select.

Select to use the fields in the Student Override group box to specify the students for which the process generates 1098-T data.

Bypass Validation Edits

Citizenship	Select to bypass the Citizenship edit, so that a 1098–T is produced for all students with eligible charges regardless of citizenship status.
Academic Credit	Select to bypass the Earned Academic Credit edit, so that a 1098–T is produced for all students with eligible charges, even if they are enrolled in classes that earn no academic credit.
Financial Aid	Select to bypass the Financial Aid edit, so that a 1098–T is produced for students who have eligible charges paid entirely by Financial Aid.
Financial Info (financial information)	Select to produce a 1098–T for students who have no financial information in boxes one through six. If the students are currently enrolled, the 1098-T is produced.

Note. Each edit bypass work independently—an institution can choose one, all, or none of the edit bypasses.

Student Override

ID	Select an ID to generate 1098-T data for the student.
National ID	Use this field to produce a 1098-T for a student who does not have a Social Security Number (SSN).
Force 1098-T	<p>The Generate 1098-T process generates 1098-T data for all students who meet the following criteria:</p> <ul style="list-style-type: none"> • The institution received payments of qualified tuition and related expenses from the student. • The student is not a nonresident alien. • The student is enrolled in courses for which he or she receives academic credit. • The student's qualified tuition and related expenses are not entirely waived or paid entirely with scholarships. • The student's qualified tuition and related expenses are not covered by a formal billing arrangement between an institution and the student's employer or a governmental entity.

If you select the Force 1098-T check box, the system generates a 1098-T record for the student specified in the ID field, even if the student does not meet the previous criteria.

The 1098-T (SFP1098P) process retrieves the necessary data from Campus Community and Student Records to populate and update the PS_SF_1098_DTL table in Student Financials. The system generates new 1098-T data for students who have no existing 1098-T records. In addition, the process compares the new 1098-T data it retrieves to any existing 1098-T data. When the process detects differences in an existing row of 1098-T data that has never been printed or included in an electronic transmission file, it updates all the affected fields in the record with the new information. However, if you have already printed a 1098-T record or included it in an electronic transmission file, the process does not update the existing record. Instead, it inserts a new row of updated 1098-T information for the student.

Reviewing 1098–T Messages

Access the Review 1098–T Messages page (Student Financials, Taxes, Review 1098–T Messages, Review 1098–T Messages).

Review 1098-T Messages			
Federal TIN:	951223331	Calendar Year:	2009
ID:	SFTX00022	Johnstone,Patrick	Run Date: 07/15/2009
Messages Customize Find View All  First 1-2 of 2 Last			
	Description		
1	Not eligible for 1098-T - Enrollment.		
2	Not eligible for 1098-T - Paid by Third Party.		

Review 1098–T Messages page

Use this page to view the messages that are created when 1098–T data is not generated for a student during the Generate 1098–T process.

Messages from only the most recent run of the Generate 1098–T process appear.

The Generate 1098–T process stores the message header values in the SSF_1098_MSGHDR table and stores the message details in the SSF_1098_MSGDTL table. You can access these tables in SF Query Tree.

ID is an optional search criteria when you enter criteria to access this page.

Reviewing and Overriding 1098-T Data

Access the 1098-T Data page (Student Financials, Taxes, Edit 1098-T Data, 1098-T Data).

1098-T Data

ID: SFTX00024 Lewis,Lauretta Federal TIN: 951223331 Calendar Year: 2006

1098-T Status Find | View All First 1 of 1 Last

Seq. Nbr. 1 Overridden Printed File Created
 Correction Correction Type: *Validation Status: Pending Validation
Date Created: 09/15/06 1:31:26PM Override Data Date Updated:
 Disable 1098-T Self Service

Student 1098-T Data

SSN: 024-24-0024 (1) Payments Received: (5) Financial Aid:
First Name: Lauretta (2) Amount Billed: 5196.00 (6) Prior Year FA Adj:
Middle Name: (3) Reporting Method Change (7) Includes Future Period
Last Name: Lewis (4) Prior Year Adj: (8) Half Time
[Student Address](#) (9) Graduate

1098-T Detail Items Customize | Find | View All First 1 of 1 Last

Box #	Item Amount	Business Unit	Item Type	Account Type	Item Term	Description	Actual Billing Date	Date Posted	Payment Date
1 002	5196.00	PSUNV	100000000004	TUT	0570	Tuition	09/15/2006	09/15/2006	

1098-T Data page

1098-T Status

Overridden

Indicates whether either you or the system has overridden a record. The system designates any records created using the Force 1098-T check box on the Generate 1098-T page as Overridden. When you click the Override Data button, the system automatically selects the Overridden check box for the resulting new row. The Generate 1098-T process updates existing overridden records only if it detects a change in the student's name or SSN. When editing a record, you can clear this check box.

Printed

Indicates whether you have printed a 1098-T form for this record. When you run the 1098-T Form Print report, the system selects this check box for all the records it prints. The date and time that the system printed the record appears to the right of the field.

To reprint a 1098-T form for a student, use the Override Data button to clear the Printed check box. Then use the 1098-T Print process to reprint the form.

File Created

Indicates whether you have included a 1098-T record in an electronic transmission file. When you run the 1098-T Form Print report, the system selects this check box for all the records it includes in the transmission file. The date and time that the system created the transmission file appears to the right of the field.

Correction

If you create a transmission file to send to the IRS and then discover an error in one of the records, you must submit a correction for that record. If you run the Generate 1098-T process and it inserts a new row for a record already included in a transmission file, the system selects this check box for the inserted row.

Note. If you manually edit a record that is already included in a transmission file, select the Correction check box.

Validation Status

Indicates whether the data in the record is valid. The 1098-T Audit report automatically sets the validation status to one of the following values. When you run the 1098-T Form Print report, the system uses this field to determine whether to pick up the record.

Do Not Report: The 1098-T Form Print report ignores records with this validation status. You can only assign this validation status to a record manually. Change the validation status to *Do Not Report* if you determine that you do not want to print or electronically file a 1098-T tax form for this student.

Failed Validation: The 1098-T Form Print report does not pick up records with this validation status. If you run the 1098-T Audit report to validate your data and it determines a record to be invalid, the system assigns this validation status to the record.

Passed Validation: The 1098-T Form Print report picks up records with this validation status. If you run the 1098-T Audit report to validate your data and it determines a record to be valid, the system assigns this validation status to the record.

Pending Validation: The 1098-T Form Print report does not pick up records with this validation status. The system assigns this validation status to all new records created by the Generate 1098-T process. In addition, if you click the Override Data button, the system assigns the new row this validation status.

Validation Overridden: The 1098-T Form Print report picks up records with this validation status. You can only assign this validation status to a record manually. Assign this value when a student's 1098-T data fails validation and you want the printing and file creation process to ignore the errors, transmitting the data exactly as it appears.

Disable 1098-T self-service

Select to prevent the current record from appearing on the 1098-T Year Select page.

By default, this check box is cleared.

Override Data

Click if you want to edit any of these fields: Overridden, Printed, File Created, Validation Status, and Correction.

You can also override data such as financial information and the SSN in the Student 1098-T Data group box.

When you click the Override Data button, the system inserts a new row for the student and selects the Overridden check box by default.

If a Social Security Number is not entered in the National ID field on the Campus Community Biographical Details page, the system enters a value of all nines (9s) in that field. This value appears by default in the SSN field on the 1098-T pages.

The IRS does not accept invalid SSNs (for example, all nines, ones, zeroes). If no valid SSN exists, the SSN can be recorded as blank, which the IRS accepts.

When you click the Override Data button, the SSN field becomes available for edit. You can then enter a valid SSN or delete the invalid SSN and leave the field blank.

Updating the SSN field on the 1098-T page does not update data in Campus Community.

Student 1098-T Data

- | | |
|--|--|
| (1) Payments Received | Displays the value that prints in Box 1 on 1098-T forms. (Payments received that applied to eligible tuition and fee charges.) |
| (2) Amount Billed | Displays the value that prints in Box 2 on 1098-T forms. (Billed eligible tuition and fee charges.) |
| (3) Reporting Method Change | Selects this check box if you have changed your reporting method on the TIN Setup page. |
| (4) Prior Year Adj (prior year adjustment) | Displays the value that prints in Box 4 on 1098-T forms.
Indicates adjustments made for a prior year to payments received or amount billed (adjustments to Box 1 or 2 for prior year). |
| (5) Financial Aid | Displays the value that prints in Box 5 on 1098-T forms.
Indicates receipt of scholarships or grants. |
| (6) Prior Year FA Adj (prior year financial aid adjustment) | Displays the value that prints in Box 6 on 1098-T forms.
Indicates adjustments to scholarships or grants for a prior year. |
| (7) Includes Future Period | Displays the value that prints in Box 7 on 1098-T forms.
The system selects this check box during the Generate 1098-T process if any of the amounts reported in Boxes 1 or 2 (Payments Received or Amount Billed) were related to an academic period that last from January through March. March of the following year. |

- (8) Half Time** Displays the value that prints in Box 8 on 1098-T forms.
The system selects this check box during the Generate 1098-T process if the student's academic load was at least half-time during any term within the tax-reporting year.
- (9) Graduate** Displays the value that prints in Box 9 on 1098-T forms.
The system selects this check box during the Generate 1098-T process if the student was enrolled as a graduate student during any term within the tax-reporting year.
- Student Address** Click to access the 1098-T Student Address page.

Note. The inquiry version of this page (Student Financials, Taxes, Review 1098–T Data, 1098–T Data) displays the same information as the (Edit 1098-T Data) 1098-T Data page. However, the inquiry page has no Override Data button, so you cannot edit any of the information that appears.

Viewing a 1098–T Form

Click the View 1098–T link on the (Review 1098–T Data) 1098–T Data page to access a 1098–T form (.pdf) and print it for a student.

You can also access the View 1098–T link on this page by clicking the 1098–T link on the finances page in the Student Service Ctr (Student).

Here is an example of the 1098–T Data page (Student Financials, Taxes, Review 1098–T Data, 1098–T Data) showing the View 1098–T link:

1098-T Data

ID: SFTX00007 Da Cruz,Hakim **Federal TIN:** 951223331 **Calendar Year:** 2009

1098-T Status Find | View All First ◀ 1 of 4 ▶ Last

Seq. Nbr. 4 **Overridden** **Printed** **File Created**
 Correction **Correction Type:** Two Transaction Correct **Validation Status:** Passed Validation
 07/13/2009 10:24:15PM **Date Updated:** 07/13/2009 10:24:15PM
 Disable 1098-T Self Service [View 1098-T](#)

Student 1098-T Data

SSN: 007-22-0007 (1) **Payments Received:** (5) **Financial Aid:** 400.00
First Name: Hakim (2) **Amount Billed:** 1200.00 (6) **Prior Year FA Adj:**
Middle Name: (3) **Reporting Method Change** (7) **Includes Future Period**
Last Name: Da Cruz (4) **Prior Year Adj:** (8) **Half Time**
[Student Address](#) (9) **Graduate**

1098-T Detail Items Customize | Find | View All First ◀ 1 of 1 ▶ Last

Box #	Item Amount	Business Unit	Item Type	Account Type	Item Term	Description	Actual Billing Date	Date Posted	Payment Date
1									

1098–T Data example page

The View 1098–T link appears only if the Use Electronic Statements check box on the 1098–T TIN Detail setup page is selected. The link appears whether or not the Display 1098–T Self Service check box on the setup page is selected.

The link is enabled only when the value in the Validation Status field is *Passed Validation* or *Validation Overridden*.

If the record fails validation because of an invalid SSN, you can use the Override Data button on the (Edit 1098–T Data) 1098–T Data page to update the value in the SSN field to blank (a blank SSN can be submitted to the IRS) or to input a valid SSN. When the Audit/Validation process is run again, blanks are treated as a valid SSN so the record will not fail validation.

See the documentation about the Override Data button earlier in this section.

Click the link to retrieve a 1098–T .pdf of the most recent 1098–T data.

The link is sensitive to the context in the 1098-T Status scroll area—that is, the .pdf is generated using the data in context (the example 1098–T page has 4 rows of data).

Note. The View 1098–T link does not appear on the (Edit 1098-T Data) 1098–T Data page.

See Also

Chapter 24, "Producing Tax Forms and Receipt Information," Validating and Auditing 1098-T Data, page 671

PeopleSoft Enterprise Campus Community 9.0 Fundamentals PeopleBook, "Using the Student Services Center Component," Viewing a Student's Self-Service Finances Information

Validating and Auditing 1098-T Data

Access the 1098-T Audit Report page (Student Financials, Taxes, Tax Reports, 1098-T Audit Report).

1098-T Audit Report

Run Control ID: PSUNV_Taxes [Report Manager](#) [Process Monitor](#) Run

*Report Mode: *Print Selection:

*Primary Sort: *Secondary Sort:

TIN Control Information Find | View All First 1 of 1 Last

*Federal TIN: *Calendar Year: PeopleSoft University Student Override

Student Override Find | View All First 1 of 1 Last

*ID:

1098-T Audit Report page

Report Mode

Select the report mode. Values are:

Audit Only: The report prints all 1098-T records meeting the parameters that you specify on this page, enabling you to check the data manually before printing or creating a transmission file.

Validate Only: The 1098-T Audit report checks each applicable record to determine the validity of its data.

If a record has an invalid SSN, name, or address, the system assigns it a validation status of *Failed Validation* and prints it on the 1098-T Audit Report. If a record has a valid SSN, name, and address, the system assigns it a validation status of *Passed Validation* and does not print it. Blanks are a valid SSN for reporting to the IRS.

In addition, if the system finds any records containing no data for the related academic statistics period, it issues a warning.

Audit and Validate: The 1098-T Audit Report prints all applicable records and assigns a validation status to them.

Print Selection

Determine which types of 1098-T records the system includes in the 1098-T Audit Report. Values are.

All 1098-T's: Select to include all types of 1098-T records.

Not Filed Corrected 1098-T's: Select to include only those 1098-T records that were included in a transmission file and have the Correction check box selected.

Not Filed Original 1098-T's: Select to include only those 1098-T records that were not included in a transmission file and do not have the Correction check box selected.

Not Printed Corrected 1098-T's: Select to include only those 1098-T records that you have not printed and that have the Correction check box selected.

Not Printed Original 1098-T's: Select to include only those 1098-T records that you have not printed and that do not have the Correction check box selected.

Primary Sort and Secondary Sort

Use these fields to determine the fields on which the system sorts when printing the report. It will sort first by the primary sort and then by the secondary sort value. Both fields have the following available values: *Country, ID, Last Name, Postal Code, SSN, and State.*

TIN Control Information**Student Override**

Clear to run the report for all applicable students who fall under the Federal TIN and calendar year that you select.

Select to use the ID field to run the report on only the students that you specify.

See Also

[Chapter 24, "Producing Tax Forms and Receipt Information," Reviewing and Overriding 1098-T Data, page 665](#)

Printing 1098-T Forms and Creating Transmission Files

Access the 1098-T Print page (Student Financials, Taxes, Tax Reports, 1098-T Form Print, 1098-T Print).

1098-T Print

Run Control ID: PSUNV_Taxes [Report Manager](#) [Process Monitor](#) Run

Transmitter's TIN: *Calendar Year: PeopleSoft University

*Media: Alignment Run Alignment Count:

Filing Status: Test File Replacement Alpha Character:

Primary Sort: Secondary Sort:

[File Parameters](#)

TIN Control Information Find | View All First 1 of 2 Last

*TIN: *Calendar Year: PeopleSoft University Student Override + -

Student Override Find | View All First 1 of 1 Last

*ID:

1098-T Print page

Transmitter Information

Calendar Year

Select the calendar year for which you are reporting.

Media

Select what you want the report to produce. Values are:

Extract File Only: Select to create a generic extract file containing the 1098-T Form data.

Extract and Transmittal Files: Select to create the IRS transmission and extract files simultaneously.

Print Only: Select to print your 1098-T tax forms using 1098-T print stock.

Print and Transmittal File: Select to create the IRS transmission file and simultaneously print your 1098-T tax forms using 1098-T print stock.

Transmittal File Only: Select to create the IRS transmission file.

Alignment Run

Select to run a print job that helps you align your print stock in the printer. When you select this check box, the report prints X instead of characters and 9 instead of numbers in the data fields of your 1098-T print stock. This field is available only if you select *Print Only* in the Media field.

Note. Because printer definitions vary, you may have to modify the SQR (Structured Query Report) for printer alignment purposes.

Alignment Count

Enter the number of *dummy* 1098-T forms that you want to print in your alignment run. This field is available only if you select the Alignment Run check box.

Filing Status

Select the type of records that you want to include in the report and specify the type of file that you intend to transmit to the IRS.

Correction: The report includes only those records that have the Correction check box selected. In addition, the system designates the file as containing only corrected records.

Original: The report includes only those records that do not have the Correction check box selected. In addition, the system designates the file as containing only original records.

Replacement: Select if the IRS rejected the file that you originally sent. The report includes only original records in the replacement file.

Note. The filing status that you select applies to the entire file. The IRS does not allow a transmitting TIN to mix original information and correction information within the same file.

Note. The 1098-T Form Print process always includes all 1098-T forms, even if they were previously printed or included in a transmission file. Use caution when running the 1098-T Form Print process after its initial run for a tax year. You should use the Student Override option with subsequent runs so that only those students whose information needs to be processed are included in the process.

Test File

Select to set a test file flag in the transmission file that is sent to the IRS. This selection indicates to the IRS that the file is for testing purposes only.

Note. You should participate in the IRS test electronic filing program. This program enables you to submit an electronic file containing 1098-T returns so that the IRS can confirm that the file is in a valid, readable format.

Replacement Alpha Character

If the IRS rejects your original file, it will request a replacement and assign you a two-character replacement alpha character to include with your file. Enter it here. This field is available only if you select *Replacement* in the Filing Status field.

Primary Sort and Secondary Sort

Use these fields to determine the fields on which the system sorts when printing the report. It will sort first by the primary sort and then by the secondary sort. Both fields have the following available values: *Country, EmplID, Last Name, Postal Code, SSN, and State.*

File Parameters

Click to access the 1098-T File Info page.

1098-T File Info Page**File Path**

Enter the location where the system sends the transmission and extract files.

Transmission File Name

Enter the name of the transmission file. If you do not specify a name for the file, the default name is IRSTAX.001.

Extract File Name If you are using another system to print your 1098-T forms, enter the name of the extract file that the system will use to print the forms. If you do not specify a name, the default name is SF1098RP.dat.

TIN Control Information

TIN Select the *TIN* for which you want to report 1098-T information. You transmit the information generated by the report using the Transmitter's TIN.

Student Override Clear to run the report for all applicable students who fall under the federal TIN and calendar year that you select.

Select to use the ID field to run the report for only the students that you specify.

Producing T2202A Tax Forms

This section lists a prerequisite and discusses how to:

1. Generate T2202A data.
2. Review and edit T2202A data.
3. Print T2202A tax information on preprinted forms.
4. Print T2202A tax information using File Extract.

Prerequisite

Determine which of your item types you want to designate as T2202A- eligible tuition and offsets.

See Also

[Chapter 2, "Completing Student Financials General Setup," Setting Up Item Types and Item Type Groups, page 55](#)

Pages Used to Produce T2202A Tax Forms

<i>Page Name</i>	<i>Definition Name</i>	<i>Navigation</i>	<i>Usage</i>
Generate T2202A	RUNCTL_SF_SFGT2202	Student Financials, Taxes, Generate T2202A	Generate T2202A data.

Page Name	Definition Name	Navigation	Usage
T2202A Data	SF_T2202A_DATA	Student Financials, Taxes, Edit T2202A Data, T2202a Data	Review and edit T2202A data, or add T2202A data manually.
Student Address	ADDREMP_SEC	Click the Student Address link on the T2202A Data page.	View and edit the address of the student whose T2202A data you are reviewing.
Print T2202A	RUNCTL_SFPR2202	Student Financials, Taxes, Print T2202A	Print T2202A tax information on preprinted forms.
Create T2202A Extract File	RUNCTL_SF_SFJT2202	Student Financials, Taxes, Create T2202A Extract File	Print T2202A tax information using the Extract File process.

Generating T2202A Data

Access the Generate T2202A page (Student Financials, Taxes, Generate T2202A).

Generate T2202A

Run Control ID: T2202A [Report Manager](#) [Process Monitor](#) Run

Parameters

Business Unit: PeopleSoft University Bursar Report Only

Institution: PeopleSoft University

Calendar Year:

Address Usage: Home, Mailing, Permanent, Work

	Country	Citizenship Status	Description		
1	CAN	<input type="text" value="1"/>	Native	+	-
2	CAN	<input type="text" value="7"/>	Canadian Citizen	+	-

Generate T2202A page

Address Usage

Select the logic that the system uses to select the student address associated with each T2202A form.

Report Only

Select to create a report of the T2202A data retrieved without actually populating your Student Financials tables with T2202A data.

Note. Because the process generates effective-dated rows of data, you cannot run the Generate T2202A Data process more than once per day. However, if you select the Report Only check box before running the process, the system does not insert rows of data into your tables. Therefore, you can run the process in report only mode as many times as you want during a given day.

Citizenship Status

Select the student citizenship status for which you want to generate T2202A data. You can select from these values: *Native, Naturalized, Alien Permanent, Alien Temporary, Permanent Resident, Employment Visa, Canadian Citizen, Student Visa, and Not Indicated.*

The Generate T2202A process reviews the Student Enrollment table for the reporting calendar year. It summarizes all enrollment units taken by month and tabulates them to determine the academic load (full-time or part-time) for each month. The process then writes these results to the T2202A Data records, along with the financial information regarding tuition amounts.

Reviewing and Editing T2202A Data

Access the T2202A Data page (Student Financials, Taxes, Edit T2202A Data, T2202A Data).

T2202A Data

Academic Institution: PSUNV ID: SFTX00009 Calendar Year: 2004

Find First 1 of 1 Last

*Effective Date: 10/08/2004 Status: A Active

Name: Patrick East

[Student Address](#) Printed

Acad Program: CNTUG Continuing Education Undergrad

Term	FROM		TO		Tuition Fees	Months Enrolled	
	Month	Year	Month	Year		Full-Time	Part-Time
0518	1	2004	5	2004	\$1,841.00		5

T2202A Data page

Student Address

Click to access the Student Address page, where you can view and edit the address information for the student whose T2202A data you are reviewing.

Printed Indicates whether you have printed a T2202A form for this row of data. When you run the Print T2202A process, the system selects this check box for all the rows of data that it prints. Subsequent runs of the Print T2202A process do not print any rows with the Printed check box selected. The date and time that the system printed the record appears to the right of the field.

Reviewing and Entering Enrollment and Tuition Information

If you are reviewing and editing T2202A data, the fields in the lower scroll area are already populated with information. If you are adding a new row of data, you must enter values in these fields manually.

Acad Program (academic program) This field displays the academic program in which the student is enrolled. The description of the selected program appears in the field to the right of this field. You can edit this description if necessary.

Term This field displays the term during which a student was enrolled.

FROM and TO The Month and Year fields under these headings display the starting and ending month and year of the term.

Tuition Fees Displays the amount of tuition that the student paid for the term.

Full-Time This field displays the number of months within the term that the student was enrolled with full-time status.

Part-Time This field displays the number of months within the term that the student was enrolled with part-time status.

Printing T2202A Tax Information on Preprinted Forms

Access the Print T2202A page (Student Financials, Taxes, Print T2202A).

Print T2202A

Run Control ID: T2202A [Report Manager](#) [Process Monitor](#)

Parameters

Institution: PSUNV PeopleSoft University

Calendar Year: 2004

Message Text:

Alignment Only Align Cnt:

Print T2202A page

Message Text	Enter any text that you want to appear in the comment section of the T2202A form.
Alignment Only	If you select this check box, the system will print <i>dummy</i> forms that enable you to align the preprinted forms properly in your printer.
Align Cnt (alignment count)	If you select the Alignment Only check box, enter the number of <i>dummy</i> forms that you want to print.

The process prints a T2202A tax form for all students for whom data is available except those with the Printed check box selected. The system selects the Printed check box for all students whose T2202A information it prints. If you want to reprint a T2202A tax form for a given student, you must first clear the Printed check box using the T2202A Data page and then rerun the Print T2202A process.

Printing T2202A Tax Information Using File Extract

Access the Create T2202A Extract File page (Student Financials, Taxes, Create T2202A Extract File).

Create T2202A Extract File page

Output File Directory Enter the location where you want the system to send the extract.

Extract File Enter the name that you want to give the extract.

Note. Unlike the Print T2202A process, this process neither recognizes nor updates the Printed check box on the T2202A Data page.

Producing T4A Tax Forms

This section lists prerequisites and discusses how to:

- Create people of interest (POI) job data for T4A.

- Generate T4A data.
- Review T4A tax forms.

Prerequisites

Before you begin generating T4A data, you must:

1. Determine which of your item types are designated as T4A income.
2. Define your T4A generation processing parameters on the Canadian/ANZ Taxes page of the SF Business Unit (BUSINESS_UNIT_SF) component.
3. Run the Create POI Job Data process.

See Also

[Chapter 2, "Completing Student Financials General Setup," Setting Up Item Types and Item Type Groups, page 55](#)

[Chapter 2, "Completing Student Financials General Setup," Setting Up Business Units, page 19](#)

[Chapter 7, "Setting Up Refunding," Creating Job Data for Payroll Refunds, page 246](#)

Pages Used to Produce T4A Tax Forms

<i>Page Name</i>	<i>Definition Name</i>	<i>Navigation</i>	<i>Usage</i>
Request Student Job Data	SSF_RUN_POIJOB	Student Financials, Taxes, Create POI Job Data, Request Student Job Data	Run this process to create job and tax records for students.
Generate T4A	RUNCTL_SF_GENT4	Student Financials, Taxes, Generate T4A	Generate T4A data by running the T4A process.
T4A Data	SF_ADJ_CAN_ERN_BAL	Student Financials, Taxes, Review T4A Data	View and validate the T4A student income balances resulting from the T4A process.

Creating POI Job Data for T4A

Access the Request Student Job Data page (Student Financials, Taxes, Create POI Job Data, Request Student Job Data).

Request Student Job Data

Run Control ID: RUN_T4A [Report Manager](#) [Process Monitor](#) Run

*Business Unit: PeopleSoft University Bursar

Job Effective Date: 11/03/2004

Processing Options

*Processing Population: ▼

Commit Frequency: **Confirm Job Data Created**

Request Student Job Data page

Processing Population Select *T4A Students* to create tax data for students.

Commit Frequency Enter a number for records committed to the database. Select this option to commit a specified number of transactions during background processing. For example, if you enter *100* in the Commit Frequency field, when you run a batch process the system will process 100 transactions and then commit them to the database until the batch is complete. At the end of a batch process, the system will commit all remaining transactions, even if the number of transactions is less than the number in the Commit Frequency field.

See [Chapter 2, "Completing Student Financials General Setup," Defining Commit Levels, page 15.](#)

Confirm Job Data Created Select to create a record in the message log of the process monitor for every job record created.

Generating T4A Data

Access the Generate T4A page (Student Financials, Taxes, Generate T4A).

Generate T4A

Run Control ID: Gen_T4A [Report Manager](#) [Process Monitor](#) Run

Parameters

Business Unit: PSUNV PeopleSoft University Bursar

Company: PSU PeopleSoft University

T4 Balance ID: CY Current Year Balances

Province: NS Nova Scotia

Wage Loss Plan: REG

Date Type

Posting date Item Effective Date Run Date

Generate T4A page

Reviewing T4A Tax Forms

Access the T4A Data page (Student Financials, Taxes, Review T4A Data, T4A Data).

T4A Data

Roland Vosgien **Person ID:** SFTX00008

Find First 1 of 1 Last

Company: PSU **Wage Loss Plan:** REG **Earnings Type:** SCH Scholarship Award

Balance ID: CY **Province:** NS

Balance Year: 2004 **Quarter:** Quarter 4

Sequence Number: 1 **Period:** October

Date Entered: 10/08/2004

T4A Earnings Balance

Earnings Adjustment	Gross Earnings MTD Adjusted	Gross Earnings QTD Adjusted	Gross Earnings YTD Adjusted
\$2,000.00	\$2,000.00	\$2,000.00	\$2,000.00

T4A Earnings by Item Nbr Find | View All First 1-2 of 3 Last

Business Unit	Item Nbr	Earnings Adjustment
PSUNV	0000000000000002	\$500.00
PSUNV	0000000000000004	\$1,000.00

T4A Data page

The T4A Data page is a display-only page.

Generating Income Tax and Donation Receipt Information

This section discusses how to:

- Generate income tax receipt information.
- Generate donation receipt information.

Pages Used to Generate Income Tax and Donation Receipt Information

Page Name	Definition Name	Navigation	Usage
Generate Tax Receipts	RUNCTL_SFRECEPT	Student Financials, Taxes, Generate Tax Receipts	Generate income tax receipt information.
Generate Donation Receipts	RUN_PARM_DONAT	Student Financials, Taxes, Generate Donation Receipts	Generate donation receipt information.

Generating Income Tax Receipt Information

Access the Generate Tax Receipts page (Student Financials, Taxes, Generate Tax Receipts).

Generate Tax Receipts page

Select values in the Academic Career and Term fields for which you want to generate income tax receipt information and run the process. The process retrieves the required data from Student Records and Student Financials to populate the PS_CAN_TAX_RECEPT table. You can then use the data in this table to create official income tax receipts for students.

Generating Donation Receipt Information

Access the Generate Donation Receipts page (Student Financials, Taxes, Generate Donation Receipts).

Generate Donation Receipts

Run Control ID: Credit [Report Manager](#) [Process Monitor](#) Run

#	Business Unit	Item Type	Description	From Date	To Date	
1	PSUNV	00000100002	Annual Fund	07/01/2004	08/31/2005	+ -

Generate Donation Receipts page

Item Type Select the item type of the donation for which you want to generate receipt information. If you have more than one donation item type within your system, insert rows to include all types of donations for which you want to generate receipt information.

From Date and To Date Enter the range of dates for which you want to generate donation receipt information.

The process retrieves the required data from Student Financials to populate the PS_CAN_DONAT_RECEIPT table. You can then use the data in this table to create official donation receipts for students and third-party organizations.

Note. The Donation Receipt process obtains information according to the item types that you select when you establish the process parameters. Therefore, you must set up specific item types for each type of donation that your institution receives.

Chapter 25

Setting Up and Using International Health Coverage

This chapter provides an overview of International Health Coverage (IHC) and discusses how to:

- Set up the IHC feature.
- Maintain student information and create schedules.
- Generate IHC letters.

Understanding International Health Coverage

This section discusses:

- IHC process flow
- Purchasing
- Reporting and paying
- Refunding

IHC Process Flow

The IHC feature was designed using the Australian Overseas Student Health Cover business process as its foundation. With the addition of this feature to the core Campus Solutions product, customers can use IHC to manage the health care policies for their international students. Customers in Australian markets will continue to enjoy the functionality they have used before, with some enhancements, including creating the premium charge directly through the IHC component and creating the schedule in electronic or paper format. Following is the general business model on which this feature is based. Institutions are not limited to this business model, but can use this as an example of the feature design:

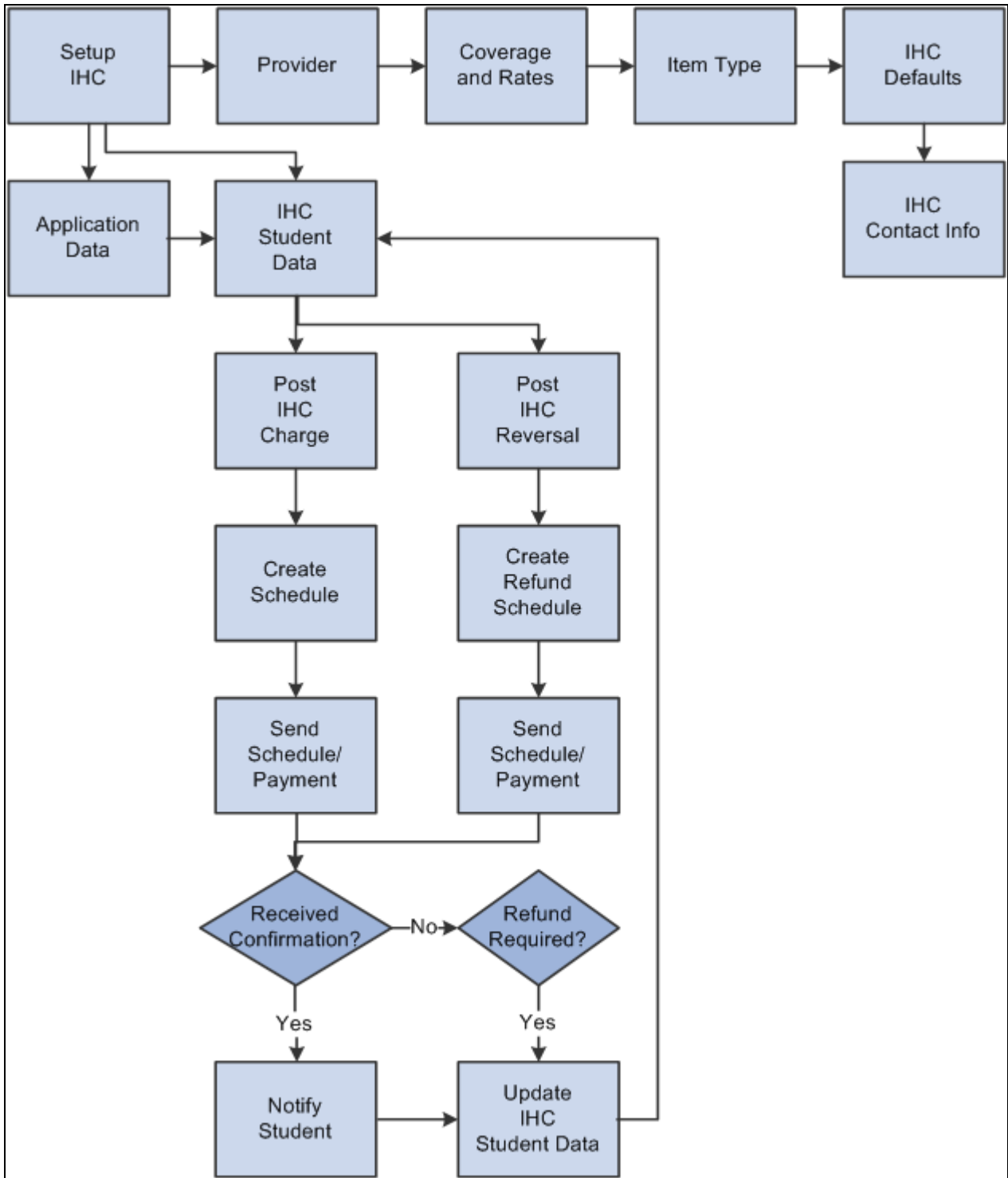

IHC process flow

Purchasing

The IHC feature assumes that international student health coverage policy rates are set by the insurance providers and that these rates can and will change at any time. In most cases, institutions then have the responsibility of processing the insurance on behalf of the student, including purchasing the policy from the provider.

International students apply for the insurance at the time they apply for admission. They are advised of the charges at the time they are offered admission and are required to pay the premium at the time of accepting admission. Coverage options can be for the student only or for the student and their family.

A new international student at your institution may have a provider number as a result of either having enrolled in a previous program at your institution or having previously accepted an offer and paid IHC to another institution before attending your institution. Students with previous coverage should provide your institution with their provider (policy) number and details of the expiration date of their current coverage. Coverage is supplied by the number of months of coverage depending on the amount of time that is required for them to complete their studies.

Reporting and Paying

Institutions have the option of generating a report (the schedule), which is a list of international students' health coverage payment fees sorted by provider. This information can then be sent to the provider in either paper or electronic format. The schedule shows the student name, student ID, existing provider number (if applicable), date of birth, length of coverage, and amount, as well as the total of all policy charges on the schedule. In one report run, separate schedules are created for students with existing provider numbers versus for students without existing provider numbers.

The schedule can be forwarded to the Accounts Payable office where a check is prepared to send to the provider. In some cases, institutions receive a commission for administering the insurance program. This commission is also calculated on the schedule.

Providers can send a letter to the institution acknowledging receipt of each schedule and advising them of the batch number assigned by the provider to the schedule and the provider member (policy) number for each student. The provider validates the period of coverage from the date that the student arrived in the visiting country, verified from the student's passport. Once notified of the batch number and provider number, the institution has the ability to notify each international student of the member number issued by the provider and the batch receipt number.

Refunding

Refunding a student's IHC premiums is done manually outside of the IHC component. If there is a policy change, for example, a change in plan (student only versus student with family coverage), or a change in the number of months of coverage, the IHC schedule will reflect the new charge amount or the difference in coverage between the previous reported charge and the resulting new charge, depending on the report options selected when the schedule is run.

This feature assumes the provider will refund IHC contributions only under the following circumstances:

- If a student does not arrive in the institution's country. (Handled by the institution).
- If the student's visa is not extended. (Handled directly by the student).

- If the student is granted resident status in the institution's country. (Handled directly by the student).
- If a student has to return to their home country due to death in the immediate family and will not return to school. (Handled directly by the student).

Setting Up the IHC Feature

This section discusses how to:

- Set up provider information.
- Set up provider coverage plans and rates.
- Set up IHC item types.
- Set up IHC contact information.

Pages Used to Set Up IHC

<i>Page Name</i>	<i>Definition Name</i>	<i>Navigation</i>	<i>Usage</i>
International Health Coverage Provider	SSF_IHC_PROVIDER	Set Up SACR, Product Related, Student Financials, International Health Coverage, Provider Table, International Health Coverage Provider	Enter or edit provider information.
Provider Coverage and Rates	SSF_IHC_PROV_COVER	Set Up SACR, Product Related, Student Financials, International Health Coverage, Coverage and Rates, Provider Coverage and Rates	Enter or edit coverage and rate information.
International Health Coverage Item Type Setup	SSF_IHC_DEFAULTS	Set Up SACR, Product Related, Student Financials, International Health Coverage, Item and Account Types, International Health Coverage Item Type Setup	Enter an item and account type for the business unit.
International Health Coverage Institutional Contact Information	SSF_IHC_CONTACT	Set Up SACR, Product Related, Student Financials, International Health Coverage, Institutional Contact, International Health Coverage Institutional Contact Information	Enter contact information for the academic institution.

Setting Up Provider Information

Access the International Health Coverage Provider page (Set Up SACR, Product Related, Student Financials, International Health Coverage, Provider Table, International Health Coverage Provider).

International Health Coverage Provider

Provider ID MBF

Find | View All First ◀ 1 of 1 ▶ Last

*Effective Date ⓘ *Status ⌵ ⏏ ⏎

*Commission Rate Last Report Number Used

Primary Business Address

*Provider Name

Country 🔍

Address 1

Address 2

City

State 🔍 Postal Code

Premium Payment Address

Same as Primary Address

Payment Name

Country

Address 1

Address 2

City

State Postal

International Health Coverage Provider page

Commission Rate Enter the percentage that is returned to the institution based on the total contribution to the provider.

Last Report Number Used Displays the last schedule number generated for this provider. Each time a schedule is generated, the last report number used is increased by one.

Primary Business Address

Provider Name The name of the provider.

Country The country of the provider's address.

Address 1 and Address 2 The first and second line of the provider's address.

City The city of the provider's address.

State The state of the provider's address.

Postal Code The post code of the provider's address.

Premium Payment Address

Same as Primary Address Enter the address where premiums for this provider should be sent. If the address for premium payments is the same as the business address, select the Same as Primary Address check box and the primary address information is automatically added to the address fields, and then are not available for editing.

Payment Name Use the Payment Name field if the payment should be made payable to someone other than the provider.

Setting Up Provider Coverage Plans and Rates

Access the Provider Coverage Plans and Rates page (Set Up SACR, Product Related, Student Financials, International Health Coverage, Coverage and Rates, Provider Coverage and Rates).

Provider Coverage Plans and Rates

Provider MBF MediBank Private

Coverage Plan FAMILY

Find | View All First 1 of 1 Last

*Effective Date 01/01/1900 *Status Active

*Description Family Health Coverage

*Short Description Family

Provider Rates		Customize Find		First	1-2 of 2	Last
	*Months of Coverage	*Amount				
1	6	285.00	USD		+	-
2	12	570.00	USD		+	-

Provider Coverage Plans and Rates page

Months of Coverage The intervals of coverage in months that IHC is offered by this provider. Enter any amount in this field up to 99 months.

Amount	The premium rate amount of the specified interval.
USD	Displays the appropriate currency type. The currency type defaults from the base currency specified on the Installation Table page.

Setting Up IHC Item Types

Access the International Health Coverage Item Type Setup page (Set Up SACR, Product Related, Student Financials, International Health Coverage, Item and Account Types, International Health Coverage Item Type Setup).

International Health Coverage Item Type Setup

Business Unit PSUNV PeopleSoft University Bursar

***Account Type** ▼

***Item Type** 🔍 International Health Coverage

International Health Coverage Item Type Setup page

Account Type	Select the account type to which the IHC charge item type is associated.
Item Type	Select the appropriate IHC charge item type.

See [Chapter 2, "Completing Student Financials General Setup," Setting Up Item Types and Item Type Groups, page 55](#) and [Chapter 2, "Completing Student Financials General Setup," Setting Up Account Types, page 51](#).

Setting Up IHC Contact Information

Access the International Health Coverage Institutional Contact Information page (Set Up SACR, Product Related, Student Financials, International Health Coverage, Institutional Contact, International Health Coverage Institutional Contact Information).

International Health Coverage Institutional Contact Information

Academic Institution PSUNV PeopleSoft University

First Name

Last Name

Telephone

International Health Coverage Institutional Contact Information page

- First Name** Enter the first name of the IHC contact at the institution. This information is used on the payment schedule.
- Last Name** Enter the last name of the IHC contact at the institution.
- Telephone** Enter the telephone number of the IHC contact at the institution.

Maintaining Student Information and Creating Schedules

This section discusses how to:

- Maintain student health coverage information.
- Create schedules.

Pages Used Maintain Student Information

<i>Page Name</i>	<i>Definition Name</i>	<i>Navigation</i>	<i>Usage</i>
International Health Coverage - Student Maintenance	SSF_IHC_STDNT	Student Financials, International Health Coverage, Student Maintenance, International Health Coverage - Student Maintenance	Maintain student health coverage information.
Create Schedules	SSF_IHC_RUNCTL	Student Financials, International Health Coverage, Create Schedules	Create schedules to send to the provider.

Maintaining Student Health Coverage Information

Access the International Health Coverage - Student Maintenance page (Student Financials, International Health Coverage, Student Maintenance, International Health Coverage - Student Maintenance).

International Health Coverage - Student Maintenance 📄 📅 💬

Mark Trimble SF0010

Find | View All
First ◀ 1 of 1 ▶ Last

Coverage Number 1
'Business Unit' PSUNV 🔍 +

Student Maintenance
Find | View All
First ◀ 1 of 1 ▶ Last

'Effective Date' 01/14/2010 📅

'Status' Active ▾

'Coverage Plan' ▾

Premium Amount 0.00 USD

Coverage Start Date 📅

Member Number

Provider Paid Directly

'Sequence' 1 + -

'Provider' ▾

'Months of Coverage' (Invalid Value) ▾

Visa Expiration Date

Coverage End Date 📅

Batch Number

Cancellation Reason ▾

Coverage Reason

'Coverage Type' New ▾

Cancellation Reason ▾

Posting Information

Term 🔍

Reference Nbr

Item Effective Date 01/14/2010 📅

Due Date 📅

Post

Posted? No

Item Nbr

Post Date

Posted Amount 0.00 USD

Payment Schedule

Run Date

Reported Amount 0.00 USD

Rpt Nbr

Reported Amount Type

Schedule Type

International Health Coverage - Student Maintenance page

At the top right of this page, there are 3C buttons you can use to add a new communication, add a new checklist, or add a new comment for this student. If you click the Add a New Communication button, you are redirected to the Communication Management 1 page.

See [Chapter 25, "Setting Up and Using International Health Coverage," Generating IHC Letters, page 698.](#)

See *PeopleSoft Enterprise Campus Community Fundamentals 9.0 PeopleBook, Managing Communications*

Coverage Number	This is an internally generated number that keeps track of the various distinct policies for a student. Students can have a policy for year 1 and another policy for year 2. In this instance, students have two Coverage Number rows, row 1 for year 1 and row 2 for year 2. Changes can be made to the distinct policies by inserting a new effective-dated row.
Business Unit	The business unit that appears here is based on user defaults and is used for posting IHC charges and charge reversals to a student's account. This is the business unit that is tied to the IHC policy governed by the coverage number. This supports the student having a different business unit per policy. When a new row is added, the user will have the ability to define the business unit for that policy. After the IHC charge is posted, the user will not be able to change the business unit. After posting has occurred, if you need to delete/replace the business unit or delete the policy, you must insert a new effective-dated row and make that row inactive, thereby deleting the policy.
Sequence	Enter the sequence number associated with this effective date. A student can have multiple sequences for a single effective date. Multiple changes could occur in a single day.
Provider	Select the name of the provider. The provider was set up on the International Health Coverage Provider page.
Coverage Plan	Select the coverage plan. This information was set up on the Provider Coverage Plans and Rates page.
Months of Coverage	Select the number of months of coverage. The choices available were defined on the Provider Coverage Plans and Rates page.
Premium Amount	The full amount of the premium displayed, based on information provided in the Provider Coverage Plans and Rates page, as well as the student's intended coverage plan and months of coverage.
Visa Expiration Date	If applicable, the student's visa expiration date is displayed.
Coverage Start Date and Coverage End Date	Enter the start and end dates of the policy. These dates are not related to the months of coverage. They are for reporting purposes only, and appear on the payment schedule.
Member Number	Enter the number assigned to the student by the provider. This number stays with the student permanently. If the student changes providers, a new number is assigned by the new provider. This field can be left blank, which indicates that the student is new from the provider's perspective. The value of this field (blank or not) is communicated to the provider on the payment schedule.
Batch Number	After the provider has processed a schedule, enter the number assigned to the student by the provider. After posting, the Member Number and the Batch Number are the only two fields that can be modified.

Provider Paid Directly Select if the provider was paid by the student directly. If this check box is selected, then the Post button becomes unavailable, the student is not included on the schedule to the provider, and any policy changes will become informational only because the student deals directly with the provider. If this check box is cleared, then the student is charged the coverage amount, and is included on the schedule to the provider. Any changes to the policy will be posted to the account and reported to the provider.

Coverage Reason

Coverage Type Select one of the following options to show changes in coverage types for a student:

New: The student does not yet have a provider number. The student will be included on the payment schedule for new students.

Increase: The student may have a provider number. Use this option to increase a previously posted premium amount. The student will be included in the new or continuing payment schedule, depending on whether the student has a provider number or not. New students do not have a provider number, while continuing students do have a provider number.

Decrease: The student has a provider number and will be included on the payment schedule for new or continuing students. Use this option to decrease a previously posted premium amount.

Renewal: The student has a provider number, has secured a new policy for a subsequent year from the same provider, and will be included on the payment schedule for continuing students.

Cancelled: This policy was cancelled either by the student, the institution, or the Provider. If the cancellation reason is *Did Not Arrive*, then the student will be included on the refund schedule to the provider.

Cancellation Reason This field is available only if the coverage type is *Cancelled*. Select one of the following options to show changes in coverage types for a student:

Death: Select this value and then click Post to initiate a charge reversal. This student will not be included on the refund schedule to the provider.

Not Arrive: Select this value and then click Post to initiate a charge reversal. This student will be included on the refund schedule to the provider.

Rejected: Select this value and then click Post to initiate a charge reversal. This student will not be included on the refund schedule to the provider.

Reclassify: Select this value and then click Post to initiate a charge reversal. This student will not be included on the refund schedule to the provider.

Error: If a user posts a non-zero transaction to the student's account in error for this policy, use this option to invalidate the transaction. Select *Error* and then click Post to initiate a charge reversal. This student will not be included on the refund schedule to the provider.

Posting Information

Term	(Optional) Select the term to which the charge is associated. If the Term field is left blank, a default term is assigned, based on installation defaults.
Reference Nbr (reference number)	(Optional) Enter the posting reference number.
Item Effective Date	If the coverage type is <i>New</i> or <i>Renewal</i> this field is required.
Due Date	(Optional) Enter the charge due date.
Post	Click to post charges. You should <i>not</i> use Student Post or Group Post to post IHC charges. Students appear on the IHC Schedule <i>only</i> if posted from the International Health Coverage - Student Maintenance page. Also note that after posting charges, the only fields you can change are the Member Number and the Batch Number fields. Any changes to a previously posted charge require that you insert a new effective date/effective sequence row.
Posted	Displays <i>Yes</i> or <i>No</i> depending on whether or not posting was successful.
Item Nbr (item number)	Displays the item number generated by posting. This field is used as a selection criterion for including a student on the payment schedule.
Post Date	Displays the post date.
Posted Amount	Displays the amount that was posted.

Payment Schedule

The Payment Schedule fields are populated if the institution generates a payment schedule or a refund schedule.

Run Date	Displays the date on which the payment or refund schedule was run.
Reported Amount	Displays the amount reported on the schedule. The reported amount is determined by the run control option Report Amount Type on the Create Schedules page.
Rpt Nbr (report number)	Displays the report number generated by the payment or refund schedule process.
Reported Amount Type	Displays whether the <i>Full Amount</i> or the <i>Difference</i> was the report amount type used for reporting the information on the new and continuing payment schedules. On the refund schedule, the reported amount is the value from the Premium Amount field; the Report Amount Type option on Create Schedules run control does not affect this field on the refund schedule.

Schedule Type

This field provides an audit trail of how the student was reported to the provider:

New: Assigned if, during the selection phase of the payment schedule, the provider number is blank. This indicates that the student does not have a relationship with the provider, either for this institution or any other previous institution and should be selected for new student payment schedule

Continuing: Assigned if, during the selection phase of the payment schedule, the provider number is not blank. This indicates that the student has a relationship with the provider, either for this institution or any other previous institution and should be selected for the continuing student payment schedule

Refund: During the selection phase of the refund schedule, the provider number can be blank or not blank, the coverage type equals *Canceled*, the cancellation reason equals *Did Not Arrive*, and the student has paid his or her IHC charge in full. This indicates that the student (and the institution) is eligible for a refund and should be selected for the refund schedule.

Creating Schedules

Access the Create Schedules page (Student Financials, International Health Coverage, Create Schedules).

Create Schedules

Run Control ID: ihc [Report Manager](#) [Process Monitor](#) Run

*Provider

*Institution

Refund Schedule

Report Amount Type

Report Full Amount
 Report Difference

Schedule Output Type

CSV File
 Paper
 Both Paper and CSV File

File Path

Re-create Schedule

Re-create Schedule?

By Report Number

Run Date

Create Schedules page

Provider	Select a provider.
Institution	Select an institution.
Refund Schedule	Select to create both a payment schedule and a refund schedule. Clear this check box to create only a payment schedule. A payment schedule will always include two schedules: one for continuing students and one for new students.

Report Amount Type

Report Full Amount	Select to report the full premium amount on the payment schedules.
Report Difference	Select to report differences between the current premium amount for a student and any prior reported amounts for that same coverage number on the payment schedules. If there are no reported amounts, the report shows the full premium amount

Schedule Output Type

CSV File	Select to produce electronic file output.
Paper	Select to produce paper output.
Both Paper and CSV File	Select to produce paper and electronic file output.
File Path	Enter the path for electronic file output.

Re-create Schedule

Note that it is possible that you could generate three schedules with one process run (for example, schedules for new students, continuing students and for refunds). Use the Report Number and Run Date options to specify which schedules you want to re-create. If you want to re-create all three reports, then you have to run the re-create process three times.

Re-create Schedule	Select x to regenerate an existing single schedule.
Report Number	Select to choose a single schedule to re-create by report number.
Run Date	Select to re-create all of the schedules that were run on a specific date.

Generating IHC Letters

This section discusses how to generate letters to students.

Page Used to Generate Letters

<i>Page Name</i>	<i>Definition Name</i>	<i>Navigation</i>	<i>Usage</i>
Person Communication	COMM_MGMT1	Click the Add a New Communication button on the International Health Coverage - Student Maintenance page. Campus Community, Communications, Person Communications, Communication Management, Person Communication	Generate letters to students.

Generating Letters to Students

Access the Communication Management 1 page (Campus Community, Communications, Person Communications, Communication Management, Person Communication).

Person Communication		Communication Recipient Data	
Mark Trimble		ID: SF0010	
Communication Assignment			
Assign DateTime:	01/14/2010 3:07:51 PM		
*Function:	IHC	International Health Coverage	Variable Data
*Institution:	PeopleSoft University		
Comm Key:	<input type="text"/>		
*Category:	<input type="text"/>		
*Context:	<input type="text"/>		
*Method:	<input type="text"/>		
*Direction:	<input type="text"/>		
Letter Code:	<input type="text"/>	<input type="checkbox"/> Include Enclosures	Enclosures
Communication Process Details			Checklist Association
Communication Date:	01/14/2010	Begin Time:	<input type="text"/>
		End Time:	<input type="text"/>
Comments:	<input type="text"/>	<input type="checkbox"/> Print Comment	Sequence:
Communication ID:	K0G001	Jones,Rebekah	Item Sequence:
Department:	<input type="text"/>		
<input type="checkbox"/> Create Joint Communications			
Communication Outcome			
Communication Generation Date:			
<input type="checkbox"/> Communication Completed	Date Activity Completed:		<input type="text"/>
<input type="checkbox"/> Unsuccessful Outcome	Reason:		<input type="text"/>
Language Used	<input type="text"/>		
Method Used	<input type="text"/>		
Process Used	<input type="text"/>		

Person Communication page

Click the Add a New Communication button on the International Health Coverage - Student Maintenance page to create a letter notifying the student of their member number and the batch number that was sent to the school by the provider.

The letter generation process creates a csv file named CCLTRIHC.CSV. This comma delimited file contains the data that you can merge into the delivered Microsoft Word document named CCLTRIHC.DOC.

Function IHC appears as a default after you click the Add a New Communication button from the International Health Coverage - Student Maintenance page.

Variable Data Click to select the appropriate coverage number from the list.

Category, Context, and Method

Select the appropriate IHC category and context codes. Letter codes, category codes, and method are set up in PeopleSoft Campus Community.

Chapter 26

(NLD) Using the Banking Interface

This chapter provides an overview of the banking interface for the Netherlands and discusses how to:

- Set up the banking interface.
- Bill students using OLA (Optical Readable Giro Slip) or VERWINFO (electronic file containing payment information).
- Use the Clieop03 process.

Understanding the Banking Interface for the Netherlands

Complete these steps to set up and run the banking interface so that Netherlands students can pay their tuition and fees:

1. Set up bank accounts for business units.
2. Set up bank accounts for students.
3. Set up several different file layouts.
4. Post and bill students.

Students can pay using these options:

- Print OLA forms and load VERWINFO payment files.
- Create Clieop03 receivables.

Setting Up the Banking Interface

This section discusses how to:

- Set up account information for business units.
- Set up bank account numbers for students.
- Set up default values for VERWINFO and Clieop03 files.

Pages Used to Set Up the Banking Interface

<i>Page Name</i>	<i>Definition Name</i>	<i>Navigation</i>	<i>Usage</i>
Business Unit Bank Accounts	SSF_ACCOUNT_BU_NLD	<ul style="list-style-type: none"> Set Up SACR, Product Related, Student Financials, Billing, Bank Accounts - Business Unit, Business Unit Bank Accounts Student Financials, Student Financials NLD, Business Unit Bank Accounts 	Establish bank account information for businesses.
Student Bank Accounts	SSF_STDNT_BNK_NLD	<ul style="list-style-type: none"> Set Up SACR, Product Related, Student Financials, Billing, Bank Accounts - Student, Student Bank Accounts Student Financials, Student Financials NLD, Student Bank Accounts 	Establish bank account information for students.
Set Up default Values VERWINFO/Clieop03	SSF_BNK_LAY_NLD	Student Financials, Student Financials NLD, Layout for Verwinfo and Clieop, Set Up default Values VERWINFO/Clieop03	Set up default values for VERWINFO or Clieop03.

Setting Up Account Information for Business Units

Access the Business Unit Bank Accounts page (Set Up SACR, Product Related, Student Financials, Billing, Bank Accounts - Business Unit, Business Unit Bank Accounts).

Business Unit Bank Accounts			
Business Unit:	PSNLD PeopleSoft	Account:	987654321
Account Type:	Current <input type="button" value="v"/>		
Country Code:	NLD <input type="button" value="m"/> Netherlands		
Bank ID:	01506801 <input type="button" value="m"/> ABN AMRO		
Account Number:	1111111111		
Account Name:	Business Unit Netherlands		
*Currency Code:	EUR <input type="button" value="m"/> euro		
Contract Code:	C-Contract <input type="button" value="v"/>	OLA Code:	12 <input type="button" value="v"/>
Description:	Business Account		
Contact Person:	John Smith		
Phone Number:	31 10 6664778		
Address Line 3:	123 First Street	Number 1	Number 2
Postal Code:	2600	City:	Amsterdam
		111	222

Business Unit Bank Accounts page

Account Type Select one of these options to specify the type of bank account:

Current

Giro

Note. If the Account Type is *Giro*, then the Bank ID is always *Postbank*. If the Account Type is *Current*, then the Bank ID can be any bank that you have set up. You can set banks up in Set Up HRMS, Common Definitions, Banking, Banks.

Country Code Select the appropriate country code.

Bank ID Select the appropriate bank ID.

Account Number Enter the account number.

Account Name Enter the account name.

Currency Code Select the currency code.

Contract Code

Select one of these options:

A-Contract: The collector is not permitted to add or cause to be added (OCR-B font) data to the reader strip of the submittal section of the accept giro.

B-Contract: The collector is not permitted to add the form code and the collector's account number to the reader strip, or to add the name, address, place of residence, or business and account number to the body.

C-Contract: The collector is permitted to add the form code and the collector's account number to the reader strip, or to add the name, address, place of residence, or business and account number to the body.

OLA Code

Select one of these options:

12: Deposit fees for payer with annotations.

13: Deposit fees for payer without annotations.

14: Deposit fees for collector with annotations.

15: Deposit fees for collector without annotations.

Description

The name of the business unit account, if one is available.

Contact Person, Phone Number, Address Line 3, Number 1, Number 2, Postal Code, and City

Enter the appropriate information about the contact person.

Setting Up Bank Account Numbers for Students

Access the Student Bank Accounts page (Set Up SACR, Product Related, Student Financials, Billing, Bank Accounts - Student, Student Bank Accounts).

Student Bank Accounts

EELCO BOONE SRN002

Find | View All | First ◀ 1 of 1 ▶ Last

Account ID:	<input type="text" value="1"/>	Account Status:	<input style="border: 1px solid #ccc;" type="text" value="Active"/>	<input type="button" value="+"/> <input type="button" value="-"/>
City:	<input type="text" value="Amsterdam"/>	<input checked="" type="checkbox"/> Tuition Check		
Account Type:	<input style="border: 1px solid #ccc;" type="text" value="Giro"/>			
Country Code:	<input type="text" value="NLD"/> <input type="button" value="🔍"/> Netherlands			
Bank ID:	<input type="text" value="01009289"/> <input type="button" value="🔍"/> POSTBANK			
Account Number:	<input type="text" value="4867461"/>			
Account Name:	<input type="text" value="Test Netherlands"/>			
*Currency Code:	<input type="text" value="EUR"/> <input type="button" value="🔍"/> euro			

Student Bank Accounts page

Account ID and Account Status Enter a unique ID for the bank account, and enter the status of the account. You can link more than one account to a student, so you must uniquely identify each account and its status.

Tuition Check Select to specify this account to be used for the payment of tuition fees. This setting tells the system which account it should use for automatic debit or for the creation of giro slips. When you link bank accounts to a student, you must select this check box for one of the accounts.

Account Type Select one of these options to specify the type of bank account:

Current

Giro

Note. If the Account Type is *Giro*, then the Bank ID is always *Postbank*. If the Account Type is *Current*, then the Bank ID can be any bank that you have set up. You can set banks up in Set Up HRMS, Common Definitions, Banking, Banks.

Country Code Select the appropriate country code from the list.

Bank ID Select the appropriate bank ID.

Bank Branch ID Select the appropriate bank branch.

Account Number Enter the account number. The system validates the account number using Elfproef, the Dutch check for valid bank account numbers. *Current* bank account numbers must be less than seven digits long. *Giro* account numbers are not checked.

Account Name Enter the account name.

Currency Code Select the currency code.

Setting Up Default Values for VERWINFO or Clieop03 Files

Access the Set Up default Values VERWINFO/Clieop03 page (Student Financials, Student Financials NLD, Layout for Verwinfo and Clieop, Set Up default Values VERWINFO/Clieop03).

Set Up default Values VERWINFO/Clieop03

SetID PSNLD **Input File Layout ID** VERWINFO

Payment Details

Processing Type: VERWINFO

***Description:** Verwinfo **Short Description:** Verwinfo

Invoice Filler: 0000000

Type of Group

Type of Group: Student Group **Account Type:** PPL Pay Plan

***Recon Origin:** 00013 ***Item Type:** 10000004000

Currency Code: EUR **Term:** 2040

***Charge Lst:** PAYPLANS

Date Format: YYMMDD

Set Up default Values VERWINFO/Clieop03 page (1 of 2)

Set Up default Values VERWINFO/Clieop03

SetID PSNLD **Input File Layout ID** CLIEOP

Payment Details

Processing Type:	<input type="text" value="CLIEOP03"/>	Short Description:	<input type="text" value="incasso"/>
*Description:	<input type="text" value="Clieop incasso"/>		

Type of Group

Type of Group	<input type="text" value="Student Group"/>	*Recon Origin:	<input type="text" value="00013"/>
		*Item Type:	<input type="text" value="10000004000"/>
*Charge Lst:	<input type="text" value="PAYPLANS"/>	Term:	<input type="text" value="2040"/>

Set Up default Values VERWINFO/Clieop03 page (2 of 2)

Payment Details

- Processing Type** Select one of these options:
 CLIEOP03
 VERWINFO
- Description and Short Description** Enter a long and a short description.
- Invoice Filler** Enter seven numeric characters.

Type of Group

Depending on the processing type, some or all of the following fields will appear.

- Type of Group** Select one of these options:
 Student Group
 External Org Group
- Account Type** Select the account type.
- Recon Origin** Select the reconciliation origin.
 (reconciliation origin)
- Item Type** Select the item type.

Currency Code	Select the currency code.
Term	Select the term.
Charge Lst (charge list)	Select the charge priority list.
Date Format	Select a date format.

See Also

[Chapter 2, "Completing Student Financials General Setup," page 5](#)

Billing Students Using OLA or VERWINFO

This section provides an overview of billing students using OLA or VERWINFO and discusses how to:

- Post student transactions.
- Print OLA forms.
- Load VERWINFO files.
- Process payments.

Understanding Billing Students Using OLA or VERWINFO

These steps must be completed to bill students using OLA or VERWINFO:

1. The institution calculates tuition and fees and bills students.
2. The institution prints and sends OLA forms to students.
3. The students sign and return OLA forms to the bank by mail or use electronic banking to notify the bank of OLA details and payments to be deducted from the banking account assigned.
4. The bank processes the OLA forms, produces the VERWINFO, and sends the VERWINFO to the institution.
5. The institution loads the VERWINFO and posts payments.

Pages Used to Bill Students Using OLA or VERWINFO

<i>Page Name</i>	<i>Definition Name</i>	<i>Navigation</i>	<i>Usage</i>
Student Post	GRP_QUICK_POST	Student Financials, Charges and Payments, Post Student Transaction, Student Post	Post transactions for individual students.
Print OLA Forms	SSF_RUNCTL_OLA_NLD	Student Financials, Student Financials NLD, Print OLA Forms	Print OLA forms.
Load VERWINFO	SSF_RUNCTL_GP_NLD	Student Financials, Student Financials NLD, Load Verwinfo	Load the VERWINFO payment file.

Posting Student Transactions

Access the Student Post page (Student Financials, Charges and Payments, Post Student Transaction, Student Post).

Post transactions.

See Also

[Chapter 21, "Maintaining Receivables," Posting Transactions for Individual Students and Organizations, page 589](#)

Printing OLA Forms

Access the Print OLA Forms page (Student Financials, Student Financials NLD, Print OLA Forms).

Print OLA Forms

Run Control ID: OLA-C [Report Manager](#) [Process Monitor](#)

Parameters	
*Business Unit:	PSNLD <input type="text"/> PeopleSoft
*Req Nbr:	<input type="text" value="2"/>
Contract Code	C-Contract <input type="button" value="v"/>
Account:	987654321 <input type="text"/> Business Account
Account #	1111111111
OLA Code	12

Print OLA Forms page

- Business Unit** Select the business unit.

- Req Nbr** (request number) Select the request number from your billing process. Before you print OLA forms, you must run billing and get the request number.

- Contract Code** Select one of the following:
 - A-Contract*
 - B-Contract*
 - C-Contract*

Loading VERWINFO Files

Access the Load VERWINFO page (Student Financials, Student Financials NLD, Load Verwinfo).

Note. Using this page, you run the process that loads payments from the banking institution.

Load VERWINFO

Run Control ID: VER [Report Manager](#) [Process Monitor](#) Run

Parameters

Business Unit: PSNLD PeopleSoft

File Name:

File Directory:

Group Type: B Bank Account

Input File Layout ID: VERWINFO Verwinfo

Balance the Group

Generate Report

Load VERWINFO page

- File Name and File Directory** This file name, which is provided by the banking institution, will be loaded into the PeopleSoft system. The File Directory is the location where the file will be sent.
- Group Type** Select a group type for creation of the Posting Group.
- Input File Layout ID** Select a layout ID from those already set up. The values in the layout will be used as defaults.
- Balance the Group** Select this check box to post the group during processing.
- Generate Report** Select this check box to create a report of the file load.

Processing Payments

Use the standard process to process payments.

See Also

[Chapter 21, "Maintaining Receivables," Applying Payments, page 603](#)

Using the Clieop03 Process

This section provides an overview of the Clieop03 process and discusses how to create Clieop03 files.

Understanding the Clieop03 Process

These steps must be completed when billing students using Incasso and the Clieop03 process:

1. The institution prints Incasso form and sends them to students.
2. Students sign and return the Incasso form to the institution.
3. The institution processes the form by assigning students to payment plans.
4. The institution creates Clieop03 receivables to produce direct debits, and it sends the file to the bank.
5. The bank runs the Clieop03 file and transfers money to the institution.
6. The institution manually processes rejects using standard payment reversal functionality.

Note. Steps 1 and 2 are functional prerequisites that are not supported by the PeopleSoft application. The Incasso is a contract between the student and the Institution stating that a student payee authorizes the Institution to deduct a certain amount of funds at certain time intervals.

Before the Clieop03 file can be created, students must be linked to a payment plan. This payment plan must be set up, and students must be linked to this payment plan. After students are linked to a payment plan, you can create the Clieop03 files.

Prerequisites

The prerequisites are:

1. A valid bank account is set up for the student.
2. The student is assigned to a payment plan.
3. The Clieop03 file was created.

Page Used for the Clieop03 Process

<i>Page Name</i>	<i>Definition Name</i>	<i>Navigation</i>	<i>Usage</i>
Create Clieop03 File	SSF_RUNCTL_CLI_NLD	Student Financials, Student Financials NLD, Create Clieop Receivables, Create Clieop03 File	Create a Clieop03 file.

Creating Clieop03 Files

Access the Create Clieop03 File page (Student Financials, Student Financials NLD, Create Clieop Receivables, Create Clieop03 File).

Create Clieop03 File

Run Control ID: CLIEOP [Report Manager](#) [Process Monitor](#)

Parameters	
Business Unit:	PSNLD <input type="text"/> PeopleSoft
Account	987654321 <input type="text"/>
*Process Date:	11/05/2004 <input type="text"/>
*Testing Code	Production <input type="text"/>
Input File Layout ID:	CLIEOP <input type="text"/>
Group Type:	B <input type="text"/>
<input checked="" type="checkbox"/> Balance the Group	<input type="checkbox"/> Generate Report
Description:	Clieop Production File <input type="text"/>
*File ID:	1 <input type="text"/>
*Clieop03 File:	CLIEOP_PRODUCTION.TXT <input type="text"/>
File Directory:	WMARMSTRO121102\Temp\ <input type="text"/>
*Letter:	LETTER_PRODUCTION.TXT <input type="text"/>
File Directory:	WMARMSTRO121102\Temp\ <input type="text"/>

Payment Plan selection	
Contract Number:	NLBU1003 <input type="text"/>
Due Date:	08/04/2004 <input type="text"/>

Create Clieop03 File page

The institution runs the Clieop03 process (SSFCL1NL) to produce direct debits, and then it sends the file to the bank.

Parameters

- Account** Enter or select the account number of the business unit that is to be used. Generally, this account number is used for the collection of tuition and fees.
- Process Date** Select a process date for the direct debits. On this date, the direct debits will be affected.
- Testing Code** Select one of these options:
Production
Test
- Input File Layout ID** Choose a layout ID that has been set up. The values in this layout will be used as defaults.
- Group Type** Select a group type to create the Post Group.

- Balance the Group** Select this check box to balance the Post Group.
- Generate Report** Select *Yes* to create a report.
- Description** Enter a description, which will be printed on the student's bank statement.
- File ID** Enter a value. Positions 1-2 are used for the creation date of the file. Positions 3-4 should be used for sequential numbering, increasing by 1 per day of the month. For example. 0503 would be May 03.
- Clieop03 File** Enter a name for the output file.
- File Directory** Enter the location of where the file will be sent.
- Letter** Enter a file name for the cover letter.
- File Directory** Enter the location of where the file will be sent.

Payment Plan selection

- Contract Number** Select a value.
- Due Date** Select the date that payment plan charges are due. All charges with a due date less than or equal to the due date and with a balance greater than zero must be included in the Clieop03 file.

See Also

- Chapter 8, "Setting Up Payment Plans," page 253
- Chapter 18, "Administering Payment Plans," page 471

Chapter 27

(AUS) Setting Up and Using Australian Loan Processing

This chapter provides an overview of loan processing for Australian higher education and discusses how to:

- Set up Australian loan defaults.
- Review Higher Education Contribution Scheme (HECS) results and run the HECS reconciliation.
- Create and update FEE-HELP loans.
- Create and update OS-HELP loans.
- Create Commonwealth Assistance Notices (CAN).

Understanding Loan Processing for Australian Higher Education

The Higher Education Loan Program (HELP) is a suite of income contingent loans: HECS-HELP, FEE-HELP, and OS-HELP.

This section discusses:

- HECS-HELP.
- Tuition Calculation for HECS.
- FEE-HELP.
- OS-HELP.
- How to prepare for setting up HELP.

HECS-HELP

The Higher Education Contribution Scheme (HECS) provides students with a loan to cover all or part of the Student Contribution amount. Students may also receive a discount if they choose to pay their Student Contribution up-front. HECS-HELP loans are available to eligible students enrolled in Commonwealth-supported places. If a student receives a HECS-HELP loan, the Australian government pays the loan amount directly to the higher education provider on the student's behalf, and a HECS-HELP debt is recorded with the Tax Office. No loan fees are charged on HECS-HELP loans.

HECS requires most students to contribute to the cost of their higher education. Student Contribution is calculated for each class based on the academic student load—the EFTSL (Equivalent Full Time Student Load) and annual course contributions—HECS Bands. Student Contribution is calculated based on a student's load as of the census date for the term. A student's total Student Contribution for the term is based on the sum of the Student Contribution amounts for each class in which the student is enrolled for that term.

Students can pay their Student Contribution in full, make a partial payment and defer the remainder, or defer the entire amount. Students who defer the payment of their Student Contribution incur a debt with the government that is repaid through the taxation system when the student's salary is above a predetermined level.

Administering HECS requires you to complete tasks using the PeopleSoft system as well as tasks outside the system. The tasks that use the system during HECS processing are listed here. They are organized into groups based on the time frame for performing the tasks during the academic cycle.

At the time of enrollment:

- Estimate each student's Student Contribution by term for the classes in which the student is enrolling.

The Student Contribution is a type of tuition fee and that you calculate using the Tuition Calculation process.

- Inform all students in writing of their Student Contribution by sending student bills.

By the census date of each term:

- Collect and enter into the system full up-front payments from students who choose the up-front payment option for HECS payments.
- Collect and enter into the system partial up-front payments from students who choose the deferred payment option for HECS payments.

After the census date of each term:

- Calculate the actual Student Contribution of each student as of the census date.
- Inform all students in writing of their Commonwealth Support.

A CAN must be issued within 28 days of the class census date.

- Refund any excess contributions, confirm payment application for Student Contributions, or both.

Note. Every time tuition is calculated or a payment is processed for a student, the system updates the student's HECS calculations.

- Supply the Australian Tax Office (ATO) with a file of data containing details of the HECS liabilities of students who elect to defer payment of their contributions together with relevant personal identification details required by the ATO.

Do this through Department of Education and Science Training (DEST) reporting.

- Supply DEST with a file of data on HECS liabilities for all students.

Do this through DEST reporting.

- Supply DEST with information regarding adjustments to up-front payments and refunds due to special circumstances.

- Supply the ATO with information about changes to HECS liabilities that were made after the initial data files were sent.

Do this through DEST reporting.

Students must complete a Commonwealth Assistance Form (CAF) for each program in which they are enrolled before the census date of the first term in which they commenced their program of study. Students who want to defer all or part of their Student Contribution must provide a valid Tax File Number (TFN) on the Payment Options Declaration form. Students cannot be enrolled if they have not completed these requirements.

Calculating Student Contribution and Deferment Amounts

The Higher Education Support Act 2003 (HESA) requires higher education providers to allocate individual units of study (courses) to funding clusters. Units of study are allocated to funding clusters based on their classification against the Australian Standard Classification of Education (ASCED). Each provider then determines the Student Contribution amount applicable to each unit of study up to a maximum Student Contribution amount allowed for the funding cluster in which the unit is classified. The funding clusters are currently grouped into four contribution bands.

Commonwealth-supported students are classified into three groups for the purpose of determining the maximum Student Contribution amount:

- Post-Reform students (student commenced course of study on or after 1 January 2005).
- Pre-2005 Differential HECS students.
- Pre-1997 students or *Fixed HECS*.

If students make up-front payments, they may be eligible for a discount on their Student Contribution amount.

If a student withdraws from a program of study on or before the census date, no Student Learning Entitlement is consumed and no contribution is payable. The institution must refund any payments made by the student for that term.

Making Payments

Students can pay their Student Contribution in these ways:

- Pay the Student Contribution in full up-front and receive a 20 percent discount on the total Student Contribution for the term.
- Make a partial up-front payment of 500.00 AUD or more and receive a 20 percent discount on that payment; the remainder of the Student Contribution is deferred. (Note that if a student's assessed fees are less than 500.00 AUD, then he or she can make a partial payment and still receive the 20 percent discount.)
- Make a payment of less than 500.00 AUD with no discount applied; the remainder of the Student Contribution is deferred.
- Defer payment and repay through the ATO when the student's income exceeds the minimum repayment threshold.

Students who complete the CAF are required to indicate their intended payment option on the form. This information is intended to provide institutions with an indication of students' intended payment options. A student's actual payment option is determined after the census date based on the up-front payments that the student made on or before the census date. This determines the student status that is applicable at the enrolment level.

Note. After the census date, students can make only repayments of deferred Student Contribution to a branch of the ATO.

Making Full Up-Front Payments

Students who want to make a full up-front payment must pay 80 percent of their Student Contribution for the term by the census date or the date set by the institution, whichever is earlier. When students pay 80 percent of their total Student Contribution, the remaining 20 percent of their Student Contribution is discounted. If a student has not made a full up-front payment of the Student Contribution for the term by the census date and has not provided a TFN, the institution must cancel the student's enrollment.

A payment of more than 80 percent of the total Student Contribution for a term cannot be used to reduce the student's HECS debt from previous terms. Any overpayment amount should be left on the student's account as an unapplied charge or can be refunded to the student.

Making Partial Up-Front Payments

Students can choose to make partial up-front payments toward their Student Contribution. If a student makes an up-front payment of 500.00 AUD or more, the student can receive a discount on that payment. Partial up-front payments can be made to the institution only before the census date.

Institutions can accept partial payments that total less than 500.00 AUD; however, payments that total less than 500.00 AUD are not discounted (unless the total Student Contribution amount applicable to the student, program, and census date is less than 500.00 AUD).

Deferring All Charges

Eligible students can choose to make no up-front payments and defer the entire Student Contribution amount. If they choose this option, they must provide a TFN to their institution on the CAF. No discount exists for students who defer their entire Student Contribution amount.

Tuition Calculation for HECS

The Tuition Calculation process calculates tuition using HECS bands. When you set up Term Fee codes for HECS charges, you indicate that the fee should be charged by band. When Tuition Calculation processes a fee charged by band, the process knows that it must calculate the HECS load factor, which is the EFTSL using billing units. The HECS load factor calculation uses the Level/Load rules from the student's academic program. The process calculates the HECS load factor for each class. It then calculates the charges for each class in which the student is enrolled by using the band assigned to the class and the band charge that is indicated on the Fee Code table (SEV_FEE_TBL). Fee codes are assigned to tuition groups and students are selected for tuition groups based on the selection criteria that is set up for the tuition group.

To calculate a HECS discount waiver or HECS deferral waiver, the Tuition Calculation process references the student liability status code, which is indicated on the AUS Student Enrol page in the Enrolment component. The appropriate discount or deferral waiver is created based on the enrolment level student status.

When a student makes a payment for HECS, the posting program updates the enrolment-level student liability status, if necessary, based on the amount of the payment. For example, if a student indicates that he or she will make a partial payment, but the student actually makes a full payment, the Payment Posting process changes the enrolment level student status code accordingly.

Note. The student liability status referenced on the HECS Election page in the Term Activation component is a default value for all enrolments in that program and term. Tuition calculation, payment processing, or HECS reconciliation processing never updates the default value.

FEE-HELP

FEE-HELP is a loan program that provides eligible fee-paying students with help to pay part or all of their tuition fees. The Commonwealth pays the amount of the loan directly to the student's provider. Students repay their loan through the tax system after their income is above the minimum threshold for compulsory repayment. A 20 percent loan fee is applied if a student in an undergraduate course of study accesses FEE-HELP.

OS-HELP

Overseas HELP (OS-HELP) assists eligible undergraduate Commonwealth-supported students to undertake some of their courses of study overseas. OS-HELP is not available to students undertaking all of their courses outside Australia. The loans are allocated to higher education providers (HEPs). The HEPs select the students who receive the loans. Eligible students can borrow up to 5,000.00 AUD per study period for one or two study periods of overseas study.

See [Chapter 27, "\(AUS\) Setting Up and Using Australian Loan Processing," Defining OS HELP Loan Defaults, page 726.](#)

Preparing for Setting Up HELP

These are some of the general setup steps that you must complete within Student Financials:

- Set up Australian loan data.
- Set up HECS-HELP account types.
- Set up HECS and FEE-HELP item types.
- Set up HECS and FEE-HELP charge priority lists.
- Set up a HECS and a FEE-HELP tuition group.

You specify the HECS Fee code in a HECS tuition group.

- Set up HECS and FEE-HELP criteria.

These are some of the general setup steps that you must complete outside of Student Financials:

- Set up foundation table reporting codes.
- Set up academic structure defaults.

- Set up DEST reporting codes.
- Set up items in the course catalog.
- Activate and enroll students.

See Also

PeopleSoft Enterprise Campus Solutions 9.0 Application Fundamentals PeopleBook, "(AUS) Setting Up Government Reporting"

PeopleSoft Enterprise Student Records 9.0 PeopleBook, "(AUS) Setting Up Government Reporting"

PeopleSoft Enterprise Student Records 9.0 PeopleBook, "(AUS) Generating Government Reports"

Setting Up Australian Loan Defaults

This section discusses how to:

- Define liability statuses.
- Define HECS HELP loan defaults.
- Define FEE HELP loan defaults.
- Define OS HELP loan defaults.
- Define status change rule loan defaults.
- Set up HECS fee codes.
- Set up HECS band fees.
- Link band fees to tuition groups.
- Exclude HECS classes.

Pages Used to Set Up Australian Loan Defaults

Page Name	Definition Name	Navigation	Usage
Liability Status	SSF_HECS_EX_TBL	Set Up SACR, Product Related, Student Financials, Australian Defaults, Liability Status	Define liability statuses.
HECS HELP	SSF_ANZ_LOAN_DEF	Set Up SACR, Product Related, Student Financials, Australian Defaults, Loan Default, HECS HELP	Define HECS HELP loan defaults.

Page Name	Definition Name	Navigation	Usage
FEE HELP	SSF_PELS_DEF_ANZ	Set Up SACR, Product Related, Student Financials, Australian Defaults, Loan Default, FEE HELP	Define FEE HELP loan defaults.
OS HELP	SSF_OSHELP_DEF_ANZ	Set Up SACR, Product Related, Student Financials, Australian Defaults, Loan Default, OS HELP	Define the OS HELP loan defaults.
Status Change Rule	SSF_STAT_CHNG_RULE	Set Up SACR, Product Related, Student Financials, Australian Defaults, Loan Default, Status Change Rule	Define status change rule loan defaults.
HECS Fee Codes	SSF_HECS_CD_TABLE	Set Up SACR, Product Related, Student Financials, Australian Defaults, HECS Band Fees, HECS Fee Codes	Set up HECS fee codes.
HECS Band Fees	SSF_HECS_FEE_TABLE	Set Up SACR, Product Related, Student Financials, Australian Defaults, HECS Band Fees	Define the band fees for HECS eligible students. These band fees can be cohort specific.
Tuition Groups - Definition	SEL_GROUP_TABLE	Set Up SACR, Product Related, Student Financials, Tuition and Fees, Tuition Groups, Definition	Link HECS band fees to tuition groups.
Term Fees	TERM_FEE_TABLE	Set Up SACR, Product Related, Student Financials, Tuition and Fees, Term Fees	Exclude HECS classes from a term fee.

Defining Liability Statuses

Access the Liability Status page (Set Up SACR, Product Related, Student Financials, Australian Defaults, Liability Status).

Liability Status

Liability Status: 111

Find | View All First 1 of 1 Last

*Effective Date: 01/01/2005  *Status: Active   

*Description: HECS-HELP Paid w/disc. pre2005

Short Description: Paid w Dis Commonwealth Assisted

Long Description:

*AUS Loan Type: HECS-HELP  *Code Type: Discount 

Liability Status page

The discount and deferral payment processes use these codes. Each liability status can be assigned only one code type. The code types are *Deferral*, *Discount*, and *Normal*.

Commonwealth Assisted Select to indicate whether the liability status is valid for reporting students in the Commonwealth Assisted Students file and the Revised Commonwealth Assisted Students file.

Ensure that the selection is correct for the file scope.

AUS Loan Type

Select the loan type. Values are:

FEE-HELP: Specify a FEE-HELP liability status.

HECS-HELP: Specify a HECS-HELP liability status.

OS-HELP: Specify an OS-HELP liability status.

Exempt: Specify an Exempt liability status. The charge for the class will not appear on the CAN, and will have an (E) for Exempt next to 0.00 AUD charge in the charge column.

Code Type

Defines the Exemption code.

Values are:

Deferral for the Exemption Status code that is used to defer liability.

Discount for the Exemption Status code that is used to discount liability.

Normal for all other Exemption Status codes.

Defining HECS HELP Loan Defaults

Access the HECS HELP page (Set Up SACR, Product Related, Student Financials, Australian Defaults, Loan Default, HECS-HELP).

HECS HELP	FEE HELP	OS HELP	Status Change Rule
SetID:	PSANZ		
*Account Type:	HEC <input type="text"/>	HECS Account	
*Discount Item Type:	350000000000 <input type="text"/>	HECS Payment Discount	
*Deferral Item Type:	3500000000003 <input type="text"/>	HECS Deferral	
Find View All First ◀ 1 of 1 ▶ Last			
*Effective Date:	01/01/2005 <input type="text"/>	*Status:	Active <input type="text"/>
Min Payment:	500.00 <input type="text"/>	Discount Percent:	20.00 <input type="text"/>

HECS HELP page

Use this page to define the minimum payment amount and the discount percent for your HECS SetID, account type, and item types.

Defining FEE HELP Loan Defaults

Access the FEE HELP page (Set Up SACR, Product Related, Student Financials, Australian Defaults, Loan Default, FEE HELP).

Use this page to define, for each career, the FEE-HELP loan fee percent amount.

HECS HELP | FEE HELP | OS HELP | Status Change Rule

SetID: PSANZ

Item Type Group: FEEHELP FEE HELP Group

Deferral Item: 350000000008 FEE-HELP Loan

Loan Fee Percent: 20.00

Find View All First 1 of 1 Last	
*Academic Career	Undergraduate

*Effective Date 28/01/2008 FEE-HELP Limit 80000.00

FEE HELP page

Defining OS HELP Loan Defaults

Access the OS HELP page (Set Up SACR, Product Related, Student Financials, Australian Defaults, Loan Default, OS HELP).

HECS HELP | FEE HELP | OS HELP | Status Change Rule

SetID: PSANZ

Loan Fee Percent: 20.00

Find View All First 1 of 1 Last	
*Academic Career	Undergraduate

OS HELP page

Use this page to define the OS-HELP loan fee percent amount. OS-HELP does not show up in a student's account; however, the loan fee percent and the loan amount appear in CAN or DEST reports.

Use the Academic Career field to designate which careers are eligible to receive an OS-HELP loan.

See Also

[Chapter 27, "\(AUS\) Setting Up and Using Australian Loan Processing," Creating Commonwealth Assistance Notices, page 743](#)

PeopleSoft Enterprise Student Records 9.0 PeopleBook, "(AUS) Setting Up Government Reporting"

Defining Status Change Rule Loan Defaults

Access the Status Change Rule page (Set Up SACR, Product Related, Student Financials, Australian Defaults, Loan Default, Status Change Rule).

HECS HELP		FEE HELP		OS HELP		Status Change Rule	
SetID:				PSANZ			
Effective Date:		01/01/2005		Status		Active	
Discount Status w/o Payment				Customize Find View All First 1-2 of 2 Last			
*Status From	Description	*Status To	Description				
1 111	HECS-HELP Paid w/disc. pre2005	110	HECS-HELP Deferred pre2005	+	-		
2 202	Paid full liability w/discount	201	HECS-HELP Deferred.	+	-		
Deferral Status with Payment				Customize Find View All First 1-5 of 6 Last			
*Status From	Description	*Status To	Description				
1 110	HECS-HELP Deferred pre2005	111	HECS-HELP Paid w/disc. pre2005	+	-		
2 201	HECS-HELP Deferred.	202	Paid full liability w/discount	+	-		
3 220	FEE-HELP pre2005 PELS	302	Paid Full - Award or Enabling	+	-		
4 230	FEE-HELP Def Award/Enabling	302	Paid Full - Award or Enabling	+	-		
5 231	FEE-HELP Def Employer Resv'd	303	Paid Full - Employer Reserved	+	-		

Status Change Rule page

Use this page to define the rules that you want to set for changing liability statuses. For example, a student is assigned a liability status of *111* for 2005, and pays his or her fees with a discount of 20 percent. After the tuition calculation and reconciliation is run, you discover that the fees did not meet the 500.00 AUD requirement, so the student's status changes to *110* (deferred).

Liability statuses are delivered values.

See [Chapter 27, "\(AUS\) Setting Up and Using Australian Loan Processing," Defining Liability Statuses, page 723.](#)

Setting Up HECS Fee Codes

Access the HECS Fee Codes page (Set Up SACR, Product Related, Student Financials, Australian Defaults, HECS Band Fees, HECS Fee Codes).

SetID:	PSAUS	HECS Fee Code:	HECSUG
*Status:	Active		
*Description:	HECS-HELP Undergraduate		
Long Description:	HECS-HELP Undergraduate		

HECS Fee Codes page

HECS band fees determine the rate of the charge (Student Contribution amount) for a course taken by a Commonwealth-Supported student. The government provides the maximum Student Contribution amount allowable via funding clusters. Student Financials uses the band ID to calculate the Student Contribution amount.

Note. Configuration of Student Contribution amounts via Band Fee Codes acknowledges the original terminology for the Higher Education Contribution Scheme (HECS). Maximum Student Contribution amounts are outlined in the current legislation and guidelines grouped by Funding Cluster. The combination of Band ID assigned to the course and cohort assigned to the band fee code allow institutions the flexibility to cater for as many student contribution amounts as desired for a single course (DEST Unit of Study).

Setting Up HECS Band Fees

Access the HECS Band Fees page (Set Up SACR, Product Related, Student Financials, Australian Defaults, HECS Band Fees).

HECS Fee Codes | **HECS Band Fees**

SetID: PSANZ **Copy Band Fee** HECS Fee Code: HECSUG HECS - HELP Band Fees

HECS Band Fee Defaults Find | View All First 2 of 16 Last

'Term': 0621 2009 Semester 1

'Account Type': HEC HECS Account

'Item Type': 100000000000 HECS Australian

'Due Date Code': STD Standard

'Adjustment Code': STD Standard

Charge for Wait Listed Class

HECS Band Fees for Cohort Find | View All First 4 of 7 Last

Cohort: 0901 2009 National Priority pre 2008 Commerce

HECS Band ID	Band Charge	Currency	Element 392	Description
Band 1	5201.00	USD	5	2009+
Band 2	7412.00	USD	5	2009+
Band 3	8677.00	USD	5	2009+
NP05 Education and Nursing	4162.00	USD	5	2009+
NP09 Maths Science Statistics	4162.00	USD	5	2009+
2008 Cluster Change Acct/Comm	7412.00	USD	4	Pre 2008

HECS Band Fees page

These are the definitions of the different HECS bands:

- Band 1: Humanities, Arts, Behavioral Science, Social Studies, Foreign Languages, Visual and Performing Arts.
- Band 2: Accounting, Commerce, Administration, Economics, Mathematics, Statistics, Computing, Built Environment, Health, Engineering, Science, Surveying, Agriculture.
- Band 3: Law, Dentistry, Medicine, Veterinary Science.
- Band 4: National Priorities: Education and Nursing.
- Fixed HECS: Enables you to set up an amount for students who started their courses before 1997.

Copy Band Fee

Click this button to copy a band fee from one term to another. If cohort values are associated with the Band Fee on the source term, these will be copied to the target term.

Term

Enter the term to which the band fee applies.

Account Type

Enter the account type that will reflect on the customer account for students subject to the band fee.

Item Type

Enter an item type applicable to the Student Contribution amount charged.

Due Date Code

Enter a due date code (calendar) to define when the fee is due and payable.

Adjustment Code

Enter the adjustment code (calendar) that governs this fee. This code determines the refund amount for students who drop classes.

Charge for Wait Listed Class

Select to charge the band fee for students who are on a waiting list for a class.

Cohort	An attribute of the Student Program for Institutions using installation settings for Australia and inherited as the default value on the student enrolment record. The cohort value on the enrolment will determine the HECS Band Fee that is applicable. The cohort value can be blank.
HECS Band ID	<p>A unique identifier assigned on the Course Offering that will determine the student contribution amounts applicable to an enrolment in the course. Traditionally, Band ID values of 1 through 4 were maintained to acknowledge a single contribution amount published by the government that was applicable to the HECS band associated with the Discipline Group Code for the Unit for Study.</p> <p>The current legislative regime allows for a maximum student contribution amount applicable to the funding cluster associated with the Unit of Study subject to transitional arrangements in place at any given time for particular cohorts of students. The Band ID associated with the course still controls the student contribution amounts charged, but any number of values may be configured to accommodate the policy and legislative requirements of the institution</p>
Band Charge	The charge (Commonwealth contribution amount) for each band ID and cohort combination.
Element 392	Select the maximum student contribution code that is reportable as Element 392 in the DEEWR Load/Liability file.

See Also

PeopleSoft Enterprise Student Records 9.0 PeopleBook, "(AUS) Setting Up Government Reporting"

Linking Band Fees to Tuition Groups

Access the Tuition Groups - Definition page (Set Up SACR, Product Related, Student Financials, Tuition and Fees, Tuition Groups, Definition).

Definition		Adjustment Codes		Criteria		Term Fees		Course Lists		Waivers	
Business Unit:	SFAUS	Tuition Group:	HECSTUTGRP								
Find View All First 1 of 1 Last											
*Effective Date:	01/01/2005	*Status:	Active								
*Description:	HECS - HELP Tuition Group										
Short Description:	HECS-HELP										
Long Description:	HECS - HELP Tuition Group										
*Priority:	999										
Transaction Fee Code:											
HECS Fee Code:	HECSUG HECS-HELP Band Fees										
<input checked="" type="checkbox"/> Tuition Calculation Group	<input type="checkbox"/> Fin Aid Calculation Group		<input type="checkbox"/> Lock In Flag								

Tuition Group - Definition page

Use the Definition page to add the HECS fee code to the tuition group.

HECS Fee Code Link the HECS Band Fee code that you set up here.

Excluding HECS Classes

Access the Term Fees page (Set Up SACR, Product Related, Student Financials, Tuition and Fees, Term Fees).

Term Fee Codes | **Term Fees** | Term Sub Fee Codes | Term Sub Fees | Term Fee Residency

SetID: PSANZ Fee Code: FEEUG FEE-HELP Term Fee Copy Term Fee

Term / Session Find | View All First 1 of 2 Last

*Term: 0549 Spr 2005 Session: [dropdown] + -

*Account Type: TUT Tuition Account

*Item Type: 100000000004 Tuition

Anticipated Item Type: [text box]

Fee Trigger: Use Criteria Use Equation

[text box]

*Adjustment Code: STD Standard

*Due Date Code: STD Standard

Minimum/Maximum Fee Code: [text box]

Minimum Amount: [text box] 0.00 Maximum Amount: [text box] 9,999,999.00 USD

Anticipated Stop Date: [text box]

Charge for Wait Listed Class Track Class pricing

Exclude Classes w/ HECS Status

Term Fees page

You can exclude HECS classes from a term fee.

Exclude Classes w/ HECS Status exclude classes with HECS status

Use to exclude classes that are covered by HECS-HELP from the tuition calculation. Each class is assigned a liability status, so one class could be covered by HECS-HELP and another by FEE-HELP (if the student has run out of HECS-HELP eligibility). Each student can be assigned only to one tuition group so that the student is not double charged for the HECS-HELP covered course. It is excluded from the calculation.

Reviewing HECS Results and Running the HECS Reconciliation

This section discusses how to:

- Review HECS results.
- Reconcile HECS on the census date.

Pages Used to Review HECS Results and Run the HECS Reconciliation

Page Name	Definition Name	Navigation	Usage
Review HECS Results	SF_STDNT_HECS	Student Financials, Tuition and Fees, Australian Loan Processing, Review HECS Results	Review HECS results.
Review HECS Results Class Prices	SSF_HECS_DETAIL_SP	Click the Display Details link to access the Review HECS Results Class Prices page.	Review HECS results class prices.
HECS Reconciliation	SSF_RUN_SFPBHECS	Student Financials, Tuition and Fees, Australian Loan Processing, Process HECS Reconciliation, HECS Reconciliation	Reconciling HECS on the census date

Reviewing HECS Results

Access the Review HECS Results page (Student Financials, Tuition and Fees, Australian Loan Processing, Process HECS Reconciliation, Review HECS Results).

Review HECS Results

Business Unit: Australia Business Unit

Student ID: SFAUS1004 Nancy Cervantes

Term: Semester 1 - Autumn 2005

Academic Career: Postgraduate

Academic Program: Master of Commerce

	Charge	Discount	Payment	Deferral		Last Update Date/Time
1	1,440.00	0.00	0.00	0.00	Display Details	08/10/2005 2:15:46AM
2	1,440.00	288.00	0.00	0.00	Display Details	08/10/2005 1:24:14AM

Review HECS Results page

This page shows the charge and any discount, payment, or deferral amount that is associated with that charge. Click the Display Details link to show the class number and description, the liability status, and the individual charge amounts for that class.

Review HECS Results							
Class Prices							
Class Nbr	Description	Liability Status	Description	Charge	Discount	Payment	Deferral
1037	Quantitative Methods:A	202	Paid full liability w/discount	720.00	144.00	0.00	0.00
1039	Quantitative Methods:B	202	Paid full liability w/discount	720.00	144.00	0.00	0.00

Review HECS Results Class Prices page

This page displays the class number and description, the liability status, and the individual charge amounts for that class.

Reconciling HECS on the Census Date

Access the HECS Reconciliation page (Student Financials, Tuition and Fees, Australian Loan Processing, Process HECS Reconciliation, HECS Reconciliation).

HECS Reconciliation

Run Control ID: PS [Report Manager](#) [Process Monitor](#) Run

Parameters

Batch ID: 999999999999

*Business Unit: PeopleSoft University Bursar

*Term: 2007 Fall

Account Type:

Discount Item Type: Deferral Item Type:

Min Payment for Discount: Discount Percent:

*From Census Date: *To Census Date:

*HECS Select Option:

Find | View All | First 1 of 1 Last

*Academic Career: Undergraduate + -

Find | View All | First 1 of 1 Last

*Academic Program			
<input type="text" value="LAU"/>	Liberal Arts Undergraduate		+ -

HECS Reconciliation page

This page displays the results of HECS reconciliation: the fees charged, payments, deferrals, and discount amounts.

The Reconciliation process reconciles the HECS payments and deferrals as of the census date. If a student has indicated he will pay his full Student Contribution, but as of the census date he has not, this process will change the student's exemption status to deferred or partial payment and remove the full 20 percent discount. The program will then apply any discounts applicable to the partial payment. This process also creates discount and deferral waivers based on the amount of payment as of the census date. You should run this process on the census date, after all of the students' payments are entered in Student Financials.

Parameters

Account Type	Displays the account type to be used when processing. The value that appears is the value that you entered on the Loan Default page.
Discount Item Type	Displays the item type that you assigned for the HECS discount. The value that appears is the value that you entered on the Loan Default page.
Deferral Item Type	Displays the item type that you assigned for the HECS deferral amount. The value that appears is the value that you entered on the Loan Default page.
Discount Percentage	Displays the percentage of Student Contribution that a student must pay to receive the HECS discount. The value that appears is the value that you entered on the Loan Default page.
HECS Select Option	Select <i>By Academic Career/Program</i> to run the process for a career. The Academic Career and Academic Program fields become available for entry to run the process for one or more careers and one or more programs. Select <i>By Student ID</i> to add student IDs to run the process for one or more students.

Creating and Updating FEE-HELP Loans

This section provides an overview of FEE-HELP loans and discusses how to:

- Create and update FEE-HELP loans.
- Using FEE-HELP process rules.
- Update statuses for FEE-HELP determinations.

Understanding FEE-HELP Loans

FEE-HELP loans help students who are paying full fees in public and eligible private HEPs. Before you create or update FEE-HELP, the following business processes must be completed:

- CHESSN allocation.
- Student eligibility for FEE-HELP.

See Also

PeopleSoft Enterprise Campus Community 9.0 Fundamentals PeopleBook, "(AUS) Managing CHESSN Data Storage"

Pages Used to Create and Update FEE-HELP Loans

Page Name	Definition Name	Navigation	Usage
FEE-HELP Loan	SSF_STDNT_LN_AUS	Student Financials, Tuition and Fees, Australian Loan Processing, Maintain FEE-HELP Loan, FEE-HELP Loan	Create and update FEE-HELP loans.
FEE-HELP Determination	SSF_RUN_SFPBFHLP	Student Financials, Tuition and Fees, Australian Loan Processing, Process FEE-HELP Determination, FEE-HELP Determination	Update statuses for FEE HELP determinations

Creating and Updating FEE-HELP Loans

Access the FEE HELP Loan page (Student Financials, Tuition and Fees, Australian Loan Processing, Maintain FEE-HELP Loan, FEE-HELP Loan).

FEE HELP Loan

ID: SFAUS036 Elspeth Greene

Academic Career: UGRD Undergraduate **Career Nbr:** 0

Term: 0599 Summer Session 2008

Academic Institution: PSAUS PeopleSoft Australia Uni

Academic Program: BCOM Bachelor of Commerce

Business Unit: SFAUS Australia Business Unit

Customize | Find | View All | First 1 of 1 Last

Status Information | Financial Information | **FEE**

Seq Nbr	Liability Status	Description	Loan Status	Notice Status
1	230	FEE-HELP Deferred Tuition	Approved	Pending

FEE HELP Loan page

Use this page to add the loan and set or change the status (both the liability and the loan status).

Status Information

Use the Status Information tab to add the loan and set the status.

Financial Information

Access the FEE HELP Loan page. Select the Financial Information tab.

FEE HELP Loan							
ID:	SFAUS036	Elspeth Greene					
Academic Career:	UGRD	Undergraduate	Career Nbr:	0			
Term:	0599	Summer Session 2008					
Academic Institution:	PSAUS	PeopleSoft Australia Uni					
Academic Program:	BCOM	Bachelor of Commerce					
Business Unit:	SFAUS	Australia Business Unit					
Customize Find View All First 1 of 1 Last							
Status Information		Financial Information		FEE			
Eligible Charges	Payments Made	Loan Amount	Loan Fee Amount	FEE-HELP Balance	Override Balance	Posted Flag	Last Update Date/Time
0.00	0.00	0.00	0.00	0.00	<input type="checkbox"/>	<input type="checkbox"/>	04/15/2008 9:35:04PM

FEE HELP Loan page - Financial Information tab

The Financial Information tab displays the eligible charges, any payments that have been made, the loan amount, the loan fee amount, the posted flag, and the last update date and time.

Updating Statuses for FEE HELP Determinations

Access the FEE HELP Determination page (Student Financials, Tuition and Fees, Australian Loan Processing, Process FEE-HELP Determination, FEE HELP Determination).

FEE HELP Determination page

The FEE-HELP Determination process is run before the census date to process and post the FEE-HELP loan to the student's account (and pay the eligible charges). The FEE-HELP Determination process must be run; otherwise, the loan will not appear on the CAN.

From Census Date and To Census Date

Select the census date range to restrict the selection of classes by census date. Where there are multiple census dates within the term of processing, the census date range allows you to apply FEE-HELP deferrals to classes with earlier census dates, allowing student time to make a decision on payment for classes within census dates later in the term.

Note. It is imperative that you increment the To Census Date on the run control when including later census dates in the term. The From Census Date parameter must include all dates within the term for which you have run deferral processing. For example, if you have two census dates in the term – 1 July and 31 August and you have run the process for Census Date 1 July, you must include 1 July in the date range when you are ready to include the second census date in August. The Override Flag check box still allows you to defer only those classes for which the census date is not past.

Posting Option

Select to post the loan to the student account. If you clear this check box, the loan will not post to the student account.

Override Flag

Select to override the census date criteria (if you are running the process after the census date has passed).

- ID Override** Select to enter a specific ID (or multiple IDs) to process.
- Academic Career** Select the careers to process.
- Academic Program** Select the programs to process for specific careers.
- ID Override** This is used in conjunction with the ID Override check box. Enter the IDs to process.

Understanding FEE-HELP Process Rules

To determine whether a FEE-HELP deferral will occur and for what amount, it is important to understand the FEE-HELP Entitlement attributes for the student:

- Entitlement check on the Student CHESSN record.
- Balance Override check box on Student Loan Record.
- Entitlement only check box on the process run control.

The combination of these attributes determines how the process assesses the student.

Note. If the student does not have a CHESSN record, no deferral occurs.

Student CHESSN Record Entitlement check box	Student FEE-HELP Loan Record Override Balance check box	FEE-HELP Process Run Control – Entitlement Request check box	FEE-HELP Deferral (pending FEE-HELP balance available)	FEE-HELP Balance Used (reflected in FEE-HELP balance field on student loan record for row inserted)
On	On	Off	Yes	Override balance entered on fee-help loan record (max row). If amount is 0.00, no deferral occurs.
On	Off	Off	Yes	FEE-HELP balance from CHESSN Record. If amount is 0.00, no deferral occurs.
Off	Off	On	No	No deferral because there is no entitlement record.

Student CHESN Record Entitlement check box	Student FEE-HELP Loan Record Override Balance check box	FEE-HELP Process Run Control – Entitlement Request check box	FEE-HELP Deferral (pending FEE-HELP balance available)	FEE-HELP Balance Used (reflected in FEE-HELP balance field on student loan record for row inserted)
Off	On	On	Yes	Override balance entered on fee-help loan record (max row). If amount is 0.00, no deferral occurs.
On	Off	On	Yes	FEE-HELP balance from CHESN Record. If amount is 0.00, no deferral occurs.
Off	On	Off	Yes	Override balance entered on fee-help loan record (max row). If amount is \$0.00, no deferral occurs.
On	On	On	Yes	FEE-HELP Limit from CHESN Record. If this is 0.00 no deferral.
Off	Off	Off	Yes	FEE-HELP Limit from CHESN Record. If this is 0.00 no deferral.
No record	On	On	No	No CHESN Record. Student skipped. Row is inserted in fee-help loan record and FEE-HELP balance override reverted to \$0.00.
No record	On	Off	No	No CHESN Record. Student skipped. Row is inserted in fee-help loan record and FEE-HELP balance override reverted to \$0.00.
No record	Off	On	No	No CHESN record. Student skipped.

Student CHESN Record Entitlement check box	Student FEE-HELP Loan Record Override Balance check box	FEE-HELP Process Run Control – Entitlement Request check box	FEE-HELP Deferral (pending FEE-HELP balance available)	FEE-HELP Balance Used (reflected in FEE-HELP balance field on student loan record for row inserted)
No record	Off	Off	No	No CHESN record. Student skipped.

Processing Rules Where the Limit is Less Than the Eligible Charge

If a student has eligible charges in excess of the available FEE-HELP balance, application of the FEE-HELP balance is applied first to classes with the earliest census date and then to the most expensive units of study. This is in accordance with the HEIMS order of precedence for entitlement consumption.

Example 1

Assume the student has a FEE-HELP balance available of 1,000 AUD and enrolls in Class A with a census date of 31 March 2007. Tuition fees for Class A are 2,000 AUD.

When the FEE-HELP process is run, it defers Class A in part for \$1,000.00. This results in a balance of 1,000 AUD remaining for payment.

The student subsequently enrolls in Class B also with a census date 31 March 2007. Tuition fees for Class B are 2,500 AUD.

When the FEE-HELP process runs, if the student has made not made any payments, the deferral of 1,000 AUD swaps to apply to Class B, the more expensive class.

Example 2

Assume the student has a FEE-HELP balance available of 1,000 AUD and enrolls in Class A with a census date 31 March 2007. Tuition fees for Class A are 2,000 AUD.

When the FEE-HELP process runs, it defers class A in part for 1,000 AUD. This results in a balance of 1,000.00 AUD remaining for payment.

The student subsequently enrolls in Class B, which is scheduled in the same term as Class A, but has a census date 15 March 2007. Tuition fees for Class B are also 2,000 AUD.

The student subsequently enrolls in Class B, which is scheduled in the same term as Class A, but has a census date 15 March 2007. Tuition fees for Class B are also 2,000 AUD.

Creating and Updating OS-HELP Loans

This section provides an overview of OS-HELP loans and discusses how to maintain OS-HELP loans.

OS-HELP loans help students who decide to take part of their study overseas. Before you create or update OS-HELP, the following business processes must exist:

- The student is not in his or her first or last year of study.

- The student is eligible and has an activated CHESSN.

See Also

PeopleSoft Enterprise Campus Community 9.0 Fundamentals PeopleBook, "(AUS) Managing CHESSN Data Storage"

Page Used to Create and Update OS-HELP Loans

Page Name	Definition Name	Navigation	Usage
Student Loan - OS HELP	SSF_STDNT_LN_OS	Student Financials, Tuition and Fees, Australian Loan Processing, Maintain OS HELP Loan, Student Loan - OS HELP	Maintain OS-HELP loans.

Maintaining OS-HELP Loans

Access the Student Loan - OS-HELP page (Student Financials, Tuition and Fees, Australian Loan Processing, Maintain OS HELP Loan, Student Loan - OS HELP).

Student Loan - OS-HELP

ID:	SFAUS4000	Frederick Chung	
Career:	UGRD	Undergraduate	Career Nbr: 0
Term:	0541	Semester 1 - Autumn 2005	
Institution:	PSAUS	PeopleSoft Australia Uni	
Acad Program:	BART	Bachelor of Arts	
Study Period:	02/28/2005		

*Liability Status:	240	OS-HELP Received Loan	
*Loan Status:	Approved	Notice Status:	Pending
Loan Amount:	<input style="width: 100%;" type="text" value="2,000.00"/>	Fee Amount:	400.00
Incurral Date:	<input style="width: 100%;" type="text" value="03/15/2005"/>		

Student Loan - OS-HELP page

Use this page to create OS loans. You can start the loan as *Pending* (until you receive further information), and then change it to *Approved* (or *Denied*) according to information that you receive.

Liability Status	Enter the appropriate liability status for this student.
Loan Status	Change the loan status based on the information that you receive about this student.
Notice Status	Displays the status of the CAN. Possible statuses are: <i>Reported to DEST</i> <i>Pending</i> <i>Ready</i> <i>Sent</i> <i>Variation Required</i>
Loan Amount and Fee Amount	Enter the OS-HELP loan payment to be made to the student. The corresponding fee amount is calculated and displayed based on the percentage loan fee configured for the academic career on the OS-HELP setup page.
Incurral Date	Enter the date that the loan was processed.

Creating Commonwealth Assistance Notices

Create the CAN after the census date to notify students of their liabilities (the loans they have secured, the amounts, and the courses). This notice must be provided to all students who are Commonwealth-supported or Commonwealth-assisted.

This section discusses how to create or update commonwealth assistance notices.

Page Used to Create Commonwealth Assistance Notices

<i>Page Name</i>	<i>Definition Name</i>	<i>Navigation</i>	<i>Usage</i>
Commonwealth Assistance Notice	SSF_RUNCTL_CAN	Student Financials, Tuition and Fees, Commonwealth Assistance Notice	Create or update Commonwealth Assistance Notices.

Creating or Updating Commonwealth Assistance Notices

Access the Commonwealth Assistance Notice page (Student Financials, Tuition and Fees, Commonwealth Assistance Notice).

Commonwealth Assistance Notice

Run Control ID: CAN [Report Manager](#) [Process Monitor](#)

Parameters

*Institution: PSUNV PeopleSoft University

*Term: 0541 Semester 1 - Autumn 2005

*From Census Date: 01/01/2005 *To Census Date: 01/01/2006

*Address Usage: LOAN_MAIL Loan Mailing Address

Reprint Enrollment information printed before will not be reprinted.

Academic Career Customize | Find | View All | First 1 of 1 Last

Student ID Customize | Find | View All | First 1 of 1 Last

Academic Program Customize | Find | View All | First 1 of 1 Last

Student Group Customize | Find | View All | First 1 of 1 Last

AUS Loan Type Customize | Find | View All | First 1 of 1 Last

Commonwealth Assistance Notice page

Reprint

Use this check box to toggle printing.

Select Reprint to re-create all of the CAN data.

Clear Reprint to re-create data only for those students who have made changes since the previous run.

For instance, if you ran the CAN process yesterday and then you run it today with Reprint cleared, the CAN process will print only the students whose data changed since the last run.

Group Boxes

You can enter information in any or all of the group boxes to define the group for which you want the CAN printed. If you leave all of the group boxes blank, you will get all students who have HECS-HELP, FEE-HELP, or OS-HELP.

Chapter 28

(NZL) StudyLink Processing

This chapter provides an overview of StudyLink and discusses how to:

- Set up StudyLink functionality.
- Process VOS requests and responses.
- Maintain StudyLink loan information.

Understanding StudyLink

StudyLink, formerly known as WINZ (Work and Income New Zealand) is a governmental agency that administers the distribution of student loans for educational costs and allowances.

In the past, a third party was used to manage the transfer of fees between the student account and StudyLink. The third-party functionality is no longer be used and payments will be posted directly to the students' accounts.

The process is initiated when a student applies for a loan through StudyLink. StudyLink requests the student's verification of study (VOS) from the institution where the student is enrolled. The institution matches the student's name, date of birth, and ID, creates a loan record, and sends the student's enrollment data and tuition charges to StudyLink in a VOS return file. StudyLink then sends the funds to the institution (if StudyLink is covering tuition) or to the student (only if StudyLink is providing allowance), or it denies the student loan.

StudyLink sends the funds through a PAY file for confirmed students, and payments are posted to the students' accounts. The Refund External Org ID is supplied to allow refunding to StudyLink as necessary. StudyLink sends a declined file (DEC), and loans are recorded as declined on the student's loan record if the loan is denied.

If a student's enrollment changes and fees are reduced, funds are returned to StudyLink. This is accomplished through Student Financials refunding through accounts payable for external organization refunding. The system generates an institution PAY file to list refunds to StudyLink.

Setting Up StudyLink Functionality

You must define various parameters to use the StudyLink process.

This section discusses how to:

- Define StudyLink institution defaults.

- Define the institution ID.
- Define StudyLink posting parameters.

Pages Used to Set Up StudyLink Functionality

<i>Page Name</i>	<i>Definition Name</i>	<i>Navigation</i>	<i>Usage</i>
StudyLink Institution Defaults	SSF_SL_INST_DFLT	Set Up SACR, Product Related, Student Financials, New Zealand Defaults, StudyLink Institution Defaults	Define StudyLink institution defaults.
Academic Institution 6	SSR_INST_FEATURES	Set Up SACR, Foundation Tables, Academic Institution Tables, Academic Institution 6	Access the Institution Table New Zealand page.
Institution Table New Zealand	SSR_INSTITUTN_NZL	Click the View NZL Institution Fields link on the Academic Institution 6 page.	Set up Ministry of Education institution ID.
StudyLink Posting Parameters	SSF_SL_BUS_UNIT	Set Up SACR, Product Related, Student Financials, New Zealand Defaults, StudyLink Posting Parameters	Define the posting parameters for the StudyLink process.

Defining StudyLink Institution Defaults

Access the StudyLink Institution Defaults page (Set Up SACR, Product Related, Student Financials, New Zealand Defaults, StudyLink Institution Defaults).

StudyLink Institution Defaults

Institution:	PSNZL	Silver Fern University
Institution ID - NZ MoE:	9999	
*Refund External Org ID:	SFNZLSL	Study Link - New Zealand
*Refund Org Contact:	1	Mellon, Mike
Start Date:	07/01/2004	
Term:	0541	Semester 1 - Autumn 2005

Transaction Parameters			
IVS Active:	<input type="text" value="4"/>	Study Period:	<input type="text" value="4"/>
Vacation:	<input type="text"/>	IVS History:	<input type="text" value="360"/>
<input checked="" type="checkbox"/> Round Dates			

Eligible Residency		First	1 of 1
*Residency			
New Zealand Resident			

Ineligible Enrollment Reasons		First	1 of 1
*Enrollment Status Reason	*Enrollment Status Exclusion		
Administrative Drop	Exclude From Enrollment		

Ineligible Withdrawal Codes		First	1 of 1
Withdrawal \ Cancel			
Cancelled			

StudyLink Institution Defaults page

Refund External Org ID Enter an ID setup for StudyLink so that the system can process refunds should there be a change in the student's program causing a reduction in fees charged. (refund external organization ID)

Refund Org Contact Enter the contact information for the external org ID. (refund organization contact)

IVS Active (institutional verification of study active)	Indicates the number of days between VOS requests. For example, as shown previously, an institution VOS will not pick up student information that has had a VOS request sent within the past four days. Information will be forwarded if a Pending, Not known, Unregistered, or Mismatch response has been received, or if no response has been received by StudyLink following a previous VOS request.
Study Period	Used to classify the enrollments into study periods that correlate to the loan period. This designates the number of days prior to the study period start date. The study start date is the date that StudyLink uses to request information. This is typically one month prior to the reported study start date. If the adjusted class start date, one day prior in the preceding example, is earlier or the same as the period start date, then the class is covered by that period. If later, the class will be added to the next period within the loan.
Vacation	Any break in study. This is used to enter the number of days constituting a break in study, as in the number of days between the end of one study period or term and the start of the next study period or term. So that the vacation period is reported in the VOS, the vacation buffer days should be fewer or equal to the number of days between terms.
IVS History (institutional verification of study history)	Used to select records for the institutional VOS. The number of days, 360 in the preceding example, is subtracted from the current date and compared with the study period start date and the transaction date on the history table. History records with a study period and transaction date greater than this date are picked up for the full institutional VOS process.
Round Dates	If this is selected, the start date is set to the Monday of the week of the first class and the end date is set to the Sunday of the week of the last class after the other date buffer calculations are done. Otherwise, the date buffer values will apply without regard to rounding.
Residency	Identifies eligible residency defaults, New Zealand, Australia, or both. This is a required field.
Enrollment Status Reason and Enrollment Status Exclusion	The default is to exclude from equivalent full-time student (EFTS) calculation or from enrollment depending on the enrollment status reason. If the enrollment status reason default matches the enrollment status, then the particular class is excluded as a covered class or the EFTS is disqualified. These are required fields.
Withdrawal/Cancel	Default for withdrawing or canceling from the program of study. Typically, cancelations result in 100 percent refund of fees. This is a required field.

Defining the Institution ID

Access the Academic Institution 6 page (Set Up SACR, Foundation Tables, Academic Institution Tables, Academic Institution 6).

Academic Institution 3		Academic Institution 4		Academic Institution 5		Academic Institution 6	
Academic Institution:		PSNZL		Silver Fern University			
						Find View All First 1 of 1 Last	
Effective Date:		01/01/1900		Status:		Active	
Australia							
		<input type="checkbox"/>		DEST, HECS, Centrelink, TAC			
Canada							
		<input type="checkbox"/>		Government Reporting			
New Zealand							
		<input checked="" type="checkbox"/>		Catalog, SDR, EFTS, StudyLink		View NZL Institution Fields	
		<input checked="" type="checkbox"/>		NZQA			
Netherlands							
		<input type="checkbox"/>		Higher Education			

Academic Institution 6 page

Access the Institution Table New Zealand page (click the View NZL Institution Fields link on the Academic Institution 6 page).

Institution Table New Zealand

Academic Institution: PSNZL Silver Fern University

Effective Date: 01/01/1900 **Status:** Active

Institution ID - NZ MoE	
*Institution ID - NZ MoE:	9999 <input type="checkbox"/> Unit Standard Enrol

EFTS Translation	
*EFTS Translation - A:	0.008333
*EFTS Translation - B:	0.00150

NZVCC Institution Code	
NZVCC Institution Code:	<input type="checkbox"/>

Institution Table New Zealand page

This page allows for multi-institution usage.

Defining StudyLink Posting Parameters

Access the StudyLink Posting Parameters page (Set Up SACR, Product Related, Student Financials, New Zealand Defaults, StudyLink Posting Parameters).

StudyLink Posting Parameters

Business Unit: PSNZL New Zealand University Bursar

*Priority:

*Payment Item Type: Payment - Cash

*Refund Item Type: StudyLink Refund

*Excess Account:

StudyLink Posting Parameters page

Priority Refers to the business unit.

Payment Item Type	The item type that is posted to the student's account.
Refund Item Type	Used to designate refunds to StudyLink.
Excess Account	Select for situations in which excess payments are posted before being refunded to StudyLink.

Processing VOS Requests and Responses

When a student applies for a loan from StudyLink, StudyLink sends a VOS request to the institution requesting enrollment details and the tuition amount. The institution creates a VOS Response file if changes occurred in the student's enrollment such as dropping courses or withdrawing from the program.

This section discusses how to:

- Request VOS information.
- Initiate VOS responses.

Pages Used to Process VOS Requests and Responses

<i>Page Name</i>	<i>Definition Name</i>	<i>Navigation</i>	<i>Usage</i>
Process VOS Requests	SSF_SL_RC_VOS	Student Financials, StudyLink, Process VOS Requests	Request VOS information.
Initiate VOS Responses	SSF_SL_RC_IVS	Student Financials, StudyLink, Initiate VOS Responses	Initiate VOS responses process.

Requesting VOS Information

Access the Process VOS Requests page(Student Financials, StudyLink, Process VOS Requests).

Process VOS Requests

Run Control ID: PS [Report Manager](#) [Process Monitor](#) Run

Institution: Silver Fern University

File Name:

Input Directory:

Output Destination:

Report Type: ▼

Report Only

Process VOS Requests page

Report Type

Values are:

Detailed Report: The output includes the student IDs, total fees, and EFTS values for each record for which the student has requested coverage of tuition and fees and not just an allowance. This report shows the confirmed students by name, biographic and demonstration data, fee coverage requested, and enrolled program.

Summary Report: The output contains the number of confirmed students and the total fee amount. This report also shows any data mismatches and unregistered students.

Report Only

Running the VOS Request in Report Only mode creates the VOS record but will not create the Loan record. If this check box is cleared, this process updates the database and creates the Loan record.

Initiating VOS Responses

Access the Initiate VOS Responses page (Student Financials, StudyLink, Initiate VOS Responses).

Initiate VOS Responses

Run Control ID: PS [Report Manager](#) [Process Monitor](#) Run

Institution: Silver Fern University

Output Destination:

VOS Selection:

Report Type:

Report Only

Initiate VOS Responses page

VOS Selection
(verification of study selection)

Values are:

Full: Selects all records that have not had a VOS request processed within the number of days that are set up on the StudyLink Defaults page in the IVS Active field.

Selected: Selects only those records that have the re-VOS check box selected on the Maintain Student Loan page.

Maintaining StudyLink Loan Information

This section provides an overview of and discusses:

- Create payment schedules.
- Process batch refunds.
- Create student reports.

Note. All of the following processes are intended for administrative users only.

Understanding Maintaining StudyLink Loan Information

Your institution must review student loan information, process payment schedules, track refunds, and create student account reports. Administrative users will run these processes to process loans for students to pay their tuition and living allowances or just the allowances. Loans for allowances only are sent to directly to the student and are not applied to the student account.

After a student has applied for a loan with StudyLink and StudyLink sends the VOS request to the institution, the institution creates the VOS return file that lists any mismatches of name, date of birth, or ID; the student's enrollment details; and the loan request amount.

Your institution receives PAY files from StudyLink for confirmed and declined student loans. For confirmed loans, a COBOL process is run that posts the payments to the students' accounts. Any excess funds will be refunded to StudyLink through the accounts payable process and by processing the refund file.

Pages Used to Maintain StudyLink Loan Information

<i>Page Name</i>	<i>Definition Name</i>	<i>Navigation</i>	<i>Usage</i>
Process PAY File	SSF_SL_RC_PAY	Student Financials, StudyLink, Process PAY File	Create the payment file and post payments to student accounts.
Batch Refund	RUNCTL_SFPREFND	Student Financials, Refunds, Process Batch Refunds, Batch Refund	Run the batch refund process.
Process Refund File	SSF_SL_RC_PYI	Student Financials, StudyLink, Process Refund File	Create the refund file.
Create Student Report	SSF_SL_RC_RPT	Student Financials, StudyLink, Create Student Report	Create reports on student loan account information.

Creating Payment Schedules

Access the Process PAY File page (Student Financials, StudyLink, Process PAY File).

Process PAY File

Run Control ID: 1120175153 [Report Manager](#) [Process Monitor](#)

[Display Messages](#)

Institution: Silver Fern University

File Name:

Input Directory:

Process PAY File page

You must run the PAY file process to create the file and to post payments to student accounts. You can run the SQR (Structured Query Report) report SFSPAYR multiple times. Run the COBOL process SFPSLPAY to post the payments to the student account.

Processing Batch Refunds

Access the Batch Refund page (Student Financials, Refunds, Process Batch Refunds, Batch Refund).

Batch Refund | Academic Programs | Accounts / Terms | Item Types

Run Control ID: 1120175153 [Report Manager](#) [Process Monitor](#)

Required Parameters

Batch ID: 999999999999 [Check Batch Refunds](#) [Batch Refund Messages](#)

Business Unit: New Zealand University Bursar

Refund Method: Accounts Payable

Run Option 1: Report Only

Run Option 2: Calc Tuition if Required

Sponsor Refund Option:

Refund Item Type: Refund - StudyLink

Address Usage: Billing,Mail,Home,Perm

Ext Org Contact Type:

Refund Service Impact:

Batch Refund page

To create refunds for StudyLink, complete the Batch Refund page as shown in the preceding sample page. Access the Process Refund File page (Student Financials, StudyLink, Process Refund File).

Process Refund file

Run Control ID: PSNZL1 [Report Manager](#) [Process Monitor](#)

Institution: Silver Fern University

Output Destination:

Report Only

All Business Unit's

Process Refund File page

Creating Student Reports

Access the Create Student Report page (Student Financials, StudyLink, Create Student Report).

Create Student Report

Run Control ID: 1 [Report Manager](#) [Process Monitor](#)

Institution: PeopleSoft University

ID:

Term 2015 Spring Qtr

Start Date

Report Type:

Create Student Report page

Chapter 29

(NZL) New Zealand Qualification Authority Fees

This section provides an overview of New Zealand Qualification Authority (NZQA) fees and discusses how to set up NZQA fee information.

Understanding NZQA Fees

NZQA is the New Zealand government body responsible for coordinating the National Qualifications Framework (NQF). Educational institutions must equate their study offerings to NQF unit standards for the purpose of cross accreditation.

Institutions are responsible for charging students a Hook-on Fee and a Per Credit Charge on behalf of the NZQA to cover administration costs. The Hook-on Fee of 25.00 NZD is charged at the time of enrollment if the student does not have an NZQA ID. If the student already has an NZQA ID, the fee is not charged. After paying the fee, as the student achieves units, these units are listed in their Record of Learning.

When students enroll in classes, they are also enrolled in the associated unit standards. Each unit standard is equivalent to a specific number of credits. As units are reported to the NQF, the NZQA charges a fee of 1.00 NZD per credit.

Setting Up NZQA Fee Information

This section discusses how to:

- Set up valid records.
- Set up valid fields.
- Set up fee triggers.
- Set up term fee codes.
- Set up term fees.
- View term sub fee codes.
- Set up term sub fees.
- Set up per credit charges.

NQF Fees

The two types of NQF fees that must be charged are:

- Hook-on fees

These fees are charged when a student enrolls in an NQF unit standard for the first time.

- NQF per credit fees

These fees are charged as earned units are reported to the NQF.

Page Used to Set Up NZQA Fees

<i>Page Name</i>	<i>Definition Name</i>	<i>Navigation</i>	<i>Usage</i>
Valid Records	SEL_VALID_RECS	Set Up SACR, Product Related, Student Financials, Valid Records	Set up the records required for hook-on fees and per credit charges.
Valid Fields	SEL_VALID_VARS	Set Up SACR, Product Related, Student Financials, Valid Fields	Set up fields required for hook-on fees and per credit charges.
Criteria	SEL_CRITERIA_TABLE	Set Up SACR, Product Related, Student Financials, Tuition and Fees, Criteria	Set up criteria types.
Criteria Details	SEL_CRITER_TABLE	Set Up SACR, Product Related, Student Financials, Tuition and Fees, Criteria Details	View criteria details.
Term Fee Codes	TERM_FEE_CD_TABLE	Set Up SACR, Product Related, Student Financials, Tuition and Fees, Term Fees, Term Fee Codes	Set up term fee codes.
Term Fees	TERM_FEE_TABLE	Set Up SACR, Product Related, Student Financials, Tuition and Fees, Term Fees, Term Fees	Set up term fees. The hook-on fee is treated as a term fee and follows the steps defined for setting up a term fee.
Term Sub Fee Codes	TERM_SF_CODE_TABLE	Set Up SACR, Product Related, Student Financials, Tuition and Fees, Term Fees, Term Sub Fee Codes	View information about term sub fee codes.
Term Sub Fees	TERM_SUBFEE_TABLE	Set Up SACR, Product Related, Student Financials, Tuition and Fees, Term Fees, Term Sub Fees	Set up term sub fees.

Page Name	Definition Name	Navigation	Usage
Per Credit Charge	SSF_PER_CREDIT_CHG	Set Up SACR, Product Related, Student Financials, New Zealand Defaults, Per Credit Charge	Set up information to apply charges based on each credit for which a student has enrolled.

Setting Up Valid Records

Access the Valid Records page (Set Up SACR, Product Related, Student Financials, Valid Records).

Valid Records		
SetID: MODEL		
Find View 8 First 1-15 of 15 Last		
*Record (Table) Name		
ACAD_PROG	Student Academic Program	+ -
ACAD_SUBPLAN	Student Academic Subplan Table	+ -
CRSE_CATALOG	Course Catalog Data	+ -
DERIVED_SF	Derived - Student Financials	+ -
EXTERNAL_SYSTEM	External System ID's	+ -
PERS_DTUSA_SBR	Personal Data Subrecord - USA	+ -
PERS_INST_REL	Institutional Relationship	+ -
RESIDENCY_OFF	Official Residency Data	+ -
SEL_STDNORES_VW	Student Data View No Residency	+ -
SF_EMPLOYEE_VW	Employee View - Stdnt Fin	+ -
SSF_STD_MLST_VW	Student Milestone View	+ -
SSR_HECS_ELEC	HECS Loan Election	+ -
STDNT_CAR_TERM	Student Career Term Table	+ -
STDNT_EQUTN_VAR	Student Equation Variables	+ -
STDNT_GRPST_HIST	Student Groups History	+ -

Valid Records page

Add a row for EXTERNAL_SYSTEM and STDNT_CAR_MLSTN.

Setting Up Valid Fields

Access the Valid Fields page (Set Up SACR, Product Related, Student Financials, Valid Fields).

Valid Fields			
SetID: MODEL			
		Find View 100	First 7-9 of 106 Last
*Record:	DERIVED_SF	*Description:	Today's Date
Field:	TODAYS_DATE	Edit Table:	68
*Record:	DERIVED_SF	*Description:	Total Billing Units
Field:	TOTAL_BILL_UNITS	Edit Table:	72
*Record:	EXTERNAL_SYSTEM	*Description:	NZQA External ID
Field:	EXTERNAL_SYSTEM_ID	Edit Table:	79

Valid Fields page (1 of 2)

For the *External_System_ID*, change the Description field to *NZQA External ID*. Add a new field value named *MILESTONE*.

Valid Fields			
SetID: MODEL			
		Find View 100	First 70-72 of 106 Last
*Record:	SSF_STD_MLST_WV	*Description:	NZQA Milestone
Field:	MILESTONE	Edit Table:	MILESTONE_TBL 80
*Record:	SSR_HECS_ELEC	*Description:	Liability Status
Field:	SSR_HECS_XMPT_STA	Edit Table:	SSF_HECS_EX_TBL 78
*Record:	STDNT_CAR_TERM	*Description:	External Org ID
Field:	EXT_ORG_ID	Edit Table:	EXT_ORG_TBL 73

Valid Fields page (2 of 2)

You no longer need to modify SFPSTDNT to load *EXTERNAL_SYSTEM_ID* from the *EXTERNAL_SYSTEM* table, where the *EXTERNAL_SYSTEM* record equals *NQA*, and *MILESTONE* from the *SSF_STD_CAR_MLSTN* table.

Setting Up Fee Triggers

Access the Criteria page (Set Up SACR, Product Related, Student Financials, Tuition and Fees, Criteria).

Criteria		Criteria Details	
Business Unit:	PSNZL	Criteria:	NZL -HOOK ON
		Find View All First 1 of 1 Last	
*Effective Date:	01/01/1900	*Status:	Active
*Description:	New Zealand Hook On Fee		
Long Description:	New Zealand Hook On Fee for Student Financials		
*Criteria Type:	Trigger Criteria		

Criteria page

Set up criteria as a fee trigger.

Access the Criteria Details page (Set Up SACR, Product Related, Student Financials, Tuition and Fees, Criteria Details).

Criteria		Criteria Details	
Business Unit:	PSNZL	Criteria:	NZL -HOOK ON New Zealand Hook On Fee
		Find View All First 1 of 1 Last	
Effective Date:	01/01/1900	Status:	Active
		Find View All First 1 of 3 Last	
*Description:	Academic Career	List Detail Values Below:	
How Specified <input checked="" type="radio"/> Selected Detail Values <input type="radio"/> Selected Tree Nodes		Tree Information TableSet: <input type="text"/> Tree Name: <input type="text"/> Level Name: <input type="text"/>	
		Find View All First 1 of 1 Last	
Operator	= Equal To	Value / Node	UGRD

Criteria Details page (1 of 2)

The screenshot displays two panels for configuring criteria details. Each panel includes a search bar for the description, radio buttons for 'How Specified' (Selected Detail Values or Selected Tree Nodes), and a 'Tree Information' section with fields for TableSet, Tree Name, and Level Name. Below these is a table with columns for 'Operator' and 'Value / Node'. The top panel shows 'BLK' as the operator and 'Is Blank' as the value. The bottom panel shows '=' as the operator and 'NZLSFMLSTN' as the value.

Operator	Value / Node
BLK	Is Blank
=	NZLSFMLSTN

Criteria Details page (2 of 2)

Set up the details of the fee trigger.

Setting Up Term Fee Codes

Access the Term Fee Codes page (Set Up SACR, Product Related, Student Financials, Tuition and Fees, Term Fees, Term Fee Codes).

Term Fee Codes		Term Fees	Term Sub Fee Codes	Term Sub Fees	Term Fee Residency
SetID:	PSNZL	Fee Code:	HOOKON	Delete Term Fee	
*Status:	Active				
*Description:	New Zealand Hook On Fee				
Long Description:	Hook On Fee for New Zealand Students.				
*Charge By:	Term				
*Use:	Bill Units	<input checked="" type="checkbox"/> Use Anticipated Units if enrollment exists			
*Fee Class:	MAN Tuition and Mandatory Fees				

Term Fee Codes page

Set up the term fee to charge hook-on fees using the previous criteria as the fee trigger.

Setting Up Term Fees

Access the Term Fees page (Set Up SACR, Product Related, Student Financials, Tuition and Fees, Term Fees, Term Fees).

Term Fee Codes		Term Fees		Term Sub Fee Codes		Term Sub Fees		Term Fee Residency	
SetID:	PSNZL	Fee Code:	HOOKON	New Zealand Hook On Fee					
Copy Term Fee									
Term / Session Find View All First 1 of 3 Last									
*Term:	0541	Aut 2005	Session:						
*Account Type:	NQA	New Zealand Qualifications							
*Item Type:	140000000003								
Anticipated Item Type:									
Fee Trigger:	<input checked="" type="radio"/> Use Criteria		<input type="radio"/> Use Equation						
	NZL-HOOK ON	New Zealand Hook On Fee							
*Adjustment Code:	STD	Standard							
*Due Date Code:	STD	Standard							
Minimum/Maximum Fee Code:									
Minimum Amount:	0.00	Maximum Amount:	9,999,999.00	USD					
Anticipated Stop Date:									
<input type="checkbox"/> Charge for Wait Listed Class		<input type="checkbox"/> Track Class pricing							
<input type="checkbox"/> Exclude Classes w/ HECS Status									

Term Fees page (1 of 3)

*Term:	0529	Spr 2004	Session:						
*Account Type:	NQA	New Zealand Qualifications							
*Item Type:	140000000003								
Anticipated Item Type:									
Fee Trigger:	<input checked="" type="radio"/> Use Criteria		<input type="radio"/> Use Equation						
	NZL-HOOK ON	New Zealand Hook On Fee							
*Adjustment Code:	STD	Standard							
*Due Date Code:	STD	Standard							
Minimum/Maximum Fee Code:									
Minimum Amount:	0.00	Maximum Amount:	9,999,999.00	USD					
Anticipated Stop Date:									
<input type="checkbox"/> Charge for Wait Listed Class		<input type="checkbox"/> Track Class pricing							
<input type="checkbox"/> Exclude Classes w/ HECS Status									

Term Fees page (2 of 3)

*Term:	0519 Aut 2004	Session:	<input type="text"/>		
*Account Type:	NQA New Zealand Qualifications				
*Item Type:	140000000003				
Anticipated Item Type:	<input type="text"/>				
Fee Trigger:	<input checked="" type="radio"/> Use Criteria	<input type="radio"/> Use Equation			
	NZL -HOOK ON	New Zealand Hook On Fee			
*Adjustment Code:	STD	Standard			
*Due Date Code:	STD	Standard			
Minimum/Maximum Fee Code:	<input type="text"/>				
Minimum Amount:	<input type="text"/> 0.00	Maximum Amount:	<input type="text"/> 9,999,999.00	USD	
Anticipated Stop Date:	<input type="text"/>				
<input type="checkbox"/> Charge for Wait Listed Class					<input type="checkbox"/> Track Class pricing
<input type="checkbox"/> Exclude Classes w/ HECS Status					

Term Fees page (3 of 3)

View information about the term fee.

Viewing Term Sub Fee Codes

Access the Term Sub Fee Codes page (Set Up SACR, Product Related, Student Financials, Tuition and Fees, Term Fees, Term Sub Fee Codes).

Term Fee Codes	Term Fees	Term Sub Fee Codes	Term Sub Fees	Term Fee Residency
SetID:	PSNZL	Fee Code:	HOOKON	New Zealand Hook On Fee
Term / Session				Find View 1 First 1-3 of 3 Last
Term:	Semester 1 - Autumn 2005	Session:		
	<input type="checkbox"/> Track Sub Fees			
Sub Fees				Find View All First 1 of 1 Last
*Sub Fee Code:	HOOKON			
*Calculation Option 1:	All Matching Rows			
*Calculation Option 2:	Against Meet Criteria Units			
Minimum Amount:	<input type="text"/> 0.00			
Maximum Amount:	<input type="text"/> 0.00	USD		
<input type="checkbox"/> Career Specific			<input type="checkbox"/> Group Specific	
<input type="checkbox"/> Subject Specific			<input type="checkbox"/> Campus Specific	
<input type="checkbox"/> Location Specific			<input type="checkbox"/> Instruction Mode Specific	
<input type="checkbox"/> Program Specific			<input type="checkbox"/> Cohort Year Specific	

Term Sub Fee Codes page (1 of 2)

Term:	Semester 2 - Spring 2004	Session:	
	<input type="checkbox"/> Track Sub Fees		
Sub Fees Find View All First 1 of 1 Last			
*Sub Fee Code:	HOOKON	+ -	
*Calculation Option 1:	All Matching Rows		
*Calculation Option 2:	Against Meet Criteria Units		
Minimum Amount:	0.00		
Maximum Amount:	0.00 USD		
<input type="checkbox"/> Career Specific		<input type="checkbox"/> Group Specific	
<input type="checkbox"/> Subject Specific		<input type="checkbox"/> Campus Specific	
<input type="checkbox"/> Location Specific		<input type="checkbox"/> Instruction Mode Specific	
<input type="checkbox"/> Program Specific		<input type="checkbox"/> Cohort Year Specific	

Term:	Semester 1 - Autumn 2004	Session:	
	<input type="checkbox"/> Track Sub Fees		
Sub Fees Find View All First 1 of 1 Last			
*Sub Fee Code:	HOOKON	+ -	
*Calculation Option 1:	All Matching Rows		
*Calculation Option 2:	Against Meet Criteria Units		
Minimum Amount:	0.00		
Maximum Amount:	0.00 USD		
<input type="checkbox"/> Career Specific		<input type="checkbox"/> Group Specific	
<input type="checkbox"/> Subject Specific		<input type="checkbox"/> Campus Specific	
<input type="checkbox"/> Location Specific		<input type="checkbox"/> Instruction Mode Specific	
<input type="checkbox"/> Program Specific		<input type="checkbox"/> Cohort Year Specific	

Term Sub Fee Codes page (2 of 2)

View default values for the term sub fee code.

Setting Up Term Sub Fees

Access the Term Sub Fees page (Set Up SACR, Product Related, Student Financials, Tuition and Fees, Term Fees, Term Sub Fees).

Term Fee Codes		Term Fees		Term Sub Fee Codes		Term Sub Fees		Term Fee Residency	
SetID:	PSNZL			Fee Code:	HOOKON New Zealand Hook On Fee				
Term / Session		Find View 1 First 1-3 of 3 Last							
Term:	Semester 1 - Autumn 2005			Session:					
<input type="checkbox"/> Audit Rate specified				<input type="checkbox"/> Audit calculated separately					
Sub Fees		Find View All First 1 of 1 Last							
Sub Fee Code:		HOOKON							
Institution:		PSNZL PSNZL			Career:	<input type="text"/>			
Academic Group:		<input type="text"/>			Subject:	<input type="text"/>			
Campus:		<input type="text"/>			Location:	<input type="text"/>			
Mode:		<input type="text"/>			Academic Program:	<input type="text"/>			
Cohort Year:		<input type="text"/>							
Unit From:	<input type="text"/> 0.00	To:	<input type="text"/> 999.00	Fee Amt Equation:	<input type="text"/>				
Amount/Unit:	<input type="text"/> 0.00			Flat Amount:	<input type="text"/> 25.00				
Amount/Unit (Audit):	<input type="text"/> 0.00			Flat Amount (Audit):	<input type="text"/> 0.00				
Surcharge Effective Unit:	<input type="text"/> 0.00								
Amount/Unit (Surcharge):	<input type="text"/> 0.00			Flat Amount (Surcharge):	<input type="text"/> 0.00 USD				

Term Sub Fees page (1 of 3)

Term:	Semester 2 - Spring 2004			Session:					
<input type="checkbox"/> Audit Rate specified				<input type="checkbox"/> Audit calculated separately					
Sub Fees		Find View All First 1 of 1 Last							
Sub Fee Code:		HOOKON							
Institution:		PSUNV PSU			Career:	<input type="text"/>			
Academic Group:		<input type="text"/>			Subject:	<input type="text"/>			
Campus:		<input type="text"/>			Location:	<input type="text"/>			
Mode:		<input type="text"/>			Academic Program:	<input type="text"/>			
Cohort Year:		<input type="text"/>							
Unit From:	<input type="text"/> 0.00	To:	<input type="text"/> 999.00	Fee Amt Equation:	<input type="text"/>				
Amount/Unit:	<input type="text"/> 0.00			Flat Amount:	<input type="text"/> 25.00				
Amount/Unit (Audit):	<input type="text"/> 0.00			Flat Amount (Audit):	<input type="text"/> 0.00				
Surcharge Effective Unit:	<input type="text"/> 0.00								
Amount/Unit (Surcharge):	<input type="text"/> 0.00			Flat Amount (Surcharge):	<input type="text"/> 0.00 USD				

Term Sub Fees page (2 of 3)

Term:	Semester 1 - Autumn 2004	Session:	<input type="checkbox"/> Audit Rate specified	<input type="checkbox"/> Audit calculated separately
Sub Fees Find View All First 1 of 1 Last				
Sub Fee Code:	HOOKON			
Institution: PSUNV PSU Career: [] [+ -]				
Academic Group:	[]	Subject:	[]	
Campus:	[]	Location:	[]	
Mode:	[]	Academic Program:	[]	
Cohort Year:	[]	Fee Amt Equation:	[]	
Unit From:	0.00	To:	999.00	Flat Amount: 25.00
Amount/Unit:	0.00		Flat Amount (Audit):	0.00
Amount/Unit (Audit):	0.00		Flat Amount (Surcharge):	0.00 USD
Surcharge Effective Unit:	0.00			
Amount/Unit (Surcharge):	0.00			

Term Sub Fees page (3 of 3)

View information about the term sub fees.

Setting Up Per Credit Charges

Access the Per Credit Charge page (Set Up SACR, Product Related, Student Financials, New Zealand Defaults, Per Credit Charge).

Per Credit Charge		
SetID:	PSNZL	
Find View All First 1 of 3 Last		
*Term:	0541	Semester 1 - Autumn 2005 [+ -]
*Account Type:	NQA	New Zealand Qualifications
*Item Type:	140000000002	New Zealand Per Credit Charge
*Due Date Code:	STD	Standard
Per Credit Charge:	1.000	USD

Per Credit Charge page

Set up information to apply charges based on each credit for which a student is enrolled.

During the tuition calculation process, the system reads the number of NQF credits determined during the Student Records process. It then multiplies that NQF credit number by the per credit charge. Student Financials uses the NQF credit number for the calculation, but the number itself is provided by the Student Records process.

Appendix A

Delivered Workflows for Student Financials

This appendix discusses delivered workflows for Student Financials.

See Also

Enterprise PeopleTools PeopleBook: Workflow Technology

Enterprise PeopleTools PeopleBook: Using PeopleSoft Applications

Delivered Workflows for Student Financials

This section discusses Student Financials workflows. The workflows are listed alphabetically by workflow name.

Corporate Collection Worklist

This section discusses the Corporate Collection workflow.

Description

Event Description	Assign Corporation to Worklist
Action Description	Create a worklist entry for Collector (using User ID or Role).
Notification Description	Worklist

Workflow Objects

Event	SSF_COLLECTION_ORG_CI
Workflow Action	Automatic

Role	Query: Roleuser by Oprid Qry (if by User ID) [ROLE] Roleuse SSF Collector (if by Role)
Email Template (or notification vehicle)	Worklist record = COLLECT_WL and PSWORKLIST
Business Process	PROCESS_ORG_COLLECTIONS
Business Activity	Create Org Collections (if by User ID) Create Org Role Collections (if by Role)
Business Event	Create Worklist

Customer Collection Worklist

This section discusses the Customer Collection workflow.

Description

Event Description	Assign Customers to Worklist.
Action Description	Create a worklist entry for a Collector (using User ID or Role).
Notification Description	Worklist

Workflow Objects

Event	SSF_COLLECTION_CI
Workflow Action	Automatic
Role	Query: Roleuser by Oprid Qry (if by User ID) [ROLE] Roleuse SSF Collector (if by Role)
Email Template (or notification vehicle)	Worklist record = COLLECT_WL and PSWORKLIST
Business Process	Process Collections
Business Activity	Create Collections Worklist (if by User ID) CREATE_COLLECTIONS_BY_ROLE (if by Role)
Business Event	Create Worklist

Department Receipt Approval

This section discusses the Department Receipt Approval workflow.

Description

Event Description	Department Receipt Approval
Action Description	Create Worklist entry for Department Receipt Approval
Notification Description	Worklist

Workflow Objects

Event	No component interface for Receipt approval
Workflow Action	Automatic
Role	Query: Roleusers by Rolename query
Email Template (or notification vehicle)	Worklist Record – CSH_DEPT_WL
Business Process	DEPT_RCPT_APPROVAL
Business Activity	Approve Department Receipts
Business Event	Send For Approval

Group Posting Approval

This section discusses the Group Posting Approval workflow.

Description

Event Description	Group Posting Approval
Action Description	Create Worklist entry for Group Approval
Notification Description	Worklist

Workflow Objects

Event	SSF_GRP_APPR_CI
Workflow Action	Automatic
Role	Query: Roleusers by Rolename query
Email Template (or notification vehicle)	Worklist Record - GROUP_WL
Business Process	GROUP_APPROVAL
Business Activity	Approve Group
Business Event	Send For Approval

Refund Approval

This section discusses the Refund Approval workflow.

Description

Event Description	Generate Refund Approval
Action Description	Send Approval
Notification Description	Worklist

Workflow Objects

Event	SSF_RFNDAPPR_CI
Workflow Action	Automatic
Role	Query: Roleuser RF by RoleName
Email Template (or notification vehicle)	Worklist Record - REFUND_WL
Business Process	REFUND_APPROVAL
Business Activity	Approve Refund
Business Event	Send For Approval

Appendix B

Student Financials Global Invoicing Reminder Letters

This appendix provides an overview of customer billing and discusses how to define and issue Student Financial global invoicing reminder letters:

Defining and Issuing Reminder Letters

This section provides institutions who use global invoicing an example of how to define and issue invoice Reminder Letters.

Reminder Letters can be generated for open invoices after the due date has passed.

Reminder Letters can include fields such as: original invoice amount, any payments, remaining unpaid balance and the number of days passed due. Institutions define a minimum balance as selection criteria when sending reminder letters. A minimum balance can be utilized at the invoice. Like the invoice, the reminder letter can include a payment voucher.

Reminders are tracked at the student level for each invoice through Campus Community Communications.

Student Financials uses Campus Community Communications Engine to generate reminder letters. The Communications Engine process supports Population Selection and uses Queries and Equations to determine who will receive a Reminder Letter and what data will be available to the template.

Note. The information below pertains to the Global Invoicing .

Additional, essential information describing the setup and generation design of communications appears in *PeopleSoft Enterprise Campus Community Fundamentals 9.0 PeopleBook*.

Pages Used to Define and Issue Reminder Letters

Page Name	Definition Name	Navigation	Usage
Communication Data Source	SCC_CG_DTASRC	Campus Community, Communications, Set up Communications, Communication Data Source	Define communication data source.

Page Name	Definition Name	Navigation	Usage
Report Definition	PSXPRPTDEFN	Reporting Tools, XML Publisher, Setup, Report Definition	Define invoice Reminder Letter properties.
Report Definition — Template	PSXPRPTMPL	Reporting Tools, XML Publisher, Setup, Report Definition, Template	Define template properties.
Report Definition — Output	PSXPRPTOUT	Reporting Tools, XML Publisher, Setup, Report Definition, Output	Define output properties.
Report Definition — Bursting	PSXPRPTBURST	Reporting Tools, XML Publisher, Setup, Report Definition, Bursting	Define bursting properties.
Standard Letters	SCC_STN_LTR_TBL	Campus Community, Communications, Set up Communications, Standard Letter Table CS	Set up standard letter.
Communication Speed Keys	COMM_SPDKEY_TABLE	Set Up SACR, Common Definitions, Communications, Communication Speed Key Table	Define communication key.
Event 3C Groups	EVNT_GRP_3C_TABLE	Campus Community, 3C Engine, Set Up 3C Engine, Event 3C Group	Define 3C Event Group.
Event Definition	EVNT_3CS_SETUP	Campus Community, 3C Engine, Set Up 3C Engine, Event Definition	Set up event definition.
3C Engine Parameters	RUN_CNTL_3CENGINE	Campus Community, 3C Engine, Run 3C Engine	Define 3C Engine parameters.
Manage Duplicate Assignment	MANAGE_DUP_ASSIGN	Campus Community, 3C Engine, Run 3C Engine, Manage Duplicate Assignment	Define Manage Duplicate Assignment.
Person Communication	COMM_MGMT1	Campus Community, Communications, Person Communications, Communication Management	Review generated communication.
Selection Parameters	SCC_CG_RUNCTL1	Campus Community, Communications, Communication Generation	Running Communication Generation process.

Page Name	Definition Name	Navigation	Usage
Process Parameters	SCC_CG_RUNCTL2	Campus Community, Communications, Communication Generation, Process Parameters	Set up process parameters.
View Communication	SCC_CG_ATTREL	Campus Community, Communications, Communication Generation, Process Parameters, View Communication	View Reminder Letter.

Defining Communication Data Source

Access the Communication Data Source page (Campus Community, Communications, Set up Communications, Communication Data Source).

Communication Data Source

*Data Source Map ID

Description

Object Owner ID

Data Source Type XMLDoc Object Active

Data Source Context

*Administrative Function Student Financials Billing Person Organization

Generic Process Data

Find First 1-12 of 12 Last

Sequence	Description	Sample Data Folder Name	Critical Data
1	List of Checklist Items	CHECKLIST_ITEMS	
2	List of Enclosures	ENCLOSURES	
3	Organization Recipient Address information	ORG_RECIP_ADDR	<input type="checkbox"/>
4	Organization Recipient Email and URL information	ORG_RECIP_EMAIL	<input type="checkbox"/>
5	Organization Recipient Names	ORG_RECIP_NAME	<input type="checkbox"/>
6	Address for a person	PER_ADDRESS	<input type="checkbox"/>
7	List of Person Communication Recipients	PER_COMM_RECIP	
8	Email Address for Person	PER_EMAIL	<input type="checkbox"/>
9	Name for individual address	PER_NAME_ADDR	<input type="checkbox"/>
10	Name for extra use	PER_NAME_EXTRA	<input type="checkbox"/>
11	Name for individual salutation	PER_NAME_SAL	<input type="checkbox"/>
12	Name for joint salutation	PER_NAME_SALJNT	<input type="checkbox"/>

Communication Data Source page (1 of 2)

Custom Extract Data					Find	First	1-6 of 6	Last
Sequence	Type	Query Name	Max Nbr	Application Class				
1	Query	SSF_COMGEN_RMDRS_SFBI	1					+ -
2	Query	SSF_COMGEN_RELINV_SFBI	50					+ -
3	Query	SSF_COMGEN_PERSONBANK	1					+ -
4	Query	SSF_COMGEN_PAYMENTS_SI	50					+ -
5	Query	SSF_COMGEN_BUBANK_SFB	1					+ -
6	Query	SSF_COMGEN_ORGBANK_SF	1					+ -

Registered Date/Time	08/17/06 2:39:46PM	Registered By	PS
Last Update Date/Time	08/17/06 2:06:32PM	Last Update User ID	PPLSOFT

Register Data Source	Data Source has been updated in XML Publisher. Click the Register Data Source button to synchronize.
-----------------------------	--

Communication Data Source page (2 of 2)

Click Register Data Source if this is a new Data Source or if the Communications Data Source definition has been modified.

Defining Invoice Reminder Letter Properties

Access the Report Definition page (Reporting Tools, XML Publisher, Setup, Report Definition).

Select the QA_CS_SF_RMD report (Invoice Reminder Letters).

Definition		Template	Output	Security	Bursting
Report Name:	SSF_PRNT_INV				
Data Source					
Data Source Type:	Rowset				
Data Source ID:	SSF_INVOICE_DEMO1				
Data Source Description:	SSF Invoice for XMLPublisher				
Report Properties					
Report Description:	<input type="text" value="Print Invoices"/>				
*Report Status:	<input type="text" value="Active"/>				
*Report Category ID:	<input type="text" value="ALLUSER"/> All PeopleSoft User				
Object Owner ID:	<input type="text" value="Student Financials"/>				
Template Type:	<input type="radio"/> PDF <input checked="" type="radio"/> RTF <input type="radio"/> eText <input type="radio"/> XSL				
Days Before Purge:	<input type="text" value="1"/>				
Registered Date/Time:	01/28/2006 3:45:49PM	Registered By:	PS		
Updated Date/Time:	10/03/2006 10:58:34AM	Updated By:	PS		
Download:	Data Schema		Sample Data		

Report Definition page

Defining Template Properties

Access the Report Definition — Template page (Reporting Tools, XML Publisher, Setup, Report Definition, Template).

Definition **Template** Output Security Bursting

Report Name: QA_CS_SF_RMD

Template Find | View All First 1 of 1 Last

Template ID: QA_CS_SF_RMD_1 **Default Template** + -

Description: Reminder Letters

***Language Code:** English **Channel:** Printer

Template Files Find | View All First 1 of 1 Last

Effective Date: 08/11/2006 + -

***Status:** Active

Template File: SSF_REMINDERS.rtf Upload Download Preview

Return to Search Previous in List Next in List Add Update/Display Include History Correct History

Report Definition — Template page

Defining Output Properties

Access the Report Definition — Output page (Reporting Tools, XML Publisher, Setup, Report Definition, Output).

Definition Template **Output** Security Bursting

Report Name: QA_CS_SF_RMD

General

PDF report output may be edited

Runtime Output Format Options

Format Type	Enabled	Default
HTML	<input type="checkbox"/>	<input type="checkbox"/>
PDF	<input checked="" type="checkbox"/>	<input checked="" type="checkbox"/>
RTF	<input type="checkbox"/>	<input type="checkbox"/>
XLS	<input type="checkbox"/>	<input type="checkbox"/>

Output Location

***Location:** Any

Return to Search Previous in List Next in List Add Update/Display Include History Correct History

Report Definition — Output page

For Format Type, select Enabled and Default for PDF.

Defining Bursting Properties

Access the Report Definition — Bursting page (Reporting Tools, XML Publisher, Setup, Report Definition, Bursting).

Definition **Template** **Output** **Security** **Bursting**

Report Name: QA_CS_SF_RMD

Bursting

Burst by: fld_CG_SORT_ORDER

Template

Template controlled by:

Template Application Criteria		
Data Value	Template ID	Language

Burst Security

Security Join Table:

Security Field: **Security ID Type:**

Field Mapping	
Security Join Table Field	Data Source Field

Search Keys

Search Field		
	+	-

Report Definition — Bursting page

For Burst by, select fld_CG_SORT_ORDER to the reminder letter will be used by the Comm Gen process.

Setting Up Standard Letter

Access the Standard Letters page (Campus Community, Communications, Set up Communications, Standard Letter Table CS).

Standard Letters

Letter Code: RM1

***Description:** **Short Description:**

Set Letter Code:

Processing Letter Details

***Function:**

Applicable to: **Person** **Organization**

***Letter Type:**

***Letter Printed Data:** **SQC Name:**

Joint Communications Allowed

Include Enclosures

Define Comm Gen Parameters

Template Selection

Find | View All First ◀ 1 of 1 ▶ Last

Report Name: Invoice Reminder Letters

Data Source ID: QA_CS_SF_REMINDERS

Template List				
Template ID	Description	Language	Method	Default
QA_CS_SF_RMD_1	Reminder Letters	English	Letter	<input checked="" type="checkbox"/>

Standard Letters page

Select the appropriate RM1 Letter Code and the Define Com Gen Parameters check box.
check box.

Template Selection

Select the QA_CS_SF_RMDreport name (Invoice Reminder Letters).

Defining Comm Key

Access the Communication Speed Keys page (Set Up SACR, Common Definitions, Communications, Communication Speed Key Table).

Communication Speed Keys

Institution: PSUNV PeopleSoft University
Function: SFBI Student Financials Billing

Comm Key Detail Find | View All First 1 of 5 Last

*Comm Key: RMND1 Print Comment
 *Description: Reminder Letter - 1st Notice Activity Completed
 Short Desc: REMIND1 Unsuccessful Outcome
 *Category: RMND1 Reminder Letter - 1st Notice
 *Context: BILL Bill
 Duration: 1
 *Method: D Document Direction: OUT Letter Code: RM1
 Comments:

Communication Speed Keys page

Select the appropriate *RM1 Comm Key*.

- *Comm Key:** Enter the name of the communication speed key to represent this set of communication elements
- Category** Enter the communication category to associate with this communication speed key
- Context** Enter the communication context to associate with this communication speed key.
- Duration** Enter Document as method of the communication that you are associating with this communication speed key.
- Direction** Enter Outgoing as the direction of the communication you are associating with this communication speed key.
- Letter Code** Enter RM1 as the code you are associating with this communication speed key

Defining Event 3C Groups

Access the Event 3C Groups page (Campus Community, 3C Engine, Set Up 3C Engine, Event 3C Group).

Event 3C Groups

Academic Institution: PSUNV PeopleSoft University
Event ID: SF_RM1 SF Reminder Letter Level 1
Function: Student Financials Billing

Update/Inquiry Group

*Group	Description		
SFIN	Student Financials	+	-

Event 3C Groups page

Defining Event Definition

Access the Event Definition page (Campus Community, 3C Engine, Set Up 3C Engine, Event Definition).

Event Definition

Academic Institution: PeopleSoft University
Event ID: SF_RM1

Event Detail Find | View All First ◀ 1 of 1 ▶ Last

*Effective Date: 01/01/1900 *Status: Active

*Description: SF Reminder Letter Level 1

*Short Description: SFRM1 User Selection

*Function: SFBI Student Financials Billing [Variable Data Joint Rules](#)

Communications

*Comm Key: RMND1 Reminder Letter - 1st Notice [Detail](#)

Comments

*Comment Category: Detail

Checklists

*Checklist Code: Detail Update Status

Event Definition page

Select the appropriate SF RM1 Event ID.

Defining 3C Engine Parameters

Access the 3C Engine Parameters page (Campus Community, 3C Engine, Run 3C Engine).

3C Engine Parameters page

Select the SSF_POP_3CENGINE_SFBI query

In the Population Selection group box, select Edit Prompts to access the Query Prompts page.

Query Prompts page.

Defining Manage Duplicate Assignment

Access the Manage Duplicate Assignment page (Campus Community, 3C Engine, Run 3C Engine, Manage Duplicate Assignment).

3C Engine Parameters		Manage Duplicate Assignment	
Run Control ID:	1157051050	Report Manager	Process Monitor
		Run	
Duplicate Communication Check			
<input checked="" type="checkbox"/>	Check Duplicate Communication	Explain	
Additional Conditions to Prevent Duplicate Communication			
Variable Data:	Match	Explain	
Communication Status:		Explain	
Duplicate Checklist Check			
<input type="checkbox"/>	Check Duplicate Checklist	Explain	
Additional Conditions to Prevent Duplicate Checklist			
Variable Data:		Explain	
Checklist Status:		Explain	

Manage Duplicate Assignment page

Check Duplicate Communication

Select the Check Duplicate Communication check box.

In the Variable Data field within the Additional Conditions to Prevent Duplicate Communication group box, select Match.

Click Run to run the process.

Reviewing the Generated Communication

Access the Person Communication page (Campus Community, Communications, Person Communications, Communication Management).

Person Communication		Communication Recipient Data	
Marcus Main		ID: SFEURO0031	
Communication Assignment			
Assign DateTime:	09/08/2006 10:31:39AM		
*Function:	SFBI	Student Financials Billing	Variable Data
*Institution:	PeopleSoft University		
Comm Key:	<input type="text"/>		
*Category:	RMND1	Reminder Letter - 1st Notice	
*Context:	BILL	Bill	
*Method:	D	Document	
*Direction:	Outgoing Communication		
Letter Code:	RM1	Reminder Letter - 1st Request	<input type="checkbox"/> Include Enclosures

Person Communication page (1 of 2)

Communication Process Details			Checklist Association		
Communication Date:	09/08/2006	Begin Time:	<input type="text"/>	End Time:	<input type="text"/>
Comments:	<input type="text"/>		<input type="checkbox"/> Print Comment	Sequence:	
Communication ID:	KU0007	Locherty, Betty		Item Sequence:	
Department:	<input type="text"/>				
<input type="checkbox"/> Create Joint Communications					
Communication Outcome					
Communication Generation Date:	09/08/2006				
<input checked="" type="checkbox"/> Communication Completed	Date Activity Completed:	09/08/2006			
<input type="checkbox"/> Unsuccessful Outcome	Reason:	<input type="text"/>			
Language Used	English				
Method Used	Letter				
Process Used	CommGen	View Generated Communication			

Person Communication page (2 of 2)

Note the Communication Completed check box is not selected.

Running Communication Generation Process

Access the Selection Parameters page (Campus Community, Communications, Communication Generation).

Selection Parameters
Process Parameters
Email Parameters
Checklist Parameters

Run Control ID: slp [Report Manager](#) [Process Monitor](#) Run

ID Selection

ID Selection: All IDs

Letter Code Selection

Letter Code: RM1 Reminder Letter - 1st Request Administrative Function: SFBI Student Financials Billing

Template Selection

Report Name: QA_CS_SF_RMD Invoice Reminder Letters
 Data Source ID: QA_CS_SF_REMINDERS

Template List

Template ID	Description	Language	Method	Default
QA_CS_SF_RMD_1	Reminder Letters	English	Letter	<input checked="" type="checkbox"/>

First 1 of 1 Last

Enclosures Assigned (Softcopy)

No Matching Template Found

Use Default Template
 Do Not Produce Communication
 Refresh Enclosure List

Communication Language Usage

Specified Language: ENG English
 Preferred

Communication Method Usage

Specified Method: L Letter
 Preferred

Selection Parameters page

Setting Up Process Parameters

Access the Process Parameters page (Campus Community, Communications, Communication Generation, Process Parameters).

Selection Parameters		Process Parameters		Email Parameters		Checklist Parameters	
Run Control ID: slp		Report Manager		Process Monitor		<input type="button" value="Run"/>	
Usage Tables				Communication Processing Dates			
Person Communication Usage				Communication Date Range Selection			
Address: <input type="text"/>		*From Date: <input type="text" value="09/08/2006"/>		*To Date: <input type="text" value="09/08/2006"/>			
Address Name: <input type="text"/>							
Salutation: <input type="text"/>							
Extra Name: <input type="text"/>							
Joint Salutation Usage				Update Communication Generation Date With			
Joint Name: <input type="text"/>				<input type="radio"/> Communication Date		<input checked="" type="radio"/> System Date	
				<input type="radio"/> User Supplied Date		<input type="text"/>	
Org Communication Usage				Update Communication Completed Date With			
Org Recipient: <input type="text"/>				<input type="radio"/> Communication Date		<input checked="" type="radio"/> System Date	
Contact Name: <input type="text"/>				<input type="radio"/> User Supplied Date		<input type="text"/>	
Output Settings							
*Sort Option:		<input type="text" value="Country, Postal"/>					
<input type="checkbox"/> Online Preview							
<input type="checkbox"/> Send to Printer							
Missing Critical Data							
<input checked="" type="checkbox"/> Produce Communication				<input checked="" type="checkbox"/> Complete Communication			

Process Parameters page

Output Settings

In the Missing Critical Data group box, select the Produce Communication check box and the Complete Communication check box.

Reviewing Communication

Access the Person Communication page (Campus Community, Communications, Person Communications, Communication Management).

Person Communication		Communication Recipient Data	
Marcus Main		ID: SFEURO0031	
Communication Assignment			
Assign DateTime:	09/08/2006 10:31:39AM		
*Function:	SFBI	Student Financials Billing	Variable Data
*Institution:	PeopleSoft University		
Comm Key:	<input type="text"/>		
*Category:	RMND1	Reminder Letter - 1st Notice	
*Context:	BILL	Bill	
*Method:	D	Document	
*Direction:	Outgoing Communication		
Letter Code:	RM1	Reminder Letter - 1st Request	<input type="checkbox"/> Include Enclosures

Person Communication page (1 of 2)

Communication Process Details			Checklist Association		
Communication Date:	09/08/2006	Begin Time:	<input type="text"/>	End Time:	<input type="text"/>
Comments:	<input type="text"/>		<input type="checkbox"/> Print Comment	Sequence:	
Communication ID:	KU0007	Locherty, Betty		Item Sequence:	
Department:	<input type="text"/>				
<input type="checkbox"/> Create Joint Communications					
Communication Outcome					
Communication Generation Date:	09/08/2006				
<input checked="" type="checkbox"/> Communication Completed	Date Activity Completed:	09/08/2006			
<input type="checkbox"/> Unsuccessful Outcome	Reason:	<input type="text"/>			
Language Used	English				
Method Used	Letter				
Process Used	CommGen	View Generated Communication			

Person Communication page (2 of 2)

Note the Communication Completed check box is selected.

Click View Generated Communication to view the reminder letter.

Access the Reminder Letter for Global Invoicing.

Appendix C

PeopleSoft Student Financials Reports

This appendix provides an overview of Student Financials reports, and enables you to view a summary tables of all reports.

Note. For samples of some of these reports, see the Portable Document Format (PDF) files published on CD-ROM with your documentation.

See Also

Enterprise PeopleTools PeopleBook: Process Scheduler

PeopleSoft Student Financials Reports: A to Z

This table lists the Student Financials reports, sorted alphanumerically by report ID.

- Crystal and SQR Reports
- Setup Table Reports

Crystal and SQR Reports

Report ID and Report Name	Description	Navigation	Run Control Page
SF707 Group Summary Report	Group posting summary report of student financial system. (Crystal)	Student Financials, Charges and Payments, Group Processing, Group Summary	RUNCTL_SF707
SF708 Fee Calculation Errors Report	This report lists all error messages for a batch ID. (Crystal)	Student Financials, Tuition and Fees, Calculate Batch Tuition, Tuition Calc Error Report	RUNCTL_SF708
SF709 Fees After Calculation Report	This report lists all tuition and fees for a student. (Crystal)	Student Financials, Tuition and Fees, Calculate Batch Tuition, Fees After Calculation Report	RUNCTL_SF709

Report ID and Report Name	Description	Navigation	Run Control Page
SF710 Fees Prior to Posting Report	This report lists a student's tuition and fees prior to posting. (Crystal)	Student Financials, Tuition and Fees, Calculate Batch Tuition, Fees Prior to Posting Report	RUNCTL_SF710
SF711ABI Crystal Bill for Student Financials	This report generates a student bill for print using Crystal. (Crystal)	Student Financials, Bill Customers, Student Bills, Print Invoice Crystal	RUNCTL_SF711AB
SF726 Daily Activity	Summary of daily posting activity, by Item type Code. (Crystal)	Student Financials, Charges and Payments, Posting Reports, Daily Activity	RUNCTL_SF726
SF727 Daily Posting Activity	Daily posting activity for student post. (Crystal)	Student Financials, Charges and Payments, Posting Reports, Daily Posting Activity	RUNCTL_SF727
SF728 Enrollment Cancellation Report	This report lists all students who have been processed for enrollment cancellation for term or class cancellations. (Crystal)	Student Financials, Tuition and Fees, Cancellation, Report Cancellation	RUNCTL_SF728
SF732 Refund Customers Rpt	This report lists information on individual refunds. (Crystal)	Student Financials, Refunds, Reports, Individual Refunds	RUNCTL_SF732
SF736 Run Organization Report	Refund External Organization Report by business unit. (Crystal)	Student Financials, Refunds, Reports, Corporation Refunds	RUNCTL_SF732
SF750 Receipts per Business Day	This report lists all information about receipts processed on a specific business date in cashiering. (Crystal)	Student Financials, Cashiering, Balance by Business Day, Receipts By Business Date	RUNCTL_SF750
SF750R Receipt by Number	This report generates a cashiering receipt for print using Crystal. It lists all receipt information. (Crystal)	Student Financials, Cashiering, Balance by Business Day, Receipts By Number Summary	RUNCTL_SF750R
SF753ABI Crystal Org Bill for SF	This report generates an external organization bill for print using Crystal. (Crystal)	Student Financials, Bill Customers, Corporate Bills, Print Invoice Crystal	RUNCTL_SF753AB_ORG
SF754 Students in Collections	This report lists students placed in collections. (Crystal)	Student Financials, Collections, Customers in Collection	RUNCTL_COLLECT_SF

Report ID and Report Name	Description	Navigation	Run Control Page
SF755 Organizations in Collections	This report lists all organizations placed in collections. (Crystal)	Student Financials, Collections, Corporations in Collection	RUNCTL_COLLECT_SF
SF756 Group Detail Report	Group posting detail report. (Crystal)	Student Financials, Charges and Payments, Group Processing, Group Detail	RUNCTL_SF707
SF757 Receipts by Deposit ID	This report lists all information about receipts processed using a specified deposit ID within cashiering. (Crystal)	Student Financials, Cashiering, Balance By Business Day, Receipts by Deposit ID Summary	RUNCTL_SF757
SF783 Late Fees Report	This report lists all individuals who were assessed late fees for a given batch ID. (Crystal)	Student Financials, Charges and Payments, Late Fees, Late Fees Report	RUNCTL_SF783
SF800 Business Unit Permission List	SF security listing of business units secured by a permission list. (Crystal)	Set Up SACR, Security, Secure Student Financials, Permission List Reports, Business Unit	PRCSRUNCNTL_SF
SF801 Business Unit User ID	SF security listing of business units secured by a single user ID. (Crystal)	Set Up SACR, Security, Secure Student Financials, User Reports, Business Unit	PRCSRUNCNTL_SF
SF802 Cashier Office Permission List	This report lists any permission lists with security for specified cashier offices. (Crystal)	Set Up SACR, Security, Secure Student Financials, Permission List Reports, Cashier Office	PRCSRUNCNTL_SF
SF803 Cashier Office User ID	This report lists all user IDs with security for specified cashier offices. (Crystal)	Set Up SACR, Security, Secure Student Financials, User Reports, Cashier Office	PRCSRUNCNTL_SF
SF804 Credit Card Permission List	This report lists any permission lists with credit card security. (Crystal)	Set Up SACR, Security, Secure Student Financials, Permission List Reports, Credit Card	PRCSRUNCNTL_SF
SF805 Credit Card User ID	This report lists any user IDs with credit card security. (Crystal)	Set Up SACR, Security, Secure Student Financials, User Reports, Credit Card	PRCSRUNCNTL_SF
SF806 Company Permission List	SF security listing of companies secured by a permission list. (Crystal)	Set Up SACR, Security, Secure Student Financials, Permission List Reports, Company	PRCSRUNCNTL_SF

Report ID and Report Name	Description	Navigation	Run Control Page
SF807 Company User ID	SF security listing of companies secured by a single user ID. (Crystal)	Set Up SACR, Security, Secure Student Financials, User Reports, Company	PRCSRUNCNTL_SF
SF809 Item Type Permission List	SF security listing of item types secured by a permission list. (Crystal)	Set Up SACR, Security, Secure Student Financials, Permission List Reports, Item Type	PRCSRUNCNTL_SF
SF810 Item Type User ID	SF security listing of item types secured by a single user ID. (Crystal)	Set Up SACR, Security, Secure Student Financials, User Reports, Item Type	PRCSRUNCNTL_SF
SF811 SetID Permission List	SF security listing of setIDs secured by a permission list. (Crystal)	Set Up SACR, Security, Secure Student Financials, Permission List Reports, SetID	PRCSRUNCNTL_SF
SF812 SetID User ID	SF security listing of setIDs secured by an individual user ID. (Crystal)	SetID Set Up SACR, Security, Secure Student Financials, User Reports, SetID	PRCSRUNCNTL_SF
SF814 TP Contracts	Third-party contract setup values. (Crystal)	Student Financials, Payment Plans, Third Party Contract, Third Party Contract Report	RUNCTL_SF814
SF815E Trial Bal by Acct (Eff Dt)	This report lists the trial balance by account by item effective date. (Crystal)	Student Financials, GL Interface, Trial Balance Reports, By Account	RUNCTL_SF815
SF815P Trial Bal by Acct (Post Date)	This report lists trial balances by account by posted date. (Crystal)	Student Financials, GL Interface, Trial Balance Reports, By Account	RUNCTL_SF815
SF816E Trial Bal by Stud Itm (Eff Dt)	Trial balance by student item (item effective date). (Crystal)	Student Financials, GL Interface, Trial Balance Reports, By Student Item	RUNCTL_SF815
SF816P Trial Bal by Stud Itm (Pst Dt)	Trial balance by student item (post date). (Crystal)	Student Financials, GL Interface, Trial Balance Reports, By Student Item	RUNCTL_SF815
SF817E Trial Bal by Student (Eff Dt)	Trial balance by student (item effective date). (Crystal)	Student Financials, GL Interface, Trial Balance Reports, By Student	RUNCTL_SF815

Report ID and Report Name	Description	Navigation	Run Control Page
SF817P Trial Bal by Student (Post Dt)	Trial balance by student (post date). (Crystal)	Student Financials, GL Interface, Trial Balance Reports, By Student	RUNCTL_SF815
SF818E Trl Bal Corp by Acct (Eff Dt)	Trial balance corporation by account (item effective date). (Crystal)	Student Financials, GL Interface, Trial Balance Reports, By Corporate Account	RUNCTL_SF815
SF818P Trl Bal Corp by Acct (Pst Dt)	Trial balance organization by account (post date). (Crystal)	Student Financials, GL Interface, Trial Balance Reports, By Corporate Account	RUNCTL_SF815
SF819E Trial Bal by Corp Itm (Eff Dt)	Trial balance by corporation item (item effective date). (Crystal)	Student Financials, GL Interface, Trial Balance Reports, By Corporate Item	RUNCTL_SF815
SF819P Trial Bal by Corp Itm (Pst Dt)	Trial balance by corporation item (post date). (Crystal)	Student Financials, GL Interface, Trial Balance Reports, By Corporate Item	RUNCTL_SF815
SF820E Trial Bal by Corp (Eff Date)	Trial balance by corporation (item effective date). (Crystal)	Student Financials, GL Interface, Trial Balance Reports, By Corporation	RUNCTL_SF815
SF820P Trial Bal by Corp (Post Date)	Trial balance by corporation (post date). (Crystal)	Student Financials, GL Interface, Trial Balance Reports, By Corporation	RUNCTL_SF815
SF821 Credit History for All Students	Credit history for all students, for a specified business unit and effective date. (Crystal)	Student Financials, Collections, Credit History, All Customer Report	RUNCTL_SFBU_ASOFDT
SF822 Credit History for One Student	Credit history for one student, for a specified business unit and effective date. (Crystal)	Student Financials, Collections, Credit History, One Customer Report	RUNCTL_SF822
SF823 Credit History for All Corporations	Credit history for all corporations, for a specified business unit and effective date. (Crystal)	Student Financials, Collections, Credit History, All Corporation Report	RUNCTL_SF823
SF824 Credit History for One Corporation	Credit history for one corporation, for a specified business unit and effective date. (Crystal)	Student Financials, Collections, Credit History, One Corporation Report	RUNCTL_SF824

Report ID and Report Name	Description	Navigation	Run Control Page
SF825 Credit History Student by Acct	Credit history for all students, by account, for a specified business unit and effective date. (Crystal)	Student Financials, Collections, Credit History, Customer Report by Account	RUNCTL_SF825
SF826 Credit History by Account for Corporations	Credit history for all corporations, by account number, for a specified business unit and effective date. (Crystal)	Student Financials, Collections, Credit History, Corporate Account Report	RUNCTL_SF826
SF828 Open Refunds	Open refunds, sorted by student name. (Crystal)	Student Financials, Refunds, Reports, Open Refunds	RUNCTL_SF828
SF829 Refunds by Date	This report lists all refunds processed for a certain date. (Crystal)	Student Financials, Refunds, Reports, Refunds by Date	RUNCTL_SF829
SF830 Completed Refunds by Date	This report lists all completed refunds by date. It also lists information on paycheck gross, taxes and net amounts. (Crystal)	Student Financials, Refunds, Reports, Completed Refunds by Date	RUNCTL_SF830
SF847 Group Post Suspended Report	Detailed list of transactions that have not been posted through the Group Post process. (Crystal)	Student Financials, Charges and Payments, Group Processing, Group Post — Suspended	RUNCTL_SF847
SF853 Batch Refund	This report lists all refunds processed within a specified Batch ID. (Crystal)	Student Financials, Refunds, Process Batch Refunds, Report Batch Refunds	RUNCTL_SF853
SF854 Batch Refund Messages	This report lists all error or warning messages encountered during a specified Batch ID. (Crystal)	Student Financials, Refunds, Process Batch Refunds, Report Batch Messages	RUNCTL_SF854
SF856 Account Audit Statement	Detail transaction listing for an individual or external organization. (Crystal)	Student Financials, Charges and Payments, Posting Reports, Account Audit Statement Report	RUNCTL_SF856
SF859 Tax Assessment Summary Report	The tax assessment summary report for a given period by business unit and tax authority. (Crystal)	Student Financials, Taxes, Tax Reports, GST Tax Summary Report	RUNCTL_SF859

Report ID and Report Name	Description	Navigation	Run Control Page
SF860 Individual tax detail	Individual tax detail report for a given reporting period. (Crystal)	Student Financials, Taxes, Tax Reports, Individual GST Tax Detail	RUNCTL_SF860
SF861 Organization Tax Detail	Organization tax detail report for a given reporting period. (Crystal)	Student Financials, Taxes, Tax Reports, Organization GST Tax Detail	RUNCTL_SF861
SF862 Batch Credit Card Detail Rpt	This report lists all the relevant credit card details per batch ID from the Refund Credit Card – Web process. (Crystal)	Student Financials, Refunds, Electronic Payment Refunds, Batch ePayment Refund Details	RUN_CNTL_SF862
SF1098RP Print 1098-T Forms	This process prints 1098-T forms and creates electronic transmission files. (SQR)	Student Financials, Taxes, Tax Reports, 1098–T Form Print	RUNCTL_SF_SF1098RP
SF1098VP 1098-T Validation and Audit	The 1098-T Validation Report lists any records with invalid data and assigns a validation status to records on the 1098-T Audit report. The Audit report lists all records generated in the 1098-T generation process for review before printing or transmitting the file. (SQR)	Student Financials, Taxes, Tax Reports, 1098–T Audit Report	RUNCTL_SF_SF1098VP
SFBILLIV Print Non-Extract File Invoice	This report generates bills for printing. (XML Publisher) (SQR)	<ul style="list-style-type: none"> • Student Financials, Bill Customers, Student Bills, Print Invoice • Student Financials, Bill Customers, Corporate Bills, Print Invoice 	RUN_CNTL_PBILL RUN_CNTL_PBILL_ORG
SFBKPOST SF Backup Post	This process purges the QUICK_POST_TBL and consolidates the transactions into a posting group for review. A listing of these transactions may be generated. (SQR)	Student Financials, Charges and Payments, Group Processing, Purge Posting Table	RUN_CNTL_SFBKPOST
SFCALTUI Tuition Residency Calculation	This report lists all students for whom tuition residency calculation has been processed. (SQR)	Student Financials, Tuition and Fees, Calculate Batch Tuition, Calculate Terms in Residency	RUNCTL_CALC_TUIT_R

Report ID and Report Name	Description	Navigation	Run Control Page
SFCOLLEC Collections	This report lists each student or corporation that has been assigned to collections. This includes the past due categories and amounts. (SQR)	Student Financials, Collections, Process Collections	RUNCTL_COLLECT_SF
SFCOLLTR Collections Dunning Letter	This is a process that creates communication records in PeopleSoft Campus Community for each collection letter requiring generation. (SQR)	Student Financials, Collections, Letter Generation, Generate Dunning Letters	RUNCTL_SFBU
SFCPTMFE Copy Term Fees	This program copies term fees from one term or one session to another. The report shows the details of the added term fees. (SQR)	Set Up SACR, Product Related, Student Financials, Tuition and Fees, Copy Term Fees	RUNCTL_SFCPTMFE
SFDONAT Generate Donation Receipts	This program generates the information for receipts for donations received by Universities from third parties. (SQR)	Student Financials, Taxes, Generate Donation Receipts	RUN_PARM_DONAT
SFGENT4 SF Generate T4A Data	Generates T4A data in preparation for printing T4A slips. (SQR)	Student Financials, Taxes, Generate T4A	RUNCTL_SF_GENT4
SFGLVAL1 Invalid GL Interface Chartfield Report	Lists invalid chartfields in SF targets, tenders, class/course fees and item types by term. (SQR)	Set Up SACR, Product Related, Student Financials, General Ledger Interface, ChartField Validation	RUNCTL_SFGLVAL1
SFGT2202 SF Generate T2202 Data	Generates T2202A data in preparation for printing T2202A forms. (SQR)	Student Financials, Taxes, Generate T2202A	RUNCTL_SF_SFGT2202
SFJT2202 Process T2202A Report File	This process generates the T2202A information. It will either update the tables in preparation for printing, or generate a report for review. (SQR)	Student Financials, Taxes, Create T2202A Extract File	RUNCTL_SF_SFJT2202
SFLOCKIN Lock In Tuition and Fees	This report lists students who have had their tuition locked in. (SQR)	Student Financials, Tuition and Fees, Process Tuition Lock In	RUNCTL_LCK_IN_TUIT

Report ID and Report Name	Description	Navigation	Run Control Page
SFPENRDP SF Enrollment Deposits	Creates and releases service indicators based on student payment of enrollment deposits. (SQR)	Student Financials, Charges and Payments, Enrollment Deposits	RUNCTL_ENRL_DPST RUNCTL_ENRL_DPST2
SFPR2202 Print T2202A Tax Forms	This process prints T2202A tax forms. (SQR)	Student Financials, Taxes, Print T2202A	RUNCTL_SFPR2202
SFPRGPLD SF External File Load	The process to load external files. A detail listing of the transactions loaded may be generated. (SQR)	Student Financials, Charges and Payments, Group Processing, External Files	RUNCTL_SFGPLOAD
SFRCRCPT Print Receipt	This program prints student payment / department receipts. (SQR) It generates income tax receipts for students enrolled in non degree courses (Canadian)	Student Financials, Taxes, Generate Tax Receipts	RUNCTL_SFRECEPT
SFRSCVW SF Load Security Views	Listing of table views used in SF security. (SQR)	Set Up SACR, Security, Secure Student Financials, Process, Set Security	RUNCTL_SFSCRTY
SFRVRGRP Group Reversal	Used to reverse a group after it has been posted. (SQR)	Student Financials, Charges and Payments, Group Processing, Reverse Groups	RUNCTL_SFRVRGRP
SFTBLVAL Table Validation Report	This process reports on, and/or corrects any referential integrity issues within SF tables. (SQR)	Student Financials, Charges and Payments, Validate Tables	RUN_CNTL_SFTBLVAL
SFTRMCPY Copy Term Session	This process copies chartfield information by Item Type Classification from one Term to another. (SQR)	Set Up SACR, Product Related, Student Financials, General Ledger Interface, Copy Term	RUNCTL_SFGL_FEE
SFWRTOFF Batch Write off	Detailed listing of accounts flagged to be written off. (SQR)	Student Financials, Collections, Write Offs, Run Write-off Process	RUNCTL_WRITE_OFF

Setup Table Crystal Reports

Report ID and Report Name	Description	Navigation	Run Control Page
SF701 Term Fees Table	This report lists all information from the Term Fees Table. (Crystal)	Reporting Tools, Query, Query Manager	RUNCTL_SFSETID
SF702 Term Sub Fees Report	This report lists information from the Term Subfees Table. (Crystal)	Reporting Tools, Query, Query Manager	RUNCTL_SF703
SF703 Class Fees Report	This report lists all information from the Class Fees Table. (Crystal)	Reporting Tools, Query, Query Manager	RUNCTL_SF704
SF704 Course Fees Report	This report lists all information from the Course Fees Table. (Crystal)	Reporting Tools, Query, Query Manager	RUNCTL_SF705
SF705 Course Rates Table	This report lists all information from the Course Rates Table. (Crystal)	Reporting Tools, Query, Query Manager	RUNCTL_SFSETID
SF712 Billing and Due Calendars	This report lists all information from the Billing and Due Calendars Table. (Crystal)	Reporting Tools, Query, Query Manager	RUNCTL_SF712
SF713 Keyword Table	This report lists all information in the Keyword Table. (Crystal)	Reporting Tools, Query, Query Manager	RUNCTL_SFSETID
SF714 Account Type Table	Detailed setup report of the institution's SF account types. (Crystal)	Reporting Tools, Query, Query Manager	RUNCTL_SF714
SF717 Fee Class Table	This report lists all information in the Fee Class Table. (Crystal)	Reporting Tools, Query, Query Manager	RUNCTL_SF717
SF718 Item Reason Table	Listing of item reason values created. (Crystal)	Reporting Tools, Query, Query Manager	RUNCTL_SF718
SF719 Charge Priority List	Listing of values defined in the Charge Priority List setup. (Crystal)	Reporting Tools, Query, Query Manager	RUNCTL_SF719

Report ID and Report Name	Description	Navigation	Run Control Page
SF720 Business Unit Table	Business Unit Table. (Crystal)	Reporting Tools, Query, Query Manager	RUNCTL_SF720
SF721 Group Type Table	Listing of the Group Type Table. (Crystal)	Reporting Tools, Query, Query Manager	RUNCTL_SF721
SF722 Origin Table	Listing of values defined the origin table setup. (Crystal)	Reporting Tools, Query, Query Manager	RUNCTL_SF722
SF730 Selection Criteria	This report lists information in the Criteria Table. (Crystal)	Reporting Tools, Query, Query Manager	RUNCTL_SF730
SF733 Cash Offered Table Report	This report lists information relative to cashiering offices. (Crystal)	Reporting Tools, Query, Query Manager	RUNCTL_SF733
SF734 Tender Key Table Report	Report for the Tender Key Table. (Crystal)	Reporting Tools, Query, Query Manager	RUNCTL_SF734
SF735 Target Key Table Report	Report for the Target Key Table. (Crystal)	Reporting Tools, Query, Query Manager	RUNCTL_SF735
SF740 Cashier Message Business Date	This report lists all cashiering office messages. (Crystal)	Reporting Tools, Query, Query Manager	RUNCTL_SF740
SF741 Cashier Message Tender	This report lists any Cashier Tender messages within a cashiering office. (Crystal)	Reporting Tools, Query, Query Manager	RUNCTL_SF741
SF742 Cashier Message Target	This report lists any Cashier Target messages within a cashiering office. (Crystal)	Reporting Tools, Query, Query Manager	RUNCTL_SF742
SF743 Valid Cashiers Per Office	Report of the valid cashiers for each office. (Crystal)	Reporting Tools, Query, Query Manager	RUNCTL_SF743
SF744 Follow Up Table	This report lists follow up actions for collections activity by setID and as of date. (Crystal)	Reporting Tools, Query, Query Manager	RUNCTL_SFASOFDT

Report ID and Report Name	Description	Navigation	Run Control Page
SF745 Collection Criteria	This report lists the criteria used to assign student collection items to the appropriate collector. (Crystal)	Reporting Tools, Query, Query Manager	RUNCTL_SFBU
SF746 Corp Collection Criteria	This report lists the criteria used to assign corporate collection items to the appropriate collector. (Crystal)	Reporting Tools, Query, Query Manager	RUNCTL_SFBU
SF747 Collector	This report lists the collectors by user ID. (Crystal)	Reporting Tools, Query, Query Manager	RUNCTL_SFBU_ASOFDT
SF748 Reason In Table	This report lists all information in the Reason In table for collection activity. (Crystal)	Reporting Tools, Query, Query Manager	RUNCTL_SFASOFDT
SF749 Reason Out Table	This report lists all information in the Reason Out table to remove a student/corporation from collections. (Crystal)	Reporting Tools, Query, Query Manager	RUNCTL_SFASOFDT
SF769 Waiver Form Table	This lists all information on the Waiver Form Table. (Crystal)	Reporting Tools, Query, Query Manager	RUNCTL_SFASOFDT
SF773 Application Fee	List of application fee codes with subfees for each term. (Crystal)	Reporting Tools, Query, Query Manager	RUNCTL_SFSETID
SF774A Course List	This report contains the Course List Details. (Crystal)	Reporting Tools, Query, Query Manager	RUNCTL_SFASOFDT
SF774B Course List Fees	This report lists all information from the Course List Fee and Course List Subfee Table. (Crystal)	Reporting Tools, Query, Query Manager	RUNCTL_SFSETID
SF775 Deposit Fees	This report lists all information from the Deposit Fee Table. (Crystal)	Reporting Tools, Query, Query Manager	RUNCTL_SFSETID
SF776 Minimum Maximum Fee	This lists all information on the Minimum Maximum Fee Table. (Crystal)	Reporting Tools, Query, Query Manager	RUNCTL_SFSETID

Report ID and Report Name	Description	Navigation	Run Control Page
SF777 Optional Fee Table	This report lists all values in the Optional Fee Table. (Crystal)	Reporting Tools, Query, Query Manager	RUNCTL_SFASOFDT
SF778 Optional Fee Term	This report lists all valid values in the Optional Fees per Term Table. (Crystal)	Reporting Tools, Query, Query Manager	RUNCTL_SFSETID
SF779 Transaction Fees	This report lists all information on the Transaction Fee Table. (Crystal)	Reporting Tools, Query, Query Manager	RUNCTL_SF779
SF779 Transaction Fee Table	Transaction Fee Table. (Crystal)	Reporting Tools, Query, Query Manager	RUNCTL_SFSETID
SF780 Calc Control Table	List of careers in use for each term and the parameters (auto calc tuition/waivers, term and transaction wash periods). (Crystal)	Reporting Tools, Query, Query Manager	RUNCTL_SF771
SF781 Waiver Table	This report lists all information on the Waiver Table. (Crystal)	Reporting Tools, Query, Query Manager	RUNCTL_SFSETID
SF784 Billing Aging Messages	This report lists all billing aging messages set up for a business unit. (Crystal)	Reporting Tools, Query, Query Manager	RUNCTL_SFBU_ASOFDT
SF785 Billing Message Table	Billing Message Table. (Crystal)	Reporting Tools, Query, Query Manager	RUNCTL_SFASOFDT
SF786 Billing Scan Line	This report lists all information from the Billing Scan Line table. (Crystal)	Reporting Tools, Query, Query Manager	PRCSRUNCNTL_SF
SF787 Billing Type Table	This report lists all information from the Billing Type Table. (Crystal)	Reporting Tools, Query, Query Manager	RUNCTL_SFASOFDT
SF788 Billing Messages for Students	This report lists information from the Billing Messages page. (Crystal)	Reporting Tools, Query, Query Manager	RUNCTL_SFBU_ASOFDT
SF789 Billing Messages for Corp	This report lists information from the Corporate Messages page. (Crystal)	Reporting Tools, Query, Query Manager	RUNCTL_SFBU_ASOFDT

Report ID and Report Name	Description	Navigation	Run Control Page
SF790 Billing Messages for Customers	This report lists information from the Customer Messages page. (Crystal)	Reporting Tools, Query, Query Manager	RUNCTL_SFBU_ASOFDT
SF791 Invoice Layout	This report lists all information from the Invoice Layout component. (Crystal)	Reporting Tools, Query, Query Manager	RUNCTL_SFSETID
SF792 Invoice Number	This report lists all information from the Invoice Number page. (Crystal)	Reporting Tools, Query, Query Manager	PRCSRUNCNTL_SF
SF793 Messages by Item Type	Messages by item type. (Crystal)	Reporting Tools, Query, Query Manager	RUNCTL_SFBU_ASOFDT
SF794 Billing Message Category	This report lists information from the Billing Message Category page. (Crystal)	Reporting Tools, Query, Query Manager	RUNCTL_SFBU_ASOFDT
SF795 Billing Standard Request	This report lists all information from the Billing Standard Request table based on setID. (Crystal)	Reporting Tools, Query, Query Manager	RUNCTL_SFASOFDT
SF855 Adjustment Calendars	List of detail for all adjustment codes in the database. Includes adjustment options, adjust reasons, terms, and line data for each category. (Crystal)	Reporting Tools, Query, Query Manager	RUNCTL_SF855
SF858 Tuition Group Report	This report lists all information for tuition groups. (Crystal)	Reporting Tools, Query, Query Manager	RUNCTL_SF858

Index

Numerics/Symbols

1098-T Audit Report page 663, 671
1098-T Citizenship page 376
1098-T Data page 662, 665
1098-T File Info page 663
1098-T forms
 aligning print stock 673
 defining item type parameters 62, 64
 generating data 663
 printing and creating transmission files 672
 producing and filing 661
 reviewing and overriding data 665
 setting up production 375
 setting up taxpayer identification numbers 376
 submitting corrections 667
 testing transmission files 674
 understanding 660
 validating and auditing data 671
1098-T Institution Address page 376
1098-T Print page 663, 672
1098-T self service set up 378
1098-T Student Address page 662
1098-T TIN page 376
1098-T TIN Table component (SF_1098_INST) 375
1098-T forms
 reviewing messages 665

A

Academic Information page 445, 516
Academic Institution 6 (NZZ) page 746, 748
Academic Programs page 440, 442
Academic Selections 2 page 299, 307
Academic Selections page 299, 305
Accounting Dates
 setup 54
Accounting Dates page 54
accounting entries
 creating 411, 414, 415
 sending to General Ledger 422
Accounting Line page 417
accounting lines
 publishing 423
 reviewing 417
accounting method 21
accounts
 viewing 593
 writing off 604
Accounts/Terms page 440, 443
Account Selections page 300, 310
accounts payable
 business units 243
 refund method 237, 436
 refund options 243
Accounts to Writeoff page 605, 607
account types

 defining billing standard requests 310
 linking item types 69
 SetID warning 70
 setting up 51, 52
Account Types page 51, 52
ACCT_TYPE_SF component 51
address verification 96, 104
ADJ_TERM_PANEL component 142
adjustment calendars
 defining administrative fees 145
 setting up 142, 143
Adjustment Calendars component (ADJ_TERM_PANEL) 142
Adjustment Calendars page 143
adjustment codes 230
Administrative Fee Setup 143
Administrative Fee Setup page 145
admit terms 181
AGING_TABLE component 37
Aging Set component (AGING_TABLE) 37
Aging Set Messages component (BI_BILL_MSG_AGE) 283
Aging Set Messages page 284, 285
Aging Set page 37
aging sets
 linking billing messages 285
 processing write-offs 609
 setting up 37
Algorithm Keyset page 87
alternative Late Fees calculation process 353
Amount Edits page 57, 62
AP Business Unit component (BUS_UNIT_AP) 243
AP Business Unit Options page 243
AP ChartFields page 57
APPLICATION_FEES component 181
Application Fee Item Types page 182, 183
application fees
 item type selection 183
 setup 181, 182
 sub fees 185
Application Fees component (APPLICATION_FEES) 181
Application Fees page 182
application messaging 109
Application Sub Fees page 182, 185
apply payments by invoice 12
 define target keys 326
approvals
 business unit options 28
 department receipts 316, 319, 322
 refunds 241, 453, 454
AP refunds
 business unit options 243
 completion 459
 messaging 459
 process flow diagram 438
 vendor set controls 245
AP Set Controls - Vendor component (SF_AP_VNDR_OPTIONS) 243
AP Set Controls - Vendor page 243, 245
Assign Collections Worklist page 644, 646
Assign Student Permissions page 634, 635

Australia

- creating and updating FEE HELP loans 736
 - creating or updating Commonwealth Assistance Notices 743
 - defining FEE HELP loan defaults 725
 - defining HECS HELP loan defaults 725
 - defining OS HELP loan defaults 726
 - defining status change rule loan defaults 727
 - defining tax parameters 32
 - excluding HECS classes 731
 - linking band fees to tuition groups 730
 - maintaining OS HELP loans 742
 - preparing for setting up HELP 721
 - reconciling HECS 734
 - reviewing HECS results 733
 - reviewing liability statuses 723
 - setting up HECS band fees 728
 - setting up HECS fee codes 728
 - setting up loan defaults 722
 - understanding FEE-HELP 721
 - understanding HECS-HELP 717
 - understanding OS-HELP 721
 - understanding the Higher Education Loan Program (HELP) 717
 - understanding the tuition calculation for HECS 720
 - updating statuses for FEE HELP determinations 737
- Australian Loan Processing
- setting up and using 717
- authorization, credit card
- 103, 318, 381, 390, 531, 547
- auto-numbering sequences 31

B

- Back Out GL Interface page 421
- BANK_INPUT_FILE component 355
- bank account numbers re-encryption 84
- banking interface
 - Netherlands functionality 703
- base currency 21, 63, 129, 315, 343
- Batch Programs page 132, 134
- batch publishing
 - control records 420
 - process 423
 - rules 133
- Batch Publish page 423
- Batch Publish Rules page 132, 133
- Batch Refund (NZL) page 754
- Batch Refund Approval page 453
- Batch Refund Lines page 440
- Batch Refund page 440, 441
- batch refunds
 - calculating 457
 - completing through payroll 455
 - confirming 457
 - creating 439
 - defining basic parameters 441
 - generating paysheets 456
 - routing to worklists 453
 - selecting academic programs 442
 - selecting account types and terms 443
 - selecting item types 444
- BI_BILL_MSG_AGE component 283
- BI_BILL_MSG_ALL component 283
- BI_BILL_MSG_CUS component 283
- BI_BILL_MSG_ITM component 283
- BI_BILL_MSG_ORG component 283
- BI_BILL_MSG_TBL component 283
- BI_INV_LAYOUT component 286
- BI_MSG_CAT_TBL component 283
- BI_SCAN_LINE component 296
- BI_STD_REQ_TBL component 298
- BI_TYPE_TBL component 298
- bill by options 490, 491
- Bill Cancellation page 513, 514
- Bill Career page 515
- Bill Detail page 516
- billing
 - billing requests 489
 - calendar creation 139
 - cancellation 513, 514
 - commit options 29
 - date calculation 142
 - information review 515
 - invoice layouts 286
 - messages 283
 - overview 489
 - Pending To Bill Items page 499
 - scan lines 296
 - setup 283
 - specific student charges 498, 500
 - standard requests 298
 - Student Invoice Summary page 502
 - types 298
- Billing Address Info page 515
- Billing and Due Calendars component (DUE_DATE_PANEL) 139
- Billing and Due Calendars page 140
- billing and due date calendars
 - creation 139
 - pivot date warning 141
- billing careers 179
- Billing Detail page 499
- billing messages
 - linking
 - item types 285
 - aging sets 285
 - business units 286
 - students 286
 - organizations 286
 - selecting 307
 - setting up 283, 284
- Billing Messages component (BI_BILL_MSG_TBL) 283
- Billing Messages page 284
- Billing Request 1 page 492
- Billing Request 2 page 492, 494
- billing requests
 - completing 489
 - defining basic parameters 492, 497
 - processing 504, 505, 506
 - selecting bill by options 490, 491
 - specifying bill terms and print options 494, 498
- Billing Scan Line component (BI_SCAN_LINE) 296
- Billing Scan Line page 296
- Billing Standard Request - Messages page 299
- Billing Standard Request component (BI_STD_REQ_TBL) 298
- billing standard requests
 - academic selections 305, 307

- account types 310
- billing messages 307
- communication information 304
- general selections 300, 302
- organization information 311
- setup 298
- student groups 308
- Billing Type component (BI_TYPE_TBL) 298
- Billing Type page 298
- billing types 298
- Bill Messages page 516
- BUS_UNIT_AP component 243
- BUSINESS_UNIT_SF component 19
- business processes 2
- Business Unit Bank Accounts (NLD) page 704
- Business Unit GL - Definition page 117
- Business Unit Message component (BI_BILL_MSG_ALL) 283
- Business Unit Messages page 284, 286
- business units
 - auto-numbering sequences 31
 - basic parameters 21, 22
 - billing messages 286
 - Canadian, Australian, and New Zealander taxes 32
 - collections setup 363, 364
 - commit options 28
 - overview 19
 - PeopleSoft General Ledger units 118
 - posting setup 24
 - recognized types 117
 - refunding setup 238
 - setup 19
 - synchronization 134, 135

C

- CALC_CNTRLOL_PANEL component 150
- Calculation Messages page 425
- calendars
 - adjustment calendar setup 142
 - billing and due dates 139
 - refunding 246
- Canada
 - defining tax parameters 32
- Canadian/ANZ Taxes page 20, 32
- cancellations *See Also* enrollment cancellation
 - default reason 23
 - tuition recalculation 431
- capture, credit card 103
- Cash Check Detail page 552
- Cash Checks page 526, 539
- cashiering
 - creating receipt messages 332
 - creating void reasons 332
 - defining cashiering offices 313
 - entering check information 545
 - entering credit card information 546
 - modifying receipt forms 335
 - posting delayed receipts 548
 - printing receipts 321, 322, 552
 - processing the GL interface 316, 413, 549
 - processing transactions 524
 - receipt and tender activity 553
 - reviewing totals 561
 - selecting exchange rates 544
 - setting up target keys 323
 - setting up tender keys 327
 - setting up valid registers and cashiers 320
 - understanding 519
 - viewing receipt details 551
 - voiding receipts 549, 550
- CASHIERING_OFFICES component 313
- Cashiering GL Interface Messages page 414
- Cashiering GL Interface page 414, 415
- Cashiering GL Interface processing
 - accounting entries 411
- cashiering GL interface process integration 413
- Cashiering Office Messages page 333
- cashiering offices
 - closing 562, 565
 - creating receipt messages 333
 - defining basic parameters 314
 - defining transaction setup 316
 - opening 520
 - reopening 566
 - setting up 313
- Cashiering Offices component (CASHIERING_OFFICES) 313
- Cashiering Offices page 313, 314
- Cashier Office Messages page 332
- cashiers, valid *See* valid cashiers
- CASHIERS component 320
- Cash Replenishment Detail page 552
- Cash Replenishment page 526, 543
- cash replenishments *See Also* cashiering
 - processing 543
 - understanding 525
- Change Corp Item Line - Line Detail Update page 598
- Change Corp Item Line page 598
- Change Item Line - Account Summary page 598
- Change Item Line - Line Detail Update page 598
- Change Item Line page 598
- character variables 156
- CHARGE_PRIORITY component 39
- Charge Corp Reversal - Charge Reversal page 601
- charge priority
 - creating lists 40
 - defining rules 41
 - example of list selection 44
 - item type warning 65
 - overriding 326, 577, 591
 - setting item types 65
 - understanding 40
- Charge Priority List - Details page 40
- Charge Priority List component (CHARGE_PRIORITY) 39
- Charge Priority List page 40
- Charge Reversal - Charge Detail page 600
- Charge Reversal page 600, 601
- charges
 - reversing 600, 601
 - writing off 604
- Chartfield Audit report 406
- Chartfield Audit Report page 409
- ChartField edit options
 - dynamic ChartFields 7
- ChartFields
 - copying item type information 137
 - defining dynamic ChartFields 7
 - defining for target keys 323
 - defining for tender keys 328
 - mapping item types 70

- setting up 119
 - validating 130, 131
- Chartfield Validation page 131
- chart of accounts *See* ChartFields
- Char Variables page 155, 156
- check cashing *See Also* cashiering
 - processing 539
 - setting rules 319
 - understanding 525
- Check Information page 527, 545
- Checklist page 648
- Class / Course Fees Rollover component (RUNCTL_FEE_RLVR) 204
- Class / Course Fees Rollover page 207, 217
- class fees
 - modal 205, 216
 - rollover 217
 - setup 204, 213
 - sub fees 214
- Class Fees Modal page 206
- Class Fees page 206, 213
- classification, item type 61
- Class Sub Fees Modal page 207
- Class Sub Fees page 206, 214
- Clieop03 703
- Close Cashier page 563
- Close Cashiers page 564
- Close Offices page 563, 565
- Close Registers page 563
- CLST_FEE_PANEL component 224
- COLL_AGREEMENT component 277
- COLL_CRITER_ORG component 367
- COLL_CRITER_SF component 367
- COLL_LTRTMP_TABLE component 370
- Collection Agreement Assess page 278
- Collection Agreement component (COLL_AGREEMENT) 277
- Collection Agreement page 278
- collection agreements
 - defining basic parameters 278
 - setting up 277
 - specifying administrative fees 280
 - understanding 473
- collection criteria
 - organizations 369
 - setup 367
 - students 367
- Collection Criteria component (COLL_CRITER_SF) 367
- Collection Criteria page 367
- Collection Information page 648, 651
- collection items
 - assigning to collectors 644
 - assigning to worklists 646
 - recording collection activity 651
 - viewing demographic information 648
 - working 646, 647
- collection letters
 - processing 655
 - selecting templates 650
 - updating information 654
- Collection Letter Template component (COLL_LTRTMP_TABLE) 370
- Collection Placement page 655
- collections *See Also* collection items
 - adding to a queue without worklist 655
 - business unit setup 363, 364
 - collection item assignment 644
 - collection items, working 646
 - criteria 367
 - follow-up actions 370
 - letter templates 370
 - overview 643
 - reason in/out codes 369
 - setup 363
 - viewing corporations in collection 657
 - viewing customers in collection 657
- Collections Dunning Letter page 647, 650, 654, 655
- Collections Letter Template page 371
- Collections page 20, 364
- COLLECTOR_SF component 366
- Collector component (COLLECTOR_SF) 366
- Collector page 366
- Collector Queue page 657
- collectors 366
- Comments page 648
- commit levels 15
- commit options 28
- Commit Options page 20, 28
- Commonwealth Assistance Notice (AUS) page 743
- Communication Info page 299, 304
- Communication page 648
- control totals 575
- Control Totals page 356, 358
- convenience fees 105
- Convert Encryption page 87
- Copy Term Fees component (RUN_SFCPTMFE) 190
- Copy Term Fees page 191, 203
- Corp Accounts page 445
- Corp Billing Request - Billing Request 1 page 492, 497
- Corp Billing Request - Billing Request 2 page 492
- Corp Collection Criteria page 369
- Corp Item Due View page 594
- Corp Item View page 593
- Corp Late Fee Messages page 615, 618
- Corp Late Fees - Late Fees Details page 615
- Corp Late Fees page 615
- Corporate Collection Criteria component (COLL_CRITER_ORG) 367
- Corporate Collection Criteria page 367
- Corporate Payment Detail page 552
- corporate payments *See Also* cashiering
 - accepting 534
 - allocating charges 536
 - tracking third-party information 537
 - understanding 525
- Corporate Payments page 526, 534
- Corporate Receipts page 554, 555
- Corporate Refund page 445, 448
- Corporate Refunds by Date page 465, 467
- Corporate Refunds by ID page 465, 467
- Corporation Credit History page 637
- Corporation Info page 300, 311
- Corporation Invoice Crystal page 507, 512
- Corporation Invoice Extract page 506, 509
- Corporation Invoice Other page 507, 511
- Corporation Messages component (BI_BILL_MSG_ORG) 283
- Corporation Messages page 284, 286
- Corp Post page 590, 592
- Corp Refund Approvals page 453
- Corp Refund Cancellation page 463, 464
- Corp Refunds By Date page 470
- Corp Refunds By ID page 470

Corp Sponsor page 250, 251
 Corp Sponsor Refunds by Date page 470
 Corp Sponsor Refunds by ID page 470
 Corp Writeoff page 605, 607
 Counters page 20, 31
 course fees
 modal 205, 212
 rate tables 207
 rollover 217
 setup 204, 209
 sub fees 210
 Course Fees component (CRSE_FEE_PANEL)
 204
 Course Fees Modal page 206
 Course Fees page 206, 209
 course list fees
 setup 224, 225
 sub fees 226
 waiver group warning 227
 Course List Fees component
 (CLST_FEE_PANEL) 224
 Course List Fees page 224, 225
 course lists
 creating 174
 linking tuition groups 234
 setting up fees 224
 Course Lists component (CRSE_LIST_PANEL)
 174
 Course Lists page 174
 Course Sub Fees Modal page 206
 Course Sub Fees page 206, 210
 Create Clieop03 File (NLD) page 714
 Create Deduction Relationship component
 (SF_PAYDED_RELATION) 359
 Create Deferral Contract component
 (DEFERRAL_CONTRACT) 253
 Create Payment Plan component
 (TP_PAYMENT_PLAN) 259
 Create Payment Plans (TP_PAYMENT_PLAN)
 359
 Create Schedules page 692
 Create Student Job Data component
 (SSF_POIJOB_TEST) 246
 Create Student Report (NZL) page 754
 Create T2202A Extract File page 676, 679
 Create Third Party Contract component
 (TP_CONTRACT) 270
 Create Vendors and Vouchers
 completion 460
 Create Vendors and Vouchers page 460
 CREDIT_CARD_TYPE component 83
 credit, credit card 103
 Credit Card Information page 527, 546
 credit card processing 382, 383
 authorizing, settling, and crediting 103
 defining credit card types 84
 defining SF merchants 100
 reviewing and canceling transactions 386
 reviewing transactions 392
 selecting transaction review criteria 393
 understanding 381
 viewing transactions 396
 Credit Card Processing page 382, 383
 credit card re-encryption 84
 credit card refunds
 other transactions 462
 web transactions 462
 Credit Card Refunds - Other page 462

Credit Card Refunds - Web page 462
 Credit Card Type component
 (CREDIT_CARD_TYPE) 83
 Credit Card Type page 84
 credit history 637
 Credit History page 637, 647
 credit invoice indicator 517
 credit invoices 489
 criteria, tuition calculation
 codes and types 159
 details 160
 setup 139
 tuition groups, linking 231
 tuition groups and fee triggers 158
 variables 155
 Criteria (NZL) page 758, 760
 Criteria component (SEL_CRITERIA_PANEL)
 158
 Criteria Details (NZL) page 758, 761
 Criteria Details page 159, 160
 Criteria page 159
 CRSE_FEE_PANEL component 204
 CRSE_LIST_PANEL component 174
 CRSE_RATE_PANEL component 204
 Currencies by Tender page 554
 currency, base 21, 63, 129, 315, 343
 Currency Conversion page 526, 544
 Currency Options page 117
 current term 43
 customer maintenance *See* maintain customers
 Customer Message component
 (BI_BILL_MSG_CUS) 283
 Customer Message page 286
 Customer Messages page 284

D

DDP Advice Print Canada page 459
 DDP Advice Print page 458
 defaults
 academic terms 81
 adjust reasons 144
 business unit parameters 23
 ePayment processing 106
 payroll refunding 242
 term control 26
 default term 81, *See Also* term default
 DEFERRAL_CONTRACT component 253
 Deferral Contract Charges page 254, 257
 Deferral Contract Fee page 254, 256
 Deferral Contract page 254
 deferral contracts
 administrative fees 256
 basic parameters 254
 eligible charges and maximum amounts 257
 linked students 473
 setup 253
 student-specific details 473
 summary 472
 Deferred Charges page 473
 Deferred ChartFields page 58
 Defer Student Charges page 473
 Defer Student page 473
 Defining Payment by Invoice 11
 delayed receipts 548
 Demographic Information page 647, 648

- Department Receipt Detail page 552
- department receipts
 - creating 537
 - defining SpeedTypes 127
 - setting approval parameters 319, 322
 - understanding 525
- Department Receipts page 526, 537
- DEPOSIT_FEES component 186
- deposit due dates
 - defining status changes 189
 - setting up 186, 188
- Deposit Due Dates page 186, 188
- Deposit Fees component (DEPOSIT_FEES) 186
- Deposit Fees page 186, 187
- Detail Calendar page 118
- Detail Refund AP Information page 469
- Detail Refund Check Information page 469
- Detail Refund Information By Student page 470
- Details page 634
- DFLT_TERM_TBL component 81
- direct deposit
 - payroll refunds 457, 458
 - setup 249
- Direct Deposit Create File page 458
- disable 1098-T self-service 667
- disbursement 26
- Display Error/Warning Controls page 151, 154
- disputed charges
 - entering information 598
 - understanding 597
- donation receipt information
 - generating 683
 - understanding 661
- DUE_DATE_PANEL component 139
- due dates
 - billing request 493
 - calendar 139
 - deposit 186
 - item type 69
 - late fee 349
 - null 11
- dunning letters 372, 650

E

- eCheck processing
 - debiting and crediting 382, 385
 - refunding 461
 - reviewing and canceling transactions 386
 - reviewing transactions 392
 - selecting transaction review criteria 393
 - understanding 381
 - viewing transactions 396
- eCheck Processing page 385
- Electronic Payment Test page 96
- encryption *See* re-encryption
- Enroll Deposit2 page 612, 613
- Enroll Deposit page 611, 612
- Enrollment Blocks page 299
- enrollment cancellation
 - item groups and options 625
 - process 619
 - student selection criteria 620
 - tuition recalculation 431
- Enrollment Cancellation 1 page 620
- Enrollment Cancellation 2 page 620, 625

- Enrollment Cancellation Messages page 620
- Enrollment Cancellation page 620
- enrollment deposits
 - defining basic parameters 612
 - processing 611
 - selecting academic programs and waiver forms 613
- EOP_PUBLISHM process 423
- ePayment
 - item types 107
- ePayment processing
 - defining credit card types 83
 - defining SF merchants 101
 - processing service requests 382
 - reviewing and canceling transactions 386
 - reviewing transactions 392
 - selecting transaction review criteria 393
 - setting minimum/maximum payment amounts 106
 - setting up 83
 - specifying convenience fees 105
 - viewing transactions 396
- ePayment refunds
 - distribution 461
- ePayment Refunds page 392, 462
- ePayment transactions 381
- Equation Dtl page 169
- Equation Editor page 163, 164
- Equation Engine Search page 163
- equations, tuition calculation
 - setup 139
 - variables 155
- Equation Variables component (STDNT_EQUTN_VARS) 155
- Error Bill Message page 492
- excess payments
 - defining group transactions parameters 578
 - moving 53
 - selecting default accounts 26
- exchange rates 21, 544
- external file layouts
 - basic parameters 356
 - control data 358
 - field positions and lengths 357
 - setup 355
- External File Layouts component (BANK_INPUT_FILE) 355
- external files 580
- External Files page 580
- Extra Refund Amount page 445, 451

F

- FE_IMAGE_TEXT component 335
- FE_UPIMG_RUNCTL component 335
- FEE_CLASS component 177
- FEE-HELP Determination (AUS) page 736
- FEE-HELP Loan (AUS) page 736
- FEE-HELP Loans
 - understanding 735
- Fee Calculation Messages (Batch) page 428
- Fee Calculation Messages page 425
- Fee Classes component (FEE_CLASS) 177
- Fee Classes page 178
- FEE HELP (AUS) page 723
- fees

- defining minimums and maximums 178
- setting up 177
- Fees After Calculation (Batch) page 428
- Fees After Calculation page 425
- fee triggers
 - class fees 215
 - course fees 211
 - course list fees 226
 - setup 158
- Field Details 1 page 356, 357
- Field Details 2 page 356
- Field Details 3 page 356
- fields, valid 18
- financial aid
 - account type setup 53
 - disbursement reversal warning 27
 - item type setup 61
 - posting setup 26
- follow-up actions 370
- FOLLOW_UP component 370
- Follow-Up Table component (FOLLOW_UP) 370
- Follow Up Table page 370
- FORM_EDITOR component 335
- Form Editor component (FORM_EDITOR) 335
- Form Editor page 335, 338
- Form Image Attributes page 335
- form image text 337
- Form Image Text component (FE_IMAGE_TEXT) 335
- Form Image Text page 335, 337
- Forms Engine 316, 321, 335, 336
- Form Text Attributes page 335
- Full Data Publish page 133, 135
- Full Table Publish Rules page 132, 134
- future term 44

G

- General 1 page 20, 21
- General 2 page 20, 22
- General Selection 2 page 299, 302
- General Selections page 299, 300
- general setup 5
- Generate 1098-T page 662, 663
- Generate Accounting Entries page 414
- Generate Donation Receipts page 683
- Generate Encryption Key page 87
- Generate Invoice page 505
- Generate Invoice page (corporate) 505
- Generate Invoice page (student) 505
- Generate T2202A page 675, 676
- Generate T4A page 680
- Generate Tax Receipts page 683
- getting started 1
- GL interface processing 132
 - accounting entries 411
 - back out process 421
 - back out warning 422
 - business units and GL units, linking 118
 - cashiering 316, 413, 549
 - ChartFields 119
 - GL unit selection 21
 - information review 416
 - item type mapping 70
 - messaging 110
 - Oracle General Ledger 110

- overview 403
- PeopleSoft General Ledger 110
- run history 417
- setup 109
- setup data, loading 112
- target keys 323
- tender keys 327, 328
- third-party/legacy systems 112
- GL interface process integration 412
- GL messaging 110, 133, 134
- global institutions
 - apply payments by invoice 12
- global invoicing 6
- GL setup data
 - PeopleSoft Application Messaging 112
- GL setup data for PeopleSoft Financials
 - review 117
- GL Term Copy page 137
- Goods and Services Tax (GST) 33
- GROUP_TYPE component 341
- group approval roles 29
- Group Entry page 573, 574
- Group Line Details page 587
- Group Line Entry page 573, 576
- Group Post Details page 586
- Group Reversal page 601, 602
- group transactions
 - adding line entries 576
 - defining source information and control
 - totals 574
 - entering 573
 - posting 587, 588
 - reversing 602
 - reviewing suspended transactions 587
 - revising before posting 586
 - updating transaction details 587
- group types 341, 343
- Group Type Table component (GROUP_TYPE) 341
- Group Type Table page 342, 343
- GST 33

H

- HECS Band Fees (AUS) page 723
- HECS HELP (AUS) page 722
- HECS Reconciliation (AUS) page 733

I

- Identify SA Deduction Codes component (SSF_SA_DED_TBL) 359
- Identify Student Charges page 499, 500
- image files
 - preparing 336
 - uploading 337
- implementation 3
- Individual Sponsor page 250
- Ind Sponsor Refunds By Date page 470
- Ind Sponsor Refunds By ID page 470
- Initial Setup page 57, 58
- Initiate VOS Responses (NZL) page 751
- Initiating VOS Responses (NZL) page 752
- Inquire Contract Assignments page 482

- INSTALLATION_SF component 5
 - installation parameters 5
 - Institution New Zealand (NZL) page 749
 - Institution Table New Zealand (NZL) page 746
 - Interim Deposit Detail page 552
 - interim deposits
 - processing 542
 - understanding 525
 - Interim Deposits page 526, 542
 - International Health Coverage
 - generating letters 698
 - overview 685
 - setting up 688
 - using 692
 - International Health Coverage - Student Maintenance page 692
 - International Health Coverage Institutional Contact Information page 688
 - International Health Coverage Item Type Setup page 688
 - International Health Coverage Provider page 688
 - INVOICE_NUMBER component 295
 - invoice/payment processing 12
 - Invoice Career page 499
 - Invoice Detail page 499
 - invoice for student receivable 6
 - Invoice Header page 499
 - Invoice ID Number component (INVOICE_NUMBER) 295
 - Invoice ID Number page 295
 - Invoice Info. Corp - Bill Detail page 516
 - Invoice Info. Corp - Bill Messages page 516
 - Invoice Info. Corp. page 516
 - Invoice Info Student page 515
 - Invoice Layout component (BI_INV_LAYOUT) 286
 - Invoice Layout One page 288, 291
 - invoice layouts
 - defining basic information 291
 - setting up 286
 - sorting and summarizing 292
 - Invoice Layout Two page 288, 292
 - Invoice Messages page 499
 - Invoice Printing page 516
 - invoices
 - defining ID number generation 295
 - printing 506, 507, 509, 511, 512
 - setting up layouts 286
 - ITEM_GROUPINGS component 55
 - ITEM_REASONS component 359
 - ITEM_TYPE_PANEL component 55
 - Item Due View page 593
 - Item Line Corp View page 593
 - Item Line View page 593
 - Item Reasons component (ITEM_REASONS) 359
 - Item Reasons page 359
 - Items to Writeoff page 605, 608
 - item type groups
 - setup 55, 76
 - third-party offset charges 276
 - Item Type Groups component (ITEM_GROUPINGS) 55
 - Item Type Groups page 58, 76
 - Item Type Message component (BI_BILL_MSG_ITM) 283
 - Item Type Messages page 284, 285
 - item types
 - accounting date control warning 60
 - account types, linking 69
 - amount edits 62
 - application fees 183
 - basic attributes 58
 - batch refunds 444
 - billing messages 285
 - charge priority list warning 65
 - ChartField information, copying 137
 - ChartField selection 70
 - classification 61
 - miscellaneous parameters 64
 - payment overall priority warning 65
 - payment plan contracts 265
 - payment priority flag warning 66
 - posting restrictions 68
 - SetID warning 70
 - setup 55
 - third-party contracts 274
 - Item Types - Account Types page 57, 69
 - Item Types - GL Interface page 57
 - Item Types component (ITEM_TYPE_PANEL) 55
 - Item Types page 440, 444
 - item type trees
 - business unit setup 25
 - charge priority 40
 - item type groups 56, 77
 - Item View page 593
- ## J
- job data
 - creating 246
 - Journal Generator Templates - Defaults page 117
 - Journal Generator Templates - Summarization page 118
 - Journal Set ChartFields page 57
- ## K
- keywords
 - creating 16
 - defining edit tables 11
 - linking to item types 58
 - setting up 5, 6
 - KEYWORDS component 5
 - Keywords component (KEYWORDS) 5
 - Keywords page 7, 16
- ## L
- LATE_FEE_TABLE component 344
 - Late Fee Details page 615
 - Late Fee Messages page 615, 617
 - late fee option 23
 - late fees
 - academic programs 351
 - account types 52
 - aging category information 348
 - basic parameters 345
 - calculation and posting 615
 - charge by warning 346
 - due date warning 351

- ID switch warning 347
- maximums and due dates 349
- processing 614
- setup 344
- late fees - billing 353
- Late Fees - Billing page 353
- Late Fees — Billing
 - processing 617
- Late Fees – Billing process page 617
- Late Fees component (LATE_FEE_TABLE) 344
- Late Fee Setup 3 page 349
- Late Fees page 615, 617
- Late Fees Setup 1 page 345
- Late Fees Setup 2 page 345
- Late Fees Setup 3 page 345
- Late Fees Setup 4 page 345, 351
- layouts, invoice *See* invoice layouts
- ledger fields *See* ChartFields
- Ledger Fields Table component
 - (SF_LED_FLDS_TBL) 119
- Ledger Fields Table page 119
- legacy general ledger systems 112
- letter generation 613, 655
- letter templates, collection 370, 371, 650
- Liability Status (AUS) page 722
- Line Detail Update page 598
- Load Paysheet Transactions page 455
- Load VERWINFO (NLD) page 711
- Lock In Tuition Amount page 430

M

- maintain customers 633
- Maintain ePayment Transaction page 387
- maintain receivables
 - account information 593
 - external file layouts 355
 - group transactions 573
 - item reasons 359
 - late fees 344
 - origins and group types 341
 - payroll deductions 359
 - setup 341
- Mass Contract Select page 482
- maximum row settings 7
- MERCHANT_TBL component 100
- Message Categories component
 - (BI_MSG_CAT_TBL) 283
- Message Categories page 284
- messages, billing *See* billing messages
- messages, receipt *See* receipt messages
- MESSAGES component 332
- Messages page 307
- messaging, GL *See* GL messaging
- MIN_MAX_FEE_PANEL component 178
- Minimum/Maximum Fees 1 page 178, 179
- Minimum/Maximum Fees 2 page 178, 180
- Minimum/Maximum Fees 3 page 179, 181
- Minimum / Maximum Fees component
 - (MIN_MAX_FEE_PANEL) 178
- minimum and maximum fees
 - admit terms 181
 - billing careers and academic years 179
 - setup 178
 - terms and sessions 180

- tuition residency 202
- Miscellaneous page 57, 64
- modal course fees and class fees 205

N

- name usage
 - 1098-T forms 377
 - business units 23
- Netherlands
 - billing students using OLA or VERWINFO 710
 - creating Clieop03 files 714
 - loading VERWINFO files 712
 - posting student transactions 711
 - printing OLA forms 711
 - processing payments 713
 - setting up account information 704
 - setting up bank account numbers for students 706
 - setting up default values for VERWINFO or Clieop03 files 708
 - setting up the banking interface 703
 - using the banking interface 703
 - using the Clieop03 process 713
- New Zealand
 - defining tax parameters 32
 - NZQA 757
 - NZQA fees 757
 - NZQA fee trigger 760
 - NZQA per credit charge 768
 - NZQA term fee codes 762
 - NZQA term fees 763
 - NZQA term sub fess 766
 - Qualification Authority Fees
 - See* New Zealand, NZQA
 - StudyLink, create student reports 756
 - StudyLink batch refunds 755
 - StudyLink information, maintain 753
 - StudyLink institution defaults 746
 - StudyLink payment schedules 754
 - StudyLink processing 745
 - StudyLink VOS requests and responses 751
- non-resident aliens (NRAs)
 - item type setup 65
- null due dates 11
- number sequence start points 7
- numeric variables 156
- Num Variables page 155, 156

O

- OLA form 703
- Online Refund Other page 445, 451
- online refunds
 - accounts and terms for extra amounts 451
 - completion through payroll 455
 - creation 444
 - extra amounts 449
 - number of days between refunds note 240
 - organizations 448
 - sponsors 451
 - students 445
- Open Cashier Offices page 520

- Open Cashiers page 520, 523
- Open Registers page 520, 522
- OPT_FEE_TABLE component 218
- optional fees
 - amounts 221
 - calculation 433
 - codes 219
 - overrides 434
 - setup 218
 - terms 220
 - values 219
- Optional Fees - Term page 218, 220
- Optional Fees component (OPT_FEE_TABLE) 218
- Optional Fees for a Student page 432, 433
- Optional Fees Override page 433, 434
- Optional Fees page 218, 219, 432
- Optional Fees per Term page 218, 221
- Oracle Financials
 - GL interface process integration 132
 - published messages 112
- ORIGIN_TABLE component 341
- origins 341, 342
- Origin Table component (ORIGIN_TABLE) 341
- Origin Table page 342
- or XML Publisher invoices
 - printing 510
- OS HELP (AUS) page 723
- OVERALL_PRIORITY component 39
- Over GL Entry page 314

P

- Pay Calculation page 455
- payment allocation 40
- payment application 39, *See Also* charge priority
- Payment Applier page 603
- Payment Corp Reversal - Payment Detail page 600
- Payment Corp Reversal page 600, 601
- Payment Details page 589
- Payment Distribution page 278, 475
- Payment Merchant page 91
- payment overall priority
 - example of eligible charge sorting 49
 - item type setup 65
 - item type warning 65
 - pay proportionate % tax warning 42
 - rules 40
 - setup 47
- Payment Overall Priority component (OVERALL_PRIORITY) 39
- Payment Overall Priority page 40, 47
- Payment Plan 1 page 259, 360, 361, 475
- Payment Plan 2 page 259, 262, 475, 476
- payment plan contracts
 - administration 474
 - administrative fees 269
 - basic parameters 259
 - eligible charges 264, 478
 - item types 265
 - parameters confirmation 475
 - plan types 263
 - recalculation 478
 - setup 259
 - summary 472
 - time frames 264
- Payment Plan Fee page 259, 269
- Payment Plan Item Type page 259, 265
- payment plans
 - collection agreements 277
 - counters 31
 - deferral contracts 253
 - interest 61
 - overview 471
 - payroll deduction assignment 361
 - setup 253
 - third-party contracts 270
- Payment Reversal - Payment Detail page 600
- Payment Reversal page 600, 601
- payments
 - application 603
 - excess accounts 26
 - reversal 600, 601
 - self-service 24
- Payment Shuffle page 603
- payroll
 - refund method 237, 436
- Payroll Deduction Group Creation page 582, 585
- Payroll Deduction Relationship page 360, 361
- payroll deductions
 - assigning to payment plans 361
 - creating groups 585
 - creating relationships 361
 - defining codes 360
 - processing 581
 - reversing 603
 - reviewing record selection results 584
 - selecting records 582
 - setting up 359
- Payroll Defaults page 20, 238, 242
- payroll refunds
 - batch calculation 457
 - batch confirmation 457
 - checks and direct deposit advice slips 458, 459
 - completion 455
 - creating job data 246
 - defaults 242
 - direct deposit 249, 457, 458
 - paysheet creation 456
 - paysheet deletion 468
 - process flow diagram 437
 - refund calendar creation 246
 - reversal 467
 - withholding amounts 243
- paysheets
 - creating 456
 - deleting 468
- Pending to Bill Items page 499
- Pending To Bill Items page 499
- Pending Transaction Detail page 393
- PeopleSoft Application Messaging 112
- PeopleSoft Campus Community 633
- PeopleSoft Financials
 - AP refund messaging process 459
 - AP refunds 459
 - business unit synchronization 135
 - GL interface process integration 132
 - published messages 112
- PeopleSoft General Ledger units 118
- Per Credit Charge (NZL) page 759, 768
- Permission Form page 634, 635
- permission forms
 - defining charge priority list rules 41
- Person Communication page 699
- pivot dates 141

- Populate Items by Invoice page 7
 - posting
 - business unit setup 24
 - cashiering 318
 - delayed receipts 548
 - group transactions 587
 - individual transaction consolidation 592
 - individual transactions 589
 - item type restrictions 68
 - organization transactions 592
 - student transactions 590
 - target keys 325
 - Posting Information page 593
 - Posting Restrictions page 57, 68
 - Posting Setup page 20, 24
 - Post Receipts page 548
 - Post Transactions page 588
 - printing
 - 1098-T forms 672
 - automatic receipts 321, 322
 - cashiering receipts 552
 - check cashing receipts 541
 - Crystal invoices 511, 512
 - department receipts 539
 - Form Based Extract Bill invoices 507, 509
 - invoices 506
 - output formats, invoice 495
 - refund checks and advice slips 458
 - SQR invoices 510
 - student payment receipts 531
 - T2202A forms 678, 679
 - Print OLA Forms (NLD) page 711
 - Print T2202A page 676, 678
 - Prior Billing page 499
 - prior term 43
 - Process Collections page 644
 - Process PAY File (NZL) page 754
 - Process PAY Schedule (NZL) page 754
 - Process Refund File (NZL) page 754
 - Process Scheduler page 87
 - Process VOS Request (NZL) page 751
 - Process VOS Requests (NZL) page 751
 - Provider Coverage and Rates page 688
 - PS_CAN_DONAT_RECEPT table 684
 - PS_CAN_TAX_RECEPT table 683
 - PS_PAY_DEDUCTION table 581, 584
 - PS_SF_1098_DTL table 665
 - Purge Posting Table page 593
- Q**
- QUICK_POST_TBL table 25, 592
- R**
- Rate Tables for Course Fees component (CRSE_RATE_PANEL) 204
 - Rate Tables for Course Fees page 206, 207
 - re-encryption 84
 - REASON_IN_SF component 369
 - REASON_OUT_SF component 369
 - reason in/out codes 369
 - Reason In component (REASON_IN_SF) 369
 - Reason In page 370
 - Reason Out component (REASON_OUT_SF) 369
 - Reason Out page 370
 - Recalc for Cancellation page 431
 - Recalc Payment Plan page 475, 478, 482
 - Recalc Third Party Contracts page 479, 481
 - receipt activity
 - by business date 554
 - organizations 555
 - review 553
 - students 556
 - receipt forms
 - modifying 335
 - setting up form image text 337
 - uploading image files 336, 337
 - using Form Editor 338
 - receipt messages
 - cashiering offices 333
 - setup 332
 - target keys 333
 - tender keys 334
 - Receipt Print Messages component (MESSAGES) 332
 - receipts, cashiering
 - creating messages 332
 - modifying forms 335
 - posting 318
 - posting, delayed 548
 - printing 552
 - printing automatically 316, 321, 322
 - viewing details 551
 - voiding 317, 549, 550
 - receipts, donation 661, 683
 - receipts, income tax 661, 683
 - Receipts By Business Date page 553, 554
 - Receipt Tender Flow page 554, 559
 - receivables collection *See* collections
 - receivables maintenance *See* maintain receivables
 - records, valid 17
 - Record Types page 356
 - reference item payment flag 27
 - Refund Address page 470
 - Refund Approval page 20, 238, 241, 453, 454
 - Refund Approvals page 453
 - Refund Calculation Controls page 151, 153
 - Refund Calculation page 457
 - Refund Check Print page 458, 459
 - Refund Check Reprint page 468
 - Refund Check Reversal page 465, 467
 - Refund Cheque Print page 458
 - Refund Confirmation page 456, 457
 - refunding *See Also* AP refunds
 - accounts payable options 243
 - approval parameters 241
 - approvals 453, 454
 - AP set controls 245
 - basic rules 238
 - batch creation 439
 - business units, accounts payable 243
 - business unit setup 238
 - calendars 246
 - cancellation 463
 - check renumbering 467, 468
 - check reprinting 467
 - credit card and eCheck distribution 461
 - defaults, payroll 242
 - direct deposit 249
 - formats 436
 - information review 469

- methods 436
- online refund creation 444
- overview 435
- processes 436
- recipients 436
- reversals 464, 465, 466, 467
- setup 237
- sponsored recipient controls 240
- sponsors 249
- withholding amounts, payroll 243
- refund method 239
- Refund Paysheet Creation page 456
- Refund Setup page 20, 238
- Refund Unsheet page 469
- Refund with Extra Amount page 445, 449
- registers, valid *See* valid registers
- REGISTERS component 320
- Reopen Cashier page 566, 568
- Reopen Office page 566
- Reopen Register page 566, 567
- reports, A to Z 793
- reports, list of 793
- Request Payroll Interface page 456
- Request Student Job Data component (SSF_RUN_POIJOB) 246
- Request Student Job Data page 247, 248
 - for T4A data 680
- Restrict payment by invoice
 - target detail 529
- Reversal Detail page 601
- reversals
 - group transactions 602
 - payments and charges 601
 - payroll deductions 603
 - refunds 464
 - write-offs 610
- Reverse Corporate Charge- Charge Detail page 601
- Reverse Corporate Charge - Charge Reversal page 601
- Review 1098–T Messages page 662
- Review Batch Messages page 440
- Review Corp Late Fees — Billing (corporation late fees) 618
- Review GL History page 416, 417
- Review GL Integration Data page 417, 420
- Review GL Messages page 414
- Review HECS Results (AUS) page 733
- Review Results by Contract page 482
- Review Selection Criteria page 399
- Review Student by Date page 470
- Review Student by ID page 469
- Review Transactions page 588
- RUN_SFCPTMFE component 190
- RUNCTL_FEE_RLVR component 204

S

- SA Payroll Deduction Codes 360
- SA Payroll Deduction Codes page 360
- SA Payroll Deduction Summary page 582, 584
- scan lines, billing 296
- Security Code Purge Process page 382
- Security Code re-encryption 84
- SEL_CRITERIA_PANEL component 158
- SEL_GROUP_PANEL component 227
- Select Charges to Pay page 526, 534, 589
- Selection Criteria page 393
- Select SA Payroll Deduction page 582
- Select Student Charges to Pay page 536
- Select Students to Pay page 526, 590
- self-service
 - accepting payments 24
- self service
 - reviewing and canceling transactions 386
- Self Service Options page 259
- sequences, auto-numbering 31
- SERVICE_IND_SETUP component 77
- Service Indicator - Career Setup page 78, 80
- Service Indicator - Details page 78
- Service Indicator page 78
- service indicators
 - collections write-offs 365
 - credit history 641
 - enrollment cancellation 625
 - enrollment deposit processing 611, 612
 - set selection 23
- service indicator sets *See Also* service indicators
 - details 78
 - eligible academic careers 80
 - setup 77
- Service Indicator Sets component (SERVICE_IND_SETUP) 77
- sessions
 - minimum and maximum fees 180
 - tuition calculation controls 153
- setup, general 5
- Set Up Default Values for VERWINFO/ Clieop03 (NLD) page 704
- set up linking charges to specified payment plan 268
- SF_1098_INST component 375
- SF_AP_VNDR_OPTIONS component 243
- SF_COMMON_ID table 589, 629
- SF_CRCRD process 462
- SF_LED_FLDS_TBL component 119
- SF_PAY_DED process 585, 586, 603
- SF_PAYDED_RELATION component 359
- SF Accounting Line Detail page 417
- SF Account Types component (ACCT_TYPE_SF) 51
- SF Business Unit component (BUSINESS_UNIT_SF) 19
- SFCCRFND process 462
- SFCOLLEC process 645
- SFDPTRC process 424
- SF Installation 2 page 7, 11
- SF Installation 3 page 7, 15
- SF Installation page 7
- SF merchants 100, 101
- SF Merchants component (MERCHANT_TBL) 100
- SF Merchants page 101
- SFP1098P process 665
- SFPAYDED process 584, 603
- SFPCCBAT process 462
- SFPGLINT process 424
- SFPGRPDR process 589
- SFPGRPST process 589
- SF Term Default component (DFLT_TERM_TBL) 81
- Short GL Entry page 314
- sorting, invoice layout 292
- SPEEDTYPE component 127
- SpeedTypes

- creating 127
- SpeedTypes component (SPEEDTYPE) 127
- SpeedTypes page 127
- sponsors
 - batch refunds 442
 - designation 249
 - individual students 250
 - online refunds 451
 - organizations 251
 - recipient controls 240
- SSF_ASGNWORK process 646
- SSF_POIJOB_TEST component 246
- SSF_RUN_POIJOB component 246
- SSF_SA_DED_TBL component 359
- standard requests, billing
 - See* billing standard requests
- start points, number sequence 7
- Status Change Rule (AUS) page 723
- status changes, deposit 189
- Status Update page 186, 189
- STDNT_EQUTN_VARS component 155
- Student Accounts page 445
- Student Address page 676
- Student Bank Accounts (NLD) page 704
- Student Fin Installation component (INSTALLATION_SF) 5
- student groups 308
- Student Groups page 299, 308
- Student Invoice Crystal page 507, 511
- Student Invoice Extract page 506, 507
- Student Invoice Other page 507, 510
- Student Invoice Summary page 499, 502
- Student Loan - OS-HELP (AUS) page 742
- Student Payment Detail page 552
- student payments
 - accepting 527
 - allocating charges 534
 - understanding 524
- Student Payments page 526, 527
- student permission form
 - attaching to student records 635
 - creating 635
- student permission forms
 - attaching to charge priority lists 636
 - understanding 634
- student permissions
 - managing 634
- Student Post page 589, 590, 711
- Student Receipts page 554, 556
- Student Refund Cancellation page 463
- Student Refund page 392, 445
- Student Refunds by Date page 465, 466
- Student Refunds by ID page 465
- students
 - billing messages 286
- Student Writeoff page 605, 606
- StudyLink Institution Defaults (NZL) page 746
- StudyLink Posting Parameters (NZL) page 746, 750
- surcharges *See* convenience fees
- Suspended Group Post page 587
- Suspended Group Post page 586

T

- T2202A Data page 676, 677
- T2202A forms 679
 - defining item type parameters 62
 - generating data 676
 - printing on preprinted forms 678
 - producing 675
 - reviewing and editing data 677
 - setting up 379
 - understanding 660
- T4A Data page 680
- T4A reports
 - creating job data 679
 - defining item type parameters 62
 - producing 679
 - reviewing 679
 - setting up 32, 379
 - understanding 660
- Table Validation page 626, 627
- TARGET_KEYS component 323
- Target Key ChartFields page 323
- target keys
 - ChartFields 323
 - receipt messages 333
 - setup 323
 - tax authorities, linking 326
- Target Keys - Definition page 323
- Target Keys - Tax Authority page 323, 326
- Target Keys component (TARGET_KEYS) 323
- Target Messages page 332, 333
- TAX_AUTHORITY component 34
- TAX_CODE_VAT component 34
- tax authorities
 - defining 35
 - linking to target keys 326
 - setting up 34
 - specifying VAT rebates 36
- Tax Authorities - Rebate page 35, 36
- Tax Authorities - Summary page 35
- Tax Authorities component (TAX_AUTHORITY) 34
- Tax Authority page 35
- tax codes 34, 36
- Tax Codes component (TAX_CODE_VAT) 34
- Tax Codes page 35, 36
- tax forms *See Also* 1098-T forms, 379
 - 1098-T forms 375
 - item type setup 62
 - production 659
 - setup 375
 - T2202A forms 379
 - T4A generation setup 32
 - T4A reports 379
- taxpayer identification number (TIN) 376, 659
- tax receipt information
 - generating 683
 - understanding 661
- TENDER_KEYS component 327
- tender activity
 - by cashier 557
 - by register 558
 - review 553
- Tender By Cashier page 554, 557
- Tender By Register page 554, 558
- tender flow 553, 559
- Tender Key ChartFields page 328
- Tender Key Over ChartFields page 328
- Tender Key page 328
- tender keys
 - ChartFields 328

- receipt messages 334
- setup 327, 328
- valid cashiers 331
- Tender Keys component (TENDER_KEYS) 327
- Tender Key Short ChartFields page 328
- Tender Key Valid Cashiers page 328, 331
- Tender Messages page 332, 334
- TERM_FEE_PANEL component 190
- term default
 - business unit setup 26
 - default term control warning 26
 - setup 81
- Term Default page 81
- Term Fee Codes (NZL) page 758, 762
- Term Fee Codes page 191
- Term Fee Residency page 191, 202
- term fees
 - calculation option warning 196
 - copying to subsequent terms 203
 - copy options warning 204
 - From Session and To Session warning 204
 - linking to tuition groups 232
 - linking waivers 233
 - setting up 190, 191, 193, 195, 198, 202
- Term Fees (NZL) page 758, 763
- Term Fees component (TERM_FEE_PANEL) 190
- Term Fees page 191, 193, 723
- Term Fee Waivers page 228, 233
- terms
 - cancel reason 23
 - minimum and maximum fees 180
 - optional fees, linking 220
- Term Sub Fee Codes (NZL) page 758, 765
- Term Sub Fee Codes page 191, 195
- Term Sub Fees (NZL) page 758, 766
- Term Sub Fees page 191, 198
- third-party contracts
 - administration 479
 - basic parameters 271
 - charge transfers 276
 - item types 274
 - recalculation 481
 - setup 270
 - students, linking 479
 - summary 472
- third-party general ledger systems 112
- Third Party Charges page 271, 276
- Third Party Contract Assess page 280
- Third Party Contract page 271, 479
- Third Party Info page 526, 537
- Third Party Information page 590
- Third Party Item Types page 271, 274
- TIN *See* taxpayer identification number (TIN)
- totals, cashiering 561
- Totals By Deposit ID page 561
- Totals page 393
- TP_CONTRACT component 270
- TP_PAYMENT_PLAN component 259, 359
- TRANSACTION_FEES component 222
- Transaction Detail page 393, 396
- Transaction Fees component
 - (TRANSACTION_FEES) 222
- Transaction Fees page 223
- transactions *See Also* group transactions
 - consolidating individual transactions 592
 - posting 589, 590, 592
 - reversing 600
- Transaction Setup page 314, 316

- tree node 42
- trees, item type 25, 77
- Tuition and Fees page 425
- tuition calculation
 - basic parameters 151
 - batch process warnings 429
 - business unit setup 23
 - controls, setting up 139, 150
 - course lists 174
 - errors and warnings 154
 - fees and tuition groups 177
 - minimum amounts, locking in 430
 - multiple students 427, 428
 - optional fees 432
 - recalculation after enrollment cancellation 431
 - refund calculation control 153
 - single students 425, 426
 - variables 155
 - waivers 171
- Tuition Calculation Controls component
 - (CALC_CNTRC_PANEL) 150
- Tuition Calculation Controls page 151
- Tuition Calculation page 425, 426
- Tuition for Multiple Students page 427, 428
- Tuition Group Priority page 229, 235
- tuition groups
 - adjustment codes 230
 - course lists 234
 - criteria 231
 - established priorities 235
 - setup 158, 177, 227, 229
 - term fees 232
 - waivers 233, 234
- Tuition Groups - Adjustment Codes page 228, 230
- Tuition Groups - Course Lists page 228, 234
- Tuition Groups - Criteria page 228, 231
- Tuition Groups - Definition page 228, 229, 723
- Tuition Groups - Term Fees page 228, 232
- Tuition Groups - Waivers page 228, 234
- Tuition Groups component
 - (SEL_GROUP_PANEL) 227
- tuition residency 202, 203, 426

U

- Update Corp Payment Invoice ID page 594
- Update Payment Invoice ID page 594
- Upload EPS Image File component
 - (FE_UPIMG_RUNCTL) 335
- Upload EPS Image File page 335, 337

V

- VALID_FIELDS component 17
- VALID_RECORD_SF component 17
- valid cashiers
 - closing 564
 - opening 523
 - reopening 568
 - setting up 320, 321
 - specifying for tender keys 331
- Valid Cashiers component (CASHIERS) 320
- Valid Cashiers page 320, 321
- Valid Fields (NZL) page 758, 759

Valid Fields component (VALID_FIELDS) 17
 Valid Fields page 17, 18
 valid records 17
 Valid Records (NZL) page 758, 759
 Valid Records component
 (VALID_RECORD_SF) 17
 Valid Records page 17
 valid registers
 closing 563
 opening 522
 reopening 567
 setting up 320
 Valid Registers component (REGISTERS) 320
 Valid Registers page 320
 Values page 218, 219
 variables
 character 156
 numeric 156
 tuition calculation 155
 yes/no flags 157
 VAT rebates 36
 VERWINFO 703
 View Corp Items by Invoice page 594
 View Items by Invoice page 594
 VOID_REASONS component 332
 Void Reasons component (VOID_REASONS)
 332
 Void Reasons page 332
 Void Receipts - All page 550
 Void Receipts page 550
 vouchers, AP 244

W

WAIVER_GROUP_PANEL component 171
 WAIVER_PANEL component 171
 waiver forms
 selecting for enrollment deposit process 613
 waiver groups 171, 173
 Waiver Groups component
 (WAIVER_GROUP_PANEL) 171
 Waiver Groups page 171, 173
 waivers
 automatic calculation 153
 excess accounts 26
 excess waiver account warning 26
 setup 171
 term fees, linking 233
 tuition calculation 139
 tuition groups, linking 234
 Waivers component (WAIVER_PANEL) 171
 Waivers page 171
 Warning Bill Message page 492
 wash periods 152
 worklists
 assigning collection items 646
 routing batch refunds 453
 Write-off ChartFields page 57
 write-offs
 account selection 607
 batch processing 608
 collections service indicators 365
 general ledger accounts 72
 item selection 608
 organizations 607
 overview 605

reversals 610, 611
 students 606
 Writeoff Corp Reversal page 606, 611
 Writeoff Detail page 606
 Writeoff Reversal page 605, 610
 Write Offs page 605, 608

Y

Y/N Flags page 156, 157
 yes/no flags 157

Z

zero bills 301, 496

