



Anton Paar

Measure,
what is measurable,
and make measurable
that which is not.

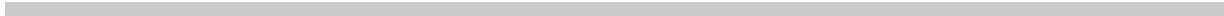
Galileo Galilei (1564-1642)

Instruction Manual

DMA 4500/5000

Density/Specific Gravity/Concentration Meter

Software Version: V5.012.c



Instruction Manual

DMA 4500/5000

Density/Specific Gravity/Concentration Meter

Software Version: V5.012.c

While every precaution has been taken in the preparation of this document, **Anton Paar** GmbH assumes no responsibility for technical or printing errors or omissions.

Nor is any liability assumed for damages resulting from the use of the information contained in this instruction manual.

Anton Paar GmbH does not make a commitment to update the information in this manual. Specifications are subject to change without notice.

All rights reserved (including translation). No part of this document may be translated, reproduced or distributed in any form (print, photocopy, microfilm or any other process) without the prior written permission of **Anton Paar** GmbH.

Trade marks may be used in this instruction manual without being marked as such. These are the property of their respective owners and are legally protected.

Published by **Anton Paar** GmbH. Printed in Austria.

Copyright © 2005 **Anton Paar** GmbH, Graz, Austria

Contact: **Anton Paar** GmbH
Anton-Paar-Str. 20
A-8054 Graz / Austria - Europe
Tel: +43 316 257-0
Fax: +43 316 257-257

E-mail: info@anton-paar.com
Web: www.anton-paar.com

Date: 04.05.2005

Document number: XDLIB07Q.fm

Contents

1	Introduction	7
2	Safety Instructions	8
3	Symbols in the Instruction Manual	10
4	Supplied Items	11
5	Putting into Operation	13
6	Functional Components	17
6.1	Display and Keypad	17
6.2	Front View	19
6.3	Rear View	20
7	General Settings	21
7.1	Display Contrast	21
7.2	Setting Date and Time	21
7.3	Setting the Language	21
7.4	Defining a Method	21
7.5	Setting the Temperature	22
7.6	Selecting the Output Data for Display, Printer and Memory	22
7.7	Defining the Display Contents and Layout	23
7.8	Defining the Printout Contents and Layout	24
7.9	Storing Measurement Values in the Memory	25
7.10	Settings for the Sample Changer/Handling Unit	25
7.11	Settings for the Measuring Procedure	26
8	Checking Procedure, Adjustment and Calibration	28
8.1	Definitions	28
8.2	Checking Procedure: Density Check	28
8.3	Adjustment	30
8.3.1	Adjustment with Air and Water at 20°C	30
8.3.2	Adjustment with Air and Water for the Entire Temperature Range (Full Range Adjustment)	32
8.3.3	Special Adjustment	34
8.4	Calibration	36
9	Measurements	37
10	Cleaning and Drying the Measuring Cell	42
11	Operation	44
11.1	Menu Operation	44
11.1.1	Using the Keys on the Keypad	44
11.1.2	Using an External Keyboard (Optional)	45
11.2	Menu Structure and Description	45
11.2.1	"Logoff user "xxx""	45
11.2.2	"audit trail"	45

11.2.3	"temperature setting"	46
11.2.4	"adjustment"	47
11.2.5	"measurement settings"	50
11.2.6	"instrument settings"	54
11.2.7	"method settings"	57
11.2.8	"sample changer configuration"	67
11.2.9	"user functions"	68
11.2.10	"custom function verification"	75
11.2.11	"data memory"	75
11.2.12	External Cell	76
11.2.13	"testmode"	76
11.2.14	"service testmode"	76
11.3	"Sample#"	77
11.3.1	Automatic Set Temperature Change via "sample#"	78
12	Audit Trail	80
12.1	Introduction	80
12.2	Activating / Deactivating Audit Trail	80
12.2.1	Activating Audit Trail	80
12.2.2	Deactivating Audit Trail	82
12.3	Audit Trail Main Menu	83
12.4	Viewing the Audit Trail Log File	83
12.5	Printing the Audit Trail Log File	84
12.6	Exporting the Audit Trail Log File	84
12.6.1	Verifying the Exported Log File	86
12.7	Clear Audit Trail	88
12.8	General Settings	89
12.9	User Management	89
12.9.1	Adding a New User	90
12.9.2	Removing a User	90
12.9.3	Changing User Settings	91
12.9.4	Print All User Settings	91
12.10	User Privileges	91
Appendix A:	Operation at High Air Humidity and/or Low Measuring Temperatures	93
Appendix B:	Technical Data	95
Appendix C:	Commands for Communication between PC and DMA 4500/5000	98
Appendix D:	Density Tables	102
Appendix E:	Possible Adjustment Errors, Adjustment Report	107
Appendix F:	Software Versions	110
Appendix G:	Wetted Parts	112
Appendix H:	Menu Tree	113
Index	117

1 Introduction

Thank you for buying the DMA 4500 or DMA 5000 density/specific gravity/concentration meter for gases and liquids. We greatly appreciate your trust and will do everything we can to ensure that your instrument provides you with years of trouble-free operation.

The DMA 4500/5000 is the first oscillating U-tube density meter which measures highest accuracy in wide viscosity and temperature ranges.

A unique reference oscillator, in addition to the U-tube oscillator, provides extraordinary long-term stability and makes adjustments at temperatures other than 20°C virtually unnecessary.

By measuring the damping of the U-tube's oscillation caused by the viscosity of the filled-in sample, the DMA 4500/5000 automatically corrects viscosity related errors.

Two integrated Pt 100 platinum thermometers provide the highest accuracy of temperature control, and are traceable to national standards.

To perform a measurement, select one out of a total of 10 individual measuring methods, and fill the sample into the measuring cell. An acoustic signal will inform you when the measurement is finished. Results are automatically converted (including temperature compensation where necessary) into concentration, specific gravity or other density-related units using the built-in conversion tables and functions.

The density results, including sample number or name, can be shown on the programmable LC display, printed out or transferred to the data memory.

For fully automatic measurements, the DMA 4500/5000 can be connected to the automatic sample changers SP-1m or SP-3m.

The automatic SH-1 or SH-3 sample handling unit is another option for the density meters DMA 4500/5000.

Some software features like temperature scan and adjustment at high density or viscosity are only available in the DMA 5000.

2 Safety Instructions

- This instruction manual does not claim to address all of the safety issues associated with the use of the DMA 4500/5000 and samples. It is the responsibility of the user to establish health and safety practices and determine the applicability of regulatory limitations prior to use.
- Before using the DMA 4500/5000, read this instruction manual completely.
- **Anton Paar** GmbH only warrants the proper functioning of the DMA 4500/5000 if no unauthorized adjustments have been made to mechanical parts, electronic parts and software, and the following points are adhered to.
- Follow all hints, warnings and instructions in the instruction manual to ensure the correct and safe functioning of the DMA 4500/5000.
- Do not use the DMA 4500/5000 for any purpose other than described in the instruction manual. **Anton Paar** GmbH is not liable for damages caused by incorrect use of the DMA 4500/5000.
- Do not use any accessories other than those supplied or approved by **Anton Paar** GmbH.
- The installation procedure should only be carried out by authorized personnel who are familiar with the installation instructions.
- Do not operate the DMA 4500/5000 if a malfunction is suspected, or damages, injuries or loss of life cannot be excluded under all circumstances.
- The DMA 4500/5000 is **not** an explosion-proof instrument and therefore must not be operated in areas where there is a risk of explosion.
- Service and/or maintenance procedures which involve removing outside covers and working with the power switched on may only be performed by authorized service personnel.
- Ensure that all operators are fully trained to use the DMA 4500/5000 correctly and safely.
- Due to the nature of the measurement, the measuring results not only depend on the correct use and functioning of the DMA 4500/5000, but may also be influenced by other factors. We therefore recommend that the analysis results are plausibility tested before consequential actions are taken.
- Repair and service procedures may only be carried out by authorized personnel or by Anton Paar GmbH.
- To lift the DMA 4500/5000, take the instrument with one hand on the front side and one hand on the rear. Keep the instrument in front and close to your body.

- Follow the precautions below for the handling and measurement of inflammable samples and cleaning materials:
 - Do not store inflammable material near the instrument.
 - Do not leave sample containers uncovered.
 - Clean all spillages immediately.
 - Ensure that the DMA 4500/5000 is located in a sufficiently ventilated area, free from inflammable gases and vapors.
 - Connect the DMA 4500/5000 to mains power via a safety switch located a safe distance from the instrument. In an emergency, turn off the power using this switch. Do not use the DMA 4500/5000 power switch.
 - Keep a fire extinguisher at hand.
 - Do not leave the DMA 4500/5000 unattended while in use.



Do not touch areas marked with this symbol when the power is turned on.

3 Symbols in the Instruction Manual

The following symbols are used in the instruction manual:



Warning:

The "Warning" sign indicates a **hazard to the operator**.

It calls attention to an operating procedure, practice, etc. which, if not correctly performed or adhered to, could result in **injury or loss of life**.

Do not proceed beyond a "Warning" sign until the indicated conditions are fully understood and met.



Important:

The "Important" sign indicates a **hazard to the equipment**.

It calls attention to an operating procedure, practice, etc. which, if not correctly performed or adhered to, could result in **damage or destruction** of the instrument or parts of it.

Do not proceed beyond an "Important" sign until the indicated conditions are fully understood and met.



Hint:

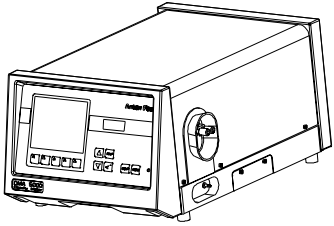
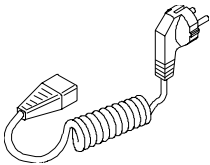


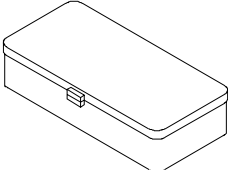
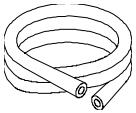
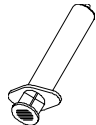
The "Hint" sign calls attention to any **additional information** which might be of use to the operator.

4 Supplied Items

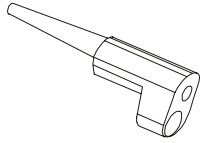

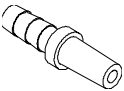
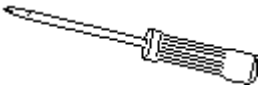
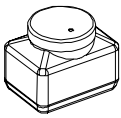


Hints:

- The DMA 4500/5000 has been tested and packed carefully before shipment. However, damage may occur during transport.
- If the DMA 4500/5000 or a supplied item has been damaged during transport, contact the transport firm as well as your local Anton Paar representative. Keep the packing material for examination by the transport firm or an insurance representative.
- If a part is missing, please contact your local Anton Paar representative.

	Pcs.	Item/Cat.No.
	1	DMA 4500 <i>Cat.No. 75846</i> DMA 5000 <i>Cat.No. 70244</i>
	1	Power cord <i>Europe: Cat.No. 65146</i> <i>USA: Cat.No. 52656</i> <i>UK: Cat.No. 61865</i>
	1	Instruction manual <i>English: Cat.No. 75747</i> <i>German: Cat.No. 75746</i> <i>French: Cat.No. 13688</i>
	1	Density standard, "Ultra pure water", 5 x 10 ml <i>Cat.No. 78169</i>
	1	Accessory kit <i>Cat.No. 70248</i> containing:
	2 m	Hose 3 x 5 mm silicone <i>Cat.No. 50814</i>
	7	Syringe 2 ml Luer <i>Cat.No. 51974</i>

4 Supplied Items

	Pcs.	Item/Cat.No.
	2	Injection adapter Luer <i>Cat.No. 12225</i>
	2	Male Luer plug PTFE <i>Cat.No. 63865</i>
	2	Adapter Luer cone <i>Cat.No. 63863</i>
	1	Screwdriver <i>Cat.No. 75030</i>
	1	Waste vessel <i>Cat.No. 6210</i>

5 Putting into Operation



Hints:

- The DMA 4500/5000 does not require any special installation conditions. The installation conditions should correspond to conditions in a typical laboratory.
- However, to guarantee temperature stability, do not place the DMA 4500/5000
 - near a heater
 - near an air conditioner
 - in direct sunlight.



Important:

A strong built-in cooling fan dissipates heat through the bottom and the rear of the DMA 4500/5000. Ensure that the airflow is not blocked.

Preparing the DMA 4500/5000 for the first start-up

1. Take 2# injection adapters Luer from the accessory box.

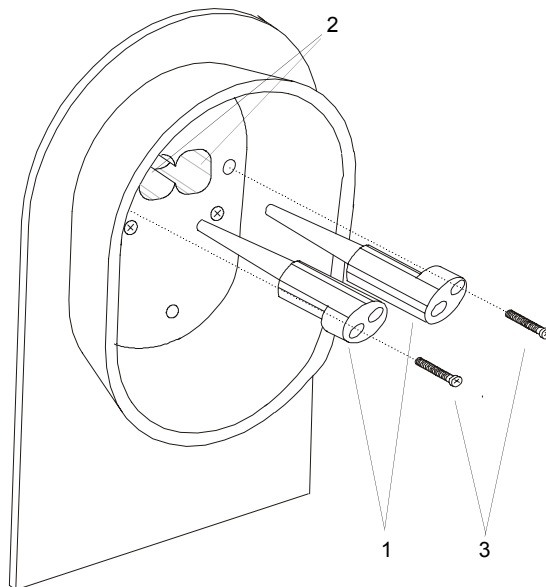


Fig. 5 - 1 Mounting the injection adapters Luer

2. Carefully insert the injection adapters Luer (1) into the openings (2) of the filling device until the tips of the adapters reach the openings of the measuring cell.
3. With moderate force, push the adapters towards the measuring cell.

4. Insert the screws (3) into the bore holes of the adapters and tighten the screws until some resistance against further turning can be felt.



Important:

Do not screw in the screws (3) too tightly. The gap between the holding plate and the adapter (1) where the thread of the screw (3) becomes visible has to be 3 to 4 mm (approx. 1/8"). If the screws are screwed in too tightly, the measuring cell may be damaged.

5. Check the connection of the adapters to the measuring cell for leak tightness:
 - Close one adapter tightly with a finger.
 - Fill air under moderate pressure through the other adapter using a 2 ml plastic syringe from the accessory box.
 - Release the plunger of the syringe.
If the connections are leak tight, the plunger of the syringe will be slowly pushed back by the pressure in the measuring cell.
If the connections are leaking, no pressure was built up in the measuring cell and the plunger will not move. Repeat step 2 to 5.
6. Cut a piece of approx. 250 mm length from the silicone hose contained in the accessory box.
7. Attach the silicone hose to the air pump outlet (see Fig. 5 - 2).

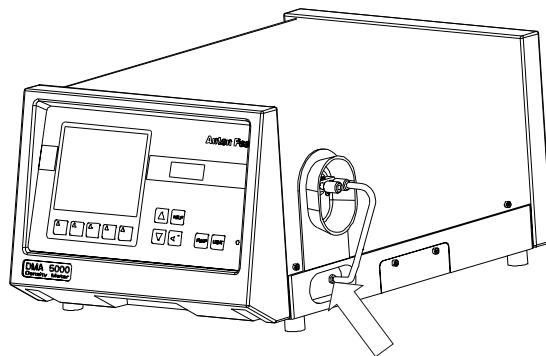


Fig. 5 - 2 Attaching the hose to the air pump

8. Attach an adapter Luer cone (from the accessory box) to the other end of the silicone hose (see Fig. 5 - 3).

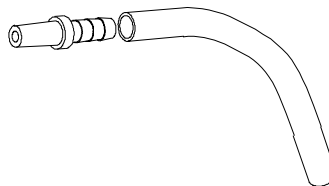


Fig. 5 - 3 Attaching the adapter Luer cone to the hose

9. If a printer will be used, plug the interface cable into the COM 2 connector at the rear of the DMA 4500/5000.
10. Check the operating voltage.

**Important:**

- Before switching the DMA 4500/5000 on, make sure that the correct line voltage is available (AC 85 to 260 V, 48 to 62 Hz). If large voltage fluctuations are to be expected, the use of a constant voltage source (UPS) is recommended.
- The non fused earth conductor of the power cord (or power inlet) has to be connected to earth.

11. Connect the power inlet of the DMA 4500/5000 to the mains using the power cord.
12. Turn on the DMA 4500/5000 using the "POWER" switch at the rear of the instrument. The green light on the front indicates that the power is on. After the start-up procedure the cell light is on continuously.

**Hints:**

- After turning on the power, the DMA 4500/5000 needs approx. 20 minutes for attemperating and additionally 5 to 10 minutes for internal temperature adjustments. During this time "attemperating" is displayed. If the desired measuring temperature is already set, do not touch any key during this time as this will considerably increase the waiting period.
- In case of high air humidity or low measuring temperatures see appendix A.

13. As soon as the attemperating of the DMA 4500/5000 to 20°C is finished, perform a density check measurement, as described below.

**Important:**

The DMA 4500/5000 is factory adjusted and this control measurement should be performed to check if the adjustment is still valid after transport.

14. Press the menu" soft key and select "adjustment" in the main menu. Select density check" and activate "density check settings".
15. Enter the appropriate density value according to the water table in appendix D.
16. Place the supplied waste vessel below the rear adapter (see Fig. 5 - 4) and connect the adapter to the waste vessel with an appropriate hose (from the accessory box).

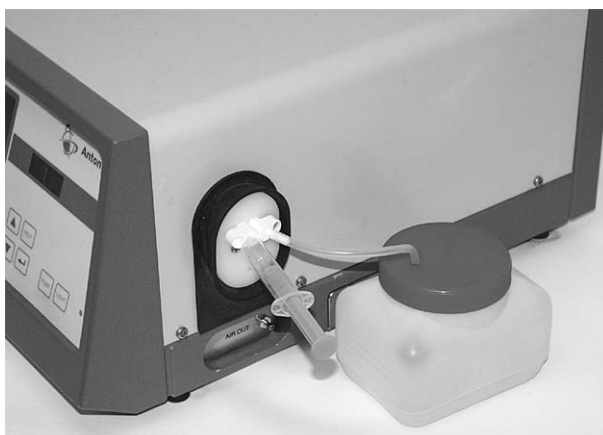


Fig. 5 - 4 Placing of the waste vessel

17. Open one bottle of the supplied liquid density standards (ultra pure water) and immediately introduce the liquid into the measuring cell of the DMA 4500/5000. Use the supplied syringes and ensure there are no air bubbles in the substance. Press OK.
18. When the measurement is finished, either "density check: OK" or "density check: not OK" appears on the display; additionally the measured density and the deviation from the set value are displayed.
 - If "density check: OK" is displayed, the instrument is ready for routine measurements.
 - If "density check: not OK" is displayed, clean the measuring cell thoroughly (see chapter 10) and repeat the density check.



Hint:

The density of (ultra pure) water is 0.99820 g/cm^3 at 20°C .

19. If the result is still "density check: not OK", perform an air/water adjustment at 20°C .



Hint:

The "density check" function can also be used when performing routine measurements in order to check the validity of the adjustment. Other density calibration liquids or standardized samples can be used.

6 Functional Components

6.1 Display and Keypad

After turning on the DMA 4500/5000, the instrument carries out a self-test and initialisation procedure (approx. 2 minutes) and then the following display is shown:



Hint:

It may be necessary to adjust the contrast of the display using the "UP" and "DOWN" keys (see Fig. 6 - 2). Save the contrast setting in the instrument settings" menu.

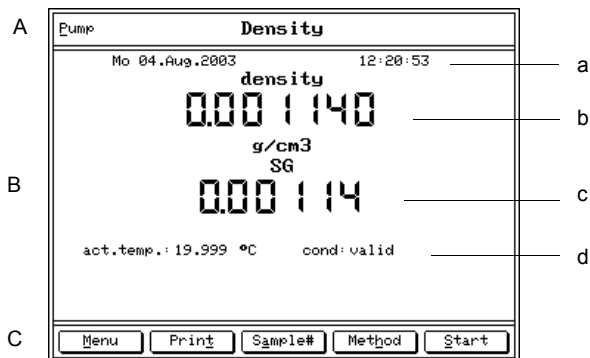


Fig. 6 - 1 The display of the DMA 5000 at the first start-up

A Headline

Pump	"Pump" blinks, if the air pump is switched on.
Density	Name of selected method.
-Osc-	"-Osc-" in the right-hand corner indicates that the density cell is not oscillating. No density or related value will be displayed or printed, the display and printout show "-----".

B Measuring window (example)



Hint:

The size and sequence of the displayed items can be changed in "Menu", "method settings", "display configuration". Density and density-dependent values are only shown after the measuring temperature has been adjusted.

- a) Date and time
- b) Density with automatic viscosity correction
- c) Specific gravity with automatic viscosity
- d) Measuring cell temperature, state of the measurement

C Bottom line

The bottom line specifies the functions of the soft keys positioned on the keypad below. The functions change depending on the menu displayed.

In the measuring mode the following soft key functions are available:

Menu	Selects menus for settings and configurations. Access to a menu can be restricted by a password.
Print	Starts a printout
Sample#	For entering a sample text and/or number
Method	Selects a measuring method (see chapter 7.4)
Start	<ul style="list-style-type: none">• Starts an automatic measuring procedure. Depending on the settings, the automatic measuring procedure includes waiting for a stable measurement, printing the results and storing them in the memory, freezing the display and increasing the sample number.• Starts the temperature scan, if activated (DMA 5000 only).• If a sample changer SP-1m or SP-3m is connected and activated, this soft key is not available. Use the "Start " key on the sample changer.• If an SH-1 or SH-3 sample handling unit is installed and activated, this soft key is named "S-Start".

6.2 Front View

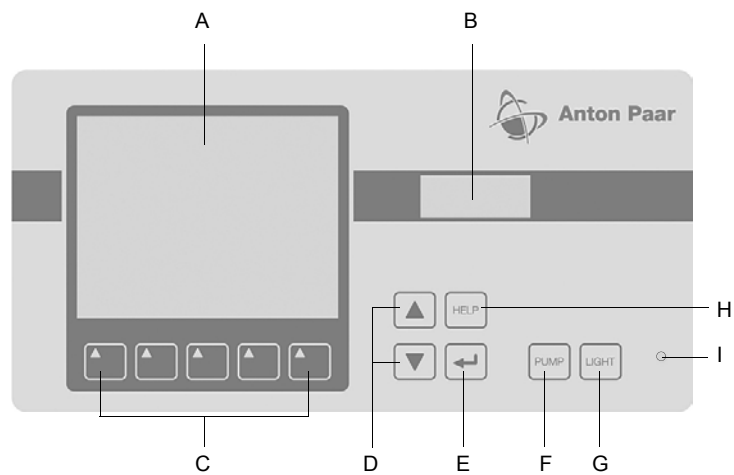


Fig. 6 - 2 Front view and keypad

- A LC display
- B Inspection window for the measuring cell
- C Soft keys
- D "UP" and "DOWN" keys
- E "←" key
- F "PUMP" key for switching on the air pump
- G "LIGHT" key for lighting up the display
- H "HELP" key
- I Green light indicates power-on

6.3 Rear View

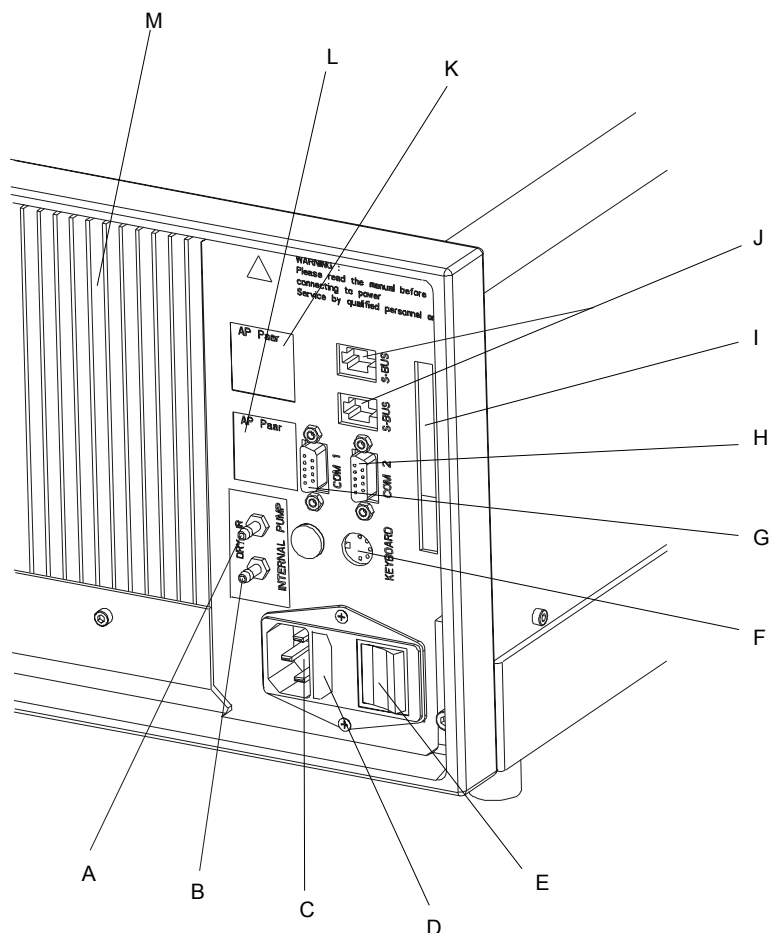


Fig. 6 - 3 Rear view

- A** "DRY AIR PUMP" nozzle for connecting a desiccator (see appendix A)
- B** "DRY AIR INTERNAL" nozzle for supplying the interior of the DMA 4500/5000 with dry air in order to prevent condensations on the cell block at low measuring temperatures (see appendix A)
- C** Power inlet
- D** Fuse holder
- E** Power switch
- F** Keyboard/bar code reader interface
- G** Computer interface (COM 1)
- H** Printer interface (COM 2)
- I** Memory card drive (PCMCIA) for software updates
- J** S-BUS interfaces for connecting a sample changer SP-1m or SP-3m or a density measuring cell DMA HP
- K** Type plate
- L** Technical data shield
- M** Cooling fins

7 General Settings

7.1 Display Contrast

- Make sure that the instrument is set to the measuring mode.
- The display contrast is adjusted by pressing the "UP" or "DOWN" keys.
- Save the setting of the display contrast permanently in the "instrument settings", "save display contrast" menu (see chapter 11.2.6).

7.2 Setting Date and Time

Date and time are set in the "instrument settings", "date & time" menu. Different formats can be selected.

7.3 Setting the Language

Select the language (English or German) in the menu "instrument settings", "language" (see chapter 11.2.6).

7.4 Defining a Method

- A method consists of the following settings: measuring temperature, display settings, printer and memory configuration, measurement settings and control settings for the optional sample changer. These are all stored under a unique method name.
- By defining and storing a method you can set all parameters according to your requirements. 10 different methods can be assigned.
- The 10 methods are factory preset, covering the most common measuring tasks. However, every method can be individually changed, adapted or renamed.
- To activate a method, press the "Method" soft key and select a method from the list.
- To rename the method select "method settings", "edit method name".
- The factory setting for each method can be recalled by selecting "reset method" in the menu "method settings" (see chapter 11.2.7).
- To change or adapt the method, follow chapter 7.5 to chapter 7.11 **in the given order**.

7.5 Setting the Temperature

Set the temperature to degrees Celsius or Fahrenheit in "temperature setting" (see chapter 11.2.3).

7.6 Selecting the Output Data for Display, Printer and Memory

- Select the output data for the display, printer and memory from 7 general domains in the "method settings", "output selection" menu.

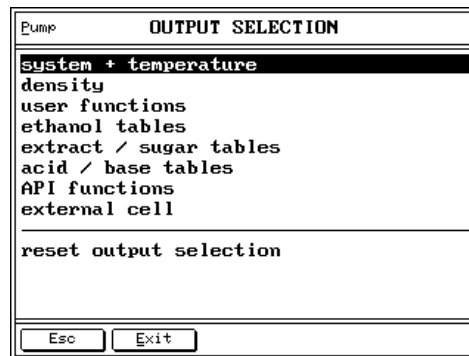


Fig. 7 - 1 Screen: Output selection

- Select items by highlighting them and switching to "Y" (= Yes, activated). Use "↓" to toggle between "Y" and "N" (= No, not activated).

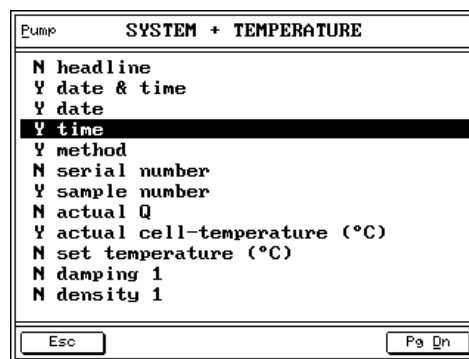


Fig. 7 - 2 Screen: System + Temperature

- Items set to "N" in the left-hand column are not assigned for output and will not appear in the configuration lists for the display, printer and memory.
- Each method has its own output data selection.

7.7 Defining the Display Contents and Layout

- Select the items to be displayed and their size in "method settings", "display configuration", "edit configuration".

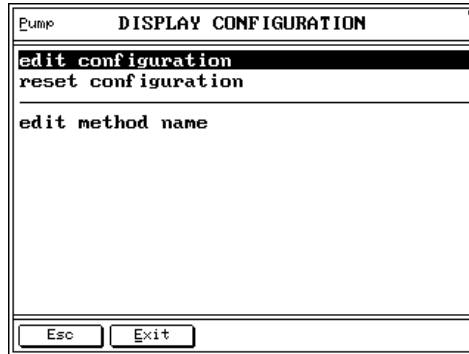


Fig. 7 - 3 Screen: Display configuration

- Determine the size of the information on the display using the "↓" key to toggle between "S" (small), "M" (medium) "L" (large), and "N" (not selected). Example for the "edit display configuration" menu (depends on the "output selection" settings):

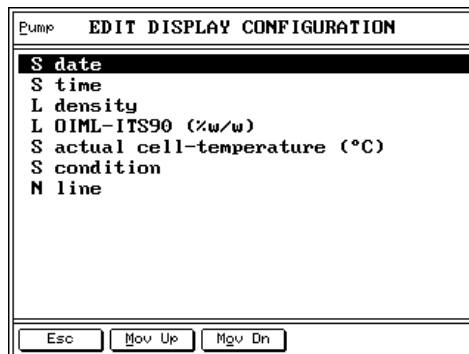


Fig. 7 - 4 Screen: Edit display configuration

- To list the selected items in your preferred order, highlight an item and move it up or down using the "Mov Up" and "Mov Dn" soft keys.
The above selection leads to the following display:

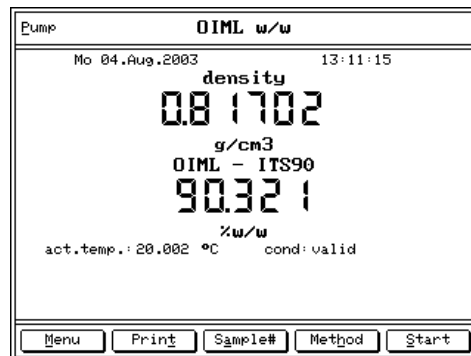


Fig. 7 - 5 Screen: OIML w/w

7.8 Defining the Printout Contents and Layout

- Select the items to be printed in "method settings", "printer configuration", "edit configuration".

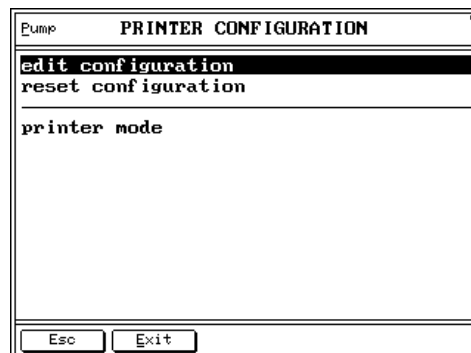


Fig. 7 - 6 Screen: Printer configuration

- Use "↵" to toggle between "Y" (yes, selected) and "N" (no, not selected). Example for the "edit printer configuration" menu (depends on the "output selection" settings):

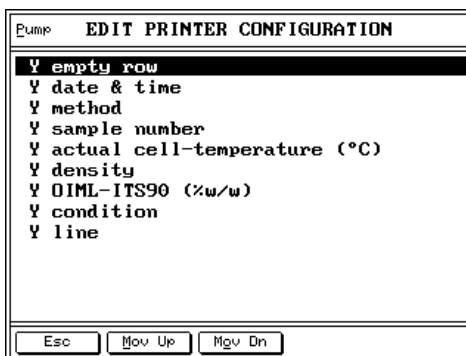


Fig. 7 - 7 Screen: Edit printer configuration

- To have the selected items in your preferred order, highlight an item and move it up or down using the "Mov Up" and "Mov Dn" soft keys.
- In "method settings", "printer configuration", "printer mode", select the mode of printout start, e.g. "manual" for the manual start using the "Print" soft keys or "meas. valid (after start)" for automatic printing after the "Start" soft key has been pressed.

7.9 Storing Measurement Values in the Memory

- Select the items to be stored in the memory in "method settings", "memory configuration", "edit configuration". Use "↵" to toggle between "Y" (yes, selected) and "N" (no, not selected) (see chapter 11.2.7).
- To list the selected items in your preferred order, highlight an item and move it up or down using the "Mov Up" and "Mov Dn" soft keys.
- In "method settings", "memory configuration", "memory mode", select the mode of data storage, e.g. "meas. valid (after start)". Data are then stored after pressing the "Start" or the "S-Start" soft key when the measuring results are valid.

7.10 Settings for the Sample Changer/Handling Unit

- The "sample changer configuration" menu will only be displayed if a sample changer/handling unit is connected and switched on.
- Select "sample changer configuration", "sample changer parameter" to enter the control parameters according to the instruction manual for the sample changers SP-1m and SP-3m.

- Select "sample changer configuration", "edit SHx/SCx mode" to enter the filling and cleaning parameters for the SH-1/SH-3 sample handling units, according to the SH-1/SH-3 instruction manual.
- Select "measurement settings", "sample filling mode: sample changer" and "method settings", "printer configuration", "printer mode", "mode: meas. valid (after start)" and if required also: "memory configuration", "memory mode", "mode: meas.valid (after start)".

7.11 Settings for the Measuring Procedure

- The parameters for the measuring procedure are set in "measurement settings" (see chapter 11.2.5).

MEASUREMENT SETTINGS	
meas. finished by: predetermination	
timeout : 600 sec	
pump terminates meas.: yes	
pump switch off mode: time	
pump switch off time: 300 sec	
type of sample identif.: number	
reset sample identif.: no	
API input: density	
temp. scan : off	temp. step : 0.30 °C
start temp.: +20.00 °C	stop temp. : +21.00 °C
Esc	

Fig. 7 - 8 Screen: Measurement settings

DMA 4500:

Measurement finished by predetermination:

For the fastest results (approx. 1 minute), set this parameter. The DMA 4500 calculates the density before complete temperature equilibrium has been reached.

Measurement finished by equilibrium:

For the highest accuracy results, set this parameter. The DMA 4500 determines the density and concentration after complete temperature equilibrium has been reached.

DMA 5000:

Measurement finished by predetermination:

For the fastest results (approx. 1 minute), set this parameter. The DMA 5000 calculates the density before complete temperature equilibrium has been reached.

For higher accuracy 3 methods can be selected: Equilibrium fast, Equilibrium medium, Equilibrium slow. The highest accuracy is achieved by using Equilibrium slow.

DMA 4500/5000:

- Sample filling mode:
This parameter is only displayed, if a sample changer/sample handling unit is connected. "Manual" filling using a syringe or filling by "sample changer" is possible.
- Pump terminates measurement:
If "yes" is selected, activating the air pump will interrupt the measurement.
- Pump switch off mode:
If "time" is selected the air pump will be switched off automatically after the specified "pump switch off time". Otherwise the air pump has to be switched off manually.
- Select the type of sample identification in "type of sample identif.". Options: number with text, text only or a list, in which a sample identification is given for each sample.
- "reset sample identif.":
Select if the entered sample identification shall be deleted after the measurement.
- API input:
Select the kind of density for calculating the API functions.

8 Checking Procedure, Adjustment and Calibration

8.1 Definitions

Adjustment of the density meter:

- The process of bringing the instrument into a state suitable for use, by setting or adjusting the density instrument constants.
- The adjustment of DMA 4500/5000 is performed with air and bi-distilled water. For adjustments with other substances, see chapter 8.3.3.

Calibration of the density meter:

- Various processes for establishing the relationship between the reference density of measurement standards and the corresponding density reading of the instrument.
- Calibrations are performed to determine the deviation of the displayed density values from the reference values of density standards.

8.2 Checking Procedure: Density Check

The "density check" function allows you either to check the validity of the factory adjustment after transport or the validity of your own adjustments.

- To check the factory adjustment, pure water is used as calibration fluid.
- To check your own adjustments either degassed, bi-distilled water or different density calibration fluids or standardized samples can be used.
- Before each series of measurements check the validity of the adjustment using degassed, bi-distilled water or an appropriate density standard.
- The density check should be performed once every day.



Hint:

Preparation of degassed, bi-distilled water:

1. Boil fresh, bi-distilled water for several minutes to remove dissolved air.
2. Fill a clean glass flask full with the boiled water and cover it.
3. Wait until the water has cooled down to the approx. measuring temperature.

Performing the density check:

1. Select "adjustment", "density check", "density check settings".

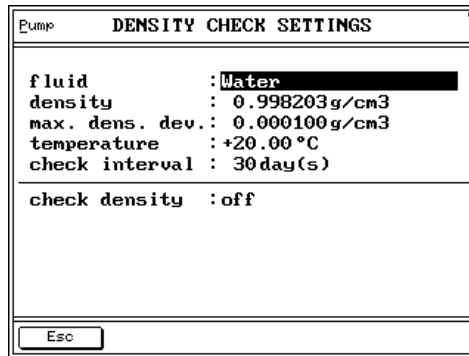


Fig. 8 - 1 Screen: Density check settings

2. Make the settings corresponding to the density-calibration fluid.



Hint:

For water the following settings are recommended:

density: 0.99820 (DMA 4500); 0.998203 (DMA 5000)

max. dens. dev.: 0.00010 g/cm³ (DMA 4500); 0.00005 g/cm³ (DMA 5000)

temperature: +20.00°C

check interval: 1 day

check density: on

Switching on the "check density" activates a memory function: Depending on the setting of the "check interval" a flashing "Density Check Needed" in the headline of the measuring window will appear to remind the user to perform a density check. The check interval can be set between 1 to 999 days.

3. Press the "Esc" key to return to the "density check" menu. Select "check density" to start the density check (the corresponding steps are shown on the display).
4.
 - If the measured density is within the permitted range, the display shows "density check: OK". Routine measurements can be carried out.
 - If the measured density is out of range, the display shows "density check: NOT OK". Clean and dry the measuring cell and repeat the density check. If the result is still "density check: NOT OK", perform a new adjustment (see chapter 8.3).



Hint:

In each case ("density check: OK" or "density check: NOT OK") the measured density and the deviation from the set density are displayed.

5. Up to 50 density checks can be stored with date and time. The activated density check or all stored density checks can be printed out.

8.3 Adjustment

- An adjustment has to be performed if deviations between the displayed values and reference values of density standards exceed the specifications of the DMA 4500/5000 or the specifications of the standard.
- Air and bi-distilled, freshly degassed water are used for normal adjustment.
- The density values of water and dry air at a specific atmospheric pressure are stored in the memory of the DMA 4500/5000 for the complete temperature range.
- A factory setting allows density measurements in the entire temperature range, although adjustment is usually only performed at 20°C.
- If measurements at different temperatures indicate deviations between the displayed values on the DMA 4500/5000 and reference values of density standards, then an air and water adjustment for the whole temperature range is necessary (see chapter 8.3.2).
- It is not recommended and does not improve the performance of the DMA 4500/5000 to adjust if calibrations with suitable density standards indicate no deviations from the reference values.

8.3.1 Adjustment with Air and Water at 20°C

- Normal adjustment is performed using dry air (see appendix A) and bi-distilled, freshly degassed water at 20°C.
- The complete adjustment procedure takes 5 to 10 minutes, if the DMA 4500/5000 is set at 20°C before the adjustment procedure is started.

Adjustment procedure at 20°C:

1. Before adjustment thoroughly clean and dry the measuring cell (see chapter 10).
2. Press the "Menu" key and select the menus "adjustment", "adjust" and "density (air, water)" using the "UP", "DOWN" and "↵" keys.

**Hint:**

If the DMA 4500/5000 is set to any other temperature, it will automatically be switched to 20°C when the adjustment procedure is started.

3. Start the adjustment by pressing the "OK" key.
4. Press the "↵" key and enter the current air pressure using the "UP", "DOWN", "Left", "Right" and "↵" keys or the keyboard.

**Hints:**

- For air adjustment, the current air pressure must be entered, as it influences the air density.
- The density values of water and air at a specific atmospheric pressure for the complete temperature range are stored in the memory.
- If the current on-site barometric pressure is not available, enter the average air pressure (depending on the altitude above sea level) according to the following table:

Altitude above sea level		Air pressure
[m]	[ft]	[mbar]
0	0	1013
400	1312	966
800	2625	921
1200	3937	877
1600	5249	835
2000	6562	795
2400	7874	756
2800	9186	719
3200	10499	683
3600	11811	649

5. Wait until the air adjustment is finished.
6. Note down the current Q value of air in the adjustment report (appendix E).
7. Fill the measuring cell with bi-distilled, freshly degassed water, checking for the presence of bubbles through the inspection window.

**Hint:**

For the degassing of water, see chapter 8.2.

8. Start the water adjustment by pressing the "OK" key.
9. Wait until the water adjustment is finished. Note down the current Q value of water in the adjustment report (appendix E). After pressing the "OK" key the deviation of the new adjustment from the last adjustment performed is displayed at a density of 1 g/cm³.
10. The adjustment is saved by selecting "SAVE" after "recommendation: SAVE" is displayed. The adjustment data are stored and can be printed, if a printer is connected and activated.

- By selecting "REPEAT" after "recommendation: REPEAT" is displayed, the adjustment is repeated (if the deviation is $\geq 0.00005 \text{ g/cm}^3$). Clean the measuring cell first (chapter 10). If the deviation remains unchanged, the adjustment can be stored by selecting "SAVE".



Hint:

If an SH-1 or SH-3 sample handling unit is installed and activated, see chapter 4.4.1 or 5.4.1 of the SH-1/SH-3 instruction manual.

8.3.2 Adjustment with Air and Water for the Entire Temperature Range (Full Range Adjustment)

- If measurements at different temperatures indicate deviations between the displayed values on the DMA 4500/5000 and reference values of density standards, then an air and water adjustment for the whole temperature range is necessary. Dry air (appendix A) and bi-distilled, freshly degassed water are used.
- The adjustment procedure is performed as follows:
 - Air adjustment at 40°C
 - Air adjustment at 60°C
 - Water adjustment at 40°C
 - Water adjustment at 60°C.
- The air and water adjustment for the entire temperature range takes approx. 2 hours.

Full range adjustment procedure:

1. Perform an air and water adjustment at 20°C (see chapter 8.3.1).
2. Thoroughly clean and dry the measuring cell (see chapter 10).
3. Press the "Menu" key and select the menus "adjustment", "adjust" and "density (temperature range)" using the "UP", "DOWN" and "↵" keys.
4. Start the full range adjustment by pressing the "OK" key.
5. Press the "↵" key and enter the current air pressure using the "UP", "DOWN", "Left", "Right" and "↵" keys or the keyboard.

**Hints:**

- For air adjustment, the current air pressure must be entered, as it influences the air density.
- The density values of water and air at a specific atmospheric pressure are stored in the memory of the DMA 4500/5000 for the complete temperature range.
- If the current on-site barometric pressure is not available, enter the average air pressure (depending on the altitude above sea level) according to the table in chapter 8.3.1.

6. The temperature of the measuring cell ("set temperature") is automatically set to 40°C and the air adjustment is performed.
7. After air adjustment at 40°C is finished, the temperature of the measuring cell ("set temperature") is automatically switched to 60°C and an air adjustment at 60°C is performed.
8. Wait until the air adjustment is finished.
9. Degas bi-distilled water by boiling and let it cool down to approx. 60 to 65°C. Inject the water into the measuring cell of the DMA 4500/5000 and check whether the cell is free of any bubbles.

**Hint:**

For the degassing of water, see chapter 8.2.

10. Start the water adjustment by pressing the "OK" key.
11. The cell temperature ("set temperature") is automatically set to 40°C and the water adjustment performed.
12. After water adjustment at 40°C is finished, the temperature of the measuring cell ("set temperature") is automatically switched to 60°C and a water adjustment at 60°C is performed.
13. Wait until the water adjustment is finished and the deviation to the last adjustment performed at a density of 1 g/cm³ is displayed.
14. The adjustment is saved by selecting "SAVE" after "recommendation: SAVE" is displayed. The adjustment data are stored and can be printed, if a printer is connected and activated.
By selecting "REPEAT" after "recommendation: REPEAT" is displayed, the adjustment is repeated. Clean the measuring cell first (chapter 10). If the deviation remains unchanged, the adjustment can be stored by selecting "SAVE".

8.3.3 Special Adjustment

- Special adjustments are user-specific adjustments for special density units, concentrations and temperatures.
- Five different special adjustments can be stored. For each special adjustment name, unit and format of the output can be specified.
- During special adjustment density coefficients are calculated from the oscillation period of two liquids of known density, according to:

$$\rho = A \times Q^2 - B$$

ρ density
 A, B density coefficients
 Q period of oscillation

- The densities of the two liquids that are used for special adjustment have to differ by at least $\Delta\rho = 0.01 \text{ g/cm}^3$.
- The Q-values of the adjustment media have to differ by at least 0.0001.
- Special adjustments can be performed at any set temperature within the specified temperature range (0 to 90°C or 32 to 194°F).
- If the instrument is operated using a special adjustment, the set measuring temperature must be the same as the temperature at which the special adjustment was performed. Otherwise no results will be obtained.
- No viscosity correction is available if the instrument is operated using a special adjustment.
- Only the user functions "user table" and "polynomial" can be used if the instrument is operated using a special adjustment.
- No adjustment history is available for special adjustments.
- The deviation of the B-values with reference to the first B-value of a specific special adjustment cannot be graphically displayed.
- The density coefficients of a special adjustment can only be used for measurements, if the corresponding special adjustment 0, ..., 4 is selected in the menu "method settings", "output selection", "user functions" and "special adjustment".
- As for any other "user function", the special adjustment must be activated in the menu "display configuration", "printer configuration" and "memory configuration".

Special adjustment procedure:

1. The special adjustment is performed at the current set temperature.
2. Press the "Menu" key and select the menu "user functions", "special adjustment" and "special adjustment X" (X = 0, ..., 4).
3. In the menu "output configuration" the name, unit and format of the output can be specified for each special adjustment (see chapter 11.2.9).
4. Select the menu "adjust" and perform the special adjustment as described below.
5. Thoroughly clean and dry the measuring cell (see chapter 10).
6. Fill the density standard 1 into the measuring cell of the DMA 4500/5000 and check whether the cell is free of air bubbles. Continue by pressing the "OK" key.
7. Enter the density or concentration of the density standard 1 in the unit, which you have defined in the menu "output configuration" and start the special adjustment with density standard 1 by pressing the "OK" key.
8. After the special adjustment using density standard 1 is finished, thoroughly clean and dry the measuring cell (chapter 10).
9. Fill the density standard 2 into the measuring cell of the DMA 4500/5000 and check whether the cell is free of air bubbles. Continue by pressing the "OK" key.
10. Enter the density or concentration of density standard 2 in the unit, which you have defined in the menu "output configuration" and start the special adjustment with density standard 2 by pressing the "OK" key.
11. After the special adjustment is finished, the deviation from the last special adjustment performed is displayed.
12. Save the special adjustment by selecting "SAVE". The special adjustment data are stored and can be printed, if a printer is connected and activated. By selecting "REPEAT" the special adjustment is repeated, if necessary. Clean the measuring cell first (chapter 10).
13. Activate the "special adjustment X" (X = 0, ..., 4) in the menu "method settings", "output selection", "user functions" and "special adjustment".

8.4 Calibration

- Calibrations are checking procedures which are carried out using certified liquid density standards.
- The displayed density value on the DMA 4500/5000 is compared to the reference value indicated in the calibration certificate of the liquid density standard, in order to check and document the accuracy of the method.
- The physical properties (density, viscosity) of the liquid density standards should be similar to those of the samples.
- The frequency of calibrations with certified liquid density standards depends on the requirements and the user's judgement. Recommendation: 1 to 2 calibrations per year.
- Notes on the liquid density standards, supplied with the DMA 4500/5000:
 - With the DMA 4500/5000 five small bottles containing ultra pure water (density standard) and the corresponding calibration certificate are supplied with the DMA 4500/5000.
 - The density of the ultra pure water is given at different temperatures with an uncertainty of 0.00001 g/cm^3 at a confidence level of 95%.
 - The listed densities are valid for the time at which the liquids were filled.
 - The calibration liquids should be stored in a cool and dark place!
 - The calibration liquids must be used immediately and only once after the container has been opened!

Calibration procedure:

1. Perform a density check (see chapter 8.2) with water and carry out an adjustment at 20°C (see chapter 8.3.1), if necessary.
2. Thoroughly clean and dry the measuring cell (see chapter 10).
3. Immediately after opening the bottle, inject the liquid density standard without any bubbles into the measuring cell of the DMA 4500/5000.
4. After the measurement is finished, print the result (density at given temperature).
5. Document the calibration procedure in a calibration protocol, which contains the operator's name, date, place, description of the calibration procedure, results and the calibration certificate of the liquid density standard.

9 Measurements

1. Activate the required method using the "Method" soft key.
- A method consists of the measuring temperature, display, printer and memory configurations, and measurement settings, all stored under an individual method name.
 - Method "Density" and a measuring temperature of 20°C are factory default settings.
 - 9 more preset methods (display, memory, printout) are already stored in the DMA 4500/5000, covering the most common measuring tasks. Each of these methods can still easily be altered, renamed and adapted according to your needs.
 - **List of the pre-set methods:**

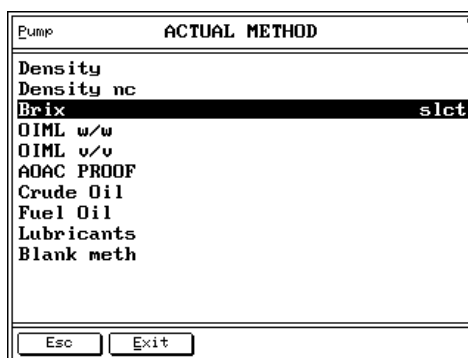


Fig. 9 - 1 Screen: Actual method

- **Density:** Measurement of density and specific gravity including viscosity correction. This method is suitable for highly accurate measurements of the true density of liquids regardless of their viscosity.
- **Density nc:** Measurement of density and specific gravity not viscosity corrected. This method is suitable for samples with a viscosity around 1 mPa.s (dilute aqueous samples) and for comparison measurements with old U-tube density meters not offering viscosity correction.
- **Brix:** Measurement of Brix concentration at 20°C, density with viscosity correction and apparent density with viscosity correction. This method is suitable for measurement of soft drinks and other sugary.

- **OIML w/w:** Measurement of ethanol concentration in % by weight at 20°C according to the OIML table ITS-90, and density with viscosity correction. Suitable for measuring the alcohol concentration of distillates.
- **OIML v/v:** Measurement of ethanol concentration in % by volume at 20°C according to the OIML table ITS-90, and density with viscosity correction. Suitable for measuring the alcohol concentration of distillates.
- **AOAC PROOF:** Measurement of ethanol concentration in % by volume at 60°F according to the AOAC table, and Proof degrees (USA). Measurement performed at 20°C. Suitable for measurement of alcohol concentration in distillates.
- **Crude oil:** Measurement of density viscosity corrected, API density, API number and SG API of the product group crude oil at any temperature corrected to 15°C. For selecting 60°F or 20°C, see chapter 11.2.7.
- **Fuel oil:** Measurement of density viscosity corrected, API density, API number and SG API of the product group fuel to heating oil at any temperature corrected to 15°C. For selecting 60°F or 20°C, see chapter 11.2.7.
- **Lubricants:** Measurement of density viscosity corrected, API density, API number and SG API of the product group lubricants at any temperature corrected to 15°C. For selecting 60°F or 20°C, see chapter 11.2.7.
- **Blank meth:** This method does not contain any settings.

2. Ensure that the measuring cell is clean and dry.
3. Fill the sample into the measuring cell.



Important:

- Before filling any sample into the DMA 4500/5000,
 - make sure that **all wetted parts** made of PTFE (adapters) and borosilicate glass (measuring cell) **are resistant** to the sample. Borosilicate glass is not resistant to samples containing hydrofluoric acid, even in traces.
 - have suitable cleaning fluids at hand for cleaning the measuring cell (see chapter 10).
- If a sample changer SP-1m or SP-3m is connected, check the resistance of the wetted parts. Material information is contained in the instruction manuals for SP-1m and SP-3m.
- Samples with a moderate tendency to corrode borosilicate glass such as strong alkali solutions (e.g. caustic soda) can be measured with the DMA 4500/5000. However, take care to remove such samples immediately after measurement and rinse the measuring cell properly. Check the validity of the adjustment more frequently than generally recommended. Perform a new adjustment, if necessary. The measuring temperature for strong alkali solutions should not be higher than 20°C. Higher temperatures dramatically increase the speed of corrosion.

**Hints:**

- The sample must be homogeneous and free of gas bubbles. Suspensions or emulsions may tend to separate in the measuring cell, giving incorrect results. Such samples should remain in the measuring cell as briefly as possible. It is therefore recommended to pre-thermostat them before filling. It may help to put spacers below the left legs of the DMA 4500/5000, thus putting it at an angle to counter balance the separation force generated by the oscillation of the measuring cell.
- In order to get fast measuring results, activate "predetermin." in the measurement settings" menu.
- Pre-thermostating the sample reduces the measuring time.
- When the DMA 4500/5000 is in the first harmonic oscillation (high-pitched sound), do not fill the sample as this might create bubbles during the filling procedure. Wait until the high-pitched sound (approx. 10 seconds) cannot be heard any more or press "Menu", "Esc" before filling.
- If the sample to be measured tends to form bubbles the substance should be degassed before the measurement. If this is not possible then introduce the sample at a temperature higher than the measuring temperature. Another remedy may be to put the density meter at a slight angle by means of proper spacers below the right side of the DMA 4500/5000 to allow the bubbles to escape (due to buoyancy).

There are several **options for filling the samples** into the measuring cell:

A. **By syringe with Luer tip**, see Fig. 9 - 2.

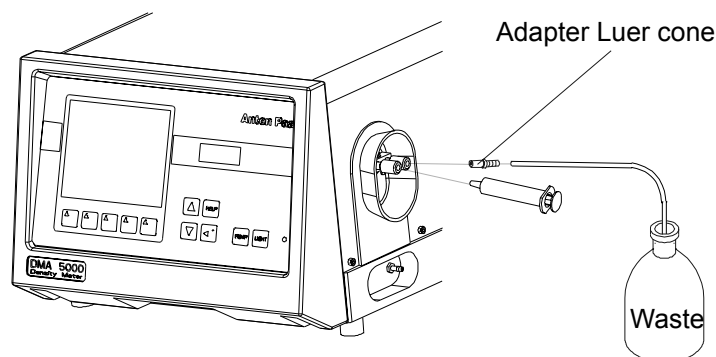


Fig. 9 - 2 Filling, using a syringe

**Hints:**

- Make sure that there is a waste bottle at the outlet of the measuring cell.
- Never fill the samples without the injection adapters Luer (see chapter 5) in order to avoid glass breakage of the measuring cell.
- Attach the syringe to the injection adapter Luer and fill the sample in the measuring cell by pushing the plunger of the syringe slowly and continuously until a drop emerges from the other nozzle.
- The filling of the measuring cell can be observed through the inspection window. Take care that the entire measuring cell is filled with sample. A sample amount of approx. 1.5 ml is necessary.
- Leave the syringe in the filling position, in order to prevent sample leakage.

- B. **By gravity**, using a funnel and a hose at the inlet and a hose with a valve (e.g. a clamp to block the flexible hose) at the outlet.
- C. Automatically, using the Anton Paar **sample changer SP-1m** or **SP-3m**.
- D. Automatically, using the Anton Paar **SH-1** or **SH-3 sample handling unit** (see chapter 4.4.2 or 5.4.2 of the SH-1/SH-3 instruction manual).
- E. Semiautomatically, using a **peristaltic pump**

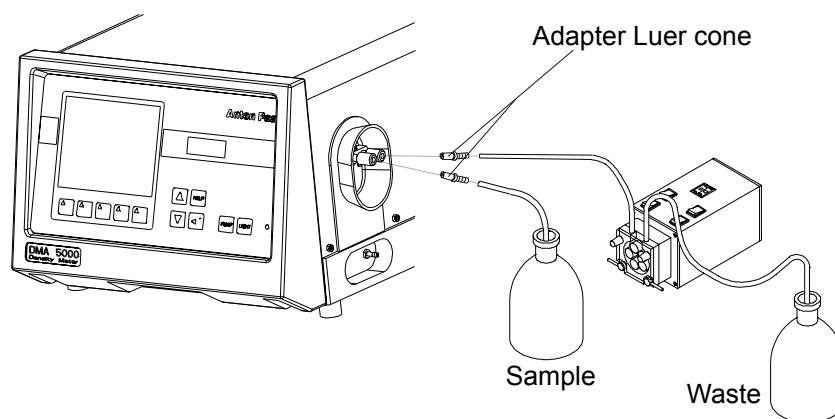


Fig. 9 - 3 Filling, using a peristaltic pump



Hints:

- Use two adapter Luer cone for the hose connections.
- Make sure that there is a waste bottle at the outlet of the peristaltic pump.
- A flow rate of 10 to 25 ml per minute is recommended for filling the sample.
- Make sure that the pump hose is resistant to all samples and cleaning liquids.
- Turn off the pump after filling a sufficient amount of sample.

4. Ensure that there are no gas bubbles in the measuring cell.
5. Print your measuring results.

A. Manual printout:

A manually printout is possible at any time:

- Press soft key "Sample#" to define a sample name and/or sample number.
- Wait until a measuring result is displayed.
- Print the measuring results by pressing the soft key "Print".

B. Automatic printout and data storage:

- If "mode" in the menu "method settings", "printer configuration", "printer mode" is set to "measurement valid" and if "mode" in the menu "method settings", "memory configuration", "memory mode" is set to "measurement valid":

Press soft key "Sample#" to define a sample name and/or sample number. Measuring results are printed and stored automatically as soon as they are valid.

- If "mode" in the menu "method settings", "printer configuration", "printer mode" is set to "meas. valid (after start)" and if "mode" in the menu "method settings", "memory configuration", "memory mode" is set to "meas.valid (after start)":
- Press soft key "Start" or "S-Start". The sample number assigned via "Sample#" is displayed. An acoustic signal and the flashing display indicate that the measurement results are valid. The measuring results are automatically stored and/or printed.
- Press soft key "Esc" to interrupt the measurement or soft key "Cont." to start the next measurement. The numerical part of the sample number is increased automatically, or the next sample number from the list is selected.

Examples for DMA 5000 printouts:

```
-----
We 06.Aug.2003 13:20:05
method:Density
sample:0001
act.cell temp.:20.038 C
density :1.29927 g/cm3
SG :1.30161
condition:pre-determined
-----
```

```
-----
We 06.Aug.2003 13:26:43
method:Density
sample:0001
act.cell temp.:20.000 C
density :1.299325g/cm3
SG :1.30166
condition:valid
-----
```

6. Fill in the next sample or clean and dry the measuring cell in-between, if necessary.



Hints:

- Clean and dry the measuring cell after each measurement if samples with different chemical compositions are to be measured. For similar samples (similar chemical composition and similar density) replace the previous sample by rinsing the measuring cell with a sufficient amount (10 ml or more) of the new sample.
- Do not leave samples in the measuring cell longer than absolutely necessary. Clean and dry the measuring cell as soon as possible.

10 Cleaning and Drying the Measuring Cell



Hint:

Cleaning should be performed with 2 cleaning liquids. Cleaning liquid 1 dissolves and removes residues, cleaning liquid 2 removes cleaning liquid 1 and is easily evaporated by a stream of dry air, in order to accelerate drying in the cell.

1. Fill the measuring cell with cleaning liquid 1 using a syringe with Luer tip. Move the plunger of the syringe in and out several times. This creates gas bubbles which improve the cleaning action. Instead of a syringe, any other suitable device such as a peristaltic pump can be used.



Important:

- Find a suitable cleaning liquid 1 before the first measurement.
- Cleaning liquid 1 should dissolve residues in the measuring cell.
- Cleaning liquid 1 must be selected so that no chemical reactions with the sample and cleaning liquid 2 are to be expected.
- For water-soluble residues water can be used.
- Do not use highly concentrated alcohol as cleaning liquid 1 for proteins, sugar or similar organic residues, because insoluble residues may form in the measuring cell.

2. Remove cleaning liquid 1 from the measuring cell.
3. Fill the measuring cell with cleaning liquid 2 using a syringe with Luer tip. Move the plunger of the syringe several times in and out.



Important:

- Cleaning liquid 2 should be volatile at measuring temperature.
- Cleaning liquid 2 must be selected so that no chemical reactions with cleaning liquid 1 are to be expected.

4. Remove cleaning liquid 2 from the measuring cell.
5. Attach the air hose (see chapter 5) to the injection adapter Luer.



Hint:

Check that the air humidity does not exceed the limits given in appendix A and use a desiccator if necessary.

6. Turn on the air pump using the "PUMP" key.
7. Let dry air blow through the measuring cell for approx. 10 minutes.

8. Turn off the air pump.
9. Remove the air hose from the injection adapter Luer.

11 Operation

11.1 Menu Operation



Fig. 11 - 1 Main menu, audit trail function deactivated

11.1.1 Using the Keys on the Keypad

- To select the main menu press the "Menu" soft key.
- To select menu items use the "UP" or "DOWN" keys and press "↵".
- In the menus found under "method settings", "output selection" and "memory configuration" and "printer configuration" toggle between "Y" (yes, selected) and "N" (no, not selected) using the "↵" key. Move to the next item using the "UP" and "DOWN" keys.
- In the menus found under "method settings", "display configuration" toggle between "N" (no, not selected), "S" (small size), "M" (medium size) and "L" (large size) using the "↵" key. Move to the next item using the "UP" and "DOWN" keys.
- In the other menus, to select a menu item
 - press "↵" to activate the item,
 - move the cursor to the desired position using the "Left" or "Right" soft keys,
 - decrease or increase the numerical value of a digit by using the "UP" or "DOWN" keys,
 - select letters and numbers by using the "UP" or "DOWN" keys,
 - conclude the setting by pressing "↵".
- To return to the previous display press the "Esc" soft key.
- To save changed data press the "Yes" soft key upon the question "Save changes?".
- To return to the measuring mode press the "Exit" soft key.

11.1.2 Using an External Keyboard (Optional)

- Connect a standard PC keyboard to the keyboard connector (PC/AT interface) at the rear of the DMA 4500/5000. If necessary, use an adapter plug (from e.g. PS/2 interface to PC/AT interface). This connector can also be used to plug in a bar code reader for sample ID. With adapters, simultaneous operation of keyboard and bar code reader is possible.
- Set the keyboard type (US or German) in the "instrument settings" menu.
- Execute the same commands as the soft keys by simultaneously pressing "Alt" and the underlined letter of the soft keys on the DMA 4500/5000 display (example: "Alt"+p activates the air pump).
- The "Esc", "UP", "DOWN", "LEFT" and "RIGHT", the "↵" and "BACKSPACE" keys of the keyboard have the same function as on the DMA 4500/5000 keypad.
- Delete characters with "SPACE".
- The F1 key activates the help function.

11.2 Menu Structure and Description



Hint:

For a graphic overview, see the menu tree in the appendix.

11.2.1 "Logoff user "xxx""

This menu is only available if the audit trail function (see chapter 12) is activated.

The current user can log off using this menu. The software activates the login window (see chapter 12.2.1) where a user is asked to login with a user name and a password.

11.2.2 "audit trail"

This menu is only available if the audit trail function (see chapter 12) is activated.

- | | |
|----------------------------|---|
| → view audit trail | All logged operation steps can be displayed (see chapter 12.4). |
| → print audit trail | All logged operation steps can be sent to a connected printer (see chapter 12.5). |

- **export audit trail** The log file can be transferred to a connected PC (see chapter 12.6).
- **clear audit trail** The log file can be deleted (see chapter 12.7).
- **general settings**
 - **audit trail: on/off** The audit trail function can be activated/deactivated.
 - **automatic logoff** An automatic logout after 0 to 1440 minutes can be set. If the DMA 4500/5000 is not in use within the set logoff time, the login window will be displayed asking the user for a new login.
- **user management**
 - **add new user** The administrator can install additional users (see chapter 12.9.1).
 - **remove user** The administrator can remove installed users (see chapter 12.9.2).
 - **change user settings** The settings for installed users can be changed (for details, see chapter 12.9.3 and 12.10)
 - **print user settings** The settings for all installed users are printed (see chapter 12.9.4).

11.2.3 "temperature setting"

Any temperature from 0 to 90°C or 32 to 194°F can be set.

- **set temperature (°C)** Temperature unit in degree Celsius.
- **set temperature (°F)** Temperature unit in degree Fahrenheit.



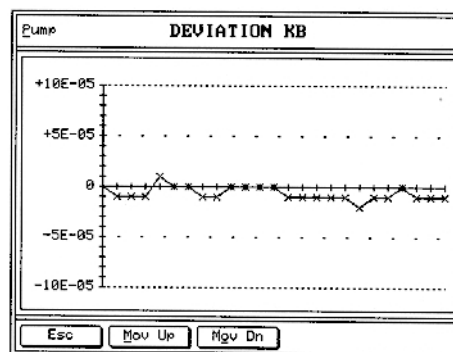
Hint:

Automatic set temperature change see chapter 11.3.1.

11.2.4 "adjustment"

- **adjust**
 - **density (air, water)** Adjustment at 20°C using air and water, detailed description see chapter 8.3.1.
 - **density (temperature range)** Air and water adjustment over the whole temperature range, detailed description see chapter 8.3.2.
 - **high density, viscosity (only DMA 5000)** Adjusting the viscosity correction: The viscosity correction is pre-set at the factory. It is usually not necessary to perform this adjustment on-site. However, if a calibration with suitable standards at known density and high viscosity indicates a measuring error, an adjustment of the viscosity correction can be carried out with density standards of a known density and viscosity. The density standards which are used can also be density standards with a considerably higher density than the density of water. Follow the directions given on the display.
 - **temperature (both sensors)** A service password is required for this menu. To adjust the measuring temperature an external thermometer (CKT 100 or MKT 100) is necessary. Please contact your local Anton Paar representative.
- **view adjustment data**
 - **temperature** The adjustment data of temperature and density sensors for all types of adjustment can be displayed for service and documentation purposes.
 - **measuring sensor:**
 - **R0:** Resistance at 0°C.
 - **a:** Linear constant.
 - **b:** Quadratic constant.
 - **control sensor:**
 - **R0:** Resistance at 0°C.
 - **a:** Linear constant.
 - **b:** Quadratic constant.

→ density	The density coefficients used for calculating the density from the period of oscillation are displayed.
→ KA:	Density coefficients for determination of the viscosity uncorrected density.
→ TKA1:	
→ TKA2:	
→ KB:	
→ TKB1:	
→ TKB2:	
→ KC:	
→ KAK:	Density coefficients for determination of the density with viscosity correction.
→ TKA1K:	
→ TKA2K:	
→ KBK:	
→ TKB1K:	
→ TKB2K:	
→ KCK:	
→ VIS1:	Coefficient 1 for viscosity correction.
→ VIS2:	Coefficient 2 for viscosity correction.
→ Q air:	
→ Q H₂O:	
→ DO air:	Damping number _{air} of the adjustment for air.
→ TK DO air:	Temperature coefficient adjustment damping air.
→ DO H₂O:	Damping number _{water} of the adjustment for water.
→ air pressure:	Air pressure entered before air adjustment.
→ KAOW:	Adjustment constants for the viscosity correction.
→ KBOW:	
→ KCOW:	
→ TKAOW1:	
→ TKAOW2:	
→ TKBOW1:	
→ TKBOW2:	
→ ETAK0:	
→ ETAK1:	
→ ETAK2:	

→ **deviation KB**

- Graphically displays the offsets of the KB-values with reference to the first KB-value displayed. The deviation of KB-values is plotted on the vertical axis, the lines on the horizontal axis represent the 25 most recent adjustments, increasing from left to right
- For the DMA 4500 a different scale is used on the vertical axis.
- Move along the vertical axis using the "UP" and "DOWN" keys.
- For examples and explanations of deviation KB-values see appendix E.

→ **print adjustment data**

For documentation purposes, all adjustment data of the temperature sensors and the density coefficients can be printed.

→ **temperature**

Printout of the latest adjustment data of the temperature sensors.

→ **density**

Printout of the latest density adjustment data.

→ **print adjustment history**

Sequential printout of the 25 most recently performed adjustments.

→ **temperature**

Printout of the 25 most recent temperature adjustment data.

→ **density**

Printout of the 25 most recent density adjustment data.

→ **activate factory adjustment**

This function can be used to reactivate the original factory adjustment. Hereby the present adjustment data are replaced by the factory adjustment data.

→ **temperature**

Activates the temperature factory adjustment.

→ **density**

Activates the density factory adjustment.

- **density check**
 - **check density** This function is used either to check the transport or to check the validity of your own adjustments in routine measurements.
 - **density check settings** Input of following parameters: fluid, density, max. density deviation, temperature, check interval, check density (on/off).
 - **print last density check**
 - **print density check history**

11.2.5 "measurement settings"

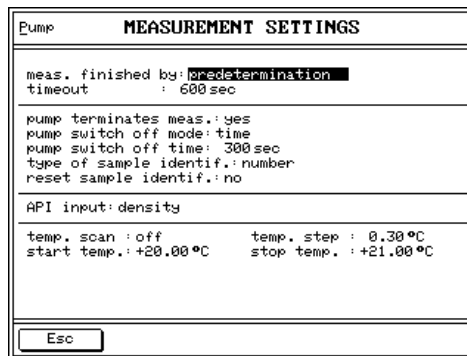


Fig. 11 - 2 Screen: Measurement settings

- **meas. finished by:**
 - **predetermin.** Pre-calculated density results to 5 decimal places (DMA 5000) or 4 decimal places (DMA 4500) before temperature equilibrium is reached.
 - **equilibrium fast/medium/slow** Valid density result to 6 decimal places (DMA 5000) or 5 decimal places (DMA 4500) after temperature equilibrium is reached.
(only DMA 5000)
- **timeout:** Measurement is interrupted if equilibrium is not reached after a preset time of 60 to 7200 sec.
- **sample filling mode:** Menu only displayed if a sample changer/sample handling unit is connected.
 - **manual** Sample filling by syringe or other manual filling device.

- **sample changer**

Automatic sample filling by sample changer/handling unit. If a sample changer is used the "Start" soft key disappears from the bottom line of the display. When using a sample handling unit the "S-Start" soft key appears at the bottom of the display and is used for starting the measurement.
- **pump terminates meas.:**
 - **yes**

Measurement is interrupted while the air pump is turned on.
 - **no**

Measurement is not interrupted although the air pump is turned on.
- **pump switch off mode:**
 - **manual**

The air pump has to be switched off manually.
 - **time**

After the specified "pump switch off time" the air pump is switched off automatically.
- **pump switch off time:**

The air pump is switched off automatically after a preset time between 30 and 3600 sec.
- **type of sample identif.:**
 - **number**

The sample identification for printout, display and storage in the memory is the number entered via the "Sample#" soft key. A pre-text and post-text can be defined. This menu is available with and without sample changer/sample handling unit.
 - **position**

This menu is only displayed if a sample changer/handling unit is connected and activated.
The sample identification for printout, display and storage in the data memory is the position transferred automatically from the sample changer SP-1m/SP-3m or the sample number when using a sample handling unit.

- **text**

The sample identification for printout, display and storage in the data memory is the text entered via the "Sample#" soft key or a bar code reader. This menu is available with and without sample changer/handling unit.
- **lst by nr.**

The sample identification is entered into a list via the "Sample#" soft key or a bar code reader. 60 individual samples can be listed.
- **lst by pos.**

The menu is only displayed if a sample changer/sample handling unit is connected and activated. The sample identification per position of the magazine or per number of measurement is entered into the list via the "Sample#" soft key or a bar code reader.
- **reset sample identif.:**
 - **yes**

The entered sample identification is automatically deleted after the completion of the measurement.
 - **no**

The entered sample identification remains unchanged after the completion of the measurement.
- **API input:**
 - **density (not viscosity correct.)**

The density value without viscosity correction is used for calculating the API functions.
 - **density**

The density value after viscosity correction is used for calculating the API functions.
 - **special adjustment 0**

The density value determined with a special adjustment is used for calculating the API functions. No viscosity correction is available if the instrument is operated using a special adjustment.
 - **special adjustment 4**
 - **external density**

(only if an external cell is connected and activated)

The density value determined with an external cell is used for calculating the API functions.

→ **temperature scan:**
(only DMA 5000)

This function can be used to increase or decrease the measuring temperature automatically in variable increments.

At each defined temperature step within the start/stop temperature a density measurement is performed automatically.



Hints:

- In order to prevent gas bubbles, it is recommended to change the set temperature to the start temperature of the temperature scan (see chapter 11.2.3).
 - scan from high to low temperature.
 - pre-thermostat the sample to the start temperature before filling.
- For automatic printout/storage select "meas. valid (after start)" in the menu "method settings", "printer/memory configuration", "printer/memory mode".
- Predetermination mode is not supported.
- Set the "timeout" to 3600 sec.
- The temperature scan function does not support sample changers/sample handling units.
- The sample identification will remain unchanged during a scan.

→ **on**

Activates the temperature scan function. To start the temperature scan, press the "Start" soft key in the measuring window.

→ **off**

Deactivates the temperature scan function.

→ **start temperature**

Enter a temperature between 0°C and 90°C.

→ **stop temperature**

Enter a temperature between 0°C and 90°C.

→ **temperature step**

Enter the temperature step in °C.

11.2.6 "instrument settings"

- **display illumination**
 - **switch off time:** Screen saving mode (display illumination switches off) after a preset time of 1 to 9 hours after the last key was pressed.
- **save display contrast** The display contrast adjusted in the measuring mode using the "UP" and "DOWN" keys is saved using this menu. After turning on the DMA 4500/5000 the setting is automatically loaded.
- **print instrument information** A list of hardware, software and system information for maintenance and software upgrades is printed using this menu.
- **printer interface configuration** If your printer is different from the Anton Paar standard printer, please consult your printer instruction manual for details. For the printer supplied by Anton Paar, all settings are already undertaken at the factory.
 - **line delimiter:** The line delimiter separates each data string from the next.
 - **<CR><LF>** Carriage return and line feed after each data string.
 - **<CR>** Carriage return after each data string.
 - **<LF>** Line feed after each data string.
 - **handshake:**
 - **hardware (RTS/CTS)**
 - **software (XON/XOFF)**
 - **none**
 - **data bits:**
 - **7**
 - **8**
 - **stop bits:**
 - **1**
 - **2**
 - **parity:**
 - **no**
 - **odd**
 - **even**
 - **baudrate:**
 - **1200**

- 2400
- 4800
- 9600
- **computer interface configuration**
- **line delimiter:**
 - <CR><LF>

If the DMA 4500/5000 is connected to a PC via COM1, the computer interface has to be adjusted depending on the software used for the data transfer from DMA 4500/5000 to the PC.

The line delimiter separates each data string from the next.

Carriage return and line feed after each data string.
 - <CR>

Carriage return after each data string.
 - <LF>

Line feed after each data string.
- **data delimiter:**
 - , (comma)

The data delimiter separates each data within a string from the next.
 - ; (semicolon)
- **handshake:**
 - hardware (RTS/CTS)
 - software (XON/XOFF)
 - none
- **data bits:**
 - 7
 - 8
- **stop bits:**
 - 1
 - 2
- **parity:**
 - no
 - odd
 - even
- **baudrate:**
 - 1200
 - 2400
 - 4800
 - 9600
- **date & time**

Using this menu, the local date and time and the time format can be set as required.

 - **setting**
 - year

- **month**
- **day**
- **hour**
- **minute**
- **second**
- **format**
 - **date format:**
 - **dd.mm.yyyy**
 - **mm/dd/yyyy**
 - **yyyy-mm-dd**
 - **weekday:**
 - **yes**
 - **no**
 - **name of month:**
 - **yes**
 - **no**
 - **time format:**
 - **12h**
 - **24h**
- **language**
 - **english**

Menu in English language.
 - **Deutsch**

Menu in German language.
- **external keyboard type**
 - **type:**
 - **us**
 - **german**

A German keyboard can be connected to the DMA 4500/5000.
- **change password**
 - **new password:**

Activate or change a password for access to the main menu. To disable a password, delete the first character of the former password using "SPACE".
 - **verify:**

Key in the same password to activate it.
- **audit trail**

The audit trail function (see chapter 12) can be activated.

**Hints:**

- After activating the audit trail function, the login window is displayed. The user is asked to login with his user name and password.
- After logging in, the sub-menus "change password" and "audit trail" are not available.

11.2.7 "method settings"

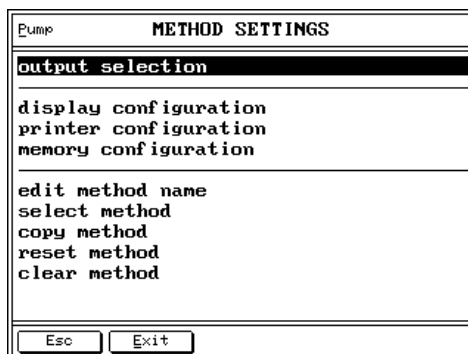
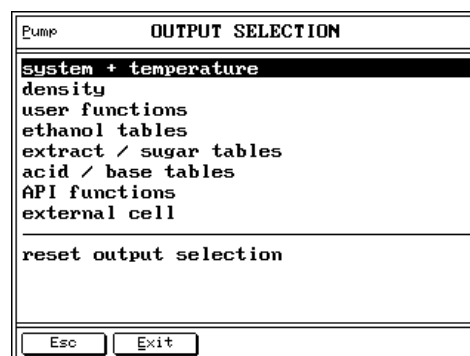


Fig. 11 - 3 Screen: Method settings

→ output selection



- From each listed menu you can select the items you require for output to the display, printer and data memory.
- Only items selected here will be available in the configuration menus for display, printer and data memory.
- Each item can be activated separately in the corresponding menu for display, printer and memory configuration.



Hint:

"external cell" is only displayed if an external cell is connected.

→ system + temperature

- **headline** Headline "DMA4500" or "DMA5000".
- **date & time** Date and time for printout.
- **date** Date for display.
- **time** Time for display.

→ method	Method name for display, printout and memory.
→ serial number	Serial number for display and printout.
→ sample number	Sample number entered via "Sample#" or a bar code reader for printout and memory.
→ actual Q	Quotient of the currently measured period of oscillation of the U-tube divided by the current period of oscillation of the reference oscillator. The DMA 4500/5000 uses this information to calculate the density using the density coefficients.
→ actual cell temperature (°C)	Temperature in the measuring cell in °Celsius measured by the Pt 100 measuring sensor for display, printout and memory.
→ set temperature (°C)	Set temperature in °Celsius.
→ damping 1	Damping represents the energy loss during oscillation caused by sample viscosity, and is used for viscosity correction of the density.
→ density 1	Density determined in the harmonic oscillation of 1 st order.
→ Q 1	Quotient of the currently measured period of oscillation of 1 st order of the U-tube divided by the current period of oscillation of the reference oscillator.
→ e	Viscosity correction factor.
→ period 1	Period of oscillation of the U-tube in the harmonic oscillation of 1 st order.
→ period	Period of oscillation of the U-tube in the harmonic oscillation of 0 th order.
→ actual cell temperature (°F)	Temperature in the measuring cell in °Fahrenheit measured by the Pt 100 measuring sensor.
→ set temperature (°F)	Set temperature in °Fahrenheit.
→ line	Separating line for display or printout. A maximum of 5 separating lines is available.
→ empty row	Line feed for printer; a maximum of 3 line feeds is available.
→ density	

-
- **Q** Final quotient of the period of oscillation of the U-tube divided by the period of oscillation of the reference oscillator when the measurement is finished. Q is used by the DMA 4500/5000 to calculate the density using the adjustment coefficients.
- **density (not viscosity correct.)** Density value without viscosity correction. The density is correct for samples with a viscosity at around 1 mPa.s (water). Noticeable high readings for samples of higher viscosity.
- **density** Density value after viscosity correction.
- **d (not viscosity corrected)**
(only DMA 5000) Density number without viscosity correction. The density number is calculated by subtracting the density of water from the measured density and dividing by the density of water at measuring temperature.
- **d (only DMA 5000)** Density number after viscosity correction.
- **condition** Actual status of the measurement:
- "measuring"
 - "valid"
 - "pre-determined"
 - "attemperating".
- "Valid" appears when the measuring temperature has been reached and the measurement taken. "Pre-determined" appears before the exact measuring temperature has been reached, when the instrument can produce a pre-determined result.
- **Apparent SG** Apparent specific gravity: This is apparent density divided by the apparent density of water at the specified temperature. Apparent density is the weight in air (not mass!) divided by the volume. SG results are reported to 5 decimal places (DMA 5000) or 4 decimal places (DMA 4500).

- **App. density brass** Apparent density referring to scales, which are adjusted with brass weights. Apparent density results are reported with 5 decimal places (DMA 5000) or 4 decimal places (DMA 4500).
- **App. density steel** Apparent density referring to scales, which are adjusted with steel weights. Apparent density results are reported with 5 decimal places (DMA 5000) or 4 decimal places (DMA4500).
- **SG (not viscosity corrected)** Specific gravity without viscosity correction. Specific gravity is the density of the sample at measuring temperature divided by the density of water at a measuring temperature. SG results are reported with 5 decimal places (DMA 5000) or 4 decimal places (DMA 4500).
- **SG** Specific gravity after viscosity correction. SG results are reported with 5 decimal places (DMA 5000) or 4 decimal places (DMA 4500).
- **user functions** Special adjustment, user tables and polynomials can be selected.
- **special adjustment 0** User-specific adjustment for special density units or concentrations, see chapter 8.3.3.
- ...
- **special adjustment 4**
- **polynomial 0 (2D)** 2D-polynomial formulas with 2 freely selectable input parameters to calculate density-related values.
- **polynomial 1 (2D)**
- ...
- **polynomial 9 (2D)**
- **user formula** Result of the user formula.
- **user formula parameter** Parameter p of the user formula.
- **polynomial 0** Polynomial formulas with 1 freely selectable input parameter to calculate density-related values.
- **polynomial 1**
- ...
- **polynomial 4**

-
- **user table 0** User-specified table converting density to concentration or any other related value.
 - **user table 1**
 - **user table 2**
 - **high/low limits** Limit monitoring of a measuring result.
 - **ethanol tables** A variety of tables for the determination of alcohol concentration of alcohol/water mixtures using density is available. The range of all tables is 0 to 100% ethanol.
A density change of $1\text{E-}5 \text{ g/cm}^3$ corresponds to a concentration change of approx. 0.007%.
 - **OIML (%v/v)** Alcohol concentration in percentage by volume according to the International Alcoholometric Tables issued by the International Organisation of Legal Metrology (OIML), temperature according to ITS 68, based on true density at 20°C.
 - **OIML (%w/w)** Alcohol concentration in percentage by weight according to the International Alcoholometric Tables issued by the International Organisation of Legal Metrology (OIML), temperature according to ITS 68, based on true density at 20°C.
 - **OIML-ITS90 (%v/v)** Alcohol concentration in percentage by volume according to the International Alcoholometric Tables issued by the International Organisation of Legal Metrology (OIML), temperature according to ITS 90, based on true density at 20°C.
 - **OIML-ITS90 (%w/w)** Alcohol concentration in percentage by weight according to the International Alcoholometric Tables issued by the International Organisation of Legal Metrology (OIML), temperature according to ITS 90, based on true density at 20°C.

-
- **IUPAC (%v/v)** Alcohol concentration in percentage by volume according to the International Union of Pure and Applied Chemistry, based on true density at 20°C. The measuring temperature **must** be 20°C (68°F).
 - **IUPAC (%w/w)** Alcohol concentration in percentage by weight according to the International Union of Pure and Applied Chemistry, based on true density at 20°C. The measuring temperature **must** be 20°C (68°F).
 - **KAEMPF (%v/v)** Alcohol concentration in percentage by volume according to W. KAEMPF, based on true density at 20°C.
 - **KAEMPF (%w/w)** Alcohol concentration in percentage by weight according to W. KAEMPF, based on true density at 20°C.
 - **AOAC 60°F (%v/v)** Alcohol concentration in percentage by volume at 15.56°C (60°F) according to the AOAC (American Organization of Analytical Chemists) Tables, based on true density at 20°C. The measuring temperature **must** be 20°C (68°F).
 - **AOAC (nc) 60°F (%v/v)** Alcohol concentration in percentage by volume at 15.56°C (60°F) according to the AOAC (American Organization of Analytical Chemists) Tables, based on true density without viscosity correction at 20°C. The measuring temperature **must** be 20°C (68°F).
 - **Proof 60°F** Alcohol concentration in Proof degrees at 15.56°C (60°F), based on true density at 20°C.
 - **Proof (nc) 60°F** Alcohol concentration in Proof degrees at 15.56°C (60°F), based on true density without viscosity correction at 20°C.
 - **HM C&E (%v/v)** Alcohol concentration in percentage by volume according to the HM C&E Table at 20°C.
 - **HM C&E (%w/w)** Alcohol concentration in percentage by weight according to the HM C&E Table at 20°C.

- **extract/sugar tables** 2 tables for the determination of saccharose/extract concentration of sugar in water using density are available. The range of both tables is 0 to 100%.
A density change of $1\text{E-}5 \text{ g/cm}^3$ corresponds to a concentration change of approx. 0.002%.
- **concentration (°Brix)** Saccharose concentration in percentage by weight according to the NBS Table 113, based on true density at 20°C.
- **concentration (°Plato)** Extract concentration in percentage by weight according to the Plato table, based on true density at 20°C.
- **concentration (°Baumé)** Concentration unit according to the given formulas below, based on specific gravity at set temperature (t).
For liquids heavier than water:
$$^{\circ}\text{Be} = (145 \times \text{SG}_{t/t} - 145) / \text{SG}_{t/t}$$

For liquids lighter than water:
$$^{\circ}\text{Be} = (140 - 130 \times \text{SG}_{t/t}) / \text{SG}_{t/t}$$
- **acid/base tables** A variety of acid/base concentration equations are stored in the DMA 4500/5000, many more are available on request.
- **hydrochloric acid (HCl) (%w/w)** Aqueous hydrochloric acid concentration in percentage by weight according to the CRC Handbook of Chemistry and Physics, based on true density at 20°C, range 0 to 40%. Accuracy approx. 0.02%.
- **sodium hydroxide (NaOH) (%w/w)** Aqueous sodium hydroxide concentration in percentage by weight according to Landolt-Boernstein, based on true density at 20°C, range 0 to 50%. Accuracy approx. 0.04%.
- **phosphoric acid (H₃PO₄) (%w/w)** Aqueous phosphoric acid concentration in percentage by weight according to Landolt-Boernstein, based on true density at 20°C, range 0 to 100%. Accuracy approx. 0.06%.

- **nitric acid (HNO₃) (%w/w)** Aqueous nitric acid concentration in percentage by weight according to Landolt-Boernstein, based on true density at 20°C, range 0 to 100%. Accuracy approx. 0.07%.
- **sulfuric acid (H₂SO₄) (%w/w)** Aqueous sulfuric acid concentration in percentage by weight according to the CRC Handbook of Chemistry and Physics, based on true density at 20°C, range 0 to 94%. Accuracy approx. 0.05%.
- **API functions** The API functions automatically convert the density values of petroleum samples measured at any temperature to density, API gravity or specific gravity at 15°C or 60°F, according to ASTM D1250-80 and DIN 51757. Additionally the same API functions are available for a reference temperature of 20°C according to the "IP Petroleum Measurement Paper No. 3, 1988". In the menu " measurement settings" the density input value for the API function can be selected. The samples are divided into the groups crude oil (group A), fuel to heating oil (group B) and lubricants (group D).
- **dens. API 15°C-C (crude oil)** Conversion of crude oil density at measuring temperature to density at 15°C.
- **dens. API 60°F-C (crude oil)** Conversion of crude oil density at measuring temperature to density at 60°F.
- **dens. API 20°C-C (crude oil)** Conversion of crude oil density at measuring temperature to density at 20°C.
- **dens. API 15°C-L (lubricating oil)** Conversion of lubricating oil density at measuring temperature to density at 15°C.
- **dens. API 60°F-L (lubricating oil)** Conversion of lubricating oil density at measuring temperature to density at 60°F.
- **dens. API 20°C-L (lubricating oil)** Conversion of lubricating oil density at measuring temperature to density at 20°C.

→ dens. API 15°C-F (fuel, heating oil)	Conversion of fuel density at measuring temperature to density at 15°C.
→ dens. API 60°F-F (fuel, heating oil)	Conversion of fuel density at measuring temperature to density at 60°F.
→ dens. API 20°C-F (fuel, heating oil)	Conversion of fuel density at measuring temperature to density at 20°C.
→ API 15°C-C (crude oil)	API gravity of crude oil converted to 15°C.
→ API 60°F-C (crude oil)	API gravity of crude oil converted to 60°F.
→ API 20°C-C (crude oil)	API gravity of crude oil converted to 20°C.
→ API 15°C-L (lubricating oil)	API gravity of lubricating oil converted to 15°C.
→ API 60°F-L (lubricating oil)	API gravity of lubricating oil converted to 60°F.
→ API 20°C-L (lubricating oil)	API gravity of lubricating oil converted to 20°C.
→ API 15°C-F (fuel, heating oil)	API gravity of fuel converted to 15°C.
→ API 60°F-F (fuel, heating oil)	API gravity of fuel converted to 60°F.
→ API 20°C-F (fuel, heating oil)	API gravity of fuel converted to 20°C.
→ SG API 15°C-C (crude oil)	Specific gravity of crude oil converted to 15°C.
→ SG API 60°F-C (crude oil)	Specific gravity of crude oil converted to 60°F.
→ SG API 20°C-C (crude oil)	Specific gravity of crude oil converted to 20°C.
→ SG API 15°C-L (lubricating oil)	Specific gravity of lubricating oil converted to 15°C.
→ SG API 60°F-L (lubricating oil)	Specific gravity of lubricating oil converted to 60°F.
→ SG API 20°C-L (lubricating oil)	Specific gravity of lubricating oil converted to 20°C.
→ SG API 15°C-F (fuel, heating oil)	Specific gravity of fuel converted to 15°C.
→ SG API 60°F-F (fuel, heating oil)	Specific gravity of fuel converted to 60°F.
→ SG API 20°C-F (fuel, heating oil)	Specific gravity of fuel converted to 20°C.

- **reset output selection** Resets the complete output selection to the factory default setting. Display, printer and memory settings will be influenced.
- **display configuration** The display of the DMA 4500/5000 can be easily custom-designed.
- **edit configuration** "S" (small), "M" (medium), "L" (large) size, "N" (not selected). Only items activated in "output selection" are listed. A maximum of 20 data can be activated.
- **reset configuration** Resets the display configuration to the factory default setting.
- **edit method name** Issues or changes an individual name for the activated method.
- **printer configuration** The printout can be easily custom-designed.
- **edit configuration** Selection of items to be printed, "Y" (yes), "N" (no). Only items activated in "output selection" are listed. A maximum of 30 data can be activated.
- **reset configuration** Resets the printer configuration to the factory default setting.
- **printer mode**
 - **mode:**
 - **manual**
 - **interval**
 - **measurement valid**
 - **meas. valid after start**
 - **interval:** Interval for automatic printout, 15 to 65535 sec.
- **memory configuration** A total of 100 measurements can be stored in the memory. When the memory is full, the oldest measurement is replaced by the new one. Data in the memory can be recalled, printed, transmitted to a PC, and statistically evaluated.
- **edit configuration** Selection of items to be saved in the data memory, "Y" (yes), "N" (no). Only items chosen in "output selection" will be listed. A maximum of 5 items per measurement result can be stored. In addition date and time are automatically stored.

- **reset configuration** Resets the memory configuration to the factory default setting.
- **memory mode**
 - **mode:**
 - **switched off**
 - **interval**
 - **measurement valid**
 - **meas. valid after start**
 - **interval:** Interval for automatic data storage, 15 to 65535 sec.
- **edit method name** Issues or changes an individual name for the activated method.
- **select method** Selects the measuring method.
- **copy method** The complete configuration of the activated method is copied to the selected target method.
- **reset method** The complete configuration of the activated method is reset to the factory setting.
- **clear method** The complete configuration of the activated method is deleted.

11.2.8 "sample changer configuration"

- This menu is only available if a sample changer/handling unit is connected.
 - If an SH-1 or SH-3 sample handling unit is used the measurement is started by pressing the "S-Start" soft key. For detailed information about SH-1 and SH-3 cleaning and filling parameters, see the SH-1/SH-3 instruction manual.
 - If an SP-1m or SP-3m sample changer is connected, the measurement is started by pressing the "Start" key on the SP-1m or SP-3m. The "Start" soft key of the DMA 4500/5000 is not available.
- **sample changer configuration** Selects all filling parameters for the sample changers SP-1m or SP-3m.
 - **sample changer parameter** A 7-digit number controls the filling procedure. Refer to the instruction manual of the SP-1m or SP-3m.
 - **measurement:** If an SP-3m is connected, each sample from one vial can be measured either once or twice.
 - **single**
 - **double**

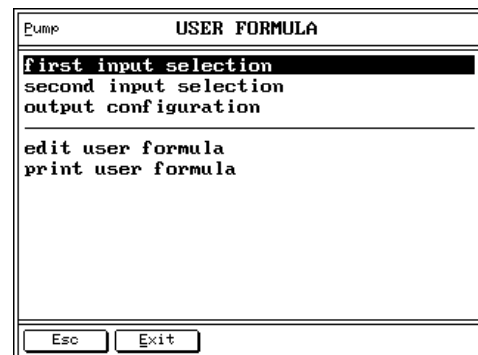
11.2.9 "user functions"

- 1 user-specified formula, 3 user-specified tables, 5 user-specified polynomial equations and 10 user-specified 2D-polynomial equations can be defined to calculate density-related values.
- The formula result can be used as an input value either for the polynomial or the user table. The polynomial result can be used as an input value either for a further polynomial or a user-table.
- 5 user-specific adjustments for special density units, concentrations and temperatures can be performed (see chapter 8.3.3). No adjustment history and no viscosity correction are available for this function.
- A high/low limits function is available for limit monitoring measuring results. Depending on the measuring results and on the specified limits, "too low/OK/too high" will be reported.
- Activates the user formula, user table, polynomial, special adjustment or limit monitoring in the "method settings", "output selection", "user functions" menu to make them available for display, printer and memory configurations.

- **special adjustment** Adjustments for special density units, concentrations and temperatures, see chapter 8.3.3. No viscosity correction or adjustment history is available if the instrument is operated using a special adjustment.
- **special adjustment 0**
- **output configuration** For each special adjustment, name, unit and format of the output can be specified.
- **terms**
- **name** Name of the special adjustment, maximum of 20 characters.
- **unit** Unit of the result, maximum of 5 characters.
- **format**
- **leading digits:** Maximum of 3 digits before the decimal point.
- **trailing digits:** Maximum of 6 digits after the decimal point.
- **exponential:** Enable or disable exponential format.
- **sign:** Enable or disable the sign before the output result.

- **adjust** Adjustment at "set temperature", using two density standards of your choice. For adjustment to special density units or single temperatures, using air and water is recommended.
- **view special adjustment data** Display of special adjustment data.
 - **coef A:** Coefficient A
 - **coef B:** Coefficient B
 - **temp:** Temperature
- **print special adjustment data** Printout of special adjustment data.
- **special adjustment 1**
- ...
- **special adjustment 4**
- **polynomials (2D)**
- **polynomial 0 (2D)** 10# 2D-polynomial formulas are provided to calculate density-related values.
- **first input selection** The first input value (x) for the polynomial (2D) can be selected from the displayed list.
 - **actual Q**
 - **actual cell temperature (°C)**
 -
 - **SG**
- **second input selection** The second input value (y) for the polynomial (2D) can be selected from the displayed list.
 - **actual Q**
 - **actual cell temperature (°C)**
 -
 - **SG**
- **output configuration** For each polynomial formula, name, unit and format of the output can be specified.
 - **terms**
 - **name** Name of the polynomial, maximum of 20 characters.
 - **unit** Unit of the result, maximum of 5 characters.
 - **format**
 - **leading digits:** Maximum of 4 digits before the decimal point.

- **trailing digits:** Maximum of 6 digits after the decimal point.
- **exponential:** Enable or disable exponential format.
- **sign:** Enable or disable the sign before the output result.
- **clear polynomial** Deletes all polynomial coefficients, name and settings.
- **edit coefficients** For each polynomial a maximum of 10 coefficients can be entered.
 Polynomial formula:
 Output = Coeff 00 + Coeff 01 * y +
 Coeff 02 * y² + Coeff 03 * y³ +
 Coeff 10 * x + Coeff 11 * x * y +
 Coeff 12 * x * y² + Coeff 20 * x² +
 Coeff 21 * x² * y + Coeff 30 * x³
 xfirst selected input value
 ysecond selected input value
 Coefficients can be calculated from density/concentration data.
- **[0,0]:** Coefficients can be entered in decimal or exponential format, including the sign.
- **[0,1]:**
- **...**
- **[3,0]:**
- **print coefficients** Printout of all coefficients.
- **polynomial 1 (2D)**
- **...**
- **polynomial 9 (2D)**
- **user formula**



- **first input selection** The first input value for the user formula can be selected from the displayed list. The most frequently used value is "density".

- **second input selection** The second input value for the user formula can be selected from the displayed list.
- **output configuration**
 - **terms**
 - **name** Name of the formula, maximum of 20 characters.
 - **unit** Unit of the result, maximum of 5 characters.
 - **format**
 - **leading digits:** Maximum of 4 digits before the decimal point.
 - **trailing digits:** Maximum of 6 digits after the decimal point.
 - **exponential:** Enable or disable exponential format.
 - **sign:** Enable or disable the sign before the output result.
- **edit user formula** The formula can be edited by two input values, parameter, operators and constants.
- **input value x:** This value is chosen in the user formula menu "first input selection".
- **input value y:** This value is chosen in the user formula menu "second input selection".
- **parameter p:** The parameter p has to be entered as an external value by pressing ENTER before the measurement.
- **operators:** +, -, *, /, (,) can be used.
- **constants:** any number
- **print user formula** Printout of the user formula and the parameter p.
- **polynomials**
 - **polynomial 0** 5 fourth order polynomial formulas are provided to calculate density-related values.

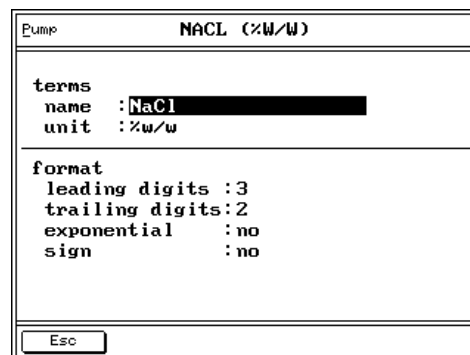
- **input selection** For each polynomial an individual input can be selected from the displayed listing. The most common input is density.
 - **actual Q**
 - **actual cell temperature (°C)**
 - **SG**
- **output configuration** For each polynomial formula, name, unit and format of the output can be specified.
 - **terms**
 - **name** Name of the polynomial, maximum of 20 characters.
 - **unit** Unit of the result, maximum of 5 characters.
 - **format**
 - **leading digits:** Maximum of 4 digits before the decimal point.
 - **trailing digits:** Maximum of 6 digits after the decimal point.
 - **exponential:** Enable or disable exponential format.
 - **sign:** Enable or disable the sign before the output result.
- **clear polynomial** Deletes all polynomial coefficients, name and settings.
- **edit coefficients** For each polynomial a maximum of 5 coefficients can be entered.

Polynomial formula:

$$\text{Output} = \text{coef } 0 + \text{coef } 1 \times (\text{input}) + \text{coef } 2 \times (\text{input})^2 + \text{coef } 3 \times (\text{input})^3 + \text{coef } 4 \times (\text{input})^4$$
 Coefficients can be calculated from density/concentration data. Coefficient 0 always must be accompanied by at least one other coefficient to allow correct calculation.

 - **coef 0:** Coefficients can be entered in decimal or exponential format, including the sign.
 - **coef 1:**
 - **coef 4:**
- **print coefficients** Printout of all coefficients.

- **data diagram** Graphically displays the polynomial function within two input values (e.g. density).
- **min. value:** Lower input value.
- **max. value:** Upper input value.
- **polynomial 1**
- ...
- **polynomial 4**
- **user tables**
- **user table 0** 3 user-specified tables for converting density-related values are available.
- **input selection** For each table an individual input can be selected from the displayed listing. The most common input is density.
- **actual Q**
- **actual cell temperature (°C)**
- ...
- **SG**
- **output configuration** The result calculated from the input is called output. For each table, the name, unit and format of the output can be specified.



- **terms**
 - **name** Name of the table, maximum of 20 characters.
 - **unit** Unit of the result, maximum of 5 characters.
- **format**
 - **leading digits:** Maximum of 4 digits before the decimal point.
 - **trailing digits:** Maximum of 6 digits after the decimal point.
 - **exponential:** Enable or disable exponential format.
 - **sign:** Enable or disable the sign before the output result.

- **clear table**
- **edit table data**

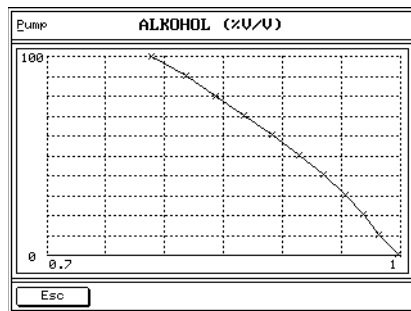
- **print table data**
- **data diagram**

Deletes all table values, name and settings.

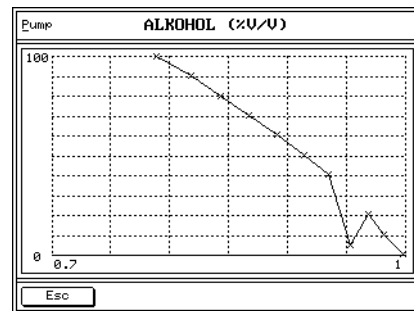
The table data are entered in data pairs. A maximum of 100 data pairs can be entered into one table. Table data can be entered in random sequence and will be automatically put in order.

Printout of all data pairs.

Graphically displays the table data.



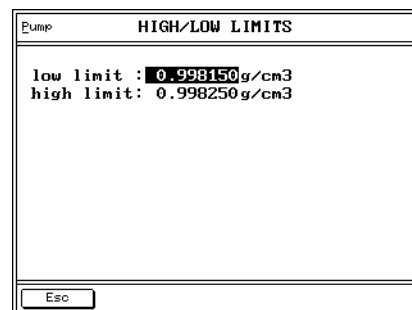
Correct table data.



Incorrect table data due to e.g. typing error

- **user table 1**
- **user table 2**
- **high / low limits**

Limit monitoring at a measuring result. The high/low limits are factory preset to 0.99825 g/cm³ and 0.99815 g/cm³, and are used in the "Dens Check" method in order to verify the validity of the actual adjustment. The preset high/low limits can be changed according to your preference.



- **input selection**
- **edit limits**

Selects the measuring result to be supervised from the displayed listing.

Defines the lower and upper limit.

→ low limit:	Lower limit
→ high limit:	Upper limit
→ print limits	Printout of the lower and upper limit.
→ user formula parameter	Enters the parameter p for the user formula

11.2.10 "custom function verification"

- The DMA 4500/5000 can be used to calculate concentrations and other density related results from manually entered density values using the built-in custom functions, tables or polynomials.
- Only items selected in the display configuration are available. Tables, formulas or functions not selected in "method settings", "display configuration" cannot be used for custom function verification.
- Select the table, polynomial formula or function from the list, and enter the required input value.
- Press "Calc" to perform the calculation.
- If API functions or SG functions are selected, the measuring temperature is also required.
- If results cannot be calculated, "-----" appears on the display (out of range).

11.2.11 "data memory"

→ browser	<p>Display of stored data.</p> <ul style="list-style-type: none"> • Browse through the stored measurements using the "UP" and "DOWN" keys. Only stored data of the currently activated method will be displayed. • Select the data to be used for statistical analysis using the "Stat." soft key. • Display the oldest stored value using the "Oldest" soft key, display the latest stored value using the "Newest" soft key. • Delete all stored data using the "Clear" soft key. The information "fetched by host computer: Y/N" shows whether the displayed stored data has been transmitted to a PC.
------------------	---

**Hint:**

"Clear" deletes all data of all methods in the memory.

- **print** Printout of all stored data. Stop the printout using the "Abort" soft key.
- **statistics** Calculation of mean value and standard deviation of the data selected in "browser", "Stat.". Print the results using the "Print" soft key.

11.2.12 External Cell

The external cell DMA HP (or the former models DMA 512 or DMA 602) can be connected to the DMA 4500/5000. For detailed information, refer to the corresponding instruction manual of the external cell.

11.2.13 "testmode"

To check instrument functions, basic measuring data of the DMA 4500/5000 can be displayed or printed. Toggle between the harmonic oscillation of 0th and 1st order using the "Mode" soft key. Toggle between the phase-shifted and not phase-shifted oscillation using the "Phase" soft key.

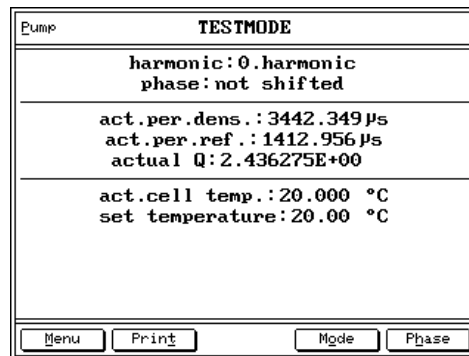


Fig. 11 - 4 Screen: Testmode

11.2.14 "service testmode"

Basic measuring data of the DMA 4500/5000 can be displayed or printed for service and maintenance purposes. The instrument switches automatically from harmonic oscillation of 1st order to 0th order.

11.3 "Sample#"

According to the settings in "measurement settings", "type of sample identif.", this soft key has different functions.

- - For sample identification by "**number**" a sample number and text before and after the number can be entered.
 - This sample number is available with or without sample changer/sample handling unit.
 - Entry of the sample number can be done through the soft keys, a PC keyboard or a bar code reader.



Hint:

A bar code reader replaces a keyboard. Therefore, the terminator of an entry must be ENTER.

- After pressing the "Start" or "S-Start" soft key the sample number will be displayed.
 - Pressing the "Cont." soft key will automatically increase the number by 1.
- **number** A 4-digit number can be entered.
 - **pre-text** Text with a maximum 8 characters can be entered before the sample number.
 - **post-text** Text with a maximum of 8 characters can be entered after the sample number.
- - The sample identification mode by "**position**" is only available if a sample changer/handling unit is connected and activated.
 - For sample identification, the sample position is transferred from the sample changer SP-1m or SP-3m to the DMA 4500/5000.
 - Using an SH-1 or SH-3 sample handling unit, the "position" number is automatically increased by 1, when a new measurement is started by pressing the "S-Start" soft key on the display.
- **position**
 - **pre-text** Text with a maximum of 8 characters can be entered before the sample number.
 - **post-text** Text with a maximum of 8 characters can be entered after the sample number.
- For sample identification by "**text**", a text of a maximum of 20 characters can be entered.
- **text** Sample name.

- For sample identification by "**list by number**", a list of up to 60 individually selected numbers or texts can be entered in 5 sequential tables. When a series of measurements is started by "Start" and continued with "Cont", the numbers or texts are assigned to each sample in the given sequence. This mode is available only without sample changer/sample handling unit.

→ **actual text:** Current position in the list. When the measurement is started by "Start", this number or text will be assigned to the first sample.

→ **text 1:** Key in number or text of sample.

→ **text 2:**

...

→ **text 60:**

- - For sample identification by "**list by position**", a list of up to 60 individually selected numbers or texts can be entered in 5 sequential tables.
 - This menu is only available if a sample changer/handling unit is connected and activated.
 - Each position of the SP-1m or SP-3m sample changer magazine is assigned with a number or text from the list.

→ **actual text:** Current position of the SP-1m or SP-3m sample changer magazine or current sample number when using a sample handling unit.

→ **text 1:** Key in number or text of sample.

→ **text 2:**

...

→ **text 60:**



Hint:

The menu "measurement settings" offers the possibility to delete the sample identification automatically after the completion of the measurement (see chapter 11.2.5).

11.3.1 Automatic Set Temperature Change via "sample#"

For some purposes it is useful to have an automated change in the measuring temperature. It is therefore possible to enter the appropriate temperature together with the name of the sample to be measured. This is done using the "sample#" - key.

Automatic activation:

The appropriate measuring temperature for each sample can be pre-defined in the sample identification using "%nn.nn" at any position, where "nn.nn" defines the measuring temperature. The selected temperature will be activated automatically when starting the next measurement.

If no measuring temperature has been entered, the DMA 4500/5000 will change to the temperature which has been entered in the menu "temperature setting", "set temperature".

**Hint:**

The temperature has to be entered in °C.

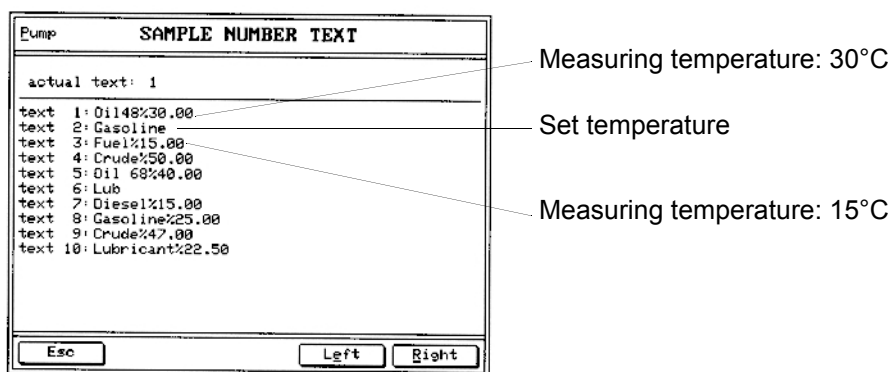


Fig. 11 - 5 Screen: Sample number text

12 Audit Trail

12.1 Introduction

The "audit trail" function electronically documents all operating steps carried out by a user (which may lead to a change in the measuring value) and stores these in a tamper-proof log file. "audit trail" therefore guarantees the traceability of all procedures.

The tamper-proof documentation of operating procedures is especially important for applications with safety requirements (pharmacy, food technology, biotechnology).

12.2 Activating / Deactivating Audit Trail

12.2.1 Activating Audit Trail

To activate "audit trail", select "audit trail" in the menu "instrument settings" and confirm with "↵".

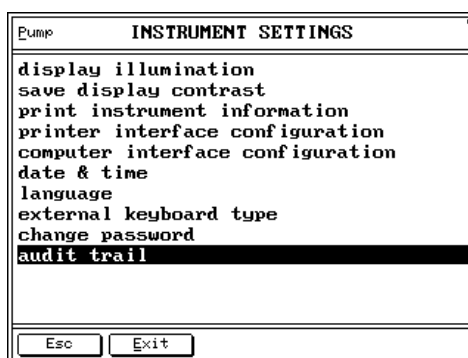


Fig. 12 - 1 Menu: Instrument settings

Switch "audit trail" to "on" and press the "Esc" key. Answer the question "Save changes?" with "Yes".



Fig. 12 - 2 Menu: Instrument settings/audit trail

The following window is shown. Log in with your user name and password:

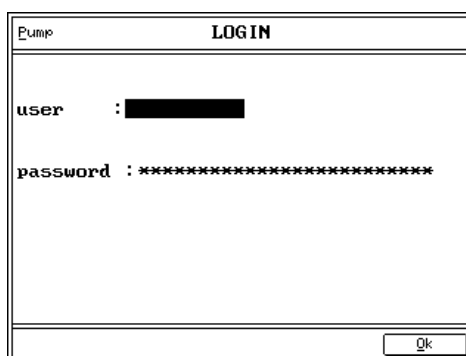


Fig. 12 - 3 Audit trail: Login



Hints:

- The first time you log in, there are 3 options available:
 - a) Login as administrator with the user name "admin" and the password "admin".
 - b) Login as main user with the user name "user" and the password "user".
 - c) Login as user with the user name "guest" and the password "guest".
- The different privileges associated with these options are described in chapter 12.10.

After login, the measuring window appears. The "audit trail" function is now activated.



Hint:

- After logging in as the administrator for the first time with user name "admin" and password "admin", we recommend changing the password to protect your data.
- If needed, the administrator can define other administrators with other user names and passwords (see also chapter 12.9.3).

12.2.2 Deactivating Audit Trail

Press the "Menu" key to enter the main menu.

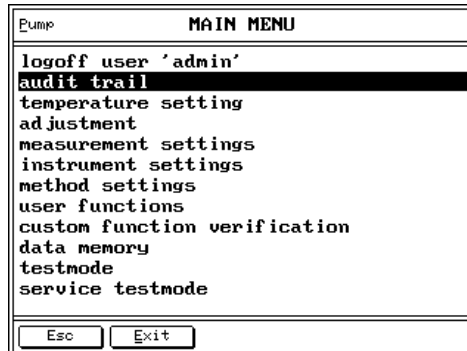


Fig. 12 - 4 Main menu

Select "audit trail" to enter the audit trail menu.

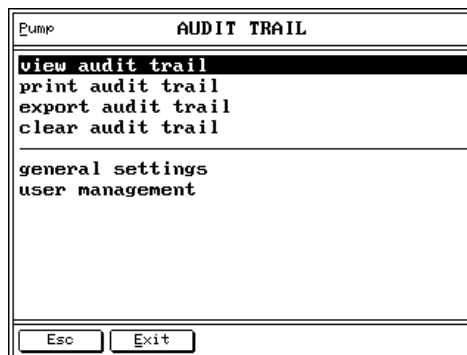


Fig. 12 - 5 Menu: Audit trail

Select "general settings" and set "audit trail" to "off". Save the changes.

12.3 Audit Trail Main Menu

To enter the audit trail main menu, press the "Menu" key and select "audit trail".

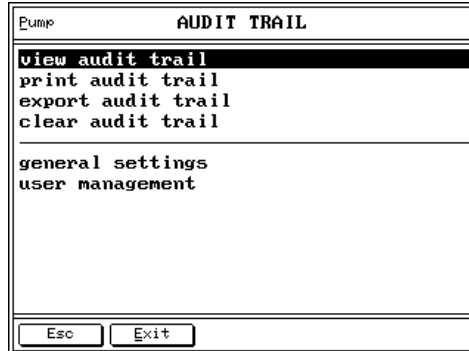


Fig. 12 - 6 Menu: Audit trail



Hint:

Depending on your privileges as a user (administrator, main user or user), some menu items may not be available (see chapter 12.10).

12.4 Viewing the Audit Trail Log File

In the audit trail main menu, select "view audit trail".

All documented operating steps can be shown on the display. Press the "Right" key to show the right side of the display and the "Left" key to show the left side of the display.

Browse to the next page with "Pg Dn" and the previous page with "Pg Up".

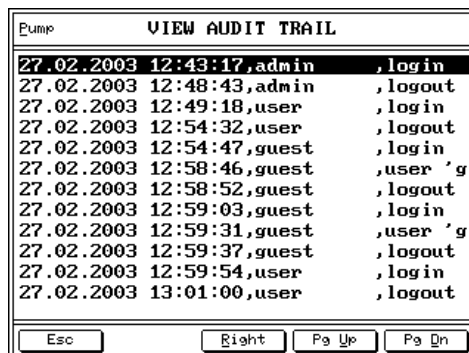


Fig. 12 - 7 Menu: Audit trail/view audit trail

12.5 Printing the Audit Trail Log File

In the audit trail main menu, select "print audit trail".

All documented operating steps can be sent to a connected printer.

Each operating step is defined as one "section" and can be printed separately.

If several (or all) sections should be printed out, enter which sections to be printed (section "from xx" "to xx").

12.6 Exporting the Audit Trail Log File

In the audit trail main menu, select "export audit trail" to send the documented operating steps to a PC. You can export the audit trail log file at any time. You must export the log file when the internal memory of the DMA is full (after 2000 entries or 100 KB).

**Hints:**

- Before the memory of the DMA 4500/5000 is full, the message "please login as administrator and export audit trail" is given. Press "OK" and export the file as described above.
- If this message is ignored several times, it is impossible to store further data. The message "log entry cannot be written, disc is full" is given. Press "OK" and export the log file as described above.

**Hint:**

Only administrators have the right to export the log file.

To export the log file, proceed as follows:

1. Connect the COM1 interface of the DMA 4500/5000 to the COM1 interface of the PC using a suitable interface cable.
2. Start an appropriate terminal program (e.g. Hyperterminal).
3. Carry out the following interface settings:
 - Baudrate: 9600
 - Data bits: 8
 - Parity: none
 - Stop bits: 1
 - Handshake: none

**Hint:**

In the following example, Hyperterminal is used as terminal program.

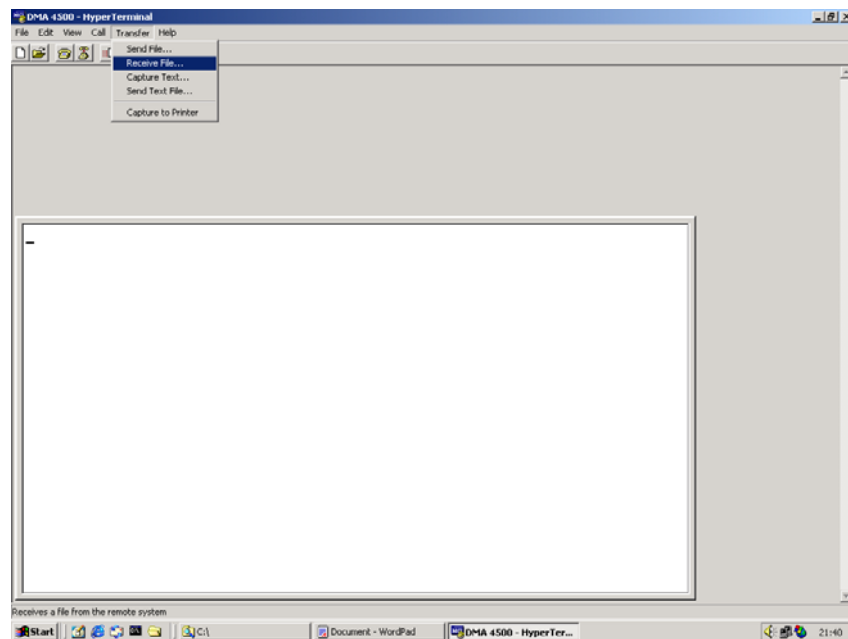
- In the audit trail main menu, select "export audit trail" and press "↵".

The following display appears:

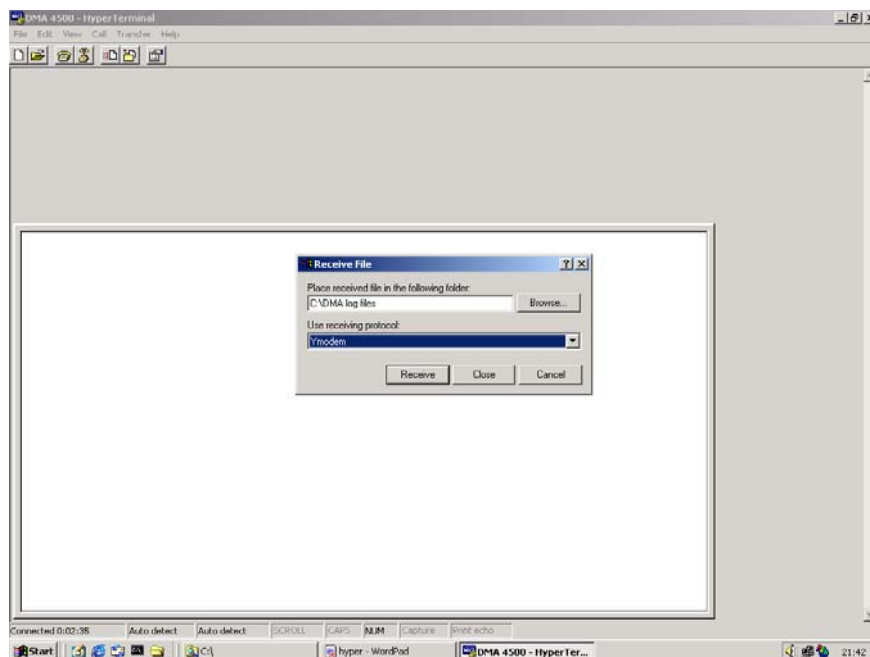


Fig. 12 - 8 Menu: Audit trail/export audit trail

- In Hyperterminal, select "Transfer", "Receive file" and enter the desired directory.



- For "Use receiving protocol:" select "Ymodem".



7. Click on "Receive". The log file is transferred to the PC.
8. After exporting the file, "Export finished" appears on the DMA display. Confirm with "OK".

The exported log file (text file) can now be viewed on the PC.

Exported files are automatically incremented (e.g. the first file as "log-001", the second file as "log-002", etc.).

12.6.1 Verifying the Exported Log File

To make the text file tamper-proof, a corresponding MD5 file is created together with the exported file. The MD5 file contains a checksum which can be used to check if the text file has been changed after export.

The MD5 checksum of the last exported file is stored in the current audit trail log file. Therefore a complete tamper-proof documentation is guaranteed.

Verification with an MD5 checksum program:

An MD5 checksum program is used to compare the checksum of the text file with the checksum of the MD5 file. Any MD5 checksum program can be used.

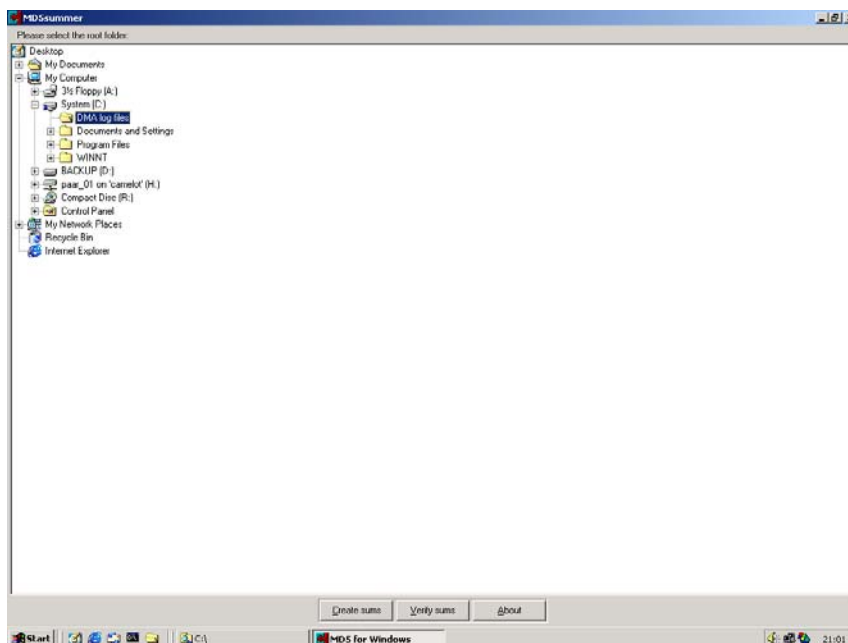


Hint:

The following example uses the program "MD5summer" (Version 1.1.0.24). This program can be downloaded free of charge under www.md5summer.org/download.html.

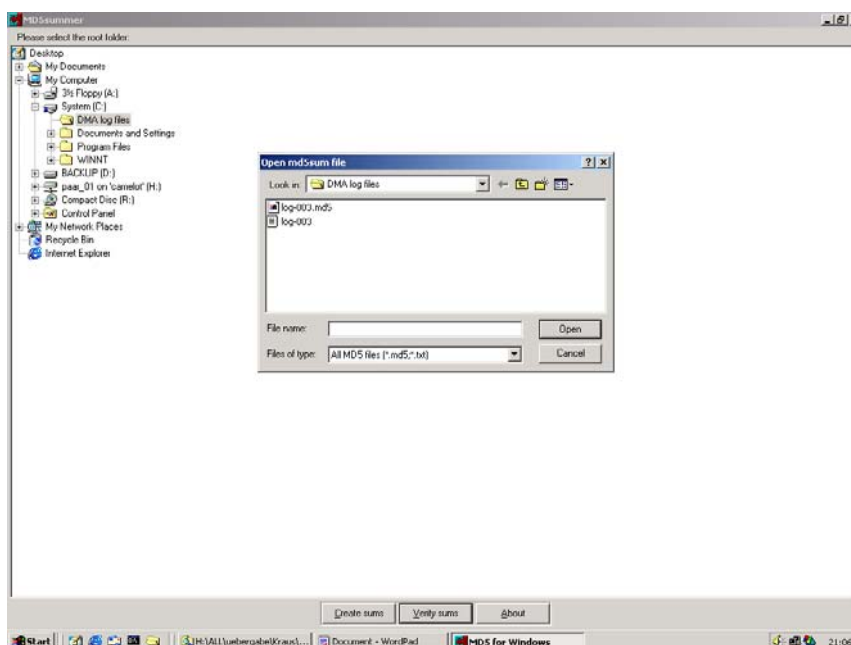
How to use "md5summer":

1. Start "md5summer.exe".
2. When asked "please select the root folder", select the directory where the log files (the md5 file and txt file) are saved.

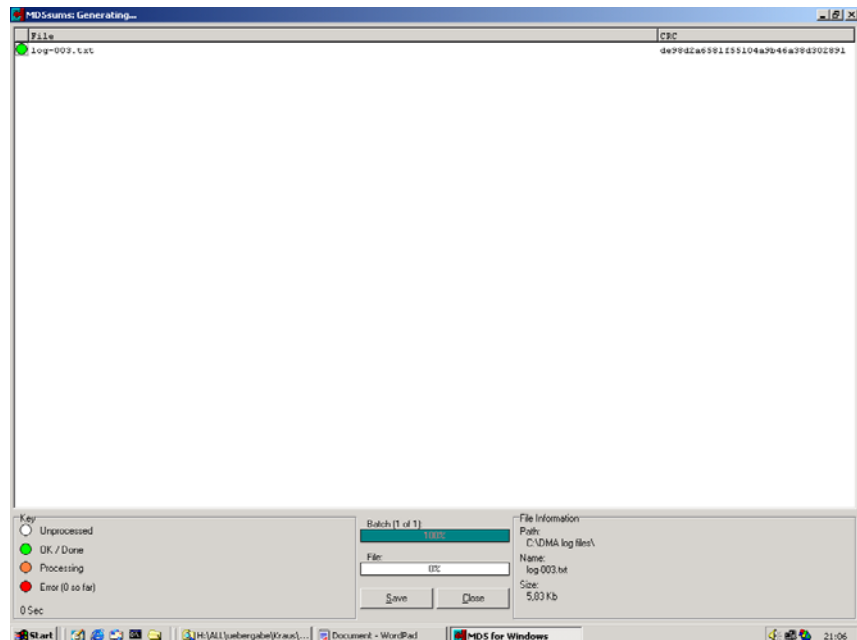


3. Click on the button "verify sums".

The following window is displayed:



4. Select the md5 file which should be checked and press "Open".
5. The check status and the result are displayed. A green light (OK/Done) means the checksums are OK, a red light (Error) means there is an error. The checked checksums appear under "CRC".



6. Quit the program by pressing "Close".

12.7 Clear Audit Trail

In the audit trail main menu, select "clear audit trail".

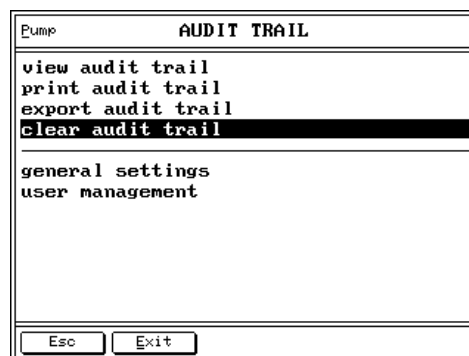


Fig. 12 - 9 Audit trail: clear audit trail

When answering the request "Clear all log entries in audit trail. Are you sure?" with "Yes", the complete log file will be deleted.

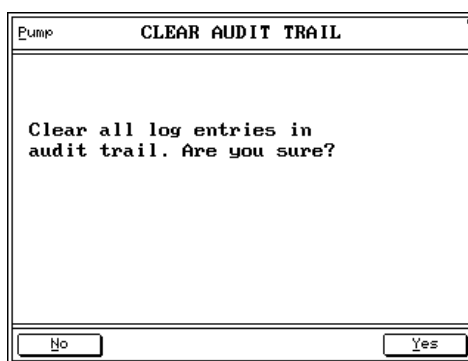


Fig. 12 - 10

For the new log file, the entry "audit trail cleared" will automatically be created. This entry contains the date, the time, and the person who deleted the last log file.

**Hint:**

The menu "clear audit trail" is only available for users with administrator privileges.

12.8 General Settings

In the audit trail main menu, select "general settings":

- Audit trail can be switched on/off.
- The automatic logout time can be set between 0 and 1440 minutes.

If the DMA 4500/5000 is not in use within the set logout time, the login window appears and the user has to log in again (see also chapter 12.2.1).

**Hints:**

- If the automatic logout time is set to 0 minutes, no automatic logout will be carried out.
- During sample changer operation or during a measurement (if it has been started with the "Start" or "Cont" key) no automatic logout will be carried out.

12.9 User Management

Settings for different users can be defined in the user management menu. To enter this menu, select "user management" in the audit trail main menu.



Fig. 12 - 11 Menu: Audit trail/user management

12.9.1 Adding a New User

Select "add new user" to add new users (as many as required).

user:	Enter the name of the user.
comment:	Enter any extra comments here.
password:	Enter the password for the user.
verify:	Enter the password again to confirm.
privileges:	The new user can be assigned certain privileges (user, main user or administrator).
active (yes/no):	To allow the user to log in, "active" has to be set to "yes".
pwd.change at next login (no/yes):	The administrator can set this function for a "main user" or "user". When the user logs in, he/she can change the password. The following window is displayed: enter new password for "user (or the name of the user)" password: verify: The new password must be entered twice (for confirmation). Afterwards, in "audit trail -> change user settings" the function "pwd.change at next login" is automatically changed from "yes" to "no".

12.9.2 Removing a User

Select "remove user". A user with administrator privileges can remove all users except himself/herself.

12.9.3 Changing User Settings


Hint:

Only administrators can change the user settings of other users (see chapter 12.10).

Select "change user settings".

Select the user and press "↵".

The same window appears as for "add new user". Change and save the settings.

12.9.4 Print All User Settings

Select "print all user settings".

The following settings are printed for all users:

user, comment, privileges, active (yes/no), pwd.change at next login (no/yes).

12.10 User Privileges

There are 3 types of users available. These have different privileges.

The table below contains an overview of the privileges of the 3 user types.

	Administrator	Main user	User
View audit trail	yes	yes	no
Print audit trail	yes	no	no
Export audit trail	yes	no	no
Clear audit trail	yes	no	no
Switch audit trail on/off	yes	no	no
Change autom. logout time	yes	no	no
Add new users and change their settings (except the user name)	yes	no	no
Change own user name	no	no	no
Change own comment	yes	yes	yes
Change own password	yes	yes	yes
Change own privileges	no	no	no
Set own user to active/inactive	no	no	no
Change password at login	yes (for other users)	no	no

	Administrator	Main user	User
Remove users	yes (except himself/ herself)	no	no
Print user settings	yes	no	no

**Hints:**

- Users with administrator or main user privileges have access all menus besides the menus listed above.
- Users with user privileges have only access to the menus "logoff user xxx" and "audit trail", "user management" after pressing the "Menu" key.

Appendix A: Operation at High Air Humidity and/or Low Measuring Temperatures

If the ambient air contains humidity and the measuring temperature is lower than the ambient temperature, condensation may occur in the measuring cell and measuring cell block. Condensation in the measuring cell causes adjustment and measurement errors. Condensation in the measuring cell block damages the electronics.

The higher the difference between the set measuring temperature and ambient temperature and the higher the air humidity, the easier condensation occurs.

Preventing condensation in the measuring cell

To prevent condensation in the measuring cell, use a drying cartridge connected to the "DRY AIR PUMP" nozzle at the rear of the DMA 4500/5000. The drying cartridge provides dry air for a thoroughly drying of the measuring cell (see chapter 10).

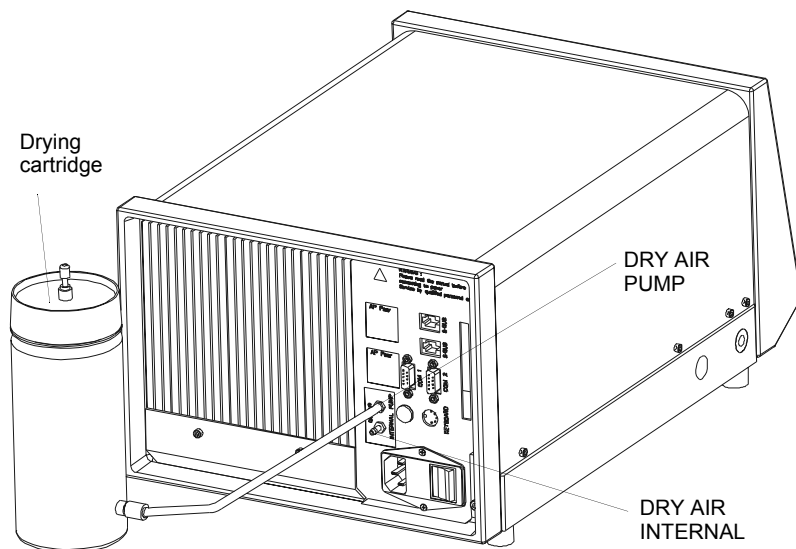


Fig. A - 1 Connections for supplying dry air



Important:

Never connect hoses containing liquids or moist gases to the "DRY AIR PUMP" nozzle as this may lead to condensations in the measuring cell and subsequently to measurement and adjustment errors.

For a measuring temperature of 20 °C, a drying cartridge must be used under the following conditions:

Ambient temperature	Relative air humidity (RH)
20 °C	> 70%
25 °C	> 50%
30 °C	> 38%

The drying cartridge contains beaded ruby gel, a non-toxic drying agent. When active, the color of the drying agent is red. Ruby gel which has absorbed liquid turns orange.

Moist ruby gel can be regenerated:

Pour the ruby gel into a glass bowl and blow hot, dry air (max. 130°C) through it for approx. 5 hours or place it in a laboratory oven for a few hours (or over night) until it is red again.



Important:

Do not use higher drying temperatures than 130°C, otherwise the indicator function of the ruby gel is spoiled.

Preventing condensation in the measuring cell block

To prevent condensation in the measuring cell block, connect a dry air supply to the "DRY AIR INTERNAL" nozzle at the rear of the DMA 4500/5000 (see Fig. A - 1).



Important:

Never connect hoses containing liquids or moist gases to the "DRY AIR INTERNAL" nozzle as this may lead to damage of the electronics.

The dry air supply must be used additionally to the drying cartridge, if the measuring temperature is more than 5°C lower than the ambient temperature.

Following specifications of the applied air are required:

- 0.2 to 0.3 bar (2.9 to 4.4 psi)
- Class 5 from ISO 8573-1
- Max. particle size: 40 µm
- Max. pressure dew point: +7°C (44.6 °F)
- Max. oil content: 25 mg/m³

Appendix B: Technical Data

Measuring range:	0 to 3 g/cm ³
Repeatability, s. d.:	
Density:	
DMA 4500:	1 x 10 ⁻⁵ g/cm ³
DMA 5000:	1 x 10 ⁻⁶ g/cm ³
Temperature:	
DMA 4500:	0.01°C
DMA 5000:	0.001°C
Measuring temperature:	0°C to +90°C (32 to 194°F)
Pressure range:	0 to 10 bar (0 to 150 psi)
Environmental conditions (EN 61010):	Indoor use only
Ambient temperature:	+15 to +35°C (+59 to +95°F)
Air humidity:	10 to 90% relative humidity, non-condensing
Pollution degree:	2
Over voltage category:	II
Amount of sample in the measuring cell:	approx. 1 ml
Typical measuring time per sample:	
DMA 4500:	approx. 30 seconds
DMA 5000:	approx. 40 seconds
Sample throughput:	10 to 30/hour
Dimensions (L x W x H):	440 x 315 x 220 mm
Weight:	approx. 21 kg
Power:	50 VA; mains voltage according to technical data shield on the rear of the DMA 4500/5000
Fuses:	glass tube fuses 5 x 20 mm; DIN 41662; 230 V, T 800 mA



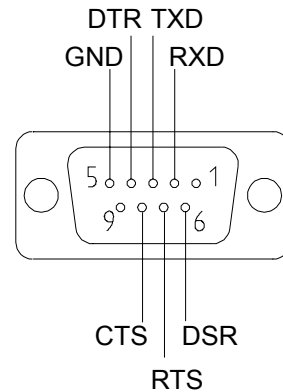
Important:
 All interfaces are designed to comply with SELV (Separated Extra-Low Voltage) requirements according to EN 60950. Interfaces, which do not comply to SELV requirements must not be connected.

Computer interface (COM1):

RS 232 C; 1200 to 9600 Baud; 1 or 2 stop bits; 7 or 8 data bits; no, odd or even parity; handshake

Factory default settings:

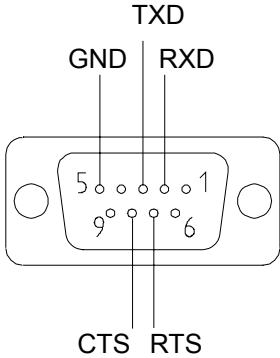
line delimiter: <CR> <LF>
 data delimiter: , (comma)
 handshake: software (XON/XOFF)
 data bits: 8
 stop bits: 1
 parity: no
 baudrate: 9600



RXD	receive data
TXD	transmit data
DTR	data terminal ready
GND	signal ground (connected to earth in the DMA 4500/5000)
DSR	data set ready
RTS	request to send
CTS	clear to send

Printer interface (COM2): RS 232 C; 1200 to 9600 Baud; 1 or 2 stop bits; 7 or 8 data bits; no, odd or even parity; handshake

Factory default settings:
line delimiter: <CR>
handshake: hardware (RTS/CTS)
data bits: 7
stop bits: 1
parity: even
baudrate: 9600



RXD receive data
TXD transmit data
GND signal ground (connected to earth in the DMA 4500/5000)
RTS request to send
CTS clear to send

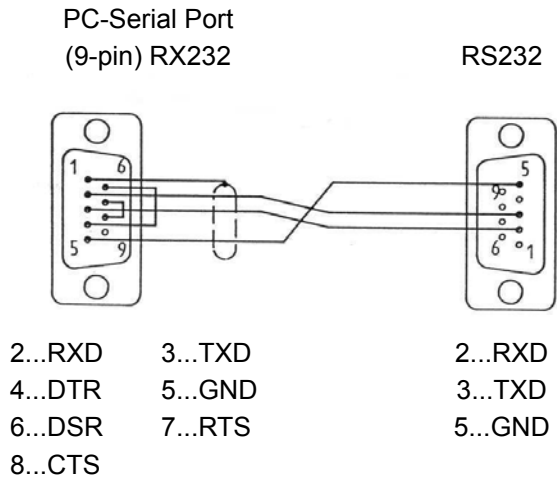
Keyboard interface: PC/AT interface

Appendix C: Commands for Communication between PC and DMA 4500/5000

- Via the interface COM1 data stored in the memory can be transferred to a PC. In addition a limited remote control of the DMA 4500/5000 is possible (e.g. changing temperature or changing measurement settings).
- Connect COM1 on the DMA 4500/5000 and the RS 232 C interface at the PC, using a proper interface cable¹ (see also appendix B).
- Synchronize the interface settings of DMA 4500/5000 and PC (see chapter 11.2.6).
- The communication can be tested using a simple interface program, e.g. Windows Terminal, Procomm or Hyper Terminal.
- When the login window of "audit trail" is displayed, the instrument cannot be controlled by the PC.
- Commands consisting of several words can be entered with or without blanks (e.g. getdata ↵ or get data ↵).
- Commands refer to the currently activated method. In addition all "get..." commands can be extended by a method number.
Example: get data head 3 ↵ ... data head of method 3 will be transmitted, independent of the activated method.
- Each set of measuring results transferred by "get data ↵" will be marked (see chapter 11.2.11) in the memory by "fetched by host computer: y".
- The DMA can also be remote-started with the built-in and activated sample handling units SH-1 or SH-3. If a sample changer SP-1m or SP-3m is connected and activated, the DMA cannot be remote-started.
- For data communication software please contact your local distributor or Anton Paar GmbH.

1. Interface cable DMA 4500/5000 - PC

Interface cable



PC command	DMA 4500/5000 response	Comments
help ↵	commands: GetDataHead [0...9] GetDataUnit [0...9] GetData [0...9] ResetData [0...9] ClearData GetMethodName [0...9] SelectMethod 0...9 GetRawData GetId Start Finished Continue Abort	If the command "help" is sent from the PC, the DMA 4500/5000 responds with a list of available commands.
get data head ↵	data head: date,time,sample number, ready data head: date,time,sample number, ready,actual cell temperature,density, SG,condition	This is the response, if no items are selected in method settings", "memory configuration". Response, if items are selected, e.g. factory default for method 0.
get data unit ↵	data unit:,,,,"C,g/cm3,,	The unit of the selected items is transferred, separated by the selected delimiter.
get data ↵	no new data available data:Mo 21.Feb.2005,13:39:12,0001, 1,20.001,0.00117,0.00117,valid	No new data available. Transfer of the first available measuring result.

PC command	DMA 4500/5000 response	Comments
get raw data ↵	actual Q, actual temperature, set temperature, sample identification	These raw data can be transferred at any time, even during measurement.
reset data ↵	reset data successful	Resets read data to "not fetched" status, e.g. for second data transfer (see chapter 11.2.11).
clear data ↵	clear data successful	Deletes the complete data memory (see chapter 11.2.11).
get method name ↵	method name: Density, 0	Name and number of the activated method.
select method ↵	number out of range	No number has been entered.
select method 3 ↵	selected method 3 OIML w/w	Method 3 is activated.
select method 3 ↵	measurement is started	This is the response, if a measurement has been started.
get id ↵	serial number:xxxxxx DMAxxxx v.5.012.c	Readout of serial number, DMA version (4500 or 5000) and software version.
start ↵	measurement started measurement already started	Remote start of measurement. A measurement has already been started.
start xx.xx ↵	measurement started measurement already started	Remote start of a measurement with a measuring temperature input xx.xx (e.g. 20.50). The entered measuring temperature [°C] is valid for one single measurement. A measurement has already been started.
finished ↵	measurement not started measurement not finished measurement finished	A measurement has not been started. A measurement is already under progress.

PC command	DMA 4500/5000 response	Comments
continue xx.xx ↵	measurement not started measurement not finished measurement continued	No measurement has been started. Previous measurement has not been finished. Remote start of a further measurement with a measuring temperature input xx.xx (e.g. 20.50). The entered measuring temperature [°C] is valid for one single measurement.
continue ↵	measurement not started measurement not finished measurement continued	No measurement has been started. Previous measurement has not been finished. The measurement is continued
abort ↵	measurement not started measurement aborted	No measurement has been started. This aborts the started measurement.

Appendix D: Density Tables

Density of Dry Air

At the temperature t in [°C] and the pressure p in [mbar] or [hPa] the density ρ of air in [g/cm³] is calculated using the following formula²:

$$\rho = \frac{0.0012930}{1 + 0.00367 \times t} \times \frac{p}{1013.25}$$

The numbers are valid for a CO₂ content in air of 0.03% by volume; the numbers change by $\pm 1/19000$ for every change in CO₂ volume content of ± 0.0001 .

2. Literature: Kohlrausch. Praktische Physik, Bd. 3, Tafeln, 22. Auflage (1968), pg. 39, B.G Teubner Stuttgart

Density of Dry Air (-10°C to +90°C)³

Composition of dry air in [v/v]: 78.110% N₂; 20.938% O₂; 0.916% Ar;
0.033% CO₂; 0.002% Ne

Meas. temp. in °C	Density in g/cm ³ at the pressure in mbar (=hPa)							
	900	920	940	960	980	1000	1013.25	1050
-10	0.001192	0.001219	0.001245	0.001272	0.001298	0.001325	0.001342	0.001391
-5	0.001170	0.001196	0.001222	0.001248	0.001274	0.001300	0.001317	0.001365
0	0.001148	0.001174	0.001200	0.001225	0.001251	0.001276	0.001293	0.001340
5	0.001128	0.001153	0.001178	0.001203	0.001228	0.001253	0.001270	0.001316
10	0.001108	0.001132	0.001157	0.001182	0.001206	0.001231	0.001247	0.001293
15	0.001088	0.001113	0.001137	0.001161	0.001185	0.001210	0.001226	0.001270
20	0.001070	0.001094	0.001117	0.001141	0.001165	0.001189	0.001205	0.001248
25	0.001052	0.001075	0.001099	0.001122	0.001145	0.001169	0.001184	0.001227
30	0.001035	0.001058	0.001081	0.001104	0.001127	0.001150	0.001165	0.001207
35	0.001018	0.001040	0.001063	0.001086	0.001108	0.001131	0.001146	0.001187
40	0.001001	0.001024	0.001046	0.001068	0.001090	0.001113	0.001127	0.001168
45	0.000986	0.001008	0.001029	0.001051	0.001073	0.001095	0.001110	0.001150
50	0.000970	0.000992	0.001014	0.001035	0.001057	0.001078	0.001093	0.001132
55	0.000956	0.000977	0.000998	0.001019	0.001041	0.001062	0.001076	0.001115
60	0.000941	0.000962	0.000983	0.001004	0.001025	0.001046	0.001060	0.001098
65	0.000927	0.000948	0.000968	0.000989	0.001010	0.001030	0.001044	0.001082
70	0.000914	0.000934	0.000954	0.000975	0.000995	0.001015	0.001029	0.001066
75	0.000901	0.000921	0.000941	0.000961	0.000981	0.001001	0.001014	0.001051
80	0.000888	0.000908	0.000927	0.000947	0.000967	0.000986	0.000999	0.001036
85	0.000875	0.000895	0.000914	0.000934	0.000953	0.000973	0.000986	0.001021
90	0.000863	0.000882	0.000902	0.000921	0.000940	0.000959	0.000972	0.001007

3. Literature: DIN 51 757 (04.1994): Testing of mineral oils and related materials; determination of density

Density of Water (0°C to 100°C)⁴

t °C	0.0	0.1	0.2	0.3	0.4	0.5	0.6	0.7	0.8	0.9
0	.999840	.999846	.999853	.999859	.999865	.999871	.999877	.999883	.999888	.999893
1	.999899	.999903	.999908	.999913	.999917	.999921	.999925	.999929	.999933	.999937
2	.999940	.999943	.999946	.999949	.999952	.999954	.999956	.999959	.999961	.999962
3	.999964	.999966	.999967	.999968	.999969	.999970	.999971	.999971	.999972	.999972
4	.999972	.999972	.999972	.999971	.999971	.999970	.999969	.999968	.999967	.999965
5	.999964	.999962	.999960	.999958	.999956	.999954	.999951	.999949	.999946	.999943
6	.999940	.999937	.999934	.999930	.999926	.999923	.999919	.999915	.999910	.999906
7	.999901	.999897	.999892	.999887	.999882	.999877	.999871	.999866	.999860	.999854
8	.999848	.999842	.999836	.999829	.999823	.999816	.999809	.999802	.999795	.999788
9	.999781	.999773	.999766	.999758	.999750	.999742	.999734	.999725	.999717	.999708
10	.999699	.999691	.999682	.999672	.999663	.999654	.999644	.999635	.999625	.999615
11	.999605	.999595	.999584	.999574	.999563	.999553	.999542	.999531	.999520	.999508
12	.999497	.999486	.999474	.999462	.999450	.999438	.999426	.999414	.999402	.999389
13	.999377	.999364	.999351	.999338	.999325	.999312	.999298	.999285	.999271	.999258
14	.999244	.999230	.999216	.999202	.999187	.999173	.999158	.999144	.999129	.999114
15	.999099	.999084	.999069	.999053	.999038	.999022	.999006	.998991	.998975	.998959
16	.998942	.998926	.998910	.998893	.998876	.998860	.998843	.998826	.998809	.998792
17	.998774	.998757	.998739	.998722	.998704	.998686	.998668	.998650	.998632	.998613
18	.998595	.998576	.998558	.998539	.998520	.998501	.998482	.998463	.998443	.998424
19	.998404	.998385	.998365	.998345	.998325	.998305	.998285	.998265	.998244	.998224
20	.998203	.998182	.998162	.998141	.998120	.998099	.998077	.998056	.998035	.998013
21	.997991	.997970	.997948	.997926	.997904	.997882	.997859	.997837	.997815	.997792
22	.997769	.997747	.997724	.997701	.997678	.997654	.997631	.997608	.997584	.997561
23	.997537	.997513	.997490	.997466	.997442	.997417	.997393	.997369	.997344	.997320
24	.997295	.997270	.997246	.997221	.997196	.997170	.997145	.997120	.997094	.997069
25	.997043	.997018	.996992	.996966	.996940	.996914	.996888	.996861	.996835	.996809
26	.996782	.996755	.996729	.996702	.996675	.996648	.996621	.996594	.996566	.996539
27	.996511	.996484	.996456	.996428	.996400	.996373	.996344	.996316	.996288	.996260
28	.996232	.996203	.996174	.996146	.996117	.996088	.996059	.996030	.996001	.995972
29	.995943	.995913	.995884	.995854	.995825	.995795	.995765	.995735	.995705	.995675
30	.995645	.995615	.995584	.995554	.995523	.995493	.995462	.995431	.995401	.995370
31	.995339	.995307	.995276	.995245	.995214	.995182	.995151	.995119	.995087	.995056
32	.995024	.994992	.994960	.994928	.994895	.994863	.994831	.994798	.994766	.994733
33	.994700	.994667	.994635	.994602	.994569	.994535	.994502	.994469	.994436	.994402
34	.994369	.994335	.994301	.994268	.994234	.994200	.994166	.994132	.994097	.994063
35	.994029	.993994	.993960	.993925	.993891	.993856	.993821	.993786	.993751	.993716

4. Literature: Spieweck, F. & Bettin, H.: Review: Solid and liquid density determination. *Technisches Messen* 59 (1992), pp. 285-292.

t °C	0.0	0.1	0.2	0.3	0.4	0.5	0.6	0.7	0.8	0.9
36	.993681	.993646	.993610	.993575	.993540	.993504	.993468	.993433	.993397	.993361
37	.993325	.993289	.993253	.993217	.993181	.993144	.993108	.993072	.993035	.992998
38	.992962	.992925	.992888	.992851	.992814	.992777	.992740	.992703	.992665	.992628
39	.992591	.992553	.992515	.992478	.992440	.992402	.992364	.992326	.992288	.992250
40	.992212	.992174	.992135	.992097	.992058	.992020	.991981	.991942	.991904	.991865
41	.991826	.991787	.991748	.991708	.991669	.991630	.991590	.991551	.991511	.991472
42	.991432	.991392	.991353	.991313	.991273	.991233	.991193	.991152	.991112	.991072
43	.991031	.990991	.990950	.990910	.990869	.990828	.990787	.990747	.990706	.990665
44	.990623	.990582	.990541	.990500	.990458	.990417	.990375	.990334	.990292	.990250
45	.990208	.990167	.990125	.990083	.990040	.989998	.989956	.989914	.989871	.989829
46	.989786	.989744	.989701	.989658	.989616	.989573	.989530	.989487	.989444	.989401
47	.989358	.989314	.989271	.989228	.989184	.989141	.989097	.989053	.989010	.988966
48	.988922	.988878	.988834	.988790	.988746	.988702	.988657	.988613	.988569	.988524
49	.988480	.988435	.988390	.988346	.988301	.988256	.988211	.988166	.988121	.988076
50	.988030	.987985	.987940	.987894	.987849	.987804	.987758	.987712	.987667	.987621
51	.987575	.987529	.987483	.987437	.987391	.987345	.987298	.987252	.987206	.987159
52	.987113	.987066	.987020	.986973	.986926	.986879	.986833	.986786	.986739	.986692
53	.986644	.986597	.986550	.986503	.986455	.986408	.986360	.986313	.986265	.986217
54	.986170	.986122	.986074	.986026	.985978	.985930	.985882	.985833	.985785	.985737
55	.985688	.985640	.985591	.985543	.985494	.985446	.985397	.985348	.985299	.985250
56	.985201	.985152	.985103	.985054	.985004	.984955	.984906	.984856	.984807	.984757
57	.984708	.984658	.984608	.984558	.984509	.984459	.984409	.984359	.984308	.984258
58	.984208	.984158	.984107	.984057	.984007	.983956	.983905	.983855	.983804	.983753
59	.983702	.983652	.983601	.983550	.983499	.983448	.983396	.983345	.983294	.983242
60	.983191	.983140	.983088	.983036	.982985	.982933	.982881	.982829	.982778	.982726
61	.982674	.982621	.982569	.982517	.982465	.982413	.982360	.982308	.982255	.982203
62	.982150	.982098	.982045	.981992	.981939	.981886	.981834	.981780	.981727	.981674
63	.981621	.981568	.981515	.981461	.981408	.981354	.981301	.981247	.981194	.981140
64	.981086	.981032	.980979	.980925	.980871	.980817	.980763	.980708	.980654	.980600
65	.980546	.980491	.980437	.980382	.980328	.980273	.980219	.980164	.980109	.980054
66	.980000	.979945	.979890	.979835	.979780	.979724	.979669	.979614	.979559	.979503
67	.979448	.979392	.979337	.979281	.979226	.979170	.979114	.979058	.979002	.978946
68	.978890	.978834	.978778	.978722	.978666	.978610	.978553	.978497	.978441	.978384
69	.978328	.978271	.978214	.978158	.978101	.978044	.977987	.977930	.977874	.977816
70	.977759	.977702	.977645	.977588	.977531	.977473	.977416	.977358	.977301	.977243
71	.977186	.977128	.977070	.977012	.976955	.976897	.976839	.976781	.976723	.976665
72	.976607	.976548	.976490	.976432	.976374	.976315	.976257	.976198	.976140	.976081
73	.976022	.975963	.975905	.975846	.975787	.975728	.975669	.975610	.975551	.975492
74	.975432	.975373	.975314	.975255	.975195	.975136	.975076	.975017	.974957	.974897
75	.974838	.974778	.974718	.974658	.974598	.974538	.974478	.974418	.974358	.974298
76	.974237	.974177	.974117	.974056	.973996	.973935	.973875	.973814	.973753	.973693

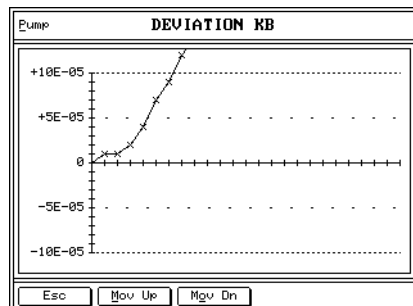
Appendix D: Density Tables

t °C	0.0	0.1	0.2	0.3	0.4	0.5	0.6	0.7	0.8	0.9
77	.973632	.973571	.973510	.973449	.973388	.973327	.973266	.973205	.973144	.973083
78	.973021	.972960	.972899	.972837	.972776	.972714	.972653	.972591	.972529	.972468
79	.972406	.972344	.972282	.972220	.972158	.972096	.972034	.971972	.971910	.971847
80	.971785	.971723	.971660	.971598	.971535	.971473	.971410	.971348	.971285	.971222
81	.971159	.971096	.971034	.970971	.970908	.970844	.970781	.970718	.970655	.970592
82	.970528	.970465	.970402	.970338	.970275	.970211	.970148	.970084	.970020	.969956
83	.969893	.969829	.969765	.969701	.969637	.969573	.969509	.969445	.969380	.969316
84	.969252	.969188	.969123	.969059	.968994	.968930	.968865	.968800	.968736	.968671
85	.968606	.968541	.968477	.968412	.968347	.968282	.968216	.968151	.968086	.968021
86	.967956	.967890	.967825	.967760	.967694	.967629	.967563	.967497	.967432	.967366
87	.967300	.967234	.967169	.967103	.967037	.966971	.966905	.966838	.966772	.966706
88	.966640	.966574	.966507	.966441	.966374	.966308	.966241	.966175	.966108	.966042
89	.965975	.965908	.965841	.965774	.965707	.965640	.965573	.965506	.965439	.965372
90	.965305	.965238	.965170	.965103	.965036	.964968	.964901	.964833	.964765	.964698
91	.964630	.964562	.964495	.964427	.964359	.964291	.964223	.964155	.964087	.964019
92	.963951	.963882	.963814	.963746	.963677	.963609	.963541	.963472	.963404	.963335
93	.963266	.963198	.963129	.963060	.962991	.962922	.962854	.962785	.962716	.962646
94	.962577	.962508	.962439	.962370	.962300	.962231	.962162	.962092	.962023	.961953
95	.961884	.961814	.961744	.961675	.961605	.961535	.961465	.961395	.961325	.961255
96	.961185	.961115	.961045	.960975	.960905	.960834	.960764	.960694	.960623	.960553
97	.960482	.960412	.960341	.960271	.960200	.960129	.960058	.959988	.959917	.959846
98	.959775	.959704	.959633	.959562	.959490	.959419	.959348	.959277	.959205	.959134
99	.959062	.958991	.958920	.958848	.958776	.958705	.958633	.958561	.958489	.958418
100	.958346	.958273	.958201	.958129	.958057	.957985	.957913	.957840	.957768	.957696

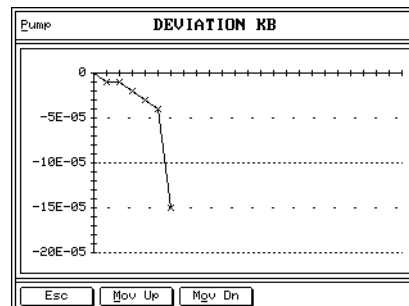
Appendix E: Possible Adjustment Errors, Adjustment Report

Cause	Correction
Direct sunlight on the DMA 4500/5000.	Make sure that the DMA 4500/5000 is not exposed to direct sunlight.
The measuring cell is not clean.	Make sure that the measuring cell is perfectly cleaned before adjustment.
The measuring cell was not perfectly dry before air adjustment. There are drops of liquid or humidity condensations in the measuring cell (check through the window).	Clean the measuring cell again according to chapter 10, and dry it carefully. If condensation is still visible through the visual control of the measuring cell, then the atmospheric humidity is too high. Connect a drying cartridge (desiccator) to the "DRY AIR PUMP" nozzle (see appendix A).
There are gas bubbles in the measuring cell.	Slowly inject the adjustment liquid into the measuring cell. The temperature of the adjustment liquid must be equal to or slightly above the measuring temperature.
The adjustment is not finished after 10 minutes.	The measuring cell is not sufficiently dry. There are gas bubbles in the measuring cell.

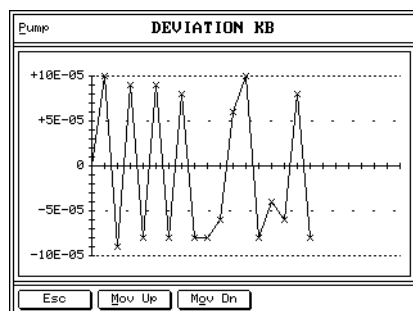
Examples and explanations of KB-value deviations:



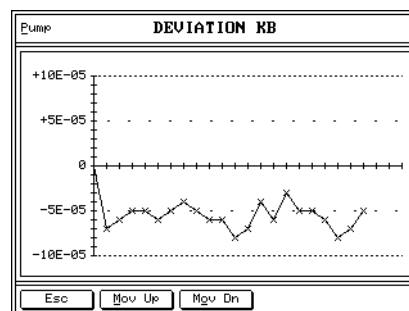
Built-up deposits inside the U-tube oscillator are indicated by the steeply increasing deviation KB.



Abrasion of glass from the U-tube oscillator is indicated by the steeply decreasing deviation KB.



- Randomly fluctuating KB-values are caused by:
 - insufficient drying prior to air adjustment
 - the presence of gas bubbles or impurities in the adjustment water
- Fluctuations within $5 \times 10^{-5} \text{ g/cm}^3$ are most probably caused by variations in the air density due to varying weather conditions. Such fluctuations can be avoided by entering the current barometric pressure before air adjustment.



Slight variations of the KB-value are normal. However, after transport a higher offset of the first KB-value with reference to the original KB-value (factory adjustment) is sometimes observed.

Appendix F: Software Versions

Software version	Date of release	Document number	Comments
V 2.004.b	30.03.1998	XDLIB07A	Software failure "not corrected density full range adjustment" eliminated.
V 2.004.g	24.09.1998	XDLIB07B XDLIB07C	<ul style="list-style-type: none"> • API calculation at low temperatures corrected. • Printout problems with polynomials corrected.
V 2.004.h	25.02.1999	XDLIB07C	SP-3m stops corrected.
V 3.003.b	17.03.1999	XDLIB07D	SH-3 support, API 20°C, API-switch, °Baumé, graph for tables and polynomials.
V 3.003.c (old DCC) V 4.003.c (new DCC)	01.04.1999	XDLIB07D	<ul style="list-style-type: none"> • Storing the display contrast corrected. • Invalid CRC calib.dat corrected.
V 3.004.a (old DCC) V 4.004.a (new DCC)	10.06.1999	XDLIB07D XDLIB07E	°Brix, ° Plato and °Baumé display format changed (only DMA 5000).
V 4.503.d	29.02.2000	XDLIB07F	SH-1 support, density check, user formula, support for external cells, German menu navigation available, extended equilibrium criterions (only for DMA 5000).
V 4.510.d	19.02.2001	XDLIB07G	<ul style="list-style-type: none"> • Remote Start of DMA 4500/5000 with SH-1/ SH-3 possible. • Readout of serial number, instrument version and software version by PC. • API-limits for product group B: 0.5 to 1.2 g/cm³ • For each position of the sample changer a certain measuring temperature can be defined. • Trailing digits for Brix and Plato have been increased to 3 (only DMA 5000).
V 4.600.b	04.01.2002	XDLIB07H	<ul style="list-style-type: none"> • 10# 2-dimensional polynomial functions (new user function). • User formula with 2 input values. • Max. automatic pump switch off time: 3600 seconds. • Temperature scan: will be continued after storing 100 data (only DMA 5000).
V 4.600.e	21.01.2003	XDLIB07I	<ul style="list-style-type: none"> • Viscosity adjustment improved.

Software version	Date of release	Document number	Comments
V 5.003.b	03.09.2003	XDLIB07J	<ul style="list-style-type: none"> "density" replaces the previous densities "density (viscosity <700 mPa.s)" and "density (viscosity >500 mPa.s)". Fully automatic viscosity correction for the entire temperature range. Audit trail function: Electronic logging of each operation step that could lead to a change of the measuring result and tamper-proof saving of the log file. Remote start with measuring temperature input possible ("start xx.xx", "continue xx.xx"). New remote command "clear data".
V5.003.c	08.03.2004	XDLIB07K	<ul style="list-style-type: none"> Communication with SP-3m improved.
V5.006.b	02.08.2004	XDLIB07L	<ul style="list-style-type: none"> Extended "Audit trail" function: "clear audit trail". Optimized communication with the sample changer SP-3m.
V5.006.c	01.09.2004	XDLIB07M	<ul style="list-style-type: none"> Boot sequence improved.
V5.009.a	21.12.2004	XDLIB07N	<ul style="list-style-type: none"> Supports the DMA HP density measuring cell. Extended measurement settings: Automatic deletion of the sample identification after the completion of the measurement possible.
V5.009.b	17.02.2005	XDLIB07O XDLIB07P	<ul style="list-style-type: none"> Improved fan control of the DMA HP.
V5.012.c	05.04.2005	XDLIB07Q	<ul style="list-style-type: none"> DMA HP: improved temperature control for ultimate safety.

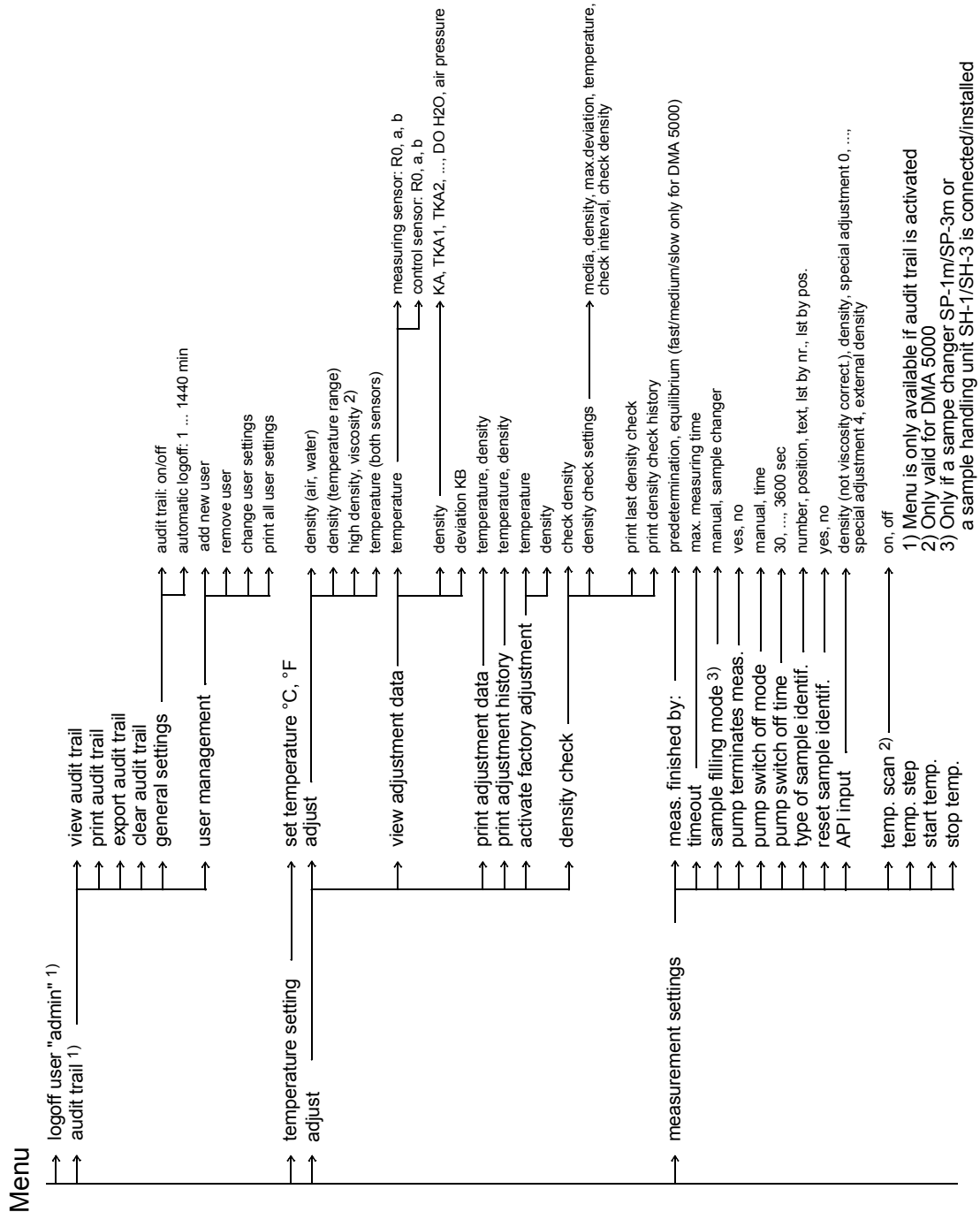
Appendix G: Wetted Parts

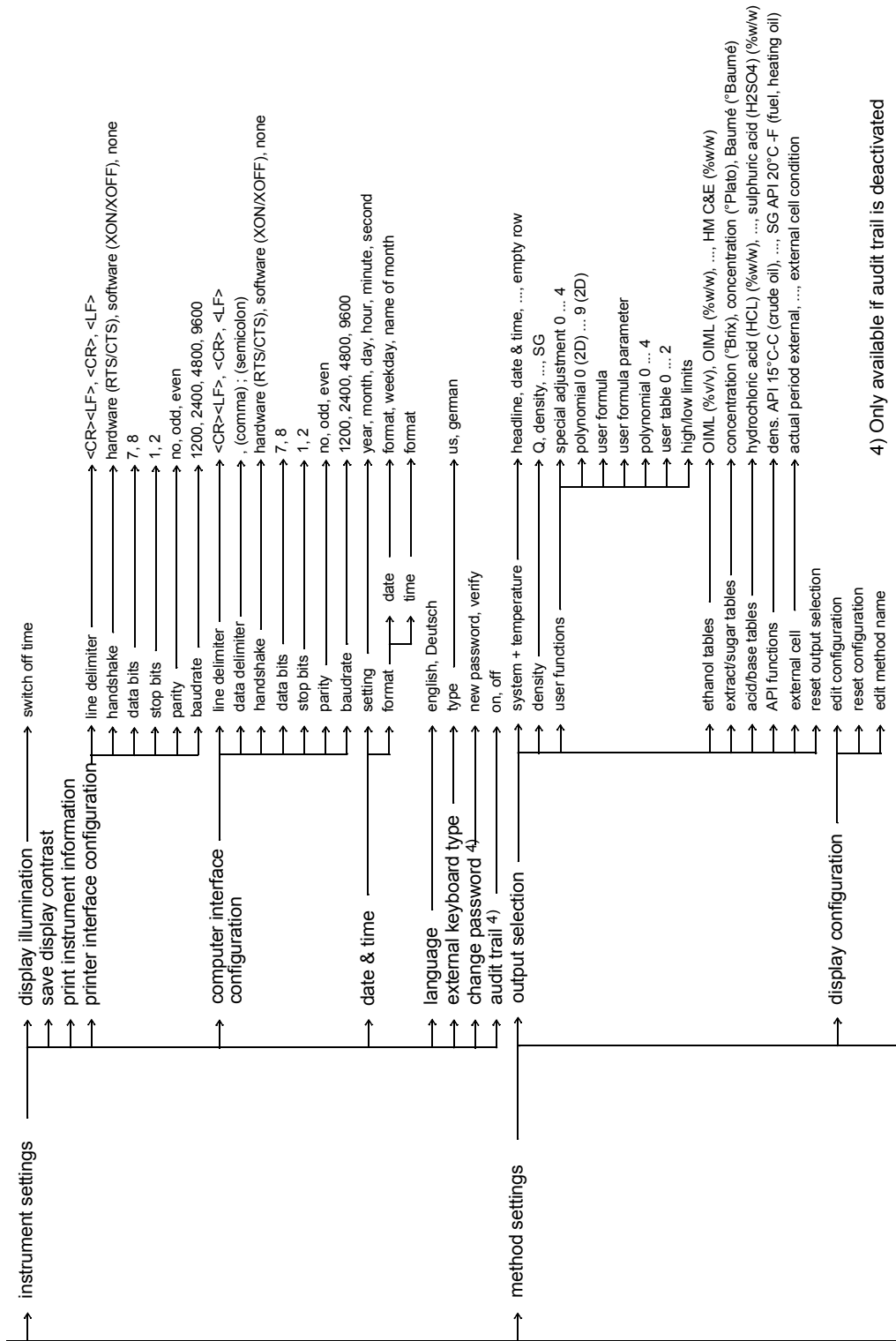
The following materials are in contact with the samples to be measured and with the cleaning agents:

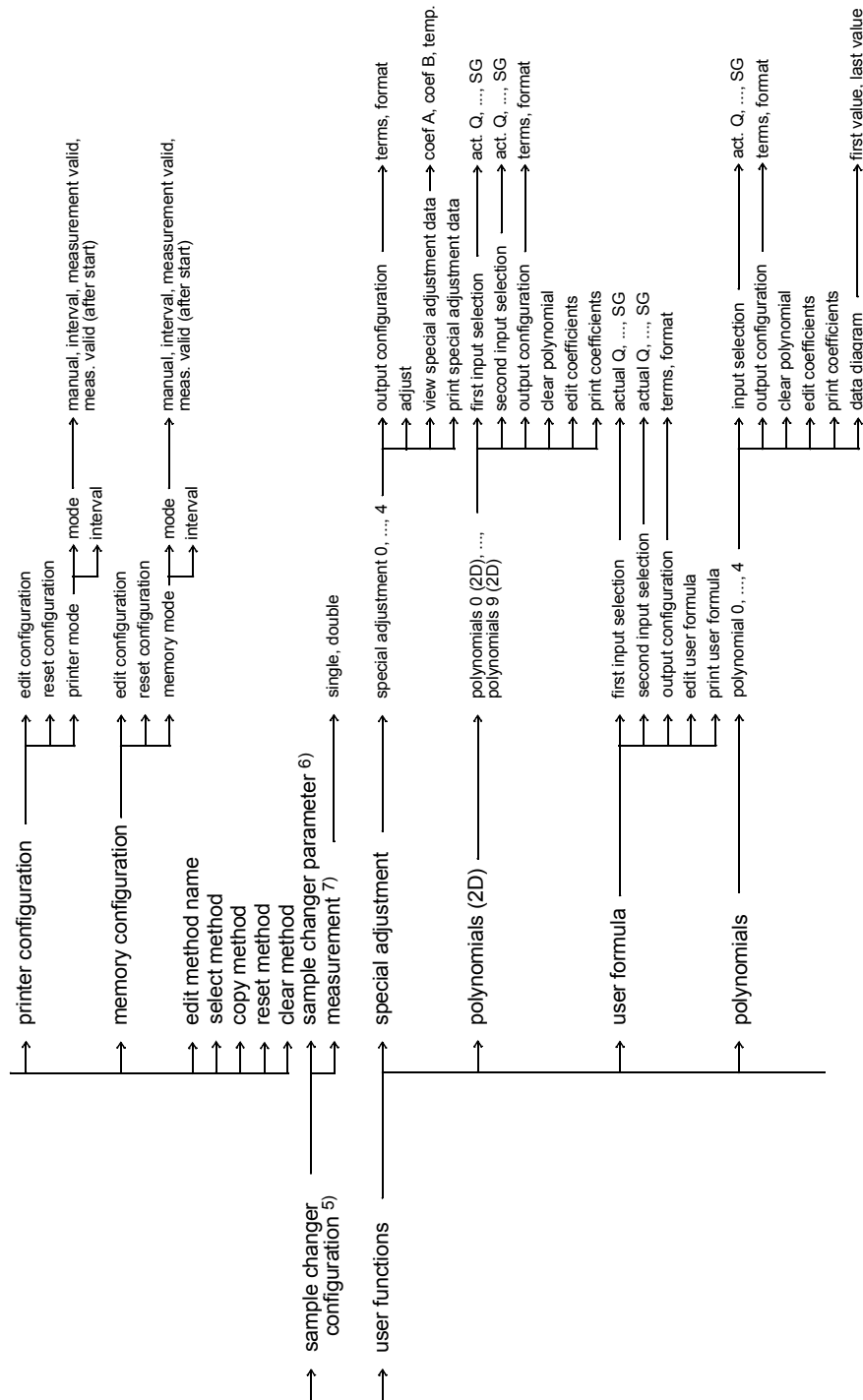
DMA 4500/5000:

Material	Part
Borosilicate glass	Measuring cell
PTFE	Filling adapter

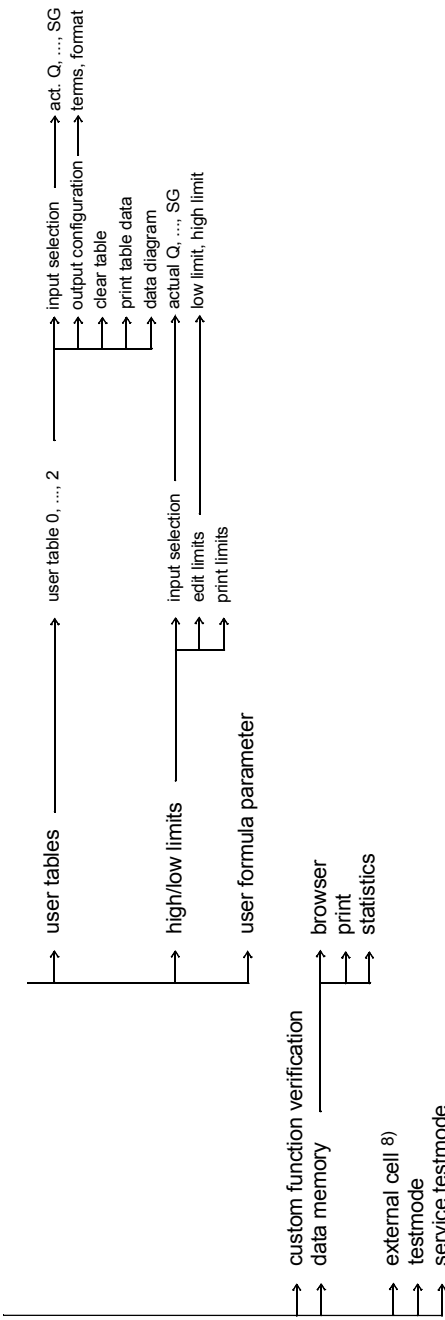
Appendix H: Menu Tree







5) Only if a sample changer/sample handling unit is connected
 For a detailed SH-1/SH-3 menu, see the SH-1/SH-3 instruction manual
 6) Only if a sample changer SP-1m/SP-3m is connected
 7) Only if a sample changer SP-3m is connected



8) Only if an external density measuring cell is connected
For a detailed menu, see the corresponding instruction manual

Index

Symbols

, (comma) 55
 ; (semicolon) 55
 <CR><LF> 55

A

Acid/base tables 63
 Adjustment 16, 28, 30, 47, 69, 108
 Adjustment coefficients 59
 Adjustment data 31, 33, 35, 47, 49, 69
 Adjustment error 107
 Adjustment history 34, 68
 Adjustment report 31, 107
 Air adjustment 31, 32, 33
 Air bubbles 16, 35
 Air humidity 15, 42, 95
 Air pressure 31, 33, 48
 Air pump 14, 17, 27, 42, 51
 Alcohol concentration 61, 62
 AOAC 38, 62
 API density 38
 API functions 52, 64, 75
 API gravity 65
 API number 38
 Apparent density 37
 Apparent specific gravity 59
 Audit trail 45, 56, 80, 81, 82, 83, 85, 89

B

Bar code reader 20, 45, 52
 Baumé 63
 Brix 37, 63

C

Calibration 28, 36
 Caustic soda 38
 Cell light 15
 Clean and dry 30, 32, 36, 38, 41
 Commands 98
 Computer interface 20, 96
 Computer interface configuration 55
 Concentration 34, 37, 63, 64, 68, 75
 Condensation 93
 Control measurement 15
 Crude oil 38, 64

D

d 59
 d (not viscosity corrected) 59
 Damping 7
 Data delimiter 55, 96
 Data diagram 73, 74
 Date and time 18, 21, 55, 57
 Density 18, 28, 36, 37, 58, 59, 64
 Density (not viscosity correct.) 52, 59
 Density check 15, 16, 28, 50
 Density coefficients 48, 58
 Density of dry air 102, 103
 Density of water 16, 104
 Desiccator 20, 42, 107
 Display 17, 19
 Display configuration 23, 66
 Display contrast 17, 21, 54
 Display illumination 54

E

Equilibrium 26
 Ethanol concentration 38
 Ethanol tables 61
 External cell 52, 57, 76
 Extract/sugar tables 63

F

Factory default settings 67, 96, 97
 Filling 39, 51
 Fuel 38, 65
 Full range adjustment 32

G

Gas bubbles 39, 40, 42, 53, 107, 108

H

H₂SO₄ 64
 H₃PO₄ 63
 HCl 63
 High/low limits 68, 74
 HM C&E 62
 HNO₃ 64
 Hydrochloric acid 63

I

Interface cable 15, 98

IUPAC 62

K

KAEMPF 62
KB-value 49, 108
Keyboard 45, 56
Keyboard interface 97
Keypad 44

L

Language 21, 56
Line delimiter 54, 55, 96, 97
Log file 83, 84, 86
Low measuring temperatures 15, 20, 93
Lubricants 38, 64

M

Main menu 44
Measurement settings 26, 50
Measuring cell 38
Measuring cell temperature 18, 58
Measuring method 18, 21
Measuring mode 21, 44, 54
Measuring range 95
Measuring result 41, 98
Measuring temperature 37, 38, 47, 75, 78, 95
Measuring window 17
Memory 25, 30, 76
Memory configuration 66
Menu 18, 45, 56
Method 37, 67
Method settings 57

N

NaOH 63
Nitric acid 64

O

OIML 38, 61
Operating voltage 15
-Osc- 17
Oscillation period 34, 48, 58, 59
Output data 22

P

Password 18, 47, 56
PC/AT interface 45, 97
Peristaltic pump 40, 42
Phosphoric acid 63
Plato 63

Polynomial 60, 68, 71
Polynomial (2D) 60, 68, 69
Power switch 20
Predetermination 26
Pre-set methods 37
Print 18
Printer configuration 24, 66
Printer interface 20, 97
Printer interface configuration 54
Printout 40, 76
Proof 62

Q

Q 58, 59
Q value 31

R

Reference oscillator 7, 58, 59
Repeatability 95
Residues 42

S

Sample amount 39, 95
Sample changer 18, 20, 38, 40, 50, 52, 67, 77
Sample changer configuration 25, 67
Sample handling unit 18, 27, 40, 50, 52, 77
Sample identification 27, 51, 77, 78
Sample number 58, 77
Sample# 18, 77
S-BUS interface 20
Serial number 58
Set temperature 53
SG 60
SG API 65
SH-1 26, 32, 40, 67, 77, 98, 113
SH-3 26, 32, 40, 67, 77, 98, 113
Sodium hydroxide 63
Soft keys 19
SP-1m 20, 25, 38, 40, 67, 77, 78, 98
SP-3m 20, 25, 38, 40, 67, 77, 78, 98
Special adjustment 34, 52, 60, 68
Specific gravity 18, 37, 60
Start 18
State of the measurement 18
Status 59
Suspension 39

T

Temperature 22
Temperature scan 18, 53
Temperature setting 46
Temperature unit 46

Testmode 76
True density 37

U

User formula 60, 68, 70
User privileges 91
User settings 46, 91
User table 61, 68, 73
U-tube 7, 58, 59, 108

V

Viscosity 36
Viscosity correction 37, 47, 48, 52, 59

W

Water adjustment 31, 32, 33
Wetted parts 38, 112