

**ONKYO®**

**Super Audio CD & DVD Audio/  
Video Player**

# *DV-SP1000* *DV-SP1000E*

## **Instruction Manual**

Thank you for purchasing the Onkyo DV-SP1000/  
DV-SP1000E Super Audio CD & DVD Audio/Video  
Player. Read this manual carefully before using your  
new player. A good understanding of its features and  
operation will allow you to achieve optimum perfor-  
mance and enjoyment.

Keep this manual for future reference.

## **Contents**

**Important Safety Instructions ..... 2**

**Introduction ..... 7**

**Before Use ..... 14**

**Getting to Know the DV-SP1000 .. 15**

**Connecting ..... 26**

**Initial Setup..... 43**

**Basic Playback ..... 45**

**Advanced Playback..... 56**

**Configuring the DV-SP1000..... 68**

**Controlling Other Components ... 86**

**Troubleshooting ..... 93**



**WARNING:**

TO REDUCE THE RISK OF FIRE OR ELECTRIC SHOCK, DO NOT EXPOSE THIS APPARATUS TO RAIN OR MOISTURE.

**CAUTION:**

TO REDUCE THE RISK OF ELECTRIC SHOCK, DO NOT REMOVE COVER (OR BACK). NO USER-SERVICEABLE PARTS INSIDE. REFER SERVICING TO QUALIFIED SERVICE PERSONNEL.



**WARNING**  
RISK OF ELECTRIC SHOCK  
DO NOT OPEN

**AVIS**  
RISQUE DE CHOC ELECTRIQUE  
NE PAS OUVRIR



The lightning flash with arrowhead symbol, within an equilateral triangle, is intended to alert the user to the presence of uninsulated "dangerous voltage" within the product's enclosure that may be of sufficient magnitude to constitute a risk of electric shock to persons.



The exclamation point within an equilateral triangle is intended to alert the user to the presence of important operating and maintenance (servicing) instructions in the literature accompanying the appliance.



## Important Safety Instructions

1. Read these instructions.
2. Keep these instructions.
3. Heed all warnings.
4. Follow all instructions.
5. Do not use this apparatus near water.
6. Clean only with dry cloth.
7. Do not block any ventilation openings. Install in accordance with the manufacturer's instructions.
8. Do not install near any heat sources such as radiators, heat registers, stoves, or other apparatus (including amplifiers) that produce heat.
9. Do not defeat the safety purpose of the polarized or grounding-type plug. A polarized plug has two blades with one wider than the other. A grounding type plug has two blades and a third grounding prong. The wide blade or the third prong are provided for your safety. If the provided plug does not fit into your outlet, consult an electrician for replacement of the obsolete outlet.
10. Protect the power cord from being walked on or pinched particularly at plugs, convenience receptacles, and the point where they exit from the apparatus.
11. Only use attachments/accessories specified by the manufacturer.
12. Use only with the cart, stand, tripod, bracket, or table specified by the manufacturer, or sold with the apparatus. When a cart is used, use caution when moving the cart/apparatus combination to avoid injury from tip-over.
 

PORTABLE CART WARNING

S3125A
13. Unplug this apparatus during lightning storms or when unused for long periods of time.
14. Refer all servicing to qualified service personnel. Servicing is required when the apparatus has been damaged in any way, such as power-supply cord or plug is damaged, liquid has been spilled or objects have fallen into the apparatus, the apparatus has been exposed to rain or moisture, does not operate normally, or has been dropped.
15. Damage Requiring Service
 

Unplug the apparatus from the wall outlet and refer servicing to qualified service personnel under the following conditions:

  - A. When the power-supply cord or plug is damaged,
  - B. If liquid has been spilled, or objects have fallen into the apparatus,
  - C. If the apparatus has been exposed to rain or water,
  - D. If the apparatus does not operate normally by following the operating instructions. Adjust only those controls that are covered by the operating instructions as an improper adjustment of other controls may result in damage and will often require extensive work by a qualified technician to restore the apparatus to its normal operation,
  - E. If the apparatus has been dropped or damaged in any way, and
  - F. When the apparatus exhibits a distinct change in performance this indicates a need for service.
16. Object and Liquid Entry
 

Never push objects of any kind into the apparatus through openings as they may touch dangerous voltage points or short-out parts that could result in a fire or electric shock.

The apparatus shall not be exposed to dripping or splashing and no objects filled with liquids, such as vases shall be placed on the apparatus.

Don't put candles or other burning objects on top of this unit.
17. Batteries
 

Always consider the environmental issues and follow local regulations when disposing of batteries.
18. If you install the apparatus in a built-in installation, such as a bookcase or rack, ensure that there is adequate ventilation.
 

Leave 20 cm (8") of free space at the top and sides and 10 cm (4") at the rear. The rear edge of the shelf or board above the apparatus shall be set 10 cm (4") away from the rear panel or wall, creating a flue-like gap for warm air to escape.

# Precautions

This unit contains a semiconductor laser system and is classified as a "CLASS 1 LASER PRODUCT". So, to use this model properly, read this Instruction Manual carefully. In case of any trouble, please contact the store where you purchased the unit.

To prevent being exposed to the laser beam, do not try to open the enclosure.

## DANGER:

VISIBLE AND INVISIBLE LASER RADIATION WHEN OPEN AND INTERLOCK FAILED OR DEFEATED. DO NOT STARE INTO BEAM.

## CAUTION:

THIS PRODUCT UTILIZES A LASER. USE OF CONTROLS OR ADJUSTMENTS OR PERFORMANCE OF PROCEDURES OTHER THAN THOSE SPECIFIED HEREIN MAY RESULT IN HAZARDOUS RADIATION EXPOSURE.

The label on the right is applied on the rear panel except for USA and Canadian models.



1. This unit is a CLASS 1 LASER PRODUCT and employs a laser inside the cabinet.
2. To prevent the laser from being exposed, do not remove the cover. Refer servicing to qualified personnel.

Dette mærke på bagpladen angiver, at:

1. Denne enhed er et KLASSE 1 LASERPRODUKT, hvor der anvendes en laser, der er placeret inde i kabinette.
2. For at undgå at laseren afdækkes må afskærmningen aldrig fjernes. Overlad al servicering til kvalificeret personale.

## FARE:

USYNLIG LASERSTRÅLING I ÅBEN TILSTAND ELLER NÅR SIKKERHEDSAFBRYDER FEJLER ELLER OMGÅS. UNDGÅ BESTRÅLING FRA LASERSTRÅLEN.

Denne etiketten som er å finne på baksidepanelet erklærer at:

1. Denne enheten er et KLASSE 1 LASERPRODUKT og benytter laser inni kabinettet.
2. For å forhindre eksponering av laser, må dekslet ikke fjernes. Overlat alt servicearbeid til kvalifisert fagpersonell.

## FARE:

UNSYNLIG BESTRÅLING NÅR ENHETEN ER ÅPEN OG LÅSEN SVIKTER ELLER ER UTE AV FUNKSJON. UNNGÅ DIREKTE BESTRÅLING.

Takaseinäissä oleva tarra limoittaa, että:

1. Tämä laite on LUOKAN 1 LASERLAITE ja sen sisällä on laser.
2. Jotta et joudu alttiiksi säteele, älä irrota laitteen kantta. Huoltotoimet on jätettävä ammattihenkilön suoritettavaksi.

## VAARA:

NÄKYMÄTÖNTÄ LASERSÄTEILYÄ, KUN LAITE ON AVATTU JA SISÄLUKITUS EPÄKUNNOSSA TAI SÄÄDETTY TOIMIMATTOMAKSI. VÄLTÄ SUORAA ALTISTUMISTA SÄTEELE.

## For U.S. model

The laser is covered by a housing which prevents exposure during operation or maintenance. However, this product is classified as a Laser Product by CDRH (Center for Devices and Radiological Health) which is a department of the Food and Drug Administration.

According to their regulations 21 CFR section 1002.30, all manufacturers who sell Laser Products must maintain records of written communications between the manufacturer, dealers and customers concerning radiation safety. If you have any complaints about instructions or explanations affecting the use of this product, please feel free to write to the address on the back page of this manual. When you write us, please include the model number and serial number of your unit.

In compliance with Federal Regulations, the certification, identification and the period of manufacture are indicated on the rear panel.

## FCC INFORMATION FOR USER

### CAUTION:

The user changes or modifications not expressly approved by the party responsible for compliance could void the user's authority to operate the equipment.

### NOTE:

This equipment has been tested and found to comply with the limits for a Class B digital device, pursuant to Part 15 of the FCC Rules.

These limits are designed to provide reasonable protection against harmful interference in a residential installation. This equipment generates, uses and can radiate radio frequency energy and, if not installed and used in accordance with the instructions, may cause harmful interference to radio communications. However, there is no guarantee that interference will not occur in a particular installation.

If this equipment does cause harmful interference to radio or television reception, which can be determined by turning the equipment off and on, the user is encouraged to try to correct the interference by one or more of the following measures:

- Reorient or relocate the receiving antenna.
- Increase the separation between the equipment and receiver.
- Connect the equipment into an outlet on a circuit different from that to which the receiver is connected.
- Consult the dealer or an experienced radio/TV technician for help.

## Precautions—Continued

### For Canadian model

**NOTE:** This class B digital apparatus complies with Canadian ICES-003.

For models having a power cord with a polarized plug:

**CAUTION: TO PREVENT ELECTRIC SHOCK, MATCH WIDE BLADE OF PLUG TO WIDE SLOT, FULLY INSERT.**

### Modèle pour les Canadien

**REMARQUE:** Cet appareil numérique de la classe B est conforme à la norme NMB-003 du Canada.

Sur les modèles dont la fiche est polarisée:

**ATTENTION: POUR ÉVITER LES CHOCS ÉLECTRIQUES, INTRODUIRE LA LAME LA PLUS LARGE DE LA FICHE DANS LA BORNE CORRESPONDANTE DE LA PRISE ET POUSSER JUSQU'AU FOND.**

### For British models

Replacement and mounting of an AC plug on the power supply cord of this unit should be performed only by qualified service personnel.

#### IMPORTANT

The wires in the mains lead are coloured in accordance with the following code:

- Blue: Neutral
- Brown: Live

As the colours of the wires in the mains lead of this apparatus may not correspond with the coloured markings identifying the terminals in your plug, proceed as follows:

The wire which is coloured blue must be connected to the terminal which is marked with the letter N or coloured black.

The wire which is coloured brown must be connected to the terminal which is marked with the letter L or coloured red.

#### IMPORTANT

A 5 ampere fuse is fitted in this plug. Should the fuse need to be replaced, please ensure that the replacement fuse has a rating of 5 amperes and that it is approved by ASTA or BSI to BS1362. Check for the ASTA mark or the BSI mark on the body of the fuse.

**IF THE FITTED MOULDED PLUG IS UNSUITABLE FOR THE SOCKET OUTLET IN YOUR HOME THEN THE FUSE SHOULD BE REMOVED AND THE PLUG CUT OFF AND DISPOSED OF SAFELY. THERE IS A DANGER OF SEVERE ELECTRICAL SHOCK IF THE CUT OFF PLUG IS INSERTED INTO ANY 13 AMPERE SOCKET.**

If in any doubt, consult a qualified electrician.

### For European Models

#### Declaration of Conformity

We, ONKYO EUROPE  
ELECTRONICS GmbH  
LIEGNITZERSTRASSE 6,  
82194 GROEBENZELL,  
GERMANY



declare in own responsibility, that the ONKYO product described in this instruction manual is in compliance with the corresponding technical standards such as EN60065, EN55013, EN55020 and EN61000-3-2, -3-3.

GROEBENZELL, GERMANY

I. MORI

ONKYO EUROPE ELECTRONICS GmbH

#### 1. Region Numbers

The DVD standard uses region numbers to control how discs can be played around the world, the world being divided into six regions. This unit will only play DVD discs that match its region number, which can be found on its rear panel (e.g., ).

#### 2. About this Manual

This manual explains how to use all of this unit's functions. Although the DVD standard offers many special features, not all discs use them all, so depending on the disc being played, this unit may not respond to certain functions. See the disc's sleeve notes for supported features.

When you attempt to use a DVD feature that is not available, this logo may appear onscreen, indicating that the feature is not supported by the current disc or this unit.

#### 3. Recording Copyright

Unless it's for personal use only, recording copyrighted material is illegal without the permission of the copyright holder.

#### 4. Power

##### WARNING

**BEFORE PLUGGING IN THE UNIT FOR THE FIRST TIME, READ THE FOLLOWING SECTION CAREFULLY.**

AC outlet voltages vary from country to country. Make sure that the voltage in your area meets the voltage requirements printed on this unit's rear panel (e.g., AC 120 V, 60 Hz).

## Precautions—Continued

### 5. Never Touch this Unit with Wet Hands

Never handle this unit or its power cord while your hands are wet or damp. If water or any other liquid gets inside this unit, have it checked by your Onkyo dealer.

### 6. Installing this Unit

- Install this unit in a well-ventilated location. Ensure that there's adequate ventilation all around this unit, especially if it's installed in an audio rack. If the ventilation is inadequate, the unit may overheat, leading to malfunction.
- Do not expose this unit to direct sunlight or heat sources, because its internal temperature may rise, shortening the life of the optical pickup.
- Avoid damp and dusty places, and places subject to vibrations from loudspeakers. Never put the unit on top of, or directly above a loudspeaker.
- Install this unit horizontally. Never use it on its side or on a sloping surface, because it may cause a malfunction.
- If you install this unit near a TV, radio, or VCR, the picture and sound quality may be affected. If this occurs, move this unit away from the TV, radio, or VCR.

### 7. Care

Occasionally, you should dust this unit all over with a soft cloth. For stubborn stains, use a soft cloth dampened with a weak solution of mild detergent and water. Dry the unit immediately afterwards with a clean cloth. Do not use abrasive cloths, thinners, alcohol, or other chemical solvents, because they may damage the finish or remove the panel lettering.

### 8. Handling Notes

- If you need to transport this unit, use the original packaging to pack it how it was when you originally bought it.
- Do not use volatile liquids, such as insect sprays, near this unit. Do not leave rubber or plastic items on this unit for a long time, because they may leave marks on the case.
- This unit's top and rear panels may get warm after prolonged use. This is normal.
- When you've finished using this unit, remove all discs and turn off the power.
- If you do not use this unit for a long time, it may not work properly the next time you turn it on, so be sure to use it occasionally.

### 9. To Obtain a Clear Picture

This unit is a high-tech, precision device. If the lens on the optical pickup, or the disc drive mechanism becomes dirty or worn, the picture quality may be affected. To maintain the best picture quality, we recommend regular inspection and maintenance (cleaning or worn part replacement) every 1,000 hours of use depending on the operating environment. Contact your Onkyo dealer for details.

### 10. Moisture Condensation

#### Moisture condensation may damage this unit.

Read the following carefully:

- When you take a glass containing a cold drink outside on a summer's day, drops of water, called condensation, form on the outside of the glass. Similarly, moisture may condense on the lens of the optical pickup, one of the most important parts inside this unit.
- Moisture condensation can occur in the following situations:
    - The unit is moved from a cold place to a warm place.
    - A heater is turned on, or cold air from an air conditioner is hitting the unit.
    - In the summer, when this unit is moved from an air conditioned room to a hot and humid place.
    - The unit is used in a humid place.
  - Do not use this unit when there's the possibility of moisture condensation occurring. Doing so may damage your discs and certain parts inside this unit. If condensation does occur, remove all discs and leave this unit turned on for two to three hours. By this time, the unit will have warmed up and any condensation will have evaporated. To reduce the risk of condensation, keep this unit connected to a wall outlet.

# Contents

<b>Important Safety Instructions .....</b>	<b>2</b>	<b>Basic Playback .....</b>	<b>45</b>
<b>Precautions.....</b>	<b>3</b>	Loading Discs .....	45
<b>Introduction .....</b>	<b>7</b>	Starting, Pausing & Stopping Playback.....	46
DV-SP1000/DV-SP1000E Features.....	7	Navigating Disc Menus.....	47
Supplied Accessories.....	8	Selecting Chapters & Titles by Number.....	48
Disc Notes.....	9	Selecting Tracks by Number .....	49
Terminology .....	12	Fast Forward & Reverse.....	50
<b>Before Use .....</b>	<b>14</b>	Frame-by-Frame Playback.....	50
Setting the Voltage Selector		Slow-motion Playback.....	51
(Worldwide model only) .....	14	Adjusting the Display Brightness.....	51
Installing the Remote's Batteries.....	14	Navigating MP3 Discs .....	52
Using the Remote Controller.....	14	Viewing a Slideshow of JPEG Images .....	53
<b>Getting to Know the DV-SP1000/ DV-SP1000E.....</b>	<b>15</b>	Making a Playlist with the Disc Navigator...	54
Front Panel.....	15	<b>Advanced Playback.....</b>	<b>56</b>
Display .....	17	Zooming.....	56
Rear Panel .....	18	Time Search .....	56
Remote Controller .....	23	Repeat Playback .....	57
<b>Connecting .....</b>	<b>26</b>	A-B Repeat Playback.....	57
Before Making Any Connections.....	26	Random Playback .....	58
AV Cables & Connectors .....	26	Memory Playback.....	59
Video Formats & DV-SP1000/ DV-SP1000E Inputs & Outputs.....	27	Selecting Camera Angles .....	61
Audio Formats & DV-SP1000/ DV-SP1000E Outputs.....	28	Selecting Soundtracks.....	62
Getting Connected .....	29	Selecting Subtitles .....	62
Connecting a Standard TV.....	30	Last Memory.....	63
Connecting an HDTV or Projector.....	31	Displaying Information.....	63
Connecting a SCART-compatible TV (European model only) .....	32	Turning Off the Video Circuits .....	66
Connecting a Component with an HDMI Input.....	32	Selecting the Video Input Source (not Canadian model).....	66
Connecting an AV Receiver's video Inputs .....	34	Setting the HDMI Output Resolution .....	66
Connecting i.LINK-compatible Components (not Chinese model) .....	35	Setting the Picture's Aspect Ratio .....	67
Connecting to an AV Receiver's Audio Inputs.....	36	Using the Picture Control Menu.....	67
Connecting a Stereo Amp .....	38	<b>Configuring the DV-SP1000/ DV-SP1000E .....</b>	<b>68</b>
Connecting Standard Video Equipment for Progressive Upconversion (not Canadian model) .....	39	Using the Onscreen Setup Menus.....	70
Connecting Components with <b>RI</b> .....	40	Picture Menu .....	72
Controlling Components That Are Out of Range .....	40	Audio Menu .....	74
Connecting the Power Cord.....	41	Language Menu.....	81
Turning On the DV-SP1000/ DV-SP1000E .....	42	Display Menu.....	82
Turning On the DV-SP1000/DV-SP1000E with the Remote Controller .....	42	Operation Menu.....	82
<b>Initial Setup.....</b>	<b>43</b>	Initial Setup Menu.....	84
First Time Setup.....	43	Selecting Other Languages.....	84
		Language Code List .....	85
		<b>Controlling Other Components.....</b>	<b>86</b>
		Entering Remote Control Codes.....	86
		Learning the Commands of Other Remote Controllers.....	91
		Deleting the Learnt Commands of One Mode .....	92
		Deleting the Learnt Commands of All Modes .....	92
		<b>Troubleshooting .....</b>	<b>93</b>
		<b>Specifications .....</b>	<b>96</b>

# Introduction

## DV-SP1000/DV-SP1000E Features

### Highlights

- THX Ultra certification<sup>1</sup>
- DVD-Video, DVD-Audio, and SACD universal player
- Dual-laser pickup
- VCD, DVD-VR, CD, and MP3 playback
- JPEG picture display and slideshow
- CD-R/RW, DVD-R/RW
- Backlit, preprogrammed leaning remote controller

### Processing

- Dolby<sup>2</sup> Digital and DTS<sup>3</sup>
- 192 kHz/24-bit audio D/A converters
- 216 MHz/14-bit video D/A converters
- Progressive upconversion with 3:2 and 2:2 reverse pulldown
- Direct Digital Path
- VLSC—Vector Linear Shaping Circuitry<sup>4</sup>

### Connections

- HDMI digital video and digital audio out<sup>5</sup>
- 2 i.LINK multichannel digital audio sockets (not Chinese model)
- 4 digital audio outputs—2 optical, 2 coaxial
- HD component video output
- 1 component video output, 2 S-Video outputs, 2 composite video outputs
- 5.1-channel analog audio output
- Dedicated downmix analog audio output
- S-Video and composite video inputs with progressive upconversion (not Canadian model)
- Bidirectional RS-232 port
- IR in/out (not Canadian model)
- **RI** compatible
- 12 V trigger input (not Canadian model)

1. THX is a trademark or registered trademark of THX Ltd. All rights reserved.
2. Manufactured under license from Dolby Laboratories. "Dolby", "Pro Logic" and the double-D symbol are trademarks of Dolby Laboratories.
3. "DTS" and "DTS Digital Surround" are registered trademarks of Digital Theater Systems, Inc.
4. VLSC is a trademark of Onkyo Corporation.
5. HDMI, the HDMI logo and High-Definition Multimedia Interface are trademarks or registered trademarks of HDMI Licensing, LLC.
6. The i.LINK logo is a trademark of Sony Corporation, registered in the U.S. and other countries.
7. Niles is a registered trademark of Niles Audio Corporation.
8. Xantech is a registered trademark of Xantech Corporation.

## Functions

- Disc Navigator for MP3 and JPEG discs
- Title, chapter, group, track, folder (MP3) and time search
- Frame-by-frame playback
- Slow motion playback
- Fast forward and reverse
- Last Memory function allows you to resume playback from a specific point on a DVD-Video disc or VCD
- Repeat playback: title, chapter, group, track, folder (MP3/JPEG)
- Random playback: title, chapter, group, track, folder (MP3/JPEG)
- Supports 4:3 and 16:9 aspect ratio TVs
- Supports up to 8 soundtracks/languages
- Supports up to 32 subtitle languages
- Multiple camera angles
- Parental Lock
- Screen Saver

## Others

- Auto Power Off function
- Toroidal power supply transformer
- Silent slide disc tray
- Aluminium front panel
- Adjustable display brightness with off setting

### THX Ultra

Before any home theater component can be THX Ultra certified, it must pass a rigorous series of quality and performance tests. Only then can a product feature the THX Ultra logo, which is your guarantee that the Home Theater products you purchase will give you superb performance for many years to come.

### THX notice

Please note that the analog audio output setup features of this player have not been evaluated by THX engineers and did not certify their technical performance. For optimum results THX recommends the use of the digital audio outputs.

## Introduction—Continued

### Supplied Accessories

Make sure you have the following accessories. If anything is missing, contact your Onkyo dealer.

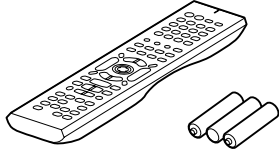

**Remote controller (RC-563DV) & three batteries (AA/R6)**

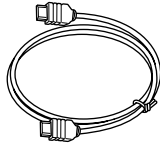

**HDMI cable**

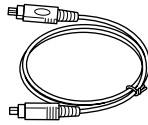

**i.LINK cable (not Chinese model)**

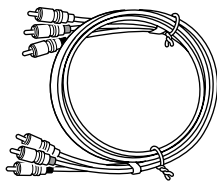

**AV cable (RCA)**

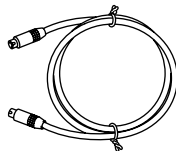

**S-Video cable**

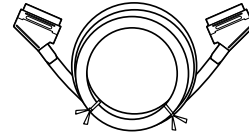

**SCART cable**  
(European model only)



**RI cable**

This cable is used to connect the DVD player to other **RI**-compatible Onkyo components for **RI** (Remote Interactive) control.

To use **RI**, in addition to an **RI** connection, you must make an analog audio connection (RCA) between the DVD player and your Onkyo AV receiver.

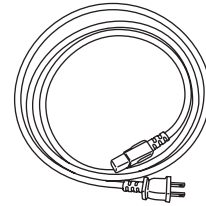

**Power cord**  
(Plug type varies from country to country.)

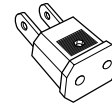

**Power-plug adapter**

Only supplied in certain countries. Use this adapter if your AC outlet does not match with the plug on the DV-SP1000/DV-SP1000E's power cord. (Adapter varies from country to country.)

\* In catalogs and on packaging, the letter added to the end of the product name indicates the color of the DV-SP1000/DV-SP1000E. Specifications and operation are the same regardless of color.



## Introduction—Continued

### Disc Notes

#### Supported Discs

The DV-SP1000/DV-SP1000E supports the following discs.

Disc	Logo	Format or file type
DVD-Video		DVD-Video
DVD-Audio		DVD-Audio
SACD		Super Audio CD (single layer, dual layer, hybrid)
DVD-R		DVD-Video
DVD-RW		DVD-Video, DVD-VR
VCD		Video CD (Version 1.1 and 2.0)
CD		Audio CD (PCM and DTS)
CD-R		Video CD, audio CD, MP3, JPEG
CD-RW		Video CD, audio CD, MP3, JPEG
JPEG CD		JPEG

- Some audio CDs feature copy protection that doesn't conform to the official CD standard. Since these are nonstandard discs, they may not play properly in the DV-SP1000/DV-SP1000E.
- The DV-SP1000/DV-SP1000E supports CD-R and CD-RW discs recorded in Video CD format, audio CD format, or ISO9660 Level 2 format with MP3 or JPEG files. It also supports DVD-R and DVD-RW discs recorded in DVD-Video or DVD-Audio format, and DVD-RW discs recorded in DVD-VR format. However, some CD-R/RW and DVD-R/RW discs may not work properly for any of the following reasons: incomplete disc finalization, disc burner characteristics, disc characteristics, the disc is damaged or dirty. See the manual supplied with your disc burner for more information. Condensation or dirt on the optical pickup lens can also affect playback.
- Since the DV-SP1000/DV-SP1000E does not support DVD-VR discs with CPRM (Content Protection for Recordable Media), do not attempt to play such discs.
- The DV-SP1000/DV-SP1000E does not support disc types not listed.

- The DV-SP1000/DV-SP1000E supports 8 cm and 12 cm discs.
- Don't use discs with an unusual shape, such as those shown below, because they may damage the DV-SP1000/DV-SP1000E.



- Don't use discs that have residue from adhesive tape, rental discs with peeling labels, or discs with custom-made labels or stickers. Doing so may damage the DV-SP1000/DV-SP1000E and you may not be able to remove the disc properly.

#### DVD-Video Regions

The DVD-Video standard uses region numbers to control how discs can be played around the world, the world being divided into six regions, as shown. The DV-SP1000/DV-SP1000E will only play DVD-Video discs that match its region number, which can be found on the rear panel (e.g., ). If you attempt to play a disc intended for another region, a message saying that the disc cannot be played appears. Discs marked ALL will play in any DVD player.

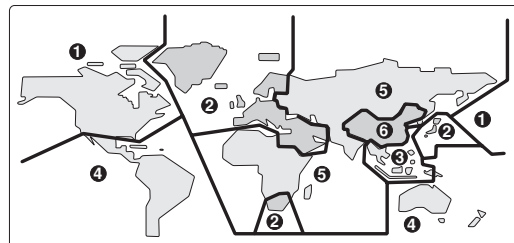

#### Unsupported DVD Features

DVD offers many special features, including multiple soundtracks, subtitles, camera angles, and so on. However, not all discs use all of these features. When you attempt to use a feature that is not supported by the current disc, for example, you press the remote controller's [AUDIO] button while playing a disc with only one soundtrack, this icon will appear onscreen, indicating that the disc doesn't support that feature.



Similarly, if a disc uses features that are not supported by the DV-SP1000/DV-SP1000E, for example, special interactive menu functions, this icon will appear onscreen, indicating that the feature is not supported by the DV-SP1000/DV-SP1000E.



## Introduction—Continued

### Video CDs

The DV-SP1000/DV-SP1000E supports Version 1.1 and Version 2.0 of the Video CD standard. Version 2.0 supports PBC (Playback Control).

#### • Video CD (Version 1.1)

On the DV-SP1000/DV-SP1000E, the contents of Video CDs that conform to Version 1.1 of the Video CD standard are handled as tracks.

#### • Video CD with PBC (Version 2.0)

In addition to the functions supported by Version 1.1, Version 2.0 offers playback control via interactive menus and search functions. Note that the DV-SP1000/DV-SP1000E doesn't support all PBC functions.

### MP3 & JPEG Compatibility

- The DV-SP1000/DV-SP1000E can play/display MP3 and JPEG files recorded on CD-R and CD-RW discs.
- Discs must be in ISO9660 Level 2 format (folders can be up to eight levels deep).
- Discs must be finalized.
- The DV-SP1000/DV-SP1000E can only recognize the first session on multisession discs.
- You can determine the order in which the DV-SP1000/DV-SP1000E plays/displays your MP3 songs and JPEG pictures by prefixing file and folder names with a three-digit number. For example 001.Root, 002.Folder, and so on, and 001.Track.mp3, 002.Track.mp3, and so on.
- Only the first eight characters of folder and track names (excluding the filename extension) appear on the display.
- The folder numbered "001" appears as "ROOT" in the Disc Navigator.
- The DV-SP1000/DV-SP1000E supports up to 999 folders and up to 671 files.
- If you try to play an incompatible file, the message "This format cannot be played" appears on the display.

#### ■ MP3

- MP3 files must be MPEG1 Audio Layer 3 format, 44.1 or 48 kHz, fixed bit-rate.
- MP3 files must have a ".mp3" or ".MP3" filename extension.
- Variable bit-rates (VBR) from 64 kbps to 384 kbps are supported. (Playing times of VBR files may be displayed incorrectly.)









#### ■ JPEG

- JPEG files must have a ".jpg" or ".jpeg" filename extension (either uppercase or lowercase is OK).
- Baseline JPEG files are supported. Progressive JPEG files are not.
- Only JPEG files with the following brightness/color difference ratios are supported: 4:4:4, 4:2:2, and 4:1:1.

- JPEG files must be less than 5 MB in size.

### Function Support

The following icons are used throughout this manual to indicate which discs can be used with each function.

Icon	Disc type	Icon	Disc type
	DVD-Video		Video CD
	DVD-Audio		Audio CD
	Super Audio CD		MP3
	DVD-VR		JPEG

### Disc Content Organization

#### ■ DVD-Video

DVD-Video discs typically contain one or more titles, which may be subdivided into chapters.

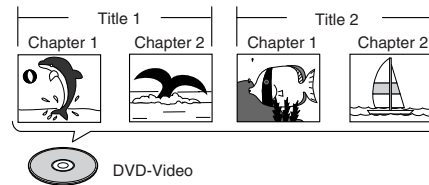

#### ■ DVD-Audio

DVD-Audio discs contain groups and tracks.

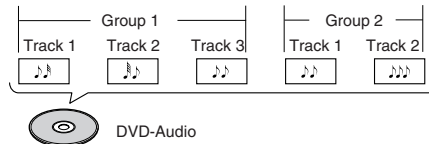

#### ■ SACD

SACDs have two separate areas for storing audio tracks—one for multichannel audio, the other for 2-channel stereo audio. In addition, hybrid SACDs have an extra layer for playback in standard CD players. You can specify how the DV-SP1000/DV-SP1000E handles SACDs on page 80.

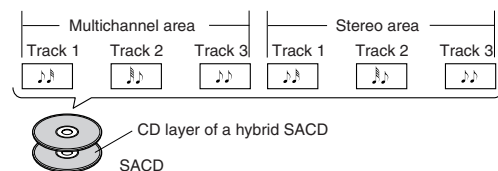

#### ■ VCD

VCDs contain video tracks.

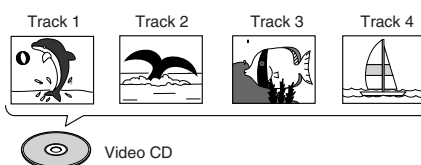

## Introduction—Continued

### ■ DVD-VR

DVD-VR discs contain programs, which may be subdivided into cells. They may also contain playlists.

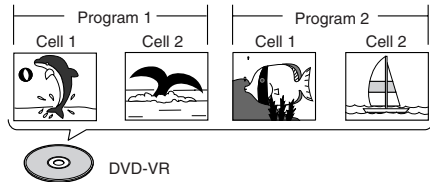

### ■ CD

CDs contain tracks.

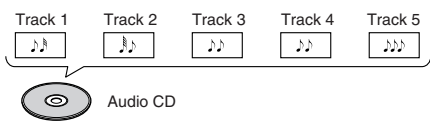

### ■ MP3

MP3 discs contain MP3 tracks organized into folders.

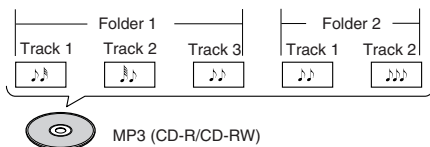

### ■ JPEG

JPEG discs contain pictures organized into folders. On the DV-SP1000/DV-SP1000E, JPEG files are handled as tracks.

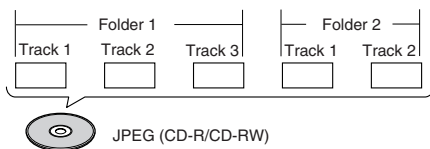

## Handling Discs

- Never touch the underside of a disc. Always hold a disc by the edge, as shown.

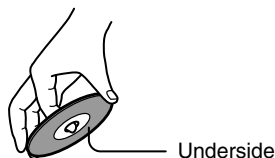

- Never attach adhesive tape or sticky labels to discs.



## Cleaning Discs

- For best results, keep your discs clean. Fingerprints and dust can affect the sound and picture quality and should be removed as follows. Using a clean, soft cloth, wipe from the center outwards, as shown. Never wipe in a circular direction.



- To remove stubborn dust or dirt, wipe the disc with a damp, soft cloth, and then dry it with a dry cloth.
- Never use solvent-based cleaning fluids, such as thinner or benzene, commercially available cleaners, or antistatic sprays intended for vinyl records, because they may damage the disc.

## Storing Discs

- Don't store discs in places subject to direct sunlight, or near heat sources.
- Don't store discs in places subject to moisture or dust, such as in a bathroom or near a humidifier.
- Always store discs in their cases and vertically. Stacking, or putting objects on unprotected discs may cause warping, scratches, or other damage.

## Copyright

It is forbidden by law to copy, broadcast, show, broadcast on cable, play in public, or rent copyrighted material without permission.

Commercial DVD-Video discs are copy-protected, and any recordings made from these discs will be distorted. This product incorporates copyright protection technology that is protected by U.S. patents and other intellectual property rights. Use of this copyright protection technology must be authorized by Macrovision, and is intended for home and other limited viewing uses only unless otherwise authorized by Macrovision. Reverse engineering or disassembly is prohibited.

## Introduction—Continued

### Terminology

■ **CD-R (compact disc recordable):** A type of CD that can be recorded only once. Can be used for VCD, CD, MP3, or JPEG.

■ **CD-RW (compact disc rewritable):** A type of CD that can be recorded over and over again. Can be used for VCD, CD, MP3, or JPEG.

■ **Chapter:** Titles on DVD-Video discs can be subdivided into chapters.

■ **Component video:** A video connection format that separates the luminance (Y) and color difference signals (PR, PB), providing better picture quality than S-Video.

■ **Composite video:** A video connection format that combines the luminance and color signals together.

■ **Direct Digital Path:** Unique Onkyo technology that uses dedicated shielded cables to connect the digital audio outputs, protecting the digital output signals against the possibility of noise and interference.

■ **Dolby Digital:** Once known as AC-3, this is the designated surround sound format for DVD-Video, HDTV, and select digital broadcasts (cable, satellite, over-the-air). A Dolby Digital bitstream may contain mono, stereo, Dolby Surround, or 5.1-channel audio information.

■ **Dolby Pro Logic:** The decoders used in home theater equipment to decode Dolby Surround material. *See* Dolby Surround.

■ **Dolby Surround:** The original Dolby surround-sound format uses matrix encoding to deliver four channels (left, right, center, and surround) over two audio channels. Can be used with VHS video, analog TV, and other analog stereo systems. The movie theater version is known as *Dolby Stereo*.

■ **Downmixing:** The process of mixing multiple audio channels into fewer channels. For example, a 5.1-channel surround mix can be downmixed to two channels for reproduction on stereo systems.

■ **Downsampling:** The process of reducing the sampling rate of digital audio.

■ **DTS (Digital Theater Systems):** Like Dolby Digital, the DTS surround-sound format offers up to 5.1-channels of information, but uses less compression for a more faithful sound.

■ **DVD-Audio:** The DVD format for storing up to six (5.1) channels of 24-bit/96 kHz digital audio or two channels of 24-bit/192 kHz digital audio.

■ **DVD-R (DVD recordable):** A type of DVD disc that can be recorded only once. Can be used for DVD-Video or DVD-Audio.

■ **DVD-RW (DVD rewritable):** A type of DVD disc that can be recorded over and over again. Can be used for DVD-Video, DVD-Audio, or DVD-VR.

■ **DVD-Video:** The format for storing MPEG2 video on DVD, with interactive menus, multiple soundtracks, subtitles, camera angles, and so on.

■ **DVD-VR (DVD Video Recording):** The DVD format used by DVD recorders for storing video on DVD-RW discs. Recorded programs can be deleted or arranged into playlists.

■ **Field:** In interlaced scanning, a field is a single scan of the screen. There are two fields per frame. *See* Interlaced Scanning *and* Progressive Scanning.

■ **Frame:** An individual TV picture is called a frame. With the NTSC color system there are 30 frames per second (25 for PAL).

■ **HD:** Abbreviation for *high definition*, as in HDTV (high-definition TV).

■ **HDMI (High Definition Multimedia Interface):** A new connection format that greatly simplifies AV connections by carrying uncompressed SD or HD digital video and up to eight channels of digital audio all in one cable.

■ **i.LINK:** Another name for the IEEE 1394 connection format. Commonly used on AV equipment. It's a bidirectional format, so connected components can talk to each other for optimal setup and perfectly synchronized audio transmission. The Chinese model doesn't support i.LINK.

■ **i.LINK Audio:** The protocol for carrying up to six (5.1) channels and up to 24-bit/192 kHz digital audio over i.LINK (IEEE 1394). Officially known as the A&M Protocol—*Audio and Music Data Transmission Protocol*. The Chinese model doesn't support i.LINK.

■ **IEEE 1394:** High-speed digital connection format used for video, audio, and computer applications. *See also* A&M Protocol *and* i.LINK. The Chinese model doesn't support i.LINK.

■ **Interlaced scanning:** TV pictures are made by scanning the screen in horizontal lines from top to bottom. With Interlaced scanning, two scans (*fields*) are used to make each picture (*frame*). *Contrast with* Progressive scanning.

■ **JPEG (Joint Photographic Experts Group):** The acronym commonly used to refer to the compressed file format used to store digital images.

■ **LFE (low-frequency effects):** The surround-sound channel used for low-frequency effects.

■ **Linear PCM:** The uncompressed digital audio format used for audio CDs. PCM stands for *Pulse Code Modulation*.

## Introduction—Continued

---

- **MP3 (MPEG 1 Audio Layer 3):** Popular compressed file format for storing digital music.
- **MPEG1 (Moving Picture Experts Group 1):** The compressed digital video format used for VCDs.
- **MPEG2 (Moving Picture Experts Group 2):** The compressed digital video format used for DVDs, offering better picture quality than MPEG1.
- **NTSC:** The color TV system used in the United States, Japan, Taiwan, and Korea.
- **PAL:** The color TV system used in most of Europe, the United Kingdom, Australia, Brazil, and China.
- **PBC (Playback Control):** Version 2.0 of the VCD standard supports interactive menus and search functions.
- **Progressive scanning:** TV pictures are made by scanning the screen in horizontal lines from top to bottom. With progressive scanning, each picture (*frame*) is made by scanning the entire screen from top to bottom in one go, resulting in a clearer and stabler picture. *Contrast with* Interlaced scanning.
- **S-Video:** A video connection format that separates the luminance (Y) and color (C) signals, providing better picture quality than composite video.
- **SACD (Super Audio CD):** SACD uses Direct Stream Digital (DSD) technology for audio performance superior to that of standard CDs. It also supports multi-channel audio, and hybrid discs can be played in standard CD players.
- **SD:** Abbreviation for *standard definition*, as in SDTV (standard-definition TV)
- **THX:** Founded in 1983 by George Lucas, THX develops quality assurance programs to ensure that movies are experienced as the director intended.
- **THX Ultra:** A quality assurance program developed by THX to ensure faithful sound and picture reproduction of movies in cinemas and home theaters.
- **Title:** The contents of DVD-Video discs are organized into titles.
- **Upconversion:** The process of converting video to a higher quality. For example, converting S-Video to component video, or standard definition TV pictures to HDTV.
- **Upsampling:** The process of converting digital audio to a higher sampling rate.
- **VCD (Video CD):** The format for storing MPEG1 video on CD.
- **VLSC (Vector Linear Shaping Circuitry):** Unique Onkyo circuitry that reduces pulse noise in analog audio signals converted from digital sources.

## Before Use

### Setting the Voltage Selector (Worldwide model only)

The Worldwide model has a voltage selector for compatibility with power systems around the world. Before you plug in this model, make sure that the voltage selector is set to the correct voltage for your area. If it isn't, use a small screwdriver to set it as appropriate. For example, if the voltage in your area is 120 volts, set the selector to "120V." If it's between 220 and 230 volts, set it to "220-230V."

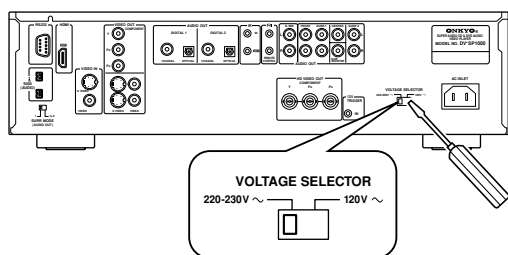

### Installing the Remote's Batteries

- 1 To open the battery compartment, press the small hollow and slide off the cover.

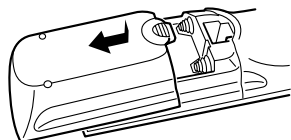

- 2 Insert the three supplied batteries (AA/R6) in accordance with the polarity markings inside the battery compartment.

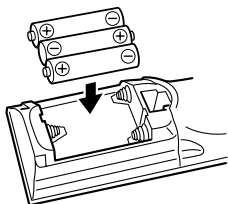

- 3 Put the cover onto the remote controller and slide it shut.

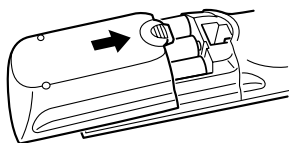

#### Notes:

- The supplied batteries should last for about six months, although this will vary with usage.
- If the remote controller doesn't work reliably, try replacing both batteries.
- Don't mix new and old batteries, or different types of batteries.
- If you intend not to use the remote controller for a long time, remove the batteries to prevent possible leakage and corrosion.
- Flat batteries should be removed as soon as possible to prevent possible leakage and corrosion.

### Using the Remote Controller

To use the remote controller, point it at the DV-SP1000/DV-SP1000E's remote control sensor, as shown below.

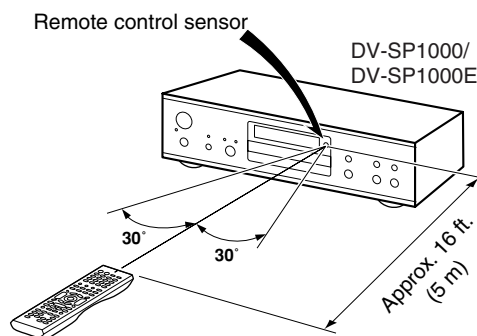

#### Notes:

- The remote controller may not work reliably if the DV-SP1000/DV-SP1000E is subjected to bright light, such as direct sunlight or inverter-type fluorescent lights. Keep this in mind when installing the DV-SP1000/DV-SP1000E.
- If another remote controller of the same type is used in the same room, or the DV-SP1000/DV-SP1000E is installed close to equipment that uses infrared rays, the remote controller may not work reliably.
- Don't put anything, such as a book, on the remote controller, because the buttons may be pressed inadvertently, thereby draining the batteries.
- The remote controller may not work reliably if the DV-SP1000/DV-SP1000E is installed in a rack behind colored glass doors. Keep this in mind when installing the DV-SP1000/DV-SP1000E.
- The remote controller will not work if there's an obstacle between it and the DV-SP1000/DV-SP1000E's remote control sensor.

# Getting to Know the DV-SP1000/DV-SP1000E

## Front Panel

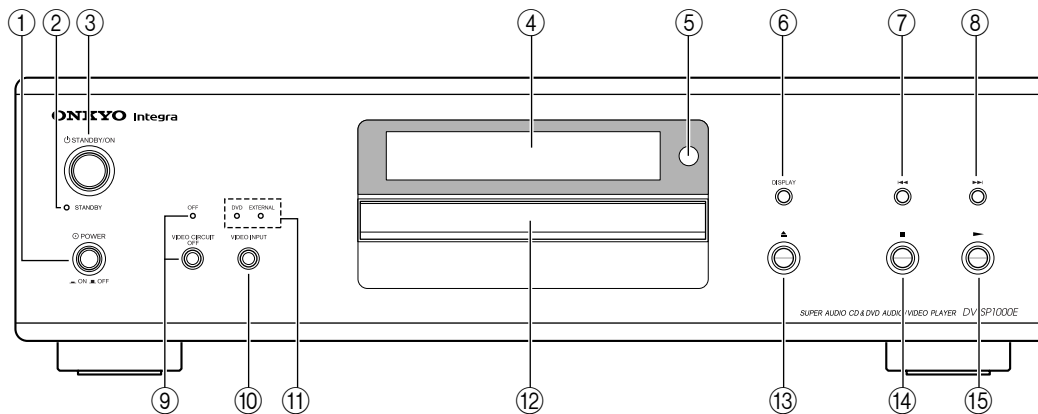

See page 16 for Canadian model.

For detailed information, refer to the pages in parenthesis.

- ① **POWER switch (42)**  
This is the main power switch. When set to OFF, the DV-SP1000/DV-SP1000E is completely shutdown. When set to ON, the DV-SP1000/DV-SP1000E can be set to On or Standby.
- ② **STANDBY indicator (42)**  
The Standby indicator lights up when the DV-SP1000/DV-SP1000E is set to Standby.
- ③ **STANDBY/ON button (42)**  
This button is used to set the DV-SP1000/DV-SP1000E to On or Standby.
- ④ **Display**  
See "Display" on page 17 for more information.
- ⑤ **Remote control sensor (14)**  
This sensor receives control signals from the remote controller.
- ⑥ **DISPLAY button (63)**  
This button is used to display information about the disc, title, chapter, group, or track, including the elapsed time, remaining time, total time, and so on.
- ⑦ **Previous [◀] button (48, 49, 52)**  
This button is used to select the previous chapter or track. During playback it selects the beginning of the current chapter or track.
- ⑧ **Next [▶] button (48, 49, 52)**  
This button is used to select the next chapter or track.
- ⑨ **VIDEO CIRCUIT OFF button & indicator (66)**  
This button is used to turn off all of the internal video circuitry, eliminating the possibility of interference when playing audio-only discs. The OFF indicator lights up when the video circuitry is turned off.
- ⑩ **VIDEO INPUT button (66)**  
This button is used to select the video input source: DVD (the DV-SP1000/DV-SP1000E) or EXTERNAL (S-Video input or composite video input).
- ⑪ **DVD & EXTERNAL indicators (66)**  
These indicators show the currently selected video input source: DVD or EXTERNAL.
- ⑫ **Disc tray (45)**  
Discs are loaded onto the disc tray.
- ⑬ **Open/Close [▲] button (45)**  
This button is used to open and close the disc tray.
- ⑭ **Stop [■] button (46)**  
This button is used to stop playback.
- ⑮ **Play [▶] button (46)**  
This button is used to start playback.

## Getting to Know the DV-SP1000/DV-SP1000E—Continued

### ■ Canadian Model

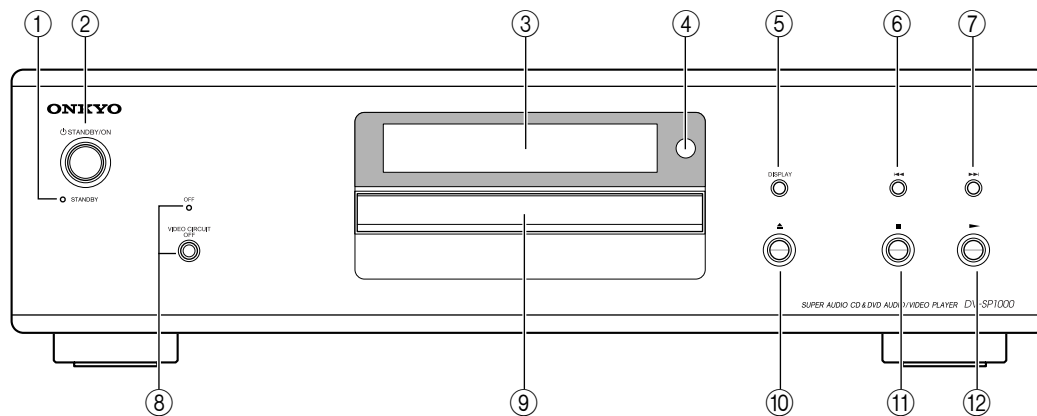

For detailed information, refer to the pages in parenthesis.

- ① **STANDBY indicator (42)**  
The Standby indicator lights up when the DV-SP1000/DV-SP1000E is set to Standby.
- ② **STANDBY/ON button (42)**  
This button is used to set the DV-SP1000/DV-SP1000E to On or Standby.
- ③ **Display**  
See “Display” on page 17 for more information.
- ④ **Remote control sensor (14)**  
This sensor receives control signals from the remote controller.
- ⑤ **DISPLAY button (63)**  
This button is used to display information about the disc, title, chapter, group, or track, including the elapsed time, remaining time, total time, and so on.
- ⑥ **Previous [◀◀] button (48, 49, 52)**  
This button is used to select the previous chapter or track. During playback it selects the beginning of the current chapter or track.
- ⑦ **Next [▶▶] button (48, 49, 52)**  
This button is used to select the next chapter or track.
- ⑧ **VIDEO CIRCUIT OFF button & indicator (66)**  
This button is used to turn off all of the internal video circuitry, eliminating the possibility of interference when playing audio-only discs. The OFF indicator lights up when the video circuitry is turned off.
- ⑨ **Disc tray (45)**  
Discs are loaded onto the disc tray.
- ⑩ **Open/Close [▲] button (45)**  
This button is used to open and close the disc tray.
- ⑪ **Stop [■] button (46)**  
This button is used to stop playback.
- ⑫ **Play [▶] button (46)**  
This button is used to start playback.



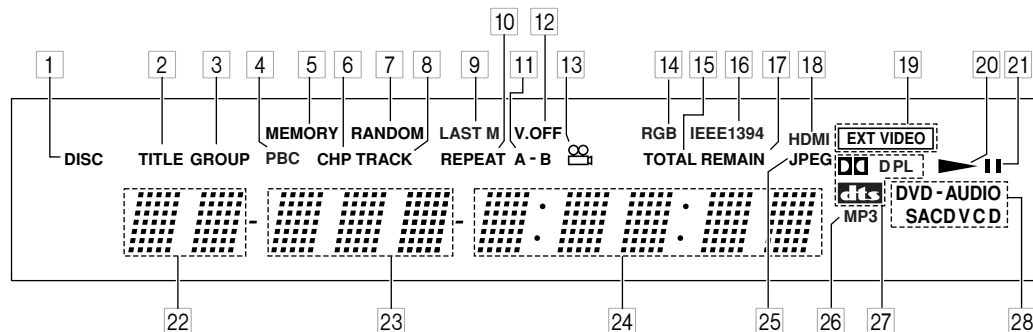

## Getting to Know the DV-SP1000/DV-SP1000E—Continued

### Display



For detailed information, refer to the pages in parenthesis.

- 1 DISC indicator (57, 58)**  
This indicator appears when using the Repeat function's Disc Repeat option or the Random function's Disc Random option.
- 2 TITLE indicator**  
While stopped, the total number of titles on the current DVD-Video disc is displayed here. During playback, the number of the current title is displayed.
- 3 GROUP indicator**  
While stopped, the total number of groups on the current DVD-Audio disc is displayed here. During playback, the number of the current group is displayed.
- 4 PBC indicator**  
This indicator appears when the VCD currently playing supports PBC (Playback Control).
- 5 MEMORY indicator (59)**  
This indicator appears when using the Memory function.
- 6 CHP indicator**  
This indicator appears while the number of the current chapter is being displayed.
- 7 RANDOM indicator (58)**  
This indicator appears when using the Random function.
- 8 TRACK indicator**  
This indicator appears while track numbers are being displayed. While stopped, the total number of tracks on a VCD, SACD, DVD-Audio group, audio CD, or MP3 disc are displayed. During playback, the number of the current track is displayed.
- 9 LAST M indicator (63)**  
This indicator appears when using the Last Memory function.
- 10 REPEAT indicator (57)**  
This indicator appears when using the Repeat function.
- 11 A-B indicators (57)**  
These indicators appear when using the A-B Repeat function.
- 12 V.OFF indicator (66)**  
This indicator appears while the video circuits are turned off.
- 13 Camera angle  indicator (61)**  
This indicator appears if the DVD-Video title currently playing features multiple camera angles.
- 14 RGB indicator (European model only) (74)**  
This indicator appears when the SCART Output Setting is set to RGB.
- 15 TOTAL indicator (63)**  
This indicator appears while the total time is being displayed.
- 16 IEEE 1394 indicator (not Chinese model)**  
This indicator appears when the DV-SP1000/DV-SP1000E is properly connected to an i.LINK (IEEE 1394) component.
- 17 REMAIN indicator (63)**  
This indicator appears while the remaining time is being displayed.
- 18 HDMI indicator**  
This indicator appears when the DV-SP1000/DV-SP1000E is properly connected to an HDMI component.
- 19 EXT VIDEO indicator (66) (not Canadian model)**  
The EXT VIDEO indicator appears when the EXTERNAL video source is selected.
- 20 Play  indicator (46)**  
This indicator appears during playback.
- 21 Pause  indicator (46)**  
This indicator appears when playback is paused.
- 22 Title/Group number**  
Title and group numbers appears here.
- 23 Chapter & track number**  
Chapter and track numbers appears here.

## Getting to Know the DV-SP1000/DV-SP1000E—Continued

### 24 Time display

Time information, such as total time, remaining time, and so on, is displayed here in hours, minutes, and seconds. Other messages are also displayed.

### 25 JPEG indicator

This indicator appears while a JPEG picture is being displayed.

### 26 MP3 indicator

This indicator appears when playing an MP3 track.

### 27 Dolby Digital ( **DD** D), Dolby Pro Logic ( **DD** PL) & DTS ( **DTS**) indicators

The Dolby Digital indicator ( **DD** D) appears when

a Dolby Digital soundtrack is selected. The Dolby Pro Logic ( **DD** PL) indicator appears when the DV-SP1000/DV-SP1000E's Dolby Pro Logic decoder is on. The DTS indicator appears when a DTS soundtrack is selected.

### 28 DVD-AUDIO & SACD VCD indicators

These indicators show the type of disc loaded.

**DVD:** DVD-Video, DVD-VR

**DVD-AUDIO:** DVD-Audio

**SACD:** Super Audio CD

**VCD:** Video CD

**CD:** Audio CD, MP3, JPEG

## Rear Panel

### ■ European Model

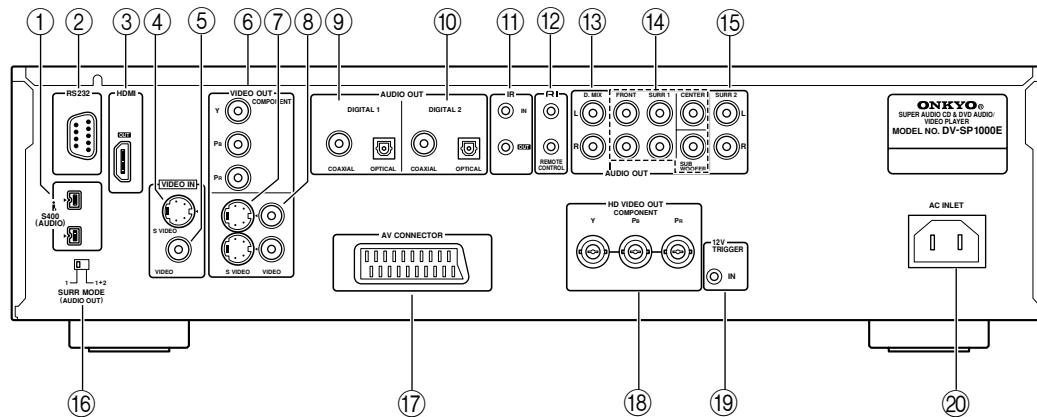

See page 20 for the Canadian model.

See page 21 for other models.

For detailed information, refer to the pages in parenthesis.

### 1 i.LINK S400 (AUDIO) (35)

These sockets can output up to six channels and up to 192 kHz/24-bit digital audio in i.LINK format and can be connected to the i.LINK sockets on a compatible AV receiver or other component. The actual output signal depends on the disc currently playing. Since i.LINK is a bidirectional connection, connected components can talk to each other for optimal setup and perfectly synchronized audio transmission.

### 2 RS 232

This bidirectional RS-232 port can be connected to an external controller.

### 3 HDMI OUT (32)

This HDMI socket outputs digital video and audio and can be connected to an HDMI input on a compatible TV or other component.

### 4 VIDEO IN S VIDEO (39)

This input accepts S-Video and can be connected to an S-Video output on a TV, camcorder, or other component.

When the video input source is set to EXTERNAL, video signals received here are upconverted to progressive video and output by the HD VIDEO OUT COMPONENT output.

### 5 VIDEO IN VIDEO (39)

This input accepts composite video and can be connected to a composite video output on a TV, camcorder, or other component.

When the video input source is set to EXTERNAL, video signals received here are upconverted to progressive video and output by the HD VIDEO OUT COMPONENT output.

### 6 VIDEO OUT COMPONENT (Y, Pr, Pb) (30)

These sockets output component video and can be connected to a component video input on a TV or projector. They output only interlaced video.

## Getting to Know the DV-SP1000/DV-SP1000E—Continued

- ⑦ **VIDEO OUT S VIDEO (30)**  
These two sockets output S-Video and can be connected to an S-Video input on a TV or projector.
- ⑧ **VIDEO OUT VIDEO (30)**  
These two sockets output composite video and can be connected to a composite video input on a TV or projector.
- ⑨ **DIGITAL 1 AUDIO OUT (36, 38)**  
These sockets output digital audio and can be connected to the digital audio input on a hi-fi amp, AV receiver, surround sound decoder (Dolby Digital, DTS), or other component. There's a coaxial output and an optical output.
- ⑩ **DIGITAL 2 AUDIO OUT (36, 38)**  
These sockets output digital audio and can be connected to the digital audio inputs on a hi-fi amp, AV receiver, surround sound decoder (Dolby Digital, DTS), or other component. There's a coaxial output and an optical output.
- ⑪ **IR IN/OUT (40)**  
The IR IN socket can be used to connect a commercially available IR receiver, which can be used to pickup signals from the remote controller when the DV-SP1000/DV-SP1000E is located in another room, installed in a rack, or is out of range of the remote controller.  
The IR OUT connector can be used to connect a commercially available IR emitter, which can be used to pass remote controller signals received by the IR IN along to other components.
- ⑫ **RI REMOTE CONTROL (40)**  
These **RI** (Remote Interactive) sockets can be connected to the **RI** sockets on other Onkyo AV components for interactive control.  
To use **RI** you must make an analog audio connection between the DV-SP1000/DV-SP1000E and your Onkyo AV receiver, even if they are connected digitally.
- ⑬ **D.MIX AUDIO OUT (30, 31, 38)**  
These sockets output analog audio and can be connected to a stereo analog audio input on a TV, hi-fi amp, or other component. If the source audio is multichannel (Dolby Digital, DTS, DVD-Audio, SACD), they output a 2-channel downmix.
- ⑭ **FRONT, SURR 1, CENTER & SUBWOOFER AUDIO OUT (37)**  
These sockets output 5.1-channel analog audio and can be connected to a 5.1-channel analog audio input on an AV receiver, surround sound decoder (Dolby Pro Logic), or other component.
- ⑮ **SURR 2 AUDIO OUT (37)**  
These sockets output the same analog audio as the SURR1 outputs and can be connected to the analog surround back left and right inputs on a 7.1-channel AV receiver or other component. When using these sockets, the SURR MODE switch should be set to 1+2.
- ⑯ **SURR MODE (AUDIO OUT) switch (37)**  
This switch is used to set the surround output mode of the analog multichannel audio outputs. If you connect the SURR 2 outputs to a 7.1-channel AV receiver or amp, set this switch to 1+2. This reduces the output level by 3 dB. If you're not using the SURR 2 outputs, set this switch to 1.
- ⑰ **AV CONNECTOR (32)**  
This SCART socket outputs RGB video, S-Video, composite video, and analog stereo audio and can be connected to the SCART socket on a TV, projector, or other component.
- ⑱ **HD VIDEO OUT COMPONENT (31)**  
These BNC sockets output HD component video and can be connected to the HD component video input on an HDTV or projector.  
When a video signal is fed to a VIDEO IN socket (S-Video or composite), and the video input source is set to EXTERNAL, that video signal is upconverted to progressive and output here.
- ⑲ **12V TRIGGER IN**  
This socket can be connected to the 12-volt trigger output on an AV receiver or other component so that the DV-SP1000/DV-SP1000E can be turned on remotely.
- ⑳ **AC INLET (41)**  
The supplied power cord should be connected here.

## Getting to Know the DV-SP1000/DV-SP1000E—Continued

### ■ Canadian Model

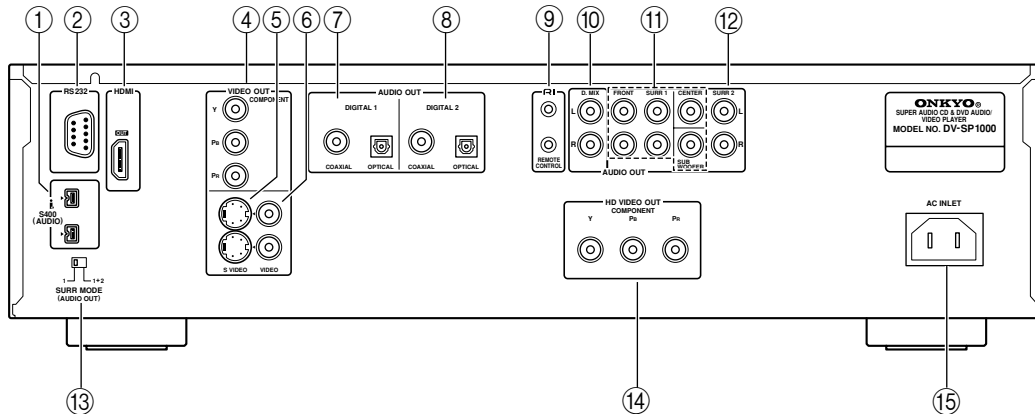

For detailed information, refer to the pages in parenthesis.

- ① **i.LINK S400 (AUDIO) (35)**  
These sockets can output up to six channels and up to 192 kHz/24-bit digital audio in i.LINK format and can be connected to the i.LINK sockets on a compatible AV receiver or other component. The actual output signal depends on the disc currently playing. Since i.LINK is a bidirectional connection, connected components can talk to each other for optimal setup and perfectly synchronized audio transmission.
- ② **RS 232**  
This bidirectional RS-232 port can be connected to an external controller.
- ③ **HDMI OUT (32)**  
This HDMI socket outputs digital video and audio and can be connected to an HDMI input on a compatible TV or other component.
- ④ **VIDEO OUT COMPONENT (Y, Pr, Pb) (30)**  
These sockets output component video and can be connected to a component video input on a TV or projector. They output only interlaced video.
- ⑤ **VIDEO OUT S VIDEO (30)**  
These two sockets output S-Video and can be connected to an S-Video input on a TV or projector.
- ⑥ **VIDEO OUT VIDEO (30)**  
These two sockets output composite video and can be connected to a composite video input on a TV or projector.
- ⑦ **DIGITAL 1 AUDIO OUT (36, 38)**  
These sockets output digital audio and can be connected to the digital audio input on a hi-fi amp, AV receiver, surround sound decoder (Dolby Digital, DTS), or other component. There's a coaxial output and an optical output.
- ⑧ **DIGITAL 2 AUDIO OUT (36, 38)**  
These sockets output digital audio and can be connected to the digital audio inputs on a hi-fi amp, AV receiver, surround sound decoder (Dolby Digital, DTS), or other component. There's a coaxial output and an optical output.
- ⑨ **RI REMOTE CONTROL (40)**  
These **RI** (Remote Interactive) sockets can be connected to the **RI** sockets on other Onkyo AV components for interactive control.  
To use **RI** you must make an analog audio connection between the DV-SP1000/DV-SP1000E and your Onkyo AV receiver, even if they are connected digitally.
- ⑩ **D.MIX AUDIO OUT (30, 31, 38)**  
These sockets output analog audio and can be connected to a stereo analog audio input on a TV, hi-fi amp, or other component. If the source audio is multichannel (Dolby Digital, DTS, DVD-Audio, SACD), they output a 2-channel downmix.
- ⑪ **FRONT, SURR 1, CENTER & SUBWOOFER AUDIO OUT (37)**  
These sockets output 5.1-channel analog audio and can be connected to a 5.1-channel analog audio input on an AV receiver, surround sound decoder (Dolby Pro Logic), or other component.
- ⑫ **SURR 2 AUDIO OUT (37)**  
These sockets output the same analog audio as the SURR1 outputs and can be connected to the analog surround back left and right inputs on a 7.1-channel AV receiver or other component. When using these sockets, the SURR MODE switch should be set to 1+2.

## Getting to Know the DV-SP1000/DV-SP1000E—Continued

### 13 SURR MODE (AUDIO OUT) switch (37)

This switch is used to set the surround output mode of the analog multichannel audio outputs. If you connect the SURR 2 outputs to a 7.1-channel AV receiver or amp, set this switch to 1+2. This reduces the output level by 3 dB. If you're not using the SURR 2 outputs, set this switch to 1.

### 14 HD VIDEO OUT COMPONENT (31)

These RCA sockets output HD component video and can be connected to the HD component video input on an HDTV or projector.

### 15 AC INLET (41)

The supplied power cord should be connected here.

### Other Models

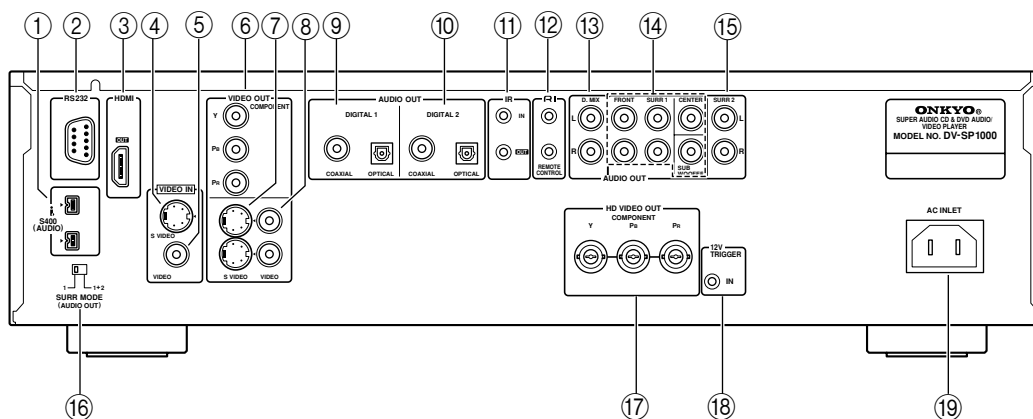

### 1 i.LINK S400 (AUDIO) (35) (not Chinese model)

These sockets can output up to six channels and up to 192 kHz/24-bit digital audio in i.LINK format and can be connected to the i.LINK sockets on a compatible AV receiver or other component. The actual output signal depends on the disc currently playing. Since i.LINK is a bidirectional connection, connected components can talk to each other for optimal setup and perfectly synchronized audio transmission.

### 2 RS 232

This bidirectional RS-232 port can be connected to an external controller.

### 3 HDMI OUT (32)

This HDMI socket outputs digital video and audio and can be connected to an HDMI input on a compatible TV or other component.

### 4 VIDEO IN S VIDEO (39)

This input accepts S-Video and can be connected to an S-Video output on a TV, camcorder, or other component.

When the video input source is set to EXTERNAL, video signals received here are upconverted to progressive video and output by the HD VIDEO OUT COMPONENT output.

### 5 VIDEO IN VIDEO (39)

This input accepts composite video and can be connected to a composite video output on a TV, camcorder, or other component.

When the video input source is set to EXTERNAL, video signals received here are upconverted to progressive video and output by the HD VIDEO OUT COMPONENT output.

### 6 VIDEO OUT COMPONENT (Y, PR, PB) (30)

These sockets output component video and can be connected to a component video input on a TV or projector. They output only interlaced video.

### 7 VIDEO OUT S VIDEO (30)

These two sockets output S-Video and can be connected to an S-Video input on a TV or projector.

### 8 VIDEO OUT VIDEO (30)

These two sockets output composite video and can be connected to a composite video input on a TV or projector.

### 9 DIGITAL 1 AUDIO OUT (36, 38)

These sockets output digital audio and can be connected to the digital audio input on a hi-fi amp, AV receiver, surround sound decoder (Dolby Digital, DTS), or other component. There's a coaxial output and an optical output.

### 10 DIGITAL 2 AUDIO OUT (36, 38)

These sockets output digital audio and can be connected to the digital audio inputs on a hi-fi amp, AV receiver, surround sound decoder (Dolby Digital, DTS), or other component. There's a coaxial output and an optical output.

## Getting to Know the DV-SP1000/DV-SP1000E—Continued

### ⑪ IR IN/OUT (40)

The IR IN socket can be used to connect a commercially available IR receiver, which can be used to pickup signals from the remote controller when the DV-SP1000/DV-SP1000E is located in another room, installed in a rack, or is out of range of the remote controller.

The IR OUT connector can be used to connect a commercially available IR emitter, which can be used to pass remote controller signals received by the IR IN along to other components.

### ⑫ RI REMOTE CONTROL (40)

These **RI** (Remote Interactive) sockets can be connected to the **RI** sockets on other Onkyo AV components for interactive control.

To use **RI** you must make an analog audio connection between the DV-SP1000/DV-SP1000E and your Onkyo AV receiver, even if they are connected digitally.

### ⑬ D.MIX AUDIO OUT (30, 31, 38)

These sockets output analog audio and can be connected to a stereo analog audio input on a TV, hi-fi amp, or other component. If the source audio is multichannel (Dolby Digital, DTS, DVD-Audio, SACD), they output a 2-channel downmix.

### ⑭ FRONT, SURR 1, CENTER & SUBWOOFER AUDIO OUT (37)

These sockets output 5.1-channel analog audio and can be connected to a 5.1-channel analog audio input on an AV receiver, surround sound decoder (Dolby Pro Logic), or other component.

### ⑮ SURR 2 AUDIO OUT (37)

These sockets output the same analog audio as the SURR1 outputs and can be connected to the analog surround back left and right inputs on a 7.1-channel AV receiver or other component. When using these sockets, the SURR MODE switch should be set to 1+2.

### ⑯ SURR MODE (AUDIO OUT) switch (37)

This switch is used to set the surround output mode of the analog multichannel audio outputs. If you connect the SURR 2 outputs to a 7.1-channel AV receiver or amp, set this switch to 1+2. This reduces the output level by 3 dB. If you're not using the SURR 2 outputs, set this switch to 1.

### ⑰ HD VIDEO OUT COMPONENT (31)

These BNC sockets output HD component video and can be connected to the HD component video input on an HDTV or projector.

When a video signal is fed to a VIDEO IN socket (S-Video or composite), and the video input source is set to EXTERNAL, that video signal is upconverted to progressive and output here.

### ⑱ 12V TRIGGER IN

This socket can be connected to the 12-volt trigger output on an AV receiver or other component so that the DV-SP1000/DV-SP1000E can be turned on remotely.

### ⑲ AC INLET (41)

The supplied power cord should be connected here.

## Getting to Know the DV-SP1000/DV-SP1000E—Continued

### Remote Controller

The DV-SP1000/DV-SP1000E's remote controller is a multipurpose device that can be used to control not just the DV-SP1000/DV-SP1000E but an Onkyo AV receiver, TV, and VCR. This section explains how it's used to control the DV-SP1000/DV-SP1000E or an Onkyo AV receiver. See page 90 for information on using it to control TVs and VCRs.

### Controlling the DV-SP1000/DV-SP1000E (DVD Mode)

In DVD mode, the remote controller controls the DV-SP1000/DV-SP1000E. To select DVD mode, press the [DVD] MODE button.

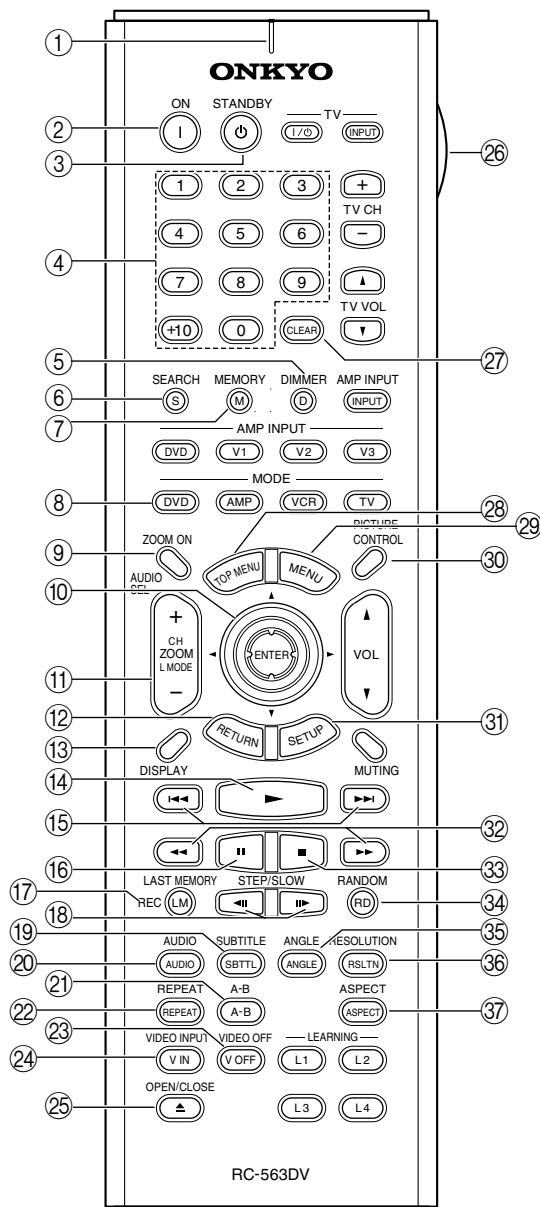

For detailed information, refer to the pages in parenthesis.

- ① **Tx/Learn indicator (86)**  
This indicator lights up when the remote controller is transmitting commands. It's also used when configuring the remote controller for use with a TV or VCR.
- ② **ON button (42)**  
This button is used to turn on the DV-SP1000/DV-SP1000E.
- ③ **STANDBY button (42)**  
This button is used to set the DV-SP1000/DV-SP1000E to Standby.
- ④ **Number buttons (48, 49, 56)**  
These buttons are used to enter title, chapter, group, and track numbers and to enter times for locating specific points in time.  
To enter a single-digit number, simply press the corresponding button. To enter a double-digit number, enter the numbers in order from left-to-right (e.g., to enter 14, press [1] then [4]).  
The [+10] button is used to enter multiples of ten (i.e., 10, 20, 30, and so on). For example, to enter the number 25, press the [+10] button twice followed by the [5] button.
- ⑤ **DIMMER button (51)**  
This button is used to adjust the display brightness.
- ⑥ **SEARCH button (48, 49, 56)**  
This button is used to search for titles, chapters, groups, tracks, and specific points in time.
- ⑦ **MEMORY button (59)**  
This button is used with the Memory function.
- ⑧ **DVD MODE button**  
This button is used to select the remote controller's DVD mode.
- ⑨ **ZOOM ON button (56)**  
This button is used to turn the Zoom function on and off.
- ⑩ **Arrow [▲]/[▼]/[◀]/[▶] & ENTER buttons (43)**  
The arrow buttons are mainly used to navigate onscreen menus. The [ENTER] button is used to confirm choices.
- ⑪ **ZOOM [+/-] button (56)**  
This button is used with the Zoom function to zoom in and out.
- ⑫ **RETURN button (47, 52, 70)**  
This button is used to return to the previously displayed onscreen setup menu.
- ⑬ **DISPLAY button (63)**  
This button is used to display information about the current disc, title, chapter, group, or track, including the elapsed time, remaining time, total time, and so on.

## Getting to Know the DV-SP1000/DV-SP1000E—Continued

- ⑭ **Play [▶] button (46)**  
This button is used to start playback.
- ⑮ **Previous/Next [◀◀]/[▶▶] buttons (48, 49, 52)**  
The Previous [◀◀] button is used to select the previous chapter or track. During playback it selects the beginning of the current chapter or track. The Next [▶▶] button is used to select the next chapter or track.
- ⑯ **Pause [⏸] button (46)**  
This button is used to pause playback.
- ⑰ **LAST MEMORY button (63)**  
This button is used with the Last Memory function.
- ⑱ **STEP/SLOW [◀⏪]/[⏩▶] buttons (50, 51)**  
These buttons are used for frame-by-frame playback and slow-motion playback.
- ⑲ **SUBTITLE button (62)**  
This button is used to select subtitles.
- ⑳ **AUDIO button (62)**  
This button is used to select foreign language soundtracks and audio formats (e.g., Dolby Digital or DTS). It's also used to select the multichannel area, 2-channel area, or CD layer on SACDs.
- ㉑ **A-B button (57)**  
This button is used to set the A–B Repeat function.
- ㉒ **REPEAT button (57)**  
This button is used to set the Repeat function.
- ㉓ **VIDEO OFF button (66)**  
This button is used to turn off all of the internal video circuitry for pure audio playback.
- ㉔ **VIDEO INPUT button (66)**  
(This button is not used on the Canadian model.)  
This button is used to select the video input source: DVD (the DV-SP1000/DV-SP1000E) or EXTERNAL (S-Video input or composite video input).
- ㉕ **OPEN/CLOSE [▲] button (45)**  
This button is used to open and close the disc tray.
- ㉖ **LIGHT button**  
This button is used to turn on or off the remote controller's illuminated buttons.
- ㉗ **CLEAR button (48, 49)**  
This button is used to cancel functions and to clear entered numbers.
- ㉘ **TOP MENU button (47)**  
This button is used to select a DVD's top menu.
- ㉙ **MENU button (47)**  
This button is used to select a DVD's menu.
- ㉚ **PICTURE CONTROL button (67)**  
This button is used to open the Picture Control menu.
- ㉛ **SETUP button (70)**  
This button is used to access the onscreen setup menus (OSD).
- ㉜ **FR/FF [◀◀]/[▶▶] buttons (50)**  
The FR [◀◀] button is used to start fast reverse. The FF [▶▶] button is used to start fast forward.
- ㉝ **Stop [■] button (46)**  
This button is used to stop playback.
- ㉞ **RANDOM button (58)**  
This button is used with the Random function.
- ㉟ **ANGLE button (61)**  
This button is used to select different camera angles.
- ㊱ **RESOLUTION button (66)**  
This button is used to select a video resolution for the HDMI OUT.
- ㊲ **ASPECT button (67)**  
This button is used to set the picture's aspect ratio.



## Getting to Know the DV-SP1000/DV-SP1000E—Continued

### Controlling an Onkyo AV Receiver (Amp Mode)

In Amp mode, the remote controller can be used to control an Onkyo AV receiver connected to the DV-SP1000/DV-SP1000E via **RI**. To select Amp mode, press the [AMP] MODE button.

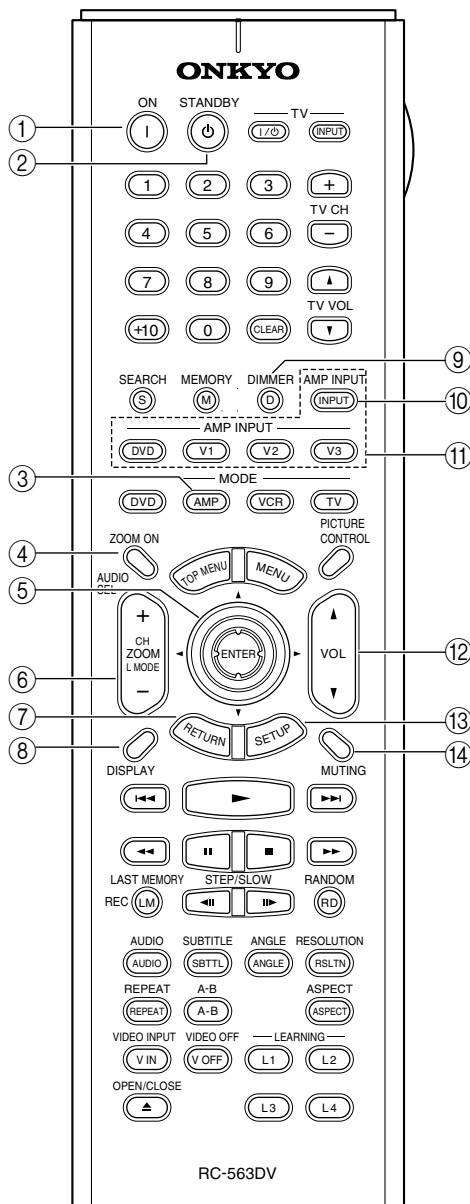

- ① **ON button**  
This button is used to turn the AV receiver on.
- ② **STANDBY button**  
This button is used to set the AV receiver to Standby.
- ③ **AMP MODE button**  
This button is used to select the remote controller's Amp mode.
- ④ **AUDIO SEL button**  
This button is used to select the audio input signal format on the AV receiver.
- ⑤ **Arrow [▲]/[▼]/[◀]/[▶] & ENTER buttons**  
The arrow buttons are mainly used to navigate onscreen menus. The [ENTER] button is used to confirm choices.
- ⑥ **L MODE [+/-] button**  
This button is used to select listening modes on the AV receiver.
- ⑦ **RETURN button**  
This button is used to return to the previously displayed menu of the AV receiver's onscreen setup menus (OSD).
- ⑧ **DISPLAY button**  
This button is used to display various information about the input source currently selected on the AV receiver.
- ⑨ **DIMMER button**  
This button is used to adjust the display brightness on the AV receiver.
- ⑩ **AMP INPUT button**  
This button is used to select the input source on the AV receiver.
- ⑪ **Amp Input (DVD, V1, V2, V3) buttons**  
These buttons are used to select the input source on the AV receiver: DVD, Video 1, Video 2, or Video 3.
- ⑫ **VOL button**  
This button is used to set the volume of the AV receiver.
- ⑬ **SETUP button**  
This button is used to access the AV receiver's onscreen setup menus (OSD).
- ⑭ **MUTING button**  
This button is used to mute the AV receiver.

# Connecting

This chapter explains how to connect the DV-SP1000/DV-SP1000E to your other AV components.

## Before Making Any Connections

- Read the manuals supplied with your AV components.
- Don't connect the power cord until you've completed all audio and video connections.

## Optical Digital Outputs

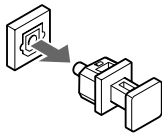

The DV-SP1000/DV-SP1000E's optical digital output sockets have dust caps for keeping out dust and dirt when they're not in use. Remove the cap before inserting an optical plug, and push the plug in all the way to make a good connection. Keep the dust cap in a safe place for future use.

## RCA AV Connection Color Coding

RCA-type AV connections are usually color coded: red, white, and yellow. Use red plugs to connect right-channel audio inputs and outputs (typically labeled "R"). Use white plugs to connect left-channel audio inputs and outputs (typically labeled "L"). And use yellow plugs to connect composite video inputs and outputs.





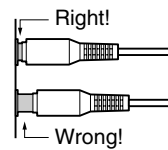





- Push each plug in all the way to make a good connection (loose connections can cause noise or malfunctions).
- To prevent interference, keep audio and video cables away from power cords and speaker cables.

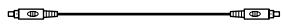

## AV Cables & Connectors

Video			
<b>HDMI</b>			HDMI connections can carry uncompressed, standard or high definition digital video and up to eight channels of digital audio, for the best picture and sound quality.
<b>Component video</b>			Component video connections separate the luminance (Y) and color difference signals (Pr, Pb) and provide picture quality better than S-Video and composite video. (Some manufacturers label their component video sockets slightly differently.)
			The DV-SP1000/DV-SP1000E's HD VIDEO OUT COMPONENT sockets are BNC connectors, except on the Canadian model, which has RCA sockets.
<b>S-Video</b>			S-Video connections provide better picture quality than composite video.
<b>Composite video</b>			Composite video is commonly used on TVs, VCRs, and other video equipment. Use only dedicated composite video cables.
<b>SCART (European model only)</b>			SCART connections carry video (RGB, S-Video, and composite) and analog stereo audio all in one cable.

## Connecting—Continued

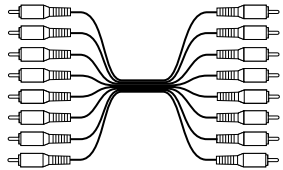
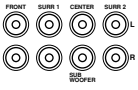
Audio			
<b>i.LINK</b>			i.LINK (IEEE 1394) connections can carry up to six (5.1) channels and up to 24-bit/192 kHz digital audio, and can be used for multichannel digital audio (DVD-Video, DVD-Audio, SACD) and stereo digital audio (VCD, CD, MP3). The Chinese model doesn't support i.LINK.
<b>Optical digital</b>			Optical digital audio connections can carry Dolby Digital or DTS multichannel digital audio (DVD-Video, DVD-Audio) or stereo digital audio (DVD-Video, DVD-Audio, SACD, VCD, CD, MP3).
<b>Coaxial digital</b>			Coaxial digital audio connections can carry Dolby Digital or DTS multichannel digital audio (DVD-Video, DVD-Audio) or stereo digital audio (DVD-Video, DVD-Audio, SACD, VCD, CD, MP3).
<b>Analog</b>			RCA analog audio connectors can be found on virtually all AV components.
<b>Multichannel analog audio cable (RCA)</b>			This cable carries multichannel analog audio and it's typically used to connect DVD players with individual 5.1/7.1-channel analog audio outputs. Several standard analog audio cables can be used instead of a multichannel cable.

## Video Formats & DV-SP1000/DV-SP1000E Inputs & Outputs

The DV-SP1000/DV-SP1000E supports several video input formats. The following table shows what's output by each video output when each of the video inputs is selected. It also shows whether or not the video is upconverted to progressive video. (The Canadian model has no video inputs.)

Selected video input	DV-SP1000/DV-SP1000E video output					SCART <sup>b</sup>
	HDMI OUT <sup>a</sup>	HD VIDEO OUT COMPONENT	COMPONENT VIDEO OUT	S VIDEO VIDEO OUT	VIDEO VIDEO OUT	
DVD (i.e., DV-SP1000/DV-SP1000E)	DVD <sup>e</sup>	DVD <sup>c</sup> (progressive)				
External	S VIDEO VIDEO IN	External <sup>e</sup>	External (progressive)	DVD (interlaced) <sup>d</sup>		
	VIDEO VIDEO IN	External <sup>e</sup>	External (progressive)			

- a. Only works with components that support HDCP (High-bandwidth Digital Content Protection).
- b. European model only. Outputs RGB (i.e., component video), S-Video, or composite video. When set to RGB, nothing is output by the component video output (see page 74).
- c. The picture can be adjusted by using the Progressive Setting (see page 73).
- d. The picture can be adjusted by using the Interlaced Setting (see page 72).
- e. Resolutions supported by the connected TV can be selected by pressing the [RESOLUTION] button (see page 66).

## Connecting—Continued

### Audio Formats & DV-SP1000/DV-SP1000E Outputs

The DV-SP1000/DV-SP1000E supports many digital audio formats. The following table shows which outputs work with each format. The Chinese model doesn't support i.LINK.

Disc type	Audio format	DV-SP1000/DV-SP1000E audio output					
		HDMI OUT (digital) <sup>a</sup>	i.LINK* (digital) <sup>b</sup>	DIGITAL 1 & 2 AUDIO OUT (digital) <sup>c</sup>	FRONT, SURR 1, CENTER, SUBWOOFER, SURR 2 (analog) <sup>d</sup>	D.MIX AUDIO OUT (analog) <sup>e</sup>	SCART (analog) <sup>f</sup>
DVD-Video	PCM	✓ <sup>g</sup>	✓ <sup>h</sup>	✓ <sup>i</sup>	✓ <sup>j</sup>	✓	✓
	Dolby Digital	✓ <sup>k</sup>	✓	✓	✓ <sup>l</sup>	✓	✓
	DTS	✓ <sup>k</sup>	✓	✓	✓	✓	✓
	MPEG <sup>m</sup>	✓ <sup>k</sup>	✓	✓	✓	✓	✓
DVD-Audio <sup>n</sup>	PCM	✗	✓	✓ <sup>o, i</sup>	✓	✓	✓
	Dolby Digital	✗	✓	✓ <sup>p</sup>	✓	✓	✓
	DTS	✗	✓	✓ <sup>p</sup>	✓	✓	✓
	MPEG <sup>m</sup>	✗	✓	✓ <sup>p</sup>	✓	✓	✓
SACD <sup>q</sup>	Stereo area	✗	✓ <sup>r</sup>	✗	✓	✓	✓
	Multichannel area	✗	✓ <sup>r</sup>	✗	✓	✓	✓
	Hybrid disc CD layer	✓	✓	✓	✓	✓	✓
VCD	MPEG1	✓	✓	✓	✓	✓	✓
CD	PCM	✓	✓	✓ <sup>i</sup>	✓ <sup>j</sup>	✓	✓
	DTS	✓ <sup>k</sup>	✓	✓	✓	✓	✓
MP3	MP3	✓	✓	✓	✓	✓	✓

- a. The Digital Out/Digital 2 settings apply to the HDMI OUT (see page 75). Components must support HDCP (High-bandwidth Digital Content Protection) in order to play DVD-Video. The DV-SP1000/DV-SP1000E does.
- b. The Digital Out/Digital 1 settings apply to the i.LINK sockets (see page 74). Components must support DTCP (Digital Transmission Content Protection) in order to play DVD-Video, DVD-Audio, and SACD. The DV-SP1000/DV-SP1000E does (not Chinese model)..
- c. If the Digital Out setting is set to Off, nothing is output by these outputs (see page 75).
- d. 2-channel stereo sources are output only by the FRONT AUDIO OUT sockets. For multichannel sources, the Downmix Setting determines how the FRONT AUDIO OUT sockets work (see page 76).
- e. 2-channel sources, including Dolby Surround, are output as they are. Multichannel sources are down mixed.
- f. European model only. 2-channel sources, including Dolby Surround, are output as they are. Multichannel sources can be down mixed to stereo or Lt/Rt (see page 76).
- g. To output PCM at sampling rates other than 44.1 kHz and 48 kHz, set the Linear PCM Out setting to Down Sample On (see page 75).
- h. Protected high sampling rate digital audio (96 kHz) will be down sampled to 48 kHz.
- i. You can choose whether or not to downsample 96 kHz audio to 48 kHz (see page 75).
- j. Set the Dolby Pro Logic setting to On to add surround sound (see page 76).
- k. To use with an HDMI TV that does not support this format, set the appropriate Digital Out/Digital 2 setting (i.e., Dolby Digital Out, DTS Out, or MPEG Out) to downmix to PCM (see page 75).
- l. Set the Dolby Pro Logic setting to Auto or On to decode Dolby Surround material. Set it to On to add surround sound to 2-channel Dolby Digital material (see page 76).
- m. Only the 2-channel audio information is used.
- n. High sampling rate DVD-Audio (192 kHz/176 kHz) will be down sampled to 96 kHz, 88.2 kHz, 48 kHz, or 44.1 kHz depending on the disc.
- o. Some DVD-Audio discs may not allow PCM output from the DIGITAL 1/2 AUDIO OUTS.
- p. Multichannel DVD-Audio will be down mixed to stereo.
- q. By default the DV-SP1000/DV-SP1000E plays the multichannel area, although you can change this (see page 80).
- r. When the i.LINK Output Setting is set to On, SACD audio is output from the i.LINK sockets, but not the analog audio outputs. When it's set to Off, SACD audio is output from the analog audio outputs, but not the i.LINK sockets (see page 76) (not Chinese model).

## Connecting—Continued

### Getting Connected

If you're not sure how to connect the DV-SP1000/DV-SP1000E to your other components, check what type of sockets they have and use the following map to locate the appropriate hookup information.

#### ▼ Video Output Connections

- ▼ Components with an HDMI input ----- page 32 (F)
- ▼ Components with a component video input
  - ▼ Digital HDTV or projector ----- page 31 (D)
  - ▼ Components that support progressive scanning ----- page 31 (D)
  - ▼ Components that do not support progressive scanning ----- page 30 (A), page 34 (G)
  - ▼ Components with a SCART socket ----- page 32 (E)
- ▼ Components with an S-Video input ----- page 30 (B), page 34 (H)
- ▼ Components with a composite video input ----- page 30 (C), page 34 (I)

#### ▼ Audio Output Connections

- ▼ Components with digital audio inputs
  - ▼ Components that support Dolby Digital and DTS ----- page 36 (K)
  - ▼ Components that do not support Dolby Digital and DTS ----- page 38 (N)
- ▼ Components with analog audio inputs
  - ▼ Components with a multichannel audio input ----- page 37 (L)
  - ▼ Components with a 2-channel audio input ----- page 38 (M)

#### ▼ i.LINK (AUDIO) Components (not Chinese model) ----- page 35 (J)

#### ▼ Video Input Connections (not Canadian model)

- ▼ Components with an S-Video output ----- page 39 (O)
- ▼ Components with a composite video output ----- page 39 (O)

## Connecting—Continued

### Connecting a Standard TV

This section shows how to connect the DV-SP1000/DV-SP1000E to a standard TV, in which the TV handles both the video and audio. If your TV has a Dolby Pro Logic decoder built-in, you'll be able to enjoy DVDs that bear the Dolby Surround logo.

To fully enjoy the Dolby Digital and DTS soundtracks available on most DVD-Video discs, or the multichannel audio of DVD-Audio and SACD, you need a suitable AV receiver (see page 36).

The DV-SP1000/DV-SP1000E has three types of video output for use with standard TVs: **component video**, **S-Video**, and **composite video**.

**Component video** offers the best picture quality, so if your TV supports it, use a commercially available component video cable to connect the DV-SP1000/DV-SP1000E's COMPONENT VIDEO OUT to the component video input on your TV. If your TV supports progressive scanning, you must use a component video connection to take advantage of it.

If you don't have component video, **S-Video** offers better picture quality than composite video, so if your TV supports it, use the supplied S-Video cable to connect the DV-SP1000/DV-SP1000E's S VIDEO VIDEO OUT to an S-Video input on your TV. Failing that, use the supplied **composite video** cable to connect the DV-SP1000/DV-SP1000E's VIDEO VIDEO OUT to a composite video input on your TV.

### A. Using Component Video

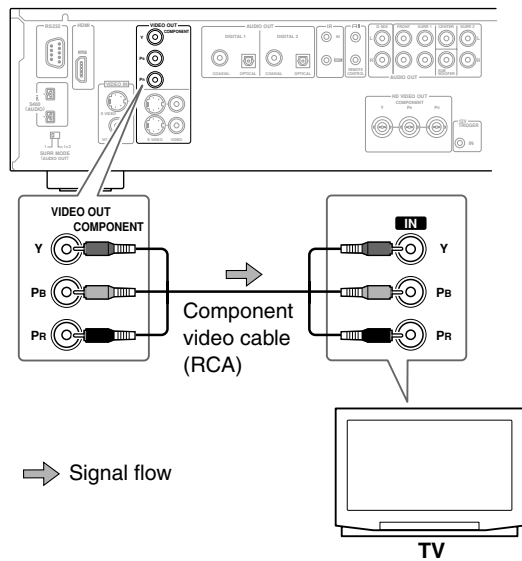

Audio connection not shown here. Make a suitable audio connection to your TV, AV receiver, or amp.

### B. Using S-Video

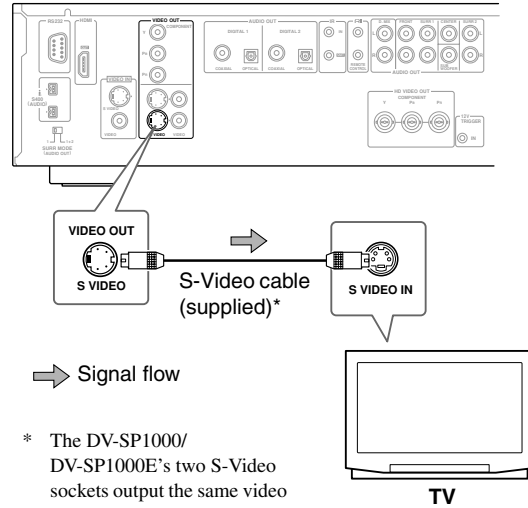

Audio connection not shown here. Make a suitable audio connection to your TV, AV receiver, or amp.

### C. Using Composite Video

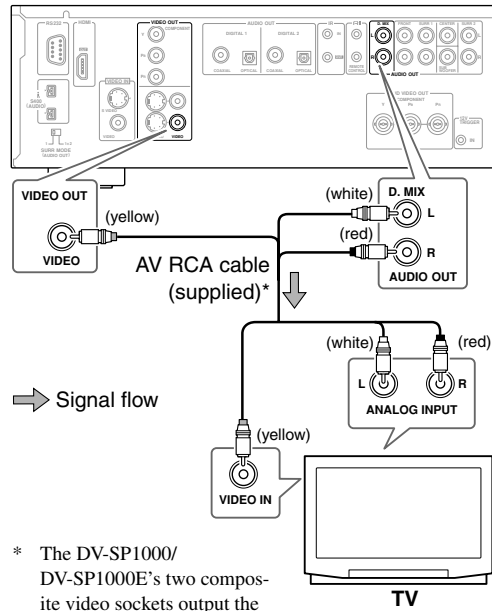

## Connecting—Continued

- 1** Turn off the DV-SP1000/DV-SP1000E and your TV, and disconnect their power cords from the wall outlets.
- 2** Connect the DV-SP1000/DV-SP1000E to your TV as shown.
- 3** When you've completed all connections, see "Turning On the DV-SP1000/DV-SP1000E" on page 42.

**Notes:**

- Before making any connections, turn off the DV-SP1000/DV-SP1000E and your TV and disconnect their power cords from the wall outlets.
- Also refer to the hookup pages in your TV's manual.
- Connect the DV-SP1000/DV-SP1000E's video outputs directly to your TV. Don't connect a VCR or other video equipment in between. Doing so may result in picture distortion, because of the copy protection system used on DVD-Video discs.
- See the tables on page 27 for details on how the DV-SP1000/DV-SP1000E outputs video and audio from each output.

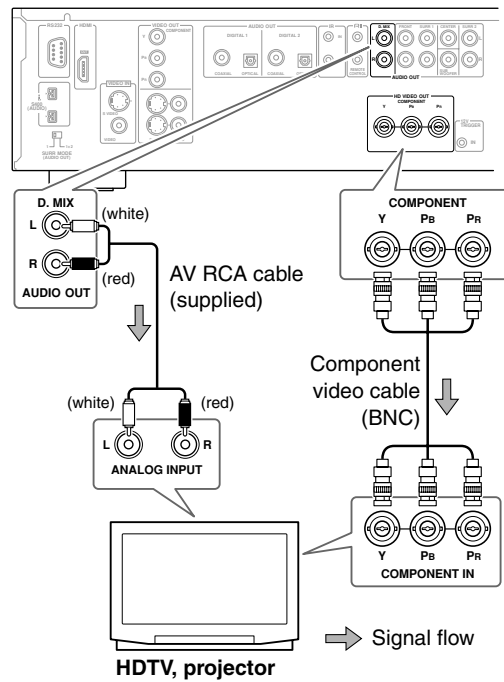

**Canadian Model**

### D. Connecting an HDTV or Projector

This section shows how to connect the DV-SP1000/DV-SP1000E to an HDTV (plasma, LCD) or projector. Use a commercially available component video cable (BNC) to connect the DV-SP1000/DV-SP1000E's HD VIDEO OUT COMPONENT socket to a component video input on your HDTV. (If you have the Canadian model, use an RCA component video cable.) Use the supplied AV cable (RCA) to connect the DV-SP1000/DV-SP1000E's D.MIX AUDIO OUT to an analog audio input on your HDTV.

**Notes:**

- The yellow plugs on the supplied AV RCA cable are not used in this example.
- Don't connect a standard TV to the HD VIDEO OUT COMPONENT socket, because you'll get no picture.
- See the tables on page 27 for details on how the DV-SP1000/DV-SP1000E outputs video and audio from each output.

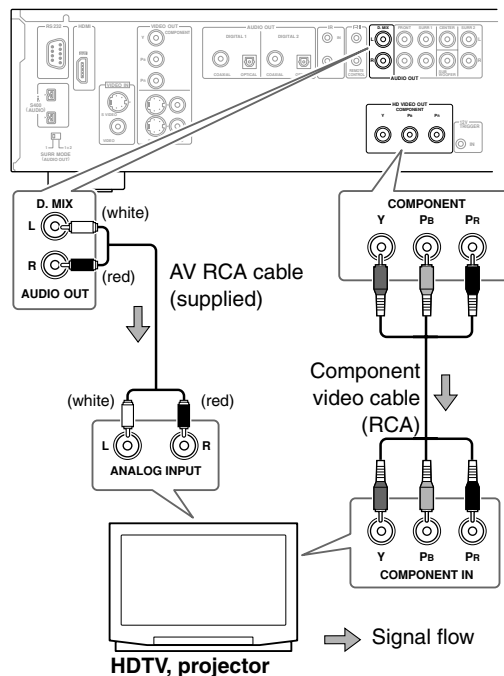

## Connecting—Continued

### E. Connecting a SCART-compatible TV (European model only)

This section shows how to connect the DV-SP1000/DV-SP1000E to a TV fitted with a SCART socket. SCART is a convenient connection format because it carries video (RGB, S-Video, composite) and stereo analog audio all in a single cable. If your TV has a Dolby Pro Logic decoder built-in, with a SCART connection you'll be able to enjoy DVDs that bear the Dolby Surround logo.

Use the supplied SCART cable to connect the DV-SP1000/DV-SP1000E's AV CONNECTOR to a SCART socket on your TV.

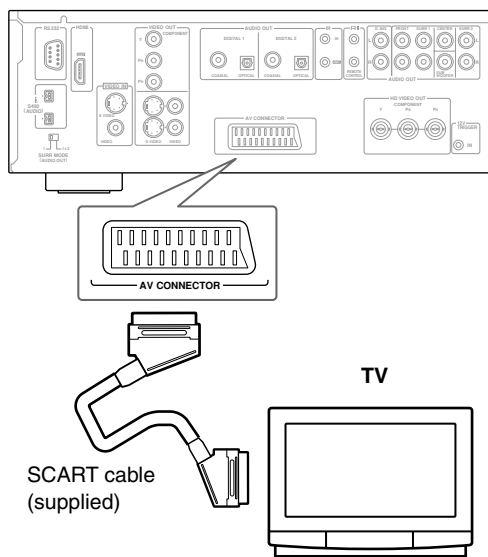

**Notes:**

- The DV-SP1000/DV-SP1000E's SCART socket can output RGB, S-Video, or composite video. The default setting is composite video. If your TV's SCART socket supports RGB or S-Video (check your TV's manual), you can change this setting and enjoy better picture quality (see page 74).
- See the tables on page 27 for details on how the DV-SP1000/DV-SP1000E outputs video and audio from its SCART socket.

### F. Connecting a Component with an HDMI Input

This section shows how to connect the DV-SP1000/DV-SP1000E to a AV receiver, HDTV, or projector that has an HDMI input socket.

**What is HDMI?**

HDMI (High Definition Multimedia Interface) is a new connection format that can carry uncompressed, standard or high definition digital video and up to eight channels of digital audio. Until now, several separate video and audio cables have been required to connect AV components together. With HDMI, a single cable is all that's necessary to achieve the best picture and audio quality. HDMI video is compatible with DVI (Digital Visual Interface). To send HDMI video to a DVI input requires an HDMI-to-DVI cable. The DV-SP1000/DV-SP1000E supports HDCP (High-bandwidth Digital Content Protection), and for an HDMI-to-DVI connection to work, the other component must also support it. Note that this may not work with some DVI components.

**Using HDMI**

Use the supplied HDMI cable to connect the DV-SP1000/DV-SP1000E's HDMI OUT to an HDMI input on your AV receiver. Alternatively, you can connect the DV-SP1000/DV-SP1000E directly to the HDMI input on your TV.

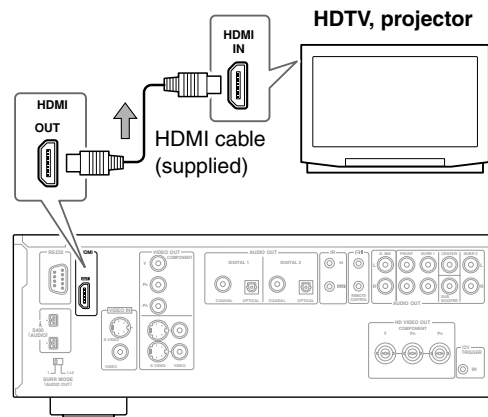

➔ Signal flow

**Notes:**

- Use the Digital Out/Digital 2 settings to match the HDMI output format with your HDTV (see page 75).
- The DV-SP1000/DV-SP1000E supports HDCP (High-bandwidth Digital Content Protection), a protection system for digital video. HDMI components that you connect to the DV-SP1000/DV-SP1000E must also support HDCP.



## Connecting—Continued

- The DV-SP1000/DV-SP1000E supports High-Definition Multimedia Interface Specification Information Version 1.0.
- See the tables on page 27 for details on how the DV-SP1000/DV-SP1000E outputs video and audio from its HDMI OUT socket.

### HDMI & the DV-SP1000/DV-SP1000E

#### ■ Video

The DV-SP1000/DV-SP1000E's HDMI OUT supports the following video resolutions:

- 640 x 480p (VGA), 60 Hz
- 720 x 480p (progressive), 60 Hz
- 720 x 576p (progressive), 50 Hz
- 1280 x 720p (progressive), 50/60 Hz
- 1920 x 1080i (interlaced), 50/60 Hz
- Source Resolution (external input video is output at the same resolution. DVD playback is output at 480p or 576p)

If the connected HDTV or projector doesn't support a resolution, you may get no picture.

When playing a DVD, or when watching an external video input source, the HDMI OUT works as follows. (The Canadian model doesn't support external video sources.)

Selected video input		HDMI OUT <sup>a</sup>
DVD playback (i.e., DV-SP1000/DV-SP1000E)		DVD <sup>b</sup>
External	S VIDEO VIDEO IN	External <sup>b</sup>
	VIDEO VIDEO IN	External <sup>b</sup>

- Only works with components that support HDCP (High-bandwidth Digital Content Protection).
- Resolutions supported by the connected TV can be selected by pressing the [RESOLUTION] button (see page 66).

On the DV-SP1000/DV-SP1000E, you can select a resolution suitable for use with the connected HDTV or projector (see page 66).

#### ■ Audio Formats

The DV-SP1000/DV-SP1000E's HDMI OUT supports the following audio formats:

- PCM (48 kHz, 44.1 kHz)
- Dolby Digital
- DTS
- MPEG

If your HDMI-compatible TV or projector doesn't support Dolby Digital, DTS, or MPEG, the HDMI OUT will not output digital audio in that format. In this case, set the Digital Out/Digital 2 setting (i.e., Dolby Digital Out, DTS Out, or MPEG Out) to downmix to PCM (see page 75).

To output 96 kHz PCM audio from a DVD-Video disc, set the Linear PCM Out setting to Down Sample On (see page 75).

Note that audio from SACD discs is not output by the HDMI OUT. For this format, you need to use the analog multichannel output (see page 37) or i.LINK (see page 35). (The Chinese model doesn't support i.LINK.)

## Connecting—Continued

### Connecting an AV Receiver's video Inputs

This section shows how to connect the DV-SP1000/DV-SP1000E's video outputs to an AV receiver's video inputs.

Component video offers the best picture quality, so if your AV receiver supports it, use a commercially available component video cable to connect the DV-SP1000/DV-SP1000E's COMPONENT VIDEO OUT to a component video input on your AV receiver. If your AV receiver supports progressive scanning, you must use a component video connection to take advantage of it.

If you don't have component video, S-Video offers better picture quality than composite video, so if your AV receiver supports it, use the supplied S-Video cable to connect the DV-SP1000/DV-SP1000E's S VIDEO VIDEO OUT to an S-Video input on your AV receiver. Failing that, use the supplied composite video cable to connect the DV-SP1000/DV-SP1000E's VIDEO VIDEO OUT to a composite video input on your AV receiver.

#### G. Using Component Video

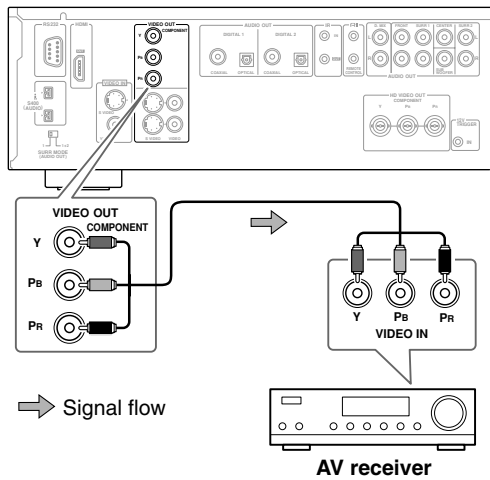

**Notes:**

- The COMPONENT VIDEO OUT supports interlaced video.
- HD COMPONENT VIDEO OUT supports progressive video.

#### H. Using S-Video

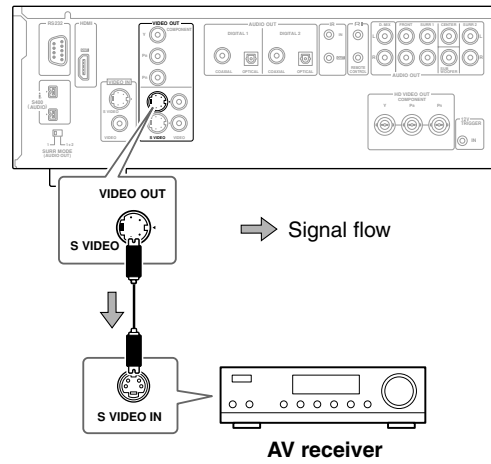

#### I. Using Composite Video

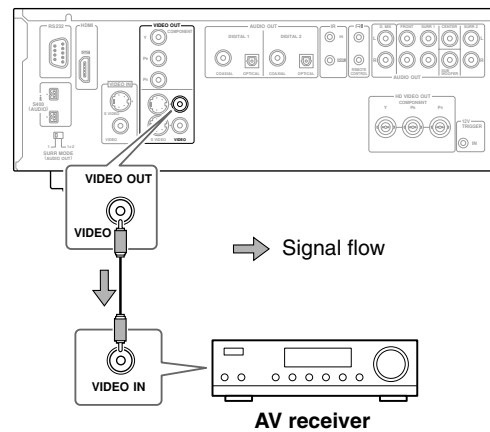

## Connecting—Continued

### J. Connecting i.LINK-compatible Components (not Chinese model)

This section shows how to connect the DV-SP1000/DV-SP1000E to an i.LINK-compatible component, such as an AV receiver.

#### What is i.LINK?

i.LINK is a brand name for IEEE 1394, the high-speed serial connection format commonly used on computers, camcorders, and other AV equipment to carry digital video and audio or other data. It's a bidirectional format, so connected components can talk to each other for optimal setup and synchronized operation.

Connecting a single i.LINK cable between the DV-SP1000/DV-SP1000E and an i.LINK-compatible AV receiver is all you need do to fully enjoy the multi-channel audio of DVD-Video, DVD-Audio, and SACD. Other advantages of i.LINK include automatic setup and source selection. For example, when you start playback on the DV-SP1000/DV-SP1000E, an AV receiver connected via i.LINK will automatically select the DV-SP1000/DV-SP1000E as its input source.

#### What is i.LINK Audio?

i.LINK Audio is the standard for carrying up to six (5.1) channels and up to 24-bit/192 kHz digital audio over i.LINK (IEEE 1394). It's officially known as the A&M Protocol—*Audio and Music Data Transmission Protocol*.

The DV-SP1000/DV-SP1000E can output digital audio from DVD-Video, DVD-Audio, SACD, VCD, CD, and MP3 discs.

#### Using i.LINK

Use the supplied i.LINK cable to connect one of the DV-SP1000/DV-SP1000E's i.LINK sockets to an i.LINK socket on your i.LINK-compatible AV receiver or other component. The DV-SP1000/DV-SP1000E has two i.LINK sockets, so you can easily connect other i.LINK-compatible components.

#### Notes:

- Make sure that the i.LINK plugs are fully inserted.
- Don't disconnect any i.LINK cables while the DV-SP1000/DV-SP1000E is on.
- A short circuit may occur if the metallic part of an i.LINK plug comes into contact with the DV-SP1000/DV-SP1000E's metal case, so make sure that your connections are secure, and don't leave one end of an i.LINK cable disconnected.
- Since i.LINK carries digital audio only, you must make separate connections for video (see pages 30 and 31).
- i.LINK cables are available with 4-pin or 6-pin connectors and it's OK to use both types together. The DV-SP1000/DV-SP1000E's i.LINK sockets accept only 4-pin plugs. The maximum cable length is 3.5 m.
- Protected 96 kHz digital audio from DVD-Video discs will be down sampled to 48 kHz before being output from the i.LINK sockets.
- The Digital Out/Digital 1 settings affect i.LINK output (see page 74).
- See the table on page 28 for details on how the DV-SP1000/DV-SP1000E outputs audio from its i.LINK sockets.

#### ■ SACD Playback

When the i.LINK Output Setting (see page 76) is set to On, SACD audio is output from the i.LINK sockets, but not the analog audio outputs. When it's set to Off, SACD audio is output from the analog audio outputs, but not the i.LINK sockets.

The DV-SP1000/DV-SP1000E's i.LINK interface complies with the following specifications:

1) IEEE Std 1394a-2000, Standard for a High Performance Serial Bus

2) Audio and Music Data Transmission Protocol 2.0

In accordance with the standard for AM824 sequence adaptation layers, the DV-SP1000/DV-SP1000E is compatible with IEC60958 bitstream, DVD-Audio, and SACD.

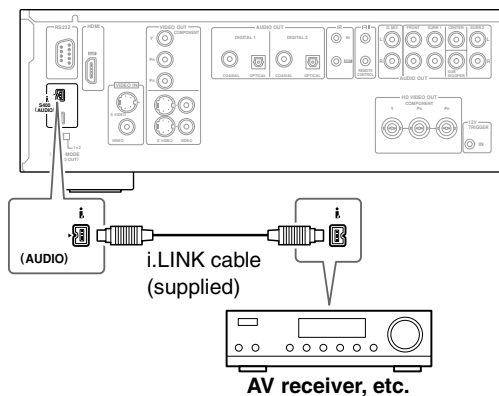

## Connecting—Continued

### Connecting Several i.LINK Components

With i.LINK it's possible to connect up to 17 components together, making the digital audio and control signals of each component available to all the other components. By using what's called an *i.LINK repeater*, it's possible to connect up to 63 components together. Multiple i.LINK components must be connected in series (Fig. 1) or in a tree-like system (Fig. 2).

Fig. 1

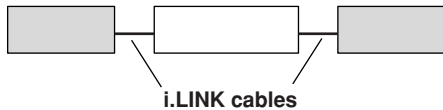
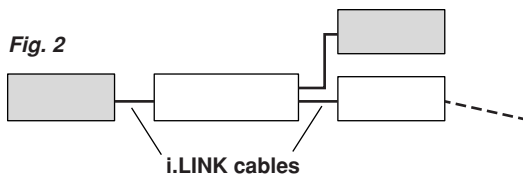
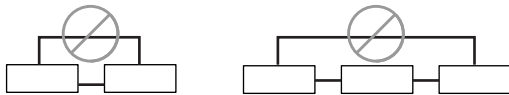

Fig. 2



i.LINK will not work if any of the connections form a loop, as shown below.



#### Notes:

- The DV-SP1000/DV-SP1000E is fully compatible with i.LINK Audio and works with other i.LINK Audio-compatible components, such as AV receivers, CD players, and so on. It may not work reliably when connected to DV camcorders or computers with i.LINK or IEEE 1394 sockets. Refer to the manuals supplied with your other components for compatibility information.
- Components must support DTCP (Digital Transmission Content Protection) in order to play DVD-Video, DVD-Audio, and SACD over i.LINK. The DV-SP1000/DV-SP1000E does.
- i.LINK currently supports three transmission speeds: S100 (100 Mbps), S200 (200 Mbps), and S400 (400 Mbps). The DV-SP1000/DV-SP1000E supports S400. Components of any speed can be connected together, although for best performance, slower components should be connected at the edges of the system (as shown by the shaded components in Fig. 1 and Fig. 2).
- When several i.LINK components are connected together, i.LINK may not work properly if certain components are on standby. i.LINK will work properly while the DV-SP1000/DV-SP1000E is on standby. However, the system will not work at all if any component is fully shutdown (i.e., power switch

set to off). Refer to the manuals supplied with your other components for more information.

- i.LINK operation may be interrupted if a connected component is turned on or off, or its i.LINK settings are turned on or off.

### Connecting to an AV Receiver's Audio Inputs

This section shows how to connect the DV-SP1000/DV-SP1000E's audio outputs to an AV receiver's audio inputs.

#### K. Digital Audio Connection (Dolby Digital & DTS)

To fully enjoy the Dolby Digital and DTS soundtracks available on most DVD-Video discs, you need to connect one of the DV-SP1000/DV-SP1000E's digital audio outputs (DIGITAL 1 or DIGITAL 2) to a digital audio input on an AV receiver that supports Dolby Digital and DTS. You can also enjoy Dolby Surround, if your receiver supports Dolby Pro Logic.

Use an optical or coaxial digital audio cable to connect one of the DV-SP1000/DV-SP1000E's DIGITAL 1 or DIGITAL 2 outputs (OPTICAL or COAXIAL) to a corresponding digital audio input on your AV receiver, as shown.

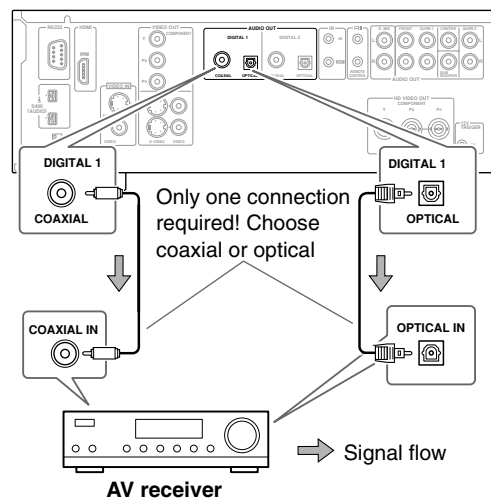

## Connecting—Continued

### Notes:

- Dolby Digital, DTS, DVD-Audio, and SACD can also be fully enjoyed by using i.LINK (page 35) (not Chinese model).
- In addition to a digital connection, it's recommended that you also connect the D.MIX AUDIO OUT to a spare analog audio input on your AV receiver, as this will allow you to record audio to a cassette recorder or CD recorder. If your AV receiver supports Zone 2, you must make an analog audio connection in order to select the DV-SP1000/DV-SP1000E as the input source for Zone 2.
- Make sure that the digital output (Digital 1 Out or Digital 2 Out) is set to Dolby Digital (see page 74). Otherwise you won't get surround sound. Likewise for DTS (see page 74).
- When playing Dolby Digital or DTS soundtracks, be sure to select Dolby Digital or DTS decoding, respectively, on your AV receiver. Refer to your AV receiver's manual.

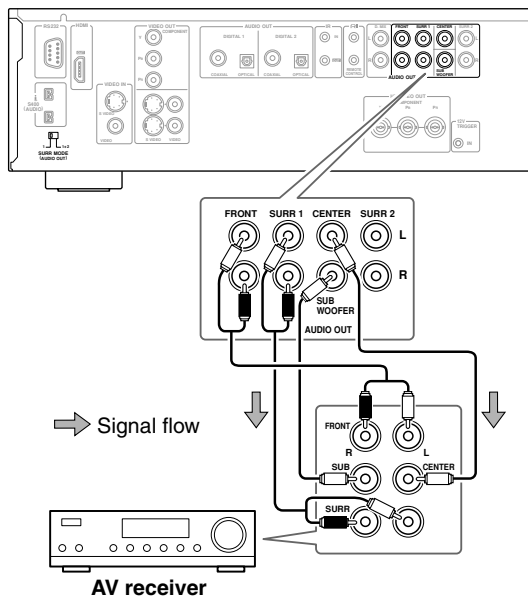

### L. Analog Audio Connection (Dolby Digital, DTS, DVD-Audio & SACD)

To fully enjoy the multichannel audio of DVD-Audio and SACD, you need to connect the DV-SP1000/DV-SP1000E's 5.1-channel analog audio output to a multichannel analog audio input on an AV receiver. Dolby Digital and DTS soundtracks can also be fully enjoyed with this type of connection.

Use a multichannel analog audio cable (RCA) to connect the DV-SP1000/DV-SP1000E's FRONT, SURR 1, CENTER, and SUBWOOFER AUDIO OUTs to a 5.1-channel analog audio input on the AV receiver. (You can use several separate RCA audio cables instead of a multichannel cable.) Set the SURR MODE (AUDIO OUT) switch to 1.

If your AV receiver supports 7.1-channels and you're using back surround speakers, connect the DV-SP1000/DV-SP1000E's SURR 2 AUDIO OUTs to the receiver's surround back left and right inputs as well, and set the DV-SP1000/DV-SP1000E's SURR MODE (AUDIO OUT) switch to 1+2.

### Notes:

- Refer to the hookup information supplied with your AV receiver.
- You can experience Dolby Digital only with DVDs that bear the Dolby Digital logo. Likewise, you can experience DTS only with DVDs or CDs that bear the DTS logo.
- DVD-Video discs may contain Dolby Digital and DTS soundtracks. The Dolby Digital soundtrack will be selected by default. To play the DTS soundtrack, use the movie's main menu and look under Language or Audio Setup. Alternatively, use the remote controller's [AUDIO] button (see page 62).
- See the table on page 28 for details on how the DV-SP1000/DV-SP1000E's audio outputs handle Dolby Digital, DTS, DVD-Audio, and SACD.

## Connecting—Continued

### Connecting a Stereo Amp

This section explains how to connect the DV-SP1000/DV-SP1000E to a stereo hi-fi amp or receiver for sound quality better than that provided by most TVs. This is great for listening to your CDs and MP3s. DVD-Video discs and VCDs will sound better too. You can also enjoy Dolby Surround, if your receiver supports Dolby Pro Logic.

#### M. Analog Connection

Use an RCA audio cable to connect the DV-SP1000/DV-SP1000E's D.MIX AUDIO OUT to a stereo analog audio input on your amp or receiver.

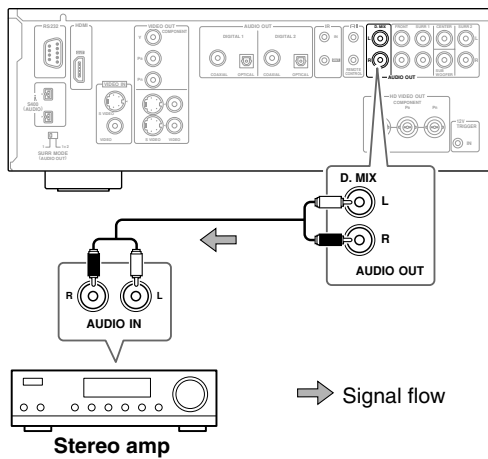

#### Notes:

- See the table on page 28 for details on how the DV-SP1000/DV-SP1000E outputs audio from the D.MIX AUDIO OUT.

### N. Digital Connection

Use an optical or coaxial digital audio cable to connect one of the DV-SP1000/DV-SP1000E's DIGITAL 1 or DIGITAL 2 outputs (OPTICAL or COAXIAL) to a corresponding digital audio input on your amp or receiver.

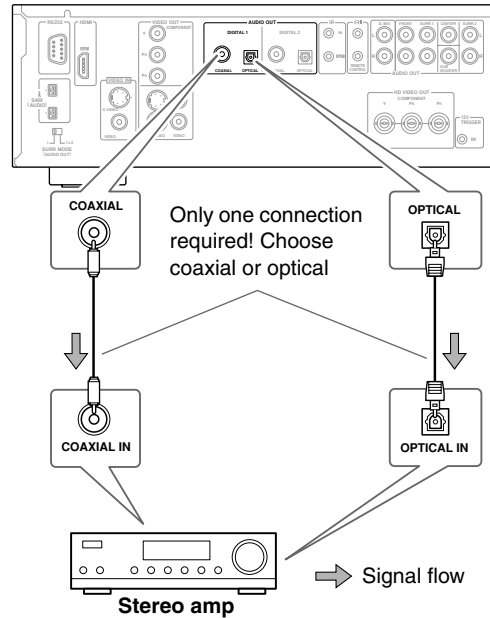

#### Notes:

- Be sure to configure the digital output (Digital 1 Out or Digital 2 Out) for PCM (see page 74). Otherwise an unpleasant digital noise may be heard, which may damage your equipment.
- The DV-SP1000/DV-SP1000E doesn't support AC-3RF, so don't connect it to the AC-3RF input on a Dolby Digital receiver.
- See the table on page 28 for details on how the DV-SP1000/DV-SP1000E outputs audio from the DIGITAL AUDIO OUTs.

## Connecting—Continued

### O. Connecting Standard Video Equipment for Progressive Upconversion (not Canadian model)

If your TV supports progressive scanning, you can connect another video component (satellite/cable tuner, LD player, etc.) to the DV-SP1000/DV-SP1000E and it will upconvert interlaced video to progressive. This is also useful when your TV doesn't have enough video inputs to connect all of your components.

You can connect your other video component to the DV-SP1000/DV-SP1000E's S-Video or composite VIDEO IN input, as shown. To use the other component, on the DV-SP1000/DV-SP1000E, set the video input source to EXTERNAL (see page 66).

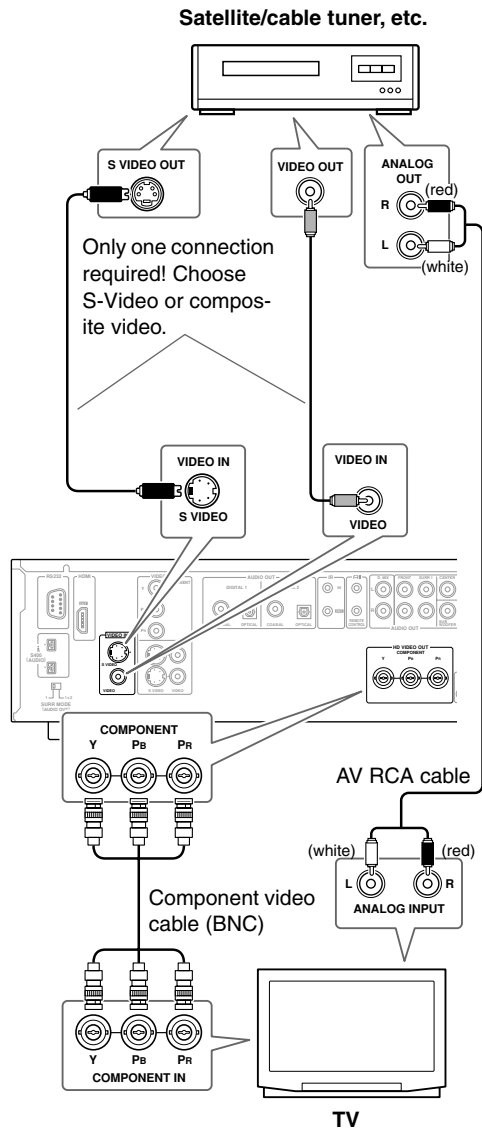

#### Notes:

- If the source video signal is unstable or of poor quality, the picture may be distorted or flicker.
- The S-Video VIDEO IN has priority. If there's no signal present at that input, the DV-SP1000/DV-SP1000E uses the composite video input.
- See the table on page 27 for details on how the DV-SP1000/DV-SP1000E's video outputs work with each video input source.

#### About the HD COMPONENT VIDEO OUT

When a video signal is fed to the S-Video or composite VIDEO IN socket, and the video input source is set to EXTERNAL, that video signal is upconverted to progressive and output by the HD VIDEO OUT COMPONENT socket.

#### Compatibility of this unit with progressive-scan TVs.

This player is compatible with progressive video Macro Vision System Copy Guard.

CONSUMERS SHOULD NOTE THAT NOT ALL HIGH DEFINITION TELEVISION SETS ARE FULLY COMPATIBLE WITH THIS PRODUCT AND MAY CAUSE ARTIFACTS TO BE DISPLAYED IN THE PICTURE. IN CASE OF 525 OR 625 PROGRESSIVE SCAN PICTURE PROBLEMS, IT IS RECOMMENDED THAT THE USER SWITCH THE CONNECTION TO THE "STANDARD DEFINITION" OUTPUT. IF THERE ARE QUESTIONS REGARDING OUR TV SET COMPATIBILITY WITH THIS MODEL 525p AND 625p DVD PLAYER, PLEASE CONTACT OUR CUSTOMER SERVICE CENTER.

## Connecting—Continued

### Connecting Components with **RI**

With **RI** (Remote Interactive) you can control the DV-SP1000/DV-SP1000E by using the remote controller supplied with your Onkyo **RI**-compatible AV receiver.

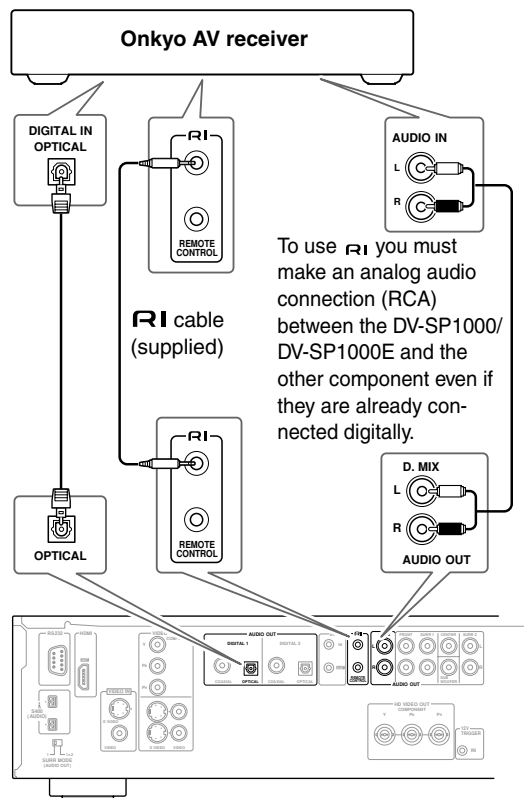

#### Notes:

- Push the plugs in all the way to make a good connection.
- Use only **RI** cables for **RI** connections.
- **To use **RI** you must make an analog audio connection (RCA) between the DV-SP1000/DV-SP1000E and Onkyo AV receiver, even if they are already connected digitally.**
- The DV-SP1000/DV-SP1000E has two **RI** sockets. You can connect either one to the Onkyo AV receiver. The other socket is for connecting additional **RI**-compatible components.
- Connect the DV-SP1000/DV-SP1000E's **RI** socket to only Onkyo components. Connecting to other manufacturer's components may cause them to malfunction.

### Controlling Components That Are Out of Range

You can use the following multiroom kits to control the DV-SP1000/DV-SP1000E when it's out of range of the remote controller:

- Multiroom kits such as those made by Niles and Xantech.

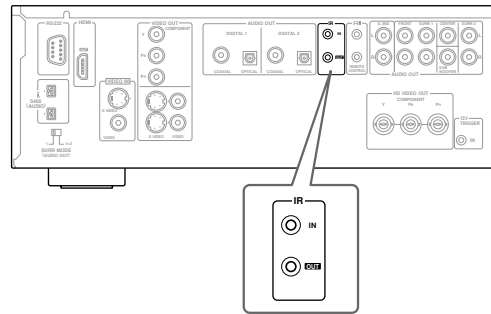

### Controlling the DV-SP1000/DV-SP1000E When It's Out of Range (not Canadian model)

If the DV-SP1000/DV-SP1000E is located in another room, installed in a cabinet, or is out of range of its remote controller, you can use a commercially available IR receiver to pick up the remote controller signals and feed them to the DV-SP1000/DV-SP1000E, as shown below.

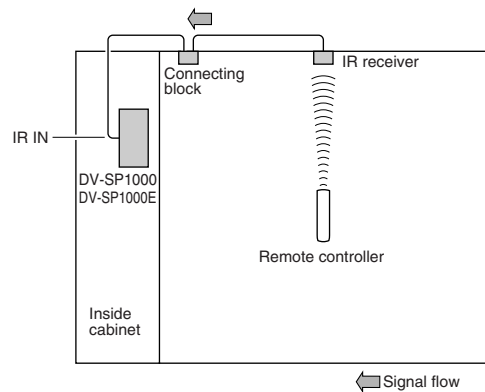



## Connecting—Continued

Connect the IR receiver to the DV-SP1000/DV-SP1000E as shown below.

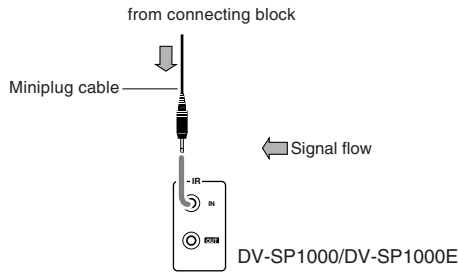

### Controlling Other Out-of-range Components

For another component that is out of range of its remote controller, you can use a commercially available IR emitter to retransmit the remote controller signals received at the DV-SP1000/DV-SP1000E's IR IN, as shown below.

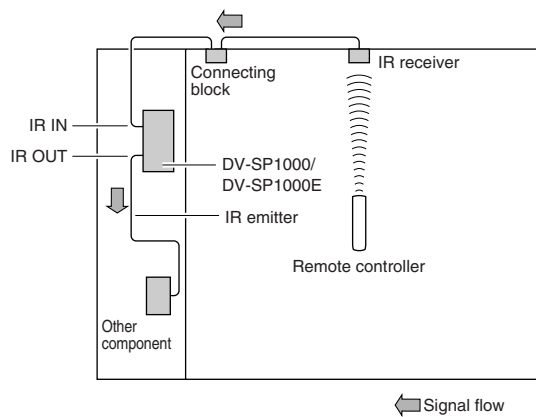

Connect the IR emitter to the DV-SP1000/DV-SP1000E's IR OUT, and place the IR emitter in front of the other AV component's remote control sensor (usually located on its front panel), as shown below. See the instructions supplied with the IR emitter.

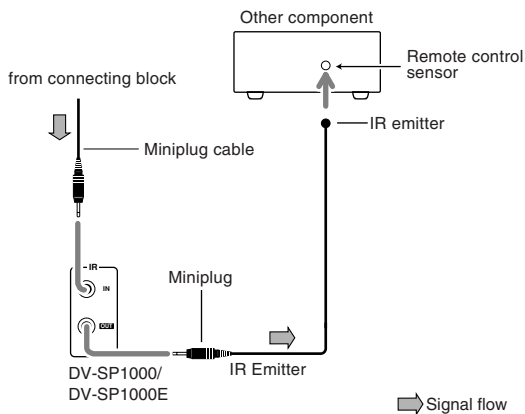

Only remote controller signals received by the DV-SP1000/DV-SP1000E's IR IN are fed through to the IR OUT. Signals picked up by the DV-SP1000/DV-SP1000E's remote control sensor are not.

### Connecting the Power Cord

#### Notes:

- Before connecting the power cord, complete all of the necessary audio and video connections.
- Do not use a power cord other than the one supplied with the DV-SP1000/DV-SP1000E, which is designed exclusively for use with the DV-SP1000/DV-SP1000E and should not be used with any other component.
- Never disconnect the power cord from the DV-SP1000/DV-SP1000E while the other end is still plugged into a wall outlet. Doing so may cause an electric shock. Always disconnect the power cord from the wall outlet first.
- The DV-SP1000/DV-SP1000E (not the Canadian model) is shipped with the POWER switch in the ON position (▲). When the power cord is connected for the very first time, the DV-SP1000/DV-SP1000E will go on standby and the STANDBY indicator will light up.
- To completely shutdown the DV-SP1000/DV-SP1000E, set the POWER switch to the OFF position (■). (This does not apply to the Canadian model).

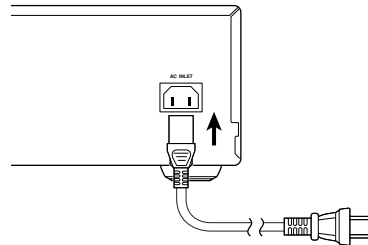

- 1 Plug the supplied power cord into the DV-SP1000/DV-SP1000E's AC INLET.**
- 2 Plug the other end of the power cord into a suitable AC wall outlet.**  
The STANDBY indicator lights up.  
The STANDBY indicator comes on only if the POWER switch is in the ON (▲) position. (This does not apply to the Canadian model).

## Connecting—Continued

### Turning On the DV-SP1000/DV-SP1000E

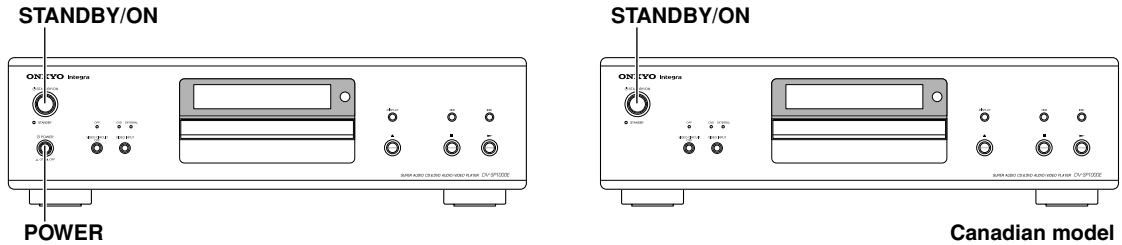

- |          |  |  |
|----------|--|--|
| <b>1</b> |  | <p><b>Set the POWER switch to the ON position (I).</b><br/>                 The STANDBY indicator lights up.<br/>                 (Ignore this step if you have the Canadian model.)</p>   |
| <b>2</b> |  | <p><b>Press the [STANDBY/ON] button.</b><br/>                 The display light ups and the STANDBY indicator goes off.<br/>                 The very first time you turn on the DV-SP1000/DV-SP1000E, the Initial Setup menu appears onscreen (see page 43).<br/>                 Press the [STANDBY/ON] button again to enter Standby.</p> |

### Turning On the DV-SP1000/DV-SP1000E with the Remote Controller

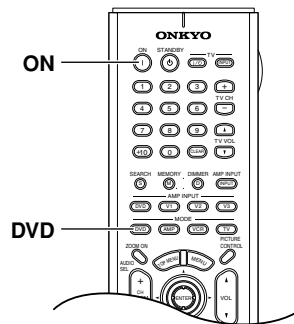

The DV-SP1000/DV-SP1000E must be in Standby mode for this procedure to work.

- |          |  |   |
|----------|--|---|
| <b>1</b> |  | <p><b>Press the [DVD] MODE button to select DVD mode.</b><br/>                 This is the mode for controlling the DV-SP1000/DV-SP1000E.</p> |
| <b>2</b> |  | <p><b>Press the [ON] button.</b><br/>                 To set the DV-SP1000/DV-SP1000E to Standby, press the [STANDBY] button.</p>             |

# Initial Setup

This chapter explains the settings you need to make the very first time the DV-SP1000/DV-SP1000E is turned on.

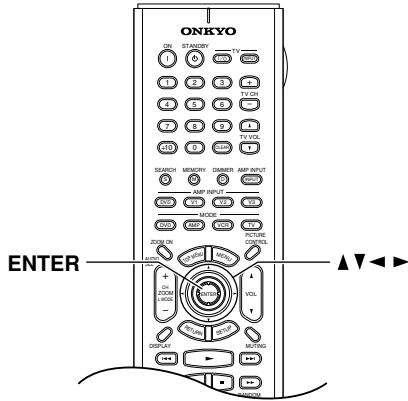

## First Time Setup

The very first time you turn on the DV-SP1000/DV-SP1000E, the Initial Setup menu appears onscreen. The Chinese model doesn't have the i.LINK Output Setting.

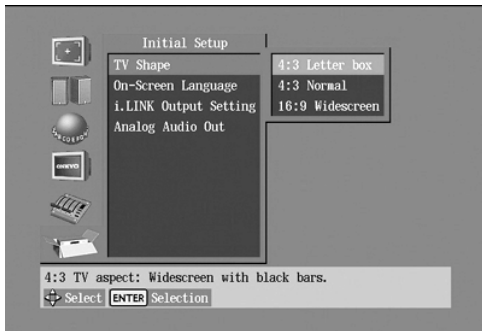

Here you need to make a few settings to get the DV-SP1000/DV-SP1000E up and running. You can change these settings later (see page 68).

**1** Remote controller

**Use the Up and Down [▲]/[▼] buttons to select a TV shape, and then press [ENTER].**

Select 4:3 Letter box or 4:3 Normal if you have a 4:3 TV. Select 16:9 Widescreen if you have a widescreen TV. See page 72 for more information.

The On-Screen Language menu appears next.

**2** Use the Up and Down [▲]/[▼] buttons to select a language, and then press [ENTER].

See page 81 for more information on the language options.

The i.LINK Output Setting menu appears (not Chinese model). The i.LINK Output Setting menu appears next.

If you have the Chinese model, go to step 4.

**3** Use the Up and Down [▲]/[▼] buttons to select Off or On for the i.LINK Output Setting (i.LINK), and then press [ENTER].

See page 76 for more information on the i.LINK Output Setting.

If the i.LINK Output Setting is set to Off, the Analog Audio Out menu appears next.

If it's set to On, the Initial Setup menu closes.

**4** On the Analog Audio Out menu, use the Up and Down [▲]/[▼] buttons to select 2 Channel or Multi Channel (default), and then press [ENTER].

Choose 2 Channel if you're connecting the FRONT AUDIO OUTs to a stereo amp.

Choose Multi Channel if you're connecting the FRONT, SURR 1/SURR 2, CENTER, and SUBWOOFER AUDIO OUTs to a multichannel amp.

If you select 2 Channel, the setup is complete and the Initial Setup menu closes. If you select Multi Channel, continue with this procedure.

## Initial Setup—Continued

**5**  
Remote controller



**Press the [ENTER] button, use the Up and Down [▲]/[▼] buttons to select On or Off, and then press the [ENTER] button.**  
Choose Off if your multichannel amp has its own speaker setup function.  
Choose On if your multichannel amp has no speaker setup function.  
If you select Off, the following settings cannot be set and the Initial Setup menu closes. If you select On, the Speaker Setting menu appears.

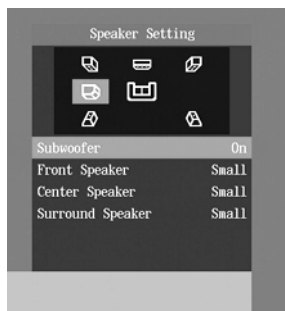

Here you can specify the size of the speakers being fed from the FRONT, SURR 1/SURR 2, CENTER, and SUBWOOFER AUDIO OUTPUTS.

For speakers with a cone diameter larger than 6-1/2 inches (16 cm), specify **Large**. For those with a smaller diameter, specify **Small**. See page 76 for more information.

**6**  
Remote controller



**Press the [ENTER] button, use the Left and Right [◀]/[▶] buttons to set the Subwoofer setting, and then press [ENTER] again.**  
**Off:** Select if no subwoofer is being used.  
**On (default):** Select if a subwoofer is being used.

**7**  
Remote controller



**Use the Left and Right [◀]/[▶] buttons to set the Front Speaker setting, and then press the [ENTER] button.**  
**Large:** Select if the front speakers are large.  
**Small (default):** Select if the front speakers are small.  
Note that if the Subwoofer setting is set to Off, this setting is fixed at Large.

**8**  
Remote controller

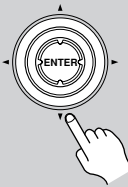

**Use the Left and Right [◀]/[▶] buttons to set the Center Speaker setting, and then press the [ENTER] button.**  
**Large:** Select if the center speaker is large.  
**Small (default):** Select if the center speaker is small.  
**Off:** Select if no center speaker is being used.

Note that if the Front Speaker setting is set to Small, the Large option cannot be selected. And if the Subwoofer setting is set to Off, only the Large and Off options can be selected.

**9**  
Remote controller

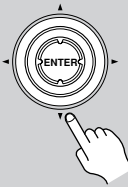

**Use the Left and Right [◀]/[▶] buttons to set the Surround Speaker setting, and then press the [ENTER] button.**  
**Large:** Select if the surround speakers are large.  
**Small (default):** Select if the surround speakers are small.  
**Off:** Select if no surround speakers are being used.

Note that if the Front Speaker setting is set to Small, the Large option cannot be selected. And if the Subwoofer setting is set to Off, only the Large and Off options can be selected.

The Initial Setup menu closes and the setup is complete.  
The DV-SP1000/DV-SP1000E is now ready for use. See page 45 for information on playing discs.

### Notes:

- You can change the language of the onscreen setup menus, and specify your preferred languages for DVD menus, soundtracks, and subtitles on the Language menu (see page 81).
- When a DVD doesn't have menus, soundtracks, and subtitles in different languages, its default language is used.
- When the DV-SP1000/DV-SP1000E is plugged in and set to Standby, it automatically checks if it's connected to any other i.LINK components. If it is, the default setting for the i.LINK Output Setting becomes On. If not, the default becomes Off. The Chinese model doesn't support i.LINK.

# Basic Playback

This chapter explains the DV-SP1000/DV-SP1000E's basic playback functions.

Don't forget to turn on your TV or projector and select the video input to which the DV-SP1000/DV-SP1000E is connected.

If you're using an AV receiver or hi-fi amp for audio playback, turn that on as well and select the audio input to which the DV-SP1000/DV-SP1000E is connected.

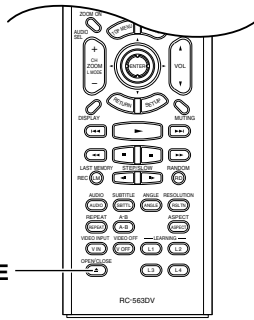
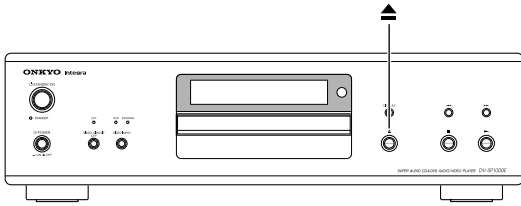

OPEN/CLOSE

## Loading Discs

DVD-V DVD-A SACD DVD-VR VCD CD MP3 JPEG

This section explains how to load discs.

<b>1</b>	<p><b>Press the OPEN/CLOSE [▲] button.</b> The disc tray opens.</p>
<b>2</b>	<p><b>Place the disc, label side up, onto the tray.</b> Make sure that the disc is seated properly.</p>

If you're loading a double-sided DVD, load it with the side that you want to play facing down.

**3 Press the OPEN/CLOSE [▲] button.**  
The disc tray closes and the relevant disc type indicator appears on the display.

See page 46 for information on playing discs.  
**Tip:** If you press the Play [▶] button, the disc tray will close and, depending on the type of disc, playback will start automatically.

- Notes:**
- The disc tray can be opened even while the DV-SP1000/DV-SP1000E is on Standby, so you don't have to turn it on to remove a disc. (The disc tray will take slightly longer to open.)
  - The DV-SP1000/DV-SP1000E supports 8 cm and 12 cm discs. To avoid damaging your discs and the DV-SP1000/DV-SP1000E, put the disc in the center of the disc bay.
  - Only load discs that are supported by the DV-SP1000/DV-SP1000E (see page 9). Don't load cartridge-type discs.
  - To avoid personal injury, keep your hands away from the disc tray as it closes.
  - Always use the OPEN/CLOSE [▲] button to open and close the disc tray. Never push the disc tray, and don't touch it or obstruct it while it's opening or closing. Don't press down on the tray while it's open, and don't load anything other than supported discs. Doing so may damage your discs and the DV-SP1000/DV-SP1000E.
  - Since the DV-SP1000/DV-SP1000E does not support DVD-VR discs with CPRM (Content Protection for Recordable Media), do not attempt to play such discs.

## Basic Playback—Continued

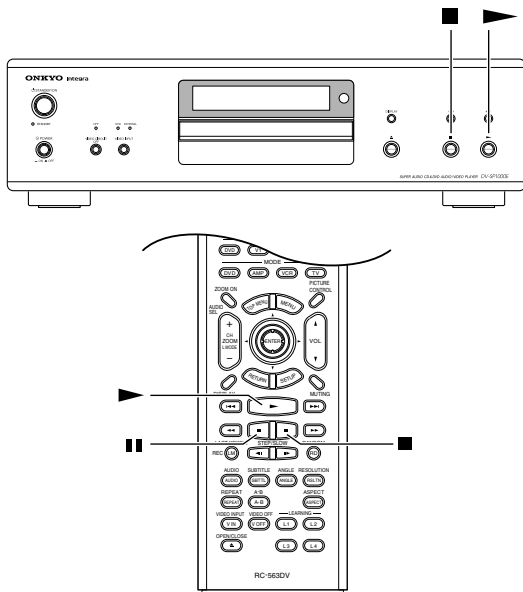

**■ Stop**  
 To stop playback, press the Stop [■] button.  
 Playback stops and the Play ► indicator disappears.

**Remote controller**

**Notes:**

- During playback, you can select chapters or tracks by using the Next [▶▶] and Previous [◀◀] buttons. The first press of the Previous [◀◀] button selects the beginning of the current chapter or track.
- When you stop playback of a DVD-Video disc or VCD, the DV-SP1000/DV-SP1000E remembers the point at which playback was stopped and “Resume” appears onscreen for a few seconds. To resume playback from that point, press the Play [▶] button. To cancel the Resume function, press the Stop [■] button again. The Resume function is reset when the disc is removed from the DV-SP1000/DV-SP1000E.
- With the Last Memory function you can resume playback from any point even if the disc has been removed (see page 63).
- Do not move the DV-SP1000/DV-SP1000E or subject it to vibration during playback. Doing so may damage the disc and the DV-SP1000/DV-SP1000E.
- You can improve the picture quality of paused playback with the Pause/Still setting (see page 82).
- Prolonged display of the same picture or menu may cause irreparable damage to your TV screen known as *screen burn-in*. To prevent this, don't keep playback paused for too long and always press the Stop [■] button when you've finished playing a DVD-Video disc or VCD. The DV-SP1000/DV-SP1000E features a screen saver to protect your TV from the effects of burn-in (see page 82).
- With some DVD-Video discs, you may experience picture noise that is not normally visible with standard TV broadcasts. This is usually because DVD-Video uses a lot of high-resolution video data. The amount of noise, if any, will depend on your particular TV and the problem can sometimes be alleviated by turning down the TV's sharpness control.

### Starting, Pausing & Stopping Playback

DVD-V DVD-A SACD DVD-VR VCD CD MP3 JPEG

This section explains how to start, pause, and stop playback.

**■ Start**  
 To start playback, press the Play [▶] button.  
 Playback starts and the Play ► indicator appears on the display.  
 If you're playing a DVD-Video disc, or a VCD with PBC (Playback Control), you may need to start playback from a menu (see page 47).  
 See page 52 for more on MP3 discs.

**Remote controller**

---

**■ Pause**  
 To pause playback, press the Pause [||] button.  
 Playback pauses and the Pause || indicator appears on the display.  
 To resume playback, press the Play [▶] button.  
 Playback resumes and the Pause || indicator disappears.

**Remote controller**

## Basic Playback—Continued

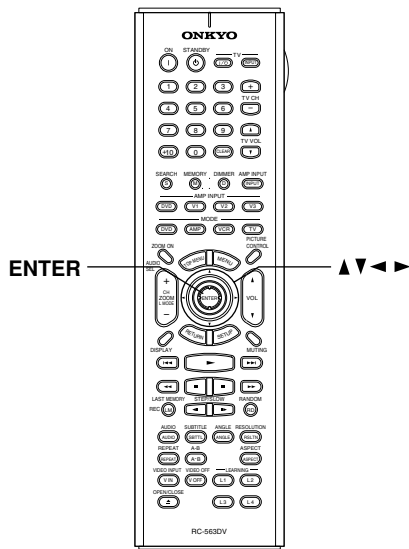

### Navigating Disc Menus



DVD-Video discs usually have a menu from which you can select titles, chapters, and other options, including soundtracks, subtitles, and audio formats (e.g., Dolby Digital or DTS). VCDs that support PBC (Playback Control) may also have an onscreen menu (see page 10).

#### 1 Load a DVD-Video disc or VCD (page 45).

With DVD-Video discs, a menu usually appears automatically. If it doesn't, try pressing the [TOP MENU] button.

With VCDs that support PBC, you may have to press the Play [▶] button to display the menu.

#### 2

Remote controller

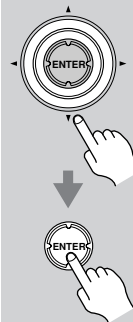

Use the remote controller's arrow [▲], [▼], [◀], [▶] buttons to select items on the menu, and use the [ENTER] button to confirm your choice.

If you select a playback option (e.g., subtitles), another menu will usually appear, in which case you use the arrow buttons to select items and the [ENTER] button to confirm your choice.

For VCDs that feature PBC, you have to enter a number to select a menu item, which you can do by using the remote controller's number buttons. If the VCD's menu consists of several pages, use the Next [▶▶] and Previous [◀◀] buttons to view them. During playback, you can return to the menu by pressing the [RETURN] button.

#### Notes:

- Not all DVDs and VCDs have menus.
- Menu operation varies from disc-to-disc. See the disc's sleeve notes for details.
- On some DVDs, options such as foreign language soundtracks, subtitles, and audio formats appear on a separate menu called the *disc menu*, and titles and chapters appear on what's called the *title menu*. To display the disc menu, press the [MENU] button. If no menu appears, press the [TOP MENU] button.
- With Some DVDs, foreign language soundtracks or audio formats can be selected during playback by using the remote controller's [AUDIO] button (see page 62). Similarly, subtitles can be selected by using the remote controller's [SUBTITLE] button (see page 62).
- To use the menu on a VCD that supports PBC, you must turn on PBC (see page 84).
- If PBC is off (see page 84), or your VCD doesn't support it, you can use the Next [▶▶] and Previous [◀◀] buttons, or the remote controller's number buttons to select tracks on a VCD.
- PBC menus can be hidden or displayed while playback is stopped by pressing the [TOP MENU] button.

## Basic Playback—Continued

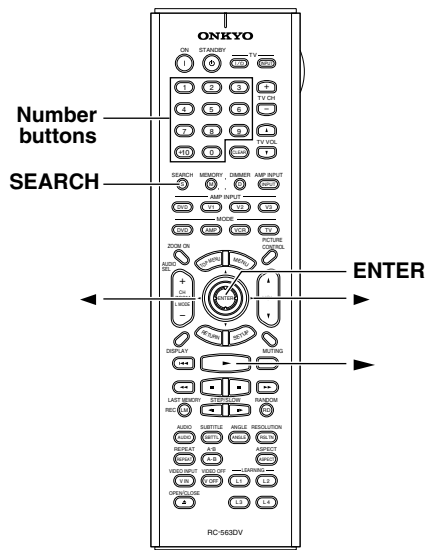

### Selecting Chapters & Titles by Number

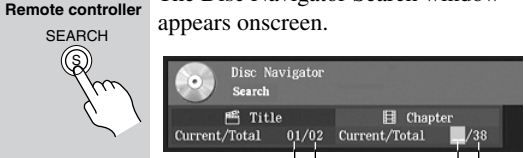

With the Search function you can select chapters and titles by number.

<b>1</b>	<b>Load a DVD-Video disc (page 45).</b>
<b>2</b>	<p><b>Press the [SEARCH] button.</b> The Disc Navigator Search window appears onscreen.</p>  <p>Current title: 01/02 Total number of titles: 38 Current chapter: 3 Total number of chapters: 38</p> <p>With some DVDs you can select only titles, and the Chapter Current/Total information is not displayed. Some discs won't even allow you to select titles.</p>

**3**  
Remote controller

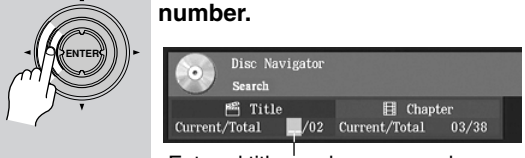

**If you want to select a title, press the Left [◀] button to move the cursor to the current title number.**  
Entered title number appears here

**4**  
Remote controller

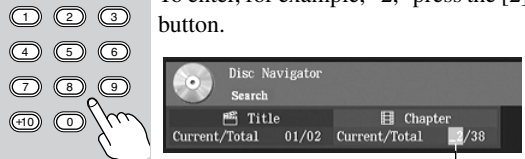

**Use the number buttons to specify a chapter or title number.**  
To enter, for example, “2,” press the [2] button.  
Entered chapter number appears here

To enter, for example, “12,” press the [1] button followed by the [2] button.



To clear a number, press the [CLEAR] button.

**5**  
Remote controller

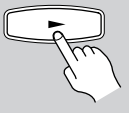

**Press the Play [▶] or [ENTER] button to start playback of the specified chapter or title.**  
During playback, you can select other chapters with the Next [▶▶] and Previous [◀◀] buttons. The first press of the Previous [◀◀] button selects the beginning of the current chapter.

**Notes:**

- During playback you can select chapters directly by using the number buttons. To select chapter #2, simply press [2] and playback starts. To select chapter #10, press [+10] and [0] and playback starts.
- If a DVD-Video disc contains only one title, you won't be able to select titles. Likewise, if it contains no chapters, you won't be able to select chapters.
- DVD-Video discs usually have menus for selecting titles and chapters (see page 47).
- With some discs you may not be able to select titles and chapters by number.



## Basic Playback—Continued

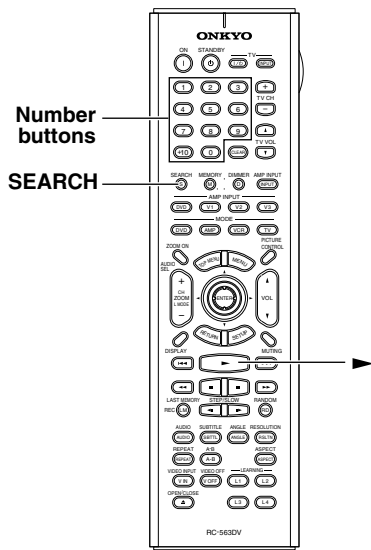

### Selecting Tracks by Number

DVD-A SACD VCD CD MP3

With the Search function you can select tracks by number.

<b>1</b>	<b>Load a DVD-Audio, SACD, VCD, CD, or MP3 disc (page 45).</b>
<b>2</b>	<b>During playback, press the [SEARCH] button.</b>

**Remote controller**  
SEARCH

The Disc Navigator Search window appears onscreen. This is what appears for CDs.

Total number of tracks  
Current track

### 3

**Remote controller**



**Use the number buttons to enter a track number.**

To enter, for example, “5,” press the [5] button.

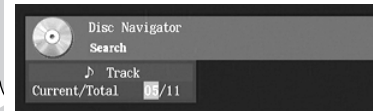

To enter, for example, “11,” press the [1] button twice.



To clear a number, press the [CLEAR] button.

If you're playing a DVD-Audio disc and you want to select a track in another group, press the Left [◀] button to select the group number and enter the number of that group first.

### 4

**Remote controller**

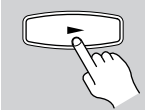

**Press the Play [▶] button to start playback of the specified track.**

You can also select tracks during playback by using the Next [▶▶] and Previous [◀◀] buttons. The first press of the Previous [◀◀] button selects the beginning of the current track.

#### Notes:

- You can select tracks directly at any time by using the number buttons (i.e., without pressing the [SEARCH] button). To select track #2, simply press [2] and playback starts. To select track #10, press [+10] and [0] and playback starts.
- If PBC is on (see page 84), and the currently playing VCD supports it, you may be able to select tracks from a menu (see page 47).
- You can't use the [SEARCH] function during random playback.

## Basic Playback—Continued

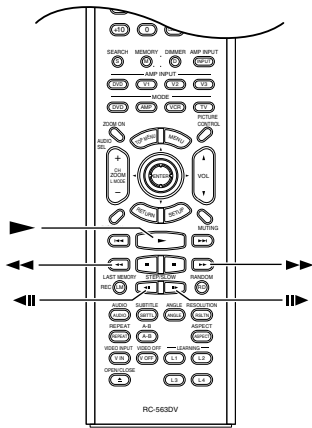

### Fast Forward & Reverse

DVD-V DVD-A SACD DVD-VR VCD CD MP3

This section explains how to fast forward and reverse.

<p>■ <b>Fast forward</b></p> <p>Remote controller</p>	<p>During playback, press the FF [▶▶] button to start fast forward. Playback fast forwards and “Fast Forward1” appears onscreen.</p> <p>To change the fast-forward speed, press the FF [▶▶] button repeatedly to cycle through the speeds: Fast Forward1, Fast Forward2, and so on.</p> <p><b>To resume normal playback, press the Play [▶] button.</b></p>
<p>■ <b>Fast reverse</b></p> <p>Remote controller</p>	<p>During playback, press the FR [◀◀] button to start fast reverse. Playback reverses and “Fast Reverse1” appears onscreen.</p> <p>To change the fast-reverse speed, press the FR [◀◀] button repeatedly to cycle through the speeds: Fast Reverse1, Fast Reverse2, and so on.</p> <p><b>To resume normal playback, press the Play [▶] button.</b></p>

**Notes:**

- There are five fast forward and reverse speeds for DVD-Video and DVD-Audio, and three for SACD, VCD, CD, and MP3.
- No sound is output during fast forward or reverse of a DVD-Video disc or VCD.
- Sound is output intermittently during fast forward or reverse of DVD-Audio, SACD, CD, and MP3 discs.
- For DVD-VR discs, fast forward and reverse cannot straddle chapters.

### Frame-by-Frame Playback

DVD-V DVD-A DVD-VR VCD

With frame-by-frame playback you can view individual picture frames one at a time either forward or backward.

<p>■ <b>Forward frame-by-frame</b></p> <p>Remote controller</p>	<p>While paused, press the STEP/SLOW Forward [⏮▶] button. Press it repeatedly to view subsequent frames.</p>
<p>■ <b>Backward frame-by-frame</b></p> <p>Remote controller</p>	<p>While paused, press the STEP/SLOW Back [◀⏭] button. Press it repeatedly to view previous frames.</p>
<p>■ <b>Resume playback</b></p> <p>Remote controller</p>	<p>To resume normal playback, press the Play [▶] button.</p>

**Notes:**

- Backward frame-by-frame playback does not work with DVD-VR and VCD discs.
- You can improve the picture quality of frame-by-frame playback with the Pause/Still setting (see page 82).
- With some discs the picture may shake when using backward frame-by-frame playback.
- No sound is output during frame-by-frame playback.
- Some DVD-Audio discs feature browsable pictures, which you can select with the STEP/SLOW Back and Forward [◀⏭]/[⏮▶] buttons.
- Prolonged display of the same picture or menu may cause irreparable damage to your TV screen known as *screen burn-in*. To prevent this, don't display the same frame for too long. The DV-SP1000/DV-SP1000E features a screen saver to protect your TV from the effects of burn-in (page 82).

## Basic Playback—Continued

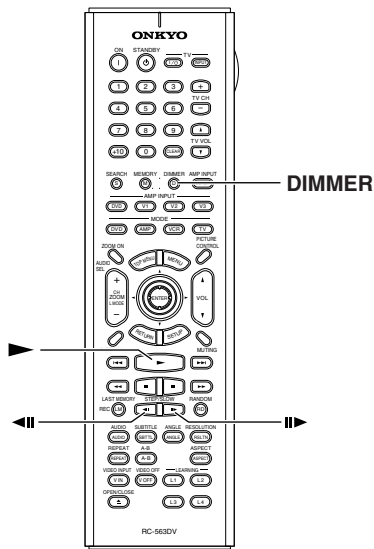

### Notes:

- There are four slow-motion speeds for DVD-Video/ DVD-VR and three for VCD.
- Backward slow-motion playback does not work with DVD-VR and VCD discs.
- No sound is output during slow-motion playback.

### Adjusting the Display Brightness

DVD-V DVD-A SACD DVD-VR VCD CD MP3 JPEG

You can adjust the brightness of the display as follows.

1

Remote controller

DIMMER



Press the [DIMMER] button repeatedly to cycle through the following options:  
dim, dimmer, off, normal.

### Slow-motion Playback

DVD-V VCD DVD-VR

With slow-motion playback you can watch a scene slowly either forward or backward.

#### ■ Forward slow motion

Remote controller



During playback, press the **STEP/SLOW Forward [II▶]** button.

Forward slow-motion playback starts and “Slow1” appears onscreen.

To change the slow-motion speed, press the STEP/SLOW Forward [II▶] button repeatedly to cycle through the speeds: Slow1, Slow2, and so on.

#### ■ Backward slow motion

Remote controller



During playback, press the **STEP/SLOW Back [◀II]** button.

Backward slow-motion playback starts and “Reverse Slow1” appears onscreen.

To change the slow-motion speed, press the STEP/SLOW Back [◀II] button repeatedly to cycle through the speeds: Reverse Slow1, Reverse Slow2, and so on.

#### ■ Resume playback

Remote controller

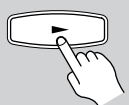

To resume normal playback, press the **Play [▶]** button.

## Basic Playback—Continued

### Navigating MP3 Discs

MP3

This section explains how to play MP3 tracks with the Disc Navigator.

**1**

**Load an MP3 disc (page 45).**  
The Disc Navigator appears.

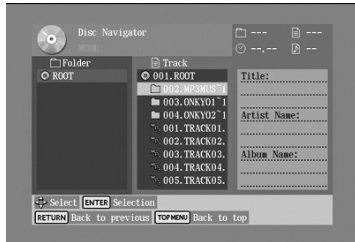

Initially, the Track list shows all of the folders at the root level. Pressing the Play [▶] button at this point will play all tracks in all folders in hierarchical order.

The DV-SP1000/DV-SP1000E numbers folders and tracks in hierarchical order. You can use these numbers to select folders and tracks directly with the Search function (see page 49).

**2**

Remote controller



**To open a folder, use the Up and Down [▲]/[▼] buttons to select it, and then press [ENTER].**  
The Track list shows the files and subfolders in the currently open folder.

**3**

Remote controller



**Use the Up and Down [▲]/[▼] buttons to select files and subfolders in the open folder.**

To open a folder in the Track list, press the [ENTER] button. To close a folder (i.e., move back up the directory tree), press the [RETURN] BUTTON. Alternatively, select the item at the top of the Track list and press the Play [▶] or [ENTER] button.

To get back to the root level, press the [TOP MENU] button. Alternatively, select the item at the top of the Folder list and press the Play [▶] or [ENTER] button.

**4**

Remote controller

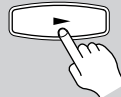

or



**To play a track, select it in the Track list, and then press the Play [▶] or [ENTER] button.**

If available, the following information about the currently selected track is displayed: Title, Artist, and Album.

During playback, the following information is displayed in the upper-right corner: folder number, track number, and elapsed time.

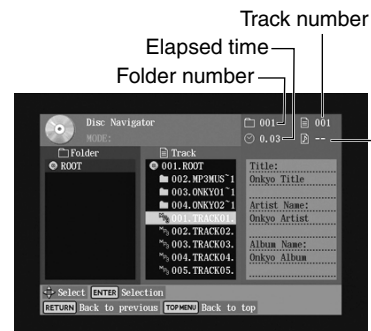

Track number

Elapsed time

Folder number

Playlist number

Subsequent tracks in the same folder are played in order.

To play all of the tracks in a folder, select the folder in the Track list (not the folder at the top of the list), and then press the Play [▶] button.

You can select the next or previous track during playback by using the Next [▶▶] and Previous [◀◀] buttons. The first press of the Previous [◀◀] button selects the beginning of the current chapter or track.

If during playback you press the [DISPLAY] button to view information about an MP3 track (see “Displaying Information” on page 65), press the [MENU] button to return to the Disc Navigator.

**5**

Remote controller

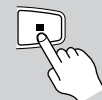

**Press the Stop [■] button to stop playback.**

## Basic Playback—Continued

### Notes:

- You can use the Repeat function to play MP3 tracks repeatedly (see page 57).
- You can use the Random function to play MP3 tracks randomly (see page 58).
- During random playback, the remote controller's arrow [▲], [▼], [◀], [▶] buttons cannot be used with the Disc Navigator.
- You can also use the Disc Navigator to create a playlist of MP3 tracks (see page 54).

### Viewing a Slideshow of JPEG Images



This section explains how to display a slideshow of JPEG images on your TV.

**1**

#### Load a JPEG disc (page 45).

Depending on the type of JPEG disc, either the first nine pictures appear in thumbnail-size or the Disc Navigator appears.

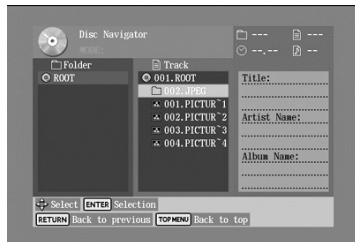

Initially, the Folder list shows all of the folders at the root level. Pressing the Play [▶] button at this point will start a slideshow of all images in all folders in hierarchical order.

The DV-SP1000/DV-SP1000E numbers folders and files in hierarchical order.

**2**

Remote controller



To open a folder, use the Up and Down [▲]/[▼] buttons to select it, and then press [ENTER].

The Track list shows the images and subfolders in the currently open folder.

**3**

Remote controller

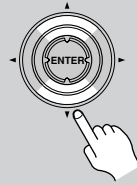

Use the Up and Down [▲]/[▼] buttons to select images and subfolders in the open folder.

A thumbnail-size preview and file size and creation date information for the currently selected image is displayed.

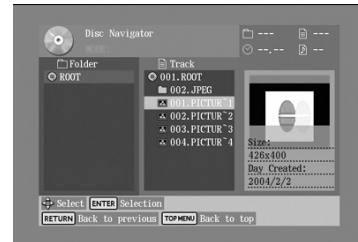

To open a folder in the Track list, press the [ENTER] button. To close a folder (i.e., move back up the directory tree), press the [RETURN] button. Alternatively, select the item at the top of the Track list and press the Play [▶] or [ENTER] button.

To get back to the root level, press the [TOP MENU] button. Alternatively, select the item at the top of the Folder list and press the Play [▶] or [ENTER] button.

**4**

Remote controller



To start a slideshow, select an image in the Track list, and then press the Play [▶] or [ENTER] button.

Subsequent images in the same folder are displayed in order, with each image being displayed for five seconds. To display an image for longer, press the Pause [■] button. Press the Play [▶] button to resume.

To start a slideshow consisting of all of the images in a folder, select the folder in the Track list (not the folder at the top of the list), and then press the Play [▶] button.

## Basic Playback—Continued

**5**

**You can use the following functions during the slideshow:**

To display the next or previous image, use the Next [▶▶] or Previous [◀◀] button.

To flip a picture 180 degrees, use the Up and Down [▲]/[▼] buttons (not while zoomed in).

To rotate a picture counterclockwise or clockwise, use the Left and Right [◀]/[▶] buttons (not while zoomed in).

To zoom in or out, use the FF [▶▶] and FR [◀◀] buttons. Alternatively, press the [ZOOM ON] button and use the Zoom [+/-] button. While zoomed in, use the [◀]/[▶] and [▲]/[▼] buttons to move around the picture. The slideshow pauses while zoomed in. To cancel the zoom and resume the slideshow, press the Play [▶] button.

**6**

Remote controller

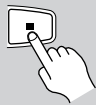

**To stop the slideshow, press the Stop [■] or [MENU] button.**

Depending on the type of JPEG disc, either the first nine pictures appear in thumbnail-size or the Disc Navigator appears.

The slideshow stops automatically when all pictures have been displayed.

**Notes:**

- If the folder containing the JPEG images also contains some MP3 tracks, the DV-SP1000/DV-SP1000E will play those tracks while showing the slideshow.
- If the selected JPEG file's resolution is 640 x 480 pixels or less, a thumbnail-size preview is shown. If the resolution exceeds 640 x 480, a preview will only be shown if the file contains thumbnail data.
- You can use the Repeat function to display JPEG images repeatedly (see page 57).
- You can use the Random function to display JPEG images randomly (see page 58).

## Making a Playlist with the Disc Navigator

MP3 JPEG

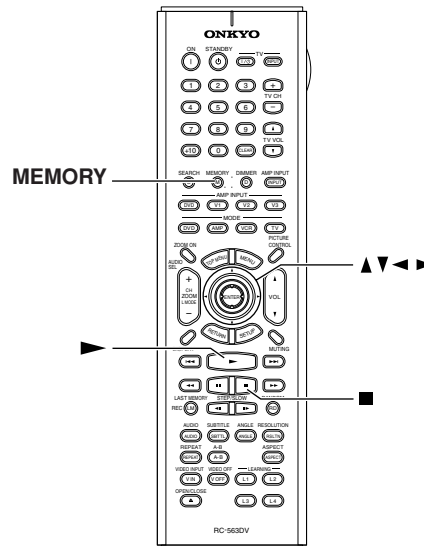

This section explains how to use the Disc Navigator to make a playlist of MP3 and JPEG files.

**1**

Remote controller

MEMORY



**With the Disc Navigator open, press the [MEMORY] button.**

The playlist appears in the right pane of the Disc Navigator.



## Basic Playback—Continued

**2**

Remote controller



To add a file to the playlist, use the [▲], [▼], [◀], [▶] buttons to select it in the Track list, and then press the [ENTER] button.



To add an entire folder to the playlist, select the folder at the top of the Track list and press [ENTER]. The folder number followed by “ALL” appears in the playlist.

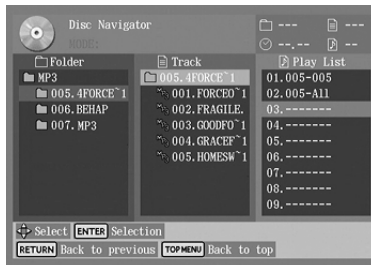

To open a folder in the Track list, press the [ENTER] button. To close a folder (i.e., move back up the directory tree), press the [RETURN] button. Alternatively, select the item at the top of the Track list and press the Play [▶] button.

**3**

Remote controller

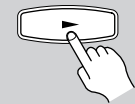

To start the playlist, select any item in the Track list except the top folder and press the Play [▶] button.

To close the Disc Navigator Play List window, press the [MEMORY] button.

**4**

Remote controller

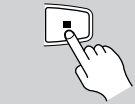

To stop the playlist, press the Stop [■] button.



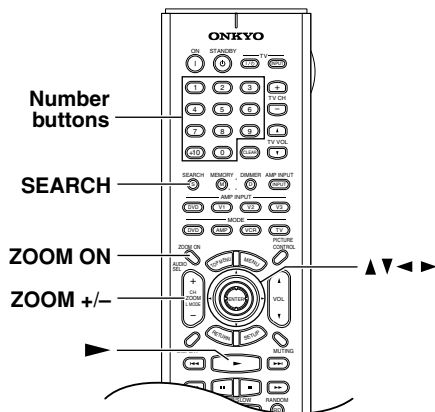

# Advanced Playback



## Zooming

DVD-V DVD-VR VCD

With the Zoom function you can enlarge any part of the picture.

<p><b>1</b> Remote controller ZOOM ON</p> 	<p><b>During playback, press the [ZOOM ON] button.</b> The Zoom x1 window appears onscreen.</p> 
<p><b>2</b> Remote controller</p> 	<p><b>Press the [+/-] part of the ZOOM [+/-] button to zoom in.</b> <b>Press the [-] part of the ZOOM [+/-] button to zoom out.</b> The following levels of zoom are available: 1/4, 1/2, x1, x2, x4</p>
<p><b>3</b> Remote controller</p> 	<p><b>To see other areas of the picture while zoomed, use the remote controller's arrow [▲], [▼], [◀], [▶] buttons.</b> The Zoom Navigator shows which area of the screen is currently zoomed.</p>
<p><b>4</b> Remote controller ZOOM ON</p> 	<p><b>To cancel the Zoom function, press the [ZOOM ON] button.</b></p>





## Notes:

- The Zoom function may not work with some DVDs.
- The Zoom function can also be used while playback is paused or during slow-motion playback.
- The Zoom function cannot be used to zoom menus.

## Time Search

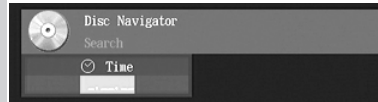
DVD-V DVD-A SACD DVD-VR VCD CD MP3

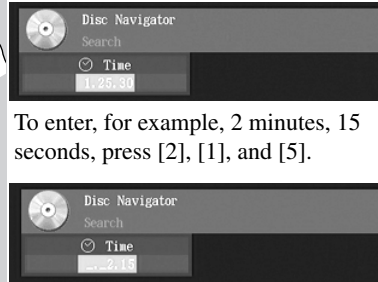
With the Time Search function you can locate specific points.

<p><b>1</b> Remote controller SEARCH</p> 	<p><b>Press the [SEARCH] button twice.</b> The Disc Navigator Search window appears onscreen.</p> 
<p><b>2</b> Remote controller</p> 	<p><b>Use the number buttons to enter a time.</b> To enter, for example, 1 hour, 25 minutes, 30 seconds, press the [1], [2], [5], [3], and [0] buttons.  To enter, for example, 2 minutes, 15 seconds, press [2], [1], and [5].</p> 
<p><b>3</b> Remote controller</p> 	<p><b>Press the Play [▶] button to locate the specified point.</b> Playback starts from the specified point.</p>

## Notes:

- Time search works within the currently playing title (DVD-Video/DVD-VR) or track (DVD-Audio, SACD, VCD, CD). If, for example, the current title is one hour long and you enter 1 hour, 30 minutes, nothing will happen.
- In some cases, playback may start from a slightly different point to the one that you specify.
- Time search may not work with some discs.
- Time search cannot be used while a DVD-Video menu is displayed onscreen, or while a VCD that supports PBC is playing.
- The [SEARCH] button cannot be used during random playback.



## Advanced Playback—Continued

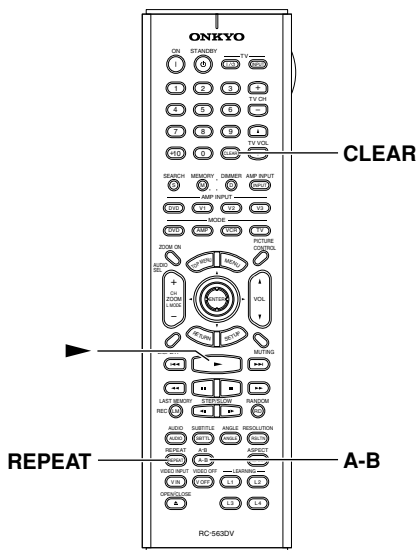

### 3

Remote controller



**To cancel repeat playback, use the [REPEAT] button to select Off.**

If you're using the Repeat function with the Disc Navigator (MP3/JPEG), the Repeat function is off when the MODE: field is blank.

#### Notes:

- Repeat playback may not work with some DVD-Video discs.
- The Repeat function can be used in combination with the Random function (see page 58).
- If the Memory function is on (see page 59), the selectable options are Memory Repeat, which plays the playlist repeatedly, and Repeat Off.
- To use the Repeat function with a VCD that supports PBC, you must first turn off PBC (see page 84).

### Repeat Playback

DVD-V DVD-A SACD DVD-VR VCD CD MP3 JPEG

With the Repeat function you can play a disc, title, chapter, group, track, or folder (MP3/JPEG) over-and-over again.

### 1

Remote controller



**Press the [REPEAT] button repeatedly to select a repeat option.**

The selected repeat option appears onscreen and the REPEAT indicator appears on the display.

The available options depend on the type of disc, as follows:

**DVD-Video, DVD-VR:** Chapter Repeat, Title Repeat, Disc Repeat, Repeat Off.

**DVD-Audio:** Track Repeat, Group Repeat, Disc Repeat, Repeat Off.

**SACD, VCD, CD:** Track Repeat, Disc Repeat, Repeat Off.

**MP3, JPEG:** Track Repeat, Folder Repeat, Disc Repeat, Repeat Off. The Chapter Repeat, Title Repeat, Track Repeat, and Group Repeat options can be selected only during playback.

### 2

Remote controller

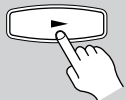

**Press the Play [▶] button to start repeat playback.**

### A-B Repeat Playback

DVD-V DVD-A SACD DVD-VR VCD CD

With the A-B Repeat function you can play a specified section over-and-over again.

### 1

Remote controller



**During playback, press the [A-B] button to set the A point (i.e., the start of the section you want to repeat).**

“A-” appears onscreen and REPEAT A indicator appears on the display.

### 2

Remote controller



**Press the [A-B] button again to set the B point (i.e., the end of the section you want to repeat).**

Playback repeats between the A and B points, and “A-B” appears onscreen and REPEAT AB indicator appears on the display.

### 3

Remote controller



**To cancel A-B repeat playback, press the [CLEAR] button, or use the [A-B] button to select Off.**

#### Notes:

- The A-B Repeat function may not work with some DVD-Video discs and VCDs that support PBC.
- In some cases, the A and B points may be at slightly different points to the ones that you specify.
- If you select a different camera angle during A-B repeat playback, the original camera angle will be selected when playback restarts from the A point.

## Advanced Playback—Continued

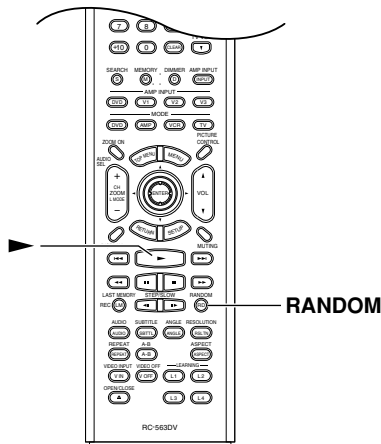

### Random Playback

DVD-V DVD-A SACD VCD CD MP3 JPEG

With the Random function you can enjoy a random selection of titles, chapters, groups, tracks, MP3s, or JPEG images.

<b>1</b>	<b>Load a disc (page 45).</b>
<b>2</b> Remote controller 	<p><b>Press the [RANDOM] button repeatedly to select a random option.</b></p> <p>The selected random option appears onscreen and the RANDOM indicator appears on the display.</p> <p>The options available depends on the type of disc, as follows:</p> <p><b>DVD-Video:</b> Title Random, Disc Random, Random Off.</p> <p><b>DVD-Audio:</b> Group Random, Disc Random, Random Off.</p> <p><b>SACD, VCD, CD:</b> Disc Random, Random Off.</p> <p><b>MP3/JPEG:</b> Folder Random (includes files in subfolders), Disc Random, Random Off.</p>

The Title Random and Group Random options can be selected only during playback.

With the Title Random option, chapters within the current title are played at random. With the Disc Random option, titles, chapters, groups, tracks, or folders on the disc are played at random. If you set the Random function during playback, random playback begins after the current chapter or track has finished.

### 3 Remote controller

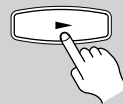

### Press the Play [▶] button to start random playback.

Random playback starts. Random playback stops automatically when all of the items have been played once. If the Repeat function is on (see page 57), random playback starts all over again when all items have been played.

### 4 Remote controller



### To cancel random playback, use the [RANDOM] button to select Off.

If you're using the Random function with the Disc Navigator (MP3/JPEG), the Repeat function is off when the MODE: field is blank.

#### Notes:

- To select the next title, chapter, group, track, MP3, or JPEG image during random playback, press the Next [▶▶] button.
- Random playback may not work with some DVD-Video and JPEG discs.
- To use the Random function with a VCD that supports PBC, you must first turn off PBC (see page 84).
- If the Memory function is on (page 59), random playback is unavailable.
- You can't use the [SEARCH] button during random playback.
- During random playback, the remote controller's arrow [▲], [▼], [◀], [▶] buttons don't work with the Disc Navigator.

## Advanced Playback—Continued

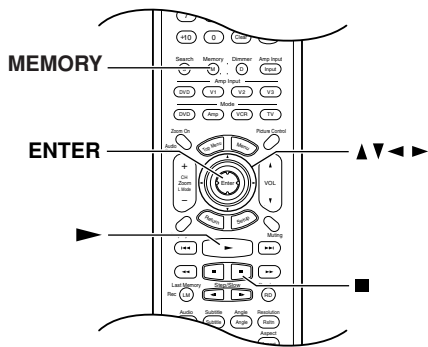

### Memory Playback

DVD-V DVD-A SACD VCD CD

With the Memory function you can create a playlist of titles, chapters, groups, or tracks.

**1**

Remote controller  
MEMORY



**Press the [MEMORY] button.**

The Memory Play Setup window appears onscreen and the MEMORY indicator appears on the display.

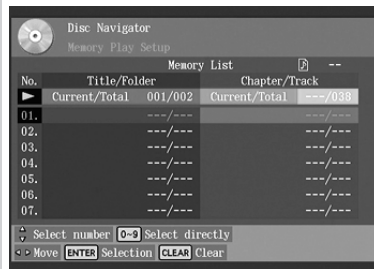

The highlighted top row (▶) is used to enter title/group/folder and chapter/track numbers. Items in the Memory List are numbered.

Move the cursor to the left when you want to enter a title/group/folder number. Move it to the right to enter a chapter/track number. Make sure that the top row is selected before you enter a number.

**2**

Remote controller



**Enter the title/group/folder and chapter/track numbers of the item you want to add to the Memory List.**

Use the remote controller's Left and Right [◀/▶] buttons to select the parameters, and use the Up and Down [▲/▼] buttons to select numbers from 001 to 999.

**3**

Remote controller



**Press the [ENTER] button.**

The new item is added to the Memory List as item #01.

In this example, All has been added to the Memory List as item #01.

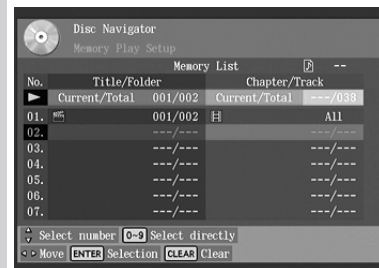

**4**

**Repeat steps 2 and 3 to add more items to the Memory List.**

**5**

Remote controller



**To play the Memory List, press the Play [▶] button.**

The Memory Play Setup window must be open when you press the Play [▶] button.

You can enter numbers directly by using the remote controller's number buttons.

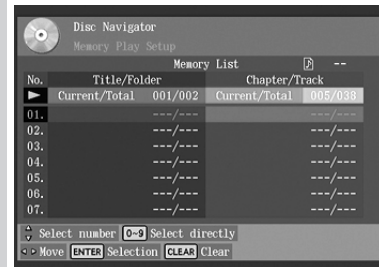

To add all of the titles, groups, folders, chapters, or tracks on a disc, select the top row, and then press the Down [▼] button.

To select all, while entering a number in the top row, press the [0] button.

## Advanced Playback—Continued

**6**  
Remote controller





To stop playback, press the Stop [■] button.



**Notes:**

- The playlist is deleted when the DV-SP1000/ DV-SP1000E is set to Standby.
- To use this function with a VCD that supports PBC, you must first turn off PBC (see page 84).
- With some discs you won't be able to make a playlist.

### Inserting New Items into the Memory List



<p><b>1</b> Remote controller MEMORY</p> 	<p><b>Press the [MEMORY] button.</b> The Memory Play Setup window appears onscreen.</p>
<p><b>2</b> Remote controller</p> 	<p><b>Use the Left or Right [◀]/[▶] button to move the cursor from the top row.</b> You must move the cursor away from the top row.</p>
<p><b>3</b> Remote controller</p> 	<p><b>Use the Up and Down [▲]/[▼] buttons to select the Memory List item before which you want to insert the new item.</b></p>
<p><b>4</b> Remote controller</p> 	<p><b>Press the [ENTER] button to insert a new blank item.</b> The cursor moves to the top row.</p>
<p><b>5</b></p>	<p><b>Enter the title/group/folder and chapter/track numbers of the item that you want to insert.</b></p>

**6**  
Remote controller

**Press the [ENTER] button.**  
The new item is inserted into the Memory List.







### Deleting Items from the Memory List

<p><b>1</b> Remote controller MEMORY</p> 	<p><b>Press the [MEMORY] button.</b> The Memory Play Setup window appears onscreen.</p>
<p><b>2</b> Remote controller</p> 	<p><b>Use the Left or Right [◀]/[▶] button to move the cursor from the top row.</b> You must move the cursor away from the top row.</p>
<p><b>3</b></p>	<p><b>Use the Up and Down [▲]/[▼] buttons to select the item that you want to delete.</b></p>
<p><b>4</b></p>	<p><b>Press the [CLEAR] button to delete the item.</b> The item is deleted and subsequent items move up the list.</p>

## Advanced Playback—Continued

### Changing Items in the Memory List

<p><b>1</b></p> <p>Remote controller MEMORY</p> 	<p><b>Press the [MEMORY] button.</b> The Memory Play Setup window appears onscreen.</p>
<p><b>2</b></p> <p>Remote controller</p> 	<p><b>Use the Left or Right [◀]/[▶] button to move the cursor from the top row.</b> You must move the cursor away from the top row.</p>
<p><b>3</b></p> <p>Remote controller</p> 	<p><b>Use the Up and Down [▲]/[▼] buttons to select the item that you want to change.</b></p>
<p><b>4</b></p>	<p><b>Use the Left or Right [◀]/[▶] button to move the cursor to the top row.</b></p>
<p><b>5</b></p>	<p><b>Change the title/group/folder and chapter/track numbers as necessary.</b></p>
<p><b>6</b></p> <p>Remote controller</p> 	<p><b>Press the [ENTER] button to enter your changes.</b></p>
<p>Remote controller MEMORY</p> 	<p><b>To close the Memory Play Setup window, press the [MEMORY] button.</b></p>



**Notes:**

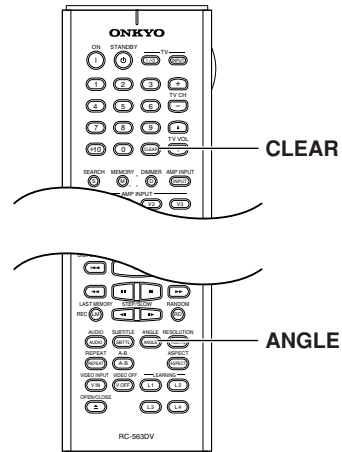

- The playlist is deleted when the DV-SP1000/DV-SP1000E is set to Standby.
- To use this function with a VCD that supports PBC, you must first turn off PBC (see page 84).



### Selecting Camera Angles



Some DVDs feature multiple camera angles that allow you to view scenes from different angles. When a DVD features multiple camera angles, the camera  indicator appears on the display. Such discs usually have the camera angle logo () printed on the sleeve.

<p><b>1</b></p> <p>Remote controller</p> 	<p><b>Press the [ANGLE] button repeatedly to cycle through the available camera angles.</b> The number of the currently selected camera angle appears onscreen. For example, on a disc with three camera angles, you'd see 1/3, 2/3, and 3/3.</p>
<p><b>2</b></p> <p>Remote controller</p> 	<p><b>Press the [CLEAR] button to select the default camera angle.</b> The camera  indicator disappears from the screen.</p>

**Notes:**

- With some DVDs you may not be able to select different camera angles even though the camera  indicator is displayed.
- With some DVDs you can select camera angles from a menu.

## Advanced Playback—Continued

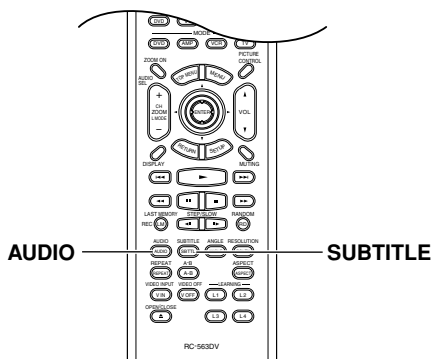

### Selecting Soundtracks

DVD-V DVD-A VCD SACD

Some DVD-Video discs feature soundtracks in several languages or audio formats (e.g., Dolby Digital or DTS). Music DVD-Video discs and DVD-Audio discs sometimes feature audio in several formats, such as PCM, Dolby Digital, or DTS. See the disc's sleeve notes for details.

Remote controller



**During playback, press the [AUDIO] button repeatedly to cycle through the available soundtracks.**

The name of the selected soundtrack appears onscreen for several seconds. With VCDs, you can select Stereo, Mono L (left), or Mono R (right). With SACDs you can select Multichannel area, 2 channel area, or CD layer.

#### Notes:

- With DVD-Video discs, when you stop playback and cancel the Resume function (see page 46), the soundtrack language will revert to your default language (see page 81), or the disc's default language.
- With some discs, selecting another soundtrack may cause the picture to skip momentarily.
- To listen to just the accompaniment on a karaoke CD, select the Mono L (left) or Mono R (right) channel. See the disc's sleeve notes for details.
- With some DVDs you need to select soundtracks from a menu, and you may not be able to select other soundtracks during playback.

### Selecting Subtitles

DVD-V

Some DVD-Video discs feature subtitles in several languages. See the disc's sleeve notes for details.

Remote controller

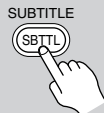

**During playback, press the [SUBTITLE] button repeatedly to cycle through the available subtitles.**

The name of the selected subtitle appears onscreen for several seconds. To turn off subtitles, use the [SUBTITLE] button to select "No Subtitle."

#### Notes:

- When you stop playback and cancel the Resume function (see page 46), the subtitle language will revert to your default subtitle language (see page 81), or the disc's default subtitle language.
- With some DVDs you can select subtitles from a menu, and you may not be able to select subtitles during playback.
- To check the subtitle language currently selected, press the [SUBTITLE] button once. The current setting will appear onscreen for several seconds.

## Advanced Playback—Continued

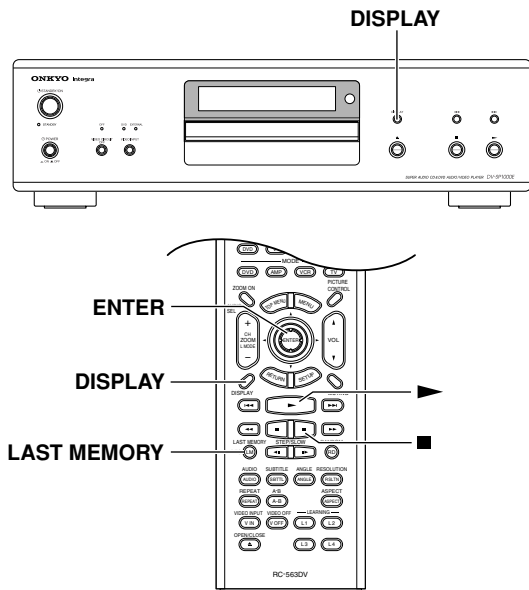

### Last Memory

DVD-V VCD

With the Last Memory function you can resume playback from where you left off even if the disc has been removed and the DV-SP1000/DV-SP1000E has been set to Standby. Last Memory also remembers the soundtrack and subtitle settings you were using.

**1**

Remote controller  
LAST MEMORY



**During playback, press the [LAST MEMORY] button.**

The last memory point for the disc is stored, the LAST M indicator appears, and “Last Mem” appears on the display. If the [LAST MEMORY] button is pressed again, the last memory point is updated.

**2**

Remote controller



**To stop playback, press the Stop [■] button once or twice. Now you may remove the disc and turn off the DV-SP1000/DV-SP1000E.**

**3**

Remote controller

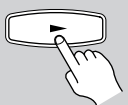

**To resume playback, load the disc, and then press the Play [▶] button.**

The Last Memory dialog box appears.

Last Memory is set.  
Start playback from memory location?

Yes No Memory Clear

**4**

Remote controller



**To resume playback from the last memory point, select Yes, and then press [ENTER].**

To start playback from the beginning, select No, and then press [ENTER].

To start playback from the beginning and delete the last memory point, select Memory Clear, and then press [ENTER].

### Notes:

- The Last Memory function can store the last point for up to six DVDs. When you set the Last Memory function for a seventh disc, the first disc’s settings are deleted.
- The Last Memory function can store the last point for only one VCD, and that point will be lost when the disc is removed.
- The Last Memory function may not work properly with VCDs that support PBC.
- The Last Memory function will not work while a menu is being displayed onscreen.
- The Last Memory function may not work with some DVDs.
- If you inadvertently turn off the DV-SP1000/DV-SP1000E during playback, you can resume playback from the last point simply by pressing the Play [▶] button.

### Displaying Information

DVD-V DVD-A SACD DVD-VR VCD CD MP3

You can display various information about a disc, title, chapter, group, or track onscreen and on the DV-SP1000/DV-SP1000E’s display.

DISPLAY



Remote controller





**During playback, press the [DISPLAY] button repeatedly.**

The information displayed depends on the type of disc. See the following tables.

## Advanced Playback—Continued



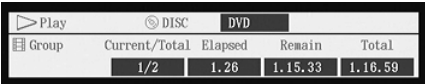

### ■ DVD-Video

Condition	Onscreen	DV-SP1000/ DV-SP1000E Display
Normal	No display	Elapsed title time
1st press		Current/total title number, elapsed title time, remaining title time, total title time, selected soundtrack, selected subtitle, number of camera angles.
2nd press		Current/total chapter number, elapsed chapter time, remaining chapter time, total chapter time, bit rate.
3rd press	No display	Elapsed title time

### ■ DVD-Audio

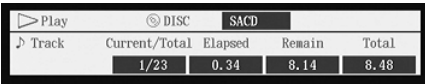
Condition	Onscreen	DV-SP1000/ DV-SP1000E Display
Normal	No display	Elapsed track time
1st press		Current/total track number, elapsed track time, remaining track time, total track time, selected soundtrack, selected subtitle, number of camera angles.
2nd press		Current/total group number, elapsed group time, remaining group time, total group time.
3rd press	No display	Elapsed track time

### ■ SACD

Condition	Onscreen	DV-SP1000/ DV-SP1000E Display
Normal	No display	Elapsed track time
1st press		Current/total track number, elapsed track time, remaining track time, total track time.
2nd press		As above plus number of audio channels.
3rd press		Current/total track number, elapsed disc time, remaining disc time, total disc time.
4th press		Title, artist name, album name.
5th press	No display	Elapsed track time

a. If the disc has no title, "No Title" appears.



## Advanced Playback—Continued

### ■ VCD & CD

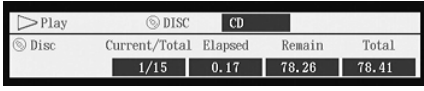
Condition	Onscreen	DV-SP1000/ DV-SP1000E Display
Normal	No display	Elapsed track time
1st press		Current/total track number, elapsed track time, remaining track time, total track time.
2nd press		Current/total track number, elapsed disc time, remaining disc time, total disc time.
3rd press	Same as for 2nd press	Remaining disc time
4th press	No display	Elapsed track time

### ■ MP3

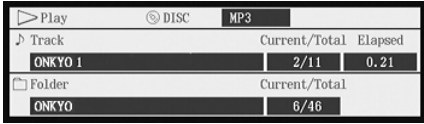
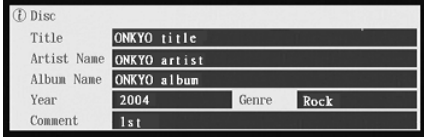
Condition	Onscreen	DV-SP1000/ DV-SP1000E Display
Normal		Disc Navigator <sup>a</sup>
1st press <sup>b</sup>		Current/Total track number, elapsed track time, current/total folder number, file name, etc.
2nd press		Title, artist name, album name, year, genre, comment.
3rd press <sup>b</sup>	No display	File name
4th press		Disc Navigator

a. If the Disc Navigator is not shown, press the [MENU] button.

b. When another folder is selected, its name is displayed for three seconds.

#### Notes:

- For DVD-Video and DVD-Audio discs, when the soundtrack, subtitle, or camera angle is changed, the setting is displayed onscreen for 10 seconds. To cancel this display, press the [DISPLAY] button twice.
- When playback is started, paused, stopped, and so on, the status is displayed onscreen for five seconds.
- For DVD-VR discs, the bit rate is not displayed.
- No information is displayed when playing a VCD with PBC.

## Advanced Playback—Continued

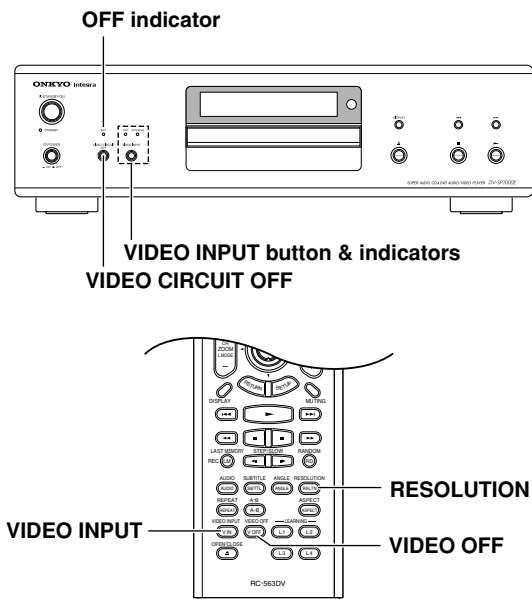

### Selecting the Video Input Source (not Canadian model)

This section explains how to select the video input source when you've connected other video components to the DV-SP1000/DV-SP1000E's video inputs, as shown on page 39.

**Press the [VIDEO INPUT] button repeatedly to select the video input source.**  
**DVD:** The DV-SP1000/DV-SP1000E.  
**EXTERNAL:** VIDEO IN (S VIDEO or VIDEO).  
 The DVD and EXTERNAL indicators show the currently selected video input source.

**Notes:**

- See the table on page 27 for details on how the DV-SP1000/DV-SP1000E's video outputs work with each video input source.

### Turning Off the Video Circuits

You can turn off all of the output video circuitry, eliminating the possibility of interference, for a pure-audio experience when playing audio-only discs.

**1** **Press the remote controller's [VIDEO OFF] button or the DV-SP1000/DV-SP1000E's [VIDEO CIRCUIT OFF] button.**  
 The output video circuitry is turned off, the VIDEO CIRCUIT OFF indicator lights up, and the V.OFF indicator appears on the display.

**2** **To turn the video circuitry back on, press the button again.**  
 The output video circuitry is turned on, the VIDEO CIRCUIT OFF indicator goes off, and the V.OFF indicator disappears from the display.

**Notes:**

- When the video circuitry is turned off, all of the DV-SP1000/DV-SP1000E's video outputs don't work. The VIDEO IN inputs are not affected.
- With some discs you need start playback from a menu, in which case you should turn off the video circuitry after starting playback.
- Although intended for use with audio discs, this function can also be used to enjoy soundtracks and music on DVD-Video discs and VCDs.

### Setting the HDMI Output Resolution

This section explains how to change the video resolution when your TV or projector is connected to the HDMI OUT.

**Press the remote controller's [RESOLUTION] button.**  
 The current resolution scrolls across the display.  
**While the resolution is scrolling, press the [RESOLUTION] button repeatedly to select another resolution.**  
 The DV-SP1000/DV-SP1000E supports the following resolutions:  
**640 x 480p:** (VGA), 60 Hz  
**720 x 480p:** (progressive), 60 Hz  
**720 x 576p:** (progressive), 50 Hz  
**1280 x 720p:** (progressive), 50/60 Hz  
**1920 x 1080i:** (interlaced), 50/60 Hz  
**Source Resolution:** External input video is output at the same resolution. DVD playback is output at 480p or 576p.

**Notes:**

- With HDMI, the TV reports to the DV-SP1000/DV-SP1000E what resolutions it supports, and then only those resolutions can be selected.
- The letters *i* and *p* indicate *interlaced* and *progressive* respectively.

## Advanced Playback—Continued

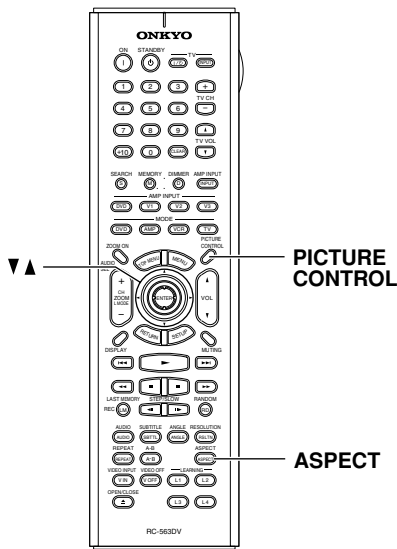

**Notes:**

- The aspect ratio cannot be changed during playback.

### Using the Picture Control Menu

The Picture Control menu provides quick access to the Interlaced, Progressive, and AV Synchronization setup memories.

**1**  
Remote controller  
PICTURE CONTROL

**Press the remote controller's [PICTURE CONTROL] button.**  
The Picture Control menu appears onscreen.

Interlaced Setting	1
Progressive Setting	2
AV Synchronization	3

**2**  
Remote controller

**Use the Up and Down [▲]/[▼] buttons to select Interlaced, Progressive, or AV Synchronization.**  
If you want to edit the settings of the current setup memory, select Interlaced Setting, Progressive Setting, or AV Synchronization, and then press the [ENTER] or Right [▶] button. Editing works the same as for the Picture setup menu (see page 72).

### Setting the Picture's Aspect Ratio

This section explains how to set the picture's aspect ratio.

Remote controller  
ASPECT

**Press the remote controller's [ASPECT] button repeatedly to select an aspect ratio.**  
Choose an aspect ratio to suit your TV and how you want to see the picture onscreen.

TV Shape	4:3 Letter box
----------	----------------

**4:3 Letter box:** Choose this option if you have a 4:3 aspect ratio TV. When you watch widescreen video sources, the entire picture will be visible but there will be black bars at the top and bottom of the screen.

TV Shape	4:3 Normal
----------	------------



**4:3 Normal:** Choose this option if you have a 4:3 aspect ratio TV and want to use the full height of the screen when watching widescreen video sources. The picture will be cropped on both sides. This option won't work with discs that don't support pan and scan.

TV Shape	16:9 Widescreen
----------	-----------------





**16:9 Widescreen:** Choose this option if you have a 16:9 widescreen TV.

# Configuring the DV-SP1000/DV-SP1000E

This chapter explains the various settings on the onscreen setup menus. Settings are arranged into six groups: *Picture*, *Audio*, *Language*, *Display*, *Operation*, and *Initial Setup*. The following table lists all of the settings, with a brief description and page number where you can find full details. (Certain settings cannot be selected or changed during playback.)

Menu	Setting	Description	Page #			
<b>Picture</b> 	TV Shape	Selects a picture format to match the aspect ratio of your TV.	72			
	Interlaced Setting	Picture adjustments for interlaced scanning.	72			
	Progressive Setting	Picture adjustments for progressive scanning.	73			
	SCART Output Setting (European model only)	Selects the video format for the SCART output: RGB, S-Video, or composite.	74			
	PAL Output Setting (not North American models)	Specify how the DV-SP1000/DV-SP1000E outputs video signals when playing NTSC discs.	74			
<b>Audio</b> 	Digital Out/ Digital1 (i.LINK) The Chinese model doesn't support i.LINK.	Dolby Digital Out	Determines whether Dolby Digital audio is downmixed.	74		
		DTS Out	Determines whether DTS audio is downmixed.	74		
		MPEG Out	Determines whether MPEG audio is downmixed.	75		
		Digital Out	Turns the DIGITAL 1 AUDIO OUTs on and off.	75		
	Digital Out/ Digital2 (HDMI)	Dolby Digital Out	Determines whether Dolby Digital audio is downmixed.	75		
		DTS Out	Determines whether DTS audio is downmixed.	75		
		MPEG Out	Determines whether MPEG audio is downmixed.	75		
		Digital Out	Turns the DIGITAL 2 AUDIO OUTs on and off.	75		
	Linear PCM Out	Determines whether 96 kHz digital audio is downsampled.	75			
	i.LINK Output Setting (not Chinese model)	Turns the i.LINK output on and off.	76			
	Analog Audio Out	2 Channel	Stereo, Lt/Rt	Determines how the FRONT AUDIO OUT sockets downmix multichannel audio.	76	
		Multi Channel	Dolby Pro Logic Setting			Determines how the built-in Dolby Pro Logic decoder works.
			Speaker Setting	On, Off		Specify which speakers are connected and their sizes, and enable (on) or disable (off) the Speaker Setting.
			Speaker Distance	On, Off		Specify the distance between each speaker and the listener, and enable (on) or disable (off) the Speaker Distance setting.
			Test Tone			Adjust individual speaker levels with the test tone.
	AV Synchronization	Resynchronizes sound and picture.		79		
	Dynamic Range Control (Dolby Digital only)	Sets the Dynamic Range function.		80		
SACD Audio Setup	Determines how SACD multichannel, 2-channel, and CD tracks are played.		80			
CD Audio Setup	Configures the digital audio outputs for CD or DTS CD.		80			

## Configuring the DV-SP1000/DV-SP1000E—Continued



Menu	Setting	Description	Page #			
<b>Language</b> 	On-Screen Language	Specify a language for the onscreen setup menus and messages.	81			
	Disc Menu Language	Specify your preferred language for disc menus.	81			
	Audio Language	Specify your preferred language for soundtracks.	81			
	Subtitle Language	Specify your preferred language for subtitles.	82			
<b>Display</b> 	On-Screen Display	Turns onscreen messages and indicators on and off.	82			
	On-Screen Display Color	Selects a color for onscreen setup menus and messages.	82			
	Background	Selects a background color for when playback is stopped.	82			
	Screen Saver	Sets the Screen Saver.	82			
<b>Operation</b> 	Pause/Still	Selects Auto or Frame for paused and still pictures.	82			
	Parental Lock	Sets the Parental Lock function.	83			
	Remote Confirmation	Turns the remote controller beeper on and off.	83			
	Title/Group Stop	Determines if playback stops at the end of the current title or group.	84			
	PBC	Turns PBC (Playback Control) for VCDs on and off.	84			
	Priority Contents	Determines what's played on DVD-Audio discs with DVD-Video content.	84			
	Auto power off	Sets the Auto power off function.	84			
<b>Initial Setup</b> 	TV Shape	This is the menu that appears automatically the very first time the DV-SP1000/DV-SP1000E is turned on.	43			
	On-Screen Language					
	i.LINK Output Setting (not Chinese model)					
	Analog Audio Out			2 Channel		
				Multi Channel	Speaker Setting	On, Off

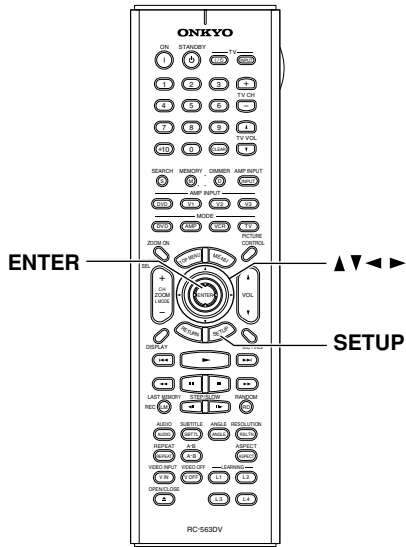

## Configuring the DV-SP1000/DV-SP1000E—Continued

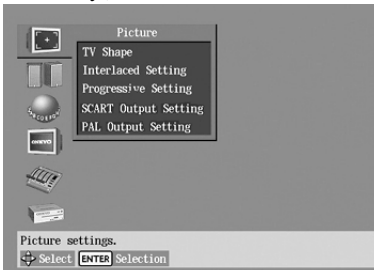

### Using the Onscreen Setup Menus

This section explains how to use the onscreen setup menus.

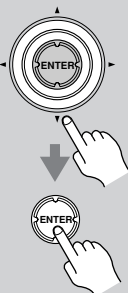
<b>1</b>	<p><b>Turn on the DV-SP1000/DV-SP1000E and your TV.</b></p> <p>On your TV, select the video input to which the DV-SP1000/DV-SP1000E is connected.</p>
<b>2</b> Remote controller	<p><b>Press the [SETUP] button.</b></p> <p>The onscreen setup menu appears. (The menus vary slightly from country to country.)</p> 
<b>3</b> Remote controller	<p><b>Use the remote controller's arrow buttons to navigate the menus.</b></p> <p>Use the Left and Right [◀]/[▶] buttons to move left and right. Use the Up and Down [▲]/[▼] buttons to move up and down.</p> 

<b>4</b> Remote controller	<p><b>When you've selected an item, press the [ENTER] button to see the available options.</b></p> 
<b>5</b> Remote controller	<p><b>Use the arrow buttons to select the options, and press the [ENTER] button to confirm your choice.</b></p> 
<b>6</b> Remote controller	<p><b>When you've finished, press the [SETUP] button again.</b></p> <p>The settings are stored and the onscreen setup menu closes.</p> 

## Configuring the DV-SP1000/DV-SP1000E—Continued

The following diagram shows how to navigate the onscreen setup menus.

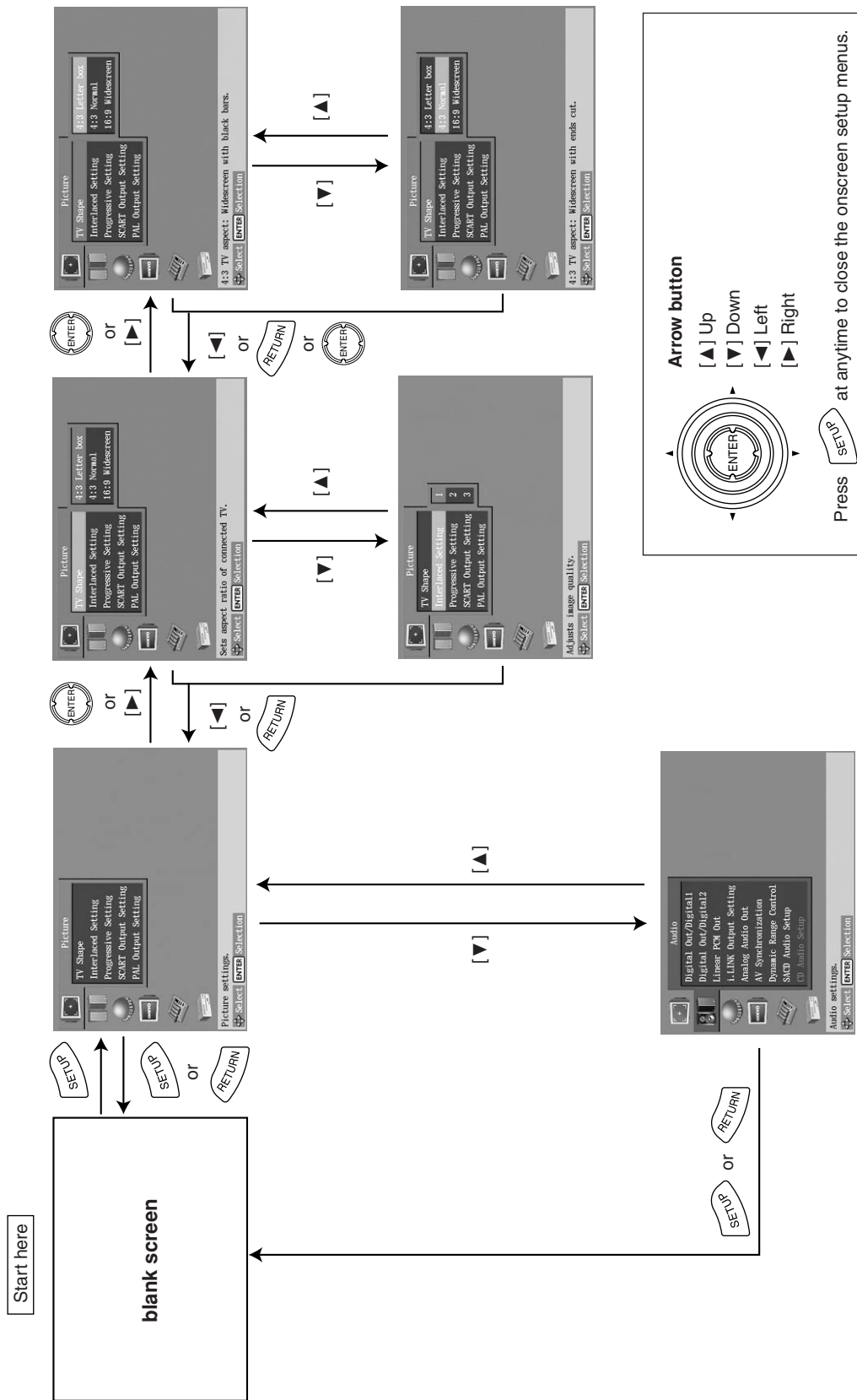

## Configuring the DV-SP1000/DV-SP1000E—Continued

### Picture Menu

#### TV Shape

With this setting you can select a picture format to match the aspect ratio of your TV.

##### 4:3 Letter box (default):

Choose this option if you have a 4:3 TV. When you watch widescreen movies, the entire picture will be visible but there will be black bars at the top and bottom of the screen, as shown.



Widescreen DVD movie on 4:3 TV with the 4:3 Letter box setting

##### 4:3 Normal

Choose this option if you have a 4:3 TV and want to use the full height of the screen when watching widescreen movies. The picture will be cropped on both sides, as shown. This option will not work with discs that don't support pan and scan.



Widescreen DVD movie on 4:3 TV with the 4:3 Normal setting

##### 16:9 Widescreen

Choose this option if you have a 16:9 widescreen TV.

#### Notes:

- With some DVDs, this setting may have no effect. See the disc's sleeve notes to see which picture format is used.

### Interlaced Setting

With this setting you can adjust various picture parameters for interlaced scanning (see page 27). There are three setup memories (1, 2, 3) for storing your favorite settings. You could, for example, use one for daytime viewing (e.g., sun shining through window) and one for nighttime viewing (e.g., curtains drawn, lights down).

Parameter	Range	Description
Blacker than black	Off, On (default)	When you use a DVD test disc to set the black level on your TV, set this to Off.
Contrast	-7...0...+7	Adjusts the picture contrast.
Brightness	-7...0...+7	Adjusts the picture brightness.
Color	-7...0...+7	Adjusts the picture color.
Tint	-7...0...+7	Adjusts the picture tint.
Sharpness	-6...0...+6	Adjusts the picture sharpness.
S, Composite Video	Light, Normal (default) <sup>a</sup>	Adjusts the black level for the S-Video and composite video outputs.
Component Video	Dark (default), Light	Adjusts the black level for the component video outputs.
Gamma	-7...0...+7	Adjusts the brightness of darker colors.
Y/C Time Correction	-4, -2, 0, +2, +4	Corrects small shifts in color.
DNR (Digital Noise Reduction)	Off (default), 1, 2, 3	Reduces picture noise. <sup>b</sup>

- On the North American model, the options are Normal and Dark.
- The effect may not always be noticeable, and depending on the video source, the picture may look better with it set to Off.



## Configuring the DV-SP1000/DV-SP1000E—Continued

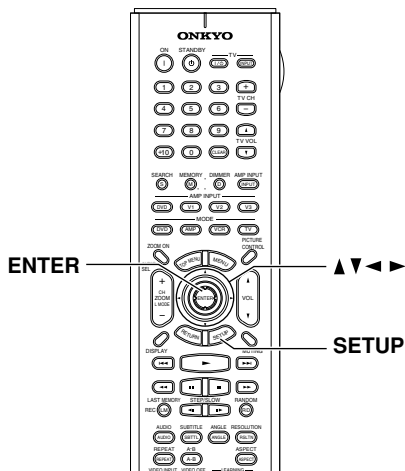

### Selecting the Interlaced Setting

**1**  
Remote controller

or

Picture

- TV Shape
- Interlaced Setting 1
- Progressive Setting 2
- SCART Output Setting 3
- PAL Output Setting

Adjusts image quality.  
Select ENTER Selection

**Select Interlaced Setting 1, 2, or 3, and then press the [ENTER] or Right [▶] button.**  
The parameters appear onscreen.

**2**  
Remote controller

**Use the Up and Down [▲]/[▼] buttons to select the parameters, press the [ENTER] button, and then use the Left and Right [◀]/[▶] buttons to set them.**

Interlaced Setting

- Blacker than black On
- Contrast 0
- Brightness 0
- Color 0
- Tint 0
- Sharpness 0
- S, Composite Video Normal
- Component Video Dark
- Gamma 0

To adjust black level with calibration disc.  
Select ENTER Selection

**3**  
Remote controller

**Press the [ENTER] button.**  
The setting is stored.  
Use the same procedure to set the other parameters, pressing the [ENTER] button when you've set each one.  
Press the [SETUP] button to exit the onscreen setup menu.

### Progressive Setting

With this setting you can adjust various picture parameters for progressive scanning (see page 27). There are three setup memories (1, 2, 3) for storing your favorite settings. You could, for example, use one for daytime viewing (e.g., sun shining through window) and one for nighttime viewing (e.g., curtains drawn, lights down).

Parameter	Range	Description
Contrast	-7...0...+7	Adjusts the picture contrast.
Brightness	-7...0...+7	Adjusts the picture brightness.
Color	-7...0...+7	Adjusts the picture color.
Tint	-7...0...+7	Adjusts the picture tint.
Sharpness	-7...0...+7	Adjusts the picture sharpness.
Gamma	-7...0...+7	Adjusts the brightness of darker colors.
Y/C Time Correction	-4...0...+4	Corrects small shifts in color.

**1**  
Remote controller

or

Picture

- TV Shape
- Interlaced Setting
- Progressive Setting 1
- SCART Output Setting 2
- PAL Output Setting 3

Adjusts picture quality (progressive scan TV)  
Select ENTER Selection

**Select Progressive Setting 1, 2, or 3, and then press the [ENTER] or Right [▶] button.**  
The parameters appear onscreen.

**2**  
Remote controller

**Use the Up and Down [▲]/[▼] buttons to select the parameters, press the [ENTER] button, and then use the Left and Right [◀]/[▶] buttons to set them.**

## Configuring the DV-SP1000/DV-SP1000E—Continued

### 3

Remote controller



**When you've finished, press the [ENTER] button.**

The setting is stored.

Use the same procedure to set the other parameters, pressing the [ENTER] button when you've set each one.

Press the [SETUP] button to exit the onscreen setup menu.

### SCART Output Setting (European model only)

With this setting you can select the video format to be used for the SCART AV CONNECTOR: RGB, S-Video, or composite video. Before changing this setting, refer to your TV's manual to see if its SCART input can accept video signals in these formats.

#### Composite (default)

Composite video offers standard quality.

#### S-Video

S-Video offers the next best picture quality.

#### RGB

This format offers the best picture quality. The RGB indicator appears on the display when this option is selected.

#### Notes:

- If you select a format that is not supported by your TV, the setup menu may disappear from the screen. If this happens, switch off your equipment, connect the DV-SP1000/DV-SP1000E to your TV with a composite video or S-Video cable, and then change this setting.
- Composite, S-Video, and RGB can also be selected from the front panel. With the DV-SP1000/DV-SP1000E turned on, while holding down the Previous [◀] button, press the [STANDBY/ON] button to select "Composite," "S-Video," or "RGB."
- When RGB is selected, nothing is output by the component video output (see page 27).

### PAL Output Setting (not North American models)

With this setting you can specify how the DV-SP1000/DV-SP1000E outputs video signals when playing NTSC format discs.

#### Auto (default)

Use this option if your TV or projector supports PAL and NTSC. When you play a PAL disc, the video output will be PAL. When you play an NTSC disc, it'll be NTSC. The DV-SP1000/DV-SP1000E does not convert the format.

#### PAL

Use this option if your TV doesn't support NTSC playback, or the picture is distorted when watching NTSC discs. The DV-SP1000/DV-SP1000E will convert NTSC format video to a PAL-compatible format known as *Mod PAL* or *60 Hz PAL*.

#### Notes:

- This setting can be changed only when playback is stopped.
- PAL and AUTO can also be selected from the front panel. With the DV-SP1000/DV-SP1000E turned on, while holding down the Next [▶] button, press the [STANDBY/ON] button to select "Auto" or "PAL."

## Audio Menu

### Digital Out/Digital1 (i.LINK)

With these settings you can determine how the DV-SP1000/DV-SP1000E outputs digital audio from its i.LINK sockets and DIGITAL 1 AUDIO OUTs. The options you choose will depend on the type of component that you connect to the DIGITAL 1 AUDIO OUTs. The Chinese model doesn't support i.LINK.

#### ■ Dolby Digital Out

With this setting you can configure the DIGITAL 1 AUDIO OUTs to output Dolby Digital audio as it is or to downmix it into 2-channel PCM.

##### Dolby Digital (default)

Choose this option if you're connecting a component with a built-in Dolby Digital decoder.

##### Dolby Digital > PCM

Choose this option if you're connecting a stereo hi-fi amp with a digital input, an AV receiver with a built-in Dolby Pro Logic decoder, or an external D/A converter.

#### ■ DTS Out

With this setting you can configure the DIGITAL 1 AUDIO OUTs to output DTS audio as it is or to downmix it into 2-channel PCM.

##### DTS (default)

Choose this option if you're connecting a component with a built-in DTS decoder.

##### DTS > PCM

Choose this option if you're connecting a stereo hi-fi amp with a digital input or an external D/A converter.

#### Notes:

- When playing the DTS audio of a DTS CD, set the CD Audio Setup setting to DTS (see page 80).

## Configuring the DV-SP1000/DV-SP1000E—Continued

### ■ MPEG Out

With this setting you can configure the DIGITAL 1 AUDIO OUTs to output MPEG audio as it is or to downmix it into 2-channel PCM.

#### MPEG

Choose this option if you're connecting a component with a built-in MPEG decoder.

#### MPEG > PCM (default)

Choose this option if you're connecting a stereo hi-fi amp with a digital input or an external D/A converter.

### ■ Digital Out

With this setting you can turn the DIGITAL 1 AUDIO OUTs on or off. Depending on how you connect the DV-SP1000/DV-SP1000E to your other components, this can be useful in certain situations.

#### On (default)

DIGITAL 1 AUDIO OUTs are on.

#### Off

DIGITAL 1 AUDIO OUTs are off.

#### Notes:

- This setting has no effect on the analog audio outputs.

### Digital Out/Digital2 (HDMI)

With these settings you can determine how the DV-SP1000/DV-SP1000E outputs digital audio from its HDMI OUT and DIGITAL 2 AUDIO OUTs. The options you choose will depend on the type of component that you connect to the DIGITAL 2 AUDIO OUTs.

### ■ Dolby Digital Out

With this setting you can configure the DIGITAL 2 AUDIO OUTs to output Dolby Digital audio as it is or to downmix it into 2-channel PCM.

#### Dolby Digital (default)

Choose this option if you're connecting a component with a built-in Dolby Digital decoder.

#### Dolby Digital > PCM

Choose this option if you're connecting a stereo hi-fi amp with a digital input, an AV receiver with a built-in Dolby Pro Logic decoder, or an external D/A converter.

### ■ DTS Out

With this setting you can configure the DIGITAL 2 AUDIO OUTs to output DTS audio as it is or to downmix it into 2-channel PCM.

#### DTS (default)

Choose this option if you're connecting a component with a built-in DTS decoder.

#### DTS > PCM

Choose this option if you're connecting a stereo hi-fi amp with a digital input or an external D/A converter.

#### Notes:

- When playing the DTS audio of a DTS CD, set the CD Audio Setup setting to DTS (see page 80).

### ■ MPEG Out

With this setting you can configure the DIGITAL 2 AUDIO OUTs to output MPEG audio as it is or to downmix it into 2-channel PCM.

#### MPEG

Choose this option if you're connecting a component with a built-in MPEG decoder.

#### MPEG > PCM (default)

Choose this option if you're connecting a stereo hi-fi amp with a digital input or an external D/A converter.

### ■ Digital Out

With this setting you can turn the DIGITAL 2 AUDIO OUTs on or off. Depending on how you connect the DV-SP1000/DV-SP1000E to your other components, this can be useful in certain situations.

#### On (default)

DIGITAL 2 AUDIO OUTs are on.

#### Off

DIGITAL 2 AUDIO OUTs are off.

#### Notes:

- This setting has no effect on the analog audio outputs.

### Linear PCM Out

DVD-V DVD-A DVD-VR VCD CD MP3

With this setting you can configure the DV-SP1000/DV-SP1000E to output digital audio with a high sampling rate (e.g., 96 kHz) as it is or to downsample it to 16-bit/48 kHz. This setting applies to the DIGITAL 1 and DIGITAL 2 AUDIO OUTs, the HDMI OUT, and i.LINK output. (The Chinese model doesn't support i.LINK.)

#### Down Sample On

Choose this option if the component connected to the DIGITAL 1 or 2 AUDIO OUTs doesn't support high sampling rates.

#### Down Sample Off (default)

Choose this option if the connected component does support high sampling rates.

#### Notes:

- Some copy-protected DVD-Video discs may use 96 kHz digital audio only for A/D conversion to the analog audio outputs.
- With some discs, even if you select Down Sample Off, digital audio will be downsampled to 48 kHz regardless, and in some cases, digital audio may not be output by the DV-SP1000/DV-SP1000E's digital audio outputs.

## Configuring the DV-SP1000/DV-SP1000E—Continued

### *i.LINK Output Setting (not Chinese model)*

 SACD

This setting is used to configure the i.LINK sockets for use with SACD. It also affects DVD-Audio output.

#### **Off (default)**

SACD audio is output by the analog audio outputs but not the i.LINK sockets. Select this option if you're not using the i.LINK sockets.

#### **On**

SACD audio is output by the i.LINK sockets but not the analog audio outputs. Select this option if you're using the i.LINK sockets.

#### **Notes:**

- When the DV-SP1000/DV-SP1000E is plugged in and set to Standby, it automatically checks if it's connected to any other i.LINK components. If it is, the default setting for the i.LINK Output Setting becomes On. If not, the default becomes Off.
- When set to On, the Analog Audio Out Speaker Setting and Speaker Distance settings have no effect and are unavailable, and multichannel SACD and DVD-Audio is output as it is.
- When an i.LINK component is connected and an SACD is loaded, if this setting is set to Off, the IEEE 1394 indicator will flash, in which case you should set this setting to On.

### *Analog Audio Out*

 DVD-V  DVD-A  SACD

With this setting you can configure the FRONT, SURR 1/SURR 2, CENTER, and SUBWOOFER AUDIO OUT sockets for use with a 2-channel amp or a multichannel amp.

#### **Notes:**

- When the i.LINK Output Setting is set to On, this setting is unavailable (not Chinese model).

#### ■ **2 Channel**

Choose this option if you're connecting just the FRONT AUDIO OUT sockets to a stereo amp.

#### ■ **Stereo Lt/Rt (Downmix)**

 DVD-V  DVD-A  SACD

To access this setting, select 2 Channel, and then press the [ENTER] or Right [▶] button.

With this setting you can determine how the FRONT AUDIO OUT sockets downmix multichannel audio sources.

#### **Stereo (default)**

Choose this option if you're connecting the FRONT AUDIO OUT sockets to a stereo amp or TV. Multichannel audio is downmixed into stereo.

#### **Lt/Rt**

Choose this option if you're connecting the FRONT AUDIO OUT sockets to an AV receiver, TV, or other component with a built-in Dolby Pro Logic decoder.

Multichannel audio is downmixed into an Lt/Rt mix, which is a 2-channel mix containing front left, front right, center, and surround channel information.

#### ■ **Multi Channel (default)**

Choose this option if you're connecting the FRONT, SURR 1/SURR 2, CENTER, and SUBWOOFER AUDIO OUTPUTs to a multichannel amp. When Multi Channel is selected, you can also set the following settings:

- Dolby Pro Logic Setting
- Speaker Setting
- Speaker Distance
- Test Tone

#### ■ **Dolby Pro Logic Setting**

This setting determines how the DV-SP1000/DV-SP1000E's built-in Dolby Pro Logic decoder works with 2-channel material.

#### **Auto (default)**

The Dolby Pro Logic decoder automatically detects and decodes only Dolby Surround material.

#### **On**

The Dolby Pro Logic decoder decodes Dolby Surround material and processes the following audio formats: 2-channel Dolby Digital on DVD-Video discs, 48 kHz (16-, 20-, and 24-bit) PCM audio on DVD-Video discs, and 2-channel audio on CDs.

#### **Off**

The Dolby Pro Logic decoder is off.

#### **Notes:**

- In the Analog Audio Out, Speaker Setting, if Center Speaker or Surround Speaker is set to Off (page 44, 78), the Dolby Pro Logic decoder will not work even if you select Auto or On.

#### ■ **Speaker Setting, Speaker Distance**

With these settings you can enable or disable the Speaker Setting and Speaker Distance settings.

#### **On**

The Speaker Setting and Speaker Distance settings are enabled. These settings are explained in the following sections.

#### **Off**

The Speaker Setting and Speaker Distance settings are disabled. Select this option if you connect the multichannel analog audio output to a multichannel analog audio input on an AV receiver that has its own speaker and distance settings.

Selecting Off is essentially the same as setting the Speaker Setting Front, Center, and Surround settings to Large, the Subwoofer setting to On, and the Speaker Distance settings to zero.

#### ■ **Test Tone**

The test tone is used to adjust the level of each speaker (see page 79).

## Configuring the DV-SP1000/DV-SP1000E—Continued

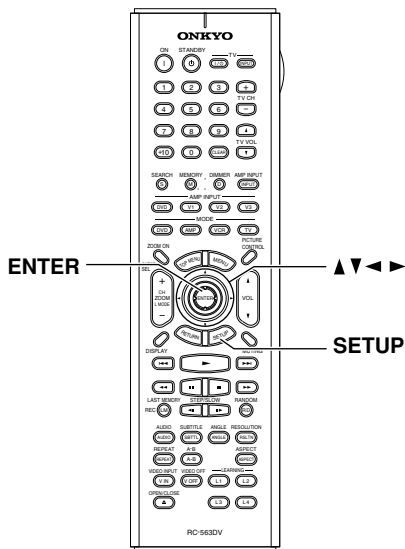

### Setting the Speaker Settings

**1**  
Remote controller

Use the Up and Down [▲]/[▼] buttons to select **Speaker Setting**, press the [ENTER] button, use the Up and Down [▲]/[▼] buttons to select **On**, and then press the [ENTER] button. When the Speaker Setting is set to Off, these settings cannot be selected.

**2**  
Remote controller

Use the Up and Down [▲]/[▼] buttons to select **Subwoofer**, press the [ENTER] button, use the Left and Right [◀]/[▶] buttons to select an option, and then press the [ENTER] button.

**Off:** Select if no subwoofer is being used.  
**On (default):** Select if a subwoofer is being used.

**3**  
Remote controller

Use the Up and Down [▲]/[▼] buttons to select **Front Speaker**, press the [ENTER] button, use the Left and Right [◀]/[▶] buttons to select an option, and then press the [ENTER] button.

When setting the Speaker Setting, for speakers with a cone diameter larger than 6-1/2 inches (16 cm), specify *Large*. For those with a smaller diameter, specify *Small*. If you're using THX-certified speakers, specify *Small* for all speakers.

**Large:** Select if the front speakers are large.  
**Small (default):** Select if the front speakers are small.

Note that if the Subwoofer setting is set to Off, this setting is fixed at Large.

**4**  
Remote controller

Use the Up and Down [▲]/[▼] buttons to select **Center Speaker**, press the [ENTER] button, use the Left and Right [◀]/[▶] buttons to select an option, and then press the [ENTER] button.

**Large:** Select if the center speaker is large.  
**Small (default):** Select if the center speaker is small.  
**Off:** Select if no center speaker is being used.

Note that if the Front Speaker setting is set to Small, the Large option cannot be selected. And if the Subwoofer setting is set to Off, only the Large and Off options can be selected.

## Configuring the DV-SP1000/DV-SP1000E—Continued

**5**  
Remote controller



Use the Up and Down [▲]/[▼] buttons to select Surround Speaker, press the [ENTER] button, use the Left and Right [◀]/[▶] buttons to select an option, and then press the [ENTER] button.

**Large:** Select if the surround speakers are large.

**Small (default):** Select if the surround speakers are small.

**Off:** Select if no surround speakers are being used.

Note that if the Front Speaker setting is set to Small, the Large option cannot be selected. And if the Subwoofer setting is set to Off, only the Large and Off options can be selected.

---

**6**  
Remote controller



When you've finished, press the [SETUP] button to exit setup, or press the Left [◀] button repeatedly to go back to the main setup menu.

The Speaker Setting doesn't apply to 192 kHz or 176 kHz DVD-Audio.

### Setting the Speaker Distances

**1**  
Remote controller



Use the Up and Down [▲]/[▼] buttons to select Speaker Distance, press the [ENTER] button, use the Up and Down [▲]/[▼] buttons to select On, and then press [ENTER] again.

When the Speaker Distance is set to Off, these settings cannot be selected.

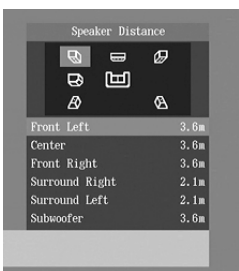

Speaker Distance	
Front Left	3.6m
Center	3.6m
Front Right	3.6m
Surround Right	2.1m
Surround Left	2.1m
Subwoofer	3.6m

**2**  
Remote controller



Use the Up and Down [▲]/[▼] buttons to select each speaker, press the [ENTER] button, use the Left and Right [◀]/[▶] buttons to specify the distance from each speaker to the listening position, and then press the [ENTER] button.

Speaker distances can be specified in steps of 1.0 ft. (0.3 m).  
(The North American model displays feet; other models display meters.)

Speaker	Range	Default
Front Left	1.0–30.0 ft. (0.3–9 m)	12.0 ft. (3.6 m)
Center		
Front Right		
Surround Right	1.0–30.0 ft. (0.3–9 m)	7.0 ft. (2.1 m)
Surround Left		
Subwoofer		12.0 ft. (3.6 m)

**Notes:**

- If the distance between the furthest and nearest speakers is greater than 20 feet, corrected values suitable for home theater use will be set automatically.

**3**  
Remote controller



When you've finished, press the [SETUP] button to exit setup, or press the Left [◀] button repeatedly to go back to the main setup menu.

**Note:**

- The Speaker Distance settings have no effect on SACD (multichannel area and 2-channel area) and 192 kHz/176.4 kHz DVD-Audio.

## Configuring the DV-SP1000/DV-SP1000E—Continued

### Setting Levels With the Test Tone

**1**  
Remote controller  
Use the Up and Down [▲]/[▼] buttons to select Test Tone, and then press the [ENTER] button. The Test Tone settings appear onscreen.

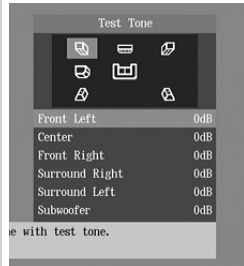

**2**  
Remote controller  
Use the Up and Down [▲]/[▼] buttons to select each speaker, press the [ENTER] button, use the Left and Right [◀]/[▶] buttons to adjust the levels, and then press the [ENTER] button. A test tone is output by each speaker as it is selected.



Speaker levels can be adjusted in 1 dB steps.

Speaker	Range	Default
Front Left	-12 dB to 0 dB	0 dB
Center		
Front Right		
Surround Right		
Surround Left		
Subwoofer		

You cannot set the level of speakers that are set to Off.

**3**  
Remote controller  
When you've finished, press the [SETUP] button to exit setup, or press the Left [◀] button repeatedly to go back to the main setup menu.



### AV Synchronization

When using progressive scanning you may find that the picture and sound are out of sync. With this setting you can delay the audio to correct this. There are three setup memories (1, 2, 3) for storing settings for up to three components. Memories 2 and 3 are already set at 50 ms, which is a good starting point when compensating for the video delay caused by a typical projector with a built-in scaler.

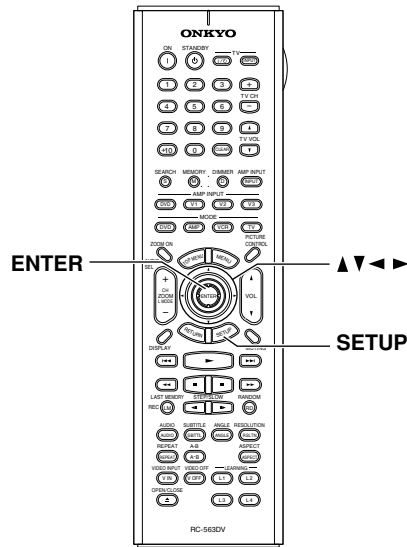

### Selecting the AV Synchronization

**1**  
Use the Up and Down [▲]/[▼] buttons to select setup 1, 2, or 3, and then press the [ENTER] or Right [▶] button. The parameters appear onscreen.

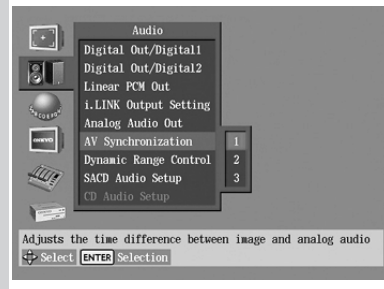

## Configuring the DV-SP1000/DV-SP1000E—Continued

**2** Use the Left and Right [◀]/[▶] buttons to set the delay time.

Memory	Range	Default
1	0–100 ms	0 ms
2		50 ms
3		50 ms



**3** When you've finished, press the [SETUP] button. The settings are stored.



**Notes:**

- This setting affects only the analog multichannel output. To delay audio from the other outputs, use the delay settings (i.e., the speaker distance settings) on the connected AV receiver.
- The AV Synchronization setting has no effect on SACD (multichannel area and 2-channel area) and 192 kHz/176.4 kHz DVD-Audio.

### Dynamic Range Control (Dolby Digital only)



With the Dynamic Range Control you can reduce the dynamic range of Dolby Digital material so that you can still hear quiet parts even when listening at low volume levels—ideal for watching movies late at night when you don't want to disturb anyone.

**Off (default)**

The full dynamic range is preserved.

**On**

The dynamic range is reduced.

**Notes:**

- The impact of the Dynamic Range Control depends on the Dolby Digital material that you are playing and with some material there will be little or no effect.
- This setting automatically reverts to Off when the DV-SP1000/DV-SP1000E is turned on.

### SACD Audio Setup



SACDs have two separate areas for storing audio tracks—one for multichannel audio, the other for 2-channel stereo audio. In addition, hybrid SACDs have an extra layer for playback in standard CD players. With this setting you can determine how SACDs are played by the DV-SP1000/DV-SP1000E.

**2 ch Area**

The 2-channel stereo audio tracks are played.

**Multi ch Area (default)**

The multichannel audio tracks are played.

**CD Area**

The CD layer of hybrid SACDs is played.

**Notes:**

- This setting determines which area of the disc is played initially. If Multi ch Area is selected, and an SACD that contains no multichannel area is loaded, the 2-channel area will be played.

### CD Audio Setup



This setting configures the digital audio outputs for use with normal CDs or DTS CDs.

**PCM (default)**

Choose this option when playing normal audio CDs.

**DTS**

Choose this option when playing DTS CDs.

**Notes:**

- This setting can be set only when the DTS Out setting for Digital Out/Digital 1 or 2 is set to "DTS->PCM."
- Selecting DTS can reduce noise that may occur when DTS CD playback is started.



## Configuring the DV-SP1000/DV-SP1000E—Continued

### Language Menu

(These menus vary slightly from country to country.)

#### On-Screen Language

With this setting you can select a language for the onscreen setup menus and messages.

For North American, European, and Australian models:

- English (default):** English
- Français:** French
- Español:** Spanish
- Deutsch:** German
- Italiano:** Italian
- 日本語:** Japanese

For East Asian and Korean models:

- English (default):** English
- Français:** French
- Deutsch:** German
- Español:** Spanish
- Italiano:** Italian
- 漢語:** Chinese

For Chinese model:

- English:** English
- Français:** French
- Deutsch:** German
- Español:** Spanish
- Italiano:** Italian
- 汉语 (default):** Chinese

#### Disc Menu Language



With this setting you can specify your preferred language for DVD-Video disc menus. When you play a disc with menus available in several languages, your preferred language will be selected automatically.

For North American, European, and Australian models:

- English (default):**
- French:**
- Spanish:**
- German:**
- Italian:**
- Japanese:**
- Others:**

See “Selecting Other Languages” on page 84

For East Asian and Korean models English is the default.

Chinese is the default on the Chinese model.

- English:**
- French:**

**Spanish:**

**German:**

**Italian:**

**Chinese:**

**Others:**

See “Selecting Other Languages” on page 84

#### Notes:

- Not all DVDs have menus in multiple languages.
- Even if a DVD has menus in multiple languages, this setting may not always work.
- If a DVD has only one menu language, that will be used.
- With some DVDs you can select languages from a menu.

#### Audio Language



With this setting you can specify your preferred language for soundtracks. When you play a DVD-Video disc with multiple language soundtracks, your preferred language will be selected automatically.

For North American, European, and Australian models:

- English (default):**
- French:**
- Spanish:**
- German:**
- Italian:**
- Japanese:**
- Others:**

See “Selecting Other Languages” on page 84

For East Asian and Korean models:

- English (default):**
- French:**
- Spanish:**
- German:**
- Italian:**
- Chinese:**
- Others:**

See “Selecting Other Languages” on page 84

#### Notes:

- Not all DVDs have soundtracks in multiple languages.
- Even if a DVD has soundtracks in multiple languages, this setting may not always work.
- If a DVD has only one soundtrack, that will be used.
- With some DVDs you can select languages from a menu.

## Configuring the DV-SP1000/DV-SP1000E—Continued

### Subtitle Language



With this setting you can specify your preferred language for subtitles. When you play a DVD-Video disc with multiple language subtitles, your preferred language will be selected automatically.

For North American, European, and Australian models:

**English:**

**French:**

**Spanish:**

**German:**

**Italian:**

**Japanese:**

**No Subtitle (default):**

No subtitles will be displayed. This option is useful with DVD-Video discs that display subtitles by default.

**Others:**

See “Selecting Other Languages” on page 84

For East Asian, Korean and Chinese models:

**English:**

**French:**

**Spanish:**

**German:**

**Italian:**

**Chinese:**

**No Subtitle (default):**

No subtitles will be displayed. This option is useful with DVD-Video discs that display subtitles by default.

**Others:**

See “Selecting Other Languages” on page 84

**Notes:**

- Not all DVDs have subtitles.
- Even if a DVD has subtitles in multiple languages, this setting may not always work.
- If a DVD has only one subtitle language, that will be used.
- With some DVDs you can select subtitles from a menu.

### Display Menu

#### On-Screen Display

With this setting you can turn on or off onscreen messages, such as “Play,” “Stop,” and “Resume.”

**Off**

Onscreen messages off.

**On (default)**

Onscreen messages on.

### On-Screen Display Color

With this setting, you can set the color for the Disc Navigator or background.

**Sapphire (default)**

**Amethyst**

**Pearl**

**Garnet**

#### Background

With this setting, you can select the color of the background and graphic.

**Blue**

**Gray**

**Graphic (default)**

The theme picture specified for the On-Screen Display Color setting is used.

### Screen Saver

With the Screen Saver you can protect your TV against screen burn-in, which can occur when the same picture is displayed for a long time.

**Off**

Screen Saver off.

**On (default)**

Screen Saver on.

When the Screen Saver is set to On, and DVD-Video, DVD-VR, or VCD playback is paused or stopped for 15 minutes, the screen saver automatically displays a moving image.

Once the screen saver has been activated, you can cancel it by pressing either the Play [▶] or Pause [■] button.

**Notes:**

- The Screen Saver also works with DVD-Audio, SACD, CD, MP3, and JPEG discs.

## Operation Menu

### Pause/Still



The Pause/Still setting determines how still pictures are displayed when playback is paused and when frame-by-frame playback is used.

**Auto (default)**

A frame or field is displayed depending on the disc.

**Frame**

A frame is displayed.

TV pictures are made up of fields, and there are two fields per picture (*frame*). In general, the Frame option will provide the best picture quality, although in some cases the picture may appear slightly blurred. Since a field has only half as much information, the picture quality will be lower, but it won't be blurred.

## Configuring the DV-SP1000/DV-SP1000E—Continued

### Parental Lock



With the Parental Lock function you can block access to certain scenes that the authors have flagged as being unsuitable for children.

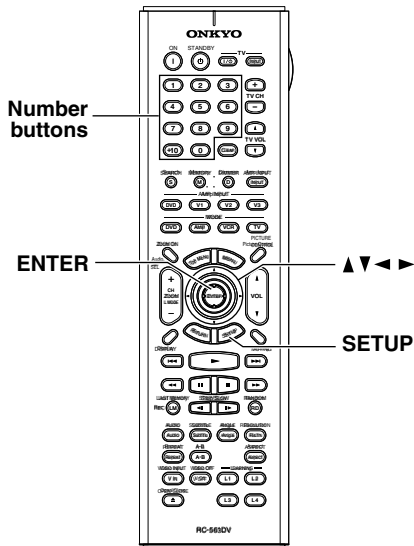

**1**

Remote controller



**Select Parental Lock→On, and then press the [ENTER] button.**

The Security Code box appears onscreen.

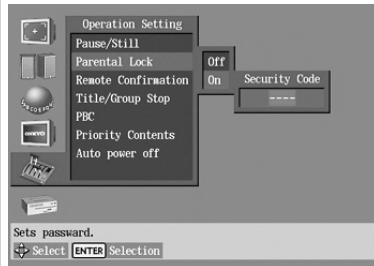

**2**

Remote controller



**Use the number buttons to enter a 4-digit security code.**

The Level box appears onscreen.

**3**

Remote controller



**Use the Up and Down [▲]/[▼] buttons to specify the parental lock level from 1 through 8, and then press [ENTER].**

The parental lock is now set. The parental lock levels conform to U.S. movie ratings as follows:

- Level 7: NC-17
- Level 6: R
- Level 4: PG13
- Level 3: PG
- Level 1: G

**4**

Remote controller



**When you've finished, press the [SETUP] button.**

The settings are stored.

#### Notes:

- When entering the security code, you can use the [CLEAR] button to delete numbers.
- This setting can be changed only when playback is stopped.
- Once this setting has been turned on and a security code set, if you want to turn off parental lock, or change the parental lock level, you'll be prompted to enter the security code.
- Not all discs use parental lock. See the disc's sleeve notes for details.
- Discs with parental lock may cut certain scenes, replace certain scenes with children-friendly scenes, or prevent playback of the entire disc.
- If you forget the security code, instead of entering the numbers, press the Stop [■] button four times.

#### Remote Confirmation

With this setting you can turn on or off the beeper that confirms the successful reception of commands from the remote controller.

**Off (default)**  
Beeper off.

**On**  
Beeper on.

## Configuring the DV-SP1000/DV-SP1000E—Continued

### Title/Group Stop

With this setting you can determine whether or not playback stops when the title or group that's currently playing ends.

**Off (default)**

Playback continues when the title or group ends.

**On**

Playback stops when the title or group ends.

**Notes:**

- The On setting may not work with some discs.

### PBC



This setting is used to enable or disable PBC (Playback Control) for VCDs.

**Off**

PBC disabled.

**On (default)**

PBC enabled.

**Notes:**

- PBC functionality depends on the disc. See the disc's sleeve notes for details.
- Some VCDs that support PBC may not use all of the PBC functions supported by the DV-SP1000/DV-SP1000E.

### Priority Contents



This setting determines what is played when a DVD-Audio disc also contains DVD-Video material.

**DVD-AUDIO (default)**

The DVD-Audio material is played.

**DVD-VIDEO**

The DVD-Video material is played.

### Auto power off

The Auto power off function automatically turns off the DV-SP1000/DV-SP1000E after 20 minutes of inactivity.

**Off (default)**

Auto power off function off.

**On**

Auto power off function on.

### Initial Setup Menu

This menu appears automatically the very first time the DV-SP1000/DV-SP1000E is turned on. See "First Time Setup" on page 43 for more information.

### Selecting Other Languages

This section explains how to select other languages for disc menus, audio, and subtitles. It should be used in conjunction with the Language settings on page 81.

**1**

Remote controller



**Select Others from the Disc Menu Language, Audio Language, or Subtitle Language menu, and then press [ENTER].**

The language code boxes appear.

**2**

Remote controller

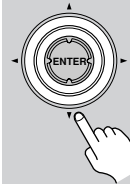

**Use the Left and Right [◀]/[▶] buttons to select the code boxes, and use the Up and Down [▲]/[▼] buttons to enter a language code.**

See the table below for language codes.

**3**

Remote controller



**When you've finished, press [ENTER].**

## Configuring the DV-SP1000/DV-SP1000E—Continued

### Language Code List

Use this list when specifying other languages.

Language	Code	Language	Code
Japanese	JA	Kirghiz	KY
English	EN	Latin	LA
French	FR	Lingala	LN
German	DE	Laothian	LO
Italian	IT	Lithuanian	LT
Spanish	ES	Latvian	LV
Chinese	ZH	Malagasy	MG
Dutch	NL	Maori	MI
Portuguese	PT	Macedonian	MK
Swedish	SV	Malayalam	ML
Russian	RU	Mongolian	MN
Korean	KO	Moldavian	MO
Greek	EL	Marathi	MR
Afar	AA	Malay	MS
Abkhazian	AB	Maltese	MT
Afrikaans	AF	Burmese	MY
Amharic	AM	Nauru	NA
Arabic	AR	Nepali	NE
Assamese	AS	Norwegian	NO
Aymara	AY	Occitan	OC
Azerbaijani	AZ	Oromo	OM
Bashkir	BA	Oriya	OR
Byelorussian	BE	Panjabi	PA
Bulgarian	BG	Polish	PL
Bihari	BH	Pashto, Pushto	PS
Bislama	BI	Quechua	QU
Bengali	BN	Rhaeto-Romance	RM
Tibetan	BO	Kirundi	RN
Breton	BR	Romanian	RO
Catalan	CA	Kinyarwanda	RW
Corsican	CO	Sanskrit	SA
Czech	CS	Sindhi	SD
Welsh	CY	Sangho	SG
Danish	DA	Serbo-Croatian	SH
Bhutani	DZ	Sinhalese	SI
Esperanto	EO	Slovak	SK
Estonian	ET	Slovenian	SL
Basque	EU	Samoan	SM
Persian	FA	Shona	SN
Finnish	FI	Somali	SO
Fiji	FJ	Albanian	SQ
Faroese	FO	Serbian	SR
Frisian	FY	Siswati	SS
Irish	GA	Sesotho	ST
Scots-Gaelic	GD	Sundanese	SU
Galician	GL	Swahili	SW
Guarani	GN	Tamil	TA
Gujarati	GU	Telugu	TE
Hausa	HA	Tajik	TG
Hindi	HI	Thai	TH
Croatian	HR	Tigrinya	TI
Hungarian	HU	Turkmen	TK
Armenian	HY	Tagalog	TL
Interlingua	IA	Setswana	TN
Interlingue	IE	Tonga	TO
Inupiak	IK	Turkish	TR

Language	Code
Indonesian	IN
Icelandic	IS
Hebrew	IW
Yiddish	JI
Javanese	JW
Georgian	KA
Kazakh	KK
Greenlandic	KL
Cambodian	KM
Kannada	KN
Kashmiri	KS
Kurdish	KU

Language	Code
Tsonga	TS
Tatar	TT
Twi	TW
Ukrainian	UK
Urdu	UR
Uzbek	UZ
Vietnamese	VI
Volapük	VO
Wolof	WO
Xhosa	XH
Yoruba	YO
Zulu	ZU

# Controlling Other Components

In addition to controlling the DV-SP1000/DV-SP1000E, the remote controller can also be used to control your TV and VCR. To do this you need to enter the appropriate control codes for your TV and VCR. The remote controller can also learn individual commands from another remote controller (see page 91).

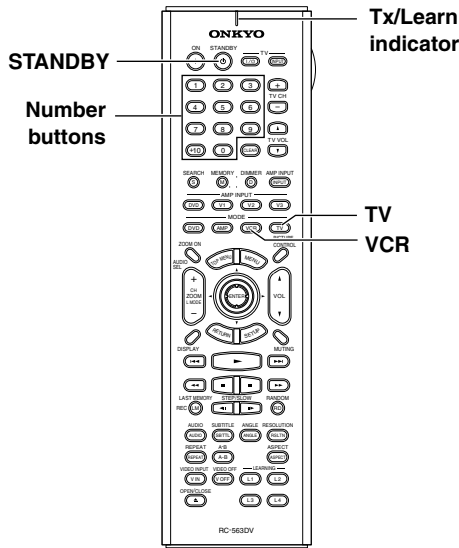

### 3

Remote controller

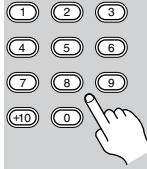

**Use the number buttons to enter the 4-digit remote control code. If the code is accepted, the Tx/Learn indicator flashes slowly twice.**

If the Tx/Learn indicator flashes quickly three times, the code has not been accepted, in which case you should try again from step 2.

#### Notes:

- The learning mode will be cancelled if you don't press any buttons for 30 seconds.
- In some cases, not all of the remote controller's buttons may work as expected.
- Individually learnt commands for the TV and VCR modes (see page 91) are deleted when a new remote control code is entered.

## Entering Remote Control Codes

Entering the appropriate remote control code for your TV and VCR will allow you to control them with the DV-SP1000/DV-SP1000E's remote controller. You'll need to perform this procedure twice to enter the codes for both your TV and VCR.

<b>1</b>	<p><b>Look up the appropriate remote control code for your TV or VCR.</b> See "Remote Control Codes" on page 87</p>
<b>2</b>	<p><b>While holding down the [VCR] or [TV] MODE button, press the [STANDBY] button, and then release both buttons.</b> The Tx/Learn indicator flashes slowly once, and then remains lit.</p>

Remote controller

MODE

VCR TV

STANDBY

## Controlling Other Components—Continued

### Remote Control Codes

When two or more codes are given, try each one in turn, and choose the one that works best.

TV	
Manufacturer	Control code
Admiral	1026, 1040, 1062
Akai	1002, 1067
Akura	1045
Alba	1035, 1043
Amplivision	1063
Amstrad	1035, 1067
Amtron	1009
Anam National	1003, 1009
Anitech	1035
AOC	1004, 1005, 1006
Arc en Ciel	1066
Arcam	1063
ASA	1040
Audiovox	1009
Autovox	1040, 1068
Baird	1069
Bang & Olufsen	1040
Baur	1036, 1054, 1055, 1058, 1059, 1068
Beko	1052
Bell & Howell	1010, 1017
Binatone	1063
Blaupunkt	1041, 1042, 1044, 1058, 1059
Boots	1063
Brionvega	1040
Bruns	1040
BSR	1048
Bush	1035, 1043, 1048, 1050, 1053, 1057
Cascade	1035
Celebrity	1002
Century	1040
Cimline	1035, 1043
Citizen	1004, 1006, 1009, 1017, 1022, 1025
Clatronic	1052
Colortyme	1004, 1006
Condor	1052
Contec	1035
Contec/Cony	1007, 1009
Continental Edison	1066
Craig	1009
Crosley	1040
Crown	1009, 1014, 1035, 1052
Curtis Mathes	1001, 1004, 1006, 1010, 1017, 1022, 1025, 1034
Daewoo	1004, 1005, 1006, 1025, 1035, 1053
Daytron	1004, 1006, 1025, 1035
Decca	1067
Dimensia	1001, 1034

TV	
Manufacturer	Control code
Dixi	1035
Dual	1057, 1068
Dumont	1004, 1039, 1040
Electroband	1002
Electrohome	1002, 1003, 1004, 1006, 1008
Elta	1035
Emerson	1004, 1006, 1007, 1009, 1010, 1017, 1025, 1027, 1029, 1033, 1040, 1070
Envision	1004, 1006
Erres	1037
Europhon	1067
Fidelity	1068
Finlux	1039, 1040, 1067
Firstline	1035, 1043, 1048, 1049, 1063
Fisher	1010, 1017, 1052, 1063, 1068
Formenti	1040
Frontech	1045, 1062
Fujitsu	1070
Funai	1009, 1045, 1048, 1070
GE	1001, 1003, 1004, 1006, 1011, 1012, 1019, 1034
GEC	1038, 1063, 1067, 1069
Geloso	1035
Genexxa	1062
GoldStar	1004, 1005, 1006, 1007, 1008, 1025, 1047, 1063
Goodmans	1043, 1053, 1063
Gorenje	1052
Graetz	1062, 1069
Granada	1063, 1067
Grundig	1039, 1041, 1042, 1058, 1059, 1064
Hallmark	1004, 1006
Hanseatic	1060, 1068
Hantarex	1067
HCM	1035
Hinari	1035, 1043
Hitachi	1004, 1006, 1007, 1013, 1027, 1038, 1062, 1063, 1069
Huanyu	1053
ICE	1045, 1063
Imperial	1052
Infinity	1014
Inno Hit	1056, 1067
Interfunk	1055, 1062, 1066, 1069
Intervision	1045, 1063
ITT	1062, 1068, 1069
JBL	1014
JC Penney	1001, 1004, 1005, 1006, 1011, 1012, 1016, 1019, 1022, 1025, 1034
Jensen	1004, 1006
JVC	1007, 1012, 1013, 1015, 1033
Kaisui	1035, 1063
Kapsch	1062, 1069

TV	
Manufacturer	Control code
Kathrein	1060
Kawasho	1002, 1004, 1006
Kendo	1043
Kenwood	1004, 1006, 1008
Kloss Novabeam	1009
Korting	1040
KTV	1009, 1025
LG	1005
Loewe	1014, 1040, 1055
Luxman	1004, 1006
LXI	1001, 1006, 1010, 1014, 1016, 1017, 1034
M Electronic	1035, 1053, 1062, 1063
Magnadyne	1040, 1067, 1068
Magnafon	1067
Magnavox	1004, 1006, 1008, 1014, 1018, 1020
Marantz	1004, 1006, 1014, 1060
Matsui	1035, 1043, 1048, 1050, 1063, 1064, 1067, 1068
Megatron	1006
Memorex	1005, 1006, 1010, 1017, 1035
Metz	1040, 1051, 1058
MGA	1004, 1005, 1006, 1008
Minerva	1039, 1058, 1059, 1064
Mitsubishi	1004, 1005, 1006, 1008, 1040, 1055, 1058
Mivar	1047, 1056, 1067
Motorola	1003, 1026
MTC	1004, 1005, 1006, 1022, 1055
Multitech	1009, 1035
NAD	1006, 1016
NEC	1003, 1004, 1005, 1006
Neckermann	1040, 1041, 1054, 1059, 1060
Nikkai	1045
Nikko	1006
Oceanic	1062
Onwa	1009
Optonica	1021, 1026
Orion	1029, 1043, 1048, 1049, 1050, 1067, 1068
Osaki	1045, 1063
Otto Versand	1036, 1041, 1043, 1054, 1055, 1058, 1059, 1060, 1063
Palladium	1052
Panasonic	1003, 1012, 1014, 1031, 1044, 1046, 1051, 1061, 1062, 1069
Pathe Marconi	1066
Philco	1003, 1004, 1005, 1006, 1007, 1008, 1014, 1018, 1040
Philips	1003, 1004, 1007, 1008, 1014, 1018, 1019, 1020, 1037, 1038, 1040, 1053
Phoenix	1040
Phonola	1037, 1040

## Controlling Other Components—Continued

TV	
Manufacturer	Control code
Pioneer	1004, 1006, 1027, 1062
Portland	1004, 1005, 1006, 1025
Price Club	1022
Prism	1012
Profex	1035
Proline	1049
Proscan	1001, 1034
Protech	1035, 1045, 1063
Proton	1004, 1006, 1007
Pye	1037
Quasar	1003, 1012, 1031
Quelle	1036, 1039, 1054, 1055, 1058, 1059, 1068
Radio Shack	1010, 1017, 1034
Radio Shack/ Realistic	1001, 1004, 1006, 1007, 1009, 1010, 1017, 1021, 1025
Radiola	1037
Radiomarelli	1040, 1067
RCA	1001, 1003, 1004, 1005, 1006, 1008, 1027, 1034
Realistic	1010, 1017, 1034
Rex	1045, 1062
RFT	1040
Roadstar	1035, 1045
Saba	1040, 1062, 1066, 1069
Saisho	1035, 1043, 1045, 1067, 1068
Salora	1062
Sambers	1056, 1067
Sampo	1004, 1006, 1025
Samsung	1004, 1005, 1006, 1007, 1008, 1022, 1025, 1035, 1045, 1047, 1052, 1056, 1060, 1063, 1065
Sansui	1029
Sanyo	1004, 1010, 1017
SBR	1037, 1038
Schaub Lorenz	1069
Schneider	1068
Scott	1004, 1006, 1007, 1009, 1070
Sears	1001, 1004, 1006, 1008, 1010, 1015, 1016, 1017, 1028, 1034, 1070
SEG	1045, 1063
SEI	1036, 1040, 1048, 1067, 1068
Seleco	1062
Sharp	1004, 1006, 1007, 1021, 1023, 1025, 1026
Shorai	1048
Siarem	1040, 1067
Siemens	1041, 1042, 1058, 1059
Singer	1040
Sinudyne	1036, 1040, 1043, 1067, 1068
Solavox	1062
Sonoko	1035
Sonolor	1062
Sony	1002, 1030, 1032, 1036, 1054

TV	
Manufacturer	Control code
Soundesign	1004, 1006, 1009, 1070
Starlite	1009
Stern	1062
Sunkai	1043, 1048, 1049, 1050
Sylvania	1004, 1006, 1008, 1014, 1018, 1020
Symphonic	1009, 1028
Tandy	1026, 1062, 1063
Tashiko	1038, 1063
Tatung	1003, 1063, 1067
Tec	1063
Technics	1012, 1044, 1061
Techwood	1004, 1006, 1012
Teknika	1004, 1005, 1006, 1007, 1009, 1022, 1025, 1031, 1070
Teleavia	1066
Telecaption	1024
Telefunken	1066
Teletech	1035
Teleton	1063
Tensai	1048
Thomson	1066
Thorn	1054, 1055, 1058
Toshiba	1010, 1016, 1017, 1022, 1024, 1039
Totevision	1025
Triumph	1067
Universal	1011, 1019
Universum	1045, 1052, 1058
Voxson	1040, 1062
Waltham	1063
Wards	1001, 1004, 1005, 1006, 1008, 1011, 1014, 1018, 1019, 1020, 1021, 1034, 1070
Watt Radio	1068
Wega	1040
Yamaha	1004, 1005, 1006, 1008
Yoko	1045, 1063
Zenith	1004

VCR	
Manufacturer	Control code
Aiwa	2012, 2046, 2047
Akai	2003, 2004, 2022
Alba	2033, 2041, 2044, 2045, 2047
Anitech	2033
ASA	2034
Baird	2036
Bell & Howell	2007
Blaupunkt	2039, 2042
Bush	2033, 2041, 2044, 2045, 2047
Canon	2010, 2011
Carver	2014
Cimline	2033
Citizen	2008, 2009
Colortyme	2005
Craig	2008
Crown	2033
Curtis Mathes	2001, 2005, 2008, 2009, 2010, 2011, 2023, 2026
Cyrus	2034
Daewoo	2012
Dansai	2033
Decca	2034
Dimensia	2001, 2026
Dumont	2034, 2036, 2037
Elcotech	2033
Emerson	2003, 2010, 2012, 2022
ESC	2043
Ferguson	2035
Finlandia	2034, 2036
Finlux	2034, 2036, 2037
Firstline	2033, 2041
Fisher	2007, 2030, 2036
Fuji	2004, 2010, 2024
Funai	2012
Garrard	2012
GE	2001, 2002, 2008, 2010, 2011, 2023, 2025, 2026
GEC	2034
GoldHand	2033
GoldStar	2005, 2009
Goodmans	2031, 2033
Gradiente	2012
Graetz	2036, 2043
Granada	2030, 2034, 2036
Grandin	2033
Grundig	2029, 2033, 2034, 2039, 2040, 2042, 2044
Harman Kardon	2005
HCM	2033, 2044
Hinari	2028, 2033, 2043, 2044, 2047
Hitachi	2013, 2021, 2025, 2028, 2037, 2038, 2043
Ingersol	2028
Interfunk	2034
ITT	2030, 2036, 2043, 2048



## Controlling Other Components—Continued

VCR	
Manufacturer	Control code
JC Penney	2005, 2006, 2007, 2008, 2010, 2011, 2013, 2014, 2021
Jensen	2013
JVC	2005, 2006, 2007, 2009, 2032, 2035, 2040, 2048
Kaisui	2033
Kendo	2041, 2046
Kenwood	2005, 2006, 2007, 2009
Kodak	2010
Loewe	2028, 2034
Logik	2028, 2043
Luxor	2030, 2031, 2036
Magnavox	2010, 2011, 2014, 2019, 2020
Marantz	2005, 2006, 2007, 2009, 2010, 2014, 2031, 2034
Matsui	2028, 2041, 2046, 2047
Matsushita	2010
Memorex	2007, 2008, 2010, 2012, 2019, 2030, 2036
Metz	2039
MGA	2022
Minerva	2039
Minolta	2013, 2021
Mitsubishi	2013, 2022, 2032, 2034
Motorola	2010
MTC	2008
Multitech	2008, 2012, 2033
NEC	2005, 2006, 2007, 2009, 2032
Neckermann	2034
Nesco	2033
NOBLEX	2008
Nokia	2030, 2036, 2043
Nordmende	2048
Okano	2046
Olympus	2010
Optonica	2017
Orion	2028, 2041, 2045, 2046, 2047
Osaki	2033
Otto Versand	2034
Palladium	2033
Panasonic	2010, 2011, 2042
Pentax	2013, 2021, 2025, 2037
Pentax Research	2009
Philco	2010, 2011, 2014
Philips	2010, 2014, 2017, 2034, 2048
Phonola	2034
Pioneer	2006, 2013, 2032, 2034
Proline	2044
Proscan	2001, 2002, 2026
Pye	2034
Quasar	2010, 2011
Quelle	2034
Radio Shack	2017
Radio Shack/Realistic	2007, 2008, 2010, 2011, 2012, 2017

VCR	
Manufacturer	Control code
Radiola	2034
RCA	2001, 2002, 2003, 2008, 2010, 2013, 2021, 2023, 2025, 2026, 2027
Realistic	2007, 2008, 2010, 2011, 2012, 2017
Rex	2048
Roadstar	2033, 2043
Runco	2019
Saba	2040, 2048
Saisho	2028, 2041
Salora	2030
Samsung	2008, 2043, 2049
Sansui	2006, 2032
Sanyo	2007, 2008, 2030, 2036
Saville	2047
SBR	2034
Schaub Lorenz	2036
Schneider	2033, 2034
Scott	2015
Sears	2007, 2010, 2013, 2021
SEG	2043
SEI	2028, 2034
Sharp	2016, 2017, 2031
Shintom	2004, 2033, 2036
Shorai	2028
Siemens	2034, 2036, 2039
Singer	2010
Sinudyne	2028, 2034
Sonolor	2030, 2031
Sony	2004, 2018, 2024
STS	2010, 2021
Sunkai	2046
Sylvania	2010, 2011, 2012, 2014
Symphonic	2012
Tandy	2007
Tatung	2034
Teac	2012
Technics	2010, 2042
Teknika	2010, 2012
Telefunken	2048
Thomson	2048
Thorn	2035, 2036
Toshiba	2013, 2015, 2022, 2034, 2048
Totevision	2008
Uher	2043
Unitech	2008
Universum	2034, 2039, 2043
Vector Research	2005, 2006
Video Concepts	2005, 2006, 2022
Wards	2008, 2010, 2012, 2013, 2017, 2021, 2027
XR-1000	2010, 2012
Yamaha	2005, 2006, 2007, 2009
Yoko	2043
Zenith	2004, 2019, 2024

## Controlling Other Components—Continued

### Controlling a TV

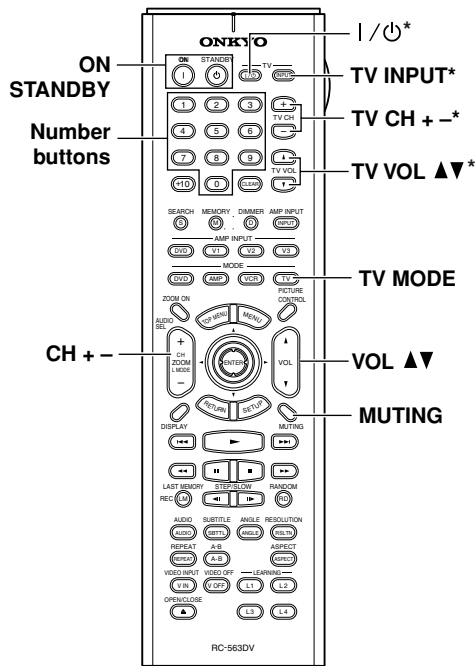

1. Press the [TV] MODE button.
2. Point the remote controller at your TV, and use the following buttons (you must enter appropriate remote control code first, see page 86).

[ON], [STANDBY]	Set the TV to On or Standby
TV [I/O]*	Set the TV to On or Standby
TV [INPUT]*	Selects TV's VCR input
TV CH [+]/[-]*	Selects channels on the TV
TV VOL [▲]/[▼]*	Adjusts the TV's volume
Number buttons	Enter numbers
CH [+/-]	Selects channels on the TV
[TV] MODE	Selects the remote controller's TV mode
VOL [▲]/[▼]	Adjusts the TV's volume
[MUTING]	Mutes the TV

\*Buttons marked with an asterisk can be used to control a TV regardless of the currently selected remote controller mode.

### Controlling a VCR

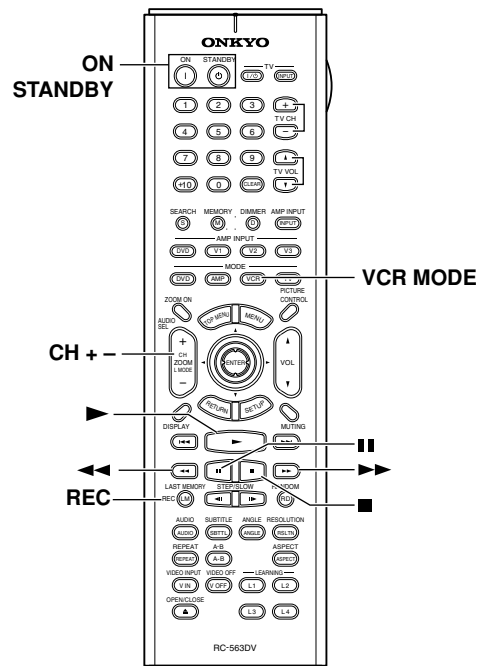

1. Press the [VCR] MODE button.
2. Point the remote controller at your VCR, and use the following buttons (you must enter appropriate remote control code first, see page 86).

[ON], [STANDBY]	Sets the VCR to On or Standby
CH [+/-]	Selects channels on the VCR
[VCR] MODE	Selects the remote controller's VCR mode
[▶]	Starts playback
[⏸]	Pauses playback
[■]	Stops playback
[◀◀]	Rewinds
[▶▶]	Fast forwards
[REC]	Used to start recording

## Controlling Other Components—Continued

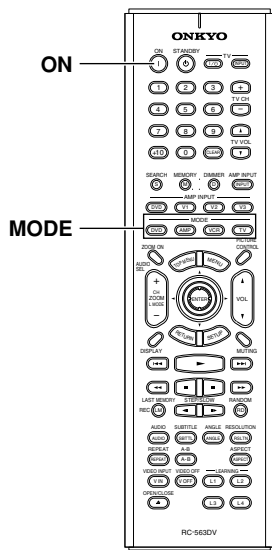

### Learning the Commands of Other Remote Controllers

The DV-SP1000/DV-SP1000E's remote controller can learn individual commands from other component's remote controllers and then be used to control those components. Commands can be learnt by the dedicated leaning buttons—[L1], [L2], [L3], and [L4]—or any button. Each button can learn up to four commands, one for each remote controller mode: DVD, Amp, VCR, and TV. If you've entered a control code for a component (page 86) and certain buttons don't work as expected, you can also use this function to program those buttons individually.

- 1 Point the remote controllers at each other, about 2 to 6 inches (5–15 cm) apart.**

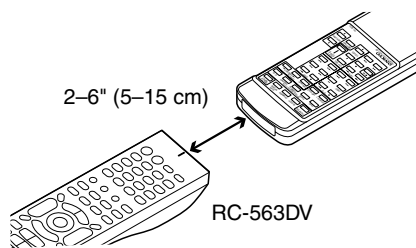

- 2 While holding down the [DVD], [AMP], [VCR], or [TV] MODE button, press the [ON] button, and then release both buttons.**

The MODE button and Tx/Learn indicator light up.

- 3 On the DV-SP1000/DV-SP1000E's remote controller, press the button that you want to learn the new command.**

The Tx/Learn indicator goes off while the button is being pressed, and comes back on again when it's released.

Use the dedicated leaning buttons—[L1], [L2], [L3], and [L4]—or another button.

- 4 On the other remote controller, press and hold the button whose command you want to learn until the Tx/Learn indicator flashes.**

If the command is learnt successfully, the Tx/Learn indicator flashes slowly twice, and then the MODE button and Tx/Learn indicator remain lit.

If the Tx/Learn indicator flashes quickly three times, the command has not been learnt, in which case you should try again from step 3.

If the Tx/Learn indicator flashes quickly six times, the remote controller's memory is full and no more commands can be learnt.

- 5 To learn more new commands, repeat steps 3 and 4.**

When you've finished, press the MODE button that you pressed in step 2.

To use the learnt command, select the relevant mode, and then press the button.

#### Notes:

- The following buttons cannot learn new commands: [LIGHT] and the [DVD], [AMP], [VCR], and [TV] MODE buttons.
- Learning mode is cancelled automatically if you don't press any buttons for 30 seconds.
- The DV-SP1000/DV-SP1000E's remote controller comes preprogrammed with the commands necessary for controlling Onkyo DVD players (DVD mode) and AV receivers (Amp mode). However, you can reprogram individual buttons if necessary. The original commands can be restored by resetting the remote controller.
- To program a button that has already learnt a command, repeat this procedure. The previously learnt command will be overwritten.
- Like most remote controllers, the DV-SP1000/DV-SP1000E's remote controller uses infrared. Commands from remote controllers that don't use infrared cannot be learnt.
- When the remote controller's batteries expire, all learnt commands may be lost and will have to be learnt all over again, so keep your other remote controllers in a safe place.

## Controlling Other Components—Continued

### Deleting the Learnt Commands of One Mode

This section explains how to delete the learnt commands of one mode: DVD, Amp, VCR, or TV.

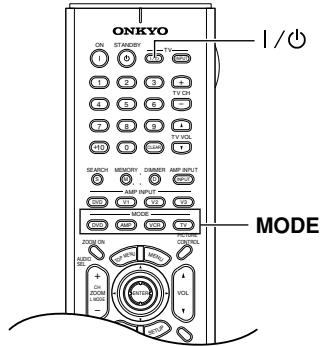

- 1 While holding down the [DVD], [AMP], [VCR], or [TV] MODE button, press the TV [I/⏻] button, and then release both buttons.**

The Tx/Learn indicator flashes slowly three times, and then remains lit.

- 2 Press the same MODE button again.**  
When the mode's commands have been deleted, the Tx/Learn indicator flashes slowly twice.  
If the Tx/Learn indicator flashes quickly three times, the commands have not been deleted, in which case you should try again from step 1.

**Notes:**

- Learning mode is cancelled automatically if you don't press any buttons for 30 seconds.

### Deleting the Learnt Commands of All Modes

This section explains how to delete the learnt commands of all modes: DVD, Amp, VCR, and TV.

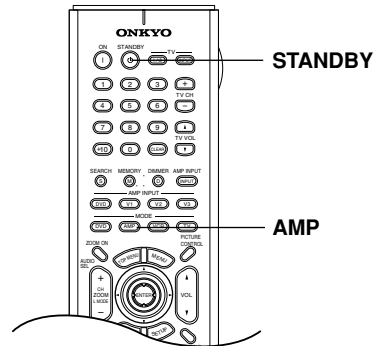

- 1 While holding down the [AMP] MODE button, press the [STANDBY] button, and then release both buttons.**

The Tx/Learn indicator flashes slowly five times, and then remains lit.

- 2 Press the [AMP] MODE button again.**  
It takes several seconds to delete the commands. When they've all been deleted, the Tx/Learn indicator flashes slowly twice.  
If the Tx/Learn indicator flashes quickly three times, the commands have not been deleted, in which case you should try again from step 1.

**Notes:**

- Learning mode is cancelled automatically if you don't press any buttons for 30 seconds.

# Troubleshooting

Symptom	Possible cause	Remedy
<b>Can't turn on the DV-SP1000/DV-SP1000E?</b>	The power cord is not connected.	Connect the power cord to a suitable wall outlet (page 41).
	External interference is affecting the DV-SP1000/DV-SP1000E's digital circuitry.	Turn off the DV-SP1000/DV-SP1000E, wait five seconds, then try turning it on again. If that fails, disconnect the power cord from the wall outlet, wait five seconds, reconnect it, then try turning it on again.
<b>The DV-SP1000/DV-SP1000E turns itself off when it's not being used?</b>	The Auto power off function will turn the DV-SP1000/DV-SP1000E off automatically after 20 minutes of inactivity.	The Auto power off function can be turned on or off as required (page 84).
<b>No picture?</b>	The wrong input source is selected on your TV.	On your TV, select the input to which the DV-SP1000/DV-SP1000E is connected (pages 30, 31).
	The video cable is not connected properly.	Check the video cable and correct as necessary (pages 30, 31).
	Not all of the video outputs work with all disc types and formats.	See page 27 for details on how the DV-SP1000/DV-SP1000E outputs video from each output.
	The video input source is set to EXTERNAL, but there's no video signal being input.	When you play a disc in the DV-SP1000/DV-SP1000E, use the [VIDEO INPUT] button to select DVD (page 66).
<b>No sound?</b>	The wrong input source is selected on your hi-fi amp or AV receiver.	On your hi-fi amp or AV receiver, select the input to which the DV-SP1000/DV-SP1000E is connected (pages 36, 38).
	The audio cable is not connected properly.	Check the audio cable and correct as necessary (pages 36, 38).
	Your hi-fi amp or AV receiver is turned off.	Turn on your hi-fi amp or AV receiver.
	The Digital Out settings are incorrect.	Check the Digital Out/Digital1 or Digital2 setting and correct as necessary (pages 74, 75).
	Not all of the analog and digital audio outputs work with all disc types and formats.	See page 28 for details on how the DV-SP1000/DV-SP1000E outputs audio from each output.
<b>The picture distorts occasionally?</b>	The disc is dirty.	Remove the disc and clean it (page 11).
	You're using the Fast Forward or Fast Reverse function.	A little picture distortion may occur when using these functions. This is normal.
<b>Picture instability or noise?</b>	The DV-SP1000/DV-SP1000E is connected to your TV via a VCR or other video equipment whose copy protection system is affecting the picture.	Connect the DV-SP1000/DV-SP1000E directly to your TV (pages 30, 31).
<b>Can't start playback?</b>	No disc loaded.	Load a disc (page 45).
	The disc is incompatible.	Load only compatible discs (page 9).
	The disc is upside down.	Load the disc the correct way up (page 45).
	The disc is not centered in the disc tray.	Place the disc in the center of the disc tray (page 45).
	The disc is dirty.	Remove the disc and clean it (page 11).
	The disc supports parental lock and the Parental Lock function is on.	Turn off the Parental Lock function (page 83).
<b>Can't watch the DVD-Video material on a DVD-Audio disc?</b>	The Priority Contents setting is set to DVD-AUDIO.	Set the Priority Contents setting to DVD-VIDEO (page 84).
<b>Can't play the multichannel area of a hybrid SACD?</b>	The SACD Audio Setup setting is not set to Multi ch Area.	Set the SACD Audio Setup setting to Multi ch Area (page 80).

## Troubleshooting—Continued

<b>Can't play MP3 and JPEG discs?</b>	The disc is not ISO 9660 Level 2 format.	Use only ISO 9660 Level 2 format discs (page 10).
	The disc has not been finalized.	Finalize the disc (page 10).
<b>Can't select MP3 files?</b>	MP3 files without a ".mp3" or ".MP3" file-name extension are not recognized.	Use the correct filename extension (page 10).
	The MP3 disc is a multisession disc.	Only files in the first session of a multisession disc can be played (page 10).
<b>Audio is not output by the HDMI OUT?</b>	The HDMI OUT is not connected properly.	Check the HDMI cable and correct as necessary.
	You're playing an SACD.	SACD audio is not output by the HDMI OUT.
	You're playing a DVD with 88.2 kHz or 96 kHz audio.	Set the Linear PCM Out setting to Down Sample On (page 75).
	You're playing a Dolby Digital, DTS, or MPEG source.	Set the Digital Out/Digital2 Dolby Digital Out, DTS Out, or MPEG Out setting for conversion to PCM (page 75).
<b>Can't view JPEG files?</b>	JPEG files without a ".jpg" or ".JPG" or ".JPEG" filename extension are not recognized.	Use the correct filename extension (page 10).
	Only Baseline JPEG files are supported. Progressive JPEG files are not.	Use Baseline JPEG files (page 10).
	Only JPEG files with the following brightness/color difference ratios are supported: 4:4:4, 4:2:2, and 4:1:1.	Use JPEG files with the supported ratio (page 10).
	The JPEG file is too big.	Use JPEG files that are less than 5 MB (page 10).
<b>The message "NO PLAY" appears on the display?</b>	The disc is dirty.	Remove the disc and clean it (page 11).
<b>Buttons on the remote controller don't work?</b>	Power supply voltage fluctuations and other anomalies, such as static electricity, can interfere with normal operation.	Turn off the DV-SP1000/DV-SP1000E, wait five seconds, then turn it on again. If that doesn't resolve the issue, disconnect the power cord from the wall outlet, wait five seconds, reconnect it, then try again.
<b>Buttons on the DV-SP1000/DV-SP1000E work OK but those on the remote controller don't?</b>	There are no batteries in the remote controller.	Install new batteries (page 14).
	The batteries are flat.	Replace with new batteries (page 14).
	The batteries are installed incorrectly.	Check the batteries and correct as necessary (page 14).
	You're not pointing the remote controller at the DV-SP1000/DV-SP1000E's remote sensor.	Point the remote controller at the DV-SP1000/DV-SP1000E's remote sensor (page 14).
	You're too far away from the DV-SP1000/DV-SP1000E.	Use the remote controller closer to the DV-SP1000/DV-SP1000E (page 14). The remote controller has a range of approximately 16 ft. (5 meters).
	A strong light source is interfering with the DV-SP1000/DV-SP1000E's remote sensor.	Make sure that the DV-SP1000/DV-SP1000E is not subjected to direct sunshine or inverter-type fluorescent lights. Relocate if necessary.
	If the DV-SP1000/DV-SP1000E is installed in a cabinet with colored glass doors, the remote controller may not work reliably when the doors are closed.	Open the doors, or use a cabinet without colored glass.

## Troubleshooting—Continued

### i.LINK Issues

(not Chinese model) SACD audio is not output by the i.LINK sockets?	This is because the i.LINK Output Setting is set to Off. If the DV-SP1000/DV-SP1000E is properly connected to an i.LINK component and an SACD is loaded, the IEEE 1394 indicator will flash.	Set the i.LINK Output Setting to On (page 76).
	The i.LINK cables are not connected properly.	Check the i.LINK connections and correct as necessary (page 35).
(not Chinese model) SACD audio is not output by the analog audio outputs?	This is because the i.LINK Output Setting is set to On.	Set the i.LINK Output Setting to Off (page 76).
(not Chinese model) Can't access the Analog Audio Out settings?	While the i.LINK Output Setting is set to On, the Analog Audio Out Speaker Setting, Speaker Distance, and Test Tone settings have no effect and are unavailable.	Set the i.LINK Output Setting to Off (page 76).
DVD, VCD, or CD audio is not output by the i.LINK sockets?	The Digital Out/Digital I Digital Out setting is set to Off.	Set the Digital Out setting to On (page 75).
When playing a DVD, some audio channels are not output by the i.LINK sockets?	The i.LINK Output Setting is set to Off.	Set the i.LINK Output Setting to On (page 75).
When playing a DVD, 96 kHz audio is downsampled to 48 kHz before being output by the i.LINK sockets?	The Linear PCM Out setting is set to Down Sample On.	Set the Linear PCM Out setting to Down Sample Off (page 75).
While using i.LINK, some RI functions don't work?	When connected to another manufacturer's AV receiver, some RI functions don't work.	

### ■ Abnormal Behavior

The DV-SP1000/DV-SP1000E contains a microprocessor for signal processing and control functions. In very rare situations, severe interference, noise from an external source, or static electricity may cause it to lockup. In the unlikely event that this should happen, unplug the power cord from the wall outlet, wait at least five seconds, and then plug it back in again. Alternatively, press and hold the Stop  button until "Reset" appears on the display (about 10 seconds).

### ■ Restoring the Default Settings

To reset the DV-SP1000/DV-SP1000E to its factory defaults, turn it on and, while holding down the Stop  button, press the [STANDBY/ON] button. "Initialize" appears on the display. When the reset is complete, "Complete" is displayed, and the DV-SP1000/DV-SP1000E enters Standby mode.

# Specifications

<b>Signal System</b>	<b>North American models:</b>	NTSC
	<b>Other models:</b>	PAL/NTSC
<b>Composite Video Output/Impedance</b>		1.0 V(p-p)/75 Ω negative sync, RCA/phono
<b>S-Video Output/Impedance</b>		Y: 1.0 V(p-p)/75 Ω negative sync, 4-pin mini DIN C: 0.286 V(p-p)/75 Ω
<b>Component Video Output/Impedance</b>		Y: 1.0 V(p-p)/75 Ω PB/PR: 0.7 V(p-p)/75 Ω, RCA/phono, BNC (not Canadian model)
<b>AV Connector (European only)</b>		1.0 V(p-p)/75 Ω, Scart
<b>Frequency Response</b>	<b>DVD Audio</b>	4 Hz–88 kHz (192 kHz)
	<b>DVD Linear Sound</b>	4 Hz–44 kHz (96 kHz)
		4 Hz–22 kHz (48 kHz)
	<b>Audio CD</b>	4 Hz–20 kHz (44.1 kHz)
<b>S/N Ratio</b>		112 dB
<b>Audio Dynamic Range</b>		106 dB
<b>THD (Total Harmonic Distortion)</b>		0.002 % (1 kHz)
<b>Wow and Flutter</b>		Below threshold of measurability
<b>Audio Output (Digital/Optical)</b>		–22.5 dBm
<b>Audio Output/Impedance (Digital/Coaxial)</b>		0.5V p-p / 75 Ω
<b>Audio Output/Impedance (Analog)</b>		2.0 V(rms) / 320 Ω
<b>HDMI socket (HDMI OUT)</b>		19-pin
<b>i.LINK socket (not Chinese model)</b>		4-pin (S400)
<b>Power Supply</b>	<b>North American models:</b>	AC 120 V, 60 Hz
	<b>European models:</b>	AC 230-240 V, 50 Hz
	<b>Korean models:</b>	AC 220-230 V, 50/60 Hz
	<b>Asian models:</b>	AC 120/220–230 V, 50/60 Hz
	<b>Chinese model:</b>	AC 220–230 V, 50/60 Hz
<b>Power Consumption</b>		48 W
<b>Stand-by Power Consumption</b>		7.1 W
<b>Dimensions (W x H x D)</b>		435 W x 123 H x 374 D mm 17. 1/8 W x 4. 13/16 H x 14. 3/4 D inches
<b>Weight</b>		12.1 kg 26.7 lbs
<b>Operation Condition Temperature</b>		5 °C – 35 °C (41 F – 95 F)
<b>Disc Compatibility</b>		DVD-Video, DVD-Audio, SACD, DVD-R (Video Mode), DVD-RW (Video Mode/VR mode), Music CD/CD-R/RW, Video CD, MP3, JPEG Disc that has not been property finalized may only be partially playable or not playable at all.

Specifications and features subject to change without notice.

## ONKYO CORPORATION

Sales & Product Planning Div. : 2-1, Nisshin-cho, Neyagawa-shi, OSAKA 572-8540, JAPAN  
Tel: 072-831-8023 Fax: 072-831-8124

### ONKYO U.S.A. CORPORATION

18 Park Way, Upper Saddle River, N.J. 07458, U.S.A.  
Tel: 201-785-2600 Fax: 201-785-2650 <http://www.onkyousa.com>

### ONKYO EUROPE ELECTRONICS GmbH

Liegnitzerstrasse 6, 82194 Groebenzell, GERMANY  
Tel: +49-8142-4401-0 Fax: +49-8142-4401-555 <http://www.onkyo.net>

### ONKYO CHINA LIMITED

Units 2102-2107, Metroplaza Tower I, 223 Hing Fong Road, Kwai Chung, N.T., HONG KONG Tel: 852-2429-3118 Fax: 852-2428-9039



Printed in Japan  
I0407-3

SN 29343646B

(C) Copyright 2004 ONKYO CORPORATION Japan. All rights reserved.



\* 2 9 3 4 3 6 4 6 B \*