



CRW-5224A

52x/24x/52x CD-RW Drive

User's Manual



Copyrights/Disclaimer

Copyright © 2002 ASUSTeK COMPUTER INC. All Rights Reserved.

No part of this manual, including the products and software described in it, may be reproduced, transmitted, transcribed, stored in a retrieval system, or translated into any language in any form or by any means, except documentation kept by the purchaser for backup purposes, without the express written permission of ASUSTeK COMPUTER INC. ("ASUS").

ASUS PROVIDES THIS MANUAL "AS IS" WITHOUT WARRANTY OF ANY KIND, EITHER EXPRESS OR IMPLIED, INCLUDING BUT NOT LIMITED TO THE IMPLIED WARRANTIES OR CONDITIONS OF MERCHANTABILITY OR FITNESS FOR A PARTICULAR PURPOSE. IN NO EVENT SHALL ASUS, ITS DIRECTORS, OFFICERS, EMPLOYEES OR AGENTS BE LIABLE FOR ANY INDIRECT, SPECIAL, INCIDENTAL, OR CONSEQUENTIAL DAMAGES (INCLUDING DAMAGES FOR LOSS OF PROFITS, LOSS OF BUSINESS, LOSS OF USE OR DATA, INTERRUPTION OF BUSINESS AND THE LIKE), EVEN IF ASUS HAS BEEN ADVISED OF THE POSSIBILITY OF SUCH DAMAGES ARISING FROM ANY DEFECT OR ERROR IN THIS MANUAL OR PRODUCT.

Product warranty or service will not be extended if: (1) the product is repaired, modified or altered, unless such repair, modification or alteration is authorized in writing by ASUS; or (2) the serial number of the product is defaced or missing.

The product name and revision number are both printed on the product itself. Manual revisions are released for each product design represented by the digit before and after the period of the manual revision number. Manual updates are represented by the third digit in the manual revision number.

SPECIFICATIONS AND INFORMATION CONTAINED IN THIS MANUAL ARE FURNISHED FOR INFORMATIONAL USE ONLY, AND ARE SUBJECT TO CHANGE AT ANY TIME WITHOUT NOTICE, AND SHOULD NOT BE CONSTRUED AS A COMMITMENT BY ASUS. ASUS ASSUMES NO RESPONSIBILITY OR LIABILITY FOR ANY ERRORS OR INACCURACIES THAT MAY APPEAR IN THIS MANUAL, INCLUDING THE PRODUCTS AND SOFTWARE DESCRIBED IN IT.

Products and corporate names appearing in this manual may or may not be registered trademarks or copyrights of their respective companies, and are used only for identification or explanation and to the owners' benefit, without intent to infringe.

Product Name:	ASUS CRW-5224A
Manual Revision:	1.00 E1103
Release Date:	October 2002

Contents

Copyrights/Disclaimer	2
FCC/CDC Statements	4
ASUS Contact Information	5
Safety Information	6
Installation Notices	6
Using the Device	7
Package Contents	8
Welcome!	9
Product Introduction	9
Specifications	9
Features	10
Front Panel	14
Rear Panel	15
Installation	16
System Requirements	16
Setting the Jumper Terminals	17
Installing the CD-RW Drive	18
Connecting the Drive Cables	20
CD-RW Drive Basics	21
Placing a Disc into the Drive	21
Ejecting a Disc from the Drive	22
Using the Emergency Eject Pinhole	23
Using Compact Discs	24
Cleaning a Disc	24
Handling a Disc	24
Technical Information	25
Environmental Specifications	25
Electrical and Audio Specifications	25

FCC/CDC Statements

Federal Communications Commission Statement

This device complies with FCC Rules Part 15. Operation is subject to the following two conditions:

- This device may not cause harmful interference, and
- This device must accept any interference received including interference that may cause undesired operation.

This equipment has been tested and found to comply with the limits for a Class B digital device, pursuant to Part 15 of the FCC Rules. These limits are designed to provide reasonable protection against harmful interference in a residential installation. This equipment generates, uses and can radiate radio frequency energy and, if not installed and used in accordance with manufacturer's instructions, may cause harmful interference to radio communications. However, there is no guarantee that interference will not occur in a particular installation. If this equipment does cause harmful interference to radio or television reception, which can be determined by turning the equipment off and on, the user is encouraged to try to correct the interference by one or more of the following measures:

- Reorient or relocate the receiving antenna.
- Increase the separation between the equipment and receiver.
- Connect the equipment to an outlet on a circuit different from that to which the receiver is connected.
- Consult the dealer or an experienced radio/TV technician for help.

WARNING! *The use of shielded cables for connection of the monitor to the graphics card is required to assure compliance with FCC regulations. Changes or modifications to this unit not expressly approved by the party responsible for compliance could void the user's authority to operate this equipment.*

Canadian Department of Communications Statement

This digital apparatus does not exceed the Class B limits for radio noise emissions from digital apparatus set out in the Radio Interference Regulations of the Canadian Department of Communications.

This class B digital apparatus complies with Canadian ICES-003.

ASUS Contact Information

ASUSTeK COMPUTER INC. (Asia-Pacific)

Address: 150 Li-Te Road, Peitou, Taipei, Taiwan 112
General Tel: +886-2-2894-3447
General Fax: +886-2-2894-3449
General Email: info@asus.com.tw

Technical Support

MB/Optical Drives (Tel): +886-2-2890-7121 (English)
Notebook (Tel): +886-2-2890-7122 (English)
Desktop/Server (Tel): +886-2-2890-7123 (English)
Support Fax: +886-2-2890-7698
Support Email: tsd@asus.com.tw
Web Site: www.asus.com
Newsgroup: cscnews.asus.com.tw

ASUS COMPUTER INTERNATIONAL (America)

Address: 6737 Mowry Avenue, Mowry Business Center,
Building 2, Newark, CA 94560, USA
General Fax: +1-510-608-4555
General Email: tmd1@asus.com

Technical Support

Support Fax: +1-510-608-4555
General Support: +1-502-995-0883
Web Site: www.asus.com
Support Email: tsd@asus.com

ASUS COMPUTER GmbH (Europe)

Address: Harkortstr. 25, 40880 Ratingen, BRD, Germany
General Fax: +49-2102-442066
General Email: sales@asuscom.de (for marketing requests only)

Technical Support

Support Hotline: MB/Optical Drives: +49-2102-9599-0
Notebook (Tel): +49-2102-9599-10
Support Fax: +49-2102-9599-11
Support (Email): www.asuscom.de/de/support (for online support)
Web Site: www.asuscom.de

Safety Information

Observe the following precautions before installing and using the ASUS CRW-5224A Drive!

Installation Notices

Do not place this device in an unstable position, or in one that vibrates.

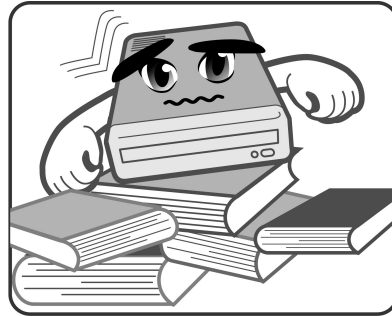

Do not place this device in areas where there is direct sunlight, high humidity, or damp condition.

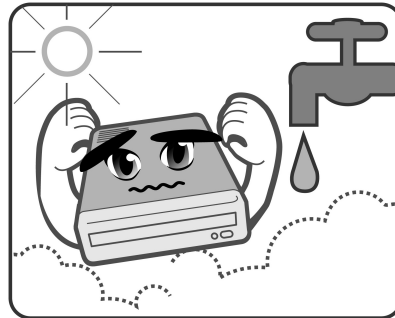

Do not use or place this device near magnetic fields, televisions, or radios, where there is interference that may affect the performance of the drive.

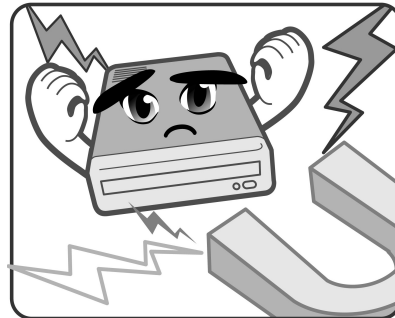

Do not attempt to disassemble or repair the drive. Opening the drive may result to exposure to laser radiation.

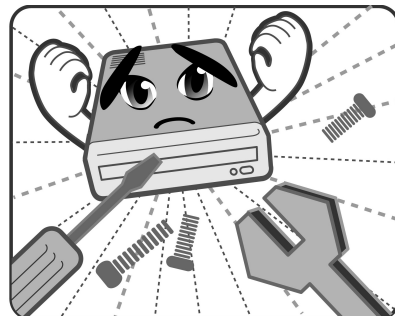

Safety Information

Using the Device

- Use of any controls, adjustments, or procedures other than those specified in this manual may result to hazardous radiation exposure.
- Do not attempt to disassemble the drive.
- Do not move the device from a cold to a warm or hot environment. Drastic change of temperature is harmful to the device.
- Before moving or uninstalling the drive, remove disc from it, if any.
- Prevent liquids or any metal to get into the device. If this situation occurs, contact your retailer for help.
- Do not use any evaporating solvents to clean the device. If you accidentally sprayed any solvent on the device, use a clean cloth to wipe it. You may also use a neutral cleaner to dilute the solvent to easily wipe it from the device.
- Try not to interrupt the supply of power while the device is in reading or writing mode.
- Do not place damaged or warped discs inside the device. A warped disc may break while in use and damage the device.
- Do not place discs into the device immediately if they came from a cold environment, specially during cold seasons. Wait until the discs have reached room temperature.

Conventions used in this guide

To make sure that you perform certain tasks properly, take note of the following symbols used throughout this manual.



WARNING/DANGER: Information to prevent injury to yourself when trying to complete a task.

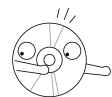

CAUTION: Information to prevent damage to the components when trying to complete a task.



IMPORTANT: Information that you **MUST** follow to complete a task.

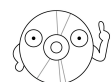

NOTE: Tips and additional information to aid in completing a task.

Package Contents

Upon opening your ASUS CRW-5224A drive package, check if all the following items are present and in good condition. If any of the items is damaged or missing, contact your retailer immediately.

- ASUS CRW-5224A internal IDE drive
- IDE cable
- Mounting screw package
- Wire cable
- Emergency eject pin and instruction slip
- ASUS High-Speed CD-R blank disc
- ASUS High-Speed CD-RW blank disc
- User's Manual (English and Traditional Chinese)
- Multi-language quick installation guide
- Bundled software CD

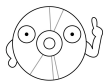

The above items are available in retail boxes only.

Welcome!

Thank you for buying the ASUS CRW-5224A Drive!

To ensure proper installation and use of this device, read the instructions and other important information contained in this manual.

Product Introduction

Specifications

The CRW-5224A has the following specifications.

- **Speeds** 52X, 48X, 40X, 32X, 24X, 16X, 12X, 8X, 4X writes
24X, 16X, 12X, 10X, 8X, 4X, 2X rewrites
52X maximum reads
- **Interface** ATAPI specification
- **Technology support** *FlextraSpeed™* Technology
FlextraLink™ Technology
Double Dynamic Suspension System II (DDSS II)
CAV Recording Technology
- **Data buffer size** 2MB
- **Application discs** 12cm or 8cm diameter, 1.2mm thick
CD-Audio, CD-ROM, CD-ROM/XA, CD-I,
Mixed Mode CD-ROM, Photo CD,
CD-Extra, Video CD, CD-Text, DVCD, CD-G,
Karaoke CD, I-trax, Bootable CD
- **Recording form** Orange Book Part 2, 3
Disc-at-once, Track-at-once
Session-at-once, Packet write,
Overburn, DAO-RAW mode
- **OS compatibility** MS-Windows 98/98SE/ME/2000/XP/NT
SCO Unix, Linux, Netware, OS/2 Warp
- **Power supply** DC 5 x (1 +/- 5%)V
DC 12 x (1 +/- 10%)V
- **Dimensions** 41.5 (h) x 149.0 (w) x 197.5 (d) mm
- **Mass** 997 g

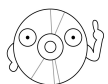

Refer to the section “Technical Information” on page 25 for detailed specifications.

Features

The ASUS CRW-5224A is a CD-RW drive with 52X-write, 24X-rewrite, and 52X-read capabilities. The drive complies with the AT Attachment Packet Interface (ATAPI) specification and comes equipped with the latest innovative technologies in CD recording.

Highlighting the major characteristic of ASUS CD-RW drives, the CRW-5224A strategically identifies the media quality at the beginning of the recording so that it can apply the appropriate writing speeds and ensure effective data storage. Thanks to the *FlextraSpeed*[™] and *FlextraLink*[™] technologies developed by ASUS.

FlextraSpeed[™] increases accuracy and reliability when rewriting across a broad base of certified media, while *FlextraLink*[™] prevents buffer underrun problems to eliminate the creation of unusable discs. The following sub-sections describe these technologies in detail.

***FlextraSpeed*[™] Technology**

The ASUS *FlextraSpeed*[™] technology provides the optimum solution to ensure quality recording when using discs that require flexible speeds. The CRW-5224A drive employs this technology that allows automatic recording speed adjustment based on the recording media.

In addition to the fact that there are low and high quality recording media, various other factors such as dye layer, temperature, humidity, dust, fingerprints, etc., affect the recording characteristics of CD-R and CD-RW discs. Due to these factors, some discs may not be able to stand the high-speed capabilities of the latest CD-RW drives. The *FlextraSpeed*[™] technology solves this problem by automatic assessment of the disc quality and recording capability. The recording speed is based on these factors. If you use a high quality recording disc, you can maximize the recording capability of the drive and get the best quality output. If you use a low quality disc, the drive speed adjusts to the level that is most appropriate for the disc, still optimizing the disc recording capability.

The *FlextraSpeed*[™] technology also helps maintain the CD-RW drive because of the controlled motor rotation speeds and reduced noise caused by spindle air, thus prolonging the drive motor's life and ensuring high-quality recording.

FlextraLink™ Technology

The ASUS FlextraLink™ technology provides a seamless combination of flexibility and ultra-reliable recording quality.

FlextraLink™ incorporates a flexible strategy that prevents buffer underrun problems caused by an empty data buffer. This CD-RW drive technology allows continuous monitoring of the data buffer status during the write process. Once the available data drops to approximately 1% of the total buffer capacity, the drive stops recording and marks the last write position. When new data is received from the host, it is loaded to the data buffer, and the laser is repositioned to link the new data with the data already written. FlextraLink™ uses minimal system resources so that your PC remains fully operational throughout the writing process, and available for other applications.

The diagram below shows the advantage of the FlextraLink™ recording technology.

FlextraLink™ Technology Solution

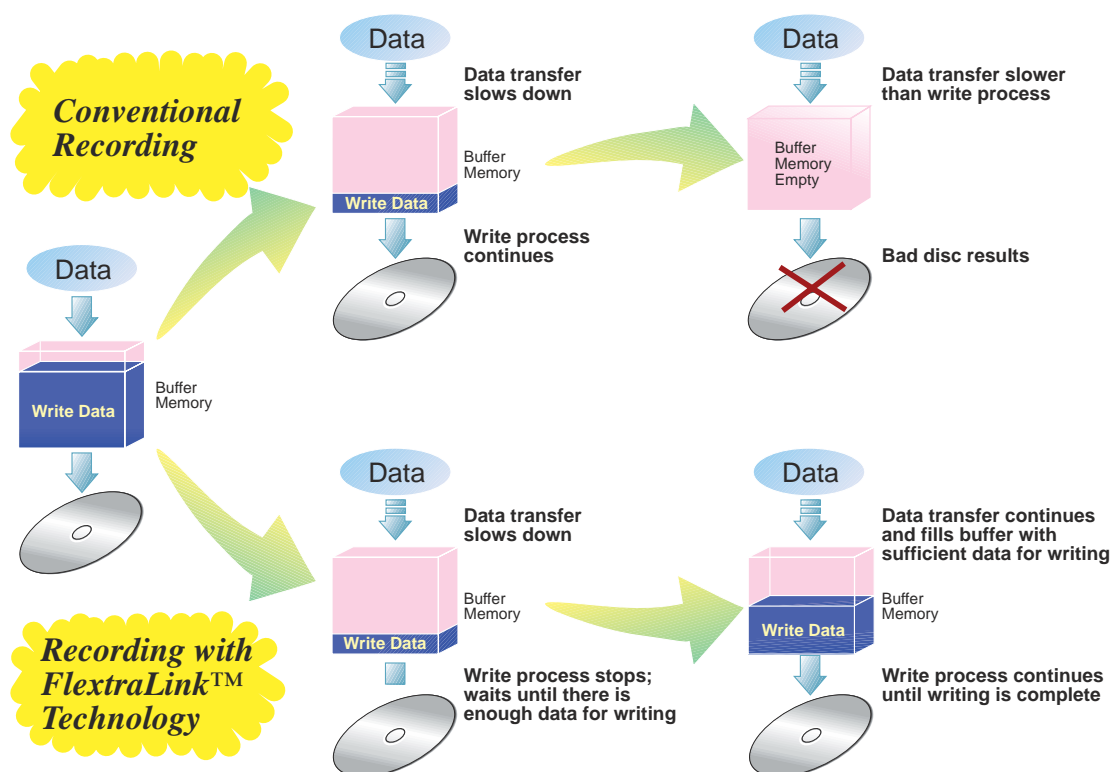



Double Dynamic Suspension System (DDSS II)

The DDSS II is an enhanced follow up to the DDSS anti-vibration system developed by ASUS. The DDSS technology is designed to reduce the vibration generated from spindle rotation of over 8900 rpm of CD-RW drives. The DDSS II improves this feature by handling up to over 10,000 rpm of the new CD-RW drives. In addition, the DDSS II stabilizes the pick-up head of the drive in both horizontal and vertical directions, making tracking and focusing even more precise.

Like the DDSS, the DDSS II vibration absorption structure contains a “dynamic mass” that can absorb the vibration caused by high revolution of spindle motor. However, the DDSS II moves the dynamic mass to be suspended to the chassis, thus providing more stability and accuracy when accessing data from the disc.

The following diagram illustrates the DDSS/DDSS II design structure.

DDSS / DDSS II Design Structure

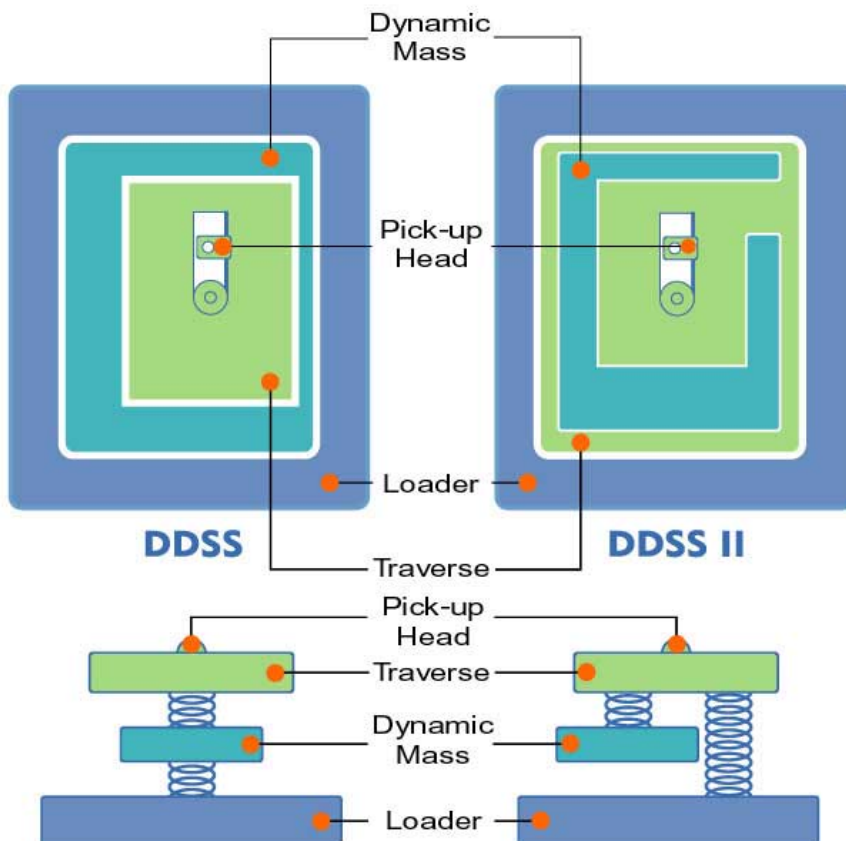

Constant Angular Velocity (CAV) Recording Technology

The CRW-5224A drive employs the Constant Angular Velocity (CAV) recording method. With CAV recording, the drive spindle motor rotates the disc at the same speed regardless of the radial position of the pickup head. This means that there is a higher transfer rate when writing data to the outer tracks of the disc than to the inner tracks, as the head traverses a longer linear path on the outer than the inner part of the disc.

Although the transfer rates vary, and may not be at maximum, depending on the part of the disc being written to, the CAV method allows faster recording speed because the rotation speed does not have to change when the head writes data to different areas of the disc. This is primarily advantageous for computer applications.

CAV Recording Method

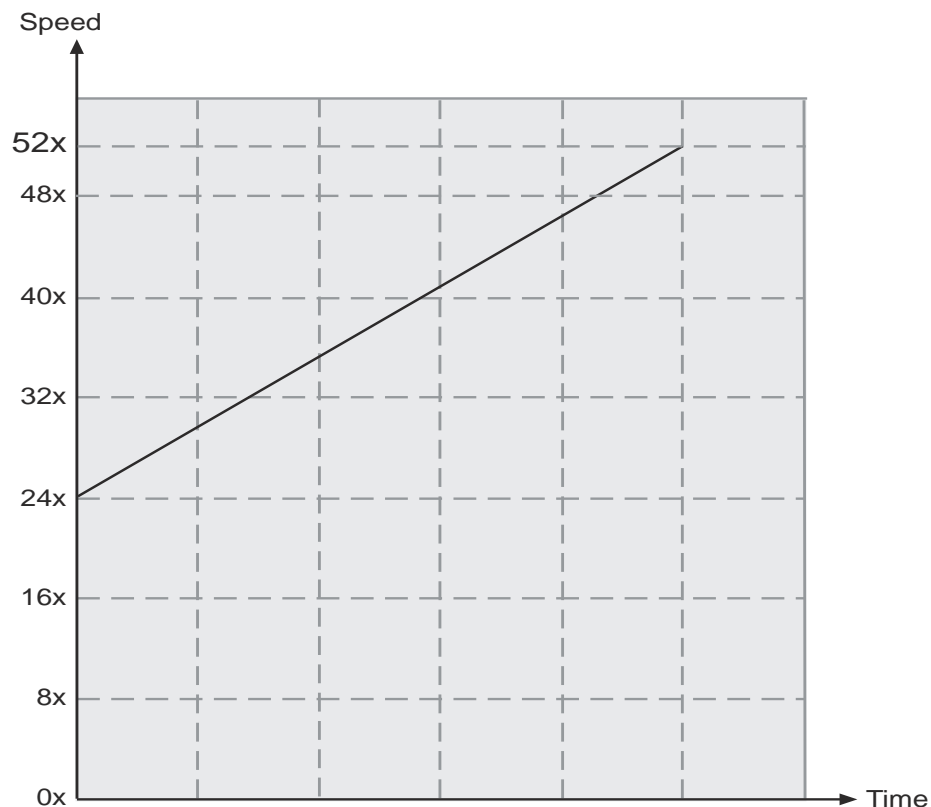

Front Panel

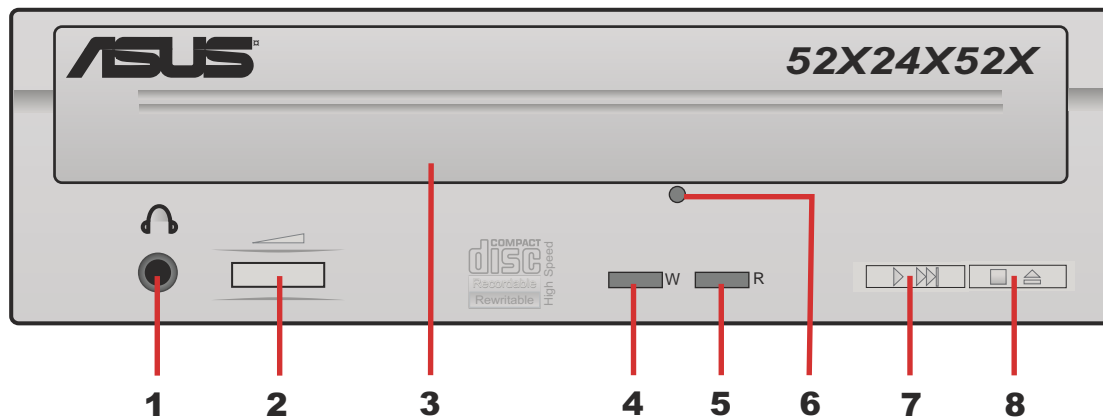

1. Headphone jack

This jack allows you to connect a headphone with a stereo mini-plug.

2. Headphone volume dial

This volume dial allows you to control the volume of the headphone connected to the drive. Turning the dial to the left decreases the volume, turning to the right increases volume.

3. Disc tray

This tray holds the disc.

4. WRITE indicator (Red LED)

This LED flashes while data is being written on the disc.

5. READ indicator (Green LED)

This LED turns ON when you place a disc on the drive tray, and stays ON until you remove the disc. The LED flashes while data is being read from the disc.

6. Emergency eject pinhole

In cases when you cannot eject a disc from the drive using the eject button due to power failure or software problems, insert a pin or a paper clip into this hole to manually eject the tray and the disc.

7. PLAY/SKIP button

This button has two functions. If the drive is idle, pressing this button will start playing an audio disc (if one is currently loaded in the drive) from the first track. While in the PLAY mode, pressing this button lets you skip to the next track on the disc.

8. STOP/EJECT button

This button has two functions. Pressing this button at any time ejects the disc tray so you can place or remove a disc. While in PLAY mode, pressing this button stops playing the disc loaded in the drive.

Rear Panel

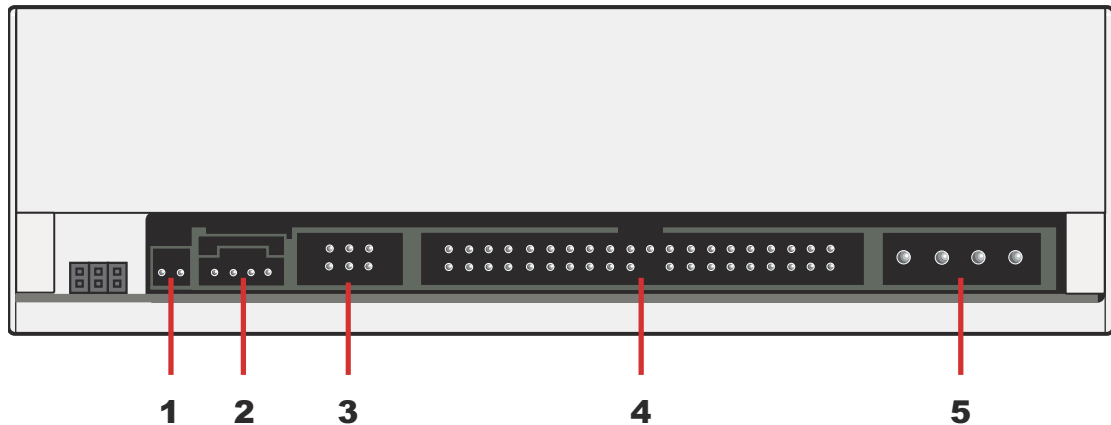

- 1. Digital audio connector**
This connector is for a digital signal output cable.
- 2. Analog audio connector**
This connector is for an analog signal output cable.
- 3. Jumper terminals**
These pins allow you to select either Master, Slave, or Cable Select mode for the CD-ROM device.
- 4. IDE connector**
This connector is for a 40-pin IDE cable to connect the drive to the IDE interface on the motherboard.
- 5. Power connector**
This DC connector is for a 4-pin power cable from the system power supply.



The jumper pins on the leftmost part of the rear panel are factory test pins. DO NOT cover these pins with jumper blocks.

Installation

System Requirements

Before installing and using the CD-RW drive, make sure that your computer system meets the following requirements.

- IBM-compatible Pentium 166MHz or higher PC
- Windows 98/98SE/ME/2000/XP/NT 4.0, Linux, or OS/2 Warp operating system
- At least 64MB system memory (128MB is recommended)
- An empty 5.25-inch external drive bay
- HDD empty storage capacity of 100MB or more
Average seek time: 20ms or less
Transmission rate: 2 MB/s or more

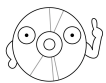

Do not use a hard disk that calibrates thermally during operation.

- Recommended media:

CD-R	Acer, AMT, CMC, Kodak, LeadData, Maxell, Mitsubishi Chemical, Mitsui, Nan Ya, Philips, Princo, Prodisc, Ricoh, Ritek, Sony, Taiyo Yuden, TDK, Verbatim, Yamaha
CD-RW	Acer, AMT, CMC, Digimaster, Maxell, MaxMax, Melody, Mitsubishi Chemical, Philips, Plextor, Prodisc, Ricoh, Ritek, Sony, TDK, Traxdata, Verbatim, Yamaha



Do not use damaged or warped disc in the CD-RW drive. The disc may break during use and cause potential body or damage to your drive.

Setting the Jumper Terminals

Configure the the jumpers to set the device to master or slave mode before physically installing it to your computer chassis. Use jumper blocks to short the pins to your desired setting.

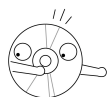

Make sure to correctly place the jumper blocks over the pins. Failure to do so may cause irreparable damage to the drive!

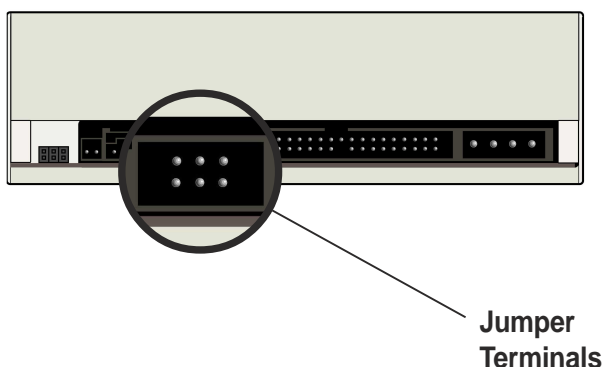

Master Mode

Cover the two pins labeled MASTER to set the CD-RW drive as a secondary master drive. This is possible only if your computer supports four IDE devices. The hard disk in the computer is set as Primary Master.

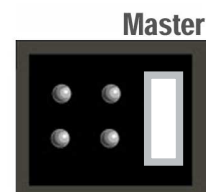

Slave Mode

Cover the two pins labeled SLAVE to set the CD-RW drive as a slave device if your computer supports only two IDE devices.

If your computer supports four IDE devices, this setting sets your CD-RW drive either as a Primary Slave or a Secondary Slave.



Cable Select Mode

Cover the two pins labeled CABLE SELECT if your computer supports a Cable Select (CSEL) signal. You need an exclusive interface cable for this setting. Refer to your computer manual for details.

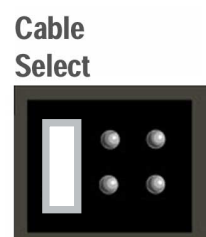

Installing the CD-RW Drive

Follow these steps to install the drive into the computer chassis.

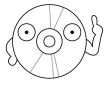

Refer to your computer manual for specific instructions on opening the chassis and installing drives.

1. Remove the cover of an empty 5.25-inch external drive bay.

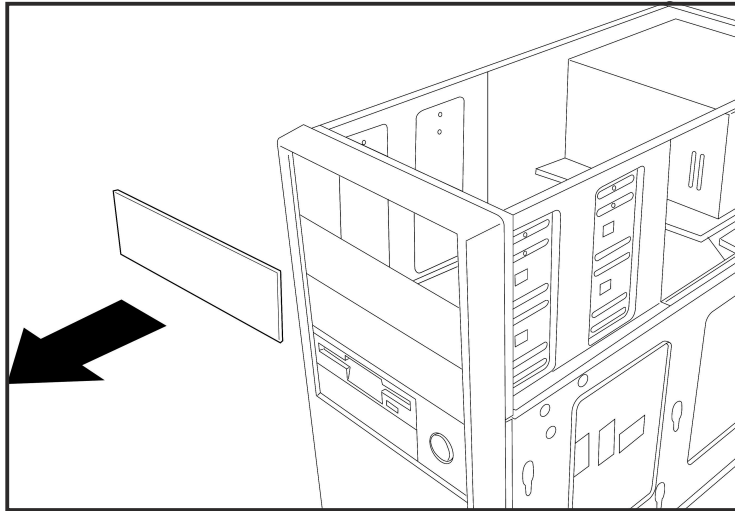

2. Carefully insert the CD-RW drive into the bay and push it inward until it is flushed to the chassis front panel. The holes on the sides of the drive should align with the holes on the drive bay.

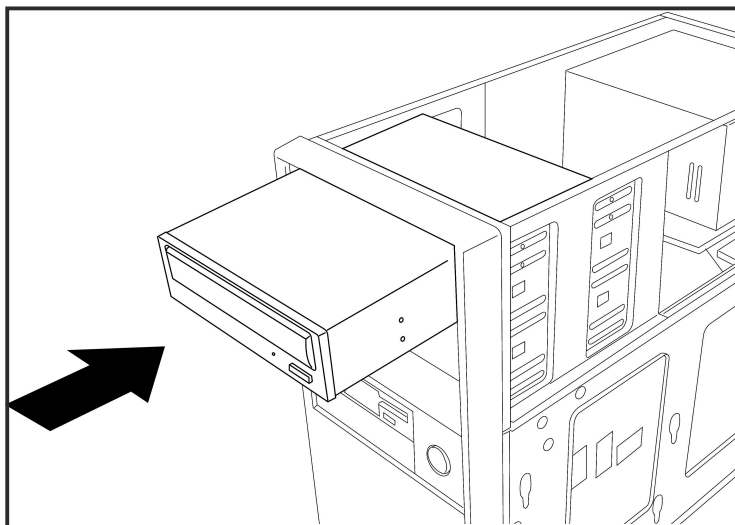

3. Secure the drive with screws that came with the drive package. Use two screws on each side of the drive.



Depending on the space on your chassis, you may need to connect the drive cables before securing the drive into the chassis. For cable connections, proceed to the following section, “Connecting the Drive Cables.”

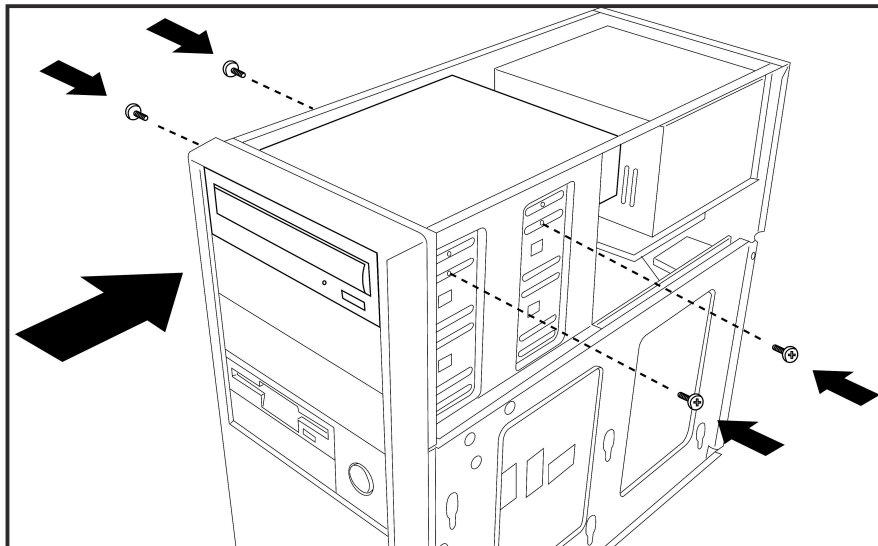

Connecting the Drive Cables

1. Connect the power cable plug to the power connector on the rear panel.
2. Connect the 40-pin IDE cable plug to the IDE connector, matching the red pin stripe on the cable with Pin 1 on the connector.
3. If your computer has a sound card or an onboard audio feature, connect an audio interface cable to the 4-pin analog audio connector on the rear of the drive. Connect the other end of the audio cable to the connector on the sound card or on the 4-pin CD connector on the motherboard.

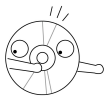

All the cable plugs are slotted so that they fit in only one orientation. If a plug does not fit in completely, try reversing it. DO NOT use too much force when fitting the cable plugs.

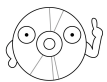
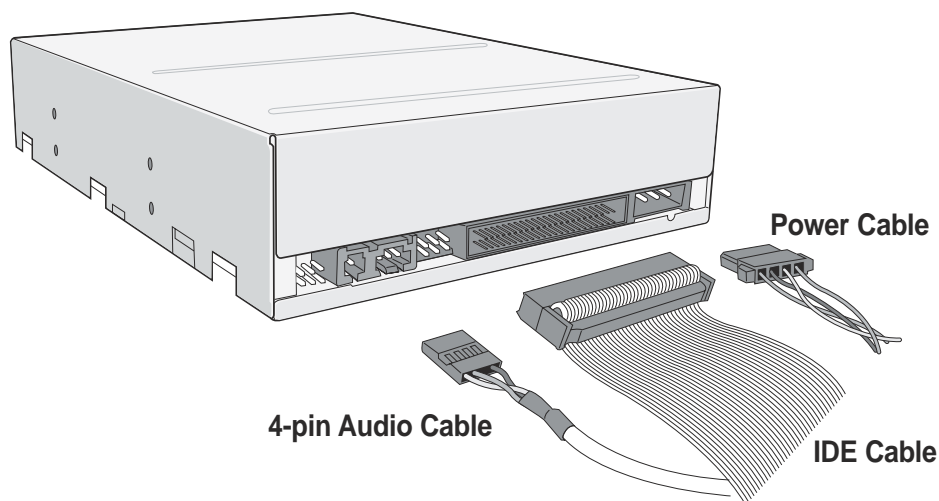

Replace the computer cover according to your computer manual.

CD-RW Drive Basics

Placing a Disc into the Drive

1. Press the eject button on the front of the drive to eject the tray.

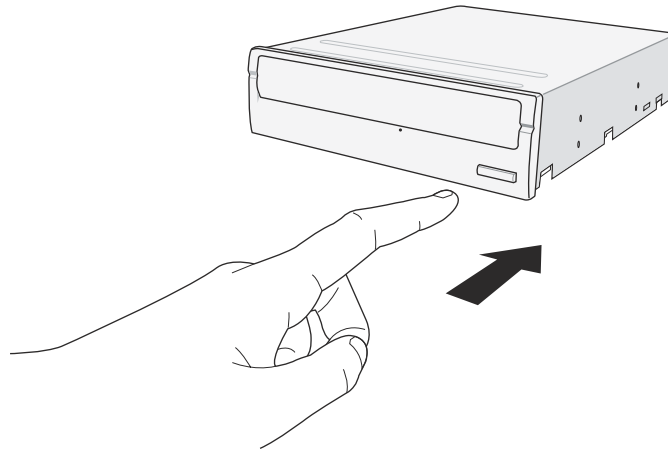

2. When the drive tray ejects out of the drive, place the disc on the tray with the label (printed) side up.

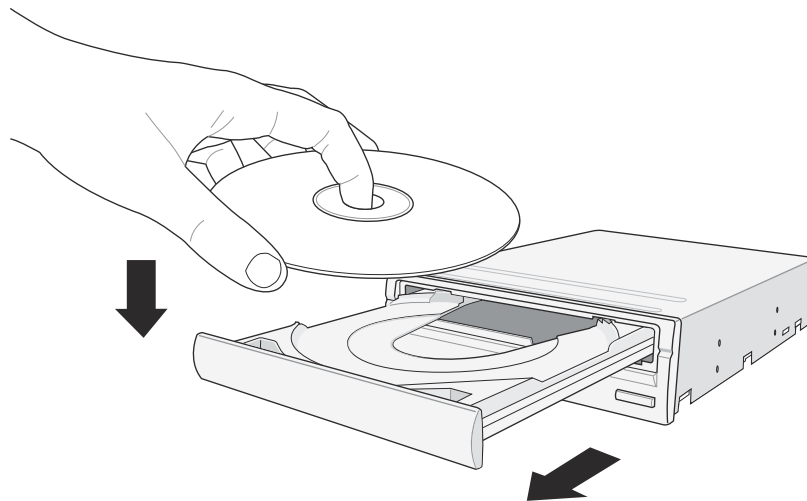

NOTE: *If you are using a 12-cm disc, place it on the tray making sure that it fits the outer circular border. This border helps hold the disc in place. If you are using an 8-cm disc, place it on the inner circular border on the tray.*

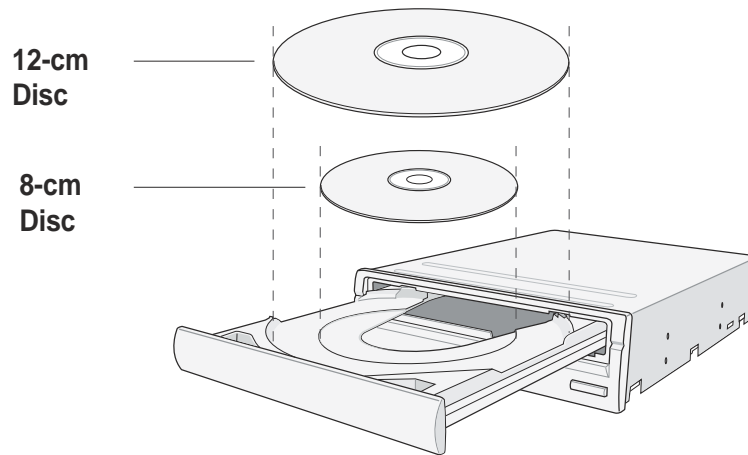

3. Press the drive eject button or lightly push the center of the drive tray to replace the tray inside the drive.

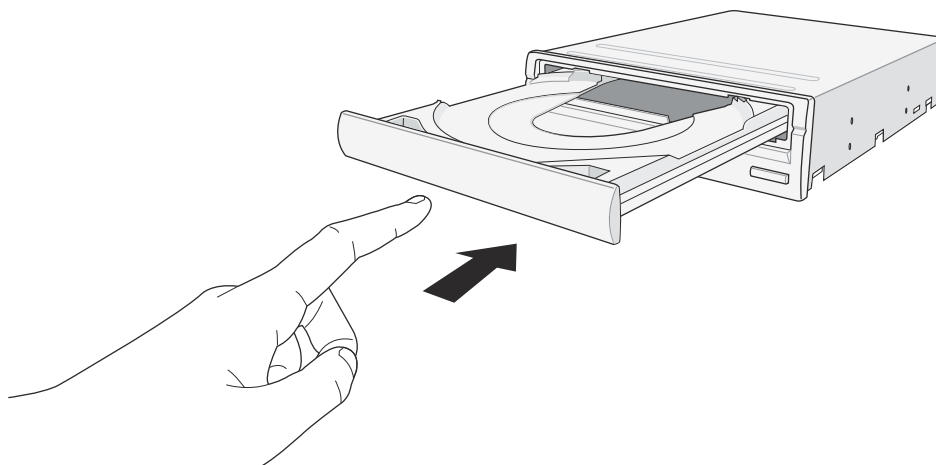

Ejecting a Disc from the Drive

1. Press the eject button on the front of the drive to eject the tray.
2. Carefully remove the disc from the tray.
3. Press the drive eject button or lightly push the center of the drive tray to load the tray back into the drive.

Using the Emergency Eject Pinhole

The emergency eject pinhole on the front of the drive allows you to manually eject the drive tray and remove a disc from the drive in the following instances:

- supply of power to the computer is cut due to electrical power outage
- the drive malfunctions



Use the manual method only as a last resort when the eject button does not work. Make sure that you have turned off your computer before ejecting the drive tray.

Follow these steps to eject the drive tray using the emergency pinhole.

1. Insert the eject pin that came with the drive package. You may also use a paper clip or any pointed rod small enough to fit into the emergency pinhole.

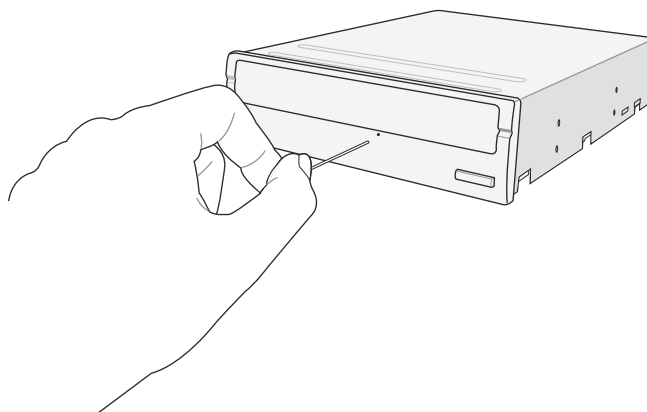

2. Carefully pull the tray out and remove the CD.

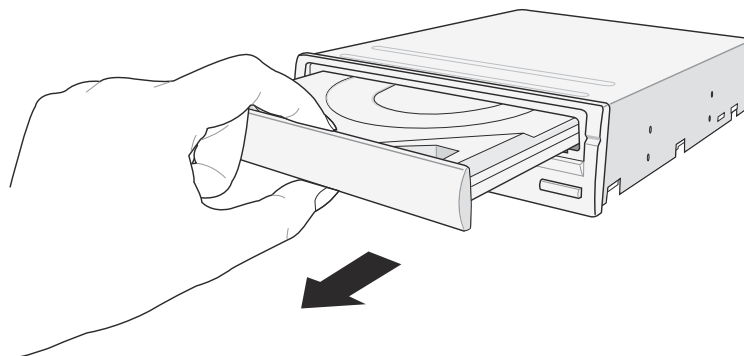

Do not force the tray open; wait until the eject pin has dislodged the tray to avoid breaking the tray panel.

Using Compact Discs

Take note of the instructions in this section when using compact discs. These instructions will help you avoid damaging the discs and your CD-RW drive.

Cleaning a Disc

Spray the disc with compressed air for about five seconds to get rid of the dust on a disc.

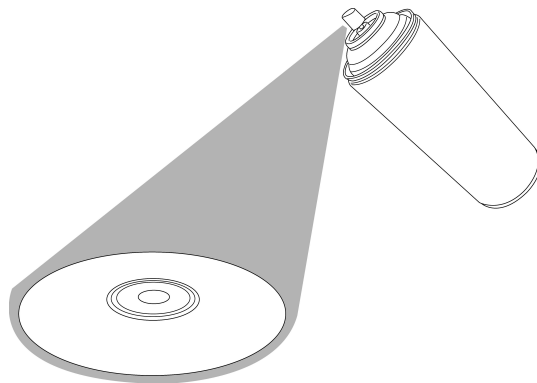

Handling a Disc

Hold a disc by the edges. Do not touch the disc surface.

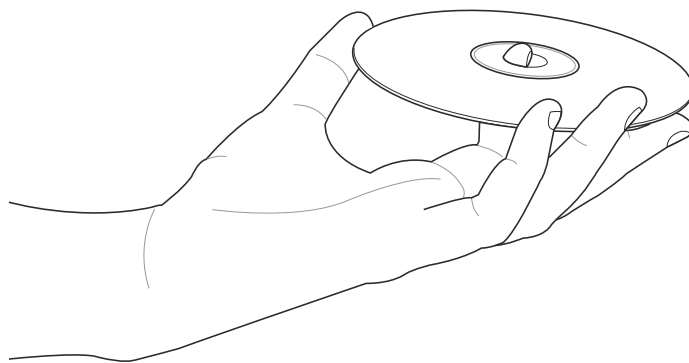

Technical Information

Environmental Specifications

Temperature	Operation:	5°C < to < 45°C
	Storage:	- 20°C to < 60°C
Humidity	Operation:	20% to 80% non-condensing
	Storage:	15% to 85% non-condensing
Vibration	Operation:	0.3G peak at 5 ~ 500 Hz
	Storage:	2.0G peak at 10 ~ 500 Hz
Impact	Non-operation:	1 oct/min – no damage Less than 50G – (at 11ms/half sine wave, 3 shock/each side)
	Packaged:	1 oct/min – no damage 91 cm high – (1 corner, 3 edges, 6 surfaces)
Acoustic	Access mode:	45.5 dB TYP
	Read mode:	45 dB TYP
(Microphone located 50cm in front of the drive, 120cm above the drive at 30° angle.)		
Reliability	MTBF:	100,000 power on hours
	ODC (Read):	20% of power on time
	ODC (Write):	1% of power on time
Mean Time To Repair (MTTR)		30 minutes

* ODC - Operating Duty Cycle

Electrical and Audio Specifications

Power Source	Voltage	+5V DC	+12V DC
	Tolerance	+/- 5%	+/- 10%
	Ripple	150m Vpp	300m Vpp
	Rating	900mA	1500mA
I/O Terminal	Power connector	4-pin +5V, +12V	
	ATAPI terminal	40-pin	
	Audio out	4-pin (analog) 2-pin (digital)	
Audio	No. of channels	2 (stereo)	
	Sampling frequency	44.1 kHz	
	Quantization	16 bits	
	Distortion	0.2% max. (at 1 kHz)	
	S/N ratio	70 dB	
	Output: Headphone	0.7 V rms (typical)	
Line Out	0.7 V rms (typical)		

