

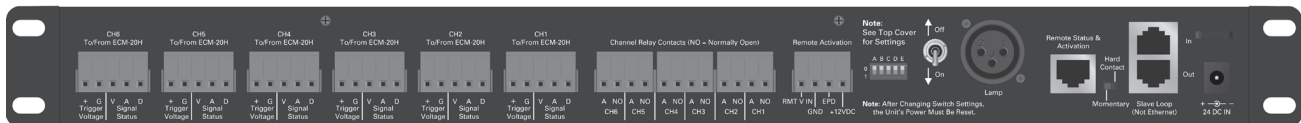

ECS-6RM^B Sequence Controller & Monitor

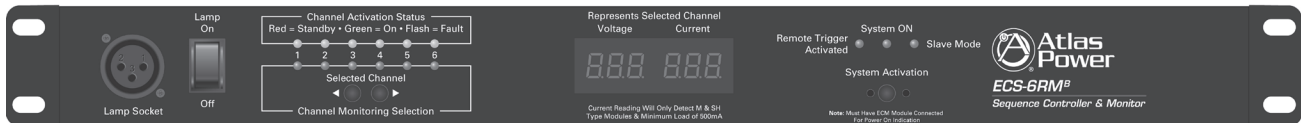

1601 Jack McKay Blvd. • Ennis, Texas 75119 U.S.A.
Telephone: 800.876.3333 • Fax: 800.765.3435



Table of Contents

Important Safety Instructions..... 3

Introduction 5

ECS-6RM Key Features..... 6

ECM Module Key Features 6

Applications 6

Front Panel Description..... 7

Rear Panel Description..... 9

Remote Activation Options 9

Emergency Power Down 11

System Configuration Switch Settings 11

Wire and Data Considerations..... 12

Internal ECM Module Features 13

AP-GNL18 - LED Gooseneck Lamp 14

ECM-15SH - Standalone 15A Electrical Control Module..... 14

ECM-20SH - Standalone 20A Electrical Control Module..... 15

ECM-20M - Electrical Control Module 15

ECM-20 - Electrical Control Module (Without Current Monitoring) 15

ECM-RACEWY6 - ECM Raceway Housing 16

ECM-3BP - Raceway Blank Plate 16

ECM-ACIN 16

ECS-KSW6 - Remote Key Switch and Monitor 17

ECS-6RM Configurations..... 18

ECM-20/M Wiring Configurations 20

Troubleshooting 21

Specifications 23

Warranty..... 24





Important Safety Instructions



The lightning flash with arrowhead symbol within an equilateral triangle, is intended to alert the user to the presence of uninsulated "dangerous voltage" within the product's enclosure that may be of sufficient magnitude to constitute a risk of electric shock to persons.



The exclamation point within an equilateral triangle is intended to alert the user to the presence of important operating and maintenance (servicing) instructions in the literature accompanying the product.

1. Read these instructions.
2. Keep these instructions.
3. Heed all warnings.
4. Follow all instructions.
5. Do not use this device near water.
6. Clean only with dry cloth.
7. Do not block any ventilation openings. Install in accordance with the manufacturer's instructions.
8. Do not install near any heat sources such as radiators, heat registers, stoves, or other device (including amplifiers) that produce heat.
9. Do not defeat the safety purpose of the polarized or grounding-type plug. A polarized plug has two blades with one wider than the other. A grounding type plug has two blades and a third grounding prong. The wide blade or the third prong are provided for your safety. If the provided plug does not fit into your outlet, consult an electrician for replacement of the obsolete outlet.
10. Protect the power cord from being walked on or pinched particularly at plugs, convenience receptacles, and the point where they exit from the device.
11. Only use attachments/accessories specified by the manufacturer.
12. Use only with the cart, stand, tripod, bracket, or table specified by the manufacturer, or sold with the device. When a cart is used, use caution when moving the cart/device combination to avoid injury from tip-over.
13. This product is equipped with a three-wire grounding-type plug, a plug having a third (grounding) pin. This plug will only fit into a grounding-type power outlet. This is a safety feature. If you are unable to insert the plug into the outlet, contact your electrician to replace your obsolete outlet. Do not defeat the safety purpose of the grounding-type plug.
14. Unplug this device during lightning storms or when unused for long periods of time.
15. Refer all servicing to qualified service personnel. Servicing is required when the device has been damaged in any way, such as power-supply cord or plug is damaged, liquid has been spilled, or objects have fallen into the device, the device has been exposed to rain or moisture, does not operate normally, or has been dropped.
16. **WARNING:** To reduce the risk of fire or electric shock, this device should not be exposed to rain or moisture and objects filled with liquids, such as a vase, should not be placed on this device.
17. To completely disconnect this equipment from the mains, disconnect the power supply cord plug from the receptacle.
18. The mains plug of the power supply cord shall remain readily operable.



1601 Jack McKay Blvd. • Ennis, Texas 75119 U.S.A.
Telephone: 800.876.3333 • Fax: 800.765.3435



WARNING When The Device Is In Use

- To prevent electric shock, do not remove the product cover as there are high voltage components inside. Refer all servicing to Atlas Sound.
- Should any of the following irregularities occur during use, immediately switch off the power, disconnect the power cord from the AC outlet and contact Atlas Sound. Do not attempt to continue operation with the product as this may cause fire or electric shock:
 - Smoke or strange smell coming from the unit.
 - If the product falls or the case is damaged.
 - If water or any metallic objects falls into the product.
 - If the power supply cord is damaged in any way.
 - If the unit is malfunctioning.
- Do not insert or drop metallic objects or flammable materials into the ventilation holes of the product's cover, as this may result in electric shock or fire.
- Do not place any containers with liquid or metallic objects on the top of the product. If any liquid spills into the unit, fire or electric shock may result.
- Never operate this product or touch the power supply cord during an electrical storm, electric shock may result.
- Never exceed the power rating on the product when connecting equipment. Fire and/or property damage may result.
- Operate the product only with the voltage specified on the unit. Fire and/or electric shock may result if a higher voltage is used.
- Do not modify, kink, or cut the power cord. Do not place the power cord in close proximity to heaters and do not place heavy objects on the power cord, including the product itself, doing so may result in fire or electrical shock.
- Ensure that the safety ground terminal is connected to a proper ground. Never connect the ground to a gas pipe as a catastrophic disaster may result.
- Be sure the installation of the product is stable, avoid slanted surfaces as the product may fall and cause injury or property damage.



CAUTION When Installing The Product

- Plugging in or unplugging the power cord with wet hands may result in electric shock.
- Never move the unit with the power cord plugged into the wall, as damage to the power cord may result.
- When unplugging the cord from the wall, grasp the plug, NOT the cord.
- Never install this product in humid or dusty locations, nor in direct sunlight, near sources of heat, or in areas where sooty smoke or steam are present. Fire and electric shock may result.
- Keep all sides of the unit at least 3½" away from objects that may obstruct air flow to prevent the unit's internal temperature rise.



CAUTION When The Product Is In Use

- Never place heavy objects on the product, causing it to fall and/or break, resulting in personal injury and property damage. In addition, the product itself may fall and cause injury and property damage.
- Contact Atlas Sound for instructions on cleaning the inside of the unit. Large accumulations of dust inside the unit may result in heat buildup and fire.
- Ensure that the power supply plug is securely plugged into the wall outlet. Never allow dust to accumulate on the power plug or inside the wall outlet.
- When cleaning the unit or the unit is not to be operated for an extended period, unplug the power cord from the wall.





Introduction

Thank you for purchasing the Atlas Sound ECS-6RM Intelligent AC Power Sequencer. The ECS-6RM (Electrical Controller Sequencer with Six Timing Sections with Remote Monitoring) modular system has been designed to meet most installation requirements for AC power distribution, equipment power conditioning and surge suppression protection. The compact 1RU unit features six sequential timing sections that can be activated at the unit or remotely. Up to three ECS-6RM units can be daisy chained together with independent trigger timing settings giving you a total of 18 sequence triggered outlets. The ECS-6RM unit is the activation controller/monitor portion of the system and requires a 120V AC Mains ECM (Electrical Controlled Module) for each triggered output. A variety of remote ECM AC modules are available to meet different installation requirements which are discussed later in this manual.

The ECS-6RM can also monitor up to six independent 20A AC main lines, both voltage and current readings can be viewed via the laboratory grade meters on the front panel. The ECS-6RM has built in intelligence that monitors the AC lines and will inform you of potentially damaging voltages. If the AC Mains voltage is between 101VAC and 107VAC or 128VAC and 132VAC the display will flash an error code indicating a potential fault has occurred and sensitive equipment should be checked. If an extreme voltage swing occurs above 128VAC or below 101VAC, the Extreme Voltage Shutdown (EVS) protection circuit will automatically turn all remote ECM modules off until the system is reset.

The ECS-6RM also features 6 sequenced independent relay contacts. The activation of the contacts works in parallel of the corresponding ECM triggered outputs. Sequence activation can be done locally or remotely via a DC voltage or by a switch. There are a variety of wall plates to choose from for remote activation. The ECS-KSW6 is ideally suited because of the remote channel monitoring it provides. The ECS-KSW6 can be placed up to 1000ft away from the ECS-6RM.

The ECS-6RM incorporates a Emergency Power Down (EPD) feature. The EPD may be required by the local fire codes to pass site inspection. When activated, this port turns off all channels at once.

To light your rack, the ECS-6RM has incorporated both front and rear XLR style sockets for the 16" gooseneck LED lamp. One AP-GNL18 lamp is included and an additional lamp can be purchased separately. LED lamps are far superior in longevity along with heat reduction when compared to traditional incandescent lamps and the XLR base mounts are more secure than the commonly used BNC type base.

The ECM modules have been designed to be flexible to meet a variety of AC power management requirements. The mating of the ECS-6RM to the ECM modules can be accomplished using any 5 conductor cable and can be placed up to 1000ft away. Each ECM module has an input DC voltage trigger of 5VDC, plus three low voltage data port connections for AC Mains monitoring. If AC outlets are required to be placed within the same rack as the ECS-6RM, the ECM-RACEWY6 raceway can house up to six ECM-20 or ECM-20M modules and six independent 20A AC 120V lines. For remote locations where single outlet turn On/Off and monitoring are required the ECM-15SH (15A) and the ECM-20SH (20A) can be a perfect fit. All ECM modules offer different and unique packaging designs and mounting options to assure they meet job requirements. Features of the ECM modules vary, allowing the customer to choose what is best for their installation.

All ECM modules feature AC spike suppression. AC Spikes, or Transients, are commonly caused by utility power plant grid switchovers. The amount of energy that can be injected into the power system can be immense with voltages reaching 6kV or amperage peaks of 3000A. These spikes are very fast and usually only last for a very short period of time. To protect against this potential problem incoming AC Mains have special suppression circuitry to eliminate the unwanted energy. This circuitry is very fast and can suppress unwanted energy within a nanosecond, while sustaining the suppression for up to 2 milliseconds, thus ensuring virtually trouble free protection. High and Low AC Main line voltages are another major contributor to equipment failures. The ECM modules support EVS circuitry which enables the module to be shut Off during Low and High AC Line conditions.

The ECM-20M, ECM-15, and ECM-20SH also feature noise filtering for unwanted Radio Frequency Interference (RFI) that is commonly introduced into the AC lines by nearby radio transmitters or wireless products. EMI filters are incorporated to reduce noise from Electromagnetic Interference (EMI) generated by items such as electric motors and switching power supplies. The benefit of these filters can be seen on video products or audibly by reducing static pops and external signal interference.

High line is also be known as surges. Surges usually are a slower, steady state rise in voltages ranging from 128VAC and up. They can be caused from fluctuations in the utility company's power lines or industrial equipment turning On and Off, and is on the same power leg of the building's incoming AC.



1601 Jack McKay Blvd. • Ennis, Texas 75119 U.S.A.
Telephone: 800.876.3333 • Fax: 800.765.3435



Low line is also known as brownouts. This happens when the AC Mains drops below 107VAC. Most of the time it is caused by the utility company not being able to supply enough power during heavy utility consumption time periods, such as heat waves.

Another factor would be from voltage drops in AC lines due to long transmissions. The ECS-6RM will inform you if any of these conditions occur. Extreme variances in Unstable AC Mains voltage are one of the main reasons for equipment failure.

The ECS-6RM offers Intelligent Sequenced Power Management control, making it the most flexible, effective power management protection system on the market today.

ECS-6RM Key Features

- 6 sequencer timing sections, 1,3, or 6 second intervals
- 6 independent ECM connections
- 6 independent contact closures
- Front panel digital AC Mains voltage and current meter
- Front and rear mounted XLR connector for 12VDC LED gooseneck lamp
- AP-GNL18 LED gooseneck lamp included, Qty 1
- External switch sequence trigger activation
- External DCV sequence trigger activation 5-24VDC
- Abnormal AC line voltage indicator for voltages between 101VAC - 107VAC or 128VAC - 132VAC
- Extreme Voltage Shutdown (EVS) below 101VAC or above 132VAC line
- EPD Emergency Power Down

ECM Module Key Features

- Manual/Auto On/Off switch
- Incoming AC present LED
- Active LED
- AC Fault LED
- Clamping spike and surge suppression EVS circuitry
- AC mains voltage and current monitoring (Voltage only for ECM-20)
- EMI & RFI filtering (Not in ECM-20)

Applications

The ECS-6RM was designed to be flexible with features that allow it to be used in a variety of applications. The sequenced outputs allow the turning of equipment On and Off in a particular order, to eliminate an inrush of current and audible pops that often occur with non-sequenced power strips. It also can be used solely for protection against voltage surges. If fuzzy video or frequent static pops occur, the AC power conditioning will eliminate or reduce those inconveniences. The following are just a few examples of applications in which the ECS-6RM can be used:

- Restaurants
- Houses of Worship
- Schools
- Home Theaters
- Office Buildings
- Sports Bars
- Industrial Facilities





Front Panel

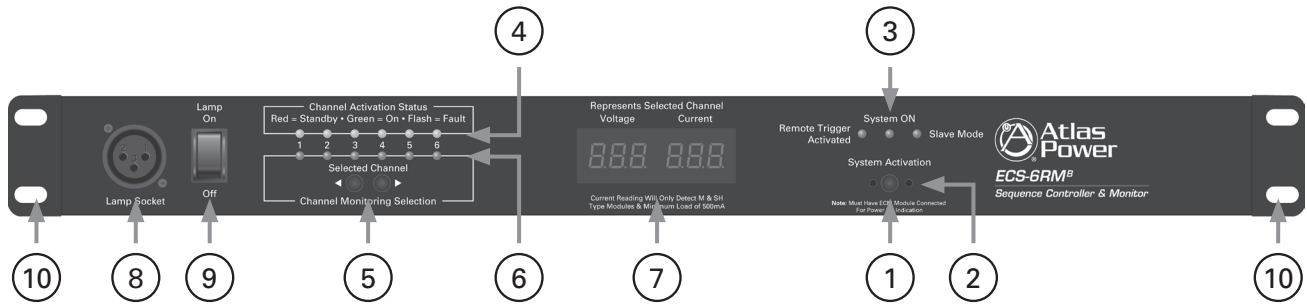

1. System Activation Switch

To activate or deactivate the system sequence, press the momentary switch once. There must be at least one ECM (Electrical Control module) connected for a sequence to occur. If there are no Channel Status LEDs illuminated or Voltage readings, no sequence will occur. The unit will only sequence through the number of ECM modules connected. **Note:** If there are ECM modules connected and the Channel Status LED are illuminated but the Activation Switch has no effect, the unit may be in External Trigger Mode. Refer to Channel Status LEDs and Relay Contacts sections.

2. System Activation Switch Security Cover

3. Unit Activation Mode LEDs

- System ON LED - When the ECS-6RM is activated the System ON LED will illuminate.
- Exterior Trigger Mode - If an External Trigger Voltage or Switch is applied to activate the ECS-6RM the Exterior Trigger Mode LED will be illuminated. **Note:** When LED is ON the System Activation switch is defeated.
- Slave Mode - When the Slave Mode LED is illuminated it indicates that there are more than one ECS-6RM connected to the trigger sequencing. Up to three ECS-6RM units can be connected in series. Refer to Rear Panel System Control for more details.

4. Channel Activation Status LEDs

There are six Bi-Color LEDs that represent Channels 1 thru 6 of the ECS-6RM. These LEDs indicate when there is AC voltage present or if there is an error within the AC Mains System.

- Red "Standby" - If a Channel on an ECM-20, ECM-20M, ECM-15SH or ECM-20SH module is connected to the ECS-6RM a Red LED will illuminate indicating that Channel is active and in Standby mode. If there are Channels of the ECS-6RM with no ECM modules connected, NO LED for that Channel will illuminate indicating NO CONNECTION (nC) has been established. **Note:** If the Channel is selected for monitoring has No CONNECTION the LCD display will read "nC".
- Green "ON" - When the ECS-6RM has been activated and sequencing is completed, the LED for the Channel with an ECM module connected will turn from Red to Green - indicating the ECM module is activated and operational.
- Red "Flashing" - If a fault in voltage occurs the ECS-6RM will shut the ECM module off and will report back to the ECS-6RM causing the Channel Activation LED to flash Red, indicating an error has occurred. Note: The LED will continue to flash until the voltage has stabilized at the ECM module and the ECS-6RM is reset. To reset the ECS-6RM, restart the sequencing. **Note:** It is also possible to have Channels flashing Red while others are operational with a steady Green LED. This is because an ECM-15SH or ECM-20SH can be placed on a different AC leg up to 1000ft away. Not all ECM modules may see the same error in AC Mains voltage thus allowing some ECM modules to remain operational.

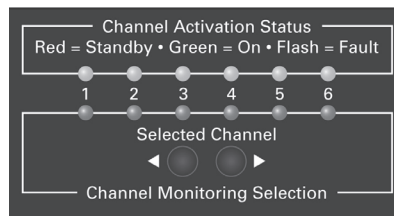
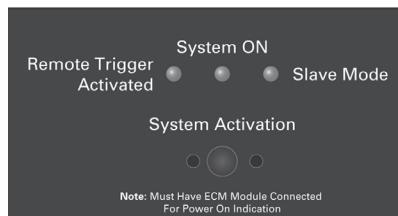

1601 Jack McKay Blvd. • Ennis, Texas 75119 U.S.A.
Telephone: 800.876.3333 • Fax: 800.765.3435



Front Panel

5. Channel Selection Switches

These push button switches allow the selection of the Channel to be viewed at the Voltage and Current Meter.

6. Channel Selected LEDs

There are six Channels in the ECS-6RM and only one Channel Voltage or Current can be viewed at a time. The Channel selected and being viewed is indicated by the illuminated LEDs.

7. AC Mains Voltage and Current Meter

There is only one Volt and Current Meter. There are up to six Channels of viewing required and to need to select the Channel you need to monitor. The Channel you are viewing will have a single LED illuminated. Refer to the Channel Select LED. The Voltmeter has a 2% accuracy tolerance and will indicate the Voltage present at an ECM module. For the Current reading to function an ECM-20M, ECM15SH or an ECM-20SH module must be connected. Also a minimum of 500mA of current draw must be at the ECM module for the ECS-6RM to read. Less than that the display will read "nA". The ECM-20 module has no current sensing circuitry, the Current display will also read "nA".

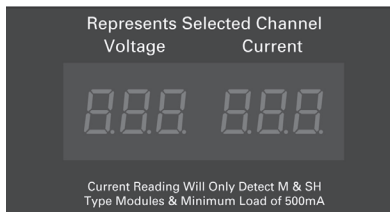

8. Light Socket

The XLR socket is used for the optional 12VDC AP-GNL18 LED Gooseneck Lamp. Note: This is not an audio connection.

9. Light On/Off Switch

This switch turns On or Off the voltage to the XLR lamp socket.

10. Adjustable and Removable Rack Mount Ears

The depth of the ECS-6RM can be adjusted to meet the requirements of the rack. Loosen the corresponding screws, set depth and retighten screws. The rack ears can also be removed.





Rear Panel

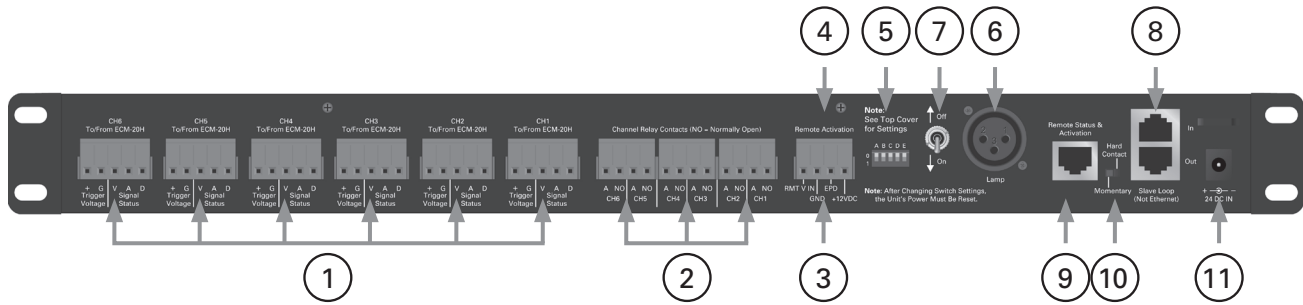

1. ECM Control Ports

Up to 6 AC Main circuits can be activated or monitored by the ECS-6RM. Each ECM control port connects to one of the following ECM modules: ECM-20M, ECM-15SH, ECM-20SH and the ECM-20. For connection between the ECS-6RM and an ECM module use a 5 conductor cable that is a minimum of 22 gauge wire. We suggest using CAT5 cable due to the common availability. Pay special attention to the port connections and **DO NOT MISS WIRE** or damage may occur. The distance between the ECS-6RM and an ECM module can be up to 1000ft.

(+) = 5VDC, G = Circuit Ground, V = AC Voltage Status Signal, A = AC Current Status Signal, D = Fault Status Signal, all signals are of low voltage and current

2. Relay Contacts

Each Channel of the ECS-6RM also has a Relay contact that works in conjunction with the ECM control port. Sequencing and timing of these connections are the same as the corresponding ECM channels. Example: Sequence 1 ECM Port output works at the same time as the CH 1 Relay contact. **Note:** All ECM modules can be trigger using the Relay contacts to activate the ECM module. See the ECM module manuals for details.

3. Remote Activation Connections

The ECS-6RM can be activated via five methods. Two of them are via the Remote Activation port. The others are via the Front Panel Activation Switch, Wall Plate switch and ECS-KSW6 Key Panel Switch.

- A. External Latching Switch (Contact Closure) - The ECS-6RM can be remotely activated from hundreds of feet away. A simple low voltage/current single contact latching switch can be applied to the two terminal Pin 1 (RMT V IN) and Pin 4 (+12VDC) on the Remote Activation port. When the two pins are shorted together the Front Panel Activation Switch is over ridden by the External Switch. The Remote Trigger Activation LED will illuminate on the Front panel indicating the status of the activation mode.

Using Hard (CC) Contact Closure

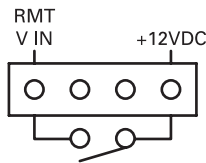

Remote Hard (CC) Contact Closure Switch
Note: Overrides Front Panel Activation Switch.



1601 Jack McKay Blvd. • Ennis, Texas 75119 U.S.A.
Telephone: 800.876.3333 • Fax: 800.765.3435



Rear Panel

3. Remote Activation Connections

- B. Remote DC Voltage Trigger** - The ECS-6RM can be remotely activated from hundreds of feet away using a DCV for activation. DC voltages ranging from 3V DC to 24V DC can be applied to the two terminal connections on the Remote Activation port marked "RMT V IN" and "GND". When these two points have the proper voltage applied, the unit will be active, when the DC voltage is removed the unit will shut off. When the proper DC voltage is applied the Front Panel Activation Switch is overridden. The Remote Trigger Activation LED will illuminate on the Front panel indicating the status of the activation mode.

Using DCV

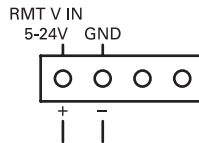

From External DC Source

Note: Overrides Front Panel Activation Switch.

- C. Front Panel Activation Switch** - See Front Panel Activation Switch for details.

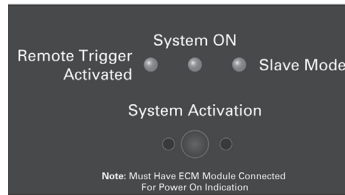

- D. Remote Control Key Switch ECS-KSW6** - This is an optional accessory item that allows you to activate, lock out, and monitor the system from up to 1000ft away. See the ECS-KSW6 manual for details.

Remote Status and Activation

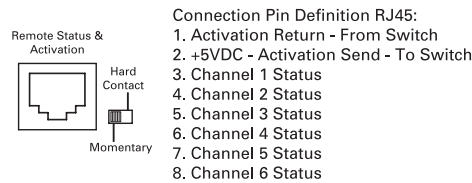

Note: This control port is to be used with Atlas model ECS-KSW6 wall plate key switch. The ECS-kSW6 is a momentary switch type device. Place the side switch next to the control port in the Momentary position. Other wiring and status monitoring can be done. Refer to the manual for details

- E. Remote Switch with LED** - This is an optional accessory item that allows you to activate the system from up to 1000ft away. You can choose the switch contact type with either Momentary (MM) or Hard latching (CC). A rear panel; selection switch allows you to choose. We suggest you use Channel one Status LED to connect to the wall plate.

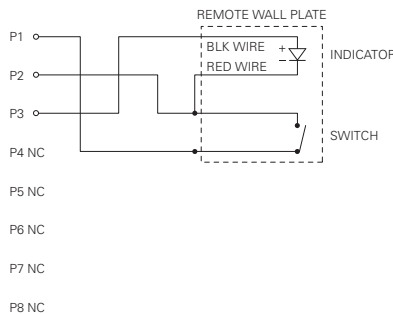

1601 Jack McKay Blvd. • Ennis, Texas 75119 U.S.A.
Telephone: 800.876.3333 • Fax: 800.765.3435



Rear Panel

4. Emergency Power Down

The Emergency Power Down may be required by the local fire codes to pass site inspections. When activated, this port turns off all channels at once. To activate an EPD, short P2 (GND) and P3 (EPD) together. To restart a sequence, the EPD pin must be released from Ground.

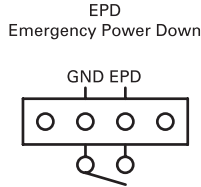

Remote Hard (CC) Contact Closure Switch
Note: When Control Port Pins are Shorted,
 All Outputs Turn Off Together.
 Release and Start a New Sequence.

5. System Configuration Switch Settings

Up to three ECS-6RM units can be daisy chained together giving you 18 sequenced outputs. To do so you need to set the timing sequence of each unit. There are five dip switches that determine the position of the unit and the delay between sequencing. Follow the steps for setup.

1. Master or Slave Unit - Determine if you daisy chaining two or three units together. Choose the position of the sequence in perspective to the equipment you are activating. The first unit will be known as the Master Unit, all others are Slave Units. Switches A & B determine the position of the unit and sequence timing. Follow the chart below and on the back of the ECS-6RM for the settings. When a unit is selected as a Slave Unit the Front Panel Slave Mode LED will illuminate. Also follow the System Control Port section below for unit daisy chain connection. **Note:** After changing a setting the unit power must be reset for the changed settings to take effect.
2. Delay Time Switches - The ECS-6RM has three timing settings between each sequence, 1 Second, 3 Seconds and 6 Seconds. Follow the chart for the settings for Switches C & D. When daisy chaining multiple units together each unit's settings only relate to that individual unit. Therefore, each unit can be different or all can have the same setting. **Example:** Unit One for 3 Seconds, Unit Two for 1 Second, and Unit Three for 6 Seconds. **Note:** After changing a setting the unit power must be reset for the changed settings to take effect.
3. Auto EVS Bypass Switch - The Extreme Voltage Shutdown (EVS) has two settings to meet your install requirements. The selection of the settings are via switch E and effects all six channels. When set to (0) "Auto Reset" the EVS circuit will trigger an ECM shutdown when an extreme voltage condition occurs and will auto reset when the AC Mains voltage has stabilized. When set to 1 "Manual Reset" the EVS circuitry will trigger a shutdown during an extreme voltage condition and will not turn back on unless the unit is manually turned on. See EVS feature definition for details. **Note:** After changing a setting the unit power must be reset for the changed setting to take effect.

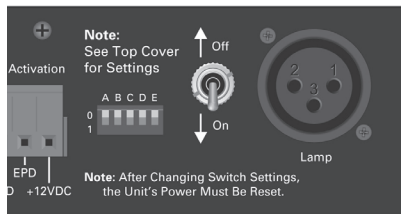

System Configuration Switch Settings							
A B C D E	System			Delay Time			
		Master	Slave 1	Slave 2	1 Sec	3 Sec	6 Sec
0	□	□	□	□	□	□	□
1	□	□	□	□	□	□	□
EVS (Extreme Voltage Shutdown)							
E	0	Auto Reset					
E	1	Manual Reset					

Note: After Changing Switch Settings, the Unit's Power Must Be Reset.



1601 Jack McKay Blvd. • Ennis, Texas 75119 U.S.A.
 Telephone: 800.876.3333 • Fax: 800.765.3435



Rear Panel

6. Light Socket

The XLR socket is used for the optional 12VDC AP-GNL18 LED Gooseneck Lamp. **Note:** This is not an audio connection.

7. Light On/Off Switch

This switch turns On or Off the voltage to the XLR lamp socket.

8. System Control In/Out Ports

These ports are used when daisy chaining more than one ECS-6RM together. Up to three units can be connected in series. Connection is via a RJ45 connector. A common Ethernet cable can be used. **Note:** This is not a IP Ethernet port and is only used for ECS-6RM connectivity between units. Distance between units can be several feet apart. Start with the Master Unit by connecting to the "OUT" connector port and then into the first Slave units "IN" connector port.

9. Remote Control Key Pad Port

This port is be used with the ECS-KSW6 Remote Key Switch / System Status Plate. This is an optional accessory item that allows activation, lock out, and monitoring of the AC Mains system from up to 1000ft away. See Remote ECS-KSW6 for details. Connection is via an RJ45 connector. A common Ethernet cable can be used. **Note:** This is not an IP Ethernet port and is only used for connectivity between ECS-6RM and the ECS-KSW6 units. Wiring of this connector is the same as an Ethernet cable. **DO NOT MISS WIRE** the connector or damage may occur.

10. Remote Control Key Pad Selection Type Switch

The control port can be configured to be used with a Momentary type switch witch mimics the front panel Activation Switch or a Hard latching type switch which overrides the front panel Activation Switch.

11. DC Power In

The ECS-6RM comes with a universal power supply that operates from 100VAC - 240VAC. The 24VDC output connects to the DC input jack. A cable tie can be used with the slot above the DC jack to secure the cable to the chassis.

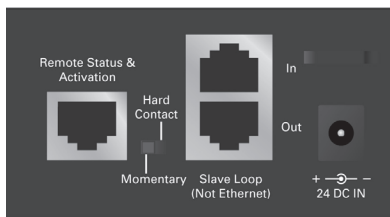

ECM Data and Wire Distance

There are six ECM control ports on the ECS-6RM and up to 6 ECM Modules can be connected to the ECS-6RM. The four different types of ECM Modules require the same interface connectivity to the ECS-6RM. All ECM Modules can be interchanged with the ECS-6RM. For connection between the ECS-6RM and an ECM module use a 5 conductor cable that is a minimum of 22 gauge wire. We suggest using CAT5 cable due to the common availability and low cost. Pay special attention to the port connections and **DO NOT MISS WIRE** or damage may occur. The distance between the ECS-6RM and the ECM Module can be up to 1000ft.

There are four different types of ECM Modules that require the same interface connectivity to the ECS-6RM. All ECM Modules can be interfaced with the ECS-6RM. For connection between the ECS-6RM and an ECM module, use a 5 conductor cable that is a minimum of 22 gauge wire. We suggest using CAT5 cable due to the common availability and low cost. Pay special attention to the port connections and **DO NOT MISS WIRE** or damage may occur. The distance between the ECS-6RM and the ECM Module can be up to 1000ft.

ECM Module Activation Without Using an ECS-6RM or ECS-3 Controller

Any of the ECM-20, ECM-20M, ECM-15SH or the ECM-20SH Modules can be triggered to activate without using an ECS type Controller. Any DCV supply will activate the ECM by applying DCV 5-24VDC to the "+" and "GND" terminals. An external switch will also activate an ECM by applying a contact to short terminals "+" and "D" together. Note: the EVS and Voltage monitoring will be disabled using either of these methods.



1601 Jack McKay Blvd. • Ennis, Texas 75119 U.S.A.
Telephone: 800.876.3333 • Fax: 800.765.3435



ECM Module Features

- EMI / RFI Filters - ECM filters for noise and unwanted Radio Frequency Interference (RFI) that are commonly introduced in the AC lines by nearby radio transmitters or wireless products. EMI filters are incorporated to reduce noise from Electromagnetic Interference (EMI) from such items as electric motors and switching power supplies. The benefit of these filters can be seen on video products or audibly by reducing static pops and external signal interference.
- AC Spike Protection - ECM modules feature AC spike suppression. AC Spikes, or Transients, are commonly caused by utility power plant grid switchovers. The amount of energy that can be injected into the power system can be immense with voltages reaching 6kV or amperage peaks of 3000A. These spikes are very fast and usually only last for a very short period of time. To protect against this potential problem incoming AC Mains has special suppression circuitry to eliminate the unwanted energy. This circuitry is very fast and can suppress unwanted energy within a nanosecond, while sustaining the suppression up to 2 milliseconds, thus ensuring virtually trouble-free protection.
- AC Surge Protection - High line can also be known as surges. Surges usually are a slower steady state rise in voltages ranging from 128VAC and up. They can be caused from fluctuations in the utility company's power lines, industrial equipment turning On and Off, and is on the same power leg of the building's incoming AC.
- EVS Protection - If an ECM Module is connected to the ECS-6RM, the ECS-6RM has built-in intelligence that monitors the AC lines from the ECM modules and will inform you of potentially damaging voltages. If the AC Mains voltage is between 101VAC and 107VAC or 128VAC and 132VAC the display will flash an error code indicating a potential fault has occurred and sensitive equipment should be checked. If an extreme voltage swing occurs above 128VAC or below 101VAC, the Extreme Voltage Shutdown (EVS) protection circuit will automatically turn all remote ECM modules Off until the system is manually reset. The EVS feature can be defeated if required via the ECS-6RM EVS bypass switch.
- Over Current Protection - In the case of excessive current draw at the ECM module. An internal Slow Blow fuse will open protecting the devices plugged into the ECM module. **Note:** This fuse must be changed by a qualified service technician.

ECM Indicator and Part Description

- A. Trigger / Status Port Pin Identification - All signals are of low voltage and current. **DO NOT MISS WIRE** or damage may occur.
1. (+) requires a minimum of 5-24V DC to activate the module with 5mA of current. **Note:** The DCV can be supplied from any source. The EVS protection requires the ECS-6RM for operation.
 2. G = Circuit Ground, Must be of the same circuit as the DCV source.
 3. V = AC Voltage Status Signal, this signal reports back to the ECS-6RM the Incoming AC Mains Voltage to the ECM module.
 4. A = AC Current Status Signal, this signal reports back to the ECS-6RM the AC Mains Current draw at the ECM module.
 5. D = Fault Status Signal, reports to the ECS-6RM fault conditions of an ECM module.
- B. External Trigger / Manual On Switch - The ECM-15SH, ECM-20SH, and ECM-20M have a manual override switch allowing them to be used as a local Power Conditioner and Surge Suppressor. For it to be remotely monitored and activated the switch must be in the "External Trigger" position.
- C. Incoming AC LED - This LED will illuminate Red when the ECM has incoming AC power present at the module. This LED must be on to operate. **Note:** If this LED is not illuminated check the following 1) The unit is plugged in, 2) The AC Mains Breaker feeding the AC leg to the ECM module is Off, 3) The internal fuse has been damaged. This should only be inspected by an authorized technician.
- D. Active LED - This LED will illuminate Green when the ECM module has sensed the proper DCV to trigger activate the power on circuit. **Note:** If connected to the ECS-6RM and the EVS circuit is activated this LED will not be On. The Channel Status LED on the ECS-6RM will flash indicating a problem and will not turn the ECM module On until the AC Mains voltage is stable.
- E. AC Fault LED - If damage to the Spike Suppression circuit occurred this LED will illuminate RED. The module may still operate but may not be protecting the items plugged into the AC outlets. This LED will not turn Off until repaired. Have the ECM module inspected by a qualified technician.
- F. AC Mains Outlet - Two 120V AC 15A outlets (ECM-15SH) 20A (ECM-20SH/ECM-20/ECM-20M).
- G. AC Mains Power Cord - 9ft (3m) 120V 15A (ECM-15SH) 20A (ECM-20SH).
- H. Mounting Bracket - There are two adjustable mounting brackets incorporated. There are three screws per side for bracket placement. Each bracket has a slide slot to allow mounting height adjustment.



1601 Jack McKay Blvd. • Ennis, Texas 75119 U.S.A.
Telephone: 800.876.3333 • Fax: 800.765.3435



ECS-6RM Accessory Items

AP-GNL18 - LED Gooseneck Lamp

The Atlas Power AP-GNL18 is an optional Gooseneck LED Lamp and works with any of the Atlas Power 12V DC XLR base mount connectors. The length of the gooseneck is 16".



ECM-15SH Standalone 15A Power Conditioner and AZ Spike Suppressor

This Electrical Control Module (ECM) is a 15A Power Conditioner and AC Spike Suppressor model is designed to be a standalone Single Housing (SH) unit that can be placed up to 1000ft away from the ECS-6RM. To make full use of the ECM-15SH features, the ECM must be connected to the ECS-6RM controller to activate features such as AC Mains voltage monitoring, load current monitoring, and Extreme Voltage Shutdown (EVS).

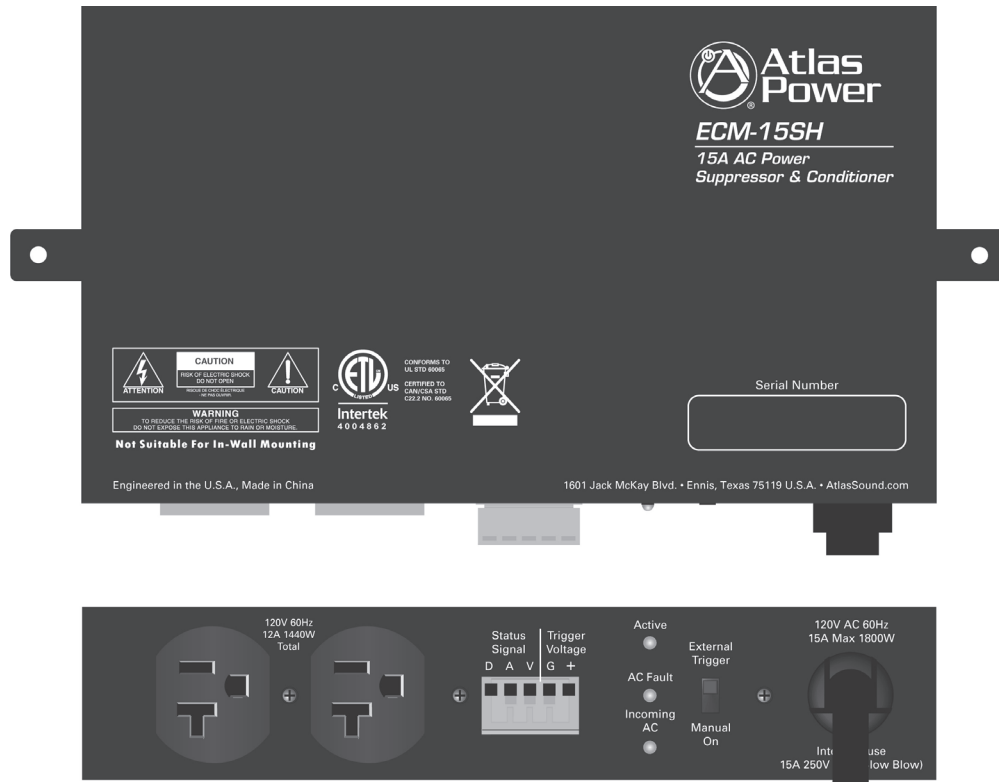

1601 Jack McKay Blvd. • Ennis, Texas 75119 U.S.A.
Telephone: 800.876.3333 • Fax: 800.765.3435



ECS-6RM Accessory Items

ECM-20SH Standalone 20A Power Conditioner and AC Spike Suppressor

This Electrical Control Module (ECM) is a 20A Power Conditioner and AC Spike Suppressor model is designed to be a standalone Single Housing (SH) unit that can be placed up to 1000ft away from the ECS-6RM. The ECM-20SH has several advanced features incorporated, refer to the individual data sheet for full instructions and specifications on the module. Many of the ECM-20SH features and connections are the same as the ECM-15SH. The ECM-20SH has two sets of mounting tab rails. These rails are designed to be breakaway if they are not needed. Simply bend the tab back and forth until the tab breaks away.

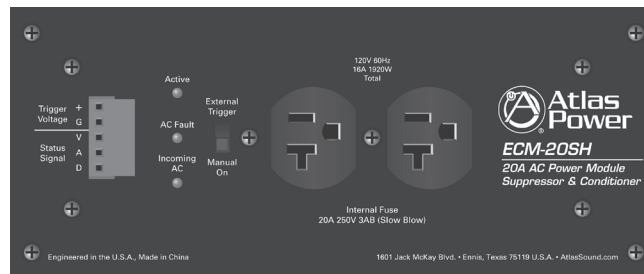

ECM-20M 20A AC Control Module

The features, data wiring and the functionality of the ECM-20M are the same as the ECM-20SH and the ECM-15SH. Read above for operation details. The ECM-20M is intended for use in the ECM-RACEWY6 and not as a single housing unit.

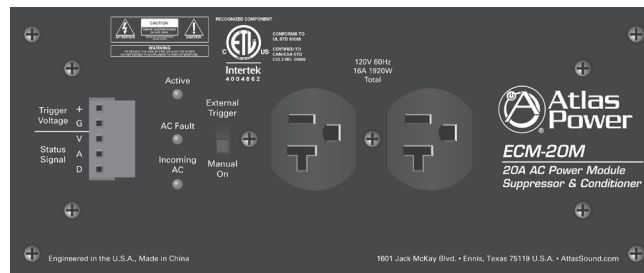

ECM-20 20A AC Control Module (No Current Monitoring)

The ECM-20 does not support the same Current monitoring or EMI/RFI Filter feature as the ECM-20M, ECM-20SH and the ECM-15SH models have. However, it does support AC Spike and Surge Suppression, AC Mains Voltage monitoring, EVS circuitry and Remote Activation.

In certain applications Atlas Sound suggests using an ECM-20 Module vs. an ECM-20M like in places where some of the features would be redundant because of the electrical location of the ECM module. There would be a cost savings to use a less expensive ECM module where redundant circuitry is not needed.

Example: One 20A Incoming AC line, Two sequenced AC outlets are required, Use one ECM-20M and one ECM-20 module wired in parallel. **Explanation:** If the AC Mains system required a sequence outlet and did not require more than 20A of service for a portion of the AC power system, a ECM-20M module can be placed in parallel with an ECM-20M module. It is not necessary to have amperage readings from both ECM Modules because you can read the current from the ECM-20M Module. It could be in parallel with a ECM-20 Module instead since it's on the same incoming AC line as the ECM-20M. They would have the same current reading because they are in parallel. Also, the EMI and RFI filtering are across the same AC line leg, so both ECM Modules connected to that line are filtered, no need to have redundant filtering. **Note:** In this wiring configuration you still get the Voltage monitoring to see if the module is active and have extra surge protection. See ECM Module wiring configurations.



1601 Jack McKay Blvd. • Ennis, Texas 75119 U.S.A.
Telephone: 800.876.3333 • Fax: 800.765.3435



ECS-6RM Accessory Items

ECM-RACEWY6 ECM Housing

The ECM-20 and ECM-20M require an electrical housing. The ECM-RACEWY6 holds up to six ECM modules. There are standard ¾" and 1" electrical knockouts on the bottom of the raceway to support standard electrical mounting hardware. Since the Raceway can house six ECM modules there can be six separate 20A AC legs coming into the Raceway for a total of 120A of power distribution. It could also be as simple as one 20A leg. **Note:** All electrical wiring must be done by a certified electrician.

All cover plates must be secured tightly. There shall be no open slots. Blank cover plates are available. Top and bottom mounting tabs are incorporated to mount inside an Atlas Rack. All rack mount rails are designed to be breakaway, if they are not needed. Simply bend the tab back and forth until the tab breaks away. Be careful of sharp edges.



ECM-3BP Module Cover Plate

The ECM- RACEWY6 can hold up to six ECM Modules, however it is OK to use less than six. The open slots on the ECM-RACEWY6 can be covered up using an ECM Module Blank Plate cover. Two of these are included with the ECM-RACEWY6. If not needed, discard them. If additional Blank Plates are required they can be purchased in packages of three.

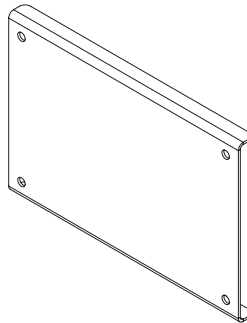

ECM-ACIN Wire Kit

Atlas offers a wire kit of standard 12 gauge UL wire for wiring the ECM-20 Modules together plus additional length for wiring the incoming AC to an AC Mains panel. 140" of each color of Green, White and Black are included. **Note:** As a reference, it takes around a foot of wire between ECM-20 modules if they are wired on the same incoming AC Main. It is highly recommended that you carefully measure the wire needed for the job. It may take more than one ECM-ACIN wire kit depending on many AC Mains and the distance from the AC Mains Panel. It is not necessary to use Atlas ECM-ACIN wire kit as long as the wire used is 12 gauge and UL listed.





ECS-6RM Accessory Items

ECS-KSW6

The ECS-6RM can be remotely activated with each channel being monitored by using the ECS-KSW6 control panel. This panel can be placed several hundred feet away from the ECS-6RM controller. A Keyed On / Off switch is provided for security. There are six Bi-Color LEDs on the ECS-KSW6 panel. One LED for each of the six sequenced channels of the ECS-6RM. These LEDs mimic the Channel Activation LEDs that are on the front of the ECS-6RM panel. Please refer to that section for complete details. Wiring the ECS-KSW6 panel requires an RJ45 connector and 8 conductors. **Note:** This is not an IP Ethernet port and is only used for connectivity between ECS-6RM and the ECS-KSW6 units. Wiring of this connector is the same as an Ethernet cable. **DO NOT MISS WIRE** the connector or damage may occur.

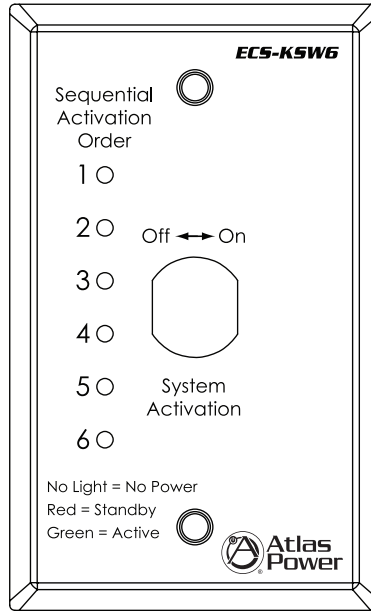

Remote Status and Activation

Remote Status & Activation

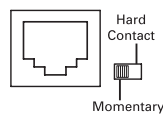

Connection Pin Definition RJ45:

- 1. Activation Return - From Switch
- 2. +5VDC - Activation Send - To Switch
- 3. Channel 1 Status
- 4. Channel 2 Status
- 5. Channel 3 Status
- 6. Channel 4 Status
- 7. Channel 5 Status
- 8. Channel 6 Status

Note: This control port is to be used with Atlas model ECS-KSW6 wall plate key switch. The ECS-kSW6 is a momentary switch type device. Place the side switch next to the control port in the Momentary position. Other wiring and status monitoring can be done. Refer to the manual for details



1601 Jack McKay Blvd. • Ennis, Texas 75119 U.S.A.
Telephone: 800.876.3333 • Fax: 800.765.3435



ECM-6RM Wiring Configuration

Example 1: ECS-6RM wired to six ECM-20 or ECM-20M Modules using an ECS-KSW6 for remote activation.

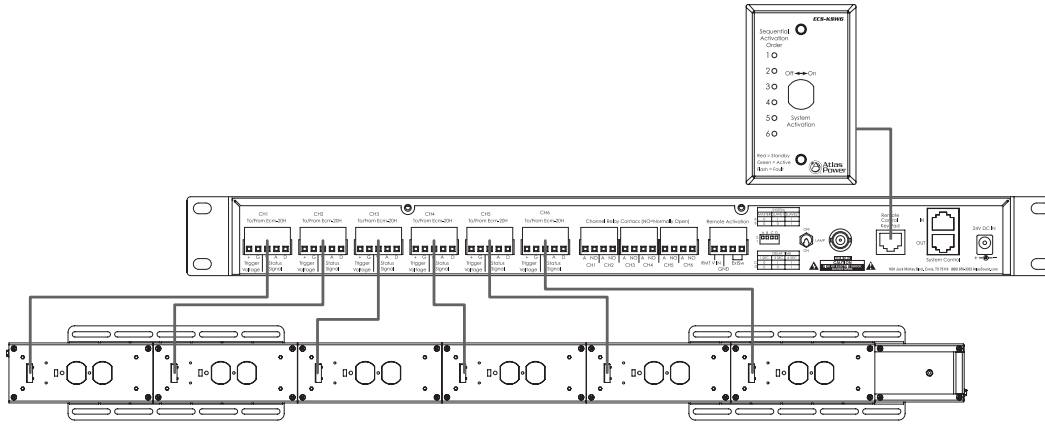

Example 2: ECS-6RM wired to six ECM-20 or ECM-20M Modules using DCV 5-24V or a Switch for remote activation.

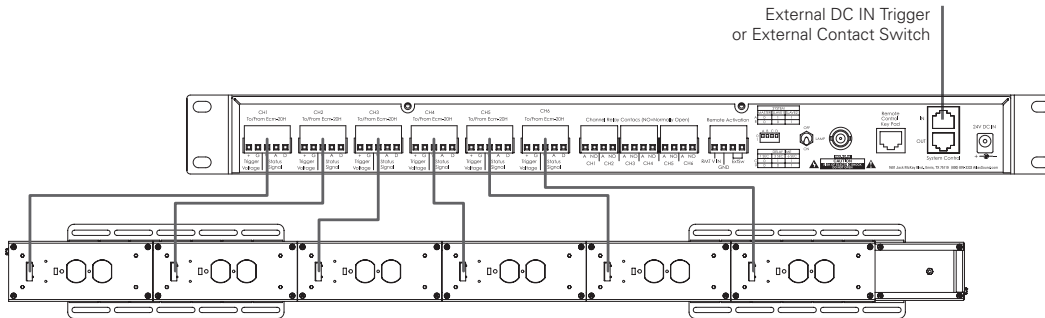

1601 Jack McKay Blvd. • Ennis, Texas 75119 U.S.A.
Telephone: 800.876.3333 • Fax: 800.765.3435



ECM-6RM Wiring Configuration

Example 3: Three ECS-6RM wired to 18 ECM-20 or ECM-20M Modules.

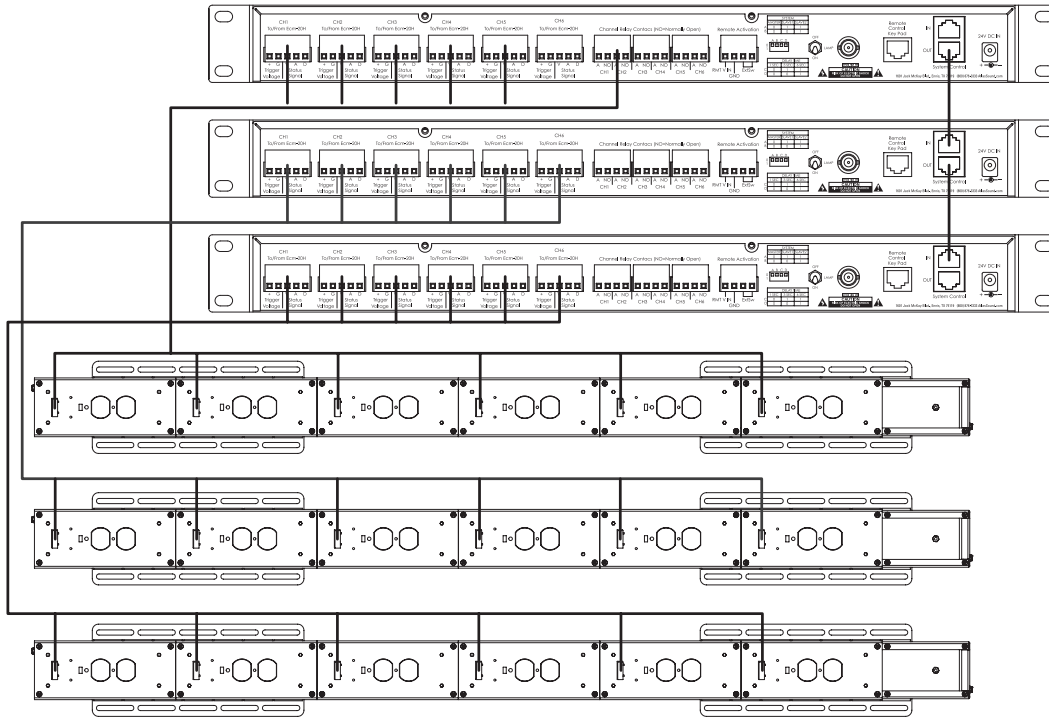

Example 4: ECS-6RM wired to 4 ECM-20 or ECM-20M Modules that are in the ECM-RACEWY6 and a separate ECM-15SH and ECM-20SH housing.

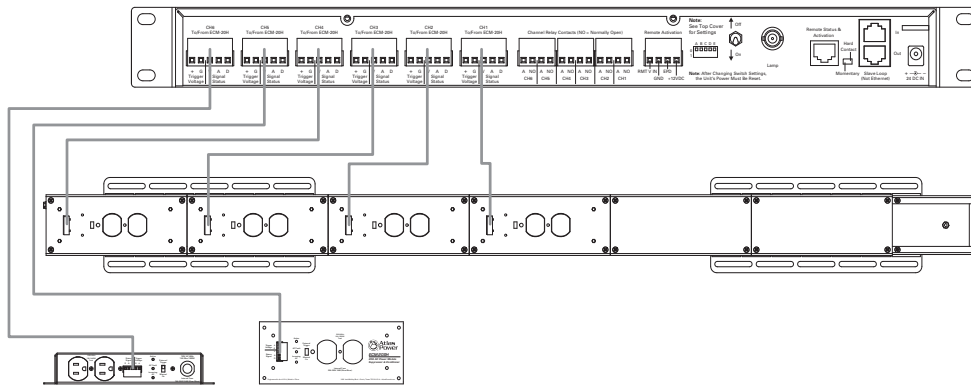

1601 Jack McKay Blvd. • Ennis, Texas 75119 U.S.A.
Telephone: 800.876.3333 • Fax: 800.765.3435



ECM-20/M Module Wiring Configuration

The ECM-20/M is designed to be mated with the ECM-RACEWY6 housing and the ECS-6RM controller. The specific job install AC power requirements and power distribution layout will dictate how the ECM-20/M Modules are wired into the Raceway. Each ECM Module can be wired as a single 20A run or in a parallel configuration as illustrated below. Each ECM module has dual 3-position screw terminal blocks that in parallel and are clearly labeled as follows:

ECM Module PCB Labeling for Incoming AC Mains:

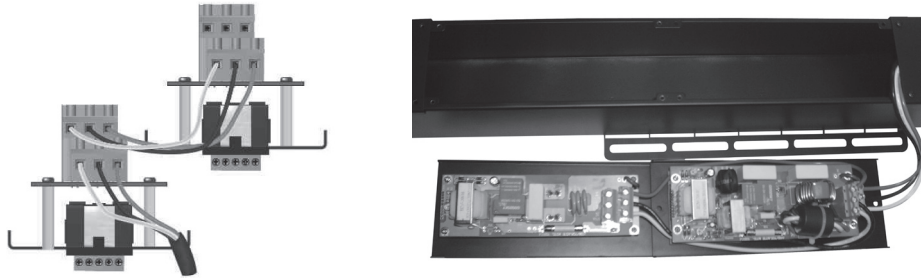

Note: The above figure shows the ECM wiring configuration of one 20A AC main line coming into an ECM-20M, then paralleling with an ECM-20 type module. It appears that the wiring is in series but the ECM Module In/Out terminals are in parallel on the PCB.

Example 1: ECM wiring configuration showing one 20A AC main line coming into a ECM-20M then paralleling with 5 ECM-20 type modules. **Note:** It appears that the wiring is in series but the ECM Module In/Out terminals are in parallel on the PCB.

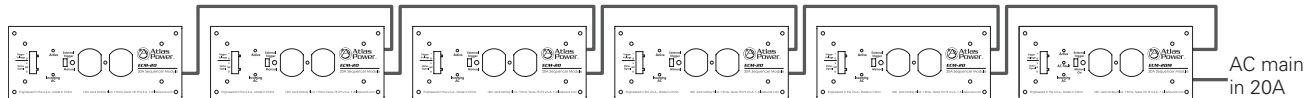

Example 2: ECM wiring configuration showing two 20A AC main line coming into the Raceway for a total of 40A available. The 20A legs are separated by feeding a 20A leg to two different ECM-20M Modules. The leg is then paralleled with two ECM-20 type modules. **Note:** It appears that the wiring is in series but the ECM Module In/Out terminals are in parallel on the PCB.

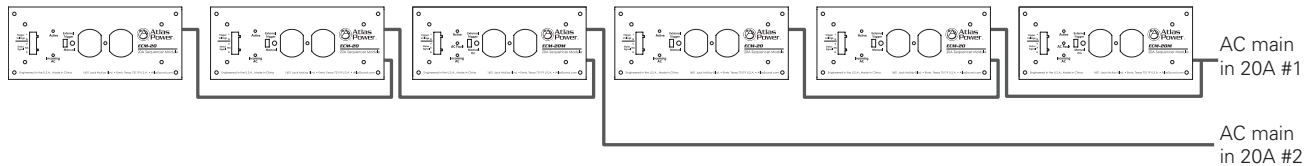

Example 3: ECM wiring configuration showing one 20A AC main line coming into 6 ECM-20M type modules. Note: It appears that the wiring is in series but the ECM Module In/Out terminals are in parallel on the PCB.

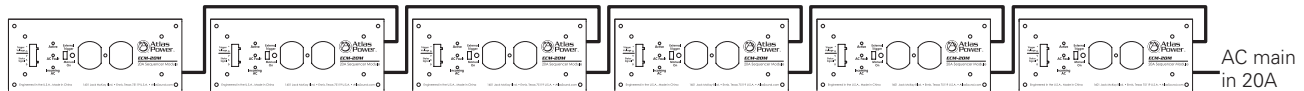

1601 Jack McKay Blvd. • Ennis, Texas 75119 U.S.A.
Telephone: 800.876.3333 • Fax: 800.765.3435



Troubleshooting

Note: ALL TROUBLESHOOTING SHOULD BE DONE BY A CERTIFIED ELECTRICIAN

Issue 1 - ECM Module Incoming AC LED is not illuminated.

Possible Cause 1

Incoming AC Mains circuit breaker has tripped due to excessive load.

Action Needed

Check the AC outlet that the ECM is plugged into for 120V AC voltage. If no voltage is present, check to see if the AC outlet is on a GFI that has been tripped. If it has not been tripped, trace the AC Mains outlet back to the electrical panel and check the AC Mains breaker to see if it is tripped.

Possible Cause 2

If the AC Mains is correct (120V), internal 15A (ECM-15SH) and 20A (ECM-20, ECM-20m, ECM-20SH) Slow Blow fuse is blown.

Action Needed

Open ECM unit and replace the fuse with a Slow Blow type.

Issue 2 - ECM Module AC Fault LED is illuminated.

Possible Cause

Although the Clamping Suppression circuit virtually assures protection from most transient voltage spikes and surges, nature has a way of occasionally creating electrical forces that are beyond the capabilities of any device to absorb without some degree of damage. In the rare instance that this occurs, the clamping circuit can be damaged during the suppression.

Action Needed

The unit will need to be repaired or replaced. It is important to have all equipment that was connected to that AC Mains Line to be inspected for proper operation.

Issue 3 - ECM Module is set to External Trigger, the Incoming AC LED is illuminated but the Active LED is not illuminated.

Possible Cause 1

External DCV from the ECS-6RM is not connected across the "+" and "G" terminals.

Possible Cause 2

External DCV voltage polarity is not correct across the "+" and "G" terminals.

Possible Cause 3

External DCV voltage is too low to activate the trigger circuit. Must be a minimum of 5vDC to activate the ECM Module. Possible short in the wiring.

Issue 4 - ECM Active LED is not illuminated but the Incoming LED is. The Abnormal LED on the ECS-6RM voltage display is flashing "OL" and the ECS-6RM Channel that is activating the ECM Module Green Status LED is flashing.

Possible Cause

The AC Mains Voltage exceeded 127VAC or the voltage dropped below 107VAC activating the "EVS" shutdown.

Action Needed

The ECS-6RM must be re-sequenced to reset the circuit. Measure the AC mains before the ECM module. If the voltage is between 117VAC and 123VAC you may proceed to reset the ECS-6RM by restating the start up sequence. **Note:** It is important to have all equipment that was connected to that AC Mains Line to be inspected for proper operation. If the problem persists, contact your local power company for the cause of unstable AC line conditions.



1601 Jack McKay Blvd. • Ennis, Texas 75119 U.S.A.
Telephone: 800.876.3333 • Fax: 800.765.3435



Troubleshooting

Issue 6 - No Voltage Reading at the ECS-6RM.

Possible Cause 1

Check issues 1 - 4 first.

Possible Cause 2

Proper Channel is not selected for viewing.

Possible Cause 3

Channel Activation LED is illuminated Green but the Voltage display is not on. Check the wiring between the ECS-6RM Channel and the ECM module. "V", "A" and "D" must be in the correct polarity.

Issue 7 - No Current Reading at the ECS-6RM, meter reads "nA".

Possible Cause 1

An ECM-20 Module is connected. This module does not support current read out.

Possible Cause 2

Check issues 1 - 4 first.

Possible Cause 3

Current Draw of ECM Module must exceed 500mA to register.

Possible Cause 4

Proper Channel is not selected for viewing.

Possible Cause 5

Channel Activation LED is Illuminated Green but the Current display reads "nA". Check the wiring between the ECS-6RM Channel and the ECM module. "V", "A" and "D" must be in the correct polarity.

Issue 8 - Not all Channel Status LEDs are illuminated Red or Green.

Possible Cause

No ECM Module is connected to the ECS-6RM. Note: For any of the six Channel Status LED to illuminate a ECM Module must be connected to the ECS-6RM. It is OK to use only some of the six channels and not have all LEDs illuminated.

Issue 9 - Sequence timing or Slave/Master Unit Dip Switches have been adjusted but no effect has taken.

Possible Cause

After changing the DIP switches you must cycle the ECS-6RM for the settings to take effect.

Issue 10 - Current Meter reads "nA" on a selected channel but the channel is functioning.

Possible Cause 1

ECM-20 module connected. Only ECM-20M, ECM-15SH and ECM-20SH module support the current read out circuitry.

Possible Cause 2

The "A" terminal wire is not connected.

Possible Cause 3

The correct module type is connected, but there is not enough current being drawn to register. **Note:** It takes .7A for current draw from the ECM module for a reading.





Specifications

Type	Power Sequencer Controller
Sequencer Sections	6
Relay Sections	6
Sequence Timing	Unit Settings of 1, 3, or 6 Seconds
Unit Link	3
Power Supply	External Wide Range 100V - 240VAC, UL Approval
Power Consumption	0.8W
RoHS Compliant	Yes

Front Panel

Lights	XLR Socket to Provide 12VDC for Optional 16" Gooseneck Lamp AP-GNL18
LED Light Switch	Two Position On / Off
Activation Switch	Momentary
AC Mains Voltmeter	Three Digits Digital
AC Mains Current Meter	Three Digits Digital
Indicators	System On, External Trigger Mode, Slave Mode
Channel Selection	Momentary Switches
Channel Selected Indicator	Single LED per channel, total six LEDs
Activation Indicators	Six Bi-Color LEDs, one for each Channel

Rear Panel

Sequenced Activation / Status Signal Port	Six Channel Interconnect Port. Trigger Out and Status Signal Return, Euro / Phoenix type connector
Remote Activation Trigger	5 - 24VDC Continuous 10 mA, Switch Contacts, Euro / Phoenix Type Connector
Sequenced Relay Contacts	Six Channels, Single Relay Contact SPST Each Channel, Euro / Phoenix Type Connector
Sequence Time Selection	Setting 1, 3, or 6 Seconds, Dip Switch Select
System Master/Slave Assignment	Master, Slave Unit 1, Slave Unit 2, Dip Switch Select
System Control Loop In/Out	One IN Control Port, One Loop OUT Control Port, for Slave or Master, Three units can be linked, Connector RJ45 (Not an Ethernet Connection)
EVS Bypass	Extreme Voltage Shut Off Auto Reset or Manual Reset
Emergency Power Down (EPD)	Requires Hard Switch Contact Closure
LED Light Socket	XLR Socket to Provide 12VDC for Optional 16" Gooseneck Lamp
LED Light Switch	Two Position On / Off
DC Input Jack	External Power Supply, Wide Range 100V - 240VAC, 20V DCV, UL Listed.



**Atlas
Sound**

1601 Jack McKay Blvd. • Ennis, Texas 75119 U.S.A.
Telephone: 800.876.3333 • Fax: 800.765.3435



Limited Warranty

All products manufactured by Atlas Sound are warranted to the original dealer/installer, industrial or commercial purchaser to be free from defects in material and workmanship and to be in compliance with our published specifications, if any. This warranty shall extend from the date of purchase for a period of three years on all Atlas Sound products, including SOUNDOLIER brand, and ATLAS SOUND brand products except as follows: one year on electronics and control systems; one year on replacement parts; and one year on Musician Series stands and related accessories. Additionally, fuses and lamps carry no warranty. Atlas Sound will solely at its discretion, replace at no charge or repair free of charge defective parts or products when the product has been applied and used in accordance with our published operation and installation instructions. We will not be responsible for defects caused by improper storage, misuse (including failure to provide reasonable and necessary maintenance), accident, abnormal atmospheres, water immersion, lightning discharge, or malfunctions when products have been modified or operated in excess of rated power, altered, serviced or installed in other than a workman like manner. The original sales invoice should be retained as evidence of purchase under the terms of this warranty. All warranty returns must comply with our returns policy set forth below. When products returned to Atlas Sound do not qualify for repair or replacement under our warranty, repairs may be performed at prevailing costs for material and labor unless there is included with the returned product(s) a written request for an estimate of repair costs before any nonwarranty work is performed. In the event of replacement or upon completion of repairs, return shipment will be made with the transportation charges collect.

EXCEPT TO THE EXTENT THAT APPLICABLE LAW PREVENTS THE LIMITATION OF CONSEQUENTIAL DAMAGES FOR PERSONAL INJURY, ATLAS SOUND SHALL NOT BE LIABLE IN TORT OR CONTRACT FOR ANY DIRECT, CONSEQUENTIAL OR INCIDENTAL LOSS OR DAMAGE ARISING OUT OF THE INSTALLATION, USE OR INABILITY TO USE THE PRODUCTS. THE ABOVE WARRANTY IS IN LIEU OF ALL OTHER WARRANTIES INCLUDING BUT NOT LIMITED TO WARRANTIES OF MERCHANTABILITY AND FITNESS FOR A PARTICULAR PURPOSE.

Atlas Sound does not assume, or does it authorize any other person to assume or extend on its behalf, any other warranty, obligation, or liability. This warranty gives you specific legal rights and you may have other rights which vary from state to state.

Service

Should your ECS-6RM require service, please contact the Atlas Sound warranty department at 1-877-689-8055, ext. 277 to obtain an RA number.

Atlas Sound Tech Support can be reached at 1-800-876-3333.

Visit our website at www.AtlasSound.com to see other Atlas products.

©2011 Atlas Sound L.P. All rights reserved. Atlas Sound is a trademark of Atlas Sound L.P.
All other trademarks are the property of their respective owners. ATS003405 RevD 2/12



1601 Jack McKay Blvd. • Ennis, Texas 75119 U.S.A.
Telephone: 800.876.3333 • Fax: 800.765.3435