

# SERVICE MANUAL

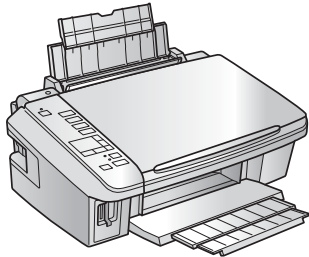
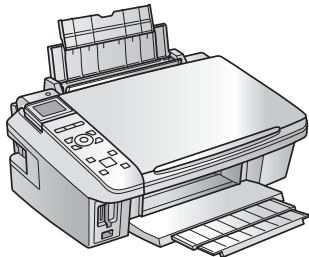
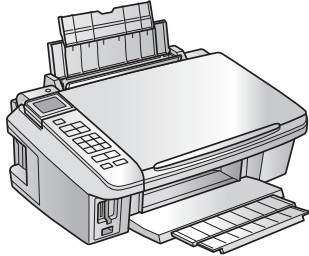

## *Color Inkjet Printer*

**Epson Stylus NX510/NX515/SX510W/  
SX515W/TX550W**

**Epson Stylus NX415/SX410/SX415/  
TX410/TX419**

**Epson Stylus NX215/SX210/SX215/  
TX210/TX213/TX219/  
ME OFFICE 510**

## Notice:

- All rights reserved. No part of this manual may be reproduced, stored in a retrieval system, or transmitted in any form or by any means, electronic, mechanical, photocopying, recording, or otherwise, without the prior written permission of SEIKO EPSON CORPORATION.
- The contents of this manual are subject to change without notice.
- All effort have been made to ensure the accuracy of the contents of this manual. However, should any errors be detected, SEIKO EPSON would greatly appreciate being informed of them.
- The above notwithstanding SEIKO EPSON CORPORATION can assume no responsibility for any errors in this manual or the consequences thereof.

EPSON is a registered trademark of SEIKO EPSON CORPORATION.

General Notice: Other product names used herein are for identification purpose only and may be trademarks or registered trademarks of their respective owners. EPSON disclaims any and all rights in those marks.

Copyright © 2009 **SEIKO EPSON CORPORATION.**  
**IJP LP CS QUALITY ASSURANCE DEPARTMENT**

# PRECAUTIONS

Precautionary notations throughout the text are categorized relative to 1) Personal injury and 2) damage to equipment.

***DANGER*** Signals a precaution which, if ignored, could result in serious or fatal personal injury. Great caution should be exercised in performing procedures preceded by DANGER Headings.

***WARNING*** Signals a precaution which, if ignored, could result in damage to equipment.

The precautionary measures itemized below should always be observed when performing repair/maintenance procedures.

## ***DANGER***

1. ALWAYS DISCONNECT THE PRODUCT FROM THE POWER SOURCE AND PERIPHERAL DEVICES PERFORMING ANY MAINTENANCE OR REPAIR PROCEDURES.
2. NO WORK SHOULD BE PERFORMED ON THE UNIT BY PERSONS UNFAMILIAR WITH BASIC SAFETY MEASURES AS DICTATED FOR ALL ELECTRONICS TECHNICIANS IN THEIR LINE OF WORK.
3. WHEN PERFORMING TESTING AS DICTATED WITHIN THIS MANUAL, DO NOT CONNECT THE UNIT TO A POWER SOURCE UNTIL INSTRUCTED TO DO SO. WHEN THE POWER SUPPLY CABLE MUST BE CONNECTED, USE EXTREME CAUTION IN WORKING ON POWER SUPPLY AND OTHER ELECTRONIC COMPONENTS.
4. WHEN DISASSEMBLING OR ASSEMBLING A PRODUCT, MAKE SURE TO WEAR GLOVES TO AVOID INJURIES FROM METAL PARTS WITH SHARP EDGES.

## ***WARNING***

1. REPAIRS ON EPSON PRODUCT SHOULD BE PERFORMED ONLY BY AN EPSON CERTIFIED REPAIR TECHNICIAN.
2. MAKE CERTAIN THAT THE SOURCE VOLTAGES IS THE SAME AS THE RATED VOLTAGE, LISTED ON THE SERIAL NUMBER/RATING PLATE. IF THE EPSON PRODUCT HAS A PRIMARY AC RATING DIFFERENT FROM AVAILABLE POWER SOURCE, DO NOT CONNECT IT TO THE POWER SOURCE.
3. ALWAYS VERIFY THAT THE EPSON PRODUCT HAS BEEN DISCONNECTED FROM THE POWER SOURCE BEFORE REMOVING OR REPLACING PRINTED CIRCUIT BOARDS AND/OR INDIVIDUAL CHIPS.
4. IN ORDER TO PROTECT SENSITIVE MICROPROCESSORS AND CIRCUITRY, USE STATIC DISCHARGE EQUIPMENT, SUCH AS ANTI-STATIC WRIST STRAPS, WHEN ACCESSING INTERNAL COMPONENTS.
5. REPLACE MALFUNCTIONING COMPONENTS ONLY WITH THOSE COMPONENTS BY THE MANUFACTURE; INTRODUCTION OF SECOND-SOURCE ICs OR OTHER NON-APPROVED COMPONENTS MAY DAMAGE THE PRODUCT AND VOID ANY APPLICABLE EPSON WARRANTY.
6. WHEN USING COMPRESSED AIR PRODUCTS; SUCH AS AIR DUSTER, FOR CLEANING DURING REPAIR AND MAINTENANCE, THE USE OF SUCH PRODUCTS CONTAINING FLAMMABLE GAS IS PROHIBITED.

# About This Manual

This manual describes basic functions, theory of electrical and mechanical operations, maintenance and repair procedures of the printer. The instructions and procedures included herein are intended for the experienced repair technicians, and attention should be given to the precautions on the preceding page.

## Manual Configuration

This manual consists of six chapters and Appendix.

### **CHAPTER 1.PRODUCT DESCRIPTIONS**

Provides a general overview and specifications of the product.

### **CHAPTER 2.OPERATING PRINCIPLES**

Describes the theory of electrical and mechanical operations of the product.

### **CHAPTER 3.TROUBLESHOOTING**

Describes the step-by-step procedures for the troubleshooting.

### **CHAPTER 4.DISASSEMBLY / ASSEMBLY**

Describes the step-by-step procedures for disassembling and assembling the product.

### **CHAPTER 5.ADJUSTMENT**

Provides Epson-approved methods for adjustment.

### **CHAPTER 6.MAINTENANCE**

Provides preventive maintenance procedures and the lists of Epson-approved lubricants and adhesives required for servicing the product.

**APPENDIX** Provides the following additional information for reference:

- Exploded Diagram
- Parts List

## Symbols Used in this Manual

Various symbols are used throughout this manual either to provide additional information on a specific topic or to warn of possible danger present during a procedure or an action. Be aware of all symbols when they are used, and always read NOTE, CAUTION, or WARNING messages.



Indicates an operating or maintenance procedure, practice or condition that is necessary to keep the product's quality.



Indicates an operating or maintenance procedure, practice, or condition that, if not strictly observed, could result in damage to, or destruction of, equipment.



May indicate an operating or maintenance procedure, practice or condition that is necessary to accomplish a task efficiently. It may also provide additional information that is related to a specific subject, or comment on the results achieved through a previous action.



Indicates an operating or maintenance procedure, practice or condition that, if not strictly observed, could result in injury or loss of life.



Indicates that a particular task must be carried out according to a certain standard after disassembly and before re-assembly, otherwise the quality of the components in question may be adversely affected.

# Revision Status

Revision	Date of Issue	Description
A	May 7, 2009	First Release

# Contents

## **Chapter 1 PRODUCT DESCRIPTION**

1.1 Features.....	9
1.2 Printing Specifications.....	10
1.2.1 Basic Specifications.....	10
1.2.2 Ink Cartridge.....	11
1.2.3 Print Mode.....	12
1.2.4 Supported Paper.....	18
1.2.5 Printing Area.....	20
1.3 Scanner Specifications.....	20
1.3.1 Scanning Range.....	21
1.4 General Specifications.....	21
1.4.1 Electrical Specifications.....	21
1.4.2 Environmental Conditions.....	22
1.4.3 Durability.....	22
1.4.4 Acoustic Noise.....	22
1.4.5 Safety Approvals (Safety standards/EMI).....	23
1.5 Interface.....	23
1.5.1 USB Interface.....	23
1.5.2 Network Interface (NX510 series only).....	24
1.5.3 Memory Card Slots.....	26
1.6 Control Panel.....	27
1.6.1 Operation Buttons & LEDs.....	27
1.6.2 Control Panel Functions in Each Mode.....	30
1.7 Specification for Each Function.....	34
1.7.1 Stand-alone Copy Function.....	34
1.7.2 Scan Function (NX510/SX210 series only).....	36
1.7.3 Memory Card Direct Print Function.....	36
1.7.4 Camera Direct Print Function (PictBridge) (NX510/SX410 series only) ..	42
1.7.5 Reprint/Restore Photos Function (NX510 series only).....	43
1.7.6 Setup Mode.....	44

## **Chapter 2 OPERATING PRINCIPLES**

2.1 Overview.....	49
2.1.1 Printer Mechanism.....	49
2.1.2 Motors & Sensors.....	50
2.1.3 Printhead.....	52
2.2 Power-On Sequence.....	53
2.3 Printer Initialization.....	55

## **Chapter 3 TROUBLESHOOTING**

3.1 Overview.....	57
3.1.1 Specified Tools.....	57
3.1.2 Preliminary Checks.....	57
3.2 Troubleshooting.....	58
3.2.1 Motor and Sensor Troubleshooting.....	58
3.3 Error Indications and Fault Occurrence Causes.....	59
3.3.1 Error Message List.....	59
3.3.2 Troubleshooting by Error Message.....	62
3.3.3 Superficial Phenomenon-Based Troubleshooting.....	81
3.4 Network Troubleshooting (NX510 series only).....	89

## **Chapter 4 DISASSEMBLY/ASSEMBLY**

4.1 Overview.....	92
4.1.1 Precautions.....	92
4.1.2 Tools.....	93
4.1.3 Work Completion Check.....	93
4.1.4 Procedural Differences between the Models.....	95
4.2 Disassembly Procedures.....	97
4.3 Removing the Housing.....	98
4.3.1 Paper Support Assy.....	98
4.3.2 Stacker Assy.....	98
4.3.3 Document Cover/ASF Cover.....	99

4.3.4 Scanner Unit/Hinge .....	100
4.3.5 Upper Housing/Card Slot Cover.....	103
4.4 Removing the Circuit Boards .....	105
4.4.1 Main Board Unit.....	105
4.4.2 Panel Unit/LCD Unit.....	108
4.4.3 Power Supply Unit.....	111
4.5 Disassembling the Printer Mechanism .....	113
4.5.1 Printhead .....	113
4.5.2 CR Scale .....	115
4.5.3 Hopper .....	116
4.5.4 Removing the Printer Mechanism (Lower Housing).....	117
4.5.5 Left Frame .....	119
4.5.6 Front Frame/Right Frame .....	120
4.5.7 Star Wheel Holder Assy .....	122
4.5.8 EJ Roller .....	122
4.5.9 PF Encoder Sensor.....	123
4.5.10 PF Scale .....	124
4.5.11 PF Motor.....	125
4.5.12 CR Motor .....	127
4.5.13 Main Frame Assy.....	128
4.5.14 CR Unit.....	131
4.5.15 Upper Paper Guide .....	132
4.5.16 ASF Unit.....	132
4.5.17 Ink System Unit.....	134
4.5.18 Front Paper Guide.....	137
4.5.19 PF Roller.....	138
4.5.20 Waste Ink Pads .....	139
4.6 Disassembling the Scanner Unit.....	141
4.6.1 Upper/Front Scanner Housing .....	141
4.6.2 Scanner Carriage Unit.....	142
4.6.3 Scanner Motor Unit .....	144
4.7 Differences in Disassembling/Reassembling SX410 series .....	146
4.7.1 Main Board Unit (SX410 series) .....	146
4.7.2 Panel Unit/LCD Unit (SX410 series) .....	148
4.7.3 Printhead (SX410 series) .....	150
4.7.4 Removing the Printer Mechanism (Lower Housing) (SX410 series).....	152
4.8 Differences in Disassembling/Reassembling SX210 series .....	154
4.8.1 Main Board Unit (SX210 series) .....	154
4.8.2 Panel Unit/LCD Unit (SX210 series) .....	155

4.8.3 Printhead (SX210 series).....	158
4.8.4 Removing the Printer Mechanism (Lower Housing) (SX210 series).....	160

## **Chapter 5 ADJUSTMENT**

---

5.1 Adjustment Items and Overview .....	162
5.1.1 Servicing Adjustment Item List.....	162
5.1.2 Required Adjustments .....	165
5.2 Using the Adjustment Program.....	167
5.2.1 TOP Margin Adjustment .....	167
5.2.2 First Dot Position Adjustment.....	167
5.2.3 Head Angular Adjustment.....	168
5.2.4 Bi-D Adjustment.....	169
5.2.5 PF Adjustment.....	170
5.2.6 PF Band Adjustment.....	171
5.2.7 Bottom Margin Adjustment (NX510/SX410 series only).....	172
5.2.8 MAC Address Setting (NX510 series only) .....	173

## **Chapter 6 MAINTENANCE**

---

6.1 Overview .....	176
6.1.1 Cleaning.....	176
6.1.2 Service Maintenance.....	176
6.1.3 Lubrication.....	177

## **Chapter 7 APPENDIX**

---

7.1 Exploded Diagram / Parts List .....	183
---	-----

CHAPTER

1

**PRODUCT DESCRIPTION**



## 1.1 Features



In this chapter, the product names are called as follows:

Notation	Product name
NX510 series	Epson Stylus NX510/NX515/SX510W/SX515W/TX550W
SX410 series	Epson Stylus NX415/SX410/SX415/TX410/TX419
SX210 series	Epson Stylus NX215/SX210/SX215/TX210/TX213/ TX219/ME OFFICE 510

This section describes the features of these three models; NX510/SX410/SX210 series. All the models are color inkjet printers with the scanner function.

### □ Common features

#### ■ Printer

- Printing from a computer or directly printing from a memory card.
- Maximum print resolution: 5760 (H) x 1440 (V) dpi
- Four independent ink cartridges is installed.
- Newly developed pigment ink is employed.
- Borderless printing on specified EPSON brand paper is available.

#### ■ Scanner

- Scanning from a computer

#### ■ Copy

- Stand alone copy using the scanning and printing functions

#### ■ Memory card slot

- Available as USB memory card slot for PC

### □ Differences of NX510/SX410/SX210 series

The differences between NX510/SX410/SX210 series are described below.

Table 1-1. Differences of NX510/SX410/SX210 series

Item	NX510 series	SX410 series	SX210 series
Printhead*1	O6-chips Turbo II	D4-chips Turbo II	D2-chips Turbo II
Color LCD	2.5-inch color a-TFT stripe LCD (with tilt function)	2.5-inch color a-TFT stripe LCD (with tilt function)	1.5-inch color LCD (Cannot be tilted.)
Scanner resolution*2 (Main scan x Sub scan)	2400 dpi x 2400 dpi	1200 dpi x 2400 dpi	1200 dpi x 2400 dpi
Network interfaces*3	Available*4	Not Available	Not Available
USB Host Port*5	Yes	Yes	No
Number of Memory Card Slots*6	2	2	1
Scan Function*7	Yes	No	Yes

Note \*1: For the nozzle configuration, see [Table 1-3](#).

\*2: For the details of the scanner specifications, see “[1.3 Scanner Specifications](#)” (p.20).

\*3: For the details of the network interfaces, see “[1.5.2 Network Interface \(NX510 series only\)](#)” (p.24).

\*4: Supports both wired network and wireless network.

\*5: Supported devices for NX510 series and SX410 series differ. For the details, see “[1.5.1 USB Interface](#)” (p.23).

\*6: CF Card slot is not mounted on SX210 series. For the details of supported memory cards, see “[1.5.3 Memory Card Slots](#)” (p.26).

\*7: For the details of the functions, see “[1.7.2 Scan Function \(NX510/SX210 series only\)](#)” (p.36).

## □ Dimensions

Table 1-2. Dimensions

	NX510 series	SX410 series	SX210 series
Dimensions* <sup>1</sup>	450 mm (W) x 342 mm (D) x 182 mm (H)		
Weight* <sup>2</sup>	6.1 kg	5.8 kg	5.7 kg

Note \*1: Paper support and stacker are closed. Rubber feet are excluded

\*2: Excluding the weight of ink cartridges and power cable

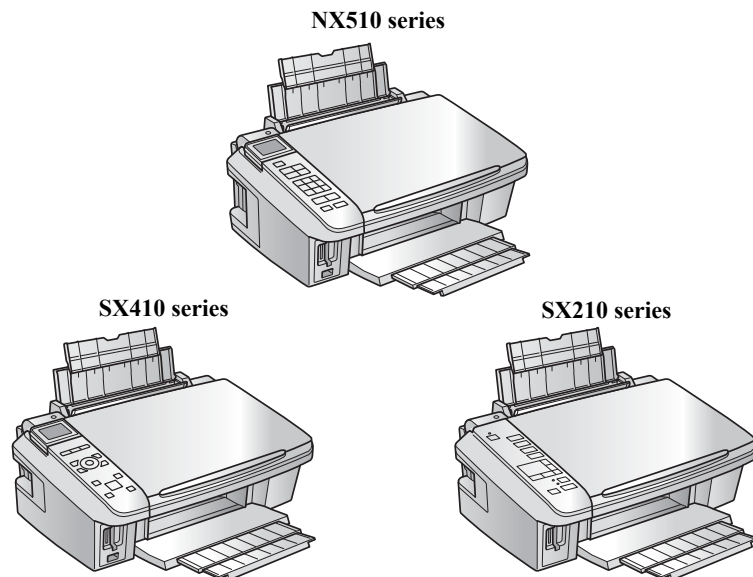

Figure 1-1. External View

## 1.2 Printing Specifications

### 1.2.1 Basic Specifications

Table 1-3. Printer Specifications

Item	Specification	
Print method	On-demand ink jet	
Nozzle configuration	NX510 series	Black: 128 nozzles x 3 Color: 128 nozzles x 3 (Cyan, Magenta, Yellow)
	SX410 series	Black: 90 nozzles x 1 Color: 90 nozzles x 3 (Cyan, Magenta, Yellow)
	SX210 series	Black: 29 nozzles x 1 Color: 29 nozzles x 3 (Cyan, Magenta, Yellow)
Print direction	Bi-directional minimum distance printing, Unidirectional printing	
Print resolution	Horizontal x Vertical (dpi) <ul style="list-style-type: none"> <li>• 360 x 120      • 1440 x 720</li> <li>• 360 x 360    • 1440 x 1440*<sup>1</sup></li> <li>• 360 x 720    • 5760 x 1440</li> <li>• 720 x 720</li> </ul>	
Control code	<ul style="list-style-type: none"> <li>• ESC/P Raster command</li> <li>• ESC/P-R (RGB) command</li> <li>• EPSON Remote command</li> </ul>	
Input buffer size	NX510 series	132 Kbytes
	SX410 series	64 Kbytes
	SX210 series	
Paper feed method	Friction feed, using the ASF (Auto Sheet Feeder)	
Paper path	Top feed, front out	
Paper feed rates (at 25.4 mm feed)	NX510 series	95 msec. (Draft 16 ips* <sup>2</sup> ), 113 msec. (Default 12 ips* <sup>2</sup> )
	SX410 series	
	SX210 series	TBD
PF interval	Programmable in 0.01764 mm (1/1440 inch) steps	

Note \*1: SX410 series only

\*2: ips = inch per second

## 1.2.2 Ink Cartridge

Specifications for the ink cartridges for each series are explained below.

**Table 1-4. Cartridge types for NX510 series**

Color	EAI	Latin	Euro	CISMEA/Asia
Black	T0971 (L2) T0681 (S) T0691 (2S)	T1031 (L1)	T1001 (L1) T0711H (S) T0711 (2S)	T1031 (L1) T0731HN (S) T0731N (2S)
Cyan	T0682 (2S) T0692 (3S)	T1032 (S)	T1002 (S) T0712 (3S)	T1032 (S) T0732N (3S)
Magenta	T0683 (2S) T0693 (3S)	T1033 (S)	T1003 (S) T0713 (3S)	T1033 (S) T0733N (3S)
Yellow	T0684 (2S) T0694 (3S)	T1034 (S)	T1004 (S) T0714 (3S)	T1034 (S) T0734N (3S)

**Table 1-5. Cartridge types for SX410 series**

Color	EAI	Latin	Euro	CISMEA/Asia
Black	T0681 (S) T0691 (2S) T0881 (3S)	T0731HN (S) T0731N (2S)	T0711H (S) T0711 (2S) T0891 (3S)	T0731HN (S) T0731N (2S)
Cyan	T0692 (3S) T0882 (4S)	T0732N (3S)	T0712 (3S) T0892 (4S)	T0732N (3S)
Magenta	T0693 (3S) T0883 (4S)	T0733N (3S)	T0713 (3S) T0893 (4S)	T0733N (3S)
Yellow	T0694 (3S) T0884 (4S)	T0734N (3S)	T0714 (3S) T0894 (4S)	T0734N (3S)

**Table 1-6. Cartridge types for SX210 series**

Color	EAI	Latin	Euro	CISMEA/Asia	ECC/EHK
Black	T0681 (S) T0691 (2S) T0881 (3S)	T0731HN (S) T0731N (2S)	T0711H (S) T0711 (2S) T0891 (3S)	T0731HN (S) T0731N (2S)	T1091 (2S)
Cyan	T0692 (3S) T0882 (4S)	T0732N (3S)	T0712 (3S) T0892 (4S)	T0732N (3S)	T1092 (2S)
Magenta	T0693 (3S) T0883 (4S)	T0733N (3S)	T0713 (3S) T0893 (4S)	T0733N (3S)	T1093 (2S)
Yellow	T0694 (3S) T0884 (4S)	T0734N (3S)	T0714 (3S) T0894 (4S)	T0734N (3S)	T1094 (2S)

- Shelf life  
Two years from production date (if unopened), six months after opening package.
- Storage Temperature

**Table 1-7. Storage Temperature**

Situation	Storage Temperature	Limit
When stored in individual boxes	-20 °C to 40 °C (-4°F to 104°F)	1 month max. at 40 °C (104°F)
When installed in main unit	-20 °C to 40 °C (-4°F to 104°F)	

- Dimension  
12.7 mm (W) x 68 mm (D) x 47 mm (H)



- Do not use expired ink cartridges.
- The ink in the ink cartridge freezes at -16 °C (3.2 °F). It takes about three hours under 25 °C (77°F) until the ink thaws and becomes usable.

## 1.2.3 Print Mode

### □ NX510 series

Table 1-8. Print Mode for NX510 series (Color)

Media	Print Mode	Resolution (H x V dpi)	Dot Size (cps)	Bi-d	Micro Weave	Border-less
<ul style="list-style-type: none"> <li>• Plain paper</li> <li>• Premium Bright White Paper (EAI)</li> <li>• Premium Bright White Inkjet Paper (others)</li> </ul>	Draft 1 / Draft 2	360x120	Eco (400cps)	ON	OFF	N/A
	Normal 2	360x360	VSD1 (300cps)	ON	OFF	N/A
	Fine 2	360x720	VSD2 (300cps)	ON	ON	N/A
	Photo 1	720x720	VSD3 (285cps)	ON	ON	N/A
<ul style="list-style-type: none"> <li>• Ultra Premium Glossy Photo Paper (EAI)</li> <li>• Ultra Glossy Photo Paper (others)</li> </ul>	Best Photo	1440x720	VSD3 (285cps)	ON	ON	OK
<ul style="list-style-type: none"> <li>• Photo Paper Glossy (EAI)</li> <li>• Glossy Photo Paper (others)</li> <li>• Premium Photo Paper Glossy (EAI)</li> <li>• Premium Glossy Photo Paper (others)</li> </ul>	Fine 1	360x720	VSD1 (300cps)	ON	ON	OK
	Best Photo	1440x720	VSD3 (285cps)	ON	ON	OK
<ul style="list-style-type: none"> <li>• Premium Photo Paper Semi-Gloss (EAI)</li> <li>• Premium Semigloss Photo Paper (other)</li> </ul>	Draft 2	360x120	Eco (400cps)	ON	OFF	N/A
	Fine 1	360x720	VSD1 (300cps)	ON	ON	OK
	Best Photo	1440x720	VSD3 (285cps)	ON	ON	OK

Table 1-8. Print Mode for NX510 series (Color)

Media	Print Mode	Resolution (H x V dpi)	Dot Size (cps)	Bi-d	Micro Weave	Border-less
Photo Paper* (other)	Fine 1	360x720	VSD1 (300cps)	ON	ON	OK
	Best Photo	1440x720	VSD3 (285cps)	ON	ON	OK
<ul style="list-style-type: none"> <li>• Premium Presentation Paper Matte (EAI)</li> <li>• Matte Paper Heavy-weight (others)</li> </ul>	Photo 2	720x720	VSD2 (285cps)	ON	ON	OK
	Best Photo	1440x720	VSD3 (285cps)	ON	ON	OK
<ul style="list-style-type: none"> <li>• Photo Quality Inkjet Paper* (others)</li> </ul>	Photo 2	720x720	VSD2 (285cps)	ON	ON	N/A
	Best Photo	1440x720	VSD3 (285cps)	ON	ON	N/A
Envelope	Normal 2	360x360	VSD1 (300cps)	OFF	OFF	N/A
	Fine 2	360x720	VSD2 (300cps)	OFF	ON	N/A

Note\* : Not supported in EAI.

Table 1-9. Print Mode for NX510 series (Monochrome)

Media	Print Mode	Resolution (H x V dpi)	Dot Size (cps)	Bi-d	Micro Weave	Border-less
<ul style="list-style-type: none"> <li>• Plain paper</li> <li>• Premium Bright White Paper (EAI)</li> <li>• Premium Ink Jet Plain papers (others)</li> </ul>	Draft 3 / Draft 4	360x360	Eco (400cps)	ON	OFF	N/A
	Normal 1	360x360	VSD1 (300cps)	ON	OFF	N/A
	Fine 2	360x720	VSD2 (300cps)	ON	ON	N/A
	Photo 1	720x720	VSD3 (285cps)	ON	ON	N/A
<ul style="list-style-type: none"> <li>• Ultra Premium Glossy Photo Paper (EAI)</li> <li>• Ultra Glossy Photo Paper (others)</li> </ul>	Best Photo	1440x720	VSD3 (285cps)	ON	ON	OK
<ul style="list-style-type: none"> <li>• Photo Paper Glossy (EAI)</li> <li>• Glossy Photo Paper (others)</li> <li>• Premium Photo Paper Glossy (EAI)</li> <li>• Premium Glossy Photo Paper (others)</li> </ul>	Fine 1	360x720	VSD1 (300cps)	ON	ON	OK
	Best Photo	1440x720	VSD3 (285cps)	ON	ON	OK
<ul style="list-style-type: none"> <li>• Premium Photo Paper Semi-Gloss (EAI)</li> <li>• Premium Semigloss Photo Paper (other)</li> </ul>	Draft 4	360x360	Eco (400cps)	ON	OFF	N/A
	Fine 1	360x720	VSD1 (300cps)	ON	ON	OK
	Best Photo	1440x720	VSD3 (285cps)	ON	ON	OK
Photo Paper* (other)	Fine 1	360x720	VSD1 (300cps)	ON	ON	OK
	Best Photo	1440x720	VSD3 (285cps)	ON	ON	OK

Table 1-9. Print Mode for NX510 series (Monochrome)

Media	Print Mode	Resolution (H x V dpi)	Dot Size (cps)	Bi-d	Micro Weave	Border-less
<ul style="list-style-type: none"> <li>• Premium Presentation Paper Matte (EAI)</li> <li>• Matte Paper Heavy-weight (others)</li> </ul>	Photo 2	720x720	VSD2 (285cps)	ON	ON	OK
	Best Photo	1440x720	VSD3 (285cps)	ON	ON	OK
<ul style="list-style-type: none"> <li>• Photo Quality Inkjet Paper* (others)</li> </ul>	Photo 2	720x720	VSD2 (285cps)	ON	ON	N/A
	Best Photo	1440x720	VSD3 (285cps)	ON	ON	N/A
Envelope	Normal 1	360x360	VSD1 (300cps)	OFF	OFF	N/A
	Fine 2	360x720	VSD2 (300cps)	OFF	ON	N/A

Note\* : Not supported in EAI.

## □ SX410 series

Table 1-10. Print Mode for SX410 series (Color)

Media	Print Mode	Resolution (H x V dpi)	Dot Size (cps)	Bi-d	Micro Weave	Border-less
<ul style="list-style-type: none"> <li>• Plain paper</li> <li>• Premium Bright White Paper (EAI)</li> <li>• Premium Bright White Inkjet Paper (others)</li> </ul>	Fast Economy / Economy	360x120	Eco (400cps)	ON	OFF	N/A
	Draft	360x120	Eco (400cps)	ON	OFF	N/A
	Normal	360x360	VSD1 (245cps)	ON	OFF	N/A
	Fine (360)	360x720	VSD2 (285cps)	ON	ON	N/A
	Fine (720)	720x720	VSD3 (285cps)	ON	ON	N/A
<ul style="list-style-type: none"> <li>• Ultra Premium Glossy Photo Paper (EAI)</li> <li>• Ultra Glossy Photo Paper (others)</li> </ul>	Photo (1440)	1440x720	VSD3 (285cps)	ON	ON	OK
	Photo 2 (1440)	1440x1440	VSD3 (285cps)	ON	ON	OK
	Photo (5760)	5760x1440	VSD3 (285cps)	ON	ON	OK
<ul style="list-style-type: none"> <li>• Photo Paper Glossy (EAI)</li> <li>• Glossy Photo Paper (others)</li> <li>• Premium Photo Paper Glossy (EAI)</li> <li>• Premium Glossy Photo Paper (others)</li> <li>• Premium Photo Paper Semi-Gloss (EAI)</li> <li>• Premium Semigloss Photo Paper (other)</li> </ul>	Photo Draft	360x720	VSD1 (245cps)	ON	ON	OK
	Photo (720)	720x720	VSD2 (285cps)	ON	ON	OK
	Photo (1440)	1440x720	VSD3 (285cps)	ON	ON	OK
	Photo 2 (1440)	1440x1440	VSD3 (285cps)	ON	ON	OK
	Photo (5760)	5760x1440	VSD3 (285cps)	ON	ON	OK

Table 1-10. Print Mode for SX410 series (Color)

Media	Print Mode	Resolution (H x V dpi)	Dot Size (cps)	Bi-d	Micro Weave	Border-less
Photo Paper* (other)	Photo Draft	360x720	VSD1 (245cps)	ON	ON	OK
	Photo (720)	720x720	VSD2 (285cps)	ON	ON	OK
	Photo (1440)	1440x720	VSD3 (285cps)	ON	ON	OK
<ul style="list-style-type: none"> <li>• Premium Presentation Paper Matte (EAI)</li> <li>• Matte Paper Heavy-weight (others)</li> </ul>	Photo (720)	720x720	VSD2 (285cps)	ON	ON	OK
	Photo (1440)	1440x720	VSD3 (285cps)	ON	ON	OK
Photo Quality Inkjet Paper (others)	Photo (720)	720x720	VSD2 (285cps)	ON	ON	N/A
	Photo (1440)	1440x720	VSD3 (285cps)	ON	ON	N/A
Envelope	Normal	360x360	VSD1 (245cps)	OFF	OFF	N/A
	Fine (720)	720x720	VSD3 (285cps)	OFF	ON	N/A

Note\* : Supports printing using the printer driver only.

Table 1-11. Print Mode for SX410 series (Monochrome)

Media	Print Mode	Resolution (H x V dpi)	Dot Size (cps)	Bi-d	Micro Weave	Border-less
<ul style="list-style-type: none"> <li>• Plain paper</li> <li>• Premium Bright White Paper (EAI)</li> <li>• Premium Bright White Inkjet Paper (others)</li> </ul>	Fast Economy / Economy	360x120	Eco (400cps)	ON	OFF	N/A
	Draft	360x120	Eco (400cps)	ON	OFF	N/A
	Normal	360x360	VSD1 (245cps)	ON	OFF	N/A
	Fine (360)	360x720	VSD2 (285cps)	ON	ON	N/A
	Fine (720)	720x720	VSD3 (285cps)	ON	ON	N/A
<ul style="list-style-type: none"> <li>• Ultra Premium Glossy Photo Paper (EAI)</li> <li>• Ultra Glossy Photo Paper (others)</li> </ul>	Photo (1440)	1440x720	VSD3 (285cps)	ON	ON	OK
	Photo 2 (1440)	1440x1440	VSD3 (285cps)	ON	ON	OK
	Photo (5760)	5760x1440	VSD3 (285cps)	ON	ON	OK
<ul style="list-style-type: none"> <li>• Photo Paper Glossy (EAI)</li> <li>• Glossy Photo Paper (others)</li> <li>• Premium Photo Paper Glossy (EAI)</li> <li>• Premium Glossy Photo Paper (others)</li> <li>• Premium Photo Paper Semi-Gloss (EAI)</li> <li>• Premium Semigloss Photo Paper (other)</li> </ul>	Photo Draft	360x720	VSD1 (245cps)	ON	ON	OK
	Photo (720)	720x720	VSD2 (285cps)	ON	ON	OK
	Photo (1440)	1440x720	VSD3 (285cps)	ON	ON	OK
	Photo 2 (1440)	1440x1440	VSD3 (285cps)	ON	ON	OK
	Photo (5760)	5760x1440	VSD3 (285cps)	ON	ON	OK

Table 1-11. Print Mode for SX410 series (Monochrome)

Media	Print Mode	Resolution (H x V dpi)	Dot Size (cps)	Bi-d	Micro Weave	Border-less
Photo Paper* (other)	Photo Draft	360x720	VSD1 (245cps)	ON	ON	OK
	Photo (720)	720x720	VSD2 (285cps)	ON	ON	OK
	Photo (1440)	1440x720	VSD3 (285cps)	ON	ON	OK
<ul style="list-style-type: none"> <li>• Premium Presentation Paper Matte (EAI)</li> <li>• Matte Paper Heavy-weight (others)</li> </ul>	Photo (720)	720x720	VSD2 (285cps)	ON	ON	OK
	Photo (1440)	1440x720	VSD3 (285cps)	ON	ON	OK
Photo Quality Inkjet Paper (others)	Photo (720)	720x720	VSD2 (285cps)	ON	ON	N/A
	Photo (1440)	1440x720	VSD3 (285cps)	ON	ON	N/A
Envelope	Normal	360x360	VSD1 (245cps)	OFF	OFF	N/A
	Fine (720)	720x720	VSD3 (285cps)	OFF	ON	N/A

Note\* : Supports printing using the printer driver only.

## □ SX210 series

Table 1-12. Print Mode for SX210 series (Color)

Media	Print Mode	Resolution (H x V dpi)	Dot Size (cps)	Bi-d	Micro Weave	Border-less
<ul style="list-style-type: none"> <li>• Plain paper</li> <li>• Premium Bright White Paper (EAI)</li> <li>• Premium Bright White Inkjet Paper (others)</li> </ul>	Fast Economy / Economy	360x120	Eco (400cps)	ON	OFF	N/A
	Normal	360x360	VSD1 (245cps)	ON	OFF	N/A
	Fine	360x720	VSD2 (285cps)	ON	ON	N/A
	Photo	720x720	VSD3 (285cps)	ON	ON	OK
<ul style="list-style-type: none"> <li>• Ultra Premium Glossy Photo Paper (EAI)</li> <li>• Ultra Glossy Photo Paper (others)</li> </ul>	Best Photo	1440x720	VSD3 (285cps)	ON	ON	OK
	Photo RPM	5760x1440	VSD3 (285cps)	ON	ON	N/A
<ul style="list-style-type: none"> <li>• Photo Paper Glossy (EAI)</li> <li>• Glossy Photo Paper (others)</li> <li>• Premium Photo Paper Glossy (EAI)</li> <li>• Premium Glossy Photo Paper (others)</li> <li>• Premium Photo Paper Semi-Gloss (EAI)</li> <li>• Premium Semigloss Photo Paper (other)</li> </ul>	Super Fine	360x720	VSD2 (285cps)	ON	ON	N/A
	Photo	720x720	VSD2 (285cps)	ON	ON	OK
	Best Photo	1440x720	VSD3 (285cps)	ON	ON	OK
	Photo RPM	5760x1440	VSD3 (285cps)	ON	ON	N/A
Photo Paper* (other)	Super Fine	360x720	VSD2 (285cps)	ON	ON	N/A
	Photo	720x720	VSD2 (285cps)	ON	ON	OK
	Best Photo	1440x720	VSD3 (285cps)	ON	ON	OK

Table 1-12. Print Mode for SX210 series (Color)

Media	Print Mode	Resolution (H x V dpi)	Dot Size (cps)	Bi-d	Micro Weave	Border-less
<ul style="list-style-type: none"> <li>• Premium Presentation Paper Matte (EAI)</li> <li>• Matte Paper Heavy-weight (others)</li> </ul>	Photo	720x720	VSD2 (285cps)	ON	ON	OK
	Best Photo	1440x720	VSD3 (285cps)	ON	ON	OK
Envelope	Normal	360x360	VSD1 (245cps)	OFF	OFF	N/A
	Fine	360x720	VSD2 (285cps)	OFF	ON	N/A

Note\* : Not supported in EAI.



Table 1-13. Print Mode for SX210 series (Monochrome)

Media	Print Mode	Resolution (H x V dpi)	Dot Size (cps)	Bi-d	Micro Weave	Borderless
<ul style="list-style-type: none"> <li>• Plain paper</li> <li>• Premium Bright White Paper (EAI)</li> <li>• Premium Bright White Inkjet Paper (others)</li> </ul>	Fast Economy / Economy	360x120	Eco (400cps)	ON	OFF	N/A
	Normal	360x360	VSD1 (245cps)	ON	OFF	N/A
	Fine	360x720	VSD2 (285cps)	ON	ON	N/A
	Photo	720x720	VSD3 (285cps)	ON	ON	OK
<ul style="list-style-type: none"> <li>• Ultra Premium Glossy Photo Paper (EAI)</li> <li>• Ultra Glossy Photo Paper (others)</li> </ul>	Best Photo	1440x720	VSD3 (285cps)	ON	ON	OK
	Photo RPM	5760x1440	VSD3 (285cps)	ON	ON	N/A
<ul style="list-style-type: none"> <li>• Photo Paper Glossy (EAI)</li> <li>• Glossy Photo Paper (others)</li> <li>• Premium Photo Paper Glossy (EAI)</li> <li>• Premium Glossy Photo Paper (others)</li> <li>• Premium Photo Paper Semi-Gloss (EAI)</li> <li>• Premium Semigloss Photo Paper (other)</li> </ul>	Super Fine	360x720	VSD2 (285cps)	ON	ON	N/A
	Photo	720x720	VSD2 (285cps)	ON	ON	OK
	Best Photo	1440x720	VSD3 (285cps)	ON	ON	OK
	Photo RPM	5760x1440	VSD3 (285cps)	ON	ON	N/A
Photo Paper* (other)	Super Fine	360x720	VSD2 (285cps)	ON	ON	N/A
	Photo	720x720	VSD2 (285cps)	ON	ON	OK
	Best Photo	1440x720	VSD3 (285cps)	ON	ON	OK

Table 1-13. Print Mode for SX210 series (Monochrome)

Media	Print Mode	Resolution (H x V dpi)	Dot Size (cps)	Bi-d	Micro Weave	Borderless
<ul style="list-style-type: none"> <li>• Premium Presentation Paper Matte (EAI)</li> <li>• Matte Paper Heavy-weight (others)</li> </ul>	Photo	720x720	VSD2 (285cps)	ON	ON	OK
	Best Photo	1440x720	VSD3 (285cps)	ON	ON	OK
Envelope	Normal	360x360	VSD1 (245cps)	OFF	OFF	N/A
	Fine	360x720	VSD2 (285cps)	OFF	ON	N/A

Note\* : Not supported in EAI.

## 1.2.4 Supported Paper

The table below lists the paper type and sizes supported by the printer. The supported paper type and sizes vary depending on destinations (between EAI, EUR, and Asia).

**Table 1-14. Supported Paper**

Paper Name	Paper Size		Thickness (mm)	Weight	EAI		EUR		Asia	
					P*1	B*2	P*1	B*2	P*1	B*2
Plain paper	Legal	215.9 x 355.6 mm (8.5"x14")	0.08-0.11	64-90 g/m <sup>2</sup> (17-24 lb.)	Y	-	Y	-	Y	-
	Letter	215.9 x 279.4 mm (8.5"x11")			Y	-	Y	-	Y	-
	A4	210 x 297 mm (8.3"x11.7")			Y	-	Y	-	Y	-
	B5	182 x 257 mm (7.2"x10.1")			-	-	Y	-	Y	-
	A5	148 x 210 mm (5.8"x8.3")			-	-	Y	-	Y	-
	Half Letter	139.7 x 215.9 mm (5.5"x8.5")			Y	-	-	-	-	-
	A6	105 x 148 mm (4.2"x5.8")			Y	-	Y	-	Y	-
	User Defined	89 x 127- 329 x 1117.6 mm (3.56"x 5.08" - 13.16"x44.7")			Y	-	Y	-	Y	-
Premium Inkjet Plain Paper	A4	210 x 297 mm (8.3"x11.7")	0.11	80 g/m <sup>2</sup> (21 lb.)	-	-	Y	-	Y	-
Premium Bright White Paper (EAI) Bright White Inkjet Paper (Euro, Asia)	Letter	215.9 x 279.4 mm (8.5"x11")	0.11	90 g/m <sup>2</sup> (24 lb.)	Y	-	-	-	-	-
	A4	210 x 297 mm (8.3"x11.7")	0.13	92.5 g/m <sup>2</sup> (25 lb.)	-	-	Y	-	Y	-
Ultra Premium Glossy Photo Paper (EAI) Ultra Glossy Photo Paper (Euro, Asia)	Letter	215.9 x 279.4 mm (8.5"x11")	0.30	290 g/m <sup>2</sup> (77 lb.)	Y	Y	-	-	-	-
	A4	210 x 297 mm (8.3"x11.7")			-	-	Y	Y	Y	Y
	8" x 10"	203.2 x 254 mm			Y	Y	-	-	-	-
	5" x 7"	127 x 178 mm			Y	Y	Y	Y	-	-
	4" x 6"	101.6 x 152.4 mm			Y	Y	Y	Y	Y	Y
Premium Photo Paper Glossy (EAI) Premium Glossy Photo Paper (Euro, Asia)	Letter	215.9 x 279.4 mm (8.5"x11")	0.27	255 g/m <sup>2</sup> (68 lb.)	Y	Y	-	-	-	-
	A4	210 x 297 mm (8.3"x11.7")			-	-	Y	Y	Y	Y
	8" x 10"	203.2 x 254 mm			Y	Y	-	-	-	-
	5" x 7"	127 x 178 mm			Y	Y	Y	Y	Y	Y
	4" x 6"	101.6 x 152.4 mm			Y	Y	Y	Y	Y	Y
	16:9 wide	101.6 x 180.6 mm			Y	Y	Y	Y	-	-

Table 1-14. Supported Paper

Paper Name	Paper Size		Thickness (mm)	Weight	EAI		EUR		Asia	
					P*1	B*2	P*1	B*2	P*1	B*2
Photo Paper Glossy (EAI) Glossy Photo Paper (Euro, Asia)	Letter	215.9 x 279.4 mm (8.5"x11")	0.25	258 g/m <sup>2</sup> (68 lb.)	Y	Y	-	-	-	-
	A4	210 x 297 mm (8.3"x11.7")			Y	Y	Y	Y	Y	Y
	5" x 7"	127 x 178 mm			-	-	Y	Y	-	-
	4" x 6"	101.6 x 152.4 mm			Y	Y	Y	Y	Y	Y
Premium Photo Paper Semi-Gloss (EAI) Premium Semigloss Photo Paper (Euro, Asia)	Letter	215.9 x 279.4 mm (8.5"x11")	0.27	250 g/m <sup>2</sup> (66 lb.)	Y	Y	-	-	-	-
	A4	210 x 297 mm (8.3"x11.7")			-	-	Y	Y	Y	Y
	4" x 6"	101.6 x 152.4 mm			Y	Y	Y	Y	Y	Y
Premium Presentation Paper Matte (EAI) Matte Paper-Heavyweight (Euro, Asia)	Letter	215.9 x 279.4 mm (8.5"x11")	0.23	167 g/m <sup>2</sup> (44 lb.)	Y	Y	-	-	-	-
	A4	210 x 297 mm (8.3"x11.7")			-	-	Y	Y	Y	Y
	8" x 10"	203.2 x 254 mm			Y	Y	-	-	-	-
Photo Quality Inkjet Paper	A4	210 x 297 mm (8.3"x11.7")	0.13	102 g/m <sup>2</sup> (27 lb.)	-	-	Y	-	Y	-
Envelopes	#10	104.8 x 241.3 mm (4.125"x9.5")	-	75-100 g/m <sup>2</sup> (20-27 lb.)	Y	-	Y	-	Y	-
	#DL	110 x 220 mm			-	-	Y	-	Y	-
	#C6	114 x 162 mm			-	-	Y	-	Y	-
Photo Paper	A4	210 x 297 mm (8.3"x11.7")	0.24	190 g/m <sup>2</sup> (51 lb.)	-	-	Y	Y	Y	Y
	5" x 7"	127 x 178 mm			-	-	Y	Y	-	-
	4" x 6"	101.6 x 152.4 mm			-	-	Y	Y	Y	Y

Note \*1: "Y" in the "P" column stands for "the paper type/size is Supported".

\*2: "Y" in the "B" column stands for "Borderless printing is available".



- Make sure the paper is not wrinkled, fluffed, torn, or folded.
- Make sure to correct the warpage of the paper before use.
- When printing on an envelope, be sure the flap is folded neatly.
- Do not use the adhesive envelopes.
- Do not use double envelopes and cellophane window envelopes.

### 1.2.5 Printing Area

The printing area for this printer is shown below.

**Table 1-15. Printing Area (Margins)**

Print Mode	Paper Size		Margin			
			Left	Right	Top	Bottom
Standard print	Any size		3 mm	3 mm	3 mm	3 mm
	Envelope		5 mm	5 mm	3 mm	20 mm
Borderless print*	NX510 series	4" x 6"	2.54 mm	2.54 mm	2.8 mm	3.39 mm
		Others			2.96 mm	
	SX410 series	A4/Letter to 2L/ 5" x 7"/16" x 9"	2.54 mm	2.54 mm	2.96 mm	4.02 mm
		4" x 6"			2.54 mm	
	SX210 series	A4/Letter to 2L/ 5" x 7"/16" x 9"	2.54 mm	2.54 mm	2.96 mm	3.39 mm
		4" x 6"			2.82 mm	

Note \*: The margins for Borderless print are margins that bleed off the edges of paper.

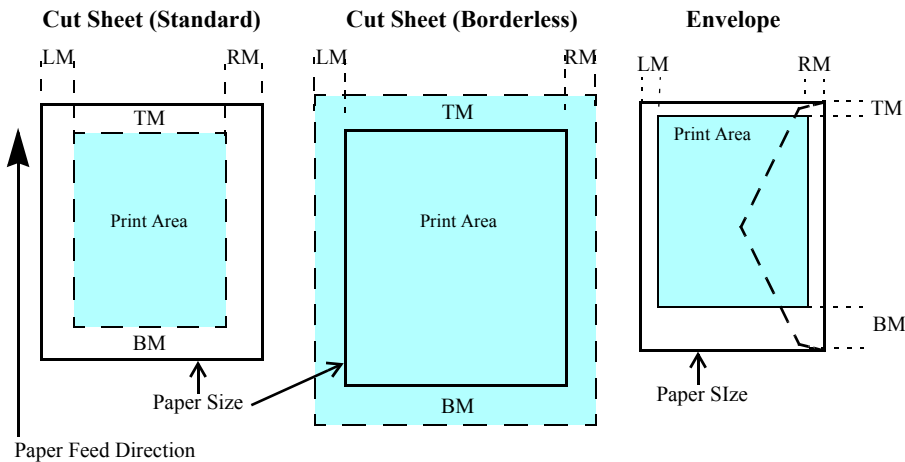

**Figure 1-2. Printing Area**

### 1.3 Scanner Specifications

**Table 1-16. Basic Specifications**

Item	Specification	
Scanner type	Flatbed, color	
Scanning method	Moving carriage, stationary document	
Home position	The front right corner	
Photoelectric device	CIS	
Light source	LED	
Maximum document sizes	A4 or US letter	
Scanning range	8.5" x 11.7" (216 mm x 297 mm)	
Maximum resolution	NX510 series	Main scan: 2400 dpi Sub scan: 2400 dpi
	SX210 series	Main scan: 1200 dpi Sub scan: 2400 dpi
	SX410 series	
Maximum effective pixels	NX510 series	20,400 x 28,800 pixels
	SX410 series	10,200 x 14,040 pixels
	SX210 series	
Pixel depth	Color: 48 bit per pixel (input) and 24 bit per pixel (output). Monochrome: 16 bit per pixel (input) and 1 bit* / 8 bit per pixel (output)	

Note \*: NX510 series only.

### 1.3.1 Scanning Range

Table 1-17. Scanning Range

RL (read length)	RW (read width)	OLM (left margin)	OTM (top margin)
216 mm	297 mm	1.5 mm	1.5 mm

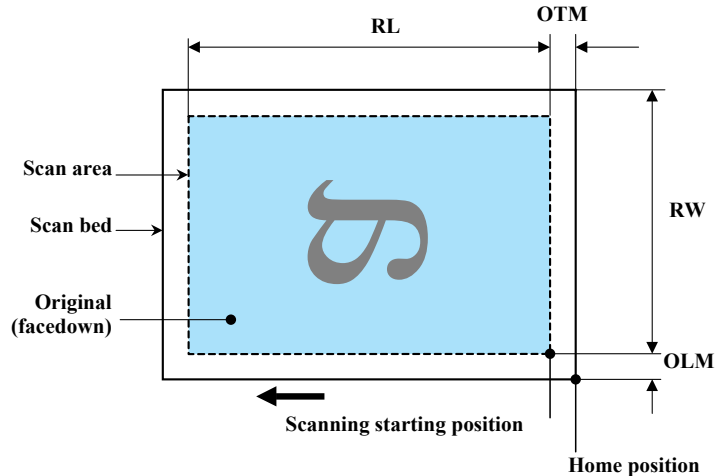

Figure 1-3. Scanning Range

## 1.4 General Specifications

### 1.4.1 Electrical Specifications

Table 1-18. Primary Power Specifications

Item		100-120 V model	220-240 V model	
Rated power supply voltage		100 to 120 VAC	220 to 240 VAC	
Input voltage range		90 to 132 VAC	198 to 264 VAC	
Rated current (Max. rated current)	NX510 series	0.6 A (1.3 A)	0.3 A (0.6 A)	
	SX410 series	0.6 A (1.0 A)	0.3 A (0.5 A)	
	SX210 series			
Rated frequency		50 to 60 Hz		
Input frequency range		49.5 to 60.5 Hz		
Insulation resistance (Primary - Secondary, 10 mA at 25 °C)		3,000 V (for one minute)		
Energy conservation		International Energy Star Program compliant		
Power consumption	NX510 series	Copy*	Approx. 16 W	Approx. 16 W
		Ready	Approx. 6.0 W	Approx. 6.0 W
		Sleep	Approx. 3.5 W	Approx. 4.0 W
		Off	Approx. 0.2 W	Approx. 0.3 W
	SX410 series	Copy*	Approx. 12 W	Approx. 12 W
		Ready	Approx. 5.0 W	Approx. 5.0 W
		Sleep	Approx. 2.5 W	Approx. 3.0 W
		Off	Approx. 0.2 W	Approx. 0.3 W
	SX210 series	Copy*	Approx. 11 W	Approx. 11 W
		Ready	Approx. 5.0 W	Approx. 5.0 W
		Sleep	Approx. 2.5 W	Approx. 2.5 W
		Off	Approx. 0.2 W	Approx. 0.3 W

Note\* : Printing pattern: ISO/IEC24712

Note : When no operation is made with the control panel for more than 13 minutes, the panel goes to the power save mode within two minutes.

## 1.4.2 Environmental Conditions

Table 1-19. Environmental Conditions

Condition	Temperature* <sup>1</sup>	Humidity* <sup>1,2</sup>	Shock	Vibration
Operating	10 to 35°C (50 to 95°F)	20 to 80%	1G (1 msec or less)	0.15G, 10 to 55Hz
Storage (unpacked)	-20 to 40°C* <sup>3</sup> (-4°F to 104°F)	5 to 85%	2G (2 msec or less)	0.50G, 10 to 55Hz

Note \*1: The combined Temperature and Humidity conditions must be within the blue-shaded range in Fig.1-4.

\*2: No condensation

\*3: Must be less than 1 month at 40°C.

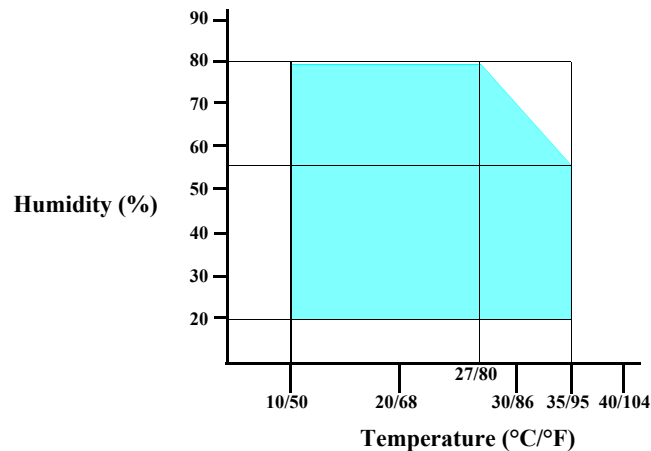

Figure 1-4. Temperature/Humidity Range

## 1.4.3 Durability

Table 1-20. Durability

Model	Total print life* <sup>1</sup>	Printhead* <sup>1</sup>	Scanner carriage
NX510 series	Black 20,000 pages * <sup>2</sup> (TBD) Color 10,000 pages * <sup>3</sup> (TBD)	Four billions shots (per nozzle) (TBD)	30,000 cycles of carriage movement (TBD)
SX410 series	Black 10,000 pages* <sup>2</sup>	Five billions shots (per nozzle)	30,000 cycles of carriage movement
SX210 series	Color 10,000 pages* <sup>3</sup>		

Note \*1: The specified value or five years whichever comes first

\*2: A4, 3.5% duty, ECMA pattern, Plain paper, Default mode

\*3: A4, ISO 24712 pattern, Plain paper, Default mode

## 1.4.4 Acoustic Noise

- NX510 series: 42.5 dB
- SX410 series: 41 dB
- SX210 series: 37.7 dB

Note : When printing from PC, on Premium Glossy Photo Paper, in highest quality

### CAUTION



- When returning the repaired printer to the customer, make sure the Printhead is covered with the cap and the ink cartridge is installed.
- If the Printhead is not covered with the cap when the printer is off, turn on the printer with the ink cartridge installed, make sure the Printhead is covered with the cap, and then turn the printer off.

## 1.4.5 Safety Approvals (Safety standards/EMI)

USA	UL60950-1 FCC Part15 Subpart B Class B
Canada	CSA No.60950-1 CAN/CSA-CEI/IEC CISPR 22 Class B
Mexico	NOM-019-SCFI-1998
Taiwan	CNS13438 Class B CNS14336 (IEC60950)
EU	EN60950-1 EN55022 Class B EN61000-3-2, EN61000-3-3 EN55024
Russia	GOST-R (IEC60950, CISPR 22)
Korea	K60950-1 KN22 Class B KN61000-4-2/-3/-4/-5/-6/-11
Argentina	IEC60950-1
Australia	AS/NZS CISPR22 Class B
Singapore* <sup>1</sup>	IEC60950-1
Hong Kong* <sup>1</sup>	IEC60950-1
China* <sup>1*2</sup>	GB8898 GB13837 Class B, GB17625.1

Note \*1: SX410 series is not compliant.

\*2: NX510 series is not compliant.

## 1.5 Interface

This printer has USB interface and memory card slots of the following specifications.

### 1.5.1 USB Interface

The mounted USB Interfaces differ between NX510/SX410/SX210 series. These products are equipped with the USB Device Port to connect a computer. Moreover, NX510/SX410 series are equipped with the USB Host Port to connect an external device such as a DSC (Digital Still Camera), etc. The specifications of each USB port are provided below.

**Table 1-21. USB Interface Specifications**

Item		USB Device port	USB Host port*
Compatible standards		<ul style="list-style-type: none"> <li>Universal Serial Bus Specifications Revision 2.0</li> <li>Universal Serial Bus Device Class Definition for Printing Devices Version 1.1</li> <li>Universal Serial Bus Mass Storage Class Bulk-Only Transport Revision 1.0</li> </ul>	<ul style="list-style-type: none"> <li>Universal Serial Bus Specifications Revision 2.0</li> </ul>
Transfer rate	NX510 series	480 Mbps (High Speed)	480 Mbps (MAX)
	SX410 series		12 Mbps (MAX)
Data format		NRZI	
Compatible connector		USB Series B	USB Series A
Max. cable length		2 [m] or less	

Note\* : The following devices can be connected to the USB Host port. (Not supported for SX210 series)

- Devices compliant with DPS Version 1.0/1.1 (PictBridge)
- Devices compliant with Universal Serial Bus Mass Storage Class Bulk-Only Transport Revision 1.0, and the Subclass code is one of the followings. (NX510 series only)
  - 0x06 (SCSI transparent command set)
  - 0x05 (SFF-8070i command set)
  - 0x02 (SFF-8020i command set)

Table 1-22. Device ID

When IEEE 1284.4 is Enabled	When IEEE 1284.4 is Disabled
@EJL<SP>ID<CR><LF> MFG:EPSON; CMD:ESCPL2,BDC,D4,D4PX,ESCPR1; MDL: <i>Model Name</i> ; CLS:PRINTER; DES:EPSON<SP> <i>Model Name</i> ; CID:EpsonRGB;	@EJL<SP>ID<CR><LF> MFG:EPSON; CMD:ESCPL2,BDC;ESCPR1; MDL: <i>Model Name</i> ; CLS:PRINTER; DES:EPSON<SP> <i>Model Name</i> ; CID:EpsonRGB;

The “*Model Name*” is replaced as shown in the following table.

Table 1-23. Model Names Indicated in the Device ID

Destination	North America	Euro	Latin/Asia/ Pacific	China
NX510 series	Epson Stylus NX510	Epson Stylus SX510W	Epson Stylus TX510W	---
SX410 series	<b>TBD</b>	<b>TBD</b>	<b>TBD</b>	---
SX210 series	Epson Stylus NX210	Epson Stylus SX210	Epson Stylus TX210	Epson ME OFFICE 510

## 1.5.2 Network Interface (NX510 series only)

NX510 series can be connected to the network via Wired or Wireless LAN connection. (They can not be used simultaneously.) The following describes each Interface.

### □ Wired LAN

The following interface is equipped for the Wired LAN connection. The communication mode can be selected from auto setting or fixed setting.

Table 1-24. Wired LAN

Item	Content
Connector	RJ-45 receptacle*: 1 port
Communication Speed	For either 10Base-T or 100Base-TX, the Full Duplex or Half Duplex can be selected.

Note\* : 10Base-T/100Base-TX Ethernet is supported. MDI/MDI-X is selected automatically.

Table 1-25. Combination of the Wired LAN communication mode settings

Setting of this printer	Setting of the connected device
Auto Setting	Auto Setting (AUTO)
	100BASE-TX Half Duplex
	10BASE-T Half Duplex
100BASE-TX Full Duplex	100BASE-TX Full Duplex
100BASE-TX Half Duplex	Auto Setting (AUTO)
	100BASE-TX Half Duplex
10BASE-T Full Duplex	10BASE-T Full Duplex
10BASE-T Half Duplex	Auto Setting (AUTO)
	10BASE-T Half Duplex



## □ Wireless LAN

The following interface is equipped for the Wireless LAN connection.

**Table 1-26. Wireless LAN**

Item	Content	
Applied Standard (2.4GHz spectrum band wireless network standards)	Conforms to IEEE802.11b, IEEE802.11g	
Wireless Operation Mode	IEEE802.11b	DS-SS (Half Duplex)
	IEEE802.11g	OFDM (Half Duplex)
Communication Range (line-of-sight distance)*	IEEE802.11b (11Mbps)	<ul style="list-style-type: none"> <li>• 60m (indoor)</li> <li>• 220m (outdoor)</li> </ul>
	IEEE802.11g (54Mbps)	<ul style="list-style-type: none"> <li>• 20m (indoor)</li> <li>• 100m (outdoor)</li> </ul>
Communication Mode	Ad-hoc (IBSS) or Infrastructure (ESS)	
Roaming Function	Not supported	
Output Signal Intensity	10mW	
Antenna	Built-in antenna (Diversity function is not supported)	

Note "\*": Referential value. It depends on surrounding conditions.

**Table 1-27. Available Channels and Standard**

Frequency Band (GHz)	Channel	IEEE Standard	Communication Speed (bps)*
2.400 - 2.4835	1 - 13	802.11b	11/5.5/2/1M
2.400 - 2.4835	1 - 13	802.11g	54/48/36/24/18/12/9/6M
2.471 - 2.497	14	802.11/11b	11/5.5/2/1M

Note "\*": The communication speed will be changed automatically, depending on radio wave strength. bps = bit per second.

## □ Switching Wired/Wireless LAN

This printer can be connect to the network via either Wired LAN or Wireless LAN connection only.

Enabling/disabling the Wireless LAN can be made from the Control Panel. When the Wireless LAN is enabled, it gets priority over the Wired Lan regardless of whether the LAN Cable is connected. The default Wireless LAN setting is "Disabled".

**Table 1-28. Wireless LAN Setting from the Control Panel**

Setting from Control Panel		LAN Cable Connection State	
		Connected	Disconnected
Wireless LAN	Disabled (Default)	Wired LAN	---*
	Enabled	Wireless LAN	Wireless LAN

Note\* : No service via network is available without connecting the LAN Cable (because network communication is not established.) except printing a status sheet or the like.



**When changing the networks while the power is on, wait at least for 10 seconds between disconnecting and reconnecting.**

### 1.5.3 Memory Card Slots



If you insert a Memory Stick DUO to the Memory Card Slot without using the adapter, make sure to turn off the printer first, then remove the card using tweezers.

Table 1-29. List of Supported Memory Card

Priority	Slot	Compatible memory card	Standard	Max. capacity	Remarks
1	Memory Stick/ Memory Stick PRO	Memory Stick	"Memory Stick Standard" Format Specification Ver.1.43-00 compatible	128MB	Includes versions with memory select function
		MagicGate Memory Stick			Copy protection function is not supported
		MagicGate Memory Stick Duo			An adapter should be used
		Memory Stick PRO	Memory Stick PRO Format Specifications-without security specifications Ver.1.02-00 compatible	32GB	Copy protection function is not supported
		Memory Stick Duo			The Memory Stick Duo adapter should be used
		Memory Stick Pro Duo			The Memory Stick Duo adapter should be used.
		Memory Stick micro			The Memory Stick adapter for standard size should be used.
2	SD/MMC	SD (Security Digital)	SD Memory Card Specifications / PART1. Physical Layer Specification Ver. 2.0 compatible	2GB	The SD adapter should be used
		miniSD/microSD			Speed Class is not supported
		SDHC		32GB	The SD adapter should be used
		miniSDHC/microSDHC		Speed Class is not supported	
		MultiMediaCard MultiMediaCard Plus	MultiMediaCard Standard Ver. 4.2 compatible	4GB/32GB	Only MultiMediaCard Plus supports 32GB
3	xD-Picture card	xD-Picture card	xD-Picture Card Specification Ver.1.20 compatible	2GB	Type M/H supported
4	CF Type II (No slot provided for SX210 series)	Compact Flash	CF+ and CompactFlash Specification Revision 4.1 compatible	32GB	True-IDE compatible memory card only
		Microdrive			

- Note:
- Memory Stick/PRO, SD/MMC and xD-Picture Card shares the same slot.
  - When cards are inserted in the two slots at once, the slot which will be accessed first is determined according to the priority shown in the table.
  - To select a card that has been inserted in a non-active slot, first remove the card in the active slot.
  - In memory card direct printing mode, the image files in the active slot are valid and have assigned frame numbers. The number of images will not change if a card is inserted in another nonselected slot.
  - When the card inserted in the slot is accessed from the PC, only one drive is displayed at a time as a removable disk\* and only the card that is in the active slot can be accessed via the removable disk. A card that has been inserted into a non-selected slot

- cannot be accessed.  
(This is for Windows. For Macintosh, the card in the active slot will be mounted on the desktop.)
- Does not support 5V type of memory cards.
- When a memory card is being accessed, do not touch the memory card.
- For detailed information on the supported file system and formatting the memory card, refer to "1.7.3 Memory Card Direct Print Function (p.36)".

## 1.6 Control Panel

### 1.6.1 Operation Buttons & LEDs

□ NX510 series

Table 1-30. NX510 series Buttons & LEDs

Button/LED	Function
Power	Turns the power ON/OFF.
Start	Starts printing.
Stop/Clear	<ul style="list-style-type: none"> <li>Stops operation and displays the menu screen.</li> <li>Stops printing and ejects paper.</li> <li>Returns the print settings in the current mode to their default and displays the Top screen. (Returns to the previous screen during printing maintaining the current settings)</li> </ul>
Setup	Goes to the Setup mode that provides maintenance menu (head cleaning, head alignment, etc.) and various setting menu.
Display/Crop	<ul style="list-style-type: none"> <li>Goes to the zoom setting screen for the selected image.</li> <li>Changes the image preview layout on the LCD.</li> </ul>
Menu	Goes to the print setting menu screen.
OK	Accepts the changed settings
Back	Cancels the previous operation.
Cross Key (Up/Down/Left/Right)	Selects a menu item or a setting value.
+	Sets the number of copies.
-	
Copy	Goes to the stand alone Copy mode.
Memory Card	Goes to the memory card direct print mode.
Photo	Goes to the Photo mode. (Repeat printing)
Scan	Goes to the Scan mode.
Power (Green)	<ul style="list-style-type: none"> <li>Flashes at power ON/OFF.</li> <li>Flashes during some sequence is in progress.</li> <li>Flashes when an fatal error occurs.</li> </ul>
WiFi (Green)	Flashes when wireless LAN connected
Card Access (Green)	<ul style="list-style-type: none"> <li>Lights when a memory card is inserted.</li> <li>Flashes when a memory card is being identified or accessed.</li> </ul>

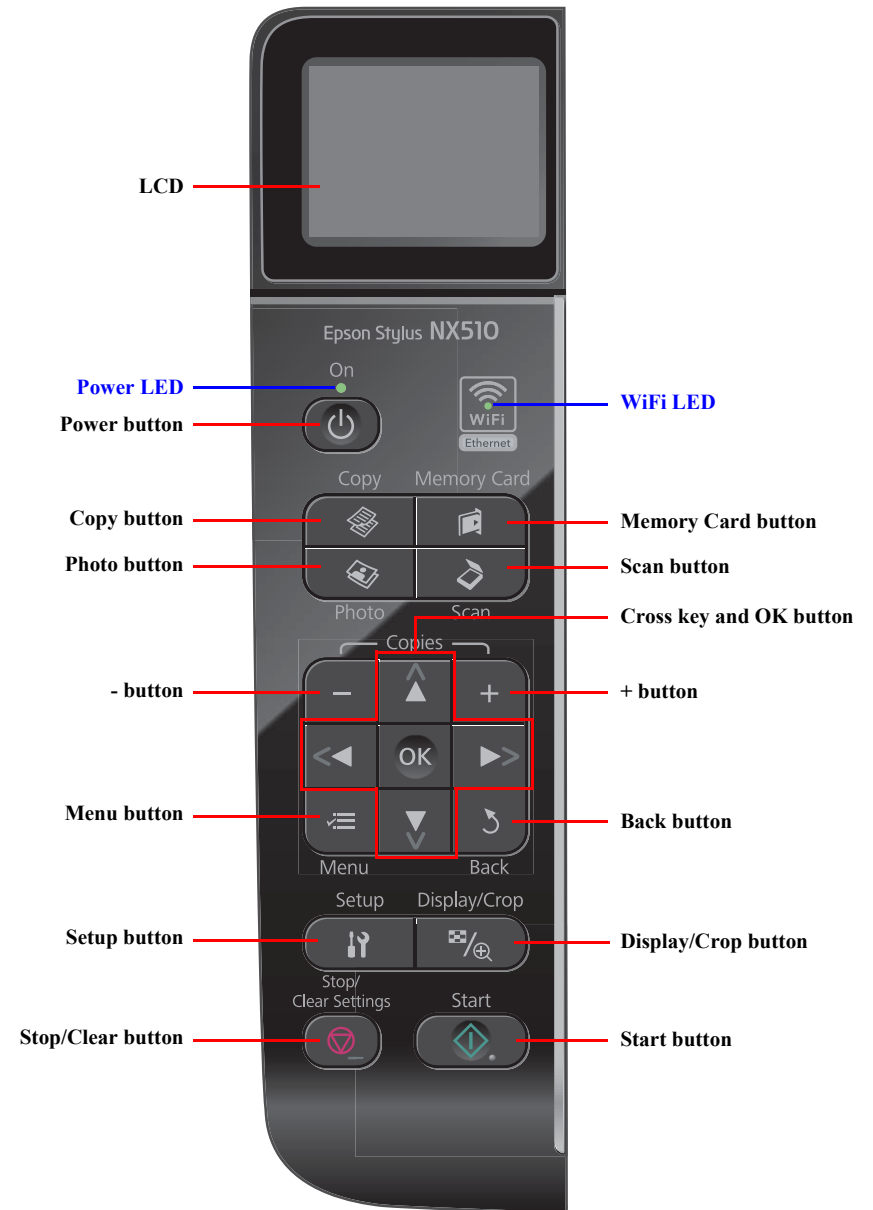

Note : The Card Access LED is provided near the memory card slot.

Figure 1-5. NX510 series Control Panel

## □ SX410 series

Table 1-31. SX410 series Buttons &amp; LEDs

Button/LED	Function
Power	Turns the power ON/OFF.
Start	Starts printing.
Stop/Clear	<ul style="list-style-type: none"> <li>Stops operation and displays the menu screen.</li> <li>Stops printing and ejects paper.</li> <li>Returns the print settings in the current mode to their default and displays the Top screen. (Returns to the previous screen during printing maintaining the current settings)</li> </ul>
Setup	Goes to the Setup mode that provides maintenance menu (head cleaning, head alignment, etc.) and various setting menu.
Display/Crop	<ul style="list-style-type: none"> <li>Goes to the zoom setting screen for the selected image.</li> <li>Changes the image preview layout on the LCD.</li> </ul>
Menu	Goes to the print setting menu screen.
OK	Accepts the changed settings
Back	Cancel the previous operation.
Cross Key (Up/Down/Left/Right)	Selects a menu item or a setting value.
+	Sets the number of copies.
-	
Copy	Goes to the stand alone Copy mode.
Memory Card	Goes to the memory card direct print mode.
Photo	Goes to the Photo mode. (Repeat printing)
LED	Power (Green) <ul style="list-style-type: none"> <li>Flashes at power ON/OFF.</li> <li>Flashes during some sequence is in progress.</li> <li>Flashes when an fatal error occurs.</li> <li>Lights when the status is other than above. (i.e. when in stand-by / in setting operation using the control panel)</li> </ul>
	Card Access (Green) <ul style="list-style-type: none"> <li>Lights when a memory card is inserted.</li> <li>Flashes when a memory card is being identified or accessed.</li> </ul>

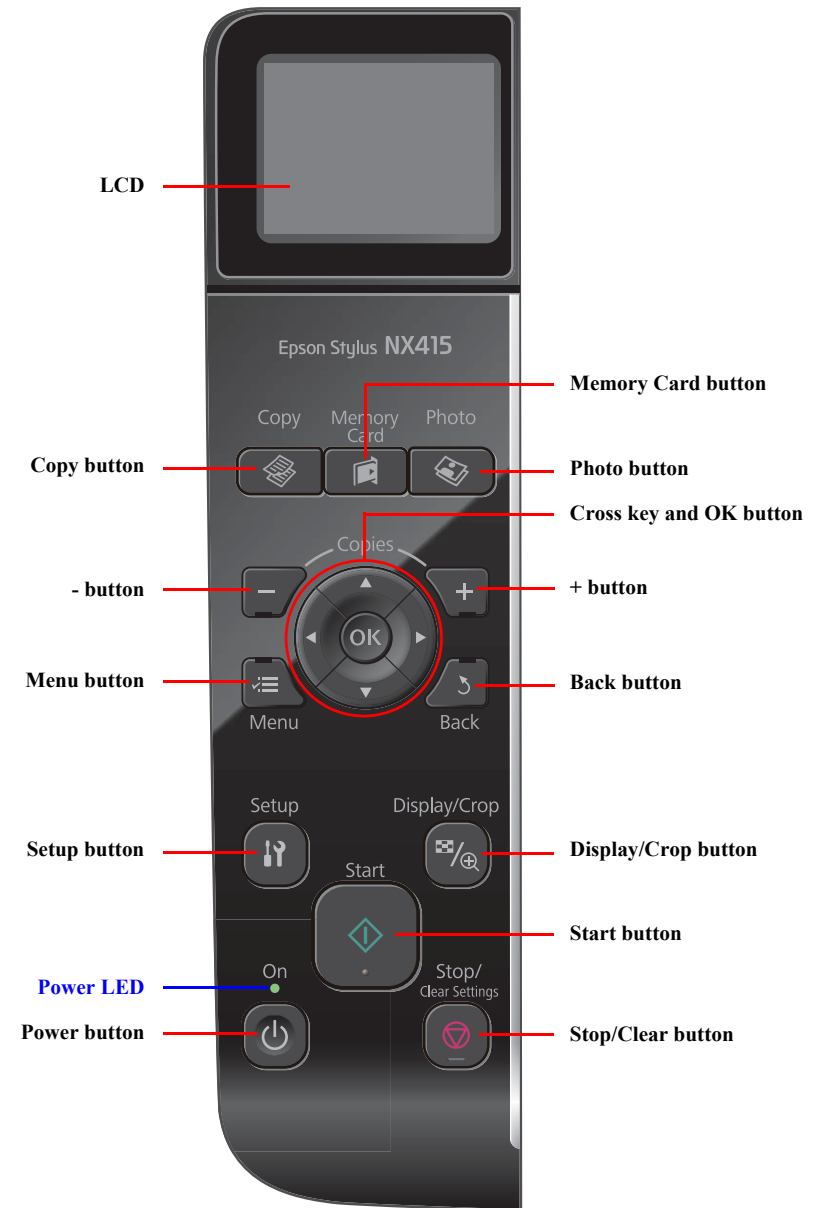

Note : The Card Access LED is provided near the memory card slot.

Figure 1-6. SX410 series Control Pane

## □ SX210 series

Table 1-32. SX210 series Buttons &amp; LEDs

Button/LED		Function
Button	Power	Turns the power ON/OFF.
	Start	Starts printing.
	Stop/Clear	<ul style="list-style-type: none"> <li>Stops operation and displays the menu screen.</li> <li>Stops printing and ejects paper.</li> <li>Returns the print settings in the current mode to their default and displays the Top screen. (Returns to the previous screen during printing maintaining the current settings)</li> </ul>
	Paper Type	Selects paper type and size.
	Zoom	Goes to the zoom setting screen.
	Left/Right	Selects a menu item or a setting value.
	+	Sets the number of copies.
	-	
	Copy	Goes to the stand alone Copy mode.
	Photo	Goes to the memory card direct print mode.
	Index Sheet	Prints an index sheet.
	Scan	Goes to the Scan mode.
	Index Sheet + Scan	Goes to the Setup mode.
	LED	Power (Green)
Paper (Green)		Selected paper type and size light.
Card Access (Green)		<ul style="list-style-type: none"> <li>Lights when a memory card is inserted.</li> <li>Flashes when a memory card is being identified or accessed.</li> </ul>

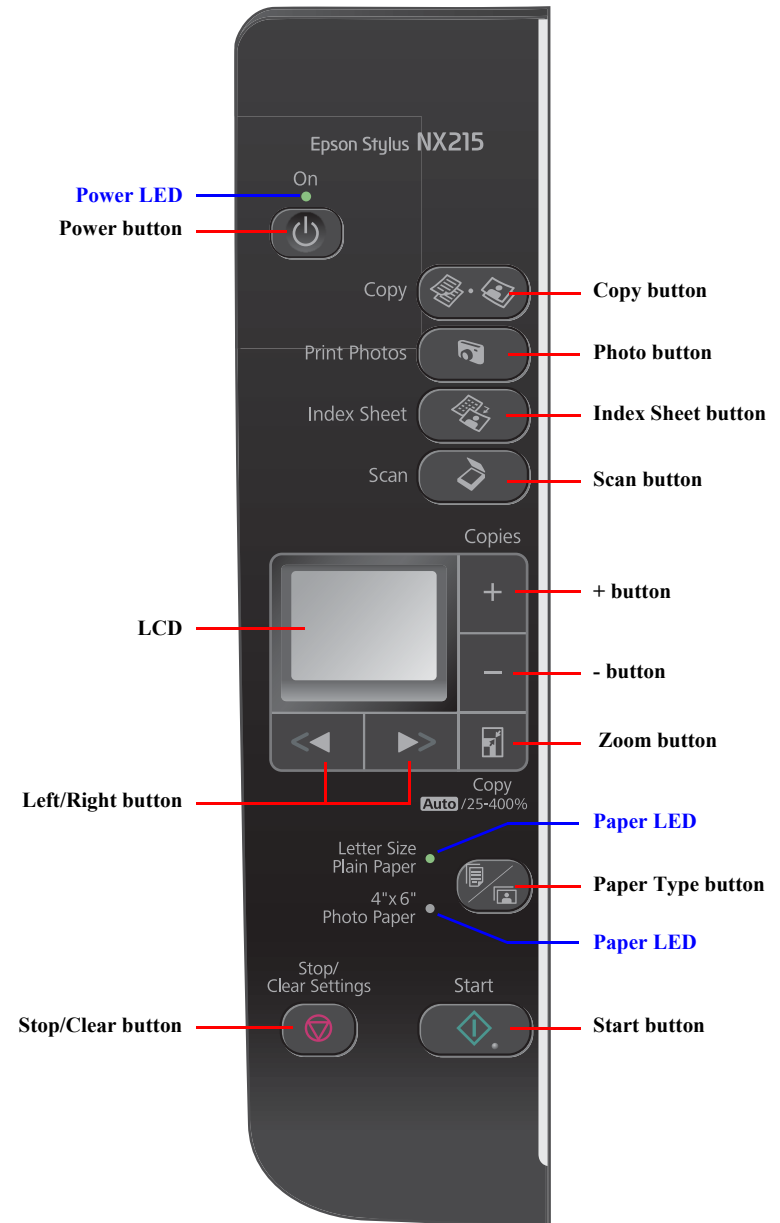

Note : The Card Access LED is provided near the memory card slot.

Figure 1-7. SX210 series Control Pane

## 1.6.2 Control Panel Functions in Each Mode

This product provides the guidance for button operations for each mode on the LCD; therefore, the details of the control panel operations are omitted here. This section describes print setting items in each mode, and the timing of saving and initialization.

### 1.6.2.1 Control Panel Functions for NX510 series

Table 1-33. Timing of Saving or Initializing Control Panel Settings (NX510 series)

Mode	Print Setting	Default Value	Saving Timing	Initializing Timing*
Copy	Number of copies	1	When the Start button is pressed	When the Stop/Clear button is pressed
	Copy Type	Color		
	Layout	With Border		
	Zoom	Actual		
	Paper Size	A4(Other), Letter(EAI)		
	Paper Type	Plain Paper		
	Quality	Standard		
	Density	±0		
	Expansion	Standard		
Memory Card	Paper Size	4x6 inch	When the Start button is pressed	When the Stop/Clear button is pressed
	Paper Type	Prem. Glossy		
	Layout	Borderless		
	Quality	Standard		
	Expansion	Standard		
	Date	Off		
	Bidirectional	On		
	Select (Print Index Sheet setting)	All Photos		
	Information (Print Index Sheet setting) (EAI only)	File Name		
Photo	Paper Size	4x6 inch	When the Start button is pressed	When the Stop/Clear button is pressed
	Paper Type	Prem. Glossy		
	Layout	Borderless		
	Quality	Standard		
	Expansion	Standard		
	Color Restoration	Off		
Scan	Select PC	USB Connection	When the OK button is pressed	When the Stop/Clear button is pressed

Table 1-33. Timing of Saving or Initializing Control Panel Settings (NX510 series)

Mode	Print Setting	Default Value	Saving Timing	Initializing Timing*
Camera Direct	Paper type	Prem. Glossy	When the settings are made in the PictBridge Setup of the Setup menu.	When the Stop/Clear button is pressed while making the settings.
	Paper size	4x6 inch		
	Layout	Borderless		
	Quality	Standard		
	Expansion	Standard		
	Date	Off		
	Bidirectional	On		

Note \* : After pressing the OK button in the "Restore Default Settings" of the Setup Menu, "Network Settings", "All except Network", and "All Settings" become selectable. Pressing the OK button of each item initializes the selected settings.

## 1.6.2.2 Control Panel Functions for SX410 series

Table 1-34. Timing of Saving or Initializing Control Panel Settings (SX410 series)

Mode	Print Setting	Default Value	Saving Timing	Initializing Timing*
Copy	Number of copies	1	When the Start button is pressed	When the Stop/Clear button is pressed
	Copy Type	Color		
	Layout	With Border		
	Zoom	Actual		
	Paper Type	Plain Paper		
	Paper Size	A4(Other), Letter(EAI)		
	Quality	Standard		
	Density	±0		
	Expansion	Standard		
Memory Card	Paper Type	Prem. Glossy	When the Start button is pressed	When the Stop/Clear button is pressed
	Paper Size	4x6 inch		
	Layout	Borderless		
	Quality	Standard		
	Expansion	Standard		
	Date	None		
	Bidirectional	On		
	Select (Print Index Sheet setting)	All Photos		
	Information (Print Index Sheet setting) (EAI only)	File Name		
Photo	Paper Type	Prem. Glossy	When the Start button is pressed	When the Stop/Clear button is pressed
	Paper Size	4x6 inch		
	Layout	Borderless		
	Quality	Standard		
	Expansion	Standard		
	Color Restoration	Off		
Camera Direct	Paper type	Prem. Glossy	When the settings are made in the PictBridge Setup of the Setup menu.	When the Stop/Clear button is pressed while making the settings.
	Paper size	4x6 inch		
	Layout	Borderless		
	Quality	Standard		
	Expansion	Standard		
	Date	None		
	Bidirectional	On		

Note \*: All the settings except "LCD Brightness" of Setup menu returns to their default when the "Restore Default Settings" of the Setup menu is executed by the OK button.



## 1.6.2.3 Control Panel Functions for SX210 series

Table 1-35. Timing of Saving or Initializing Control Panel Settings (SX210 series)

Mode	Print Setting	Default Value	Saving Timing	Initializing Timing*
Copy	Number of copies	1	When the Start button is pressed	When the Stop/Clear button is pressed
	Copy Type	Color		
	Zoom	Actual		
	Paper Size/Paper Type	A4(Other), Letter(EAL) / Plain Paper		
Photo	Paper Size/Paper Type	4x6 inch, Photo Paper	When the Start button is pressed	When the Stop/Clear button is pressed

## 1.7 Specification for Each Function

### 1.7.1 Stand-alone Copy Function

#### 1.7.1.1 Supported Paper and Copy Mode

Table 1-36. Supported Paper and Copy Mode for NX510/SX410 series

Paper Type	Size	Print Quality	Resolution	Dot Size	Bi-D	Micro Weave	Borderless
Plain paper	A4, Letter*1	Draft	360x120	Eco	ON	OFF	NA
		Standard	360x360	VSD1	ON	OFF	NA
		Best	720x720	VSD3	ON	ON	NA
Matte paper	A4, Letter*1	Standard	1440x720	VSD3	ON	ON	OK
Photo Paper*2	4x6, 5x7, A4,	Standard	1440x720	VSD3	ON	ON	OK
Glossy*3	4x6, 5x7*2, A4, Letter*	Standard	1440x720	VSD3	ON	ON	OK
Prem. Glossy	4x6, 5x7, A4, Letter*1	Standard	1440x720	VSD3	ON	ON	OK
Ultra Glossy	4x6, 5x7, A4, Letter*1	Standard	1440x720	VSD3	ON	ON	OK

Note \*1: Letter size is supported for EAI only.

\*2: Not supported for EAI.

\*3: NX510 series only.

Table 1-37. Supported Paper and Copy Mode for SX210 series

Paper Type	Size	Print Quality	Resolution	Dot Size	Bi-D	Micro Weave	Borderless
Plain paper	A4, Letter*	Draft	360x120	Eco	ON	OFF	NA
		Standard	360x360	VSD1	ON	OFF	NA
Photo Paper	4x6	Standard	1440x720	VSD3	ON	ON	OK

Note \*: Letter size is supported for EAI only.

For Latin, A4 and Letter are selectable on the panel.

#### 1.7.1.2 Stand-alone Copy Menu

The following are the menu (settable items) for stand-alone copy.

Table 1-38. Copy Menus for NX510/SX410 series

Menu	Function	
Number of copies	Sets the number of copies within the range of 1 to 99.	
Copy type	Selects either color or monochrome.	
Layout	Selects from the following two layouts: <ul style="list-style-type: none"> <li>• With Border (normal layout with 3mm margins)</li> <li>• Borderless (no margins)</li> </ul>	
Print setting	Paper type	Selects paper type from the options shown in <a href="#">Table 1-36</a> .
	Paper size	Selects paper size from the options shown in <a href="#">Table 1-36</a> .
	Quality	Selects print quality from the options shown in <a href="#">Table 1-36</a> .
	Zoom	Selects Actual or Auto Fit Page. Or reduction/enlargement ratio can be specified within the range of 25% to 400%.
Density	Selects from the nine density levels of -4 to +/-0 to +4.	
Expansion (for borderless print)	Selects the margins level (margins bleed off the edges of paper) from the Standard (100%), Mid. (50%) or Min. (25%).	

Table 1-39. Copy Settings for SX210 series

Setting Item	Operation and Function	
Number of copies	Sets the number of copies within the range of 1 to 99.	
Copy type	Selects either color or monochrome.	
Print setting	Paper type	Selects paper type and size from the options shown in <a href="#">Table 1-37</a> using the Paper Type button.
	Paper size	
	Quality	Selects print quality from the options shown in <a href="#">Table 1-37</a> .
	Zoom	Selects Actual or Auto Fit Page. Or reduction/enlargement ratio can be specified within the range of 25% to 400%.

### 1.7.1.3 Relation Between Original and Copy

The scanning start position is located on the front right of the scan bed. The relations between the original placed face down and its copy are as follows.

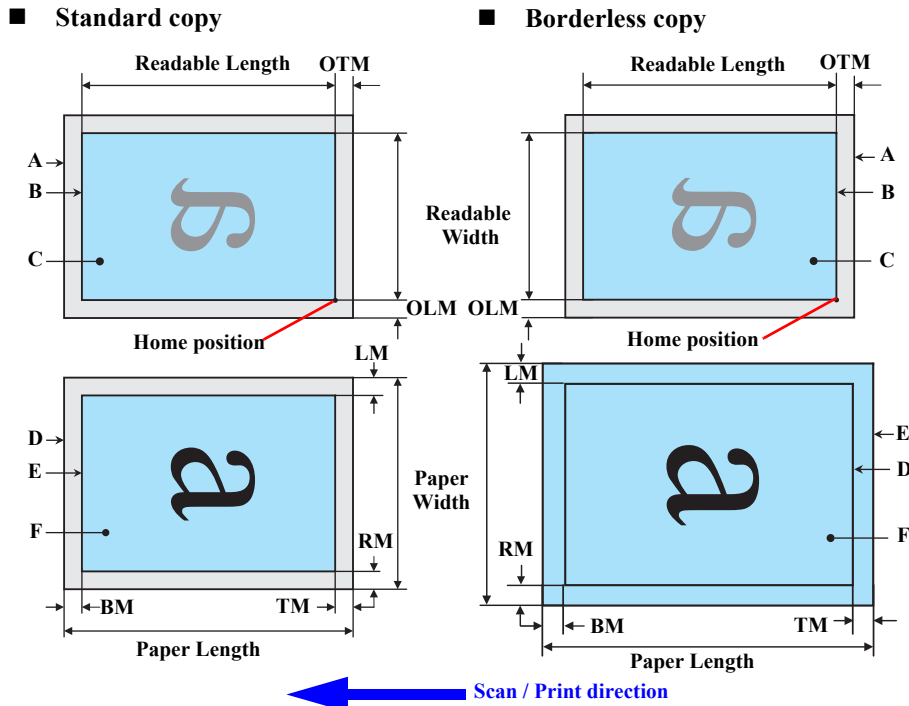

Figure 1-8. Relation Between Original and Copy (Borderless/With Borders)

#### Original Document

A	Scan bed	---
B	Scan area	“1-17 Scanning Range” (p.21)
C	Original (face down)	---
OTM	Top margin (out of scan range)	“1-17 Scanning Range” (p.21)
OLM	Left margin (out of scan range)	“1-17 Scanning Range” (p.21)

#### Copied Document

D	Copied paper	---
E	Print area	“1-15 Printing Area (Margins)” (p.20)
F	Copy	---
LM, RM	Left margin, Right margin	“1-15 Printing Area (Margins)” (p.20)
TM, BM	Top margin, Bottom margin	

### 1.7.1.4 Copy Speed

Table 1-40. Copy Speed

Copy Conditions (eMemo3, A4 Letter size)		Model		
		NX510 series	SX410 series	SX210 series
Draft 360 x 120	Monochrome copy	36 cpm	33 cpm	32 cpm
	Color copy	36 cpm	33 cpm	9 cpm
Default 360 x 360	Monochrome copy	27 cpm	TBD cpm	TBD cpm
	Color copy	10 cpm	TBD cpm	TBD cpm

## 1.7.2 Scan Function (NX510/SX210 series only)

The following shows the scan menu. When each menu is selected, Epson Scan installed in PC runs each function.

- Scan to PC
- Scan to PDF
- Scan to Email

For NX510 series; after selecting one of those above, the selection menu of the connected PC appears. When connected via USB, “USB Connection” is displayed. When connected via a wired network, the PC name connected via the network is displayed (selecting “Last Used” can choose the PC connected last). Then the function is run on the selected PC.

## 1.7.3 Memory Card Direct Print Function

### 1.7.3.1 Supported Paper and Print Mode

Table 1-41. NX510/SX410 series Supported Paper Type & Print Mode

Paper Type	Size	Print Quality	Resolution	Dot Size	Bi-D	Micro Weave	Border-less
Plain Paper	A4, Letter* <sup>1</sup>	Standard	360x360	VSD1	ON	OFF	NA
		Best	720x720	VSD3	ON	ON	NA
Matte Paper	A4, Letter* <sup>1</sup>	Standard	1440x720	VSD3	ON	ON	OK
Photo Paper* <sup>2</sup>	4x6, 5x7, A4, Letter* <sup>1</sup>	Standard	1440x720	VSD3	ON	ON	OK
Glossy* <sup>3</sup>	4x6, 5x7* <sup>2</sup> , A4, Letter* <sup>1</sup>	Standard	1440x720	VSD3	ON	ON	OK
Prem. Glossy	4x6, 5x7, 16:9wide* <sup>4</sup> , A4, Letter* <sup>1</sup>	Standard	1440x720	VSD3	ON	ON	OK
Ultra Glossy	4x6, 5x7, A4, Letter* <sup>1</sup>	Standard	1440x720	VSD3	ON	ON	OK

Note \*1: Letter size is supported for EAI only.

\*2: Not supported for EAI.

\*3: NX510 series only.

\*4: Not supported for SX410 series for EAI.

Table 1-42. SX210 series Supported Paper Type & Print Mode

Paper Type	Size	Print Quality	Resolution	Dot Size	Bi-D	Micro Weave	Border-less
Plain Paper* <sup>1</sup>	A4, Letter* <sup>3</sup>	Standard	360x360	VSD1	ON	OFF	NA
Photo paper* <sup>2</sup>	4x6, 5x7, 16:9wide* <sup>4</sup> , A4, Letter* <sup>3</sup>	Standard	1440x720	VSD3	ON	ON	OK

Note \*1: For printing an Index Sheet

\*2: For printing images according to the information read from the Index Sheet.

\*3: Letter size is supported for EAI only.

For Latin, A4 and Letter are selectable on the panel.

\*4: The 16:9wide is not supported for EAI.

### 1.7.3.2 Supported File Type and Media Type

The followings describe the file system, media format, and file type supported by the memory card direct function.

**Table 1-43. Supported File System, Types and Media Format**

Item		Specification
File system		DCF Version 1.0 or 2.0 *1 compliant. Other than those does not ensure proper operation. File systems available with the card reader function are restricted by the host's specification.
Media format	Memory card	<ul style="list-style-type: none"> <li>DCF Version 1.0 or 2.0 compliant</li> <li>DOS FAT format (FAT12/FAT16/FAT32 *2) with single partition (basic partitioned)</li> </ul>
File type	JPEG (*.JPG)	Image files conform to Exif Version 2.21. (Exif version 1.0/2.0/2.1/2.2/2.21 are supported)
	Camera definition file (*.MRK)	Camera definition files used for DPOF mode. "MISC\AUTOPRINT.MRK" file is valid.

Note \*1: Refer to the Camera File System Standard; "DCF Version 2.0, JEIDA-CP-3461" for more details.

\*2: FAT32 is not specified in the xD-Picture card standards; however, reading of xD-Picture card formatted in FAT32 is supported. (NX510 series only)



**The printer does not detect any files stored under the following directories or their sub-directories.**

- Directories containing system properties or hidden properties.
- "RECYCLED" (Windows directory for deleted files)
- "PREVIEW" (directories of CASIO DSC for thumbnail images)
- "SCENE" (directories of CASIO DSC for its Best Shot function)
- "MSSONY" (directories of SONY DSC for e-mail images, voice memos, movies, or non-compressed images)
- "DCIM\ALBUM\IMAGE" (directories of CASIO DSC for its album function)

### 1.7.3.3 Automatic Detection of Images in Memory Card

When a memory card is inserted in the card slot on the printer, or when a memory card is detected at power-on, the printer automatically searches for all images stored in the card. When the card is removed, the printer erases the information on the all detected files.

### 1.7.3.4 Specifications for Handling Image Data

**Table 1-44. Specifications for Handling Image Data**

Item	Specification	Remarks	
Image size (pixel)	<ul style="list-style-type: none"> <li>Horizontal: <math>80 \leq X \leq 9200</math></li> <li>Vertical: <math>80 \leq Y \leq 9200</math></li> </ul>	---	
Maximum number of images	NX510 series	Up to 9,990 images	When a memory card stores 9,990 or more images, the first 9,990 images are detected and become valid in the printer. The detecting order varies depending on the folder configuration in the card, in such a case, which images are included in the 9,990 or not cannot be guaranteed. In addition, the files that can be handled are 9,990; however, the files that can be displayed on the LCD at a time are 999. When the existing files exceed 999, the files that are displayed should be selected with UI. But, images specified by camera definition files can be selected to be printed even when the total number of images has exceeded 9,990. The image files that can be specified are limited up to 999.
	SX410/SX210 series	Up to 999 images	When a memory card stores 1,000 or more images, the first 999 images are detected and become valid in the printer. The detecting order varies depending on the folder configuration in the card, so which images are included in the first 999 cannot be defined. However, images specified by camera definition files can be selected to be printed even when the total number of images has exceeded 999. Up to 999 camera defined image files can be specified.

Table 1-44. Specifications for Handling Image Data

Item	Specification	Remarks
Maximum number of copies	99 copies for each image. Up to 999 sheets in total.	---
Valid date and time	01/01/1980 00:00:00 to 12/31/2099 23:59:59	---
Thumbnail image data	Supports DCF Ver.1.0 or 2.0-compatible data (Exif format, 160x120 pixels)	Thumbnail images are used for the Print Index Sheet function.
File sorting	The printer sorts image files in ascending ASCII order based on their full-pathnames such as “\DCIM\100EPSON\EPSN0000.JPG”, and assigns a number to each of them.	<ul style="list-style-type: none"> <li>• The image number assigned by the printer may be different from that assigned by the camera.</li> <li>• If two or more files have the same full pathname, the sorting function may not operate properly. (existence of the same full-pathname is not allowed under DOS)</li> </ul>

Table 1-44. Specifications for Handling Image Data

Item	Specification	Remarks	
Acquisition of date and time information	NX510 series	Date and time information applied on DOS-compliant file system.	---
	SX410/SX210 series	<p>The printer acquires date and time information included in image files in the order of precedence shown below.</p> <ol style="list-style-type: none"> <li>1. Shooting date and time information in digital camera standard format (Exif)</li> <li>2. Digitized date and time information in digital camera standard format (Exif)</li> <li>3. Date and time information in digital camera standard format (Exif)</li> <li>4. Date and time information applied on DOS-compliant file system.</li> <li>5. Fixed date and time information (01/01/1980, 00:00:00)</li> </ol>	Date and time information included in an image file is not always the shooting date and time. It changes each time the image is edited and restored. The printer acquires the latest date and time information.

### 1.7.3.5 Memory Card Direct Print Menu

The following describes the menu (settable items) in Memory Card Mode for NX510/SX410 series. For SX210 series, only the Print Index Sheet function is available.

**Table 1-45. Memory Card Mode Menu**

Menu Item	Function
View and Print Photos* <sup>1,3</sup>	Prints the selected images.
Print All Photos* <sup>1,3</sup>	Prints all images in a memory card. Specified number of copies is applied to the all images (the default is 1 copy). Specifying it for each of the images independently also can be made in the preview screen.
Print by Date* <sup>1</sup>	The date of the images are listed in the descending order with the number of images by date. Selecting date from the list selects the images that has the selected date information. Specified number of copies is applied to the selected images (the default is 1 copy). Specifying it for each of the images independently also can be made in the preview screen.
Print Index Sheet (For SX210 series, only this function is available.)	<b>Print Index Sheet</b> * <sup>2</sup> Prints an index sheet that prints images in a memory card in thumbnail form. The number of images to be included in the sheet can be selected from the following four options. “All image” (default), “Latest 30”, “Latest 60”, “Latest 90”* <sup>3</sup>
	<b>Make Prints from Index Sheet</b> Scans the index sheet, and prints images according to markings written on the sheet.
Slide Show* <sup>4</sup>	Starts a slide show on the LCD. Images in a memory card is displayed one by one in the order sorted by the printer. Printing one of the images can be made from the paused screen.

Note \*1: 0 to 99 copies can be specified for each of the images. Up to 999 copies in total.

\*2: For SX210 series, press the [Index Sheet] button to print the index sheet. All images in a memory card are included in the sheet.

\*3: The images are listed in ASCII descending order.

\*4: While performing the slide show, displaying number of copies, printing from an external device or from a computer cannot be made.

### 1.7.3.6 Makes Prints from Index Sheet Function

#### □ Print settings

**Table 1-46. Print Settings**

Item	Print Index Sheet	Makes Prints from Index Sheet
Number of copies	---	According to the marking on the index sheet.
Paper Type	Plain paper	
Paper Size	A4, Letter	
Layout	---	
Quality	Standard	Standard
Expansion* <sup>1</sup>	---	Standard
Date	YYYY.MM.DD (2007.09.21)* <sup>2</sup>	According to the marking on the index sheet.
BiDirectional	On	On
Print Index Sheet Setting-Select* <sup>2</sup>	According to the setting made by the control panel.	---

Note \*1: NX510 series only. SX410/SX210 series do not support it.

\*2: NX510/SX410 series only. SX210 series do not support it.



#### □ Rules on reading Index Sheet markings

The user can specify images to be printed and their print settings shown in [Table 1-46](#) by putting marking on the Index Sheet. The printer reads the markings according to the following rules.

**Table 1-47. Rules on Reading Markings**

Item	Mark	Description	Remarks
Left edge (one each)		Reference position for reading markings.	An error occurs if these markings cannot be read due to ink stain or any other cause.
Right edge (one each)		Reference position for reading markings.	
Block code (36 pcs.)		Sheet information (memory card, page)	
Image selection (30 pcs. x 3)		Selects the image to be printed.	An error occurs if no image selection marking is read.
Paper type/size (4 pcs.)		Selects the paper type/size.	An error occurs if two or more markings are read for one image.

Table 1-47. Rules on Reading Markings

Item	Mark	Description	Remarks
Layout (2pcs.)		Selects the layout.	An error occurs if two or more markings are read for one image. If no marking is read, borderless layout is applied.
Date		Prints the date information	When this marking is read, the date is printed on the image.
Print all		Select all the images	If mark is recognized, print all the image one each.

- Note:
- About 50% or more range of the mark area must be marked out to be read by the printer.
  - For running out and excessive marking out, the two white/black search patterns shown above are superimposed on the mark, and judgement is made according to this matching ratio.
  - The judgement criteria is as follows;  
black matching: 80% or more, white matching: 50% or more.
  - The figure below shows the judgement example according to the rules described above.



□ Index Sheet errors

Table 1-48. Index Sheet Error List

Error Name	Description
Index sheet scan error (incorrect sheet setting)	The Index Sheet is not properly placed on the document glass.
Index sheet scan error (incorrect image selection marking)	Image selection markings are not correct.
Index sheet scan error (incorrect paper selection marking)	Paper selection markings are not correct.
Index sheet scan error (unmatch between memory card and sheet)	The memory card may have been changed or some images may have been added or deleted after the Index Sheet is printed.

1.7.3.7 Print Layout

The memory card direct print function supports two print layouts for printing images; Borderless, and With Border. The Borderless layout is not allowed for some type of paper (refer to Table 1-41 and Table 1-42). And see “1.2.5 Printing Area” (p.20) for information on the print area and margins of “Borderless” and “With Border” layouts.

□ Trimming Function

A trimming function is provided as a means of coordinating an image with the types of photo frames handled by the printer. This function can be switched On/Off. This function is described briefly below.

The printed photo frame and an image to be printed are matched in length along one side and the image is resized along the perpendicular side to fit the frame on that side. Any part of the image that does not fit within the photo frame is trimmed away (not printed). However, if the number of pixels of the longer side of the image are more than twice as long as the shortest side, the trimming function is not effective when printing even the trimming is set. The trimming function is always set On if borderless or upper half layout is selected.

Trimming On

- When an image is aligned vertically with the photo frame.

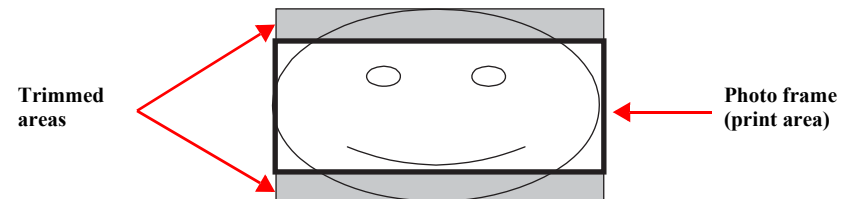

- When an image is aligned horizontally with the photo frame.

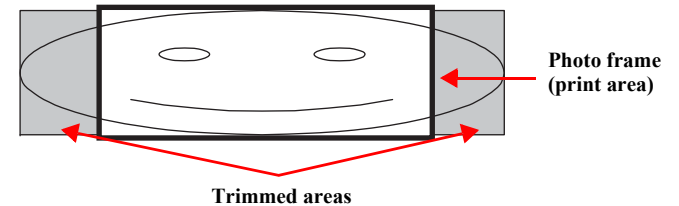
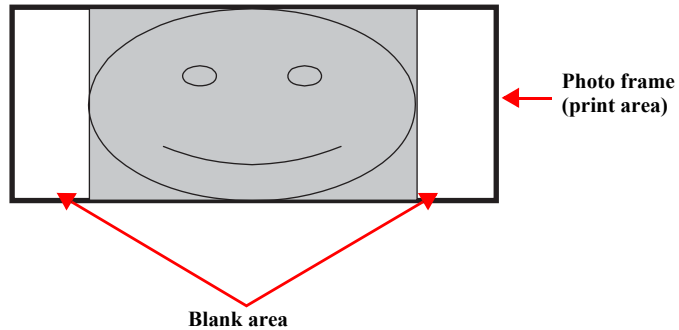

Figure 1-9. Trimming Function (when trimming is being operated)



## Trimming Off

- When an image is aligned vertically with the photo frame.



- When an image is aligned horizontally with the photo frame.

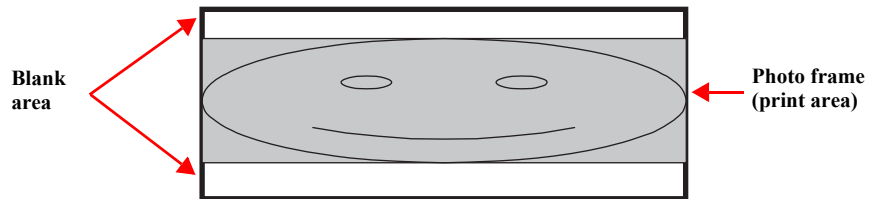

Figure 1-10. Trimming Function (when trimming is not operated)

### □ Rules on Numbering and Rotating Images

The numbers shown in the figure below indicate the photo frame numbers used for the print layout. Horizontally oriented images are printed as shown by the numbers. Vertically oriented images, which has more pixels vertically than horizontally, the vertical photo data is allocated instead, and the number shown in the figure below is then rotated 90 degrees before being printed. In Index printing mode, the numbers are printed as they are shown below, regardless of the shape of the photo data.

However, when the photo data has an equal number of pixels vertically and horizontally the photos are printed without rotation, regardless of the layout.

**NOTE:** The vertical photo data refers to when the photo data file itself is set for a vertical (portrait) orientation. Photo data is defined as the vertical photo data if it is taken by a digital camera with a portrait position detecting function.)

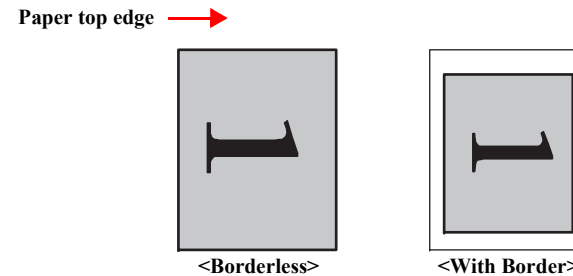

Figure 1-11. Rules on Numbering and Rotating Images

## 1.7.4 Camera Direct Print Function (PictBridge) (NX510/SX410 series only)

Printing operations (selecting images to be printed, making print settings, starting/canceling printing, and monitoring print process) can be carried out from a directly connected DSC (Digital Still Camera) that conforms to the standard described below.

### 1.7.4.1 Available DSC

Those devices which are compliant with "CIPA DC-001-2003 Digital Photo Solutions for Imaging Devices" (DPS Version 1.0) or "CIPA DC-001-2003 Rev.2.0, Digital Photo Solutions for Imaging Devices" (DPS Version 1.1).

### 1.7.4.2 Print Settings Available from DSC

The following print settings can be made from the DSC. However, depending on the DSC, some of the settings may not be available.

**Table 1-49. Print Settings Available from DSC**

Item	PictBridge
How to specify images	Single Sheet / Multiple Sheet / DPOF specified
Paper type	Plain Paper/ Prem. Glossy
Paper size	4 x 6, 5 x 7, Letter (EAI model only), A4, 16:9wide
Layout	Borderless / With Borders
Date	On / Off
Quality	Not available
Auto Correct	Not available
Fit to Frame	Any range specified
Control of printer	The following operations are available; Getting the printer status, starting a print job or canceling it immediately or after printing the current page is finished.

### 1.7.4.3 General Operation Procedure



**Before connecting the DSC, check that the printer is in the following status.**

- No print job from a computer is processed or performed.
- Direct print from a memory card is not processed or performed.
- Stand alone copy using the scanner function is not operating.
- No paper out error or ink out error is occurring.

The DSC direct print procedure differs depending on the DSC specifications. The following explains common procedure.

1. Setting on the printer  
Before connecting a DSC with a USB cable, make the print settings such as paper type/size, layout setting on the printer. This may not be required for some DSCs.
2. Setting on the DSC  
Make the following settings on the DSC before connecting it to the printer. Some DSCs may require to first connect to the printer for making the settings.
  - When printing multiple images, specify images and number of copies using the DPOF and Multiple Sheet menus. The menus may not be available on some DSCs.
  - When printing a single image  
Specify an image and the number of copies. Specifying the number of copies may not be available on some DSCs.
  - Select the paper type/size, layout, and make the Fit to Frame setting if necessary. These settings may not be available on some DSCs.
3. Starting to print  
When the print settings on both the printer and the DSC is completed, follow the procedure below to start printing.
  1. Connect the printer and the DSC with a USB cable. Using a USB cable included in the DSC package is recommended.
  2. Operate the DSC to start printing.
  3. Printing is carried out according to the settings made on the DSC. When some print settings have not been made on the DSC, the corresponding settings made on the printer are applied.

### 1.7.4.4 Operating Specifications during Connecting DSC

**Table 1-50. Operations during Connecting DSC**

Operation	Specifications
Connecting DSC (print start)	If an DSC is connected in Step 3-(1) of “1.7.4.3 General Operation Procedure (p. 42)”, the PictBridge logo is displayed on the LCD.
Canceling printing	A print job can be canceled from the DSC. The [Stop/Clear setting] button also cancels the print job.
After printing is completed	When performing memory card direct print after printing from a DSC, the USB cable connecting the DSC must be disconnected from the printer in advance.
Exclusion control	Print settings made on both the DSC and the printer can become impossible settings for the printer due to unsupported combination of paper type, paper size and layout. In such case, the print settings are automatically changed as follows. The settings made on the DSC are maintained. Any print setting items that are not specified by the DSC are changed in accordance with the DSC settings. When the paper type is changed, changed to Prem. Glossy, when the paper size is changed, changed to 4x6 size. And when the layout is changed, changed to Borderless layout.

### 1.7.5 Reprint/Restore Photos Function (NX510 series only)

NX510 series offers the photo copy function. This function allows the user to copy their silver halide film-based pictures. The printer scans the pictures automatically detecting them as silver halide film-based picture, and makes a copy of them.

#### 1.7.5.1 Supported Paper Type and Print Mode

**Table 1-51. Paper Type and Print Mode**

Paper Type	Size	Quality	Resolution	Dot size	Bi-D	Micro Weave	Borderless
Matte paper	A4, Letter*1	Standard	1440x720	VSD3	ON	ON	OK
Photo Paper	4x6, 5x7*2, A4, Letter*1	Standard	1440x720	VSD3	ON	ON	OK
Prem. Glossy	4x6, 5x7, A4, Letter*1	Standard	1440x720	VSD3	ON	ON	OK
Ultra Glossy	4x6, 5x7, A4, Letter*1	Standard	1440x720	VSD3	ON	ON	OK

Note \*1: Letter size is supported for EAI only.

\*2: The Photo Paper 5x7 size is not supported for EAI.

#### 1.7.5.2 Reprint/Restore Photos Menu

**Table 1-52. Reprint/Restore Photos Menu**

Items	Function
Number of copies	Sets the number of copies within the range of 1 to 99.
Paper type	Selects paper type from the options shown in Table 1-51.
Paper size	Selects paper size from the options shown in Table 1-51.
Layout	Selects print layout from the following three options: <ul style="list-style-type: none"> <li>• Standard (normal layout with 3mm margins)</li> <li>• Borderless (no margins)</li> </ul>
Quality	Fixed to “Standard”.
Expansion	Selects the margins level (margins bleed off the edges of paper) from the Standard (100%), Mid. (50%) or Min. (25%).
Color restoration	Selects from On or Off. The default is Off.

### 1.7.5.3 How to Place Silver Halide Pictures

The following explains how to place silver halide film-based pictures on the document glass of the printer.

- Available picture size: 30x40 mm to 127x178mm (5"x7")
- Lay the pictures on the glass face down.
  - The number of pictures available at one time is as follows:
    - 4x6 or smaller: up to 2 pictures
    - 5x7: up to 1 picture
- The following spaces are needed:
  - 5 mm or more space from the right and front edges of the document glass.
  - 5 mm or more space between pictures.
- The pictures must not be tilted.

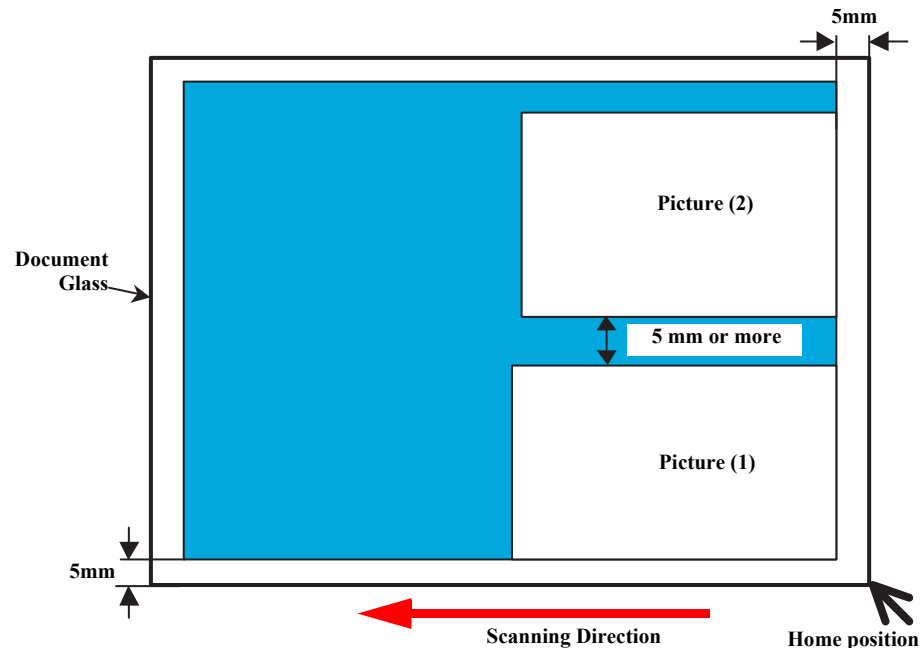

Figure 1-12. Laying Silver Halide Pictures

### 1.7.6 Setup Mode

NX510/SX410 series turns into the Setup mode by pressing the [Setup] button, and each setting and maintenance become available. For SX210 series, simultaneously pressing the [Index sheet] button and the [Scan] button provides the same function.

Table 1-53. NX510/SX410 series Common Setup Mode Menu

Item	Function
Ink Cartridge Status	<p>The current ink levels are displayed in bar chart by the rules described below. After displaying the ink levels, the next operation can be selected from the following two options; "OK" or "Replace Cartridge".</p> <ul style="list-style-type: none"> <li>• The bar chart is displayed in the order of black, magenta, yellow, and cyan from the left.</li> <li>• When initial filling is completed, or after replacing the cartridge, the ink level becomes 100% (full).</li> <li>• The ink level is indicated in increment of 1%. Lower than 1% is rounded up.</li> <li>• When the remaining ink level becomes lower than approximately 10%, zero (ink low status) will be displayed.</li> </ul>
Maintenance	<p>Runs various maintenance for the printer. The following shows each menu.</p> <ul style="list-style-type: none"> <li>• Nozzle Check A nozzle check pattern to check the Printhead nozzles status is printed. A head cleaning can be run if necessary. (Refer to <a href="#">Figure 1-13</a>, <a href="#">Figure 1-14</a> for Printout patterns.)</li> <li>• Head Cleaning Runs a printhead cleaning. The cleaning cannot be made when low ink level is detected.</li> <li>• Head Alignment Adjustment to improve the bi-directional print quality. Head alignment icon and the instructions for the adjustment are displayed on the LCD.</li> <li>• Cartridge Replacement Runs an ink cartridge replacement sequence. This can be done from the Ink Cartridge Status menu or by following the instructions on the LCD when an ink-related error occurs.</li> </ul>

Table 1-53. NX510/SX410 series Common Setup Mode Menu

Item	Function
Maintenance	<ul style="list-style-type: none"> <li>• Language Sets the language.</li> <li>• Display Format Display format can be selected from the following three types.                             <ul style="list-style-type: none"> <li>■ 1-up with Info</li> <li>■ 1-up without Info</li> <li>■ View Thumbnail Images</li> </ul> </li> </ul>
PictBridge Setup	The print settings for the camera direct print (PictBridge) can be selected and set. When print conditions (paper type, paper size, layout, quality, and auto correct) are specified from the DSC, the DSC settings take priority over the settings made here. For details, refer to “1.7.4 Camera Direct Print Function (PictBridge) (NX510/SX410 series only) (p.42)”.
Restore Default Settings	Restores the default settings of the panel settings.*

Note \*: For NX510 series, the following items are settable.

- “All Settings”
- “Network Settings”
- ”All except Network”

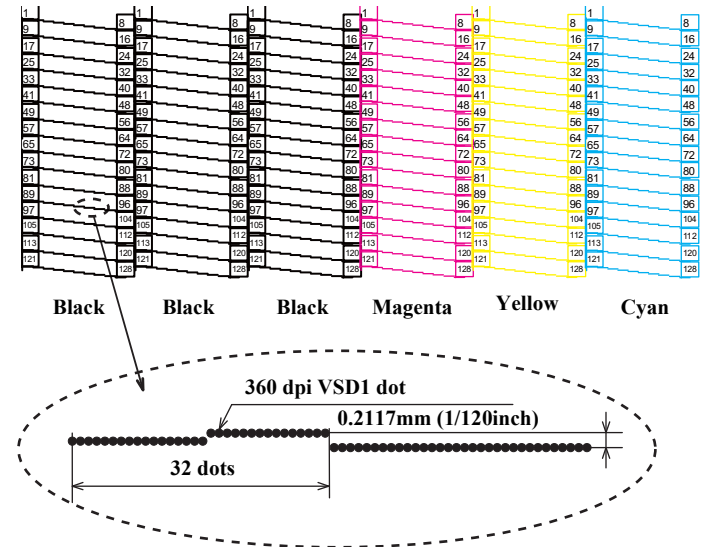

Figure 1-13. Nozzle Check Pattern for NX510 series\*

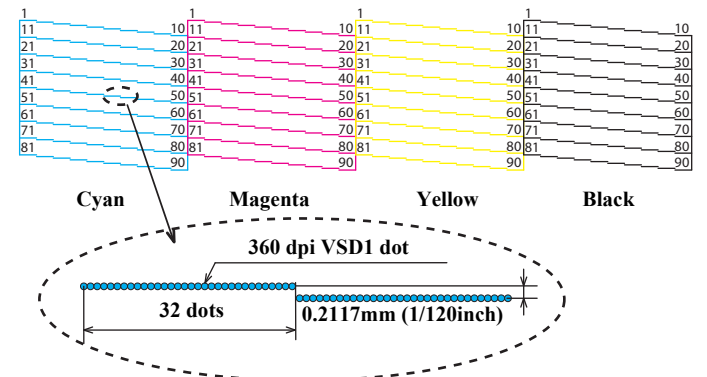

Figure 1-14. Nozzle Check Pattern for SX410 series\*

Note \*: The numbers shown in the figure are nozzle numbers. The numbers and the color names are not printed on an actual nozzle check pattern.

Table 1-54. Setup Mode Menu available only for NX510 series

Item	Function
Network Settings*	Changes settings for Network. <ul style="list-style-type: none"> <li>• Confirmation of Network Settings Displays the current settings. Status Sheet can be printed. (Refer to Figure 1-15.)</li> <li>• Network Basic Settings Changes settings for printer name and TCP/IP (auto/manual).</li> <li>• Wireless LAN Setting Enabling/disabling Wireless LAN.</li> <li>• File Sharing Setup Changes settings of the files in a memory card for file sharing via network.</li> </ul>
Select Location	Change the group of photos to display.

Note\* : When the network settings are changed, the network connection can be shut down temporarily.

```

HHHH EPSON Status Sheet HHHH
<General Information>
MAC Address          XX:XX:XX:XX:XX:XX
Software             $$ . $$$$$$ $$ ( ---- / $$$$$$$$)
Printer Model        $$$$$$$$
Printer Name         $$$$$$$$

<Ethernet>
Network Status      Auto ( 100BASE-TX, Full Duplex )
Port Type           Auto

<Wireless>
Wireless Mode       Off
Communication Mode   Infrastructure
Operation Mode      IEEE802.11b/g
Communication Speed  Auto(5.5Mbps)
SSID                $$$$$$$$
Channel             $$$$$$$$
Security Level       WEP-128bit(104bit)
AP Authentication Method Auto(Open System)
Link Status          Disconnect
Access Point(MAC Address) XX:XX:XX:XX:XX:XX
Signal Strength      No Good
SSID List            $$$$$$$$
Configuration method WPS-PIN

<TCP/IP>
Obtain IP Address    Manual
IP Address           XXX.XXX.XXX.XXX
Subnet Mask          XXX.XXX.XXX.XXX
Default Gateway      XXX.XXX.XXX.XXX
APIPA                Disable
Bonjour              Disable
Bonjour Name         $$$$$$$$1$$$$$.local.
Bonjour Printer Name $$$$$$$$1$$$$$

<Vista>
WSD                  Disable

<MS Network(R)>
Host Name            $$$$$$$$1$$$$$
Workgroup Name       $$$$$$$$1$$$$$
File Share Name      $$$$$$$$1$$
File Sharing Mode    Full Access

<Idle Timeout>
LPR                  XXXX[sec]
Port9100             XXXX[sec]
WSD-Print            XXXX[sec]
WSD-Scan             XXXX[sec]

HHHHHHHHHH 1/1 HHHHHHHHHH
    
```

Figure 1-15. Sample of Network Status Sheet

Table 1-55. Setup Mode Menu for SX210 series

Item	Function
Nozzle Check	A nozzle check pattern to check the Printhead nozzles status is printed. A head cleaning can be run if necessary. (Refer to <a href="#">Figure 1-16.</a> )
Head Cleaning	Runs a printhead cleaning. The cleaning cannot be made when low ink level is detected. In such a case, an ink low error is displayed instead of running the cleaning.
Head Alignment	Adjustment to improve the bi-directional print quality. Head alignment icon and the instructions for the adjustment are displayed on the LCD.
Cartridge Replacement	Runs an ink cartridge replacement sequence. This can be done from the Ink Cartridge Status menu or by following the instructions on the LCD when an ink-related error occurs.
Language	Sets the language.
Restore Default Settings	Restores the default settings of the panel settings.

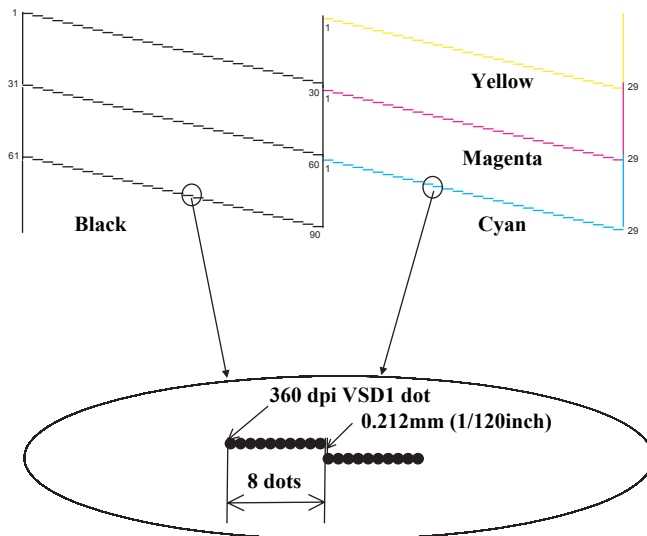

Figure 1-16. SX210 series の Nozzle Check Pattern\*

Note\* : The numbers shown in the figure are nozzle numbers. The numbers and the color names are not printed on an actual nozzle check pattern.

CHAPTER

2

# OPERATING PRINCIPLES



## 2.1 Overview

CHECK  
POINT



In this chapter, the product names are called as follows:

Notation	Product name
NX510 series	Epson Stylus NX510/NX515/SX510W/SX515W/TX550W
SX410 series	Epson Stylus NX415/SX410/SX415/TX410/TX419
SX210 series	Epson Stylus NX215/SX210/SX215/TX210/TX213/ TX219/ME OFFICE 510

This section describes the operating principles of the printer mechanism and the electrical circuit board of this product.

### 2.1.1 Printer Mechanism

The printer mechanism of this product consists of the printhead, carriage mechanism, paper loading mechanism, paper feed mechanism, and the ink system.

As the conventional models, this product is equipped with two DC motors; one is used to drive the paper loading and paper feed mechanisms, and also the pump mechanism that includes the carriage lock mechanism. The other one is used to drive the carriage mechanism. Paper is fed from the rear at the ASF unit with the LD roller and Retard roller, and ejected to the front at the tray.

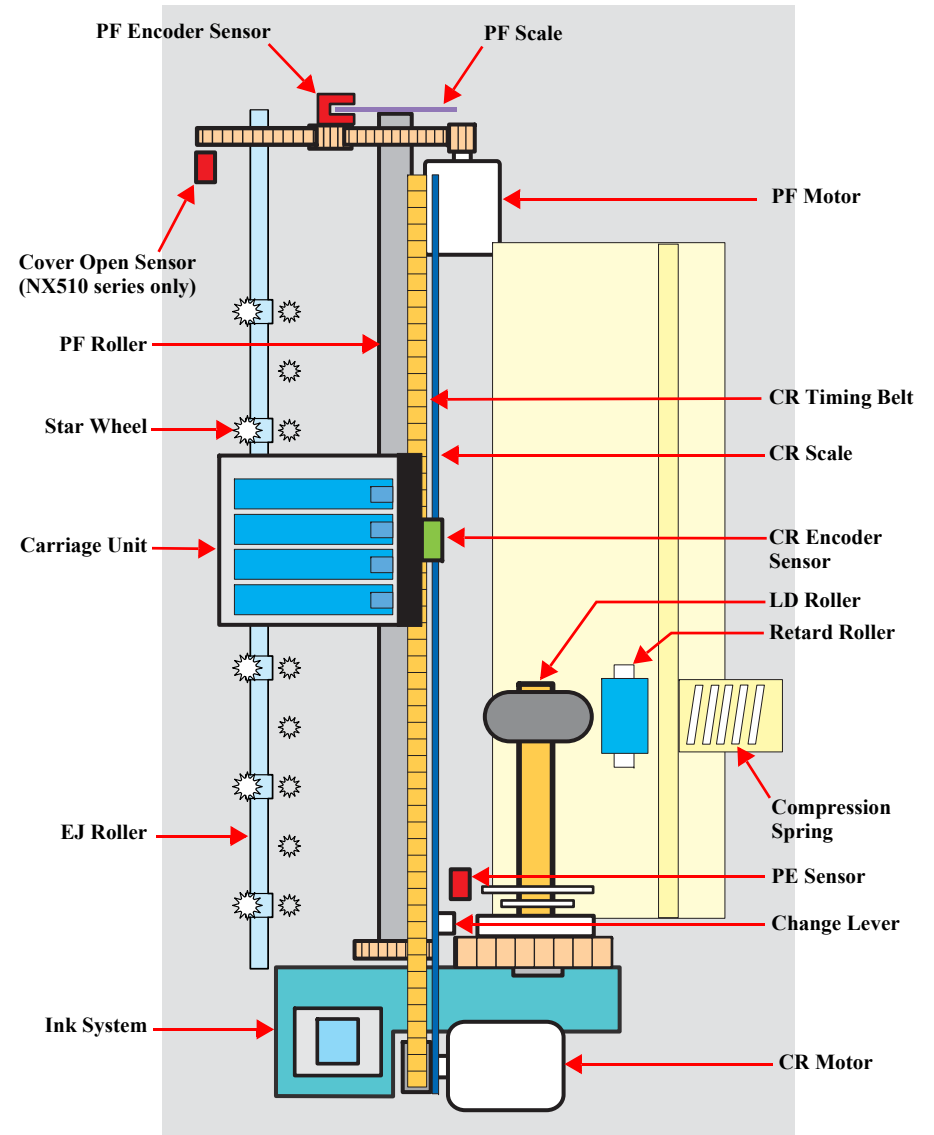

Figure 2-1. Printer Mechanism block diagram

## 2.1.2 Motors & Sensors

The printer mechanism of this product is equipped with the following printheads, motors and sensors.

**Table 2-1. Printer Mechanism Motors & Sensors**

No.	Name	Specification
1	Printhead	NX510 series O6-chips Turbo II head*
		SX410 series D4-chips Turbo II head*
		SX210 series D2-chips Turbo II head*
2	CR Motor	NX510 series Type: DC motor Drive voltage: 42 VDC $\pm$ 5% (DRV IC voltage) Coil resistance: 22.7 $\Omega$ $\pm$ 10% Inductance: 15.9 mH (1 KHz) Drive method: PWM, constant-current chopping
		SX410/ SX210 series Type: DC motor Drive voltage: 42 VDC $\pm$ 5% (DRV IC voltage) Coil resistance: 28.8 $\Omega$ $\pm$ 10% Inductance: 20.1 mH (1 KHz) Drive method: PWM, constant-current chopping
3	PF Motor	Type: DC motor Drive voltage: 42 VDC $\pm$ 5% (DRV IC voltage) Coil resistance: 21.2 $\Omega$ $\pm$ 10% Inductance: 17.2 mH (1 kHz) Drive method: PWM, constant-current chopping
4	PE Sensor	Purpose : Detection of paper top and bottom edge, for control to set paper at the print start position Type: Photo interrupter
5	CR Contact Module	CSIC board
6	CR Encoder Sensor	Type: Photo interrupter Resolution: 180 pulse/inch
7	PF Encoder Sensor	Type: Photo interrupter Resolution: 180 pulse/inch
8	Cover Open Sensor (NX510 series only)	Purpose: To detect the cover's (scanner unit) open/close status Type: Mechanical contact point

Note "\*": For the details of each printhead, see 2.1.3 "Printhead (p52)".

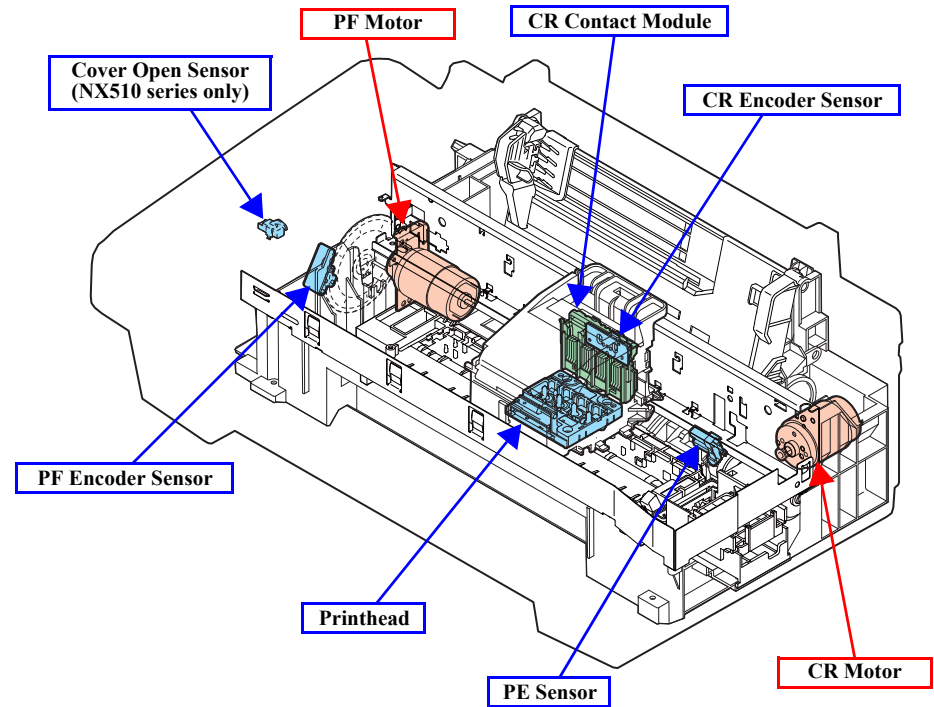

**Figure 2-2. Motors & Sensors in Printer Mechanism**

Table 2-2. Scanner Mechanism CIS &amp; Motor

No.	Name	Specification
1	CIS Unit	NX510 series Resolution: 20,400 pixel Black: 16 bit per pixel (input), 1 bit/ 8 bit per pixel (output) Color: 48 bit per pixel (input), 24 bit per pixel (output)
		SX410/ SX210 series Resolution: 10,200 pixel Black: 16 bit per pixel (input), 8 bit per pixel (output) Color: 48 bit per pixel (input), 24 bit per pixel (output)
2	CR Motor	NX510 series Type: 2-phase 96-pole PM type stepping motor Voltage: 42 VDC $\pm$ 5% (DRV IC voltage) Coil resistance: 43 $\Omega$ $\pm$ 10% (OKI) / 38 $\Omega$ $\pm$ 10% (MITSUMI) (at 25 $^{\circ}$ C) Inductance: 24.5 mH $\pm$ 20% (OKI) / 23 mH $\pm$ 20% (MITSUMI) (at 1 KHz, 1 Vrms) Drive method: Bipolar fixed current drive
		SX410/ SX210 series Type: 2-phase 96-pole PM type stepping motor Voltage: 42 VDC $\pm$ 5% (DRV IC voltage) Coil resistance: 43 $\Omega$ $\pm$ 10% (OKI) / 48 $\Omega$ $\pm$ 10% (MITSUMI) (at 25 $^{\circ}$ C) Inductance: 24.5 mH $\pm$ 20% (OKI) / 29 mH $\pm$ 20% (MITSUMI) (at 1 KHz, 1 Vrms) Drive method: Bipolar fixed current drive

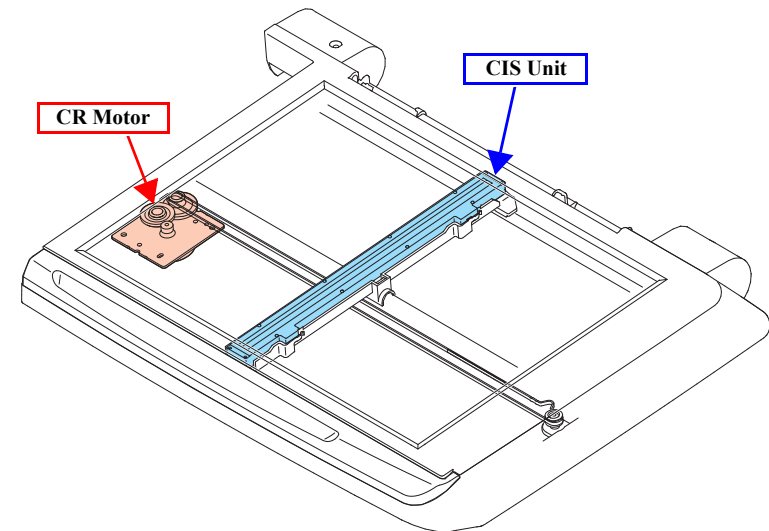
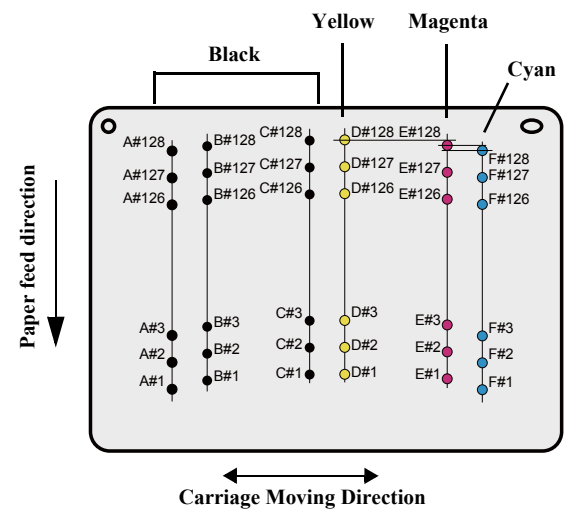
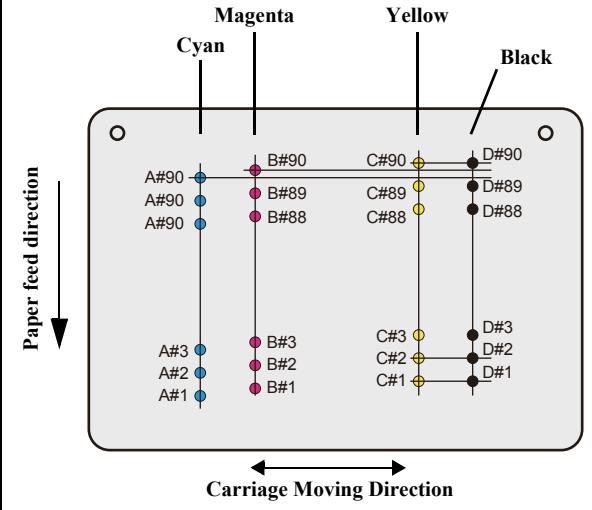
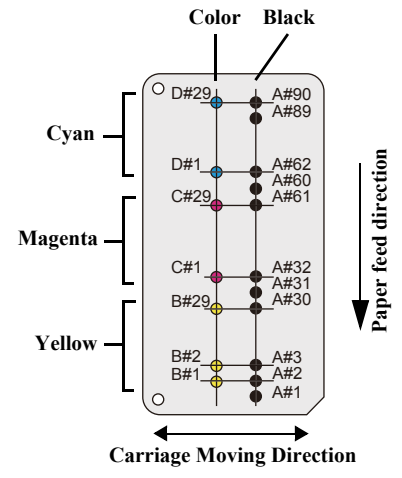

Figure 2-3. CIS Unit and CR Motor in Scanner Mechanism

### 2.1.3 Printhead

Each model of this product employs a different type of printhead. The printhead configurations are as follows.

**Table 2-3. Printheads of this product**

Item		NX510 series	SX410 series	SX210 series
Type		O6-chips Turbo II head	D4-chips Turbo II head	D2-chips Turbo II head
Nozzle configuration	Black	128 nozzles x 3 A/B/C column	90 nozzles x 1 D column	90 nozzles x 1 Black column A#1 - #90
	Color	128 nozzles x 3 D column: yellow E column: magenta F column: cyan	90 nozzles x 3 A column: cyan B column: magenta C column: yellow	90 nozzles x 1 Color column B#1 - #29: yellow C#1 - #29: magenta D#1 - #29: cyan
Nozzle layout (as seen from behind the printhead)				

## 2.2 Power-On Sequence

This section describes the power-on sequences in two conditions. The sequences for these three series are basically similar with the exception of the CR lock setting sequence (operation 8); therefore, they are described based on NX510 series in the following conditions.

□ Condition 1: Normal power-on sequence (refer to Table 2-4)

- Turning on the printer after turning it off without an error.
- Completing ink charge.
- No paper on the paper path.
- The Printhead is capped with the Cap of the Ink System.
- The Carriage is fixed by the CR Lock.

**NOTE:** For SX410/SX210 series, the CR lock setting sequence (operation 8) differs from the sequence for NX510 series.

□ Condition 2: Power-on sequence after recovering from a paper jam error (refer to Table 2-5)

- Turning on the printer after turning it off with a paper jam error.
- There still remains paper on the paper path out of the detecting area of the PE sensor.

**NOTE:** For SX410 series, the detecting remaining paper sequence (operation 6) is not implemented.

Table 2-4. Condition 1: Normal power-on sequence

Operation <sup>*1</sup>	Carriage/PF roller movement and position <sup>*2</sup>
<b>1. Checking waste ink overflow</b>	
<b>2. Avoiding deadlock sequence<sup>*3</sup></b>	
2-1. The carriage moves to the 0-digit side slowly and confirms it touches the CR lock.	
2-2. The carriage slightly moves to the 80-digit side slowly.	
2-3. The PF Motor rotates clockwise, and releases the CR lock.	

Table 2-4. Condition 1: Normal power-on sequence

Operation <sup>*1</sup>	Carriage/PF roller movement and position <sup>*2</sup>
2-4. The carriage moves to the 0-digit side slowly and confirms it touches the Right Frame.	
2-5. The carriage returns to its home position.	
<b>3. Releasing the CR lock</b>	
3-1. The PF motor rotates clockwise, and releases the CR lock.	
<b>4. Seeking the home position</b>	
4-1. The carriage moves to the 0-digit side slowly and confirms it touches the Right Frame.	
4-2. The carriage slowly moves to the CR lock set position.	
4-3. The PF motor rotates clockwise, and releases the CR lock.	
4-4. The PF motor rotates counterclockwise, and sets the CR lock.	
4-5. The carriage moves to the 80-digit side slowly and confirms it touches the CR lock.	
4-6. The carriage slowly moves to the 0-digit side to the CR lock set position.	
4-7. The PF motor rotates clockwise, and releases the CR lock.	
4-8. The carriage moves to the 80-digit side slowly and confirms it does not touch the CR lock.	
4-9. The carriage slowly moves to its original position, and the home position is fixed. Afterward, the carriage position is monitored according to the signals from the CR Encoder.	

Table 2-4. Condition 1: Normal power-on sequence

Operation <sup>*1</sup>	Carriage/PF roller movement and position <sup>*2</sup>
<b>5. Checking for remaining paper on the paper path and measurement of the PF Motor</b>	
5-1. The carriage slowly moves to the ASF trigger position.	
5-2. Checks if paper exists with the PE sensor <sup>*4</sup> and the PF Motor rotates clockwise for one second. (PF initialization)	
5-3. The carriage slowly moves to the 0-digit side, then to the ASF trigger holding position.	
5-4. The PF motor rotates clockwise for two seconds, and performs the load measurement. <sup>*5</sup>	
<b>6. Low temperature operation sequence<sup>*6</sup></b>	
6-1. The PF motor rotates clockwise, and releases the CR lock.	
6-2. The carriage moves back and forth between the CR lock and the 80-digit side for two times.	
<b>7. Detecting ink cartridge and initializing ink system<sup>*7</sup></b>	
7-1. After rotating the PF motor clockwise to release the CR lock, rotates the PF motor again clockwise for one second, and resets the PF roller. <sup>*8</sup>	
7-2. After the carriage moves to the 80-digit side and checks the ink end sensor, detects the ink remaining.	
7-3. The carriage quickly returns to its home position.	
<b>8. CR lock setting<sup>*9</sup></b>	
8-1. The carriage slowly returns to its home position. <sup>*10</sup>	
8-2. The carriage slowly moves to the CR lock set position.	
8-3. The PF motor rotates counterclockwise, and sets the CR lock.	

Table 2-4. Condition 1: Normal power-on sequence

Operation <sup>*1</sup>	Carriage/PF roller movement and position <sup>*2</sup>
8-4. The carriage slowly returns to its home position.	

Note \*1: The rotation directions of the PF Motor are as follows.

- Clockwise : Paper is fed normally
- Counterclockwise : Paper is fed backward

\*2: The conditions of the CR lock are as follows.

- Red : CR lock is set
- White : CR lock is released

\*3: Confirms the carriage is not deadlocked such as the CR lock is caught in the gap of the carriage.

\*4: Eject paper if any.

\*5: When paper exists, the existing measurement value is read out, so the PF motor does not rotate.

\*6: Executed when the detected temperature is under 5 °C (41 °F) by the thermistor on the Printhead.

\*7: The empty suction operation may occur depending on situations.

\*8: When paper remains in the printer, rotates the PF Roller until the paper is forcibly ejected.

\*9: For NX510 series, the CR lock is actually set at the beginning of power-saving mode for enhancing throughput.

\*10: This operation is applied for NX510 series only.

Table 2-5. Condition 2: Power-on sequence after recovering from a paper jam error

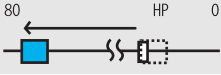
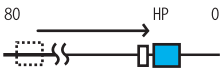
Operation	Carriage/PF Roller movement and position
Executes No.1 to No.5 on the normal power-on sequence (Table 2-4).	
<b>6. Detecting remaining paper</b>	
6-1. The carriage moves to the 80-digit side and confirms there is no paper.*1	
6-2. The carriage quickly returns to its home position, and displays on the LCD that the paper jam error occurs.	
When the user removes the paper and releases the paper jam error by panel operation, the normal power-on sequence from No.1 (Table 2-4) is executed again.*2	

Note : The power-on operations of SX410 series in condition 2 differs from the above sequence since the detecting remaining paper sequence (operation 6) is not implemented for SX410 series.

Note \*1: “Paper exists” is detected when the carriage touches the paper. When “paper does not exist” is detected, the power-on sequence of condition 1 (Table 2-4) is executed from No.6.

\*2: If the paper jam error cannot be solved after repeating the power-on sequence on condition 2 (Table 2-5) twice, the printer turns into the paper jam fatal error for the third time.

## 2.3 Printer Initialization

There are four kinds of initialization method, and the following explains each initialization

1. Hardware initialization  
This printer is initialized when turning the printer power on, or printer recognized the cold-reset command (remote RS command).  
When printer is initialized, the following actions are performed.
  - (a) Initializes printer mechanism
  - (b) Clears input data buffer
  - (c) Clears print buffer
  - (d) Sets default values
2. Operator initialization  
Initialization when resetting the USB software, and the following are performed.
  - (a) Clears input data buffer
  - (b) Clears print buffer
  - (c) Sets default values
3. Software initialization  
The ESC@ command also initialize the printer.  
When printer is initialized, the following actions are performed.
  - (a) Clears print buffer
  - (b) Sets default values
4. IEEE 1284.4 “rs” command initialization  
The printer recognized the IEEE 1284.4 “rs” command.  
When printer is initialized, the following action is performed.
  - Initialization when an error occurs.
    - (a) Initializes printer mechanism
    - (b) Clears input data buffer
    - (c) Clears print buffer
    - (d) Sets default values
  - Initialization in normal operation
    - (a) Clears input data buffer
    - (b) Clears print buffer
    - (c) Sets default values

CHAPTER

3

# TROUBLESHOOTING



## 3.1 Overview

This chapter describes how to solve problems.

### WARNING



- To avoid electric shocks, be careful when checking the electrical circuit boards below while the power is on.
  - NX510 series: CA48 MAIN and C687 PSE/PSB boards
  - SX410 series: CA20 MAIN and C687 PSE/PSB boards
  - SX210 series: CA47 MAIN and C687 PSE/PSB boards
- Touching an FET, transistor or heat sink with one hand while touching a metal part of the mechanism with the other hand could result in an electric shock, so carefully avoid this.
- After initial filling of ink has been repeated several times, immediate moving or tilting of the printer could result in leaking of ink that has not been completely absorbed by the Waste Ink Pad. When initial filling of ink has been repeated several times, check the ink remaining in the tip of the Waste Ink Tube and the waste ink not absorbed by the Waste Ink Pad before moving the printer.

### CHECK POINT



- Disassembly and reassembly of parts is often required when identifying the causes of problems. The parts should be disassembled and re-assembled correctly while referring to “DISASSEMBLY/ASSEMBLY” (p.91) so that the operation and status of each check item can be correctly verified.
- Some individual part and units may require adjustment once they are removed or replaced. If removing or replacing parts which have specific instructions for adjustment included in “DISASSEMBLY/ASSEMBLY” (p.91), be sure to make these adjustments after repairing the problem location.
- In this chapter, the product names are called as follows:

Notation	Product name
NX510 series	Epson Stylus NX510/NX515/SX510W/SX515W/TX550W
SX410 series	Epson Stylus NX415/SX410/SX415/TX410/TX419
SX210 series	Epson Stylus NX215/SX210/SX215/TX210/TX213/TX219/ME OFFICE 510

### 3.1.1 Specified Tools

This printer does not require any specified tools for troubleshooting.

### 3.1.2 Preliminary Checks

Before starting troubleshooting, be sure to verify that the following conditions are all met:

- The power supply voltage must be within the specification limits. (Measure the voltage at the wall socket.)
- The power code must be free from damage, short circuit or breakage, or miswiring in the power code.
- The printer must be grounded properly.
- The printer should not be located in a place where it can be exposed to too high or low temperature, too high or low humidity, or abrupt temperature change.
- The printer should not be located near waterworks, near humidifiers, near heaters or near flames, in a dusty atmosphere or in a place where the printer can be exposed to blast from an air conditioner.
- The printer should not be located in a place where volatile or inflammable gases are produced.
- The printer should not be located in a place where it can be exposed to direct rays of the sun.
- The printer must be placed on a strong and steady level table (without an inclination larger than five degrees).
- Any vibrating equipment must not be placed on or under the printer.
- The paper used must conform to the specification.
- There is no error in handling of the printer.
- Check the inside of the printer, and remove foreign matters if any, such as paper clips, staples, bits of paper, paper dust or toner.
- Clean the inside of the printer and the rubber rolls.

## 3.2 Troubleshooting

### 3.2.1 Motor and Sensor Troubleshooting

#### □ Motors

The resistance values for the CR motor and the PF motor are given below, however, the values cannot be used to check the motors status since they are DC motor and the resistance between the electric poles varies. Visually check the motors for abnormal operation and if it is hard to judge, replace the motor.

##### ■ NX510 series

**Table 3-1. Motor resistance and check point (NX510 series)**

Motor	Motor Type	Drive Voltage	Resistance
PF motor	DC motor with brush	DC 42V ± 5%	21.2Ω ± 10%
CR motor			22.7Ω ± 10%
Scanner motor	2-phase, 96-pole PM stepping motor		43.0Ω ± 10% <sup>*1</sup> or 38.0Ω ± 10% <sup>*2</sup>

Note \*1: Manufactured by Oki Electric Industry Co., Ltd.

\*2: Manufactured by MITSUMI ELECTRIC CO., LTD.

##### ■ SX410/SX210 series

**Table 3-2. Motor resistance and check point (SX410/SX210 series)**

Motor	Motor Type	Drive Voltage	Resistance
PF motor	DC motor with brush	DC 42V ± 5%	21.2Ω ± 10%
CR motor			28.8Ω ± 10%
Scanner motor	2-phase, 96-pole PM stepping motor		43.0Ω ± 10% <sup>*1</sup> or 48.0Ω ± 10% <sup>*2</sup>

Note \*1: Manufactured by Oki Electric Industry Co., Ltd.

\*2: Manufactured by MITSUMI ELECTRIC CO., LTD.

#### □ Sensors

##### ■ NX510 series

**Table 3-3. Sensor check point (NX510 series)**

Sensor name	Check point	Signal level	Switch mode
PE Sensor	CN15/Pin 1 and 2	Less than 0.4V	Off: No paper
		More than 2.4V	On: Detect the paper
Cover Open Sensor	CN16/Pin 1 and 2	Less than 0.4V	Off: Cover Close
		More than 2.4V	On: Cover Open

##### ■ SX410/SX210 series

**Table 3-4. Sensor check point (SX410/SX210 series)**

Sensor name	Check point	Signal level	Switch mode
PE Sensor	CN24/Pin 1 and 2	Less than 0.4V	Off: No paper
		More than 2.4V	On: Detect the paper

### 3.3 Error Indications and Fault Occurrence Causes

This section explains error/warning messages indicated when an error occurs at each sequence/operation(power-on, paper loading/feeding, ink suction, etc.) and their error causes.

#### 3.3.1 Error Message List

**Table 3-5. Error Indications and Fault Occurrence Causes**

Error Name	LCD Message			STM3 Message	Error Cause	Reference
	NX510 series	SX410 series	SX210 series			
Fatal error (scanner)	A scanner error has occurred. See your documentation.		Scanner error has occurred.	Turn the printer off and delete all print jobs. Open the scanner unit and remove any paper from inside the printer and turn the printer back on. Click the [How to] button for instructions on removing jammed paper.	Scanner error occurs.	Table 3-6. (p62)
Fatal error (printer mechanism)	A printer error has occurred. Turn off the printer, then press On button to turn on. See your documentation.		Printer error has occurred.		Mechanical trouble occurs.	
Maintenance error (waste ink overflow)	The printer's ink pads are at the end of their service life. Please contact Epson Support.	Waste ink pad in the printer is saturated. Contact your dealer to replace it.	Ink pads need service. Contact Epson.	The printer's ink pads are at the end of their servicelife. Please contact Epson support.	The waste ink counter exceeds to capacity.	Table 3-7. (p68)
Paper jam error	Paper jam. Open the scanner unit and remove the paper. Press the Start Button to eject the paper inside. See you documentation.		Paper jam. Remove jammed paper.	Click the [How to] button for instructions on removing jammed paper.	Paper stays in the paper path after paper ejection.	Table 3-8. (p68)
Ink cartridges error	Cannot recognize ink cartridges.		Ink cartridges not recognized.	Black: XXXX* <sup>1</sup> Color: XXXX* <sup>1</sup> .....	Ink is out in some I/C or no I/C is set or incorrect I/C is set.	Table 3-9. (p71)
Ink cartridge cover open error	Ink cartridge cover is open. Open the scanner unit and close the ink cartridge cover.		Close cartridge cover.	Epson recommends the genuine Epson cartridges listed above. Click the [How to] button for ink cartridge installation instructions.		
Replace Ink Cartridge	Press the OK button to replace the ink cartridges.		The ink is expended.	Black: XXXX* <sup>1</sup> Color: XXXX* <sup>1</sup> ..... Epson recommends the genuine Epson cartridges listed above. Click the [How to] button for ink cartridge replacement instructions.		

Table 3-5. Error Indications and Fault Occurrence Causes

Error Name	LCD Message			STM3 Message	Error Cause	Reference
	NX510 series	SX410 series	SX210 series			
Paper out error	Paper out. Load paper and press the Start button.		Paper out Load paper.	Reload the paper, then press the Start button on the printer or click the [Continue] button if it appears on the screen. To cancel the print job, click the [Cancel] button.	Failure to load paper to print.	Table 3-10. (p72)
Double feed error	Multi-page feed error. Remove and reload the paper, then press the Start button.		Multi-page feed error.	A page has not been printed, multiple pages have been fed into the printer at once, or the wrong paper size has been fed into the printer. Remove and reload the paper. Press the Start button if necessary.	Double feed during double sided printing.	Table 3-18. (p76)
Memory card error	Cannot recognize the memory card or disk.		Memory card not recognized.	--	That memory card is not available with this unit. Or no image can be found in that card when memory card print is started.	Table 3-13. (p74)
Index sheet error 1 (No index sheet)	There is no index sheet or it is not positioned correctly. Check it and try again.		No Index Sheet on scanner.	--	The direction of order sheet is opposite. No index sheet is recognized correctly.	Table 3-14. (p75)
Index sheet error 2 (Image marking error)	Photos are not selected or the ovals are marked incorrectly. Please correct and try again.		No photos selected.	--	When there is a mismatch in the content of the order sheet (When it is not marked though the selection is necessary.)	Table 3-15. (p75)
Index sheet error 3 (Paper marking error)	The paper type is not selected or the ovals are marked incorrectly. Please correct and try again.		Select paper type.	--		
Index sheet error 4 (Incorrect card)	The contents of the memory card have changed. Print a new index sheet and try again.		Memory card does not match Index Sheet.	--	The different card or updated card is found for that sheet.	Table 3-16. (p75)
DSC Direct error*2	Cannot recognize the device.		N/A	--	A device not supported is connected to the port for the connection of external memory devices. The DSC demands the current larger than mechanical limit.	Table 3-12. (p74)

Table 3-5. Error Indications and Fault Occurrence Causes

Error Name	LCD Message			STM3 Message	Error Cause	Reference
	NX510 series	SX410 series	SX210 series			
Head cleaning (Ink low error)	Replace ink cartridge before cleaning Printhead.		Replace ink before cleaning.	Black: XXXX* <sup>1</sup> Color: XXXX* <sup>1</sup> ..... You may continue printing, or click the [How to] button to change the ink cartridge now.	Head cleaning was attempted in the Ink low status.	Table 3-11. (p74)
Pre-scanning error (photo)* <sup>2</sup>	No photos could be recognized. Make sure the photos are positioned correctly. See your documentation.		N/A	--	Photos cannot be recognized.	Table 3-17. (p76)
Communication error	--			Check all connections and make sure all devices are on. If the power was turned off during printing, cancel the print job. If the error does not clear, see your printer documentation.	The printer cannot communicate with the PC properly.	Table 3-19. (p77)
Scanner unit open error* <sup>3</sup>	Close the Scanner unit.	N/A	N/A	Close the scanner unit.	Scanner unit was opened during printing.	Table 3-20. (p80)
Network error* <sup>3</sup>	--	N/A	N/A	--	A network related error occurred.	“3.4 Network Troubleshooting (NX510 series only)” (p.89)
Unknown error	--			Turn the printer off, and remove any jammed paper. After a few minutes, turn the printer back on. Please wait.	An unexpected error occurred.	--

Note \*1: The “XXXX” represents the part number of the Ink Cartridge.

\*2: NX510/SX410 series only.

\*3: NX510 series only.

### 3.3.2 Troubleshooting by Error Message

The following tables provide troubleshooting procedures. Confirm the error message indicated on the LCD or the STM3 screen on the PC's display, and verify it in the following list and the figures at the end of this chapter for the corresponding troubleshooting remedy. If some parts need to be replaced or repaired, make sure to follow the procedure given in Chapter 4 "Disassembly / Assembly".

**Table 3-6. Check point for Fatal error according to each phenomenon**

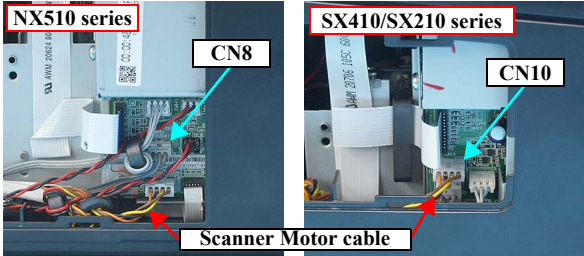
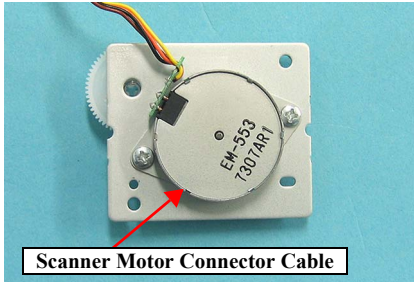
Occurrence timing CR position	Detailed phenomenon	Defective unit/part name	Check point	Remedy
<ul style="list-style-type: none"> <li>• Power on</li> <li>• Anywhere</li> </ul>	The Scanner Unit does not initialize when the power is turned on.	Scanner Motor	<p>1. Check if the Scanner Motor cable is connected to the connector on the Main Board Unit shown below.</p> <ul style="list-style-type: none"> <li>■ NX510 series: CN8</li> <li>■ SX410/SX210 series: CN10</li> </ul> 	<p>1. Connect the Scanner Motor cable to the connector on the Main Board Unit shown below.</p> <ul style="list-style-type: none"> <li>■ NX510 series: CN8</li> <li>■ SX410/SX210 series: CN10</li> </ul>
			<p>2. Check the coil resistance with a tester if it matches the following value. (refer to Table 3-1).</p> <ul style="list-style-type: none"> <li>■ NX510 series: Approx. 43Ω*1 or 38Ω*2</li> <li>■ SX410/SX210 series: Approx. 43Ω*1 or 48Ω*2</li> </ul> 	<p>2. Replace the Scanner Motor with a new one.</p>
			<p>3. Check if the Scanner Motor Connector Cable is damaged.</p>	<p>3. Replace the Scanner Motor with a new one.</p>

Note \*1: Manufactured by Oki Electric Industry Co., Ltd.

\*2: Manufactured by MITSUMI ELECTRIC CO., LTD.

Table 3-6. Check point for Fatal error according to each phenomenon

Occurrence timing CR position	Detailed phenomenon	Defective unit/part name	Check point	Remedy
<ul style="list-style-type: none"> <li>• Power on</li> <li>• Anywhere</li> </ul>	The Scanner Unit does not initialize when the power is turned on.	Scanner Carriage FFC	1. Check if the Scanner Carriage FFC is connected to the connector on the Main Board Unit shown below. <ul style="list-style-type: none"> <li>■ NX510 series: CN17</li> <li>■ SX410/SX210 series: CN21</li> </ul> 	1. Connect the Scanner Carriage FFC to the connector on the Main Board Unit shown below. <ul style="list-style-type: none"> <li>■ NX510 series: CN17</li> <li>■ SX410/SX210 series: CN21</li> </ul>
		Scanner Carriage Unit	1. Check if the Scanner Carriage Unit is damaged. 	1. Replace the Scanner Carriage Unit with a new one.

Table 3-6. Check point for Fatal error according to each phenomenon

Occurrence timing CR position	Detailed phenomenon	Defective unit/part name	Check point	Remedy
<ul style="list-style-type: none"> <li>• Power on</li> <li>• Anywhere</li> </ul>	When turning on the power, the CR Motor does not operate at all.	CR Motor	1. Check if the CR Motor Connector Cable is connected to the connector on the Main Board Unit shown below. <ul style="list-style-type: none"> <li>■ NX510 series: CN6</li> <li>■ SX410/SX210 series: CN8</li> </ul> 	1. Connect the CR Motor Connector Cable to the connector on the Main Board Unit shown below. <ul style="list-style-type: none"> <li>■ NX510 series: CN6</li> <li>■ SX410/SX210 series: CN8</li> </ul>
			2. Check if the CR Motor Connector Cable is not damaged.	2. Replace the CR Motor with a new one.
			3. Check if the CR Motor operates.	3. Replace the CR Motor with a new one.
	When turning on the power, the PF Motor does not operate at all	PF Motor	1. Check if the PF Motor Connector Cable is connected to the connector on the Main Board Unit shown below. <ul style="list-style-type: none"> <li>■ NX510 series: CN7</li> <li>■ SX410/SX210 series: CN9</li> </ul> 	1. Connect the PF Motor Connector Cable to the connector on the Main Board Unit shown below. <ul style="list-style-type: none"> <li>■ NX510 series: CN7</li> <li>■ SX410/SX210 series: CN9</li> </ul>
			2. Check if the PF Motor Connector Cable is not damaged.	2. Replace the PF Motor with a new one.
			3. Check if the PF Motor operates.	3. Replace the PF Motor with a new one.

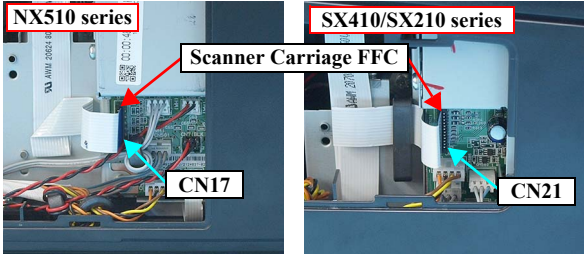
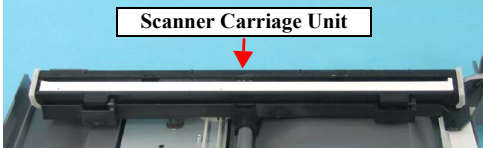

Table 3-6. Check point for Fatal error according to each phenomenon

Occurrence timing CR position	Detailed phenomenon	Defective unit/part name	Check point	Remedy
<ul style="list-style-type: none"> <li>• Power on</li> <li>• Anywhere</li> </ul>	<p>When turning on the power, the Carriage Unit collides to the Change Lever located to the front side of the printer.</p>	PF Motor	<ol style="list-style-type: none"> <li>1. Check if the PF Motor Connector Cable is connected to the connector on the Main Board Unit shown below.               <ul style="list-style-type: none"> <li>■ NX510 series: CN7</li> <li>■ SX410/SX210 series: CN9.</li> </ul> </li> <li>2. Check if the PF Motor Connector Cable is not damaged.</li> <li>3. Check if the PF Motor operates.</li> </ol>	<ol style="list-style-type: none"> <li>1. Connect the PF Motor Connector Cable to the connector on the Main Board Unit shown below.               <ul style="list-style-type: none"> <li>■ NX510 series: CN7</li> <li>■ SX410/SX210 series: CN9</li> </ul> </li> <li>2. Replace the PF Motor with a new one.</li> <li>3. Replace the PF Motor with a new one.</li> </ol>
		ASF Unit	<ol style="list-style-type: none"> <li>1. Check if the Compression Spring 2.36 does not come off in the Change Lever.</li> </ol> 	<ol style="list-style-type: none"> <li>1. Replace the ASF Unit with a new one.</li> </ol>
		Upper Paper Guide Unit	<ol style="list-style-type: none"> <li>1. Check if the Paper Guide Upper Unit is correctly assembled.</li> </ol> 	<ol style="list-style-type: none"> <li>1. Reassemble the Upper Paper Guide Unit to the Main Frame correctly.</li> </ol>

Table 3-6. Check point for Fatal error according to each phenomenon

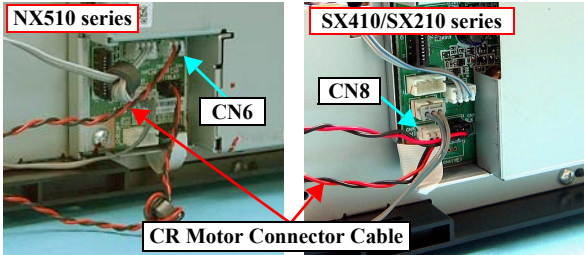
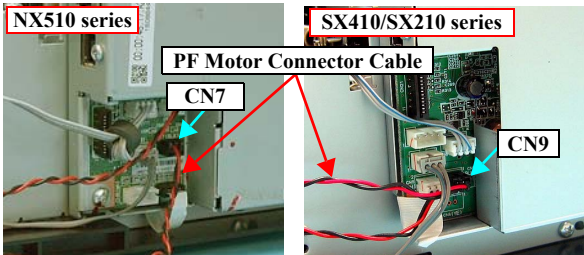
Occurrence timing CR position	Detailed phenomenon	Defective unit/part name	Check point	Remedy
<ul style="list-style-type: none"> <li>• Power on</li> <li>• Anywhere</li> </ul>	When turning on the power, the Carriage Unit collides to the right side of the Main Frame.	CR Scale	1. Check if the CR Scale does not come off or it properly passes through the slit of the CR Encoder Board. 	1. Reassemble the CR Scale correctly. * If the problem is not solved, replace the Main Board with a new one.
			2. Check if the CR Scale is not damaged or contaminated. 	2. Replace the CR Scale with a new one or clean it completely.
		CR Encoder Board	1. Check if the Encoder FFC is connected to the CR Encoder Board. 	1. Connect the Encoder FFC to the CR Encoder Board.
			2. Check if the Encoder FFC is not damaged.	2. Replace the Encoder FFC with a new one.
			3. Check if the CR Encoder Board is not damaged.	3. Replace the CR Encoder Board with a new one.

Table 3-6. Check point for Fatal error according to each phenomenon

Occurrence timing CR position	Detailed phenomenon	Defective unit/part name	Check point	Remedy	
<ul style="list-style-type: none"> <li>Power on</li> <li>Anywhere</li> </ul>	The eject rollers are rotating at high speed when power is turned on. (For about 1 cycle.)	PF Scale/PF Encoder Sensor	1. Check if the PF Scale is not damaged or contaminated.	1. Replace the PF Scale with a new one.	
					
<ul style="list-style-type: none"> <li>Operation</li> <li>Anywhere</li> </ul>	The Scanner Carriage Unit does not operate.	Lower Scanner Housing	1. Check if the grease is applied enough on the surface of the Guide Rail of the Lower Scanner Housing.	1. Apply the grease on the surface of the Guide Rail of the Lower Scanner Housing after wiping the old grease with a dry, soft cloth. (Refer to Chapter 6 “MAINTENANCE” (p.175))	
			2. Check if the Scanner Carriage Unit is set correctly.		2. Reassemble the Scanner Carriage Unit.
	A paper feeding sequence failed to feed the paper, but a paper ejection sequence is performed.	ASF Unit	1. Check if the PE Sensor Connector Cable is connected to the connector on the Main Board Unit shown below. <ul style="list-style-type: none"> <li>■ NX510 series: CN15</li> <li>■ SX410/SX210 series: CN24</li> </ul>		1. Connect the the PE Sensor Connector Cable to the connector on the Main Board Unit shown below. <ul style="list-style-type: none"> <li>■ NX510 series: CN15</li> <li>■ SX410/SX210 series: CN24</li> </ul>
			2. Check if the PE Sensor Connector Cable is not damaged.		
			3. Check if the PE Sensor is not damaged.	3. Replace the ASF Unit with a new one.	

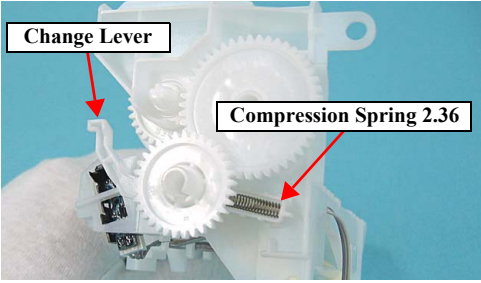
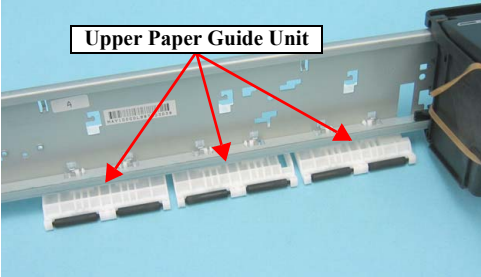
Table 3-7. Check point for the Maintenance request according to each phenomenon

Occurrence timing CR position	Detailed phenomenon	Defective unit/part name	Check point	Remedy
<ul style="list-style-type: none"> <li>• Operation</li> <li>• –</li> </ul>	An error is indicated on the LED and STM or LCD.	Waste Ink Pads	---	1. Change the Waste Ink Pads and initialize the Waste Ink Pad Counter. (Refer to <a href="#">Chapter 5 “ADJUSTMENT” (p.161)</a> )

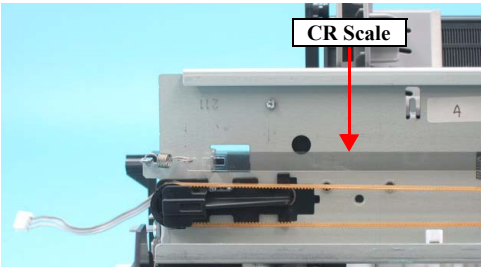
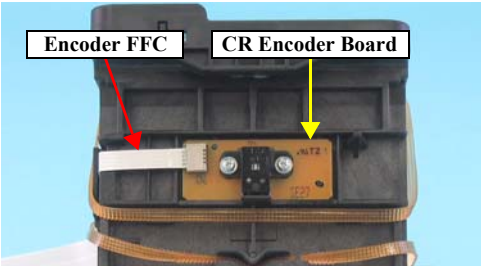
Table 3-8. Check point for Paper jam error according to each phenomenon

Occurrence timing CR position	Detailed phenomenon	Defective unit/part name	Check point	Remedy
<ul style="list-style-type: none"> <li>• Operation</li> <li>• Outside HP</li> </ul>	A paper feeding sequence failed to feed the paper, but a paper ejection sequence is performed.	ASF Unit	<ol style="list-style-type: none"> <li>1. Check if the ASF Unit is properly installed.</li> <li>2. Check if the Paper Back Lever operates correctly in the paper loading sequence.</li> </ol> 	<ol style="list-style-type: none"> <li>1. Install the ASF Unit properly.</li> <li>2. Set the Extension Spring 0.099 between the ASF Frame and the Paper Back Lever.</li> </ol>
	Paper is being resent during paper feeding operation.	ASF Unit	<ol style="list-style-type: none"> <li>1. Check if the Extension Spring Retard operates correctly in the paper loading sequence.</li> </ol> 	<ol style="list-style-type: none"> <li>1. Set the Extension Spring Retard between the Retard Roller Unit and the ASF Frame.</li> </ol>

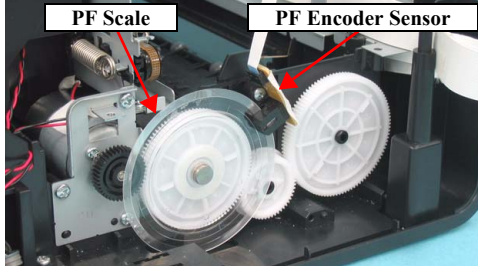
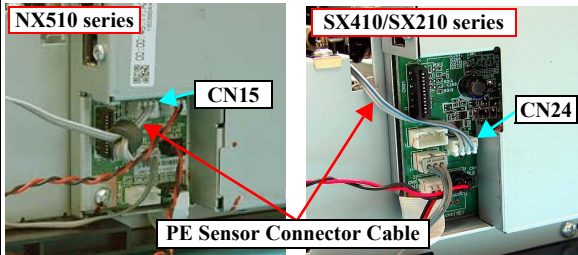
Table 3-8. Check point for Paper jam error according to each phenomenon

Occurrence timing CR position	Detailed phenomenon	Defective unit/part name	Check point	Remedy
<ul style="list-style-type: none"> <li>• Operation</li> <li>• -</li> </ul>	<p>The top edge of paper does not go through between the EJ Roller Unit and the Star Wheel.</p>	Star Wheel Holder Assy*	<p>1. Check if the Star Wheel Holder Assy is correctly assembled.</p> 	<p>1. Reassemble the Star Wheel Holder Assy correctly.</p>
			<p>2. Check if the Star Wheel Holders does not come off.</p> 	<p>2. Reassemble the Star Wheel Holders correctly.</p>
		EJ Roller Unit*	<p>1. Check if the EJ Roller Unit is correctly assembled.</p> 	<p>1. Reassemble the EJ Roller Unit correctly.</p>
	<p>2. Replace the EJ Roller Unit with a new one.</p>			

Table 3-8. Check point for Paper jam error according to each phenomenon

Occurrence timing CR position	Detailed phenomenon	Defective unit/part name	Check point	Remedy
<ul style="list-style-type: none"> <li>• Operation</li> <li>• —</li> </ul>	The top edge of paper is not loaded to the PF Roller Unit.	Upper Paper Guide Unit*	1. Check if the Upper Paper Guide Unit is correctly assembled. <div data-bbox="972 379 1451 630" style="text-align: center;">  </div>	1. Reassemble the Upper Paper Guide Unit to the Main Frame correctly.

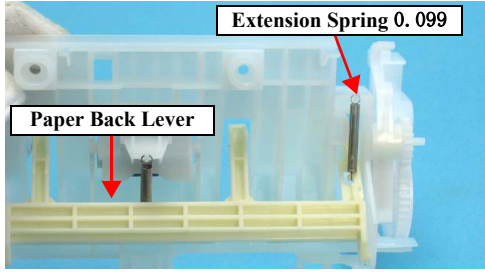
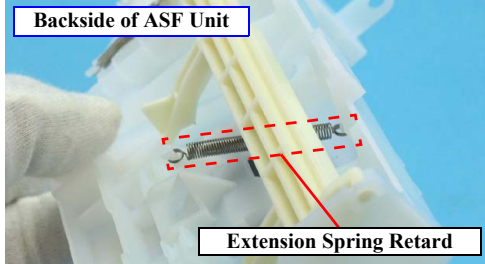
Note \* : In case that the paper jam error occurs in each operation, the jammed paper contacts the nozzle surface of the Printhead and the Printhead may be damaged.

Table 3-9. Check point for CSIC error / Incorrect Ink Cartridge according to each phenomenon

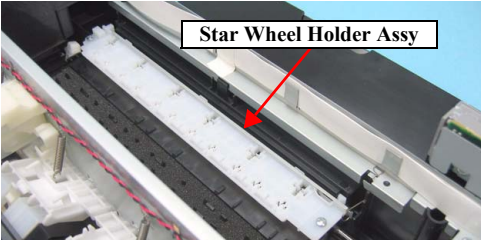
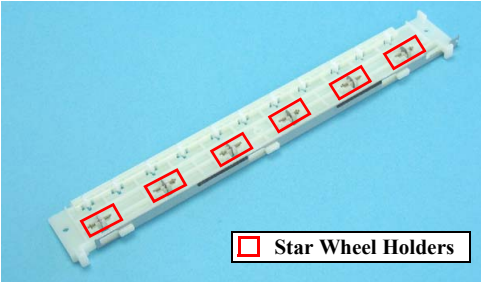
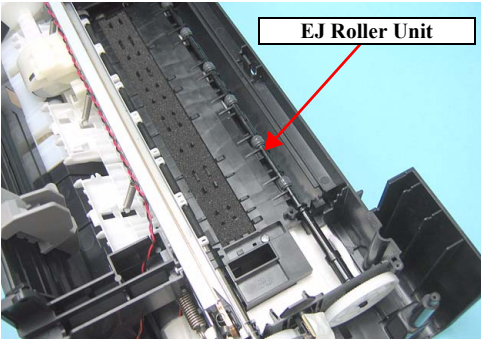
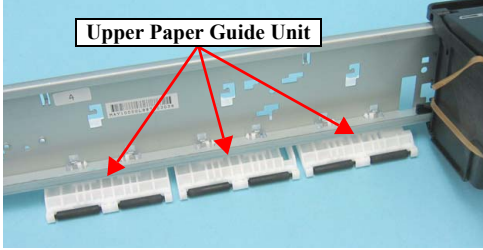
Occurrence timing CR position	Detailed phenomenon	Defective unit/part name	Check point	Remedy
<ul style="list-style-type: none"> <li>• Power on</li> <li>• Inside HP</li> </ul>	After the printer detects that the carriage is at the home position, an error is displayed.	Ink Cartridge	<ol style="list-style-type: none"> <li>1. Check if Ink Cartridge is properly installed.</li> <li>2. Check if the Memory Chip is not disconnected or not chipped.</li> </ol> 	<ol style="list-style-type: none"> <li>1. Install the Ink Cartridge properly.</li> <li>2. Replace the Ink Cartridge with a new one.</li> </ol>
		CSIC Board	<ol style="list-style-type: none"> <li>1. Check if the Head FFC is connected to connector on the CSIC Board.</li> </ol> 	<ol style="list-style-type: none"> <li>1. Connect the Head FFC to connector on the CSIC Board.</li> </ol>
		CSIC Connector	<ol style="list-style-type: none"> <li>1. Check if the CSIC Connector is not damaged.</li> </ol> 	<ol style="list-style-type: none"> <li>2. Check if the CSIC Board is not damaged.</li> </ol> <ol style="list-style-type: none"> <li>1. Replace the CSIC Board with a new one.</li> </ol>

Table 3-10. Check point for Paper out error according to each phenomenon

Occurrence timing CR position	Detailed phenomenon	Defective unit/part name	Check point	Remedy
<ul style="list-style-type: none"> <li>• Operation</li> <li>• -</li> </ul>	<p>The LD Roller cannot pick up paper although the LD Roller attempt to rotate correctly.</p>	ASF Unit	<p>1. Check if any paper dust is not adhered to the surface of the LD Roller.</p> 	<p>1. Set a cleaning sheet in the ASF Unit up side down. Then holding the top edge, try to load the paper from the Printer driver. The micro pearl on the LD Roller surface is removed. To remove severe smear, staple a cloth moistened with alcohol to a post card and clean the roller in the same manner.</p>  <p>*If the problem is not solved, replace the ASF unit with new one.</p>
	<p>The Hopper does not operate during the paper loading sequence although the LD Roller rotates to load paper from the ASF Unit.</p>	ASF Unit	<p>1. Check if the Hopper operates correctly in the paper loading sequence.</p> 	<p>1. Reassemble the Compression Spring 3.43 between the Base Frame and the Hopper.</p>

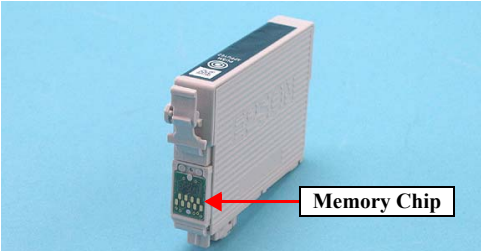
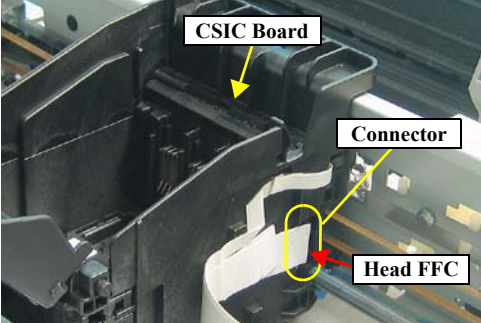
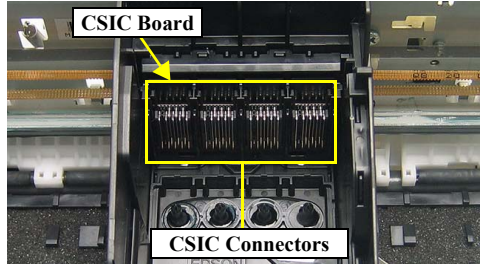

Table 3-10. Check point for Paper out error according to each phenomenon

Occurrence timing CR position	Detailed phenomenon	Defective unit/part name	Check point	Remedy
<ul style="list-style-type: none"> <li>• Operation</li> <li>• –</li> </ul>	The drive of the PF Motor is not transmitted to the LD Roller Shaft.	ASF Unit	1. Check if the Extension Spring 0.143 does not come off in the Clutch mechanism. 	1. Reassemble the Extension Spring 0.143 in the Clutch mechanism.
			2. Check if the positioning hole of the Clutch does not come off from the guide pin of the LD Roller Shaft. 	2. Reassemble the positioning hole of the Clutch on the guide pin of the LD Roller Shaft.
			3. Check if the Clutch tooth is not damaged.	3. Replace the ASF Unit with a new one.
			4. Check if the Clutch is not damaged.	4. Replace the ASF Unit with a new one.
			5. Check if the Compression Spring 2.36 does not come off in the Change Lever. 	5. Replace the ASF Unit with a new one.

Table 3-10. Check point for Paper out error according to each phenomenon

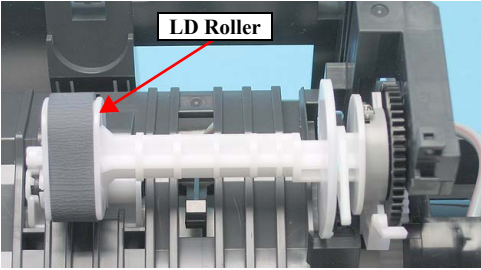
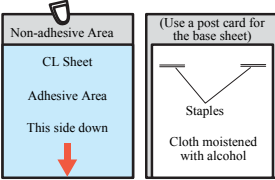
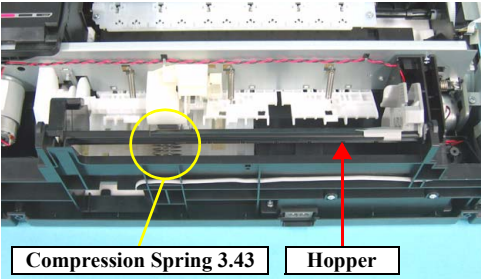
Occurrence timing CR position	Detailed phenomenon	Defective unit/part name	Check point	Remedy
<ul style="list-style-type: none"> <li>• Operation</li> <li>• –</li> </ul>	The LD Roller is not set to the ASF home position and paper is always loaded from the ASF Unit during the paper loading sequence.	ASF Unit	1. Check if the tip of the Change Lever is not damaged.	1. Replace the ASF Unit with a new one.

Table 3-11. Check point for Head Cleaning error (Ink low error) according to each phenomenon

Occurrence timing CR position	Detailed phenomenon	Defective unit/part name	Check point	Remedy
<ul style="list-style-type: none"> <li>• Operation</li> <li>• –</li> </ul>	Head Cleaning is not carried out.	Ink Cartridge	1. Check if the ink remains in the Ink Cartridge. 2. Check if the Ink Cartridge can be used by installing it to other printer.	1. Replace the Ink Cartridge with a new one. 2. Replace the Ink Cartridge with a new one.

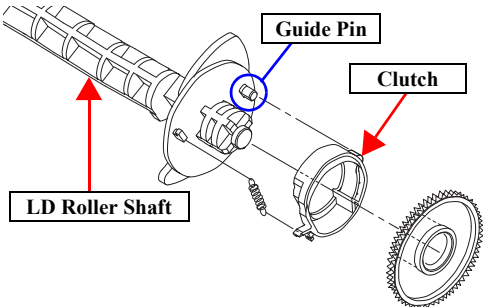
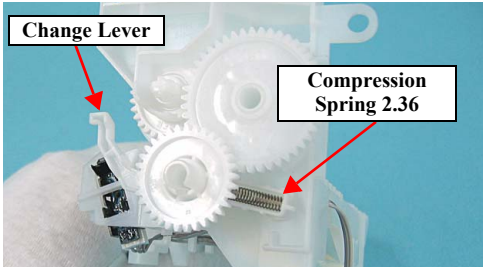
Table 3-12. Check point for DSC Direct error according to each phenomenon (NX510/SX410 series only)

Occurrence timing CR position	Detailed phenomenon	Defective unit/part name	Check point	Remedy
<ul style="list-style-type: none"> <li>• Operation</li> <li>• –</li> </ul>	The Digital Camera (as a USB device) cannot be recognized and an error is indicated.	USB Cable	1. Check if the USB Cable is damaged.	1. Replace the USB Cable with a new one.
		Digital Camera	2. Confirm whether the digital camera is compatible with the printer.	2. Replace the digital camera with a compatible one.

Table 3-13. Check point for Memory Card error according to each phenomenon

Occurrence timing CR position	Detailed phenomenon	Defective unit/part name	Check point	Remedy
<ul style="list-style-type: none"> <li>• Operation</li> <li>• –</li> </ul>	The Memory Card cannot be recognized and an error is indicated.	Memory Card	1. Check if the Memory Card is compatible with the printer. 2. Check if the Memory Card is damaged. 3. Check if a memory card that the adaptor is needed is inserted into the slot without using the adaptor.	1. Replace the Memory Card with a compatible one. 2. Replace the Memory Card with a new one. 3. Turn off the printer, then remove the card using tweezers or a similar tool.
		Main Board Unit	1. Check if the Memory Card slot pins on the Main Board is bent or broken.	1. Replace the Main Board Unit with a new one.

Table 3-14. Check point for Index Sheet 1 error (No index Sheet) according to each phenomenon

Occurrence timing CR position	Detailed phenomenon	Defective unit/part name	Check point	Remedy
<ul style="list-style-type: none"> <li>• Operation</li> <li>• –</li> </ul>	This error occurs when attempting to print using the Index Sheet.	Document Cover	1. Check if the Document Cover is open.	1. Close the Document Cover.
		Index Sheet	1. Check if the Index Sheet is set in the wrong way.	1. Set the Index Sheet correctly.
			2. Check if the Index Sheet's standard position is clean.	2. Reprint the Index Sheet.
Scanner Housing Upper	1. Check if the Document Glass is clean.	1. Clean the Document Glass.		

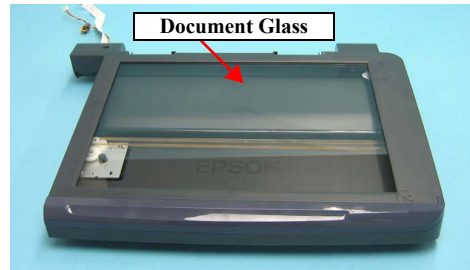

Table 3-15. Check point for Index Sheet error 2 (Image marking error) &amp; Index Sheet error 3 (Paper marking error) according to each phenomenon

Occurrence timing CR position	Detailed phenomenon	Defective unit/part name	Check point	Remedy
<ul style="list-style-type: none"> <li>• Operation</li> <li>• –</li> </ul>	This error occurs when attempting to print using the Index Sheet.	Index Sheet	1. Check if the checkboxes on the Index Sheet are properly marked out.	1. Mark it out properly.

Table 3-16. Check point for Index Sheet error 4 (Incorrect card) according to each phenomenon

Occurrence timing CR position	Detailed phenomenon	Defective unit/part name	Check point	Remedy
<ul style="list-style-type: none"> <li>• Operation</li> <li>• –</li> </ul>	This error is generated when attempting to print from Index Sheet.	Index Sheet	1. Check if the Index Sheet was printed from the inserted Memory Card.	1. Change the Index Sheet to the one printed from the inserted Memory Card.
		Memory Card	1. Check if the Memory Card storing the Index Sheet data is inserted.	1. Insert Memory Card storing the Index Sheet data.
			2. Check if the Memory Card is damaged.	2. Replace the Memory Card with a new one.

Table 3-17. Check point for Pre-scanning error (photo) according to each phenomenon (NX510/SX410 series only)

Occurrence timing CR position	Detailed phenomenon	Defective unit/part name	Check point	Remedy
<ul style="list-style-type: none"> <li>• Operation</li> <li>• –</li> </ul>	No photos cannot be recognized and an error is indicated.	Photo	1. Check if the photo is set correctly.	1. Set the photo correctly.

Table 3-18. Check point for Double feed error according to each phenomenon

Occurrence timing CR position	Detailed phenomenon	Defective unit/part name	Check point	Remedy
<ul style="list-style-type: none"> <li>• Operation</li> <li>• –</li> </ul>	After both surfaces were printed, the paper was ejected but an error is displayed.	ASF Unit	1. Check if the Extension Spring Retard operates correctly in the paper loading sequence.	1. Set the Extension Spring Retard between the Retard Roller Unit and the ASF Frame.
			2. Check if the Paper Back Lever operates correctly in the paper loading sequence.	

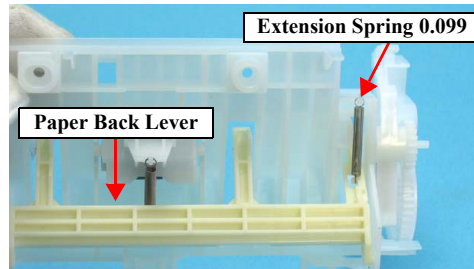
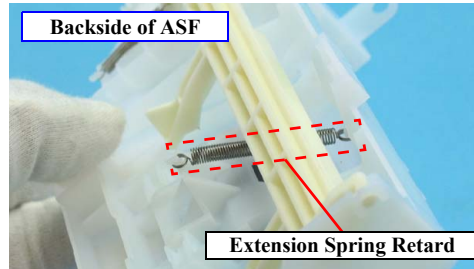

Table 3-19. Check point for Communication error according to each phenomenon

Occurrence timing CR position	Detailed phenomenon	Defective unit/part name	Check point	Remedy
<ul style="list-style-type: none"> <li>• Power on</li> <li>• Anywhere</li> </ul>	When turning on the power, the printer does not operate at all.	Panel Unit	1. Check if the Panel FFC is connected to CN1 on the Panel Board.	1. Connect the Panel FFC to CN1 on the Panel Board.
				
			2. Check if the Panel FFC is not damaged.	
			3. Check if the Panel Board is not damaged.	3. Replace the Panel FFC with new one.

Table 3-19. Check point for Communication error according to each phenomenon

Occurrence timing CR position	Detailed phenomenon	Defective unit/part name	Check point	Remedy
<ul style="list-style-type: none"> <li>• Power on</li> <li>• Anywhere</li> </ul>	When turning on the power, the printer does not operate at all.	PS Board Unit	1. Check if the PS Board Connector Cable is connected to the connector on the Main Board Unit shown below. <ul style="list-style-type: none"> <li>■ NX510 series: CN501</li> <li>■ SX410/SX210 series: CN1</li> </ul>  2. Check if the PS Board Connector Cable/PS Board is not damaged. 	1. Connect the the PS Board Connector Cable to the connector on the Main Board Unit shown below. <ul style="list-style-type: none"> <li>■ NX510 series: CN501</li> <li>■ SX410/SX210 series: CN1</li> </ul> 2. Replace the PS Board Unit with new one. <p>* If the problem is not solved, replace the Main Board with new one.</p>

Table 3-19. Check point for Communication error according to each phenomenon

Occurrence timing CR position	Detailed phenomenon	Defective unit/part name	Check point	Remedy
<ul style="list-style-type: none"> <li>• Power on</li> <li>• —</li> </ul>	When turning on the power, the power on sequence is performed correctly. But, when any printer job is sent to the printer, a communication error is indicated with STM3.	USB Cable	1. Check if the USB Cable is connected between the printer and the PC.	1. Connect the USB Cable to the printer and the PC.
		Main Board Unit	1. Check if an correct model name is stored into the address of the EEPROM on the Main Board.  1. Check if the Panel FFC is connected to the connector on the Main Board Unit shown below. <ul style="list-style-type: none"> <li>■ NX510 series: CN5</li> <li>■ SX410 series: CN12</li> <li>■ SX210 series: CN18</li> </ul> 	1. Use the Adjustment Program to write the correct value to the EEPROM address.  1. Connect the the Panel FFC to the connector on the Main Board Unit shown below. <ul style="list-style-type: none"> <li>■ NX510 series: CN5</li> <li>■ SX410 series: CN12</li> <li>■ SX210 series: CN18</li> </ul>

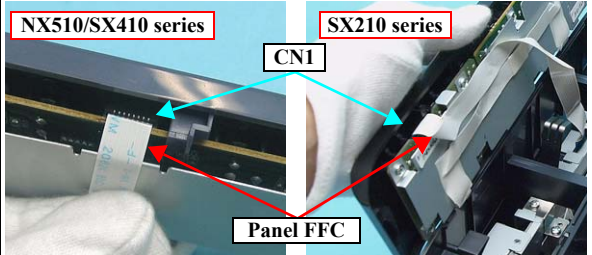
Table 3-20. Check point for Scanner unit open error according to each phenomenon (NX510 series only)

Occurrence timing CR position	Detailed phenomenon	Defective unit/part name	Check point	Remedy
<ul style="list-style-type: none"> <li>• Operation</li> <li>• Anywhere</li> </ul>	The Printer Cover is closed, but the cover open error is displayed.	Cover Open Sensor	1. Is the Cover Open Sensor cable properly connected to CN16 on the Main Board? 	1. Connect the Cover Open Sensor cable to CN16 on the Main Board.
			2. Is the Cover Open Sensor cable damaged?	2. Replace the Cover Open Sensor cable with a new one.
			3. Is the Cover Open Sensor damaged?	3. Replace the Cover Open Sensor with a new one.

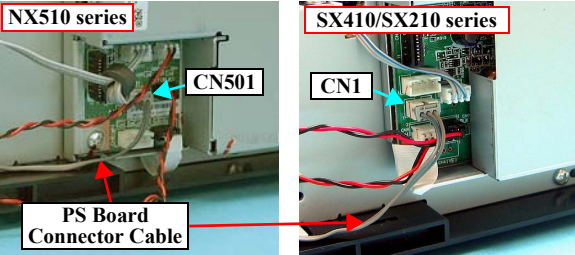
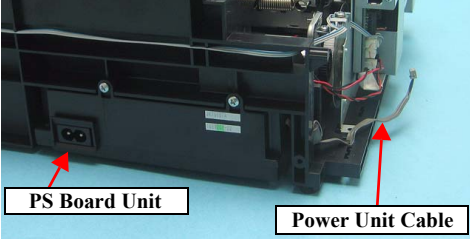

### 3.3.3 Superficial Phenomenon-Based Troubleshooting

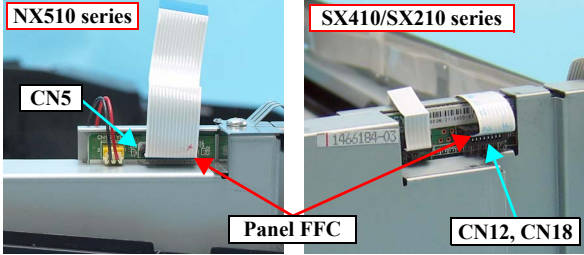
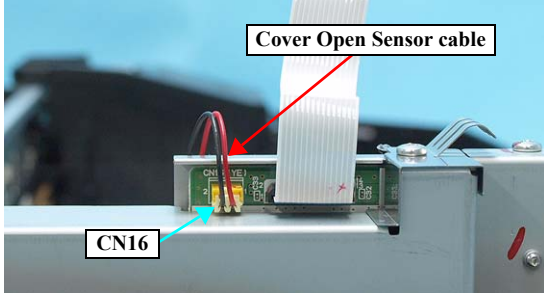
This section explains the fault locations of the error states (print quality and abnormal noise) other than the error states (LED and STM3) in the previous section.

**Table 3-21. Check point for the error that multiple sheets of paper are always loaded without LEDs and STM3**

Occurrence timing CR position	Detailed phenomenon	Defective unit/part name	Check point	Remedy
<ul style="list-style-type: none"> <li>• Operation</li> <li>• –</li> </ul>	<p>The LEDs and STM3 are not indicating error conditions. But, multiple sheets of paper are always loaded from the ASF Unit.</p>	ASF Unit	<ol style="list-style-type: none"> <li>1. Check if the Extension Spring Retard operates correctly in the paper loading sequence.</li> </ol>  <ol style="list-style-type: none"> <li>2. Check if the Paper Back Lever operates correctly in the paper loading sequence.</li> </ol> 	<ol style="list-style-type: none"> <li>1. Set the Extension Spring Retard between the Retard Roller Unit and the ASF Frame.</li> <li>2. Set the Extension Spring 0.099 between the ASF Frame and the Paper Back Lever.</li> </ol>

Table 3-22. Check point for the abnormal noise

Occurrence timing CR position	Detailed phenomenon	Defective unit/part name	Check point	Remedy
<ul style="list-style-type: none"> <li>• Anytime</li> <li>• Anywhere</li> </ul>	The abnormal noise occurs at the first power on timing and during each operation although the printing operation is performed.	Carriage Unit	1. Check if the grease on the Carriage Path is sufficient.	1. Wipe off the remaining grease on the Carriage path and lubricate it on its frame.
		ASF Unit	1. Check if the Change Lever moves smoothly.	1. Replace the ASF Unit with a new one.
	The Carriage Unit collides to the Upper Paper Guide Unit during each operation.	Upper Paper Guide Unit	1. Check if the Upper Paper Guide Unit is attached securely. (check if it interferes with the Carriage Unit)	1. Reassemble the Upper Paper Guide to the Main Frame.

Table 3-23. Check point for the defective scanned image quality

Print Quality State	Detailed phenomenon	Defective unit/part name	Check point	Remedy
<ul style="list-style-type: none"> <li>• Scanned image is not clear.</li> </ul>	There are dusts or the like on the Document Glass. (white dots appear on the scanned image)	Upper Scanner Housing	1. Check if there is any foreign material on the Document Glass.	1. Remove the foreign material from the Document Glass. (Refer to <a href="#">Chapter 6 “MAINTENANCE” (p.175)</a> .)
	There are dusts or the like on the LED inside the Rod Lens Array. (vertical stripes appear on the scanned image)	Scanner Carriage Unit	1. Check if there is not foreign material on the LED.	1. Remove the foreign material from the Document Glass (blow away the dusts).
	The LED of Scanner Carriage Unit does not light up.	Scanner Carriage Unit	1. Check if the LED lights up.	1. Replace the Scanner Carriage Unit with a new one.

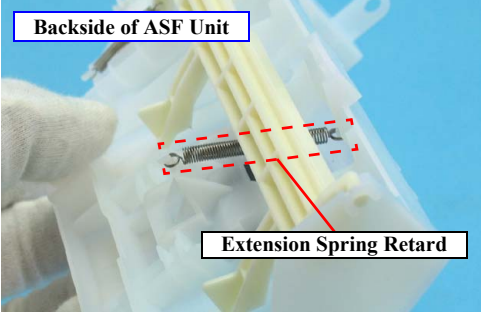
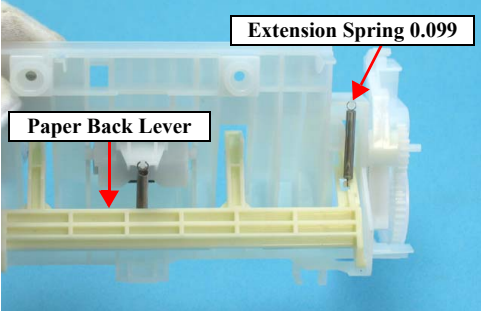
Table 3-24. Check point for the defective printing quality

Print Quality State	Detailed phenomenon	Defective unit/part name	Check point	Remedy
• Dot missing and mixed colors	Ink is scarcely ejected to the Cap from the Printhead.	Ink System Unit (Cap Unit)	1. Check if there is not any foreign material/damage around the seal rubber part on the Cap Unit. 	1. Remove the foreign material around the seal rubber parts carefully.
	Ink is ejected to the Cap from the Printhead, but the printer does not recover from the error after cleaning or ink change.	Printhead	Printhead	2. Check if the Compression Spring is correctly mounted on the Cap Unit.
Cleaner Blade				1. Check if it returns to normal by performing CL operation or replacing the Ink Cartridge.
Main Board			2. Check if the Printhead is not damaged.	2. Replace the Printhead with a new one.
		Cleaner Blade	1. Check if the Cleaner Blade does not have paper dust or bending.	1. Replace the Ink System Unit with a new one.
		Main Board	1. Check if the Main Board is not damaged.	1. Replace the Main Board with a new one.

Table 3-24. Check point for the defective printing quality

Print Quality State	Detailed phenomenon	Defective unit/part name	Check point	Remedy
• White streak / abnormal discharge	Ink is ejected to the Cap from the Printhead, but printing is not done at all after cleaning or ink change, or abnormal discharge occurs.	Head FFC	<p>1. Check if the Head FFC is connected to the connector on the Main Board Unit shown below.</p> <ul style="list-style-type: none"> <li>■ NX510 series: CN11, CN12, CN13</li> <li>■ SX410 series: CN5, CN6, CN7</li> <li>■ SX210 series: CN5, CN6</li> </ul> <p>The diagrams illustrate the connection of the Head FFC to the Main Board Unit for different printer models. The top-left image shows the Head FFC being inserted into a connector on the Main Board Unit. The top-right image shows the NX510 series connection points: CN11, CN12, and CN13. The bottom-left image shows the SX410 series connection points: CN5, CN6, and CN7. The bottom-right image shows the SX210 series connection points: CN5 and CN6. Labels include 'Printhead', 'Connector', 'Head FFC', 'NX510 series', 'SX410 series', and 'SX210 series'.</p>	1. Connect the Head FFC to the Printhead and the Main Board Connectors.
		Printhead	<p>2. Check if the Head FFC is not damaged.</p> <p>1. Check if it returns to normal by performing CL operation or replacing the Ink Cartridge.</p>	2. Replace the Head FFC with a new one. 1. Perform CL operation and the Ink Cartridge replacement specified times. If it doesn't work, change the Printhead with a new one.
		Main Board Unit	1. Check if the Main Board is not damaged.	1. Replace the Main Board Unit with a new one.

Table 3-24. Check point for the defective printing quality

Print Quality State	Detailed phenomenon	Defective unit/part name	Check point	Remedy
<ul style="list-style-type: none"> <li>White streak / color unevenness occurrence</li> </ul>	Vertical banding appears against the CR movement direction. And, it looks like uneven printing.    [Note] If the problem is not solved, replace the CR Motor with a new one.	Adjustment	1. For printing in the Bi-D mode, check if Bi-D Adjustment has been performed properly.	1. Perform Bi-D Adjustment to correct print start timing in bi-directional printing. (Refer to Chapter 5 "ADJUSTMENT" (p.161).)
		Printhead	1. Check if the Nozzle Check Pattern is printed properly.	2. Perform Head Cleaning and check the Nozzle Check Pattern. (Refer to Chapter 5 "ADJUSTMENT" (p.161).) If the problem is not solved, replace the Printhead with a new one.
		Main Frame	1. Check if there is any foreign material on the Carriage path. 2. Check if the Main Frame is deformed. 3. Check if the grease is enough on the Carriage path of the Main Frame.	1. Remove foreign material from surface of the Carriage path. 2. Replace the Main Frame with a new one. 3. After wiping the grease G-71 on the Carriage path with a dry, soft cloth, coat it with grease. (Refer to Chapter 6 "MAINTENANCE" (p.175).)

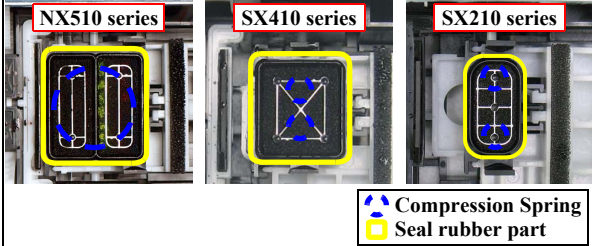
Table 3-24. Check point for the defective printing quality

Print Quality State	Detailed phenomenon	Defective unit/part name	Check point	Remedy	
<ul style="list-style-type: none"> <li>White streak / color unevenness occurrence</li> </ul>	Micro banding appears horizontally against the CR movement direction and it appears with the same width.   [Note] If the problem is not solved, replace the PF Motor with a new one.	Printer driver & exclusive paper	1. Check if the suitable paper is used according to the printer driver setting.	1. Use the suitable paper according to the printer driver setting.	
		Printhead	1. Check if the Nozzle Check Pattern is printed correctly.	1. Perform the Head Cleaning and check the Nozzle Check Pattern. (Refer to <a href="#">Chapter 5 "ADJUSTMENT"</a> (p.161).) If the problem is not solved, replace the Printhead with a new one.	
		PF Roller Unit	1. Check if there is not any foreign material on the surface of the PF Roller Unit.	1. Clean the surface of the PF Roller Unit carefully with the soft cloth.	
					
			2. Check if the PF Roller Unit is not damaged.	2. Replace the PF Roller Unit with a new one.	
		The Star wheel mark against the CR movement direction.  	Star Wheel Holder Assy	1. Check if the Star Wheel Holder does not come off. 2. Check if the surface of the Star Wheel Holder Assy is flat.	1. Reassemble the Star Wheel Holder correctly. 2. Replace the Star Wheel Holder Assy with a new one.
	Printing is blurred.	Printer driver & exclusive paper	1. Check if the suitable paper is used according to the printer driver setting.	1. Use the suitable paper according to the printer driver setting.	
		Printhead	1. Check if the correct Head ID is stored into the EEPROM by using the Adjustment Program.	1. Input 16-digit code of the Head ID into the EEPROM by using the Adjustment Program.	

Table 3-24. Check point for the defective printing quality

Print Quality State	Detailed phenomenon	Defective unit/part name	Check point	Remedy
• Print start position slip	The printing operation is correctly performed. But, the top margin is insufficient than usual one.	ASF Unit	1. Check if any paper dust is not adhered to the surface of the LD Roller. 	1. Set a cleaning sheet in the ASF up side down. Then holding the top edge, try to load the paper from the Printer driver. The micro pearl on the LD Roller surface is removed. To remove severe smear, staple a cloth moistened with alcohol to a post card and clean the roller in the same manner. As for the cleaning sheet, refer to “Check point for Paper out error according to each phenomenon” (p.72). * If the problem is not solved, replace the ASF Unit with a new one.
• Ink stain of paper	Ink stain occurs at the back, top end or bottom end of the print paper.	Front Paper Guide	1. Check if the Front Paper Guide Unit is free from ink stain. 	1. Clean the Front Paper Guide Unit with a soft cloth.
			2. Check if heaps of ink are not formed on Porous Pad Front Paper Guide.	2. Replace the Front Paper Guide Assy with a new one.
		EJ Roller Unit	1. Check if the EJ Roller Unit is free from ink stain.	1. Clean the EJ Roller Unit with a soft cloth.
		PF Roller Unit	1. Check if the PF Roller Unit is free from ink stain.	1. Clean the PF Roller Unit with a soft cloth.

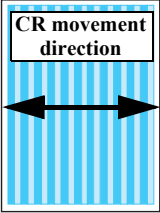
Table 3-24. Check point for the defective printing quality

Print Quality State	Detailed phenomenon	Defective unit/part name	Check point	Remedy
• Ink stain of paper	Ink sticks to other than the print area of the paper, resulting in contamination.	Printhead	1. Check if the Printhead Cover does not have the ink drop.	1. Clean the Printhead Cover carefully with a soft cloth.
		Upper Paper Guide Unit	1. Check if the Upper Paper Guide Unit is free from ink stain.	1. Clean the Upper Paper Guide Unit with a soft cloth.
		Star Wheel Holder Assy	1. Check if the Star Wheels is free from ink stain. 	1. Clean the Star Wheels with a soft cloth.

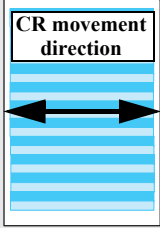
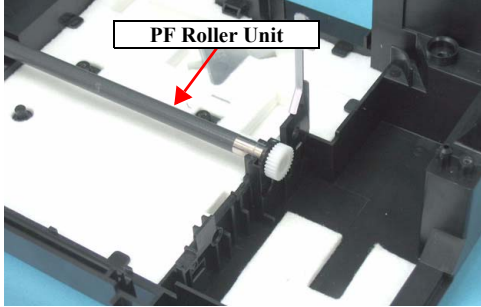
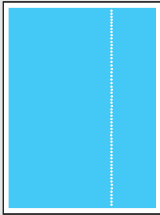

## 3.4 Network Troubleshooting (NX510 series only)

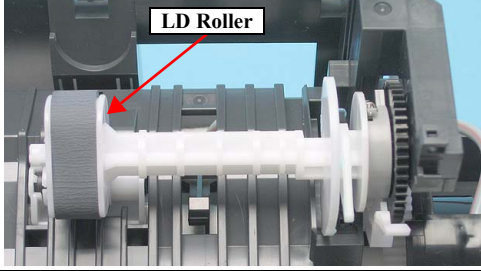
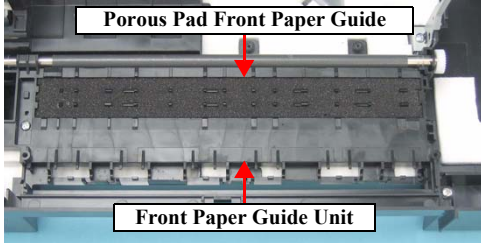
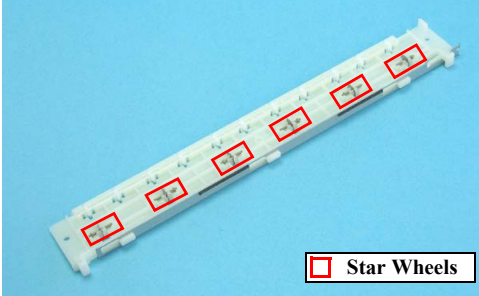
The following table describes the troubleshooting related to the Network function of the NX510 series.

### □ Troubles in Network Settings

**Table 3-25. Troubles in Network Settings**

Symptom	Check Point	Remedy
Connection with Access Point/ Detection of Access Point can not be made (Wireless LAN)	1. Check if Access Point is ready for the connection.	Check if the connection can be made from the other devices.
	2. Check if Access Point is too far from the printer or blocked by obstruction.	Move Access Point closer to the printer or clear off the obstruction.
	3. Check if Access Point has any limitation for the access.	Check Access Point and change the setting for the access by setting the MAC Address or IP Address, etc. of the printer.
	4. Check if Access Point setting is made for non-display of the SSID (Network).	Input the SSID from the Control Panel.
	5. Check if WEP key or setting for the password is correct.	Check the WEP key and the password in a case-sensitive manner.
Communication with wired LAN can not be made	1. Check if the Wireless LAN Setting on the Control Panel is "Disable".	Change the Wireless LAN Setting into "Disable", because Wireless LAN and Wired LAN can not be used at the same time.
	2. Check if the combination for the HUB and router etc. and Link Speed of the Printer is proper.	Correct the Link Speed setting properly.
	3. Check if 10Base-T Repeater HUB is used.	Try other HUBs (Switching HUB etc.).

### □ Troubles in installing a software

**Table 3-26. Troubles in Installing a Software**

Symptom	Check Point	Remedy
"Can not connect to internet thru LAN" is displayed.	1. In Wireless LAN's case, check if the network connection between the PC and Access Point is made.	Correctly connect the computer and the Access Point.
	2. In Wired LAN's case, check if the computer and the printer are properly connected to a LAN port such as a hub or a router.	Correctly connect the computer and the printer to a LAN port such as a hub or router using a LAN cable.
	3. Check the status of network settings/connection by printing the network status sheet.	Correctly set the network connection again if the network connection is not made.
	4. Check if the link lamp on the Access Point or hub connected to the printer is lighting or flashing.	<ul style="list-style-type: none"> <li>• Try using another port.</li> <li>• Replace the LAN cable.</li> <li>• Configure Wireless LAN setting correctly.</li> </ul>
	5. Check is IP address is correctly set.	Correctly set IP address.
	6. For the setting of the Windows Firewall or commercially available security software, check if the installed network access is set to "Shut down" or "Block" etc.	Set the Windows Firewall or commercially available software as the exceptional application. *If the problem is not solved when using the commercially available security software, restart it once.

- Troubles during printing and scanning from PC

**Table 3-27. Troubles during printing and scanning from PC**

Symptom	Check Point	Remedy
Print cannot be made Scan cannot be made	1. In Wireless LAN's case, check if the network connection between the PC and Access Point is made.	Correctly connect the computer and the Access Point.
	2. In Wired LAN's case, check if the computer and the printer are properly connected to a LAN port such as a hub or router.	Correctly connect the computer and the printer to a LAN port such as a hub or router using a LAN cable.
	3. Check the status of network settings/connection by printing the network status sheet.	Correctly set the network connection again if the network connection is not made.
	4. Check if the link lamp on the Access Point or hub connected to the printer is lighting or flashing.	<ul style="list-style-type: none"> <li>• Try using another port.</li> <li>• Replace the LAN cable.</li> <li>• Configure Wireless LAN setting correctly.</li> </ul>
	5. Check if the network settings are correctly configured?	Correctly configure the network settings.
	6. Check if the network setting screen is displayed on the Control Panel.	Close the screen.
EPSON Scan cannot be started	1. For EPSON Scan settings, check if IP address is set directly.	If IP address is set using the DHCP function, specify IP address by searching address.

CHAPTER

4

**DISASSEMBLY/ASSEMBLY**

## 4.1 Overview



In this chapter, the product names are called as follows:

Notation	Product name
NX510 series	Epson Stylus NX510/NX515/SX510W/SX515W/TX550W
SX410 series	Epson Stylus NX415/SX410/SX415/TX410/TX419
SX210 series	Epson Stylus NX215/SX210/SX215/TX210/TX213/ TX219/ME OFFICE 510

This chapter describes procedures for disassembling the main components of this product. Unless otherwise specified, disassembled units or components can be reassembled by reversing the disassembly procedure. Procedures which, if not strictly observed, could result in personal injury are described under the heading “WARNING”. “CAUTION” signals a precaution which, if ignored, could result in damage to equipment. Important tips for procedures are described under the heading “CHECK POINT”. If the assembly procedure is different from the reversed disassembly procedure, the correct procedure is described under the heading “REASSEMBLY”. Any adjustments required after reassembly of components or parts are described under the heading “ADJUSTMENT REQUIRED”. When you have to remove any components or parts that are not described in this chapter, refer to the exploded diagrams in the appendix.

Read the following precautions before disassembling and assembling.

### 4.1.1 Precautions

See the precautions given under the heading “WARNING” and “CAUTION” in the following columns when disassembling or assembling this product.



- Disconnect the power cable before disassembling or assembling the printer.
- If you need to work on the printer with power applied, strictly follow the instructions in this manual.
- Always wear gloves for disassembly and reassembly to protect your eyes from ink. If any ink gets in your eyes, wash your eyes with clean water and consult a doctor immediately.
- Always wear gloves for disassembly and reassembly to avoid injury from sharp metal edges.
- To protect sensitive microprocessors and circuitry, use static discharge equipment, such as anti-static wrist straps, when accessing internal components.
- Never touch the ink or wasted ink with bare hands. If ink comes into contact with your skin, wash it off with soap and water immediately. If you have a skin irritation, consult a doctor immediately.



- When transporting the printer after installing the ink cartridge, pack the printer for transportation without removing the ink cartridge and be sure to secure the Ink Cartridge to the printer cover with tape tightly to keep it from moving.
- Use only recommended tools for disassembling, assembling or adjusting the printer.
- Observe the specified torque when tightening screws.
- Apply lubricants as specified.  
(See [Chapter 6 MAINTENANCE \(p.175\)](#) for details.)
- Make the specified adjustments when you disassemble the printer. (See [Chapter 5 ADJUSTMENT \(p.161\)](#) for details.)
- when reassembling the Waste Ink Tube, make sure that the tip of waste ink tube is placed in the correct position, otherwise ink may leak.
- When using compressed air products; such as air duster, for cleaning during repair and maintenance, the use of such products containing flammable gas is prohibited.

## 4.1.2 Tools

Use only specified tools to avoid damaging the printer.

**Table 4-1. Tools**

Name	EPSON Tool Code*
(+) Phillips screwdriver #1	1080530
(+) Phillips screwdriver #2	---
Flathead screwdriver	---
Flathead Precision screwdriver #1	---
Tweezers	---
Longnose pliers	---
Acetate tape	1003963
Nippers	---

Note \*: All of the tools listed above are commercially available.  
EPSON provides the tools listed with EPSON tool code.

## 4.1.3 Work Completion Check

If any service is made to the printer, use the checklist shown below to confirm all works are completed properly and the printer is ready to be returned to the user.

**Table 4-2. Work Completion Check**

Classification	Item	Check Point	Status
Printer Unit	Self-test	Is the operation normal?	<input type="checkbox"/> OK / <input type="checkbox"/> NG
	ON-line Test	Is the printing successful?	<input type="checkbox"/> OK / <input type="checkbox"/> NG
	Printhead (Nozzle check pattern print)	Is ink discharged normally from all the nozzles?	<input type="checkbox"/> OK / <input type="checkbox"/> NG
	Carriage Mechanism	Does it move smoothly?	<input type="checkbox"/> OK / <input type="checkbox"/> NG
		Is there any abnormal noise during its operation?	<input type="checkbox"/> OK / <input type="checkbox"/> NG
		Is the CR Motor at the correct temperature? (Not too hot to touch?)	<input type="checkbox"/> OK / <input type="checkbox"/> NG
	Paper Feeding Mechanism	Is paper advanced smoothly?	<input type="checkbox"/> OK / <input type="checkbox"/> NG
		No paper jamming?	<input type="checkbox"/> OK / <input type="checkbox"/> NG
		No paper skew?	<input type="checkbox"/> OK / <input type="checkbox"/> NG
		No multiple feeding?	<input type="checkbox"/> OK / <input type="checkbox"/> NG
		No abnormal noise?	<input type="checkbox"/> OK / <input type="checkbox"/> NG
		Is the paper path free of any obstructions?	<input type="checkbox"/> OK / <input type="checkbox"/> NG
		Is the PF Motor at correct temperature?	<input type="checkbox"/> OK / <input type="checkbox"/> NG

Table 4-2. Work Completion Check

Classification	Item	Check Point	Status
Scanner unit	Mechanism	Is glass surface dirty?	<input type="checkbox"/> OK / <input type="checkbox"/> NG
		Is any foreign substance mixed in the CR movement area?	<input type="checkbox"/> OK / <input type="checkbox"/> NG
	CR mechanism	Does CR operate smoothly?	<input type="checkbox"/> OK / <input type="checkbox"/> NG
		Does CR operate together with scanner unit?	<input type="checkbox"/> OK / <input type="checkbox"/> NG
		Does CR make abnormal noise during its operation?	<input type="checkbox"/> OK / <input type="checkbox"/> NG
LED	Does LED turn on normally? And is white reflection test done near home position?	<input type="checkbox"/> OK / <input type="checkbox"/> NG	
ON-line Test	ON-line Test	Is the operation normal?	<input type="checkbox"/> OK / <input type="checkbox"/> NG
Copy	Copy	Is the local copy action normal?	<input type="checkbox"/> OK / <input type="checkbox"/> NG
Adjustment	Specified Adjustment	Are all the adjustment done correctly	<input type="checkbox"/> OK / <input type="checkbox"/> NG
Lubrication	Specified Lubrication	Are all the lubrication made at the specified points?	<input type="checkbox"/> OK / <input type="checkbox"/> NG
		Is the amount of lubrication correct?	<input type="checkbox"/> OK / <input type="checkbox"/> NG
Function	ROM Version	Version:	<input type="checkbox"/> OK / <input type="checkbox"/> NG
Packing	Ink Cartridge	Are the ink cartridges installed correctly?	<input type="checkbox"/> OK / <input type="checkbox"/> NG
	Waste Ink pad	Are the waste ink pads adequate to absorb?	<input type="checkbox"/> OK / <input type="checkbox"/> NG
	Protective materials	Is the printer carriage placed at the capping position?	<input type="checkbox"/> OK / <input type="checkbox"/> NG
Others	Attachments, Accessories	Have all the relevant items been included in the package?	<input type="checkbox"/> OK / <input type="checkbox"/> NG

## 4.1.4 Procedural Differences between the Models

This chapter describes the disassembling/reassembling procedures based on NX510 series. As for some parts/components; however, the procedures differ between each model. Refer to the following table to confirm the differences and the reference.

Table 4-3. Differences between Models





Item	Difference	NX510 series	SX410 series	SX210 series	Reference*
Panel Unit	Disassembling/reassembling procedures (The shape of the Panel Units differs.)				<ul style="list-style-type: none"> <li>■ <b>NX510 series</b> “4.4.2 Panel Unit/LCD Unit” (p108)</li> <li>■ <b>SX410 series</b> “4.7.2 Panel Unit/LCD Unit (SX410 series)” (p148)</li> <li>■ <b>SX210 series</b> “4.8.2 Panel Unit/LCD Unit (SX210 series)” (p155)</li> </ul>
Printhead	Disassembling/reassembling procedures (The Printheads differ.)				<ul style="list-style-type: none"> <li>■ <b>NX510 series</b> “4.5.1 Printhead” (p113)</li> <li>■ <b>SX410 series</b> “4.7.3 Printhead (SX410 series)” (p150)</li> <li>■ <b>SX210 series</b> “4.8.3 Printhead (SX210 series)” (p158)</li> </ul>
Main Board Unit	Disassembling/reassembling procedures (The shape and the connector locations differ.)				<ul style="list-style-type: none"> <li>■ <b>NX510 series</b> “4.4.1 Main Board Unit” (p105)</li> <li>■ <b>SX410 series</b> “4.7.1 Main Board Unit (SX410 series)” (p146)</li> <li>■ <b>SX210 series</b> “4.8.1 Main Board Unit (SX210 series)” (p154)</li> </ul>
Cover Open Sensor	Existence of Cover Open Sensor	Yes	No	No	“4.5.4 Removing the Printer Mechanism (Lower Housing)” (p117)
Wireless LAN Board	Existence of Wireless LAN Board	Yes	No	No	“4.4.1 Main Board Unit” (p105)
Scanner Carriage FFC	Existence of Ferrite core	No	Yes	No	“4.3.4 Scanner Unit/Hinge” (p100)
Left Frame	Existence of Ferrite core	Yes	No	No	“4.5.5 Left Frame” (p119)

Table 4-3. Differences between Models

Item	Difference	NX510 series	SX410 series	SX210 series	Reference*
Front Frame	Existence of Ferrite core	Yes	No	No	"4.5.6 Front Frame/Right Frame" (p120)
	Number of pieces of acetate tape that secure the Head FFC to the Front Frame	One piece	Two pieces	Two pieces	
Right Frame	Existence of Porous Pad Frame Right	Yes	Yes	No	
PF Encoder Sensor	Existence of Acetate Tape	Yes	No	Yes	"4.5.9 PF Encoder Sensor" (p123)
Ink System Unit	Number of the Waste Ink Tubes	Two tubes	One tube	One tube	"4.5.17 Ink System Unit" (p134)
PF Roller	Attachment location of the Grounding Spring that is in contact with the PF Roller				"4.5.19 PF Roller" (p138) "4.5.11 PF Motor" (p125)
PF Motor	Length of the PF Motor cable				"4.5.11 PF Motor" (p125)
Printer Mechanism	Disassembling/reassembling procedures differ due to the difference in the following items: <ul style="list-style-type: none"> <li>• Routing of cables around the Main Board Unit</li> <li>• Number of screws</li> <li>• Existence of Cover Open Sensor</li> </ul>				<ul style="list-style-type: none"> <li>■ <b>NX510 series</b> "4.5.4 Removing the Printer Mechanism (Lower Housing)" (p117)</li> <li>■ <b>SX410 series</b> "4.7.4 Removing the Printer Mechanism (Lower Housing) (SX410 series)" (p152)</li> <li>■ <b>SX210 series</b> "4.8.4 Removing the Printer Mechanism (Lower Housing) (SX210 series)" (p160)</li> </ul>
USB Cover	The shape of the USB Cover differs.				"4.3.4 Scanner Unit/Hinge" (p100)
Scanner Unit	Connector Numbers on the Main Board Unit for the Scanner Carriage FFC and the Scanner Motor cable				
Power Supply Unit	Connector Number on the Main Board Unit for the Power Unit Cable				"4.4.3 Power Supply Unit" (p111)
Cartridge Position Label	The attachment standard and the type of the Cartridge Position Label				"4.3.5 Upper Housing/Card Slot Cover" (p103)
Waste Ink Pads	Quantity and the shape of Waste Ink Pads				"4.5.20 Waste Ink Pads" (p139)

Note \*: When indicating one reference, the instructions for each model are described in the procedure.

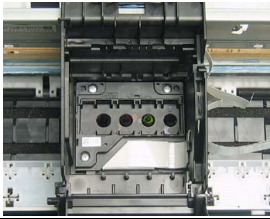

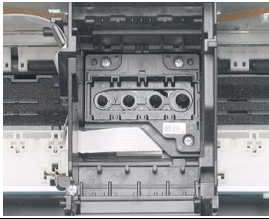
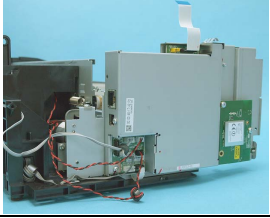
## 4.2 Disassembly Procedures

For disassembling each unit, refer to the pages in the following flowchart.

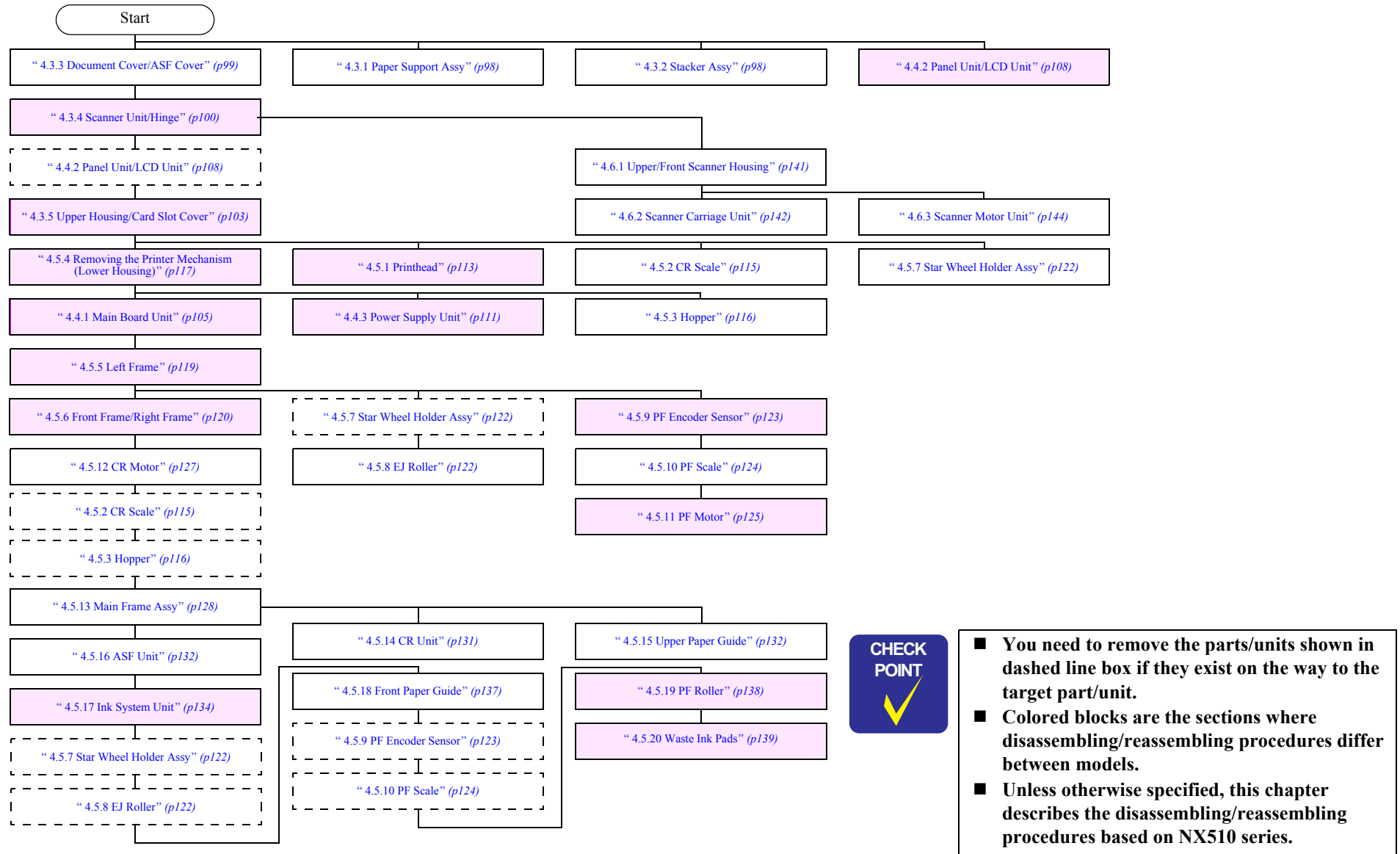

Figure 4-1. Disassembling Flowchart

## 4.3 Removing the Housing

### 4.3.1 Paper Support Assy

- Parts/Components need to be removed in advance: None
- Removal procedure
  1. Release the guide pins (x2) that secure the Paper Support Assy and remove it from the Upper Housing.

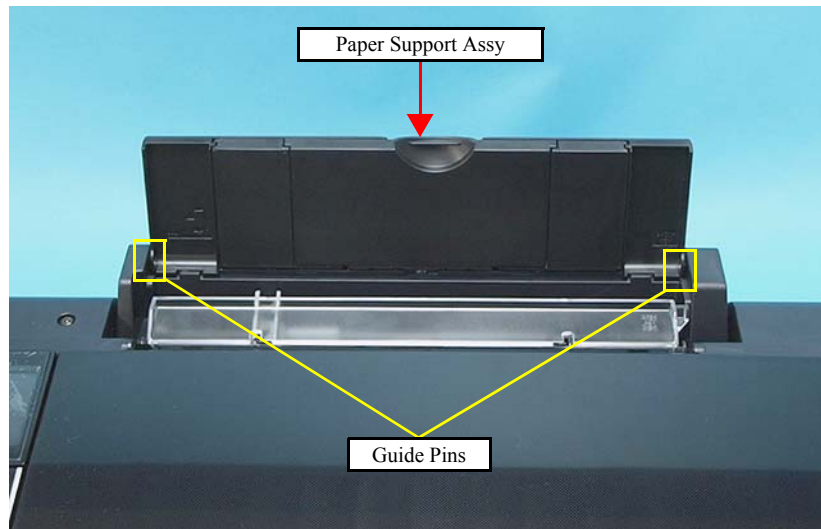

Figure 4-2. Removing the Paper Support Assy

### 4.3.2 Stacker Assy

- Parts/Components need to be removed in advance: None
- Removal procedure
  1. Open the Stacker Assy.
  2. Release the Stacker Assy while pressing in the hook (x1) on the left with a flathead precision screwdriver or a similar tool, and remove it.

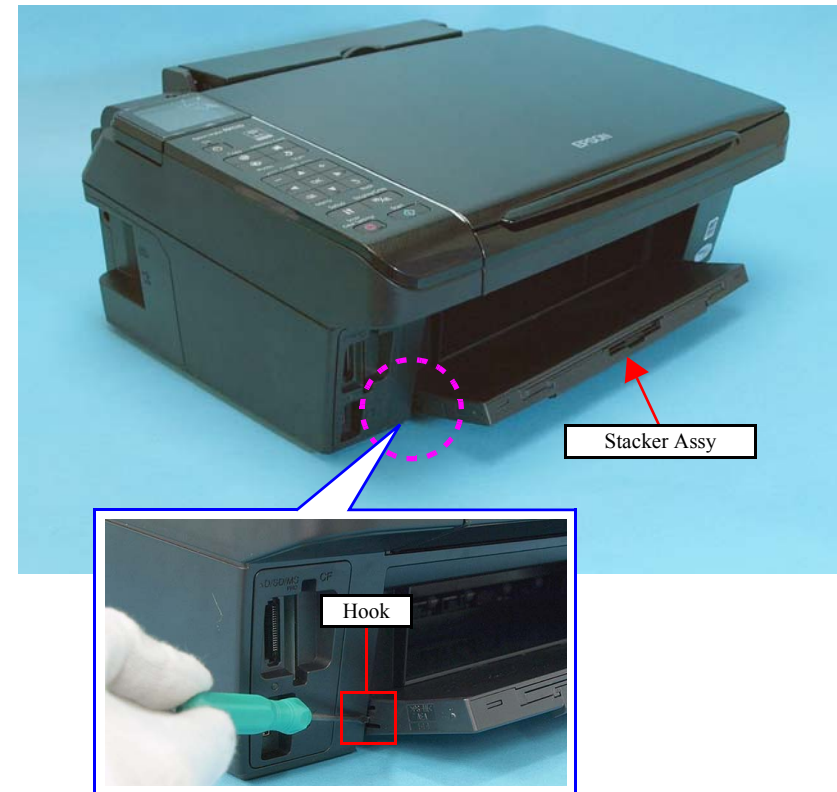

Figure 4-3. Removing the Stacker Assy

### 4.3.3 Document Cover/ASF Cover

□ Parts/Components need to be removed in advance: None

□ Removal procedure

■ Document Cover

1. Open the Paper Support Assy
2. Bend the Document Cover, and remove the Document Cover by releasing the guide pins on both sides from the Scanner Unit.

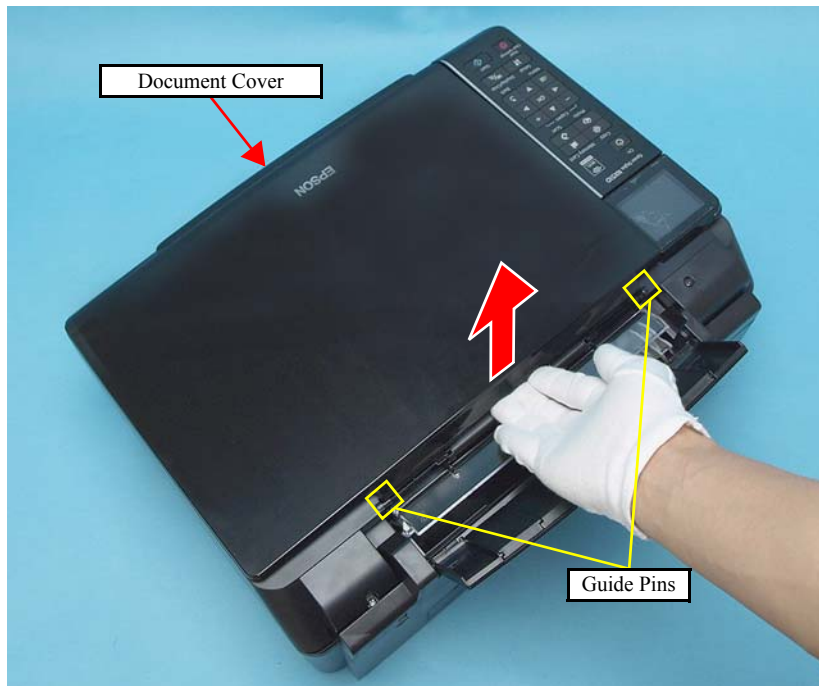

Figure 4-4. Removing the Document Cover

■ ASF Cover

1. Release the both guide pins of the ASF Cover from the holes of the Scanner Unit, and remove the ASF Cover.

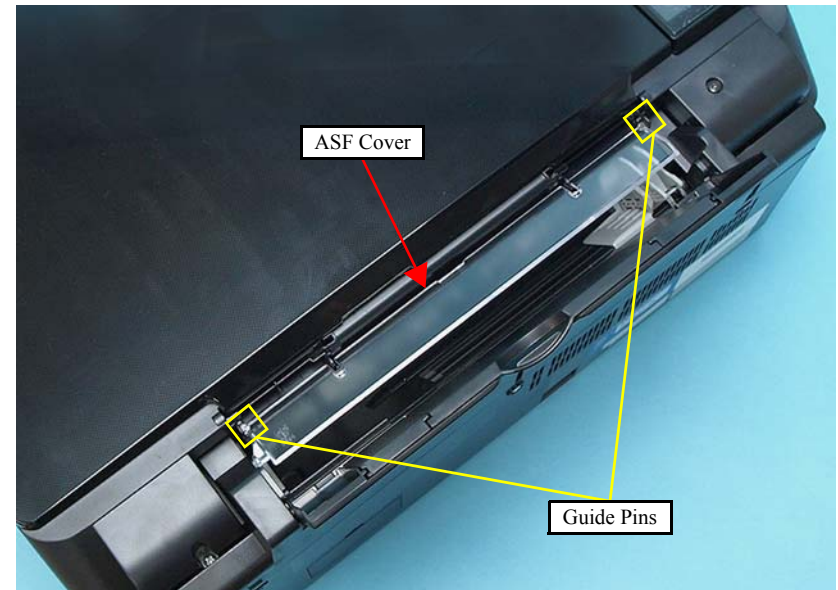

Figure 4-5. Removing the ASF Cover

### 4.3.4 Scanner Unit/Hinge

- Parts/Components need to be removed in advance
  - Document Cover/ASF Cover
- Removal procedure



**In this section, some disassembling procedures differ between models. Skip the model-specified steps if not applied to your model.**

1. Remove the screw (x1) that secures the USB Cover.
2. Pull the USB Cover at its screwing part, and remove it by sliding it to the left (in the direction of the arrow).

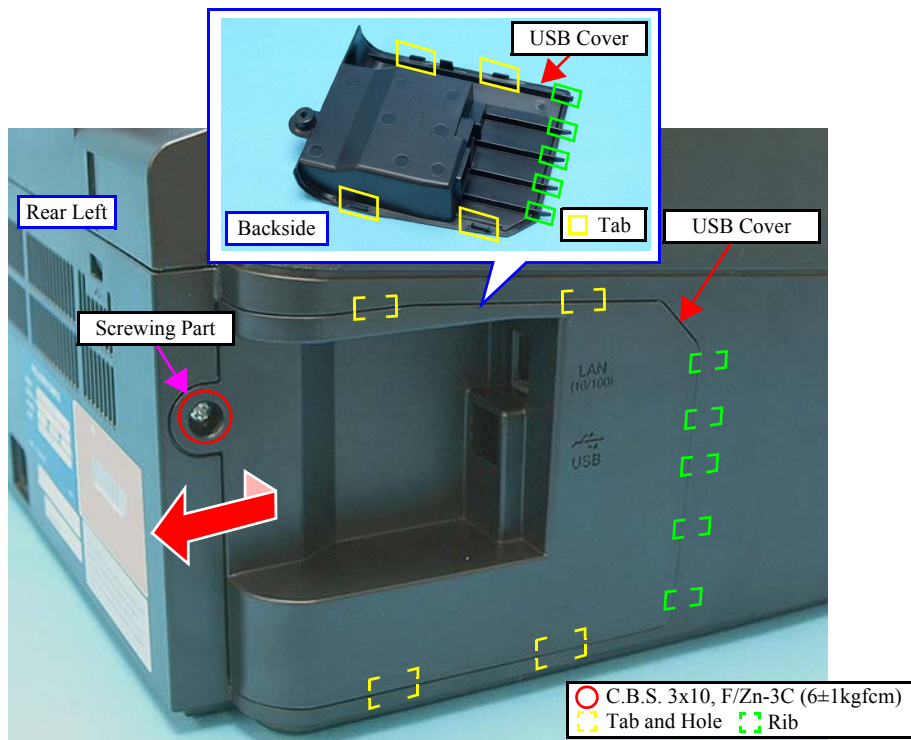

Figure 4-6. Removing the USB Cover



**Be careful of the sharp edges shown in Figure 4-8 when assembling or reassembling.**

3. Disconnect the Scanner Carriage FFC and the Scanner Motor Cable from the connectors on the Main Board Unit. The connector numbers are as follows:

Cable/FFC	NX510 series	SX410/SX210 series
Scanner Motor Cable	CN8	CN10
Scanner Carriage FFC	CN17	CN21

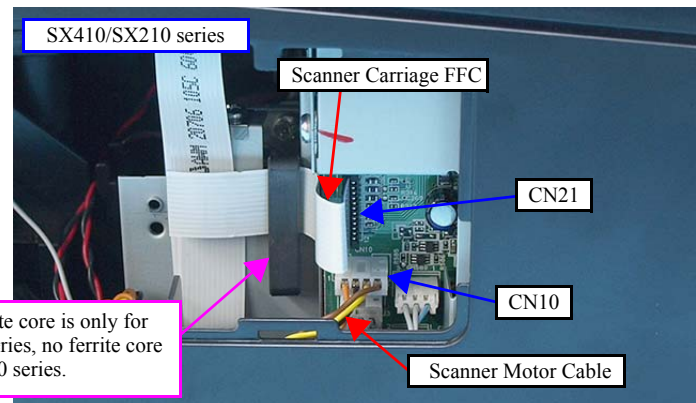
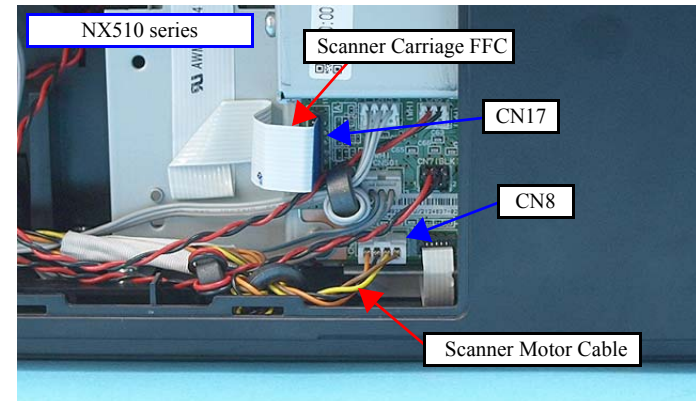

Figure 4-7. Removing the Scanner Unit (1)

4. Peel off the double-sided tape (x1) that secures the Scanner Carriage FFC to the Main Board Frame.  
(For SX410 series, remove the Scanner Carriage FFC with the core.)
5. Peel off the double-sided tape (x1) that secures the Scanner Carriage FFC to the Upper Housing.

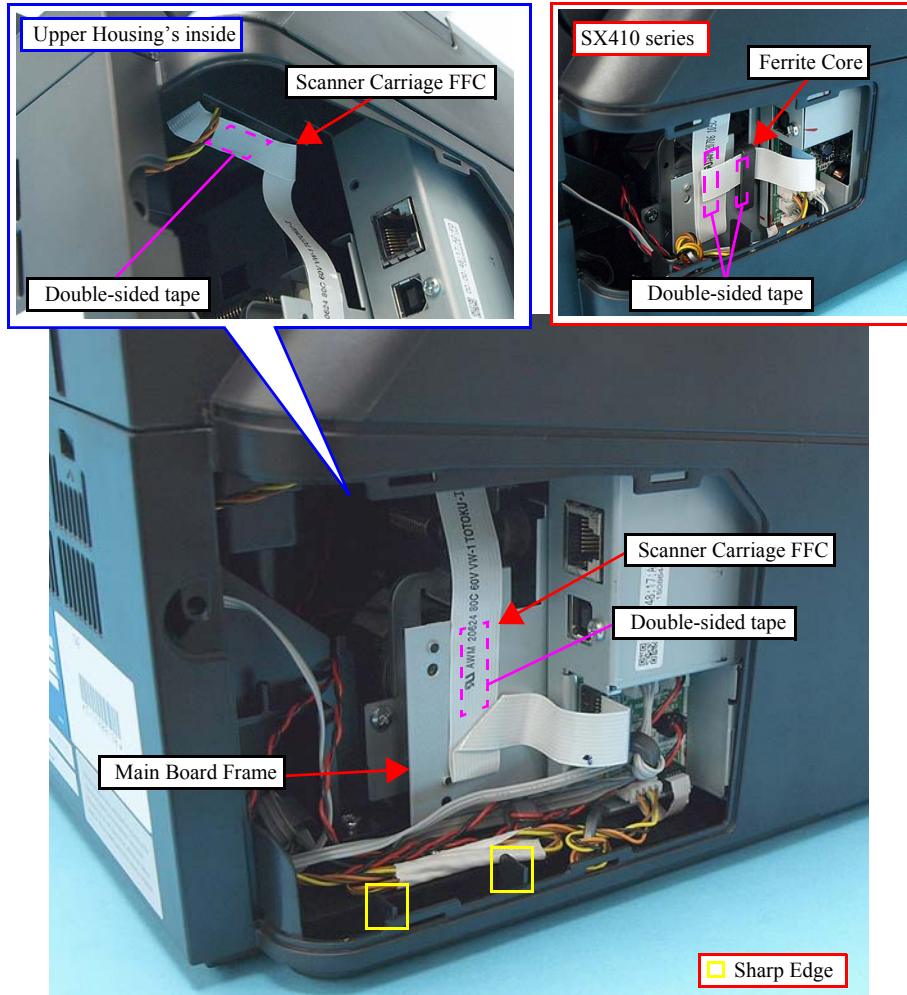

Figure 4-8. Removing the Scanner Unit (2)

6. Remove the screws (x2) that secure the Scanner Unit.
7. Open the Scanner Unit.
8. Pull out the Scanner Unit in the direction of the arrow, taking care not to let the Scanner Motor Cable and Scanner Carriage FFC get caught by the Upper Housing.



Figure 4-9. Removing the Scanner Unit (3)

9. Remove the screw (x1) that secures the Hinge, and remove the Hinge.

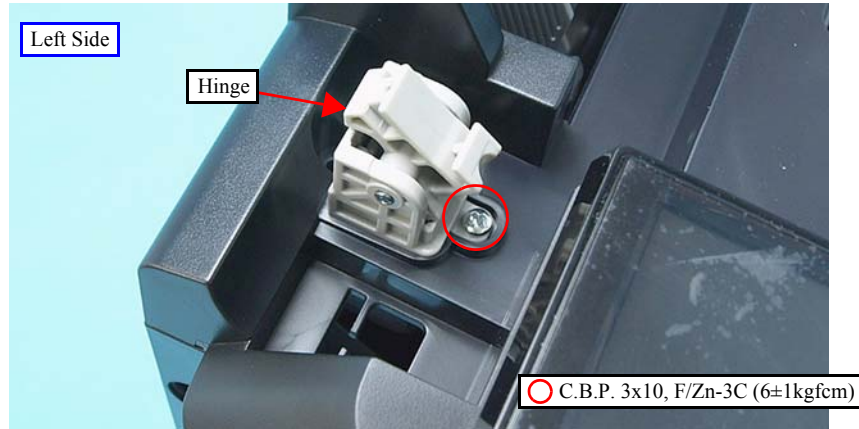

Figure 4-10. Removing the Hinge



- Route the Scanner Carriage FFC and secure it to the Upper Housing and Main Board Frame with double-sided tape as shown in [Figure 4-8](#).
- When installing the Scanner Unit, engage the groove of the Scanner Unit with the hook of the Hinge as shown in [Figure 4-11](#).

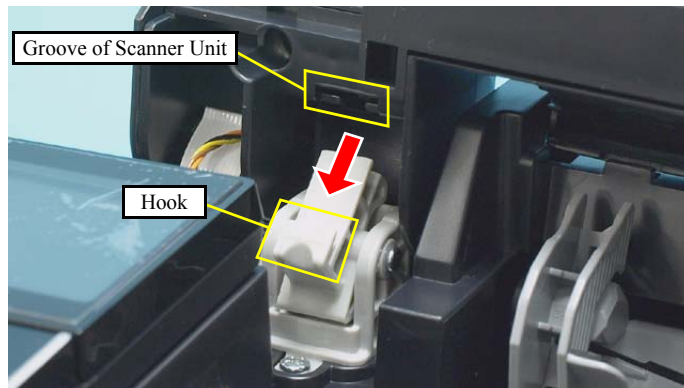

Figure 4-11. Installing the Scanner Unit



- Make sure to follow the instructions below because the shape of the USB Cover for NX510 series and SX410/SX210 series differs.

- NX510 series:  
Install the USB Cover while aligning the tabs (x4) on it and the holes (x4) on the Upper Housing shown in [Figure 4-6](#).
- SX410/SX210 series:  
Install the USB Cover while aligning the tabs (x4) and the holes (x4) on the Upper Housing shown in the figure below.

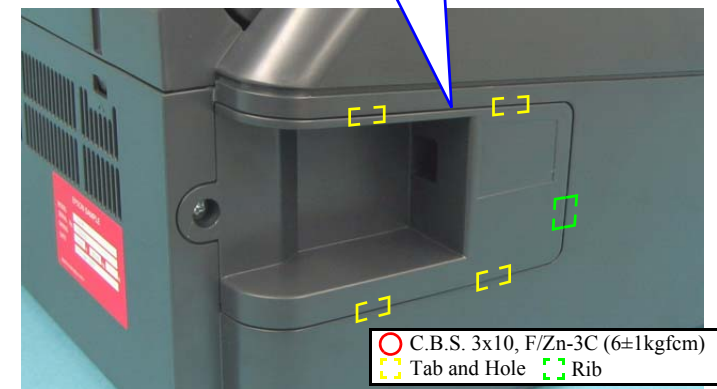
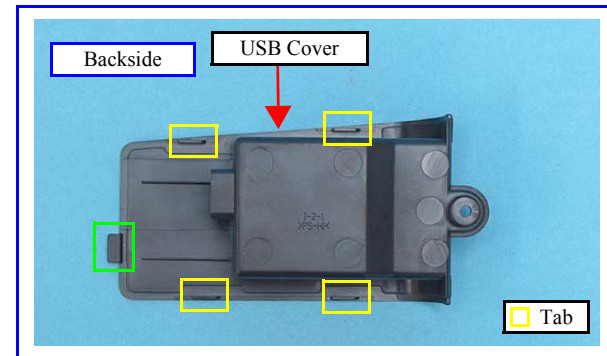

Figure 4-12. Installing the USB Cover

### 4.3.5 Upper Housing/Card Slot Cover

- Parts/Components need to be removed in advance  
Document Cover/ASF Cover/Scanner Unit/Panel Unit

- Removal procedure

- Upper Housing

1. Remove the screws (x6) that secure the Upper Housing.
2. Release the hooks (x5) that secure the Upper Housing and remove the Upper Housing.

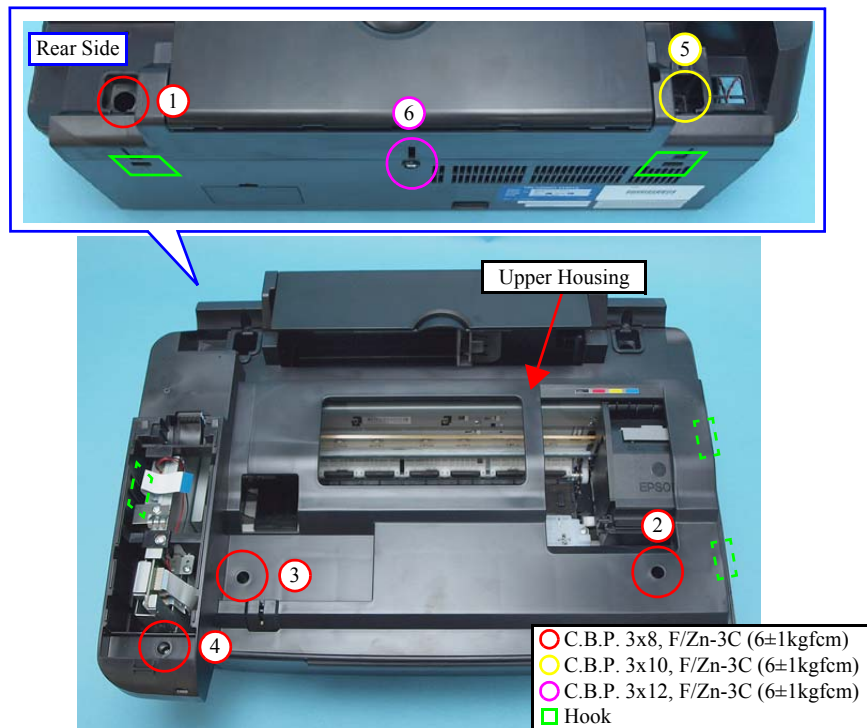

Figure 4-13. Removing the Upper Housing

- Card Slot Cover

  1. Remove the screw (x1) that secures the Card Slot Cover.
  2. Release the hook (x1) of the Card Slot Cover and remove the Card Slot Cover.

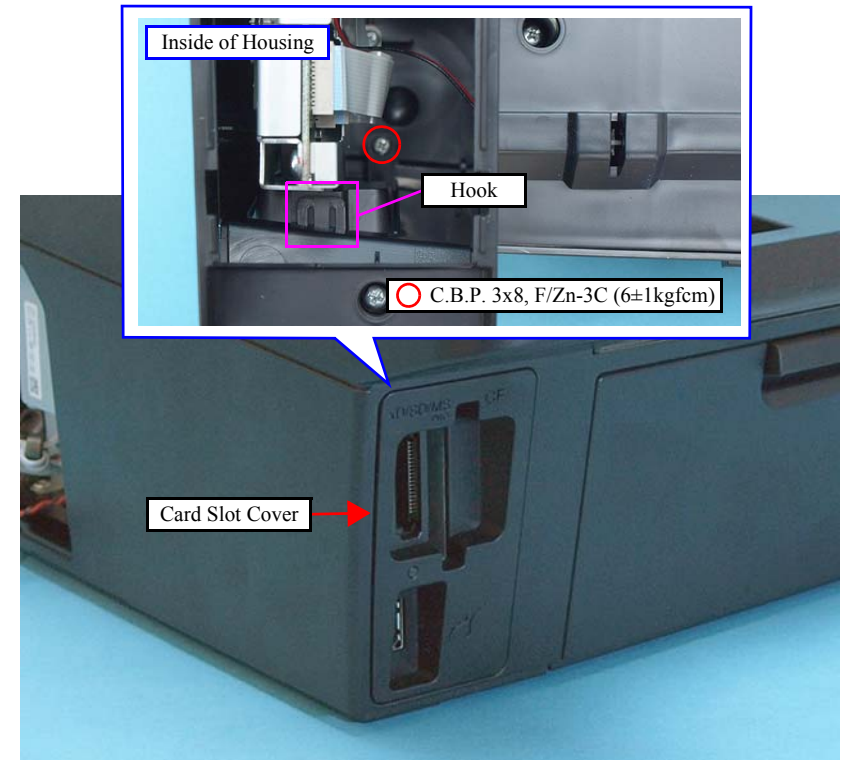

Figure 4-14. Removing the Card Slot Cover



- Tighten the screws in the order given in [Figure 4-13](#).
- The Ink Position Label is not included in the Upper Housing as an ASP. When replacing the Upper Housing, attach the label following the instructions below.
  - NX510 series:  
Attach it while aligning it with the marking shown below.

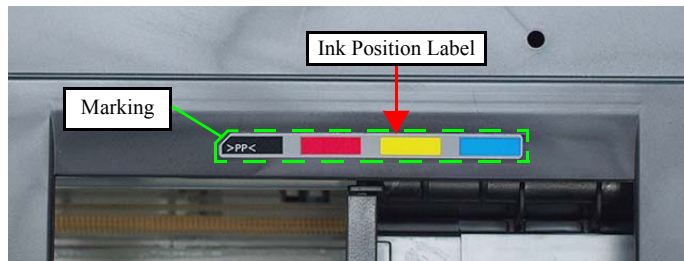

Figure 4-15. Attaching Ink Position Label (NX510 series)

- SX410 series:  
Attach it following the standard below.

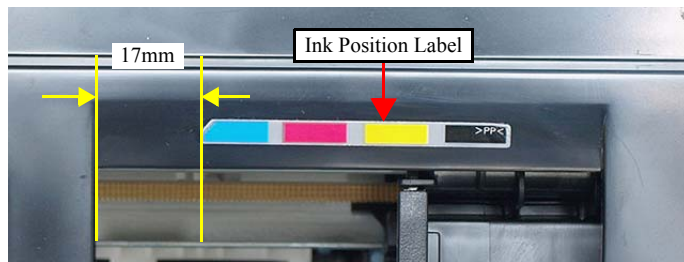

Figure 4-16. Attaching Ink Position Label (SX410 series)

- SX210 series:  
Attach it while aligning it with the marking shown below.

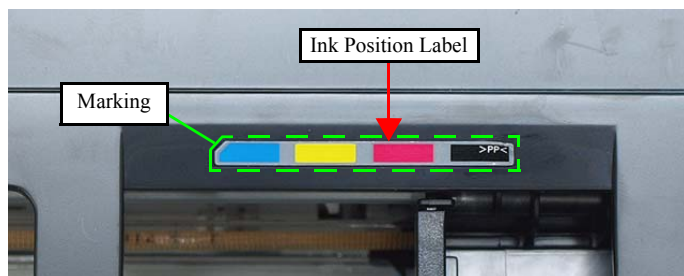

Figure 4-17. Attaching Ink Position Label (SX210 series)



## 4.4 Removing the Circuit Boards

### 4.4.1 Main Board Unit

CHECK  
POINT



See the following because the disassembling/reassembling procedures of the Main Board Unit for SX410/SX210 series differ from those of NX510 series.

- SX410 series: “4.7.1 Main Board Unit (SX410 series)” (p146)
- SX210 series: “4.8.1 Main Board Unit (SX210 series)” (p154)

- Parts/Components need to be removed in advance

Document Cover/ASF Cover/Scanner Unit/Panel Unit/Upper Housing/Card Slot Cover/Lower Housing

- Removal procedure

1. Disconnect the following cables (x4) and FFCs (x5) from the connectors on the Main Board Unit.

CN No.	Cable	CN No.	Cable
CN501	Power Supply Unit cable	CN12	Head FFC
CN5	Panel FFC	CN13	Head FFC
CN6	CR Motor cable	CN14	PF Encoder FFC
CN7	PF Motor cable	CN15	PE Sensor cable
CN11	Head FFC		

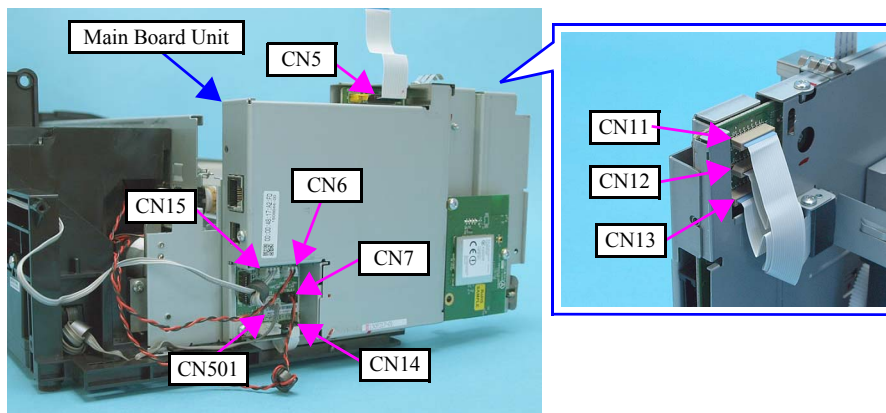

Figure 4-18. Removing the Main Board Unit (1)

2. Remove the screw (x1) that secures the Panel Grounding Plate, and remove the Panel Grounding Plate from the Main Board Unit.
3. Remove the screws (x2) that secure the Main Board Unit, and remove the Main Board Unit.

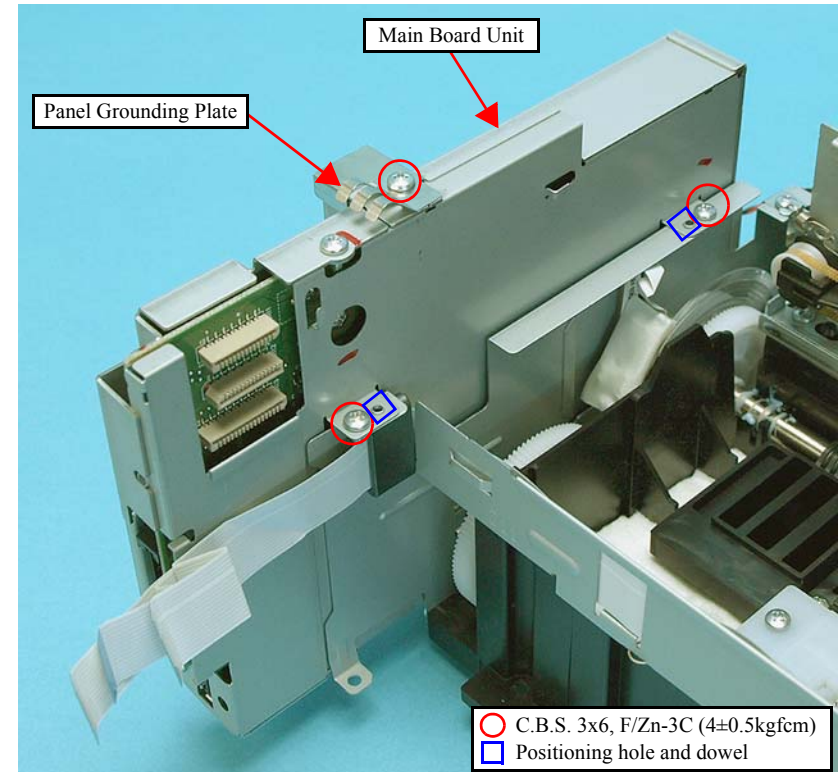

Figure 4-19. Removing the Main Board Unit (2)



- When installing the Main Board Unit, insert its hooks (x2) into the cutouts (x2) of the Left Frame.

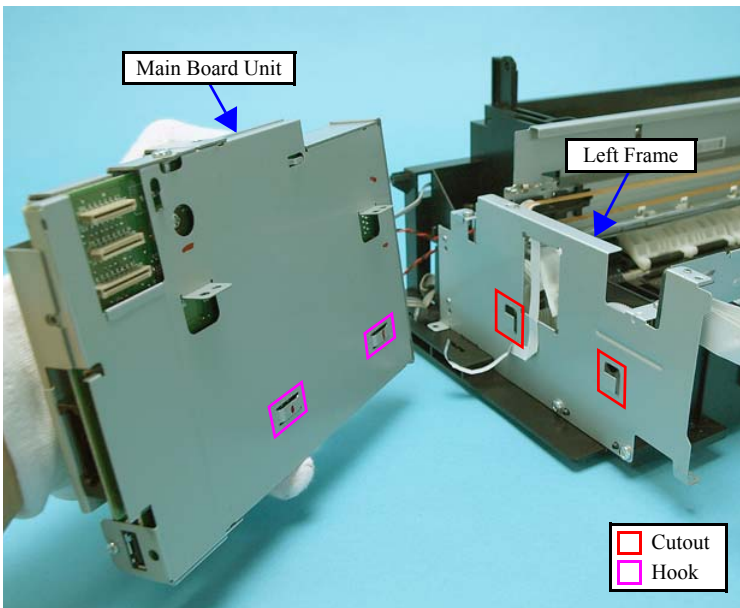

Figure 4-20. Installing the Main Board Unit

- When reassembling the Main Board Unit, make sure to align the positioning holes (x2) to the dowels (x2) of the Left Frame as shown in Figure 4-19.
- Tighten the screws in the order given in Figure 4-19.

- Disassembling the Main Board Unit

1. Remove the Main Board Unit. (p105)
2. Remove the screws (x2) that secure the Wireless LAN Board.
3. Disconnect the Wireless LAN cable from the connector (CN3), and remove the Wireless LAN Board.

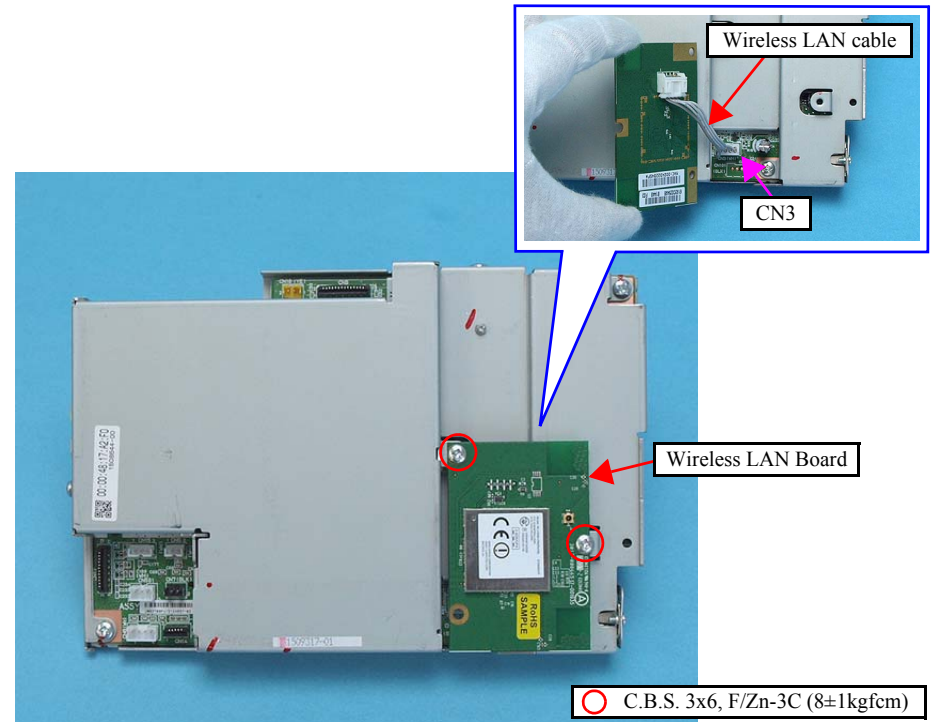

Figure 4-21. Removing the Wireless LAN Board

4. Remove the screws (x6) and remove the Upper Shield Plate.

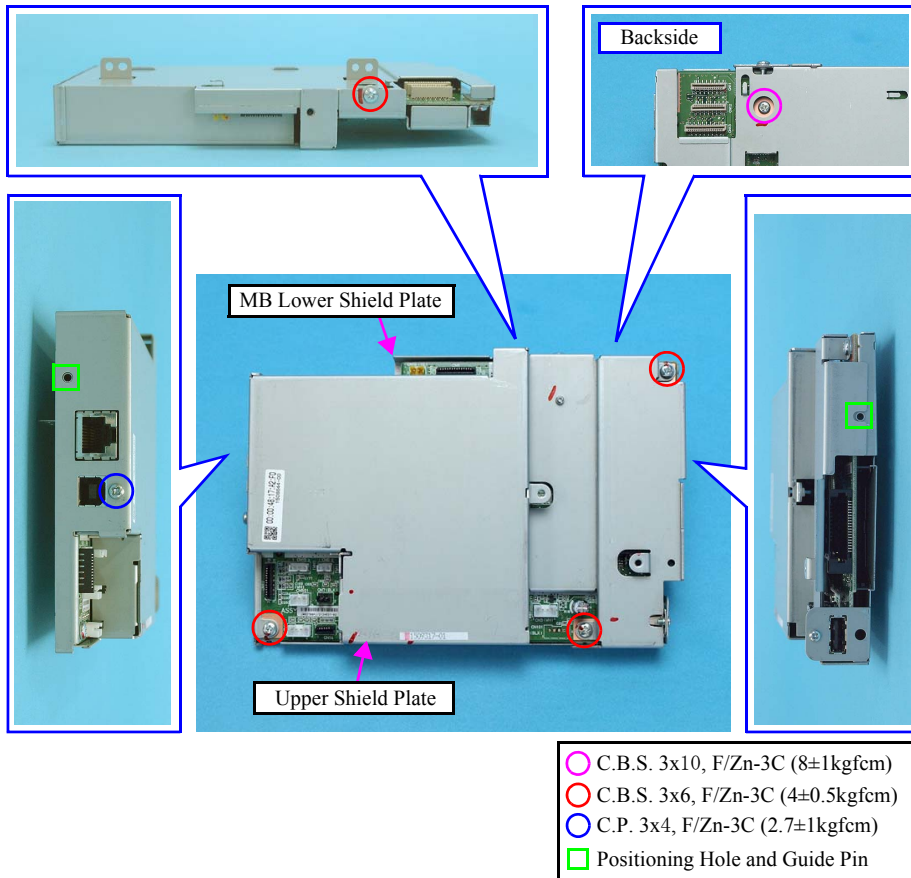

Figure 4-22. Removing the Main Board (1)

5. Remove the screw (x2) that secures the Main Board, and remove the Main Board.

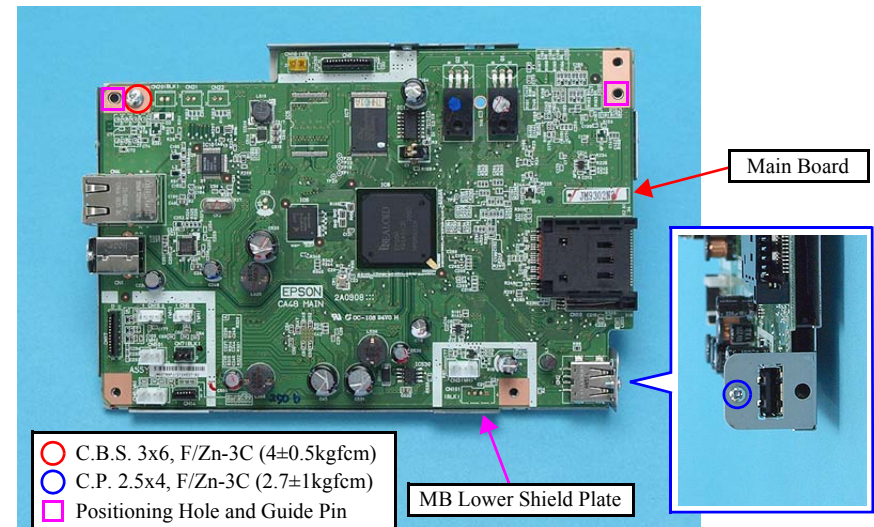

Figure 4-23. Removing the Main Board (2)



When installing the Main Board, pay attention to the following instructions.

- Align the positioning holes of the Upper Shield Plate with the guide pins of the Main Board as shown in [Figure 4-23](#).
- Align the positioning holes (x2) of the Upper Shield Plate and the guide pins (x2) of the MB Lower Shield Plate as shown in [Figure 4-22](#).
- Install the Main Board with the Upper Shield Plate over the MB Lower Shield Plate as shown in [Figure 4-22](#).

ADJUSTMENT  
REQUIRED

■ **NX510 series only:**

When replacing the Main Board, the MAC address need to be set if the EEPROM data could not be read from the old Main Board. In this case, attach the new “Label, MAC address (Parts number: **TBD**)” to the position shown in **Figure 4-24** and execute “5.2.8 MAC Address Setting (NX510 series only)” (p173).

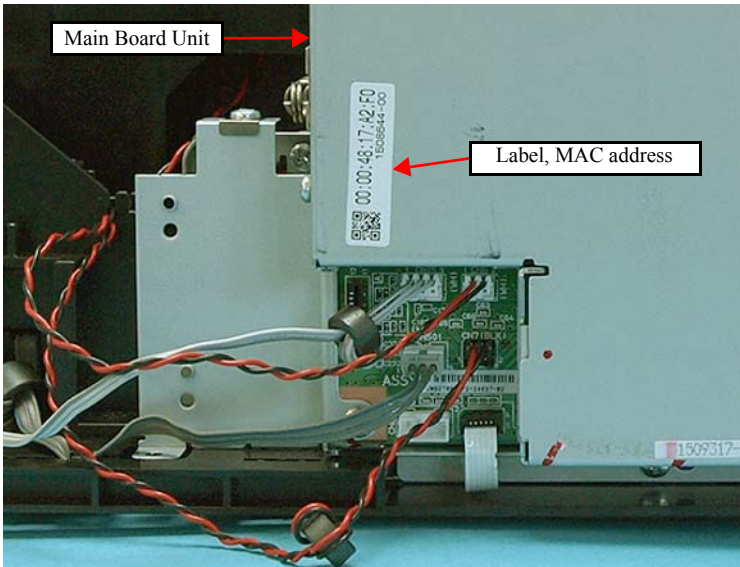

Figure 4-24. Position for the MAC Address Label

- Whenever the Main Board is removed/replaced, the required adjustments must be carried out.
  - Chapter 5 “ADJUSTMENT” (p.161)

## 4.4.2 Panel Unit/LCD Unit

CHECK  
POINT

See the following because the disassembling/reassembling procedures of the Panel Unit/LCD Unit for SX410/SX210 series differ from those of NX510 series.

- **SX410 series:**  
“4.7.2 Panel Unit/LCD Unit (SX410 series)” (p148)
- **SX210 series:**  
“4.8.2 Panel Unit/LCD Unit (SX210 series)” (p155)

- Parts/Components need to be removed in advance: None
- Removal procedure
  1. Open the Scanner Unit.
  2. Raise the LCD Unit.

CAUTION



Do not lift the Panel Unit too far, since the Panel FFC is connected to it.

3. Lifting the front of the Panel Unit, and release the tabs of it.
4. Slide the Panel Unit in the direction of the arrow, and release the hooks of it from the Upper Housing.

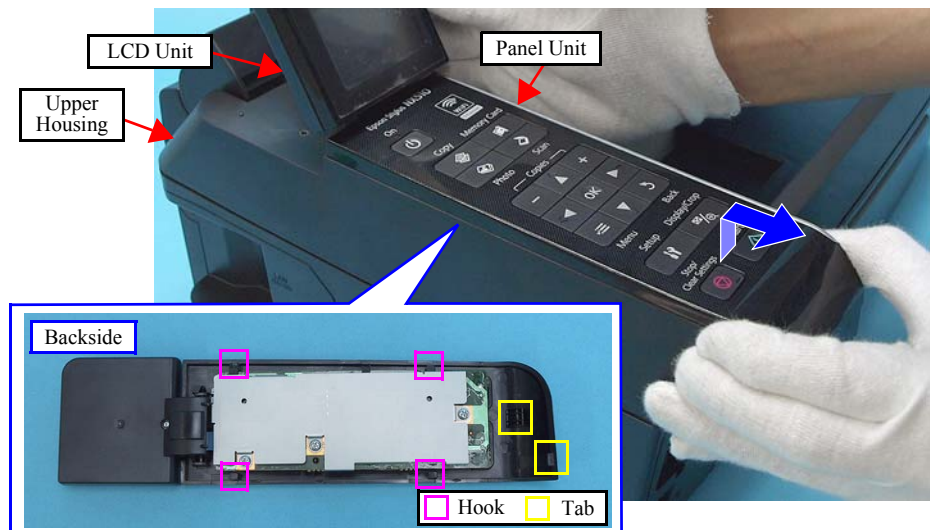

Figure 4-25. Removing the Panel Unit and LCD Unit (1)

**CHECK  
POINT**

Be sure to disconnect the Panel FFC from the connector on the Panel Board.

5. Disconnect the Panel FFC from the connector (CN1) of the Panel Board, and remove the Panel Unit together with the LCD Unit.

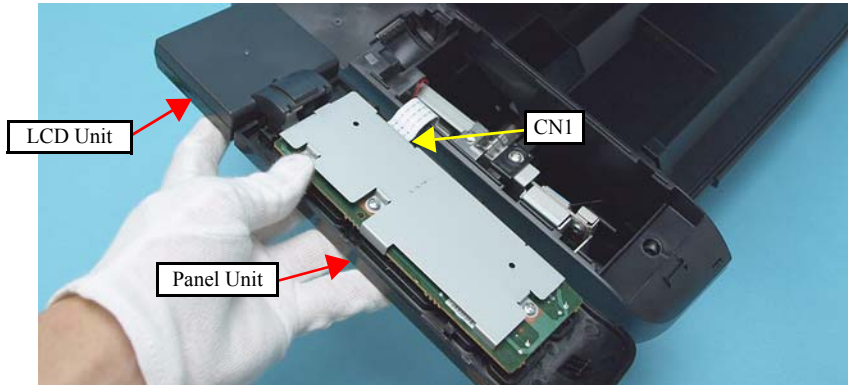

Figure 4-26. Removing the Panel Unit and LCD Unit (2)

6. Disconnect the LCD FFC from the connector (CN2) of the Panel Unit.
7. Release the dowels (x2) that secure the LCD Unit, and separate the LCD Unit from the Panel Unit.

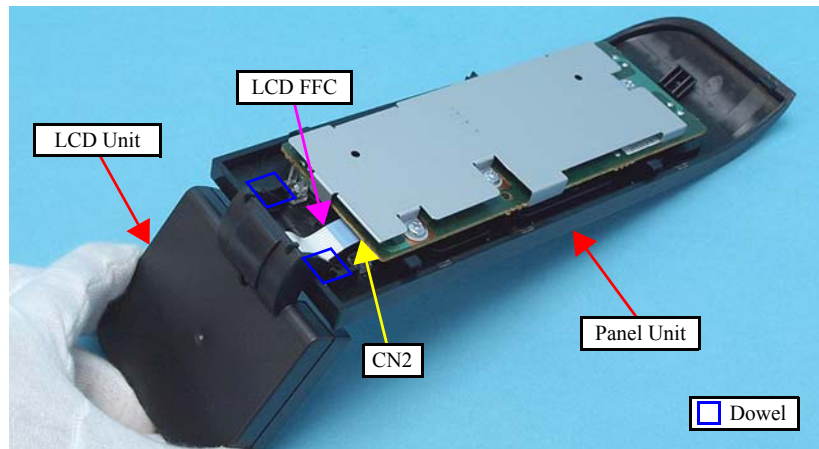

Figure 4-27. Removing the Panel Unit and LCD Unit (3)

8. Remove the screws (x3) that secure the Panel Board and Panel Board Frame, and remove the Panel Board together with the Panel Board Frame.

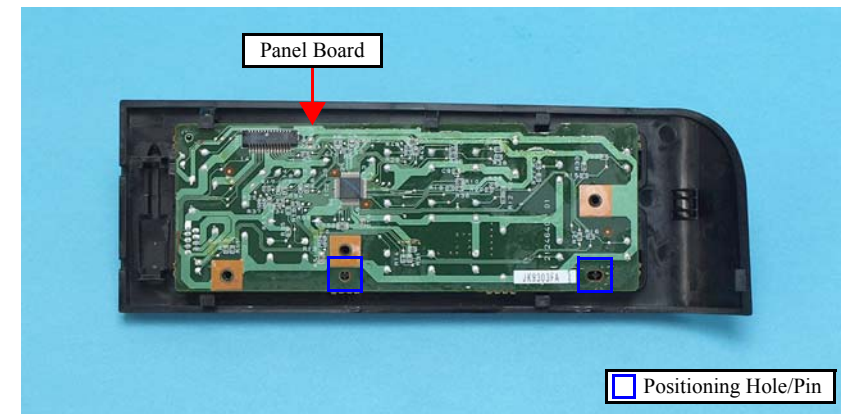
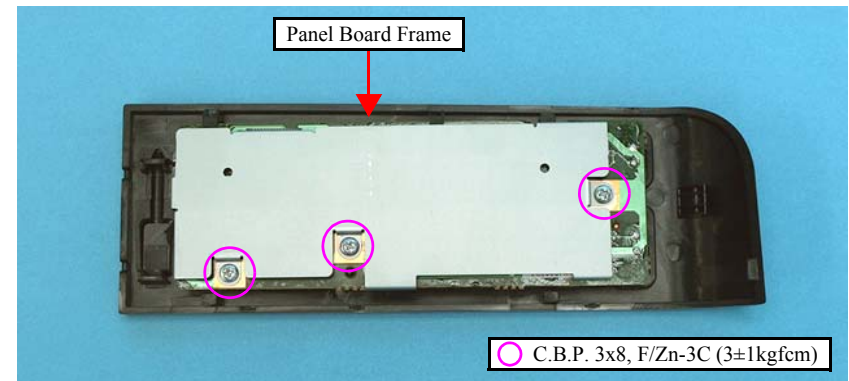

Figure 4-28. Removing the Panel Board

9. Remove each switch button from the Panel Cover.

No.	Button	No.	Button
1	Power SW button	10	OK SW button
2	Copy mode SW button	11	Right SW button
3	Memory Card mode SW button	12	Menu SW button
4	Photo mode SW button	13	Down SW button
5	Scan mode SW button	14	Back SW button
6	- SW button	15	Setup SW button
7	Up SW button	16	Display SW button
8	+ SW button	17	Stop SW button
9	Left SW button	18	Start SW button

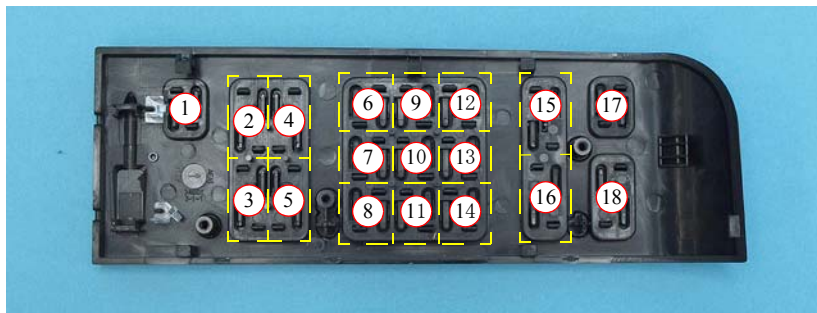

Figure 4-29. Removing the Switch button



- When installing the Panel Board, align the positioning holes of the Panel Board with their positioning pins of the Panel Housing as shown in [Figure 4-28](#).
- When installing the Panel Unit, attach it without any gap with the Upper Housing.

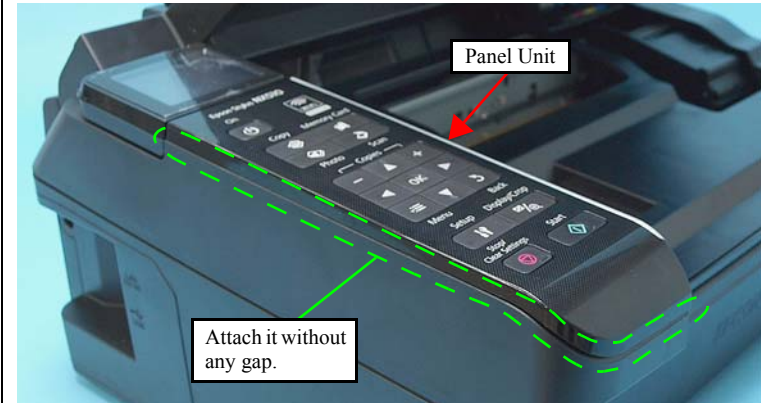

Figure 4-30. Installing the Panel Unit

### 4.4.3 Power Supply Unit

- Parts/Components need to be removed in advance  
Document Cover/ASF Cover/Scanner Unit/Panel Unit/Upper Housing/Card Slot Cover/Lower Housing
- Removal procedure



**In this section, some disassembling procedures differ between models. Skip the model-specified steps if not applied to your model.**

1. Disconnect the Power Unit Cable from the connector on the Main Board Unit below.

Item	NX510 series	SX410/SX210 series
Connector No.	CN501	CN1

2. Release the Power Unit Cable from the hook of the Base Frame.

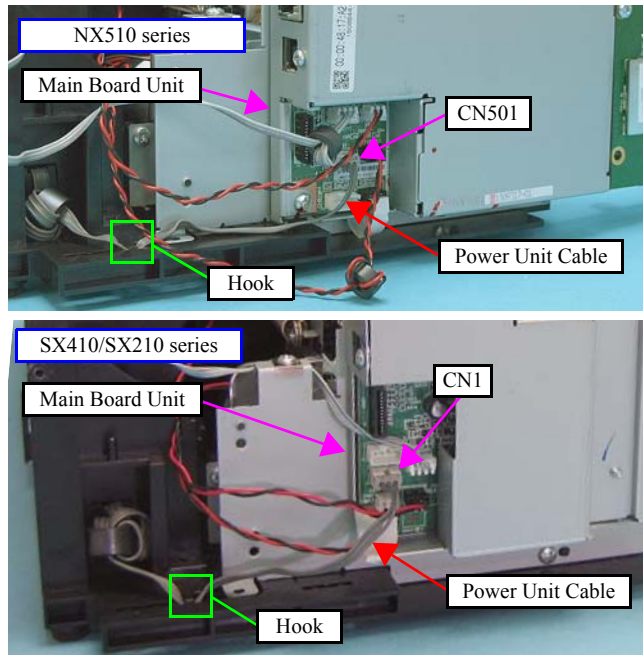

Figure 4-31. Removing the Power Supply Unit (1)

3. Remove the screws (x2) that secure the Power Supply Unit.
4. Lift the Base Frame a little, and remove the Power Supply Unit.

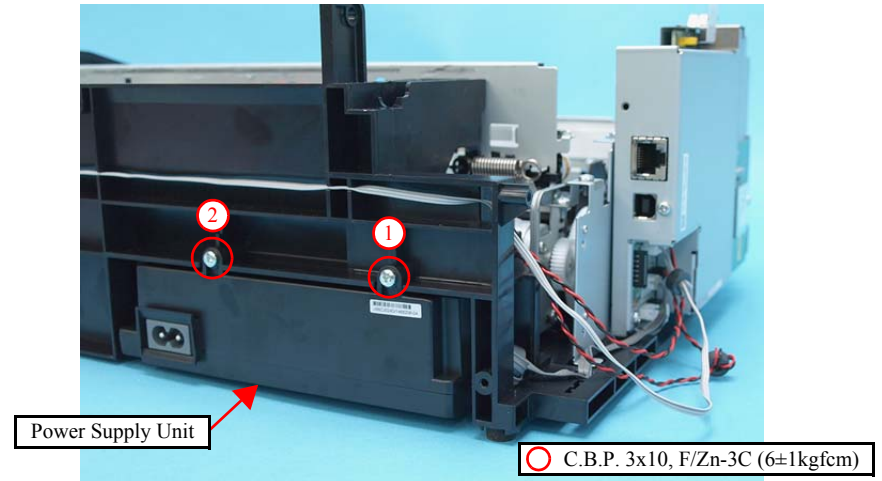

Figure 4-32. Removing the Power Supply Unit (2)



When installing the Power Supply Unit, make sure to check the following point.

- Insert the tabs (x2) of the Power Supply Unit into the holes on the Base Frame.

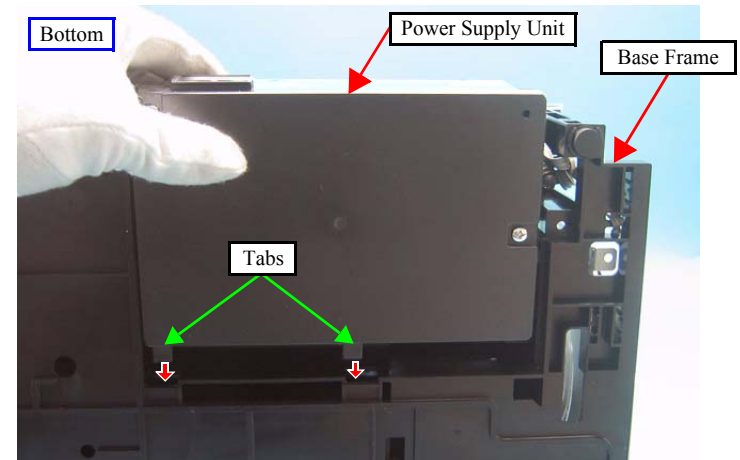

Figure 4-33. Installing the Power Supply Unit

**REASSEMBLY**

- Tighten the screws in the order given in [Figure 4-32](#).
- Secure the Power Unit Cable with the hook of the Base Frame as shown in the figure below.
- Following the standard below, store the Power Unit Cable in the hole on the Base Frame.

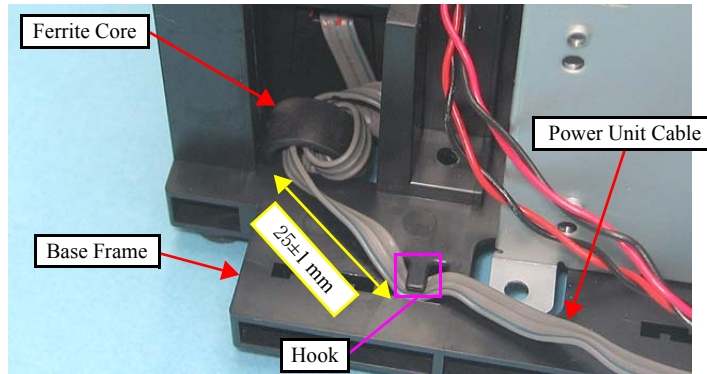

Figure 4-34. Routing the Power Unit Cable

**ADJUSTMENT  
REQUIRED**

Whenever the Power Supply Unit is removed/replaced, the required adjustments must be carried out.

- [Chapter 5 “ADJUSTMENT” \(p.161\)](#)



## 4.5 Disassembling the Printer Mechanism

### 4.5.1 Printhead

CHECK  
POINT



See the following for the Step 9 and later because the disassembling/reassembling procedures of the Printhead for SX410/SX210 series differ from those of NX510 series.

- SX410 series:  
“4.7.3 Printhead (SX410 series)” (p150)
- SX210 series:  
“4.8.3 Printhead (SX210 series)” (p158)

- Parts/Components need to be removed in advance  
Document Cover/ASF Cover/Scanner Unit/Panel Unit/Upper Housing
- Removal procedure
  1. Rotate the Spur Gear 51.5 to unlock the carriage, and move the CR Unit to the center.

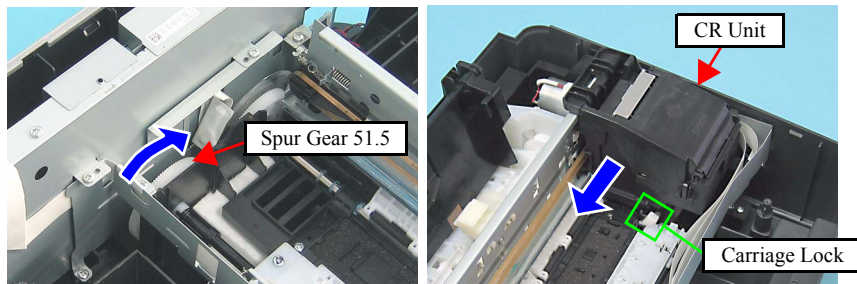

Figure 4-35. Unlocking the Carriage and Moving the CR Unit

2. Open the Cartridge Cover and remove all the ink cartridges from the CR Unit.

CHECK  
POINT



The Cartridge Cover Hinge must be broken to be removed since the hinge is permanently-set. When replacing the Printhead, make sure to replace the Cartridge Cover Hinge with a new one.

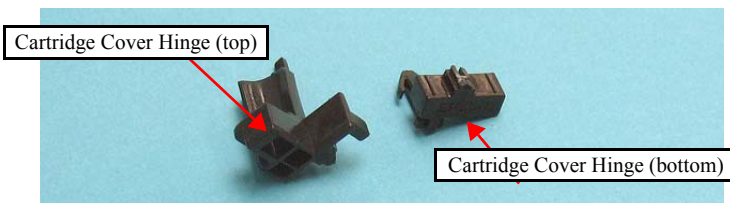

Figure 4-36. Cartridge Cover Hinge

3. Cut the Cartridge Cover Hinge with a nipper, and remove the upper half of it and Hinge Cover Cartridge.
4. Release the hooks of the lower half of the Cartridge Cover Hinge with tweezers, and remove the lower half of it. (See Figure 4-36)

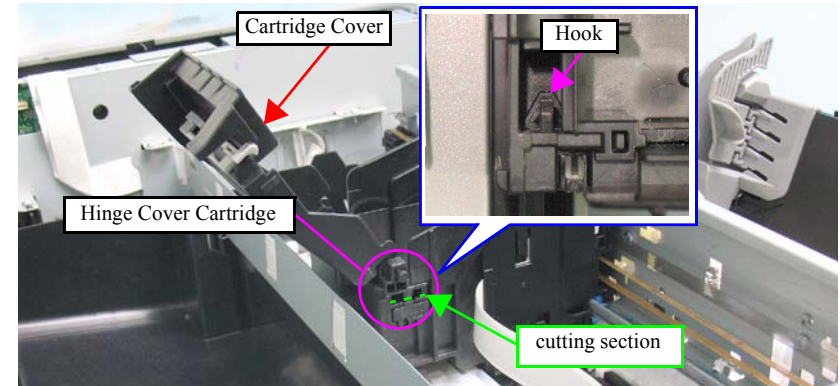

Figure 4-37. Removing the Cartridge Cover

5. Release the hook □ (x1) of the Head Cable Cover with a flathead precision screwdriver, and remove the Head Cable Cover downward.
6. Release the hook □ (x1) securing the Ink Guide and remove the Ink Guide.

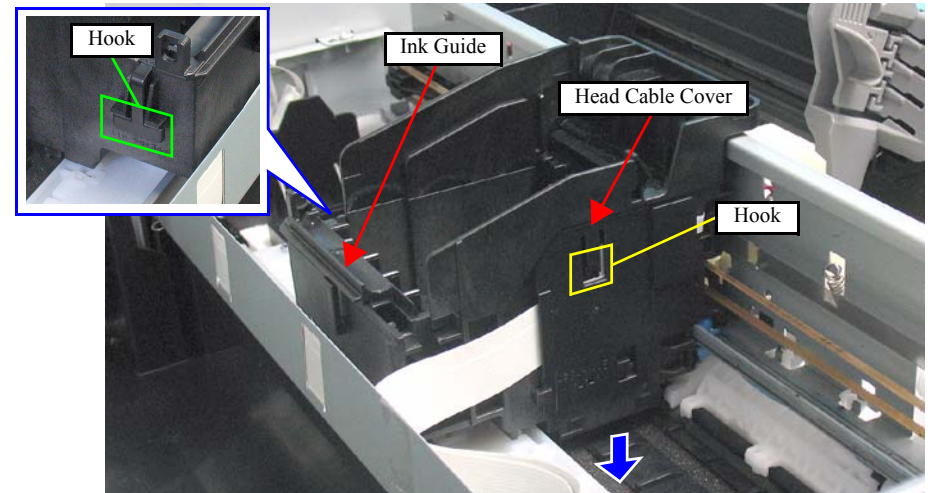
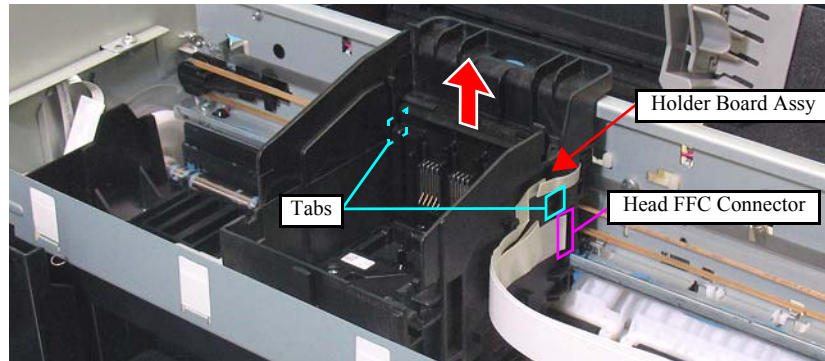

Figure 4-38. Removing the Head Cable Cover

7. Disconnect the Head FFC (x1) that is connected to the CSIC Board.
8. Release the tabs (x2) securing the Holder Board Assy with a flathead screwdriver or the like, and remove the Holder Board Assy upward.



**Figure 4-39. Removing the Holder Board Assy**

9. Remove the Head Cable Inner Cover according to the following procedure.
  - 9-1. Release the hook (x1) and release the rib (1) of the Head Cable Inner Cover from the Carriage Unit by lifting upward.
  - 9-2. Remove the Rib (2) of the Head Cable Inner Cover from the Carriage Unit while sliding it in the direction of the arrow.

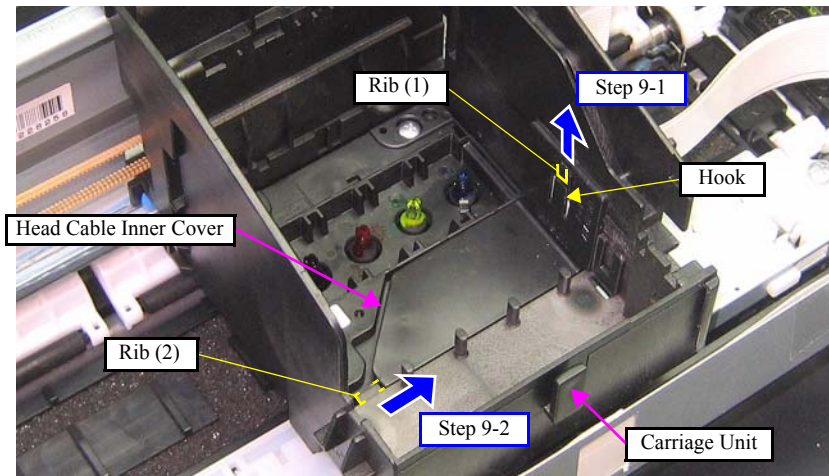
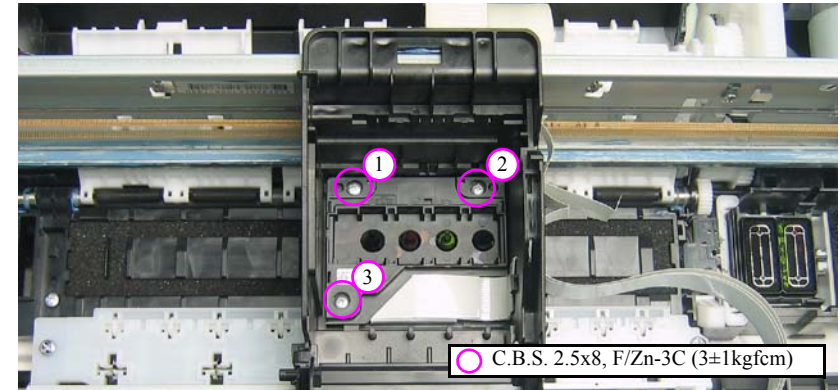

**Figure 4-40. Removing the Head Cable Inner Cover**



**Do not touch or damage the nozzles or the ink supply needles of the Printhead.**

10. Remove the screws (x3) that secure the Printhead, and lift the Printhead with longnose pliers.



**Figure 4-41. Removing the Printhead (1)**

11. Disconnect the Head FFC from the connectors (x3) of the Printhead, and remove the Printhead.

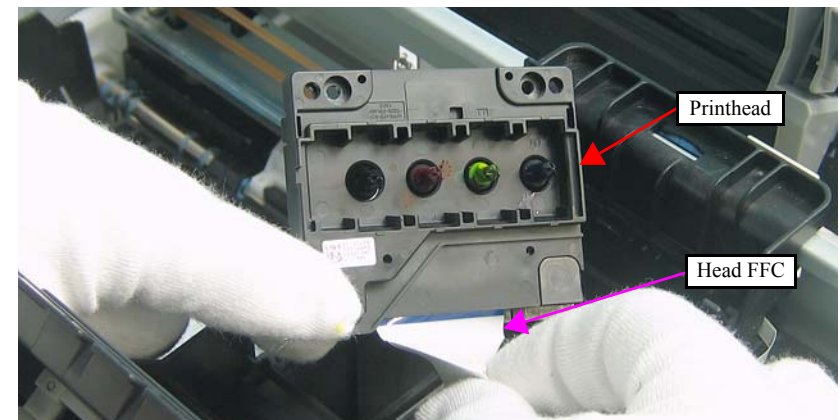

**Figure 4-42. Removing the Printhead (2)**

**REASSEMBLY**

- Tighten the screws in the order given in [Figure 4-41](#).
- Insert the Holder Board Assy vertically into the CR Unit so as not to put the Holder Board Assy on the rib of the Printhead.

**ADJUSTMENT  
REQUIRED**

Whenever the Printhead is removed/replaced, the required adjustments must be carried out.

- [Chapter 5 “ADJUSTMENT” \(p.161\)](#)

## 4.5.2 CR Scale

- Parts/Components need to be removed in advance  
Document Cover/ASF Cover/Scanner Unit/Panel Unit/Upper Housing
- Removal procedure



Pay attention to the following instructions:

- Do not touch the CR Scale with bare hands.
- Do not damage the CR Scale.
- Do not stretch Extension Spring 1.41 too much.

1. Release the right end of the CR Scale from the hook.
2. Pull out the CR Scale through the slit of the CR Encoder Sensor.

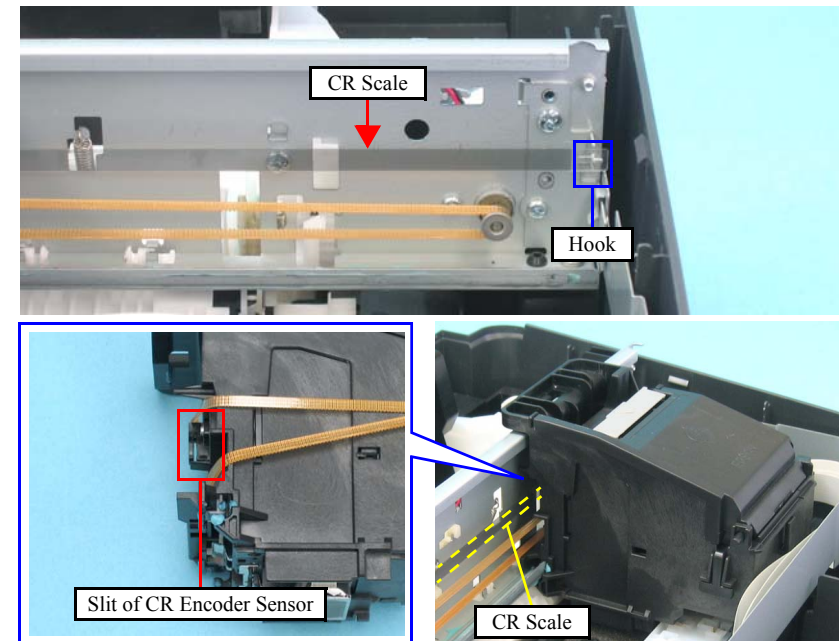

Figure 4-43. Removing the CR Scale (1)

3. Release the Extension Spring 1.41 from the hook of the Main Frame.
4. Rotate the CR Scale 90 degrees as shown in the figure and remove the scale from the Main Frame.

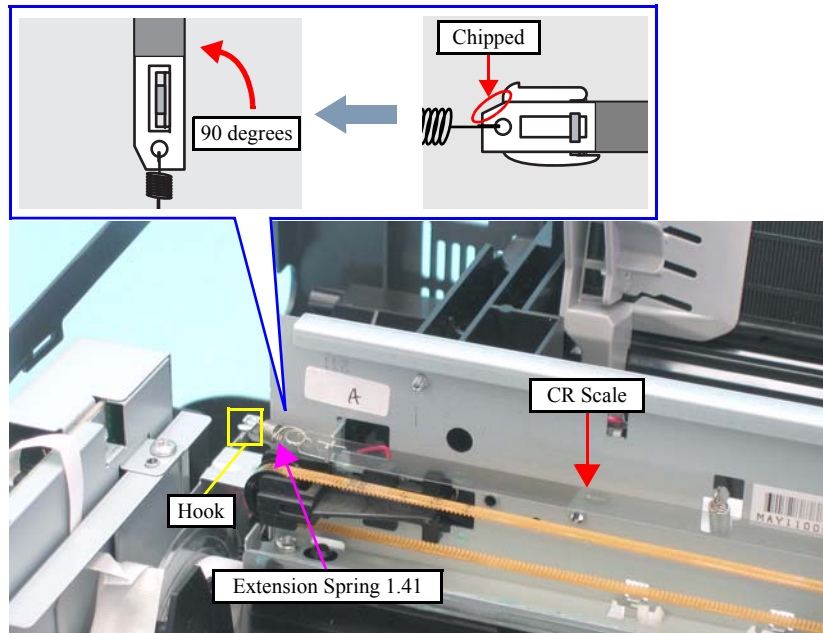

Figure 4-44. Removing the CR Scale (2)

#### REASSEMBLY



When installing the CR Scale, pay attention to the following instructions:

- Chipped part of the CR Scale must face upward.
- CR scale should be passed through the slit of the CR Encoder Sensor.
- Make sure that the Extension Spring 1.41 is not be twisted, and then attach its end to the hook of the Main Frame.

### 4.5.3 Hopper

- Parts/Components need to be removed in advance

Document Cover/ASF Cover/Scanner Unit/Panel Unit/Upper Housing/Card Slot Cover/Lower Housing

- Removal procedure

1. Release the dowel A of the Hopper.
2. Release the dowel B of the Hopper, and remove the Hopper together with the Compression Spring 3.43.

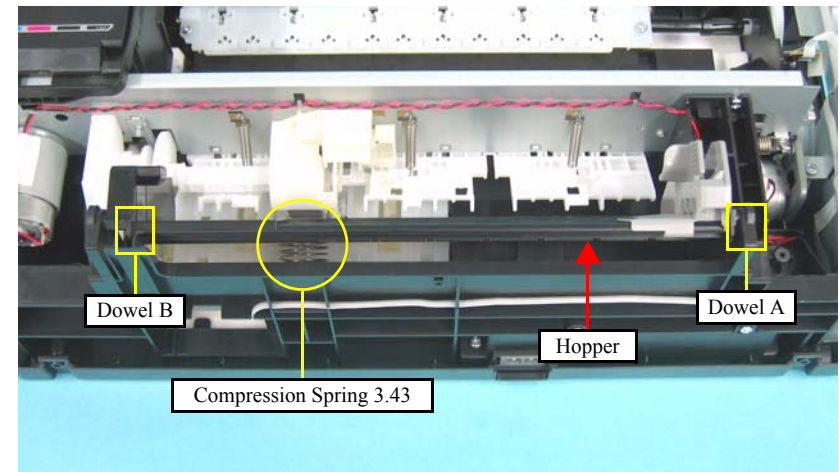

Figure 4-45. Removing the Hopper

**REASSEMBLY**

When installing the Hopper, be sure to engage the rib of the Hopper with the guide groove of the Base Frame.

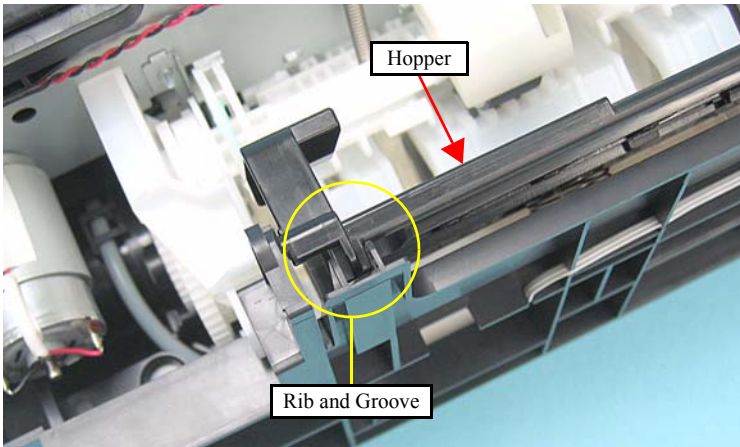

Figure 4-46. Installing the Hopper

**ADJUSTMENT  
REQUIRED**

Whenever the Hopper is removed/replaced, the required adjustments must be carried out.

- Chapter 5 “ADJUSTMENT” (p.161)

## 4.5.4 Removing the Printer Mechanism (Lower Housing)

**CHECK  
POINT**

See the following because the disassembling/reassembling procedures of the Printer Mechanism for SX410/SX210 series differ from those of NX510 series.

- SX410 series:  
“4.7.4 Removing the Printer Mechanism (Lower Housing) (SX410 series)” (p152)
- SX210 series:  
“4.8.4 Removing the Printer Mechanism (Lower Housing) (SX210 series)” (p160)

- Parts/Components need to be removed in advance  
Document Cover/ASF Cover/Scanner Unit/Panel Unit/Upper Housing/Card Slot Cover
- Removal procedure
  1. Release the Cover Open Sensor cable from the hooks (x2) on the Main Board Unit.
  2. Disconnect the Panel FFC (CN5) and the Cover Open Sensor cable (CN16) from the Main Board Unit.

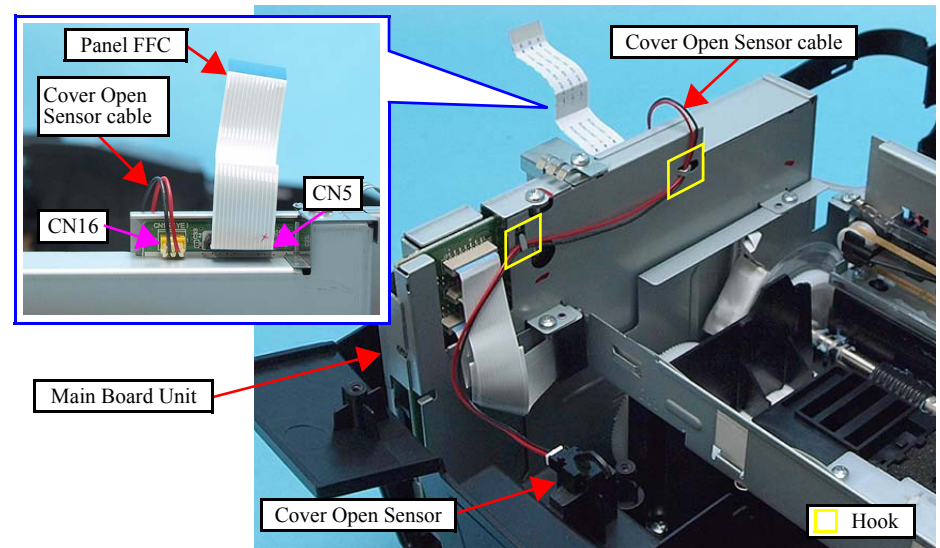

Figure 4-47. Removing the Printer Mechanism (1)

3. Release the hook that secures the Rear Cover and remove the Rear Cover.

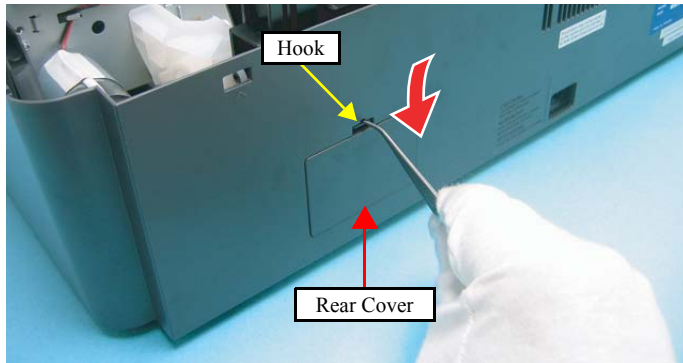

Figure 4-48. Removing the Printer Mechanism (2)

4. Remove the screws (x5) that secure the Printer Mechanism, and remove the Printer Mechanism.

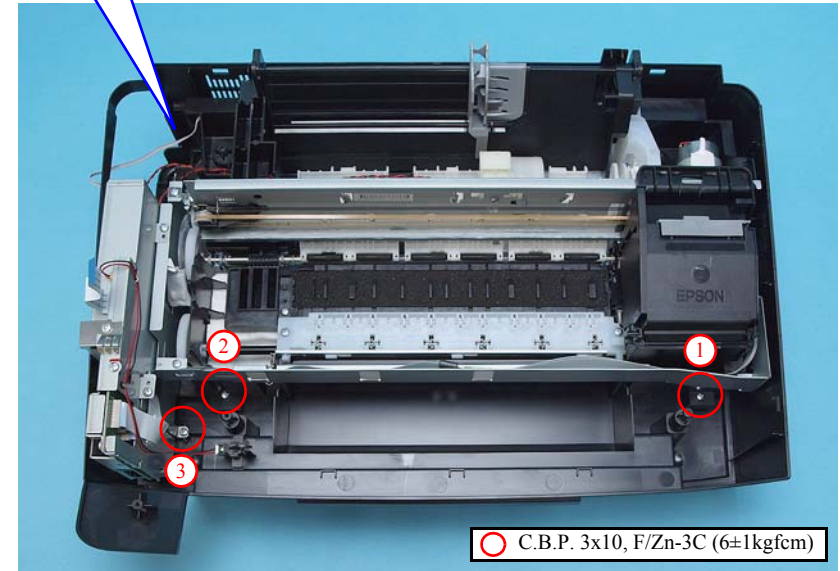
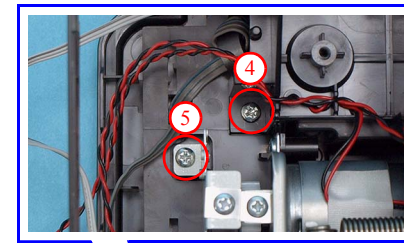

Figure 4-50. Removing the Printer Mechanism (3)

**CAUTION**



When lifting the Printer Mechanism, be sure to hold the positions specified in the figure below to prevent the Main Frame from being deformed.

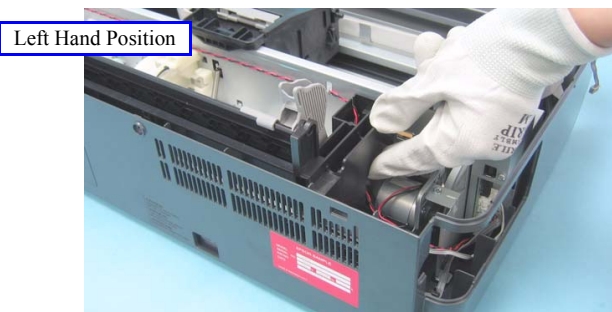

Figure 4-49. Printer Mechanism Handling Precaution

**REASSEMBLY**



Tighten the screws in the order given in [Figure 4-50](#).

## 4.5.5 Left Frame

- Parts/Components need to be removed in advance

Document Cover/ASF Cover/Scanner Unit/Panel Unit/Upper Housing/Card Slot Cover/Lower Housing/Main Board Unit

- Removal procedure

### CHECK POINT



In this section, some disassembling procedures differ between models. Skip the model-specified steps if not applied to your model.

1. For NX510 series: Peel off the double-sided tape that secures the ferrite core, and remove the ferrite core from the Left Frame.
2. Remove the screws (x2), and remove the grounding plate.
3. Remove the screws (x3) that secure the Left Frame, and remove the Left Frame.

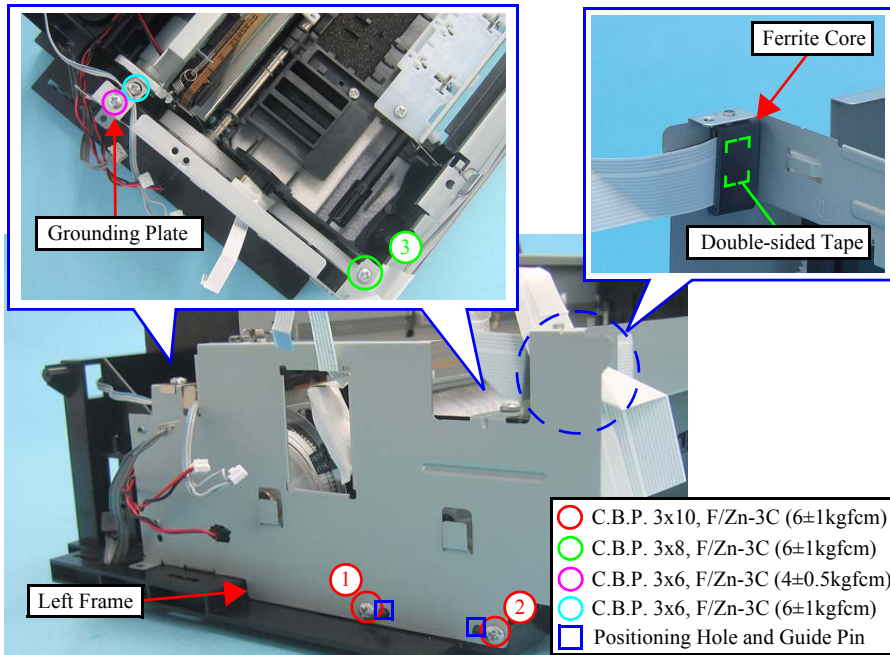

Figure 4-51. Removing the Left Frame



- When installing the Left Frame, lead the PF Encoder FFC through the hole of the Left Frame.

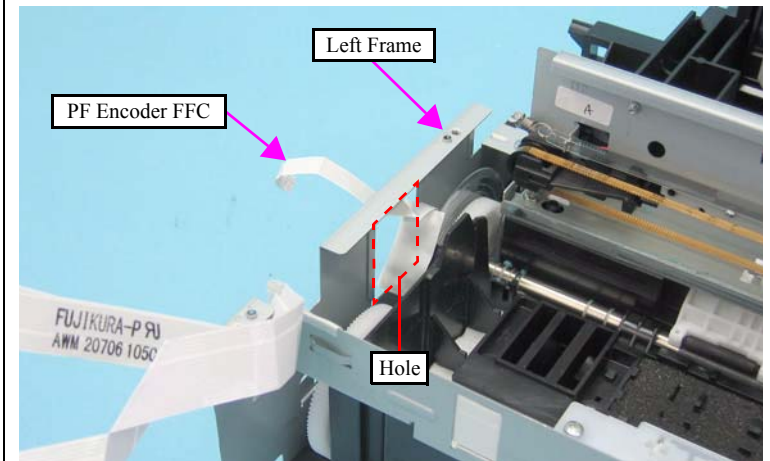

Figure 4-52. Routing the PF Encoder FFC

- When installing the Left Frame, align the guide pins (x2) of the Base Frame with their positioning holes (x2) of the Left Frame as shown in Figure 4-51.
- NX510 series only:  
When installing the Left Frame, attach the ferrite core to the location shown in Figure 4-51.
- Tighten the screws in the order given in Figure 4-51.

### 4.5.6 Front Frame/Right Frame

- Parts/Components need to be removed in advance

Document Cover/ASF Cover/Scanner Unit/Panel Unit/Upper Housing/Card Slot Cover/Lower Housing/Main Board Unit/Left Frame

- Removal procedure



**In this section, some disassembling procedures differ between models. Skip the model-specified steps if not applied to your model.**

- Remove the acetate tape and the ferrite core shown below from the Front Frame.

Item	NX510 series	SX410/SX210 series
Ferrite core	1 piece	---
Acetate tape	1 piece	2 pieces

- Release the Head FFC from the hooks (x3) of the Front Frame.
- Remove the Grounding Spring from the Front Frame.

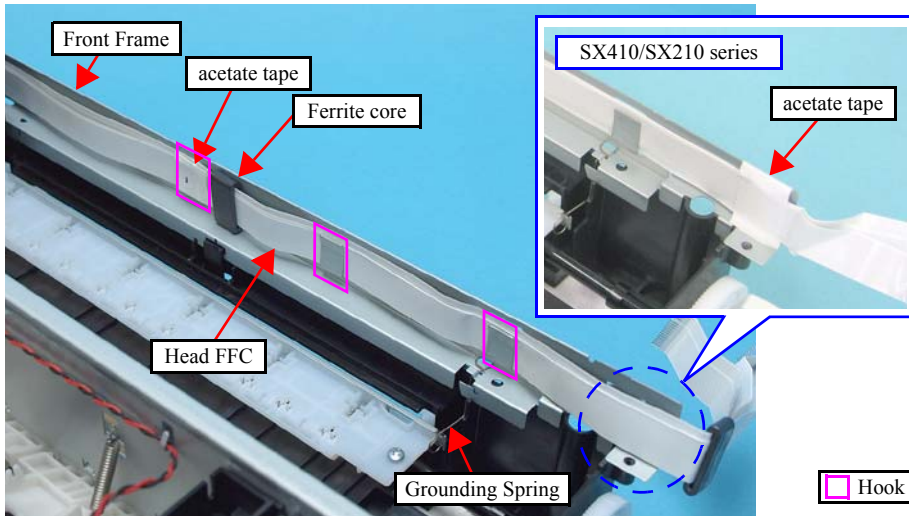

Figure 4-53. Removing the Front Frame/Right Frame (1)

- For NX510/SX410 series: Peel off the Porous Pad Frame Right from the Right Frame and the Base Frame.

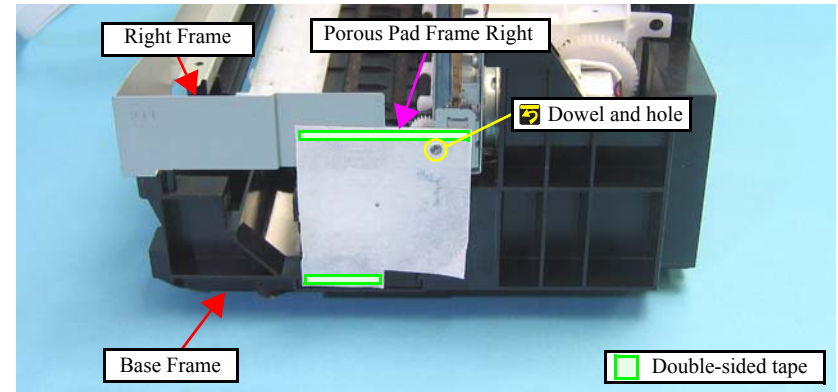

Figure 4-54. Removing the Front Frame/Right Frame (2)

- Remove the screw (x1) that secures the Front Frame and the Right Frame together.
- Release the dowel (x1) and the hook (x1) that secure the Right Frame, and remove the Right Frame.

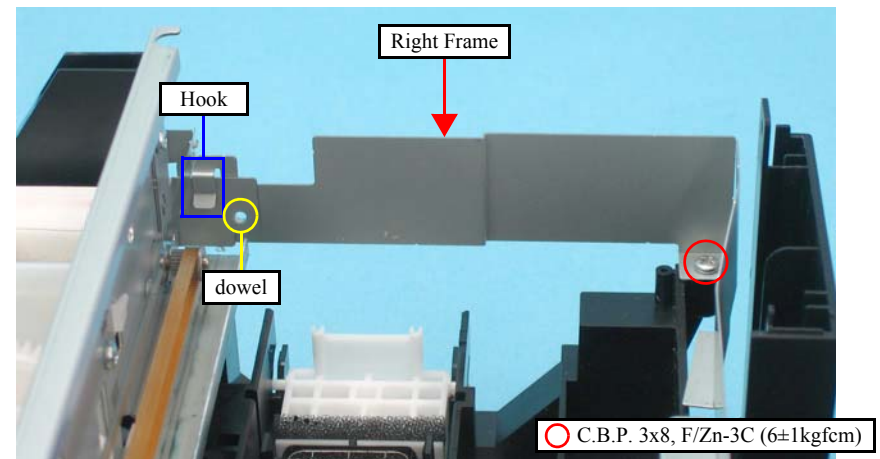

Figure 4-55. Removing the Front Frame/Right Frame (3)



7. Release the hook (x1), and remove the Front Frame.

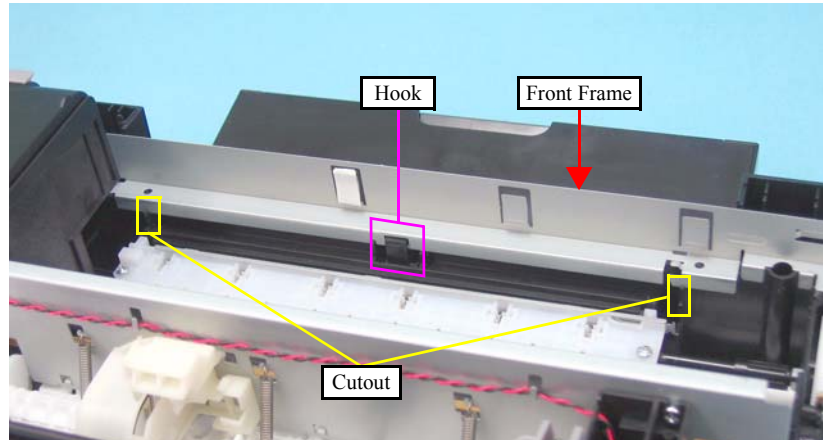

Figure 4-56. Removing the Front Frame/Right Frame (4)



- NX510 series only:  
Align the ferrite core with the line mark shown in [Figure 4-57](#), then secure it to the Front Frame with double-sided tape.
- After replacing the Front Frame, be sure to attach acetate tape as shown in the figure below.

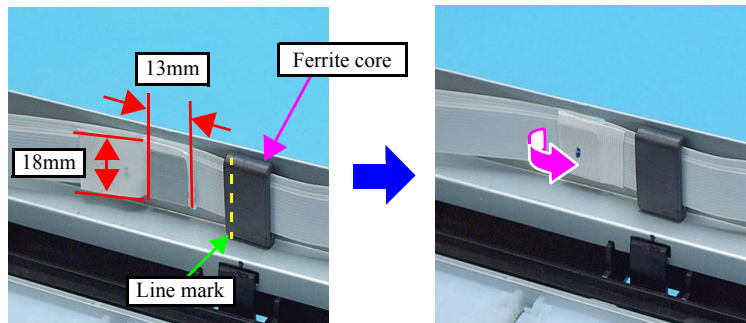

Figure 4-57. Standard of acetate tape attachment



- When installing the Front Frame, pay attention to the following instructions.
  - As shown in [Figure 4-56](#), be sure to secure the Front Frame with the hook (x1) and the cutouts (x2).
  - As shown in [Figure 4-55](#), secure the Front Frame and Right Frame together with the screw. (Place the Right Frame on top of the Front Frame.)
- Before securing the Porous Pad Frame Right, align the hole of the Porous Pad Frame Right with the dowel of the Right Frame as shown in [Figure 4-54](#).
- SX410/SX210 series only:  
Secure the Head FFCs (x3) to the Front Frame with the acetate tape (x1) as shown in the figure below.

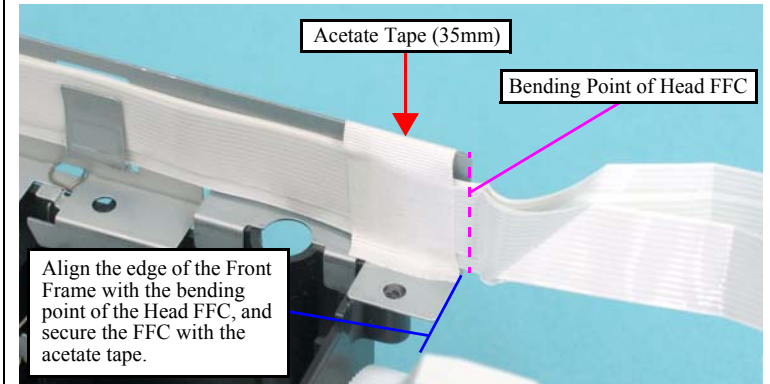

Figure 4-58. Acetate Tape Position

### 4.5.7 Star Wheel Holder Assy

- Parts/Components need to be removed in advance  
Document Cover/ASF Cover/Scanner Unit/Panel Unit/Upper Housing
- Removal procedure
  1. Remove the Grounding Spring from the Star Wheel Holder Assy.
  2. Remove the screws (x2) that secure the Star Wheel Holder Assy, and remove the Star Wheel Holder Assy.

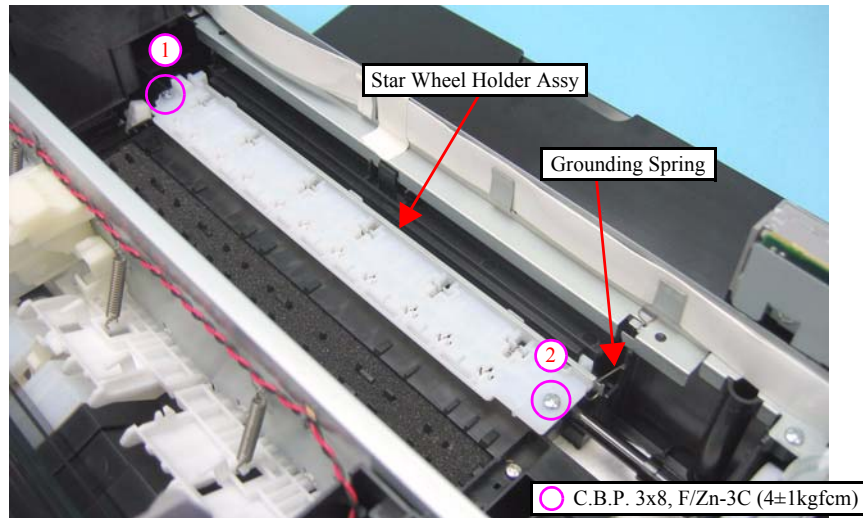

Figure 4-59. Removing the Star Wheel Holder Assy



Tighten the screws in the order given in [Figure 4-59](#).

### 4.5.8 EJ Roller

- Parts/Components need to be removed in advance  
Document Cover/ASF Cover/Scanner Unit/Panel Unit/Upper Housing/Card Slot Cover/Lower Housing/Main Board Unit/Left Frame/Star Wheel Holder Assy
- Removal procedure

CHECK  
POINT



The Spur Gear 51.5 cannot be reused after it is removed.  
Whenever the gear is removed, make sure to attach a new one.

1. Insert a flathead precision screwdriver between the Spur Gear 51.5 and the EJ Roller, and remove the Spur Gear 51.5 by pushing it in the direction of the arrow.

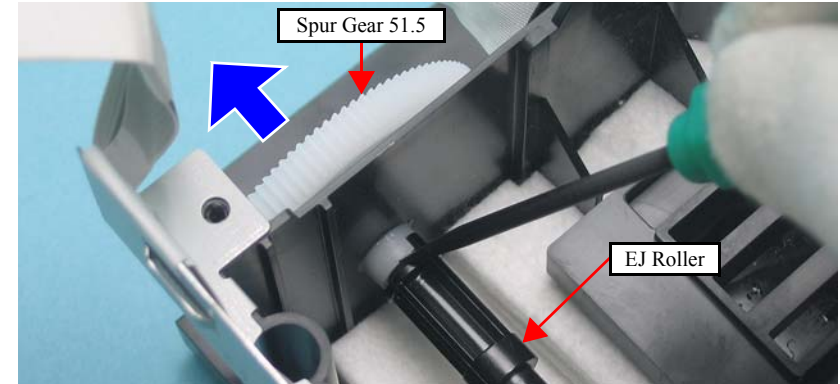

Figure 4-60. Removing the EJ Roller (1)

2. Remove the EJ Roller while pushing the tab on the right side of the Base Frame in the direction of the arrow.

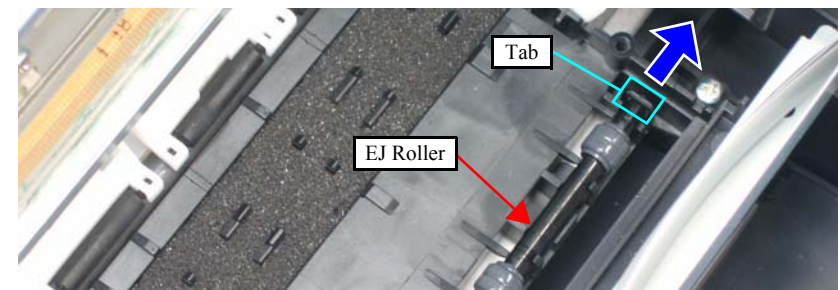

Figure 4-61. Removing the EJ Roller (2)

## REASSEMBLY



- When installing the EJ Roller, pay attention to the following instructions.
  - Make sure that the rubber part of the EJ Roller does not contact with the hook of the Front Paper Guide.
  - Be cautious not to touch the rubber part of the EJ Roller.
  - Be sure to align the rib (x1) of the Front Paper Guide with the slit on the EJ Roller.

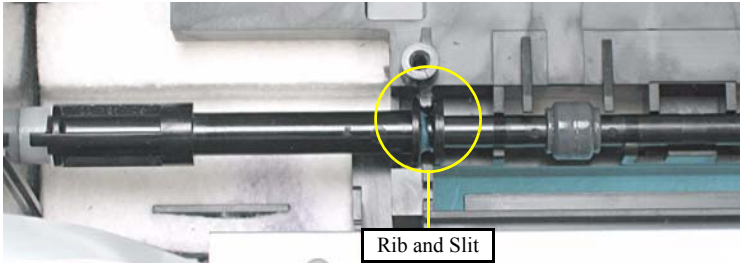

Figure 4-62. Installing the EJ Roller

- When installing the Spur Gear 51.5, be sure to align the concave section of it with the convex section of the EJ Roller.

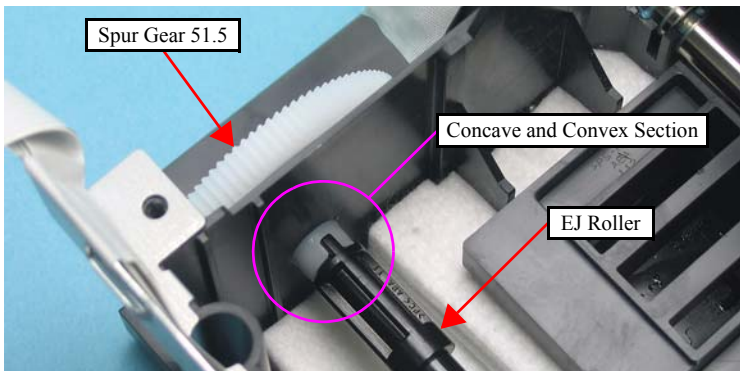

Figure 4-63. Installing the Spur Gear 51.5

ADJUSTMENT  
REQUIRED

- Whenever the EJ Roller is removed/replaced, the required adjustments must be carried out.
  - Chapter 5 “ADJUSTMENT” (p.161)
- After replacing the EJ roller, be sure to perform the required lubrication.
  - Chapter 6 “MAINTENANCE” (p.175)

## 4.5.9 PF Encoder Sensor

- Parts/Components need to be removed in advance  
Document Cover/ASF Cover/Scanner Unit/Panel Unit/Upper Housing/Card Slot Cover/Lower Housing/Main Board Unit/Left Frame
- Removal procedure

CHECK  
POINT

In this section, some disassembling procedures differ between models. Skip the model-specified steps if not applied to your model.

1. For NX510/SX210 series: Peel off the acetate tape (x1) from the PF Encoder Sensor.
2. Release the PF Encoder FFC from the connector (x1) of the PF Encoder Sensor.
3. Remove the screw (x1) that secures the PF Encoder Sensor, and remove the PF Encoder Sensor.

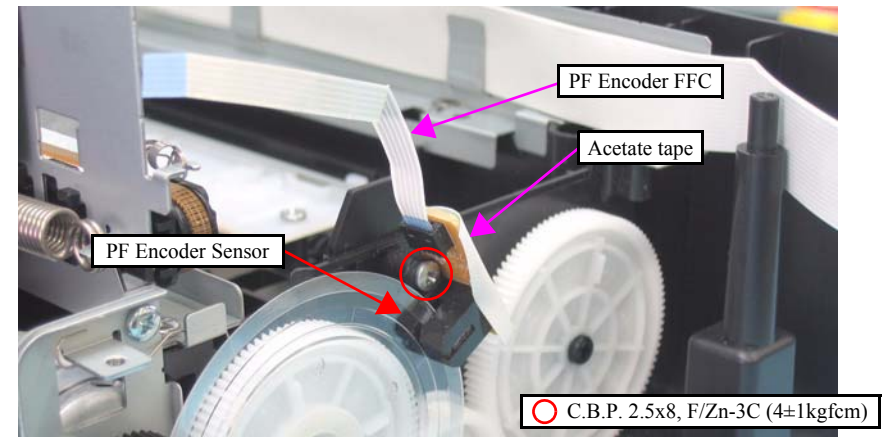

Figure 4-64. Removing the PF Encoder Sensor

**REASSEMBLY**

NX510/SX210 series only:

When installing the PF Encoder Sensor, be sure to attach the acetate tape (x1) referring to the figure below.

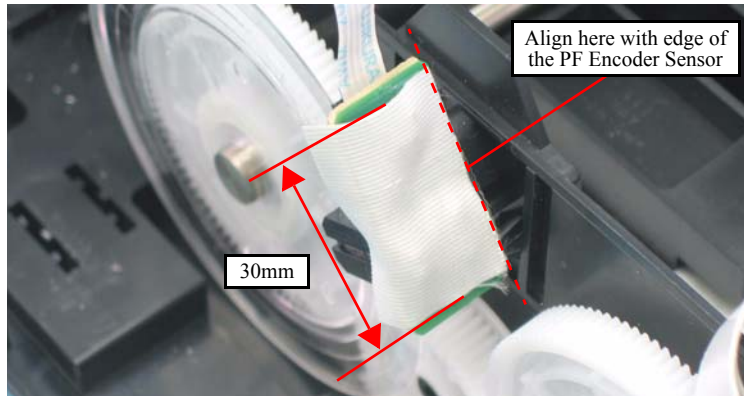

Figure 4-65. Acetate Tape Position

#### 4.5.10 PF Scale

- Parts/Components need to be removed in advance

Document Cover/ASF Cover/Scanner Unit/Panel Unit/Upper Housing/Card Slot Cover/Lower Housing/Main Board Unit/Left Frame/PF Encoder Sensor

- Removal procedure

**CAUTION**

Pay attention to the following instructions.

- Do not touch the PF Scale with bare hand.
- Do not damage the PF Scale.

1. Peel of the PF Scale that is secured with the double-sided tape (x1) from the Spur Gear 32.4.

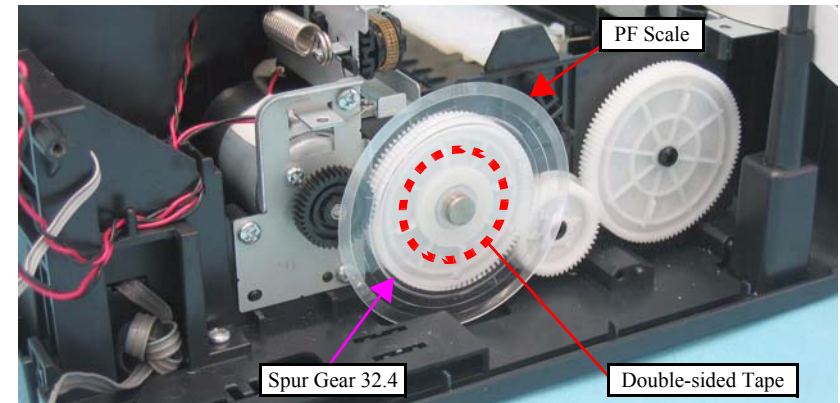

Figure 4-66. Removing the PF Scale

## 4.5.11 PF Motor

- Parts/Components need to be removed in advance

Document Cover/ASF Cover/Scanner Unit/Panel Unit/Upper Housing/Card Slot Cover/Lower Housing/Main Board Unit/Left Frame/PF Encoder Sensor/PF Scale

- Removal procedure

CHECK  
POINT



In this section, some disassembling procedures differ between models. Skip the model-specified steps if not applied to your model.

1. Release the PF Motor connector cable from the notches (x2) of the Base Frame.

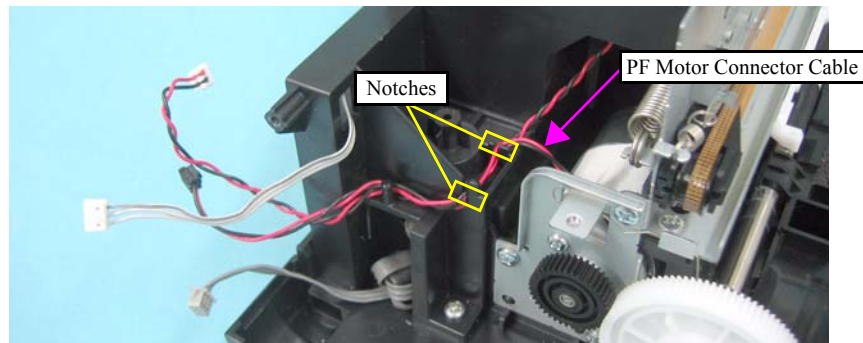

Figure 4-67. Removing the PF Motor (1)

2. For SX410/SX210 series : Remove the Grounding Spring from the PF Motor.
3. Remove the screws (x3) that secure the PF Motor, and remove it.

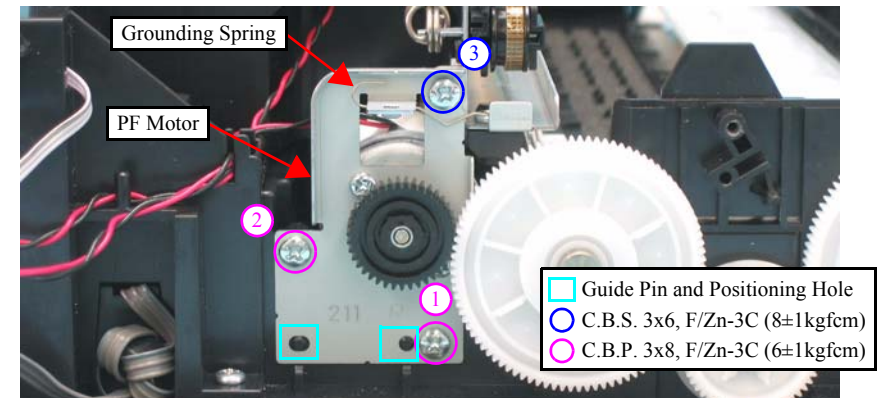

Figure 4-68. Removing the PF Motor (2)



- When installing the PF Motor, pay attention to the following instructions.
  - Do not damage the PF Scale.
  - Insert the guide pins (x2) on the Base Frame into the positioning holes (x2) of the PF Motor as shown in [Figure 4-68](#).
  - Route the PF Motor Connector Cable as shown in the figure below.

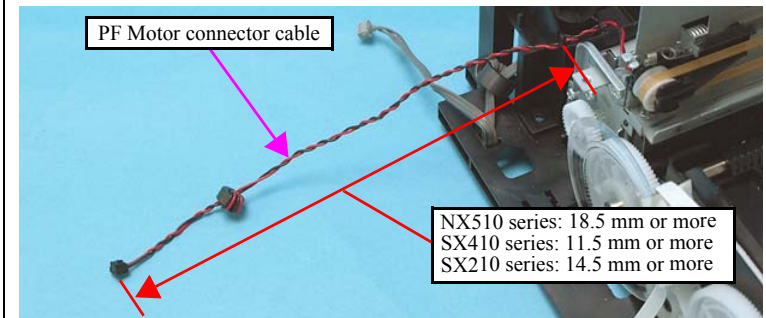

Figure 4-69. Routing the PF Motor Connector Cable

- Tighten the screws in the order given in [Figure 4-68](#).

**REASSEMBLY**

■ **SX410/SX210 series only:**

Follow the steps below to install the Grounding Spring.

1. Attach the larger U-shaped end of the Grounding Spring to the PF Roller.

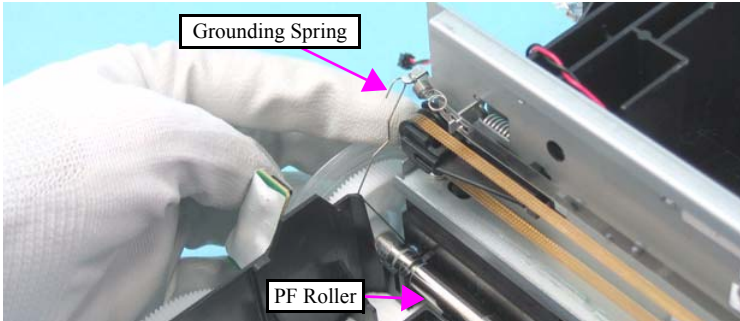

Figure 4-70. Installing the Grounding Spring (1)

2. Pass the Grounding Spring along the inner side of the hook of the Main Frame.
3. Ground the smaller U-shaped end of the Grounding Spring with the undersurface of the frame for PF Motor.

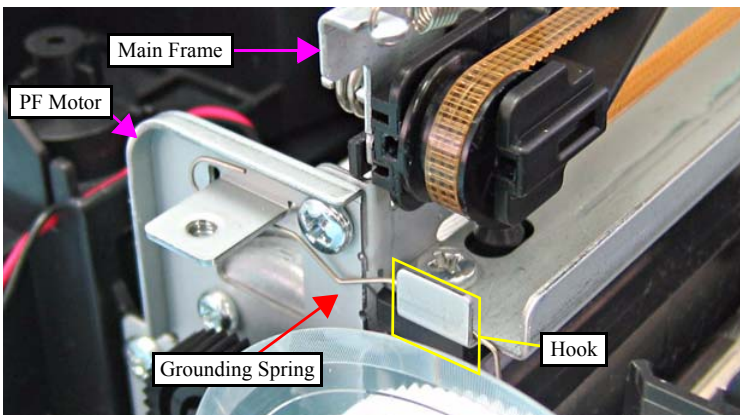

Figure 4-71. Installing the Grounding Spring (2)

**ADJUSTMENT  
REQUIRED**

Whenever the PF Motor is removed/replaced, the required adjustments must be carried out.

- [Chapter 5 “ADJUSTMENT” \(p.161\)](#)

## 4.5.12 CR Motor

- Parts/Components need to be removed in advance

Document Cover/ASF Cover/Scanner Unit/Panel Unit/Upper Housing/Card Slot Cover/Lower Housing/Main Board Unit/Left Frame/Front Frame/Right Frame

- Removal procedure

1. Turn the Spur Gear 51.5 to release the Carriage Lock, and move the CR Unit to the center.

(Refer to 4.5.1 Printhead Step1 (p113))

### CAUTION

Be careful not to damage the CR Motor cable when releasing the cable from the hooks of the Main Frame.

2. Release the CR Motor cable from the notches (x3) of the Base Frame and the hooks (x3) of the Main Frame, and then pull out the cable through the hole of the Base Frame.

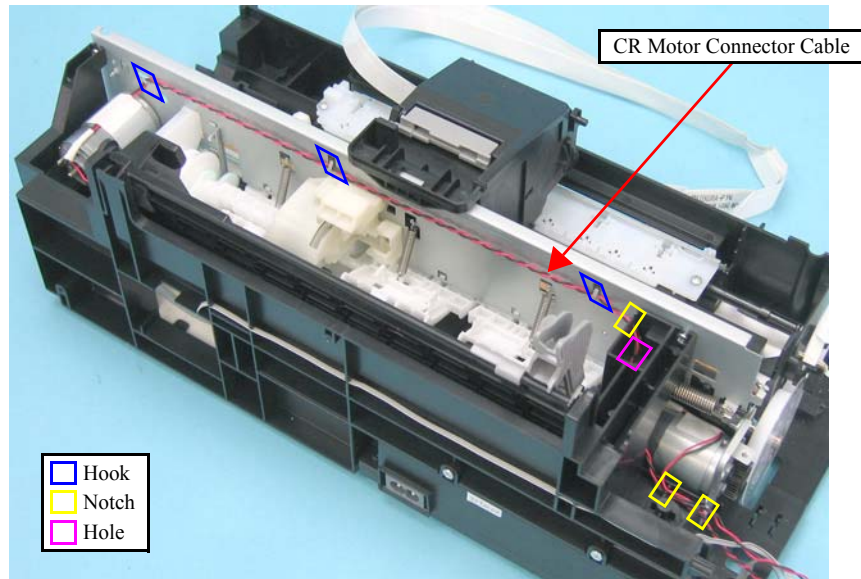

Figure 4-72. Removing the CR Motor (1)

### CAUTION

After releasing the Timing Belt, temporarily secure the belt to the Cartridge Cover with a tape or the like so as not to allow the grease to come in contact with the Timing Belt. Contaminating the belt with grease can result in malfunction of the printer.

3. Loosen the tension of the Timing Belt by pressing the Driven Pulley Holder in the direction of the arrow as shown in the figure, and release the Timing Belt from the pinion gear of the CR Motor.

### CAUTION

Do not damage the pinion gear of the CR Motor.

4. Remove the screws (x2) that secure the CR Motor, and remove the CR Motor.

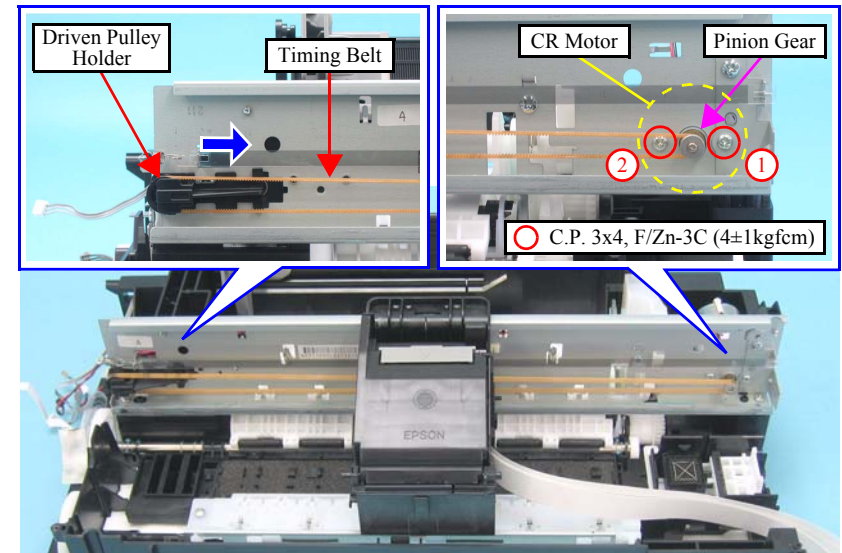

Figure 4-73. Removing the CR Motor (2)

**REASSEMBLY**

- Be sure to install the CR Motor so that the groove on it faces downward.

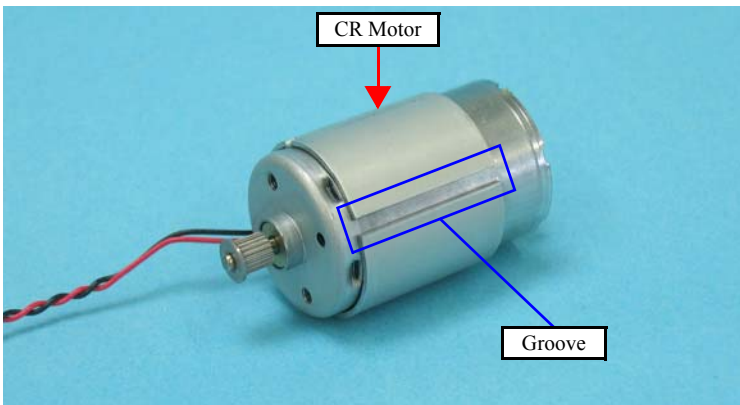

Figure 4-74. CR Motor

- Tighten the screws in the order given in [Figure 4-73](#).
- Make sure that there is no gap between the CR Motor and the Main Frame.

**ADJUSTMENT  
REQUIRED**

- Whenever the CR Motor is removed/replaced, the required adjustments must be carried out.
  - [Chapter 5 “ADJUSTMENT” \(p.161\)](#)

### 4.5.13 Main Frame Assy

- Parts/Components need to be removed in advance

Document Cover/ASF Cover/Scanner Unit/Panel Unit/Upper Housing/Card Slot Cover/Lower Housing/Main Board Unit/Left Frame/Front Frame/Right Frame/CR Motor/CR Scale/Hopper

**CHECK  
POINT**

- In this section, some disassembling procedures differ between models. Skip the model-specified steps if not applied to your model.
- Main Frame Assy consists of the following parts.
  - Main Frame
  - CR Unit
  - Printhead
  - Upper Paper Guide

- Removal procedure

1. For SX410/SX210 series: Remove the Grounding Spring from the PF Motor. ([Refer to 4.5.11 PF Motor Step2 \(p125\)](#))
2. Release one end of the Extension Spring from the hook of the Main Frame with longnose pliers, and then remove the spring together with the Driven Pulley Holder.

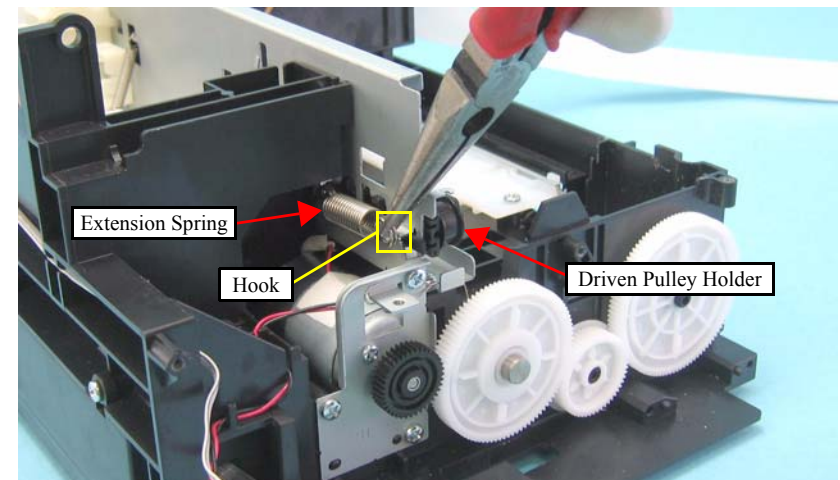

Figure 4-75. Removing the Extension Spring and Driven Pulley Holder



3. Move the CR Unit to the left side of the printer.
4. Remove the screw (x1) that secures the LD Shaft Holder.
5. Move the LD Shaft Holder in the direction of the arrow while holding down its tab with a flathead precision screwdriver, and remove the LD Shaft Holder.

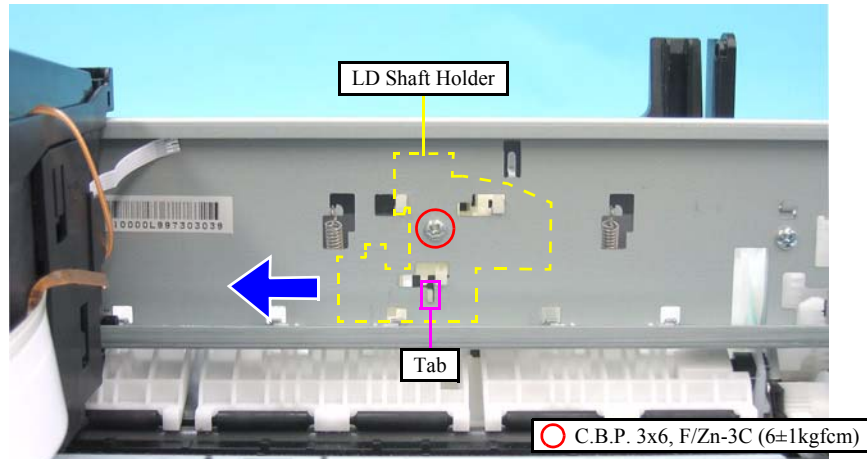

Figure 4-76. Removing the LD Shaft Holder

6. Remove the Extension Springs 10.99 (x3) from each hook of the Main Frame and the Upper Paper Guide.

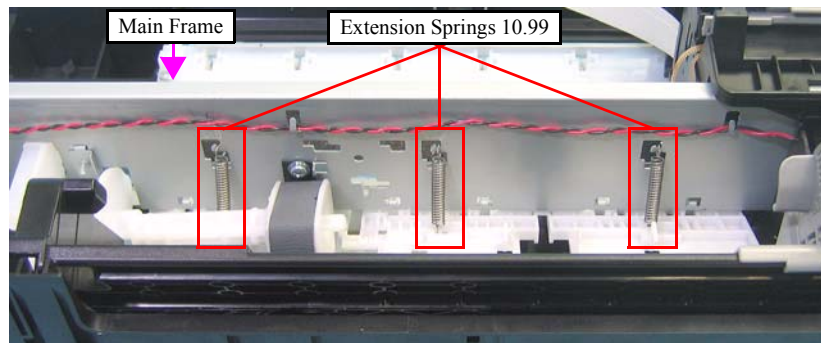

Figure 4-77. Removing the Upper Paper Guide



When laying the Main Frame Assy, make sure to put it as shown in the figure below. Do not lay it with the rollers of the Upper Paper Guide facing downward, or the rollers or the nozzle surface may get damaged.

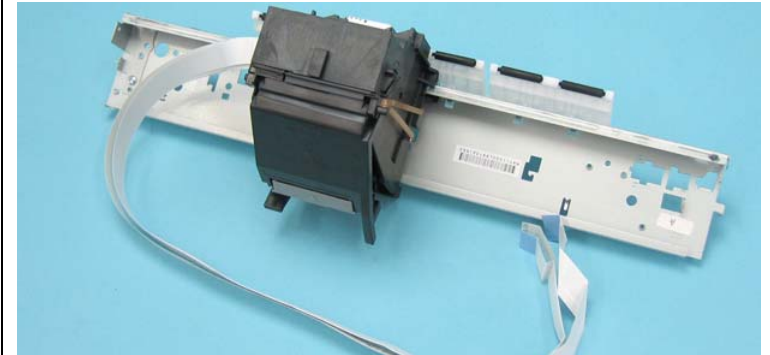

Figure 4-78. Precaution on Handling Main Frame Assy

7. Remove the screws (x6) that secure the Main Frame, and remove it while avoiding the LD Roller Shaft so as not to hit the Upper Paper Guide.

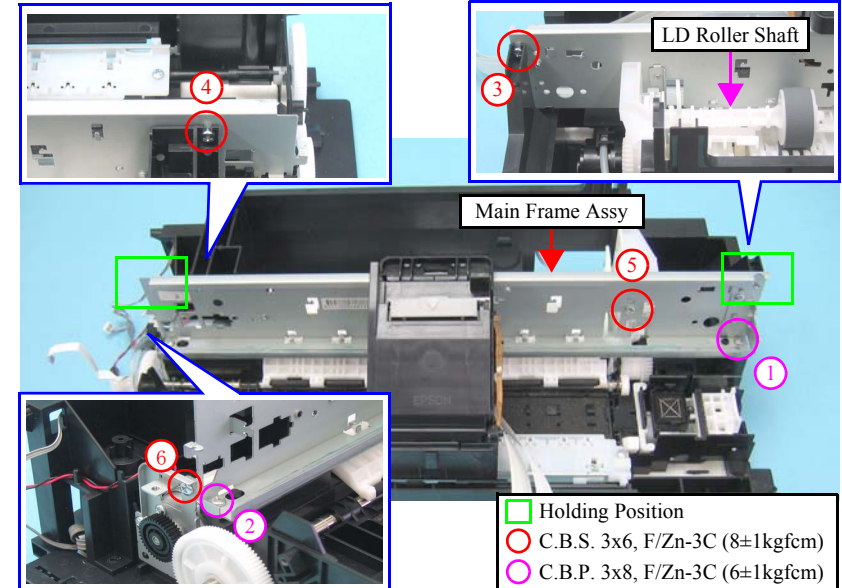

Figure 4-79. Removing the Main Frame Assy

## REASSEMBLY



- When installing the Main Frame Assy, pay attention to the following instructions.
  1. Put the right part of the Upper Paper Guide under the LD Roller Shaft as shown in the figure below.
  2. Align the hook (x1) of the Frame Support with the positioning hole (x1) of the Main Frame.
  3. Align the hook (x1) of the ASF Unit with the positioning hole (x1) of the Main Frame.
  4. Align the guide pins (x2) of the Base Frame with the positioning holes (x2) of the Main Frame.

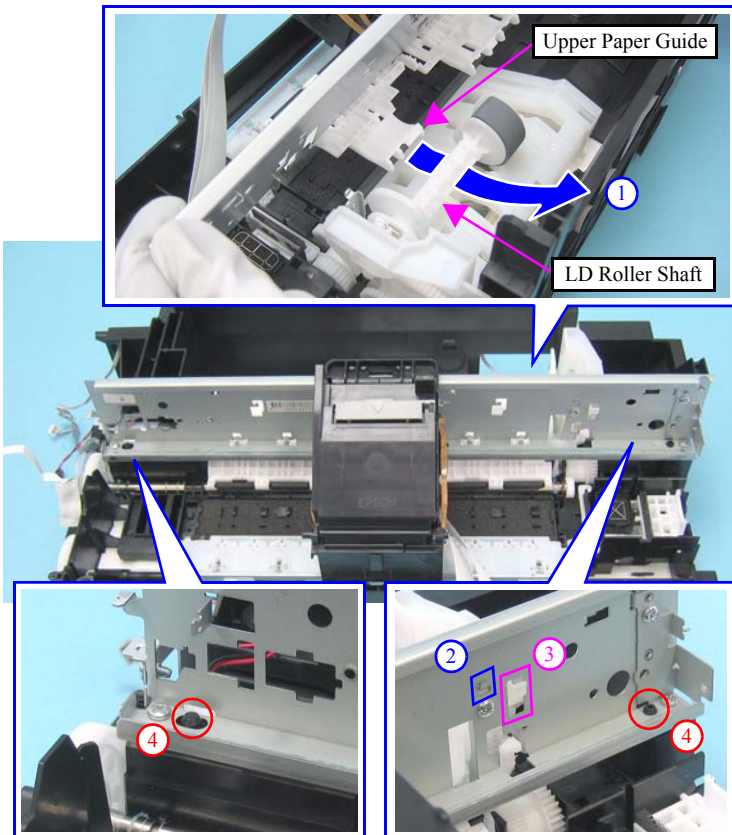

Figure 4-80. Main Frame Assy

## REASSEMBLY



- Tighten the screws in the order given in [Figure 4-79](#).
- Follow the steps below to install the Extension Spring 10.99 to the Upper Paper Guide.
  1. Attach the one end of the Extension Spring 10.99 to the hook of the Upper Paper Guide.
  2. Attach the other end of the Extension Spring 10.99 to the hook of the Main Frame with longnose pliers.

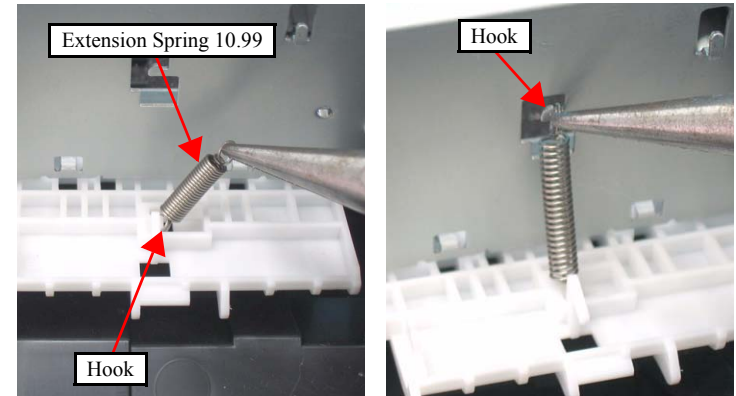

Figure 4-81. Installing the Extension Spring 10.99

- Be sure to install the Grounding Spring referring to [Figure 4-70](#) and [Figure 4-71](#).

ADJUSTMENT  
REQUIRED

- Whenever the Main Frame is removed/replaced, the required adjustments must be carried out.
  - [Chapter 5 “ADJUSTMENT” \(p.161\)](#)
- After replacing the Main Frame, be sure to perform the specified lubrication.
  - [Chapter 6 “MAINTENANCE” \(p.175\)](#)

## 4.5.14 CR Unit

- Parts/Components need to be removed in advance

Document Cover/ASF Cover/Scanner Unit/Panel Unit/Upper Housing/Card Slot Cover/Lower Housing/Main Board Unit/Left Frame/Front Frame/Right Frame/CR Motor/CR Scale/Hopper/Main Frame Assy/Printhead

- Removal procedure

1. Remove the screw (x1) that secures the CR Scale Holder, and remove the CR Scale Holder.
2. Move the CR Unit in the direction of the arrow to remove the CR Unit.

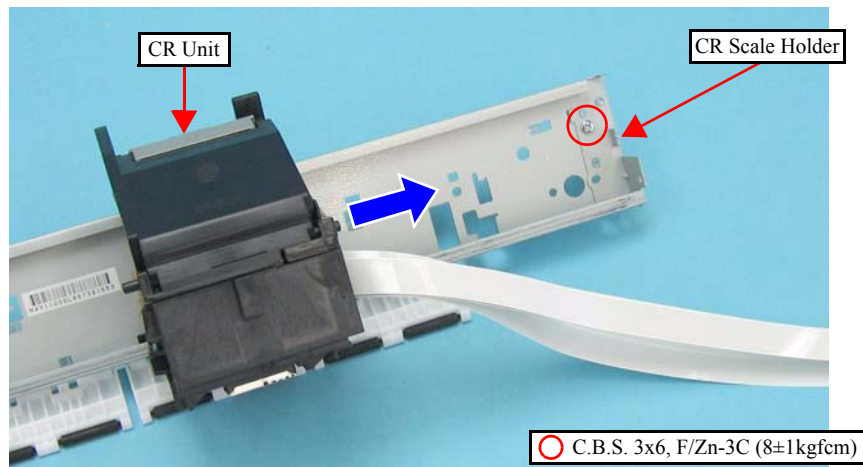

Figure 4-82. Removing the CR Unit (1)

3. Release the Timing Belt from the groove of the CR Unit.

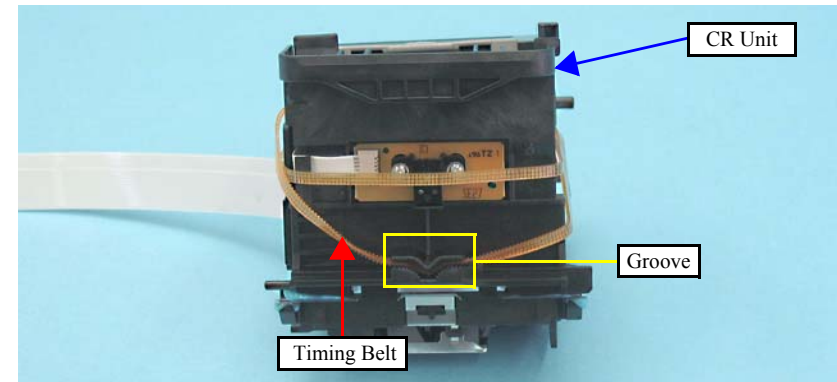

Figure 4-83. Removing the CR Unit (2)



- Put the part of the Timing Belt toothed on its both sides into the groove of the CR Unit.

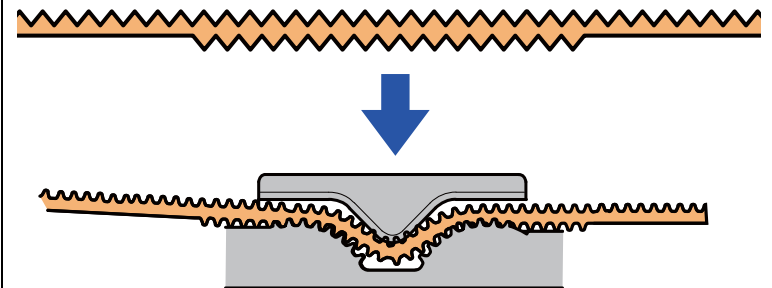

Figure 4-84. Installing the Timing Belt



- Whenever the CR Unit is removed/replaced, the required adjustments must be carried out.
  - [Chapter 5 “ADJUSTMENT” \(p.161\)](#)
- After replacing the CR Unit, be sure to perform the required lubrication.
  - [Chapter 6 “MAINTENANCE” \(p.175\)](#)

### 4.5.15 Upper Paper Guide

- Parts/Components need to be removed in advance  
Document Cover/ASF Cover/Scanner Unit/Panel Unit/Upper Housing/Card Slot Cover/Lower Housing/Main Board Unit/Left Frame/Front Frame/Right Frame/CR Motor/CR Scale/Hopper/Main Frame Assy
- Removal procedure
  1. Release the hooks (x6), and remove the Upper Paper Guide.

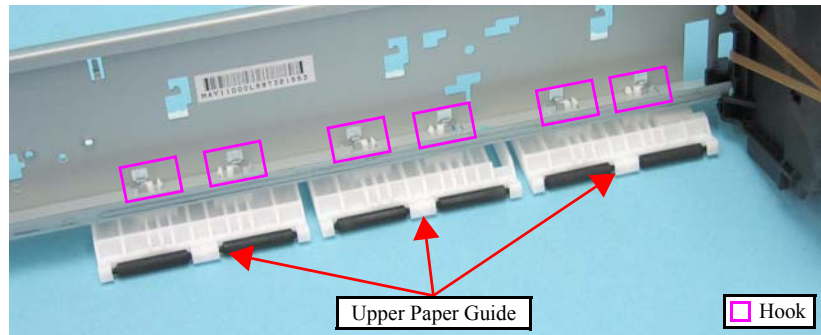

Figure 4-85. Removing the Upper Paper Guide (1)

#### REASSEMBLY



When installing the Upper Paper Guide, attach the legs (x2) of the antistatic cloth into the holes (x2) of Upper Paper Guide as shown in the figure below.

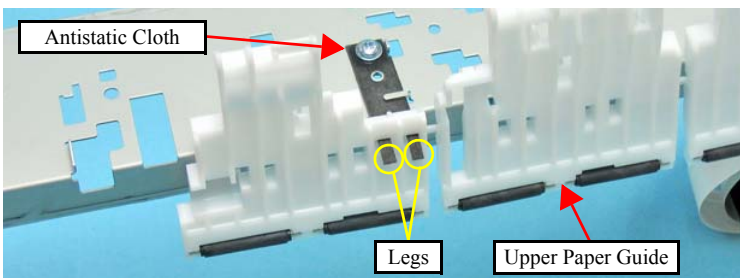

Figure 4-86. Installing the Upper Paper Guide

#### ADJUSTMENT REQUIRED



Whenever the Upper Paper Guide is removed/replaced, the required adjustments must be carried out.

- Chapter 5 “ADJUSTMENT” (p.161)

### 4.5.16 ASF Unit

- Parts/Components need to be removed in advance  
Document Cover/ASF Cover/Scanner Unit/Panel Unit/Upper Housing/Card Slot Cover/Lower Housing/Main Board Unit/Left Frame/Front Frame/Right Frame/CR Motor/CR Scale/Hopper/Main Frame Assy
- Removal procedure
  1. Release the PE Sensor cable from the notches (x6) of the Base Frame and pull out the cable from the hole (x1).

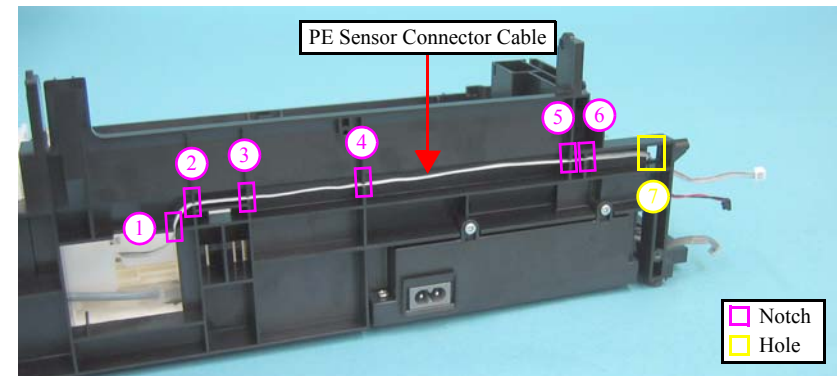

Figure 4-87. Releasing the PE Sensor Connector Cable

#### CAUTION



When performing the following steps, be cautious not to get injured with the sharp edges of the Frame Support.

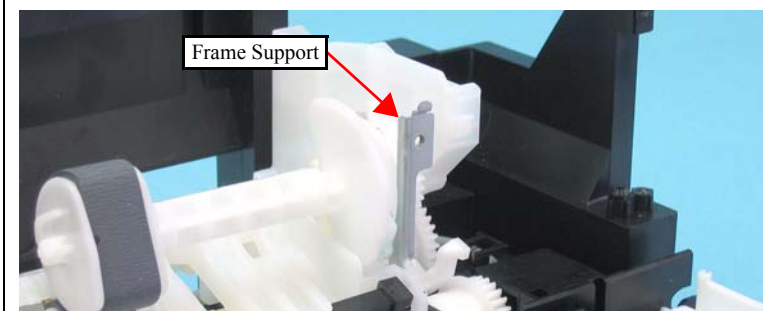

Figure 4-88. Sharp Edges of the Frame Support

2. Remove the screws (x2) that secure the ASF Unit.

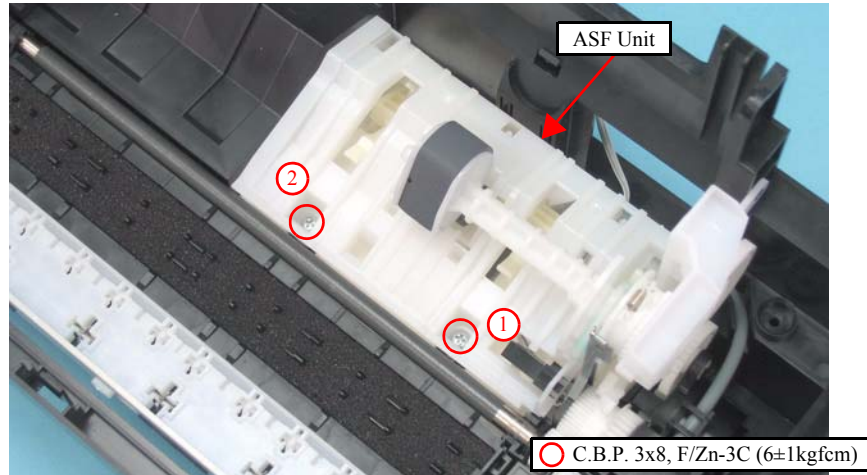

Figure 4-89. Removing the ASF Unit (1)

3. Release the dowel (x1) and guide pins (x2) of the Base Frame and the shaft (x1) of the ASF Unit, then remove the ASF Unit.

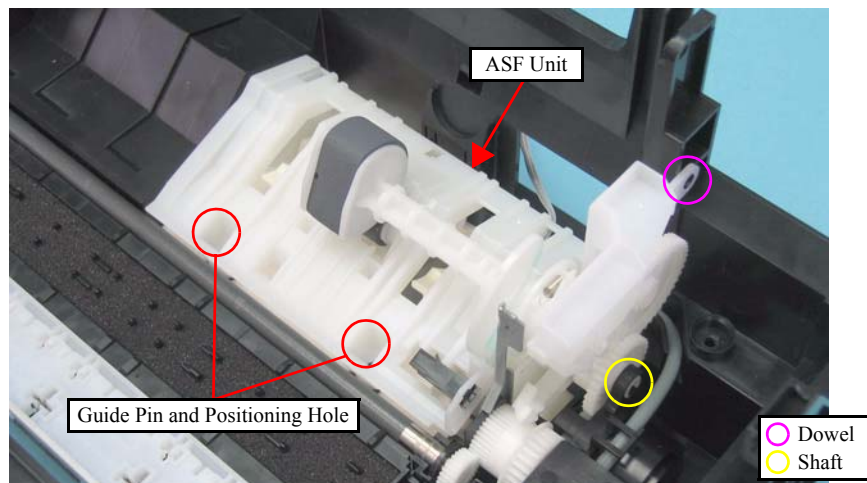

Figure 4-90. Removing the ASF Unit (2)



- When installing the ASF Unit, be sure to align the guide pins (x2) of the Base Frame with the positioning holes (x2) of the ASF Unit as shown in [Figure 4-90](#).
- Tighten the screws in the order given in [Figure 4-89](#).
- When routing the PE Sensor cable, pay attention to the following instructions.
  - Route the cable in the order given in [Figure 4-87](#).
  - Make sure to attach the cable with the blue line facing toward the Base Frame.

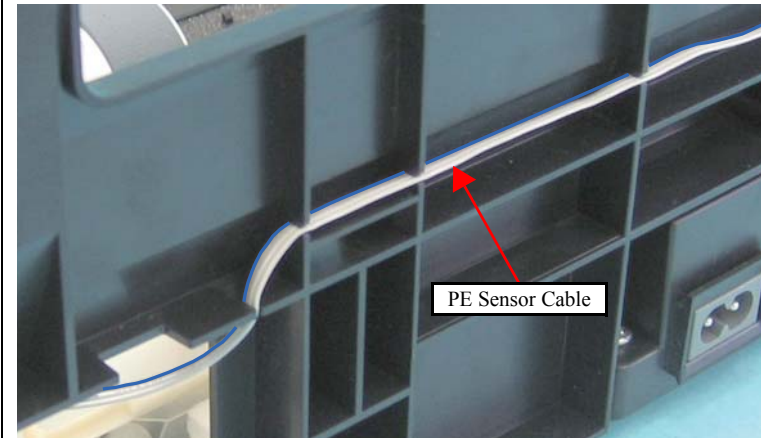

Figure 4-91. Routing PE Sensor Cable

- Check that the cable is tightly routed and there is no slack of it.



Whenever the ASF Unit is removed/replaced, the required adjustments must be carried out.

- [Chapter 5 “ADJUSTMENT” \(p.161\)](#)

## 4.5.17 Ink System Unit

- Parts/Components need to be removed in advance

Document Cover/ASF Cover/Scanner Unit/Panel Unit/Upper Housing/Card Slot Cover/Lower Housing/Main Board Unit/Left Frame/Front Frame/Right Frame/CR Motor/CR Scale/Hopper/Main Frame Assy/ASF Unit

- Removal procedure

CHECK  
POINT



In this section, some disassembling procedures differ between models. Skip the model-specified steps if not applied to your model.

CAUTION



When disassembling/assembling the Ink System Unit, pay attention to the following instructions.

- Be cautious not to get injured with the sharp edges of the Frame Support.

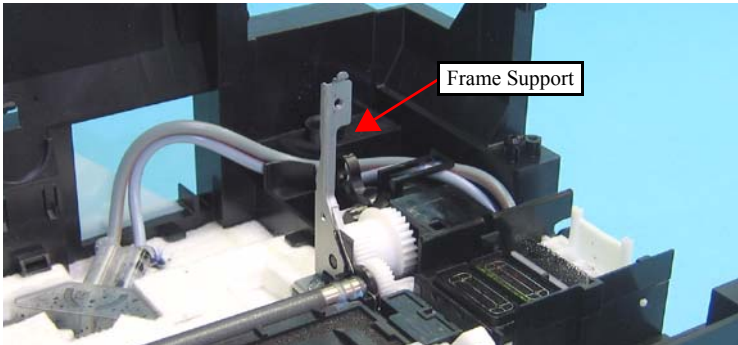

Figure 4-92. Sharp Edges of Frame Support

- Do not touch or damage the Sealing Rubber or the Head Cleaner.
- Mark the connecting point before removing the Ink Tube.

1. For NX510 series:  
Detach the Waste Ink Tubes (x2) together with the Tube Stopper from the Waste Ink Cover.  
For SX410/SX210 series:  
Detach the Waste Ink Tube (x1) together with the Tube Stopper from the Waste Ink Cover.
2. Detach the Waste Ink Tube (x2) from the groove of the Base Frame.

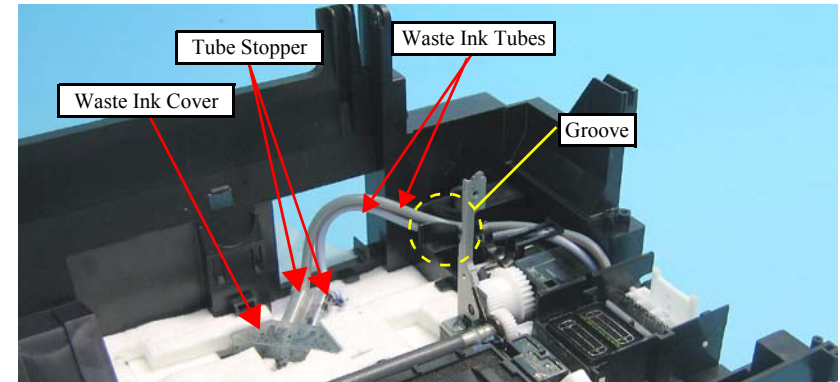

Figure 4-93. Detaching Waste Ink Tube

3. Remove the screw (x1) that secures the Ink System Unit.
4. Slide the Ink System Unit in the direction of the arrow while releasing the hook with a flathead precision screwdriver or a similar tool, and remove the Ink System Unit.

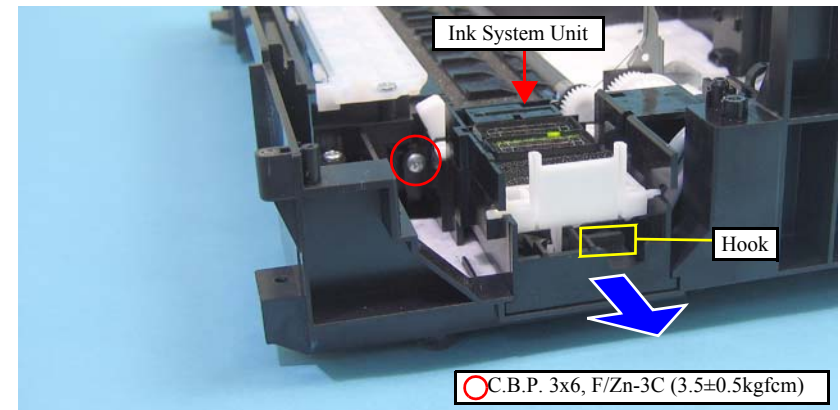

Figure 4-94. Removing the Ink System Unit

**REASSEMBLY**

- If the Carriage lock lever comes off, reassemble it following the steps below.
  1. Attach the one end of the Extension Spring 0.8 to the hook of the Carriage Lock Lever.
  2. Attach the other end of the Extension Spring 0.8 to the Ink System Unit.
  3. Insert the dowel (x1) of the Carriage Lock Lever into the hole (x1) of the Ink System Unit.

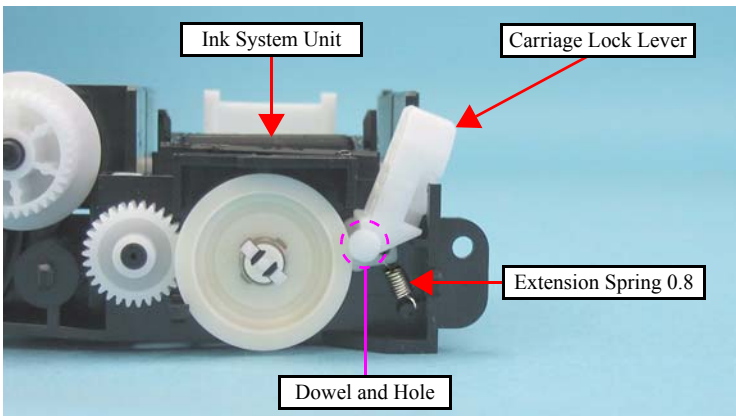

Figure 4-95. Installing the Carriage Lock Lever

**REASSEMBLY**

- When installing the Ink System Unit, pay attention to the following instructions.
  - Align the dowels (x3) of the Ink System Unit with the positioning holes (x3) of the Base Frame.

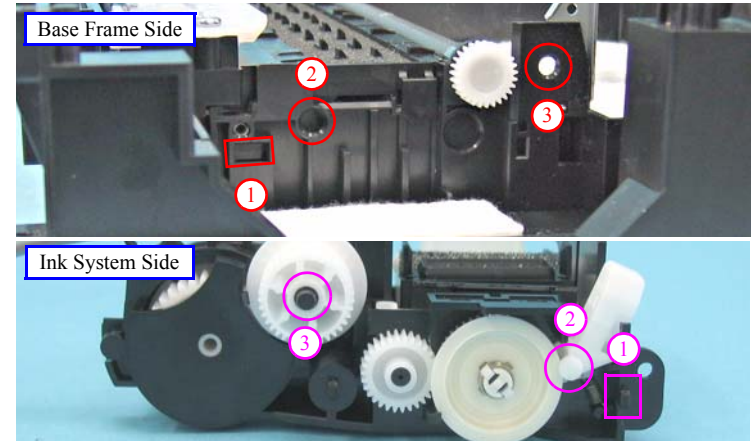

Figure 4-96. Installing the Ink System Unit (1)

- Align the ribs (x2) of the Ink System Unit with the grooves (x2) of the Base Frame.

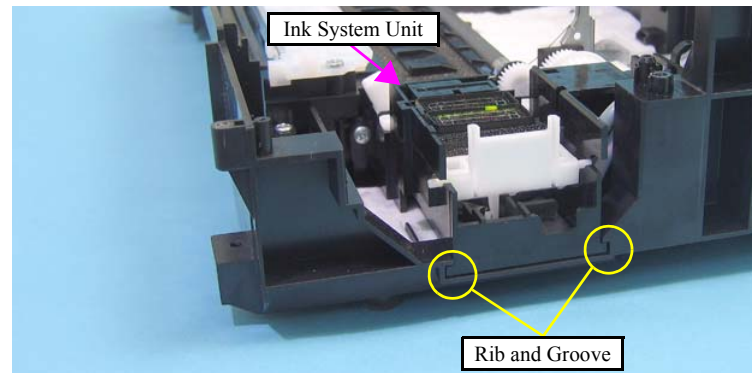

Figure 4-97. Installing the Ink System Unit (2)

**REASSEMBLY**

■ For NX510 series:

- Place the tube with a red line to the rear as shown below, and route the waste ink tubes (x2) without any twisting.

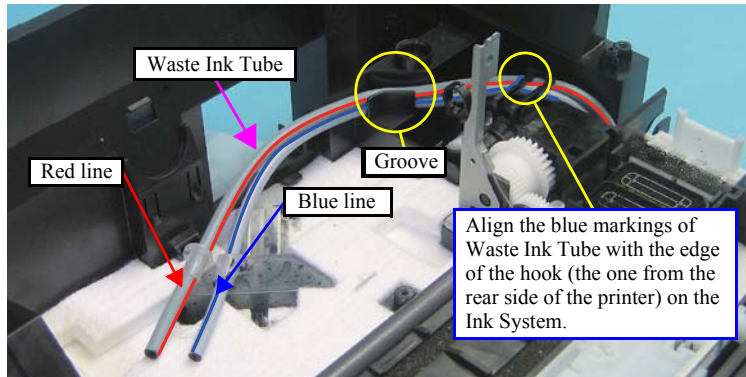

Figure 4-98. Routing the Waste Ink Tube

- Attach the Tube Stopper to the Waste Ink Tube as shown in the figure below, and insert them into the Waste Ink Cover.

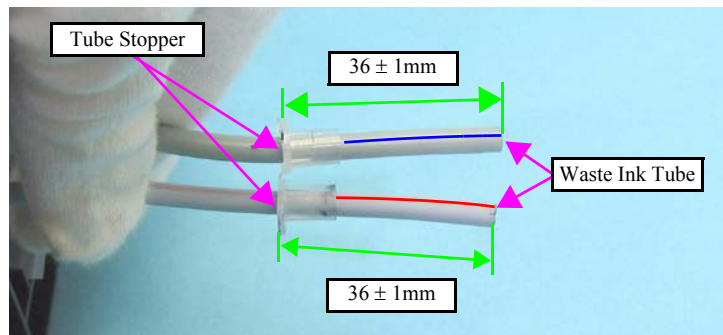

Figure 4-99. Installing the Waste Ink Tube

- When inserting the Waste Ink Tube into the Waste Ink Cover, make sure that there is no gap between the Tube Stopper and Waste Ink Cover.

**REASSEMBLY**

■ For SX410/SX210 series:

- Route the Waste Ink Tube through the groove of the Base Frame so that the red line of the Waste Ink Tube faces to the Ink System Unit side.

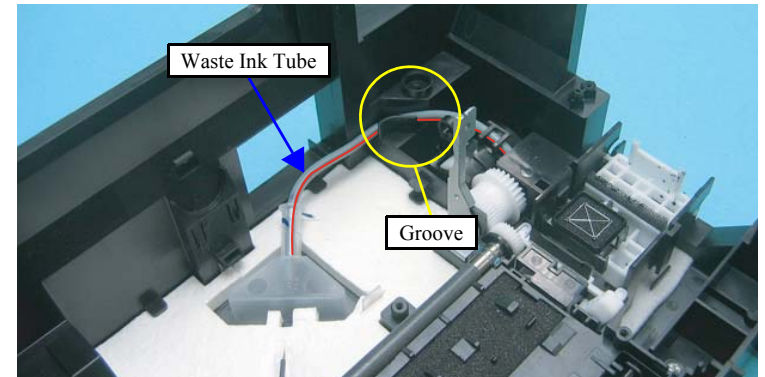

Figure 4-100. Routing the Waste Ink Tube

- Attach the Tube Stopper to the Waste Ink Tube as shown in the figure below, and insert them into the Waste Ink Cover.

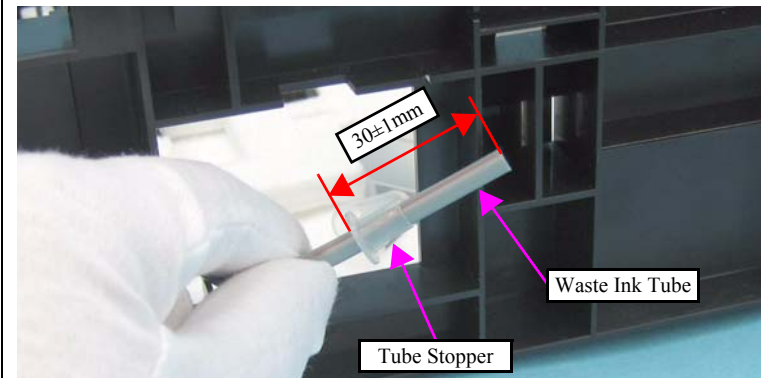

Figure 4-101. Installing the Waste Ink Tube

- When inserting the Waste Ink Tube into the Waste Ink Cover, make sure that there is no gap between the Tube Stopper and Waste Ink Cover.



## 4.5.18 Front Paper Guide

- Parts/Components need to be removed in advance

Document Cover/ASF Cover/Scanner Unit/Panel Unit/Upper Housing/Card Slot Cover/Lower Housing/Main Board Unit/Left Frame/Front Frame/Right Frame/CR Motor/CR Scale/Hopper/Main Frame Assy/ASF Unit/Ink System Unit/Star Wheel Holder Assy/EJ Roller

- Removal procedure

### CAUTION



When removing the Front Paper Guide, be cautious not to damage the ribs on the upper surface of the Front Paper Guide.

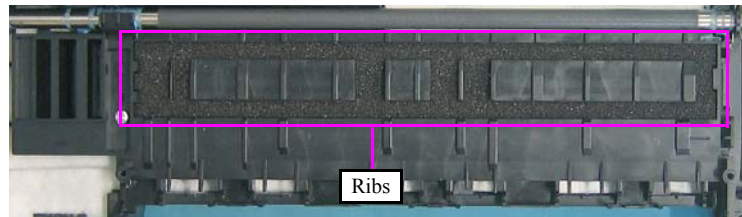

Figure 4-102. Ribs of the Front Paper Guide

1. Remove the screws (x2) that secure the Front Paper Guide.

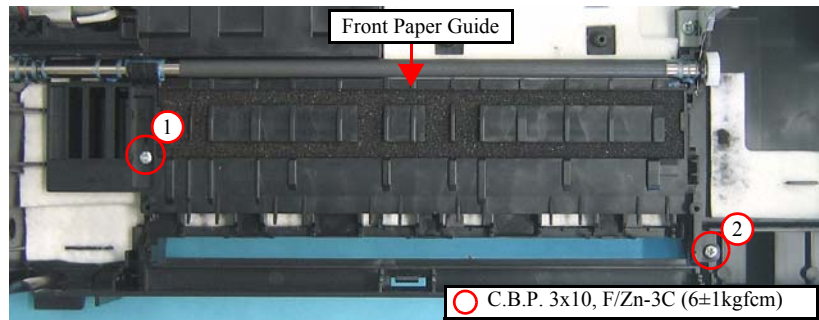

Figure 4-103. Removing the Front Paper Guide (1)

2. Release the hook (x1) of the Front Paper Guide, and remove the Front Paper Guide.

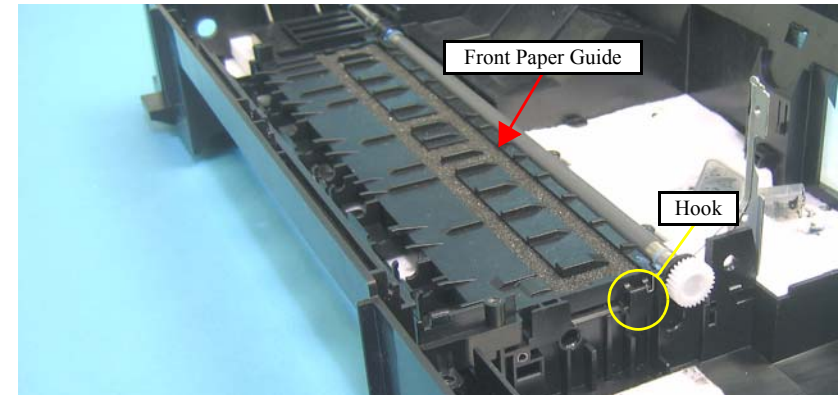

Figure 4-104. Removing the Front Paper Guide (2)

### REASSEMBLY



- When installing the Front Paper Guide, be cautious not to damage the PF Roller.
- NX510 series only: Install the Front Paper Guide so that the Grounding Spring comes outside of the hook of the Front Paper Guide.
- Confirm that the leg of the Pad Front Paper Guide is not caught between the Front Paper Guide and Base Frame.

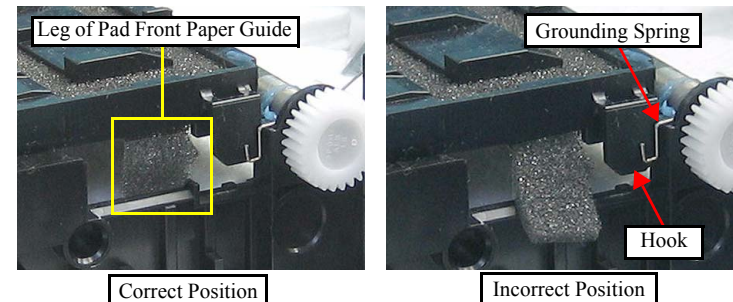

Figure 4-105. Installing the Front Paper Guide

- Tighten the screws in the order given in [Figure 4-103](#).

ADJUSTMENT  
REQUIRED

- Whenever the Front Paper Guide, is removed/replaced, the required adjustments must be carried out.
  - Chapter 5 “ADJUSTMENT” (p.161)
- After replacing the Front Paper Guide, be sure to perform the required lubrication.
  - Chapter 6 “MAINTENANCE” (p.175)

## 4.5.19 PF Roller

- Parts/Components need to be removed in advance

Document Cover/ASF Cover/Scanner Unit/Panel Unit/Upper Housing/Card Slot Cover/Lower Housing/Main Board Unit/Left Frame/Front Frame/Right Frame/CR Motor/CR Scale/Hopper/Main Frame Assy/ASF Unit/Ink System Unit/Star Wheel Holder Assy/EJ Roller/Front Paper Guide/PF Encoder Sensor/PF Scale

- Removal procedure

CAUTION



When removing the PF Roller, be cautious not to touch or damage the coated surface of the PF Roller.

1. Remove the Spur Gear 13.5 from the PF Roller with a flathead precision screwdriver or a similar tool.

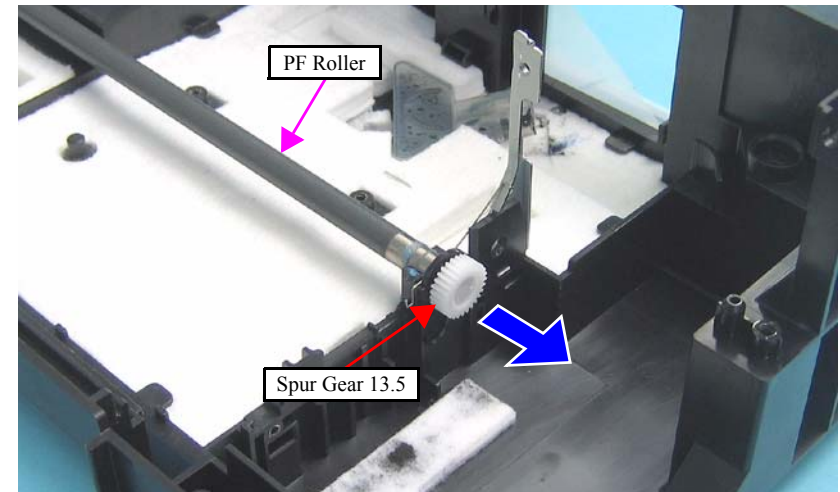

Figure 4-106. Removing the PF Roller (1)

- Release the PF Roller from the cutout of the Base Frame (Step 2-1), and remove the PF Roller (Step 2-2)

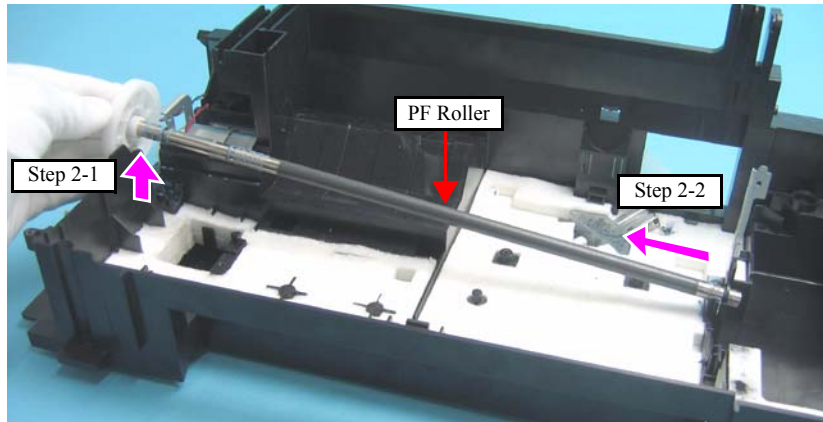

Figure 4-107. Removing the PF Roller (2)



**NX510 series only:**  
Install the PF Roller after attaching the Grounding Spring as shown in the figure below.

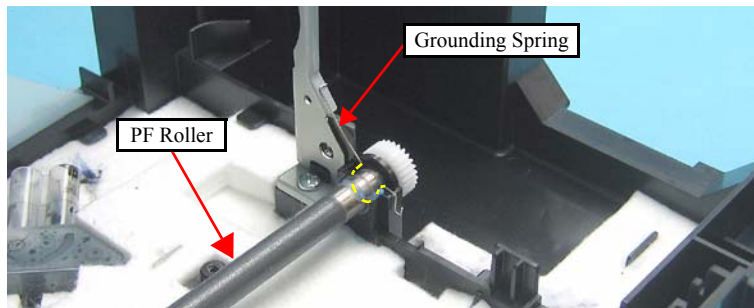

Figure 4-108. Installing the PF Roller



Whenever the PF Roller, is removed/replaced, the required adjustments must be carried out.

- Chapter 5 “ADJUSTMENT” (p.161)
- After replacing the Front Paper Guide, be sure to perform the required lubrication.
- Chapter 6 “MAINTENANCE” (p.175)

## 4.5.20 Waste Ink Pads

- Parts/Components need to be removed in advance

Document Cover/ASF Cover/Scanner Unit/Panel Unit/Upper Housing/Card Slot Cover/Lower Housing/Main Board Unit/Left Frame/Front Frame/Right Frame/CR Motor/CR Scale/Hopper/Main Frame Assy/ASF Unit/Ink System Unit/Star Wheel Holder Assy/EJ Roller/Front Paper Guide/PF Encoder Sensor/PF Scale/PF Roller

- Removal procedure



**In this section, some disassembling procedures differ between models. Skip the model-specified steps if not applied to your model.**

- Remove the Waste Ink Pads shown below from the A, B, and C sections of the Base Frame.

Waste Ink Pads	NX510 series	SX410/SX210 series
Section A	2 pieces	2 pieces
Section B	3 pieces	2 pieces
Section C	1 piece	1 piece

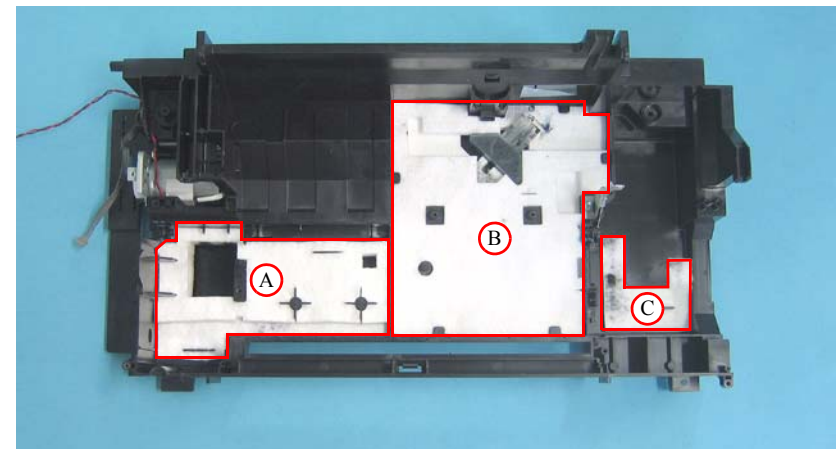

Figure 4-109. Removing the Waste Ink Pads

2. Remove the Waste Ink Cover and the Diffusion Sheet.

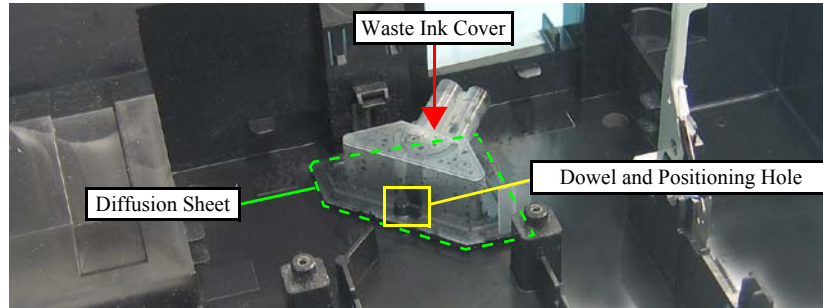

Figure 4-110. Removing the Waste Ink Cover and Diffusion Sheet



- When installing the Waste Ink Cover, be sure to align the dowel (x1) of the Base Frame with the positioning hole (x1) of the Waste Ink Cover as shown in [Figure 4-110](#). Make sure to confirm the cover is properly secured on the Diffusion Sheet without any gap.
- When installing the Diffusion Sheet, Waste Ink Cover, and the Waste Ink Pads on section B, attach them in the order given in the figure below.
  - NX510 series: see [Figure 4-111](#).
  - SX410 series: see [Figure 4-112](#).
  - SX210 series: see [Figure 4-113](#).

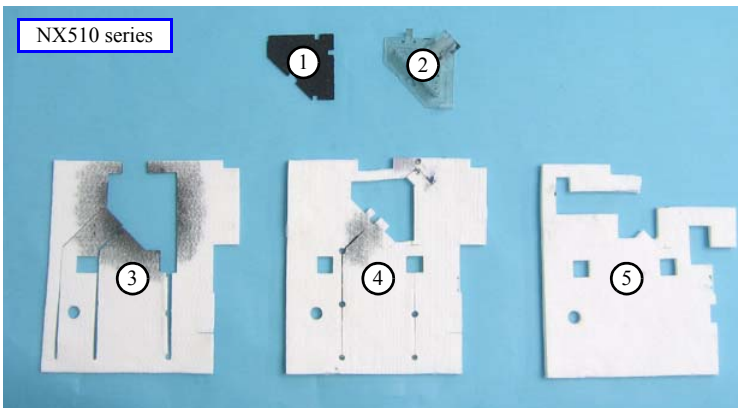

Figure 4-111. Installing the Waste Ink Pads (NX510 series)

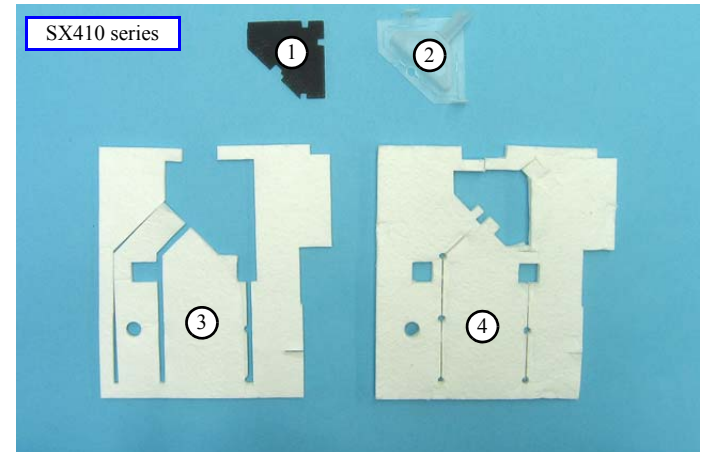

Figure 4-112. Installing the Waste Ink Pads (SX410 series)

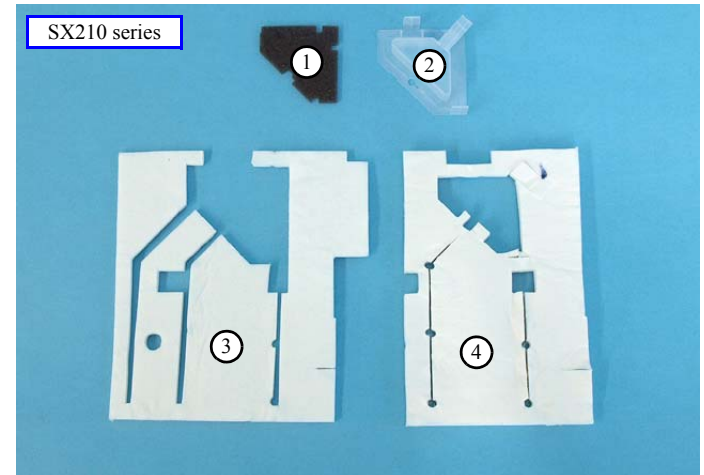

Figure 4-113. Installing the Waste Ink Pads (SX210 series)



Whenever the Waste Ink Pads is removed/replaced, the required adjustments must be carried out.

- [Chapter 5 “ADJUSTMENT” \(p.161\)](#)

## 4.6 Disassembling the Scanner Unit

### 4.6.1 Upper/Front Scanner Housing

- Parts/Components need to be removed in advance

Document Cover/ASF Cover/Scanner Unit

- Removal procedure
  - Upper Scanner Housing

#### CAUTION



- Following work should be performed in a room where there is a little dust. A clean room or a clean bench would be preferable.
- Do not scratch the Rod Lens Array when removing the CIS Assy.

#### CHECK POINT



If the Hinge R or the Driven Pulley comes off during disassembling, reassemble them as shown in the figure below.

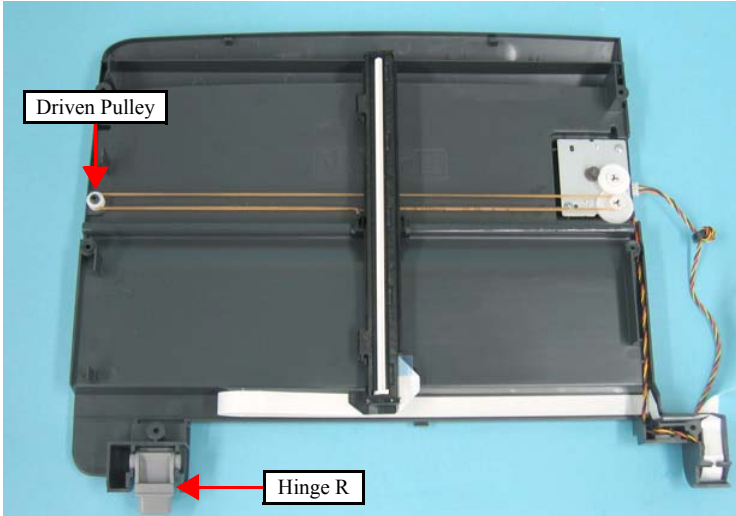

Figure 4-114. Installing the Hinge R or the Driven Pulley

1. Remove the screws (x6) that secure the Upper Scanner Housing, and release the hooks (x2) inside the Lower Scanner Housing, then remove the Upper Scanner Housing by lifting the front of it.

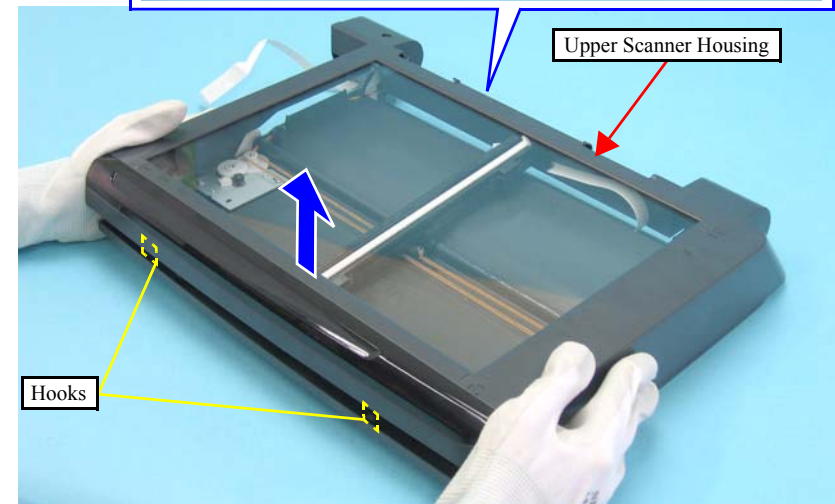

Figure 4-115. Removing the Upper Scanner Housing



When installing the Upper Scanner Housing, attach the Hinge R to the place as shown in [Figure 4-114](#).

### ■ Front Scanner Housing

1. Remove the Upper Scanner Housing toward you. (p141)
2. Release the hooks at the bottom of the Upper Scanner Housing, and remove the Front Scanner Housing.

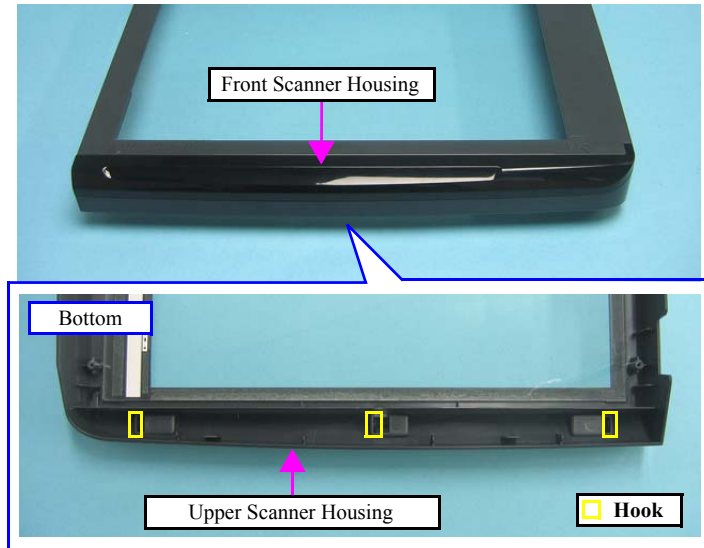

Figure 4-116. Removing the Front Scanner Housing

### 4.6.2 Scanner Carriage Unit

- Parts/Components need to be removed in advance

Document Cover/ASF Cover/Scanner Unit/Upper Scanner Housing

- Removal procedure



**Do not scratch the Rod Lens Array when removing the Scanner Carriage Unit.**

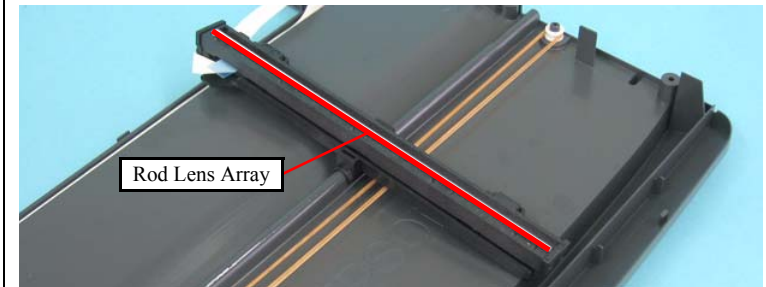

Figure 4-117. Handling the Scanner Carriage Unit

1. Move the Scanner Carriage Unit to the center.

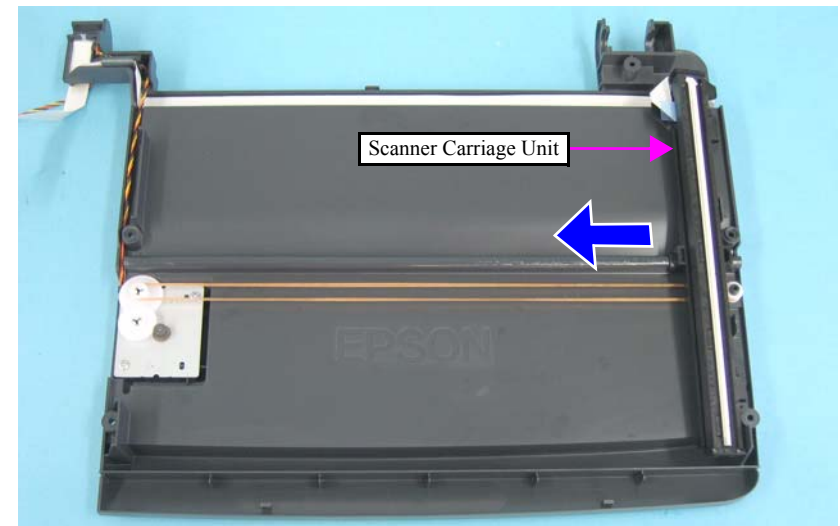

Figure 4-118. Moving the Scanner Carriage Unit

**CAUTION**

Take extra care not to contaminate the Scanner Timing Belt with grease on the rail of the Lower Scanner Housing.

2. Release the Pulley from the Lower Scanner Housing, and release the Scanner Timing Belt from the Combination Gear 25.2, 9.0553 and the Driven Pulley.

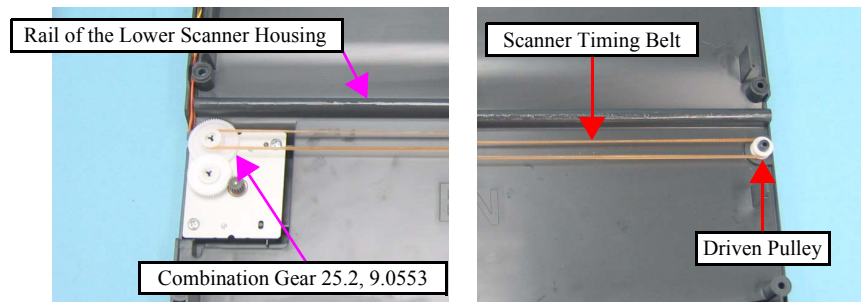

Figure 4-119. Removing the Scanner Carriage Unit (1)

**CAUTION**

Be careful about the double-sided tape fixing the Scanner Carriage FFC.

3. Release the Scanner Carriage FFC from the Scanner Carriage Unit, and remove the Scanner Carriage Unit together with the Scanner Timing Belt.

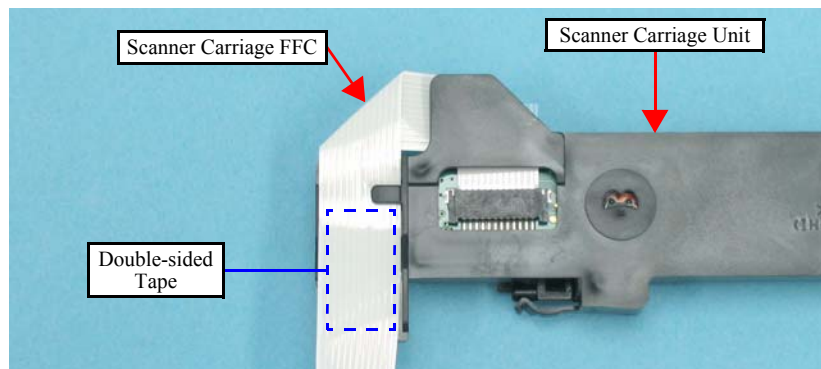

Figure 4-120. Removing the Scanner Carriage Unit (2)

4. Release the tabs (x2) from the hooks (x2) on the Scanner CR Holder and remove the CIS Unit.

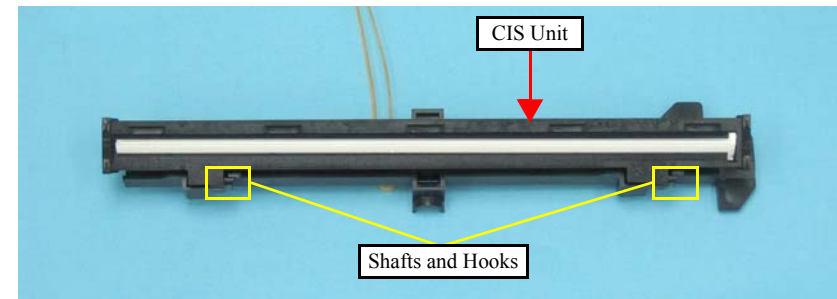

Figure 4-121. Removing the CIS Unit

5. Remove the CIS Springs (x2) from the Scanner CR Holder.

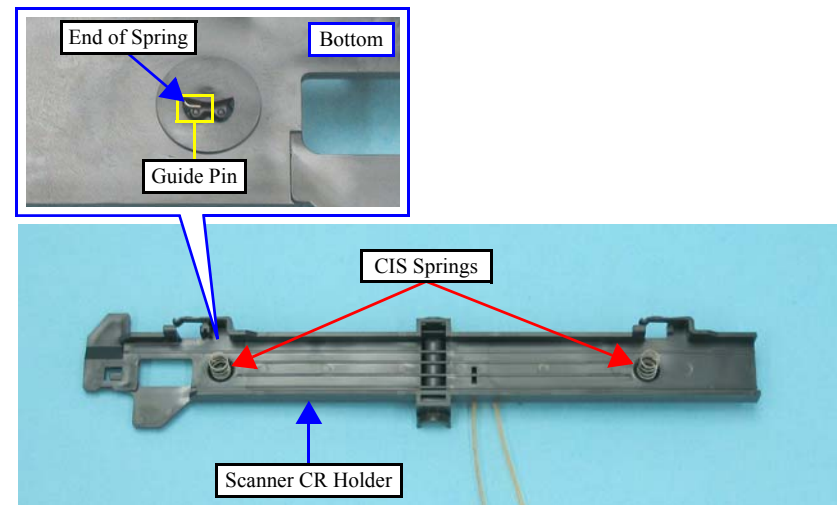

Figure 4-122. Removing the CIS Springs

6. Remove the Belt Clamp that secures the Timing Belt.
7. Remove the Scanner Timing Belt together with the Torsion Spring from the Scanner CR Holder.

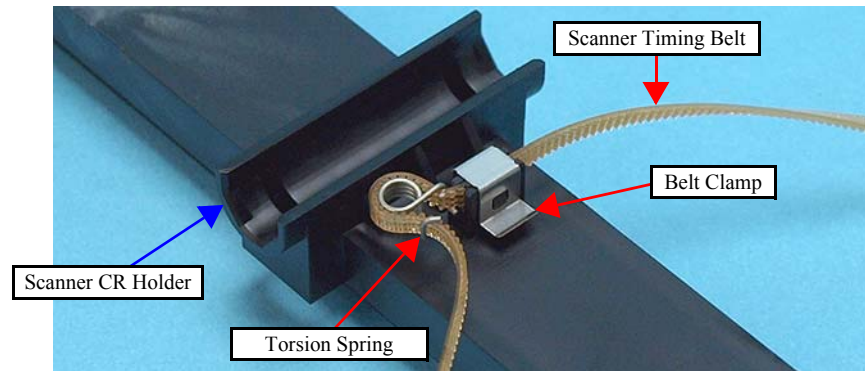

Figure 4-123. Removing the Scanner Timing Belt and Torsion Spring



- When installing the Scanner Timing Belt, attach the Torsion Spring as shown in [Figure 4-123](#).
- When installing the CIS Springs (x2), attach each end to their positioning tabs (x1 each) of the Scanner CR Holder as shown in [Figure 4-122](#).
- When replacing the CIS Unit, be sure to replace the spacers on both ends. Check the label on the CIS Unit and select the corresponding Spacers as shown below.
  - Label A: cis, A17 Spacer
  - Label B: cis, B19 Spacer
  - Label C: cis, C21 Spacer

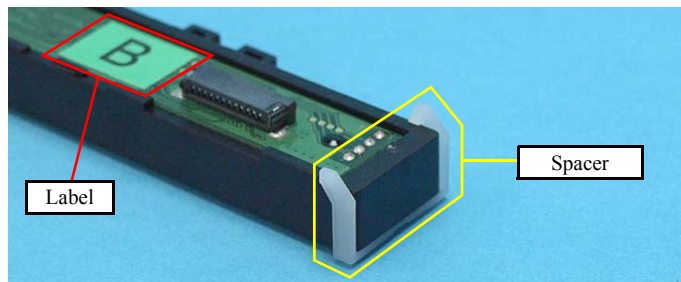

Figure 4-124. Replacing the Spacers

### 4.6.3 Scanner Motor Unit

- Parts/Components need to be removed in advance

Document Cover/ASF Cover/Scanner Unit/Upper Scanner Housing

- Removal procedure

1. Move the Scanner Carriage Unit to the center.  
(Refer to [4.6.2 Scanner Carriage Unit Step1 \(p142\)](#))
2. Release the Driven Pulley from the Lower Scanner Housing, and release the Scanner Timing Belt from the Combination Gear 25.2, 9.0553 and the Driven Pulley. (Refer to [4.6.2 Scanner Carriage Unit Step2 \(p143\)](#))
3. Pull out the ferrite core through the opening (1), and release the Scanner Motor cable from the hooks of the Lower Scanner Housing.
4. Remove the screws (x2) that secure the Scanner Motor Unit and remove the Scanner Motor Unit.

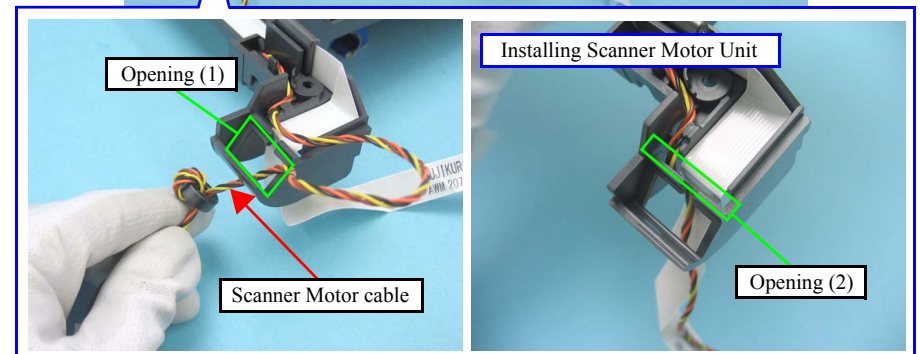
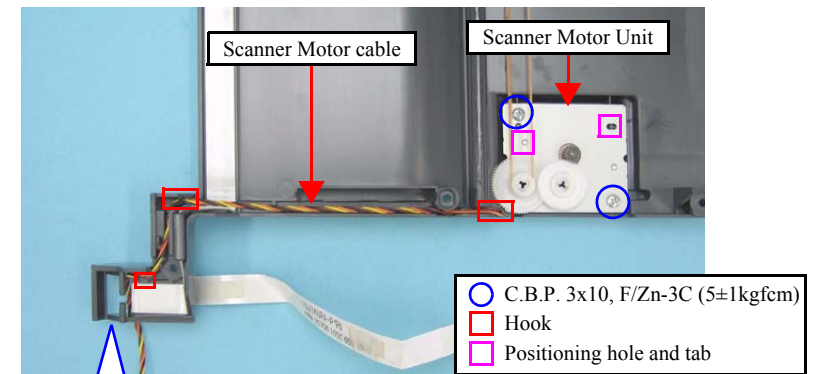

Figure 4-125. Removing the Scanner Motor Unit





- When installing the Scanner Motor Unit, align the positioning holes (x2) of the Scanner Motor Unit with their positioning tabs (x2) of the Lower Scanner Housing as shown in [Figure 4-125](#).
- When routing the Scanner Motor cable, place the ferrite core in the opening (1) after leading the Scanner Motor cable through the opening (2) as shown in [Figure 4-125](#).

## 4.7 Differences in Disassembling/Reassembling SX410 series

### 4.7.1 Main Board Unit (SX410 series)

CHECK  
POINT



See the following because the disassembling/reassembling procedures of the Main Board Unit for NX510/SX210 series differ from those of SX410 series.

- NX510 series: “4.4.1 Main Board Unit” (p105)
- SX210 series: “4.8.1 Main Board Unit (SX210 series)” (p154)

- Parts/Components need to be removed in advance

Document Cover/ASF Cover/Scanner Unit/Panel Unit/Upper Housing/Card Slot Cover/Lower Housing

- Removal procedure

1. Remove the screws (x2) that secure the Panel Grounding Plate to the Main Board Unit, and remove the Panel Grounding Plate.

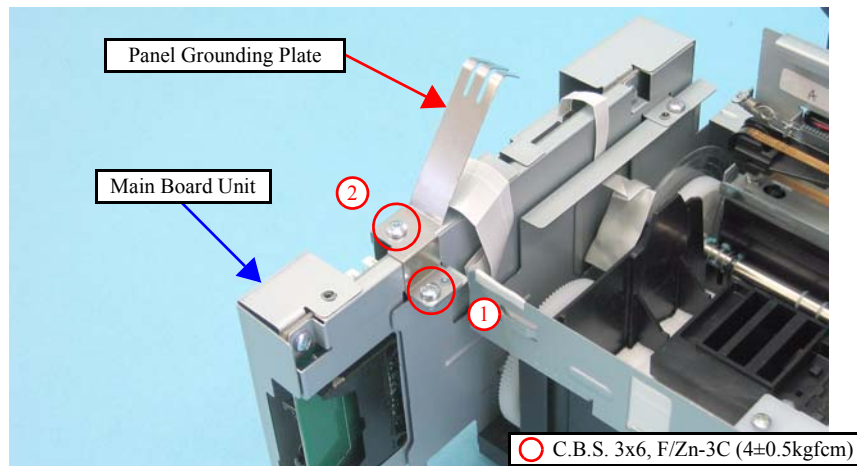

Figure 4-126. Removing the Panel Grounding Plate

2. Disconnect the following connectors (x4) and FFCs (x5) from the Main Board.

CN No.	Cable	CN No.	Cable
CN1	Power Supply Unit cable	CN9	PF Motor cable
CN5	Head FFC	CN11	PF Encoder FFC
CN6	Head FFC	CN12	Panel FFC
CN7	Head FFC	CN24	PE Sensor cable
CN8	CR Motor cable		

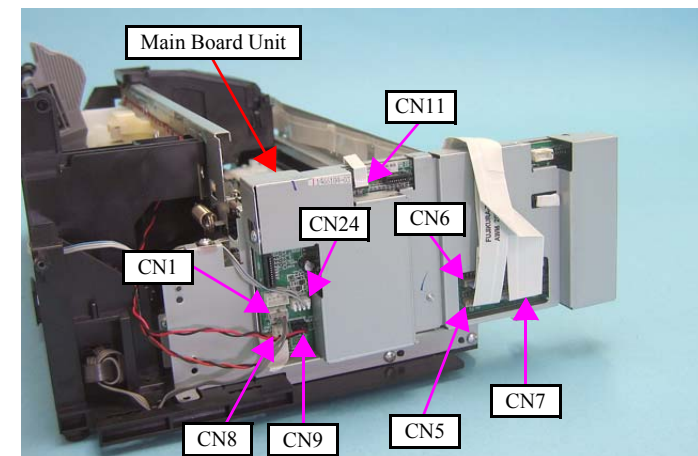

Figure 4-127. Removing the Main Board Unit (1)

- Remove the screw (x1) that secures the Main Board Unit, and remove the Main Board Unit.

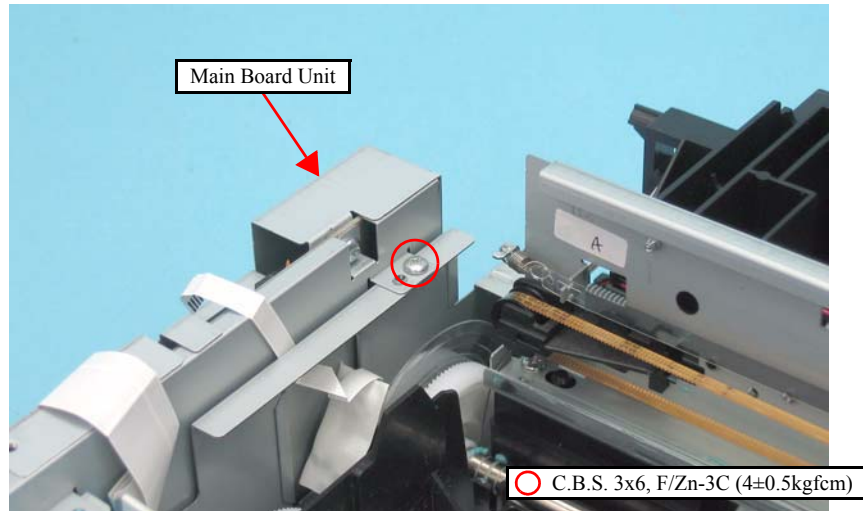

Figure 4-128. Removing the Main Board Unit (2)



- When installing the Main Board Unit, insert its hooks (x2) into the cutouts (x2) of the Left Frame.

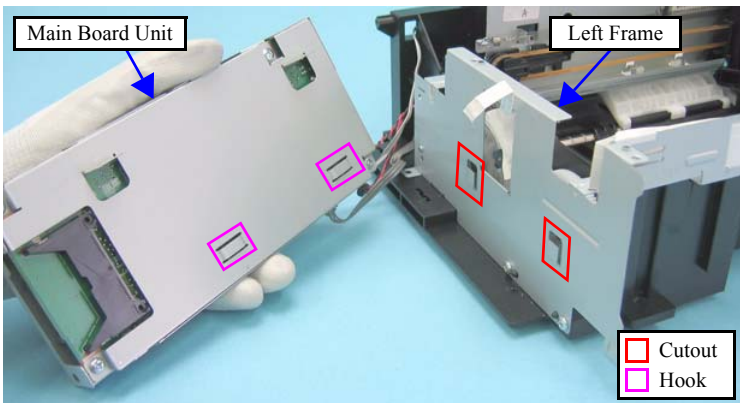

Figure 4-129. Installing the Main Board Unit

- Tighten the screws in the order given in Figure 4-126.

- Disassembling the Main Board Unit

- Remove the Main Board Unit. (p146)
- Peel off the acetate tape.
- Remove the screws (x5) and remove the MB Lower Shield Plate.

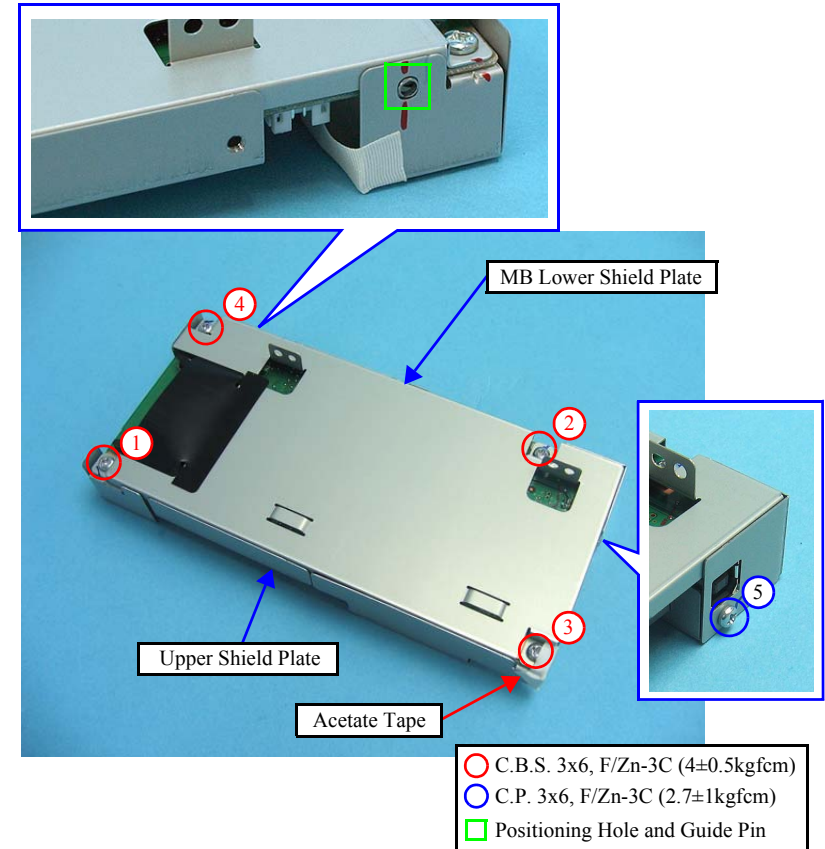

Figure 4-130. Removing the Main Board (1)

4. Remove the screw (x1) that secures the Main Board, and remove the Main Board.

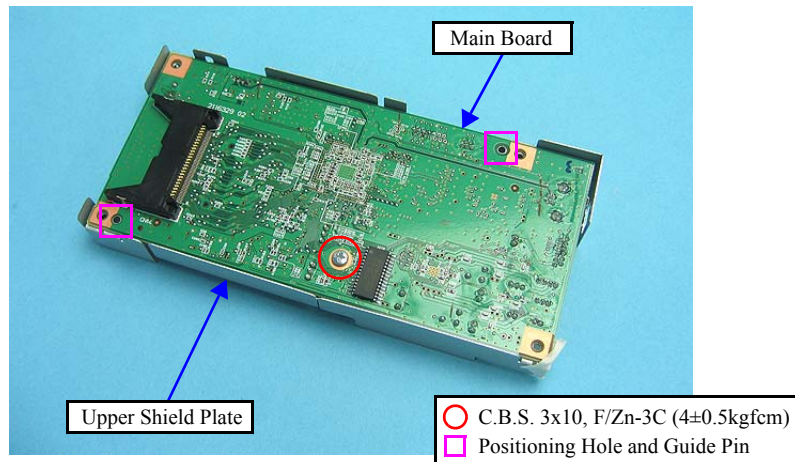

Figure 4-131. Removing the Main Board (2)



When installing the Main Board, pay attention to the following instructions.

- Align the positioning holes of the Upper Shield Plate with the guide pins of the Main Board as shown in [Figure 4-131](#).
- Align the positioning hole of the Main Board with the guide pin of the MB Lower Shield Plate as shown in [Figure 4-130](#).
- When installing the MB Lower Shield Plate, make sure that the Upper Shield Plate is set over the MB Lower Shield Plate as shown in [Figure 4-130](#).



Whenever the Main Board is removed/replaced, the required adjustments must be carried out.

- [Chapter 5 “ADJUSTMENT” \(p.161\)](#)

## 4.7.2 Panel Unit/LCD Unit (SX410 series)

CHECK POINT



See the following because the disassembling/reassembling procedures of the Panel Unit/LCD Unit for NX510/SX210 series differ from those of SX410 series.

- NX510 series:  
“[4.4.2 Panel Unit/LCD Unit](#)” (p108)
- SX210 series:  
“[4.8.2 Panel Unit/LCD Unit \(SX210 series\)](#)” (p155)

- Parts/Components need to be removed in advance: None
- Removal procedure
  1. Open the Scanner Unit
  2. Raise the LCD Unit.

CAUTION



Do not lift the Panel Unit too fast, since the Panel FFC is connected to it.

3. Lifting the front of the Panel Unit, and release the tabs of it.
4. Slide the Panel Unit in the direction of the arrow, and release the hooks of it from the Upper Housing.

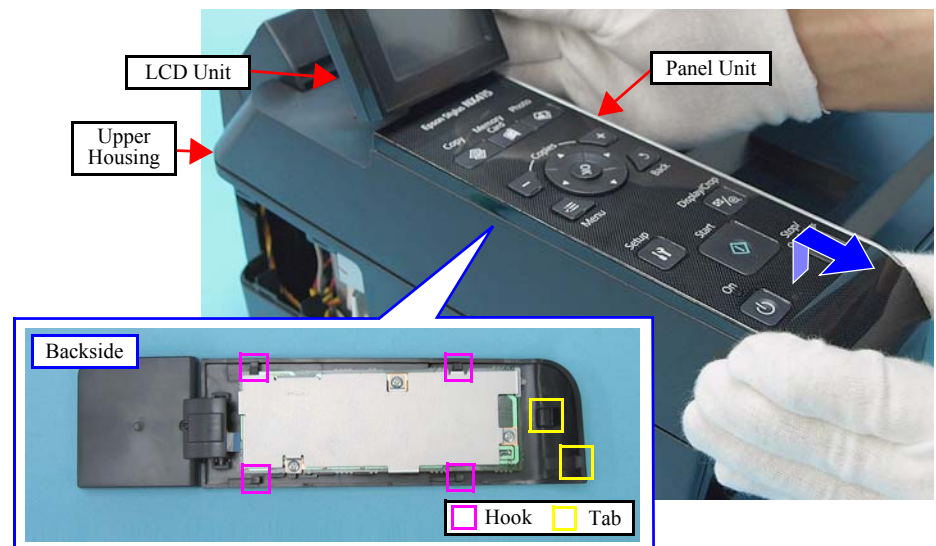
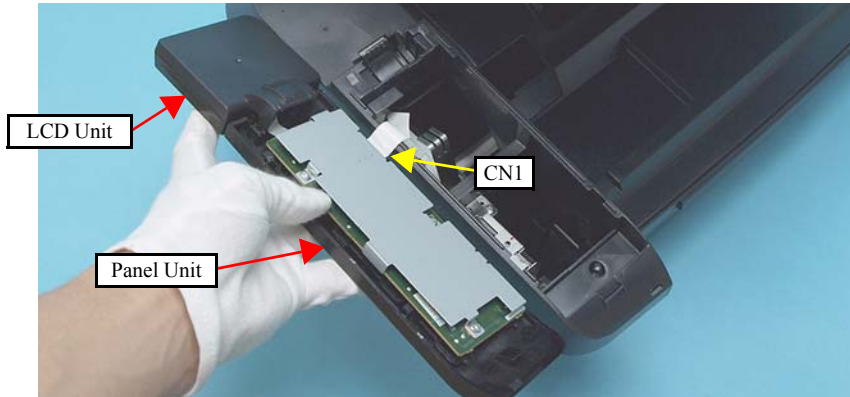

Figure 4-132. Removing the Panel Unit and LCD Unit (1)

**CHECK  
POINT**

**Be sure to disconnect the Panel FFC from the connector on the Panel Board.**

5. Disconnect the Panel FFC from the connector (CN1) of the Panel Board, and remove the Panel Unit together with the LCD Unit.



**Figure 4-133. Removing the Panel Unit and LCD Unit (2)**

6. Disconnect the LCD FFC from the connector (CN2) of the Panel Unit.
7. Release the dowels (x2) that secure the LCD Unit, and separate the LCD Unit from the Panel Unit.

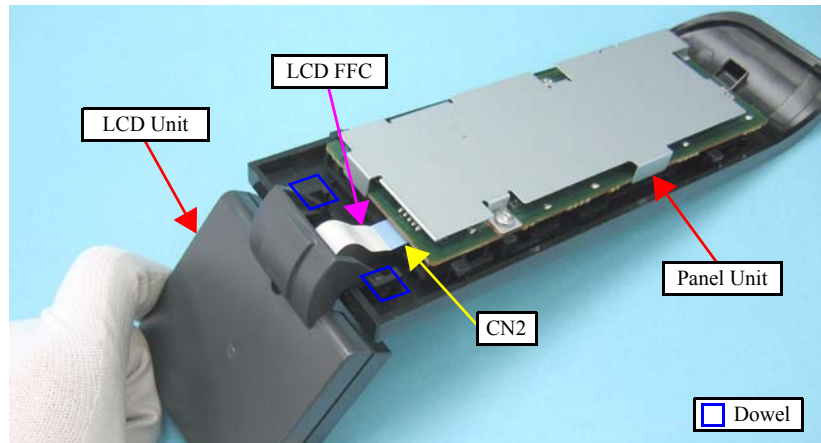

**Figure 4-134. Removing the Panel Unit and LCD Unit (3)**

8. Remove the screws (x3) that secure the Panel Board and Panel Board Frame, and remove the Panel Board together with the Panel Board Frame.

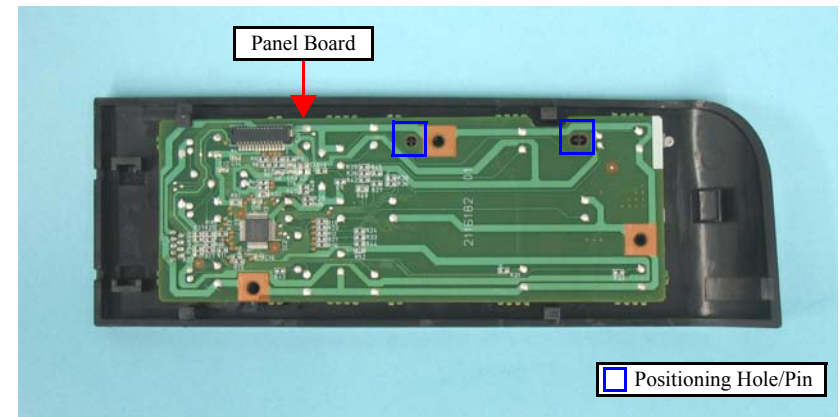
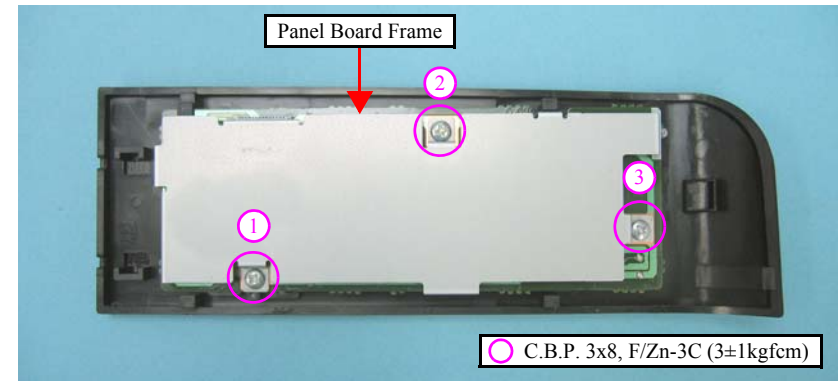

**Figure 4-135. Removing the Panel Board**

9. Remove each switch button from the Panel Cover.

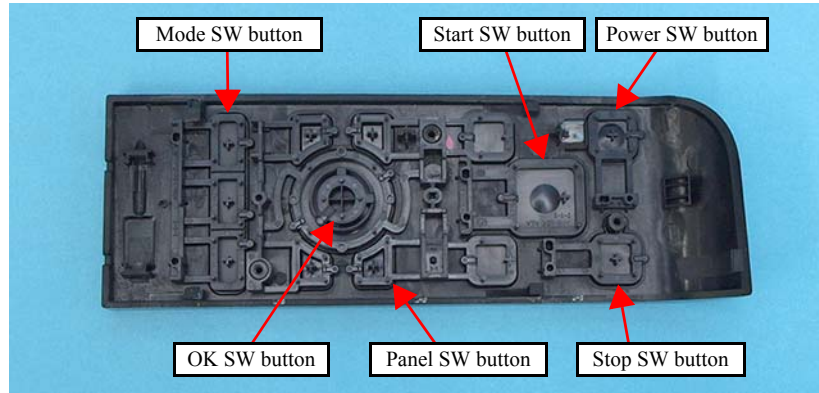

Figure 4-136. Removing the Switch button



- When installing the Panel Board, align the positioning holes of the Panel Board with their positioning pins of the Panel Housing as shown in [Figure 4-135](#).
- Tighten the screws in the order given in [Figure 4-135](#).
- When installing the Panel Unit, attach it without any gap with the Upper Housing. (See [Figure 4-30](#).)

### 4.7.3 Printhead (SX410 series)



See the following because the disassembling/reassembling procedures of the Printhead for NX510/SX210 series differ from those of SX410 series.

- NX510 series:  
“4.5.1 Printhead” (p113)
- SX210 series:  
“4.8.3 Printhead (SX210 series)” (p158)

- Parts/Components need to be removed in advance  
Document Cover/ASF Cover/Scanner Unit/Panel Unit/Upper Housing
- Removal procedure
  1. Perform [Step 1](#) to [Step 8](#) of “4.5.1 Printhead (p113)”.
  2. Remove the Head Cable Inner Cover according to the following procedure.
    - 2-1. Release the rib A (x1) of the Head Cable Inner Cover from the cutout (x1) of the CR Unit.
    - 2-2. Release the tab (x1) of the Head Cable Inner Cover from the groove (x1) of the CR Unit.
    - 2-3. Release the rib B of the Head Cable Inner Cover from the cutout of the CR Unit.

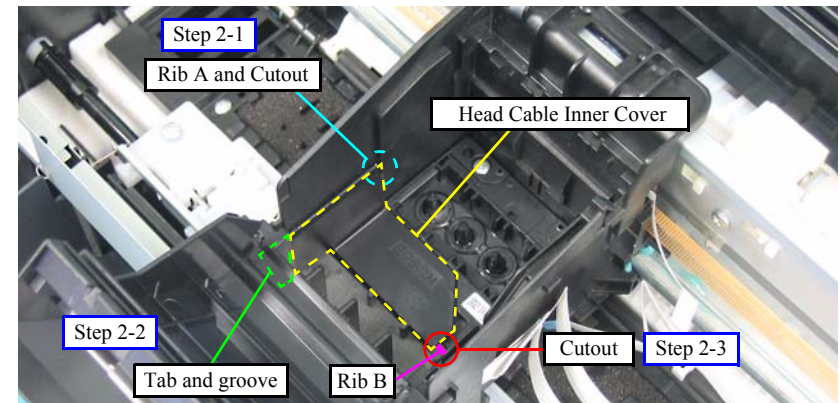

Figure 4-137. Removing the Sub FFC Guide

**CAUTION**

Do not touch or damage the nozzles or the ink supply needles of the Printhead.

- Remove the screws (x3) that secure the Printhead, and lift the Printhead with longnose pliers.

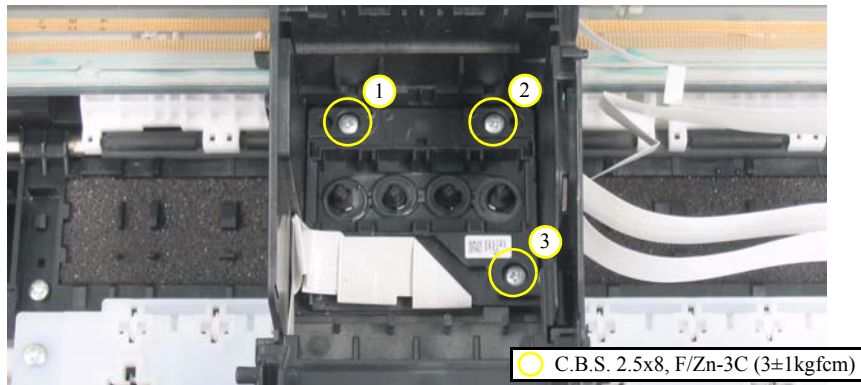

Figure 4-138. Removing the Printhead (1)

- Disconnect the Head FFC from the connectors (x2) of the Printhead, and remove the Printhead.

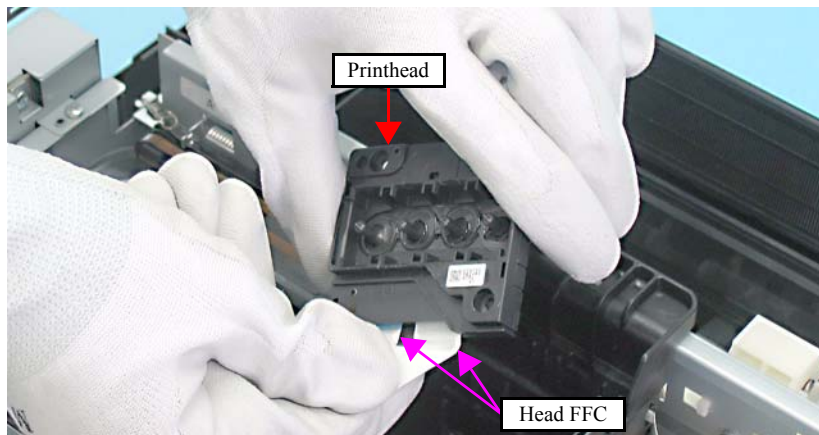

Figure 4-139. Removing the Printhead (2)

**REASSEMBLY**

- Tighten the screws in the order given in [Figure 4-138](#).
- Insert the Holder Board Assy vertically into the CR Unit so as not to put the Holder Board Assy on the rib of the Printhead.

**ADJUSTMENT  
REQUIRED**

Whenever the Printhead is removed/replaced, the required adjustments must be carried out.

- [Chapter 5 “ADJUSTMENT” \(p.161\)](#)

## 4.7.4 Removing the Printer Mechanism (Lower Housing) (SX410 series)

CHECK  
POINT



See the following because the disassembling/reassembling procedures of the Printer Mechanism for NX510/SX210 series differ from those of SX410 series.

- NX510 series:  
“4.5.4 Removing the Printer Mechanism (Lower Housing)”  
(p117)
- SX210 series:  
“4.8.4 Removing the Printer Mechanism (Lower Housing)  
(SX210 series)” (p160)

- Parts/Components need to be removed in advance  
Document Cover/ASF Cover/Scanner Unit/Panel Unit/Upper Housing/Card Slot Cover
- Removal procedure
  1. Disconnect the Interface Connector Cable (CN3) and Panel FFC (CN12) from the Main Board.
  2. Release the Interface Connector Cable from the hook of the Main Board Unit.

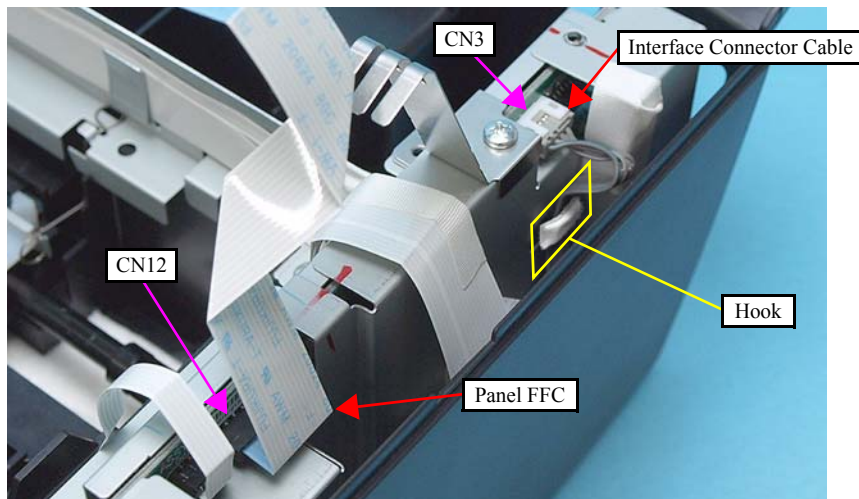

Figure 4-140. Removing the Printer Mechanism (1)

3. Release the hook that secures the Rear Cover and remove the Rear Cover. (See Figure 4-48.)



When lifting the Printer Mechanism, be sure to hold the positions specified in the figure below to prevent the Main Frame from being deformed. (See Figure 4-49.)

4. Remove the screws (x5) that secure the Printer Mechanism, and remove the Printer Mechanism.

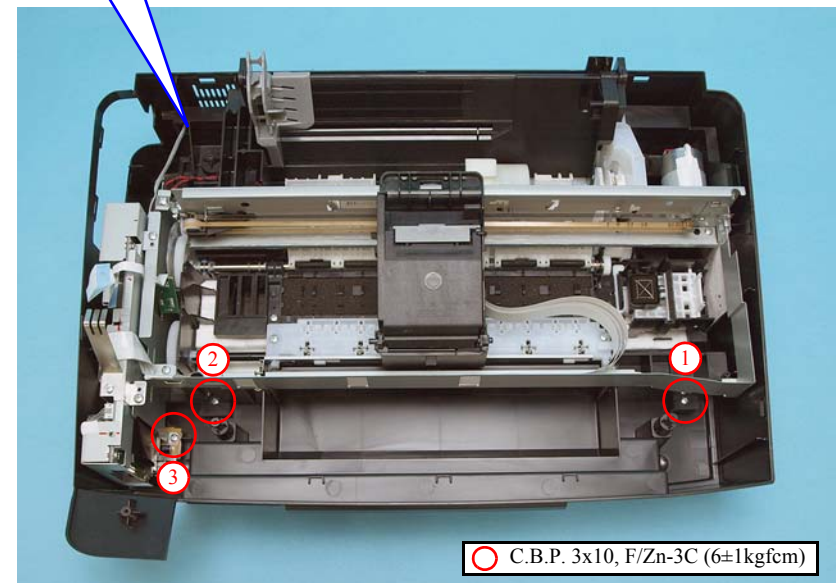
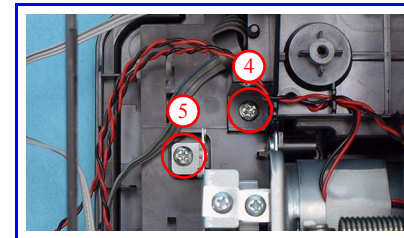

Figure 4-141. Removing the Printer Mechanism (2)



**REASSEMBLY**

- Before installing the Printer Mechanism, hang the Interface Connector Cable on the Lower Housing so as not to damage the cable with the Printer Mechanism.

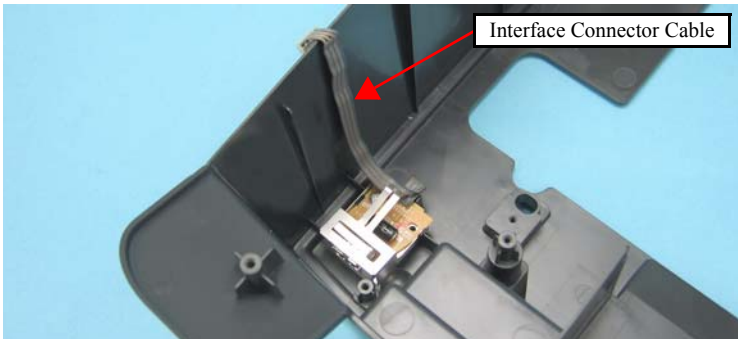

Figure 4-142. Routing the Interface Connector Cable

- Tighten the screws in the order given in [Figure 4-141](#).

## 4.8 Differences in Disassembling/Reassembling SX210 series

### 4.8.1 Main Board Unit (SX210 series)



See the following because the disassembling/reassembling procedures of the Main Board Unit for NX510/SX410 series differ from those of SX210 series.

- NX510 series: “4.4.1 Main Board Unit” (p105)
- SX410 series: “4.7.1 Main Board Unit (SX410 series)” (p146)

- Parts/Components need to be removed in advance  
Document Cover/ASF Cover/Scanner Unit/Panel Unit/Upper Housing/Card Slot Cover/Lower Housing
- Removal procedure
  1. Disconnect the following connectors (x4) and FFCs (x3) from the Main Board.

CN No.	Cable	CN No.	Cable
CN1	Power Supply Unit cable	CN9	PF Motor cable
CN5	Head FFC	CN11	PF Encoder FFC
CN6	Head FFC	CN24	PE Sensor cable
CN8	CR Motor cable		

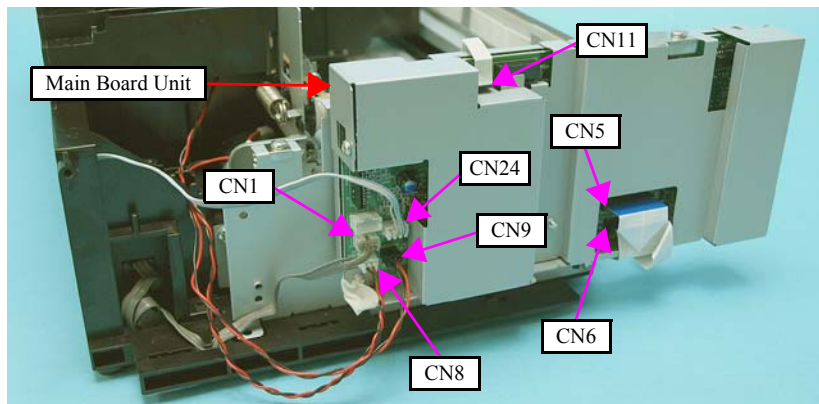

Figure 4-143. Removing the Main Board Unit (1)

2. Remove the screw (x1) that secures the Main Board Unit, and remove the Main Board Unit.

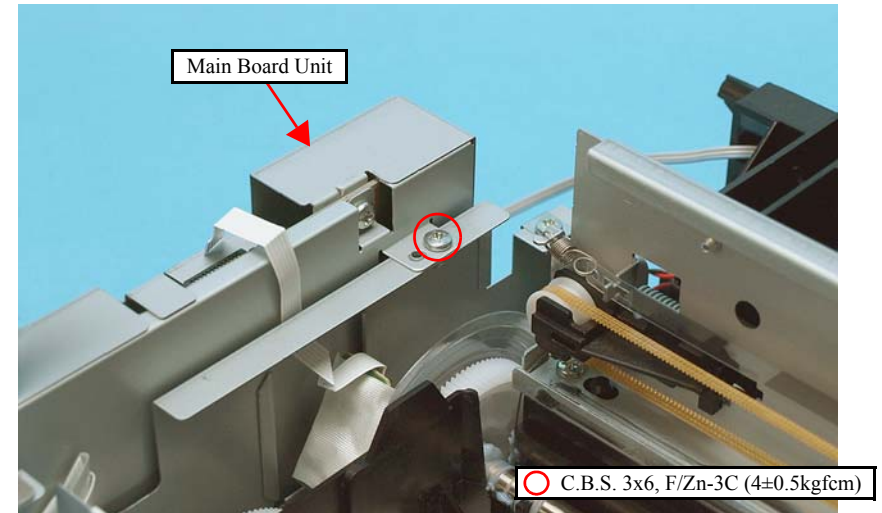

Figure 4-144. Removing the Main Board Unit (2)



- When installing the Main Board Unit, insert its hooks (x2) into the cutouts (x2) of the Left Frame.

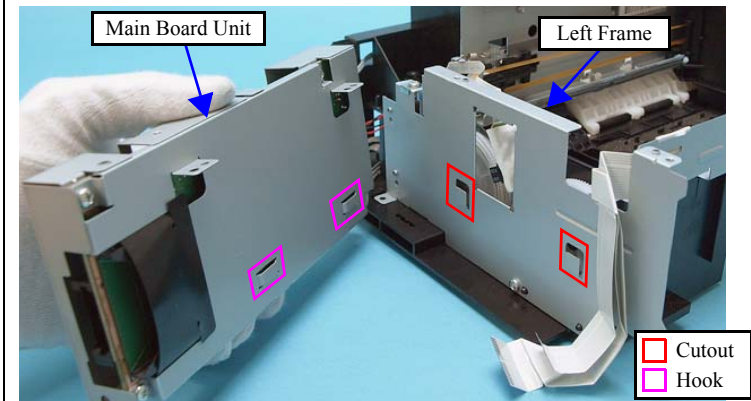

Figure 4-145. Installing the Main Board Unit

- Tighten the screws in the order given in Figure 4-126.

□ Disassembling the Main Board Unit

For the disassembling/reassembling procedures of the Main Board Unit of SX210 series, see [Disassembling the Main Board Unit \(p147\)](#) because they are the same as SX410 series.

## 4.8.2 Panel Unit/LCD Unit (SX210 series)

**CHECK POINT**



See the following because the disassembling/reassembling procedures of the Panel Unit/LCD Unit for NX510/SX410 series differ from those of SX210 series.

- NX510 series:  
“4.4.2 Panel Unit/LCD Unit” (p108)
- SX410 series:  
“4.7.2 Panel Unit/LCD Unit (SX410 series)” (p148)

- Parts/Components need to be removed in advance: None
- Removal procedure
  1. Open the Scanner Unit.

**CAUTION**



Do not pull away the Panel Unit too far, because the Panel FFC and the grounding wire are connected to the backside of the Panel Unit.

2. Lifting the front of the Panel Unit, and release the tabs of it.
3. Slide the Panel Unit in the direction of the arrow, and release the hooks of it from the Upper Housing.

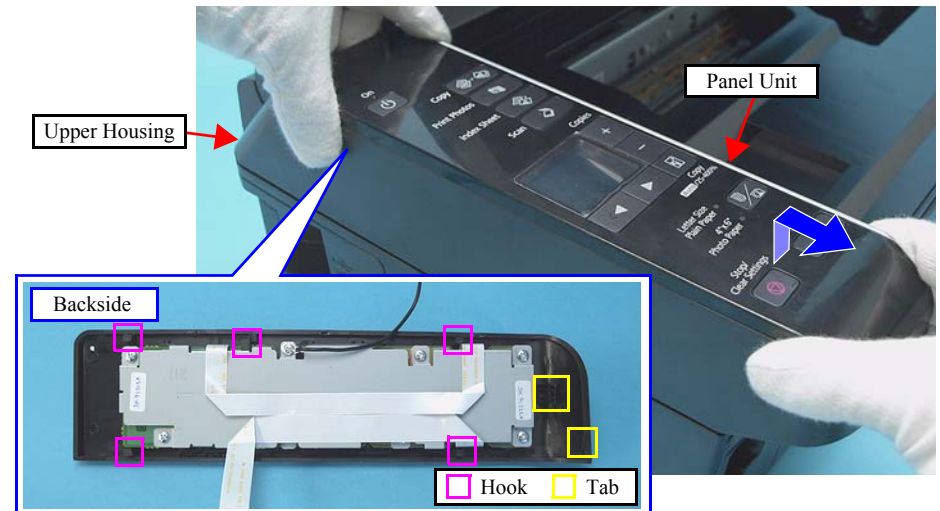
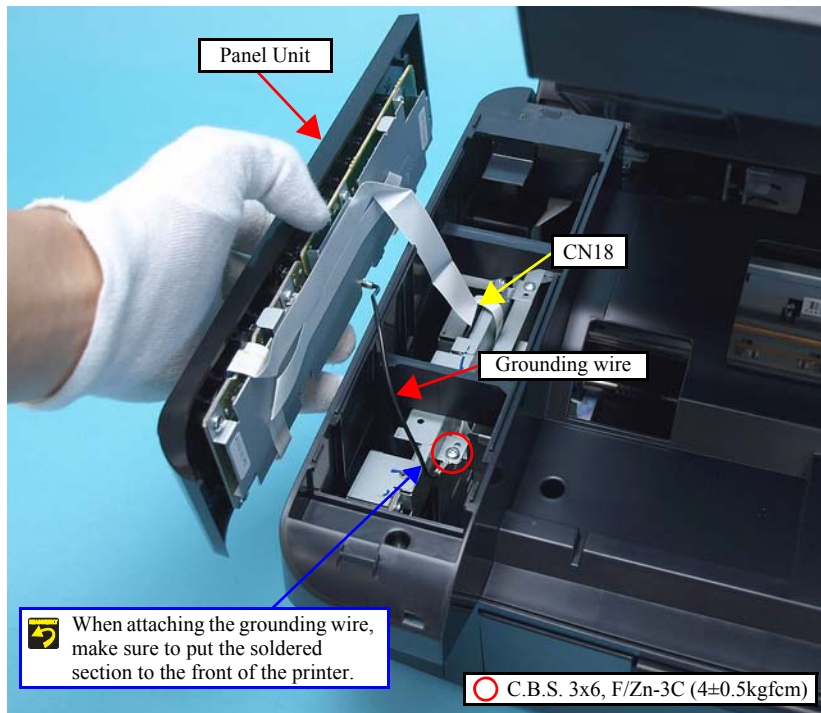

Figure 4-146. Removing the Panel Unit (1)



**Be sure to disconnect the Panel FFC from the connector on the Main Board.**

4. Remove the screw that secures the grounding wire.
5. Disconnect the Panel FFC from the connector (CN18) of the Main Board, and remove the Panel Unit.



**Figure 4-147. Removing the Panel Unit (2)**

6. Peel off the double-sided tape (x1) that secure the Panel FFC, and remove the Panel FFC from the Panel Board Frame.

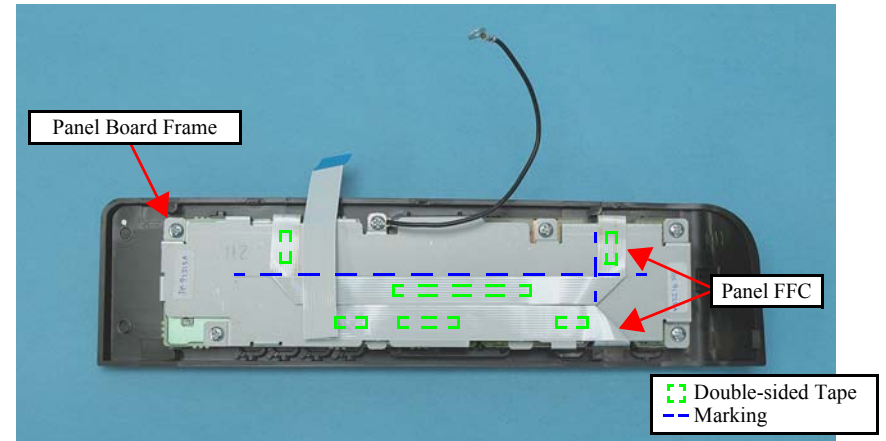

**Figure 4-148. Removing the Panel Board Frame**

7. Remove the screws (x8) that secure the Panel Board and the Panel Board Frame, and remove the Panel Board Frame and the grounding wire.

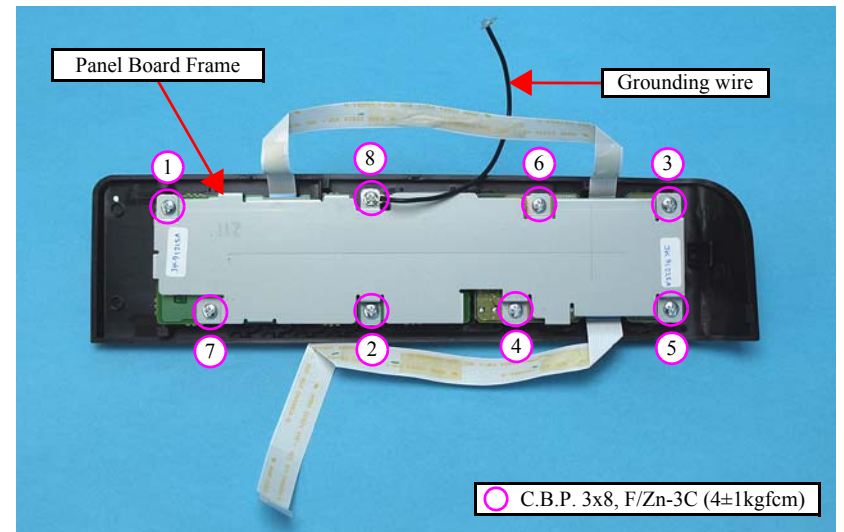

**Figure 4-149. Removing the Panel Board Frame**

8. Unlock the connector (CN2) on the Panel Board B, and disconnect the LCD FFC.
9. Remove the Panel Board A, B from the Panel Housing.
10. Remove the Panel FFCs (x2) from the connectors (CN1, CN3) on the Panel Board B, and the connector (CN1) on the Panel Board A.

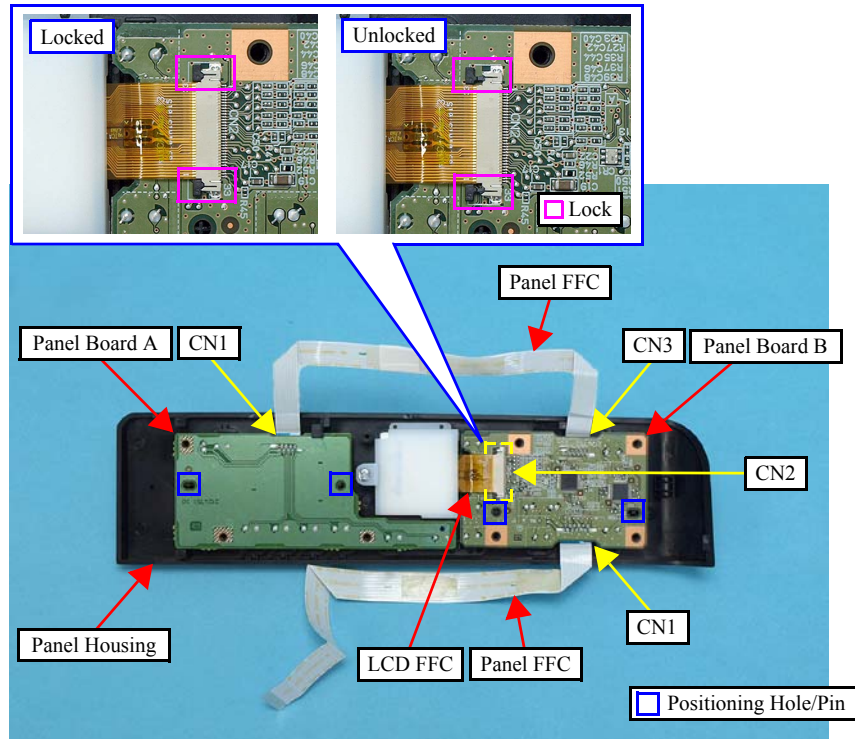

Figure 4-150. Removing the Panel Board

11. Remove the screw (x1) that secures the LCD Unit, and remove it from the Panel Housing.

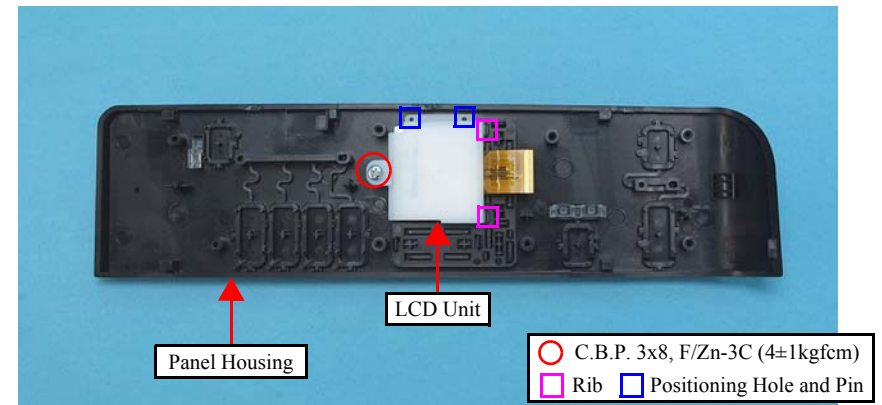

Figure 4-151. Removing the LCD Unit

12. Remove each button from the Panel Housing.

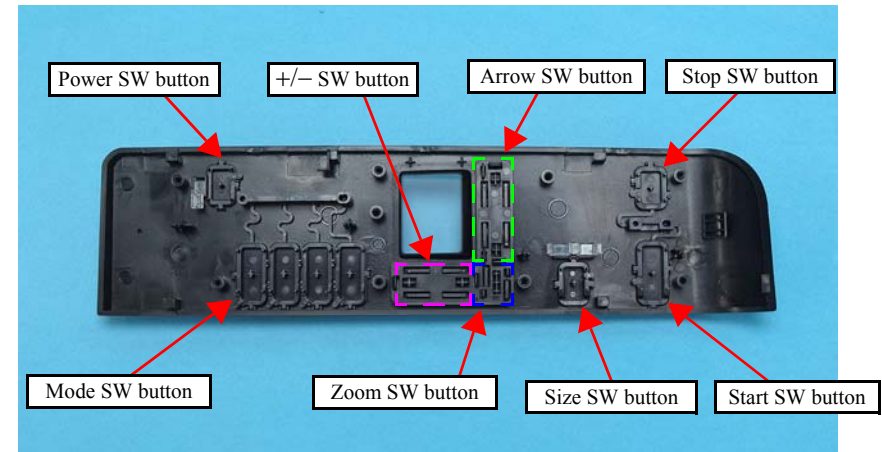

Figure 4-152. Removing the Switch Button



- When installing each button, securely engage the hooks, or align the dowels and the positioning holes correctly. After assembling them, press all the buttons to confirm they sure click. (See [Figure 4-152](#).)
- When installing the LCD Unit, insert the ribs (x2) of LCD Unit into the holes (x2) on the Panel Housing, and attach it while aligning the positioning holes and pins. (See [Figure 4-151](#).)
- When installing the Panel Board A/B, attach them while aligning the positioning holes (x4) and the pins (x4). (See [Figure 4-150](#).)
- When connecting the LCD FFC to the Panel Board B, lock the connector (CN2) securely. (See [Figure 4-150](#).)
- Tighten the screws in the order given in [Figure 4-149](#). As for the screw # 8, secure the grounding wire together.
- When connecting the Panel FFCs (x2), align them with the marking on Panel Board Frame, and secure them with double-sided tape to the locations shown in [Figure 4-148](#)
- When attaching the grounding wire, make sure to put the soldered section to the front of the printer, and secure it with the screw. (See [Figure 4-147](#).)
- When installing the Panel Unit, attach it without any gap with the Upper Housing. (See [Figure 4-30](#).)

### 4.8.3 Printhead (SX210 series)



See the following because the disassembling/reassembling procedures of the Printhead for NX510/SX410 series differ from those of SX210 series.

- NX510 series:  
“[4.5.1 Printhead](#)” (p113)
- SX410 series:  
“[4.7.3 Printhead \(SX410 series\)](#)” (p150)

- Parts/Components need to be removed in advance  
Document Cover/ASF Cover/Scanner Unit/Panel Unit/Upper Housing
- Removal procedure
  1. Perform [Step 1](#) to [Step 8](#) of “[4.5.1 Printhead \(p113\)](#)”.
  2. Remove the Head Cable Inner Cover according to the following procedure.
    - 2-1. Release the cutout (x1) of the Head Cable Inner Cover from the hook (x1) of the CR Unit.
    - 2-2. Release the tab (x1) of the Head Cable Inner Cover from the groove (x1) of the CR Unit.
    - 2-3. Release the rib of the Head Cable Inner Cover from the cutout of the CR Unit.

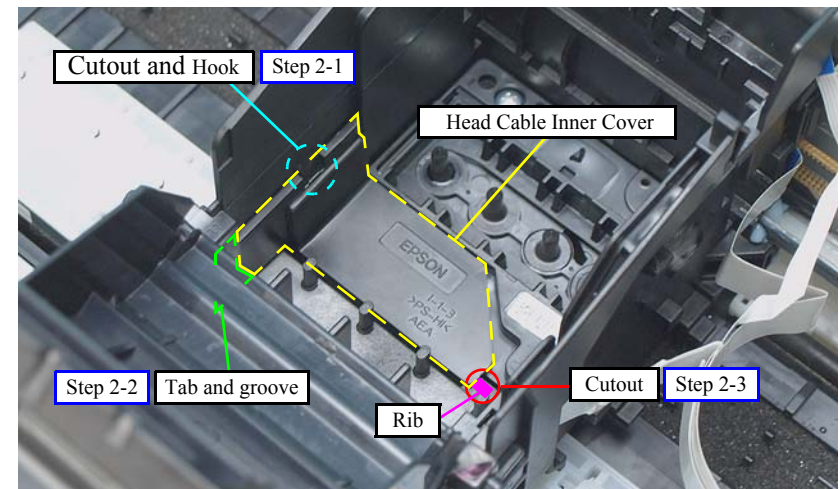

Figure 4-153. Removing the Sub FFC Guide

**CAUTION**

Do not touch or damage the nozzles or the ink supply needles of the Printhead.

- Remove the screws (x3) that secure the Printhead, and lift the Printhead with longnose pliers.

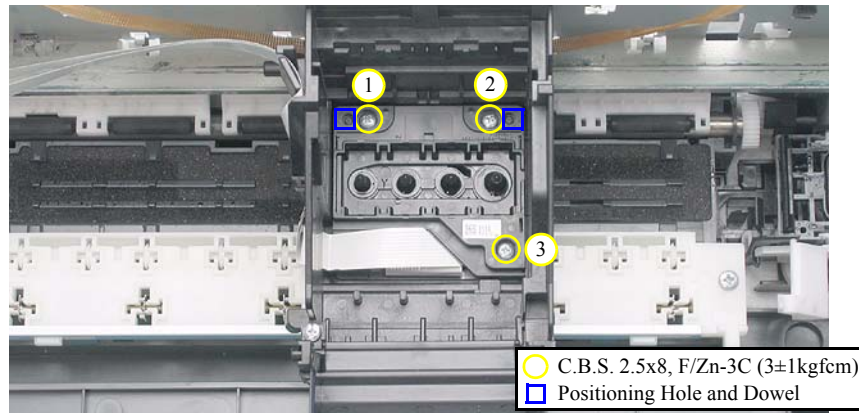

Figure 4-154. Removing the Printhead (1)

- Disconnect the Head FFC from the connectors (x2) of the Printhead, and remove the Printhead.

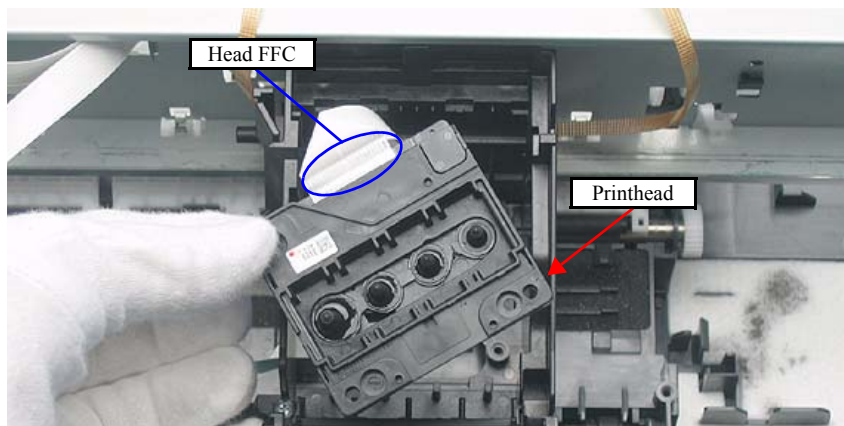

Figure 4-155. Removing the Printhead (2)

**REASSEMBLY**

- When installing the Printhead, attach it while aligning the positioning holes (x2) on the Printhead and dowels (x2) on the CR Unit.
- Tighten the screws in the order given in [Figure 4-138](#).
- Insert the Holder Board Assy vertically into the CR Unit so as not to put the Holder Board Assy on the rib of the Printhead.

**ADJUSTMENT  
REQUIRED**

Whenever the Printhead is removed/replaced, the required adjustments must be carried out.

- [Chapter 5 “ADJUSTMENT” \(p.161\)](#)

## 4.8.4 Removing the Printer Mechanism (Lower Housing) (SX210 series)

### CHECK POINT



See the following because the disassembling/reassembling procedures of the Printer Mechanism for NX510/SX410 series differ from those of SX210 series.

- NX510 series:  
“4.5.4 Removing the Printer Mechanism (Lower Housing)”  
(p117)
- SX410 series:  
“4.7.4 Removing the Printer Mechanism (Lower Housing)  
(SX410 series)” (p152)

- Parts/Components need to be removed in advance

Document Cover/ASF Cover/Scanner Unit/Panel Unit/Upper Housing/Card Slot Cover

- Removal procedure

1. Release the hook that secures the Rear Cover and remove the Rear Cover.  
(See [Figure 4-48](#).)

### CAUTION



When lifting the Printer Mechanism, be sure to hold the positions specified in the figure below to prevent the Main Frame from being deformed. (See [Figure 4-49](#).)

2. Remove the screws (x4) that secure the Printer Mechanism, and remove the Printer Mechanism.

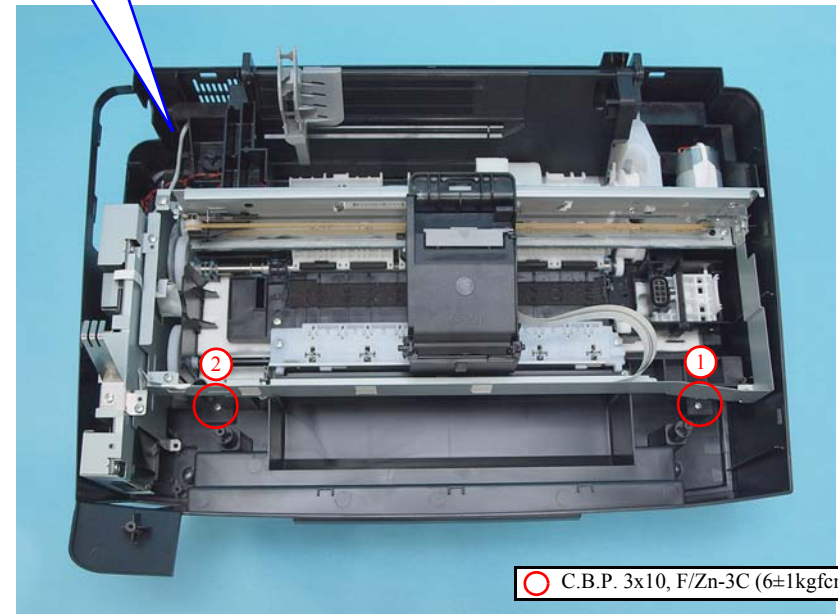
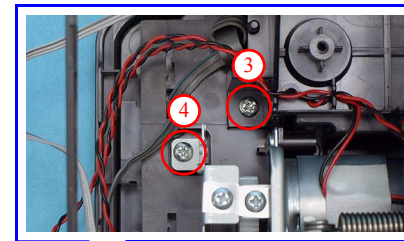

Figure 4-156. Removing the Printer Mechanism

### REASSEMBLY



Tighten the screws in the order given in [Figure 4-156](#).



CHAPTER

5

**ADJUSTMENT**

## 5.1 Adjustment Items and Overview

This chapter describes adjustments required after the disassembly/reassembly of the printer.

### 5.1.1 Servicing Adjustment Item List

The adjustment items of this product are as follows.



- In this chapter, the product names are called as follows:

Notation	Product name
NX510 series	Epson Stylus NX510/NX515/SX510W/SX515W/TX550W
SX410 series	Epson Stylus NX415/SX410/SX415/TX410/TX419
SX210 series	Epson Stylus NX215/SX210/SX215/TX210/TX213/ TX219/ME OFFICE 510

- For information on how to carry out the adjustments and media required for the adjustments, see the instructions displayed by the Adjustment Program.

Table 5-1. Adjustment Items

Adjustment Item	Purpose	Method Outline	Tool
EEPROM data copy	When the main board needs to be replaced, use this to copy adjustment values stored on the old main board to the new board. If this copy is completed successfully, all the other adjustments required after replacing the main board are no longer necessary.	Readout the EEPROM data from the main board before removing it. Then replace the board with a new one, and load the EEPROM data to the new board.	• Adjustment Program
Initial setting	This must be carried out after replacing the main board to apply settings for the target market.	Select the target market. The selected market settings are automatically written to the main board.	• Adjustment Program
USB ID input	This sets a USB ID of the printer. A computer identifies the printer by the ID when multiple same models are connected via a USB hub.	Enter the product serial number of the printer. The ID is automatically generated and written to the main board.	• Adjustment Program
Head ID input	This must be carried out after replacing the Printhead in order to enter the new Printhead ID (Head ID) that reduces variation between Printheads.	Enter the ID printed on the Head QR code label attached on the Printhead. The correction values are automatically written to the main board.	• Adjustment Program
MAC address read/write*1	When the Main board needs to be replaced use this menu to write necessary information onto the new board.	See “5.2.8 MAC Address Setting (NX510 series only) (p173)” for the detailed procedure.	• Adjustment Program • USB Cable
TOP margin adjustment	This corrects top margin of printout.	A top margin adjustment pattern is printed. Examine the lines printed near the top edge of the printout, and enter the value for the line that is exactly 3 mm away from the top edge.	• Adjustment Program • Ruler
First dot position adjustment	This corrects left margin of printout. The print start position in the carriage moving direction is corrected by software.	A first dot adjustment pattern is printed. Examine the lines printed near the left edge of the printout and enter the value for the line that is exactly 5 mm away from the left edge.	• Adjustment Program • Ruler
Head angular adjustment	This must be carried out after replacing the Printhead in order to correct tilt of the Printhead by software.	A head angular adjustment pattern is printed. Examine the printed lines and enter the value for the most straight lines.	• Adjustment Program
Bi-D adjustment	This corrects print start timing in bi-directional printing to improve the print quality.	A Bi-D adjustment pattern is printed. Black and color patterns are printed for each of the five dot sizes (ECO, VSD1, VSD2, VSD3, VSD4). So, there are 10 groups. Examine the patterns and enter the value for the pattern with no gap and overlap for each mode.	• Adjustment Program

Table 5-1. Adjustment Items

Adjustment Item	Purpose	Method Outline	Tool
Initialize PF deterioration offset	This resets the counter to maintain paper feed accuracy which decreases due to paper dust.	Reset the counter to its default.	• Adjustment Program
Disable PF deterioration offset	When reading the counter value from the old main board is impossible in the case of replacing the board, use this to set the counter to its maximum value.	Set the counter to its maximum value (10000).	• Adjustment Program
CR motor heat protection control	This must be carried out for efficient heat control of the CR motor. Electrical variation of the motor and the power supply board are measured to acquire correction values for them.	Select the parts that you replaced. The correction values are automatically written to the main board.	• Adjustment Program
PF motor heat protection control	This must be carried out for efficient heat control of the PF motor. Electrical variation of the motor and the power supply board are measured to acquire correction values for them.	Select the parts that you replaced. The correction values are automatically written to the main board.	• Adjustment Program
PF adjustment	This corrects variations in paper feed accuracy when using the Microweave to achieve higher print quality.	A PF adjustment pattern is printed. Examine the printout patterns and enter the value for the best pattern to register the correction value to the printer. (Carry out the procedure for each color.)	• Adjustment Program
PF band adjustment	This corrects variations in paper feed accuracy in the band print mode to achieve higher print quality.	A PF band adjustment pattern is printed. Examine the printout patterns and enter the value for the best pattern to register the correction value to the printer.	• Adjustment Program
Bottom margin adjustment*2	In order to improve the throughput, the printer minimizes the number of print passes when printing on the bottom margin (bleed) in the borderless printing. This may cause white area to appear on the bottom edge of the borderless printout. In such case, use this adjustment to correct the printing range on the bottom margin (bleed).	A bottom margin adjustment pattern is printed. Examine the printout patterns and enter the value for best pattern to register the correction value to the printer.	• Adjustment Program • Ruler

Note \*1: NX510 series only.

\*2: NX510/SX410 series only.

Table 5-2. Maintenance Items

Maintenance Item	Purpose	Method Outline	Tool
Waste ink pad counter	The printer causes a maintenance error when the waste ink pad counter reaches its maximum. Use this to reset the counter after replacing the Waste Ink Pad. If you find the counter is close to the maximum during servicing, carry out the pad replacement and the counter reset to avoid the printer returned from the user due to the maintenance error.	After replacing the Waste Ink Pad, reset the counter to its default.	• Adjustment Program
Ink charge	This must be carried out after replacing the Printhead in order to fill ink inside the new Printhead. The Printhead becomes ready for print.	Filling ink inside the Printhead is automatically performed. Print a nozzle check pattern to check if all nozzles are firing ink properly.	• Adjustment Program

Table 5-3. Additional Functions

Additional Functions		Purpose	Method Outline	Tool
Final check pattern print	A4 size	Use this to check if the all adjustments have been properly made.	The all adjustment patterns are printed automatically.	• Adjustment Program
	US Letter size			
EEPROM dump		Use this to readout the EEPROM data for analysis.	The all EEPROM data is automatically readout and stored as a file.	• Adjustment Program
Printer information check	Manual CL counter	Use this to readout information on the printer operations.	The printer information is automatically readout.	• Adjustment Program
	I/C exchange CL counter			
	Timer CL counter			
	Print path counter			

## 5.1.2 Required Adjustments

The table below lists the required adjustments depending upon the parts being repaired or replaced. Find the part(s) you removed or replaced, and check which adjustment(s) must be carried out.

**Table 5-4. Required Adjustment List**

Priority		1	2	3	4	5	6	7	8	9	10	11	12	13	14	15	16	17
Adjustment Item		EEPROM data copy	Initial setting	USB ID input	Waste ink pad counter	MAC address setting <sup>*1</sup>	Ink charge	Head ID input	Top margin adjustment	First dot position adjustment	Head angular adjustment	Bi-D adjustment	Initialize PF deterioration offset/ Disenable PF deterioration offset	CR motor heat protection control	PF motor heat protection control	PF adjustment	PF band adjustment	Bottom margin adjustment <sup>*2</sup>
Part Name																		
Main board unit	Remove	---	---	---	---	---	---	---	---	---	---	---	---	---	---	---	---	---
	Replace (Read OK)	O	---	---	---	---	---	---	---	---	---	---	---	---	---	---	---	---
	Replace (Read NG)	---	O	O	O Replace the pad	O	---	O	O	O	O	O	O Input max. value (10000)	O	O	O	O	O
Printhead	Remove	---	---	---	---	---	---	---	O	O	O	O	---	---	---	O	O	O
	Replace	---	---	---	---	---	O	O	O	O	O	O	---	---	---	O	O	O
Power Supply unit	Remove	---	---	---	---	---	---	---	---	---	---	---	---	---	---	---	---	---
	Replace	---	---	---	---	---	---	---	---	---	---	---	---	O	O	---	---	---
Hopper	Remove	---	---	---	---	---	---	---	O	O	---	---	---	---	---	---	---	---
	Replace	---	---	---	---	---	---	---	O	O	---	---	---	---	---	---	---	---
CR motor	Remove	---	---	---	---	---	---	---	---	---	---	---	---	---	---	---	---	---
	Replace	---	---	---	---	---	---	---	---	---	---	---	---	O	---	---	---	---
EJ roller	Remove	---	---	---	---	---	---	---	---	---	---	O	---	---	---	O	O	O
	Replace	---	---	---	---	---	---	---	---	---	---	O	---	---	---	O	O	O
PF motor	Remove	---	---	---	---	---	---	---	---	---	---	---	---	---	---	---	---	---
	Replace	---	---	---	---	---	---	---	---	---	---	---	---	---	O	---	---	---
Main frame	Remove	---	---	---	---	---	---	---	---	---	O	O	---	---	---	---	---	---
	Replace	---	---	---	---	---	---	---	---	---	O	O	---	O	---	---	---	---

Table 5-4. Required Adjustment List

Priority		1	2	3	4	5	6	7	8	9	10	11	12	13	14	15	16	17
Adjustment Item		EEPROM data copy	Initial setting	USB ID input	Waste ink pad counter	MAC address setting <sup>*1</sup>	Ink charge	Head ID input	Top margin adjustment	First dot position adjustment	Head angular adjustment	Bi-D adjustment	Initialize PF deterioration offset/ Disenable PF deterioration offset	CR motor heat protection control	PF motor heat protection control	PF adjustment	PF band adjustment	Bottom margin adjustment <sup>*2</sup>
Part Name																		
ASF unit	Remove	---	---	---	---	---	---	---	O	O	---	---	---	---	---	O	O	O
	Replace	---	---	---	---	---	---	---	O	O	---	---	---	---	---	O	O	O
CR unit	Remove	---	---	---	---	---	---	---	O	O	O	O	---	---	---	O	O	O
	Replace	---	---	---	---	---	---	---	O	O	O	O	---	---	---	O	O	O
Upper paper guide	Remove	---	---	---	---	---	---	---	O	---	---	---	---	---	---	O	O	O
	Replace	---	---	---	---	---	---	---	O	---	---	---	O Reset to 0	---	---	O	O	O
Front paper guide unit	Remove	---	---	---	---	---	---	---	O*	---	O	O	---	---	---	O	O	O
	Replace	---	---	---	---	---	---	---	O*	---	O	O	---	---	---	O	O	O
PF roller	Remove	---	---	---	---	---	---	---	O*	---	---	---	---	---	---	O	O	O
	Replace	---	---	---	---	---	---	---	O*	---	---	---	---	---	---	O	O	O
Waste ink pad	Remove	---	---	---	---	---	---	---	---	---	---	---	---	---	---	---	---	---
	Replace	---	---	---	O	---	---	---	---	---	---	---	---	---	---	---	---	---

**CAUTION**

- When the EEPROM data copy is impossible with the main board that needs to be replaced, the Waste Ink Pad must be replaced after replacing the main board with a new one.
- After all required adjustments are completed, use the “Final check pattern print” function to print all adjustment patterns for final check. If you find a problem with the printout patterns, carry out the adjustment again.
- When using a new main board for replacing the Printer Mechanism, the Initial setting must have been made to the main board.

Note : <Meaning of the marks in the table>

"O" indicates that the adjustment must be carried out. "O\*" indicates that the adjustment is recommended. "---" indicates that the adjustment is not required.

If you have removed or replaced multiple parts, make sure to check the required adjustments for the all parts. And when multiple adjustments must be carried out, be sure to carry out them in the order given in the "Priority" row.

Note \*1: NX510 series only.

\*2: NX510/SX410 series only.

## 5.2 Using the Adjustment Program

This section explains how to judge print samples using the adjustment program. See the appropriate print sample when the printing patterns are different of each model. Follow the instructions of the adjustment program for details of the adjustment methods.

### 5.2.1 TOP Margin Adjustment

The following pattern is printed.

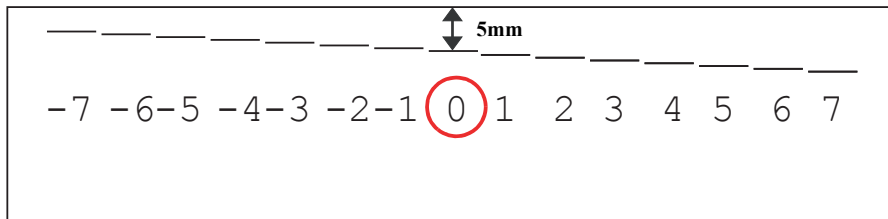

Figure 5-1. Top Margin Adjustment Printout Pattern

#### How to Judge

Measure the length from the top edge of the paper to the printed line. Enter the value for the line that is exactly 5 mm away from the top edge.

### 5.2.2 First Dot Position Adjustment

The following pattern is printed.

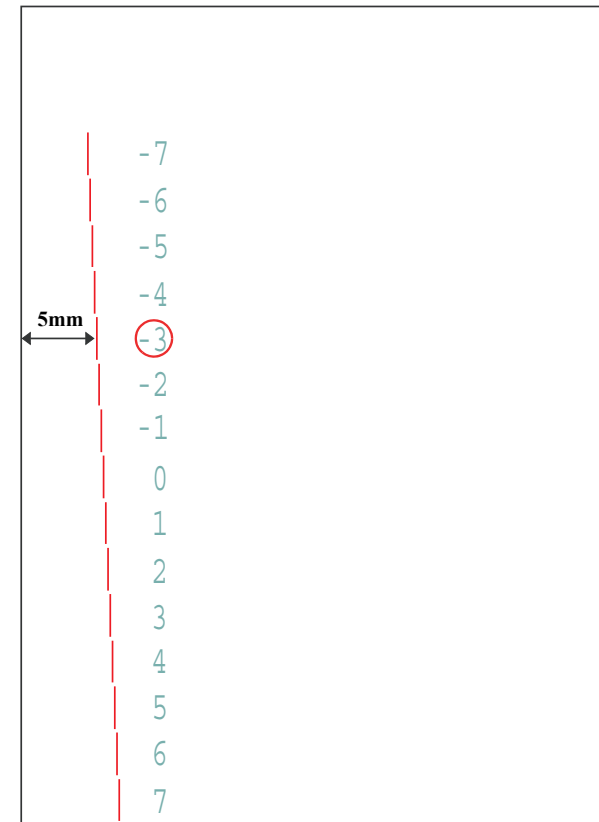

Figure 5-2. First Dot Position Adjustment Printout Pattern

#### How to judge

Measure the length from the left edge of the paper to the printed line. Enter the value for the line that is exactly 5 mm away from the left edge.

### 5.2.3 Head Angular Adjustment

Two patterns are printed as shown below.

#### BAND PATTERN

The following pattern is printed. The lines below “1 to 80” are printed while the carriage moves from the home to the other side, and lines below “80 to 1” are printed while the carriage returns to the home.

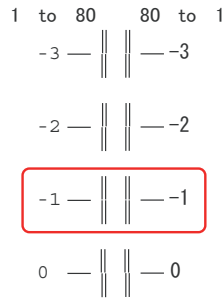

Figure 5-3. Head Angular Adjustment Printout Pattern (1)

#### How to Judge

Examine the printout patterns for both "0>>80" and "0<<80", and enter the values of the most straight lines.

#### Additional information

If the most straight lines are found on the pattern of either end, reassemble the Printhead and carry out this adjustment again.



#### Example for judgement

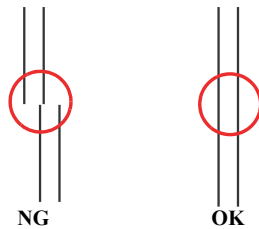

#### MICROWEAVE PATTERN (NX510/SX410 SERIES ONLY)

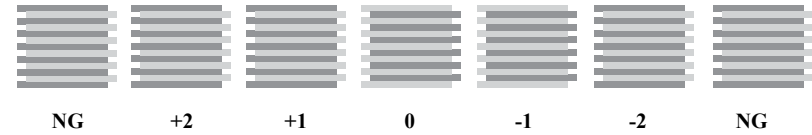

Figure 5-4. Head angular adjustment Pattern Printing (2)

#### How to Judge

Examine the printout patterns (+2 to -2) and select the value for the group of which the gaps between the 2 color bars are the smallest.

#### Additional information

If no appropriate pattern is found, reassemble/replace the Printhead.

When “+2” or “-2” is the group of which the gaps between the 2 color bars are the smallest, reassemble/replace the Printhead.



#### Example for judgement

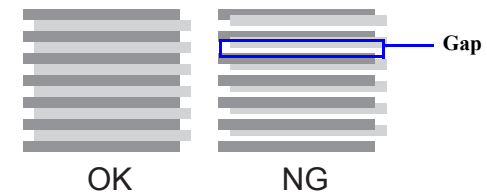



### 5.2.4 Bi-D Adjustment

- NX510/SX210 series

The following pattern is printed for each of the four print mode (four dot size modes).

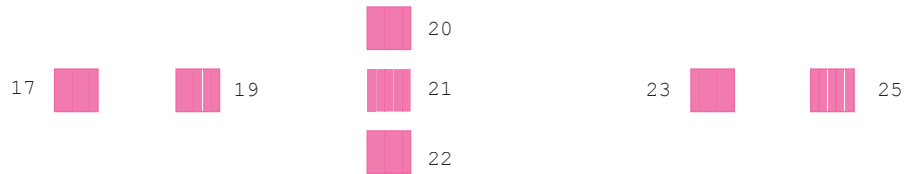

Figure 5-5. Bi-D Adjustment Printout Pattern

#### How to Judge

Examine the printout patterns for each of the four modes, and enter the value for the pattern with no gap and overlap for each mode.

#### Additional Information

If no OK pattern is printed, enter the value for the best one, and print the adjustment pattern again.

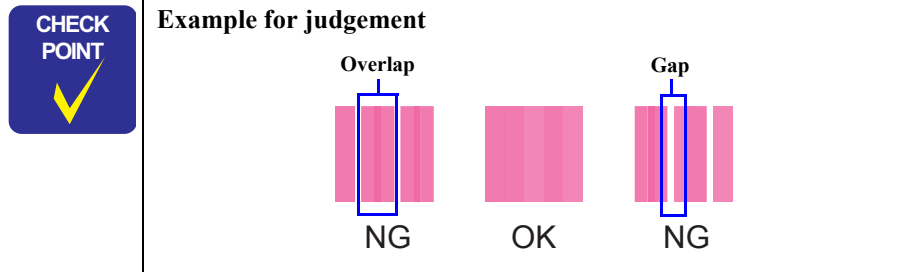

- SX410 series

The following pattern is printed for each of the four print mode (four dot size modes).



Figure 5-6. Bi-D Adjustment Printout Pattern

#### How to Judge

Examine the printout patterns for each of the four modes, and enter the value for the pattern with no gap and overlap for each mode.

#### Additional Information

If no OK pattern is printed, enter the value for the best one, and print the adjustment pattern again.

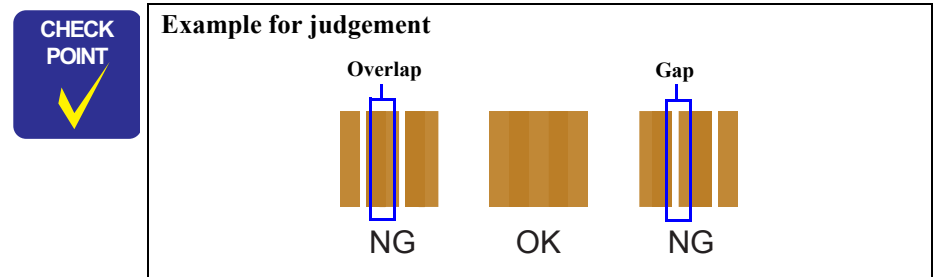

## 5.2.5 PF Adjustment

### PF- FOR STANDARD PRINT AREA

#### □ NX510 series

The following pattern is printed.

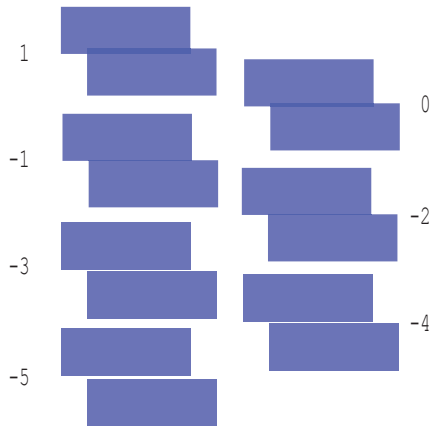

Figure 5-7. PF (standard print area) Adjustment Printout Pattern

#### How to Judge

Examine the printout patterns and enter the value for the pattern with no overlap and gap between the two rectangles.

#### Additional Information

When overlap and gap are observed in the all patterns, enter the value for the best one, and print the adjustment pattern again.

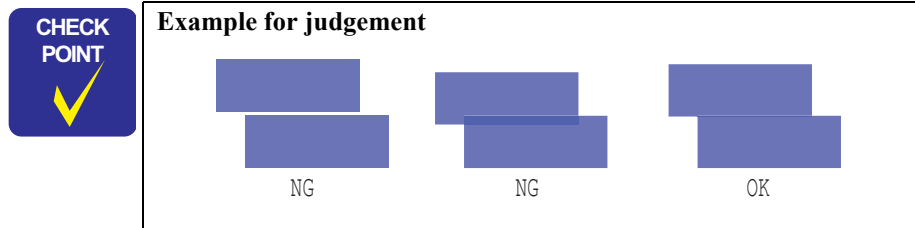

Figure 5-9. PF Adjustment (1)

- Examine the printed patches from the right to the left, and select a value for the patch with least white lines on its lower (bottom) area. If two or more patches are found as the best patch, be sure to select a value for the right most one. If it is difficult to judge, compare the most likely patch with the one on the left.

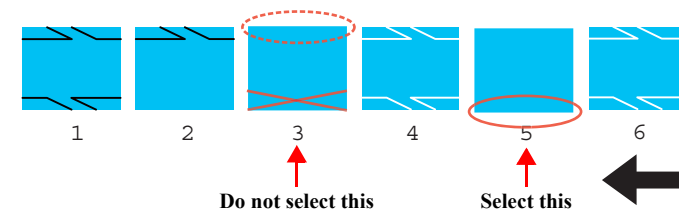

Figure 5-10. PF Adjustment (2)

- Input the selected value for each of the top and bottom in the program, and print a PF adjustment check pattern.

#### □ SX410/SX210 series

The following pattern is printed.

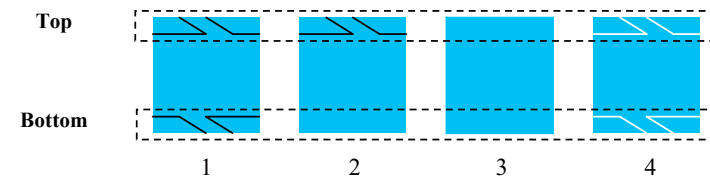
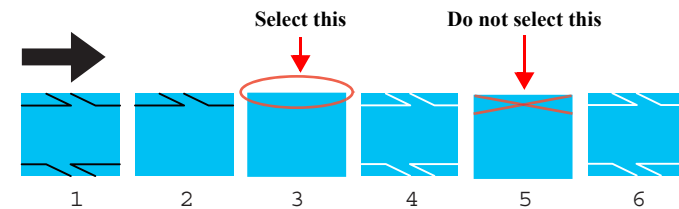

Figure 5-8. PF (standard print area) Adjustment Printout Pattern

#### How to Judge

- Examine the printed patches from the left to the right, and select a value for the patch with least white oblique lines on its upper (top) area. If two or more patches are found as the best patch, be sure to select a value for the left most one.



**PF- FOR BOTTOM MARGIN AREA**

The following pattern is printed.

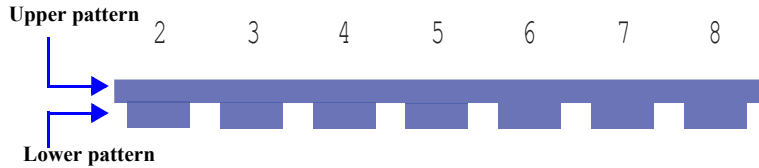

**Figure 5-11. PF (bottom margin area) Adjustment Printout Pattern**

**How to Judge**

Examine the printout patterns, and enter the value for the pattern with no overlap and gap between the upper and lower ones.

**Additional Information**

When overlap and gap are observed in the all patterns, enter the value for the best one, and print the adjustment pattern again.

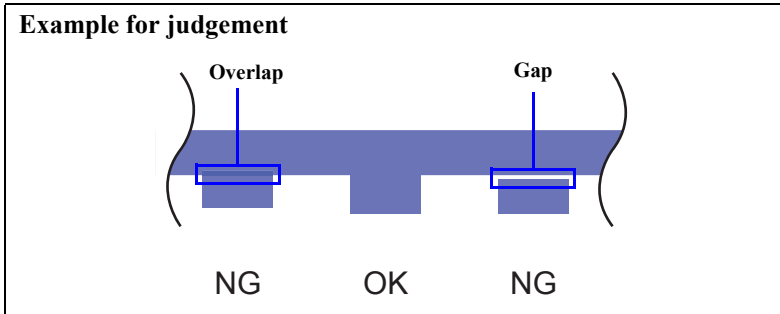

**5.2.6 PF Band Adjustment**

The following pattern is printed.

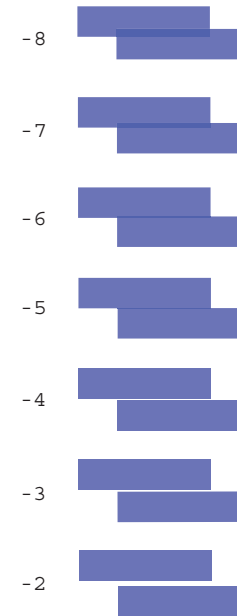

**Figure 5-12. PF Band Adjustment Printout Pattern**

**How to Judge**

Examine the printout patterns and enter the value for the pattern with no overlap and gap between the two rectangles.

**Additional Information**

When overlap and gap are observed in the all patterns, enter the value for the best one, and print the adjustment pattern again.

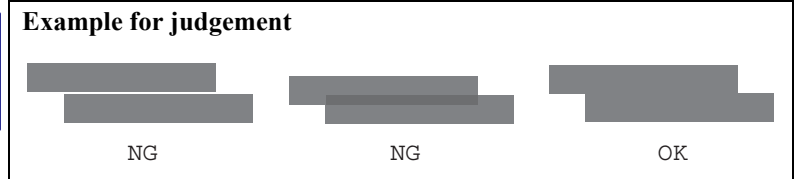

## 5.2.7 Bottom Margin Adjustment (NX510/SX410 series only)

The following pattern is printed.

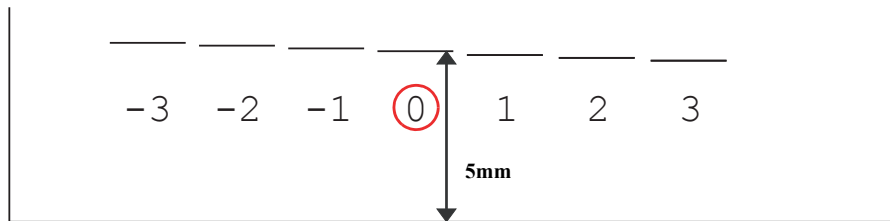

Figure 5-13. Bottom Margin Adjustment Printout Pattern

### How to Judge

Measure the length from the bottom edge of the paper to the printed line. Enter the value for the line that is exactly 5 mm away from the bottom edge.

## 5.2.8 MAC Address Setting (NX510 series only)

### □ Overview

NX510 series have a network function and stores their MAC address (Media Access Control Address) in the EEPROM on the Main Board. The Main Board supplied as an ASP does not come with the MAC address written on it, therefore, you are required to set the MAC address to the new Main Board after replacement. The following explains the procedure.

#### CAUTION



- When the data of EEPROM on the old Main Board can be read out, this adjustment is not required.
- To avoid a conflict of MAC address on a network, make sure to correctly follow the MAC address setting flowchart given on the right.
- The user should be notified of the change of MAC address because of the following reasons.
  - If the user has set the printer's MAC address on a router, the repaired printer with a new MAC address cannot be connected to the network.
  - The default printer name on a network consists of "EPSON" and the last six digits of the MAC address. Therefore, the printer name becomes different from the previous one.

### □ Preparation

When replacing the Main Board, make sure to note down the MAC address written on a label on the MB Upper Shield Plate. If the address is not readable due to contamination or any other cause, attach a new MAC address label (part code: TBD) and note down the new address. See "4.4.1 Main Board Unit" (p.105) for description about the label position.



You are required to enter the last six digits of the MAC address (xx:yy:zz) on the Adjustment Program.  
MAC address example: 00:00:48:xx:yy:zz  
("xx, yy, zz" represents a value unique to each printer)

### □ Setting flowchart

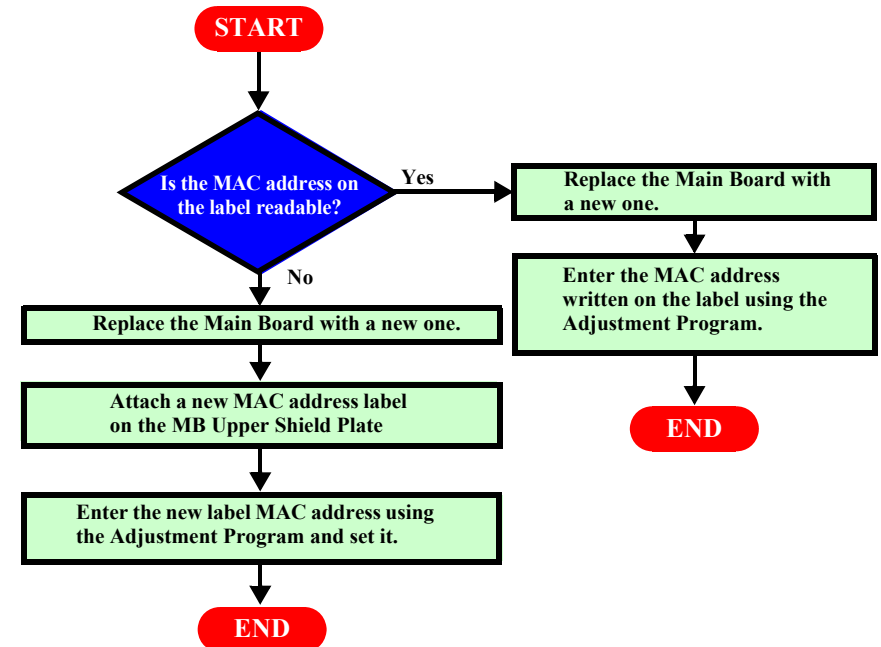

Figure 5-14. MAC Address Setting Flowchart

## □ Setting procedure



The MAC address required on the Adjustment Program is written on the MAC address label on the MB Upper Shield Plate. Make sure to correctly enter the address.

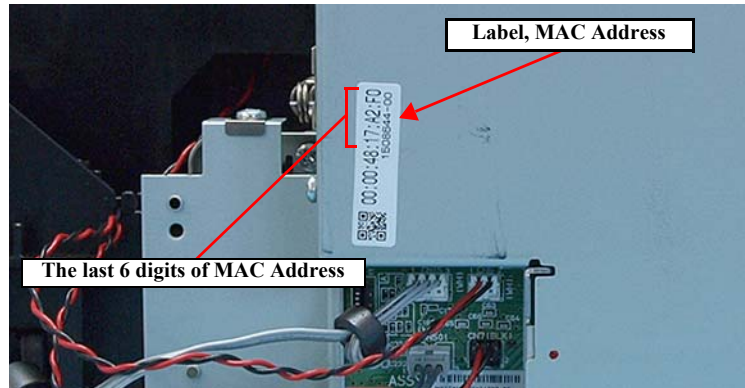

Figure 5-15. MAC Address Label

1. Connect the printer and a computer using a USB cable.
2. Start the Adjustment Program.
3. Select the “Initial Setting” from the menu. The initial setting screen appears.
4. Enter the last six digits of MAC address into the MAC address entry field, and click the MAC Address input button.  
(Enter the address again into the second entry field to confirm it.)
5. Select the network status sheet print menu on the printer’s control panel, and print the sheet. Check the MAC address printed on the sheet to see if it is correct.

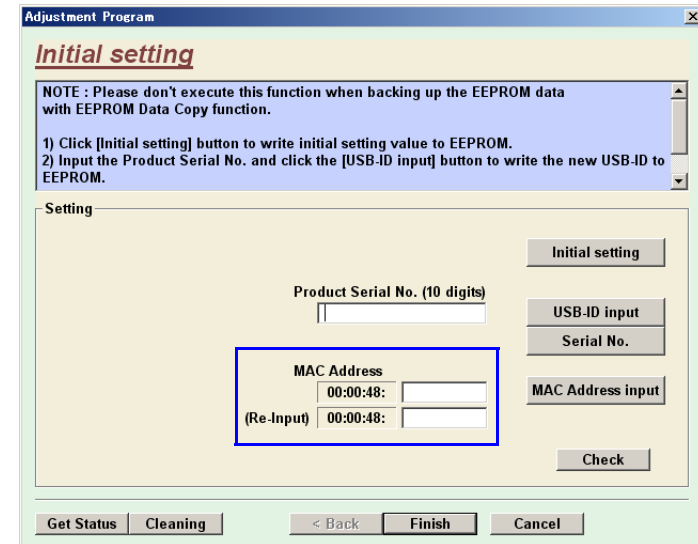

Figure 5-16. MAC Address Setting Screen

CHAPTER

6

**MAINTENANCE**

## 6.1 Overview

This section provides information to maintain the printer in its optimum condition.

### 6.1.1 Cleaning

This printer has no mechanical components which require regular cleaning except the Printhead. Therefore, when returning the printer to the user, check the following parts and perform appropriate cleaning if stain is noticeable.

**CAUTION**

- **Never use chemical solvents, such as thinner, benzine, and acetone to clean the exterior parts of the printer like the Housing. These chemicals may deform or deteriorate the components of the printer.**
- **Be careful not to damage any components when you clean inside the printer.**
- **Do not scratch the coated surface of the PF roller. Use a soft brush to wipe off any dusts.**
- **Use a soft cloth moistened with alcohol to remove the ink stain.**
- **When using compressed air products; such as air duster, for cleaning during repair and maintenance, the use of such products containing flammable gas is prohibited.**

- Exterior parts  
Use a clean soft cloth moistened with water, and wipe off any dirt. If the exterior parts are stained by the ink, use a cloth moistened with neutral detergent to wipe it off.
- Inside the printer  
Use a vacuum cleaner to remove any paper dust.
- LD Roller  
When paper loading function does not operate because friction of the LD roller is lowered by any paper dust, use a soft cloth moistened with alcohol to remove the paper dust.

### 6.1.2 Service Maintenance

If any abnormal print (dot missing, white line, etc.) has occurred or the printer indicates the "Maintenance request error" (This error is displayed as "Service Required" in the STM3), take the following actions to clear the error.

#### 6.1.2.1 Printhead cleaning

When dot missing or banding phenomenon has occurred, you need to perform the Printhead cleaning operation\* by using the Printhead cleaning function. This function can be performed by the control panel operation, the printer driver utility and the Adjustment program.

\* : This product has three modes for manual cleaning, and even during printing, the appropriate cleaning mode is automatically selected and performed according to various conditions. Therefore the ink consumption amount for manual cleaning varies depending on each mode.

#### 6.1.2.2 Maintenance request error

Ink is used for the Printhead cleaning or cap flushing operation as well as the printing operation. When the ink is used for the Printhead cleaning or flushing operation, the ink is drained via the pump to the Waste ink pads. The amount of the waste ink is stored as the waste ink counter into the EEPROM on the Main Board. Due to this, when the waste ink counter has reached the limit of the absorbing capability of the Waste ink pads, the Maintenance call error is indicated on Status monitor 3. However, the limit value of the waste ink counter varies according to the usage.

**CHECK POINT**

**Refer to following chapter about indication of the maintenance request error.**

- **Chapter 3" TROUBLESHOOTING" (p.56)**

When the maintenance request error has occurred, replace the waste ink pad with new one and clear the waste ink counter stored into the EEPROM. If the waste ink counter is closed to its limit, we recommend to replace the Waste ink pad with new one. This is because the Maintenance request error will may occur after returning the repaired product to the customer.



### 6.1.3 Lubrication

The type and amount of the grease used to lubricate the printer parts are determined based on the results of the internal evaluations. Therefore, be sure to apply the specified type and amount of the grease to the specified part of the printer mechanism on the following occasion.

- Any parts required the lubrication are replaced.
- The printer is disassembled/assembled. (If necessary)



- Never use oil or grease other than those specified in this manual. Use of different types of oil or grease may damage the component or give bad influence on the printer function.
- Never apply larger amount of grease than specified in this manual.

Table 6-1. Specified Lubricant

Type	Name	EPSON Code	Supplier
Grease	G-45	1033657	EPSON
Grease	G-71	1304682	EPSON
Grease	G-74	1409257	EPSON

- Refer to the following figures for the lubrication points.

<Lubrication Point>

1. Shaft hole of the Driven Pulley
2. Two contact points between the Driven Pulley Holder and the Driven Pulley Shaft
3. Contact points (x9) with the Main Frame.

<Lubrication Type>  
G-71

<Lubrication Amount>  
φ 1 mm x 1 mm

<Remarks>  
Use an injector to apply G-71.

Figure 6-1. Lubrication on Driven Pulley

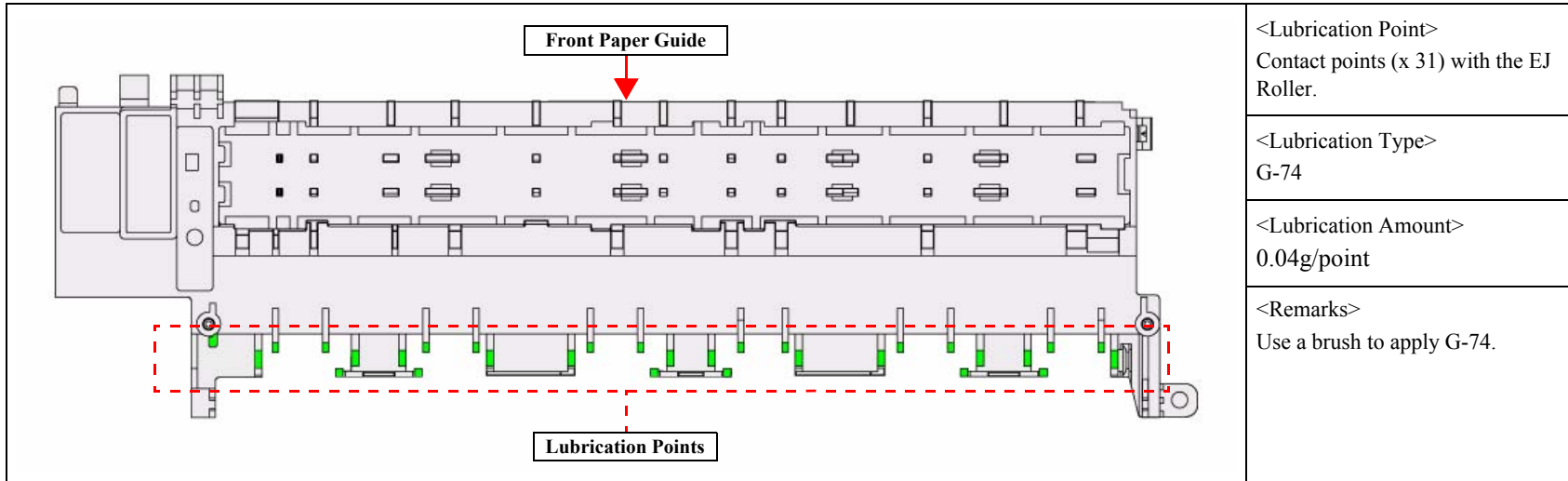

Figure 6-2. Lubrication on Front Paper Guide (1)

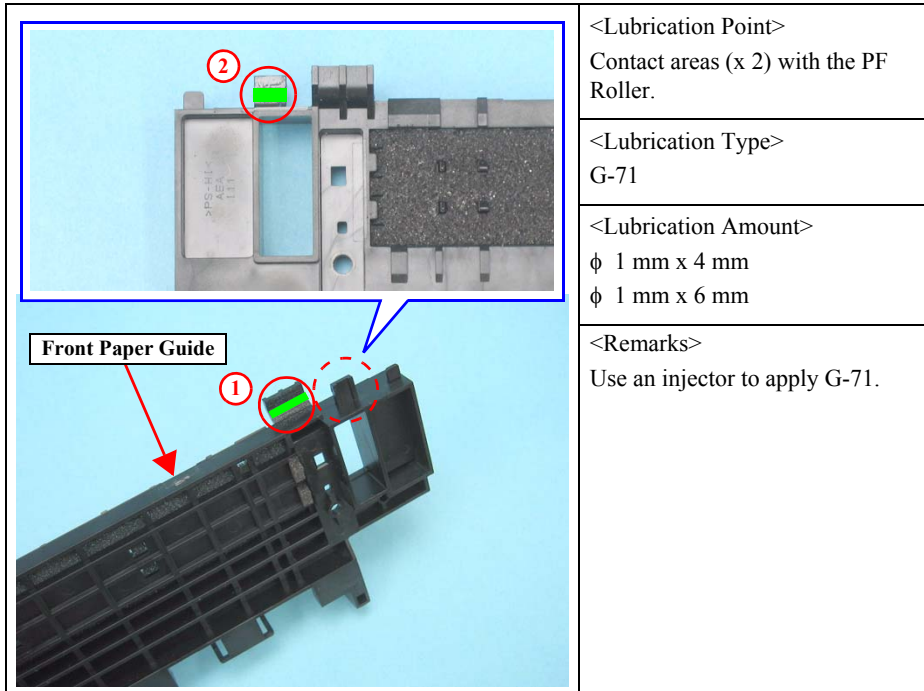

Figure 6-3. Lubrication on Front Paper Guide (2)

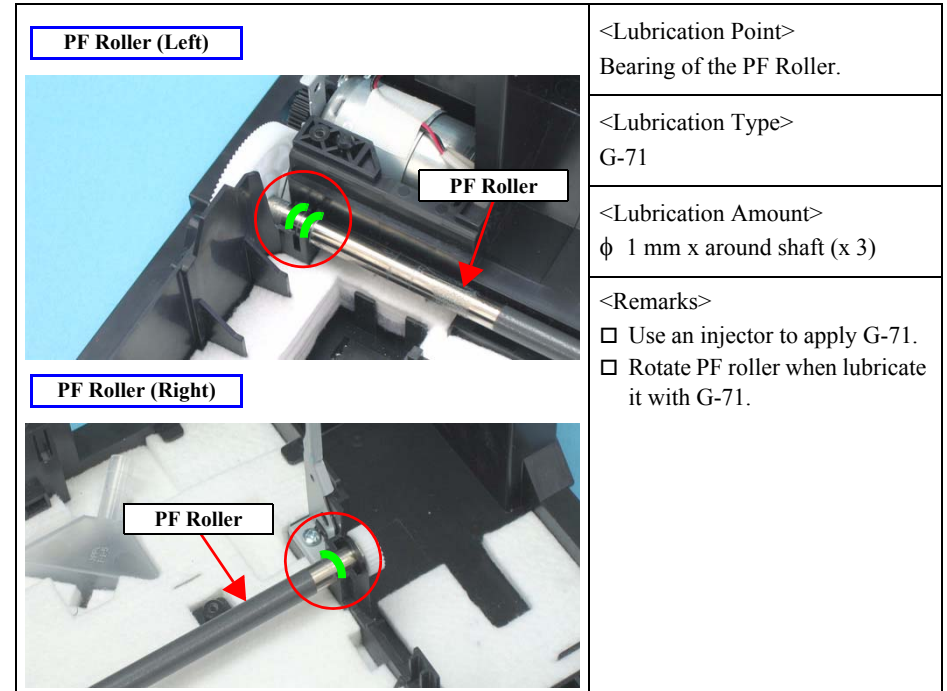

Figure 6-4. Lubrication on PF Roller

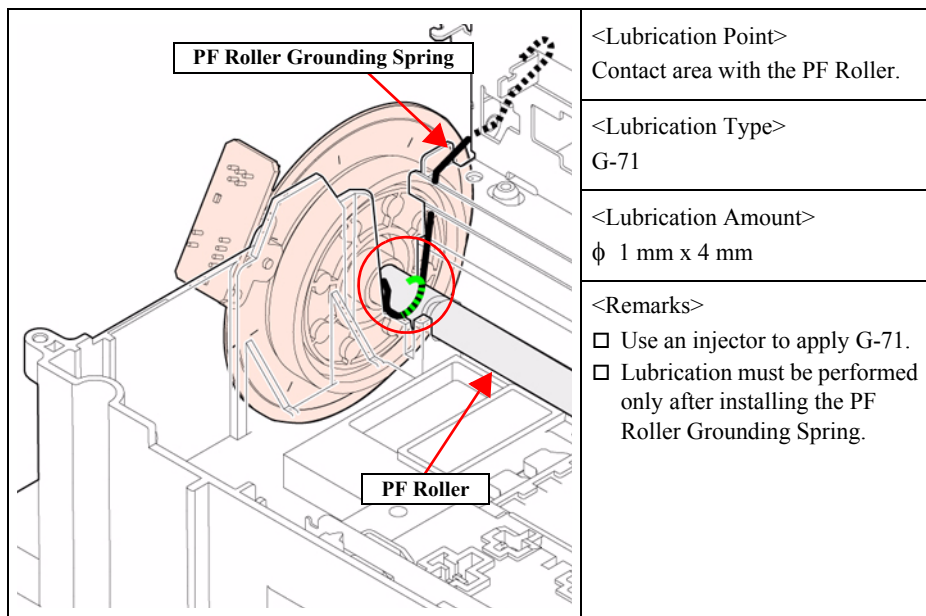

Figure 6-5. Lubrication on PF Roller Grounding Spring

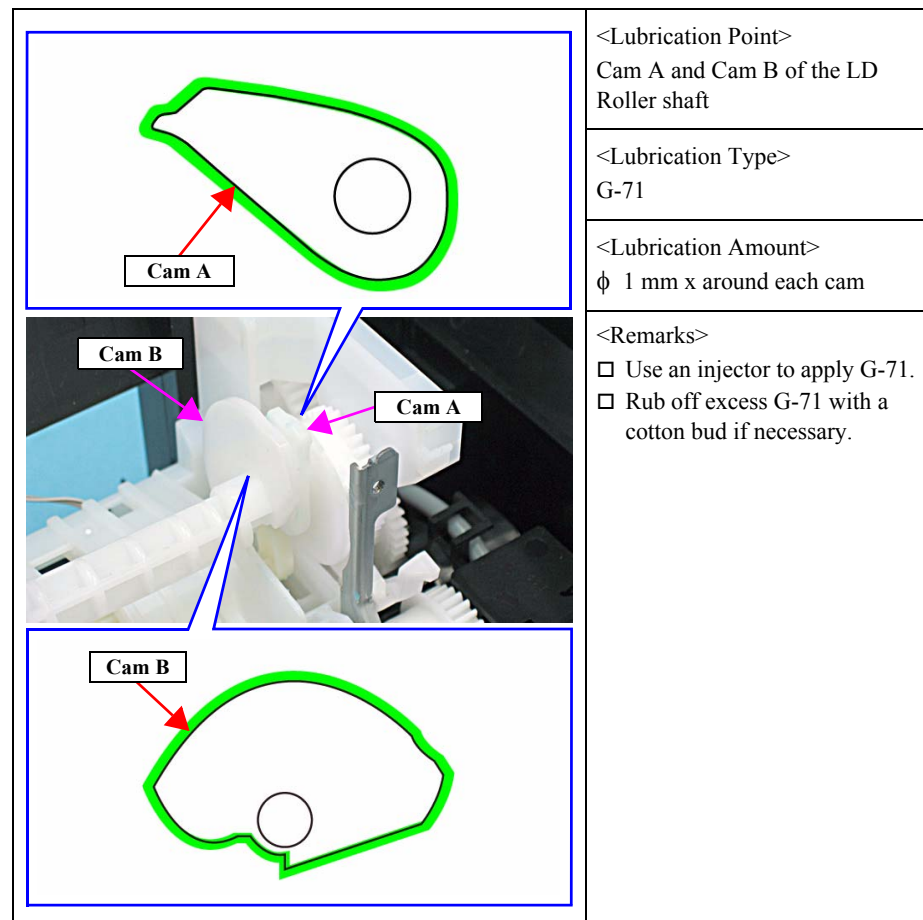

Figure 6-6. Lubrication on LD Roller Shaft

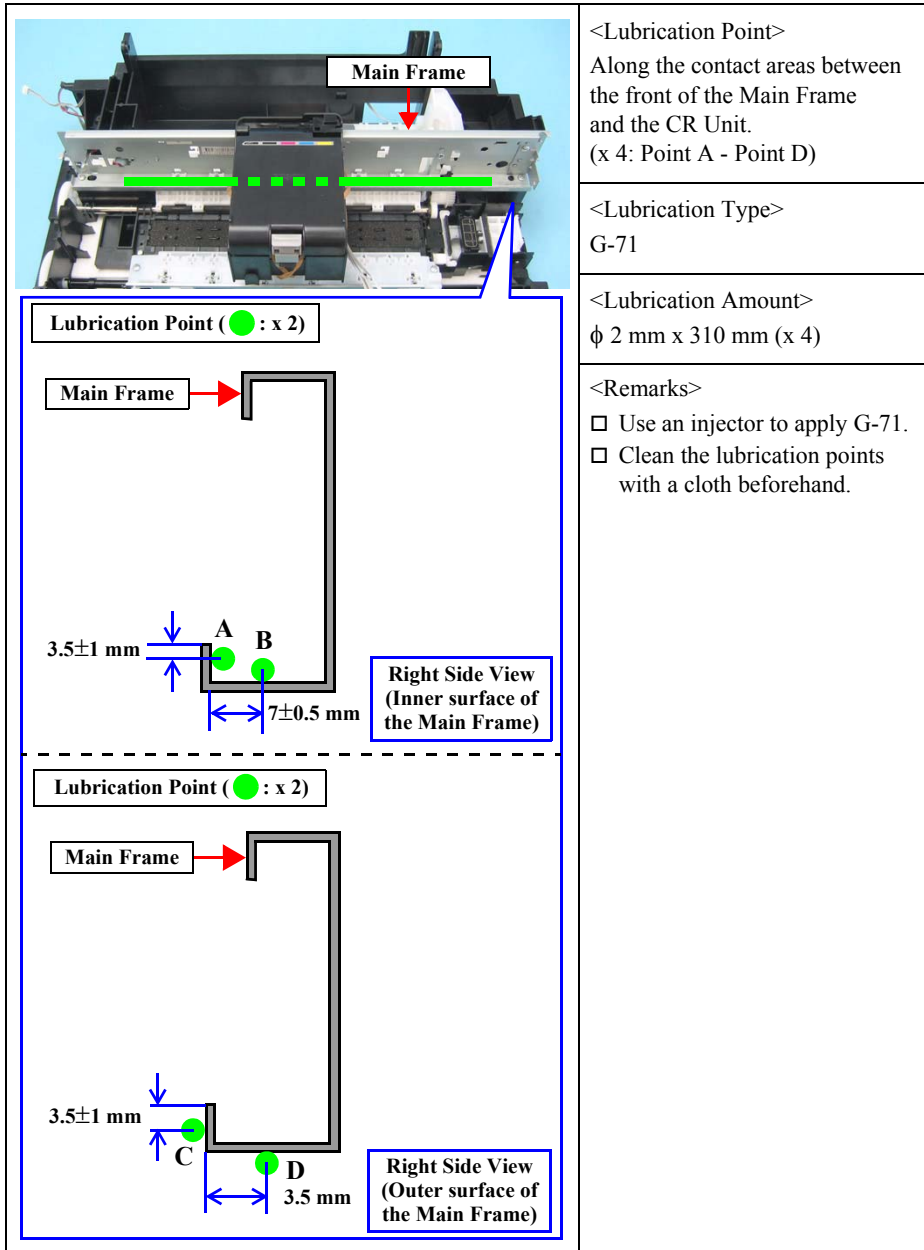

Figure 6-7. Lubrication on Main Frame (1)

<Lubrication Point>  
 Along the contact areas between the front of the Main Frame and the CR Unit.  
 (x 4: Point A - Point D)

<Lubrication Type>  
 G-71

<Lubrication Amount>  
 φ 2 mm x 310 mm (x 4)

<Remarks>

- Use an injector to apply G-71.
- Clean the lubrication points with a cloth beforehand.

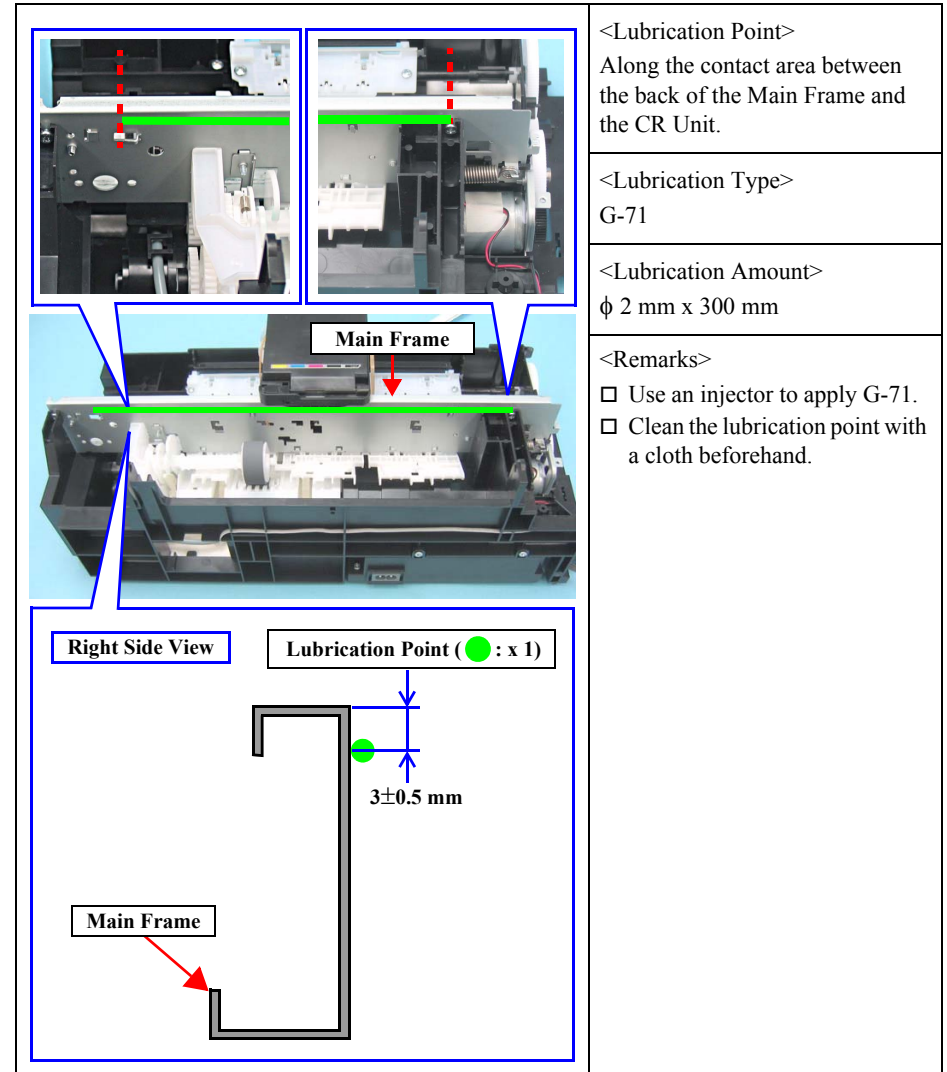

Figure 6-8. Lubrication on Main Frame (2)

<Lubrication Point>  
 Along the contact area between the back of the Main Frame and the CR Unit.

<Lubrication Type>  
 G-71

<Lubrication Amount>  
 φ 2 mm x 300 mm

<Remarks>

- Use an injector to apply G-71.
- Clean the lubrication point with a cloth beforehand.

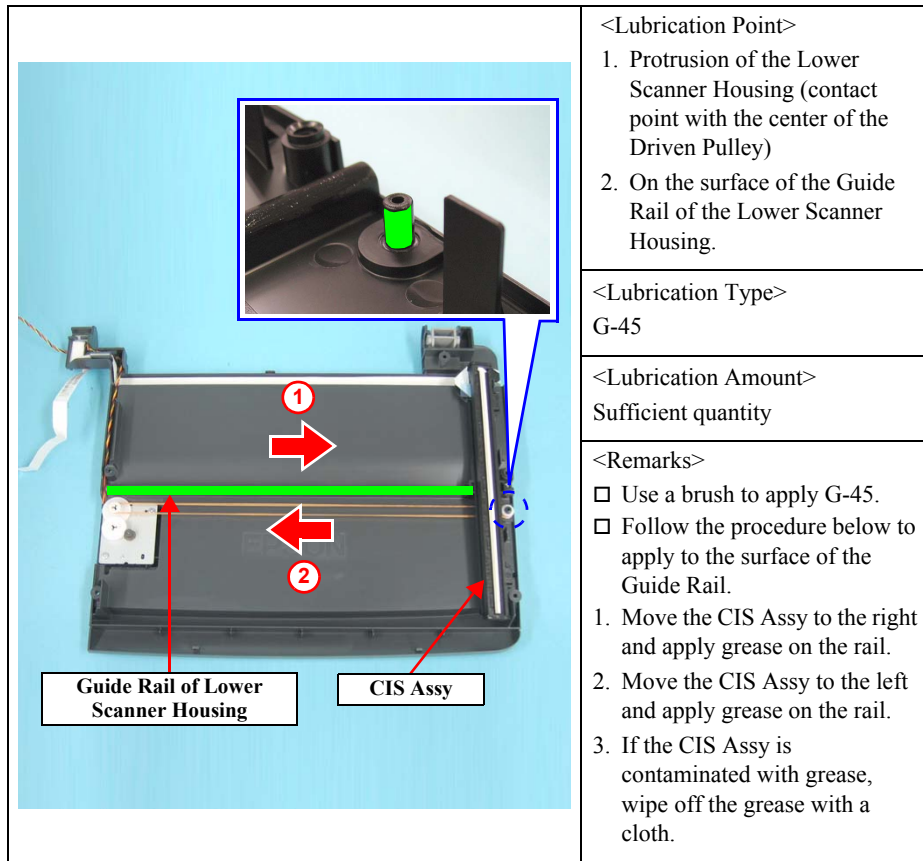

Figure 6-9. Lubrication on the Guide Rail of the Lower Scanner Housing

**CHAPTER**

**7**

**APPENDIX**

## **7.1 Exploded Diagram / Parts List**

---

This manual does not provide exploded diagrams or parts list.  
For the information, see SPI (Service Parts Information).

[www.s-manuals.com](http://www.s-manuals.com)