

ESP32 Technical Reference Manual

Version 2.9



Espressif Systems

About This Manual

The **ESP32 Technical Reference Manual** is addressed to application developers. The manual provides detailed and complete information on how to use the ESP32 memory and peripherals.

For pin definition, electrical characteristics and package information, please see [ESP32 Datasheet](#).

Related Resources

Additional documentation and other resources about ESP32 can be accessed here: [ESP32 Resources](#).

Release Notes

Date	Version	Release notes
2016.08	V1.0	Initial release.
2016.09	V1.1	Added Chapter I2C Controller .
2016.11	V1.2	Added Chapter PID/MPU/MMU ; Updated Section IO_MUX and GPIO Matrix Register Summary ; Updated Section LED_PWM Register Summary .
2016.12	V1.3	Added Chapter eFuse Controller ; Added Chapter RSA Accelerator ; Added Chapter Random Number Generator ; Updated Section I2C Controller Interrupt and Section I2C Controller Registers .
2017.01	V1.4	Added Chapter SPI ; Added Chapter UART Controllers .
2017.03	V1.5	Added Chapter I2S .
2017.03	V1.6	Added Chapter SD/MMC Host Controller ; Added register IO_MUX_PIN_CTRL in Chapter IO_MUX and GPIO Matrix .
2017.05	V1.7	Added Chapter On-Chip Sensors and Analog Signal Processing ; Added Section Audio PLL ; Updated Section eFuse Controller Register Summary ; Updated Sections I2S PDM and LCD MODE ; Updated Section Communication Format Supported by GP-SPI Slave .
2017.06	V1.8	Added register I2S_STATE_REG in Chapter I2S ; Updated Chapter IO_MUX and GPIO Matrix ; Added Chapter ULP Co-processor .
2017.06	V1.9	Updated Chapter IO_MUX and GPIO Matrix ; Added Chapter MCPWM .
2017.07	V2.0	Added Chapter SDIO Slave .
2017.07	V2.1	Updated the addresses of the GPIO configuration/data registers and the GPIO RTC function configuration registers in Chapter IO_MUX and GPIO Matrix ; Added Chapter PID Controller .
2017.07	V2.2	Added Chapter Low-Power Management .
2017.08	V2.3	Added Chapter Flash Encryption/Decryption .

Date	Version	Release notes
2017.09	V2.4	<p>Added the description of register SLC0HOST_TOKEN_RDATA in Chapter SDIO Slave;</p> <p>Added notes in Section The Clock of I2S Module;</p> <p>Added a note in Section GP-SPI Master Mode;</p> <p>Added Chapter DPort Register;</p> <p>Added Chapter DMA Controller.</p>
2017.11	V2.5	<p>Updated the addresses for register SPI_CTRL_REG in Section SPI Register Summary;</p> <p>Added Section Clock Phase Selection in Chapter SD/MMC Host Controller, and a description of register CLK_EDGE_SEL;</p> <p>Major revision on Chapter I2C Controller.</p>
2017.11	V2.6	<p>Updated Chapter Remote Controller Peripheral:</p> <ul style="list-style-type: none"> • Updated Figure 88 RMT Architecture; • Updated section RMT RAM; • Updated section Transmitter; • Updated the description of RMT_CH_nTX_THR_EVENT_INT. <p>Added notes in Section UART RAM and Register UART_CONFO_REG.</p>
2017.12	V2.7	<p>Added Subsection Cache in Section System and Memory;</p> <p>Updated Section Timers and the naming of several registers in LED_PWM;</p> <p>Updated the description of console_debug_disable in Chapter eFuse Controller.</p>
2018.01	V2.8	<p>Added Chapter Ethernet MAC.</p> <p>Added the description of system parameter BLK3_part_reserve in Chapter eFuse Controller.</p>
2018.02	V2.9	<p>Updated sections 4.2.2, 4.2.3, 4.3.2;</p> <p>Added registers I2S_FIFO_WR_REG and I2S_FIFO_RD_REG in Section I2S Registers.</p>

Documentation Change Notification

Espressif provides email notifications to keep customers updated on changes to technical documentation. Please subscribe [here](#).

Certification

Download certificates for Espressif products from [here](#).

Disclaimer and Copyright Notice

Information in this document, including URL references, is subject to change without notice. THIS DOCUMENT IS PROVIDED AS IS WITH NO WARRANTIES WHATSOEVER, INCLUDING ANY WARRANTY OF MERCHANTABILITY, NON-INFRINGEMENT, FITNESS FOR ANY PARTICULAR PURPOSE, OR ANY WARRANTY OTHERWISE ARISING OUT OF ANY PROPOSAL, SPECIFICATION OR SAMPLE.

All liability, including liability for infringement of any proprietary rights, relating to the use of information in this document, is disclaimed. No licenses express or implied, by estoppel or otherwise, to any intellectual property rights are granted herein. The Wi-Fi Alliance Member logo is a trademark of the Wi-Fi Alliance. The Bluetooth logo is a registered trademark of Bluetooth SIG.

All trade names, trademarks and registered trademarks mentioned in this document are property of their respective owners, and are hereby acknowledged.

Copyright © 2018 Espressif Inc. All rights reserved.

Contents

1	System and Memory	23
1.1	Introduction	23
1.2	Features	23
1.3	Functional Description	25
1.3.1	Address Mapping	25
1.3.2	Embedded Memory	25
1.3.2.1	Internal ROM 0	26
1.3.2.2	Internal ROM 1	26
1.3.2.3	Internal SRAM 0	27
1.3.2.4	Internal SRAM 1	27
1.3.2.5	Internal SRAM 2	28
1.3.2.6	DMA	28
1.3.2.7	RTC FAST Memory	28
1.3.2.8	RTC SLOW Memory	28
1.3.3	External Memory	28
1.3.4	Cache	29
1.3.5	Peripherals	30
1.3.5.1	Asymmetric PID Controller Peripheral	31
1.3.5.2	Non-Contiguous Peripheral Memory Ranges	31
1.3.5.3	Memory Speed	32
2	Interrupt Matrix	33
2.1	Introduction	33
2.2	Features	33
2.3	Functional Description	33
2.3.1	Peripheral Interrupt Source	33
2.3.2	CPU Interrupt	36
2.3.3	Allocate Peripheral Interrupt Sources to Peripheral Interrupt on CPU	36
2.3.4	CPU NMI Interrupt Mask	37
2.3.5	Query Current Interrupt Status of Peripheral Interrupt Source	37
3	Reset and Clock	38
3.1	System Reset	38
3.1.1	Introduction	38
3.1.2	Reset Source	38
3.2	System Clock	39
3.2.1	Introduction	39
3.2.2	Clock Source	40
3.2.3	CPU Clock	40
3.2.4	Peripheral Clock	41
3.2.4.1	APB_CLK Source	41
3.2.4.2	REF_TICK Source	42
3.2.4.3	LEDC_SCLK Source	42
3.2.4.4	APLL_SCLK Source	42

3.2.4.5	PLL_D2_CLK Source	42
3.2.4.6	Clock Source Considerations	43
3.2.5	Wi-Fi BT Clock	43
3.2.6	RTC Clock	43
3.2.7	Audio PLL	43
4	IO_MUX and GPIO Matrix	45
4.1	Overview	45
4.2	Peripheral Input via GPIO Matrix	46
4.2.1	Summary	46
4.2.2	Functional Description	46
4.2.3	Simple GPIO Input	47
4.3	Peripheral Output via GPIO Matrix	47
4.3.1	Summary	47
4.3.2	Functional Description	48
4.3.3	Simple GPIO Output	49
4.4	Direct I/O via IO_MUX	49
4.4.1	Summary	49
4.4.2	Functional Description	49
4.5	RTC IO_MUX for Low Power and Analog I/O	49
4.5.1	Summary	49
4.5.2	Functional Description	50
4.6	Light-sleep Mode Pin Functions	50
4.7	Pad Hold Feature	50
4.8	I/O Pad Power Supply	50
4.8.1	VDD_SDIO Power Domain	51
4.9	Peripheral Signal List	51
4.10	IO_MUX Pad List	56
4.11	RTC_MUX Pin List	57
4.12	Register Summary	58
4.13	Registers	62
5	DPort Register	83
5.1	Introduction	83
5.2	Features	83
5.3	Functional Description	83
5.3.1	System and Memory Register	83
5.3.2	Reset and Clock Registers	83
5.3.3	Interrupt Matrix Register	84
5.3.4	DMA Registers	88
5.3.5	PID/MPU/MMU Registers	88
5.3.6	APP_CPU Controller Registers	91
5.3.7	Peripheral Clock Gating and Reset	91
5.4	Register Summary	94
5.5	Registers	100
6	DMA Controller	114

6.1	Overview	114
6.2	Features	114
6.3	Functional Description	114
6.3.1	DMA Engine Architecture	114
6.3.2	Linked List	115
6.4	UART DMA (UDMA)	115
6.5	SPI DMA Interface	116
6.6	I2S DMA Interface	117
7	SPI	119
7.1	Overview	119
7.2	SPI Features	119
7.3	GP-SPI	120
7.3.1	GP-SPI Master Mode	120
7.3.2	GP-SPI Slave Mode	121
7.3.2.1	Communication Format Supported by GP-SPI Slave	121
7.3.2.2	Command Definitions Supported by GP-SPI Slave in Half-duplex Mode	121
7.3.3	GP-SPI Data Buffer	122
7.4	GP-SPI Clock Control	122
7.4.1	GP-SPI Clock Polarity (CPOL) and Clock Phase (CPHA)	123
7.4.2	GP-SPI Timing	123
7.5	Parallel QSPI	124
7.5.1	Communication Format of Parallel QSPI	125
7.6	GP-SPI Interrupt Hardware	125
7.6.1	SPI Interrupts	125
7.6.2	DMA Interrupts	126
7.7	Register Summary	126
7.8	Registers	129
8	SDIO Slave	151
8.1	Overview	151
8.2	Features	151
8.3	Functional Description	151
8.3.1	SDIO Slave Block Diagram	151
8.3.2	Sending and Receiving Data on SDIO Bus	152
8.3.3	Register Access	152
8.3.4	DMA	153
8.3.5	Packet-Sending/-Receiving Procedure	154
8.3.5.1	Sending Packets to SDIO Host	154
8.3.5.2	Receiving Packets from SDIO Host	155
8.3.6	SDIO Bus Timing	156
8.3.7	Interrupt	157
8.3.7.1	Host Interrupt	157
8.3.7.2	Slave Interrupt	157
8.4	Register Summary	158
8.5	SLC Registers	160
8.6	SLC Host Registers	168

8.7	HINF Registers	181
9	SD/MMC Host Controller	182
9.1	Overview	182
9.2	Features	182
9.3	SD/MMC External Interface Signals	182
9.4	Functional Description	183
9.4.1	SD/MMC Host Controller Architecture	183
9.4.1.1	BIU	184
9.4.1.2	CIU	184
9.4.2	Command Path	184
9.4.3	Data Path	185
9.4.3.1	Data Transmit Operation	185
9.4.3.2	Data Receive Operation	186
9.5	Software Restrictions for Proper CIU Operation	186
9.6	RAM for Receiving and Sending Data	187
9.6.1	Transmit RAM Module	187
9.6.2	Receive RAM Module	188
9.7	Descriptor Chain	188
9.8	The Structure of a Linked List	188
9.9	Initialization	190
9.9.1	DMAC Initialization	190
9.9.2	DMAC Transmission Initialization	191
9.9.3	DMAC Reception Initialization	191
9.10	Clock Phase Selection	192
9.11	Interrupt	192
9.12	Register Summary	193
9.13	Registers	194
10	Ethernet MAC	214
10.1	Overview	214
10.2	EMAC_CORE	216
10.2.1	Transmit Operation	216
10.2.1.1	Transmit Flow Control	217
10.2.1.2	Retransmission During a Collision	217
10.2.2	Receive Operation	217
10.2.2.1	Reception Protocol	218
10.2.2.2	Receive Frame Controller	218
10.2.2.3	Receive Flow Control	218
10.2.2.4	Reception of Multiple Frames	219
10.2.2.5	Error Handling	219
10.2.2.6	Receive Status Word	219
10.3	MAC Interrupt Controller	219
10.4	MAC Address Filtering	220
10.4.1	Unicast Destination Address Filtering	220
10.4.2	Multicast Destination Address Filtering	220
10.4.3	Broadcast Address Filtering	220

10.4.4	Unicast Source Address Filtering	220
10.4.5	Inverse Filtering Operation	221
10.4.6	Good Transmitted Frames and Received Frames	222
10.5	EMAC_MTL (MAC Transaction Layer)	223
10.6	PHY Interface	223
10.6.1	MII (Media Independent Interface)	223
10.6.1.1	Interface Signals Between MII and PHY	223
10.6.1.2	MII Clock	224
10.6.2	RMII (Reduced Media-Independent Interface)	225
10.6.2.1	RMII Interface Signal Description	225
10.6.2.2	RMII Clock	226
10.6.3	Station Management Agent (SMA) Interface	226
10.7	Ethernet DMA Features	226
10.8	Linked List Descriptors	227
10.8.1	Transmit Descriptors	227
10.8.2	Receive Descriptors	233
10.9	Register Summary	238
10.10	Registers	240
11	I2C Controller	265
11.1	Overview	265
11.2	Features	265
11.3	Functional Description	265
11.3.1	Introduction	265
11.3.2	Architecture	266
11.3.3	I2C Bus Timing	267
11.3.4	I2C cmd Structure	267
11.3.5	I2C Master Writes to Slave	268
11.3.6	I2C Master Reads from Slave	272
11.3.7	Interrupts	274
11.4	Register Summary	275
11.5	Registers	277
12	I2S	288
12.1	Overview	288
12.2	Features	289
12.3	The Clock of I2S Module	290
12.4	I2S Mode	291
12.4.1	Supported Audio Standards	291
12.4.1.1	Philips Standard	291
12.4.1.2	MSB Alignment Standard	291
12.4.1.3	PCM Standard	292
12.4.2	Module Reset	292
12.4.3	FIFO Operation	292
12.4.4	Sending Data	293
12.4.5	Receiving Data	294
12.4.6	I2S Master/Slave Mode	296

12.4.7	I2S PDM	296
12.5	LCD Mode	298
12.5.1	LCD Master Transmitting Mode	298
12.5.2	Camera Slave Receiving Mode	299
12.5.3	ADC/DAC mode	300
12.6	I2S Interrupts	301
12.6.1	FIFO Interrupts	301
12.6.2	DMA Interrupts	301
12.7	Register Summary	302
12.8	Registers	304
13	UART Controllers	322
13.1	Overview	322
13.2	UART Features	322
13.3	Functional Description	322
13.3.1	Introduction	322
13.3.2	UART Architecture	323
13.3.3	UART RAM	324
13.3.4	Baud Rate Detection	324
13.3.5	UART Data Frame	325
13.3.6	Flow Control	326
13.3.6.1	Hardware Flow Control	326
13.3.6.2	Software Flow Control	327
13.3.7	UART DMA	327
13.3.8	UART Interrupts	327
13.3.9	UCHI Interrupts	328
13.4	Register Summary	328
13.5	Registers	332
14	LED_PWM	359
14.1	Introduction	359
14.2	Functional Description	359
14.2.1	Architecture	359
14.2.2	Timers	360
14.2.3	Channels	360
14.2.4	Interrupts	361
14.3	Register Summary	362
14.4	Registers	365
15	Remote Control Peripheral	375
15.1	Introduction	375
15.2	Functional Description	375
15.2.1	RMT Architecture	375
15.2.2	RMT RAM	376
15.2.3	Clock	376
15.2.4	Transmitter	377
15.2.5	Receiver	377

15.2.6	Interrupts	377
15.3	Register Summary	377
15.4	Registers	379
16	MCPWM	384
16.1	Introduction	384
16.2	Features	384
16.3	Submodules	386
16.3.1	Overview	386
16.3.1.1	Prescaler Submodule	386
16.3.1.2	Timer Submodule	386
16.3.1.3	Operator Submodule	387
16.3.1.4	Fault Detection Submodule	389
16.3.1.5	Capture Submodule	389
16.3.2	PWM Timer Submodule	389
16.3.2.1	Configurations of the PWM Timer Submodule	389
16.3.2.2	PWM Timer's Working Modes and Timing Event Generation	390
16.3.2.3	PWM Timer Shadow Register	394
16.3.2.4	PWM Timer Synchronization and Phase Locking	394
16.3.3	PWM Operator Submodule	394
16.3.3.1	PWM Generator Submodule	395
16.3.3.2	Dead Time Generator Submodule	405
16.3.3.3	PWM Carrier Submodule	409
16.3.3.4	Fault Handler Submodule	411
16.3.4	Capture Submodule	413
16.3.4.1	Introduction	413
16.3.4.2	Capture Timer	413
16.3.4.3	Capture Channel	413
16.4	Register Summary	414
16.5	Registers	416
17	PULSE_CNT	459
17.1	Introduction	459
17.2	Functional Description	459
17.2.1	Architecture	459
17.2.2	Counter Channel Inputs	459
17.2.3	Watchpoints	460
17.2.4	Examples	461
17.2.5	Interrupts	461
17.3	Register Summary	461
17.4	Registers	463
18	64-bit Timers	467
18.1	Introduction	467
18.2	Functional Description	467
18.2.1	16-bit Prescaler	467
18.2.2	64-bit Time-base Counter	467

18.2.3 Alarm Generation	468
18.2.4 MWDT	468
18.2.5 Interrupts	468
18.3 Register Summary	468
18.4 Registers	470
19 Watchdog Timers	477
19.1 Introduction	477
19.2 Features	477
19.3 Functional Description	477
19.3.1 Clock	477
19.3.1.1 Operating Procedure	478
19.3.1.2 Write Protection	478
19.3.1.3 Flash Boot Protection	478
19.3.1.4 Registers	479
20 eFuse Controller	480
20.1 Introduction	480
20.2 Features	480
20.3 Functional Description	480
20.3.1 Structure	480
20.3.1.1 System Parameter efuse_wr_disable	481
20.3.1.2 System Parameter efuse_rd_disable	482
20.3.1.3 System Parameter coding_scheme	482
20.3.1.4 BLK3_part_reserve	483
20.3.2 Programming of System Parameters	483
20.3.3 Software Reading of System Parameters	486
20.3.4 The Use of System Parameters by Hardware Modules	487
20.3.5 Interrupts	488
20.4 Register Summary	488
20.5 Registers	490
21 AES Accelerator	500
21.1 Introduction	500
21.2 Features	500
21.3 Functional Description	500
21.3.1 AES Algorithm Operations	500
21.3.2 Key, Plaintext and Ciphertext	500
21.3.3 Endianness	501
21.3.4 Encryption and Decryption Operations	503
21.3.5 Speed	503
21.4 Register Summary	503
21.5 Registers	505
22 SHA Accelerator	507
22.1 Introduction	507
22.2 Features	507

22.3	Functional Description	507
22.3.1	Padding and Parsing the Message	507
22.3.2	Message Digest	507
22.3.3	Hash Operation	508
22.3.4	Speed	508
22.4	Register Summary	508
22.5	Registers	510
23	RSA Accelerator	515
23.1	Introduction	515
23.2	Features	515
23.3	Functional Description	515
23.3.1	Initialization	515
23.3.2	Large Number Modular Exponentiation	515
23.3.3	Large Number Modular Multiplication	517
23.3.4	Large Number Multiplication	517
23.4	Register Summary	518
23.5	Registers	519
24	Random Number Generator	521
24.1	Introduction	521
24.2	Feature	521
24.3	Functional Description	521
24.4	Register Summary	521
24.5	Register	521
25	Flash Encryption/Decryption	522
25.1	Overview	522
25.2	Features	522
25.3	Functional Description	522
25.3.1	Key Generator	523
25.3.2	Flash Encryption Block	523
25.3.3	Flash Decryption Block	524
25.4	Register Summary	524
25.5	Register	526
26	PID/MPU/MMU	527
26.1	Introduction	527
26.2	Features	527
26.3	Functional Description	527
26.3.1	PID Controller	527
26.3.2	MPU/MMU	528
26.3.2.1	Embedded Memory	528
26.3.2.2	External Memory	534
26.3.2.3	Peripheral	540
27	PID Controller	542

27.1	Overview	542
27.2	Features	542
27.3	Functional Description	542
27.3.1	Interrupt Identification	543
27.3.2	Information Recording	543
27.3.3	Proactive Process Switching	545
27.4	Register Summary	547
27.5	Registers	548
28	On-Chip Sensors and Analog Signal Processing	552
28.1	Introduction	552
28.2	Capacitive Touch Sensor	552
28.2.1	Introduction	552
28.2.2	Features	552
28.2.3	Available GPIOs	553
28.2.4	Functional Description	553
28.2.5	Touch FSM	554
28.3	SAR ADC	555
28.3.1	Introduction	555
28.3.2	Features	556
28.3.3	Outline of Function	556
28.3.4	RTC SAR ADC Controllers	558
28.3.5	DIG SAR ADC Controllers	559
28.4	Low-Noise Amplifier	561
28.4.1	Introduction	561
28.4.2	Features	561
28.4.3	Overview of Function	561
28.5	Hall Sensor	562
28.5.1	Introduction	562
28.5.2	Features	563
28.5.3	Functional Description	563
28.6	Temperature Sensor	563
28.6.1	Introduction	563
28.6.2	Features	564
28.6.3	Functional Description	564
28.7	DAC	564
28.7.1	Introduction	564
28.7.2	Features	564
28.7.3	Structure	565
28.7.4	Cosine Waveform Generator	565
28.7.5	DMA support	566
28.8	Register Summary	567
28.8.1	Sensors	567
28.8.2	Advanced Peripheral Bus	567
28.8.3	RTC I/O	568
28.9	Registers	569
28.9.1	Sensors	569

28.9.2	Advanced Peripheral Bus	580
28.9.3	RTC I/O	583
29	ULP Co-processor	584
29.1	Introduction	584
29.2	Features	584
29.3	Functional Description	585
29.4	Instruction Set	585
29.4.1	ALU - Perform Arithmetic/Logic Operations	586
29.4.1.1	Operations among Registers	586
29.4.1.2	Operations with Immediate Value	587
29.4.1.3	Operations with Stage Count Register	587
29.4.2	ST – Store Data in Memory	588
29.4.3	LD – Load Data from Memory	588
29.4.4	JUMP – Jump to an Absolute Address	589
29.4.5	JUMPR – Jump to a Relative Offset (Conditional upon R0)	589
29.4.6	JUMPS – Jump to a Relative Address (Conditional upon Stage Count Register)	590
29.4.7	HALT – End the Program	590
29.4.8	WAKE – Wake up the Chip	591
29.4.9	Sleep – Set the ULP Timer's Wake-up Period	591
29.4.10	WAIT – Wait for a Number of Cycles	591
29.4.11	TSENS – Take Measurements with the Temperature Sensor	591
29.4.12	ADC – Take Measurement with ADC	592
29.4.13	I2C_RD/I2C_WR – Read/Write I2C	593
29.4.14	REG_RD – Read from Peripheral Register	593
29.4.15	REG_WR – Write to Peripheral Register	594
29.5	ULP Program Execution	594
29.6	RTC_I2C Controller	596
29.6.1	Configuring RTC_I2C	596
29.6.2	Using RTC_I2C	596
29.6.2.1	I2C_RD - Read a Single Byte	597
29.6.2.2	I2C_WR - Write a Single Byte	597
29.6.2.3	Detecting Error Conditions	598
29.6.2.4	Connecting I2C Signals	598
29.7	Register Summary	599
29.7.1	SENS_ULP Address Space	599
29.7.2	RTC_I2C Address Space	599
29.8	Registers	600
29.8.1	SENS_ULP Address Space	600
29.8.2	RTC_I2C Address Space	602
30	Low-Power Management	609
30.1	Introduction	609
30.2	Features	609
30.3	Functional Description	610
30.3.1	Overview	610
30.3.2	Digital Core Voltage Regulator	610

30.3.3	Low-Power Voltage Regulator	610
30.3.4	Flash Voltage Regulator	611
30.3.5	Brownout Detector	612
30.3.6	RTC Module	612
30.3.7	Low-Power Clocks	614
30.3.8	Power-Gating Implementation	615
30.3.9	Predefined Power Modes	616
30.3.10	Wakeup Source	617
30.3.11	RTC Timer	618
30.3.12	RTC Boot	618
30.4	Register Summary	620
30.5	Registers	622

List of Tables

2	Address Mapping	25
3	Embedded Memory Address Mapping	26
4	Module with DMA	28
5	External Memory Address Mapping	29
6	Cache memory mode	29
7	Peripheral Address Mapping	30
8	PRO_CPU, APP_CPU Interrupt Configuration	34
9	CPU Interrupts	36
10	PRO_CPU and APP_CPU Reset Reason Values	38
11	CPU_CLK Source	40
12	CPU_CLK Derivation	41
13	Peripheral Clock Usage	41
14	APB_CLK Derivation	42
15	REF_TICK Derivation	42
16	LEDC_SCLK Derivation	42
17	IO_MUX Light-sleep Pin Function Registers	50
18	GPIO Matrix Peripheral Signals	51
19	IO_MUX Pad Summary	56
20	RTC_MUX Pin Summary	57
25	SPI Signal and Pin Signal Function Mapping	119
26	Clock Polarity and Phase, and Corresponding SPI Register Values for SPI Master	123
27	Clock Polarity and Phase, and Corresponding SPI Register Values for SPI Slave	123
32	SD/MMC Signal Description	183
33	DES0	189
34	DES1	190
35	DES2	190
36	DES3	190
38	Destination Address Filtering	221
39	Source Address Filtering	222
40	Transmit Descriptor 0 (TDES0)	227
41	Transmit Descriptor 1 (TDES1)	231
42	Transmit Descriptor 2 (TDES2)	231
43	Transmit Descriptor 3 (TDES3)	231
44	Transmit Descriptor 6 (TDES6)	231
45	Transmit Descriptor 7 (TDES7)	232
46	Receive Descriptor 0 (RDES0)	233
47	Receive Descriptor 1 (RDES1)	235
48	Receive Descriptor 2 (RDES2)	236
49	Receive Descriptor 3 (RDES3)	236
50	Receive Descriptor 4 (RDES4)	236
51	Receive Descriptor 6 (RDES6)	238
52	Receive Descriptor 7 (RDES7)	238
55	I2S Signal Bus Description	289
56	Register Configuration	293
57	Send Channel Mode	293

58	Modes of Writing Received Data into FIFO and the Corresponding Register Configuration	295
59	The Register Configuration to Which the Four Modes Correspond	295
60	Upsampling Rate Configuration	297
61	Down-sampling Configuration	298
67	Configuration Parameters of the Operator Submodule	388
68	Timing Events Used in PWM Generator	396
69	Timing Events Priority When PWM Timer Increments	396
70	Timing Events Priority when PWM Timer Decrements	397
71	Dead Time Generator Switches Control Registers	406
72	Typical Dead Time Generator Operating Modes	407
77	System Parameter	480
78	BLOCK1/2/3 Encoding	482
79	Program Register	484
80	Timing Configuration	485
81	Software Read Register	486
83	Operation Mode	500
84	AES Text Endianness	501
85	AES-128 Key Endianness	502
86	AES-192 Key Endianness	502
87	AES-256 Key Endianness	502
93	MPU and MMU Structure for Internal Memory	528
94	MPU for RTC FAST Memory	529
95	MPU for RTC SLOW Memory	529
96	Page Mode of MMU for the Remaining 128 KB of Internal SRAM0 and SRAM2	530
97	Page Boundaries for SRAM0 MMU	531
98	Page Boundaries for SRAM2 MMU	531
99	DPORT_DMMU_TABLE n _REG & DPORT_IMMU_TABLE n _REG	532
100	MPU for DMA	533
101	Virtual Address for External Memory	535
102	MMU Entry Numbers for PRO_CPU	535
103	MMU Entry Numbers for APP_CPU	535
104	MMU Entry Numbers for PRO_CPU (Special Mode)	536
105	MMU Entry Numbers for APP_CPU (Special Mode)	536
106	Virtual Address Mode for External SRAM	537
107	Virtual Address for External SRAM (Normal Mode)	538
108	Virtual Address for External SRAM (Low-High Mode)	538
109	Virtual Address for External SRAM (Even-Odd Mode)	538
110	MMU Entry Numbers for External RAM	539
111	MPU for Peripheral	540
112	DPORT_AHBLITE_MPU_TABLE X _REG	541
113	Interrupt Vector Entry Address	543
114	Configuration of PIDCTRL_LEVEL_REG	543
115	Configuration of PIDCTRL_FROM n _REG	544
117	ESP32 Capacitive Sensing Touch Pads	553
118	Inputs of SAR ADC module	557
119	ESP32 SAR ADC Controllers	558
120	Fields of the Pattern Table Register	560

121	Fields of Type I DMA Data Format	561
122	Fields of Type II DMA Data Format	561
125	ALU Operations among Registers	586
126	ALU Operations with Immediate Value	587
127	ALU Operations with Stage Count Register	588
128	Input Signals Measured using the ADC Instruction	592
131	RTC Power Domains	615
132	Wake-up Source	618

List of Figures

1	System Structure	24
2	System Address Mapping	24
3	Cache Block Diagram	29
4	Interrupt Matrix Structure	33
5	System Reset	38
6	System Clock	39
7	IO_MUX, RTC IO_MUX and GPIO Matrix Overview	45
8	Peripheral Input via IO_MUX, GPIO Matrix	46
9	Output via GPIO Matrix	48
10	ESP32 I/O Pad Power Sources	51
11	DMA Engine Architecture	114
12	Linked List Structure	115
13	Data Transfer in UDMA Mode	116
14	SPI DMA	117
15	SPI Architecture	119
16	SPI Master and Slave Full-duplex Communication	120
17	SPI Data Buffer	122
18	Parallel QSPI	124
19	Communication Format of Parallel QSPI	125
20	SDIO Slave Block Diagram	151
21	SDIO Bus Packet Transmission	152
22	CMD53 Content	152
23	SDIO Slave DMA Linked List Structure	153
24	SDIO Slave Linked List	153
25	Packet Sending Procedure (Initiated by Slave)	154
26	Packet Receiving Procedure (Initiated by Host)	155
27	Loading Receiving Buffer	156
28	Sampling Timing Diagram	156
29	Output Timing Diagram	157
30	SD/MMC Controller Topology	182
31	SD/MMC Controller External Interface Signals	183
32	SDIO Host Block Diagram	183
33	Command Path State Machine	185
34	Data Transmit State Machine	185
35	Data Receive State Machine	186
36	Descriptor Chain	188
37	The Structure of a Linked List	188
38	Clock Phase Selection	192
39	Ethernet MAC Functionality Overview	214
40	Ethernet Block Diagram	216
41	MII Interface	223
42	MII Clock	225
43	RMII Interface	225
44	RMII Clock	226
45	Transmit Descriptor	227

46	Receive Descriptor	233
47	I2C Master Architecture	266
48	I2C Slave Architecture	266
49	I2C Sequence Chart	267
50	Structure of The I2C Command Register	267
51	I2C Master Writes to Slave with 7-bit Address	268
52	I2C Master Writes to Slave with 10-bit Address	270
53	I2C Master Writes to addrM in RAM of Slave with 7-bit Address	270
54	I2C Master Writes to Slave with 7-bit Address in Three Segments	271
55	I2C Master Reads from Slave with 7-bit Address	272
56	I2C Master Reads from Slave with 10-bit Address	272
57	I2C Master Reads N Bytes of Data from addrM in Slave with 7-bit Address	273
58	I2C Master Reads from Slave with 7-bit Address in Three Segments	273
59	I2S System Block Diagram	288
60	I2S Clock	290
61	Philips Standard	291
62	MSB Alignment Standard	291
63	PCM Standard	292
64	Tx FIFO Data Mode	293
65	The First Stage of Receiving Data	294
66	Modes of Writing Received Data into FIFO	295
67	PDM Transmitting Module	296
68	PDM Sends Signal	297
69	PDM Receives Signal	297
70	PDM Receive Module	298
71	LCD Master Transmitting Mode	298
72	LCD Master Transmitting Data Frame, Form 1	299
73	LCD Master Transmitting Data Frame, Form 2	299
74	Camera Slave Receiving Mode	299
75	ADC Interface of I2S0	300
76	DAC Interface of I2S	300
77	Data Input by I2S DAC Interface	300
78	UART Basic Structure	323
79	UART shared RAM	324
80	UART Data Frame Structure	325
81	AT_CMD Character Format	325
82	Hardware Flow Control	326
83	LED_PWM Architecture	359
84	LED_PWM High-speed Channel Diagram	359
85	LED_PWM Divider	360
86	LED PWM Output Signal Diagram	361
87	Output Signal Diagram of Gradient Duty Cycle	361
88	RMT Architecture	375
89	Data Structure	376
90	MCPWM Module Overview	384
91	Prescaler Submodule	386
92	Timer Submodule	386

93	Operator Submodule	387
94	Fault Detection Submodule	389
95	Capture Submodule	389
96	Count-Up Mode Waveform	390
97	Count-Down Mode Waveforms	391
98	Count-Up-Down Mode Waveforms, Count-Down at Synchronization Event	391
99	Count-Up-Down Mode Waveforms, Count-Up at Synchronization Event	391
100	UTEP and UTEZ Generation in Count-Up Mode	392
101	DTEP and DTEZ Generation in Count-Down Mode	393
102	DTEP and UTEZ Generation in Count-Up-Down Mode	393
103	Submodules Inside the PWM Operator	395
104	Symmetrical Waveform in Count-Up-Down Mode	398
105	Count-Up, Single Edge Asymmetric Waveform, with Independent Modulation on PWMxA and PWMxB — Active High	399
106	Count-Up, Pulse Placement Asymmetric Waveform with Independent Modulation on PWMxA	400
107	Count-Up-Down, Dual Edge Symmetric Waveform, with Independent Modulation on PWMxA and PWMxB — Active High	401
108	Count-Up-Down, Dual Edge Symmetric Waveform, with Independent Modulation on PWMxA and PWMxB — Complementary	402
109	Example of an NCI Software-Force Event on PWMxA	403
110	Example of a CNTU Software-Force Event on PWMxB	404
111	Options for Setting up the Dead Time Generator Submodule	406
112	Active High Complementary (AHC) Dead Time Waveforms	407
113	Active Low Complementary (ALC) Dead Time Waveforms	408
114	Active High (AH) Dead Time Waveforms	408
115	Active Low (AL) Dead Time Waveforms	408
116	Example of Waveforms Showing PWM Carrier Action	410
117	Example of the First Pulse and the Subsequent Sustaining Pulses of the PWM Carrier Submodule	411
118	Possible Duty Cycle Settings for Sustaining Pulses in the PWM Carrier Submodule	411
119	PULSE_CNT Architecture	459
120	PULSE_CNT Upcounting Diagram	461
121	PULSE_CNT Downcounting Diagram	461
122	Flash Encryption/Decryption Module Architecture	522
123	MMU Access Example	530
124	Interrupt Nesting	545
125	Touch Sensor	552
126	Touch Sensor Structure	553
127	Touch Sensor Operating Flow	554
128	Touch FSM Structure	555
129	SAR ADC Depiction	556
130	SAR ADC Outline of Function	557
131	RTC SAR ADC Outline of Function	559
132	Diagram of DIG SAR ADC Controllers	560
133	Structure of Low-Noise Amplifier	561
134	Low-Noise Amplifier – Sequence of Operation	562
135	Hall Sensor	563
136	Temperature Sensor	564

137	Diagram of DAC Function	565
138	Cosine Waveform (CW) Generator	566
139	ULP Co-processor Diagram	584
140	The ULP Co-processor Instruction Format	585
141	Instruction Type — ALU for Operations among Registers	586
142	Instruction Type — ALU for Operations with Immediate Value	587
143	Instruction Type — ALU for Operations with Stage Count Register	587
144	Instruction Type — ST	588
145	Instruction Type — LD	588
146	Instruction Type — JUMP	589
147	Instruction Type — JUMPR	589
148	Instruction Type — JUMP	590
149	Instruction Type — HALT	590
150	Instruction Type — WAKE	591
151	Instruction Type — SLEEP	591
152	Instruction Type — WAIT	591
153	Instruction Type — TSENS	591
154	Instruction Type — ADC	592
155	Instruction Type — I2C	593
156	Instruction Type — REG_RD	593
157	Instruction Type — REG_WR	594
158	Control of ULP Program Execution	595
159	Sample of a ULP Operation Sequence	596
160	I2C Read Operation	597
161	I2C Write Operation	598
162	ESP32 Power Control	609
163	Digital Core Voltage Regulator	610
164	Low-Power Voltage Regulator	611
165	Flash Voltage Regulator	612
166	Brownout Detector	612
167	RTC Structure	613
168	RTC Low-Power Clocks	614
169	Digital Low-Power Clocks	614
170	RTC States	615
171	Power Modes	617
172	ESP32 Boot Flow	619

1. System and Memory

1.1 Introduction

The ESP32 is a dual-core system with two Harvard Architecture Xtensa LX6 CPUs. All embedded memory, external memory and peripherals are located on the data bus and/or the instruction bus of these CPUs.

With some minor exceptions (see below), the address mapping of two CPUs is symmetric, meaning that they use the same addresses to access the same memory. Multiple peripherals in the system can access embedded memory via DMA.

The two CPUs are named “PRO_CPU” and “APP_CPU” (for “protocol” and “application”), however, for most purposes the two CPUs are interchangeable.

1.2 Features

- Address Space
 - Symmetric address mapping
 - 4 GB (32-bit) address space for both data bus and instruction bus
 - 1296 KB embedded memory address space
 - 19704 KB external memory address space
 - 512 KB peripheral address space
 - Some embedded and external memory regions can be accessed by either data bus or instruction bus
 - 328 KB DMA address space
- Embedded Memory
 - 448 KB Internal ROM
 - 520 KB Internal SRAM
 - 8 KB RTC FAST Memory
 - 8 KB RTC SLOW Memory
- External Memory

Off-chip SPI memory can be mapped into the available address space as external memory. Parts of the embedded memory can be used as transparent cache for this external memory.

 - Supports up to 16 MB off-Chip SPI Flash.
 - Supports up to 8 MB off-Chip SPI SRAM.
- Peripherals
 - 41 peripherals
- DMA
 - 13 modules are capable of DMA operation

The block diagram in Figure 1 illustrates the system structure, and the block diagram in Figure 2 illustrates the address map structure.

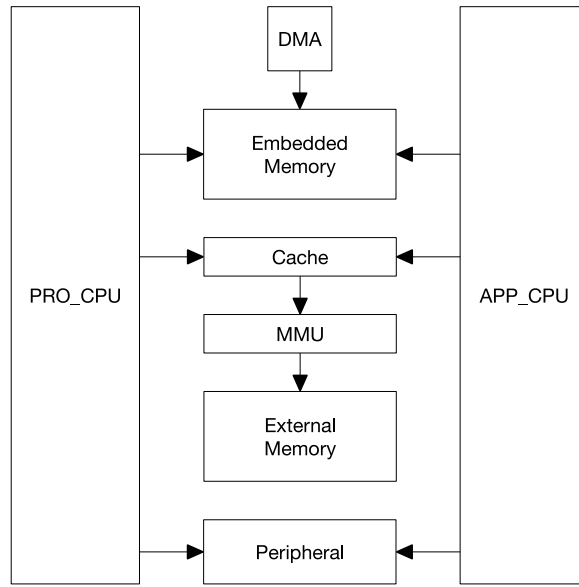


Figure 1: System Structure

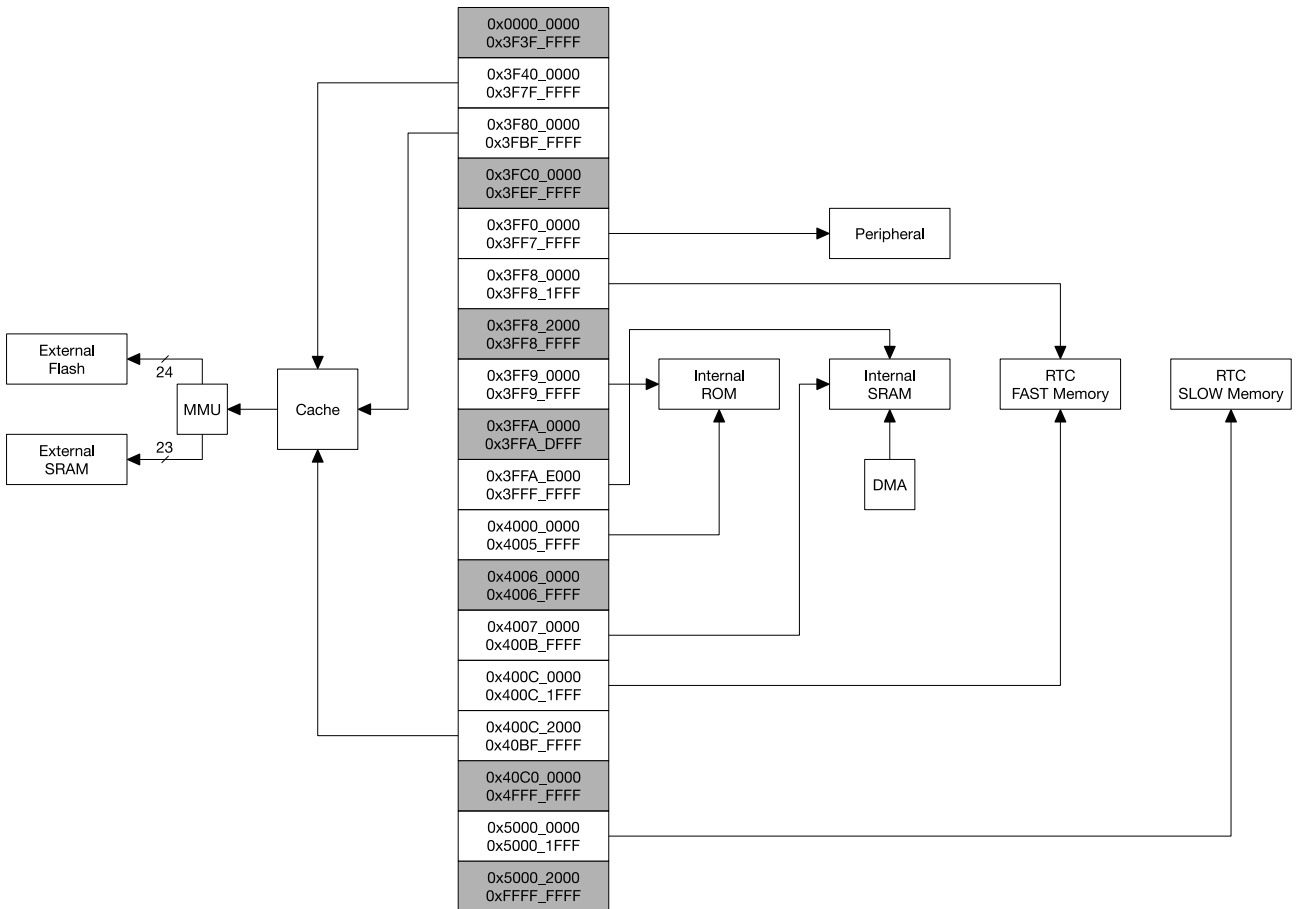


Figure 2: System Address Mapping

1.3 Functional Description

1.3.1 Address Mapping

Each of the two Harvard Architecture Xtensa LX6 CPUs has 4 GB (32-bit) address space. Address spaces are symmetric between the two CPUs.

Addresses below 0x4000_0000 are serviced using the data bus. Addresses in the range 0x4000_0000 ~ 0x4FFF_FFFF are serviced using the instruction bus. Finally, addresses over and including 0x5000_0000 are shared by the data and instruction bus.

The data bus and instruction bus are both little-endian: for example, byte addresses 0x0, 0x1, 0x2, 0x3 access the least significant, second least significant, second most significant, and the most significant bytes of the 32-bit word stored at the 0x0 address, respectively. The CPU can access data bus addresses via aligned or non-aligned byte, half-word and word read-and-write operations. The CPU can read and write data through the instruction bus, but only in a **word aligned manner**; non-word-aligned access will cause a CPU exception.

Each CPU can directly access embedded memory through both the data bus and the instruction bus, external memory which is mapped into the address space (via transparent caching & MMU), and peripherals. Table 2 illustrates address ranges that can be accessed by each CPU's data bus and instruction bus.

Some embedded memories and some external memories can be accessed via the data bus or the instruction bus. In these cases, the same memory is available to either of the CPUs at two address ranges.

Table 2: Address Mapping

Bus Type	Boundary Address		Size	Target
	Low Address	High Address		
	0x0000_0000	0x3F3F_FFFF		Reserved
Data	0x3F40_0000	0x3F7F_FFFF	4 MB	External Memory
Data	0x3F80_0000	0x3FBF_FFFF	4 MB	External Memory
	0x3FC0_0000	0x3FEF_FFFF	3 MB	Reserved
Data	0x3FF0_0000	0x3FF7_FFFF	512 KB	Peripheral
Data	0x3FF8_0000	0x3FFF_FFFF	512 KB	Embedded Memory
Instruction	0x4000_0000	0x400C_1FFF	776 KB	Embedded Memory
Instruction	0x400C_2000	0x40BF_FFFF	11512 KB	External Memory
	0x40C0_0000	0x4FFF_FFFF	244 MB	Reserved
Data Instruction	0x5000_0000	0x5000_1FFF	8 KB	Embedded Memory
	0x5000_2000	0xFFFF_FFFF		Reserved

1.3.2 Embedded Memory

The Embedded Memory consists of four segments: internal ROM (448 KB), internal SRAM (520 KB), RTC FAST memory (8 KB) and RTC SLOW memory (8 KB).

The 448 KB internal ROM is divided into two parts: Internal ROM 0 (384 KB) and Internal ROM 1 (64 KB). The 520 KB internal SRAM is divided into three parts: Internal SRAM 0 (192 KB), Internal SRAM 1 (128 KB), and Internal SRAM 2 (200 KB). RTC FAST Memory and RTC SLOW Memory are both implemented as SRAM.

Table 3 lists all embedded memories and their address ranges on the data and instruction buses.

Table 3: Embedded Memory Address Mapping

Bus Type	Boundary Address		Size	Target	Comment
	Low Address	High Address			
Data	0x3FF8_0000	0x3FF8_1FFF	8 KB	RTC FAST Memory	PRO_CPU Only
	0x3FF8_2000	0x3FF8_FFFF	56 KB	Reserved	-
Data	0x3FF9_0000	0x3FF9_FFFF	64 KB	Internal ROM 1	-
	0x3FFA_0000	0x3FFA_DFFF	56 KB	Reserved	-
Data	0x3FFA_E000	0x3FFD_FFFF	200 KB	Internal SRAM 2	DMA
Data	0x3FFE_0000	0x3FFF_FFFF	128 KB	Internal SRAM 1	DMA
Bus Type	Boundary Address		Size	Target	Comment
	Low Address	High Address			
Instruction	0x4000_0000	0x4000_7FFF	32 KB	Internal ROM 0	Remap
Instruction	0x4000_8000	0x4005_FFFF	352 KB	Internal ROM 0	-
	0x4006_0000	0x4006_FFFF	64 KB	Reserved	-
Instruction	0x4007_0000	0x4007_FFFF	64 KB	Internal SRAM 0	Cache
Instruction	0x4008_0000	0x4009_FFFF	128 KB	Internal SRAM 0	-
Instruction	0x400A_0000	0x400A_FFFF	64 KB	Internal SRAM 1	-
Instruction	0x400B_0000	0x400B_7FFF	32 KB	Internal SRAM 1	Remap
Instruction	0x400B_8000	0x400B_FFFF	32 KB	Internal SRAM 1	-
Instruction	0x400C_0000	0x400C_1FFF	8 KB	RTC FAST Memory	PRO_CPU Only
Bus Type	Boundary Address		Size	Target	Comment
	Low Address	High Address			
Data Instruction	0x5000_0000	0x5000_1FFF	8 KB	RTC SLOW Memory	-

1.3.2.1 Internal ROM 0

The capacity of Internal ROM 0 is 384 KB. It is accessible by both CPUs through the address range 0x4000_0000 ~ 0x4005_FFFF, which is on the instruction bus.

The address range of the first 32 KB of the ROM 0 (0x4000_0000 ~ 0x4000_7FFF) can be remapped in order to access a part of Internal SRAM 1 that normally resides in a memory range of 0x400B_0000 ~ 0x400B_7FFF. While remapping, the 32 KB SRAM cannot be accessed by an address range of 0x400B_0000 ~ 0x400B_7FFF any more, but it can still be accessible through the data bus (0x3FFE_8000 ~ 0x3FFE_FFFF). This can be done on a per-CPU basis: setting bit 0 of register DPORT_PRO_BOOT_REMAP_CTRL_REG or DPORT_APP_BOOT_REMAP_CTRL_REG will remap SRAM for the PRO_CPU and APP_CPU, respectively.

1.3.2.2 Internal ROM 1

The capacity of Internal ROM 1 is 64 KB. It can be read by either CPU at an address range 0x3FF9_0000 ~ 0x3FF9_FFFF of the data bus.

1.3.2.3 Internal SRAM 0

The capacity of Internal SRAM 0 is 192 KB. Hardware can be configured to use the first 64 KB to cache external memory access. When not used as cache, the first 64 KB can be read and written by either CPU at addresses 0x4007_0000 ~ 0x4007_FFFF of the instruction bus. The remaining 128 KB can always be read and written by either CPU at addresses 0x4008_0000 ~ 0x4009_FFFF of instruction bus.

1.3.2.4 Internal SRAM 1

The capacity of Internal SRAM 1 is 128 KB. Either CPU can read and write this memory at addresses 0x3FFE_0000 ~ 0x3FFF_FFFF of the data bus, and also at addresses 0x400A_0000 ~ 0x400B_FFFF of the instruction bus.

The address range accessed via the instruction bus is in reverse order (word-wise) compared to access via the data bus. That is to say, address

0x3FFE_0000 and 0x400B_FFFC access the same word

0x3FFE_0004 and 0x400B_FFF8 access the same word

0x3FFE_0008 and 0x400B_FFF4 access the same word

.....

0x3FFF_FFF4 and 0x400A_0008 access the same word

0x3FFF_FFF8 and 0x400A_0004 access the same word

0x3FFF_FFFC and 0x400A_0000 access the same word

The data bus and instruction bus of the CPU are still both little-endian, so the byte order of individual words is not reversed between address spaces. For example, address

0x3FFE_0000 accesses the least significant byte in the word accessed by 0x400B_FFFC.

0x3FFE_0001 accesses the second least significant byte in the word accessed by 0x400B_FFFC.

0x3FFE_0002 accesses the second most significant byte in the word accessed by 0x400B_FFFC.

0x3FFE_0003 accesses the most significant byte in the word accessed by 0x400B_FFFC.

0x3FFE_0004 accesses the least significant byte in the word accessed by 0x400B_FFF8.

0x3FFE_0005 accesses the second least significant byte in the word accessed by 0x400B_FFF8.

0x3FFE_0006 accesses the second most significant byte in the word accessed by 0x400B_FFF8.

0x3FFE_0007 accesses the most significant byte in the word accessed by 0x400B_FFF8.

.....

0x3FFF_FFF8 accesses the least significant byte in the word accessed by 0x400A_0004.

0x3FFF_FFF9 accesses the second least significant byte in the word accessed by 0x400A_0004.

0x3FFF_FFFA accesses the second most significant byte in the word accessed by 0x400A_0004.

0x3FFF_FFFB accesses the most significant byte in the word accessed by 0x400A_0004.

0x3FFF_FFFC accesses the least significant byte in the word accessed by 0x400A_0000.

0x3FFF_FFFD accesses the second most significant byte in the word accessed by 0x400A_0000.

0x3FFF_FFFE accesses the second most significant byte in the word accessed by 0x400A_0000.

0x3FFF_FFFF accesses the most significant byte in the word accessed by 0x400A_0000.

Part of this memory can be remapped onto the ROM 0 address space. See [Internal Rom 0](#) for more information.

1.3.2.5 Internal SRAM 2

The capacity of Internal SRAM 2 is 200 KB. It can be read and written by either CPU at addresses 0x3FFA_E000 ~ 0x3FFD_FFFF on the data bus.

1.3.2.6 DMA

DMA uses the same addressing as the CPU data bus to read and write Internal SRAM 1 and Internal SRAM 2. This means DMA uses an address range of 0x3FFE_0000 ~ 0x3FFF_FFFF to read and write Internal SRAM 1 and an address range of 0x3FFA_E000 ~ 0x3FFD_FFFF to read and write Internal SRAM 2.

In the ESP32, 13 peripherals are equipped with DMA. Table 4 lists these peripherals.

Table 4: Module with DMA

UART0	UART1	UART2
SPI1	SPI2	SPI3
I2S0	I2S1	
SDIO Slave	SDMMC	
EMAC		
BT	WIFI	

1.3.2.7 RTC FAST Memory

RTC FAST Memory is 8 KB of SRAM. It can be read and written by PRO_CPU only at an address range of 0x3FF8_0000 ~ 0x3FF8_1FFF on the data bus or at an address range of 0x400C_0000 ~ 0x400C_1FFF on the instruction bus. Unlike most other memory regions, RTC FAST memory cannot be accessed by the APP_CPU.

The two address ranges of PRO_CPU access RTC FAST Memory in the same order, so, for example, addresses 0x3FF8_0000 and 0x400C_0000 access the same word. **On the APP_CPU, these address ranges do not provide access to RTC FAST Memory or any other memory location.**

1.3.2.8 RTC SLOW Memory

RTC SLOW Memory is 8 KB of SRAM which can be read and written by either CPU at an address range of 0x5000_0000 ~ 0x5000_1FFF. This address range is shared by both the data bus and the instruction bus.

1.3.3 External Memory

The ESP32 can access external SPI flash and SPI SRAM as external memory. Table 5 provides a list of external memories that can be accessed by either CPU at a range of addresses on the data and instruction buses. When a CPU accesses external memory through the Cache and MMU, the cache will map the CPU's address to an external physical memory address (in the external memory's address space), according to the MMU settings. Due to this address mapping, the ESP32 can address up to 16 MB External Flash and 8 MB External SRAM.

Table 5: External Memory Address Mapping

Bus Type	Boundary Address		Size	Target	Comment
	Low Address	High Address			
Data	0x3F40_0000	0x3F7F_FFFF	4 MB	External Flash	Read
Data	0x3F80_0000	0x3FBF_FFFF	4 MB	External SRAM	Read and Write
Bus Type	Boundary Address		Size	Target	Comment
	Low Address	High Address			
Instruction	0x400C_2000	0x40BF_FFFF	11512 KB	External Flash	Read

1.3.4 Cache

As shown in Figure 3, each of the two CPUs in ESP32 has 32 KB of cache for accessing external storage. PRO CPU uses bit PRO_CACHE_ENABLE in register DPORT_PRO_CAHCE_CTRL_REG to enable the Cache, while APP CPU uses bit APP_CACHE_ENABLE in register DPORT_APP_CAHCE_CTRL_REG to enable the same function.

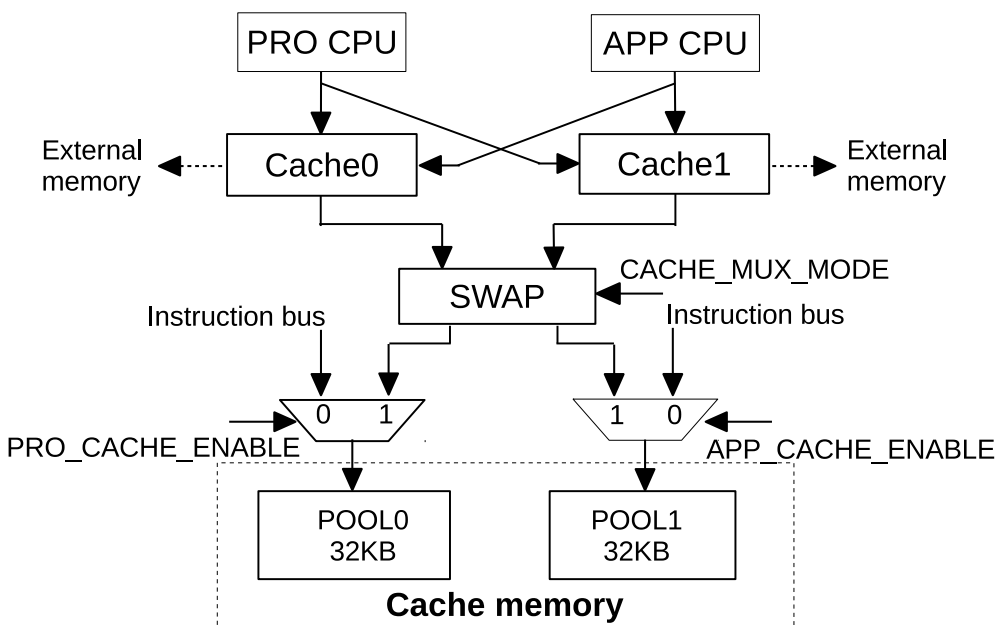


Figure 3: Cache Block Diagram

ESP32 uses a two-way set-associative cache. When the Cache function is to be used either by PRO CPU or APP CPU, bit CACHE_MUX_MODE[1:0] in register DPORT_CACHE_MUX_MODE_REG can be set to select POOL0 or POOL1 in the Internal SRAM0 as the cache memory. When both PRO CPU and APP CPU use the Cache function, POOL0 and POOL1 in the Internal SRAM0 will be used simultaneously as the cache memory, while they can also be used by the instruction bus. This is depicted in table 6 below.

Table 6: Cache memory mode

CACHE_MUX_MODE	POOL0	POOL1
0	PRO CPU	APP CPU
1	PRO CPU/APP CPU	-
2	-	PRO CPU/APP CPU
3	APP CPU	PRO CPU

As described in table 6, when bit `CACHE_MUX_MODE` is set to 1 or 2, PRO CPU and APP CPU cannot enable the Cache function at the same time. When the Cache function is enabled, POOL0 or POOL1 can only be used as the cache memory, and cannot be used by the instruction bus as well.

ESP32 Cache supports the Flush function. It is worth noting that when the Flush function is used, the data written in the cache will be disposed rather than being rewritten into the External SRAM. To enable the Flush function, first clear bit `x_CACHE_FLUSH_ENA` in register `DPORT_x_CACHE_CTRL_REG`, then set this bit to 1. Afterwards, the system hardware will set bit `x_CACHE_FLUSH_DONE` to 1, where `x` can be "PRO" or "APP", indicating that the cache flush operation has been completed.

For more information about the address mapping of ESP32 Cache, please refer to [Embedded Memory](#) and [External Memory](#).

1.3.5 Peripherals

The ESP32 has 41 peripherals. Table 7 specifically describes the peripherals and their respective address ranges. Nearly all peripheral modules can be accessed by either CPU at the same address with just a single exception; this being the PID Controller.

Table 7: Peripheral Address Mapping

Bus Type	Boundary Address		Size	Target	Comment
	Low Address	High Address			
Data	0x3FF0_0000	0x3FF0_0FFF	4 KB	DPort Register	
Data	0x3FF0_1000	0x3FF0_1FFF	4 KB	AES Accelerator	
Data	0x3FF0_2000	0x3FF0_2FFF	4 KB	RSA Accelerator	
Data	0x3FF0_3000	0x3FF0_3FFF	4 KB	SHA Accelerator	
Data	0x3FF0_4000	0x3FF0_4FFF	4 KB	Secure Boot	
	0x3FF0_5000	0x3FF0_FFFF	44 KB	Reserved	
Data	0x3FF1_0000	0x3FF1_3FFF	16 KB	Cache MMU Table	
	0x3FF1_4000	0x3FF1_EFFF	44 KB	Reserved	
Data	0x3FF1_F000	0x3FF1_FFFF	4 KB	PID Controller	Per-CPU peripheral
	0x3FF2_0000	0x3FF3_FFFF	128 KB	Reserved	
Data	0x3FF4_0000	0x3FF4_0FFF	4 KB	UART0	
	0x3FF4_1000	0x3FF4_1FFF	4 KB	Reserved	
Data	0x3FF4_2000	0x3FF4_2FFF	4 KB	SPI1	
Data	0x3FF4_3000	0x3FF4_3FFF	4 KB	SPI0	
Data	0x3FF4_4000	0x3FF4_4FFF	4 KB	GPIO	
	0x3FF4_5000	0x3FF4_7FFF	12 KB	Reserved	
Data	0x3FF4_8000	0x3FF4_8FFF	4 KB	RTC	
Data	0x3FF4_9000	0x3FF4_9FFF	4 KB	IO MUX	
	0x3FF4_A000	0x3FF4_AFFF	4 KB	Reserved	
Data	0x3FF4_B000	0x3FF4_BFFF	4 KB	SDIO Slave	One of three parts
Data	0x3FF4_C000	0x3FF4_CFFF	4 KB	UDMA1	
	0x3FF4_D000	0x3FF4_EFFF	8 KB	Reserved	
Data	0x3FF4_F000	0x3FF4_FFFF	4 KB	I2S0	
Data	0x3FF5_0000	0x3FF5_0FFF	4 KB	UART1	
	0x3FF5_1000	0x3FF5_2FFF	8 KB	Reserved	

Bus Type	Boundary Address		Size	Target	Comment
	Low Address	High Address			
Data	0x3FF5_3000	0x3FF5_3FFF	4 KB	I2C0	
Data	0x3FF5_4000	0x3FF5_4FFF	4 KB	UDMA0	
Data	0x3FF5_5000	0x3FF5_5FFF	4 KB	SDIO Slave	One of three parts
Data	0x3FF5_6000	0x3FF5_6FFF	4 KB	RMT	
Data	0x3FF5_7000	0x3FF5_7FFF	4 KB	PCNT	
Data	0x3FF5_8000	0x3FF5_8FFF	4 KB	SDIO Slave	One of three parts
Data	0x3FF5_9000	0x3FF5_9FFF	4 KB	LED PWM	
Data	0x3FF5_A000	0x3FF5_AFFF	4 KB	Efuse Controller	
Data	0x3FF5_B000	0x3FF5_BFFF	4 KB	Flash Encryption	
	0x3FF5_C000	0x3FF5_DFFF	8 KB	Reserved	
Data	0x3FF5_E000	0x3FF5_EFFF	4 KB	PWM0	
Data	0x3FF5_F000	0x3FF5_FFFF	4 KB	TIMG0	
Data	0x3FF6_0000	0x3FF6_0FFF	4 KB	TIMG1	
	0x3FF6_1000	0x3FF6_3FFF	12 KB	Reserved	
Data	0x3FF6_4000	0x3FF6_4FFF	4 KB	SPI2	
Data	0x3FF6_5000	0x3FF6_5FFF	4 KB	SPI3	
Data	0x3FF6_6000	0x3FF6_6FFF	4 KB	SYSCON	
Data	0x3FF6_7000	0x3FF6_7FFF	4 KB	I2C1	
Data	0x3FF6_8000	0x3FF6_8FFF	4 KB	SDMMC	
Data	0x3FF6_9000	0x3FF6_AFFF	8 KB	EMAC	
	0x3FF6_B000	0x3FF6_BFFF	4 KB	Reserved	
Data	0x3FF6_C000	0x3FF6_CFFF	4 KB	PWM1	
Data	0x3FF6_D000	0x3FF6_DFFF	4 KB	I2S1	
Data	0x3FF6_E000	0x3FF6_EFFF	4 KB	UART2	
Data	0x3FF6_F000	0x3FF6_FFFF	4 KB	PWM2	
Data	0x3FF7_0000	0x3FF7_0FFF	4 KB	PWM3	
	0x3FF7_1000	0x3FF7_4FFF	16 KB	Reserved	
Data	0x3FF7_5000	0x3FF7_5FFF	4 KB	RNG	
	0x3FF7_6000	0x3FF7_FFFF	40 KB	Reserved	

1.3.5.1 Asymmetric PID Controller Peripheral

There are two PID Controllers in the system. They serve the PRO_CPU and the APP_CPU, respectively. **The PRO_CPU and the APP_CPU can only access their own PID Controller and not that of their counterpart.** Each CPU uses the same memory range 0x3FF1_F000 ~ 3FF1_FFFF to access its own PID Controller.

1.3.5.2 Non-Contiguous Peripheral Memory Ranges

The SDIO Slave peripheral consists of three parts and the two CPUs use non-contiguous addresses to access these. The three parts are accessed at the address ranges 0x3FF4_B000 ~ 3FF4_BFFF, 0x3FF5_5000 ~ 3FF5_5FFF and 0x3FF5_8000 ~ 3FF5_8FFF of each CPU's data bus. Similarly to other peripherals, access to this peripheral is identical for both CPUs.

1.3.5.3 Memory Speed

The ROM as well as the SRAM are both clocked from CPU_CLK and can be accessed by the CPU in a single cycle. The RTC FAST memory is clocked from the APB_CLOCK and the RTC SLOW memory from the FAST_CLOCK, so access to these memories may be slower. DMA uses the APB_CLK to access memory.

Internally, the SRAM is organized in 32K-sized banks. Each CPU and DMA channel can simultaneously access the SRAM at full speed, provided they access addresses in different memory banks.

2. Interrupt Matrix

2.1 Introduction

The Interrupt Matrix embedded in the ESP32 independently allocates peripheral interrupt sources to the two CPUs' peripheral interrupts. This configuration is made to be highly flexible in order to meet many different needs.

2.2 Features

- Accepts 71 peripheral interrupt sources as input.
- Generates 26 peripheral interrupt sources per CPU as output (52 total).
- CPU NMI Interrupt Mask.
- Queries current interrupt status of peripheral interrupt sources.

The structure of the Interrupt Matrix is shown in Figure 4.

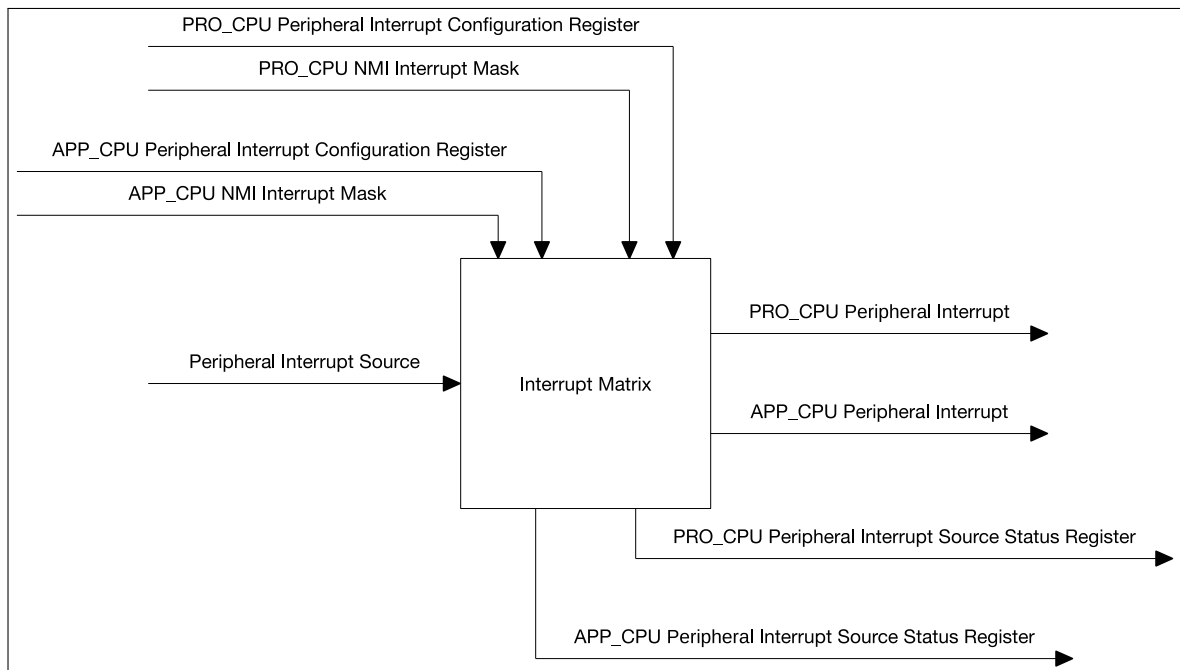


Figure 4: Interrupt Matrix Structure

2.3 Functional Description

2.3.1 Peripheral Interrupt Source

ESP32 has 71 peripheral interrupt sources in total. All peripheral interrupt sources are listed in table 8. 67 of 71 ESP32 peripheral interrupt sources can be allocated to either CPU.

The four remaining peripheral interrupt sources are CPU-specific, two per CPU. `GPIO_INTERRUPT_PRO` and `GPIO_INTERRUPT_PRO_NMI` can only be allocated to PRO_CPU. `GPIO_INTERRUPT_APP` and `GPIO_INTERRUPT_APP_NMI` can only be allocated to APP_CPU. As a result, PRO_CPU and APP_CPU each have 69 peripheral interrupt sources.

Table 8: PRO_CPU, APP_CPU Interrupt Configuration

PRO_CPU				APP_CPU					
Peripheral Interrupt Configuration Register	Bit	Status Register Name	Peripheral Interrupt Source		Status Register Name	Bit	Peripheral Interrupt Configuration Register		
			No.	Name				No.	Name
PRO_MAC_INTR_MAP_REG	0	PRO_INTR_STATUS_REG_0	0	MAC_INTR	0	APP_INTR_STATUS_REG_0	APP_MAC_INTR_MAP_REG		
PRO_MAC_NMI_MAP_REG	1		1	MAC_NMI	1		1	APP_MAC_NMI_MAP_REG	
PRO_BB_INT_MAP_REG	2		2	BB_INT	2		2	APP_BB_INT_MAP_REG	
PRO_BT_MAC_INT_MAP_REG	3		3	BT_MAC_INT	3		3	APP_BT_MAC_INT_MAP_REG	
PRO_BT_BB_INT_MAP_REG	4		4	BT_BB_INT	4		4	APP_BT_BB_INT_MAP_REG	
PRO_BT_BB_NMI_MAP_REG	5		5	BT_BB_NMI	5		5	APP_BT_BB_NMI_MAP_REG	
PRO_RWB_T_IRQ_MAP_REG	6		6	RWB_T_IRQ	6		6	APP_RWB_T_IRQ_MAP_REG	
PRO_BT_BB_NMI_MAP_REG	5		5	BT_BB_NMI	5		5	APP_BT_BB_NMI_MAP_REG	
PRO_RWB_T_IRQ_MAP_REG	6		6	RWB_T_IRQ	6		6	APP_RWB_T_IRQ_MAP_REG	
PRO_RWBLE_IRQ_MAP_REG	7		7	RWBLE_IRQ	7		7	APP_RWBLE_IRQ_MAP_REG	
PRO_RWB_T_NMI_MAP_REG	8		8	RWB_T_NMI	8		8	APP_RWB_T_NMI_MAP_REG	
PRO_RWBLE_NMI_MAP_REG	9		9	RWBLE_NMI	9		9	APP_RWBLE_NMI_MAP_REG	
PRO_SLCO_INTR_MAP_REG	10		10	SLCO_INTR	10		10	APP_SLCO_INTR_MAP_REG	
PRO_SL_C1_INTR_MAP_REG	11		11	SLC1_INTR	11		11	APP_SL_C1_INTR_MAP_REG	
PRO_UHCIO_INTR_MAP_REG	12		12	UHCIO_INTR	12		12	APP_UHCIO_INTR_MAP_REG	
PRO_UHC1_INTR_MAP_REG	13		13	UHC1_INTR	13		13	APP_UHC1_INTR_MAP_REG	
PRO_TG_TO_LEVEL_INT_MAP_REG	14		14	TG_TO_LEVEL_INT	14		14	APP_TG_TO_LEVEL_INT_MAP_REG	
PRO_TG_T1_LEVEL_INT_MAP_REG	15		15	TG_T1_LEVEL_INT	15		15	APP_TG_T1_LEVEL_INT_MAP_REG	
PRO_TG_WDT_LEVEL_INT_MAP_REG	16		16	TG_WDT_LEVEL_INT	16		16	APP_TG_WDT_LEVEL_INT_MAP_REG	
PRO_TG_LACT_LEVEL_INT_MAP_REG	17		17	TG_LACT_LEVEL_INT	17		17	APP_TG_LACT_LEVEL_INT_MAP_REG	
PRO_TG1_TO_LEVEL_INT_MAP_REG	18		18	TG1_TO_LEVEL_INT	18		18	APP_TG1_TO_LEVEL_INT_MAP_REG	
PRO_TG1_T1_LEVEL_INT_MAP_REG	19		19	TG1_T1_LEVEL_INT	19		19	APP_TG1_T1_LEVEL_INT_MAP_REG	
PRO_TG1_WDT_LEVEL_INT_MAP_REG	20		20	TG1_WDT_LEVEL_INT	20		20	APP_TG1_WDT_LEVEL_INT_MAP_REG	
PRO_TG1_LACT_LEVEL_INT_MAP_REG	21		21	TG1_LACT_LEVEL_INT	21		21	APP_TG1_LACT_LEVEL_INT_MAP_REG	
PRO_GPIO_INTERRUPT_PRO_MAP_REG	22		22	GPIO_INTERRUPT_PRO GPIO_INTERRUPT_APP			22	22	APP_GPIO_INTERRUPT_APP_MAP_REG
PRO_GPIO_INTERRUPT_PRO_NMI_MAP_REG	23		23	GPIO_INTERRUPT_PRO_NMI GPIO_INTERRUPT_APP_NMI			23	23	APP_GPIO_INTERRUPT_APP_NMI_MAP_REG
PRO_CPU_INTR_FROM_CPU_0_MAP_REG	24		24	24	CPU_INTR_FROM_CPU_0		24	24	APP_CPU_INTR_FROM_CPU_0_MAP_REG
PRO_CPU_INTR_FROM_CPU_1_MAP_REG	25	25	25	CPU_INTR_FROM_CPU_1	25	25	APP_CPU_INTR_FROM_CPU_1_MAP_REG		
PRO_CPU_INTR_FROM_CPU_2_MAP_REG	26	26	26	CPU_INTR_FROM_CPU_2	26	26	APP_CPU_INTR_FROM_CPU_2_MAP_REG		
PRO_CPU_INTR_FROM_CPU_3_MAP_REG	27	27	27	CPU_INTR_FROM_CPU_3	27	27	APP_CPU_INTR_FROM_CPU_3_MAP_REG		
PRO_SPI_INTR_0_MAP_REG	28	28	28	SPI_INTR_0	28	28	APP_SPI_INTR_0_MAP_REG		
PRO_SPI_INTR_1_MAP_REG	29	29	29	SPI_INTR_1	29	29	APP_SPI_INTR_1_MAP_REG		
PRO_SPI_INTR_2_MAP_REG	30	30	30	SPI_INTR_2	30	30	APP_SPI_INTR_2_MAP_REG		
PRO_SPI_INTR_3_MAP_REG	31	31	31	SPI_INTR_3	31	31	APP_SPI_INTR_3_MAP_REG		
PRO_I2S0_INT_MAP_REG	0	PRO_INTR_STATUS_REG_1	32	I2S0_INT	32	APP_INTR_STATUS_REG_1	APP_I2S0_INT_MAP_REG		
PRO_I2S1_INT_MAP_REG	1		33	I2S1_INT	33		1	APP_I2S1_INT_MAP_REG	
PRO_UART_INTR_MAP_REG	2		34	UART_INTR	34		2	APP_UART_INTR_MAP_REG	
PRO_UART1_INTR_MAP_REG	3		35	UART1_INTR	35		3	APP_UART1_INTR_MAP_REG	
PRO_UART2_INTR_MAP_REG	4		36	UART2_INTR	36		4	APP_UART2_INTR_MAP_REG	
PRO_SDIO_HOST_INTERRUPT_MAP_REG	5		37	SDIO_HOST_INTERRUPT	37		5	APP_SDIO_HOST_INTERRUPT_MAP_REG	
PRO_EMAC_INT_MAP_REG	6		38	EMAC_INT	38		6	APP_EMAC_INT_MAP_REG	
PRO_PWM0_INTR_MAP_REG	7		39	PWM0_INTR	39		7	APP_PWM0_INTR_MAP_REG	
PRO_PWM1_INTR_MAP_REG	8		40	PWM1_INTR	40		8	APP_PWM1_INTR_MAP_REG	
PRO_PWM2_INTR_MAP_REG	9		41	PWM2_INTR	41		9	APP_PWM2_INTR_MAP_REG	
PRO_PWM3_INTR_MAP_REG	10		42	PWM3_INTR	42		10	APP_PWM3_INTR_MAP_REG	
PRO_LEDC_INT_MAP_REG	11		43	LEDC_INT	43		11	APP_LEDC_INT_MAP_REG	
PRO_EFUSE_INT_MAP_REG	12		44	EFUSE_INT	44		12	APP_EFUSE_INT_MAP_REG	
PRO_CAN_INT_MAP_REG	13		45	CAN_INT	45		13	APP_CAN_INT_MAP_REG	
PRO_RTC_CORE_INTR_MAP_REG	14		46	RTC_CORE_INTR	46		14	APP_RTC_CORE_INTR_MAP_REG	
PRO_RMT_INTR_MAP_REG	15		47	RMT_INTR	47		15	APP_RMT_INTR_MAP_REG	
PRO_PCNT_INTR_MAP_REG	16		48	PCNT_INTR	48		16	APP_PCNT_INTR_MAP_REG	
PRO_I2C_EXT0_INTR_MAP_REG	17		49	I2C_EXT0_INTR	49		17	APP_I2C_EXT0_INTR_MAP_REG	
PRO_I2C_EXT1_INTR_MAP_REG	18		50	I2C_EXT1_INTR	50		18	APP_I2C_EXT1_INTR_MAP_REG	
PRO_RSA_INTR_MAP_REG	19		51	RSA_INTR	51		19	APP_RSA_INTR_MAP_REG	
PRO_SPI1_DMA_INT_MAP_REG	20	52	SPI1_DMA_INT	52	20	APP_SPI1_DMA_INT_MAP_REG			

Peripheral Interrupt Configuration Register	PRO_CPU				APP_CPU					
	Bit	Status Register Name	No.	Peripheral Interrupt Source		Status Register Name	Bit	Peripheral Interrupt Configuration Register		
				Name	No.					
PRO_SPI2_DMA_INT_MAP_REG	21	PRO_INTR_STATUS_REG_1	53	SPI2_DMA_INT	53	APP_INTR_STATUS_REG_1	21	APP_SPI2_DMA_INT_MAP_REG		
PRO_SPI3_DMA_INT_MAP_REG	22		54	SPI3_DMA_INT	54		22	APP_SPI3_DMA_INT_MAP_REG		
PRO_WDG_INT_MAP_REG	23		55	WDG_INT	55		23	APP_WDG_INT_MAP_REG		
PRO_TIMER_INT1_MAP_REG	24		56	TIMER_INT1	56		24	APP_TIMER_INT1_MAP_REG		
PRO_TIMER_INT2_MAP_REG	25		57	TIMER_INT2	57		25	APP_TIMER_INT2_MAP_REG		
PRO_TG_T0_EDGE_INT_MAP_REG	26		58	TG_T0_EDGE_INT	58		26	APP_TG_T0_EDGE_INT_MAP_REG		
PRO_TG_T1_EDGE_INT_MAP_REG	27		59	TG_T1_EDGE_INT	59		27	APP_TG_T1_EDGE_INT_MAP_REG		
PRO_TG_WDT_EDGE_INT_MAP_REG	28		60	TG_WDT_EDGE_INT	60		28	APP_TG_WDT_EDGE_INT_MAP_REG		
PRO_TG_LACT_EDGE_INT_MAP_REG	29		61	TG_LACT_EDGE_INT	61		29	APP_TG_LACT_EDGE_INT_MAP_REG		
PRO_TG1_T0_EDGE_INT_MAP_REG	30		62	TG1_T0_EDGE_INT	62		30	APP_TG1_T0_EDGE_INT_MAP_REG		
PRO_TG1_T1_EDGE_INT_MAP_REG	31		63	TG1_T1_EDGE_INT	63		31	APP_TG1_T1_EDGE_INT_MAP_REG		
PRO_TG1_WDT_EDGE_INT_MAP_REG	0		PRO_INTR_STATUS_REG_2	64	TG1_WDT_EDGE_INT		64	APP_INTR_STATUS_REG_2	0	APP_TG1_WDT_EDGE_INT_MAP_REG
PRO_TG1_LACT_EDGE_INT_MAP_REG	1			65	TG1_LACT_EDGE_INT		65		1	APP_TG1_LACT_EDGE_INT_MAP_REG
PRO_MMU_IA_INT_MAP_REG	2			66	MMU_IA_INT		66		2	APP_MMU_IA_INT_MAP_REG
PRO_MPU_IA_INT_MAP_REG	3	67		MPU_IA_INT	67	3	APP_MPU_IA_INT_MAP_REG			
PRO_CACHE_IA_INT_MAP_REG	4		68	CACHE_IA_INT	68		4	APP_CACHE_IA_INT_MAP_REG		

2.3.2 CPU Interrupt

Both of the two CPUs (PRO and APP) have 32 interrupts each, of which 26 are peripheral interrupts. All interrupts in a CPU are listed in Table 9.

Table 9: CPU Interrupts

No.	Category	Type	Priority Level
0	Peripheral	Level-Triggered	1
1	Peripheral	Level-Triggered	1
2	Peripheral	Level-Triggered	1
3	Peripheral	Level-Triggered	1
4	Peripheral	Level-Triggered	1
5	Peripheral	Level-Triggered	1
6	Internal	Timer.0	1
7	Internal	Software	1
8	Peripheral	Level-Triggered	1
9	Peripheral	Level-Triggered	1
10	Peripheral	Edge-Triggered	1
11	Internal	Profiling	3
12	Peripheral	Level-Triggered	1
13	Peripheral	Level-Triggered	1
14	Peripheral	NMI	NMI
15	Internal	Timer.1	3
16	Internal	Timer.2	5
17	Peripheral	Level-Triggered	1
18	Peripheral	Level-Triggered	1
19	Peripheral	Level-Triggered	2
20	Peripheral	Level-Triggered	2
21	Peripheral	Level-Triggered	2
22	Peripheral	Edge-Triggered	3
23	Peripheral	Level-Triggered	3
24	Peripheral	Level-Triggered	4
25	Peripheral	Level-Triggered	4
26	Peripheral	Level-Triggered	5
27	Peripheral	Level-Triggered	3
28	Peripheral	Edge-Triggered	4
29	Internal	Software	3
30	Peripheral	Edge-Triggered	4
31	Peripheral	Level-Triggered	5

2.3.3 Allocate Peripheral Interrupt Sources to Peripheral Interrupt on CPU

In this section:

- Source_X stands for any particular peripheral interrupt source.
- PRO_X_MAP_REG (or APP_X_MAP_REG) stands for any particular peripheral interrupt configuration

register of the PRO_CPU (or APP_CPU). The peripheral interrupt configuration register corresponds to the peripheral interrupt source Source_X. In Table 8 the registers listed under “PRO_CPU (APP_CPU) - Peripheral Interrupt Configuration Register” correspond to the peripheral interrupt sources listed in “Peripheral Interrupt Source - Name”.

- Interrupt_P stands for CPU peripheral interrupt, numbered as Num_P. Num_P can take the ranges 0 ~ 5, 8 ~ 10, 12 ~ 14, 17 ~ 28, 30 ~ 31.
- Interrupt_I stands for the CPU internal interrupt numbered as Num_I. Num_I can take values 6, 7, 11, 15, 16, 29.

Using this terminology, the possible operations of the Interrupt Matrix controller can be described as follows:

- **Allocate peripheral interrupt source Source_X to CPU (PRO_CPU or APP_CPU)**
Set PRO_X_MAP_REG or APP_X_MAP_REG to Num_P. Num_P can be any CPU peripheral interrupt number. CPU interrupts can be shared between multiple peripherals (see below).
- **Disable peripheral interrupt source Source_X for CPU (PRO_CPU or APP_CPU)**
Set PRO_X_MAP_REG or APP_X_MAP_REG for peripheral interrupt source to any Num_I. The specific choice of internal interrupt number does not change behaviour, as none of the interrupt numbered as Num_I is connected to either CPU.
- **Allocate multiple peripheral sources Source_X_n ORed to PRO_CPU (APP_CPU) peripheral interrupt**
Set multiple PRO_X_n_MAP_REG (APP_X_n_MAP_REG) to the same Num_P. Any of these peripheral interrupts will trigger CPU Interrupt_P.

2.3.4 CPU NMI Interrupt Mask

The Interrupt Matrix temporarily masks all peripheral interrupt sources allocated to PRO_CPU's (or APP_CPU's) NMI interrupt, if it receives the signal PRO_CPU NMI Interrupt Mask (or APP_CPU NMI Interrupt Mask) from the peripheral PID Controller, respectively.

2.3.5 Query Current Interrupt Status of Peripheral Interrupt Source

The current interrupt status of a peripheral interrupt source can be read via the bit value in PRO_INTR_STATUS_REG_n (APP_INTR_STATUS_REG_n), as shown in the mapping in Table 8.

3. Reset and Clock

3.1 System Reset

3.1.1 Introduction

The ESP32 has three reset levels: CPU reset, Core reset, and System reset. None of these reset levels clear the RAM. Figure 5 shows the subsystems included in each reset level.

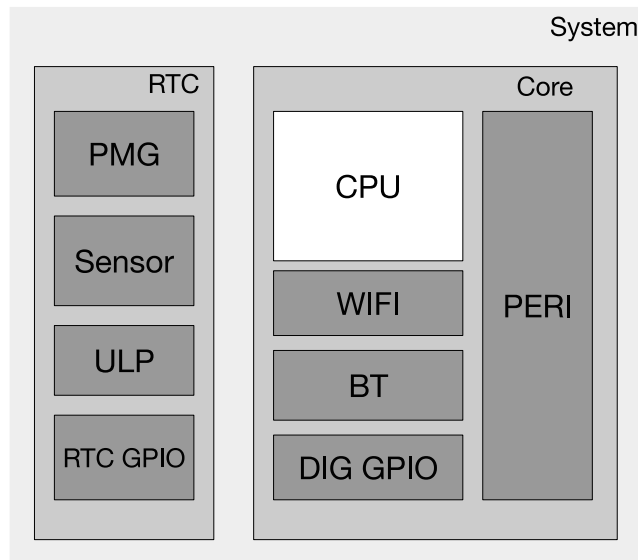


Figure 5: System Reset

- CPU reset: Only resets the registers of one or both of the CPU cores.
- Core reset: Resets all the digital registers, including CPU cores, external GPIO and digital GPIO. The RTC is not reset.
- System reset: Resets all the registers on the chip, including those of the RTC.

3.1.2 Reset Source

While most of the time the APP_CPU and PRO_CPU will be reset simultaneously, some reset sources are able to reset only one of the two cores. The reset reason for each core can be looked up individually: the PRO_CPU reset reason will be stored in RTC_CNTL_RESET_CAUSE_PROCPU, the reset reason for the APP_CPU in APP_CNTL_RESET_CAUSE_PROCPU. Table 10 shows the possible reset reason values that can be read from these registers.

Table 10: PRO_CPU and APP_CPU Reset Reason Values

PRO	APP	Source	Reset Type	Note
0x01	0x01	Chip Power On Reset	System Reset	-
0x10	0x10	RWDT System Reset	System Reset	See WDT Chapter .
0x0F	0x0F	Brown Out Reset	System Reset	See Power Management Chapter .
0x03	0x03	Software System Reset	Core Reset	Configure RTC_CNTL_SW_SYS_RST register.
0x05	0x05	Deep Sleep Reset	Core Reset	See Power Management Chapter .
0x07	0x07	MWDT0 Global Reset	Core Reset	See WDT Chapter .

PRO	APP	APP Source	Reset Type	Note
0x08	0x08	MWDT1 Global Reset	Core Reset	See WDT Chapter .
0x09	0x09	RWDT Core Reset	Core Reset	See WDT Chapter .
0x0B	-	MWDT0 CPU Reset	CPU Reset	See WDT Chapter .
0x0C	-	Software CPU Reset	CPU Reset	Configure RTC_CNTL_SW_APPCPU_RST register.
-	0x0B	MWDT1 CPU Reset	CPU Reset	See WDT Chapter .
-	0x0C	Software CPU Reset	CPU Reset	Configure RTC_CNTL_SW_APPCPU_RST register.
0x0D	0x0D	RWDT CPU Reset	CPU Reset	See WDT Chapter .
-	0xE	PRO CPU Reset	CPU Reset	Indicates that the PRO CPU has independently reset the APP CPU by configuring the DPORT_APPCPU_RESETTING register.

3.2 System Clock

3.2.1 Introduction

The ESP32 integrates multiple clock sources for the CPU cores, the peripherals and the RTC. These clocks can be configured to meet different requirements. Figure 6 shows the system clock structure.

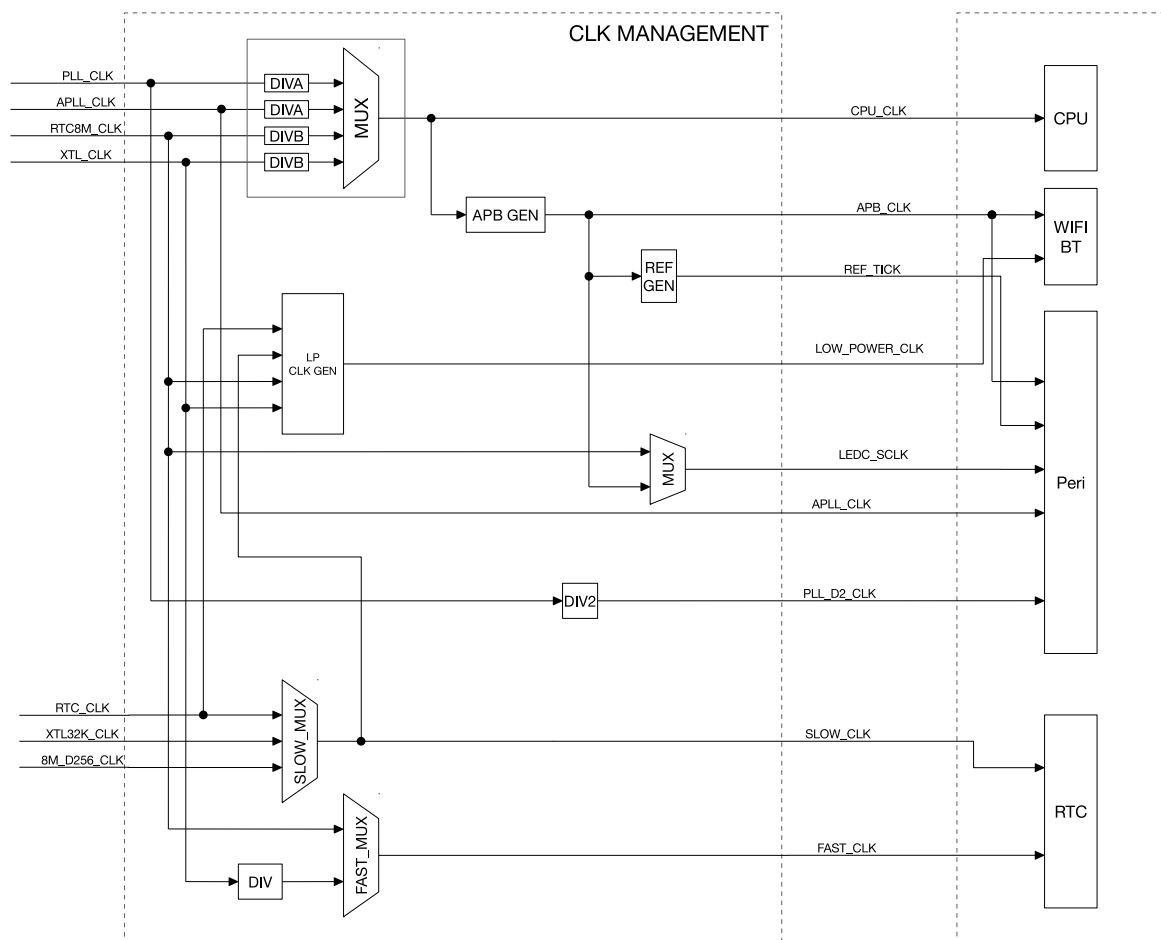


Figure 6: System Clock

3.2.2 Clock Source

The ESP32 can use an external crystal oscillator, an internal PLL or an oscillating circuit as a clock source. Specifically, the clock sources available are:

- High Speed Clocks
 - PLL_CLK is an internal PLL clock with a frequency of 320 MHz.
 - XTL_CLK is a clock signal generated using an external crystal with a frequency range of 2 ~ 40 MHz.
- Low Power Clocks
 - XTL32K_CLK is a clock generated using an external crystal with a frequency of 32 KHz.
 - RTC8M_CLK is an internal clock with a default frequency of 8 MHz. This frequency is adjustable.
 - RTC8M_D256_CLK is divided from RTC8M_CLK 256. Its frequency is (RTC8M_CLK / 256). With the default RTC8M_CLK frequency of 8 MHz, this clock runs at 31.250 KHz.
 - RTC_CLK is an internal low power clock with a default frequency of 150 KHz. This frequency is adjustable.
- Audio Clock
 - APLL_CLK is an internal Audio PLL clock with a frequency range of 16 ~ 128 MHz.

3.2.3 CPU Clock

As Figure 6 shows, CPU_CLK is the master clock for both CPU cores. CPU_CLK clock can be as high as 160 MHz when the CPU is in high performance mode. Alternatively, the CPU can run at lower frequencies to reduce power consumption.

The CPU_CLK clock source is determined by the RTC_CNTL_SOC_CLK_SEL register. PLL_CLK, APLL_CLK, RTC8M_CLK and XTL_CLK can be set as the CPU_CLK source; see Table 11 and 12.

Table 11: CPU_CLK Source

RTC_CNTL_SOC_CLK_SEL Value	Clock Source
0	XTL_CLK
1	PLL_CLK
2	RTC8M_CLK
3	APLL_CLK

Table 12: CPU_CLK Derivation

Clock Source	SEL*	CPU Clock
0 / XTL_CLK	-	CPU_CLK = XTL_CLK / (APB_CTRL_PRE_DIV_CNT+1) APB_CTRL_PRE_DIV_CNT range is 0 ~ 1023. Default is 0.
1 / PLL_CLK	0	CPU_CLK = PLL_CLK / 4 CPU_CLK frequency is 80 MHz
1 / PLL_CLK	1	CPU_CLK = PLL_CLK / 2 CPU_CLK frequency is 160 MHz
2 / RTC8M_CLK	-	CPU_CLK = RTC8M_CLK / (APB_CTRL_PRE_DIV_CNT+1) APB_CTRL_PRE_DIV_CNT range is 0 ~ 1023. Default is 0.
3 / APLL_CLK	0	CPU_CLK = APLL_CLK / 4
3 / APLL_CLK	1	CPU_CLK = APLL_CLK / 2

*SEL: DPORT_CPUPERIOD_SEL value

3.2.4 Peripheral Clock

Peripheral clocks include APB_CLK, REF_TICK, LEDC_SCLK, APLL_CLK and PLL_D2_CLK.

Table 13 shows which clocks can be used by which peripherals.

Table 13: Peripheral Clock Usage

Peripherals	APB_CLK	REF_TICK	LEDC_SCLK	APLL_CLK	PLL_D2_CLK
EMAC	Y	N	N	Y	N
TIMG	Y	N	N	N	N
I2S	Y	N	N	Y	Y
UART	Y	Y	N	N	N
RMT	Y	Y	N	N	N
LED PWM	Y	Y	Y	N	N
PWM	Y	N	N	N	N
I2C	Y	N	N	N	N
SPI	Y	N	N	N	N
PCNT	Y	N	N	N	N
Efuse Controller	Y	N	N	N	N
SDIO Slave	Y	N	N	N	N
SDMMC	Y	N	N	N	N

3.2.4.1 APB_CLK Source

The APB_CLK is derived from CPU_CLK as detailed in Table 14. The division factor depends on the CPU_CLK source.

Table 14: APB_CLK Derivation

CPU_CLK Source	APB_CLK
PLL_CLK	PLL_CLK / 4
APLL_CLK	CPU_CLK / 2
XTAL_CLK	CPU_CLK
RTC8M_CLK	CPU_CLK

3.2.4.2 REF_TICK Source

REF_TICK is derived from APB_CLK via a divider. The divider value used depends on the APB_CLK source, which in turn depends on the CPU_CLK source.

By configuring correct divider values for each APB_CLK source, the user can ensure that the REF_TICK frequency does not change when CPU_CLK changes source, causing the APB_CLK frequency to change.

Clock divider registers are shown in Table 15.

Table 15: REF_TICK Derivation

CPU_CLK & APB_CLK Source	Clock Divider Register
PLL_CLK	APB_CTRL_PLL_TICK_NUM
XTAL_CLK	APB_CTRL_XTAL_TICK_NUM
APLL_CLK	APB_CTRL_APLL_TICK_NUM
RTC8M_CLK	APB_CTRL_CK8M_TICK_NUM

3.2.4.3 LEDC_SCLK Source

The LEDC_SCLK clock source is selected by the LEDC_APB_CLK_SEL register, as shown in Table 16.

Table 16: LEDC_SCLK Derivation

LEDC_APB_CLK_SEL Value	LEDC_SCLK Source
0	RTC8M_CLK
1	APB_CLK

3.2.4.4 APLL_SCLK Source

The APLL_CLK is sourced from PLL_CLK, with its output frequency configured using the APLL configuration registers.

3.2.4.5 PLL_D2_CLK Source

PLL_D2_CLK is half the PLL_CLK frequency.

3.2.4.6 Clock Source Considerations

Most peripherals will operate using the APB_CLK frequency as a reference. When this frequency changes, the peripherals will need to update their clock configuration to operate at the same frequency after the change. Peripherals accessing REF_TICK can continue operating normally when switching clock sources, without changing clock source. Please see Table 13 for details.

The LED PWM module can use RTC8M_CLK as a clock source when APB_CLK is disabled. In other words, when the system is in low-power consumption mode (see [Power Management Chapter](#)), normal peripherals will be halted (APB_CLK is turned off), but the LED PWM can work normally via RTC8M_CLK.

3.2.5 Wi-Fi BT Clock

Wi-Fi and BT can only operate if APB_CLK uses PLL_CLK as its clock source. Suspending PLL_CLK requires Wi-Fi and BT to both have entered low-power consumption mode first.

For LOW_POWER_CLK, one of RTC_CLK, SLOW_CLK, RTC8M_CLK or XTL_CLK can be selected as the low-power consumption mode clock source for Wi-Fi and BT.

3.2.6 RTC Clock

The clock sources of SLOW_CLK and FAST_CLK are low-frequency clocks. The RTC module can operate when most other clocks are stopped.

SLOW_CLK is used to clock the Power Management module. It can be sourced from RTC_CLK, XTL32K_CLK or RTC8M_D256_CLK

FAST_CLK is used to clock the On-chip Sensor module. It can be sourced from a divided XTL_CLK or from RTC8M_CLK.

3.2.7 Audio PLL

The operation of audio and other time-critical data-transfer applications requires highly-configurable, low-jitter, and accurate clock sources. The clock sources derived from system clocks that serve digital peripherals may carry jitter and, therefore, they do not support a high-precision clock frequency setting.

Providing an integrated precision clock source can minimize system cost. To this end, ESP32 integrates an audio PLL intended for I2S peripherals. More details on how to clock the I2S module, using an APLL clock, can be found in Chapter [I2S](#). The Audio PLL formula is as follows:

$$f_{\text{out}} = \frac{f_{\text{xtal}}(\text{sdm2} + \frac{\text{sdm1}}{2^8} + \frac{\text{sdm0}}{2^{16}} + 4)}{2(\text{odiv} + 2)}$$

The parameters of this formula are defined below:

- f_{xtal} : the frequency of the crystal oscillator, usually 40 MHz;
- sdm0: the value is 0 ~ 255;
- sdm1: the value is 0 ~ 255;
- sdm2: the value is 0 ~ 63;
- odir: the value is 0 ~ 31;

The operating frequency range of the numerator is 350 MHz ~ 500 MHz:

$$350MHz < f_{xtal}(sdm2 + \frac{sdm1}{2^8} + \frac{sdm0}{2^{16}} + 4) < 500MHz$$

Please note that sdm1 and sdm0 are not available on revision0 of ESP32. Please consult the silicon revision in [ECO and Workarounds for Bugs in ESP32](#) for further details.

Audio PLL can be manually enabled or disabled via registers RTC_CNTL_PLLA_FORCE_PU and RTC_CNTL_PLLA_FORCE_PD, respectively. Disabling it takes priority over enabling it. When RTC_CNTL_PLLA_FORCE_PU and RTC_CNTL_PLLA_FORCE_PD are 0, PLL will follow the state of the system, i.e., when the system enters sleep mode, PLL will be disabled automatically; when the system wakes up, PLL will be enabled automatically.

4. IO_MUX and GPIO Matrix

4.1 Overview

The ESP32 chip features 34 physical GPIO pads. Each pad can be used as a general-purpose I/O, or be connected to an internal peripheral signal. The IO_MUX, RTC IO_MUX and the GPIO matrix are responsible for routing signals from the peripherals to GPIO pads. Together these systems provide highly configurable I/O.

This chapter describes the signal selection and connection between the digital pads (FUNC_SEL, IE, OE, WPU, WDU, etc.), 162 peripheral input and 176 output signals (control signals: SIG_IN_SEL, SIG_OUT_SEL, IE, OE, etc.), fast peripheral input/output signals (control signals: IE, OE, etc.), and RTC IO_MUX.

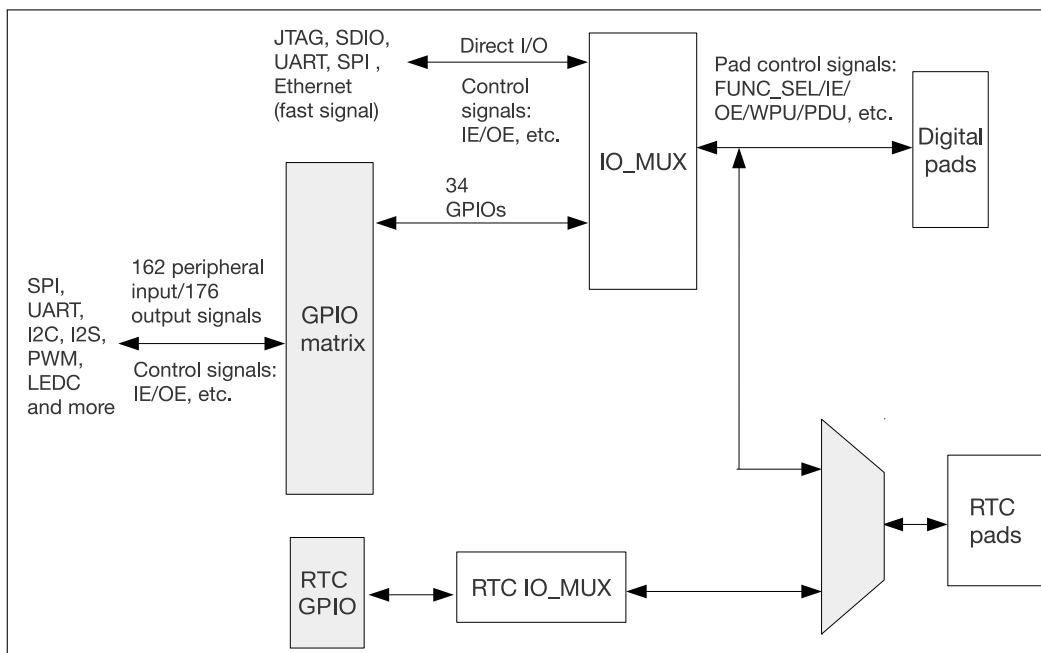


Figure 7: IO_MUX, RTC IO_MUX and GPIO Matrix Overview

1. The IO_MUX contains one register per GPIO pad. Each pad can be configured to perform a "GPIO" function (when connected to the GPIO Matrix) or a direct function (bypassing the GPIO Matrix). Some high-speed digital functions (Ethernet, SDIO, SPI, JTAG, UART) can bypass the GPIO Matrix for better high-frequency digital performance. In this case, the IO_MUX is used to connect these pads directly to the peripheral.)

See Section 4.10 for a list of IO_MUX functions for each I/O pad.

2. The GPIO Matrix is a full-switching matrix between the peripheral input/output signals and the pads.
 - For input to the chip: Each of the 162 internal peripheral inputs can select any GPIO pad as the input source.
 - For output from the chip: The output signal of each of the 34 GPIO pads can be from one of the 176 peripheral output signals.

See Section 4.9 for a list of GPIO Matrix peripheral signals.

3. RTC IO_MUX is used to connect GPIO pads to their low-power and analog functions. Only a subset of GPIO pads have these optional "RTC" functions.

See Section 4.11 for a list of RTC IO_MUX functions.

4.2 Peripheral Input via GPIO Matrix

4.2.1 Summary

To receive a peripheral input signal via the GPIO Matrix, the GPIO Matrix is configured to source the peripheral signal's input index (0-18, 23-36, 39-58, 61-90, 95-124, 140-155, 164-181, 190-195, 198-206) from one of the 34 GPIOs (0-19, 21-23, 25-27, 32-39).

The input signal is read from the GPIO pad through the IO_MUX. The IO_MUX must be configured to set the chosen pad to "GPIO" function. This causes the GPIO pad input signal to be routed into the GPIO Matrix, which in turn routes it to the selected peripheral input.

4.2.2 Functional Description

Figure 8 shows the logic for input selection via GPIO Matrix.

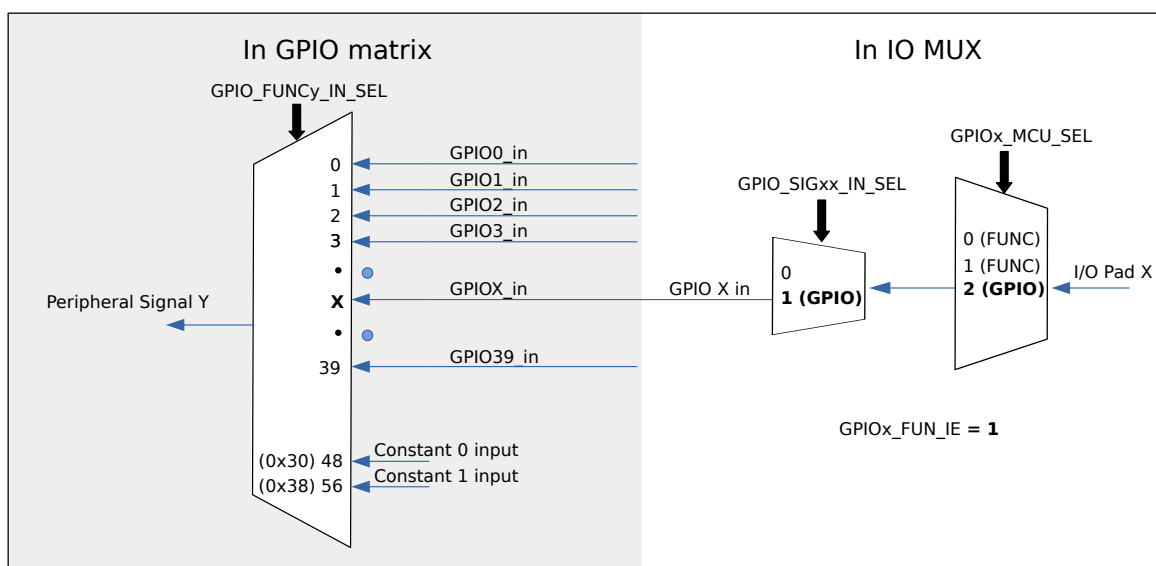


Figure 8: Peripheral Input via IO_MUX, GPIO Matrix

To read GPIO pad X into peripheral signal Y , follow the steps below:

- Configure the `GPIO_FUNCy_IN_SEL_CFG` register corresponding to peripheral signal Y in the GPIO Matrix:
 - Set the `GPIO_FUNCx_IN_SEL` field in this register, corresponding to the GPIO pad X to read from. Clear all other fields corresponding to other GPIO pads.
- Configure the `GPIO_FUNCx_OUT_SEL_CFG` register and clear the `GPIO_ENABLE_DATA[x]` field corresponding to GPIO pad X in the GPIO Matrix:
 - Set the `GPIO_FUNCx_OEN_SEL` bit in the `GPIO_FUNCx_OUT_SEL_CFG` register to force the pin's output state to be determined always by the `GPIO_ENABLE_DATA[x]` field.
 - The `GPIO_ENABLE_DATA[x]` field is a bit in either `GPIO_ENABLE_REG` (GPIOs 0-31) or `GPIO_ENABLE1_REG` (GPIOs 32-39). Clear this bit to disable the output driver for the GPIO pad.
- Configure the IO_MUX to select the GPIO Matrix. Set the `IO_MUX_x_REG` register corresponding to GPIO pad X as follows:
 - Set the function field (`IO_x_MCU_SEL`) to the IO_MUX function corresponding to GPIO X (this is Function #3—numeric value 2—for all pins).

- Enable the input by setting the FUN_IE bit.
- Set or clear the FUN_WPU and FUN_WPD bits, as desired, to enable/disable internal pull-up/pull-down resistors.

Notes:

- One input pad can be connected to multiple input_signals.
- The input signal can be inverted with GPIO_FUNC x _IN_INV_SEL.
- It is possible to have a peripheral read a constantly low or constantly high input value without connecting this input to a pad. This can be done by selecting a special GPIO_FUNC y _IN_SEL input, instead of a GPIO number:
 - When GPIO_FUNC x _IN_SEL is 0x30, input_signal x is always 0.
 - When GPIO_FUNC x _IN_SEL is 0x38, input_signal x is always 1.

For example, to connect RMT peripheral channel 0 input signal (RMT_SIG_IN0_IDX, signal index 83) to GPIO 15, please follow the steps below. Note that GPIO 15 is also named the MTDO pin:

1. Set the GPIO_FUNC_83_IN_SEL_CFG register field GPIO_FUNC83_IN_SEL value to 15.
2. As this is an input-only signal, set GPIO_FUNC15_OEN_SEL bit in GPIO_FUNC15_OUT_SEL_CFG_REG.
3. Clear bit 15 of GPIO_ENABLE_REG (field GPIO_ENABLE_DATA[15]).
4. Set the IO_MUX_GPIO15 register MCU_SEL field to 2 (GPIO function) and also set the FUN_IE bit (input mode).

4.2.3 Simple GPIO Input

The GPIO_IN_REG/GPIO_IN1_REG register holds the input values of each GPIO pad.

The input value of any GPIO pin can be read at any time without configuring the GPIO Matrix for a particular peripheral signal. However, it is necessary to enable the input in the IO_MUX by setting the FUN_IE bit in the IO_MUX x _REG register corresponding to pad X , as mentioned in Section 4.2.2.

4.3 Peripheral Output via GPIO Matrix

4.3.1 Summary

To output a signal from a peripheral via the GPIO Matrix, the GPIO Matrix is configured to route the peripheral output signal (0-18, 23-37, 61-121, 140-125, 224-228) to one of the 34 GPIOs (0-19, 21-23, 25-27, 32-39).

The output signal is routed from the peripheral into the GPIO Matrix. It is then routed into the IO_MUX, which is configured to set the chosen pad to "GPIO" function. This causes the output GPIO signal to be connected to the pad.

Note:

The peripheral output signals 224 to 228 can be configured to be routed in from one GPIO and output directly from another GPIO.

4.3.2 Functional Description

One of the 176 output signals can be selected to go through the GPIO matrix into the IO_MUX and then to a pad. Figure 9 illustrates the configuration.

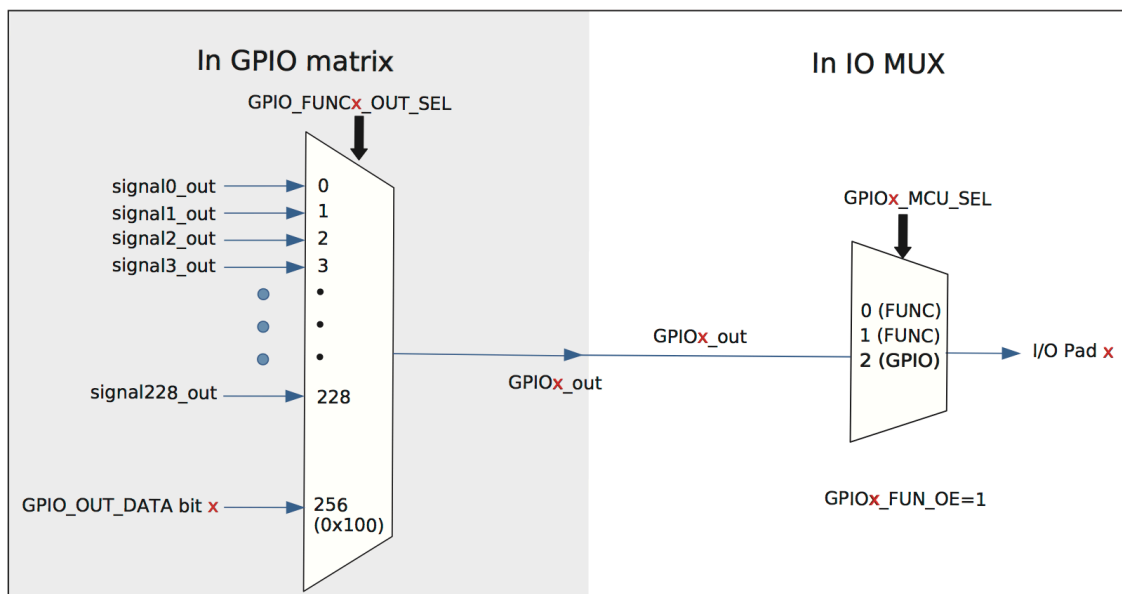


Figure 9: Output via GPIO Matrix

To output peripheral signal Y to particular GPIO pad X , follow these steps:

- Configure the `GPIO_FUNC x _OUT_SEL_CFG` register and `GPIO_ENABLE_DATA $[x]$` field corresponding to GPIO X in the GPIO Matrix:
 - Set the `GPIO_FUNC x _OUT_SEL` field in `GPIO_FUNC x _OUT_SEL_CFG` to the numeric index (Y) of desired peripheral output signal Y .
 - If the signal should always be enabled as an output, set the `GPIO_FUNC x _OEN_SEL` bit in the `GPIO_FUNC x _OUT_SEL_CFG` register and the `GPIO_ENABLE_DATA $[x]$` field in the `GPIO_ENABLE_REG` register corresponding to GPIO pad X . To have the output enable signal decided by internal logic, clear the `GPIO_FUNC x _OEN_SEL` bit instead.
 - The `GPIO_ENABLE_DATA $[x]$` field is a bit in either `GPIO_ENABLE_REG` (GPIOs 0-31) or `GPIO_ENABLE1_REG` (GPIOs 32-39). Clear this bit to disable the output driver for the GPIO pad.
- For an open drain output, set the `GPIO_PIN x _PAD_DRIVER` bit in the `GPIO_PIN x` register corresponding to GPIO pad X . For push/pull mode (default), clear this bit.
- Configure the IO_MUX to select the GPIO Matrix. Set the `IO_MUX $_x$ _REG` register corresponding to GPIO pad X as follows:
 - Set the function field (`IO $_x$ _MCU_SEL`) to the IO_MUX function corresponding to GPIO X (this is Function #3—numeric value 2—for all pins).
 - Set the `FUN_DRV` field to the desired value for output strength (1-3). The higher the drive strength, the more current can be sourced/sunk from the pin.
 - If using open drain mode, set/clear the `FUNC_WPU` and `FUNC_WPD` bits to enable/disable the internal pull-up/down resistors.

Notes:

- The output signal from a single peripheral can be sent to multiple pads simultaneously.
- Only the 34 GPIOs can be used as outputs.
- The output signal can be inverted by setting the GPIO_FUNC x _OUT_INV_SEL bit.

4.3.3 Simple GPIO Output

The GPIO Matrix can also be used for simple GPIO output – setting a bit in the GPIO_OUT_DATA register will write to the corresponding GPIO pad.

To configure a pad as simple GPIO output, the GPIO Matrix GPIO_FUNC x _OUT_SEL register is configured with a special peripheral index value (0x100).

4.4 Direct I/O via IO_MUX

4.4.1 Summary

Some high speed digital functions (Ethernet, SDIO, SPI, JTAG, UART) can bypass the GPIO Matrix for better high-frequency digital performance. In this case, the IO_MUX is used to connect these pads directly to the peripheral.

Selecting this option is less flexible than using the GPIO Matrix, as the IO_MUX register for each GPIO pad can only select from a limited number of functions. However, better high-frequency digital performance will be maintained.

4.4.2 Functional Description

Two registers must be configured in order to bypass the GPIO Matrix for peripheral I/O:

1. IO_MUX for the GPIO pad must be set to the required pad function. (Please refer to section 4.10 for a list of pad functions.)
2. For inputs, the SIG_IN_SEL register must be set to route the input directly to the peripheral.

4.5 RTC IO_MUX for Low Power and Analog I/O

4.5.1 Summary

18 GPIO pads have low power capabilities (RTC domain) and analog functions which are handled by the RTC subsystem of ESP32. The IO_MUX and GPIO Matrix are not used for these functions; rather, the RTC_MUX is used to redirect the I/O to the RTC subsystem.

When configured as RTC GPIOs, the output pads can still retain the output level value when the chip is in Deep-sleep mode, and the input pads can wake up the chip from Deep-sleep.

Section 4.11 has a list of RTC_MUX pins and their functions.

4.5.2 Functional Description

Each pad with analog and RTC functions is controlled by the RTC_IO_TOUCH_PAD x _TO_GPIO bit in the RTC_GPIO_PIN x register. By default this bit is set to 1, routing all I/O via the IO_MUX subsystem as described in earlier subsections.

If the RTC_IO_TOUCH_PAD x _TO_GPIO bit is cleared, then I/O to and from that pad is routed to the RTC subsystem. In this mode, the RTC_GPIO_PIN x register is used for digital I/O and the analog features of the pad are also available. See Section 4.11 for a list of RTC pin functions.

See 4.11 for a table mapping GPIO pads to their RTC equivalent pins and analog functions. Note that the RTC_IO_PIN x registers use the RTC GPIO pin numbering, not the GPIO pad numbering.

4.6 Light-sleep Mode Pin Functions

Pins can have different functions when the ESP32 is in Light-sleep mode. If the GPIO xx _SLP_SEL bit in the IO_MUX register for a GPIO pad is set to 1, a different set of registers is used to control the pad when the ESP32 is in Light-sleep mode:

Table 17: IO_MUX Light-sleep Pin Function Registers

IO_MUX Function	Normal Execution OR GPIO xx _SLP_SEL = 0	Light-sleep Mode AND GPIO xx _SLP_SEL = 1
Output Drive Strength	GPIO xx _FUNC_DRV	GPIO xx _MCU_DRV
Pullup Resistor	GPIO xx _FUNC_WPU	GPIO xx _MCU_WPU
Pulldown Resistor	GPIO xx _FUNC_WPD	GPIO xx _MCU_WPD
Output Enable	(From GPIO Matrix _OEN field)	GPIO xx _MCU_OE

If GPIO xx _SLP_SEL is set to 0, the pin functions remain the same in both normal execution and Light-sleep modes.

4.7 Pad Hold Feature

Each IO pad (including the RTC pads) has an individual hold function controlled by a RTC register. When the pad is set to hold, the state is latched at that moment and will not change no matter how the internal signals change or how the IO_MUX configuration or GPIO configuration is modified. Users can use the hold function for the pads to retain the pad state through a core reset and system reset triggered by watchdog time-out or Deep-sleep events.

4.8 I/O Pad Power Supply

IO pad power supply is shown in Figure 10.

- Pads marked blue are RTC pads that have their individual analog function and can also act as normal digital IO pads. For details, please see Section 4.11.
- Pads marked pink and green have digital functions only.
- Pads marked green can be powered externally or internally via VDD_SDIO (see below).

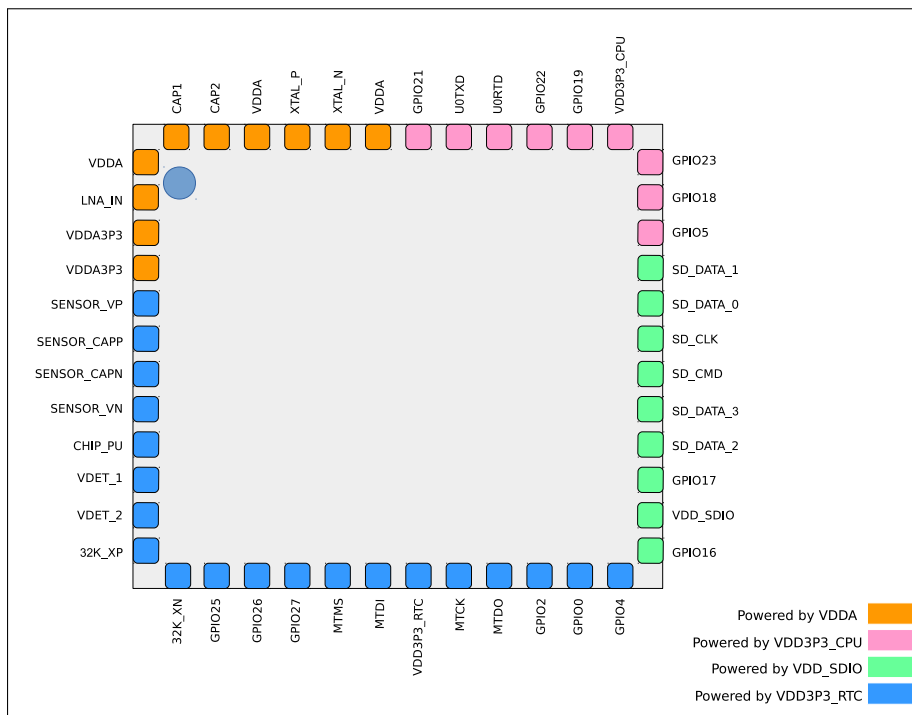


Figure 10: ESP32 I/O Pad Power Sources

4.8.1 VDD_SDIO Power Domain

VDD_SDIO can source or sink current, allowing this power domain to be powered externally or internally. To power VDD_SDIO externally, apply the same power supply of VDD3P3_RTC to the VDD_SDIO pad.

Without an external power supply, the internal regulator will supply VDD_SDIO. The VDD_SDIO voltage can be configured to be either 1.8V or the same as VDD3P3_RTC), depending on the state of the MTDI pad at reset – a high level configures 1.8V and a low level configures the voltage to be the same as VDD3P3_RTC. Setting the efuse bit determines the default voltage of the VDD_SDIO. In addition, software can change the voltage of the VDD_SDIO by configuring register bits.

4.9 Peripheral Signal List

Table 18 contains a list of Peripheral Input/Output signals used by the GPIO Matrix:

Table 18: GPIO Matrix Peripheral Signals

Signal	Input Signal	Output Signal	Direct I/O in IO_MUX
0	SPICLK_in	SPICLK_out	YES
1	SPIQ_in	SPIQ_out	YES
2	SPID_in	SPID_out	YES
3	SPIHD_in	SPIHD_out	YES
4	SPIWP_in	SPIWP_out	YES
5	SPICS0_in	SPICS0_out	YES
6	SPICS1_in	SPICS1_out	
7	SPICS2_in	SPICS2_out	
8	HSPICLK_in	HSPICLK_out	YES
9	HSPIQ_in	HSPIQ_out	YES

Signal	Input Signal	Output Signal	Direct I/O in IO_MUX
10	HSPID_in	HSPID_out	YES
11	HSPICS0_in	HSPICS0_out	YES
12	HSPIHD_in	HSPIHD_out	YES
13	HSPIWP_in	HSPIWP_out	YES
14	U0RXD_in	U0TXD_out	YES
15	U0CTS_in	U0RTS_out	YES
16	U0DSR_in	U0DTR_out	
17	U1RXD_in	U1TXD_out	YES
18	U1CTS_in	U1RTS_out	YES
23	I2S0O_BCK_in	I2S0O_BCK_out	
24	I2S1O_BCK_in	I2S1O_BCK_out	
25	I2S0O_WS_in	I2S0O_WS_out	
26	I2S1O_WS_in	I2S1O_WS_out	
27	I2S0I_BCK_in	I2S0I_BCK_out	
28	I2S0I_WS_in	I2S0I_WS_out	
29	I2CEXT0_SCL_in	I2CEXT0_SCL_out	
30	I2CEXT0_SDA_in	I2CEXT0_SDA_out	
31	pwm0_sync0_in	sdio_tohost_int_out	
32	pwm0_sync1_in	pwm0_out0a	
33	pwm0_sync2_in	pwm0_out0b	
34	pwm0_f0_in	pwm0_out1a	
35	pwm0_f1_in	pwm0_out1b	
36	pwm0_f2_in	pwm0_out2a	
37		pwm0_out2b	
39	pcnt_sig_ch0_in0		
40	pcnt_sig_ch1_in0		
41	pcnt_ctrl_ch0_in0		
42	pcnt_ctrl_ch1_in0		
43	pcnt_sig_ch0_in1		
44	pcnt_sig_ch1_in1		
45	pcnt_ctrl_ch0_in1		
46	pcnt_ctrl_ch1_in1		
47	pcnt_sig_ch0_in2		
48	pcnt_sig_ch1_in2		
49	pcnt_ctrl_ch0_in2		
50	pcnt_ctrl_ch1_in2		
51	pcnt_sig_ch0_in3		
52	pcnt_sig_ch1_in3		
53	pcnt_ctrl_ch0_in3		
54	pcnt_ctrl_ch1_in3		
55	pcnt_sig_ch0_in4		
56	pcnt_sig_ch1_in4		
57	pcnt_ctrl_ch0_in4		
58	pcnt_ctrl_ch1_in4		

Signal	Input Signal	Output Signal	Direct I/O in IO_MUX
61	HSPICS1_in	HSPICS1_out	
62	HSPICS2_in	HSPICS2_out	
63	VSPICLK_in	VSPICLK_out_mux	YES
64	VSPIQ_in	VSPIQ_out	YES
65	VSPID_in	VSPID_out	YES
66	VSPiHD_in	VSPiHD_out	YES
67	VSPiWP_in	VSPiWP_out	YES
68	VSPICS0_in	VSPICS0_out	YES
69	VSPICS1_in	VSPICS1_out	
70	VSPICS2_in	VSPICS2_out	
71	pcnt_sig_ch0_in5	ledc_hs_sig_out0	
72	pcnt_sig_ch1_in5	ledc_hs_sig_out1	
73	pcnt_ctrl_ch0_in5	ledc_hs_sig_out2	
74	pcnt_ctrl_ch1_in5	ledc_hs_sig_out3	
75	pcnt_sig_ch0_in6	ledc_hs_sig_out4	
76	pcnt_sig_ch1_in6	ledc_hs_sig_out5	
77	pcnt_ctrl_ch0_in6	ledc_hs_sig_out6	
78	pcnt_ctrl_ch1_in6	ledc_hs_sig_out7	
79	pcnt_sig_ch0_in7	ledc_ls_sig_out0	
80	pcnt_sig_ch1_in7	ledc_ls_sig_out1	
81	pcnt_ctrl_ch0_in7	ledc_ls_sig_out2	
82	pcnt_ctrl_ch1_in7	ledc_ls_sig_out3	
83	rmt_sig_in0	ledc_ls_sig_out4	
84	rmt_sig_in1	ledc_ls_sig_out5	
85	rmt_sig_in2	ledc_ls_sig_out6	
86	rmt_sig_in3	ledc_ls_sig_out7	
87	rmt_sig_in4	rmt_sig_out0	
88	rmt_sig_in5	rmt_sig_out1	
89	rmt_sig_in6	rmt_sig_out2	
90	rmt_sig_in7	rmt_sig_out3	
91		rmt_sig_out4	
92		rmt_sig_out5	
93		rmt_sig_out6	
94		rmt_sig_out7	
95	I2CEXT1_SCL_in	I2CEXT1_SCL_out	
96	I2CEXT1_SDA_in	I2CEXT1_SDA_out	
97	host_card_detect_n_1	host_ccmd_od_pullup_en_n	
98	host_card_detect_n_2	host_rst_n_1	
99	host_card_write_prt_1	host_rst_n_2	
100	host_card_write_prt_2	gpio_sd0_out	
101	host_card_int_n_1	gpio_sd1_out	
102	host_card_int_n_2	gpio_sd2_out	
103	pwm1_sync0_in	gpio_sd3_out	
104	pwm1_sync1_in	gpio_sd4_out	

Signal	Input Signal	Output Signal	Direct I/O in IO_MUX
105	pwm1_sync2_in	gpio_sd5_out	
106	pwm1_f0_in	gpio_sd6_out	
107	pwm1_f1_in	gpio_sd7_out	
108	pwm1_f2_in	pwm1_out0a	
109	pwm0_cap0_in	pwm1_out0b	
110	pwm0_cap1_in	pwm1_out1a	
111	pwm0_cap2_in	pwm1_out1b	
112	pwm1_cap0_in	pwm1_out2a	
113	pwm1_cap1_in	pwm1_out2b	
114	pwm1_cap2_in	pwm2_out1h	
115	pwm2_fta	pwm2_out1l	
116	pwm2_ftb	pwm2_out2h	
117	pwm2_cap1_in	pwm2_out2l	
118	pwm2_cap2_in	pwm2_out3h	
119	pwm2_cap3_in	pwm2_out3l	
120	pwm3_fta	pwm2_out4h	
121	pwm3_ftb	pwm2_out4l	
122	pwm3_cap1_in		
123	pwm3_cap2_in		
124	pwm3_cap3_in		
140	I2S0I_DATA_in0	I2S0O_DATA_out0	
141	I2S0I_DATA_in1	I2S0O_DATA_out1	
142	I2S0I_DATA_in2	I2S0O_DATA_out2	
143	I2S0I_DATA_in3	I2S0O_DATA_out3	
144	I2S0I_DATA_in4	I2S0O_DATA_out4	
145	I2S0I_DATA_in5	I2S0O_DATA_out5	
146	I2S0I_DATA_in6	I2S0O_DATA_out6	
147	I2S0I_DATA_in7	I2S0O_DATA_out7	
148	I2S0I_DATA_in8	I2S0O_DATA_out8	
149	I2S0I_DATA_in9	I2S0O_DATA_out9	
150	I2S0I_DATA_in10	I2S0O_DATA_out10	
151	I2S0I_DATA_in11	I2S0O_DATA_out11	
152	I2S0I_DATA_in12	I2S0O_DATA_out12	
153	I2S0I_DATA_in13	I2S0O_DATA_out13	
154	I2S0I_DATA_in14	I2S0O_DATA_out14	
155	I2S0I_DATA_in15	I2S0O_DATA_out15	
156		I2S0O_DATA_out16	
157		I2S0O_DATA_out17	
158		I2S0O_DATA_out18	
159		I2S0O_DATA_out19	
160		I2S0O_DATA_out20	
161		I2S0O_DATA_out21	
162		I2S0O_DATA_out22	
163		I2S0O_DATA_out23	

Signal	Input Signal	Output Signal	Direct I/O in IO_MUX
164	I2S1I_BCK_in	I2S1I_BCK_out	
165	I2S1I_WS_in	I2S1I_WS_out	
166	I2S1I_DATA_in0	I2S1O_DATA_out0	
167	I2S1I_DATA_in1	I2S1O_DATA_out1	
168	I2S1I_DATA_in2	I2S1O_DATA_out2	
169	I2S1I_DATA_in3	I2S1O_DATA_out3	
170	I2S1I_DATA_in4	I2S1O_DATA_out4	
171	I2S1I_DATA_in5	I2S1O_DATA_out5	
172	I2S1I_DATA_in6	I2S1O_DATA_out6	
173	I2S1I_DATA_in7	I2S1O_DATA_out7	
174	I2S1I_DATA_in8	I2S1O_DATA_out8	
175	I2S1I_DATA_in9	I2S1O_DATA_out9	
176	I2S1I_DATA_in10	I2S1O_DATA_out10	
177	I2S1I_DATA_in11	I2S1O_DATA_out11	
178	I2S1I_DATA_in12	I2S1O_DATA_out12	
179	I2S1I_DATA_in13	I2S1O_DATA_out13	
180	I2S1I_DATA_in14	I2S1O_DATA_out14	
181	I2S1I_DATA_in15	I2S1O_DATA_out15	
182		I2S1O_DATA_out16	
183		I2S1O_DATA_out17	
184		I2S1O_DATA_out18	
185		I2S1O_DATA_out19	
186		I2S1O_DATA_out20	
187		I2S1O_DATA_out21	
188		I2S1O_DATA_out22	
189		I2S1O_DATA_out23	
190	I2S0I_H_SYNC	pwm3_out1h	
191	I2S0I_V_SYNC	pwm3_out1l	
192	I2S0I_H_ENABLE	pwm3_out2h	
193	I2S1I_H_SYNC	pwm3_out2l	
194	I2S1I_V_SYNC	pwm3_out3h	
195	I2S1I_H_ENABLE	pwm3_out3l	
196		pwm3_out4h	
197		pwm3_out4l	
198	U2RXD_in	U2TXD_out	YES
199	U2CTS_in	U2RTS_out	YES
200	emac_mdc_i	emac_mdc_o	
201	emac_mdio_i	emac_mdio_o	
202	emac_crs_i	emac_crs_o	
203	emac_col_i	emac_col_o	
204	pcmfssync_in	bt_audio0_irq	
205	pcmcclk_in	bt_audio1_irq	
206	pcmdin	bt_audio2_irq	
207		ble_audio0_irq	

Signal	Input Signal	Output Signal	Direct I/O in IO_MUX
208		ble_audio1_irq	
209		ble_audio2_irq	
210		pcmfsync_out	
211		pcmclk_out	
212		pcmdout	
213		ble_audio_sync0_p	
214		ble_audio_sync1_p	
215		ble_audio_sync2_p	
224		sig_in_func224	
225		sig_in_func225	
226		sig_in_func226	
227		sig_in_func227	
228		sig_in_func228	

Direct I/O in IO_MUX "YES" means that this signal is also available directly via IO_MUX. To apply the GPIO Matrix to these signals, their corresponding SIG_IN_SEL register must be cleared.

4.10 IO_MUX Pad List

Table 19 shows the IO_MUX functions for each I/O pad:

Table 19: IO_MUX Pad Summary

GPIO	Pad Name	Function 1	Function 2	Function 3	Function 4	Function 5	Function 6	Reset	Notes
0	GPIO0	GPIO0	CLK_OUT1	GPIO0	-	-	EMAC_TX_CLK	3	R
1	U0TXD	U0TXD	CLK_OUT3	GPIO1	-	-	EMAC_RXD2	3	-
2	GPIO2	GPIO2	HSPIWP	GPIO2	HS2_DATA0	SD_DATA0	-	2	R
3	U0RXD	U0RXD	CLK_OUT2	GPIO3	-	-	-	3	-
4	GPIO4	GPIO4	HSPIHD	GPIO4	HS2_DATA1	SD_DATA1	EMAC_TX_ER	2	R
5	GPIO5	GPIO5	VSPICS0	GPIO5	HS1_DATA6	-	EMAC_RX_CLK	3	-
6	SD_CLK	SD_CLK	SPICLK	GPIO6	HS1_CLK	U1CTS	-	3	-
7	SD_DATA_0	SD_DATA0	SPIQ	GPIO7	HS1_DATA0	U2RTS	-	3	-
8	SD_DATA_1	SD_DATA1	SPID	GPIO8	HS1_DATA1	U2CTS	-	3	-
9	SD_DATA_2	SD_DATA2	SPIHD	GPIO9	HS1_DATA2	U1RXD	-	3	-
10	SD_DATA_3	SD_DATA3	SPIWP	GPIO10	HS1_DATA3	U1TXD	-	3	-
11	SD_CMD	SD_CMD	SPICS0	GPIO11	HS1_CMD	U1RTS	-	3	-
12	MTDI	MTDI	HSPIQ	GPIO12	HS2_DATA2	SD_DATA2	EMAC_TXD3	2	R
13	MTCK	MTCK	HSPID	GPIO13	HS2_DATA3	SD_DATA3	EMAC_RX_ER	1	R
14	MTMS	MTMS	HSPICLK	GPIO14	HS2_CLK	SD_CLK	EMAC_TXD2	1	R
15	MTDO	MTDO	HSPICS0	GPIO15	HS2_CMD	SD_CMD	EMAC_RXD3	3	R
16	GPIO16	GPIO16	-	GPIO16	HS1_DATA4	U2RXD	EMAC_CLK_OUT	1	-
17	GPIO17	GPIO17	-	GPIO17	HS1_DATA5	U2TXD	EMAC_CLK_180	1	-
18	GPIO18	GPIO18	VSPICLK	GPIO18	HS1_DATA7	-	-	1	-
19	GPIO19	GPIO19	VSPIQ	GPIO19	U0CTS	-	EMAC_TXD0	1	-
21	GPIO21	GPIO21	VSPID	GPIO21	-	-	EMAC_TX_EN	1	-
22	GPIO22	GPIO22	VSPICLK	GPIO22	U0RTS	-	EMAC_TXD1	1	-
23	GPIO23	GPIO23	VSPID	GPIO23	HS1_STROBE	-	-	1	-
25	GPIO25	GPIO25	-	GPIO25	-	-	EMAC_RXD0	0	R
26	GPIO26	GPIO26	-	GPIO26	-	-	EMAC_RXD1	0	R
27	GPIO27	GPIO27	-	GPIO27	-	-	EMAC_RX_DV	1	R
32	32K_XP	GPIO32	-	GPIO32	-	-	-	0	R
33	32K_XN	GPIO33	-	GPIO33	-	-	-	0	R

GPIO	Pad Name	Function 1	Function 2	Function 3	Function 4	Function 5	Function 6	Reset	Notes
34	VDET_1	GPIO34	-	GPIO34	-	-	-	0	R, I
35	VDET_2	GPIO35	-	GPIO35	-	-	-	0	R, I
36	SENSOR_VP	GPIO36	-	GPIO36	-	-	-	0	R, I
37	SENSOR_CAPP	GPIO37	-	GPIO37	-	-	-	0	R, I
38	SENSOR_CAPN	GPIO38	-	GPIO38	-	-	-	0	R, I
39	SENSOR_VN	GPIO39	-	GPIO39	-	-	-	0	R, I

Reset Configurations

"Reset" column shows each pad's default configurations after reset:

- **0** - IE=0 (input disabled).
- **1** - IE=1 (input enabled).
- **2** - IE=1, WPD=1 (input enabled, pulldown resistor).
- **3** - IE=1, WPU=1 (input enabled, pullup resistor).

Notes

- **R** - Pad has RTC/analog functions via RTC_MUX.
- **I** - Pad can only be configured as input GPIO.

Please refer to the ESP32 Pin Lists in [ESP32 Datasheet](#) for more details.

4.11 RTC_MUX Pin List

Table 20 shows the RTC pins and how they correspond to GPIO pads:

Table 20: RTC_MUX Pin Summary

RTC GPIO Num	GPIO Num	Pad Name	Analog Function		
			1	2	3
0	36	SENSOR_VP	ADC_H	ADC1_CH0	-
1	37	SENSOR_CAPP	ADC_H	ADC1_CH1	-
2	38	SENSOR_CAPN	ADC_H	ADC1_CH2	-
3	39	SENSOR_VN	ADC_H	ADC1_CH3	-
4	34	VDET_1	-	ADC1_CH6	-
5	35	VDET_2	-	ADC1_CH7	-
6	25	GPIO25	DAC_1	ADC2_CH8	-
7	26	GPIO26	DAC_2	ADC2_CH9	-
8	33	32K_XN	XTAL_32K_N	ADC1_CH5	TOUCH8
9	32	32K_XP	XTAL_32K_P	ADC1_CH4	TOUCH9
10	4	GPIO4	-	ADC2_CH0	TOUCH0
11	0	GPIO0	-	ADC2_CH1	TOUCH1
12	2	GPIO2	-	ADC2_CH2	TOUCH2
13	15	MTDO	-	ADC2_CH3	TOUCH3
14	13	MTCK	-	ADC2_CH4	TOUCH4
15	12	MTDI	-	ADC2_CH5	TOUCH5
16	14	MTMS	-	ADC2_CH6	TOUCH6

RTC GPIO Num	GPIO Num	Pad Name	Analog Function		
			1	2	3
17	27	GPIO27	-	ADC2_CH7	TOUCH7

4.12 Register Summary

Name	Description	Address	Access
GPIO_OUT_REG	GPIO 0-31 output register	0x3FF44004	R/W
GPIO_OUT_W1TS_REG	GPIO 0-31 output register_W1TS	0x3FF44008	WO
GPIO_OUT_W1TC_REG	GPIO 0-31 output register_W1TC	0x3FF4400C	WO
GPIO_OUT1_REG	GPIO 32-39 output register	0x3FF44010	R/W
GPIO_OUT1_W1TS_REG	GPIO 32-39 output bit set register	0x3FF44014	WO
GPIO_OUT1_W1TC_REG	GPIO 32-39 output bit clear register	0x3FF44018	WO
GPIO_ENABLE_REG	GPIO 0-31 output enable register	0x3FF44020	R/W
GPIO_ENABLE_W1TS_REG	GPIO 0-31 output enable register_W1TS	0x3FF44024	WO
GPIO_ENABLE_W1TC_REG	GPIO 0-31 output enable register_W1TC	0x3FF44028	WO
GPIO_ENABLE1_REG	GPIO 32-39 output enable register	0x3FF4402C	R/W
GPIO_ENABLE1_W1TS_REG	GPIO 32-39 output enable bit set register	0x3FF44030	WO
GPIO_ENABLE1_W1TC_REG	GPIO 32-39 output enable bit clear register	0x3FF44034	WO
GPIO_STRAP_REG	Bootstrap pin value register	0x3FF44038	RO
GPIO_IN_REG	GPIO 0-31 input register	0x3FF4403C	RO
GPIO_IN1_REG	GPIO 32-39 input register	0x3FF44040	RO
GPIO_STATUS_REG	GPIO 0-31 interrupt status register	0x3FF44044	R/W
GPIO_STATUS_W1TS_REG	GPIO 0-31 interrupt status register_W1TS	0x3FF44048	WO
GPIO_STATUS_W1TC_REG	GPIO 0-31 interrupt status register_W1TC	0x3FF4404C	WO
GPIO_STATUS1_REG	GPIO 32-39 interrupt status register1	0x3FF44050	R/W
GPIO_STATUS1_W1TS_REG	GPIO 32-39 interrupt status bit set register	0x3FF44054	WO
GPIO_STATUS1_W1TC_REG	GPIO 32-39 interrupt status bit clear register	0x3FF44058	WO
GPIO_ACPU_INT_REG	GPIO 0-31 APP_CPU interrupt status	0x3FF44060	RO
GPIO_ACPU_NMI_INT_REG	GPIO 0-31 APP_CPU non-maskable interrupt status	0x3FF44064	RO
GPIO_PCPU_INT_REG	GPIO 0-31 PRO_CPU interrupt status	0x3FF44068	RO
GPIO_PCPU_NMI_INT_REG	GPIO 0-31 PRO_CPU non-maskable interrupt status	0x3FF4406C	RO
GPIO_ACPU_INT1_REG	GPIO 32-39 APP_CPU interrupt status	0x3FF44074	RO
GPIO_ACPU_NMI_INT1_REG	GPIO 32-39 APP_CPU non-maskable interrupt status	0x3FF44078	RO
GPIO_PCPU_INT1_REG	GPIO 32-39 PRO_CPU interrupt status	0x3FF4407C	RO
GPIO_PCPU_NMI_INT1_REG	GPIO 32-39 PRO_CPU non-maskable interrupt status	0x3FF44080	RO
GPIO_PIN0_REG	Configuration for GPIO pin 0	0x3FF44088	R/W
GPIO_PIN1_REG	Configuration for GPIO pin 1	0x3FF4408C	R/W
GPIO_PIN2_REG	Configuration for GPIO pin 2	0x3FF44090	R/W
...	...		

Name	Description	Address	Access
GPIO_PIN38_REG	Configuration for GPIO pin 38	0x3FF44120	R/W
GPIO_PIN39_REG	Configuration for GPIO pin 39	0x3FF44124	R/W
GPIO_FUNC0_IN_SEL_CFG_REG	Peripheral function 0 input selection register	0x3FF44130	R/W
GPIO_FUNC1_IN_SEL_CFG_REG	Peripheral function 1 input selection register	0x3FF44134	R/W
...	...		
GPIO_FUNC254_IN_SEL_CFG_REG	Peripheral function 254 input selection register	0x3FF44528	R/W
GPIO_FUNC255_IN_SEL_CFG_REG	Peripheral function 255 input selection register	0x3FF4452C	R/W
GPIO_FUNC0_OUT_SEL_CFG_REG	Peripheral output selection for GPIO 0	0x3FF44530	R/W
GPIO_FUNC1_OUT_SEL_CFG_REG	Peripheral output selection for GPIO 1	0x3FF44534	R/W
...	...		
GPIO_FUNC38_OUT_SEL_CFG_REG	Peripheral output selection for GPIO 38	0x3FF445C8	R/W
GPIO_FUNC39_OUT_SEL_CFG_REG	Peripheral output selection for GPIO 39	0x3FF445CC	R/W

Name	Description	Address	Access
IO_MUX_PIN_CTRL	Clock output configuration register	0x3FF49000	R/W
IO_MUX_GPIO36_REG	Configuration register for pad GPIO36	0x3FF49004	R/W
IO_MUX_GPIO37_REG	Configuration register for pad GPIO37	0x3FF49008	R/W
IO_MUX_GPIO38_REG	Configuration register for pad GPIO38	0x3FF4900C	R/W
IO_MUX_GPIO39_REG	Configuration register for pad GPIO39	0x3FF49010	R/W
IO_MUX_GPIO34_REG	Configuration register for pad GPIO34	0x3FF49014	R/W
IO_MUX_GPIO35_REG	Configuration register for pad GPIO35	0x3FF49018	R/W
IO_MUX_GPIO32_REG	Configuration register for pad GPIO32	0x3FF4901C	R/W
IO_MUX_GPIO33_REG	Configuration register for pad GPIO33	0x3FF49020	R/W
IO_MUX_GPIO25_REG	Configuration register for pad GPIO25	0x3FF49024	R/W
IO_MUX_GPIO26_REG	Configuration register for pad GPIO26	0x3FF49028	R/W
IO_MUX_GPIO27_REG	Configuration register for pad GPIO27	0x3FF4902C	R/W
IO_MUX_MTMS_REG	Configuration register for pad MTMS	0x3FF49030	R/W
IO_MUX_MTDI_REG	Configuration register for pad MTDI	0x3FF49034	R/W
IO_MUX_MTCK_REG	Configuration register for pad MTCK	0x3FF49038	R/W
IO_MUX_MTDO_REG	Configuration register for pad MTDO	0x3FF4903C	R/W
IO_MUX_GPIO2_REG	Configuration register for pad GPIO2	0x3FF49040	R/W
IO_MUX_GPIO0_REG	Configuration register for pad GPIO0	0x3FF49044	R/W
IO_MUX_GPIO4_REG	Configuration register for pad GPIO4	0x3FF49048	R/W
IO_MUX_GPIO16_REG	Configuration register for pad GPIO16	0x3FF4904C	R/W
IO_MUX_GPIO17_REG	Configuration register for pad GPIO17	0x3FF49050	R/W
IO_MUX_SD_DATA2_REG	Configuration register for pad SD_DATA2	0x3FF49054	R/W
IO_MUX_SD_DATA3_REG	Configuration register for pad SD_DATA3	0x3FF49058	R/W
IO_MUX_SD_CMD_REG	Configuration register for pad SD_CMD	0x3FF4905C	R/W
IO_MUX_SD_CLK_REG	Configuration register for pad SD_CLK	0x3FF49060	R/W
IO_MUX_SD_DATA0_REG	Configuration register for pad SD_DATA0	0x3FF49064	R/W
IO_MUX_SD_DATA1_REG	Configuration register for pad SD_DATA1	0x3FF49068	R/W
IO_MUX_GPIO5_REG	Configuration register for pad GPIO5	0x3FF4906C	R/W
IO_MUX_GPIO18_REG	Configuration register for pad GPIO18	0x3FF49070	R/W
IO_MUX_GPIO19_REG	Configuration register for pad GPIO19	0x3FF49074	R/W

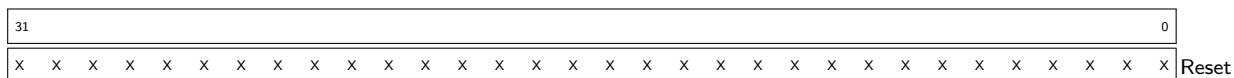
Name	Description	Address	Access
IO_MUX_GPIO20_REG	Configuration register for pad GPIO20	0x3FF49078	R/W
IO_MUX_GPIO21_REG	Configuration register for pad GPIO21	0x3FF4907C	R/W
IO_MUX_GPIO22_REG	Configuration register for pad GPIO22	0x3FF49080	R/W
IO_MUX_U0RXD_REG	Configuration register for pad U0RXD	0x3FF49084	R/W
IO_MUX_U0TXD_REG	Configuration register for pad U0TXD	0x3FF49088	R/W
IO_MUX_GPIO23_REG	Configuration register for pad GPIO23	0x3FF4908C	R/W
IO_MUX_GPIO24_REG	Configuration register for pad GPIO24	0x3FF49090	R/W

Name	Description	Address	Access
GPIO configuration / data registers			
RTCIO_RTC_GPIO_OUT_REG	RTC GPIO output register	0x3FF48400	R/W
RTCIO_RTC_GPIO_OUT_W1TS_REG	RTC GPIO output bit set register	0x3FF48404	WO
RTCIO_RTC_GPIO_OUT_W1TC_REG	RTC GPIO output bit clear register	0x3FF48408	WO
RTCIO_RTC_GPIO_ENABLE_REG	RTC GPIO output enable register	0x3FF4840C	R/W
RTCIO_RTC_GPIO_ENABLE_W1TS_REG	RTC GPIO output enable bit set register	0x3FF48410	WO
RTCIO_RTC_GPIO_ENABLE_W1TC_REG	RTC GPIO output enable bit clear register	0x3FF48414	WO
RTCIO_RTC_GPIO_STATUS_REG	RTC GPIO interrupt status register	0x3FF48418	WO
RTCIO_RTC_GPIO_STATUS_W1TS_REG	RTC GPIO interrupt status bit set register	0x3FF4841C	WO
RTCIO_RTC_GPIO_STATUS_W1TC_REG	RTC GPIO interrupt status bit clear register	0x3FF48420	WO
RTCIO_RTC_GPIO_IN_REG	RTC GPIO input register	0x3FF48424	RO
RTCIO_RTC_GPIO_PIN0_REG	RTC configuration for pin 0	0x3FF48428	R/W
RTCIO_RTC_GPIO_PIN1_REG	RTC configuration for pin 1	0x3FF4842C	R/W
RTCIO_RTC_GPIO_PIN2_REG	RTC configuration for pin 2	0x3FF48430	R/W
RTCIO_RTC_GPIO_PIN3_REG	RTC configuration for pin 3	0x3FF48434	R/W
RTCIO_RTC_GPIO_PIN4_REG	RTC configuration for pin 4	0x3FF48438	R/W
RTCIO_RTC_GPIO_PIN5_REG	RTC configuration for pin 5	0x3FF4843C	R/W
RTCIO_RTC_GPIO_PIN6_REG	RTC configuration for pin 6	0x3FF48440	R/W
RTCIO_RTC_GPIO_PIN7_REG	RTC configuration for pin 7	0x3FF48444	R/W
RTCIO_RTC_GPIO_PIN8_REG	RTC configuration for pin 8	0x3FF48448	R/W
RTCIO_RTC_GPIO_PIN9_REG	RTC configuration for pin 9	0x3FF4844C	R/W
RTCIO_RTC_GPIO_PIN10_REG	RTC configuration for pin 10	0x3FF48450	R/W
RTCIO_RTC_GPIO_PIN11_REG	RTC configuration for pin 11	0x3FF48454	R/W
RTCIO_RTC_GPIO_PIN12_REG	RTC configuration for pin 12	0x3FF48458	R/W
RTCIO_RTC_GPIO_PIN13_REG	RTC configuration for pin 13	0x3FF4845C	R/W
RTCIO_RTC_GPIO_PIN14_REG	RTC configuration for pin 14	0x3FF48460	R/W
RTCIO_RTC_GPIO_PIN15_REG	RTC configuration for pin 15	0x3FF48464	R/W
RTCIO_RTC_GPIO_PIN16_REG	RTC configuration for pin 16	0x3FF48468	R/W
RTCIO_RTC_GPIO_PIN17_REG	RTC configuration for pin 17	0x3FF4846C	R/W
RTCIO_DIG_PAD_HOLD_REG	RTC GPIO hold register	0x3FF48474	R/W
GPIO RTC function configuration registers			
RTCIO_HALL_SENS_REG	Hall sensor configuration	0x3FF48478	R/W
RTCIO_SENSOR_PADS_REG	Sensor pads configuration register	0x3FF4847C	R/W
RTCIO_ADC_PAD_REG	ADC configuration register	0x3FF48480	R/W
RTCIO_PAD_DAC1_REG	DAC1 configuration register	0x3FF48484	R/W

Name	Description	Address	Access
RTCIO_PAD_DAC2_REG	DAC2 configuration register	0x3FF48488	R/W
RTCIO_XTAL_32K_PAD_REG	32KHz crystal pads configuration register	0x3FF4848C	R/W
RTCIO_TOUCH_CFG_REG	Touch sensor configuration register	0x3FF48490	R/W
RTCIO_TOUCH_PAD0_REG	Touch pad configuration register	0x3FF48494	R/W
...	...		
RTCIO_TOUCH_PAD9_REG	Touch pad configuration register	0x3FF484B8	R/W
RTCIO_EXT_WAKEUP0_REG	External wake up configuration register	0x3FF484BC	R/W
RTCIO_XTL_EXT_CTR_REG	Crystal power down enable GPIO source	0x3FF484C0	R/W
RTCIO_SAR_I2C_IO_REG	RTC I2C pad selection	0x3FF484C4	R/W

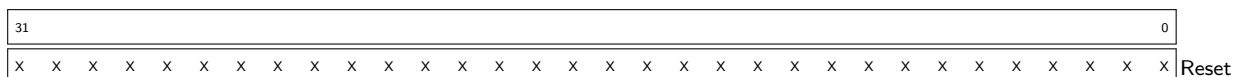
4.13 Registers

Register 4.1: GPIO_OUT_REG (0x0004)



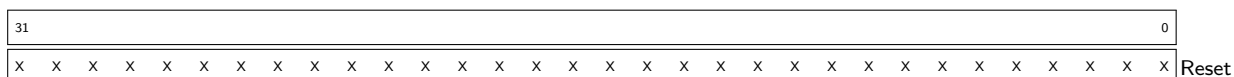
GPIO_OUT_REG GPIO0-31 output value. (R/W)

Register 4.2: GPIO_OUT_W1TS_REG (0x0008)



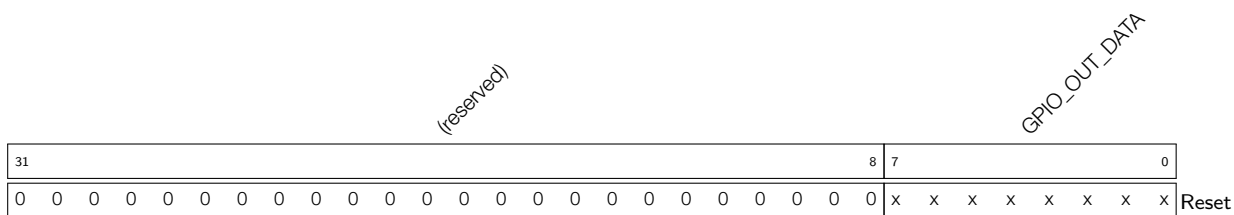
GPIO_OUT_W1TS_REG GPIO0-31 output set register. For every bit that is 1 in the value written here, the corresponding bit in GPIO_OUT_REG will be set. (WO)

Register 4.3: GPIO_OUT_W1TC_REG (0x000c)



GPIO_OUT_W1TC_REG GPIO0-31 output clear register. For every bit that is 1 in the value written here, the corresponding bit in GPIO_OUT_REG will be cleared. (WO)

Register 4.4: GPIO_OUT1_REG (0x0010)



GPIO_OUT_DATA GPIO32-39 output value. (R/W)

Register 4.5: GPIO_OUT1_W1TS_REG (0x0014)

31	(reserved)	7	0
0 0		x x x x x x x x	

Reset

GPIO_OUT_DATA GPIO32-39 output value set register. For every bit that is 1 in the value written here, the corresponding bit in GPIO_OUT1_DATA will be set. (WO)

Register 4.6: GPIO_OUT1_W1TC_REG (0x0018)

31	(reserved)	7	0
0 0		x x x x x x x x	

Reset

GPIO_OUT_DATA GPIO32-39 output value clear register. For every bit that is 1 in the value written here, the corresponding bit in GPIO_OUT1_DATA will be cleared. (WO)

Register 4.7: GPIO_ENABLE_REG (0x0020)

31	0
x x	

Reset

GPIO_ENABLE_REG GPIO0-31 output enable. (R/W)

Register 4.8: GPIO_ENABLE_W1TS_REG (0x0024)

31	0
x x	

Reset

GPIO_ENABLE_W1TS_REG GPIO0-31 output enable set register. For every bit that is 1 in the value written here, the corresponding bit in GPIO_ENABLE will be set. (WO)

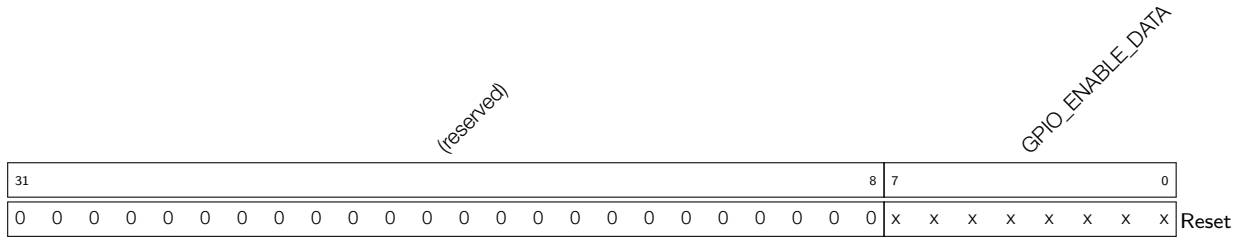
Register 4.9: GPIO_ENABLE_W1TC_REG (0x0028)

31	0
x x	

Reset

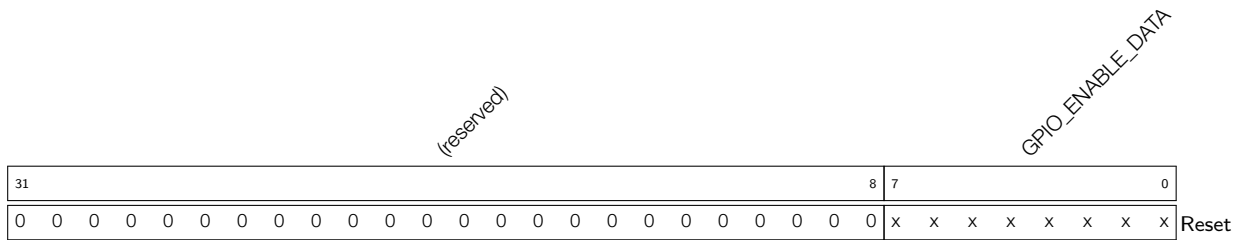
GPIO_ENABLE_W1TC_REG GPIO0-31 output enable clear register. For every bit that is 1 in the value written here, the corresponding bit in GPIO_ENABLE will be cleared. (WO)

Register 4.10: GPIO_ENABLE1_REG (0x002c)



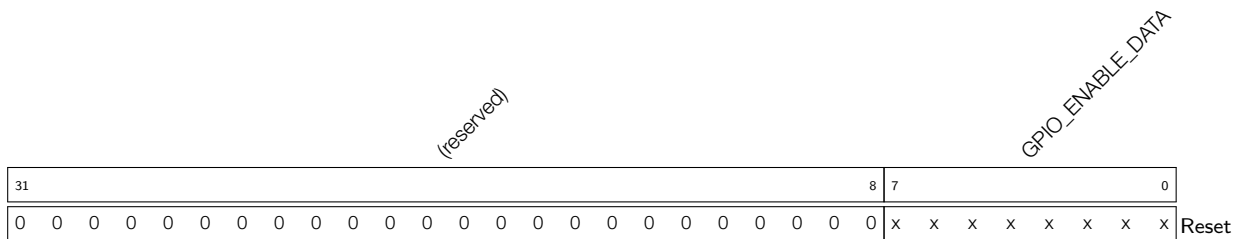
GPIO_ENABLE_DATA GPIO32-39 output enable. (R/W)

Register 4.11: GPIO_ENABLE1_W1TS_REG (0x0030)



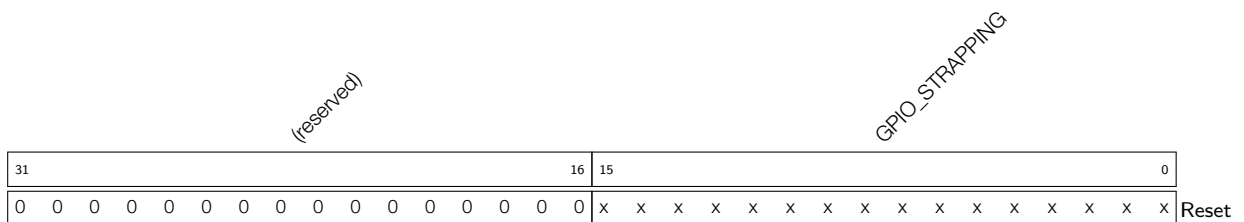
GPIO_ENABLE_DATA GPIO32-39 output enable set register. For every bit that is 1 in the value written here, the corresponding bit in GPIO_ENABLE1 will be set. (WO)

Register 4.12: GPIO_ENABLE1_W1TC_REG (0x0034)

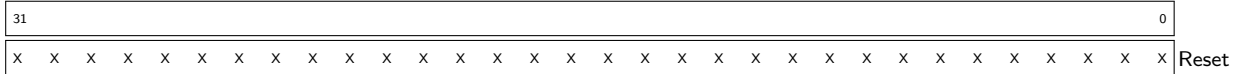


GPIO_ENABLE_DATA GPIO32-39 output enable clear register. For every bit that is 1 in the value written here, the corresponding bit in GPIO_ENABLE1 will be cleared. (WO)

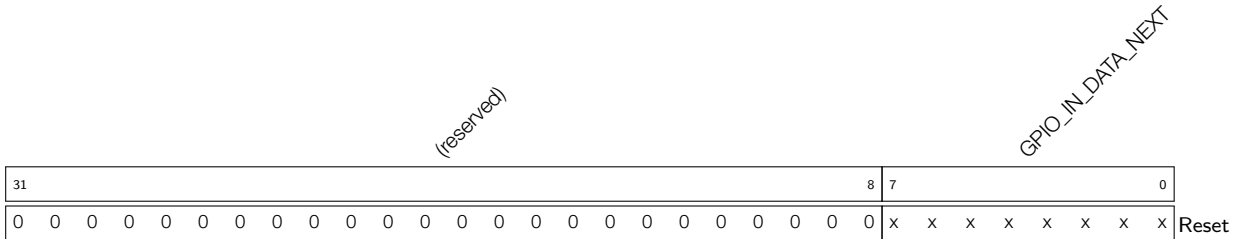
Register 4.13: GPIO_STRAP_REG (0x0038)



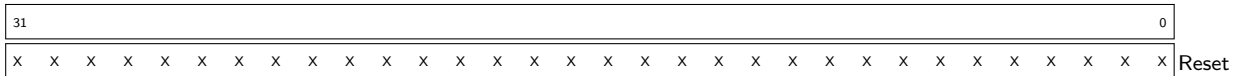
GPIO_STRAPPING GPIO strapping results: Bit5-bit0 of boot_sel_chip[5:0] correspond to MTDI, GPIO0, GPIO2, GPIO4, MTDO, GPIO5, respectively.

Register 4.14: GPIO_IN_REG (0x003c)

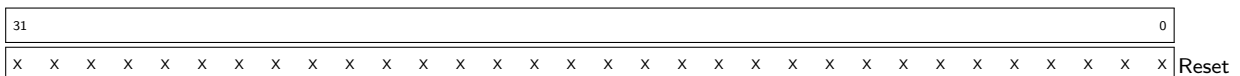
GPIO_IN_REG GPIO0-31 input value. Each bit represents a pad input value, 1 for high level and 0 for low level. (RO)

Register 4.15: GPIO_IN1_REG (0x0040)

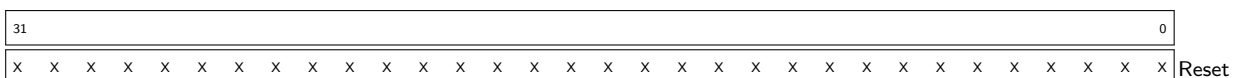
GPIO_IN_DATA_NEXT GPIO32-39 input value. Each bit represents a pad input value. (RO)

Register 4.16: GPIO_STATUS_REG (0x0044)

GPIO_STATUS_REG GPIO0-31 interrupt status register. Each bit can be either of the two interrupt sources for the two CPUs. The enable bits in GPIO_STATUS_INTERRUPT, corresponding to the 0-4 bits in GPIO_PIN_n_REG should be set to 1. (R/W)

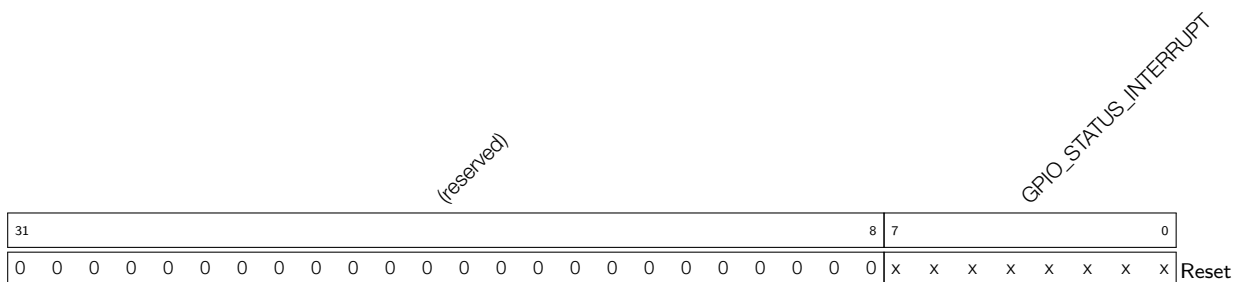
Register 4.17: GPIO_STATUS_W1TS_REG (0x0048)

GPIO_STATUS_W1TS_REG GPIO0-31 interrupt status set register. For every bit that is 1 in the value written here, the corresponding bit in GPIO_STATUS_INTERRUPT will be set. (WO)

Register 4.18: GPIO_STATUS_W1TC_REG (0x004c)

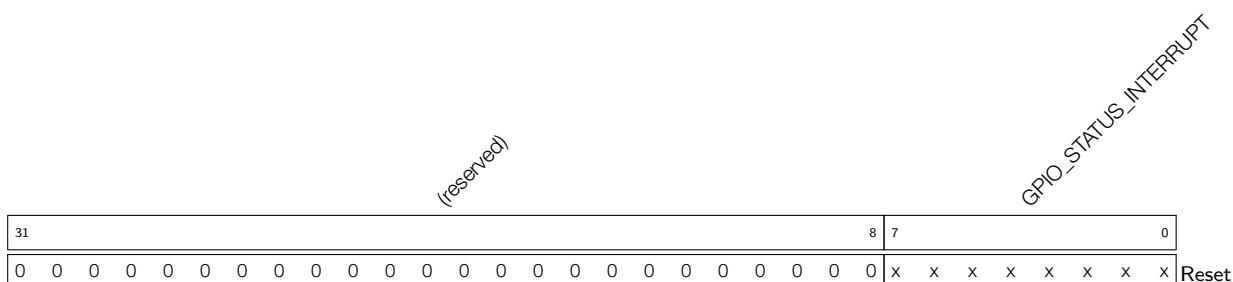
GPIO_STATUS_W1TC_REG GPIO0-31 interrupt status clear register. For every bit that is 1 in the value written here, the corresponding bit in GPIO_STATUS_INTERRUPT will be cleared. (WO)

Register 4.19: GPIO_STATUS1_REG (0x0050)



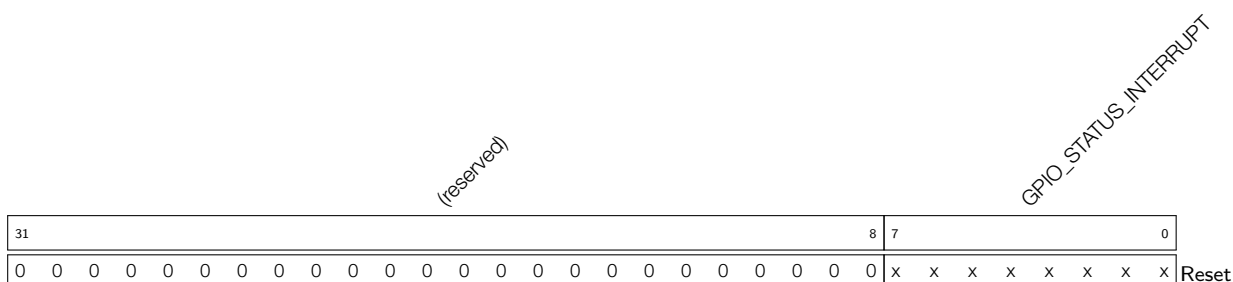
GPIO_STATUS_INTERRUPT GPIO32-39 interrupt status. (R/W)

Register 4.20: GPIO_STATUS1_W1TS_REG (0x0054)



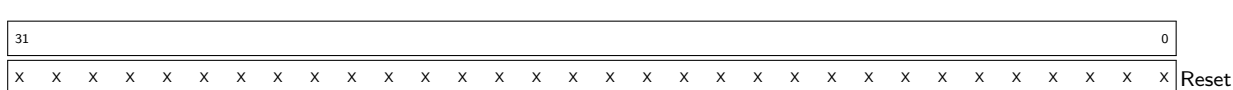
GPIO_STATUS_INTERRUPT GPIO32-39 interrupt status set register. For every bit that is 1 in the value written here, the corresponding bit in GPIO_STATUS_INTERRUPT1 will be set. (WO)

Register 4.21: GPIO_STATUS1_W1TC_REG (0x0058)



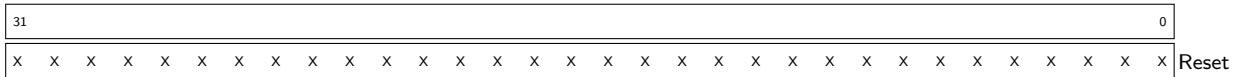
GPIO_STATUS_INTERRUPT GPIO32-39 interrupt status clear register. For every bit that is 1 in the value written here, the corresponding bit in GPIO_STATUS_INTERRUPT1 will be cleared. (WO)

Register 4.22: GPIO_ACPU_INT_REG (0x0060)



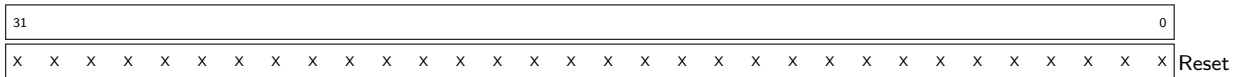
GPIO_ACPU_INT_REG GPIO0-31 APP CPU interrupt status. (RO)

Register 4.23: GPIO_ACPU_NMI_INT_REG (0x0064)



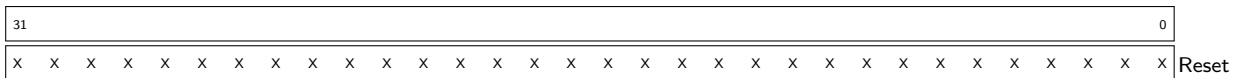
GPIO_ACPU_NMI_INT_REG GPIO0-31 APP CPU non-maskable interrupt status. (RO)

Register 4.24: GPIO_PCPU_INT_REG (0x0068)



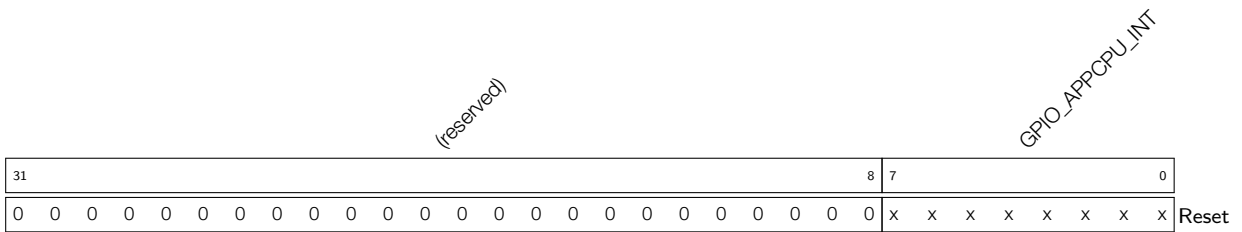
GPIO_PCPU_INT_REG GPIO0-31 PRO CPU interrupt status. (RO)

Register 4.25: GPIO_PCPU_NMI_INT_REG (0x006c)



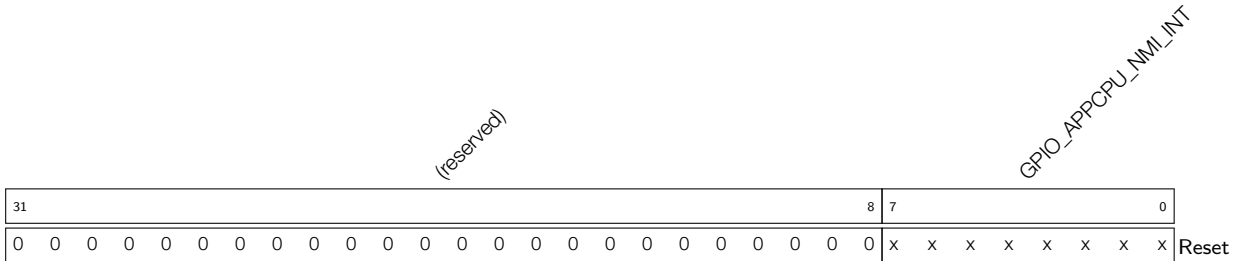
GPIO_PCPU_NMI_INT_REG GPIO0-31 PRO CPU non-maskable interrupt status. (RO)

Register 4.26: GPIO_ACPU_INT1_REG (0x0074)



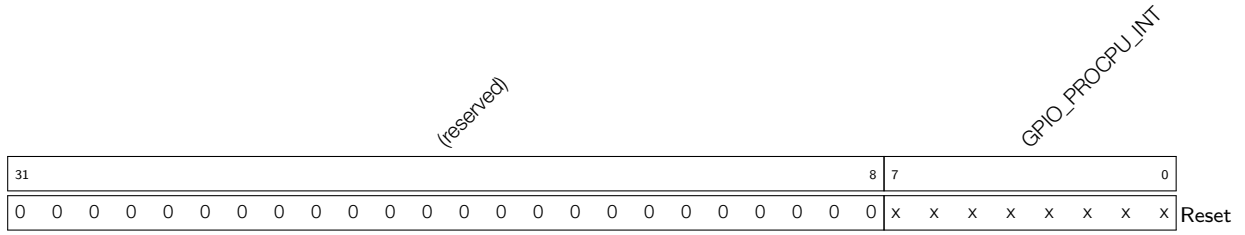
GPIO_APPCPU_INT GPIO32-39 APP CPU interrupt status. (RO)

Register 4.27: GPIO_ACPU_NMI_INT1_REG (0x0078)



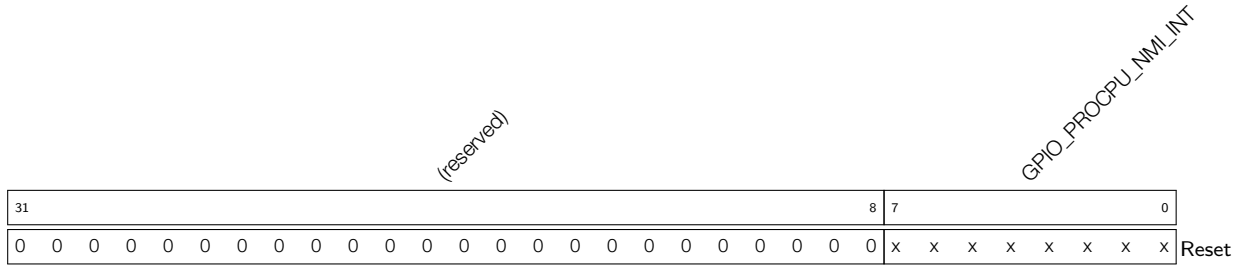
GPIO_APPCPU_NMI_INT GPIO32-39 APP CPU non-maskable interrupt status. (RO)

Register 4.28: GPIO_PCPU_INT1_REG (0x007c)



GPIO_PROCPU_INT GPIO32-39 PRO CPU interrupt status. (RO)

Register 4.29: GPIO_PCPU_NMI_INT1_REG (0x0080)



GPIO_PROCPU_NMI_INT GPIO32-39 PRO CPU non-maskable interrupt status. (RO)

Register 4.30: GPIO_PIN n _REG (n : 0-39) (0x88+0x4* n)

(reserved)											GPIO_PIN n _INT_ENA				(reserved)				GPIO_PIN n _WAKEUP_ENABLE				GPIO_PIN n _INT_TYPE				(reserved)				GPIO_PIN n _PAD_DRIVER				(reserved)											
31																		18	17				13	12	11	10	9			7	6				3	2	3	2								
0																		0	0	0	0	0	0	0	0	0	0	0	x	x	x	x	x	0	0	x	x	x	x	0	0	0	0	x	0	0

Reset

GPIO_PIN n _INT_ENA Interrupt enable bits for pin n : (R/W)

- bit0: APP CPU interrupt enable;
- bit1: APP CPU non-maskable interrupt enable;
- bit3: PRO CPU interrupt enable;
- bit4: PRO CPU non-maskable interrupt enable.

GPIO_PIN n _WAKEUP_ENABLE GPIO wake-up enable will only wake up the CPU from Light-sleep. (R/W)

GPIO_PIN n _INT_TYPE Interrupt type selection: (R/W)

- 0: GPIO interrupt disable;
- 1: rising edge trigger;
- 2: falling edge trigger;
- 3: any edge trigger;
- 4: low level trigger;
- 5: high level trigger.

GPIO_PIN n _PAD_DRIVER 0: normal output; 1: open drain output. (R/W)

Register 4.31: GPIO_FUNC m _IN_SEL_CFG_REG (m : 0-255) (0x130+0x4* m)

(reserved)																								GPIO_SIG m _IN_SEL				GPIO_FUNC m _IN_INV_SEL				GPIO_FUNC m _IN_SEL																				
31																		8	7	6	5												0																			
0																								x	x	x	x	x	x	x	x	x	x	x	x	x	x	x	x	x	x	x	x	x	x	x	x	x	x	x	x	x

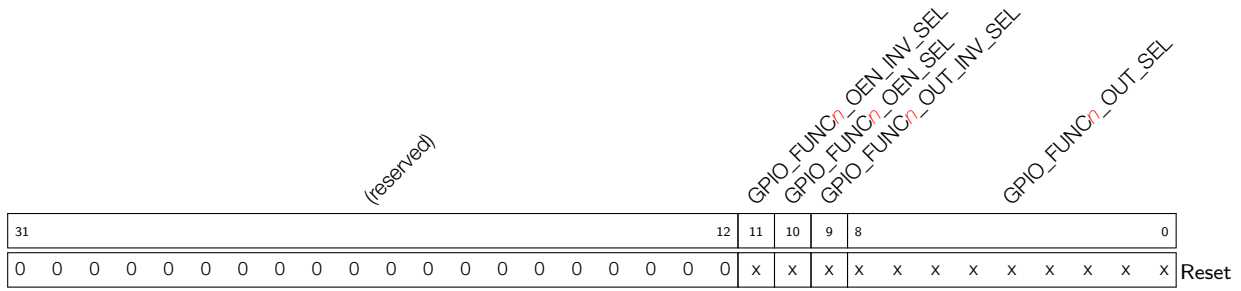
Reset

GPIO_SIG m _IN_SEL Bypass the GPIO Matrix. 0: route through GPIO Matrix, 1: connect signal directly to peripheral configured in the IO_MUX. (R/W)

GPIO_FUNC m _IN_INV_SEL Invert the input value. 1: invert; 0: do not invert. (R/W)

GPIO_FUNC m _IN_SEL Selection control for peripheral input m . A value of 0-39 selects which of the 40 GPIO Matrix input pins this signal is connected to, or 0x38 for a constantly high input or 0x30 for a constantly low input. (R/W)

Register 4.32: GPIO_FUNC n _OUT_SEL_CFG_REG (n : 0-39) (0x530+0x4*n)



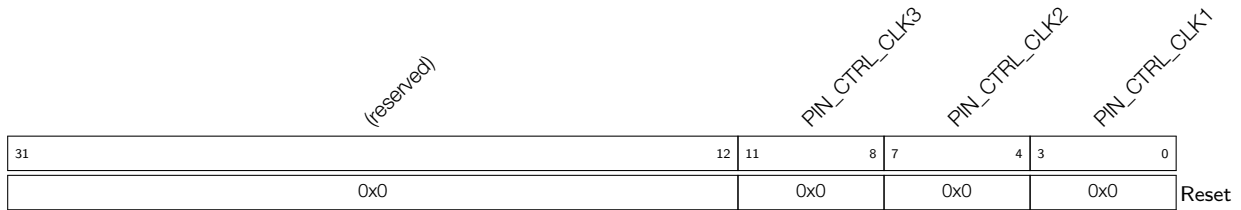
GPIO_FUNC n _OEN_INV_SEL 1: Invert the output enable signal; 0: do not invert the output enable signal. (R/W)

GPIO_FUNC n _OEN_SEL 1: Force the output enable signal to be sourced from bit n of GPIO_ENABLE_REG; 0: use output enable signal from peripheral. (R/W)

GPIO_FUNC n _OUT_INV_SEL 1: Invert the output value; 0: do not invert the output value. (R/W)

GPIO_FUNC n _OUT_SEL Selection control for GPIO output n . A value of s ($0 \leq s < 256$) connects peripheral output s to GPIO output n . A value of 256 selects bit n of GPIO_OUT_REG/GPIO_OUT1_REG and GPIO_ENABLE_REG/GPIO_ENABLE1_REG as the output value and output enable. (R/W)

Register 4.33: IO_MUX_PIN_CTRL (0x3FF49000)



If you want to output clock for I2S0 to:

- CLK_OUT1, then set PIN_CTRL[3:0] = 0x0;
- CLK_OUT2, then set PIN_CTRL[3:0] = 0x0 and PIN_CTRL[7:4] = 0x0;
- CLK_OUT3, then set PIN_CTRL[3:0] = 0x0 and PIN_CTRL[11:8] = 0x0.

If you want to output clock for I2S1 to:

- CLK_OUT1, then set PIN_CTRL[3:0] = 0xF;
- CLK_OUT2, then set PIN_CTRL[3:0] = 0xF and PIN_CTRL[7:4] = 0x0;
- CLK_OUT3, then set PIN_CTRL[3:0] = 0xF and PIN_CTRL[11:8] = 0x0. (R/W)

Note:

Only the above mentioned combinations of clock source and clock output pins are possible. The CLK_OUT1-3 can be found in the [IO_MUX Pad Summary](#).

Register 4.34: IO_MUX_x_REG (x: GPIO0-GPIO39) (0x10+4*x)

(reserved)															IO_x_MCU_SEL	IO_x_FUNC_DRV	IO_x_FUNC_IE	IO_x_FUNC_WPU	IO_x_FUNC_WPD	IO_x_MCU_DRV	IO_x_MCU_IE	IO_x_MCU_WPU	IO_x_MCU_WPD	IO_x_SLP_SEL	IO_x_MCU_OE								
31															15	14	12	11	10	9	8	7	6	5	4	3	2	1	0				
0 0 0 0 0 0 0 0 0 0 0 0 0 0 0															0x0	0x2	0	0	0	0x0	0	0	0	0	0	0	0	0	0	0	0	0	Reset

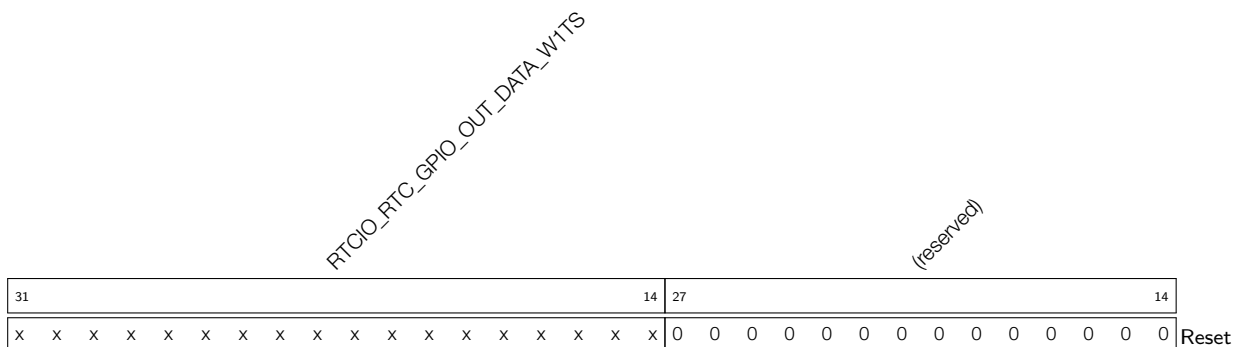
- IO_x_MCU_SEL** Select the IO_MUX function for this signal. 0 selects Function 1, 1 selects Function 2, etc. (R/W)
- IO_x_FUNC_DRV** Select the drive strength of the pad. A higher value corresponds with a higher strength. (R/W)
- IO_x_FUNC_IE** Input enable of the pad. 1: input enabled; 0: input disabled. (R/W)
- IO_x_FUNC_WPU** Pull-up enable of the pad. 1: internal pull-up enabled; 0: internal pull-up disabled. (R/W)
- IO_x_FUNC_WPD** Pull-down enable of the pad. 1: internal pull-down enabled, 0: internal pull-down disabled. (R/W)
- IO_x_MCU_DRV** Select the drive strength of the pad during sleep mode. A higher value corresponds with a higher strength. (R/W)
- IO_x_MCU_IE** Input enable of the pad during sleep mode. 1: input enabled; 0: input disabled. (R/W)
- IO_x_MCU_WPU** Pull-up enable of the pad during sleep mode. 1: internal pull-up enabled; 0: internal pull-up disabled. (R/W)
- IO_x_MCU_WPD** Pull-down enable of the pad during sleep mode. 1: internal pull-down enabled; 0: internal pull-down disabled. (R/W)
- IO_x_SLP_SEL** Sleep mode selection of this pad. Set to 1 to put the pad in sleep mode. (R/W)
- IO_x_MCU_OE** Output enable of the pad in sleep mode. 1: enable output; 0: disable output. (R/W)

Register 4.35: RTCIO_RTC_GPIO_OUT_REG (0x0000)

RTCIO_RTC_GPIO_OUT_DATA															(reserved)																					
31															14	27																			14	Reset
x x x x x x x x x x x x x x x x x															0 0																					

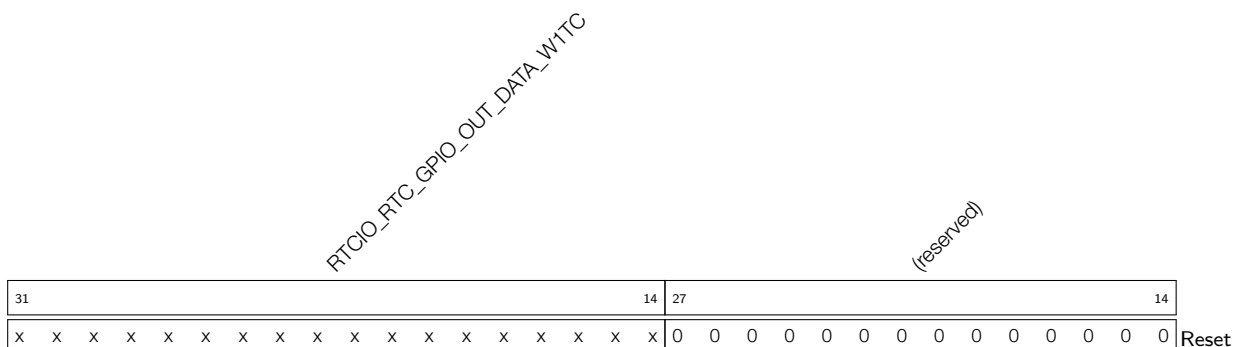
RTCIO_RTC_GPIO_OUT_DATA GPIO0-17 output register. Bit14 is GPIO[0], bit15 is GPIO[1], etc. (R/W)

Register 4.36: RTCIO_RTC_GPIO_OUT_W1TS_REG (0x0004)



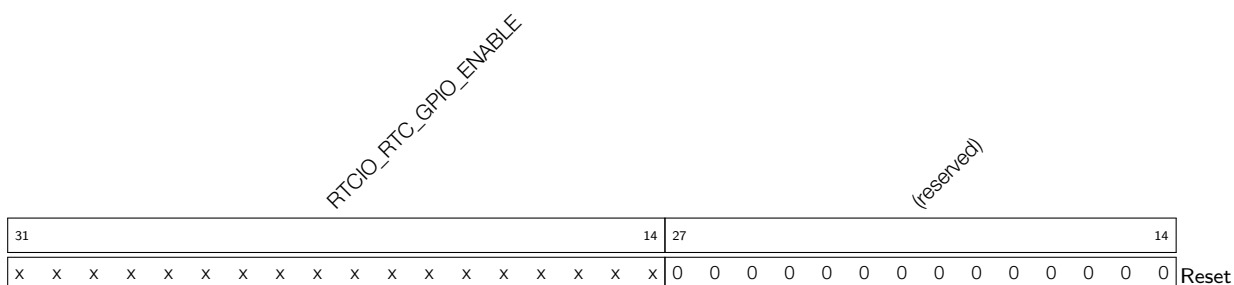
RTCIO_RTC_GPIO_OUT_DATA_W1TS GPIO0-17 output set register. For every bit that is 1 in the value written here, the corresponding bit in RTCIO_RTC_GPIO_OUT will be set. (WO)

Register 4.37: RTCIO_RTC_GPIO_OUT_W1TC_REG (0x0008)



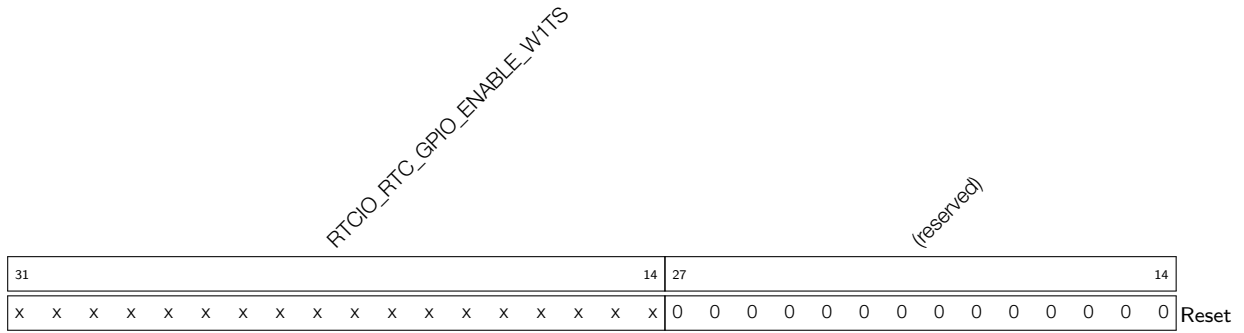
RTCIO_RTC_GPIO_OUT_DATA_W1TC GPIO0-17 output clear register. For every bit that is 1 in the value written here, the corresponding bit in RTCIO_RTC_GPIO_OUT will be cleared. (WO)

Register 4.38: RTCIO_RTC_GPIO_ENABLE_REG (0x000C)



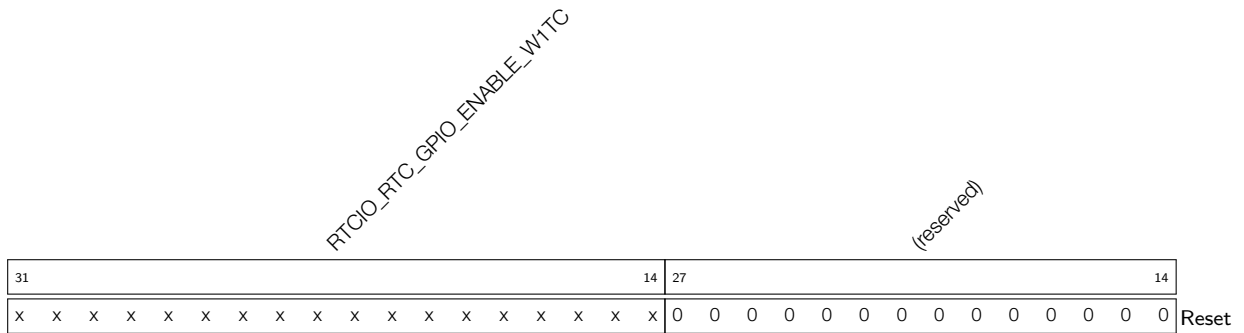
RTCIO_RTC_GPIO_ENABLE GPIO0-17 output enable. Bit14 is GPIO[0], bit15 is GPIO[1], etc. 1 means this GPIO pad is output. (R/W)

Register 4.39: RTCIO_RTC_GPIO_ENABLE_W1TS_REG (0x0010)



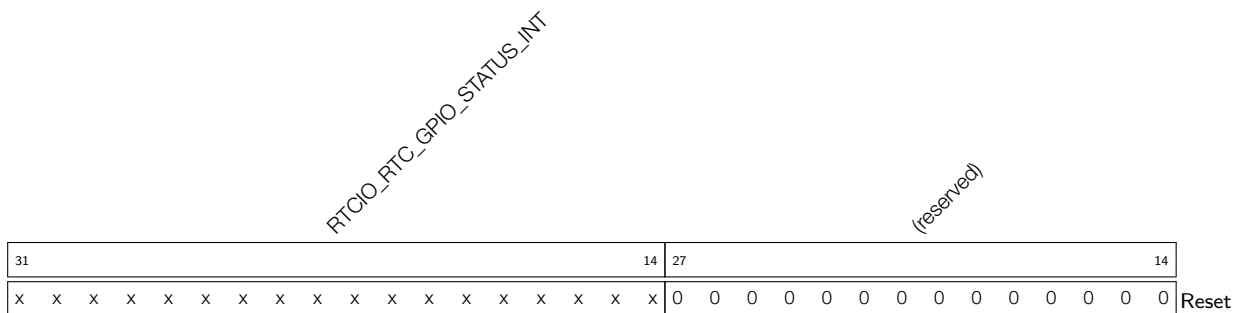
RTCIO_RTC_GPIO_ENABLE_W1TS GPIO0-17 output enable set register. For every bit that is 1 in the value written here, the corresponding bit in RTCIO_RTC_GPIO_ENABLE will be set. (WO)

Register 4.40: RTCIO_RTC_GPIO_ENABLE_W1TC_REG (0x0014)



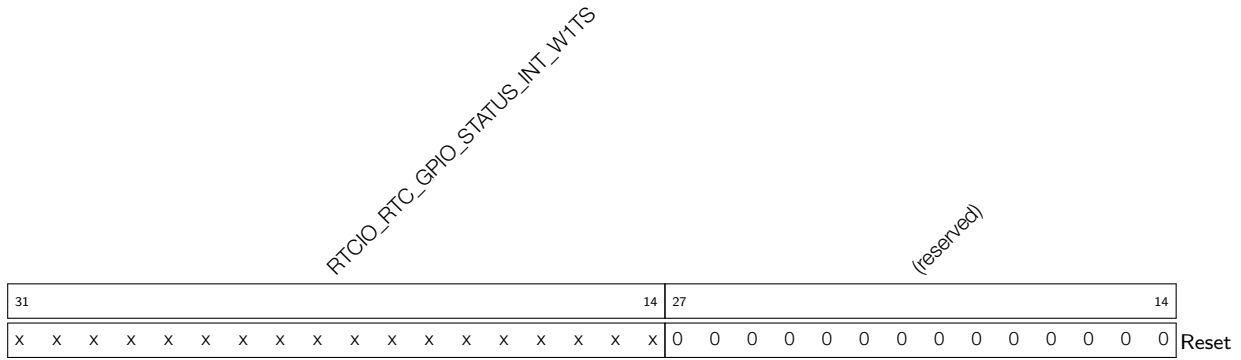
RTCIO_RTC_GPIO_ENABLE_W1TC GPIO0-17 output enable clear register. For every bit that is 1 in the value written here, the corresponding bit in RTCIO_RTC_GPIO_ENABLE will be cleared. (WO)

Register 4.41: RTCIO_RTC_GPIO_STATUS_REG (0x0018)



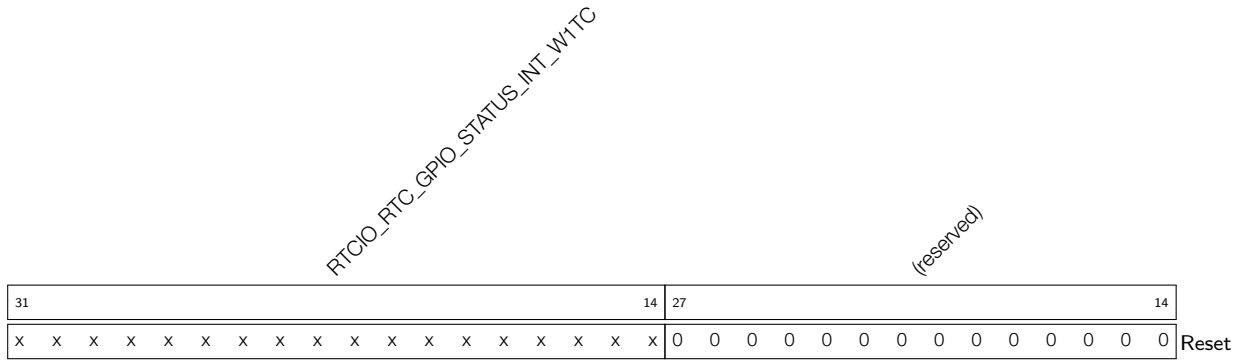
RTCIO_RTC_GPIO_STATUS_INT GPIO0-17 interrupt status. Bit14 is GPIO[0], bit15 is GPIO[1], etc. This register should be used together with RTCIO_RTC_GPIO_PIN_n_INT_TYPE in RTCIO_RTC_GPIO_PIN_n_REG. 1: corresponding interrupt; 0: no interrupt. (R/W)

Register 4.42: RTCIO_RTC_GPIO_STATUS_W1TS_REG (0x001C)



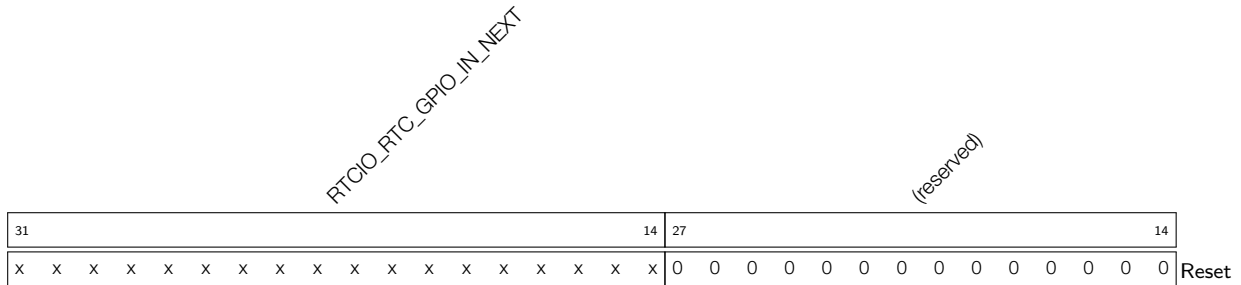
RTCIO_RTC_GPIO_STATUS_INT_W1TS GPIO0-17 interrupt set register. For every bit that is 1 in the value written here, the corresponding bit in RTCIO_RTC_GPIO_STATUS_INT will be set. (WO)

Register 4.43: RTCIO_RTC_GPIO_STATUS_W1TC_REG (0x0020)



RTCIO_RTC_GPIO_STATUS_INT_W1TC GPIO0-17 interrupt clear register. For every bit that is 1 in the value written here, the corresponding bit in RTCIO_RTC_GPIO_STATUS_INT will be cleared. (WO)

Register 4.44: RTCIO_RTC_GPIO_IN_REG (0x0024)



RTCIO_RTC_GPIO_IN_NEXT GPIO0-17 input value. Bit14 is GPIO[0], bit15 is GPIO[1], etc. Each bit represents a pad input value, 1 for high level, and 0 for low level. (RO)

Register 4.45: RTCIO_RTC_GPIO_PIN n _REG (n : 0-17) (28+4* n)

(reserved)											<i>RTCIO_RTC_GPIO_PINn_WAKEUP_ENABLE</i>				<i>RTCIO_RTC_GPIO_PINn_INT_TYPE</i>				(reserved)		<i>RTCIO_RTC_GPIO_PINn_PAD_DRIVER</i>		(reserved)											
31																					11	10	9		7	6					3	2	3	2
0	0	0	0	0	0	0	0	0	0	0	0	0	0	0	0	0	0	0	0	0	0	x	x	x	x	0	0	0	0	x	0	0	0	Reset

RTCIO_RTC_GPIO_PIN n _WAKEUP_ENABLE GPIO wake-up enable. This will only wake up the ESP32 from Light-sleep. (R/W)

RTCIO_RTC_GPIO_PIN n _INT_TYPE GPIO interrupt type selection. (R/W)

- 0: GPIO interrupt disable;
- 1: rising edge trigger;
- 2: falling edge trigger;
- 3: any edge trigger;
- 4: low level trigger;
- 5: high level trigger.

RTCIO_RTC_GPIO_PIN n _PAD_DRIVER Pad driver selection. 0: normal output; 1: open drain. (R/W)

Register 4.46: RTCIO_DIG_PAD_HOLD_REG (0x0074)

31																														0
0																														Reset

RTCIO_DIG_PAD_HOLD_REG Select which digital pads are on hold. While 0 allows normal operation, 1 puts the pad on hold. (R/W)

Register 4.47: RTCIO_HALL_SENS_REG (0x0078)

<i>RTCIO_HALL_XPD_HALL</i>		<i>RTCIO_HALL_PHASE</i>		(reserved)																																		
31	30	59																												30								
0	0	0	0	0	0	0	0	0	0	0	0	0	0	0	0	0	0	0	0	0	0	0	0	0	0	0	0	0	0	0	0	0	0	0	0	0	0	Reset

RTCIO_HALL_XPD_HALL Power on hall sensor and connect to VP and VN. (R/W)

RTCIO_HALL_PHASE Reverse the polarity of the hall sensor. (R/W)

Register 4.48: RTCIO_SENSOR_PADS_REG (0x007C)

(reserved)																														
31	30	29	28	27	26	25	24	23	22	21	20	19	18	17	16	15	14	13	12	11	10	9	8	7	6	5	4	7	4	
0	0	0	0	0	0	0	0	0	0	0	0	0	0	0	0	0	0	0	0	0	0	0	0	0	0	0	0	0	0	0

Reset

RTCIO_SENSOR_SENSE n _HOLD Set to 1 to hold the output value on sense n ; 0 is for normal operation. (R/W)

RTCIO_SENSOR_SENSE n _MUX_SEL 1: route sense n to the RTC block; 0: route sense n to the digital IO_MUX. (R/W)

RTCIO_SENSOR_SENSE n _FUN_SEL Select the RTC IO_MUX function for this pad. 0: select Function 0; 1: select Function 1. (R/W)

RTCIO_SENSOR_SENSE n _SLP_SEL Selection of sleep mode for the pad: set to 1 to put the pad in sleep mode. (R/W)

RTCIO_SENSOR_SENSE n _SLP_IE Input enable of the pad in sleep mode. 1: enabled; 0: disabled. (R/W)

RTCIO_SENSOR_SENSE n _FUN_IE Input enable of the pad. 1: enabled; 0: disabled. (R/W)

Register 4.49: RTCIO_ADC_PAD_REG (0x0080)

RTCIO_ADC_ADC1_HOLD RTCIO_ADC_ADC2_HOLD RTCIO_ADC_ADC1_MUX_SEL RTCIO_ADC_ADC2_MUX_SEL RTCIO_ADC_ADC1_FUN_SEL RTCIO_ADC_ADC1_SLP_SEL RTCIO_ADC_ADC1_SLP_IE RTCIO_ADC_ADC1_FUN_IE RTCIO_ADC_ADC2_FUN_SEL RTCIO_ADC_ADC2_SLP_SEL RTCIO_ADC_ADC2_SLP_IE RTCIO_ADC_ADC2_FUN_IE (reserved)														18	
31	30	29	28	27	26	25	24	23	22	21	20	19	18	35	18
0	0	0	0	0	0	0	0	0	0	0	0	0	0	0	0

Reset

RTCIO_ADC_ADC n _HOLD Set to 1 to hold the output value on the pad; 0 is for normal operation. (R/W)

RTCIO_ADC_ADC n _MUX_SEL 0: route pad to the digital IO_MUX; (R/W)
1: route pad to the RTC block.

RTCIO_ADC_ADC n _FUN_SEL Select the RTC function for this pad. 0: select Function 0; 1: select Function 1. (R/W)

RTCIO_ADC_ADC n _SLP_SEL Signal selection of pad's sleep mode. Set this bit to 1 to put the pad to sleep. (R/W)

RTCIO_ADC_ADC n _SLP_IE Input enable of the pad in sleep mode. 1 enabled; 0 disabled. (R/W)

RTCIO_ADC_ADC n _FUN_IE Input enable of the pad. 1 enabled; 0 disabled. (R/W)

Register 4.50: RTCIO_PAD_DAC1_REG (0x0084)

RTCIO_PAD_PDAC1_DRV						RTCIO_PAD_PDAC1_DAC				RTCIO_PAD_PDAC1_XPD_DAC								(reserved)																									
RTCIO_PAD_PDAC1_HOLD						RTCIO_PAD_PDAC1_MUX_SEL				RTCIO_PAD_PDAC1_FUN_SEL								RTCIO_PAD_PDAC1_SLP_SEL																									
RTCIO_PAD_PDAC1_RDE						RTCIO_PAD_PDAC1_SLP_IE				RTCIO_PAD_PDAC1_SLP_OE								RTCIO_PAD_PDAC1_FUN_IE																									
RTCIO_PAD_PDAC1_RUE						RTCIO_PAD_PDAC1_DAC_XPD_FORCE																																					
31	30	29	28	27	26												19	18	17	16	15	14	13	12	11	10	19												10				
2	0	0	0	0								0	0	0	0	0	0	0	0	0	0	0	0	0	0	0	0	0	0	0	0												0
Reset																																											

- RTCIO_PAD_PDAC1_DRV** Select the drive strength of the pad. (R/W)
- RTCIO_PAD_PDAC1_HOLD** Set to 1 to hold the output value on the pad; set to 0 for normal operation. (R/W)
- RTCIO_PAD_PDAC1_RDE** 1: Pull-down on pad enabled; 0: Pull-down disabled. (R/W)
- RTCIO_PAD_PDAC1_RUE** 1: Pull-up on pad enabled; 0: Pull-up disabled. (R/W)
- RTCIO_PAD_PDAC1_DAC** PAD DAC1 output value. (R/W)
- RTCIO_PAD_PDAC1_XPD_DAC** Power on DAC1. Usually, PDAC1 needs to be tristated if we power on the DAC, i.e. IE=0, OE=0, RDE=0, RUE=0. (R/W)
- RTCIO_PAD_PDAC1_MUX_SEL** 0: route pad to the digital IO_MUX; (R/W)
1: route to the RTC block.
- RTCIO_PAD_PDAC1_FUN_SEL** the functional selection signal of the pad. (R/W)
- RTCIO_PAD_PDAC1_SLP_SEL** Sleep mode selection signal of the pad. Set this bit to 1 to put the pad to sleep. (R/W)
- RTCIO_PAD_PDAC1_SLP_IE** Input enable of the pad in sleep mode. 1: enabled; 0: disabled. (R/W)
- RTCIO_PAD_PDAC1_SLP_OE** Output enable of the pad. 1: enabled ; 0: disabled. (R/W)
- RTCIO_PAD_PDAC1_FUN_IE** Input enable of the pad. 1: enabled it; 0: disabled. (R/W)
- RTCIO_PAD_PDAC1_DAC_XPD_FORCE** Power on DAC1. Usually, we need to tristate PDAC1 if we power on the DAC, i.e. IE=0, OE=0, RDE=0, RUE=0. (R/W)

Register 4.51: RTCIO_PAD_DAC2_REG (0x0088)

RTCIO_PAD_PDAC2_DRV		RTCIO_PAD_PDAC2_HOLD		RTCIO_PAD_PDAC2_RDE		RTCIO_PAD_PDAC2_RUE		RTCIO_PAD_PDAC2_DAC		RTCIO_PAD_PDAC2_XPD_DAC		RTCIO_PAD_PDAC2_MUX_SEL		RTCIO_PAD_PDAC2_FUN_SEL		RTCIO_PAD_PDAC2_SLP_SEL		RTCIO_PAD_PDAC2_SLP_IE		RTCIO_PAD_PDAC2_SLP_OE		RTCIO_PAD_PDAC2_FUN_IE		RTCIO_PAD_PDAC2_DAC_XPD_FORCE		(reserved)				
31	30	29	28	27	26					19	18	17	16	15	14	13	12	11	10	9	8	7	6	5	4	3	2	1	0	
2	0	0	0			0				0	0	0	0	0	0	0	0	0	0	0	0	0	0	0	0	0	0	0	0	0

Reset

RTCIO_PAD_PDAC2_DRV Select the drive strength of the pad. (R/W)

RTCIO_PAD_PDAC2_HOLD Set to 1 to hold the output value on the pad; 0 is for normal operation. (R/W)

RTCIO_PAD_PDAC2_RDE 1: Pull-down on pad enabled; 0: Pull-down disabled. (R/W)

RTCIO_PAD_PDAC2_RUE 1: Pull-up on pad enabled; 0: Pull-up disabled. (R/W)

RTCIO_PAD_PDAC2_DAC PAD DAC2 output value. (R/W)

RTCIO_PAD_PDAC2_XPD_DAC Power on DAC2. PDAC2 needs to be tristated if we power on the DAC, i.e. IE=0, OE=0, RDE=0, RUE=0. (R/W)

RTCIO_PAD_PDAC2_MUX_SEL 0: route pad to the digital IO_MUX; (R/W)
1: route to the RTC block.

RTCIO_PAD_PDAC2_FUN_SEL Select the RTC function for this pad. 0: select Function 0; 1: select Function 1. (R/W)

RTCIO_PAD_PDAC2_SLP_SEL Sleep mode selection signal of the pad. Set this bit to 1 to put the pad to sleep. (R/W)

RTCIO_PAD_PDAC2_SLP_IE Input enable of the pad in sleep mode. 1: enabled; 0: disabled. (R/W)

RTCIO_PAD_PDAC2_SLP_OE Output enable of the pad. 1: enabled; 0: disabled. (R/W)

RTCIO_PAD_PDAC2_FUN_IE Input enable of the pad. 1: enabled; 0: disabled. (R/W)

RTCIO_PAD_PDAC2_DAC_XPD_FORCE Power on DAC2. Usually, we need to tristate PDAC2 if we power on the DAC, i.e. IE=0, OE=0, RDE=0, RUE=0. (R/W)

Register 4.52: RTCIO_XTAL_32K_PAD_REG (0x008C)

31	30	29	28	27	26	25	24	23	22	21	20	19	18	17	16	15	14	13	12	11	10	9	8	7	6	5	4	3	2	1	1
2	0	0	0	0	2	0	0	0	0	0	1	0	0	0	0	0	0	0	0	0	0	0	0	0	0	0	1	0	0	0	0

Reset

RTCIO_XTAL_X32N_DRV Select the drive strength of the pad. (R/W)

RTCIO_XTAL_X32N_HOLD Set to 1 to hold the output value on the pad; 0 is for normal operation. (R/W)

RTCIO_XTAL_X32N_RDE 1: Pull-down on pad enabled; 0: Pull-down disabled. (R/W)

RTCIO_XTAL_X32N_RUE 1: Pull-up on pad enabled; 0: Pull-up disabled. (R/W)

RTCIO_XTAL_X32P_DRV Select the drive strength of the pad. (R/W)

RTCIO_XTAL_X32P_HOLD Set to 1 to hold the output value on the pad, 0 is for normal operation. (R/W)

RTCIO_XTAL_X32P_RDE 1: Pull-down on pad enabled; 0: Pull-down disabled. (R/W)

RTCIO_XTAL_X32P_RUE 1: Pull-up on pad enabled; 0: Pull-up disabled. (R/W)

RTCIO_XTAL_DAC_XTAL_32K 32K XTAL bias current DAC value. (R/W)

RTCIO_XTAL_XPD_XTAL_32K Power up 32 KHz crystal oscillator. (R/W)

RTCIO_XTAL_X32N_MUX_SEL 0: route X32N pad to the digital IO_MUX; 1: route to RTC block. (R/W)

RTCIO_XTAL_X32P_MUX_SEL 0: route X32P pad to the digital IO_MUX; 1: route to RTC block. (R/W)

RTCIO_XTAL_X32N_FUN_SEL Select the RTC function. 0: select function 0; 1: select function 1. (R/W)

RTCIO_XTAL_X32N_SLP_SEL Sleep mode selection. Set this bit to 1 to put the pad to sleep. (R/W)

RTCIO_XTAL_X32N_SLP_IE Input enable of the pad in sleep mode. 1: enabled; 0: disabled. (R/W)

RTCIO_XTAL_X32N_SLP_OE Output enable of the pad. 1: enabled; 0: disabled. (R/W)

RTCIO_XTAL_X32N_FUN_IE Input enable of the pad. 1: enabled; 0: disabled. (R/W)

RTCIO_XTAL_X32P_FUN_SEL Select the RTC function. 0: select function 0; 1: select function 1. (R/W)

RTCIO_XTAL_X32P_SLP_SEL Sleep mode selection. Set this bit to 1 to put the pad to sleep. (R/W)

RTCIO_XTAL_X32P_SLP_IE Input enable of the pad in sleep mode. 1: enabled; 0: disabled. (R/W)

RTCIO_XTAL_X32P_SLP_OE Output enable of the pad in sleep mode. 1: enabled; 0: disabled. (R/W)

RTCIO_XTAL_X32P_FUN_IE Input enable of the pad. 1: enabled; 0: disabled. (R/W)

RTCIO_XTAL_DRES_XTAL_32K 32K XTAL resistor bias control. (R/W)

RTCIO_XTAL_DBIAS_XTAL_32K 32K XTAL self-bias reference control. (R/W)

Register 4.53: RTCIO_TOUCH_CFG_REG (0x0090)

			RTCIO_TOUCH_XPD_BIAS								(reserved)																									
			RTCIO_TOUCH_DREFH																																	
			RTCIO_TOUCH_DREFL																																	
			RTCIO_TOUCH_DRANGE																																	
			RTCIO_TOUCH_DCUR																																	
31	30	29	28	27	26	25	24	23	45													23														
0	1	1	0	0	1	1	0	0	0	0	0	0	0	0	0	0	0	0	0	0	0	0	0	0	0	0	0	0	0	0	0	0	0	0	0	Reset

RTCIO_TOUCH_XPD_BIAS Touch sensor bias power on bit. 1: power on; 0: disabled. (R/W)

RTCIO_TOUCH_DREFH Touch sensor saw wave top voltage. (R/W)

RTCIO_TOUCH_DREFL Touch sensor saw wave bottom voltage. (R/W)

RTCIO_TOUCH_DRANGE Touch sensor saw wave voltage range. (R/W)

RTCIO_TOUCH_DCUR Touch sensor bias current. When BIAS_SLEEP is enabled, this setting is available. (R/W)

Register 4.54: RTCIO_TOUCH_PAD n _REG (n : 0-9) (94+4 \cdot n)

(reserved)						RTCIO_TOUCH_PAD n _DAC														(reserved)																
						RTCIO_TOUCH_PAD n _START																														
						RTCIO_TOUCH_PAD n _TIE_OPT																														
						RTCIO_TOUCH_PAD n _XPD																														
						RTCIO_TOUCH_PAD n _TO_GPIO																														
31						26	25				23	22	21	20	19	37													19							
0	0	0	0	0	0	0	0x4	0	0	0	0	0	0	0	0	0	0	0	0	0	0	0	0	0	0	0	0	0	0	0	0	0	0	0	0	Reset

RTCIO_TOUCH_PAD n _DAC Touch sensor slope control. 3-bit for each touch pad, defaults to 100. (R/W)

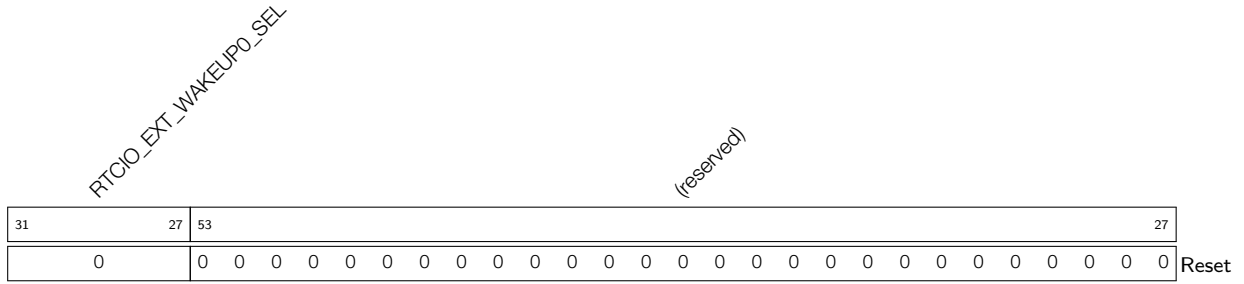
RTCIO_TOUCH_PAD n _START Start touch sensor. (R/W)

RTCIO_TOUCH_PAD n _TIE_OPT Default touch sensor tie option. 0: tie low; 1: tie high. (R/W)

RTCIO_TOUCH_PAD n _XPD Touch sensor power on. (R/W)

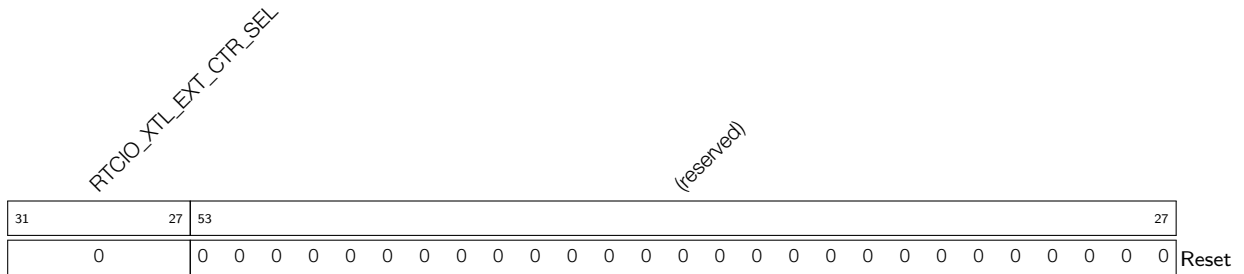
RTCIO_TOUCH_PAD n _TO_GPIO Connect the RTC pad input to digital pad input; 0 is available. (R/W)

Register 4.55: RTCIO_EXT_WAKEUP0_REG (0x00BC)



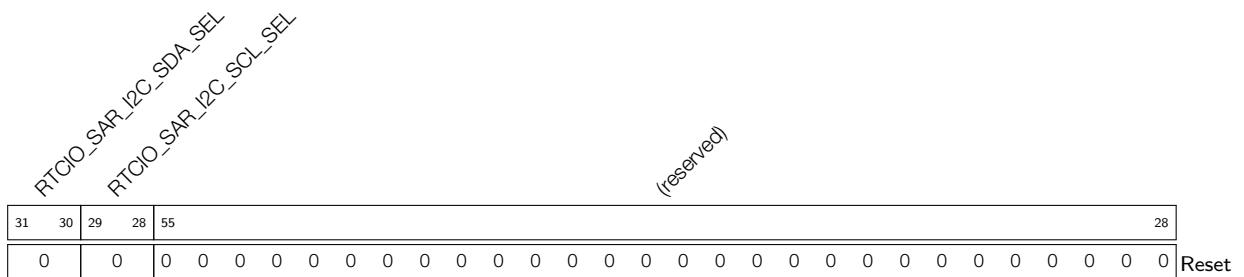
RTCIO_EXT_WAKEUP0_SEL GPIO[0-17] can be used to wake up the chip when the chip is in the sleep mode. This register prompts the pad source to wake up the chip when the latter is in deep/light sleep mode. 0: select GPIO0; 1: select GPIO2, etc. (R/W)

Register 4.56: RTCIO_XTL_EXT_CTR_REG (0x00C0)



RTCIO_XTL_EXT_CTR_SEL Select the external crystal power down enable source to get into sleep mode. 0: select GPIO0; 1: select GPIO2, etc. The input value on this pin XOR RTCIO_RTC_EXT_XTAL_CONF_REG[30] is the crystal power down enable signal. (R/W)

Register 4.57: RTCIO_SAR_I2C_IO_REG (0x00C4)



RTCIO_SAR_I2C_SDA_SEL Selects a different pad as the RTC I2C SDA signal. 0: use pad TOUCH_PAD[1]; 1: use pad TOUCH_PAD[3]. (R/W)

RTCIO_SAR_I2C_SCL_SEL Selects a different pad as the RTC I2C SCL signal. 0: use pad TOUCH_PAD[0]; 1: use pad TOUCH_PAD[2]. (R/W)

5. DPort Register

5.1 Introduction

The ESP32 integrates a large number of peripherals, and enables the control of individual peripherals to achieve optimal characteristics in performance-vs-power-consumption scenarios. The DPort registers control clock management (clock gating), power management, and the configuration of peripherals and core-system modules. The system arranges each module with configuration registers contained in the DPort Register.

5.2 Features

DPort registers correspond to different peripheral blocks and core modules:

- System and memory
- Reset and clock
- Interrupt matrix
- DMA
- PID/MPU/MMU
- APP_CPU
- Peripheral clock gating and reset

5.3 Functional Description

5.3.1 System and Memory Register

The following registers are used for system and memory configuration, such as cache configuration and memory remapping. For a detailed description of these registers, please refer to Chapter [System and Memory](#).

- DPORT_PRO_BOOT_REMAP_CTRL_REG
- DPORT_APP_BOOT_REMAP_CTRL_REG
- DPORT_CACHE_MUX_MODE_REG

5.3.2 Reset and Clock Registers

The following register is used for Reset and Clock. For a detailed description of the register, please refer to [Reset and Clock](#).

- DPORT_CPU_PER_CONF_REG

5.3.3 Interrupt Matrix Register

The following registers are used for configuring and mapping interrupts through the interrupt matrix. For a detailed description of the registers, please refer to [Interrupt Matrix](#).

- DPORT_CPU_INTR_FROM_CPU_0_REG
- DPORT_CPU_INTR_FROM_CPU_1_REG
- DPORT_CPU_INTR_FROM_CPU_2_REG
- DPORT_CPU_INTR_FROM_CPU_3_REG
- DPORT_PRO_INTR_STATUS_0_REG
- DPORT_PRO_INTR_STATUS_1_REG
- DPORT_PRO_INTR_STATUS_2_REG
- DPORT_APP_INTR_STATUS_0_REG
- DPORT_APP_INTR_STATUS_1_REG
- DPORT_APP_INTR_STATUS_2_REG
- DPORT_PRO_MAC_INTR_MAP_REG
- DPORT_PRO_MAC_NMI_MAP_REG
- DPORT_PRO_BB_INT_MAP_REG
- DPORT_PRO_BT_MAC_INT_MAP_REG
- DPORT_PRO_BT_BB_INT_MAP_REG
- DPORT_PRO_BT_BB_NMI_MAP_REG
- DPORT_PRO_RWBT_IRQ_MAP_REG
- DPORT_PRO_RWBLE_IRQ_MAP_REG
- DPORT_PRO_RWBT_NMI_MAP_REG
- DPORT_PRO_RWBLE_NMI_MAP_REG
- DPORT_PRO_SLC0_INTR_MAP_REG
- DPORT_PRO_SLC1_INTR_MAP_REG
- DPORT_PRO_UHCI0_INTR_MAP_REG
- DPORT_PRO_UHCI1_INTR_MAP_REG
- DPORT_PRO_TG_T0_LEVEL_INT_MAP_REG
- DPORT_PRO_TG_T1_LEVEL_INT_MAP_REG
- DPORT_PRO_TG_WDT_LEVEL_INT_MAP_REG
- DPORT_PRO_TG_LACT_LEVEL_INT_MAP_REG
- DPORT_PRO_TG1_T0_LEVEL_INT_MAP_REG
- DPORT_PRO_TG1_T1_LEVEL_INT_MAP_REG
- DPORT_PRO_TG1_WDT_LEVEL_INT_MAP_REG

- DPORT_PRO_TG1_LACT_LEVEL_INT_MAP_REG
- DPORT_PRO_GPIO_INTERRUPT_MAP_REG
- DPORT_PRO_GPIO_INTERRUPT_NMI_MAP_REG
- DPORT_PRO_CPU_INTR_FROM_CPU_0_MAP_REG
- DPORT_PRO_CPU_INTR_FROM_CPU_1_MAP_REG
- DPORT_PRO_CPU_INTR_FROM_CPU_2_MAP_REG
- DPORT_PRO_CPU_INTR_FROM_CPU_3_MAP_REG
- DPORT_PRO_SPI_INTR_0_MAP_REG
- DPORT_PRO_SPI_INTR_1_MAP_REG
- DPORT_PRO_SPI_INTR_2_MAP_REG
- DPORT_PRO_SPI_INTR_3_MAP_REG
- DPORT_PRO_I2S0_INT_MAP_REG
- DPORT_PRO_I2S1_INT_MAP_REG
- DPORT_PRO_UART_INTR_MAP_REG
- DPORT_PRO_UART1_INTR_MAP_REG
- DPORT_PRO_UART2_INTR_MAP_REG
- DPORT_PRO_SDIO_HOST_INTERRUPT_MAP_REG
- DPORT_PRO_EMAC_INT_MAP_REG
- DPORT_PRO_PWM0_INTR_MAP_REG
- DPORT_PRO_PWM1_INTR_MAP_REG
- DPORT_PRO_PWM2_INTR_MAP_REG
- DPORT_PRO_PWM3_INTR_MAP_REG
- DPORT_PRO_LEDC_INT_MAP_REG
- DPORT_PRO_EFUSE_INT_MAP_REG
- DPORT_PRO_CAN_INT_MAP_REG
- DPORT_PRO_RTC_CORE_INTR_MAP_REG
- DPORT_PRO_RMT_INTR_MAP_REG
- DPORT_PRO_PCNT_INTR_MAP_REG
- DPORT_PRO_I2C_EXT0_INTR_MAP_REG
- DPORT_PRO_I2C_EXT1_INTR_MAP_REG
- DPORT_PRO_RSA_INTR_MAP_REG
- DPORT_PRO_SPI1_DMA_INT_MAP_REG
- DPORT_PRO_SPI2_DMA_INT_MAP_REG
- DPORT_PRO_SPI3_DMA_INT_MAP_REG

- DPORT_PRO_WDG_INT_MAP_REG
- DPORT_PRO_TIMER_INT1_MAP_REG
- DPORT_PRO_TIMER_INT2_MAP_REG
- DPORT_PRO_TG_T0_EDGE_INT_MAP_REG
- DPORT_PRO_TG_T1_EDGE_INT_MAP_REG
- DPORT_PRO_TG_WDT_EDGE_INT_MAP_REG
- DPORT_PRO_TG_LACT_EDGE_INT_MAP_REG
- DPORT_PRO_TG1_T0_EDGE_INT_MAP_REG
- DPORT_PRO_TG1_T1_EDGE_INT_MAP_REG
- DPORT_PRO_TG1_WDT_EDGE_INT_MAP_REG
- DPORT_PRO_TG1_LACT_EDGE_INT_MAP_REG
- DPORT_PRO_MMU_IA_INT_MAP_REG
- DPORT_PRO_MPU_IA_INT_MAP_REG
- DPORT_PRO_CACHE_IA_INT_MAP_REG
- DPORT_APP_MAC_INTR_MAP_REG
- DPORT_APP_MAC_NMI_MAP_REG
- DPORT_APP_BB_INT_MAP_REG
- DPORT_APP_BT_MAC_INT_MAP_REG
- DPORT_APP_BT_BB_INT_MAP_REG
- DPORT_APP_BT_BB_NMI_MAP_REG
- DPORT_APP_RWBT_IRQ_MAP_REG
- DPORT_APP_RWBLE_IRQ_MAP_REG
- DPORT_APP_RWBT_NMI_MAP_REG
- DPORT_APP_RWBLE_NMI_MAP_REG
- DPORT_APP_SLC0_INTR_MAP_REG
- DPORT_APP_SLC1_INTR_MAP_REG
- DPORT_APP_UHCI0_INTR_MAP_REG
- DPORT_APP_UHCI1_INTR_MAP_REG
- DPORT_APP_TG_T0_LEVEL_INT_MAP_REG
- DPORT_APP_TG_T1_LEVEL_INT_MAP_REG
- DPORT_APP_TG_WDT_LEVEL_INT_MAP_REG
- DPORT_APP_TG_LACT_LEVEL_INT_MAP_REG
- DPORT_APP_TG1_T0_LEVEL_INT_MAP_REG
- DPORT_APP_TG1_T1_LEVEL_INT_MAP_REG

- DPORT_APP_TG1_WDT_LEVEL_INT_MAP_REG
- DPORT_APP_TG1_LACT_LEVEL_INT_MAP_REG
- DPORT_APP_GPIO_INTERRUPT_MAP_REG
- DPORT_APP_GPIO_INTERRUPT_NMI_MAP_REG
- DPORT_APP_CPU_INTR_FROM_CPU_0_MAP_REG
- DPORT_APP_CPU_INTR_FROM_CPU_1_MAP_REG
- DPORT_APP_CPU_INTR_FROM_CPU_2_MAP_REG
- DPORT_APP_CPU_INTR_FROM_CPU_3_MAP_REG
- DPORT_APP_SPI_INTR_0_MAP_REG
- DPORT_APP_SPI_INTR_1_MAP_REG
- DPORT_APP_SPI_INTR_2_MAP_REG
- DPORT_APP_SPI_INTR_3_MAP_REG
- DPORT_APP_I2S0_INT_MAP_REG
- DPORT_APP_I2S1_INT_MAP_REG
- DPORT_APP_UART_INTR_MAP_REG
- DPORT_APP_UART1_INTR_MAP_REG
- DPORT_APP_UART2_INTR_MAP_REG
- DPORT_APP_SDIO_HOST_INTERRUPT_MAP_REG
- DPORT_APP_EMAC_INT_MAP_REG
- DPORT_APP_PWM0_INTR_MAP_REG
- DPORT_APP_PWM1_INTR_MAP_REG
- DPORT_APP_PWM2_INTR_MAP_REG
- DPORT_APP_PWM3_INTR_MAP_REG
- DPORT_APP_LEDC_INT_MAP_REG
- DPORT_APP_EFUSE_INT_MAP_REG
- DPORT_APP_CAN_INT_MAP_REG
- DPORT_APP_RTC_CORE_INTR_MAP_REG
- DPORT_APP_RMT_INTR_MAP_REG
- DPORT_APP_PCNT_INTR_MAP_REG
- DPORT_APP_I2C_EXT0_INTR_MAP_REG
- DPORT_APP_I2C_EXT1_INTR_MAP_REG
- DPORT_APP_RSA_INTR_MAP_REG
- DPORT_APP_SPI1_DMA_INT_MAP_REG
- DPORT_APP_SPI2_DMA_INT_MAP_REG

- DPORT_APP_SPI3_DMA_INT_MAP_REG
- DPORT_APP_WDG_INT_MAP_REG
- DPORT_APP_TIMER_INT1_MAP_REG
- DPORT_APP_TIMER_INT2_MAP_REG
- DPORT_APP_TG_T0_EDGE_INT_MAP_REG
- DPORT_APP_TG_T1_EDGE_INT_MAP_REG
- DPORT_APP_TG_WDT_EDGE_INT_MAP_REG
- DPORT_APP_TG_LACT_EDGE_INT_MAP_REG
- DPORT_APP_TG1_T0_EDGE_INT_MAP_REG
- DPORT_APP_TG1_T1_EDGE_INT_MAP_REG
- DPORT_APP_TG1_WDT_EDGE_INT_MAP_REG
- DPORT_APP_TG1_LACT_EDGE_INT_MAP_REG
- DPORT_APP_MMU_IA_INT_MAP_REG
- DPORT_APP_MPU_IA_INT_MAP_REG
- DPORT_APP_CACHE_IA_INT_MAP_REG

5.3.4 DMA Registers

The following register is used for the SPI DMA configuration. For a detailed description of the register, please refer to [DMA](#).

- DPORT_SPI_DMA_CHAN_SEL_REG

5.3.5 PID/MPU/MMU Registers

The following registers are used for PID/MPU/MMU configuration and operation control. For a detailed description of the registers, please refer to [PID/MPU/MMU](#).

- DPORT_PRO_CACHE_CTRL_REG
- DPORT_APP_CACHE_CTRL_REG
- DPORT_IMMU_PAGE_MODE_REG
- DPORT_DMMU_PAGE_MODE_REG
- DPORT_AHB_MPU_TABLE_0_REG
- DPORT_AHB_MPU_TABLE_1_REG
- DPORT_AHBLITE_MPU_TABLE_UART_REG
- DPORT_AHBLITE_MPU_TABLE_SPI1_REG
- DPORT_AHBLITE_MPU_TABLE_SPI0_REG
- DPORT_AHBLITE_MPU_TABLE_GPIO_REG
- DPORT_AHBLITE_MPU_TABLE_FE2_REG

- DPORT_AHBLITE_MPU_TABLE_FE_REG
- DPORT_AHBLITE_MPU_TABLE_TIMER_REG
- DPORT_AHBLITE_MPU_TABLE_RTC_REG
- DPORT_AHBLITE_MPU_TABLE_IO_MUX_REG
- DPORT_AHBLITE_MPU_TABLE_WDG_REG
- DPORT_AHBLITE_MPU_TABLE_HINF_REG
- DPORT_AHBLITE_MPU_TABLE_UHCI1_REG
- DPORT_AHBLITE_MPU_TABLE_I2S0_REG
- DPORT_AHBLITE_MPU_TABLE_UART1_REG
- DPORT_AHBLITE_MPU_TABLE_I2C_EXT0_REG
- DPORT_AHBLITE_MPU_TABLE_UHCI0_REG
- DPORT_AHBLITE_MPU_TABLE_SLCHOST_REG
- DPORT_AHBLITE_MPU_TABLE_RMT_REG
- DPORT_AHBLITE_MPU_TABLE_PCNT_REG
- DPORT_AHBLITE_MPU_TABLE_SLC_REG
- DPORT_AHBLITE_MPU_TABLE_LEDC_REG
- DPORT_AHBLITE_MPU_TABLE_EFUSE_REG
- DPORT_AHBLITE_MPU_TABLE_SPI_ENCRYPT_REG
- DPORT_AHBLITE_MPU_TABLE_PWM0_REG
- DPORT_AHBLITE_MPU_TABLE_TIMERGROUP_REG
- DPORT_AHBLITE_MPU_TABLE_TIMERGROUP1_REG
- DPORT_AHBLITE_MPU_TABLE_SPI2_REG
- DPORT_AHBLITE_MPU_TABLE_SPI3_REG
- DPORT_AHBLITE_MPU_TABLE_APB_CTRL_REG
- DPORT_AHBLITE_MPU_TABLE_I2C_EXT1_REG
- DPORT_AHBLITE_MPU_TABLE_SDIO_HOST_REG
- DPORT_AHBLITE_MPU_TABLE_EMAC_REG
- DPORT_AHBLITE_MPU_TABLE_PWM1_REG
- DPORT_AHBLITE_MPU_TABLE_I2S1_REG
- DPORT_AHBLITE_MPU_TABLE_UART2_REG
- DPORT_AHBLITE_MPU_TABLE_PWM2_REG
- DPORT_AHBLITE_MPU_TABLE_PWM3_REG
- DPORT_AHBLITE_MPU_TABLE_PWR_REG
- DPORT_IMMU_TABLE0_REG

- DPORT_IMMU_TABLE1_REG
- DPORT_IMMU_TABLE2_REG
- DPORT_IMMU_TABLE3_REG
- DPORT_IMMU_TABLE4_REG
- DPORT_IMMU_TABLE5_REG
- DPORT_IMMU_TABLE6_REG
- DPORT_IMMU_TABLE7_REG
- DPORT_IMMU_TABLE8_REG
- DPORT_IMMU_TABLE9_REG
- DPORT_IMMU_TABLE10_REG
- DPORT_IMMU_TABLE11_REG
- DPORT_IMMU_TABLE12_REG
- DPORT_IMMU_TABLE13_REG
- DPORT_IMMU_TABLE14_REG
- DPORT_IMMU_TABLE15_REG
- DPORT_DMMU_TABLE0_REG
- DPORT_DMMU_TABLE1_REG
- DPORT_DMMU_TABLE2_REG
- DPORT_DMMU_TABLE3_REG
- DPORT_DMMU_TABLE4_REG
- DPORT_DMMU_TABLE5_REG
- DPORT_DMMU_TABLE6_REG
- DPORT_DMMU_TABLE7_REG
- DPORT_DMMU_TABLE8_REG
- DPORT_DMMU_TABLE9_REG
- DPORT_DMMU_TABLE10_REG
- DPORT_DMMU_TABLE11_REG
- DPORT_DMMU_TABLE12_REG
- DPORT_DMMU_TABLE13_REG
- DPORT_DMMU_TABLE14_REG
- DPORT_DMMU_TABLE15_REG

5.3.6 APP_CPU Controller Registers

DPort registers are used for some basic configuration of the APP_CPU, such as performing a stalling execution, and for configuring the ROM boot jump address.

- APP_CPU is reset when DPORT_APPCPU_RESETTING=1. It is released when DPORT_APPCPU_RESETTING=0.
- When DPORT_APPCPU_CLKGATE_EN=0, the APP_CPU clock can be disabled to reduce power consumption.
- When DPORT_APPCPU_RUNSTALL=1, the APP_CPU can be put into a stalled state.
- When APP_CPU is booted up with a ROM code, it will jump to the address stored in the DPORT_APPCPU_BOOT_ADDR register.

5.3.7 Peripheral Clock Gating and Reset

Reset and clock gating registers covered in this section are active-high registers. Note that the reset bits are not self-cleared by hardware. When a clock-gating register bit is set to 1, the corresponding clock is enabled. Setting the register bit to 0 disables the clock. Setting a reset register bit to 1 puts the peripheral in a reset state, while setting the register bit to 0 disables the reset state, thus enabling normal operation.

- DPORT_PERI_CLK_EN_REG: enables the hardware accelerator clock.
 - BIT4, Digital Signature
 - BIT3, Secure boot
 - BIT2, RSA Accelerator
 - BIT1, SHA Accelerator
 - BIT0, AES Accelerator
- DPORT_PERI_RST_EN_REG: resets the accelerator.
 - BIT4, Digital Signature
AES Accelerator and RSA Accelerator will also be reset.
 - BIT3, Secure boot
AES Accelerator and SHA Accelerator will also be reset.
 - BIT2, RSA Accelerator
 - BIT1, SHA Accelerator
 - BIT0, AES Accelerator
- DPORT_PERIP_CLK_EN_REG=1: enables the peripheral clock.
 - BIT26, PWM3
 - BIT25, PWM2
 - BIT24, UART MEM
All UART-shared memory. As long as a UART is working, the UART memory clock cannot be in the gating state.
 - BIT23, UART2

- BIT22, SPI_DMA
 - BIT21, I2S1
 - BIT20, PWM1
 - BIT19, CAN
 - BIT18, I2C1
 - BIT17, PWM0
 - BIT16, SPI3
 - BIT15, Timer Group1
 - BIT14, eFuse
 - BIT13, Timer Group0
 - BIT12, UHCI1
 - BIT11, LED_PWM
 - BIT10, PULSE_CNT
 - BIT9, Remote Controller
 - BIT8, UHCIO
 - BIT7, I2C0
 - BIT6, SPI2
 - BIT5, UART1
 - BIT4, I2S0
 - BIT3, WDG
 - BIT2, UART
 - BIT1, SPI
 - BIT0, Timers
- DPORT_PERIP_RST_EN_REG: resets peripherals
 - BIT26, PWM3
 - BIT25, PWM2
 - BIT24, UART MEM
 - BIT23, UART2
 - BIT22, SPI_DMA
 - BIT21, I2S1
 - BIT20, PWM1
 - BIT19, CAN
 - BIT18, I2C1
 - BIT17, PWM0

- BIT16, SPI3
 - BIT15, Timer Group1
 - BIT14, eFuse
 - BIT13, Timer Group0
 - BIT12, UHCI1
 - BIT11, LED_PWM
 - BIT10, PULSE_CNT
 - BIT9, Remote Controller
 - BIT8, UHCI0
 - BIT7, I2C0
 - BIT6, SPI2
 - BIT5, UART1
 - BIT4, I2S0
 - BIT3, WDG
 - BIT2, UART
 - BIT1, SPI
 - BIT0, Timers
- DPORT_WIFI_CLK_EN_REG: used for Wi-Fi and BT clock gating.
 - DPORT_WIFI_RST_EN_REG: used for Wi-Fi and BT reset.

5.4 Register Summary

Name	Description	Address	Access
PRO_BOOT_REMAP_CTRL_REG	remap mode for PRO_CPU	0x3FF00000	R/W
APP_BOOT_REMAP_CTRL_REG	remap mode for APP_CPU	0x3FF00004	R/W
PERI_CLK_EN_REG	clock gate for peripherals	0x3FF0001C	R/W
PERI_RST_EN_REG	reset for peripherals	0x3FF00020	R/W
APPCPU_CTRL_REG_A_REG	reset for APP_CPU	0x3FF0002C	R/W
APPCPU_CTRL_REG_B_REG	clock gate for APP_CPU	0x3FF00030	R/W
APPCPU_CTRL_REG_C_REG	stall for APP_CPU	0x3FF00034	R/W
APPCPU_CTRL_REG_D_REG	boot address for APP_CPU	0x3FF00038	R/W
PRO_CACHE_CTRL_REG	determines the virtual address mode of the external SRAM	0x3FF00040	R/W
APP_CACHE_CTRL_REG	determines the virtual address mode of the external SRAM	0x3FF00058	R/W
CACHE_MUX_MODE_REG	the mode of the two caches sharing the memory	0x3FF0007C	R/W
IMMU_PAGE_MODE_REG	page size in the MMU for the internal SRAM 0	0x3FF00080	R/W
DMMU_PAGE_MODE_REG	page size in the MMU for the internal SRAM 2	0x3FF00084	R/W
SRAM_PD_CTRL_REG_0_REG	powers down internal SRAM_REG	0x3FF00098	R/W
SRAM_PD_CTRL_REG_1_REG	powers down internal SRAM_REG	0x3FF0009C	R/W
AHB_MPU_TABLE_0_REG	MPU for configuring DMA	0x3FF000B4	R/W
AHB_MPU_TABLE_1_REG	MPU for configuring DMA	0x3FF000B8	R/W
PERIP_CLK_EN_REG	clock gate for peripherals	0x3FF000C0	R/W
PERIP_RST_EN_REG	reset for peripherals	0x3FF000C4	R/W
SLAVE_SPI_CONFIG_REG	enables decryption in external flash	0x3FF000C8	R/W
WIFI_CLK_EN_REG	clock gate for Wi-Fi	0x3FF000CC	R/W
WIFI_RST_EN_REG	reset for Wi-Fi	0x3FF000D0	R/W
CPU_INTR_FROM_CPU_0_REG	interrupt 0 in both CPUs	0x3FF000DC	R/W
CPU_INTR_FROM_CPU_1_REG	interrupt 1 in both CPUs	0x3FF000E0	R/W
CPU_INTR_FROM_CPU_2_REG	interrupt 2 in both CPUs	0x3FF000E4	R/W
CPU_INTR_FROM_CPU_3_REG	interrupt 3 in both CPUs	0x3FF000E8	R/W
PRO_INTR_STATUS_REG_0_REG	PRO_CPU interrupt status 0	0x3FF000EC	RO
PRO_INTR_STATUS_REG_1_REG	PRO_CPU interrupt status 1	0x3FF000F0	RO
PRO_INTR_STATUS_REG_2_REG	PRO_CPU interrupt status 2	0x3FF000F4	RO
APP_INTR_STATUS_REG_0_REG	APP_CPU interrupt status 0	0x3FF000F8	RO
APP_INTR_STATUS_REG_1_REG	APP_CPU interrupt status 1	0x3FF000FC	RO
APP_INTR_STATUS_REG_2_REG	APP_CPU interrupt status 2	0x3FF00100	RO
PRO_MAC_INTR_MAP_REG	interrupt map	0x3FF00104	R/W
PRO_MAC_NMI_MAP_REG	interrupt map	0x3FF00108	R/W
PRO_BB_INT_MAP_REG	interrupt map	0x3FF0010C	R/W
PRO_BT_MAC_INT_MAP_REG	interrupt map	0x3FF00110	R/W
PRO_BT_BB_INT_MAP_REG	interrupt map	0x3FF00114	R/W

Name	Description	Address	Access
PRO_BT_BB_NMI_MAP_REG	interrupt map	0x3FF00118	R/W
PRO_RWB_T_IRQ_MAP_REG	interrupt map	0x3FF0011C	R/W
PRO_RWBLE_IRQ_MAP_REG	interrupt map	0x3FF00120	R/W
PRO_RWB_T_NMI_MAP_REG	interrupt map	0x3FF00124	R/W
PRO_RWBLE_NMI_MAP_REG	interrupt map	0x3FF00128	R/W
PRO_SLC0_INTR_MAP_REG	interrupt map	0x3FF0012C	R/W
PRO_SLC1_INTR_MAP_REG	interrupt map	0x3FF00130	R/W
PRO_UHCI0_INTR_MAP_REG	interrupt map	0x3FF00134	R/W
PRO_UHCI1_INTR_MAP_REG	interrupt map	0x3FF00138	R/W
PRO_TG_T0_LEVEL_INT_MAP_REG	interrupt map	0x3FF0013C	R/W
PRO_TG_T1_LEVEL_INT_MAP_REG	interrupt map	0x3FF00140	R/W
PRO_TG_WDT_LEVEL_INT_MAP_REG	interrupt map	0x3FF00144	R/W
PRO_TG_LACT_LEVEL_INT_MAP_REG	interrupt map	0x3FF00148	R/W
PRO_TG1_T0_LEVEL_INT_MAP_REG	interrupt map	0x3FF0014C	R/W
PRO_TG1_T1_LEVEL_INT_MAP_REG	interrupt map	0x3FF00150	R/W
PRO_TG1_WDT_LEVEL_INT_MAP_REG	interrupt map	0x3FF00154	R/W
PRO_TG1_LACT_LEVEL_INT_MAP_REG	interrupt map	0x3FF00158	R/W
PRO_GPIO_INTERRUPT_MAP_REG	interrupt map	0x3FF0015C	R/W
PRO_GPIO_INTERRUPT_NMI_MAP_REG	interrupt map	0x3FF00160	R/W
PRO_CPU_INTR_FROM_CPU_0_MAP_REG	interrupt map	0x3FF00164	R/W
PRO_CPU_INTR_FROM_CPU_1_MAP_REG	interrupt map	0x3FF00168	R/W
PRO_CPU_INTR_FROM_CPU_2_MAP_REG	Interrupt map	0x3FF0016C	R/W
PRO_CPU_INTR_FROM_CPU_3_MAP_REG	interrupt map	0x3FF00170	R/W
PRO_SPI_INTR_0_MAP_REG	interrupt map	0x3FF00174	R/W
PRO_SPI_INTR_1_MAP_REG	interrupt map	0x3FF00178	R/W
PRO_SPI_INTR_2_MAP_REG	interrupt map	0x3FF0017C	R/W
PRO_SPI_INTR_3_MAP_REG	interrupt map	0x3FF00180	R/W
PRO_I2S0_INT_MAP_REG	interrupt map	0x3FF00184	R/W
PRO_I2S1_INT_MAP_REG	interrupt map	0x3FF00188	R/W
PRO_UART_INTR_MAP_REG	interrupt map	0x3FF0018C	R/W
PRO_UART1_INTR_MAP_REG	interrupt map	0x3FF00190	R/W
PRO_UART2_INTR_MAP_REG	interrupt map	0x3FF00194	R/W
PRO_SDIO_HOST_INTERRUPT_MAP_REG	interrupt map	0x3FF00198	R/W
PRO_EMAC_INT_MAP_REG	interrupt map	0x3FF0019C	R/W
PRO_PWM0_INTR_MAP_REG	interrupt map	0x3FF001A0	R/W
PRO_PWM1_INTR_MAP_REG	interrupt map	0x3FF001A4	R/W
PRO_PWM2_INTR_MAP_REG	interrupt map	0x3FF001A8	R/W
PRO_PWM3_INTR_MAP_REG	interrupt map	0x3FF001AC	R/W
PRO_LEDC_INT_MAP_REG	interrupt map	0x3FF001B0	R/W
PRO_EFUSE_INT_MAP_REG	interrupt map	0x3FF001B4	R/W
PRO_CAN_INT_MAP_REG	interrupt map	0x3FF001B8	R/W
PRO_RTC_CORE_INTR_MAP_REG	interrupt map	0x3FF001BC	R/W
PRO_RMT_INTR_MAP_REG	interrupt map	0x3FF001C0	R/W
PRO_PCNT_INTR_MAP_REG	interrupt map	0x3FF001C4	R/W

Name	Description	Address	Access
PRO_I2C_EXT0_INTR_MAP_REG	interrupt map	0x3FF001C8	R/W
PRO_I2C_EXT1_INTR_MAP_REG	interrupt map	0x3FF001CC	R/W
PRO_RSA_INTR_MAP_REG	interrupt map	0x3FF001D0	R/W
PRO_SPI1_DMA_INT_MAP_REG	interrupt map	0x3FF001D4	R/W
PRO_SPI2_DMA_INT_MAP_REG	interrupt map	0x3FF001D8	R/W
PRO_SPI3_DMA_INT_MAP_REG	interrupt map	0x3FF001DC	R/W
PRO_WDG_INT_MAP_REG	interrupt map	0x3FF001E0	R/W
PRO_TIMER_INT1_MAP_REG	interrupt map	0x3FF001E4	R/W
PRO_TIMER_INT2_MAP_REG	interrupt map	0x3FF001E8	R/W
PRO_TG_T0_EDGE_INT_MAP_REG	interrupt map	0x3FF001EC	R/W
PRO_TG_T1_EDGE_INT_MAP_REG	interrupt map	0x3FF001F0	R/W
PRO_TG_WDT_EDGE_INT_MAP_REG	interrupt map	0x3FF001F4	R/W
PRO_TG_LACT_EDGE_INT_MAP_REG	interrupt map	0x3FF001F8	R/W
PRO_TG1_T0_EDGE_INT_MAP_REG	interrupt map	0x3FF001FC	R/W
PRO_TG1_T1_EDGE_INT_MAP_REG	interrupt map	0x3FF00200	R/W
PRO_TG1_WDT_EDGE_INT_MAP_REG	interrupt map	0x3FF00204	R/W
PRO_TG1_LACT_EDGE_INT_MAP_REG	interrupt map	0x3FF00208	R/W
PRO_MMU_IA_INT_MAP_REG	interrupt map	0x3FF0020C	R/W
PRO_MPU_IA_INT_MAP_REG	interrupt map	0x3FF00210	R/W
PRO_CACHE_IA_INT_MAP_REG	interrupt map	0x3FF00214	R/W
APP_MAC_INTR_MAP_REG	interrupt map	0x3FF00218	R/W
APP_MAC_NMI_MAP_REG	interrupt map	0x3FF0021C	R/W
APP_BB_INT_MAP_REG	interrupt map	0x3FF00220	R/W
APP_BT_MAC_INT_MAP_REG	interrupt map	0x3FF00224	R/W
APP_BT_BB_INT_MAP_REG	interrupt map	0x3FF00228	R/W
APP_BT_BB_NMI_MAP_REG	interrupt map	0x3FF0022C	R/W
APP_RWBT_IRQ_MAP_REG	interrupt map	0x3FF00230	R/W
APP_RWBLE_IRQ_MAP_REG	interrupt map	0x3FF00234	R/W
APP_RWBT_NMI_MAP_REG	interrupt map	0x3FF00238	R/W
APP_RWBLE_NMI_MAP_REG	interrupt map	0x3FF0023C	R/W
APP_SLC0_INTR_MAP_REG	interrupt map	0x3FF00240	R/W
APP_SLC1_INTR_MAP_REG	interrupt map	0x3FF00244	R/W
APP_UHCI0_INTR_MAP_REG	interrupt map	0x3FF00248	R/W
APP_UHCI1_INTR_MAP_REG	interrupt map	0x3FF0024C	R/W
APP_TG_T0_LEVEL_INT_MAP_REG	interrupt map	0x3FF00250	R/W
APP_TG_T1_LEVEL_INT_MAP_REG	interrupt map	0x3FF00254	R/W
APP_TG_WDT_LEVEL_INT_MAP_REG	interrupt map	0x3FF00258	R/W
APP_TG_LACT_LEVEL_INT_MAP_REG	interrupt map	0x3FF0025C	R/W
APP_TG1_T0_LEVEL_INT_MAP_REG	interrupt map	0x3FF00260	R/W
APP_TG1_T1_LEVEL_INT_MAP_REG	interrupt map	0x3FF00264	R/W
APP_TG1_WDT_LEVEL_INT_MAP_REG	interrupt map	0x3FF00268	R/W
APP_TG1_LACT_LEVEL_INT_MAP_REG	interrupt map	0x3FF0026C	R/W
APP_GPIO_INTERRUPT_MAP_REG	interrupt map	0x3FF00270	R/W
APP_GPIO_INTERRUPT_NMI_MAP_REG	interrupt map	0x3FF00274	R/W

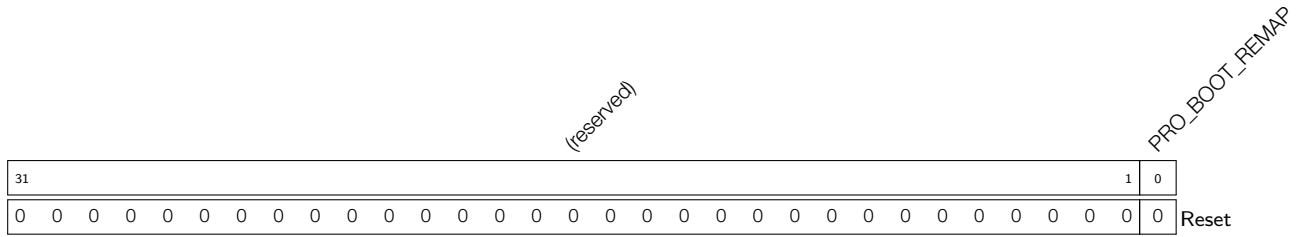
Name	Description	Address	Access
APP_CPU_INTR_FROM_CPU_0_MAP_REG	interrupt map	0x3FF00278	R/W
APP_CPU_INTR_FROM_CPU_1_MAP_REG	interrupt map	0x3FF0027C	R/W
APP_CPU_INTR_FROM_CPU_2_MAP_REG	interrupt map	0x3FF00280	R/W
APP_CPU_INTR_FROM_CPU_3_MAP_REG	interrupt map	0x3FF00284	R/W
APP_SPI_INTR_0_MAP_REG	interrupt map	0x3FF00288	R/W
APP_SPI_INTR_1_MAP_REG	interrupt map	0x3FF0028C	R/W
APP_SPI_INTR_2_MAP_REG	interrupt map	0x3FF00290	R/W
APP_SPI_INTR_3_MAP_REG	interrupt map	0x3FF00294	R/W
APP_I2S0_INT_MAP_REG	interrupt map	0x3FF00298	R/W
APP_I2S1_INT_MAP_REG	interrupt map	0x3FF0029C	R/W
APP_UART_INTR_MAP_REG	interrupt map	0x3FF002A0	R/W
APP_UART1_INTR_MAP_REG	interrupt map	0x3FF002A4	R/W
APP_UART2_INTR_MAP_REG	interrupt map	0x3FF002A8	R/W
APP_SDIO_HOST_INTERRUPT_MAP_REG	interrupt map	0x3FF002AC	R/W
APP_EMAC_INT_MAP_REG	interrupt map	0x3FF002B0	R/W
APP_PWM0_INTR_MAP_REG	interrupt map	0x3FF002B4	R/W
APP_PWM1_INTR_MAP_REG	interrupt map	0x3FF002B8	R/W
APP_PWM2_INTR_MAP_REG	interrupt map	0x3FF002BC	R/W
APP_PWM3_INTR_MAP_REG	interrupt map	0x3FF002C0	R/W
APP_LEDC_INT_MAP_REG	interrupt map	0x3FF002C4	R/W
APP_EFUSE_INT_MAP_REG	interrupt map	0x3FF002C8	R/W
APP_CAN_INT_MAP_REG	interrupt map	0x3FF002CC	R/W
APP_RTC_CORE_INTR_MAP_REG	interrupt map	0x3FF002D0	R/W
APP_RMT_INTR_MAP_REG	interrupt map	0x3FF002D4	R/W
APP_PCNT_INTR_MAP_REG	interrupt map	0x3FF002D8	R/W
APP_I2C_EXT0_INTR_MAP_REG	interrupt map	0x3FF002DC	R/W
APP_I2C_EXT1_INTR_MAP_REG	interrupt map	0x3FF002E0	R/W
APP_RSA_INTR_MAP_REG	interrupt map	0x3FF002E4	R/W
APP_SPI1_DMA_INT_MAP_REG	interrupt map	0x3FF002E8	R/W
APP_SPI2_DMA_INT_MAP_REG	interrupt map	0x3FF002EC	R/W
APP_SPI3_DMA_INT_MAP_REG	interrupt map	0x3FF002F0	R/W
APP_WDG_INT_MAP_REG	interrupt map	0x3FF002F4	R/W
APP_TIMER_INT1_MAP_REG	interrupt map	0x3FF002F8	R/W
APP_TIMER_INT2_MAP_REG	interrupt map	0x3FF002FC	R/W
APP_TG_T0_EDGE_INT_MAP_REG	interrupt map	0x3FF00300	R/W
APP_TG_T1_EDGE_INT_MAP_REG	interrupt map	0x3FF00304	R/W
APP_TG_WDT_EDGE_INT_MAP_REG	interrupt map	0x3FF00308	R/W
APP_TG_LACT_EDGE_INT_MAP_REG	interrupt map	0x3FF0030C	R/W
APP_TG1_T0_EDGE_INT_MAP_REG	interrupt map	0x3FF00310	R/W
APP_TG1_T1_EDGE_INT_MAP_REG	interrupt map	0x3FF00314	R/W
APP_TG1_WDT_EDGE_INT_MAP_REG	interrupt map	0x3FF00318	R/W
APP_TG1_LACT_EDGE_INT_MAP_REG	interrupt map	0x3FF0031C	R/W
APP_MMU_IA_INT_MAP_REG	interrupt map	0x3FF00320	R/W
APP_MPU_IA_INT_MAP_REG	interrupt map	0x3FF00324	R/W

Name	Description	Address	Access
APP_CACHE_IA_INT_MAP_REG	interrupt map	0x3FF00328	R/W
AHBLITE_MPU_TABLE_UART_REG	MPU for peripherals	0x3FF0032C	R/W
AHBLITE_MPU_TABLE_SPI1_REG	MPU for peripherals	0x3FF00330	R/W
AHBLITE_MPU_TABLE_SPI0_REG	MPU for peripherals	0x3FF00334	R/W
AHBLITE_MPU_TABLE_GPIO_REG	MPU for peripherals	0x3FF00338	R/W
AHBLITE_MPU_TABLE_RTC_REG	MPU for peripherals	0x3FF00348	R/W
AHBLITE_MPU_TABLE_IO_MUX_REG	MPU for peripherals	0x3FF0034C	R/W
AHBLITE_MPU_TABLE_HINF_REG	MPU for peripherals	0x3FF00354	R/W
AHBLITE_MPU_TABLE_UHCI1_REG	MPU for peripherals	0x3FF00358	R/W
AHBLITE_MPU_TABLE_I2S0_REG	MPU for peripherals	0x3FF00364	R/W
AHBLITE_MPU_TABLE_UART1_REG	MPU for peripherals	0x3FF00368	R/W
AHBLITE_MPU_TABLE_I2C_EXT0_REG	MPU for peripherals	0x3FF00374	R/W
AHBLITE_MPU_TABLE_UHCI0_REG	MPU for peripherals	0x3FF00378	R/W
AHBLITE_MPU_TABLE_SLCHOST_REG	MPU for peripherals	0x3FF0037C	R/W
AHBLITE_MPU_TABLE_RMT_REG	MPU for peripherals	0x3FF00380	R/W
AHBLITE_MPU_TABLE_PCNT_REG	MPU for peripherals	0x3FF00384	R/W
AHBLITE_MPU_TABLE_SLC_REG	MPU for peripherals	0x3FF00388	R/W
AHBLITE_MPU_TABLE_LEDC_REG	MPU for peripherals	0x3FF0038C	R/W
AHBLITE_MPU_TABLE_EFUSE_REG	MPU for peripherals	0x3FF00390	R/W
AHBLITE_MPU_TABLE_SPI_ENCRYPT_REG	MPU for peripherals	0x3FF00394	R/W
AHBLITE_MPU_TABLE_PWM0_REG	MPU for peripherals	0x3FF0039C	R/W
AHBLITE_MPU_TABLE_TIMERGROUP_REG	MPU for peripherals	0x3FF003A0	R/W
AHBLITE_MPU_TABLE_TIMERGROUP1_REG	MPU for peripherals	0x3FF003A4	R/W
AHBLITE_MPU_TABLE_SPI2_REG	MPU for peripherals	0x3FF003A8	R/W
AHBLITE_MPU_TABLE_SPI3_REG	MPU for peripherals	0x3FF003AC	R/W
AHBLITE_MPU_TABLE_APB_CTRL_REG	MPU for peripherals	0x3FF003B0	R/W
AHBLITE_MPU_TABLE_I2C_EXT1_REG	MPU for peripherals	0x3FF003B4	R/W
AHBLITE_MPU_TABLE_SDIO_HOST_REG	MPU for peripherals	0x3FF003B8	R/W
AHBLITE_MPU_TABLE_EMAC_REG	MPU for peripherals	0x3FF003BC	R/W
AHBLITE_MPU_TABLE_PWM1_REG	MPU for peripherals	0x3FF003C4	R/W
AHBLITE_MPU_TABLE_I2S1_REG	MPU for peripherals	0x3FF003C8	R/W
AHBLITE_MPU_TABLE_UART2_REG	MPU for peripherals	0x3FF003CC	R/W
AHBLITE_MPU_TABLE_PWM2_REG	MPU for peripherals	0x3FF003D0	R/W
AHBLITE_MPU_TABLE_PWM3_REG	MPU for peripherals	0x3FF003D4	R/W
AHBLITE_MPU_TABLE_PWR_REG	MPU for peripherals	0x3FF003E4	R/W
IMMU_TABLE0_REG	MMU register 1 for internal SRAM 0	0x3FF00504	R/W
IMMU_TABLE1_REG	MMU register 1 for internal SRAM 0	0x3FF00508	R/W
IMMU_TABLE2_REG	MMU register 1 for Internal SRAM 0	0x3FF0050C	R/W
IMMU_TABLE3_REG	MMU register 1 for internal SRAM 0	0x3FF00510	R/W
IMMU_TABLE4_REG	MMU register 1 for internal SRAM 0	0x3FF00514	R/W
IMMU_TABLE5_REG	MMU register 1 for internal SRAM 0	0x3FF00518	R/W
IMMU_TABLE6_REG	MMU register 1 for internal SRAM 0	0x3FF0051C	R/W
IMMU_TABLE7_REG	MMU register 1 for internal SRAM 0	0x3FF00520	R/W
IMMU_TABLE8_REG	MMU register 1 for internal SRAM 0	0x3FF00524	R/W

Name	Description	Address	Access
IMMU_TABLE9_REG	MMU register 1 for internal SRAM 0	0x3FF00528	R/W
IMMU_TABLE10_REG	MMU register 1 for internal SRAM 0	0x3FF0052C	R/W
IMMU_TABLE11_REG	MMU register 1 for internal SRAM 0	0x3FF00530	R/W
IMMU_TABLE12_REG	MMU register 1 for Internal SRAM 0	0x3FF00534	R/W
IMMU_TABLE13_REG	MMU register 1 for internal SRAM 0	0x3FF00538	R/W
IMMU_TABLE14_REG	MMU register 1 for internal SRAM 0	0x3FF0053C	R/W
IMMU_TABLE15_REG	MMU register 1 for internal SRAM 0	0x3FF00540	R/W
DMMU_TABLE0_REG	MMU register 1 for Internal SRAM 2	0x3FF00544	R/W
DMMU_TABLE1_REG	MMU register 1 for internal SRAM 2	0x3FF00548	R/W
DMMU_TABLE2_REG	MMU register 1 for internal SRAM 2	0x3FF0054C	R/W
DMMU_TABLE3_REG	MMU register 1 for internal SRAM 2	0x3FF00550	R/W
DMMU_TABLE4_REG	MMU register 1 for internal SRAM 2	0x3FF00554	R/W
DMMU_TABLE5_REG	MMU register 1 for internal SRAM 2	0x3FF00558	R/W
DMMU_TABLE6_REG	MMU register 1 for internal SRAM 2	0x3FF0055C	R/W
DMMU_TABLE7_REG	MMU register 1 for internal SRAM 2	0x3FF00560	R/W
DMMU_TABLE8_REG	MMU register 1 for internal SRAM 2	0x3FF00564	R/W
DMMU_TABLE9_REG	MMU register 1 for internal SRAM 2	0x3FF00568	R/W
DMMU_TABLE10_REG	MMU register 1 for internal SRAM 2	0x3FF0056C	R/W
DMMU_TABLE11_REG	MMU register 1 for internal SRAM 2	0x3FF00570	R/W
DMMU_TABLE12_REG	MMU register 1 for internal SRAM 2	0x3FF00574	R/W
DMMU_TABLE13_REG	MMU register 1 for internal SRAM 2	0x3FF00578	R/W
DMMU_TABLE14_REG	MMU register 1 for internal SRAM 2	0x3FF0057C	R/W
DMMU_TABLE15_REG	MMU register 1 for internal SRAM 2	0x3FF00580	R/W
SECURE_BOOT_CTRL_REG	mode for secure_boot	0x3FF005A4	R/W
SPI_DMA_CHAN_SEL_REG	selects DMA channel for SPI1, SPI2, and SPI3	0x3FF005A8	R/W

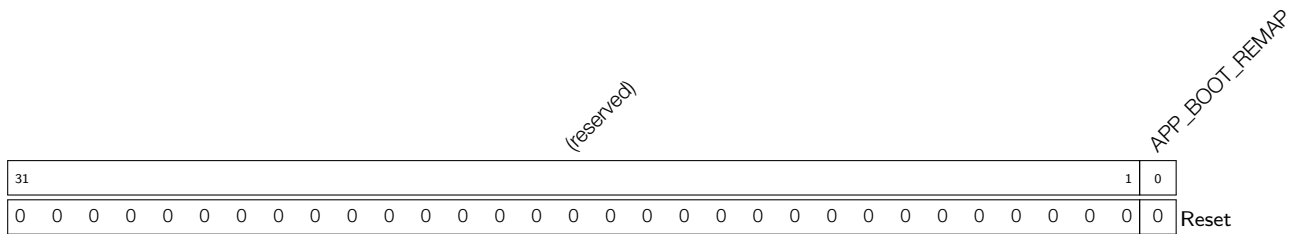
5.5 Registers

Register 5.1: PRO_BOOT_REMAP_CTRL_REG (0x000)



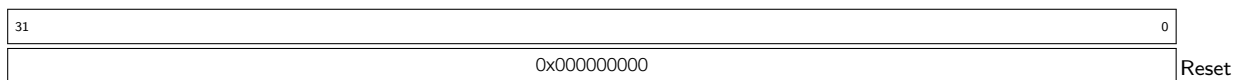
PRO_BOOT_REMAP Remap mode for PRO_CPU. (R/W)

Register 5.2: APP_BOOT_REMAP_CTRL_REG (0x004)



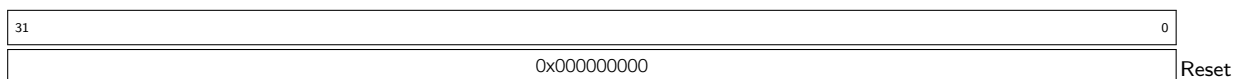
APP_BOOT_REMAP Remap mode for APP_CPU. (R/W)

Register 5.3: PERI_CLK_EN_REG (0x01C)



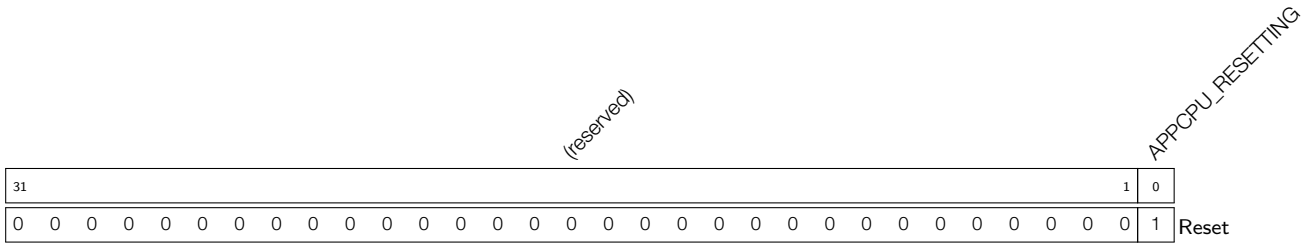
PERI_CLK_EN_REG Clock gate for peripherals. (R/W)

Register 5.4: PERI_RST_EN_REG (0x020)



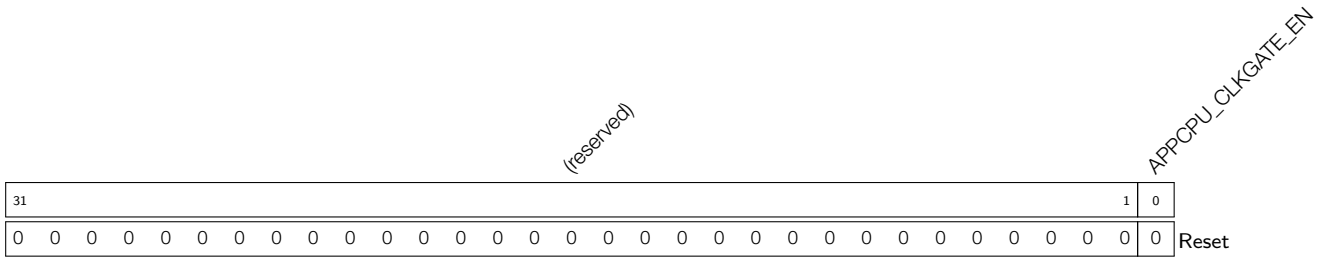
PERI_RST_EN_REG Reset for peripherals. (R/W)

Register 5.5: APPCPU_CTRL_REG_A_REG (0x02C)



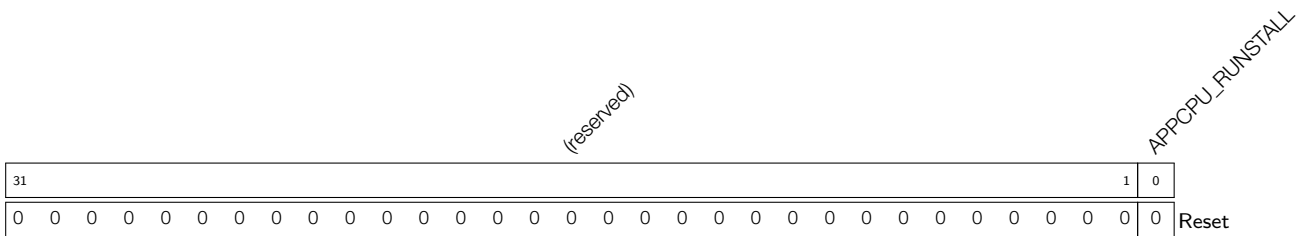
APPCPU_RESETTING Reset for APP_CPU. (R/W)

Register 5.6: APPCPU_CTRL_REG_B_REG (0x030)



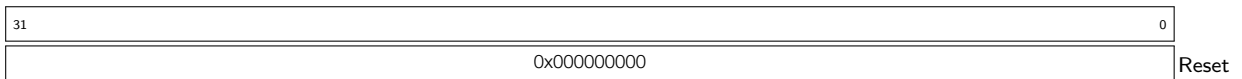
APPCPU_CLKGATE_EN Clock gate for APP_CPU. (R/W)

Register 5.7: APPCPU_CTRL_REG_C_REG (0x034)



APPCPU_RUNSTALL Stall for APP_CPU. (R/W)

Register 5.8: APPCPU_CTRL_REG_D_REG (0x038)



APPCPU_CTRL_REG_D_REG Boot address for APP_CPU. (R/W)

Register 5.9: CPU_PER_CONF_REG (0x03C)

(reserved)														CPU_CPUPERIOD_SEL										
31																				2	1	0		
0 0 0 0 0 0 0 0 0 0 0 0 0 0 0 0 0 0 0 0																			0	0	0	Reset		

CPU_CPUPERIOD_SEL Select CPU clock. (R/W)

Register 5.10: PRO_CACHE_CTRL_REG (0x040)

(reserved)														PRO_DRAM_HL			(reserved)		PRO_DRAM_SPLIT				PRO_SINGLE_IRAM_ENA			(reserved)		PRO_CACHE_FLUSH_DONE			PRO_CACHE_FLUSH_ENA		PRO_CACHE_ENABLE		(reserved)			
31													17	16	15					12	11	10	9				6	5	4	3	5			3				
0 0 0 0 0 0 0 0 0 0 0 0												0	0	0	0	0	0	0	0	0	0	0	0	0	0	0	0	0	0	0	1	0	0	0	0	Reset		

PRO_DRAM_HL Determines the virtual address mode of the external SRAM. (R/W)

PRO_DRAM_SPLIT Determines the virtual address mode of the external SRAM. (R/W)

PRO_SINGLE_IRAM_ENA Determines a special mode for PRO_CPU access to the external flash.
(R/W)

PRO_CACHE_FLUSH_DONE PRO_CPU cache-flush done. (RO)

PRO_CACHE_FLUSH_ENA Flushes the PRO_CPU cache. (R/W)

PRO_CACHE_ENABLE Enables the PRO_CPU cache. (R/W)

Register 5.11: APP_CACHE_CTRL_REG (0x058)

31	(reserved)										15	14	13	12	11	10	9	(reserved)			6	5	4	3	5	3	Reset
0	0	0	0	0	0	0	0	0	0	0	0	0	0	0	0	0	0	0	0	0	0	1	0	0	0	0	

APP_DRAM_HL Determines the virtual address mode of the External SRAM. (R/W)

APP_DRAM_SPLIT Determines the virtual address mode of the External SRAM. (R/W)

APP_SINGLE_IRAM_ENA Determines a special mode for APP_CPU access to the external flash. (R/W)

APP_CACHE_FLUSH_DONE APP_CPU cache-flush done. (RO)

APP_CACHE_FLUSH_ENA Flushes the APP_CPU cache. (R/W)

APP_CACHE_ENABLE Enables the APP_CPU cache. (R/W)

Register 5.12: CACHE_MUX_MODE_REG (0x07C)

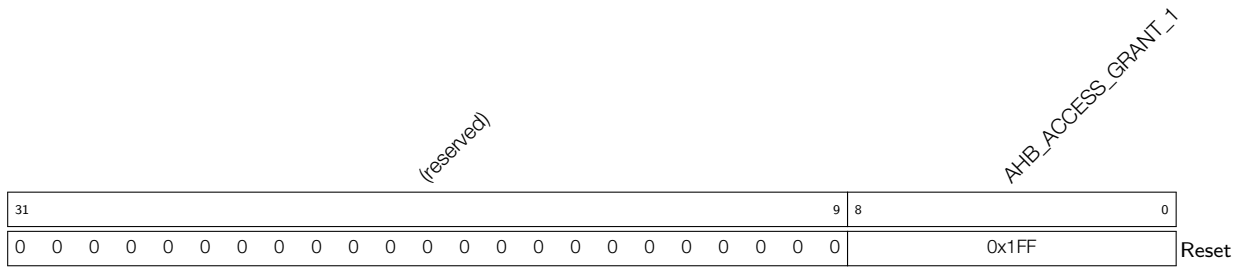
31	(reserved)																							2	1	0	Reset
0	0	0	0	0	0	0	0	0	0	0	0	0	0	0	0	0	0	0	0	0	0	0	0	0	0	0	

CACHE_MUX_MODE The mode of the two caches sharing the memory. (R/W)

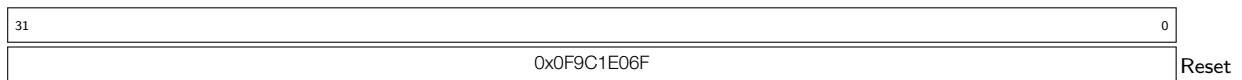
Register 5.13: IMMU_PAGE_MODE_REG (0x080)

31	(reserved)																							3	2	1	1	Reset
0	0	0	0	0	0	0	0	0	0	0	0	0	0	0	0	0	0	0	0	0	0	0	0	0	0	0	0	

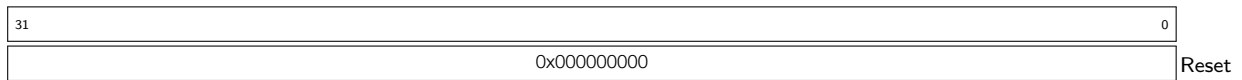
IMMU_PAGE_MODE Page size in the MMU for the internal SRAM 0. (R/W)

Register 5.18: AHB_MPU_TABLE_1_REG (0x0B8)

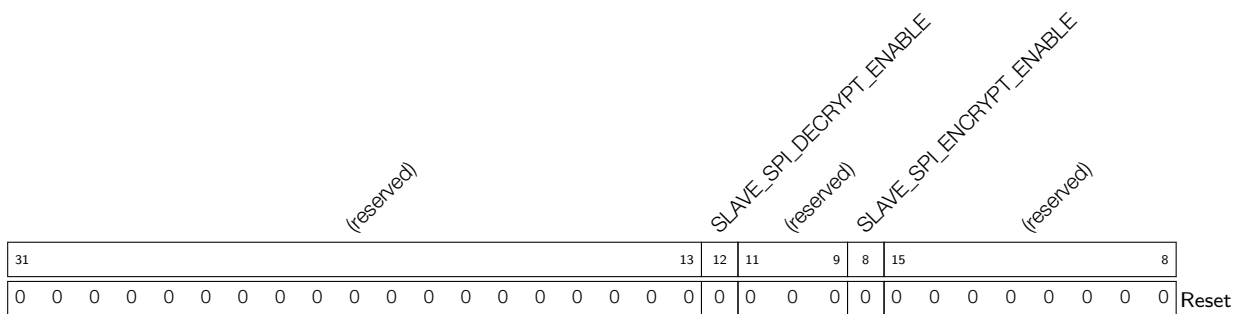
AHB_ACCESS_GRANT_1 MPU for DMA. (R/W)

Register 5.19: PERIP_CLK_EN_REG (0x0C0)

PERIP_CLK_EN_REG Clock gate for peripherals. (R/W)

Register 5.20: PERIP_RST_EN_REG (0x0C4)

PERIP_RST_EN_REG Reset for peripherals. (R/W)

Register 5.21: SLAVE_SPI_CONFIG_REG (0x0C8)

SLAVE_SPI_DECRYPT_ENABLE Enables decryption in the external flash. (R/W)

SLAVE_SPI_ENCRYPT_ENABLE Enables encryption in the external flash. (R/W)

Register 5.22: WIFI_CLK_EN_REG (0x0CC)

31	0
0x0FFFCE030	
Reset	

WIFI_CLK_EN_REG Clock gate for Wi-Fi. (R/W)

Register 5.23: WIFI_RST_EN_REG (0x0D0)

31	0
0x00000000	
Reset	

WIFI_RST_EN_REG Reset for Wi-Fi. (R/W)

Register 5.24: CPU_INTR_FROM_CPU_n_REG (n: 0-3) (0xDC+4*n)

31	1	0
(reserved)		
CPU_INTR_FROM_CPU_n		
0 0		0
Reset		

CPU_INTR_FROM_CPU_n Interrupt in both CPUs. (R/W)

Register 5.25: PRO_INTR_STATUS_REG_n_REG (n: 0-2) (0xEC+4*n)

31	0
0x00000000	
Reset	

PRO_INTR_STATUS_REG_n_REG PRO_CPU interrupt status. (RO)

Register 5.26: APP_INTR_STATUS_REG_n_REG (n: 0-2) (0xF8+4*n)

31	0
0x00000000	
Reset	

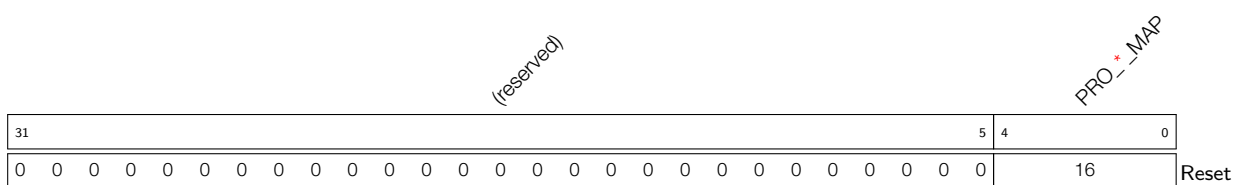
APP_INTR_STATUS_REG_n_REG APP_CPU interrupt status. (RO)

Register 5.27: PRO_MAC_INTR_MAP_REG (0x104)

Register 5.28: PRO_MAC_NMI_MAP_REG (0x108)

- Register 5.29: PRO_BB_INT_MAP_REG (0x10C)
- Register 5.30: PRO_BT_MAC_INT_MAP_REG (0x110)
- Register 5.31: PRO_BT_BB_INT_MAP_REG (0x114)
- Register 5.32: PRO_BT_BB_NMI_MAP_REG (0x118)
- Register 5.33: PRO_RWBT_IRQ_MAP_REG (0x11C)
- Register 5.34: PRO_RWBLE_IRQ_MAP_REG (0x120)
- Register 5.35: PRO_RWBT_NMI_MAP_REG (0x124)
- Register 5.36: PRO_RWBLE_NMI_MAP_REG (0x128)
- Register 5.37: PRO_SLC0_INTR_MAP_REG (0x12C)
- Register 5.38: PRO_SLC1_INTR_MAP_REG (0x130)
- Register 5.39: PRO_UHCI0_INTR_MAP_REG (0x134)
- Register 5.40: PRO_UHCI1_INTR_MAP_REG (0x138)
- Register 5.41: PRO_TG_T0_LEVEL_INT_MAP_REG (0x13C)
- Register 5.42: PRO_TG_T1_LEVEL_INT_MAP_REG (0x140)
- Register 5.43: PRO_TG_WDT_LEVEL_INT_MAP_REG (0x144)
- Register 5.44: PRO_TG_LACT_LEVEL_INT_MAP_REG (0x148)
- Register 5.45: PRO_TG1_T0_LEVEL_INT_MAP_REG (0x14C)
- Register 5.46: PRO_TG1_T1_LEVEL_INT_MAP_REG (0x150)
- Register 5.47: PRO_TG1_WDT_LEVEL_INT_MAP_REG (0x154)
- Register 5.48: PRO_TG1_LACT_LEVEL_INT_MAP_REG (0x158)
- Register 5.49: PRO_GPIO_INTERRUPT_MAP_REG (0x15C)
- Register 5.50: PRO_GPIO_INTERRUPT_NMI_MAP_REG (0x160)
- Register 5.51: PRO_CPU_INTR_FROM_CPU_0_MAP_REG (0x164)
- Register 5.52: PRO_CPU_INTR_FROM_CPU_1_MAP_REG (0x168)
- Register 5.53: PRO_CPU_INTR_FROM_CPU_2_MAP_REG (0x16C)
- Register 5.54: PRO_CPU_INTR_FROM_CPU_3_MAP_REG (0x170)
- Register 5.55: PRO_SPI_INTR_0_MAP_REG (0x174)
- Register 5.56: PRO_SPI_INTR_1_MAP_REG (0x178)
- Register 5.57: PRO_SPI_INTR_2_MAP_REG (0x17C)
- Register 5.58: PRO_SPI_INTR_3_MAP_REG (0x180)
- Register 5.59: PRO_I2S0_INT_MAP_REG (0x184)
- Register 5.60: PRO_I2S1_INT_MAP_REG (0x188)
- Register 5.61: PRO_UART_INTR_MAP_REG (0x18C)
- Register 5.62: PRO_UART1_INTR_MAP_REG (0x190)
- Register 5.63: PRO_UART2_INTR_MAP_REG (0x194)
- Register 5.64: PRO_SDIO_HOST_INTERRUPT_MAP_REG (0x198)

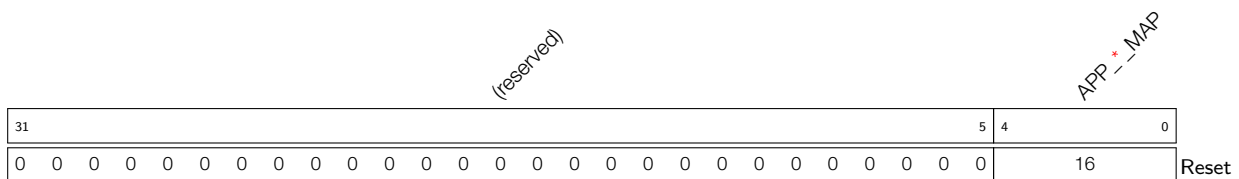
- Register 5.65: PRO_EMAC_INT_MAP_REG (0x19C)
- Register 5.66: PRO_PWM0_INTR_MAP_REG (0x1A0)
- Register 5.67: PRO_PWM1_INTR_MAP_REG (0x1A4)
- Register 5.68: PRO_PWM2_INTR_MAP_REG (0x1A8)
- Register 5.69: PRO_PWM3_INTR_MAP_REG (0x1AC)
- Register 5.70: PRO_LEDC_INT_MAP_REG (0x1B0)
- Register 5.71: PRO_EFUSE_INT_MAP_REG (0x1B4)
- Register 5.72: PRO_CAN_INT_MAP_REG (0x1B8)
- Register 5.73: PRO_RTC_CORE_INTR_MAP_REG (0x1BC)
- Register 5.74: PRO_RMT_INTR_MAP_REG (0x1C0)
- Register 5.75: PRO_PCNT_INTR_MAP_REG (0x1C4)
- Register 5.76: PRO_I2C_EXT0_INTR_MAP_REG (0x1C8)
- Register 5.77: PRO_I2C_EXT1_INTR_MAP_REG (0x1CC)
- Register 5.78: PRO_RSA_INTR_MAP_REG (0x1D0)
- Register 5.79: PRO_SPI1_DMA_INT_MAP_REG (0x1D4)
- Register 5.80: PRO_SPI2_DMA_INT_MAP_REG (0x1D8)
- Register 5.81: PRO_SPI3_DMA_INT_MAP_REG (0x1DC)
- Register 5.82: PRO_WDG_INT_MAP_REG (0x1E0)
- Register 5.83: PRO_TIMER_INT1_MAP_REG (0x1E4)
- Register 5.84: PRO_TIMER_INT2_MAP_REG (0x1E8)
- Register 5.85: PRO_TG_T0_EDGE_INT_MAP_REG (0x1EC)
- Register 5.86: PRO_TG_T1_EDGE_INT_MAP_REG (0x1F0)
- Register 5.87: PRO_TG_WDT_EDGE_INT_MAP_REG (0x1F4)
- Register 5.88: PRO_TG_LACT_EDGE_INT_MAP_REG (0x1F8)
- Register 5.89: PRO_TG1_T0_EDGE_INT_MAP_REG (0x1FC)
- Register 5.90: PRO_TG1_T1_EDGE_INT_MAP_REG (0x200)
- Register 5.91: PRO_TG1_WDT_EDGE_INT_MAP_REG (0x204)
- Register 5.92: PRO_TG1_LACT_EDGE_INT_MAP_REG (0x208)
- Register 5.93: PRO_MMU_IA_INT_MAP_REG (0x20C)
- Register 5.94: PRO_MPU_IA_INT_MAP_REG (0x210)
- Register 5.95: PRO_CACHE_IA_INT_MAP_REG (0x214)



PRO*_MAP Interrupt map. (R/W)

- Register 5.96: APP_ **MAC_INTR_MAP_REG** (0x218)
- Register 5.97: APP_ **MAC_NMI_MAP_REG** (0x21C)
- Register 5.98: APP_ **BB_INT_MAP_REG** (0x220)
- Register 5.99: APP_ **BT_MAC_INT_MAP_REG** (0x224)
- Register 5.100: APP_ **BT_BB_INT_MAP_REG** (0x228)
- Register 5.101: APP_ **BT_BB_NMI_MAP_REG** (0x22C)
- Register 5.102: APP_ **RWBT_IRQ_MAP_REG** (0x230)
- Register 5.103: APP_ **RWBLE_IRQ_MAP_REG** (0x234)
- Register 5.104: APP_ **RWBT_NMI_MAP_REG** (0x238)
- Register 5.105: APP_ **RWBLE_NMI_MAP_REG** (0x23C)
- Register 5.106: APP_ **SLC0_INTR_MAP_REG** (0x240)
- Register 5.107: APP_ **SLC1_INTR_MAP_REG** (0x244)
- Register 5.108: APP_ **UHCI0_INTR_MAP_REG** (0x248)
- Register 5.109: APP_ **UHCI1_INTR_MAP_REG** (0x24C)
- Register 5.110: APP_ **TG_T0_LEVEL_INT_MAP_REG** (0x250)
- Register 5.111: APP_ **TG_T1_LEVEL_INT_MAP_REG** (0x254)
- Register 5.112: APP_ **TG_WDT_LEVEL_INT_MAP_REG** (0x258)
- Register 5.113: APP_ **TG_LACT_LEVEL_INT_MAP_REG** (0x25C)
- Register 5.114: APP_ **TG1_T0_LEVEL_INT_MAP_REG** (0x260)
- Register 5.115: APP_ **TG1_T1_LEVEL_INT_MAP_REG** (0x264)
- Register 5.116: APP_ **TG1_WDT_LEVEL_INT_MAP_REG** (0x268)
- Register 5.117: APP_ **TG1_LACT_LEVEL_INT_MAP_REG** (0x26C)
- Register 5.118: APP_ **GPIO_INTERRUPT_MAP_REG** (0x270)
- Register 5.119: APP_ **GPIO_INTERRUPT_NMI_MAP_REG** (0x274)
- Register 5.120: APP_ **CPU_INTR_FROM_CPU_0_MAP_REG** (0x278)
- Register 5.121: APP_ **CPU_INTR_FROM_CPU_1_MAP_REG** (0x27C)
- Register 5.122: APP_ **CPU_INTR_FROM_CPU_2_MAP_REG** (0x280)
- Register 5.123: APP_ **CPU_INTR_FROM_CPU_3_MAP_REG** (0x284)
- Register 5.124: APP_ **SPI_INTR_0_MAP_REG** (0x288)
- Register 5.125: APP_ **SPI_INTR_1_MAP_REG** (0x28C)
- Register 5.126: APP_ **SPI_INTR_2_MAP_REG** (0x290)
- Register 5.127: APP_ **SPI_INTR_3_MAP_REG** (0x294)
- Register 5.128: APP_ **I2S0_INT_MAP_REG** (0x298)
- Register 5.129: APP_ **I2S1_INT_MAP_REG** (0x29C)
- Register 5.130: APP_ **UART_INTR_MAP_REG** (0x2A0)
- Register 5.131: APP_ **UART1_INTR_MAP_REG** (0x2A4)

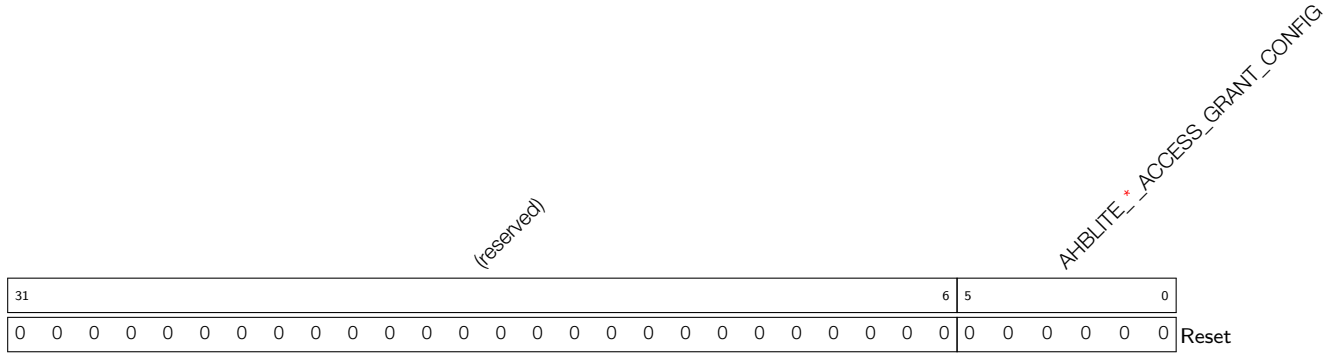
- Register 5.132: APP_UART2_INTR_MAP_REG (0x2A8)
- Register 5.133: APP_SDIO_HOST_INTERRUPT_MAP_REG (0x2AC)
- Register 5.134: APP_EMAC_INT_MAP_REG (0x2B0)
- Register 5.135: APP_PWM0_INTR_MAP_REG (0x2B4)
- Register 5.136: APP_PWM1_INTR_MAP_REG (0x2B8)
- Register 5.137: APP_PWM2_INTR_MAP_REG (0x2BC)
- Register 5.138: APP_PWM3_INTR_MAP_REG (0x2C0)
- Register 5.139: APP_LEDC_INT_MAP_REG (0x2C4)
- Register 5.140: APP_EFUSE_INT_MAP_REG (0x2C8)
- Register 5.141: APP_CAN_INT_MAP_REG (0x2CC)
- Register 5.142: APP_RTC_CORE_INTR_MAP_REG (0x2D0)
- Register 5.143: APP_RMT_INTR_MAP_REG (0x2D4)
- Register 5.144: APP_PCNT_INTR_MAP_REG (0x2D8)
- Register 5.145: APP_I2C_EXT0_INTR_MAP_REG (0x2DC)
- Register 5.146: APP_I2C_EXT1_INTR_MAP_REG (0x2E0)
- Register 5.147: APP_RSA_INTR_MAP_REG (0x2E4)
- Register 5.148: APP_SPI1_DMA_INT_MAP_REG (0x2E8)
- Register 5.149: APP_SPI2_DMA_INT_MAP_REG (0x2EC)
- Register 5.150: APP_SPI3_DMA_INT_MAP_REG (0x2F0)
- Register 5.151: APP_WDG_INT_MAP_REG (0x2F4)
- Register 5.152: APP_TIMER_INT1_MAP_REG (0x2F8)
- Register 5.153: APP_TIMER_INT2_MAP_REG (0x2FC)
- Register 5.154: APP_TG_T0_EDGE_INT_MAP_REG (0x300)
- Register 5.155: APP_TG_T1_EDGE_INT_MAP_REG (0x304)
- Register 5.156: APP_TG_WDT_EDGE_INT_MAP_REG (0x308)
- Register 5.157: APP_TG_LACT_EDGE_INT_MAP_REG (0x30C)
- Register 5.158: APP_TG1_T0_EDGE_INT_MAP_REG (0x310)
- Register 5.159: APP_TG1_T1_EDGE_INT_MAP_REG (0x314)
- Register 5.160: APP_TG1_WDT_EDGE_INT_MAP_REG (0x318)
- Register 5.161: APP_TG1_LACT_EDGE_INT_MAP_REG (0x31C)
- Register 5.162: APP_MMU_IA_INT_MAP_REG (0x320)
- Register 5.163: APP_MPU_IA_INT_MAP_REG (0x324)
- Register 5.164: APP_CACHE_IA_INT_MAP_REG (0x328)



APP_*_MAP Interrupt map. (R/W)

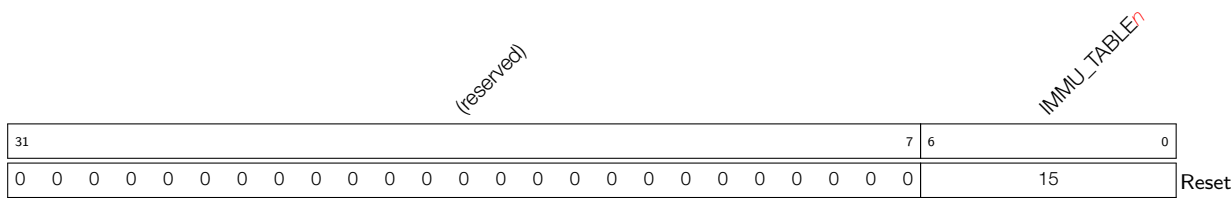
- Register 5.165: AHBLITE_MPU_TABLE_ **UART**_REG (0x32C)
- Register 5.166: AHBLITE_MPU_TABLE_ **SPI1**_REG (0x330)
- Register 5.167: AHBLITE_MPU_TABLE_ **SPI0**_REG (0x334)
- Register 5.168: AHBLITE_MPU_TABLE_ **GPIO**_REG (0x338)
- Register 5.169: AHBLITE_MPU_TABLE_ **RTC**_REG (0x348)
- Register 5.170: AHBLITE_MPU_TABLE_ **IO_MUX**_REG (0x34C)
- Register 5.171: AHBLITE_MPU_TABLE_ **HINF**_REG (0x354)
- Register 5.172: AHBLITE_MPU_TABLE_ **UHCI1**_REG (0x358)
- Register 5.173: AHBLITE_MPU_TABLE_ **I2S0**_REG (0x364)
- Register 5.174: AHBLITE_MPU_TABLE_ **UART1**_REG (0x368)
- Register 5.175: AHBLITE_MPU_TABLE_ **I2C_EXT0**_REG (0x374)
- Register 5.176: AHBLITE_MPU_TABLE_ **UHCI0**_REG (0x378)
- Register 5.177: AHBLITE_MPU_TABLE_ **SLCHOST**_REG (0x37C)
- Register 5.178: AHBLITE_MPU_TABLE_ **RMT**_REG (0x380)
- Register 5.179: AHBLITE_MPU_TABLE_ **PCNT**_REG (0x384)
- Register 5.180: AHBLITE_MPU_TABLE_ **SLC**_REG (0x388)
- Register 5.181: AHBLITE_MPU_TABLE_ **LEDC**_REG (0x38C)
- Register 5.182: AHBLITE_MPU_TABLE_ **EFUSE**_REG (0x390)
- Register 5.183: AHBLITE_MPU_TABLE_ **SPI_ENCRYPT**_REG (0x394)
- Register 5.184: AHBLITE_MPU_TABLE_ **PWM0**_REG (0x39C)
- Register 5.185: AHBLITE_MPU_TABLE_ **TIMERGROUP**_REG (0x3A0)
- Register 5.186: AHBLITE_MPU_TABLE_ **TIMERGROUP1**_REG (0x3A4)
- Register 5.187: AHBLITE_MPU_TABLE_ **SPI2**_REG (0x3A8)
- Register 5.188: AHBLITE_MPU_TABLE_ **SPI3**_REG (0x3AC)
- Register 5.189: AHBLITE_MPU_TABLE_ **APB_CTRL**_REG (0x3B0)
- Register 5.190: AHBLITE_MPU_TABLE_ **I2C_EXT1**_REG (0x3B4)
- Register 5.191: AHBLITE_MPU_TABLE_ **SDIO_HOST**_REG (0x3B8)
- Register 5.192: AHBLITE_MPU_TABLE_ **EMAC**_REG (0x3BC)
- Register 5.193: AHBLITE_MPU_TABLE_ **PWM1**_REG (0x3C4)
- Register 5.194: AHBLITE_MPU_TABLE_ **I2S1**_REG (0x3C8)
- Register 5.195: AHBLITE_MPU_TABLE_ **UART2**_REG (0x3CC)
- Register 5.196: AHBLITE_MPU_TABLE_ **PWM2**_REG (0x3D0)
- Register 5.197: AHBLITE_MPU_TABLE_ **PWM3**_REG (0x3D4)

Register 5.198: AHBLITE_MPU_TABLE_PWR_REG (0x3E4)



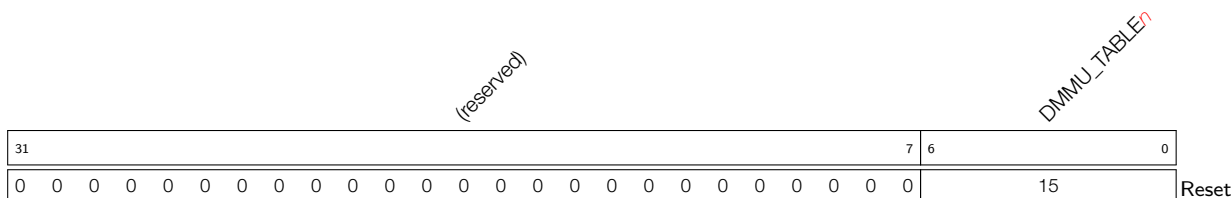
AHBLITE_*_ACCESS_GRANT_CONFIG MPU for peripherals. (R/W)

Register 5.199: IMMU_TABLE n _REG (n : 0-15) (0x504+4* n)



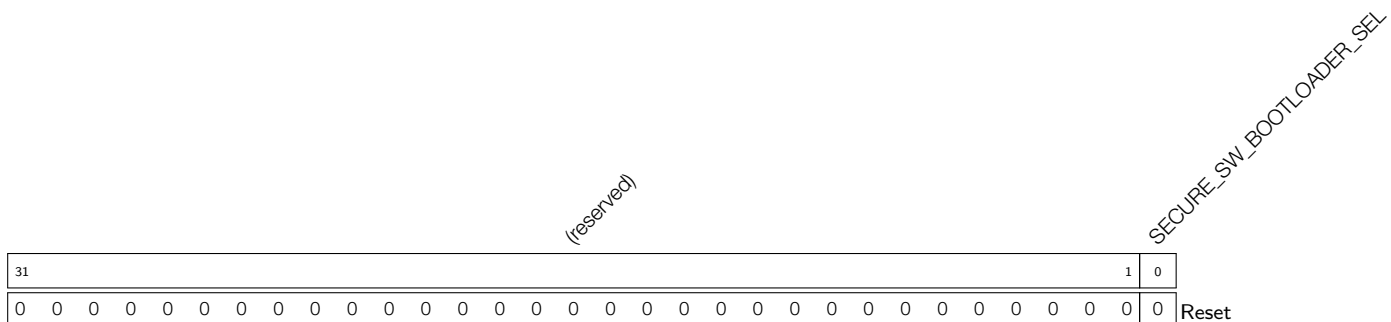
IMMU_TABLE n MMU for internal SRAM. (R/W)

Register 5.200: DMMU_TABLE n _REG (n : 0-15) (0x544+4* n)



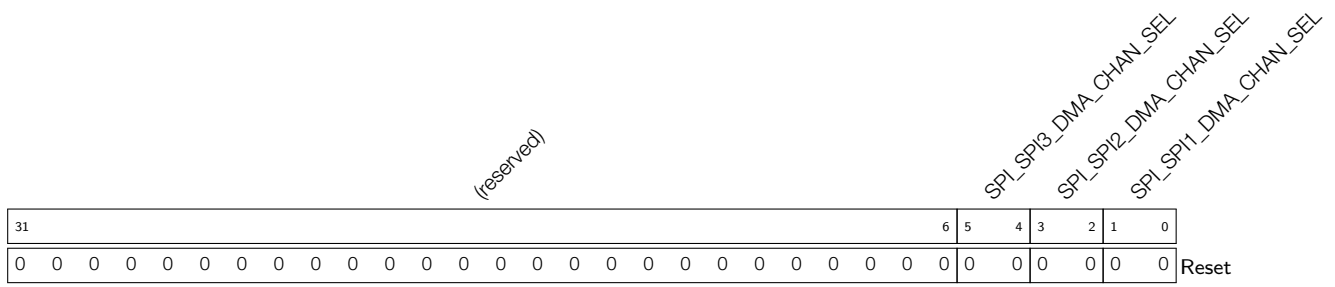
DMMU_TABLE n MMU for internal SRAM. (R/W)

Register 5.201: SECURE_BOOT_CTRL_REG (0x5A4)



SECURE_SW_BOOTLOADER_SEL Mode for secure_boot. (R/W)

Register 5.202: SPI_DMA_CHAN_SEL_REG (0x5A8)



SPI_SPI3_DMA_CHAN_SEL Selects DMA channel for SPI3. (R/W)

SPI_SPI2_DMA_CHAN_SEL Selects DMA channel for SPI2. (R/W)

SPI_SPI1_DMA_CHAN_SEL Selects DMA channel for SPI1. (R/W)

6. DMA Controller

6.1 Overview

Direct Memory Access (DMA) is used for high-speed data transfer between peripherals and memory, as well as from memory to memory. Data can be quickly moved with DMA without any CPU intervention, thus allowing for more efficient use of the cores when processing data.

In the ESP32, 13 peripherals are capable of using DMA for data transfer, namely, UART0, UART1, UART2, SPI1, SPI2, SPI3, I2S0, I2S1, SDIO slave, SD/MMC host, EMAC, BT, and Wi-Fi.

6.2 Features

The DMA controllers in the ESP32 feature:

- AHB bus architecture
- Support for full-duplex and half-duplex data transfers
- Programmable data transfer length in bytes
- Support for 4-beat burst transfer
- 328 KB DMA address space
- All high-speed communication modules powered by DMA

6.3 Functional Description

All modules that require high-speed data transfer in bulk contain a DMA controller. DMA addressing uses the same data bus as the CPU to read/write to the internal RAM.

Each DMA controller features different functions. However, the architecture of the DMA engine (DMA_ENGINE) is the same in all DMA controllers.

6.3.1 DMA Engine Architecture

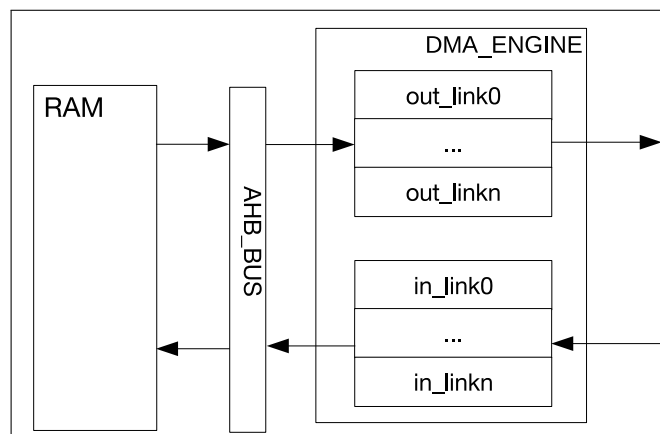


Figure 11: DMA Engine Architecture

The DMA Engine accesses SRAM over the AHB BUS. In Figure 11, the RAM represents the internal SRAM banks available on ESP32. Further details on the SRAM addressing range can be found in Chapter [System and Memory](#). Software can use a DMA Engine by assigning a linked list to define the DMA operational parameters.

The DMA Engine transmits the data from the RAM to a peripheral, according to the contents of the out_link descriptor. Also, the DMA Engine stores the data received from a peripheral into a specified RAM location, according to the contents of the in_link descriptor.

6.3.2 Linked List

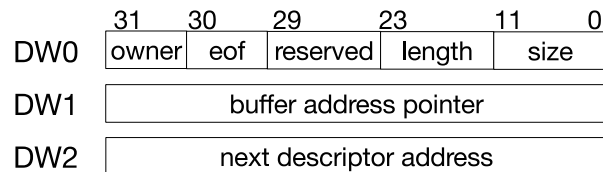


Figure 12: Linked List Structure

The DMA descriptor's linked lists (out_link and in_link) have the same structure. As shown in Figure 12, a linked-list descriptor consists of three words. The meaning of each field is as follows:

- owner (DW0) [31]: The allowed operator of the buffer corresponding to the current linked list.
 - 1'b0: the allowed operator is the CPU;
 - 1'b1: the allowed operator is the DMA controller.
- eof (DW0) [30]: End-Of-File character.
 - 1'b0: the linked-list item does not mark the end of the linked list;
 - 1'b1: the linked-list item is at the end of the linked list.
- reserved (DW0) [29:24]: Reserved bits.
 - Software should not write 1's in this space.
- length (DW0) [23:12]: The number of valid bytes in the buffer corresponding to the current linked list. The field value indicates the number of bytes to be transferred to/from the buffer denoted by word DW1.
- size (DW0) [11:0]: The size of the buffer corresponding to the current linked list.
 - NOTE:** The size must be word-aligned.
- buffer address pointer (DW1): Buffer address pointer. This is the address of the data buffer.
 - NOTE:** The buffer address must be word-aligned.
- next descriptor address (DW2): The address pointer of the next linked-list item. The value is 0, if the current linked-list item is the last on the list (eof=1).

When receiving data, if the data transfer length is smaller than the specified buffer size, DMA will not use the remaining space. This enables the DMA engine to be used for transferring an arbitrary number of data bytes.

6.4 UART DMA (UDMA)

The ESP32 has three UART interfaces that share two UDMA (UART DMA) controllers. The UHCIX_UART_CE (x is 0 or 1) is used for selecting the UDMA.

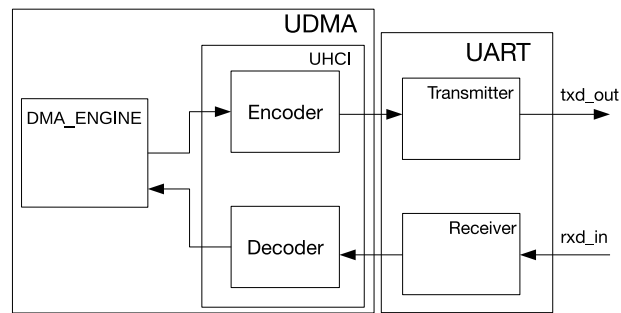


Figure 13: Data Transfer in UDMA Mode

Figure 13 shows the data transfer in UDMA mode. Before the DMA Engine receives data, software must initialize the receive-linked-list. `UHCIx_INLINK_ADDR` is used to point to the first `in_link` descriptor. The register must be programmed with the lower 20 bits of the address of the initial linked-list item. After `UHCIx_INLINK_START` is set, the Universal Host Controller Interface (UHCI) will transmit the data received by UART to the Decoder. After being parsed, the data will be stored in the RAM as specified by the receive-linked-list descriptor.

Before DMA transmits data, software must initialize the transmit-linked-list and the data to be transferred. `UHCI_OUTLINK_ADDR` is used to point to the first `out_link` descriptor. The register must be programmed with the lower 20 bits of the address of the initial transmit-linked-list item. After `UHCIx_OUTLINK_START` is set, the DMA Engine will read data from the RAM location specified by the linked-list descriptor and then transfer the data through the Encoder. The DMA Engine will then shift the data out serially through the UART transmitter.

The UART DMA follows a format of (separator + data + separator). The Encoder is used for adding separators before and after data, as well as using special-character sequences to replace data that are the same as separators. The Decoder is used for removing separators before and after data, as well as replacing the special-character sequences with separators. There can be multiple consecutive separators marking the beginning or end of data. These separators can be configured through `UHCIx_SEPER_CH`, with the default values being `0xC0`. Data that are the same as separators can be replaced with `UHCIx_ESC_SEQ0_CHAR0` (`0xDB` by default) and `UHCIx_ESC_SEQ0_CHAR1` (`0xDD` by default). After the transmission process is complete, a `UHCIx_OUT_TOTAL_EOF_INT` interrupt will be generated. After the reception procedure is complete, a `UHCIx_IN_SUC_EOF_INT` interrupt will be generated.

6.5 SPI DMA Interface

ESP32 SPI modules can use DMA as well as the CPU for data exchange with peripherals. As can be seen from Figure 14, two DMA channels are shared by SPI1, SPI2 and SPI3 controllers. Each DMA channel can be used by any one SPI controller at any given time.

The ESP32 SPI DMA Engine also uses a linked list to receive/transmit data. Burst transmission is supported. The minimum data length for a single transfer is one byte. Consecutive data transfer is also supported.

`SPI1_DMA_CHAN_SEL[1:0]`, `SPI2_DMA_CHAN_SEL[1:0]` and `SPI3_DMA_CHAN_SEL[1:0]` in `DPORT_SPI_DMA_CHAN_SEL_REG` must be configured to enable the SPI DMA interface for a specific SPI controller. Each SPI controller corresponds to one domain which has two bits with values 0, 1 and 2. Value 3 is reserved and must not be configured for operation.

Considering SPI1 as an example,

if `SPI1_DMA_CHAN_SEL[1:0] = 0`, then SPI1 does not use any DMA channel;

if `SPI1_DMA_CHAN_SEL[1:0] = 1`, then SPI1 enables DMA channel1;

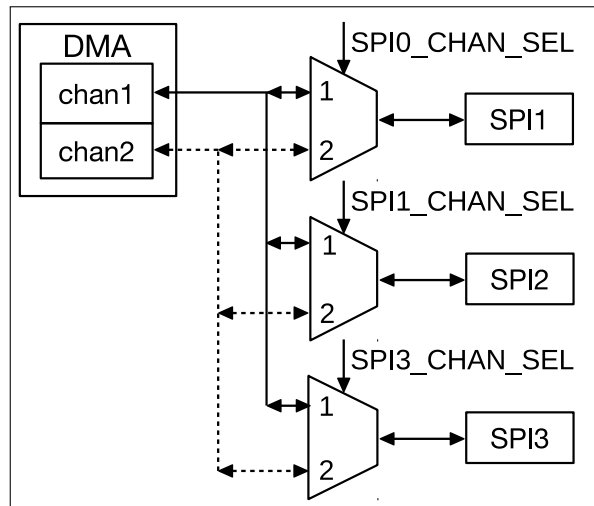


Figure 14: SPI DMA

if `SPI1_DMA_CHAN_SEL[1:0] = 2`, then SPI1 enables DMA channel2.

The `SPI_OUTLINK_START` bit in `SPI_DMA_OUT_LINK_REG` and the `SPI_INLINK_START` bit in `SPI_DMA_IN_LINK_REG` are used for enabling the DMA Engine. The two bits are self-cleared by hardware. When `SPI_OUTLINK_START` is set to 1, the DMA Engine starts processing the outbound linked list descriptor and prepares to transmit data. When `SPI_INLINK_START` is set to 1, then the DMA Engine starts processing the inbound linked-list descriptor and gets prepared to receive data.

Software should configure the SPI DMA as follows:

1. Reset the DMA state machine and FIFO parameters;
2. Configure the DMA-related registers for operation;
3. Configure the SPI-controller-related registers accordingly;
4. Set `SPI_USR` to enable DMA operation.

6.6 I2S DMA Interface

The ESP32 integrates two I2S modules, I2S0 and I2S1, each of which is powered by a DMA channel. The `REG_I2S_DSCR_EN` bit in `I2S_FIFO_CONF_REG` is used for enabling the DMA operation. ESP32 I2S DMA uses the standard linked-list descriptor to configure DMA operations for data transfer. Burst transfer is supported. However, unlike the SPI DMA channels, the data size for a single transfer is one word, or four bytes. `REG_I2S_RX_EOF_NUM[31:0]` bit in `I2S_RXEOF_NUM_REG` is used for configuring the data size of a single transfer operation, in multiples of one word.

`I2S_OUTLINK_START` bit in `I2S_OUT_LINK_REG` and `I2S_INLINK_START` bit in `I2S_IN_LINK_REG` are used for enabling the DMA Engine and are self-cleared by hardware. When `I2S_OUTLINK_START` is set to 1, the DMA Engine starts processing the outbound linked-list descriptor and gets prepared to send data. When `I2S_INLINK_START` is set to 1, the DMA Engine starts processing the inbound linked-list descriptor and gets prepared to receive data.

Software should configure the I2S DMA as follows:

1. Configure I2S-controller-related registers;

2. Reset the DMA state machine and FIFO parameters;
3. Configure DMA-related registers for operation;
4. In I2S master mode, set I2S_TX_START bit or I2S_RX_START bit to initiate an I2S operation;
In I2S slave mode, set I2S_TX_START bit or I2S_RX_START bit and wait for data transfer to be initiated by the host device.

For more information on I2S DMA interrupts, please see Section [DMA Interrupts](#), in Chapter [I2S](#).

7. SPI

7.1 Overview

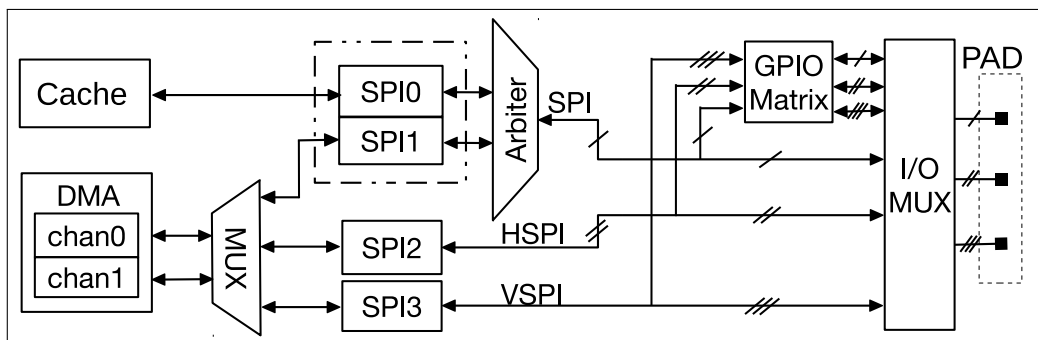


Figure 15: SPI Architecture

As Figure 15 shows, ESP32 integrates four SPI controllers which can be used to communicate with external devices that use the SPI protocol. Controller SPI0 is used as a buffer for accessing external memory. Controller SPI1 can be used as a master. Controllers SPI2 and SPI3 can be configured as either a master or a slave. When used as a master, each SPI controller can drive multiple CS signals (CS0 ~ CS2) to activate multiple slaves. Controllers SPI1 ~ SPI3 share two DMA channels.

The SPI signal buses consist of D, Q, CS0-CS2, CLK, WP, and HD signals, as Table 25 shows. Controllers SPI0 and SPI1 share one signal bus through an arbiter; the signals of the shared bus start with "SPI". Controllers SPI2 and SPI3 use signal buses starting with "HSPI" and "VSPI" respectively. The I/O lines included in the above-mentioned signal buses can be mapped to pins via either the IO_MUX module or the GPIO matrix. (Please refer to Chapter IO_MUX for details.)

The SPI controller supports four-line half-duplex and full-duplex communication (MOSI, MISO, CS, and CLK lines) and three-line-bit half-duplex-only communication (DATA, CS, and CLK lines) in GP-SPI mode. In QSPI mode, a SPI controller accesses the flash or SRAM by using signal buses D, Q, CS0 ~ CS2, CLK, WP, and HD as a four-bit parallel SPI bus. The mapping between the GP-SPI signal bus and the QSPI signal bus is shown in Table 25.

Table 25: SPI Signal and Pin Signal Function Mapping

Four-line GP-SPI Full-duplex signal bus	Three-line GP-SPI Half-duplex signal bus	QSPI Signal bus	Pin function signals		
			SPI signal bus	HSPI signal bus	VSPI signal bus
MOSI	DATA	D	SPID	HSPID	VSPID
MISO	-	Q	SPIQ	HSPIQ	VSPIQ
CS	CS	CS	SPIC0	HSPICS0	VSPIC0
CLK	CLK	CLK	SPICLK	HSPICLK	VSPICLK
-	-	WP	SPIWP	HSPIWP	VSPIWP
-	-	HD	SPIHD	HSPIHD	VSPIHD

7.2 SPI Features

General Purpose SPI (GP-SPI)

- Programmable data transaction length, in multiples of 1 byte
- Four-line full-duplex communication and three-line half-duplex communication support
- Master mode and slave mode
- Programmable CPOL and CPHA
- Programmable clock

Parallel QSPI

- Communication format support for specific slave devices such as flash
- Programmable communication format
- Six variations of flash-read operations available
- Automatic shift between flash and SRAM access
- Automatic wait states for flash access

SPI DMA Support

- Support for sending and receiving data using linked lists

SPI Interrupt Hardware

- SPI interrupts
- SPI DMA interrupts

7.3 GP-SPI

The SPI1 ~ SPI3 controllers can communicate with other slaves as a standard SPI master. Every SPI master can be connected to three slaves at most by default. In non-DMA mode, the maximum length of data received/sent in one burst is 64 bytes. The data length is in multiples of 1 byte.

7.3.1 GP-SPI Master Mode

The SPI master mode supports four-line full-duplex communication and three-line half-duplex communication. The connections needed for four-line full-duplex communications are outlined in Figure 16.

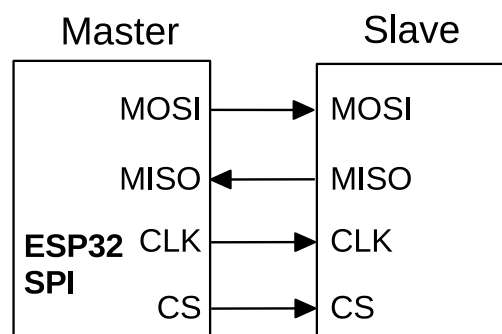


Figure 16: SPI Master and Slave Full-duplex Communication

For four-line full-duplex communication, the length of received and sent data needs to be set by configuring the SPI_MISO_DLEN_REG, SPI_MOSI_DLEN_REG registers for master mode as well as

SPI_SLV_RDBUF_DLEN_REG, SPI_SLV_WRBUF_DLEN_REG registers for slave mode. The SPI_DOUTDIN bit and SPI_USR_MOSI bit in register SPI_USER_REG should also be configured. The SPI_USR bit in register SPI_CMD_REG needs to be configured to initialize data transfer.

If ESP32 SPI is configured as a slave using three-line half-duplex communication, the master-slave communication should meet a certain communication format. Please refer to 7.3.2.1 for details. For example, if ESP32 SPI acts as a slave, the communication format should be: command + address + received/sent data. The address length of the master should be the same as that of the slave; the value of the address should be 0.

Note:

When using ESP32 as a master in half-duplex communication, the communication format "command + address + sent data + received data" and "sent data + received data" are not applicable to DMA.

The byte order in which ESP32 SPI reads and writes is controlled by the SPI_RD_BYTE_ORDER bit and the SPI_WR_BYTE_ORDER bit in register SPI_USER_REG. The bit order is controlled by the SPI_RD_BIT_ORDER bit and the SPI_WR_BIT_ORDER bit in register SPI_CTRL_REG.

7.3.2 GP-SPI Slave Mode

ESP32 SPI2 ~ SPI3 can communicate with other host devices as a slave device. ESP32 SPI should use particular protocols when acting as a slave. Data received or sent at one time can be no more than 64 bytes when not using DMA. During a valid read/write process, the appropriate CS signal must be maintained at a low level. If the CS signal is pulled up during transmission, the internal state of the slave will be reset.

7.3.2.1 Communication Format Supported by GP-SPI Slave

The communication format of ESP32 SPI is: command + address + read/write data. When using half-duplex communication, the slave read and write operations use fixed hardware commands from which the address part can not be removed. The command is specified as follows:

1. command: length: 3 ~ 16 bits; Master Out Slave In (MOSI).
2. address: length: 1 ~ 32 bits; Master Out Slave In (MOSI).
3. data read/write: length 0 ~ 512 bits (64 bytes); Master Out Slave In (MOSI) or Master In Slave Out (MISO).

When ESP32 SPI is used as a slave in full-duplex communication, data transaction can be directly initiated without the master sending command and address. However, please note that the CS should be pulled low at least one SPI clock period before a read/write process is initiated, and should be pulled high at least one SPI clock period after the read/write process is completed.

7.3.2.2 Command Definitions Supported by GP-SPI Slave in Half-duplex Mode

The minimum length of a command received by the slave should be three bits. The lowest three bits correspond to fixed hardware read and write operations as follows:

1. 0x1 (received by slave): Writes data sent by the master into the slave status register via MOSI.
2. 0x2 (received by slave): Writes data sent by the master into the slave data buffer.
3. 0x3 (sent by slave): Sends data in the slave buffer to master via MISO.

4. 0x4 (sent by slave): Sends data in the slave status register to master via MISO.
5. 0x6 (received and then sent by slave): Writes master data on MOSI into data buffer and then sends the data in the slave data buffer to MISO.

The master can write the slave status register SPI_SLV_WR_STATUS_REG, and decide whether to read data from register SPI_SLV_WR_STATUS_REG or register SPI_RD_STATUS_REG via the SPI_SLV_STATUS_READBACK bit in the register SPI_SLAVE1_REG. The SPI master can maintain communication with the slave by reading and writing slave status register, thus realizing relatively complex communication with ease.

7.3.3 GP-SPI Data Buffer

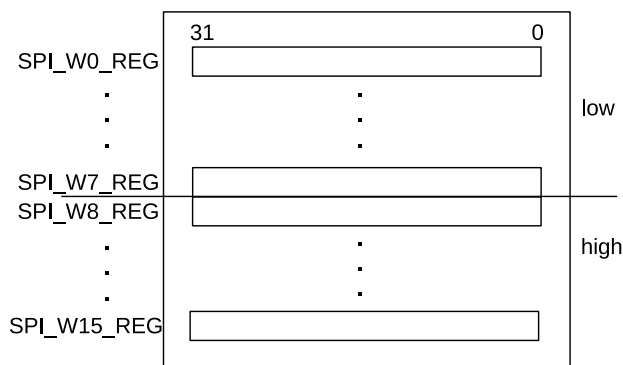


Figure 17: SPI Data Buffer

ESP32 SPI has 16 x 32 bits of data buffer to buffer data-send and data-receive operations. As is shown in Figure 17, received data is written from the low byte of SPI_W0_REG by default and the writing ends with SPI_W15_REG. If the data length is over 64 bytes, the extra part will be written from SPI_W0_REG.

Data buffer blocks SPI_W0_REG ~ SPI_W7_REG and SPI_W8_REG ~ SPI_W15_REG data correspond to the lower part and the higher part respectively. They can be used separately, and are controlled by the SPI_USR_MOSI_HIGHPART bit and the SPI_USR_MISO_HIGHPART bit in register SPI_USER_REG. For example, if SPI is configured as a master, when SPI_USR_MOSI_HIGHPART = 1, SPI_W8_REG ~ SPI_W15_REG are used as buffer for sending data; when SPI_USR_MISO_HIGHPART = 1, SPI_W8_REG ~ SPI_W15_REG are used as buffer for receiving data. If SPI acts as a slave, when SPI_USR_MOSI_HIGHPART = 1, SPI_W8_REG ~ SPI_W15_REG are used as buffer for receiving data; when SPI_USR_MISO_HIGHPART = 1, SPI_W8_REG ~ SPI_W15_REG are used as buffer for sending data.

7.4 GP-SPI Clock Control

The maximum output clock frequency of ESP32 GP-SPI master is $f_{apb}/2$, and the maximum input clock frequency of the ESP32 GP-SPI slave is $f_{apb}/8$. The master can derive other clock frequencies via frequency division.

$$f_{spi} = \frac{f_{apb}}{(SPI_CLKCNT_N+1)(SPI_CLKDIV_PRE+1)}$$

SPI_CLKCNT_N and SPI_CLKDIV_PRE are two bits of register SPI_CLOCK_REG (Please refer to 7.8 Register Description for details). When the SPI_CLK_EQU_SYSCLK bit in the register SPI_CLOCK_REG is set to 1, and the other bits are set to 0, SPI output clock frequency is f_{apb} . For other clock frequencies, SPI_CLK_EQU_SYSCLK needs to be 0.

7.4.1 GP-SPI Clock Polarity (CPOL) and Clock Phase (CPHA)

The clock polarity and clock phase of ESP32 SPI are controlled by the SPI_CK_IDLE_EDGE bit in register SPI_PIN_REG, the SPI_CK_OUT_EDGE bit and the SPI_CK_I_EDGE bit in register SPI_USER_REG, the SPI_MISO_DELAY_MODE[1:0] bit, the SPI_MISO_DELAY_NUM[2:0] bit, the SPI_MOSI_DELAY_MODE[1:0] bit, and the SPI_MOSI_DELAY_NUM[2:0] bit in register SPI_CTRL2_REG. Table 26 and Table 27 show the clock polarity and phase as well as the corresponding register values for ESP32 SPI master and slave, respectively.

Table 26: Clock Polarity and Phase, and Corresponding SPI Register Values for SPI Master

Registers	mode0	mode1	mode2	mode3
SPI_CK_IDLE_EDGE	0	0	1	1
SPI_CK_OUT_EDGE	0	1	1	0
SPI_MISO_DELAY_MODE	2(0)	1(0)	1(0)	2(0)
SPI_MISO_DELAY_NUM	0	0	0	0
SPI_MOSI_DELAY_MODE	0	0	0	0
SPI_MOSI_DELAY_NUM	0	0	0	0

Table 27: Clock Polarity and Phase, and Corresponding SPI Register Values for SPI Slave

Registers	mode0	mode1	mode2	mode3
SPI_CK_IDLE_EDGE	0	0	1	1
SPI_CK_I_EDGE	0	1	1	0
SPI_MISO_DELAY_MODE	0	0	0	0
SPI_MISO_DELAY_NUM	0	0	0	0
SPI_MOSI_DELAY_MODE	2	1	1	2
SPI_MOSI_DELAY_NUM	0	0	0	0

1. mode0 means CPOL=0, CPHA=0. When SPI is idle, the clock output is logic low; data change on the falling edge of the SPI clock and are sampled on the rising edge;
2. mode1 means CPOL=0, CPHA=1. When SPI is idle, the clock output is logic low; data change on the rising edge of the SPI clock and are sampled on the falling edge;
3. mode2 means when CPOL=1, CPHA=0. When SPI is idle, the clock output is logic high; data change on the rising edge of the SPI clock and are sampled on the falling edge;
4. mode3 means when CPOL=1, CPHA=1. When SPI is idle, the clock output is logic high; data change on the falling edge of the SPI clock and are sampled on the rising edge.

7.4.2 GP-SPI Timing

The data signals of ESP32 GP-SPI can be mapped to physical pins via IO_MUX or via IO_MUX and GPIO matrix. When signals pass through the matrix, they will be delayed by two clk_{apb} clock cycles.

When GP-SPI is used as master and the data signals are not received by the SPI controller via GPIO matrix, if GP-SPI output clock frequency is not higher than $clk_{apb}/2$, register SPI_MISO_DELAY_MODE should be set to 0 when configuring the clock polarity. If GP-SPI output clock frequency is not higher than $clk_{apb}/4$, register

SPI_MISO_DELAY_MODE can be set to the corresponding value in Table 26 when configuring the clock polarity.

When GP-SPI is used in master mode and the data signals enter the SPI controller via the GPIO matrix:

1. If GP-SPI output clock frequency is $clk_{apb}/2$, register SPI_MISO_DELAY_MODE should be set to 0 and the dummy state should be enabled (SPI_USR_DUMMY = 1) for one clk_{spi} clock cycle (SPI_USR_DUMMY_CYCLELEN = 0) when configuring the clock polarity;
2. If GP-SPI output clock frequency is $clk_{apb}/4$, register SPI_MISO_DELAY_MODE should be set to 0 when configuring the clock polarity;
3. If GP-SPI output clock frequency is not higher than $clk_{apb}/8$, register SPI_MISO_DELAY_MODE can be set to the corresponding value in Table 26 when configuring the clock polarity.

When GP-SPI is used in slave mode, the maximum slave input clock frequency is $f_{apb}/8$. In addition, the clock signal and the data signals should be routed to the SPI controller via the same path, i.e., neither the clock signal nor the data signals enter the SPI controller via the GPIO matrix, or both the clock signal and the data signals enter the SPI controller via the GPIO matrix. This is important in ensuring that the signals are not delayed by different time periods before they reach the SPI hardware.

7.5 Parallel QSPI

ESP32 SPI controllers support SPI bus memory devices (such as flash and SRAM). The hardware connection between the SPI pins and the memories is shown by Figure 18.

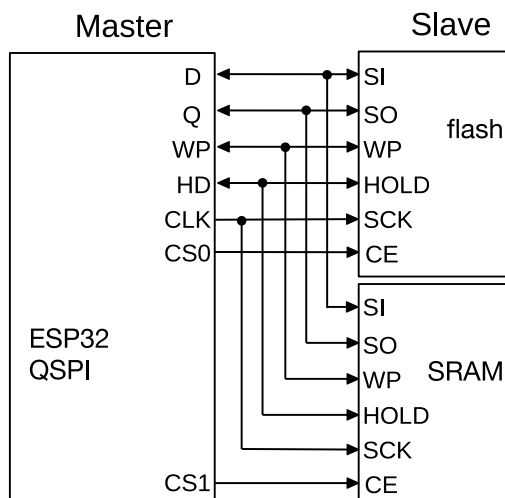


Figure 18: Parallel QSPI

SPI1, SPI2 and SPI3 controllers can also be configured as QSPI master to connect to external memory. The maximum output clock frequency of the SPI memory interface is f_{apb} , with the same clock configuration as that of the GP-SPI master.

ESP32 QSPI supports flash-read operation in one-line mode, two-line mode, and four-line mode.

7.5.1 Communication Format of Parallel QSPI

To support communication with special slave devices, ESP32 QSPI implements a specifically designed communication protocol. The communication format of ESP32 QSPI master is command + address + read/write data, as shown in Figure 19, with details as follows:

1. Command: length: 1 ~ 16 bits; Master Out Slave In.
2. Address: length: 0 ~ 64 bits; Master Out Slave In.
3. Data read/write: length: 0 ~ 512 bits (64 bytes); Master Out Slave In or Master In Slave Out.

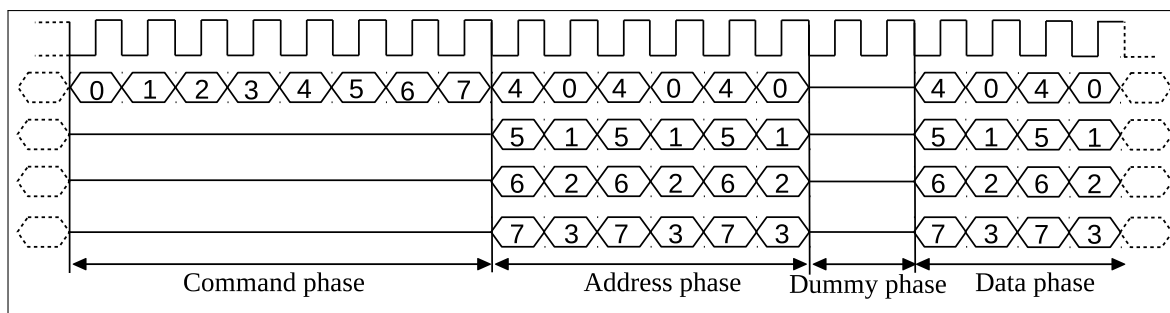


Figure 19: Communication Format of Parallel QSPI

When ESP32 SPI is configured as a master and communicates with slaves that use the SPI protocol, options such as command, address, data, etc., can be adjusted as required by the specific application. When ESP32 SPI reads special devices such as Flash and SRAM, a dummy state with a programmable length can be inserted between the address phase and the data phase.

7.6 GP-SPI Interrupt Hardware

ESP32 SPI generates two types of interrupts. One is the SPI interrupt and the other is the SPI DMA interrupt.

ESP32 SPI reckons the completion of send and/or receive operations as the completion of one operation from the controller and generates one interrupt. When ESP32 SPI is configured to slave mode, the slave will generate read/write status registers and read/write buffer data interrupts according to different operations.

7.6.1 SPI Interrupts

The SPI_*_INTEN bits in the SPI_SLAVE_REG register can be set to enable SPI interrupts. When an SPI interrupt happens, the interrupt flag in the corresponding SPI_*_DONE register will get set. This flag is writable, and an interrupt can be cleared by setting the bit to zero.

- SPI_TRANS_DONE_INT: Triggered when a SPI operation is done.
- SPI_SLV_WR_STA_INT: Triggered when a SPI slave status write is done.
- SPI_SLV_RD_STA_INT: Triggered when a SPI slave status read is done.
- SPI_SLV_WR_BUF_INT: Triggered when a SPI slave buffer write is done.
- SPI_SLV_RD_BUD_INT: Triggered when a SPI slave buffer read is done.

7.6.2 DMA Interrupts

- SPI_OUT_TOTAL_EOF_INT: Triggered when all linked lists are sent.
- SPI_OUT_EOF_INT: Triggered when one linked list is sent.
- SPI_OUT_DONE_INT: Triggered when the last linked list item has zero length.
- SPI_IN_SUC_EOF_INT: Triggered when all linked lists are received.
- SPI_IN_ERR_EOF_INT: Triggered when there is an error receiving linked lists.
- SPI_IN_DONE_INT: Triggered when the last received linked list had a length of 0.
- SPI_INLINK_DSCR_ERROR_INT: Triggered when the received linked list is invalid.
- SPI_OUTLINK_DSCR_ERROR_INT: Triggered when the linked list to be sent is invalid.
- SPI_INLINK_DSCR_EMPTY_INT: Triggered when no valid linked list is available.

7.7 Register Summary

Name	Description	SPI0	SPI1	SPI2	SPI3	Acc
Control and configuration registers						
SPI_CTRL_REG	Bit order and QIO/DIO/QOUT/DOOUT mode settings	3FF43008	3FF42008	3FF65000	3FF65000	R/W
SPI_CTRL1_REG	CS delay configuration	3FF4300C	3FF4200C	3FF6400C	3FF6400C	R/W
SPI_CTRL2_REG	Timing configuration	3FF43014	3FF42014	3FF64014	3FF64014	R/W
SPI_CLOCK_REG	Clock configuration	3FF43018	3FF42018	3FF64018	3FF64018	R/W
SPI_PIN_REG	Polarity and CS configuration	3FF43034	3FF42034	3FF64034	3FF64034	R/W
Slave mode configuration registers						
SPI_SLAVE_REG	Slave mode configuration and interrupt status	3FF43038	3FF42038	3FF64038	3FF64038	R/W
SPI_SLAVE1_REG	Slave data bit lengths	3FF4303C	3FF4203C	3FF6403C	3FF6403C	R/W
SPI_SLAVE2_REG	Dummy cycle length configuration	3FF43040	3FF42040	3FF64040	3FF64040	R/W
SPI_SLAVE3_REG	Read/write status/buffer register	3FF43044	3FF42044	3FF64044	3FF64044	R/W
SPI_SLV_WR_STATUS_REG	Slave status/higher master address	3FF43030	3FF42030	3FF64030	3FF64030	R/W
SPI_SLV_WRBUF_DLEN_REG	Write-buffer operation length	3FF43048	3FF42048	3FF64048	3FF64048	R/W
SPI_SLV_RDBUF_DLEN_REG	Read-buffer operation length	3FF4304C	3FF4204C	3FF6404C	3FF6404C	R/W
SPI_SLV_RD_BIT_REG	Read data operation length	3FF43064	3FF42064	3FF64064	3FF64064	R/W

User-defined command mode registers						
SPI_CMD_REG	Start user-defined command	3FF43000	3FF42000	3FF64000	3FF64000	R/W
SPI_ADDR_REG	Address data	3FF43004	3FF42004	3FF64004	3FF64004	R/W
SPI_USER_REG	User defined command configuration	3FF4301C	3FF4201C	3FF6401C	3FF6401C	R/W
SPI_USER1_REG	Address and dummy cycle configuration	3FF43020	3FF42020	3FF64020	3FF64020	R/W
SPI_USER2_REG	Command length and value configuration	3FF43024	3FF42024	3FF64024	3FF64024	R/W
SPI_MOSI_DLEN_REG	MOSI length	3FF43028	3FF42028	3FF64028	3FF64028	R/W
SPI_W0_REG	SPI data register 0	3FF43080	3FF42080	3FF64080	3FF64080	R/W
SPI_W1_REG	SPI data register 1	3FF43084	3FF42084	3FF64084	3FF64084	R/W
SPI_W2_REG	SPI data register 2	3FF43088	3FF42088	3FF64088	3FF64088	R/W
SPI_W3_REG	SPI data register 3	3FF4308C	3FF4208C	3FF6408C	3FF6408C	R/W
SPI_W4_REG	SPI data register 4	3FF43090	3FF42090	3FF64090	3FF64090	R/W
SPI_W5_REG	SPI data register 5	3FF43094	3FF42094	3FF64094	3FF64094	R/W
SPI_W6_REG	SPI data register 6	3FF43098	3FF42098	3FF64098	3FF64098	R/W
SPI_W7_REG	SPI data register 7	3FF4309C	3FF4209C	3FF6409C	3FF6409C	R/W
SPI_W8_REG	SPI data register 8	3FF430A0	3FF420A0	3FF640A0	3FF640A0	R/W
SPI_W9_REG	SPI data register 9	3FF430A4	3FF420A4	3FF640A4	3FF640A4	R/W
SPI_W10_REG	SPI data register 10	3FF430A8	3FF420A8	3FF640A8	3FF640A8	R/W
SPI_W11_REG	SPI data register 11	3FF430AC	3FF420AC	3FF640AC	3FF640AC	R/W
SPI_W12_REG	SPI data register 12	3FF430B0	3FF420B0	3FF640B0	3FF640B0	R/W
SPI_W13_REG	SPI data register 13	3FF430B4	3FF420B4	3FF640B4	3FF640B4	R/W
SPI_W14_REG	SPI data register 14	3FF430B8	3FF420B8	3FF640B8	3FF640B8	R/W
SPI_W15_REG	SPI data register 15	3FF430BC	3FF420BC	3FF640BC	3FF640BC	R/W
SPI_TX_CRC_REG	CRC32 of 256 bits of data (SPI1 only)	3FF430C0	3FF420C0	3FF640C0	3FF640C0	R/W
Status registers						
SPI_RD_STATUS_REG	Slave status and fast read mode	3FF43010	3FF42010	3FF64010	3FF64010	R/W
DMA configuration registers						
SPI_DMA_CONF_REG	DMA configuration register	3FF43100	3FF42100	3FF64100	3FF64100	R/W
SPI_DMA_OUT_LINK_REG	DMA outlink address and configuration	3FF43104	3FF42104	3FF64104	3FF64104	R/W
SPI_DMA_IN_LINK_REG	DMA inlink address and configuration	3FF43108	3FF42108	3FF64108	3FF64108	R/W
SPI_DMA_STATUS_REG	DMA status	3FF4310C	3FF4210C	3FF6410C	3FF6410C	RO
SPI_IN_ERR_EOF_DES_ADDR_REG	Descriptor address where an error occurs	3FF43120	3FF42120	3FF64120	3FF64120	RO

SPI_IN_SUC_EOF_DES_ADDR_REG	Descriptor address where EOF occurs	3FF43124	3FF42124	3FF64124	3FF64124	RO
SPI_INLINK_DSCR_REG	Current descriptor pointer	3FF43128	3FF42128	3FF64128	3FF64128	RO
SPI_INLINK_DSCR_BF0_REG	Next descriptor data pointer	3FF4312C	3FF4212C	3FF6412C	3FF6412C	RO
SPI_INLINK_DSCR_BF1_REG	Current descriptor data pointer	3FF43130	3FF42130	3FF64130	3FF64130	RO
SPI_OUT_EOF_BFR_DES_ADDR_REG	Relative buffer address where EOF occurs	3FF43134	3FF42134	3FF64134	3FF64134	RO
SPI_OUT_EOF_DES_ADDR_REG	Descriptor address where EOF occurs	3FF43138	3FF42138	3FF64138	3FF64138	RO
SPI_OUTLINK_DSCR_REG	Current descriptor pointer	3FF4313C	3FF4213C	3FF6413C	3FF6413C	RO
SPI_OUTLINK_DSCR_BF0_REG	Next descriptor data pointer	3FF43140	3FF42140	3FF64140	3FF64140	RO
SPI_OUTLINK_DSCR_BF1_REG	Current descriptor data pointer	3FF43144	3FF42144	3FF64144	3FF64144	RO
SPI_DMA_RSTATUS_REG	DMA memory read status	3FF43148	3FF42148	3FF64148	3FF64148	RO
SPI_DMA_TSTATUS_REG	DMA memory write status	3FF4314C	3FF4214C	3FF6414C	3FF6414C	RO
DMA interrupt registers						
SPI_DMA_INT_RAW_REG	Raw interrupt status	3FF43114	3FF42114	3FF64114	3FF64114	RO
SPI_DMA_INT_ST_REG	Masked interrupt status	3FF43118	3FF42118	3FF64118	3FF64118	RO
SPI_DMA_INT_ENA_REG	Interrupt enable bits	3FF43110	3FF42110	3FF64110	3FF64110	R/W
SPI_DMA_INT_CLR_REG	Interrupt clear bits	3FF4311C	3FF4211C	3FF6411C	3FF6411C	R/W

7.8 Registers

Register 7.1: SPI_CMD_REG (0x0)

(reserved)										SPI_USR		(reserved)																				
31											19	18	35																			18
0 0																																Reset

SPI_USR This bit is used to enable user-defined commands. An operation will be triggered when this bit is set. The bit will be cleared once the operation is done. (R/W)

Register 7.2: SPI_ADDR_REG (0x4)

31																															0	
0x00000000																																Reset

SPI_ADDR_REG Address to slave or from master. If the address length is bigger than 32 bits, SPI_SLV_WR_STATUS_REG contains the lower 32 bits while this register contains the higher address bits. (R/W)

Register 7.5: SPI_RD_STATUS_REG (0x10)

<i>SPI_STATUS_EXT</i>										<i>SPI_STATUS</i>									
31	24	23	16	15											0				
0x000		0x000			0 0 0 0 0 0 0 0 0 0 0 0 0 0 0 0										Reset				

SPI_STATUS_EXT In slave mode, this is the status for the master to read. (R/W)

SPI_STATUS In slave mode, this is the status for the master to read. (R/W)

Register 7.6: SPI_CTRL2_REG (0x14)

<i>SPI_CS_DELAY_NUM</i>		<i>SPI_CS_DELAY_MODE</i>		<i>SPI_MOSI_DELAY_NUM</i>		<i>SPI_MOSI_DELAY_MODE</i>		<i>SPI_MISO_DELAY_NUM</i>		<i>SPI_MISO_DELAY_MODE</i>		<i>SPI_CK_OUT_HIGH_MODE</i>		<i>reserved</i>		<i>SPI_HOLD_TIME</i>		<i>SPI_SETUP_TIME</i>	
31	28	27	26	25	23	22	21	20	18	17	16	15	12	11	8	7	4	3	0
0x00		0x0		0x0		0x0		0x0		0x0		0x00		0x00		0x01		0x01	
Reset																			

SPI_CS_DELAY_NUM The spi_cs signal is delayed by the number of system clock cycles configured here. (R/W)

SPI_CS_DELAY_MODE This register field determines the way the spi_cs signal is delayed by spi_clk. (R/W)

0: none.

1: if SPI_CK_OUT_EDGE or SPI_CK_I_EDGE is set, spi_cs is delayed by half a cycle, otherwise it is delayed by one cycle.

2: if SPI_CK_OUT_EDGE or SPI_CK_I_EDGE is set, spi_cs is delayed by one cycle, otherwise it is delayed by half a cycle.

3: the spi_cs signal is delayed by one cycle.

SPI_MOSI_DELAY_NUM The MOSI signals are delayed by the number of system clock cycles configured here. (R/W)

SPI_MOSI_DELAY_MODE This register field determines the way the MOSI signals are delayed by spi_clk. (R/W)

0: none.

1: if SPI_CK_OUT_EDGE or SPI_CK_I_EDGE is set, the MOSI signals are delayed by half a cycle, otherwise they are delayed by one cycle.

2: if SPI_CK_OUT_EDGE or SPI_CK_I_EDGE is set, the MOSI signals are delayed by one cycle, otherwise they are delayed by half a cycle.

3: the MOSI signals are delayed one cycle.

SPI_MISO_DELAY_NUM The MISO signals are delayed by the number of system clock cycles specified here. (R/W)

SPI_MISO_DELAY_MODE This register field determines the way MISO signals are delayed by spi_clk. (R/W)

0: none.

1: if SPI_CK_OUT_EDGE or SPI_CK_I_EDGE is set, the MISO signals are delayed by half a cycle, otherwise they are delayed by one cycle.

2: if SPI_CK_OUT_EDGE or SPI_CK_I_EDGE is set, the MISO signals are delayed by one cycle, otherwise they are delayed by half a cycle.

3: the MISO signals are delayed by one cycle.

SPI_HOLD_TIME The number of spi_clk cycles by which CS pin signals are delayed. These bits are used in conjunction with the SPI_CS_HOLD bit. (R/W)

SPI_SETUP_TIME The number of spi_clk cycles for which spi_cs is made active before the SPI data transaction starts. This register field is used when SPI_CS_SETUP is set. (R/W)

Register 7.7: SPI_CLOCK_REG (0x18)

SPI_CLK_EQU_SYSCLK		SPI_CLKDIV_PRE						SPI_CLKCNT_N				SPI_CLKCNT_H		SPI_CLKCNT_L					
31	30							18	17			12	11			6	5	0	
1	0 0 0 0 0 0 0 0 0 0 0 0 0 0 0 0						0x03				0x01		0x03				Reset		

SPI_CLK_EQU_SYSCLK In master mode, when this bit is set to 1, spi_clk is equal to system clock; when set to 0, spi_clk is divided from system clock. (R/W)

SPI_CLKDIV_PRE In master mode, the value of this register field is the pre-divider value for spi_clk, minus one. (R/W)

SPI_CLKCNT_N In master mode, this is the divider for spi_clk minus one. The spi_clk frequency is $\text{system_clock}/(\text{SPI_CLKDIV_PRE}+1)/(\text{SPI_CLKCNT_N}+1)$. (R/W)

SPI_CLKCNT_H For a 50% duty cycle, set this to $\text{floor}((\text{SPI_CLKCNT_N}+1)/2-1)$. (R/W)

SPI_CLKCNT_L In master mode, this must be equal to SPI_CLKCNT_N. In slave mode this must be 0. (R/W)

Register 7.8: SPI_USER_REG (0x1C)

SPI_USR_COMMAND			SPI_USR_ADDR			SPI_USR_DUMMY			SPI_USR_MISO			SPI_USR_MOSI			SPI_USR_DUMMY_IDLE			SPI_USR_MOSI_HIGHPART			SPI_USR_MISO_HIGHPART			(reserved)			SPI_SIO			SPI_FWRITE_QIO			SPI_FWRITE_DIO			SPI_FWRITE_QUAD			SPI_WR_BYTE_ORDER			SPI_RD_BYTE_ORDER			(reserved)			SPI_CK_OUT_EDGE			SPI_CK_I_EDGE			SPI_CS_SETUP			SPI_CS_HOLD			(reserved)			SPI_DOUTDIN		
31	30	29	28	27	26	25	24	23										17	16	15	14	13	12	11	10	9	8	7	6	5	4	3							1	0																									
1	0	0	0	0	0	0	0	0	0	0	0	0	0	0	0	0	0	0	0	0	0	0	0	0	0	0	0	0	1	0	0	0	0	0	0	0	0	0	0	0	0																								

Reset

- SPI_USR_COMMAND** This bit enables the command phase of an operation. (R/W)
- SPI_USR_ADDR** This bit enables the address phase of an operation. (R/W)
- SPI_USR_DUMMY** This bit enables the dummy phase of an operation. (R/W)
- SPI_USR_MISO** This bit enables the read-data phase of an operation. (R/W)
- SPI_USR_MOSI** This bit enables the write-data phase of an operation. (R/W)
- SPI_USR_DUMMY_IDLE** The spi_clk signal is disabled in the dummy phase when the bit is set. (R/W)
- SPI_USR_MOSI_HIGHPART** If set, data written to the device is only read from SPI_W8-SPI_W15 of the SPI buffer. (R/W)
- SPI_USR_MISO_HIGHPART** If set, data read from the device is only written to SPI_W8-SPI_W15 of the SPI buffer. (R/W)
- SPI_SIO** Set this bit to enable three-line half-duplex communication where MOSI and MISO signals share the same pin. (R/W)
- SPI_FWRITE_QIO** This bit enables the use of four data lines for address and MISO data writes. 1: enable; 0: disable. (R/W)
- SPI_FWRITE_DIO** This bit enables the use of two data lines for address and MISO data writes. 1: enable; 0: disable. (R/W)
- SPI_FWRITE_QUAD** This bit enables the use of four data lines for MISO data writes. 1: enable; 0: disable. (R/W)
- SPI_FWRITE_DUAL** This bit determines whether to use two data lines for MISO data writes or not. 1: enable; 0: disable. (R/W)
- SPI_WR_BYTE_ORDER** This bit determines the byte-endianness for writing command, address, and MOSI data. 1: big-endian; 0: little-endian. (R/W)
- SPI_RD_BYTE_ORDER** This bit determines the byte-endianness for reading MISO data. 1: big-endian; 0: little_endian. (R/W)
- SPI_CK_OUT_EDGE** This bit, combined with SPI_MOSI_DELAY_MODE, sets the MOSI signal delay mode. (R/W)
- SPI_CK_I_EDGE** In slave mode, the bit is the same as SPI_CK_OUT_EDGE in master mode. It is combined with SPI_MISO_DELAY_MODE. (R/W)
- SPI_CS_SETUP** Setting this bit enables a delay between spi_cs being active and starting data transfer, as specified in SPI_SETUP_TIME. This bit only is valid in half-duplex mode, that is, when SPI_DOUTDIN is not set. (R/W)
- SPI_CS_HOLD** Setting this bit enables a delay between the end of a transmission and spi_cs being made inactive, as specified in SPI_HOLD_TIME. (R/W)
- SPI_DOUTDIN** Set the bit to enable full-duplex communication, meaning that MOSI data is sent out at the same time MISO data is received. 1: enable; 0: disable. (R/W)

Register 7.9: SPI_USER1_REG (0x20)

31	SPL_USR_ADDR_BITLEN	26	25	(reserved)	8	7	0	SPL_USR_DUMMY_CYCLELEN
23	0 0 0 0 0 0 0 0 0 0 0 0 0 0 0 0 0 0						7	Reset

SPI_USR_ADDR_BITLEN The bit length of the address phase minus one. (RO)

SPI_USR_DUMMY_CYCLELEN The number of spi_clk cycles for the dummy phase, minus one.
(R/W)

Register 7.10: SPI_USER2_REG (0x24)

31	SPL_USR_COMMAND_BITLEN	28	27	(reserved)	16	15	0	SPL_USR_COMMAND_VALUE
7	0 0						0	Reset

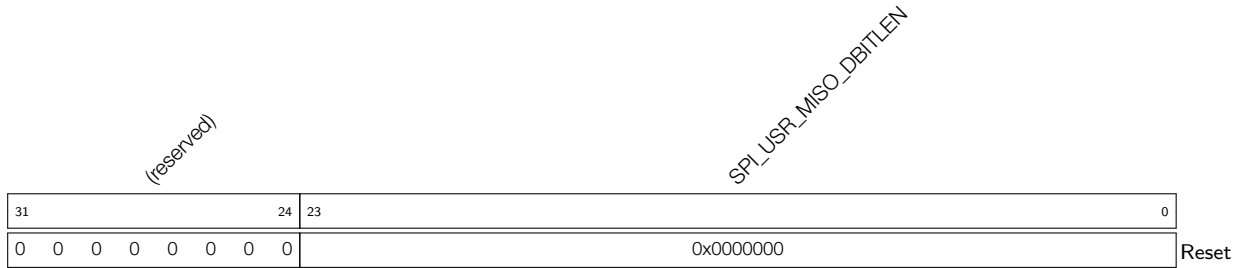
SPI_USR_COMMAND_BITLEN The bit length of the command phase minus one. (R/W)

SPI_USR_COMMAND_VALUE The value of the command. (R/W)

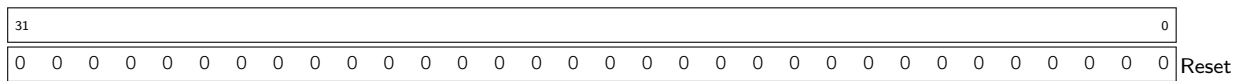
Register 7.11: SPI_MOSI_DLEN_REG (0x28)

31	(reserved)	24	23	SPL_USR_MOSI_DBITLEN	0	
0 0 0 0 0 0 0 0			0x0000000			Reset

SPI_USR_MOSI_DBITLEN The bit length of the data to be written to the device minus one. (R/W)

Register 7.12: SPI_MISO_DLEN_REG (0x2C)

SPI_USR_MISO_DBITLEN The bit length of the data to be read from the device, minus one. (R/W)

Register 7.13: SPI_SLV_WR_STATUS_REG (0x30)

SPI_SLV_WR_STATUS_REG In the slave mode this register is the status register for the master to write into. In the master mode, if the address length is bigger than 32 bits, this register contains the lower 32 bits. (R/W)

Register 7.14: SPI_PIN_REG (0x34)

(reserved)				(reserved)												SPI_MASTER_CK_SEL			(reserved)			SPI_MASTER_CS_POL			(reserved)			SPI_CS2_DIS			SPI_CS1_DIS			SPI_CS0_DIS			
31	30	29	28													14	13	11	10	9	8				6	5	4	3	2	1	0	Reset					
0	0	0	0	0	0	0	0	0	0	0	0	0	0	0	0	0	0	0	0	0	0	0	0	0	0	0	0	0	0	0	0	1	1	0			

SPI_CS_KEEP_ACTIVE When set, the spi_cs will be kept active even when not in a data transaction. (R/W)

SPI_CK_IDLE_EDGE The idle state of the spi_clk line. (R/W)
 1: the spi_clk line is high when idle;
 0: the spi_clk line is low when idle.

SPI_MASTER_CK_SEL This register field contains one bit per spi_cs line. When a bit is set in master mode, the corresponding spi_cs line is made active and the spi_cs pin outputs spi_clk. (R/W)

SPI_MASTER_CS_POL This register field selects the polarity of the spi_cs line. It contains one bit per spi_cs line. Possible values of the bits: (R/W)
 0: spi_cs is active-low;
 1: spi_cs is active-high.

SPI_CK_DIS When set, output of the spi_clk signal is disabled. (R/W)

SPI_CS2_DIS This bit enables the SPI CS2 pin. 1: disables CS2; 0: spi_cs2 is active during the data transaction. (R/W)

SPI_CS1_DIS This bit enables the SPI CS1 pin. 1: disables CS1; 0: spi_cs1 is active during the data transaction (R/W)

SPI_CS0_DIS This bit enables the SPI CS0 pin. 1: disables CS0; 0: spi_cs0 is active during the data transaction. (R/W)

Register 7.15: SPI_SLAVE_REG (0x38)

SPI_SYNC_RESET		SPI_SLAVE_MODE		SPI_SLV_WR_RD_BUF_EN		SPI_SLV_WR_RD_STA_EN		SPI_SLV_CMD_DEFINE		SPI_TRANS_CNT		SPI_SLV_LAST_STATE		SPI_SLV_LAST_COMMAND		(reserved)		SPI_CS_I_MODE		SPI_TRANS_INTEN		SPI_SLV_WR_STA_INTEN		SPI_SLV_RD_STA_INTEN		SPI_SLV_WR_BUF_INTEN		SPI_SLV_RD_BUF_INTEN		SPI_TRANS_DONE		SPI_SLV_WR_STA_DONE		SPI_SLV_WR_BUF_DONE		SPI_SLV_RD_BUF_DONE			
31	30	29	28	27	26	25	24	23	22	21	20	19	18	17	16	15	14	13	12	11	10	9	8	7	6	5	4	3	2	1	0	Reset							
0	0	0	0	0	0	0	0	0	0	0	0	0	0	0	0	0	0	0	0	0	0	0	0	0	0	0	0	0	0	0	0	0	0	0	0	0	0	0	0

SPI_SYNC_RESET This bit is used to enable software reset. When set, it resets the latched values of the SPI clock line, cs line and data lines. (R/W)

SPI_SLAVE_MODE This bit is used to set the mode of the SPI device. (R/W)

- 1: slave mode;
- 0: master mode.

SPI_SLV_WR_RD_BUF_EN Setting this bit enables the write and read buffer commands in slave mode. (R/W)

SPI_SLV_WR_RD_STA_EN Setting this bit enables the write and read status commands in slave mode. (R/W)

SPI_SLV_CMD_DEFINE This bit is used to enable custom slave mode commands. (R/W)

- 1: slave mode commands are defined in SPI_SLAVE3.
- 0: slave mode commands are fixed as: 0x1: write-status; 0x2: write-buffer, 0x3: read-buffer; and 0x4: read-status.

SPI_TRANS_CNT The counter for operations in both the master mode and the slave mode. (RO)

SPI_SLV_LAST_STATE In slave mode, this contains the state of the SPI state machine. (RO)

SPI_SLV_LAST_COMMAND In slave mode, this contains the value of the received command. (RO)

SPI_CS_I_MODE In the slave mode, this selects the mode to synchronize the input SPI cs signal and eliminate SPI cs jitter. (R/W)

- 0: configured through registers (SPI_CS_DELAY_NUM and SPI_CS_DELAY_MODE);
- 1: using double synchronization method and configured through registers (SPI_CS_DELAY_NUM and SPI_CS_DELAY_MODE);
- 2: using double synchronization method.

SPI_TRANS_INTEN The interrupt enable bit for the [SPI_TRANS_DONE_INT](#) interrupt. (R/W)

SPI_SLV_WR_STA_INTEN The interrupt enable bit for the [SPI_SLV_WR_STA_INT](#) interrupt. (R/W)

SPI_SLV_RD_STA_INTEN The interrupt enable bit for the [SPI_SLV_RD_STA_INT](#) interrupt. (R/W)

SPI_SLV_WR_BUF_INTEN The interrupt enable bit for the [SPI_SLV_WR_BUF_INT](#) interrupt. (R/W)

SPI_SLV_RD_BUF_INTEN The interrupt enable bit for the [SPI_SLV_RD_BUF_INT](#) interrupt. (R/W)

SPI_TRANS_DONE The raw interrupt status bit for the [SPI_TRANS_DONE_INT](#) interrupt. (R/W)

SPI_SLV_WR_STA_DONE The raw interrupt status bit for the [SPI_SLV_WR_STA_INT](#) interrupt. (R/W)

SPI_SLV_RD_STA_DONE The raw interrupt status bit for the [SPI_SLV_RD_STA_INT](#) interrupt. (R/W)

SPI_SLV_WR_BUF_DONE The raw interrupt status bit for the [SPI_SLV_WR_BUF_INT](#) interrupt. (R/W)

SPI_SLV_RD_BUF_DONE The raw interrupt status bit for the [SPI_SLV_RD_BUF_INT](#) interrupt. (R/W)

Register 7.16: SPI_SLAVE1_REG (0x3C)

SPI_SLV_STATUS_BITLEN					SPI_SLV_STATUS_FAST_EN					SPI_SLV_STATUS_READBACK					(reserved)					SPI_SLV_RD_ADDR_BITLEN					SPI_SLV_WR_ADDR_BITLEN					SPI_SLV_WRSTA_DUMMY_EN					SPI_SLV_RDSTA_DUMMY_EN					SPI_SLV_WRBUF_DUMMY_EN					SPI_SLV_RDBUF_DUMMY_EN				
31	27	26	25	24	16	15	10	9	4	3	2	1	0	Reset																																			
0	0	0	0	0	0	1	0	0	0	0	0	0	0	0	0x00	0x00	0	0	0	0	0	0	0	0																									

SPI_SLV_STATUS_BITLEN In slave mode, this sets the length of the status field. (R/W)

SPI_SLV_STATUS_FAST_EN In slave mode, this enables fast reads of the status. (R/W)

SPI_SLV_STATUS_READBACK In slave mode, this selects the active status register. (R/W)

1: reads register of SPI_SLV_WR_STATUS;

0: reads register of SPI_RD_STATUS.

SPI_SLV_RD_ADDR_BITLEN In slave mode, this contains the address length in bits for a read-buffer operation, minus one. (R/W)

SPI_SLV_WR_ADDR_BITLEN In slave mode, this contains the address length in bits for a write-buffer operation, minus one. (R/W)

SPI_SLV_WRSTA_DUMMY_EN In slave mode, this bit enables the dummy phase for write-status operations. (R/W)

SPI_SLV_RDSTA_DUMMY_EN In slave mode, this bit enables the dummy phase for read-status operations. (R/W)

SPI_SLV_WRBUF_DUMMY_EN In slave mode, this bit enables the dummy phase for write-buffer operations. (R/W)

SPI_SLV_RDBUF_DUMMY_EN In slave mode, this bit enables the dummy phase for read-buffer operations. (R/W)

Register 7.17: SPI_SLAVE2_REG (0x40)

<i>SPI_SLV_WRBUF_DUMMY_CYCLELEN</i>								<i>SPI_SLV_RDBUF_DUMMY_CYCLELEN</i>								<i>SPI_SLV_WRSTA_DUMMY_CYCLELEN</i>								<i>SPI_SLV_RDSTA_DUMMY_CYCLELEN</i>								
31								24	23							16	15							8	7							0
0 0 0 0 0 0 0 0								0x000								0x000								0x000								Reset

SPI_SLV_WRBUF_DUMMY_CYCLELEN In slave mode, this contains number of spi_clk cycles for the dummy phase for write-buffer operations, minus one. (R/W)

SPI_SLV_RDBUF_DUMMY_CYCLELEN In slave mode, this contains the number of spi_clk cycles for the dummy phase for read-buffer operations, minus one (R/W)

SPI_SLV_WRSTA_DUMMY_CYCLELEN In slave mode, this contains the number of spi_clk cycles for the dummy phase for write-status operations, minus one. (R/W)

SPI_SLV_RDSTA_DUMMY_CYCLELEN In slave mode, this contains the number of spi_clk cycles for the dummy phase for read-status operations, minus one. (R/W)

Register 7.18: SPI_SLAVE3_REG (0x44)

<i>SPI_SLV_WRSTA_CMD_VALUE</i>								<i>SPI_SLV_RDSTA_CMD_VALUE</i>								<i>SPI_SLV_WRBUF_CMD_VALUE</i>								<i>SPI_SLV_RDBUF_CMD_VALUE</i>								
31								24	23							16	15							8	7							0
0 0 0 0 0 0 0 0								0 0 0 0 0 0 0 0								0 0 0 0 0 0 0 0								0 0 0 0 0 0 0 0								Reset

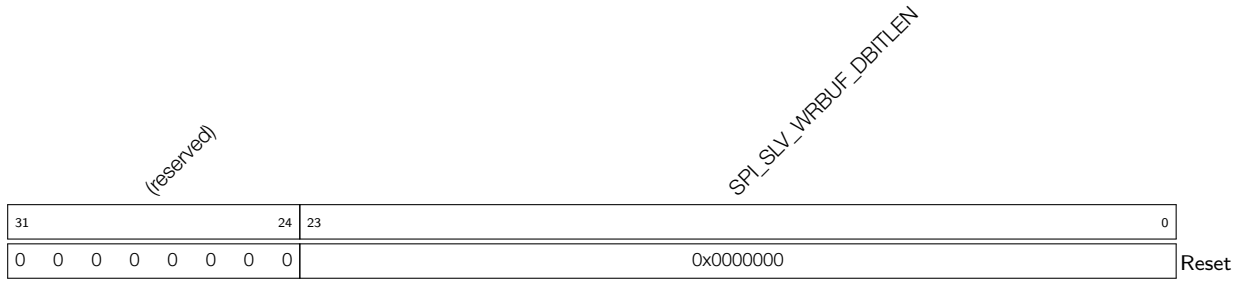
SPI_SLV_WRSTA_CMD_VALUE In slave mode, this contains the value of the write-status command. (R/W)

SPI_SLV_RDSTA_CMD_VALUE In slave mode, this contains the value of the read-status command. (R/W)

SPI_SLV_WRBUF_CMD_VALUE In slave mode, this contains the value of the write-buffer command. (R/W)

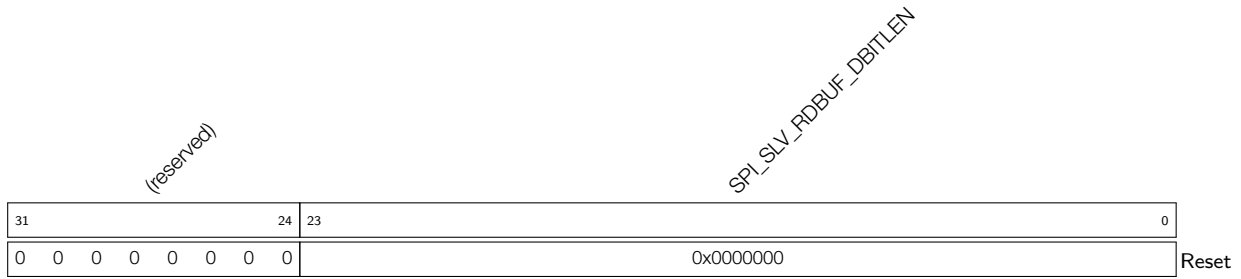
SPI_SLV_RDBUF_CMD_VALUE In slave mode, this contains the value of the read-buffer command. (R/W)

Register 7.19: SPI_SLV_WRBUF_DLEN_REG (0x48)



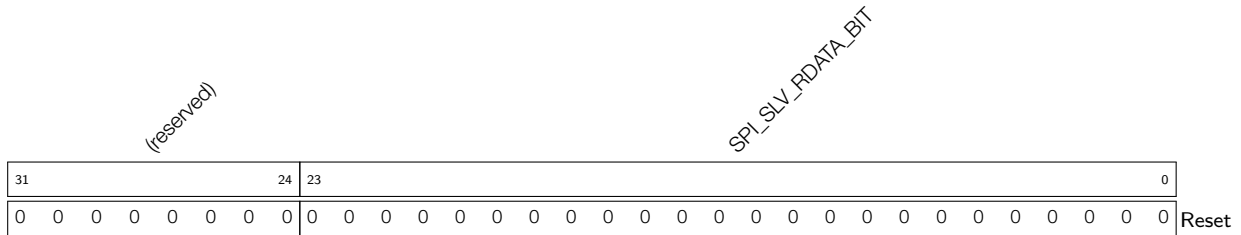
SPI_SLV_WRBUF_DBITLEN This equals to the bit length of data written into the slave buffer, minus one. (R/W)

Register 7.20: SPI_SLV_RDBUF_DLEN_REG (0x4C)



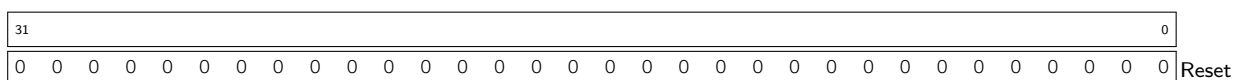
SPI_SLV_RDBUF_DBITLEN This equals to the bit length of data read from the slave buffer, minus one. (R/W)

Register 7.21: SPI_SLV_RD_BIT_REG (0x64)



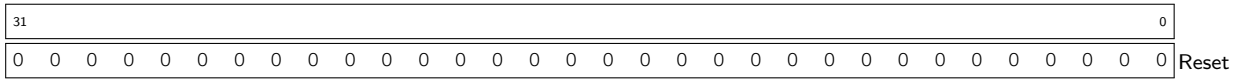
SPI_SLV_RDATA_BIT This equals to the bit length of data the master reads from the slave, minus one. (R/W)

Register 7.22: SPI_W_n_REG (n: 0-15) (0x80+4*n)



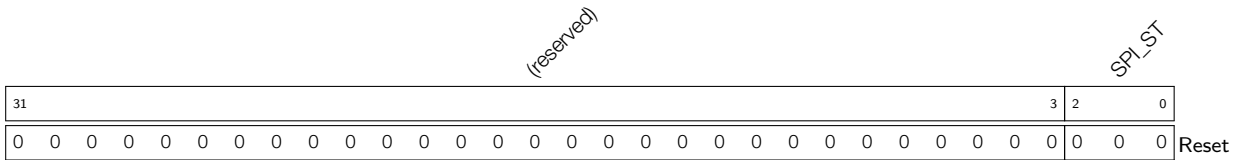
SPI_W_n_REG Data buffer. (R/W)

Register 7.23: SPI_TX_CRC_REG (0xC0)



SPI_TX_CRC_REG For SPI1, this contains the CRC32 value of 256 bits of data. (R/W)

Register 7.24: SPI_EXT2_REG (0xF8)



SPI_ST The current state of the SPI state machine: (RO)

- 0: idle state
- 1: preparation state
- 2: send command state
- 3: send data state
- 4: read data state
- 5: write data state
- 6: wait state
- 7: done state

Register 7.25: SPI_DMA_CONF_REG (0x100)

(reserved)																	SPI_DMA_CONTINUE		SPI_DMA_TX_STOP		SPI_DMA_RX_STOP		(reserved)		SPI_OUT_DATA_BURST_EN		SPI_INDSOCR_BURST_EN		SPI_OUTDSCR_BURST_EN		(reserved)		SPI_AHBM_RST		SPI_AHBM_FIFO_RST		SPI_OUT_RST		SPI_IN_RST		(reserved)	
31																17	16	15	14	13	12	11	10	9	8			6	5	4	3	2	3	2								
0	0	0	0	0	0	0	0	0	0	0	0	0	0	0	0	0	0	0	1	0	0	0	0	0	0	0	0	0	0	0	0	0	0	0								

Reset

SPI_DMA_CONTINUE This bit enables SPI DMA continuous data Tx/Rx mode. (R/W)

SPI_DMA_TX_STOP When in continuous Tx/Rx mode, setting this bit stops sending data. (R/W)

SPI_DMA_RX_STOP When in continuous Tx/Rx mode, setting this bit stops receiving data. (R/W)

SPI_OUT_DATA_BURST_EN SPI DMA reads data from memory in burst mode. (R/W)

SPI_INDSOCR_BURST_EN SPI DMA reads descriptor in burst mode when writing data to the memory. (R/W)

SPI_OUTDSCR_BURST_EN SPI DMA reads descriptor in burst mode when reading data from the memory. (R/W)

SPI_OUT_EOF_MODE DMA out-EOF-flag generation mode. (R/W)

1: out-EOF-flag is generated when DMA has popped all data from the FIFO;

0: out-EOF-flag is generated when DMA has pushed all data to the FIFO.

SPI_AHBM_RST reset SPI DMA AHB master. (R/W)

SPI_AHBM_FIFO_RST This bit is used to reset SPI DMA AHB master FIFO pointer. (R/W)

SPI_OUT_RST The bit is used to reset DMA out-FSM and out-data FIFO pointer. (R/W)

SPI_IN_RST The bit is used to reset DMA in-DSM and in-data FIFO pointer. (R/W)

Register 7.26: SPI_DMA_OUT_LINK_REG (0x104)

(reserved)				SPI_OUTLINK_RESTART		SPI_OUTLINK_START		SPI_OUTLINK_STOP		(reserved)										SPI_OUTLINK_ADDR		
31	30	29	28	27						20	19											0
0	0	0	0	0	0	0	0	0	0	0	0	0x000000										0

Reset

SPI_OUTLINK_RESTART Set the bit to add new outlink descriptors. (R/W)

SPI_OUTLINK_START Set the bit to start to use outlink descriptor. (R/W)

SPI_OUTLINK_STOP Set the bit to stop to use outlink descriptor. (R/W)

SPI_OUTLINK_ADDR The address of the first outlink descriptor. (R/W)

Register 7.27: SPI_DMA_IN_LINK_REG (0x108)

(reserved)				SPI_INLINK_RESTART	(reserved)				SPI_INLINK_AUTO_RET	(reserved)											SPI_INLINK_ADDR			0	Reset			
31	30	29	28	27	21	20	19												0x000000			0						
0	0	0	0	0	0	0	0	0	0	0	0	0	0	0	0	0	0	0	0	0	0	0	0	0	0	0	0	0

SPI_INLINK_RESTART Set the bit to add new inlink descriptors. (R/W)

SPI_INLINK_START Set the bit to start to use inlink descriptor. (R/W)

SPI_INLINK_STOP Set the bit to stop to use inlink descriptor. (R/W)

SPI_INLINK_AUTO_RET when the bit is set, inlink descriptor jumps to the next descriptor when a packet is invalid. (R/W)

SPI_INLINK_ADDR The address of the first inlink descriptor. (R/W)

Register 7.28: SPI_DMA_STATUS_REG (0x10C)

(reserved)																											SPI_DMA_TX_EN			SPI_DMA_RX_EN			Reset
31																										2	1	0	0	0			
0	0	0	0	0	0	0	0	0	0	0	0	0	0	0	0	0	0	0	0	0	0	0	0	0	0	0	0	0	0	0			

SPI_DMA_TX_EN SPI DMA write-data status bit. (RO)

SPI_DMA_RX_EN SPI DMA read-data status bit. (RO)

Register 7.29: SPI_DMA_INT_ENA_REG (0x110)

(reserved)										SPI_OUT_TOTAL_EOF_INT_ENA SPI_OUT_EOF_INT_ENA SPI_OUT_DONE_INT_ENA SPI_IN_SUC_EOF_INT_ENA SPI_IN_ERR_EOF_INT_ENA SPI_IN_DONE_INT_ENA SPI_INLINK_DSCR_ERROR_INT_ENA SPI_OUTLINK_DSCR_ERROR_INT_ENA SPI_INLINK_DSCR_EMPTY_INT_ENA																												
31																			9	8	7	6	5	4	3	2	1	0	Reset									
0																			0	0	0	0	0	0	0	0	0	0	0	0	0	0	0	0	0	0	0	0

SPI_OUT_TOTAL_EOF_INT_ENA The interrupt enable bit for the [SPI_OUT_TOTAL_EOF_INT](#) interrupt. (R/W)

SPI_OUT_EOF_INT_ENA The interrupt enable bit for the [SPI_OUT_EOF_INT](#) interrupt. (R/W)

SPI_OUT_DONE_INT_ENA The interrupt enable bit for the [SPI_OUT_DONE_INT](#) interrupt. (R/W)

SPI_IN_SUC_EOF_INT_ENA The interrupt enable bit for the [SPI_IN_SUC_EOF_INT](#) interrupt. (R/W)

SPI_IN_ERR_EOF_INT_ENA The interrupt enable bit for the [SPI_IN_ERR_EOF_INT](#) interrupt. (R/W)

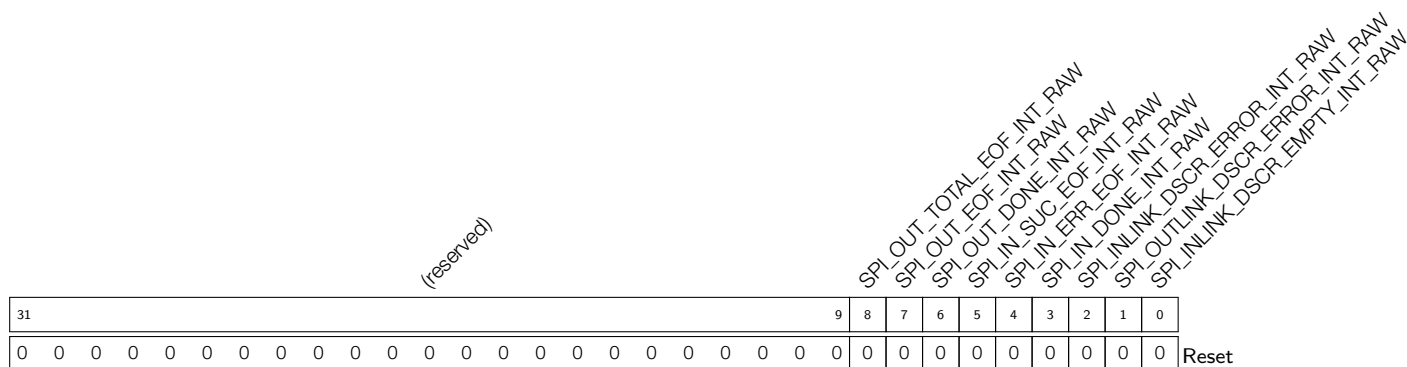
SPI_IN_DONE_INT_ENA The interrupt enable bit for the [SPI_IN_DONE_INT](#) interrupt. (R/W)

SPI_INLINK_DSCR_ERROR_INT_ENA The interrupt enable bit for the [SPI_INLINK_DSCR_ERROR_INT](#) interrupt. (R/W)

SPI_OUTLINK_DSCR_ERROR_INT_ENA The interrupt enable bit for the [SPI_OUTLINK_DSCR_ERROR_INT](#) interrupt. (R/W)

SPI_INLINK_DSCR_EMPTY_INT_ENA The interrupt enable bit for the [SPI_INLINK_DSCR_EMPTY_INT](#) interrupt. (R/W)

Register 7.30: SPI_DMA_INT_RAW_REG (0x114)



SPI_OUT_TOTAL_EOF_INT_RAW The raw interrupt status bit for the [SPI_OUT_TOTAL_EOF_INT](#) interrupt. (RO)

SPI_OUT_EOF_INT_RAW The raw interrupt status bit for the [SPI_OUT_EOF_INT](#) interrupt. (RO)

SPI_OUT_DONE_INT_RAW The raw interrupt status bit for the [SPI_OUT_DONE_INT](#) interrupt. (RO)

SPI_IN_SUC_EOF_INT_RAW The raw interrupt status bit for the [SPI_IN_SUC_EOF_INT](#) interrupt. (RO)

SPI_IN_ERR_EOF_INT_RAW The raw interrupt status bit for the [SPI_IN_ERR_EOF_INT](#) interrupt. (RO)

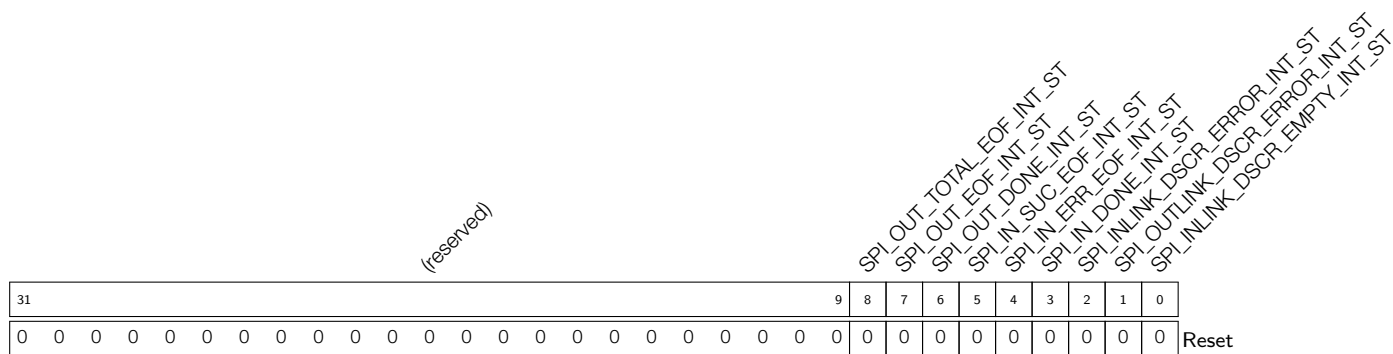
SPI_IN_DONE_INT_RAW The raw interrupt status bit for the [SPI_IN_DONE_INT](#) interrupt. (RO)

SPI_INLINK_DSCR_ERROR_INT_RAW The raw interrupt status bit for the [SPI_INLINK_DSCR_ERROR_INT](#) interrupt. (RO)

SPI_OUTLINK_DSCR_ERROR_INT_RAW The raw interrupt status bit for the [SPI_OUTLINK_DSCR_ERROR_INT](#) interrupt. (RO)

SPI_INLINK_DSCR_EMPTY_INT_RAW The raw interrupt status bit for the [SPI_INLINK_DSCR_EMPTY_INT](#) interrupt. (RO)

Register 7.31: SPI_DMA_INT_ST_REG (0x118)



SPI_OUT_TOTAL_EOF_INT_ST The masked interrupt status bit for the [SPI_OUT_TOTAL_EOF_INT](#) interrupt. (RO)

SPI_OUT_EOF_INT_ST The masked interrupt status bit for the [SPI_OUT_EOF_INT](#) interrupt. (RO)

SPI_OUT_DONE_INT_ST The masked interrupt status bit for the [SPI_OUT_DONE_INT](#) interrupt. (RO)

SPI_IN_SUC_EOF_INT_ST The masked interrupt status bit for the [SPI_IN_SUC_EOF_INT](#) interrupt. (RO)

SPI_IN_ERR_EOF_INT_ST The masked interrupt status bit for the [SPI_IN_ERR_EOF_INT](#) interrupt. (RO)

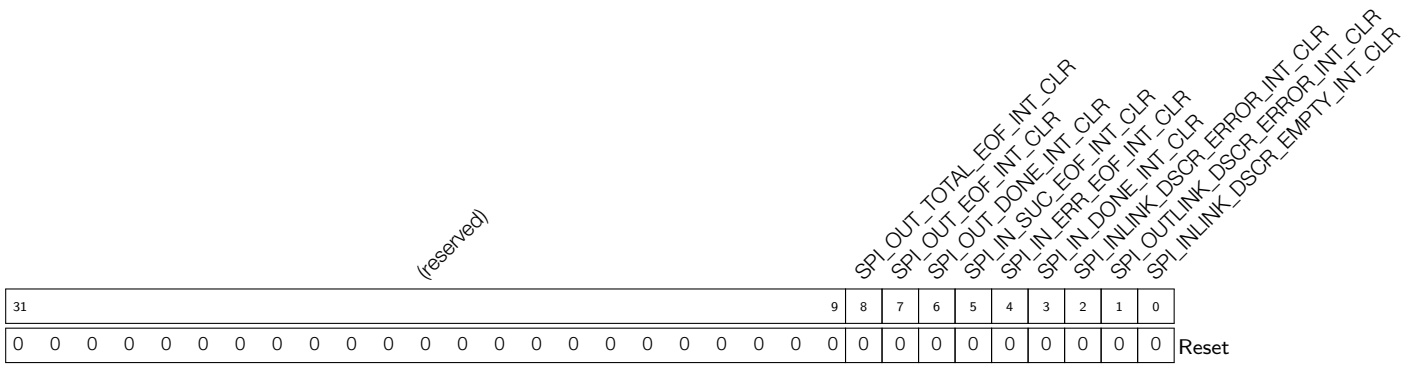
SPI_IN_DONE_INT_ST The masked interrupt status bit for the [SPI_IN_DONE_INT](#) interrupt. (RO)

SPI_INLINK_DSCR_ERROR_INT_ST The masked interrupt status bit for the [SPI_INLINK_DSCR_ERROR_INT](#) interrupt. (RO)

SPI_OUTLINK_DSCR_ERROR_INT_ST The masked interrupt status bit for the [SPI_OUTLINK_DSCR_ERROR_INT](#) interrupt. (RO)

SPI_INLINK_DSCR_EMPTY_INT_ST The masked interrupt status bit for the [SPI_INLINK_DSCR_EMPTY_INT](#) interrupt. (RO)

Register 7.32: SPI_DMA_INT_CLR_REG (0x11C)



SPI_OUT_TOTAL_EOF_INT_CLR Set this bit to clear the [SPI_OUT_TOTAL_EOF_INT](#) interrupt. (R/W)

SPI_OUT_EOF_INT_CLR Set this bit to clear the [SPI_OUT_EOF_INT](#) interrupt. (R/W)

SPI_OUT_DONE_INT_CLR Set this bit to clear the [SPI_OUT_DONE_INT](#) interrupt. (R/W)

SPI_IN_SUC_EOF_INT_CLR Set this bit to clear the [SPI_IN_SUC_EOF_INT](#) interrupt. (R/W)

SPI_IN_ERR_EOF_INT_CLR Set this bit to clear the [SPI_IN_ERR_EOF_INT](#) interrupt. (R/W)

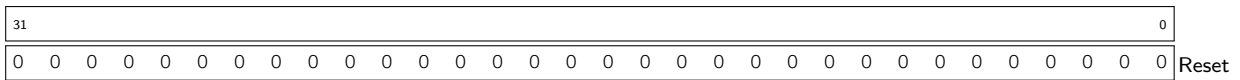
SPI_IN_DONE_INT_CLR Set this bit to clear the [SPI_IN_DONE_INT](#) interrupt. (R/W)

SPI_INLINK_DSCR_ERROR_INT_CLR Set this bit to clear the [SPI_INLINK_DSCR_ERROR_INT](#) interrupt. (R/W)

SPI_OUTLINK_DSCR_ERROR_INT_CLR Set this bit to clear the [SPI_OUTLINK_DSCR_ERROR_INT](#) interrupt. (R/W)

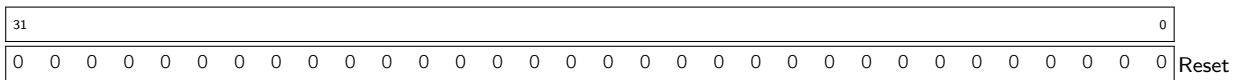
SPI_INLINK_DSCR_EMPTY_INT_CLR Set this bit to clear the [SPI_INLINK_DSCR_EMPTY_INT](#) interrupt. (R/W)

Register 7.33: SPI_IN_ERR_EOF_DES_ADDR_REG (0x120)



SPI_IN_ERR_EOF_DES_ADDR_REG The inlink descriptor address when SPI DMA encountered an error in receiving data. (RO)

Register 7.34: SPI_IN_SUC_EOF_DES_ADDR_REG (0x124)



SPI_IN_SUC_EOF_DES_ADDR_REG The last inlink descriptor address when SPI DMA encountered EOF. (RO)

Register 7.35: SPI_INLINK_DSCR_REG (0x128)

31	0
0 0	

Reset

SPI_INLINK_DSCR_REG The address of the current inlink descriptor. (RO)

Register 7.36: SPI_INLINK_DSCR_BF0_REG (0x12C)

31	0
0 0	

Reset

SPI_INLINK_DSCR_BF0_REG The address of the next inlink descriptor. (RO)

Register 7.37: SPI_INLINK_DSCR_BF1_REG (0x130)

31	0
0 0	

Reset

SPI_INLINK_DSCR_BF1_REG The address of the next inlink data buffer. (RO)

Register 7.38: SPI_OUT_EOF_BFR_DES_ADDR_REG (0x134)

31	0
0 0	

Reset

SPI_OUT_EOF_BFR_DES_ADDR_REG The buffer address corresponding to the outlink descriptor that produces EOF. (RO)

Register 7.39: SPI_OUT_EOF_DES_ADDR_REG (0x138)

31	0
0 0	

Reset

SPI_OUT_EOF_DES_ADDR_REG The last outlink descriptor address when SPI DMA encountered EOF. (RO)

Register 7.40: SPI_OUTLINK_DSCR_REG (0x13C)

31	0
0 0	

Reset

SPI_OUTLINK_DSCR_REG The address of the current outlink descriptor. (RO)

Register 7.41: SPI_OUTLINK_DSCR_BF0_REG (0x140)

31																													0											
0	0	0	0	0	0	0	0	0	0	0	0	0	0	0	0	0	0	0	0	0	0	0	0	0	0	0	0	0	0	0	0	0	0	0	0	0	0	0	0	Reset

SPI_OUTLINK_DSCR_BF0_REG The address of the next outlink descriptor. (RO)

Register 7.42: SPI_OUTLINK_DSCR_BF1_REG (0x144)

31																													0											
0	0	0	0	0	0	0	0	0	0	0	0	0	0	0	0	0	0	0	0	0	0	0	0	0	0	0	0	0	0	0	0	0	0	0	0	0	0	0	0	Reset

SPI_OUTLINK_DSCR_BF1_REG The address of the next outlink data buffer. (RO)

Register 7.43: SPI_DMA_RSTATUS_REG (0x148)

TX_FIFO_EMPTY TX_FIFO_FULL			(reserved)																	TX_DES_ADDRESS		0																				
31	30	29																		20	19			0																		
0	0	0	0	0	0	0	0	0	0	0	0	0	0	0	0	0	0	0	0	0	0	0	0	0	0	0	0	0	0	0	0	0	0	0	0	0	0	0	0	0	0	Reset

TX_FIFO_EMPTY The SPI DMA Tx FIFO is empty. (RO)

TX_FIFO_FULL The SPI DMA Tx FIFO is full. (RO)

TX_DES_ADDRESS The LSB of the SPI DMA outlink descriptor address. (RO)

Register 7.44: SPI_DMA_TSTATUS_REG (0x14C)

RX_FIFO_EMPTY RX_FIFO_FULL			(reserved)																	RX_DES_ADDRESS		0																					
31	30	29																		20	19			0																			
0	0	0	0	0	0	0	0	0	0	0	0	0	0	0	0	0	0	0	0	0	0	0	0	0	0	0	0	0	0	0	0	0	0	0	0	0	0	0	0	0	0	0	Reset

RX_FIFO_EMPTY The SPI DMA Rx FIFO is empty. (RO)

RX_FIFO_FULL The SPI DMA Rx FIFO is full. (RO)

RX_DES_ADDRESS The LSB of the SPI DMA inlink descriptor address. (RO)

8. SDIO Slave

8.1 Overview

The ESP32 features hardware support for the industry-standard Secure Digital (SD) device interface that conforms to the SD Input/Output (SDIO) Specification Version 2.0. This allows a host controller to access the ESP32 via an SDIO bus protocol, enabling high-speed data transfer.

The SDIO interface may be used to read ESP32 SDIO registers directly and access shared memory via Direct Memory Access (DMA), thus reducing processing overhead while maintaining high performance.

8.2 Features

- Meets SDIO V2.0 specification
- Supports SDIO SPI, 1-bit, and 4-bit transfer modes
- Full host clock range of 0 ~ 50 MHz
- Configurable sample and drive clock edge
- Integrated, SDIO-accessible registers for information interaction
- Supports SDIO interrupt mechanism
- Automatic data padding
- Block size of up to 512 bytes
- Interrupt vector between Host and Slave for bidirectional interrupt
- Supports DMA for data transfer

8.3 Functional Description

8.3.1 SDIO Slave Block Diagram

The functional block diagram of the SDIO slave module is shown in Figure 20.

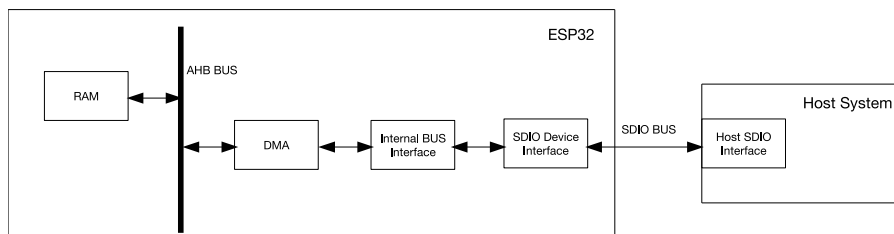


Figure 20: SDIO Slave Block Diagram

The Host System represents any SDIO specification V2.0-compatible host device. The Host System interacts with the ESP32 (configured as the SDIO slave) via the standard SDIO bus implementation.

The SDIO Device Interface block enables effective communication with the external Host by directly providing SDIO interface registers and enabling DMA operation for high-speed data transfer over the Advanced High-performance Bus (AHB) without engaging the CPU.

8.3.2 Sending and Receiving Data on SDIO Bus

Data is transmitted between Host and Slave through the SDIO bus I/O Function1. After the Host enables the I/O Function1 in the Slave, according to the SDIO protocol, data transmission will begin.

ESP32 segregates data into packets sent to/from the Host. To achieve high bus utilization and data transfer rates, we recommend the single block transmission mode. For detailed information on this mode, please refer to the SDIO V2.0 protocol specification. When Host and Slave exchange data as blocks on the SDIO bus, the Slave automatically pads data-when sending data out-and automatically strips padding data from the incoming data block.

Whether the Slave pads or discards the data depends on the data address on the SDIO bus. When the data address is equal to, or greater than, 0x1F800, the Slave will start padding or discarding data. Therefore, the starting data address should be 0x1F800 - Packet_length, where Packet_length is measured in bytes. Data flow on the SDIO bus is shown in Figure 21.

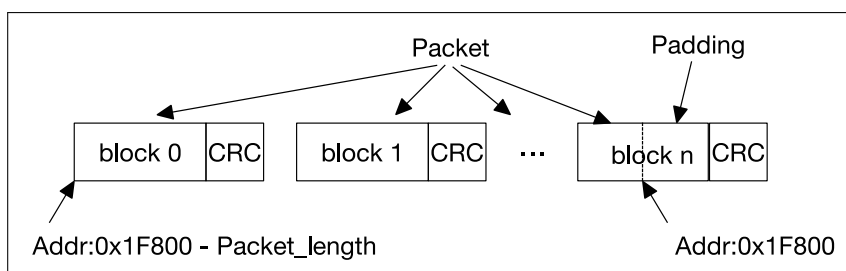


Figure 21: SDIO Bus Packet Transmission

The standard IO_RW_EXTENDED (CMD53) command is used to initiate a packet transfer of an arbitrary length. The content of the CMD53 command used in data transmission is as illustrated in Figure 22 below. For detailed information on CMD53, please refer to the SDIO protocol specifications.

S	D	Command Index 11010b	R/W Flag	Function Number 001b	Block Mode 1b	OP Code 1b	Register Address 0x1F800-Packet_length	CRC7	E
1	1	6	1	3	1	1	17	7	1

Figure 22: CMD53 Content

8.3.3 Register Access

For effective interaction between Host and Slave, the Host can access certain registers in the Slave via the SDIO bus I/O Function1. These registers are in continuous address fields from SLCHOST_TOKEN_RDATA to SLCHOST_INF_ST. The Host device can access these registers by simply setting the register addresses of CMD52 or CMD53 to the low 10 bits of the corresponding register address. The Host can access several consecutive registers at one go with CMD53, thus achieving a higher effective transfer rate.

There are 54 bytes of field between SLCHOST_CONF_W0_REG and SLCHOST_CONF_W15_REG. Host and Slave can access and change these fields, thus facilitating the information interaction between Host and Slave.

8.3.4 DMA

The SDIO Slave module uses dedicated DMA to access data residing in the RAM. As shown in Figure 20, the RAM is accessed over the AHB. DMA accesses RAM through a linked-list descriptor. Every linked list is composed of three words, as shown in Figure 23.

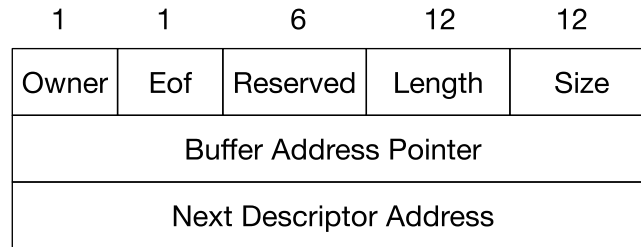


Figure 23: SDIO Slave DMA Linked List Structure

- Owner: The allowed operator of the buffer that corresponds to the current linked list. 0: CPU is the allowed operator; 1: DMA is the allowed operator.
- Eof: End-of-file marker, indicating that this linked-list element is the last element of the data packet.
- Length: The number of valid bytes in the buffer, i.e., the number of bytes that should be accessed from the buffer for reading/writing.
- Size: The maximum number of available buffers.
- Buffer Address Pointer: The address of the data buffer as seen by the CPU (according to the RAM address space).
- Next Descriptor Address: The address of the next linked-list element in the CPU RAM address space. If the current linked list is the last one, the Eof bit should be 1, and the last descriptor address should be 0.

The Slave's linked-list chain is shown in Figure 24:

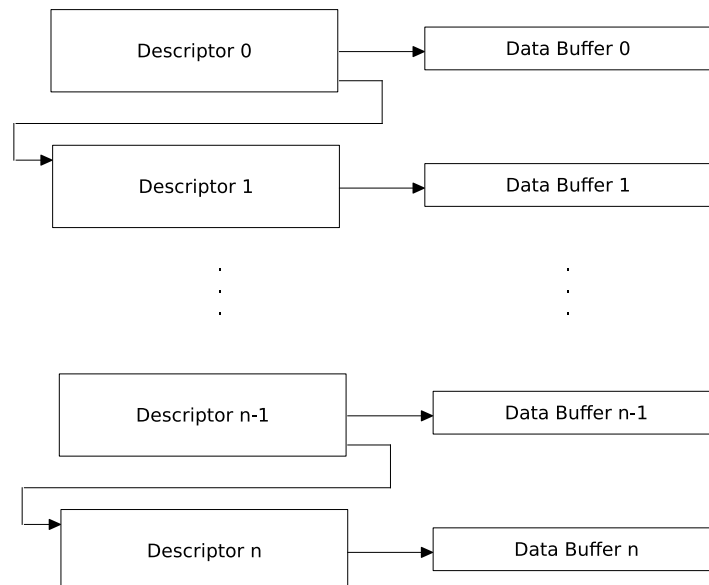


Figure 24: SDIO Slave Linked List

8.3.5 Packet-Sending/-Receiving Procedure

The SDIO Host and Slave devices need to follow specific data transfer procedures to successfully exchange data over the SDIO interface.

8.3.5.1 Sending Packets to SDIO Host

The transmission of packets from Slave to Host is initiated by the Slave. The Host will be notified with an interrupt (for detailed information on interrupts, please refer to SDIO protocol). After the Host reads the relevant information from the Slave, it will initiate an SDIO bus transaction accordingly. The whole procedure is illustrated in Figure 25.

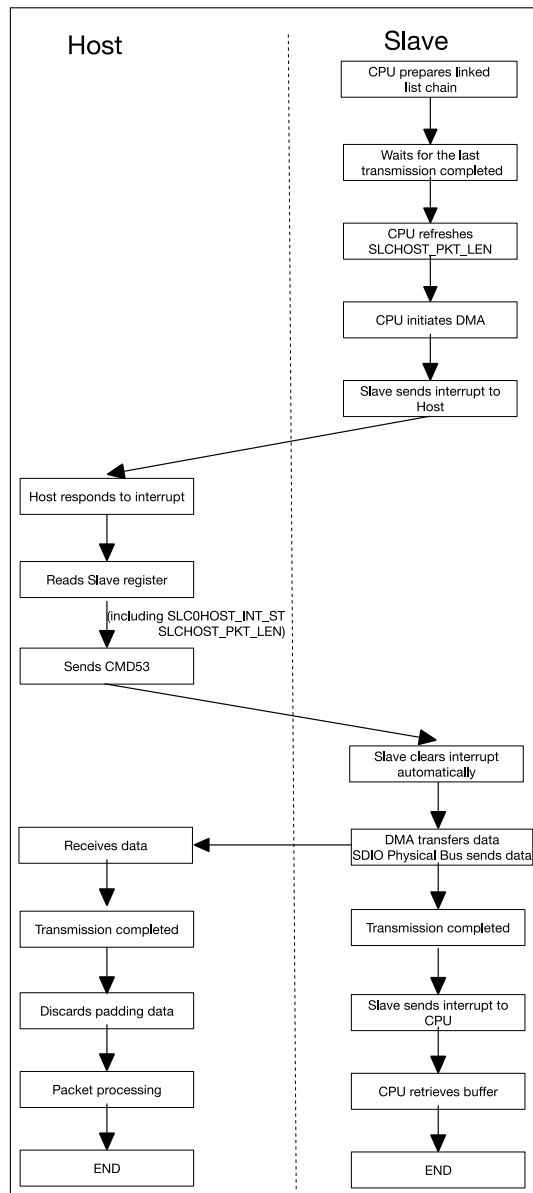


Figure 25: Packet Sending Procedure (Initiated by Slave)

When the Host is interrupted, it reads relevant information from the Slave by visiting registers SLC0HOST_INT and SLC0HOST_PKT_LEN.

- SLC0HOST_INT: Interrupt status register. If the value of SLC0_RX_NEW_PACKET_INT_ST is 1, this indicates that the Slave has a packet to send.
- SLCHOST_PKT_LEN: Packet length accumulator register. The current value minus the value of last time equals the packet length sent this time.

In order to start DMA, the CPU needs to write the low 20 bits of the address of the first linked-list element to the SLC0_RXLINK_ADDR bit of SLC0RX_LINK, then set the SLC0_RXLINK_START bit of SLC0RX_LINK. The DMA will automatically complete the data transfer. Upon completion of the operation, DMA will interrupt the CPU so that the buffer space can be freed or reused.

8.3.5.2 Receiving Packets from SDIO Host

Transmission of packets from Host to Slave is initiated by the Host. The Slave receives data via DMA and stores it in RAM. After transmission is completed, the CPU will be interrupted to process the data. The whole procedure is demonstrated in Figure 26.

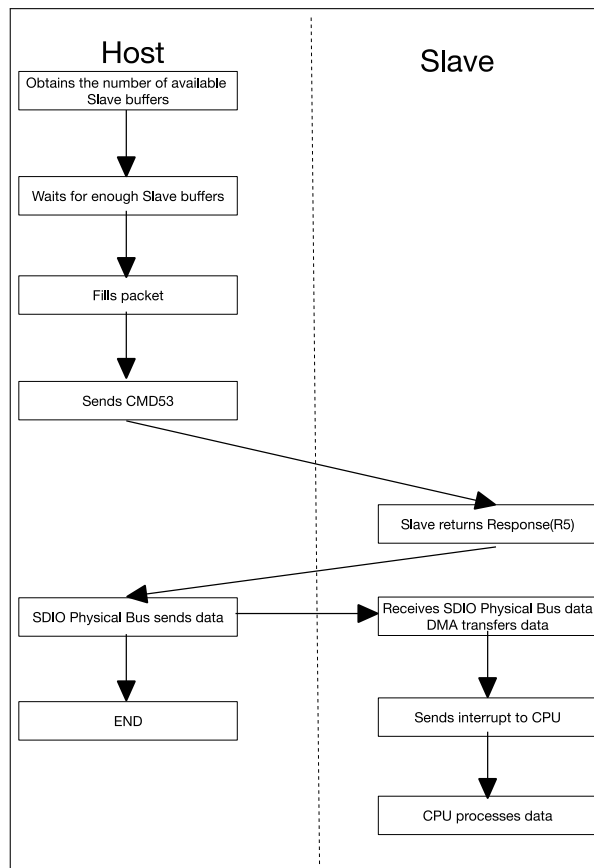


Figure 26: Packet Receiving Procedure (Initiated by Host)

The Host obtains the number of available receiving buffers from the Slave by accessing register SLC0HOST_TOKEN_RDATA. The Slave CPU should update this value after the receiving DMA linked list is prepared.

HOSTREG_SLC0_TOKEN1 in SLC0HOST_TOKEN_RDATA stores the accumulated number of available buffers.

The Host can figure out the available buffer space, using HOSTREG_SLC0_TOKEN1 minus the number of buffers already used.

If the buffers are not enough, the Host needs to constantly poll the register until there are enough buffers available.

To ensure sufficient receiving buffers, the Slave CPU must constantly load buffers on the receiving linked list. The process is shown in Figure 27.

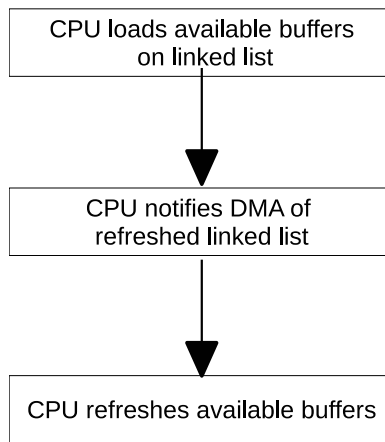


Figure 27: Loading Receiving Buffer

The CPU first needs to append new buffer segments at the end of the linked list that is being used by DMA and is available for receiving data.

The CPU then needs to notify the DMA that the linked list has been modified. This can be done by setting bit `SLC0_TXLINK_RESTART` of the `SLC0TX_LINK` register. Please note that when the CPU initiates DMA to receive packets for the first time, `SLC0_TXLINK_RESTART` should be set to 1.

Lastly, the CPU refreshes any available buffer information by writing to the `SLC0TOKEN1` register.

8.3.6 SDIO Bus Timing

The SDIO bus operates at a very high speed and the PCB trace length usually affects signal integrity by introducing latency. To ensure that the timing characteristics conform to the desired bus timing, the SDIO Slave module supports configuration of input sampling clock edge and output driving clock edge.

When the incoming data changes near the rising edge of the clock, the Slave will perform sampling on the falling edge of the clock, or vice versa, as Figure 28 shows.

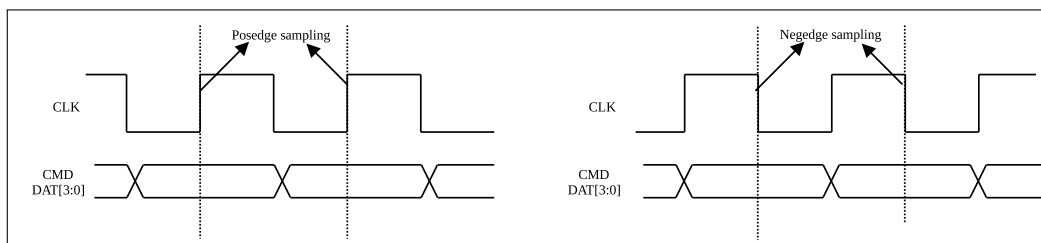


Figure 28: Sampling Timing Diagram

Sampling edges are configured via the `FRC_POS_SAMP` and `FRC_NEG_SAMP` bitfields in the `SLCHOST_CONF` register. Each field is five bits wide, with bits corresponding to the `CMD` line and four `DATA` lines (0-3). Setting a bit in `FRC_POS_SAMP` causes the corresponding line to be sampled for input at the rising clock edge, whereas setting a bit in `FRC_NEG_SAMP` causes the corresponding line to be sampled for input at the falling clock edge.

The Slave can also select the edge at which data output lines are driven to accommodate for any latency caused by the physical signal path, as shown in Figure 29.

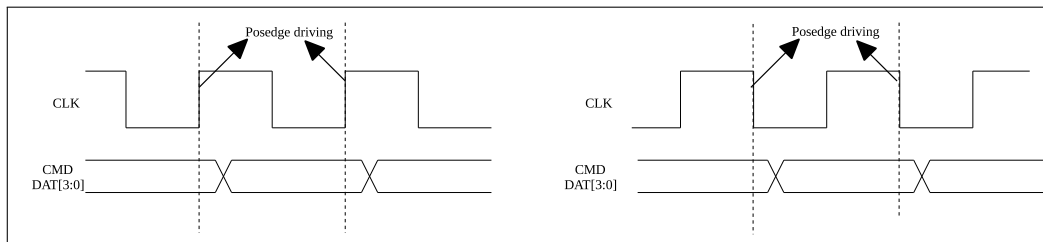


Figure 29: Output Timing Diagram

Driving edges are configured via the `FRC_SDIO20` and `FRC_SDIO11` bitfields in the `SLCHOST_CONF` register. Each field is five bits wide, with bits corresponding to the CMD line and four DATA lines (0-3). Setting a bit in `FRC_SDIO20` causes the corresponding line to output at the rising clock edge, whereas setting a bit in `FRC_SDIO11` causes the corresponding line to output at the falling clock edge.

8.3.7 Interrupt

Host and Slave can interrupt each other via the interrupt vector. Both Host and Slave have eight interrupt vectors. The interrupt is enabled by configuring the interrupt vector register (setting the enable bit to 1). The interrupt vector registers can clear themselves automatically, which means one interrupt at a time and no other configuration is required.

8.3.7.1 Host Interrupt

- `SLC0HOST_SLC0_RX_NEW_PACKET_INT` Slave has a packet to send.
- `SLC0HOST_SLC0_TX_OVF_INT` Slave receiving buffer overflow interrupt.
- `SLC0HOST_SLC0_RX_UDF_INT` Slave sending buffer underflow interrupt.
- `SLC0HOST_SLC0_TOHOST_BITn_INT` (n : 0 ~ 7) Slave interrupts Host.

8.3.7.2 Slave Interrupt

- `SLC0INT_SLC0_RX_DSCR_ERR_INT` Slave sending descriptor error.
- `SLC0INT_SLC0_TX_DSCR_ERR_INT` Slave receiving descriptor error.
- `SLC0INT_SLC0_RX_EOF_INT` Slave sending operation is finished.
- `SLC0INT_SLC0_RX_DONE_INT` A single buffer is sent by Slave.
- `SLC0INT_SLC0_TX_SUC_EOF_INT` Slave receiving operation is finished.
- `SLC0INT_SLC0_TX_DONE_INT` A single buffer is finished during receiving operation.
- `SLC0INT_SLC0_TX_OVF_INT` Slave receiving buffer overflow interrupt.
- `SLC0INT_SLC0_RX_UDF_INT` Slave sending buffer underflow interrupt.
- `SLC0INT_SLC0_TX_START_INT` Slave receiving interrupt initialization.
- `SLC0INT_SLC0_RX_START_INT` Slave sending interrupt initialization.

- `SLC0INT_SLC_FRHOST_BITn_INT` (n : 0 ~ 7) Host interrupts Slave.

8.4 Register Summary

Name	Description	Address	Access
SDIO DMA (SLC) configuration registers			
<code>SLCCONF0_REG</code>	SLCCONF0_SLC configuration	0x3FF58000	R/W
<code>SLC0INT_RAW_REG</code>	Raw interrupt status	0x3FF58004	RO
<code>SLC0INT_ST_REG</code>	Interrupt status	0x3FF58008	RO
<code>SLC0INT_ENA_REG</code>	Interrupt enable	0x3FF5800C	R/W
<code>SLC0INT_CLR_REG</code>	Interrupt clear	0x3FF58010	WO
<code>SLC0RX_LINK_REG</code>	Transmitting linked list configuration	0x3FF5803C	R/W
<code>SLC0TX_LINK_REG</code>	Receiving linked list configuration	0x3FF58040	R/W
<code>SLCINTVEC_TOHOST_REG</code>	Interrupt sector for Slave to interrupt Host	0x3FF5804C	WO
<code>SLC0TOKEN1_REG</code>	Number of receiving buffer	0x3FF58054	WO
<code>SLCCONF1_REG</code>	Control register	0x3FF58060	R/W
<code>SLC_RX_DSCR_CONF_REG</code>	DMA transmission configuration	0x3FF58098	R/W
<code>SLC0_LEN_CONF_REG</code>	Length control of the transmitting packets	0x3FF580E4	R/W
<code>SLC0_LENGTH_REG</code>	Length of the transmitting packets	0x3FF580E8	R/W

Name	Description	Address	Access
SDIO SLC Host registers			
<code>SLC0HOST_INT_RAW_REG</code>	Raw interrupt	0x3FF55000	RO
<code>SLC0HOST_TOKEN_RDATA</code>	The accumulated number of Slave's receiving buffers	0x3FF55044	RO
<code>SLC0HOST_INT_ST_REG</code>	Masked interrupt status	0x3FF55058	RO
<code>SLCHOST_PKT_LEN_REG</code>	Length of the transmitting packets	0x3FF55060	RO
<code>SLCHOST_CONF_W0_REG</code>	Host and Slave communication register0	0x3FF5506C	R/W
<code>SLCHOST_CONF_W1_REG</code>	Host and Slave communication register1	0x3FF55070	R/W
<code>SLCHOST_CONF_W2_REG</code>	Host and Slave communication register2	0x3FF55074	R/W
<code>SLCHOST_CONF_W3_REG</code>	Host and Slave communication register3	0x3FF55078	R/W
<code>SLCHOST_CONF_W4_REG</code>	Host and Slave communication register4	0x3FF5507C	R/W
<code>SLCHOST_CONF_W6_REG</code>	Host and Slave communication register6	0x3FF55088	R/W
<code>SLCHOST_CONF_W7_REG</code>	Interrupt vector for Host to interrupt Slave	0x3FF5508C	WO
<code>SLCHOST_CONF_W8_REG</code>	Host and Slave communication register8	0x3FF5509C	R/W
<code>SLCHOST_CONF_W9_REG</code>	Host and Slave communication register9	0x3FF550A0	R/W
<code>SLCHOST_CONF_W10_REG</code>	Host and Slave communication register10	0x3FF550A4	R/W
<code>SLCHOST_CONF_W11_REG</code>	Host and Slave communication register11	0x3FF550A8	R/W
<code>SLCHOST_CONF_W12_REG</code>	Host and Slave communication register12	0x3FF550AC	R/W
<code>SLCHOST_CONF_W13_REG</code>	Host and Slave communication register13	0x3FF550B0	R/W
<code>SLCHOST_CONF_W14_REG</code>	Host and Slave communication register14	0x3FF550B4	R/W
<code>SLCHOST_CONF_W15_REG</code>	Host and Slave communication register15	0x3FF550B8	R/W
<code>SLC0HOST_INT_CLR_REG</code>	Interrupt clear	0x3FF550D4	WO
<code>SLC0HOST_FUNC1_INT_ENA_REG</code>	Interrupt enable	0x3FF550DC	R/W

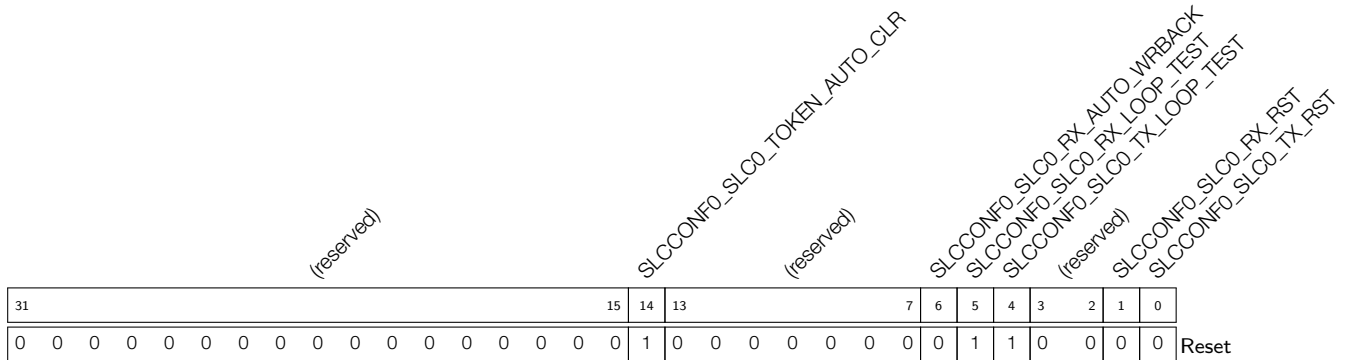
SLCHOST_CONF_REG	Edge configuration	0x3FF551F0	R/W
------------------	--------------------	------------	-----

Name	Description	Address	Access
SDIO HINF registers			
HINF_CFG_DATA1_REG	SDIO specification configuration	0x3FF4B004	R/W

8.5 SLC Registers

The first block of SDIO control registers starts at 0x3FF5_8000.

Register 8.1: SLCCONF0_REG (0x0)



SLCCONF0_SLC0_TOKEN_AUTO_CLR Please initialize to 0. Do not modify it. (R/W)

SLCCONF0_SLC0_RX_AUTO_WRBACK Allows changing the owner bit of the transmitting buffer's linked list when transmitting data. (R/W)

SLCCONF0_SLC0_RX_LOOP_TEST Loop around when the slave buffer finishes sending packets. When set to 1, hardware will not change the owner bit in the linked list. (R/W)

SLCCONF0_SLC0_TX_LOOP_TEST Loop around when the slave buffer finishes receiving packets. When set to 1, hardware will not change the owner bit in the linked list. (R/W)

SLCCONF0_SLC0_RX_RST Set this bit to reset the transmitting FSM. (R/W)

SLCCONF0_SLC0_TX_RST Set this bit to reset the receiving FSM. (R/W)

Register 8.2: SLC0INT_RAW_REG (0x4)

31	27	26	21	20	19	18	17	16	15	14	13	12	11	10	9	8	7	6	5	4	3	2	1	0
0x00	0	0	0	0	0	0	0	0	0	0	0	0	0	0	0	0	0	0	0	0	0	0	0	0

Reset

SLC0INT_SLC0_RX_DSCR_ERR_INT_RAW The raw interrupt bit for Slave sending descriptor error (RO)

SLC0INT_SLC0_TX_DSCR_ERR_INT_RAW The raw interrupt bit for Slave receiving descriptor error. (RO)

SLC0INT_SLC0_RX_EOF_INT_RAW The interrupt mark bit when Slave sending operation is finished. (RO)

SLC0INT_SLC0_RX_DONE_INT_RAW The raw interrupt bit to mark single buffer as sent by Slave. (RO)

SLC0INT_SLC0_TX_SUC_EOF_INT_RAW The raw interrupt bit to mark Slave receiving operation as finished. (RO)

SLC0INT_SLC0_TX_DONE_INT_RAW The raw interrupt bit to mark a single buffer as finished during Slave receiving operation. (RO)

SLC0INT_SLC0_TX_OVF_INT_RAW The raw interrupt bit to mark Slave receiving buffer overflow. (RO)

SLC0INT_SLC0_RX_UDF_INT_RAW The raw interrupt bit for Slave sending buffer underflow. (RO)

SLC0INT_SLC0_TX_START_INT_RAW The raw interrupt bit for registering Slave receiving initialization interrupt. (RO)

SLC0INT_SLC0_RX_START_INT_RAW The raw interrupt bit to mark Slave sending initialization interrupt. (RO)

SLC0INT_SLC_FRH0ST_BIT7_INT_RAW The interrupt mark bit 7 for Host to interrupt Slave. (RO)

SLC0INT_SLC_FRH0ST_BIT6_INT_RAW The interrupt mark bit 6 for Host to interrupt Slave. (RO)

SLC0INT_SLC_FRH0ST_BIT5_INT_RAW The interrupt mark bit 5 for Host to interrupt Slave. (RO)

SLC0INT_SLC_FRH0ST_BIT4_INT_RAW The interrupt mark bit 4 for Host to interrupt Slave. (RO)

SLC0INT_SLC_FRH0ST_BIT3_INT_RAW The interrupt mark bit 3 for Host to interrupt Slave. (RO)

SLC0INT_SLC_FRH0ST_BIT2_INT_RAW The interrupt mark bit 2 for Host to interrupt Slave. (RO)

SLC0INT_SLC_FRH0ST_BIT1_INT_RAW The interrupt mark bit 1 for Host to interrupt Slave. (RO)

SLC0INT_SLC_FRH0ST_BIT0_INT_RAW The interrupt mark bit 0 for Host to interrupt Slave. (RO)

Register 8.3: SLC0INT_ST_REG (0x8)

31	27	26	25	24	23	22	21	20	19	18	17	16	15	14	13	12	11	10	9	8	7	6	5	4	3	2	1	0	Reset	
(reserved)		(reserved)					SLC0INT_SLC0_RX_DSCR_ERR_INT_ST	SLC0INT_SLC0_TX_DSCR_ERR_INT_ST	(reserved)	SLC0INT_SLC0_RX_EOF_INT_ST	SLC0INT_SLC0_RX_DONE_INT_ST	SLC0INT_SLC0_TX_SUC_EOF_INT_ST	(reserved)				SLC0INT_SLC0_TX_DONE_INT_ST	SLC0INT_SLC0_TX_OVF_INT_ST	SLC0INT_SLC0_RX_UDF_INT_ST	SLC0INT_SLC0_TX_START_INT_ST	SLC0INT_SLC_FRHOST_BIT7_INT_ST	SLC0INT_SLC_FRHOST_BIT6_INT_ST	SLC0INT_SLC_FRHOST_BIT5_INT_ST	SLC0INT_SLC_FRHOST_BIT4_INT_ST	SLC0INT_SLC_FRHOST_BIT3_INT_ST	SLC0INT_SLC_FRHOST_BIT2_INT_ST	SLC0INT_SLC_FRHOST_BIT1_INT_ST	SLC0INT_SLC_FRHOST_BIT0_INT_ST		
0x00		0	0	0	0	0	0	0	0	0	0	0	0	0	0	0	0	0	0	0	0	0	0	0	0	0	0	0	0	

SLC0INT_SLC0_RX_DSCR_ERR_INT_ST The interrupt status bit for Slave sending descriptor error. (RO)

SLC0INT_SLC0_TX_DSCR_ERR_INT_ST The interrupt status bit for Slave receiving descriptor error. (RO)

SLC0INT_SLC0_RX_EOF_INT_ST The interrupt status bit for finished Slave sending operation. (RO)

SLC0INT_SLC0_RX_DONE_INT_ST The interrupt status bit for finished Slave sending operation. (RO)

SLC0INT_SLC0_TX_SUC_EOF_INT_ST The interrupt status bit for marking Slave receiving operation as finished. (RO)

SLC0INT_SLC0_TX_DONE_INT_ST The interrupt status bit for marking a single buffer as finished during the receiving operation. (RO)

SLC0INT_SLC0_TX_OVF_INT_ST The interrupt status bit for Slave receiving overflow interrupt. (RO)

SLC0INT_SLC0_RX_UDF_INT_ST The interrupt status bit for Slave sending buffer underflow. (RO)

SLC0INT_SLC0_TX_START_INT_ST The interrupt status bit for Slave receiving interrupt initialization. (RO)

SLC0INT_SLC0_RX_START_INT_ST The interrupt status bit for Slave sending interrupt initialization. (RO)

SLC0INT_SLC_FRHOST_BIT7_INT_ST The interrupt status bit 7 for Host to interrupt Slave. (RO)

SLC0INT_SLC_FRHOST_BIT6_INT_ST The interrupt status bit 6 for Host to interrupt Slave. (RO)

SLC0INT_SLC_FRHOST_BIT5_INT_ST The interrupt status bit 5 for Host to interrupt Slave. (RO)

SLC0INT_SLC_FRHOST_BIT4_INT_ST The interrupt status bit 4 for Host to interrupt Slave. (RO)

SLC0INT_SLC_FRHOST_BIT3_INT_ST The interrupt status bit 3 for Host to interrupt Slave. (RO)

SLC0INT_SLC_FRHOST_BIT2_INT_ST The interrupt status bit 2 for Host to interrupt Slave. (RO)

SLC0INT_SLC_FRHOST_BIT1_INT_ST The interrupt status bit 1 for Host to interrupt Slave. (RO)

SLC0INT_SLC_FRHOST_BIT0_INT_ST The interrupt status bit 0 for Host to interrupt Slave. (RO)

Register 8.4: SLC0INT_ENA_REG (0xC)

(reserved)		(reserved)		SLC0INT_SLC0_RX_DSCR_ERR_INT_ENA		SLC0INT_SLC0_TX_DSCR_ERR_INT_ENA		(reserved)		SLC0INT_SLC0_RX_EOF_INT_ENA		SLC0INT_SLC0_RX_DONE_INT_ENA		SLC0INT_SLC0_TX_SUC_EOF_INT_ENA		(reserved)		SLC0INT_SLC0_TX_OVF_INT_ENA		SLC0INT_SLC0_RX_UDF_INT_ENA		SLC0INT_SLC0_TX_START_INT_ENA		SLC0INT_SLC_FRHOST_BIT7_INT_ENA		SLC0INT_SLC_FRHOST_BIT6_INT_ENA		SLC0INT_SLC_FRHOST_BIT5_INT_ENA		SLC0INT_SLC_FRHOST_BIT4_INT_ENA		SLC0INT_SLC_FRHOST_BIT3_INT_ENA		SLC0INT_SLC_FRHOST_BIT2_INT_ENA		SLC0INT_SLC_FRHOST_BIT1_INT_ENA		SLC0INT_SLC_FRHOST_BIT0_INT_ENA	
31	27	26	25	24	23	22	21	20	19	18	17	16	15	14	13	12	11	10	9	8	7	6	5	4	3	2	1	0	Reset										
0x00		0	0	0	0	0	0	0	0	0	0	0	0	0	0	0	0	0	0	0	0	0	0	0	0	0	0	0	0	0	0	0	0	0	0	0	0	0	0

SLC0INT_SLC0_RX_DSCR_ERR_INT_ENA The interrupt enable bit for Slave sending linked list descriptor error. (R/W)

SLC0INT_SLC0_TX_DSCR_ERR_INT_ENA The interrupt enable bit for Slave receiving linked list descriptor error. (R/W)

SLC0INT_SLC0_RX_EOF_INT_ENA The interrupt enable bit for Slave sending operation completion. (R/W)

SLC0INT_SLC0_RX_DONE_INT_ENA The interrupt enable bit for single buffer's sent interrupt, in Slave sending mode. (R/W)

SLC0INT_SLC0_TX_SUC_EOF_INT_ENA The interrupt enable bit for Slave receiving operation completion. (R/W)

SLC0INT_SLC0_TX_DONE_INT_ENA The interrupt enable bit for single buffer's full event, in Slave receiving mode. (R/W)

SLC0INT_SLC0_TX_OVF_INT_ENA The interrupt enable bit for Slave receiving buffer overflow. (R/W)

SLC0INT_SLC0_RX_UDF_INT_ENA The interrupt enable bit for Slave sending buffer underflow. (R/W)

SLC0INT_SLC0_TX_START_INT_ENA The interrupt enable bit for Slave receiving operation initialization. (R/W)

SLC0INT_SLC0_RX_START_INT_ENA The interrupt enable bit for Slave sending operation initialization. (R/W)

SLC0INT_SLC_FRHOST_BIT7_INT_ENA The interrupt enable bit 7 for Host to interrupt Slave. (R/W)

SLC0INT_SLC_FRHOST_BIT6_INT_ENA The interrupt enable bit 6 for Host to interrupt Slave. (R/W)

SLC0INT_SLC_FRHOST_BIT5_INT_ENA The interrupt enable bit 5 for Host to interrupt Slave. (R/W)

SLC0INT_SLC_FRHOST_BIT4_INT_ENA The interrupt enable bit 4 for Host to interrupt Slave. (R/W)

SLC0INT_SLC_FRHOST_BIT3_INT_ENA The interrupt enable bit 3 for Host to interrupt Slave. (R/W)

SLC0INT_SLC_FRHOST_BIT2_INT_ENA The interrupt enable bit 2 for Host to interrupt Slave. (R/W)

SLC0INT_SLC_FRHOST_BIT1_INT_ENA The interrupt enable bit 1 for Host to interrupt Slave. (R/W)

SLC0INT_SLC_FRHOST_BIT0_INT_ENA The interrupt enable bit 0 for Host to interrupt Slave. (R/W)

Register 8.5: SLC0INT_CLR_REG (0x10)

(reserved)					(reserved)					SLC0INT_SLC0_RX_DSCR_ERR_INT_CLR	SLC0INT_SLC0_TX_DSCR_ERR_INT_CLR	(reserved)	SLC0INT_SLC0_RX_EOF_INT_CLR	SLC0INT_SLC0_RX_DONE_INT_CLR	SLC0INT_SLC0_TX_SUC_EOF_INT_CLR	SLC0INT_SLC0_TX_DONE_INT_CLR	(reserved)	SLC0INT_SLC0_TX_OVF_INT_CLR	SLC0INT_SLC0_RX_UDF_INT_CLR	SLC0INT_SLC0_TX_START_INT_CLR	SLC0INT_SLC0_RX_START_INT_CLR	SLC0INT_SLC_FRHOST_BIT7_INT_CLR	SLC0INT_SLC_FRHOST_BIT6_INT_CLR	SLC0INT_SLC_FRHOST_BIT5_INT_CLR	SLC0INT_SLC_FRHOST_BIT4_INT_CLR	SLC0INT_SLC_FRHOST_BIT3_INT_CLR	SLC0INT_SLC_FRHOST_BIT2_INT_CLR	SLC0INT_SLC_FRHOST_BIT1_INT_CLR	SLC0INT_SLC_FRHOST_BIT0_INT_CLR
31		27	26		21	20	19	18	17	16	15	14	13	12	11	10	9	8	7	6	5	4	3	2	1	0			Reset
0x00			0	0	0	0	0	0	0	0	0	0	0	0	0	0	0	0	0	0	0	0	0	0	0	0	0	0	0

- SLC0INT_SLC0_RX_DSCR_ERR_INT_CLR** Interrupt clear bit for Slave sending linked list descriptor error. (WO)
- SLC0INT_SLC0_TX_DSCR_ERR_INT_CLR** Interrupt clear bit for Slave receiving linked list descriptor error. (WO)
- SLC0INT_SLC0_RX_EOF_INT_CLR** Interrupt clear bit for Slave sending operation completion. (WO)
- SLC0INT_SLC0_RX_DONE_INT_CLR** Interrupt clear bit for single buffer's sent interrupt, in Slave sending mode. (WO)
- SLC0INT_SLC0_TX_SUC_EOF_INT_CLR** Interrupt clear bit for Slave receiving operation completion. (WO)
- SLC0INT_SLC0_TX_DONE_INT_CLR** Interrupt clear bit for single buffer's full event, in Slave receiving mode. (WO)
- SLC0INT_SLC0_TX_OVF_INT_CLR** Set this bit to clear the Slave receiving overflow interrupt. (WO)
- SLC0INT_SLC0_RX_UDF_INT_CLR** Set this bit to clear the Slave sending underflow interrupt. (WO)
- SLC0INT_SLC0_TX_START_INT_CLR** Set this bit to clear the interrupt for Slave receiving operation initialization. (WO)
- SLC0INT_SLC0_RX_START_INT_CLR** Set this bit to clear the interrupt for Slave sending operation initialization. (WO)
- SLC0INT_SLC_FRHOST_BIT7_INT_CLR** Set this bit to clear the [SLC0INT_SLC_FRHOST_BIT7_INT](#) interrupt. (WO)
- SLC0INT_SLC_FRHOST_BIT6_INT_CLR** Set this bit to clear the [SLC0INT_SLC_FRHOST_BIT6_INT](#) interrupt. (WO)
- SLC0INT_SLC_FRHOST_BIT5_INT_CLR** Set this bit to clear the [SLC0INT_SLC_FRHOST_BIT5_INT](#) interrupt. (WO)
- SLC0INT_SLC_FRHOST_BIT4_INT_CLR** Set this bit to clear the [SLC0INT_SLC_FRHOST_BIT4_INT](#) interrupt. (WO)
- SLC0INT_SLC_FRHOST_BIT3_INT_CLR** Set this bit to clear the [SLC0INT_SLC_FRHOST_BIT3_INT](#) interrupt. (WO)
- SLC0INT_SLC_FRHOST_BIT2_INT_CLR** Set this bit to clear the [SLC0INT_SLC_FRHOST_BIT2_INT](#) interrupt. (WO)
- SLC0INT_SLC_FRHOST_BIT1_INT_CLR** Set this bit to clear the [SLC0INT_SLC_FRHOST_BIT1_INT](#) interrupt. (WO)
- SLC0INT_SLC_FRHOST_BIT0_INT_CLR** Set this bit to clear the [SLC0INT_SLC_FRHOST_BIT0_INT](#) interrupt. (WO)

Register 8.6: SLC0RX_LINK_REG (0x3C)

(reserved)				SLC0RX_SLC0_RXLINK_RESTART				(reserved)				SLC0RX_SLC0_RXLINK_ADDR				0
31	30	29	28	27					20	19					0	
0	0	0	0	0	0	0	0	0	0	0	0	0	0	0	0x000000	

Reset

SLC0RX_SLC0_RXLINK_RESTART Set this bit to restart and continue the linked list operation for sending packets. (R/W)

SLC0RX_SLC0_RXLINK_START Set this bit to start the linked list operation for sending packets. Sending will start from the address indicated by SLC0_RXLINK_ADDR. (R/W)

SLC0RX_SLC0_RXLINK_STOP Set this bit to stop the linked list operation. (R/W)

SLC0RX_SLC0_RXLINK_ADDR The lowest 20 bits in the initial address of Slave's sending linked list. (R/W)

Register 8.7: SLC0TX_LINK_REG (0x40)

(reserved)				SLC0TX_SLC0_TXLINK_RESTART				(reserved)				SLC0TX_SLC0_TXLINK_ADDR				0
31	30	29	28	27					20	19					0	
0	0	0	0	0	0	0	0	0	0	0	0	0	0	0	0x000000	

Reset

SLC0TX_SLC0_TXLINK_RESTART Set this bit to restart and continue the linked list operation for receiving packets. (R/W)

SLC0TX_SLC0_TXLINK_START Set this bit to start the linked list operation for receiving packets. Receiving will start from the address indicated by SLC0_TXLINK_ADDR. (R/W)

SLC0TX_SLC0_TXLINK_STOP Set this bit to stop the linked list operation for receiving packets. (R/W)

SLC0TX_SLC0_TXLINK_ADDR The lowest 20 bits in the initial address of Slave's receiving linked list. (R/W)

Register 8.8: SLCINTVEC_TOHOST_REG (0x4C)

(reserved)				(reserved)				(reserved)				SLCINTVEC_SLC0_TOHOST_INTVEC				
31	24	23	16	15	8	7							0			
0x000				0 0 0 0 0 0 0 0				0x000				0x000				Reset

SLCINTVEC_SLC0_TOHOST_INTVEC The interrupt vector for Slave to interrupt Host. (WO)

Register 8.9: SLC0TOKEN1_REG (0x54)

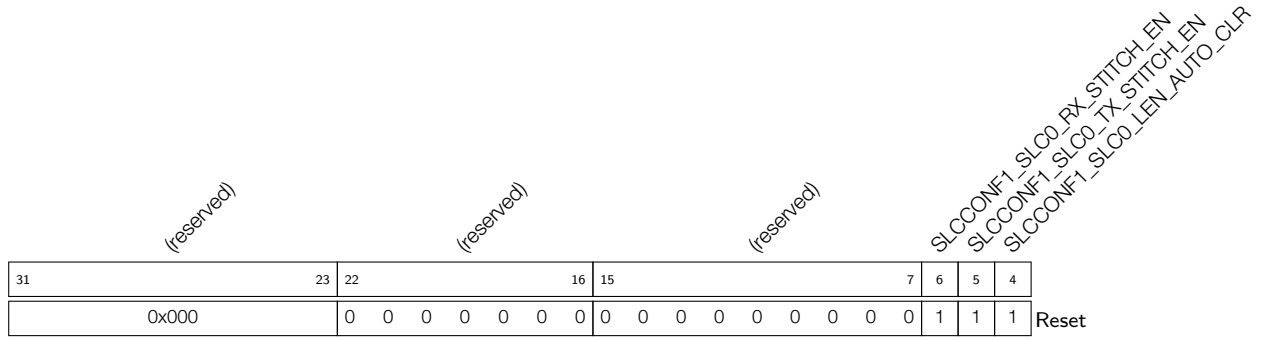
(reserved)				SLC0TOKEN1_SLC0_TOKEN1				(reserved)				SLC0TOKEN1_SLC0_TOKEN1_INC_MORE				SLC0TOKEN1_SLC0_TOKEN1_WDATA			
31	28	27					16	15	14	13	12	11							0
0x00		0x0000						0	0	0	0	0x0000						Reset	

SLC0TOKEN1_SLC0_TOKEN1 The accumulated number of buffers for receiving packets. (RO)

SLC0TOKEN1_SLC0_TOKEN1_INC_MORE Set this bit to add the value of SLC0TOKEN1_SLC0_TOKEN1_WDATA to that of SLC0TOKEN1_SLC0_TOKEN1. (WO)

SLC0TOKEN1_SLC0_TOKEN1_WDATA The number of available receiving buffers. (WO)

Register 8.10: SLCCONF1_REG (0x60)

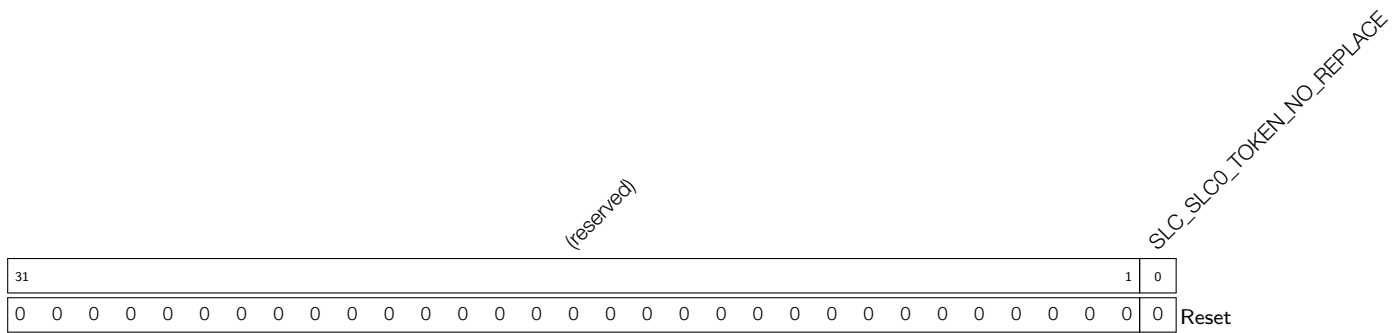


SLCCONF1_SLC0_RX_STITCH_EN Please initialize to 0. Do not modify it. (R/W)

SLCCONF1_SLC0_TX_STITCH_EN Please initialize to 0. Do not modify it. (R/W)

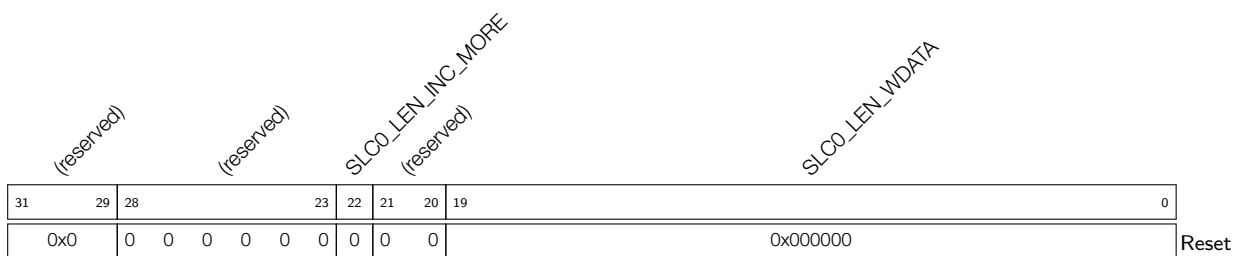
SLCCONF1_SLC0_LEN_AUTO_CLR Please initialize to 0. Do not modify it. (R/W)

Register 8.11: SLC_RX_DSCR_CONF_REG (0x98)



SLC_SLC0_TOKEN_NO_REPLACE Please initialize to 1. Do not modify it. (R/W)

Register 8.12: SLC0_LEN_CONF_REG (0xE4)



SLC0_LEN_INC_MORE Set this bit to add the value of SLC0_LEN to that of SLC0_LEN_WDATA. (WO)

SLC0_LEN_WDATA The packet length sent. (WO)

Register 8.13: SLC0_LENGTH_REG (0xE8)

(reserved)		SLC0_LEN	
31	20	19	0
0x0000		0x000000	
Reset			

SLC0_LEN Indicates the packet length sent by the Slave. (RO)

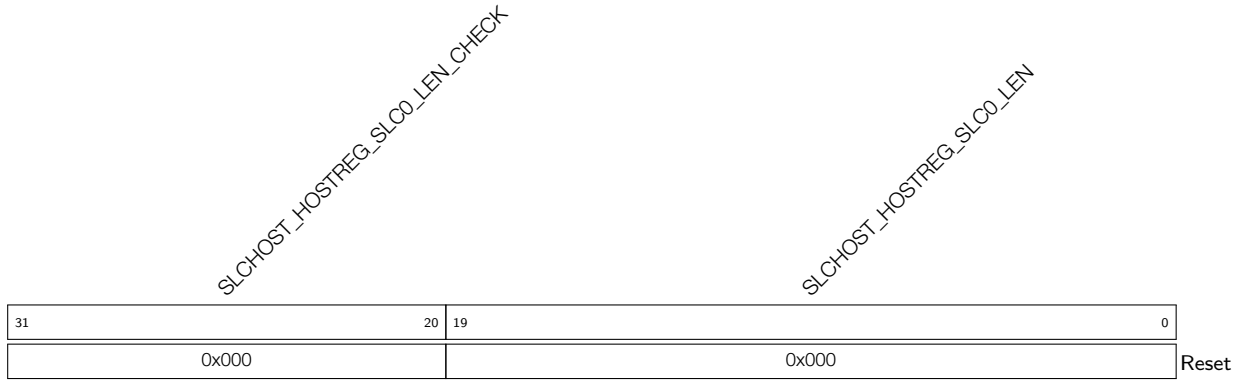
8.6 SLC Host Registers

The second block of SDIO control registers starts at 0x3FF5_5000.

Register 8.14: SLC0HOST_TOKEN_RDATA (0x44)

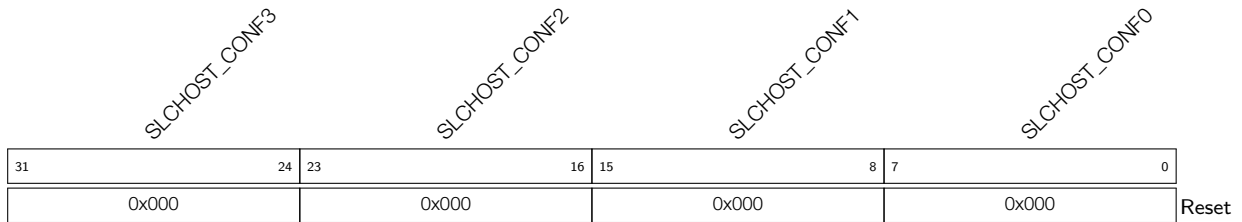
(reserved)		HOSTREG_SLC0_TOKEN1		(reserved)	
31	28	27	16	15	0
0x000		0x000		0x000	
Reset					

HOSTREG_SLC0_TOKEN1 The accumulated number of Slave's receiving buffers. (RO)

Register 8.17: SLCHOST_PKT_LEN_REG (0x60)

SLCHOST_HOSTREG_SLC0_LEN_CHECK Its value is HOSTREG_SLC0_LEN[9:0] plus HOSTREG_SLC0_LEN[19:10]. (RO)

SLCHOST_HOSTREG_SLC0_LEN The accumulated value of the data length sent by the Slave. The value gets updated only when the Host reads it.

Register 8.18: SLCHOST_CONF_W0_REG (0x6C)

SLCHOST_CONF3 The information interaction register between Host and Slave. Both Host and Slave can access it. (R/W)

SLCHOST_CONF2 The information interaction register between Host and Slave. Both Host and Slave can access it. (R/W)

SLCHOST_CONF1 The information interaction register between Host and Slave. Both Host and Slave can access it. (R/W)

SLCHOST_CONF0 The information interaction register between Host and Slave. Both Host and Slave can access it. (R/W)

Register 8.19: SLCHOST_CONF_W1_REG (0x70)

<i>SLCHOST_CONF7</i>				<i>SLCHOST_CONF6</i>				<i>SLCHOST_CONF5</i>				<i>SLCHOST_CONF4</i>				
31	24	23	16	15	8	7	0	31	24	23	16	15	8	7	0	
0x000				0x000				0x000				0x000				Reset

SLCHOST_CONF7 The information interaction register between Host and Slave. Both Host and Slave can access it. (R/W)

SLCHOST_CONF6 The information interaction register between Host and Slave. Both Host and Slave can access it. (R/W)

SLCHOST_CONF5 The information interaction register between Host and Slave. Both Host and Slave can access it. (R/W)

SLCHOST_CONF4 The information interaction register between Host and Slave. Both Host and Slave can access it. (R/W)

Register 8.20: SLCHOST_CONF_W2_REG (0x74)

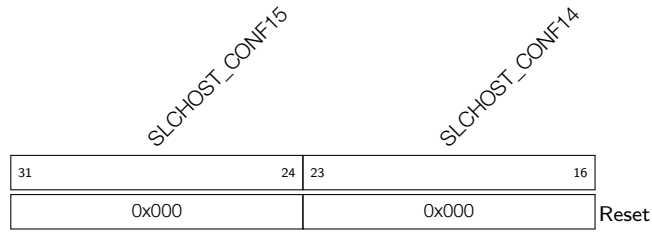
<i>SLCHOST_CONF11</i>				<i>SLCHOST_CONF10</i>				<i>SLCHOST_CONF9</i>				<i>SLCHOST_CONF8</i>				
31	24	23	16	15	8	7	0	31	24	23	16	15	8	7	0	
0x000				0x000				0x000				0x000				Reset

SLCHOST_CONF11 The information interaction register between Host and Slave. Both Host and Slave can access it. (R/W)

SLCHOST_CONF10 The information interaction register between Host and Slave. Both Host and Slave can access it. (R/W)

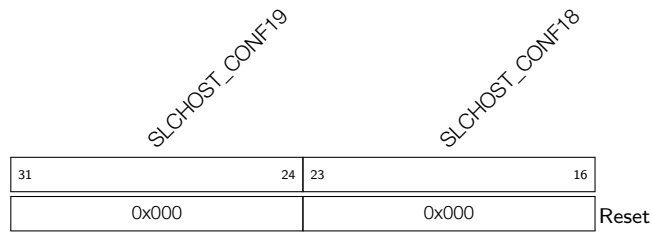
SLCHOST_CONF9 The information interaction register between Host and Slave. Both Host and Slave can access it. (R/W)

SLCHOST_CONF8 The information interaction register between Host and Slave. Both Host and Slave can access it. (R/W)

Register 8.21: SLCHOST_CONF_W3_REG (0x78)

SLCHOST_CONF15 The information interaction register between Host and Slave. Both Host and Slave can be read from and written to this. (R/W)

SLCHOST_CONF14 The information interaction register between Host and Slave. Both Host and Slave can be read from and written to this. (R/W)

Register 8.22: SLCHOST_CONF_W4_REG (0x7C)

SLCHOST_CONF19 The information interaction register between Host and Slave. Both Host and Slave can access it. (R/W)

SLCHOST_CONF18 The information interaction register between Host and Slave. Both Host and Slave can access it. (R/W)

Register 8.23: SLCHOST_CONF_W6_REG (0x88)

<i>SLCHOST_CONF27</i>								<i>SLCHOST_CONF26</i>								<i>SLCHOST_CONF25</i>								<i>SLCHOST_CONF24</i>											
31								24	23								16	15								8	7								0
0x000								0x000								0x000								0x000								Reset			

SLCHOST_CONF27 The information interaction register between Host and Slave. Both Host and Slave can access it. (R/W)

SLCHOST_CONF26 The information interaction register between Host and Slave. Both Host and Slave can access it. (R/W)

SLCHOST_CONF25 The information interaction register between Host and Slave. Both Host and Slave can access it. (R/W)

SLCHOST_CONF24 The information interaction register between Host and Slave. Both Host and Slave can access it. (R/W)

Register 8.24: SLCHOST_CONF_W7_REG (0x8C)

<i>SLCHOST_CONF31</i>								<i>(reserved)</i>								<i>SLCHOST_CONF29</i>								<i>(reserved)</i>											
31								24	23								16	15								8	7								0
0 0 0 0 0 0 0 0								0x000								0 0 0 0 0 0 0 0								0x000								Reset			

SLCHOST_CONF31 The interrupt vector used by Host to interrupt Slave. This bit will not be cleared automatically. (WO)

SLCHOST_CONF29 The interrupt vector used by Host to interrupt Slave. This bit will not be cleared automatically. (WO)

Register 8.25: SLCHOST_CONF_W8_REG (0x9C)

<i>SLCHOST_CONF35</i>				<i>SLCHOST_CONF34</i>				<i>SLCHOST_CONF33</i>				<i>SLCHOST_CONF32</i>				
31	24	23	16	15	8	7	0									
0x000				0x000				0x000				0x000				Reset

SLCHOST_CONF35 The information interaction register between Host and Slave. Both Host and Slave can access it. (R/W)

SLCHOST_CONF34 The information interaction register between Host and Slave. Both Host and Slave can access it. (R/W)

SLCHOST_CONF33 The information interaction register between Host and Slave. Both Host and Slave can access it. (R/W)

SLCHOST_CONF32 The information interaction register between Host and Slave. Both Host and Slave can access it. (R/W)

Register 8.26: SLCHOST_CONF_W9_REG (0xA0)

<i>SLCHOST_CONF39</i>				<i>SLCHOST_CONF38</i>				<i>SLCHOST_CONF37</i>				<i>SLCHOST_CONF36</i>				
31	24	23	16	15	8	7	0									
0x000				0x000				0x000				0x000				Reset

SLCHOST_CONF39 The information interaction register between Host and Slave. Both Host and Slave can access it. (R/W)

SLCHOST_CONF38 The information interaction register between Host and Slave. Both Host and Slave can access it. (R/W)

SLCHOST_CONF37 The information interaction register between Host and Slave. Both Host and Slave can access it. (R/W)

SLCHOST_CONF36 The information interaction register between Host and Slave. Both Host and Slave can access it. (R/W)

Register 8.27: SLCHOST_CONF_W10_REG (0xA4)

<i>SLCHOST_CONF43</i>				<i>SLCHOST_CONF42</i>				<i>SLCHOST_CONF41</i>				<i>SLCHOST_CONF40</i>				
31	24	23	16	15	8	7	0									
0x000				0x000				0x000				0x000				Reset

SLCHOST_CONF43 The information interaction register between Host and Slave. Both Host and Slave can access it. (R/W)

SLCHOST_CONF42 The information interaction register between Host and Slave. Both Host and Slave can access it. (R/W)

SLCHOST_CONF41 The information interaction register between Host and Slave. Both Host and Slave can access it. (R/W)

SLCHOST_CONF40 The information interaction register between Host and Slave. Both Host and Slave can access it. (R/W)

Register 8.28: SLCHOST_CONF_W11_REG (0xA8)

<i>SLCHOST_CONF47</i>				<i>SLCHOST_CONF46</i>				<i>SLCHOST_CONF45</i>				<i>SLCHOST_CONF44</i>				
31	24	23	16	15	8	7	0									
0x000				0x000				0x000				0x000				Reset

SLCHOST_CONF47 The information interaction register between Host and Slave. Both Host and Slave can access it. (R/W)

SLCHOST_CONF46 The information interaction register between Host and Slave. Both Host and Slave can access it. (R/W)

SLCHOST_CONF45 The information interaction register between Host and Slave. Both Host and Slave can access it. (R/W)

SLCHOST_CONF44 The information interaction register between Host and Slave. Both Host and Slave can access it. (R/W)

Register 8.29: SLCHOST_CONF_W12_REG (0xAC)

<i>SLCHOST_CONF51</i>				<i>SLCHOST_CONF50</i>				<i>SLCHOST_CONF49</i>				<i>SLCHOST_CONF48</i>				
31	24	23	16	15	8	7	0									
0x000				0x000				0x000				0x000				Reset

SLCHOST_CONF51 The information interaction register between Host and Slave. Both Host and Slave can access it. (R/W)

SLCHOST_CONF50 The information interaction register between Host and Slave. Both Host and Slave can access it. (R/W)

SLCHOST_CONF49 The information interaction register between Host and Slave. Both Host and Slave can access it. (R/W)

SLCHOST_CONF48 The information interaction register between Host and Slave. Both Host and Slave can access it. (R/W)

Register 8.30: SLCHOST_CONF_W13_REG (0xB0)

<i>SLCHOST_CONF55</i>				<i>SLCHOST_CONF54</i>				<i>SLCHOST_CONF53</i>				<i>SLCHOST_CONF52</i>				
31	24	23	16	15	8	7	0									
0x000				0x000				0x000				0x000				Reset

SLCHOST_CONF55 The information interaction register between Host and Slave. Both Host and Slave can access it. (R/W)

SLCHOST_CONF54 The information interaction register between Host and Slave. Both Host and Slave can access it. (R/W)

SLCHOST_CONF53 The information interaction register between Host and Slave. Both Host and Slave can access it. (R/W)

SLCHOST_CONF52 The information interaction register between Host and Slave. Both Host and Slave can access it. (R/W)

Register 8.31: SLCHOST_CONF_W14_REG (0xB4)

<i>SLCHOST_CONF59</i>				<i>SLCHOST_CONF58</i>				<i>SLCHOST_CONF57</i>				<i>SLCHOST_CONF56</i>				
31	24	23	16	15	8	7	0									
0x000				0x000				0x000				0x000				Reset

SLCHOST_CONF59 The information interaction register between Host and Slave. Both Host and Slave can access it. (R/W)

SLCHOST_CONF58 The information interaction register between Host and Slave. Both Host and Slave can access it. (R/W)

SLCHOST_CONF57 The information interaction register between Host and Slave. Both Host and Slave can access it. (R/W)

SLCHOST_CONF56 The information interaction register between Host and Slave. Both Host and Slave can access it. (R/W)

Register 8.32: SLCHOST_CONF_W15_REG (0xB8)

<i>SLCHOST_CONF63</i>				<i>SLCHOST_CONF62</i>				<i>SLCHOST_CONF61</i>				<i>SLCHOST_CONF60</i>				
31	24	23	16	15	8	7	0									
0x000				0x000				0x000				0x000				Reset

SLCHOST_CONF63 The information interaction register between Host and Slave. Both Host and Slave can access it. (R/W)

SLCHOST_CONF62 The information interaction register between Host and Slave. Both Host and Slave can access it. (R/W)

SLCHOST_CONF61 The information interaction register between Host and Slave. Both Host and Slave can access it. (R/W)

SLCHOST_CONF60 The information interaction register between Host and Slave. Both Host and Slave can access it. (R/W)

Register 8.33: SLC0HOST_INT_CLR_REG (0xD4)

(reserved)				(reserved)				SLC0HOST_SLC0_RX_NEW_PACKET_INT_CLR	(reserved)				SLC0HOST_SLC0_TX_OVF_INT_CLR	(reserved)				SLC0HOST_SLC0_TOHOST_BIT7_INT_CLR	SLC0HOST_SLC0_TOHOST_BIT6_INT_CLR	SLC0HOST_SLC0_TOHOST_BIT5_INT_CLR	SLC0HOST_SLC0_TOHOST_BIT4_INT_CLR	SLC0HOST_SLC0_TOHOST_BIT3_INT_CLR	SLC0HOST_SLC0_TOHOST_BIT2_INT_CLR	SLC0HOST_SLC0_TOHOST_BIT1_INT_CLR	SLC0HOST_SLC0_TOHOST_BIT0_INT_CLR	Reset	
31	26	25	24	23	22	18	17	16	15	8	7	6	5	4	3	2	1	0									
0x00				0	0	0	0	0	0	0	0	0	0	0	0	0	0	0	0	0	0	0	0	0	0	0	0

SLC0HOST_SLC0_RX_NEW_PACKET_INT_CLR Set this bit to clear the [SLC0HOST_SLC0_RX_NEW_PACKET_INT](#) interrupt. (WO)

SLC0HOST_SLC0_TX_OVF_INT_CLR Set this bit to clear the [SLC0HOST_SLC0_TX_OVF_INT](#) interrupt. (WO)

SLC0HOST_SLC0_RX_UDF_INT_CLR Set this bit to clear the [SLC0HOST_SLC0_RX_UDF_INT](#) interrupt. (WO)

SLC0HOST_SLC0_TOHOST_BIT7_INT_CLR Set this bit to clear the [SLC0HOST_SLC0_TOHOST_BIT7_INT](#) interrupt. (WO)

SLC0HOST_SLC0_TOHOST_BIT6_INT_CLR Set this bit to clear the [SLC0HOST_SLC0_TOHOST_BIT6_INT](#) interrupt. (WO)

SLC0HOST_SLC0_TOHOST_BIT5_INT_CLR Set this bit to clear the [SLC0HOST_SLC0_TOHOST_BIT5_INT](#) interrupt. (WO)

SLC0HOST_SLC0_TOHOST_BIT4_INT_CLR Set this bit to clear the [SLC0HOST_SLC0_TOHOST_BIT4_INT](#) interrupt. (WO)

SLC0HOST_SLC0_TOHOST_BIT3_INT_CLR Set this bit to clear the [SLC0HOST_SLC0_TOHOST_BIT3_INT](#) interrupt. (WO)

SLC0HOST_SLC0_TOHOST_BIT2_INT_CLR Set this bit to clear the [SLC0HOST_SLC0_TOHOST_BIT2_INT](#) interrupt. (WO)

SLC0HOST_SLC0_TOHOST_BIT1_INT_CLR Set this bit to clear the [SLC0HOST_SLC0_TOHOST_BIT1_INT](#) interrupt. (WO)

SLC0HOST_SLC0_TOHOST_BIT0_INT_CLR Set this bit to clear the [SLC0HOST_SLC0_TOHOST_BIT0_INT](#) interrupt. (WO)

Register 8.34: SLC0HOST_FUNC1_INT_ENA_REG (0xDC)

(reserved)						(reserved)						(reserved)						(reserved)																																		
(reserved)						SLC0HOST_FN1_SLC0_RX_NEW_PACKET_INT_ENA						(reserved)						(reserved)																																		
(reserved)						SLC0HOST_FN1_SLC0_TX_OVF_INT_ENA						(reserved)						(reserved)																																		
(reserved)						SLC0HOST_FN1_SLC0_RX_UDF_INT_ENA						(reserved)						(reserved)																																		
(reserved)						SLC0HOST_FN1_SLC0_TOHOST_BIT7_INT_ENA						(reserved)						(reserved)																																		
(reserved)						SLC0HOST_FN1_SLC0_TOHOST_BIT6_INT_ENA						(reserved)						(reserved)																																		
(reserved)						SLC0HOST_FN1_SLC0_TOHOST_BIT5_INT_ENA						(reserved)						(reserved)																																		
(reserved)						SLC0HOST_FN1_SLC0_TOHOST_BIT4_INT_ENA						(reserved)						(reserved)																																		
(reserved)						SLC0HOST_FN1_SLC0_TOHOST_BIT3_INT_ENA						(reserved)						(reserved)																																		
(reserved)						SLC0HOST_FN1_SLC0_TOHOST_BIT2_INT_ENA						(reserved)						(reserved)																																		
(reserved)						SLC0HOST_FN1_SLC0_TOHOST_BIT1_INT_ENA						(reserved)						(reserved)																																		
(reserved)						SLC0HOST_FN1_SLC0_TOHOST_BIT0_INT_ENA						(reserved)						(reserved)																																		
31					26	25	24	23	22							18	17	16	15							8	7	6	5	4	3	2	1	0																		
0x00																																																				
																										0	0	0	0	0	0	0	0	0	0	0	0	0	0	0	0	0	0	0	0	0	0	0	0	0	0	0
Reset																																																				

SLC0HOST_FN1_SLC0_RX_NEW_PACKET_INT_ENA The interrupt enable bit for the [SLC0HOST_FN1_SLC0_RX_NEW_PACKET_INT](#) interrupt. (R/W)

SLC0HOST_FN1_SLC0_TX_OVF_INT_ENA The interrupt enable bit for the [SLC0HOST_FN1_SLC0_TX_OVF_INT](#) interrupt. (R/W)

SLC0HOST_FN1_SLC0_RX_UDF_INT_ENA The interrupt enable bit for the [SLC0HOST_FN1_SLC0_RX_UDF_INT](#) interrupt. (R/W)

SLC0HOST_FN1_SLC0_TOHOST_BIT7_INT_ENA The interrupt enable bit for the [SLC0HOST_FN1_SLC0_TOHOST_BIT7_INT](#) interrupt. (R/W)

SLC0HOST_FN1_SLC0_TOHOST_BIT6_INT_ENA The interrupt enable bit for the [SLC0HOST_FN1_SLC0_TOHOST_BIT6_INT](#) interrupt. (R/W)

SLC0HOST_FN1_SLC0_TOHOST_BIT5_INT_ENA The interrupt enable bit for the [SLC0HOST_FN1_SLC0_TOHOST_BIT5_INT](#) interrupt. (R/W)

SLC0HOST_FN1_SLC0_TOHOST_BIT4_INT_ENA The interrupt enable bit for the [SLC0HOST_FN1_SLC0_TOHOST_BIT4_INT](#) interrupt. (R/W)

SLC0HOST_FN1_SLC0_TOHOST_BIT3_INT_ENA The interrupt enable bit for the [SLC0HOST_FN1_SLC0_TOHOST_BIT3_INT](#) interrupt. (R/W)

SLC0HOST_FN1_SLC0_TOHOST_BIT2_INT_ENA The interrupt enable bit for the [SLC0HOST_FN1_SLC0_TOHOST_BIT2_INT](#) interrupt. (R/W)

SLC0HOST_FN1_SLC0_TOHOST_BIT1_INT_ENA The interrupt enable bit for the [SLC0HOST_FN1_SLC0_TOHOST_BIT1_INT](#) interrupt. (R/W)

SLC0HOST_FN1_SLC0_TOHOST_BIT0_INT_ENA The interrupt enable bit for the [SLC0HOST_FN1_SLC0_TOHOST_BIT0_INT](#) interrupt. (R/W)

Register 8.35: SLCHOST_CONF_REG (0x1F0)

<i>(reserved)</i>				<i>(reserved)</i>				<i>SLCHOST_FRC_POS_SAMP</i>				<i>SLCHOST_FRC_NEG_SAMP</i>				<i>SLCHOST_FRC_SDIO20</i>				<i>SLCHOST_FRC_SDIO11</i>												
31	28	27	26	25	24	23	22	21	20	19	18	17	16	15	14	13	12	11	10	9	8	7	6	5	4	3	2	1	0			
0	0	0	0	0	0	0	0	0	0	0	0	0	0	0	0	0	0	0	0	0	0	0	0	0	0	0	0	0	0	0	0	0

Reset

SLCHOST_FRC_POS_SAMP Set this bit to sample the corresponding signal at the rising clock edge.
(R/W)

SLCHOST_FRC_NEG_SAMP Set this bit to sample the corresponding signal at the falling clock edge.
(R/W)

SLCHOST_FRC_SDIO20 Set this bit to output the corresponding signal at the rising clock edge.
(R/W)

SLCHOST_FRC_SDIO11 Set this bit to output the corresponding signal at the falling clock edge.
(R/W)

8.7 HINF Registers

The third block of SDIO control registers starts at 0x3FF4_B000.

Register 8.36: HINF_CFG_DATA1_REG (0x4)

<i>(reserved)</i>																								<i>HINF_HIGH_SPEED_ENABLE</i>		<i>HINF_SDIO_IOREADY1</i>						
31	30	29	28	27	26	25	24	23	22	21	20	19	18	17	16	15	14	13	12	11	10	9	8	7	6	5	4	3	2	1	0	
0	0	0	0	0	0	0	0	0	0	0	0	0	0	0	0	0	0	0	0	0	0	0	0	0	0	0	0	0	0	0	0	0

Reset

HINF_HIGH_SPEED_ENABLE Please initialize to 1. Do not modify it. (R/W)

HINF_SDIO_IOREADY1 Please initialize to 1. Do not modify it. (R/W)

9. SD/MMC Host Controller

9.1 Overview

The ESP32 memory card interface controller provides a hardware interface between the Advanced Peripheral Bus (APB) and an external memory device. The memory card interface allows the ESP32 to be connected to SDIO memory cards, MMC cards and devices with a CE-ATA interface. It supports two external cards (Card0 and Card1).

9.2 Features

This module has the following features:

- Two external cards
- Supports SD Memory Card standard: versions 3.0 and 3.01
- Supports MMC: versions 4.41, 4.5, and 4.51
- Supports CE-ATA: version 1.1
- Supports 1-bit, 4-bit, and 8-bit (Card0 only) modes

The SD/MMC controller topology is shown in Figure 30. The controller supports two peripherals which cannot be functional at the same time.

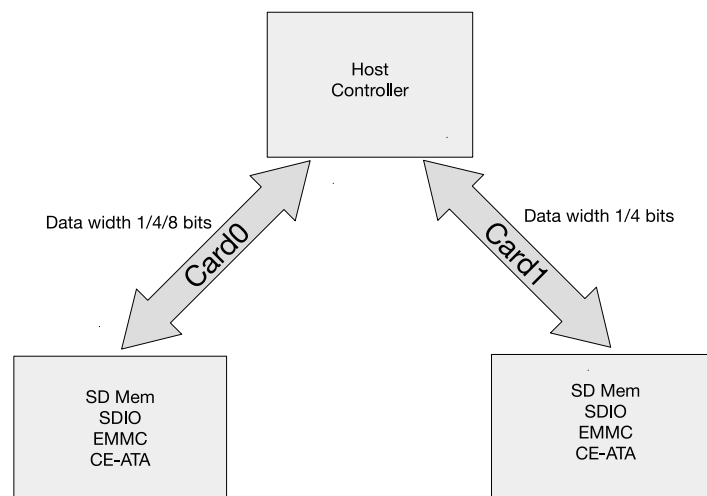


Figure 30: SD/MMC Controller Topology

9.3 SD/MMC External Interface Signals

The primary external interface signals, which enable the SD/MMC controller to communicate with an external device, are clock (clk), command (cmd) and data signals. Additional signals include the card interrupt, card detect, and write-protect signals. The direction of each signal is shown in Figure 31. The direction and description of each pin are listed in Table 32.

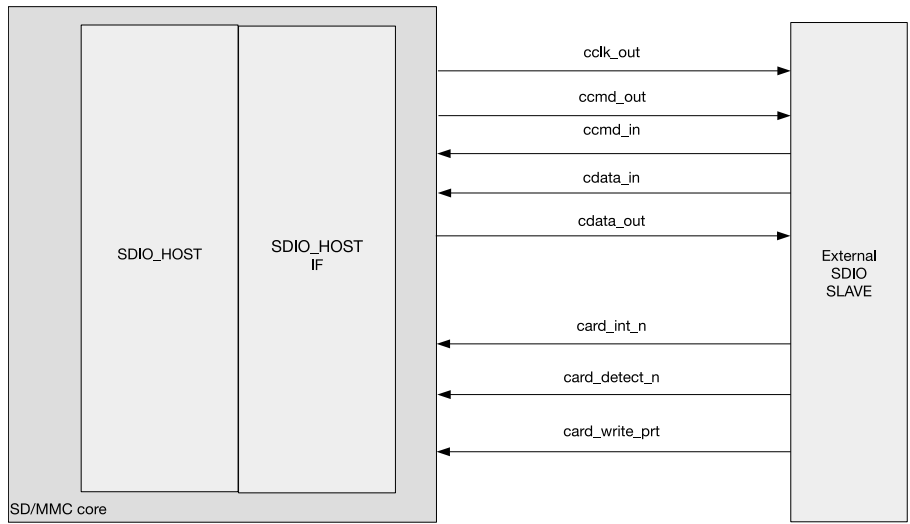


Figure 31: SD/MMC Controller External Interface Signals

Table 32: SD/MMC Signal Description

Pin	Direction	Description
cclk_out	Output	Clock signals for slave device
ccmd	Duplex	Duplex command/response lines
cdata	Duplex	Duplex data read/write lines
card_detect_n	Input	Card detection input line
card_write_prt	Input	Card write protection status input

9.4 Functional Description

9.4.1 SD/MMC Host Controller Architecture

The SD/MMC host controller consists of two main functional blocks, as shown in Figure 32:

- Bus Interface Unit (BIU): It provides APB interfaces for registers, data read and write operation by FIFO and DMA.
- Card Interface Unit (CIU): It handles external memory card interface protocols. It also provides clock control.

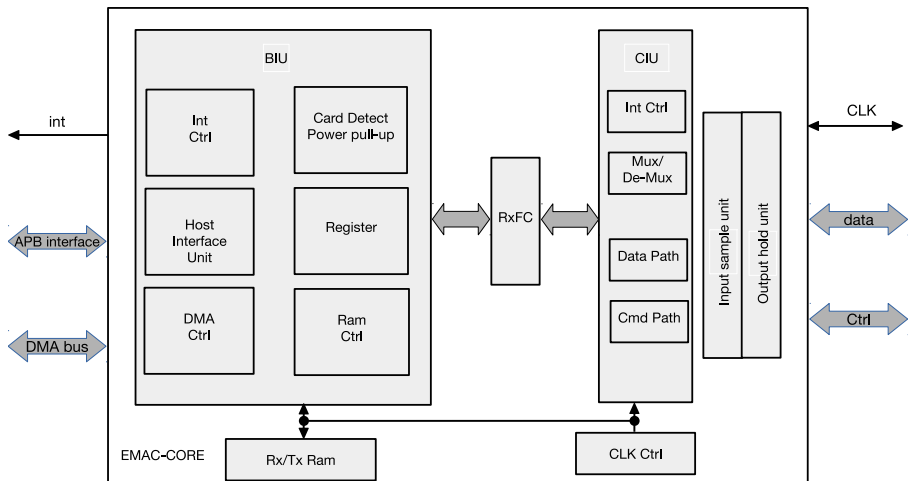


Figure 32: SDIO Host Block Diagram

9.4.1.1 BIU

The BIU provides the access to registers and FIFO data through the Host Interface Unit (HIU). Additionally, it provides FIFO access to independent data through a DMA interface. The host interface can be configured as an APB interface. Figure 32 illustrates the internal components of the BIU. The BIU provides the following functions:

- Host interface
- DMA interface
- Interrupt control
- Register access
- FIFO access
- Power/pull-up control and card detection

9.4.1.2 CIU

The CIU module implements the card-specific protocols. Within the CIU, the command path control unit and data path control unit prompt the controller to interface with the command and data ports, respectively, of the SD/MMC/CE-ATA cards. The CIU also provides clock control. Figure 32 illustrates the internal structure of the CIU, which consists of the following primary functional blocks:

- Command path
- Data path
- SDIO interrupt control
- Clock control
- Mux/demux unit

9.4.2 Command Path

The command path performs the following functions:

- Configures clock parameters
- Configures card command parameters
- Sends commands to card bus (ccmd_out line)
- Receives responses from card bus (ccmd_in line)
- Sends responses to BIU
- Drives the P-bit on the command line

The command path State Machine is shown in Figure 33.

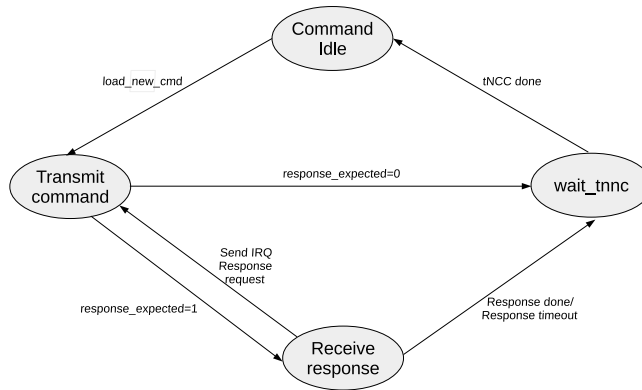


Figure 33: Command Path State Machine

9.4.3 Data Path

The data path block pops FIFO data and transmits them on cdata_out during a write-data transfer, or it receives data on cdata_in and pushes them into FIFO during a read-data transfer. The data path loads new data parameters, i.e., expected data, read/write data transfer, stream/block transfer, block size, byte count, card type, timeout registers, etc., whenever a data transfer command is not in progress.

If the data_expected bit is set in the Command register, the new command is a data-transfer command and the data path starts one of the following operations:

- Transmitting data if the read/write bit = 1
- Receiving data if read/write bit = 0

9.4.3.1 Data Transmit Operation

The data transmit state machine is illustrated in Figure 34. The module starts data transmission two clock cycles after a response for the data-write command is received. This occurs even if the command path detects a response error or a cyclic redundancy check (CRC) error in a response. If no response is received from the card until the response timeout, no data are transmitted. Depending on the value of the transfer_mode bit in the Command register, the data-transmit state machine adds data to the card's data bus in a stream or in block(s). The data transmit state machine is shown in Figure 34.

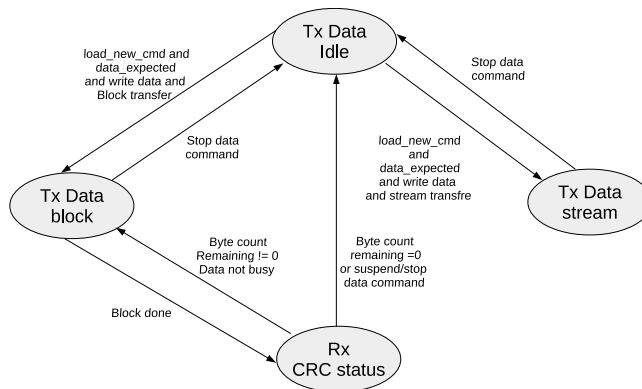


Figure 34: Data Transmit State Machine

9.4.3.2 Data Receive Operation

The data-receive state machine is illustrated in Figure 35. The module receives data two clock cycles after the end bit of a data-read command, even if the command path detects a response error or a CRC error. If no response is received from the card and a response timeout occurs, the BIU does not receive a signal about the completion of the data transfer. If the command sent by the CIU is an illegal operation for the card, it would prevent the card from starting a read-data transfer, and the BIU will not receive a signal about the completion of the data transfer.

If no data are received by the data timeout, the data path signals a data timeout to the BIU, which marks an end to the data transfer. Based on the value of the transfer_mode bit in the Command register, the data-receive state machine gets data from the card's data bus in a stream or block(s). The data receive state machine is shown in Figure 35.

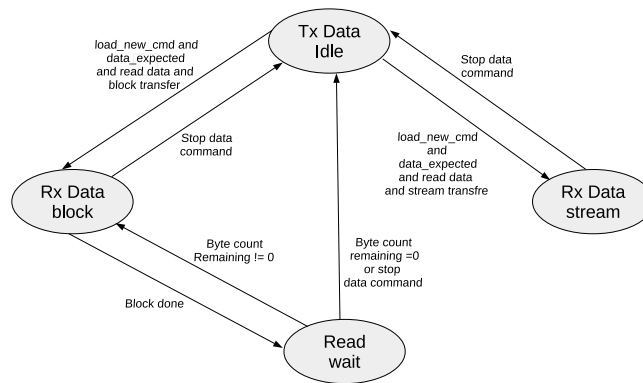


Figure 35: Data Receive State Machine

9.5 Software Restrictions for Proper CIU Operation

- Only one card at a time can be selected to execute a command or data transfer. For example, when data are being transferred to or from a card, a new command must not be issued to another card. A new command, however, can be issued to the same card, allowing it to read the device status or stop the transfer.
- Only one command at a time can be issued for data transfers.
- During an open-ended card-write operation, if the card clock is stopped due to FIFO being empty, the software must fill FIFO with data first, and then start the card clock. Only then can it issue a stop/abort command to the card.
- During an SDIO/COMBO card transfer, if the card function is suspended and the software wants to resume the suspended transfer, it must first reset FIFO, and then issue the resume command as if it were a new data-transfer command.
- When issuing card reset commands (CMD0, CMD15 or CMD52_reset), while a card data transfer is in progress, the software must set the stop_abort_cmd bit in the Command register, so that the CIU can stop the data transfer after issuing the card reset command.
- When the data's end bit error is set in the RINTSTS register, the CIU does not guarantee SDIO interrupts. In such a case, the software ignores SDIO interrupts and issues a stop/abort command to the card, so that the card stops sending read-data.

- If the card clock is stopped due to FIFO being full during a card read, the software will read at least two FIFO locations to restart the card clock.
- Only one CE-ATA device at a time can be selected for a command or data transfer. For example, when data are transferred from a CE-ATA device, a new command should not be sent to another CE-ATA device.
- If a CE-ATA device's interrupts are enabled (nIEN=0), a new RW_BLK command should not be sent to the same device if the execution of a RW_BLK command is already in progress (the RW_BLK command used in this databook is the RW_MULTIPLE_BLOCK MMC command defined by the CE-ATA specifications). Only the CCSD can be sent while waiting for the CCS.
- If, however, a CE-ATA device's interrupts are disabled (nIEN=1), a new command can be issued to the same device, allowing it to read status information.
- Open-ended transfers are not supported in CE-ATA devices.
- The send_auto_stop signal is not supported (software should not set the send_auto_stop bit) in CE-ATA transfers.

After configuring the command start bit to 1, the values of the following registers cannot be changed before a command has been issued:

- CMD - command
- CMDARG - command argument
- BYTCNT - byte count
- BLKSIZ - block size
- CLKDIV - clock divider
- CKLENA - clock enable
- CLKSRC - clock source
- TMOUT - timeout
- CTYPE - card type

9.6 RAM for Receiving and Sending Data

The submodule RAM is a buffer area for sending and receiving data. It can be divided into two units: the one is for sending data, and the other is for receiving data. The process of sending and receiving data can also be achieved by the CPU and DMA for reading and writing. The latter method is described in detail in Section 9.8.

9.6.1 Transmit RAM Module

There are two ways to enable a write operation: DMA and CPU read/write.

If SDIO-sending is enabled, data can be written to the transferred RAM module by APB interface or DMA. Data will be written from register EMAC_FIFO to the CPU, directly, by an APB interface.

9.6.2 Receive RAM Module

There are two ways to enable a read operation: DMA and CPU read/write.

When a subunit of the data path receives data, the subdata will be written onto the receive-RAM. Then, these subdata can be read either with the APB or the DMA method at the reading end. Register EMAC_FIFO can be read by the APB directly.

9.7 Descriptor Chain

Each linked list module consists of two parts: the linked list itself and a data buffer. In other words, each module points to a unique data buffer and the linked list that follows the module. Figure 36 shows the descriptor chain.

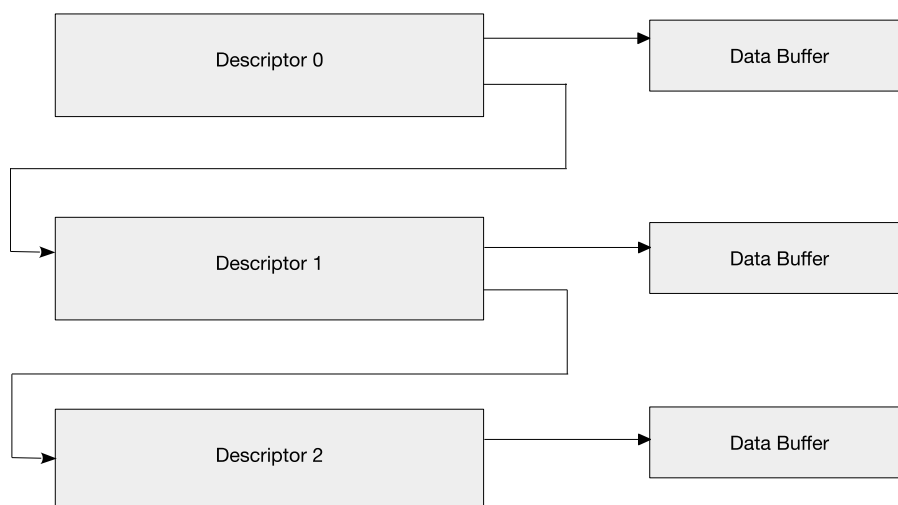


Figure 36: Descriptor Chain

9.8 The Structure of a Linked List

Each linked list consists of four words. As is shown below, Figure 37 demonstrates the linked list’s structure, and Table 33, Table 34, Table 35, Table 36 provide the descriptions of linked lists.

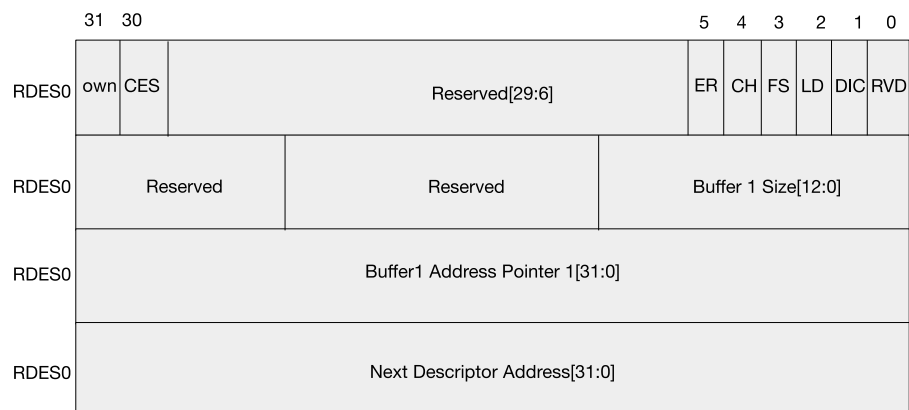


Figure 37: The Structure of a Linked List

The DES0 element contains control and status information.

Table 33: DES0

Bits	Name	Description
31	OWN	When set, this bit indicates that the descriptor is owned by the DMAC. When reset, it indicates that the descriptor is owned by the Host. The DMAC clears this bit when it completes the data transfer.
30	CES (Card Error Summary)	These error bits indicate the status of the transition to or from the card. The following bits are also present in RINTSTS, which indicates their digital logic OR gate. <ul style="list-style-type: none"> • EBE: End Bit Error • RTO: Response Time out • RCRC: Response CRC • SBE: Start Bit Error • DRTO: Data Read Timeout • DCRC: Data CRC for Receive • RE: Response Error
29:6	Reserved	Reserved
5	ER (End of Ring)	When set, this bit indicates that the descriptor list has reached its final descriptor. The DMAC then returns to the base address of the list, creating a Descriptor Ring.
4	CH (Second Address Chained)	When set, this bit indicates that the second address in the descriptor is the Next Descriptor address. When this bit is set, BS2 (DES1[25:13]) should be all zeros.
3	FD (First Descriptor)	When set, this bit indicates that this descriptor contains the first buffer of the data. If the size of the first buffer is 0, the Next Descriptor contains the beginning of the data.
2	LD (Last Descriptor)	This bit is associated with the last block of a DMA transfer. When set, the bit indicates that the buffers pointed by this descriptor are the last buffers of the data. After this descriptor is completed, the remaining byte count is 0. In other words, after the descriptor with the LD bit set is completed, the remaining byte count should be 0.
1	DIC (Disable Interrupt on Completion)	When set, this bit will prevent the setting of the TI/RI bit of the DMAC Status Register (IDSTS) for the data that ends in the buffer pointed by this descriptor.
0	Reserved	Reserved

The DES1 element contains the buffer size.

Table 34: DES1

Bits	Name	Description
31:26	Reserved	Reserved
25:13	Reserved	Reserved
12:0	BS1 (Buffer 1 Size)	Indicates the data buffer byte size, which must be a multiple of four. In the case where the buffer size is not a multiple of four, the resulting behavior is undefined. This field should not be zero.

The DES2 element contains the address pointer to the data buffer.

Table 35: DES2

Bits	Name	Description
31:0	Buffer Address Pointer 1	These bits indicate the physical address of the data buffer.

The DES3 element contains the address pointer to the next descriptor if the present descriptor is not the last one in a chained descriptor structure.

Table 36: DES3

Bits	Name	Description
31:0	Next Descriptor Address	If the Second Address Chained (DES0[4]) bit is set, then this address contains the pointer to the physical memory where the Next Descriptor is present. If this is not the last descriptor, then the Next Descriptor address pointer must be DES3[1:0] = 0.

9.9 Initialization

9.9.1 DMAC Initialization

The DMAC initialization should proceed as follows:

- Write to the DMAC Bus Mode Register (BMOD_REG) will set the Host bus's access parameters.
- Write to the DMAC Interrupt Enable Register (IDINTEN) will mask any unnecessary interrupt causes.
- The software driver creates either the transmit or the receive descriptor list. Then, it writes to the DMAC Descriptor List Base Address Register (DBADDR), providing the DMAC with the starting address of the list.
- The DMAC engine attempts to acquire descriptors from descriptor lists.

9.9.2 DMAC Transmission Initialization

The DMAC transmission occurs as follows:

1. The Host sets up the elements (DES0-DES3) for transmission, and sets the OWN bit (DES0[31]). The Host also prepares the data buffer.
2. The Host programs the write-data command in the CMD register in BIU.
3. The Host also programs the required transmit threshold (TX_WMARK field in FIFOTH register).
4. The DMAC engine fetches the descriptor and checks the OWN bit. If the OWN bit is not set, it means that the host owns the descriptor. In this case, the DMAC enters a suspend-state and asserts the Descriptor Unable interrupt in the IDSTS register. In such a case, the host needs to release the DMAC by writing any value to PLDMND_REG.
5. It then waits for the Command Done (CD) bit and no errors from BIU, which indicates that a transfer can be done.
6. Subsequently, the DMAC engine waits for a DMA interface request (dw_dma_req) from BIU. This request will be generated, based on the programmed transmit-threshold value. For the last bytes of data which cannot be accessed using a burst, single transfers are performed on the AHB Master Interface.
7. The DMAC fetches the transmit data from the data buffer in the Host memory and transfers them to FIFO for transmission to card.
8. When data span across multiple descriptors, the DMAC fetches the next descriptor and extends its operation using the following descriptor. The last descriptor bit indicates whether the data span multiple descriptors or not.
9. When data transmission is complete, the status information is updated in the IDSTS register by setting the Transmit Interrupt, if it has already been enabled. Also, the OWN bit is cleared by the DMAC by performing a write transaction to DES0.

9.9.3 DMAC Reception Initialization

The DMAC reception occurs as follows:

1. The Host sets up the element (DES0-DES3) for reception, and sets the OWN bit (DES0[31]).
2. The Host programs the read-data command in the CMD register in BIU.
3. Then, the Host programs the required level of the receive-threshold (RX_WMARK field in FIFOTH register).
4. The DMAC engine fetches the descriptor and checks the OWN bit. If the OWN bit is not set, it means that the host owns the descriptor. In this case, the DMA enters a suspend-state and asserts the Descriptor Unable interrupt in the IDSTS register. In such a case, the host needs to release the DMAC by writing any value to PLDMND_REG.
5. It then waits for the Command Done (CD) bit and no errors from BIU, which indicates that a transfer can be done.
6. The DMAC engine then waits for a DMA interface request (dw_dma_req) from BIU. This request will be generated, based on the programmed receive-threshold value. For the last bytes of the data which cannot be accessed using a burst, single transfers are performed on the AHB.
7. The DMAC fetches the data from FIFO and transfers them to the Host memory.

8. When data span across multiple descriptors, the DMAC will fetch the next descriptor and extend its operation using the following descriptor. The last descriptor bit indicates whether the data span multiple descriptors or not.
9. When data reception is complete, the status information is updated in the IDSTS register by setting Receive-Interrupt, if it has already been enabled. Also, the OWN bit is cleared by the DMAC by performing a write-transaction to DES0.

9.10 Clock Phase Selection

If the setup time requirements for the input or output data signal are not met, users can specify the clock phase, as shown in the figure below.

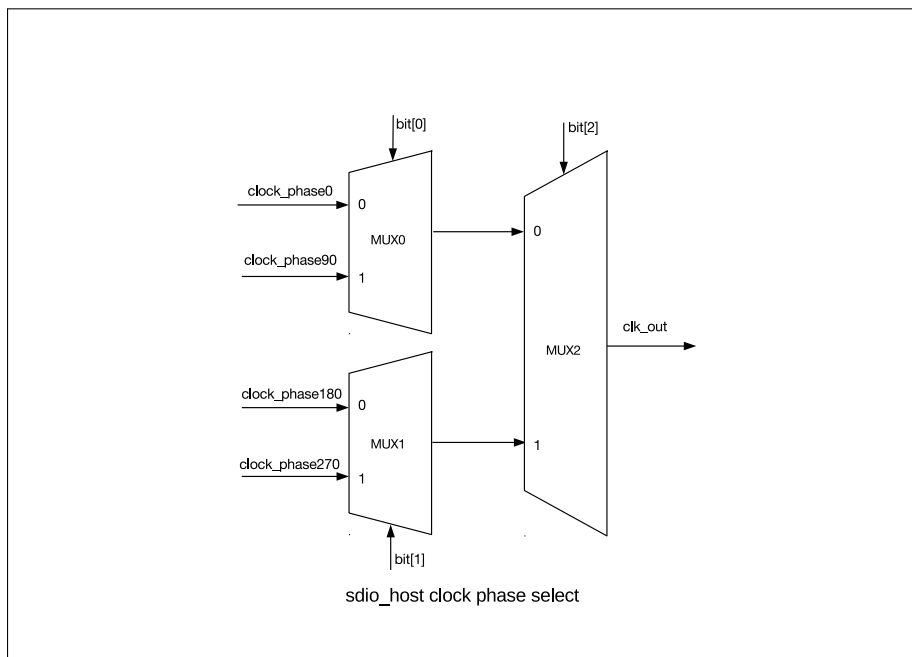


Figure 38: Clock Phase Selection

Please find detailed information on the clock phase selection register [CLK_EDGE_SEL](#) in Section Registers.

9.11 Interrupt

Interrupts can be generated as a result of various events. The IDSTS register contains all the bits that might cause an interrupt. The IDINTEN register contains an enable bit for each of the events that can cause an interrupt.

There are two groups of summary interrupts, "Normal" ones (bit8 NIS) and "Abnormal" ones (bit9 AIS), as outlined in the IDSTS register. Interrupts are cleared by writing 1 to the position of the corresponding bit. When all the enabled interrupts within a group are cleared, the corresponding summary bit is also cleared. When both summary bits are cleared, the interrupt signal `dmac_intr_o` is de-asserted (stops signalling).

Interrupts are not queued up, and if a new interrupt-event occurs before the driver has responded to it, no additional interrupts are generated. For example, the Receive Interrupt IDSTS[1] indicates that one or more data were transferred to the Host buffer.

An interrupt is generated only once for concurrent events. The driver must scan the IDSTS register for the interrupt cause.

9.12 Register Summary

Name	Description	Address	Access
CTRL_REG	Control register	0x0000	R/W
CLKDIV_REG	Clock divider configuration register	0x0008	R/W
CLKSRC_REG	Clock source selection register	0x000C	R/W
CLKENA_REG	Clock enable register	0x0010	R/W
TMOUT_REG	Data and response timeout configuration register	0x0014	R/W
CTYPE_REG	Card bus width configuration register	0x0018	R/W
BLKSIZ_REG	Card data block size configuration register	0x001C	R/W
BYCNT_REG	Data transfer length configuration register	0x0020	R/W
INTMASK_REG	SDIO interrupt mask register	0x0024	R/W
CMDARG_REG	Command argument data register	0x0028	R/W
CMD_REG	Command and boot configuration register	0x002C	R/W
RESP0_REG	Response data register	0x0030	RO
RESP1_REG	Long response data register	0x0034	RO
RESP2_REG	Long response data register	0x0038	RO
RESP3_REG	Long response data register	0x003C	RO
MINTSTS_REG	Masked interrupt status register	0x0040	RO
RINTSTS_REG	Raw interrupt status register	0x0044	R/W
STATUS_REG	SD/MMC status register	0x0048	RO
FIFOTH_REG	FIFO configuration register	0x004C	R/W
CDETECT_REG	Card detect register	0x0050	RO
WRTPRT_REG	Card write protection (WP) status register	0x0054	RO
TCBCNT_REG	Transferred byte count register	0x005C	RO
TBBCNT_REG	Transferred byte count register	0x0060	RO
DEBNCE_REG	Debounce filter time configuration register	0x0064	R/W
USRID_REG	User ID (scratchpad) register	0x0068	R/W
RST_N_REG	Card reset register	0x0078	R/W
BMOD_REG	Burst mode transfer configuration register	0x0080	R/W
PLDMND_REG	Poll demand configuration register	0x0084	WO
DBADDR_REG	Descriptor base address register	0x0088	R/W
IDSTS_REG	IDMAC status register	0x008C	R/W
IDINTEN_REG	IDMAC interrupt enable register	0x0090	R/W
DSCADDR_REG	Host descriptor address pointer	0x0094	RO
BUFADDR_REG	Host buffer address pointer register	0x0098	RO
CLK_EDGE_SEL	Clock phase selection register	0x0800	R/W

9.13 Registers

SD/MMC controller registers can be accessed by the APB bus of the CPU.

Register 9.1: CTRL_REG (0x0000)

31	25	24	131	120	11	10	9	8	7	6	5	4	3	2	1	0	Reset	
(reserved)			(reserved)			(reserved)			CEATA_DEVICE_INTERRUPT_STATUS SEND_AUTO_STOP_CCSD SEND_CCSD ABORT_READ_DATA SEND_IRQ_RESPONSE READ_WAIT (reserved) INT_ENABLE (reserved) DMA_RESET FIFO_RESET CONTROLLER_RESET								Reset	
0x00			1	0x00			0	0	0	0	0	0	0	0	0	0	0	Reset

CEATA_DEVICE_INTERRUPT_STATUS Software should appropriately write to this bit after the power-on reset or any other reset to the CE-ATA device. After reset, the CE-ATA device's interrupt is usually disabled ($nIEN = 1$). If the host enables the CE-ATA device's interrupt, then software should set this bit. (R/W)

SEND_AUTO_STOP_CCSD Always set `send_auto_stop_ccsd` and `send_ccsd` bits together; `send_auto_stop_ccsd` should not be set independently of `send_ccsd`. When set, SD/MMC automatically sends an internally-generated STOP command (CMD12) to the CE-ATA device. After sending this internally-generated STOP command, the Auto Command Done (ACD) bit in RINTSTS is set and an interrupt is generated for the host, in case the ACD interrupt is not masked. After sending the Command Completion Signal Disable (CCSD), SD/MMC automatically clears the `send_auto_stop_ccsd` bit. (R/W)

SEND_CCSD When set, SD/MMC sends CCSD to the CE-ATA device. Software sets this bit only if the current command is expecting CCS (that is, `RW_BLK`), and if interrupts are enabled for the CE-ATA device. Once the CCSD pattern is sent to the device, SD/MMC automatically clears the `send_ccsd` bit. It also sets the Command Done (CD) bit in the RINTSTS register, and generates an interrupt for the host, in case the Command Done interrupt is not masked. NOTE: Once the `send_ccsd` bit is set, it takes two card clock cycles to drive the CCSD on the CMD line. Due to this, within the boundary conditions the CCSD may be sent to the CE-ATA device, even if the device has signalled CCS. (R/W)

ABORT_READ_DATA After a suspend-command is issued during a read-operation, software polls the card to find when the suspend-event occurred. Once the suspend-event has occurred, software sets the bit which will reset the data state machine that is waiting for the next block of data. This bit is automatically cleared once the data state machine is reset to idle. (R/W)

SEND_IRQ_RESPONSE Bit automatically clears once response is sent. To wait for MMC card interrupts, host issues CMD40 and waits for interrupt response from MMC card(s). In the meantime, if host wants SD/MMC to exit waiting for interrupt state, it can set this bit, at which time SD/MMC command state-machine sends CMD40 response on bus and returns to idle state. (R/W)

Register 9.2: CTRL_REG (continued) (0x0000)

(reserved)	(reserved)	(reserved)	CEATA_DEVICE_INTERRUPT_STATUS	SEND_AUTO_STOP_CCSD	SEND_CCSD	ABORT_READ_DATA	SEND_IRQ_WAIT	READ_WAIT	DMA_ENABLE	INT_ENABLE	(reserved)	DMA_RESET	FIFO_RESET	CONTROLLER_RESET		
31	25	24	131	120	11	10	9	8	7	6	5	4	3	2	1	0
0x00	1	0x00	0	0	0	0	0	0	0	0	0	0	0	0	0	0

READ_WAIT For sending read-wait to SDIO cards. (R/W)

INT_ENABLE Global interrupt enable/disable bit. 0: Disable; 1: Enable. (R/W)

DMA_RESET To reset DMA interface, firmware should set bit to 1. This bit is auto-cleared after two AHB clocks. (R/W)

FIFO_RESET To reset FIFO, firmware should set bit to 1. This bit is auto-cleared after completion of reset operation. Note: FIFO pointers will be out of reset after 2 cycles of system clocks in addition to synchronization delay (2 cycles of card clock), after the fifo_reset is cleared. (R/W)

CONTROLLER_RESET To reset controller, firmware should set this bit. This bit is auto-cleared after two AHB and two cclk_in clock cycles. (R/W)

Register 9.3: CLKDIV_REG (0x0008)

<i>CLK_DIVIDER3</i>								<i>CLK_DIVIDER2</i>								<i>CLK_DIVIDER1</i>								<i>CLK_DIVIDER0</i>								
31								24	23							16	15			8	7							0				
0x000								0x000								0x000								0x000								Reset

CLK_DIVIDER3 Clock divider-3 value. Clock division factor is 2^n , where $n=0$ bypasses the divider (division factor of 1). For example, a value of 1 means divide by $2^1 = 2$, a value of 0xFF means divide by $2^{255} = 510$, and so on. In MMC-Ver3.3-only mode, these bits are not implemented because only one clock divider is supported. (R/W)

CLK_DIVIDER2 Clock divider-2 value. Clock division factor is 2^n , where $n=0$ bypasses the divider (division factor of 1). For example, a value of 1 means divide by $2^1 = 2$, a value of 0xFF means divide by $2^{255} = 510$, and so on. In MMC-Ver3.3-only mode, these bits are not implemented because only one clock divider is supported. (R/W)

CLK_DIVIDER1 Clock divider-1 value. Clock division factor is 2^n , where $n=0$ bypasses the divider (division factor of 1). For example, a value of 1 means divide by $2^1 = 2$, a value of 0xFF means divide by $2^{255} = 510$, and so on. In MMC-Ver3.3-only mode, these bits are not implemented because only one clock divider is supported. (R/W)

CLK_DIVIDER0 Clock divider-0 value. Clock division factor is 2^n , where $n=0$ bypasses the divider (division factor of 1). For example, a value of 1 means divide by $2^1 = 2$, a value of 0xFF means divide by $2^{255} = 510$, and so on. In MMC-Ver3.3-only mode, these bits are not implemented because only one clock divider is supported. (R/W)

Register 9.4: CLKSRC_REG (0x000C)

<i>(reserved)</i>																<i>CLKSRC_REG</i>			
31													4	3			0		
0x000000												0x0				Reset			

CLKSRC_REG Clock divider source for two SD cards is supported. Each card has two bits assigned to it. For example, bit[1:0] are assigned for card 0, bit[3:2] are assigned for card 1. Card 0 maps and internally routes clock divider[0:3] outputs to cclk_out[1:0] pins, depending on bit value.

00 : Clock divider 0;

01 : Clock divider 1;

10 : Clock divider 2;

11 : Clock divider 3.

In MMC-Ver3.3-only controller, only one clock divider is supported. The cclk_out is always from clock divider 0, and this register is not implemented. (R/W)

Register 9.5: CLKENA_REG (0x0010)

(reserved)	CCLK_ENABEL
31	2 1 0
0x00000	0x00000 Reset

CCLK_ENABEL Clock-enable control for two SD card clocks and one MMC card clock is supported.

0: Clock disabled;

1: Clock enabled.

In MMC-Ver3.3-only mode, since there is only one cclk_out, only cclk_enable[0] is used. (R/W)

Register 9.6: TMOUT_REG (0x0014)

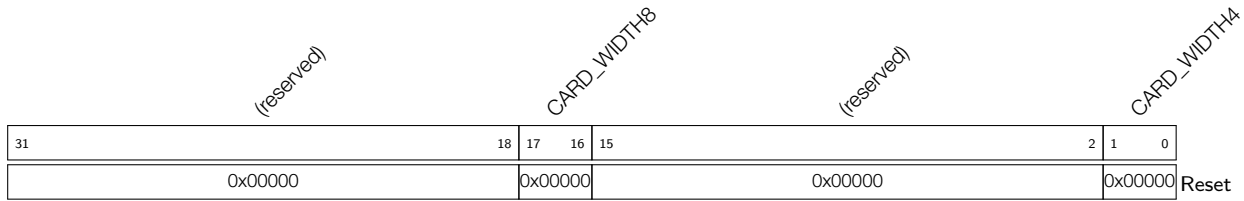
DATA_TIMEOUT	RESPONSE_TIMEOUT
31	8 7 0
0x0FFFFFFF	0x040 Reset

DATA_TIMEOUT Value for card data read timeout. This value is also used for data starvation by host timeout. The timeout counter is started only after the card clock is stopped. This value is specified in number of card output clocks, i.e. cclk_out of the selected card.

NOTE: The software timer should be used if the timeout value is in the order of 100 ms. In this case, read data timeout interrupt needs to be disabled. (R/W)

RESPONSE_TIMEOUT Response timeout value. Value is specified in terms of number of card output clocks, i.e., cclk_out. (R/W)

Register 9.7: CTYPE_REG (0x0018)



CARD_WIDTH8 One bit per card indicates if card is in 8-bit mode.

0: Non 8-bit mode;

1: 8-bit mode.

Bit[17:16] correspond to card[1:0] respectively. (R/W)

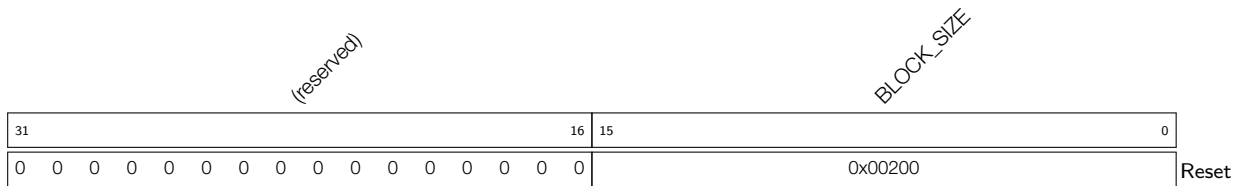
CARD_WIDTH4 One bit per card indicates if card is 1-bit or 4-bit mode.

0: 1-bit mode;

1: 4-bit mode.

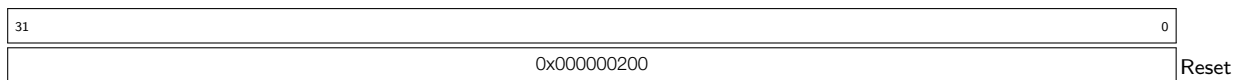
Bit[1:0] correspond to card[1:0] respectively. Only NUM_CARDS*2 number of bits are implemented. (R/W)

Register 9.8: BLKSIZ_REG (0x001C)

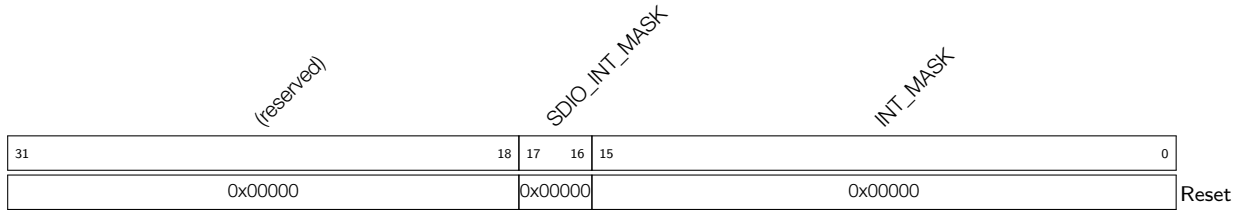


BLOCK_SIZE Block size. (R/W)

Register 9.9: BYTCNT_REG (0x0020)



BYTCNT_REG Number of bytes to be transferred, should be an integral multiple of Block Size for block transfers. For data transfers of undefined byte lengths, byte count should be set to 0. When byte count is set to 0, it is the responsibility of host to explicitly send stop/abort command to terminate data transfer. (R/W)

Register 9.10: INTMASK_REG (0x0024)

SDIO_INT_MASK SDIO interrupt mask, one bit for each card. Bit[17:16] correspond to card[15:0] respectively. When masked, SDIO interrupt detection for that card is disabled. 0 masks an interrupt, and 1 enables an interrupt. In MMC-Ver3.3-only mode, these bits are always 0. (R/W)

INT_MASK These bits used to mask unwanted interrupts. A value of 0 masks interrupt, and a value of 1 enables the interrupt. (R/W)

Bit 15 (EBE): End-bit error, read/write (no CRC)

Bit 14 (ACD): Auto command done

Bit 13 (SBE/BCI): Start Bit Error/Busy Clear Interrupt

Bit 12 (HLE): Hardware locked write error

Bit 11 (FRUN): FIFO underrun/overflow error

Bit 10 (HTO): Data starvation-by-host timeout/Volt_switch_int

Bit 9 (DRTO): Data read timeout

Bit 8 (RTO): Response timeout

Bit 7 (DCRC): Data CRC error

Bit 6 (RCRC): Response CRC error

Bit 5 (RXDR): Receive FIFO data request

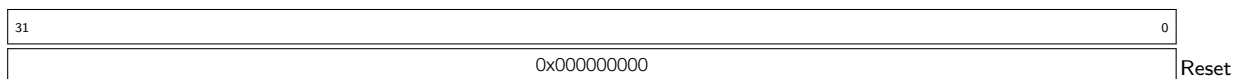
Bit 4 (TXDR): Transmit FIFO data request

Bit 3 (DTO): Data transfer over

Bit 2 (CD): Command done

Bit 1 (RE): Response error

Bit 0 (CD): Card detect

Register 9.11: CMDARG_REG (0x0028)

CMDARG_REG Value indicates command argument to be passed to the card. (R/W)

Register 9.12: CMD_REG (0x002C)

31	30	29	28	27	26	25	24	23	22	21	20	16	15	14	13	12	11	10	9	8	7	6	5	0	Reset
0	0	1	0	0	0	0	0	0	0	0	0	0x00	0	0	0	0	0	0	0	0	0	0	0	0x00	

START_CMD Start command. Once command is served by the CIU, this bit is automatically cleared.

When this bit is set, host should not attempt to write to any command registers. If a write is attempted, hardware lock error is set in raw interrupt register. Once command is sent and a response is received from SD/MMC_CEATA cards, Command Done bit is set in the raw interrupt Register. (R/W)

USE_HOLE Use Hold Register. (R/W) 0: CMD and DATA sent to card bypassing HOLD Register; 1: CMD and DATA sent to card through the HOLD Register.

CCS_EXPECTED Expected Command Completion Signal (CCS) configuration. (R/W)

0: Interrupts are not enabled in CE-ATA device ($nIEN = 1$ in ATA control register), or command does not expect CCS from device.

1: Interrupts are enabled in CE-ATA device ($nIEN = 0$), and RW_BLK command expects command completion signal from CE-ATA device.

If the command expects Command Completion Signal (CCS) from the CE-ATA device, the software should set this control bit. SD/MMC sets Data Transfer Over (DTO) bit in RINTSTS register and generates interrupt to host if Data Transfer Over interrupt is not masked.

READ_CEATA_DEVICE Read access flag. (R/W)

0: Host is not performing read access (RW_REG or RW_BLK) towards CE-ATA device

1: Host is performing read access (RW_REG or RW_BLK) towards CE-ATA device.

Software should set this bit to indicate that CE-ATA device is being accessed for read transfer. This bit is used to disable read data timeout indication while performing CE-ATA read transfers. Maximum value of I/O transmission delay can be no less than 10 seconds. SD/MMC should not indicate read data timeout while waiting for data from CE-ATA device. (R/W)

Register 9.13: CMD_REG (continued) (0x002C)

31	30	29	28	27	26	25	24	23	22	21	20	16	15	14	13	12	11	10	9	8	7	6	5	0	Reset	
0	0	1	0	0	0	0	0	0	0	0	0	0x00	0	0	0	0	0	0	0	0	0	0	0	0	0x00	

UPDATE_CLOCK_REGISTERS_ONLY (R/W)

0: Normal command sequence.

1: Do not send commands, just update clock register value into card clock domain

Following register values are transferred into card clock domain: CLKDIV, CLRSRC, and CLKENA. Changes card clocks (change frequency, truncate off or on, and set low-frequency mode). This is provided in order to change clock frequency or stop clock without having to send command to cards.

During normal command sequence, when update_clock_registers_only = 0, following control registers are transferred from BIU to CIU: CMD, CMDARG, TMOUT, CTYPE, BLKSIZ, and BYTCNT. CIU uses new register values for new command sequence to card(s). When bit is set, there are no Command Done interrupts because no command is sent to SD_MMC_CEATA cards.

CARD_NUMBER Card number in use. Represents physical slot number of card being accessed. In MMC-Ver3.3-only mode, up to two cards are supported. In SD-only mode, up to two cards are supported. (R/W)

SEND_INITIALIZATION (R/W)

0: Do not send initialization sequence (80 clocks of 1) before sending this command.

1: Send initialization sequence before sending this command.

After power on, 80 clocks must be sent to card for initialization before sending any commands to card. Bit should be set while sending first command to card so that controller will initialize clocks before sending command to card.

STOP_ABORT_CMD (R/W)

0: Neither stop nor abort command can stop current data transfer. If abort is sent to function-number currently selected or not in data-transfer mode, then bit should be set to 0.

1: Stop or abort command intended to stop current data transfer in progress. When open-ended or predefined data transfer is in progress, and host issues stop or abort command to stop data transfer, bit should be set so that command/data state-machines of CIU can return correctly to idle state.

Register 9.14: CMD_REG (continued) (0x002C)

START_CMD (reserved)		USE_HOLE (reserved)		(reserved)		(reserved)		(reserved)		CCS_EXPECTED		READ_CEATA_DEVICE		UPDATE_CLOCK_REGISTERS_ONLY		CARD_NUMBER		SEND_INITIALIZATION		STOP_ABORT_CMD		WAIT_PRVDATA_COMPLETE		SEND_AUTO_STOP		TRANSFER_MODE		READ/WRITE		DATA_EXPECTED		CHECK_RESPONSE_CRC		RESPONSE_LENGTH		RESPONSE_EXPECT		CMD_INDEX	
31	30	29	28	27	26	25	24	23	22	21	20	16	15	14	13	12	11	10	9	8	7	6	5							0									
0	0	1	0	0	0	0	0	0	0	0	0	0x00	0	0	0	0	0	0	0	0	0	0	0	0	0	0	0	0	0	0	0	0	0	0	0x00	Reset			

WAIT_PRVDATA_COMPLETE (R/W)

- 0: Send command at once, even if previous data transfer has not completed;
- 1: Wait for previous data transfer to complete before sending Command.

The wait_prvdata_complete = 0 option is typically used to query status of card during data transfer or to stop current data transfer. card_number should be same as in previous command.

SEND_AUTO_STOP (R/W)

- 0: No stop command is sent at the end of data transfer;
- 1: Send stop command at the end of data transfer.

TRANSFER_MODE (R/W)

- 0: Block data transfer command;
- 1: Stream data transfer command. Don't care if no data expected.

READ/WRITE (R/W)

- 0: Read from card;
 - 1: Write to card.
- Don't care if no data is expected from card.

DATA_EXPECTED (R/W)

- 0: No data transfer expected.
- 1: Data transfer expected.

CHECK_RESPONSE_CRC (R/W)

- 0: Do not check;
 - 1: Check response CRC.
- Some of command responses do not return valid CRC bits. Software should disable CRC checks for those commands in order to disable CRC checking by controller.

RESPONSE_LENGTH (R/W)

- 0: Short response expected from card;
- 1: Long response expected from card.

RESPONSE_EXPECT (R/W)

- 0: No response expected from card;
- 1: Response expected from card.

CMD_INDEX Command index. (R/W)

Register 9.15: RESP0_REG (0x0030)

31	0
0x00000000	
Reset	

RESP0_REG Bit[31:0] of response. (RO)

Register 9.16: RESP1_REG (0x0034)

31	0
0x00000000	
Reset	

RESP1_REG Bit[63:32] of long response. (RO)

Register 9.17: RESP2_REG (0x0038)

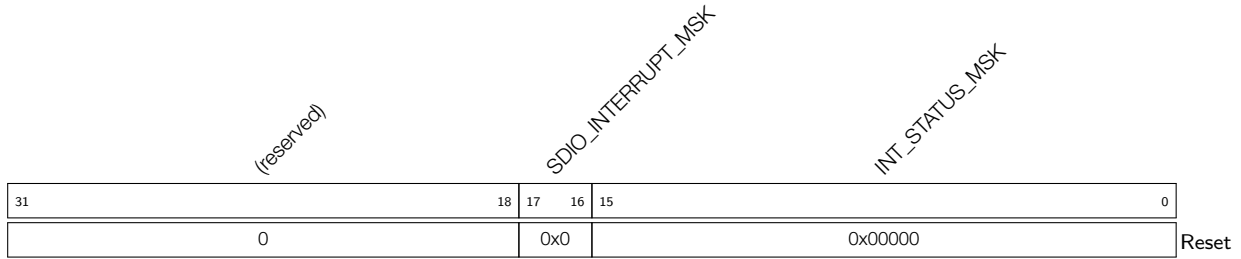
31	0
0x00000000	
Reset	

RESP2_REG Bit[95:64] of long response. (RO)

Register 9.18: RESP3_REG (0x003C)

31	0
0x00000000	
Reset	

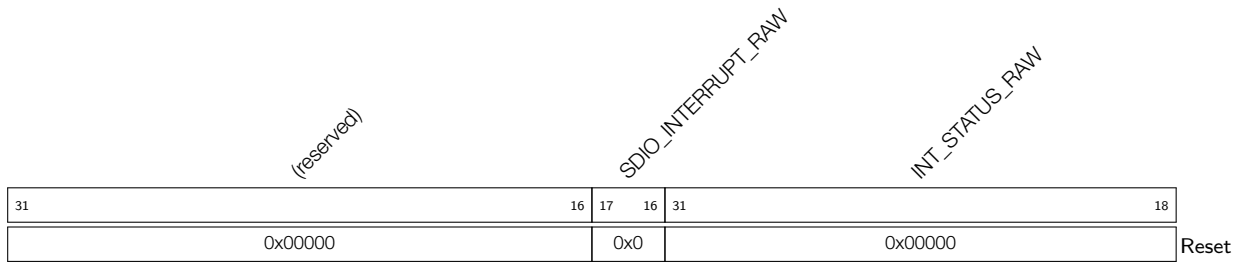
RESP3_REG Bit[127:96] of long response. (RO)

Register 9.19: MINTSTS_REG (0x0040)

SDIO_INTERRUPT_MSK Interrupt from SDIO card, one bit for each card. Bit[17:16] correspond to card1 and card0, respectively. SDIO interrupt for card is enabled only if corresponding `sdio_int_mask` bit is set in Interrupt mask register (Setting mask bit enables interrupt). (RO)

INT_STATUS_MSK Interrupt enabled only if corresponding bit in interrupt mask register is set. (RO)

- Bit 15 (EBE): End-bit error, read/write (no CRC)
- Bit 14 (ACD): Auto command done
- Bit 13 (SBE/BCI): Start Bit Error/Busy Clear Interrupt
- Bit 12 (HLE): Hardware locked write error
- Bit 11 (FRUN): FIFO underrun/overflow error
- Bit 10 (HTO): Data starvation by host timeout (HTO)
- Bit 9 (DTRO): Data read timeout
- Bit 8 (RTO): Response timeout
- Bit 7 (DCRC): Data CRC error
- Bit 6 (RCRC): Response CRC error
- Bit 5 (RXDR): Receive FIFO data request
- Bit 4 (TXDR): Transmit FIFO data request
- Bit 3 (DTO): Data transfer over
- Bit 2 (CD): Command done
- Bit 1 (RE): Response error
- Bit 0 (CD): Card detect

Register 9.20: RINTSTS_REG (0x0044)

SDIO_INTERRUPT_RAW Interrupt from SDIO card, one bit for each card. Bit[17:16] correspond to card1 and card0, respectively. Setting a bit clears the corresponding interrupt bit and writing 0 has no effect. (R/W)

0: No SDIO interrupt from card;

1: SDIO interrupt from card.

In MMC-Ver3.3-only mode, these bits are always 0. Bits are logged regardless of interrupt-mask status. (R/W)

INT_STATUS_RAW Setting a bit clears the corresponding interrupt and writing 0 has no effect. Bits are logged regardless of interrupt mask status. (R/W)

Bit 15 (EBE): End-bit error, read/write (no CRC)

Bit 14 (ACD): Auto command done

Bit 13 (SBE/BCI): Start Bit Error/Busy Clear Interrupt

Bit 12 (HLE): Hardware locked write error

Bit 11 (FRUN): FIFO underrun/overflow error

Bit 10 (HTO): Data starvation by host timeout (HTO)

Bit 9 (DTRO): Data read timeout

Bit 8 (RTO): Response timeout

Bit 7 (DCRC): Data CRC error

Bit 6 (RCRC): Response CRC error

Bit 5 (RXDR): Receive FIFO data request

Bit 4 (TXDR): Transmit FIFO data request

Bit 3 (DTO): Data transfer over

Bit 2 (CD): Command done

Bit 1 (RE): Response error

Bit 0 (CD): Card detect

Register 9.21: STATUS_REG (0x0048)

(reserved)		FIFO_COUNT															RESPONSE_INDEX		DATA_STATE_MC_BUSY			DATA_BUSY	DATA_3_STATUS	COMMAND_FSM_STATES					FIFO_FULL	FIFO_EMPTY	FIFO_TX_WATERMARK	FIFO_RX_WATERMARK		
31	30	29													17	16			11	10	9	8	7						4	3	2	1	0	
0	0		0x000														0x00		1	1	1			0x01					0	1	1	0	0	Reset

FIFO_COUNT FIFO count, number of filled locations in FIFO. (RO)

RESPONSE_INDEX Index of previous response, including any auto-stop sent by core. (RO)

DATA_STATE_MC_BUSY Data transmit or receive state-machine is busy. (RO)

DATA_BUSY Inverted version of raw selected card_data[0]. (RO)

- 0: Card data not busy;
- 1: Card data busy.

DATA_3_STATUS Raw selected card_data[3], checks whether card is present. (RO)

- 0: card not present;
- 1: card present.

COMMAND_FSM_STATES Command FSM states. (RO)

- 0: Idle
- 1: Send init sequence
- 2: Send cmd start bit
- 3: Send cmd tx bit
- 4: Send cmd index + arg
- 5: Send cmd crc7
- 6: Send cmd end bit
- 7: Receive resp start bit
- 8: Receive resp IRQ response
- 9: Receive resp tx bit
- 10: Receive resp cmd idx
- 11: Receive resp data
- 12: Receive resp crc7
- 13: Receive resp end bit
- 14: Cmd path wait NCC
- 15: Wait, cmd-to-response turnaround

FIFO_FULL FIFO is full status. (RO)

FIFO_EMPTY FIFO is empty status. (RO)

FIFO_TX_WATERMARK FIFO reached Transmit watermark level, not qualified with data transfer. (RO)

FIFO_RX_WATERMARK FIFO reached Receive watermark level, not qualified with data transfer. (RO)

Register 9.22: FIFOTH_REG (0x004C)

(reserved)		DMA_MULTIPLE_TRANSACTION_SIZE				(reserved)				RX_WMARK				(reserved)				TX_WMARK			
31	30	28	27	26		16	15	12	11											0	
0	0x0	0	x	x	x	x	x	x	x	x	x	x	x	x	0	0	0	0	0x0000	Reset	

DMA_MULTIPLE_TRANSACTION_SIZE Burst size of multiple transaction, should be programmed same as DMA controller multiple-transaction-size SRC/DEST_MSIZ. 000: 1-byte transfer; 001: 4-byte transfer; 010: 8-byte transfer; 011: 16-byte transfer; 100: 32-byte transfer; 101: 64-byte transfer; 110: 128-byte transfer; 111: 256-byte transfer. (R/W)

RX_WMARK FIFO threshold watermark level when receiving data to card. When FIFO data count reaches greater than this number (FIFO_RX_WATERMARK), DMA/FIFO request is raised. During end of packet, request is generated regardless of threshold programming in order to complete any remaining data. In non-DMA mode, when receiver FIFO threshold (RXDR) interrupt is enabled, then interrupt is generated instead of DMA request. During end of packet, interrupt is not generated if threshold programming is larger than any remaining data. It is responsibility of host to read remaining bytes on seeing Data Transfer Done interrupt. In DMA mode, at end of packet, even if remaining bytes are less than threshold, DMA request does single transfers to flush out any remaining bytes before Data Transfer Done interrupt is set. (R/W)

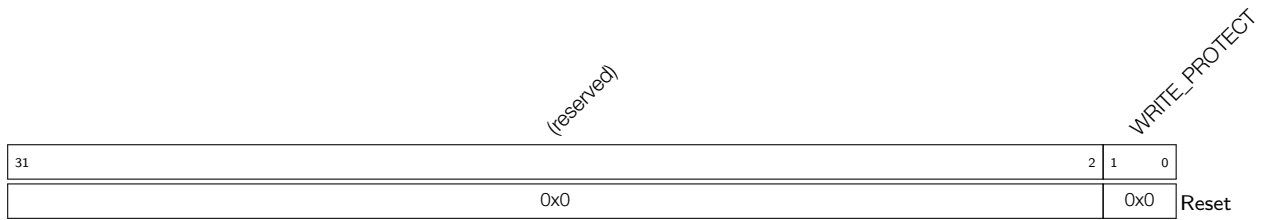
TX_WMARK FIFO threshold watermark level when transmitting data to card. When FIFO data count is less than or equal to this number (FIFO_TX_WATERMARK), DMA/FIFO request is raised. If Interrupt is enabled, then interrupt occurs. During end of packet, request or interrupt is generated, regardless of threshold programming. In non-DMA mode, when transmit FIFO threshold (TXDR) interrupt is enabled, then interrupt is generated instead of DMA request. During end of packet, on last interrupt, host is responsible for filling FIFO with only required remaining bytes (not before FIFO is full or after CIU completes data transfers, because FIFO may not be empty). In DMA mode, at end of packet, if last transfer is less than burst size, DMA controller does single cycles until required bytes are transferred. (R/W)

Register 9.23: CDETECT_REG (0x0050)

(reserved)																CARD_DETECT_N		
31																2	1	0
																0x0	0x0	Reset

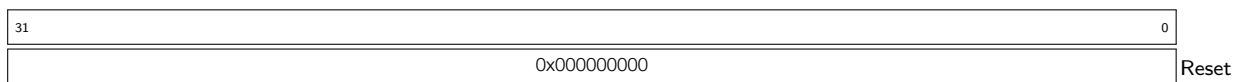
CARD_DETECT_N Value on card_detect_n input ports (1 bit per card), read-only bits. 0 represents presence of card. Only NUM_CARDS number of bits are implemented. (RO)

Register 9.24: WRTprt_REG (0x0054)



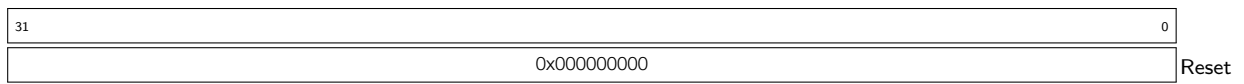
WRITE_PROTECT Value on card_write_prt input ports (1 bit per card). 1 represents write protection. Only NUM_CARDS number of bits are implemented. (RO)

Register 9.25: TCBCNT_REG (0x005C)



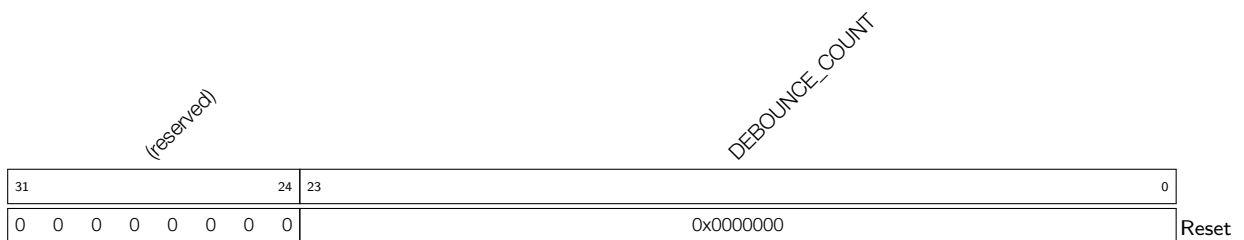
TCBCNT_REG Number of bytes transferred by CIU unit to card. (RO)

Register 9.26: TBBCNT_REG (0x0060)



TBBCNT_REG Number of bytes transferred between Host/DMA memory and BIU FIFO. (RO)

Register 9.27: DEBNCE_REG (0x0064)



DEBOUNCE_COUNT Number of host clocks (clk) used by debounce filter logic. The typical debounce time is 5 ~ 25 ms to prevent the card instability when the card is inserted or removed. (R/W)

Register 9.28: USRID_REG (0x0068)

31	0
0x00000000	
Reset	

USRID_REG User identification register, value set by user. Default reset value can be picked by user while configuring core before synthesis. Can also be used as a scratchpad register by user. (R/W)

Register 9.29: RST_N_REG (0x0078)

31	2	1	0
(reserved)			RST_CARD_RESET
0			0x1
Reset			

RST_CARD_RESET Hardware reset. 1: Active mode; 0: Reset. These bits cause the cards to enter pre-idle state, which requires them to be re-initialized. CARD_RESET[0] should be set to 1'b0 to reset card0, CARD_RESET[1] should be set to 1'b0 to reset card1. The number of bits implemented is restricted to NUM_CARDS. (R/W)

Register 9.30: BMOD_REG (0x0080)

31	11	10	8	7	6	2	1	0	
(reserved)						BMOD_PBL	BMOD_DE	(reserved)	BMOD_FB BMOD_SWR
0 0						0x0	0	0x00	0 0
Reset									

BMOD_PBL Programmable Burst Length. These bits indicate the maximum number of beats to be performed in one IDMAC transaction. The IDMAC will always attempt to burst as specified in PBL each time it starts a burst transfer on the host bus. The permissible values are 1, 4, 8, 16, 32, 64, 128 and 256. This value is the mirror of MSIZE of FIFOTH register. In order to change this value, write the required value to FIFOTH register. This is an encode value as follows:

000: 1-byte transfer; 001: 4-byte transfer; 010: 8-byte transfer; 011: 16-byte transfer; 100: 32-byte transfer; 101: 64-byte transfer; 110: 128-byte transfer; 111: 256-byte transfer.

PBL is a read-only value and is applicable only for data access, it does not apply to descriptor access. (R/W)

BMOD_DE IDMAC Enable. When set, the IDMAC is enabled. (R/W)

BMOD_FB Fixed Burst. Controls whether the AHB Master interface performs fixed burst transfers or not. When set, the AHB will use only SINGLE, INCR4, INCR8 or INCR16 during start of normal burst transfers. When reset, the AHB will use SINGLE and INCR burst transfer operations. (R/W)

BMOD_SWR Software Reset. When set, the DMA Controller resets all its internal registers. It is automatically cleared after one clock cycle. (R/W)

Register 9.31: PLDMND_REG (0x0080)

31	0
0x00000000	
Reset	

PLDMND_REG Poll Demand. If the OWN bit of a descriptor is not set, the FSM goes to the Suspend state. The host needs to write any value into this register for the IDMAC FSM to resume normal descriptor fetch operation. This is a write only register, PD bit is write-only. (WO)

Register 9.32: DBADDR_REG (0x0088)

31	0
0x00000000	
Reset	

DBADDR_REG Start of Descriptor List. Contains the base address of the First Descriptor. The LSB bits [1:0] are ignored and taken as all-zero by the IDMAC internally. Hence these LSB bits may be treated as read-only. (R/W)

Register 9.33: IDSTS_REG (0x008C)

(reserved)																	IDSTS_FSM				IDSTS_FBE_CODE				IDSTS_AIS		IDSTS_NIS		(reserved)		IDSTS_CES		IDSTS_DU		(reserved)		IDSTS_FBE		IDSTS_RI		IDSTS_TI	
31														17	16					13	12					10	9	8	7	6	5	4	3	2	1	0						
0	0	0	0	0	0	0	0	0	0	0	0	0	0	0	0	0	0	0	0	0	0	0	0	0	0	0	0	0	0	0	0	0	0	0	0	0	0	0				

Reset

IDSTS_FSM DMAC FSM present state: (RO)

0: DMA_IDLE; 1: DMA_SUSPEND; 2: DESC_RD; 3: DESC_CHK; 4: DMA_RD_REQ_WAIT
5: DMA_WR_REQ_WAIT; 6: DMA_RD; 7: DMA_WR; 8: DESC_CLOSE.

IDSTS_FBE_CODE Fatal Bus Error Code. Indicates the type of error that caused a Bus Error. Valid only when the Fatal Bus Error bit IDSTS[2] is set. This field does not generate an interrupt. (RO)

3b001: Host Abort received during transmission;
3b010: Host Abort received during reception;
Others: Reserved.

IDSTS_AIS Abnormal Interrupt Summary. Logical OR of the following: IDSTS[2] : Fatal Bus Interrupt, IDSTS[4] : DU bit Interrupt. Only unmasked bits affect this bit. This is a sticky bit and must be cleared each time a corresponding bit that causes AIS to be set is cleared. Writing 1 clears this bit. (R/W)

IDSTS_NIS Normal Interrupt Summary. Logical OR of the following: IDSTS[0] : Transmit Interrupt, IDSTS[1] : Receive Interrupt. Only unmasked bits affect this bit. This is a sticky bit and must be cleared each time a corresponding bit that causes NIS to be set is cleared. Writing 1 clears this bit. (R/W)

IDSTS_CES Card Error Summary. Indicates the status of the transaction to/from the card, also present in RINTSTS. Indicates the logical OR of the following bits: EBE : End Bit Error, RTO : Response Timeout/Boot Ack Timeout, RCRC : Response CRC, SBE : Start Bit Error, DRTO : Data Read Timeout/BDS timeout, DCRC : Data CRC for Receive, RE : Response Error.
Writing 1 clears this bit. The abort condition of the IDMAC depends on the setting of this CES bit. If the CES bit is enabled, then the IDMAC aborts on a response error. (R/W)

IDSTS_DU Descriptor Unavailable Interrupt. This bit is set when the descriptor is unavailable due to OWN bit = 0 (DES0[31] =0). Writing 1 clears this bit. (R/W)

IDSTS_FBE Fatal Bus Error Interrupt. Indicates that a Bus Error occurred (IDSTS[12:10]) . When this bit is set, the DMA disables all its bus accesses. Writing 1 clears this bit. (R/W)

IDSTS_RI Receive Interrupt. Indicates the completion of data reception for a descriptor. Writing 1 clears this bit. (R/W)

IDSTS_TI Transmit Interrupt. Indicates that data transmission is finished for a descriptor. Writing 1 clears this bit. (R/W)

Register 9.34: IDINTEN_REG (0x0090)

(reserved)										IDINTEN_AI	IDINTEN_NI	(reserved)		IDINTEN_CES	IDINTEN_DU	(reserved)		IDINTEN_FBE	IDINTEN_RI	IDINTEN_TI			
31											10	9	8	7	6	5	4	3	2	1	0		
0 0										0	0	0	0	0	0	0	0	0	0	0	0	0	Reset

IDINTEN_AI Abnormal Interrupt Summary Enable. (R/W)

When set, an abnormal interrupt is enabled. This bit enables the following bits:

- IDINTEN[2]: Fatal Bus Error Interrupt;
- IDINTEN[4]: DU Interrupt.

IDINTEN_NI Normal Interrupt Summary Enable. (R/W)

When set, a normal interrupt is enabled. When reset, a normal interrupt is disabled. This bit enables the following bits:

- IDINTEN[0]: Transmit Interrupt;
- IDINTEN[1]: Receive Interrupt.

IDINTEN_CES Card Error summary Interrupt Enable. When set, it enables the Card Interrupt summary. (R/W)

IDINTEN_DU Descriptor Unavailable Interrupt. When set along with Abnormal Interrupt Summary Enable, the DU interrupt is enabled. (R/W)

IDINTEN_FBE Fatal Bus Error Enable. When set with Abnormal Interrupt Summary Enable, the Fatal Bus Error Interrupt is enabled. When reset, Fatal Bus Error Enable Interrupt is disabled. (R/W)

IDINTEN_RI Receive Interrupt Enable. When set with Normal Interrupt Summary Enable, Receive Interrupt is enabled. When reset, Receive Interrupt is disabled. (R/W)

IDINTEN_TI Transmit Interrupt Enable. When set with Normal Interrupt Summary Enable, Transmit Interrupt is enabled. When reset, Transmit Interrupt is disabled. (R/W)

Register 9.35: DSCADDR_REG (0x0094)

31	0
0x00000000	
	Reset

DSCADDR_REG Host Descriptor Address Pointer, updated by IDMAC during operation and cleared on reset. This register points to the start address of the current descriptor read by the IDMAC. (RO)

Register 9.36: BUFADDR_REG (0x0098)

31	0
0x00000000	
Reset	

BUFADDR_REG Host Buffer Address Pointer, updated by IDMAC during operation and cleared on reset. This register points to the current Data Buffer Address being accessed by the IDMAC. (RO)

Register 9.37: CLK_EDGE_SEL (0x0800)

(reserved)				CCLKIN_EDGE_N		CCLKIN_EDGE_L		CCLKIN_EDGE_H		CCLKIN_EDGE_SLF_SEL		CCLKIN_EDGE_SAM_SEL		CCLKIN_EDGE_DRV_SEL	
31	21	20	17	16	13	12	9	8	6	5	3	2	0		
0x000				0x1		0x0		0x1		0x0		0x0		0x0	
														Reset	

CCLKIN_EDGE_N This value should be equal to CCLKIN_EDGE_L. (R/W)

CCLKIN_EDGE_L The low level of the divider clock. The value should be larger than CCLKIN_EDGE_H. (R/W)

CCLKIN_EDGE_H The high level of the divider clock. The value should be smaller than CCLKIN_EDGE_L. (R/W)

CCLKIN_EDGE_SLF_SEL It is used to select the clock phase of the internal signal from phase90, phase180, or phase270. (R/W)

CCLKIN_EDGE_SAM_SEL It is used to select the clock phase of the input signal from phase90, phase180, or phase270. (R/W)

CCLKIN_EDGE_DRV_SEL It is used to select the clock phase of the output signal from phase90, phase180, or phase270. (R/W)

10. Ethernet MAC

10.1 Overview

Features of Ethernet

By using the external Ethernet PHY (physical layer), ESP32 can send and receive data via Ethernet MAC (Media Access Controller) according to the IEEE 802.3 standard, as Figure 39 shows. Ethernet is currently the most commonly used network protocol that controls how data is transmitted over local- and wide-area networks, abbreviated as LAN and WAN, respectively.

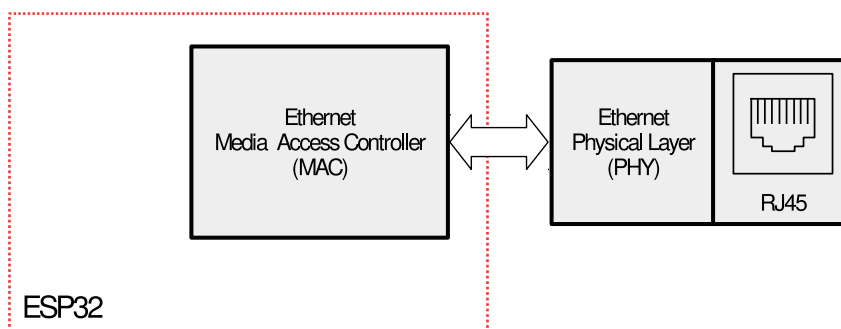


Figure 39: Ethernet MAC Functionality Overview

ESP32 MAC Ethernet complies with the following criteria:

- IEEE 802.3-2002 for Ethernet MAC
- IEEE 1588-2008 standard for specifying the accuracy of networked clock synchronization
- Two industry-standard interfaces conforming with IEEE 802.3-2002: Media-Independent Interface (MII) and Reduced Media-Independent Interface (RMII).

Features of MAC Layer

- Support for a data transmission rate of 10 Mbit/s or 100 Mbit/s through an external PHY interface
- Communication with an external Fast Ethernet PHY through IEEE 802.3-compliant MII and RMII interfaces
- Support for:
 - Carrier Sense Multiple Access / Collision Detection (CSMA/CD) protocol in half-duplex mode
 - IEEE 802.3x flow control in full-duplex mode
 - operations in full-duplex mode, forwarding the received pause-control frame to the user application
 - backpressure flow control in half-duplex mode
 - If the flow control input signal disappears during a full-duplex operation, a pause frame with zero pause time value is automatically transmitted.
- The Preamble and the Start Frame Delimiter (SFD) are inserted in the Transmit path, and deleted in the Receive path.
- Cyclic Redundancy Check (CRC) and Pad can be controlled on a per-frame basis.
- The Pad is generated automatically, if data is below the minimum frame length.

- Programmable frame length supporting jumbo frames of up to 16 KB
- Programmable Inter-frame Gap (IFG) (40-96 bit times in steps of 8)
- Support for a variety of flexible address filtering modes:
 - Up to eight 48-bit perfect address filters to mask each byte
 - Up to eight 48-bit SA address comparison checks to mask each byte
 - All multicast address frames can be transmitted
 - All frames in mixed mode can be transmitted without being filtered for network monitoring
 - A status report is attached each time all incoming packets are transmitted and filtered.
- Returning a 32-bit status for transmission and reception of packets respectively
- Separate transmission, reception, and control interfaces for the application
- Use of the Management Data Input/Output (MDIO) interface to configure and manage PHY devices
- Support for the offloading of received IPv4 and TCP packets encapsulated by an Ethernet frame in the reception function
- Support for checking IPv4 header checksums, as well as TCP, UDP, or ICMP (Internet Control Message Protocol) checksums encapsulated in IPv4/IPv6 packets in the enhanced reception function
- Support for Ethernet frame timestamps. (For details please refer to IEEE 1588-2008.) Each frame has a 64-bit timestamp when transmitted or received.
- Two sets of FIFOs: one 2 KB Tx FIFO with programmable threshold and one 2 KB Rx FIFO with configurable threshold (64 bytes by default)
- When Rx FIFO stores multiple frames, the Receive Status Vector is inserted into the Rx FIFO after transmitting an EOF (end of frame), so that the Rx FIFO does not need to store the Receive Status of these frames.
- In store-and-forward mode, all error frames can be filtered during reception, but not forwarded to the application.
- Under-sized good frames can be forwarded.
- Support for data statistics by generating pulses for lost or corrupted frames in the Rx FIFO due to an overflow
- Support for store-and-forward mechanism when transmitting data to the MAC core
- Automatic re-transmission of collided frames during transmission (subject to certain conditions, see section [10.2.1.2](#))
- Discarding frames in cases of late collisions, excessive collisions, excessive deferrals, and under-run conditions
- The Tx FIFO is flushed by software control.
- Calculating the IPv4 header checksum, as well as the TCP, UDP, or ICMP checksum, and then inserting them into frames transmitted in store-and-forward mode.

Ethernet Block Diagram

Figure 40 shows the block diagram of the Ethernet.

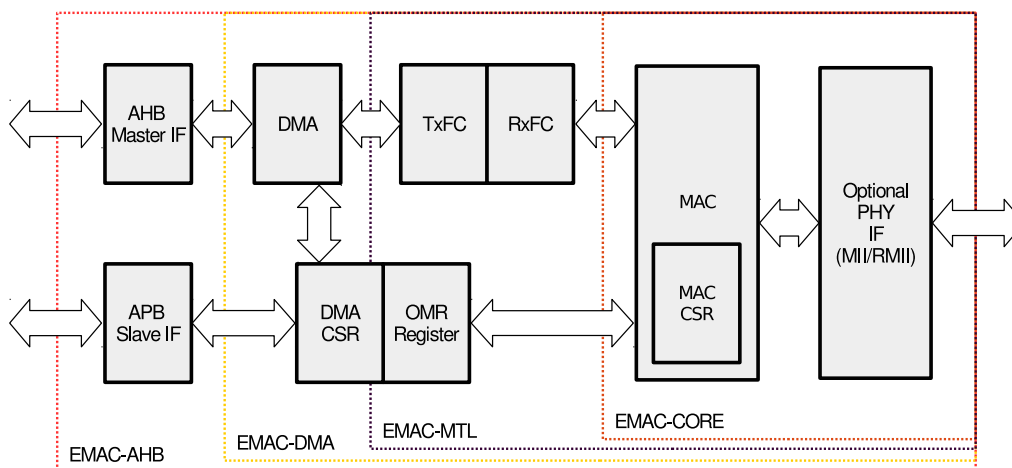


Figure 40: Ethernet Block Diagram

Ethernet MAC consists of the MAC-layer configuration register module and three layers: EMAC_CORE (MAC Core Layer), EMAC_MTL (MAC Transition Layer), and EMAC_DMA (Direct Memory Access). Each of these three layers has two directions: Tx and Rx. They are connected to the system through the Advanced High-Performance Bus (AHB) and the Advanced Peripheral Bus (APB) on the chip. Off the chip, they communicate with the external PHY through the MII and RMII interfaces to materialize an Ethernet connection.

10.2 EMAC_CORE

The MAC supports many interfaces with the PHY chip. The PHY interface can be selected only once after reset. The MAC communicates with the application side (DMA side), using the MAC Transmit Interface (MTI), MAC Receive Interface (MRI) and the MAC Control Interface (MCI).

10.2.1 Transmit Operation

A transmit operation is initiated when the MTL Application pushes in data at the time a response signal is asserted. When the SOF (start of frame) signal is detected, the MAC accepts the data and begins transmitting to the RMII or MII. The time required to transmit the frame data to the RMII or MII, after the application initiates transmission, varies, depending on delay factors like IFG delay, time to transmit Preamble or SFD (Start Frame Delimiter), and any back-off delays in half-duplex mode. Until then, the MAC does not accept the data received from MTL by de-asserting the ready signal.

After the EOF (end of frame) is transmitted to the MAC, the MAC completes the normal transmission and yields the Transmit Status to the MTL. If a normal collision (in half-duplex mode) occurs during transmission, the MAC makes valid the Transmit Status in the MTL. It then accepts and drops all further data until the next SOF is received. The MTL block should retransmit the same frame from SOF upon observing a retry request (in the Status) from the MAC.

The MAC issues an underflow status if the MTL is not able to provide the data continuously during transmission. During the normal transmission of a frame from MTL, if the MAC receives an SOF without getting an EOF for the previous frame, it ignores the SOF and considers the new frame as a continuation of the previous one.

10.2.1.1 Transmit Flow Control

In full-duplex mode, when the Transmit Flow Control Enable bit (TFE bit in the Flow Control Register) is set to 1, the MAC will generate and send a pause frame, as needed. The pause frame is added and transmitted together with the calculated CRC. The generation of pause frames can be initiated in two ways.

When the application sets the Flow Control Busy bit (FCB bit in the Flow Control Register) to 1, or when the Rx FIFO is full, a pause frame is transmitted.

- If an application has requested flow control by setting the FCB bit in the Flow Control Register to 1, the MAC will generate and send a single pause frame. The pause time value in the generated frame is the pause time value programmed in the Flow Control Register. To extend or end the pause time before the time specified in the previously transmitted pause frame, the application program must configure the pause time value in the Flow Control Register to the appropriate value and, then, request another pause frame transmission.
- If the application has requested flow control when the Rx FIFO is full, the MAC will generate and transmit a pause frame. The value of the pause time of the generated frame is the pause time value programmed in the Flow Control Register. If the Rx FIFO remains full during the configurable interval, which is determined by the Pause Low Threshold bit (PLT) in the Flow Control Register before the pause time expires, a second pause frame will be transmitted. As long as the Rx FIFO remains full, the process repeats itself. If the FIFO is no longer full before the sample time, the MAC will send a pause frame with zero pause time, indicating to the remote end that the Rx buffer is ready to receive the new data frame.

10.2.1.2 Retransmission During a Collision

In half-duplex mode, a collision may occur on the MAC line interface when frames are transmitted to the MAC. The MAC may even give a status to indicate a retry before the end of the frame is received. The retransmission is then enabled and the frame is popped out from the FIFO. When more than 96 bytes are transmitted to the MAC core, the FIFO controller frees the space in the FIFO, allowing the DMA to push more data into FIFO. This means that data cannot be retransmitted after the threshold is exceeded or when the MAC core indicates that a late collision has occurred.

The MAC transmitter may abort the transmission of a frame because of collision, Tx FIFO underflow, loss of carrier, jabber timeout, no carrier, excessive deferral, and late collision. When frame transmission is aborted because of collision, the MAC requests retransmission of the frame.

10.2.2 Receive Operation

A receive operation is initiated when the MAC detects an SFD on the RMII or MII. The MAC strips the Preamble and SFD before processing the frame. The header fields are checked for the filtering and the FCS (Frame Check Sequence) field used to verify the CRC for the frame. The received frame is stored in a shallow buffer until the address filtering is performed. The frame is dropped in the MAC if it fails the address filtering.

The frame received by the MAC will be pushed into the Rx FIFO. Once the FIFO status exceeds the Receive Threshold, configured by the Receive Threshold Control (RTC) bit in the Operation Mode register, the DMA can initiate a preconfigured burst transmission to the AHB interface.

In the default pass-through mode, when the FIFO receives a complete packet or 64 bytes configured by the RTC bit in the Operation Mode Register, the data pops up and its availability is notified to the DMA. After the DMA initiates the transmission to the AHB interface, the data transmission continues from the FIFO until the complete

packet is transmitted. Upon completing transmitting the EOF, the status word will pop up and be transmitted to the DMA controller.

In the Rx FIFO Store-and-Forward mode (configured through the RSF or Receive Store and Forward bit in the Operation Mode Register), only the valid frames are read and forwarded to the application. In the passthrough mode, error frames are not discarded because the error status is received at the end of the frame. The start of frame will have been read from the FIFO at that point.

10.2.2.1 Reception Protocol

After the receive module receives the packets, the Preamble and SFD of the received frames are removed. When the SFD is detected, the MAC starts sending Ethernet frame data to the Rx FIFO, starting at the first byte (destination address) following the SFD. This timestamp is passed on to the application, unless the MAC filters out and drops the frame.

If the received frame length/type is less than 0x600 and the automatic CRC/Pad removal option is programmed for the MAC, the MAC will send frame data to the Rx FIFO (the amount of data does not exceed the number specified in the length/type field). Then MAC begins discarding the remaining section, including the FCS field. If the frame length/type is greater than, or equal to, 0x600, the MAC will send all received Ethernet frame data to the Rx FIFO, regardless of the programmed value of the automatic CRC removal option. By default, the MAC watchdog timer is enabled, meaning that frames, including DA, SA, LT, data, pad and FCS, which exceed 2048 bytes, are cut off. This function can be disabled by programming the Watchdog Disable (WD) bit in the MAC Configuration Register. However, even if the watchdog timer is disabled, frames longer than 16 KB will be cut off and the watchdog timeout status will be given.

10.2.2.2 Receive Frame Controller

If the RA (Receive All) bit in the MAC Frame Filter Register is reset, the MAC will filter frames based on the destination and source addresses. If the application decides not to receive any bad frames, such as runt frames and CRC error frames, another level of filtering is needed. When a frame fails the filtering, the frame is discarded and is not transmitted to the application. When the filter parameters are changed dynamically, if a frame fails the DA and SA filterings, the remaining part of the frame is discarded and the Receive Status word is updated immediately and, therefore, the zero frame length bit, CRC error bit, and runt frame error bit are set to 1. This indicates that the frame has failed the filtering.

10.2.2.3 Receive Flow Control

The MAC will detect the received pause frame and pause transmission of frames for a specified delay within the received pause frame (in full-duplex mode only). The Pause Frame Detect Function can be enabled or disabled by the RFCE (Receive Flow Control Enable) bit in the Flow Control Register. When receive flow control is enabled, it starts monitoring whether the destination address of the received frame matches the multicast address of the control frame (0x0180 C200 0001). If a match is detected (i.e. the destination address of the received frame matches the destination address of the reserved control frame), the MAC will determine whether to transmit the received control frame to the application, according to the PCF (Pass Control Frames) bit in the Frame Filter Register.

The MAC will also decode the type, the opcode, and the pause timer field of the Receive Control Frame. If the value of the status byte counter is 64 bits and there are no CRC errors, the MAC transmitter will halt the transmission of any data frame. The duration of the pause is the decoded pause time value multiplied by the interval (which is 64 bytes for both 10 Mbit/s and 100 Mb/s modes). At the same time, if another pause frame of zero pause time is detected, the MAC will reset the pause time to manage the new pause request.

If the type field (0x8808), the opcode (0x00001), and the byte length (64 bytes) of the received control frame are not 0x8808, 0x00001, and 64 bytes, respectively, or if there is a CRC error, the MAC will not generate a pause.

If a pause frame has a multicast destination address, the MAC filters the frame, according to the address matching.

For pause frames with a unicast destination address, the MAC checks whether the DA matches the content of the EMACADDR0 Register, and whether the Unicast Pause Frame Detect (UPFD) bit in the Flow Control Register is set to 1. The Pass Control Frames (PCF) bits in the Frame Filter Register [7:6] control the filtering of frames and addresses.

10.2.2.4 Reception of Multiple Frames

Since the status is available immediately after the data is received. Frames can be stored there, as long as the FIFO is not full.

10.2.2.5 Error Handling

If the Rx FIFO is full before receiving the EOF data from the MAC, an overflow will be generated and the entire frame will be discarded. In fact, status bit RDES0[11] will indicate that this frame is partial due to an overflow, and that it should be discarded.

If the function that corresponds to the Flush Transmit FIFO (FTF) bit and the Forward Undersized Good Frames (FUGF) bit in the Operation Mode Register is enabled, the Rx FIFO can filter error frames and runt frames. If the receive FIFO is configured to operate in store-and-forward mode, all error frames will be filtered and discarded.

In passthrough mode, if a frame's status and length are available when reading a SOF from the Rx FIFO, the entire error frame can be discarded. DMA can clear the error frame being read from the FIFO by enabling the Receive Frame Clear bit. The data transmission to the application (DMA) will then stop, and the remaining frames will be read internally and discarded. If FIFO is available, the transmission of the next frame will be initiated.

10.2.2.6 Receive Status Word

After receiving the Ethernet frames, the MAC outputs the receive status to the application. The detailed description of the receive status is the same as that which is configured by bit [31:0] in RDES0.

10.3 MAC Interrupt Controller

The MAC core can generate interrupts due to various events.

The interrupt register bits only indicate various interrupt events. To clear the interrupts, the corresponding status register and other registers must be read. An Interrupt Status Register describes the events that prompt the MAC core to generate interrupts. Each interrupt event can be prevented by setting the corresponding mask bit in the Interrupt Mask Register to 1. For example, if bit3 of the interrupt register is set high, it indicates that a magic packet or Wake-on-LAN frame has been received in Power-down mode. The PMT Control and Status register must be read to clear this interrupt event.

10.4 MAC Address Filtering

Address filtering will check the destination and source addresses of all received frames and report the address filtering status accordingly. For example, filtered frames can be identified either as multicast or broadcast. The address check, then, is based on the parameters selected by the application (Frame Filter Registers).

Physical (MAC) addresses are used for address checking during address filtering.

10.4.1 Unicast Destination Address Filtering

The MAC supports up to 8 MAC addresses for perfect filtering of unicast addresses. If a perfect filtering is selected (by resetting bit[1] in the Frame Filter Register), the MAC compares all 48 bits of the received unicast address with the programmed MAC address to determine if there is a match. By default, EMACADDR0 is always enabled, and the other addresses (EMACADDR0 ~ EMACADDR7) are selected by a separate enable bit. When the individual bytes of the other addresses (EMACADDR0 ~ EMACADDR7) are compared with the DA bytes received, the latter can be masked by setting the corresponding Mask Byte Control bit in the register to 1. This facilitates the DA group address filtering.

10.4.2 Multicast Destination Address Filtering

The MAC can be programmed to pass all multicast frames by setting the Pass All Multicast (PAM) bit in the Frame Filter Register to 1. If the PAM bit is reset, the MAC will filter multicast addresses, according to Bit[2] in the Frame Filter Register.

In perfect filtering mode, the multicast address is compared with the programmed MAC Destination Address Registers (EMACADDR0 ~ EMACADDR7). Group address filtering is also supported.

10.4.3 Broadcast Address Filtering

The MAC does not filter any broadcast frames in the default mode. However, if the MAC is programmed to reject all broadcast frames, which can happen by setting the Disable Broadcast Frames (DBF) bit in the Frame Filter Register to 1, all broadcast frames will be discarded.

10.4.4 Unicast Source Address Filtering

The MAC may also perform a perfect filtering based on the source address field of the received frame. By default, the Address Filtering Module (AFM) compares the Source Address (SA) field with the values programmed in the SA register. By setting Bit[30] in the SA register to 1, the MAC Address Register (EMACADDR0 - EMACADDR7) can be configured to contain SA, instead of Destination Address (DA), for filtering. Group filtering with SA is also supported. If the Source Address Filter (SAF) enable bit in the Frame Filter Register is set to 1, the MAC discards frames that do not pass the SA filtering. Otherwise, the result of SA filtering is given as a status bit in the Receive Status word (Please refer to Table 46).

When the SAF enable bit is set to 1, the result of the SA filtering and DA filtering is AND'ed to determine whether or not to forward the frame. Any frame that fails to pass will be discarded. Frames need to pass both filterings in order to be forwarded to the application.

10.4.5 Inverse Filtering Operation

For both destination address (DA) and source address (SA) filtering, you can invert the results matched through the filtering at the final output. The inverse filtering of DA and SA are controlled by the DAIF and SAIF bits, respectively, in the Frame Filter Register. The DAIF bit applies to both unicast and multicast DA frames. When DAIF is set to 1, the result of unicast or multicast destination address filtering will be inverted. Similarly, when the SAIF bit is set to 1, the result of unicast SA filtering is reversed.

The following two tables summarize the destination address and source address filtering, based on the type of the frames received.

Table 38: Destination Address Filtering

Frame Type	PM	PF	DAIF	PAM	DB	DA Filter Result
Broadcast	1	X	X	X	X	Pass
	0	X	X	X	0	Pass
	0	X	X	X	1	Fail
Unicast	1	X	X	X	X	All frames pass.
	0	X	0	X	X	Pass when results of perfect/group filtering match.
	0	X	1	X	X	Fail when results of perfect/group filtering match.
	0	1	0	X	X	Pass when results of perfect/group filtering match.
	0	1	1	X	X	Fail when results of perfect/group filtering match.
Multicast	1	X	X	X	X	All frames pass.
	X	X	X	1	X	All frames pass.
	0	X	0	0	X	Pass when results of perfect/group filtering match and pause control frame is discarded, if PCF = 0x.
	0	1	0	0	X	Pass when results of perfect/group filtering match and pause control frame is discarded, if PCF = 0x.
	0	X	1	0	X	Fail when results of perfect/group filtering match and pause control frame is discarded, if PCF = 0x.
	0	1	1	0	X	Fail when results of perfect/group filtering match and pause control frame is discarded, if PCF = 0x.
	0	1	1	0	X	Fail when results of perfect/group filtering match and pause control frame is discarded, if PCF = 0x.

The filtering parameters in the MAC Frame Filter Register described in Table 38 are as follows.

Parameter name:

PM: Pass All Multicast

PF: Perfect Filter

DAIF: Destination Address Inverse Filtering

PAM: Pass All Multicast

DB: Disable Broadcast Frames

Parameter setting:

1: Set

0: Cleared

Table 39: Source Address Filtering

Frame Type	PM	SAIF	SAF	Source Address Filter Operation
Unicast	1	X	X	Pass all frames
	0	0	0	Pass when results of perfect/group filtering match. Frames not passed are not discarded.
	0	1	0	Fail when results of perfect/group filtering match. Frames not passed are not discarded.
	0	0	1	Pass when results of perfect/group filtering match. Frames not passed are discarded.
	0	1	1	Fail when results of perfect/group filtering match. Frames not passed are discarded.

The filtering parameters in the MAC Frame Filter Register described in Table 39 are as follows.

Parameter name:	Parameter setting:
PM: Pass All Multicast	1: Set
SAF: Source Address Filtering	0: Cleared
SAIF: Source Address Inverse Filtering	X: Don't care

10.4.6 Good Transmitted Frames and Received Frames

A frame successfully transmitted is considered a "good frame". In other words, a transmitted frame is considered to be good, if the frame transmission is not aborted due to the following errors:

- Jabber timeout
- No carrier or loss of carrier
- Late collision
- Frame underflow
- Excessive deferral
- Excessive collision

The received frames are considered "good frames", if there are not any of the following errors:

- CRC error
- Runt frames (frames shorter than 64 bytes)
- Alignment error (in 10/100 Mbps modes only)
- Length error (non-type frames only)
- Frame size over the maximum size (for non-type frames over the maximum frame size only)
- MII_RXER input error

The maximum frame size depends on the frame type:

- The maximum size of untagged frames = 1518 bytes
- The maximum size of VLAN frames = 1522 bytes

10.5 EMAC_MTL (MAC Transaction Layer)

The MAC Transaction Layer provides FIFO memory to buffer and regulates the frames between the application system memory and the MAC. It also enables the data to be transmitted between the application clock domain and the MAC clock domains. The MTL layer has two data paths, namely the Transmit path and the Receive path. The data path for both directions is 32-bit wide and operates with a simple FIFO protocol.

10.6 PHY Interface

The DMA and the Host driver communicate through two data structures:

- Control and Status Registers (CSR)
- Descriptor lists and data buffers

For details please refer to [Register Summary](#) and [Linked List Descriptors](#).

10.6.1 MII (Media Independent Interface)

Media Independent Interface (MII) defines the interconnection between MAC sublayers and PHYs at the data transmission rate of 10 Mbit/s and 100 Mbit/s.

10.6.1.1 Interface Signals Between MII and PHY

Interface signals between MII and PHY are shown in Figure 41.

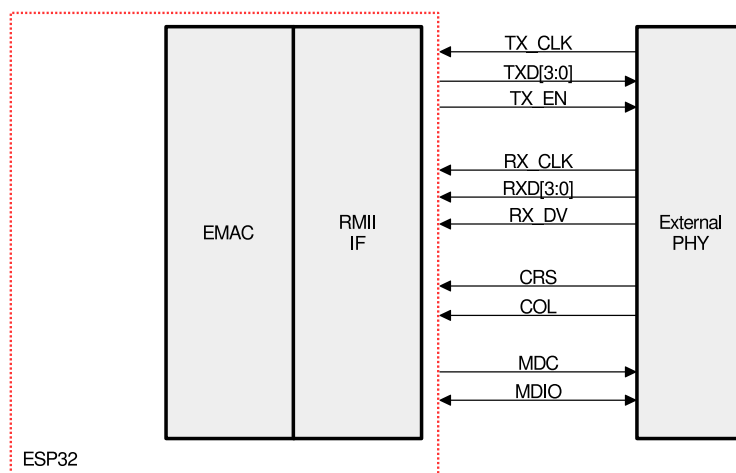


Figure 41: MII Interface

MII Interface Signal Description:

- MII_TX_CLK: TX clock signal. This signal provides the reference timing for TX data transmission. The frequencies are divided into two types: 2.5 MHz at a data transmission rate of 10 Mbit/s, and 25 MHz at 100 Mbit/s.
- MII_TXD[3:0]: Transmit data signal in groups of four, syn-driven by the MAC sub-layer, and valid only when the MII_TX_EN signal is valid. MII_TXD[0] is the lowest significant bit and MII_TXD[3] is the highest significant bit. When the signal MII_TX_EN is pulled low, sending data does not have any effect on the PHY.

- **MII_TX_EN**: Transmit data enable signal. This signal indicates that the MAC is currently sending nibbles (4 bits) for the MII. This signal must be synchronized with the first nibble of the header (**MII_TX_CLK**) and must be synchronized when all nibbles to be transmitted are sent to the MII.
- **MII_RX_CLK**: RX clock signal. This signal provides the reference timing for RX data transmission. The frequencies are divided into two types: 2.5 MHz at the data transmission rate of 10 Mbit/s, and 25 MHz at 100 Mbit/s.
- **MII_RXD[3:0]**: Receive data signal in groups of four, syn-driven by the PHY, and valid only when **MII_RX_DV** signal is valid. **MII_RXD[0]** is the lowest significant bit and **MII_RXD[3]** is the highest significant bit. When **MII_RX_DV** is disabled and **MII_RX_ER** is enabled, the specific **MII_RXD[3:0]** value represents specific information from the PHY.
- **MII_RX_DV**: Receive data valid signal. This signal indicates that the PHY is currently receiving the recovered and decoded nibble that will be transmitted to the MII. This signal must be synchronized with the first nibble of the recovered frame (**MII_RX_CLK**) and remain synchronized till the last nibble of the recovered frame. This signal must be disabled before the first clock cycle following the last nibble. In order to receive the frame correctly, the **MII_RX_DV** signal must cover the frame to be received over the time range, starting no later than when the SFD field appears.
- **MII_CRFS**: Carrier sense signal. When the transmitting or receiving medium is in the non-idle state, the signal is enabled by the PHY. When the transmitting or receiving medium is in the idle state, the signal is disabled by the PHY. The PHY must ensure that the **MII_CRFS** signal remains valid under conflicting conditions. This signal does not need to be synchronized with the TX and RX clocks. In full-duplex mode, this signal is insignificant.
- **MII_COL**: Collision detection signal. After a collision is detected on the medium, the PHY must immediately enable the collision detection signal, and the collision detection signal must remain active as long as a condition for collision exists. This signal does not need to be synchronized with the TX and RX clocks. In full-duplex mode, this signal is meaningless.
- **MII_RX_ER**: Receive error signal. The signal must remain for one or more cycles (**MII_RX_CLK**) to indicate to the MAC sublayer that an error has been detected somewhere in the frame.
- **MDIO and MDC**: Management Data Input/Output and Management Data Clock. The two signals constitute a serial bus defined for the Ethernet family of IEEE 802.3 standards, used to transfer control and data information to the PHY, see section [Station Management Agent \(SMA\) Interface](#).

10.6.1.2 MII Clock

In MII mode, there are two directions of clock, Tx and Rx clocks in the interface between MII and the PHY. **MII_TX_CLK** is used to synchronize the TX data, and **MII_RX_CLK** is used to synchronize the RX data. The **MII_RX_CLK** clock is provided by the PHY. The **MII_TX_CLK** is provided by the chip's internal PLL or external crystal oscillator. For details regarding Figure 42, please refer to the clock-related registers in [Register Summary](#).

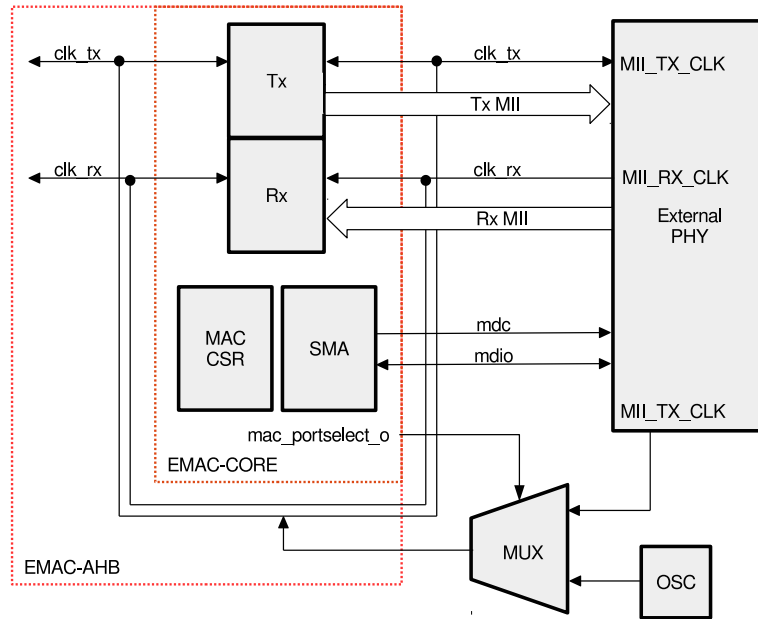


Figure 42: MII Clock

10.6.2 RMII (Reduced Media-Independent Interface)

RMII interface signals are shown in figure 43.

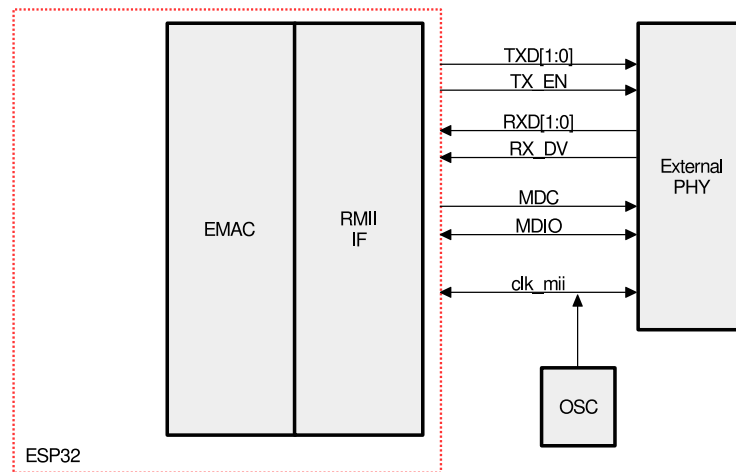


Figure 43: RMII Interface

10.6.2.1 RMII Interface Signal Description

The Reduced Media-Independent Interface (RMII) specification reduces the number of pins between the microcontroller’s external peripherals and the external PHY at a data transmission rate of 10 Mbit/s or 100 Mbit/s. According to the IEEE 802.3u standard, MII includes 16 pins that contain data and control signals. The RMII specification reduces 62.5% of the pins to the number of seven.

RMII has the following features:

- Support for an operating rate of 10 Mbit/s or 100 Mbit/s
- The reference clock frequency must be 50 MHz.

- The same reference clock must be provided externally both to the MAC and the external Ethernet PHY. It provides independent 2-bit-wide Tx and Rx data paths.

10.6.2.2 RMII Clock

The configuration of the RMII clock is as figure 44 shows.

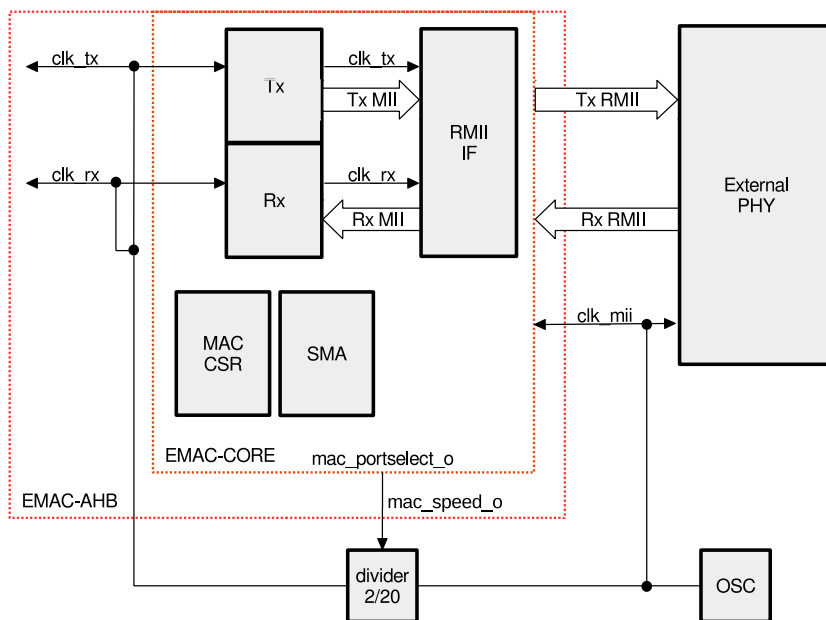


Figure 44: RMII Clock

10.6.3 Station Management Agent (SMA) Interface

As Figure 42 shows, the MAC uses MDC and MDIO signals to transfer control and data information to the PHY. The maximum clock frequency is 2.5 MHz. The clock is generated from the application clock by a clock divider. The PHY transmits register data during a write/read operation through the MDIO. This signal is driven synchronously to the MDC clock.

Please refer to [Register Summary](#) for details about the EMII Address Register and the EMII Data Register.

10.7 Ethernet DMA Features

The DMA has independent Transmit and Receive engines, and a CSR (Control and Status Registers) space. The Transmit engine transfers data from the system memory to the device port (MTL), while the Receive engine transmits data from the device port to the system memory. The controller uses descriptors to efficiently move data from source to destination with minimal Host CPU intervention. The DMA is designed for packet-oriented data transmission, such as frames in Ethernet. The controller can be programmed to interrupt the Host CPU for normal situations, such as the completion of frame transmission or reception, or when errors occur.

10.8 Linked List Descriptors

This section shows the structure of the linked lists and the descriptors. Every linked list consists of eight words.

10.8.1 Transmit Descriptors

The structure of the transmitter linked lists is shown in Figure 45. Table 40 to Table 45 show the description of the linked lists.

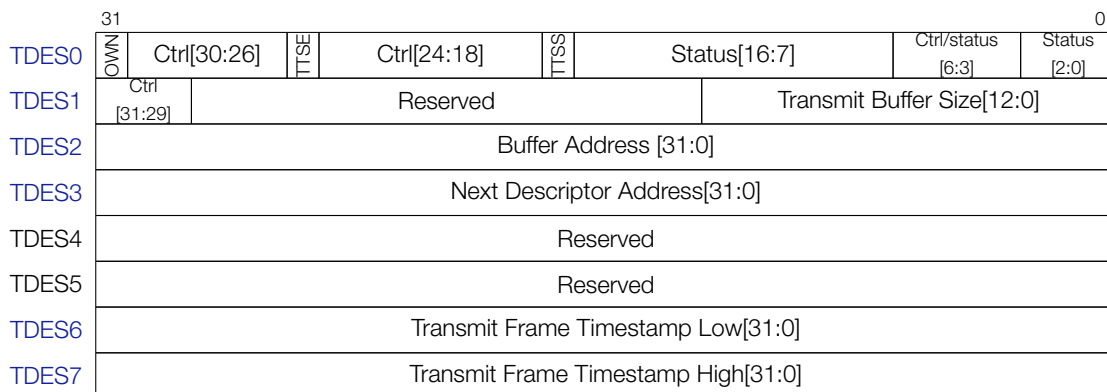


Figure 45: Transmit Descriptor

Table 40: Transmit Descriptor 0 (TDES0)

Bits	Name	Description
[31]	OWN: Own Bit	When set, this bit indicates that the descriptor is owned by the DMA. When this bit is reset, it indicates that the descriptor is owned by the Host. The DMA clears this bit, either when it completes the frame transmission or when the buffers allocated to the descriptor are empty. The ownership bit of the First Descriptor of the frame should be set after all subsequent descriptors belonging to the same frame have been set. This avoids a possible race condition between fetching a descriptor and the driver setting an ownership bit.
[30]	IC: Interrupt on Completion	When set, this bit sets the Transmit Interrupt (Register 5[0]) after the present frame has been transmitted. This bit is valid only when the last segment bit (TDES0[29]) is set.
[29]	LS: Last Segment	When set, this bit indicates that the buffer contains the last segment of the frame. When this bit is set, the TBS1 or TBS2 field in TDES1 should have a non-zero value.
[28]	FS: First Segment	When set, this bit indicates that the buffer contains the first segment of a frame.
[27]	DC: Disable CRC	When this bit is set, the MAC does not append a cyclic redundancy check (CRC) to the end of the transmitted frame. This is valid only when the first segment (TDES0[28]) is set.

Bits	Name	Description
[26]	DP: Disable Pad	When set, the MAC does not automatically add padding to a frame shorter than 64 bytes. When this bit is reset, the DMA automatically adds padding and CRC to a frame shorter than 64 bytes, and the CRC field is added despite the state of the DC (TDES0[27]) bit. This is valid only when the first segment (TDES0[28]) is set.
[25]	TTSE: Transmit Timestamp Enable	When set, this bit enables IEEE1588 hardware timestamping for the transmit frame referenced by the descriptor. This field is valid only when the First Segment control bit (TDES0[28]) is set.
[24]	CRCR: CRC Replacement Control	When set, the MAC replaces the last four bytes of the transmitted packet with recalculated CRC bytes. The host should ensure that the CRC bytes are present in the frame being transmitted from the Transmit Buffer. This bit is valid when the First Segment control bit (TDES0[28]) is set. In addition, CRC replacement is done only when Bit TDES0[27] is set to 1.
[23:22]	CIC: Checksum Insertion Control	<p>These bits control the checksum calculation and insertion. The following list describes the bit encoding:</p> <ul style="list-style-type: none"> • 2'b00: Checksum insertion is disabled. • 2'b01: Only IP header checksum calculation and insertion are enabled. • 2'b10: IP header checksum and payload checksum calculation and insertion are enabled, but pseudo-header checksum is not calculated in hardware. • 2'b11: IP Header checksum and payload checksum calculation and insertion are enabled, and pseudo-header checksum is calculated in hardware. <p>This field is valid when the First Segment control bit (TDES0[28]) is set.</p>
[21]	TER: Transmit End of Ring	When set, this bit indicates that the descriptor list reached its final descriptor. The DMA returns to the base address of the list, creating a Descriptor Ring.
[20]	TCH: Second Address Chained	When set, this bit indicates that the second address in the descriptor is the Next Descriptor address, rather than the second buffer address. When TDES0[20] is set, TBS2 (TDES1[28:16]) is a "don't care" value. TDES0[21] takes precedence over TDES0[20]. This bit should be set to 1.

Bits	Name	Description
[19:18]	VLIC: VLAN Insertion Control	<p>When set, these bits request the MAC to perform VLAN tagging or untagging before transmitting the frames. If the frame is modified for VLAN tags, the MAC automatically recalculates and replaces the CRC bytes. The following list describes the values of these bits:</p> <ul style="list-style-type: none"> • 2'b00: Do not add a VLAN tag. • 2'b01: Remove the VLAN tag from the frames before transmission. This option should be used only with the VLAN frames. • 2'b10: Insert a VLAN tag with the tag value programmed in VLAN Tag Inclusion or Replacement Register. • 2'b11: Replace the VLAN tag in frames with the Tag value programmed in VLAN Tag Inclusion or Replacement Register. This option should be used only with the VLAN frames.
[17]	TTSS: Transmit Timestamp Status	<p>This field is used as a status bit to indicate that a timestamp was captured for the described transmit frame. When this bit is set, TDES2 and TDES3 have a timestamp value captured for the transmit frame. This field is only valid when the descriptor's Last Segment control bit (TDES0[29]) is set.</p>
[16]	IHE: IP Header Error	<p>When set, this bit indicates that the MAC transmitter detected an error in the IP datagram header. The transmitter checks the header length in the IPv4 packet against the number of header bytes received from the application, and indicates an error status if there is a mismatch. For IPv6 frames, a header error is reported if the main header length is not 40 bytes. Furthermore, the Ethernet Length/Type field value for an IPv4 or IPv6 frame must match the IP header version received with the packet. For IPv4 frames, an error status is also indicated if the Header Length field has a value less than 0x5.</p>
[15]	ES: Error Summary	<p>Indicates the logical OR of the following bits:</p> <ul style="list-style-type: none"> • TDES0[14]: Jabber Timeout • TDES0[13]: Frame Flush • TDES0[11]: Loss of Carrier • TDES0[10]: No Carrier • TDES0[9]: Late Collision • TDES0[8]: Excessive Collision • TDES0[2]: Excessive Deferral • TDES0[1]: Underflow Error • TDES0[16]: IP Header Error • TDES0[12]: IP Payload Error
[14]	JT: Jabber Timeout	<p>When set, this bit indicates the MAC transmitter has experienced a jabber timeout. This bit is only set when EMACCONFIG_REG's bit EMACJABBER is not set.</p>
[13]	FF: Frame Flushed	<p>When set, this bit indicates that the DMA or MTL flushed the frame because of a software Flush command given by the CPU.</p>

Bits	Name	Description
[12]	IPE: IP Payload Error	When set, this bit indicates that MAC transmitter detected an error in the TCP, UDP, or ICMP IP datagram payload. The transmitter checks the payload length received in the IPv4 or IPv6 header against the actual number of TCP, UDP, or ICMP packet bytes received from the application, and issues an error status in case of a mismatch.
[11]	LOC: Loss of Carrier	When set, this bit indicates that a loss of carrier occurred during frame transmission (that is, the MII_CRS signal was inactive for one or more transmit clock periods during frame transmission). This is valid only for the frames transmitted without collision when the MAC operates in the half-duplex mode.
[10]	NC: No Carrier	When set, this bit indicates that the Carrier Sense signal from the PHY was not asserted during transmission.
[9]	LC: Late Collision	When set, this bit indicates that frame transmission is aborted because of a collision occurring after the collision window (64 byte-times including Preamble in MII mode, and 512 byte-times including Preamble and Carrier Extension). This bit is not valid if the Underflow Error bit is set.
[8]	EC: Excessive Collision	When set, this bit indicates that the transmission was aborted after 16 successive collisions while attempting to transmit the current frame. If bit EMACRETRY of EMACCONFIG_REG is set, this bit is set after the first collision, and the transmission of the frame is aborted.
[7]	VF: VLAN Frame	When set, this bit indicates that the transmitted frame is a VLAN-type frame.
[6:3]	Ctrl/status	These status bits indicate the number of collisions that occurred before the frame was transmitted. This count is not valid when the Excessive Collisions bit (TDES0[8]) is set. The core updates this status field only in the half-duplex mode.
[2]	ED: Excessive Deferral	When set, this bit indicates that the transmission has ended because of excessive deferral of over 24,288 bit times (if Jumbo Frame is enabled) if bit EMACDEFERRAL of EMACCONFIG_REG is set high.
[1]	UF: Underflow Error	When set, this bit indicates that the MAC aborted the frame because the data arrived late from the Host memory. Underflow Error indicates that the DMA encountered an empty transmit buffer while transmitting the frame. The transmission process enters the Suspended state and sets both Bit[5] in Transmit Underflow Register (Status Register) and Bit[0] in Transmit Interrupt Register (Status Register).
[0]	DB: Deferred Bit	When set, this bit indicates that the MAC defers before transmission because of the presence of a carrier. This bit is valid only in the half-duplex mode.

Table 41: Transmit Descriptor 1 (TDES1)

Bits	Name	Description
[31:29]	SAIC: SA Insertion Control	<p>These bits request the MAC to add or replace the Source Address field in the Ethernet frame with the value given in the MAC Address 0 register. If the Source Address field is modified in a frame, the MAC automatically recalculates and replaces the CRC bytes. The Bit[31] specifies the MAC Address Register value (1 or 0) that is used for Source Address insertion or replacement. The following list describes the values of Bits[30:29]:</p> <ul style="list-style-type: none"> • 2'b00: Do not include the source address. • 2'b01: Include or insert the source address. For reliable transmission, the application must provide frames without source addresses. • 2'b10: Replace the source address. For reliable transmission, the application must provide frames with source addresses. • 2'b11: Reserved <p>These bits are valid when the First Segment control bit (TDES0[28]) is set.</p>
[28:16]	Reserved	Reserved
[15:13]	Reserved	Reserved
[12:0]	TBS1: Transmit Buffer 1 Size	These bits indicate the data buffer byte size in bytes. If this field is 0, the DMA ignores this buffer and uses Buffer 2 or the next descriptor.

Table 42: Transmit Descriptor 2 (TDES2)

Bits	Name	Description
[31:0]	Buffer 1 Address Pointer	These bits indicate the physical address of Buffer 1.

Table 43: Transmit Descriptor 3 (TDES3)

Bits	Name	Description
[31:0]	Next Descriptor Address	This address contains the pointer to the physical memory where the Next Descriptor is present.

Table 44: Transmit Descriptor 6 (TDES6)

Bits	Name	Description
[31:0]	TTSL: Transmit Frame Timestamp Low	This field is updated by DMA with the least significant 32 bits of the timestamp captured for the corresponding transmit frame. This field has the timestamp only if the Last Segment (LS) bit in the descriptor is set, and the Timestamp Status (TTSS) bit is set too.

Table 45: Transmit Descriptor 7 (TDES7)

Bits	Name	Description
[31:0]	TTSH: Transmit Frame Timestamp High	This field is updated by DMA with the most significant 32 bits of the timestamp captured for the corresponding receive frame. This field has the timestamp only if the Last Segment (LS) bit in the descriptor is set, and the Timestamp Status (TTSS) bit is set too.

10.8.2 Receive Descriptors

The structure of the receiver linked lists is shown in Figure 46. Table 46 to Table 52 provide the description of the linked lists.

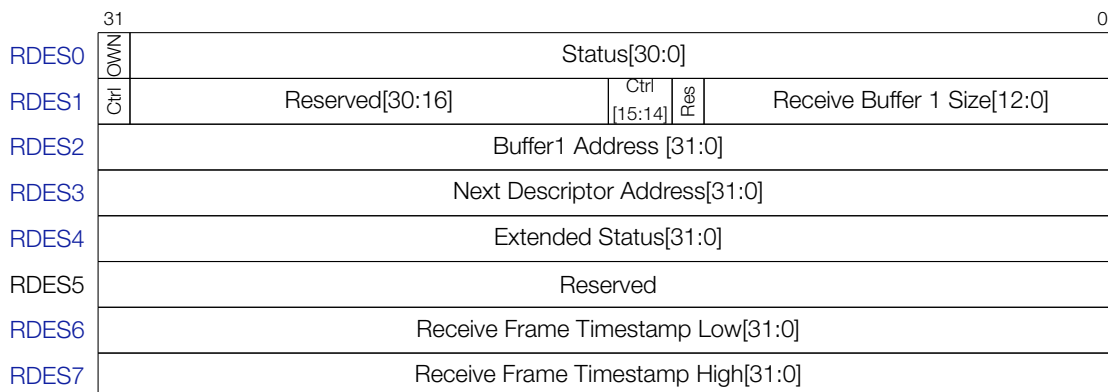


Figure 46: Receive Descriptor

Table 46: Receive Descriptor 0 (RDES0)

Bits	Name	Description
[31]	OWN: Own Bit	When set, this bit indicates that the descriptor is owned by the DMA of the DWC_gmac. When this bit is reset, it indicates that the descriptor is owned by the Host. The DMA clears this bit either when it completes the frame reception or when the buffers that are associated with this descriptor are full.
[30]	AFM: Destination Address Filter Fail	When set, this bit indicates a frame that failed in the DA Filter in the MAC.
[29:16]	FL: Frame Length	These bits indicate the byte length of the received frame that was transmitted to host memory. This field is valid when Last Descriptor (RDES0[8]) is set and either the Descriptor Error (RDES0[14]) or Overflow Error bits is reset. The frame length also includes the two bytes appended to the Ethernet frame when IP checksum calculation (Type 1) is enabled and the received frame is not a MAC control frame.
[15]	ES: Error Summary	Indicates the logical OR of the following bits: <ul style="list-style-type: none"> • RDES0[1]: CRC Error • RDES0[3]: Receive Error • RDES0[4]: Watchdog Timeout • RDES0[6]: Late Collision • RDES0[7]: Giant Frame • RDES4[4:3]: IP Header or Payload Error • RDES0[11]: Overflow Error • RDES0[14]: Descriptor Error This field is valid only when the Last Descriptor (RDES0[8]) is set.
[14]	DE: Descriptor Error	When set, this bit indicates a frame truncation caused by a frame that does not fit within the current descriptor buffers, and that the DMA does not own the Next Descriptor. The frame is truncated. This field is valid only when the Last Descriptor (RDES0[8]) is set.

Bits	Name	Description
[13]	SAF: Source Address Filter Fail	When set, this bit indicates that the SA field of frame failed the SA Filter in the MAC.
[12]	LE: Length Error	When set, this bit indicates that the actual length of the frame received and that the Length/Type field does not match. This bit is valid only when the Frame Type (RDES0[5]) bit is reset.
[11]	OE: Overflow Error	When set, this bit indicates that the received frame was damaged because of buffer overflow in MTL.
[10]	VLAN: VLAN Tag	When set, this bit indicates that the frame to which this descriptor is pointing is a VLAN frame tagged by the MAC. The VLAN tagging depends on checking the VLAN fields of the received frame based on the Register (VLAN Tag Register) settings.
[9]	FS: First Descriptor	When set, this bit indicates that this descriptor contains the first buffer of the frame. If the size of the first buffer is 0, the second buffer contains the beginning of the frame. If the size of the second buffer is also 0, the next Descriptor contains the beginning of the frame.
[8]	LS: Last Descriptor	When set, this bit indicates that the buffers pointed to by this descriptor are the last buffers of the frame.
[7]	Timestamp Available, IP Checksum Error (Type1), or Giant Frame	<p>When the Advanced Timestamp feature is present, and when this bit set, it indicates that a snapshot of the Timestamp is written in descriptor words 6 (RDES6) and 7 (RDES7). This is valid only when the Last Descriptor bit (RDES0[8]) is set.</p> <p>When IP Checksum Engine (Type 1) is selected, this bit, if set, indicates one of the following:</p> <ul style="list-style-type: none"> • The 16-bit IPv4 header checksum calculated by the core did not match the received checksum bytes. • The header checksum checking is bypassed for non-IPv4 frames. <p>Otherwise, this bit, when set, indicates the Giant Frame Status. Giant frames are larger than 1,518 bytes (or 1,522 bytes for VLAN or 2,000 bytes when Bit[27] of the MAC Configuration register is set), normal frames and larger-than-9,018-byte (9,022-byte for VLAN) frames when Jumbo Frame processing is enabled.</p>
[6]	LC: Late Collision	When set, this bit indicates that a late collision has occurred while receiving the frame in the half-duplex mode.
[5]	FT: Frame Type	When set, this bit indicates that the Receive Frame is an Ethernet-type frame (the LT field is greater than, or equal to, 1,536). When this bit is reset, it indicates that the received frame is an IEEE 802.3 frame. This bit is not valid for Runt frames which are less than 14 bytes.
[4]	RWT: Receive Watchdog Timeout	When set, this bit indicates that the Receive Watchdog Timer has expired while receiving the current frame and the current frame is truncated after the Watchdog Timeout.
[3]	RE: Receive Error	When set, this bit indicates that the MII_RXER signal is asserted while MII_RXDV is asserted during frame reception.

Bits	Name	Description
[2]	DE: Dribble Bit Error	When set, this bit indicates that the received frame has a non-integer multiple of bytes (odd nibbles). This bit is valid only in the MII Mode.
[1]	CE: CRC Error	When set, this bit indicates that a Cyclic Redundancy Check (CRC) Error occurred on the received frame. This field is valid only when the Last Descriptor (RDES0[8]) is set.
[0]	Extended Status Available/ Rx MAC Address	<p>When either Advanced Timestamp or IP Checksum Offload (Type 2) is present, this bit, when set, indicates that the extended status is available in descriptor word 4 (RDES4). This is valid only when the Last Descriptor bit (RDES0[8]) is set. This bit is invalid when Bit 30 is set.</p> <p>When IP Checksum Offload (Type 2) is present, this bit is set even when the IP Checksum Offload engine bypasses the processing of the received frame. The bypassing may be because of a non-IP frame or an IP frame with a non-TCP/UDP/ICMP payload.</p> <p>When the Advance Timestamp Feature or the IPC Full Offload is not selected, this bit indicates an Rx MAC Address status. When set, this bit indicates that the Rx MAC Address registers value (1 to 15) matched the frame's DA field. When reset, this bit indicates that the Rx MAC Address Register 0 value matched the DA field.</p>

Table 47: Receive Descriptor 1 (RDES1)

Bits	Name	Description
[31]	Ctrl	When set, this bit prevents setting the Status Register's RI bit (CSR5[6]) for the received frame that ends in the buffer indicated by this descriptor. This, in turn, disables the assertion of the interrupt to Host because of the RI for that frame.
[30:29]	Reserved	Reserved
[28:16]	Reserved	Reserved
[15]	RER: Receive End of Ring	When set, this bit indicates that the descriptor list reached its final descriptor. The DMA returns to the base address of the list, creating a Descriptor Ring.
[14]	RCH: Second Address Chained	When set, this bit indicates that the second address in the descriptor is the Next Descriptor address rather than the second buffer address. When this bit is set, RBS2 (RDES1[28:16]) is a "don't care" value. RDES1[15] takes precedence over RDES1[14].
[13]	Reserved	Reserved
[12:0]	RBS1: Receive Buffer 1 Size	Indicates the first data buffer size in bytes. The buffer size must be a multiple of 4, even if the value of RDES2 (buffer1 address pointer) is not aligned to bus width. When the buffer size is not a multiple of 4, the resulting behavior is undefined. If this field is 0, the DMA ignores this buffer and uses Buffer 2 or the next descriptor depending on the value of RCH (Bit[14]).

Table 48: Receive Descriptor 2 (RDES2)

Bits	Name	Description
[31:0]	Buffer 1 Address Pointer	These bits indicate the physical address of Buffer 1.

Table 49: Receive Descriptor 3 (RDES3)

Bits	Name	Description
[31:0]	Next Descriptor Address	This address contains the pointer to the physical memory where the Next Descriptor is present.

Table 50: Receive Descriptor 4 (RDES4)

Bits	Name	Description
[31:28]	Reserved	Reserved
[27:26]	Reserved	Reserved
[25]	Reserved	Reserved
[24]	Reserved	Reserved
[23:21]	Reserved	Reserved
[20:18]	Reserved	Reserved
[17]	Reserved	Reserved
[16]	Reserved	Reserved
[15]	Reserved	Reserved
[14]	Timestamp Dropped	When set, this bit indicates that the timestamp was captured for this frame but got dropped in the MTL Rx FIFO because of an overflow.
[13]	PTP Version	When set, this bit indicates that the received PTP message is having the IEEE 1588 version 2 format. When reset, it has the version 1 format.
[12]	PTP Frame Type	When set, this bit indicates that the PTP message is sent directly over the Ethernet. When this bit is not set and the message type is non-zero, it indicates that the PTP message is sent over UDP-IPv4 or UDP-IPv6. The information about IPv4 or IPv6 can be obtained from Bits 6 and 7.

Bits	Name	Description
[11:8]	Message Type	<p>These bits are encoded to give the type of the message received.</p> <ul style="list-style-type: none"> • 3'b0000: No PTP message received • 3'b0001: SYNC (all clock types) • 3'b0010: Follow_Up (all clock types) • 3'b0011: Delay_Req (all clock types) • 3'b0100: Delay_Resp (all clock types) • 3'b0101: Pdelay_Req (in peer-to-peer transparent clock) • 3'b0110: Pdelay_Resp (in peer-to-peer transparent clock) • 3'b0111: Pdelay_Resp_Follow_Up (in peer-to-peer transparent clock) • 3'b1000: Announce • 3'b1001: Management • 3'b1010: Signaling • 3'b1011-3'b1110: Reserved • 3'b1111: PTP packet with Reserved message type
[7]	IPv6 Packet Received	When set, this bit indicates that the received packet is an IPv6 packet. This bit is updated only when Bit[10] (IPC) of Register (MAC Configuration Register) is set.
[6]	IPv4 Packet Received	When set, this bit indicates that the received packet is an IPv4 packet. This bit is updated only when Bit[10] (IPC) of Register (MAC Configuration Register) is set.
[5]	IP Checksum Bypassed	When set, this bit indicates that the checksum offload engine is bypassed.
[4]	IP Payload Error	When set, this bit indicates that the 16-bit IP payload checksum (that is, the TCP, UDP, or ICMP checksum) that the core calculated does not match the corresponding checksum field in the received segment. It is also set when the TCP, UDP, or ICMP segment length does not match the payload length value in the IP Header field. This bit is valid when either Bit 7 or Bit 6 is set.
[3]	IP Header Error	When set, this bit indicates that either the 16-bit IPv4 header checksum calculated by the core does not match the received checksum bytes, or the IP datagram version is not consistent with the Ethernet Type value. This bit is valid when either Bit[7] or Bit[6] is set.
[2:0]	IP Payload Type	<p>These bits indicate the type of payload encapsulated in the IP datagram processed by the Receive Checksum Offload Engine (COE). The COE also sets these bits to 2'b00 if it does not process the IP datagram's payload due to an IP header error or fragmented IP.</p> <ul style="list-style-type: none"> • 3'b000: Unknown or did not process IP payload • 3'b001: UDP • 3'b010: TCP • 3'b011: ICMP • 3'b1xx: Reserved <p>This bit is valid when either Bit[7] or Bit[6] is set.</p>

Table 51: Receive Descriptor 6 (RDES6)

Bits	Name	Description
[31:0]	RTSH: Receive Frame Timestamp Low	This field is updated by DMA with the least significant 32 bits of the timestamp captured for the corresponding receive frame. This field is updated by DMA only for the last descriptor of the receive frame which is indicated by the Last Descriptor status bit (RDES0[8]).

Table 52: Receive Descriptor 7 (RDES7)

Bits	Name	Description
[31:0]	RTSH: Receive Frame Timestamp High	This field is updated by DMA with the most significant 32 bits of the timestamp captured for the corresponding receive frame. This field is updated by DMA only for the last descriptor of the receive frame which is indicated by the Last Descriptor status bit (RDES0[8]).

10.9 Register Summary

Note that specific fields or bits of a given register may have different access attributes. Below is the list of all attributes together with the abbreviations used in register descriptions.

- Read Only (RO)
- Write Only (WO)
- Read and Write (R/W)
- Read, Write, and Self Clear (R/W/SC)
- Read, Self Set, and Write Clear (R/SS/WC)
- Read, Write Set, and Self Clear (R/WS/SC)
- Read, Self Set, and Self Clear or Write Clear (R/SS/SC/WC)
- Read Only and Write Trigger (RO/WT)
- Read, Self Set, and Read Clear (R/SS/RC)
- Read, Write, and Self Update (R/W/SU)
- Latched-low (LL)
- Latched-high (LH)

Name	Description	Address	Access
DMA configuration and control registers			
DMABUSMODE_REG	Bus mode configuration	0x60029000	R/WS/SC
DMATXPOLLDEMAND_REG	Pull demand for data transmit	0x60029004	RO/WT
DMARXPOLLDEMAND_REG	Pull demand for data receive	0x60029008	RO/WT
DMARXBASEADDR_REG	Base address of the first receive descriptor	0x6002900C	R/W

Name	Description	Address	Access
DMATXBASEADDR_REG	Base address of the first transmit descriptor	0x60029010	R/W
DMASTATUS_REG	State of interrupts, errors and other events	0x60029014	R/SS/WC
DMAIN_EN_REG	Enable / disable interrupts	0x6002901C	R/W
DMARINTWDTIMER_REG	Watchdog timer count on receive	0x60029024	R/W
DMATXCURRDESC_REG	Pointer to current transmit descriptor	0x60029048	RO
DMARXCURRDESC_REG	Pointer to current receive descriptor	0x6002904C	RO
DMATXCURRADDR_BUF_REG	Pointer to current transmit buffer	0x60029050	RO
DMARXCURRADDR_BUF_REG	Pointer to current receive buffer	0x60029054	RO
MAC configuration and control registers			
EMACCONFIG_REG	MAC configuration	0x6002A000	R/W
EMACFF_REG	Frame filter settings	0x6002A004	R/W
EMACMIIADDR_REG	PHY configuration access	0x6002A010	R/WS/SC
EMACMIIDATA_REG	PHY data read write	0x6002A014	R/W
EMACFC_REG	frame flow control	0x6002A018	R/WS/SC(FCB) R/W(BPA)
EMACDEBUG_REG	Status debugging bits	0x6002A024	RO
EMACINTS_REG	Interrupt status	0x6002A038	RO
EMACINTMASK_REG	Interrupt mask	0x6002A03C	R/W
EMACADDR0HIGH_REG	Upper 16 bits of the first 6-byte MAC address	0x6002A040	R/W
EMACADDR0LOW_REG	Lower 32 bits of the first 6-byte MAC address	0x6002A044	R/W
EMACADDR1HIGH_REG	MAC address filtering and upper 16 bits of the second 6-byte MAC address	0x6002A048	R/W
EMACADDR1LOW_REG	Lower 32 bits of the second 6-byte MAC address	0x6002A04C	R/W
EMAC_AN_CONTROL_REG	Auto negotiation control	0x6002A0C0	R/WS/SC
EMAC_AN_STATUS_REG	Auto negotiation status	0x6002A0C4	RO
EMACCSTATUS_REG	Link communication status	0x6002A0D8	RO
EMACWDOGTO_REG	Watchdog timeout control	0x6002A0DC	R/W
Clock configuration registers			
EMAC_EX_CLKOUT_CONF_REG	RMII clock divider setting	0x60029800	R/W
EMAC_EX_OSCCLK_CONF_REG	RMII clock half and whole divider settings	0x60029804	R/W
EMAC_EX_CLK_CTRL_REG	Clock enable and external / internal clock selection	0x60029808	R/W
PHY type and SRAM configuration registers			
EMAC_EX_PHYINF_CONF_REG	Selection of MII / RMII phy	0x6002980C	R/W
EMAC_PD_SEL_REG	Ethernet RAM power-down enable	0x60029810	R/W

10.10 Registers

Note: The value of all reset registers must be set to the reset value.

Register 10.1: DMABUSMODE_REG (0x0000)

(reserved)					DMAMIXEDBURST DMAADDRALIBEA PBLX8_MODE USE_SEP_PBL				RX_DMA_PBL			FIXED_BURST PRI_RATIO		PROG_BURST_LEN			ALT_DESC_SIZE			DESC_SKIP_LEN		DMA_ARB_SCH SW_RST	
31	27	26	25	24	23	22	17	16	15	14	13	8	7	6	2	1	0						
0	0	0	0	0	0	0	0x01	0	0x0			0x01	0		0x00	0	1						

Reset

DMAMIXEDBURST When this bit is set high and the FB bit is low, the AHB master interface starts all bursts of a length more than 16 with INCR (undefined burst), whereas it reverts to fixed burst transfers (INCRx and SINGLE) for burst length of 16 and less. (R/W)

DMAADDRALIBEA When this bit is set high and the FB bit is 1, the AHB interface generates all bursts aligned to the start address LS bits. If the FB bit is 0, the first burst (accessing the start address of data buffer) is not aligned, but subsequent bursts are aligned to the address. (R/W)

PBLX8_MODE When set high, this bit multiplies the programmed PBL value (Bits[22:17] and Bits[13:8]) eight times. Therefore, the DMA transfers the data in 8, 16, 32, 64, 128, and 256 beats depending on the PBL value. (R/W)

USE_SEP_PBL When set high, this bit configures the Rx DMA to use the value configured in Bits[22:17] as PBL. The PBL value in Bits[13:8] is applicable only to the Tx DMA operations. When reset to low, the PBL value in Bits[13:8] is applicable for both DMA engines. (R/W)

RX_DMA_PBL This field indicates the maximum number of beats to be transferred in one Rx DMA transaction. This is the maximum value that is used in a single block Read or Write. The Rx DMA always attempts to burst as specified in the RPBL bit each time it starts a burst transfer on the host bus. You can program RPBL with values of 1, 2, 4, 8, 16, and 32. Any other value results in undefined behavior. This field is valid and applicable only when USP is set high. (R/W)

FIXED_BURST This bit controls whether the AHB master interface performs fixed burst transfers or not. When set, the AHB interface uses only SINGLE, INCR4, INCR8, or INCR16 during start of the normal burst transfers. When reset, the AHB interface uses SINGLE and INCR burst transfer operations. (R/W)

PRI_RATIO These bits control the priority ratio in the weighted round-robin arbitration between the Rx DMA and Tx DMA. These bits are valid only when Bit 1 (DA) is reset. The priority ratio Rx:Tx represented by each bit: (R/W)

- 2'b00 — 1: 1
- 2'b01 — 2: 0
- 2'b10 — 3: 1
- 2'b11 — 4: 1

Continued on the next page...

Register 10.1: DMABUSMODE_REG (0x0000)

Continued from the previous page ...

PROG_BURST_LEN These bits indicate the maximum number of beats to be transferred in one DMA transaction. If the number of beats to be transferred is more than 32, then perform the following steps: 1. Set the PBLx8 mode; 2. Set the PBL. (R/W)

ALT_DESC_SIZE When set, the size of the alternate descriptor increases to 32 bytes. (R/W)

DESC_SKIP_LEN This bit specifies the number of Word to skip between two unchained descriptors. The address skipping starts from the end of current descriptor to the start of next descriptor. When the DSL value is equal to zero, the descriptor table is taken as contiguous by the DMA in Ring mode. (R/W)

DMA_ARB_SCH This bit specifies the arbitration scheme between the transmit and receive paths. 1'b0: weighted round-robin with RX:TX or TX:RX, priority specified in PR (bit[15:14]); 1'b1 Fixed priority (Rx priority to Tx). (R/W)

SW_RST When this bit is set, the MAC DMA Controller resets the logic and all internal registers of the MAC. It is cleared automatically after the reset operation is complete in all of the ETH_MAC clock domains. Before reprogramming any register of the ETH_MAC, you should read a zero (0) value in this bit. (R/WS/SC)

Register 10.2: DMATXPOLLDEMAND_REG (0x0004)

31	0
0x00000000	
Reset	

DMATXPOLLDEMAND_REG When these bits are written with any value, the DMA reads the current descriptor to which the Register (Current Host Transmit Descriptor Register) is pointing. If that descriptor is not available (owned by the Host), the transmission returns to the suspend state and Bit[2] (TU) of Status Register is asserted. If the descriptor is available, the transmission resumes. (RO/WT)

Register 10.3: DMARXPOLLDEMAND_REG (0x0008)

31	0
0x00000000	
Reset	

DMARXPOLLDEMAND_REG When these bits are written with any value, the DMA reads the current descriptor to which the Current Host Receive Descriptor Register is pointing. If that descriptor is not available (owned by the Host), the reception returns to the Suspended state and Bit[7] (RU) of Status Register is asserted. If the descriptor is available, the Rx DMA returns to the active state. (RO/WT)

Register 10.4: DMARXBASEADDR_REG (0x000C)

31	0
0x00000000	

Reset

DMARXBASEADDR_REG This field contains the base address of the first descriptor in the Receive Descriptor list. The LSB Bits[1:0] are ignored and internally taken as all-zero by the DMA. Therefore, these LSB bits are read-only. (R/W)

Register 10.5: DMATXBASEADDR_REG (0x0010)

31	0
0x00000000	

Reset

DMATXBASEADDR_REG This field contains the base address of the first descriptor in the Transmit Descriptor list. The LSB Bits[1:0] are ignored and are internally taken as all-zero by the DMA. Therefore, these LSB bits are read-only. (R/W)

Register 10.6: DMASTATUS_REG (0x0014)

31	30	29	28	27	26	25	23	22	20	19	17	16	15	14	13	12	11	10	9	8	7	6	5	4	3	2	1	0															
(reserved)		TS_TRI_INT		EMAC_PMT_INT		(reserved)		ERROR_BITS		TRANS_PROC_STATE		RECV_PROC_STATE		NORM_INT_SUMM		ABN_INT_SUMM		EARLY_RECV_INT		FATAL_BUS_ERR_INT		(reserved)		EARLY_TRANS_INT		RECV_WDT_TO		RECV_PROC_STOP		RECV_BUF_UNAVAIL		TRANS_UNDFLOW		TRANS_OVFLOW		TRANS_JABBER_TO		TRANS_BUF_UNAVAIL		TRANS_PROC_STOP		TRANS_INT	
0		0		0		0		0		0x0		0x0		0x0		0		0		0		0		0		0		0		0		0		0		0		0		0			

Reset

TS_TRI_INT This bit indicates an interrupt event in the Timestamp Generator block of the ETH_MAC. The software must read the corresponding registers in the ETH_MAC to get the exact cause of the interrupt and clear its source to reset this bit to 1'b0. (RO)

EMAC_PMT_INT This bit indicates an interrupt event in the PMT module of the ETH_MAC. The software must read the PMT Control and Status Register in the MAC to get the exact cause of interrupt and clear its source to reset this bit to 1'b0. (RO)

Continued on the next page...

Register 10.6: DMASTATUS_REG (0x0014)

Continued from the previous page ...

ERROR_BITS This field indicates the type of error that caused a Bus Error, for example, error response on the AHB interface. This field is valid only when Bit[13] (FBI) is set. This field does not generate an interrupt. (RO)

- 3'b000: Error during Rx DMA Write Data Transfer.
- 3'b011: Error during Tx DMA Read Data Transfer.
- 3'b100: Error during Rx DMA Descriptor Write Access.
- 3'b101: Error during Tx DMA Descriptor Write Access.
- 3'b110: Error during Rx DMA Descriptor Read Access.
- 3'b111: Error during Tx DMA Descriptor Read Access.

TRANS_PROC_STATE This field indicates the Transmit DMA FSM state. This field does not generate an interrupt. (RO)

- 3'b000: Stopped. Reset or Stop Transmit Command issued.
- 3'b001: Running. Fetching Transmit Transfer Descriptor.
- 3'b010: Reserved for future use.
- 3'b011: Running. Waiting for TX packets.
- 3'b100: Suspended. Receive Descriptor Unavailable.
- 3'b101: Running. Closing Transmit Descriptor.
- 3'b110: TIME_STAMP write state.
- 3'b111: Running. Transferring the TX packets data from transmit buffer to host memory.

RECV_PROC_STATE This field indicates the Receive DMA FSM state. This field does not generate an interrupt. (RO)

- 3'b000: Stopped. Reset or Stop Receive Command issued.
- 3'b001: Running. Fetching Receive Transfer Descriptor.
- 3'b010: Reserved for future use.
- 3'b011: Running. Waiting for RX packets.
- 3'b100: Suspended. Receive Descriptor Unavailable.
- 3'b101: Running. Closing Receive Descriptor.
- 3'b110: TIME_STAMP write state.
- 3'b111: Running. Transferring the TX packets data from receive buffer to host memory.

Continued on the next page...

Register 10.6: DMASTATUS_REG (0x0014)

Continued from the previous page ...

NORM_INT_SUMM Normal Interrupt Summary bit value is the logical OR of the following bits when the corresponding interrupt bits are enabled in Interrupt Enable Register: (R/SS/WC)

- Bit[0]: Transmit Interrupt.
- Bit[2]: Transmit Buffer Unavailable.
- Bit[6]: Receive Interrupt.
- Bit[14]: Early Receive Interrupt. Only unmasked bits affect the Normal Interrupt Summary bit. This is a sticky bit and must be cleared (by writing 1 to this bit) each time a corresponding bit, which causes NIS to be set, is cleared.

ABN_INT_SUMM Abnormal Interrupt Summary bit value is the logical OR of the following when the corresponding interrupt bits are enabled in Interrupt Enable Register: (R/SS/WC)

- Bit[1]: Transmit Process Stopped.
- Bit[3]: Transmit Jabber Timeout.
- Bit[4]: Receive FIFO Overflow.
- Bit[5]: Transmit Underflow.
- Bit[7]: Receive Buffer Unavailable. Bit[8]: Receive Process Stopped.
- Bit[9]: Receive Watchdog Timeout.
- Bit[10]: Early Transmit Interrupt.
- Bit[13]: Fatal Bus Error. Only unmasked bits affect the Abnormal Interrupt Summary bit. This is a sticky bit and must be cleared (by writing 1 to this bit) each time a corresponding bit, which causes AIS to be set, is cleared.

EARLY_RECV_INT This bit indicates that the DMA filled the first data buffer of the packet. This bit is cleared when the software writes 1 to this bit or when Bit[6] (RI) of this register is set (whichever occurs earlier). (R/SS/WC)

FATAL_BUS_ERR_INT This bit indicates that a bus error occurred, as described in Bits [25:23]. When this bit is set, the corresponding DMA engine disables all of its bus accesses. (R/SS/WC)

EARLY_TRANS_INT This bit indicates that the frame to be transmitted is fully transferred to the MTL Transmit FIFO. (R/SS/WC)

RECV_WDT_TO When set, this bit indicates that the Receive Watchdog Timer expired while receiving the current frame and the current frame is truncated after the watchdog timeout. (R/SS/WC)

Continued on the next page...

Register 10.6: DMASTATUS_REG (0x0014)

Continued from the previous page ...

RECV_PROC_STOP This bit is asserted when the Receive Process enters the Stopped state. (R/SS/WC)

RECV_BUF_UNAVAIL This bit indicates that the host owns the Next Descriptor in the Receive List and the DMA cannot acquire it. The Receive Process is suspended. To resume processing Receive descriptors, the host should change the ownership of the descriptor and issue a Receive Poll Demand command. If no Receive Poll Demand is issued, the Receive Process resumes when the next recognized incoming frame is received. This bit is set only when the previous Receive Descriptor is owned by the DMA. (R/SS/WC)

RECV_INT This bit indicates that the frame reception is complete. When reception is complete, the Bit[31] of RDES1 (Disable Interrupt on Completion) is reset in the last Descriptor, and the specific frame status information is updated in the descriptor. The reception remains in the Running state. (R/SS/WC)

TRANS_UNDFLOW This bit indicates that the Transmit Buffer had an Underflow during frame transmission. Transmission is suspended and an Underflow Error TDES0[1] is set. (R/SS/WC)

RECV_OVFLOW This bit indicates that the Receive Buffer had an Overflow during frame reception. If the partial frame is transferred to the application, the overflow status is set in RDES0[11]. (R/SS/WC)

TRANS_JABBER_TO This bit indicates that the Transmit Jabber Timer expired, which happens when the frame size exceeds 2,048 (10,240 bytes when the Jumbo frame is enabled). When the Jabber Timeout occurs, the transmission process is aborted and placed in the Stopped state. This causes the Transmit Jabber Timeout TDES0[14] flag to assert. (R/SS/WC)

TRANS_BUF_UNAVAIL This bit indicates that the host owns the Next Descriptor in the Transmit List and the DMA cannot acquire it. Transmission is suspended. Bits[22:20] explain the Transmit Process state transitions. To resume processing Transmit descriptors, the host should change the ownership of the descriptor by setting TDES0[31] and then issue a Transmit Poll Demand command. (R/SS/WC)

TRANS_PROC_STOP This bit is set when the transmission is stopped. (R/SS/WC)

TRANS_INT This bit indicates that the frame transmission is complete. When transmission is complete, Bit[31] (OWN) of TDES0 is reset, and the specific frame status information is updated in the descriptor. (R/SS/WC)

Register 10.7: DMAIN_EN_REG (0x001C)

(reserved)																	DMAIN_NISE DMAIN_AISE DMAIN_ERIE DMAIN_FBEE (reserved) DMAIN_ETIE DMAIN_RWTE DMAIN_RSE DMAIN_RBUFE DMAIN_RIE DMAIN_UIE DMAIN_OIE DMAIN_TJTE DMAIN_TBUFE DMAIN_TSE DMAIN_TIE																		
31																	17	16	15	14	13	12	11	10	9	8	7	6	5	4	3	2	1	0	Reset
0																	0																		

DMAIN_NISE When this bit is set, normal interrupt summary is enabled. When this bit is reset, normal interrupt summary is disabled. This bit enables the following interrupts in Status Register: (R/W)

- Bit[0]: Transmit Interrupt.
- Bit[2]: Transmit Buffer Unavailable.
- Bit[6]: Receive Interrupt.
- Bit[14]: Early Receive Interrupt.

DMAIN_AISE When this bit is set, abnormal interrupt summary is enabled. When this bit is reset, the abnormal interrupt summary is disabled. This bit enables the following interrupts in Status Register:(R/W)

- Bit[1]: Transmit Process Stopped.
- Bit[3]: Transmit Jabber Timeout.
- Bit[4]: Receive Overflow.
- Bit[5]: Transmit Underflow.
- Bit[7]: Receive Buffer Unavailable.
- Bit[8]: Receive Process Stopped.
- Bit[9]: Receive Watchdog Timeout.
- Bit[10]: Early Transmit Interrupt.
- Bit[13]: Fatal Bus Error.

DMAIN_ERIE When this bit is set with Normal Interrupt Summary Enable (Bit[16]), the Early Receive Interrupt is enabled. When this bit is reset, the Early Receive Interrupt is disabled. (R/W)

Continued on the next page...

Register 10.7: DMABUSMODE_REG (0x0000)

Continued from the previous page ...

DMAIN_FBEE When this bit is set with Abnormal Interrupt Summary Enable (Bit[15]), the Fatal Bus Error Interrupt is enabled. When this bit is reset, the Fatal Bus Error Enable Interrupt is disabled. (R/W)

DMAIN_ETIE When this bit is set with an Abnormal Interrupt Summary Enable (Bit[15]), the Early Transmit Interrupt is enabled. When this bit is reset, the Early Transmit Interrupt is disabled. (R/W)

DMAIN_RWTE When this bit is set with Abnormal Interrupt Summary Enable (Bit[15]), the Receive Watchdog Timeout Interrupt is enabled. When this bit is reset, the Receive Watchdog Timeout Interrupt is disabled. (R/W)

DMAIN_RSE When this bit is set with Abnormal Interrupt Summary Enable (Bit[15]), the Receive Stopped Interrupt is enabled. When this bit is reset, the Receive Stopped Interrupt is disabled. (R/W)

DMAIN_RBUE When this bit is set with Abnormal Interrupt Summary Enable (Bit[15]), the Receive Buffer Unavailable Interrupt is enabled. When this bit is reset, the Receive Buffer Unavailable Interrupt is disabled. (R/W)

DMAIN_RIE When this bit is set with Normal Interrupt Summary Enable (Bit[16]), the Receive Interrupt is enabled. When this bit is reset, the Receive Interrupt is disabled. (R/W)

DMAIN_UIE When this bit is set with Abnormal Interrupt Summary Enable (Bit[15]), the Transmit Underflow Interrupt is enabled. When this bit is reset, the Underflow Interrupt is disabled. (R/W)

DMAIN_OIE When this bit is set with Abnormal Interrupt Summary Enable (Bit[15]), the Receive Overflow Interrupt is enabled. When this bit is reset, the Overflow Interrupt is disabled. (R/W)

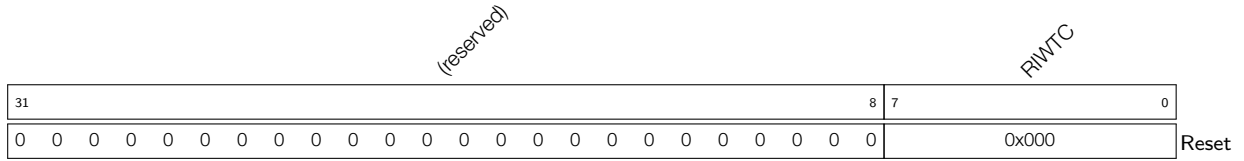
DMAIN_TJTE When this bit is set with Abnormal Interrupt Summary Enable (Bit[15]), the Transmit Jabber Timeout Interrupt is enabled. When this bit is reset, the Transmit Jabber Timeout Interrupt is disabled. (R/W)

DMAIN_TBUE When this bit is set with Normal Interrupt Summary Enable (Bit 16), the Transmit Buffer Unavailable Interrupt is enabled. When this bit is reset, the Transmit Buffer Unavailable Interrupt is disabled. (R/W)

DMAIN_TSE When this bit is set with Abnormal Interrupt Summary Enable (Bit[15]), the Transmission Stopped Interrupt is enabled. When this bit is reset, the Transmission Stopped Interrupt is disabled. (R/W)

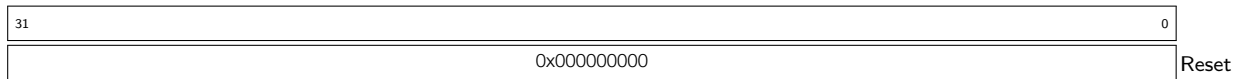
DMAIN_TIE When this bit is set with Normal Interrupt Summary Enable (Bit[16]), the Transmit Interrupt is enabled. When this bit is reset, the Transmit Interrupt is disabled. (R/W)

Register 10.8: DMARINTWDTIMER_REG (0x0024)



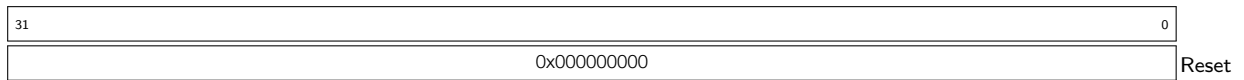
RIWTC This bit indicates the number of system clock cycles multiplied by 256 for which the watchdog timer is set. The watchdog timer gets triggered with the programmed value after the Rx DMA completes the transfer of a frame for which the RI status bit is not set because of the setting in the corresponding descriptor RDES1[31]. When the watchdog timer runs out, the RI bit is set and the timer is stopped. The watchdog timer is reset when the RI bit is set high because of automatic setting of RI as per RDES1[31] of any received frame. (R/W)

Register 10.9: DMATXCURRDESC_REG (0x0048)



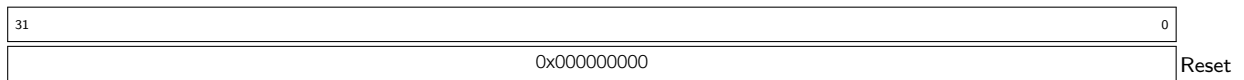
DMATXCURRDESC_REG The address of the current receive descriptor list. Cleared on Reset. Pointer updated by the DMA during operation. (RO)

Register 10.10: DMARXCURRDESC_REG (0x004C)



DMARXCURRDESC_REG The address of the current receive descriptor list. Cleared on Reset. Pointer updated by the DMA during operation. (RO)

Register 10.11: DMATXCURRADDR_BUF_REG (0x0050)



DMATXCURRADDR_BUF_REG The address of the current receive descriptor list. Cleared on Reset. Pointer updated by the DMA during operation. (RO)

Register 10.12: DMARXCURRADDR_BUF_REG (0x0054)

31	0
0x00000000	

Reset

DMARXCURRADDR_BUF_REG The address of the current receive descriptor list. Cleared on Reset. Pointer updated by the DMA during operation. (RO)

Register 10.13: EMACCONFIG_REG (0x1000)

(reserved)	SAIRC	ASS2KP	(reserved)	EMACWATCHDOG	EMACJABBER	(reserved)	EMACJUMBOFRAME	EMACINTERFRAMEGAP	EMACDISABLECRS	EMACMII	EMACFESPEED	EMACRYOWIN	EMACLOOPBACK	EMACRXIPCOFFLOAD	(reserved)	EMACPADCRICSTRIP	EMACBACKOFFLIMIT	EMACTX	EMACRX	PLTF									
31	30	28	27	26	24	23	22	21	20	19	17	16	15	14	13	12	11	10	9	8	7	6	5	4	3	2	1	0	
0	0x0	0	0	0	0	0	0	0	0	0	0	0	0	0	0	0	0	0	0	0	0	0x0	0	0	0	0	0	0x0	Reset

SAIRC This field controls the source address insertion or replacement for all transmitted frames. Bit[30] specifies which MAC Address register (0 or 1) is used for source address insertion or replacement based on the values of Bits [29:28]: (R/W)

- 2'b0x: The input signals mti_sa_ctrl_i and ati_sa_ctrl_i control the SA field generation.
- 2'b10: If Bit[30] is set to 0, the MAC inserts the content of the MAC Address 0 registers in the SA field of all transmitted frames. If Bit[30] is set to 1 the MAC inserts the content of the MAC Address 1 registers in the SA field of all transmitted frames.
- 2'b11: If Bit[30] is set to 0, the MAC replaces the content of the MAC Address 0 registers in the SA field of all transmitted frames. If Bit[30] is set to 1, the MAC replaces the content of the MAC Address 1 registers in the SA field of all transmitted frames.

ASS2KP When set, the MAC considers all frames, with up to 2,000 bytes length, as normal packets. When Bit[20] (JE) is not set, the MAC considers all received frames of size more than 2K bytes as Giant frames. When this bit is reset and Bit[20] (JE) is not set, the MAC considers all received frames of size more than 1,518 bytes (1,522 bytes for tagged) as Giant frames. When Bit[20] is set, setting this bit has no effect on Giant Frame status. (R/W)

EMACWATCHDOG When this bit is set, the MAC disables the watchdog timer on the receiver. The MAC can receive frames of up to 16,383 bytes. When this bit is reset, the MAC does not allow a receive frame which more than 2,048 bytes (10,240 if JE is set high) or the value programmed in Register (Watchdog Timeout Register). The MAC cuts off any bytes received after the watchdog limit number of bytes. (R/W)

EMACJABBER When this bit is set, the MAC disables the jabber timer on the transmitter. The MAC can transfer frames of up to 16,383 bytes. When this bit is reset, the MAC cuts off the transmitter if the application sends out more than 2,048 bytes of data (10,240 if JE is set high) during transmission. (R/W)

EMACJUMBOFRAME When this bit is set, the MAC allows Jumbo frames of 9,018 bytes (9,022 bytes for VLAN tagged frames) without reporting a giant frame error in the receive frame status. (R/W)

Continued on the next page...

Register 10.13: EMACCONFIG_REG (0x1000)

Continued from the previous page ...

EMACINTERFRAMEGAP These bits control the minimum IFG between frames during transmission.
(R/W)

- 3'b000: 96 bit times.
- 3'b001: 88 bit times.
- 3'b010: 80 bit times.
- 3'b111: 40 bit times. In the half-duplex mode, the minimum IFG can be configured only for 64 bit times (IFG = 100). Lower values are not considered.

EMACDISABLECRS When set high, this bit makes the MAC transmitter ignore the MII CRS signal during frame transmission in the half-duplex mode. This request results in no errors generated because of Loss of Carrier or No Carrier during such transmission. When this bit is low, the MAC transmitter generates such errors because of Carrier Sense and can even abort the transmissions.
(R/W)

EMACMII This bit selects the Ethernet line speed. It should be set to 1 for 10 or 100 Mbps operations. In 10 or 100 Mbps operations, this bit, along with FES bit, it selects the exact linespeed. In the 10/100 Mbps-only operations, the bit is always 1. (R/W)

EMACFESPEED This bit selects the speed in the MII, RMI interface. 0: 10 Mbps; 1: 100 Mbps.
(R/W)

EMACRXOWN When this bit is set, the MAC disables the reception of frames when the TX_EN is asserted in the half-duplex mode. When this bit is reset, the MAC receives all packets that are given by the PHY while transmitting. This bit is not applicable if the MAC is operating in the full-duplex mode. (R/W)

EMACLOOPBACK When this bit is set, the MAC operates in the loopback mode MII. The MII Receive clock input (CLK_RX) is required for the loopback to work properly, because the transmit clock is not looped-back internally. (R/W)

EMACDUPLEX When this bit is set, the MAC operates in the full-duplex mode where it can transmit and receive simultaneously. This bit is read only with default value of 1'b1 in the full-duplex-mode.
(R/W)

EMACRXIPCOFFLOAD When this bit is set, the MAC calculates the 16-bit one's complement of the one's complement sum of all received Ethernet frame payloads. It also checks whether the IPv4 Header checksum (assumed to be bytes 25/26 or 29/30 (VLAN-tagged) of the received Ethernet frame) is correct for the received frame and gives the status in the receive status word. The MAC also appends the 16-bit checksum calculated for the IP header datagram payload (bytes after the IPv4 header) and appends it to the Ethernet frame transferred to the application (when Type 2 COE is deselected). When this bit is reset, this function is disabled. (R/W)

Continued on the next page...

Register 10.13: EMACCONFIG_REG (0x1000)

Continued from the previous page ...

EMACRETRY When this bit is set, the MAC attempts only one transmission. When a collision occurs on the MII interface, the MAC ignores the current frame transmission and reports a Frame Abort with excessive collision error in the transmit frame status. When this bit is reset, the MAC attempts retries based on the settings of the BL field (Bits [6:5]). This bit is applicable only in the half-duplex mode. (R/W)

EMACPADCRGSTRIP When this bit is set, the MAC strips the Pad or FCS field on the incoming frames only if the value of the length field is less than 1,536 bytes. All received frames with length field greater than or equal to 1,536 bytes are passed to the application without stripping the Pad or FCS field. When this bit is reset, the MAC passes all incoming frames, without modifying them, to the Host. (R/W)

EMACBACKOFFLIMIT The Back-Off limit determines the random integer number (r) of slot time delays (512 bit times for 10/100 Mbps) for which the MAC waits before rescheduling a transmission attempt during retries after a collision. This bit is applicable only in the half-duplex mode.

- 00: $k = \min(n, 10)$.
- 01: $k = \min(n, 8)$.
- 10: $k = \min(n, 4)$.
- 11: $k = \min(n, 1)$, $n =$ retransmission attempt. The random integer r takes the value in the range $0 \sim 2000$.

EMACDEFERRALCHECK Deferral Check. (R/W)

EMACTX When this bit is set, the transmit state machine of the MAC is enabled for transmission on the MII. When this bit is reset, the MAC transmit state machine is disabled after the completion of the transmission of the current frame, and does not transmit any further frames. (R/W)

EMACRX When this bit is set, the receiver state machine of the MAC is enabled for receiving frames from the MII. When this bit is reset, the MAC receive state machine is disabled after the completion of the reception of the current frame, and does not receive any further frames from the MII. (R/W)

PLTF These bits control the number of preamble bytes that are added to the beginning of every Transmit frame. The preamble reduction occurs only when the MAC is operating in the full-duplex mode. 2'b00: 7 bytes of preamble. 2'b01: 5 bytes of preamble. 2'b10: 3 bytes of preamble. (R/W)

Register 10.14: EMACFF_REG (0x1004)

RECEIVE_ALL		(reserved)										SAFE	SAIF	PCF	DBF	PAM	DAIF	(reserved)		P.MODE				
31	30											10	9	8	7	6	5	4	3	2	1	0		
0	0	0	0	0	0	0	0	0	0	0	0	0	0	0	0x0	0	0	0	0	0	0	0	0	Reset

RECEIVE_ALL When this bit is set, the MAC Receiver module passes all received frames, irrespective of whether they pass the address filter or not, to the Application. The result of the SA or DA filtering is updated (pass or fail) in the corresponding bits in the Receive Status Word. When this bit is reset, the Receiver module passes only those frames to the Application that pass the SA or DA address filter. (R/W)

SAFE When this bit is set, the MAC compares the SA field of the received frames with the values programmed in the enabled SA registers. If the comparison fails, the MAC drops the frame. When this bit is reset, the MAC forwards the received frame to the application with updated SAF bit of the Rx Status depending on the SA address comparison. (R/W)

SAIF When this bit is set, the Address Check block operates in inverse filtering mode for the SA address comparison. The frames whose SA matches the SA registers are marked as failing the SA Address filter. When this bit is reset, frames whose SA does not match the SA registers are marked as failing the SA Address filter. (R/W)

PCF These bits control the forwarding of all control frames (including unicast and multicast Pause frames). (R/W)

- 2'b00: MAC filters all control frames from reaching the application.
- 2'b01: MAC forwards all control frames except Pause frames to application even if they fail the Address filter.
- 2'b10: MAC forwards all control frames to application even if they fail the Address Filter.
- 2'b11: MAC forwards control frames that pass the Address Filter.

The following conditions should be true for the Pause frames processing:

- Condition 1: The MAC is in the full-duplex mode and flow control is enabled by setting Bit 2 (RFE) of Register (Flow Control Register) to 1.
- Condition 2: The destination address (DA) of the received frame matches the special multicast address or the MAC Address 0 when Bit 3 (UP) of the Register(Flow Control Register) is set.
- Condition 3: The Type field of the received frame is 0x8808 and the OPCODE field is 0x0001.

DBF When this bit is set, the AFM module blocks all incoming broadcast frames. In addition, it overrides all other filter settings. When this bit is reset, the AFM module passes all received broadcast frames. (R/W)

PAM When set, this bit indicates that all received frames with a multicast destination address (first bit in the destination address field is '1') are passed. When reset, filtering of multicast frame depends on HMC bit. (R/W)

Continued on the next page...

Register 10.14: EMACFF_REG (0x1004)

Continued from the previous page ...

DAIF When this bit is set, the Address Check block operates in inverse filtering mode for the DA address comparison for both unicast and multicast frames. When reset, normal filtering of frames is performed. (R/W)

PMODE When this bit is set, the Address Filter module passes all incoming frames irrespective of the destination or source address. The SA or DA Filter Fails status bits of the Receive Status Word are always cleared when PR is set. (R/W)

Register 10.15: EMACMIIADDR_REG (0x1010)

(reserved)																MIIDEV						MIIREG				MIICSRCLK				MIIWRITE		MIIBUSY		
31															16	15					11	10			6	5			2	1	0			
0																0						0				0				0		0		Reset

MIIDEV This field indicates which of the 32 possible PHY devices are being accessed. (R/W)

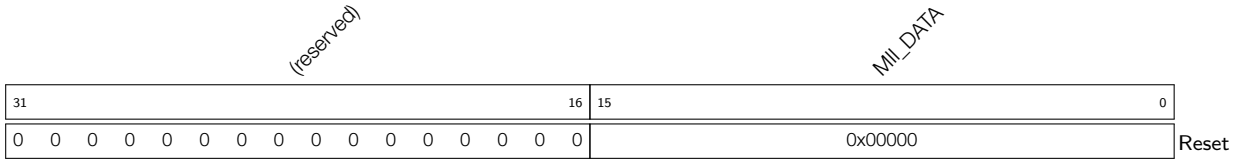
MIIREG These bits select the desired MII register in the selected PHY device. (R/W)

MIICSRCLK CSR clock range: 1.0 MHz ~ 2.5 MHz. (R/W)

- 4'b0000: When the APB clock frequency is 80 MHz, the MDC clock frequency is APB CLK/42;
- 4'b0000: When the APB clock frequency is 40 MHz, the MDC clock frequency is APB CLK/26.

MIIWRITE When set, this bit indicates to the PHY that this is a Write operation using the MII Data register. If this bit is not set, it indicates that this is a Read operation, that is, placing the data in the MII Data register. (R/W)

MIIBUSY This bit should read logic 0 before writing to PHY Addr Register and PHY data Register. During a PHY register access, the software sets this bit to 1'b1 to indicate that a Read or Write access is in progress. PHY data Register is invalid until this bit is cleared by the MAC. Therefore, PHY data Register (MII Data) should be kept valid until the MAC clears this bit during a PHY Write operation. Similarly for a read operation, the contents of Register 5 are not valid until this bit is cleared. The subsequent read or write operation should happen only after the previous operation is complete. Because there is no acknowledgment from the PHY to MAC after a read or write operation is completed, there is no change in the functionality of this bit even when the PHY is not present. (R/WS/SC)

Register 10.16: EMACMIIDATA_REG (0x1014)

MII_DATA This field contains the 16-bit data value read from the PHY after a Management Read operation or the 16-bit data value to be written to the PHY before a Management Write operation. (R/W)

Register 10.17: EMACFC_REG (0x1018)

<i>PAUSE_TIME</i>																<i>(reserved)</i>										<i>PLT</i>		<i>UPFD</i>		<i>RFCE</i>		<i>TFCE</i>		<i>FCBBA</i>	
31															16	15							6	5	4	3	2	1	0						
0x00000																0 0 0 0 0 0 0 0 0 0 0						0x0		0		0		0		0		Reset			

PAUSE_TIME This field holds the value to be used in the Pause Time field in the transmit control frame. If the Pause Time bits is configured to be double-synchronized to the MII clock domain, then consecutive writes to this register should be performed only after at least four clock cycles in the destination clock domain. (R/W)

PLT This field configures the threshold of the Pause timer automatic retransmission of the Pause frame. The threshold values should be always less than the Pause Time configured in Bits[31:16]. For example, if PT = 100H (256 slot-times), and PLT = 01, then a second Pause frame is automatically transmitted at 228 (256-28) slot times after the first Pause frame is transmitted. The following list provides the threshold values for different values: (R/W)

- 2'b00: The threshold is Pause time minus 4 slot times (PT-4 slot times).
- 2'b01: The threshold is Pause time minus 28 slot times (PT-28 slot times).
- 2'b10: The threshold is Pause time minus 144 slot times (PT-144 slot times).
- 2'b11: The threshold is Pause time minus 256 slot times (PT-256 slot times). The slot time is defined as the time taken to transmit 512 bits (64 bytes) on the MII interface.

UPFD A pause frame is processed when it has the unique multicast address specified in the IEEE Std 802.3. When this bit is set, the MAC can also detect Pause frames with unicast address of the station. This unicast address should be as specified in the EMACADDR0 High Register and EMACADDR0 Low Register. When this bit is reset, the MAC only detects Pause frames with unique multicast address. (R/W)

RFCE When this bit is set, the MAC decodes the received Pause frame and disables its transmitter for a specified (Pause) time. When this bit is reset, the decode function of the Pause frame is disabled. (R/W)

TFCE In the full-duplex mode, when this bit is set, the MAC enables the flow control operation to transmit Pause frames. When this bit is reset, the flow control operation in the MAC is disabled, and the MAC does not transmit any Pause frames. In the half-duplex mode, when this bit is set, the MAC enables the backpressure operation. When this bit is reset, the backpressure feature is disabled. (R/W)

FCBBA This bit initiates a Pause frame in the full-duplex mode and activates the backpressure function in the half-duplex mode if the TFE bit is set. In the full-duplex mode, this bit should be read as 1'b0 before writing to the Flow Control register. To initiate a Pause frame, the Application must set this bit to 1'b1. During a transfer of the Control Frame, this bit continues to be set to signify that a frame transmission is in progress. After the completion of Pause frame transmission, the MAC resets this bit to 1'b0. The Flow Control register should not be written to until this bit is cleared. In the half-duplex mode, when this bit is set (and TFE is set), then backpressure is asserted by the MAC. During backpressure, when the MAC receives a new frame, the transmitter starts sending a JAM pattern resulting in a collision. When the MAC is configured for the full-duplex mode, the BPA is automatically disabled. (R/WS/SC)(FCB)/(R/W)(BPA)

Register 10.18: EMACDEBUG_REG (0x1024)

(reserved)							MTLTSFFS	MTLTFNES	(reserved)			MTLTFWCS	MTLTFRCS	MACTP	MACTFCS	(reserved)				MTLRFFLS	(reserved)			MTLRFRCs	MTLRFWCAS	(reserved)		MACRFFCS	MACRPES				
31							26	25	24	23	22	21	20	19	18	17	16	15					10	9	8	7	6	5	4	3	2	1	0
0	0	0	0	0	0	0	0	0	0	0	0x0	0	0x0	0	0	0	0	0	0	0	0	0x0	0	0x0	0	0	0	0	0x0	0	0	0	Reset

MTLTSFFS When high, this bit indicates that the MTL TxStatus FIFO is full. Therefore, the MTL cannot accept any more frames for transmission. (RO)

MTLTFNES When high, this bit indicates that the MTL Tx FIFO is not empty and some data is left for transmission. (RO)

MTLTFWCS When high, this bit indicates that the MTL Tx FIFO Write Controller is active and is transferring data to the Tx FIFO. (RO)

MTLTFRCS This field indicates the state of the Tx FIFO Read Controller: (RO)

- 2'b00: IDLE state.
- 2'b01: READ state (transferring data to the MAC transmitter).
- 2'b10: Waiting for TxStatus from the MAC transmitter.
- 2'b11: Writing the received TxStatus or flushing the Tx FIFO.

MACTP When high, this bit indicates that the MAC transmitter is in the Pause condition (in the full-duplex-mode) and hence does not schedule any frame for transmission. (RO)

MACTFCS This field indicates the state of the MAC Transmit Frame Controller module: (RO)

- 2'b00: IDLE state.
- 2'b01: Waiting for status of previous frame or IFG or backoff period to be over.
- 2'b10: Generating and transmitting a Pause frame (in the full-duplex mode).
- 2'b11: Transferring input frame for transmission.

MACTPES When high, this bit indicates that the MAC MII transmit protocol engine is actively transmitting data and is not in the IDLE state. (RO)

MTLRFFLS This field gives the status of the fill-level of the Rx FIFO: (RO)

- 2'b00: Rx FIFO Empty.
- 2'b01: Rx FIFO fill-level below flow-control deactivate threshold.
- 2'b10: Rx FIFO fill-level above flow-control activate threshold.
- 2'b11: Rx FIFO Full.

Continued on the next page...

Register 10.18: EMACDEBUG_REG (0x1024)

Continued from the previous page ...

MTLRFRC This field gives the state of the Rx FIFO read Controller: (RO)

2'b00: IDLE state.

2'b01: Reading frame data.

2'b10: Reading frame status (or timestamp).

2'b11: Flushing the frame data and status.

MTLRFWCAS When high, this bit indicates that the MTL Rx FIFO Write Controller is active and is transferring a received frame to the FIFO. (RO)

MACRFFCS When high, this field indicates the active state of the FIFO Read and Write controllers of the MAC Receive Frame Controller Module. RFCFCSTS[1] represents the status of FIFO Read controller. RFCFCSTS[0] represents the status of small FIFO Write controller. (RO)

MACRPES When high, this bit indicates that the MAC MII receive protocol engine is actively receiving data and not in IDLE state. (RO)

Register 10.19: EMACINTS_REG (0x1038)

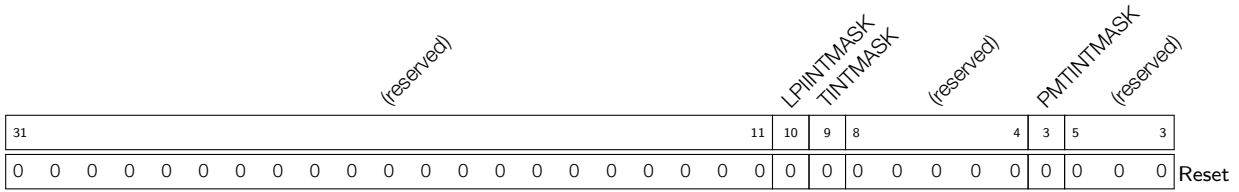
(reserved)											LPIINTS TINTS		(reserved)				PMTINTS		(reserved)					
31												11	10	9	8					4	3	2	0	
0	0	0	0	0	0	0	0	0	0	0	0	0	0	0	0	0	0	0	0	0	0	0	0	Reset

LPIINTS When the Energy Efficient Ethernet feature is enabled, this bit is set for any LPI state entry or exit in the MAC Transmitter or Receiver. This bit is cleared on reading Bit[0] of Register (LPI Control and Status Register). (RO)

TINTS this bit is set when any of the following conditions is true: The system time value equals or exceeds the value specified in the Target Time High and Low registers. There is an overflow in the seconds register. The Auxiliary snapshot trigger is asserted. This bit is cleared on reading Bit[0] of Register (Timestamp Status Register). If default Timestamping is enabled, when set, this bit indicates that the system time value is equal to or exceeds the value specified in the Target Time registers. In this mode, this bit is cleared after the completion of the read of this bit. (RO/R/SS/RC)

PMTINTS This bit is set when a magic packet or remote wake-up frame is received in the power-down mode (see Bit[5] and Bit[6] in the PMT Control and Status Register). This bit is cleared when both Bits[6:5] are cleared because of a read operation to the PMT Control and Status register. This bit is valid only when you select the optional PMT module during core configuration. (RO)

Register 10.20: EMACINTMASK_REG (0x103C)

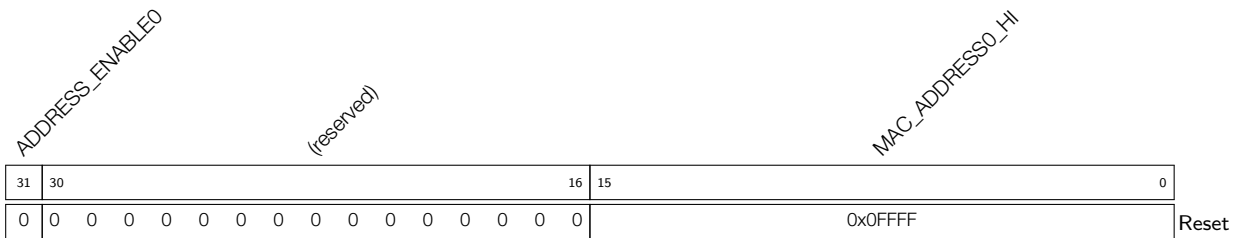


LPIINTMASK When set, this bit disables the assertion of the interrupt signal because of the setting of the LPI Interrupt Status bit in Register (Interrupt Status Register). (R/W)

TINTMASK When set, this bit disables the assertion of the interrupt signal because of the setting of Timestamp Interrupt Status bit in Register (Interrupt Status Register). This bit is valid only when IEEE1588 timestamping is enabled. In all other modes, this bit is reserved. (R/W)

PMTINTMASK When set, this bit disables the assertion of the interrupt signal because of the setting of PMT Interrupt Status bit in Register (Interrupt Status Register). (R/W)

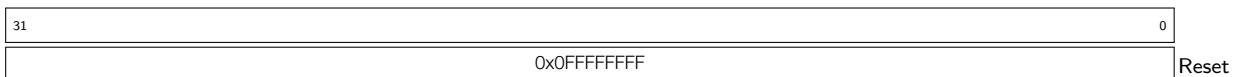
Register 10.21: EMACADDR0HIGH_REG (0x1040)



ADDRESS_ENABLE0 This bit is always set to 1 (RO)

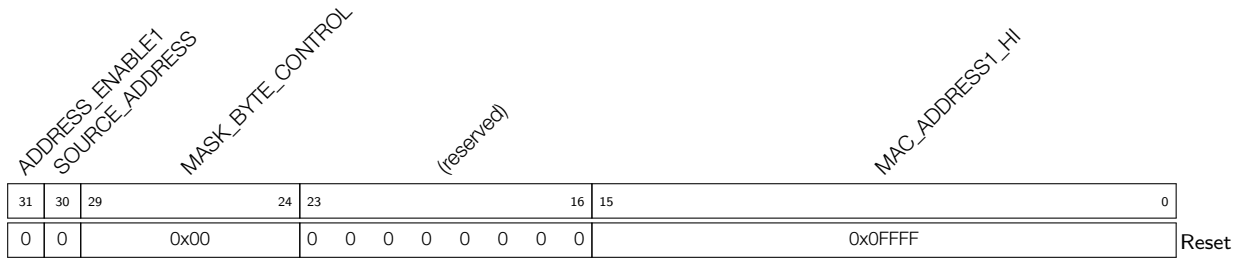
MAC_ADDRESS0_HI This field contains the upper 16 bits (47:32) of the first 6-byte MAC address. The MAC uses this field for filtering the received frames and inserting the MAC address in the Transmit Flow Control (Pause) Frames. (R/W)

Register 10.22: EMACADDR0LOW_REG (0x1044)



EMACADDR0LOW_REG This field contains the lower 32 bits of the first 6-byte MAC address. This is used by the MAC for filtering the received frames and inserting the MAC address in the Transmit Flow Control (Pause) Frames. (R/W)

Register 10.23: EMACADDR1HIGH_REG (0x1048)



ADDRESS_ENABLE1 When this bit is set, the address filter module uses the second MAC address for perfect filtering. When this bit is reset, the address filter module ignores the address for filtering. (R/W)

SOURCE_ADDRESS When this bit is set, the EMACADDR1[47:0] is used to compare with the SA fields of the received frame. When this bit is reset, the EMACADDR1[47:0] is used to compare with the DA fields of the received frame. (R/W)

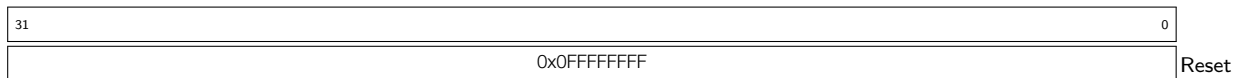
MASK_BYTE_CONTROL These bits are mask control bits for comparison of each of the EMACADDR1 bytes. When set high, the MAC does not compare the corresponding byte of received DA or SA with the contents of EMACADDR1 registers. Each bit controls the masking of the bytes as follows:

- Bit[29]: EMACADDR1 High [15:8].
- Bit[28]: EMACADDR1 High [7:0].
- Bit[27]: EMACADDR1 Low [31:24].
- Bit[24]: EMACADDR1 Low [7:0].

You can filter a group of addresses (known as group address filtering) by masking one or more bytes of the address. (R/W)

MAC_ADDRESS1_HI This field contains the upper 16 bits, Bits[47:32] of the second 6-byte MAC address. (R/W)

Register 10.24: EMACADDR1LOW_REG (0x104C)



EMACADDR1LOW_REG This field contains the lower 32 bits of the second 6-byte MAC address. The content of this field is undefined, so the register needs to be configured after the initialization process. (R/W)

Register 10.25: EMAC_AN_CONTROL_REG (0x10C0)

(reserved)													EMAC_ANEN (reserved)			EMAC_RAN			(reserved)										
31													13	12	11	10	9	17											9
0													0			0			0										0

Reset

EMAC_ANEN When set, this bit enables the MAC to perform auto-negotiation with the link partner. Clearing this bit disables the auto-negotiation. (R/W)

EMAC_RAN When set, this bit causes auto-negotiation to restart if Bit[12](ANE) is set. This bit is self-clearing after auto-negotiation starts. This bit should be cleared for normal operation. (R/WS/SC)

Register 10.26: EMAC_AN_STATUS_REG (0x10C4)

(reserved)																				EMAC_ANC (reserved)			EMAC_ANA (reserved)		(reserved)												
31																	6	5	4	3	2									0							
0																				0			0		1								0		0		0

Reset

EMAC_ANC When set, this bit indicates that the auto-negotiation process is complete. This bit is cleared when auto-negotiation is reinitiated. (RO)

EMAC_ANA This bit is always high because the MAC supports auto-negotiation. (RO)

EMAC_LS This bit decides whether the data link is established. Setting this bit to 1 means not establishing the link. (R/WS/SC)

Register 10.27: EMACSTATUS_REG (0x10D8)

(reserved)										SMDRXS					(reserved)										(JABBER_TIMEOUT) (reserved)				LINK_SPEED		LINK_MODE		
31																																	Reset
0										0					0										0				0				

JABBER_TIMEOUT This bit indicates whether there is jabber timeout error (1'b1) in the received frame. (RO)

LINK_SPEED This bit indicates the current speed of the link: (RO)

- 2'b00: 2.5 MHz.
- 2'b01: 25 MHz.
- 2'b10: 125 MHz.

LINK_MODE This bit indicates the current mode of operation of the link: (RO)

- 1'b0: Half-duplex mode.
- 1'b1: Full-duplex mode.

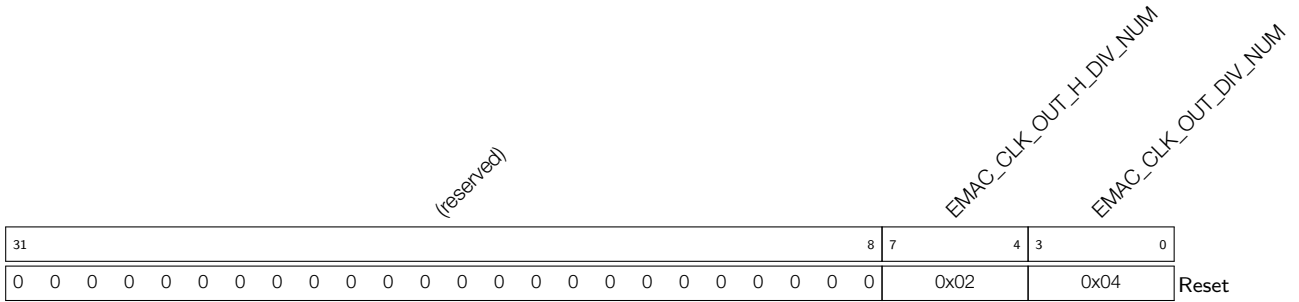
Register 10.28: EMACWDOGTO_REG (0x10DC)

(reserved)										PWDGEN (reserved)					WDOGTO																			
31																																		Reset
0										0					0x0000																			

PWDGEN When this bit is set and Bit[23] (WD) of EMACCONFIG_REG is reset, the WTO field (Bits[13:0]) is used as watchdog timeout for a received frame. When this bit is cleared, the watchdog timeout for a received frame is controlled by the setting of Bit[23] (WD) and Bit[20] (JE) in EMACCONFIG_REG. (R/W)

WDOGTO When Bit[16] (PWE) is set and Bit[23] (WD) of EMACCONFIG_REG is reset, this field is used as watchdog timeout for a received frame. If the length of a received frame exceeds the value of this field, such frame is terminated and declared as an error frame. (R/W)

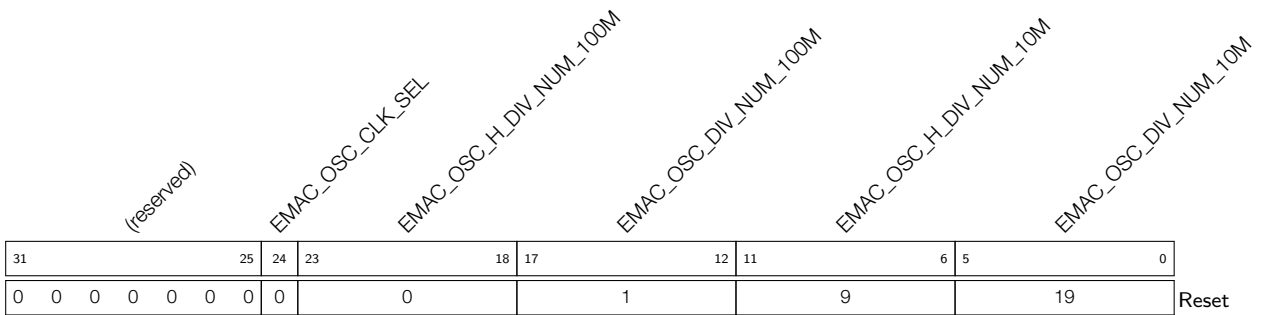
Register 10.29: EMAC_EX_CLKOUT_CONF_REG (0x0000)



EMAC_CLK_OUT_H_DIV_NUM RMII CLK using internal PLLA CLK, the half divider number, when using RMII PHY. (R/W)

EMAC_CLK_OUT_DIV_NUM RMII CLK using internal PLLA CLK, the whole divider number, when using RMII PHY. (R/W)

Register 10.30: EMAC_EX_OSCCLK_CONF_REG (0x0004)



EMAC_OSC_CLK_SEL Ethernet work using external PHY output clock or not for RMII CLK, when using RMII PHY. When this bit is set to 1, external PHY CLK is used. When this bit is set to 0, PLLA CLK is used. (R/W)

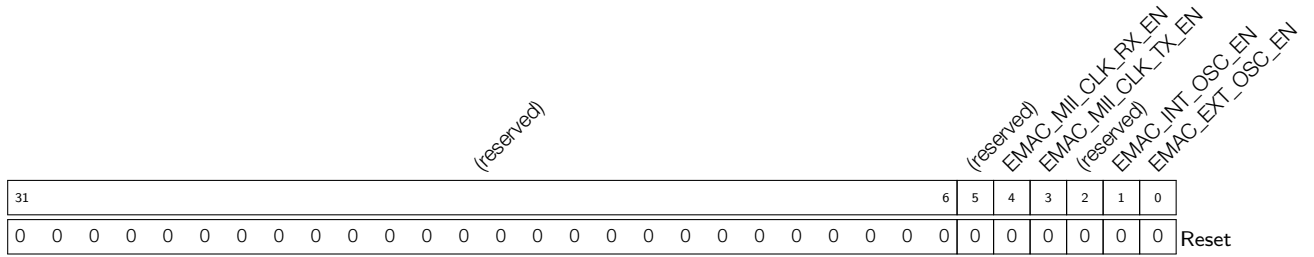
EMAC_OSC_H_DIV_NUM_100M RMII/MII half-integer divider, when register EMAC_EX_CLKOUT_CONF clock divider's speed is 100M. (R/W)

EMAC_OSC_DIV_NUM_100M RMII/MII whole-integer divider, when register EMAC_EX_CLKOUT_CONF clock divider's speed is 100M. (R/W)

EMAC_OSC_H_DIV_NUM_10M RMII/MII half-integer divider, when register EMAC_EX_CLKOUT_CONF clock divider's speed is 10M. (R/W)

EMAC_OSC_DIV_NUM_10M RMII/MII whole-integer divider, when register EMAC_EX_CLKOUT_CONF clock divider's speed is 10M. (R/W)

Register 10.31: EMAC_EX_CLK_CTRL_REG (0x0008)



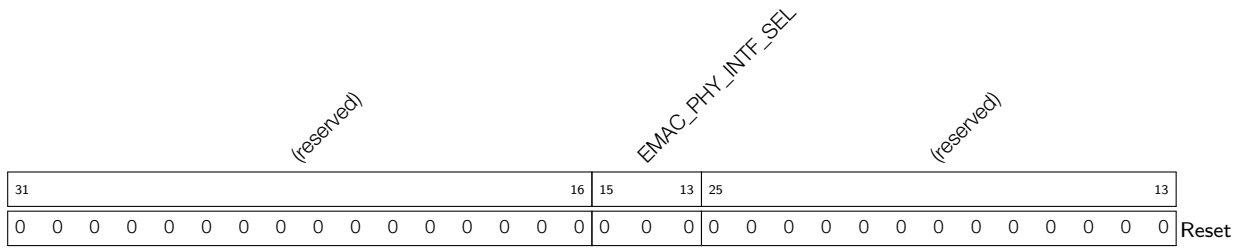
EMAC_MII_CLK_RX_EN Enable Ethernet RX CLK. (R/W)

EMAC_MII_CLK_TX_EN Enable Ethernet TX CLK. (R/W)

EMAC_INT_OSC_EN Using internal PLLA CLK in RMII PHY mode. (R/W)

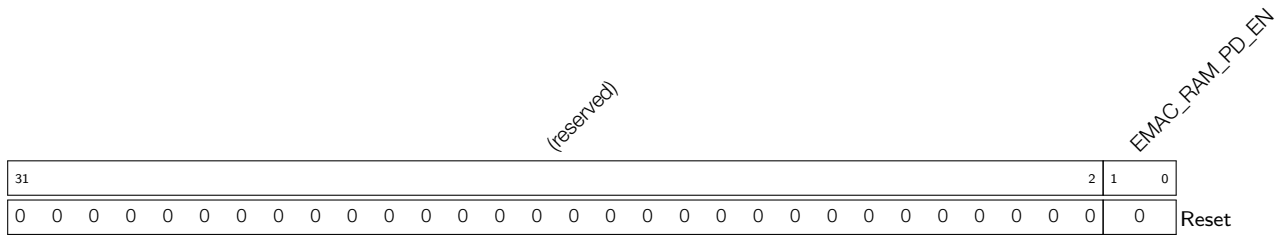
EMAC_EXT_OSC_EN Using external PLLA CLK in RMII PHY mode. (R/W)

Register 10.32: EMAC_EX_PHYINF_CONF_REG (0x000c)



EMAC_PHY_INTF_SEL The PHY interface selected. 0x0: PHY MII, 0x4: PHY RMII. (R/W)

Register 10.33: EMAC_PD_SEL_REG (0x0010)



EMAC_RAM_PD_EN Ethernet RAM power-down enable signal. Bit[0]: TX SRAM; Bit[1]: RX SRAM. Setting the bit to 1 powers down the RAM. (R/W)

11. I2C Controller

11.1 Overview

An I2C (Inter-Integrated Circuit) bus can be used for communication with several external devices connected to the same bus as ESP32. The ESP32 has dedicated hardware to communicate with peripherals on the I2C bus.

11.2 Features

The I2C controller has the following features:

- Supports both master mode and slave mode
- Supports multi-master and multi-slave communication
- Supports standard mode (100 kbit/s)
- Supports fast mode (400 kbit/s)
- Supports 7-bit addressing and 10-bit addressing
- Supports continuous data transmission with disabled Serial Clock Line (SCL)
- Supports programmable digital noise filter

11.3 Functional Description

11.3.1 Introduction

I2C is a two-wire bus, consisting of an SDA and an SCL line. These lines are configured to open the drain output. The lines are shared by two or more devices: usually one or more masters and one or more slaves.

Communication starts when a master sends out a start condition: it will pull the SDA line low, and will then pull the SCL line high. It will send out nine clock pulses over the SCL line. The first eight pulses are used to shift out a byte consisting of a 7-bit address and a read/write bit. If a slave with this address is active on the bus, the slave can answer by pulling the SDA low on the ninth clock pulse. The master can then send out more 9-bit clock pulse clusters and, depending on the read/write bit sent, the device or the master will shift out data on the SDA line, with the other side acknowledging the transfer by pulling the SDA low on the ninth clock pulse. During data transfer, the SDA line changes only when the SCL line is low. When the master has finished the communication, it will send a stop condition on the bus by raising SDA, while SCL will already be high.

The ESP32 I2C peripheral can handle the I2C protocol, freeing up the processor cores for other tasks.

11.3.2 Architecture

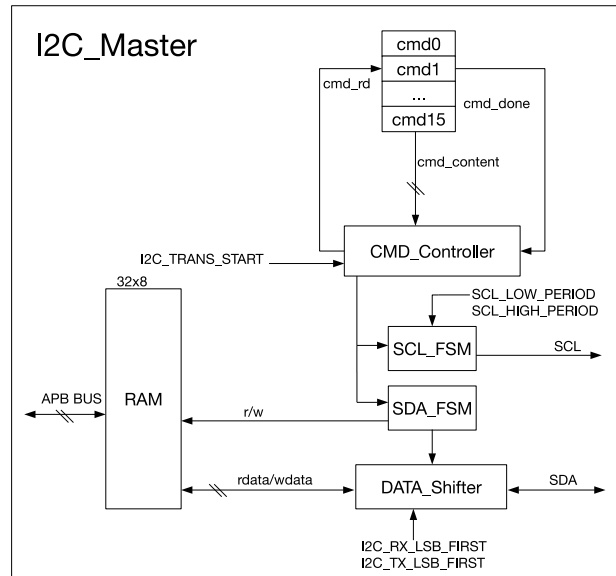


Figure 47: I2C Master Architecture

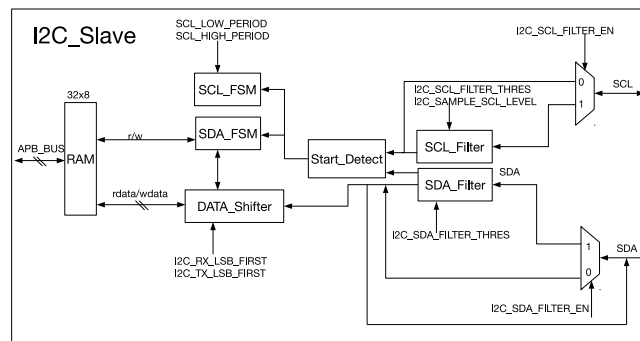


Figure 48: I2C Slave Architecture

An I2C controller can operate either in master mode or slave mode. The `I2C_MS_MODE` register is used to select the mode. Figure 47 shows the I2C Master architecture, while Figure 48 shows the I2C Slave architecture. The I2C controller contains the following units:

- RAM, the size of which is 32 x 8 bits, and it is directly mapped onto the address space of the CPU cores, starting at address `REG_I2C_BASE+0x100`. Each byte of I2C data is stored in a 32-bit word of memory (so, the first byte is at `+0x100`, the second byte at `+0x104`, the third byte at `+0x108`, etc.) Users need to set register `I2C_NONFIFO_EN`.
- A `CMD_Controller` and 16 command registers (`cmd0 ~ cmd15`), which are used by the I2C Master to control data transmission. One command at a time is executed by the I2C controller.
- `SCL_FSM`: A state machine that controls the SCL clock. The `I2C_SCL_HIGH_PERIOD_REG` and `I2C_SCL_LOW_PERIOD_REG` registers are used to configure the frequency and duty cycle of the signal on the SCL line.
- `SDA_FSM`: A state machine that controls the SDA data line.
- `DATA_Shifter` which converts the byte data to an outgoing bitstream, or converts an incoming bitstream to byte data. `I2C_RX_LSB_FIRST` and `I2C_TX_LSB_FIRST` can be used for configuring whether the LSB or MSB is stored or transmitted first.

- SCL_Filter and SDA_Filter: Input noise filter for the I2C_Slave. The filter can be enabled or disabled by configuring I2C_SCL_FILTER_EN and I2C_SDA_FILTER_EN. The filter can remove line glitches with pulse width less than I2C_SCL_FILTER_THRES and I2C_SDA_FILTER_THRES ABP clock cycles.

11.3.3 I2C Bus Timing

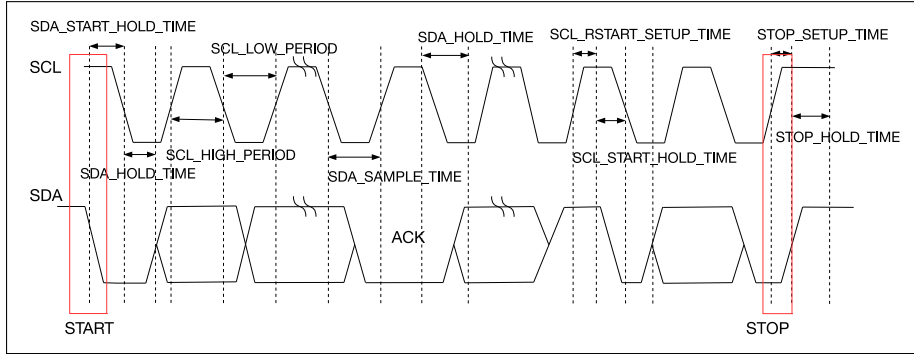


Figure 49: I2C Sequence Chart

Figure 49 is an I2C sequence chart. When the I2C controller works in master mode, SCL is an output signal. In contrast, when the I2C controller works in slave mode, the SCL becomes an input signal. The values assigned to I2C_SDA_HOLD_REG and I2C_SDA_SAMPLE_REG are still valid in slave mode. Users need to configure the values of I2C_SDA_HOLD_TIME and I2C_SDA_SAMPLE_TIME, according to the host characteristics, for the I2C slave to receive data properly.

According to the I2C protocol, each transmission of data begins with a START condition and ends with a STOP condition. Data is transmitted by one byte at a time, and each byte has an ACK bit. The receiver informs the transmitter to continue transmission by pulling down SDA, which indicates an ACK. The receiver can also indicate it wants to stop further transmission by pulling up the SDA line, thereby not indicating an ACK.

Figure 49 also shows the registers that can configure the START bit, STOP bit, SDA hold time, and SDA sample time.

If the I2C pads are configured in open-drain mode, it will take longer for the signal lines to transition from a low level to a high level. This will result in a poorly performing I2C bus. Proper external pull-up resistors are required on I2C signal lines for bus operation when I2C pads are configured in open-drain mode. Typically, a stronger pull-up is required for a higher frequency I2C bus operation.

11.3.4 I2C cmd Structure

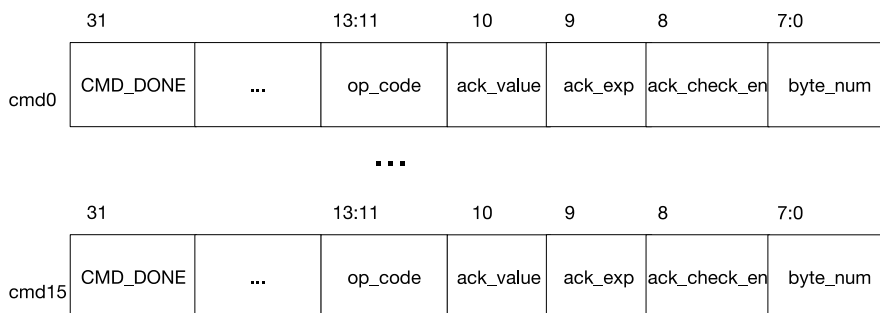


Figure 50: Structure of The I2C Command Register

The Command register is active only in I2C master mode, with its internal structure shown in Figure 50.

CMD_DONE: The CMD_DONE bit of every command can be read by software to tell if the command has been handled by hardware.

op_code: op_code is used to indicate the command. The I2C controller supports four commands:

- **RSTART:** op_code = 0 is the RSTART command to control the transmission of a START or RESTART I2C condition.
- **WRITE:** op_code = 1 is the WRITE command for the I2C Master to transmit data.
- **READ:** op_code = 2 is the READ command for the I2C Master to receive data.
- **STOP:** op_code = 3 is the STOP command to control the transmission of a STOP I2C condition.
- **END:** op_code = 4 is the END command for continuous data transmission. When the END command is given, SCL is temporarily disabled to allow software to reload the command and data registers for subsequent events before resuming. Transmission will then continue seamlessly.

A complete data transmission process begins with an RSTART command, and ends with a STOP command.

ack_value: When receiving data, this bit is used to indicate whether the receiver will send an ACK after this byte has been received.

ack_exp: This bit is to set an expected ACK value for the transmitter.

ack_check_en: When transmitting a byte, this bit enables checking the ACK value received against the ack_exp value. Checking is enabled by 1, while 0 disables it.

byte_num: This register specifies the length of data (in bytes) to be read or written. The maximum length is 255, while the minimum is 1. When the op_code is RSTART, STOP or END, this value is meaningless.

11.3.5 I2C Master Writes to Slave

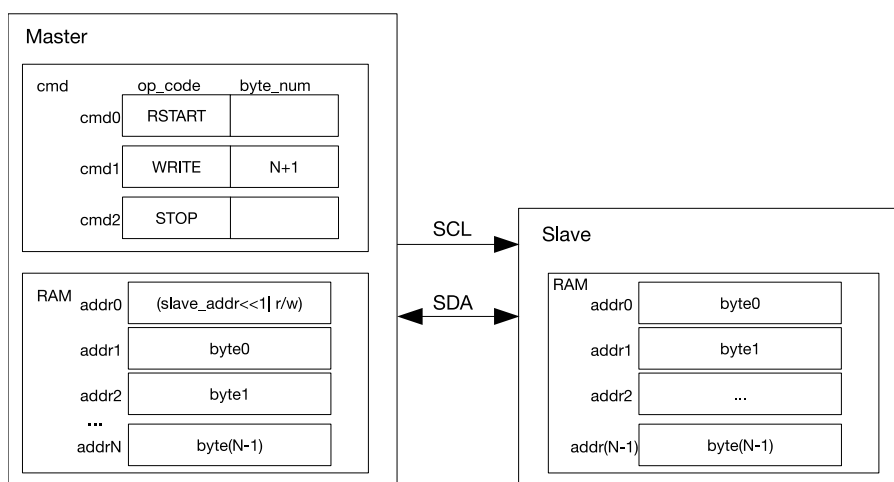


Figure 51: I2C Master Writes to Slave with 7-bit Address

In all subsequent figures that illustrate I2C transactions and behavior, both the I2C Master and Slave devices are assumed to be ESP32 I2C peripheral controllers for ease of demonstration.

Figure 51 shows the I2C Master writing N bytes of data to an I2C Slave. According to the I2C protocol, the first byte is the Slave address. As shown in the diagram, the first byte of the RAM unit has been populated with the Slave's 7-bit address plus the 1-bit read/write flag. In this case, the flag is zero, indicating a write operation. The

rest of the RAM unit holds N bytes of data ready for transmission. The cmd unit has been populated with the sequence of commands for the operation.

For the I2C master to begin an operation, the bus must not be busy, i.e. the SCL line must not be pulled low by another device on the I2C bus. The I2C operation can only begin when the SCL line is released (made high) to indicate that the I2C bus is free. After the cmd unit and data are prepared, I2C_TRANS_START bit in I2C_CTR_REG must be set to begin the configured I2C Master operation. The I2C Master then initiates a START condition on the bus and progresses to the WRITE command which will fetch N+1 bytes from RAM and send them to the Slave. The first of these bytes is the address byte.

When the transmitted data size exceeds I2C_NONFIFO_TX_THRES, an I2C_TX_SEND_EMPTY_INT interrupt will be generated. After detecting the interrupt, software can read TXFIFO_END_ADDR in register RXFIFO_ST_REG, get the last address of the data in the RAM and refresh the old data in the RAM. TXFIFO_END_ADDR will be refreshed each time interrupt I2C_TX_SEND_EMPTY_INT or I2C_TRANS_COMPLETE_INT occurs.

When ack_check_en is set to 1, the Master will check the ACK value each time it sends a data byte. If the ACK value received does not match ack_exp (the expected ACK value) in the WRITE command, then the Master will generate an I2C_ACK_ERR_INT interrupt and stop the transmission.

During transmission, when the SCL is high, if the input value and output value of SDA do not match, then the Master will generate an I2C_ARBITRATION_LOST_INT interrupt. When the transmission is finished, the Master will generate an I2C_TRANS_COMPLETE_INT interrupt.

After detecting the START bit sent from the Master, the Slave will start receiving the address and comparing it to its own. If the address does not match I2C_SLAVE_ADDR, then the Slave will ignore the rest of the transmission. If they do match, the Slave will store the rest of the data into RAM in the receiving order. When the data size exceeds I2C_NONFIFO_RX_THRES, an I2C_RX_REC_FULL_INT interrupt is generated. After detecting the interrupt, software will get the starting and ending addresses in the RAM by reading RXFIFO_START_ADDR and RXFIFO_END_ADDR bits in register RXFIFO_ST_REG, and fetch the data for further processing. Register RXFIFO_START_ADDR is refreshed only once during each transmission, while RXFIFO_END_ADDR gets refreshed every time when either I2C_RX_REC_FULL_INT or I2C_TRANS_COMPLETE_INT interrupt is generated.

When the END command is not used, the I2C master can transmit up to $(14 \times 255 - 1)$ bytes of valid data, and the cmd unit is populated with RSTART + 14 WRITE + 1 STOP.

There are several special cases to be noted:

- If the Master fails to send a STOP bit, because the SDA is pulled low by other devices, then the Master needs to be reset.
- If the Master fails to send a START bit, because the SDA or SCL is pulled low by other devices, then the Master needs to be reset. It is recommended that the software uses a timeout period to implement the reset.
- If the SDA is pulled low by the Slave during transmission, the Master can simply release it by sending it nine SCL clock signals at the most.

It is important to note that the behaviour of another I2C master or slave device on the bus may not always be similar to that of the ESP32 I2C peripheral in the master- or slave-mode operation described above. Please consult the datasheets of the respective I2C devices to ensure proper operation under all bus conditions.

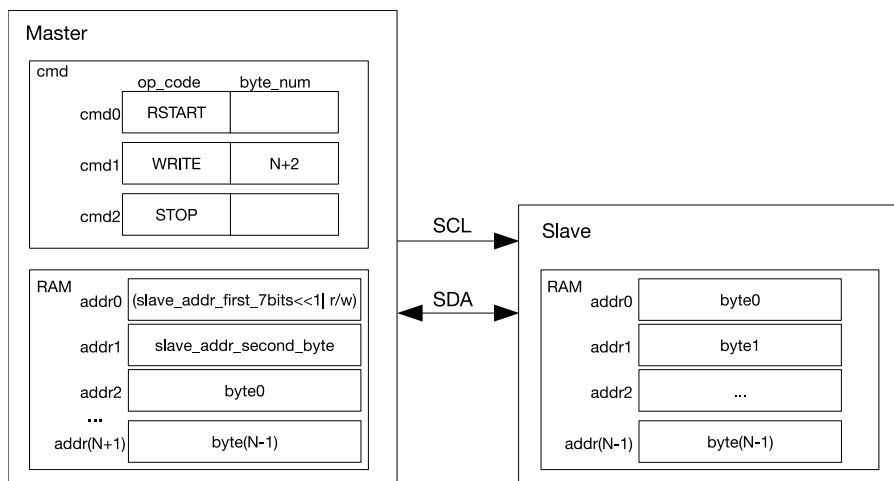


Figure 52: I2C Master Writes to Slave with 10-bit Address

The ESP32 I2C controller uses 7-bit addressing by default. However, 10-bit addressing can also be used. In the master, this is done by sending a second I2C address byte after the first address byte. In the slave, the `I2C_SLAVE_ADDR_10BIT_EN` bit in `I2C_SLAVE_ADDR_REG` can be set to activate a 10-bit addressing mode. `I2C_SLAVE_ADDR` is used to configure the I2C Slave address, as per usual. Figure 52 shows the equivalent of I2C Master operation writing N-bytes of data to an I2C Slave with a 10-bit address. Since 10-bit Slave addresses require an extra address byte, both the `byte_num` field of the WRITE command and the number of total bytes in RAM increase by one.

When the END command is not used, the I2C master can transmit up to $(14 \times 255 - 2)$ bytes of valid data to Slave with 10-bit address.

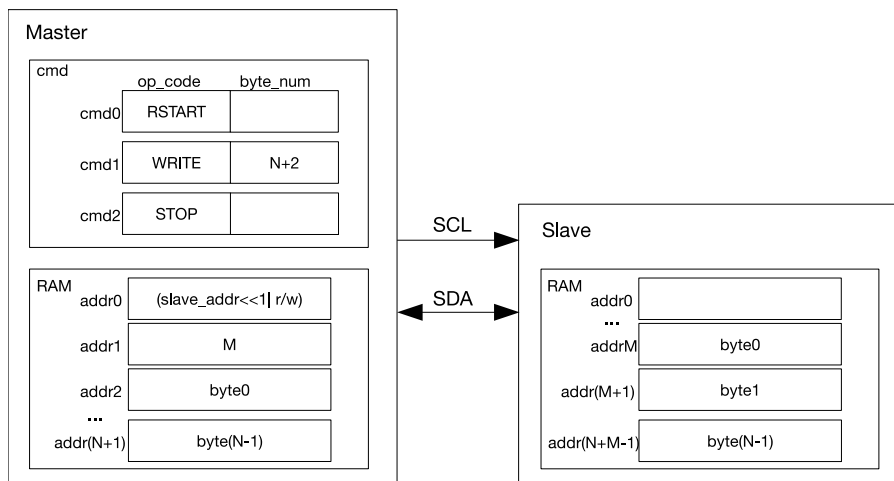


Figure 53: I2C Master Writes to addrM in RAM of Slave with 7-bit Address

One way many I2C Slave devices are designed is by exposing a register block containing various settings. The I2C Master can write one or more of these registers by sending the Slave a register address. The ESP32 I2C Slave controller has hardware support for such a scheme.

Specifically, on the Slave, `I2C_FIFO_ADDR_CFG_EN` can be set so that the I2C Master can write to a specified register address inside the I2C Slave memory block. Figure 53 shows the I2C Master writing N-bytes of data **byte0 ~ byte(N-1)** from the RAM unit to register address **M** (determined by **addrM** in RAM unit) with the Slave. In this mode, I2C Slave can receive up to 32 bytes of valid data. When I2C Master needs to transmit extra amount of data, segmented transmission can be enabled.

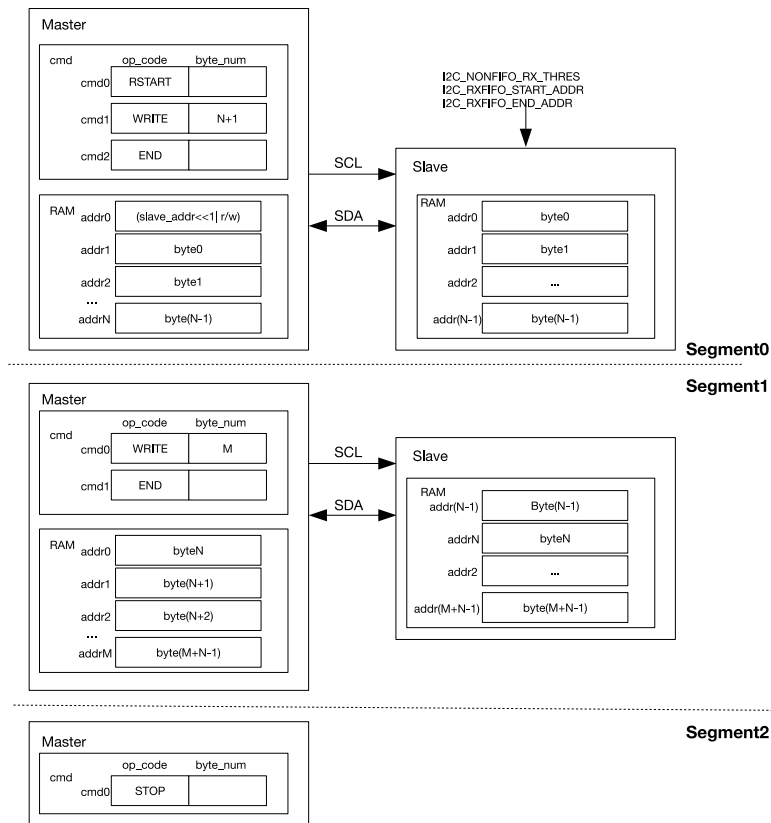


Figure 54: I2C Master Writes to Slave with 7-bit Address in Three Segments

If the data size exceeds the capacity of a 14-byte read/write cmd, the END command can be called to enable segmented transmission. Figure 54 shows the I2C Master writing data to the Slave, in three segments. The first segment shows the configuration of the Master's commands and the preparation of data in the RAM unit. When the I2C_TRANS_START bit is enabled, the Master starts transmission. After executing the END command, the Master will turn off the SCL clock and pull the SCL low to reserve the I2C bus and prevent any other device from transacting on the bus. The controller will generate an I2C_END_DETECT_INT interrupt to notify the software.

After detecting an I2C_END_DETECT_INT interrupt, the software can refresh the contents of the cmd and RAM blocks, as shown in the second segment. Subsequently, it should clear the I2C_END_DETECT_INT interrupt and resume the transaction by setting the I2C_TRANS_START bit. To stop the transaction, it should configure the cmd, as the third segment shows, and enable the I2C_TRANS_START bit to generate a STOP bit, after detecting the I2C_END_DETECT_INT interrupt.

Please note that the other masters on the I2C bus will be starved of bus time between two segments. The bus is only released after a STOP signal is sent.

Note: When there are more than three segments, the address of an END command in the cmd should not be altered into another command by the next segment.

11.3.6 I2C Master Reads from Slave

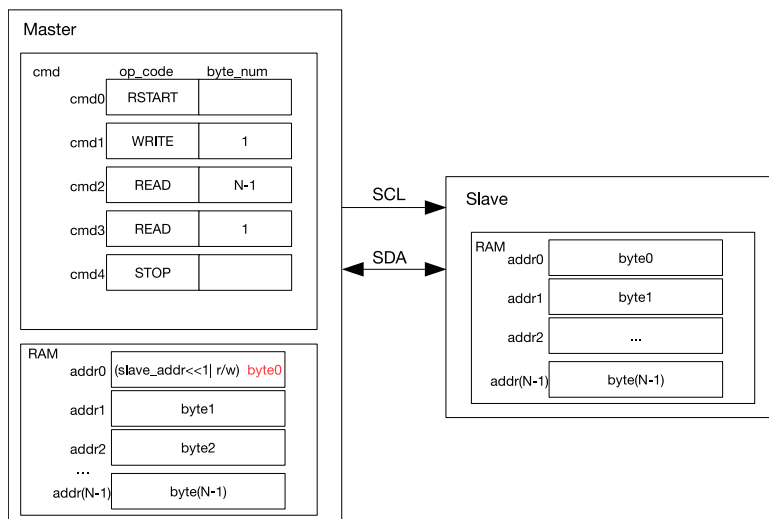


Figure 55: I2C Master Reads from Slave with 7-bit Address

Figure 55 shows the I2C Master reading N-bytes of data from an I2C Slave with a 7-bit address. At first, the I2C Master needs to send the address of the I2C Slave, so cmd1 is a WRITE command. The byte that this command sends is the I2C slave address plus the R/W flag, which in this case is 1 and, therefore, indicates that this is going to be a read operation. The I2C Slave starts to send data to the Master if the addresses match. The Master will return ACK, according to the ack_value in the READ command, upon receiving every byte. As can be seen from Figure 55, READ is divided into two segments. The I2C Master replies ACK to N-1 bytes in cmd2 and does not reply ACK to the single byte READ command in cmd3, i.e., the last transmitted data. Users can configure it as they wish.

When storing the received data, I2C Master will start from the first address in RAM. Byte0 (Slave address + 1-bit R/W marker bit) will be overwritten.

When the END command is not used, the I2C Master can transmit up to (13*255) bytes of valid data. The cmd unit is populated with RSTART + 1 WRITE + 13 READ + 1 STOP.

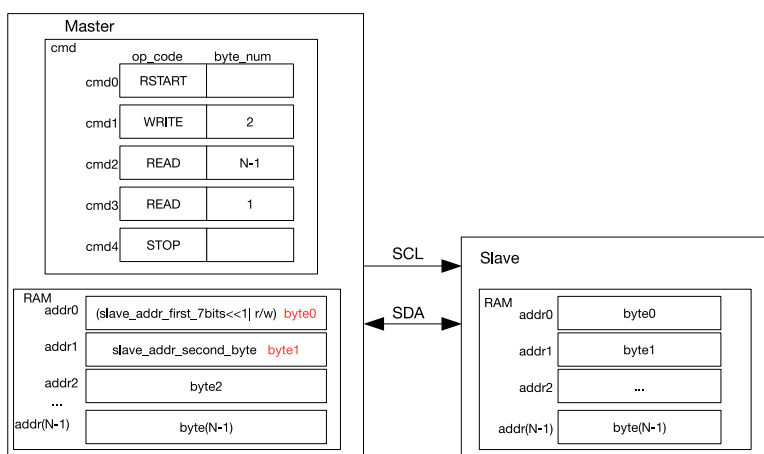


Figure 56: I2C Master Reads from Slave with 10-bit Address

Figure 56 shows the I2C Master reading data from a slave with a 10-bit address. This mode can be enabled by setting I2C_SLAVE_ADDR_10BIT_EN bit and preparing data to be sent in the slave RAM. In the Master, two bytes of RAM are used for a 10-bit address. Finally, the I2C_TRANS_START bit must be set to enable one transaction.

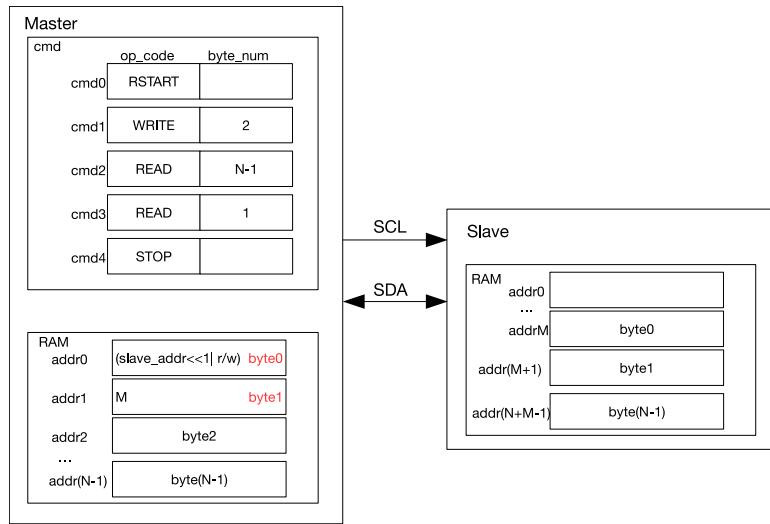


Figure 57: I2C Master Reads N Bytes of Data from addrM in Slave with 7-bit Address

Figure 57 shows the I2C Master reading data from a specified address in the I2C Slave. This mode can be enabled by setting I2C_FIFO_ADDR_CFG_EN and preparing the data to be read by the master in the Slave RAM block. Subsequently, the address of the Slave and the address of the specified register (that is, M) have to be determined by the master. Finally, the I2C_TRANS_START bit must be set in the Master to initiate the read operation, following which the I2C Slave will fetch N bytes of data from RAM and send them to the Master.

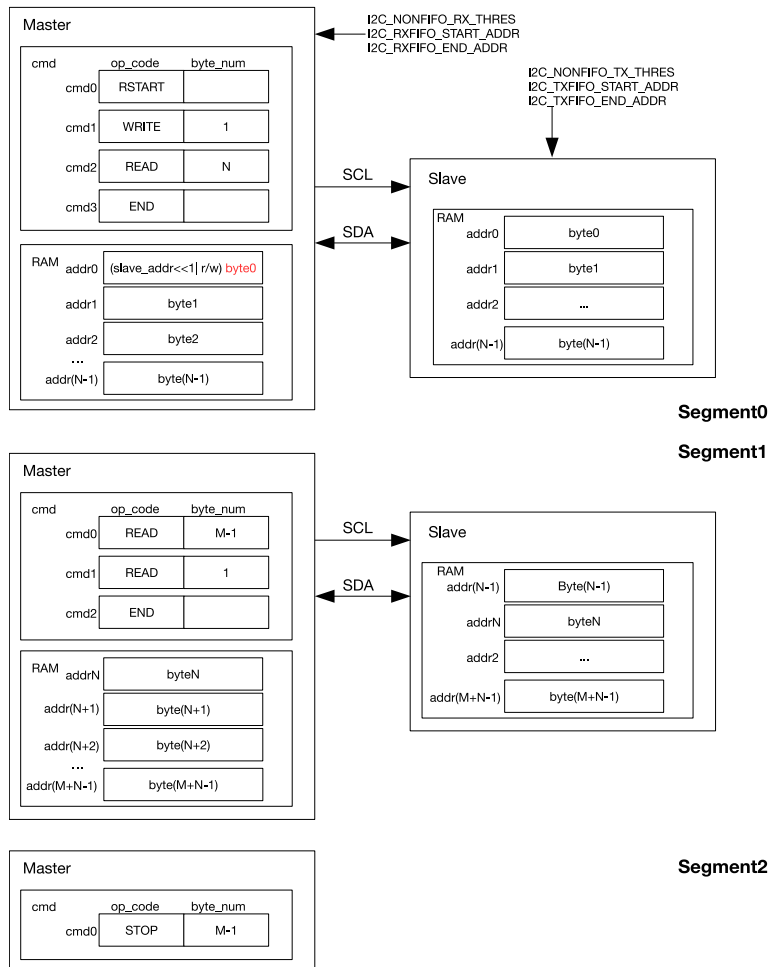


Figure 58: I2C Master Reads from Slave with 7-bit Address in Three Segments

Figure 58 shows the I2C Master reading N+M bytes of data in three segments from the I2C Slave. The first segment shows the configuration of the cmd and the preparation of data in the Slave RAM. When the I2C_TRANS_START bit is enabled, the I2C Master starts the operation. The I2C Master will refresh the cmd after executing the END command. It will clear the I2C_END_DETECT_INT interrupt, set the I2C_TRANS_START bit and resume the transaction. To stop the transaction, the I2C Master will configure the cmd, as the third segment shows, after detecting the I2C_END_DETECT_INT interrupt. After setting the I2C_TRANS_START bit, I2C Master will send a STOP bit to stop the transaction.

11.3.7 Interrupts

- I2C_TX_SEND_EMPTY_INT: Triggered when the I2C has sent nonfifo_tx_thres bytes of data.
- I2C_RX_REC_FULL_INT: Triggered when the I2C has received nonfifo_rx_thres bytes of data.
- I2C_ACK_ERR_INT: Triggered when the I2C Master receives an ACK that is not as expected, or when the I2C Slave receives an ACK whose value is 1.
- I2C_TRANS_START_INT: Triggered when the I2C sends the START bit.
- I2C_TIME_OUT_INT: Triggered when the SCL stays high or low for more than I2C_TIME_OUT clocks.
- I2C_TRANS_COMPLETE_INT: Triggered when the I2C detects a STOP bit.
- I2C_MASTER_TRAN_COMP_INT: Triggered when the I2C Master sends or receives a byte.
- I2C_ARBITRATION_LOST_INT: Triggered when the I2C Master's SCL is high, while the output value and input value of the SDA do not match.
- I2C_SLAVE_TRAN_COMP_INT: Triggered when the I2C Slave detects a STOP bit.
- I2C_END_DETECT_INT: Triggered when the I2C deals with the END command.

11.4 Register Summary

Name	Description	I2C0	I2C1	Acc
Configuration registers				
I2C_SLAVE_ADDR_REG	Configures the I2C slave address	0x3FF53010	0x3FF67010	R/W
I2C_RXFIFO_ST_REG	FIFO status register	0x3FF53014	0x3FF67014	RO
I2C_FIFO_CONF_REG	FIFO configuration register	0x3FF53018	0x3FF67018	R/W
Timing registers				
I2C_SDA_HOLD_REG	Configures the hold time after a negative SCL edge	0x3FF53030	0x3FF67030	R/W
I2C_SDA_SAMPLE_REG	Configures the sample time after a positive SCL edge	0x3FF53034	0x3FF67034	R/W
I2C_SCL_LOW_PERIOD_REG	Configures the low level width of the SCL clock	0x3FF53000	0x3FF67000	R/W
I2C_SCL_HIGH_PERIOD_REG	Configures the high level width of the SCL clock	0x3FF53038	0x3FF67038	R/W
I2C_SCL_START_HOLD_REG	Configures the delay between the SDA and SCL negative edge for a start condition	0x3FF53040	0x3FF67040	R/W
I2C_SCL_RSTART_SETUP_REG	Configures the delay between the positive edge of SCL and the negative edge of SDA	0x3FF53044	0x3FF67044	R/W
I2C_SCL_STOP_HOLD_REG	Configures the delay after the SCL clock edge for a stop condition	0x3FF53048	0x3FF67048	R/W
I2C_SCL_STOP_SETUP_REG	Configures the delay between the SDA and SCL positive edge for a stop condition	0x3FF5304C	0x3FF6704C	R/W
Filter registers				
I2C_SCL_FILTER_CFG_REG	SCL filter configuration register	0x3FF53050	0x3FF67050	R/W
I2C_SDA_FILTER_CFG_REG	SDA filter configuration register	0x3FF53054	0x3FF67054	R/W
Interrupt registers				
I2C_INT_RAW_REG	Raw interrupt status	0x3FF53020	0x3FF67020	RO
I2C_INT_ENA_REG	Interrupt enable bits	0x3FF53028	0x3FF67028	R/W
I2C_INT_CLR_REG	Interrupt clear bits	0x3FF53024	0x3FF67024	WO
Command registers				
I2C_COMD0_REG	I2C command register 0	0x3FF53058	0x3FF67058	R/W
I2C_COMD1_REG	I2C command register 1	0x3FF5305C	0x3FF6705C	R/W
I2C_COMD2_REG	I2C command register 2	0x3FF53060	0x3FF67060	R/W
I2C_COMD3_REG	I2C command register 3	0x3FF53064	0x3FF67064	R/W
I2C_COMD4_REG	I2C command register 4	0x3FF53068	0x3FF67068	R/W
I2C_COMD5_REG	I2C command register 5	0x3FF5306C	0x3FF6706C	R/W
I2C_COMD6_REG	I2C command register 6	0x3FF53070	0x3FF67070	R/W
I2C_COMD7_REG	I2C command register 7	0x3FF53074	0x3FF67074	R/W
I2C_COMD8_REG	I2C command register 8	0x3FF53078	0x3FF67078	R/W
I2C_COMD9_REG	I2C command register 9	0x3FF5307C	0x3FF6707C	R/W
I2C_COMD10_REG	I2C command register 10	0x3FF53080	0x3FF67080	R/W
I2C_COMD11_REG	I2C command register 11	0x3FF53084	0x3FF67084	R/W
I2C_COMD12_REG	I2C command register 12	0x3FF53088	0x3FF67088	R/W

Name	Description	I2C0	I2C1	Acc
I2C_COMD13_REG	I2C command register 13	0x3FF5308C	0x3FF6708C	R/W
I2C_COMD14_REG	I2C command register 14	0x3FF53090	0x3FF67090	R/W
I2C_COMD15_REG	I2C command register 15	0x3FF53094	0x3FF67094	R/W

11.5 Registers

Register 11.1: I2C_SCL_LOW_PERIOD_REG (0x0000)

<i>(reserved)</i>														<i>I2C_SCL_LOW_PERIOD</i>																
31														14	13															0
0 0 0 0 0 0 0 0 0 0 0 0 0 0														0 0																Reset

I2C_SCL_LOW_PERIOD This register is used to configure for how long SCL remains low in master mode, in APB clock cycles. (R/W)

Register 11.2: I2C_CTR_REG (0x0004)

<i>(reserved)</i>																<i>I2C_RX_LSB_FIRST</i>										<i>I2C_TX_LSB_FIRST</i>										<i>I2C_TRANS_START</i>										<i>(reserved)</i>										<i>I2C_MS_MODE</i>										<i>I2C_SAMPLE_SCL_LEVEL</i>										<i>I2C_SCL_FORCE_OUT</i>										<i>I2C_SDA_FORCE_OUT</i>																																																										
31																8	7	6	5	4	3	2	1	0																8	7	6	5	4	3	2	1	0																8	7	6	5	4	3	2	1	0																8	7	6	5	4	3	2	1	0																8	7	6	5	4	3	2	1	0																8	7	6	5	4	3	2	1	0
0 0 0 0 0 0 0 0 0 0 0 0 0 0 0 0																0 0 0 0 0 0 0 0 0 0 0 0 0 0 0 0										0 0 0 0 0 0 0 0 0 0 0 0 0 0 0 0										0 0 0 0 0 0 0 0 0 0 0 0 0 0 0 0										0 0															0 0															0 0															0 0															Reset																																						

I2C_RX_LSB_FIRST This bit is used to control the storage mode for received data. (R/W)

- 1: receive data from the least significant bit;
- 0: receive data from the most significant bit.

I2C_TX_LSB_FIRST This bit is used to control the sending mode for data needing to be sent. (R/W)

- 1: send data from the least significant bit;
- 0: send data from the most significant bit.

I2C_TRANS_START Set this bit to start sending the data in txfifo. (R/W)

I2C_MS_MODE Set this bit to configure the module as an I2C Master. Clear this bit to configure the module as an I2C Slave. (R/W)

I2C_SAMPLE_SCL_LEVEL 1: sample SDA data on the SCL low level; 0: sample SDA data on the SCL high level. (R/W)

I2C_SCL_FORCE_OUT 0: direct output; 1: open drain output. (R/W)

I2C_SDA_FORCE_OUT 0: direct output; 1: open drain output. (R/W)

Register 11.3: I2C_SR_REG (0x0008)

(reserved)		I2C_SCL_STATE_LAST		(reserved)		I2C_SCL_MAIN_STATE_LAST		I2C_TXFIFO_CNT				(reserved)		I2C_RXFIFO_CNT				(reserved)		I2C_BYTE_TRANS		I2C_SLAVE_ADDRESSED		I2C_BUS_BUSY		I2C_ARB_LOST		I2C_TIME_OUT		I2C_SLAVE_RW		I2C_ACK_REC	
31	30	28	27	26	24	23		18	17		14	13			8	7	6	5	4	3	2	1	0	Reset									
0	0	0	0	0	0	0	0	0	0	0	0	0	0	0	0	0	0	0	0	0	0	0	0	0	0	0	0	0	0	0	0	0	

I2C_SCL_STATE_LAST This field indicates the states of the state machine used to produce SCL. (RO)
0: Idle; 1: Start; 2: Negative edge; 3: Low; 4: Positive edge; 5: High; 6: Stop

I2C_SCL_MAIN_STATE_LAST This field indicates the states of the I2C module state machine. (RO)
0: Idle; 1: Address shift; 2: ACK address; 3: Rx data; 4: Tx data; 5: Send ACK; 6: Wait ACK

I2C_TXFIFO_CNT This field stores the amount of received data in RAM. (RO)

I2C_RXFIFO_CNT This field represents the amount of data needed to be sent. (RO)

I2C_BYTE_TRANS This field changes to 1 when one byte is transferred. (RO)

I2C_SLAVE_ADDRESSED When configured as an I2C Slave, and the address sent by the master is equal to the address of the slave, then this bit will be of high level. (RO)

I2C_BUS_BUSY 1: the I2C bus is busy transferring data; 0: the I2C bus is in idle state. (RO)

I2C_ARB_LOST When the I2C controller loses control of SCL line, this register changes to 1. (RO)

I2C_TIME_OUT When the I2C controller takes more than I2C_TIME_OUT clocks to receive a data bit, this field changes to 1. (RO)

I2C_SLAVE_RW When in slave mode, 1: master reads from slave; 0: master writes to slave. (RO)

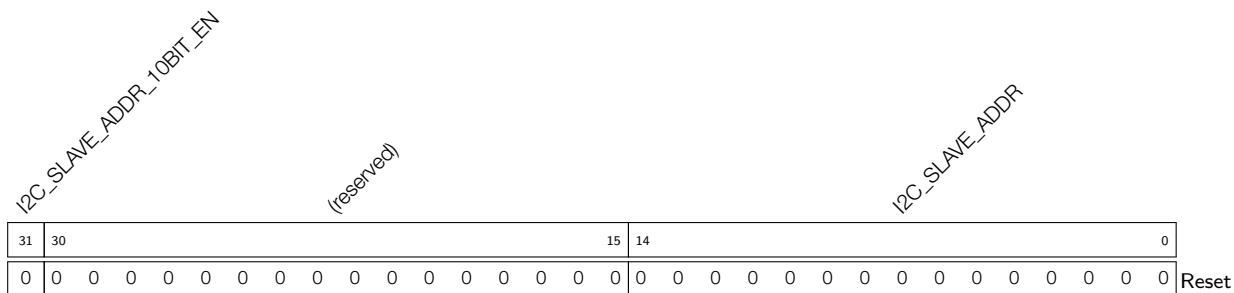
I2C_ACK_REC This register stores the value of the received ACK bit. (RO)

Register 11.4: I2C_TO_REG (0x000c)

(reserved)										I2C_TIME_OUT_REG																								
31								20	19																							0	Reset	
0	0	0	0	0	0	0	0	0	0	0	0	0	0	0	0	0	0	0	0	0	0	0	0	0	0	0	0	0	0	0	0	0	0	0

I2C_TIME_OUT_REG This register is used to configure the timeout for receiving a data bit in APB clock cycles. (R/W)

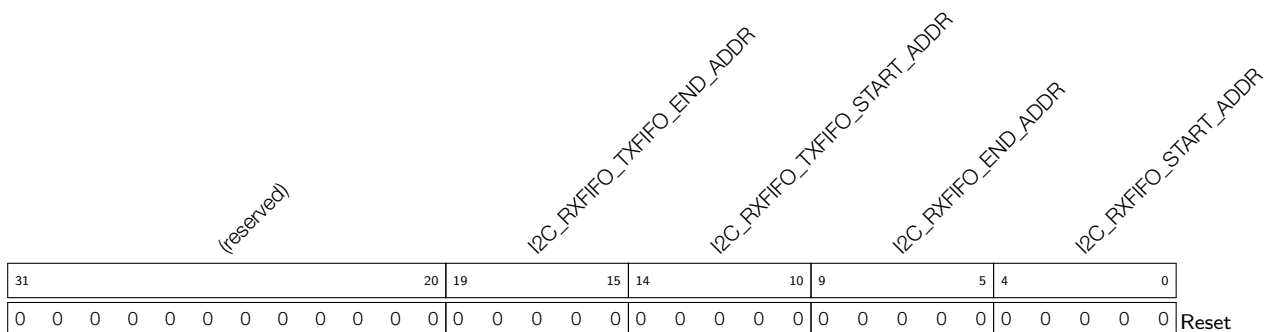
Register 11.5: I2C_SLAVE_ADDR_REG (0x0010)



I2C_SLAVE_ADDR_10BIT_EN This field is used to enable the slave 10-bit addressing mode in master mode. (R/W)

I2C_SLAVE_ADDR When configured as an I2C Slave, this field is used to configure the slave address. (R/W)

Register 11.6: I2C_RXFIFO_ST_REG (0x0014)



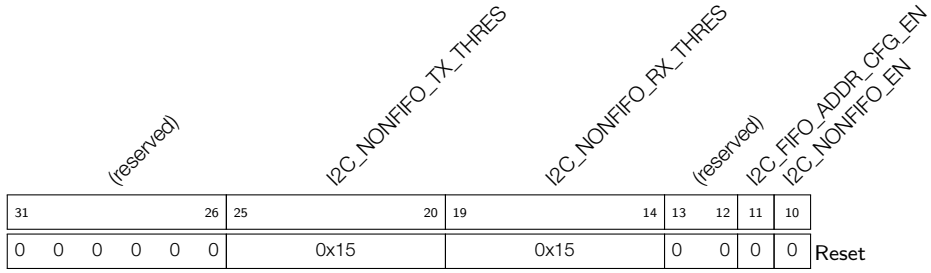
I2C_TXFIFO_END_ADDR This is the offset address of the last sent data, as described in nonfifo_tx_thres register. The value refreshes when I2C_TX_SEND_EMPTY_INT or I2C_TRANS_COMPLETE_INT interrupt is generated. (RO)

I2C_TXFIFO_START_ADDR This is the offset address of the first sent data, as described in nonfifo_tx_thres register. (RO)

I2C_RXFIFO_END_ADDR This is the offset address of the last received data, as described in nonfifo_rx_thres_register. This value refreshes when I2C_RX_REC_FULL_INT or I2C_TRANS_COMPLETE_INT interrupt is generated. (RO)

I2C_RXFIFO_START_ADDR This is the offset address of the last received data, as described in nonfifo_rx_thres_register. (RO)

Register 11.7: I2C_FIFO_CONF_REG (0x0018)



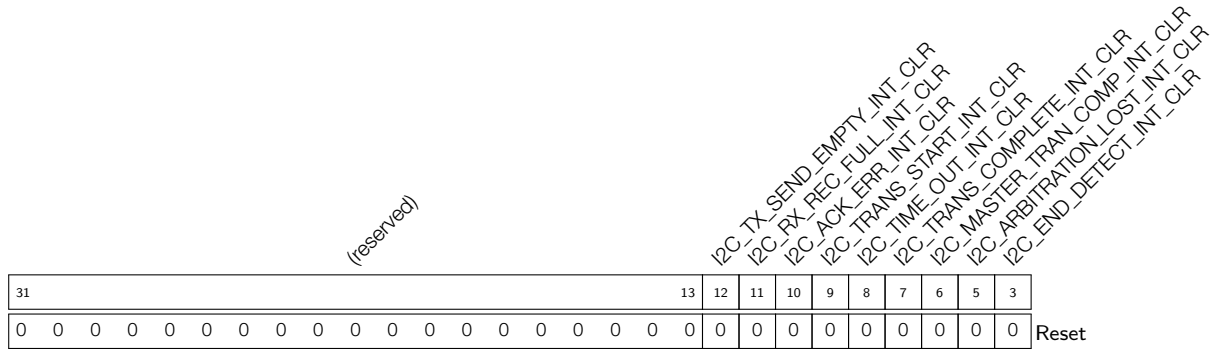
I2C_NONFIFO_TX_THRES When I2C sends more than nonfifo_tx_thres bytes of data, it will generate a tx_send_empty_int_raw interrupt and update the current offset address of the sent data. (R/W)

I2C_NONFIFO_RX_THRES When I2C receives more than nonfifo_rx_thres bytes of data, it will generate a rx_send_full_int_raw interrupt and update the current offset address of the received data. (R/W)

I2C_FIFO_ADDR_CFG_EN When this bit is set to 1, the byte received after the I2C address byte represents the offset address in the I2C Slave RAM. (R/W)

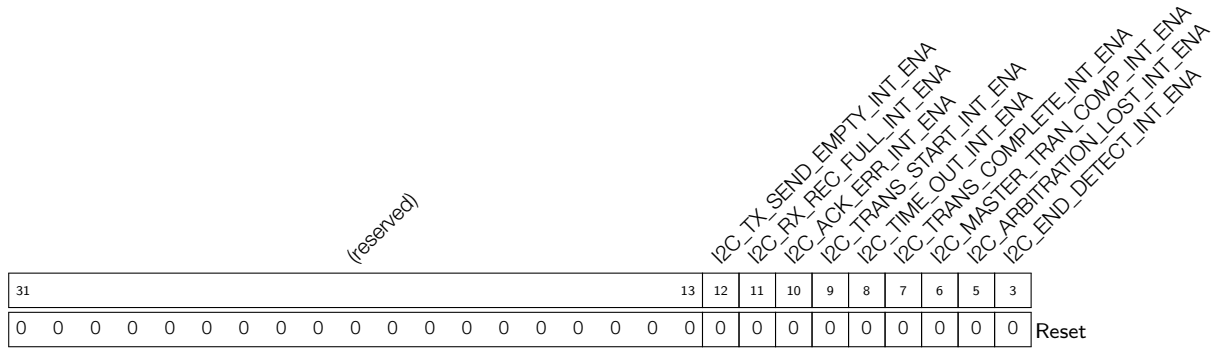
I2C_NONFIFO_EN Set this bit to enable APB nonfifo access. (R/W)

Register 11.9: I2C_INT_CLR_REG (0x0024)



- I2C_TX_SEND_EMPTY_INT_CLR** Set this bit to clear the [I2C_TX_SEND_EMPTY_INT](#) interrupt. (WO)
- I2C_RX_REC_FULL_INT_CLR** Set this bit to clear the [I2C_RX_REC_FULL_INT](#) interrupt. (WO)
- I2C_ACK_ERR_INT_CLR** Set this bit to clear the [I2C_ACK_ERR_INT](#) interrupt. (WO)
- I2C_TRANS_START_INT_CLR** Set this bit to clear the [I2C_TRANS_START_INT](#) interrupt. (WO)
- I2C_TIME_OUT_INT_CLR** Set this bit to clear the [I2C_TIME_OUT_INT](#) interrupt. (WO)
- I2C_TRANS_COMPLETE_INT_CLR** Set this bit to clear the [I2C_TRANS_COMPLETE_INT](#) interrupt. (WO)
- I2C_MASTER_TRAN_COMP_INT_CLR** Set this bit to clear the [I2C_MASTER_TRAN_COMP_INT](#) interrupt. (WO)
- I2C_ARBITRATION_LOST_INT_CLR** Set this bit to clear the [I2C_ARBITRATION_LOST_INT](#) interrupt. (WO)
- I2C_END_DETECT_INT_CLR** Set this bit to clear the [I2C_END_DETECT_INT](#) interrupt. (WO)

Register 11.10: I2C_INT_ENA_REG (0x0028)



I2C_TX_SEND_EMPTY_INT_ENA The interrupt enable bit for the [I2C_TX_SEND_EMPTY_INT](#) interrupt. (R/W)

I2C_RX_REC_FULL_INT_ENA The interrupt enable bit for the [I2C_RX_REC_FULL_INT](#) interrupt. (R/W)

I2C_ACK_ERR_INT_ENA The interrupt enable bit for the [I2C_ACK_ERR_INT](#) interrupt. (R/W)

I2C_TRANS_START_INT_ENA The interrupt enable bit for the [I2C_TRANS_START_INT](#) interrupt. (R/W)

I2C_TIME_OUT_INT_ENA The interrupt enable bit for the [I2C_TIME_OUT_INT](#) interrupt. (R/W)

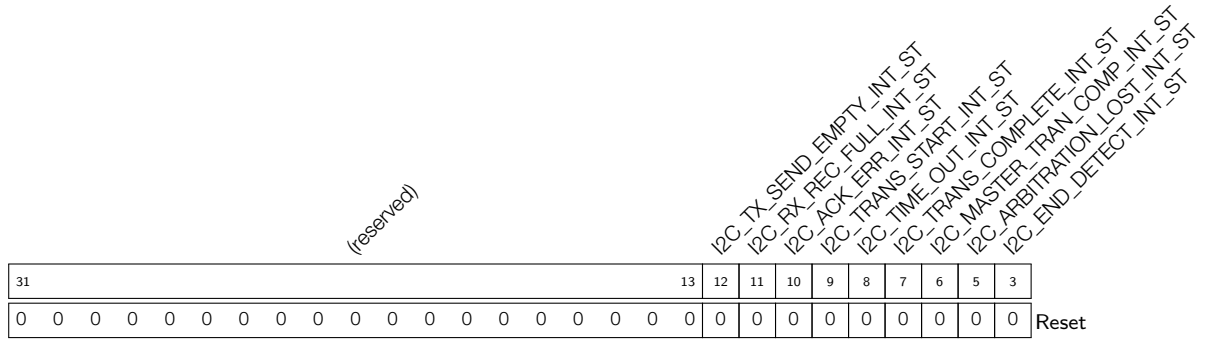
I2C_TRANS_COMPLETE_INT_ENA The interrupt enable bit for the [I2C_TRANS_COMPLETE_INT](#) interrupt. (R/W)

I2C_MASTER_TRAN_COMP_INT_ENA The interrupt enable bit for the [I2C_MASTER_TRAN_COMP_INT](#) interrupt. (R/W)

I2C_ARBITRATION_LOST_INT_ENA The interrupt enable bit for the [I2C_ARBITRATION_LOST_INT](#) interrupt. (R/W)

I2C_END_DETECT_INT_ENA The interrupt enable bit for the [I2C_END_DETECT_INT](#) interrupt. (R/W)

Register 11.11: I2C_INT_STATUS_REG (0x002c)



I2C_TX_SEND_EMPTY_INT_ST The masked interrupt status bit for the [I2C_TX_SEND_EMPTY_INT](#) interrupt. (RO)

I2C_RX_REC_FULL_INT_ST The masked interrupt status bit for the [I2C_RX_REC_FULL_INT](#) interrupt. (RO)

I2C_ACK_ERR_INT_ST The masked interrupt status bit for the [I2C_ACK_ERR_INT](#) interrupt. (RO)

I2C_TRANS_START_INT_ST The masked interrupt status bit for the [I2C_TRANS_START_INT](#) interrupt. (RO)

I2C_TIME_OUT_INT_ST The masked interrupt status bit for the [I2C_TIME_OUT_INT](#) interrupt. (RO)

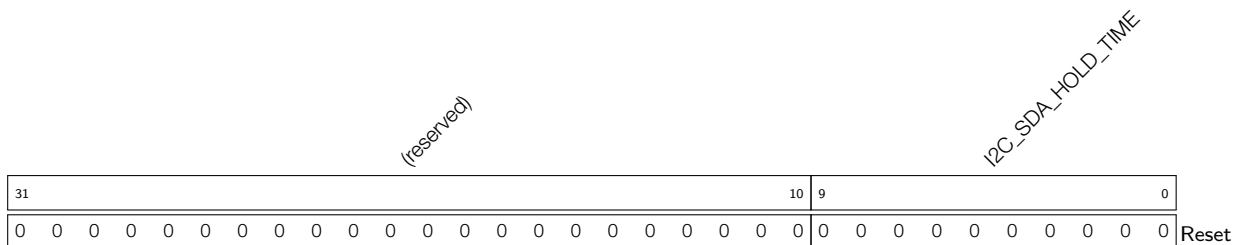
I2C_TRANS_COMPLETE_INT_ST The masked interrupt status bit for the [I2C_TRANS_COMPLETE_INT](#) interrupt. (RO)

I2C_MASTER_TRAN_COMP_INT_ST The masked interrupt status bit for the [I2C_MASTER_TRAN_COMP_INT](#) interrupt. (RO)

I2C_ARBITRATION_LOST_INT_ST The masked interrupt status bit for the [I2C_ARBITRATION_LOST_INT](#) interrupt. (RO)

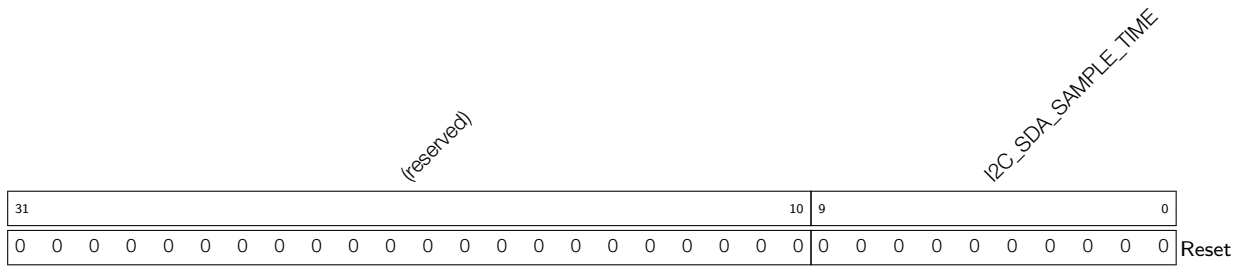
I2C_END_DETECT_INT_ST The masked interrupt status bit for the [I2C_END_DETECT_INT](#) interrupt. (RO)

Register 11.12: I2C_SDA_HOLD_REG (0x0030)



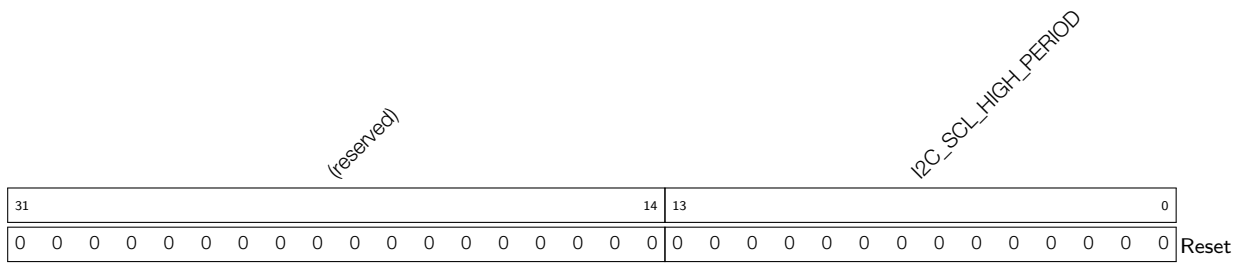
I2C_SDA_HOLD_TIME This register is used to configure the time to hold the data after the negative edge of SCL, in APB clock cycles. (R/W)

Register 11.13: I2C_SDA_SAMPLE_REG (0x0034)



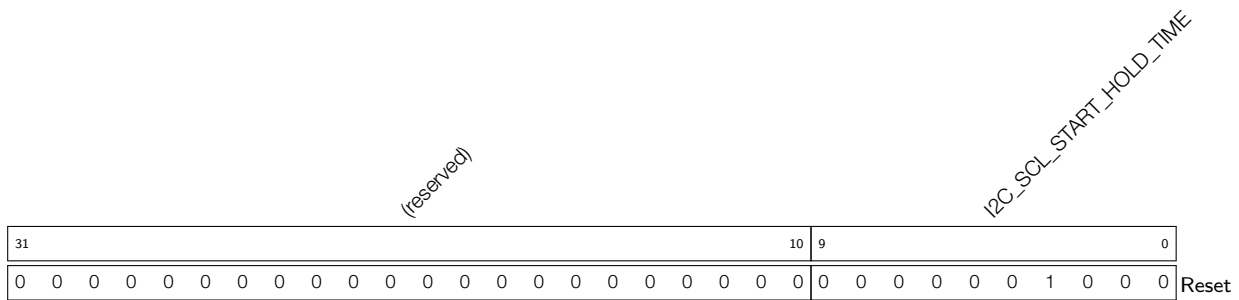
I2C_SDA_SAMPLE_TIME This register is used to configure for how long SDA is sampled, in APB clock cycles. (R/W)

Register 11.14: I2C_SCL_HIGH_PERIOD_REG (0x0038)



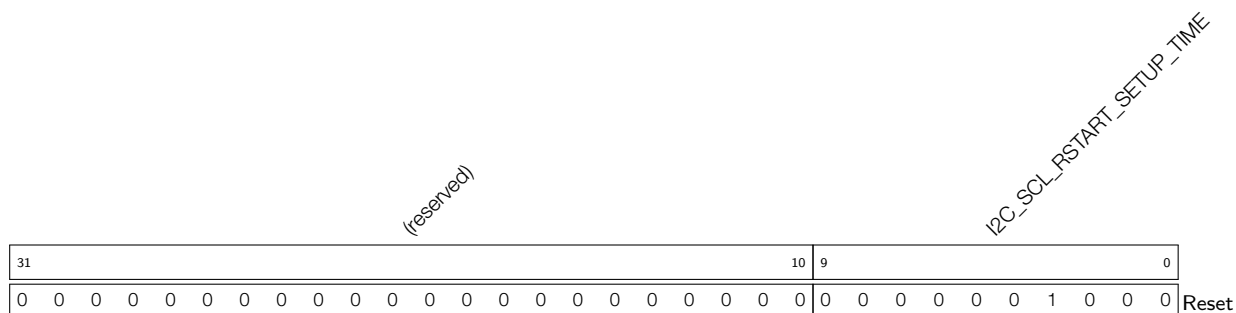
I2C_SCL_HIGH_PERIOD This register is used to configure for how long SCL remains high in master mode, in APB clock cycles. (R/W)

Register 11.15: I2C_SCL_START_HOLD_REG (0x0040)



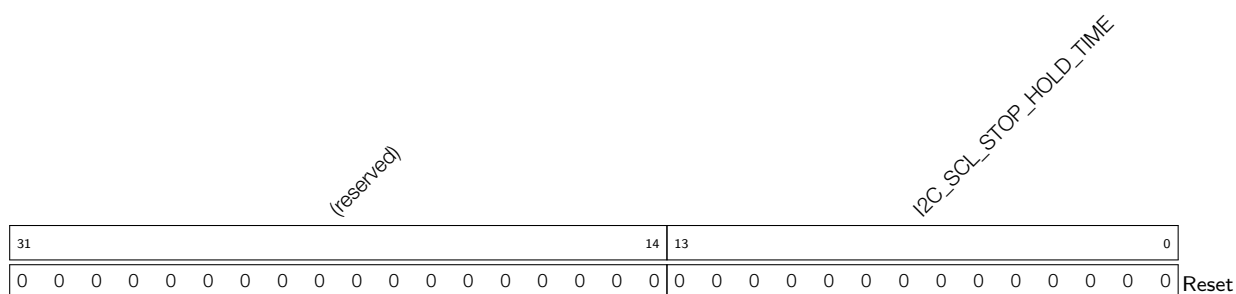
I2C_SCL_START_HOLD_TIME This register is used to configure the time between the negative edge of SDA and the negative edge of SCL for a START condition, in APB clock cycles. (R/W)

Register 11.16: I2C_SCL_RSTART_SETUP_REG (0x0044)



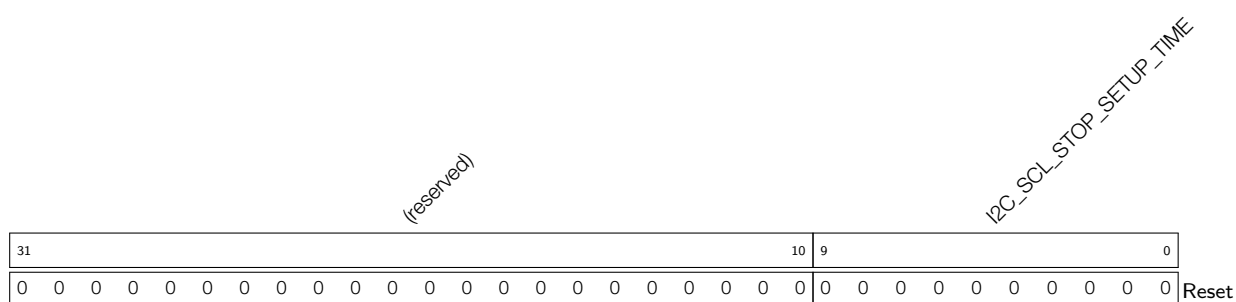
I2C_SCL_RSTART_SETUP_TIME This register is used to configure the time between the positive edge of SCL and the negative edge of SDA for a RESTART condition, in APB clock cycles. (R/W)

Register 11.17: I2C_SCL_STOP_HOLD_REG (0x0048)



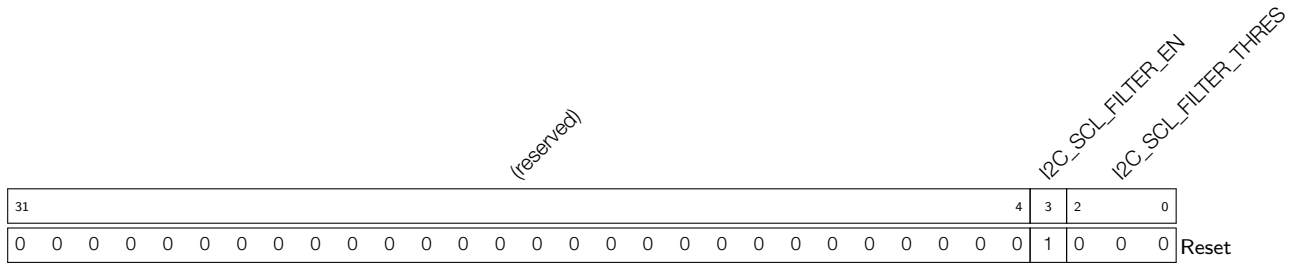
I2C_SCL_STOP_HOLD_TIME This register is used to configure the delay after the STOP condition, in APB clock cycles. (R/W)

Register 11.18: I2C_SCL_STOP_SETUP_REG (0x004C)



I2C_SCL_STOP_SETUP_TIME This register is used to configure the time between the positive edge of SCL and the positive edge of SDA, in APB clock cycles. (R/W)

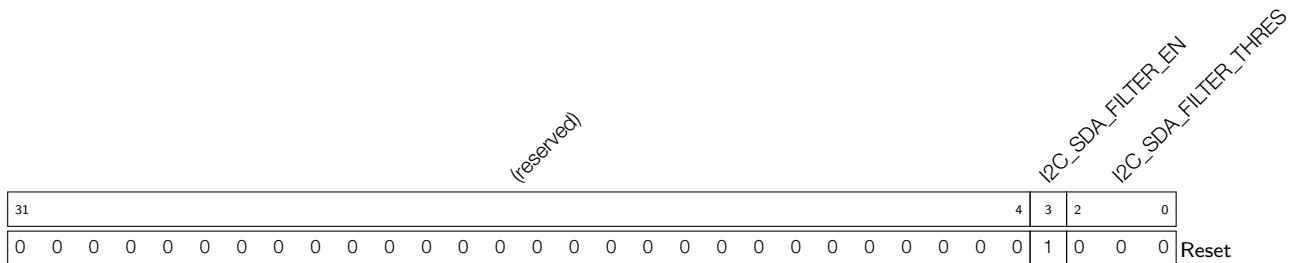
Register 11.19: I2C_SCL_FILTER_CFG_REG (0x0050)



I2C_SCL_FILTER_EN This is the filter enable bit for SCL. (R/W)

I2C_SCL_FILTER_THRES When a pulse on the SCL input has smaller width than this register value in APB clock cycles, the I2C controller will ignore that pulse. (R/W)

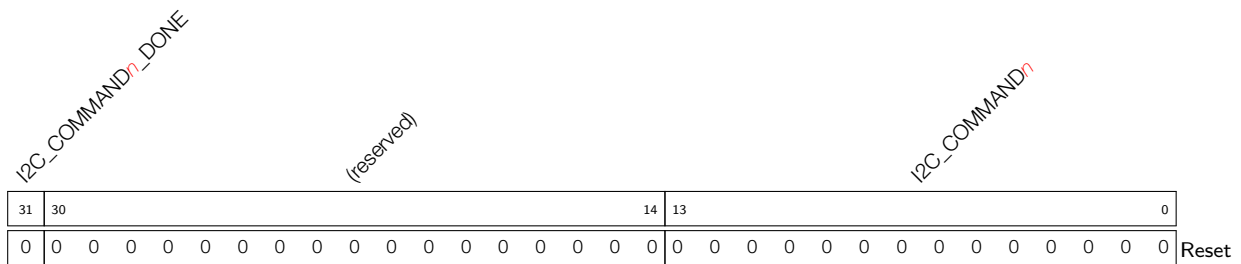
Register 11.20: I2C_SDA_FILTER_CFG_REG (0x0054)



I2C_SDA_FILTER_EN This is the filter enable bit for SDA. (R/W)

I2C_SDA_FILTER_THRES When a pulse on the SDA input has smaller width than this register value in APB clock cycles, the I2C controller will ignore that pulse. (R/W)

Register 11.21: I2C_CMD_n_REG (*n*: 0-15) (0x58+4n*)**



I2C_COMMAND_n_DONE When command *n* is done in I2C Master mode, this bit changes to high level. (R/W)

I2C_COMMAND_n This is the content of command *n*. It consists of three parts: (R/W)
 op_code is the command, 0: RSTART; 1: WRITE; 2: READ; 3: STOP; 4: END.
 Byte_num represents the number of bytes that need to be sent or received.
 ack_check_en, ack_exp and ack are used to control the ACK bit. See [I2C cmd structure](#) for more information.

12. I2S

12.1 Overview

The I2S bus provides a flexible communication interface for streaming digital data in multimedia applications, especially digital audio applications. The ESP32 includes two I2S interfaces: I2S0 and I2S1.

The I2S standard bus defines three signals: a clock signal, a channel selection signal, and a serial data signal. A basic I2S data bus has one master and one slave. The roles remain unchanged throughout the communication. The I2S modules on the ESP32 provide separate transmit and receive channels for high performance.

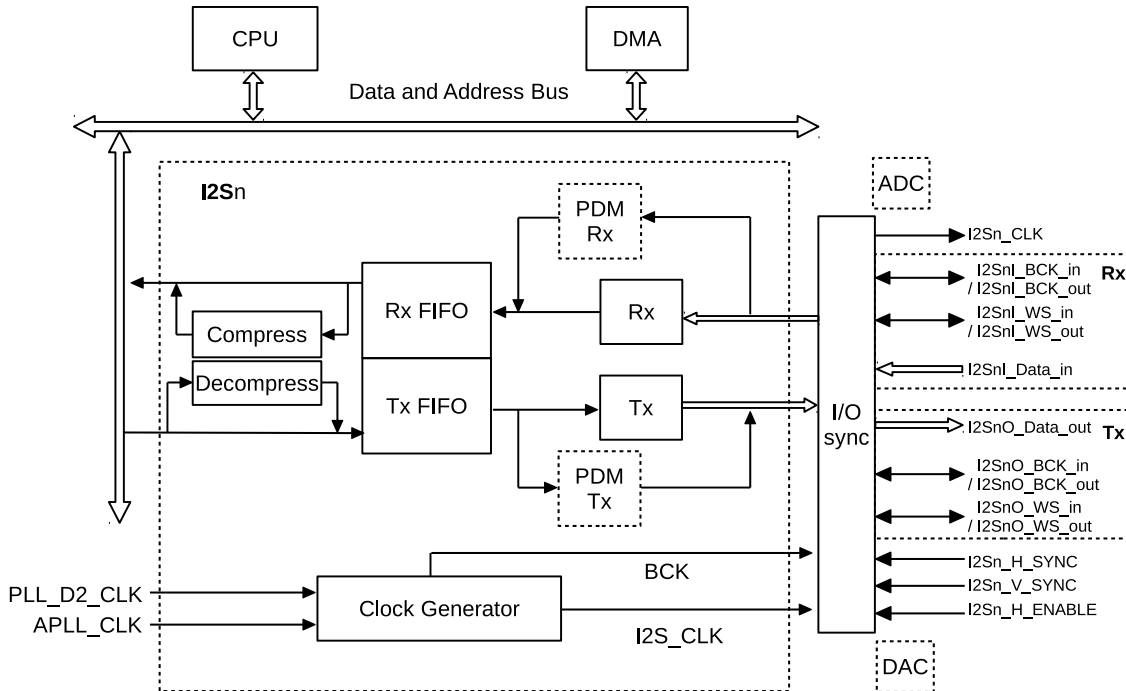


Figure 59: I2S System Block Diagram

Figure 59 is the system block diagram of the ESP32 I2S module. In the figure above, the value of "n" can be either 0 or 1. There are two independent I2S modules embedded in ESP32, namely I2S0 and I2S1. Each I2S module contains a Tx (transmit) unit and a Rx (receive) unit. Both the Tx unit and the Rx unit have a three-wire interface that includes a clock line, a channel selection line and a serial data line. The serial data line of the Tx unit is fixed as output, and the serial data line of the receive unit is fixed as input. The clock line and the channel selection line of the Tx and Rx units can be configured to both master transmitting mode and slave receiving mode. In the LCD mode, the serial data line extends to the parallel data bus. Both the Tx unit and the Rx unit have a 32-bit-wide FIFO with a depth of 64. Besides, only I2S0 supports on-chip DAC/ADC modes, as well as receiving and transmitting PDM signals.

The right side of Figure 59 shows the signal bus of the I2S module. The signal naming rule of the Rx and Tx units is I2SnA_B_C, where "n" stands for either I2S0 or I2S1; "A" represents the direction of I2S module's data bus signal, "I" represents input, "O" represents output; "B" represents signal function; "C" represents the signal direction, "in" means that the signal is input into the I2S module, while "out" means that the I2S module outputs the signal. For a detailed description of the I2S signal bus, please refer to Table 55.

Table 55: I2S Signal Bus Description

Signal Bus	Signal Direction	Data Signal Direction
I2S n I_BCK_in	In slave mode, I2S module accepts signals.	I2S module receives data.
I2S n I_BCK_out	In master mode, I2S module outputs signals.	I2S module receives data.
I2S n I_WS_in	In slave mode, I2S module accepts signals.	I2S module receives data.
I2S n I_WS_out	In master mode, I2S module outputs signals.	I2S module receives data.
I2S n I_Data_in	I2S module accepts signals.	In I2S mode, I2S n I_Data_in[15] is the serial data bus of I2S. In LCD mode, the data bus width can be configured as needed.
I2S n O_Data_out	I2S module outputs signals.	In I2S mode, I2S n O_Data_out[23] is the serial data bus of I2S. In LCD mode, the data bus width can be configured as needed.
I2S n O_BCK_in	In slave mode, I2S module accepts signals.	I2S module sends data.
I2S n O_BCK_out	In master mode, I2S module outputs signals.	I2S module sends data.
I2S n O_WS_in	In slave mode, I2S module accepts signals.	I2S module sends data.
I2S n O_WS_out	In master mode, I2S module outputs signals.	I2S module sends data.
I2S n _CLK	I2S module outputs signals.	It is used as a clock source for peripheral chips.
I2S n _H_SYNC	In Camera mode, I2S module accepts signals.	The signals are sent from the Camera.
I2S n _V_SYNC		
I2S n _H_ENABLE		

Table 55 describes the signal bus of the I2S module. Except for the I2S n _CLK signal, all other signals are mapped to the chip pin via the GPIO matrix and IO MUX. The I2S n _CLK signal is mapped to the chip pin via the IO_MUX. For details, please refer to the chapter about [IO_MUX](#) and the [GPIO Matrix](#).

12.2 Features

I2S mode

- Configurable high-precision output clock
- Full-duplex and half-duplex data transmit and receive modes
- Supports multiple digital audio standards
- Embedded A-law compression/decompression module
- Configurable clock signal
- Supports PDM signal input and output
- Configurable data transmit and receive modes

LCD mode

- Supports multiple LCD modes, including external LCD
- Supports external Camera

- Supports on-chip DAC/ADC modes

I2S interrupts

- Standard I2S interface interrupts
- I2S DMA interface interrupts

12.3 The Clock of I2S Module

As is shown in Figure 60, I2Sn_CLK, as the master clock of I2S module, is derived from the 160 MHz clock PLL_D2_CLK or the configurable analog PLL output clock APLL_CLK. The serial clock (BCK) of the I2S module is derived from I2Sn_CLK. The I2S_CLKA_ENA bit of register I2S_CLKM_CONF_REG is used to select either PLL_D2_CLK or APLL_CLK as the clock source for I2Sn. PLL_D2_CLK is used as the clock source for I2Sn, by default.

Notice:

- When using PLL_D2_CLK as the clock source, it is not recommended to divide it using decimals. For high performance audio applications, the analog PLL output clock source APLL_CLK must be used to acquire highly accurate I2Sn_CLK and BCK. For further details, please refer to the chapter entitled [Reset and Clock](#).
- When ESP32 I2S works in slave mode, the master must use I2Sn_CLK as the master clock and $f_{i2s} \geq 8 * f_{BCK}$.

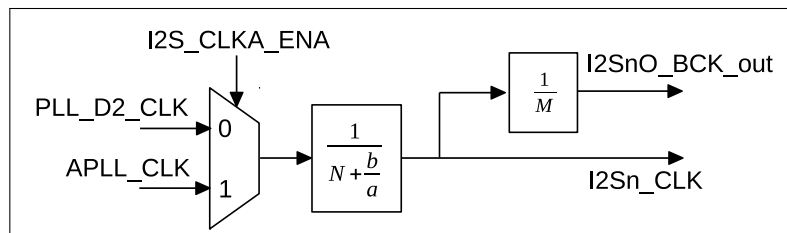


Figure 60: I2S Clock

The relation between I2Sn_CLK frequency f_{i2s} and the divider clock source frequency f_{pll} can be seen in the equation below:

$$f_{i2s} = \frac{f_{pll}}{N + \frac{b}{a}}$$

"N", whose value is ≥ 2 , corresponds to the REG_CLKM_DIV_NUM [7: 0] bits of register I2S_CLKM_CONF_REG, "b" is the I2S_CLKM_DIV_B[5:0] bit and "a" is the I2S_CLKM_DIV_A[5:0] bit.

In master mode, the serial clock BCK in the I2S module is derived from I2Sn_CLK, that is:

$$f_{BCK} = \frac{f_{i2s}}{M}$$

In master transmitting mode, "M", whose value is ≥ 2 , is the I2S_TX_BCK_DIV_NUM[5:0] bit of register I2S_SAMPLE_RATE_CONF_REG. In master receiving mode, "M" is the I2S_RX_BCK_DIV_NUM[5:0] bit of register I2S_SAMPLE_RATE_CONF_REG.

12.4 I2S Mode

The ESP32 I2S module integrates an A-law compression/decompression module to enable compression/decompression of the received audio data. The RX_PCM_BYPASS bit and the TX_PCM_BYPASS bit of register I2S_CONF1_REG should be cleared when using the A-law compression/decompression module.

12.4.1 Supported Audio Standards

In the I2S bus, BCK is the serial clock, WS is the left- /right-channel selection signal (also called word select signal), and SD is the serial data signal for transmitting/receiving digital audio data. WS and SD signals in the I2S module change on the falling edge of BCK, while the SD signal can be sampled on the rising edge of BCK. If the I2S_RX_RIGHT_FIRST bit and the I2S_TX_RIGHT_FIRST bit of register I2S_CONF_REG are set to 1, the I2S module is configured to receive and transmit right-channel data first. Otherwise, the I2S module receives and transmits left-channel data first.

12.4.1.1 Philips Standard

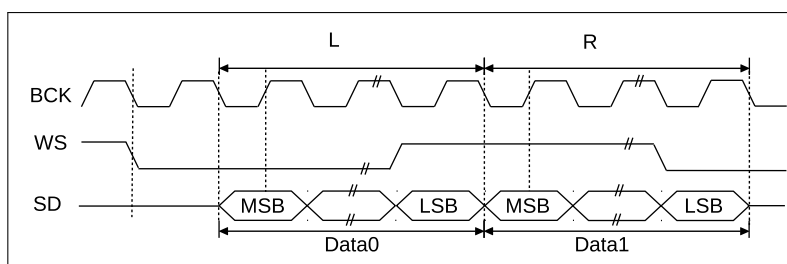


Figure 61: Philips Standard

As is shown in Figure 61, the Philips I2S bus specifications require that the WS signal starts to change a BCK clock cycle earlier than the SD signal, which means that the WS signal takes effect a clock cycle before the first bit of the current channel-data transmission, while the WS signal continues until the end of the current channel-data transmission. The SD signal line transmits the most significant bit of audio data first. If the I2S_RX_MSB_SHIFT bit and the I2S_TX_MSB_SHIFT bit of register I2S_CONF_REG are set to 1, respectively, the I2S module will use the Philips standard when receiving and transmitting data.

12.4.1.2 MSB Alignment Standard

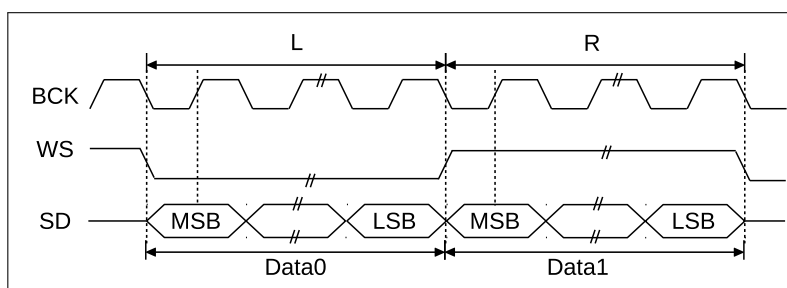


Figure 62: MSB Alignment Standard

The MSB alignment standard is shown in Figure 62. WS and SD signals both change simultaneously on the falling edge of BCK under the MSB alignment standard. The WS signal continues until the end of the current channel-data transmission, and the SD signal line transmits the most significant bit of audio data first. If the I2S_RX_MSB_SHIFT and I2S_TX_MSB_SHIFT bits of register I2S_CONF_REG are cleared, the I2S module will use the MSB alignment standard when receiving and transmitting data.

12.4.1.3 PCM Standard

As is shown in Figure 63, under the short frame synchronization mode of the PCM standard, the WS signal starts to change a BCK clock cycle earlier than the SD signal, which means that the WS signal takes effect a clock cycle earlier than the first bit of the current channel-data transmission and continues for one extra BCK clock cycle. The SD signal line transmits the most significant bit of audio data first. If the I2S_RX_SHORT_SYNC and I2S_TX_SHORT_SYNC bits of register I2S_CONF_REG are set, the I2S module will receive and transmit data in the short frame synchronization mode.

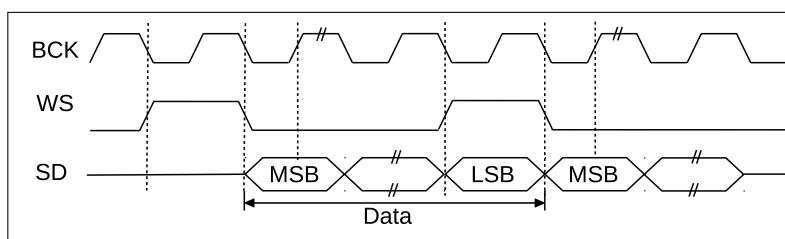


Figure 63: PCM Standard

12.4.2 Module Reset

The four low-order bits in register I2S_CONF_REG, that is, I2S_TX_RESET, I2S_RX_RESET, I2S_TX_FIFO_RESET and I2S_RX_FIFO_RESET reset the receive module, the transmit module and the corresponding FIFO buffer, respectively. In order to finish a reset operation, the corresponding bit should be set and then cleared by software.

12.4.3 FIFO Operation

The data read/write packet length for a FIFO operation is 32 bits. The data packet format for the FIFO buffer can be configured using configuration registers. As shown in Figure 59, both sent and received data should be written into FIFO first and then read from FIFO. There are two approaches to accessing the FIFO; one is to directly access the FIFO using a CPU, the other is to access the FIFO using a DMA controller.

Generally, both the I2S_RX_FIFO_MOD_FORCE_EN bit and I2S_TX_FIFO_MOD_FORCE_EN bits of register I2S_FIFO_CONF_REG should be set to 1. I2S_TX_DATA_NUM[5:0] bit and I2S_RX_DATA_NUM[5:0] are used to control the length of the data that have been sent, received and buffered. Hardware inspects the received-data length RX_LEN and the transmitted-data length TX_LEN. Both the received and the transmitted data are buffered in the FIFO method.

When RX_LEN is greater than I2S_RX_DATA_NUM[5:0], the received data, which is buffered in FIFO, has reached the set threshold and needs to be read out to prevent an overflow. When TX_LEN is less than I2S_TX_DATA_NUM[5:0], the transmitted data, which is buffered in FIFO, has not reached the set threshold and software can continue feeding data into FIFO.

12.4.4 Sending Data

The ESP32 I2S module carries out a data-transmit operation in three stages:

- Read data from internal storage and transfer it to FIFO
- Read data to be sent from FIFO
- Clock out data serially, or in parallel, as configured by the user

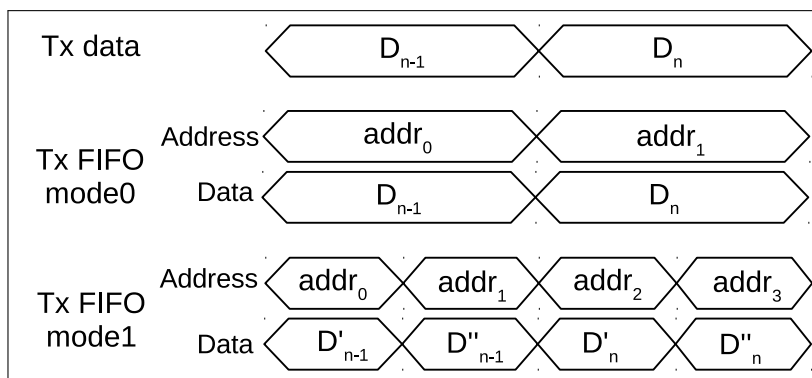


Figure 64: Tx FIFO Data Mode

Table 56: Register Configuration

	I2S_TX_FIFO_MOD[2:0]	Description
Tx FIFO mode0	0	16-bit dual channel data
	2	32-bit dual channel data
	3	32-bit single channel data
Tx FIFO mode1	1	16-bit single channel data

At the first stage, there are two modes for data to be sent and written into FIFO. In Tx FIFO mode0, the Tx data-to-be-sent are written into FIFO according to the time order. In Tx FIFO mode1, the data-to-be-sent are divided into 16 high- and 16 low-order bits. Then, both the 16 high- and 16 low-order bits are recomposed and written into FIFO. The details are shown in Figure 64 with the corresponding registers listed in Table 56. D'_n consists of 16 high-order bits of D_n and 16 zeros. D''_n consists of 16 low-order bits of D_n and 16 zeros. That is to say, $D'_n = \{D_n[31 : 16], 16'h0\}$, $D''_n = \{D_n[15 : 0], 16'h0\}$.

At the second stage, the system reads data that will be sent from FIFO, according to the relevant register configuration. The mode in which the system reads data from FIFO is relevant to the configuration of I2S_TX_FIFO_MOD[2:0] and I2S_TX_CHAN_MOD[2:0]. I2S_TX_FIFO_MOD[2:0] determines whether the data are 16-bit or 32-bit, as shown in Table 56, while I2S_TX_CHAN_MOD[2:0] determines the format of the data-to-be-sent, as shown in Table 57.

Table 57: Send Channel Mode

I2S_TX_CHAN_MOD[2:0]	Description
0	Dual channel mode
1	Mono mode
	When I2S_TX_MSB_RIGHT equals 0, the left-channel data are "holding" their values and the right-channel data change into the left-channel data.

I2S_TX_CHAN_MOD[2:0]	Description
	When I2S_TX_MSB_RIGHT equals 1, the right-channel data are "holding" their values and the left-channel data change into the right-channel data.
2	Mono mode When I2S_TX_MSB_RIGHT equals 0, the right-channel data are "holding" their values and the left-channel data change into the right-channel data. When I2S_TX_MSB_RIGHT equals 1, the left-channel data are "holding" their values and the right-channel data change into the left-channel data.
3	Mono mode When I2S_TX_MSB_RIGHT equals 0, the left-channel data are constants in the range of REG[31:0]. When I2S_TX_MSB_RIGHT equals 1, the right-channel data are constants in the range of REG[31:0].
4	Mono mode When I2S_TX_MSB_RIGHT equals 0, the right-channel data are constants in the range of REG[31:0]. When I2S_TX_MSB_RIGHT equals 1, the left-channel data are constants in the range of REG[31:0].

REG[31:0] is the value of register I2S_CONF_SINGLE_DATA_REG[31:0].

The output of the third stage is determined by the mode of the I2S and I2S_TX_BITS_MOD[5:0] bits of register I2S_SAMPLE_RATE_CONF_REG.

12.4.5 Receiving Data

The data-receive phase of the ESP32 I2S module consists of another three stages:

- The input serial-bit stream is transformed into a 64-bit parallel-data stream in I2S mode. In LCD mode, the input parallel-data stream will be extended to a 64-bit parallel-data stream.
- Received data are written into FIFO.
- Data are read from FIFO by CPU/DMA and written into the internal memory.

At the first stage of receiving data, the received-data stream is expanded to a zero-padded parallel-data stream with 32 high-order bits and 32 low-order bits, according to the level of the I2S_{nl}_WS_out (or I2S_{nl}_WS_in) signal. The I2S_RX_MSB_RIGHT bit of register I2S_CONF_REG is used to determine how the data are to be expanded.

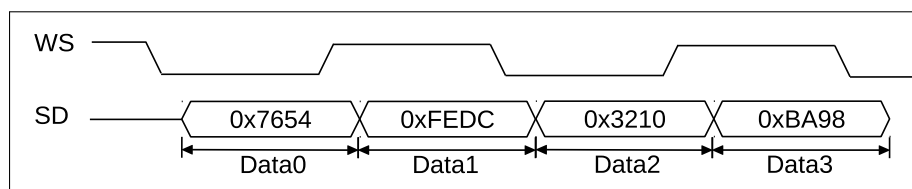


Figure 65: The First Stage of Receiving Data

For example, as is shown in Figure 65, if the width of serial data is 16 bits, when I2S_RX_RIGHT_FIRST equals 1, Data0 will be discarded and I2S will start receiving data from Data1. If I2S_RX_MSB_RIGHT equals 1, data of the first stage would be {0xFEDC0000, 0x32100000}. If I2S_RX_MSB_RIGHT equals 0, data of the first stage would

be $\{0x32100000, 0xFEDC0000\}$. When I2S_RX_RIGHT_FIRST equals 0, I2S will start receiving data from Data0. If I2S_RX_MSB_RIGHT equals 1, data of the first stage would be $\{0xFEDC0000, 0x76540000\}$. If I2S_RX_MSB_RIGHT equals 0, data of the first stage would be $\{0x76540000, 0xFEDC0000\}$.

As is shown in Table 58 and Figure 66, at the second stage, the received data of the Rx unit is written into FIFO. There are four modes of writing received data into FIFO. Each mode corresponds to a value of I2S_RX_FIFO_MOD[2:0] bit.

Table 58: Modes of Writing Received Data into FIFO and the Corresponding Register Configuration

I2S_RX_FIFO_MOD[2:0]	Data format
0	16-bit dual channel data
1	16-bit single channel data
2	32-bit dual channel data
3	32-bit single channel data

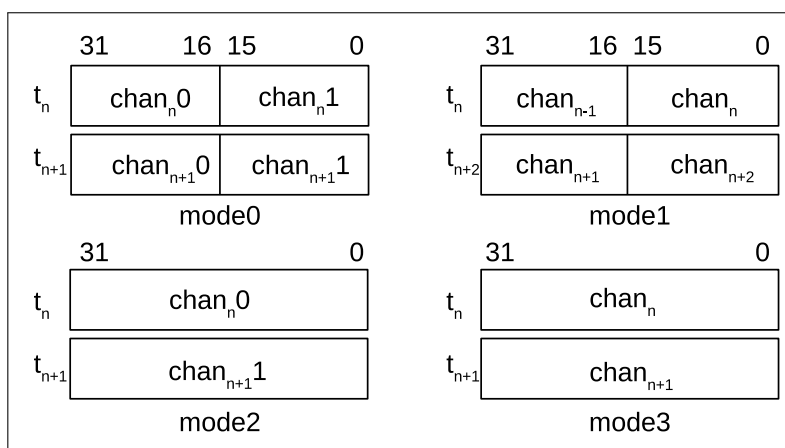


Figure 66: Modes of Writing Received Data into FIFO

At the third stage, CPU or DMA will read data from FIFO and write them into the internal memory directly. The register configuration that each mode corresponds to is shown in Table 59.

Table 59: The Register Configuration to Which the Four Modes Correspond

I2S_RX_MSB_RIGHT	I2S_RX_CHAN_MOD	mode0	mode1	mode2	mode3
0	0	left channel + right channel	-	left channel + right channel	-
	1		left channel + left channel		left channel + left channel
	2		right channel + right channel		right channel + right channel
	3		-		-
1	0	right channel + left channel	-	right channel + left channel	-
	1		right channel + right channel		right channel + right channel
	2		left channel + left channel		left channel + left channel
	3		-		-

12.4.6 I2S Master/Slave Mode

The ESP32 I2S module can be configured to act as a master or slave device on the I2S bus. The module supports slave transmitter and receiver configurations in addition to master transmitter and receiver configurations. All these modes can support full-duplex and half-duplex communication over the I2S bus.

I2S_RX_SLAVE_MOD bit and I2S_TX_SLAVE_MOD bit of register I2S_CONF_REG can configure I2S to slave receiving mode and slave transmitting mode, respectively.

I2S_TX_START bit of register I2S_CONF_REG is used to enable transmission. When I2S is in master transmitting mode and this bit is set, the module will keep driving the clock signal and data of left and right channels. If FIFO sends out all the buffered data and there are no new data to shift, the last batch of data will be looped on the data line. When this bit is reset, master will stop driving clock and data lines. When I2S is configured to slave transmitting mode and this bit is set, the module will wait for the master BCK clock to enable a transmit operation.

The I2S_RX_START bit of register I2S_CONF_REG is used to enable a receive operation. When I2S is in master transmitting mode and this bit is set, the module will keep driving the clock signal and sampling the input data stream until this bit is reset. If I2S is configured to slave receiving mode and this bit is set, the receiving module will wait for the master BCK clock to enable a receiving operation.

12.4.7 I2S PDM

As is shown in Figure 59, ESP32 I2S0 allows for pulse density modulation (PDM), which enables fast conversion between pulse code modulation (PCM) and PDM signals.

The output clock of PDM is mapped to the I2S0*_WS_out signal. Its configuration is identical to I2S's BCK. Please refer to section 12.3, "The Clock of I2S Module", for further details. The bit width for both received and transmitted I2S PCM signals is 16 bits.

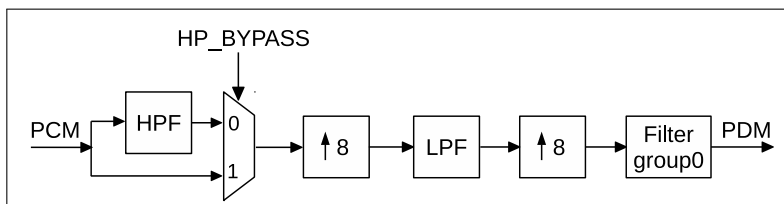


Figure 67: PDM Transmitting Module

The PDM transmitting module is used to convert PCM signals into PDM signals, as shown in Figure 67. HPF is a high-speed channel filter, and LPF is a low-speed channel filter. The PDM signal is derived from the PCM signal, after upsampling and filtering. Signal I2S_TX_PDM_HP_BYPASS of register I2S_PDM_CONF_REG can be set to bypass the HPF at the PCM input. Filter module group0 carries out the upsampling. If the frequency of the PDM signal is f_{pdm} and the frequency of the PCM signal is f_{pcm} , the relation between f_{pdm} and f_{pcm} is given by:

$$f_{\text{pdm}} = 64 \times f_{\text{pcm}} \times \frac{I2S_TX_PDM_FP}{I2S_TX_PDM_FS}$$

The upsampling factor of 64 is the result of the two upsampling stages.

Table 60 lists the configuration rates of the I2S_TX_PDM_FP bit and the I2S_TX_PDM_FS bit of register I2S_PDM_FREQ_CONF_REG, whose output PDM signal frequency remains 48×128 KHz at different PCM signal frequencies.

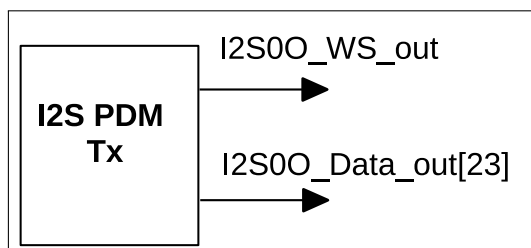
Table 60: Upsampling Rate Configuration

f_{pcm} (KHz)	I2S_TX_PDM_FP	I2S_TX_PDM_FS	f_{pdm} (KHz)
48	960	480	48×128
44.1	960	441	
32	960	320	
24	960	240	
16	960	160	
8	960	80	

The I2S_TX_PDM_SINC_OSR2 bit of I2S_PDM_CONF_REG is the upsampling rate of the Filter group0.

$$I2S_TX_PDM_SINC_OSR2 = \left\lfloor \frac{I2S_TX_PDM_FP}{I2S_TX_PDM_FS} \right\rfloor$$

As is shown in Figure 68, the I2S_TX_PDM_EN bit and the I2S_PCM2PDM_CONV_EN bit of register I2S_PDM_CONF_REG should be set to 1 to use the PDM sending module. The I2S_TX_PDM_SIGMADELTA_IN_SHIFT bit, I2S_TX_PDM_SINC_IN_SHIFT bit, I2S_TX_PDM_LP_IN_SHIFT bit and I2S_TX_PDM_HP_IN_SHIFT bit of register I2S_PDM_CONF_REG are used to adjust the size of the input signal of each filter module.

**Figure 68: PDM Sends Signal**

As is shown in Figure 69, the I2S_RX_PDM_EN bit and the I2S_PDM2PCM_CONV_EN bit of register I2S_PDM_CONF_REG should be set to 1, in order to use the PDM receiving module. As is shown in Figure 70, the PDM receiving module will convert the received PDM signal into a 16-bit PCM signal. Filter group1 is used to downsample the PDM signal, and the I2S_RX_PDM_SINC_DSR_16_EN bit of register I2S_PDM_CONF_REG is used to adjust the corresponding down-sampling rate.

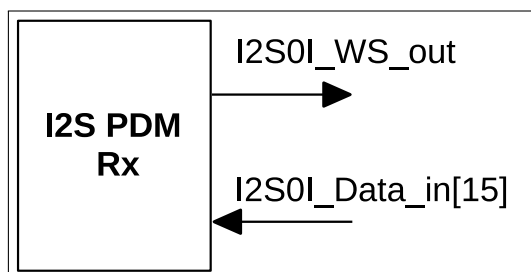
**Figure 69: PDM Receives Signal**

Table 61 shows the configuration of the I2S_RX_PDM_SINC_DSR_16_EN bit whose PCM signal frequency remains 48 KHz at different PDM signal frequencies.

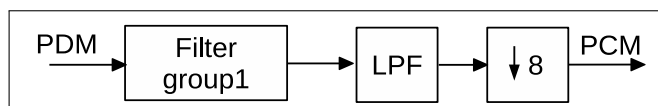


Figure 70: PDM Receive Module

Table 61: Down-sampling Configuration

PDM freq (KHz)	I2S_RX_PDM_SINC_DSR_16_EN	PCM freq (KHz)
$f_{\text{pcm}} \times 128$	1	f_{pcm}
$f_{\text{pcm}} \times 64$	0	

12.5 LCD Mode

There are three operational modes in the LCD mode of ESP32 I2S:

- LCD master transmitting mode
- Camera slave receiving mode
- ADC/DAC mode

The clock configuration of the LCD master transmitting mode is identical to I2S's clock configuration. In the LCD mode, the frequency of WS is half of f_{BCK} .

In the ADC/DAC mode, use PLL_D2_CLK as the clock source.

12.5.1 LCD Master Transmitting Mode

As is shown in Figure 71, the WR signal of LCD connects to the WS signal of I2S. The LCD data bus width is 24 bits.

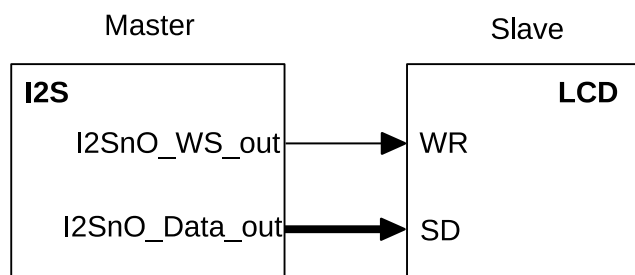


Figure 71: LCD Master Transmitting Mode

The I2S_LCD_EN bit of register I2S_CONF2_REG needs to be set and the I2S_TX_SLAVE_MOD bit of register I2S_CONF_REG needs to be cleared, in order to configure I2S to the LCD master transmitting mode. Meanwhile, data should be sent under the correct mode, according to the I2S_TX_CHAN_MOD[2:0] bit of register I2S_CONF_CHAN_REG and the I2S_TX_FIFO_MOD[2:0] bit of register I2S_FIFO_CONF_REG. The WS signal needs to be inverted when it is routed through the GPIO Matrix. For details, please refer to the chapter about [IO_MUX and the GPIO Matrix](#). The I2S_LCD_TX_SDX2_EN bit and the I2S_LCD_TX_WRX2_EN bit of register I2S_CONF2_REG should be set to the LCD master transmitting mode, so that both the data bus and WR signal work in the appropriate mode.

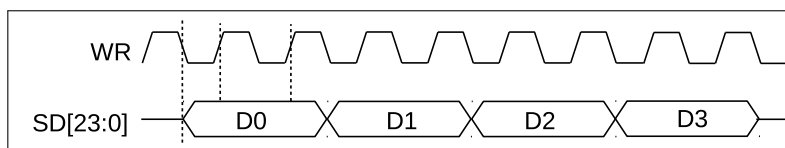


Figure 72: LCD Master Transmitting Data Frame, Form 1

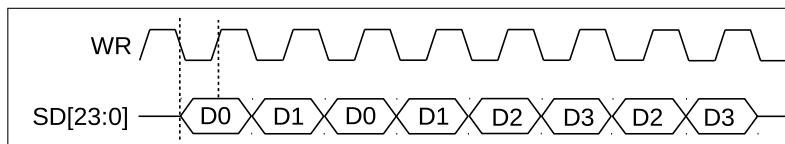


Figure 73: LCD Master Transmitting Data Frame, Form 2

As is shown in Figure 72 and Figure 73, the I2S_LCD_TX_WRX2_EN bit should be set to 1 and the I2S_LCD_TX_SDX2_EN bit should be set to 0 in the data frame, form 1. Both I2S_LCD_TX_SDX2_EN bit and I2S_LCD_TX_WRX2_EN bit are set to 1 in the data frame, form 2.

12.5.2 Camera Slave Receiving Mode

ESP32 I2S supports a camera slave mode for high-speed data transfer from external camera modules. As shown in Figure 74, in this mode, I2S is set to slave receiving mode. Besides the 16-channel data signal bus I2Sn_iData_{in}, there are other signals, such as I2Sn_iH_SYNC, I2Sn_iV_SYNC and I2Sn_iH_ENABLE.

The PCLK in the Camera module connects to I2Sn_iWS_{in} in the I2S module, as Figure 74 shows.

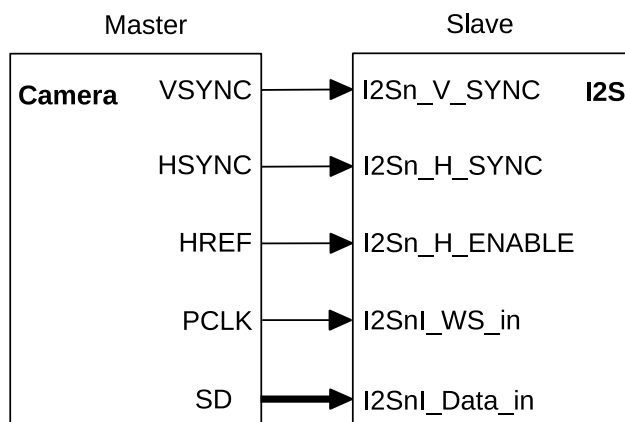


Figure 74: Camera Slave Receiving Mode

When I2S is in the camera slave receiving mode, and when I2Sn_iH_SYNC, I2Sn_iV_SYNC and I2Sn_iH_REF are held high, the master starts transmitting data, that is,

$$transmission_start = (I2Sn_H_SYNC == 1) \&\& (I2Sn_V_SYNC == 1) \&\& (I2Sn_H_ENABLE == 1)$$

Thus, during data transmission, these three signals should be kept at a high level. For example, if the I2Sn_iV_SYNC signal of a camera is at low level during data transmission, it will be inverted when routed to the I2S module. ESP32 supports signal inversion through the GPIO matrix. For details, please refer to the chapter about [IO_MUX and the GPIO Matrix](#).

In order to make I2S work in camera mode, the I2S_LCD_EN bit and the I2S_CAMERA_EN bit of register I2S_CONF2_REG are set to 1, the I2S_RX_SLAVE_MOD bit of register I2S_CONF_REG is set to 1, the I2S_RX_MSB_RIGHT bit and the I2S_RX_RIGHT_FIRST bit of I2S_CONF_REG are set to 0. Thus, I2S works in

the LCD slave receiving mode. At the same time, in order to use the correct mode to receive data, both the I2S_RX_CHAN_MOD[2:0] bit of register I2S_CONF_CHAN_REG and the I2S_RX_FIFO_MOD[2:0] bit of register I2S_FIFO_CONF_REG are set to 1.

12.5.3 ADC/DAC mode

In LCD mode, ESP32's ADC and DAC can receive data. When the I2S0 module connects to the on-chip ADC, the I2S0 module should be set to master receiving mode. Figure 75 shows the signal connection between the I2S0 module and the ADC.

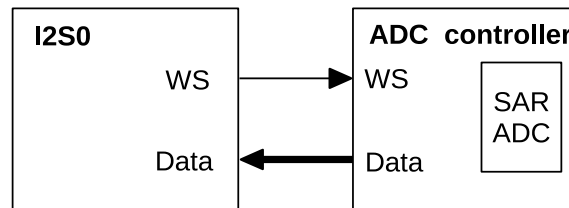


Figure 75: ADC Interface of I2S0

Firstly, the I2S_LCD_EN bit of register I2S_CONF2_REG is set to 1, and the I2S_RX_SLAVE_MOD bit of register I2S_CONF_REG is set to 0, so that the I2S0 module works in LCD master receiving mode, and the I2S0 module clock is configured such that the WS signal of I2S0 outputs an appropriate frequency. Then, the APB_CTRL_SARADC_DATA_TO_I2S bit of register APB_CTRL_APB_SARADC_CTRL_REG is set to 1. Enable I2S to receive data after configuring the relevant registers of SARADC. For details, please refer to Chapter [On-Chip Sensors and Analog Signal Processing](#).

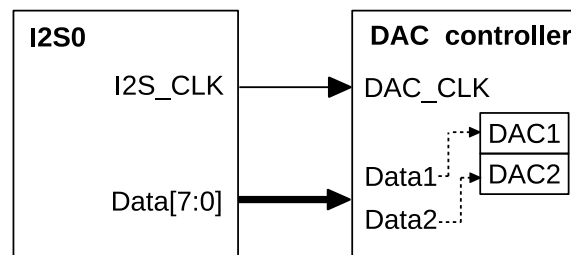


Figure 76: DAC Interface of I2S

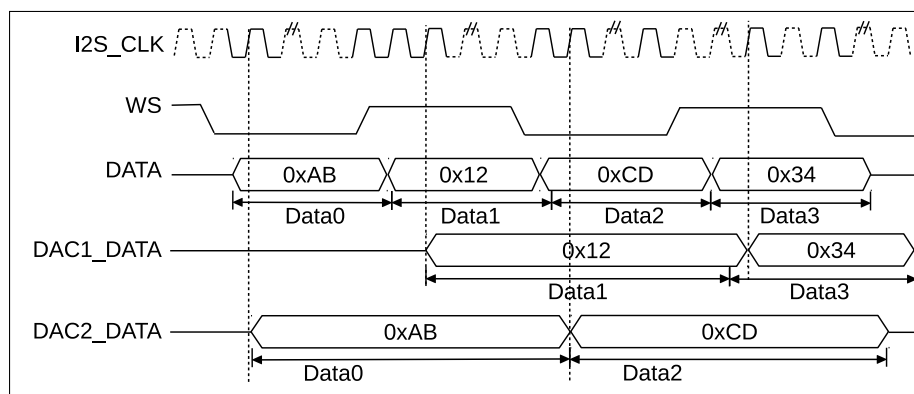


Figure 77: Data Input by I2S DAC Interface

The I2S0 module should be configured to master transmitting mode when it connects to the on-chip DAC. Figure 76 shows the signal connection between the I2S0 module and the DAC. The DAC's control module regards I2S_CLK as the clock in this configuration. As shown in Figure 77, when the data bus inputs data to the DAC's

control module, the latter will input right-channel data to DAC1 module and left-channel data to DAC2 module. When using the I2S DMA module, 8 bits of data-to-be-transmitted are shifted to the left by 8 bits of data-to-be-received into the DMA double-byte type of buffer.

The I2S_LCD_EN bit of register I2S_CONF2_REG should be set to 1, while I2S_RX_SHORT_SYNC, I2S_TX_SHORT_SYNC, I2S_CONF_REG, I2S_RX_MSB_SHIFT and I2S_TX_MSB_SHIFT should all be reset to 0. The I2S_TX_SLAVE_MOD bit of register I2S_CONF_REG should be set to 0, as well, when using the DAC mode of I2S0. Select a suitable transmit mode according to the standards of transmitting a 16-bit digital data stream. Configure the I2S0 module clock to output a suitable frequency for the I2S_CLK and the WS of I2S. Enable I2S0 to send data after configuring the relevant DAC registers.

12.6 I2S Interrupts

12.6.1 FIFO Interrupts

- I2S_TX_HUNG_INT: Triggered when transmitting data is timed out.
- I2S_RX_HUNG_INT: Triggered when receiving data is timed out.
- I2S_TX_EMPTY_INT: Triggered when the transmit FIFO is empty.
- I2S_TX_WFULL_INT: Triggered when the transmit FIFO is full.
- I2S_RX_EMPTY_INT: Triggered when the receive FIFO is empty.
- I2S_RX_WFULL_INT: Triggered when the receive FIFO is full.
- I2S_TX_PUT_DATA_INT: Triggered when the transmit FIFO is almost empty.
- I2S_RX_TAKE_DATA_INT: Triggered when the receive FIFO is almost full.

12.6.2 DMA Interrupts

- I2S_OUT_TOTAL_EOF_INT: Triggered when all transmitting linked lists are used up.
- I2S_IN_DSCR_EMPTY_INT: Triggered when there are no valid receiving linked lists left.
- I2S_OUT_DSCR_ERR_INT: Triggered when invalid rxlink descriptors are encountered.
- I2S_IN_DSCR_ERR_INT: Triggered when invalid txlink descriptors are encountered.
- I2S_OUT_EOF_INT: Triggered when rxlink has finished sending a packet.
- I2S_OUT_DONE_INT: Triggered when all transmitted and buffered data have been read.
- I2S_IN_SUC_EOF_INT: Triggered when all data have been received.
- I2S_IN_DONE_INT: Triggered when the current txlink descriptor is handled.

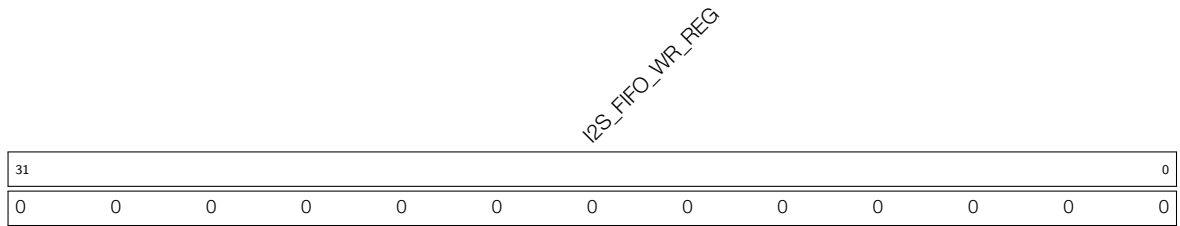
12.7 Register Summary

Name	Description	I2S0	I2S1	Acc
I2S FIFO registers				
I2S_FIFO_WR_REG	Writes the data sent by I2S into FIFO	0x3FF4F000	0x3FF6D000	WO
I2S_FIFO_RD_REG	Stores the data that I2S receives from FIFO	0x3FF4F004	0x3FF6D004	RO
Configuration registers				
I2S_CONF_REG	Configuration and start/stop bits	0x3FF4F008	0x3FF6D008	R/W
I2S_CONF1_REG	PCM configuration register	0x3FF4F0A0	0x3FF6D0A0	R/W
I2S_CONF2_REG	ADC/LCD/camera configuration register	0x3FF4F0A8	0x3FF6D0A8	R/W
I2S_TIMING_REG	Signal delay and timing parameters	0x3FF4F01C	0x3FF6D01C	R/W
I2S_FIFO_CONF_REG	FIFO configuration	0x3FF4F020	0x3FF6D020	R/W
I2S_CONF_SINGLE_DATA_REG	Static channel output value	0x3FF4F028	0x3FF6D028	R/W
I2S_CONF_CHAN_REG	Channel configuration	0x3FF4F02C	0x3FF6D02C	R/W
I2S_LC_HUNG_CONF_REG	Timeout detection configuration	0x3FF4F074	0x3FF6D074	R/W
I2S_CLKM_CONF_REG	Bitclock configuration	0x3FF4F0AC	0x3FF6D0AC	R/W
I2S_SAMPLE_RATE_CONF_REG	Sample rate configuration	0x3FF4F0B0	0x3FF6D0B0	R/W
I2S_PD_CONF_REG	Power-down register	0x3FF4F0A4	0x3FF6D0A4	R/W
I2S_STATE_REG	I2S status register	0x3FF4F0BC	0x3FF6D0BC	RO
DMA registers				
I2S_LC_CONF_REG	DMA configuration register	0x3FF4F060	0x3FF6D060	R/W
I2S_RXEOF_NUM_REG	Receive data count	0x3FF4F024	0x3FF6D024	R/W
I2S_OUT_LINK_REG	DMA transmit linked list configuration and address	0x3FF4F030	0x3FF6D030	R/W
I2S_IN_LINK_REG	DMA receive linked list configuration and address	0x3FF4F034	0x3FF6D034	R/W
I2S_OUT_EOF_DES_ADDR_REG	The address of transmit link descriptor producing EOF	0x3FF4F038	0x3FF6D038	RO
I2S_IN_EOF_DES_ADDR_REG	The address of receive link descriptor producing EOF	0x3FF4F03C	0x3FF6D03C	RO
I2S_OUT_EOF_BFR_DES_ADDR_REG	The address of transmit buffer producing EOF	0x3FF4F040	0x3FF6D040	RO
I2S_INLINK_DSCR_REG	The address of current inlink descriptor	0x3FF4F048	0x3FF6D048	RO
I2S_INLINK_DSCR_BF0_REG	The address of next inlink descriptor	0x3FF4F04C	0x3FF6D04C	RO
I2S_INLINK_DSCR_BF1_REG	The address of next inlink data buffer	0x3FF4F050	0x3FF6D050	RO
I2S_OUTLINK_DSCR_REG	The address of current outlink descriptor	0x3FF4F054	0x3FF6D054	RO
I2S_OUTLINK_DSCR_BF0_REG	The address of next outlink descriptor	0x3FF4F058	0x3FF6D058	RO

I2S_OUTLINK_DSCR_BF1_REG	The address of next outlink data buffer	0x3FF4F05C	0x3FF6D05C	RO
I2S_LC_STATE0_REG	DMA receive status	0x3FF4F06C	0x3FF6D06C	RO
I2S_LC_STATE1_REG	DMA transmit status	0x3FF4F070	0x3FF6D070	RO
Pulse density (DE) modulation registers				
I2S_PDM_CONF_REG	PDM configuration	0x3FF4F0B4	0x3FF6D0B4	R/W
I2S_PDM_FREQ_CONF_REG	PDM frequencies	0x3FF4F0B8	0x3FF6D0B8	R/W
Interrupt registers				
I2S_INT_RAW_REG	Raw interrupt status	0x3FF4F00C	0x3FF6D00C	RO
I2S_INT_ST_REG	Masked interrupt status	0x3FF4F010	0x3FF6D010	RO
I2S_INT_ENA_REG	Interrupt enable bits	0x3FF4F014	0x3FF6D014	R/W
I2S_INT_CLR_REG	Interrupt clear bits	0x3FF4F018	0x3FF6D018	WO

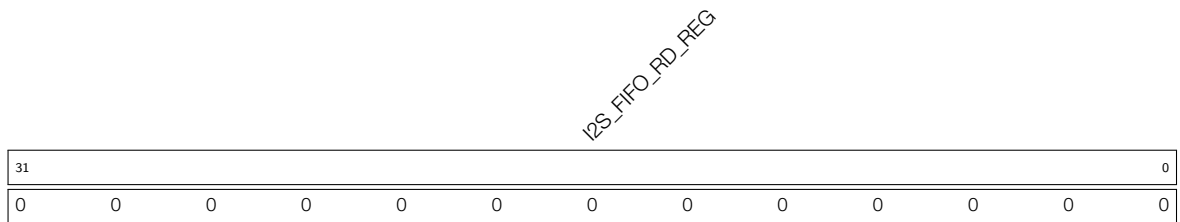
12.8 Registers

Register 12.1: I2S_FIFO_WR_REG (0x0000)



I2S_FIFO_WR_REG Writes the data sent by I2S into FIFO. (WO)

Register 12.2: I2S_FIFO_RD_REG (0x0004)



I2S_FIFO_RD_REG Stores the data that I2S receives from FIFO. (RO)

Register 12.3: I2S_CONF_REG (0x0008)

(reserved)																			<div style="display: flex; justify-content: space-between;"> <div style="writing-mode: vertical-rl; transform: rotate(180deg);">I2S_SIG_LOOPBACK</div> <div style="writing-mode: vertical-rl; transform: rotate(180deg);">I2S_RX_MSB_RIGHT</div> <div style="writing-mode: vertical-rl; transform: rotate(180deg);">I2S_TX_MSB_RIGHT</div> <div style="writing-mode: vertical-rl; transform: rotate(180deg);">I2S_RX_MONO</div> <div style="writing-mode: vertical-rl; transform: rotate(180deg);">I2S_TX_MONO</div> <div style="writing-mode: vertical-rl; transform: rotate(180deg);">I2S_RX_SHORT_SYNC</div> <div style="writing-mode: vertical-rl; transform: rotate(180deg);">I2S_TX_SHORT_SYNC</div> <div style="writing-mode: vertical-rl; transform: rotate(180deg);">I2S_RX_MSB_SHIFT</div> <div style="writing-mode: vertical-rl; transform: rotate(180deg);">I2S_TX_MSB_SHIFT</div> <div style="writing-mode: vertical-rl; transform: rotate(180deg);">I2S_RX_RIGHT_FIRST</div> <div style="writing-mode: vertical-rl; transform: rotate(180deg);">I2S_TX_RIGHT_FIRST</div> <div style="writing-mode: vertical-rl; transform: rotate(180deg);">I2S_RX_SLAVE_MOD</div> <div style="writing-mode: vertical-rl; transform: rotate(180deg);">I2S_TX_SLAVE_MOD</div> <div style="writing-mode: vertical-rl; transform: rotate(180deg);">I2S_RX_START</div> <div style="writing-mode: vertical-rl; transform: rotate(180deg);">I2S_TX_START</div> <div style="writing-mode: vertical-rl; transform: rotate(180deg);">I2S_RX_FIFO_RESET</div> <div style="writing-mode: vertical-rl; transform: rotate(180deg);">I2S_TX_FIFO_RESET</div> <div style="writing-mode: vertical-rl; transform: rotate(180deg);">I2S_RX_RESET</div> <div style="writing-mode: vertical-rl; transform: rotate(180deg);">I2S_TX_RESET</div> </div>																																							
31																				19	18	17	16	15	14	13	12	11	10	9	8	7	6	5	4	3	2	1	0	Reset																		
0																			0	0	0	0	1	1	1	1	0	0	0	0	0	0	0	0	0	0	0	0	0	0	0	0	0	0	0	0	0	0	0	0	0	0	0	0	0	0	0	0

I2S_SIG_LOOPBACK Enable signal loopback mode, with transmitter module and receiver module sharing the same WS and BCK signals. (R/W)

I2S_RX_MSB_RIGHT Set this to place right-channel data at the MSB in the receive FIFO. (R/W)

I2S_TX_MSB_RIGHT Set this bit to place right-channel data at the MSB in the transmit FIFO. (R/W)

I2S_RX_MONO Set this bit to enable receiver's mono mode in PCM standard mode. (R/W)

I2S_TX_MONO Set this bit to enable transmitter's mono mode in PCM standard mode. (R/W)

I2S_RX_SHORT_SYNC Set this bit to enable receiver in PCM standard mode. (R/W)

I2S_TX_SHORT_SYNC Set this bit to enable transmitter in PCM standard mode. (R/W)

I2S_RX_MSB_SHIFT Set this bit to enable receiver in Philips standard mode. (R/W)

I2S_TX_MSB_SHIFT Set this bit to enable transmitter in Philips standard mode. (R/W)

I2S_RX_RIGHT_FIRST Set this bit to receive right-channel data first. (R/W)

I2S_TX_RIGHT_FIRST Set this bit to transmit right-channel data first. (R/W)

I2S_RX_SLAVE_MOD Set this bit to enable slave receiver mode. (R/W)

I2S_TX_SLAVE_MOD Set this bit to enable slave transmitter mode. (R/W)

I2S_RX_START Set this bit to start receiving data. (R/W)

I2S_TX_START Set this bit to start transmitting data. (R/W)

I2S_RX_FIFO_RESET Set this bit to reset the receive FIFO. (R/W)

I2S_TX_FIFO_RESET Set this bit to reset the transmit FIFO. (R/W)

I2S_RX_RESET Set this bit to reset the receiver. (R/W)

I2S_TX_RESET Set this bit to reset the transmitter. (R/W)

Register 12.4: I2S_INT_RAW_REG (0x000c)

(reserved)																	<i>I2S_OUT_TOTAL_EOF_INT_RAW</i> <i>I2S_IN_DSCR_EMPTY_INT_RAW</i> <i>I2S_OUT_DSCR_ERR_INT_RAW</i> <i>I2S_IN_DSCR_ERR_INT_RAW</i> <i>I2S_OUT_EOF_INT_RAW</i> (reserved) <i>I2S_IN_SUC_EOF_INT_RAW</i> <i>I2S_IN_DONE_INT_RAW</i> <i>I2S_TX_HUNG_INT_RAW</i> <i>I2S_RX_HUNG_INT_RAW</i> <i>I2S_TX_EMPTY_INT_RAW</i> <i>I2S_RX_WFULL_INT_RAW</i> <i>I2S_RX_EMPTY_INT_RAW</i> <i>I2S_TX_WFULL_INT_RAW</i> <i>I2S_RX_PUT_DATA_INT_RAW</i> <i>I2S_RX_TAKE_DATA_INT_RAW</i>																		
31																	17	16	15	14	13	12	11	10	9	8	7	6	5	4	3	2	1	0	Reset
0 0																																			

I2S_OUT_TOTAL_EOF_INT_RAW The raw interrupt status bit for the [I2S_OUT_TOTAL_EOF_INT](#) interrupt. (RO)

I2S_IN_DSCR_EMPTY_INT_RAW The raw interrupt status bit for the [I2S_IN_DSCR_EMPTY_INT](#) interrupt. (RO)

I2S_OUT_DSCR_ERR_INT_RAW The raw interrupt status bit for the [I2S_OUT_DSCR_ERR_INT](#) interrupt. (RO)

I2S_IN_DSCR_ERR_INT_RAW The raw interrupt status bit for the [I2S_IN_DSCR_ERR_INT](#) interrupt. (RO)

I2S_OUT_EOF_INT_RAW The raw interrupt status bit for the [I2S_OUT_EOF_INT](#) interrupt. (RO)

I2S_OUT_DONE_INT_RAW The raw interrupt status bit for the [I2S_OUT_DONE_INT](#) interrupt. (RO)

I2S_IN_SUC_EOF_INT_RAW The raw interrupt status bit for the [I2S_IN_SUC_EOF_INT](#) interrupt. (RO)

I2S_IN_DONE_INT_RAW The raw interrupt status bit for the [I2S_IN_DONE_INT](#) interrupt. (RO)

I2S_TX_HUNG_INT_RAW The raw interrupt status bit for the [I2S_TX_HUNG_INT](#) interrupt. (RO)

I2S_RX_HUNG_INT_RAW The raw interrupt status bit for the [I2S_RX_HUNG_INT](#) interrupt. (RO)

I2S_TX_EMPTY_INT_RAW The raw interrupt status bit for the [I2S_TX_EMPTY_INT](#) interrupt. (RO)

I2S_TX_WFULL_INT_RAW The raw interrupt status bit for the [I2S_TX_WFULL_INT](#) interrupt. (RO)

I2S_RX_EMPTY_INT_RAW The raw interrupt status bit for the [I2S_RX_EMPTY_INT](#) interrupt. (RO)

I2S_RX_WFULL_INT_RAW The raw interrupt status bit for the [I2S_RX_WFULL_INT](#) interrupt. (RO)

I2S_TX_PUT_DATA_INT_RAW The raw interrupt status bit for the [I2S_TX_PUT_DATA_INT](#) interrupt. (RO)

I2S_RX_TAKE_DATA_INT_RAW The raw interrupt status bit for the [I2S_RX_TAKE_DATA_INT](#) interrupt. (RO)

Register 12.5: I2S_INT_ST_REG (0x0010)

(reserved)																	I2S_OUT_TOTAL_EOF_INT_ST I2S_IN_DSCR_EMPTY_INT_ST I2S_OUT_DSCR_ERR_INT_ST I2S_IN_DSCR_ERR_INT_ST I2S_OUT_EOF_INT_ST I2S_OUT_DONE_INT_ST I2S_IN_SUC_EOF_INT_ST I2S_TX_DONE_INT_ST I2S_TX_HUNG_INT_ST I2S_RX_HUNG_INT_ST I2S_TX_REMPTY_INT_ST I2S_RX_WFULL_INT_ST I2S_RX_REMPTY_INT_ST I2S_TX_PUT_DATA_INT_ST I2S_RX_TAKE_DATA_INT_ST																		
31																	17	16	15	14	13	12	11	10	9	8	7	6	5	4	3	2	1	0	Reset
0																	0																		

I2S_OUT_TOTAL_EOF_INT_ST The masked interrupt status bit for the [I2S_OUT_TOTAL_EOF_INT](#) interrupt. (RO)

I2S_IN_DSCR_EMPTY_INT_ST The masked interrupt status bit for the [I2S_IN_DSCR_EMPTY_INT](#) interrupt. (RO)

I2S_OUT_DSCR_ERR_INT_ST The masked interrupt status bit for the [I2S_OUT_DSCR_ERR_INT](#) interrupt. (RO)

I2S_IN_DSCR_ERR_INT_ST The masked interrupt status bit for the [I2S_IN_DSCR_ERR_INT](#) interrupt. (RO)

I2S_OUT_EOF_INT_ST The masked interrupt status bit for the [I2S_OUT_EOF_INT](#) interrupt. (RO)

I2S_OUT_DONE_INT_ST The masked interrupt status bit for the [I2S_OUT_DONE_INT](#) interrupt. (RO)

I2S_IN_SUC_EOF_INT_ST The masked interrupt status bit for the [I2S_IN_SUC_EOF_INT](#) interrupt. (RO)

I2S_IN_DONE_INT_ST The masked interrupt status bit for the [I2S_IN_DONE_INT](#) interrupt. (RO)

I2S_TX_HUNG_INT_ST The masked interrupt status bit for the [I2S_TX_HUNG_INT](#) interrupt. (RO)

I2S_RX_HUNG_INT_ST The masked interrupt status bit for the [I2S_RX_HUNG_INT](#) interrupt. (RO)

I2S_TX_REMPTY_INT_ST The masked interrupt status bit for the [I2S_TX_REMPTY_INT](#) interrupt. (RO)

I2S_TX_WFULL_INT_ST The masked interrupt status bit for the [I2S_TX_WFULL_INT](#) interrupt. (RO)

I2S_RX_REMPTY_INT_ST The masked interrupt status bit for the [I2S_RX_REMPTY_INT](#) interrupt. (RO)

I2S_RX_WFULL_INT_ST The masked interrupt status bit for the [I2S_RX_WFULL_INT](#) interrupt. (RO)

I2S_TX_PUT_DATA_INT_ST The masked interrupt status bit for the [I2S_TX_PUT_DATA_INT](#) interrupt. (RO)

I2S_RX_TAKE_DATA_INT_ST The masked interrupt status bit for the [I2S_RX_TAKE_DATA_INT](#) interrupt. (RO)

Register 12.7: I2S_INT_CLR_REG (0x0018)

(reserved)																	<i>I2S_OUT_TOTAL_EOF_INT_CLR</i> <i>I2S_IN_DSCR_EMPTY_INT_CLR</i> <i>I2S_OUT_DSCR_ERR_INT_CLR</i> <i>I2S_IN_DSCR_ERR_INT_CLR</i> <i>I2S_OUT_EOF_INT_CLR</i> <i>I2S_OUT_DONE_INT_CLR</i> (reserved) <i>I2S_IN_SUC_EOF_INT_CLR</i> <i>I2S_IN_DONE_INT_CLR</i> <i>I2S_TX_HUNG_INT_CLR</i> <i>I2S_RX_HUNG_INT_CLR</i> <i>I2S_TX_EMPTY_INT_CLR</i> <i>I2S_RX_WFULL_INT_CLR</i> <i>I2S_TX_REMPTY_INT_CLR</i> <i>I2S_RX_REMPTY_INT_CLR</i> <i>I2S_TX_PUT_DATA_INT_CLR</i> <i>I2S_RX_TAKE_DATA_INT_CLR</i>																		
31																	17	16	15	14	13	12	11	10	9	8	7	6	5	4	3	2	1	0	Reset
0																	0																		

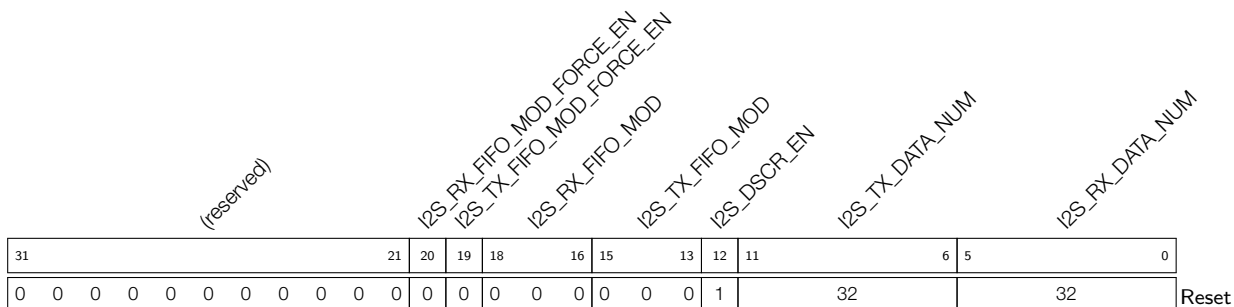
- I2S_OUT_TOTAL_EOF_INT_CLR** Set this bit to clear the [I2S_OUT_TOTAL_EOF_INT](#) interrupt. (WO)
- I2S_IN_DSCR_EMPTY_INT_CLR** Set this bit to clear the [I2S_IN_DSCR_EMPTY_INT](#) interrupt. (WO)
- I2S_OUT_DSCR_ERR_INT_CLR** Set this bit to clear the [I2S_OUT_DSCR_ERR_INT](#) interrupt. (WO)
- I2S_IN_DSCR_ERR_INT_CLR** Set this bit to clear the [I2S_IN_DSCR_ERR_INT](#) interrupt. (WO)
- I2S_OUT_EOF_INT_CLR** Set this bit to clear the [I2S_OUT_EOF_INT](#) interrupt. (WO)
- I2S_OUT_DONE_INT_CLR** Set this bit to clear the [I2S_OUT_DONE_INT](#) interrupt. (WO)
- I2S_IN_SUC_EOF_INT_CLR** Set this bit to clear the [I2S_IN_SUC_EOF_INT](#) interrupt. (WO)
- I2S_IN_DONE_INT_CLR** Set this bit to clear the [I2S_IN_DONE_INT](#) interrupt. (WO)
- I2S_TX_HUNG_INT_CLR** Set this bit to clear the [I2S_TX_HUNG_INT](#) interrupt. (WO)
- I2S_RX_HUNG_INT_CLR** Set this bit to clear the [I2S_RX_HUNG_INT](#) interrupt. (WO)
- I2S_TX_REMPTY_INT_CLR** Set this bit to clear the [I2S_TX_REMPTY_INT](#) interrupt. (WO)
- I2S_TX_WFULL_INT_CLR** Set this bit to clear the [I2S_TX_WFULL_INT](#) interrupt. (WO)
- I2S_RX_REMPTY_INT_CLR** Set this bit to clear the [I2S_RX_REMPTY_INT](#) interrupt. (WO)
- I2S_RX_WFULL_INT_CLR** Set this bit to clear the [I2S_RX_WFULL_INT](#) interrupt. (WO)
- I2S_TX_PUT_DATA_INT_CLR** Set this bit to clear the [I2S_TX_PUT_DATA_INT](#) interrupt. (WO)
- I2S_RX_TAKE_DATA_INT_CLR** Set this bit to clear the [I2S_RX_TAKE_DATA_INT](#) interrupt. (WO)

Register 12.8: I2S_TIMING_REG (0x001c)

(reserved)							I2S_TX_BCK_IN_INV		I2S_DATA_ENABLE_DELAY		I2S_RX_DSSYNC_SW		I2S_TX_DSSYNC_SW		I2S_RX_BCK_OUT_DELAY		I2S_RX_WS_OUT_DELAY		I2S_TX_SD_OUT_DELAY		I2S_TX_WS_OUT_DELAY		I2S_TX_BCK_OUT_DELAY		I2S_RX_SD_IN_DELAY		I2S_RX_WS_IN_DELAY		I2S_RX_BCK_IN_DELAY		I2S_TX_WS_IN_DELAY		I2S_TX_BCK_IN_DELAY		
31	30	29	28	27	26	25	24	23	22	21	20	19	18	17	16	15	14	13	12	11	10	9	8	7	6	5	4	3	2	1	0				
0	0	0	0	0	0	0	0	0	0	0	0	0	0	0	0	0	0	0	0	0	0	0	0	0	0	0	0	0	0	0	0	0	0	0	Reset

- I2S_TX_BCK_IN_INV** Set this bit to invert the BCK signal into the slave transmitter. (R/W)
- I2S_DATA_ENABLE_DELAY** Number of delay cycles for data valid flag. (R/W)
- I2S_RX_DSSYNC_SW** Set this bit to synchronize signals into the receiver in double sync method. (R/W)
- I2S_TX_DSSYNC_SW** Set this bit to synchronize signals into the transmitter in double sync method. (R/W)
- I2S_RX_BCK_OUT_DELAY** Number of delay cycles for BCK signal out of the receiver. (R/W)
- I2S_RX_WS_OUT_DELAY** Number of delay cycles for WS signal out of the receiver. (R/W)
- I2S_TX_SD_OUT_DELAY** Number of delay cycles for SD signal out of the transmitter. (R/W)
- I2S_TX_WS_OUT_DELAY** Number of delay cycles for WS signal out of the transmitter. (R/W)
- I2S_TX_BCK_OUT_DELAY** Number of delay cycles for BCK signal out of the transmitter. (R/W)
- I2S_RX_SD_IN_DELAY** Number of delay cycles for SD signal into the receiver. (R/W)
- I2S_RX_WS_IN_DELAY** Number of delay cycles for WS signal into the receiver. (R/W)
- I2S_RX_BCK_IN_DELAY** Number of delay cycles for BCK signal into the receiver. (R/W)
- I2S_TX_WS_IN_DELAY** Number of delay cycles for WS signal into the transmitter. (R/W)
- I2S_TX_BCK_IN_DELAY** Number of delay cycles for BCK signal into the transmitter. (R/W)

Register 12.9: I2S_FIFO_CONF_REG (0x0020)



I2S_RX_FIFO_MOD_FORCE_EN The bit should always be set to 1. (R/W)

I2S_TX_FIFO_MOD_FORCE_EN The bit should always be set to 1. (R/W)

I2S_RX_FIFO_MOD Receive FIFO mode configuration bit. (R/W)

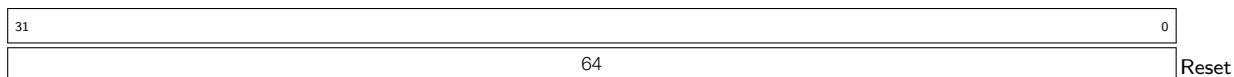
I2S_TX_FIFO_MOD Transmit FIFO mode configuration bit. (R/W)

I2S_DSCR_EN Set this bit to enable I2S DMA mode. (R/W)

I2S_TX_DATA_NUM Threshold of data length in the transmit FIFO. (R/W)

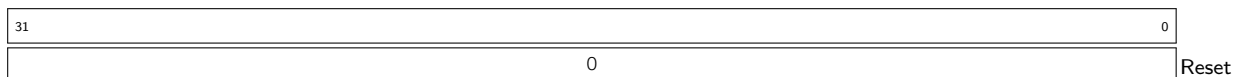
I2S_RX_DATA_NUM Threshold of data length in the receive FIFO. (R/W)

Register 12.10: I2S_RXEOF_NUM_REG (0x0024)



I2S_RXEOF_NUM_REG The length of the data to be received. It will trigger [I2S_IN_SUC_EOF_INT](#). (R/W)

Register 12.11: I2S_CONF_SINGLE_DATA_REG (0x0028)



I2S_CONF_SINGLE_DATA_REG The right channel or the left channel outputs constant values stored in this register according to [TX_CHAN_MOD](#) and [I2S_TX_MSB_RIGHT](#). (R/W)

Register 12.15: I2S_OUT_EOF_DES_ADDR_REG (0x0038)

31	0
0x00000000	
Reset	

I2S_OUT_EOF_DES_ADDR_REG The address of outlink descriptor that produces EOF. (RO)

Register 12.16: I2S_IN_EOF_DES_ADDR_REG (0x003c)

31	0
0x00000000	
Reset	

I2S_IN_EOF_DES_ADDR_REG The address of inlink descriptor that produces EOF. (RO)

Register 12.17: I2S_OUT_EOF_BFR_DES_ADDR_REG (0x0040)

31	0
0x00000000	
Reset	

I2S_OUT_EOF_BFR_DES_ADDR_REG The address of the buffer corresponding to the outlink descriptor that produces EOF. (RO)

Register 12.18: I2S_INLINK_DSCR_REG (0x0048)

31	0
0 0	
Reset	

I2S_INLINK_DSCR_REG The address of current inlink descriptor. (RO)

Register 12.19: I2S_INLINK_DSCR_BF0_REG (0x004c)

31	0
0 0	
Reset	

I2S_INLINK_DSCR_BF0_REG The address of next inlink descriptor. (RO)

Register 12.20: I2S_INLINK_DSCR_BF1_REG (0x0050)

31	0
0 0	
Reset	

I2S_INLINK_DSCR_BF1_REG The address of next inlink data buffer. (RO)

Register 12.21: I2S_OUTLINK_DSCR_REG (0x0054)

31	0
0 0	

Reset

I2S_OUTLINK_DSCR_REG The address of current outlink descriptor. (RO)

Register 12.22: I2S_OUTLINK_DSCR_BF0_REG (0x0058)

31	0
0 0	

Reset

I2S_OUTLINK_DSCR_BF0_REG The address of next outlink descriptor. (RO)

Register 12.23: I2S_OUTLINK_DSCR_BF1_REG (0x005c)

31	0
0 0	

Reset

I2S_OUTLINK_DSCR_BF1_REG The address of next outlink data buffer. (RO)

Register 12.24: I2S_LC_CONF_REG (0x0060)

31	(reserved)													13	12	11	10	9	8	7	6	5	4	3	2	1	0	Reset
0 1 0 0 0 0 0 0 0 0 0																												

- I2S_CHECK_OWNER** Set this bit to check the owner bit by hardware. (R/W)
- I2S_OUT_DATA_BURST_EN** Transmitter data transfer mode configuration bit. (R/W)
 - 1: Transmit data in burst mode;
 - 0: Transmit data in byte mode.
- I2S_INDSCR_BURST_EN** DMA inlink descriptor transfer mode configuration bit. (R/W)
 - 1: Transfer inlink descriptor in burst mode;
 - 0: Transfer inlink descriptor in byte mode.
- I2S_OUTDSCR_BURST_EN** DMA outlink descriptor transfer mode configuration bit. (R/W)
 - 1: Transfer outlink descriptor in burst mode;
 - 0: Transfer outlink descriptor in byte mode.
- I2S_OUT_EOF_MODE** DMA [I2S_OUT_EOF_INT](#) generation mode. (R/W)
 - 1: When DMA has popped all data from the FIFO;
 - 0: When AHB has pushed all data to the FIFO.
- I2S_OUT_AUTO_WBACK** Set this bit to enable automatic outlink-writeback when all the data in tx buffer has been transmitted. (R/W)
- I2S_OUT_LOOP_TEST** Set this bit to loop test outlink. (R/W)
- I2S_IN_LOOP_TEST** Set this bit to loop test inlink. (R/W)
- I2S_AHBM_RST** Set this bit to reset AHB interface of DMA. (R/W)
- I2S_AHBM_FIFO_RST** Set this bit to reset AHB interface cmdFIFO of DMA. (R/W)
- I2S_OUT_RST** Set this bit to reset out DMA FSM. (R/W)
- I2S_IN_RST** Set this bit to reset in DMA FSM. (R/W)

Register 12.25: I2S_LC_STATE0_REG (0x006c)

31																																0	
0x00000000																																	Reset

I2S_LC_STATE0_REG Receiver DMA channel status register. (RO)

Register 12.26: I2S_LC_STATE1_REG (0x0070)

31	0
0x00000000	
Reset	

I2S_LC_STATE1_REG Transmitter DMA channel status register. (RO)

Register 12.27: I2S_LC_HUNG_CONF_REG (0x0074)

<i>(reserved)</i>												<i>I2S_LC_FIFO_TIMEOUT_ENA</i>			<i>I2S_LC_FIFO_TIMEOUT_SHIFT</i>			<i>I2S_LC_FIFO_TIMEOUT</i>					
31												12	11	10				8	7				0
0 0 0 0 0 0 0 0 0 0 0 0												1	0	0	0	0x010						Reset	

I2S_LC_FIFO_TIMEOUT_ENA The enable bit for FIFO timeout. (R/W)

I2S_LC_FIFO_TIMEOUT_SHIFT The bits are used to set the tick counter threshold. The tick counter is reset when the counter value $\geq 88000/2^{i2s_lc_fifo_timeout_shift}$. (R/W)

I2S_LC_FIFO_TIMEOUT When the value of FIFO hung counter is equal to this bit value, sending data-timeout interrupt or receiving data-timeout interrupt will be triggered. (R/W)

Register 12.28: I2S_CONF1_REG (0x00a0)

(reserved)																I2S_TX_STOP_EN	I2S_RX_PCM_BYPASS	I2S_RX_PCM_CONF	I2S_TX_PCM_BYPASS	I2S_TX_PCM_CONF			
31																9	8	7	6	4	3	2	0
0 0 0 0 0 0 0 0 0 0 0 0 0 0 0 0																0	1	0x0	1	0x1	Reset		

I2S_TX_STOP_EN Set this bit and the transmitter will stop transmitting BCK signal and WS signal when tx FIFO is empty. (R/W)

I2S_RX_PCM_BYPASS Set this bit to bypass the Compress/Decompress module for the received data. (R/W)

I2S_RX_PCM_CONF Compress/Decompress module configuration bit. (R/W)
 0: Decompress received data;
 1: Compress received data.

I2S_TX_PCM_BYPASS Set this bit to bypass the Compress/Decompress module for the transmitted data. (R/W)

I2S_TX_PCM_CONF Compress/Decompress module configuration bit. (R/W)
 0: Decompress transmitted data;
 1: Compress transmitted data.

Register 12.29: I2S_PD_CONF_REG (0x00a4)

(reserved)																(reserved)	(reserved)	I2S_FIFO_FORCE_PU	I2S_FIFO_FORCE_PD	
31																4	3	2	1	0
0 0 0 0 0 0 0 0 0 0 0 0 0 0 0 0																1	0	1	0	Reset

I2S_FIFO_FORCE_PU Force FIFO power-up. (R/W)

I2S_FIFO_FORCE_PD Force FIFO power-down. (R/W)

Register 12.30: I2S_CONF2_REG (0x00a8)

(reserved)																I2S_INTER_VALID_EN			I2S_EXT_ADC_START_EN			I2S_LCD_EN			(reserved)			I2S_LCD_TX_SDX2_EN			I2S_LCD_TX_WRX2_EN			I2S_CAMERA_EN		
31																8	7	6	5	4	3	2	1	0										Reset		
0																0	0	1	0	0	0	0	0	0												

- I2S_INTER_VALID_EN** Set this bit to enable camera's internal validation. (R/W)
- I2S_EXT_ADC_START_EN** Set this bit to enable the start of external ADC . (R/W)
- I2S_LCD_EN** Set this bit to enable LCD mode. (R/W)
- I2S_LCD_TX_SDX2_EN** Set this bit to duplicate data pairs (Data Frame, Form 2) in LCD mode. (R/W)
- I2S_LCD_TX_WRX2_EN** One datum will be written twice in LCD mode. (R/W)
- I2S_CAMERA_EN** Set this bit to enable camera mode. (R/W)

Register 12.31: I2S_CLKM_CONF_REG (0x00ac)

(reserved)											I2S_CLKM_CONF_REG		(reserved)		I2S_CLKM_DIV_A				I2S_CLKM_DIV_B				I2S_CLKM_DIV_NUM								
31											22	21	20	19					14	13					8	7					0
0											0	0	0x00				0x00				4				0				Reset		

- I2S_CLKM_CONF_REG** Set this bit to enable clk_apll. (R/W)
- I2S_CLKM_DIV_A** Fractional clock divider's denominator value. (R/W)
- I2S_CLKM_DIV_B** Fractional clock divider's numerator value. (R/W)
- I2S_CLKM_DIV_NUM** I2S clock divider's integral value. (R/W)

Register 12.32: I2S_SAMPLE_RATE_CONF_REG (0x00b0)

<i>(reserved)</i>								<i>I2S_RX_BITS_MOD</i>						<i>I2S_TX_BITS_MOD</i>						<i>I2S_RX_BCK_DIV_NUM</i>						<i>I2S_TX_BCK_DIV_NUM</i>																					
31								24		23						18		17							12		11							6		5								0			
0								0								0								0								0								0							
								16								16								6						6						Reset											

I2S_RX_BITS_MOD Set the bits to configure the bit length of I2S receiver channel. (R/W)

I2S_TX_BITS_MOD Set the bits to configure the bit length of I2S transmitter channel. (R/W)

I2S_RX_BCK_DIV_NUM Bit clock configuration bit in receiver mode. (R/W)

I2S_TX_BCK_DIV_NUM Bit clock configuration bit in transmitter mode. (R/W)

Register 12.35: I2S_STATE_REG (0x00bc)

(reserved)													I2S_RX_FIFO_RESET_BACK				
(reserved)													I2S_TX_FIFO_RESET_BACK				
(reserved)													I2S_TX_IDLE				
31											3	2	1	0			
0	0	0	0	0	0	0	0	0	0	0	0	0	0	0	0	1	Reset

I2S_RX_FIFO_RESET_BACK This bit is used to confirm if the Rx FIFO reset is done. 1: reset is not ready; 0: reset is ready. (RO)

I2S_TX_FIFO_RESET_BACK This bit is used to confirm if the Tx FIFO reset is done. 1: reset is not ready; 0: reset is ready. (RO)

I2S_TX_IDLE The status bit of the transmitter. 1: the transmitter is idle; 0: the transmitter is busy. (RO)

13. UART Controllers

13.1 Overview

Embedded applications often require a simple method of exchanging data between devices that need minimal system resources. The Universal Asynchronous Receiver/Transmitter (UART) is one such standard that can realize a flexible full-duplex data exchange among different devices. The three UART controllers available on a chip are compatible with UART-enabled devices from various manufacturers. The UART can also carry out an IrDA (Infrared Data Exchange), or function as an RS-485 modem.

All UART controllers integrated in the ESP32 feature an identical set of registers for ease of programming and flexibility. In this documentation, these controllers are referred to as UART n , where $n = 0, 1, \text{ and } 2$, referring to UART0, UART1, and UART2, respectively.

13.2 UART Features

The UART modules have the following main features:

- Programmable baud rate
- 1024 x 8-bit RAM shared by three UART transmit-FIFOs and receive-FIFOs
- Supports input baud rate self-check
- Supports 5/6/7/8 bits of data length
- Supports 1/1.5/2/3/4 STOP bits
- Supports parity bit
- Supports RS485 Protocol
- Supports IrDA Protocol
- Supports DMA to communicate data in high speed
- Supports UART wake-up
- Supports both software and hardware flow control

13.3 Functional Description

13.3.1 Introduction

UART is a character-oriented data link that can be used to achieve communication between two devices. The asynchronous mode of transmission means that it is not necessary to add clocking information to the data being sent. This, in turn, requires that the data rate, STOP bits, parity, etc., be identical at the transmitting and receiving end for the devices to communicate successfully.

A typical UART frame begins with a START bit, followed by a “character” and an optional parity bit for error detection, and it ends with a STOP condition. The UART controllers available on the ESP32 provide hardware support for multiple lengths of data and STOP bits. In addition, the controllers support both software and hardware flow control, as well as DMA, for seamless high-speed data transfer. This allows the developer to employ multiple UART ports in the system with minimal software overhead.

13.3.2 UART Architecture

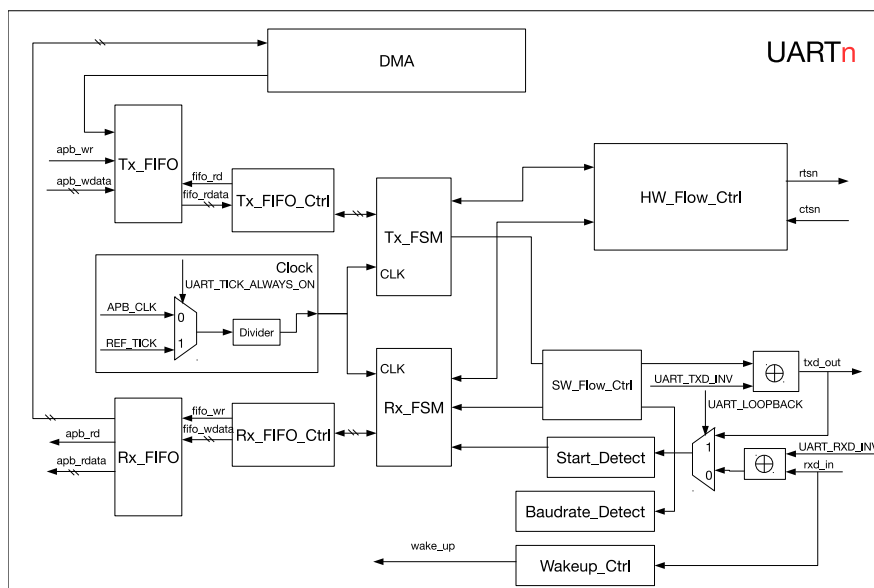


Figure 78: UART Basic Structure

Figure 78 shows the basic block diagram of the UART controller. The UART block can derive its clock from two sources: the 80-MHz APB_CLK, or the reference clock REF_TICK (please refer to Chapter [Reset and Clock](#) for more details). These two clock sources can be selected by configuring UART_TICK_REF_ALWAYS_ON.

Then, a divider in the clock path divides the selected clock source to generate clock signals that drive the UART module. UART_CLKDIV_REG contains the clock divider value in two parts — UART_CLKDIV (integral part) and UART_CLKDIV_FRAG (decimal part).

The UART controller can be further broken down into two functional blocks — the transmit block and the receive block.

The transmit block contains a transmit-FIFO buffer, which buffers data awaiting to be transmitted. Software can write Tx_FIFO via APB, and transmit data into Tx_FIFO via DMA. Tx_FIFO_Ctrl is used to control read- and write-access to the Tx_FIFO. When Tx_FIFO is not null, Tx_FSM reads data via Tx_FIFO_Ctrl, and transmits data out according to the set frame format. The outgoing bit stream can be inverted by appropriately configuring the register UART_TXD_INV.

The receive-block contains a receive-FIFO buffer, which buffers incoming data awaiting to be processed. The input bit stream, rxd_in, is fed to the UART controller. Negation of the input stream can be controlled by configuring the UART_RXD_INV register. Baudrate_Detect measures the baud rate of the input signal by measuring the minimum pulse width of the input bit stream. Start_Detect is used to detect a START bit in a frame of incoming data. After detecting the START bit, RX_FSM stores data retrieved from the received frame into Rx_FIFO through Rx_FIFO_Ctrl.

Software can read data in the Rx_FIFO through the APB. In order to free the CPU from engaging in data transfer operations, the DMA can be configured for sending or receiving data.

HW_Flow_Ctrl is able to control the data flow of rxd_in and txd_out through standard UART RTS and CTS flow control signals (rtsn_out and ctsn_in). SW_Flow_Ctrl controls the data flow by inserting special characters in the incoming and outgoing data flow. When UART is in Light-sleep mode (refer to Chapter [Low-Power Management](#)), Wakeup_Ctrl will start counting pulses in rxd_in. If the number of pulses is greater than UART_ACTIVE_THRESHOLD, a wake_up signal will be generated and sent to RTC. RTC will then wake up the

UART controller.

13.3.3 UART RAM

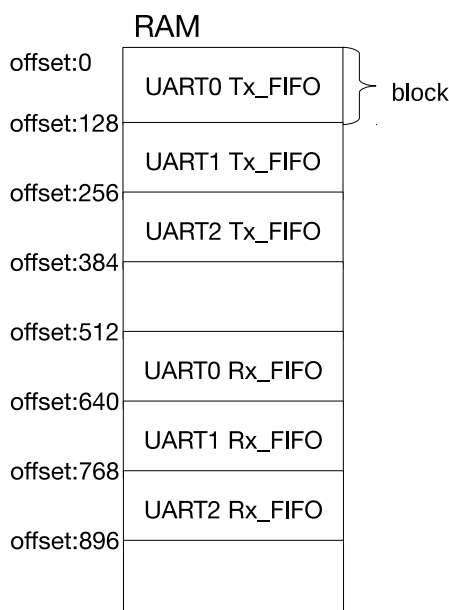


Figure 79: UART shared RAM

Three UART controllers share a 1024 x 8-bit RAM space. As illustrated in Figure 79, RAM is allocated in different blocks. One block holds 128 x 8-bit data. Figure 79 illustrates the default RAM allocated to Tx_FIFO and Rx_FIFO of the three UART controllers. Tx_FIFO of UART n can be extended by setting UART n _TX_SIZE, while Rx_FIFO of UART n can be extended by setting UART n _RX_SIZE.

NOTICE: Extending the FIFO space of a UART controller may take up the FIFO space of another UART controller.

If none of the UART controllers is active, setting UART_MEM_PD, UART1_MEM_PD, and UART2_MEM_PD can prompt the RAM to enter low-power mode.

In UART0, bit UART_TXFIFO_RST and bit UART_RXFIFO_RST can be set to reset Tx_FIFO or Rx_FIFO, respectively. In UART1, bit UART1_TXFIFO_RST and bit UART1_RXFIFO_RST can be set to reset Tx_FIFO or Rx_FIFO, respectively.

Note:

UART2 doesn't have any register to reset Tx_FIFO or Rx_FIFO, and the UART1_TXFIFO_RST and UART1_RXFIFO_RST in UART1 may impact the functioning of UART2. Therefore, these 2 registers in UART1 should only be used when the Tx_FIFO and Rx_FIFO in UART2 do not have any data.

13.3.4 Baud Rate Detection

Setting UART_AUTOBAUD_EN for a UART controller will enable the baud rate detection function. The Baudrate_Detect block shown in Figure 78 can filter glitches with a pulse width lower than UART_GLITCH_FILT.

In order to use the baud rate detection feature, some random data should be sent to the receiver before starting

the UART communication stream. This is required so that the baud rate can be determined based on the pulse width. `UART_LOWPULSE_MIN_CNT` stores minimum low-pulse width, `UART_HIGHPULSE_MIN_CNT` stores minimum high-pulse width. By reading these two registers, software can calculate the baud rate of the transmitter.

13.3.5 UART Data Frame

Figure 80 shows the basic data frame structure. A data frame starts with a START condition and ends with a STOP condition. The START condition requires 1 bit and the STOP condition can be realized using 1/1.5/2/3/4-bit widths (as set by `UART_BIT_NUM`, `UART_DL1_EN`, and `UART_DLO_EN`). The START is low level, while the STOP is high level.

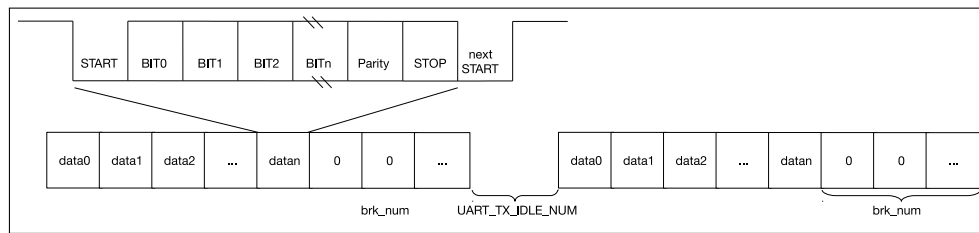


Figure 80: UART Data Frame Structure

The length of a character (BIT0 to BITn) can comprise 5 to 8 bits and can be configured by `UART_BIT_NUM`. When `UART_PARITY_EN` is set, the UART controller hardware will add the appropriate parity bit after the data. `UART_PARITY` is used to select odd parity or even parity. If the receiver detects an error in the input character, interrupt `UART_PARITY_ERR_INT` will be generated. If the receiver detects an error in the frame format, interrupt `UART_FRM_ERR_INT` will be generated.

Interrupt `UART_TX_DONE_INT` will be generated when all data in `Tx_FIFO` have been transmitted. When `UART_TXD_BRK` is set, the transmitter sends several NULL characters after the process of sending data is completed. The number of NULL characters can be configured by `UART_TX_BRK_NUM`. After the transmitter finishes sending all NULL characters, interrupt `UART_TX_BRK_DONE_INT` will be generated. The minimum interval between data frames can be configured with `UART_TX_IDLE_NUM`. If the idle time of a data frame is equal to, or larger than, the configured value of register `UART_TX_IDLE_NUM`, interrupt `UART_TX_BRK_IDLE_DONE_INT` will be generated.

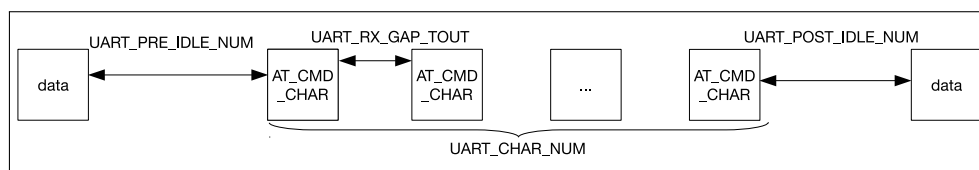


Figure 81: AT_CMD Character Format

Figure 81 shows a special AT_CMD character format. If the receiver constantly receives `UART_AT_CMD_CHAR` characters and these characters satisfy the following conditions, interrupt `UART_AT_CMD_CHAR_DET_INT` will be generated.

- Between the first `UART_AT_CMD_CHAR` and the last non-`UART_AT_CMD_CHAR`, there are at least `UART_PER_IDLE_NUM` APB clock cycles.
- Between every `UART_AT_CMD_CHAR` character there are at least `UART_RX_GAP_TOUT` APB clock cycles.

- The number of received UART_AT_CMD_CHAR characters must be equal to, or greater than, UART_CHAR_NUM.
- Between the last UART_AT_CMD_CHAR character received and the next non-UART_AT_CMD_CHAR, there are at least UART_POST_IDLE_NUM APB clock cycles.

13.3.6 Flow Control

UART controller supports both hardware and software flow control. Hardware flow control regulates data flow through input signal `dsrn_in` and output signal `rtsn_out`. Software flow control regulates data flow by inserting special characters in the flow of sent data and by detecting special characters in the flow of received data.

13.3.6.1 Hardware Flow Control

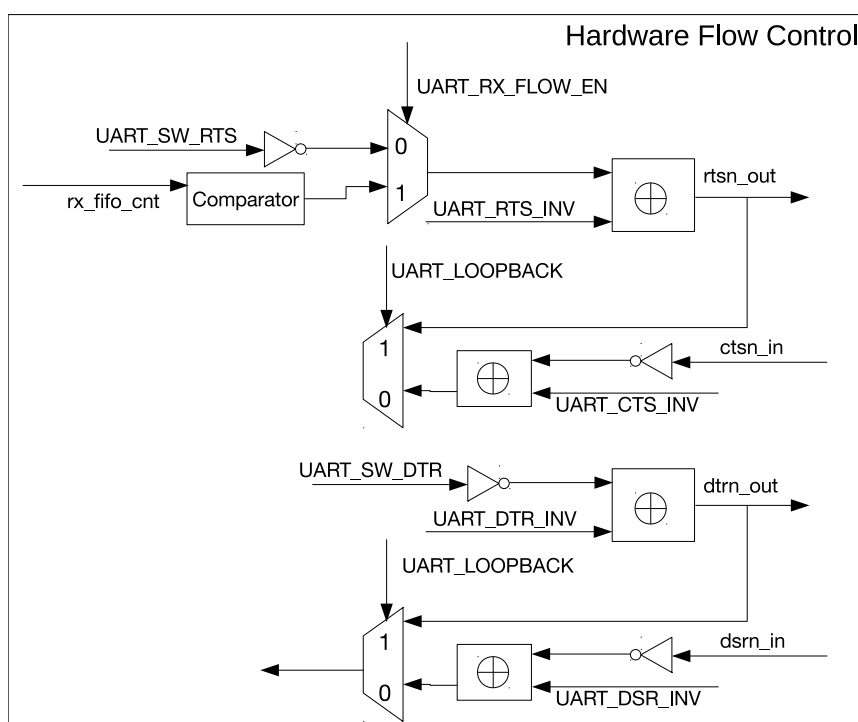


Figure 82: Hardware Flow Control

Figure 82 illustrates how the UART hardware flow control works. In hardware flow control, a high state of the output signal `rtsn_out` signifies that a data transmission is requested, while a low state of the same signal notifies the counterpart to stop data transmission until `rtsn_out` is pulled high again. There are two ways for a transmitter to realize hardware flow control:

- `UART_RX_FLOW_EN` is 0: The level of `rtsn_out` can be changed by configuring `UART_SW_RTS`.
- `UART_RX_FLOW_EN` is 1: If data in `Rx_FIFO` is greater than `UART_RXFIFO_FULL_THRHD`, the level of `rtsn_out` will be lowered.

If the UART controller detects an edge on `ctsn_in`, it will generate interrupt `UART_CTS_CHG_INT` and will stop transmitting data, once the current data transmission is completed.

The high level of the output signal `dtrn_out` signifies that the transmitter has finished data preparation. UART controller will generate interrupt `UART_DSR_CHG_INT`, after it detects an edge on the input signal `dsrn_in`. After

the software detects the above-mentioned interrupt, the input signal level of `dsrn_in` can be figured out by reading `UART_DSRN`. The software then decides whether it is able to receive data at that time or not.

Setting `UART_LOOPBACK` will enable the UART loopback detection function. In this mode, the output signal `txd_out` of UART is connected to its input signal `rx_d_in`, `rtsn_out` is connected to `ctsn_in`, and `dtrn_out` is connected to `dsrn_out`. If the data transmitted corresponds to the data received, UART is able to transmit and receive data normally.

13.3.6.2 Software Flow Control

Software can force the transmitter to stop transmitting data by setting `UART_FORCE_XOFF`, as well as force the transmitter to continue sending data by setting `UART_FORCE_XON`.

UART can also control the software flow by transmitting special characters. Setting `UART_SW_FLOW_CON_EN` will enable the software flow control function. If the number of data bytes that UART has received exceeds that of the `UART_XOFF` threshold, the UART controller can send `UART_XOFF_CHAR` to instruct its counterpart to stop data transmission.

When `UART_SW_FLOW_CON_EN` is 1, software can send flow control characters at any time. When `UART_SEND_XOFF` is set, the transmitter will insert a `UART_XOFF_CHAR` and send it after the current data transmission is completed. When `UART_SEND_XON` is set, the transmitter will insert a `UART_XON_CHAR` and send it after the current data transmission is completed.

13.3.7 UART DMA

For information on the UART DMA, please refer to Chapter [DMA Controller](#).

13.3.8 UART Interrupts

- `UART_AT_CMD_CHAR_DET_INT`: Triggered when the receiver detects the configured `at_cmd` char.
- `UART_RS485_CLASH_INT`: Triggered when a collision is detected between transmitter and receiver in RS-485 mode.
- `UART_RS485_FRM_ERR_INT`: Triggered when a data frame error is detected in RS-485.
- `UART_RS485_PARITY_ERR_INT`: Triggered when a parity error is detected in RS-485 mode.
- `UART_TX_DONE_INT`: Triggered when the transmitter has sent out all FIFO data.
- `UART_TX_BRK_IDLE_DONE_INT`: Triggered when the transmitter's idle state has been kept to a minimum after sending the last data.
- `UART_TX_BRK_DONE_INT`: Triggered when the transmitter completes sending NULL characters, after all data in transmit-FIFO are sent.
- `UART_GLITCH_DET_INT`: Triggered when the receiver detects a START bit.
- `UART_SW_XOFF_INT`: Triggered, if the receiver gets an Xon char when `uart_sw_flow_con_en` is set to 1.
- `UART_SW_XON_INT`: Triggered, if the receiver gets an Xoff char when `uart_sw_flow_con_en` is set to 1.
- `UART_RXFIFO_TOUT_INT`: Triggered when the receiver takes more time than `rx_tout_thrhd` to receive a byte.

- UART_BRK_DET_INT: Triggered when the receiver detects a 0 level after the STOP bit.
- UART_CTS_CHG_INT: Triggered when the receiver detects an edge change of the CTS_n signal.
- UART_DSR_CHG_INT: Triggered when the receiver detects an edge change of the DSR_n signal.
- UART_RXFIFO_OVF_INT: Triggered when the receiver gets more data than the FIFO can store.
- UART_FRM_ERR_INT: Triggered when the receiver detects a data frame error .
- UART_PARITY_ERR_INT: Triggered when the receiver detects a parity error in the data.
- UART_TXFIFO_EMPTY_INT: Triggered when the amount of data in the transmit-FIFO is less than what tx_mem_cnttxfifo_cnt specifies.
- UART_RXFIFO_FULL_INT: Triggered when the receiver gets more data than what (rx_flow_thrhd_h3, rx_flow_thrhd) specifies.

13.3.9 UCHI Interrupts

- UHCI_SEND_A_REG_Q_INT: When using the always_send registers to send a series of short packets, this is triggered when DMA has sent a short packet.
- UHCI_SEND_S_REG_Q_INT: When using the single_send registers to send a series of short packets, this is triggered when DMA has sent a short packet.
- UHCI_OUT_TOTAL_EOF_INT: Triggered when all data have been sent.
- UHCI_OUTLINK_EOF_ERR_INT: Triggered when there are some errors in EOF in the outlink descriptor.
- UHCI_IN_DSCR_EMPTY_INT: Triggered when there are not enough inlinks for DMA.
- UHCI_OUT_DSCR_ERR_INT: Triggered when there are some errors in the inlink descriptor.
- UHCI_IN_DSCR_ERR_INT: Triggered when there are some errors in the outlink descriptor.
- UHCI_OUT_EOF_INT: Triggered when the current descriptor's EOF bit is 1.
- UHCI_OUT_DONE_INT: Triggered when an outlink descriptor is completed.
- UHCI_IN_ERR_EOF_INT: Triggered when there are some errors in EOF in the inlink descriptor.
- UHCI_IN_SUC_EOF_INT: Triggered when a data packet has been received.
- UHCI_IN_DONE_INT: Triggered when an inlink descriptor has been completed.
- UHCI_TX_HUNG_INT: Triggered when DMA takes much time to read data from RAM.
- UHCI_RX_HUNG_INT: Triggered when DMA takes much time to receive data .
- UHCI_TX_START_INT: Triggered when DMA detects a separator char.
- UHCI_RX_START_INT: Triggered when a separator char has been sent.

13.4 Register Summary

Name	Description	UART0	UART1	UART2	Acc
Configuration registers					
UART_CONF0_REG	Configuration register 0	0x3FF40020	0x3FF50020	0x3FF6E020	R/W

UART_CONF1_REG	Configuration register 1	0x3FF40024	0x3FF50024	0x3FF6E024	R/W
UART_CLKDIV_REG	Clock divider configuration	0x3FF40014	0x3FF50014	0x3FF6E014	R/W
UART_FLOW_CONF_REG	Software flow-control configuration	0x3FF40034	0x3FF50034	0x3FF6E034	R/W
UART_SWFC_CONF_REG	Software flow-control character configuration	0x3FF4003C	0x3FF5003C	0x3FF6E03C	R/W
UART_SLEEP_CONF_REG	Sleep-mode configuration	0x3FF40038	0x3FF50038	0x3FF6E038	R/W
UART_IDLE_CONF_REG	Frame-end idle configuration	0x3FF40040	0x3FF50040	0x3FF6E040	R/W
UART_RS485_CONF_REG	RS485 mode configuration	0x3FF40044	0x3FF50044	0x3FF6E044	R/W
Status registers					
UART_STATUS_REG	UART status register	0x3FF4001C	0x3FF5001C	0x3FF6E01C	RO
Autobaud registers					
UART_AUTOBAUD_REG	Autobaud configuration register	0x3FF40018	0x3FF50018	0x3FF6E018	R/W
UART_LOWPULSE_REG	Autobaud minimum low pulse duration register	0x3FF40028	0x3FF50028	0x3FF6E028	RO
UART_HIGHPULSE_REG	Autobaud minimum high pulse duration register	0x3FF4002C	0x3FF5002C	0x3FF6E02C	RO
UART_POSPULSE_REG	Autobaud high pulse register	0x3FF40068	0x3FF50068	0x3FF6E068	RO
UART_NEGPULSE_REG	Autobaud low pulse register	0x3FF4006C	0x3FF5006C	0x3FF6E06C	RO
UART_RXD_CNT_REG	Autobaud edge change count register	0x3FF40030	0x3FF50030	0x3FF6E030	RO
AT escape sequence detection configuration					
UART_AT_CMD_PRECNT_REG	Pre-sequence timing configuration	0x3FF40048	0x3FF50048	0x3FF6E048	R/W
UART_AT_CMD_POSTCNT_REG	Post-sequence timing configuration	0x3FF4004C	0x3FF5004C	0x3FF6E04C	R/W
UART_AT_CMD_GAPTOUR_REG	Timeout configuration	0x3FF40050	0x3FF50050	0x3FF6E050	R/W
UART_AT_CMD_CHAR_REG	AT escape sequence detection configuration	0x3FF40054	0x3FF50054	0x3FF6E054	R/W
FIFO configuration					
UART_FIFO_REG	FIFO data register	0x3FF40000	0x3FF50000	0x3FF6E000	RO
UART_MEM_CONF_REG	UART threshold and allocation configuration	0x3FF40058	0x3FF50058	0x3FF6E058	R/W
UART_MEM_CNT_STATUS_REG	Receive and transmit memory configuration	0x3FF40064	0x3FF50064	0x3FF6E064	RO
Interrupt registers					

UART_INT_RAW_REG	Raw interrupt status	0x3FF40004	0x3FF50004	0x3FF6E004	RO
UART_INT_ST_REG	Masked interrupt status	0x3FF40008	0x3FF50008	0x3FF6E008	RO
UART_INT_ENA_REG	Interrupt enable bits	0x3FF4000C	0x3FF5000C	0x3FF6E00C	R/W
UART_INT_CLR_REG	Interrupt clear bits	0x3FF40010	0x3FF50010	0x3FF6E010	WO

Name	Description	UDMA0	UDMA1	Acc
Configuration registers				
UHCI_CONF0_REG	UART and frame separation config	0x3FF54000	0x3FF4C000	R/W
UHCI_CONF1_REG	UHCI config register	0x3FF5402C	0x3FF4C02C	R/W
UHCI_ESCAPE_CONF_REG	Escape characters configuration	0x3FF54064	0x3FF4C064	R/W
UHCI_HUNG_CONF_REG	Timeout configuration	0x3FF54068	0x3FF4C068	R/W
UHCI_ESC_CONF0_REG	Escape sequence configuration register 0	0x3FF540B0	0x3FF4C0B0	R/W
UHCI_ESC_CONF1_REG	Escape sequence configuration register 1	0x3FF540B4	0x3FF4C0B4	R/W
UHCI_ESC_CONF2_REG	Escape sequence configuration register 2	0x3FF540B8	0x3FF4C0B8	R/W
UHCI_ESC_CONF3_REG	Escape sequence configuration register 3	0x3FF540BC	0x3FF4C0BC	R/W
DMA configuration				
UHCI_DMA_OUT_LINK_REG	Link descriptor address and control	0x3FF54024	0x3FF4C024	R/W
UHCI_DMA_IN_LINK_REG	Link descriptor address and control	0x3FF54028	0x3FF4C028	R/W
UHCI_DMA_OUT_PUSH_REG	FIFO data push register	0x3FF54018	0x3FF4C018	R/W
UHCI_DMA_IN_POP_REG	FIFO data pop register	0x3FF54020	0x3FF4C020	RO
DMA status				
UHCI_DMA_OUT_STATUS_REG	DMA FIFO status	0x3FF54014	0x3FF4C014	RO
UHCI_DMA_OUT_EOF_DES_ADDR_REG	Out EOF link descriptor address on success	0x3FF54038	0x3FF4C038	RO
UHCI_DMA_OUT_EOF_BFR_DES_ADDR_REG	Out EOF link descriptor address on error	0x3FF54044	0x3FF4C044	RO
UHCI_DMA_IN_SUC_EOF_DES_ADDR_REG	In EOF link descriptor address on success	0x3FF5403C	0x3FF4C03C	RO
UHCI_DMA_IN_ERR_EOF_DES_ADDR_REG	In EOF link descriptor address on error	0x3FF54040	0x3FF4C040	RO
UHCI_DMA_IN_DSCR_REG	Current inlink descriptor, first word	0x3FF5404C	0x3FF4C04C	RO
UHCI_DMA_IN_DSCR_BF0_REG	Current inlink descriptor, second word	0x3FF54050	0x3FF4C050	RO
UHCI_DMA_IN_DSCR_BF1_REG	Current inlink descriptor, third word	0x3FF54054	0x3FF4C054	RO

UHCI_DMA_OUT_DSCR_REG	Current outlink descriptor, first word	0x3FF54058	0x3FF4C058	RO
UHCI_DMA_OUT_DSCR_BF0_REG	Current outlink descriptor, second word	0x3FF5405C	0x3FF4C05C	RO
UHCI_DMA_OUT_DSCR_BF1_REG	Current outlink descriptor, third word	0x3FF54060	0x3FF4C060	RO
Interrupt registers				
UHCI_INT_RAW_REG	Raw interrupt status	0x3FF54004	0x3FF4C004	RO
UHCI_INT_ST_REG	Masked interrupt status	0x3FF54008	0x3FF4C008	RO
UHCI_INT_ENA_REG	Interrupt enable bits	0x3FF5400C	0x3FF4C00C	R/W
UHCI_INT_CLR_REG	Interrupt clear bits	0x3FF54010	0x3FF4C010	WO

Register 13.2: UART_INT_RAW_REG (0x4)

(reserved)																		UART_AT_CMD_CHAR_DET_INT_RAW												UART_RS485_CLASH_INT_RAW	UART_RS485_FRM_ERR_INT_RAW	UART_RS485_PARITY_ERR_INT_RAW	UART_TX_DONE_INT_RAW	UART_TX_BRK_IDLE_DONE_INT_RAW	UART_GLITCH_DET_INT_RAW	UART_SW_XOFF_INT_RAW	UART_SW_XON_INT_RAW	UART_RXFIFO_TOUT_INT_RAW	UART_BRK_DET_INT_RAW	UART_CTS_CHG_INT_RAW	UART_DSR_CHG_INT_RAW	UART_RXFIFO_OVF_INT_RAW	UART_FRM_ERR_INT_RAW	UART_PARITY_ERR_INT_RAW	UART_TXFIFO_EMPTY_INT_RAW	UART_RXFIFO_FULL_INT_RAW	Reset
31																			19	18	17	16	15	14	13	12	11	10	9	8	7	6	5	4	3	2	1	0									
0	0	0	0	0	0	0	0	0	0	0	0	0	0	0	0	0	0	0	0	0	0	0	0	0	0	0	0	0	0	0	0																

UART_AT_CMD_CHAR_DET_INT_RAW The raw interrupt status bit for the [UART_AT_CMD_CHAR_DET_INT](#) interrupt. (RO)

UART_RS485_CLASH_INT_RAW The raw interrupt status bit for the [UART_RS485_CLASH_INT](#) interrupt. (RO)

UART_RS485_FRM_ERR_INT_RAW The raw interrupt status bit for the [UART_RS485_FRM_ERR_INT](#) interrupt. (RO)

UART_RS485_PARITY_ERR_INT_RAW The raw interrupt status bit for the [UART_RS485_PARITY_ERR_INT](#) interrupt. (RO)

UART_TX_DONE_INT_RAW The raw interrupt status bit for the [UART_TX_DONE_INT](#) interrupt. (RO)

UART_TX_BRK_IDLE_DONE_INT_RAW The raw interrupt status bit for the [UART_TX_BRK_IDLE_DONE_INT](#) interrupt. (RO)

UART_TX_BRK_DONE_INT_RAW The raw interrupt status bit for the [UART_TX_BRK_DONE_INT](#) interrupt. (RO)

UART_GLITCH_DET_INT_RAW The raw interrupt status bit for the [UART_GLITCH_DET_INT](#) interrupt. (RO)

UART_SW_XOFF_INT_RAW The raw interrupt status bit for the [UART_SW_XOFF_INT](#) interrupt. (RO)

UART_SW_XON_INT_RAW The raw interrupt status bit for the [UART_SW_XON_INT](#) interrupt. (RO)

UART_RXFIFO_TOUT_INT_RAW The raw interrupt status bit for the [UART_RXFIFO_TOUT_INT](#) interrupt. (RO)

UART_BRK_DET_INT_RAW The raw interrupt status bit for the [UART_BRK_DET_INT](#) interrupt. (RO)

UART_CTS_CHG_INT_RAW The raw interrupt status bit for the [UART_CTS_CHG_INT](#) interrupt. (RO)

UART_DSR_CHG_INT_RAW The raw interrupt status bit for the [UART_DSR_CHG_INT](#) interrupt. (RO)

UART_RXFIFO_OVF_INT_RAW The raw interrupt status bit for the [UART_RXFIFO_OVF_INT](#) interrupt. (RO)

UART_FRM_ERR_INT_RAW The raw interrupt status bit for the [UART_FRM_ERR_INT](#) interrupt. (RO)

UART_PARITY_ERR_INT_RAW The raw interrupt status bit for the [UART_PARITY_ERR_INT](#) interrupt. (RO)

UART_TXFIFO_EMPTY_INT_RAW The raw interrupt status bit for the [UART_TXFIFO_EMPTY_INT](#) interrupt. (RO)

UART_RXFIFO_FULL_INT_RAW The raw interrupt status bit for the [UART_RXFIFO_FULL_INT](#) interrupt. (RO)

Register 13.3: UART_INT_ST_REG (0x8)

(reserved)																			UART_AT_CMD_CHAR_DET_INT_ST UART_RS485_CLASH_INT_ST UART_RS485_FRM_ERR_INT_ST UART_RS485_PARITY_ERR_INT_ST UART_TX_DONE_INT_ST UART_TX_BRK_IDLE_DONE_INT_ST UART_GLITCH_DET_INT_ST UART_SW_XOFF_INT_ST UART_SW_XON_INT_ST UART_RXFIFO_TOUT_INT_ST UART_BRK_DET_INT_ST UART_CTS_CHG_INT_ST UART_DSR_CHG_INT_ST UART_RXFIFO_OVF_INT_ST UART_FRM_ERR_INT_ST UART_PARITY_ERR_INT_ST UART_TXFIFO_EMPTY_INT_ST UART_RXFIFO_FULL_INT_ST																				
31																				19	18	17	16	15	14	13	12	11	10	9	8	7	6	5	4	3	2	1	0
0 0																																Reset							

UART_AT_CMD_CHAR_DET_INT_ST The masked interrupt status bit for the [UART_AT_CMD_CHAR_DET_INT](#) interrupt. (RO)

UART_RS485_CLASH_INT_ST The masked interrupt status bit for the [UART_RS485_CLASH_INT](#) interrupt. (RO)

UART_RS485_FRM_ERR_INT_ST The masked interrupt status bit for the [UART_RS485_FRM_ERR_INT](#) interrupt. (RO)

UART_RS485_PARITY_ERR_INT_ST The masked interrupt status bit for the [UART_RS485_PARITY_ERR_INT](#) interrupt. (RO)

UART_TX_DONE_INT_ST The masked interrupt status bit for the [UART_TX_DONE_INT](#) interrupt. (RO)

UART_TX_BRK_IDLE_DONE_INT_ST The masked interrupt status bit for the [UART_TX_BRK_IDLE_DONE_INT](#) interrupt. (RO)

UART_TX_BRK_DONE_INT_ST The masked interrupt status bit for the [UART_TX_BRK_DONE_INT](#) interrupt. (RO)

UART_GLITCH_DET_INT_ST The masked interrupt status bit for the [UART_GLITCH_DET_INT](#) interrupt. (RO)

UART_SW_XOFF_INT_ST The masked interrupt status bit for the [UART_SW_XOFF_INT](#) interrupt. (RO)

UART_SW_XON_INT_ST The masked interrupt status bit for the [UART_SW_XON_INT](#) interrupt. (RO)

UART_RXFIFO_TOUT_INT_ST The masked interrupt status bit for the [UART_RXFIFO_TOUT_INT](#) interrupt. (RO)

UART_BRK_DET_INT_ST The masked interrupt status bit for the [UART_BRK_DET_INT](#) interrupt. (RO)

UART_CTS_CHG_INT_ST The masked interrupt status bit for the [UART_CTS_CHG_INT](#) interrupt. (RO)

UART_DSR_CHG_INT_ST The masked interrupt status bit for the [UART_DSR_CHG_INT](#) interrupt. (RO)

UART_RXFIFO_OVF_INT_ST The masked interrupt status bit for the [UART_RXFIFO_OVF_INT](#) interrupt. (RO)

UART_FRM_ERR_INT_ST The masked interrupt status bit for the [UART_FRM_ERR_INT](#) interrupt. (RO)

UART_PARITY_ERR_INT_ST The masked interrupt status bit for the [UART_PARITY_ERR_INT](#) interrupt. (RO)

UART_TXFIFO_EMPTY_INT_ST The masked interrupt status bit for the [UART_TXFIFO_EMPTY_INT](#) interrupt. (RO)

UART_RXFIFO_FULL_INT_ST The masked interrupt status bit for [UART_RXFIFO_FULL_INT](#). (RO)

Register 13.4: UART_INT_ENA_REG (0xC)

(reserved)																			UART_AT_CMD_CHAR_DET_INT_ENA UART_RS485_CLASH_INT_ENA UART_RS485_FRM_ERR_INT_ENA UART_RS485_PARITY_ERR_INT_ENA UART_TX_DONE_INT_ENA UART_TX_BRK_IDLE_DONE_INT_ENA UART_TX_BRK_DONE_INT_ENA UART_GLITCH_DET_INT_ENA UART_SW_XOFF_INT_ENA UART_SW_XON_INT_ENA UART_RXFIFO_TOUT_INT_ENA UART_BRK_DET_INT_ENA UART_CTS_CHG_INT_ENA UART_DSR_CHG_INT_ENA UART_RXFIFO_OVF_INT_ENA UART_FRM_ERR_INT_ENA UART_PARITY_ERR_INT_ENA UART_TXFIFO_EMPTY_INT_ENA UART_RXFIFO_FULL_INT_ENA																				
31																				19	18	17	16	15	14	13	12	11	10	9	8	7	6	5	4	3	2	1	0
0																																Reset							

UART_AT_CMD_CHAR_DET_INT_ENA The interrupt enable bit for the [UART_AT_CMD_CHAR_DET_INT](#) interrupt. (R/W)

UART_RS485_CLASH_INT_ENA The interrupt enable bit for the [UART_RS485_CLASH_INT](#) interrupt. (R/W)

UART_RS485_FRM_ERR_INT_ENA The interrupt enable bit for the [UART_RS485_FRM_ERR_INT](#) interrupt. (R/W)

UART_RS485_PARITY_ERR_INT_ENA The interrupt enable bit for the [UART_RS485_PARITY_ERR_INT](#) interrupt. (R/W)

UART_TX_DONE_INT_ENA The interrupt enable bit for the [UART_TX_DONE_INT](#) interrupt. (R/W)

UART_TX_BRK_IDLE_DONE_INT_ENA The interrupt enable bit for the [UART_TX_BRK_IDLE_DONE_INT](#) interrupt. (R/W)

UART_TX_BRK_DONE_INT_ENA The interrupt enable bit for the [UART_TX_BRK_DONE_INT](#) interrupt. (R/W)

UART_GLITCH_DET_INT_ENA The interrupt enable bit for the [UART_GLITCH_DET_INT](#) interrupt. (R/W)

UART_SW_XOFF_INT_ENA The interrupt enable bit for the [UART_SW_XOFF_INT](#) interrupt. (R/W)

UART_SW_XON_INT_ENA The interrupt enable bit for the [UART_SW_XON_INT](#) interrupt. (R/W)

UART_RXFIFO_TOUT_INT_ENA The interrupt enable bit for the [UART_RXFIFO_TOUT_INT](#) interrupt. (R/W)

UART_BRK_DET_INT_ENA The interrupt enable bit for the [UART_BRK_DET_INT](#) interrupt. (R/W)

UART_CTS_CHG_INT_ENA The interrupt enable bit for the [UART_CTS_CHG_INT](#) interrupt. (R/W)

UART_DSR_CHG_INT_ENA The interrupt enable bit for the [UART_DSR_CHG_INT](#) interrupt. (R/W)

UART_RXFIFO_OVF_INT_ENA The interrupt enable bit for the [UART_RXFIFO_OVF_INT](#) interrupt. (R/W)

UART_FRM_ERR_INT_ENA The interrupt enable bit for the [UART_FRM_ERR_INT](#) interrupt. (R/W)

UART_PARITY_ERR_INT_ENA The interrupt enable bit for the [UART_PARITY_ERR_INT](#) interrupt. (R/W)

UART_TXFIFO_EMPTY_INT_ENA The interrupt enable bit for the [UART_TXFIFO_EMPTY_INT](#) interrupt. (R/W)

UART_RXFIFO_FULL_INT_ENA The interrupt enable bit for the [UART_RXFIFO_FULL_INT](#) interrupt. (R/W)

Register 13.5: UART_INT_CLR_REG (0x10)

31	(reserved)																		0	Reset	
19	18	17	16	15	14	13	12	11	10	9	8	7	6	5	4	3	2	1	0		
0	0	0	0	0	0	0	0	0	0	0	0	0	0	0	0	0	0	0	0	0	

UART_AT_CMD_CHAR_DET_INT_CLR Set this bit to clear the [UART_AT_CMD_CHAR_DET_INT](#) interrupt. (WO)

UART_RS485_CLASH_INT_CLR Set this bit to clear the [UART_RS485_CLASH_INT](#) interrupt. (WO)

UART_RS485_FRM_ERR_INT_CLR Set this bit to clear the [UART_RS485_FRM_ERR_INT](#) interrupt. (WO)

UART_RS485_PARITY_ERR_INT_CLR Set this bit to clear the [UART_RS485_PARITY_ERR_INT](#) interrupt. (WO)

UART_TX_DONE_INT_CLR Set this bit to clear the [UART_TX_DONE_INT](#) interrupt. (WO)

UART_TX_BRK_IDLE_DONE_INT_CLR Set this bit to clear the [UART_TX_BRK_IDLE_DONE_INT](#) interrupt. (WO)

UART_TX_BRK_DONE_INT_CLR Set this bit to clear the [UART_TX_BRK_DONE_INT](#) interrupt. (WO)

UART_GLITCH_DET_INT_CLR Set this bit to clear the [UART_GLITCH_DET_INT](#) interrupt. (WO)

UART_SW_XOFF_INT_CLR Set this bit to clear the [UART_SW_XOFF_INT](#) interrupt. (WO)

UART_SW_XON_INT_CLR Set this bit to clear the [UART_SW_XON_INT](#) interrupt. (WO)

UART_RXFIFO_TOUT_INT_CLR Set this bit to clear the [UART_RXFIFO_TOUT_INT](#) interrupt. (WO)

UART_BRK_DET_INT_CLR Set this bit to clear the [UART_BRK_DET_INT](#) interrupt. (WO)

UART_CTS_CHG_INT_CLR Set this bit to clear the [UART_CTS_CHG_INT](#) interrupt. (WO)

UART_DSR_CHG_INT_CLR Set this bit to clear the [UART_DSR_CHG_INT](#) interrupt. (WO)

UART_RXFIFO_OVF_INT_CLR Set this bit to clear the [UART_RXFIFO_OVF_INT](#) interrupt. (WO)

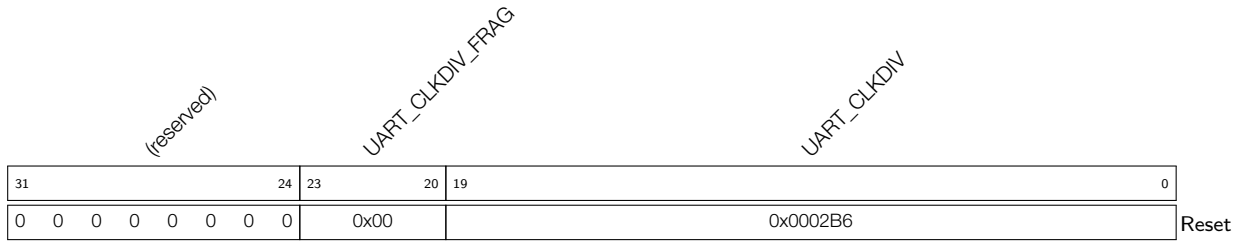
UART_FRM_ERR_INT_CLR Set this bit to clear the [UART_FRM_ERR_INT](#) interrupt. (WO)

UART_PARITY_ERR_INT_CLR Set this bit to clear the [UART_PARITY_ERR_INT](#) interrupt. (WO)

UART_TXFIFO_EMPTY_INT_CLR Set this bit to clear the [UART_TXFIFO_EMPTY_INT](#) interrupt. (WO)

UART_RXFIFO_FULL_INT_CLR Set this bit to clear the [UART_RXFIFO_FULL_INT](#) interrupt. (WO)

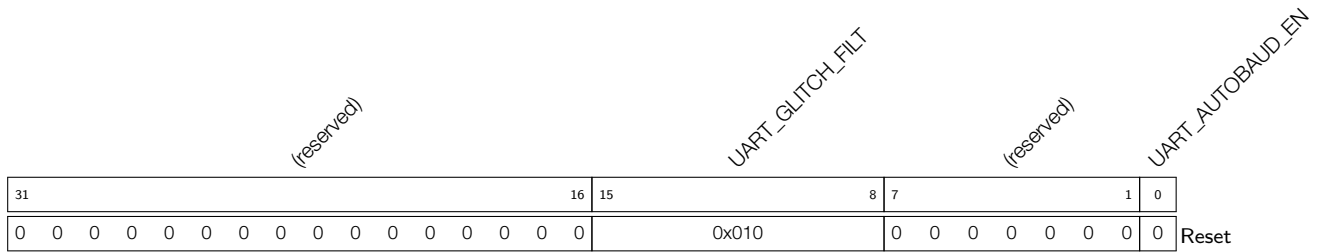
Register 13.6: UART_CLKDIV_REG (0x14)



UART_CLKDIV_FRAG The decimal part of the frequency divider factor. (R/W)

UART_CLKDIV The integral part of the frequency divider factor. (R/W)

Register 13.7: UART_AUTOBAUD_REG (0x18)



UART_GLITCH_FILT When the input pulse width is lower than this value, the pulse is ignored. This register is used in the autobauding process. (R/W)

UART_AUTOBAUD_EN This is the enable bit for autobaud. (R/W)

Register 13.9: UART_CONF0_REG (0x20)

(reserved)	UART_TICK_REF_ALWAYS_ON	(reserved)	UART_DTR_INV	UART_RTS_INV	UART_TXD_INV	UART_DSR_INV	UART_CTS_INV	UART_RXD_INV	UART_TXFIFO_RST	UART_RXFIFO_RST	UART_IRDA_EN	UART_TX_FLOW_EN	UART_LOOPBACK	UART_IRDA_RX_INV	UART_IRDA_TX_INV	UART_IRDA_WCTL	UART_IRDA_TX_EN	UART_TXD_DPLX	UART_SW_BRK	UART_SW_DTR	UART_STOP_BIT_NUM	UART_BIT_NUM	UART_PARITY_EN	UART_PARITY					
31	28	27	26	25	24	23	22	21	20	19	18	17	16	15	14	13	12	11	10	9	8	7	6	5	4	3	2	1	0
0	0	0	0	1	0	0	0	0	0	0	0	0	0	0	0	0	0	0	0	0	0	0	0	0	1	3	0	0	

Reset

UART_TICK_REF_ALWAYS_ON This register is used to select the clock; 1: APB clock; 0: REF_TICK. (R/W)

UART_DTR_INV Set this bit to invert the level of the UART DTR signal. (R/W)

UART_RTS_INV Set this bit to invert the level of the UART RTS signal. (R/W)

UART_TXD_INV Set this bit to invert the level of the UART TxD signal. (R/W)

UART_DSR_INV Set this bit to invert the level of the UART DSR signal. (R/W)

UART_CTS_INV Set this bit to invert the level of the UART CTS signal. (R/W)

UART_RXD_INV Set this bit to invert the level of the UART Rxd signal. (R/W)

UART_TXFIFO_RST Set this bit to reset the UART transmit-FIFO. **NOTICE:** UART2 doesn't have any register to reset Tx_FIFO or Rx_FIFO, and the UART1_TXFIFO_RST and UART1_RXFIFO_RST in UART1 may impact the functioning of UART2. Therefore, these two registers in UART1 should only be used when the Tx_FIFO and Rx_FIFO in UART2 do not have any data. (R/W)

UART_RXFIFO_RST Set this bit to reset the UART receive-FIFO. **NOTICE:** UART2 doesn't have any register to reset Tx_FIFO or Rx_FIFO, and the UART1_TXFIFO_RST and UART1_RXFIFO_RST in UART1 may impact the functioning of UART2. Therefore, these two registers in UART1 should only be used when the Tx_FIFO and Rx_FIFO in UART2 do not have any data. (R/W)

UART_IRDA_EN Set this bit to enable the IrDA protocol. (R/W)

UART_TX_FLOW_EN Set this bit to enable the flow control function for the transmitter. (R/W)

UART_LOOPBACK Set this bit to enable the UART loopback test mode. (R/W)

UART_IRDA_RX_INV Set this bit to invert the level of the IrDA receiver. (R/W)

UART_IRDA_TX_INV Set this bit to invert the level of the IrDA transmitter. (R/W)

UART_IRDA_WCTL 1: The IrDA transmitter's 11th bit is the same as its 10th bit; 0: set IrDA transmitter's 11th bit to 0. (R/W)

UART_IRDA_TX_EN This is the start enable bit of the IrDA transmitter. (R/W)

UART_IRDA_DPLX Set this bit to enable the IrDA loopback mode. (R/W)

UART_TXD_BRK Set this bit to enable the transmitter to send NULL, when the process of sending data is completed. (R/W)

UART_SW_DTR This register is used to configure the software DTR signal used in software flow control. (R/W)

UART_SW_RTS This register is used to configure the software RTS signal used in software flow control. (R/W)

UART_STOP_BIT_NUM This register is used to set the length of the stop bit; 1: 1 bit, 2: 1.5 bits. (R/W)

UART_BIT_NUM This register is used to set the length of data; 0: 5 bits, 1: 6 bits, 2: 7 bits, 3: 8 bits. (R/W)

UART_PARITY_EN Set this bit to enable the UART parity check. (R/W)

UART_PARITY This register is used to configure the parity check mode; 0: even, 1: odd. (R/W)

Register 13.10: UART_CONF1_REG (0x24)

<i>UART_RX_TOUT_EN</i>				<i>UART_RX_TOUT_THRHD</i>				<i>UART_RX_FLOW_EN</i>				<i>UART_RX_FLOW_THRHD</i>				<i>(reserved)</i>				<i>UART_TXFIFO_EMPTY_THRHD</i>				<i>(reserved)</i>				<i>UART_RXFIFO_FULL_THRHD</i>			
31	30	24	23	22	16	15	14	8	7	6	0																				
0	0	0	0	0	0	0	0	0	0	0	0	0x00	0	0x60	0	0x60	Reset														

UART_RX_TOUT_EN This is the enable bit for the UART receive-timeout function. (R/W)

UART_RX_TOUT_THRHD This register is used to configure the UART receiver's timeout value when receiving a byte. (R/W)

UART_RX_FLOW_EN This is the flow enable bit of the UART receiver; 1: choose software flow control by configuring the sw_rts signal; 0: disable software flow control. (R/W)

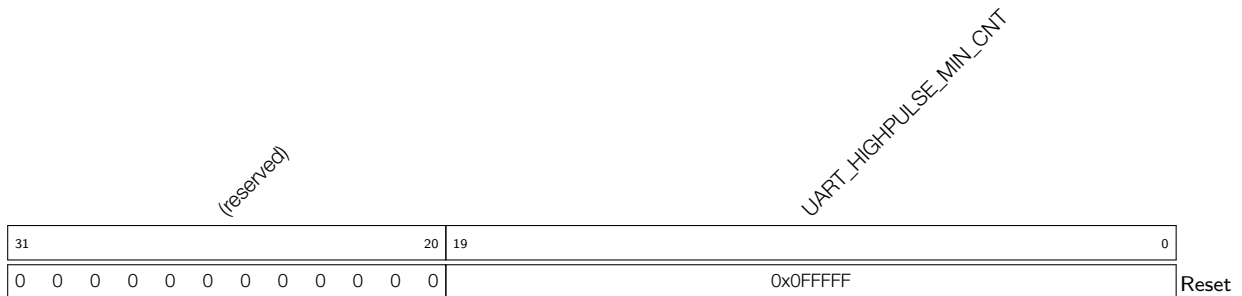
UART_RX_FLOW_THRHD When the receiver gets more data than its threshold value, the receiver produces a signal that tells the transmitter to stop transferring data. The threshold value is (rx_flow_thrhd_h3, rx_flow_thrhd). (R/W)

UART_TXFIFO_EMPTY_THRHD When the data amount in transmit-FIFO is less than its threshold value, it will produce a TXFIFO_EMPTY_INT_RAW interrupt. The threshold value is (tx_mem_empty_thrhd, txfifo_empty_thrhd). (R/W)

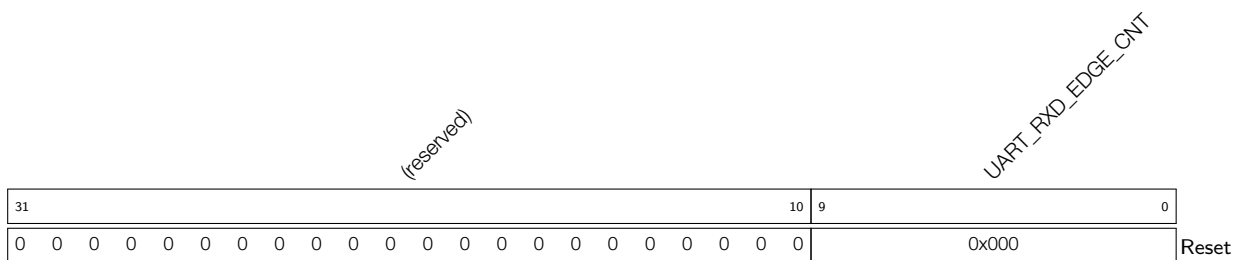
UART_RXFIFO_FULL_THRHD When the receiver gets more data than its threshold value, the receiver will produce an RXFIFO_FULL_INT_RAW interrupt. The threshold value is (rx_flow_thrhd_h3, rxfifo_full_thrhd). (R/W)

Register 13.11: UART_LOWPULSE_REG (0x28)

UART_LOWPULSE_MIN_CNT This register stores the value of the minimum duration of the low-level pulse. It is used in the baud rate detection process. (RO)

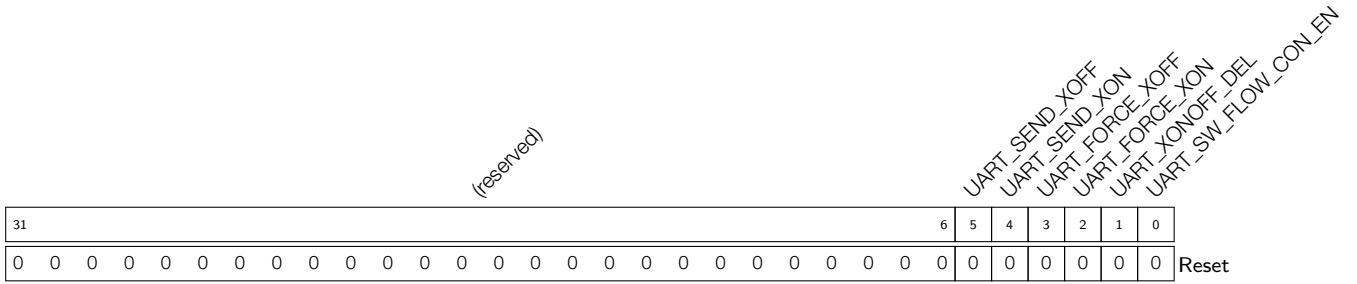
Register 13.12: UART_HIGHPULSE_REG (0x2C)

UART_HIGHPULSE_MIN_CNT This register stores the value of the minimum duration of the high level pulse. It is used in baud rate detection process. (RO)

Register 13.13: UART_RXD_CNT_REG (0x30)

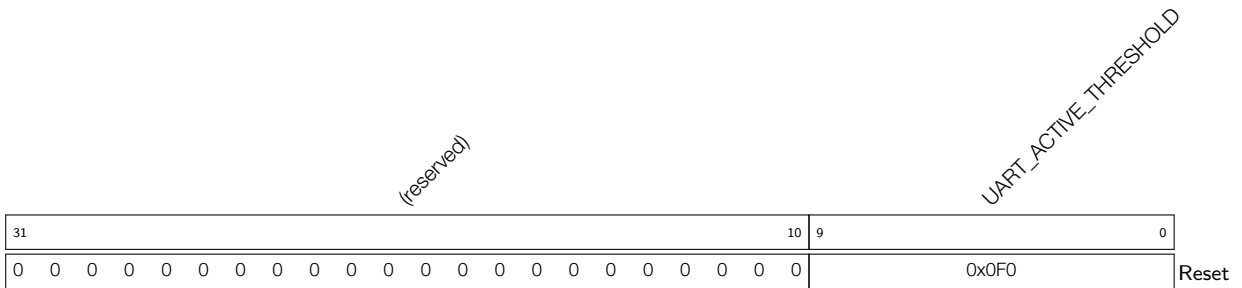
UART_RXD_EDGE_CNT This register stores the count of the RxD edge change. It is used in the baud rate detection process. (RO)

Register 13.14: UART_FLOW_CONF_REG (0x34)



- UART_SEND_XOFF** Hardware auto-clear; set to 1 to send Xoff char. (R/W)
- UART_SEND_XON** Hardware auto-clear; set to 1 to send Xon char. (R/W)
- UART_FORCE_XOFF** Set this bit to set the CTSn and enable the transmitter to continue sending data. (R/W)
- UART_FORCE_XON** Set this bit to clear the CTSn and stop the transmitter from sending data. (R/W)
- UART_XONOFF_DEL** Set this bit to remove the flow-control char from the received data. (R/W)
- UART_SW_FLOW_CON_EN** Set this bit to enable software flow control. It is used with register sw_xon or sw_xoff. (R/W)

Register 13.15: UART_SLEEP_CONF_REG (0x38)



- UART_ACTIVE_THRESHOLD** When the input RxD edge changes more times than what this register indicates, the system emerges from Light-sleep mode and becomes active. (R/W)

Register 13.16: UART_SWFC_CONF_REG (0x3C)

<i>UART_XOFF_CHAR</i>				<i>UART_XON_CHAR</i>				<i>UART_XOFF_THRESHOLD</i>				<i>UART_XON_THRESHOLD</i>				
31	24	23	16	15	8	7	0	31	24	23	16	15	8	7	0	
0x013				0x011				0x0E0				0x000				Reset

UART_XOFF_CHAR This register stores the Xoff flow control char. (R/W)

UART_XON_CHAR This register stores the Xon flow control char. (R/W)

UART_XOFF_THRESHOLD When the data amount in receive-FIFO is less than what this register indicates, it will send an Xon char, with `uart_sw_flow_con_en` set to 1. (R/W)

UART_XON_THRESHOLD When the data amount in receive-FIFO is more than what this register indicates, it will send an Xoff char, with `uart_sw_flow_con_en` set to 1. (R/W)

Register 13.17: UART_IDLE_CONF_REG (0x40)

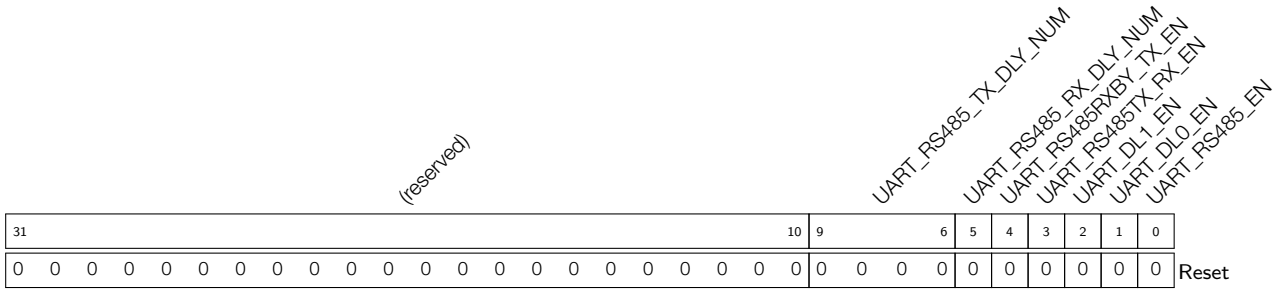
<i>(reserved)</i>				<i>UART_TX_BRK_NUM</i>				<i>UART_TX_IDLE_NUM</i>				<i>UART_RX_IDLE_THRHD</i>				
31	28	27	20	19	10	9	0	31	24	23	16	15	8	7	0	
0	0	0	0	0x00A				0x100				0x100				Reset

UART_TX_BRK_NUM This register is used to configure the number of zeros (0) sent, after the process of sending data is completed. It is active when `txd_brk` is set to 1. (R/W)

UART_TX_IDLE_NUM This register is used to configure the duration between transfers. (R/W)

UART_RX_IDLE_THRHD When the receiver takes more time to receive Byte data than what this register indicates, it will produce a frame-end signal. (R/W)

Register 13.18: UART_RS485_CONF_REG (0x44)



UART_RS485_TX_DLY_NUM This register is used to delay the transmitter’s internal data signal. (R/W)

UART_RS485_RX_DLY_NUM This register is used to delay the receiver’s internal data signal. (R/W)

UART_RS485RXBY_TX_EN 1: enable the RS-485 transmitter to send data, when the RS-485 receiver line is busy; 0: the RS-485 transmitter should not send data, when its receiver is busy. (R/W)

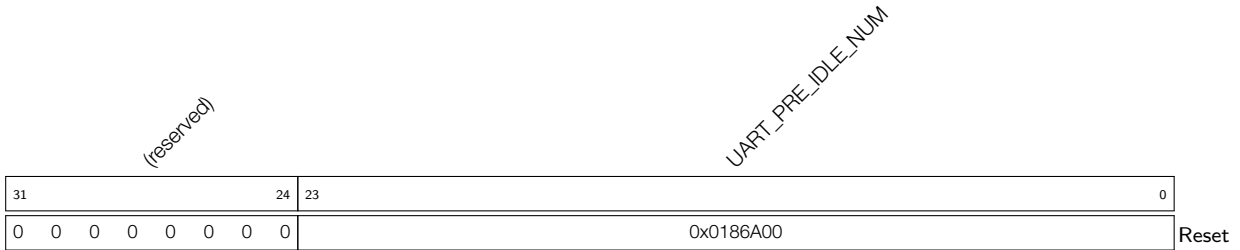
UART_RS485TX_RX_EN Set this bit to enable the transmitter’s output signal loop back to the receiver’s input signal. (R/W)

UART_DL1_EN Set this bit to delay the STOP bit by 1 bit. (R/W)

UART_DLO_EN Set this bit to delay the STOP bit by 1 bit. (R/W)

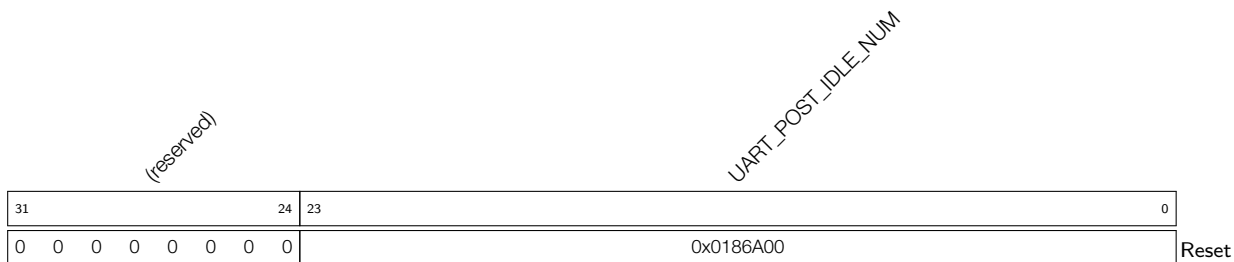
UART_RS485_EN Set this bit to choose the RS-485 mode. (R/W)

Register 13.19: UART_AT_CMD_PRECNT_REG (0x48)



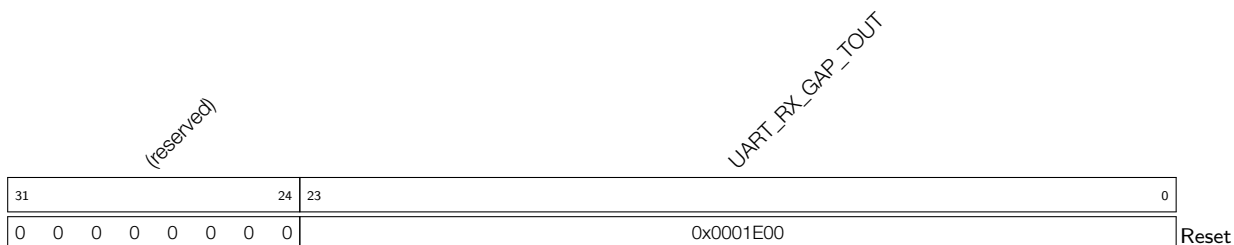
UART_PRE_IDLE_NUM This register is used to configure the idle-time duration before the first at_cmd is received by the receiver. When the duration is less than what this register indicates, it will not take the next data received as an at_cmd char. (R/W)

Register 13.20: UART_AT_CMD_POSTCNT_REG (0x4c)



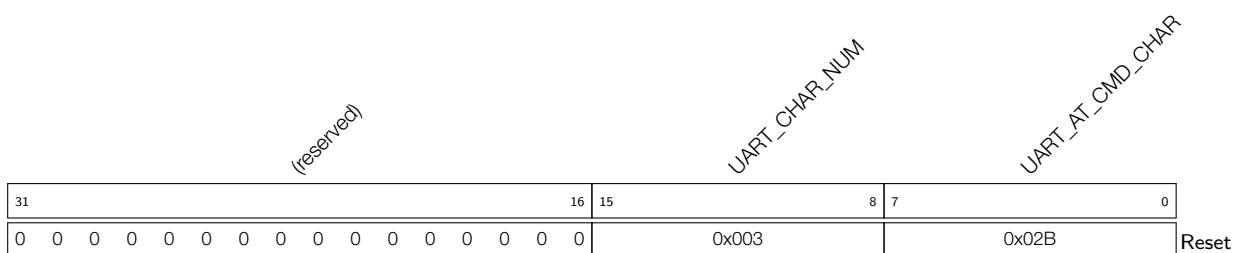
UART_POST_IDLE_NUM This register is used to configure the duration between the last at_cmd and the next data. When the duration is less than what this register indicates, it will not take the previous data as an at_cmd char. (R/W)

Register 13.21: UART_AT_CMD_GAPTOU_REG (0x50)



UART_RX_GAP_TOUT This register is used to configure the duration between the at_cmd chars. When the duration is less than what this register indicates, it will not take the data as continuous at_cmd chars. (R/W)

Register 13.22: UART_AT_CMD_CHAR_REG (0x54)



UART_CHAR_NUM This register is used to configure the number of continuous at_cmd chars received by the receiver. (R/W)

UART_AT_CMD_CHAR This register is used to configure the content of an at_cmd char. (R/W)

Register 13.23: UART_MEM_CONF_REG (0x58)

(reserved)		UART_TX_MEM_EMPTY_THRHD		UART_RX_MEM_FULL_THRHD		UART_XOFF_THRESHOLD_H2		UART_XON_THRESHOLD_H2		UART_RX_TOUT_THRHD_H3		UART_RX_FLOW_THRHD_H3		(reserved)		UART_TX_SIZE		UART_RX_SIZE		(reserved)		UART_MEM_PD	
31	30	28	27	25	24	23	22	21	20	18	17	15	14	11	10	7	6	3	2	1	0	Reset	
0	0x0	0x0	0x0	0x0	0x0	0x0	0x0	0x0	0x0	0	0	0	0	0x01	0x01	0x01	0x01	0	0	0	0	0	0

- UART_TX_MEM_EMPTY_THRHD** Refer to the description of txfifo_empty_thrhd. (R/W)
- UART_RX_MEM_FULL_THRHD** Refer to the description of rxfifo_full_thrhd. (R/W)
- UART_XOFF_THRESHOLD_H2** Refer to the description of uart_xoff_threshold. (R/W)
- UART_XON_THRESHOLD_H2** Refer to the description of uart_xon_threshold. (R/W)
- UART_RX_TOUT_THRHD_H3** Refer to the description of rx_tout_thrhd. (R/W)
- UART_RX_FLOW_THRHD_H3** Refer to the description of rx_flow_thrhd. (R/W)
- UART_TX_SIZE** This register is used to configure the amount of memory allocated to the transmit-FIFO. The default number is 128 bytes. (R/W)
- UART_RX_SIZE** This register is used to configure the amount of memory allocated to the receive-FIFO. The default number is 128 bytes. (R/W)
- UART_MEM_PD** Set this bit to power down the memory. When the reg_mem_pd register is set to 1 for all UART controllers, Memory will enter the low-power mode. (R/W)

Register 13.24: UART_MEM_CNT_STATUS_REG (0x64)

(reserved)																UART_TX_MEM_CNT		UART_RX_MEM_CNT					
31															6	5	3	2	0	Reset			
0	0	0	0	0	0	0	0	0	0	0	0	0	0	0	0	0	0	0	0	0	0	0	0

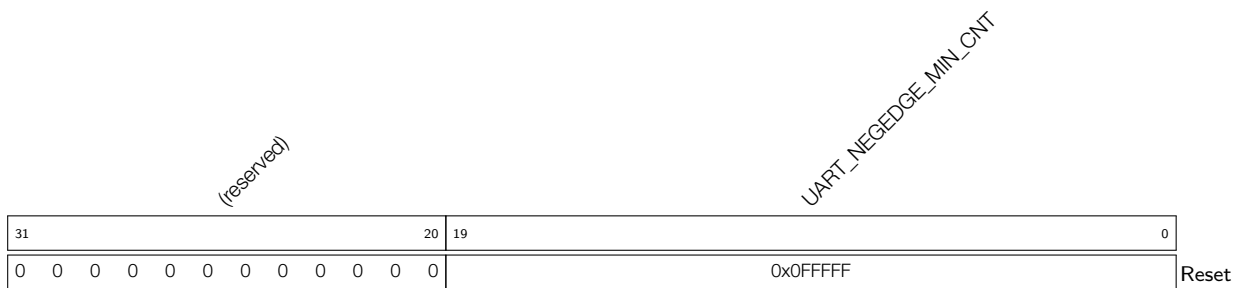
- UART_TX_MEM_CNT** Refer to the description of txfifo_cnt. (RO)
- UART_RX_MEM_CNT** Refer to the description of rxfifo_cnt. (RO)

Register 13.25: UART_POSPULSE_REG (0x68)



UART_POSEDGE_MIN_CNT This register stores the count of RxD positive edges. It is used in the autobaud detection process. (RO)

Register 13.26: UART_NEGPULSE_REG (0x6c)



UART_NEGEDGE_MIN_CNT This register stores the count of RxD negative edges. It is used in the autobaud detection process. (RO)

Register 13.27: UHCI_CONF0_REG (0x0)

(reserved)										UHCI_ENCODE_CRC_EN UHCI_LEN_EOF_EN UHCI_UART_IDLE_EOF_EN UHCI_CRC_REC_EN UHCI_HEAD_EN UHCI_SEPER_EN							(reserved)			UHCI_UART2_CE UHCI_UART1_CE UHCI_UART0_CE			(reserved)														
31											22	21	20	19	18	17	16	15				12	11	10	9	17											9
0 0 0 0 0 0 0 0 0 0										1	1	0	1	1	1	0 0 0 0			0	0	0	0	0 0 0 0			0 0										0	

- UHCI_ENCODE_CRC_EN** Reserved. Please initialize it to 0. (R/W)
- UHCI_LEN_EOF_EN** Reserved. Please initialize it to 0. (R/W)
- UHCI_UART_IDLE_EOF_EN** Reserved. Please initialize it to 0. (R/W)
- UHCI_CRC_REC_EN** Reserved. Please initialize it to 0. (R/W)
- UHCI_HEAD_EN** Reserved. Please initialize it to 0. (R/W)
- UHCI_SEPER_EN** Set this bit to use a special char and separate the data frame. (R/W)
- UHCI_UART2_CE** Set this bit to use UART2 and transmit or receive data. (R/W)
- UHCI_UART1_CE** Set this bit to use UART1 and transmit or receive data. (R/W)
- UHCI_UART0_CE** Set this bit to use UART and transmit or receive data. (R/W)

Register 13.28: UHCI_INT_RAW_REG (0x4)

(reserved)														UHCI_OUT_TOTAL_EOF_INT_RAW UHCI_OUTLINK_EOF_ERR_INT_RAW UHCI_IN_DSCR_EMPTY_INT_RAW UHCI_OUT_DSCR_ERR_INT_RAW UHCI_OUT_EOF_INT_RAW UHCI_IN_DONE_INT_RAW UHCI_IN_ERR_EOF_INT_RAW UHCI_IN_SUC_EOF_INT_RAW UHCI_IN_DONE_INT_RAW UHCI_TX_HUNG_INT_RAW UHCI_RX_HUNG_INT_RAW UHCI_TX_START_INT_RAW UHCI_RX_START_INT_RAW																			
31	30	29	28	27	26	25	24	23	22	21	20	19	18	17	16	15	14	13	12	11	10	9	8	7	6	5	4	3	2	1	0		
0	0	0	0	0	0	0	0	0	0	0	0	0	0	0	0	0	0	0	0	0	0	0	0	0	0	0	0	0	0	0	0	0	Reset

UHCI_OUT_TOTAL_EOF_INT_RAW The raw interrupt status bit for the [UHCI_OUT_TOTAL_EOF_INT](#) interrupt. (RO)

UHCI_OUTLINK_EOF_ERR_INT_RAW The raw interrupt status bit for the [UHCI_OUTLINK_EOF_ERR_INT](#) interrupt. (RO)

UHCI_IN_DSCR_EMPTY_INT_RAW The raw interrupt status bit for the [UHCI_IN_DSCR_EMPTY_INT](#) interrupt. (RO)

UHCI_OUT_DSCR_ERR_INT_RAW The raw interrupt status bit for the [UHCI_OUT_DSCR_ERR_INT](#) interrupt. (RO)

UHCI_IN_DSCR_ERR_INT_RAW The raw interrupt status bit for the [UHCI_IN_DSCR_ERR_INT](#) interrupt. (RO)

UHCI_OUT_EOF_INT_RAW The raw interrupt status bit for the [UHCI_OUT_EOF_INT](#) interrupt. (RO)

UHCI_OUT_DONE_INT_RAW The raw interrupt status bit for the [UHCI_OUT_DONE_INT](#) interrupt. (RO)

UHCI_IN_ERR_EOF_INT_RAW The raw interrupt status bit for the [UHCI_IN_ERR_EOF_INT](#) interrupt. (RO)

UHCI_IN_SUC_EOF_INT_RAW The raw interrupt status bit for the [UHCI_IN_SUC_EOF_INT](#) interrupt. (RO)

UHCI_IN_DONE_INT_RAW The raw interrupt status bit for the [UHCI_IN_DONE_INT](#) interrupt. (RO)

UHCI_TX_HUNG_INT_RAW The raw interrupt status bit for the [UHCI_TX_HUNG_INT](#) interrupt. (RO)

UHCI_RX_HUNG_INT_RAW The raw interrupt status bit for the [UHCI_RX_HUNG_INT](#) interrupt. (RO)

UHCI_TX_START_INT_RAW The raw interrupt status bit for the [UHCI_TX_START_INT](#) interrupt. (RO)

UHCI_RX_START_INT_RAW The raw interrupt status bit for the [UHCI_RX_START_INT](#) interrupt. (RO)

Register 13.29: UHCI_INT_ST_REG (0x8)

(reserved)																	UHCI_DMA_INFO_FIFO_FULL_WM_INT_ST UHCI_SEND_A_REG_Q_INT_ST UHCI_SEND_S_REG_Q_INT_ST UHCI_OUT_TOTAL_EOF_INT_ST UHCI_OUTLINK_EOF_ERR_INT_ST UHCI_IN_DSCR_EMPTY_INT_ST UHCI_OUT_DSCR_ERR_INT_ST UHCI_OUT_EOF_INT_ST UHCI_IN_DONE_INT_ST UHCI_IN_ERR_EOF_INT_ST UHCI_IN_SUC_EOF_INT_ST UHCI_TX_HUNG_INT_ST UHCI_RX_HUNG_INT_ST UHCI_TX_START_INT_ST UHCI_RX_START_INT_ST																		
31																	17	16	15	14	13	12	11	10	9	8	7	6	5	4	3	2	1	0	Reset
0 0																																			

UHCI_SEND_A_REG_Q_INT_ST The masked interrupt status bit for the [UHCI_SEND_A_REG_Q_INT](#) interrupt. (RO)

UHCI_SEND_S_REG_Q_INT_ST The masked interrupt status bit for the [UHCI_SEND_S_REG_Q_INT](#) interrupt. (RO)

UHCI_OUT_TOTAL_EOF_INT_ST The masked interrupt status bit for the [UHCI_OUT_TOTAL_EOF_INT](#) interrupt. (RO)

UHCI_OUTLINK_EOF_ERR_INT_ST The masked interrupt status bit for the [UHCI_OUTLINK_EOF_ERR_INT](#) interrupt. (RO)

UHCI_IN_DSCR_EMPTY_INT_ST The masked interrupt status bit for the [UHCI_IN_DSCR_EMPTY_INT](#) interrupt. (RO)

UHCI_OUT_DSCR_ERR_INT_ST The masked interrupt status bit for the [UHCI_OUT_DSCR_ERR_INT](#) interrupt. (RO)

UHCI_IN_DSCR_ERR_INT_ST The masked interrupt status bit for the [UHCI_IN_DSCR_ERR_INT](#) interrupt. (RO)

UHCI_OUT_EOF_INT_ST The masked interrupt status bit for the [UHCI_OUT_EOF_INT](#) interrupt. (RO)

UHCI_OUT_DONE_INT_ST The masked interrupt status bit for the [UHCI_OUT_DONE_INT](#) interrupt. (RO)

UHCI_IN_ERR_EOF_INT_ST The masked interrupt status bit for the [UHCI_IN_ERR_EOF_INT](#) interrupt. (RO)

UHCI_IN_SUC_EOF_INT_ST The masked interrupt status bit for the [UHCI_IN_SUC_EOF_INT](#) interrupt. (RO)

UHCI_IN_DONE_INT_ST The masked interrupt status bit for the [UHCI_IN_DONE_INT](#) interrupt. (RO)

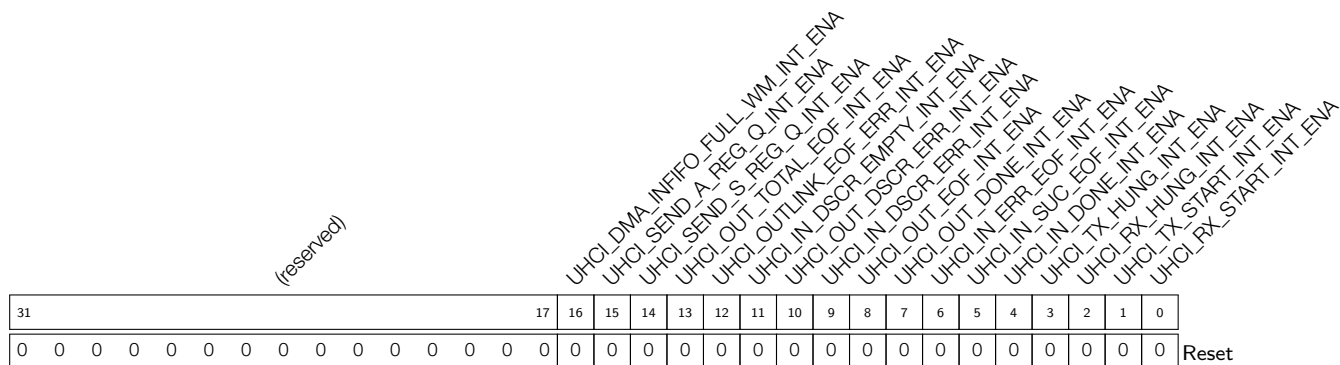
UHCI_TX_HUNG_INT_ST The masked interrupt status bit for the [UHCI_TX_HUNG_INT](#) interrupt. (RO)

UHCI_RX_HUNG_INT_ST The masked interrupt status bit for the [UHCI_RX_HUNG_INT](#) interrupt. (RO)

UHCI_TX_START_INT_ST The masked interrupt status bit for the [UHCI_TX_START_INT](#) interrupt. (RO)

UHCI_RX_START_INT_ST The masked interrupt status bit for the [UHCI_RX_START_INT](#) interrupt. (RO)

Register 13.30: UHCI_INT_ENA_REG (0xC)



UHCI_SEND_A_REG_Q_INT_ENA The interrupt enable bit for the [UHCI_SEND_A_REG_Q_INT](#) interrupt. (R/W)

UHCI_SEND_S_REG_Q_INT_ENA The interrupt enable bit for the [UHCI_SEND_S_REG_Q_INT](#) interrupt. (R/W)

UHCI_OUT_TOTAL_EOF_INT_ENA The interrupt enable bit for the [UHCI_OUT_TOTAL_EOF_INT](#) interrupt. (R/W)

UHCI_OUTLINK_EOF_ERR_INT_ENA The interrupt enable bit for the [UHCI_OUTLINK_EOF_ERR_INT](#) interrupt. (R/W)

UHCI_IN_DSCR_EMPTY_INT_ENA The interrupt enable bit for the [UHCI_IN_DSCR_EMPTY_INT](#) interrupt. (R/W)

UHCI_OUT_DSCR_ERR_INT_ENA The interrupt enable bit for the [UHCI_OUT_DSCR_ERR_INT](#) interrupt. (R/W)

UHCI_IN_DSCR_ERR_INT_ENA The interrupt enable bit for the [UHCI_IN_DSCR_ERR_INT](#) interrupt. (R/W)

UHCI_OUT_EOF_INT_ENA The interrupt enable bit for the [UHCI_OUT_EOF_INT](#) interrupt. (R/W)

UHCI_OUT_DONE_INT_ENA The interrupt enable bit for the [UHCI_OUT_DONE_INT](#) interrupt. (R/W)

UHCI_IN_ERR_EOF_INT_ENA The interrupt enable bit for the [UHCI_IN_ERR_EOF_INT](#) interrupt. (R/W)

UHCI_IN_SUC_EOF_INT_ENA The interrupt enable bit for the [UHCI_IN_SUC_EOF_INT](#) interrupt. (R/W)

UHCI_IN_DONE_INT_ENA The interrupt enable bit for the [UHCI_IN_DONE_INT](#) interrupt. (R/W)

UHCI_TX_HUNG_INT_ENA The interrupt enable bit for the [UHCI_TX_HUNG_INT](#) interrupt. (R/W)

UHCI_RX_HUNG_INT_ENA The interrupt enable bit for the [UHCI_RX_HUNG_INT](#) interrupt. (R/W)

UHCI_TX_START_INT_ENA The interrupt enable bit for the [UHCI_TX_START_INT](#) interrupt. (R/W)

UHCI_RX_START_INT_ENA The interrupt enable bit for the [UHCI_RX_START_INT](#) interrupt. (R/W)

Register 13.31: UHCI_INT_CLR_REG (0x10)

(reserved)																	UHCI_DMA_INFIFO_FULL_WM_INT_CLR	UHCI_SEND_A_REG_Q_INT_CLR	UHCI_SEND_S_REG_Q_INT_CLR	UHCI_OUT_TOTAL_EOF_INT_CLR	UHCI_OUTLINK_EOF_ERR_INT_CLR	UHCI_IN_DSCR_EMPTY_INT_CLR	UHCI_OUT_DSCR_ERR_INT_CLR	UHCI_OUT_EOF_INT_CLR	UHCI_IN_DSCR_ERR_INT_CLR	UHCI_IN_DONE_INT_CLR	UHCI_IN_ERR_EOF_INT_CLR	UHCI_IN_SUC_EOF_INT_CLR	UHCI_IN_DONE_INT_CLR	UHCI_TX_HUNG_INT_CLR	UHCI_RX_HUNG_INT_CLR	UHCI_TX_START_INT_CLR	UHCI_RX_START_INT_CLR															
31																	17	16	15	14	13	12	11	10	9	8	7	6	5	4	3	2	1	0	Reset													
0																	0	0	0	0	0	0	0	0	0	0	0	0	0	0	0	0	0	0	0	0	0	0	0	0	0	0	0	0	0	0	0	0

UHCI_SEND_A_REG_Q_INT_CLR Set this bit to clear the [UHCI_SEND_A_REG_Q_INT](#) interrupt. (WO)

UHCI_SEND_S_REG_Q_INT_CLR Set this bit to clear the [UHCI_SEND_S_REG_Q_INT](#) interrupt. (WO)

UHCI_OUT_TOTAL_EOF_INT_CLR Set this bit to clear the [UHCI_OUT_TOTAL_EOF_INT](#) interrupt. (WO)

UHCI_OUTLINK_EOF_ERR_INT_CLR Set this bit to clear the [UHCI_OUTLINK_EOF_ERR_INT](#) interrupt. (WO)

UHCI_IN_DSCR_EMPTY_INT_CLR Set this bit to clear the [UHCI_IN_DSCR_EMPTY_INT](#) interrupt. (WO)

UHCI_OUT_DSCR_ERR_INT_CLR Set this bit to clear the [UHCI_OUT_DSCR_ERR_INT](#) interrupt. (WO)

UHCI_IN_DSCR_ERR_INT_CLR Set this bit to clear the [UHCI_IN_DSCR_ERR_INT](#) interrupt. (WO)

UHCI_OUT_EOF_INT_CLR Set this bit to clear the [UHCI_OUT_EOF_INT](#) interrupt. (WO)

UHCI_OUT_DONE_INT_CLR Set this bit to clear the [UHCI_OUT_DONE_INT](#) interrupt. (WO)

UHCI_IN_ERR_EOF_INT_CLR Set this bit to clear the [UHCI_IN_ERR_EOF_INT](#) interrupt. (WO)

UHCI_IN_SUC_EOF_INT_CLR Set this bit to clear the [UHCI_IN_SUC_EOF_INT](#) interrupt. (WO)

UHCI_IN_DONE_INT_CLR Set this bit to clear the [UHCI_IN_DONE_INT](#) interrupt. (WO)

UHCI_TX_HUNG_INT_CLR Set this bit to clear the [UHCI_TX_HUNG_INT](#) interrupt. (WO)

UHCI_RX_HUNG_INT_CLR Set this bit to clear the [UHCI_RX_HUNG_INT](#) interrupt. (WO)

UHCI_TX_START_INT_CLR Set this bit to clear the [UHCI_TX_START_INT](#) interrupt. (WO)

UHCI_RX_START_INT_CLR Set this bit to clear the [UHCI_RX_START_INT](#) interrupt. (WO)

Register 13.32: UHCI_DMA_OUT_STATUS_REG (0x14)

(reserved)																	UHCI_OUT_EMPTY UHCI_OUT_FULL				
31																			2	1	0
0 0																	1	0	Reset		

UHCI_OUT_EMPTY 1: DMA inlink descriptor's FIFO is empty. (RO)

UHCI_OUT_FULL 1: DMA outlink descriptor's FIFO is full. (RO)

Register 13.33: UHCI_DMA_OUT_PUSH_REG (0x18)

(reserved)										UHCI_OUTFIFO_PUSH								(reserved)		UHCI_OUTFIFO_WDATA															
31																	17	16	15					9	8								0		
0 0 0 0 0 0 0 0 0 0 0 0 0 0 0 0 0																	0	0	0	0	0	0	0	0	0	0	0	0x000							Reset

UHCI_OUTFIFO_PUSH Set this bit to push data into DMA FIFO. (R/W)

UHCI_OUTFIFO_WDATA This is the data that need to be pushed into DMA FIFO. (R/W)

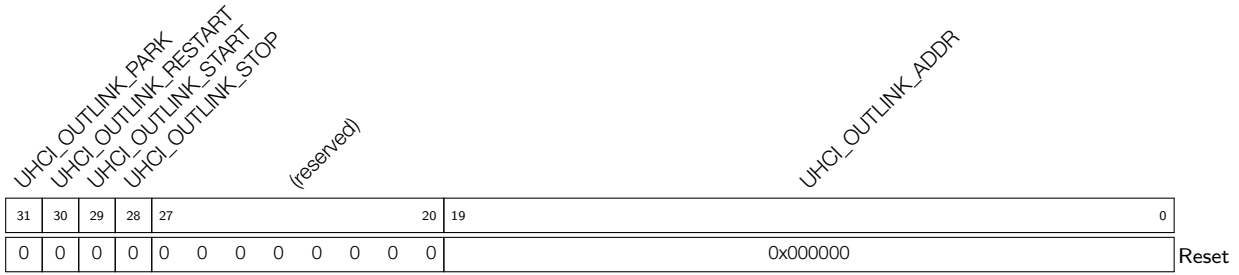
Register 13.34: UHCI_DMA_IN_POP_REG (0x20)

(reserved)										UHCI_INFIFO_POP						(reserved)				UHCI_INFIFO_RDATA												
31																	17	16	15				12	11								0
0 0 0 0 0 0 0 0 0 0 0 0 0 0 0 0 0																	0	0	0	0	0	0	0x0000							Reset		

UHCI_INFIFO_POP Set this bit to pop data from DMA FIFO. (R/W)

UHCI_INFIFO_RDATA This register stores the data popping from DMA FIFO. (RO)

Register 13.35: UHCI_DMA_OUT_LINK_REG (0x24)



UHCI_OUTLINK_PARK 1: the outlink descriptor’s FSM is in idle state; 0: the outlink descriptor’s FSM is working. (RO)

UHCI_OUTLINK_RESTART Set this bit to restart the outlink descriptor from the last address. (R/W)

UHCI_OUTLINK_START Set this bit to start a new outlink descriptor. (R/W)

UHCI_OUTLINK_STOP Set this bit to stop dealing with the outlink descriptor. (R/W)

UHCI_OUTLINK_ADDR This register stores the least significant 20 bits of the first outlink descriptor’s address. (R/W)

Register 13.36: UHCI_DMA_IN_LINK_REG (0x28)



UHCI_INLINK_PARK 1: the inlink descriptor’s FSM is in idle state; 0: the inlink descriptor’s FSM is working. (RO)

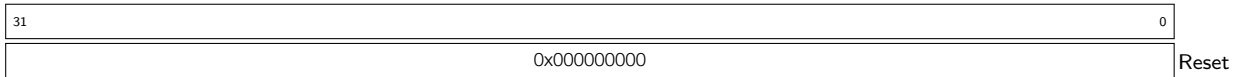
UHCI_INLINK_RESTART Set this bit to mount new inlink descriptors. (R/W)

UHCI_INLINK_START Set this bit to start dealing with the inlink descriptors. (R/W)

UHCI_INLINK_STOP Set this bit to stop dealing with the inlink descriptors. (R/W)

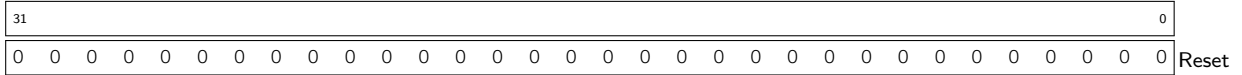
UHCI_INLINK_ADDR This register stores the 20 least significant bits of the first inlink descriptor’s address. (R/W)

Register 13.41: UHCI_DMA_OUT_EOF_BFR_DES_ADDR_REG (0x44)



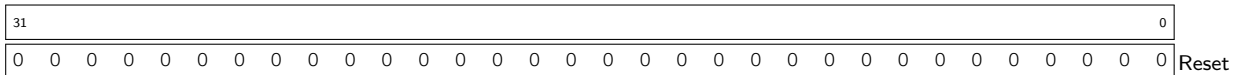
UHCI_DMA_OUT_EOF_BFR_DES_ADDR_REG This register stores the address of the outlink descriptor when there are some errors in this descriptor. (RO)

Register 13.42: UHCI_DMA_IN_DSCR_REG (0x4C)



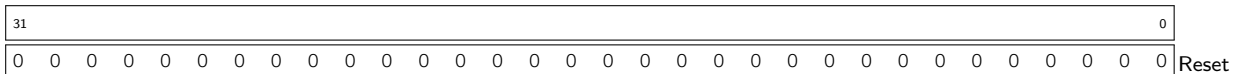
UHCI_DMA_IN_DSCR_REG The address of the current inlink descriptor *x*. (RO)

Register 13.43: UHCI_DMA_IN_DSCR_BF0_REG (0x50)



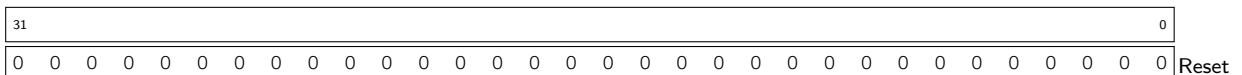
UHCI_DMA_IN_DSCR_BF0_REG The address of the last inlink descriptor *x-1*. (RO)

Register 13.44: UHCI_DMA_IN_DSCR_BF1_REG (0x54)



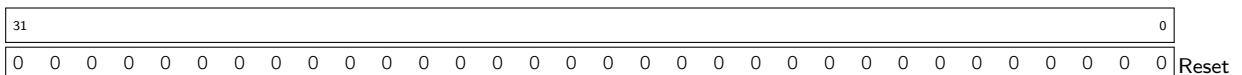
UHCI_DMA_IN_DSCR_BF1_REG The address of the second-to-last inlink descriptor *x-2*. (RO)

Register 13.45: UHCI_DMA_OUT_DSCR_REG (0x58)



UHCI_DMA_OUT_DSCR_REG The address of the current outlink descriptor *y*. (RO)

Register 13.46: UHCI_DMA_OUT_DSCR_BF0_REG (0x5C)



UHCI_DMA_OUT_DSCR_BF0_REG The address of the last outlink descriptor *y-1*. (RO)

Register 13.47: UHCI_DMA_OUT_DSCR_BF1_REG (0x60)

31		0
0 0		
Reset		

UHCI_DMA_OUT_DSCR_BF1_REG The address of the second-to-last outlink descriptor $y-2$. (RO)

Register 13.48: UHCI_ESCAPE_CONF_REG (0x64)

31	(reserved)								8	7	6	5	4	3	2	1	0
0 1 1 0 0 1 1																	
Reset																	

UHCI_RX_13_ESC_EN
 UHCI_RX_11_ESC_EN
 UHCI_RX_DB_ESC_EN
 UHCI_RX_C0_ESC_EN
 UHCI_TX_13_ESC_EN
 UHCI_TX_11_ESC_EN
 UHCI_TX_DB_ESC_EN
 UHCI_TX_C0_ESC_EN

UHCI_RX_13_ESC_EN Set this bit to enable replacing flow control char 0x13, when DMA sends data. (R/W)

UHCI_RX_11_ESC_EN Set this bit to enable replacing flow control char 0x11, when DMA sends data. (R/W)

UHCI_RX_DB_ESC_EN Set this bit to enable replacing 0xdb char, when DMA sends data. (R/W)

UHCI_RX_C0_ESC_EN Set this bit to enable replacing 0xc0 char, when DMA sends data. (R/W)

UHCI_TX_13_ESC_EN Set this bit to enable decoding flow control char 0x13, when DMA receives data. (R/W)

UHCI_TX_11_ESC_EN Set this bit to enable decoding flow control char 0x11, when DMA receives data. (R/W)

UHCI_TX_DB_ESC_EN Set this bit to enable decoding 0xdb char, when DMA receives data. (R/W)

UHCI_TX_C0_ESC_EN Set this bit to enable decoding 0xc0 char, when DMA receives data. (R/W)

Register 13.49: UHCI_HUNG_CONF_REG (0x68)

(reserved)								UHCI_RXFIFO_TIMEOUT_ENA				UHCI_RXFIFO_TIMEOUT_SHIFT				UHCI_RXFIFO_TIMEOUT				UHCI_TXFIFO_TIMEOUT_ENA				UHCI_TXFIFO_TIMEOUT_SHIFT				UHCI_TXFIFO_TIMEOUT			
31	24	23	22	20	19	12	11	10	8	7	0	31	24	23	22	20	19	12	11	10	8	7	0								
0	0	0	0	0	0	0	0	0	0	0	0	1	0	0	0	0	0	0	0	0	0	0	0	0x010	0x010	0x010	0x010	0x010	0x010	Reset	

UHCI_RXFIFO_TIMEOUT_ENA This is the enable bit for DMA send-data timeout. (R/W)

UHCI_RXFIFO_TIMEOUT_SHIFT The tick count is cleared when its value is equal to or greater than (17'd8000»reg_rxfifo_timeout_shift). (R/W)

UHCI_RXFIFO_TIMEOUT This register stores the timeout value. When DMA takes more time to read data from RAM than what this register indicates, it will produce the UHCI_RX_HUNG_INT interrupt. (R/W)

UHCI_TXFIFO_TIMEOUT_ENA The enable bit for Tx FIFO receive-data timeout (R/W)

UHCI_TXFIFO_TIMEOUT_SHIFT The tick count is cleared when its value is equal to or greater than (17'd8000»reg_txfifo_timeout_shift). (R/W)

UHCI_TXFIFO_TIMEOUT This register stores the timeout value. When DMA takes more time to receive data than what this register indicates, it will produce the UHCI_TX_HUNG_INT interrupt. (R/W)

Register 13.50: UHCI_ESC_CONF_n_REG (n: 0-3) (0xB0+4*n)

(reserved)								UHCI_ESC_SEQ2_CHAR1								UHCI_ESC_SEQ2_CHAR0								UHCI_ESC_SEQ2								
31	24	23	16	15	8	7	0	31	24	23	16	15	8	7	0	31	24	23	16	15	8	7	0	31	24	23	16	15	8	7	0	
0	0	0	0	0	0	0	0	0x0DF	0x0DF	0x0DF	0x0DF	0x0DF	0x0DF	0x0DF	0x0DF	0x0DB	0x0DB	0x0DB	0x0DB	0x0DB	0x0DB	0x0DB	0x0DB	0x013	0x013	0x013	0x013	0x013	0x013	0x013	0x013	Reset

UHCI_ESC_SEQ2_CHAR1 This register stores the second char used to replace the reg_esc_seq2 in data. (R/W)

UHCI_ESC_SEQ2_CHAR0 This register stores the first char used to replace the reg_esc_seq2 in data. (R/W)

UHCI_ESC_SEQ2 This register stores the flow_control char to turn off the flow_control. (R/W)

14. LED_PWM

14.1 Introduction

The LED_PWM controller is primarily designed to control the intensity of LEDs, although it can be used to generate PWM signals for other purposes as well. It has 16 channels which can generate independent waveforms that can be used to drive RGB LED devices. For maximum flexibility, the high-speed as well as the low-speed channels can be driven from one of four high-speed/low-speed timers. The PWM controller also has the ability to automatically increase or decrease the duty cycle gradually, allowing for fades without any processor interference. To increase resolution, the LED_PWM controller is also able to dither between two values, when a fractional PWM value is configured.

The LED_PWM controller has eight high-speed and eight low-speed PWM generators. In this document, they will be referred to as $hschn$ and $lschn$, respectively. These channels can be driven from four timers which will be indicated by h_timerx and l_timerx .

14.2 Functional Description

14.2.1 Architecture

Figure 83 shows the architecture of the LED_PWM controller. As can be seen in the figure, the LED_PWM controller contains eight high-speed and eight low-speed channels. There are four high-speed clock modules for the high-speed channels, from which one h_timerx can be selected. There are also four low-speed clock modules for the low-speed channels, from which one l_timerx can be selected.

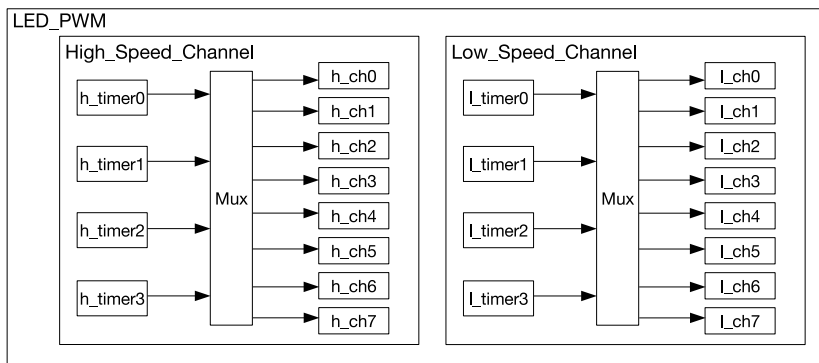


Figure 83: LED_PWM Architecture

Figure 84 illustrates a PWM channel with its selected timer; in this instance a high-speed channel and associated high-speed timer.

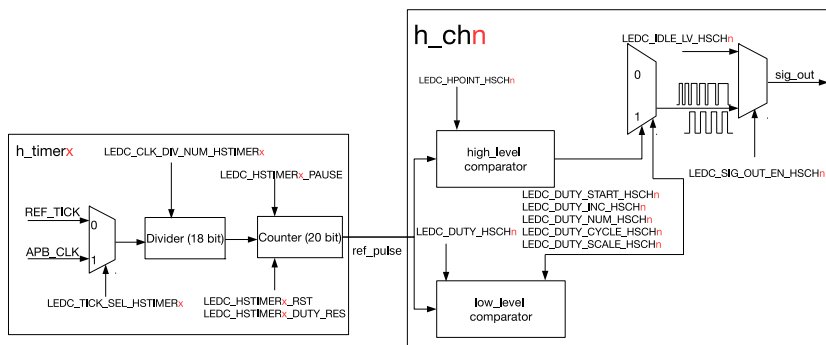


Figure 84: LED_PWM High-speed Channel Diagram

14.2.2 Timers

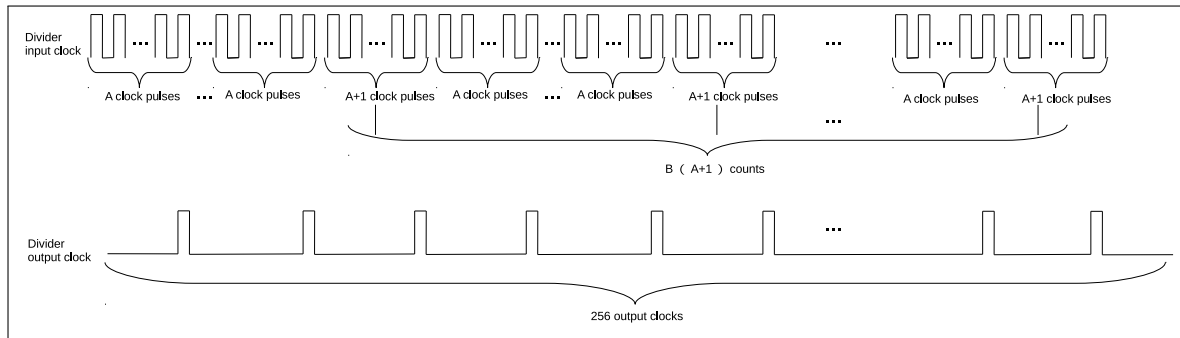


Figure 85: LED_PWM Divider

A high-speed timer consists of a multiplexer to select one of two clock sources: either REF_TICK or APB_CLK. For more information on the clock sources, please see Chapter [Reset And Clock](#). The input clock is divided down by a divider first. The division factor is specified by LEDC_CLK_DIV_NUM_HSTIMER x which contains a fixed point number: the highest 10 bits represent the integer portion A, while the lowest eight bits contain the fractional portion B. The effective division factor is as follows:

$$LEDC_CLK_DIV_NUM_HSTIMER_x = A \frac{B}{256}$$

Figure 85 shows the input/output clock when the fractional portion B is not 0. As shown in the figure, the 256 output clocks consist of B output clocks as result of division by (A+1) divider and (256-B) output clocks as result of division by A divider. The B output clocks are evenly distributed in the 256 output clocks.

The output clock of the divider is the base clock for the counter which will count up to the value specified in LEDC_HSTIMER x _DUTY_RES. An overflow interrupt will be generated once the counting value reaches $2^{LEDC_HSTIMER_x_DUTY_RES} - 1$, at which point the counter restarts counting from 0. It is also possible to reset, suspend, and read the values of the counter by software.

The output signal of the timer is the 20-bit value generated by the counter. The cycle period of this signal defines the frequency of the signals of any PWM channels connected to this timer. This frequency depends on both the division factor of the divider, as well as the range of the counter:

$$f_{\text{sig_out}} = \frac{f_{\text{REF_TICK}} \cdot (!LEDC_TICK_SEL_HSTIMER_x) + f_{\text{APB_CLK}} \cdot LEDC_TICK_SEL_HSTIMER_x}{LEDC_CLK_DIV_NUM_HSTIMER_x \cdot 2^{LEDC_HSTIMER_x_DUTY_RES}}$$

The low-speed timers l_timer x on the low-speed channel differ from the high-speed timers h_timer x in two aspects:

1. Where the high-speed timer clock source can be clocked from REF_TICK or APB_CLK, the low-speed timers are sourced from either REF_TICK or SLOW_CLOCK. The SLOW_CLOCK source can be either APB_CLK (80 MHz) or 8 MHz, and can be selected using LEDC_APB_CLK_SEL.
2. The high-speed counter and divider are glitch-free, which means that if the software modifies the maximum counter or divisor value, the update will come into effect after the next overflow interrupt. In contrast, the low-speed counter and divider will update these values only when LEDC_LSTIMER x _PARA_UP is set.

14.2.3 Channels

A channel takes the 20-bit value from the counter of the selected high-speed timer and compares it to a set of two values in order to set the channel output. The first value it is compared to is the content of

LEDC_HPOINT_HSCH n ; if these two match, the output will be latched high. The second value is the sum of LEDC_HPOINT_HSCH n and LEDC_DUTY_HSCH n [24..4]. When this value is reached, the output is latched low. By using these two values, the relative phase and the duty cycle of the PWM output can be set. Figure 86 illustrates this.

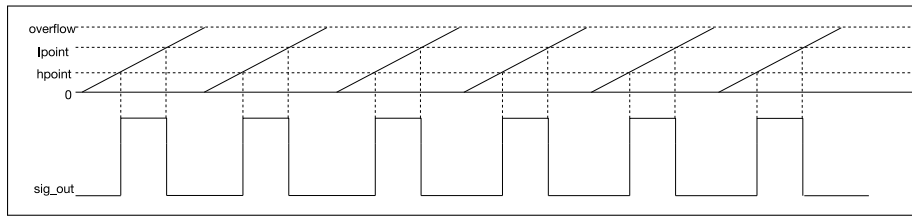


Figure 86: LED PWM Output Signal Diagram

LEDC_DUTY_HSCH n is a fixed-point register with four fractional bits. As mentioned before, when LEDC_DUTY_HSCH n [24..4] is used in the PWM calculation directly, LEDC_DUTY_HSCH n [3..0] can be used to dither the output. If this value is non-zero, with a statistical chance of LEDC_DUTY_HSCH n [3..0]/16, the actual PWM pulse will be one cycle longer. This effectively increases the resolution of the PWM generator to 24 bits, but at the cost of a slight jitter in the duty cycle.

The channels also have the ability to automatically fade from one duty cycle value to another. This feature is enabled by setting LEDC_DUTY_START_HSCH n . When this bit is set, the PWM controller will automatically increment or decrement the value in LEDC_DUTY_HSCH n , depending on whether the bit LEDC_DUTY_INC_HSCH n is set or cleared, respectively. The speed the duty cycle changes is defined as such: every time the LEDC_DUTY_CYCLE_HSCH n cycles, the content of LEDC_DUTY_SCALE_HSCH n is added to or subtracted from LEDC_DUTY_HSCH n [24..4]. The length of the fade can be limited by setting LEDC_DUTY_NUM_HSCH n : the fade will only last that number of cycles before finishing. A finished fade also generates an interrupt.

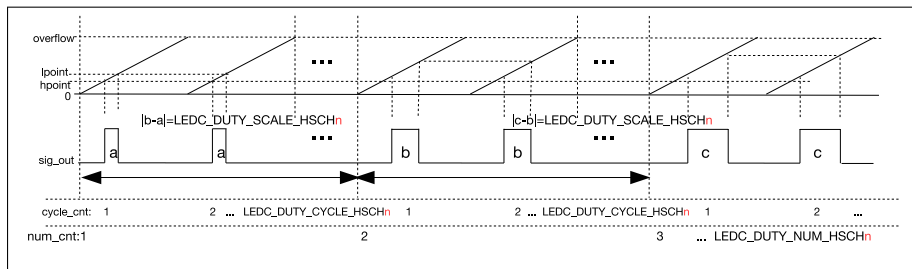


Figure 87: Output Signal Diagram of Gradient Duty Cycle

Figure 87 is an illustration of this. In this configuration, LEDC_DUTY_NUM_HSCH n _R increases by LEDC_DUTY_SCALE_HSCH n for every LEDC_DUTY_CYCLE_HSCH n clock cycles, which is reflected in the duty cycle of the output signal.

14.2.4 Interrupts

- LEDC_DUTY_CHNG_END_LSCH n _INT: Triggered when a fade on a low-speed channel has finished.
- LEDC_DUTY_CHNG_END_HSCH n _INT: Triggered when a fade on a high-speed channel has finished.
- LEDC_HS_TIMER x _OVF_INT: Triggered when a high-speed timer has reached its maximum counter value.
- LEDC_LS_TIMER x _OVF_INT: Triggered when a low-speed timer has reached its maximum counter value.

14.3 Register Summary

Name	Description	Address	Access
Configuration registers			
LEDC_CONF_REG	Global ledc configuration register	0x3FF59190	R/W
LEDC_HSCH0_CONF0_REG	Configuration register 0 for high-speed channel 0	0x3FF59000	R/W
LEDC_HSCH1_CONF0_REG	Configuration register 0 for high-speed channel 1	0x3FF59014	R/W
LEDC_HSCH2_CONF0_REG	Configuration register 0 for high-speed channel 2	0x3FF59028	R/W
LEDC_HSCH3_CONF0_REG	Configuration register 0 for high-speed channel 3	0x3FF5903C	R/W
LEDC_HSCH4_CONF0_REG	Configuration register 0 for high-speed channel 4	0x3FF59050	R/W
LEDC_HSCH5_CONF0_REG	Configuration register 0 for high-speed channel 5	0x3FF59064	R/W
LEDC_HSCH6_CONF0_REG	Configuration register 0 for high-speed channel 6	0x3FF59078	R/W
LEDC_HSCH7_CONF0_REG	Configuration register 0 for high-speed channel 7	0x3FF5908C	R/W
LEDC_HSCH0_CONF1_REG	Configuration register 1 for high-speed channel 0	0x3FF5900C	R/W
LEDC_HSCH1_CONF1_REG	Configuration register 1 for high-speed channel 1	0x3FF59020	R/W
LEDC_HSCH2_CONF1_REG	Configuration register 1 for high-speed channel 2	0x3FF59034	R/W
LEDC_HSCH3_CONF1_REG	Configuration register 1 for high-speed channel 3	0x3FF59048	R/W
LEDC_HSCH4_CONF1_REG	Configuration register 1 for high-speed channel 4	0x3FF5905C	R/W
LEDC_HSCH5_CONF1_REG	Configuration register 1 for high-speed channel 5	0x3FF59070	R/W
LEDC_HSCH6_CONF1_REG	Configuration register 1 for high-speed channel 6	0x3FF59084	R/W
LEDC_HSCH7_CONF1_REG	Configuration register 1 for high-speed channel 7	0x3FF59098	R/W
LEDC_LSCH0_CONF0_REG	Configuration register 0 for low-speed channel 0	0x3FF590A0	R/W
LEDC_LSCH1_CONF0_REG	Configuration register 0 for low-speed channel 1	0x3FF590B4	R/W
LEDC_LSCH2_CONF0_REG	Configuration register 0 for low-speed channel 2	0x3FF590C8	R/W
LEDC_LSCH3_CONF0_REG	Configuration register 0 for low-speed channel 3	0x3FF590DC	R/W
LEDC_LSCH4_CONF0_REG	Configuration register 0 for low-speed channel 4	0x3FF590F0	R/W
LEDC_LSCH5_CONF0_REG	Configuration register 0 for low-speed channel 5	0x3FF59104	R/W
LEDC_LSCH6_CONF0_REG	Configuration register 0 for low-speed channel 6	0x3FF59118	R/W
LEDC_LSCH7_CONF0_REG	Configuration register 0 for low-speed channel 7	0x3FF5912C	R/W
LEDC_LSCH0_CONF1_REG	Configuration register 1 for low-speed channel 0	0x3FF590AC	R/W
LEDC_LSCH1_CONF1_REG	Configuration register 1 for low-speed channel 1	0x3FF590C0	R/W
LEDC_LSCH2_CONF1_REG	Configuration register 1 for low-speed channel 2	0x3FF590D4	R/W
LEDC_LSCH3_CONF1_REG	Configuration register 1 for low-speed channel 3	0x3FF590E8	R/W
LEDC_LSCH4_CONF1_REG	Configuration register 1 for low-speed channel 4	0x3FF590FC	R/W
LEDC_LSCH5_CONF1_REG	Configuration register 1 for low-speed channel 5	0x3FF59110	R/W
LEDC_LSCH6_CONF1_REG	Configuration register 1 for low-speed channel 6	0x3FF59124	R/W
LEDC_LSCH7_CONF1_REG	Configuration register 1 for low-speed channel 7	0x3FF59138	R/W
Duty-cycle registers			
LEDC_HSCH0_DUTY_REG	Initial duty cycle for high-speed channel 0	0x3FF59008	R/W
LEDC_HSCH1_DUTY_REG	Initial duty cycle for high-speed channel 1	0x3FF5901C	R/W
LEDC_HSCH2_DUTY_REG	Initial duty cycle for high-speed channel 2	0x3FF59030	R/W
LEDC_HSCH3_DUTY_REG	Initial duty cycle for high-speed channel 3	0x3FF59044	R/W
LEDC_HSCH4_DUTY_REG	Initial duty cycle for high-speed channel 4	0x3FF59058	R/W
LEDC_HSCH5_DUTY_REG	Initial duty cycle for high-speed channel 5	0x3FF5906C	R/W
LEDC_HSCH6_DUTY_REG	Initial duty cycle for high-speed channel 6	0x3FF59080	R/W
LEDC_HSCH7_DUTY_REG	Initial duty cycle for high-speed channel 7	0x3FF59094	R/W

Name	Description	Address	Access
LEDC_HSCH0_DUTY_R_REG	Current duty cycle for high-speed channel 0	0x3FF59010	RO
LEDC_HSCH1_DUTY_R_REG	Current duty cycle for high-speed channel 1	0x3FF59024	RO
LEDC_HSCH2_DUTY_R_REG	Current duty cycle for high-speed channel 2	0x3FF59038	RO
LEDC_HSCH3_DUTY_R_REG	Current duty cycle for high-speed channel 3	0x3FF5904C	RO
LEDC_HSCH4_DUTY_R_REG	Current duty cycle for high-speed channel 4	0x3FF59060	RO
LEDC_HSCH5_DUTY_R_REG	Current duty cycle for high-speed channel 5	0x3FF59074	RO
LEDC_HSCH6_DUTY_R_REG	Current duty cycle for high-speed channel 6	0x3FF59088	RO
LEDC_HSCH7_DUTY_R_REG	Current duty cycle for high-speed channel 7	0x3FF5909C	RO
LEDC_LSCH0_DUTY_REG	Initial duty cycle for low-speed channel 0	0x3FF590A8	R/W
LEDC_LSCH1_DUTY_REG	Initial duty cycle for low-speed channel 1	0x3FF590BC	R/W
LEDC_LSCH2_DUTY_REG	Initial duty cycle for low-speed channel 2	0x3FF590D0	R/W
LEDC_LSCH3_DUTY_REG	Initial duty cycle for low-speed channel 3	0x3FF590E4	R/W
LEDC_LSCH4_DUTY_REG	Initial duty cycle for low-speed channel 4	0x3FF590F8	R/W
LEDC_LSCH5_DUTY_REG	Initial duty cycle for low-speed channel 5	0x3FF5910C	R/W
LEDC_LSCH6_DUTY_REG	Initial duty cycle for low-speed channel 6	0x3FF59120	R/W
LEDC_LSCH7_DUTY_REG	Initial duty cycle for low-speed channel 7	0x3FF59134	R/W
LEDC_LSCH0_DUTY_R_REG	Current duty cycle for low-speed channel 0	0x3FF590B0	RO
LEDC_LSCH1_DUTY_R_REG	Current duty cycle for low-speed channel 1	0x3FF590C4	RO
LEDC_LSCH2_DUTY_R_REG	Current duty cycle for low-speed channel 2	0x3FF590D8	RO
LEDC_LSCH3_DUTY_R_REG	Current duty cycle for low-speed channel 3	0x3FF590EC	RO
LEDC_LSCH4_DUTY_R_REG	Current duty cycle for low-speed channel 4	0x3FF59100	RO
LEDC_LSCH5_DUTY_R_REG	Current duty cycle for low-speed channel 5	0x3FF59114	RO
LEDC_LSCH6_DUTY_R_REG	Current duty cycle for low-speed channel 6	0x3FF59128	RO
LEDC_LSCH7_DUTY_R_REG	Current duty cycle for low-speed channel 7	0x3FF5913C	RO
Timer registers			
LEDC_HSTIMER0_CONF_REG	High-speed timer 0 configuration	0x3FF59140	R/W
LEDC_HSTIMER1_CONF_REG	High-speed timer 1 configuration	0x3FF59148	R/W
LEDC_HSTIMER2_CONF_REG	High-speed timer 2 configuration	0x3FF59150	R/W
LEDC_HSTIMER3_CONF_REG	High-speed timer 3 configuration	0x3FF59158	R/W
LEDC_HSTIMER0_VALUE_REG	High-speed timer 0 current counter value	0x3FF59144	RO
LEDC_HSTIMER1_VALUE_REG	High-speed timer 1 current counter value	0x3FF5914C	RO
LEDC_HSTIMER2_VALUE_REG	High-speed timer 2 current counter value	0x3FF59154	RO
LEDC_HSTIMER3_VALUE_REG	High-speed timer 3 current counter value	0x3FF5915C	RO
LEDC_LSTIMER0_CONF_REG	Low-speed timer 0 configuration	0x3FF59160	R/W
LEDC_LSTIMER1_CONF_REG	Low-speed timer 1 configuration	0x3FF59168	R/W
LEDC_LSTIMER2_CONF_REG	Low-speed timer 2 configuration	0x3FF59170	R/W
LEDC_LSTIMER3_CONF_REG	Low-speed timer 3 configuration	0x3FF59178	R/W
LEDC_LSTIMER0_VALUE_REG	Low-speed timer 0 current counter value	0x3FF59164	RO
LEDC_LSTIMER1_VALUE_REG	Low-speed timer 1 current counter value	0x3FF5916C	RO
LEDC_LSTIMER2_VALUE_REG	Low-speed timer 2 current counter value	0x3FF59174	RO
LEDC_LSTIMER3_VALUE_REG	Low-speed timer 3 current counter value	0x3FF5917C	RO
Interrupt registers			
LEDC_INT_RAW_REG	Raw interrupt status	0x3FF59180	RO
LEDC_INT_ST_REG	Masked interrupt status	0x3FF59184	RO

Name	Description	Address	Access
LEDC_INT_ENA_REG	Interrupt enable bits	0x3FF59188	R/W
LEDC_INT_CLR_REG	Interrupt clear bits	0x3FF5918C	WO

14.4 Registers

Register 14.1: LEDC_HSCH n _CONF0_REG (n : 0-7) (0x1C+0x10* n)

(reserved)				LEDC_IDLE_LV_HSCH n LEDC_SIG_OUT_EN_HSCH n LEDC_TIMER_SEL_HSCH n					
31	4	3	2	1	0				
0x00000000						0	0	0	Reset

LEDC_IDLE_LV_HSCH n This bit is used to control the output value when high-speed channel n is inactive. (R/W)

LEDC_SIG_OUT_EN_HSCH n This is the output enable control bit for high-speed channel n . (R/W)

LEDC_TIMER_SEL_HSCH n There are four high-speed timers. These two bits are used to select one of them for high-speed channel n : (R/W)

- 0: select hstimer0;
- 1: select hstimer1;
- 2: select hstimer2;
- 3: select hstimer3.

Register 14.2: LEDC_HSCH n _HPOINT_REG (n : 0-7) (0x20+0x10* n)

(reserved)		LEDC_HPOINT_HSCH n		
31	20	19	0	
0x0000		0x000000		Reset

LEDC_HPOINT_HSCH n The output value changes to high when htimer x (x =[0,3]), selected by high-speed channel n , has reached LEDC_HPOINT_HSCH n [19:0]. (R/W)

Register 14.3: LEDC_HSCH_n_DUTY_REG (*n*: 0-7) (0x24+0x10n*)**

(reserved)		LEDC_DUTY_HSCH _n	
31	25	24	0
0x00		0x0000000	
			Reset

LEDC_DUTY_HSCH_n The register is used to control output duty. When hstimerx(x=[0,3]), selected by high-speed channel *n*, has reached LEDC_LPOINT_HSCH_n, the output signal changes to low. (R/W)

LEDC_LPOINT_HSCH_n=LEDC_LPOINT_HSCH_n[19:0]+LEDC_DUTY_HSCH_n[24:4] (1)

LEDC_LPOINT_HSCH_n=LEDC_LPOINT_HSCH_n[19:0]+LEDC_DUTY_HSCH_n[24:4] + 1) (2)

See the [Functional Description](#) for more information on when (1) or (2) is chosen.

Register 14.4: LEDC_HSCH_n_CONF1_REG (*n*: 0-7) (0x28+0x10n*)**

LEDC_DUTY_START_HSCH _n LEDC_DUTY_INC_HSCH _n		LEDC_DUTY_NUM_HSCH _n		LEDC_DUTY_CYCLE_HSCH _n		LEDC_DUTY_SCALE_HSCH _n	
31	30	29	20	19	10	9	0
0	1	0x000		0x000		0x000	
							Reset

LEDC_DUTY_START_HSCH_n When LEDC_DUTY_NUM_HSCH_n, LEDC_DUTY_CYCLE_HSCH_n and LEDC_DUTY_SCALE_HSCH_n has been configured, these register will not take effect until LEDC_DUTY_START_HSCH_n is set. This bit is automatically cleared by hardware. (R/W)

LEDC_DUTY_INC_HSCH_n This register is used to increase or decrease the duty of output signal for high-speed channel *n*. (R/W)

LEDC_DUTY_NUM_HSCH_n This register is used to control the number of times the duty cycle is increased or decreased for high-speed channel *n*. (R/W)

LEDC_DUTY_CYCLE_HSCH_n This register is used to increase or decrease the duty cycle every time LEDC_DUTY_CYCLE_HSCH_n cycles for high-speed channel *n*. (R/W)

LEDC_DUTY_SCALE_HSCH_n This register is used to increase or decrease the step scale for high-speed channel *n*. (R/W)

Register 14.5: LEDC_HSCH n _DUTY_R_REG (n : 0-7) (0x2C+0x10* n)

(reserved)		LEDC_DUTY_HSCH n _R	
31	25	24	0
0x00		0x0000000	
			Reset

LEDC_DUTY_HSCH n _R This register represents the current duty cycle of the output signal for high-speed channel n . (RO)

Register 14.6: LEDC_LSCH n _CONF0_REG (n : 0-7) (0xBC+0x10* n)

(reserved)					LEDC_PARA_UP_LSCH n LEDC_IDLE_LV_LSCH n LEDC_SIG_OUT_EN_LSCH n LEDC_TIMER_SEL_LSCH n					
31					5	4	3	2	1	0
0x0000000					0	0	0	0	0	0
										Reset

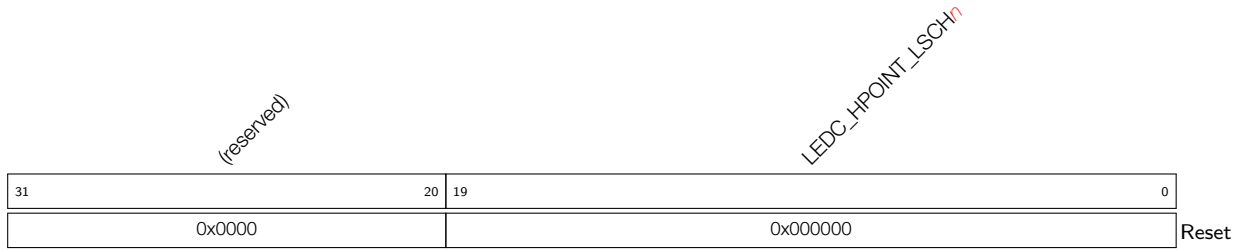
LEDC_PARA_UP_LSCH n This bit is used to update register LEDC_LSCH n _HPOINT and LEDC_LSCH n _DUTY for low-speed channel n . (R/W)

LEDC_IDLE_LV_LSCH n This bit is used to control the output value, when low-speed channel n is inactive. (R/W)

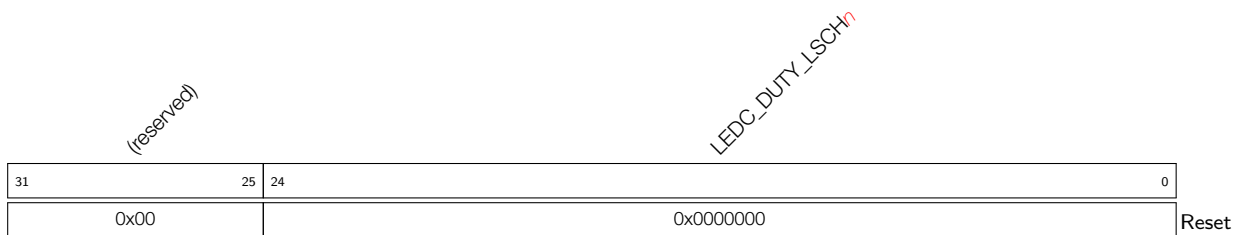
LEDC_SIG_OUT_EN_LSCH n This is the output enable control bit for low-speed channel n . (R/W)

LEDC_TIMER_SEL_LSCH n There are four low-speed timers, the two bits are used to select one of them for low-speed channel n . (R/W)

- 0: select Istimer0;
- 1: select Istimer1;
- 2: select Istimer2;
- 3: select Istimer3.

Register 14.7: LEDC_LSCH n _HPOINT_REG (n : 0-7) (0xC0+0x10* n)

LEDC_HPOINT_LSCH n The output value changes to high when Istimer x (x =[0,3]), selected by low-speed channel n , has reached LEDC_HPOINT_LSCH n [19:0]. (R/W)

Register 14.8: LEDC_LSCH n _DUTY_REG (n : 0-7) (0xC4+0x10* n)

LEDC_DUTY_LSCH n The register is used to control output duty. When Istimer x (x =[0,3]), chosen by low-speed channel n , has reached LEDC_LPOINT_LSCH n , the output signal changes to low. (R/W)

LEDC_LPOINT_LSCH n =(LEDC_HPOINT_LSCH n [19:0]+LEDC_DUTY_LSCH n [24:4]) (1)

LEDC_LPOINT_LSCH n =(LEDC_HPOINT_LSCH n [19:0]+LEDC_DUTY_LSCH n [24:4] +1) (2)

See the [Functional Description](#) for more information on when (1) or (2) is chosen.

Register 14.9: LEDC_LSCH n _CONF1_REG (n : 0-7) (0xC8+0x10* n)

LEDC_DUTY_START_LSCH n LEDC_DUTY_INC_LSCH n		LEDC_DUTY_NUM_LSCH n		LEDC_DUTY_CYCLE_LSCH n		LEDC_DUTY_SCALE_LSCH n	
31	30	29	20	19	10	9	0
0	1	0x000		0x000		0x000	

Reset

LEDC_DUTY_START_LSCH n When LEDC_DUTY_NUM_HSCH n , LEDC_DUTY_CYCLE_HSCH n and LEDC_DUTY_SCALE_HSCH n have been configured, these settings will not take effect until set LEDC_DUTY_START_HSCH n . This bit is automatically cleared by hardware. (R/W)

LEDC_DUTY_INC_LSCH n This register is used to increase or decrease the duty of output signal for low-speed channel n . (R/W)

LEDC_DUTY_NUM_LSCH n This register is used to control the number of times the duty cycle is increased or decreased for low-speed channel n . (R/W)

LEDC_DUTY_CYCLE_LSCH n This register is used to increase or decrease the duty every LEDC_DUTY_CYCLE_LSCH n cycles for low-speed channel n . (R/W)

LEDC_DUTY_SCALE_LSCH n This register is used to increase or decrease the step scale for low-speed channel n . (R/W)

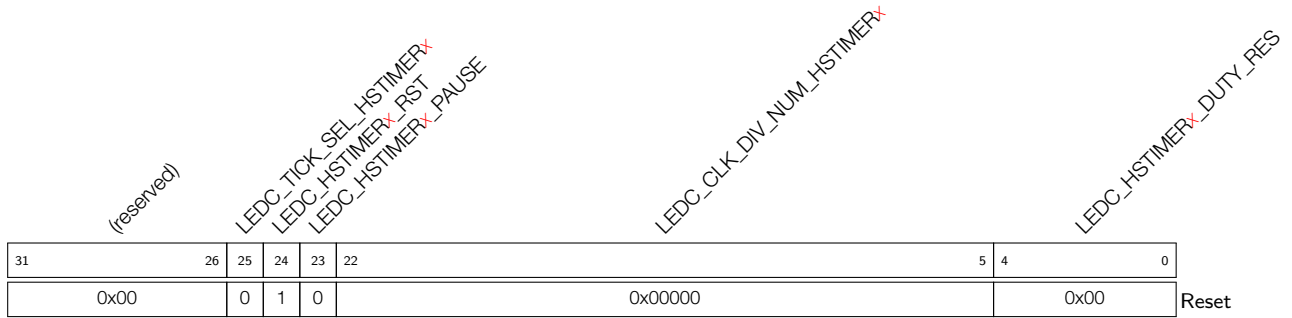
Register 14.10: LEDC_LSCH n _DUTY_R_REG (n : 0-7) (0xCC+0x10* n)

(reserved)		LEDC_DUTY_LSCH n _R	
31	25	24	0
0x00		0x0000000	

Reset

LEDC_DUTY_LSCH n _R This register represents the current duty of the output signal for low-speed channel n . (RO)

Register 14.11: LEDC_HSTIMER_x_CONF_REG (x: 0-3) (0x140+8*x)



LEDC_TICK_SEL_HSTIMER_x This bit is used to select APB_CLK or REF_TICK for high-speed timer _x. (R/W)
 1: APB_CLK;
 0: REF_TICK.

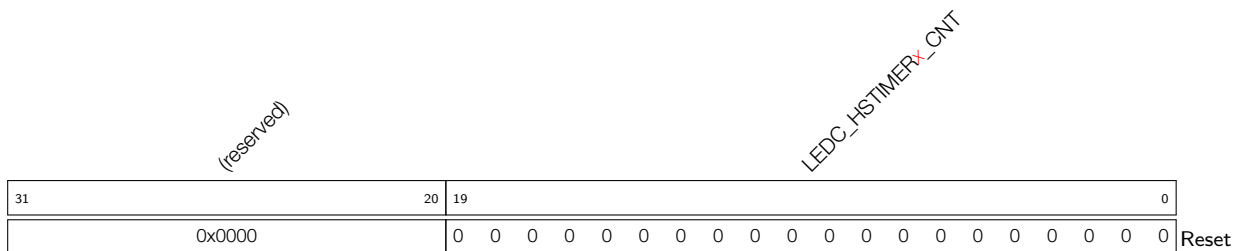
LEDC_HSTIMER_x_RST This bit is used to reset high-speed timer _x. The counter value will be 'zero' after reset. (R/W)

LEDC_HSTIMER_x_PAUSE This bit is used to suspend the counter in high-speed timer _x. (R/W)

LEDC_CLK_DIV_NUM_HSTIMER_x This register is used to configure the division factor for the divider in high-speed timer _x. The least significant eight bits represent the fractional part. (R/W)

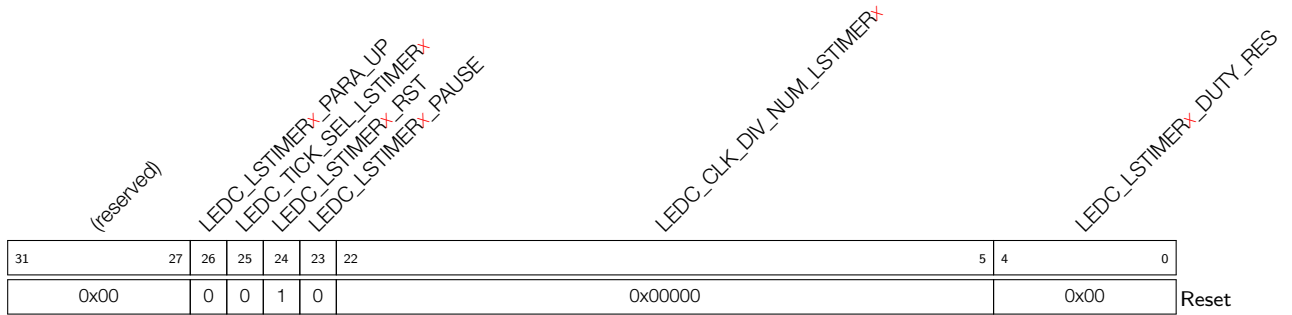
LEDC_HSTIMER_x_DUTY_RES This register is used to control the range of the counter in high-speed timer _x. The counter range is [0,2**LEDC_HSTIMER_x_DUTY_RES], the maximum bit width for counter is 20. (R/W)

Register 14.12: LEDC_HSTIMER_x_VALUE_REG (x: 0-3) (0x144+8*x)



LEDC_HSTIMER_x_CNT Software can read this register to get the current counter value of high-speed timer _x. (RO)

Register 14.13: LEDC_LSTIMER_x_CONF_REG (x: 0-3) (0x160+8*x)



LEDC_LSTIMER_x_PARA_UP Set this bit to update LEDC_CLK_DIV_NUM_LSTIME_x and LEDC_LSTIMER_x_DUTY_RES. (R/W)

LEDC_TICK_SEL_LSTIMER_x This bit is used to select SLOW_CLK or REF_TICK for low-speed timer _x. (R/W)

1: SLOW_CLK;

0: REF_TICK.

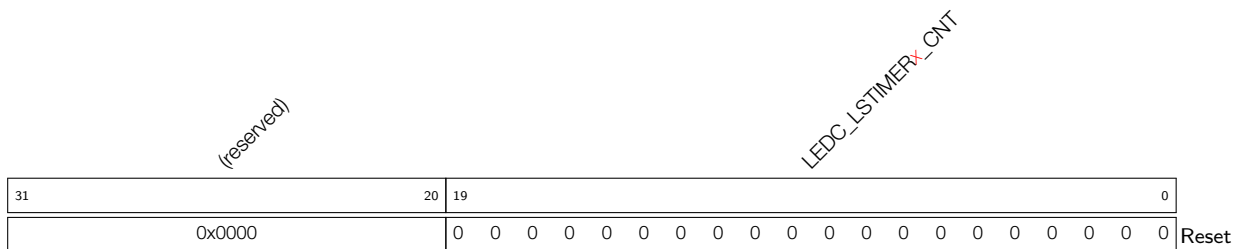
LEDC_LSTIMER_x_RST This bit is used to reset low-speed timer _x. The counter will show 0 after reset. (R/W)

LEDC_LSTIMER_x_PAUSE This bit is used to suspend the counter in low-speed timer _x. (R/W)

LEDC_CLK_DIV_NUM_LSTIMER_x This register is used to configure the division factor for the divider in low-speed timer _x. The least significant eight bits represent the fractional part. (R/W)

LEDC_LSTIMER_x_DUTY_RES This register is used to control the range of the counter in low-speed timer _x. The counter range is [0,2**LEDC_LSTIMER_x_DUTY_RES], the max bit width for counter is 20. (R/W)

Register 14.14: LEDC_LSTIMER_x_VALUE_REG (x: 0-3) (0x164+8*x)



LEDC_LSTIMER_x_CNT Software can read this register to get the current counter value of low-speed timer _x. (RO)

Register 14.15: LEDC_INT_RAW_REG (0x0180)

(reserved)								LEDC_DUTY_CHNG_END_LSCH7_INT_RAW																							
(reserved)								LEDC_DUTY_CHNG_END_LSCH6_INT_RAW																							
(reserved)								LEDC_DUTY_CHNG_END_LSCH5_INT_RAW																							
(reserved)								LEDC_DUTY_CHNG_END_LSCH4_INT_RAW																							
(reserved)								LEDC_DUTY_CHNG_END_LSCH3_INT_RAW																							
(reserved)								LEDC_DUTY_CHNG_END_LSCH2_INT_RAW																							
(reserved)								LEDC_DUTY_CHNG_END_LSCH1_INT_RAW																							
(reserved)								LEDC_DUTY_CHNG_END_HSCH0_INT_RAW																							
(reserved)								LEDC_DUTY_CHNG_END_HSCH7_INT_RAW																							
(reserved)								LEDC_DUTY_CHNG_END_HSCH6_INT_RAW																							
(reserved)								LEDC_DUTY_CHNG_END_HSCH5_INT_RAW																							
(reserved)								LEDC_DUTY_CHNG_END_HSCH4_INT_RAW																							
(reserved)								LEDC_DUTY_CHNG_END_HSCH3_INT_RAW																							
(reserved)								LEDC_DUTY_CHNG_END_HSCH2_INT_RAW																							
(reserved)								LEDC_DUTY_CHNG_END_HSCH1_INT_RAW																							
(reserved)								LEDC_LSTIMER3_OVF_INT_RAW																							
(reserved)								LEDC_LSTIMER2_OVF_INT_RAW																							
(reserved)								LEDC_LSTIMER1_OVF_INT_RAW																							
(reserved)								LEDC_HSTIMER3_OVF_INT_RAW																							
(reserved)								LEDC_HSTIMER2_OVF_INT_RAW																							
(reserved)								LEDC_HSTIMER1_OVF_INT_RAW																							
(reserved)								LEDC_HSTIMER0_OVF_INT_RAW																							
31	24	23	22	21	20	19	18	17	16	15	14	13	12	11	10	9	8	7	6	5	4	3	2	1	0	Reset					
0	0	0	0	0	0	0	0	0	0	0	0	0	0	0	0	0	0	0	0	0	0	0	0	0	0	0	0	0			

LEDC_DUTY_CHNG_END_LSCH n _INT_RAW The raw interrupt status bit for the [LEDC_DUTY_CHNG_END_LSCH \$n\$ _INT](#) interrupt. (RO)

LEDC_DUTY_CHNG_END_HSCH n _INT_RAW The raw interrupt status bit for the [LEDC_DUTY_CHNG_END_HSCH \$n\$ _INT](#) interrupt. (RO)

LEDC_LSTIMER x _OVF_INT_RAW The raw interrupt status bit for the [LEDC_LSTIMER \$x\$ _OVF_INT](#) interrupt. (RO)

LEDC_HSTIMER x _OVF_INT_RAW The raw interrupt status bit for the [LEDC_HSTIMER \$x\$ _OVF_INT](#) interrupt. (RO)

Register 14.16: LEDC_INT_ST_REG (0x0184)

(reserved)								LEDC_DUTY_CHNG_END_LSCH7_INT_ST																							
(reserved)								LEDC_DUTY_CHNG_END_LSCH6_INT_ST																							
(reserved)								LEDC_DUTY_CHNG_END_LSCH5_INT_ST																							
(reserved)								LEDC_DUTY_CHNG_END_LSCH4_INT_ST																							
(reserved)								LEDC_DUTY_CHNG_END_LSCH3_INT_ST																							
(reserved)								LEDC_DUTY_CHNG_END_LSCH2_INT_ST																							
(reserved)								LEDC_DUTY_CHNG_END_LSCH1_INT_ST																							
(reserved)								LEDC_DUTY_CHNG_END_HSCH0_INT_ST																							
(reserved)								LEDC_DUTY_CHNG_END_HSCH7_INT_ST																							
(reserved)								LEDC_DUTY_CHNG_END_HSCH6_INT_ST																							
(reserved)								LEDC_DUTY_CHNG_END_HSCH5_INT_ST																							
(reserved)								LEDC_DUTY_CHNG_END_HSCH4_INT_ST																							
(reserved)								LEDC_DUTY_CHNG_END_HSCH3_INT_ST																							
(reserved)								LEDC_DUTY_CHNG_END_HSCH2_INT_ST																							
(reserved)								LEDC_DUTY_CHNG_END_HSCH1_INT_ST																							
(reserved)								LEDC_LSTIMER3_OVF_INT_ST																							
(reserved)								LEDC_LSTIMER2_OVF_INT_ST																							
(reserved)								LEDC_LSTIMER1_OVF_INT_ST																							
(reserved)								LEDC_HSTIMER3_OVF_INT_ST																							
(reserved)								LEDC_HSTIMER2_OVF_INT_ST																							
(reserved)								LEDC_HSTIMER1_OVF_INT_ST																							
(reserved)								LEDC_HSTIMER0_OVF_INT_ST																							
31	24	23	22	21	20	19	18	17	16	15	14	13	12	11	10	9	8	7	6	5	4	3	2	1	0	Reset					
0	0	0	0	0	0	0	0	0	0	0	0	0	0	0	0	0	0	0	0	0	0	0	0	0	0	0	0				

LEDC_DUTY_CHNG_END_LSCH n _INT_ST The masked interrupt status bit for the [LEDC_DUTY_CHNG_END_LSCH \$n\$ _INT](#) interrupt. (RO)

LEDC_DUTY_CHNG_END_HSCH n _INT_ST The masked interrupt status bit for the [LEDC_DUTY_CHNG_END_HSCH \$n\$ _INT](#) interrupt. (RO)

LEDC_LSTIMER x _OVF_INT_ST The masked interrupt status bit for the [LEDC_LSTIMER \$x\$ _OVF_INT](#) interrupt. (RO)

LEDC_HSTIMER x _OVF_INT_ST The masked interrupt status bit for the [LEDC_HSTIMER \$x\$ _OVF_INT](#) interrupt. (RO)

Register 14.17: LEDC_INT_ENA_REG (0x0188)

(reserved)								LEDC_DUTY_CHNG_END_LSCH7_INT_ENA	LEDC_DUTY_CHNG_END_LSCH6_INT_ENA	LEDC_DUTY_CHNG_END_LSCH5_INT_ENA	LEDC_DUTY_CHNG_END_LSCH4_INT_ENA	LEDC_DUTY_CHNG_END_LSCH3_INT_ENA	LEDC_DUTY_CHNG_END_LSCH2_INT_ENA	LEDC_DUTY_CHNG_END_LSCH1_INT_ENA	LEDC_DUTY_CHNG_END_HSCH7_INT_ENA	LEDC_DUTY_CHNG_END_HSCH6_INT_ENA	LEDC_DUTY_CHNG_END_HSCH5_INT_ENA	LEDC_DUTY_CHNG_END_HSCH4_INT_ENA	LEDC_DUTY_CHNG_END_HSCH3_INT_ENA	LEDC_DUTY_CHNG_END_HSCH2_INT_ENA	LEDC_DUTY_CHNG_END_HSCH1_INT_ENA	LEDC_LSTIMER3_OVF_INT_ENA	LEDC_LSTIMER2_OVF_INT_ENA	LEDC_LSTIMER1_OVF_INT_ENA	LEDC_HSTIMER3_OVF_INT_ENA	LEDC_HSTIMER2_OVF_INT_ENA	LEDC_HSTIMER1_OVF_INT_ENA	LEDC_HSTIMER0_OVF_INT_ENA
31	24	23	22	21	20	19	18	17	16	15	14	13	12	11	10	9	8	7	6	5	4	3	2	1	0	Reset		
0	0	0	0	0	0	0	0	0	0	0	0	0	0	0	0	0	0	0	0	0	0	0	0	0	0	0	0	0

LEDC_DUTY_CHNG_END_LSCH n _INT_ENA The interrupt enable bit for the [LEDC_DUTY_CHNG_END_LSCH \$n\$ _INT](#) interrupt. (R/W)

LEDC_DUTY_CHNG_END_HSCH n _INT_ENA The interrupt enable bit for the [LEDC_DUTY_CHNG_END_HSCH \$n\$ _INT](#) interrupt. (R/W)

LEDC_LSTIMER x _OVF_INT_ENA The interrupt enable bit for the [LEDC_LSTIMER \$x\$ _OVF_INT](#) interrupt. (R/W)

LEDC_HSTIMER x _OVF_INT_ENA The interrupt enable bit for the [LEDC_HSTIMER \$x\$ _OVF_INT](#) interrupt. (R/W)

Register 14.18: LEDC_INT_CLR_REG (0x018C)

(reserved)								LEDC_DUTY_CHNG_END_LSCH7_INT_CLR	LEDC_DUTY_CHNG_END_LSCH6_INT_CLR	LEDC_DUTY_CHNG_END_LSCH5_INT_CLR	LEDC_DUTY_CHNG_END_LSCH4_INT_CLR	LEDC_DUTY_CHNG_END_LSCH3_INT_CLR	LEDC_DUTY_CHNG_END_LSCH2_INT_CLR	LEDC_DUTY_CHNG_END_LSCH1_INT_CLR	LEDC_DUTY_CHNG_END_HSCH7_INT_CLR	LEDC_DUTY_CHNG_END_HSCH6_INT_CLR	LEDC_DUTY_CHNG_END_HSCH5_INT_CLR	LEDC_DUTY_CHNG_END_HSCH4_INT_CLR	LEDC_DUTY_CHNG_END_HSCH3_INT_CLR	LEDC_DUTY_CHNG_END_HSCH2_INT_CLR	LEDC_DUTY_CHNG_END_HSCH1_INT_CLR	LEDC_LSTIMER3_OVF_INT_CLR	LEDC_LSTIMER2_OVF_INT_CLR	LEDC_LSTIMER1_OVF_INT_CLR	LEDC_HSTIMER3_OVF_INT_CLR	LEDC_HSTIMER2_OVF_INT_CLR	LEDC_HSTIMER1_OVF_INT_CLR	LEDC_HSTIMER0_OVF_INT_CLR
31	24	23	22	21	20	19	18	17	16	15	14	13	12	11	10	9	8	7	6	5	4	3	2	1	0	Reset		
0	0	0	0	0	0	0	0	0	0	0	0	0	0	0	0	0	0	0	0	0	0	0	0	0	0	0	0	

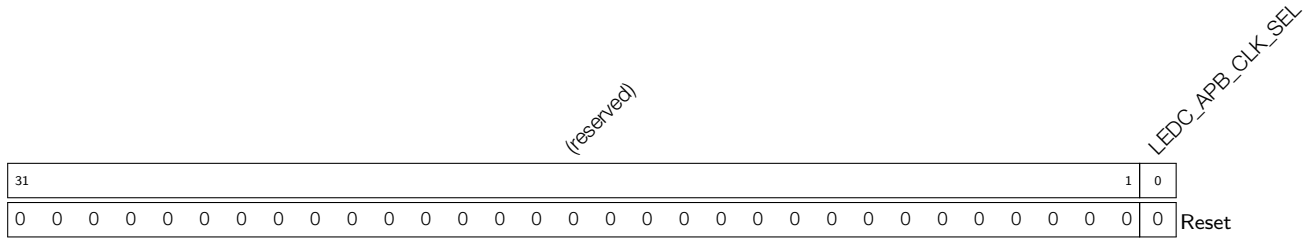
LEDC_DUTY_CHNG_END_LSCH n _INT_CLR Set this bit to clear the [LEDC_DUTY_CHNG_END_LSCH \$n\$ _INT](#) interrupt. (WO)

LEDC_DUTY_CHNG_END_HSCH n _INT_CLR Set this bit to clear the [LEDC_DUTY_CHNG_END_HSCH \$n\$ _INT](#) interrupt. (WO)

LEDC_LSTIMER x _OVF_INT_CLR Set this bit to clear the [LEDC_LSTIMER \$x\$ _OVF_INT](#) interrupt. (WO)

LEDC_HSTIMER x _OVF_INT_CLR Set this bit to clear the [LEDC_HSTIMER \$x\$ _OVF_INT](#) interrupt. (WO)

Register 14.19: LEDC_CONF_REG (0x0190)



LEDC_APB_CLK_SEL This bit is used to set the frequency of SLOW_CLK. (R/W)
 0: 8 MHz;
 1: 80 MHz.

15. Remote Control Peripheral

15.1 Introduction

The RMT (Remote Control) module is primarily designed to send and receive infrared remote control signals that implement on-off keying in a carrier frequency, but due to its design it can be used to generate various types of signals. An RMT transmitter does this by reading consecutive duration values of an active and inactive output from the built-in RAM block, optionally modulating it with a carrier wave. A receiver will inspect its input signal, optionally filtering it, and will place the lengths of time the signal is active and inactive in the RAM block.

The RMT module has eight channels, numbered zero to seven; registers, signals and blocks that are duplicated in each channel are indicated by an *n* which is used as a placeholder for the channel number.

15.2 Functional Description

15.2.1 RMT Architecture

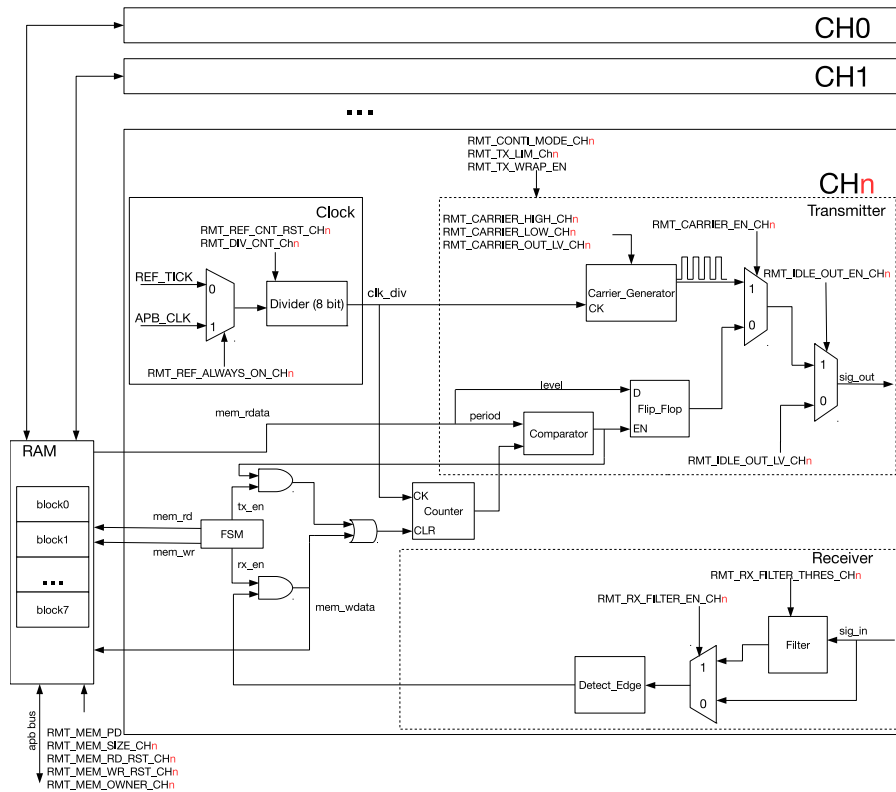


Figure 88: RMT Architecture

The RMT module contains eight channels. Each channel has both a transmitter and a receiver, but only one of them can be active in every channel. The eight channels share a 512x32-bit RAM block which can be read and written by the processor cores over the APB bus, read by the transmitters, and written by the receivers. The transmitted signal can optionally be modulated by a carrier wave. Each channel is clocked by a divided-down signal derived from either the APB bus clock or REF_TICK.

15.2.2 RMT RAM

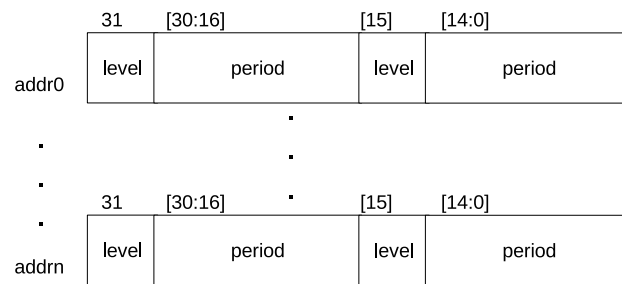


Figure 89: Data Structure

The data structure in RAM is shown in Figure 89. Each 32-bit value contains two 16-bit entries, with two fields in every entry, "level" and "period". "Level" indicates whether a high-/low-level value was received or is going to be sent, while "period" points out the divider-clock cycles for which the level lasts. A zero period is interpreted as an end-marker: the transmitter will stop transmitting once it has read this, and the receiver will write this, once it has detected that the signal it received has gone idle.

Normally, only one block of 64x32-bit worth of data can be sent or received. If the data size is larger than this block size, blocks can be extended or the channel can be configured for the wraparound mode.

The RMT RAM can be accessed via the APB bus. The initial address is the RMT base address + 0x800. The RAM block is divided into eight 64x32-bit blocks. By default, each channel uses one block (block zero for channel zero, block one for channel one, and so on). Users can extend the memory to a specific channel by configuring the RMT_MEM_SIZE_CH n register; setting this to >1 will prompt the channel to use the memory of subsequent channels as well. The RAM address range of channel n is start_addr_CH n to end_addr_CH n , which is defined by:

start_addr_ch n = RMT base address + 0x800 + 64 * 4 * n , and

end_addr_ch n = RMT base address + 0x800 + (64 * 4 * n + 64 * 4 * RMT_MEM_SIZE_CH n) mod (512 * 4) - 4

To protect a receiver from overwriting the blocks a transmitter is about to transmit, RMT_MEM_OWNER_CH n can be configured to designate the owner, be it a transmitter or receiver, of channel n 's RAM block. This way, if this ownership is violated, the RMT_CH n _ERR interrupt will be generated.

Note: When enabling the continuous transmission mode by setting RMT_REG_TX_CONTI_MODE, the transmitter will transmit the data on the channel continuously, that is, from the first byte to the last one, then from the first to the last again, and so on. In this mode, there will be an idle level lasting one clk_div cycle between N and $N+1$ transmissions.

15.2.3 Clock

The main clock of a channel is generated by taking either the 80 MHz APB clock or REF_TICK (usually 1MHz), according to the state of RMT_REF_ALWAYS_ON_CH n . (For more information on clock sources, please see Chapter [Reset And Clock](#).) Then, the aforementioned state gets scaled down using a configurable 8-bit divider to create the channel clock which is used by both the carrier wave generator and the counter. The divider value can be set by configuring RMT_DIV_CNT_CH n .

15.2.4 Transmitter

When the RMT_TX_START_CH n register is 1, the transmitter of channel n will start reading and sending data from RAM. The transmitter will receive a 32-bit value each time it reads from RAM. Of these 32 bits, the low 16-bit entry is sent first and the high entry second.

To transmit more data than can be fitted in the channel's RAM, the wraparound mode can be enabled. In this mode, when the transmitter has reached the last entry in the channel's memory, it will loop back to the first byte. To use this mechanism for sending more data than can be fitted in the channel's RAM, fill the RAM with the initial events and set RMT_CH n _TX_LIM_REG to cause an RMT_CH n _TX_THR_EVENT_INT interrupt before the wraparound happens. Then, when the interrupt happens, the already sent data should be replaced by subsequent events, so that when the wraparound happens the transmitter will seamlessly continue sending the new events.

With or without the wraparound mode enabled, transmission ends when an entry with zero length is encountered. When this happens, the transmitter will generate an RMT_CH n _TX_END_INT interrupt and return to the idle state. When a transmitter is in the idle state, the output level defaults to end-mark 0. Users can also configure RMT_IDLE_OUT_EN_CH n and RMT_IDLE_OUT_LV_CH n to control the output level manually.

The output of the transmitter can be modulated using a carrier wave by setting RMT_CARRIER_EN_CH n . The carrier frequency and duty cycle can be configured by adjusting the carrier's high and low durations in channel-clock cycles, in RMT_CARRIER_HIGH_CH n and RMT_CARRIER_LOW_CH n .

15.2.5 Receiver

When RMT_RX_EN_CH n is set to 1, the receiver in channel n becomes active, measuring the duration between input signal edges. These will be written as period/level value pairs to the channel RAM in the same fashion as the transmitter sends them. Receiving ends, when the receiver detects no change in signal level for more than RMT_IDLE_THRES_CH n channel clock ticks. The receiver will write a final entry with 0 period, generate an RMT_CH n _RX_END_INT_RAW interrupt and return to the idle state.

The receiver has an input signal filter which can be configured using RMT_RX_FILTER_EN_CH n : The filter will remove pulses with a length of less than RMT_RX_FILTER_THRES_CH n in APB clock periods.

When the RMT module is inactive, the RAM can be put into low-power mode by setting the RMT_MEM_PD register to 1.

15.2.6 Interrupts

- RMT_CH n _TX_THR_EVENT_INT: Triggered when the amount of data the transmitter has sent matches the value of RMT_CH n _TX_LIM_REG.
- RMT_CH n _TX_END_INT: Triggered when the transmitter has finished transmitting the signal.
- RMT_CH n _RX_END_INT: Triggered when the receiver has finished receiving a signal.

15.3 Register Summary

Name	Description	Address	Access
Configuration registers			
RMT_CHOCONF0_REG	Channel 0 config register 0	0x3FF56020	R/W

RMT_CH0CONF1_REG	Channel 0 config register 1	0x3FF56024	R/W
RMT_CH1CONF0_REG	Channel 1 config register 0	0x3FF56028	R/W
RMT_CH1CONF1_REG	Channel 1 config register 1	0x3FF5602C	R/W
RMT_CH2CONF0_REG	Channel 2 config register 0	0x3FF56030	R/W
RMT_CH2CONF1_REG	Channel 2 config register 1	0x3FF56034	R/W
RMT_CH3CONF0_REG	Channel 3 config register 0	0x3FF56038	R/W
RMT_CH3CONF1_REG	Channel 3 config register 1	0x3FF5603C	R/W
RMT_CH4CONF0_REG	Channel 4 config register 0	0x3FF56040	R/W
RMT_CH4CONF1_REG	Channel 4 config register 1	0x3FF56044	R/W
RMT_CH5CONF0_REG	Channel 5 config register 0	0x3FF56048	R/W
RMT_CH5CONF1_REG	Channel 5 config register 1	0x3FF5604C	R/W
RMT_CH6CONF0_REG	Channel 6 config register 0	0x3FF56050	R/W
RMT_CH6CONF1_REG	Channel 6 config register 1	0x3FF56054	R/W
RMT_CH7CONF0_REG	Channel 7 config register 0	0x3FF56058	R/W
RMT_CH7CONF1_REG	Channel 7 config register 1	0x3FF5605C	R/W
Interrupt registers			
RMT_INT_RAW_REG	Raw interrupt status	0x3FF560A0	RO
RMT_INT_ST_REG	Masked interrupt status	0x3FF560A4	RO
RMT_INT_ENA_REG	Interrupt enable bits	0x3FF560A8	R/W
RMT_INT_CLR_REG	Interrupt clear bits	0x3FF560AC	WO
Carrier wave duty cycle registers			
RMT_CH0CARRIER_DUTY_REG	Channel 0 duty cycle configuration register	0x3FF560B0	R/W
RMT_CH1CARRIER_DUTY_REG	Channel 1 duty cycle configuration register	0x3FF560B4	R/W
RMT_CH2CARRIER_DUTY_REG	Channel 2 duty cycle configuration register	0x3FF560B8	R/W
RMT_CH3CARRIER_DUTY_REG	Channel 3 duty cycle configuration register	0x3FF560BC	R/W
RMT_CH4CARRIER_DUTY_REG	Channel 4 duty cycle configuration register	0x3FF560C0	R/W
RMT_CH5CARRIER_DUTY_REG	Channel 5 duty cycle configuration register	0x3FF560C4	R/W
RMT_CH6CARRIER_DUTY_REG	Channel 6 duty cycle configuration register	0x3FF560C8	R/W
RMT_CH7CARRIER_DUTY_REG	Channel 7 duty cycle configuration register	0x3FF560CC	R/W
Tx event configuration registers			
RMT_CH0_TX_LIM_REG	Channel 0 Tx event configuration register	0x3FF560D0	R/W
RMT_CH1_TX_LIM_REG	Channel 1 Tx event configuration register	0x3FF560D4	R/W
RMT_CH2_TX_LIM_REG	Channel 2 Tx event configuration register	0x3FF560D8	R/W
RMT_CH3_TX_LIM_REG	Channel 3 Tx event configuration register	0x3FF560DC	R/W
RMT_CH4_TX_LIM_REG	Channel 4 Tx event configuration register	0x3FF560E0	R/W
RMT_CH5_TX_LIM_REG	Channel 5 Tx event configuration register	0x3FF560E4	R/W
RMT_CH6_TX_LIM_REG	Channel 6 Tx event configuration register	0x3FF560E8	R/W
RMT_CH7_TX_LIM_REG	Channel 7 Tx event configuration register	0x3FF560EC	R/W
Other registers			
RMT_APB_CONF_REG	RMT-wide configuration register	0x3FF560F0	R/W

15.4 Registers

Register 15.1: RMT_CH n CONF0_REG (n : 0-7) (0x0058+8* n)

(reserved)		RMT_MEM_PD		RMT_CARRIER_OUT_LV_CH n		RMT_CARRIER_EN_CH n		RMT_MEM_SIZE_CH n		RMT_IDLE_THRES_CH n		RMT_DIV_CNT_CH n	
31	30	29	28	27	24	23		8	7				0
0x0	0	1	1		0x01			0x01000					0x002

Reset

RMT_MEM_PD This bit is used to power down the entire RMT RAM block. (It only exists in RMT_CH0CONF0). 1: power down memory; 0: power up memory. (R/W)

RMT_CARRIER_OUT_LV_CH n This bit is used for configuration when the carrier wave is being transmitted. Transmit on low output level with 1, and transmit on high output level with 0. (R/W)

RMT_CARRIER_EN_CH n This is the carrier modulation enable-control bit for channel n . Carrier modulation is enabled with 1, while carrier modulation is disabled with 0. (R/W)

RMT_MEM_SIZE_CH n This register is used to configure the amount of memory blocks allocated to channel n (R/W)

RMT_IDLE_THRES_CH n In receive mode, when no edge is detected on the input signal for longer than reg_idle_thres_ch n channel clock cycles, the receive process is finished. (R/W)

RMT_DIV_CNT_CH n This register is used to set the divider for the channel clock of channel n . (R/W)

Register 15.2: RMT_CH n CONF1_REG (n : 0-7) (0x005c+8* n)

(reserved)	RMT_IDLE_OUT_EN_CH n	RMT_IDLE_OUT_LV_CH n	RMT_REF_ALWAYS_ON_CH n	RMT_REF_CNT_RST_CH n	RMT_RX_FILTER_THRES_CH n	RMT_RX_FILTER_EN_CH n	RMT_TX_CONTI_MODE_CH n	RMT_MEM_OWNER_CH n	(reserved)	RMT_MEM_RD_RST_CH n	RMT_MEM_WR_RST_CH n	RMT_RX_EN_CH n	RMT_TX_START_CH n													
31	20	19	18	17	16	15	8	7	6	5	4	3	2	1	0											
0x0000					0					0x00F					0	0	1	0	0	0	0	0	0	0	0	Reset

RMT_IDLE_OUT_EN_CH n This is the output enable-control bit for channel n in IDLE state. (R/W)

RMT_IDLE_OUT_LV_CH n This bit configures the level of output signals in channel n when the latter is in IDLE state. (R/W)

RMT_REF_ALWAYS_ON_CH n This bit is used to select the channel's base clock. 1:clk_apb; 0:clk_ref. (R/W)

RMT_REF_CNT_RST_CH n Setting this bit resets the clock divider of channel n . (R/W)

RMT_RX_FILTER_THRES_CH n In receive mode, channel n ignores input pulse when the pulse width is smaller than this value in APB clock periods. (R/W)

RMT_RX_FILTER_EN_CH n This is the receive filter's enable-bit for channel n . (R/W)

RMT_TX_CONTI_MODE_CH n If this bit is set, instead of going to an idle state when transmission ends, the transmitter will restart transmission. This results in a repeating output signal. (R/W)

RMT_MEM_OWNER_CH n This bit marks channel n 's RAM block ownership. Number 1 indicates that the receiver is using the RAM, while 0 indicates that the transmitter is using the RAM. (R/W)

RMT_MEM_RD_RST_CH n Set this bit to reset the read-RAM address for channel n by accessing the transmitter. (R/W)

RMT_MEM_WR_RST_CH n Set this bit to reset the write-RAM address for channel n by accessing the receiver. (R/W)

RMT_RX_EN_CH n Set this bit to enable receiving data on channel n . (R/W)

RMT_TX_START_CH n Set this bit to start sending data on channel n . (R/W)

Register 15.3: RMT_INT_RAW_REG (0x00a0)

<div style="display: flex; justify-content: space-between;"> <div style="writing-mode: vertical-rl; transform: rotate(180deg);">RMT_CH7_TX_THR_EVENT_INT_RAW</div> <div style="writing-mode: vertical-rl; transform: rotate(180deg);">RMT_CH6_TX_THR_EVENT_INT_RAW</div> <div style="writing-mode: vertical-rl; transform: rotate(180deg);">RMT_CH5_TX_THR_EVENT_INT_RAW</div> <div style="writing-mode: vertical-rl; transform: rotate(180deg);">RMT_CH4_TX_THR_EVENT_INT_RAW</div> <div style="writing-mode: vertical-rl; transform: rotate(180deg);">RMT_CH3_TX_THR_EVENT_INT_RAW</div> <div style="writing-mode: vertical-rl; transform: rotate(180deg);">RMT_CH2_TX_THR_EVENT_INT_RAW</div> <div style="writing-mode: vertical-rl; transform: rotate(180deg);">RMT_CH1_TX_THR_EVENT_INT_RAW</div> <div style="writing-mode: vertical-rl; transform: rotate(180deg);">RMT_CH0_TX_THR_EVENT_INT_RAW</div> <div style="writing-mode: vertical-rl; transform: rotate(180deg);">RMT_CH7_ERR_INT_RAW</div> <div style="writing-mode: vertical-rl; transform: rotate(180deg);">RMT_CH6_ERR_INT_RAW</div> <div style="writing-mode: vertical-rl; transform: rotate(180deg);">RMT_CH5_ERR_INT_RAW</div> <div style="writing-mode: vertical-rl; transform: rotate(180deg);">RMT_CH4_ERR_INT_RAW</div> <div style="writing-mode: vertical-rl; transform: rotate(180deg);">RMT_CH3_ERR_INT_RAW</div> <div style="writing-mode: vertical-rl; transform: rotate(180deg);">RMT_CH2_ERR_INT_RAW</div> <div style="writing-mode: vertical-rl; transform: rotate(180deg);">RMT_CH1_ERR_INT_RAW</div> <div style="writing-mode: vertical-rl; transform: rotate(180deg);">RMT_CH0_ERR_INT_RAW</div> <div style="writing-mode: vertical-rl; transform: rotate(180deg);">RMT_CH7_RX_END_INT_RAW</div> <div style="writing-mode: vertical-rl; transform: rotate(180deg);">RMT_CH6_RX_END_INT_RAW</div> <div style="writing-mode: vertical-rl; transform: rotate(180deg);">RMT_CH5_RX_END_INT_RAW</div> <div style="writing-mode: vertical-rl; transform: rotate(180deg);">RMT_CH4_RX_END_INT_RAW</div> <div style="writing-mode: vertical-rl; transform: rotate(180deg);">RMT_CH3_RX_END_INT_RAW</div> <div style="writing-mode: vertical-rl; transform: rotate(180deg);">RMT_CH2_RX_END_INT_RAW</div> <div style="writing-mode: vertical-rl; transform: rotate(180deg);">RMT_CH1_RX_END_INT_RAW</div> <div style="writing-mode: vertical-rl; transform: rotate(180deg);">RMT_CH0_RX_END_INT_RAW</div> <div style="writing-mode: vertical-rl; transform: rotate(180deg);">RMT_CH7_TX_END_INT_RAW</div> <div style="writing-mode: vertical-rl; transform: rotate(180deg);">RMT_CH6_TX_END_INT_RAW</div> <div style="writing-mode: vertical-rl; transform: rotate(180deg);">RMT_CH5_TX_END_INT_RAW</div> <div style="writing-mode: vertical-rl; transform: rotate(180deg);">RMT_CH4_TX_END_INT_RAW</div> <div style="writing-mode: vertical-rl; transform: rotate(180deg);">RMT_CH3_TX_END_INT_RAW</div> <div style="writing-mode: vertical-rl; transform: rotate(180deg);">RMT_CH2_TX_END_INT_RAW</div> <div style="writing-mode: vertical-rl; transform: rotate(180deg);">RMT_CH1_TX_END_INT_RAW</div> <div style="writing-mode: vertical-rl; transform: rotate(180deg);">RMT_CH0_TX_END_INT_RAW</div> </div>																																		
31	30	29	28	27	26	25	24	23	22	21	20	19	18	17	16	15	14	13	12	11	10	9	8	7	6	5	4	3	2	1	0			
0	0	0	0	0	0	0	0	0	0	0	0	0	0	0	0	0	0	0	0	0	0	0	0	0	0	0	0	0	0	0	0	0	0	Reset

- RMT_CH_nTX_THR_EVENT_INT_RAW** The raw interrupt status bit for the [RMT_CH_nTX_THR_EVENT_INT](#) interrupt. (RO)
- RMT_CH_nERR_INT_RAW** The raw interrupt status bit for the [RMT_CH_nERR_INT](#) interrupt. (RO)
- RMT_CH_nRX_END_INT_RAW** The raw interrupt status bit for the [RMT_CH_nRX_END_INT](#) interrupt. (RO)
- RMT_CH_nTX_END_INT_RAW** The raw interrupt status bit for the [RMT_CH_nTX_END_INT](#) interrupt. (RO)

Register 15.4: RMT_INT_ST_REG (0x00a4)

<div style="display: flex; justify-content: space-between;"> <div style="writing-mode: vertical-rl; transform: rotate(180deg);">RMT_CH7_TX_THR_EVENT_INT_ST</div> <div style="writing-mode: vertical-rl; transform: rotate(180deg);">RMT_CH6_TX_THR_EVENT_INT_ST</div> <div style="writing-mode: vertical-rl; transform: rotate(180deg);">RMT_CH5_TX_THR_EVENT_INT_ST</div> <div style="writing-mode: vertical-rl; transform: rotate(180deg);">RMT_CH4_TX_THR_EVENT_INT_ST</div> <div style="writing-mode: vertical-rl; transform: rotate(180deg);">RMT_CH3_TX_THR_EVENT_INT_ST</div> <div style="writing-mode: vertical-rl; transform: rotate(180deg);">RMT_CH2_TX_THR_EVENT_INT_ST</div> <div style="writing-mode: vertical-rl; transform: rotate(180deg);">RMT_CH1_TX_THR_EVENT_INT_ST</div> <div style="writing-mode: vertical-rl; transform: rotate(180deg);">RMT_CH0_TX_THR_EVENT_INT_ST</div> <div style="writing-mode: vertical-rl; transform: rotate(180deg);">RMT_CH7_ERR_INT_ST</div> <div style="writing-mode: vertical-rl; transform: rotate(180deg);">RMT_CH6_ERR_INT_ST</div> <div style="writing-mode: vertical-rl; transform: rotate(180deg);">RMT_CH5_ERR_INT_ST</div> <div style="writing-mode: vertical-rl; transform: rotate(180deg);">RMT_CH4_ERR_INT_ST</div> <div style="writing-mode: vertical-rl; transform: rotate(180deg);">RMT_CH3_ERR_INT_ST</div> <div style="writing-mode: vertical-rl; transform: rotate(180deg);">RMT_CH2_ERR_INT_ST</div> <div style="writing-mode: vertical-rl; transform: rotate(180deg);">RMT_CH1_ERR_INT_ST</div> <div style="writing-mode: vertical-rl; transform: rotate(180deg);">RMT_CH0_ERR_INT_ST</div> <div style="writing-mode: vertical-rl; transform: rotate(180deg);">RMT_CH7_RX_END_INT_ST</div> <div style="writing-mode: vertical-rl; transform: rotate(180deg);">RMT_CH6_RX_END_INT_ST</div> <div style="writing-mode: vertical-rl; transform: rotate(180deg);">RMT_CH5_RX_END_INT_ST</div> <div style="writing-mode: vertical-rl; transform: rotate(180deg);">RMT_CH4_RX_END_INT_ST</div> <div style="writing-mode: vertical-rl; transform: rotate(180deg);">RMT_CH3_RX_END_INT_ST</div> <div style="writing-mode: vertical-rl; transform: rotate(180deg);">RMT_CH2_RX_END_INT_ST</div> <div style="writing-mode: vertical-rl; transform: rotate(180deg);">RMT_CH1_RX_END_INT_ST</div> <div style="writing-mode: vertical-rl; transform: rotate(180deg);">RMT_CH0_RX_END_INT_ST</div> <div style="writing-mode: vertical-rl; transform: rotate(180deg);">RMT_CH7_TX_END_INT_ST</div> <div style="writing-mode: vertical-rl; transform: rotate(180deg);">RMT_CH6_TX_END_INT_ST</div> <div style="writing-mode: vertical-rl; transform: rotate(180deg);">RMT_CH5_TX_END_INT_ST</div> <div style="writing-mode: vertical-rl; transform: rotate(180deg);">RMT_CH4_TX_END_INT_ST</div> <div style="writing-mode: vertical-rl; transform: rotate(180deg);">RMT_CH3_TX_END_INT_ST</div> <div style="writing-mode: vertical-rl; transform: rotate(180deg);">RMT_CH2_TX_END_INT_ST</div> <div style="writing-mode: vertical-rl; transform: rotate(180deg);">RMT_CH1_TX_END_INT_ST</div> <div style="writing-mode: vertical-rl; transform: rotate(180deg);">RMT_CH0_TX_END_INT_ST</div> </div>																																	
31	30	29	28	27	26	25	24	23	22	21	20	19	18	17	16	15	14	13	12	11	10	9	8	7	6	5	4	3	2	1	0		
0	0	0	0	0	0	0	0	0	0	0	0	0	0	0	0	0	0	0	0	0	0	0	0	0	0	0	0	0	0	0	0	0	Reset

- RMT_CH_nTX_THR_EVENT_INT_ST** The masked interrupt status bit for the [RMT_CH_nTX_THR_EVENT_INT](#) interrupt. (RO)
- RMT_CH_nERR_INT_ST** The masked interrupt status bit for the [RMT_CH_nERR_INT](#) interrupt. (RO)
- RMT_CH_nRX_END_INT_ST** The masked interrupt status bit for the [RMT_CH_nRX_END_INT](#) interrupt. (RO)
- RMT_CH_nTX_END_INT_ST** The masked interrupt status bit for the [RMT_CH_nTX_END_INT](#) interrupt. (RO)

Register 15.5: RMT_INT_ENA_REG (0x00a8)

<div style="display: flex; justify-content: space-between;"> <div style="writing-mode: vertical-rl; transform: rotate(180deg);">RMT_CH7_TX_THR_EVENT_INT_ENA</div> <div style="writing-mode: vertical-rl; transform: rotate(180deg);">RMT_CH6_TX_THR_EVENT_INT_ENA</div> <div style="writing-mode: vertical-rl; transform: rotate(180deg);">RMT_CH5_TX_THR_EVENT_INT_ENA</div> <div style="writing-mode: vertical-rl; transform: rotate(180deg);">RMT_CH4_TX_THR_EVENT_INT_ENA</div> <div style="writing-mode: vertical-rl; transform: rotate(180deg);">RMT_CH3_TX_THR_EVENT_INT_ENA</div> <div style="writing-mode: vertical-rl; transform: rotate(180deg);">RMT_CH2_TX_THR_EVENT_INT_ENA</div> <div style="writing-mode: vertical-rl; transform: rotate(180deg);">RMT_CH1_TX_THR_EVENT_INT_ENA</div> <div style="writing-mode: vertical-rl; transform: rotate(180deg);">RMT_CH0_TX_THR_EVENT_INT_ENA</div> <div style="writing-mode: vertical-rl; transform: rotate(180deg);">RMT_CH7_ERR_INT_ENA</div> <div style="writing-mode: vertical-rl; transform: rotate(180deg);">RMT_CH6_ERR_INT_ENA</div> <div style="writing-mode: vertical-rl; transform: rotate(180deg);">RMT_CH5_ERR_INT_ENA</div> <div style="writing-mode: vertical-rl; transform: rotate(180deg);">RMT_CH4_ERR_INT_ENA</div> <div style="writing-mode: vertical-rl; transform: rotate(180deg);">RMT_CH3_ERR_INT_ENA</div> <div style="writing-mode: vertical-rl; transform: rotate(180deg);">RMT_CH2_ERR_INT_ENA</div> <div style="writing-mode: vertical-rl; transform: rotate(180deg);">RMT_CH1_ERR_INT_ENA</div> <div style="writing-mode: vertical-rl; transform: rotate(180deg);">RMT_CH0_ERR_INT_ENA</div> <div style="writing-mode: vertical-rl; transform: rotate(180deg);">RMT_CH7_RX_END_INT_ENA</div> <div style="writing-mode: vertical-rl; transform: rotate(180deg);">RMT_CH6_RX_END_INT_ENA</div> <div style="writing-mode: vertical-rl; transform: rotate(180deg);">RMT_CH5_RX_END_INT_ENA</div> <div style="writing-mode: vertical-rl; transform: rotate(180deg);">RMT_CH4_RX_END_INT_ENA</div> <div style="writing-mode: vertical-rl; transform: rotate(180deg);">RMT_CH3_RX_END_INT_ENA</div> <div style="writing-mode: vertical-rl; transform: rotate(180deg);">RMT_CH2_RX_END_INT_ENA</div> <div style="writing-mode: vertical-rl; transform: rotate(180deg);">RMT_CH1_RX_END_INT_ENA</div> <div style="writing-mode: vertical-rl; transform: rotate(180deg);">RMT_CH0_RX_END_INT_ENA</div> <div style="writing-mode: vertical-rl; transform: rotate(180deg);">RMT_CH7_TX_END_INT_ENA</div> <div style="writing-mode: vertical-rl; transform: rotate(180deg);">RMT_CH6_TX_END_INT_ENA</div> <div style="writing-mode: vertical-rl; transform: rotate(180deg);">RMT_CH5_TX_END_INT_ENA</div> <div style="writing-mode: vertical-rl; transform: rotate(180deg);">RMT_CH4_TX_END_INT_ENA</div> <div style="writing-mode: vertical-rl; transform: rotate(180deg);">RMT_CH3_TX_END_INT_ENA</div> <div style="writing-mode: vertical-rl; transform: rotate(180deg);">RMT_CH2_TX_END_INT_ENA</div> <div style="writing-mode: vertical-rl; transform: rotate(180deg);">RMT_CH1_TX_END_INT_ENA</div> <div style="writing-mode: vertical-rl; transform: rotate(180deg);">RMT_CH0_TX_END_INT_ENA</div> </div>																																	
31	30	29	28	27	26	25	24	23	22	21	20	19	18	17	16	15	14	13	12	11	10	9	8	7	6	5	4	3	2	1	0	Reset	
0	0	0	0	0	0	0	0	0	0	0	0	0	0	0	0	0	0	0	0	0	0	0	0	0	0	0	0	0	0	0	0	0	0

RMT_CH_nTX_THR_EVENT_INT_ENA The interrupt enable bit for the [RMT_CH_nTX_THR_EVENT_INT](#) interrupt. (R/W)

RMT_CH_nERR_INT_ENA The interrupt enable bit for the [RMT_CH_nERROR_INT](#) interrupt. (R/W)

RMT_CH_nRX_END_INT_ENA The interrupt enable bit for the [RMT_CH_nRX_END_INT](#) interrupt. (R/W)

RMT_CH_nTX_END_INT_ENA The interrupt enable bit for the [RMT_CH_nTX_END_INT](#) interrupt. (R/W)

Register 15.6: RMT_INT_CLR_REG (0x00ac)

<div style="display: flex; justify-content: space-between;"> <div style="writing-mode: vertical-rl; transform: rotate(180deg);">RMT_CH7_TX_THR_EVENT_INT_CLR</div> <div style="writing-mode: vertical-rl; transform: rotate(180deg);">RMT_CH6_TX_THR_EVENT_INT_CLR</div> <div style="writing-mode: vertical-rl; transform: rotate(180deg);">RMT_CH5_TX_THR_EVENT_INT_CLR</div> <div style="writing-mode: vertical-rl; transform: rotate(180deg);">RMT_CH4_TX_THR_EVENT_INT_CLR</div> <div style="writing-mode: vertical-rl; transform: rotate(180deg);">RMT_CH3_TX_THR_EVENT_INT_CLR</div> <div style="writing-mode: vertical-rl; transform: rotate(180deg);">RMT_CH2_TX_THR_EVENT_INT_CLR</div> <div style="writing-mode: vertical-rl; transform: rotate(180deg);">RMT_CH1_TX_THR_EVENT_INT_CLR</div> <div style="writing-mode: vertical-rl; transform: rotate(180deg);">RMT_CH0_TX_THR_EVENT_INT_CLR</div> <div style="writing-mode: vertical-rl; transform: rotate(180deg);">RMT_CH7_ERR_INT_CLR</div> <div style="writing-mode: vertical-rl; transform: rotate(180deg);">RMT_CH6_ERR_INT_CLR</div> <div style="writing-mode: vertical-rl; transform: rotate(180deg);">RMT_CH5_ERR_INT_CLR</div> <div style="writing-mode: vertical-rl; transform: rotate(180deg);">RMT_CH4_ERR_INT_CLR</div> <div style="writing-mode: vertical-rl; transform: rotate(180deg);">RMT_CH3_ERR_INT_CLR</div> <div style="writing-mode: vertical-rl; transform: rotate(180deg);">RMT_CH2_ERR_INT_CLR</div> <div style="writing-mode: vertical-rl; transform: rotate(180deg);">RMT_CH1_ERR_INT_CLR</div> <div style="writing-mode: vertical-rl; transform: rotate(180deg);">RMT_CH0_ERR_INT_CLR</div> <div style="writing-mode: vertical-rl; transform: rotate(180deg);">RMT_CH7_RX_END_INT_CLR</div> <div style="writing-mode: vertical-rl; transform: rotate(180deg);">RMT_CH6_RX_END_INT_CLR</div> <div style="writing-mode: vertical-rl; transform: rotate(180deg);">RMT_CH5_RX_END_INT_CLR</div> <div style="writing-mode: vertical-rl; transform: rotate(180deg);">RMT_CH4_RX_END_INT_CLR</div> <div style="writing-mode: vertical-rl; transform: rotate(180deg);">RMT_CH3_RX_END_INT_CLR</div> <div style="writing-mode: vertical-rl; transform: rotate(180deg);">RMT_CH2_RX_END_INT_CLR</div> <div style="writing-mode: vertical-rl; transform: rotate(180deg);">RMT_CH1_RX_END_INT_CLR</div> <div style="writing-mode: vertical-rl; transform: rotate(180deg);">RMT_CH0_RX_END_INT_CLR</div> <div style="writing-mode: vertical-rl; transform: rotate(180deg);">RMT_CH7_TX_END_INT_CLR</div> <div style="writing-mode: vertical-rl; transform: rotate(180deg);">RMT_CH6_TX_END_INT_CLR</div> <div style="writing-mode: vertical-rl; transform: rotate(180deg);">RMT_CH5_TX_END_INT_CLR</div> <div style="writing-mode: vertical-rl; transform: rotate(180deg);">RMT_CH4_TX_END_INT_CLR</div> <div style="writing-mode: vertical-rl; transform: rotate(180deg);">RMT_CH3_TX_END_INT_CLR</div> <div style="writing-mode: vertical-rl; transform: rotate(180deg);">RMT_CH2_TX_END_INT_CLR</div> <div style="writing-mode: vertical-rl; transform: rotate(180deg);">RMT_CH1_TX_END_INT_CLR</div> <div style="writing-mode: vertical-rl; transform: rotate(180deg);">RMT_CH0_TX_END_INT_CLR</div> </div>																																
31	30	29	28	27	26	25	24	23	22	21	20	19	18	17	16	15	14	13	12	11	10	9	8	7	6	5	4	3	2	1	0	Reset
0	0	0	0	0	0	0	0	0	0	0	0	0	0	0	0	0	0	0	0	0	0	0	0	0	0	0	0	0	0	0	0	0

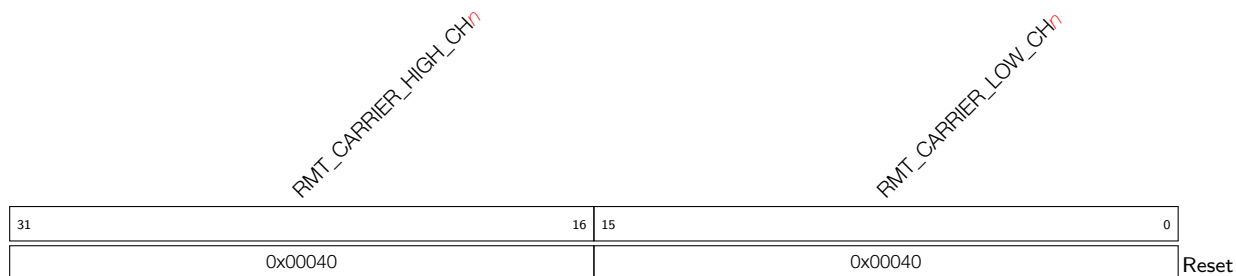
RMT_CH_nTX_THR_EVENT_INT_CLR Set this bit to clear the [RMT_CH_nTX_THR_EVENT_INT](#) interrupt. (WO)

RMT_CH_nERR_INT_CLR Set this bit to clear the [RMT_CH_nERRINT](#) interrupt. (WO)

RMT_CH_nRX_END_INT_CLR Set this bit to clear the [RMT_CH_nRX_END_INT](#) interrupt. (WO)

RMT_CH_nTX_END_INT_CLR Set this bit to clear the [RMT_CH_nTX_END_INT](#) interrupt. (WO)

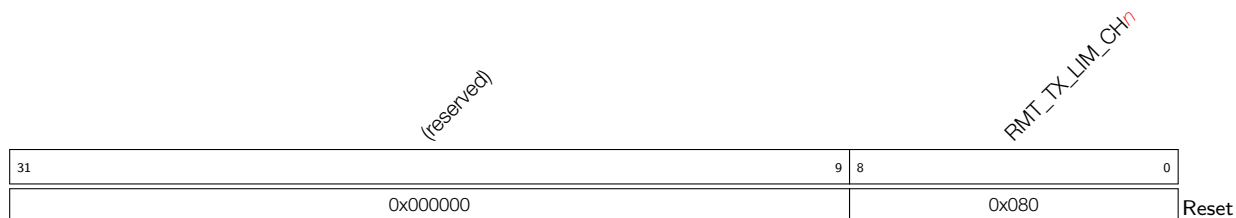
Register 15.7: RMT_CH n CARRIER_DUTY_REG (n : 0-7) (0x00cc+4* n)



RMT_CARRIER_HIGH_CH n This field is used to configure the carrier wave’s high-level duration (in channel clock periods) for channel n . (R/W)

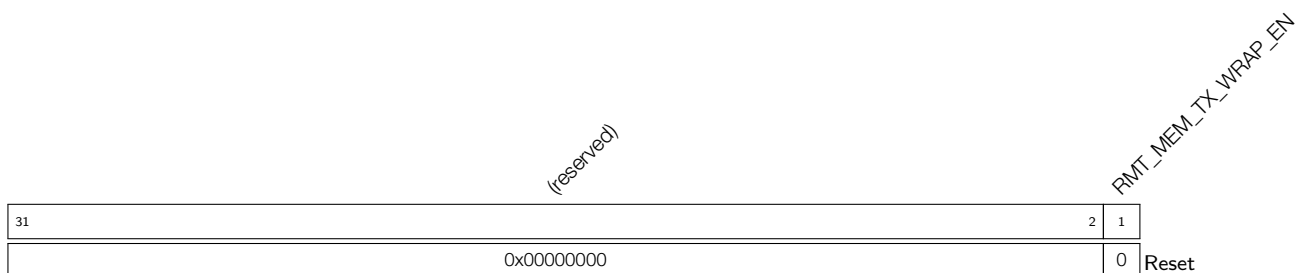
RMT_CARRIER_LOW_CH n This field is used to configure the carrier wave’s low-level duration (in channel clock periods) for channel n . (R/W)

Register 15.8: RMT_CH n _TX_LIM_REG (n : 0-7) (0x00ec+4* n)



RMT_TX_LIM_CH n When channel n sends more entries than specified here, it produces a TX_THR_EVENT interrupt. (R/W)

Register 15.9: RMT_APB_CONF_REG (0x00f0)



RMT_MEM_TX_WRAP_EN bit enables wraparound mode: when the transmitter of a channel has reached the end of its memory block, it will resume sending at the start of its memory region. (R/W)

16. MCPWM

16.1 Introduction

The **M**otor **C**ontrol **P**ulse **W**idth **M**odulator (MCPWM) peripheral is intended for motor and power control. It provides six PWM outputs that can be set up to operate in several topologies. One common topology uses a pair of PWM outputs driving an H-bridge to control motor rotation speed and rotation direction.

The timing and control resources inside are allocated into two major types of submodules: PWM timers and PWM operators. Each PWM timer provides timing references that can either run freely or be synced to other timers or external sources. Each PWM operator has all necessary control resources to generate waveform pairs for one PWM channel. The MCPWM peripheral also contains a dedicated capture submodule that is used in systems where accurate timing of external events is important.

ESP32 contains two MCPWM peripherals: MCPWM0 and MCPWM1. Their [control registers](#) are located in 4-KB memory blocks starting at memory locations 0x3FF5E000 and 0x3FF6C000 respectively.

16.2 Features

Each MCPWM peripheral has one clock divider (prescaler), three PWM timers, three PWM operators, and a capture module. Figure 90 shows the submodules inside and the signals on the interface. PWM timers are used for generating timing references. The PWM operators generate desired waveform based on the timing references. Any PWM operator can be configured to use the timing references of any PWM timers. Different PWM operators can use the same PWM timer's timing references to produce related PWM signals. PWM operators can also use different PWM timers' values to produce the PWM signals that work alone. Different PWM timers can also be synced together.

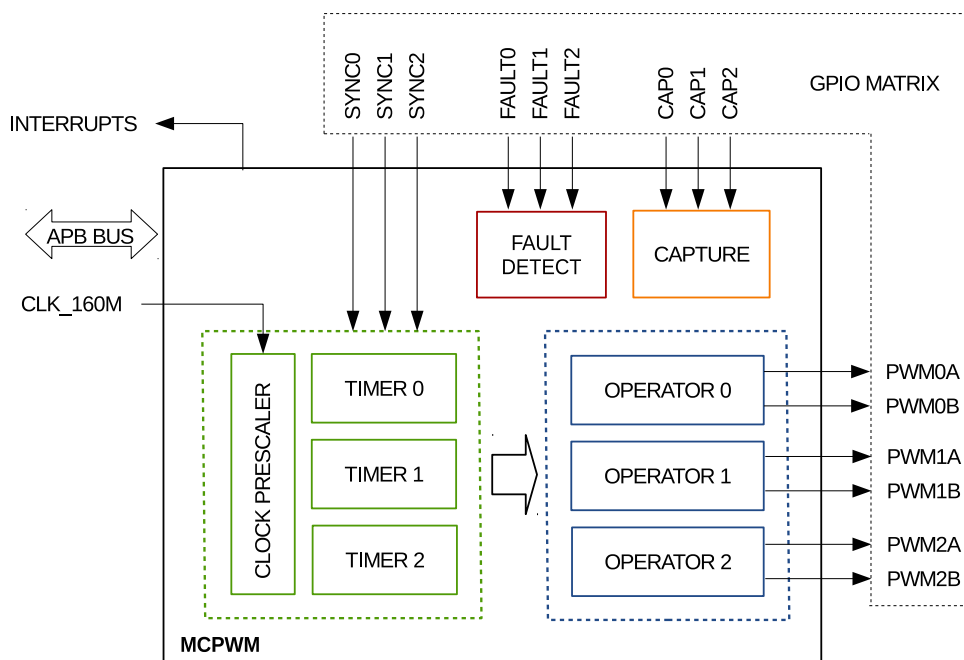


Figure 90: MCPWM Module Overview

An overview of the submodules' function in Figure 90 is shown below:

- PWM Timers 0, 1 and 2
 - Every PWM timer has a dedicated 8-bit clock prescaler.
 - The 16-bit counter in the PWM timer can work in count-up mode, count-down mode or count-up-down mode.
 - A hardware sync can trigger a reload on the PWM timer with a phase register. It will also trigger the prescaler's restart, so that the timer's clock can also be synced. The source of the sync can come from any GPIO or any other PWM timer's sync_out.
- PWM Operators 0, 1 and 2
 - Every PWM operator has two PWM outputs: PWMxA and PWMxB. They can work independently, in symmetric and asymmetric configuration.
 - Software, asynchronous override control of PWM signals.
 - Configurable dead-time on rising and falling edges; each set up independently.
 - All events can trigger CPU interrupts.
 - Modulating of PWM output by high-frequency carrier signals, useful when gate drives are insulated with a transformer.
 - Period, time stamps and important control registers have shadow registers with flexible updating methods.
- Fault Detection Module
 - Programmable fault handling allocated on fault condition in both cycle-by-cycle mode and one-shot mode.
 - A fault condition can force the PWM output to either high or low logic levels.
- Capture Module
 - Speed measurement of rotating machinery (for example, toothed sprockets sensed with Hall sensors)
 - Measurement of elapsed time between position sensor pulses
 - Period and duty-cycle measurement of pulse train signals
 - Decoding current or voltage amplitude derived from duty-cycle-encoded signals from current/voltage sensors
 - Three individual capture channels, each of which has a time-stamp register (32 bits)
 - Selection of edge polarity and prescaling of input capture signal
 - The capture timer can sync with a PWM timer or external signals.
 - Interrupt on each of the three capture channels

16.3 Submodules

16.3.1 Overview

This section lists the configuration parameters of key submodules. For information on adjusting a specific parameter, e.g. synchronization source of PWM timer, please refer to Section 16.3.2 for details.

16.3.1.1 Prescaler Submodule



Figure 91: Prescaler Submodule

Configuration parameter:

- Scale the PWM clock according to CLK_160M.

16.3.1.2 Timer Submodule

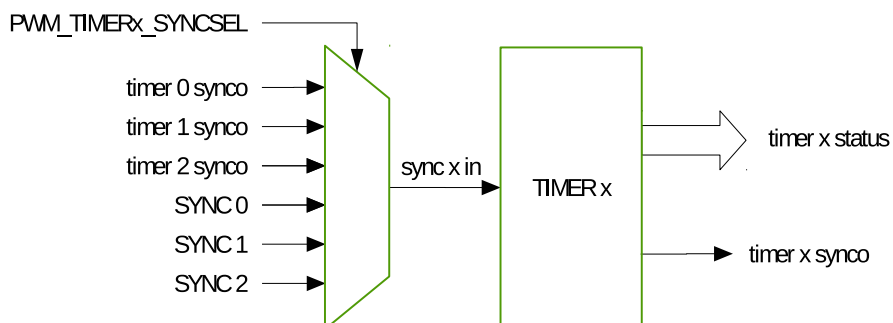


Figure 92: Timer Submodule

Configuration parameters:

- Set the PWM timer frequency or period.
- Configure the working mode for the timer:
 - Count-Up Mode: for asymmetric PWM outputs
 - Count-Down Mode: for asymmetric PWM outputs
 - Count-Up-Down Mode: for symmetric PWM outputs
- Configure the the reloading phase (including the value and the phase) used during software and hardware synchronization.

- Synchronize the PWM timers with each other. Either hardware or software synchronization may be used.
- Configure the source of the PWM timer's the synchronization input to one of the seven sources below:
 - The three PWM timer's synchronization outputs.
 - Three synchronization signals from the GPIO matrix: SYNC0, SYNC1, SYNC2.
 - No synchronization input signal selected
- Configure the source of the PWM timer's synchronization output to one of the four sources below:
 - Synchronization input signal
 - Event generated when value of the PWM timer is equal to zero
 - Event generated when value of the PWM timer is equal to period
 - No synchronization output generated
- Configure the method of period updating.

16.3.1.3 Operator Submodule

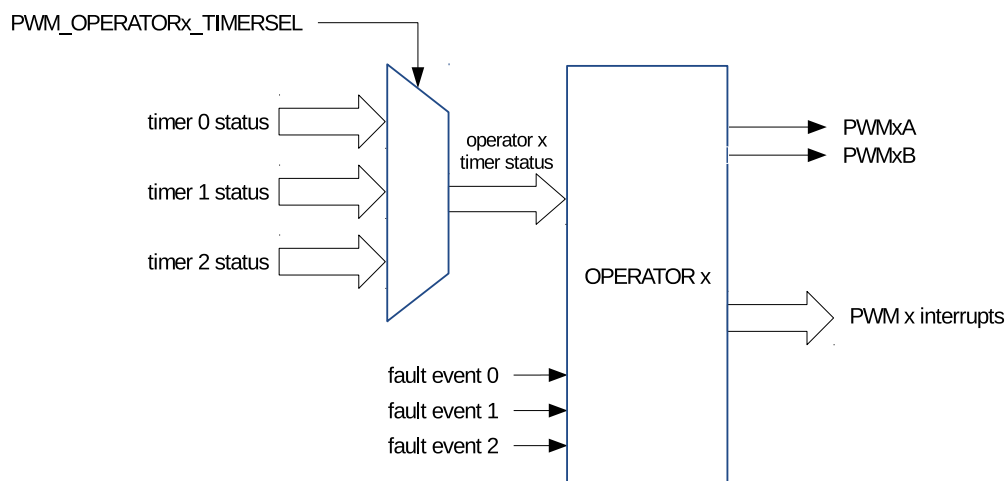


Figure 93: Operator Submodule

The configuration parameters of the operator submodule are shown in Table 67.

Table 67: Configuration Parameters of the Operator Submodule

Submodule	Configuration Parameter or Option
PWM Generator	<ul style="list-style-type: none"> • Set up the PWM duty cycle for PWMxA and/or PWMxB output. • Set up at which time the timing events occur. • Define what action should be taken on timing events: <ul style="list-style-type: none"> – Switch high or low PWMxA and/or PWMxB outputs – Toggle PWMxA and/or PWMxB outputs – Take no action on outputs • Use direct s/w control to force the state of PWM outputs • Add a dead time to raising and / or falling edge on PWM outputs. • Configure update method for this submodule.
Dead Time Generator	<ul style="list-style-type: none"> • Control of complementary dead time relationship between upper and lower switches. • Specify the dead time on rising edge. • Specify the dead time on falling edge. • Bypass the dead time generator module. The PWM waveform will pass through without inserting dead time. • Allow PWMxB phase shifting with respect to the PWMxA output. • Configure updating method for this submodule.
PWM Carrier	<ul style="list-style-type: none"> • Enable carrier and set up carrier frequency. • Configure duration of the first pulse in the carrier waveform. • Set up the duty cycle of the following pulses. • Bypass the PWM carrier module. The PWM waveform will be passed through without modification.
Fault Handler	<ul style="list-style-type: none"> • Configure if and how the PWM module should react the fault event signals. • Specify the action taken when a fault event occurs: <ul style="list-style-type: none"> – Force PWMxA and/or PWMxB high. – Force PWMxA and/or PWMxB low. – Configure PWMxA and/or PWMxB to ignore any fault event. • Configure how often the PWM should react to fault events: <ul style="list-style-type: none"> – One-shot – Cycle-by-cycle • Generate interrupts. • Bypass the fault handler submodule entirely. • Set up an option for cycle-by-cycle actions clearing. • If desired, independently-configured actions can be taken when time-base counter is counting down or up.

16.3.1.4 Fault Detection Submodule

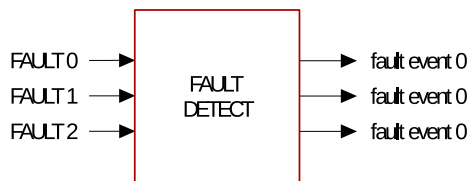


Figure 94: Fault Detection Submodule

Configuration parameters:

- Enable fault event generation and configure the polarity of fault event generation for every fault signal
- Generate fault event interrupts

16.3.1.5 Capture Submodule

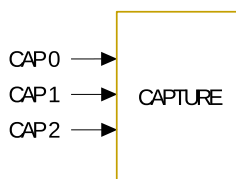


Figure 95: Capture Submodule

Configuration parameters:

- Select the edge polarity and prescaling of the capture input.
- Set up a software-triggered capture.
- Configure the capture timer's sync trigger and sync phase.
- Software syncs the capture timer.

16.3.2 PWM Timer Submodule

Each MCPWM module has three PWM timer submodules. Any of them can determine the necessary event timing for any of the three PWM operator submodules. Built-in synchronization logic allows multiple PWM timer submodules, in one or more MCPWM modules, to work together as a system, when using synchronization signals from the GPIO matrix.

16.3.2.1 Configurations of the PWM Timer Submodule

Users can configure the following functions of the PWM timer submodule:

- Control how often events occur by specifying the PWM timer frequency or period.

- Configure a particular PWM timer to synchronize with other PWM timers or modules.
- Get a PWM timer in phase with other PWM timers or modules.
- Set one of the following timer counting modes: count-up, count-down, count-up-down.
- Change the rate of the PWM timer clock (PT_clk) with a prescaler. Each timer has its own prescaler configured with PWM_TIMER_x_PRESCALE of register PWM_TIMER0_CFG0_REG. The PWM timer increments or decrements at a slower pace, depending on the setting of this register.

16.3.2.2 PWM Timer's Working Modes and Timing Event Generation

The PWM timer has three working modes, selected by the PWM_x timer mode register:

- **Count-Up Mode:**
In this mode, the PWM timer increments from zero until reaching the value configured in the period register. Once done, the PWM timer returns to zero and starts increasing again. PWM period is equal to the period value configured in register.
- **Count-Down Mode:**
The PWM timer decrements to zero, starting from the value configured in the period register. After reaching zero, it is set back to the period value. Then it starts to decrement again. In this case, the PWM period is also equal to the value configured in the period register.
- **Count-Up-Down Mode:**
This is a combination of the two modes mentioned above. The PWM timer starts increasing from zero until the period value is reached. Then, the timer decreases back to zero. This pattern is then repeated. The PWM period is the result of the value in the period register multiplied by 2.

Figures 96 to 99 show PWM timer waveforms in different modes, including timer behavior during synchronization events.

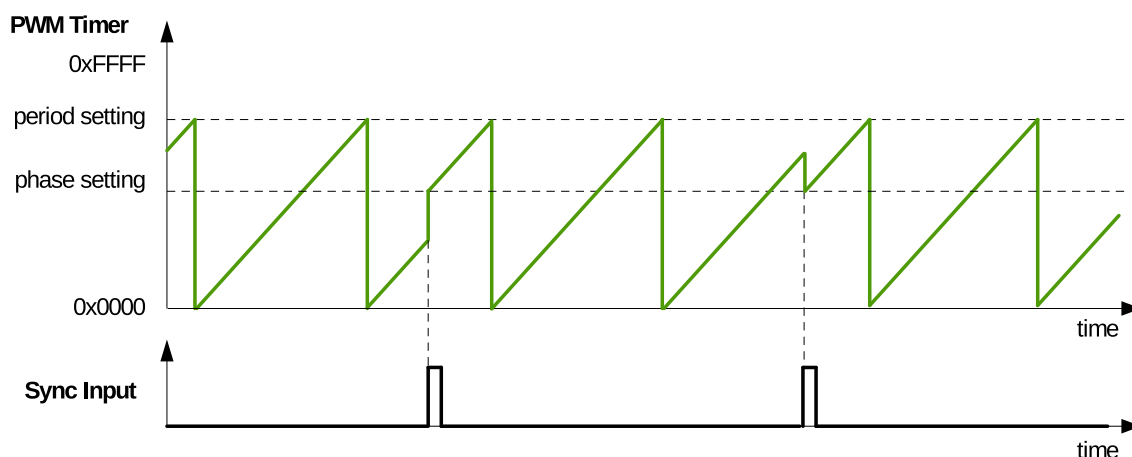


Figure 96: Count-Up Mode Waveform

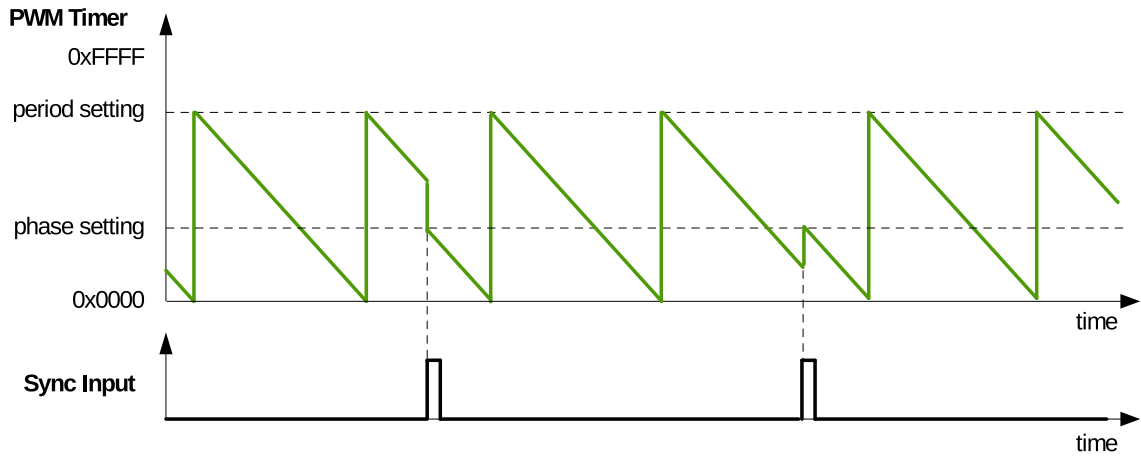


Figure 97: Count-Down Mode Waveforms

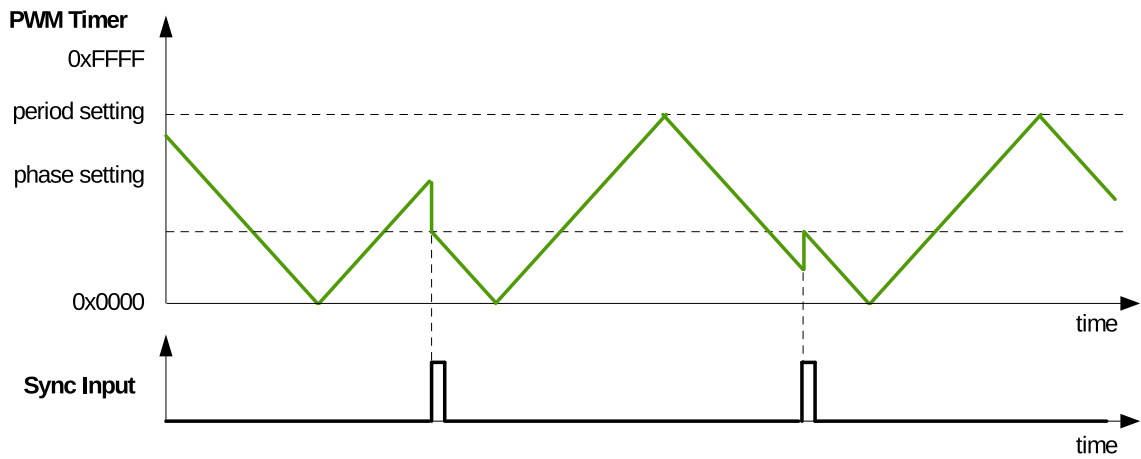


Figure 98: Count-Up-Down Mode Waveforms, Count-Down at Synchronization Event

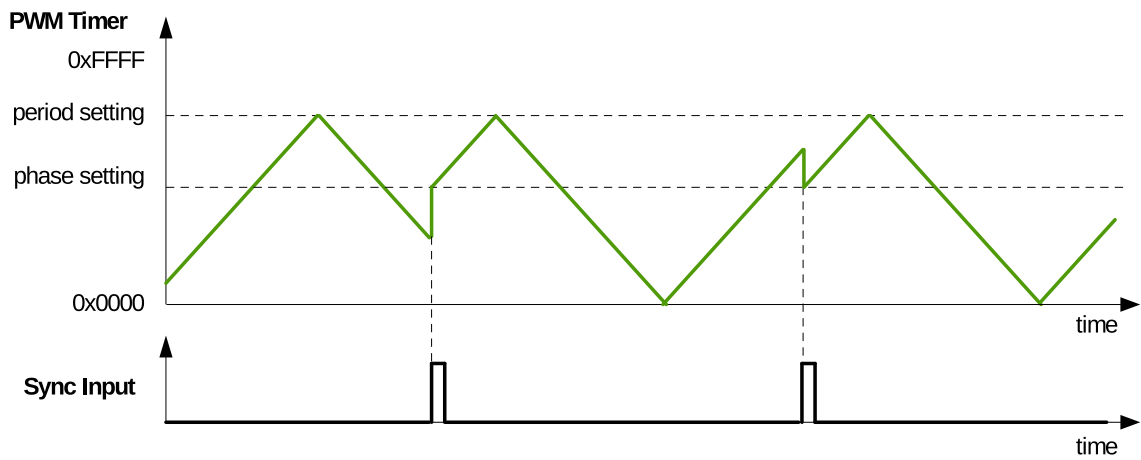


Figure 99: Count-Up-Down Mode Waveforms, Count-Up at Synchronization Event

When the PWM timer is running, it generates the following timing events periodically and automatically:

- UTEP
The timing event generated when the PWM timer's value equals to the value of the period register (PWM_TIMER_x_PERIOD) and when the PWM timer is increasing.
- UTEZ
The timing event generated when the PWM timer's value equals to zero and when the PWM timer is increasing.
- DTEP
The timing event generated when the PWM timer's value equals to the value of the period register (PWM_TIMER_x_PERIOD) and when the PWM timer is decreasing.
- DTEZ
The timing event generated when the PWM timer's value equals to zero and when the PWM timer is decreasing.

Figures 100 to 102 show the timing waveforms of U/DTEP and U/DTEZ.

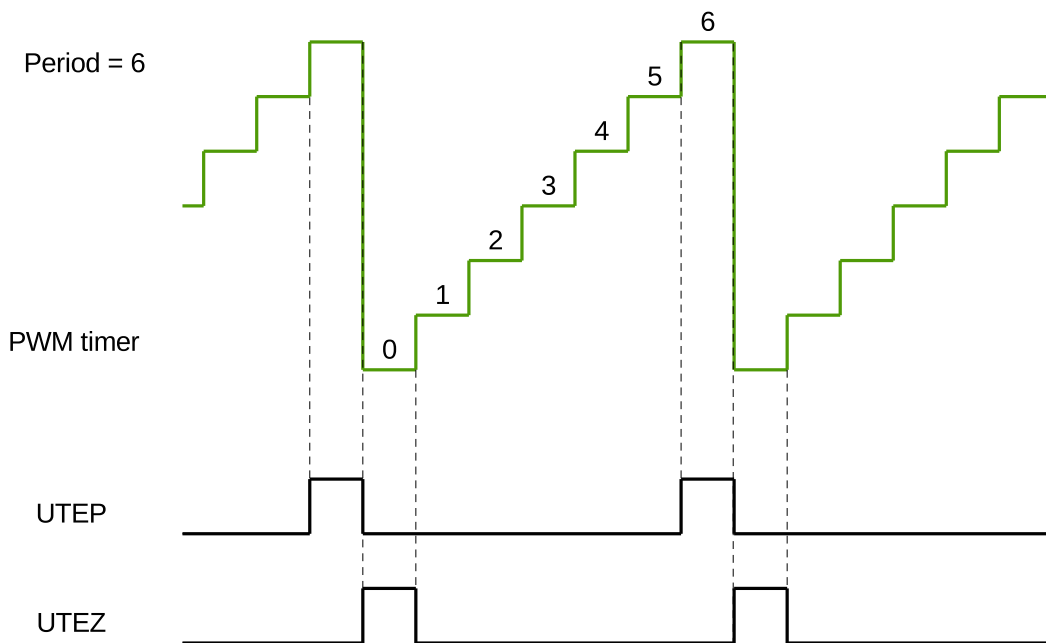


Figure 100: UTEP and UTEZ Generation in Count-Up Mode

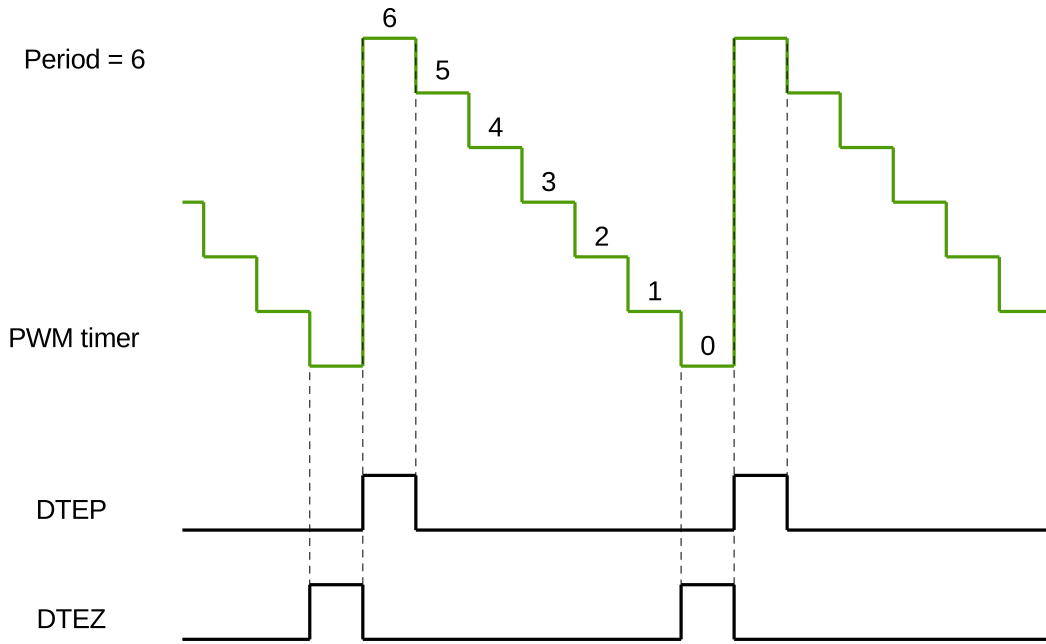


Figure 101: DTEP and DTEZ Generation in Count-Down Mode

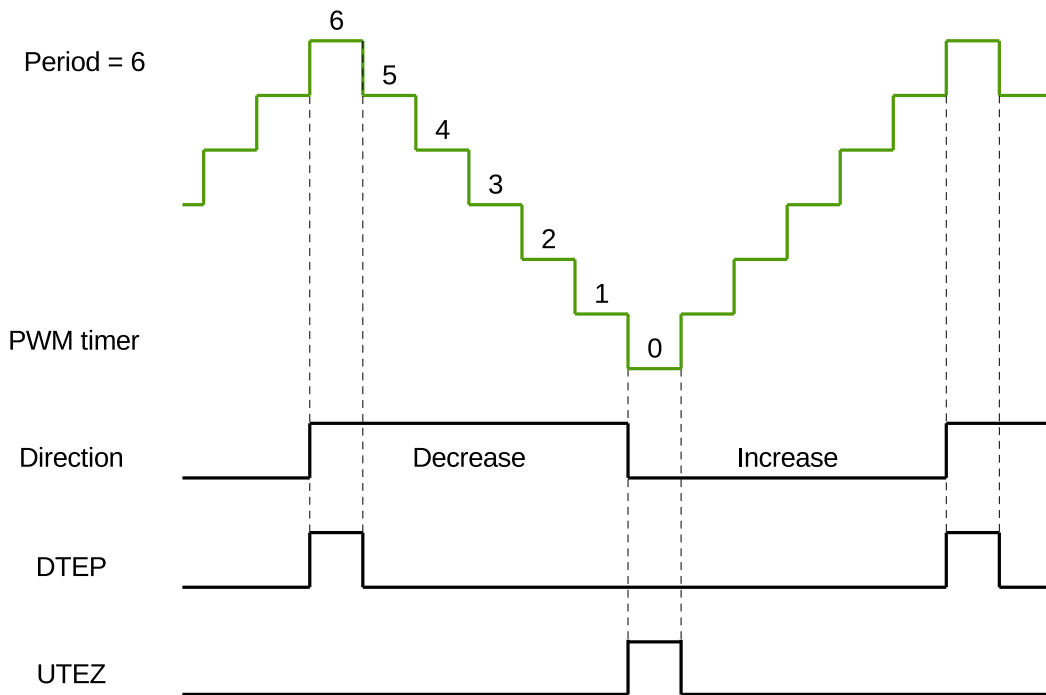


Figure 102: DTEP and UTEZ Generation in Count-Up-Down Mode

16.3.2.3 PWM Timer Shadow Register

The PWM timer's period register and the PWM timer's clock prescaler register have shadow registers. The purpose of a shadow register is to save a copy of the value to be written into the active register at a specific moment synchronized with the hardware. Both register types are defined as follows:

- Active Register

This register is directly responsible for controlling all actions performed by hardware.

- Shadow Register

It acts as a temporary buffer for a value to be written on the active register. Before this happens, the content of the shadow register has no direct effect on the controlled hardware. At a specific, user-configured point in time, the value saved in the shadow register is copied to the active register. This helps to prevent spurious operation of the hardware, which may happen when a register is asynchronously modified by software. Both the shadow register and the active register have the same memory address. The software always writes into, or reads from the shadow register. The moment of updating the active register is determined by its specific update method register. The update can start when the PWM timer is equal to zero, when the PWM timer is equal to period, at a synchronization moment, or immediately. Software can trigger a globally forced update which will prompt all registers in the module to be updated according to shadow registers.

16.3.2.4 PWM Timer Synchronization and Phase Locking

The PWM modules adopt a flexible synchronization method. Each PWM timer has a synchronization input and a synchronization output. The synchronization input can be selected from three synchronization outputs and three synchronization signals from the GPIO matrix. The synchronization output can be generated from the synchronization input signal, or when the PWM timer's value is equal to period or zero. Thus, the PWM timers can be chained together with their phase locked. During synchronization, the PWM timer clock prescaler will reset its counter in order to synchronize the PWM timer clock.

16.3.3 PWM Operator Submodule

The PWM Operator submodule has the following functions:

- Generates a PWM signal pair, based on timing references obtained from the corresponding PWM timer.
- Each signal out of the PWM signal pair includes a specific pattern of dead time.
- Superimposes a carrier on the PWM signal, if configured to do so.
- Handles response under fault conditions.

Figure 103 shows the block diagram of a PWM operator.

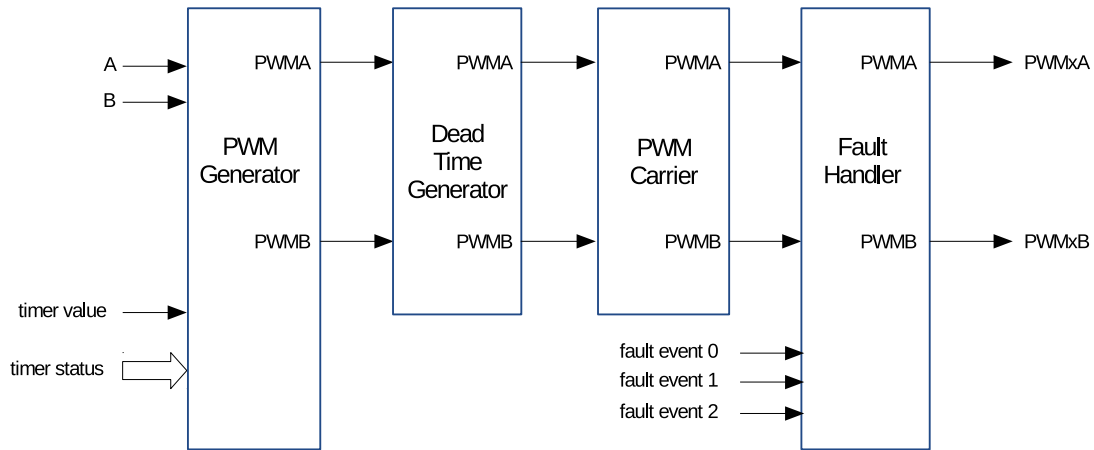


Figure 103: Submodules Inside the PWM Operator

16.3.3.1 PWM Generator Submodule

Purpose of the PWM Generator Submodule

In this submodule, important timing events are generated or imported. The events are then converted into specific actions to generate the desired waveforms at the PWMxA and PWMxB outputs.

The PWM generator submodule performs the following actions:

- Generation of timing events based on time stamps configured using the A and B registers. Events happen when the following conditions are satisfied:
 - UTEA: the PWM timer is counting up and its value is equal to register A.
 - UTEB: the PWM timer is counting up and its value is equal to register B.
 - DTEA: the PWM timer is counting down and its value is equal to register A.
 - DTEB: the PWM timer is counting down and its value is equal to register B.
- Generation of U/DT1, U/DT2 timing events based on fault or synchronization events.
- Management of priority when these timing events occur concurrently.
- Qualification and generation of set, clear and toggle actions, based on the timing events.
- Controlling of the PWM duty cycle, depending on configuration of the PWM generator submodule.
- Handling of new time stamp values, using shadow, registers to prevent glitches in the PWM cycle.

PWM Operator Shadow Registers

The time stamp registers A and B, as well as action configuration registers [PWM_GENx_A_REG](#) and [PWM_GENx_B_REG](#) are shadowed. Shadowing provides a way of updating registers in sync with the hardware. For a description of the shadow registers, please see [16.3.2.3](#).

Timing Events

For convenience, all timing signals and events are summarized in Table 68.

Table 68: Timing Events Used in PWM Generator

Signal	Event Description	PWM Timer Operation
DTEP	PWM timer value is equal to the period register value	PWM timer counts down.
DTEZ	PWM timer value is equal to zero	
DTEA	PWM timer value is equal to A register	
DTEB	PWM timer value is equal to B register	
DT0 event	Based on fault or synchronization events	
DT1 event	Based on fault or synchronization events	
UTEP	PWM timer value is equal to the period register value	PWM timer counts up.
UTEZ	PWM timer value is equal to zero	
UTEA	PWM timer value is equal to A register	
UTEB	PWM timer value is equal to B register	
UT0 event	Based on fault or synchronization events	
UT1 event	Based on fault or synchronization events	
Software-force event	Software-initiated asynchronous event	N/A

The purpose of a software-force event is to impose non-continuous or continuous changes on the PWM_xA and PWM_xB outputs. The change is done asynchronously. Software-force control is handled by the `PWM_PWM_GENx_FORCE_REG` registers.

The selection and configuration of T0/T1 in the PWM generator submodule is independent of the configuration of fault events in the fault handler submodule. A particular trip event may or may not be configured to cause trip action in the fault handler submodule, but the same event can be used by the PWM generator to trigger T0/T1 for controlling PWM waveforms.

It is important to know that when the PWM timer is in count-up-down mode, it will always decrement after a TEP event, and will always increment after a TEZ event. So when the PWM timer is in count-up-down mode, DTEP and UTEZ events will occur, while the events UTEP and DTEZ will never occur.

The PWM generator can handle multiple events at the same time. Events are prioritized by the hardware and relevant details are provided in Table 69 and Table 70. Priority levels range from 1 (the highest) to 7 (the lowest). Please note that the priority of TEP and TEZ events depends on the PWM timer's direction.

If the value of A or B is set to be greater than the period, then U/DTEA and U/DTEB will never occur.

Table 69: Timing Events Priority When PWM Timer Increments

Priority Level	Event
1 (highest)	Software-force event
2	UTEP
3	UT0
4	UT1
5	UTEB
6	UTEA
7 (lowest)	UTEZ

Table 70: Timing Events Priority when PWM Timer Decrements

Priority level	Event
1 (highest)	Software-force event
2	DTEZ
3	DT0
4	DT1
5	DTEB
6	DTEA
7 (lowest)	DTEP

Notes:

1. UTEP and UTEZ do not happen simultaneously. When the PWM timer is in count-up mode, UTEP will always happen one cycle earlier than UTEZ, as demonstrated in Figure 100, so their action on PWM signals will not interrupt each other. When the PWM timer is in count-up-down mode, UTEP will not occur.
2. DTEP and DTEZ do not happen simultaneously. When the PWM timer is in count-down mode, DTEZ will always happen one cycle earlier than DTEP, as demonstrated in Figure 101, so their action on PWM signals will not interrupt each other. When the PWM timer is in count-up-down mode, DTEZ will not occur.

PWM Signal Generation

The PWM generator submodule controls the behavior of outputs PWMxA and PWMxB when a particular timing event occurs. The timing events are further qualified by the PWM timer's counting direction (up or down). Knowing the counting direction, the submodule may then perform an independent action at each stage of the PWM timer counting up or down.

The following actions may be configured on outputs PWMxA and PWMxB:

- **Set High:**
Set the output of PWMxA or PWMxB to a high level.
- **Clear Low:**
Clear the output of PWMxA or PWMxB by setting it to a low level.
- **Toggle:**
Change the current output level of PWMxA or PWMxB to the opposite value. If it is currently pulled high, pull it low, or vice versa.
- **Do Nothing:**
Keep both outputs PWMxA and PWMxB unchanged. In this state, interrupts can still be triggered.

The configuration of actions on outputs is done by using registers `PWN_GENx_A_REG` and `PWN_GENx_B_REG`. So, the action to be taken on each output is set independently. Also there is great flexibility in selecting actions to be taken on a given output based on events. More specifically, any event listed in Table 68 can operate on either output PWMxA or PWMxB. To check out registers for particular generator 0, 1 or 2, please refer to register description in Section 16.4.

Waveforms for Common Configurations

Figure 104 presents the symmetric PWM waveform generated when the PWM timer is counting up and down. DC 0%–100% modulation can be calculated via the formula below:

$$Duty = (Period - A) \div Period$$

If A matches the PWM timer value and the PWM timer is incrementing, then the PWM output is pulled up. If A matches the PWM timer value while the PWM timer is decrementing, then the PWM output is pulled low.

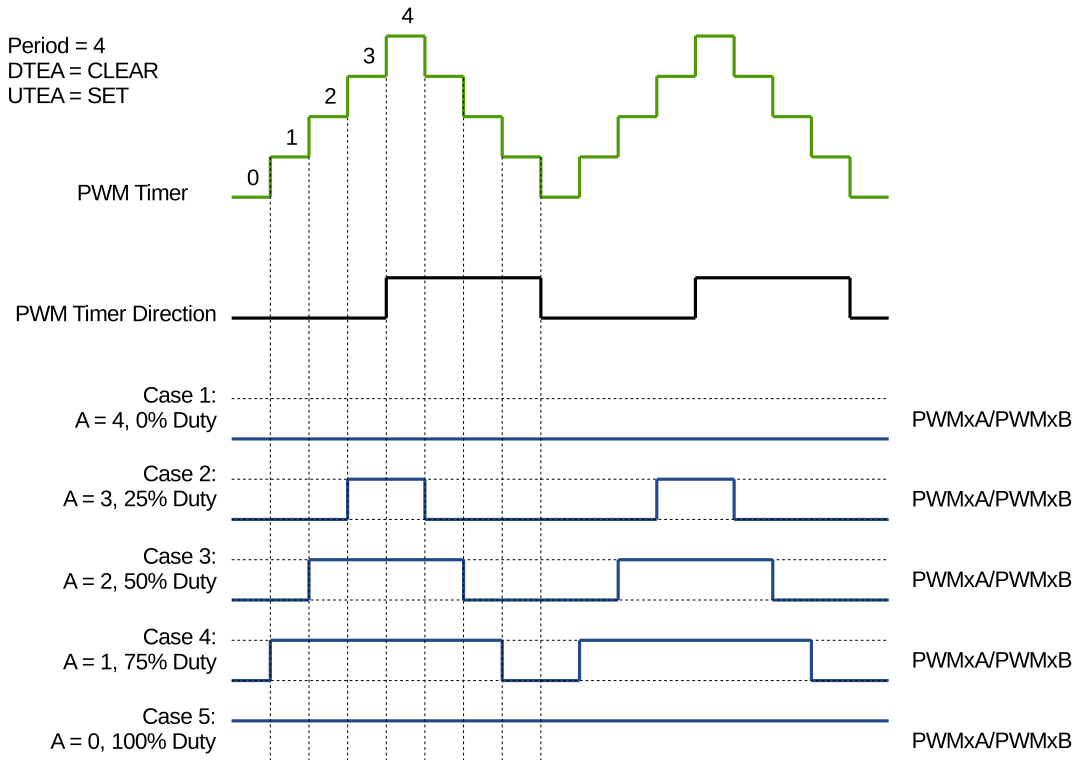


Figure 104: Symmetrical Waveform in Count-Up-Down Mode

The PWM waveforms in Figures 105 to 108 show some common PWM operator configurations. The following conventions are used in the figures:

- Period A and B refer to the values written in the corresponding registers.
- PWMxA and PWMxB are the output signals of PWM Operator x.

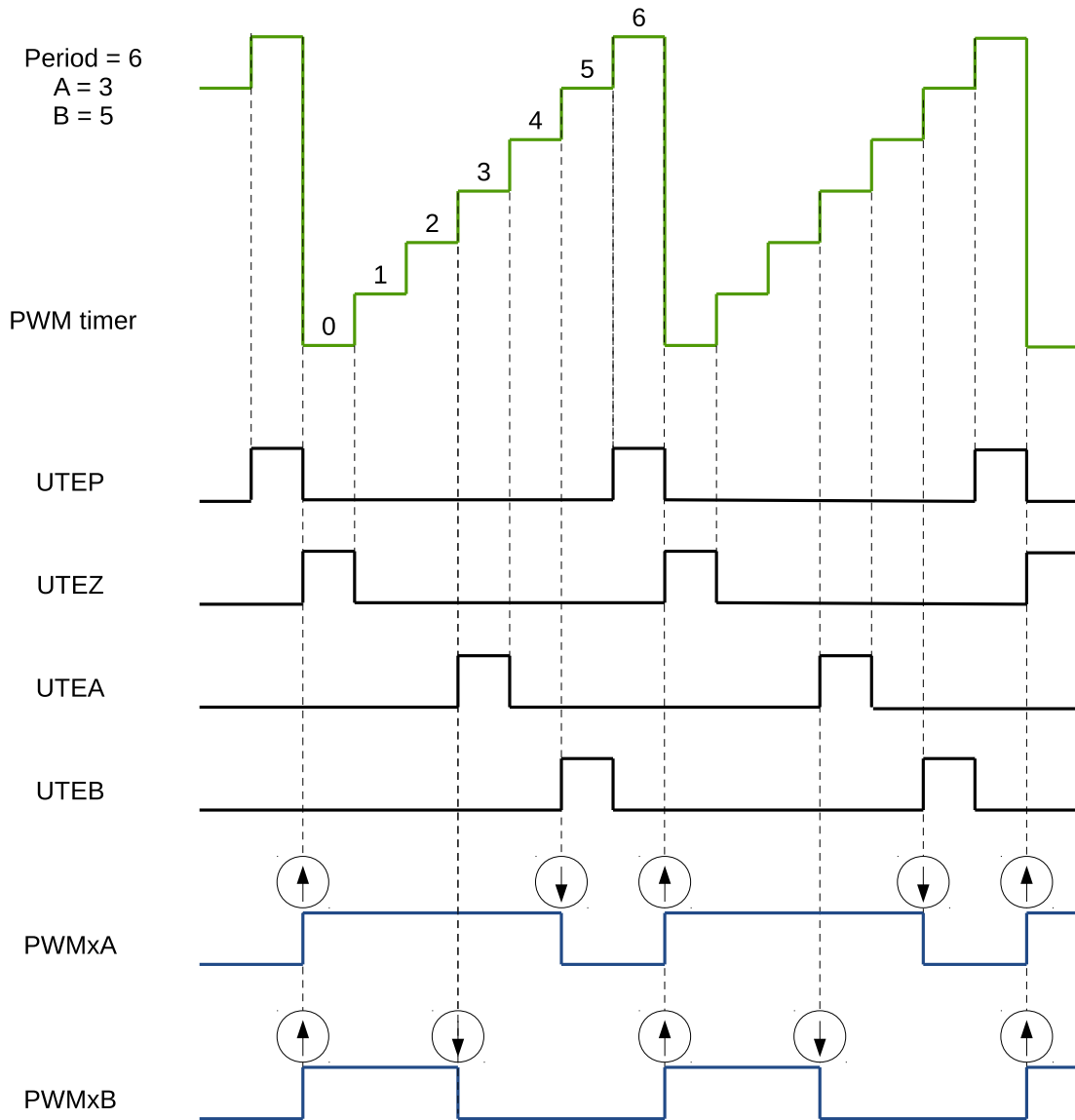


Figure 105: Count-Up, Single Edge Asymmetric Waveform, with Independent Modulation on PWMxA and PWMxB – Active High

The duty modulation for PWMxA is set by B, active high and proportional to B.

The duty modulation for PWMxB is set by A, active high and proportional to A.

$$Period = (PWM_TIMER_PERIOD + 1) \times T_{PT_clk}$$

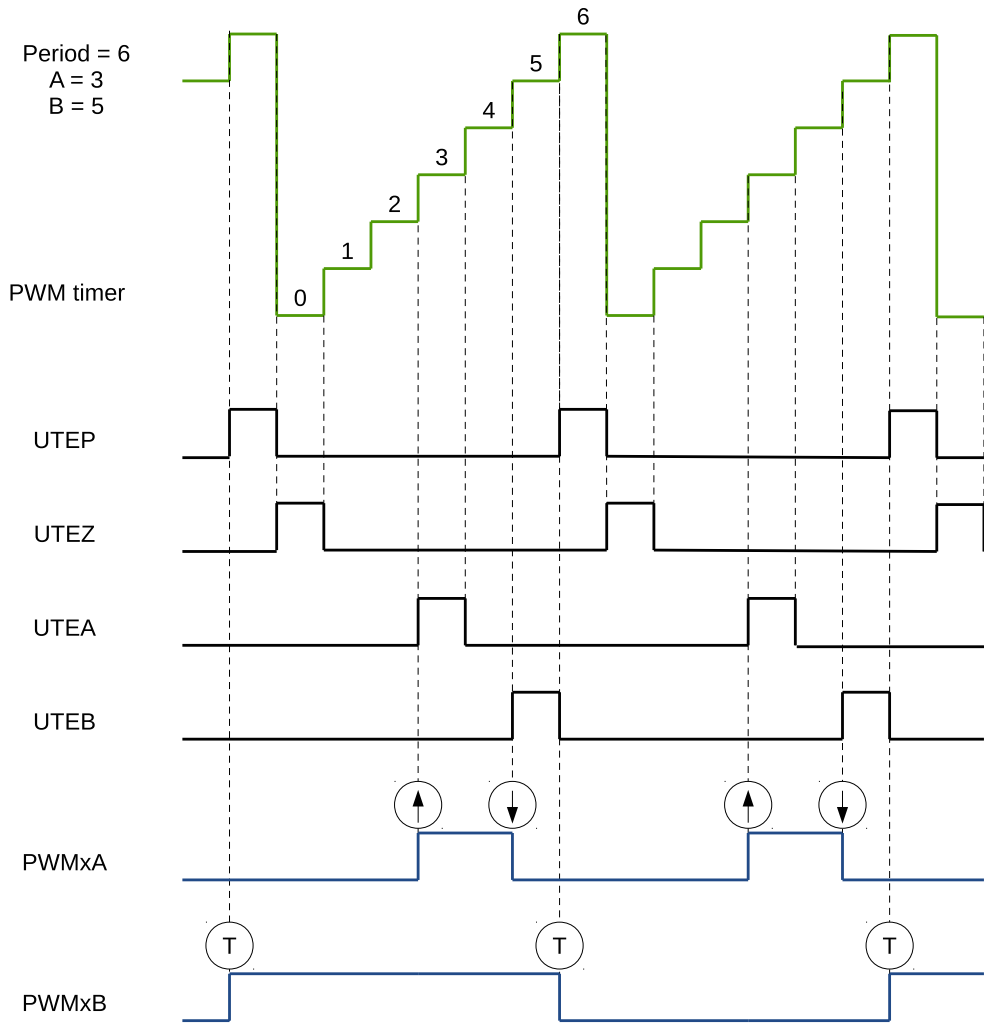


Figure 106: Count-Up, Pulse Placement Asymmetric Waveform with Independent Modulation on PWMxA

Pulses may be generated anywhere within the PWM cycle (zero – period).

PWMxA's high time duty is proportional to (B – A).

$$Period = (PWM_TIMERx_PERIOD + 1) \times T_{PT_clk}$$

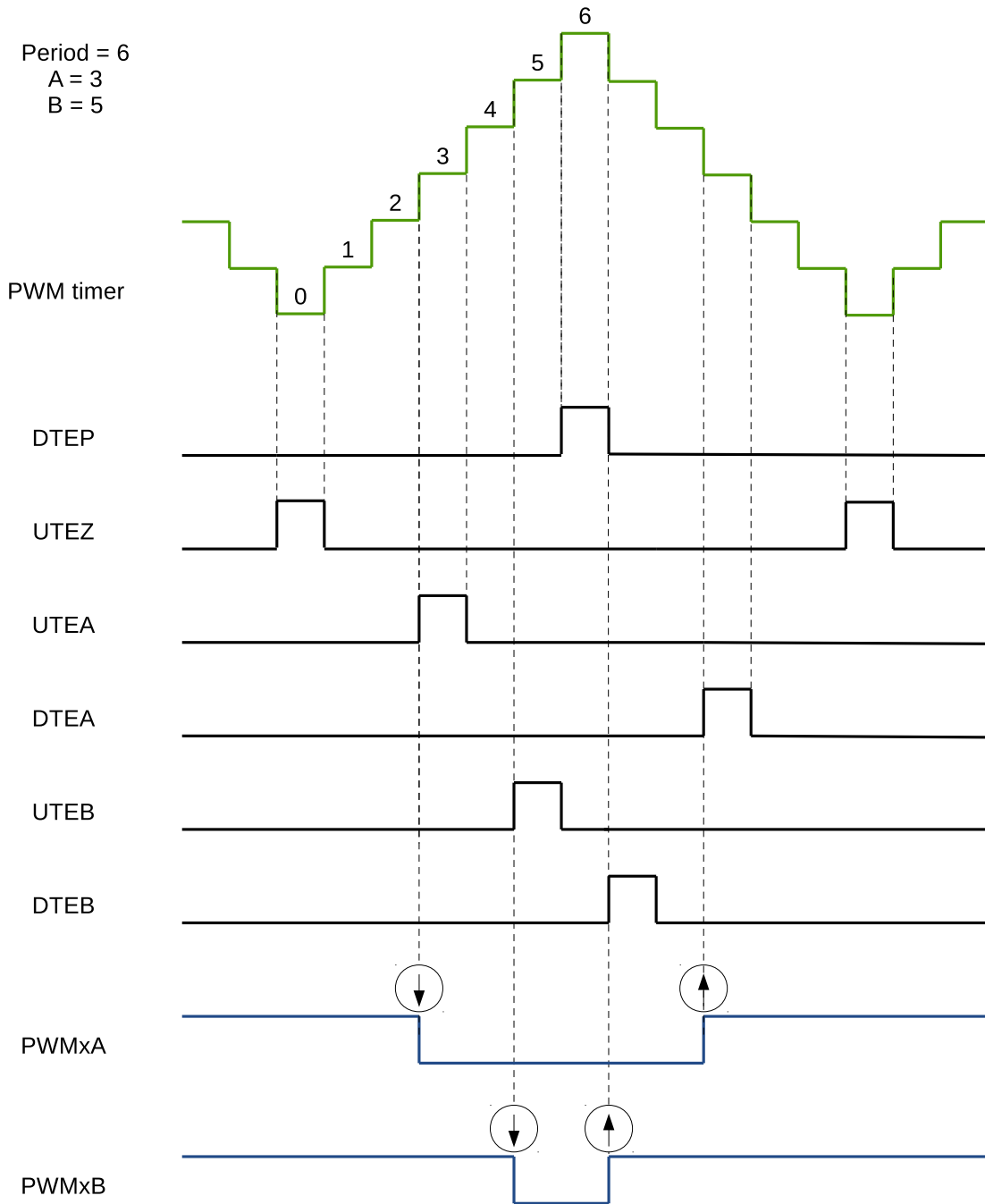


Figure 107: Count-Up-Down, Dual Edge Symmetric Waveform, with Independent Modulation on PWMxA and PWMxB – Active High

The duty modulation for PWMxA is set by A, active high and proportional to A.
The duty modulation for PWMxB is set by B, active high and proportional to B.
Outputs PWMxA and PWMxB can drive independent switches.

$$Period = 2 \times PWM_TIMER_PERIOD \times T_{PT_clk}$$

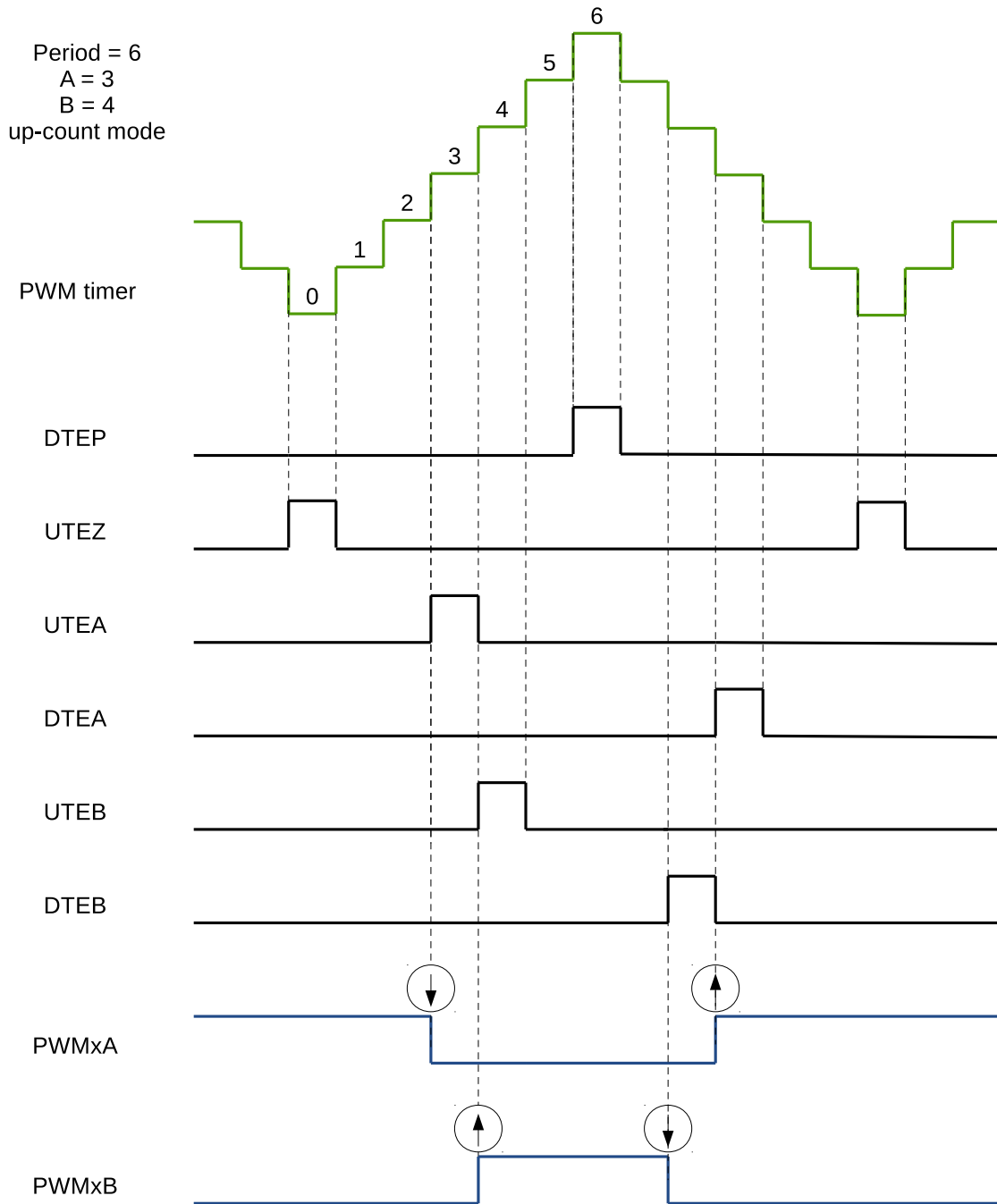


Figure 108: Count-Up-Down, Dual Edge Symmetric Waveform, with Independent Modulation on PWMxA and PWMxB – Complementary

The duty modulation of PWMxA is set by A, is active high and proportional to A.

The duty modulation of PWMxB is set by B, is active low and proportional to B.

Outputs PWMx can drive upper/lower (complementary) switches.

Dead-time = B – A; Edge placement is fully programmable by software. Use the dead-time generator module if another edge delay method is required.

$$Period = 2 \times PWM_TIMERx_PERIOD \times T_{PT_clk}$$

Software-Force Events

There are two types of software-force events inside the PWM generator:

- Non-continuous-immediate (NCI) software-force events
Such types of events are immediately effective on PWM outputs when triggered by software. The forcing is non-continuous, meaning the next active timing events will be able to alter the PWM outputs.
- Continuous (CNTU) software-force events
Such types of events are continuous. The forced PWM outputs will continue until they are released by software. The events' triggers are configurable. They can be timing events or immediate events.

Figure 109 shows a waveform of NCI software-force events. NCI events are used to force PWMxA output low. Forcing on PWMxB is disabled in this case.

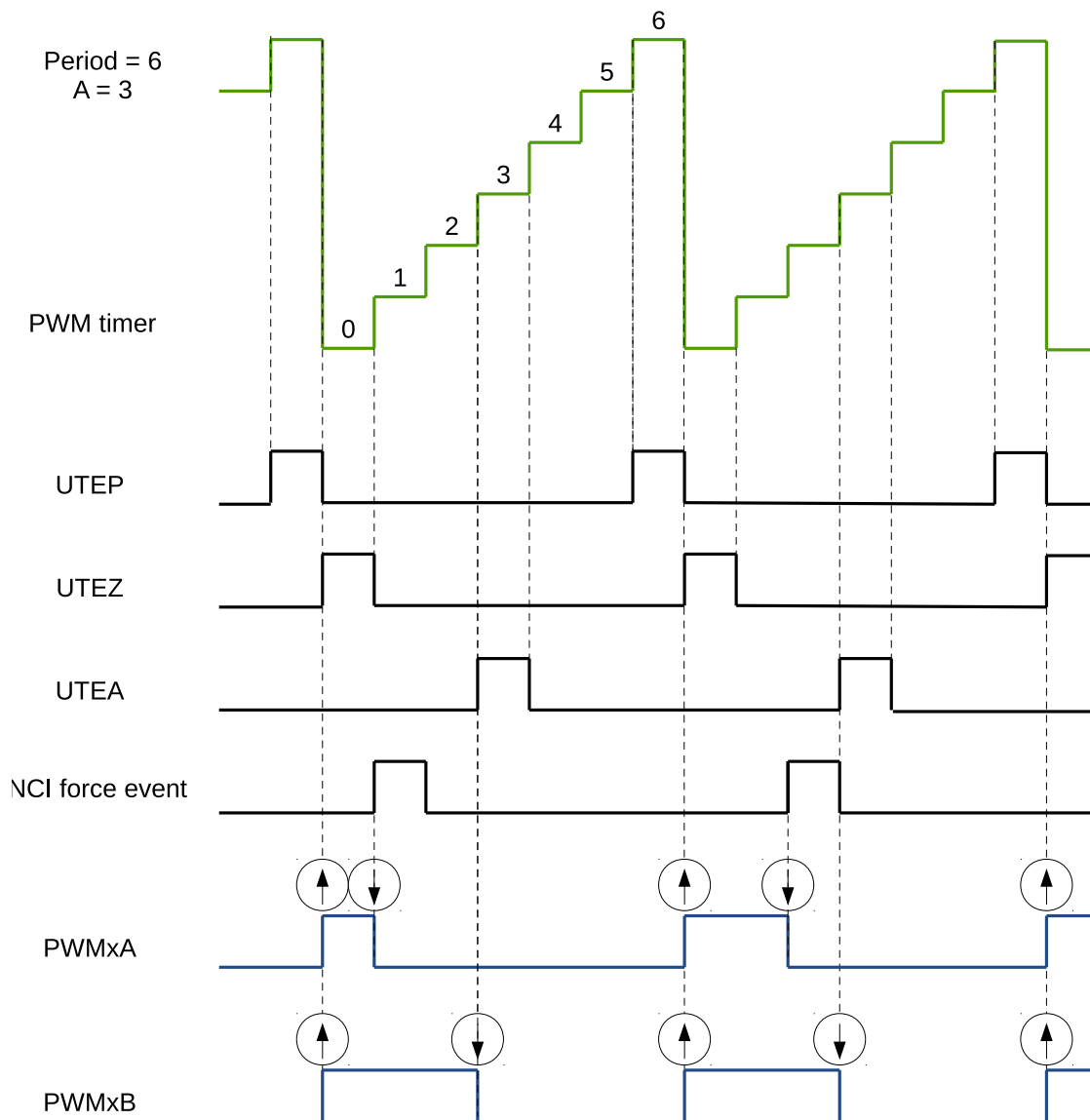


Figure 109: Example of an NCI Software-Force Event on PWMxA

Figure 110 shows a waveform of CNTU software-force events. UTEZ events are selected as triggers for CNTU software-force events. CNTU is used to force the PWMxB output low. Forcing on PWMxA is disabled.

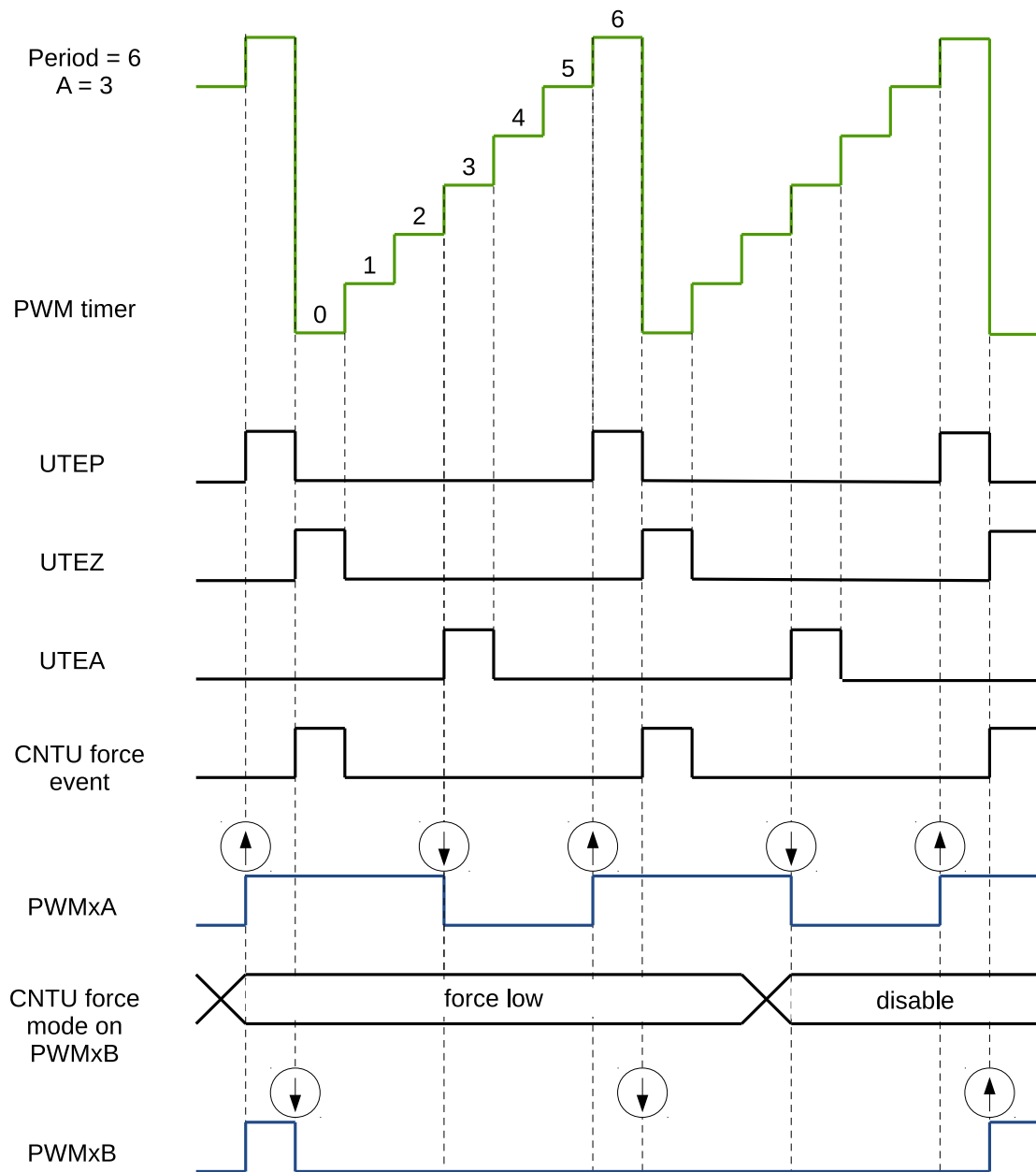


Figure 110: Example of a CNTU Software-Force Event on PWMxB

16.3.3.2 Dead Time Generator Submodule

Purpose of the Dead Time Generator Submodule

Several options to generate signals on PWMxA and PWMxB outputs, with a specific placement of signal edges, have been discussed in section 16.3.3.1. The required dead time is obtained by altering the edge placement between signals and by setting the signal's duty cycle. Another option is to control the dead time using a specialized submodule – the Dead Time Generator.

The key functions of the dead time generator submodule are as follows:

- Generating signal pairs (PWMxA and PWMxB) with a dead time from a single PWMxA input
- Creating a dead time by adding delay to signal edges:
 - Rising edge delay (RED)
 - Falling edge delay (FED)
- Configuring the signal pairs to be:
 - Active high complementary (AHC)
 - Active low complementary (ALC)
 - Active high (AH)
 - Active low (AL)
- This submodule may also be bypassed, if the dead time is configured directly in the generator submodule.

Dead Time Generator's Shadow Registers

Delay registers RED and FED are shadowed with registers `PWM_DTx_RED_CFG_REG` and `PWM_DTx_FED_CFG_REG`. For the description of shadow registers, please see section 16.3.2.3.

Highlights for Operation of the Dead Time Generator

Options for setting up the dead-time submodule are shown in Figure 111.

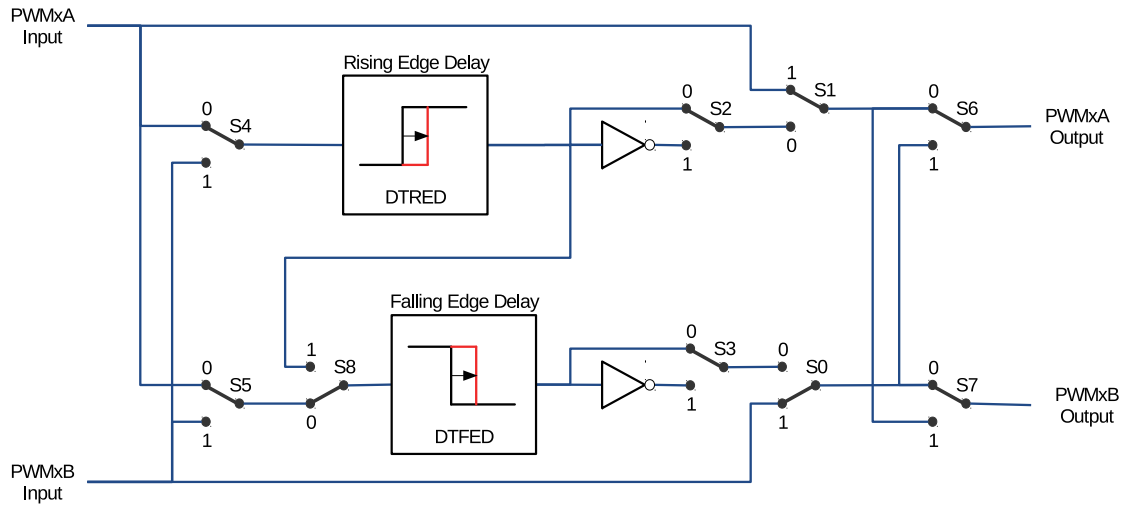


Figure 111: Options for Setting up the Dead Time Generator Submodule

S0-8 in the figure above are switches controlled by registers `PWM_DTx_CFG_REG` shown in Table 71.

Table 71: Dead Time Generator Switches Control Registers

Switch	Register
S0	<code>PWM_DT_x_B_OUTBYPASS</code>
S1	<code>PWM_DT_x_A_OUTBYPASS</code>
S2	<code>PWM_DT_x_RED_OUTINVERT</code>
S3	<code>PWM_DT_x_FED_OUTINVERT</code>
S4	<code>PWM_DT_x_RED_INSEL</code>
S5	<code>PWM_DT_x_FED_INSEL</code>
S6	<code>PWM_DT_x_A_OUTSWAP</code>
S7	<code>PWM_DT_x_B_OUTSWAP</code>
S8	<code>PWM_DT_x_DEB_MODE</code>

All switch combinations are supported, but not all of them represent the typical modes of use. Table 72 documents some typical dead time configurations. In these configurations the position of S4 and S5 sets PWMxA as the common source of both falling-edge and rising-edge delay. The modes presented in table 72 may be categorized as follows:

- Mode 1: Bypass delays on both falling (FED) as well as raising edge (RED)**
 In this mode the dead time submodule is disabled. Signals PWMxA and PWMxB pass through without any modifications.
- Mode 2-5: Classical Dead Time Polarity Settings**
 These modes represent typical configurations of polarity and should cover the active-high/low modes in available industry power switch gate drivers. The typical waveforms are shown in Figures 112 to 115.
- Modes 6 and 7: Bypass delay on falling edge (FED) or rising edge (RED)**

In these modes, either RED (Rising Edge Delay) or FED (Falling Edge Delay) is bypassed. As a result, the corresponding delay is not applied.

Table 72: Typical Dead Time Generator Operating Modes

Mode	Mode Description	S0	S1	S2	S3
1	PWMxA and PWMxB Pass Through/No Delay	1	1	X	X
2	Active High Complementary (AHC), see Figure 112	0	0	0	1
3	Active Low Complementary (ALC), see Figure 113	0	0	1	0
4	Active High (AH), see Figure 114	0	0	0	0
5	Active Low (AL), see Figure 115	0	0	1	1
6	PWMxA Output = PWMxA In (No Delay) PWMxB Output = PWMxA Input with Falling Edge Delay	0	1	0 or 1	0 or 1
7	PWMxA Output = PWMxA Input with Rising Edge Delay PWMxB Output = PWMxB Input with No Delay	1	0	0 or 1	0 or 1

Note: For all the modes above, the position of the binary switches S4 to S8 is set to 0.

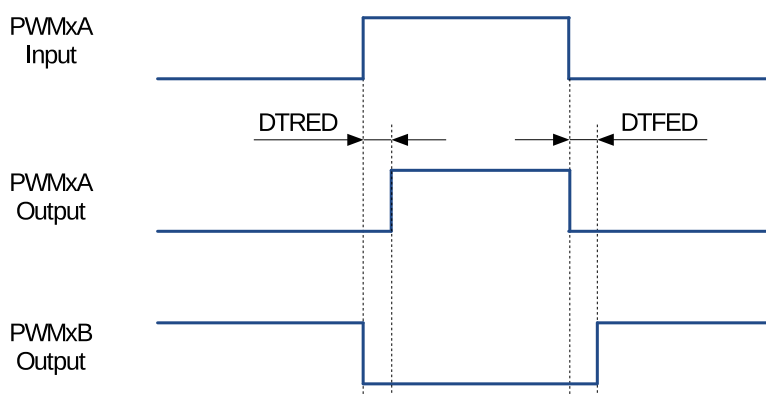


Figure 112: Active High Complementary (AHC) Dead Time Waveforms

Rising edge (RED) and falling edge (FED) delays may be set up independently. The delay value is programmed using the 16-bit registers `PWM_DTx_RED` and `PWM_DTx_FED`. The register value represents the number of clock (`DT_clk`) periods by which a signal edge is delayed. `DT_CLK` can be selected from `PWM_clk` or `PT_clk` through register `PWM_DTx_CLK_SEL`.

To calculate the delay on falling edge (FED) and rising edge (RED), use the following formulas:

$$FED = PWM_DT_{x_FED} \times T_{DT_clk}$$

$$RED = PWM_DT_{x_RED} \times T_{DT_clk}$$

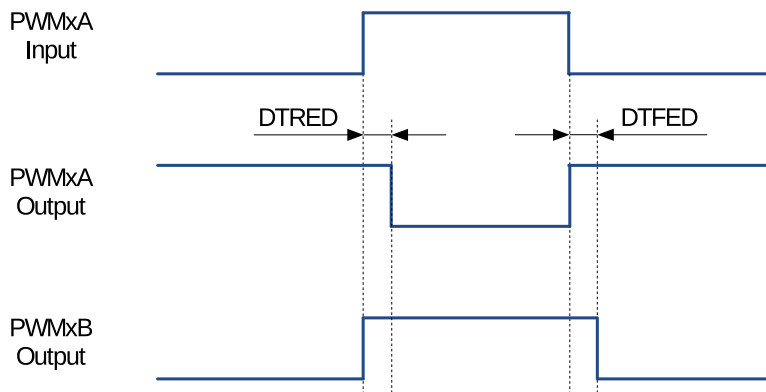


Figure 113: Active Low Complementary (ALC) Dead Time Waveforms

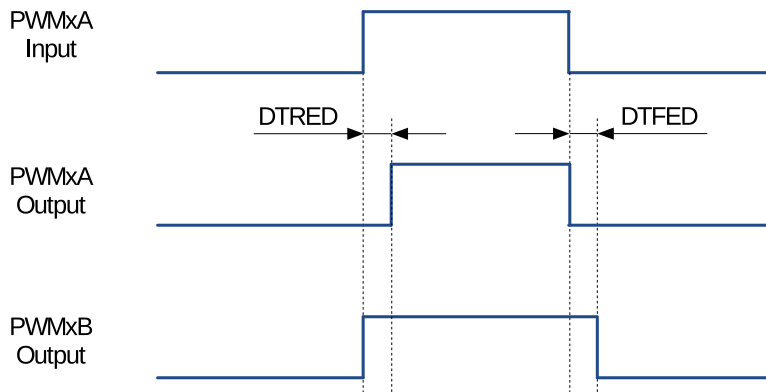


Figure 114: Active High (AH) Dead Time Waveforms

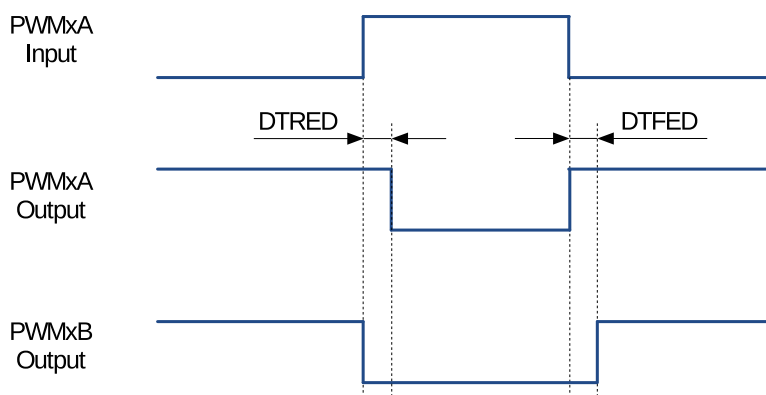


Figure 115: Active Low (AL) Dead Time Waveforms

16.3.3.3 PWM Carrier Submodule

The coupling of PWM output to a motor driver may need isolation with a transformer. Transformers deliver only AC signals, while the duty cycle of a PWM signal may range anywhere from 0% to 100%. The PWM carrier submodule passes such a PWM signal through a transformer by using a high frequency carrier to modulate the signal.

Function Overview

The following key characteristics of this submodule are configurable:

- Carrier frequency
- Pulse width of the first pulse
- Duty cycle of the second and the subsequent pulses
- Enabling/disabling the carrier function

Operational Highlights

The PWM carrier clock (PC_clk) is derived from PWM_clk. The frequency and duty cycle are configured by the PWM_CARRIER_x_PRESCALE and PWM_CARRIER_x_DUTY bits in the [PWM_CARRIER_x_CFG_REG](#) register. The purpose of one-shot pulses is to provide high-energy impulse to reliably turn on the power switch. Subsequent pulses sustain the power-on status. The width of a one-shot pulse is configurable with the PWM_CARRIER_x_OSHTWTH bits. Enabling/disabling of the carrier submodule is done with the PWM_CARRIER_x_EN bit.

Waveform Examples

Figure 116 shows an example of waveforms, where a carrier is superimposed on original PWM pulses. This figure do not show the first one-shot pulse and the duty-cycle control. Related details are covered in the following two sections.

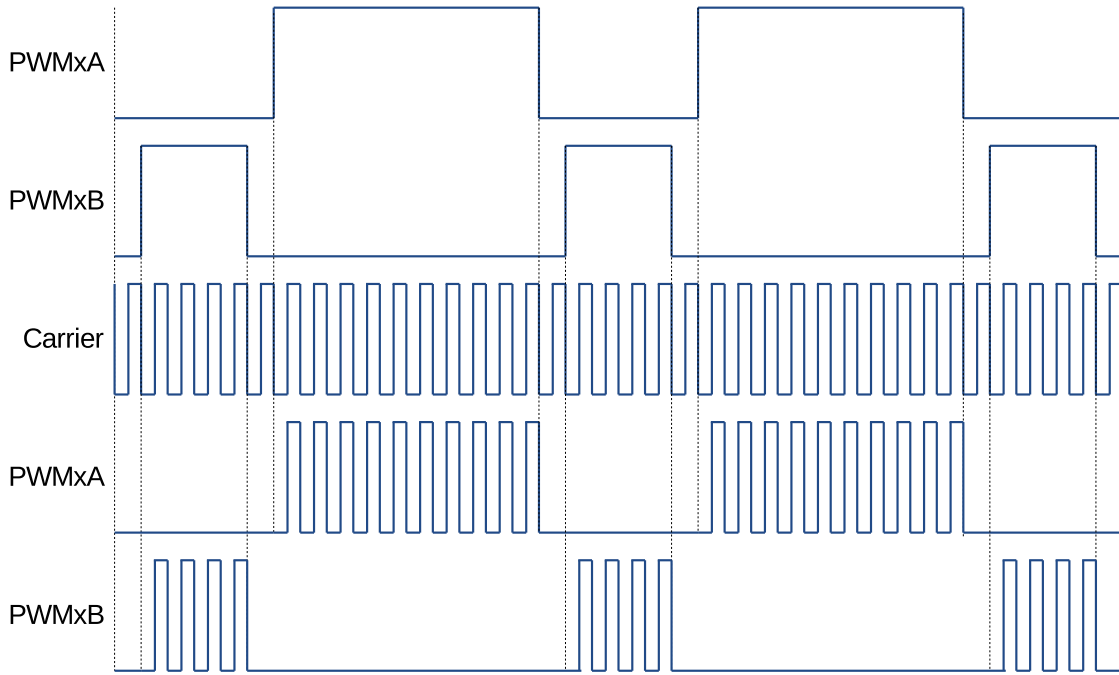


Figure 116: Example of Waveforms Showing PWM Carrier Action

One-Shot Pulse

The width of the first pulse is configurable. It may assume one of 16 possible values and is described by the formula below:

$$T_{1stpulse} = T_{PWM_clk} \times 8 \times (PWM_CARRIERx_PRESCALE + 1) \times (PWM_CARRIERx_OSHTWTH + 1)$$

Where:

- T_{PWM_clk} is the period of the PWM clock (PWM_clk).
- $(PWM_CARRIERx_OSHTWTH + 1)$ is the width of the first pulse (whose value ranges from 1 to 16).
- $(PWM_CARRIERx_PRESCALE + 1)$ is the PWM carrier clock's (PC_clk) prescaler value.

The first one-shot pulse and subsequent sustaining pulses are shown in Figure 117.

Duty Cycle Control

After issuing the first one-shot pulse, the remaining PWM signal is modulated according to the carrier frequency. Users can configure the duty cycle of this signal. Tuning of duty may be required, so that the signal passes through the isolating transformer and can still operate (turn on/off) the motor drive, changing rotation speed and direction.

The duty cycle may be set to one of seven values, using PWM_CARRIERx_DUTY, or bits [7:5] of register PWM_CARRIERx_CFG_REG.

Below is the formula for calculating the duty cycle:

$$Duty = PWM_CARRIERx_DUTY \div 8$$

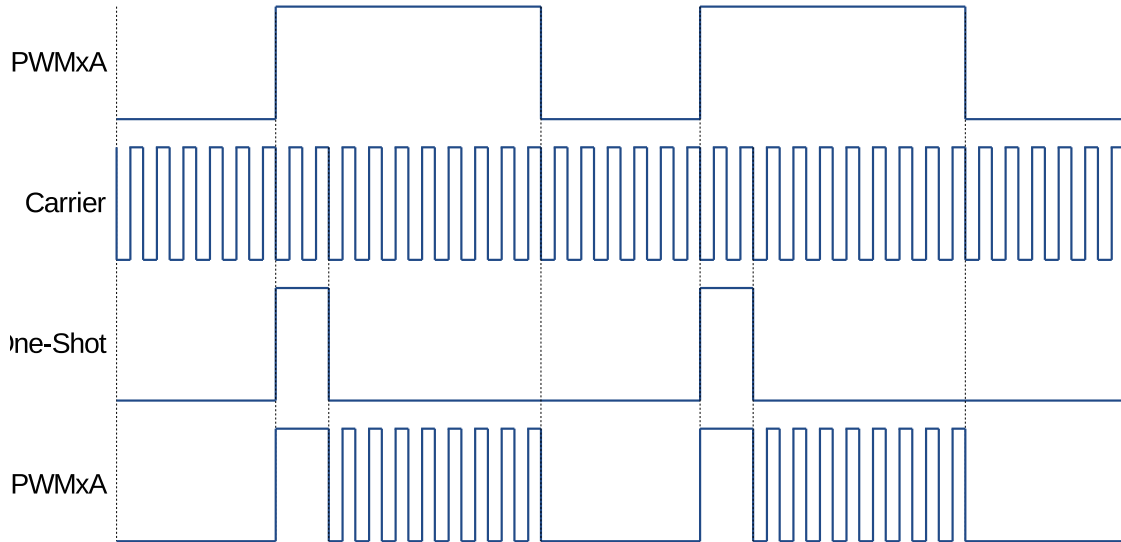


Figure 117: Example of the First Pulse and the Subsequent Sustaining Pulses of the PWM Carrier Submodule

All seven settings of the duty cycle are shown in Figure 118.

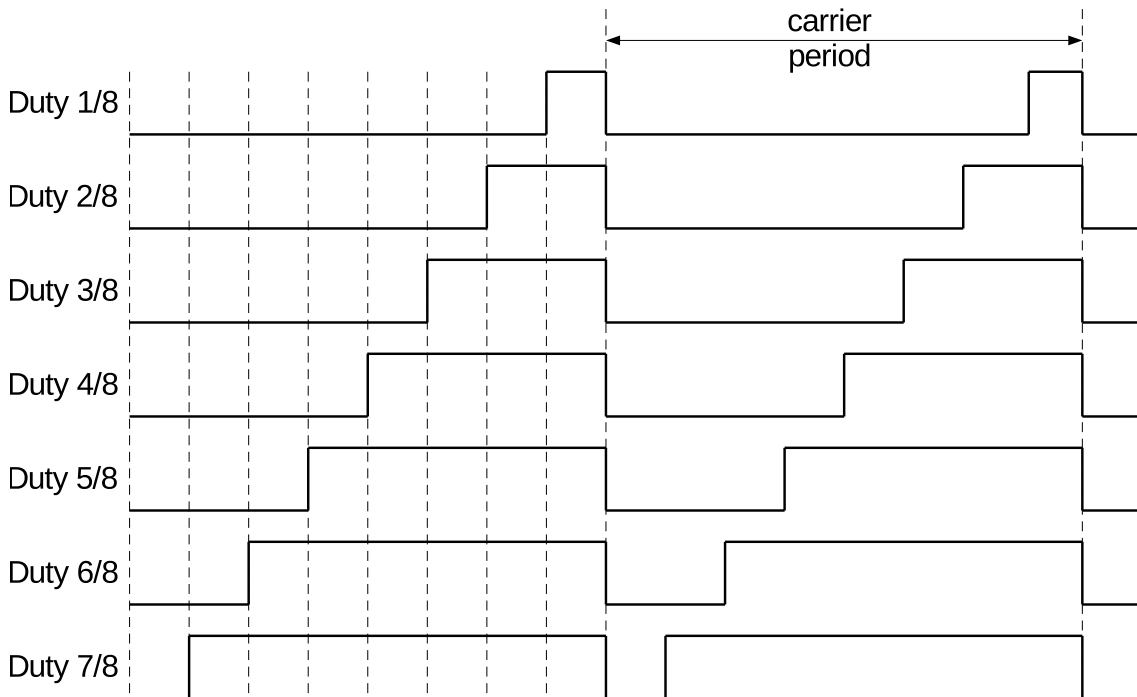


Figure 118: Possible Duty Cycle Settings for Sustaining Pulses in the PWM Carrier Submodule

16.3.3.4 Fault Handler Submodule

Each MCPWM peripheral is connected to three fault signals (FAULT0, FAULT1 and FAULT2) which are sourced from the GPIO matrix. These signals are intended to indicate external fault conditions, and may be preprocessed by the fault detection submodule to generate fault events. Fault events can then execute the user code to control

MCPWM outputs in response to specific faults.

Function of Fault Handler Submodule

The key actions performed by the fault handler submodule are:

- Forcing outputs PWMxA and PWMxB, upon detected fault, to one of the following states:
 - High
 - Low
 - Toggle
 - No action taken
- Execution of one-shot trip (OST) upon detection of over-current conditions/short circuits.
- Cycle-by-cycle tripping (CBC) to provide current-limiting operation.
- Allocation of either one-shot or cycle-by-cycle operation for each fault signal.
- Generation of interrupts for each fault input.
- Support for software-force tripping.
- Enabling or disabling of submodule function as required.

Operation and Configuration Tips

This section provides the operational tips and set-up options for the fault handler submodule.

Fault signals coming from pads are sampled and synced in the GPIO matrix. In order to guarantee the successful sampling of fault pulses, each pulse duration must be at least two APB clock cycles. The fault detection submodule will then sample fault signals by using PWM_clk. So, the duration of fault pulses coming from GPIO matrix must be at least one PWM_clk cycle. Differently put, regardless of the period relation between APB clock and PWM_clk, the width of fault signal pulses on pads must be at least equal to the sum of two APB clock cycles and one PWM_clk cycle.

Each level of fault signals, FAULT0 to FAULT2, can be used by the fault handler submodule to generate fault events (fault_event0 to fault_event2). Every fault event can be configured individually to provide CBC action, OST action, or none.

- **Cycle-by-Cycle (CBC) action:**

When CBC action is triggered, the state of PWMxA and PWMxB will be changed immediately according to the configuration of registers [PWM_FHx_A_CBC_U/D](#) and [PWM_FHx_B_CBC_U/D](#). Different actions can be indicted when the PWM timer is incrementing or decrementing. Different CBC action interrupts can be triggered for different fault events. Status register [PWM_FHx_CBC_ON](#) indicates whether a CBC action is on or off. When the fault event is no longer present, CBC actions on PWMxA/B will be cleared at a specified point, which is either a D/UTEP or D/UTEZ event. Register [PWM_FHx_CBCPULSE](#) determines at which event PWMxA and PWMxB will be able to resume normal actions. Therefore, in this mode, the CBC action is cleared or refreshed upon every PWM cycle.

- **One-Shot (OST) action:**

When OST action is triggered, the state of PWMxA and PWMxB will be changed immediately, depending on the setting of registers `PWM_FHx_A_OST_U/D` and `PWM_FHx_B_OST_U/D`. Different actions can be configured when PWM timer is incrementing or decrementing. Different OST action interrupts can be triggered from different fault events. Status register `PWM_FHx_OST_ON` indicates whether an OST action is on or off. The OST actions on PWMxA/B are not automatically cleared when the fault event is no longer present. One-shot actions must be cleared manually by negating the value stored in register `PWM_FHx_CLR_OST`.

16.3.4 Capture Submodule

16.3.4.1 Introduction

The capture submodule contains three complete capture channels. Channel inputs CAP0, CAP1 and CAP2 are sourced from the GPIO matrix. Thanks to the flexibility of the GPIO matrix, CAP0, CAP1 and CAP2 can be configured from any PAD input. Multiple capture channels can be sourced from the same PAD input, while prescaling for each channel can be set differently. Also, capture channels are sourced from different PADs. This provides several options for handling capture signals by hardware in the background, instead of having them processed directly by the CPU. A capture submodule has the following independent key resources:

- One 32-bit timer (counter) which can be synchronized with the PWM timer, another submodule or software.
- Three capture channels, each equipped with a 32-bit time-stamp and a capture prescaler.
- Independent edge polarity (rising/falling edge) selection for any capture channel.
- Input capture signal prescaling (from 1 to 256).
- Interrupt capabilities on any of the three capture events.

16.3.4.2 Capture Timer

The capture timer is a 32-bit counter incrementing continuously, once enabled. On the input it has an APB clock running typically at 80 MHz. At a sync event the counter is loaded with phase stored in register `PWM_CAP_TIMER_PHASE_REG`. Sync events can come from PWM timers sync-out, PWM module sync-in or software. The capture timer provides timing references for all three capture channels.

16.3.4.3 Capture Channel

The capture signal coming to a capture channel will be inverted first, if needed, and then prescaled. Finally, specified edges of preprocessed capture signal will trigger capture events. When a capture event occurs, the capture timer's value is stored in time-stamp register `PWM_CAP_CHx_REG`. Different interrupts can be generated for different capture channels at capture events. The edge that triggers a capture event is recorded in register `PWM_CAPx_EDGE`. The capture event can be also forced by software.

16.4 Register Summary

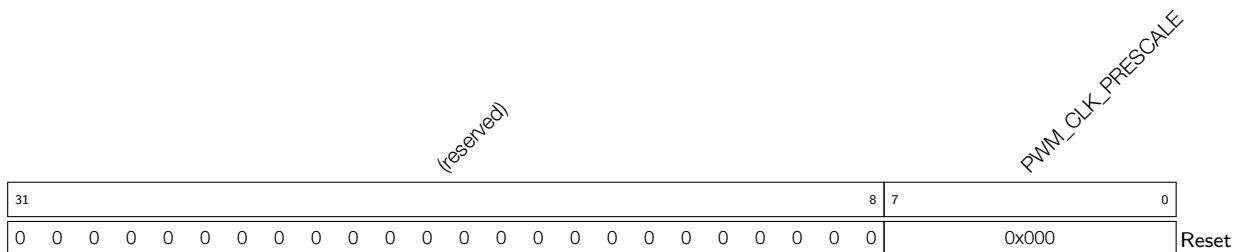
Name	Description	PWM0	PWM1	Acc
Prescaler configuration				
PWM_CLK_CFG_REG	Configuration of the prescaler	0x3FF5E000	0x3FF6C000	R/W
PWM Timer 0 Configuration and status				
PWM_TIMER0_CFG0_REG	Timer period and update method	0x3FF5E004	0x3FF6C004	R/W
PWM_TIMER0_CFG1_REG	Working mode and start/stop control	0x3FF5E008	0x3FF6C008	R/W
PWM_TIMER0_SYNC_REG	Synchronization settings	0x3FF5E00C	0x3FF6C00C	R/W
PWM_TIMER0_STATUS_REG	Timer status	0x3FF5E010	0x3FF6C010	RO
PWM Timer 1 Configuration and Status				
PWM_TIMER1_CFG0_REG	Timer update method and period	0x3FF5E014	0x3FF6C014	R/W
PWM_TIMER1_CFG1_REG	Working mode and start/stop control	0x3FF5E018	0x3FF6C018	R/W
PWM_TIMER1_SYNC_REG	Synchronization settings	0x3FF5E01C	0x3FF6C01C	R/W
PWM_TIMER1_STATUS_REG	Timer status	0x3FF5E020	0x3FF6C020	RO
PWM Timer 2 Configuration and status				
PWM_TIMER2_CFG0_REG	Timer update method and period	0x3FF5E024	0x3FF6C024	R/W
PWM_TIMER2_CFG1_REG	Working mode and start/stop control	0x3FF5E028	0x3FF6C028	R/W
PWM_TIMER2_SYNC_REG	Synchronization settings	0x3FF5E02C	0x3FF6C02C	R/W
PWM_TIMER2_STATUS_REG	Timer status	0x3FF5E030	0x3FF6C030	RO
Common configuration for PWM timers				
PWM_TIMER_SYNCI_CFG_REG	Synchronization input selection for timers	0x3FF5E034	0x3FF6C034	R/W
PWM_OPERATOR_TIMERSEL_REG	Select specific timer for PWM operators	0x3FF5E038	0x3FF6C038	R/W
PWM Operator 0 Configuration and Status				
PWM_GEN0_STMP_CFG_REG	Transfer status and update method for time stamp registers A and B	0x3FF5E03C	0x3FF6C03C	R/W
PWM_GEN0_TSTMP_A_REG	Shadow register for register A	0x3FF5E040	0x3FF6C040	R/W
PWM_GEN0_TSTMP_B_REG	Shadow register for register B	0x3FF5E044	0x3FF6C044	R/W
PWM_GEN0_CFG0_REG	Fault event T0 and T1 handling	0x3FF5E048	0x3FF6C048	R/W
PWM_GEN0_FORCE_REG	Permissives to force PWM0A and PWM0B outputs by software	0x3FF5E04C	0x3FF6C04C	R/W
PWM_GEN0_A_REG	Actions triggered by events on PWM0A	0x3FF5E050	0x3FF6C050	R/W
PWM_GEN0_B_REG	Actions triggered by events on PWM0B	0x3FF5E054	0x3FF6C054	R/W
PWM_DT0_CFG_REG	Dead time type selection and configuration	0x3FF5E058	0x3FF6C058	R/W
PWM_DT0_FED_CFG_REG	Shadow register for falling edge delay (FED)	0x3FF5E05C	0x3FF6C05C	R/W
PWM_DT0_RED_CFG_REG	Shadow register for rising edge delay (RED)	0x3FF5E060	0x3FF6C060	R/W
PWM_CARRIER0_CFG_REG	Carrier enable and configuration	0x3FF5E064	0x3FF6C064	R/W

Name	Description	PWM0	PWM1	Acc
PWM_FH0_CFG0_REG	Actions on PWM0A and PWM0B on trip events	0x3FF5E068	0x3FF6C068	R/W
PWM_FH0_CFG1_REG	Software triggers for fault handler actions	0x3FF5E06C	0x3FF6C06C	R/W
PWM_FH0_STATUS_REG	Status of fault events	0x3FF5E070	0x3FF6C070	RO
PWM Operator 1 Configuration and Status				
PWM_GEN1_STMP_CFG_REG	Transfer status and update method for time stamp registers A and B	0x3FF5E074	0x3FF6C074	R/W
PWM_GEN1_TSTMP_A_REG	Shadow register for register A	0x3FF5E078	0x3FF6C078	R/W
PWM_GEN1_TSTMP_B_REG	Shadow register for register B	0x3FF5E07C	0x3FF6C07C	R/W
PWM_GEN1_CFG0_REG	Fault event T0 and T1 handling	0x3FF5E080	0x3FF6C080	R/W
PWM_GEN1_FORCE_REG	Permissives to force PWM1A and PWM1B outputs by software	0x3FF5E084	0x3FF6C084	R/W
PWM_GEN1_A_REG	Actions triggered by events on PWM1A	0x3FF5E088	0x3FF6C088	R/W
PWM_GEN1_B_REG	Actions triggered by events on PWM1B	0x3FF5E08C	0x3FF6C08C	R/W
PWM_DT1_CFG_REG	Dead time type selection and configuration	0x3FF5E090	0x3FF6C090	R/W
PWM_DT1_FED_CFG_REG	Shadow register for FED	0x3FF5E094	0x3FF6C094	R/W
PWM_DT1_RED_CFG_REG	Shadow register for RED	0x3FF5E098	0x3FF6C098	R/W
PWM_CARRIER1_CFG_REG	Carrier enable and configuration	0x3FF5E09C	0x3FF6C09C	R/W
PWM_FH1_CFG0_REG	Actions on PWM1A and PWM1B on fault events	0x3FF5E0A0	0x3FF6C0A0	R/W
PWM_FH1_CFG1_REG	Software triggers for fault handler actions	0x3FF5E0A4	0x3FF6C0A4	R/W
PWM_FH1_STATUS_REG	Status of fault events	0x3FF5E0A8	0x3FF6C0A8	RO
PWM Operator 2 Configuration and Status				
PWM_GEN2_STMP_CFG_REG	Transfer status and updating method for time stamp registers A and B	0x3FF5E0AC	0x3FF6C0AC	R/W
PWM_GEN2_TSTMP_A_REG	Shadow register for register A	0x3FF5E0B0	0x3FF6C0B0	R/W
PWM_GEN2_TSTMP_B_REG	Shadow register for register B	0x3FF5E0B4	0x3FF6C0B4	R/W
PWM_GEN2_CFG0_REG	Fault event T0 and T1 handling	0x3FF5E080	0x3FF6C080	R/W
PWM_GEN2_FORCE_REG	Permissives to force PWM2A and PWM2B outputs by software	0x3FF5E0BC	0x3FF6C0BC	R/W
PWM_GEN2_A_REG	Actions triggered by events on PWM2A	0x3FF5E0C0	0x3FF6C0C0	R/W
PWM_GEN2_B_REG	Actions triggered by events on PWM2B	0x3FF5E0C4	0x3FF6C0C4	R/W
PWM_DT2_CFG_REG	Dead time type selection and configuration	0x3FF5E0C8	0x3FF6C0C8	R/W
PWM_DT2_FED_CFG_REG	Shadow register for FED	0x3FF5E0CC	0x3FF6C0CC	R/W
PWM_DT2_RED_CFG_REG	Shadow register for RED	0x3FF5E0D0	0x3FF6C0D0	R/W
PWM_CARRIER2_CFG_REG	Carrier enable and configuration	0x3FF5E0D4	0x3FF6C0D4	R/W

Name	Description	PWM0	PWM1	Acc
PWM_FH2_CFG0_REG	Actions at PWM2A and PWM2B on trip events	0x3FF5E0D8	0x3FF6C0D8	R/W
PWM_FH2_CFG1_REG	Software triggers for fault handler actions	0x3FF5E0DC	0x3FF6C0DC	R/W
PWM_FH2_STATUS_REG	Status of fault events	0x3FF5E0E0	0x3FF6C0E0	RO
Fault Detection Configuration and Status				
PWM_FAULT_DETECT_REG	Fault detection configuration and status	0x3FF5E0E4	0x3FF6C0E4	R/W
Capture Configuration and Status				
PWM_CAP_TIMER_CFG_REG	Configure capture timer	0x3FF5E0E8	0x3FF6C0E8	R/W
PWM_CAP_TIMER_PHASE_REG	Phase for capture timer sync	0x3FF5E0EC	0x3FF6C0EC	R/W
PWM_CAP_CH0_CFG_REG	Capture channel 0 configuration and enable	0x3FF5E0F0	0x3FF6C0F0	R/W
PWM_CAP_CH1_CFG_REG	Capture channel 1 configuration and enable	0x3FF5E0F4	0x3FF6C0F4	R/W
PWM_CAP_CH2_CFG_REG	Capture channel 2 configuration and enable	0x3FF5E0F8	0x3FF6C0F8	R/W
PWM_CAP_CH0_REG	Value of last capture on channel 0	0x3FF5E0FC	0x3FF6C0FC	RO
PWM_CAP_CH1_REG	Value of last capture on channel 1	0x3FF5E100	0x3FF6C100	RO
PWM_CAP_CH2_REG	Value of last capture on channel 2	0x3FF5E104	0x3FF6C104	RO
PWM_CAP_STATUS_REG	Edge of last capture trigger	0x3FF5E108	0x3FF6C108	RO
Enable update of active registers				
PWM_UPDATE_CFG_REG	Enable update	0x3FF5E10C	0x3FF6C10C	R/W
Manage Interrupts				
INT_ENA_PWM_REG	Interrupt enable bits	0x3FF5E110	0x3FF6C110	R/W
INT_RAW_PWM_REG	Raw interrupt status	0x3FF5E114	0x3FF6C114	RO
INT_ST_PWM_REG	Masked interrupt status	0x3FF5E118	0x3FF6C118	RO
INT_CLR_PWM_REG	Interrupt clear bits	0x3FF5E11C	0x3FF6C11C	WO

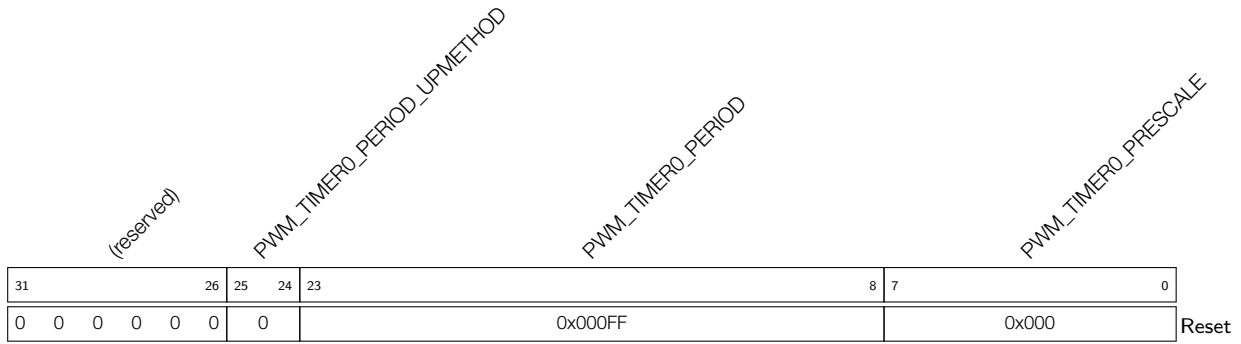
16.5 Registers

Register 16.1: PWM_CLK_CFG_REG (0x0000)



PWM_CLK_PRESCALE Period of PWM_clk = 6.25ns * (PWM_CLK_PRESCALE + 1). (R/W)

Register 16.2: PWM_TIMER0_CFG0_REG (0x0004)

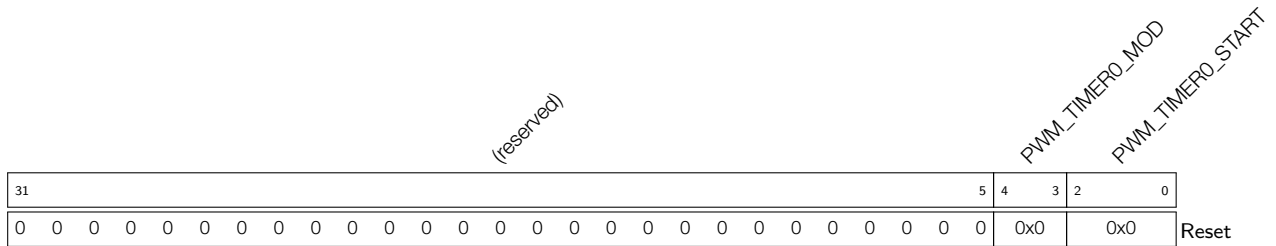


PWM_TIMER0_PERIOD_UPMETHOD Updating method for active register of PWM timer0 period.
 0: immediately, 1: update at TEZ, 2: update at sync, 3: update at TEZ or sync. TEZ here and below means that the event that happens when the timer equals to zero. (R/W)

PWM_TIMER0_PERIOD Period shadow register of PWM timer0. (R/W)

PWM_TIMER0_PRESCALE Period of PT0_clk = Period of PWM_clk * (PWM_TIMER0_PRESCALE + 1). (R/W)

Register 16.3: PWM_TIMER0_CFG1_REG (0x0008)



PWM_TIMER0_MOD PWM timer0 working mode. 0: freeze, 1: increase mode, 2: decrease mode, 3: up-down mode. (R/W)

PWM_TIMER0_START PWM timer0 start and stop control. 0: if PWM timer0 starts, then stops at TEZ; 1: if timer0 starts, then stops at TEP; 2: PWM timer0 starts and runs on; 3: timer0 starts and stops at the next TEZ; 4: timer0 starts and stops at the next TEP. TEP here and below means the event that happens when the timer equals to period. (R/W)

Register 16.4: PWM_TIMER0_SYNC_REG (0x000c)

(reserved)										PWM_TIMER0_PHASE				PWM_TIMER0_SYNC_SEL PWM_TIMER0_SYNC_SW PWM_TIMER0_SYNCLEN				Reset
31										21	20			4	3	2	1	
0 0 0 0 0 0 0 0 0 0										0				0	0	0	0	0

PWM_TIMER0_PHASE Phase for timer reload at sync event. (R/W)

PWM_TIMER1_SYNCO_SEL PWM timer0 sync_out selection. 0: sync_in; 1: TEZ; 2: TEP; otherwise: sync_out is always 0. (R/W)

PWM_TIMER1_SYNC_SW Toggling this bit will trigger a software sync. (R/W)

PWM_TIMER1_SYNCI_EN When set, timer reloading with phase on sync input event is enabled. (R/W)

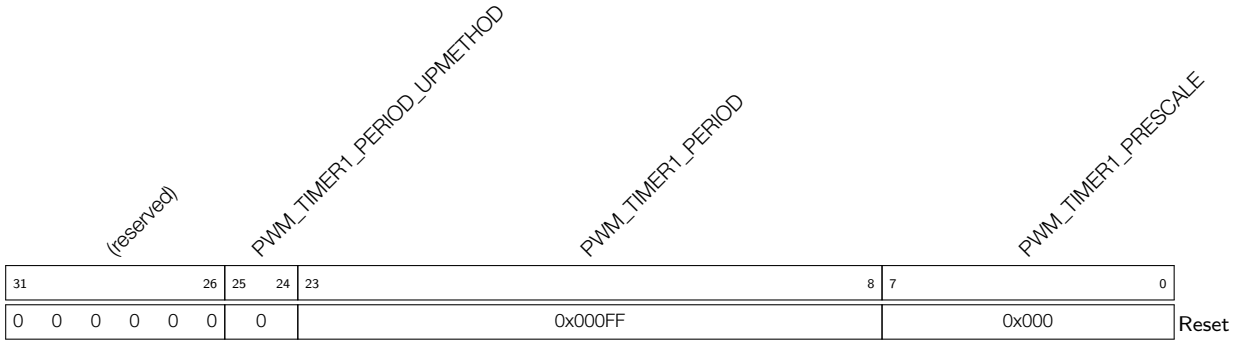
Register 16.5: PWM_TIMER0_STATUS_REG (0x0010)

(reserved)														PWM_TIMER0_DIRECTION		PWM_TIMER0_VALUE				Reset
31														17	16	15				
0 0 0 0 0 0 0 0 0 0 0 0 0 0														0	0				0	

PWM_TIMER0_DIRECTION Current direction of the PWM timer0 counter. 0: increment, 1: decrement. (RO)

PWM_TIMER0_VALUE Current value of the PWM timer0 counter. (RO)

Register 16.6: PWM_TIMER1_CFG0_REG (0x0014)

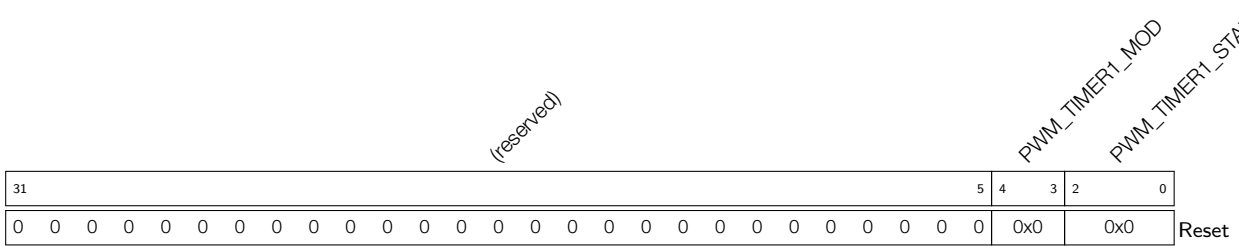


PWM_TIMER1_PERIOD_UPMETHOD Updating method for the active register of PWM timer1 period. 0: immediately, 1: update at TEZ, 2: update at sync, 3: update at TEZ or sync. (R/W)

PWM_TIMER1_PERIOD Period shadow register of the PWM timer1. (R/W)

PWM_TIMER1_PRESCALE Period of PT1_clk = Period of PWM_clk * (PWM_TIMER1_PRESCALE + 1) (R/W)

Register 16.7: PWM_TIMER1_CFG1_REG (0x0018)



PWM_TIMER1_MOD PWM timer1 working mode. 0: freeze, 1: increase mode, 2: decrease mode, 3: up-down mode. (R/W)

PWM_TIMER1_START PWM timer1 start and stop control. 0: if PWM timer1 starts, then stops at TEZ; 1: if PWM timer1 starts, then stops at TEP; 2: PWM timer1 starts and runs on; 3: PWM timer1 starts and stops at the next TEZ; 4: PWM timer1 starts and stops at the next TEP. (R/W)

Register 16.8: PWM_TIMER1_SYNC_REG (0x001c)

(reserved)										PWM_TIMER1_PHASE										PWM_TIMER1_SYNC_SEL PWM_TIMER1_SYNC_SW PWM_TIMER1_SYNCLEN							
31											21											4	3	2	1	0	
0 0 0 0 0 0 0 0 0 0 0 0										0										0 0 0 0				Reset			

PWM_TIMER1_PHASE Phase for timer reload at sync event. (R/W)

PWM_TIMER1_SYNC_SEL PWM timer1 sync_out selection. 0: sync_in; 1: TEZ; 2: TEP; otherwise: sync_out is always 0. (R/W)

PWM_TIMER1_SYNC_SW Toggling this bit will trigger a software sync. (R/W)

PWM_TIMER1_SYNCI_EN When set, timer reloading with phase at a sync input event is enabled. (R/W)

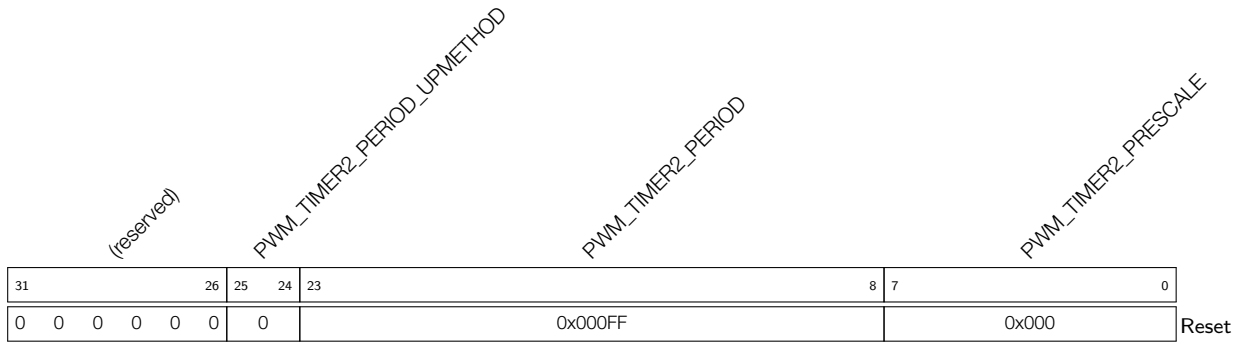
Register 16.9: PWM_TIMER1_STATUS_REG (0x0020)

(reserved)										PWM_TIMER1_DIRECTION										PWM_TIMER1_VALUE										
31											17	16	15											0						
0 0 0 0 0 0 0 0 0 0 0 0										0										0										Reset

PWM_TIMER1_DIRECTION Current direction of the PWM timer1 counter. 0: increment 1: decrement. (RO)

PWM_TIMER1_VALUE Current value of the PWM timer1 counter. (RO)

Register 16.10: PWM_TIMER2_CFG0_REG (0x0024)



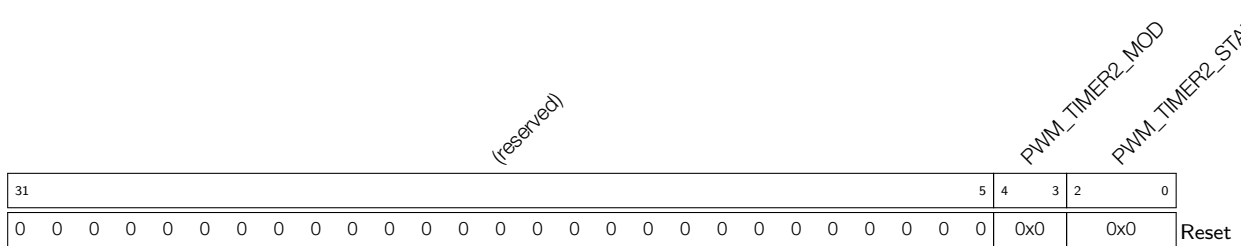
PWM_TIMER2_PERIOD_UPMETHOD Updating method for active register of PWM timer2 period.

0: immediately, 1: update at TEZ, 2: update at sync, 3: update at TEZ or sync. (R/W)

PWM_TIMER2_PERIOD Period shadow register of PWM timer2. (R/W)

PWM_TIMER2_PRESCALE Period of PT2_clk = Period of PWM_clk * (PWM_TIMER2_PRESCALE + 1). (R/W)

Register 16.11: PWM_TIMER2_CFG1_REG (0x0028)



PWM_TIMER2_MOD PWM timer2 working mode. 0: freeze, 1: increase mode, 2: decrease mode, 3: up-down mode. (R/W)

PWM_TIMER2_START PWM timer2 start and stop control. 0: if PWM timer2 starts, then stops at TEZ; 1: if PWM timer2 starts, then stops at TEP; 2: PWM timer2 starts and runs on; 3: PWM timer2 starts and stops at the next TEZ; 4: PWM timer2 starts and stops at the next TEP. (R/W)

Register 16.12: PWM_TIMER2_SYNC_REG (0x002c)

(reserved)										PWM_TIMER2_PHASE				PWM_TIMER2_SYNC_SEL PWM_TIMER2_SYNC_SW PWM_TIMER2_SYNCI_EN								
31											21	20					4	3	2	1	0	Reset
0 0 0 0 0 0 0 0 0 0 0 0											0				0	0	0	0				

PWM_TIMER2_PHASE Phase for timer reload at sync event. (R/W)

PWM_TIMER2_SYNC_SEL PWM timer2 sync_out selection. 0: sync_in; 1: TEZ; 2: TEP; otherwise: sync_out is always 0. (R/W)

PWM_TIMER2_SYNC_SW Toggling this bit will trigger a software sync. (R/W)

PWM_TIMER2_SYNCI_EN When set, timer reloading with phase on sync input event is enabled. (R/W)

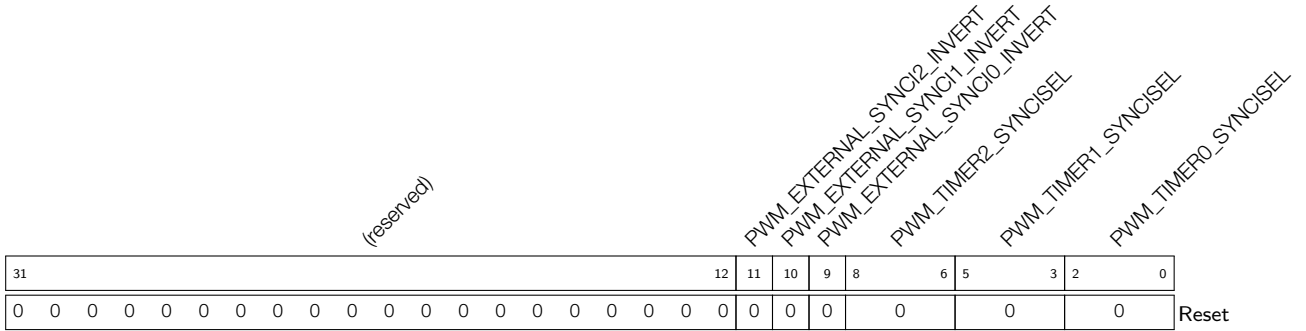
Register 16.13: PWM_TIMER2_STATUS_REG (0x0030)

(reserved)													PWM_TIMER2_DIRECTION			PWM_TIMER2_VALUE																
31														17	16	15															0	Reset
0 0 0 0 0 0 0 0 0 0 0 0 0 0														0	0																	

PWM_TIMER2_DIRECTION Current direction of the PWM timer2 counter. 0: increment, 1: decrement. (RO)

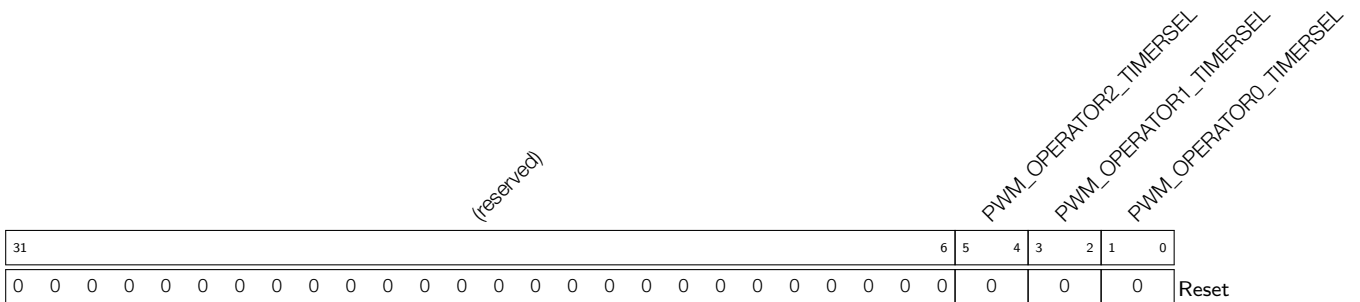
PWM_TIMER2_VALUE Current value of the PWM timer2 counter. (RO)

Register 16.14: PWM_TIMER_SYNCI_CFG_REG (0x0034)



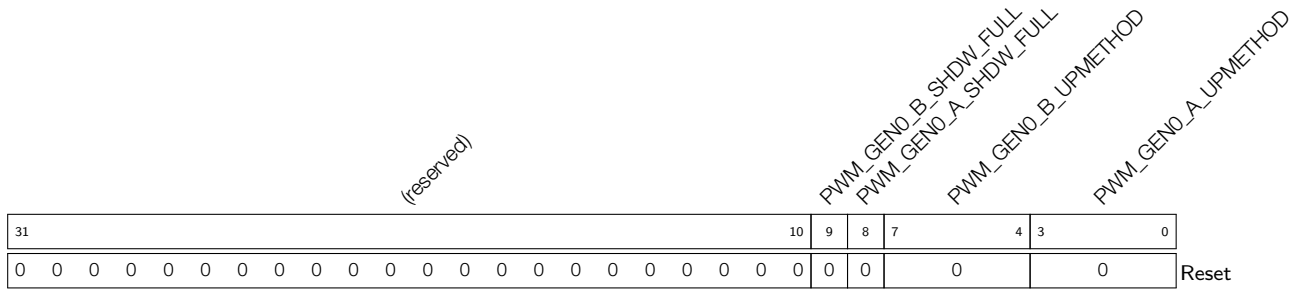
- PWM_EXTERNAL_SYNCI2_INVERT** Invert SYNC2 from GPIO matrix. (R/W)
- PWM_EXTERNAL_SYNCI1_INVERT** Invert SYNC1 from GPIO matrix. (R/W)
- PWM_EXTERNAL_SYNCI0_INVERT** Invert SYNC0 from GPIO matrix. (R/W)
- PWM_TIMER2_SYNCISEL** Select sync input for PWM timer2. 1: PWM timer0 sync_out, 2: PWM timer1 sync_out, 3: PWM timer2 sync_out, 4: SYNC0 from GPIO matrix, 5: SYNC1 from GPIO matrix, 6: SYNC2 from GPIO matrix, other values: no sync input selected. (R/W)
- PWM_TIMER1_SYNCISEL** Select sync input for PWM timer1. 1: PWM timer0 sync_out, 2: PWM timer1 sync_out, 3: PWM timer2 sync_out, 4: SYNC0 from GPIO matrix, 5: SYNC1 from GPIO matrix, 6: SYNC2 from GPIO matrix, other values: no sync input selected. (R/W)
- PWM_TIMER0_SYNCISEL** Select sync input for PWM timer0. 1: PWM timer0 sync_out, 2: PWM timer1 sync_out, 3: PWM timer2 sync_out, 4: SYNC0 from GPIO matrix, 5: SYNC1 from GPIO matrix, 6: SYNC2 from GPIO matrix, other values: no sync input selected. (R/W)

Register 16.15: PWM_OPERATOR_TIMERSEL_REG (0x0038)



- PWM_OPERATOR2_TIMERSEL** Select the PWM timer for PWM operator2's timing reference. 0: timer0, 1: timer1, 2: timer2. (R/W)
- PWM_OPERATOR1_TIMERSEL** Select the PWM timer for PWM operator1's timing reference. 0: timer0, 1: timer1, 2: timer2. (R/W)
- PWM_OPERATOR0_TIMERSEL** Select the PWM timer for PWM operator0's timing reference. 0: timer0, 1: timer1, 2: timer2. (R/W)

Register 16.16: PWM_GEN0_STMP_CFG_REG (0x003c)



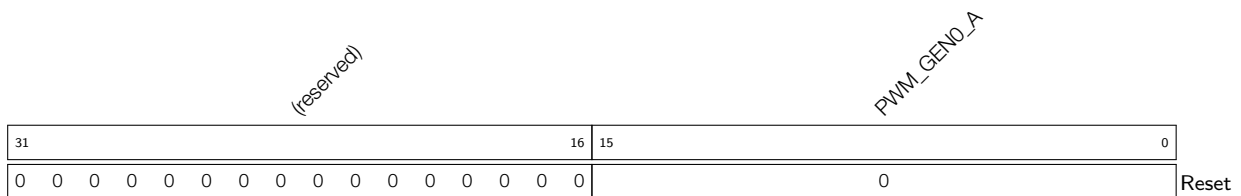
PWM_GEN0_B_SHDW_FULL Set and reset by hardware. If set, PWM generator 0 time stamp B’s shadow register.ister is filled and to be transferred to time stamp B’s active register. If cleared, time stamp B’s active register has been updated with Shadow register latest value. (RO)

PWM_GEN0_A_SHDW_FULL Set and reset by hardware. If set, PWM generator 0 time stamp A’s shadow register.ister is filled and to be transferred to time stamp A’s active register. If cleared, time stamp A’s active register has been updated with Shadow register latest value. (RO)

PWM_GEN0_B_UPMETHOD Updating method for PWM generator 0 time stamp B’s active register. When all bits are set to 0: immediately; when bit0 is set to 1: TEZ; when bit1 is set to 1: TEP; when bit2 is set to 1: sync; when bit3 is set to 1: disable the update. (R/W)

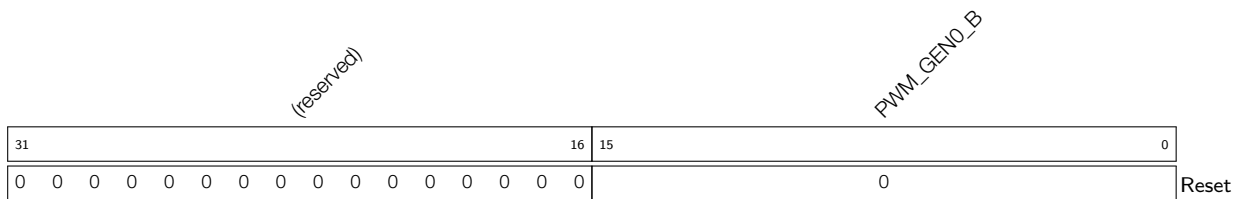
PWM_GEN0_A_UPMETHOD Updating method for PWM generator 0 time stamp A’s active register. When all bits are set to 0: immediately; when bit0 is set to 1: TEZ; when bit1 is set to 1: TEP; when bit2 is set to 1: sync; when bit3 is set to 1: disable the update. (R/W)

Register 16.17: PWM_GEN0_TSTMP_A_REG (0x0040)



PWM_GEN0_A PWM generator 0 time stamp A’s shadow register. (R/W)

Register 16.18: PWM_GEN0_TSTMP_B_REG (0x0044)



PWM_GEN0_B PWM generator 0 time stamp B’s shadow register. (R/W)

Register 16.20: PWM_GEN0_FORCE_REG (0x004c)

(reserved)																PWM_GEN0_B_NCIFORCE_MODE		PWM_GEN0_B_NCIFORCE		PWM_GEN0_A_NCIFORCE_MODE		PWM_GEN0_A_NCIFORCE		PWM_GEN0_B_CNTUFORCE_MODE		PWM_GEN0_A_CNTUFORCE_MODE		PWM_GEN0_CNTUFORCE_UPMETHOD	
31																16	15	14	13	12	11	10	9	8	7	6	5	0	
0																0		0		0		0		0		0x20		Reset	

PWM_GEN0_B_NCIFORCE_MODE Non-continuous immediate software-force mode for PWM0B.
 0: disabled, 1: low, 2: high, 3: disabled. (R/W)

PWM_GEN0_B_NCIFORCE Trigger of non-continuous immediate software-force event for PWM0B;
 a toggle will trigger a force event. (R/W)

PWM_GEN0_A_NCIFORCE_MODE Non-continuous immediate software-force mode for PWM0A,
 0: disabled, 1: low, 2: high, 3: disabled. (R/W)

PWM_GEN0_A_NCIFORCE Trigger of non-continuous immediate software-force event for PWM0A;
 a toggle will trigger a force event. (R/W)

PWM_GEN0_B_CNTUFORCE_MODE Continuous software-force mode for PWM0B. 0: disabled,
 1: low, 2: high, 3: disabled. (R/W)

PWM_GEN0_A_CNTUFORCE_MODE Continuous software-force mode for PWM0A. 0: disabled, 1:
 low, 2: high, 3: disabled. (R/W)

PWM_GEN0_CNTUFORCE_UPMETHOD Updating method for continuous software force of PWM
 generator0. When all bits are set to 0: immediately; when bit0 is set to 1: TEZ; when bit1 is set
 to 1: TEP; when bit2 is set to 1: TEA; when bit3 is set to 1: TEB; when bit4 is set to 1: sync;
 when bit5 is set to 1: disable update. (TEA/B here and below means an event generated when
 the timer's value equals to that of register A/B.) (R/W)

Register 16.21: PWM_GEN0_A_REG (0x0050)

(reserved)								PWM_GEN0_A_DT1		PWM_GEN0_A_DT0		PWM_GEN0_A_DTEB		PWM_GEN0_A_DTEA		PWM_GEN0_A_DTEP		PWM_GEN0_A_DTEZ		PWM_GEN0_A_UT1		PWM_GEN0_A_UT0		PWM_GEN0_A_UTEB		PWM_GEN0_A_UTEA		PWM_GEN0_A_UTEZ					
31	30	29	28	27	26	25	24	23	22	21	20	19	18	17	16	15	14	13	12	11	10	9	8	7	6	5	4	3	2	1	0		
0	0	0	0	0	0	0	0	0	0	0	0	0	0	0	0	0	0	0	0	0	0	0	0	0	0	0	0	0	0	0	0	0	0

Reset

PWM_GEN0_A_DT1 Action on PWM0A triggered by event_t1 when the timer decreases. 0: no change, 1: low, 2: high, 3: toggle. (R/W)

PWM_GEN0_A_DT0 Action on PWM0A triggered by event_t0 when the timer decreases. (R/W)

PWM_GEN0_A_DTEB Action on PWM0A triggered by event TEB when the timer decreases. (R/W)

PWM_GEN0_A_DTEA Action on PWM0A triggered by event TEA when the timer decreases. (R/W)

PWM_GEN0_A_DTEP Action on PWM0A triggered by event TEP when the timer decreases. (R/W)

PWM_GEN0_A_DTEZ Action on PWM0A triggered by event TEZ when the timer decreases. (R/W)

PWM_GEN0_A_UT1 Action on PWM0A triggered by event_t1 when the timer increases. (R/W)

PWM_GEN0_A_UT0 Action on PWM0A triggered by event_t0 when the timer increases. (R/W)

PWM_GEN0_A_UTEB Action on PWM0A triggered by event TEB when the timer increases. (R/W)

PWM_GEN0_A_UTEA Action on PWM0A triggered by event TEA when the timer increases. (R/W)

PWM_GEN0_A_UTEZ Action on PWM0A triggered by event TEZ when the timer increases. (R/W)

Register 16.22: PWM_GEN0_B_REG (0x0054)

(reserved)								PWM_GEN0_B_DT1	PWM_GEN0_B_DT0	PWM_GEN0_B_DTEB	PWM_GEN0_B_DTEA	PWM_GEN0_B_DTEP	PWM_GEN0_B_DTEZ	PWM_GEN0_B_UT1	PWM_GEN0_B_UT0	PWM_GEN0_B_UTEB	PWM_GEN0_B_UTEA	PWM_GEN0_B_UTEZ							
31	24	23	22	21	20	19	18	17	16	15	14	13	12	11	10	9	8	7	6	5	4	3	2	1	0
0	0	0	0	0	0	0	0	0	0	0	0	0	0	0	0	0	0	0	0	0	0	0	0	0	0

Reset

PWM_GEN0_B_DT1 Action on PWM0B triggered by event_t1 when the timer decreases. 0: no change, 1: low, 2: high, 3: toggle. (R/W)

PWM_GEN0_B_DT0 Action on PWM0B triggered by event_t0 when the timer decreases. (R/W)

PWM_GEN0_B_DTEB Action on PWM0B triggered by event TEB when the timer decreases. (R/W)

PWM_GEN0_B_DTEA Action on PWM0B triggered by event TEA when the timer decreases. (R/W)

PWM_GEN0_B_DTEP Action on PWM0B triggered by event TEP when the timer decreases. (R/W)

PWM_GEN0_B_DTEZ Action on PWM0B triggered by event TEZ when the timer decreases. (R/W)

PWM_GEN0_B_UT1 Action on PWM0B triggered by event_t1 when the timer increases. (R/W)

PWM_GEN0_B_UT0 Action on PWM0B triggered by event_t0 when the timer increases. (R/W)

PWM_GEN0_B_UTEB Action on PWM0B triggered by event TEB when the timer increases. (R/W)

PWM_GEN0_B_UTEA Action on PWM0B triggered by event TEA when the timer increases. (R/W)

PWM_GEN0_B_UTEZ Action on PWM0B triggered by event TEZ when the timer increases. (R/W)

Register 16.23: PWM_DT0_CFG_REG (0x0058)

(reserved)																		PWM_DT0_CLK_SEL	PWM_DT0_B_OUTBYPASS	PWM_DT0_A_OUTBYPASS	PWM_DT0_FED_OUTINVERT	PWM_DT0_RED_OUTINVERT	PWM_DT0_FED_INSEL	PWM_DT0_RED_INSEL	PWM_DT0_B_OUTSWAP	PWM_DT0_A_OUTSWAP	PWM_DT0_DEB_MODE	PWM_DT0_RED_UPMETHOD			PWM_DT0_FED_UPMETHOD																	
31																		18	17	16	15	14	13	12	11	10	9	8	7				4	3	0													
0																		0	1	1	0	0	0	0	0	0	0	0	0	0	0	0	0	0	0	0	0	0	0	0	0	0	0	0	0	0	0	Reset

PWM_DT0_CLK_SEL Dead time generator 0 clock selection. 0: PWM_clk, 1: PT_clk. (R/W)

PWM_DT0_B_OUTBYPASS S0 in Table 71. (R/W)

PWM_DT0_A_OUTBYPASS S1 in Table 71. (R/W)

PWM_DT0_FED_OUTINVERT S3 in Table 71. (R/W)

PWM_DT0_RED_OUTINVERT S2 in Table 71. (R/W)

PWM_DT0_FED_INSEL S5 in Table 71. (R/W)

PWM_DT0_RED_INSEL S4 in Table 71. (R/W)

PWM_DT0_B_OUTSWAP S7 in Table 71. (R/W)

PWM_DT0_A_OUTSWAP S6 in Table 71. (R/W)

PWM_DT0_DEB_MODE S8 in Table 71, dual-edge B mode. 0: FED/RED take effect on different paths separately, 1: FED/RED take effect on B path. (R/W)

PWM_DT0_RED_UPMETHOD Updating method for RED (rising edge delay) active register. 0: immediately; when bit0 is set to 1: TEZ; when bit1 is set to 1: TEP; when bit2 is set to 1: sync; when bit3 is set to 1: disable the update. (R/W)

PWM_DT0_FED_UPMETHOD Updating method for FED (falling edge delay) active register. 0: immediately; when bit0 is set to 1: TEZ; when bit1 is set to 1: TEP; when bit2 is set to 1: sync; when bit3 is set to 1: disable the update. (R/W)

Register 16.24: PWM_DT0_FED_CFG_REG (0x005c)

(reserved)																PWM_DT0_FED		
31																16	15	0
0																0	0	Reset

PWM_DT0_FED Shadow register for FED. (R/W)

Register 16.25: PWM_DT0_RED_CFG_REG (0x0060)

(reserved)																PWM_DT0_RED															
31															16	15														0	
0																0															Reset

PWM_DT0_RED Shadow register for RED. (R/W)

Register 16.26: PWM_CARRIER0_CFG_REG (0x0064)

(reserved)																PWM_CARRIER0_IN_INVERT		PWM_CARRIER0_OUT_INVERT		PWM_CARRIER0_OSHWTH		PWM_CARRIER0_DUTY		PWM_CARRIER0_PRESCALE		PWM_CARRIER0_EN				
31															14	13	12	11			8	7			5	4			1	0
0																0	0	0		0		0		0		0	0	0		0

PWM_CARRIER0_IN_INVERT When set, invert the input of PWM0A and PWM0B for this submodule. (R/W)

PWM_CARRIER0_OUT_INVERT When set, invert the output of PWM0A and PWM0B for this submodule. (R/W)

PWM_CARRIER0_OSHWTH Width of the first pulse in number of periods of the carrier. (R/W)

PWM_CARRIER0_DUTY Carrier duty selection. Duty = PWM_CARRIER0_DUTY/8. (R/W)

PWM_CARRIER0_PRESCALE PWM carrier0 clock (PC_clk) prescale value. Period of PC_clk = period of PWM_clk * (PWM_CARRIER0_PRESCALE + 1). (R/W)

PWM_CARRIER0_EN When set, carrier0 function is enabled. When cleared, carrier0 is bypassed. (R/W)

Register 16.27: PWM_FH0_CFG0_REG (0x0068)

(reserved)								PWM_FH0_B_OST_U	PWM_FH0_B_OST_D	PWM_FH0_B_CBC_U	PWM_FH0_B_CBC_D	PWM_FH0_A_OST_U	PWM_FH0_A_OST_D	PWM_FH0_A_CBC_U	PWM_FH0_A_CBC_D	PWM_FH0_F0_OST	PWM_FH0_F1_OST	PWM_FH0_F2_OST	PWM_FH0_SW_OST	PWM_FH0_F0_CBC	PWM_FH0_F1_CBC	PWM_FH0_F2_CBC	PWM_FH0_SW_CBC		
31	24	23	22	21	20	19	18	17	16	15	14	13	12	11	10	9	8	7	6	5	4	3	2	1	0
0	0	0	0	0	0	0	0	0	0	0	0	0	0	0	0	0	0	0	0	0	0	0	0	0	0

Reset

PWM_FH0_B_OST_U One-shot mode action on PWM0B when a fault event occurs and the timer is increasing. 0: do nothing, 1: force low, 2: force high, 3: toggle. (R/W)

PWM_FH0_B_OST_D One-shot mode action on PWM0B when a fault event occurs and the timer is decreasing. 0: do nothing, 1: force low, 2: force high, 3: toggle. (R/W)

PWM_FH0_B_CBC_U Cycle-by-cycle mode action on PWM0B when a fault event occurs and the timer is increasing. 0: do nothing, 1: force low, 2: force high, 3: toggle. (R/W)

PWM_FH0_B_CBC_D Cycle-by-cycle mode action on PWM0B when a fault event occurs and the timer is decreasing. 0: do nothing, 1: force low, 2: force high, 3: toggle. (R/W)

PWM_FH0_A_OST_U One-shot mode action on PWM0A when a fault event occurs and the timer is increasing. 0: do nothing, 1: force low, 2: force high, 3: toggle. (R/W)

PWM_FH0_A_OST_D One-shot mode action on PWM0A when a fault event occurs and the timer is decreasing. 0: do nothing, 1: force low, 2: force high, 3: toggle. (R/W)

PWM_FH0_A_CBC_U Cycle-by-cycle mode action on PWM0A when a fault event occurs and the timer is increasing. 0: do nothing, 1: force low, 2: force high, 3: toggle. (R/W)

PWM_FH0_A_CBC_D Cycle-by-cycle mode action on PWM0A when a fault event occurs and the timer is decreasing. 0: do nothing, 1: force low, 2: force high, 3: toggle. (R/W)

PWM_FH0_F0_OST event_f0 will trigger one-shot mode action. 0: disable, 1: enable. (R/W)

PWM_FH0_F1_OST event_f1 will trigger one-shot mode action. 0: disable, 1: enable. (R/W)

PWM_FH0_F2_OST event_f2 will trigger one-shot mode action. 0: disable, 1: enable. (R/W)

PWM_FH0_SW_OST Enable register for software-forced one-shot mode action. 0: disable, 1: enable. (R/W)

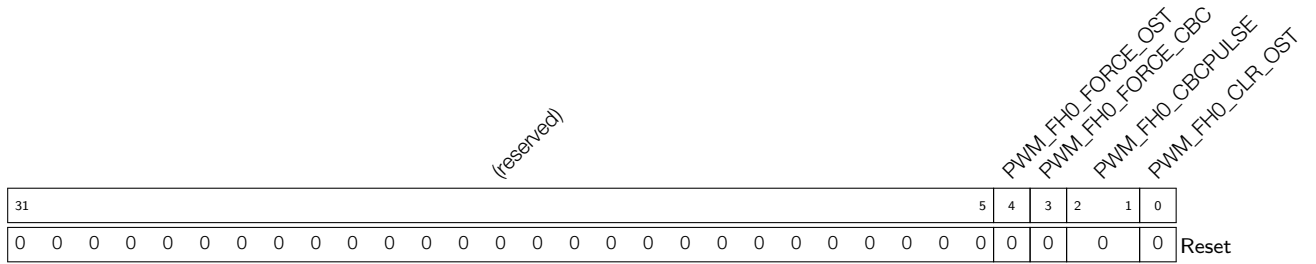
PWM_FH0_F0_CBC event_f0 will trigger cycle-by-cycle mode action. 0: disable, 1: enable. (R/W)

PWM_FH0_F1_CBC event_f1 will trigger cycle-by-cycle mode action. 0: disable, 1: enable. (R/W)

PWM_FH0_F2_CBC event_f2 will trigger cycle-by-cycle mode action. 0: disable, 1: enable. (R/W)

PWM_FH0_SW_CBC Enable register for software-forced cycle-by-cycle mode action. 0: disable, 1: enable. (R/W)

Register 16.28: PWM_FH0_CFG1_REG (0x006c)



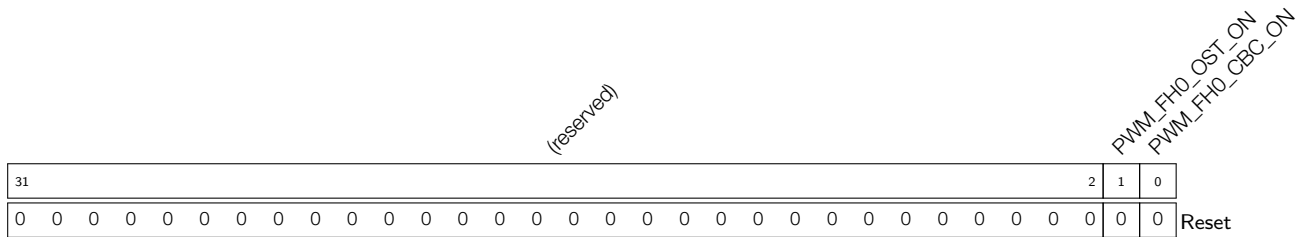
PWM_FH0_FORCE_OST A toggle (software negation of this bit’s value) triggers a one-shot mode action. (R/W)

PWM_FH0_FORCE_CBC A toggle triggers a cycle-by-cycle mode action. (R/W)

PWM_FH0_CBCPULSE The cycle-by-cycle mode action refresh moment selection. When bit0 is set to 1: TEZ; when bit1 is set to 1: TEP. (R/W)

PWM_FH0_CLR_OST A toggle will clear on-going one-shot mode action. (R/W)

Register 16.29: PWM_FH0_STATUS_REG (0x0070)



PWM_FH0_OST_ON Set and reset by hardware. If set, a one-shot mode action is on-going. (RO)

PWM_FH0_CBC_ON Set and reset by hardware. If set, a cycle-by-cycle mode action is on-going. (RO)

Register 16.33: PWM_GEN1_CFG0_REG (0x0080)

(reserved)										PWM_GEN1_T1_SEL		PWM_GEN1_T0_SEL		PWM_GEN1_CFG_UPMETHOD				
31											10	9	7	6	4	3	0	
0	0	0	0	0	0	0	0	0	0	0	0	0	0	0	0	0	0	Reset

PWM_GEN1_T1_SEL Source selection for PWM generator1 event_t1, taking effect immediately, 0: fault_event0, 1: fault_event1, 2: fault_event2, 3: sync_taken, 4: none. (R/W)

PWM_GEN1_T0_SEL Source selection for PWM generator1 event_t0, taking effect immediately, 0: fault_event0, 1: fault_event1, 2: fault_event2, 3: sync_taken, 4: none. (R/W)

PWM_GEN1_CFG_UPMETHOD Updating method for PWM generator1's active register of configuration. 0: immediately; when bit0 is set to 1: TEZ; when bit1 is set to 1: TEP; when bit2 is set to 1: sync. bit3: disable the update. (R/W)

Register 16.34: PWM_GEN1_FORCE_REG (0x0084)

(reserved)																PWM_GEN1_B_NCIFORCE_MODE		PWM_GEN1_B_NCIFORCE		PWM_GEN1_A_NCIFORCE_MODE		PWM_GEN1_A_NCIFORCE		PWM_GEN1_B_CNTUFORCE_MODE		PWM_GEN1_A_CNTUFORCE_MODE		PWM_GEN1_CNTUFORCE_UPMETHOD		
31															16	15	14	13	12	11	10	9	8	7	6	5			0	
0																0	0	0	0	0	0	0	0	0	0	0x20				Reset

PWM_GEN1_B_NCIFORCE_MODE Non-continuous immediate software-force mode for PWM1B.
 0: disabled, 1: low, 2: high, 3: disabled. (R/W)

PWM_GEN1_B_NCIFORCE Trigger of non-continuous immediate software-force event for PWM1B;
 a toggle will trigger a force event. (R/W)

PWM_GEN1_A_NCIFORCE_MODE Non-continuous immediate software-force mode for PWM1A.
 0: disabled, 1: low, 2: high, 3: disabled. (R/W)

PWM_GEN1_A_NCIFORCE Trigger of non-continuous immediate software-force event for PWM1A;
 a toggle will trigger a force event. (R/W)

PWM_GEN1_B_CNTUFORCE_MODE Continuous software-force mode for PWM1B. 0: disabled,
 1: low, 2: high, 3: disabled. (R/W)

PWM_GEN1_A_CNTUFORCE_MODE Continuous software-force mode for PWM1A. 0: disabled, 1:
 low, 2: high, 3: disabled. (R/W)

PWM_GEN1_CNTUFORCE_UPMETHOD Updating method for continuous software force of PWM
 generator1. When all bits are set to 0: immediately; when bit0 is set to 1: TEZ; when bit1 is set
 to 1: TEP; when bit2 is set to 1: TEA; when bit3 is set to 1: TEB; when bit4 is set to 1: sync;
 when bit5 is set to 1: disable update. (TEA/B here and below means an event generated when
 the timer's value equals to that of register A/B). (R/W)

Register 16.35: PWM_GEN1_A_REG (0x0088)

(reserved)								PWM_GEN1_A_DT1	PWM_GEN1_A_DT0	PWM_GEN1_A_DTEB	PWM_GEN1_A_DTEA	PWM_GEN1_A_DTEP	PWM_GEN1_A_DTEZ	PWM_GEN1_A_UT1	PWM_GEN1_A_UT0	PWM_GEN1_A_UTEB	PWM_GEN1_A_UTEA	PWM_GEN1_A_UTEZ							
31	24	23	22	21	20	19	18	17	16	15	14	13	12	11	10	9	8	7	6	5	4	3	2	1	0
0	0	0	0	0	0	0	0	0	0	0	0	0	0	0	0	0	0	0	0	0	0	0	0	0	0

Reset

PWM_GEN1_A_DT1 Action on PWM1A triggered by event_t1 when the timer decreases. 0: no change, 1: low, 2: high, 3: toggle. (R/W)

PWM_GEN1_A_DT0 Action on PWM1A triggered by event_t0 when the timer decreases. (R/W)

PWM_GEN1_A_DTEB Action on PWM1A triggered by event TEB when the timer decreases. (R/W)

PWM_GEN1_A_DTEA Action on PWM1A triggered by event TEA when the timer decreases. (R/W)

PWM_GEN1_A_DTEP Action on PWM1A triggered by event TEP when the timer decreases. (R/W)

PWM_GEN1_A_DTEZ Action on PWM1A triggered by event TEZ when the timer decreases. (R/W)

PWM_GEN1_A_UT1 Action on PWM1A triggered by event_t1 when the timer increases. (R/W)

PWM_GEN1_A_UT0 Action on PWM1A triggered by event_t0 when the timer increases. (R/W)

PWM_GEN1_A_UTEB Action on PWM1A triggered by event TEB when the timer increases. (R/W)

PWM_GEN1_A_UTEA Action on PWM1A triggered by event TEA when the timer increases. (R/W)

PWM_GEN1_A_UTEZ Action on PWM1A triggered by event TEZ when the timer increases. (R/W)

Register 16.36: PWM_GEN1_B_REG (0x008c)

(reserved)								PWM_GEN1_B_DT1	PWM_GEN1_B_DT0	PWM_GEN1_B_DTEB	PWM_GEN1_B_DTEA	PWM_GEN1_B_DTEP	PWM_GEN1_B_DTEZ	PWM_GEN1_B_UT1	PWM_GEN1_B_UT0	PWM_GEN1_B_UTEB	PWM_GEN1_B_UTEA	PWM_GEN1_B_UTEP	PWM_GEN1_B_UTEZ						
31	24	23	22	21	20	19	18	17	16	15	14	13	12	11	10	9	8	7	6	5	4	3	2	1	0
0	0	0	0	0	0	0	0	0	0	0	0	0	0	0	0	0	0	0	0	0	0	0	0	0	0

Reset

PWM_GEN1_B_DT1 Action on PWM1B triggered by event_t1 when the timer decreases. 0: no change, 1: low, 2: high, 3: toggle. (R/W)

PWM_GEN1_B_DT0 Action on PWM1B triggered by event_t0 when the timer decreases. (R/W)

PWM_GEN1_B_DTEB Action on PWM1B triggered by event TEB when the timer decreases. (R/W)

PWM_GEN1_B_DTEA Action on PWM1B triggered by event TEA when the timer decreases. (R/W)

PWM_GEN1_B_DTEP Action on PWM1B triggered by event TEP when the timer decreases. (R/W)

PWM_GEN1_B_DTEZ Action on PWM1B triggered by event TEZ when the timer decreases. (R/W)

PWM_GEN1_B_UT1 Action on PWM1B triggered by event_t1 when the timer increases. (R/W)

PWM_GEN1_B_UT0 Action on PWM1B triggered by event_t0 when the timer increases. (R/W)

PWM_GEN1_B_UTEB Action on PWM1B triggered by event TEB when the timer increases. (R/W)

PWM_GEN1_B_UTEA Action on PWM1B triggered by event TEA when the timer increases. (R/W)

PWM_GEN1_B_UTEP Action on PWM1B triggered by event TEP when the timer increases. (R/W)

PWM_GEN1_B_UTEZ Action on PWM1B triggered by event TEZ when the timer increases. (R/W)

Register 16.37: PWM_DT1_CFG_REG (0x0090)

(reserved)																		PWM_DT1_CLK_SEL	PWM_DT1_B_OUTBYPASS	PWM_DT1_A_OUTBYPASS	PWM_DT1_FED_OUTINVERT	PWM_DT1_RED_OUTINVERT	PWM_DT1_FED_INSEL	PWM_DT1_RED_INSEL	PWM_DT1_B_OUTSWAP	PWM_DT1_A_OUTSWAP	PWM_DT1_DEB_MODE	PWM_DT1_RED_UPMETHOD			PWM_DT1_FED_UPMETHOD																	
31																		18	17	16	15	14	13	12	11	10	9	8	7				4	3	0													
0																		0	1	1	0	0	0	0	0	0	0	0	0	0	0	0	0	0	0	0	0	0	0	0	0	0	0	0	0	0	0	Reset

PWM_DT1_CLK_SEL Dead time generator 1 clock selection. 0: PWM_clk, 1: PT_clk. (R/W)

PWM_DT1_B_OUTBYPASS S0 in Table 71. (R/W)

PWM_DT1_A_OUTBYPASS S1 in Table 71. (R/W)

PWM_DT1_FED_OUTINVERT S3 in Table 71. (R/W)

PWM_DT1_RED_OUTINVERT S2 in Table 71. (R/W)

PWM_DT1_FED_INSEL S5 in Table 71. (R/W)

PWM_DT1_RED_INSEL S4 in Table 71. (R/W)

PWM_DT1_B_OUTSWAP S7 in Table 71. (R/W)

PWM_DT1_A_OUTSWAP S6 in Table 71. (R/W)

PWM_DT1_DEB_MODE S8 in Table 71; dual-edge B mode. 0: FED/RED take effect on different paths separately; 1: FED (falling edge delay)/RED (rising edge delay) take effect on B path. (R/W)

PWM_DT1_RED_UPMETHOD Updating method for RED active register. 0: immediately; when bit0 is set to 1: TEZ; when bit1 is set to 1: TEP; when bit2 is set to 1: sync; when bit3 is set to 1: disable the update. (R/W)

PWM_DT1_FED_UPMETHOD Updating method for FED active register. 0: immediately; when bit0 is set to 1: TEZ; when bit1 is set to 1: TEP; when bit2 is set to 1: sync; when bit3 is set to 1: disable the update. (R/W)

Register 16.38: PWM_DT1_FED_CFG_REG (0x0094)

(reserved)																PWM_DT1_FED		
31																16	15	0
0																0	0	Reset

PWM_DT1_FED Shadow register for FED. (R/W)

Register 16.39: PWM_DT1_RED_CFG_REG (0x0098)

(reserved)																PWM_DT1_RED															
31															16	15														0	
0																0															Reset

PWM_DT1_RED Shadow register for RED. (R/W)

Register 16.40: PWM_CARRIER1_CFG_REG (0x009c)

(reserved)																PWM_CARRIER1_IN_INVERT		PWM_CARRIER1_OUT_INVERT		PWM_CARRIER1_OSHWTH		PWM_CARRIER1_DUTY		PWM_CARRIER1_PRESCALE		PWM_CARRIER1_EN				
31															14	13	12	11			8	7			5	4			1	0
0																0	0	0		0		0		0		0	0	0		0

PWM_CARRIER1_IN_INVERT When set, invert the input of PWM1A and PWM1B for this submodule. (R/W)

PWM_CARRIER1_OUT_INVERT When set, invert the output of PWM1A and PWM1B for this submodule. (R/W)

PWM_CARRIER1_OSHWTH Width of the first pulse in number of periods of the carrier. (R/W)

PWM_CARRIER1_DUTY Carrier duty selection. Duty = PWM_CARRIER1_DUTY/8. (R/W)

PWM_CARRIER1_PRESCALE PWM carrier1 clock (PC_clk) prescale value. Period of PC_clk = period of PWM_clk * (PWM_CARRIER1_PRESCALE + 1). (R/W)

PWM_CARRIER1_EN When set, carrier1 function is enabled. When cleared, carrier1 is bypassed. (R/W)

Register 16.41: PWM_FH1_CFG0_REG (0x00a0)

(reserved)								PWM_FH1_B_OST_U		PWM_FH1_B_OST_D		PWM_FH1_B_CBC_U		PWM_FH1_B_CBC_D		PWM_FH1_A_OST_U		PWM_FH1_A_OST_D		PWM_FH1_A_CBC_U		PWM_FH1_A_CBC_D		PWM_FH1_F0_OST		PWM_FH1_F1_OST		PWM_FH1_F2_OST		PWM_FH1_SW_OST		PWM_FH1_F0_CBC		PWM_FH1_F1_CBC		PWM_FH1_F2_CBC		PWM_FH1_SW_CBC									
31	30	29	28	27	26	25	24	23	22	21	20	19	18	17	16	15	14	13	12	11	10	9	8	7	6	5	4	3	2	1	0	Reset															
0	0	0	0	0	0	0	0	0	0	0	0	0	0	0	0	0	0	0	0	0	0	0	0	0	0	0	0	0	0	0	0	0	0	0	0	0	0	0	0	0	0	0	0	0	0	0	0

PWM_FH1_B_OST_U One-shot mode action on PWM1B when a fault event occurs and the timer is increasing. 0: do nothing, 1: force low, 2: force high, 3: toggle. (R/W)

PWM_FH1_B_OST_D One-shot mode action on PWM1B when a fault event occurs and the timer is decreasing. 0: do nothing, 1: force low, 2: force high, 3: toggle. (R/W)

PWM_FH1_B_CBC_U Cycle-by-cycle mode action on PWM1B when a fault event occurs and the timer is increasing. 0: do nothing, 1: force low, 2: force high, 3: toggle. (R/W)

PWM_FH1_B_CBC_D Cycle-by-cycle mode action on PWM1B when a fault event occurs and the timer is decreasing. 0: do nothing, 1: force low, 2: force high, 3: toggle. (R/W)

PWM_FH1_A_OST_U One-shot mode action on PWM1A when a fault event occurs and the timer is increasing. 0: do nothing, 1: force low, 2: force high, 3: toggle. (R/W)

PWM_FH1_A_OST_D One-shot mode action on PWM1A when a fault event occurs and the timer is decreasing. 0: do nothing, 1: force low, 2: force high, 3: toggle. (R/W)

PWM_FH1_A_CBC_U Cycle-by-cycle mode action on PWM1A when a fault event occurs and the timer is increasing. 0: do nothing, 1: force low, 2: force high, 3: toggle. (R/W)

PWM_FH1_A_CBC_D Cycle-by-cycle mode action on PWM1A when a fault event occurs and the timer is decreasing. 0: do nothing, 1: force low, 2: force high, 3: toggle. (R/W)

PWM_FH1_F0_OST Enable event_f0 to trigger one-shot mode action. 0: disable, 1: enable. (R/W)

PWM_FH1_F1_OST Enable event_f1 to trigger one-shot mode action. 0: disable, 1: enable. (R/W)

PWM_FH1_F2_OST Enable event_f2 to trigger one-shot mode action. 0: disable, 1: enable. (R/W)

PWM_FH1_SW_OST Enable the register for software-forced one-shot mode action. 0: disable, 1: enable. (R/W)

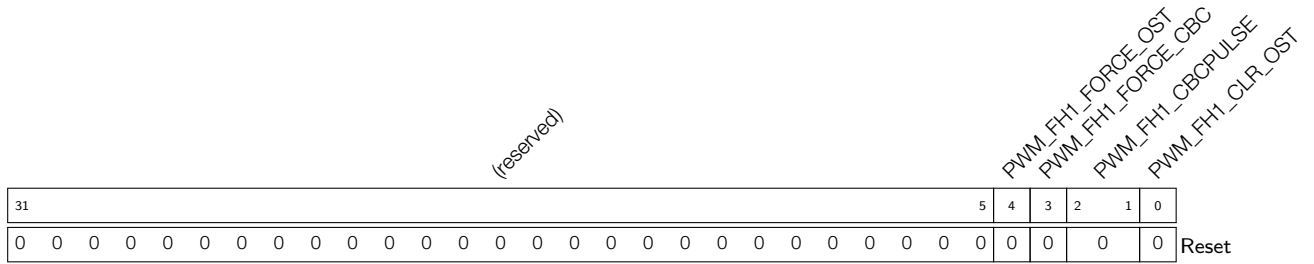
PWM_FH1_F0_CBC Enable event_f0 to trigger cycle-by-cycle mode action. 0: disable, 1: enable. (R/W)

PWM_FH1_F1_CBC Enable event_f1 to trigger cycle-by-cycle mode action. 0: disable, 1: enable. (R/W)

PWM_FH1_F2_CBC Enable event_f2 to will trigger cycle-by-cycle mode action. 0: disable, 1: enable. (R/W)

PWM_FH1_SW_CBC Enable the register for software-forced cycle-by-cycle mode action. 0: disable, 1: enable. (R/W)

Register 16.42: PWM_FH1_CFG1_REG (0x00a4)



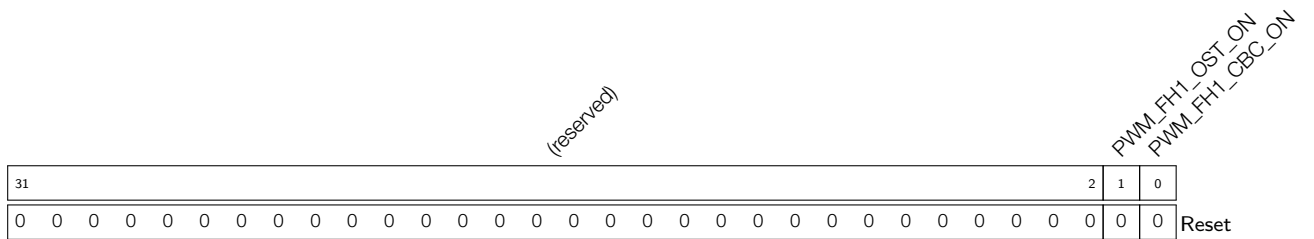
PWM_FH1_FORCE_OST A toggle (software negation of this bit's value) triggers a one-shot mode action. (R/W)

PWM_FH1_FORCE_CBC A toggle triggers a cycle-by-cycle mode action. (R/W)

PWM_FH1_CBCPULSE The cycle-by-cycle mode action refresh moment selection. When bit0 is set to 1: TEZ; when bit1 is set to 1: TEP. (R/W)

PWM_FH1_CLR_OST A toggle will clear on-going one-shot mode action. (R/W)

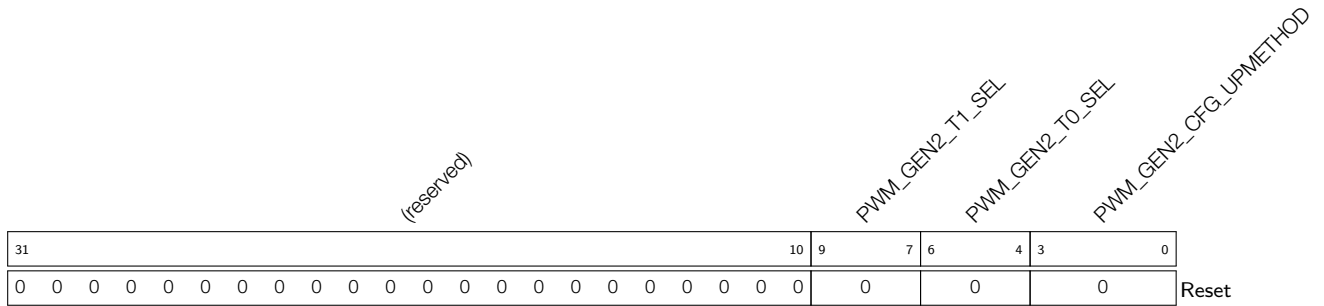
Register 16.43: PWM_FH1_STATUS_REG (0x00a8)



PWM_FH1_OST_ON Set and reset by hardware. If set, a one-shot mode action is on-going. (RO)

PWM_FH1_CBC_ON Set and reset by hardware. If set, a cycle-by-cycle mode action is on-going. (RO)

Register 16.47: PWM_GEN2_CFG0_REG (0x00b8)



PWM_GEN2_T1_SEL Source selection for PWM generator2 event_t1, take effect immediately, 0: fault_event0, 1: fault_event1, 2: fault_event2, 3: sync_taken, 4: none. (R/W)

PWM_GEN2_T0_SEL Source selection for PWM generator2 event_t0, take effect immediately, 0: fault_event0, 1: fault_event1, 2: fault_event2, 3: sync_taken, 4: none. (R/W)

PWM_GEN2_CFG_UPMETHOD Updating method for PWM generator2's active register of configuration. 0: immediately; when bit0 is set to 1: TEZ; when bit1 is set to 1: TEP; when bit2 is set to 1: sync. bit3: disable the update. (R/W)

Register 16.48: PWM_GEN2_FORCE_REG (0x00bc)

(reserved)																PWM_GEN2_B_NCIFORCE_MODE				PWM_GEN2_B_NCIFORCE				PWM_GEN2_A_NCIFORCE_MODE				PWM_GEN2_A_NCIFORCE				PWM_GEN2_B_CNTUFORCE_MODE				PWM_GEN2_A_CNTUFORCE_MODE				PWM_GEN2_CNTUFORCE_UPMETHOD			
31																16	15	14	13	12	11	10	9	8	7	6	5											0					
0																0				0				0				0				0x20				Reset							

PWM_GEN2_B_NCIFORCE_MODE Non-continuous immediate software-force mode for PWM2B, 0: disabled, 1: low, 2: high, 3: disabled. (R/W)

PWM_GEN2_B_NCIFORCE Trigger of non-continuous immediate software-force event for PWM2B, a toggle will trigger a force event. (R/W)

PWM_GEN2_A_NCIFORCE_MODE Non-continuous immediate software-force mode for PWM2A, 0: disabled, 1: low, 2: high, 3: disabled. (R/W)

PWM_GEN2_A_NCIFORCE Trigger of non-continuous immediate software-force event for PWM2A, a toggle will trigger a force event. (R/W)

PWM_GEN2_B_CNTUFORCE_MODE Continuous software-force mode for PWM2B. 0: disabled, 1: low, 2: high, 3: disabled. (R/W)

PWM_GEN2_A_CNTUFORCE_MODE Continuous software-force mode for PWM2A. 0: disabled, 1: low, 2: high, 3: disabled. (R/W)

PWM_GEN2_CNTUFORCE_UPMETHOD Updating method for continuous software force of PWM generator2. 0: immediately; when bit0 is set to 1: TEZ; when bit1 is set to 1: TEP; when bit2 is set to 1: TEA; when bit3 is set to 1: TEB; when bit4 is set to 1: sync; when bit5 is set to 1: disable update. (TEA/B here and below means an event generated when the timer value equals that of register A/B.) (R/W)

Register 16.49: PWM_GEN2_A_REG (0x00c0)

(reserved)								PWM_GEN2_A_DT1		PWM_GEN2_A_DT0		PWM_GEN2_A_DTEB		PWM_GEN2_A_DTEA		PWM_GEN2_A_DTEP		PWM_GEN2_A_DTEZ		PWM_GEN2_A_UT1		PWM_GEN2_A_UT0		PWM_GEN2_A_UTEB		PWM_GEN2_A_UTEA		PWM_GEN2_A_UTEZ					
31	30	29	28	27	26	25	24	23	22	21	20	19	18	17	16	15	14	13	12	11	10	9	8	7	6	5	4	3	2	1	0		
0	0	0	0	0	0	0	0	0	0	0	0	0	0	0	0	0	0	0	0	0	0	0	0	0	0	0	0	0	0	0	0	0	0

Reset

PWM_GEN2_A_DT1 Action on PWM2A triggered by event_t1 when the timer decreases. 0: no change, 1: low, 2: high, 3: toggle. (R/W)

PWM_GEN2_A_DT0 Action on PWM2A triggered by event_t0 when the timer decreases. (R/W)

PWM_GEN2_A_DTEB Action on PWM2A triggered by event TEB when the timer decreases. (R/W)

PWM_GEN2_A_DTEA Action on PWM2A triggered by event TEA when the timer decreases. (R/W)

PWM_GEN2_A_DTEP Action on PWM2A triggered by event TEP when the timer decreases. (R/W)

PWM_GEN2_A_DTEZ Action on PWM2A triggered by event TEZ when the timer decreases. (R/W)

PWM_GEN2_A_UT1 Action on PWM2A triggered by event_t1 when the timer increases. (R/W)

PWM_GEN2_A_UT0 Action on PWM2A triggered by event_t0 when the timer increases. (R/W)

PWM_GEN2_A_UTEB Action on PWM2A triggered by event TEB when the timer increases. (R/W)

PWM_GEN2_A_UTEA Action on PWM2A triggered by event TEA when the timer increases. (R/W)

PWM_GEN2_A_UTEZ Action on PWM2A triggered by event TEZ when the timer increases. (R/W)

Register 16.50: PWM_GEN2_B_REG (0x00c4)

(reserved)								PWM_GEN2_B_DT1	PWM_GEN2_B_DT0	PWM_GEN2_B_DTEB	PWM_GEN2_B_DTEA	PWM_GEN2_B_DTEP	PWM_GEN2_B_DTEZ	PWM_GEN2_B_UT1	PWM_GEN2_B_UT0	PWM_GEN2_B_UTEB	PWM_GEN2_B_UTEA	PWM_GEN2_B_UTEZ							
31	24	23	22	21	20	19	18	17	16	15	14	13	12	11	10	9	8	7	6	5	4	3	2	1	0
0	0	0	0	0	0	0	0	0	0	0	0	0	0	0	0	0	0	0	0	0	0	0	0	0	0

Reset

PWM_GEN2_B_DT1 Action on PWM2B triggered by event_t1 when the timer decreases. 0: no change, 1: low, 2: high, 3: toggle. (R/W)

PWM_GEN2_B_DT0 Action on PWM2B triggered by event_t0 when the timer decreases. (R/W)

PWM_GEN2_B_DTEB Action on PWM2B triggered by event TEB when the timer decreases. (R/W)

PWM_GEN2_B_DTEA Action on PWM2B triggered by event TEA when the timer decreases. (R/W)

PWM_GEN2_B_DTEP Action on PWM2B triggered by event TEP when the timer decreases. (R/W)

PWM_GEN2_B_DTEZ Action on PWM2B triggered by event TEZ when the timer decreases. (R/W)

PWM_GEN2_B_UT1 Action on PWM2B triggered by event_t1 when the timer increases. (R/W)

PWM_GEN2_B_UT0 Action on PWM2B triggered by event_t0 when the timer increases. (R/W)

PWM_GEN2_B_UTEB Action on PWM2B triggered by event TEB when the timer increases. (R/W)

PWM_GEN2_B_UTEA Action on PWM2B triggered by event TEA when the timer increases. (R/W)

PWM_GEN2_B_UTEZ Action on PWM2B triggered by event TEZ when the timer increases. (R/W)

Register 16.51: PWM_DT2_CFG_REG (0x00c8)

(reserved)																		PWM_DT2_CLK_SEL	PWM_DT2_B_OUTBYPASS	PWM_DT2_A_OUTBYPASS	PWM_DT2_FED_OUTINVERT	PWM_DT2_RED_OUTINVERT	PWM_DT2_FED_INSEL	PWM_DT2_RED_INSEL	PWM_DT2_B_OUTSWAP	PWM_DT2_A_OUTSWAP	PWM_DT2_DEB_MODE	PWM_DT2_RED_UPMETHOD			PWM_DT2_FED_UPMETHOD																	
31																		18	17	16	15	14	13	12	11	10	9	8	7				4	3	0													
0																		0	1	1	0	0	0	0	0	0	0	0	0	0	0	0	0	0	0	0	0	0	0	0	0	0	0	0	0	0	0	Reset

PWM_DT2_CLK_SEL Dead time generator 1 clock selection. 0: PWM_clk; 1: PT_clk. (R/W)

PWM_DT2_B_OUTBYPASS S0 in Table 71. (R/W)

PWM_DT2_A_OUTBYPASS S1 in Table 71. (R/W)

PWM_DT2_FED_OUTINVERT S3 in Table 71. (R/W)

PWM_DT2_RED_OUTINVERT S2 in Table 71. (R/W)

PWM_DT2_FED_INSEL S5 in Table 71. (R/W)

PWM_DT2_RED_INSEL S4 in Table 71. (R/W)

PWM_DT2_B_OUTSWAP S7 in Table 71. (R/W)

PWM_DT2_A_OUTSWAP S6 in Table 71. (R/W)

PWM_DT2_DEB_MODE S8 in Table 71, dual-edge B mode, 0: FED/RED take effect on different path separately, 1: FED/RED take effect on B path. (R/W)

PWM_DT2_RED_UPMETHOD Updating method for RED (rising edge delay) active register. 0: immediately; when bit0 is set to 1: TEZ; when bit1 is set to 1: TEP; when bit2 is set to 1: sync; when bit3 is set to 1: disable the update. (R/W)

PWM_DT2_FED_UPMETHOD Updating method for FED (falling edge delay) active register. 0: immediately; when bit0 is set to 1: TEZ; when bit1 is set to 1: TEP; when bit2 is set to 1: sync; when bit3 is set to 1: disable the update. (R/W)

Register 16.52: PWM_DT2_FED_CFG_REG (0x00cc)

(reserved)																PWM_DT2_FED		
31																16	15	0
0																0	0	Reset

PWM_DT2_FED Shadow register for FED. (R/W)

Register 16.53: PWM_DT2_RED_CFG_REG (0x00d0)

(reserved)																PWM_DT2_RED															
31															16	15														0	
0																0															Reset

PWM_DT2_RED Shadow register for RED. (R/W)

Register 16.54: PWM_CARRIER2_CFG_REG (0x00d4)

(reserved)																PWM_CARRIER2_IN_INVERT		PWM_CARRIER2_OUT_INVERT		PWM_CARRIER2_OSHWTH		PWM_CARRIER2_DUTY		PWM_CARRIER2_PRESCALE		PWM_CARRIER2_EN				
31															14	13	12	11			8	7			5	4			1	0
0																0		0		0		0		0		0		0		Reset

PWM_CARRIER2_IN_INVERT When set, invert the input of PWM2A and PWM2B for this submodule. (R/W)

PWM_CARRIER2_OUT_INVERT When set, invert the output of PWM2A and PWM2B for this submodule. (R/W)

PWM_CARRIER2_OSHWTH Width of the first pulse in number of periods of the carrier. (R/W)

PWM_CARRIER2_DUTY Carrier duty selection. Duty = PWM_CARRIER2_DUTY / 8. (R/W)

PWM_CARRIER2_PRESCALE PWM carrier2 clock (PC_clk) prescale value. Period of PC_clk = period of PWM_clk * (PWM_CARRIER2_PRESCALE + 1). (R/W)

PWM_CARRIER2_EN When set, carrier2 function is enabled. When cleared, carrier2 is bypassed. (R/W)

Register 16.55: PWM_FH2_CFG0_REG (0x00d8)

(reserved)								PWM_FH2_B_OST_U		PWM_FH2_B_OST_D		PWM_FH2_B_CBC_U		PWM_FH2_B_CBC_D		PWM_FH2_A_OST_U		PWM_FH2_A_OST_D		PWM_FH2_A_CBC_U		PWM_FH2_A_CBC_D		PWM_FH2_F0_OST		PWM_FH2_F1_OST		PWM_FH2_F2_OST		PWM_FH2_SW_OST		PWM_FH2_F0_CBC		PWM_FH2_F1_CBC		PWM_FH2_F2_CBC		PWM_FH2_SW_CBC		
31	24	23	22	21	20	19	18	17	16	15	14	13	12	11	10	9	8	7	6	5	4	3	2	1	0															
0	0	0	0	0	0	0	0	0	0	0	0	0	0	0	0	0	0	0	0	0	0	0	0	0	0	0	0	0	0	0	0	0	0	0	0	0	0	0	0	Reset

PWM_FH2_B_OST_U One-shot mode action on PWM2B when a fault event occurs and the timer is increasing. 0: do nothing, 1: force low, 2: force high, 3: toggle. (R/W)

PWM_FH2_B_OST_D One-shot mode action on PWM2B when a fault event occurs and the timer is decreasing. 0: do nothing, 1: force low, 2: force high, 3: toggle. (R/W)

PWM_FH2_B_CBC_U Cycle-by-cycle mode action on PWM2B when a fault event occurs and the timer is increasing. 0: do nothing, 1: force low, 2: force high, 3: toggle. (R/W)

PWM_FH2_B_CBC_D Cycle-by-cycle mode action on PWM2B when a fault event occurs and the timer is decreasing. 0: do nothing, 1: force low, 2: force high, 3: toggle. (R/W)

PWM_FH2_A_OST_U One-shot mode action on PWM2A when a fault event occurs and the timer is increasing. 0: do nothing, 1: force low, 2: force high, 3: toggle. (R/W)

PWM_FH2_A_OST_D One-shot mode action on PWM2A when a fault event occurs and the timer is decreasing. 0: do nothing, 1: force low, 2: force high, 3: toggle. (R/W)

PWM_FH2_A_CBC_U Cycle-by-cycle mode action on PWM2A when a fault event occurs and the timer is increasing. 0: do nothing, 1: force low, 2: force high, 3: toggle. (R/W)

PWM_FH2_A_CBC_D Cycle-by-cycle mode action on PWM2A when a fault event occurs and the timer is decreasing. 0: do nothing, 1: force low, 2: force high, 3: toggle. (R/W)

PWM_FH2_F0_OST event_f0 will trigger one-shot mode action. 0: disable, 1: enable. (R/W)

PWM_FH2_F1_OST event_f1 will trigger one-shot mode action. 0: disable, 1: enable. (R/W)

PWM_FH2_F2_OST event_f2 will trigger one-shot mode action. 0: disable, 1: enable. (R/W)

PWM_FH2_SW_OST Enable register for software-forced one-shot mode action. 0: disable, 1: enable. (R/W)

PWM_FH2_F0_CBC event_f0 will trigger cycle-by-cycle mode action. 0: disable, 1: enable. (R/W)

PWM_FH2_F1_CBC event_f1 will trigger cycle-by-cycle mode action. 0: disable, 1: enable. (R/W)

PWM_FH2_F2_CBC event_f2 will trigger cycle-by-cycle mode action. 0: disable, 1: enable. (R/W)

PWM_FH2_SW_CBC Enable register for software-forced cycle-by-cycle mode action. 0: disable, 1: enable. (R/W)

Register 16.58: PWM_FAULT_DETECT_REG (0x00e4)

(reserved)											<div style="display: flex; justify-content: space-around; font-size: small;"> PWM_EVENT_F2 PWM_EVENT_F1 PWM_EVENT_F0 PWM_F2_POLE PWM_F1_POLE PWM_F0_POLE PWM_F2_EN PWM_F1_EN PWM_F0_EN </div>									
31										9	8	7	6	5	4	3	2	1	0	
0 0 0 0 0 0 0 0 0 0 0 0 0 0 0 0 0 0 0																			Reset	

- PWM_EVENT_F2** Set and reset by hardware. If set, event_f2 is on-going. (RO)
- PWM_EVENT_F1** Set and reset by hardware. If set, event_f1 is on-going. (RO)
- PWM_EVENT_F0** Set and reset by hardware. If set, event_f0 is on-going. (RO)
- PWM_F2_POLE** Set event_f2 trigger polarity on FAULT2 source from GPIO matrix. 0: level low, 1: level high. (R/W)
- PWM_F1_POLE** Set event_f1 trigger polarity on FAULT2 source from GPIO matrix. 0: level low, 1: level high. (R/W)
- PWM_F0_POLE** Set event_f0 trigger polarity on FAULT2 source from GPIO matrix. 0: level low, 1: level high. (R/W)
- PWM_F2_EN** Set to enable the generation of event_f2. (R/W)
- PWM_F1_EN** Set to enable the generation of event_f1. (R/W)
- PWM_F0_EN** Set to enable the generation of event_f0. (R/W)

Register 16.59: PWM_CAP_TIMER_CFG_REG (0x00e8)

(reserved)											<div style="display: flex; justify-content: space-around; font-size: small;"> PWM_CAP_SYNC_SW PWM_CAP_SYNCI_SEL PWM_CAP_SYNCI_EN PWM_CAP_TIMER_EN </div>					
31										6	5	4	2	1	0	
0 0 0 0 0 0 0 0 0 0 0 0 0 0 0															Reset	

- PWM_CAP_SYNC_SW** Set this bit to force a capture timer sync; the capture timer is loaded with the value in the phase register. (WO)
- PWM_CAP_SYNCI_SEL** Capture module sync input selection. 0: none, 1: timer0 sync_out, 2: timer1 sync_out, 3: timer2 sync_out, 4: SYNC0 from GPIO matrix, 5: SYNC1 from GPIO matrix, 6: SYNC2 from GPIO matrix. (R/W)
- PWM_CAP_SYNCI_EN** When set, the capture timer sync is enabled. (R/W)
- PWM_CAP_TIMER_EN** When set, the capture timer incrementing under APB_clk is enabled. (R/W)

Register 16.60: PWM_CAP_TIMER_PHASE_REG (0x00ec)

31																															0	
0																																Reset

PWM_CAP_TIMER_PHASE_REG Phase value for the capture timer sync operation. (R/W)

Register 16.61: PWM_CAP_CH0_CFG_REG (0x00f0)

(reserved)													PWM_CAP0_SW PWM_CAP0_IN_INVERT		PWM_CAP0_PRESCALE			PWM_CAP0_MODE PWM_CAP0_EN				
31											13	12	11	10				3	2	1	0	
0													0	0	0			0	0	0	0	Reset

PWM_CAP0_SW When set, a software-forced capture on channel 0 is triggered. (WO)

PWM_CAP0_IN_INVERT When set, CAP0 form GPIO matrix is inverted before prescaling. (R/W)

PWM_CAP0_PRESCALE Prescaling value on the positive edge of CAP0. Prescaling value = PWM_CAP0_PRESCALE + 1. (R/W)

PWM_CAP0_MODE Edge of capture on channel 0 after prescaling. When bit0 is set to 1: enable capture on the negative edge; When bit1 is set to 1: enable capture on the positive edge. (R/W)

PWM_CAP0_EN When set, capture on channel 0 is enabled. (R/W)

Register 16.62: PWM_CAP_CH1_CFG_REG (0x00f4)

(reserved)													PWM_CAP1_SW PWM_CAP1_IN_INVERT		PWM_CAP1_PRESCALE			PWM_CAP1_MODE PWM_CAP1_EN				
31											13	12	11	10				3	2	1	0	
0													0	0	0			0	0	0	0	Reset

PWM_CAP1_SW Write 1 will trigger a software-forced capture on channel 1. (WO)

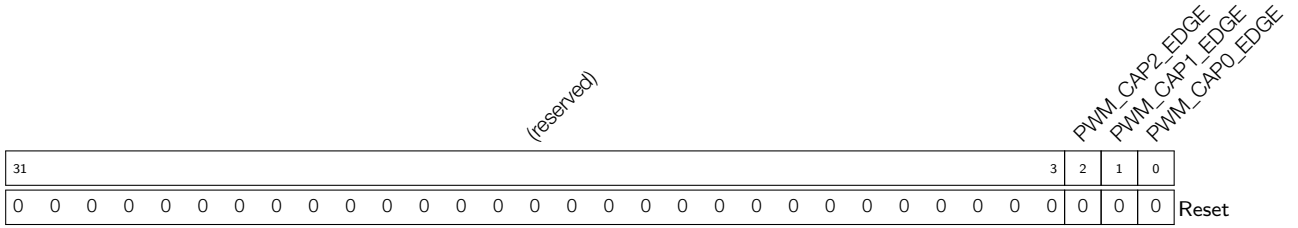
PWM_CAP1_IN_INVERT When set, CAP1 form GPIO matrix is inverted before prescaling. (R/W)

PWM_CAP1_PRESCALE Value of prescale on the positive edge of CAP1. Prescale value = PWM_CAP1_PRESCALE + 1. (R/W)

PWM_CAP1_MODE Edge of capture on channel 1 after prescaling. When bit0 is set to 1: enable capture on the negative edge; When bit1 is set to 1: enable capture on the positive edge. (R/W)

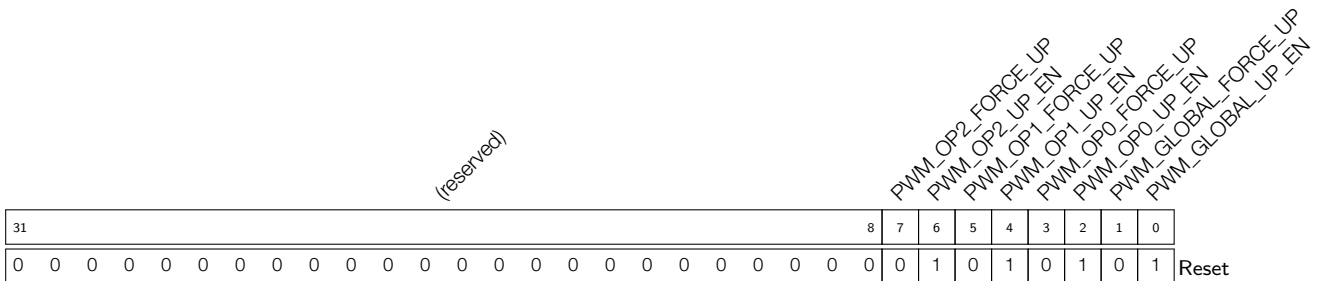
PWM_CAP1_EN When set, capture on channel 1 is enabled. (R/W)

Register 16.67: PWM_CAP_STATUS_REG (0x0108)



- PWM_CAP2_EDGE** Edge of the last capture trigger on channel 2. 0: posedge; 1: negedge. (RO)
- PWM_CAP1_EDGE** Edge of the last capture trigger on channel 1. 0: posedge; 1: negedge. (RO)
- PWM_CAP0_EDGE** Edge of the last capture trigger on channel 0. 0: posedge; 1: negedge. (RO)

Register 16.68: PWM_UPDATE_CFG_REG (0x010c)



- PWM_OP2_FORCE_UP** A toggle (software negation of this bit's value) will trigger a forced update of active registers in PWM operator 2. (R/W)
- PWM_OP2_UP_EN** When set and PWM_GLOBAL_UP_EN is set, update of active registers in PWM operator 2 are enabled (R/W)
- PWM_OP1_FORCE_UP** A toggle (software negation of this bit's value) will trigger a forced update of active registers in PWM operator 1. (R/W)
- PWM_OP1_UP_EN** When set and PWM_GLOBAL_UP_EN is set, update of active registers in PWM operator 1 are enabled. (R/W)
- PWM_OP0_FORCE_UP** A toggle (software negation of this bit's value) will trigger a forced update of active registers in PWM operator 0. (R/W)
- PWM_OP0_UP_EN** When set and PWM_GLOBAL_UP_EN is set, update of active registers in PWM operator 0 are enabled. (R/W)
- PWM_GLOBAL_FORCE_UP** A toggle (software negation of this bit's value) will trigger a forced update of all active registers in the MCPWM module. (R/W)
- PWM_GLOBAL_UP_EN** The global enable of update of all active registers in the MCPWM module. (R/W)

Register 16.69: INT_ENA_PWM_REG (0x0110)

(reserved)	INT_CAP2_INT_ENA	INT_CAP1_INT_ENA	INT_CAP0_INT_ENA	INT_FH2_OST_INT_ENA	INT_FH1_OST_INT_ENA	INT_FH0_OST_INT_ENA	INT_FH2_CBC_INT_ENA	INT_FH1_CBC_INT_ENA	INT_FH0_CBC_INT_ENA	INT_OP2_TEB_INT_ENA	INT_OP1_TEB_INT_ENA	INT_OP0_TEB_INT_ENA	INT_OP2_TEA_INT_ENA	INT_OP1_TEA_INT_ENA	INT_OP0_TEA_INT_ENA	INT_FAULT2_CLR_INT_ENA	INT_FAULT1_CLR_INT_ENA	INT_FAULT0_CLR_INT_ENA	INT_FAULT2_INT_ENA	INT_FAULT1_INT_ENA	INT_FAULT0_INT_ENA	INT_TIMER2_TEP_INT_ENA	INT_TIMER1_TEP_INT_ENA	INT_TIMER0_TEP_INT_ENA	INT_TIMER2_TEZ_INT_ENA	INT_TIMER1_TEZ_INT_ENA	INT_TIMER0_TEZ_INT_ENA	INT_TIMER2_STOP_INT_ENA	INT_TIMER1_STOP_INT_ENA	INT_TIMER0_STOP_INT_ENA	
31	30	29	28	27	26	25	24	23	22	21	20	19	18	17	16	15	14	13	12	11	10	9	8	7	6	5	4	3	2	1	0
0	0	0	0	0	0	0	0	0	0	0	0	0	0	0	0	0	0	0	0	0	0	0	0	0	0	0	0	0	0	0	0

Reset

- INT_CAP2_INT_ENA** The enable bit for the interrupt triggered by capture on channel 2. (R/W)
- INT_CAP1_INT_ENA** The enable bit for the interrupt triggered by capture on channel 1. (R/W)
- INT_CAP0_INT_ENA** The enable bit for the interrupt triggered by capture on channel 0. (R/W)
- INT_FH2_OST_INT_ENA** The enable bit for the interrupt triggered by a one-shot mode action on PWM2. (R/W)
- INT_FH1_OST_INT_ENA** The enable bit for the interrupt triggered by a one-shot mode action on PWM0. (R/W)
- INT_FH0_OST_INT_ENA** The enable bit for the interrupt triggered by a one-shot mode action on PWM0. (R/W)
- INT_FH2_CBC_INT_ENA** The enable bit for the interrupt triggered by a cycle-by-cycle mode action on PWM2. (R/W)
- INT_FH1_CBC_INT_ENA** The enable bit for the interrupt triggered by a cycle-by-cycle mode action on PWM1. (R/W)
- INT_FH0_CBC_INT_ENA** The enable bit for the interrupt triggered by a cycle-by-cycle mode action on PWM0. (R/W)
- INT_OP2_TEB_INT_ENA** The enable bit for the interrupt triggered by a PWM operator 2 TEB event (R/W)
- INT_OP1_TEB_INT_ENA** The enable bit for the interrupt triggered by a PWM operator 1 TEB event (R/W)
- INT_OP0_TEB_INT_ENA** The enable bit for the interrupt triggered by a PWM operator 0 TEB event (R/W)
- INT_OP2_TEA_INT_ENA** The enable bit for the interrupt triggered by a PWM operator 2 TEA event (R/W)
- INT_OP1_TEA_INT_ENA** The enable bit for the interrupt triggered by a PWM operator 1 TEA event (R/W)
- INT_OP0_TEA_INT_ENA** The enable bit for the interrupt triggered by a PWM operator 0 TEA event (R/W)
- INT_FAULT2_CLR_INT_ENA** The enable bit for the interrupt triggered when event_f2 ends. (R/W)
- INT_FAULT1_CLR_INT_ENA** The enable bit for the interrupt triggered when event_f1 ends. (R/W)
- INT_FAULT0_CLR_INT_ENA** The enable bit for the interrupt triggered when event_f0 ends. (R/W)
- INT_FAULT2_INT_ENA** The enable bit for the interrupt triggered when event_f2 starts. (R/W)
- INT_FAULT1_INT_ENA** The enable bit for the interrupt triggered when event_f1 starts. (R/W)
- INT_FAULT0_INT_ENA** The enable bit for the interrupt triggered when event_f0 starts. (R/W)
- INT_TIMER2_TEP_INT_ENA** The enable bit for the interrupt triggered by a PWM timer 2 TEP event. (R/W)
- INT_TIMER1_TEP_INT_ENA** The enable bit for the interrupt triggered by a PWM timer 1 TEP event. (R/W)
- INT_TIMER0_TEP_INT_ENA** The enable bit for the interrupt triggered by a PWM timer 0 TEP event. (R/W)
- INT_TIMER2_TEZ_INT_ENA** The enable bit for the interrupt triggered by a PWM timer 2 TEZ event. (R/W)
- INT_TIMER1_TEZ_INT_ENA** The enable bit for the interrupt triggered by a PWM timer 1 TEZ event. (R/W)
- INT_TIMER0_TEZ_INT_ENA** The enable bit for the interrupt triggered by a PWM timer 0 TEZ event. (R/W)
- INT_TIMER2_STOP_INT_ENA** The enable bit for the interrupt triggered when the timer 2 stops. (R/W)
- INT_TIMER1_STOP_INT_ENA** The enable bit for the interrupt triggered when the timer 1 stops. (R/W)
- INT_TIMER0_STOP_INT_ENA** The enable bit for the interrupt triggered when the timer 0 stops. (R/W)

Register 16.70: INT_RAW_PWM_REG (0x0114)

(reserved)	INT_CAP2_INT_RAW	INT_CAP1_INT_RAW	INT_CAP0_INT_RAW	INT_FH2_OST_INT_RAW	INT_FH1_OST_INT_RAW	INT_FH0_OST_INT_RAW	INT_FH2_CBC_INT_RAW	INT_FH1_CBC_INT_RAW	INT_FH0_CBC_INT_RAW	INT_OP2_TEB_INT_RAW	INT_OP1_TEB_INT_RAW	INT_OP0_TEB_INT_RAW	INT_OP2_TEA_INT_RAW	INT_OP1_TEA_INT_RAW	INT_OP0_TEA_INT_RAW	INT_FAULT2_CLR_INT_RAW	INT_FAULT1_CLR_INT_RAW	INT_FAULT0_CLR_INT_RAW	INT_FAULT2_INT_RAW	INT_FAULT1_INT_RAW	INT_FAULT0_INT_RAW	INT_TIMER2_TEP_INT_RAW	INT_TIMER1_TEP_INT_RAW	INT_TIMER0_TEP_INT_RAW	INT_TIMER2_TEZ_INT_RAW	INT_TIMER1_TEZ_INT_RAW	INT_TIMER0_TEZ_INT_RAW	INT_TIMER2_STOP_INT_RAW	INT_TIMER1_STOP_INT_RAW	INT_TIMER0_STOP_INT_RAW		
31	30	29	28	27	26	25	24	23	22	21	20	19	18	17	16	15	14	13	12	11	10	9	8	7	6	5	4	3	2	1	0	
0	0	0	0	0	0	0	0	0	0	0	0	0	0	0	0	0	0	0	0	0	0	0	0	0	0	0	0	0	0	0	0	Reset

- INT_CAP2_INT_RAW** The raw status bit for the interrupt triggered by capture on channel 2. (RO)
- INT_CAP1_INT_RAW** The raw status bit for the interrupt triggered by capture on channel 1. (RO)
- INT_CAP0_INT_RAW** The raw status bit for the interrupt triggered by capture on channel 0. (RO)
- INT_FH2_OST_INT_RAW** The raw status bit for the interrupt triggered by a one-shot mode action on PWM2. (RO)
- INT_FH1_OST_INT_RAW** The raw status bit for the interrupt triggered by a one-shot mode action on PWM0. (RO)
- INT_FH0_OST_INT_RAW** The raw status bit for the interrupt triggered by a one-shot mode action on PWM0. (RO)
- INT_FH2_CBC_INT_RAW** The raw status bit for the interrupt triggered by a cycle-by-cycle mode action on PWM2. (RO)
- INT_FH1_CBC_INT_RAW** The raw status bit for the interrupt triggered by a cycle-by-cycle mode action on PWM1. (RO)
- INT_FH0_CBC_INT_RAW** The raw status bit for the interrupt triggered by a cycle-by-cycle mode action on PWM0. (RO)
- INT_OP2_TEB_INT_RAW** The raw status bit for the interrupt triggered by a PWM operator 2 TEB event. (RO)
- INT_OP1_TEB_INT_RAW** The raw status bit for the interrupt triggered by a PWM operator 1 TEB event. (RO)
- INT_OP0_TEB_INT_RAW** The raw status bit for the interrupt triggered by a PWM operator 0 TEB event. (RO)
- INT_OP2_TEA_INT_RAW** The raw status bit for the interrupt triggered by a PWM operator 2 TEA event. (RO)
- INT_OP1_TEA_INT_RAW** The raw status bit for the interrupt triggered by a PWM operator 1 TEA event. (RO)
- INT_OP0_TEA_INT_RAW** The raw status bit for the interrupt triggered by a PWM operator 0 TEA event. (RO)
- INT_FAULT2_CLR_INT_RAW** The raw status bit for the interrupt triggered when event_f2 ends. (RO)
- INT_FAULT1_CLR_INT_RAW** The raw status bit for the interrupt triggered when event_f1 ends. (RO)
- INT_FAULT0_CLR_INT_RAW** The raw status bit for the interrupt triggered when event_f0 ends. (RO)
- INT_FAULT2_INT_RAW** The raw status bit for the interrupt triggered when event_f2 starts. (RO)
- INT_FAULT1_INT_RAW** The raw status bit for the interrupt triggered when event_f1 starts. (RO)
- INT_FAULT0_INT_RAW** The raw status bit for the interrupt triggered when event_f0 starts. (RO)
- INT_TIMER2_TEP_INT_RAW** The raw status bit for the interrupt triggered by a PWM timer 2 TEP event. (RO)
- INT_TIMER1_TEP_INT_RAW** The raw status bit for the interrupt triggered by a PWM timer 1 TEP event. (RO)
- INT_TIMER0_TEP_INT_RAW** The raw status bit for the interrupt triggered by a PWM timer 0 TEP event. (RO)
- INT_TIMER2_TEZ_INT_RAW** The raw status bit for the interrupt triggered by a PWM timer 2 TEZ event. (RO)
- INT_TIMER1_TEZ_INT_RAW** The raw status bit for the interrupt triggered by a PWM timer 1 TEZ event. (RO)
- INT_TIMER0_TEZ_INT_RAW** The raw status bit for the interrupt triggered by a PWM timer 0 TEZ event. (RO)
- INT_TIMER2_STOP_INT_RAW** The raw status bit for the interrupt triggered when the timer 2 stops. (RO)
- INT_TIMER1_STOP_INT_RAW** The raw status bit for the interrupt triggered when the timer 1 stops. (RO)
- INT_TIMER0_STOP_INT_RAW** The raw status bit for the interrupt triggered when the timer 0 stops. (RO)

Register 16.71: INT_ST_PWM_REG (0x0118)

(reserved)	INT_CAP2_INT_ST	INT_CAP1_INT_ST	INT_CAP0_INT_ST	INT_FH2_OST_INT_ST	INT_FH1_OST_INT_ST	INT_FH0_OST_INT_ST	INT_FH2_CBC_INT_ST	INT_FH1_CBC_INT_ST	INT_FH0_CBC_INT_ST	INT_OP2_TEB_INT_ST	INT_OP1_TEB_INT_ST	INT_OP0_TEB_INT_ST	INT_OP2_TEA_INT_ST	INT_OP1_TEA_INT_ST	INT_OP0_TEA_INT_ST	INT_FAULT2_CLR_INT_ST	INT_FAULT1_CLR_INT_ST	INT_FAULT0_CLR_INT_ST	INT_FAULT2_INT_ST	INT_FAULT1_INT_ST	INT_FAULT0_INT_ST	INT_TIMER2_TEP_INT_ST	INT_TIMER1_TEP_INT_ST	INT_TIMER0_TEP_INT_ST	INT_TIMER2_TEZ_INT_ST	INT_TIMER1_TEZ_INT_ST	INT_TIMER0_TEZ_INT_ST	INT_TIMER2_STOP_INT_ST	INT_TIMER1_STOP_INT_ST	INT_TIMER0_STOP_INT_ST	Reset		
31	30	29	28	27	26	25	24	23	22	21	20	19	18	17	16	15	14	13	12	11	10	9	8	7	6	5	4	3	2	1	0		
0	0	0	0	0	0	0	0	0	0	0	0	0	0	0	0	0	0	0	0	0	0	0	0	0	0	0	0	0	0	0	0	0	

- INT_CAP2_INT_ST** The masked status bit for the interrupt triggered by capture on channel 2. (RO)
- INT_CAP1_INT_ST** The masked status bit for the interrupt triggered by capture on channel 1. (RO)
- INT_CAP0_INT_ST** The masked status bit for the interrupt triggered by capture on channel 0. (RO)
- INT_FH2_OST_INT_ST** The masked status bit for the interrupt triggered by a one-shot mode action on PWM2. (RO)
- INT_FH1_OST_INT_ST** The masked status bit for the interrupt triggered by a one-shot mode action on PWM1. (RO)
- INT_FH0_OST_INT_ST** The masked status bit for the interrupt triggered by a one-shot mode action on PWM0. (RO)
- INT_FH2_CBC_INT_ST** The masked status bit for the interrupt triggered by a cycle-by-cycle mode action on PWM2. (RO)
- INT_FH1_CBC_INT_ST** The masked status bit for the interrupt triggered by a cycle-by-cycle mode action on PWM1. (RO)
- INT_FH0_CBC_INT_ST** The masked status bit for the interrupt triggered by a cycle-by-cycle mode action on PWM0. (RO)
- INT_OP2_TEB_INT_ST** The masked status bit for the interrupt triggered by a PWM operator 2 TEB event. (RO)
- INT_OP1_TEB_INT_ST** The masked status bit for the interrupt triggered by a PWM operator 1 TEB event. (RO)
- INT_OP0_TEB_INT_ST** The masked status bit for the interrupt triggered by a PWM operator 0 TEB event. (RO)
- INT_OP2_TEA_INT_ST** The masked status bit for the interrupt triggered by a PWM operator 2 TEA event. (RO)
- INT_OP1_TEA_INT_ST** The masked status bit for the interrupt triggered by a PWM operator 1 TEA event. (RO)
- INT_OP0_TEA_INT_ST** The masked status bit for the interrupt triggered by a PWM operator 0 TEA event. (RO)
- INT_FAULT2_CLR_INT_ST** The masked status bit for the interrupt triggered when event_f2 ends. (RO)
- INT_FAULT1_CLR_INT_ST** The masked status bit for the interrupt triggered when event_f1 ends. (RO)
- INT_FAULT0_CLR_INT_ST** The masked status bit for the interrupt triggered when event_f0 ends. (RO)
- INT_FAULT2_INT_ST** The masked status bit for the interrupt triggered when event_f2 starts. (RO)
- INT_FAULT1_INT_ST** The masked status bit for the interrupt triggered when event_f1 starts. (RO)
- INT_FAULT0_INT_ST** The masked status bit for the interrupt triggered when event_f0 starts. (RO)
- INT_TIMER2_TEP_INT_ST** The masked status bit for the interrupt triggered by a PWM timer 2 TEP event. (RO)
- INT_TIMER1_TEP_INT_ST** The masked status bit for the interrupt triggered by a PWM timer 1 TEP event. (RO)
- INT_TIMER0_TEP_INT_ST** The masked status bit for the interrupt triggered by a PWM timer 0 TEP event. (RO)
- INT_TIMER2_TEZ_INT_ST** The masked status bit for the interrupt triggered by a PWM timer 2 TEZ event. (RO)
- INT_TIMER1_TEZ_INT_ST** The masked status bit for the interrupt triggered by a PWM timer 1 TEZ event. (RO)
- INT_TIMER0_TEZ_INT_ST** The masked status bit for the interrupt triggered by a PWM timer 0 TEZ event. (RO)
- INT_TIMER2_STOP_INT_ST** The masked status bit for the interrupt triggered when the timer 2 stops. (RO)
- INT_TIMER1_STOP_INT_ST** The masked status bit for the interrupt triggered when the timer 1 stops. (RO)
- INT_TIMER0_STOP_INT_ST** The masked status bit for the interrupt triggered when the timer 0 stops. (RO)

Register 16.72: INT_CLR_PWM_REG (0x011c)

(reserved)	INT_CAP2_INT_CLR	INT_CAP1_INT_CLR	INT_CAP0_INT_CLR	INT_FH2_OST_INT_CLR	INT_FH1_OST_INT_CLR	INT_FH0_OST_INT_CLR	INT_FH2_CBC_INT_CLR	INT_FH1_CBC_INT_CLR	INT_FH0_CBC_INT_CLR	INT_OP2_TEB_INT_CLR	INT_OP1_TEB_INT_CLR	INT_OP0_TEB_INT_CLR	INT_OP2_TEA_INT_CLR	INT_OP1_TEA_INT_CLR	INT_OP0_TEA_INT_CLR	INT_FAULT2_CLR_INT_CLR	INT_FAULT1_CLR_INT_CLR	INT_FAULT0_CLR_INT_CLR	INT_FAULT2_INT_CLR	INT_FAULT1_INT_CLR	INT_FAULT0_INT_CLR	INT_TIMER2_TEP_INT_CLR	INT_TIMER1_TEP_INT_CLR	INT_TIMER0_TEP_INT_CLR	INT_TIMER2_TEZ_INT_CLR	INT_TIMER1_TEZ_INT_CLR	INT_TIMER0_TEZ_INT_CLR	INT_TIMER2_STOP_INT_CLR	INT_TIMER1_STOP_INT_CLR	INT_TIMER0_STOP_INT_CLR		
31	30	29	28	27	26	25	24	23	22	21	20	19	18	17	16	15	14	13	12	11	10	9	8	7	6	5	4	3	2	1	0	
0	0	0	0	0	0	0	0	0	0	0	0	0	0	0	0	0	0	0	0	0	0	0	0	0	0	0	0	0	0	0	0	Reset

INT_CAP2_INT_CLR Set this bit to clear interrupt triggered by capture on channel 2. (WO)

INT_CAP1_INT_CLR Set this bit to clear interrupt triggered by capture on channel 1. (WO)

INT_CAP0_INT_CLR Set this bit to clear interrupt triggered by capture on channel 0. (WO)

INT_FH2_OST_INT_CLR Set this bit to clear interrupt triggered by a one-shot mode action on PWM2. (WO)

INT_FH1_OST_INT_CLR Set this bit to clear interrupt triggered by a one-shot mode action on PWM1. (WO)

INT_FH0_OST_INT_CLR Set this bit to clear interrupt triggered by a one-shot mode action on PWM0. (WO)

INT_FH2_CBC_INT_CLR Set this bit to clear interrupt triggered by a cycle-by-cycle mode action on PWM2. (WO)

INT_FH1_CBC_INT_CLR Set this bit to clear interrupt triggered by a cycle-by-cycle mode action on PWM1. (WO)

INT_FH0_CBC_INT_CLR Set this bit to clear interrupt triggered by a cycle-by-cycle mode action on PWM0. (WO)

INT_OP2_TEB_INT_CLR Set this bit to clear interrupt triggered by a PWM operator 2 TEB event. (WO)

INT_OP1_TEB_INT_CLR Set this bit to clear interrupt triggered by a PWM operator 1 TEB event. (WO)

INT_OP0_TEB_INT_CLR Set this bit to clear interrupt triggered by a PWM operator 0 TEB event. (WO)

INT_OP2_TEA_INT_CLR Set this bit to clear interrupt triggered by a PWM operator 2 TEA event. (WO)

INT_OP1_TEA_INT_CLR Set this bit to clear interrupt triggered by a PWM operator 1 TEA event. (WO)

INT_OP0_TEA_INT_CLR Set this bit to clear interrupt triggered by a PWM operator 0 TEA event. (WO)

INT_FAULT2_CLR_INT_CLR Set this bit to clear interrupt triggered when event_f2 ends. (WO)

INT_FAULT1_CLR_INT_CLR Set this bit to clear interrupt triggered when event_f1 ends. (WO)

INT_FAULT0_CLR_INT_CLR Set this bit to clear interrupt triggered when event_f0 ends. (WO)

INT_FAULT2_INT_CLR Set this bit to clear interrupt triggered when event_f2 starts. (WO)

INT_FAULT1_INT_CLR Set this bit to clear interrupt triggered when event_f1 starts. (WO)

INT_FAULT0_INT_CLR Set this bit to clear interrupt triggered when event_f0 starts. (WO)

INT_TIMER2_TEP_INT_CLR Set this bit to clear interrupt triggered by a PWM timer 2 TEP event. (WO)

INT_TIMER1_TEP_INT_CLR Set this bit to clear interrupt triggered by a PWM timer 1 TEP event. (WO)

INT_TIMER0_TEP_INT_CLR Set this bit to clear interrupt triggered by a PWM timer 0 TEP event. (WO)

INT_TIMER2_TEZ_INT_CLR Set this bit to clear interrupt triggered by a PWM timer 2 TEZ event. (WO)

INT_TIMER1_TEZ_INT_CLR Set this bit to clear interrupt triggered by a PWM timer 1 TEZ event. (WO)

INT_TIMER0_TEZ_INT_CLR Set this bit to clear interrupt triggered by a PWM timer 0 TEZ event. (WO)

INT_TIMER2_STOP_INT_CLR Set this bit to clear interrupt triggered when the timer 2 stops. (WO)

INT_TIMER1_STOP_INT_CLR Set this bit to clear interrupt triggered when the timer 1 stops. (WO)

INT_TIMER0_STOP_INT_CLR Set this bit to clear interrupt triggered when the timer 0 stops. (WO)

17. PULSE_CNT

17.1 Introduction

The pulse counter module is designed to count the number of rising and/or falling edges of an input signal. Each pulse counter unit has a 16-bit signed counter register and two channels that can be configured to either increment or decrement the counter. Each channel has a signal input that accepts signal edges to be detected, as well as a control input that can be used to enable or disable the signal input. The inputs have optional filters that can be used to discard unwanted glitches in the signal.

The pulse counter has eight independent units, referred to as PULSE_CNT_0n.

17.2 Functional Description

17.2.1 Architecture

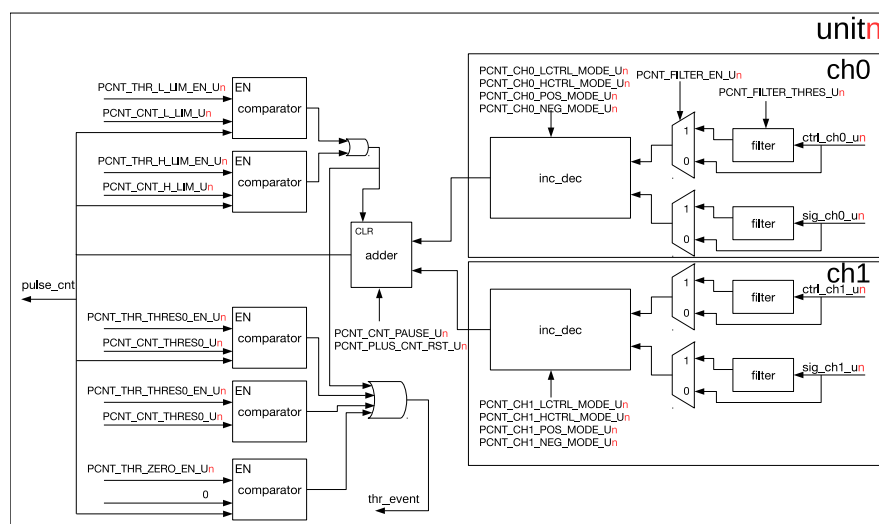


Figure 119: PULSE_CNT Architecture

The architecture of a pulse counter unit is illustrated in Figure 119. Each unit has two channels: ch0 and ch1, which are functionally equivalent. Each channel has a signal input, as well as a control input, which can both be connected to I/O pads. The counting behavior on both the positive and negative edge can be configured separately to increase, decrease, or do nothing to the counter value. Separately, for both control signal levels, the hardware can be configured to modify the edge action: invert it, disable it, or do nothing. The counter itself is a 16-bit signed up/down counter. Its value can be read by software directly, but is also monitored by a set of comparators which can trigger an interrupt.

17.2.2 Counter Channel Inputs

As stated before, the two inputs of a channel can affect the pulse counter in various ways. The specifics of this behaviour are set by LCTRL_MODE and HCTRL_MODE in this case when the control signal is low or high, respectively, and POS_MODE and NEG_MODE for positive and negative edges of the input signal. Setting POS_MODE and NEG_MODE to 1 will increase the counter when an edge is detected, setting them to 2 will decrease the counter and setting at any other value will neutralize the effect of the edge on the counter. LCTR_MODE and HCTR_MODE modify this behaviour, when the control input has the corresponding low or high

value: 0 does not modify the NEG_MODE and POS_MODE behaviour, 1 inverts it (setting POS_MODE/NEG_MODE to increase the counter should now decrease the counter and vice versa) and any other value disables counter effects for that signal level.

To summarize, a few examples have been considered. In this table, the effect on the counter for a rising edge is shown for both a low and a high control signal, as well as various other configuration options. For clarity, a short description in brackets is added after the values. Note: x denotes 'do not care'.

POS_MODE	LCTRL_MODE	HCTRL_MODE	sig l→h when ctrl=0	sig l→h when ctrl=1
1 (inc)	0 (-)	0 (-)	Inc ctr	Inc ctr
2 (dec)	0 (-)	0 (-)	Dec ctr	Dec ctr
0 (-)	x	x	No action	No action
1 (inc)	0 (-)	1 (inv)	Inc ctr	Dec ctr
1 (inc)	1 (inv)	0 (-)	Dec ctr	Inc ctr
2 (dec)	0 (-)	1 (inv)	Dec ctr	Inc ctr
1 (inc)	0 (-)	2 (dis)	Inc ctr	No action
1 (inc)	2 (dis)	0 (-)	No action	Inc ctr

This table is also valid for negative edges (sig h→l) on substituting NEG_MODE for POS_MODE.

Each pulse counter unit also features a filter on each of the four inputs, adding the option to ignore short glitches in the signals. If a PCNT_FILTER_EN_Un can be set to filter the four input signals of the unit. If this filter is enabled, any pulses shorter than REG_FILTER_THRES_Un number of APB_CLK clock cycles will be filtered out and will have no effect on the counter. With the filter disabled, in theory infinitely small glitches could possibly trigger pulse counter action. However, in practice the signal inputs are sampled on APB_CLK edges and even with the filter disabled, pulse widths lasting shorter than one APB_CLK cycle may be missed.

Apart from the input channels, software also has some control over the counter. In particular, the counter value can be frozen to the current value by configuring PCNT_CNT_PAUSE_Un. It can also be reset to 0 by configuring PCNT_PULSE_CNT_RST_Un.

17.2.3 Watchpoints

The pulse counters have five watchpoints that share one interrupt. Interrupt generation can be enabled or disabled for each individual watchpoint. The watchpoints are:

- Maximum count value: Triggered when $PULSE_CNT \geq PCNT_THR_H_LIM_Un$. Additionally, this will reset the counter to 0.
- Minimum count value: Triggered when $PULSE_CNT \leq PCNT_THR_L_LIM_Un$. Additionally, this will reset the counter to 0. This is most useful when PCNT_THR_L_LIM_Un is set to a negative number.
- Two threshold values: Triggered when $PULSE_CNT = PCNT_THR_THRES0_Un$ or $PCNT_THR_THRES1_Un$.
- Zero: Triggered when $PULSE_CNT = 0$.

17.2.4 Examples

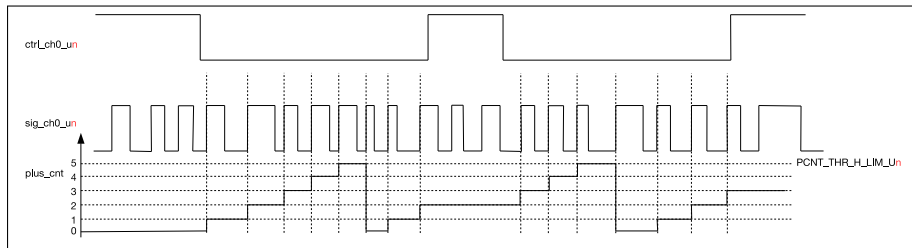


Figure 120: PULSE_CNT Upcounting Diagram

Figure 120 shows channel 0 being used as an up-counter. The configuration of channel 0 is shown below.

- $CNT_CH0_POS_MODE_Un = 1$: increase counter on the rising edge of sig_ch0_un .
- $PCNT_CH0_NEG_MODE_Un = 0$: no counting on the falling edge of sig_ch0_un .
- $PCNT_CH0_LCTRL_MODE_Un = 0$: Do not modify counter mode when sig_ch0_un is low.
- $PCNT_CH0_HCTRL_MODE_Un = 2$: Do not allow counter increments/decrements when sig_ch0_un is high.
- $PCNT_THR_H_LIM_Un = 5$: PULSE_CNT resets to 0 when the count value increases to 5.

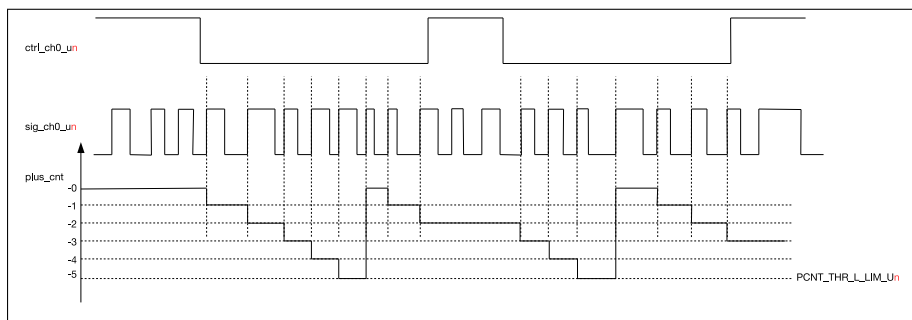


Figure 121: PULSE_CNT Downcounting Diagram

Figure 121 shows channel 0 decrementing the counter. The configuration of channel 0 differs from that in Figure 120 in the following two aspects:

- $PCNT_CH0_LCTRL_MODE_Un = 1$: invert counter mode when $ctrl_ch0_un$ is at low level, so it will decrease, rather than increase, the counter.
- $PCNT_THR_H_LIM_Un = -5$: PULSE_CNT resets to 0 when the count value decreases to -5.

17.2.5 Interrupts

$PCNT_CNT_THR_EVENT_Un_INT$: This interrupt gets triggered when one of the five channel comparators detects a match.

17.3 Register Summary

Name	Description	Address	Access
Configuration registers			

Name	Description	Address	Access
PCNT_U0_CONF0_REG	Configuration register 0 for unit 0	0x3FF57000	R/W
PCNT_U1_CONF0_REG	Configuration register 0 for unit 1	0x3FF5700C	R/W
PCNT_U2_CONF0_REG	Configuration register 0 for unit 2	0x3FF57018	R/W
PCNT_U3_CONF0_REG	Configuration register 0 for unit 3	0x3FF57024	R/W
PCNT_U4_CONF0_REG	Configuration register 0 for unit 4	0x3FF57030	R/W
PCNT_U5_CONF0_REG	Configuration register 0 for unit 5	0x3FF5703C	R/W
PCNT_U6_CONF0_REG	Configuration register 0 for unit 6	0x3FF57048	R/W
PCNT_U7_CONF0_REG	Configuration register 0 for unit 7	0x3FF57054	R/W
PCNT_U0_CONF1_REG	Configuration register 1 for unit 0	0x3FF57004	R/W
PCNT_U1_CONF1_REG	Configuration register 1 for unit 1	0x3FF57010	R/W
PCNT_U2_CONF1_REG	Configuration register 1 for unit 2	0x3FF5701C	R/W
PCNT_U3_CONF1_REG	Configuration register 1 for unit 3	0x3FF57028	R/W
PCNT_U4_CONF1_REG	Configuration register 1 for unit 4	0x3FF57034	R/W
PCNT_U5_CONF1_REG	Configuration register 1 for unit 5	0x3FF57040	R/W
PCNT_U6_CONF1_REG	Configuration register 1 for unit 6	0x3FF5704C	R/W
PCNT_U7_CONF1_REG	Configuration register 1 for unit 7	0x3FF57058	R/W
PCNT_U0_CONF2_REG	Configuration register 2 for unit 0	0x3FF57008	R/W
PCNT_U1_CONF2_REG	Configuration register 2 for unit 1	0x3FF57014	R/W
PCNT_U2_CONF2_REG	Configuration register 2 for unit 2	0x3FF57020	R/W
PCNT_U3_CONF2_REG	Configuration register 2 for unit 3	0x3FF5702C	R/W
PCNT_U4_CONF2_REG	Configuration register 2 for unit 4	0x3FF57038	R/W
PCNT_U5_CONF2_REG	Configuration register 2 for unit 5	0x3FF57044	R/W
PCNT_U6_CONF2_REG	Configuration register 2 for unit 6	0x3FF57050	R/W
PCNT_U7_CONF2_REG	Configuration register 2 for unit 7	0x3FF5705C	R/W
Counter values			
PCNT_U0_CNT_REG	Counter value for unit 0	0x3FF57060	RO
PCNT_U1_CNT_REG	Counter value for unit 1	0x3FF57064	RO
PCNT_U2_CNT_REG	Counter value for unit 2	0x3FF57068	RO
PCNT_U3_CNT_REG	Counter value for unit 3	0x3FF5706C	RO
PCNT_U4_CNT_REG	Counter value for unit 4	0x3FF57070	RO
PCNT_U5_CNT_REG	Counter value for unit 5	0x3FF57074	RO
PCNT_U6_CNT_REG	Counter value for unit 6	0x3FF57078	RO
PCNT_U7_CNT_REG	Counter value for unit 7	0x3FF5707C	RO
Control registers			
PCNT_CTRL_REG	Control register for all counters	0x3FF570B0	R/W
Interrupt registers			
PCNT_INT_RAW_REG	Raw interrupt status	0x3FF57080	RO
PCNT_INT_ST_REG	Masked interrupt status	0x3FF57084	RO
PCNT_INT_ENA_REG	Interrupt enable bits	0x3FF57088	R/W
PCNT_INT_CLR_REG	Interrupt clear bits	0x3FF5708C	WO

17.4 Registers

Register 17.1: PCNT_U n _CONF0_REG (n : 0-7) (0x0+0x0C*n)

PCNT_CH1_LCTRL_MODE_U n										PCNT_CH1_HCTRL_MODE_U n										PCNT_CH1_POS_MODE_U n										PCNT_CH1_NEG_MODE_U n										PCNT_CH0_LCTRL_MODE_U n										PCNT_CH0_HCTRL_MODE_U n										PCNT_CH0_POS_MODE_U n										PCNT_CH0_NEG_MODE_U n										PCNT_THR_THRES1_EN_U n										PCNT_THR_THRES0_EN_U n										PCNT_THR_L_LIM_EN_U n										PCNT_THR_H_LIM_EN_U n										PCNT_THR_ZERO_EN_U n										PCNT_FILTER_EN_U n										PCNT_FILTER_THRES_U n									
31	30	29	28	27	26	25	24	23	22	21	20	19	18	17	16	15	14	13	12	11	10	9											0																																																																																																																				
0	0	0	0	0	0	0	0	0	0	0	0	0	0	0	0	0	0	1	1	1	1	0x010										0																																																																																																																					

Reset

PCNT_CH1_LCTRL_MODE_U n This register configures how the CH1_POS_MODE/CH1_NEG_MODE settings will be modified when the control signal is low. (R/W) 0: No modification; 1: Invert behaviour (increase -> decrease, decrease -> increase); 2, 3: Inhibit counter modification

PCNT_CH1_HCTRL_MODE_U n This register configures how the CH1_POS_MODE/CH1_NEG_MODE settings will be modified when the control signal is low. (R/W) 0: No modification; 1: Invert behaviour (increase -> decrease, decrease -> increase); 2, 3: Inhibit counter modification

PCNT_CH1_POS_MODE_U n This register sets the behaviour when the signal input of channel 1 detects a positive edge. (R/W) 1: Increment the counter; 2: Decrement the counter; 0, 3: No effect on counter

PCNT_CH1_NEG_MODE_U n This register sets the behaviour when the signal input of channel 1 detects a negative edge. (R/W) 1: Increment the counter; 2: Decrement the counter; 0, 3: No effect on counter

PCNT_CH0_LCTRL_MODE_U n This register configures how the CH0_POS_MODE/CH0_NEG_MODE settings will be modified when the control signal is low. (R/W) 0: No modification; 1: Invert behaviour (increase -> decrease, decrease -> increase); 2, 3: Inhibit counter modification

PCNT_CH0_HCTRL_MODE_U n This register configures how the CH0_POS_MODE/CH0_NEG_MODE settings will be modified when the control signal is low. (R/W) 0: No modification; 1: Invert behaviour (increase -> decrease, decrease -> increase); 2, 3: Inhibit counter modification

PCNT_CH0_POS_MODE_U n This register sets the behaviour when the signal input of channel 0 detects a positive edge. (R/W) 1: Increase the counter; 2: Decrease the counter; 0, 3: No effect on counter

PCNT_CH0_NEG_MODE_U n This register sets the behaviour when the signal input of channel 0 detects a negative edge. (R/W) 1: Increase the counter; 2: Decrease the counter; 0, 3: No effect on counter

PCNT_THR_THRES1_EN_U n This is the enable bit for unit n 's thres1 comparator. (R/W)

PCNT_THR_THRES0_EN_U n This is the enable bit for unit n 's thres0 comparator. (R/W)

PCNT_THR_L_LIM_EN_U n This is the enable bit for unit n 's thr_l_lim comparator. (R/W)

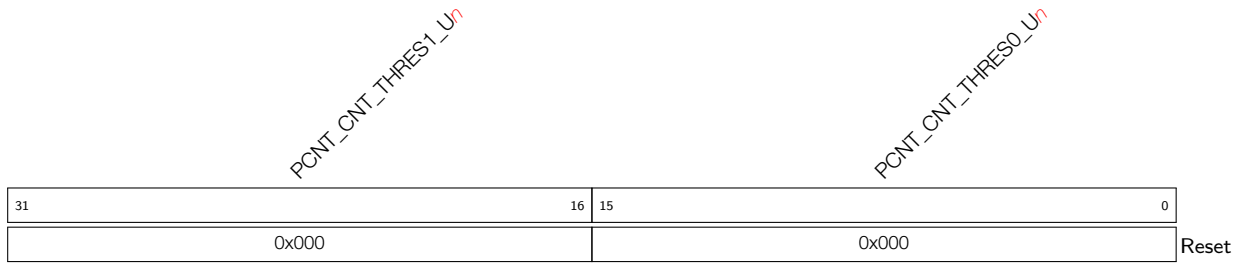
PCNT_THR_H_LIM_EN_U n This is the enable bit for unit n 's thr_h_lim comparator. (R/W)

PCNT_THR_ZERO_EN_U n This is the enable bit for unit n 's zero comparator. (R/W)

PCNT_FILTER_EN_U n This is the enable bit for unit n 's input filter. (R/W)

PCNT_FILTER_THRES_U n This sets the maximum threshold, in APB_CLK cycles, for the filter. Any pulses lasting shorter than this will be ignored when the filter is enabled. (R/W)

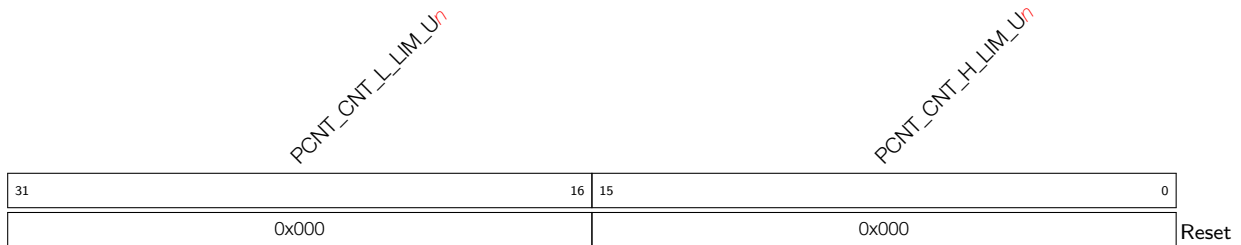
Register 17.2: PCNT_U n _CONF1_REG (n : 0-7) (0x4+0x0C* n)



PCNT_CNT_THRES1_Un This register is used to configure the thres1 value for unit n . (R/W)

PCNT_CNT_THRES0_Un This register is used to configure the thres0 value for unit n . (R/W)

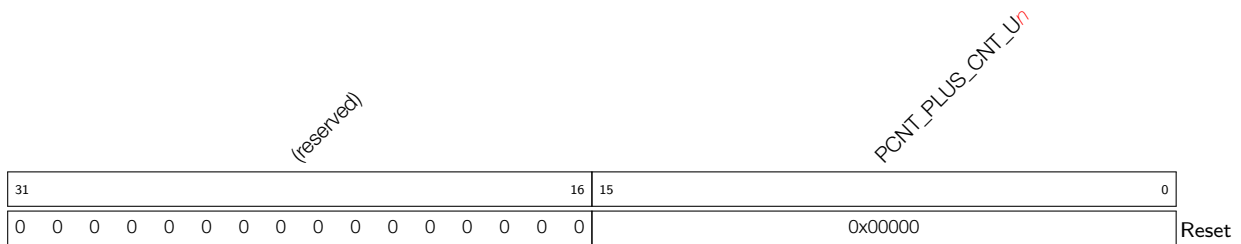
Register 17.3: PCNT_U n _CONF2_REG (n : 0-7) (0x8+0x0C* n)



PCNT_CNT_L_LIM_Un This register is used to configure the thr_l_lim value for unit n . (R/W)

PCNT_CNT_H_LIM_Un This register is used to configure the thr_h_lim value for unit n . (R/W)

Register 17.4: PCNT_U n _CNT_REG (n : 0-7) (0x28+0x0C* n)



PCNT_PLUS_CNT_Un This register stores the current pulse count value for unit n . (RO)

Register 17.5: PCNT_INT_RAW_REG (0x0080)

(reserved)								PCNT_CNT_THR_EVENT_U7_INT_RAW PCNT_CNT_THR_EVENT_U6_INT_RAW PCNT_CNT_THR_EVENT_U5_INT_RAW PCNT_CNT_THR_EVENT_U4_INT_RAW PCNT_CNT_THR_EVENT_U3_INT_RAW PCNT_CNT_THR_EVENT_U2_INT_RAW PCNT_CNT_THR_EVENT_U1_INT_RAW PCNT_CNT_THR_EVENT_U0_INT_RAW											
31	8	7	6	5	4	3	2	1	0	8	7	6	5	4	3	2	1	0	
0x0000000										0 0 0 0 0 0 0 0 0 0									Reset

PCNT_CNT_THR_EVENT_U n _INT_RAW The raw interrupt status bit for the [PCNT_CNT_THR_EVENT_U \$n\$ _INT](#) interrupt. (RO)

Register 17.6: PCNT_INT_ST_REG (0x0084)

(reserved)								PCNT_CNT_THR_EVENT_U7_INT_ST PCNT_CNT_THR_EVENT_U6_INT_ST PCNT_CNT_THR_EVENT_U5_INT_ST PCNT_CNT_THR_EVENT_U4_INT_ST PCNT_CNT_THR_EVENT_U3_INT_ST PCNT_CNT_THR_EVENT_U2_INT_ST PCNT_CNT_THR_EVENT_U1_INT_ST PCNT_CNT_THR_EVENT_U0_INT_ST											
31	8	7	6	5	4	3	2	1	0	8	7	6	5	4	3	2	1	0	
0x0000000										0 0 0 0 0 0 0 0 0 0									Reset

PCNT_CNT_THR_EVENT_U n _INT_ST The masked interrupt status bit for the [PCNT_CNT_THR_EVENT_U \$n\$ _INT](#) interrupt. (RO)

Register 17.7: PCNT_INT_ENA_REG (0x0088)

(reserved)								PCNT_CNT_THR_EVENT_U7_INT_ENA PCNT_CNT_THR_EVENT_U6_INT_ENA PCNT_CNT_THR_EVENT_U5_INT_ENA PCNT_CNT_THR_EVENT_U4_INT_ENA PCNT_CNT_THR_EVENT_U3_INT_ENA PCNT_CNT_THR_EVENT_U2_INT_ENA PCNT_CNT_THR_EVENT_U1_INT_ENA PCNT_CNT_THR_EVENT_U0_INT_ENA											
31	8	7	6	5	4	3	2	1	0	8	7	6	5	4	3	2	1	0	
0x0000000										0 0 0 0 0 0 0 0 0 0									Reset

PCNT_CNT_THR_EVENT_U n _INT_ENA The interrupt enable bit for the [PCNT_CNT_THR_EVENT_U \$n\$ _INT](#) interrupt. (R/W)

Register 17.8: PCNT_INT_CLR_REG (0x008c)

(reserved)								PCNT_CNT_THR_EVENT_U7_INT_CLR PCNT_CNT_THR_EVENT_U6_INT_CLR PCNT_CNT_THR_EVENT_U5_INT_CLR PCNT_CNT_THR_EVENT_U4_INT_CLR PCNT_CNT_THR_EVENT_U3_INT_CLR PCNT_CNT_THR_EVENT_U2_INT_CLR PCNT_CNT_THR_EVENT_U1_INT_CLR PCNT_CNT_THR_EVENT_U0_INT_CLR									
31								8	7	6	5	4	3	2	1	0	
0x0000000								0	0	0	0	0	0	0	0	0	Reset

PCNT_CNT_THR_EVENT_U n _INT_CLR Set this bit to clear the **PCNT_CNT_THR_EVENT_U n _INT** interrupt. (WO)

Register 17.9: PCNT_CTRL_REG (0x00b0)

(reserved)														PCNT_CNT_PAUSE_U7 PCNT_PLUS_CNT_RST_U7 PCNT_CNT_PAUSE_U6 PCNT_PLUS_CNT_RST_U6 PCNT_CNT_PAUSE_U5 PCNT_PLUS_CNT_RST_U5 PCNT_CNT_PAUSE_U4 PCNT_PLUS_CNT_RST_U4 PCNT_CNT_PAUSE_U3 PCNT_PLUS_CNT_RST_U3 PCNT_CNT_PAUSE_U2 PCNT_PLUS_CNT_RST_U2 PCNT_CNT_PAUSE_U1 PCNT_PLUS_CNT_RST_U1 PCNT_PLUS_CNT_RST_U0																												
31																	17	16	15	14	13	12	11	10	9	8	7	6	5	4	3	2	1	0								
0x0000																	0	0	1	0	1	0	1	0	1	0	1	0	1	0	1	0	1	0	1	0	1	0	1	0	1	Reset

PCNT_CNT_PAUSE_U n Set this bit to freeze unit n 's counter. (R/W)

PCNT_PLUS_CNT_RST_U n Set this bit to clear unit n 's counter. (R/W)

18. 64-bit Timers

18.1 Introduction

There are four general-purpose timers embedded in the ESP32. They are all 64-bit generic timers based on 16-bit prescalers and 64-bit auto-reload-capable up/downcounters.

The ESP32 contains two timer modules, each containing two timers. The two timers in a block are indicated by an x in `TIMG n _Tx`; the blocks themselves are indicated by an n .

The timers feature:

- A 16-bit clock prescaler, from 2 to 65536
- A 64-bit time-base counter
- Configurable up/down time-base counter: incrementing or decrementing
- Halt and resume of time-base counter
- Auto-reload at alarm
- Software-controlled instant reload
- Level and edge interrupt generation

18.2 Functional Description

18.2.1 16-bit Prescaler

Each timer uses the APB clock (`APB_CLK`, normally 80 MHz) as the basic clock. This clock is then divided down by a 16-bit prescaler which generates the time-base counter clock (`TB_clk`). Every cycle of `TB_clk` causes the time-base counter to increment or decrement by one. The timer must be disabled (`TIMG n _Tx_EN` is cleared) before changing the prescaler divisor which is configured by `TIMG n _Tx_DIVIDER` register; changing it on an enabled timer can lead to unpredictable results. The prescaler can divide the APB clock by a factor from 2 to 65536. Specifically, when `TIMG n _Tx_DIVIDER` is either 1 or 2, the clock divisor is 2; when `TIMG n _Tx_DIVIDER` is 0, the clock divisor is 65536. Any other value will cause the clock to be divided by exactly that value.

18.2.2 64-bit Time-base Counter

The 64-bit time-base counter can be configured to count either up or down, depending on whether `TIMG n _Tx_INCREASE` is set or cleared, respectively. It supports both auto-reload and software instant reload. An alarm event can be set when the counter reaches a value specified by the software.

Counting can be enabled and disabled by setting and clearing `TIMG n _Tx_EN`. Clearing this bit essentially freezes the counter, causing it to neither count up nor count down; instead, it retains its value until `TIMG n _Tx_EN` is set again. Reloading the counter when `TIMG n _Tx_EN` is cleared will change its value, but counting will not be resumed until `TIMG n _Tx_EN` is set.

Software can set a new counter value by setting registers `TIMG n _Tx_LOAD_LO` and `TIMG n _Tx_LOAD_HI` to the intended new value. The hardware will ignore these register settings until a reload; a reload will cause the contents of these registers to be copied to the counter itself. A reload event can be triggered by an alarm (auto-reload at alarm) or by software (software instant reload). To enable auto-reload at alarm, the register

TIMG n _Tx_AUTORELOAD should be set. If auto-reload at alarm is not enabled, the time-base counter will continue incrementing or decrementing after the alarm. To trigger a software instant reload, any value can be written to the register TIMG n _Tx_LOAD_REG; this will cause the counter value to change instantly. Software can also change the direction of the time-base counter instantly by changing the value of TIMG n _Tx_INCREASE.

The time-base counter can also be read by software, but because the counter is 64-bit, the CPU can only get the value as two 32-bit values, the counter value needs to be latched onto TIMG n _TxLO_REG and TIMG n _TxHI_REG first. This is done by writing any value to TIMG n _TxUPDATE_REG; this will instantly latch the 64-bit timer value onto the two registers. Software can then read them at any point in time. This approach stops the timer value being read erroneously when a carry-over happens between reading the low and high word of the timer value.

18.2.3 Alarm Generation

The timer can trigger an alarm, which can cause a reload and/or an interrupt to occur. The alarm is triggered when the alarm registers TIMG n _Tx_ALARMLO_REG and TIMG n _Tx_ALARMHI_REG match the current timer value. In order to simplify the scenario where these registers are set 'too late' and the counter has already passed these values, the alarm also triggers when the current timer value is higher (for an up-counting timer) or lower (for a down-counting timer) than the current alarm value: if this is the case, the alarm will be triggered immediately upon loading the alarm registers.

18.2.4 MWDT

Each timer module also contains a Main System Watchdog Timer and its associated registers. While these registers are described here, their functional description can be found in the chapter entitled [Watchdog Timer](#).

18.2.5 Interrupts

- TIMG n _Tx_INT_WDT_INT: Generated when a watchdog timer interrupt stage times out.
- TIMG n _Tx_INT_T1_INT: An alarm event on timer 1 generates this interrupt.
- TIMG n _Tx_INT_T0_INT: An alarm event on timer 0 generates this interrupt.

18.3 Register Summary

Name	Description	TIMG0	TIMG1	Acc
Timer 0 configuration and control registers				
TIMGn_T0CONFIG_REG	Timer 0 configuration register	0x3FF5F000	0x3FF60000	R/W
TIMGn_T0LO_REG	Timer 0 current value, low 32 bits	0x3FF5F004	0x3FF60004	RO
TIMGn_T0HI_REG	Timer 0 current value, high 32 bits	0x3FF5F008	0x3FF60008	RO
TIMGn_T0UPDATE_REG	Write to copy current timer value to TIMG n _T0_(LO/HI)_REG	0x3FF5F00C	0x3FF6000C	WO
TIMGn_T0ALARMLO_REG	Timer 0 alarm value, low 32 bits	0x3FF5F010	0x3FF60010	R/W
TIMGn_T0ALARMHI_REG	Timer 0 alarm value, high bits	0x3FF5F014	0x3FF60014	R/W
TIMGn_T0LOADLO_REG	Timer 0 reload value, low 32 bits	0x3FF5F018	0x3FF60018	R/W

Name	Description	TIMG0	TIMG1	Acc
TIMG _n _T0LOAD_REG	Write to reload timer from TIMG _n _T0_(LOADLOLOADHI)_REG	0x3FF5F020	0x3FF60020	WO
Timer 1 configuration and control registers				
TIMG _n _T1CONFIG_REG	Timer 1 configuration register	0x3FF5F024	0x3FF60024	R/W
TIMG _n _T1LO_REG	Timer 1 current value, low 32 bits	0x3FF5F028	0x3FF60028	RO
TIMG _n _T1HI_REG	Timer 1 current value, high 32 bits	0x3FF5F02C	0x3FF6002C	RO
TIMG _n _T1UPDATE_REG	Write to copy current timer value to TIMG _n _T1_(LO/HI)_REG	0x3FF5F030	0x3FF60030	WO
TIMG _n _T1ALARMLO_REG	Timer 1 alarm value, low 32 bits	0x3FF5F034	0x3FF60034	R/W
TIMG _n _T1ALARMHI_REG	Timer 1 alarm value, high 32 bits	0x3FF5F038	0x3FF60038	R/W
TIMG _n _T1LOADLO_REG	Timer 1 reload value, low 32 bits	0x3FF5F03C	0x3FF6003C	R/W
TIMG _n _T1LOAD_REG	Write to reload timer from TIMG _n _T1_(LOADLOLOADHI)_REG	0x3FF5F044	0x3FF60044	WO
System watchdog timer configuration and control registers				
TIMG _n _Tx_WDTCONFIG0_REG	Watchdog timer configuration register	0x3FF5F048	0x3FF60048	R/W
TIMG _n _Tx_WDTCONFIG1_REG	Watchdog timer prescaler register	0x3FF5F04C	0x3FF6004C	R/W
TIMG _n _Tx_WDTCONFIG2_REG	Watchdog timer stage 0 timeout value	0x3FF5F050	0x3FF60050	R/W
TIMG _n _Tx_WDTCONFIG3_REG	Watchdog timer stage 1 timeout value	0x3FF5F054	0x3FF60054	R/W
TIMG _n _Tx_WDTCONFIG4_REG	Watchdog timer stage 2 timeout value	0x3FF5F058	0x3FF60058	R/W
TIMG _n _Tx_WDTCONFIG5_REG	Watchdog timer stage 3 timeout value	0x3FF5F05C	0x3FF6005C	R/W
TIMG _n _Tx_WDTFEED_REG	Write to feed the watchdog timer	0x3FF5F060	0x3FF60060	WO
TIMG _n _Tx_WDTWPROTECT_REG	Watchdog write protect register	0x3FF5F064	0x3FF60064	R/W
Interrupt registers				
TIMG _n _Tx_INT_RAW_REG	Raw interrupt status	0x3FF5F09C	0x3FF6009C	RO
TIMG _n _Tx_INT_ST_REG	Masked interrupt status	0x3FF5F0A0	0x3FF600A0	RO
TIMG _n _Tx_INT_ENA_REG	Interrupt enable bits	0x3FF5F098	0x3FF60098	R/W
TIMG _n _Tx_INT_CLR_REG	Interrupt clear bits	0x3FF5F0A4	0x3FF600A4	WO

18.4 Registers

Register 18.1: TIMG_n_TXCONFIG_REG (x: 0-1) (0x0+0x24*x)

31	30	29	28	13	12	11	10			
0	1	1	0x00001				0	0	0	Reset

TIMG_n_TX_EN When set, the timer *x* time-base counter is enabled. (R/W)

TIMG_n_TX_INCREASE When set, the timer *x* time-base counter will increment every clock tick. When cleared, the timer *x* time-base counter will decrement. (R/W)

TIMG_n_TX_AUTORELOAD When set, timer *x* auto-reload at alarm is enabled. (R/W)

TIMG_n_TX_DIVIDER Timer *x* clock (Tx_clk) prescale value. (R/W)

TIMG_n_TX_EDGE_INT_EN When set, an alarm will generate an edge type interrupt. (R/W)

TIMG_n_TX_LEVEL_INT_EN When set, an alarm will generate a level type interrupt. (R/W)

TIMG_n_TX_ALARM_EN When set, the alarm is enabled. (R/W)

Register 18.2: TIMG_n_TXLO_REG (x: 0-1) (0x4+0x24*x)

31	0
0x00000000	
	Reset

TIMG_n_TXLO_REG After writing to TIMG_n_TXUPDATE_REG, the low 32 bits of the time-base counter of timer *x* can be read here. (RO)

Register 18.3: TIMG_n_TXHI_REG (x: 0-1) (0x8+0x24*x)

31	0
0x00000000	
	Reset

TIMG_n_TXHI_REG After writing to TIMG_n_TXUPDATE_REG, the high 32 bits of the time-base counter of timer *x* can be read here. (RO)

Register 18.4: TIMG_n_TXUPDATE_REG (x: 0-1) (0xC+0x24*x)

31	0
0x00000000	
Reset	

TIMG_n_TXUPDATE_REG Write any value to trigger a timer *x* time-base counter value update (timer *x* current value will be stored in registers above). (WO)

Register 18.5: TIMG_n_TXALARMLO_REG (x: 0-1) (0x10+0x24*x)

31	0
0x00000000	
Reset	

TIMG_n_TXALARMLO_REG Timer *x* alarm trigger time-base counter value, low 32 bits. (R/W)

Register 18.6: TIMG_n_TXALARMHI_REG (x: 0-1) (0x14+0x24*x)

31	0
0x00000000	
Reset	

TIMG_n_TXALARMHI_REG Timer *x* alarm trigger time-base counter value, high 32 bits. (R/W)

Register 18.7: TIMG_n_TXLOADLO_REG (x: 0-1) (0x18+0x24*x)

31	0
0x00000000	
Reset	

TIMG_n_TXLOADLO_REG Low 32 bits of the value that a reload will load onto timer *x* time-base counter. (R/W)

Register 18.8: TIMG_n_TXLOADHI_REG (x: 0-1) (0x1C+0x24*x)

31	0
0x00000000	
Reset	

TIMG_n_TXLOADHI_REG High 32 bits of the value that a reload will load onto timer *x* time-base counter. (R/W)

Register 18.9: TIMG_n_TXLOAD_REG (x: 0-1) (0x20+0x24*x)

31	0
0x00000000	
Reset	

TIMG_n_TXLOAD_REG Write any value to trigger a timer *x* time-base counter reload. (WO)

Register 18.10: TIMG_n_TX_WDTCONFIG0_REG (0x0048)

31	30	29	28	27	26	25	24	23	22	21	20	18	17	15	14
0	0	0	0	0	0	0	0	0	0	0	0x1	0x1	0x1	0x1	1
Reset															

TIMG_n_TX_WDT_EN When set, MWDT is enabled. (R/W)

TIMG_n_TX_WDT_STG0 Stage 0 configuration. 0: off, 1: interrupt, 2: reset CPU, 3: reset system. (R/W)

TIMG_n_TX_WDT_STG1 Stage 1 configuration. 0: off, 1: interrupt, 2: reset CPU, 3: reset system. (R/W)

TIMG_n_TX_WDT_STG2 Stage 2 configuration. 0: off, 1: interrupt, 2: reset CPU, 3: reset system. (R/W)

TIMG_n_TX_WDT_STG3 Stage 3 configuration. 0: off, 1: interrupt, 2: reset CPU, 3: reset system. (R/W)

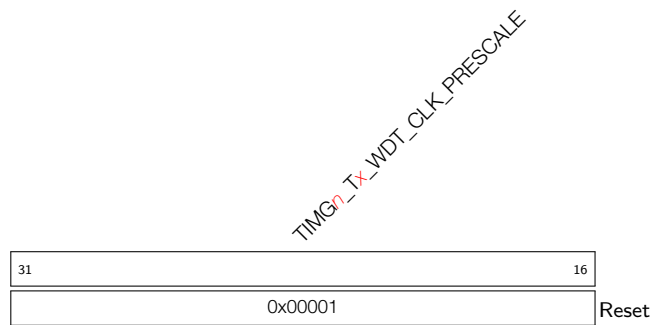
TIMG_n_TX_WDT_EDGE_INT_EN When set, an edge type interrupt will occur at the timeout of a stage configured to generate an interrupt. (R/W)

TIMG_n_TX_WDT_LEVEL_INT_EN When set, a level type interrupt will occur at the timeout of a stage configured to generate an interrupt. (R/W)

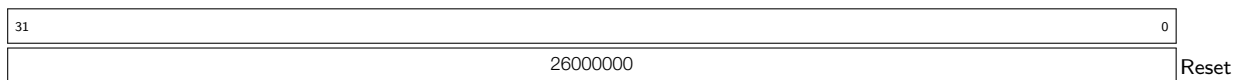
TIMG_n_TX_WDT_CPU_RESET_LENGTH CPU reset signal length selection. 0: 100 ns, 1: 200 ns, 2: 300 ns, 3: 400 ns, 4: 500 ns, 5: 800 ns, 6: 1.6 μs, 7: 3.2 μs. (R/W)

TIMG_n_TX_WDT_SYS_RESET_LENGTH System reset signal length selection. 0: 100 ns, 1: 200 ns, 2: 300 ns, 3: 400 ns, 4: 500 ns, 5: 800 ns, 6: 1.6 μs, 7: 3.2 μs. (R/W)

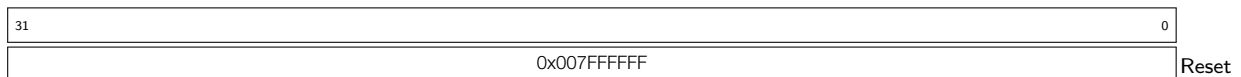
TIMG_n_TX_WDT_FLASHBOOT_MOD_EN When set, Flash boot protection is enabled. (R/W)

Register 18.11: TIMG_n_Tx_WDTCONFIG1_REG (0x004c)

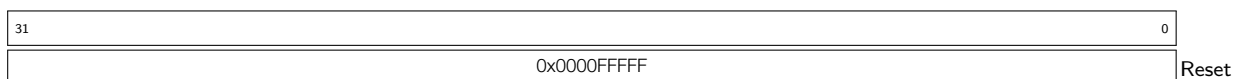
TIMG_n_Tx_WDT_CLK_PRESCALE MWDT clock prescale value. MWDT clock period = 12.5 ns * TIMG_n_Tx_WDT_CLK_PRESCALE. (R/W)

Register 18.12: TIMG_n_Tx_WDTCONFIG2_REG (0x0050)

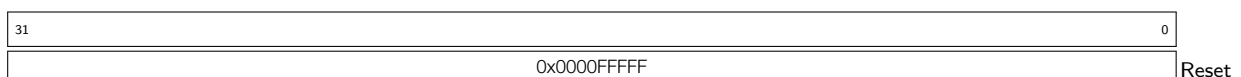
TIMG_n_Tx_WDTCONFIG2_REG Stage 0 timeout value, in MWDT clock cycles. (R/W)

Register 18.13: TIMG_n_Tx_WDTCONFIG3_REG (0x0054)

TIMG_n_Tx_WDTCONFIG3_REG Stage 1 timeout value, in MWDT clock cycles. (R/W)

Register 18.14: TIMG_n_Tx_WDTCONFIG4_REG (0x0058)

TIMG_n_Tx_WDTCONFIG4_REG Stage 2 timeout value, in MWDT clock cycles. (R/W)

Register 18.15: TIMG_n_Tx_WDTCONFIG5_REG (0x005c)

TIMG_n_Tx_WDTCONFIG5_REG Stage 3 timeout value, in MWDT clock cycles. (R/W)

Register 18.16: TIMG_n_Tx_WDTFEED_REG (0x0060)

31	0
0x00000000	
Reset	

TIMG_n_Tx_WDTFEED_REG Write any value to feed the MWDT. (WO)

Register 18.17: TIMG_n_Tx_WDTWPROTECT_REG (0x0064)

31	0
0x050D83AA1	
Reset	

TIMG_n_Tx_WDTWPROTECT_REG If the register contains a different value than its reset value, write protection is enabled. (R/W)

Register 18.18: TIMG_n_Tx_INT_ENA_REG (0x0098)

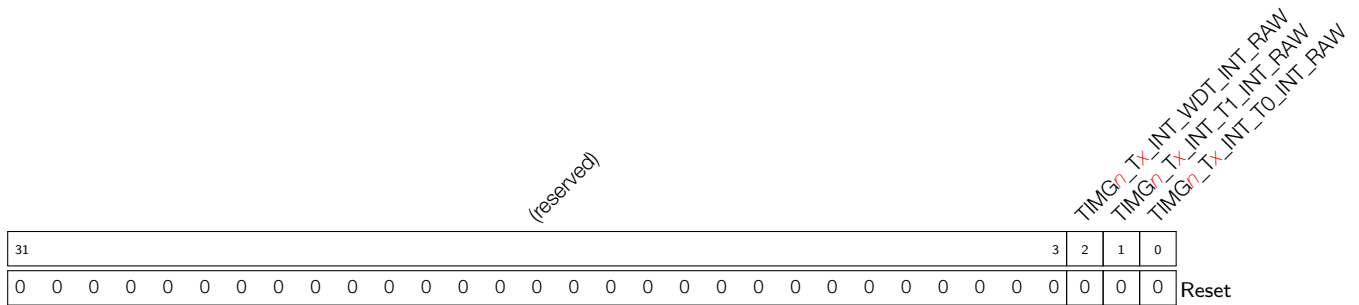
(reserved)																												<div style="display: flex; justify-content: space-around;"> TIMG_n_Tx_INT_WDT_INT_ENA TIMG_n_Tx_INT_T1_INT_ENA TIMG_n_Tx_INT_T0_INT_ENA </div>		
31																											3	2	1	0
0 0																														
Reset																														

TIMG_n_Tx_INT_WDT_INT_ENA The interrupt enable bit for the TIMG_n_Tx_INT_WDT_INT interrupt. (R/W) (R/W)

TIMG_n_Tx_INT_T1_INT_ENA The interrupt enable bit for the TIMG_n_Tx_INT_T1_INT interrupt. (R/W) (R/W)

TIMG_n_Tx_INT_T0_INT_ENA The interrupt enable bit for the TIMG_n_Tx_INT_T0_INT interrupt. (R/W) (R/W)

Register 18.19: TIMG_n_Tx_INT_RAW_REG (0x009c)

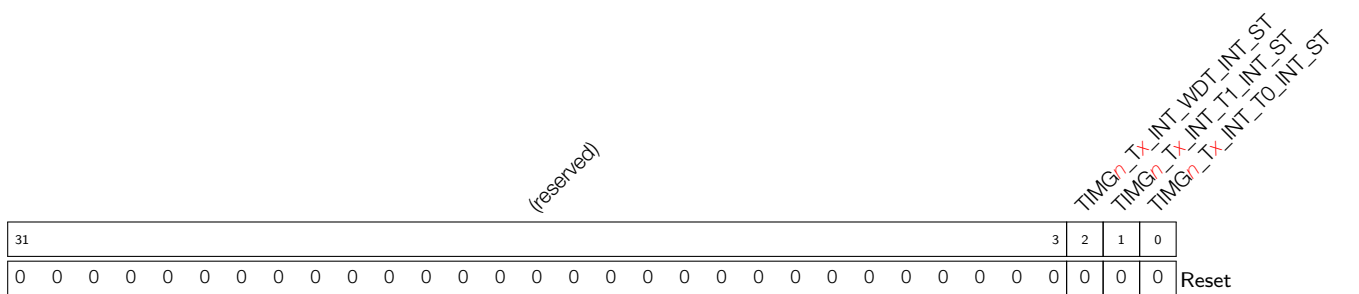


TIMG_n_Tx_INT_WDT_INT_RAW The raw interrupt status bit for the TIMG_n_Tx_INT_WDT_INT interrupt. (RO)

TIMG_n_Tx_INT_T1_INT_RAW The raw interrupt status bit for the TIMG_n_Tx_INT_T1_INT interrupt. (RO)

TIMG_n_Tx_INT_TO_INT_RAW The raw interrupt status bit for the TIMG_n_Tx_INT_TO_INT interrupt. (RO)

Register 18.20: TIMG_n_Tx_INT_ST_REG (0x00a0)



TIMG_n_Tx_INT_WDT_INT_ST The masked interrupt status bit for the TIMG_n_Tx_INT_WDT_INT interrupt. (RO)

TIMG_n_Tx_INT_T1_INT_ST The masked interrupt status bit for the TIMG_n_Tx_INT_T1_INT interrupt. (RO)

TIMG_n_Tx_INT_TO_INT_ST The masked interrupt status bit for the TIMG_n_Tx_INT_TO_INT interrupt. (RO)

19. Watchdog Timers

19.1 Introduction

The ESP32 has three watchdog timers: one in each of the two timer modules (called Main System Watchdog Timer, or MWDT) and one in the RTC module (which is called the RTC Watchdog Timer, or RWDT). These watchdog timers are intended to recover from an unforeseen fault, causing the application program to abandon its normal sequence. A watchdog timer has four stages. Each stage may take one out of three or four actions upon the expiry of a programmed period of time for this stage, unless the watchdog is fed or disabled. The actions are: interrupt, CPU reset, core reset and system reset. Only the RWDT can trigger the system reset, and is able to reset the entire chip and the main system including the RTC itself. A timeout value can be set for each stage individually.

During flash boot, the RWDT and the first MWDT start automatically in order to detect and recover from booting problems.

19.2 Features

- Four stages, each of which can be configured or disabled separately
- Programmable time period for each stage
- One out of three or four possible actions (interrupt, CPU reset, core reset and system reset) upon the expiry of each stage
- 32-bit expiry counter
- Write protection, to prevent the RWDT and MWDT configuration from being inadvertently altered.
- Flash boot protection
If the boot process from an SPI flash does not complete within a predetermined period of time, the watchdog will reboot the entire main system.

19.3 Functional Description

19.3.1 Clock

The RWDT is clocked from the RTC slow clock, which usually will be 32 KHz. The MWDT clock source is derived from the APB clock via a pre-MWDT 16-bit configurable prescaler. For either watchdog, the clock source is fed into the 32-bit expiry counter. When this counter reaches the timeout value of the current stage, the action configured for the stage will execute, the expiry counter will be reset and the next stage will become active.

19.3.1.1 Operating Procedure

When a watchdog timer is enabled, it will proceed in loops from stage 0 to stage 3, then back to stage 0 and start again. The expiry action and time period for each stage can be configured individually.

Every stage can be configured for one of the following actions when the expiry timer reaches the stage's timeout value:

- Trigger an interrupt
When the stage expires an interrupt is triggered.
- Reset a CPU core
When the stage expires the designated CPU core will be reset. MWDT0 CPU reset only resets the PRO CPU. MWDT1 CPU reset only resets the APP CPU. The RWDT CPU reset can reset either of them, or both, or none, depending on configuration.
- Reset the main system
When the stage expires, the main system, including the MWDTs, will be reset. In this article, the main system includes the CPU and all peripherals. The RTC is an exception to this, and it will not be reset.
- Reset the main system and RTC
When the stage expires the main system and the RTC will both be reset. This action is only available in the RWDT.
- Disabled
This stage will have no effects on the system.

When software feeds the watchdog timer, it returns to stage 0 and its expiry counter restarts from 0.

19.3.1.2 Write Protection

Both the MWDTs, as well as the RWDT, can be protected from accidental writing. To accomplish this, they have a write-key register (TIMERS_WDT_WKEY for the MWDT, RTC_CNTL_WDT_WKEY for the RWDT.) On reset, these registers are initialized to the value 0x50D83AA1. When the value in this register is changed from 0x50D83AA1, write protection is enabled. Writes to any WDT register, including the feeding register (but excluding the write-key register itself), are ignored. The recommended procedure for accessing a WDT is:

1. Disable the write protection
2. Make the required modification or feed the watchdog
3. Re-enable the write protection

19.3.1.3 Flash Boot Protection

During flash booting, the MWDT in timer group 0 (TIMG0), as well as the RWDT, are automatically enabled. Stage 0 for the enabled MWDT is automatically configured to reset the system upon expiry; stage 0 for the RWDT resets the RTC when it expires. After booting, the register TIMERS_WDT_FLASHBOOT_MOD_EN should be cleared to stop the flash boot protection procedure for the MWDT, and RTC_CNTL_WDT_FLASHBOOT_MOD_EN should be cleared to do the same for the RWDT. After this, the MWDT and RWDT can be configured by software.

19.3.1.4 Registers

The MWDT registers are part of the timer submodule and are described in the [Timer Registers](#) section. The RWDT registers are part of the RTC submodule and are described in the [RTC Registers](#) section.

20. eFuse Controller

20.1 Introduction

The ESP32 has a number of eFuses which store system parameters. Fundamentally, an eFuse is a single bit of non-volatile memory with the restriction that once an eFuse bit is programmed to 1, it can never be reverted to 0. Software can instruct the eFuse Controller to program each bit for each system parameter as needed.

Some of these system parameters can be read by software using the eFuse Controller. Some of the system parameters are also directly used by hardware modules.

20.2 Features

- Configuration of 27 system parameters
- Optional write-protection
- Optional software-read-protection

20.3 Functional Description

20.3.1 Structure

Twenty-seven system parameters with different bit width are stored in the eFuses. The name of each system parameter and the corresponding bit width are shown in Table 77. Among those parameters, `efuse_wr_disable`, `efuse_rd_disable`, `BLK3_part_reserve` and `coding_scheme` are directly used by the eFuse Controller.

Table 77: System Parameter

Name	Bit width	Program -Protection by <code>efuse_wr_disable</code>	Software-Read -Protection by <code>efuse_rd_disable</code>	Description
<code>efuse_wr_disable</code>	16	1	-	controls the eFuse Controller
<code>efuse_rd_disable</code>	4	0	-	controls the eFuse Controller
<code>flash_crypt_cnt</code>	8	2	-	governs the flash encryption/ decryption
<code>WIFI_MAC_Address</code>	56	3	-	Wi-Fi MAC address and CRC
<code>SPI_pad_config_hd</code>	5	3	-	configures the SPI I/O to a cer- tain pad
<code>chip_version</code>	4	3	-	chip version
<code>XPD_SDIO_REG</code>	1	5	-	powers up the flash regulator
<code>SDIO_TIEH</code>	1	5	-	configures the flash regulator voltage: set to 1 for 3.3 V and set to 0 for 1.8 V
<code>sdio_force</code>	1	5	-	determines whether <code>XPD_SDIO_REG</code> and <code>SDIO_TIEH</code> can control the flash regulator

Name	Bit width	Program -Protection by efuse_wr_disable	Software-Read -Protection by efuse_rd_disable	Description
BLK3_part_reseve	2	10	3	controls the eFuse controller
SPI_pad_config_clk	5	6	-	configures the SPI I/O to a certain pad
SPI_pad_config_q	5	6	-	configures the SPI I/O to a certain pad
SPI_pad_config_d	5	6	-	configures the SPI I/O to a certain pad
SPI_pad_config_cs0	5	6	-	configures the SPI I/O to a certain pad
flash_crypt_config	4	10	3	governs flash encryption/decryption
coding_scheme*	2	10	3	controls the eFuse Controller
console_debug_disable	1	15	-	Disables the ROM BASIC debug console fallback mode when set to 1
abstract_done_0	1	12	-	determines the status of Secure Boot
abstract_done_1	1	13	-	determines the status of Secure Boot
JTAG_disable	1	14	-	disables access to the JTAG controllers so as to effectively disable external use of JTAG
download_dis_encrypt	1	15	-	governs flash encryption/decryption
download_dis_decrypt	1	15	-	governs flash encryption/decryption
download_dis_cache	1	15	-	disables cache when boot mode is the Download Mode
key_status	1	10	3	determines whether BLOCK3 is deployed for user purposes
BLOCK1*	256/192/128	7	0	governs flash encryption/decryption
BLOCK2*	256/192/128	8	1	key for Secure Boot
BLOCK3*	256/192/128	9	2	key for user purposes

20.3.1.1 System Parameter efuse_wr_disable

The system parameter efuse_wr_disable determines whether all of the system parameters are write-protected. Since efuse_wr_disable is a system parameter as well, it also determines whether it itself is write-protected.

If a system parameter is not write-protected, its unprogrammed bits can be programmed from 0 to 1. The bits

previously programmed to 1 will remain 1. When a system parameter is write-protected, none of its bits can be programmed: The unprogrammed bits will always remain 0 and the programmed bits will always remain 1.

The write-protection status of each system parameter corresponds to a bit in `efuse_wr_disable`. When the corresponding bit is set to 0, the system parameter is not write-protected. When the corresponding bit is set to 1, the system parameter is write-protected. If a system parameter is already write-protected, it will remain write-protected. The column entitled "Program-Protection by `efuse_wr_disable`" in Table 77 lists the corresponding bits that determine the write-protection status of each system parameter.

20.3.1.2 System Parameter `efuse_rd_disable`

Of the 26 system parameters, 20 are not constrained by software-read-protection. These are marked by "-" in the column entitled "Software-Read-Protection by `efuse_rd_disable`" in Table 77. Those system parameters, some of which are used by software and hardware modules at the same time, can be read by software via the eFuse Controller at any time.

When not software-read-protected, the other six system parameters can both be read by software and used by hardware modules. When they are software-read-protected, they can only be used by the hardware modules.

The column "Software-Read-Protection by `efuse_rd_disable`" in Table 77 lists the corresponding bits in `efuse_rd_disable` that determine the software read-protection status of the six system parameters. If a bit in the system parameter `efuse_rd_disable` is 0, the system parameter controlled by the bit is not software-read-protected. If a bit in the system parameter `efuse_rd_disable` is 1, the system parameter controlled by the bit is software-read-protected. If a system parameter is software-read-protected, it will remain in this state.

20.3.1.3 System Parameter `coding_scheme`

As Table 77 shows, only three system parameters, BLOCK1, BLOCK2, and BLOCK3, have variable bit width. Their bit width is controlled by another system parameter, `coding_scheme`. Despite their variable bit width, BLOCK1, BLOCK2, and BLOCK3 are assigned a fixed number of bits in eFuse. There is an encoding mapping between these three system parameters and their corresponding stored values in eFuse. For details please see Table 78.

Table 78: BLOCK1/2/3 Encoding

<code>coding_scheme[1:0]</code>	Width of BLOCK1/2/3	Coding scheme	Number of bits in eFuse
00/11	256	None	256
01	192	3/4	256
10	128	Repeat	256

The three coding schemes are explained as follows:

- *BLOCKN* represents any of the following three system parameters: BLOCK1, BLOCK2 or BLOCK3.
- *BLOCKN*[255 : 0], *BLOCKN*[191 : 0], and *BLOCKN*[127 : 0] represent each bit of the three system parameters in the three encoding schemes.

- ${}^eBLOCKN[255 : 0]$ represents each corresponding bit of those system parameters in eFuse after being encoded.

None

$${}^eBLOCKN[255 : 0] = BLOCKN[255 : 0]$$

3/4

$$BLOCKN_i^j[7 : 0] = BLOCKN[48i + 8j + 7 : 48i + 8j] \quad i \in \{0, 1, 2, 3\} \quad j \in \{0, 1, 2, 3, 4, 5\}$$

$${}^eBLOCKN_i^j[7 : 0] = {}^eBLOCKN[64i + 8j + 7 : 64i + 8j] \quad i \in \{0, 1, 2, 3\} \quad j \in \{0, 1, 2, 3, 4, 5, 6, 7\}$$

$${}^eBLOCKN_i^j[7 : 0] = \begin{cases} BLOCKN_i^j[7 : 0] & j \in \{0, 1, 2, 3, 4, 5\} \\ \begin{aligned} &BLOCKN_i^0[7 : 0] \oplus BLOCKN_i^1[7 : 0] \\ &\oplus BLOCKN_i^2[7 : 0] \oplus BLOCKN_i^3[7 : 0] \\ &\oplus BLOCKN_i^4[7 : 0] \oplus BLOCKN_i^5[7 : 0] \end{aligned} & j \in \{6\} \\ \sum_{l=0}^5 (l+1) \sum_{k=0}^7 BLOCKN_i^l[k] & j \in \{7\} \end{cases} \quad i \in \{0, 1, 2, 3\}$$

\oplus means bitwise XOR

\sum and $+$ mean summation

Repeat

$${}^eBLOCKN[255 : 128] = {}^eBLOCKN[127 : 0] = BLOCKN[127 : 0]$$

20.3.1.4 BLK3_part_reserve

System parameters coding_scheme, BLOCK1, BLOCK2, and BLOCK3 are controlled by the parameter BLK3_part_reserve.

When the value of BLK3_part_reserve is 0, coding_scheme, BLOCK1, BLOCK2, and BLOCK3 can be set to any value.

When the value of BLK3_part_reserve is 1, coding_scheme, BLOCK1, BLOCK2, and BLOCK3 are controlled by 3/4 coding scheme. Meanwhile, $BLOCK3[143 : 96]$, namely, ${}^eBLOCK3[191 : 128]$ is unavailable.

20.3.2 Programming of System Parameters

The programming of variable-length system parameters BLOCK1, BLOCK2, and BLOCK3 is different from that of the fixed-length system parameters. **We program the ${}^eBLOCKN[255 : 0]$ value of encoded system parameters BLOCK1, BLOCK2, and BLOCK3 instead of directly programming the system parameters. The bit width of ${}^eBLOCKN[255 : 0]$ is always 256.** Fixed-length system parameters, in contrast, are programmed without encoding them first.

Each bit of the 24 fixed-length system parameters and the three encoded variable-length system parameters corresponds to a program register bit, as shown in Table 79. The register bits will be used when programming system parameters.

Table 79: Program Register

System parameter			Register	
Name	Width	Bit	Name	Bit
efuse_wr_disable	16	[15:0]	EFUSE_BLK0_WDATA0_REG	[15:0]
efuse_rd_disable	4	[3:0]		[19:16]
flash_crypt_cnt	8	[7:0]		[27:20]
WIFI_MAC_Address	56	[31:0]	EFUSE_BLK0_WDATA1_REG	[31:0]
		[55:32]	EFUSE_BLK0_WDATA2_REG	[23:0]
SPI_pad_config_hd	5	[4:0]	EFUSE_BLK0_WDATA3_REG	[8:4]
chip_version	4	[3:0]		[12:9]
BLK3_part_reserve	1	[0]		[14]
XPD_SDIO_REG	1	[0]	EFUSE_BLK0_WDATA4_REG	[14]
SDIO_TIEH	1	[0]		[15]
sdio_force	1	[0]		[16]
SPI_pad_config_clk	5	[4:0]	EFUSE_BLK0_WDATA5_REG	[4:0]
SPI_pad_config_q	5	[4:0]		[9:5]
SPI_pad_config_d	5	[4:0]		[14:10]
SPI_pad_config_cs0	5	[4:0]		[19:15]
flash_crypt_config	4	[3:0]		[31:28]
coding_scheme	2	[1:0]	EFUSE_BLK0_WDATA6_REG	[1:0]
console_debug_disable	1	[0]		[2]
abstract_done_0	1	[0]		[4]
abstract_done_1	1	[0]		[5]
JTAG_disable	1	[0]		[6]
download_dis_encrypt	1	[0]		[7]
download_dis_decrypt	1	[0]		[8]
download_dis_cache	1	[0]		[9]
key_status	1	[0]		[10]
BLOCK1	256/192/128	[31:0]		EFUSE_BLK1_WDATA0_REG
		[63:32]	EFUSE_BLK1_WDATA1_REG	[31:0]
		[95:64]	EFUSE_BLK1_WDATA2_REG	[31:0]
		[127:96]	EFUSE_BLK1_WDATA3_REG	[31:0]
		[159:128]	EFUSE_BLK1_WDATA4_REG	[31:0]
		[191:160]	EFUSE_BLK1_WDATA5_REG	[31:0]
		[223:192]	EFUSE_BLK1_WDATA6_REG	[31:0]
BLOCK2	256/192/128	[31:0]	EFUSE_BLK2_WDATA0_REG	[31:0]
		[63:32]	EFUSE_BLK2_WDATA1_REG	[31:0]
		[95:64]	EFUSE_BLK2_WDATA2_REG	[31:0]
		[127:96]	EFUSE_BLK2_WDATA3_REG	[31:0]
		[159:128]	EFUSE_BLK2_WDATA4_REG	[31:0]
		[191:160]	EFUSE_BLK2_WDATA5_REG	[31:0]
		[223:192]	EFUSE_BLK2_WDATA6_REG	[31:0]
		[255:224]	EFUSE_BLK2_WDATA7_REG	[31:0]

System parameter			Register	
Name	Width	Bit	Name	Bit
BLOCK3	256/192/128	[31:0]	EFUSE_BLK3_WDATA0_REG	[31:0]
		[63:32]	EFUSE_BLK3_WDATA1_REG	[31:0]
		[95:64]	EFUSE_BLK3_WDATA2_REG	[31:0]
		[127:96]	EFUSE_BLK3_WDATA3_REG	[31:0]
		[159:128]	EFUSE_BLK3_WDATA4_REG	[31:0]
		[191:160]	EFUSE_BLK3_WDATA5_REG	[31:0]
		[223:192]	EFUSE_BLK3_WDATA6_REG	[31:0]
		[255:224]	EFUSE_BLK3_WDATA7_REG	[31:0]

The process of programming system parameters is as follows:

1. Configure EFUSE_CLK_SEL0 bit, EFUSE_CLK_SEL1 bit of register EFUSE_CLK, and EFUSE_DAC_CLK_DIV bit of register EFUSE_DAC_CONF.
2. Set the corresponding register bit of the system parameter bit to be programmed to 1.
3. Write 0x5A5A into register EFUSE_CONF.
4. Write 0x2 into register EFUSE_CMD.
5. Poll register EFUSE_CMD until it is 0x0, or wait for a program-done interrupt.
6. Write 0x5AA5 into register EFUSE_CONF.
7. Write 0x1 into register EFUSE_CMD.
8. Poll register EFUSE_CMD until it is 0x0, or wait for a read-done interrupt.
9. Set the corresponding register bit of the programmed bit to 0.

The configuration values of the EFUSE_CLK_SEL0 bit, EFUSE_CLK_SEL1 bit of register EFUSE_CLK, and the EFUSE_DAC_CLK_DIV bit of register EFUSE_DAC_CONF are based on the current APB_CLK frequency, as is shown in Table 80.

Table 80: Timing Configuration

Configuration Value		APB_CLK Frequency		
		26 MHz	40 MHz	80 MHz
Register				
EFUSE_CLK	EFUSE_CLK_SEL0[7:0]	8'd250	8'd160	8'd80
	EFUSE_CLK_SEL1[7:0]	8'd255	8'd255	8'd128
EFUSE_DAC_CONF	EFUSE_DAC_CLK_DIV[7:0]	8'd52	8'd80	8'd160

The two methods to identify the generation of program/read-done interrupts are as follows:

Method One:

1. Poll bit 1/0 in register EFUSE_INT_RAW until bit 1/0 is 1, which represents the generation of an program/read-done interrupt.
2. Set the bit 1/0 in register EFUSE_INT_CLR to 1 to clear the program/read-done interrupts.

Method Two:

1. Set bit 1/0 in register EFUSE_INT_ENA to 1 to enable eFuse Controller to post a program/read-done interrupt.
2. Configure Interrupt Matrix to enable the CPU to respond to an EFUSE_INT interrupt.
3. A program/read-done interrupt is generated.
4. Read bit 1/0 in register EFUSE_INT_ST to identify the generation of the program/read-done interrupt.
5. Set bit 1/0 in register EFUSE_INT_CLR to 1 to clear the program/read-done interrupt.

The programming of different system parameters and even the programming of different bits of the same system parameter can be completed separately in multiple programmings. It is, however, recommended that users minimize programming cycles, and program all the bits that need to be programmed in a system parameter in one programming action. In addition, after all system parameters controlled by a certain bit of efuse_wr_disable are programmed, that bit should be immediately programmed. The programming of system parameters controlled by a certain bit of efuse_wr_disable, and the programming of that bit can even be completed at the same time. **Repeated programming of programmed bits is strictly forbidden.**

20.3.3 Software Reading of System Parameters

Each bit of the 24 fixed-length system parameters and the three variable-length system parameters corresponds to a software-read register bit, as shown in Table 81. Software can use the value of each system parameter by reading the value in the corresponding register.

The bit width of system parameters BLOCK1, BLOCK2, and BLOCK3 is variable. Although 256 register bits have been assigned to each of the three parameters, as shown in Table 81, some of the 256 register bits are useless in the 3/4 coding and the Repeat coding scheme. In the None coding scheme, the corresponding register bit of each bit of *BLOCKN*[255 : 0] is used. In the 3/4 coding scheme, only the corresponding register bits of *BLOCKN*[191 : 0] are useful. In Repeat coding scheme, only the corresponding bits of *BLOCKN*[127 : 0] are useful. In different coding schemes, the values of useless register bits read by software are invalid. **The values of useful register bits read by software are the system parameters BLOCK1, BLOCK2, and BLOCK3 themselves instead of their values after being encoded.**

Table 81: Software Read Register

System parameter			Register	
Name	Bit Width	Bit	Name	Bit
efuse_wr_disable	16	[15:0]	EFUSE_BLK0_RDATA0_REG	[15:0]
efuse_rd_disable	4	[3:0]		[19:16]
flash_crypt_cnt	8	[7:0]		[27:20]
WIFI_MAC_Address	56	[31:0]	EFUSE_BLK0_RDATA1_REG	[31:0]
		[55:32]	EFUSE_BLK0_RDATA2_REG	[23:0]
SPI_pad_config_hd	5	[4:0]	EFUSE_BLK0_WDATA3_REG	[8:4]
chip_version	4	[3:0]		[12:9]
BLK3_part_reserve	1	[0]		[14]
XPD_SDIO_REG	1	[0]	EFUSE_BLK0_RDATA4_REG	[14]
SDIO_TIEH	1	[0]		[15]
sdio_force	1	[0]		[16]
SPI_pad_config_clk	5	[4:0]	EFUSE_BLK0_RDATA5_REG	[4:0]
SPI_pad_config_q	5	[4:0]		[9:5]

System parameter			Register	
Name	Bit Width	Bit	Name	Bit
SPI_pad_config_d	5	[4:0]		[14:10]
SPI_pad_config_cs0	5	[4:0]		[19:15]
flash_crypt_config	4	[3:0]		[31:28]
coding_scheme	2	[1:0]	EFUSE_BLK0_RDATA6_REG	[1:0]
console_debug_disable	1	[0]		[2]
abstract_done_0	1	[0]		[4]
abstract_done_1	1	[0]		[5]
JTAG_disable	1	[0]		[6]
download_dis_encrypt	1	[0]		[7]
download_dis_decrypt	1	[0]		[8]
download_dis_cache	1	[0]		[9]
key_status	1	[0]		[10]
BLOCK1	256/192/128	[31:0]		EFUSE_BLK1_RDATA0_REG
		[63:32]	EFUSE_BLK1_RDATA1_REG	[31:0]
		[95:64]	EFUSE_BLK1_RDATA2_REG	[31:0]
		[127:96]	EFUSE_BLK1_RDATA3_REG	[31:0]
		[159:128]	EFUSE_BLK1_RDATA4_REG	[31:0]
		[191:160]	EFUSE_BLK1_RDATA5_REG	[31:0]
		[223:192]	EFUSE_BLK1_RDATA6_REG	[31:0]
BLOCK2	256/192/128	[255:224]	EFUSE_BLK1_RDATA7_REG	[31:0]
		[31:0]	EFUSE_BLK2_RDATA0_REG	[31:0]
		[63:32]	EFUSE_BLK2_RDATA1_REG	[31:0]
		[95:64]	EFUSE_BLK2_RDATA2_REG	[31:0]
		[127:96]	EFUSE_BLK2_RDATA3_REG	[31:0]
		[159:128]	EFUSE_BLK2_RDATA4_REG	[31:0]
		[191:160]	EFUSE_BLK2_RDATA5_REG	[31:0]
BLOCK3	256/192/128	[223:192]	EFUSE_BLK2_RDATA6_REG	[31:0]
		[255:224]	EFUSE_BLK2_RDATA7_REG	[31:0]
		[31:0]	EFUSE_BLK3_RDATA0_REG	[31:0]
		[63:32]	EFUSE_BLK3_RDATA1_REG	[31:0]
		[95:64]	EFUSE_BLK3_RDATA2_REG	[31:0]
		[127:96]	EFUSE_BLK3_RDATA3_REG	[31:0]
		[159:128]	EFUSE_BLK3_RDATA4_REG	[31:0]
[191:160]	EFUSE_BLK3_RDATA5_REG	[31:0]		
[223:192]	EFUSE_BLK3_RDATA6_REG	[31:0]		
[255:224]	EFUSE_BLK3_RDATA7_REG	[31:0]		

20.3.4 The Use of System Parameters by Hardware Modules

Hardware modules are directly hardwired to the ESP32 in order to use the system parameters. Software cannot change this behaviour. **Hardware modules use the decoded values of system parameters BLOCK1, BLOCK2, and BLOCK3, not their encoded values.**

20.3.5 Interrupts

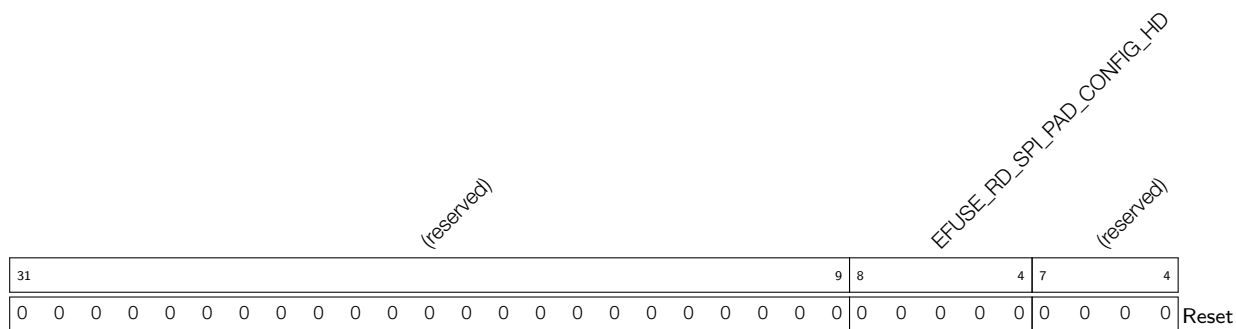
- EFUSE_PGM_DONE_INT: Triggered when eFuse programming has finished.
- EFUSE_READ_DONE_INT: Triggered when eFuse reading has finished.

20.4 Register Summary

Name	Description	Address	Access
eFuse data read registers			
EFUSE_BLK0_RDATA0_REG	Returns data word 0 in eFuse BLOCK 0	0x3FF5A000	RO
EFUSE_BLK0_RDATA1_REG	Returns data word 1 in eFuse BLOCK 0	0x3FF5A004	RO
EFUSE_BLK0_RDATA2_REG	Returns data word 2 in eFuse BLOCK 0	0x3FF5A008	RO
EFUSE_BLK0_RDATA3_REG	Returns data word 3 in eFuse BLOCK 0	0x3FF5A00C	RO
EFUSE_BLK0_RDATA4_REG	Returns data word 4 in eFuse BLOCK 0	0x3FF5A010	RO
EFUSE_BLK0_RDATA5_REG	Returns data word 5 in eFuse BLOCK 0	0x3FF5A014	RO
EFUSE_BLK0_RDATA6_REG	Returns data word 6 in eFuse BLOCK 0	0x3FF5A018	RO
EFUSE_BLK1_RDATA0_REG	Returns data word 0 in eFuse BLOCK 1	0x3FF5A038	RO
EFUSE_BLK1_RDATA1_REG	Returns data word 1 in eFuse BLOCK 1	0x3FF5A03C	RO
EFUSE_BLK1_RDATA2_REG	Returns data word 2 in eFuse BLOCK 1	0x3FF5A040	RO
EFUSE_BLK1_RDATA3_REG	Returns data word 3 in eFuse BLOCK 1	0x3FF5A044	RO
EFUSE_BLK1_RDATA4_REG	Returns data word 4 in eFuse BLOCK 1	0x3FF5A048	RO
EFUSE_BLK1_RDATA5_REG	Returns data word 5 in eFuse BLOCK 1	0x3FF5A04C	RO
EFUSE_BLK1_RDATA6_REG	Returns data word 6 in eFuse BLOCK 1	0x3FF5A050	RO
EFUSE_BLK1_RDATA7_REG	Returns data word 7 in eFuse BLOCK 1	0x3FF5A054	RO
EFUSE_BLK2_RDATA0_REG	Returns data word 0 in eFuse BLOCK 2	0x3FF5A058	RO
EFUSE_BLK2_RDATA1_REG	Returns data word 1 in eFuse BLOCK 2	0x3FF5A05C	RO
EFUSE_BLK2_RDATA2_REG	Returns data word 2 in eFuse BLOCK 2	0x3FF5A060	RO
EFUSE_BLK2_RDATA3_REG	Returns data word 3 in eFuse BLOCK 2	0x3FF5A064	RO
EFUSE_BLK2_RDATA4_REG	Returns data word 4 in eFuse BLOCK 2	0x3FF5A068	RO
EFUSE_BLK2_RDATA5_REG	Returns data word 5 in eFuse BLOCK 2	0x3FF5A06C	RO
EFUSE_BLK2_RDATA6_REG	Returns data word 6 in eFuse BLOCK 2	0x3FF5A070	RO
EFUSE_BLK2_RDATA7_REG	Returns data word 7 in eFuse BLOCK 2	0x3FF5A074	RO
EFUSE_BLK3_RDATA0_REG	Returns data word 0 in eFuse BLOCK 3	0x3FF5A078	RO
EFUSE_BLK3_RDATA1_REG	Returns data word 1 in eFuse BLOCK 3	0x3FF5A07C	RO
EFUSE_BLK3_RDATA2_REG	Returns data word 2 in eFuse BLOCK 3	0x3FF5A080	RO
EFUSE_BLK3_RDATA3_REG	Returns data word 3 in eFuse BLOCK 3	0x3FF5A084	RO
EFUSE_BLK3_RDATA4_REG	Returns data word 4 in eFuse BLOCK 3	0x3FF5A088	RO
EFUSE_BLK3_RDATA5_REG	Returns data word 5 in eFuse BLOCK 3	0x3FF5A08C	RO
EFUSE_BLK3_RDATA6_REG	Returns data word 6 in eFuse BLOCK 3	0x3FF5A090	RO
EFUSE_BLK3_RDATA7_REG	Returns data word 7 in eFuse BLOCK 3	0x3FF5A094	RO
eFuse data write registers			
EFUSE_BLK0_WDATA0_REG	Writes data to word 0 in eFuse BLOCK 0	0x3FF5A01c	R/W
EFUSE_BLK0_WDATA1_REG	Writes data to word 1 in eFuse BLOCK 0	0x3FF5A020	R/W
EFUSE_BLK0_WDATA2_REG	Writes data to word 2 in eFuse BLOCK 0	0x3FF5A024	R/W
EFUSE_BLK0_WDATA3_REG	Writes data to word 3 in eFuse BLOCK 0	0x3FF5A028	R/W

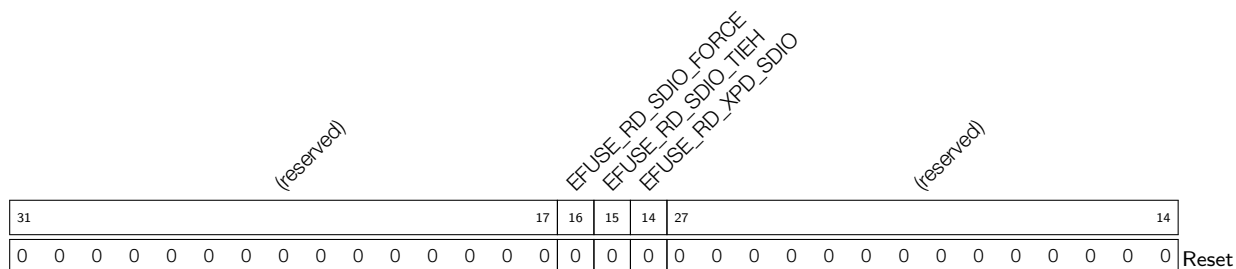
Name	Description	Address	Access
EFUSE_BLK0_WDATA4_REG	Writes data to word 4 in eFuse BLOCK 0	0x3FF5A02c	R/W
EFUSE_BLK0_WDATA5_REG	Writes data to word 5 in eFuse BLOCK 0	0x3FF5A030	R/W
EFUSE_BLK0_WDATA6_REG	Writes data to word 6 in eFuse BLOCK 0	0x3FF5A034	R/W
EFUSE_BLK1_WDATA0_REG	Writes data to word 0 in eFuse BLOCK 1	0x3FF5A098	R/W
EFUSE_BLK1_WDATA1_REG	Writes data to word 1 in eFuse BLOCK 1	0x3FF5A09c	R/W
EFUSE_BLK1_WDATA2_REG	Writes data to word 2 in eFuse BLOCK 1	0x3FF5A0a0	R/W
EFUSE_BLK1_WDATA3_REG	Writes data to word 3 in eFuse BLOCK 1	0x3FF5A0a4	R/W
EFUSE_BLK1_WDATA4_REG	Writes data to word 4 in eFuse BLOCK 1	0x3FF5A0a8	R/W
EFUSE_BLK1_WDATA5_REG	Writes data to word 5 in eFuse BLOCK 1	0x3FF5A0ac	R/W
EFUSE_BLK1_WDATA6_REG	Writes data to word 6 in eFuse BLOCK 1	0x3FF5A0b0	R/W
EFUSE_BLK1_WDATA7_REG	Writes data to word 7 in eFuse BLOCK 1	0x3FF5A0b4	R/W
EFUSE_BLK2_WDATA0_REG	Writes data to word 0 in eFuse BLOCK 2	0x3FF5A0b8	R/W
EFUSE_BLK2_WDATA1_REG	Writes data to word 1 in eFuse BLOCK 2	0x3FF5A0bc	R/W
EFUSE_BLK2_WDATA2_REG	Writes data to word 2 in eFuse BLOCK 2	0x3FF5A0c0	R/W
EFUSE_BLK2_WDATA3_REG	Writes data to word 3 in eFuse BLOCK 2	0x3FF5A0c4	R/W
EFUSE_BLK2_WDATA4_REG	Writes data to word 4 in eFuse BLOCK 2	0x3FF5A0c8	R/W
EFUSE_BLK2_WDATA5_REG	Writes data to word 5 in eFuse BLOCK 2	0x3FF5A0cc	R/W
EFUSE_BLK2_WDATA6_REG	Writes data to word 6 in eFuse BLOCK 2	0x3FF5A0d0	R/W
EFUSE_BLK2_WDATA7_REG	Writes data to word 7 in eFuse BLOCK 2	0x3FF5A0d4	R/W
EFUSE_BLK3_WDATA0_REG	Writes data to word 0 in eFuse BLOCK 3	0x3FF5A0d8	R/W
EFUSE_BLK3_WDATA1_REG	Writes data to word 1 in eFuse BLOCK 3	0x3FF5A0dc	R/W
EFUSE_BLK3_WDATA2_REG	Writes data to word 2 in eFuse BLOCK 3	0x3FF5A0e0	R/W
EFUSE_BLK3_WDATA3_REG	Writes data to word 3 in eFuse BLOCK 3	0x3FF5A0e4	R/W
EFUSE_BLK3_WDATA4_REG	Writes data to word 4 in eFuse BLOCK 3	0x3FF5A0e8	R/W
EFUSE_BLK3_WDATA5_REG	Writes data to word 5 in eFuse BLOCK 3	0x3FF5A0ec	R/W
EFUSE_BLK3_WDATA6_REG	Writes data to word 6 in eFuse BLOCK 3	0x3FF5A0f0	R/W
EFUSE_BLK3_WDATA7_REG	Writes data to word 7 in eFuse BLOCK 3	0x3FF5A0f4	R/W
Control registers			
EFUSE_CLK_REG	Timing configuration register	0x3FF5A0F8	R/W
EFUSE_CONF_REG	Opcode register	0x3FF5A0FC	R/W
EFUSE_CMD_REG	Read/write command register	0x3FF5A104	R/W
Interrupt registers			
EFUSE_INT_RAW_REG	Raw interrupt status	0x3FF5A108	RO
EFUSE_INT_ST_REG	Masked interrupt status	0x3FF5A10C	RO
EFUSE_INT_ENA_REG	Interrupt enable bits	0x3FF5A110	R/W
EFUSE_INT_CLR_REG	Interrupt clear bits	0x3FF5A114	WO
Misc registers			
EFUSE_DAC_CONF_REG	Efuse timing configuration	0x3FF5A118	R/W
EFUSE_DEC_STATUS_REG	Status of 3/4 coding scheme	0x3FF5A11C	RO

Register 20.4: EFUSE_BLK0_RDATA3_REG (0x00c)



EFUSE_RD_SPI_PAD_CONFIG_HD This field returns the value of SPI_pad_config_hd. (RO)

Register 20.5: EFUSE_BLK0_RDATA4_REG (0x010)

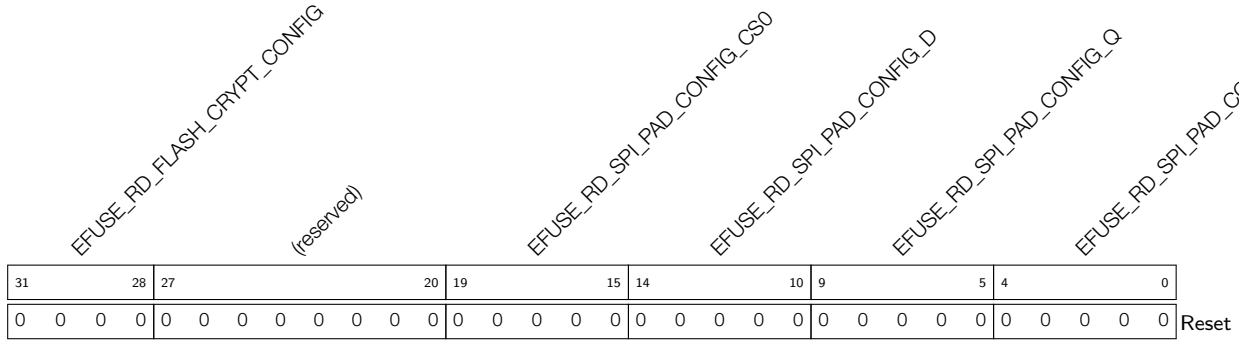


EFUSE_RD_SDIO_FORCE This field returns the value of sdio_force. (RO)

EFUSE_RD_SDIO_TIEH This field returns the value of SDIO_TIEH. (RO)

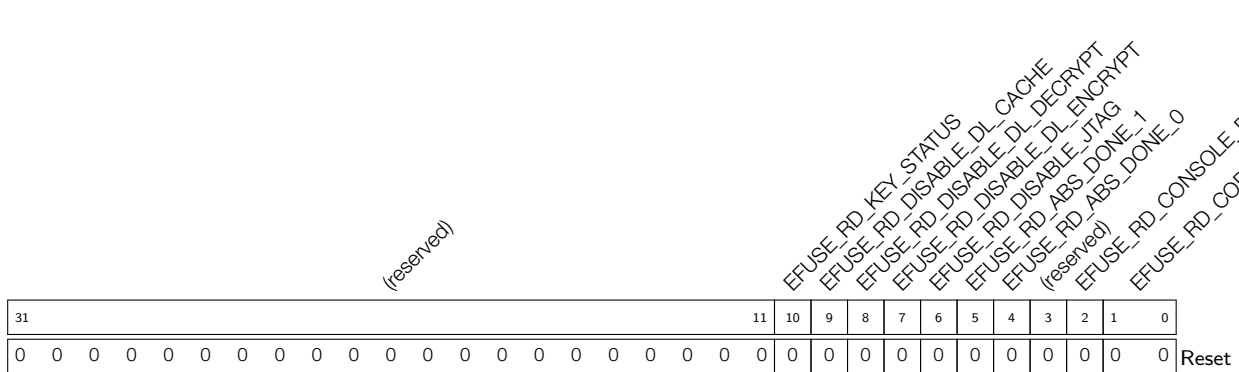
EFUSE_RD_XPD_SDIO This field returns the value of XPD_SDIO_REG. (RO)

Register 20.6: EFUSE_BLK0_RDATA5_REG (0x014)



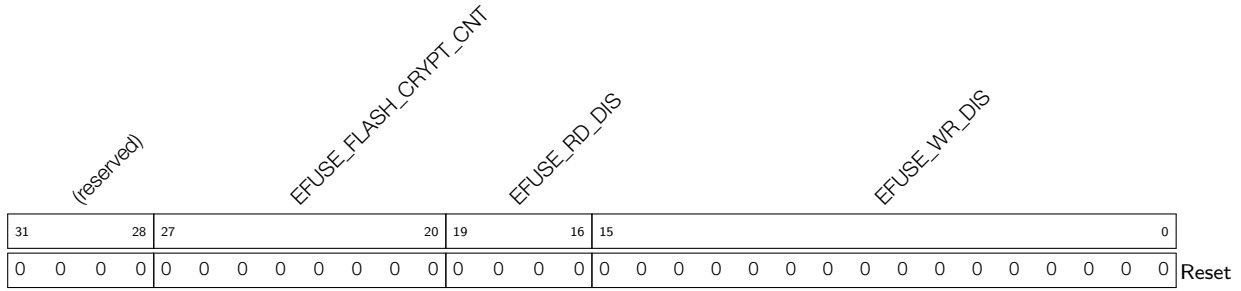
- EFUSE_RD_FLASH_CRYPT_CONFIG** This field returns the value of flash_crypt_config. (RO)
- EFUSE_RD_SPI_PAD_CONFIG_CS0** This field returns the value of SPI_pad_config_cs0. (RO)
- EFUSE_RD_SPI_PAD_CONFIG_D** This field returns the value of SPI_pad_config_d. (RO)
- EFUSE_RD_SPI_PAD_CONFIG_Q** This field returns the value of SPI_pad_config_q. (RO)
- EFUSE_RD_SPI_PAD_CONFIG_CLK** This field returns the value of SPI_pad_config_clk. (RO)

Register 20.7: EFUSE_BLK0_RDATA6_REG (0x018)



- EFUSE_RD_KEY_STATUS** This field returns the value of key_status. (RO)
- EFUSE_RD_DISABLE_DL_CACHE** This field returns the value of download_dis_cache. (RO)
- EFUSE_RD_DISABLE_DL_DECRYPT** This field returns the value of download_dis_decrypt. (RO)
- EFUSE_RD_DISABLE_DL_ENCRYPT** This field returns the value of download_dis_encrypt. (RO)
- EFUSE_RD_DISABLE_JTAG** This field returns the value of JTAG_disable. (RO)
- EFUSE_RD_ABS_DONE_1** This field returns the value of abstract_done_1. (RO)
- EFUSE_RD_ABS_DONE_0** This field returns the value of abstract_done_0. (RO)
- EFUSE_RD_CONSOLE_DEBUG_DISABLE** This field returns the value of console_debug_disable. (RO)
- EFUSE_RD_CODING_SCHEME** This field returns the value of coding_scheme. (RO)

Register 20.8: EFUSE_BLK0_WDATA0_REG (0x01c)

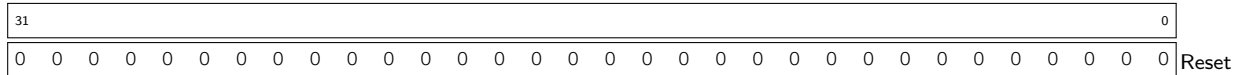


EFUSE_FLASH_CRYPT_CNT This field programs the value of flash_crypt_cnt. (R/W)

EFUSE_RD_DIS This field programs the value of efuse_rd_disable. (R/W)

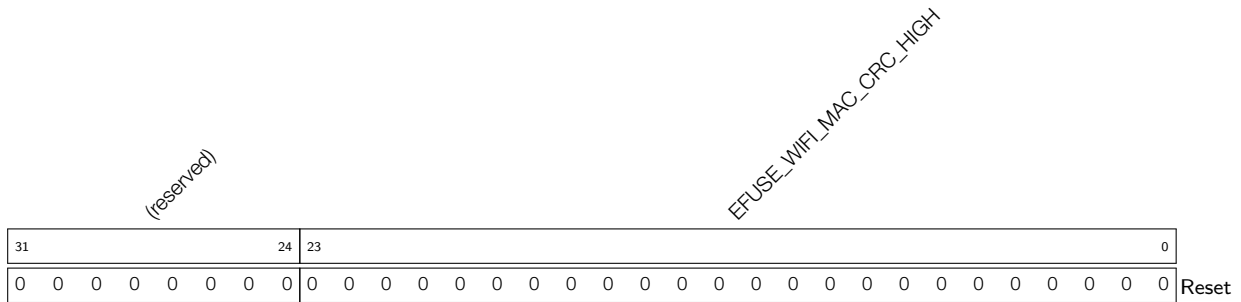
EFUSE_WR_DIS This field programs the value of efuse_wr_disable. (R/W)

Register 20.9: EFUSE_BLK0_WDATA1_REG (0x020)



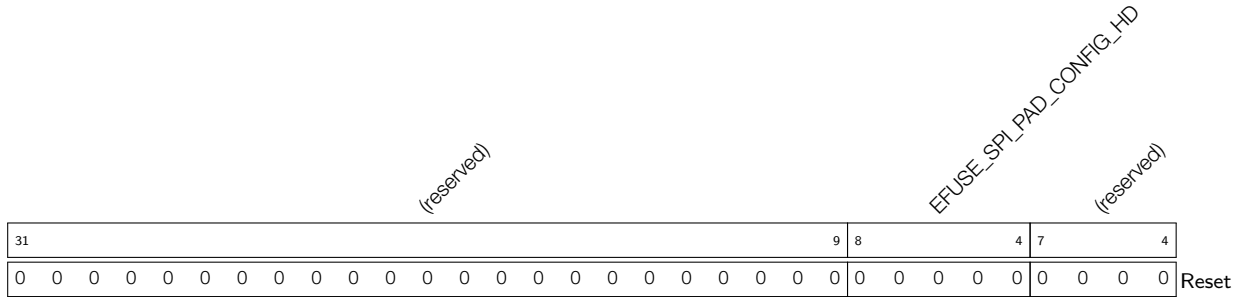
EFUSE_BLK0_WDATA1_REG This field programs the value of lower 32 bits of WIFI_MAC_Address. (R/W)

Register 20.10: EFUSE_BLK0_WDATA2_REG (0x024)



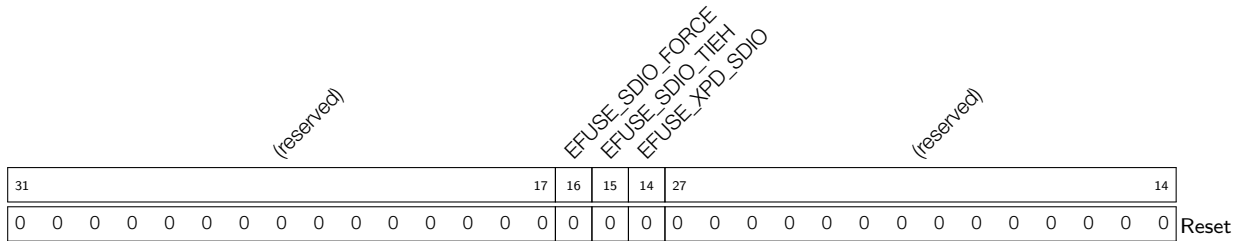
EFUSE_WIFI_MAC_CRC_HIGH This field programs the value of higher 24 bits of WIFI_MAC_Address. (R/W)

Register 20.11: EFUSE_BLK0_WDATA3_REG (0x028)



EFUSE_SPI_PAD_CONFIG_HD This field programs the value of SPI_pad_config_hd. (R/W)

Register 20.12: EFUSE_BLK0_WDATA4_REG (0x02c)

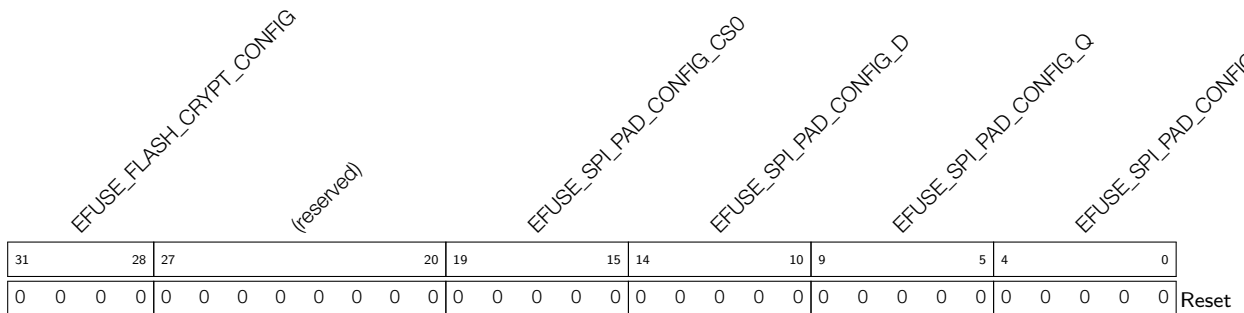


EFUSE_SDIO_FORCE This field programs the value of SDIO_TIEH. (R/W)

EFUSE_SDIO_TIEH This field programs the value of SDIO_TIEH. (R/W)

EFUSE_XPD_SDIO This field programs the value of XPD_SDIO_REG. (R/W)

Register 20.13: EFUSE_BLK0_WDATA5_REG (0x030)



EFUSE_FLASH_CRYPT_CONFIG This field programs the value of flash_crypt_config. (R/W)

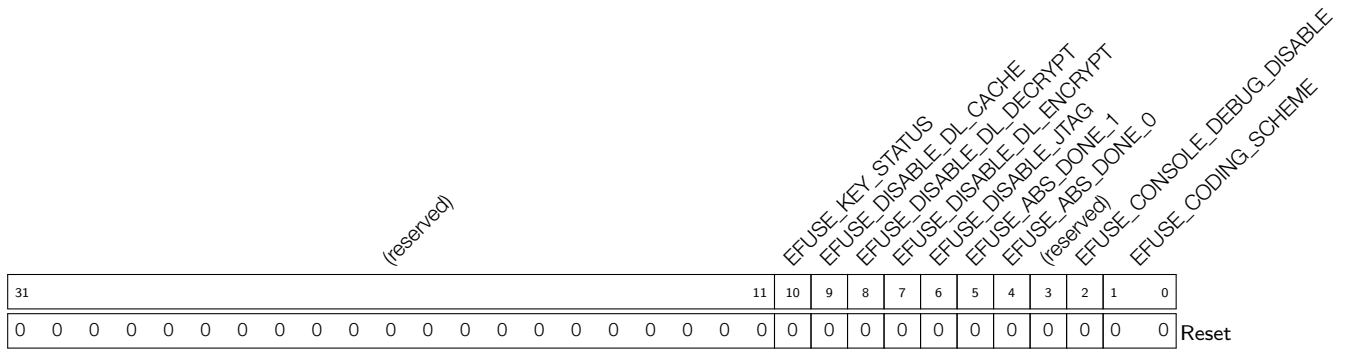
EFUSE_SPI_PAD_CONFIG_CS0 This field programs the value of SPI_pad_config_cs0. (R/W)

EFUSE_SPI_PAD_CONFIG_D This field programs the value of SPI_pad_config_d. (R/W)

EFUSE_SPI_PAD_CONFIG_Q This field programs the value of SPI_pad_config_q. (R/W)

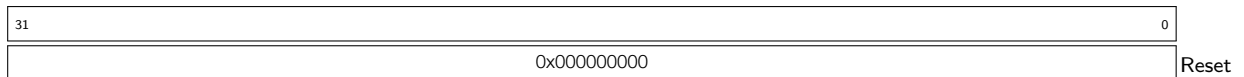
EFUSE_SPI_PAD_CONFIG_CLK This field programs the value of SPI_pad_config_clk. (R/W)

Register 20.14: EFUSE_BLK0_WDATA6_REG (0x034)



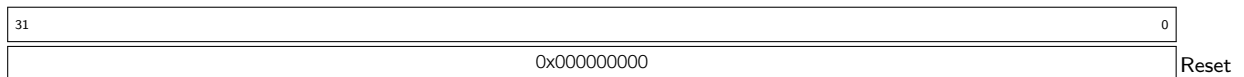
- EFUSE_KEY_STATUS** This field programs the value of key_status. (R/W)
- EFUSE_DISABLE_DL_CACHE** This field programs the value of download_dis_cache. (R/W)
- EFUSE_DISABLE_DL_DECRYPT** This field programs the value of download_dis_decrypt. (R/W)
- EFUSE_DISABLE_DL_ENCRYPT** This field programs the value of download_dis_encrypt. (R/W)
- EFUSE_DISABLE_JTAG** This field programs the value of JTAG_disable. (R/W)
- EFUSE_ABS_DONE_1** This field programs the value of abstract_done_1. (R/W)
- EFUSE_ABS_DONE_0** This field programs the value of abstract_done_0. (R/W)
- EFUSE_CONSOLE_DEBUG_DISABLE** This field programs the value of console_debug_disable. (R/W)
- EFUSE_CODING_SCHEME** This field programs the value of coding_scheme. (R/W)

Register 20.15: EFUSE_BLK1_RDATA_n_REG (n: 0-7) (0x38+4*n)



EFUSE_BLK1_RDATA_n_REG This field returns the value of word *n* in BLOCK1. (RO)

Register 20.16: EFUSE_BLK2_RDATA_n_REG (n: 0-7) (0x58+4*n)



EFUSE_BLK2_RDATA_n_REG This field returns the value of word *n* in BLOCK2. (RO)

Register 20.17: EFUSE_BLK3_RDATA_{*n*}_REG (*n*: 0-7) (0x78+4n*)**

31	0
0x00000000	

Reset

EFUSE_BLK3_RDATA_{*n*}_REG This field returns the value of word *n* in BLOCK3. (RO)

Register 20.18: EFUSE_BLK1_WDATA_{*n*}_REG (*n*: 0-7) (0x98+4n*)**

31	0
0x00000000	

Reset

EFUSE_BLK1_WDATA_{*n*}_REG This field programs the value of word *n* in of BLOCK1. (R/W)

Register 20.19: EFUSE_BLK2_WDATA_{*n*}_REG (*n*: 0-7) (0xB8+4n*)**

31	0
0x00000000	

Reset

EFUSE_BLK2_WDATA_{*n*}_REG This field programs the value of word *n* in of BLOCK2. (R/W)

Register 20.20: EFUSE_BLK3_WDATA_{*n*}_REG (*n*: 0-7) (0xD8+4n*)**

31	0
0x00000000	

Reset

EFUSE_BLK3_WDATA_{*n*}_REG This field programs the value of word *n* in of BLOCK3. (R/W)

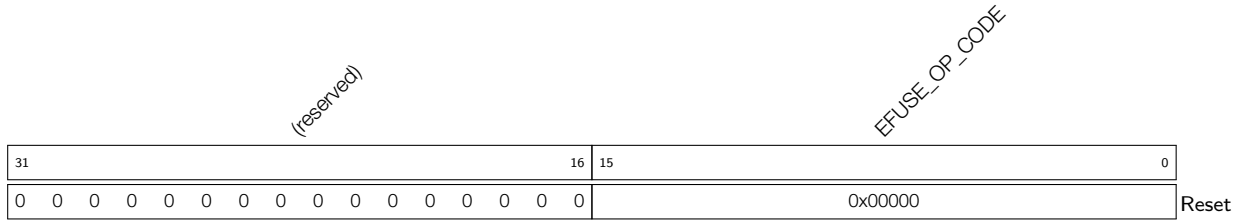
Register 20.21: EFUSE_CLK_REG (0x0f8)

31	(reserved)	EFUSE_CLK_SEL1	EFUSE_CLK_SEL0	0
16	15	8	7	0
0 0 0 0 0 0 0 0 0 0 0 0 0 0 0 0		0x040	0x052	Reset

EFUSE_CLK_SEL1 eFuse clock configuration field. (R/W)

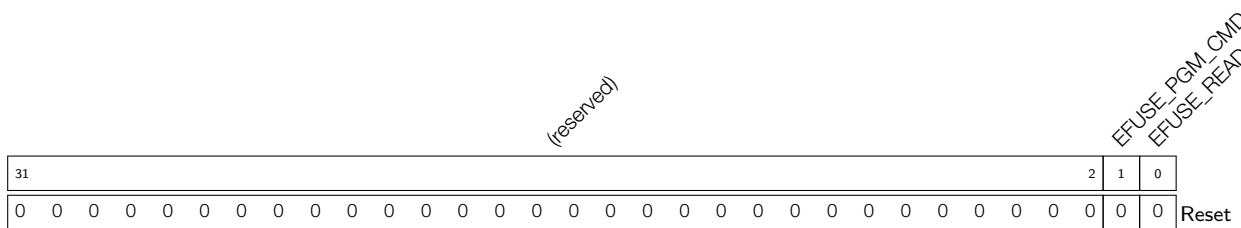
EFUSE_CLK_SEL0 eFuse clock configuration field. (R/W)

Register 20.22: EFUSE_CONF_REG (0x0fc)



EFUSE_OP_CODE eFuse operation code register. (R/W)

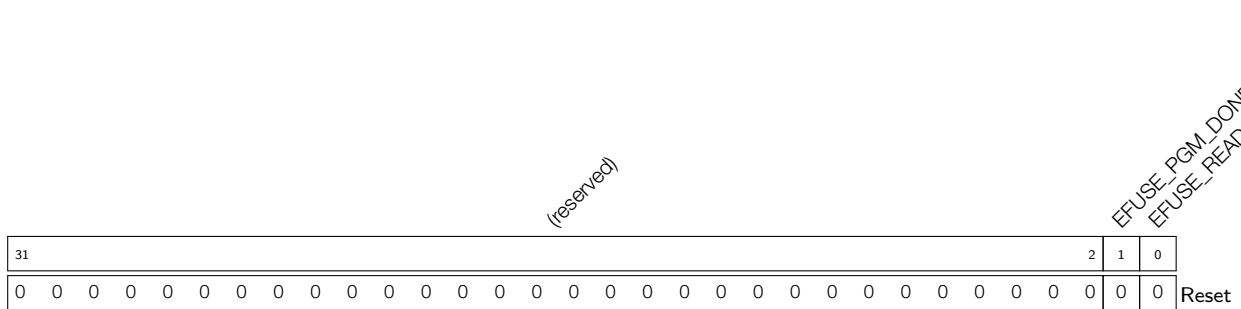
Register 20.23: EFUSE_CMD_REG (0x104)



EFUSE_PGM_CMD Set this to 1 to start a program operation. Reverts to 0 when the program operation is done. (R/W)

EFUSE_READ_CMD Set this to 1 to start a read operation. Reverts to 0 when the read operation is done. (R/W)

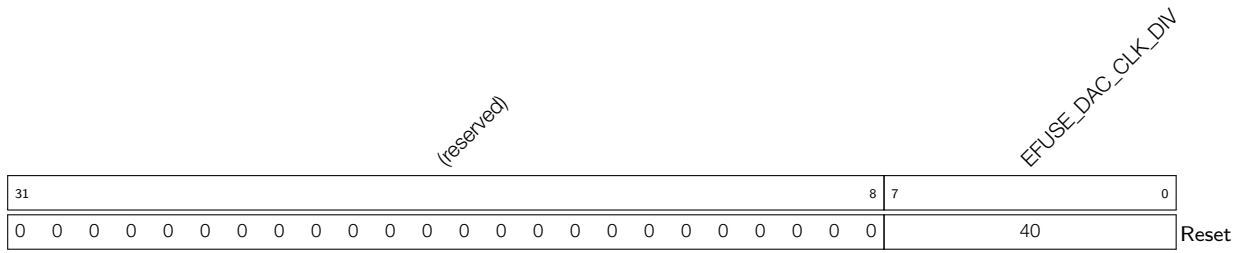
Register 20.24: EFUSE_INT_RAW_REG (0x108)



EFUSE_PGM_DONE_INT_RAW The raw interrupt status bit for the [EFUSE_PGM_DONE_INT](#) interrupt. (RO)

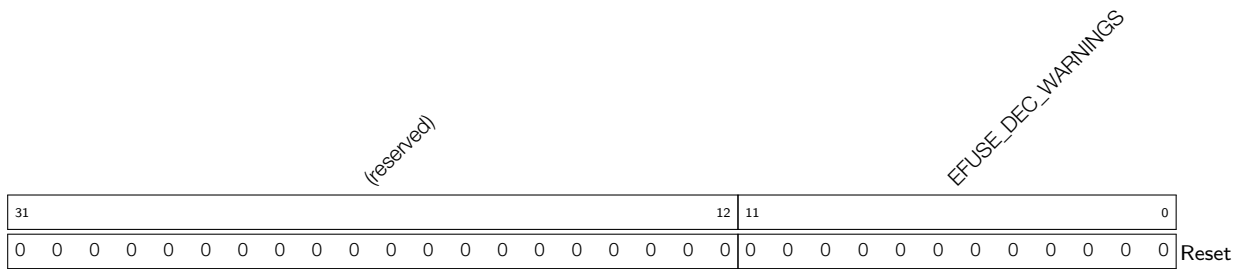
EFUSE_READ_DONE_INT_RAW The raw interrupt status bit for the [EFUSE_READ_DONE_INT](#) interrupt. (RO)

Register 20.28: EFUSE_DAC_CONF_REG (0x118)



EFUSE_DAC_CLK_DIV eFuse timing configuration register. (R/W)

Register 20.29: EFUSE_DEC_STATUS_REG (0x11c)



EFUSE_DEC_WARNINGS If a bit is set in this register, it means some errors were corrected while decoding the 3/4 encoding scheme. (RO)

21. AES Accelerator

21.1 Introduction

The AES Accelerator speeds up AES operations significantly, compared to AES algorithms implemented solely in software. The AES Accelerator supports six algorithms of FIPS PUB 197, specifically AES-128, AES-192 and AES-256 encryption and decryption.

21.2 Features

- Supports AES-128 encryption and decryption
- Supports AES-192 encryption and decryption
- Supports AES-256 encryption and decryption
- Supports four variations of key endianness and four variations of text endianness

21.3 Functional Description

21.3.1 AES Algorithm Operations

The AES Accelerator supports six algorithms of FIPS PUB 197, specifically AES-128, AES-192 and AES-256 encryption and decryption. The AES_MODE_REG register can be configured to different values to enable different algorithm operations, as shown in Table 83.

Table 83: Operation Mode

AES_MODE_REG[2:0]	Operation
0	AES-128 Encryption
1	AES-192 Encryption
2	AES-256 Encryption
4	AES-128 Decryption
5	AES-192 Decryption
6	AES-256 Decryption

21.3.2 Key, Plaintext and Ciphertext

The encryption or decryption key is stored in AES_KEY_*n*_REG, which is a set of eight 32-bit registers. For AES-128 encryption/decryption, the 128-bit key is stored in AES_KEY_0_REG ~ AES_KEY_3_REG. For AES-192 encryption/decryption, the 192-bit key is stored in AES_KEY_0_REG ~ AES_KEY_5_REG. For AES-256 encryption/decryption, the 256-bit key is stored in AES_KEY_0_REG ~ AES_KEY_7_REG.

Plaintext and ciphertext is stored in the AES_TEXT_*m*_REG registers. There are four 32-bit registers. To enable AES-128/192/256 encryption, initialize the AES_TEXT_*m*_REG registers with plaintext before encryption. When encryption is finished, the AES Accelerator will store back the resulting ciphertext in the AES_TEXT_*m*_REG registers. To enable AES-128/192/256 decryption, initialize the AES_TEXT_*m*_REG registers with ciphertext before decryption. When decryption is finished, the AES Accelerator will store back the resulting plaintext in the AES_TEXT_*m*_REG registers.

21.3.3 Endianness

Key Endianness

Bit 0 and bit 1 in AES_ENDIAN_REG define the key endianness. For detailed information, please see Table 85, Table 86 and Table 87. $w[0] \sim w[3]$ in Table 85, $w[0] \sim w[5]$ in Table 86 and $w[0] \sim w[7]$ in Table 87 are “the first N_k words of the expanded key” as specified in “5.2: Key Expansion” of FIPS PUB 197. “Column Bit” specifies the bytes in the word from $w[0]$ to $w[7]$. The bytes of AES_KEY_ n _REG comprise “the first N_k words of the expanded key”.

Text Endianness

Bit 2 and bit 3 in AES_ENDIAN_REG define the endianness of input text, while Bit 4 and Bit 5 define the endianness of output text. The input text refers to the plaintext in AES-128/192/256 encryption and the ciphertext in decryption. The output text refers to the ciphertext in AES-128/192/256 encryption and the plaintext in decryption. For details, please see Table 84. “State” in Table 84 is defined as that in “3.4: The State” of FIPS PUB 197: “The AES algorithm operations are performed on a two-dimensional array of bytes called the State”. The ciphertext or plaintexts stored in each byte of AES_TEXT_ m _REG comprise the State.

Table 84: AES Text Endianness

AES_ENDIAN_REG[3]/[5]	AES_ENDIAN_REG[2]/[4]	Plaintext/Ciphertext					
0	0	State		c			
		r	0	AES_TEXT_3_REG[31:24]	AES_TEXT_2_REG[31:24]	AES_TEXT_1_REG[31:24]	AES_TEXT_0_REG[31:24]
			1	AES_TEXT_3_REG[23:16]	AES_TEXT_2_REG[23:16]	AES_TEXT_1_REG[23:16]	AES_TEXT_0_REG[23:16]
			2	AES_TEXT_3_REG[15:8]	AES_TEXT_2_REG[15:8]	AES_TEXT_1_REG[15:8]	AES_TEXT_0_REG[15:8]
3	AES_TEXT_3_REG[7:0]		AES_TEXT_2_REG[7:0]	AES_TEXT_1_REG[7:0]	AES_TEXT_0_REG[7:0]		
0	1	State		c			
		r	0	AES_TEXT_3_REG[7:0]	AES_TEXT_2_REG[7:0]	AES_TEXT_1_REG[7:0]	AES_TEXT_0_REG[7:0]
			1	AES_TEXT_3_REG[15:8]	AES_TEXT_2_REG[15:8]	AES_TEXT_1_REG[15:8]	AES_TEXT_0_REG[15:8]
			2	AES_TEXT_3_REG[23:16]	AES_TEXT_2_REG[23:16]	AES_TEXT_1_REG[23:16]	AES_TEXT_0_REG[23:16]
3	AES_TEXT_3_REG[31:24]		AES_TEXT_2_REG[31:24]	AES_TEXT_1_REG[31:24]	AES_TEXT_0_REG[31:24]		
1	0	State		c			
		r	0	AES_TEXT_0_REG[31:24]	AES_TEXT_1_REG[31:24]	AES_TEXT_2_REG[31:24]	AES_TEXT_3_REG[31:24]
			1	AES_TEXT_0_REG[23:16]	AES_TEXT_1_REG[23:16]	AES_TEXT_2_REG[23:16]	AES_TEXT_3_REG[23:16]
			2	AES_TEXT_0_REG[15:8]	AES_TEXT_1_REG[15:8]	AES_TEXT_2_REG[15:8]	AES_TEXT_3_REG[15:8]
3	AES_TEXT_0_REG[7:0]		AES_TEXT_1_REG[7:0]	AES_TEXT_2_REG[7:0]	AES_TEXT_3_REG[7:0]		
1	1	State		c			
		r	0	AES_TEXT_0_REG[7:0]	AES_TEXT_1_REG[7:0]	AES_TEXT_2_REG[7:0]	AES_TEXT_3_REG[7:0]
			1	AES_TEXT_0_REG[15:8]	AES_TEXT_1_REG[15:8]	AES_TEXT_2_REG[15:8]	AES_TEXT_3_REG[15:8]
			2	AES_TEXT_0_REG[23:16]	AES_TEXT_1_REG[23:16]	AES_TEXT_2_REG[23:16]	AES_TEXT_3_REG[23:16]
3	AES_TEXT_0_REG[31:24]		AES_TEXT_1_REG[31:24]	AES_TEXT_2_REG[31:24]	AES_TEXT_3_REG[31:24]		

21.3.4 Encryption and Decryption Operations

Single Operation

1. Initialize AES_MODE_REG, AES_KEY_n_REG, AES_TEXT_m_REG and AES_ENDIAN_REG.
2. Write 1 to AES_START_REG.
3. Wait until AES_IDLE_REG reads 1.
4. Read results from AES_TEXT_m_REG.

Consecutive Operations

Every time an operation is completed, only AES_TEXT_m_REG is modified by the AES Accelerator. Initialization can, therefore, be simplified in a series of consecutive operations.

1. Update contents of AES_MODE_REG, AES_KEY_n_REG and AES_ENDIAN_REG, if required.
2. Load AES_TEXT_m_REG.
3. Write 1 to AES_START_REG.
4. Wait until AES_IDLE_REG reads 1.
5. Read results from AES_TEXT_m_REG.

21.3.5 Speed

The AES Accelerator requires 11 to 15 clock cycles to encrypt a message block, and 21 or 22 clock cycles to decrypt a message block.

21.4 Register Summary

Name	Description	Address	Access
Configuration registers			
AES_MODE_REG	Mode of operation of the AES Accelerator	0x3FF01008	R/W
AES_ENDIAN_REG	Endianness configuration register	0x3FF01040	R/W
Key registers			
AES_KEY_0_REG	AES key material register 0	0x3FF01010	R/W
AES_KEY_1_REG	AES key material register 1	0x3FF01014	R/W
AES_KEY_2_REG	AES key material register 2	0x3FF01018	R/W
AES_KEY_3_REG	AES key material register 3	0x3FF0101C	R/W
AES_KEY_4_REG	AES key material register 4	0x3FF01020	R/W
AES_KEY_5_REG	AES key material register 5	0x3FF01024	R/W
AES_KEY_6_REG	AES key material register 6	0x3FF01028	R/W
AES_KEY_7_REG	AES key material register 7	0x3FF0102C	R/W
Encrypted/decrypted data registers			
AES_TEXT_0_REG	AES encrypted/decrypted data register 0	0x3FF01030	R/W
AES_TEXT_1_REG	AES encrypted/decrypted data register 1	0x3FF01034	R/W
AES_TEXT_2_REG	AES encrypted/decrypted data register 2	0x3FF01038	R/W
AES_TEXT_3_REG	AES encrypted/decrypted data register 3	0x3FF0103C	R/W
Control/status registers			

Name	Description	Address	Access
AES_START_REG	AES operation start control register	0x3FF01000	WO
AES_IDLE_REG	AES idle status register	0x3FF01004	RO

21.5 Registers

Register 21.1: AES_START_REG (0x000)

31	(reserved)	1	0	AES_START
0x00000000				x
				Reset

AES_START Write 1 to start the AES operation. (WO)

Register 21.2: AES_IDLE_REG (0x004)

31	(reserved)	1	0	AES_IDLE
0x00000000				1
				Reset

AES_IDLE AES Idle register. Reads 'zero' while the AES Accelerator is busy processing; reads 'one' otherwise. (RO)

Register 21.3: AES_MODE_REG (0x008)

31	(reserved)	3	2	0	AES_MODE
0x00000000				0	Reset

AES_MODE Selects the AES accelerator mode of operation. See Table 83 for details. (R/W)

Register 21.4: AES_KEY_n_REG (n: 0-7) (0x10+4*n)

31	0
0x00000000	
Reset	

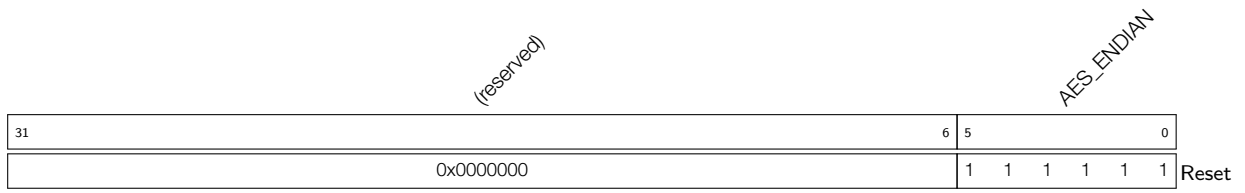
AES_KEY_n_REG (n: 0-7) AES key material register. (R/W)

Register 21.5: AES_TEXT_m_REG (m: 0-3) (0x30+4*m)

31	0
0x00000000	
Reset	

AES_TEXT_m_REG (m: 0-3) Plaintext and ciphertext register. (R/W)

Register 21.6: AES_ENDIAN_REG (0x040)



AES_ENDIAN Endianness selection register. See Table 84 for details. (R/W)

22. SHA Accelerator

22.1 Introduction

The SHA Accelerator is included to speed up SHA hashing operations significantly, compared to SHA hashing algorithms implemented solely in software. The SHA Accelerator supports four algorithms of FIPS PUB 180-4, specifically SHA-1, SHA-256, SHA-384 and SHA-512.

22.2 Features

Hardware support for popular secure hashing algorithms:

- SHA-1
- SHA-256
- SHA-384
- SHA-512

22.3 Functional Description

22.3.1 Padding and Parsing the Message

The SHA Accelerator can only accept one message block at a time. Software divides the message into blocks according to “5.2 Parsing the Message” in FIPS PUB 180-4 and writes one block to the SHA_TEXT_0_REG ~ SHA_TEXT_15_REG registers each time. For SHA-1 and SHA-256, software writes a 512-bit message block to SHA_TEXT_0_REG ~ SHA_TEXT_15_REG each time. For SHA-384 and SHA-512, software writes a 1024-bit message block to SHA_TEXT_0_REG ~ SHA_TEXT_31_REG each time.

The SHA Accelerator is unable to perform the padding operation of “5.1 Padding the Message” in FIPS PUB 180-4; Note that the user software is expected to pad the message before feeding it into the accelerator.

As described in “2.2.1: Parameters” in FIPS PUB 180-4, “ $M_0^{(i)}$ is the leftmost word of message block i ”. $M_0^{(i)}$ is stored in SHA_TEXT_0_REG. In the same fashion, the SHA_TEXT_1_REG register stores the second left-most word of a message block $H_1^{(N)}$, etc.

22.3.2 Message Digest

When the hashing operation is finished, the message digest will be refreshed by SHA Accelerator and will be stored in SHA_TEXT_0_REG ~ SHA_TEXT_15_REG. SHA-1 produces a 160-bit message digest and stores it in SHA_TEXT_0_REG ~ SHA_TEXT_4_REG. SHA-256 produces a 256-bit message digest and stores it in SHA_TEXT_0_REG ~ SHA_TEXT_7_REG. SHA-384 produces a 384-bit message digest and stores it in SHA_TEXT_0_REG ~ SHA_TEXT_11_REG. SHA-512 produces a 512-bit message digest and stores it in SHA_TEXT_0_REG ~ SHA_TEXT_15_REG.

As described in “2.2.1 Parameters” in FIPS PUB 180-4, “ $H^{(N)}$ is the final hash value, and is used to determine the message digest”, while “ $H_0^{(i)}$ is the leftmost word of hash value i ”, so the leftmost word $H_0^{(N)}$ in the message digest is stored in SHA_TEXT_0_REG. In the same fashion, the second leftmost word $H_1^{(N)}$ in the message digest is stored in SHA_TEXT_1_REG, etc.

22.3.3 Hash Operation

There is a set of control registers for SHA-1, SHA-256, SHA-384 and SHA-512, respectively; different hashing algorithms use different control registers.

SHA-1 uses SHA_SHA1_START_REG, SHA_SHA1_CONTINUE_REG, SHA_SHA1_LOAD_REG and SHA_SHA1_BUSY_REG.

SHA-256 uses SHA_SHA256_START_REG, SHA_SHA256_CONTINUE_REG, SHA_SHA256_LOAD_REG and SHA_SHA256_BUSY_REG. SHA-384 uses SHA_SHA384_START_REG, SHA_SHA384_CONTINUE_REG, SHA_SHA384_LOAD_REG and SHA_SHA384_BUSY_REG.

SHA-512 uses SHA_SHA512_START_REG, SHA_SHA512_CONTINUE_REG, SHA_SHA512_LOAD_REG and SHA_SHA512_BUSY_REG. The following steps describe the operation in a detailed manner.

1. Feed the accelerator with the first message block:
 - (a) Use the first message block to initialize SHA_TEXT_*n*_REG.
 - (b) Write 1 to SHA_X_START_REG.
 - (c) Wait for SHA_X_BUSY_REG to read 0, indicating that the operation is completed.
2. Similarly, feed the accelerator with subsequent message blocks:
 - (a) Initialize SHA_TEXT_*n*_REG using the subsequent message block.
 - (b) Write 1 to SHA_X_CONTINUE_REG.
 - (c) Wait for SHA_X_BUSY_REG to read 0, indicating that the operation is completed.
3. Get message digest:
 - (a) Write 1 to SHA_X_LOAD_REG.
 - (b) Wait for SHA_X_BUSY_REG to read 0, indicating that operation is completed.
 - (c) Read message digest from SHA_TEXT_*n*_REG.

22.3.4 Speed

The SHA Accelerator requires 60 to 100 clock cycles to process a message block and 8 to 20 clock cycles to calculate the final digest.

22.4 Register Summary

Name	Description	Address	Access
Encrypted/decrypted data registers			
SHA_TEXT_0_REG	SHA encrypted/decrypted data register 0	0x3FF03000	R/W
SHA_TEXT_1_REG	SHA encrypted/decrypted data register 1	0x3FF03004	R/W
SHA_TEXT_2_REG	SHA encrypted/decrypted data register 2	0x3FF03008	R/W
SHA_TEXT_3_REG	SHA encrypted/decrypted data register 3	0x3FF0300C	R/W
SHA_TEXT_4_REG	SHA encrypted/decrypted data register 4	0x3FF03010	R/W
SHA_TEXT_5_REG	SHA encrypted/decrypted data register 5	0x3FF03014	R/W
SHA_TEXT_6_REG	SHA encrypted/decrypted data register 6	0x3FF03018	R/W
SHA_TEXT_7_REG	SHA encrypted/decrypted data register 7	0x3FF0301C	R/W

Name	Description	Address	Access
SHA_TEXT_8_REG	SHA encrypted/decrypted data register 8	0x3FF03020	R/W
SHA_TEXT_9_REG	SHA encrypted/decrypted data register 9	0x3FF03024	R/W
SHA_TEXT_10_REG	SHA encrypted/decrypted data register 10	0x3FF03028	R/W
SHA_TEXT_11_REG	SHA encrypted/decrypted data register 11	0x3FF0302C	R/W
SHA_TEXT_12_REG	SHA encrypted/decrypted data register 12	0x3FF03030	R/W
SHA_TEXT_13_REG	SHA encrypted/decrypted data register 13	0x3FF03034	R/W
SHA_TEXT_14_REG	SHA encrypted/decrypted data register 14	0x3FF03038	R/W
SHA_TEXT_15_REG	SHA encrypted/decrypted data register 15	0x3FF0303C	R/W
SHA_TEXT_16_REG	SHA encrypted/decrypted data register 16	0x3FF03040	R/W
SHA_TEXT_17_REG	SHA encrypted/decrypted data register 17	0x3FF03044	R/W
SHA_TEXT_18_REG	SHA encrypted/decrypted data register 18	0x3FF03048	R/W
SHA_TEXT_19_REG	SHA encrypted/decrypted data register 19	0x3FF0304C	R/W
SHA_TEXT_20_REG	SHA encrypted/decrypted data register 20	0x3FF03050	R/W
SHA_TEXT_21_REG	SHA encrypted/decrypted data register 21	0x3FF03054	R/W
SHA_TEXT_22_REG	SHA encrypted/decrypted data register 22	0x3FF03058	R/W
SHA_TEXT_23_REG	SHA encrypted/decrypted data register 23	0x3FF0305C	R/W
SHA_TEXT_24_REG	SHA encrypted/decrypted data register 24	0x3FF03060	R/W
SHA_TEXT_25_REG	SHA encrypted/decrypted data register 25	0x3FF03064	R/W
SHA_TEXT_26_REG	SHA encrypted/decrypted data register 26	0x3FF03068	R/W
SHA_TEXT_27_REG	SHA encrypted/decrypted data register 27	0x3FF0306C	R/W
SHA_TEXT_28_REG	SHA encrypted/decrypted data register 28	0x3FF03070	R/W
SHA_TEXT_29_REG	SHA encrypted/decrypted data register 29	0x3FF03074	R/W
SHA_TEXT_30_REG	SHA encrypted/decrypted data register 30	0x3FF03078	R/W
SHA_TEXT_31_REG	SHA encrypted/decrypted data register 31	0x3FF0307C	R/W
Control/status registers			
SHA_SHA1_START_REG	Control register to initiate SHA1 operation	0x3FF03080	WO
SHA_SHA1_CONTINUE_REG	Control register to continue SHA1 operation	0x3FF03084	WO
SHA_SHA1_LOAD_REG	Control register to calculate the final SHA1 hash	0x3FF03088	WO
SHA_SHA1_BUSY_REG	Status register for SHA1 operation	0x3FF0308C	RO
SHA_SHA256_START_REG	Control register to initiate SHA256 operation	0x3FF03090	WO
SHA_SHA256_CONTINUE_REG	Control register to continue SHA256 operation	0x3FF03094	WO
SHA_SHA256_LOAD_REG	Control register to calculate the final SHA256 hash	0x3FF03098	WO
SHA_SHA256_BUSY_REG	Status register for SHA256 operation	0x3FF0309C	RO
SHA_SHA384_START_REG	Control register to initiate SHA384 operation	0x3FF030A0	WO
SHA_SHA384_CONTINUE_REG	Control register to continue SHA384 operation	0x3FF030A4	WO
SHA_SHA384_LOAD_REG	Control register to calculate the final SHA384 hash	0x3FF030A8	WO
SHA_SHA384_BUSY_REG	Status register for SHA384 operation	0x3FF030AC	RO
SHA_SHA512_START_REG	Control register to initiate SHA512 operation	0x3FF030B0	WO
SHA_SHA512_CONTINUE_REG	Control register to continue SHA512 operation	0x3FF030B4	WO
SHA_SHA512_LOAD_REG	Control register to calculate the final SHA512 hash	0x3FF030B8	WO
SHA_SHA512_BUSY_REG	Status register for SHA512 operation	0x3FF030BC	RO

22.5 Registers

Register 22.1: SHA_TEXT_*n*_REG (*n*: 0-31) (0x0+4n*)**

31			0
(reserved)			Reset
0x00000000			

SHA_TEXT_*n*_REG (*n*: 0-31) SHA Message block and hash result register. (R/W)

Register 22.2: SHA_SHA1_START_REG (0x080)

31			1	0
(reserved)			SHA_SHA1_START	
0x00000000			0	Reset

SHA_SHA1_START Write 1 to start an SHA-1 operation on the first message block. (WO)

Register 22.3: SHA_SHA1_CONTINUE_REG (0x084)

31			1	0
(reserved)			SHA_SHA1_CONTINUE	
0x00000000			0	Reset

SHA_SHA1_CONTINUE Write 1 to continue the SHA-1 operation with subsequent blocks. (WO)

Register 22.4: SHA_SHA1_LOAD_REG (0x088)

31			1	0
(reserved)			SHA_SHA1_LOAD	
0x00000000			0	Reset

SHA_SHA1_LOAD Write 1 to finish the SHA-1 operation to calculate the final message hash. (WO)

Register 22.5: SHA_SHA1_BUSY_REG (0x08C)

(reserved)		SHA_SHA1_BUSY	
31	1	0	
0x00000000		0	Reset

SHA_SHA1_BUSY SHA-1 operation status: 1 if the SHA accelerator is processing data, 0 if it is idle.
(RO)

Register 22.6: SHA_SHA256_START_REG (0x090)

(reserved)		SHA_SHA256_START	
31	1	0	
0x00000000		0	Reset

SHA_SHA256_START Write 1 to start an SHA-256 operation on the first message block. (WO)

Register 22.7: SHA_SHA256_CONTINUE_REG (0x094)

(reserved)		SHA_SHA256_CONTINUE	
31	1	0	
0x00000000		0	Reset

SHA_SHA256_CONTINUE Write 1 to continue the SHA-256 operation with subsequent blocks. (WO)

Register 22.8: SHA_SHA256_LOAD_REG (0x098)

(reserved)		SHA_SHA256_LOAD	
31	1	0	
0x00000000		0	Reset

SHA_SHA256_LOAD Write 1 to finish the SHA-256 operation to calculate the final message hash.
(WO)

Register 22.9: SHA_SHA256_BUSY_REG (0x09C)

31	(reserved)	1	0	
		0	0	Reset
		0x00000000		

SHA_SHA256_BUSY SHA-256 operation status: 1 if the SHA accelerator is processing data, 0 if it is idle. (RO)

Register 22.10: SHA_SHA384_START_REG (0x0A0)

31	(reserved)	1	0	
		0	0	Reset
		0x00000000		

SHA_SHA384_START Write 1 to start an SHA-384 operation on the first message block. (WO)

Register 22.11: SHA_SHA384_CONTINUE_REG (0x0A4)

31	(reserved)	1	0	
		0	0	Reset
		0x00000000		

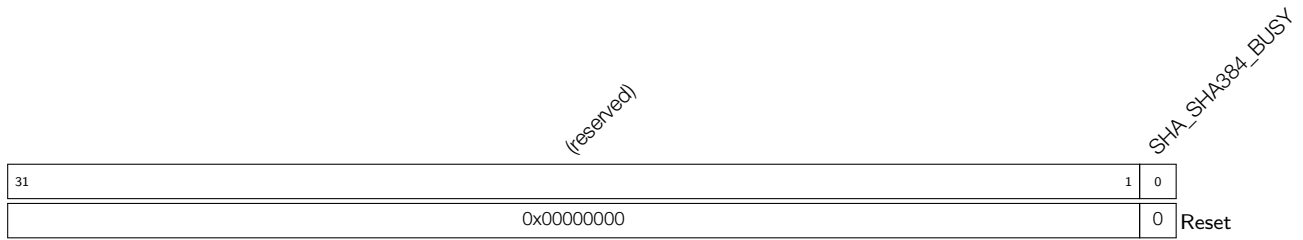
SHA_SHA384_CONTINUE Write 1 to continue the SHA-384 operation with subsequent blocks. (WO)

Register 22.12: SHA_SHA384_LOAD_REG (0x0A8)

31	(reserved)	1	0	
		0	0	Reset
		0x00000000		

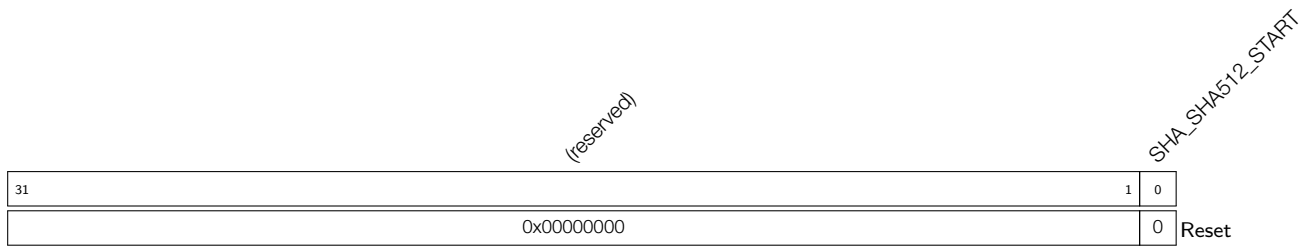
SHA_SHA384_LOAD Write 1 to finish the SHA-384 operation to calculate the final message hash. (WO)

Register 22.13: SHA_SHA384_BUSY_REG (0x0AC)



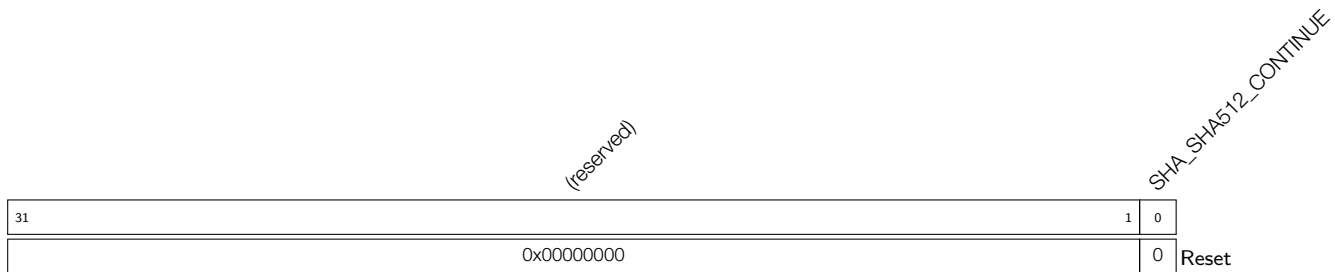
SHA_SHA384_BUSY SHA-384 operation status: 1 if the SHA accelerator is processing data, 0 if it is idle. (RO)

Register 22.14: SHA_SHA512_START_REG (0x0B0)



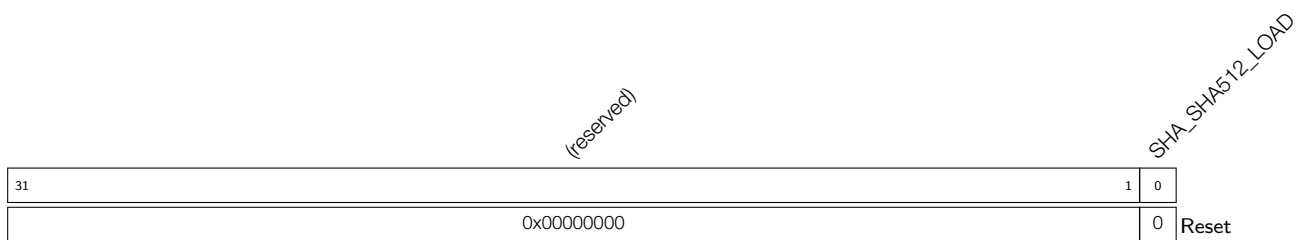
SHA_SHA512_START Write 1 to start an SHA-512 operation on the first message block. (WO)

Register 22.15: SHA_SHA512_CONTINUE_REG (0x0B4)



SHA_SHA512_CONTINUE Write 1 to continue the SHA-512 operation with subsequent blocks. (WO)

Register 22.16: SHA_SHA512_LOAD_REG (0x0B8)



SHA_SHA512_LOAD Write 1 to finish the SHA-512 operation to calculate the final message hash. (WO)

Register 22.17: SHA_SHA512_BUSY_REG (0x0BC)

31	<i>(reserved)</i>	1	0	
	0x00000000	0		Reset

SHA_SHA512_BUSY SHA-512 operation status: 1 if the SHA accelerator is processing data, 0 if it is idle. (RO)

23. RSA Accelerator

23.1 Introduction

The RSA Accelerator provides hardware support for multiple precision arithmetic operations used in RSA asymmetric cipher algorithms.

Sometimes, multiple precision arithmetic is also called "bignum arithmetic", "bigint arithmetic" or "arbitrary precision arithmetic".

23.2 Features

- Support for large-number modular exponentiation
- Support for large-number modular multiplication
- Support for large-number multiplication
- Support for various lengths of operands

23.3 Functional Description

23.3.1 Initialization

The RSA Accelerator is activated by enabling the corresponding peripheral clock, and by clearing the DPORT_RSA_PD bit in the DPORT_RSA_PD_CTRL_REG register. This releases the RSA Accelerator from reset.

When the RSA Accelerator is released from reset, the register RSA_CLEAN_REG reads 0 and an initialization process begins. Hardware initializes the four memory blocks by setting them to 0. After initialization is complete, RSA_CLEAN_REG reads 1. For this reason, software should query RSA_CLEAN_REG after being released from reset, and before writing to any RSA Accelerator memory blocks or registers for the first time.

23.3.2 Large Number Modular Exponentiation

Large-number modular exponentiation performs $Z = X^Y \bmod M$. The operation is based on Montgomery multiplication. Aside from the arguments X , Y , and M , two additional ones are needed — \bar{r} and M' . These arguments are calculated in advance by software.

The RSA Accelerator supports operand lengths of $N \in \{512, 1024, 1536, 2048, 2560, 3072, 3584, 4096\}$ bits. The bit length of arguments Z , X , Y , M , and \bar{r} can be any one from the N set, but all numbers in a calculation must be of the same length. The bit length of M' is always 32.

To represent the numbers used as operands, define a base- b positional notation, as follows:

$$b = 2^{32}$$

In this notation, each number is represented by a sequence of base- b digits, where each base- b digit is a 32-bit word. Representing an N -bit number requires n base- b digits (all of the possible N lengths are multiples of 32).

$$n = \frac{N}{32}$$

$$Z = (Z_{n-1}Z_{n-2} \cdots Z_0)_b$$

$$X = (X_{n-1}X_{n-2} \cdots X_0)_b$$

$$Y = (Y_{n-1}Y_{n-2} \cdots Y_0)_b$$

$$M = (M_{n-1}M_{n-2} \cdots M_0)_b$$

$$\bar{r} = (\bar{r}_{n-1}\bar{r}_{n-2} \cdots \bar{r}_0)_b$$

Each of the n values in $Z_{n-1} \sim Z_0$, $X_{n-1} \sim X_0$, $Y_{n-1} \sim Y_0$, $M_{n-1} \sim M_0$, $\bar{r}_{n-1} \sim \bar{r}_0$ represents one base- b digit (a 32-bit word).

Z_{n-1} , X_{n-1} , Y_{n-1} , M_{n-1} and \bar{r}_{n-1} are the most significant bits of Z , X , Y , M , while Z_0 , X_0 , Y_0 , M_0 and \bar{r}_0 are the least significant bits.

If we define

$$R = b^n$$

then, we can calculate the additional arguments, as follows:

$$\bar{r} = R^2 \bmod M \tag{1}$$

$$\begin{cases} M'' \times M + 1 = R \times R^{-1} \\ M' = M'' \bmod b \end{cases} \tag{2}$$

(Equation 2 is written in a form suitable for calculations using the extended binary GCD algorithm.)

Software can implement large-number modular exponentiations in the following order:

1. Write $(\frac{N}{512} - 1)$ to RSA_MODEXP_MODE_REG.
2. Write X_i , Y_i , M_i and \bar{r}_i ($i \in [0, n) \cap \mathbb{N}$) to memory blocks RSA_X_MEM, RSA_Y_MEM, RSA_M_MEM and RSA_Z_MEM. The capacity of each memory block is 128 words. Each word of each memory block can store one base- b digit. The memory blocks use the little endian format for storage, i.e. the least significant digit of each number is in the lowest address.

Users need to write data to each memory block only according to the length of the number; data beyond this length are ignored.
3. Write M' to RSA_M_PRIME_REG.
4. Write 1 to RSA_MODEXP_START_REG.
5. Wait for the operation to be completed. Poll RSA_INTERRUPT_REG until it reads 1, or until the RSA_INTR interrupt is generated.
6. Read the result Z_i ($i \in [0, n) \cap \mathbb{N}$) from RSA_Z_MEM.
7. Write 1 to RSA_INTERRUPT_REG to clear the interrupt.

After the operation, the RSA_MODEXP_MODE_REG register, memory blocks RSA_Y_MEM and RSA_M_MEM, as well as the RSA_M_PRIME_REG will not have changed. However, X_i in RSA_X_MEM and \bar{r}_i in RSA_Z_MEM

will have been overwritten. In order to perform another operation, refresh the registers and memory blocks, as required.

23.3.3 Large Number Modular Multiplication

Large-number modular multiplication performs $Z = X \times Y \bmod M$. This operation is based on Montgomery multiplication. The same values \bar{r} and M' are derived by software using the formulas 1 and 2 shown above.

The RSA Accelerator supports large-number modular multiplication with eight different operand lengths, which are the same as in the large-number modular exponentiation. The operation is performed by a combination of software and hardware. The software performs two hardware operations in sequence.

The software process is as follows:

1. Write $(\frac{N}{512} - 1)$ to RSA_MULT_MODE_REG.
2. Write X_i , M_i and \bar{r}_i ($i \in [0, n) \cap \mathbb{N}$) to registers RSA_X_MEM, RSA_M_MEM and RSA_Z_MEM. Write data to each memory block only according to the length of the number. Data beyond this length are ignored.
3. Write M' to RSA_M_PRIME_REG.
4. Write 1 to RSA_MULT_START_REG.
5. Wait for the first round of the operation to be completed. Poll RSA_INTERRUPT_REG until it reads 1, or until the RSA_INTR interrupt is generated.
6. Write 1 to RSA_INTERRUPT_REG to clear the interrupt.
7. Write Y_i ($i \in [0, n) \cap \mathbb{N}$) to RSA_X_MEM.

Users need to write to the memory block only according to the length of the number. Data beyond this length are ignored.

8. Write 1 to RSA_MULT_START_REG.
9. Wait for the second round of the operation to be completed. Poll RSA_INTERRUPT_REG until it reads 1, or until the RSA_INTR interrupt is generated.
10. Read the result Z_i ($i \in [0, n) \cap \mathbb{N}$) from RSA_Z_MEM.
11. Write 1 to RSA_INTERRUPT_REG to clear the interrupt.

After the operation, the RSA_MULT_MODE_REG register, and memory blocks RSA_M_MEM and RSA_M_PRIME_REG remain unchanged. Users do not need to refresh these registers or memory blocks if the values remain the same.

23.3.4 Large Number Multiplication

Large-number multiplication performs $Z = X \times Y$. The length of Z is twice that of X and Y . Therefore, the RSA Accelerator supports large-number multiplication with only four operand lengths of $N \in \{512, 1024, 1536, 2048\}$ bits. The length \hat{N} of the result Z is $2 \times N$ bits.

Operands X and Y need to be extended to form arguments \hat{X} and \hat{Y} which have the same length (\hat{N} bits) as

the result Z . X is left-extended and Y is right-extended, and defined as follows:

$$n = \frac{N}{32}$$

$$\hat{N} = 2 \times N$$

$$\hat{n} = \frac{\hat{N}}{32} = 2n$$

$$\hat{X} = (\hat{X}_{\hat{n}-1} \hat{X}_{\hat{n}-2} \cdots \hat{X}_0)_b = (\underbrace{00 \cdots 0}_n X)_b = (\underbrace{00 \cdots 0}_n X_{n-1} X_{n-2} \cdots X_0)_b$$

$$\hat{Y} = (\hat{Y}_{\hat{n}-1} \hat{Y}_{\hat{n}-2} \cdots \hat{Y}_0)_b = (Y \underbrace{00 \cdots 0}_n)_b = (Y_{n-1} Y_{n-2} \cdots Y_0 \underbrace{00 \cdots 0}_n)_b$$

Software performs the operation in the following order:

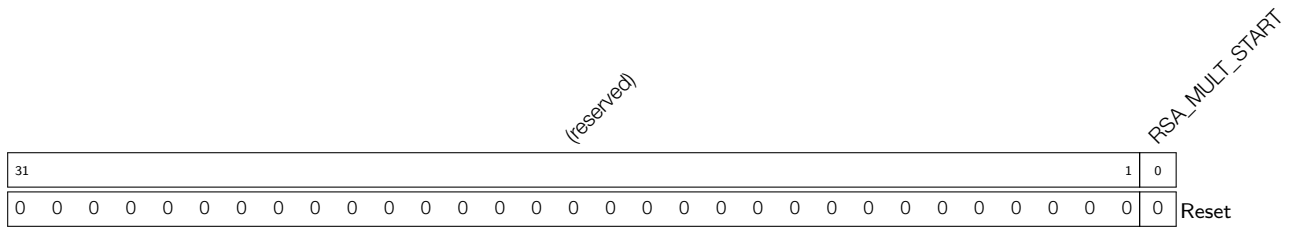
1. Write $(\frac{\hat{N}}{512} - 1 + 8)$ to RSA_MULT_MODE_REG.
2. Write \hat{X}_i and \hat{Y}_i ($i \in [0, \hat{n}) \cap \mathbb{N}$) to RSA_X_MEM and RSA_Z_MEM, respectively.
Write the valid data into each number's memory block, according to their lengths. Values beyond this length are ignored. Half of the base- b positional notations written to the memory are zero (using the derivations shown above). These zero values are indispensable.
3. Write 1 to RSA_MULT_START_REG.
4. Wait for the operation to be completed. Poll RSA_INTERRUPT_REG until it reads 1, or until the RSA_INTR interrupt is generated.
5. Read the result Z_i ($i \in [0, \hat{n}) \cap \mathbb{N}$) from RSA_Z_MEM.
6. Write 1 to RSA_INTERRUPT_REG to clear the interrupt.

After the operation, only the RSA_MULT_MODE_REG register remains unmodified.

23.4 Register Summary

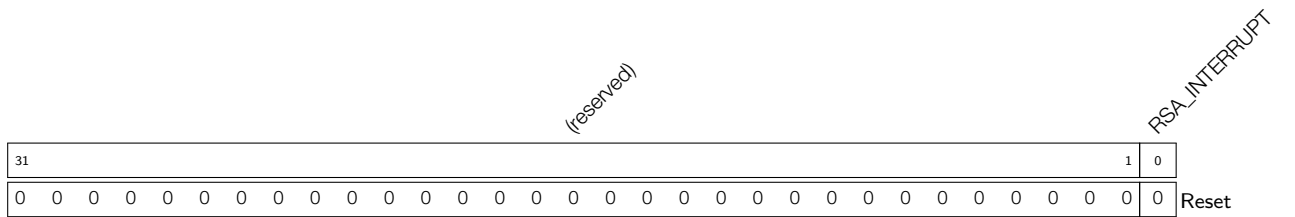
Name	Description	Address	Access
Configuration registers			
RSA_M_PRIME_REG	Register to store M'	0x3FF02800	R/W
Modular exponentiation registers			
RSA_MODEXP_MODE_REG	Modular exponentiation mode	0x3FF02804	R/W
RSA_MODEXP_START_REG	Start bit	0x3FF02808	WO
Modular multiplication registers			
RSA_MULT_MODE_REG	Modular multiplication mode	0x3FF0280C	R/W
RSA_MULT_START_REG	Start bit	0x3FF02810	WO
Misc registers			
RSA_INTERRUPT_REG	RSA interrupt register	0x3FF02814	R/W
RSA_CLEAN_REG	RSA clean register	0x3FF02818	RO

Register 23.5: RSA_MULT_START_REG (0x810)



RSA_MULT_START Write 1 to start modular multiplication or multiplication. (WO)

Register 23.6: RSA_INTERRUPT_REG (0x814)



RSA_INTERRUPT RSA interrupt status register. Will read 1 once an operation has completed. (R/W)

Register 23.7: RSA_CLEAN_REG (0x818)



RSA_CLEAN This bit will read 1 once the memory initialization is completed. (RO)

24. Random Number Generator

24.1 Introduction

The ESP32 contains a true random number generator, whose values can be used as a basis for cryptographic operations, among other things.

24.2 Feature

It can generate true random numbers.

24.3 Functional Description

When used correctly, every 32-bit value the system reads from the RNG_DATA_REG register of the random number generator is a true random number. These true random numbers are generated based on the noise in the Wi-Fi/BT RF system. When Wi-Fi and BT are disabled, the random number generator will give out pseudo-random numbers.

When Wi-Fi or BT is enabled, the random number generator is fed two bits of entropy every APB clock cycle (normally 80 MHz). Thus, for the maximum amount of entropy, it is advisable to read the random register at a maximum rate of 5 MHz.

A data sample of 2 GB, read from the random number generator with Wi-Fi enabled and the random register read at 5 MHz, has been tested using the Dieharder Random Number Testsuite (version 3.31.1). The sample passed all tests.

24.4 Register Summary

Name	Description	Address	Access
RNG_DATA_REG	Random number data	0x3FF75144	RO

24.5 Register

Register 24.1: RNG_DATA_REG (0x144)

31	0
0x00000000	
Reset	

RNG_DATA_REG Random number source. (RO)

25. Flash Encryption/Decryption

25.1 Overview

Many variants of the ESP32 must store programs and data in external flash memory. The external flash memory chip is likely to contain proprietary firmware and sensitive user data, such as credentials for gaining access to a private network. The Flash Encryption block can encrypt code and write encrypted code to off-chip flash memory for enhanced hardware security. When the CPU reads off-chip flash through the cache, the Flash Decryption block can automatically decrypt instructions and data read from the off-chip flash, thus providing hardware-based security for application code.

25.2 Features

- Various key generation methods
- Software-based encryption
- High-speed, hardware decryption
- Register configuration, system parameters and boot mode jointly determine the flash encryption/decryption function.

25.3 Functional Description

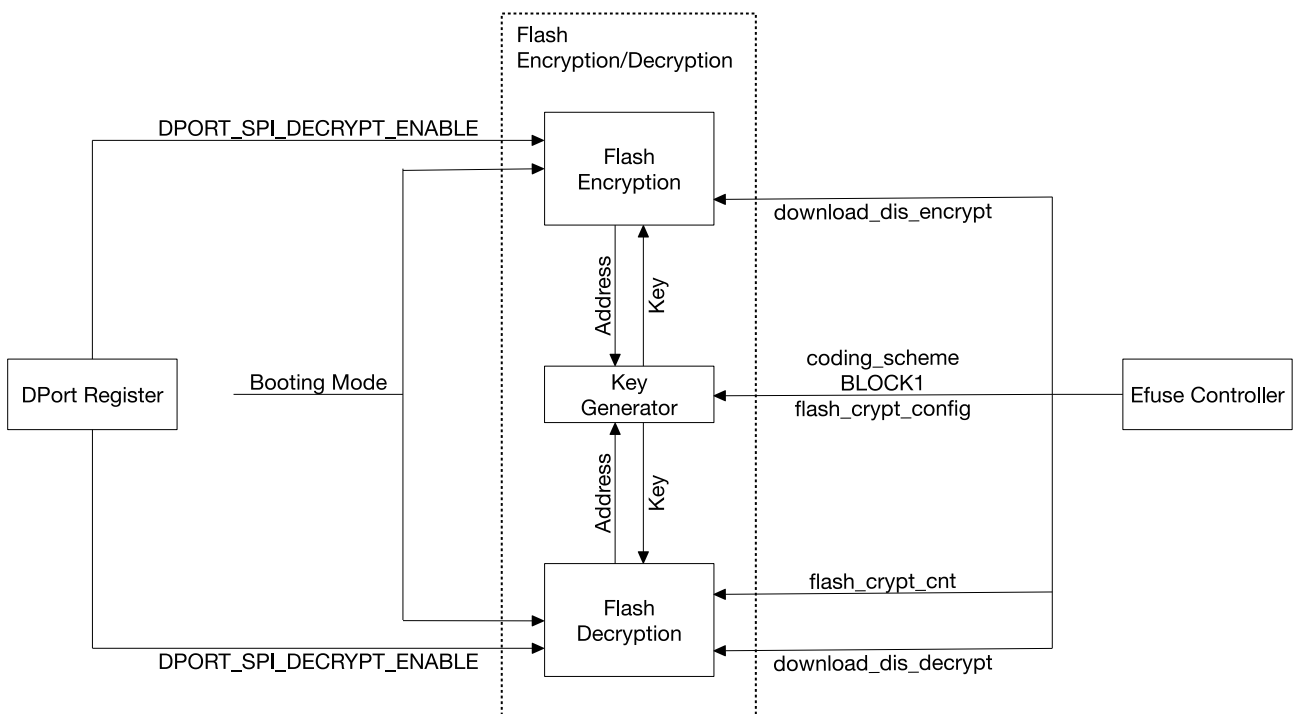


Figure 122: Flash Encryption/Decryption Module Architecture

The Flash Encryption/Decryption module consists of three parts, namely the Key Generator, Flash Encryption block and Flash Decryption block. The structure of these parts is shown in Figure 122. The Key Generator is

shared by both the Flash Encryption block and the Flash Decryption block, which can function simultaneously.

In the peripheral DPort Register, the register relevant to Flash Encryption/Decryption is DPORT_SPI_ENCRYPT_ENABLE bit and DPORT_SPI_DECRYPT_ENABLE bit in DPORT_SLAVE_SPI_CONFIG_REG. The Flash Encryption/Decryption module will fetch six system parameters from the peripheral eFuse Controller. These parameters are: coding_scheme, BLOCK1, flash_crypt_config, download_dis_encrypt, flash_crypt_cnt, and download_dis_decrypt.

25.3.1 Key Generator

According to system parameters coding_scheme and BLOCK1, the Key Generator will first generate $Key_o = f(\text{coding_scheme}, \text{BLOCK1})$.

Then, according to system parameter flash_crypt_config, and off-chip flash physical addresses $Addr_e$ and $Addr_d$ accessed by the Flash Encryption block and the Flash Decryption block, the Key Generator will respectively figure out that:

$$Key_e = g(Key_o, \text{flash_crypt_config}, Addr_e),$$

$$Key_d = g(Key_o, \text{flash_crypt_config}, Addr_d).$$

When all values of system parameter flash_crypt_config are 0, Key_e and Key_d are not relevant to the physical address of the off-chip flash. When all values of system parameter flash_crypt_config are not 0, every 8-word block on the off-chip flash has a dedicated Key_e and Key_d .

25.3.2 Flash Encryption Block

The Flash Encryption block is equipped with registers that can be accessed by the CPU directly. Registers embedded in the Flash Encryption block, registers in the peripheral DPort Register, system parameters and Boot Mode jointly configure and control this block.

The Flash Encryption block requires software intervention during operation. The steps are as follows:

1. Set the DPORT_SPI_ENCRYPT_ENABLE bit of register DPORT_SLAVE_SPI_CONFIG_REG.
2. Write the physical address prepared for the off-chip flash on register FLASH_ENCRYPT_ADDRESS_REG. The address must be 8-word boundary aligned.
3. The Flash Encryption block must encrypt 8-word long code segments. Write the lowest word to register FLASH_ENCRYPT_BUFFER_0_REG, the second-lowest word into FLASH_ENCRYPT_BUFFER_1_REG, and so on, up to FLASH_ENCRYPT_BUFFER_7_REG.
4. Set the FLASH_START bit in FLASH_ENCRYPT_START_REG.
5. Wait for the FLASH_DONE bit to be set in FLASH_ENCRYPT_DONE_REG.
6. Use this function and write any 8-word code to the 8-word aligned address on the off-chip flash via the peripheral SPI0.

In Steps 1 to 5, the Flash Encryption block encrypts 8-word long codes. The key encryption algorithm uses Key_e . The encryption result will also be 8-word long. In Step 6, the peripheral SPI0 writes encrypted results of the Flash Encryption block to the off-chip flash. One parameter of the function used in Step 6 will be the physical address of the off-chip flash. The physical address must be 8-word boundary aligned. Also, the value must be the same as the value written into register FLASH_ENCRYPT_ADDRESS_REG during Step 2. Even though the function used in Step 6 still has a parameter with an 8-word long code, the parameter will be meaningless if

Steps 1 to 5 are executed. The Peripheral SPI0 will use the encrypted result instead. If the Flash Encryption block is not operating, or has not executed Steps 1 to 5, Step 6 will not use the encrypted result. Instead, the function parameter will be used.

Flash Encryption Operating Conditions:

- During SPI Flash Boot

If the DPORT_SPI_ENCRYPT_ENABLE bit of register DPORT_SLAVE_SPI_CONFIG_REG is 1, the Flash Encryption block is operational. Otherwise, it is not.

- During Download Boot

If the DPORT_SPI_ENCRYPT_ENABLE bit of register DPORT_SLAVE_SPI_CONFIG_REG is 1, and system parameter download_dis_encrypt is 0, the Flash Encryption block is operational. Otherwise, it is not.

Even though software participates in the whole process, it cannot directly read the encrypted codes. Instead, the encrypted codes are integrated into the off-chip flash. Even though the CPU can skip the cache and get the encrypted code directly by reading the off-chip flash, the software can by no means access *Key_e*.

25.3.3 Flash Decryption Block

Flash Decryption is not a conventional peripheral, and is not equipped with registers. Therefore, the CPU cannot directly access the Flash Decryption block. The Peripheral DPort Register, system parameters and Booting Mode jointly control and configure the Flash Decryption block.

When the Flash Decryption block is operating, the CPU will read instructions and data from the off-chip flash via the cache. The Flash Decryption block automatically decrypts the instructions and data in the cache. The entire decryption process does not need software intervention and is transparent to the cache. The decryption algorithm can decrypt the code that has been encrypted by the Flash Encryption block. Software cannot access the key algorithm *Key_d* used.

When the Flash Encryption block is not operating, it does not have any effect on the contents stored in the off-chip flash, be they encrypted or unencrypted. What the CPU reads via the cache is the original information stored in the off-chip flash.

Flash Encryption Operating Conditions:

- During SPI Flash Boot

In the low 7 bits of flash_crypt_cnt, if the number of value 1 is odd, the Flash Decryption block is operational. Otherwise, it is not.

- During Download Boot

If the DPORT_SPI_DECRYPT_ENABLE bit in DPORT_SLAVE_SPI_CONFIG_REG is 1, and system parameter download_dis_decrypt is 0, the Flash Decryption block is operational. Otherwise, it is not.

25.4 Register Summary

Name	Description	Address	Access
FLASH_ENCRYPTION_BUFFER_0_REG	Flash encryption buffer register 0	0x3FF5B000	WO
FLASH_ENCRYPTION_BUFFER_1_REG	Flash encryption buffer register 1	0x3FF5B004	WO
FLASH_ENCRYPTION_BUFFER_2_REG	Flash encryption buffer register 2	0x3FF5B008	WO

Name	Description	Address	Access
FLASH_ENCRYPTION_BUFFER_3_REG	Flash encryption buffer register 3	0x3FF5B00C	WO
FLASH_ENCRYPTION_BUFFER_4_REG	Flash encryption buffer register 4	0x3FF5B010	WO
FLASH_ENCRYPTION_BUFFER_5_REG	Flash encryption buffer register 5	0x3FF5B014	WO
FLASH_ENCRYPTION_BUFFER_6_REG	Flash encryption buffer register 6	0x3FF5B018	WO
FLASH_ENCRYPTION_BUFFER_7_REG	Flash encryption buffer register 7	0x3FF5B01C	WO
FLASH_ENCRYPTION_START_REG	Encrypt operation control register	0x3FF5B020	WO
FLASH_ENCRYPTION_ADDRESS_REG	External flash address register	0x3FF5B024	WO
FLASH_ENCRYPTION_DONE_REG	Encrypt operation status register	0x3FF5B028	RO

25.5 Register

Register 25.1: FLASH_ENCRYPTION_BUFFER_n_REG (n: 0-7) (0x0+4*n)

31	0
0x00000000	
Reset	

FLASH_ENCRYPTION_BUFFER_n_REG Data buffers for encryption. (WO)

Register 25.2: FLASH_ENCRYPTION_START_REG (0x020)

31	1	0
(reserved)		
FLASH_START		
0 0		0
Reset		

FLASH_START Set this bit to start encryption operation on data buffer. (WO)

Register 25.3: FLASH_ENCRYPTION_ADDRESS_REG (0x024)

31	0
0x00000000	
Reset	

FLASH_ENCRYPTION_ADDRESS_REG The physical address on the off-chip flash must be 8-word boundary aligned. (WO)

Register 25.4: FLASH_ENCRYPTION_DONE_REG (0x028)

31	1	0
(reserved)		
FLASH_DONE		
0 0		0
Reset		

FLASH_DONE Set this bit when encryption operation is complete. (RO)

26. PID/MPU/MMU

26.1 Introduction

Every peripheral and memory section in the ESP32 is accessed through either an MMU (Memory Management Unit) or an MPU (Memory Protection Unit). An MPU can allow or disallow the access of an application to a memory range or peripheral, depending on what kind of permission the OS has given to that particular application. An MMU can perform the same operation, as well as a virtual-to-physical memory address translation. This can be used to map an internal or external memory range to a certain virtual memory area. These mappings can be application-specific. Therefore, each application can be adjusted and have the memory configuration that is necessary for it to run properly. To differentiate between the OS and applications, there are eight Process Identifiers (or PIDs) that each application, or OS, can run. Furthermore, each application, or OS, is equipped with their own sets of mappings and rights.

26.2 Features

- Eight processes in each of the PRO_CPU and APP_CPU
- MPU/MMU management of on-chip memories, off-chip memories, and peripherals, based on process ID
- On-chip memory management by MPU/MMU
- Off-chip memory management by MMU
- Peripheral management by MPU

26.3 Functional Description

26.3.1 PID Controller

In the ESP32, a PID controller acts as an indicator that signals the MMU/MPU the owner PID of the code that is currently running. The intention is that the OS updates the PID in the PID controller every time it switches context to another application. The PID controller can detect interrupts and automatically switch PIDs to that of the OS, if so configured.

There are two peripheral PID controllers in the system, one for each of the two CPUs in the ESP32. Having a PID controller per CPU allows running different processes on different CPUs, if so desired.

26.3.2 MPU/MMU

The MPU and MMU manage on-chip memories, off-chip memories, and peripherals. To do this they are based on the process of accessing the peripheral or memory region. More specifically, when a code tries to access a MMU/MPU-protected memory region or peripheral, the MMU or MPU will receive the PID from the PID generator that is associated with the CPU on which the process is running.

For on-chip memory and peripherals, the decisions the MMU and MPU make are only based on this PID, whereas the specific CPU the code is running on is not taken into account. Subsequently, the MMU/MPU configuration for the internal memory and peripherals allows entries only for the eight different PIDs. In contrast, the MMU moderating access to the external memory takes not only the PID into account, but also the CPU the request is coming from. This means that MMUs have configuration options for every PID when running on the APP_CPU, as well as every PID when running on the PRO_CPU. While, in practice, accesses from both CPUs will be configured to have the same result for a specific process, doing so is not a hardware requirement.

The decision an MPU can make, based on this information, is to allow or deny a process to access the memory region or peripheral. An MMU has the same function, but additionally it redirects the virtual memory access, which the process acquired, into a physical memory access that can possibly reach out an entirely different physical memory region. This way, MMU-governed memory can be remapped on a process-by-process basis.

26.3.2.1 Embedded Memory

The on-chip memory is governed by fixed-function MPUs, configurable MPUs, and MMUs:

Table 93: MPU and MMU Structure for Internal Memory

Name	Size	Address range		Governed by
		From	To	
ROM0	384 KB	0x4000_0000	0x4005_FFFF	Static MPU
ROM1	64 KB	0x3FF9_0000	0x3FF9_FFFF	Static MPU
SRAM0	64 KB	0x4007_0000	0x4007_FFFF	Static MPU
	128 KB	0x4008_0000	0x4009_FFFF	SRAM0 MMU
SRAM1 (aliases)	128 KB	0x3FFE_0000	0x3FFF_FFFF	Static MPU
	128 KB	0x400A_0000	0x400B_FFFF	Static MPU
	32 KB	0x4000_0000	0x4000_7FFF	Static MPU
SRAM2	72 KB	0x3FFA_E000	0x3FFB_FFFF	Static MPU
	128 KB	0x3FFC_0000	0x3FFD_FFFF	SRAM2 MMU
RTC FAST (aliases)	8 KB	0x3FF8_0000	0x3FF8_1FFF	RTC FAST MPU
	8 KB	0x400C_0000	0x400C_1FFF	RTC FAST MPU
RTC SLOW	8 KB	0x5000_0000	0x5000_1FFF	RTC SLOW MPU

Static MPUs

ROM0, ROM1, the lower 64 KB of SRAM0, SRAM1 and the lower 72 KB of SRAM2 are governed by a static MPU. The behaviour of these MPUs are hardwired and cannot be configured by software. They moderate access to the memory region solely through the PID of the current process. When the PID of the process is 0 or 1, the memory can be read (and written when it is RAM) using the addresses specified in Table 93. When it is 2 ~ 7, the memory cannot be accessed.

RTC FAST & RTC SLOW MPU

The 8 KB RTC FAST Memory as well as the 8 KB of RTC SLOW Memory are governed by two configurable MPUs. The MPUs can be configured to allow or deny access to each individual PID, using the RTC_CNTL_RTC_PID_CONFIG_REG and DPORT_AHBLITE_MPU_TABLE_RTC_REG registers. Setting a bit in these registers will allow the corresponding PID to read or write from the memory; clearing the bit disallows access. Access for PID 0 and 1 to RTC SLOW memory cannot be configured and is always enabled. Table 94 and 95 define the bit-to-PID mappings of the registers.

Table 94: MPU for RTC FAST Memory

Size	Boundary address		Authority
	Low	High	PID RTC_CNTL_RTC_PID_CONFIG bit
8 KB	0x3FF8_0000	0x3FF8_1FFF	0 1 2 3 4 5 6 7
8 KB	0x400C_0000	0x400C_1FFF	0 1 2 3 4 5 6 7

Table 95: MPU for RTC SLOW Memory

Size	Boundary address			Authority
	Low	High	PID = 0/1	PID DPORT_AHBLITE_MPU_TABLE_RTC_REG bit
8 KB	0x5000_0000	0x5000_1FFF	Read/Write	2 3 4 5 6 7 0 1 2 3 4 5

Register RTC_CNTL_RTC_PID_CONFIG_REG is part of the RTC peripheral and can only be modified by processes with a PID of 0; register DPORT_AHBLITE_MPU_TABLE_RTC_REG is a Dport register and can be changed by processes with a PID of 0 or 1.

SRAM0 and SRAM2 upper 128 KB MMUs

Both the upper 128 KB of SRAM0 and the upper 128 KB of SRAM2 are governed by an MMU. Not only can these MMUs allow or deny access to the memory they govern (just like the MPUs do), but they are also capable of translating the address a CPU reads from or writes to (which is a virtual address) to a possibly different address in memory (the physical address).

In order to accomplish this, the internal RAM MMUs divide the memory range they govern into 16 pages. The page size is configurable as 8 KB, 4 KB and 2 KB. When the page size is 8 KB, the 16 pages span the entire 128 KB memory region; when the page size is 4 KB or 2 KB, a non-MMU-covered region of 64 or 96 KB, respectively, will exist at the end of the memory space. Similar to the virtual and physical addresses, it is also possible to imagine the pages as having a virtual and physical component. The MMU can convert an address within a virtual page to an address within a physical page.

For PID 0 and 1, this mapping is 1-to-1, meaning that a read from or write to a certain virtual page will always be converted to a read from or write to the exact same physical page. This allows an operating system, running under PID 0 and/or 1, to always have access to the entire physical memory range.

For PID 2 to 7, however, every virtual page can be reconfigured, on a per-PID basis, to map to a different physical page. This way, reads and writes to an offset within a virtual page get translated into reads and writes to the

same offset within a different physical page. This is illustrated in Figure 123: the CPU (running a process with a PID between 2 to 7) tries to access memory address 0x3FFC_2345. This address is within the virtual Page 1 memory region, at offset 0x0345. The MMU is instructed that for this particular PID, it should translate an access to virtual page 1 into physical Page 2. This causes the memory access to be redirected to the same offset as the virtual memory access, yet in Page 2, which results in the effective access of physical memory address 0x3FFC_4345. The page size in this example is 8 KB.

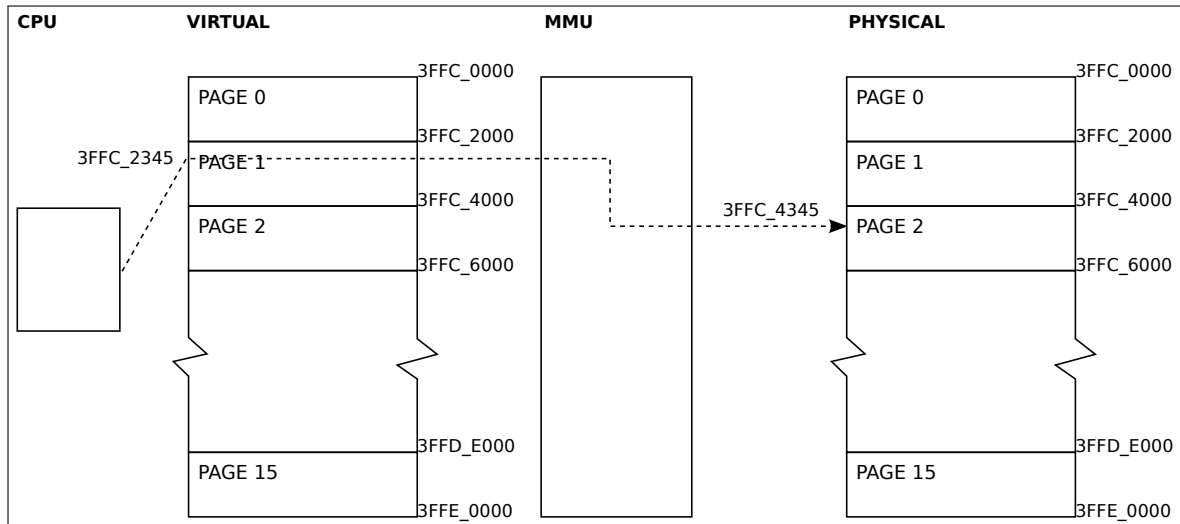


Figure 123: MMU Access Example

Table 96: Page Mode of MMU for the Remaining 128 KB of Internal SRAM0 and SRAM2

DPORT_IMMU_PAGE_MODE	DPORT_DMMU_PAGE_MODE	Page size
0	0	8 KB
1	1	4 KB
2	2	2 KB

Non-MMU Governed Memory

For the MMU-managed region of SRAM0 and SRAM2, the page size is configurable as 8 KB, 4 KB and 2 KB. The configuration is done by setting the DPORT_IMMU_PAGE_MODE (for SRAM0) and DPORT_DMMU_PAGE_MODE (for SRAM2) bits in registers DPORT_IMMU_PAGE_MODE_REG and DPORT_DMMU_PAGE_MODE_REG, as detailed in Table 96. Because the number of pages for either region is fixed at 16, the total amount of memory covered by these pages is 128 KB when 8 KB pages are selected, 64 KB when 4 KB pages are selected, and 32 KB when 2 KB pages are selected. This implies that for 8 KB pages, the entire MMU-managed range is used, but for the other page sizes there will be a part of the 128 KB memory that will not be governed by the MMU settings. Concretely, for a page size of 4 KB, these regions are 0x4009_0000 to 0x4009_FFFF and 0x3FFD_0000 to 0x3FFD_FFFF; for a page size of 2 KB, the regions are 0x4008_8000 to 0x4009_FFFF and 0x3FFC_8000 to 0x3FFD_FFFF. These ranges are readable and writable by processes with a PID of 0 or 1; processes with other PIDs cannot access this memory.

The layout of the pages in memory space is linear, namely, an SRAM0 MMU page n covers address space $0x40080000 + (pagesize * n)$ to $0x40080000 + (pagesize * (n + 1) - 1)$; similarly, an SRAM2 MMU page n covers $0x3FFC0000 + (pagesize * n)$ to $0x3FFC0000 + (pagesize * (n + 1) - 1)$. Tables 97 and 98 show the resulting addresses in full.

Table 97: Page Boundaries for SRAM0 MMU

Page	8 KB Pages		4 KB Pages		2 KB Pages	
	Bottom	Top	Bottom	Top	Bottom	Top
0	40080000	40081FFF	40080000	40080FFF	40080000	400807FF
1	40082000	40083FFF	40081000	40081FFF	40080800	40080FFF
2	40084000	40085FFF	40082000	40082FFF	40081000	400817FF
3	40086000	40087FFF	40083000	40083FFF	40081800	40081FFF
4	40088000	40089FFF	40084000	40084FFF	40082000	400827FF
5	4008A000	4008BFFF	40085000	40085FFF	40082800	40082FFF
6	4008C000	4008DFFF	40086000	40086FFF	40083000	400837FF
7	4008E000	4008FFFF	40087000	40087FFF	40083800	40083FFF
8	40090000	40091FFF	40088000	40088FFF	40084000	400847FF
9	40092000	40093FFF	40089000	40089FFF	40084800	40084FFF
10	40094000	40095FFF	4008A000	4008AFFF	40085000	400857FF
11	40096000	40097FFF	4008B000	4008BFFF	40085800	40085FFF
12	40098000	40099FFF	4008C000	4008CFFF	40086000	400867FF
13	4009A000	4009BFFF	4008D000	4008DFFF	40086800	40086FFF
14	4009C000	4009DFFF	4008E000	4008EFFF	40087000	400877FF
15	4009E000	4009FFFF	4008F000	4008FFFF	40087800	40087FFF
Rest	-	-	40090000	4009FFFF	4008800	4009FFFF

Table 98: Page Boundaries for SRAM2 MMU

Page	8 KB Pages		4 KB Pages		2 KB Pages	
	Bottom	Top	Bottom	Top	Bottom	Top
0	3FFC0000	3FFC1FFF	3FFC0000	3FFC0FFF	3FFC0000	3FFC07FF
1	3FFC2000	3FFC3FFF	3FFC1000	3FFC1FFF	3FFC0800	3FFC0FFF
2	3FFC4000	3FFC5FFF	3FFC2000	3FFC2FFF	3FFC1000	3FFC17FF
3	3FFC6000	3FFC7FFF	3FFC3000	3FFC3FFF	3FFC1800	3FFC1FFF
4	3FFC8000	3FFC9FFF	3FFC4000	3FFC4FFF	3FFC2000	3FFC27FF
5	3FFCA000	3FFCBFFF	3FFC5000	3FFC5FFF	3FFC2800	3FFC2FFF
6	3FFCC000	3FFCDFFF	3FFC6000	3FFC6FFF	3FFC3000	3FFC37FF
7	3FFCE000	3FFCFFFF	3FFC7000	3FFC7FFF	3FFC3800	3FFC3FFF
8	3FFD0000	3FFD1FFF	3FFC8000	3FFC8FFF	3FFC4000	3FFC47FF
9	3FFD2000	3FFD3FFF	3FFC9000	3FFC9FFF	3FFC4800	3FFC4FFF
10	3FFD4000	3FFD5FFF	3FFCA000	3FFCAFFF	3FFC5000	3FFC57FF
11	3FFD6000	3FFD7FFF	3FFCB000	3FFCBFFF	3FFC5800	3FFC5FFF
12	3FFD8000	3FFD9FFF	3FFCC000	3FFCCFFF	3FFC6000	3FFC67FF
13	3FFDA000	3FFDBFFF	3FFCD000	3FFCDFFF	3FFC6800	3FFC6FFF
14	3FFDC000	3FFDDFFF	3FFCE000	3FFCEFFF	3FFC7000	3FFC77FF
15	3FFDE000	3FFDFFFF	3FFCF000	3FFCFFFF	3FFC7800	3FFC7FFF
Rest	-	-	3FFD0000	3FFDFFFF	3FFC8000	3FFDFFFF

MMU Mapping

For each of the SRAM0 and SRAM2 MMUs, access rights and virtual to physical page mapping are done by a set of 16 registers. In contrast to most of the other MMUs, each register controls a physical page, not a virtual one. These registers control which of the PIDs have access to the physical memory, as well as which virtual page maps to this physical page. The bits in the register are described in Table 99. Keep in mind that these registers only govern accesses from processes with PID 2 to 7; PID 0 and 1 always have full read and write access to all pages and no virtual-to-physical mapping is done. In other words, if a process with a PID of 0 or 1 accesses virtual page x , the access will always go to physical page x , regardless of these register settings. These registers, as well as the page size selection registers DPORT_IMMU_PAGE_MODE_REG and DPORT_DMMU_PAGE_MODE_REG, are only writable from a process with PID 0 or 1.

Table 99: DPORT_DMMU_TABLE n _REG & DPORT_IMMU_TABLE n _REG

[6:4]	Access rights for PID 2 ~ 7	[3:0]	Address authority
0	None of PIDs 2 ~ 7 have access.	0x00	Virtual page 0 accesses this physical page.
1	All of PIDs 2 ~ 7 have access.	0x01	Virtual page 1 accesses this physical page.
2	Only PID 2 has access.	0x02	Virtual page 2 accesses this physical page.
3	Only PID 3 has access.	0x03	Virtual page 3 accesses this physical page.
4	Only PID 4 has access.	0x04	Virtual page 4 accesses this physical page.
5	Only PID 5 has access.	0x05	Virtual page 5 accesses this physical page.
6	Only PID 6 has access.	0x06	Virtual page 6 accesses this physical page.
7	Only PID 7 has access.	0x07	Virtual page 7 accesses this physical page.
		0x08	Virtual page 8 accesses this physical page.
		0x09	Virtual page 9 accesses this physical page.
		0x10	Virtual page 10 accesses this physical page.
		0x11	Virtual page 11 accesses this physical page.
		0x12	Virtual page 12 accesses this physical page.
		0x13	Virtual page 13 accesses this physical page.
		0x14	Virtual page 14 accesses this physical page.
		0x15	Virtual page 15 accesses this physical page.

Differences Between SRAM0 and SRAM2 MMU

The memory governed by the SRAM0 MMU is accessed through the processors I-bus, while the processor accesses the memory governed by the SRAM2 MMU through the D-bus. Thus, the normal envisioned use is for the code to be stored in the SRAM0 MMU pages and data in the MMU pages of SRAM2. In general, applications running under a PID of 2 to 7 are not expected to modify their own code, because for these PIDs access to the MMU pages of SRAM0 is read-only. These applications must, however, be able to modify their data section, so that they are allowed to read as well as write MMU pages located in SRAM2. As stated before, processes running under PID 0 or 1 always have full read-and-write access to both memory ranges.

DMA MPU

Applications may want to configure the DMA to send data straight from or to the peripherals they can control. With access to DMA, a malicious process may also be able to copy data from or to a region it cannot normally

access. In order to be secure against that scenario, there is a DMA MPU which can be used to disallow DMA transfers from memory regions with sensitive data in them.

For each 8 KB region in the SRAM1 and SRAM2 regions, there is a bit in the DPORT_AHB_MPU_TABLE_0_REG registers which tells the MPU to either allow or disallow DMA access to this region. The DMA MPU uses only these bits to decide if a DMA transfer can be started; the PID of the process is not a factor. This means that when the OS wants to restrict its processes in a heterogenous fashion, it will need to re-load these registers with the values applicable to the process to be run on every context switch.

The register bits that govern access to the 8 KB regions are detailed in Table 100. When a register bit is set, DMA can read/write the corresponding 8 KB memory range. When the bit is cleared, access to that memory range is denied.

Table 100: MPU for DMA

Size	Boundary address		Authority	
	Low	High	Register	Bit
Internal SRAM 2				
8 KB	0x3FFA_E000	0x3FFA_FFFF	DPORT_AHB_MPU_TABLE_0_REG	0
8 KB	0x3FFB_0000	0x3FFB_1FFF	DPORT_AHB_MPU_TABLE_0_REG	1
8 KB	0x3FFB_2000	0x3FFB_3FFF	DPORT_AHB_MPU_TABLE_0_REG	2
8 KB	0x3FFB_4000	0x3FFB_5FFF	DPORT_AHB_MPU_TABLE_0_REG	3
8 KB	0x3FFB_6000	0x3FFB_7FFF	DPORT_AHB_MPU_TABLE_0_REG	4
8 KB	0x3FFB_8000	0x3FFB_9FFF	DPORT_AHB_MPU_TABLE_0_REG	5
8 KB	0x3FFB_A000	0x3FFB_BFFF	DPORT_AHB_MPU_TABLE_0_REG	6
8 KB	0x3FFB_C000	0x3FFB_DFFF	DPORT_AHB_MPU_TABLE_0_REG	7
8 KB	0x3FFB_E000	0x3FFB_FFFF	DPORT_AHB_MPU_TABLE_0_REG	8
8 KB	0x3FFC_0000	0x3FFC_1FFF	DPORT_AHB_MPU_TABLE_0_REG	9
8 KB	0x3FFC_2000	0x3FFC_3FFF	DPORT_AHB_MPU_TABLE_0_REG	10
8 KB	0x3FFC_4000	0x3FFC_5FFF	DPORT_AHB_MPU_TABLE_0_REG	11
8 KB	0x3FFC_6000	0x3FFC_7FFF	DPORT_AHB_MPU_TABLE_0_REG	12
8 KB	0x3FFC_8000	0x3FFC_9FFF	DPORT_AHB_MPU_TABLE_0_REG	13
8 KB	0x3FFC_A000	0x3FFC_BFFF	DPORT_AHB_MPU_TABLE_0_REG	14
8 KB	0x3FFC_C000	0x3FFC_DFFF	DPORT_AHB_MPU_TABLE_0_REG	15
8 KB	0x3FFC_E000	0x3FFC_FFFF	DPORT_AHB_MPU_TABLE_0_REG	16
8 KB	0x3FFD_0000	0x3FFD_1FFF	DPORT_AHB_MPU_TABLE_0_REG	17
8 KB	0x3FFD_2000	0x3FFD_3FFF	DPORT_AHB_MPU_TABLE_0_REG	18
8 KB	0x3FFD_4000	0x3FFD_5FFF	DPORT_AHB_MPU_TABLE_0_REG	19
8 KB	0x3FFD_6000	0x3FFD_7FFF	DPORT_AHB_MPU_TABLE_0_REG	20
8 KB	0x3FFD_8000	0x3FFD_9FFF	DPORT_AHB_MPU_TABLE_0_REG	21
8 KB	0x3FFD_A000	0x3FFD_BFFF	DPORT_AHB_MPU_TABLE_0_REG	22
8 KB	0x3FFD_C000	0x3FFD_DFFF	DPORT_AHB_MPU_TABLE_0_REG	23
8 KB	0x3FFD_E000	0x3FFD_FFFF	DPORT_AHB_MPU_TABLE_0_REG	24
Internal SRAM 1				
8 KB	0x3FFE_0000	0x3FFE_1FFF	DPORT_AHB_MPU_TABLE_0_REG	25
8 KB	0x3FFE_2000	0x3FFE_3FFF	DPORT_AHB_MPU_TABLE_0_REG	26
8 KB	0x3FFE_4000	0x3FFE_5FFF	DPORT_AHB_MPU_TABLE_0_REG	27
8 KB	0x3FFE_6000	0x3FFE_7FFF	DPORT_AHB_MPU_TABLE_0_REG	28

Size	Boundary address		Authority	
	Low	High	Register	Bit
8 KB	0x3FFE_8000	0x3FFE_9FFF	DPORT_AHB_MPU_TABLE_0_REG	29
8 KB	0x3FFE_A000	0x3FFE_BFFF	DPORT_AHB_MPU_TABLE_0_REG	30
8 KB	0x3FFE_C000	0x3FFE_DFFF	DPORT_AHB_MPU_TABLE_0_REG	31
8 KB	0x3FFE_E000	0x3FFE_FFFF	DPORT_AHB_MPU_TABLE_1_REG	0
8 KB	0x3FFF_0000	0x3FFF_1FFF	DPORT_AHB_MPU_TABLE_1_REG	1
8 KB	0x3FFF_2000	0x3FFF_3FFF	DPORT_AHB_MPU_TABLE_1_REG	2
8 KB	0x3FFF_4000	0x3FFF_5FFF	DPORT_AHB_MPU_TABLE_1_REG	3
8 KB	0x3FFF_6000	0x3FFF_7FFF	DPORT_AHB_MPU_TABLE_1_REG	4
8 KB	0x3FFF_8000	0x3FFF_9FFF	DPORT_AHB_MPU_TABLE_1_REG	5
8 KB	0x3FFF_A000	0x3FFF_BFFF	DPORT_AHB_MPU_TABLE_1_REG	6
8 KB	0x3FFF_C000	0x3FFF_DFFF	DPORT_AHB_MPU_TABLE_1_REG	7
8 KB	0x3FFF_E000	0x3FFF_FFFF	DPORT_AHB_MPU_TABLE_1_REG	8

Registers DPORT_AHB_MPU_TABLE_0_REG DPORT_AHB_MPU_TABLE_1_REG are located in the DPort address space. Only processes with a PID of 0 or 1 can modify these two registers.

26.3.2.2 External Memory

Accesses to the external flash and external SPI RAM are done through a cache and are also handled by an MMU. This Cache MMU can apply different mappings, depending on the PID of the process as well as the CPU the process is running on. The MMU does this in a way that is similar to the internal memory MMU, that is, for every page of virtual memory, it has a register detailing which physical page this virtual page should map to. There are differences between the MMUs governing the internal memory and the Cache MMU, though. First of all, the Cache MMU has a fixed page size (which is 64 KB for external flash and 32 KB for external RAM) and secondly, instead of specifying access rights in the MMU entries, the Cache MMU has explicit mapping tables for each PID and processor core. The MMU mapping configuration registers will be referred to as 'entries' in the rest of this chapter. These registers are only accessible from processes with a PID of 0 or 1; processes with a PID of 2 to 7 will have to delegate to one of the above-mentioned processes to change their MMU settings.

The MMU entries, as stated before, are used for mapping a virtual memory page access to a physical memory page access. The MMU controls five regions of virtual address space, detailed in Table 101. $VAddr_1$ to $VAddr_4$ are used for accessing external flash, whereas $VAddr_{RAM}$ is used for accessing external RAM. Note that $VAddr_4$ is a subset of $VAddr_0$.

Table 101: Virtual Address for External Memory

Name	Size	Boundary address		Page quantity
		Low	High	
<i>VAddr</i> ₀	4 MB	0x3F40_0000	0x3F7F_FFFF	64
<i>VAddr</i> ₁	4 MB	0x4000_0000	0x403F_FFFF	64*
<i>VAddr</i> ₂	4 MB	0x4040_0000	0x407F_FFFF	64
<i>VAddr</i> ₃	4 MB	0x4080_0000	0x40BF_FFFF	64
<i>VAddr</i> ₄	1 MB	0x3F40_0000	0x3F4F_FFFF	16
<i>VAddr</i> _{RAM}	4 MB	0x3F80_0000	0x3FBF_FFFF	128

* The configuration entries for address range 0x4000_0000 ~ 0x403F_FFFF are implemented and documented as if it were a full 4 MB address range, but it is not accessible as such. Instead, the address range 0x4000_0000 ~ 0x400C_1FFF accesses on-chip memory. This means that some of the configuration entries for *VAddr*₁ will not be used.

External Flash

For flash, the relationships among entry numbers, virtual memory ranges, and PIDs are detailed in Tables 102 and 103, which for every memory region and PID combination specify the first MMU entry governing the mapping. This number refers to the MMU entry governing the very first page; the entire region is described by the amount of pages specified in the 'count' column.

These two tables are essentially the same, with the sole difference being that the APP_CPU entry numbers are 2048 higher than the corresponding PRO_CPU numbers. Note that memory regions *VAddr*₀ and *VAddr*₁ are only accessible using PID 0 and 1, while *VAddr*₄ can only be accessed by PID 2 ~ 7.

Table 102: MMU Entry Numbers for PRO_CPU

VAddr	Count	First MMU entry for PID						
		0/1	2	3	4	5	6	7
<i>VAddr</i> ₀	64	0	-	-	-	-	-	-
<i>VAddr</i> ₁	64	64	-	-	-	-	-	-
<i>VAddr</i> ₂	64	128	256	384	512	640	768	896
<i>VAddr</i> ₃	64	192	320	448	576	704	832	960
<i>VAddr</i> ₄	16	-	1056	1072	1088	1104	1120	1136

Table 103: MMU Entry Numbers for APP_CPU

VAddr	Count	First MMU entry for PID						
		0/1	2	3	4	5	6	7
<i>VAddr</i> ₀	64	2048	-	-	-	-	-	-
<i>VAddr</i> ₁	64	2112	-	-	-	-	-	-
<i>VAddr</i> ₂	64	2176	2304	2432	2560	2688	2816	2944
<i>VAddr</i> ₃	64	2240	2368	2496	2624	2752	2880	3008
<i>VAddr</i> ₄	16	-	3104	3120	3136	3152	3168	3184

As these tables show, virtual address *VAddr*₁ can only be used by processes with a PID of 0 or 1. There is a

special mode to allow processes with a PID of 2 to 7 to read the External Flash via address $VAddr_1$. When the DPORT_PRO_SINGLE_IRAM_ENA bit of register DPORT_PRO_CACHE_CTRL_REG is 1, the MMU enters this special mode for PRO_CPU memory accesses. Similarly, when the DPORT_APP_SINGLE_IRAM_ENA bit of register DPORT_APP_CACHE_CTRL_REG is 1, the APP_CPU accesses memory using this special mode. In this mode, the process and virtual address page supported by each configuration entry of MMU are different. For details please see Table 104 and 105. As shown in these tables, in this special mode $VAddr_2$ and $VAddr_3$ cannot be used to access External Flash.

Table 104: MMU Entry Numbers for PRO_CPU (Special Mode)

VAddr	Count	First MMU entry for PID						
		0/1	2	3	4	5	6	7
$VAddr_0$	64	0	-	-	-	-	-	-
$VAddr_1$	64	64	256	384	512	640	768	896
$VAddr_2$	64	-	-	-	-	-	-	-
$VAddr_3$	64	-	-	-	-	-	-	-
$VAddr_4$	16	-	1056	1072	1088	1104	1120	1136

Table 105: MMU Entry Numbers for APP_CPU (Special Mode)

VAddr	Count	First MMU entry for PID						
		0/1	2	3	4	5	6	7
$VAddr_0$	64	2048	-	-	-	-	-	-
$VAddr_1$	64	2112	2304	2432	2560	2688	2816	2944
$VAddr_2$	64	-	-	-	-	-	-	-
$VAddr_3$	64	-	-	-	-	-	-	-
$VAddr_4$	16	-	3104	3120	3136	3152	3168	3184

Every configuration entry of MMU maps a virtual address page of a CPU process to a physical address page. An entry is 32 bits wide. Of these, bits 0~7 indicate the physical page the virtual page is mapped to. Bit 8 should be cleared to indicate that the MMU entry is valid; entries with this bit set will not map any physical address to the virtual address. Bits 10 to 32 are unused and should be written as zero. Because there are eight address bits in an MMU entry, and the page size for external flash is 64 KB, a maximum of $256 * 64 \text{ KB} = 16 \text{ MB}$ of external flash is supported.

Examples

Example 1. A PRO_CPU process, with a PID of 1, needs to read external flash address 0x07_2375 via virtual address 0x3F70_2375. The MMU is not in the special mode.

- According to Table 101, virtual address 0x3F70_2375 resides in the 0x30'th page of $VAddr_0$.
- According to Table 102, the MMU entry for $VAddr_0$ for PID 0/1 for the PRO_CPU starts at 0.
- The modified MMU entry is $0 + 0x30 = 0x30$.
- Address 0x07_2375 resides in the 7'th 64 KB-sized page.
- MMU entry 0x30 needs to be set to 7 and marked as valid by setting the 8'th bit to 0. Thus, 0x007 is written to MMU entry 0x30.

Example 2. An APP_CPU process, with a PID of 4, needs to read external flash address 0x44_048C via virtual address 0x4044_048C. The MMU is not in special mode.

- According to Table 101, virtual address 0x4044_048C resides in the 0x4'th page of $VAddr_2$.
- According to Table 103, the MMU entry for $VAddr_2$ for PID 4 for the APP_CPU starts at 2560.
- The modified MMU entry is $2560 + 0x4 = 2564$.
- Address 0x44_048C resides in the 0x44'th 64 KB-sized page.
- MMU entry 2564 needs to be set to 0x44 and marked as valid by setting the 8'th bit to 0. Thus, 0x044 is written to MMU entry 2564.

External RAM

Processes running on PRO_CPU and APP_CPU can read and write External SRAM via the Cache at virtual address range $VAddr_{RAM}$, which is 0x3F80_0000 ~ 0x3FBF_FFFF. As with the flash MMU, the address space and the physical memory are divided into pages. For the External RAM MMU, the page size is 32 KB and the MMU is able to map 256 physical pages into the virtual address space, allowing for $32 \text{ KB} * 256 = 8 \text{ MB}$ of physical external RAM to be mapped.

The mapping of virtual pages into this memory range depends on the mode this MMU is in: Low-High mode, Even-Odd mode, or Normal mode. In all cases, the DPORT_PRO_DRAM_HL bit and DPORT_PRO_DRAM_SPLIT bit in register DPORT_PRO_CACHE_CTRL_REG, the DPORT_APP_DRAM_HL bit and DPORT_APP_DRAM_SPLIT bit in register DPORT_APP_CACHE_CTRL_REG determine the virtual address mode for External SRAM. For details, please see Table 106. If a different mapping for the PRO_CPU and APP_CPU is required, the Normal Mode should be selected, as it is the only mode that can provide this. If it is allowable for the PRO_CPU and the APP_CPU to share the same mapping, using either High-Low or Even-Odd mode can give a speed gain when both CPUs access memory frequently.

In case the APP_CPU cache is disabled, which renders the region of 0x4007_8000 to 0x4007_FFFF usable as normal internal RAM, the usability of the various cache modes changes. Normal mode will allow PRO_CPU access to external RAM to keep functioning, but the APP_CPU will be unable to access the external RAM. High-Low mode allows both CPUs to use external RAM, but only for the 2 MB virtual memory addresses from 0x3F80_0000 to 0x3F9F_FFFF. It is not advised to use Even-Odd mode with the APP_CPU cache region disabled.

Table 106: Virtual Address Mode for External SRAM

Mode	DPORT_PRO_DRAM_HL DPORT_APP_DRAM_HL	DPORT_PRO_DRAM_SPLIT DPORT_APP_DRAM_SPLIT
Low-High	1	0
Even-Odd	0	1
Normal	0	0

In normal mode, the virtual-to-physical page mapping can be different for both CPUs. Page mappings for PRO_CPU are set using the MMU entries for $^L VAddr_{RAM}$, and page mappings for the APP_CPU can be configured using the MMU entries for $^R VAddr_{RAM}$. In this mode, all 128 pages of both $^L VAddr$ and $^R VAddr$ are fully used, allowing a maximum of 8 MB of memory to be mapped; 4 MB into PRO_CPU address space and a possibly different 4 MB into the APP_CPU address space, as can be seen in Table 107.

Table 107: Virtual Address for External SRAM (Normal Mode)

Virtual address	Size	PRO_CPU address	
		Low	High
${}^L V Addr_{RAM}$	4 MB	0x3F80_0000	0x3FBF_FFFF
Virtual address	Size	APP_CPU address	
		Low	High
${}^R V Addr_{RAM}$	4 MB	0x3F80_0000	0x3FBF_FFFF

In Low-High mode, both the PRO_CPU and the APP_CPU use the same mapping entries. In this mode ${}^L V Addr_{RAM}$ is used for the lower 2 MB of the virtual address space, while ${}^R V Addr_{RAM}$ is used for the upper 2 MB. This also means that the upper 64 MMU entries for ${}^L V Addr_{RAM}$, as well as the lower 64 entries for ${}^R V Addr_{RAM}$, are unused. Table 108 details these address ranges.

Table 108: Virtual Address for External SRAM (Low-High Mode)

Virtual address	Size	PRO_CPU/APP_CPU address	
		Low	High
${}^L V Addr_{RAM}$	2 MB	0x3F80_0000	0x3F9F_FFFF
${}^R V Addr_{RAM}$	2 MB	0x3FA0_0000	0x3FBF_FFFF

In Even-Odd memory, the VRAM is split into 32-byte chunks. The even chunks are resolved through the MMU entries for ${}^L V Addr_{RAM}$, the odd chunks through the entries for ${}^R V Addr_{RAM}$. Generally, the MMU entries for ${}^L V Addr_{RAM}$ and ${}^R V Addr_{RAM}$ are set to the same values, so that the virtual pages map to a contiguous region of physical memory. Table 109 details this mode.

Table 109: Virtual Address for External SRAM (Even-Odd Mode)

Virtual address	Size	PRO_CPU/APP_CPU address	
		Low	High
${}^L V Addr_{RAM}$	32 Bytes	0x3F80_0000	0x3F80_001F
${}^R V Addr_{RAM}$	32 Bytes	0x3F80_0020	0x3F80_003F
${}^L V Addr_{RAM}$	32 Bytes	0x3F80_0040	0x3F80_005F
${}^R V Addr_{RAM}$	32 Bytes	0x3F80_0060	0x3F80_007F
...			
${}^L V Addr_{RAM}$	32 Bytes	0x3FBF_FFC0	0x3FBF_FFDF
${}^R V Addr_{RAM}$	32 Bytes	0x3FBF_FFE0	0x3FBF_FFFF

The bit configuration of the External RAM MMU entries is the same as for the flash memory: the entries are 32-bit registers, with the lower nine bits being used. Bits 0~7 contain the physical page the entry should map its associate virtual page address to, while bit 8 is cleared when the entry is valid and set when it is not. Table 110 details the first MMU entry number for ${}^L V Addr_{RAM}$ and ${}^R V Addr_{RAM}$ for all PIDs.

Table 110: MMU Entry Numbers for External RAM

VAddr	Count	First MMU entry for PID						
		0/1	2	3	4	5	6	7
${}^L VAddr_{RAM}$	128	1152	1280	1408	1536	1664	1792	1920
${}^R VAddr_{RAM}$	128	3200	3328	3456	3584	3712	3840	3968

Examples

Example 1. A PRO_CPU process, with a PID of 7, needs to read or write external RAM address 0x7F_A375 via virtual address 0x3FA7_2375. The MMU is in Low-High mode.

- According to Table 101, virtual address 0x3FA7_2375 resides in the 0x4E'th 32-KB-page of $VAddr_{RAM}$.
- According to Table 108, virtual address 0x3FA7_2375 is governed by ${}^R VAddr_{RAM}$.
- According to Table 110, the MMU entry for ${}^R VAddr_{RAM}$ for PID 7 for the PRO_CPU starts at 3968.
- The modified MMU entry is $3968 + 0x4E = 4046$.
- Address 0x7F_A375 resides in the 255'th 32 KB-sized page.
- MMU entry 4046 needs to be set to 255 and marked as valid by clearing the 8'th bit. Thus, 0x0FF is written to MMU entry 4046.

Example 2. An APP_CPU process, with a PID of 5, needs to read or write external RAM address 0x55_5805 up to 0x55_5823 starting at virtual address 0x3F85_5805. The MMU is in Even-Odd mode.

- According to Table 101, virtual address 0x3F85_5805 resides in the 0x0A'th 32-KB-page of $VAddr_{RAM}$.
- According to Table 109, the range to be read/written spans both a 32-byte region in ${}^R VAddr_{RAM}$ and ${}^L VAddr_{RAM}$.
- According to Table 110, the MMU entry for ${}^L VAddr_{RAM}$ for PID 5 starts at 1664.
- According to Table 110, the MMU entry for ${}^R VAddr_{RAM}$ for PID 5 starts at 3712.
- The modified MMU entries are $1664 + 0x0A = 1674$ and $3712 + 0x0A = 3722$.
- The addresses 0x55_5805 to 0x55_5823 reside in the 0xAA'th 32 KB-sized page.
- MMU entries 1674 and 3722 need to be set to 0xAA and marked as valid by setting the 8'th bit to 0. Thus, 0x0AA is written to MMU entries 1674 and 3722. This mapping applies to both the PRO_CPU and the APP_CPU.

Example 3. A PRO_CPU process, with a PID of 1, and an APP_CPU process whose PID is also 1, need to read or write external RAM using virtual address 0x3F80_0876. The PRO_CPU needs this region to access physical address 0x10_0876, while the APP_CPU wants to access physical address 0x20_0876 through this virtual address. The MMU is in Normal mode.

- According to Table 101, virtual address 0x3F80_0876 resides in the 0'th 32-KB-page of $VAddr_{RAM}$.
- According to Table 110, the MMU entry for PID 1 for the PRO_CPU starts at 1152.
- According to Table 110, the MMU entry for PID 1 for the APP_CPU starts at 3200.
- The MMU entries that are modified are $1152 + 0 = 1152$ for the PRO_CPU and $3200 + 0 = 3200$ for the APP_CPU.
- Address 0x10_0876 resides in the 0x20'th 32 KB-sized page.
- Address 0x20_0876 resides in the 0x40'th 32 KB-sized page.
- For the PRO_CPU, MMU entry 1152 needs to be set to 0x20 and marked as valid by clearing the 8'th bit. Thus, 0x020 is written to MMU entry 1152.

- For the APP_CPU, MMU entry 3200 needs to be set to 0x40 and marked as valid by clearing the 8th bit. Thus, 0x040 is written to MMU entry 3200.
- Now, the PRO_CPU and the APP_CPU can access different physical memory regions through the same virtual address.

26.3.2.3 Peripheral

The Peripheral MPU manages the 41 peripheral modules. This MMU can be configured per peripheral to only allow access from a process with a certain PID. The registers to configure this are detailed in Table 111.

Table 111: MPU for Peripheral

Peripheral	Authority	
	PID = 0/1	PID = 2 ~ 7
DPort Register	Access	Forbidden
AES Accelerator	Access	Forbidden
RSA Accelerator	Access	Forbidden
SHA Accelerator	Access	Forbidden
Secure Boot	Access	Forbidden
Cache MMU Table	Access	Forbidden
PID Controller	Access	Forbidden
UART0	Access	DPORT_AHBLITE_MPU_TABLE_UART_REG
SPI1	Access	DPORT_AHBLITE_MPU_TABLE_SPI1_REG
SPI0	Access	DPORT_AHBLITE_MPU_TABLE_SPI0_REG
GPIO	Access	DPORT_AHBLITE_MPU_TABLE_GPIO_REG
RTC	Access	DPORT_AHBLITE_MPU_TABLE_RTC_REG
IO MUX	Access	DPORT_AHBLITE_MPU_TABLE_IO_MUX_REG
SDIO Slave	Access	DPORT_AHBLITE_MPU_TABLE_HINF_REG
UDMA1	Access	DPORT_AHBLITE_MPU_TABLE_UHCI1_REG
I2S0	Access	DPORT_AHBLITE_MPU_TABLE_I2S0_REG
UART1	Access	DPORT_AHBLITE_MPU_TABLE_UART1_REG
I2C0	Access	DPORT_AHBLITE_MPU_TABLE_I2C_EXT0_REG
UDMA0	Access	DPORT_AHBLITE_MPU_TABLE_UHCIO_REG
SDIO Slave	Access	DPORT_AHBLITE_MPU_TABLE_SLCHOST_REG
RMT	Access	DPORT_AHBLITE_MPU_TABLE_RMT_REG
PCNT	Access	DPORT_AHBLITE_MPU_TABLE_PCNT_REG
SDIO Slave	Access	DPORT_AHBLITE_MPU_TABLE_SLC_REG
LED PWM	Access	DPORT_AHBLITE_MPU_TABLE_LEDC_REG
Efuse Controller	Access	DPORT_AHBLITE_MPU_TABLE_EFUSE_REG
Flash Encryption	Access	DPORT_AHBLITE_MPU_TABLE_SPI_ENCRYPT_REG
PWM0	Access	DPORT_AHBLITE_MPU_TABLE_PWM0_REG
TIMG0	Access	DPORT_AHBLITE_MPU_TABLE_TIMERGROUP_REG
TIMG1	Access	DPORT_AHBLITE_MPU_TABLE_TIMERGROUP1_REG
SPI2	Access	DPORT_AHBLITE_MPU_TABLE_SPI2_REG
SPI3	Access	DPORT_AHBLITE_MPU_TABLE_SPI3_REG
SYSCON	Access	DPORT_AHBLITE_MPU_TABLE_APB_CTRL_REG

Peripheral	Authority	
	PID = 0/1	PID = 2 ~ 7
I2C1	Access	DPORT_AHBLITE_MPU_TABLE_I2C_EXT1_REG
SDMMC	Access	DPORT_AHBLITE_MPU_TABLE_SDIO_HOST_REG
EMAC	Access	DPORT_AHBLITE_MPU_TABLE_EMAC_REG
PWM1	Access	DPORT_AHBLITE_MPU_TABLE_PWM1_REG
I2S1	Access	DPORT_AHBLITE_MPU_TABLE_I2S1_REG
UART2	Access	DPORT_AHBLITE_MPU_TABLE_UART2_REG
PWM2	Access	DPORT_AHBLITE_MPU_TABLE_PWM2_REG
PWM3	Access	DPORT_AHBLITE_MPU_TABLE_PWM3_REG
RNG	Access	DPORT_AHBLITE_MPU_TABLE_PWR_REG

Each bit of register DPORT_AHBLITE_MPU_TABLE_X_REG determines whether each process can access the peripherals managed by the register. For details please see Table 112. When a bit of register DPORT_AHBLITE_MPU_TABLE_X_REG is 1, it means that a process with the corresponding PID can access the corresponding peripheral of the register. Otherwise, the process cannot access the corresponding peripheral.

Table 112: DPORT_AHBLITE_MPU_TABLE_X_REG

PID	2 3 4 5 6 7
DPORT_AHBLITE_MPU_TABLE_X_REG bit	0 1 2 3 4 5

All the DPORT_AHBLITE_MPU_TABLE_X_REG registers are in peripheral DPort Register. Only processes with PID 0/1 can modify these registers.

27. PID Controller

27.1 Overview

The ESP32 is a dual core device and is capable of running and managing multiple processes. The PID Controller supports switching of PID when a process switch occurs. In addition to PID management, the PID Controller also facilitates management of nested interrupts by recording execution status just before an interrupt service routine is executed. This enables the user application to manage process switches and nested interrupts more efficiently.

27.2 Features

The PID Controller features:

- Process management and priority
- Process PID switch
- Interrupt information recording
- Nested interrupt management

27.3 Functional Description

Eight processes run on the CPU, and are assigned with PID of 0 ~ 7 respectively. Among the eight processes, processes with PID of 0 or 1 are elevated processes with higher authority compared to processes with PID ranging from 2 ~ 7.

A CPU process switch may occur in two cases:

- An interrupt occurs and the CPU fetches an instruction from the interrupt vector. Instruction fetch or execution from interrupt vector is always treated as a process with PID of 0, irrespective of which process was being executed on the CPU when the interrupt occurred.
- A currently active process explicitly performs a process switch. Only elevated processes with PID of 0 or 1 may perform a process switch.

27.3.1 Interrupt Identification

Interrupts are classified into seven priority levels: Level 1, Level 2, Level 3, Level 4, Level 5, Level 6 (Debug), and NMI. Each level of interrupt is assigned an interrupt vector entry address. The PID Controller recognizes CPU instruction fetch from an interrupt vector entry address and automatically switches PID to 0. If CPU only accesses the interrupt vector entry address, PID Controller performs no action.

[PIDCTRL_INTERRUPT_ENABLE_REG](#) determines whether the PID Controller identifies and registers an interrupt of certain priority. When a bit of register [PIDCTRL_INTERRUPT_ENABLE_REG](#) is 1, PID Controller will take action when CPU fetches instruction from the interrupt vector entry address of the corresponding interrupt. Otherwise, PID Controller performs no action. The registers [PIDCTRL_INTERRUPT_ADDR_1_REG](#) ~ [PIDCTRL_INTERRUPT_ADDR_7_REG](#) define the interrupt vector entry address for all the interrupt priority levels. For details please refer to Table 113.

Table 113: Interrupt Vector Entry Address

Priority level	PIDCTRL_INTERRUPT_ENABLE_REG bit controlling interrupt identification	Interrupt vector entry address
Level 1	1	PIDCTRL_INTERRUPT_ADDR_1_REG
Level 2	2	PIDCTRL_INTERRUPT_ADDR_2_REG
Level 3	3	PIDCTRL_INTERRUPT_ADDR_3_REG
Level 4	4	PIDCTRL_INTERRUPT_ADDR_4_REG
Level 5	5	PIDCTRL_INTERRUPT_ADDR_5_REG
Level 6 (Debug)	6	PIDCTRL_INTERRUPT_ADDR_6_REG
NMI	7	PIDCTRL_INTERRUPT_ADDR_7_REG

27.3.2 Information Recording

When PID Controller identifies an interrupt, it records three items of information in addition to switching PID to 0. The recorded information includes the priority level of current interrupt, previous interrupt status of the system and the previous process running on the CPU.

PID Controller records the priority level of the current interrupt in register [PIDCTRL_LEVEL_REG](#). For details please refer to Table 114.

Table 114: Configuration of PIDCTRL_LEVEL_REG

Value	Priority level of the current interrupt
0	No interrupt
1	Level 1
2	Level 2
3	Level 3
4	Level 4
5	Level 5
6	Level 6
7	NMI

PID Controller also records in register [PIDCTRL_FROM_n_REG](#) the status of the system before the interrupt occurred. The bit width of register [PIDCTRL_FROM_n_REG](#) is 7. The highest four bits represent the interrupt

status of the system before the interrupt indicated by the register occurred. The lowest three bits represent the process running on the CPU before the interrupt indicated by the register occurred. For details please refer to Table 115.

Table 115: Configuration of PIDCTRL_FROM_n_REG

[6:3]	Previous interrupt	[2:0]	Previous process
0	No interrupt	0	Process with PID of 0
1	Level 1 Interrupt	1	Process with PID of 1
2	Level 2 Interrupt	2	Process with PID of 2
3	Level 3 Interrupt	3	Process with PID of 3
4	Level 4 Interrupt	4	Process with PID of 4
5	Level 5 Interrupt	5	Process with PID of 5
6	Level 6 Interrupt	6	Process with PID of 6
7	Level 7 Interrupt	7	Process with PID of 7

PID Controller possesses registers PIDCTRL_FROM_1_REG ~ PIDCTRL_FROM_7_REG, which correspond to the interrupts of Level 1, Level 2, Level 3, Level 4, Level 5, Level 6 (Debug), and NMI respectively. This enables the system to implement interrupt nesting. Please refer to Table 124 for examples.

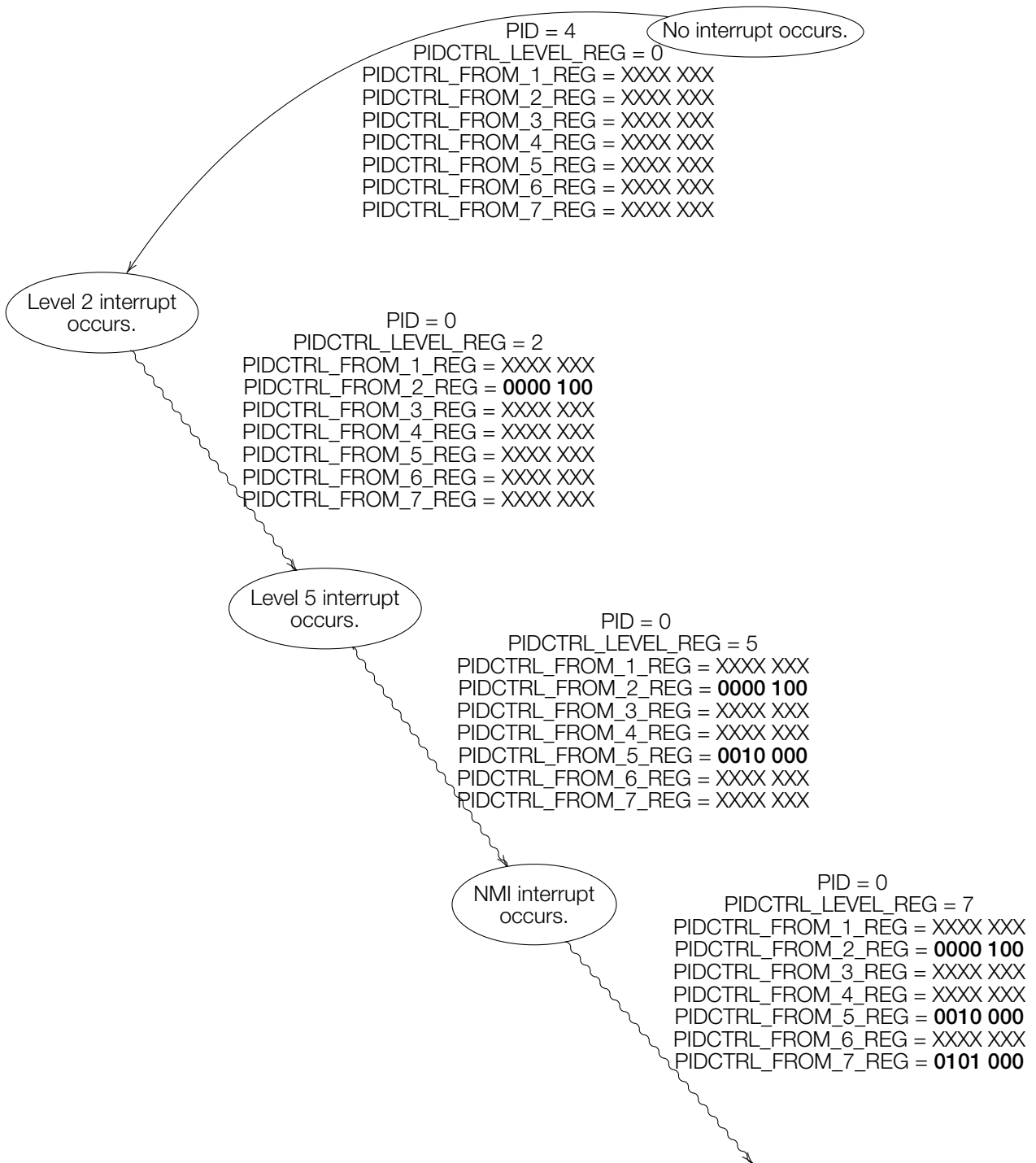


Figure 124: Interrupt Nesting

If the configuration of register `PIDCTRL_INTERRUPT_ENABLE_REG` prevents PID Controller from identifying an interrupt, PID Controller will not record any information, and `PIDCTRL_LEVEL_REG` and `PIDCTRL_FROM_n_REG` will remain unchanged.

27.3.3 Proactive Process Switching

As mentioned before, only an elevated process with PID of 0/1 can initiate a process switch. The new process may have any PID from 0 ~ 7 after the process switch. The key for successful proactive process switching is that when the last command of the current process switches to the first command of the new process, PID should

switch from 0/1 to that of the new process.

The software procedure for proactive process switching is as follows:

1. Mask all the interrupts except NMI by using software.
2. Set register [PIDCTRL_NMI_MASK_ENABLE_REG](#) to 1 to generate a CPU NMI Interrupt Mask signal.
3. Configure registers [PIDCTRL_PID_DELAY_REG](#) and [PIDCTRL_NMI_DELAY_REG](#).
4. Configure register [PIDCTRL_PID_NEW_REG](#).
5. Configure register [PIDCTRL_LEVEL_REG](#) and [PIDCTRL_FROM_n_REG](#).
6. Set register [PIDCTRL_PID_CONFIRM_REG](#) and register [PIDCTRL_NMI_MASK_DISABLE_REG](#) to 1.
7. Revoke the masking of all interrupts but NMI.
8. Switch to the new process and fetch instruction.

Though we can deal with interrupt nesting, an elevated process should not be interrupted during the process switching, and therefore the interrupts have been masked in step 1 and step 2.

In step 3, the configured values of registers [PIDCTRL_PID_DELAY_REG](#) and [PIDCTRL_NMI_DELAY_REG](#) will affect step 6.

In step 4, the configured value of register [PIDCTRL_PID_NEW_REG](#) will be the new PID after step 6.

If the system is currently in a nested interrupt and needs to revert to the previous interrupt, register [PIDCTRL_LEVEL_REG](#) must be restored based on the information recorded in register [PIDCTRL_FROM_n_REG](#) in step 5.

In step 6, after the values of register [PIDCTRL_PID_CONFIRM_REG](#) and register [PIDCTRL_NMI_MASK_DISABLE_REG](#) are set to 1, PID Controller will not immediately switch PID to the value of register [PIDCTRL_PID_NEW_REG](#), nor disable CPU NMI Interrupt Mask signal at once. Instead, PID Controller performs each task after a different number of clock cycles. The numbers of clock cycles are the values specified in register [PIDCTRL_PID_DELAY_REG](#) and [PIDCTRL_NMI_DELAY_REG](#) respectively.

In step 7, other tasks can be implemented as well. To do this, the cost of those tasks should be included when configuring registers [PIDCTRL_PID_DELAY_REG](#) and [PIDCTRL_NMI_DELAY_REG](#) in step 3.

27.4 Register Summary

Name	Description	Address	Access
PIDCTRL_INTERRUPT_ENABLE_REG	PID interrupt identification enable	0x3FF1F000	R/W
PIDCTRL_INTERRUPT_ADDR_1_REG	Level 1 interrupt vector address	0x3FF1F004	R/W
PIDCTRL_INTERRUPT_ADDR_2_REG	Level 2 interrupt vector address	0x3FF1F008	R/W
PIDCTRL_INTERRUPT_ADDR_3_REG	Level 3 interrupt vector address	0x3FF1F00C	R/W
PIDCTRL_INTERRUPT_ADDR_4_REG	Level 4 interrupt vector address	0x3FF1F010	R/W
PIDCTRL_INTERRUPT_ADDR_5_REG	Level 5 interrupt vector address	0x3FF1F014	R/W
PIDCTRL_INTERRUPT_ADDR_6_REG	Level 6 interrupt vector address	0x3FF1F018	R/W
PIDCTRL_INTERRUPT_ADDR_7_REG	NMI interrupt vector address	0x3FF1F01C	R/W
PIDCTRL_PID_DELAY_REG	New PID valid delay	0x3FF1F020	R/W
PIDCTRL_NMI_DELAY_REG	NMI mask signal disable delay	0x3FF1F024	R/W
PIDCTRL_LEVEL_REG	Current interrupt priority	0x3FF1F028	R/W
PIDCTRL_FROM_1_REG	System status before Level 1 interrupt	0x3FF1F02C	R/W
PIDCTRL_FROM_2_REG	System status before Level 2 interrupt	0x3FF1F030	R/W
PIDCTRL_FROM_3_REG	System status before Level 3 interrupt	0x3FF1F034	R/W
PIDCTRL_FROM_4_REG	System status before Level 4 interrupt	0x3FF1F038	R/W
PIDCTRL_FROM_5_REG	System status before Level 5 interrupt	0x3FF1F03C	R/W
PIDCTRL_FROM_6_REG	System status before Level 6 interrupt	0x3FF1F040	R/W
PIDCTRL_FROM_7_REG	System status before NMI	0x3FF1F044	R/W
PIDCTRL_PID_NEW_REG	New PID configuration register	0x3FF1F048	R/W
PIDCTRL_PID_CONFIRM_REG	New PID confirmation register	0x3FF1F04C	WO
PIDCTRL_NMI_MASK_ENABLE_REG	NMI mask enable register	0x3FF1F054	WO
PIDCTRL_NMI_MASK_DISABLE_REG	NMI mask disable register	0x3FF1F058	WO

Register 27.6: PIDCTRL_INTERRUPT_ADDR_5_REG (0x014)

31	0
0x040000240	

Reset

PIDCTRL_INTERRUPT_ADDR_5_REG Level 5 interrupt vector entry address. (R/W)

Register 27.7: PIDCTRL_INTERRUPT_ADDR_6_REG (0x018)

31	0
0x040000280	

Reset

PIDCTRL_INTERRUPT_ADDR_6_REG Level 6 interrupt vector entry address. (R/W)

Register 27.8: PIDCTRL_INTERRUPT_ADDR_7_REG (0x01C)

31	0
0x0400002C0	

Reset

PIDCTRL_INTERRUPT_ADDR_7_REG NMI interrupt vector entry address. (R/W)

Register 27.9: PIDCTRL_PID_DELAY_REG (0x020)

31	(reserved)	12	11	0
		PIDCTRL_PID_DELAY		
0 0				20

Reset

PIDCTRL_PID_DELAY Delay until newly assigned PID is valid. (R/W)

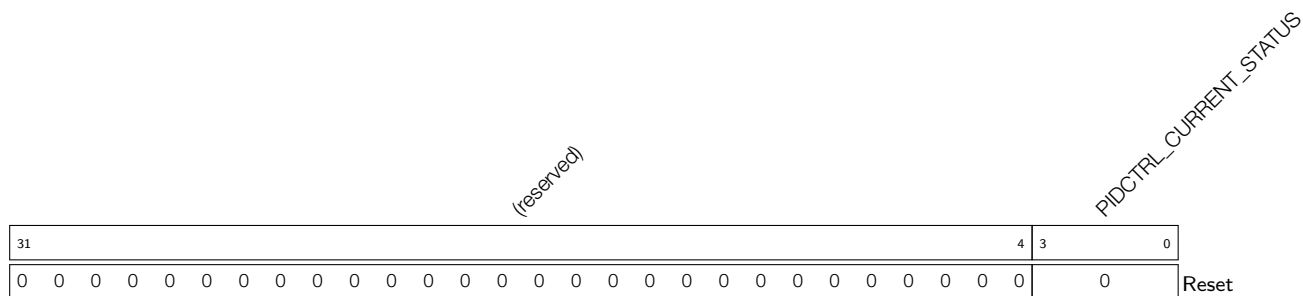
Register 27.10: PIDCTRL_NMI_DELAY_REG (0x024)

31	(reserved)	12	11	0
		PIDCTRL_NMI_DELAY		
0 0				16

Reset

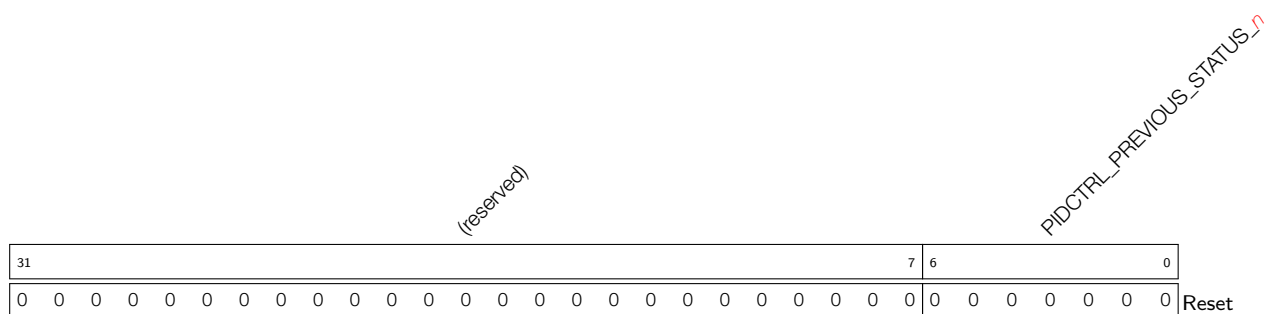
PIDCTRL_NMI_DELAY Delay for disabling CPU NMI interrupt mask signal. (R/W)

Register 27.11: PIDCTRL_LEVEL_REG (0x028)



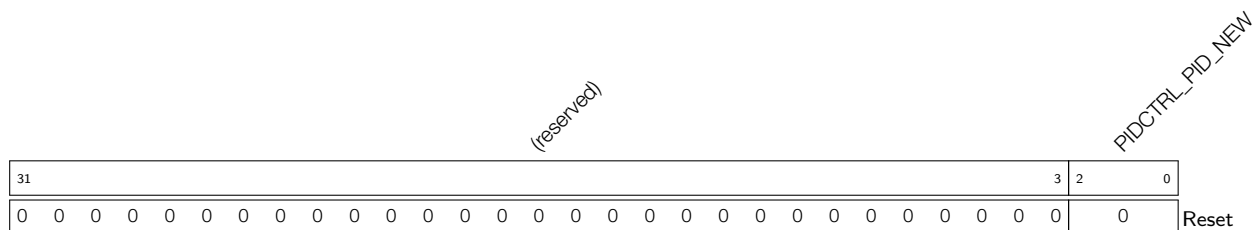
PIDCTRL_CURRENT_STATUS The current status of the system. (R/W)

Register 27.12: PIDCTRL_FROM_n_REG (n: 1-7) (0x28+0x4*n)



PIDCTRL_PREVIOUS_STATUS_n System status before any of Level 1 to Level 6, NMI interrupts occurs. (R/W)

Register 27.13: PIDCTRL_PID_NEW_REG (0x048)



PIDCTRL_PID_NEW New PID. (R/W)

28. On-Chip Sensors and Analog Signal Processing

28.1 Introduction

ESP32 has three types of built-in sensors for various applications: a [capacitive touch sensor](#) with up to 10 inputs, a [Hall effect sensor](#) and a [temperature sensor](#).

The processing of analog signals is done by two [successive approximation ADCs](#) (SAR ADC). There are five controllers dedicated to operating ADCs. This provides flexibility when it comes to converting analog inputs in both high-performance and low-power modes, with minimum processor overhead.

There is an attractive complement to the input of SAR ADC1, which processes small signals – the [low noise analog amplifier](#) with an adjustable amplification ratio.

ESP32 is also capable of generating analog signals, using two [independent DACs](#) and a [cosine waveform generator](#).

28.2 Capacitive Touch Sensor

28.2.1 Introduction

A touch-sensor system is built on a substrate which carries electrodes and relevant connections under a protective flat surface; see [Figure 125](#). When a user touches the surface, the capacitance variation is triggered and a binary signal is generated to indicate whether the touch is valid.

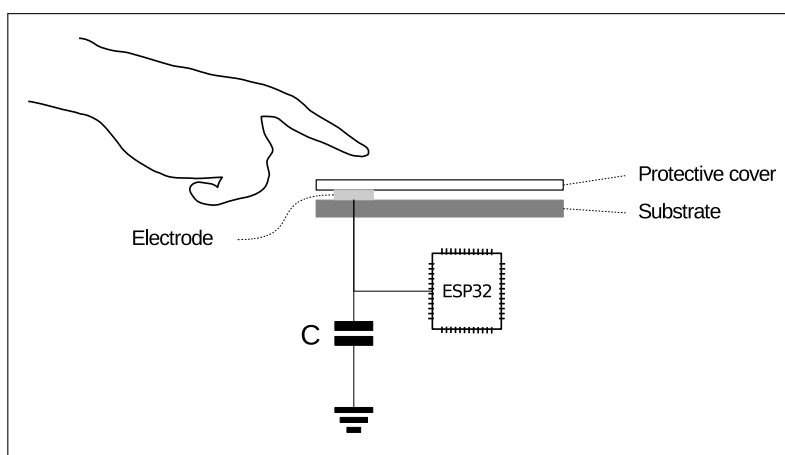


Figure 125: Touch Sensor

28.2.2 Features

- Up to 10 capacitive touch pads / GPIOs
- The sensing pads can be arranged in different combinations, so that a larger area or more points can be detected.
- The touch pad sensing process is under the control of a hardware-implemented finite-state machine (FSM) which is initiated by software or a dedicated hardware timer.
- Information that a pad has been touched can be obtained:

- by checking touch-sensor registers directly through software,
 - from an interrupt triggered by a touch detection,
 - by waking up the CPU from deep sleep upon touch detection.
- Support for low-power operation in the following scenarios:
 - CPU waiting in deep sleep and saving power until touch detection and subsequent wake up
 - Touch detection managed by the ULP coprocessor
 The user program in ULP coprocessor can trigger a scanning process by checking and writing into specific registers, in order to verify whether the touch threshold is reached.

28.2.3 Available GPIOs

All 10 available sensing GPIOs (pads) are listed in Table 117.

Table 117: ESP32 Capacitive Sensing Touch Pads

Touch Sensing Signal Name	Pin Name
T0	GPIO4
T1	GPIO0
T2	GPIO2
T3	MTDO
T4	MTCK
T5	MTDI
T6	MTMS
T7	GPIO27
T8	32K_XN
T9	32K_XP

28.2.4 Functional Description

The internal structure of the touch sensor is shown in Figure 126. The operating flow is shown in Figure 127.

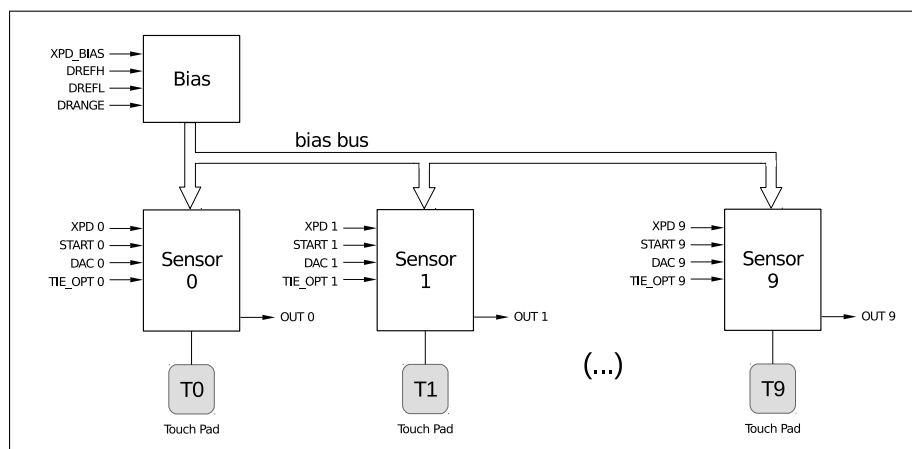


Figure 126: Touch Sensor Structure

The capacitance of a touch pad is periodically charged and discharged. The chart "Pad Voltage" shows the

charge/discharge voltage that swings from DREFH (reference voltage high) to DREFL (reference voltage low). During each swing, the touch sensor generates an output pulse, shown in the chart as "OUT". The swing slope is different when the pad is touched (high capacitance) and when it is not (low capacitance). By comparing the difference between the output pulse counts during the same time interval, we can conclude whether the touch pad has been touched. TIE_OPT is used to establish the initial voltage level that starts the charge/discharge cycle.

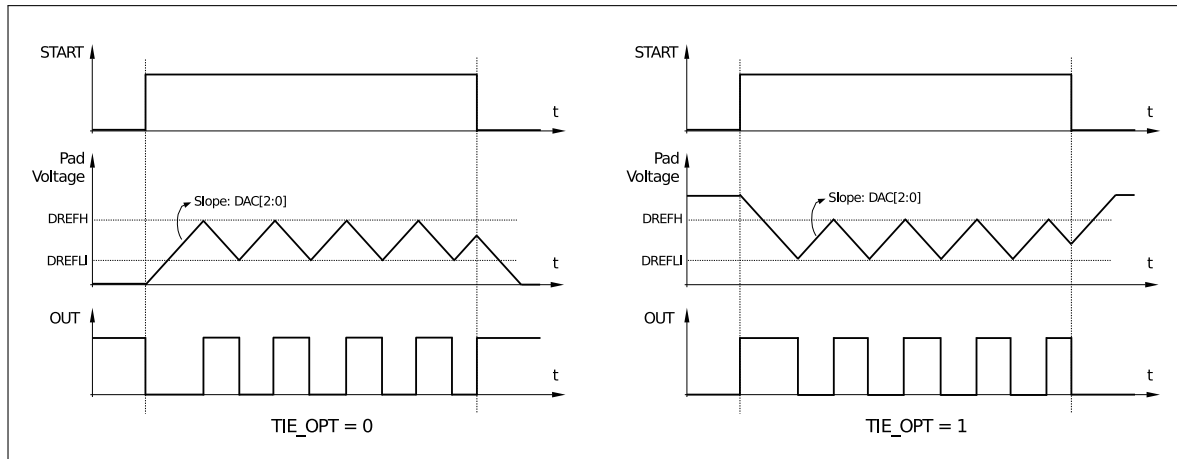


Figure 127: Touch Sensor Operating Flow

28.2.5 Touch FSM

The Touch FSM performs a measurement sequence described in section 28.2.4. Software can operate the Touch FSM through dedicated registers. The internal structure of a touch FSM is shown in Figure 128.

The functions of Touch FSM include:

- Receipt of a start signal, either from software or a timer
 - when `SENS_SAR_TOUCH_START_FORCE=1`, `SENS_SAR_TOUCH_START_EN` is used to initiate a single measurement
 - when `SENS_SAR_TOUCH_START_FORCE=0`, measurement is triggered periodically with a timer.

The Touch FSM can be active in sleep mode. The `SENS_SAR_TOUCH_SLEEP_CYCLES` register can be used to set the cycles. The sensor is operated by `FAST_CLK`, which normally runs at 8 MHz. More information on that can be found in chapter [Reset and Clock](#).

- Generation of `XPD_TOUCH_BIAS` / `TOUCH_XPD` / `TOUCH_START` with adjustable timing sequence
To select enabled pads, `TOUCH_XPD` / `TOUCH_START` is masked by the 10-bit register `SENS_SAR_TOUCH_PAD_WORKEN`.
- Counting of pulses on `TOUCH0_OUT` ~ `TOUCH9_OUT`
The result can be read from `SENS_SAR_TOUCH_MEAS_OUTn`. All ten touch sensors can work simultaneously.
- Generation of a wakeup interrupt
The FSM regards the touch pads as “touched”, if the number of counted pulses is below the threshold. The 10-bit registers `SENS_TOUCH_PAD_OUTEN1` & `SENS_TOUCH_PAD_OUTEN2` define two sets of touch pads, i.e. SET1 & SET2. If at least one of the pads in SET1 is “touched”, the wakeup interrupt will be

generated by default. It is also possible to configure the wakeup interrupt to be generated only when pads from both sets are “touched”.

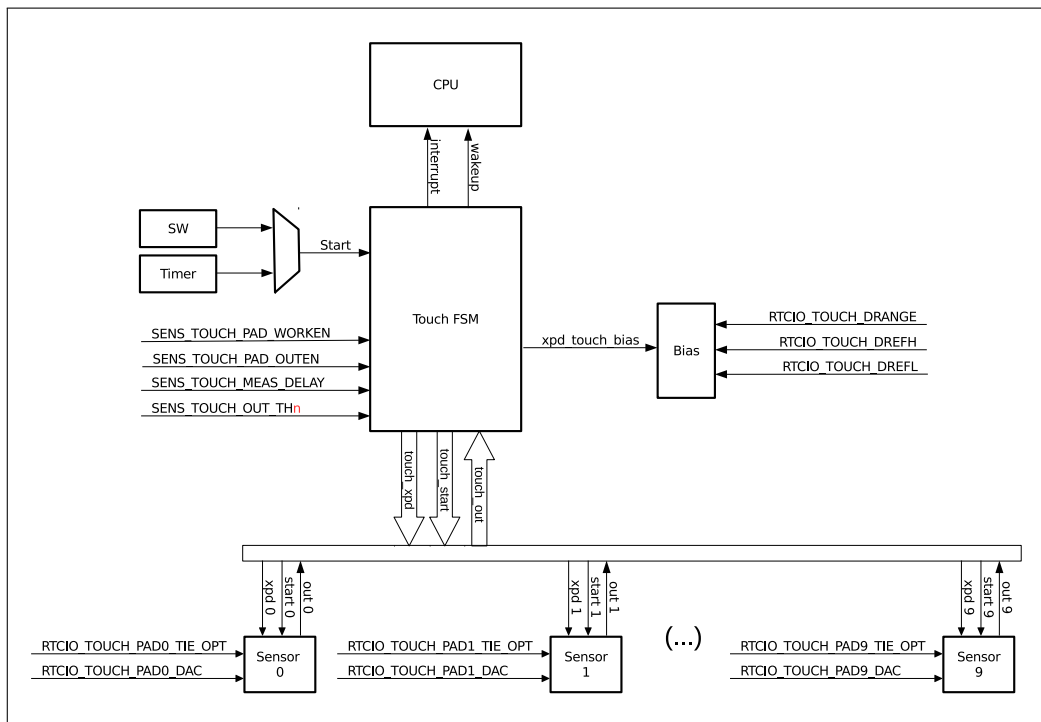


Figure 128: Touch FSM Structure

28.3 SAR ADC

28.3.1 Introduction

ESP32 integrates two 12-bit SAR ADCs. They are managed by five SAR ADC controllers, and are able to measure signals from one to 18 analog pads. It is also possible to measure internal signals, such as vdd33. Some of the pads can be used to build a programmable gain-amplifier which measures small analog signals.

The SAR ADC controllers have specialized uses. Two of them support high-performance multiple-channel scanning. Another two are used for low-power operation during deep sleep, and the last one is dedicated to PWDET / PKDET (power and peak detection). A diagram of the SAR ADCs is shown in Figure 129.

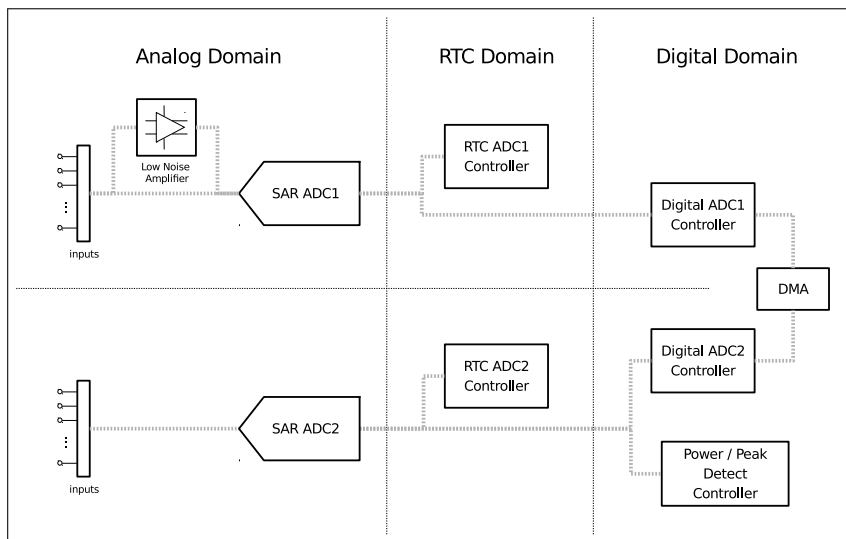


Figure 129: SAR ADC Depiction

28.3.2 Features

- Two SAR ADCs, with simultaneous sampling and conversion
- Up to five SAR ADC controllers for different purposes (e.g. high performance, low power or PWDET / PKDET).
- Up to 18 analog input pads
- One channel for internal voltage vdd33, two for pa_pkdet (available on selected controllers)
- Low-noise amplifier for small analog signals (available on one controller)
- 12-bit, 11-bit, 10-bit, 9-bit configurable resolution
- DMA support (available on one controller)
- Multiple channel-scanning modes (available on two controllers)
- Operation during deep sleep (available on one controller)
- Controlled by a ULP coprocessor (available on two controllers)

28.3.3 Outline of Function

The SAR ADC module's major components, and their interconnections, are shown in Figure 130.

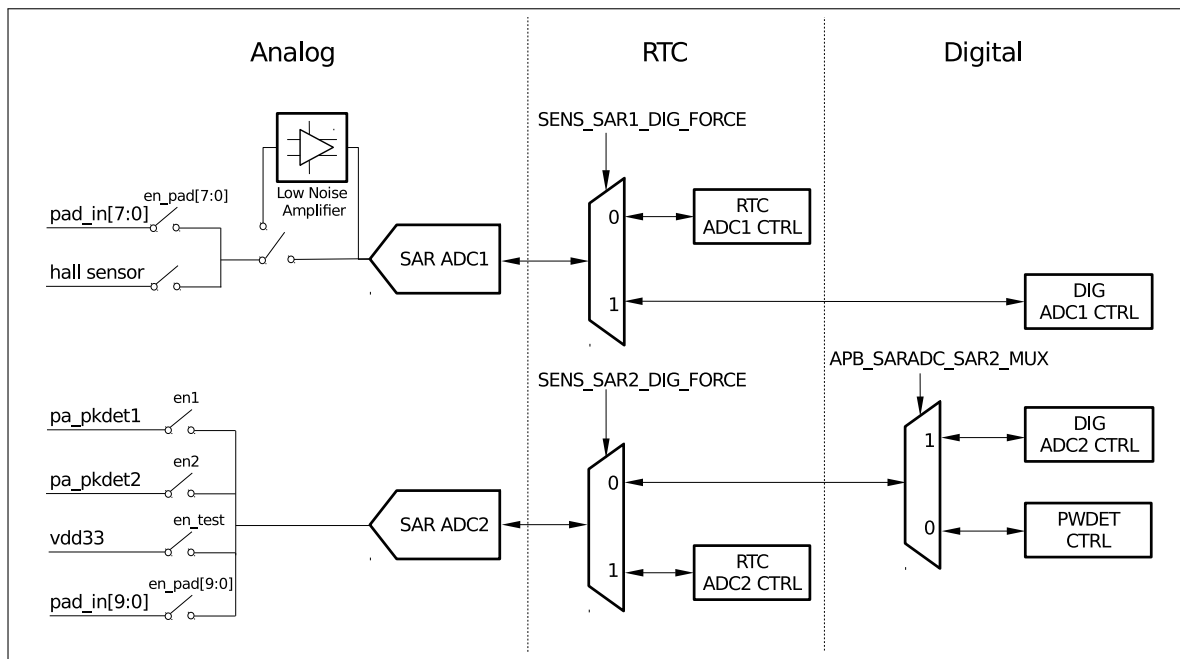


Figure 130: SAR ADC Outline of Function

A summary of all the analog signals that may be sent to the SAR ADC module for processing by either ADC1 or ADC2 is presented in Table 118.

Table 118: Inputs of SAR ADC module

Signal Name	Pad #	Processed by
VDET_2	7	SAR ADC1
VDET_1	6	
32K_XN	5	
32K_XP	4	
SENSOR_VN	3	
SENSOR_CAPN	2	
SENSOR_CAPP	1	
SENSOR_VP	0	
Hall sensor	n/a	
GPIO26	9	SAR ADC2
GPIO25	8	
GPIO27	7	
MTMS	6	
MTDI	5	
MTCK	4	
MTDO	3	
GPIO2	2	
GPIO0	1	
GPIO4	0	
pa_pkdet1	n/a	
pa_pkdet2	n/a	
vdd33	n/a	

There are five ADC controllers in ESP32: RTC ADC1 CTRL, RTC ADC2 CTRL, DIG ADC1 CTRL, DIG ADC2 CTRL and PWDET CTRL. The differences between them are summarized in Table 119.

Table 119: ESP32 SAR ADC Controllers

	RTC ADC1	RTC ADC2	DIG ADC1	DIG ADC2	PWDET
DAC	Y	-	-	-	-
Low-Noise Amplifier	Y	-	-	-	-
Support deep sleep	Y	Y	-	-	-
ULP coprocessor	Y	Y	-	-	-
vdd33	-	Y	-	Y	-
PWDET/PKDET	-	-	-	-	Y
Hall sensor	Y	-	-	-	-
DMA	-	-	Y	-	-

28.3.4 RTC SAR ADC Controllers

The purpose of SAR ADC controllers in the RTC power domain – RTC ADC1 CTRL and RTC ADC2 CTRL – is to provide ADC measurement with minimal power consumption in a low frequency.

The outline of a single controller's function is shown in Figure 131. For each controller, the start of analog-to-digital conversion can be triggered by register `SENS_SAR_MEASn_START_SAR`. The measurement's result can be obtained from register `SENS_SAR_MEASn_DATA_SAR`.

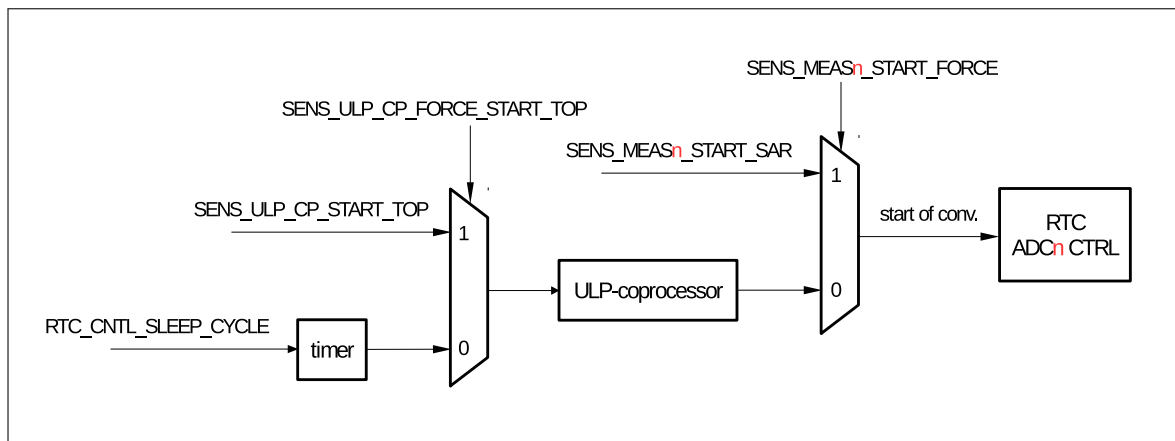


Figure 131: RTC SAR ADC Outline of Function

The controllers are intertwined with the ULP coprocessor, as the ULP coprocessor has a built-in instruction to start an ADC measurement. In many cases, the controllers need to cooperate with the ULP coprocessor, e.g.:

- when periodically monitoring a channel during deep sleep, where the ULP coprocessor is the only trigger source during this mode;
- when scanning channels continuously in a sequence. Continuous scanning or DMA is not supported by the controllers. However, it is possible with the help of the ULP coprocessor.

The SAR ADC1 controller supports the low-noise amplifier, as well as DAC. As such, SAR ADC1 can be used in complex application scenarios.

28.3.5 DIG SAR ADC Controllers

Compared to RTC SAR ADC controllers, DIG SAR ADC controllers have optimized performance and throughput. Some of their features are:

- High performance; the clock is much faster, therefore, the sample rate is highly increased.
- Multiple-channel scanning mode; there is a pattern table that defines the measurement rule for each SAR ADC. The scanning mode can be configured as a single mode, double mode, or alternate mode.
- The scanning can be started by software or I2S.
- DMA support; an interrupt will be generated when scanning is finished.

Note:

We do not use the term “start of conversion” in this section, because there is no direct access to starting a single SAR analog-to-digital conversion. We use “start of scan” instead, which implies that we expect to scan a sequence of channels with DIG ADC controllers.

Figure 132 shows a diagram of DIG SAR ADC controllers.

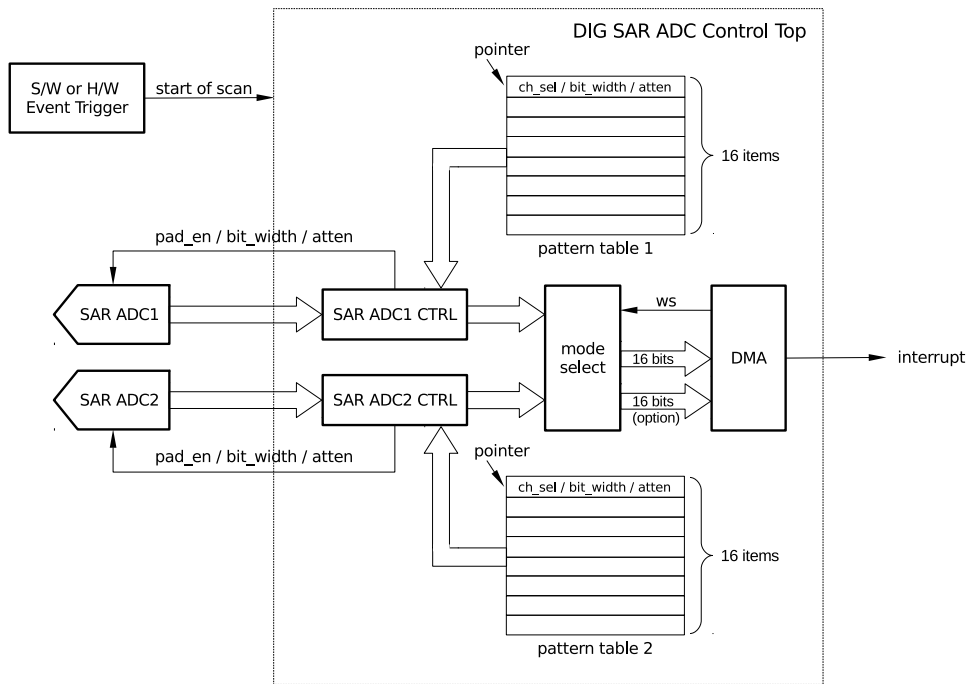


Figure 132: Diagram of DIG SAR ADC Controllers

The pattern tables contain the measurement rules mentioned above. Each table has 16 items which store information on channel selection, resolution and attenuation. When scanning starts, the controller reads measurement rules one-by-one from a pattern table. For each controller the scanning sequence includes 16 different rules at most, before repeating itself.

The 8-bit item (the pattern table register) is composed of three fields that contain channel, resolution and attenuation information, as shown in Table 120.

Table 120: Fields of the Pattern Table Register

Pattern Table Register [7:0]		
ch_sel[3:0]	bit_width[1:0]	atten[1:0]
channel to be scanned	resolution	attenuation

There are three scanning modes: single mode, double mode and alternate mode.

- Single mode: channels of either SAR ADC1 or SAR ADC2 will be scanned.
- Double mode: channels of SAR ADC1 and SAR ADC2 will be scanned simultaneously.
- Alternate mode: channels of SAR ADC1 and SAR ADC2 will be scanned alternately.

ESP32 supports up to a 12-bit SAR ADC resolution. The 16-bit data in DMA is composed of the ADC result and some necessary information related to the scanning mode:

- For single mode, only 4-bit information on channel selection is added.
- For double mode or alternate mode, 4-bit information on channel selection is added plus one extra bit indicating which SAR ADC was selected.

For each scanning mode there is a corresponding data format, called Type I and Type II. Both data formats are described in Tables 121 and 122.

Table 121: Fields of Type I DMA Data Format

Type I DMA Data Format [15:0]	
ch_sel[3:0]	data[11:0]
channel	SAR ADC data

Table 122: Fields of Type II DMA Data Format

Type II DMA Data Format [15:0]		
sar_sel	ch_sel[3:0]	SAR ADC data[10:0]
SAR ADCn	channel	SAR ADC data

For Type I the resolution of SAR ADC is up to 12 bits, while for Type II the resolution is 11 bits at most.

DIG SAR ADC Controllers allow the use of I2S for direct memory access. The WS signal of I2S acts as a measurement-trigger signal. The DATA signal provides the information that the measurement result is ready. Software can configure `APB_SARADC_DATA_TO_I2S`, in order to connect ADC to I2S.

28.4 Low-Noise Amplifier

28.4.1 Introduction

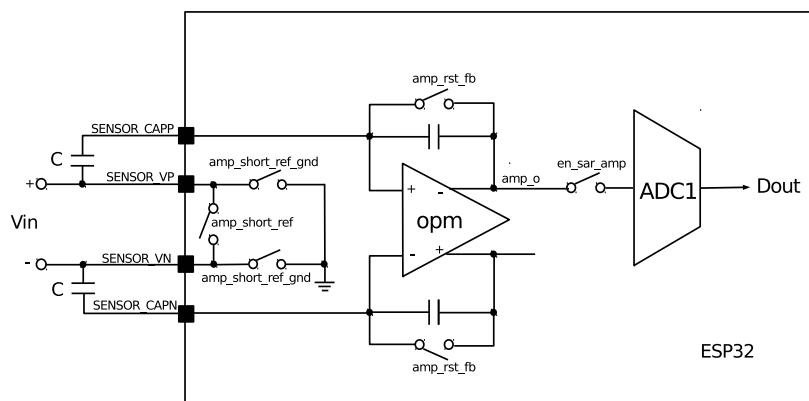
ESP32 integrates an analog amplifier designed to amplify a small DC signal that is then passed on to SAR ADC1 for sampling. The amplification gain is adjustable with two off-chip capacitors.

28.4.2 Features

- Configurable gain by changing the value of two sampling capacitors connected to pins `SENSOR_CAPP` / `SENSOR_VP` and `SENSOR_CAPN` / `SENSOR_VN`; see Figure 133.
- Designed to operate with other on-chip components like e.g. DAC or ULP coprocessor.

28.4.3 Overview of Function

The structure of the low-noise amplifier is shown in Figure 133:

**Figure 133: Structure of Low-Noise Amplifier**

The amplifier's sequence of operation is shown in Figure 134:

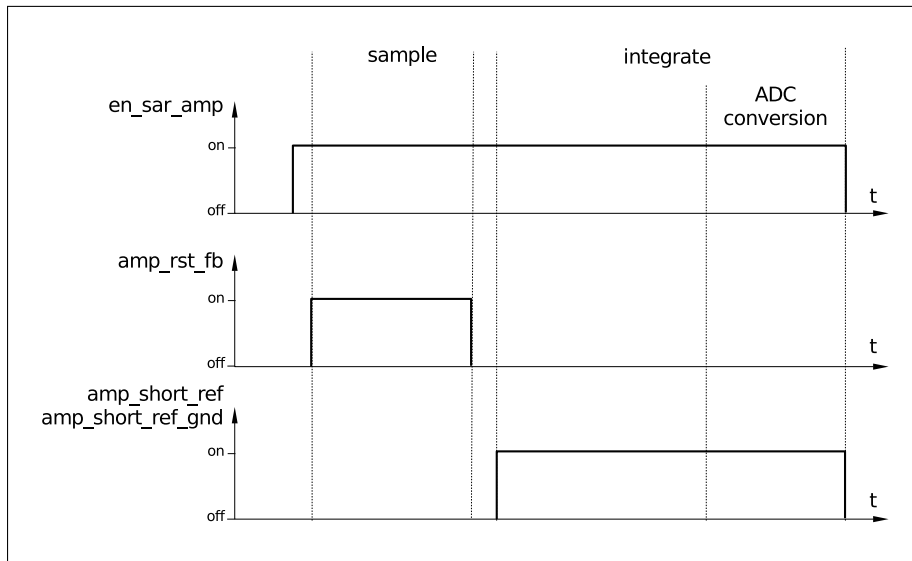


Figure 134: Low-Noise Amplifier – Sequence of Operation

1. The process is started by en_sar_amp. The amplifier is powered up and connected to the SAR ADC1.
2. A pulse on amp_rst_fb resets the amplifier. V_{in} is sampled by charging external capacitors.
3. Finally, amp_short_ref is closed. This starts integrating the V_{in} sample by the amplifier.

$$V_{ampo} = V_{in} \cdot C + V_{cm}$$

C is the value of external capacitors in pF. V_{cm} is the common-mode voltage of the amplifier output, which is fixed.

If the common-mode voltage input, V_{in} , is about 0V, amp_short_ref_gnd could take the place of amp_short_ref. In other cases, the bit controlling this signal should be always cleared. After the V_{ampo} becomes stable, the SAR ADC1 converts it into a digital value.

Since the low-power amplifier works always together with SAR ADC, it is usually controlled by the FSM in RTC ADC1 CTRL.

28.5 Hall Sensor

28.5.1 Introduction

The Hall effect is the generation of a voltage difference across an n-type semiconductor passing electrical current, when a magnetic field is applied to it in a direction perpendicular to that of the flow of the current. The voltage is proportional to the product of the magnetic field's strength and current value. A Hall-effect sensor could be used to measure the strength of a magnetic field, when constant current flows through it, or when the current is in the presence of a constant magnetic field. As the heart of many applications, the Hall-effect sensors provide proximity detection, positioning, speed measurement, and current sensing.

Inside of ESP32 there is a Hall sensor for magnetic field-sensing applications, which is designed to feed voltage signals to the ultra-low noise amplifier and SAR ADC. It can be controlled by the ULP coprocessor, when low-power operation is required. Such functionality, which enhances the power-processing and flexibility of ESP32, makes it an attractive solution for position sensing, proximity detection, speed measurement, etc.

28.5.2 Features

- Built-in Hall element with amplifier
- Designed to operate with low-noise amplifier and ADC
- Capable of outputting both analog voltage and digital signals related to the strength of the magnetic field
- Powerful and easy-to-implement functionality, due to its integration with built-in ULP coprocessor, GPIOs, CPU, Wi-Fi, etc.

28.5.3 Functional Description

The Hall sensor converts the magnetic field into voltage, feeds it into an amplifier, and then outputs it through pin SENSOR_VP and pin SENSOR_VN. ESP32's built-in low-noise amplifier and ADC convert the voltage into a digital value for processing by the CPU in the digital domain.

The inner structure of a Hall sensor is shown in Figure 135.

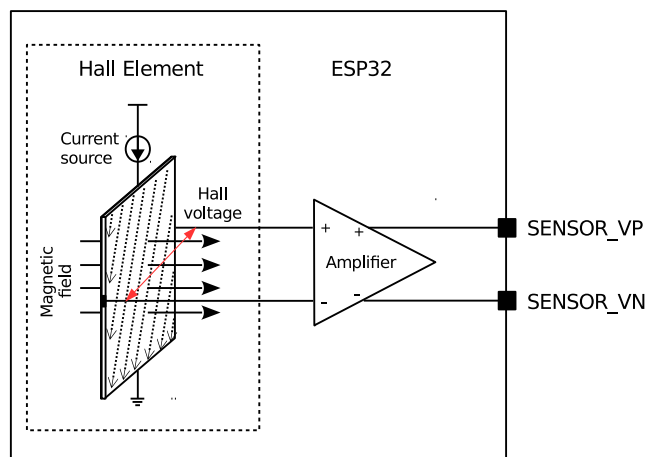


Figure 135: Hall Sensor

The configuration of a Hall sensor for reading is done with registers [SENS_SAR_TOUCH_CTRL1_REG](#) and [RTCIO_HALL_SENS_REG](#), which are used to power up the Hall sensor and connect it to the low-noise amplifier. The subsequent processing is done by SAR ADC1. The result is obtained from the RTC ADC1 controller. For more details, please refer to sections [28.4](#) and [28.3](#).

28.6 Temperature Sensor

28.6.1 Introduction

The temperature sensor generates a voltage that changes linearly with temperature. The output voltage is then converted with ADC into a digital value. The temperature measurement range is $-40^{\circ}\text{C} \sim 125^{\circ}\text{C}$.

It should be noted that temperature measurements are affected by heat generated by Wi-Fi circuitry. This depends on power transmission, data transfer, module / PCB construction and the related dispersion of heat. Also, temperature-versus-voltage characteristics have different offset from chip to chip, due to process variation.

Therefore, the temperature sensor is suitable mainly for applications that detect temperature changes rather than the absolute value of temperature.

Improvement of accuracy in absolute temperature measurement is possible by performing sensor calibration and by operating ESP32 in low-power modes which reduce variation and the amount of heat generated by the module itself.

28.6.2 Features

- Temperature measurement range: -40°C to 125°C
- Suitable for applications that detect changes in temperature rather than the absolute value of temperature.

28.6.3 Functional Description

A generic schematic description of the temperature sensor's operation is provided in Figure 136. The temperature-sensing device converts the temperature into voltage; then, the ADC samples and converts the voltage into a digital value. Eventually, this value can be processed by a user application.

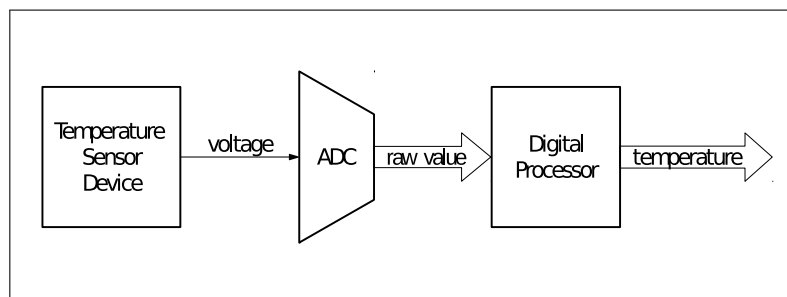


Figure 136: Temperature Sensor

The configuration of the temperature sensor is done by using register [SENS_SAR_TSENS_CTRL_REG](#). The conversion status is available in register [SENS_TSENS_RDY_OUT](#). The measurement result can be read from [SENS_TSENS_OUT](#).

28.7 DAC

28.7.1 Introduction

Two 8-bit DAC channels can be used to convert digital values into analog output signals (up to two of them). The design structure is composed of integrated resistor strings and a buffer. This dual DAC supports power supply and uses it as input voltage reference. The dual DAC also supports independent or simultaneous signal conversions inside of its channels.

28.7.2 Features

The features of DAC are as follows:

- Two 8-bit DAC channels
- Independent or simultaneous conversion in channels
- Voltage reference from the VDD3P3_RTC pin

- Cosine waveform (CW) generator
- DMA capability
- Start of conversion can be triggered by software or SAR ADC FSM (please refer to the [SAR ADC chapter](#) for more details)
- Can be fully controlled by the ULP coprocessor

A diagram showing the DAC channel's function is presented in Figure 137. For a detailed description, see the sections below.

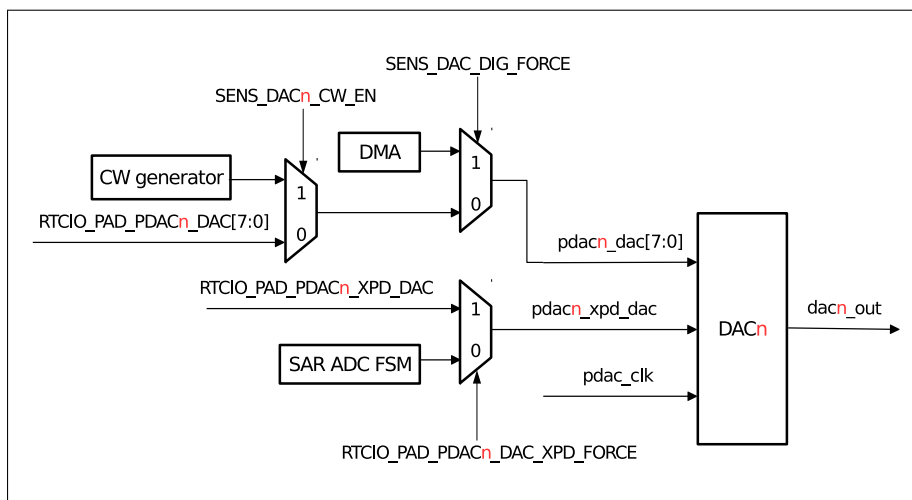


Figure 137: Diagram of DAC Function

28.7.3 Structure

The two 8-bit DAC channels can be configured independently. For each DAC channel, the output analog voltage can be calculated as follows:

$$\text{DAC}_n\text{_OUT} = \text{VDD3P3_RTC} \cdot \text{PDAC}_n\text{_DAC} / 256$$

- VDD3P3_RTC is the voltage on pin VDD3P3_RTC (typically 3.3V).
- PDAC_n_DAC has multiple sources: CW generator, register RTCIO_PAD_DAC_n_REG, and DMA.

The start of conversion is determined by register RTCIO_PAD_PDAC_n_XPD_DAC. The conversion process itself is controlled by software or SAR ADC FSM; see Figure 137.

28.7.4 Cosine Waveform Generator

The cosine waveform (CW) generator can be used to generate a cosine / sine tone. A diagram showing cosine waveform generator's function is presented in Figure 138.

The CW generator has the following features:

- Adjustable frequency
The frequency of CW can be adjusted by register SENS_SAR_SW_FSTEP[15:0]:

$$\text{freq} = \text{dig_clk_rtc_freq} \cdot \text{SENS_SAR_SW_FSTEP} / 65536$$

The frequency of dig_clk_rtc is typically 8 MHz.

- **Scaling**
Configuring register `SENS_SAR_DAC_SCALEn[1:0]`; the amplitude of a CW can be multiplied by 1, 1/2, 1/4 or 1/8.
- **DC offset**
The offset may be introduced by register `SENS_SAR_DAC_DCn[7:0]`. The result will be saturated.
- **Phase shift**
A phase-shift of 0 / 90 / 180 / 270 degrees can be added by setting register `SENS_SAR_DAC_INVn[1:0]`.

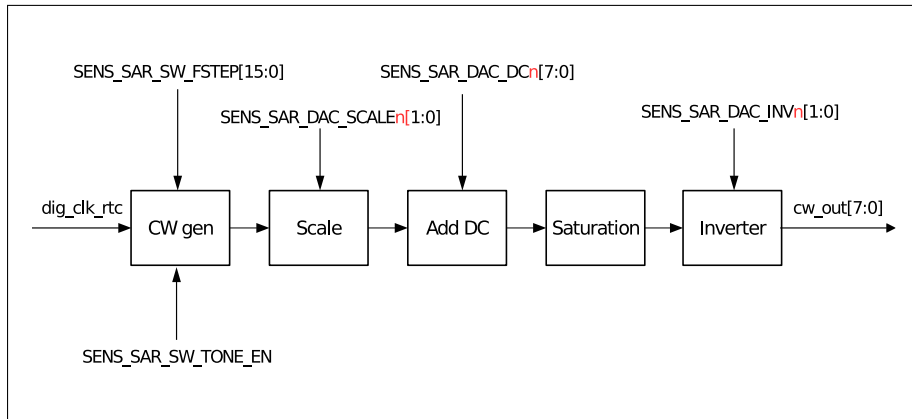


Figure 138: Cosine Waveform (CW) Generator

28.7.5 DMA support

A DMA controller with dual DMA channels can be used to set the output of two DAC channels. By configuring `SENS_SAR_DAC_DIG_FORCE`, `I2S_clk` can be connected to DAC clk, and `I2S_DATA_OUT` can be connected to `DAC_DATA` for direct memory access.

For details, please refer to chapter [DMA](#).

28.8 Register Summary

Note: The registers listed below have been grouped, according to their functionality. This particular grouping does not reflect the exact sequential order of their place in memory.

28.8.1 Sensors

Name	Description	Address	Access
Touch pad setup and control registers			
SENS_SAR_TOUCH_CTRL1_REG	Touch pad control	0x3FF48858	R/W
SENS_SAR_TOUCH_CTRL2_REG	Touch pad control and status	0x3FF48884	RO
SENS_SAR_TOUCH_ENABLE_REG	Wakeup interrupt control and working set	0x3FF4888C	R/W
SENS_SAR_TOUCH_THRES1_REG	Threshold setup for pads 0 and 1	0x3FF4885C	R/W
SENS_SAR_TOUCH_THRES2_REG	Threshold setup for pads 2 and 3	0x3FF48860	R/W
SENS_SAR_TOUCH_THRES3_REG	Threshold setup for pads 4 and 5	0x3FF48864	R/W
SENS_SAR_TOUCH_THRES4_REG	Threshold setup for pads 6 and 7	0x3FF48868	R/W
SENS_SAR_TOUCH_THRES5_REG	Threshold setup for pads 8 and 9	0x3FF4886C	R/W
SENS_SAR_TOUCH_OUT1_REG	Counters for pads 0 and 1	0x3FF48870	RO
SENS_SAR_TOUCH_OUT2_REG	Counters for pads 2 and 3	0x3FF48874	RO
SENS_SAR_TOUCH_OUT3_REG	Counters for pads 4 and 5	0x3FF48878	RO
SENS_SAR_TOUCH_OUT4_REG	Counters for pads 6 and 6	0x3FF4887C	RO
SENS_SAR_TOUCH_OUT5_REG	Counters for pads 8 and 9	0x3FF48880	RO
SAR ADC control register			
SENS_SAR_START_FORCE_REG	SAR ADC1 and ADC2 control	0x3FF4882C	R/W
SAR ADC1 control registers			
SENS_SAR_READ_CTRL_REG	SAR ADC1 data and sampling control	0x3FF48800	R/W
SENS_SAR_MEAS_START1_REG	SAR ADC1 conversion control and status	0x3FF48854	RO
SAR ADC2 control registers			
SENS_SAR_READ_CTRL2_REG	SAR ADC2 data and sampling control	0x3FF48890	R/W
SENS_SAR_MEAS_START2_REG	SAR ADC2 conversion control and status	0x3FF48894	RO
ULP coprocessor configuration register			
SENS_ULP_CP_SLEEP_CYC0_REG	Sleep cycles for ULP coprocessor	0x3FF48818	R/W
Pad attenuation configuration registers			
SENS_SAR_ATTEN1_REG	2-bit attenuation for each pad	0x3FF48834	R/W
SENS_SAR_ATTEN2_REG	2-bit attenuation for each pad	0x3FF48838	R/W
Temperature sensor registers			
SENS_SAR_TSENS_CTRL_REG	Temperature sensor configuration	0x3FF4884C	R/W
SENS_SAR_SLAVE_ADDR3_REG	Temperature sensor readout	0x3FF48844	RO
DAC control registers			
SENS_SAR_DAC_CTRL1_REG	DAC control	0x3FF48898	R/W
SENS_SAR_DAC_CTRL2_REG	DAC output control	0x3FF4889C	R/W

28.8.2 Advanced Peripheral Bus

Name	Description	Address	Access
SAR ADC1 and ADC2 common configuration registers			

APB_SARADC_CTRL_REG	SAR ADC common configuration	0x06002610	R/W
APB_SARADC_CTRL2_REG	SAR ADC common configuration	0x06002614	R/W
APB_SARADC_FSM_REG	SAR ADC FSM sample cycles configuration	0x06002618	R/W
SAR ADC1 pattern table registers			
APB_SARADC_SAR1_PATT_TAB1_REG	Items 0 - 3 of pattern table	0x0600261C	R/W
APB_SARADC_SAR1_PATT_TAB2_REG	Items 4 - 7 of pattern table	0x06002620	R/W
APB_SARADC_SAR1_PATT_TAB3_REG	Items 8 - 11 of pattern table	0x06002624	R/W
APB_SARADC_SAR1_PATT_TAB4_REG	Items 12 - 15 of pattern table	0x06002628	R/W
SAR ADC2 pattern table registers			
APB_SARADC_SAR2_PATT_TAB1_REG	Items 0 - 3 of pattern table	0x0600262C	R/W
APB_SARADC_SAR2_PATT_TAB2_REG	Items 4 - 7 of pattern table	0x06002630	R/W
APB_SARADC_SAR2_PATT_TAB3_REG	Items 8 - 11 of pattern table	0x06002634	R/W
APB_SARADC_SAR2_PATT_TAB4_REG	Items 12 - 15 of pattern table	0x06002638	R/W

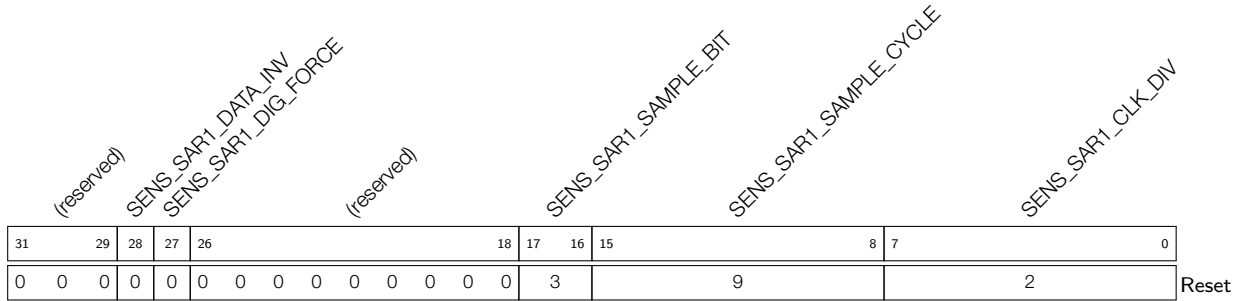
28.8.3 RTC I/O

For details, please refer to Section [Register Summary](#) in Chapter [IO_MUX and GPIO Matrix](#).

28.9 Registers

28.9.1 Sensors

Register 28.1: SENS_SAR_READ_CTRL_REG (0x0000)



SENS_SAR1_DATA_INV Invert SAR ADC1 data. (R/W)

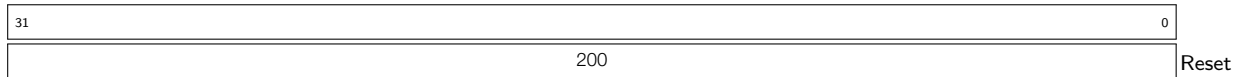
SENS_SAR1_DIG_FORCE 1: SAR ADC1 controlled by DIG ADC1 CTR, 0: SAR ADC1 controlled by RTC ADC1 CTRL. (R/W)

SENS_SAR1_SAMPLE_BIT Bit width of SAR ADC1, 00: for 9-bit, 01: for 10-bit, 10: for 11-bit, 11: for 12-bit. (R/W)

SENS_SAR1_SAMPLE_CYCLE Sample cycles for SAR ADC1. (R/W)

SENS_SAR1_CLK_DIV Clock divider. (R/W)

Register 28.2: SENS_ULP_CP_SLEEP_CYC0_REG (0x0018)



SENS_ULP_CP_SLEEP_CYC0_REG Sleep cycles for ULP coprocessor timer. (R/W)

Register 28.9: SENS_SAR_TOUCH_CTRL1_REG (0x0058)

(reserved)				SENS_HALL_PHASE_FORCE				SENS_XPD_HALL_FORCE				SENS_TOUCH_OUT_1EN				SENS_TOUCH_OUT_SEL				SENS_TOUCH_XPD_WAIT				SENS_TOUCH_MEAS_DELAY			
31	28	27	26	25	24	23									16	15									0		
0	0	0	0	0	0	1	0	0x004								0x01000								Reset			

SENS_HALL_PHASE_FORCE 1: HALL PHASE is controlled by SW, 0: HALL PHASE is controlled by FSM in ULP coprocessor. (R/W)

SENS_XPD_HALL_FORCE 1: XPD HALL is controlled by SW, 0: XPD HALL is controlled by FSM in ULP coprocessor. (R/W)

SENS_TOUCH_OUT_1EN 1: wakeup interrupt is generated if SET1 is touched, 0: wakeup interrupt is generated only if both SET1 & SET2 are touched. (R/W)

SENS_TOUCH_OUT_SEL 1: the touch pad is considered touched when the value of the counter is greater than the threshold, 0: the touch pad is considered touched when the value of the counter is less than the threshold. (R/W)

SENS_TOUCH_XPD_WAIT The waiting time (in 8 MHz cycles) between TOUCH_START and TOUCH_XPD. (R/W)

SENS_TOUCH_MEAS_DELAY The measurement's duration (in 8 MHz cycles). (R/W)

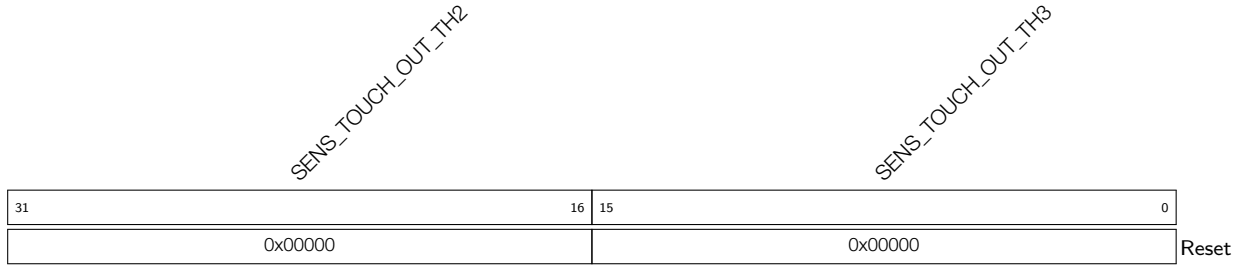
Register 28.10: SENS_SAR_TOUCH_THRES1_REG (0x005c)

SENS_TOUCH_OUT_TH0																SENS_TOUCH_OUT_TH1																
31															16	15															0	
0x00000																0x00000																Reset

SENS_TOUCH_OUT_TH0 The threshold for touch pad 0. (R/W)

SENS_TOUCH_OUT_TH1 The threshold for touch pad 1. (R/W)

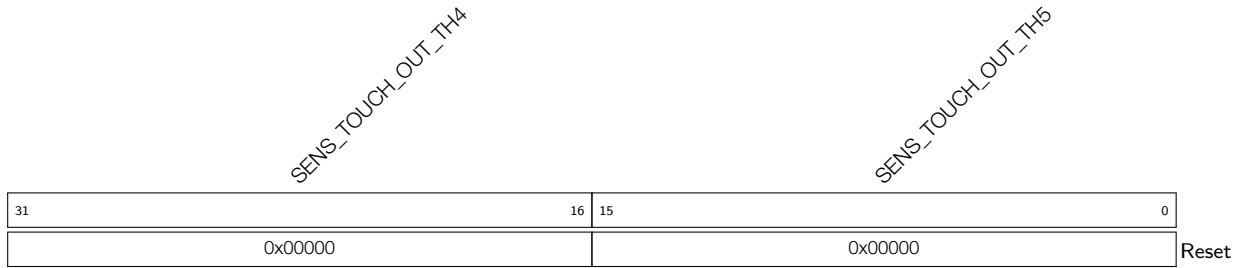
Register 28.11: SENS_SAR_TOUCH_THRES2_REG (0x0060)



SENS_TOUCH_OUT_TH2 The threshold for touch pad 2. (R/W)

SENS_TOUCH_OUT_TH3 The threshold for touch pad 3. (R/W)

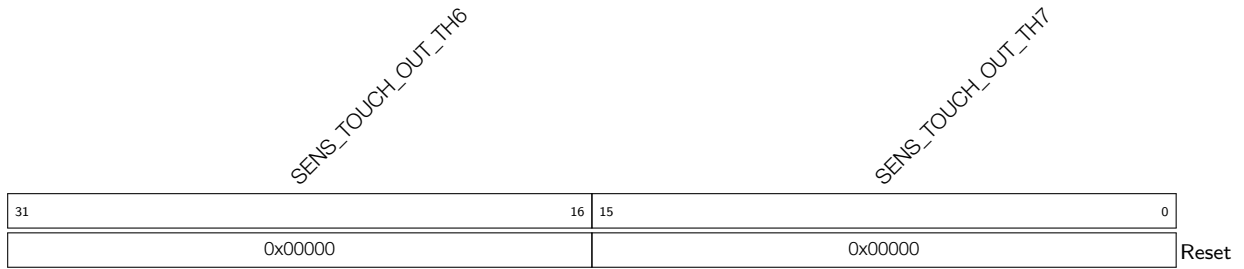
Register 28.12: SENS_SAR_TOUCH_THRES3_REG (0x0064)



SENS_TOUCH_OUT_TH4 The threshold for touch pad 4. (R/W)

SENS_TOUCH_OUT_TH5 The threshold for touch pad 5. (R/W)

Register 28.13: SENS_SAR_TOUCH_THRES4_REG (0x0068)



SENS_TOUCH_OUT_TH6 The threshold for touch pad 6. (R/W)

SENS_TOUCH_OUT_TH7 The threshold for touch pad 7. (R/W)

Register 28.14: SENS_SAR_TOUCH_THRES5_REG (0x006c)

<i>SENS_TOUCH_OUT_TH8</i>		<i>SENS_TOUCH_OUT_TH9</i>	
31	16	15	0
0x00000		0x00000	
			Reset

SENS_TOUCH_OUT_TH8 The threshold for touch pad 8. (R/W)

SENS_TOUCH_OUT_TH9 The threshold for touch pad 9. (R/W)

Register 28.15: SENS_SAR_TOUCH_OUT1_REG (0x0070)

<i>SENS_TOUCH_MEAS_OUT0</i>		<i>SENS_TOUCH_MEAS_OUT1</i>	
31	16	15	0
0x00000		0x00000	
			Reset

SENS_TOUCH_MEAS_OUT0 The counter for touch pad 0. (RO)

SENS_TOUCH_MEAS_OUT1 The counter for touch pad 1. (RO)

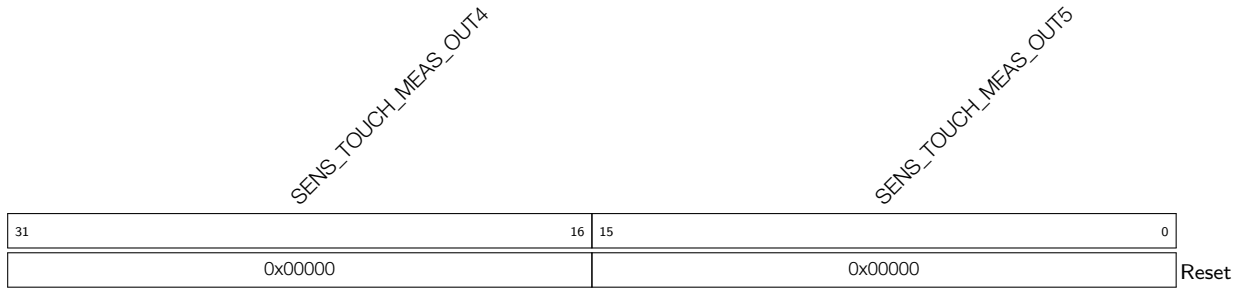
Register 28.16: SENS_SAR_TOUCH_OUT2_REG (0x0074)

<i>SENS_TOUCH_MEAS_OUT2</i>		<i>SENS_TOUCH_MEAS_OUT3</i>	
31	16	15	0
0x00000		0x00000	
			Reset

SENS_TOUCH_MEAS_OUT2 The counter for touch pad 2. (RO)

SENS_TOUCH_MEAS_OUT3 The counter for touch pad 3. (RO)

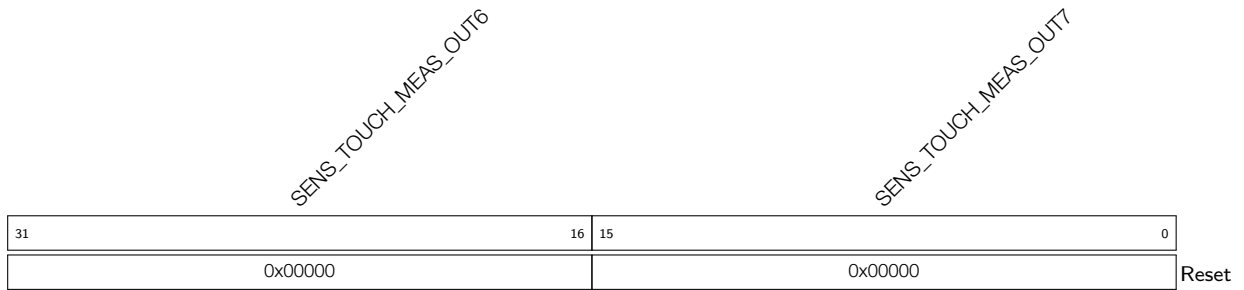
Register 28.17: SENS_SAR_TOUCH_OUT3_REG (0x0078)



SENS_TOUCH_MEAS_OUT4 The counter for touch pad 4. (RO)

SENS_TOUCH_MEAS_OUT5 The counter for touch pad 5. (RO)

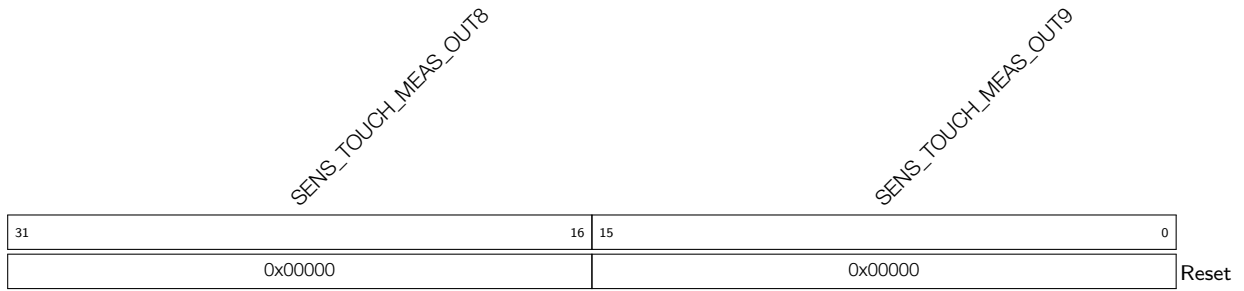
Register 28.18: SENS_SAR_TOUCH_OUT4_REG (0x007c)



SENS_TOUCH_MEAS_OUT6 The counter for touch pad 6. (RO)

SENS_TOUCH_MEAS_OUT7 The counter for touch pad 7. (RO)

Register 28.19: SENS_SAR_TOUCH_OUT5_REG (0x0080)



SENS_TOUCH_MEAS_OUT8 The counter for touch pad 8. (RO)

SENS_TOUCH_MEAS_OUT9 The counter for touch pad 9. (RO)

Register 28.20: SENS_SAR_TOUCH_CTRL2_REG (0x0084)

(reserved)			SENS_TOUCH_MEAS_EN_CLR												SENS_TOUCH_SLEEP_CYCLES						SENS_TOUCH_START_FORCE				SENS_TOUCH_START_EN				SENS_TOUCH_START_FSM_EN				SENS_TOUCH_MEAS_DONE										SENS_TOUCH_MEAS_EN									
31	30	29												14	13	12	11	10	9												0																					
0	0	0x00100											0	0	1	0	0x000											Reset																								

SENS_TOUCH_MEAS_EN_CLR Set to clear reg_touch_meas_en. (WO)

SENS_TOUCH_SLEEP_CYCLES Sleep cycles for timer. (R/W)

SENS_TOUCH_START_FORCE 1: starts the Touch FSM via software; 0: starts the Touch FSM via timer. (R/W)

SENS_TOUCH_START_EN 1: starts the Touch FSM; this is valid when reg_touch_start_force is set. (R/W)

SENS_TOUCH_START_FSM_EN 1: TOUCH_START & TOUCH_XPD are controlled by the Touch FSM; 0: TOUCH_START & TOUCH_XPD are controlled by registers. (R/W)

SENS_TOUCH_MEAS_DONE Set to 1 by FSM, indicating that touch measurement is done. (RO)

SENS_TOUCH_MEAS_EN 10-bit register indicating which pads are touched. (RO)

Register 28.21: SENS_SAR_TOUCH_ENABLE_REG (0x008c)

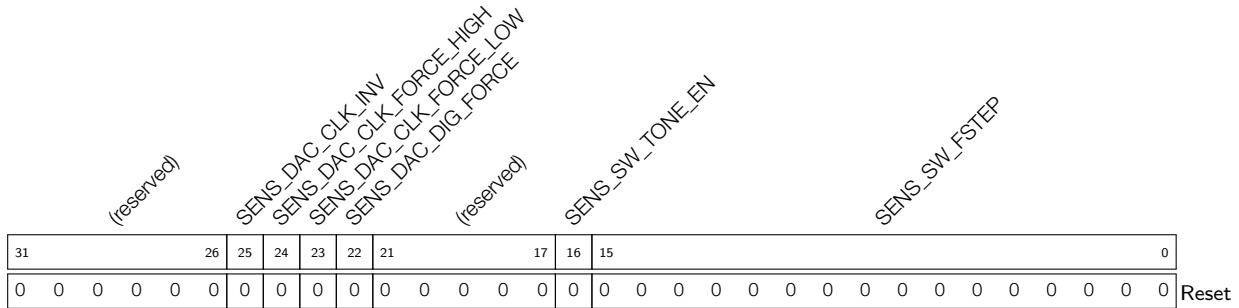
(reserved)			SENS_TOUCH_PAD_OUTEN1																	SENS_TOUCH_PAD_OUTEN2																	SENS_TOUCH_PAD_WORKEN																		
31	30	29																	20	19																	10	9																	0
0	0	0x3FF																0x3FF																0x3FF																Reset					

SENS_TOUCH_PAD_OUTEN1 Bitmap defining SET1 for generating a wakeup interrupt; SET1 is considered touched if at least one of the touch pads in SET1 is touched. (R/W)

SENS_TOUCH_PAD_OUTEN2 Bitmap defining SET2 for generating a wakeup interrupt; SET2 is considered touched if at least one of the touch pads in SET2 is touched. (R/W)

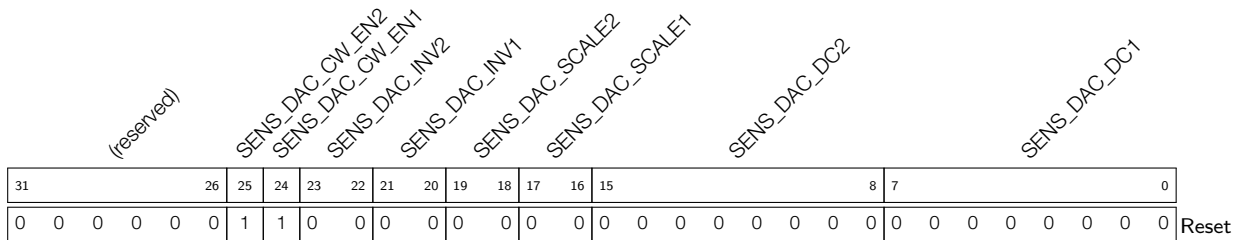
SENS_TOUCH_PAD_WORKEN Bitmap defining the working set during measurement. (R/W)

Register 28.24: SENS_SAR_DAC_CTRL1_REG (0x0098)



- SENS_DAC_CLK_INV** 1: inverts PDAC_CLK, 0: no inversion. (R/W)
- SENS_DAC_CLK_FORCE_HIGH** forces PDAC_CLK to be 1. (R/W)
- SENS_DAC_CLK_FORCE_LOW** forces PDAC_CLK to be 0. (R/W)
- SENS_DAC_DIG_FORCE** 1: DAC1 & DAC2 use DMA, 0: DAC1 & DAC2 do not use DMA. (R/W)
- SENS_SW_TONE_EN** 1: enable CW generator, 0: disable CW generator. (R/W)
- SENS_SW_FSTEP** Frequency step for CW generator; can be used to adjust the frequency. (R/W)

Register 28.25: SENS_SAR_DAC_CTRL2_REG (0x009c)



- SENS_DAC_CW_EN2** 1: selects CW generator as source for PDAC2_DAC[7:0], 0: selects register reg_pdac2_dac[7:0] as source for PDAC2_DAC[7:0]. (R/W)
- SENS_DAC_CW_EN1** 1: selects CW generator as source for PDAC1_DAC[7:0], 0: selects register reg_pdac1_dac[7:0] as source for PDAC1_DAC[7:0]. (R/W)
- SENS_DAC_INV2** DAC2, 00: does not invert any bits, 01: inverts all bits, 10: inverts MSB, 11: inverts all bits except for MSB. (R/W)
- SENS_DAC_INV1** DAC1, 00: does not invert any bits, 01: inverts all bits, 10: inverts MSB, 11: inverts all bits except for MSB. (R/W)
- SENS_DAC_SCALE2** DAC2, 00: no scale, 01: scale to 1/2, 10: scale to 1/4, scale to 1/8. (R/W)
- SENS_DAC_SCALE1** DAC1, 00: no scale, 01: scale to 1/2, 10: scale to 1/4, scale to 1/8. (R/W)
- SENS_DAC_DC2** DC offset for DAC2 CW generator. (R/W)
- SENS_DAC_DC1** DC offset for DAC1 CW generator. (R/W)

28.9.2 Advanced Peripheral Bus

Register 28.26: APB_SARADC_CTRL_REG (0x10)

(reserved)					APB_SARADC_DATA_TO_I2S				APB_SARADC_DATA_SAR_SEL				APB_SARADC_SAR2_PATT_P_CLEAR				APB_SARADC_SAR1_PATT_P_CLEAR				APB_SARADC_SAR2_PATT_LEN				APB_SARADC_SAR1_PATT_LEN				APB_SARADC_SAR_CLK_DIV				APB_SARADC_SAR_CLK_GATED				APB_SARADC_SAR_SEL				APB_SARADC_WORK_MODE				APB_SARADC_SAR2_MUX				APB_SARADC_START				APB_SARADC_START_FORCE			
31	27	26	25	24	23	22	19	18	15	14	7	6	5	4	3	2	1	0	Reset																																					
0	0	0	0	0	0	0	0	0	0	15	15	4	1	0	0	0	0	0	0																																					

APB_SARADC_DATA_TO_I2S 1: I2S input data is from SAR ADC (for DMA), 0: I2S input data is from GPIO matrix. (R/W)

APB_SARADC_DATA_SAR_SEL 1: sar_sel will be coded by the MSB of the 16-bit output data, in this case, the resolution should not contain more than 11 bits; 0: using 12-bit SAR ADC resolution. (R/W)

APB_SARADC_SAR2_PATT_P_CLEAR Clears the pointer of pattern table for DIG ADC2 CTRL. (R/W)

APB_SARADC_SAR1_PATT_P_CLEAR Clears the pointer of pattern table for DIG ADC1 CTRL. (R/W)

APB_SARADC_SAR2_PATT_LEN SAR ADC2, 0 - 15 means pattern table length of 1 - 16. (R/W)

APB_SARADC_SAR1_PATT_LEN SAR ADC1, 0 - 15 means pattern table length of 1 - 16. (R/W)

APB_SARADC_SAR_CLK_DIV SAR clock divider. (R/W)

APB_SARADC_SAR_CLK_GATED Reserved. Please initialize to 0b1 (R/W)

APB_SARADC_SAR_SEL 0: SAR1, 1: SAR2, this setting is applicable in the single SAR mode. (R/W)

APB_SARADC_WORK_MODE 0: single mode, 1: double mode, 2: alternate mode. (R/W)

APB_SARADC_SAR2_MUX 1: SAR ADC2 is controlled by DIG ADC2 CTRL, 0: SAR ADC2 is controlled by PWDET CTRL. (R/W)

APB_SARADC_START Reserved. Please initialize to 0 (R/W)

APB_SARADC_START_FORCE Reserved. Please initialize to 0 (R/W)

Register 28.30: APB_SARADC_SAR1_PATT_TAB2_REG (0x20)

31	0
0x00F0F0F0F	

Reset

APB_SARADC_SAR1_PATT_TAB2_REG Pattern tables 4 - 7 for SAR ADC1, one byte for each pattern table: [31:28] pattern4_channel, [27:26] pattern4_bit_width, [25:24] pattern4_attenuation, [23:20] pattern5_channel, etc. (R/W)

Register 28.31: APB_SARADC_SAR1_PATT_TAB3_REG (0x24)

31	0
0x00F0F0F0F	

Reset

APB_SARADC_SAR1_PATT_TAB3_REG Pattern tables 8 - 11 for SAR ADC1, one byte for each pattern table: [31:28] pattern8_channel, [27:26] pattern8_bit_width, [25:24] pattern8_attenuation, [23:20] pattern9_channel, etc. (R/W)

Register 28.32: APB_SARADC_SAR1_PATT_TAB4_REG (0x28)

31	0
0x00F0F0F0F	

Reset

APB_SARADC_SAR1_PATT_TAB4_REG Pattern tables 12 - 15 for SAR ADC1, one byte for each pattern table: [31:28] pattern12_channel, [27:26] pattern12_bit_width, [25:24] pattern12_attenuation, [23:20] pattern13_channel, etc. (R/W)

Register 28.33: APB_SARADC_SAR2_PATT_TAB1_REG (0x2C)

31	0
0x00F0F0F0F	

Reset

APB_SARADC_SAR2_PATT_TAB1_REG Pattern tables 0 - 3 for SAR ADC2, one byte for each pattern table: [31:28] pattern0_channel, [27:26] pattern0_bit_width, [25:24] pattern0_attenuation, [23:20] pattern1_channel, etc. (R/W)

Register 28.34: APB_SARADC_SAR2_PATT_TAB2_REG (0x30)

31	0
0x00F0F0F0F	

Reset

APB_SARADC_SAR2_PATT_TAB2_REG Pattern tables 4 - 7 for SAR ADC2, one byte for each pattern table: [31:28] pattern4_channel, [27:26] pattern4_bit_width, [25:24] pattern4_attenuation, [23:20] pattern5_channel, etc. (R/W)

Register 28.35: APB_SARADC_SAR2_PATT_TAB3_REG (0x34)

31	0
0x00F0F0F0F	
Reset	

APB_SARADC_SAR2_PATT_TAB3_REG Pattern tables 8 - 11 for SAR ADC2, one byte for each pattern table: [31:28] pattern8_channel, [27:26] pattern8_bit_width, [25:24] pattern8_attenuation, [23:20] pattern9_channel, etc. (R/W)

Register 28.36: APB_SARADC_SAR2_PATT_TAB4_REG (0x38)

31	0
0x00F0F0F0F	
Reset	

APB_SARADC_SAR2_PATT_TAB4_REG Pattern tables 12 - 15 for SAR ADC2, one byte for each pattern table: [31:28] pattern12_channel, [27:26] pattern12_bit_width, [25:24] pattern12_attenuation, [23:20] pattern13_channel, etc. (R/W)

28.9.3 RTC I/O

For details, please refer to Section [Registers](#) in Chapter [IO_MUX and GPIO Matrix](#).

29. ULP Co-processor

29.1 Introduction

The ULP co-processor is an ultra-low-power processor that remains powered on during the Deep-sleep mode of the main SoC. Hence, the developer can store in the RTC memory a program for the ULP co-processor to access peripheral devices, internal sensors and RTC registers during deep sleep. This is useful for designing applications where the CPU needs to be woken up by an external event, or timer, or a combination of these, while maintaining minimal power consumption.

29.2 Features

- Contains up to 8 KB of SRAM for instructions and data
- Uses RTC_FAST_CLK, which is 8 MHz
- Works both in normal and deep sleep
- Is able to wake up the digital core or send an interrupt to the CPU
- Can access peripheral devices, internal sensors and RTC registers
- Contains four 16-bit general-purpose registers (R0, R1, R2, R3) for manipulating data and accessing memory
- Includes one 8-bit Stage_cnt register which can be manipulated by ALU and used in JUMP instructions

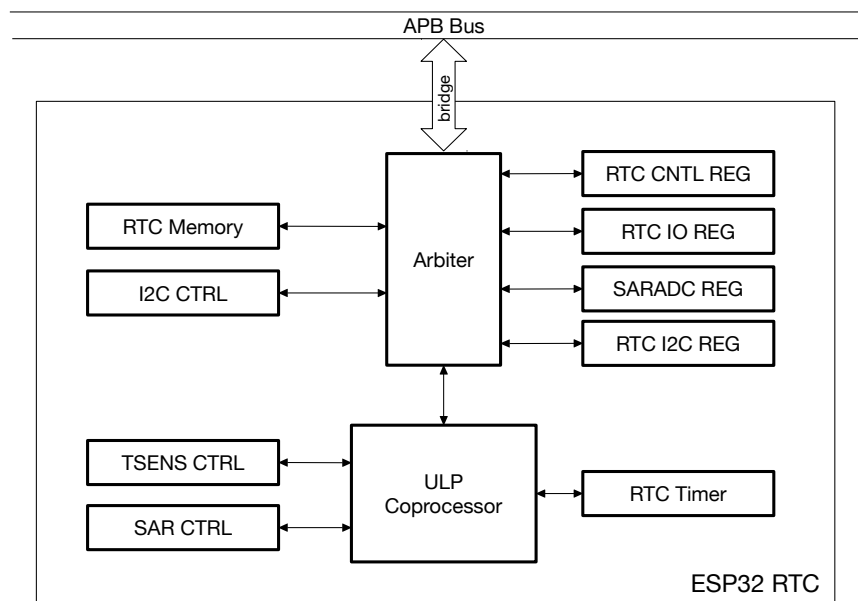


Figure 139: ULP Co-processor Diagram

29.3 Functional Description

The ULP co-processor is a programmable FSM (Finite State Machine) that can work during deep sleep. Like general-purpose CPUs, ULP co-processor also has some instructions which can be useful for a relatively complex logic, and also some special commands for RTC controllers/peripherals. The 8 KB of SRAM RTC slow memory can be accessed by both the ULP co-processor and the CPU; hence, it is usually used to store instructions and share data between the ULP co-processor and the CPU.

The ULP co-processor can be started by software or a periodically-triggered timer. The operation of the ULP co-processor is ended by executing the [HALT](#) instruction. Meanwhile, it can access almost every module in RTC domain, either through built-in instructions or RTC registers. In many cases the ULP co-processor can be a good supplement to, or replacement of, the CPU, especially for power-sensitive applications. Figure 139 shows the overall layout of a ULP co-processor.

29.4 Instruction Set

The ULP co-processor provides the following instructions:

- Perform arithmetic and logic operations - ALU
- Load and store data - LD, ST, REG_RD and REG_WR
- Jump to a certain address - JUMP
- Manage program execution - WAIT/HALT
- Control sleep period of ULP co-processor - SLEEP
- Wake up/communicate with SoC - WAKE
- Take measurements - TSENS and ADC
- Communicate using I2C - I2C_RD/I2C_WR

The ULP co-processor's instruction format is shown in Figure 140.

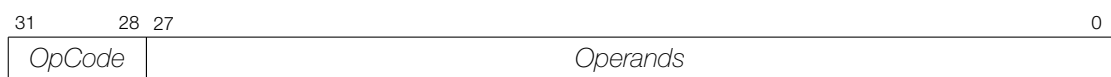


Figure 140: The ULP Co-processor Instruction Format

An instruction, which has one *OpCode*, can perform various different operations, depending on the setting of *Operands* bits. A good example is the [ALU](#) instruction, which is able to perform ten arithmetic and logic operations; or the [JUMP](#) instruction, which may be conditional or unconditional, absolute or relative.

Each instruction has a fixed width of 32 bits. A series of instructions can make a program be executed by the ULP co-processor. The execution flow inside the program uses 32-bit addressing. The program is stored in a dedicated region called Slow Memory (RTC_SLOW_MEM), which is visible to the main CPUs as one that has an address range of 0x5000_0000 to 0x5000_1FFF (8 KB).

ALU_sel	Instruction	Operation	Description
0	STAGE_INC	$Stage_cnt = Stage_cnt + Imm$	Increment stage count register
1	STAGE_DEC	$Stage_cnt = Stage_cnt - Imm$	Decrement stage count register
2	STAGE_RST	$Stage_cnt = 0$	Reset stage count register

Table 127: ALU Operations with Stage Count Register

29.4.2 ST – Store Data in Memory



Figure 144: Instruction Type – ST

Operand **Description** - see Figure 144

Offset 10-bit signed value, offset expressed in 32-bit words

Rsrc Register R[0-3], 16-bit value to store

Rdst Register R[0-3], address of the destination, expressed in 32-bit words

Description

The instruction stores the 16-bit value of *Rsrc* in the lower half-word of memory with address $Rdst + Offset$. The upper half-word is written with the current program counter (PC) expressed in words and shifted to the left by 5 bits:

$$\text{Mem} [Rdst + Offset]\{31:0\} = \{PC[10:0], 5'b0, Rsrc[15:0]\}$$

The application can use the higher 16 bits to determine which instruction in the ULP program has written any particular word into memory.

Note:

- This instruction can only access 32-bit memory words.
- Data from *Rsrc* is always stored in the lower 16 bits of a memory word. Differently put, it is not possible to store *Rsrc* in the upper 16 bits of memory.
- The "Mem" written is the RTC_SLOW_MEM memory. Address 0, as seen by the ULP co-processor, corresponds to address 0x50000000, as seen by the main CPUs.

29.4.3 LD – Load Data from Memory

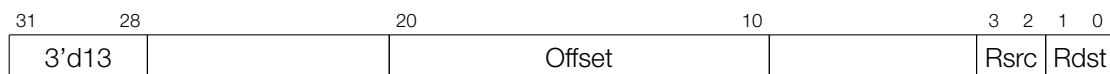


Figure 145: Instruction Type – LD

Operand **Description** - see Figure 145

Offset 10-bit signed value, offset expressed in 32-bit words

Rsrc Register R[0-3], address of destination memory, expressed in 32-bit words

Rdst Register R[0-3], destination

Description

The instruction loads the lower 16-bit half-word from memory with address $Rsrc + offset$ into the destination register *Rdst*:

Description

The instruction prompts a jump to a relative address, if the above-mentioned condition is true. The condition itself is the result of comparing the R0 register value and the *Threshold* value.

Note:

All jump addresses are expressed in 32-bit words.

29.4.6 JUMPS – Jump to a Relative Address (Conditional upon Stage Count Register)

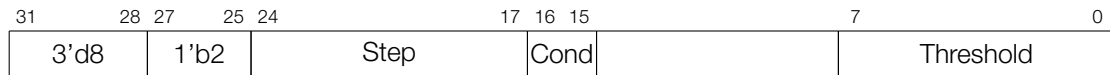


Figure 148: Instruction Type – JUMP

Operand **Description** - see Figure 148

Step Relative shift from current position, expressed in 32-bit words:

if $Step[7] = 0$, then $PC = PC + Step[6:0]$

if $Step[7] = 1$, then $PC = PC - Step[6:0]$

Threshold Threshold value for condition (see *Cond* below) to jump

Cond Condition of jump:

1X - jump if $Stage_cnt == Threshold$

00 - jump if $Stage_cnt < Threshold$

01 - jump if $Stage_cnt > Threshold$

Note:

- A description of how to set the stage count register is provided in section 29.4.1.3.
- All jump addresses are expressed in 32-bit words.

Description

The instruction prompts a jump to a relative address if the above-mentioned condition is true. The condition itself is the result of comparing the value of *Stage_cnt* (stage count register) and the *Threshold* value.

29.4.7 HALT – End the Program

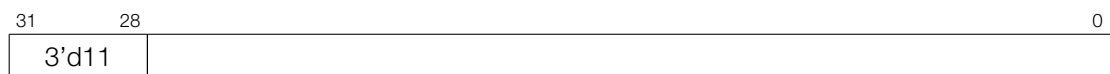


Figure 149: Instruction Type – HALT

Description

The instruction ends the operation of the processor and puts it into power-down mode.

Note:

After executing this instruction, the ULP co-processor timer gets started.

29.4.8 WAKE – Wake up the Chip



Figure 150: Instruction Type – WAKE

Description

This instruction sends an interrupt from the ULP co-processor to the RTC controller.

- If the SoC is in Deep-sleep mode, and the ULP wake-up is enabled, the above-mentioned interrupt will wake up the SoC.
- If the SoC is not in Deep-sleep mode, and the ULP interrupt bit (RTC_CNTL_ULP_CP_INT_ENA) is set in register RTC_CNTL_INT_ENA_REG, a RTC interrupt will be triggered.

29.4.9 Sleep – Set the ULP Timer's Wake-up Period



Figure 151: Instruction Type – SLEEP

Operand **Description** - see Figure 151

sleep_reg Selects one of five SENS_ULP_CP_SLEEP_CYC n _REG (n : 0-4) as the wake-up period of the ULP co-processor

Description

The instruction selects which one of the SENS_ULP_CP_SLEEP_CYC n _REG (n : 0-4) register values is to be used by the ULP timer as the wake-up period. By default, the value of SENS_ULP_CP_SLEEP_CYC0_REG is used.

29.4.10 WAIT – Wait for a Number of Cycles

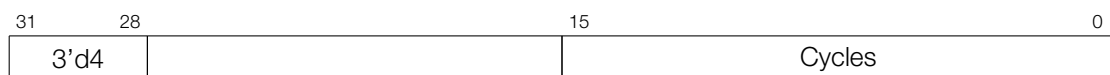


Figure 152: Instruction Type – WAIT

Operand **Description** - see Figure 152

Cycles the number of cycles to wait between sleeps

Description

The instruction will delay the ULP co-processor from getting into sleep for a certain number of *Cycles*.

29.4.11 TSENS – Take Measurements with the Temperature Sensor

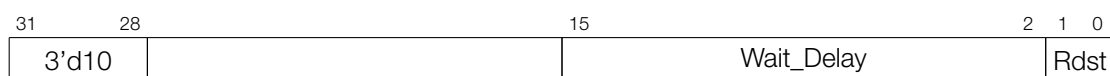


Figure 153: Instruction Type – TSENS

Operand **Description** - see Figure 153

Rdst Destination Register R[0-3], results will be stored in this register.

Wait_Delay Number of cycles needed to obtain a measurement

Description

Longer *Wait_Delay* can improve the accuracy of measurement.

The instruction prompts a measurement to be taken with the use of the on-chip temperature sensor. The measurement result is stored into a general-purpose register.

29.4.12 ADC – Take Measurement with ADC**Figure 154: Instruction Type – ADC****Operand Description** - see Figure 154

Rdst Destination Register R[0-3], results will be stored in this register.

Sel Selected ADC : 0 = SAR ADC1, 1 = SAR ADC2, see Table 128.

Sar Mux SARADC Pad [Sar_Mux - 1] is enabled, see Table 128.

Table 128: Input Signals Measured using the ADC Instruction

Pad Name/Signal/GPIO	<i>Sar_Mux</i>	Processed by <i>/Sel</i>
SENSOR_VP (GPIO36)	1	SAR ADC1/ <i>Sel</i> = 0
SENSOR_CAPP (GPIO37)	2	
SENSOR_CAPN (GPIO38)	3	
SENSOR_VN (GPIO39)	4	
32K_XP (GPIO33)	5	
32K_XN (GPIO32)	6	
VDET_1 (GPIO34)	7	
VDET_2 (GPIO35)	8	
Hall phase 1	9	
Hall phase 0	10	
GPIO4	1	SAR ADC2/ <i>Sel</i> = 1
GPIO0	2	
GPIO2	3	
MTDO (GPIO15)	4	
MTCK (GPIO13)	5	
MTDI (GPIO12)	6	
MTMS (GPIO14)	7	
GPIO27	8	
GPIO25	9	
GPIO26	10	

Description

The instruction prompts the taking of measurements with the use of ADC. Pads/signals available for ADC measurement are provided in Table 128.

29.4.13 I2C_RD/I2C_WR – Read/Write I2C

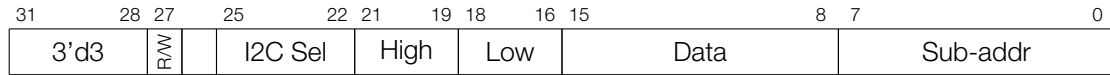


Figure 155: Instruction Type – I2C

Operand **Description** - see Figure 155

Sub-addr Slave register address

Data Data to write in I2C_WR operation (not used in I2C_RD operation)

Low High part of bit mask

High Low part of bit mask

I2C Sel Select register *n* of `SENS_I2C_SLAVE_ADDRn` (*n*: 0-7), which contains the I2C slave address.

R/W I2C communication direction:
 1 - I2C write
 0 - I2C read

Description

Communicate (read/write) with external I2C slave devices. Details on using the RTC I2C peripheral are provided in section 29.6.

Note:

When working in master mode, RTC_I2C samples the SDA input on the negative edge of SCL.

29.4.14 REG_RD – Read from Peripheral Register



Figure 156: Instruction Type – REG_RD

Operand **Description** - see Figure 156

Addr Register address, expressed in 32-bit words

High High part of R0

Low Low part of R0

Description

The instruction prompts a read of up to 16 bits from a peripheral register into a general-purpose register:

$$R0 = \text{REG}[\text{Addr}][\text{High}:\text{Low}]$$

In case of more than 16 bits being requested, i.e. $\text{High} - \text{Low} + 1 > 16$, then the instruction will return $[\text{Low}+15:\text{Low}]$.

Note:

- This instruction can access registers in RTC_CNTL, RTC_IO, SENS and RTC_I2C peripherals. The address of the register, as seen from the ULP co-processor, can be calculated from the address of the same register on the DPORT bus, as follows:

$$\text{addr_ulp} = (\text{addr_dport} - \text{DR_REG_RTCCNTL_BASE})/4$$

- The *addr_ulp* is expressed in 32-bit words (not in bytes), and value 0 maps onto the DR_REG_RTCCNTL_BASE (as seen from the main CPUs). Thus, 10 bits of address cover a 4096-byte range of peripheral register space, including regions DR_REG_RTCCNTL_BASE, DR_REG_RTCIO_BASE, DR_REG_SENS_BASE and DR_REG_RTC_I2C_BASE.

29.4.15 REG_WR – Write to Peripheral Register

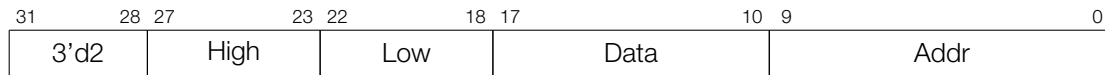


Figure 157: Instruction Type – REG_WR

Operand Description - see Figure 157

<i>Addr</i>	Register address, expressed in 32-bit words
<i>High</i>	High part of R0
<i>Low</i>	Low part of R0
<i>Data</i>	Value to write, 8 bits

Description

The instruction prompts the writing of up to 8 bits from a general-purpose register into a peripheral register.

$$\text{REG}[\text{Addr}][\text{High}:\text{Low}] = \text{Data}$$

If more than 8 bits are requested, i.e. $\text{High} - \text{Low} + 1 > 8$, then the instruction will pad with zeros the bits above the eighth bit.

Note:

See notes regarding *addr_ulp* in section 29.4.14 above.

29.5 ULP Program Execution

The ULP co-processor is designed to operate independently of the main CPUs, while they are either in deep sleep or running.

In a typical power-saving scenario, the ULP co-processor operates while the main CPUs are in deep sleep. To save power even further, the ULP co-processor can get into sleep mode, as well. In such a scenario, there is a specific hardware timer in place to wake up the ULP co-processor, since there is no software program running at the same time. This timer should be configured in advance by setting and then selecting one of the [SENS_ULP_CP_SLEEP_CYC_n_REG](#) registers that contain the expiration period. This can be done either by the main program, or the ULP program with the [REG_WR](#) and [SLEEP](#) instructions. Then, the ULP timer should be enabled by setting bit `RTC_CNTL_ULP_CP_SLP_TIMER_EN` in the `RTC_CNTL_STATE0_REG` register.

The ULP co-processor puts itself into sleep mode by executing the [HALT](#) instruction. This also triggers the ULP timer to start counting `RTC_SLOW_CLK` ticks which, by default, originate from an internal 150 kHz RC oscillator. Once the timer expires, the ULP co-processor is powered up and runs a program with the program counter (PC) which is stored in register `SENS_PC_INIT`. The relationship between the described signals and registers is shown in Figure 158.

On reset or power-up the above-mentioned ULP program may start up only after the expiration of `SENS_ULP_CP_SLEEP_CYC0_REG`, which is the default selection period of the ULP timer.

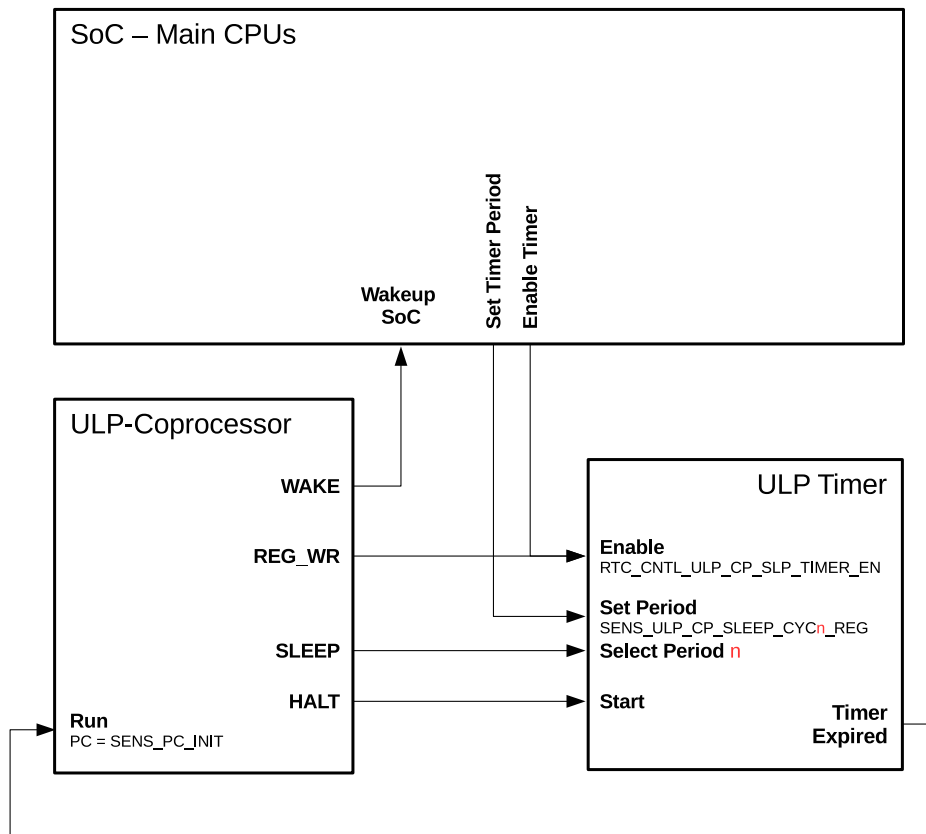


Figure 158: Control of ULP Program Execution

A sample operation sequence of the ULP program is shown in Figure 159, where the following steps are executed:

1. Software enables the ULP timer by using bit RTC_CNTL_ULP_CP_SLP_TIMER_EN.
2. The ULP timer expires and the ULP co-processor starts running the program at PC = SENS_PC_INIT.
3. The ULP program executes the HALT instruction; the ULP co-processor is halted and the timer gets restarted.
4. The ULP program executes the SLEEP instruction to change the sleep timer period register.
5. The ULP program, or software, disables the ULP timer by using bit RTC_CNTL_ULP_CP_SLP_TIMER_EN.

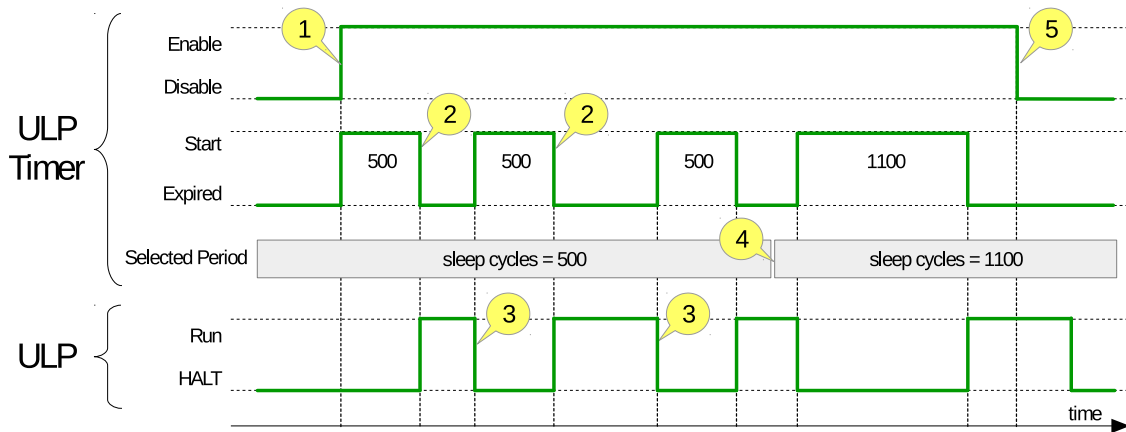


Figure 159: Sample of a ULP Operation Sequence

29.6 RTC_I2C Controller

The ULP co-processor can use a separate I2C controller, located in the RTC domain, to communicate with external I2C slave devices. RTC_I2C has a limited feature set, compared to I2C0/I2C1 peripherals.

29.6.1 Configuring RTC_I2C

Before the ULP co-processor can use the I2C instruction, certain parameters of the RTC_I2C need to be configured. This can be done by the program running on one of the main CPUs, or by the ULP co-processor itself. Configuration is performed by writing certain timing parameters into the RTC_I2C registers:

1. Set the low and high SCL half-periods by using [RTC_I2C_SCL_LOW_PERIOD_REG](#) and [RTC_I2C_SCL_HIGH_PERIOD_REG](#) in RTC_FAST_CLK cycles (e.g. RTC_I2C_SCL_LOW_PERIOD=40, RTC_I2C_SCL_HIGH_PERIOD=40 for 100 kHz frequency).
2. Set the number of cycles between the SDA switch and the falling edge of SCL by using [RTC_I2C_SDA_DUTY_REG](#) in RTC_FAST_CLK (e.g. RTC_I2C_SDA_DUTY=16).
3. Set the waiting time after the START condition by using [RTC_I2C_SCL_START_PERIOD_REG](#) (e.g. RTC_I2C_SCL_START_PERIOD=30).
4. Set the waiting time before the END condition by using [RTC_I2C_SCL_STOP_PERIOD_REG](#) (e.g. RTC_I2C_SCL_STOP_PERIOD=44).
5. Set the transaction timeout by using [RTC_I2C_TIMEOUT_REG](#) (e.g. RTC_I2C_TIMEOUT=200).
6. Enable the master mode (set the RTC_I2C_MS_MODE bit in [RTC_I2C_CTRL_REG](#)).
7. Write the address(es) of external slave(s) to [SENS_I2C_SLAVE_ADDR_n](#) (n : 0-7). Up to eight slave addresses can be pre-programmed this way. One of these addresses can then be selected for each transaction as part of the ULP I2C instruction.

Once RTC_I2C is configured, instructions [ULP I2C_RD](#) and [I2C_WR](#) can be used.

29.6.2 Using RTC_I2C

The ULP co-processor supports two instructions (with a single OpCode) for using RTC_I2C: [I2C_RD](#) (read) and [I2C_WR](#) (write).

29.6.2.1 I2C_RD - Read a Single Byte

The I2C_RD instruction performs the following I2C transaction (see Figure 160):

1. Master generates a START condition.
2. Master sends slave address, with r/w bit set to 0 (“write”). Slave address is obtained from `SENS_I2C_SLAVE_ADDR n` , where n is given as an argument to the I2C_RD instruction.
3. Slave generates ACK.
4. Master sends slave register address (given as an argument to the I2C_RD instruction).
5. Slave generates ACK.
6. Master generates a repeated START condition.
7. Master sends slave address, with r/w bit set to 1 (“read”).
8. Slave sends one byte of data.
9. Master generates NACK.
10. Master generates a STOP condition.

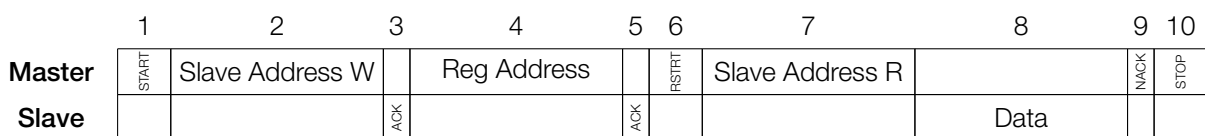


Figure 160: I2C Read Operation

Note:

The RTC_I2C peripheral samples the SDA signals on the falling edge of SCL. If the slave changes SDA in less than 0.38 microseconds, the master will receive incorrect data.

The byte received from the slave is stored into the R0 register.

29.6.2.2 I2C_WR - Write a Single Byte

The I2C_WR instruction performs the following I2C transaction (see Figure 161):

1. Master generates a START condition.
2. Master sends slave address, with r/w bit set to 0 (“write”). Slave address is obtained from `SENS_I2C_SLAVE_ADDR n` , where n is given as an argument to the I2C_WR instruction.
3. Slave generates ACK.
4. Master sends slave register address (given as an argument to the I2C_WR instruction).
5. Slave generates ACK.
6. Master generates a repeated START condition.
7. Master sends slave address, with r/w bit set to 0 (“write”).
8. Master sends one byte of data.
9. Slave generates ACK.

10. Master generates a STOP condition.

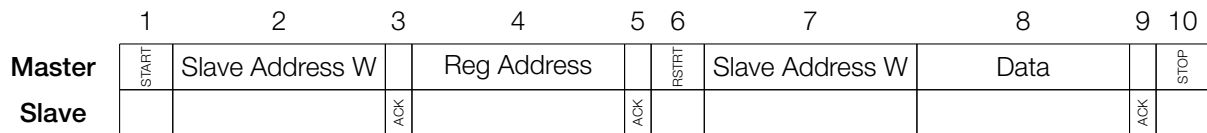


Figure 161: I2C Write Operation

29.6.2.3 Detecting Error Conditions

ULP I2C_RD and I2C_WR instructions will not report error conditions, such as a NACK from a slave, via ULP registers. Instead, applications can query specific bits in the [RTC_I2C_INT_ST_REG](#) register to determine if the transaction was successful. To enable checking for specific communication events, their corresponding bits should be set in register [RTC_I2C_INT_EN_REG](#). Note that the bit map is shifted by 1. If a specific communication event is detected and set in register [RTC_I2C_INT_ST_REG](#), it can then be cleared using [RTC_I2C_INT_CLR_REG](#).

29.6.2.4 Connecting I2C Signals

SDA and SCL signals can be mapped onto two out of the four GPIO pins, which are identified in the ESP32 pin lists in [ESP32 Datasheet](#), using the RTCIO_SAR_I2C_IO_REG register.

29.7 Register Summary

29.7.1 SENS_ULP Address Space

Name	Description	Address	Access
ULP Timer cycles select			
SENS_ULP_CP_SLEEP_CYC0_REG	Timer cycles setting 0	0x3FF48818	R/W
SENS_ULP_CP_SLEEP_CYC1_REG	Timer cycles setting 1	0x3FF4881C	R/W
SENS_ULP_CP_SLEEP_CYC2_REG	Timer cycles setting 2	0x3FF48820	R/W
SENS_ULP_CP_SLEEP_CYC3_REG	Timer cycles setting 3	0x3FF48824	R/W
SENS_ULP_CP_SLEEP_CYC4_REG	Timer cycles setting 4	0x3FF48828	R/W
RTC I2C slave address select			
SENS_SAR_SLAVE_ADDR1_REG	I2C addresses 0 and 1	0x3FF4883C	R/W
SENS_SAR_SLAVE_ADDR2_REG	I2C addresses 2 and 4	0x3FF48840	R/W
SENS_SAR_SLAVE_ADDR3_REG	I2C addresses 4 and 5	0x3FF48844	R/W
SENS_SAR_SLAVE_ADDR4_REG	I2C addresses 6 and 7, I2C control	0x3FF48848	R/W
RTC I2C control			
SENS_SAR_I2C_CTRL_REG	I2C control registers	0x3FF48850	R/W

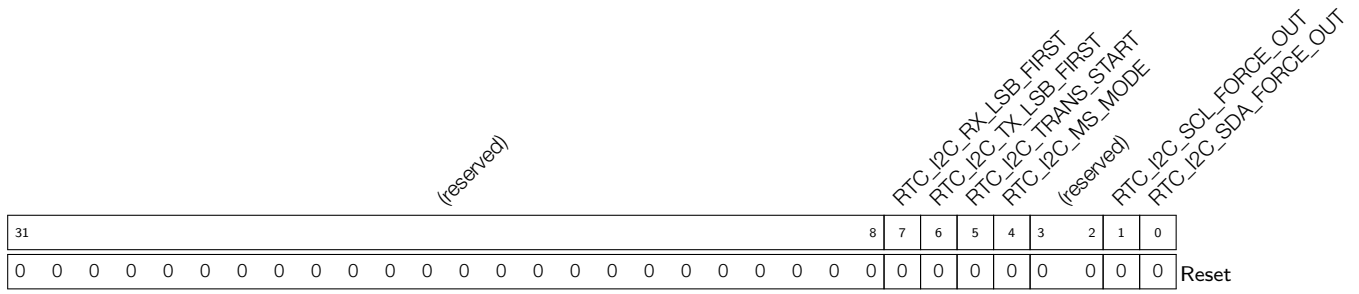
29.7.2 RTC_I2C Address Space

Name	Description	Address	Access
RTC I2C control registers			
RTC_I2C_CTRL_REG	Transmission setting	0x3FF48C04	R/W
RTC_I2C_DEBUG_STATUS_REG	Debug status	0x3FF48C08	R/W
RTC_I2C_TIMEOUT_REG	Timeout setting	0x3FF48C0C	R/W
RTC_I2C_SLAVE_ADDR_REG	Local slave address setting	0x3FF48C10	R/W
RTC I2C signal setting registers			
RTC_I2C_SDA_DUTY_REG	Configures the SDA hold time after a negative SCL edge	0x3FF48C30	R/W
RTC_I2C_SCL_LOW_PERIOD_REG	Configures the low level width of SCL	0x3FF48C00	R/W
RTC_I2C_SCL_HIGH_PERIOD_REG	Configures the high level width of SCL	0x3FF48C38	R/W
RTC_I2C_SCL_START_PERIOD_REG	Configures the delay between the SDA and SCL negative edge for a start condition	0x3FF48C40	R/W
RTC_I2C_SCL_STOP_PERIOD_REG	Configures the delay between the SDA and SCL positive edge for a stop condition	0x3FF48C44	R/W
RTC I2C interrupt registers - listed only for debugging			
RTC_I2C_INT_CLR_REG	Clear status of I2C communication events	0x3FF48C24	R/W
RTC_I2C_INT_EN_REG	Enable capture of I2C communication status events	0x3FF48C28	R/W
RTC_I2C_INT_ST_REG	Status of captured I2C communication events	0x3FF48C2C	R/O

Note:

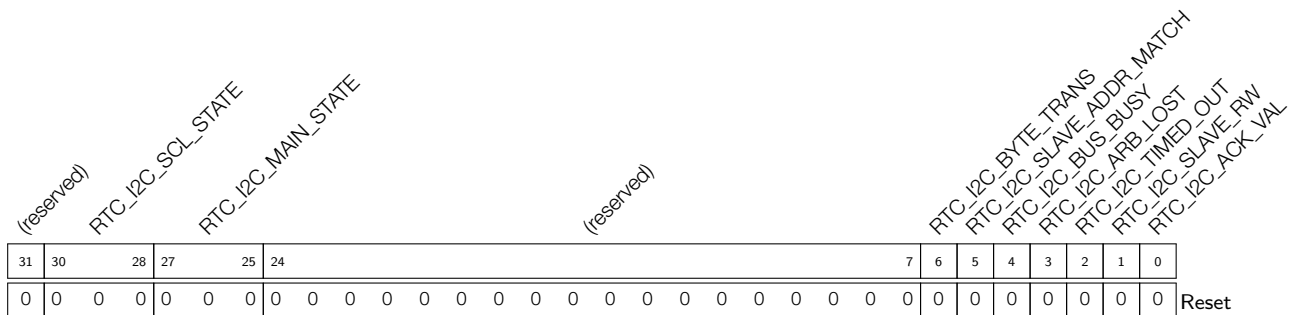
Interrupts from RTC_I2C are not connected. The interrupt registers above are listed only for [debugging](#) purposes.

Register 29.9: RTC_I2C_CTRL_REG (0x004)



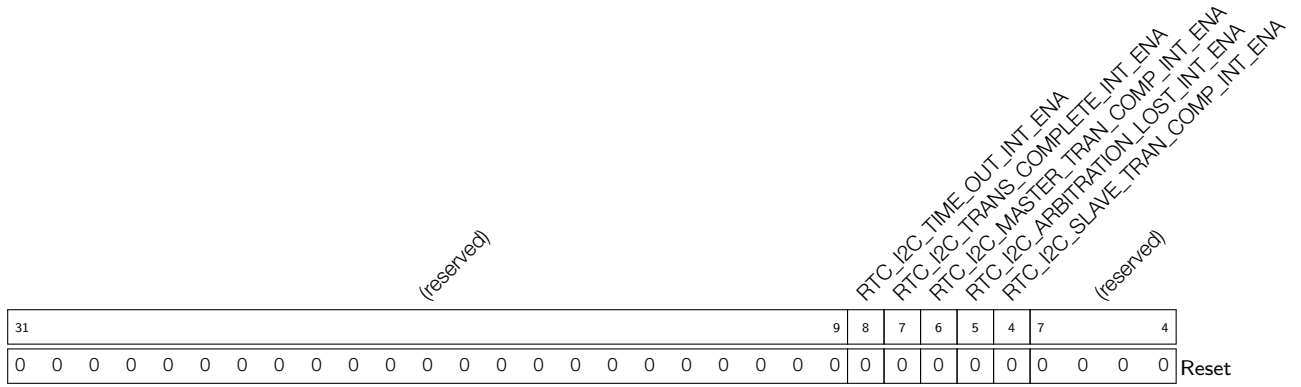
- RTC_I2C_RX_LSB_FIRST** Send LSB first. (R/W)
- RTC_I2C_TX_LSB_FIRST** Receive LSB first. (R/W)
- RTC_I2C_TRANS_START** Force to generate a start condition. (R/W)
- RTC_I2C_MS_MODE** Master (1), or slave (0). (R/W)
- RTC_I2C_SCL_FORCE_OUT** SCL is push-pull (1) or open-drain (0). (R/W)
- RTC_I2C_SDA_FORCE_OUT** SDA is push-pull (1) or open-drain (0). (R/W)

Register 29.10: RTC_I2C_DEBUG_STATUS_REG (0x008)



- RTC_I2C_SCL_STATE** State of SCL machine. (R/W)
- RTC_I2C_MAIN_STATE** State of the main machine. (R/W)
- RTC_I2C_BYTE_TRANS** 8-bit transmit done. (R/W)
- RTC_I2C_SLAVE_ADDR_MATCH** Indicates whether the addresses are matched, when in slave mode. (R/W)
- RTC_I2C_BUS_BUSY** Operation is in progress. (R/W)
- RTC_I2C_ARB_LOST** Indicates the loss of I2C bus control, when in master mode. (R/W)
- RTC_I2C_TIMED_OUT** Transfer has timed out. (R/W)
- RTC_I2C_SLAVE_RW** Indicates the value of the received R/W bit, when in slave mode. (R/W)
- RTC_I2C_ACK_VAL** The value of ACK signal on the bus. (R/W)

Register 29.14: RTC_I2C_INT_EN_REG (0x028)



RTC_I2C_TIME_OUT_INT_ENA Enable interrupt upon timeout. (R/W)

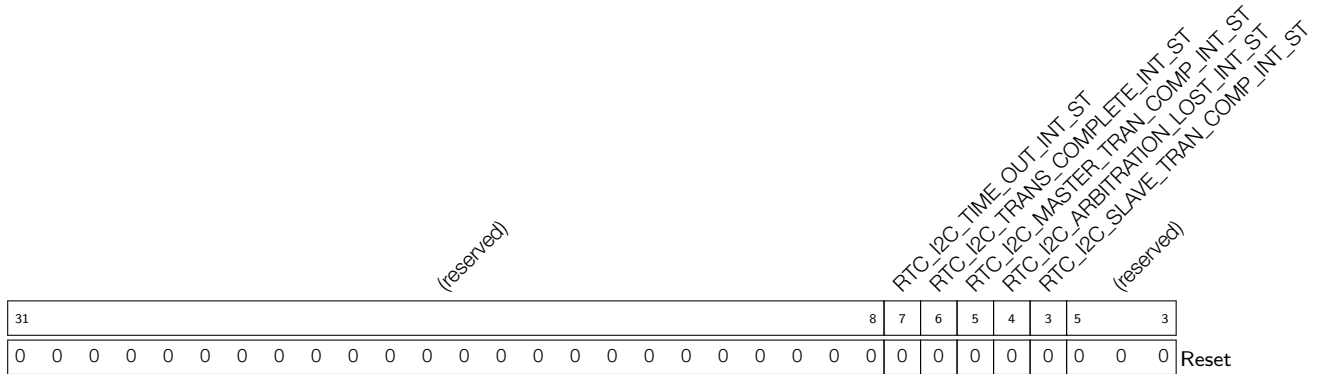
RTC_I2C_TRANS_COMPLETE_INT_ENA Enable interrupt upon detecting a stop pattern. (R/W)

RTC_I2C_MASTER_TRAN_COMP_INT_ENA Enable interrupt upon completion of transaction, when in master mode. (R/W)

RTC_I2C_ARBITRATION_LOST_INT_ENA Enable interrupt upon losing control of the bus, when in master mode. (R/W)

RTC_I2C_SLAVE_TRAN_COMP_INT_ENA Enable interrupt upon completion of transaction, when in slave mode. (R/W)

Register 29.15: RTC_I2C_INT_ST_REG (0x02c)



RTC_I2C_TIME_OUT_INT_ST Detected timeout. (R/O)

RTC_I2C_TRANS_COMPLETE_INT_ST Detected stop pattern on I2C bus. (R/O)

RTC_I2C_MASTER_TRAN_COMP_INT_ST Transaction completed, when in master mode. (R/O)

RTC_I2C_ARBITRATION_LOST_INT_ST Bus control lost, when in master mode. (R/O)

RTC_I2C_SLAVE_TRAN_COMP_INT_ST Transaction completed, when in slave mode. (R/O)

30. Low-Power Management

30.1 Introduction

ESP32 offers efficient and flexible power-management technology to achieve the best balance between power consumption, wakeup latency and available wakeup sources. Users can select out of five predefined power modes of the main processors to suit specific needs of the application. In addition, to save power in power-sensitive applications, control may be executed by the Ultra-Low-Power co-processor (ULP co-processor), while the main processors are in Deep-sleep mode.

30.2 Features

- Five predefined power modes to support various applications
- Up to 16 KB of retention memory
- 8 x 32 bits of retention registers
- ULP co-processor enabled in all low-power modes
- RTC boot supported to shorten the wakeup latency

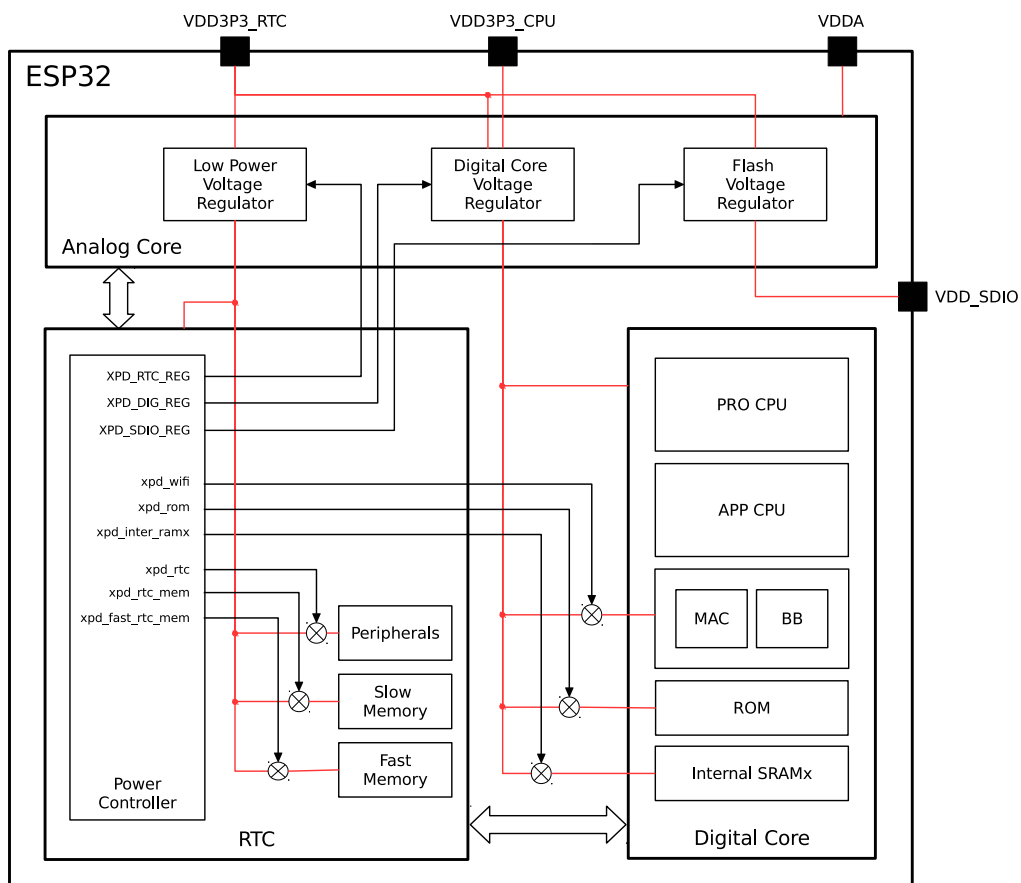


Figure 162: ESP32 Power Control

30.3 Functional Description

30.3.1 Overview

The low-power management unit includes voltage regulators, a power controller, power switch cells, power domain isolation cells, etc. Figure 162 shows the high-level architecture of ESP32's low-power management.

30.3.2 Digital Core Voltage Regulator

The built-in voltage regulator can convert the external power supply (typically 3.3V) to 1.1V to support the internal digital core. It receives a wide range of external power supply from 1.8V to 3.6V, and provides an output voltage from 0.85V to 1.2V.

1. When `XPD_DIG_REG == 1`, the regulator outputs a 1.1V voltage and the digital core is able to run; when `XPD_DIG_REG == 0`, both the regulator and the digital core stop running.
2. `DIG_REG_DBIAS[2:0]` tunes the supply voltage of the digital core:

$$VDD_DIG = 0.85 + DBIAS \cdot 0.05V$$

3. The current to the digital core comes from pin `VDD3P3_CPU` and pin `VDD3P3_RTC`.

Figure 163 shows the structure of a digital core's voltage regulator.

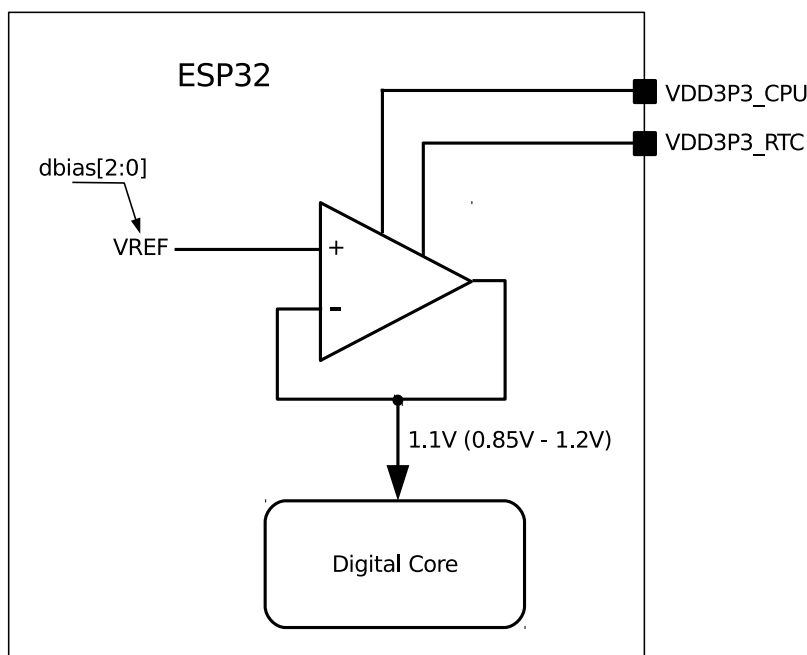


Figure 163: Digital Core Voltage Regulator

30.3.3 Low-Power Voltage Regulator

The built-in low-power voltage regulator can convert the external power supply (typically 3.3V) to 1.1V to support the internal RTC core. To save power, it receives a wide range of external power supply from 1.8V to 3.6V, and supports an adjustable output voltage of 0.85V to 1.2V in normal work mode, a fixed output voltage of about 0.75V both in Deep-sleep mode and Hibernation mode.

1. When the pin CHIP_PU is at a high level, the low-power voltage regulator cannot be turned off. It should be switched only between normal-work mode and Deep-sleep mode.
2. In normal-work mode, RTC_DBIAS[2:0] can be used to tune the output voltage:

$$VDD_RTC = 0.85 + DBIAS \cdot 0.05V$$

3. In Deep-sleep mode, the output voltage of the regulator is fixed at about 0.75V.
4. The current to the RTC core comes from pin VDD3P3_RTC.

Figure 164 shows the structure of a low-power voltage regulator.

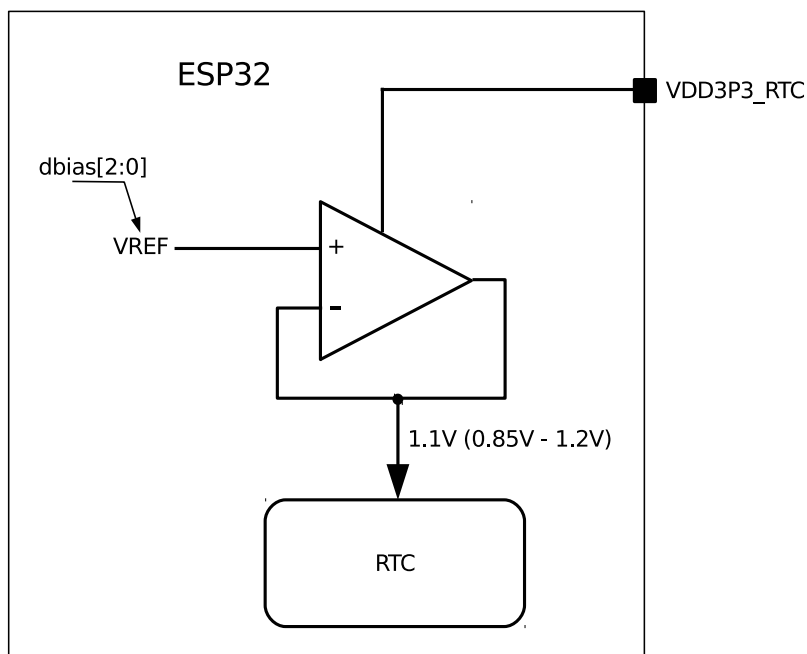


Figure 164: Low-Power Voltage Regulator

30.3.4 Flash Voltage Regulator

The built-in flash voltage regulator can supply a voltage of 3.3V or 1.8V to other devices (flash, for example) in the system, with a maximum output current of 40 mA.

1. When `XPD_SDIO_VREG == 1`, the regulator outputs a voltage of 3.3V or 1.8V; when `XPD_SDIO_VREG == 0`, the output is high-impedance and, in this case, the voltage is provided by the external power supply.
2. When `SDIO_TIEH == 1`, the regulator shorts pin VDD_SDIO to pin VDD3P3_RTC. The regulator then outputs a voltage of 3.3V which is the voltage of pin VDD3P3_RTC. When `SDIO_TIEH == 0`, the inner loop ties the regulator output to the voltage of VREF, which is typically 1.8V.
3. DREFH_SDIO, DREFM_SDIO and DREFL_SDIO could be used to tune the reference voltage VREF slightly. However, it is recommended that users do not change the value of these registers, since it may affect the stability of the inner loop.
4. When the regulator output is 3.3V or 1.8V, the output current comes from the pin VDD3P3_RTC.

Figure 165 shows the structure of a flash voltage regulator.

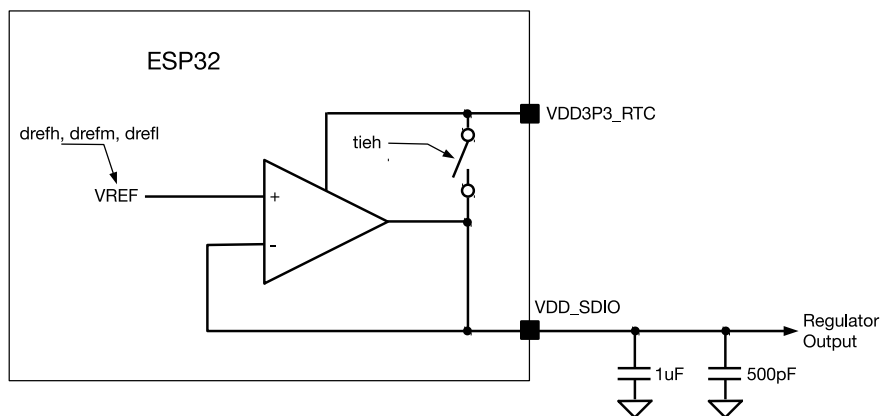


Figure 165: Flash Voltage Regulator

30.3.5 Brownout Detector

The brownout detector checks the voltage of pin VDD3P3_RTC. If the voltage drops rapidly and becomes too low, the detector would trigger a signal to shut down some power-consuming blocks (such as LNA, PA, etc.) to allow extra time for the digital block to save and transfer important data. The power consumption of the detector is ultra low. It remains enabled whenever the chip is powered on, with an adjustable trigger level calibrated around 2.5V.

1. As the output of the brownout detector, [RTC_CNTL_BROWN_OUT_DET](#) goes high when the voltage of pin VDD3P3_RTC is lower than the threshold value.
2. [RTC_CNTL_DBROWN_OUT_THRES\[2:0\]](#) is used to tune the threshold voltage, which is usually calibrated around 2.5V.

Figure 166 shows the structure of a brownout detector.

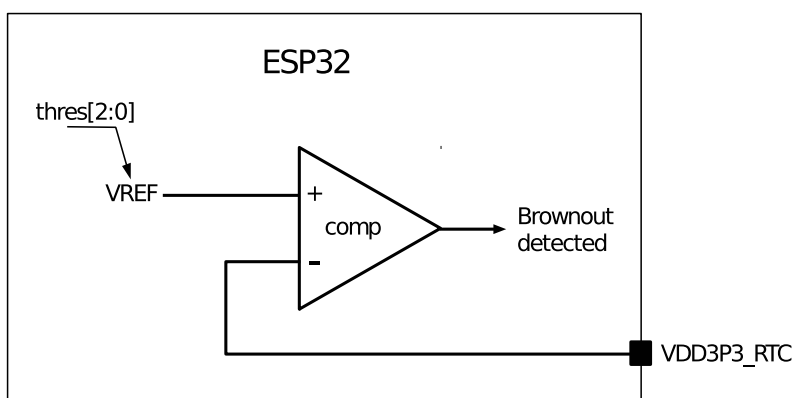


Figure 166: Brownout Detector

30.3.6 RTC Module

The RTC module is designed to handle the entry into, and exit from, the low-power mode, and control the clock sources, PLL, power switch and isolation cells to generate power-gating, clock-gating, and reset signals. As for the low-power management, RTC is composed of the following modules (see Figure 167):

- RTC main state machine: records the power state.

- Digital & analog power controller: generates actual power-gating/clock-gating signals for digital parts and analog parts.
- Sleep & wakeup controller: handles the entry into & exit from the low-power mode.
- Timers: include RTC main timer, ULP co-processor timer and touch timer.
- Low-Power processor and sensor controllers: include ULP co-processor, touch controller, SAR ADC controller, etc.
- Retention memory:
 - RTC slow memory: an 8 KB SRAM, mostly used as retention memory or instruction & data memory for the ULP co-processor. The CPU accesses it through the APB, starting from address 0x50000000.
 - RTC fast memory: an 8 KB SRAM, mostly used as retention memory. The CPU accesses it through IRAM0/DRAM0. Fast RTC memory is about 10 times faster than the RTC slow memory.
- Retention registers: always-on registers of 8 x 32 bits, serving as data storage.
- RTC IO pads: 18 always-on analog pads, usually functioning as wake-up sources.

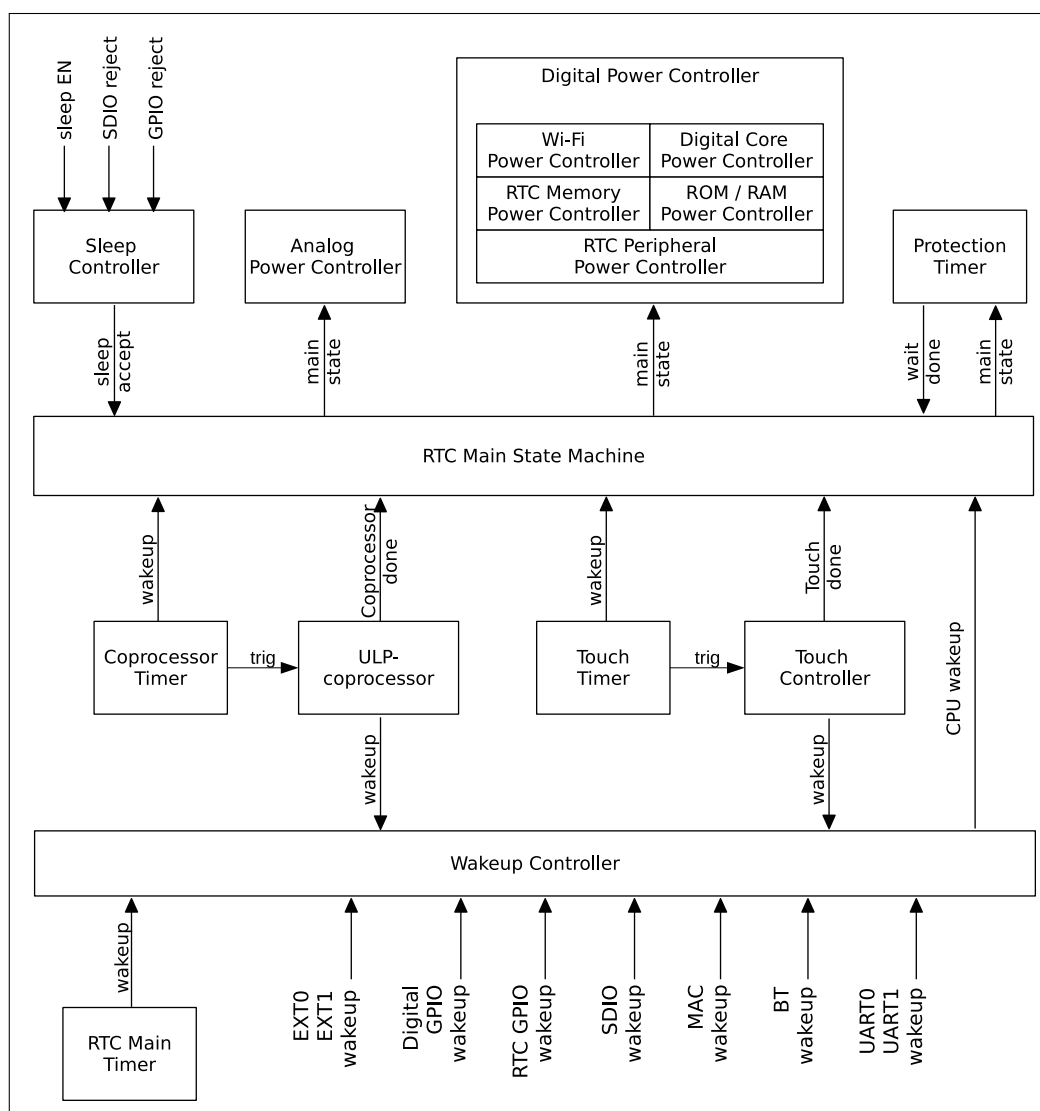


Figure 167: RTC Structure

30.3.7 Low-Power Clocks

In the low-power mode, the 40 MHz crystal and PLL are usually powered down to save power. But clocks are needed for the chip to remain active in the low-power mode.

For the RTC core, there are five possible clock sources:

- external low-speed (32.768 kHz) crystal clock CK_XTAL_32K,
- external high-speed (2 MHz ~ 40 MHz) crystal clock CK_40M_DIG,
- internal RC oscillator SLOW_CK (typically about 150 kHz and adjustable),
- internal 8-MHz oscillator CK8M_OUT, and
- internal 31.25-kHz clock CK8M_D256_OUT (derived from the internal 8-MHz oscillator divided by 256).

With these clocks, `fast_rtc_clk` and `slow_rtc_clk` is derived. By default, `fast_rtc_clk` is CK8M_OUT while `slow_rtc_clk` is SLOW_CK. For details, please see Figure 168.

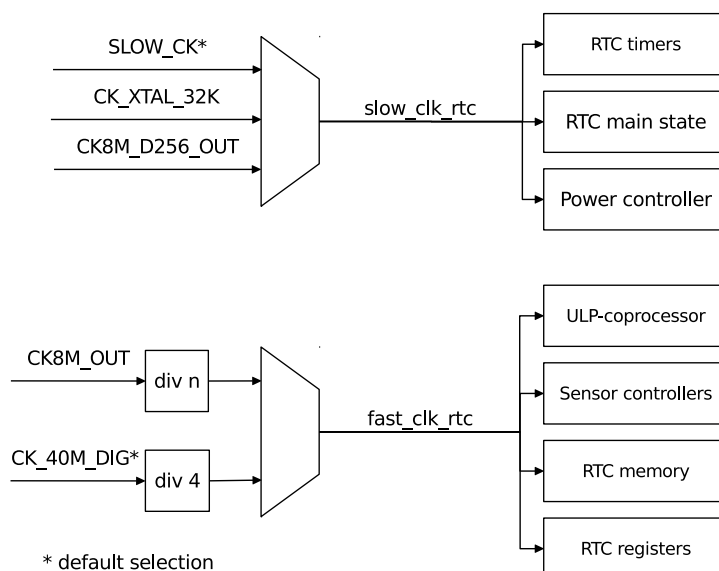


Figure 168: RTC Low-Power Clocks

For the digital core, `low_power_clk` is switched among four sources. For details, please see Figure 169.

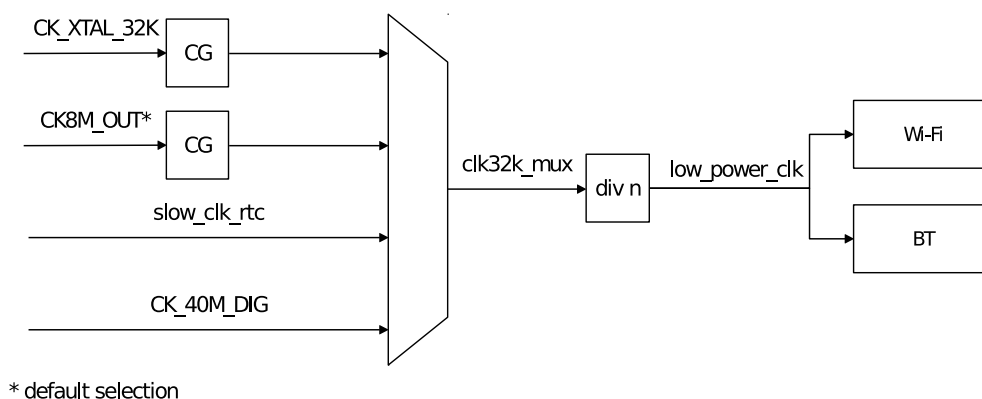


Figure 169: Digital Low-Power Clocks

30.3.8 Power-Gating Implementation

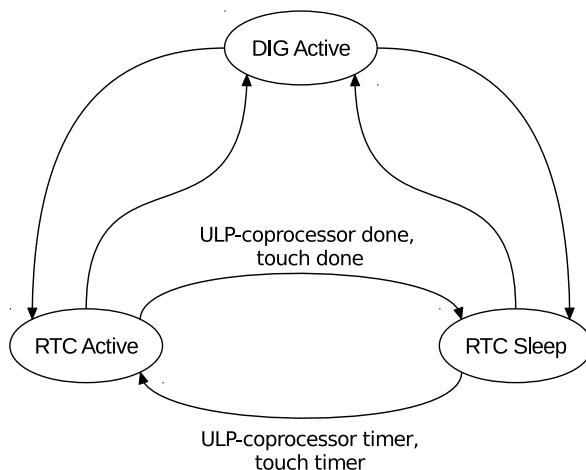


Figure 170: RTC States

The switch among power-gating states can be seen in Figure 170. The actual power-control signals could also be set by software as force-power-up (FPU) or force-power-down (FPD). Since the power domains can be power-gated independently, there are many combinations for different applications. Table 131 shows how the power domains in ESP32 are controlled.

Table 131: RTC Power Domains

Power Domains		RTC Main State			S/W Options		Notes*
		DIG Active	RTC Active	RTC Sleep	FPU	FPD	
RTC	RTC Digital Core	ON	ON	ON	N	N	1
	RTC Peripherals	ON	ON	OFF	Y	Y	2
	RTC Slow Memory	ON	OFF	OFF	Y	Y	3
	RTC Fast Memory	ON	OFF	OFF	Y	Y	4
Digital	Digital Core	ON	OFF	OFF	Y	Y	5
	Wi-Fi	ON	OFF	OFF	Y	Y	6
	ROM	ON	OFF	OFF	Y	Y	-
	Internal SRAM	ON	OFF	OFF	Y	Y	7
Analog	40 MHz Crystal	ON	OFF	OFF	Y	Y	-
	PLL	ON	OFF	OFF	Y	Y	-
	8 MHz OSC	ON	OFF	OFF	Y	Y	-
	Radio	-	-	-	Y	Y	-

Notes*:

1. The power-domain RTC core is the “always-on” power domain, and the FPU/FPD option is not available.
2. The power-domain RTC peripherals include most of the fast logic in RTC, including the ULP co-processor, sensor controllers, etc.
3. The power-domain RTC slow memory should be forced to power on when it is used as retention memory, or when the ULP co-processor is working.
4. The power-domain RTC fast memory should be forced to power on, when it is used as retention memory.
5. When the power-domain digital core is powered down, all included in power domains are powered

down.

6. The power-domain Wi-Fi includes the Wi-Fi MAC and BB.

7. Each internal SRAM can be power-gated independently.

30.3.9 Predefined Power Modes

In ESP32, we recommend that you always use the predefined power modes first, before trying to tune each power control signal. The predefined power modes should cover most scenarios:

- Active mode
 - The CPU is clocked at XTAL_DIV_N (40 MHz/26 MHz) or PLL (80 MHz/160 MHz/240 MHz).
 - The chip can receive, transmit, or listen.
- Modem-sleep mode
 - The CPU is operational and the clock is configurable.
 - The Wi-Fi/Bluetooth baseband is clock-gated or powered down. The radio is turned off.
 - Current consumption: ~30 mA with 80 MHz PLL.
 - Current consumption: ~3 mA with 2 MHz XTAL.
 - Immediate wake-up.
- Light-sleep mode
 - The internal 8 MHz oscillator, 40 MHz high-speed crystal, PLL, and radio are disabled.
 - The clock in the digital core is gated. The CPUs are stalled.
 - The ULP co-processor and touch controller can be periodically triggered by monitor sensors.
 - Current consumption: ~ 800 μ A.
 - Wake-up latency: less than 1 ms.
- Deep-sleep mode
 - The internal 8 MHz oscillator, 40 MHz high-speed crystal, PLL and radio are disabled.
 - The digital core is powered down. The CPU context is lost.
 - The supply voltage to the RTC core drops to 0.7V.
 - 8 x 32 bits of data are kept in general-purpose retention registers.
 - The RTC memory and fast RTC memory can be retained.
 - Current consumption: ~ 6.5 μ A.
 - Wake-up latency: less than 1 ms.
 - Recommended for ultra-low-power infrequently-connected Wi-Fi/Bluetooth applications.
- Hibernation mode
 - The internal 8 MHz oscillator, 40 MHz high-speed crystal, PLL, and radio are disabled.
 - The digital core is powered down. The CPU context is lost.
 - The RTC peripheral domain is powered down.

- The supply voltage to the RTC core drops to 0.7V.
- 8 x 32 bits of data are kept in general-purpose retention registers.
- The RTC memory and fast RTC memory are powered down.
- Current consumption: $\sim 4.5 \mu\text{A}$.
- Wake-up source: RTC timer only.
- Wake-up latency: less than 1 ms.
- Recommended for ultra-low-power infrequently-connected Wi-Fi/Bluetooth applications.

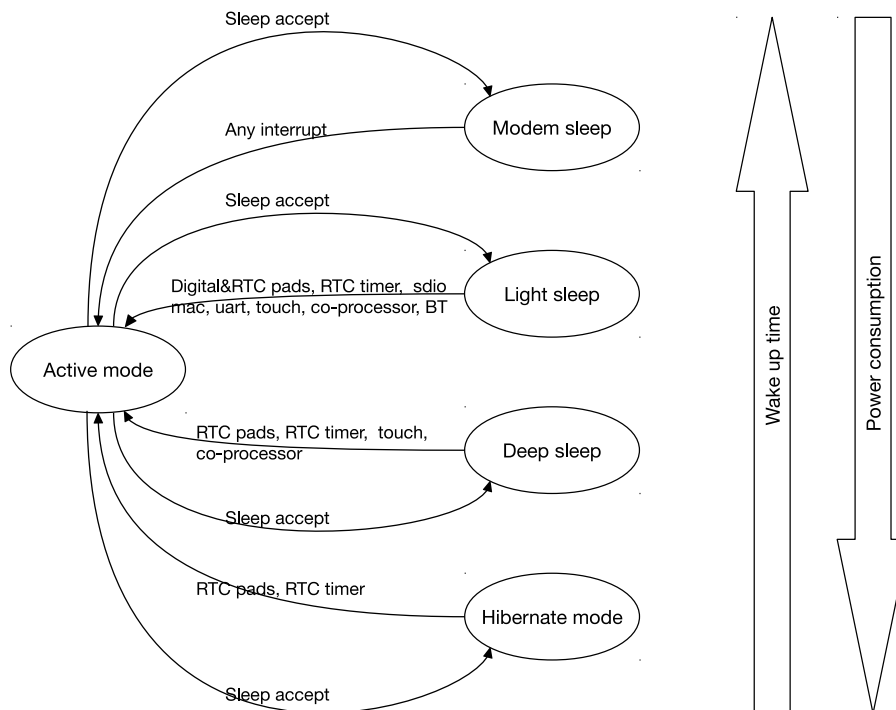


Figure 171: Power Modes

By default, the ESP32 is in active mode after a system reset. There are several low-power modes for saving power when the CPU does not need to be kept running, for example, when waiting for an external event. It is up to the user to select the mode that best balances power consumption, wake-up latency and available wake-up sources. For details, please see Figure 171.

Please note that the predefined power mode could be further optimized and adapted to any application.

30.3.10 Wakeup Source

The ESP32 supports various wake-up sources, which could wake up the CPU in different sleep modes. The wake-up source is determined by `RTC_CNTL_WAKEUP_ENA`, as shown in Table 132.

Table 132: Wake-up Source

WAKEUP_ENA	Wake-up Source	Light-sleep	Deep-sleep	Hibernation	Notes*
0x1	EXT0	Y	Y	-	1
0x2	EXT1	Y	Y	Y	2
0x4	GPIO	Y	Y	-	3
0x8	RTC timer	Y	Y	Y	-
0x10	SDIO	Y	-	-	4
0x20	Wi-Fi	Y	-	-	5
0x40	UART0	Y	-	-	6
0x80	UART1	Y	-	-	6
0x100	TOUCH	Y	Y	-	-
0x200	ULP co-processor	Y	Y	-	-
0x400	BT	Y	-	-	5

Notes*:

- EXT0 can only wake up the chip in light-sleep/deep-sleep mode. If `RTC_CNTL_EXT_WAKEUP0_LV` is 1, it is pad high-level triggered; otherwise, it is low-level triggered. Users can set `RTCIO_EXT_WAKEUP0_SEL[4:0]` to select one of the RTC PADS to be the wake-up source.
- EXT1 is especially designed to wake up the chip from any sleep mode, and it also supports multiple pads' combinations. First, `RTC_CNTL_EXT_WAKEUP1_SEL[17:0]` should be configured with the bitmap of PADS selected as a wake-up source. Then, if `RTC_CNTL_EXT_WAKEUP1_LV` is 1, as long as one of the PADS is at high-voltage level, it can trigger a wake-up. However, if `RTC_CNTL_EXT_WAKEUP1_LV` is 0, it needs all selected PADS to be at low-voltage level to trigger a wake-up.
- In Deep-sleep mode, only RTC GPIOs (not DIGITAL GPIOs) can work as wakeup source.
- Wake-up is triggered by receiving any SDIO command.
- To wake up the chip with a Wi-Fi or BT source, the power mode switches between the Active, Modem- and Light-sleep modes. The CPU, Wi-Fi, Bluetooth, and radio are woken up at predetermined intervals to keep Wi-Fi/BT connections active.
- Wake-up is triggered when the number of RX pulses received is greater than the value stored in the threshold register.

30.3.11 RTC Timer

The RTC timer is a 48-bit counter that can be read. The clock is `RTC_SLOW_CLK`. Any reset/sleep mode, except for the power-up reset, will not stop or reset the RTC timer.

The RTC timer can be used to wake up the CPU at a designated time, and to wake up TOUCH or the ULP co-processor periodically.

30.3.12 RTC Boot

Since the CPU, ROM and RAM are powered down during Deep-sleep and Hibernation mode, the wake-up time is much longer than that in Light sleep/Modem sleep, because of the ROM unpacking and data-copying from the flash (SPI booting). There are two types of SRAM in the RTC, named slow RTC memory and fast RTC memory, which remain powered-on in Deep-sleep mode. For small-scale codes (less than 8 KB), there are two methods of speeding up the wake-up time, i.e. avoiding ROM unpacking and SPI booting.

The first method is to use the RTC slow memory:

1. Set register `RTC_CNTL_PROCPU_STAT_VECTOR_SEL` for PRO_CPU (or register `RTC_CNTL_APPCPU_STAT_VECTOR_SEL` for APP_CPU) to 0.
2. Put the chip into sleep.
3. When the CPU is powered up, the reset vector starts from 0x50000000, instead of 0x40000400. ROM unpacking & SPI boot are not needed. The code in RTC memory has to do itself some initialization for the C program environment.

The second method is to use the fast RTC memory:

1. Set register `RTC_CNTL_PROCPU_STAT_VECTOR_SEL` for PRO_CPU (or register `RTC_CNTL_APPCPU_STAT_VECTOR_SEL` for APP_CPU) to 1.
2. Calculate CRC for the fast RTC memory, and save the result in register `RTC_CNTL_RTC_STORE6_REG[31:0]`.
3. Input register `RTC_CNTL_RTC_STORE7_REG[31:0]` with the entry address in the fast RTC memory.
4. Put the chip into sleep.
5. When the CPU is powered up, after ROM unpacking and some necessary initialization, the CRC is calculated again. If the result matches with register `RTC_CNTL_RTC_STORE6_REG[31:0]`, the CPU will jump to the entry address.

The boot flow is shown in Figure 172.

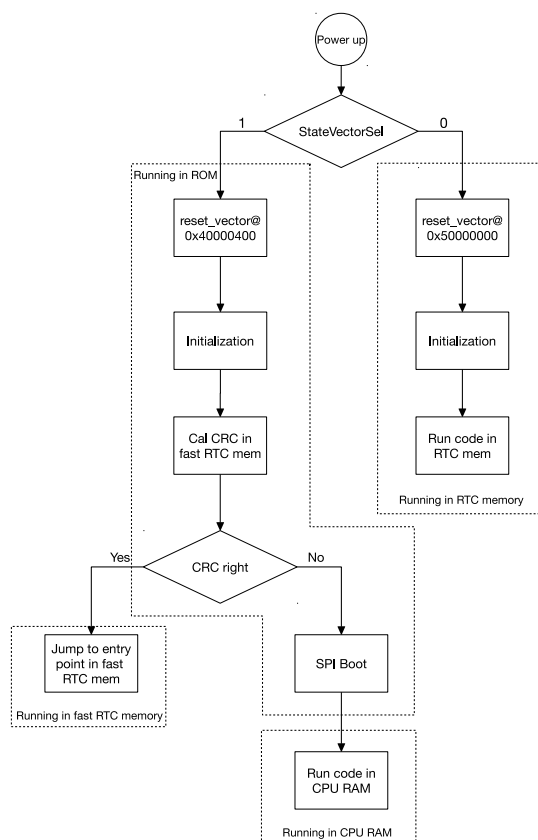


Figure 172: ESP32 Boot Flow

30.4 Register Summary

Notes:

- The registers listed below have been grouped according to their functionality. This particular grouping does not reflect the exact sequential order in which they are stored in memory.
- The base address for registers is 0x60008000 when accessed by AHB, and 0x3FF48000 when accessed by DPORT bus.

Name	Description	Address	Access
RTC option register			
RTC_CNTL_OPTIONS0_REG	Configure RTC options	0x3FF48000	R/W
Control and configuration of RTC timer registers			
RTC_CNTL_SLP_TIMER0_REG	RTC sleep timer	0x3FF48001	R/W
RTC_CNTL_SLP_TIMER1_REG	RTC sleep timer, alarm and control	0x3FF48002	R/W
RTC_CNTL_TIME_UPDATE_REG	Update control of RTC timer	0x3FF48003	RO
RTC_CNTL_TIME0_REG	RTC timer low 32 bits	0x3FF48004	RO
RTC_CNTL_TIME1_REG	RTC timer high 16 bits	0x3FF48005	RO
RTC_CNTL_STATE0_REG	RTC sleep, SDIO and ULP control	0x3FF48006	R/W
RTC_CNTL_TIMER1_REG	CPU stall enable	0x3FF48007	R/W
RTC_CNTL_TIMER2_REG	Slow clock and touch controller configuration	0x3FF48008	R/W
RTC_CNTL_TIMER5_REG	Minimal sleep cycles in slow clock	0x3FF4800B	R/W
Reset state and wakeup control registers			
RTC_CNTL_RESET_STATE_REG	Reset state control and cause of CPUs	0x3FF4800D	RO
RTC_CNTL_WAKEUP_STATE_REG	Wake-up filter, enable and cause	0x3FF4800E	RO
RTC_CNTL_EXT_WAKEUP_CONF_REG	Configuration of wake-up at low/high level	0x3FF48018	R/W
RTC_CNTL_EXT_WAKEUP1_REG	Selection of pads for external wake-up and wake-up clear bit	0x3FF48033	R/W
RTC_CNTL_EXT_WAKEUP1_STATUS_REG	External wake-up status	0x3FF48034	RO
RTC interrupt control and status registers			
RTC_CNTL_INT_ENA_REG	Interrupt enable bits	0x3FF4800F	R/W
RTC_CNTL_INT_RAW_REG	Raw interrupt status	0x3FF48010	RO
RTC_CNTL_INT_ST_REG	Masked interrupt status	0x3FF48011	RO
RTC_CNTL_INT_CLR_REG	Interrupt clear bits	0x3FF48012	WO
RTC general purpose retention registers			
RTC_CNTL_STORE0_REG	General purpose retention register 0	0x3FF48013	R/W
RTC_CNTL_STORE1_REG	General purpose retention register 1	0x3FF48014	R/W
RTC_CNTL_STORE2_REG	General purpose retention register 2	0x3FF48015	R/W
RTC_CNTL_STORE3_REG	General purpose retention register 3	0x3FF48016	R/W
RTC_CNTL_STORE4_REG	General purpose retention register 4	0x3FF4802C	R/W
RTC_CNTL_STORE5_REG	General purpose retention register 5	0x3FF4802D	R/W
RTC_CNTL_STORE6_REG	General purpose retention register 6	0x3FF4802E	R/W
RTC_CNTL_STORE7_REG	General purpose retention register 7	0x3FF4802F	R/W
Internal power management registers			
RTC_CNTL_ANA_CONF_REG	Power-up/down configuration	0x3FF4800C	R/W

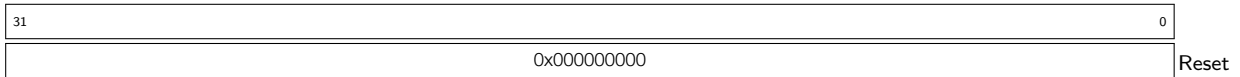
Name	Description	Address	Access
RTC_CNTL_VREG_REG	Internal power distribution and control	0x3FF4801F	R/W
RTC_CNTL_PWC_REG	RTC domain power management	0x3FF48020	R/W
RTC_CNTL_DIG_PWC_REG	Digital domain power management	0x3FF48021	R/W
RTC_CNTL_DIG_ISO_REG	Digital domain isolation control	0x3FF48022	RO
RTC watchdog configuration and control registers			
RTC_CNTL_WDTCONFIG0_REG	WDT Configuration register 0	0x3FF48023	R/W
RTC_CNTL_WDTCONFIG1_REG	WDT Configuration register 1	0x3FF48024	R/W
RTC_CNTL_WDTCONFIG2_REG	WDT Configuration register 2	0x3FF48025	R/W
RTC_CNTL_WDTCONFIG3_REG	WDT Configuration register 3	0x3FF48026	R/W
RTC_CNTL_WDTCONFIG4_REG	WDT Configuration register 4	0x3FF48027	R/W
RTC_CNTL_WDTFEED_REG	Watchdog feed register	0x3FF48028	WO
RTC_CNTL_WDTWPROTECT_REG	Watchdog write protect register	0x3FF48029	R/W
Miscellaneous RTC configuration registers			
RTC_CNTL_EXT_XTL_CONF_REG	XTAL control by external pads	0x3FF48017	R/W
RTC_CNTL_SLP_REJECT_CONF_REG	Reject cause and enable control	0x3FF48019	R/W
RTC_CNTL_CPU_PERIOD_CONF_REG	CPU period select	0x3FF4801A	R/W
RTC_CNTL_CLK_CONF_REG	Configuration of RTC clocks	0x3FF4801C	R/W
RTC_CNTL_SDIO_CONF_REG	SDIO configuration	0x3FF4801D	R/W
RTC_CNTL_SW_CPU_STALL_REG	Stall of CPUs	0x3FF4802B	R/W
RTC_CNTL_HOLD_FORCE_REG	RTC pad hold register	0x3FF48032	R/W
RTC_CNTL_BROWN_OUT_REG	Brownout management	0x3FF48035	R/W

RTC_CNTL_SW_APPCPU_RST APP_CPU SW reset. (WO)

RTC_CNTL_SW_STALL_PROCPU_C0 described under [RTC_CNTL_SW_CPU_STALL_REG](#). (R/W)

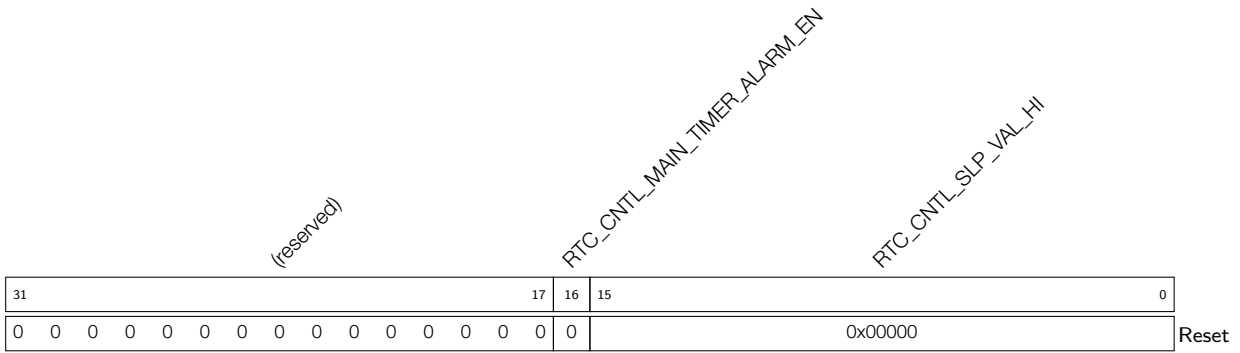
RTC_CNTL_SW_STALL_APPCPU_C0 described under [RTC_CNTL_SW_CPU_STALL_REG](#). (R/W)

Register 30.2: RTC_CNTL_SLP_TIMER0_REG (0x0001)



RTC_CNTL_SLP_TIMER0_REG RTC sleep timer low 32 bits. (R/W)

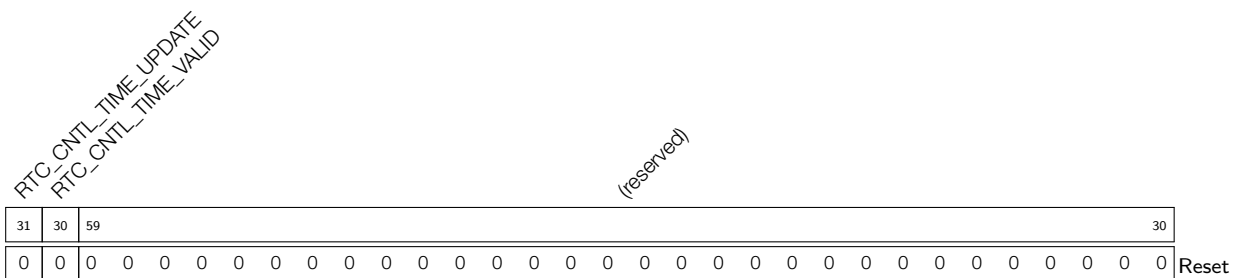
Register 30.3: RTC_CNTL_SLP_TIMER1_REG (0x0002)



RTC_CNTL_MAIN_TIMER_ALARM_EN Timer alarm enable bit. (R/W)

RTC_CNTL_SLP_VAL_HI RTC sleep timer high 16 bits. (R/W)

Register 30.4: RTC_CNTL_TIME_UPDATE_REG (0x0003)



RTC_CNTL_TIME_UPDATE Set 1: to update register with RTC timer. (WO)

RTC_CNTL_TIME_VALID Indicates that the register is updated. (RO)

Register 30.5: RTC_CNTL_TIME0_REG (0x0004)

31	0
0x00000000	

Reset

RTC_CNTL_TIME0_REG RTC timer low 32 bits. (RO)

Register 30.6: RTC_CNTL_TIME1_REG (0x0005)

<i>(reserved)</i>																<i>RTC_CNTL_TIME_HI</i>																
31															16	15																0
0 0 0 0 0 0 0 0 0 0 0 0 0 0 0 0																0x00000																

Reset

RTC_CNTL_TIME_HI RTC timer high 16 bits. (RO)

Register 30.7: RTC_CNTL_STATE0_REG (0x0006)

<i>RTC_CNTL_SLEEP_EN</i>										<i>RTC_CNTL_SLP_REJECT</i>										<i>RTC_CNTL_SLP_WAKEUP</i>										<i>RTC_CNTL_SDIO_ACTIVE_IND</i>										<i>(reserved)</i>										<i>RTC_CNTL_ULP_CP_SLP_TIMER_EN</i>										<i>RTC_CNTL_TOUCH_SLP_TIMER_EN</i>										<i>(reserved)</i>									
31	30	29	28	27				25	24	23																45																23																																					
0 0																																																																															

Reset

RTC_CNTL_SLEEP_EN Sleep enable bit. (R/W)

RTC_CNTL_SLP_REJECT Sleep reject bit. (R/W)

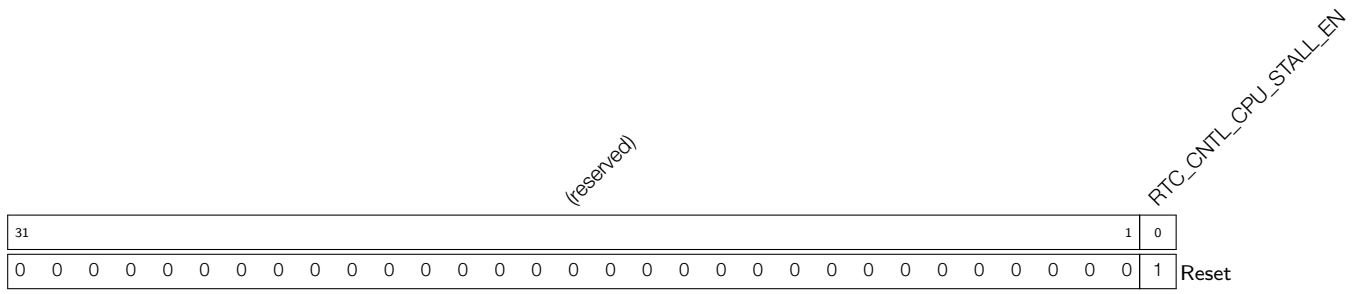
RTC_CNTL_SLP_WAKEUP Sleep wake-up bit. (R/W)

RTC_CNTL_SDIO_ACTIVE_IND SDIO active indication. (RO)

RTC_CNTL_ULP_CP_SLP_TIMER_EN ULP co-processor timer enable bit. (R/W)

RTC_CNTL_TOUCH_SLP_TIMER_EN Touch timer enable bit. (R/W)

Register 30.8: RTC_CNTL_TIMER1_REG (0x0007)



RTC_CNTL_CPU_STALL_EN CPU stall enable bit. (R/W)

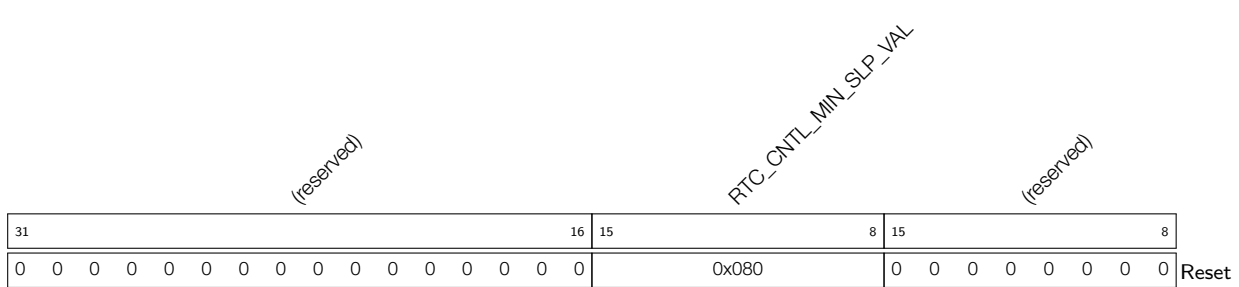
Register 30.9: RTC_CNTL_TIMER2_REG (0x0008)



RTC_CNTL_MIN_TIME_CK8M_OFF Minimal amount of cycles in slow_clk_rtc to power down CK8M. (R/W)

RTC_CNTL_ULPCP_TOUCH_START_WAIT Awaited cycles in slow_clk_rtc before ULP co-processor/touch controller starts working. (R/W)

Register 30.10: RTC_CNTL_TIMER5_REG (0x000b)



RTC_CNTL_MIN_SLP_VAL Minimal amount of sleep cycles in slow_clk_rtc. (R/W)

Register 30.13: RTC_CNTL_WAKEUP_STATE_REG (0x000e)

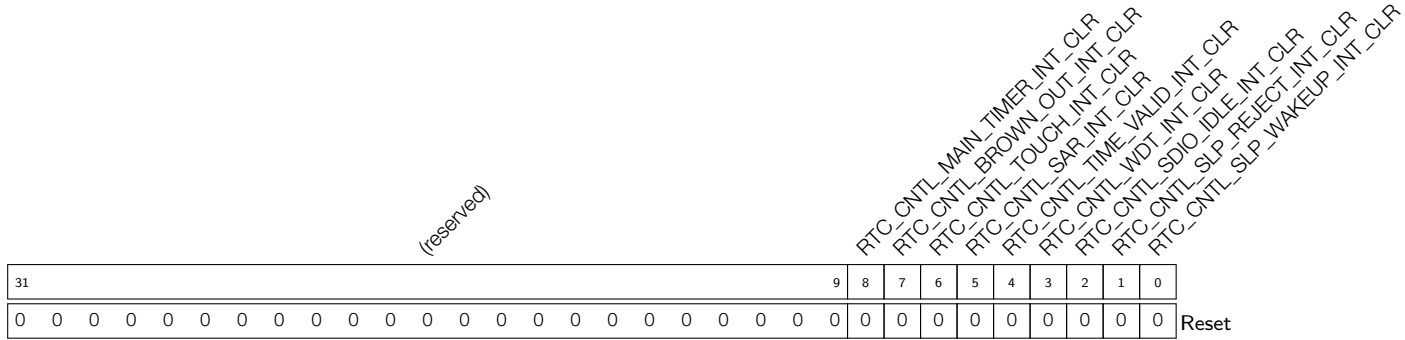
<i>(reserved)</i>										<i>RTC_CNTL_GPIO_WAKEUP_FILTER</i>										<i>RTC_CNTL_WAKEUP_ENA</i>										<i>RTC_CNTL_WAKEUP_CAUSE</i>												
31										23	22										21										11	10										0
0 0 0 0 0 0 0 0 0 0										0 0 0 0 0 0 0 0 0 0										0 0 0 0 0 0 0 0 1 1 0 0										0x000										Reset		

RTC_CNTL_GPIO_WAKEUP_FILTER Enable filter for GPIO wake-up event. (R/W)

RTC_CNTL_WAKEUP_ENA Wake-up enable bitmap. (R/W)

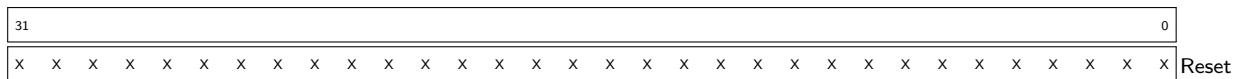
RTC_CNTL_WAKEUP_CAUSE Wake-up cause. (RO)

Register 30.17: RTC_CNTL_INT_CLR_REG (0x0012)



- RTC_CNTL_MAIN_TIMER_INT_CLR** Set this bit to clear the RTC_CNTL_MAIN_TIMER_INT interrupt. (WO)
- RTC_CNTL_BROWN_OUT_INT_CLR** Set this bit to clear the RTC_CNTL_BROWN_OUT_INT interrupt. (WO)
- RTC_CNTL_TOUCH_INT_CLR** Set this bit to clear the RTC_CNTL_TOUCH_INT interrupt. (WO)
- RTC_CNTL_SAR_INT_CLR** Set this bit to clear the RTC_CNTL_SAR_INT interrupt. (WO)
- RTC_CNTL_TIME_VALID_INT_CLR** Set this bit to clear the RTC_CNTL_TIME_VALID_INT interrupt. (WO)
- RTC_CNTL_WDT_INT_CLR** Set this bit to clear the RTC_CNTL_WDT_INT interrupt. (WO)
- RTC_CNTL_SDIO_IDLE_INT_CLR** Set this bit to clear the RTC_CNTL_SDIO_IDLE_INT interrupt. (WO)
- RTC_CNTL_SLP_REJECT_INT_CLR** Set this bit to clear the RTC_CNTL_SLP_REJECT_INT interrupt. (WO)
- RTC_CNTL_SLP_WAKEUP_INT_CLR** Set this bit to clear the RTC_CNTL_SLP_WAKEUP_INT interrupt. (WO)

Register 30.18: RTC_CNTL_STORE_n_REG (n: 0-3) (0x13+1*n)



RTC_CNTL_STORE_n_REG 32-bit general-purpose retention register. (R/W)

Register 30.25: RTC_CNTL_VREG_REG (0x001f)

RTC_CNTL_PREG_FORCE_PU		RTC_CNTL_PREG_FORCE_PD		RTC_CNTL_DBOOST_FORCE_PU		RTC_CNTL_DBOOST_FORCE_PD		RTC_CNTL_DBIAS_WAK		RTC_CNTL_DBIAS_SLP		RTC_CNTL_SCK_DCAP		RTC_CNTL_DIG_VREG_DBIAS_WAK		RTC_CNTL_DIG_VREG_DBIAS_SLP		(reserved)		
31	30	29	28	27	25	24	22	21	14	13	11	10	8	15						8
1	0	1	0	4		4		0		4		4		0 0 0 0 0 0 0 0					Reset	

RTC_CNTL_VREG_FORCE_PU RTC voltage regulator - force power up. (R/W)

RTC_CNTL_VREG_FORCE_PD RTC voltage regulator - force power down (in this case power down means decreasing the voltage to 0.8V or lower). (R/W)

RTC_CNTL_DBOOST_FORCE_PU RTC_DBOOST force power up. (R/W)

RTC_CNTL_DBOOST_FORCE_PD RTC_DBOOST force power down. (R/W)

RTC_CNTL_DBIAS_WAK RTC_DBIAS during wake-up. (R/W)

RTC_CNTL_DBIAS_SLP RTC_DBIAS during sleep. (R/W)

RTC_CNTL_SCK_DCAP Used to adjust the frequency of RTC slow clock. (R/W)

RTC_CNTL_DIG_VREG_DBIAS_WAK Digital voltage regulator DBIAS during wake-up. (R/W)

RTC_CNTL_DIG_VREG_DBIAS_SLP Digital voltage regulator DBIAS during sleep. (R/W)

Register 30.27: RTC_CNTL_DIG_PWC_REG (0x0021)

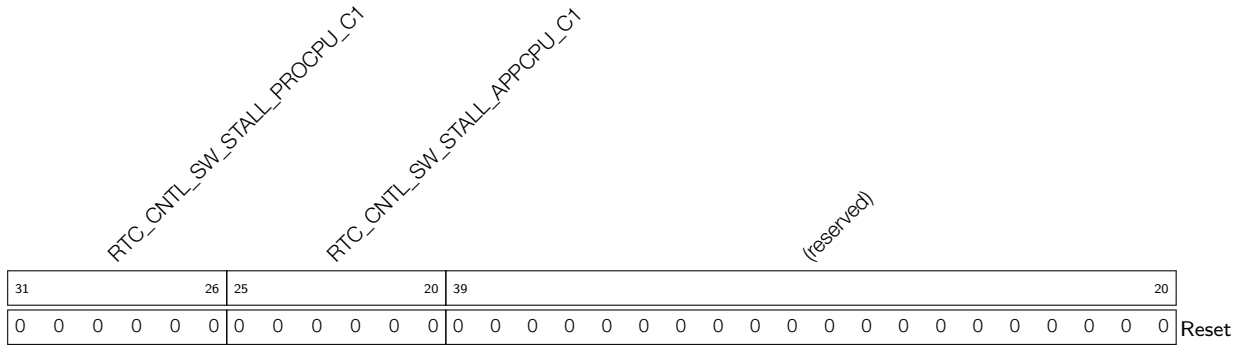
<div style="display: flex; justify-content: space-between;"> <div style="width: 45%;"> <p>RTC_CNTL_DG_WRAP_PD_EN</p> <p>RTC_CNTL_WIFI_PD_EN</p> <p>RTC_CNTL_INTER_RAM4_PD_EN</p> <p>RTC_CNTL_INTER_RAM3_PD_EN</p> <p>RTC_CNTL_INTER_RAM2_PD_EN</p> <p>RTC_CNTL_INTER_RAM1_PD_EN</p> <p>RTC_CNTL_ROM0_PD_EN</p> <p>(reserved)</p> </div> <div style="width: 45%;"> <p>RTC_CNTL_DG_WRAP_FORCE_PU</p> <p>RTC_CNTL_DG_WRAP_FORCE_PD</p> <p>RTC_CNTL_WIFI_FORCE_PU</p> <p>RTC_CNTL_WIFI_FORCE_PD</p> <p>RTC_CNTL_INTER_RAM4_FORCE_PU</p> <p>RTC_CNTL_INTER_RAM4_FORCE_PD</p> <p>RTC_CNTL_INTER_RAM3_FORCE_PU</p> <p>RTC_CNTL_INTER_RAM3_FORCE_PD</p> <p>RTC_CNTL_INTER_RAM2_FORCE_PU</p> <p>RTC_CNTL_INTER_RAM2_FORCE_PD</p> <p>RTC_CNTL_INTER_RAM1_FORCE_PU</p> <p>RTC_CNTL_INTER_RAM1_FORCE_PD</p> <p>RTC_CNTL_ROM0_FORCE_PU</p> <p>RTC_CNTL_ROM0_FORCE_PD</p> <p>RTC_CNTL_LSLP_MEM_FORCE_PU</p> <p>RTC_CNTL_LSLP_MEM_FORCE_PD</p> <p>(reserved)</p> </div> </div>																							Reset										
31	30	29	28	27	26	25	24	23	22	21	20	19	18	17	16	15	14	13	12	11	10	9	8	7	6	5	4	3	2	1	0	3	
x	x	x	x	x	x	x	x	0	0	0	1	0	1	0	1	0	1	0	1	0	1	0	1	0	1	0	1	0	1	0	0	0	0

- RTC_CNTL_DG_WRAP_PD_EN** Enable power down digital core in sleep mode. (R/W)
- RTC_CNTL_WIFI_PD_EN** Enable power down Wi-Fi in sleep. (R/W)
- RTC_CNTL_INTER_RAM4_PD_EN** Enable power down internal SRAM 4 in sleep mode. (R/W)
- RTC_CNTL_INTER_RAM3_PD_EN** Enable power down internal SRAM 3 in sleep mode. (R/W)
- RTC_CNTL_INTER_RAM2_PD_EN** Enable power down internal SRAM 2 in sleep mode. (R/W)
- RTC_CNTL_INTER_RAM1_PD_EN** Enable power down internal SRAM 1 in sleep mode. (R/W)
- RTC_CNTL_INTER_RAM0_PD_EN** Enable power down internal SRAM 0 in sleep mode. (R/W)
- RTC_CNTL_ROM0_PD_EN** Enable power down ROM in sleep mode. (R/W)
- RTC_CNTL_DG_WRAP_FORCE_PU** Digital core force power up. (R/W)
- RTC_CNTL_DG_WRAP_FORCE_PD** Digital core force power down. (R/W)
- RTC_CNTL_WIFI_FORCE_PU** Wi-Fi force power up. (R/W)
- RTC_CNTL_WIFI_FORCE_PD** Wi-Fi force power down. (R/W)
- RTC_CNTL_INTER_RAM4_FORCE_PU** Internal SRAM 4 force power up. (R/W)
- RTC_CNTL_INTER_RAM4_FORCE_PD** Internal SRAM 4 force power down. (R/W)
- RTC_CNTL_INTER_RAM3_FORCE_PU** Internal SRAM 3 force power up. (R/W)
- RTC_CNTL_INTER_RAM3_FORCE_PD** Internal SRAM 3 force power down. (R/W)
- RTC_CNTL_INTER_RAM2_FORCE_PU** Internal SRAM 2 force power up. (R/W)
- RTC_CNTL_INTER_RAM2_FORCE_PD** Internal SRAM 2 force power down. (R/W)
- RTC_CNTL_INTER_RAM1_FORCE_PU** Internal SRAM 1 force power up. (R/W)
- RTC_CNTL_INTER_RAM1_FORCE_PD** Internal SRAM 1 force power down. (R/W)
- RTC_CNTL_INTER_RAM0_FORCE_PU** Internal SRAM 0 force power up. (R/W)
- RTC_CNTL_INTER_RAM0_FORCE_PD** Internal SRAM 0 force power down. (R/W)
- RTC_CNTL_ROM0_FORCE_PU** ROM force power up. (R/W)
- RTC_CNTL_ROM0_FORCE_PD** ROM force power down. (R/W)

RTC_CNTL_LSLP_MEM_FORCE_PU Memories in digital core force power up in sleep mode.
(R/W)

RTC_CNTL_LSLP_MEM_FORCE_PD Memories in digital core force power down in sleep mode.
(R/W)

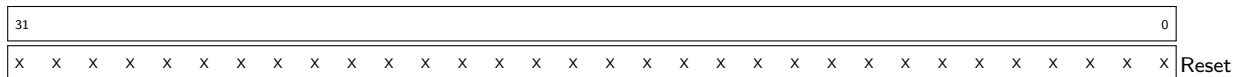
Register 30.32: RTC_CNTL_SW_CPU_STALL_REG (0x002b)



RTC_CNTL_SW_STALL_PROCPU_C1 reg_rtc_cntl_sw_stall_procpu_c1[5:0],
 reg_rtc_cntl_sw_stall_procpu_c0[1:0] == 0x86 (100001 10) will stall PRO_CPU, see also
[RTC_CNTL_OPTIONS0_REG](#). (R/W)

RTC_CNTL_SW_STALL_APPCPU_C1 reg_rtc_cntl_sw_stall_appcpu_c1[5:0],
 reg_rtc_cntl_sw_stall_appcpu_c0[1:0] == 0x86 (100001 10) will stall APP_CPU, see also
[RTC_CNTL_OPTIONS0_REG](#). (R/W)

Register 30.33: RTC_CNTL_STORE_n_REG (n: 4-7) (0x28+1*n)



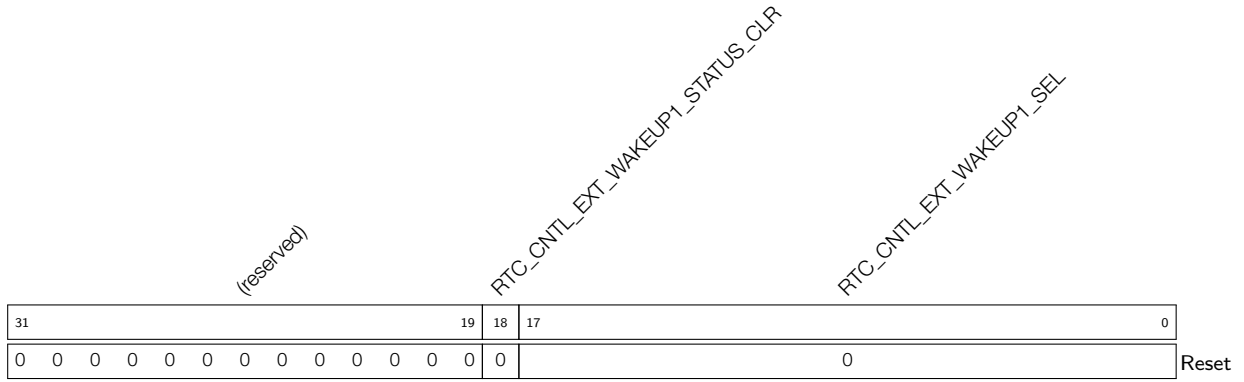
RTC_CNTL_STORE_n_REG 32-bit general-purpose retention register. (R/W)

Register 30.34: RTC_CNTL_HOLD_FORCE_REG (0x0032)

(reserved)																		RTC_CNTL_X32N_HOLD_FORCE RTC_CNTL_X32P_HOLD_FORCE RTC_CNTL_TOUCH_PAD7_HOLD_FORCE RTC_CNTL_TOUCH_PAD6_HOLD_FORCE RTC_CNTL_TOUCH_PAD5_HOLD_FORCE RTC_CNTL_TOUCH_PAD4_HOLD_FORCE RTC_CNTL_TOUCH_PAD3_HOLD_FORCE RTC_CNTL_TOUCH_PAD2_HOLD_FORCE RTC_CNTL_TOUCH_PAD1_HOLD_FORCE RTC_CNTL_TOUCH_PAD0_HOLD_FORCE RTC_CNTL_SENSE4_HOLD_FORCE RTC_CNTL_SENSE3_HOLD_FORCE RTC_CNTL_SENSE2_HOLD_FORCE RTC_CNTL_PDAC2_HOLD_FORCE RTC_CNTL_PDAC1_HOLD_FORCE RTC_CNTL_ADC2_HOLD_FORCE RTC_CNTL_ADC1_HOLD_FORCE													
31	18	17	16	15	14	13	12	11	10	9	8	7	6	5	4	3	2	1	0	Reset											
0	0	0	0	0	0	0	0	0	0	0	0	0	0	0	0	0	0	0	0	0	0										

- RTC_CNTL_X32N_HOLD_FORCE** Set to preserve pad's state during hibernation. (R/W)
- RTC_CNTL_X32P_HOLD_FORCE** Set to preserve pad's state during hibernation. (R/W)
- RTC_CNTL_TOUCH_PAD7_HOLD_FORCE** Set to preserve pad's state during hibernation. (R/W)
- RTC_CNTL_TOUCH_PAD6_HOLD_FORCE** Set to preserve pad's state during hibernation. (R/W)
- RTC_CNTL_TOUCH_PAD5_HOLD_FORCE** Set to preserve pad's state during hibernation. (R/W)
- RTC_CNTL_TOUCH_PAD4_HOLD_FORCE** Set to preserve pad's state during hibernation. (R/W)
- RTC_CNTL_TOUCH_PAD3_HOLD_FORCE** Set to preserve pad's state during hibernation. (R/W)
- RTC_CNTL_TOUCH_PAD2_HOLD_FORCE** Set to preserve pad's state during hibernation. (R/W)
- RTC_CNTL_TOUCH_PAD1_HOLD_FORCE** Set to preserve pad's state during hibernation. (R/W)
- RTC_CNTL_TOUCH_PAD0_HOLD_FORCE** Set to preserve pad's state during hibernation. (R/W)
- RTC_CNTL_SENSE4_HOLD_FORCE** Set to preserve pad's state during hibernation. (R/W)
- RTC_CNTL_SENSE3_HOLD_FORCE** Set to preserve pad's state during hibernation. (R/W)
- RTC_CNTL_SENSE2_HOLD_FORCE** Set to preserve pad's state during hibernation. (R/W)
- RTC_CNTL_SENSE1_HOLD_FORCE** Set to preserve pad's state during hibernation. (R/W)
- RTC_CNTL_PDAC2_HOLD_FORCE** Set to preserve pad's state during hibernation. (R/W)
- RTC_CNTL_PDAC1_HOLD_FORCE** Set to preserve pad's state during hibernation. (R/W)
- RTC_CNTL_ADC2_HOLD_FORCE** Set to preserve pad's state during hibernation. (R/W)
- RTC_CNTL_ADC1_HOLD_FORCE** Set to preserve pad's state during hibernation. (R/W)

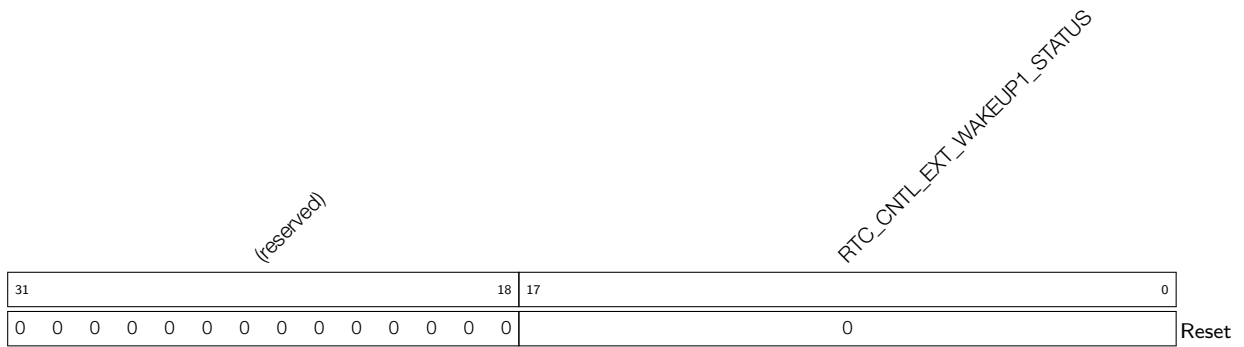
Register 30.35: RTC_CNTL_EXT_WAKEUP1_REG (0x0033)



RTC_CNTL_EXT_WAKEUP1_STATUS_CLR Clear external wakeup1 status. (WO)

RTC_CNTL_EXT_WAKEUP1_SEL Bitmap to select RTC pads for external wakeup1. (R/W)

Register 30.36: RTC_CNTL_EXT_WAKEUP1_STATUS_REG (0x0034)



RTC_CNTL_EXT_WAKEUP1_STATUS External wakeup1 status. (RO)

