

EXIDOR

Exidor

PANIC & EMERGENCY EXIT HARDWARE
500 SERIES

BOLTS & LATCHES RANGE



CE

What's inside

04	Universal Keep for uPVC Doors	20	Keep options
06	Choose your finish	26	Technical data
07	Product selector	27	Parts list
10	Emergency exit range for single doors	28	Regulations
13	Panic exit range for single doors	29	Glossary
16	Outside access devices	30	Product features
18	Accessories		

Guarantee

To support the high quality and first class engineering that has gone into the Exidor range, the manufacturer gives a ten year guarantee (subject to conditions) against defects due to faulty manufacturing, workmanship or defective material. The manufacturer agrees to replace any defective Exidor product free of charge provided the product has been fitted in accordance with the fitting instructions and maintained correctly.

Technical Support

Comprehensive information and technical support services are available by contacting:

Tel: +44 (0)1543 460040 Fax: +44 (0)1543 570050
email: technical@exidor.co.uk

Or visit our website:

exidor.co.uk

There are a number of enhancements we've made to the Exidor website. You'll also find new company info, technical data, and downloadable pdfs of the latest product literature – all presented in a clear and contemporary style that we hope you'll enjoy.

We're aiming to keep on improving the website, with more new specifiers on the way, and additions to our gallery of products and projects. If you have comments and ideas on ways we can make it even better and more useful, just let us know.





Introducing the 500 Series Bolts & Latches

Exidor Ltd is a UK based engineering company manufacturing a comprehensive, high specification range of innovative panic and emergency hardware, door controls and builders ironmongery.

We've been meeting the needs of architects, specifiers, project managers, OEM's and building managers for more than 80 years. In that time, we've built an unrivalled record of developing and continually enhancing a product range that's known and used all over the world.

The Exidor 500 series panic and emergency hardware offers a modern, aesthetically pleasing style giving optimum safety and security, and is certified to the European standards to ensure peace of mind.

BS EN179 – For offices, factories etc

BS EN1125 – For areas of entertainment, public buildings etc

With smooth stylish lines, high quality powder coated finishes and the excellence of British engineering, the Exidor 500 series provides the best solution for panic and emergency exits and is stylish enough for use in prestigious buildings with integrated interiors.

Offered as a complete package, including specialist keeps and fixings, the range is designed for use on doors with narrow stiles, and there is a selection of products specifically for doors constructed from wood, aluminium or uPVC.

The unique uPVC "one size fits all" keeps ensure that the Exidor 500 series can be specified with the confidence of knowing that the panic and emergency hardware will fit every time, regardless of the uPVC profile.

The range combines attractive colours and styling with quality engineering, and offers a choice of adjustable bolts, or the smoother and quieter action of either vertical or horizontal Pullman latches. Certified to 200,000 uses, the Exidor 500 series offers a range of accessories including a choice of outside access devices, upgrade kits, Pullman latch kits and a variety of keeps for different door materials and applications.

What does British manufacturing mean to us?

Understanding what our customers need. Providing local and reliable service. Having a wide range of standard units available from stock for next day delivery. Being able to provide non-standard products. Reacting quickly, when it matters. Working to International quality and manufacturing standards and certified to ISO 9001. And caring – professionally – about quality.

Universal Keep For uPVC Doors – One Product Fits All Profiles

The Exidor 500 series of panic and emergency hardware is now offered as a complete product, including keeps and fixings, for doors constructed from wood, aluminium and uPVC.

The uPVC products are supplied with the new innovative universal keep, ensuring that whatever the profile of the door and frame, the product can be easily specified and fitted.

This is achieved by using the unique keep with a number of different thickness packing pieces, which are combined to ensure the correct operation on any profile of the door and frame.

There are two uPVC universal keeps available - one for the centre latch and one for the top and bottom Pullman latches.

Each keep is supplied complete with packing pieces and fixings.

This means that one product is suitable for all profiles, eliminating the need to stock and offer a range of keeps along with the difficulties associated in identifying which keep is required for a specific profile.

The Pullman latch keeps are suitable for both vertical and horizontal latches, and all are offered in an epoxy powder coated white finish as standard.



3 point panic bolt with horizontal Pullman latches



3 point panic bolt with shoot bolts

Exidor Ltd can also offer a range of popular RAL & Hewi colours to match other ironmongery products that may be fitted.

For applications where shoot bolts are preferred there is also a dedicated uPVC range of products providing all the keeps and fixings required.

Finally, for convenience, upgrade kits are also available allowing other Exidor 500 series products to be used on wood, aluminium and uPVC doors, giving greater flexibility and lower stock holding.



Choose Your Finish

Exidor Ltd uses epoxy powder coating for all painted surfaces to give a quality finish to our products, and offers silver, white with green cross bars and black with red cross bars as standard finishes for the Exidor 500 series.

There is also a range of popular RAL and Hewi colours to match other ironmongery products that may be fitted, but plated finishes are not available. When ordering, please suffix the product code with the RAL or Hewi number.

A choice of finishes

All exit devices and outside access devices are available in a wide range of finishes:

Standard finishes:



Silver
(RAL 9022)



Black/Red



White/Green

Popular RAL colours available:

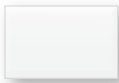

Pure white
9010



Ultra marine
blue
5002



Ruby red
3003



Traffic yellow
1023



Fir green
6009



Agate grey
7038



Mint green
6029



Ivory
1014



Jet black
9005



Anthracite
grey
7016



Olive
brown
8008



Black green
6012



Black red
3007



Steel blue
5011



Gold



Product Selector

Single doors

EN 179

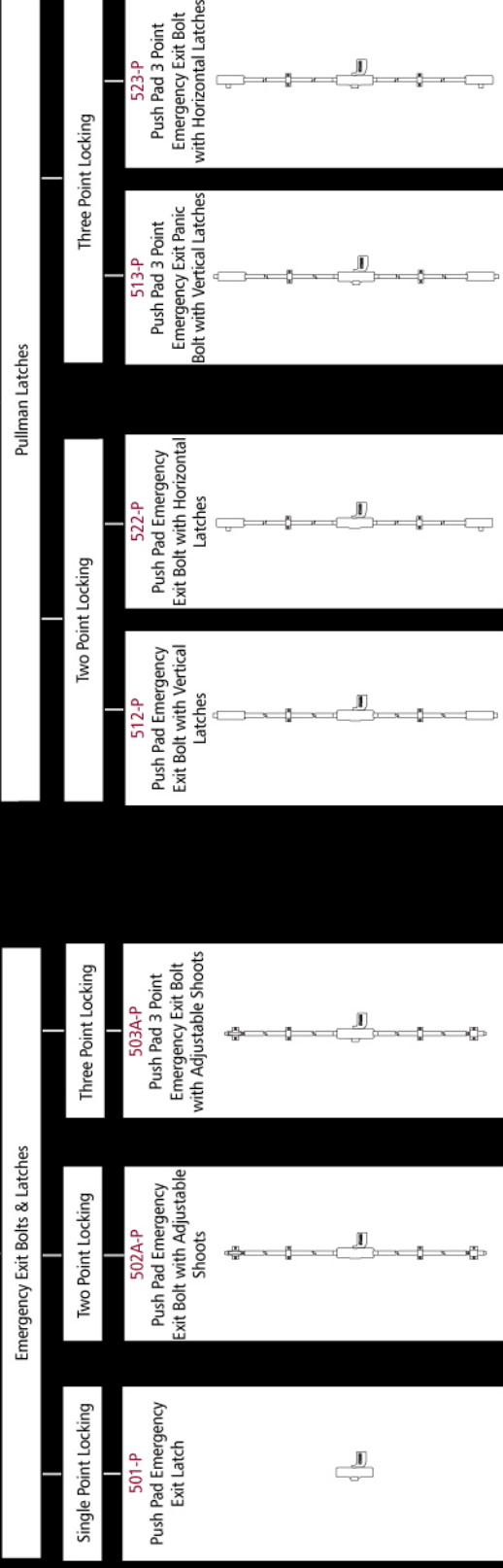



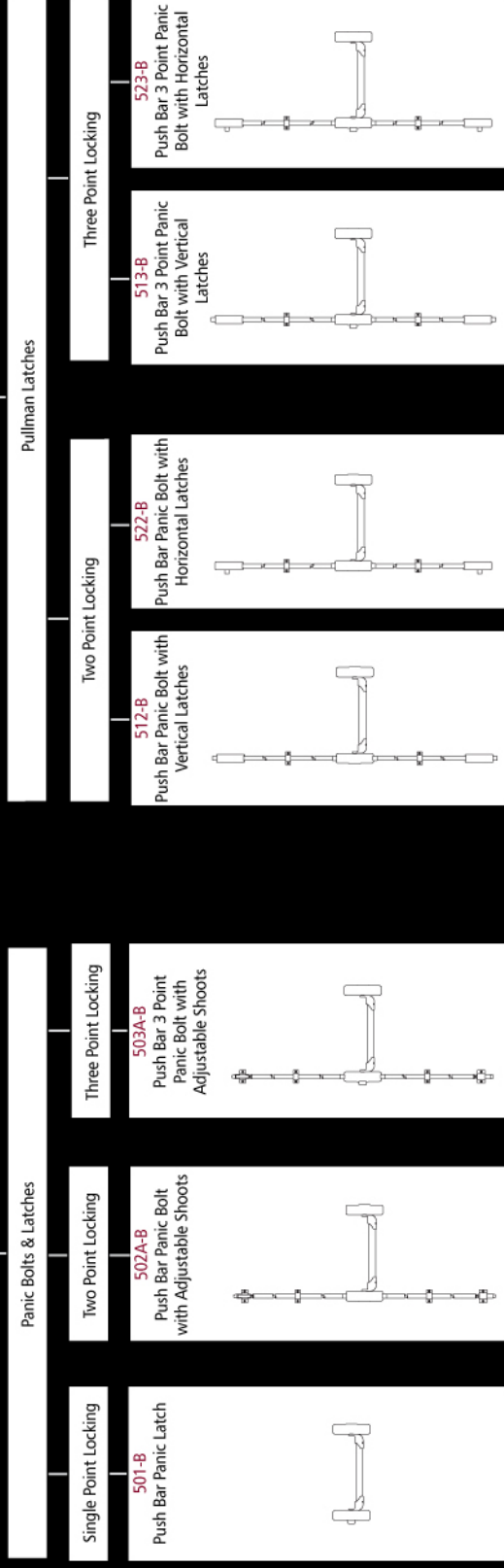

EN 1125

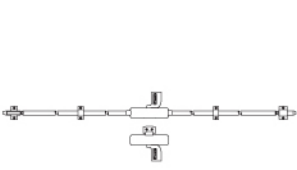
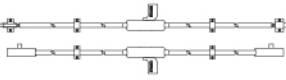

Product Selector

Rebated double doors

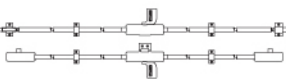
EN 179

Emergency Exit Bolts & Latches		Pullman Latches			
<p>Three Point Locking</p> <p>501-P + 502A-P + SL-0144 Push Pad Emergency Exit Bolt with Adjustable Shoots and Latch</p> 	<p>Four Point Locking</p> <p>522P + 502A-P + 406A + 406A Push Pad Emergency Exit Bolt with Adjustable Shoots and Push Pad Emergency Exit Bolt with Horizontal Latches</p> 	<p>Three Point Locking</p> <p>501-P + 512P + SL-0144 Push Pad Emergency Exit Bolt with Vertical Latches and Latch</p> 	<p>Four Point Locking</p> <p>522P + 512-P + 406A + 406A Push Pad Emergency Exit Bolt with Vertical Latches and Push Pad Emergency Exit Bolt with Horizontal Latches</p> 	<p>Five Point Locking</p> <p>523P + 502A-P + SL-0144 + 406A + 406A Push Pad 3 Point Emergency Exit Bolt with Horizontal Latches and Push Pad Emergency Exit Bolt with Adjustable Shoots</p> 	<p>Five Point Locking</p> <p>523P + 512-P + SL-0144 + 406A + 406A Push Pad Emergency Exit Bolt with Vertical Latches and Push Pad Emergency Exit 3 Point Bolt with Horizontal Latches</p> 

EN 1125

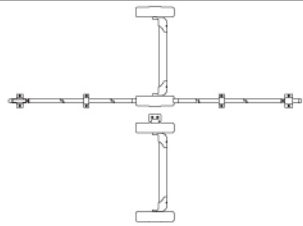
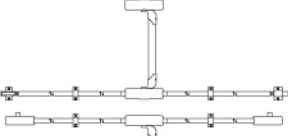
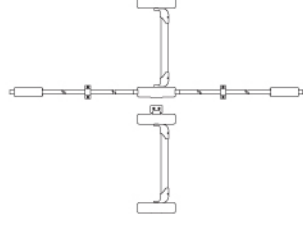
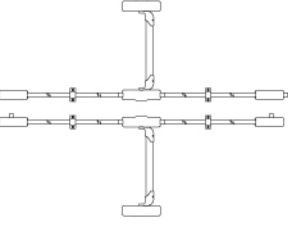
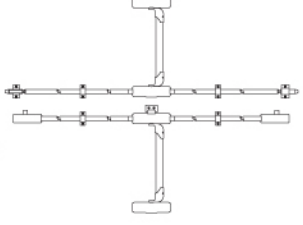
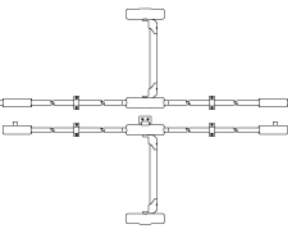
Panic Bolts & Latches		Pullman Latches			
<p>Three Point Locking</p> <p>501-B + 502A-B + SL-0144 Push Bar Panic Bolt with Adjustable Shoots and Latch</p> 	<p>Four Point Locking</p> <p>522B + 502A-B + 406A + 406A Push Bar Panic Bolt with Adjustable Shoots and Push Bar Panic Bolt with Horizontal Latches</p> 	<p>Three Point Locking</p> <p>501-B + 512-B + SL-0144 Push Bar Panic Bolt with Vertical Latches and Latch</p> 	<p>Four Point Locking</p> <p>522B + 512-B + 406A + 406A Push Bar Panic Bolt with Vertical Latches and Push Bar Panic Bolt with Horizontal Latches</p> 	<p>Five Point Locking</p> <p>523-B + 502A-B + SL-0144 + 406A + 406A Push Bar 3 Point Panic Bolt with Horizontal Latches and Push Bar Panic Bolt with Adjustable Shoots</p> 	<p>Five Point Locking</p> <p>523B + 512-B + SL-0144 + 406A + 406A Push Bar Panic Bolt with Vertical Latches and Push Bar 3 Point Panic Bolt with Horizontal Latches</p> 

Product Selector

Non-rebated double doors

EN 179

Emergency Exit Bolts & Latches

Four Point Locking

502A-P + 502A-P
Push Pad Emergency Exit Bolts with Adjustable Shoots



Five Point Locking

503A-P + 502A-P + SL-0144
Push Pad Emergency Exit Bolt with Adjustable Shoots and Push Pad 3 Point Emergency Exit Bolt with Adjustable Shoots



Pullman Latches

Four Point Locking

512-P + 512-P
Push Pad Emergency Exit Bolts with Vertical Latches

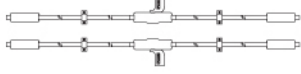

Five Point Locking

513P + 512-P + SL-0144
Push Pad Emergency Exit Bolt with Vertical Latches and Push Pad 3 Point Emergency Exit Bolt with Vertical Latches



EN 1125

Panic Bolts & Latches

Four Point Locking

502A-B + 502A-B
Push Bar Panic Bolts with Adjustable Shoots

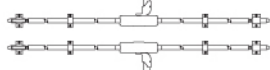

Five Point Locking

503A-B + 502A-B + SL-0144
Push Bar Panic Bolt with Adjustable Shoots and Push Bar 3 Point Panic Bolt with Adjustable Shoots

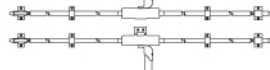

Pullman Latches

Four Point Locking

512-B + 512-B
Push Bar Panic Bolts with Vertical Latches

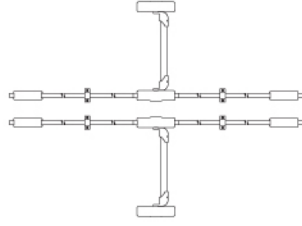

Five Point Locking

513-B + 512-B + SL-0144
Push Bar Panic Bolt with Vertical Latches and Push Bar 3 Point Panic Bolt with Vertical Latches

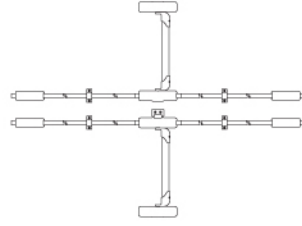

Single Doors 501-P

BS EN 179



SINGLE POINT LOCKING

Classification No.	3	7	6	0	1	3	2	2	B	A
EN 179 : 2008										

501-P Push Pad Emergency Exit Latch For Wooden Doors 501-P/AD Push Pad Emergency Exit Latch For Aluminium Doors

The Exidor 501-P is a surface mounted rim latch for single and double door applications. The slimline 38mm wide footprint makes it particularly suitable for use on doors with narrow stiles. Simply depressing the pad provides safe and speedy exit in the event of an emergency, whilst maintaining security against intrusion. Combining smooth stylish lines with the excellence of British engineering and a high quality powder coated finish ensures the 501-P is stylish enough for use in the most prestigious buildings with integrated interiors.

- Non-handed
- CE marked for safety
- Surface mounted
- 38mm wide footprint
- Suitable for doors with narrow stiles
- Standard colours: silver, white with green push pad and black with red push pad
- Available in most RAL colours



Optional accessories for the 501-P emergency exit latch

- 500/LEC Outside access device with Euro cylinder – lever operated
- 500/LEA Outside access device with Euro aperture – lever operated
- 500/KEC Outside access device with Euro cylinder – knob operated
- 500/KEA Outside access device with Euro aperture – knob operated
- CL1 Mechanical push button outside access device
- CL2 Mechanical push button outside access device with passage facility
- CL3 Quick code mechanical push button outside access device
- CL4 Quick code mechanical push button outside access device with passage facility

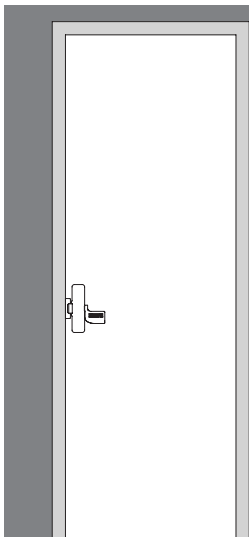

501-P

Single Doors 502A-P | 512-P | 522-P

BS EN 179



TWO POINT LOCKING

Classification No.	3	7	6	0	1	3	2	2	B	A
EN 179 : 2008										

- 502A-P** Push Pad Emergency Exit Bolt For Wooden Doors
- 502A-P/AD** Push Pad Emergency Exit Bolt For Aluminium Doors
- 502A-P/UD** Push Pad Emergency Exit Bolt For uPVC Doors

The Exidor 502A-P is an elegant and highly functional emergency exit bolt for single and double door applications. Incorporated as standard is an automatic top trip and easy clean floor socket. The main body is fitted with an anti-thrust device, which prevents leverage of both the top and bottom shoot bolts from their sockets.

- 512-P** Push Pad Emergency Exit Bolt With Vertical Latches For Wooden Doors
- 512-P/AD** Push Pad Emergency Exit Bolt With Vertical Latches For Aluminium Doors
- 512-P/UD** Push Pad Emergency Exit Bolt With Vertical Latches For uPVC Doors

The Exidor 512-P offers all the elegance and functions of the Exidor push pad emergency exit bolt with the added feature of vertical Pullman latches which increases security and offers a smooth latching action.

- 522-P** Push Pad Emergency Exit Bolt With Horizontal Latches For Wooden Doors
- 522-P/AD** Push Pad Emergency Exit Bolt With Horizontal Latches For Aluminium Doors
- 522-P/UD** Push Pad Emergency Exit Bolt With Horizontal Latches For uPVC Doors

The Exidor 522-P offers all the elegance and functions of the Exidor push pad emergency exit bolt with the added feature of horizontal Pullman latches which increases security and offers a smooth latching action.

- Non-handed
- CE marked for safety
- Surface mounted
- 38mm wide footprint
- Suitable for doors with narrow stiles
- Standard colours: silver, white with green push pad and black with red push pad
- Available in most RAL colours



Standard Sizes

Standard size emergency exit bolts are suitable for single doors up to 2440mm high. Special sizes are available on request.

Optional accessories for all the single emergency exit bolts

- 500/LEC Outside access device with Euro cylinder – lever operated
- 500/LEA Outside access device with Euro aperture – lever operated
- 500/KEC Outside access device with Euro cylinder – knob operated
- 500/KEA Outside access device with Euro aperture – knob operated
- CL1 Mechanical push button outside access device
- CL2 Mechanical push button outside access device with passage facility
- CL3 Quick code mechanical push button outside access device
- CL4 Quick code mechanical push button outside access device with passage facility

Exidor threshold seal ES1 can be fitted as an alternative to the floor keep. Please suffix CB after the product code i.e. 502A-P/CB (See Exidor door seal range leaflet for details)

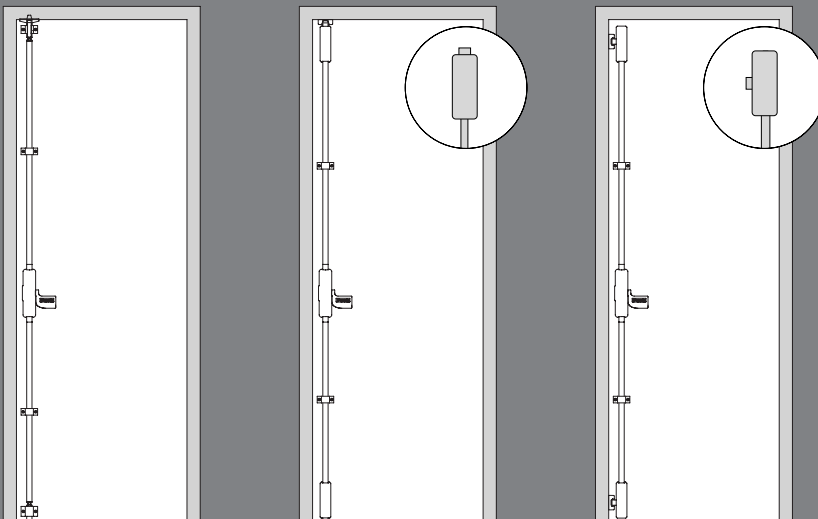

502A-P

512-P

522-P

Single Doors 503A-P | 513-P | 523-P

BS EN 179



THREE POINT LOCKING

Classification No.	3	7	6	0	1	3	2	2	B	A
EN 179 : 2008										

- 503A-P** Push Pad Three Point Emergency Exit Bolt For Wooden Doors
- 503A-P/AD** Push Pad Three Point Emergency Exit Bolt For Aluminium Doors
- 503A-P/UD** Push Pad Three Point Emergency Exit Bolt For uPVC Doors

The Exidor 503A-P is an elegant and highly functional three point emergency exit bolt for single and double door applications. Incorporated as standard is an automatic top trip and easy clean floor socket. The three locking points ensure a higher level of security and the main body is fitted with an anti-thrust device, which prevents leverage of both the top and bottom shoot bolts from their sockets.

- 513-P** Push Pad Three Point Emergency Exit Bolt With Vertical Latches For Wooden Doors
- 513-P/AD** Push Pad Three Point Emergency Exit Bolt With Vertical Latches For Aluminium Doors
- 513-P/UD** Push Pad Three Point Emergency Exit Bolt With Vertical Latches For uPVC Doors

The Exidor 513-P offers all the security, elegance and functions of the Exidor push pad three point emergency exit bolt with the added feature of vertical Pullman latches which increases security and offers a smooth latching action.

- 523-P** Push Pad Three Point Emergency Exit Bolt With Horizontal Latches For Wooden Doors
- 523-P/AD** Push Pad Three Point Emergency Exit Bolt With Horizontal Latches For Aluminium Doors
- 523-P/UD** Push Pad Three Point Emergency Exit Bolt With Horizontal Latches For uPVC Doors

The Exidor 523-P offers all the elegance and functions of the Exidor push pad three point emergency exit bolt with the added feature of horizontal Pullman latches which increases security and offers a smooth latching action.

- Non-handed
- CE marked for safety
- Surface mounted
- 38mm wide footprint
- Suitable for doors with narrow stiles
- Standard colours: silver, white with green push pad and black with red push pad
- Available in most RAL colours



Standard Sizes

Standard size emergency exit bolts are suitable for single doors up to 2440mm high. Special sizes are available on request.

Optional accessories for all the three point emergency exit bolts

- 500/LEC Outside access device with Euro cylinder – lever operated
- 500/LEA Outside access device with Euro aperture – lever operated
- 500/KEC Outside access device with Euro cylinder – knob operated
- 500/KEA Outside access device with Euro aperture – knob operated
- CL1 Mechanical push button outside access device
- CL2 Mechanical push button outside access device with passage facility
- CL3 Quick code mechanical push button outside access device
- CL4 Quick code mechanical push button outside access device with passage facility

Exidor threshold seal ES1 can be fitted as an alternative to the floor keep. Please suffix CB after the product code i.e. 503A-P/CB (See Exidor door seal range leaflet for details)

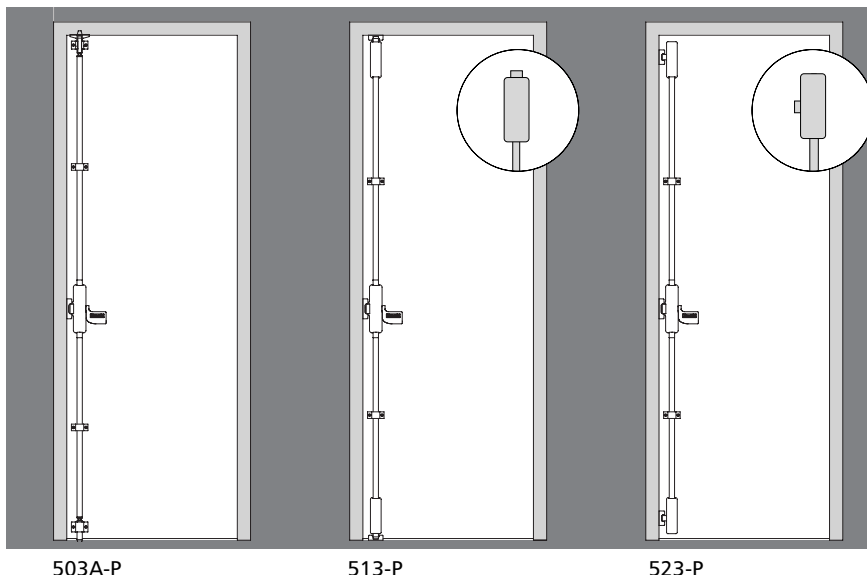

503A-P

513-P

523-P

Single Doors 501-B

BS EN 1125



SINGLE POINT LOCKING

Classification No.	3	7	6	0	1	3	2	2	A	A
EN 1125 : 2008										

501-B Push Bar Panic Latch For Wooden Doors 501-B/AD Push Bar Panic Latch For Aluminium Doors

The Exidor 501-B panic latch is designed for single and double door applications. The slimline 38mm wide footprint makes it particularly suitable for use on doors with narrow stiles. The unit is operated by a thrust of the cross bar to give a speedy exit in panic situations. For situations that require the panic latch to be linked to a monitoring or alarm system, a microswitch can be fitted in the slave unit. The microswitch closes/opens an electrical circuit when the cross bar is operated. Combining smooth stylish lines with the excellence of British engineering and a high quality powder coated finish ensures the 501-B is stylish enough for use in the most prestigious buildings with integrated interiors.

- Non-handed
- CE marked for safety
- Surface mounted
- 38mm wide footprint
- Suitable for doors with narrow stiles
- Microswitch version available
- Standard colours: silver, white with green cross bar and black with red cross bar
- Available in most RAL colours



Standard Sizes

Standard size panic latches are suitable for single doors up to 1220mm wide. Special sizes are available on request.

Additional options

The Exidor reversible panic latches can be supplied with a microswitch (suffix MS after the product code)

Optional accessories for the 501-B panic latch

- 500/LEC Outside access device with Euro cylinder – lever operated
- 500/LEA Outside access device with Euro aperture – lever operated
- 500/KEC Outside access device with Euro cylinder – knob operated
- 500/KEA Outside access device with Euro aperture – knob operated
- CL1 Mechanical push button outside access device
- CL2 Mechanical push button outside access device with passage facility
- CL3 Quick code mechanical push button outside access device
- CL4 Quick code mechanical push button outside access device with passage facility

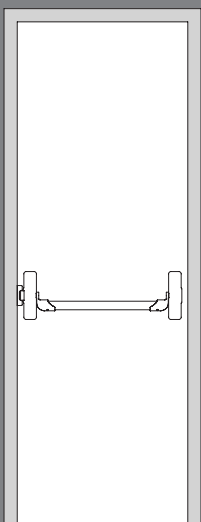

501-B

Single Doors 502A-B | 512-B | 522-B

BS EN 1125



TWO POINT LOCKING

Classification No.	3	7	6	0	1	3	2	2	A	A
EN 1125 : 2008										

- 502A-B** Push Bar Panic Bolt For Wooden Doors
- 502A-B/AD** Push Bar Panic Bolt For Aluminium Doors
- 502A-B/UD** Push Bar Panic Bolt For uPVC Doors

The Exidor 502A-B is an elegant and highly functional panic bolt for single and double door applications. Incorporated as standard is an automatic top trip and easy clean floor socket. The main body is fitted with an anti-thrust device, which prevents leverage of both the top and bottom shoot bolts from their sockets. For situations that require the panic bolt to be linked to a monitoring or alarm system, a microswitch can be fitted in the slave unit. The microswitch closes/opens an electrical circuit when the cross bar is operated.

- 512-B** Push Bar Panic Bolt With Vertical Latches For Wooden Doors
- 512-B/AD** Push Bar Panic Bolt With Vertical Latches For Aluminium Doors
- 512-B/UD** Push Bar Panic Bolt With Vertical Latches For uPVC Doors

The Exidor 512-B offers all the elegance and functions of the Exidor push bar panic bolt with the added feature of vertical Pullman latches which increases security and offers a smooth latching action.

- 522-B** Push Bar Panic Bolt With Horizontal Latches For Wooden Doors
- 522-B/AD** Push Bar Panic Bolt With Horizontal Latches For Aluminium Doors
- 522-B/UD** Push Bar Panic Bolt With Horizontal Latches For uPVC Doors

The Exidor 522-B offers all the elegance and functions of the Exidor push bar panic bolt with the added feature of horizontal Pullman latches which increases security and offers a smooth latching action.

- Non-handed
- CE marked for safety
- Surface mounted
- 38mm wide footprint
- Suitable for doors with narrow stiles
- Microswitch version available
- Standard colours: silver, white with green cross bar and black with red cross bar
- Available in most RAL colours



Standard Sizes

Standard size panic bolts are suitable for single doors up to 1220mm wide and 2440mm high. Special sizes are available on request

Additional options

The Exidor reversible single panic bolts can be supplied with a microswitch (suffix MS after the product code)

Optional accessories for all the single panic bolts

- 500/LEC Outside access device with Euro cylinder – lever operated
- 500/LEA Outside access device with Euro aperture – lever operated
- 500/KEC Outside access device with Euro cylinder – knob operated
- 500/KEA Outside access device with Euro aperture – knob operated
- CL1 Mechanical push button outside access device
- CL2 Mechanical push button outside access device with passage facility
- CL3 Quick code mechanical push button outside access device
- CL4 Quick code mechanical push button outside access device with passage facility

Exidor threshold seal ES1 can be fitted as an alternative to the floor keep. Please suffix CB after the product code i.e. 502A-B/CB (See Exidor door seal range leaflet for details)

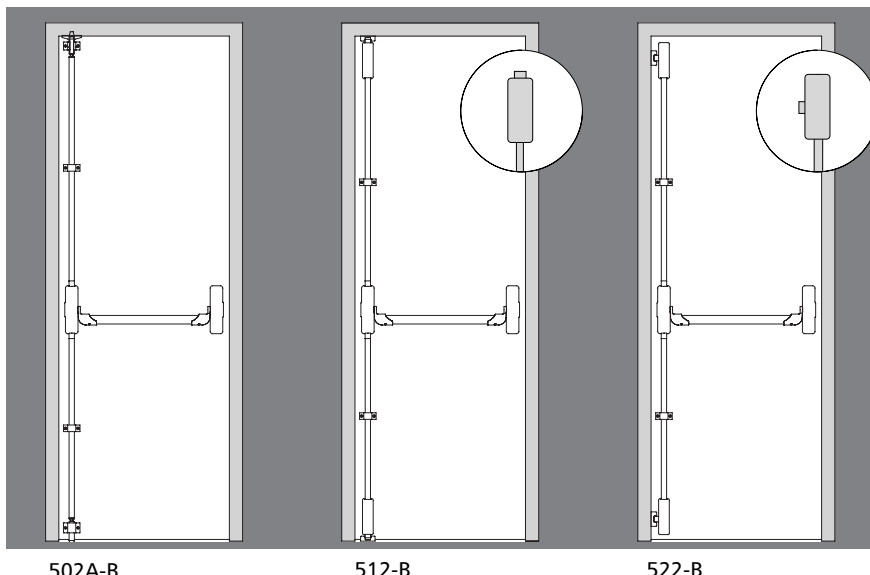

502A-B

512-B

522-B

Single Doors 503A-B | 513-B | 523-B

BS EN 1125



THREE POINT LOCKING

Classification No.	3	7	6	0	1	3	2	2	A	A
EN 1125 : 2008										

- 503A-B** Push Bar Three Point Panic Bolt For Wooden Doors
- 503A-B/AD** Push Bar Three Point Panic Bolt For Aluminium Doors
- 503A-B/UD** Push Bar Three Point Panic Bolt For uPVC Doors

The Exidor 503A-B is an elegant and highly functional three point panic bolt for single and double door applications. Incorporated as standard is an automatic top trip and easy clean floor socket. The three locking bolts ensures a higher level of security and the main body is fitted with an anti-thrust device, which prevents leverage of both the top and bottom shoot bolts from their sockets. For situations that require the panic bolt to be linked to a monitoring or alarm system, a microswitch can be fitted in the slave unit. The microswitch closes/opens an electrical circuit when the cross bar is operated.

- 513-B** Push Bar Three Point Panic Bolt With Vertical Latches For Wooden Doors
- 513-B/AD** Push Bar Three Point Panic Bolt With Vertical Latches For Aluminium Doors
- 513-B/UD** Push Bar Three Point Panic Bolt With Vertical Latches For uPVC Doors

The Exidor 513-P offers all the elegance and functions of the Exidor push bar three point panic bolt with the added feature of vertical Pullman latches, which increases security and offers a smooth latching action.

- 523-B** Push Bar Three Point Panic Bolt With Horizontal Latches For Wooden Doors
- 523-B/AD** Push Bar Three Point Panic Bolt With Horizontal Latches For Aluminium Doors
- 523-B/UD** Push Bar Three Point Panic Bolt With Horizontal Latches For uPVC Doors

The Exidor 523-B offers all the security, elegance and functions of the Exidor push bar three point panic bolt with the added feature of horizontal Pullman latches, which increases security and offers a smooth latching action.

- Non-handed
- CE marked for safety
- Surface mounted
- 38mm wide footprint
- Suitable for doors with narrow stiles
- Microswitch version available
- Standard colours: silver, white with green cross bar and black with red cross bar
- Available in most RAL colours



Standard Sizes

Standard size three point panic bolts are suitable for single doors up to 1220mm wide and 2440mm high. Special sizes are available on request.

Additional options

The Exidor reversible three point panic bolts can be supplied with a microswitch (suffix MS after the product code)

Optional accessories for all the three point panic bolts

- 500/LEC Outside access device with Euro cylinder – lever operated
- 500/LEA Outside access device with Euro aperture – lever operated
- 500/KEC Outside access device with Euro cylinder – knob operated
- 500/KEA Outside access device with Euro aperture – knob operated
- CL1 Mechanical push button outside access device
- CL2 Mechanical push button outside access device with passage facility
- CL3 Quick code mechanical push button outside access device
- CL4 Quick code mechanical push button outside access device with passage facility

Exidor threshold seal ES1 can be fitted as an alternative to the floor keep. Please suffix CB after the product code i.e. 503A-B/CB (See Exidor door seal range leaflet for details)

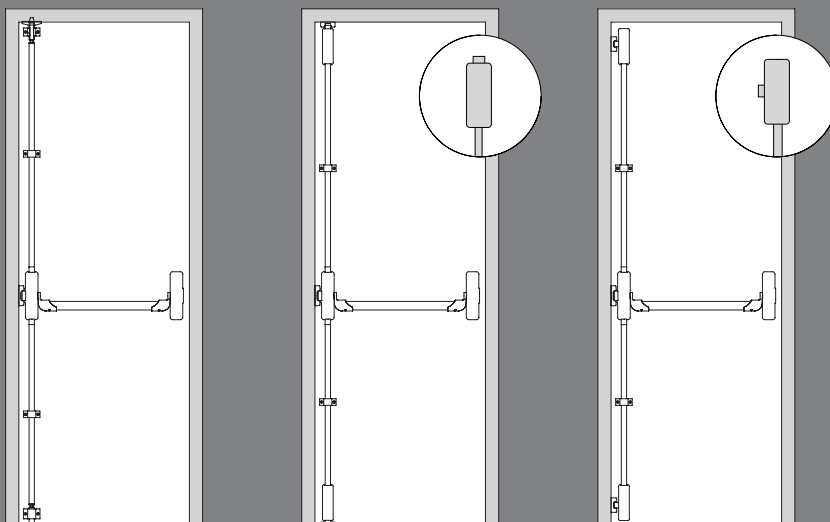

503A-B

513-B

523-B

Outside Access Devices



All Exidor 500 series OAD's have been certified for use with the Exidor 500 series range of bolts and latches. The use of any other OAD will invalidate the CE marking on these products.

500/L Lever Operated Outside Access Device

The Exidor 500/L offers a lever operated outside access device that meets the dimensional requirements of the Equality Act 2010 (formerly known as the DDA) and BS8300 – Approved Document “M”.

The 500/L is supplied with three keys, and has the advantage that a master keyed 40mm Euro profile cylinder can be used. Suitable for use with the Exidor 500 series, the 500/L offers access from the outside of the door.

- Non-handed
- Meets the dimensional requirements of BS8300 and approved document “M”
- Surface mounted on the outside of the door using two/three machine screws
- Same fixing points as the 500/K – easy retro fit
- Supplied as standard for doors up to 55mm thick

Performance

When locked, the lever is disengaged from the mechanism and still rotates therefore preventing unauthorised entry and damage to the unit. When unlocked, the lever, spindle and mechanism engage allowing the shoot bolts, latch or Pullman latches to be withdrawn from the outside of the door. The lever remains engaged until the mechanism is re-locked.

Finishes

Available as standard in silver, white or black, there is also a choice of RAL colours (see page 4).

500/K Knob Operated Outside Access Device

The Exidor 500/K offers a Knob operated outside access device that is supplied with three keys and has the advantage that a master keyed 40mm Euro profile cylinder can be used. Suitable for use with the Exidor 500 series, the 500/K offers access from the outside of the door.

- Non-handed
- Surface mounted on the outside of the door using two/three machine screws
- Same fixing points as the 500/L – easy retro fit
- Supplied as standard for doors up to 55mm thick

Performance

When locked, the Knob is disengaged from the mechanism and still rotates therefore preventing unauthorised entry and damage to the unit. When unlocked, the Knob, spindle and mechanism engage allowing the shoot bolts, latch or Pullman latches to be withdrawn from the outside of the door. The Knob remains engaged until the mechanism is re-locked.

Finishes

Available as standard in silver, white or black, there is also a choice of RAL colours (see page 4).



500/LEC

Options available

- 500/LEC Lever operated OAD with Euro cylinder
- 500/LEA Lever operated OAD with Euro profile aperture



500/KEC

Options available

- 500/KEC Knob operated OAD with Euro cylinder
- 500/KEA Knob operated OAD with Euro profile aperture

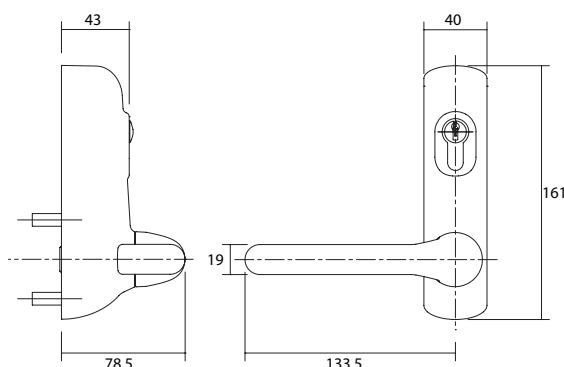

500/LEC

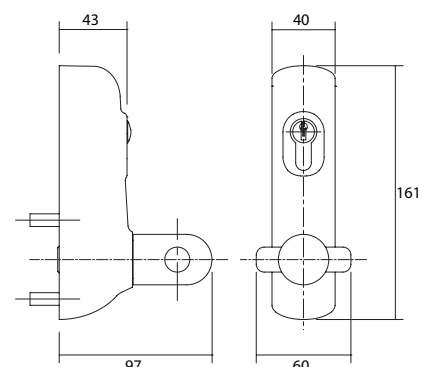

500/KEC

Mechanical Push Button Outside Access Devices

- CL1 Push Button Mechanical Code Lock**
- CL2 Push Button Mechanical Code Lock with Passage Function**
- CL3 Quick Code Mechanical Code Lock**
(Code can be changed without removing the unit)
- CL4 Quick Code Mechanical Code Lock with Passage Function**
(Code can be changed without removing the unit)

The CL range of mechanical push button outside access devices offer a simple solution where access control is required to operate the 500 series of panic and emergency hardware.

There are two options within the range, the standard CL1/CL2 and the quick code CL3/CL4.

The quick code option allows the mechanical code to be changed swiftly, without having to remove the unit from the door.

Each version is available as a standard product, or with the passage function which allows the unit to be set in the code free mode allowing the handle to be opened without entering a code.

Finished in PVD stainless steel or PVD brass, the CL range is suitable for high usage exterior applications, including corrosive environments, and all are supplied with three spindles, ensuring complete compatibility with the Exidor 500 series.

- 1,584 different codes available
- Non handed
- Reversible safety lever
- Surface mounted using concealed screws
- Clutch protection on the outside lever
- Supplied with spindles for doors from 35mm to 60mm thick
- PVD weather resistant finish
- Available in stainless steel or brass finishes

Performance

Once the correct code has been entered, the handle is released allowing the operation of the 500 series panic and emergency hardware from the outside of the door. When the handle returns to the horizontal position, it re-locks and the code needs to be entered again if access is required.

If the unit is set in passage mode, no code is required to operate the handle.

Finishes

PVD stainless steel or PVD brass.



CL1 / CL2



CL3 / CL4

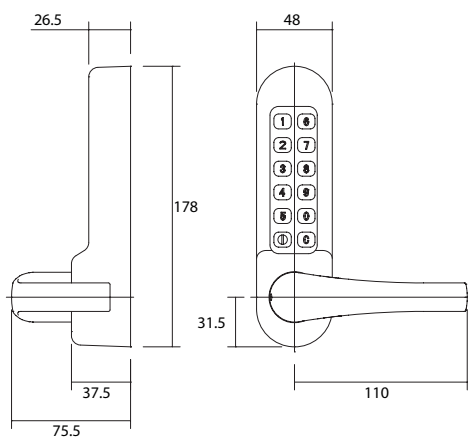

CL1 / CL2

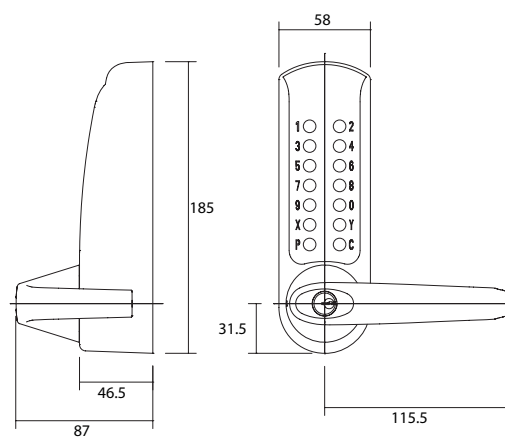

CL3 / CL4

The Exidor upgrade kits allow the Exidor 500 series to be easily converted for use on a door made out of different materials.

Available for all of the Exidor 500 series panic and emergency hardware, the kits allow maximum flexibility of stock whilst keeping stock holding to a minimum.

They are available for wooden, aluminium and uPVC doors and are supplied complete with all the keeps and fixings to allow for ease of conversion.

501U Panic Latch Upgrade Kit for Wooden Doors

501U/AD Panic Latch Upgrade Kit for Aluminium Doors

502U 2 Point Panic/Emergency Exit Bolt Upgrade Kit for Wooden Doors

502U/AD 2 Point Panic/Emergency Exit Bolt Upgrade Kit for Aluminium Doors

502U/UD 2 Point Panic/Emergency Exit Bolt Upgrade Kit for uPVC Doors

512U 2 Point Panic/Emergency Exit Bolt With Vertical Pullman Latches Upgrade Kit for Wooden Doors

512U/AD 2 Point Panic/Emergency Exit Bolt With Vertical Pullman Latches Upgrade Kit for Aluminium Doors

512U/UD 2 Point Panic/Emergency Exit Bolt With Vertical Pullman Latches Upgrade Kit for uPVC Doors

522U 2 Point Panic/Emergency Exit Bolt With Horizontal Pullman Latches Upgrade Kit for Wooden Doors

522U/AD 2 Point Panic/Emergency Exit Bolt With Horizontal Pullman Latches Upgrade Kit for Aluminium Doors

522U/UD 2 Point Panic/Emergency Exit Bolt With Horizontal Pullman Latches Upgrade Kit for uPVC Doors

503U 3 Point Panic/Emergency Exit Bolt Upgrade Kit for Wooden Doors

503U/AD 3 Point Panic/Emergency Exit Bolt Upgrade Kit for Aluminium Doors

503U/UD 3 Point Panic/Emergency Exit Bolt Upgrade Kit for uPVC Doors

513U 3 Point Panic/Emergency Exit Bolt With Vertical Pullman Latches Upgrade Kit for Wooden Doors

513U/AD 3 Point Panic/Emergency Exit Bolt With Vertical Pullman Latches Upgrade Kit for Aluminium Doors

513U/UD 3 Point Panic/Emergency Exit Bolt With Vertical Pullman Latches Upgrade Kit for uPVC Doors

523U 3 Point Panic/Emergency Exit Bolt With Horizontal Pullman Latches Upgrade Kit for Wooden Door

523U/AD 3 Point Panic/Emergency Exit Bolt With Horizontal Pullman Latches Upgrade Kit for Aluminium Doors

523U/UD 3 Point Panic/Emergency Exit Bolt With Horizontal Pullman Latches Upgrade Kit for uPVC Doors

514 Vertical Pullman Latch Kit

515 Horizontal Pullman Latch Kit

The Exidor Pullman latch kits can be supplied for any Exidor panic/emergency exit bolt range to upgrade a unit from adjustable bolts to pullman latches, and are suitable for doors that are subject to a high volume of traffic, or when a higher level of security is required.

The Pullman latches are available in both vertical and horizontal versions and provide a smooth and quiet alternative to the traditional top trip catch. They are recommended for interconnecting doors as well as external doors. The level of security is increased as the latches operate independently and yet they maintain the emergency facility in that they are retracted in one action by the cross bar or push pad when required. The Pullman latches are housed in an enclosed keep and are designed so that they can only be attacked through the door. However, due to the design, the latch will throw outwards, rather than retract if attacked, thus increasing security.



514

515

Accessories For Non-Standard Doors

For doors that exceed the size of 1220mm wide and 2400mm high, the following top shoots tubes and oval push bars are available

Top Shoot Tube

P0801 1210mm top shoot tube for doors up to 2440mm high

P0802 1600mm top shoot tube for doors up to 2680mm high

P0803 2100mm top shoot tube for doors up to 3180mm high

Oval Push Bar Tube

P1001 1180mm oval push bar tube for panic bolts up to 1220mm wide

P1002 1600mm oval push bar tube for panic bolts up to 1650mm wide

P1003 2100mm oval push bar tube for panic bolts up to 2150mm wide



TIMBER DOOR KEEPS

Latch Bolt Keeps

SL-0140 Standard Latch Keep

- 500 series standard centre latch keep
- Supplied as standard with the 501, 503, 513 & 523

Construction – diecast aluminium

Finish – black powder coated/RAL finish available on request

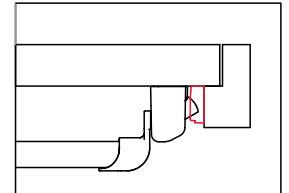

SL-0140

SL-0144 Rebated Double/Flush Doors and Frames Latch Keep

- 500 series rebated double door centre latch keep
- Used for rebated double doors or flush doors and frames
- Used with the 501, 503, 513 & 523

Construction - diecast aluminium

Finish – black powder coated/RAL finish available on request



DOUBLE DOOR APPLICATION

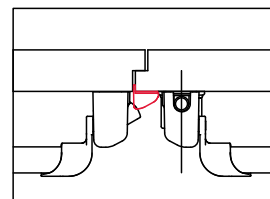

SL-0144

SINGLE FLUSH FACED DOOR/
FRAME APPLICATION

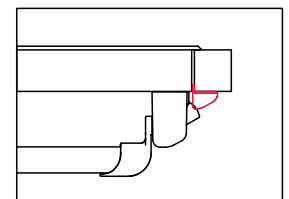

SL-0144

Top Bolt Keeps

P0401 Standard Top Trip

- Used for standard bolts on timber frames.
- Supplied as standard with the 502 and 503 panic and emergency exit bolts

Construction - mild steel

Finish - electro galvanised/RAL finish available on request

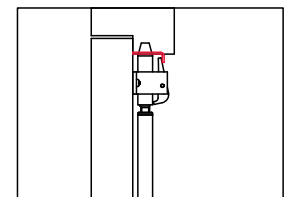
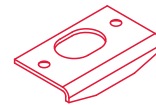

P0401

2405 Top Trip

- Surface mounted keep for top shoot bolts on timber frames
- For flush fitting doors/frames
- Used with the 502 and 503 panic and emergency exit bolts

Construction - mild steel

Finish - electro galvanised/RAL finish available on request

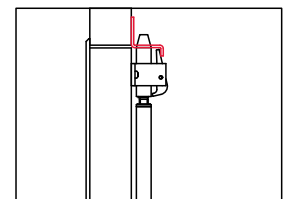
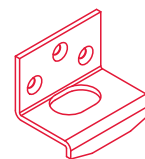

2405

3405A Top Trip

- Surface mounted keep for timber top header rail
- No clearance hole required in the header rail to accept the top shoot bolt
- Used with the 502 and 503 panic and emergency exit bolts

Construction - diecast zinc/mild steel

Finish - electro galvanised/RAL finish available on request

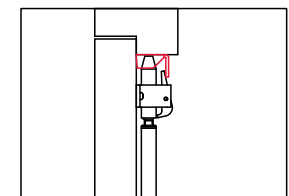
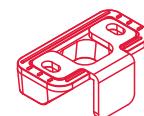

3405A

2401 Top Trip

- Surface mounted keep for top shoot bolts
- Kit supplied includes spacers for applications where the distance between the header rail and the door face is between 14mm and 21mm
- Used with the 502 and 503 panic and emergency bolts

Construction - mild steel

Finish - electro galvanised/RAL finish available on request

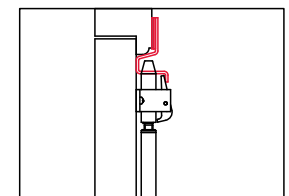
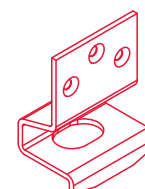

2401

Bottom Bolt Keeps

P1301 Standard Bottom Keep

- Standard 500 series bottom bolt keep
- Supplied as standard with the 502 and 503 panic and emergency exit bolts

Construction - mild steel
Finish - electro galvanised

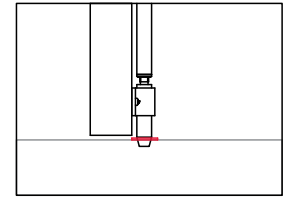
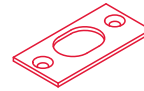

P1301

P0301 Easy Clean Socket

- Supplied as standard with the 502 and 503 panic and emergency exit bolts

Construction – grey cast iron
Finish - electro galvanised

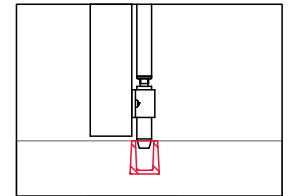
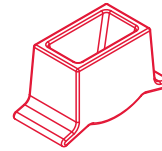

P0301

2403 Low Threshold Bottom Keep

- For low thresholds, or an alternative to boring a hole in a concrete floor to accept the bottom shoot bolt
- Designed to the requirements of CEN standards and building regulations
- Used with the 502 and 503 panic and emergency exit bolts

Construction - mild steel
Finish - electro galvanised / RAL finish available on request

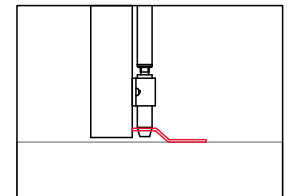
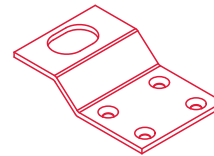

2403

3405 Bottom Keep

- Surface mounted keep for bottom shoot bolts
- No clearance hole in the floor is required
- Used with the 502 and 503 panic and emergency exit bolts

Construction - diecast zinc
Finish - electro galvanised

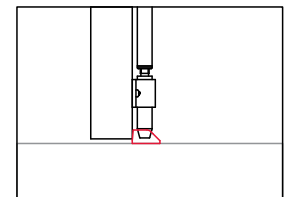
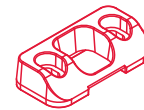

3405

Pullman Latch Keeps

3402 Standard Vertical Pullman Latch Keep

- Surface mounted keep for top and bottom vertical Pullman latches
- Supplied as standard with the 512 and 513 panic and emergency exit bolts

Construction – diecast aluminium
Finish – black powder coated/RAL finish available on request

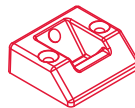

TOP VERTICAL PULLMAN LATCH

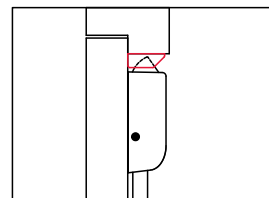

3402

BOTTOM VERTICAL PULLMAN LATCH

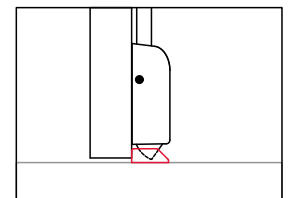

3402

SL-0142 Standard Horizontal Pullman Latch Keep

- Surface mounted keep for top and bottom horizontal Pullman latches
- Supplied as standard with the 522 and 523 panic and emergency exit bolts

Construction – diecast aluminium
Finish – black powder coated/RAL finish available on request

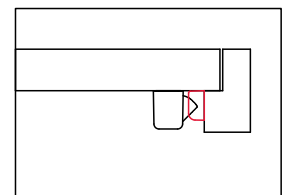

SL-0142

406A Horizontal Pullman Latch Keep For Rebated Double Doors

- Used with the Exidor horizontal Pullman latches for double rebated door applications
- Used with the 522 and 523 panic and emergency exit bolts

Construction – diecast aluminium
 Finish – powder coated/RAL finish available on request



HORIZONTAL PULLMAN LATCH-
DOUBLE DOOR APPLICATION

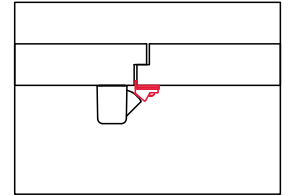

406A

406A Vertical/Horizontal Pullman Latch Keep For Flush Doors and Frames

- Used with the Exidor vertical/horizontal Pullman latches for flush door and frame applications
- Used with the 512 and 513 panic and emergency exit bolts

Construction – diecast aluminium
 Finish – powder coated/RAL finish available on request



VERTICAL PULLMAN LATCH FOR
FLUSH FACED DOOR / FRAME

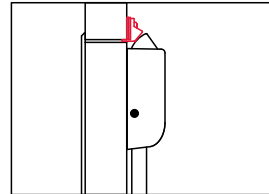

406A

HORIZONTAL PULLMAN LATCH
FOR FLUSH FACED DOOR / FRAME

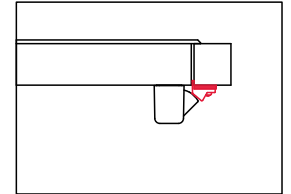

406A

ALUMINIUM DOOR KEEPS

Latch Bolt Keeps

SL-0140 Standard Latch Keep

- 500 series standard centre latch keep
- Supplied as standard with the 501, 503, 513 & 523

Construction – diecast aluminium
 Finish – black powder coated/RAL finish available on request

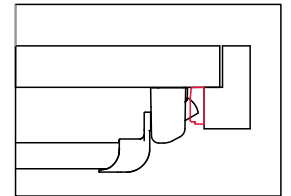
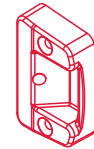

SL-0140

SL-0144 Rebated Double Door Latch/Flush Faced single door and frame Keep

- 500 series rebated double door centre latch keep
- Used for rebated double doors
- Used for flush faced single doors and frames
- Used with the 501, 503, 513 & 523

Construction - diecast aluminium
 Finish – powder coated/RAL finish available on request



DOUBLE DOOR APPLICATION

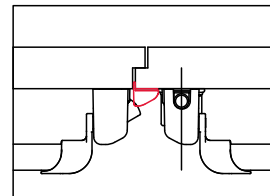

SL-0144

SINGLE FLUSH FACED DOOR/
FRAME APPLICATION

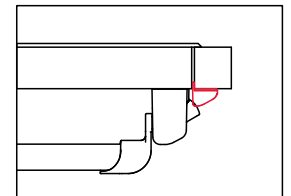

SL-0144

Top Bolt Keeps

2401 Top Trip

- Surface mounted keep for top shoot bolts
- Kit supplied includes spacers for applications where the distance between the header rail and the door face is between 14mm and 21mm
- Supplied as standard with the 502 and 503 panic and emergency exit bolts

Construction - mild steel
 Finish - electro galvanised/RAL finish available on request

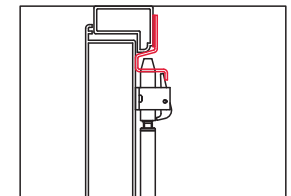
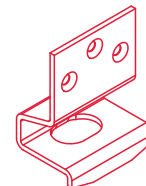

2401

P0401 Standard Top Trip

- Used for standard bolts on aluminium frames.
- Supplied as standard with the 502 and 503 panic and emergency exit bolts

Construction - mild steel
 Finish - electro galvanised/RAL finish available on request

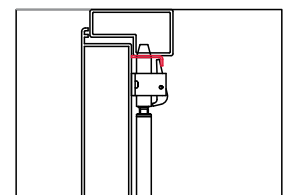

P0401

2405 Top Trip

- Surface mounted keep for top shoot bolts on aluminium frames
- For flush fitting doors/frames
- Used with the 502 and 503 series panic and emergency exit bolts

Construction - mild steel

Finish - electro galvanised/RAL finish available on request

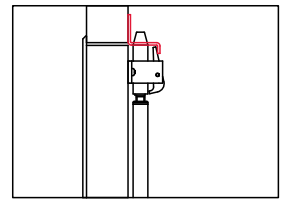
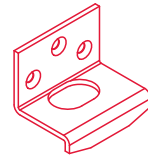

2405

3405A Top Trip

- Surface mounted keep for aluminium top header rail
- No clearance hole in the header rail to accept the top shoot bolt is required
- Used with the 502 and 503 series panic and emergency exit bolts

Construction - diecast zinc/mild steel

Finish - electro galvanised

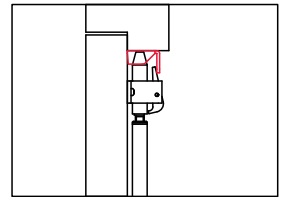
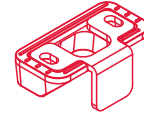

3405A

Bottom Bolt Keeps

P1301 Standard Bottom Keep

- Standard 500 series bottom bolt keep
- Supplied as standard with the 502 and 503 panic and emergency exit bolts

Construction - mild steel

Finish - electro galvanised

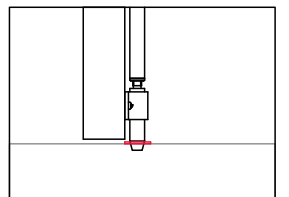
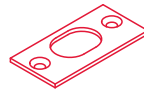

P1301

P0301 Easy Clean Socket

- Supplied as standard with the 502 and 503 panic and emergency exit bolts

Construction – grey cast iron

Finish – electro galvanised

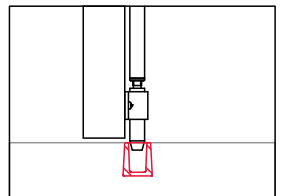
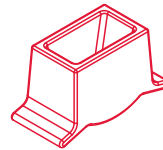

P0301

2403 Low Threshold Bottom Keep

- For low thresholds or an alternative to boring a hole in a concrete floor to accept the bottom shoot bolt
- Designed to the requirements of CEN standards and building regulations
- Supplied as standard with the 502 and 503 series panic and emergency exit bolts

Construction - mild steel

Finish - electro galvanised/RAL finish available on request

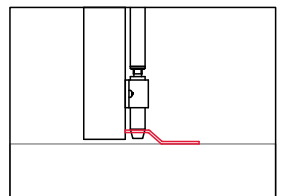
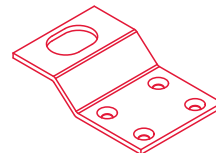

2403

3405 Bottom Keep

- Surface mounted keep for bottom shoot bolts
- No clearance hole in the floor is required
- Used with the 502 and 503 series panic and emergency exit bolts

Construction - diecast zinc

Finish - electro galvanised

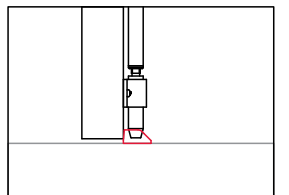

3405

SL-0159 Threshold Seal Bottom Keep

- Bottom bolt keep plate for use with a vertical faced threshold seal
- No clearance hole in the floor or threshold seal required
- Used with the 502 and 503 panic and emergency exit bolts
- Multiple keeps can be used for additional thickness, if required

Construction – stainless steel

Finish – self colour

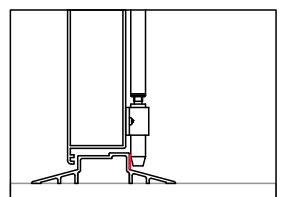
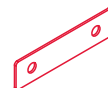

SL-0159

Pullman Latch Keeps

3402 Standard Vertical Pullman Latch Keep

- Surface mounted keep for top and bottom vertical Pullman latches
- Supplied as standard with the 512 and 513 panic and emergency exit bolts

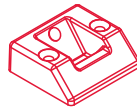

Construction – diecast aluminium
 Finish – black powder coated/RAL finish available on request

TOP VERTICAL PULLMAN LATCH

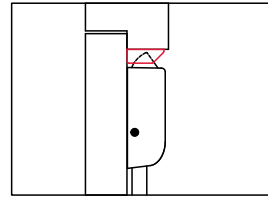

3402

BOTTOM VERTICAL PULLMAN LATCH

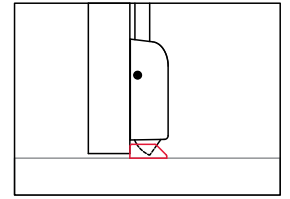

3402

SL-0142 Standard Horizontal Pullman Latch Keep

- Surface mounted keep for top and bottom horizontal Pullman latches
- Supplied as standard with the 522 and 523 panic and emergency exit bolts

Construction – diecast aluminium
 Finish – black powder coated/RAL finish available on request

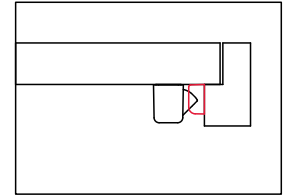

SL-0142

SL-0317 Horizontal Pullman Latch Keep

- Used with the Exidor horizontal Pullman latches for both flush fitting doors/frames and on double rebated door applications
- Used with the 522 and 523 panic and emergency exit bolts

Construction – diecast zinc
 Finish – electro nickel plated

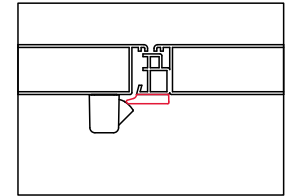
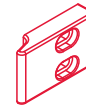

SL-0317

uPVC DOOR KEEPS

Latch Bolt Keeps

SL-0160 Standard uPVC Latch Keep

- 500 series standard centre latch keep
- Suitable for all uPVC profiles
- Supplied as standard with the 503, 513 & 523

Construction – diecast aluminium
 Finish – white powder coated/brown finish available on request

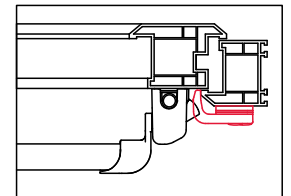
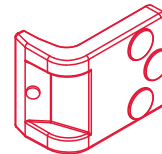

SL-0160

Top Bolt Keeps

SL-0150 Standard Top Trip

- Surface mounted keep for top shoot bolts
- Supplied as standard with the 502 and 503 panic and emergency exit bolts

Construction – mild steel
 Finish – white powder coated/RAL finish available on request

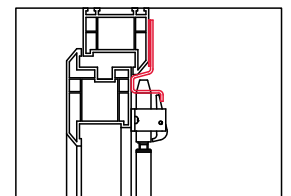
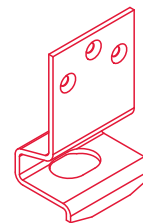

SL-0150

2401 Top Trip

- Surface mounted keep for top shoot bolts
- Kit supplied includes spacers for applications where the distance between the header rail and the door face is between 14mm and 21mm
- Used with the 502 and 503 panic and emergency exit bolts

Construction – mild steel
 Finish – electro galvanised/RAL finish available on request

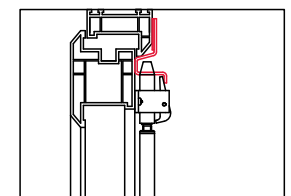
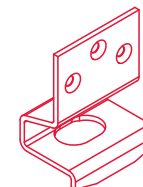

2401

Bottom Bolt Keeps

P1301 Standard Bottom Keep

- Standard 500 series bottom bolt keep
- Supplied as standard with the 502 and 503 panic and emergency exit bolts

Construction - mild steel
Finish - electro galvanised

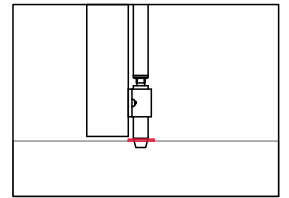
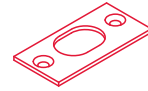

P1301

2403 Low Threshold Bottom Keep

- For low thresholds or an alternative to boring a hole in a concrete floor to accept the bottom shoot bolt
- Designed to the requirements of CEN standards and building regulations
- Used with the 502 and 503 series panic and emergency exit bolts

Construction - mild steel
Finish - electro galvanised/RAL finish available on request

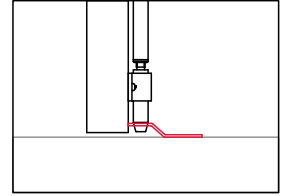
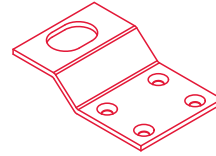

2403

3405 Bottom Keep

- Surface mounted keep for bottom shoot bolts
- No clearance hole in the floor is required
- Used with the 502 and 503 series panic and emergency exit bolts

Construction - diecast zinc
Finish - electro galvanised

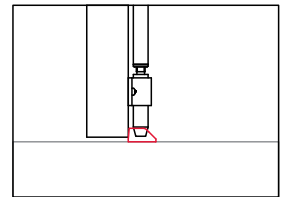
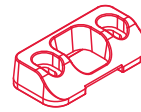

3405

SL-0159 Threshold Seal Bottom Keep

- Bottom bolt keep plate for use with a vertical faced threshold seal
- No clearance hole in the floor or threshold seal required
- Used with the 502 and 503 panic and emergency exit bolts

Construction – stainless steel
Finish – self colour

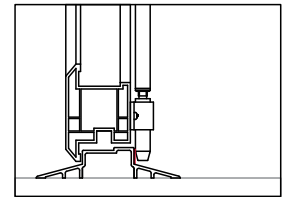
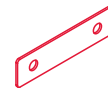

SL-0159

SL-0151 uPVC Bottom Keep

- For uPVC doors/frames that have a high threshold
- Complete with spacers for applications where the distance between the door face and the face of the threshold is between 14mm and 21mm
- Used with the 502 and 503 panic and emergency exit bolts

Construction – mild steel
Finish – white powder coated/RAL finish available on request

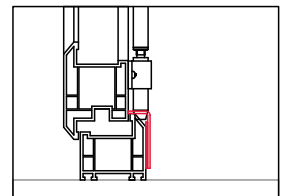
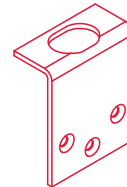

SL-0151

Pullman Latch Keeps

SL-0161 Standard uPVC Vertical and Horizontal Pullman Latch Keep

- 500 series standard vertical and horizontal Pullman latch keep
- Suitable for all uPVC profiles
- Supplied as standard with the 512, 513, 522 & 523 panic and emergency exit bolts

Construction – diecast aluminium
Finish – white powder coated/brown finish available on request

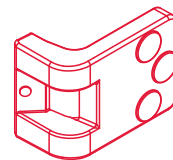

HORIZONTAL PULLMAN LATCH -
SINGLE DOOR

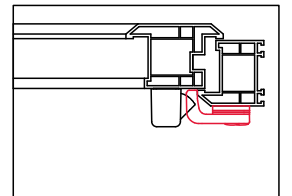

SL-0161

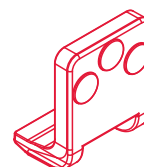

VERTICAL PULLMAN LATCH -
SINGLE DOOR

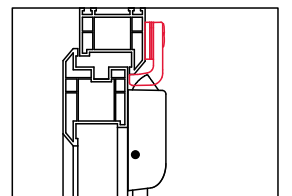

SL-0161

Technical Data

Maintenance

It is important that all panic and emergency exit hardware devices are inspected and maintained properly to ensure safety when exiting a building in any situation.

Once the device is fitted regular maintenance is recommended.

Weekly:

- Make sure the exit device functions correctly
- Any fixings that have worked loose should be re-secured
- Any damaged components should be replaced
- Ensure there are no obstructions which prevent the panic/emergency exit unit from functioning correctly

Every three months:

- Check for wear. Any visible worn components should be replaced

Fixing / Installation

Installation instructions are supplied with all the Exidor panic and emergency exit hardware. Provided the instructions are followed and the units are fitted by a competent person, the Exidor range will offer a high degree of safety and security. No responsibility can be accepted by the manufacturer if the installation instructions are not followed.

In order to meet the CEN European standards the door and frame should be of good quality and suitable to support the hardware.

Make sure that any weather strips or fixings on the door or frame do not interfere with the opening and closing of the door.

All bars and shoots should be cut to the exact size on site and each shoot is supplied with loose end plugs.

Construction

The main chassis and mounting plate are constructed of steel. The covers are diecast zinc and the guides are extruded aluminium. Zinc diecast and steel are used for the internal components. Shoot ends are made of steel with tubular steel rods and crossbar. The centre latch is nickel plated zinc diecast.

Passivate Protection - On Request

The passivation process gives extra protection to steel shoot tubes and crossbar, and is recommended when the product is to be used in harsh conditions, such as external gates, around swimming pools or coastal areas.

Standard Sizes

Standard sized units are suitable for doors up to 1220mm wide and 2440mm high. The shoot bolts and cross bars can be cut down on site to suit the door height and width.

For larger doors above 2440mm high special size top shoot bolt lengths are available upon request. The following lengths are stocked by Exidor Ltd.

- 1210mm for doors up to 2440mm high (Standard size supplied)
- 1600mm for doors up to 2680mm high
- 2100mm for doors up to 3180mm high

Threshold Seal

The ES1 threshold seal plate is for outward opening broad butt hinged doors. The seal meets the requirements of the Equality Act and has been fire, smoke and acoustic tested.

PUSH PAD EMERGENCY EXIT LATCH

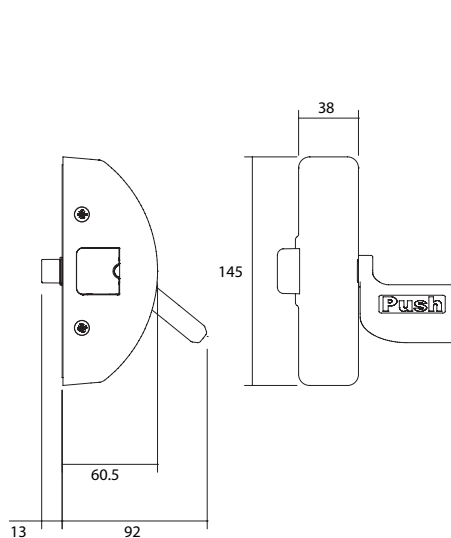

PUSH BAR THREE POINT PANIC BOLT

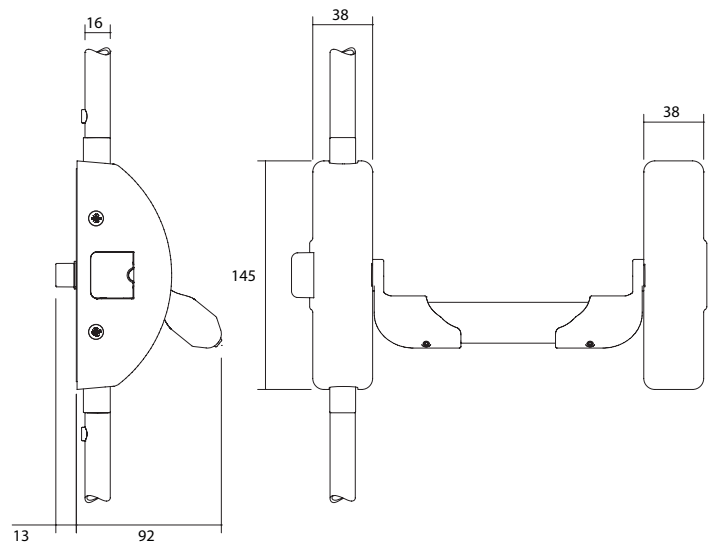

All measurements in mm

Parts List

1. Oval Push Bar
2. Top Shoot Tube
3. Bottom Shoot Tube
4. Guide
5. Push Bar Panic Bolt Mechanism
6. Slave Unit
7. Push Pad Emergency Exit Latch Mechanism
8. Top Trip Plate
9. Top Trip Assembly
10. Top Shoot End Plug
11. Bottom Shoot End Plug
12. Bottom Guide
13. Bottom Socket Plate
14. Vertical Pullman Cover
15. Vertical Pullman Assembly
16. Horizontal Pullman Assembly
17. Horizontal Pullman Cover
18. Mechanism Unit Mounting Plate
19. Slave Unit Mounting Plate
20. Centre Latch Keep
21. Threaded Shoot Bush
22. Vertical Pullman Latch Keep
23. Horizontal Pullman Latch Keep

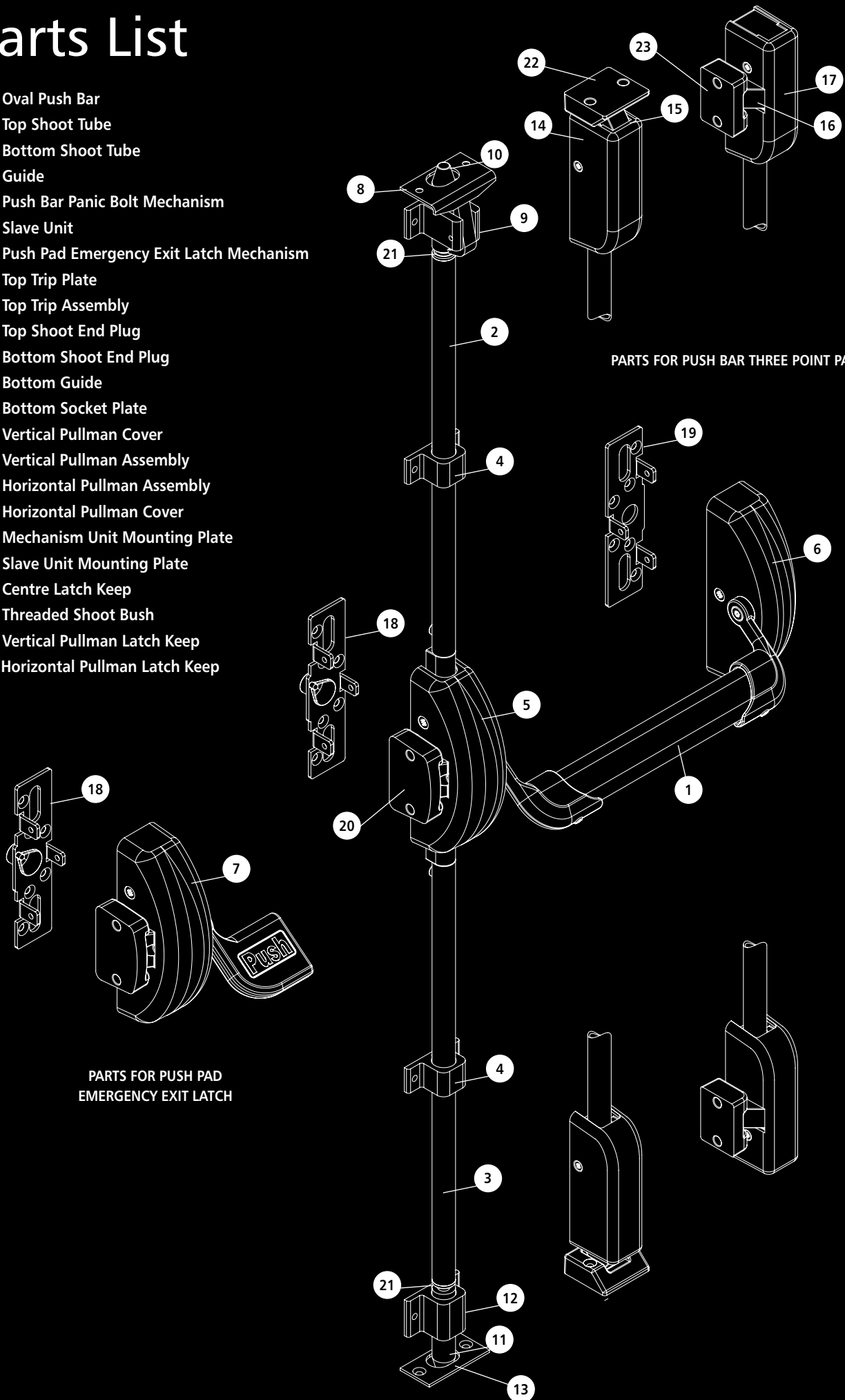

PARTS FOR PUSH BAR THREE POINT PANIC BOLT

PARTS FOR PUSH PAD EMERGENCY EXIT LATCH

Regulations

The two standards for panic and emergency exit hardware are as follows:-

EN1125: 2008

For push bar and touch bar devices which can be used in any environment, particularly areas open to members of the public.

Application examples: shopping centres, areas of entertainment, public buildings



EN179: 2008

For push pad and lever handle devices which can only be used in areas where occupants of the building are familiar with the layout and means of escape, and where members of the public do not have access.

Application examples: factory, warehouse, offices



Classification Coding System for Panic and Emergency Exit Hardware

Under both these two standards each product is tested and classified accordingly to show its compliance by the identification of a 10-digit code that is visible on the product and fitting instructions. Each digit represents a category and how it measured against the standard to which it was tested.

Example:

Digit:	1	2	3	4	5	6	7	8	9	10
Classification No.	3	7	6	0	1	3	2	2	A	A



Digit 1 - Category of Use

Only one category is identified

3 = high frequency of use where there is little incentive to exercise care, i.e. where there is a chance of an accident occurring and misuse.

Example: Doors to shops, hospitals, schools and other buildings which provide access to designated areas and which are used by the public and others frequently carrying or propelling bulky objects.

Digit 2 - Durability

6 = tested up to 100,000 cycles

7 = tested up to 200,000 cycles

Digit 3 - Door Mass

5 = for doors up to 100kg

6 = for doors up to 200kg

7 = for doors over 200kg

Digit 4 - Suitability for Use on Fire / Smoke Doors

0 = not approved for use on fire / smoke door assemblies

A = suitable for use on smoke door assemblies

B = Suitable for use on fire and smoke door assemblies based on a test in accordance with EN1634-1

Digit 5 - Safety

Only the top grade is allowed on panic and emergency exit hardware

1 = safety

Digit 6 - Corrosion Resistance to EN 1670

3 = high resistance

4 = very high resistance

Digit 7 - Security for Products

EN 1125

2 = 1,000 N - this is the only grade allowed under EN 1125

EN 179

2 = 1,000N / 3 = 2,000N / 4 = 3,000N / 5 = 5,000N

These four grades are used to allow the opportunity of greater security because these devices are subject to testing with doors under a greater pressure.

Digit 8 - Projection of Device

1 = large projection (projection of 150mm from the face of the door)

2 = standard projection (projection of 100mm from the face of the door)

Digit 9 - Type of Device

EN 179

A = emergency device using a lever handle

B = emergency device using a push pad

EN 1125

A = panic device using a push bar

B = panic device using a touch bar

Digit 10 - Door Application

EN 179

A = outwardly opening single exit door, double exit door: active or inactive leaf

B = outwardly opening single exit door only

C = outwardly opening double exit door: inactive leaf only

D = inwardly opening single exit door only

EN 1125

A = single door, double door: active or inactive leaf

B = single door only

C = double door, inactive leaf only

Glossary

Emergency Exit Hardware

Products that are classified as emergency exit hardware offer a single operation of a lever or push pad to release the device. These are certified to EN 179 and can only be used on premises that require prior knowledge of its operation and where panic situations are not foreseen, such as offices and areas that are not open to the public.

Panic Exit Hardware

Products that are classified as panic exit hardware offer a single operation of a push bar or touch bar to release the device. These are certified to EN 1125 and can be used on premises that do not require prior knowledge of its operation and where panic situations are foreseen, such as places of entertainment, public buildings and areas open to the public.

Rebated Doors

A pair of double doors that are rebated.

Non-Rebated Doors

A pair of double doors that are flush fitting.

Mechanism Unit

This is the main unit that controls the travel of the bolts and latches.

Automatic Top Trip

Device used to hold the bolts in the withdrawn position when the door is open. When the door is closed, the automatic top trip releases the bolts securing the door.

Anti-thrust

A device built into a unit to prevent either a bolt or latch from being forced back when in the closed position, thus increasing the level of security.

Adjustable Shoots

To overcome the problem of bolts not fully engaging in the keeps due to the door or frame moving after a period of time, adjustable shoots are used on Exidor panic and emergency exit bolts. They allow ± 5 mm of adjustment, and are particularly suited for soft wood, uPVC and aluminium doors.

Slave Unit

The slave unit supports the cross bar on any panic hardware.

Microswitch

For situations that require the panic hardware to be linked to a monitoring or alarm system a microswitch can be fitted in the slave unit. The microswitch opens/closes an electrical circuit when the cross bar is operated.

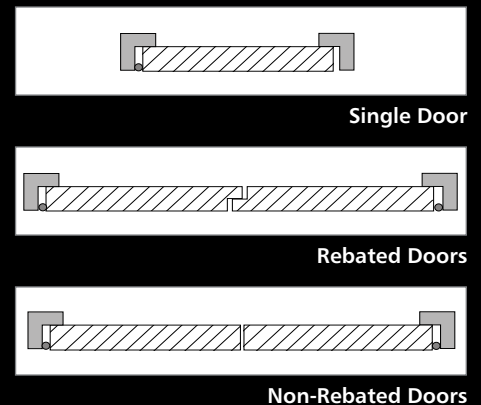

Product Features

Single doors

Product No.	Description	EN Standard		Bolt Type			Door Type			Locking Points	CE Mark
		179	1125	Adjustable	Vertical Pullman Latches	Horizontal Pullman Latches	Timber Door	Aluminium Door	uPVC Door		
501-P	Push pad single emergency exit latch	●					●			1	●
501-P/AD	Push pad single emergency exit latch	●						●		1	●
501-B	Push bar single panic latch		●				●			1	●
501-B/AD	Push bar single panic latch		●					●		1	●
502A-P	Push pad single emergency exit bolt	●		●			●			2	●
502A-P/AD	Push pad single emergency exit bolt	●		●				●		2	●
502A-P/UD	Push pad single emergency exit bolt	●		●					●	2	●
502A-B	Push bar single panic bolt		●	●			●			2	●
502A-B/AD	Push bar single panic bolt		●	●				●		2	●
502A-B/UD	Push bar single panic bolt		●	●					●	2	●
503A-P	Push pad three point emergency exit bolt	●		●			●			3	●
503A-P/AD	Push pad three point emergency exit bolt	●		●				●		3	●
503A-P/UD	Push pad three point emergency exit bolt	●		●					●	3	●
503A-B	Push bar three point panic bolt		●	●			●			3	●
503A-B/AD	Push bar three point panic bolt		●	●				●		3	●
503A-B/UD	Push bar three point panic bolt		●	●					●	3	●
512-P	Push pad single emergency exit bolt with vertical Pullman latches	●			●		●			2	●
512-P/AD	Push pad single emergency exit bolt with vertical Pullman latches	●			●			●		2	●
512-P/UD	Push pad single emergency exit bolt with vertical Pullman latches	●			●				●	2	●
512-B	Push bar single panic bolt with vertical Pullman latches		●		●		●			2	●
512-B/AD	Push bar single panic bolt with vertical Pullman latches		●		●			●		2	●
512-B/UD	Push bar single panic bolt with vertical Pullman latches		●		●				●	2	●
522-P	Push pad single emergency exit bolt with horizontal Pullman latches	●				●	●			2	●
522-P/AD	Push pad single emergency exit bolt with horizontal Pullman latches	●				●		●		2	●
522-P/UD	Push pad single emergency exit bolt with horizontal Pullman latches	●				●			●	2	●
522-B	Push bar single panic bolt with horizontal Pullman latches		●			●	●			2	●
522-B/AD	Push bar single panic bolt with horizontal Pullman latches		●			●		●		2	●
522-B/UD	Push bar single panic bolt with horizontal Pullman latches		●			●			●	2	●

Product No.	Description	EN Standard		Bolt Type			Door Type			Locking Points	CE Mark
		179	1125	Adjustable	Vertical Pullman Latches	Horizontal Pullman Latches	Timber Door	Aluminium Door	uPVC Door		
513-P	Push pad three point emergency exit bolt with vertical Pullman latches	●			●		●			3	●
513-P/AD	Push pad three point emergency exit bolt with vertical Pullman latches	●			●			●		3	●
513-P/UD	Push pad three point emergency exit bolt with vertical Pullman latches	●			●				●	3	●
513-B	Push bar three point panic bolt with vertical Pullman latches		●		●		●			3	●
513-B/AD	Push bar three point panic bolt with vertical Pullman latches		●		●			●		3	●
513-B/UD	Push bar three point panic bolt with vertical Pullman latches		●		●				●	3	●
523-P	Push pad three point emergency exit bolt with horizontal Pullman latches	●				●	●			3	●
523-P/AD	Push pad three point emergency exit bolt with horizontal Pullman latches	●				●		●		3	●
523-P/UD	Push pad three point emergency exit bolt with horizontal Pullman latches	●				●			●	3	●
523-B	Push bar three point panic bolt with horizontal Pullman latches		●			●	●			3	●
523-B/AD	Push bar three point panic bolt with horizontal Pullman latches		●			●		●		3	●
523-B/UD	Push bar three point panic bolt with horizontal Pullman latches		●			●			●	3	●

Uniclass L4181	EPIC D181
CI/SfB (31.59)	X

Exidor Limited

Progress Drive, Cannock
Staffordshire, WS11 0JE
England, UK

Tel: +44 (0)1543 578661
Fax: +44 (0)1543 570050
Web: www.exidor.co.uk
Email: sales@exidor.co.uk



Every effort has been made to ensure the accuracy of the particulars contained in this brochure. All details and specifications were deemed correct at time of going to press. However, Exidor Limited reserve the right to alter specifications with or without prior notice and at such times in a manner they think fit. Customers are advised to call Exidor Limited on +44 (0) 1543 578661 if they require further details or clarification of specifications.