

CMP-2401B/CMP-2402B

Fire Alarm Control Panel

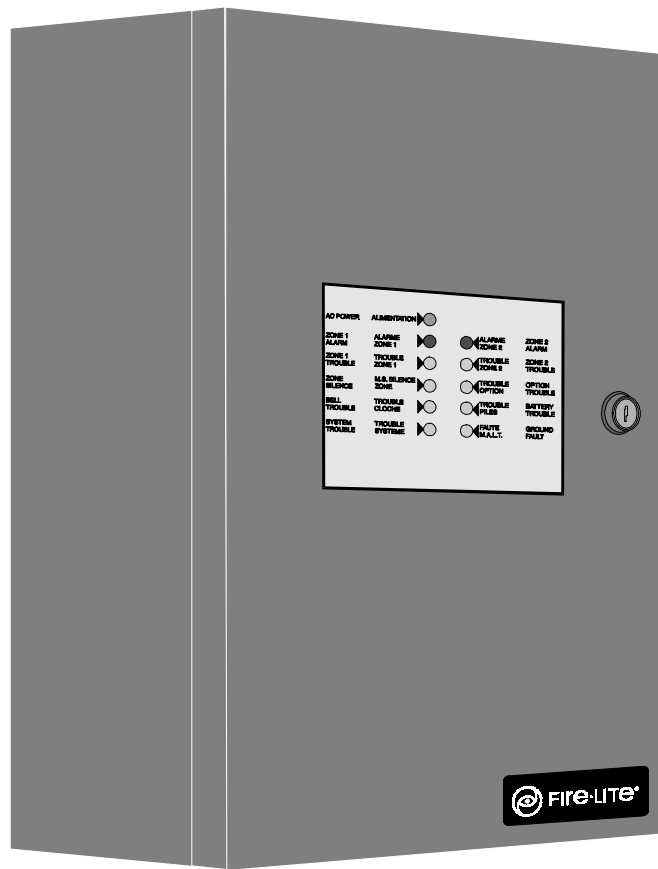

Installation, Maintenance and Operating Instruction Manual

Fire Alarm System Limitations

An automatic fire alarm system—typically made up of smoke detectors, heat detectors, manual pull stations, audible warning devices, and a fire alarm control with remote notification capability—can provide early warning of a developing fire. Such a system, however, does not assure protection against property damage or loss of life resulting from a fire.

The Manufacturer recommends that smoke and/or heat detectors be located throughout a protected premise following the recommendations of the current edition of the National Fire Protection Association Standard 72 (NFPA 72), manufacturer's recommendations, State and local codes, and the recommendations contained in the Guide for Proper Use of System Smoke Detectors, which is made available at no charge to all installing dealers. A study by the Federal Emergency Management Agency (an agency of the United States government) indicated that smoke detectors may not go off in as many as 35% of all fires. While fire alarm systems are designed to provide early warning against fire, they do not guarantee warning or protection against fire. A fire alarm system may not provide timely or adequate warning, or simply may not function, for a variety of reasons:

Smoke detectors may not sense fire where smoke cannot reach the detectors such as in chimneys, in or behind walls, on roofs, or on the other side of closed doors. Smoke detectors also may not sense a fire on another level or floor of a building. A second-floor detector, for example, may not sense a first-floor or basement fire.

Particles of combustion or "smoke" from a developing fire may not reach the sensing chambers of smoke detectors because:

- Barriers such as closed or partially closed doors, walls, or chimneys may inhibit particle or smoke flow.
- Smoke particles may become "cold," stratify, and not reach the ceiling or upper walls where detectors are located.
- Smoke particles may be blown away from detectors by air outlets.
- Smoke particles may be drawn into air returns before reaching the detector.

The amount of "smoke" present may be insufficient to alarm smoke detectors. Smoke detectors are designed to alarm at various levels of smoke density. If such density levels are not created by a developing fire at the location of detectors, the detectors will not go into alarm.

Smoke detectors, even when working properly, have sensing limitations. Detectors that have photoelectronic sensing chambers tend to detect smoldering fires better than flaming fires, which have little visible smoke. Detectors that have ionizing-type sensing chambers tend to detect fast-flaming fires better than smoldering fires. Because fires develop in different ways and are often unpredictable in their growth, neither type of detector is necessarily best and a given type of detector may not provide adequate warning of a fire.

Smoke detectors cannot be expected to provide adequate warning of fires caused by arson, children playing with matches (especially in bedrooms), smoking in bed, and violent explosions (caused by escaping gas, improper storage of flammable materials, etc.).

While a fire alarm system may lower insurance rates, it is not a substitute for fire insurance!

Heat detectors do not sense particles of combustion and alarm only when heat on their sensors increases at a predetermined rate or reaches a predetermined level. Rate-of-rise heat detectors may be subject to reduced sensitivity over time. For this reason, the rate-of-rise feature of each detector should be tested at least once per year by a qualified fire protection specialist. *Heat detectors are designed to protect property, not life.*

IMPORTANT! Smoke detectors must be installed in the same room as the control panel and in rooms used by the system for the connection of alarm transmission wiring, communications, signaling, and/or power. If detectors are not so located, a developing fire may damage the alarm system, crippling its ability to report a fire.

Audible warning devices such as bells may not alert people if these devices are located on the other side of closed or partly open doors or are located on another floor of a building. Any warning device may fail to alert people with a disability or those who have recently consumed drugs, alcohol or medication. Please note that:

- Strobes can, under certain circumstances, cause seizures in people with conditions such as epilepsy.
- Studies have shown that certain people, even when they hear a fire alarm signal, do not respond or comprehend the meaning of the signal. It is the property owner's responsibility to conduct fire drills and other training exercise to make people aware of fire alarm signals and instruct them on the proper reaction to alarm signals.
- In rare instances, the sounding of a warning device can cause temporary or permanent hearing loss.

A fire alarm system will not operate without any electrical power. If AC power fails, the system will operate from standby batteries only for a specified time and only if the batteries have been properly maintained and replaced regularly.

Equipment used in the system may not be technically compatible with the control. It is essential to use only equipment listed for service with your control panel.

Telephone lines needed to transmit alarm signals from a premise to a central monitoring station may be out of service or temporarily disabled. For added protection against telephone line failure, backup radio transmission systems are recommended.

The most common cause of fire alarm malfunction is inadequate maintenance. To keep the entire fire alarm system in excellent working order, ongoing maintenance is required per the manufacturer's recommendations, and UL and NFPA standards. At a minimum, the requirements of Chapter 7 of NFPA 72 shall be followed. Environments with large amounts of dust, dirt or high air velocity require more frequent maintenance. A maintenance agreement should be arranged through the local manufacturer's representative. Maintenance should be scheduled monthly or as required by National and/or local fire codes and should be performed by authorized professional fire alarm installers only. Adequate written records of all inspections should be kept.

Installation Precautions

WARNING - Several different sources of power can be connected to the fire alarm control panel. Disconnect all sources of power before servicing. Control unit and associated equipment may be damaged by removing and/or inserting cards, modules, or interconnecting cables while the unit is energized. Do not attempt to install, service, or operate this unit until this manual is read and understood.

CAUTION - *System Reacceptance Test after Software Changes.* To ensure proper system operation, this product must be tested in accordance with NFPA 72 Chapter 7 after any programming operation or change in site-specific software. Reacceptance testing is required after any change, addition or deletion of system components, or after any modification, repair or adjustment to system hardware or wiring.

All components, circuits, system operations, or software functions known to be affected by a change must be 100% tested. In addition, to ensure that other operations are not inadvertently affected, at least 10% of initiating devices that are not directly affected by the change, up to a maximum of 50 devices, must also be tested and proper system operation verified.

This system meets NFPA requirements for operation at 0-49° C/32-120° F and at a relative humidity of 85% RH (non-condensing) at 30° C/86° F. However, the useful life of the system's standby batteries and the electronic components may be adversely affected by extreme temperature ranges and humidity. Therefore, it is recommended that this system and all peripherals be installed in an environment with a nominal room temperature of 15-27° C/60-80° F.

Verify that wire sizes are adequate for all initiating and indicating device loops. Most devices cannot tolerate more than a 10% I.R. drop from the specified device voltage.

Adherence to the following will aid in problem-free installation with long-term reliability:

Like all solid state electronic devices, this system may operate erratically or can be damaged when subjected to lightning-induced transients. Although no system is completely immune from lightning transients and interferences, proper grounding will reduce susceptibility. *Overhead or outside aerial wiring is not recommended, due to an increased susceptibility to nearby lightning strikes.* Consult with the Technical Services Department if any problems are anticipated or encountered.

Disconnect AC power and batteries prior to removing or inserting circuit boards. Failure to do so can damage circuits.

Remove all electronic assemblies prior to any drilling, filing, reaming, or punching of the enclosure. When possible, make all cable entries from the sides or rear. Before making modifications, verify that they will not interfere with battery, transformer, and printed circuit board location.

Do not tighten screw terminals more than 9 in-lbs. Over-tightening may damage threads, resulting in reduced terminal contact pressure and difficulty with screw terminal removal.

Though designed to last many years, system components can fail at any time. This system contains static-sensitive components. Always ground yourself with a proper wrist strap before handling any circuits so that static charges are removed from the body. Use static-suppressive packaging to protect electronic assemblies removed from the unit.

Follow the instructions in the installation, operating, and programming manuals. These instructions must be followed to avoid damage to the control panel and associated equipment. FACP operation and reliability depend upon proper installation by authorized personnel.

FCC Warning

WARNING: This equipment generates, uses, and can radiate radio frequency energy and if not installed and used in accordance with the instruction manual, may cause interference to radio communications. It has been tested and found to comply with the limits for class A computing device pursuant to Subpart B of Part 15 of FCC Rules, which is designed to provide reasonable protection against such interference when operated in a commercial environment. Operation of this equipment in a residential area is likely to cause interference, in which case the user will be required to correct the interference at his own expense.

Canadian Requirements

This digital apparatus does not exceed the Class A limits for radiation noise emissions from digital apparatus set out in the Radio Interference Regulations of the Canadian Department of Communications.

Le présent appareil numérique n'émet pas de bruits radioélectriques dépassant les limites applicables aux appareils numériques de la classe A prescrites dans le Règlement sur le brouillage radioélectrique édicté par le ministère des Communications du Canada.

Notes

Table of Contents

CHAPTER 1: Product Description	9
1.1: Product Features	9
FIGURE 1-1: CMP-2401B/CMP-2402B.....	10
1.2: Specifications	11
1.3: Controls, Indicators and Operation	12
1.3.1: Front Panel Slide Switches	12
FIGURE 1-2: CMP-2401B/CMP-2402B Control Switches	12
1.3.2: LED Indicators	13
FIGURE 1-3: LED Indicators (CMP-2402B Illustrated).....	13
1.3.3: Local Sounder	14
1.3.4: Normal Standby Operation	14
1.3.5: Alarm Condition	14
1.3.6: Trouble Condition	14
1.4: Circuits	15
1.5: Components.....	15
1.6: Optional Modules and Accessories	16
CHAPTER 2: Installation.....	17
2.1: Mounting Options	17
FIGURE 2-1: CMP-2401B/CMP-2402B Mounting	17
2.2: Backbox Mounting.....	17
FIGURE 2-2: Cabinet Dimensions and Knockout Locations.....	18
FIGURE 2-3: FACP Backbox.....	19
2.3: Operating Power.....	20
FIGURE 2-4: Operating Power Connections.....	20
2.4: Input Circuits.....	21
FIGURE 2-5: CMP-2402B Style B Initiating Device Circuit Connections	21
2.5: Output Circuits	22
FIGURE 2-6: Auxiliary Power Connection.....	22
FIGURE 2-7: Notification Appliance Circuit Connections.....	22
FIGURE 2-8: Relay Terminals	23
2.6: UL Power-limited Wiring Requirements	23
FIGURE 2-9: Typical Wiring Diagram for UL Power-limited Requirements	23
2.7: Installation of Optional Module	24
2.7.1: 4XTMF Transmitter Module.....	24
FIGURE 2-10: 4XTMF Module Connections	24
2.7.2: RTB - Remote Trouble Buzzer.....	25
FIGURE 2-11: RTB Remote Trouble Buzzer Connection	25
CHAPTER 3: Programming Options.....	26
3.1: Earth Ground Fault Detection	26
FIGURE 3-1: Ground Fault Detection Circuit.....	26
3.2: Optional 4XTMF Transmitter Module Placement Supervision	26
FIGURE 3-2: 4XTMF Module Placement Supervision	26
CHAPTER 4: Periodic Testing and Maintenance.....	27
CHAPTER 5: Battery Calculations.....	28
TABLE 5-1: Battery Calculations.....	28
5.1: The Main Power Supply.....	29
TABLE 5-2: Load in Standby	29
TABLE 5-3: Load in Alarm.....	30

Notes

This control panel has been designed to comply with standards set forth by the following regulatory agencies:

- Underwriters Laboratories Standard UL 864
- NFPA 72 National Fire Alarm Code
- CAN/ULC - S527M Standard for Control Units for Fire Alarm Systems

Before proceeding, the installer should be familiar with the following documents.



NFPA Standards

This Fire Alarm Control Panel complies with the following NFPA Standards:

NFPA 72 National Fire Alarm Code for Local Fire Alarm Systems and Remote Station Fire Alarm Systems (requires an optional Remote Station Output Module).

Underwriters Laboratories Canada Documents:



CAN/ULC - S524M Standard for Installation of Fire Alarm Systems

CAN/ULC - S527-M87 Standard for Control Units for Fire Alarm Systems

Other:

Applicable Local and State Building Codes

C22.1 Canadian Electrical Code, Part I

C22.2 No. 0, General Requirements - Canadian Electrical Code, Part II

C22.2 No. 0.4, Bonding and Grounding of Electrical Equipment (Protective Grounding) - Canadian

C282, Emergency Electrical Power Supply for Buildings - Canadian

Requirements of the Local Authority Having Jurisdiction (LAHJ)

Fire•Lite Documents

Fire•Lite Device Compatibility Document Document #15384

CMP-2401B/CMP-2402B Main Circuit Board

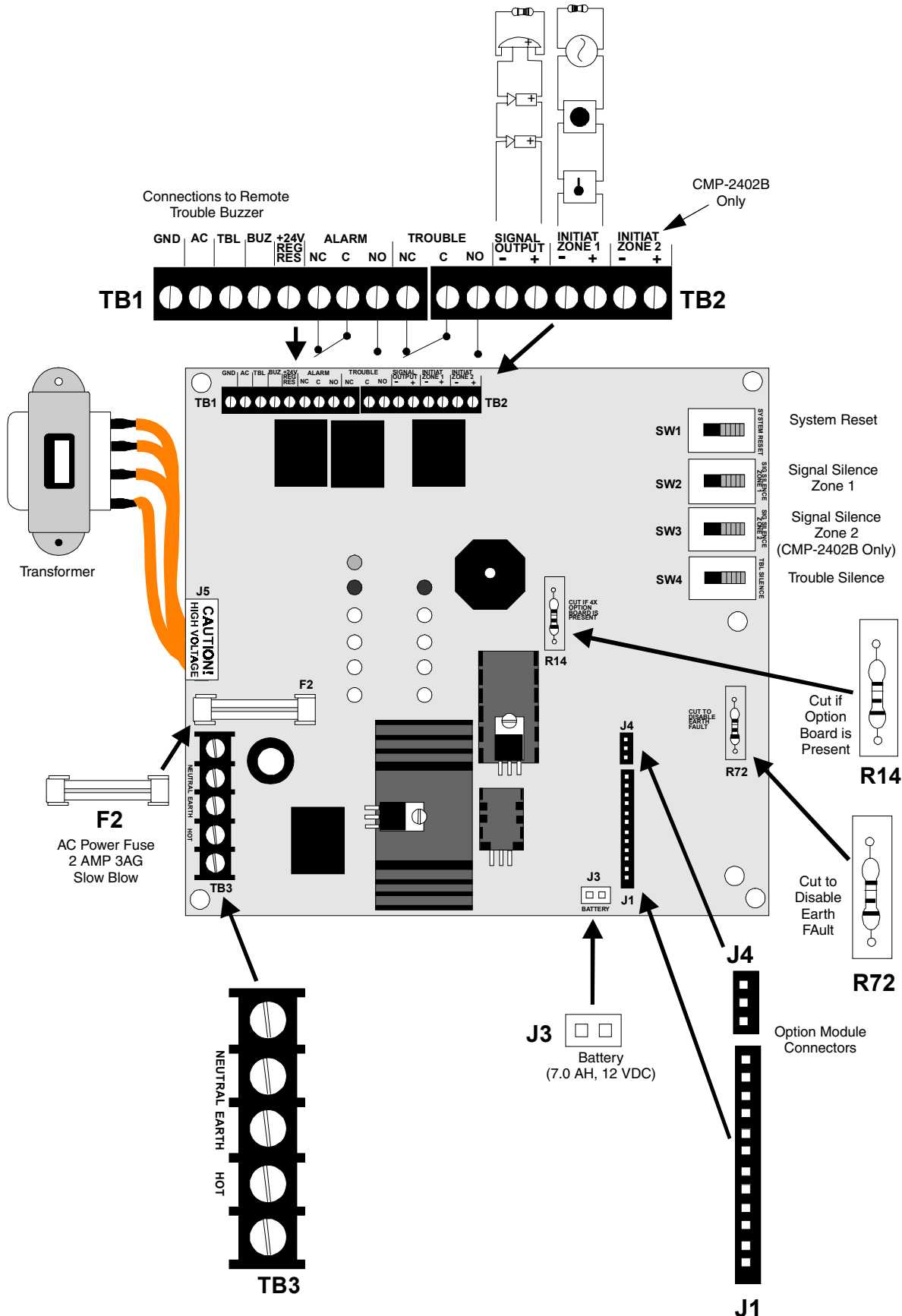

2402LAVO CDR

CHAPTER 1 *Product Description*

The CMP-2401B is a one zone FACP (Fire Alarm Control Panel) and the CMP-2402B is a two zone FACP. This manual will use the term FACP to refer to both the CMP-2401B and CMP-2402B where features are identical. These control panels provide reliable fire signaling protection for small to medium sized commercial, industrial and institutional buildings. The FACPs use conventional input devices such as two-wire smoke detectors, four-wire smoke detectors, pull stations, waterflow devices and other normally-open contact devices. Outputs include one NAC (Notification Appliance Circuit) and 24 volt resettable power. The FACP also supervises all wiring, AC voltage and battery level.

Activation of a compatible smoke detector or any normally open fire alarm initiating device will activate audible and visual signaling devices, illuminate an indicating LED and sound the piezo at the FACP, activate the FACP alarm relay and operate an optional module used to notify a remote station or initiate a supplementary control function.

1.1 Product Features

- Style B (Class B) Initiating Device Circuit (IDC)
 - ✓ CMP-2401B - one IDC
 - ✓ CMP-2402B - two IDCs
- One NFPA Style Y (Class B) Notification Appliance Circuit (NAC)
- Form-C Alarm Relay
- Form-C Trouble Relay
- Control switches
 - ✓ Reset
 - ✓ Trouble Silence
 - ✓ Signal Silence - Zone One
 - ✓ Signal Silence - Zone Two (CMP-2402B only)
- LED Indicators
 - ✓ AC Power
 - ✓ Zone Alarm and Trouble
 - ✓ Bell Trouble
 - ✓ Option Module Trouble
 - ✓ System Trouble
 - ✓ Zone Silence
 - ✓ Ground Fault
 - ✓ Battery Trouble
- Piezo Sounder for alarm and trouble signal
- Dress Panel coverplate
- 24 volt operation
- Small backbox size
- Low AC voltage sense
- Silence Inhibit Notification Appliance Circuit
- Automatic Battery Float Charger
- Battery Deep Discharge Protection
- Optional Remote Trouble Buzzer

FIGURE 1-1: CMP-2401B/CMP-2402B

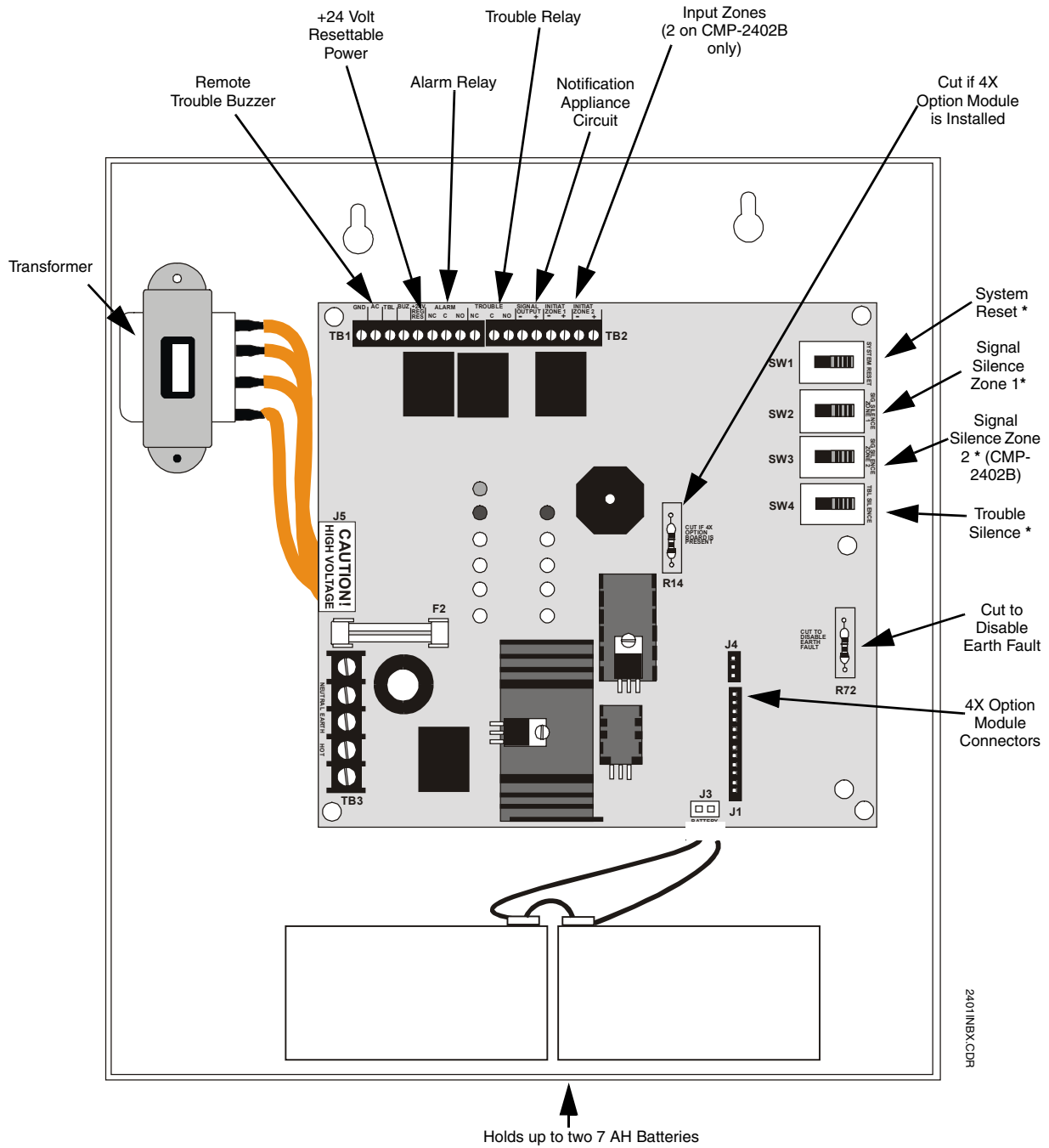

* Note that all switches are illustrated in the **normal** position.

1.2 Specifications

AC Power - TB3

120 VAC, 60 Hz, 0.5 amps

Fuse F2 - 2 Amp, 3AG Slow Blow

Wire size: minimum #14 AWG (2.0 mm²) with 600V insulation

Battery (lead acid only) - J3

Maximum Charging Circuit: Normal Flat Charge - 27.6V @ 0.8 amp

Maximum Charger Capacity: 7.0 Amp Hour battery which can be housed in the FACP cabinet

Battery Deep Discharge Protection:

In order to protect the battery, the *deep discharge circuit* disconnects the battery from the FACP when the battery voltage drops below 15 VDC. The FACP will restart and the battery will begin recharging only after primary AC power is restored.

Initiating Device Circuit(s) - TB2

Zone 1 - TB2 Terminals Initiating Zone 1 (-) & (+)

Zone 2 - TB2 Terminals Initiating Zone 2 (-) & (+) (CMP-2402B only)

Power-limited circuitry

Operation: NFPA Style B (Class B)

Normal Operating Voltage: Nominal 24 VDC , ripple 2.0 V_{P-P}

Alarm Current: 20 mA minimum

Short Circuit Current: 40 mA maximum

Maximum Loop Resistance: 100 ohms per side (200 ohms total zone resistance)

End-of-Line Resistor: 3.9K ohm, ½ watt

Detector Loop Current is sufficient to ensure operation of two alarmed detectors per zone

Standby Current: 9 mA (includes ELR and 3 mA maximum detector current)

Smoke Detector Identifier A

Refer to Fire•Lite Device Compatibility Document for listed compatible devices

Notification Appliance Circuit - TB2, Terminals Signal Output (-) and Signal Output (+)

Operation: NFPA Style Y (Class B)

Power-limited circuitry

Normal Operating Voltage: Nominal 24 VDC

Current Limit: via PTC

Maximum signaling current: 1.25 amps

End-of-Line Resistor: 3.9K ohm, ½ watt

Refer to Fire•Lite Device Compatibility Document for listed compatible devices

Two Form-C Relays - Terminals Alarm (NC, C, NO) and Trouble (NC, C, NO)

Relay contact ratings: 2.0 amps @ 30 VDC (resistive), 2.0 amps @ 30 VAC (resistive)

Resettable Power - TB1, Terminals Ground and +24V Resettable

Operating Voltage: Nominal 24 VDC

Up to 85 mA is available for powering 4-wire smoke detectors

Power-limited circuitry

Refer to Fire•Lite Device Compatibility Document for compatible listed devices

1.3 Controls, Indicators and Operation

1.3.1 Front Panel Slide Switches

FIGURE 1-2: CMP-2401B/CMP-2402B Control Switches

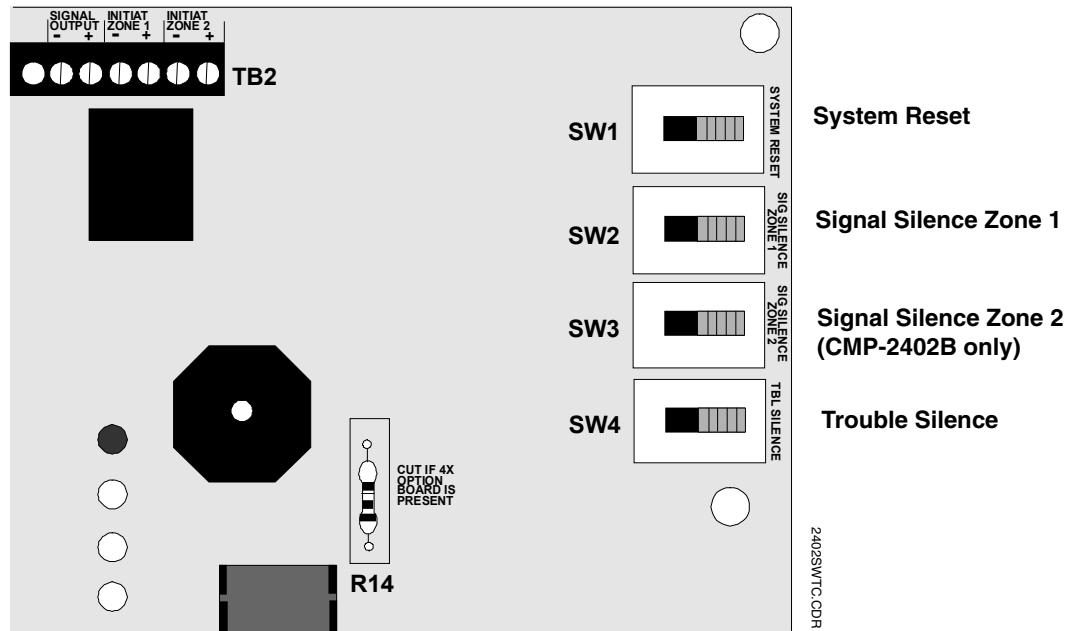

All switches are illustrated in their normal position. The function of each switch is listed below.

System Reset

The function of this nonlatching switch is:

1. to reset the FACP and the smoke detectors provided the alarm condition has been cleared and 60 seconds has elapsed since the first alarm
2. LED test

Signal Silence - Zone 1

Placing the switch in the Silence position will silence the Notification Appliance Circuit if 60 seconds has elapsed since the first alarm. A trouble condition is indicated while the switch is in the Silence position. If an alarm occurs on the silenced zone, the alarm LED will indicate the alarm condition and the alarm relay will transfer.

Signal Silence - Zone 2 (CMP-2402B only)

Placing the switch in the Silence position will silence the Notification Appliance Circuit if 60 seconds has elapsed since the first alarm. A trouble condition is indicated while the switch is in the Silence position. If an alarm occurs on the silenced zone, the alarm LED will indicate the alarm condition and the alarm relay will transfer.

Trouble Silence

This latching, two-position switch, will silence the piezo sounder. The trouble LED will continue to indicate a trouble condition. An intermittent tone will sound when the trouble is cleared to indicate that this switch should be returned to its normal position.

1.3.2 LED Indicators

FIGURE 1-3: LED Indicators (CMP-2402B Illustrated)

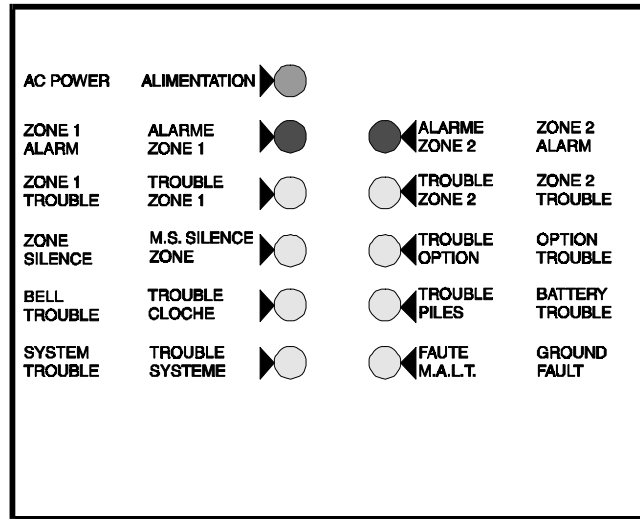

The LED indicators for the CMP-2401B/CMP-2402B are labeled in English and French. The purpose of each indicator is listed below:

AC Power (Alimentation) - green LED

The green LED is on when the FACP is operating from normal AC power. The LED turns off to indicate a below normal AC voltage (brownout) or complete loss of AC power. The System Trouble LED will also turn on.

Option Trouble (Trouble Option) - yellow LED

This yellow LED turns on to indicate the removal of the optional supervised 4XTMF Transmitter Module or a trouble with the module.

Zone 1 Alarm (Alarme Zone 1) - red LED

This red LED turns on to indicate an alarm condition, even if the Zone Silence switch is in the Silence position.

Zone 2 Alarm (Alarme Zone 2) - red LED (CMP-2402B only)

This red LED turns on to indicate an alarm condition, even if the Zone Silence switch is in the Silence position.

Zone 1 Trouble (Trouble Zone 1) - yellow LED

This yellow LED turns on to indicate a trouble condition, such as an open in the field wiring, on the IDC (Initiating Device Circuit) zone 1.

Zone 2 Trouble (Trouble Zone 2) - yellow LED (CMP-2402B only)

This yellow LED turns on to indicate a trouble condition, such as an open in the field wiring on the IDC (Initiating Device Circuit) zone 2.

Zone Silence (M.S. Silence Zone) - yellow LED

This yellow LED turns on to indicate that the Notification Appliance Circuit has been silenced.

Bell Trouble (Trouble Cloche) - yellow LED

This yellow LED turns on to indicate a trouble condition, such as an open or short in the field wiring, on the Notification Appliance Circuit.

Battery Trouble (Trouble Piles) - yellow LED

This yellow LED turns on to indicate a low battery/no battery condition or battery charger fault.

System Trouble (Trouble Systeme) - yellow LED

This yellow LED turns on for all faults or abnormal operating conditions.

Ground Fault (Faute M.A.L.T.) - yellow LED

This yellow LED turns on to indicate a ground fault condition (low impedance to ground) on any field wiring or battery connections.

1.3.3 Local Sounder

A piezo sounder provides distinct signals for alarm and trouble conditions:

- Alarm - steady
- Trouble - pulse

1.3.4 Normal Standby Operation

Normal standby operation indicates that there are no alarms or trouble conditions present on the FACP and that the IDC zone(s) have not been Silenced. In Normal Operation:

- All switches must be in their normal positions. Refer to Figure 1-1, "CMP-2401B/CMP-2402B," on page 10.
- The green AC power LED is on steady
- The red alarm LED(s) are off
- All yellow trouble LEDs are off

1.3.5 Alarm Condition

Alarm condition indicates that an IDC (input) zone has detected an alarm (active smoke detector, pull station activation, etc.). In Alarm Operation:

- The zone alarm LED will turn on
- The notification appliances are activated
- The optional 4XTMF Transmitter Module is activated
- Piezo sounder turns on steady
- The alarm relay will transfer

1.3.6 Trouble Condition

Trouble condition indicates that one or more faults have been detected by the FACP. Contact the local service representative for immediate correction of the fault since FACP operation may be impaired. A Trouble condition will cause the following:

- The yellow System Trouble LED will light steady
- Additional trouble LEDs may turn on
- The piezo sounder will pulse

1.4 Circuits

Input Circuits

The CMP-2401B has one IDC (Initiating Device Circuit) and the CMP-2402B has two IDCs. Input circuit(s) provide Style B (Class B) configuration and accept 2-wire smoke detectors and normally-open contact devices.

Output Circuits

- 24 Volt Resettable Power Output 85 mA
- 24 Volt Battery Charger (up to two 7 AH batteries)

Notification Appliance Circuit

One Style Y (Class B) Notification Appliance Circuit @ 1.25 amps maximum

Relays

Two dry Form-C relays for system alarm and system trouble are provided standard. Contacts are rated 2.0 amps @ 30 VDC (resistive), 2.0 amps @ 30 VAC (resistive).

Battery Charger

The battery charger will charge up to two 7 AH batteries. The FACP cabinet holds a maximum of two 7 AH batteries.

1.5 Components

Main Circuit Board

The main circuit board contains power supply, alarm and trouble relays, control switches, LED indicators, option jumpers, wiring interface connectors and other primary components. The option module plugs in and is mounted to the main circuit board. The main circuit board is delivered premounted in the cabinet.

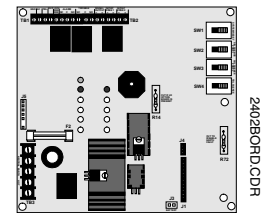

Cabinet

The cabinet is red. The backbox measures 14.5" (36.83 cm) high X 12.5" (31.75 cm) wide X 2.875" (7.303 cm) deep and provides space for two batteries (up to 7.0 Amp Hours each). Also supplied is a blue dress panel which mounts inside the cabinet.

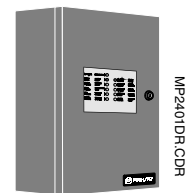

Dress Panel

A blue dress panel, which is required for Canadian installations, is provided with the cabinet. The dress panel restricts access to the system wiring while allowing access to the control switches.

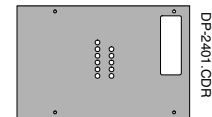

Transformer Assembly

One transformer is provided standard with the panel. The transformer plugs into connector J5 on the main circuit board.

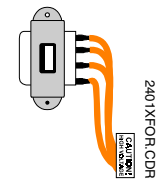

Batteries

The cabinet provides space for two 7 Amp Hour batteries which must be ordered separately.

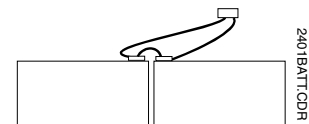

1.6 Optional Modules and Accessories

4XTMF Transmitter Module

The 4XTMF Transmitter Module provides a supervised output for local energy municipal box transmitter and alarm and trouble reverse polarity. It includes a disable switch and disable trouble LED on the module. A jumper option on the module allows the reverse polarity circuit to open with a system trouble condition if no alarm condition exists.

Remote Trouble Buzzer

One Remote Trouble Buzzer can be connected to the FACP using four wires. The remote unit includes an AC LED, System Trouble LED and piezo sounder which are controlled by the control panel. It mounts to a single-gang electrical box.

CHAPTER 2 *Installation*

2.1 Mounting Options

The cabinet may be either semi-flush or surface mounted. The door is removable during the installation period by opening and lifting the door off the hinges. The cabinet mounts using two key slots and two additional 0.250" (0.635 cm) diameter holes located in the backbox. The key slots are located at the top of the backbox and the two securing holes at the bottom.

Carefully unpack the system and check for shipping damage. Mount the cabinet in a clean, dry, vibration-free area where extreme temperatures are not encountered. The area should be readily accessible with sufficient room to easily install and maintain the panel. Locate the top of the cabinet approximately five feet above the floor with the hinge mounting on the left. Determine the number of conductors required for the devices to be installed. Sufficient knockouts are provided for wiring convenience. Select the appropriate knockout(s) and pull the required conductors into the box. Note that there are no knockouts on the left (hinged) side of the cabinet. All wiring should be in accordance with the National and/or Local codes for fire alarm systems.

FIGURE 2-1: CMP-2401B/CMP-2402B Mounting

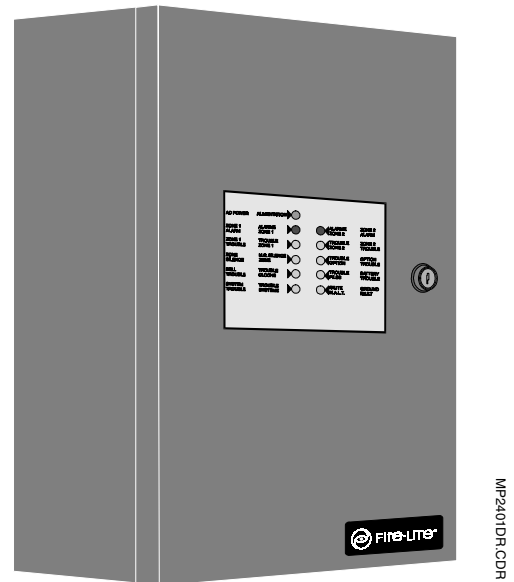

2.2 Backbox Mounting

1. Open the door.
2. Remove the main PC board assembly by unscrewing the four screws in the corners of the board. Set the board aside in a safe, clean place. Avoid static discharge which may damage the board.
3. Mark and predrill holes for the top two keyhole mounting bolts using the dimensions illustrated in Figure 2-2.
4. Install two upper fasteners in the wall with the screw heads protruding.
5. Using the upper keyholes, mount the backbox over the two screws.
6. Mark and drill the lower two holes.
7. Mount the backbox, install the remaining fasteners and tighten.
8. When the location is dry and free of construction dust, reinstall the main PC board.

Backbox Mounting

Draw wires through the respective knockout locations.

FIGURE 2-2: Cabinet Dimensions and Knockout Locations

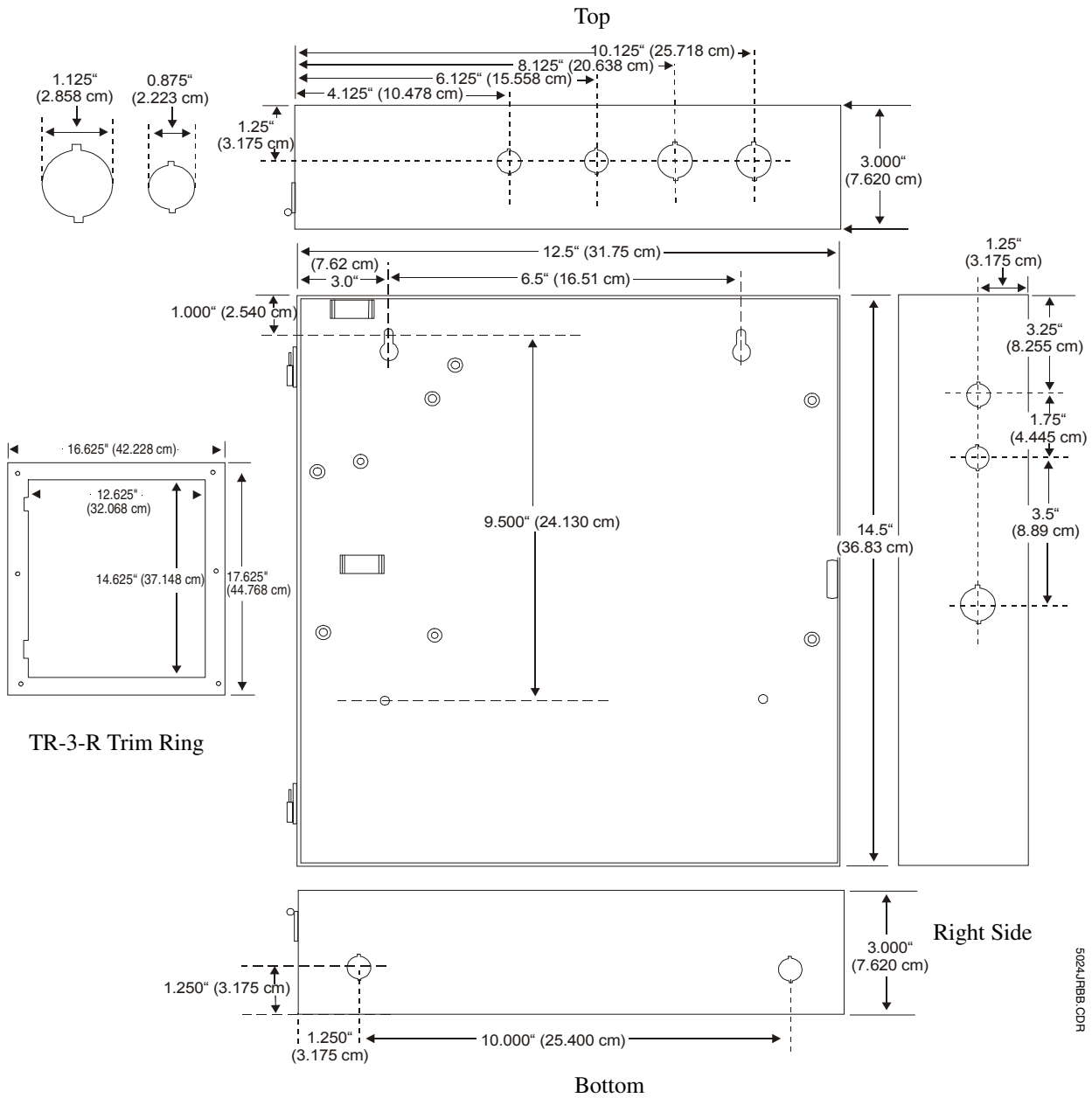

5024JF18B CDR

Backbox Mounting

FIGURE 2-3: FACP Backbox

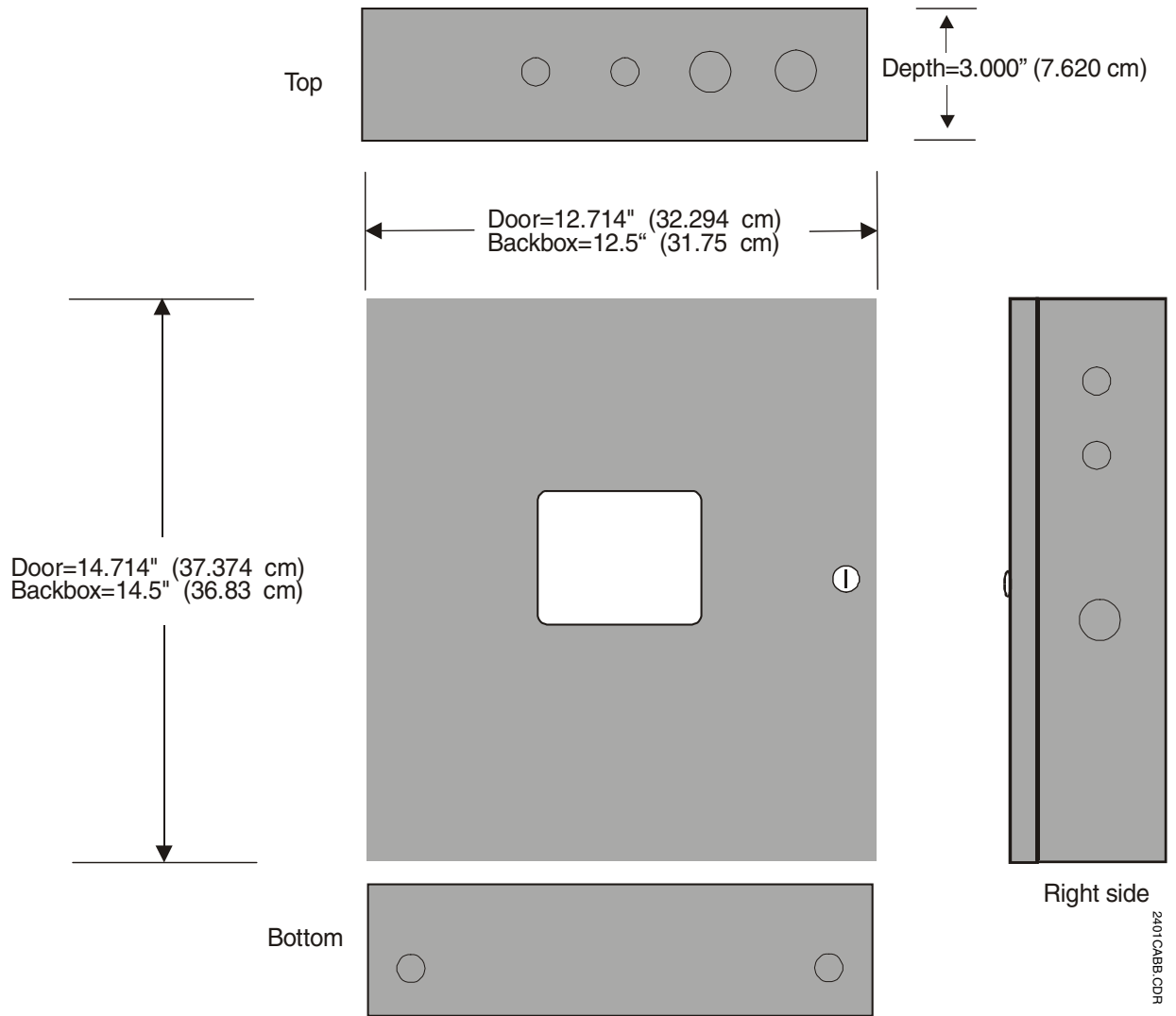

2.3 Operating Power

! WARNING: Several different sources of power can be connected to this panel. Disconnect all sources of power before servicing. The panel and associated equipment may be damaged by removing and/or inserting modules, interconnecting cables or wiring while this unit is energized.

Primary Power Source (AC) and Earth Ground Connections

AC connections are made inside the control panel cabinet. The AC input circuit is limited by fuse F2 (2 amp, 3AG Slow Blow). The primary power source for the FACP is 120 VAC, 60 Hz, 0.5 amps. Run a pair of wires (with ground conductor) from the protected premises main breaker box to TB3 of the main circuit board. As per the National and Canadian Electric Code, use 14 AWG (2.00 mm², 1.6 mm O.D.) or heavier gauge wire with 600V insulation. No other equipment may be connected to this circuit. In addition, this circuit must be provided with overcurrent protection and may not contain any power disconnect devices. A separate Earth Ground connection must be made to ensure proper panel operation and lightning and transient protection. Connect the Earth Ground wire [minimum 14 AWG (2.00 mm²)] to the grounding stud on the backbox. Do not use conduit for the Earth Ground connection since this does not provide reliable protection.

Secondary Power Source (Batteries)

Observe polarity when connecting the battery. Connect the battery cable to J3 on the main circuit board using the plug-in connector and cable provided. The battery charger is current-limited and capable of recharging sealed lead acid type batteries. The charger shuts off when the system is in alarm. See Battery Calculations for calculation of the correct battery rating.

! WARNING: Battery contains sulfuric acid which can cause severe burns to the skin and eyes and can destroy fabrics. If contact is made with sulfuric acid, immediately flush the skin or eyes with water for 15 minutes and seek immediate medical attention.

FIGURE 2-4: Operating Power Connections

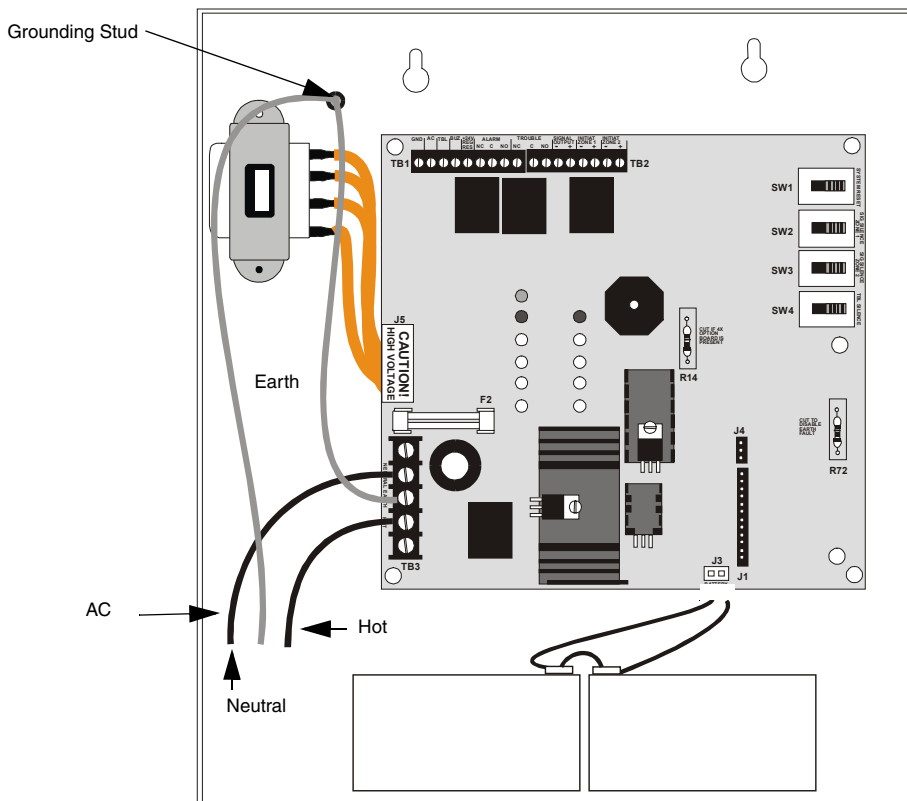

2402AOBX.CDR

2.4 Input Circuits

The CMP-2401B has one IDC (Initiating Device Circuit) and the CMP-2402B has two IDCs. The maximum total loop resistance limit for each input circuit is 200 ohms. The field wiring is supervised for opens, shorts and ground faults. All conditions are visually and audibly annunciated.

The zone(s) is a Style B (Class B) Initiating Device Circuit designed to accept any normally-open contact devices and conventional 2-wire or 4-wire, 24 VDC smoke detectors. Resettable power is provided via TB1 Terminals 24V Resettable (+) and Ground (-). Remove the End-of Line resistor from the FACP and install it on the IDC wiring after the last device in the circuit. Refer to the Fire•Lite Device Compatibility Document for a list of compatible smoke detectors.

It is allowable to mix an assortment of device types (i.e. smoke detectors, heat detectors, pull stations, etc.) on the same zone.

FIGURE 2-5: CMP-2402B Style B Initiating Device Circuit Connections

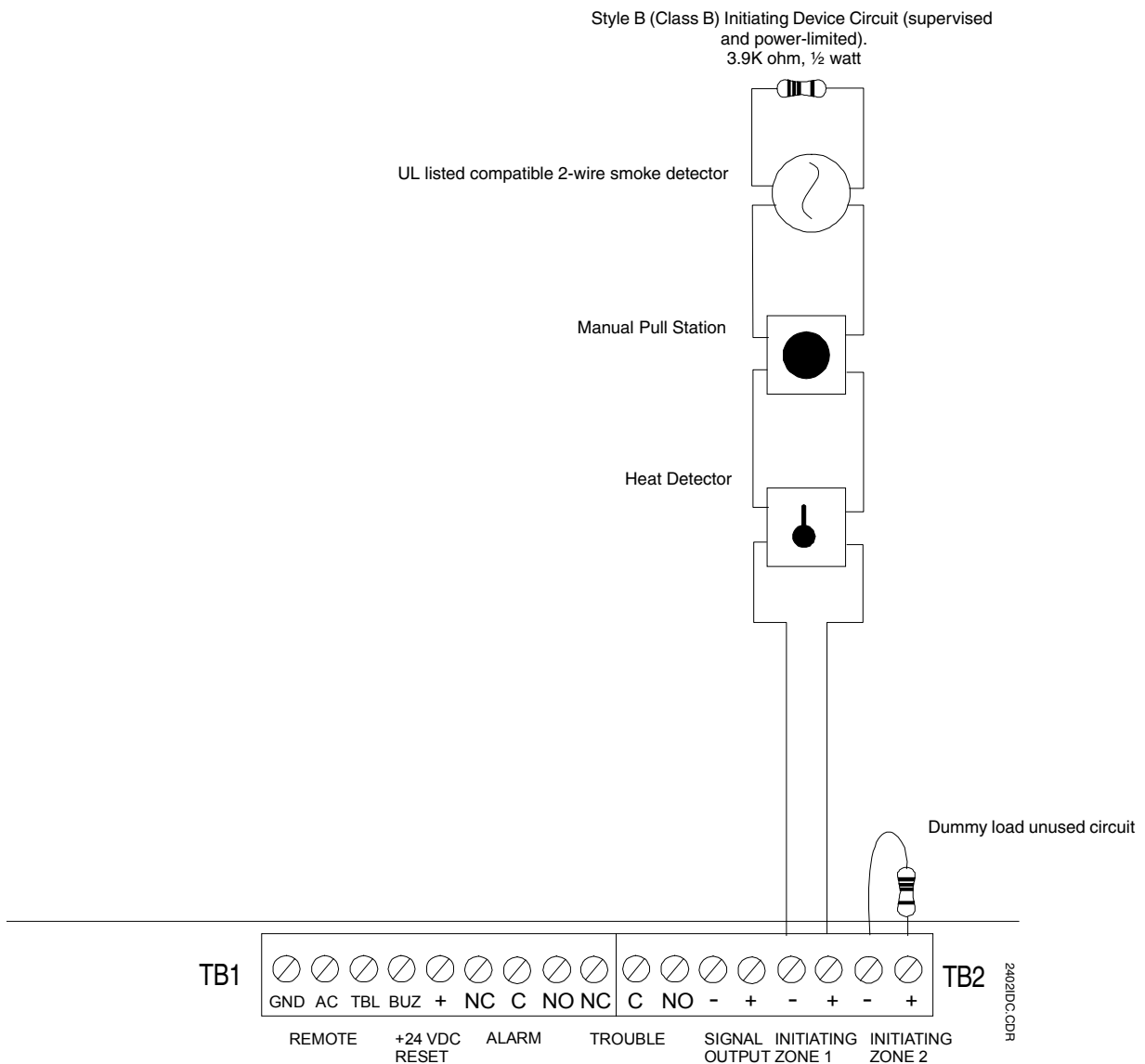

2.5 Output Circuits

DC Power Output Connections

FIGURE 2-6: Auxiliary Power Connection

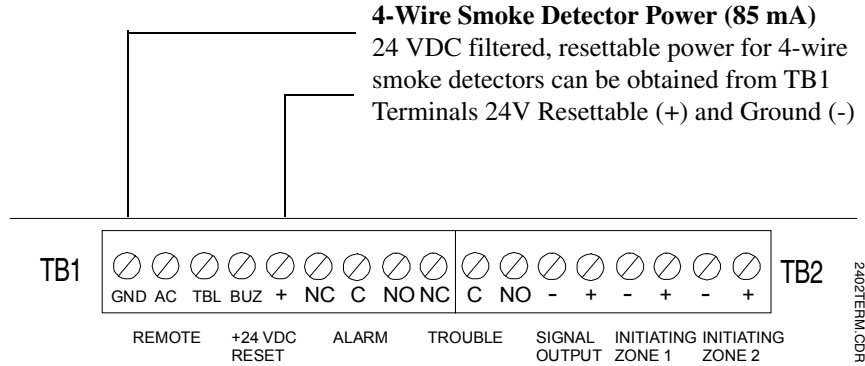

Notification Appliance Circuit

The FACP provides one supervised Notification Appliance Circuit as Style Y (Class B). The circuit is capable of 1.25 amps of current. Observe polarity when connecting polarized devices to the NAC. Remove the End-of-Line resistor from the FACP and install it on the Notification Appliance Circuit wiring after the last device. Refer to the Fire•Lite Device Compatibility Document for a listing of compatible notification appliances.

FIGURE 2-7: Notification Appliance Circuit Connections

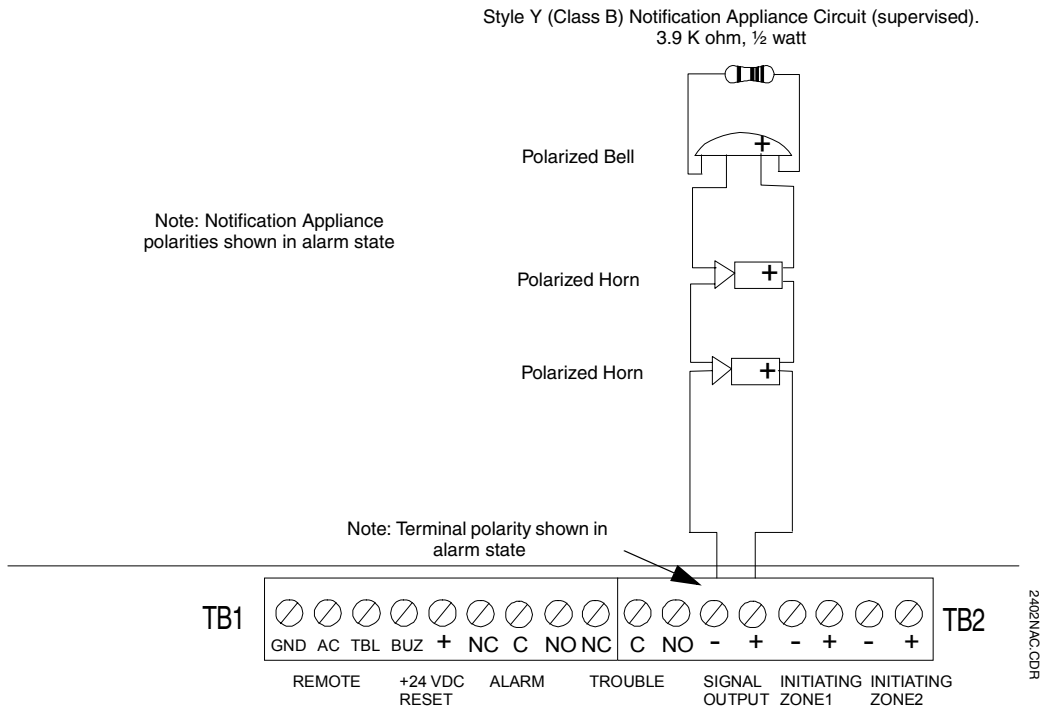

Standard Relays

The FACP provides two Form-C relays rated for 2.0 amps @ 30 VDC (resistive) and 2.0 amps @ 30 VAC (resistive).

FIGURE 2-8: Relay Terminals

Relay connections may be power-limited or nonpower-limited, provided that a minimum of 0.25" is maintained between conductors of power-limited and nonpower-limited circuits.

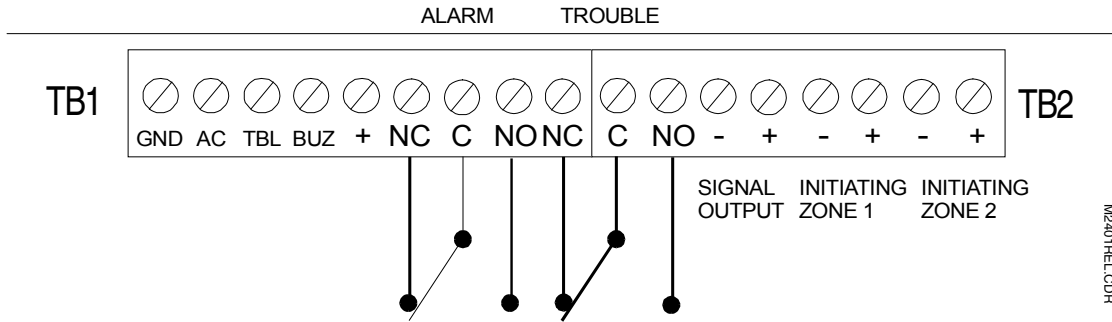

2.6 UL Power-limited Wiring Requirements

Power-limited and nonpower-limited circuit wiring must remain separated in the cabinet. All power-limited circuit wiring must remain at least 0.25" (6.35 mm) away from any nonpower-limited circuit wiring. Furthermore, all power-limited and nonpower-limited circuit wiring must enter and exit the cabinet through different knockouts and/or conduits. A typical wiring diagram for the FACP is illustrated below.

FIGURE 2-9: Typical Wiring Diagram for UL Power-limited Requirements

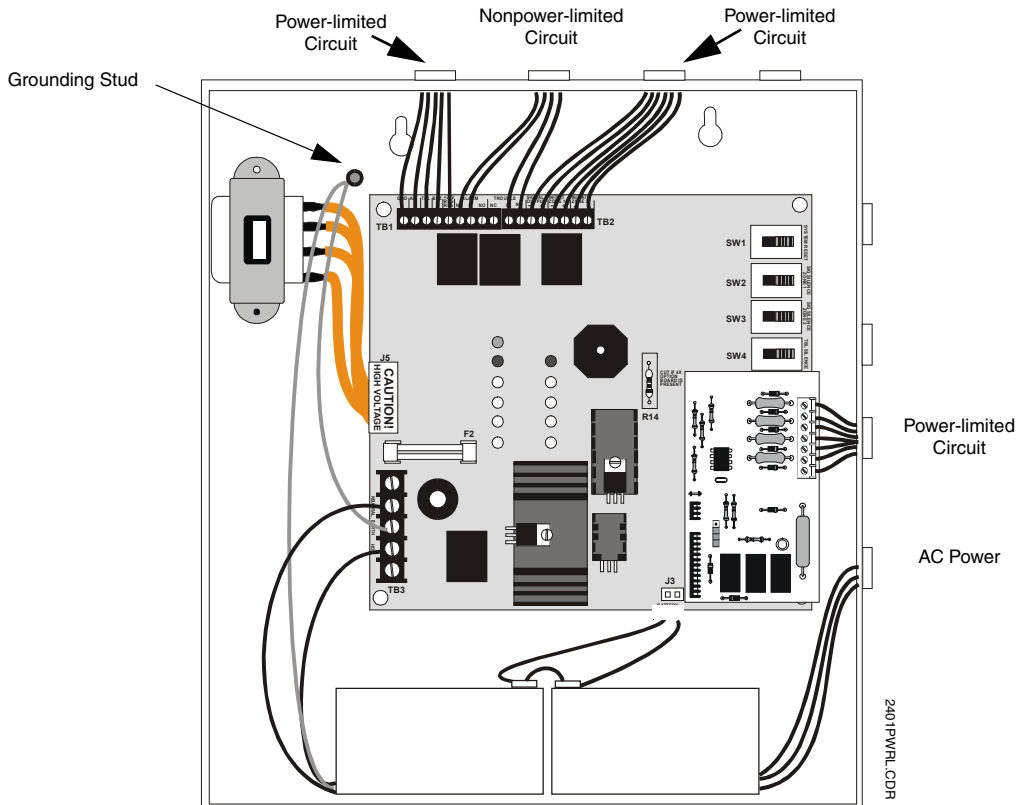

2.7.2 RTB - Remote Trouble Buzzer

The RTB is a Remote Trouble Buzzer which provides a green AC Power LED and a yellow Trouble LED along with a piezo sounder, all of which mimic the condition of the control panel. The RTB can be mounted remotely in a single-gang electrical box. Four wires are required to connect the RTB to the CMP-2401B/CMP-2402B control panel as illustrated in Figure 2-11.

FIGURE 2-11:RTB Remote Trouble Buzzer Connection

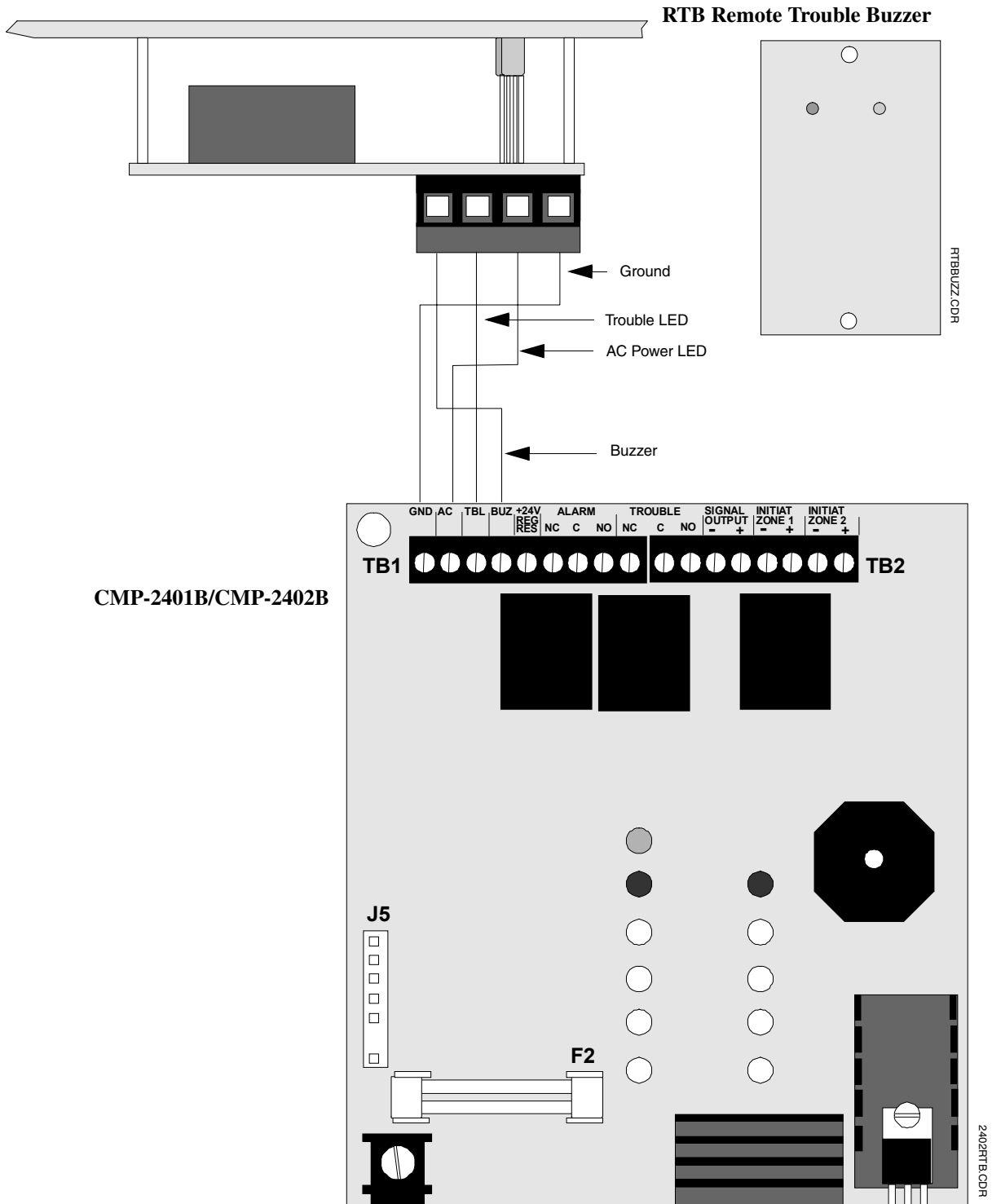

CHAPTER 3 *Programming Options*

This chapter describes the programming options available by cutting resistors on the FACP main circuit board. Options should be selected (resistors cut if necessary) prior to applying power to the control panel.

3.1 Earth Ground Fault Detection

The FACP is factory configured to automatically detect ground fault conditions. A ground fault occurs when a low resistance is detected between an FACP circuit and earth ground. This condition will cause the System Trouble LED and Ground Fault LED to turn on and the piezo sounder to pulse.

The Ground Fault Detection circuit can be disabled by cutting resistor R72 on the main circuit board. Refer to the local codes and consult the local Authority Having Jurisdiction before disabling the Ground Fault Detection circuit.

FIGURE 3-1: Ground Fault Detection Circuit

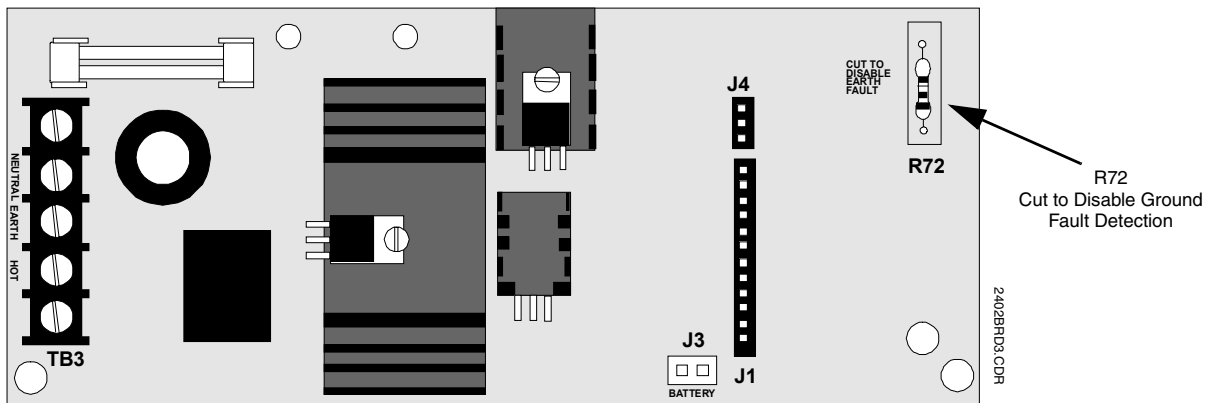

3.2 Optional 4XTMF Transmitter Module Placement Supervision

The 4XTMF module can be used to connect the FACP to a City Box or Reverse Polarity Remote Station. To supervise placement and operation of the module, cut resistor R14. Refer to the local codes and consult the local Authority Having Jurisdiction before installing the 4XTMF Transmitter Module.

FIGURE 3-2: 4XTMF Module Placement Supervision

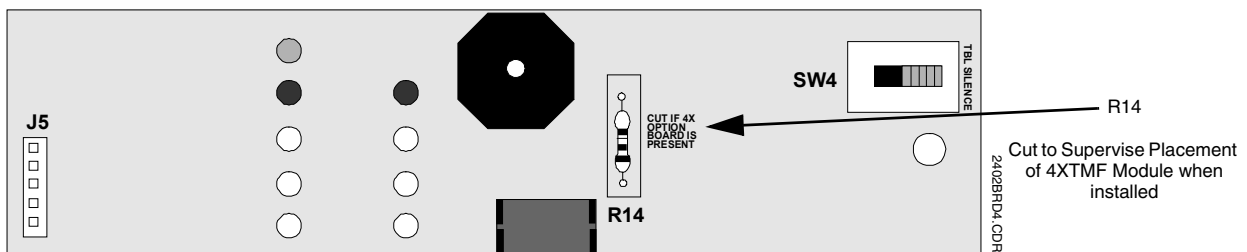

CHAPTER 4 *Periodic Testing and Maintenance*

To ensure proper and reliable operation, it is recommended that system inspection and testing be scheduled monthly or as required by national and/or local fire codes. Testing should be done by a qualified service representative if a malfunction is encountered.

Before Testing:

1. Notify the fire department and/or central alarm receiving station if an alarm condition will be transmitted.
2. Notify the facility personnel of a test so that alarm sounding devices are ignored during the test period.
3. When necessary, activation of notification appliances can be prevented by using the Signal Silence switch to silence the zone.

Testing:

1. Activate a zone via an alarm initiating device and check that active notification appliances sound and the alarm LED lights. Reset the system and repeat the procedure for each zone*.
2. Momentarily activate the following switches (one at a time) and check for a trouble signal:
 - ✓ Reset (all LEDs should illuminate for Lamp Test)
 - ✓ Signal Silence
3. Depress the Trouble Silence switch and check for an intermittent audible signal. Return the Trouble Silence switch to the normal position.
4. Momentarily open the following circuits one at a time and check for a trouble signal:
 - ✓ Notification Appliance (bell) Circuit
 - ✓ Initiating Device Circuit Zone 1
 - ✓ Initiating Device Circuit Zone 2 (CMP-2402B only)
5. If new batteries were installed, wait 48 hours before completing this step. Remove AC power, activate a zone and check that:
 - ✓ The Alarm LED lights
 - ✓ All active notification appliances soundMeasure battery voltage while the notification appliances are sounding. Replace any battery with terminal voltage less than 85% of rating. Reapply AC power and press the Reset switch*.
6. Return all switches to their normal positions. Notify the fire department, central station and/or building personnel that testing is completed.

**Note that the Reset and Signal Silence switches will not operate for one minute following activation of an alarm.*

CHAPTER 5 *Battery Calculations*

Use the Total Standby and Alarm Load Currents calculated in Table 5-2 and Table 5-3 for the following battery calculation.

TABLE 5-1: Battery Calculations

Standby Load Current (amps) []	X	Required Standby Time in Hours (24 or 60 Hours) []	=	_____
Alarm Load Current (amps) []	X	Required Alarm Time in Hours (i.e. 5 minutes = 0.084 10 minutes = 0.167) []	=	_____
Add Standby and Alarm Load for Required Ampere Hour Battery			=	
Multiply by the Derating Factor of 1.2			X1.2	
Total Ampere Hours (AH) Required			=	

Note:

1. 7 Ampere Hour battery can be located in the backbox.

5.1 The Main Power Supply

The FACP provides filtered power for operating the fire alarm control panel, external devices and the standby battery. The power for operating external devices is limited. Use Table 5-2 (standby or nonalarm) and Table 5-3 (alarm) to determine if external loading is within the capabilities of the power supply.

For 4-wire smoke detectors, be sure to power them from TB1 Terminals (+24V Resettable) and (-Ground).

TABLE 5-2: Load in Standby

Device Type	# of Devices		Current (amps)	=	Total Current (amps)
Main Circuit Board	1	X	0.075	=	0.075
4XTMF	(1 max.)	X	0.005	=	
Remote Trouble Unit	(1 max.)	X	0.020	=	
2-wire Detector Heads	[]	X	[] ¹	=	
4-wire Detector Heads	[]	X	[] ¹	=	
Power Supervision Relays ²	[]	X	[]	=	
Additional Current Draw from TB1 (nonalarm) ³				=	
Sum Column for Standby Load				=	amps

1. Refer to the Device Compatibility Document for 2-wire smoke detector standby current.
2. Must use compatible listed Power Supervision Relay.
3. The total standby current must include the resettable power from TB1. Caution must be taken to ensure that current drawn from this output during alarm does not exceed maximum ratings specified (see Table 5-3)

TABLE 5-3: Load in Alarm

Device Type	# of Devices		Current (amps)		Total Current (amps)
Main Circuit Board	1	X	0.125 ¹	=	
4XTMF	(1 max.)	X	0.045	=	
Remote Trouble Unit	(1 max.)	X	0.050	=	
4-wire Detector Heads ²	[]	X	[]	=	
Power Supervision Relays ³	[]	X	[]	=	
Notification Appliances ⁴	[]	X	[]	=	
Additional Current Draw from TB1 (nonalarm) ²				=	
Sum Column for Alarm Load				=	amps

1. The current shown represents the CMP-2401B control panel in alarm. If both zones of the CMP-2402B control panel are in alarm, the current draw increases to 0.175 amps.
2. Current limitations of terminals:
TB1, Terminals Ground and +24V Resettable = 0.085 amps, filtered, 24 VDC +/-5%, ripple @ 10mV_{RMS}.
3. Must use compatible listed Power Supervision Relay
4. Enter current draw of each device. Current limitation of TB2 Notification Appliance Circuit is 1.25 amps.

Index

Numerics

4XTMF
see Transmitter Module

A

Alarm 14

B

Backbox 19
Battery 15
 Alarm 30
 Calculations 28
 Charger 15
 see also Power - Battery
 Standby 29
 Trouble 13

C

Cabinet 15
 Dimensions 18
 Knockouts 18
 see also Backbox

D

Description 9
Discharge Protection 11
Dress Panel 15

E

Earth Ground 20
 Fault Detection 26

F

Form-C Relays
 See also Relays

G

Ground Fault
 see also Earth Ground - Fault Detection

I

Indicators 13
 AC Power 13
 Battery Trouble 13
 Bell Trouble 13
 Ground Fault 14
 Option Trouble 13
 System Trouble 14
 see also Trouble
 Zone Alarm 13
 see also Alarm
 Zone Silence 13
 Zone Trouble 13
Initiating Device Circuit
 Current
 Alarm 11
 Short Circuit 11
 Standby 11
 End-of-Line Resistor 11
 Style Y 11
 Voltage 11
Input Circuits 15, 21

L

LED
 see Indicators

M

Maintenance 27
Mounting 17

N

Notification Appliance Circuit 11, 15, 22
 Current 11
 End-of-Line Resistor 11
 Style Y 11
 Voltage 11

O

Operational Power 20
 Primary 20
 see Battery
Output Circuits 22
 Resettable Power 15
 see 'Battery' - 'Charger'

P

Piezo
 see Sounder
Power
 AC 11
 AC fuse 11
 see also Operational Power - Primary
 Battery 11
 Charger Capacity 11
 charging circuit 11
 Deep Discharge Protection 11
Programming 26

R

Relays 11, 15, 23
 Contact Rating 11
Remote Trouble Buzzer 16, 25
Resettable Power
 Current 11
 voltage 11
Resistor, End-of-Line
 Initiating Device Circuit 11
 Notification Appliance Circuit 11
RTB
 see Remote Trouble Buzzer

S

Sounder
 Alarm 14
 Trouble 14
Standby 14
Style B 9
Style Y 9
Switches 12
 Reset 12
 Signal Silence 12
 Trouble Silence 12

T

Testing 27
Transformer Assembly 15
Transmitter Module 16, 24
 Placement Supervision 26
 Trouble 14

U

UL Power-limited Wiring 23

Notes

Notes

Notes

Limited Warranty

The manufacturer warrants its products to be free from defects in materials and workmanship for eighteen (18) months from the date of manufacture, under normal use and service. Products are date-stamped at time of manufacture. The sole and exclusive obligation of the manufacturer is to repair or replace, at its option, free of charge for parts and labor, any part which is defective in materials or workmanship under normal use and service. For products not under the manufacturer's date-stamp control, the warranty is eighteen (18) months from date of original purchase by the manufacturer's distributor unless the installation instructions or catalog sets forth a shorter period, in which case the shorter period shall apply. This warranty is void if the product is altered, repaired, or serviced by anyone other than the manufacturer or its authorized distributors, or if there is a failure to maintain the products and systems in which they operate in a proper and workable manner. In case of defect, secure a Return Material Authorization form from our customer service department. Return product, transportation prepaid, to the manufacturer.

This writing constitutes the only warranty made by this manufacturer with respect to its products. The manufacturer does not represent that its products will prevent any loss by fire or otherwise, or that its products will in all cases provide the protection for which they are installed or intended. Buyer acknowledges that the manufacturer is not an insurer and assumes no risk for loss or damages or the cost of any inconvenience, transportation, damage, misuse, abuse, accident, or similar incident.

THE MANUFACTURER GIVES NO WARRANTY, EXPRESSED OR IMPLIED, OF MERCHANTABILITY, FITNESS FOR ANY PARTICULAR PURPOSE, OR OTHERWISE WHICH EXTEND BEYOND THE DESCRIPTION ON THE FACE HEREOF. UNDER NO CIRCUMSTANCES SHALL THE MANUFACTURER BE LIABLE FOR ANY LOSS OF OR DAMAGE TO PROPERTY, DIRECT, INCIDENTAL, OR CONSEQUENTIAL, ARISING OUT OF THE USE OF, OR INABILITY TO USE THE MANUFACTURER'S PRODUCTS. FURTHERMORE, THE MANUFACTURER SHALL NOT BE LIABLE FOR ANY PERSONAL INJURY OR DEATH WHICH MAY ARISE IN THE COURSE OF, OR AS A RESULT OF, PERSONAL, COMMERCIAL, OR INDUSTRIAL USE OF ITS PRODUCTS.

This warranty replaces all previous warranties and is the only warranty made by the manufacturer. No increase or alteration, written or verbal, of the obligation of this warranty is authorized.



World Headquarters

One Fire-Lite Place, Northford, CT 06472-1653 USA

203-484-7161 • Fax 203-484-7118

www.firelite.com

ISO 9001
CERTIFIED
ENGINEERING & MANUFACTURING