

# *Grizzly* *Industrial, Inc.*®

## AIR COMPRESSOR

MODEL G0471

## INSTRUCTION MANUAL



COPYRIGHT © JULY, 2005 BY GRIZZLY INDUSTRIAL, INC.

**WARNING: NO PORTION OF THIS MANUAL MAY BE REPRODUCED IN ANY SHAPE OR FORM WITHOUT THE WRITTEN APPROVAL OF GRIZZLY INDUSTRIAL, INC.**

#EW7400 PRINTED IN CHINA



# **WARNING!**

**Some dust created by power sanding, sawing, grinding, drilling, and other construction activities contains chemicals known to the State of California to cause cancer, birth defects or other reproductive harm. Some examples of these chemical are:**

- **Lead from lead-based paints.**
- **Crystalline silica from bricks, cement and other masonry products.**
- **Arsenic and chromium from chemically-treated lumber.**

**Your risk from these exposures varies, depending on how often you do this type of work. To reduce your exposure to these chemicals: Work in a well ventilated area, and work with approved safety equipment, such as those dust masks that are specially designed to filter out microscopic particles.**

# Table of Contents

<b>INTRODUCTION</b> .....	<b>2</b>
Foreword.....	2
Machine Data.....	2
Contact Info.....	2
<b>SECTION 1: SAFETY</b> .....	<b>3</b>
Safety Instructions for Pneumatic Tools.....	3
Additional Safety Instructions for Air Compressors.....	5
<b>SECTION 2: CIRCUIT REQUIREMENTS</b> .....	<b>6</b>
220V Operation.....	6
<b>SECTION 3: SET UP</b> .....	<b>8</b>
Set Up Safety.....	8
Unpacking.....	8
Items Needed For Set Up.....	8
Inventory.....	9
Assembly.....	9
Placement.....	11
<b>SECTION 4: OPERATIONS</b> .....	<b>12</b>
Operation Safety.....	12
Starting.....	12
Line Pressure Regulation.....	13
Connecting Tools.....	14
Storage.....	15
<b>SECTION 5: MAINTENANCE</b> .....	<b>16</b>
Schedule.....	16
Draining Tank.....	17
Pressure Safety Valve.....	17
Maintenance Notes.....	18
<b>SECTION 6: SERVICE</b> .....	<b>19</b>
Troubleshooting.....	19
Changing Oil.....	21
Check Valve.....	22
Fixing Air Leaks.....	22
Pressure Switch.....	23
Changing V-Belt.....	24
Service Notes.....	25
G0471 Parts Breakdown.....	26
G0471 Parts List.....	27
<b>WARRANTY AND RETURNS</b> .....	<b>28</b>

# INTRODUCTION

## Foreword

We are proud to offer the Model G0471 3 HP Air Compressor. These models are part of a growing Grizzly family of fine power tools. When used according to the guidelines set forth in this manual, you can expect years of trouble-free, enjoyable operation and proof of Grizzly's commitment to customer satisfaction.

It is our pleasure to provide this manual with your air compressor. It was written to encourage safety considerations and guide you through general operating procedures and maintenance.

The specifications, details, and photographs in this manual represent these air compressors as supplied when the manual was prepared. However, owing to Grizzly's policy of continuous improvement, changes may be made at any time with no obligation on the part of Grizzly.

## Machine Data

Motor .....	3 HP, 220V, 18A
Tank Volume .....	13.2 Gal
Maximum PSI .....	125 PSI
CFM at 40 PSI .....	6.7
CFM at 90 PSI .....	5.7
Shipping Weight .....	150 lbs.
Machine Weight.....	143 lbs.

## Contact Info

If you have any comments regarding this manual, please write to us at the following address:

Grizzly Industrial, Inc.  
C/O Technical Documentation  
P.O. Box 2069  
Bellingham, WA 98227-2069

Most importantly, we stand behind our tools. If you have any service questions or parts requests, please call or write us at the location listed below.

Grizzly Industrial, Inc.  
1203 Lycoming Mall Circle  
Muncy, PA 17756  
Phone: (570) 546-9663  
Fax: (800) 438-5901  
E-Mail: [techsupport@grizzly.com](mailto:techsupport@grizzly.com)  
Web Site: <http://www.grizzly.com>

## WARNING

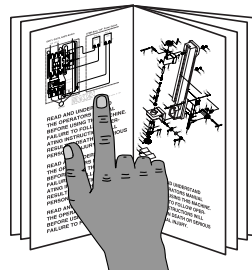

**Read the manual before operation. Become familiar with this air compressor, its safety instructions, and its operation before beginning any work. Serious personal injury may result if safety or operational information is not understood or followed.**

# SECTION 1: SAFETY

## **WARNING**

### **For Your Own Safety Read Instruction Manual Before Operating This Equipment**

The purpose of safety symbols is to attract your attention to possible hazardous conditions. This manual uses a series of symbols and signal words which are intended to convey the level of importance of the safety messages. The progression of symbols is described below. Remember that safety messages by themselves do not eliminate danger and are not a substitute for proper accident prevention measures.



Indicates an imminently hazardous situation which, if not avoided, WILL result in death or serious injury.



Indicates a potentially hazardous situation which, if not avoided, COULD result in death or serious injury.



Indicates a potentially hazardous situation which, if not avoided, MAY result in minor or moderate injury. It may also be used to alert against unsafe practices.

**NOTICE**

This symbol is used to alert the user to useful information about proper operation of the equipment.

## **WARNING**

### **Safety Instructions for Pneumatic Tools**

- 1. READ THROUGH THE ENTIRE MANUAL BEFORE STARTING MACHINERY.** Machinery presents serious injury hazards to untrained users.
- 2. ALWAYS USE ANSI APPROVED SAFETY GLASSES WHEN OPERATING MACHINERY.** Everyday eyeglasses only have impact resistant lenses, they are NOT safety glasses.
- 3. ALWAYS WEAR AN ANSI APPROVED RESPIRATOR WHEN OPERATING MACHINERY THAT PRODUCES DUST.** Wood dust is a carcinogen and can cause cancer and severe respiratory illnesses.
- 4. ALWAYS USE HEARING PROTECTION WHEN OPERATING MACHINERY.** Machinery noise can cause permanent hearing damage.
- 5. WEAR PROPER APPAREL.** DO NOT wear loose clothing, gloves, neckties, rings, or jewelry which may get caught in moving parts. Wear protective hair covering to contain long hair and wear non-slip footwear.
- 6. NEVER OPERATE MACHINERY WHEN TIRED, OR UNDER THE INFLUENCE OF DRUGS OR ALCOHOL.** Be mentally alert at all times when running machinery.

7. **KEEP CHILDREN AND VISITORS AWAY.** Keep all children and visitors a safe distance from the work area.
8. **MAKE WORKSHOP CHILD PROOF.** Use padlocks, master switches, and remove start switch keys. Shut off air supply before leaving shop.
9. **NEVER LEAVE UNATTENDED TOOL CONNECTED TO AIR.** DO NOT leave before relieving the tool of air pressure and disconnecting it from the air hose.
10. **DO NOT USE IN DANGEROUS ENVIRONMENTS.** DO NOT use in damp, wet locations, or where flammable or noxious fumes may exist.
11. **KEEP WORK AREA CLEAN AND WELL LIT.** Clutter and dark shadows may cause accidents.
12. **USE A GROUNDED EXTENSION CORD RATED FOR THE MACHINE AMPERAGE.** Undersized cords overheat and lose power. Replace extension cords if they become damaged. DO NOT use extension cords for 220V machinery.
13. **ONLY ALLOW TRAINED AND PROPERLY SUPERVISED PERSONNEL TO OPERATE MACHINERY.** Make sure operation instructions are safe and understood.
14. **MAKE SURE GUARDS ARE IN PLACE AND WORK CORRECTLY BEFORE USING MACHINERY.**
15. **CHECK FOR DAMAGED PARTS BEFORE USING MACHINERY.** Check for binding and alignment of parts, broken parts, part mounting, loose bolts, and any other conditions that may affect machine operation. Repair or replace damaged parts.
16. **REMOVE ADJUSTING KEYS AND WRENCHES.** Make a habit of checking for keys and adjusting wrenches before turning machinery **ON**.
17. **REDUCE THE RISK OF UNINTENTIONAL FIRING.** DO NOT carry tool with hand on trigger and disconnect from air when not in use.
18. **USE PROPER AIR HOSE** for the tool. Make sure your air hose is in good condition and is long enough to reach your work without stretching.
19. **DO NOT FORCE MACHINERY.** Work at the speed for which the machine or accessory was designed.
20. **DO NOT OVERREACH.** Keep proper footing and balance at all times.
21. **SECURE WORKPIECE.** Use clamps or a vise to hold the workpiece when practical. A secured workpiece protects your hands and frees both hands to operate the tool.
22. **USE SUGGESTED ACCESSORIES.** Refer to the instruction manual for recommended accessories. The use of improper accessories may cause risk of injury.
23. **MAINTAIN MACHINERY WITH CARE.** Keep tools lubricated and clean for best and safest performance. Follow instructions for lubricating and changing accessories.
24. **ALWAYS DISCONNECT FROM POWER SOURCE BEFORE SERVICING MACHINERY.** Make sure switch is in OFF position before reconnecting.
25. **DISCONNECT PNEUMATIC TOOLS FROM COMPRESSOR.** Always disconnect tools before servicing or changing accessories.
26. **BE AWARE THAT CERTAIN WOODS MAY CAUSE ALLERGIC REACTIONS IN PEOPLE AND ANIMALS, ESPECIALLY WHEN EXPOSED TO FINE DUST.** Make sure you know what type of wood dust you will be exposed to and always wear an approved respirator.

# **WARNING**

## **Additional Safety Instructions for Air Compressors**

1. **AIR NOZZLE.** Never aim an air nozzle directly at yourself or others. Compressed air can break the skin, or enter the bloodstream through soft tissue or a cut, and cause a stroke or death.
2. **AIR COMPRESSOR STORAGE.** DO NOT store the compressor while plugged into power. If a leak develops, the compressor may run continuously, causing overheating and possibly a fire.
3. **UNATTENDED TOOLS.** DO NOT leave before relieving the tool of air pressure and disconnecting it from the air hose.
4. **AVOID BURNS.** DO NOT touch the motor or the air supply pipe, they will become hot during operation.
5. **AIR HOSE.** Make sure your air hose has a PSI rating exceeding the maximum PSI of your compressor, is in good condition, and is long enough to reach your work without stretching. Make sure the air lines and power cord do not come in contact with sharp or abrasive objects.
6. **COMPRESSED AIR USE.** Do not use the compressor for filling breathing or diving tanks. Compressed air from this compressor cannot be used for pharmaceutical, food or health applications.
7. **PLASTIC (PVC) PIPE.** DO NOT use plastic pipe for high pressure air lines. It could shatter, resulting in serious injury.
8. **TANK CORROSION.** Drain the tank after each use to prevent corrosion and possible tank rupture. Inspect the tank for unsafe conditions such as rust, pin holes and cracks. NEVER weld or drill holes in an air tank.
9. **SAFETY VALVE OR PRESSURE SWITCHES.** NEVER adjust safety valve or pressure switch to allow the compressor to build higher PSI than rated. Keep safety valve free from paint and other accumulations to provide safety against over-pressure.
10. **CHECK OIL LEVEL.** Use the sight gauge on the bottom of the crankcase to make sure the oil level is at the proper height.

### **WARNING**

There is danger associated with the use of air compressors. Accidents are frequently caused by lack of familiarity or failure to pay attention. Use this air compressor with respect and caution to lessen the possibility of operator injury. If normal safety precautions are overlooked or ignored, serious personal injury may occur.

### **CAUTION**

No list of safety guidelines can be complete. Every environment is different. Always consider safety first, as it applies to your individual working conditions. Use this and other machinery with caution and respect. Failure to do so could result in serious personal injury, damage to equipment or poor work results.

# SECTION 2: CIRCUIT REQUIREMENTS

## 220V Operation

### **! WARNING**

Serious personal injury could occur if you connect the machine to the power source before you have completed the set up process. **DO NOT** connect the machine to the power source until instructed to do so.

### Amperage Draw

The 3 HP motor on the Model G0471 will draw the following amps:

G0471 Motor Draw..... 18 Amps

### Circuit Requirements

Only connect your machine to a circuit that meets the requirements below. Always check to see if the wires and circuit breaker in your circuit are capable of handling the amperage draw from your machine, as well as any other machines that could be operating on the same circuit. If you are unsure, consult a qualified electrician.

Minimum Circuit Requirement..... 20 Amp

### Plug/Receptacle Type

Plug Type ..... NEMA 6-20 (Figure 1)

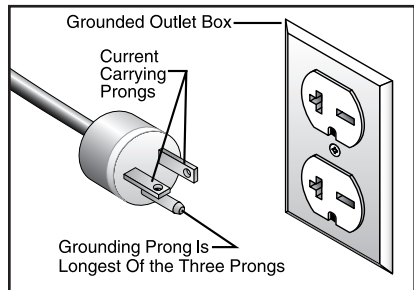
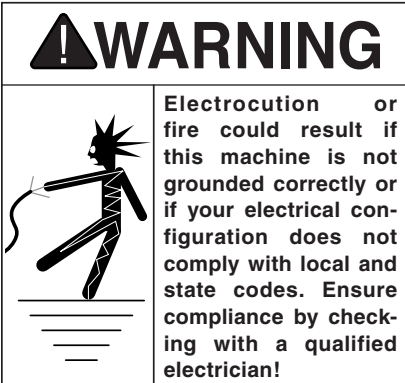

Figure 1. Typical NEMA 6-20 plug and receptacle.



## Grounding

In the event of an electrical short, grounding reduces the risk of electric shock. The grounding wire in the power cord must be properly connected to the grounding prong on the plug; likewise, the outlet must be properly installed and grounded. All electrical connections must be made in accordance with local codes and ordinances.



## Extension Cords

We do not recommend the use of extension cords on 220V equipment. Instead, arrange the placement of your equipment and the installed wiring to eliminate the need for extension cords.

If you find it absolutely necessary to use an extension cord at 220V with your machine, check with a qualified electrician for the correct sizing, type, and maximum possible length for your needs.

# SECTION 3: SET UP

## Set Up Safety

### **WARNING**

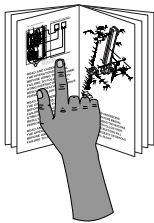

This machine presents serious injury hazards to untrained users. Read through this entire manual to become familiar with the controls and operations before starting the machine!

### **WARNING**



Wear safety glasses during the entire set up process!

### **WARNING**



The Model G0471 has a shipping weight of 150 lbs. DO NOT over-exert yourself while unpacking or moving your machine—get assistance.

## Unpacking

Your air compressor left our warehouse in a carefully packed crate or box. If you discover the air compressor is damaged after you have signed for delivery, *please immediately call Customer Service at (570) 546-9663 for advice.*

Save the container and packing materials for possible inspection by the carrier or its agent. Otherwise, filing a freight claim can be difficult.

## Items Needed For Set Up

The following items are needed to complete the set up process, but are not included with your machine:

Description	Qty
• Wrench or Socket 14mm .....	2
• Wrench or Socket 17mm .....	2

# Inventory

After you have unpacked the carton you should find the following.

## Model G0471 Inventory (Figure 2)

A. Compressor.....	1
B. Wheels .....	2
C. Handle.....	1
D. Air Filter.....	1

## Hardware (Not shown)

• Axle Bolts M10-1.5 x 50.....	2
• Lock Washers 10mm .....	2
• Hex Nuts M10-1.5.....	2
• Hex Bolts M8-1.25 x 45 .....	2
• Flat Washers 8mm.....	2
• Lock Washers 8mm .....	2
• Hex Nuts M8-1.25.....	2

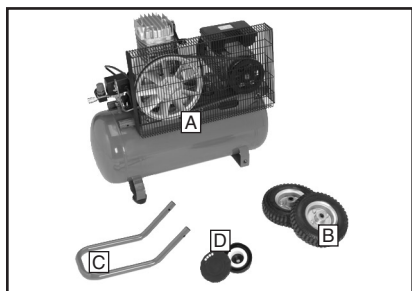

Figure 2. Model G0471 inventory.

In the event that any non proprietary parts are missing (e.g. a nut or a washer), we would be glad to replace them, or for the sake of expediency, replacements can be obtained at your local hardware store.

# Assembly

## To assemble the air compressor:

1. Remove all packing materials and any protective plastic bags, zip tie labels or tags from the compressor.
2. Insert the axle bolts into the wheels.
3. Slide the axle bolts through the struts and secure with 10mm lock washers and M10-1.5 hex nuts (see Figure 3).

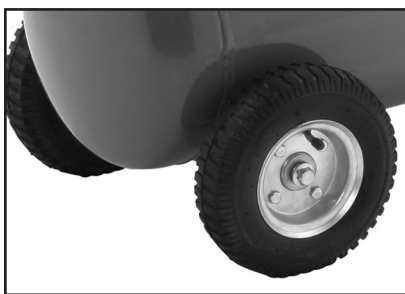

Figure 3. Wheels attached to the tank.

4. Attach the air filter to the cylinder head as shown in Figure 4.

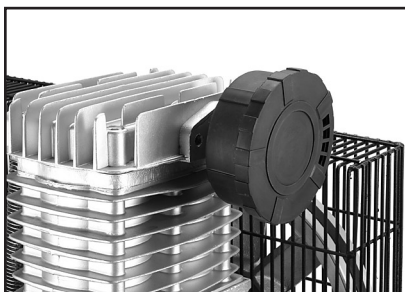
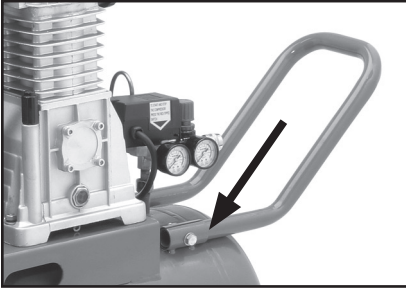

Figure 4. Air filter attached to cylinder head.

5. Slide the handle into the sockets on the tank and secure with M8-1.25 x 45 hex bolts, flat washers, lock washers, and hex nuts as shown in **Figure 5**.

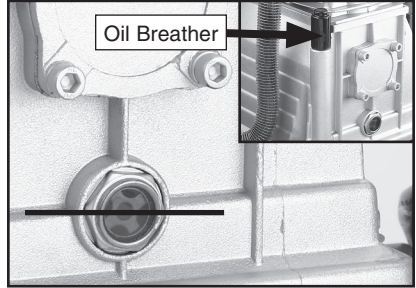

**Figure 5.** Air compressor handle.

## ***NOTICE***

Never run this compressor without a full oil reservoir. The oil provides lubrication to the cylinder rings, which deliver the compressed air. Severe damage to the internal moving parts can occur if there is not adequate oil flow. Check the oil level frequently, and change the oil every 3 months.

6. Remove the oil breather (inset in **Figure 6**) on top of the crankcase and add compressor oil, or ISO 100/SAE 30W non-detergent oil, to the crankcase. The oil level should be in the center of the sight glass as shown in **Figure 6**.



**Figure 6.** Proper oil level.

## ***NOTICE***

The oil breather releases excess pressure from the crankcase. Clogged holes in the oil breather can lead to damaged oil seals, gaskets, and may cause the compressor to seize.

# Placement

---

---

When determining where to set up the air compressor in the shop or when taking the air compressor to a job site, an important consideration is access to an adequate and properly fused power supply. Refer to **SECTION 2: CIRCUIT REQUIREMENTS** for the needs of your particular compressor.

Place the compressor on a solid and level surface. Make sure that the hoses attached to your pneumatic device are unrestricted in movement and not subject to being run over by vehicles or punctured by sharp objects.

Since air compressors are often used for a sustained period of time, sometimes in restricted areas, wear ear protection to avoid long term exposure to the noise.

Make sure the compressor is operating in an environment where there are no explosive, flammable, or caustic fumes or gases. A clear and well ventilated area is best for its safe operation.

## **WARNING**

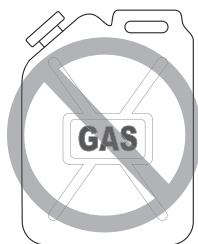

**Do not place the compressor next to flammable liquids or gas! The compressor motor and air supply pipe can reach high temperatures and cause the flammable gas to ignite. Keep work area clear from flammable gas when using the compressor.**

## **WARNING**



**Do not place the compressor in a paint spraying or gluing booth. The electric motor on the compressor could cause the fumes to explode.**

# SECTION 4: OPERATIONS

## Operation Safety

### ⚠ CAUTION



Long term exposure to this machine may cause hearing loss. To protect your hearing, always wear ANSI approved ear protection when operating this air compressor.

### ⚠ WARNING



Operating this equipment has the potential for flying debris to cause eye injury. Always wear safety glasses or goggles when operating equipment. Everyday glasses or reading glasses only have impact resistant lenses, they are not safety glasses. Be certain the safety glasses you wear meet the appropriate standards of the American National Standards Institute (ANSI).

## Starting

To start the air compressor:

1. Place the compressor on a solid, level surface with access to a properly fused power supply. DO NOT operate the compressor in an environment where there are explosive, flammable, or caustic fumes or gases.
2. Make sure the compressor switch is in the OFF position (lever with red cap shown in **Figure 7**) before connecting to the power supply.

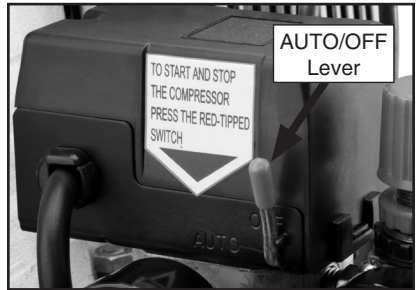
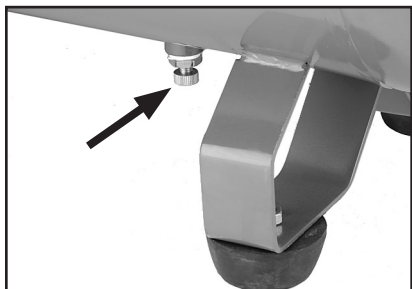

Figure 7. AUTO/OFF lever.

3. Double check the oil level to make sure the oil reservoir is full.
4. Connect the compressor to the power supply.
5. Leave the drain valve open, flip the switch to the AUTO position and allow the compressor to run for 5 minutes before completing **Step 6**.

**Note:** Whenever the compressor has not been run for more than a few days, allow it to run with the drain valve open for 5 minutes to fully lubricate the motor.

6. Close the drain valve (**Figure 8**) to allow the tank to build up pressure.



**Figure 8.** Drain valve.

7. Check the tank pressure gauge (**Figure 9**) to see that the tank pressure climbs to approximately 110-120 PSI (around 8 BAR) and turns **OFF**.

**Note:** If the compressor does not turn **OFF** before reaching 120 PSI, flip the **AUTO/OFF** switch to **OFF** before the pressure reaches 125 PSI. See **Pressure Switch on Page 23** to adjust the automatic shut-off.

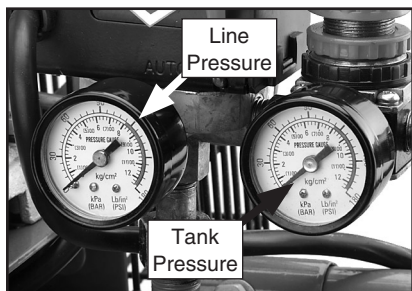

**Figure 9.** G0471 Pressure gauges.

## Line Pressure Regulation

The air tool that you attach to the air compressor should have a preferred PSI operating level. Set the pressure to be delivered according to the pressure required by the tool.

**To control the air supply to your tool:**

1. Adjust the air control knob, shown in **Figure 10**, to set the PSI that will be delivered to your tool. Turn the knob clockwise to increase the pressure or counterclockwise to decrease the pressure.

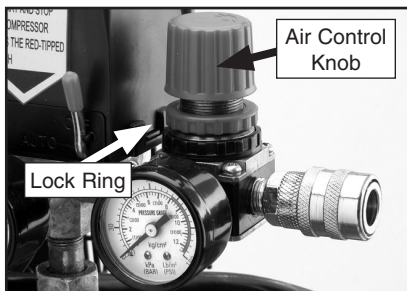

**Figure 10.** Tool air control knob.

2. Rotate the lock ring shown in **Figure 10** against the bottom of the air control knob to prevent changes in the air pressure.

# Connecting Tools

When choosing air tools, consider the amount of air used (cubic feet per minute or CFM) by the tool. Nailers and staple guns have a low CFM requirement because they use air in short bursts. A paint sprayer or a pneumatic grinder uses a more continuous stream of air requiring a high CFM. Make sure the air tool you plan to connect does not exceed the CFM output of your compressor. Most air tools will have an air requirement stated in terms of a specific CFM at a specific pressure.

Air tools being operated with insufficient air volume will not perform their function satisfactorily and they will cause the air compressor to run continually. When an air compressor runs continually it may overheat, causing damage to the compressor and the possibility of a fire. This compressor is fitted with thermal protection inside the motor. If the compressor overheats, the motor will automatically turn **OFF** until it cools down.

## To connect air tools to your air compressor:

1. Follow the compressor **Starting** instructions on **Page 12**.
2. Connect the tool to a good quality air hose that is long enough to reach from the point of use to the compressor.

**Note:** *Be aware of the placement of the hose to prevent damage. Make certain the air hose is not located where it can become constricted, cut by a sharp object, or run over. Running over a hose with a vehicle may not cause an immediate leak, but it will shorten the life of the hose.*

3. Connect an air line with a 1/4" NPT plug to the quick-connect coupler on the air compressor shown in **Figure 11**.

**Note:** *There are many styles of 1/4" NPT quick connect couplers. If the quick connect coupler included with the compressor does not fit the plug on your air hose, purchase a matched set at your local hardware store.*



**Figure 11.** Quick connect coupler.

## **!WARNING**

**These air compressors are specifically designed for air tool operation. DO NOT modify, or use this machine for any other purpose. Modifications or improper use of this tool will void the warranty. If you are confused about any aspect of this machine, DO NOT use it until your questions have been answered. Serious personal injury may occur.**



# Storage

---

---

When storing your air compressor, follow these guidelines:

1. Turn the compressor switch lever to OFF.
2. Unplug the compressor.
3. Turn the regulator counterclockwise to set the line pressure to zero.
4. Run the air tool to relieve the air pressure in the hose, then remove the air hose and the tool.
5. Drain water from the tank as instructed in **Draining Tank** on **Page 17**. Leave the valve open until the next usage.

**Note:** *Draining the air from the tank will be extremely loud. Wear ear protection when draining the tank.*

6. Store the air compressor in its normal operating position in a cool protected area.

## CAUTION

Failure to unplug the air compressor before storage may result in the compressor running continuously, causing overheating, damage to the compressor, and possibly a fire.

## WARNING

Water will condense in the air compressor tank. Water left in the tank can cause the tank to weaken and corrode, increasing the risk of tank rupture.

## WARNING

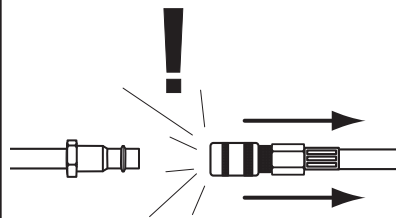

Always disconnect the air hose from tools whenever not in use or while servicing! During maintenance, a tool connected to air may operate accidentally, causing serious personal injury!

# SECTION 5: MAINTENANCE

## Schedule

### **WARNING**

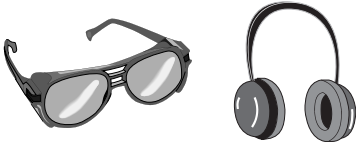

Operating this equipment has the potential to cause eye injury and hearing loss. Always wear eye and ear protection when operating an air compressor. Be certain the safety protection you wear meets the appropriate standards of the American National Standards Institute (ANSI).

For optimum performance from your machine, follow this maintenance schedule and refer to any specific instructions given in this section.

### Daily

1. Check the oil level! Use the sight glass on the crankcase to make sure the oil reservoir is at the correct level.
2. Check for worn or damaged cords and plugs.
3. Check for any other condition that could hamper the safe operation of this air compressor.
4. When finished using the air compressor, drain the condensation from the tank as instructed in **Draining Tank** on **Page 17**, and leave the drain valve open until the next use.

If the compressor is used on a daily basis, perform the following checks each week.

### Weekly

1. Blow dirt and dust off of the air filter (**Figure 12**), then re-install.



**Figure 12.** Air filter foam element.

2. Check for loose bolts or fittings.
3. Clean off all dirt and dust from the cylinder head, motor, fan, air lines, exhaust pipe, couplers and frame. Dirt can lead to overheating.
4. Check air lines and connectors to make sure they are in good condition.
5. Pull the safety drain valve to make sure it is working properly (see **Draining Tank** on **Page 17**).

*Continued on next page* →

### **WARNING**

The air compressor will turn **ON** automatically when it is set on **AUTO**. When performing maintenance make sure the **AUTO/OFF** lever is in the **OFF** position, the compressor is unplugged, and the air pressure has been bled out of the tank.

## Monthly

After the first 50 working hours or 30 days, perform the following maintenance:

1. Change the oil in the air compressor pump as described in **Changing Oil** on **Page 21**.

## Quarterly

After every 300 working hours or 3 months, perform the following maintenance:

1. Change the oil in the air compressor pump as described in **Changing Oil** on **Page 21**.
2. Check for air leaks and correct as needed.

# Draining Tank

Some water may accumulate in the tank depending on usage and humidity. Drain water from the tank daily to increase the lifespan of the compressor and air tools.

### To drain the tank:

1. Leave the tank pressurized and open the drain valve, shown in **Figure 13**, to drain the water out of the tank.

**Note:** *Draining the air from the tank will be extremely loud. Wear ear protection when draining the tank.*

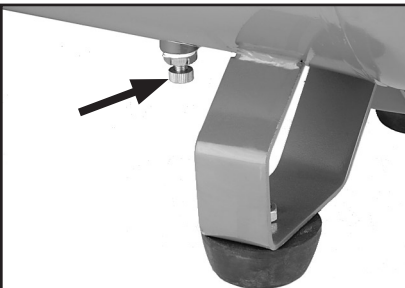

**Figure 13.** Tank drain valve.

# Pressure Safety Valve

The pressure safety valve prevents damage to the tank by releasing pressure when the tank reaches maximum capacity.

### To check the pressure safety valve:

1. Locate the pressure safety valve shown in **Figure 14**.

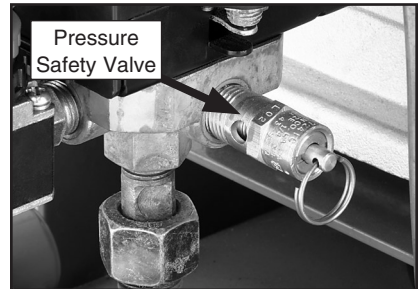

**Figure 14.** Pressure safety valve.

## CAUTION

Releasing the safety valve will be extremely loud. Protect your hearing with ANSI approved ear protection.

2. Clean any dirt or dust from the pressure safety valve.
3. Pull the metal ring on top of the safety valve to ensure the valve will release air. The pressure safety valve must be replaced if it cannot be pulled, or if it leaks after releasing pressure.

**Note:** *The safety valve is preset to release air if the tank exceeds its maximum pressure. DO NOT try to adjust the safety valve pressure setting!*



# SECTION 6: SERVICE

This section is provided for your convenience—it is not a substitute for the Grizzly Service Department. If you need help troubleshooting, replacing parts, or you are unsure of how to perform the procedures in this section, then feel free to call our Technical Support at (570) 546-9663.

## Troubleshooting

Symptom	Possible Cause	Possible Solution
Motor will not start.	<ol style="list-style-type: none"><li>1. Tank already pressurized.</li><li>2. Thermal overload switch has tripped.</li><li>3. Low voltage.</li><li>4. Short circuit in motor or cord, or loose connections.</li><li>5. Incorrect fuses or circuit breakers in power line.</li><li>6. Pressure switch is bad.</li></ol>	<ol style="list-style-type: none"><li>1. Motor will not start if tank is fully pressurized.</li><li>2. Wait for motor to cool.</li><li>3. Check power line for proper voltage.</li><li>4. Inspect all connections on motor for loose or shorted terminals or worn insulation.</li><li>5. Install correct fuses or circuit breakers.</li><li>6. Replace the pressure switch.</li></ol>
Motor fails to develop full power (output of motor decreases rapidly with decrease in voltage at motor terminals).	<ol style="list-style-type: none"><li>1. Power line overloaded with lights, appliances, and other motors.</li><li>2. Undersized wires or circuits too long.</li></ol>	<ol style="list-style-type: none"><li>1. Reduce load on power line.</li><li>2. Increase wire sizes or reduce length of the circuit.</li></ol>
Motor overheats and thermal overload turns motor <b>OFF</b> .	<ol style="list-style-type: none"><li>1. Cooling fins dirty.</li><li>2. Air filter clogged.</li><li>3. Compressor is running too long without a break.</li><li>4. Air circulation through the motor restricted.</li></ol>	<ol style="list-style-type: none"><li>1. Clean cylinder fins and motor area.</li><li>2. Inspect and clean air filter.</li><li>3. Do not use air tools with CFM needs that exceed the compressor CFM rating.</li><li>4. Clean out motor to provide normal air circulation.</li></ol>

Symptom	Possible Cause	Possible Solution
Loud repetitious noise coming from air compressor.	<ol style="list-style-type: none"> <li>1. Pulley setscrews or keys are missing or loose.</li> <li>2. Motor fan is hitting the cover.</li> </ol>	<ol style="list-style-type: none"> <li>1. Inspect keys and setscrews. Replace or tighten if necessary.</li> <li>2. Adjust fan cover mounting position, tighten fan, or shim fan cover.</li> </ol>
Low pressure at the tool.	<ol style="list-style-type: none"> <li>1. Pressure regulator.</li> <li>2. Air leaks in hoses.</li> <li>3. Pressure gauge bad.</li> <li>4. Pressure switch turns the motor <b>OFF</b> too soon.</li> </ol>	<ol style="list-style-type: none"> <li>1. Adjust pressure regulator, if no improvement, inspect regulator for leaks or replace.</li> <li>2. Check air hoses and all connections for leaks (see <b>Page 22</b>).</li> <li>3. Replace the pressure gauge.</li> <li>4. Adjust the pressure switch (see <b>Page 23</b>)</li> </ol>
Low pressure at the tanks, or tank pressure drops after compressor is turned <b>OFF</b> .	<ol style="list-style-type: none"> <li>1. Air leaks in tanks or delivery pipes.</li> <li>2. Drain valve open.</li> <li>3. Air filter clogged.</li> <li>4. Leaking check valve.</li> <li>5. Pressure relief valve releasing below 120 PSI.</li> <li>6. Gaskets leaking.</li> <li>7. Worn rings.</li> <li>8. Pressure switch turns the motor <b>OFF</b> too soon.</li> </ol>	<ol style="list-style-type: none"> <li>1. Check air tanks, pipes and all connections for leaks (see <b>Page 22</b>).</li> <li>2. Close drain valve.</li> <li>3. Inspect and clean air filter.</li> <li>4. Repair the check valve (see <b>Page 22</b>).</li> <li>5. Replace pressure relief valve.</li> <li>6. Check gaskets on cylinder head assembly, repair or replace as needed.</li> <li>7. Inspect and replace pump piston rings.</li> <li>8. Adjust the pressure switch (see <b>Page 23</b>).</li> </ol>
Compressor knocking.	<ol style="list-style-type: none"> <li>1. Improper oil level.</li> <li>2. Air filter clogged.</li> <li>3. Piston assembly loose.</li> </ol>	<ol style="list-style-type: none"> <li>1. Check oil level and add oil (see <b>Page 10</b>).</li> <li>2. Inspect and clean air filter.</li> <li>3. Inspect and repair piston and connecting rod.</li> </ol>
Pressure relief valve stays open and motor won't stop running.	<ol style="list-style-type: none"> <li>1. Pressure switch adjusted too high.</li> <li>2. Faulty pressure switch, unit is trying to overpressure the tank.</li> <li>3. Faulty pressure relief valve.</li> </ol>	<ol style="list-style-type: none"> <li>1. Adjust the pressure switch (see <b>Page 23</b>)</li> <li>2. Turn compressor <b>OFF</b>, unplug from power supply, and empty tank. <b>DO NOT USE</b> until switch is replaced.</li> <li>3. Relief valve is relieving pressure too early. Replace pressure relief valve.</li> </ol>

Symptom	Possible Cause	Possible Solution
Air leaks from pressure switch.	1. Faulty check valve. 2. Faulty pressure switch.	1. Repair the check valve (see <b>Page 22</b> ). 2. Replace pressure switch.
Air is dirty or has excessive moisture.	1. Tank is not drained. 2. Delivery pipes are dirty.	1. Open drain valve and make certain all the water is drained out. 2. Remove delivery pipes, clean out and replace.

## Changing Oil

Change the oil in the air compressor pump after the initial 50 hours, or 30 days of use; and every 300 hours, or 3 months after the first oil change. Use compressor oil or ISO 100/SAE 30W, non-detergent type oil.

### To change the oil:

1. **Unplug the air compressor and drain all the air from the tank.**
2. Place a container on the floor to catch the oil, then tip the compressor so the cap screw shown in **Figure 15** is over the container.

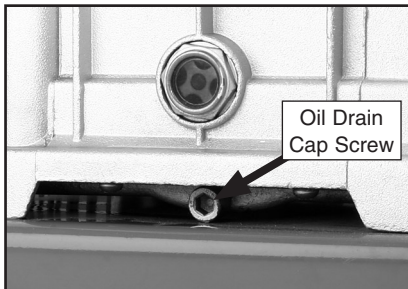

**Figure 15.** Oil drain cap screw.

3. Use a hex wrench to remove the oil drain cap screw shown in **Figure 15**.
4. Drain all of the oil from the crank case then tip the compressor upright.

5. Replace the oil drain cap screw and remove the oil breather fill plug shown in **Figure 16**.

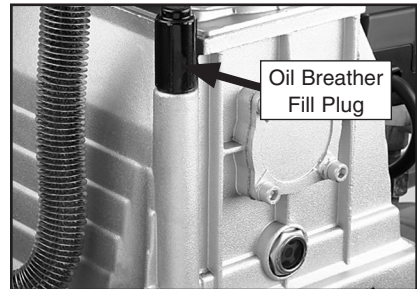

**Figure 16.** Oil breather fill plug.

6. Fill the crank case with oil until the oil level is in the center of the sight glass, then replace the oil breather fill plug.

# Check Valve

The diaphragm and O-ring in the check valve can become damaged, twisted, or dirty and cause the check valve or pressure switch to leak air.

**To fix the check valve:**

1. **Unplug the air compressor and drain all the air from the tank.**
2. Remove the cap from the check valve shown in **Figure 17**.



**Figure 17.** Check valve.

3. Inspect the O-ring and diaphragm (**Figure 18**) for damage and dirt.

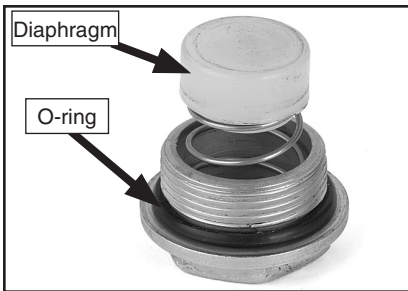

**Figure 18.** Check valve diaphragm and spring.

4. Clean dirt off of the diaphragm and O-ring and replace any damaged parts.
5. Re-assemble the check valve. Make sure the diaphragm presses squarely against the air supply tube opening.

# Fixing Air Leaks

Air leaks will cause low air output and increase the time the compressor must run.

**To find air leaks:**

1. Turn the compressor **OFF** when the tank is fully pressurized and unplug the compressor.
2. Listen for the sound of air to find fittings that may be leaking.
3. Spray the suspected air leak with a soap and water solution. If you see air bubbles, you have found your leak.

**To fix air leaking around fitting threads:**

1. **Unplug the air compressor and drain all the air from the tank.**
2. Unscrew the fitting that is leaking. Clean and wrap teflon tape and/or spread pipe dope on the threads.
3. Re-install the fitting to the compressor.

**To fix air leaking through a valve:**

1. **Unplug the air compressor and drain all the air from the tank.**
2. Remove the valve, clean it thoroughly, then re-install with teflon tape and/or pipe dope.
3. If the valve continues to leak, replace it with a new valve.



# Pressure Switch

The pressure switch has been factory set for the highest PSI that is safe for this compressor.

The pressure switch ensures the compressor will shut **OFF** when the air tank reaches maximum PSI.

## NOTICE

This air compressor has been factory set to turn **ON** and **OFF** at the proper PSI range. Only attempt to adjust the pressure regulator if your air compressor does not reach, or pressurizes beyond the proper PSI level.

### To adjust the pressure switch:

1. **Unplug the air compressor from the power supply.**
2. Make sure the compressor switch is in the OFF position.
3. Drain the pressure from the tank.
4. Remove the black AUTO/OFF switch cover (**Figure 19**) by removing the screw in the recess of the cover. Pull the black cover up and set it aside.

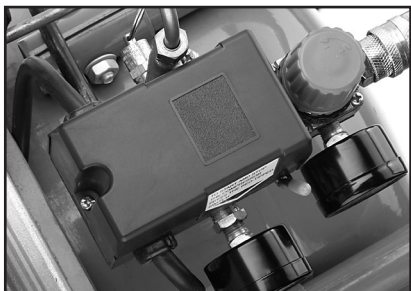

**Figure 19.** Pressure switch cover.

5. Turn the black plastic pressure adjustment screw (**Figure 20**) a half turn clockwise to increase the maximum tank pressure and a half turn counter-clockwise to decrease the pressure.

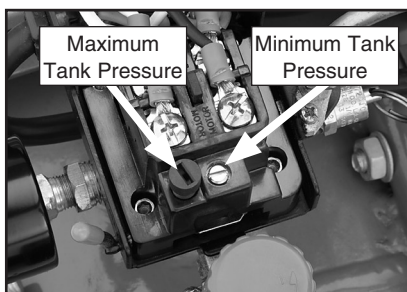

**Figure 20.** Pressure adjustment screws.

6. Adjust the metal pressure adjustment screw to change how low the pressure can drop before the motor turns **ON**.
7. Connect the compressor to the power supply and start the compressor. If the compressor does not automatically turn **OFF** at 120 PSI, flip the ON/OFF switch to OFF before the pressure reaches 125 PSI.
8. If the PSI level still needs adjustment, repeat **Steps 1–7**.
9. Replace the cover when the proper adjustments have been completed.

# Changing V-Belt

**To change the V-belt drive on your air compressor:**

1. Remove the belt guard. The guard is attached to the compressor frame by the mounting bolts shown in **Figure 21**.

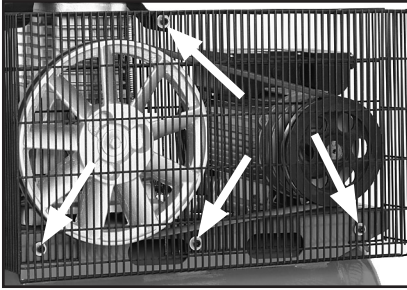

**Figure 21.** Belt guard mounting bolts.

2. Loosen the four nuts (one side shown in **Figure 22**) that secure the motor to the compressor frame so the motor can slide towards crankcase, relieving the tension on the V-belt.

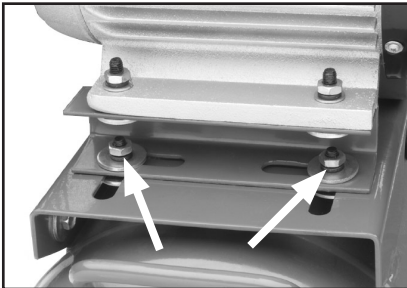

**Figure 22.** Motor mounting bolts.

3. Remove the V-belt from the motor pulley and fly pulley.
4. Install the new V-belt.
5. Reposition the motor to tension the belt and secure the mounting bolts loosened in **step 2**.

**Note:** A properly tensioned V-belt will have about a  $\frac{1}{2}$ " deflection as shown in **Figure 23**.

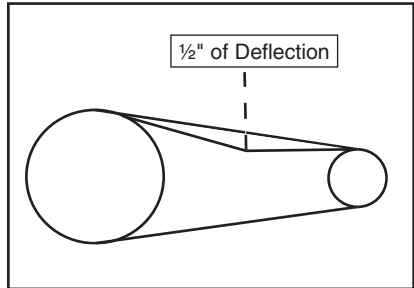

**Figure 23.** V-belt deflection.

6. Replace belt guard.

## **!WARNING**

Make sure the V-belt is properly tensioned. If the V-belt is too tight, the motor could overheat and cause machine damage or fire. If the V-belt is too loose, the belt will slip on the pulley and cause belt damage and compressor inefficiency.

# **Service Notes**

---

---

# G0471 Parts Breakdown

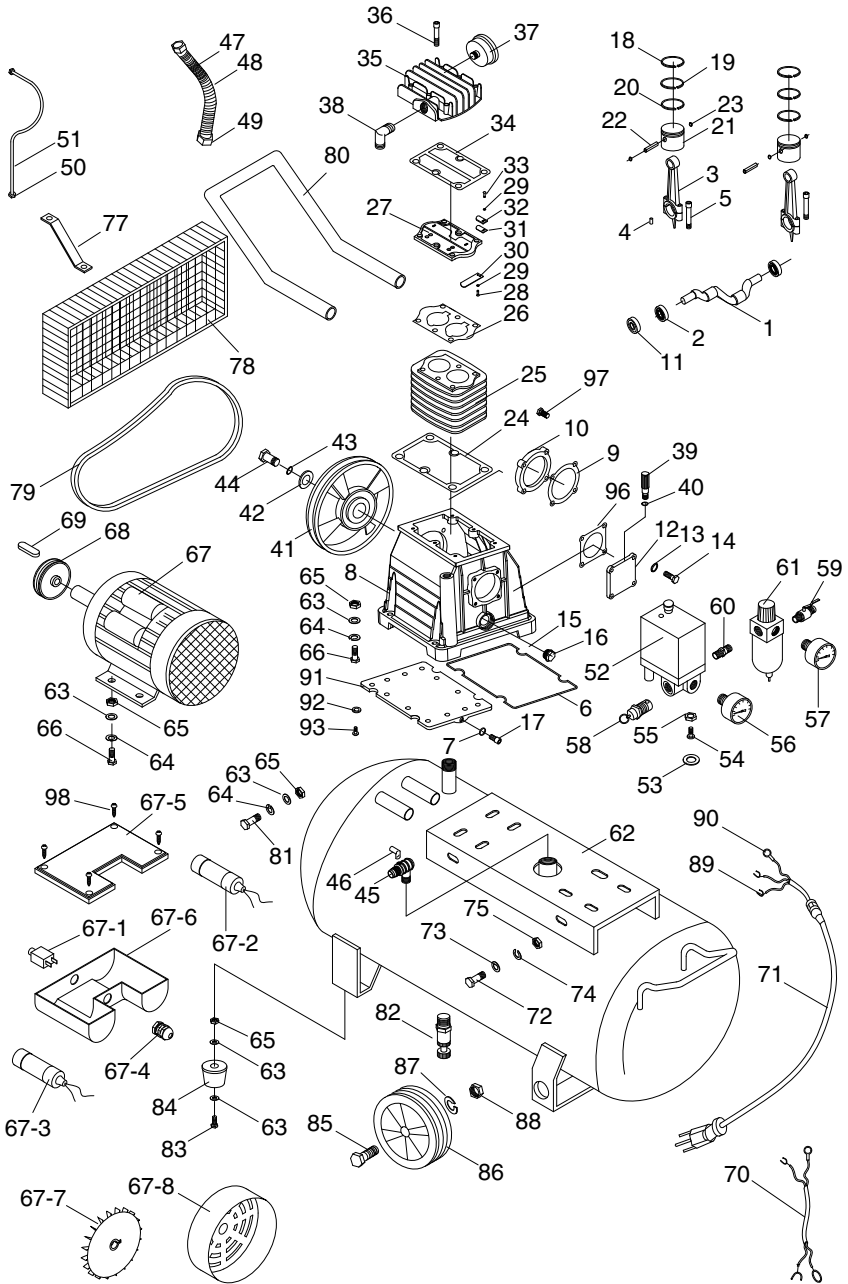

# G0471 Parts List

REF	PART #	DESCRIPTION
1	P0471001	CRANKSHAFT
2	P6205	BALL BEARING 6205
3	P0471003	CONNECTING ROD
4	P0471004	POSITION PIN
5	PSB12M	CAP SCREW M8-1.25 X 40
6	P0471006	LOWER CRANKCASE GASKET
7	P0471007	O-RING
8	P0471008	CRANKCASE
9	P0471009	FRONT COVER GASKET
10	P0471010	FRONT COVER
11	P0471011	OIL SEAL
12	P0471012	BACK COVER
13	PLW03M	LOCK WASHER 6MM
14	PB08M	HEX BOLT M6-1 X 20
15	P0471015	OIL SIGHT SEAL
16	P0471016	OIL SIGHT
17	PSB52M	CAP SCREW M8-1.25 X 10
18	P0471018	COMPRESSION RING
19	P0471019	COMPRESSION RING
20	P0471020	OIL RING
21	P0471021	PISTON
22	P0471022	PISTON PIN
23	PR05M	EXT RETAINING RING 15MM
24	P0471024	LOWER GASKET
25	P0471025	CYLINDER
26	P0471026	UPPER GASKET
27	P0471027	VALVE PLATE
28	PS55M	PHLP HD SCR M3-.5 X 10
29	PLW09M	LOCK WASHER 3MM
30	P0471030	INLET VALVE
31	P0471031	OUTLET VALVE
32	P0471032	LIMITATION
33	PS50M	PHLP HD SCR M3-.5 X 12
34	P0471034	HEAD GASKET
35	P0471035	CYLINDER HEAD
36	PSB45M	CAP SCREW M8-1.25 X 45
37	P0471037	AIR FILTER ASSEMBLY
38	P0471038	EXHAUST ELBOW
39	P0471039	OIL FILL CAP
40	P0471040	O-RING
41	P0471041	FLYWHEEL
42	PW01M	FLAT WASHER 8MM
43	PLW04M	LOCK WASHER 8MM
44	PB20M	HEX BOLT M8-1.25 X 35
45	P0471045	CHECK VALVE
46	P0471046	ELBOW
47	P0471047	OUTLET TUBE
48	P0471048	FIN TUBING
49	P0471049	COMPRESSION NUT
50	P0471050	COMPRESSION NUT
51	P0471051	RELIEF TUBE
52	P0471052	PRESSURE SWITCH

REF	PART #	DESCRIPTION
53	P0471053	SPECIAL WASHER
54	P0471054	CONNECT
55	P0471055	COMPRESSION NUT
56	P0471056	PRESSURE GAUGE
57	P0471057	PRESSURE GAUGE
58	P0471058	SAFETY VALVE
59	P0471059	AIR COCK
60	P0471060	CONNECTOR
61	P0471061	REGULATOR
62	P0471062	TANK 13.2 GAL
63	PW01M	FLAT WASHER 8MM
64	PLW04M	LOCK WASHER 8MM
65	PN03M	HEX NUT M8-1.25
66	PB26M	HEX BOLT M8-1.25 X 30
67	P0471067	MOTOR
67-1	P0471067-1	RESET BUTTON
67-2	PC040C	CAPACITOR 40 MFD 450 VAC
67-3	PC200A	CAPACITOR 200 MFD 250 VAC
67-4	P0471067-4	STRAIN RELIEF
67-5	P0471067-5	CAPACITOR BOX COVER
67-6	P0471067-6	CAPACITOR BOX
67-7	P0471094	FAN
67-8	P0471095	FAN COVER
68	P0471068	PULLEY
69	PK07M	KEY 6 X 6 X 20
70	P0471070	MOTOR POWER CORD
71	P0471071	POWER CORD
72	PB08M	HEX BOLT M6-1 X 20
73	PW03M	FLAT WASHER 6MM
74	PLW03M	LOCK WASHER 6MM
75	PN01M	HEX NUT M6-1
77	P0471077	SUPPORT BRACKET
78	P0471078	SAFETY GUARD
79	P0471079	V-BELT A-34 4L340
80	P0471080	HANDLE
81	PB118M	HEX BOLT M8-1.25 X 45
82	P0471082	DRAIN VALVE
83	PB09M	HEX BOLT M8-1.25 X 20
84	P0471084	RUBBER FOOT
85	P0471085	AXLE BOLT M10-1.5 X 50
86	P0471086	PNEUMATIC TIRE 8"
87	PLW06M	LOCK WASHER 10MM
88	PN02M	HEX NUT M10-1.5
89	P0471089	CABLE CONNECTOR (U)
90	P0471090	CABLE CONNECTOR (O)
91	P0471091	CRANKCASE BOTTOM PLATE
92	PW05M	FLAT WASHER 4MM
93	PS07M	PHLP HD SCR M4-.7 X 8
96	P0471096	BACK COVER GASKET
97	PB09M	HEX BOLT M8-1.25 X 20
98	PHTEK6M	TAP SCREW M4 X 16

# WARRANTY AND RETURNS

---

---

Grizzly Industrial, Inc. warrants every product it sells for a period of **1 year** to the original purchaser from the date of purchase. This warranty does not apply to defects due directly or indirectly to misuse, abuse, negligence, accidents, repairs or alterations or lack of maintenance. This is Grizzly's sole written warranty and any and all warranties that may be implied by law, including any merchantability or fitness, for any particular purpose, are hereby limited to the duration of this written warranty. We do not warrant or represent that the merchandise complies with the provisions of any law or acts unless the manufacturer so warrants. In no event shall Grizzly's liability under this warranty exceed the purchase price paid for the product and any legal actions brought against Grizzly shall be tried in the State of Washington, County of Whatcom.

We shall in no event be liable for death, injuries to persons or property or for incidental, contingent, special, or consequential damages arising from the use of our products.

To take advantage of this warranty, contact us by mail or phone and give us all the details. We will then issue you a "Return Authorization Number," which must be clearly posted on the outside as well as the inside of the carton. We will not accept any item back without this number. Proof of purchase must accompany the merchandise.

The manufacturers reserve the right to change specifications at any time because they constantly strive to achieve better quality equipment. We make every effort to ensure that our products meet high quality and durability standards and we hope you never need to use this warranty.

Please feel free to write or call us if you have any questions about the machine or the manual.

**Grizzly Industrial, Inc.**  
**1203 Lycoming Mall Circle**  
**Muncy, PA 17756**  
**Phone: (570) 546-9663**  
**Fax: (800) 438-5901**

**E-Mail:**  
**techsupport@grizzly.com**

**Web Site: <http://www.grizzly.com>**

Thank you again for your business and continued support. We hope to serve you again soon!



# WARRANTY CARD

Name \_\_\_\_\_

Street \_\_\_\_\_

City \_\_\_\_\_ State \_\_\_\_\_ Zip \_\_\_\_\_

Phone # \_\_\_\_\_ Email \_\_\_\_\_ Invoice # \_\_\_\_\_

Model # \_\_\_\_\_ Order # \_\_\_\_\_ Serial # \_\_\_\_\_

*The following information is given on a voluntary basis. It will be used for marketing purposes to help us develop better products and services. **All information is strictly confidential.***

1. How did you learn about us?

Advertisement     Friend     Catalog  
 Card Deck     Website    Other: \_\_\_\_\_

2. Which of the following magazines do you subscribe to?

Cabinet Maker     Popular Mechanics     Today's Homeowner  
 Family Handyman     Popular Science     Wood  
 Hand Loader     Popular Woodworking     Wooden Boat  
 Handy     Practical Homeowner     Woodshop News  
 Home Shop Machinist     Precision Shooter     Woodsmith  
 Journal of Light Cont.     Projects in Metal     Woodwork  
 Live Steam     RC Modeler     Woodworker West  
 Model Airplane News     Rifle     Woodworker's Journal  
 Modeltec     Shop Notes     Other:  
 Old House Journal     Shotgun News

3. What is your annual household income?

\$20,000-\$29,000     \$30,000-\$39,000     \$40,000-\$49,000  
 \$50,000-\$59,000     \$60,000-\$69,000     \$70,000+

4. What is your age group?

20-29     30-39     40-49  
 50-59     60-69     70+

5. How long have you been a woodworker/metalworker?

0-2 Years     2-8 Years     8-20 Years     20+ Years

6. How many of your machines or tools are Grizzly?

0-2     3-5     6-9     10+

7. Do you think your machine represents a good value?  Yes     No

8. Would you recommend Grizzly Industrial to a friend?  Yes     No

9. Would you allow us to use your name as a reference for our customers in your area?

Note: *We never use names more than 3 times.*     Yes     No

10. Comments: \_\_\_\_\_

\_\_\_\_\_

\_\_\_\_\_

\_\_\_\_\_

Send a Grizzly Catalog to a friend:

Name _____
Street _____
City _____ State _____ Zip _____

FOLD ALONG DOTTED LINE



Place  
Stamp  
Here



GRIZZLY INDUSTRIAL, INC.  
P.O. BOX 2069  
BELLINGHAM, WA 98227-2069



TAPE ALONG EDGES--PLEASE DO NOT STAPLE