

NV53

# SERVICEGUIDE



## Revision History

Please refer to the table below for the updates made on the NV53 service guide.

Date	Chapter	Updates

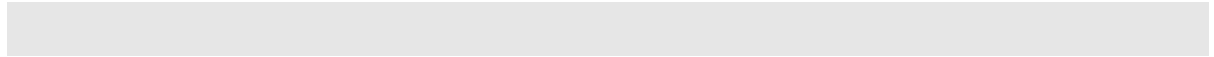

Service guide files and updates are available on the ACER/CSD web. For more information, refer to <http://csd.acer.com.tw>

## Copyright

© 2009 Gateway, Inc. All rights reserved. Gateway, Gateway Country, the Gateway stylized logo, and the black-and-white spot design are trademarks or registered trademarks of Gateway, Inc. in the United States and other countries. All other brands and product names are trademarks or registered trademarks of their respective companies.

# Contents

Chapter 1: System specifications	1
Preface	2
Conventions	2
General information	2
Features	3
System block diagram	6
Hardware specifications and configurations	7
CPU	7
Controllers	7
BIOS	7
Memory	8
Hard Disk Drive	9
Optical drive	9
LCD	10
Keyboard	11
Pointing device	11
Memory card reader	11
Audio	12
Wired LAN	12
Bluetooth	12
Wireless LAN	13
USB	13
Buttons/Indicators/Ports	13
Camera	14
Fans	14
Battery	14
Power supply	15
Power savings	15
Notebook product tour	16
Front View	16
Left View	16
Right View	17
Rear View	18
Bottom View	18
Keyboard area	19
LCD panel	20
Using the status indicators	21
Using the keyboard	21
Using the capacitive touch keys	24
Using the EZ Pad touchpad	25
Using the webcam	26
Chapter 2: System utilities	27
BIOS setup utility	28

Navigating the BIOS setup utility .....	29
BIOS setup utility menus .....	29
BIOS recovery .....	38
Creating the Crisis Recovery disk .....	38
Performing a BIOS recovery .....	38
Running the Flash utility: .....	39
Clearing a BIOS password .....	40
Unlocking the hard drive .....	41
Chapter 3: Replacing notebook components .....	43
Preventing static electricity discharge .....	44
Tape .....	44
Preparing the work space .....	45
Required tools .....	46
Preparing the notebook .....	47
Removing the battery .....	48
Removing the bay cover .....	49
Adding or replacing memory modules .....	50
Replacing the wireless card .....	52
Replacing the hard drive .....	54
Replacing the optical drive .....	56
Replacing the keyboard cover .....	58
Replacing the multimedia board .....	60
Replacing the keyboard .....	62
Replacing the LCD panel assembly .....	64
Replacing the palm rest .....	68
Replacing the speakers .....	72
Replacing the touchpad board .....	74
Replacing the modem board .....	77
Replacing the USB board .....	80
Replacing the Bluetooth module .....	83
Replacing the system board .....	86
Replacing the cooling assembly .....	89
Replacing the processor .....	92
Replacing the LCD front panel .....	95
Replacing the webcam .....	98
Replacing the LCD .....	100
Replacing the LCD panel hinge brackets .....	103
Replacing the power button board .....	105
Replacing the Kensington lock cap .....	107
Replacing the microphone .....	109
Replacing the antennas .....	111
Replacing the LCD assembly lid .....	113

<b>Chapter 4: Troubleshooting</b> .....	<b>115</b>
Diagnosing problems .....	116
System test procedures .....	117
Testing the optical drive .....	117
Testing the keyboard or auxiliary input device .....	117
Testing the memory .....	118
Testing the power system .....	118
Testing the touchpad .....	119
Power-On Self-Test (POST) error message .....	120
Index of error messages .....	121
Error codes .....	121
Error messages .....	121
No-beep error messages .....	123
Phoenix BIOS beep codes .....	124
Symptom-to-FRU error messages .....	129
LCD .....	129
Power .....	129
Memory .....	130
Sound .....	130
Power management .....	130
Devices .....	131
Keyboard and touchpad .....	131
Intermittent problems .....	132
Undetermined problems .....	133
 <b>Chapter 5: Connector locations</b> .....	 <b>135</b>
System board layout .....	136
Top view .....	136
Bottom view .....	137
 <b>Chapter 6: FRU (Field-Replaceable Unit) list</b> .....	 <b>139</b>
Introduction .....	140
Exploded diagram .....	140
FRU list .....	142
 <b>Appendix A: Test compatible components</b> .....	 <b>151</b>
Introduction .....	152
Microsoft® Windows Vista® Environment Test .....	152
 <b>Appendix B: Online support information.</b> .....	 <b>155</b>

## Contents

# CHAPTER 1

## System specifications

- [Preface](#)
- [Features](#)
- [System block diagram](#)
- [Hardware specifications and configurations](#)
- [Notebook product tour](#)

# Preface

## Conventions

The following conventions are used in this manual:



**Warning**

Indicates a potential for personal injury.

---



**Caution**

Indicates a potential loss of data or damage to equipment.

---



**Important**

Indicates information that is important to know for the proper completion of a procedure, choice of an option, or completing a task.

---

## General information

Before using this information and the product it supports, read the following general information.

This service guide provides you with all technical information relating to the basic configuration decided for Acer's global product offering. To better fit local market requirements and enhance product competitiveness, your regional office may have decided to extend the functionality of a machine (such as add-on cards, modems, or extra memory capabilities). These localized features are not covered in this generic service guide. In such cases, contact your regional offices or the responsible personnel/channel to provide you with further technical details.

When ordering FRU parts: Check the most up-to-date information available on your regional web or channel. If, for whatever reason, a part number change is made, it may not be noted in this printed service guide.

Acer-authorized Service Providers: Your Acer office may have a different part number code to those given in the FRU list of this printed service guide. You must use the list provided by your regional Acer office to order FRU parts for repair and service of customer machines.



# Features

## Platform

- Processor
  - AMD Turion™ II Ultra Dual-Core Mobile Processors: M640 (2.6 GHz), M620 (2.5 GHz), M600 (2.4 GHz)
  - AMD Turion™ II Dual-Core Mobile Processors: M520 (2.3 GHz), M500 (2.2 GHz)
  - AMD Athlon™ II Dual-Core Mobile Processors: M320 (2.1 GHz), M300 (2.0 GHz)
- Core logic: ATI RS880M + SB710
- Wireless: Intel WiFi Link 5300/5100, Atheros b/g/n, or Ralink b/g/n

## System memory

- Dual-channel DDR2 SDRAM support
- Up to 4 GB of DDR2 667/800 MHz, upgradeable using two SO-DIMM modules

## Display and graphics

- 15.6" WXGA TFT LCD display panel
- 1366x768 resolution
- VGA memory: shared or 512 MB
- VGA controller: RS780M or ATI M92-XT
- Dual independent display support
- 16.7 million colors
- MPEG-2/DVD hardware-assisted capability (acceleration)
- MPEG-2/DVD decoding (for selected models)
- WMV9 (VC-1) support (acceleration)
- WMV9 (VC-1) and H.264 (AVC) decoding (for selected models)
- HDMI™ (High-Definition Multimedia Interface) with HDCP (High-bandwidth Digital Content Protection) support

## Storage subsystem

- Industry standard 2.5" 120–500 GB hard disk drive
- Optical drive options:
  - Blu-ray Disc™/DVD-Super Multi double-layer drive
  - DVD-Super Multi double-layer drive
- 5-in-1 card reader, supporting Secure Digital™ (SD), MultiMediaCard (MMC), Memory Stick® (MS), Memory Stick PRO™ (MS PRO), xD-Picture Card™ (xD)

## Input devices

- 99-, 100-, or 103-key keyboard, 2.5 mm (minimum) key travel
- Twelve function keys, four cursor keys, two Windows® keys
- Touchpad pointing device
- Capacitive touch keys

## Audio

- Two built-in stereo speakers
- High-definition audio support
- MS-Sound compatible
- Built-in microphone on webcam

## Communication

- Integrated webcam
- WLAN: Intel® WiFi Link 5300/5100 a/b/g/n, Atheros b/g/n, or Ralink b/g/n
- WPAN: Bluetooth® 2.0+EDR (Enhanced Data Rate)
- LAN: 10/100/1000 Ethernet

## I/O ports

- USB (four)
- External display (VGA) port
- Ethernet (RJ45)
- Modem (RJ11)
- Headphone/SPDIF Audio Out
- Microphone in
- DC in jack for AC adapter
- 5-in-1 card reader (SD™, MMC, MS, MS PRO, xD)
- HDMI™ port with HDCP support

## Security

- Kensington lock slot
- BIOS-based user, supervisor, and HDD passwords

## Physical specifications

- Dimensions: 372 × 250 × 37 mm (14.65 × 9.84 × 1.46 in)
- Weight: 3.1 kg (6.83 lb)

## Environmental specifications

- Temperature
  - Operating: 32 °F to 90 °F (0 °C to 35 °C)
  - Non-operating: -4 °F to 140 °F (-20 °C to 60 °C)
- Humidity (non-condensing)
  - Operating: 10% to 90%
  - Non-operating: 5% to 95%

# System block diagram

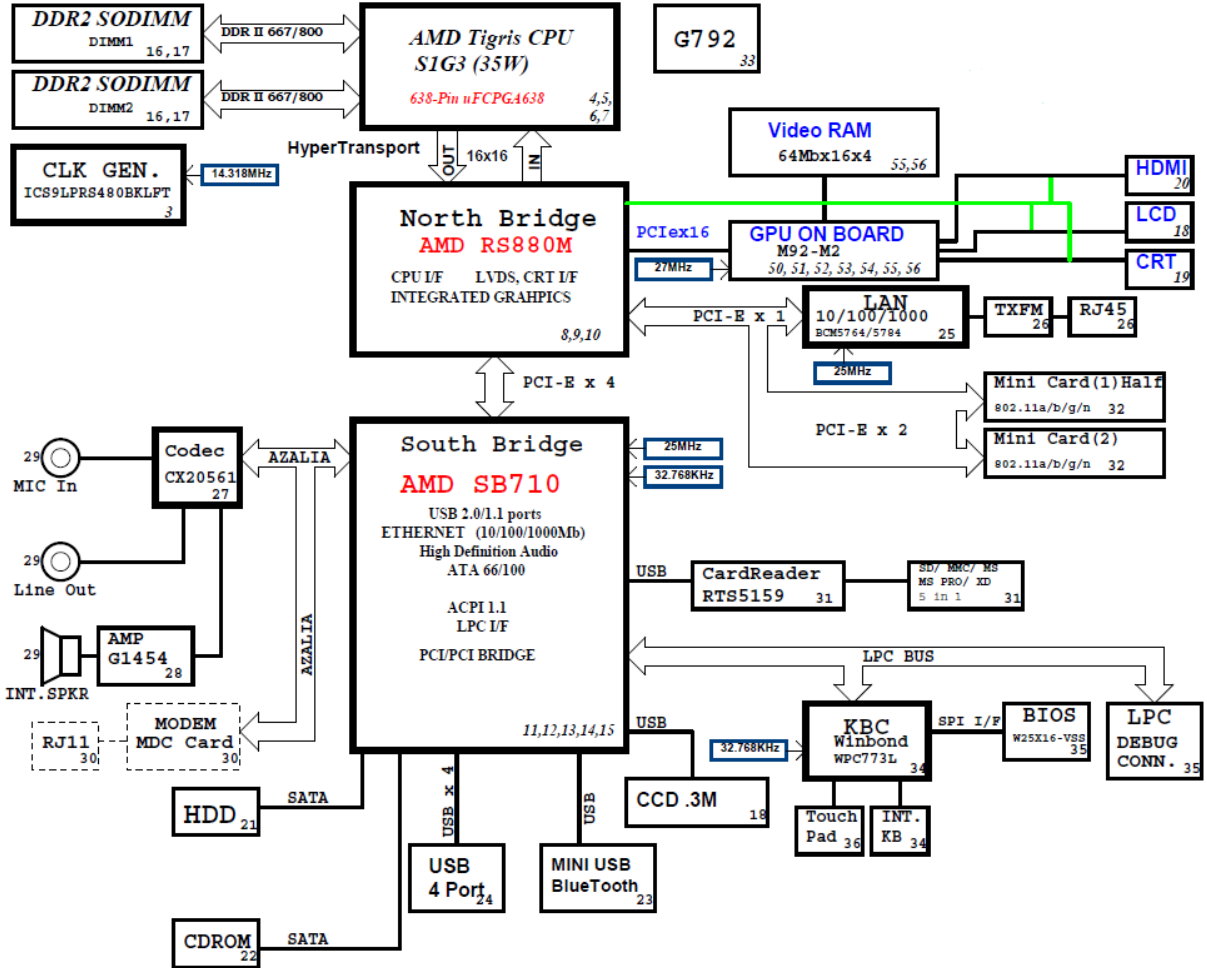

# Hardware specifications and configurations

## CPU

Item	Specification
CPU type	AMD Turion™ II Ultra Dual-Core Mobile Processors, AMD Turion™ II Dual-Core Mobile Processors, or AMD Athlon™ II Dual-Core Mobile Processors
Core logic	ATI RS880M + SB710
CPU package	Socket-S1 (S1g2), µFCPGA
CPU core voltage	1.075V to 1.125V

## Controllers

Item	Controller
Core logic	ATI RS880M + SB710
VGA	<ul style="list-style-type: none"> <li>▪ ATI Mobility Radeon HD 3200</li> <li>▪ ATI M92-XT</li> </ul>
LAN	Broadcom BCM5764/BCM5784
USB 2.0	ATI RS880M
Bluetooth	Broadcom BCM2045
Wireless 802.11	<ul style="list-style-type: none"> <li>▪ Intel WiFi Link 5100</li> <li>▪ Intel WiFi Link 5300</li> <li>▪ Atheros AR5B91/HB93 b/g/n</li> <li>▪ Atheros XB63 b/g</li> <li>▪ Ralink RT2700E b/g/n</li> </ul>
Memory Card Reader	Realtek RTS5159
Audio Codec	Conexant CX20561 (Azalia)

## BIOS

Item	Specification
BIOS vendor	Phoenix
BIOS version	V1.01

Item	Specification
Supported protocols	<ul style="list-style-type: none"> <li>▫ ACPI 1.0b/2.0/3.0 compliance</li> <li>▫ PCI 2.2 or later</li> <li>▫ System/HDD Password Security Control</li> <li>▫ INT 13H Extensions</li> <li>▫ PnP BIOS 1.0a</li> <li>▫ SMBIOS 2.4 or later</li> <li>▫ BIOS Boot Specification</li> <li>▫ Simple Boot Flag 1.0</li> <li>▫ Boot Block</li> <li>▫ PCI Bus Power Management Interface Specification</li> <li>▫ USB Specification 1.1/2.0</li> <li>▫ IEEE 1394 1.0</li> <li>▫ USB/1394 CD-ROM Boot Up support</li> <li>▫ PC Card Standard 1995 (PCMCIA 3.0 Compliant Device)</li> <li>▫ IrDA 1.0</li> <li>▫ Support HD audio</li> <li>▫ WfM 2.0, PXE 2.1</li> <li>▫ Preboot Execution Environment (PXE) 2.1</li> <li>▫ Boot Integrity Service Application Program Interface (BIS) 1.0</li> <li>▫ PC2002/2005 compliant</li> <li>▫ Intel Enhanced Speedstep Technology</li> <li>▫ ASF 2.0</li> <li>▫ TPM v1.2</li> <li>▫ AHCI support</li> <li>▫ iAMT 4.0 or later (for Intel platform)</li> </ul>
BIOS password control	Manually set Supervisor and User passwords.

## Memory

Item	Specification
Memory controller	Built-in
Memory size	0 MB (no on-board memory)
SO-DIMM socket number	2 sockets
Supports memory size per socket	2 GB per SO-DIMM
Supports maximum memory size	4 GB
Supports SO-DIMM type	▫ DDR 2 Synchronous DRAM
Supports SO-DIMM Speed	▫ 667/800 MHz
Supports SO-DIMM voltage	<ul style="list-style-type: none"> <li>▫ 1.8V and 0.9V</li> <li>▫ 1.5V</li> </ul>
Supports SO-DIMM package	200-pin SO-DIMM
Memory module combinations	You can install memory modules in any combination as long as they match the above specifications.

## Hard Disk Drive

Item				
Vendor & Model Name	ST9160310AS MK1655GSX HTS543216L9A300 WD1600BEVT-22ZC T0	ST9250315AS ST9250320AS MK2555GSX HTS545025B9A300 WD2500BEVT-22ZCT0	ST9320320AS MK3255GSX HTS545032B9A300 WD3200BEVT-22ZC T0	ST9500325AS MK5055GSX HTS545050B9A300 WD5000BEVT-22ZA T0
Capacity (MB)	160000	250000	320000	500000
Bytes per sector	512	512	512	512
Data heads	3/4	4	4	4
Drive Format				
Disks	2	2	2	2
Spindle speed (RPM)	5400 RPM	5400 RPM	5400 RPM	5400 RPM
Performance Specifications				
Buffer size	8MB	8MB	8MB	8MB
Interface	SATA	SATA	SATA	SATA
Max. media transfer rate (disk-buffer, Mbytes/s)	540	540	850	3.0 GB/s (Max.) Buffer to Host
DC Power Requirements				
Voltage tolerance	5V(DC) +/- 5%	5V(DC) +/- 5%	5V(DC) +/- 5%	5V(DC) +/- 5%

## Optical drive

Item	Specification	
Vendor & model name	TOSHIBA SUPER-MULTI DRIVE DL 8X TS-L633B LF HLDS SUPER-MULTI DRIVE TRAY DL 8X GT20N LF SONY SUPER-MULTI DRIVE DL 8X AD-7580S LF PLDS SUPER-MULTI DRIVE DL 8X DS-8A3S LF	SONY BD COMBO 12.7mm Tray DL 2X BC-5500S LF PLDS BD COMBO 12.7mm Tray DL 2X DS-4E1S HLDS BD COMBO 12.7mm Tray DL 2X CT-10
Performance Specification		
Transfer rate (KB/sec)	Sustained: ▪ with CD: Max 3.6Mbytes/sec ▪ with DVD: Max 10.08Mbytes/sec	Sustained: ▪ with CD: Max 3.6Mbytes/sec ▪ with DVD: Max 10.8Mbytes/sec ▪ with BD: Max 11Mbytes/sec
Buffer Memory	2MB	▪ for CD/DVD: 2MB ▪ for BD: 4.5MB
Interface	SATA	

## CHAPTER 1: System specifications

Item	Specification
Applicable disc format	CD: CD-DA, CD-ROM, CD-ROM XA, Photo CD (multi-session), Video CD, Cd-Extra (CD+), CD-text DVD: DVD-VIDEO, DVD-ROM, DVD-R (3.9GB, 4.7GB) DVD-R DL, DVD-RW, DVD-RAM, DVD+R, DVD+R DL, DVD+RW CD: CD-DA (Red Book) - Standard Audio CD & CD-TEXT CD-ROM (Yellow Book Mode1 & 2) - Standard Data CD-ROM XA (Mode2 Form1 & 2) - Photo CD, Multi-Session CD-I (Green Book, Mode2 Form1 & 2, Ready, Bridge) CD-Extra/ CD-Plus (Blue Book) - Audio & Text/Video Video-CD (White Book) - MPEG1 Video CD-R (Orange Book Part) CD-RW & HSRW (Orange Book Part Volume1 & Volume 2) Super Audio CD (SACD) Hybrid type US & US+ RW DVD: DVD-ROM (Book 1.02), DVD-Dual DVD-Video (Book 1.1) DVD-R (Book 1.0, 3.9G) DVD-R (Book 2.0, 4.7G) - General & Authoring DVD+R (Version 1.0) DVD+RW DVD-RW (Non CPRM & CPRM) DVD <sup>+</sup> R Dual  Blu-Ray: BD-R, BD-R DL, BD-RE, BD-RE DL
Loading mechanism	Load: Manual Release: (a) Electrical (Release Button), (b) ATAPI command, (c) Emergency
<b>Power Requirement</b>	
Input Voltage	5 V +/- 5% (Operating) <span style="float: right;">5 V +/- 5% (Operating)</span>

## LCD

Item	Specification
Vendor	<ul style="list-style-type: none"> <li>▪ CMO</li> <li>▪ AUO</li> <li>▪ Samsung</li> <li>▪ LPL</li> </ul>
Screen diagonal (mm)	15.6 inches
Display resolution (pixels)	1366x768
Pixel pitch	0.204 x 0.204
Pixel arrangement	R.G.B. Vertical Stripe
Display mode	Normally white
Typical white luminance (NIT) also called brightness	220
Luminance uniformity	1.25 max.
Contrast ratio	400~500 typical
Response tme (msec)	8
Nominal input voltage VDD	+3.3V



Item	Specification
Viewing angle (degree) Horizontal: Right/Left Vertical: Upper/Lower	45/45 15/35
Temperature range(° C) Operating Storage (shipping)	0 to +50 -40 to +60

## Keyboard

Item	Specification
Keyboard controller	Winbond WPC773
Total number of keypads	99/100/103-key
Windows logo key	Yes
Internal & external keyboard work simultaneously	Plug USB keyboard to the USB port directly

## Pointing device

Item	Specification
Type	<ul style="list-style-type: none"> <li>▪ Synaptics TM00540-001 Touchpad</li> <li>▪ ALPS KGDF0031A Touchpad</li> </ul>
Buttons	Left/Right

## Memory card reader

Item	Specification
Controller	Realtek RTS5159
Cards supported	Support 5-in-1 card reader (MMC, MS, MS-pro, SD, and xD)
Compliance	<ul style="list-style-type: none"> <li>▪ Complies to SDIO Host Interface Specification Rev 1.0</li> <li>▪ Supports MMC, MMCplus, SD Memory, and SDIO cards</li> <li>▪ SDIO Version 1.10 compliant with High-Speed Mode</li> <li>▪ SD Host Interface Specification v1.0</li> <li>▪ SD Host Interface Specification v2.0</li> <li>▪ SD HC (High Capacity SD memory card)</li> <li>▪ Supports SD memory card, with CPRM security</li> <li>▪ Complies to MultiMediaCard™ Version 4.0</li> <li>▪ Supports Memory Stick™ and MS PRO media cards</li> <li>▪ Supports xD-Picture™ card and SmartMedia™ cards</li> </ul>

## Audio

Item	Specification
Audio controller	Conexant CX20561
Audio onboard or optional	Built-in
Mono or stereo	Stereo
Resolution	24-bit DAC and ADC
Compatibility	HD Audio
Sampling rate	192 kHz maximum sample rate
Internal microphone	With webcam
Internal speaker/quantity	2 speakers

## Wired LAN

Item	Specification
LAN chipset	Broadcom BCM5764/BCM5784
Supports LAN protocol	10/100/1000 Mbps
LAN connector type	RJ45
LAN connector location	Left side
Features	<ul style="list-style-type: none"> <li>▪ Integrated 10/10/1000 BASE-T transceiver</li> <li>▪ PCI v2.2 compliant</li> <li>▪ Wake on LAN support meeting ACPI requirements</li> </ul>

## Bluetooth

Item	Specification
Chipset	Broadcom BCM2045
Data throughput	2.1 Mbit/s
Protocol	Bluetooth 2.0
Interface	USB (board level)
Connector type	Wireless via Bluetooth protocols

## Wireless LAN

Item	Specification
Chipset	<ul style="list-style-type: none"> <li>▫ Intel WiFi Link 5100</li> <li>▫ Intel WiFi Link 5300</li> <li>▫ Atheros AR5B91/HB93 b/g/n</li> <li>▫ Atheros XB63 b/g</li> <li>▫ Ralink RT2700E b/g/n</li> <li>▫ WNC WiMAX</li> </ul>
Data throughput	11~54 Mbps, up to 270 Mbps for Draft-N
Protocol	<ul style="list-style-type: none"> <li>▫ IEEE 802.11a</li> <li>▫ IEEE 802.11b</li> <li>▫ IEEE 802.11g</li> <li>▫ IEEE 802.11 Draft-N</li> <li>▫ IEEE 802.16e</li> </ul>
Interface	PCI bus (mini PCI socket for wireless module)

## USB

Item	Specification
Chipset	ATI SB710
USB compliancy level	2.0
OHCI	USB 1.1 and USB 2.0 host controller
Number of USB ports	4
Location	<ul style="list-style-type: none"> <li>▫ Two on the left side</li> <li>▫ Two on the right side</li> </ul>

## Buttons/Indicators/Ports

Item	Specification
Buttons	<ul style="list-style-type: none"> <li>▫ Power button</li> <li>▫ Capacitive touch keys</li> </ul>
Indicators	<ul style="list-style-type: none"> <li>▫ Bluetooth</li> <li>▫ Hard drive</li> <li>▫ Num lock</li> <li>▫ Caps lock</li> <li>▫ Battery charge</li> <li>▫ Power</li> </ul>
Ports	<ul style="list-style-type: none"> <li>▫ USB (four)</li> <li>▫ External display (VGA) port</li> <li>▫ Ethernet (RJ45)</li> <li>▫ Modem (RJ11)</li> <li>▫ Headphone/SPDIF Audio Out</li> <li>▫ Microphone in</li> <li>▫ DC in jack for AC adapter</li> <li>▫ 5-in-1 card reader (SD™, MMC, MS, MS PRO, xD)</li> <li>▫ HDMI™ port with HDCP support</li> </ul>

## Camera

Item	Specification
Model	<ul style="list-style-type: none"> <li>▪ Chicony CNF701721004973L</li> <li>▪ Suyin CN0314-SN30-OV03-5</li> </ul>
Interface	USB 2.0
Resolution	0.3 M pixels (640x480)
Signal to noise ratio	42 dB
Sensor	CMOS 1/4
Power	5 V
Built-in microphone	Yes
LED	No

## Fans

CPU temperature (° C)	Fan speed (rpm)	Acoustic level (dBA)
45-50	0-3000	29
55-66	0-3300	33
68-74	3300-3800	38
78-83	3800-4100	40
86-91	4100-4800	40

Throttling 50%: % is controlled by operating system. Temperature point is 95 °C. OS shut down at 100 °C; H/W shut down at 105 °C

## Battery

Item	Specification
Vendor	<ul style="list-style-type: none"> <li>▪ Panasonic</li> <li>▪ Sanyo</li> <li>▪ Sony</li> <li>▪ Simplo</li> </ul>
type	Li-ion
Pack capacity	4400mAH—5800mAH
Number of battery cell	6
Package configuration	3 cells in series, 2 series in parallel
Normal voltage	11.1V
Charge voltage	12.6V (max)

## Power supply

Item	Specification
Vendor	<ul style="list-style-type: none"> <li>▫ Delta</li> <li>▫ Liteon</li> <li>▫ Hipro</li> </ul>
Input rating	90V AC to 264V AC, 47Hz to 63Hz
Maximum input AC current	1.7A (max)
Output rating	19V DC, 3.42A, 65W

## Power savings

ACPI mode	Power Management
Mech. Off (G3)	All devices in the notebook are turned off completely.
Soft Off (G2/S5)	OS initiated shutdown. All devices in the notebook are turned off completely.
Working (G0/S0)	Individual devices such as the CPU and hard disc may be power managed in this state.
Suspend to RAM (S3)	<ul style="list-style-type: none"> <li>▫ CPU set power down</li> <li>▫ VGA suspend</li> <li>▫ PCMCIA suspend</li> <li>▫ Audio power down</li> <li>▫ Hard drive power down</li> <li>▫ Optical drive power down</li> <li>▫ Super I/O low power mode</li> </ul>
Save to Disk (S4)	Also called Hibernation mode. System saves all system states and data onto the disc prior to powering off the whole system.

# Notebook product tour



**Important**

Case color may vary from that shown in the pictures.

## Front View





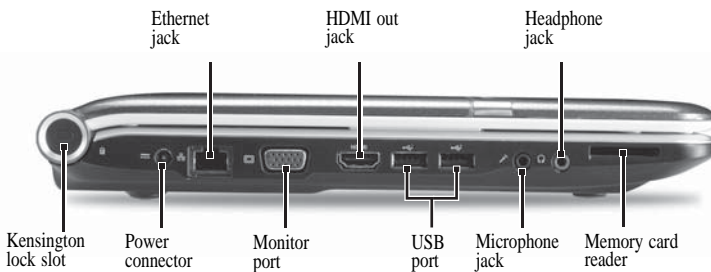

Component	Icon	Description
Ventilation fan		Helps cool internal components. Warning: Do not work with the notebook resting on your lap. If the air vents are blocked, the notebook may become hot enough to harm your skin. Caution: Do not block or insert objects into these slots. If these slots are blocked, your notebook may overheat resulting in unexpected shutdown or permanent damage to the notebook. Caution: Provide adequate space around your notebook so air vents are not obstructed. Do not use the notebook on a bed, sofa, rug, or other similar surface.

## Left View





Component	Icon	Description
Kensington™ lock slot		Secure your notebook to an object by connecting a Kensington cable lock to this slot.
Power connector		Plug the AC adapter cable into this connector.
Ethernet jack		Plug an Ethernet network cable into this jack. Plug the other end of the cable into a cable modem, DSL modem, or an Ethernet network jack.
Monitor port		Plug an analog VGA monitor or projector into this port.
HDMI out jack		Plug an HDMI device, such as a high definition television, into this optional jack.

Component	Icon	Description
USB port		Plug USB devices (such as a diskette drive, flash drive, printer, scanner, camera, keyboard, or mouse) into these ports.
Microphone jack		Plug a microphone into this jack.
Headphone jack		Plug amplified speakers or headphones into this jack. The built-in speakers are turned off when speakers or headphones are plugged into this jack. Headphone with SPDIF support
Memory card reader		Insert a memory card from a digital camera, MP3 player, PDA, or cellular telephone into the memory card reader. The memory card reader supports Memory Stick®, Memory Stick Pro®, MultiMediaCard™, Secure Digital™, and xD-Picture Card™ cards.

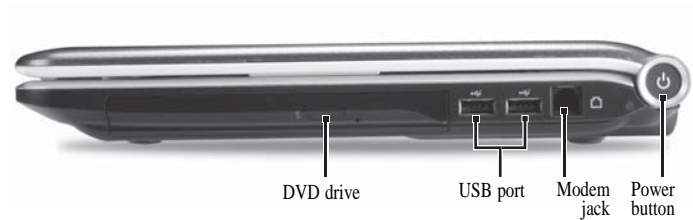
## Right View



Component	Icon	Description
USB port		Plug a USB device (such as a diskette drive, flash drive, printer, scanner, camera, keyboard, or mouse) into this port.
DVD drive		Insert CDs or DVDs into this drive.
Modem jack		Plug a dial-up modem cable into this optional jack.
Power button		Press to turn the power on or off. You can also configure the power button for Sleep/Resume mode.



## Rear View

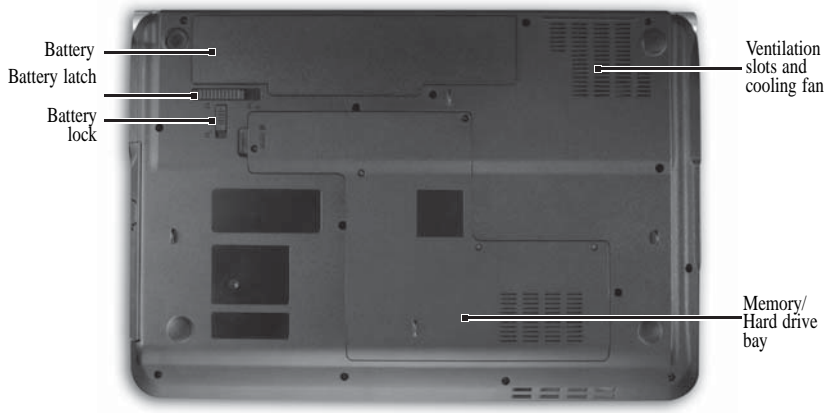

Component	Icon	Description
Ventilation fan		Helps cool internal components. Warning: Do not work with the notebook resting on your lap. If the air vents are blocked, the notebook may become hot enough to harm your skin. Caution: Do not block or insert objects into these slots. If these slots are blocked, your notebook may overheat resulting in unexpected shutdown or permanent damage to the notebook. Caution: Provide adequate space around your notebook so air vents are not obstructed. Do not use the notebook on a bed, sofa, rug, or other similar surface.

## Bottom View





Component	Icon	Description
Battery		Provides power when the notebook is not plugged into AC power.
Battery lock		Slide to unlock the battery.
Battery latch		Slide to release the battery.
Memory bay		Memory modules are located in this bay.

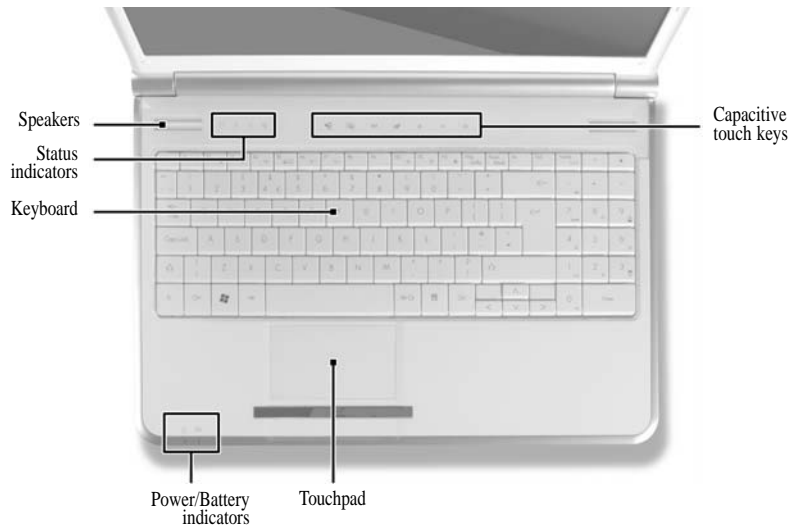

Component	Icon	Description
Hard drive bay		The hard drive is located in this bay.
Ventilation slots and cooling fan		Helps cool internal components. Warning: Do not work with the notebook resting on your lap. If the air vents are blocked, the notebook may become hot enough to harm your skin. Caution: Do not block or insert objects into these slots. If these slots are blocked, your notebook may overheat resulting in unexpected shutdown or permanent damage to the notebook. Caution: Provide adequate space around your notebook so air vents are not obstructed. Do not use the notebook on a bed, sofa, rug, or other similar surface.

## Keyboard area



Component	Icon	Description
Speakers		Left and right speakers deliver stereo audio output.
Status indicators		Inform you when a drive is in use or when a button has been pressed that affects how the keyboard is used. For more information, see <a href="#">"Using the status indicators" on page 21</a> .
Keyboard		Provides all the features of a full-sized, computer keyboard. For more information, see <a href="#">"Using the keyboard" on page 21</a> .
Power indicator		<ul style="list-style-type: none"> <li>▫ LED on - Notebook is on.</li> <li>▫ LED blinking - Notebook is in Sleep or Hybrid Sleep mode.</li> <li>▫ LED off - Notebook is off.</li> </ul>
Battery charge indicator		<ul style="list-style-type: none"> <li>▫ LED orange - Battery is fully charged.</li> <li>▫ LED blinking orange - Battery is charging.</li> <li>▫ LED blinking red - Battery charge is very low.</li> <li>▫ LED solid red - Battery is malfunctioning.</li> </ul> <p>Important: This LED only lights up when your notebook is connected to AC power or the battery charge is very low.</p>

Component	Icon	Description
Touchpad		Provides all the functionality of a mouse. For more information, see <a href="#">“Using the EZ Pad touchpad” on page 25</a> .
Capacitive touch keys		Press to access capacitive touch key function. For more information, see <a href="#">“Using the capacitive touch keys” on page 24</a> .

## LCD panel

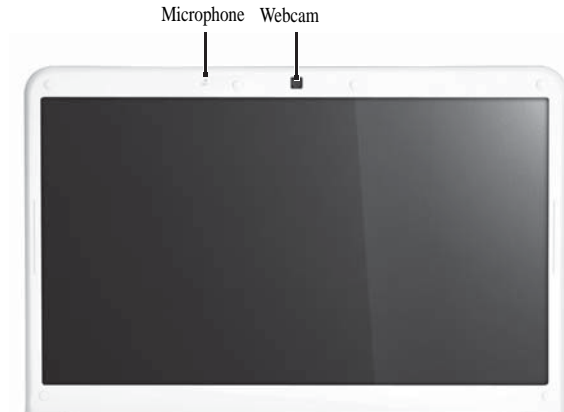

Component	Icon	Description
Webcam		Use to let others see who they are communicating with when making VoIP calls. For more information, see <a href="#">“Using the webcam” on page 26</a> .
Microphone		Use to talk through when making Voice over Internet Protocol (VoIP) calls.

## Using the status indicators



### Important

If none of the indicators are on, you may need to press FN+F1 to toggle the status indicators on.

Status indicators inform you when a drive is being used or when a button has been pressed that affects how the keyboard is used. The status indicators are located below the screen.

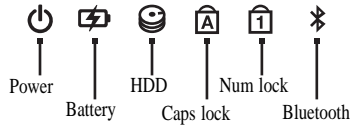

Indicator	Icon	Description
Bluetooth		<ul style="list-style-type: none"> <li>LED on - Bluetooth communication is turned on.</li> <li>LED off - Bluetooth communication is turned off.</li> </ul>
Hard drive		<ul style="list-style-type: none"> <li>LED blinking - The drive is being accessed.</li> <li>LED off - The drive is not being accessed.</li> </ul>
Num lock		<ul style="list-style-type: none"> <li>LED on - Num lock is turned on.</li> <li>LED off - Num lock is turned off.</li> </ul>
Caps lock		<ul style="list-style-type: none"> <li>LED on - Caps lock is turned on.</li> <li>LED off - Caps lock is turned off.</li> </ul>
Battery charge indicator		<ul style="list-style-type: none"> <li>LED blue - Battery is fully charged.</li> <li>LED red - Battery is charging.</li> </ul> <p>Important: This LED only lights up when your notebook is connected to AC power.</p>
Power indicator		<ul style="list-style-type: none"> <li>LED on - Notebook is on.</li> <li>LED blinking - Notebook is in Sleep or Hybrid Sleep mode.</li> <li>LED off - Notebook is off.</li> </ul>

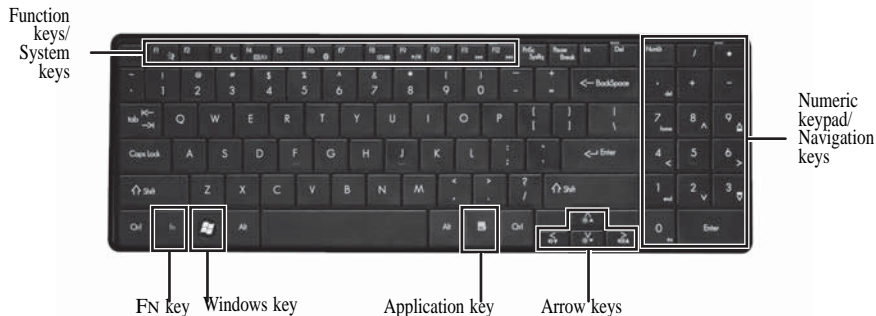

## Using the keyboard

Your notebook features a full-size keyboard that functions the same as a desktop computer keyboard. Many of the keys have been assigned alternate functions, including shortcut keys for Windows and function keys for specific system operations.





## Key types







The keyboard has several different types of keys. Some keys perform specific actions when pressed alone and other actions when pressed in combination with another key.

Key type	Icon	Description
Function keys		Press these keys labeled F1 to F12 to perform actions in programs. For example, pressing F1 may open help. Each program uses different function keys for different purposes. See the program documentation to find out more about the function key actions.
System keys		Press these colored keys in combination with the <b>FN</b> key to perform specific actions. For more information, see <a href="#">“System key combinations” on page 22</a> .
Navigation keys		Press these keys to move the cursor to the beginning of a line, to the end of a line, up the page, down the page, to the beginning of a document, or to the end of a document.
FN key		Press the <b>FN</b> key in combination with a colored system key to perform a specific action.
Windows key		Press this key to open the Windows Start menu. This key can also be used in combination with other keys to open utilities like F (Search utility), R (Run utility), and E (Computer window).
Application key		Press this key for quick access to shortcut menus and help assistants in Windows.
Arrow keys		Press these keys to move the cursor up, down, right, or left.

## System key combinations

When you press the **FN** key and a system key at the same time, your notebook performs the action identified by the text or icon on the key.

Press and hold <b>FN</b> , then press this system key...	To...
	Turn the capacitive touch key LEDs on or off. For more information, see <a href="#">“Using the status indicators” on page 21</a> .
	Enter Sleep mode or Hybrid Sleep mode. Press the power button to leave Sleep mode.
	Toggle the notebook display in the following order: <ul style="list-style-type: none"> <li>▫ The LCD</li> <li>▫ An external monitor or projector (a monitor or projector must be plugged into the monitor port or HDMI port on your notebook)</li> <li>▫ Both displays at the same time</li> </ul>

Press and hold FN, then press this system key...	To...
	Turn the optional Bluetooth radio on or off. Warning: Radio frequency wireless communication can interfere with equipment on commercial aircraft. Current aviation regulations require wireless devices to be turned off while traveling in an airplane. Bluetooth communication devices are examples of devices that provide wireless communication. Important: The wireless network switch must be in the ON position for this button to work. For more information, see <a href="#">"Left View" on page 16</a> .
	Mute the sound. Press the key combination again to restore the sound.
	Turns the display screen backlight off to save power. Press any key to return.
	Play/ Pause—Plays or pauses the CD or DVD.
	Stop—Stops playing the CD or DVD.
	Previous—Skips back one CD track or DVD chapter.
	Next—Skips ahead one CD track or DVD chapter.

---



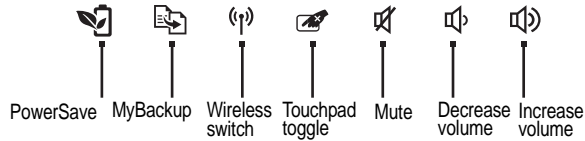

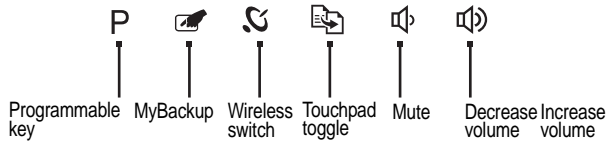

## Using the capacitive touch keys



(only for certain models)



(only for certain models)

Button	Description
	PowerSave key—enable Gateway PowerSave solution. The Gateway PowerSave solution uses the power-saving features of your computer's graphics sub-system to reduce overall power consumption. When you press the Gateway PowerSave key, the Windows graphics scheme will be changed to Windows Vista Basic, screen brightness reduced and the graphics chip will be switched to a lower speed. Press the Gateway PowerSave key again to return to your previous settings. (only for certain models)
P	Programmable key—the programmable key will run the Launch Manager, you can assign an application as you needed. (only for certain models)
	MyBackup key—launch Gateway MyBackup solution. The Gateway MyBackup solution is a simple three-step process that allows you to create backup copies of your entire system or selected files and folders according to a schedule or as you need to.
	Wireless switch—turn the optional IEEE 802.11 wireless network radio on or off. For more information, see “Wireless Ethernet Networking” in your online <i>User Guide</i> . Warning: Radio frequency wireless communication can interfere with equipment on commercial aircraft. Current aviation regulations require wireless devices to be turned off while traveling in an airplane. IEEE 802.11 communication devices are examples of devices that provide wireless communication.
	Touchpad toggle—turn the internal touchpad on and off.
	Mute—mutes the sound. Press again to restore the sound.
	Decrease volume—press to decrease volume.
	Increase volume—press to increase volume.

## Using the EZ Pad touchpad

The EZ Pad™ consists of a touchpad, two buttons, and a scroll zone.

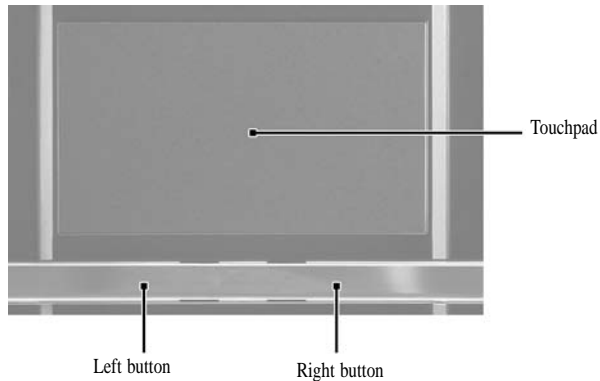

When you move your finger on the touchpad, the *pointer* (arrow) on the screen moves in the same direction. You can use the scroll zone to scroll through documents. Use of the scroll zone may vary from program to program.

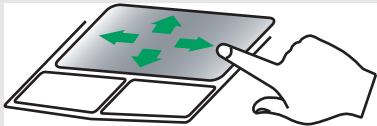
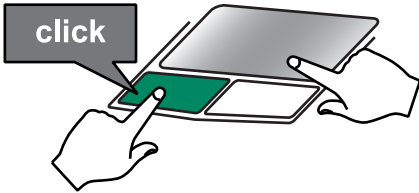

You can use the EZ Pad *left* and *right* buttons below the touchpad to select objects.

To...	Do this...
Move the pointer on the screen.	 Move your finger around on the touchpad. If you run out of space and need to move the pointer farther, lift your finger, move it to the middle of the touchpad, then continue moving your finger.
Select an object on the screen.	 Position the pointer over the object. Quickly press and release the left button once. This action is called <i>clicking</i> .

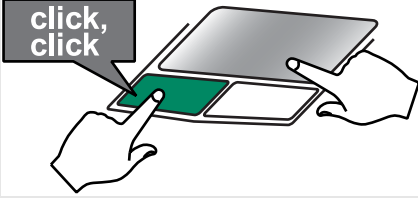
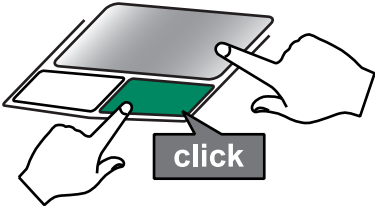
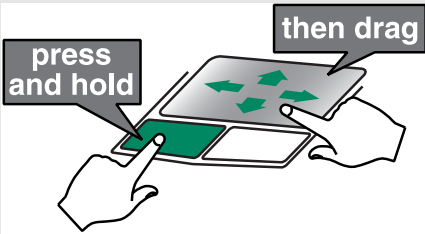
To...	Do this...	
Start a program or open a file or folder.		Position the pointer over the object. Press the left button twice in rapid succession. This action is called <i>double-clicking</i> .
Access a shortcut menu or find more information about an object on the screen.		Position the pointer over the object. Quickly press and release the right button once. This action is called <i>right-clicking</i> .
Move an object on the screen.		Position the pointer over the object. Press the left button and hold it down, then use the touchpad to move (drag) the object to the appropriate part of the screen. Release the button to drop the object where you want it.

## Using the webcam

You can use the optional webcam with many of the available Internet chat programs to add video and audio to your chat session. In addition, by using the software included with the webcam, you can take pictures or create video clips.

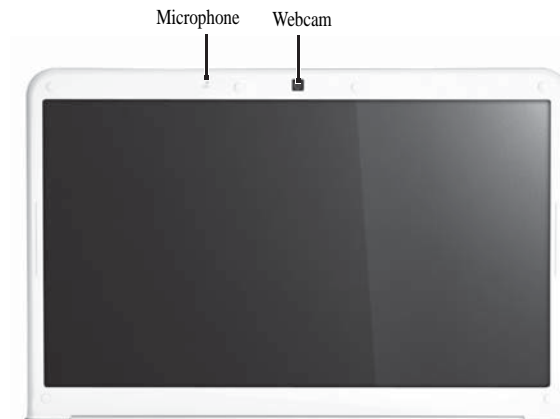



# CHAPTER 2

## System utilities

- BIOS setup utility
- BIOS recovery
- Clearing a BIOS password
- Unlocking the hard drive

# BIOS setup utility

The BIOS setup utility is a hardware configuration program built into the notebook's BIOS (Basic Input/Output System). The notebook was shipped already properly configured and optimized. However, if the user encounters configuration problems, you may need to run Setup.

► To run the BIOS Setup Utility:

- 1 Turn on the notebook.

If the computer is already turned on, save your data and close all open applications, then restart the computer.

- 2 Press F2 when the **Press <F2> to enter Setup** prompt appears on the bottom of the screen.

Use the left and right arrow keys to move between selections on the menu bar.

```

Phoenix SecureCore (tm) Setup Utility
-----
Information  Main  Security  Boot  Exit

CPU Type:          AMD Turion(tm) II Ultra Dual-Core Mobile M640
CPU Speed:         2.60 GHz
IDE0 Model Name:   Hitachi HTS545050B9A300- (S1)
IDE0 Serial Number: 090709PB4400Q7H9ARZG
ATAPI Model Name:  Slimtype BD E DS4E1S- (S2)
System BIOS Version: U1.02
UGA BIOS Version:  BK-ATI VER011.020.000.012.033584

KBC Version:       03.07
Serial Number:     914FM01001G9280003F2200
Asset Tag Number:  None
Product Name:     NU53 Series
Manufacturer Name: Gateway
UUID:             216cab40-7301-11de-909b-b1b0a0f4560d

F1 Help  ↑↓ Select Item  F5/F6 Change Values  F9 Setup Defaults
Esc Exit  ←→ Select Menu  Enter Select ► Sub-Menu  F10 Save and Exit

```

## Navigating the BIOS setup utility

Use the keys listed in the legend bar on the bottom of the Setup screen to work your way through the various menu and submenu screens.

► To use the BIOS setup utility:

- To choose a menu, use the left ← and right → arrow keys.
- To choose an item, use the up ↑ and down ↓ arrow keys.
- To change the value of a parameter, press F5 or F6.
- A plus sign (+) indicates the item has sub-items. Press ENTER to expand this item.
- To load default settings, press F9.
- To save changes made and close the utility, press F10.

1 Press Esc while you are in any of the menu screen to display the Exit menu.

---

 **Important**

- You can change the value of a parameter if it is enclosed in square brackets.
  - Navigation keys for a particular menu are shown on the bottom of the screen. Help for parameters are found in the Item Specific Help part of the screen. Read this information carefully when making changes to parameter values.
  - The screenshots used in this section are for illustration only. The values displayed may not be the same as those in your computer.
- 



## BIOS setup utility menus

The Setup utility has five menus for configuring the various system functions. These include: Information, Main, Security, Boot, and Exit.

---

 **Important**

- The screenshots used in this section are for illustration only. The values displayed may not be the same as those in your computer. Actual screen information varies by model, installed features, and location.
  - In the descriptive table following each of the screenshot, settings in **boldface** are the default settings.
-

## Information

The Information menu displays a summary of your computer hardware information. These information are necessary for troubleshooting and may be required when asking for technical support.

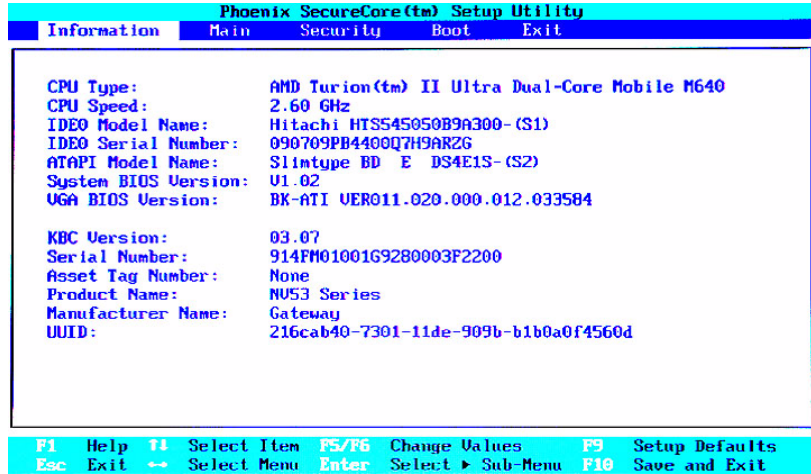

Parameter	Description
CPU Type	Displays the processor model and speed.
CPU Speed	Displays the processor speed.
IDE0 Model Name	Displays the model name of the hard drive installed on the primary IDE master.
IDE0 Serial Number	Displays the serial number of the hard drive installed on the primary IDE master.
ATAPI Model Name	Displays the model name of the installed optical drive.
System BIOS Version	Displays system BIOS version.
VGA BIOS Version	Displays the VGA firmware version.
KBC Version	Displays the keyboard controller version.
Serial Number	Displays the system serial number.
Asset Tag Number	Displays the system asset tag number
Product Name	Displays the official model name of the computer.
Manufacturer Name	Displays the name of the computer manufacturer.
UUID Number	Displays the computer's UUID (universally unique identifier). UUID is an identifier standard used in software construction, standardized by the Open Software Foundation (OSF) as part of the Distributed Computing Environment (DCE).

## Main

Use the Main menu to set the system time and date, and other basic options.

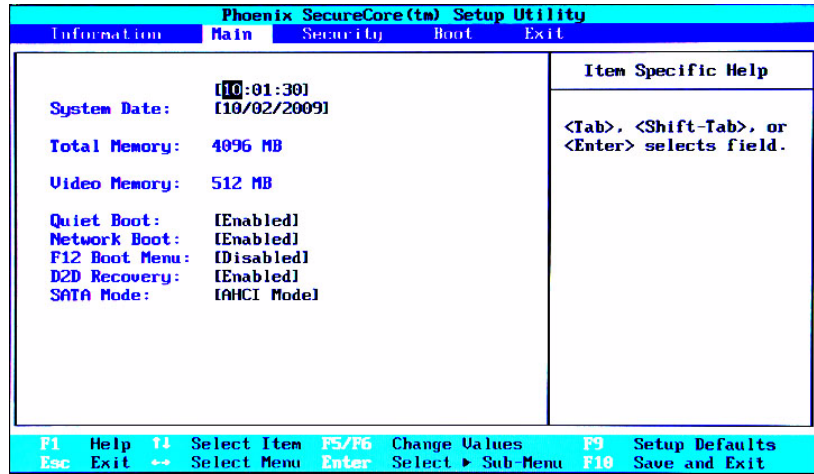

Parameter	Description	Format/Options
System Time	Displays the system time. The time is expressed in a 24-hour format.	HH:MM:SS (hour:minute:second)
System Date	Displays the system date.	MM/DD/YYYY (month/day/year)
Total Memory	Displays the size of system memory detected during boot-up.	
Video Memory	Displays the size of video memory detected during boot-up.	
Quiet Boot	Enables or disables the Quiet Boot function. When enabled, BIOS setup is in graphical mode and displays only the computer brand logo during POST and while booting. When disabled, BIOS setup is in conventional text mode and displays the system Summary Screen.	Disabled <b>Enabled</b>
Network Boot	When enabled, a remote host with appropriate boot image can boot this computer. (only works with an Ethernet device.)	Disabled <b>Enabled</b>
F12 Boot Menu	Enables or disables the Boot menu during POST.	<b>Disabled</b> Enabled

Parameter	Description	Format/Options
D2D Recovery	Enables or disables the D2D Recovery function. This function allows the user to create a hidden partition on the hard drive to store the operation system. User can then use this partition to restore the system to factory defaults by pressing the Alt+F10 keys during system boot-up.	Disabled <b>Enabled</b>
SATA Mode	Select the SATA controller operating mode. When set to AHCI (Advanced Host Controller Interface), the SATA controller enables its AHCI and RAID features when the computer boots up. When set to IDE, the SATA controller disables its AHCI and RAID functions when the computer boots up. <b>Note:</b> If you do not intend to use the AHCI or RAID features set this parameter to IDE to speed up the boot-up time.	AHCI IDE

## Security

Use the Security menu option to set system passwords to protect your computer from unauthorized use.

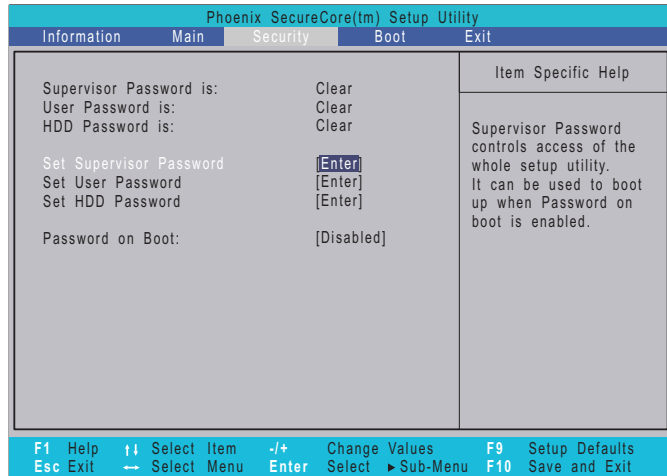

Parameter	Description	Option
Supervisor Password Is	Displays the supervisor password status.	Clear Set
User Password Is	Displays the user password status.	Clear Set
HDD Password Is	Displays the hard drive password status.	Clear Set

Parameter	Description	Option
Set Supervisor Password	Press Enter to set a supervisor password. When set, this password will allow the user to access and change all settings in the Setup Utility.	
Set User Password	Press Enter to set a user password. When set, this password will restrict a user's access to the Setup menus. Only the following menus will be accessible: <ul style="list-style-type: none"> <li>• System Time and System Date</li> <li>• All Exit menu options excluding Load Setup Defaults</li> </ul> <b>Note:</b> A supervisor password must first be set before creating a user password. If Password on Boot is enabled, the user must enter the user password each time the notebook is turned on or wakes from Sleep.	
Set HDD Password	Press Enter to set password for accessing the hard disk drive (HDD) password. It will be required during boot-up or when waking from hibernation mode.	
Password on Boot	Referred to as the power-on password. When enabled, the user or supervisor password will be required to boot up the system. <b>Note:</b> A supervisor password must first be set before creating a user password.	<b>Disabled</b> Enabled

 **Caution**

When you are prompted to enter a password, you have three tries before the system halts. Don't forget your password.

Setting a password

Note the following reminders before you define a system password:

- The maximum length of password contains 8 alphanumeric characters.
- System passwords are case-insensitive.
- When typing the password, only shaded blocks representing each typed character are visible.

► To set a supervisor password:

- 1 Press ↑ or ↓ to highlight Set Supervisor Password, then press Enter. The *Set Supervisor Password* box opens.



- 2 Type a password, then press Enter.

- 3 Retype the password to verify the first entry, then press Enter.  
You will be prompted to save the new password.
- 4 Press Enter.
- 5 Press F10 to save the password and close the Setup Utility or you can proceed to setting a user password.



► To set a user password:

- 1 Press ↑ or ↓ to highlight Set User Password, then press Enter.  
The *Set User Password* box opens.
- 2 Type a password, then press Enter.
- 3 Retype the password to verify the first entry, then press Enter.  
You will be prompted to save the new password.
- 4 Press Enter.
- 5 Press F10 to save the password and close the Setup Utility.



Changing a password

► To change a password:

- 1 Press ↑ or ↓ to highlight the Set Supervisor Password or Set User Password field, then press Enter.  
The *Set Supervisor Password* or *Set User Password* box opens.



- 2 Type the current password, then press Enter.
- 3 Type a new password, then press Enter.
- 4 Retype the new password to verify the first entry, then press Enter.  
You will be prompted to save the new password.
- 5 Press Enter.
- 6 Press F10 to save the password and close the Setup Utility or you can proceed to setting a user password.





## Removing a password

► To remove a password:

- 1 Press  $\uparrow$  or  $\downarrow$  to highlight the Set Supervisor Password or Set User Password field, then press Enter.

The *Set Supervisor Password* or *Set User Password* box opens.



- 2 Type the current password, then press Enter.
- 3 Press Enter twice without entering anything in the new and confirm password fields.  
You will be prompted to confirm the password removal.
- 4 Press Enter.
- 5 Press F10 to save the password and close the Setup Utility or you can proceed to setting a user password.



## Resetting a password

If you have forgotten the user password, the computer will continue to function normally but you will have limited access to the Setup utility.

If you have enabled the Password on Boot field and you forget the supervisor password, you will not be able to boot up the computer. The same thing applies if you forget the HDD password.

To clear a lost BIOS password (user or supervisor password) you need to short the clear password hardware gap located on the system board. Go to [page 40](#) for instructions.

To regain access to your computer if you lose the HDD password, you need to generate a master password and unlock your hard drive. Go to [page 41](#) for instructions.

## Boot

Use the Boot menu to set the preferred drive sequence in which the Setup utility attempts to boot the operating system.

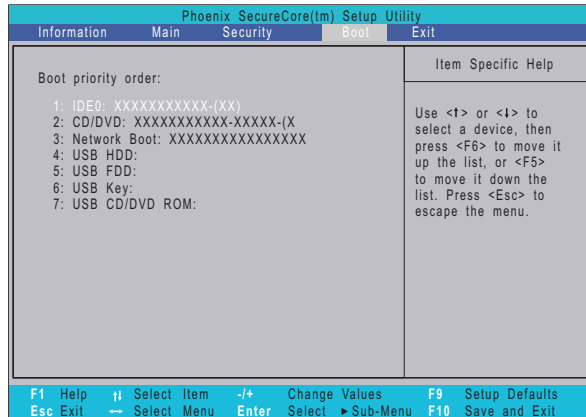

► To set boot drive sequence:

- 1 Press ↑ or ↓ to highlight a bootable device.
- 2 Press F5 or F6 to move the selected device up or down the boot sequence.
- 3 Press F10 to save the changes you made and close the Setup utility.



## Exit

The Exit menu screen lists options for quitting from the Setup Utility.

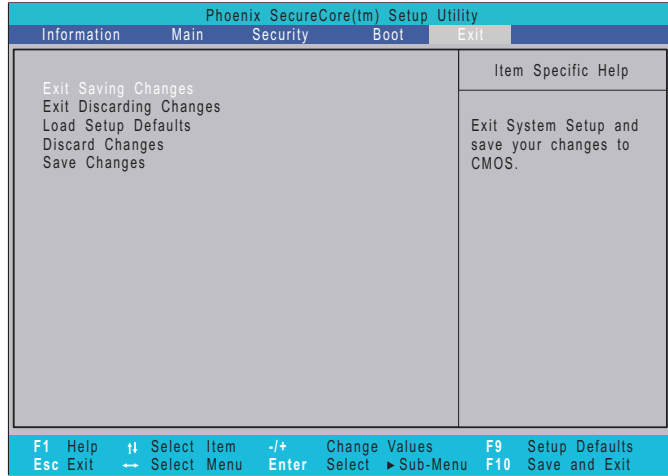

Option	Description
Exit Saving Changes	Saves changes made and closes the Setup utility. Keyboard shortcut: F10
Exit Discarding Changes	Discards changes made and closes the Setup utility.
Load Setup Default	Loads the factory-default settings for all Setup parameters. Keyboard shortcut: F9
Discard Changes	Discards all changes made to the Setup utility and loads previous configuration settings.
Save Changes	Saves all changes made to the Setup utility.

# BIOS recovery

An interruption during a BIOS flash procedure (e.g. a power outage) can corrupt the BIOS code, which will cause the system to go into an unbootable state. You need to access and execute the boot block program to reboot the computer and recover the regular BIOS code.



## Caution

Observe the following when performing a BIOS recovery:

- Make sure the battery pack is installed to the system and that the computer is connected to a UPS unit during the BIOS recovery and BIOS flash procedures.
- The BIOS crisis recovery disk should be prepared in a computer running the Windows XP or Windows Vista OS.

## Creating the Crisis Recovery disk

► To create the Crisis Recovery disk:

- 1 Prepare a removable USB storage device with a capacity size greater than 10 MB.  
Note that all data on the USB storage device will be cleared during the creation of the crisis disk.
- 2 Set up a computer running the Windows XP or Windows Vista OS and plug in the USB storage device into an available USB port.
- 3 Decompress the Crisis Package Source.
- 4 Select WINCRIS.exe and then select Run as administrator.
- 5 Keep the default settings and then click Start button.
- 6 When the pop-up warning dialog box appears, click OK to create the crisis disk.
- 7 Click No if you do not want to create another crisis disk.
- 8 Eject and reconnect the USB removable storage device, and make sure it contains the BIOS.wph, MINIDOS.sys, and PHLASH16.exe files.



## Performing a BIOS recovery

► To perform a BIOS recovery:

- 1 Shut down the BIOS failed-computer.
- 2 Connect the USB storage device containing the Crisis Recovery disk files to the failed computer.
- 3 Press and hold the Fn+Esc keys (this is the BIOS recovery hotkey), then press the power button.  
The BIOS recovery process begins. When the process is complete the computer will automatically reboot.
- 4 Disconnect the USB storage device from the computer.
- 5 Perform a BIOS flash procedure to update the BIOS firmware.



## Running the Flash utility:

- ▶ To run the Flash utility:
  - 1 Rename the BIOS file as "XXXXXXX.FD".
  - 2 Copy the "XXXXXXX.FD" file to a bootable USB device containing the Crisis Recovery disk files.
  - 3 Turn off the computer.
  - 4 Insert the USB device containing the renamed BIOS file and the Crisis Recovery disk files to any USB port.
  - 5 Press and hold the Fn+Esc keys (this is the BIOS recovery hotkey), then press the power button.
  - 6 Release the Fn+Esc keys after POST.



# Clearing a BIOS password

To clear a lost BIOS password (user or supervisor password) you need to short the clear password hardware gap (G27) located on the system board.

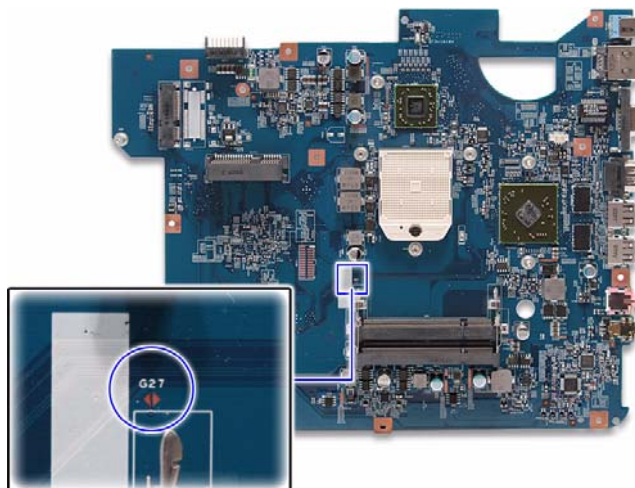

Gap	Default setting	Function
G27	Open (normal)	Short to clear the user and supervisor passwords.

► To clear a BIOS password:

- 1 Turn off the notebook and unplug all the peripherals connected to it.
- 2 Complete the steps in [“Removing the battery” on page 48](#).
- 3 Complete the steps in [“Removing the bay cover” on page 49](#).
- 4 Remove the memory module(s) and locate the G27 gap.
- 5 Use an electrical conductivity tool to short the two contacts on the hardware gap together.
- 6 While resting the tool on the two contacts, plug one end of the AC adapter into the DC power jack and plug one end to an electrical outlet.
- 7 Press the power button to turn on the system.
- 8 After the POST, remove the tool from the hardware gap.
- 9 Reinstall the memory module(s), battery pack, and the bay cover.
- 10 Turn on the notebook and press F2 during bootup to access the Setup utility.
- 11 Press F9 to load the system defaults.
- 12 Press F10 to save the changes you made and close the setup Utility.



# Unlocking the hard drive

To regain access to your computer if you lose the HDD password, you need to generate a master password and unlock the hard drive.

▶ To unlock a hard drive:

- 1 Open the computer in a DOS environment.
- 2 Type the following command:  
A\> unlock6 XXXXX 00
- 3 Press Enter to display the command options.
- 4 Select option 2 (upper case ASCII code), then press Enter.
- 5 Write down the generated master password.
- 6 Reboot the computer.
- 7 In the HDD password prompt, type the master password generated in [step 5](#), then press Enter.







# CHAPTER 3

## Replacing notebook components

- Preventing static electricity discharge
- Preparing the work space
- Required tools
- Preparing the notebook
- Adding or replacing memory modules
- Replacing the wireless card
- Replacing the hard drive
- Replacing the optical drive
- Replacing the keyboard cover
- Replacing the multimedia board
- Replacing the keyboard
- Replacing the LCD panel assembly
- Replacing the palm rest
- Replacing the speakers
- Replacing the touchpad board
- Replacing the modem board
- Replacing the USB board
- Replacing the Bluetooth module
- Replacing the system board
- Replacing the cooling assembly
- Replacing the processor
- Replacing the LCD front panel
- Replacing the webcam
- Replacing the LCD
- Replacing the LCD panel hinge brackets
- Replacing the power button board
- Replacing the Kensington lock cap
- Replacing the microphone
- Replacing the antennas
- Replacing the LCD assembly lid

# Preventing static electricity discharge



---

**Warning**

To avoid exposure to dangerous electrical voltages and moving parts, turn off your notebook, remove the battery, and unplug the power cord and network cable before opening the case.

---



---

**Warning**

To prevent risk of electric shock, do not insert any object into the vent holes of the notebook.

---



---

**Important**

Before performing maintenance on the notebook, you should read and understand the information in this section.

---

The components inside your notebook are extremely sensitive to static electricity, also known as *electrostatic discharge* (ESD).

Before performing maintenance on the notebook, follow these guidelines:

- Avoid static-causing surfaces such as carpeted floors, plastic, and packing foam.
- Remove components from their antistatic bags only when you are ready to use them. Do not lay components on the outside of antistatic bags because only the inside of the bags provide electrostatic protection.
- Always hold components by their edges. Avoid touching the edge connectors. Never slide components over any surface.
- Wear a grounding wrist strap (available at most electronics stores) and attach it to a bare metal part of your workbench or other grounded connection.
- Touch a bare metal surface on your workbench or other grounded object.

## Tape

Some of the procedures in this guide involve removing tape that secures cables or components. Two types of tape are used in this notebook:

- Mylar, non-conductive tape is typically transparent, with a red or brown tint.
- Conductive tape is typically grey or silver in color.

If the existing tape cannot be reused, replace it with the same type. Make sure the replacement tape is of the non-ESD generating kind. Do not use cellophane tape.

# Preparing the work space

Before performing maintenance on the notebook, make sure that your work space and the notebook are correctly prepared.

- Wear a grounding (ESD) wrist strap, and use a grounded or dissipative work mat.
- Use a sturdy table. Make sure that the table top is wide enough to hold each component as you remove it.
- Ensure that clear lighting condition is available to make part identification easier.
- Keep your work surface free from clutter and debris that may damage components.
- Use a magnetized screwdriver for removing screws.
- When removing components that are attached to the notebook by a cable, unplug the cable before removing the screws, when possible, to avoid damaging the cable.
- As you remove components and screws, lay them toward the rear of your work surface (behind the notebook) or far enough to the side that your arms will not accidentally brush them onto the floor.
- To help keep track of screws, try the following:
  - Place each component's screws in their own section of a parts sorter.
  - Place each component's screws next to the component on your work surface.
  - Print the first page of each task, then place the page toward the rear of your work surface. As you remove screws, place the screws in their respective section on the page.
  - After loosening screws that are deeply recessed in a hole (for example, on the bottom of the base assembly), you can leave the screws in the holes if you place small pieces of masking tape over the hole openings. When reassembling the component, just remove the tape and tighten the screws.
  - When you place flat-headed screws on the work surface, stand them on their heads to prevent the screws from rolling off the table.

# Required tools

To disassemble the notebook, you need the following tools:

- Wrist grounding strap (for ESD prevention)



- Conductive mat (for ESD prevention)

- Flat screwdriver



- Phillips screwdriver



- Non-marring plastic scribe



# Preparing the notebook

► To prepare the notebook for maintenance:

- 1 Make sure that the optical disc drive is empty.
- 2 Turn off the notebook.
- 3 Close the LCD panel.
- 4 Disconnect the AC adapter.



- 5 Disconnect the network cable and all peripheral devices connected to the notebook.
- 6 Make sure there is no memory card on the card reader slot. To remove a memory card:
  - a Push against the card, as if you were pushing it further into the slot, letting the card spring out
  - b Pull the memory card out of its slot.



# Removing the battery

► To remove the battery:

- 1 Turn the notebook over so the base is facing up.
- 2 Slide the battery lock to the unlocked position.



- 3 Slide the battery release latch (a), then remove the battery out of the notebook (b).



---

**Note**

The battery is highlighted with a yellow circle in the above image. Follow local regulations for battery disposal.

---



# Removing the bay cover

To remove or replace components located on the lower bay, you need to remove the bay cover first.

Tools you need to complete this task:



Phillips #0 screwdriver



Non-marring plastic scribe

► To remove the bay cover:

- 1 Complete the steps in [“Preparing the notebook” on page 47](#).
- 2 Turn the notebook over so the base is facing up.
- 3 Loosen the bay cover screws (these screws cannot be removed).

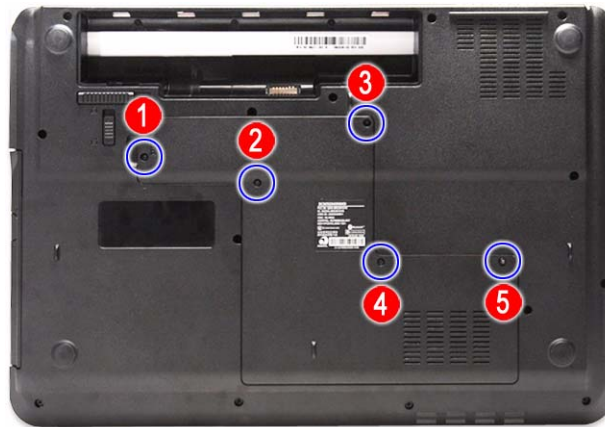

- 4 Insert a non-marring plastic scribe on the cover's notch to release the cover from the computer, and then remove the cover.



# Adding or replacing memory modules



## Important

Use only memory modules designed for this Gateway notebook.

Tools you need to complete this task:



Phillips #0 screwdriver



Non-marring plastic scribe

► To add or replace memory modules:

- 1 Complete the steps in [“Preparing the notebook”](#) on page 47.
- 2 Complete the steps in [“Removing the bay cover”](#) on page 49.
- 3 If you are replacing a memory module, go to [step 4](#).  
If you installing an additional memory module, go to [step 6](#).
- 4 Use a non-marring plastic scribe to push out the latches on both sides of the memory slot until the module tilts upward.

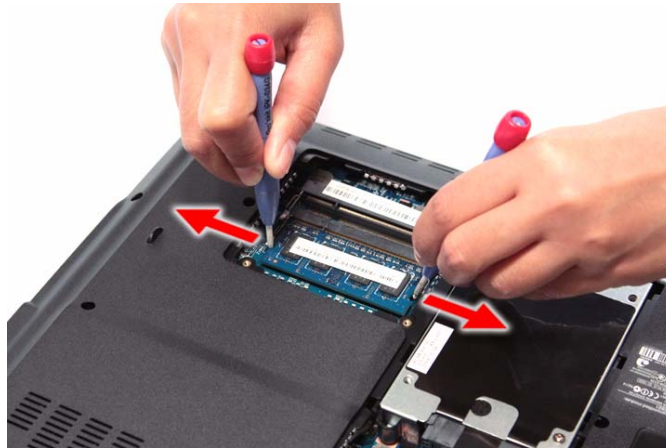

- 5 Remove the memory module from its slot.





- 6 Insert the new memory module at a 30° angle into an empty memory slot, and then press it down until it clicks into place.

The module is keyed so it can only be inserted in one direction. If the module does not fit, make sure that the notch in the module lines up with the tab in the memory slot.

- 7 Reinstall the bay cover.



# Replacing the wireless card

Tools you need to complete this task:



Screws removed during this task:

-  1 black M2x5 (wireless card)

► To replace the wireless card:

- 1 Complete the steps in [“Preparing the notebook” on page 47](#).
- 2 Complete the steps in [“Removing the bay cover” on page 49](#).
- 3 Detach the bar code sticker covering the antenna cables.
- 4 Unplug the antenna cables. Note which color cable corresponds to each of the connectors.



### Important

The number of antenna cables varies depending on the type of wireless card installed on the notebook. IEEE 802.11n cards typically have three antenna cables. Other types of wireless cards usually have only two antenna cables.



- 5 Move the antenna cables away from the wireless card screw.

- 6 Remove the screw securing the wireless card.



- 7 Pull the card out of the slot.

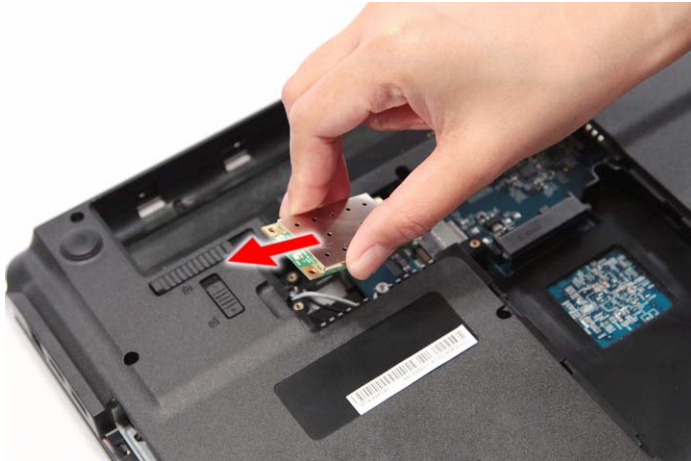

- 8 Insert the new wireless card at a 30° angle into the empty Mini Card slot. The card is keyed so it can only be inserted in one direction. If the card does not fit, make sure that the notch in the card lines up with the tab in the card slot.
- 9 Secure the new wireless card with the screw removed in [step 6](#).
- 10 Reconnect the antenna cables to the connectors.
- 11 Reinstall the bay cover.





# Replacing the hard drive

Tools you need to complete this task:



Screws removed during this task:

-  1 black M2x5 (hard drive)
-  2 chrome M3x3 (hard drive bracket)

► To replace the hard drive:

- 1 Complete the steps in [“Preparing the notebook” on page 47](#).
- 2 Complete the steps in [“Removing the bay cover” on page 49](#).
- 3 Remove the hard drive screw.

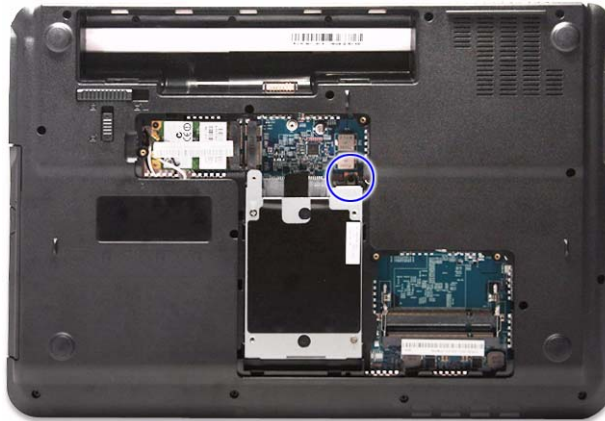

- 4 Grasp the black mylar tab and use it to disengage the hard drive from its connector, and then remove the drive from its compartment.



- 5 If your new hard drive already includes the hard drive bracket, go to [step 8](#).  
If you need to use the bracket from the old hard drive, go to [step 6](#).
- 6 Remove the screws that secure the hard drive bracket, and then detach the bracket from the drive.

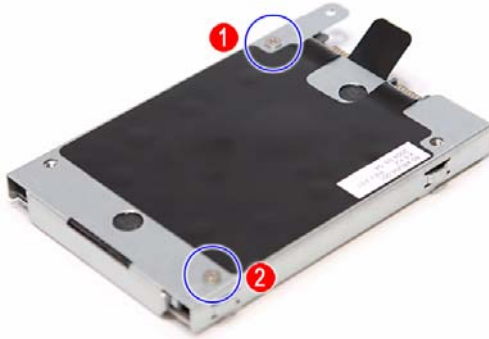

- 7 Place the bracket on the new drive and secure it with the two screws removed in [step 6](#).
- 8 Slide the new hard drive into the hard drive compartment and make sure it's properly engaged to the SATA1 connector.
- 9 Secure the new drive to the system board with the screw removed in [step 6](#).
- 10 Reinstall the bay cover.



# Replacing the optical drive

Tools you need to complete this task:



Screws removed during this task:

- 1 black M2.5x6 (optical drive)
- 1 chrome M2x3 (optical drive bracket)

► To replace the optical drive:

- 1 Complete the steps in [“Preparing the notebook” on page 47](#).
- 2 Complete the steps in [“Removing the bay cover” on page 49](#).
- 3 Remove the optical drive screw.

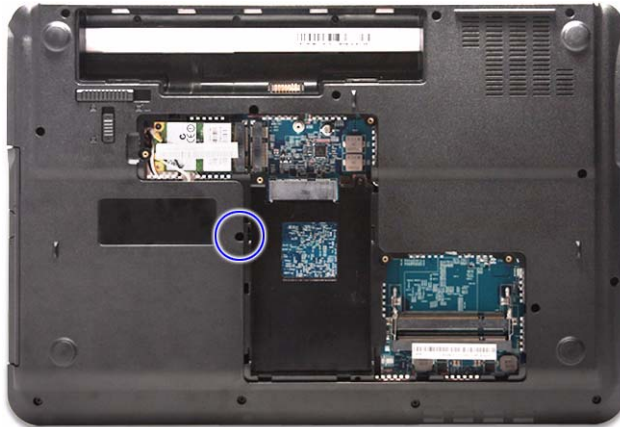

- 4 Use the non-marring plastic scribe to carefully push the optical drive out of the drive bay, and then slide the drive out.



- 5 If your new optical drive already has its own bracket and bezel, go to [step 10](#). If you need to use the bracket and bezel from the old optical drive, perform steps [6–9](#) as necessary.
- 6 Detach the bezel from the old optical drive.



- 7 Remove the screw that secures the optical drive bracket, and then detach the bracket from the drive.



- 8 Attach the bezel to the new optical drive.
- 9 Attach the bracket to the new optical drive and secure it with the screw removed in [step 7](#).
- 10 Slide the new optical drive into the drive bay and make sure it's properly engaged to the ODD1 connector.
- 11 Secure the new drive to the system board with the screw removed in [step 3](#).
- 12 Reinstall the bay cover.



# Replacing the keyboard cover

Tools you need to complete this task:



or

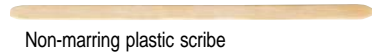

Screws removed during this task:

-  3 black M2.5x6 (keyboard cover)

► To replace the keyboard cover:

- 1 Complete the steps in [“Preparing the notebook” on page 47](#).
- 2 Complete the steps in [“Removing the battery” on page 48](#).
- 3 Remove the screws securing the keyboard cover.

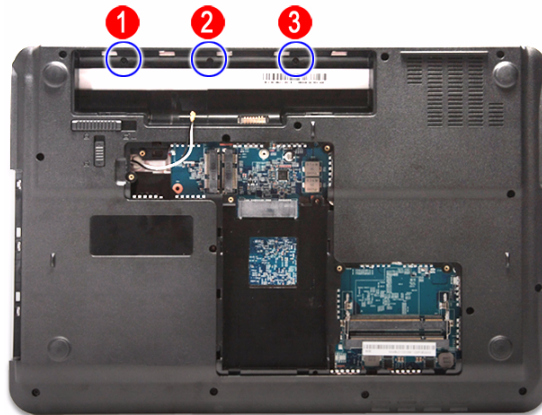

- 4 Turn the notebook over and open the LCD panel to its fully extended position.
- 5 Insert a small flat-blade screwdriver or non-marring scribe between the LCD hinge side and the keyboard cover, and carefully pry the cover up.







**Caution**

The keyboard cover is connected to the notebook through the multimedia board cable. Disconnect this cable first before pulling the cover away from the palm rest assembly.

- 6 Detach the keyboard cover from the palm rest assembly and turn it over the keyboard to access its underside **(a)**.  
Open the multimedia board cable connector **(b)** and disconnect the cable **(c)**.



- 7 If you will be using the multimedia board from the old keyboard cover, remove it by performing steps 3 and 4 of the “[Replacing the multimedia board](#)” procedure on [page 60](#).
- 8 Secure the multimedia board, with the connector facing up, on the new keyboard cover.
- 9 Insert the multimedia cable to its connector on the multimedia board, then close the clip to lock the cable in place.
- 10 Insert the tabs on the front side of the keyboard cover into the slots located on the top corners of the palm rest assembly, then press down on the back part.
- 11 Press down on the cover until it clicks in place.  
The keyboard cover is correctly mounted when you can run your finger along the sides of the cover and find no gaps.
- 12 Close the LCD panel and turn the notebook over so the base is facing up.
- 13 Secure the keyboard cover with the screws removed in [step 3](#).



**Caution**

If the cover is not correctly installed, your notebook could be damaged when you try to close the LCD panel.

- 14 Reinstall the battery.



# Replacing the multimedia board

Tools you need to complete this task:

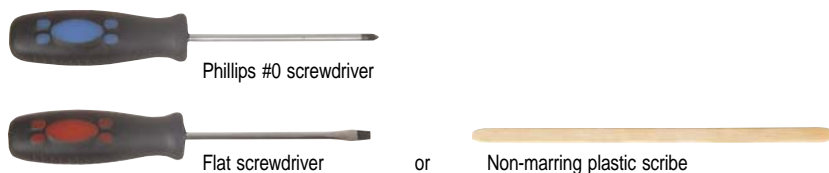

Screws removed during this task:

-  3 black M2.5×6 (keyboard cover)

► To replace the multimedia board:

- 1 Complete the steps in [“Preparing the notebook”](#) on page 47.
- 2 Remove the keyboard cover by performing steps 2–6 of the [“Replacing the keyboard cover”](#) procedure on page 58.



### Caution

The multimedia board is glued to the keyboard cover. Remove this board only if it is defective.

- 3 Insert a small flat-blade screwdriver or non-marring scribe between the multimedia board and the keyboard cover’s underside, and carefully pry the board loose.

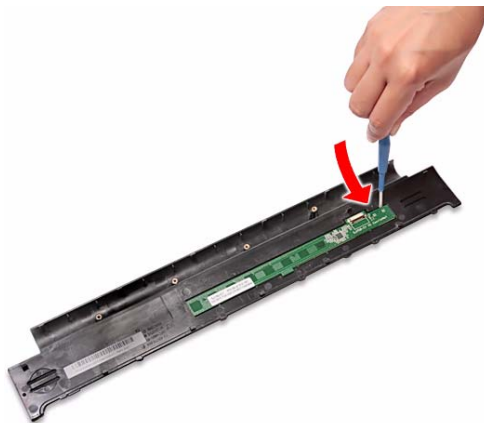

- 4 Remove the multimedia board from the keyboard cover.



### Note

A circuit board that is  $>10 \text{ cm}^2$  has been highlighted with a yellow rectangle as shown in the above image. Follow the local regulations for disposing this type of circuit board.

- 5 Secure the new multimedia board, with the connector facing up, on the keyboard cover.
- 6 Insert the multimedia cable to its connector on the multimedia board, then close the clip to lock the cable in place.
- 7 Insert the tabs on the front side of the keyboard cover into the slots located on the top corners of the palm rest assembly, then press down on the back part.
- 8 Press down on the cover until it clicks in place.  
The keyboard cover is correctly mounted when you can run your finger along the sides of the cover and find no gaps.
- 9 Close the LCD panel and turn the notebook over so the base is facing up.
- 10 Secure the keyboard cover with the screws removed in [step 3](#) of the ["Replacing the keyboard cover"](#) procedure on [page 58](#).



**Caution**

If the cover is not correctly installed, your notebook could be damaged when you try to close the LCD panel.

---

- 11 Reinstall the battery.



# Replacing the keyboard

Tools you need to complete this task:

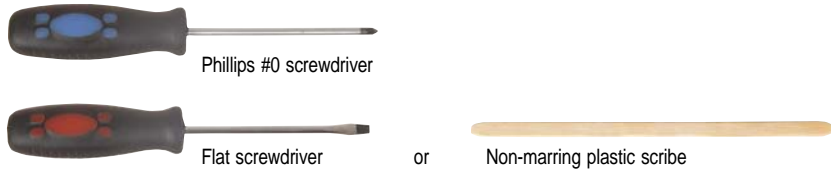

Screws removed during this task:

-  3 black M2.5x6 (keyboard cover)

► To replace the keyboard:

- 1 Complete the steps in [“Preparing the notebook”](#) on page 47.
- 2 Remove the keyboard cover by performing steps 2–6 of the [“Replacing the keyboard cover”](#) procedure on page 58.



### Caution

The keyboard is connected to the notebook through the keyboard cable. Disconnect this cable first before pulling the keyboard away from the palm rest.

- 3 Lift the back edge of the keyboard slightly, then carefully slide it toward the LCD panel to release the keyboard retaining tabs from the palm rest.
- 4 Flip the keyboard over onto the touchpad area to access to the keyboard cable **(a)**.

Open the keyboard cable connector **(b)** and disconnect the cable **(c)**.

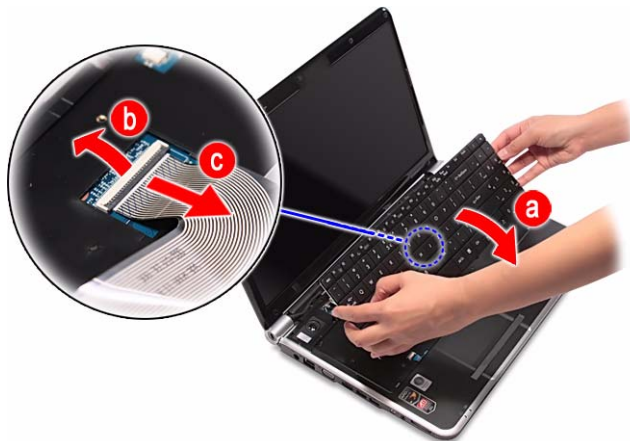

- 5 Insert the retaining tabs of the new keyboard into the slots located on the top side of the touchpad area.
- 6 Reach underneath the keyboard and insert the keyboard cable to its system board connector, then close the clip to lock the cable in place.



---

**Important**

The keyboard cable is correctly oriented if it is not twisted.

---

- 7 Gently press the keyboard down until it is flat all the way across.
- 8 Reinstall the keyboard cover by performing steps [9–13](#) of the “[Replacing the keyboard cover](#)” procedure on [page 58](#).
- 9 Reinstall the battery.



# Replacing the LCD panel assembly

Tools you need to complete this task:

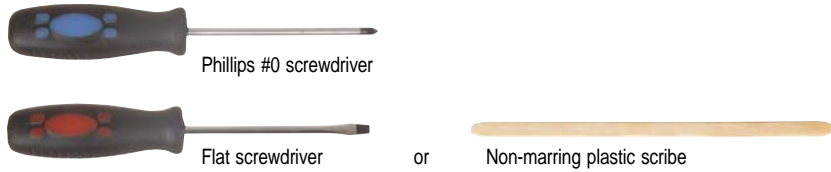

Screws removed during this task:

- 3 black M2.5x6 (keyboard cover)
- 2 black M2.5x6 (LCD panel hinges - bottom)
- 2 black M2.5x6+Nylok (LCD panel hinges - top)

► To replace the LCD panel assembly:

- 1 Complete the steps in [“Preparing the notebook”](#) on page 47.
- 2 If the notebook has a wireless card installed, complete the steps in [“Removing the bay cover”](#) on page 49, and then unplug the antenna cables. If there’s no wireless card installed, proceed to [step 5](#).
- 3 Remove the keyboard by performing steps 2–4 of the [“Replacing the keyboard”](#) procedure on page 62.



### Caution

The keyboard is connected to the notebook through a keyboard cable. Disconnect this cable first before pulling the keyboard away from the palm rest assembly.

- 4 Turn the notebook over so the base is facing up.
- 5 Remove the base screws that secure the LCD panel hinges.

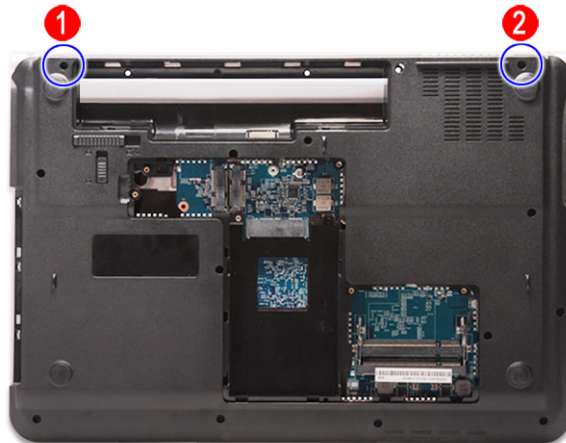

- 6 Turn the notebook over again so the palm rest is facing up.
- 7 Disconnect the LCD, webcam, and microphone cables from their system board connectors.



- 8 Release the LCD, webcam, and microphone cables from their latches.

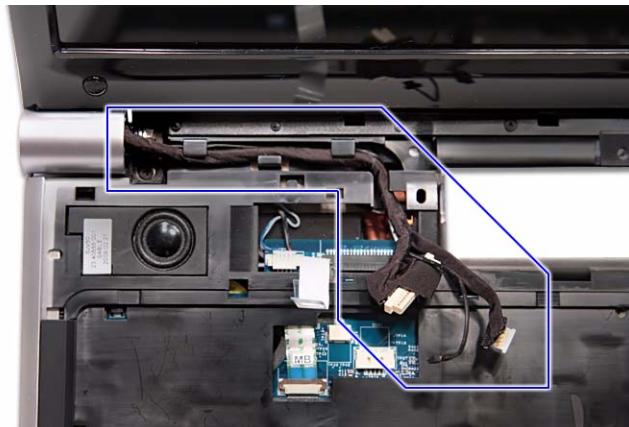

- 9 If the notebook has a wireless card installed, note the antenna cable routing for later reference and then perform [step 10](#) to release the antenna cables from the palm rest.

If there's no wireless card installed, proceed to [step 11](#) to disconnect the power button board cable.

- 10 Release the antenna cables from their palm rest latches, and then pull them out from underneath the computer.

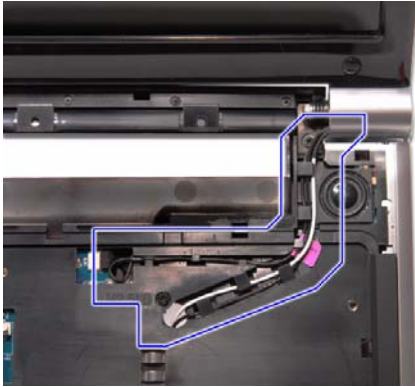

- 11 Disconnect the power button board cable from its system board connector, and then release it from its palm rest latches.



- 12 Carefully open the LCD panel to its fully extended position.
- 13 Move the LCD, webcam, and microphone cables away from the top hinge screws.
- 14 Remove the top hinge screws securing the LCD assembly.

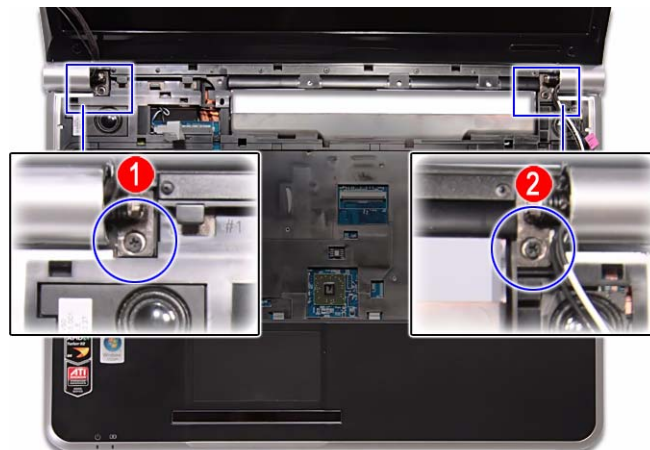



- 15 Lift the LCD panel assembly up and away from the notebook.



- 16 Position the new LCD panel assembly on the notebook, and then secure it with the hinge screws removed in [step 14](#).
- 17 If the notebook has a wireless card installed, proceed to [step 18](#) to arrange the antenna cables.  
If there's no wireless card installed, proceed to [step 19](#) to reconnect the power button board cable.
- 18 Refer to the antenna cable routing note made on [step 9](#) and secure the antenna cables to the palm rest before pulling the ends downward to the wireless card compartment.
- 19 Arrange the power button cable on the palm rest and reconnect it to its system board connector.
- 20 Arrange the LCD, webcam, and microphone cables on the palm rest and reconnect them to their system board connectors.
- 21 Close the LCD panel and turn the notebook over so the base is facing up.
- 22 If the notebook has a wireless card installed, reconnect the antenna cables and then reinstall the bay cover.
- 23 Return the base hinge screws removed in [step 5](#).
- 24 Turn the notebook over so the palm rest is facing up.
- 25 Reinstall the keyboard and the keyboard cover by performing steps [5–8](#) of the "[Replacing the keyboard](#)" procedure on [page 62](#).
- 26 Reinstall the battery.



## ■ Replacing the palm rest







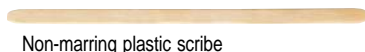

Tools you need to complete this task:



or



Screws removed during this task:

-  1 black M2x5 (hard drive)
-  1 black M2.5x6 (optical drive)
-    3 black M2.5x6 (keyboard cover)
-   2 black M2.5x6 (LCD panel hinges - bottom)
-   2 black M2.5x6+Nylok (LCD panel hinges - top)
-          10 M2.5x6 black (palm rest - base side)
-    3 M2.5x6 black (palm rest - top side)

► To replace the palm rest:

- 1 Complete the steps in [“Preparing the notebook” on page 47](#).
- 2 Complete the steps in [“Removing the bay cover” on page 49](#).
- 3 If the notebook has a wireless card installed, unplug the antenna cables.
- 4 Remove the hard drive screw, and then remove the hard drive from its compartment.

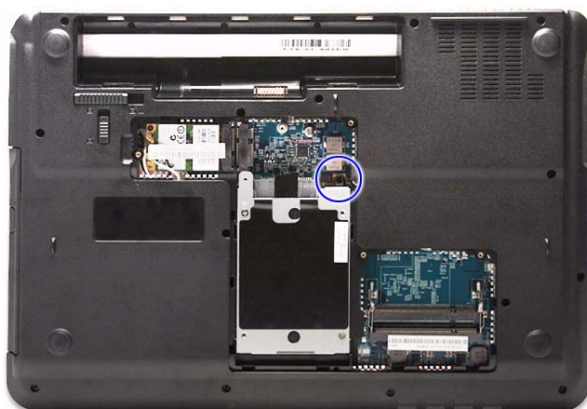

- 5 Remove the optical drive screw.

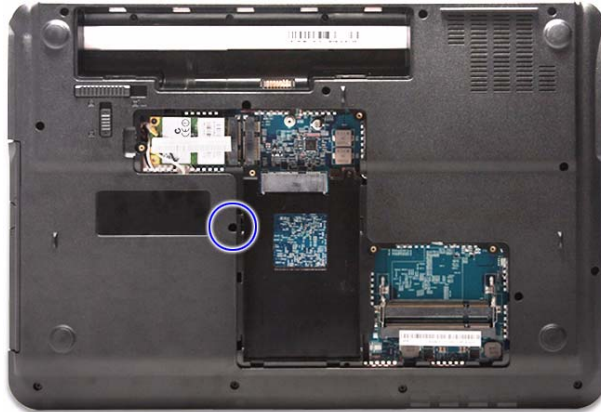

- 6 Remove the keyboard cover by performing steps 2–6 of the “Replacing the keyboard cover” procedure on page 58.
- 7 Remove the keyboard by performing steps 3 and 4 of the “Replacing the keyboard” procedure on page 62.
- 8 Remove the LCD panel assembly by performing steps 5–15 of the “Replacing the LCD panel assembly” procedure on page 64.
- 9 Disconnect the speaker cable from the system board.

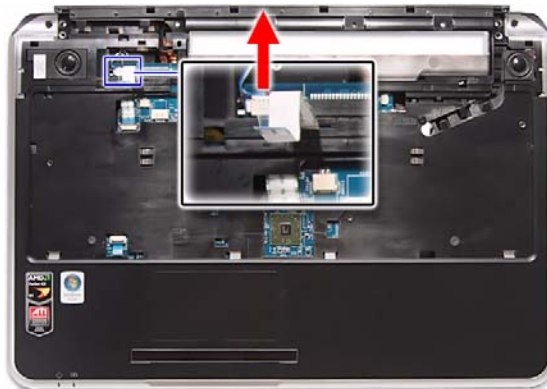

- 10 Open the multimedia cable connector (a) and disconnect the cable (b).

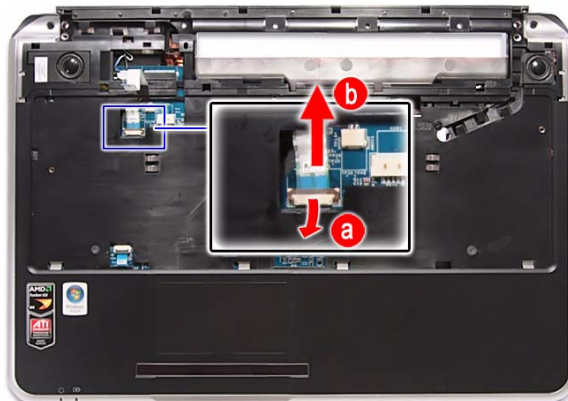

- 11 Open the touchpad cable connector **(a)** and disconnect the cable from the system board **(b)**.

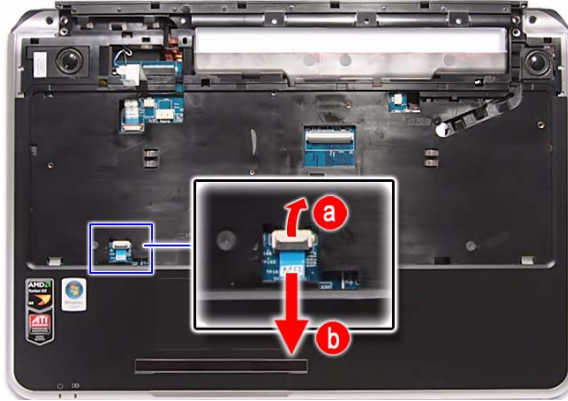

- 12 Turn the notebook over so the base is facing up.
- 13 Remove the screws securing the palm rest on the base side.

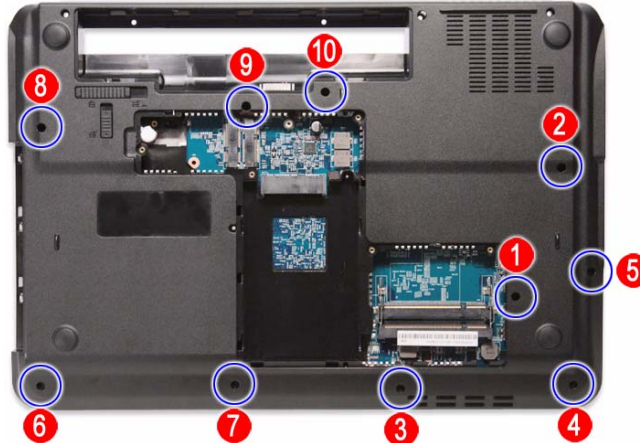

- 14 Turn the notebook over again so the palm rest is facing up.
- 15 Remove the screws securing the palm rest on the top side.

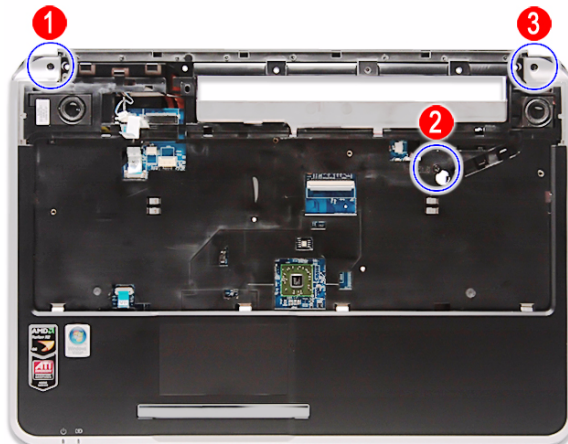

- 16 Locate the small gaps on the top side of the palm rest and insert a small flat-blade screwdriver or non-marring scribe into each gap to separate the palm rest from the base enclosure.



- 17 Once the top side is separated, pry loose the left and right sides of the palm rest, and finally the bottom side until all the palm rest retaining tabs have been released.
- 18 Lift the palm rest assembly from the base enclosure.

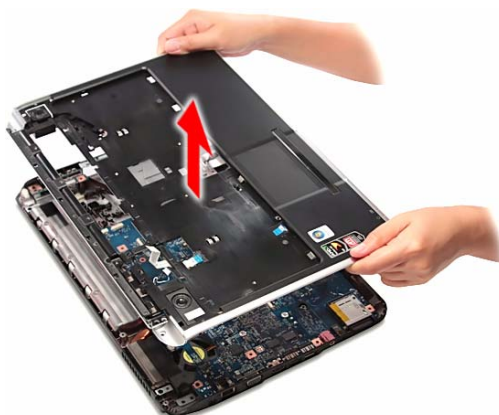

- 19 Place the new palm rest assembly on top of the base enclosure and press it down on all sides until it snaps into place.
- 20 Reconnect the speaker, multimedia, and touchpad cables to their respective system board connectors.
- 21 Secure the palm rest assembly with the screws removed in steps 13 and 15.
- 22 Reinstall the LCD panel assembly by performing steps 16–23 of the [“Replacing the LCD panel assembly”](#) procedure on [page 64](#).
- 23 Reinstall the keyboard and the keyboard cover by performing steps 5–8 of the [“Replacing the keyboard”](#) procedure on [page 62](#).
- 24 Return the optical screw drive in its place.
- 25 Reinstall the hard drive by performing steps 8 and 9 of the [“Replacing the hard drive”](#) procedure on [page 54](#).
- 26 If you have disconnected any wireless antennas, reconnect them now.
- 27 Reinstall the bay cover.



# Replacing the speakers







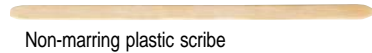















Tools you need to complete this task:



or



Screws removed during this task:

-  1 black M2x5 (hard drive)
-  1 black M2.5x6 (optical drive)
-    3 black M2.5x6 (keyboard cover)
-   2 black M2.5x6 (LCD panel hinges - bottom)
-   2 black M2.5x6+Nylok (LCD panel hinges - top)
-          10 M2.5x6 black (palm rest - base side)
-    3 M2.5x6 black (palm rest - top side)
-   2 chrome M2x3 (speakers)

► To replace the speakers:

- 1 Complete the steps in [“Preparing the notebook” on page 47](#).
- 2 Remove the palm rest by performing steps 2–18 of the [“Replacing the palm rest” procedure on page 68](#).
- 3 Turn the palm rest over so that its underside is facing up.
- 4 Peel off the tape covering the left speaker screw.

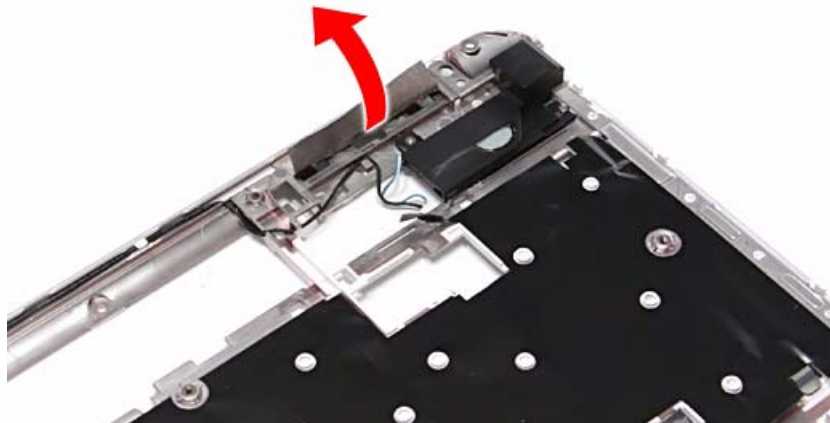

- 5 Remove the speaker screws.

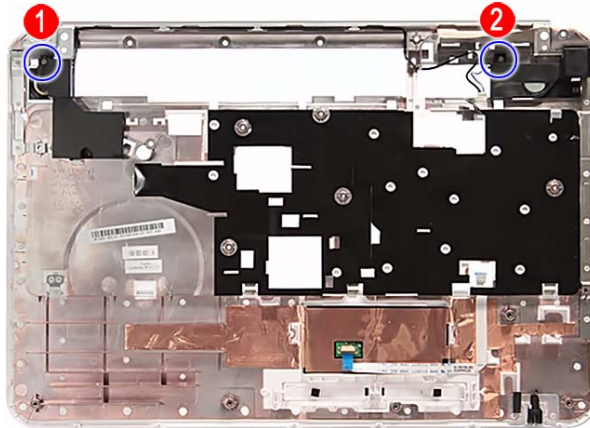

- 6 Release the speaker cable from the palm rest, and then remove the speakers.

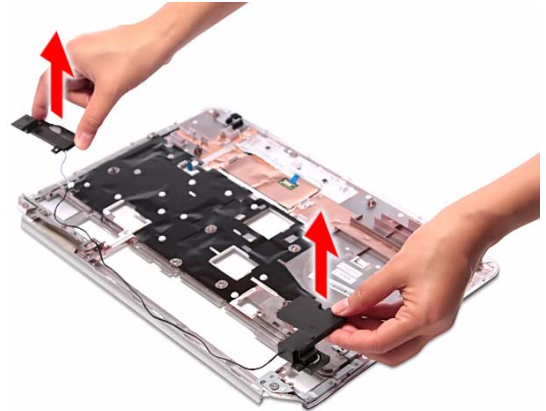

- 7 Position the new speakers on the palm rest.
- 8 Secure the speakers with the screws removed in [step 5](#) and cover it with the tape that was detached in [step 4](#).
- 9 Secure the speaker cable on the palm rest latches
- 10 Reinstall the palm rest by performing steps [19–21](#) of the [“Replacing the palm rest”](#) procedure on [page 68](#).
- 11 Reinstall the LCD panel assembly by performing steps [16–23](#) of the [“Replacing the LCD panel assembly”](#) procedure on [page 64](#).
- 12 Reinstall the keyboard and the keyboard cover by performing steps [5–8](#) of the [“Replacing the keyboard”](#) procedure on [page 62](#).
- 13 Return the optical screw drive in its place.
- 14 Reinstall the hard drive by performing steps [8](#) and [9](#) of the [“Replacing the hard drive”](#) procedure on [page 54](#).
- 15 If you have disconnected any wireless antennas, reconnect them now.
- 16 Reinstall the bay cover.



# Replacing the touchpad board

Tools you need to complete this task:

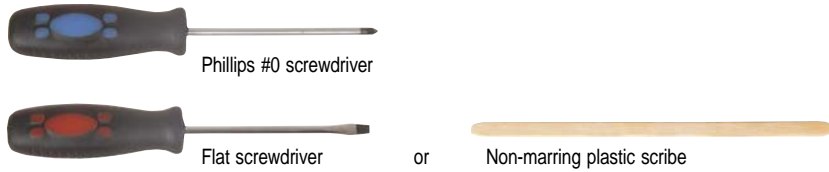

Screws removed during this task:

- 1 black M2x5 (hard drive)
- 1 black M2.5x6 (optical drive)
- 3 black M2.5x6 (keyboard cover)
- 2 black M2.5x6 (LCD panel hinge - bottom)
- 2 black M2.5x6+Nylok (LCD panel hinge - top)
- 10 M2.5x6 black (palm rest - base side)
- 3 M2.5x6 black (palm rest - top side)

► To replace the touchpad board:

- 1 Complete the steps in [“Preparing the notebook”](#) on page 47.
- 2 Remove the palm rest by performing steps 2–18 of the [“Replacing the palm rest”](#) procedure on page 68.
- 3 Turn the palm rest over so that its underside is facing up.
- 4 Open the touchpad board cable connector **(a)** and disconnect the cable **(b)**.

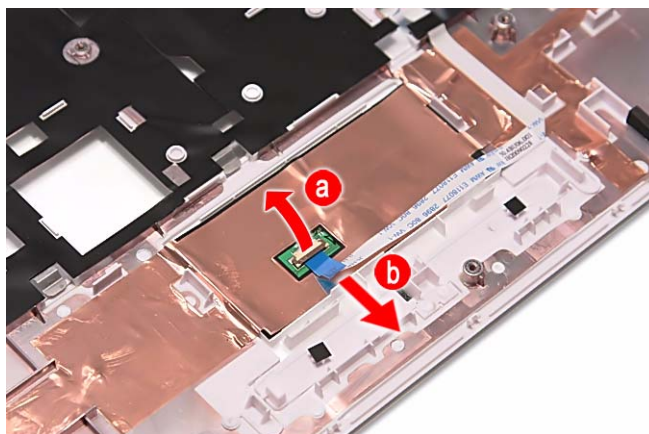



- 5 Remove the touchpad cable from the palm rest.



- 6 Peel off the tape protecting the touchpad board.

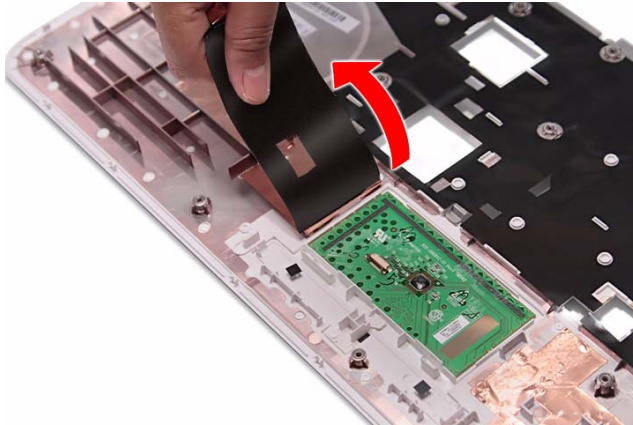

- 7 Note the orientation of the touchpad board for later reference in installing the new touchpad board.

- 8 Insert a small flat-blade screwdriver or non-marring scribe between the touchpad board and the palm rest's underside, and carefully pry the board loose.

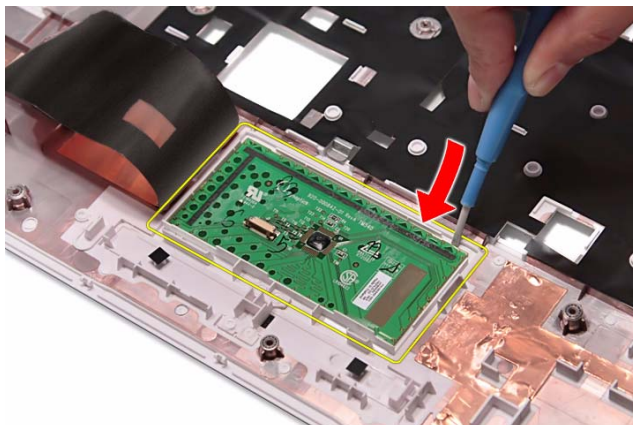

- 9 Remove the touchpad board from the palm rest.



**Note**

A circuit board that is  $>10 \text{ cm}^2$  has been highlighted with a yellow rectangle as shown in the above image. Follow the local regulations for disposing this type of circuit board.

- 10 Observing the same orientation as the old touchpad board, secure the new board on the palm rest.
- 11 Cover the new touchpad board with the tape removed in [step 6](#).
- 12 Insert the touchpad cable to the touchpad board cable connector, and then close the clip to lock the cable in place.
- 13 Reinstall the palm rest by performing steps [19–21](#) of the “[Replacing the palm rest](#)” procedure on [page 68](#).
- 14 Reinstall the LCD panel assembly by performing steps [16–23](#) of the “[Replacing the LCD panel assembly](#)” procedure on [page 64](#).
- 15 Reinstall the keyboard and the keyboard cover by performing steps [5–8](#) of the “[Replacing the keyboard](#)” procedure on [page 62](#).
- 16 Return the optical screw drive in its place.
- 17 Reinstall the hard drive by performing steps [8](#) and [9](#) of the “[Replacing the hard drive](#)” procedure on [page 54](#).
- 18 If you have disconnected any wireless antennas, reconnect them now.
- 19 Reinstall the bay cover.







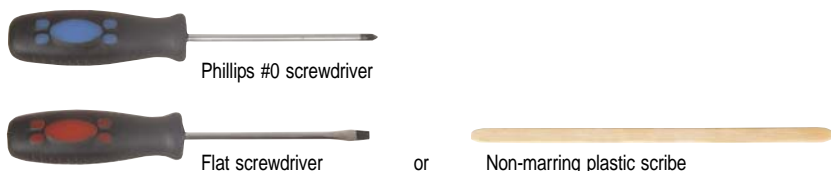

















# Replacing the modem board

Tools you need to complete this task:



Screws removed during this task:

-  1 black M2x5 (hard drive)
-  1 black M2.5x6 (optical drive)
-    3 black M2.5x6 (keyboard cover)
-   2 black M2.5x6 (LCD panel hinge - bottom)
-   2 black M2.5x6+Nylok (LCD panel hinge - top)
-          10 M2.5x6 black (palm rest - base side)
-    3 M2.5x6 black (palm rest - top side)
-  1 black M2x4 (modem board)

► To replace the system board:

- 1 Complete the steps in [“Preparing the notebook”](#) on page 47.
- 2 Complete the steps in [“Removing the battery”](#) on page 48.
- 3 Remove the memory from the old system board and install it on the new system board by following the instructions in the [“Adding or replacing memory modules”](#) section on page 50.
- 4 If the notebook has a wireless card installed, remove the card from the old system board and install it on the new system board by following the instructions in the [“Replacing the wireless card”](#) section on page 52.
- 5 Remove the hard drive by performing steps 3 and 4 of the [“Replacing the hard drive”](#) procedure on page 54.
- 6 Remove the optical drive by performing steps 3 and 4 of the [“Replacing the optical drive”](#) procedure on page 56.
- 7 Remove the palm rest by following steps 6–18 of the [“Replacing the palm rest”](#) procedure on page 68.

- 8 Disconnect the modem cable from the modem board.



- 9 Remove the modem board screw.



- 10 Remove the old modem board from the system board.

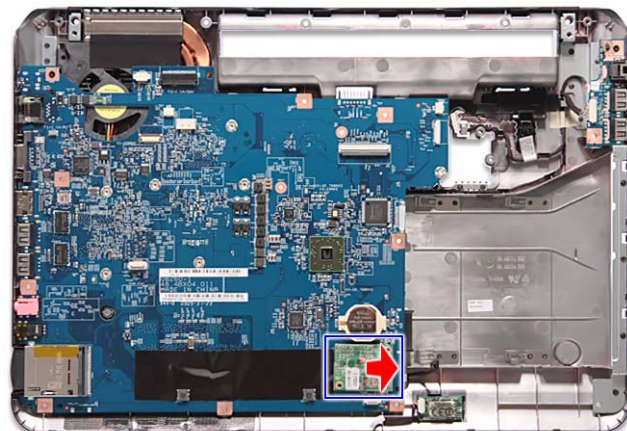

- 11 Connect the modem cable to the new modem board, and then attach to board to its system board connector.
- 12 Secure the new modem board with the screw removed in [step 9](#).
- 13 Reinstall the palm rest by performing steps [19–21](#) of the “[Replacing the palm rest](#)” procedure on [page 68](#).
- 14 Reinstall the LCD panel assembly by following the steps [16–23](#) of the “[Replacing the LCD panel assembly](#)” procedure on [page 64](#).
- 15 Reinstall the keyboard and the keyboard cover by performing steps [5–8](#) of the “[Replacing the keyboard](#)” procedure on [page 62](#).
- 16 Close the LCD panel and turn the notebook over so the base is facing up.
- 17 Reinstall the optical drive by performing steps [10](#) and [11](#) of the “[Replacing the optical drive](#)” procedure on [page 56](#).
- 18 Reinstall the hard drive by performing steps [8](#) and [9](#) of the “[Replacing the hard drive](#)” procedure on [page 54](#).
- 19 If you have disconnected any wireless antennas, reconnect them now.
- 20 Reinstall the bay cover.
- 21 Reinstall the battery.



# Replacing the USB board





Tools you need to complete this task:

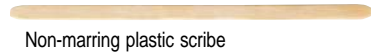

or



Screws removed during this task:

-  1 black M2x5 (hard drive)
-  1 black M2.5x6 (optical drive)
-    3 black M2.5x6 (keyboard cover)
-   2 black M2.5x6 (LCD panel hinge - bottom)
-   2 black M2.5x6+Nylok (LCD panel hinge - top)
-          10 M2.5x6 black (palm rest - base side)
-    3 M2.5x6 black (palm rest - top side)

► To replace the USB board:

- 1 Complete the steps in [“Preparing the notebook” on page 47](#).
- 2 Complete the steps in [“Removing the battery” on page 48](#).
- 3 Complete the steps in [“Removing the bay cover” on page 49](#).
- 4 If the notebook has a wireless card installed, unplug the antenna cables.
- 5 Remove the hard drive screw, and then remove the hard drive from its compartment.

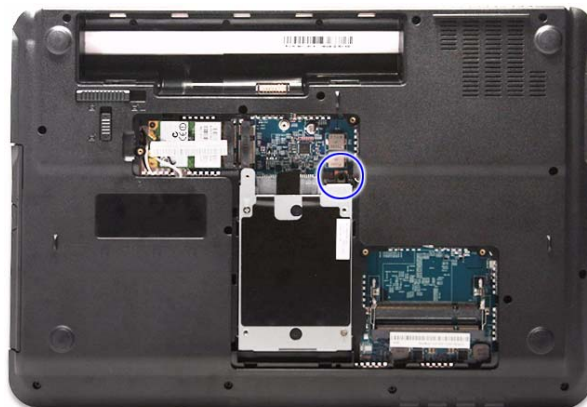

- 6 Remove the optical drive screw.

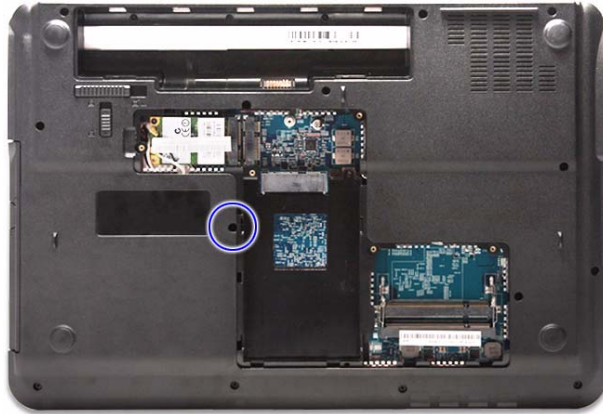

- 7 Remove the palm rest by performing steps 6–18 of the “Replacing the palm rest” procedure on [page 68](#).
- 8 Disconnect the USB board and modem board cables from the USB board.



- 9 Remove the USB board screw.



- 10 Remove the USB board from the base enclosure.

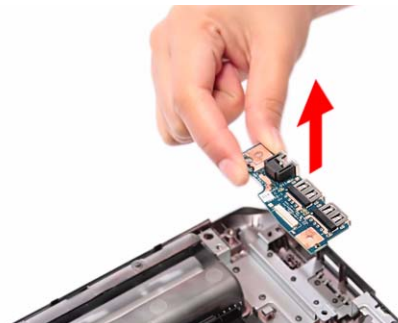

- 11 Place the new USB board in the base enclosure and secure it with the screw removed in [step 9](#).
- 12 Connect the USB board and modem board cables to the new USB board.
- 13 Reinstall the palm rest by performing steps [19–21](#) of the “[Replacing the palm rest](#)” procedure on [page 68](#).
- 14 Reinstall the LCD panel assembly by performing steps [16–23](#) of the “[Replacing the LCD panel assembly](#)” procedure on [page 64](#).
- 15 Reinstall the keyboard and the keyboard cover by performing steps [5–8](#) of the “[Replacing the keyboard](#)” procedure on [page 62](#).
- 16 Close the LCD panel and turn the notebook over so the base is facing up.
- 17 Return the optical screw drive in its place.
- 18 Reinstall the hard drive by performing steps [8](#) and [9](#) of the “[Replacing the hard drive](#)” procedure on [page 54](#).
- 19 If you have disconnected any wireless antennas, reconnect them now.
- 20 Reinstall the bay cover.
- 21 Reinstall the battery.





# Replacing the Bluetooth module

Tools you need to complete this task:



Phillips #0 screwdriver







Flat screwdriver

or



Non-marring plastic scribe

Screws removed during this task:

-  1 black M2x5 (hard drive)
-  1 black M2.5x6 (optical drive)
-    3 black M2.5x6 (keyboard cover)
-   2 black M2.5x6 (LCD panel hinge - bottom)
-   2 black M2.5x6+Nylok (LCD panel hinge - top)
-          10 M2.5x6 black (palm rest - base side)
-    3 M2.5x6 black (palm rest - top side)

► To replace the Bluetooth module:

- 1 Complete the steps in [“Preparing the notebook”](#) on page 47.
- 2 Complete the steps in [“Removing the battery”](#) on page 48.
- 3 Complete the steps in [“Removing the bay cover”](#) on page 49.
- 4 If the notebook has a wireless card installed, unplug the antenna cables.
- 5 Remove the hard drive screw, and then remove the hard drive from its compartment.

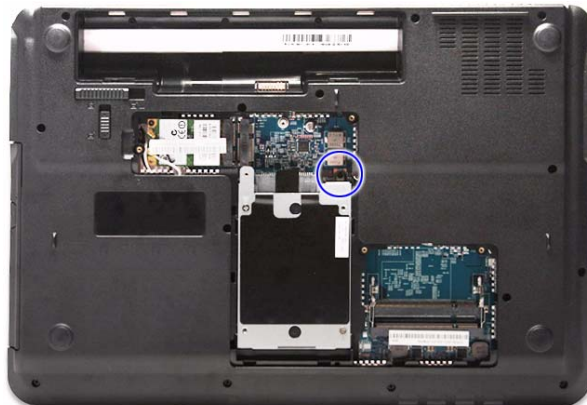

- 6 Remove the optical drive screw.

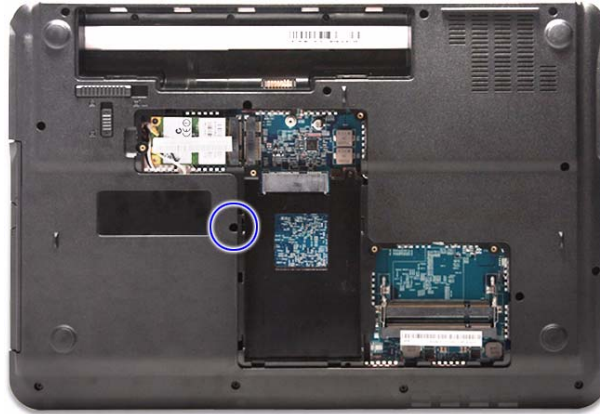

- 7 Remove the palm rest by performing steps 6–18 of the “Replacing the palm rest” procedure on [page 68](#).
- 8 Disconnect the Bluetooth cable from the Bluetooth module.

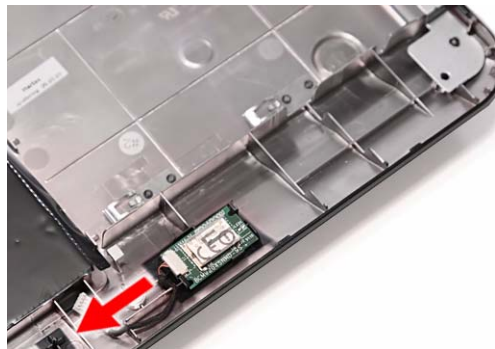

- 9 Release the Bluetooth module from the tabs securing it.

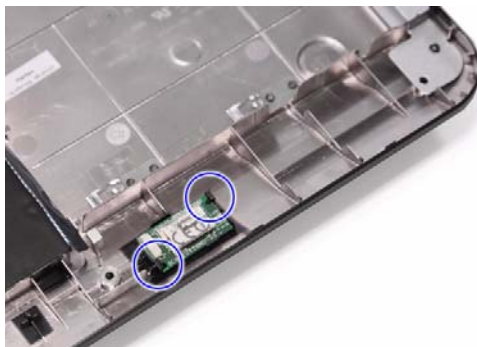

- 10 Secure the new Bluetooth module on the base enclosure and connect the Bluetooth cable to it.
- 11 Reinstall the palm rest by performing steps 19–21 of the “[Replacing the palm rest](#)” procedure on [page 68](#).
- 12 Reinstall the LCD panel assembly by performing steps 16–23 of the “[Replacing the LCD panel assembly](#)” procedure on [page 64](#).
- 13 Reinstall the keyboard and the keyboard cover by performing steps 5–8 of the “[Replacing the keyboard](#)” procedure on [page 62](#).
- 14 Close the LCD panel and turn the notebook over so the base is facing up.
- 15 Return the optical screw drive in its place.
- 16 Reinstall the hard drive by performing steps 8 and 9 of the “[Replacing the hard drive](#)” procedure on [page 54](#).
- 17 If you have disconnected any wireless antennas, reconnect them now.
- 18 Reinstall the bay cover.
- 19 Reinstall the battery.







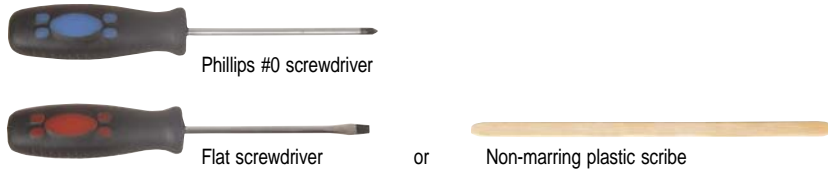

















# Replacing the system board

Tools you need to complete this task:



Screws removed during this task:

-  1 black M2x5 (hard drive)
  -  1 black M2.5x6 (optical drive)
  -    3 black M2.5x6 (keyboard cover)
  -   2 black M2.5x6 (LCD panel hinge - bottom)
  -   2 black M2.5x6+Nyllok (LCD panel hinge - top)
  -           10 M2.5x6 black (palm rest - base side)
  -    3 M2.5x6 black (palm rest - top side)
  -  1 black M2x4 (system board)
- To replace the system board:
- 1 Complete the steps in [“Preparing the notebook” on page 47](#).
  - 2 Complete the steps in [“Removing the battery” on page 48](#).
  - 3 Remove the memory from the old system board and install it on the new system board by following the instructions in the [“Adding or replacing memory modules”](#) section on [page 50](#).
  - 4 If the notebook has a wireless card installed, remove the card from the old system board and install it on the new system board by following the instructions in the [“Replacing the wireless card”](#) section on [page 52](#).
  - 5 Remove the hard drive by performing steps [3](#) and [4](#) of the [“Replacing the hard drive”](#) procedure on [page 54](#).
  - 6 Remove the optical drive by performing steps [3](#) and [4](#) of the [“Replacing the optical drive”](#) procedure on [page 56](#).
  - 7 Remove the palm rest by following steps [6–18](#) of the [“Replacing the palm rest”](#) procedure on [page 68](#).

- 8 Disconnect the USB board and Bluetooth module cables from their system board connectors; then disconnect the modem cable from the modem board.

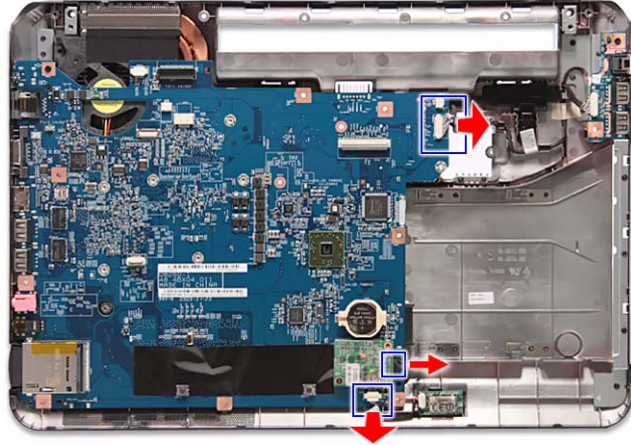

- 9 Remove the system board screw.

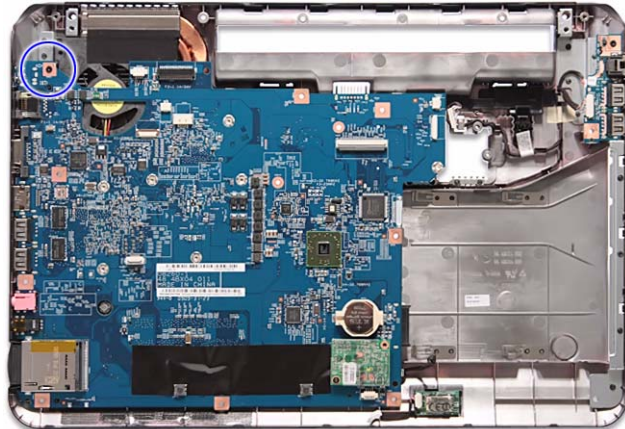

- 10 Carefully remove the system board from the base enclosure.

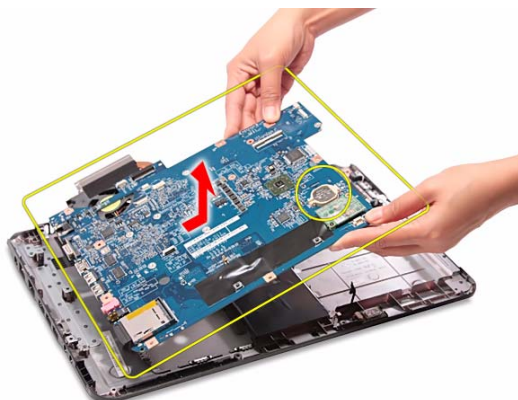
**Note**

A circuit board that is  $>10\text{ cm}^2$  has been highlighted with a yellow rectangle as shown in the previous image. Follow the local regulations for disposing this type of circuit board.

The RTC battery has been highlighted with a yellow circle in the previous image. Detach the RTC battery and follow the local regulations for disposing it.

- 11 Turn the system board over and remove the cooling assembly by performing steps 4–7 of the “Replacing the cooling assembly” procedure on page 89.
- 12 If your new system board does not include a processor, remove the processor from the old system board and install it on the new system board by performing steps 4–7 in the “Replacing the processor” section on page 92.
- 13 Reinstall the cooling assembly by performing steps 9–12 of the “Replacing the cooling assembly” procedure on page 89.
- 14 Place the new system board in the base enclosure and secure it with the screw removed in step 9.
- 15 Reconnect the USB board and Bluetooth module cables to their system board connectors; then reconnect the modem cable to the modem board.
- 16 Reinstall the palm rest by performing steps 19–21 of the “Replacing the palm rest” procedure on page 68.
- 17 Reinstall the LCD panel assembly by following the steps 16–23 of the “Replacing the LCD panel assembly” procedure on page 64.
- 18 Reinstall the keyboard and the keyboard cover by performing steps 5–8 of the “Replacing the keyboard” procedure on page 62.
- 19 Close the LCD panel and turn the notebook over so the base is facing up.
- 20 Reinstall the optical drive by performing steps 10 and 11 of the “Replacing the optical drive” procedure on page 56.
- 21 Reinstall the hard drive by performing steps 8 and 9 of the “Replacing the hard drive” procedure on page 54.
- 22 If you have disconnected any wireless antennas, reconnect them now.
- 23 Reinstall the bay cover.
- 24 Reinstall the battery.



# Replacing the cooling assembly

Tools you need to complete this task:

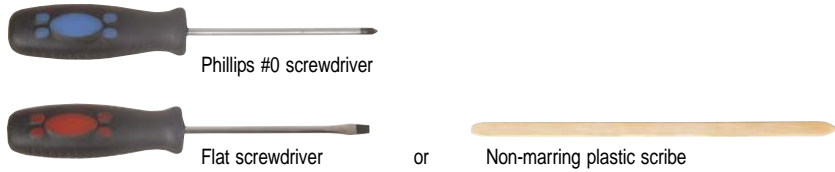

Additional materials you need to complete this task:

- Soft cloth and isopropyl alcohol; or alcohol pad
- Thermal grease

Screws removed during this task:

- 1 black M2x5 (hard drive)
- 1 black M2.5x6 (optical drive)
- 3 black M2.5x6 (keyboard cover)
- 2 black M2.5x6 (LCD panel hinge - bottom)
- 2 black M2.5x6+Nylok (LCD panel hinge - top)
- 10 M2.5x6 black (palm rest - base side)
- 3 M2.5x6 black (palm rest - top side)
- 1 black M2x4 (system board)

► To replace the cooling assembly:

- 1 Complete the steps in [“Preparing the notebook” on page 47](#).
- 2 Remove the system board by performing steps 2–10 of the [“Replacing the system board”](#) procedure on [page 86](#).
- 3 Turn the system board over to access the cooling fan cable.
- 4 Disconnect the cooling fan cable from its system board connector.

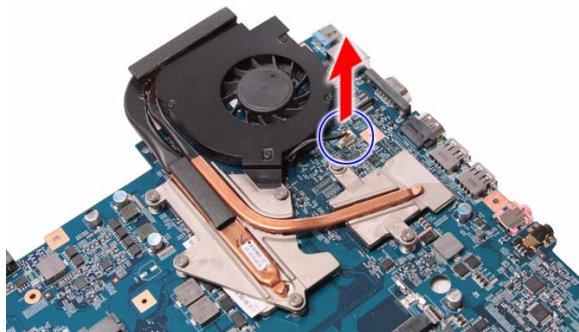

- 5 Loosen the spring-loaded captive screws securing cooling assembly. Follow the screw sequence indicated on the below images.

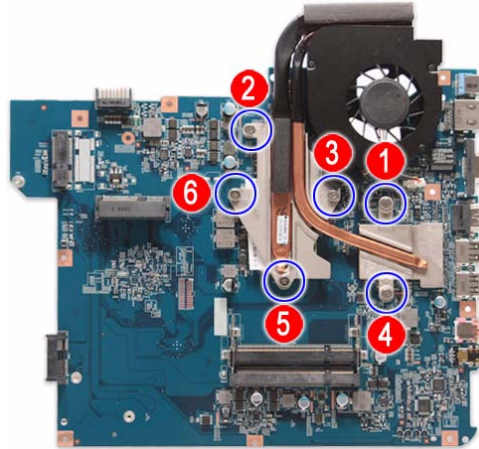

- 6 Remove the cooling assembly from the system board.

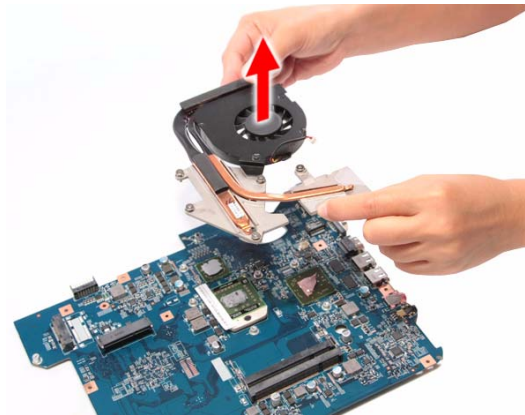

- 7 Lay the cooling assembly down in an upright position to avoid tainting your work space with thermal grease.



- 8 Remove the barcode sticker on top of the processor.

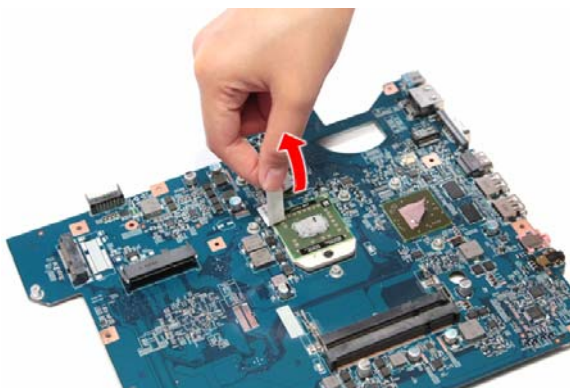

- 9 Moisten a soft cloth with isopropyl alcohol and clean the processor die to remove any thermal grease residue. Wipe the die surface several times to make sure that no particles or dust contaminants are evident. Allow the alcohol to evaporate before continuing.



#### Caution

Do not touch the contact surface of the new cooling assembly nor the processor die as this may leave dead skin cells or oils from your finger that can result in poor thermal grease performance.

- 10 Apply just enough thermal grease to evenly coat the surface of the processor die.
- 11 Place the new cooling assembly on the system board and tighten its captive screws to secure it in place. Follow the sequence of the number beside each screw when securing the cooling assembly.
- 12 Reconnect the cooling fan cable to its system board connector.
- 13 Reinstall the system board by performing steps 14 and 15 of the “[Replacing the system board](#)” procedure on [page 86](#).
- 14 Reinstall the palm rest by performing steps 19–21 of the “[Replacing the palm rest](#)” procedure on [page 68](#).
- 15 Reinstall the LCD panel assembly by performing steps 16–23 of the “[Replacing the LCD panel assembly](#)” procedure on [page 64](#).
- 16 Reinstall the keyboard and the keyboard cover by performing steps 5–8 of the “[Replacing the keyboard](#)” procedure on [page 62](#).
- 17 Close the LCD panel and turn the notebook over so the base is facing up.
- 18 Reinstall the optical drive by performing steps 10 and 11 of the “[Replacing the optical drive](#)” procedure on [page 56](#).
- 19 Reinstall the hard drive by performing steps 8 and 9 of the “[Replacing the hard drive](#)” procedure on [page 54](#).
- 20 If you have disconnected any wireless antennas, reconnect them now.
- 21 Reinstall the bay cover.
- 22 Reinstall the battery.



# Replacing the processor



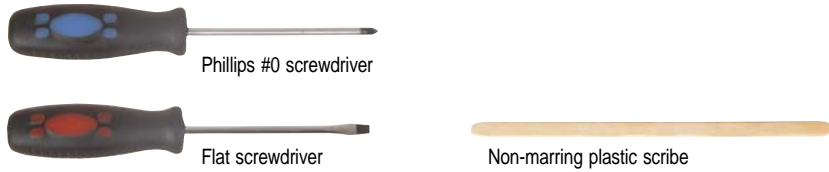

















Tools you need to complete this task:



Additional materials you need to complete this task:

- Soft cloth and isopropyl alcohol; or alcohol pad
- Thermal grease

Screws removed during this task:

-  1 black M2x5 (hard drive)
  -  1 black M2.5x6 (optical drive)
  -    3 black M2.5x6 (keyboard cover)
  -   2 black M2.5x6 (LCD panel hinge - bottom)
  -   2 black M2.5x6+Nylok (LCD panel hinge - top)
  -         10 M2.5x6 black (palm rest - base side)
  -    3 M2.5x6 black (palm rest - top side)
  -  1 black M2x4 (system board)
- To replace the processor:
- 1 Complete the steps in [“Preparing the notebook”](#) on page 47.
  - 2 Remove the cooling assembly by performing steps 2–7 of the [“Replacing the cooling assembly”](#) procedure on page 89.
  - 3 Remove the barcode sticker on top of the processor.

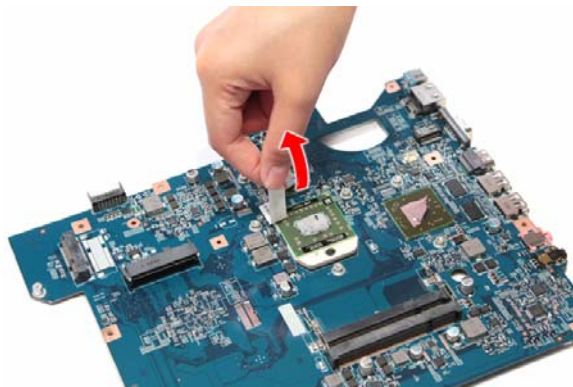

- 4 Use a flat-blade screwdriver to turn the processor lock screw 180° counter-clockwise.

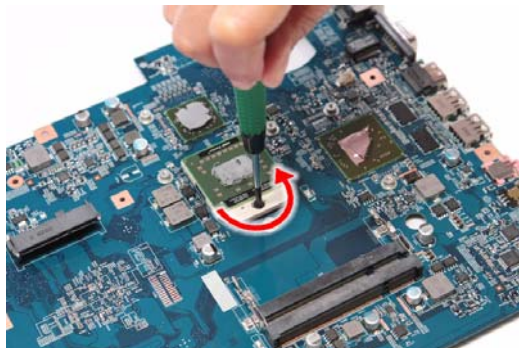

- 5 Remove the old processor from the system board.

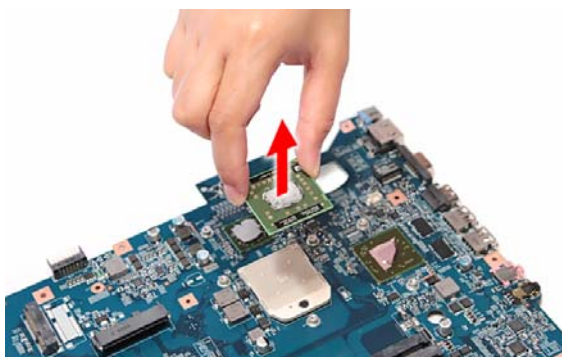

- 6 Align pin 1 of the new processor (indicated by the gold arrow on the corner of the processor) with the beveled corner of the processor socket.  
The processor will easily fit into the socket if you oriented it properly.
- 7 Use a flat-blade screwdriver to turn the lock screw 180° clockwise to secure the processor in place.
- 8 Apply just enough thermal grease to evenly coat the surface of the processor die.
- 9 Reinstall the cooling assembly by performing steps 9–12 of the [“Replacing the cooling assembly”](#) procedure on [page 89](#).
- 10 Reinstall the system board by performing steps 14 and 15 of the [“Replacing the system board”](#) procedure on [page 86](#).
- 11 Reinstall the palm rest by performing steps 19–21 of the [“Replacing the palm rest”](#) procedure on [page 68](#).
- 12 Reinstall the LCD panel assembly by performing steps 16–23 of the [“Replacing the LCD panel assembly”](#) procedure on [page 64](#).
- 13 Reinstall the keyboard and the keyboard cover by performing steps 5–8 of the [“Replacing the keyboard”](#) procedure on [page 62](#).
- 14 Close the LCD panel and turn the notebook over so the base is facing up.
- 15 Reinstall the optical drive by performing steps 10 and 11 of the [“Replacing the optical drive”](#) procedure on [page 56](#).

- 16 Reinstall the hard drive by performing steps 8 and 9 of the [“Replacing the hard drive”](#) procedure on [page 54](#).
- 17 If you have disconnected any wireless antennas, reconnect them now.
- 18 Reinstall the bay cover.
- 19 Reinstall the battery.



# Replacing the LCD front panel

Tools you need to complete this task:

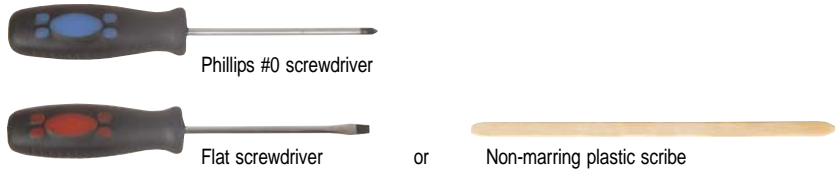

Screws removed during this task:

- 1 black M2x5 (hard drive)
- 1 black M2.5x6 (optical drive)
- 3 black M2.5x6 (keyboard cover)
- 2 black M2.5x6 (LCD panel hinges - bottom)
- 2 black M2.5x6+Nylok (LCD panel hinges - top)
- 4 black M2.5x6+Nylok (LCD front panel)
- 2 chrome M2x4 (LCD hinge covers)

► To replace the LCD front panel:

- 1 Complete the steps in [“Preparing the notebook”](#) on page 47.
- 2 Remove the LCD panel assembly by performing steps 2–15 of the [“Replacing the LCD panel assembly”](#) procedure on page 64.
- 3 Remove the rubber inserts from the corners of the LCD front panel.



- 4 Remove the LCD front panel screws.



- 5 Remove the LCD hinge cover screws.



- 6 Carefully pry loose the front panel from the LCD assembly lid. Start on the top side (a), continue to the left and right sides (b), and finally the bottom side (c).

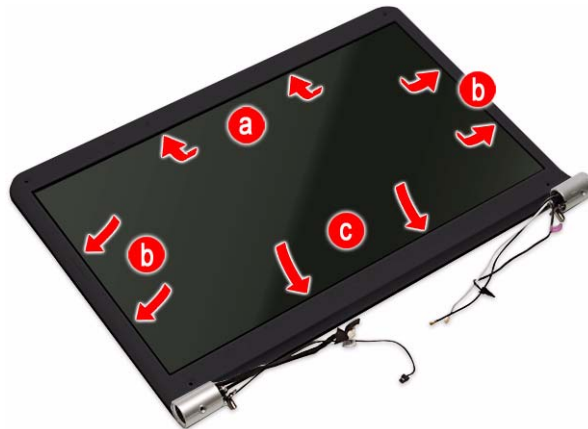

- 7 Remove the front panel.

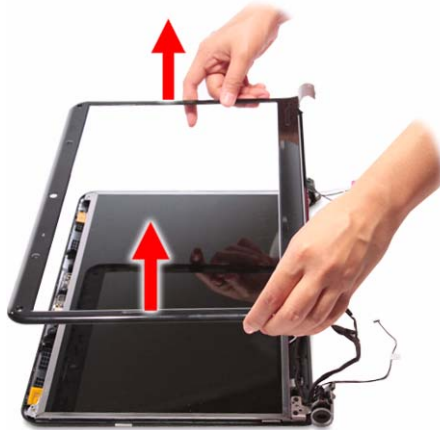

- 8 Place the new front panel on top of the LCD assembly lid.  
Make sure that the LCD, webcam, microphone, antenna, and power button cables are properly routed on the hinge sides.
- 9 Press the front panel on all sides until it snaps into place.  
Make sure that there is no gap between the front panel and the LCD assembly lid.
- 10 Secure the front panel with screws removed in steps 4 and 5.
- 11 Return the LCD front panel rubber inserts to their places.
- 12 Reinstall the LCD panel assembly by performing steps 16–23 of the “Replacing the LCD panel assembly” procedure on page 64.
- 13 Turn the notebook over so the palm rest is facing up.
- 14 Reinstall the keyboard and the keyboard cover by performing steps 5–8 of the “Replacing the keyboard” procedure on page 62.
- 15 Reinstall the battery.



# Replacing the webcam

Tools you need to complete this task:

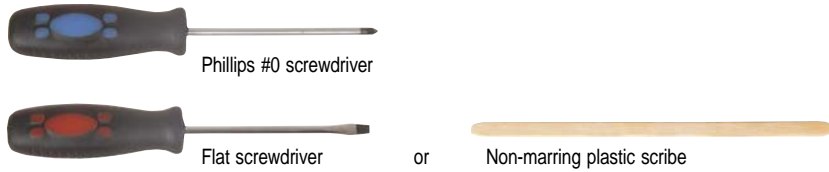

Screws removed during this task:

- 1 black M2x5 (hard drive)
- 1 black M2.5x6 (optical drive)
- 3 black M2.5x6 (keyboard cover)
- 2 black M2.5x6 (LCD panel hinges - bottom)
- 2 black M2.5x6+Nylok (LCD panel hinges - top)
- 4 black M2.5x6+Nylok (LCD front panel)
- 2 chrome M2x4 (LCD hinge covers)
- 4 black M2.5x6+Nylok (LCD front panel)

► To replace the webcam:

- 1 Complete the steps in [“Preparing the notebook”](#) on page 47.
- 2 Remove the LCD panel assembly by performing steps 2–15 of the [“Replacing the LCD panel assembly”](#) procedure on page 64.
- 3 Remove the LCD front panel by performing steps 3–7 of the [“Replacing the LCD front panel”](#) procedure on page 95.
- 4 Disconnect the webcam board cable.





- 5 Place the new webcam on the top side of the LCD assembly lid.
- 6 Reinstall the LCD front panel by performing steps 8–11 of the “[Replacing the LCD front panel](#)” procedure on [page 95](#).  
Make sure the webcam lens is aligned with camera peephole on the LCD front panel before you secure the panel in place.
- 7 Reinstall the LCD panel assembly by performing steps 16–23 of the “[Replacing the LCD panel assembly](#)” procedure on [page 64](#).
- 8 Turn the notebook over so the palm rest is facing up.
- 9 Reinstall the keyboard and the keyboard cover by performing steps 5–8 of the “[Replacing the keyboard](#)” procedure on [page 62](#).
- 10 Reinstall the battery.



# Replacing the LCD

























Tools you need to complete this task:



or



Screws removed during this task:

-  1 black M2x5 (hard drive)
-  1 black M2.5x6 (optical drive)
-    3 black M2.5x6 (keyboard cover)
-   2 black M2.5x6 (LCD panel hinges - bottom)
-   2 black M2.5x6+Nylok (LCD panel hinges - top)
-     4 black M2.5x6+Nylok (LCD front panel)
-   2 chrome M2x4 (LCD hinge covers)
-     4 black M2.5x6+Nylok (LCD front panel)
-     4 black M2.5x5 (LCD panel hinges)
-     4 chrome M2x3 (LCD panel brackets)

► To replace the LCD:

- 1 Complete the steps in [“Preparing the notebook” on page 47](#).
- 2 Remove the LCD panel assembly by performing steps 2–15 of the [“Replacing the LCD panel assembly” procedure on page 64](#).
- 3 Remove the LCD front panel by performing steps 3–7 of the [“Replacing the LCD front panel” procedure on page 95](#).
- 4 Release the LCD, webcam, microphone, antenna, and power button from their LCD assembly lid latches.



- 5 Disconnect the webcam cable from the webcam board.



- 6 Remove the LCD hinge screws.



- 7 Remove the LCD from the LCD assembly lid.



- 8 Lay the LCD on its front to access the LCD-webcam cable.

- 9 Detach the LCD-webcam from the LCD's underside (a) and disconnect it from the LCD PCB (b).



- 10 Remove the screws securing the LCD panel brackets.



- 11 Attach the LCD panel brackets and the LCD cable to the new LCD.
- 12 Place the new LCD on the LCD assembly lid and secure it with the screws removed in [step 10](#).
- 13 Reinstall the LCD front panel by performing steps 8–11 of the “[Replacing the LCD front panel](#)” procedure on [page 95](#).
- 14 Reinstall the LCD panel assembly by performing steps 16–23 of the “[Replacing the LCD panel assembly](#)” procedure on [page 64](#).
- 15 Turn the notebook over so the palm rest is facing up.
- 16 Reinstall the keyboard and the keyboard cover by performing steps 5–8 of the “[Replacing the keyboard](#)” procedure on [page 62](#).
- 17 Reinstall the battery.



# Replacing the LCD panel hinge brackets

Tools you need to complete this task:

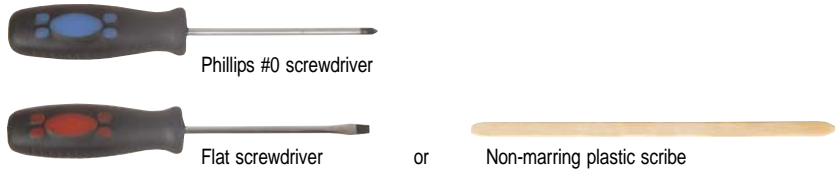

Screws removed during this task:

- 1 black M2x5 (hard drive)
- 1 black M2.5x6 (optical drive)
- 3 black M2.5x6 (keyboard cover)
- 2 black M2.5x6 (LCD panel hinges - bottom)
- 2 black M2.5x6+Nylok (LCD panel hinges - top)
- 4 black M2.5x6+Nylok (LCD front panel)
- 2 chrome M2x4 (LCD hinge covers)
- 4 black M2.5x6+Nylok (LCD front panel)
- 4 black M2.5x5 (LCD panel hinges)
- 4 chrome M2x3 (LCD panel brackets)

► To replace the LCD:

- 1 Complete the steps in [“Preparing the notebook”](#) on page 47.
- 2 Remove the LCD panel assembly by performing steps 2–15 of the [“Replacing the LCD panel assembly”](#) procedure on page 64.
- 3 Remove the LCD front panel by performing steps 3–7 of the [“Replacing the LCD front panel”](#) procedure on page 95.
- 4 Remove the LCD by performing steps 4–7 of the [“Replacing the LCD”](#) procedure on page 100.
- 5 Remove the screws securing the LCD panel brackets.



- 6 Attach the new LCD panel brackets to the LCD.
- 7 Place the LCD on the LCD assembly lid and secure it with the screws removed in [step](#) .
- 8 Reinstall the LCD front panel by performing steps [8–11](#) of the “[Replacing the LCD front panel](#)” procedure on [page 95](#).
- 9 Reinstall the LCD panel assembly by performing steps [16–23](#) of the “[Replacing the LCD panel assembly](#)” procedure on [page 64](#).
- 10 Turn the notebook over so the palm rest is facing up.
- 11 Reinstall the keyboard and the keyboard cover by performing steps [5–8](#) of the “[Replacing the keyboard](#)” procedure on [page 62](#).
- 12 Reinstall the battery.



# Replacing the power button board







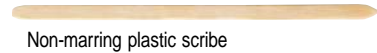















Tools you need to complete this task:



or



Screws removed during this task:

-  1 black M2x5 (hard drive)
  -  1 black M2.5x6 (optical drive)
  -    3 black M2.5x6 (keyboard cover)
  -   2 black M2.5x6 (LCD panel hinges - bottom)
  -   2 black M2.5x6+Nylok (LCD panel hinges - top)
  -     4 black M2.5x6+Nylok (LCD front panel)
  -   2 chrome M2x4 (LCD hinge covers)
  -     4 black M2.5x6+Nylok (LCD front panel)
  -     4 black M2.5x5 (LCD panel hinges)
- To replace the power button board:
- 1 Complete the steps in [“Preparing the notebook”](#) on page 47.
  - 2 Remove the LCD panel assembly by performing steps 2–15 of the [“Replacing the LCD panel assembly”](#) procedure on page 64.
  - 3 Remove the LCD front panel by performing steps 3–7 of the [“Replacing the LCD front panel”](#) procedure on page 95.
  - 4 Remove the LCD by performing steps 4–7 of the [“Replacing the LCD”](#) procedure on page 100.

- 5 Note the orientation of the power button board for later reference and then remove the board from the LCD assembly lid.

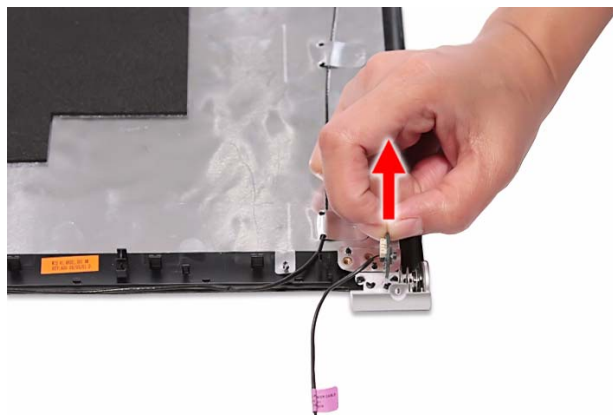

- 6 Disconnect the power button cable from the board.



- 7 Connect the power button cable to the new power button board.
- 8 Position the new power button board on the LCD assembly lid making sure it is in the same orientation noted on [step 5](#).  
The board should fit snugly against the spring to ensure proper contact when pressing the power button.
- 9 Place the LCD back on the LCD assembly lid.
- 10 Return the hinge screws to their places.
- 11 Reinstall the LCD front panel by performing steps [8–11](#) of the “[Replacing the LCD front panel](#)” procedure on [page 95](#).
- 12 Reinstall the LCD panel assembly by performing steps [16–23](#) of the “[Replacing the LCD panel assembly](#)” procedure on [page 64](#).
- 13 Turn the notebook over so the palm rest is facing up.
- 14 Reinstall the keyboard and the keyboard cover by performing steps [5–8](#) of the “[Replacing the keyboard](#)” procedure on [page 62](#).
- 15 Reinstall the battery.









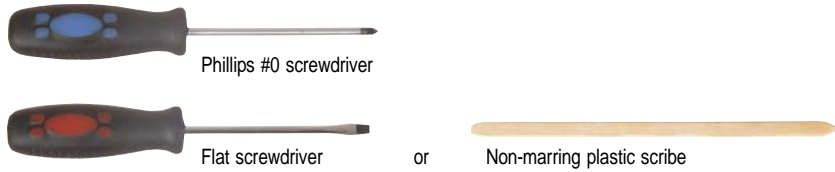

















# Replacing the Kensington lock cap

Tools you need to complete this task:



Screws removed during this task:

-  1 black M2x5 (hard drive)
  -  1 black M2.5x6 (optical drive)
  -    3 black M2.5x6 (keyboard cover)
  -   2 black M2.5x6 (LCD panel hinges - bottom)
  -   2 black M2.5x6+Nylok (LCD panel hinges - top)
  -     4 black M2.5x6+Nylok (LCD front panel)
  -   2 chrome M2x4 (LCD hinge covers)
  -     4 black M2.5x6+Nylok (LCD front panel)
  -    3 black (Kensington lock cap)
- To replace the Kensington lock cap:
- 1 Complete the steps in [“Preparing the notebook”](#) on page 47.
  - 2 Remove the LCD panel assembly by performing steps 2–15 of the [“Replacing the LCD panel assembly”](#) procedure on page 64.
  - 3 Remove the LCD front panel by performing steps 3–7 of the [“Replacing the LCD front panel”](#) procedure on page 95.
  - 4 Move the LCD, webcam, microphone, and antenna cables away from the Kensington lock cap screws.

- 5 Note the orientation of the Kensington lock cap for later reference and then remove the screws securing it.

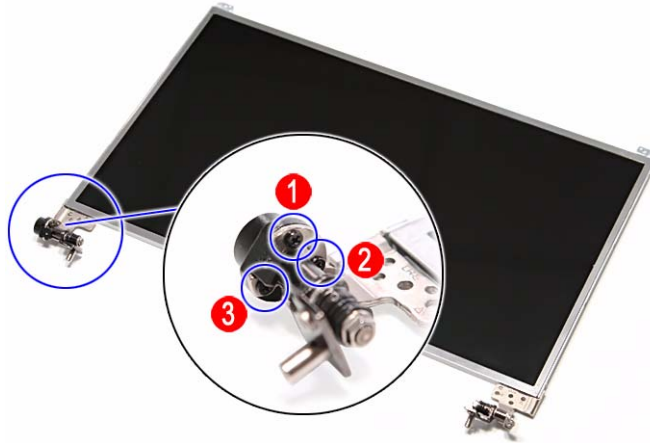

- 6 Detach the Kensington lock cap from the left hinge.



- 7 Position the new Kensington lock cap on the left hinge making sure it is in the same orientation noted on [step 5](#).
- 8 Secure the cap with the screws removed in [step 5](#).
- 9 Reinstall the LCD front panel by performing steps [8–11](#) of the “[Replacing the LCD front panel](#)” procedure on [page 95](#).
- 10 Reinstall the LCD panel assembly by performing steps [16–23](#) of the “[Replacing the LCD panel assembly](#)” procedure on [page 64](#).
- 11 Turn the notebook over so the palm rest is facing up.
- 12 Reinstall the keyboard and the keyboard cover by performing steps [5–8](#) of the “[Replacing the keyboard](#)” procedure on [page 62](#).
- 13 Reinstall the battery.



# Replacing the microphone

Tools you need to complete this task:

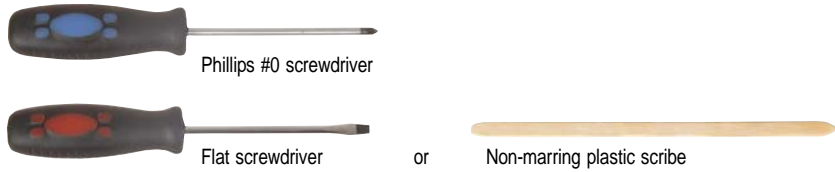

Screws removed during this task:

- 1 black M2x5 (hard drive)
- 1 black M2.5x6 (optical drive)
- 3 black M2.5x6 (keyboard cover)
- 2 black M2.5x6 (LCD panel hinges - bottom)
- 2 black M2.5x6+Nylok (LCD panel hinges - top)
- 4 black M2.5x6+Nylok (LCD front panel)
- 2 chrome M2x4 (LCD hinge covers)
- 4 black M2.5x6+Nylok (LCD front panel)
- 4 black M2.5x5 (LCD panel hinges)

► To replace the microphone:

- 1 Complete the steps in [“Preparing the notebook”](#) on page 47.
- 2 Remove the LCD panel assembly by performing steps 2–15 of the [“Replacing the LCD panel assembly”](#) procedure on page 64.
- 3 Remove the LCD front panel by performing steps 3–7 of the [“Replacing the LCD front panel”](#) procedure on page 95.
- 4 Remove the LCD by performing steps 4–7 of the [“Replacing the LCD”](#) procedure on page 100.
- 5 Release the microphone cable from the adhesive tabs securing it.

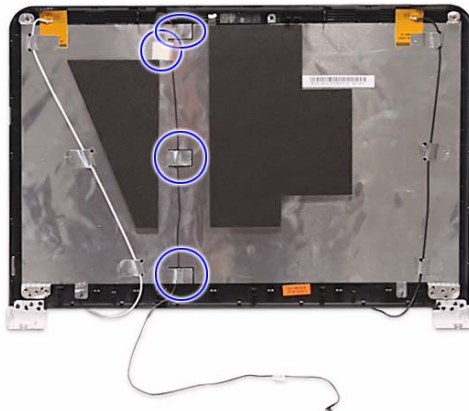

- 6 Remove the microphone from the LCD assembly lid.



- 7 Place the new microphone on the LCD assembly lid and secure its cable on the adhesive tabs.
- 8 Place the LCD back on the LCD assembly lid.
- 9 Return the hinge screws to their places.
- 10 Reinstall the LCD front panel by performing steps 8–11 of the [“Replacing the LCD front panel”](#) procedure on [page 95](#).
- 11 Reinstall the LCD panel assembly by performing steps 16–23 of the [“Replacing the LCD panel assembly”](#) procedure on [page 64](#).
- 12 Turn the notebook over so the palm rest is facing up.
- 13 Reinstall the keyboard and the keyboard cover by performing steps 5–8 of the [“Replacing the keyboard”](#) procedure on [page 62](#).
- 14 Reinstall the battery.



# Replacing the antennas

Tools you need to complete this task:

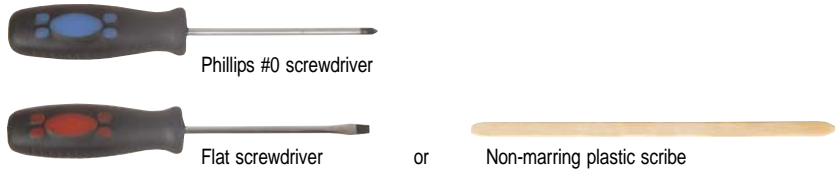

Screws removed during this task:

- 1 black M2x5 (hard drive)
- 1 black M2.5x6 (optical drive)
- 3 black M2.5x6 (keyboard cover)
- 2 black M2.5x6 (LCD panel hinges - bottom)
- 2 black M2.5x6+Nylok (LCD panel hinges - top)
- 4 black M2.5x6+Nylok (LCD front panel)
- 2 chrome M2x4 (LCD hinge covers)
- 4 black M2.5x6+Nylok (LCD front panel)
- 4 black M2.5x5 (LCD panel hinges)

► To replace the antennas:

- 1 Complete the steps in [“Preparing the notebook”](#) on page 47.
- 2 Remove the LCD panel assembly by performing steps 2–15 of the [“Replacing the LCD panel assembly”](#) procedure on page 64.
- 3 Remove the LCD front panel by performing steps 3–7 of the [“Replacing the LCD front panel”](#) procedure on page 95.
- 4 Remove the LCD by performing steps 4–7 of the [“Replacing the LCD”](#) procedure on page 100.
- 5 Release the antenna cables from the adhesive tabs securing them.

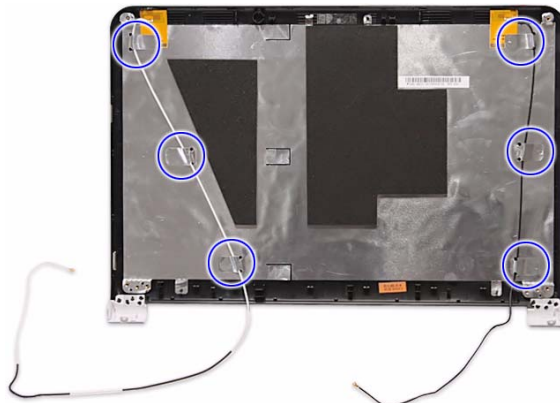

- 6 Carefully pry the antenna boards loose from the LCD assembly lid to remove the antennas.

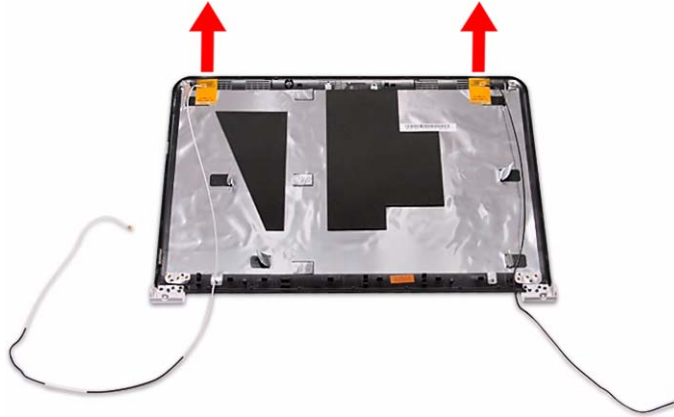

- 7 Secure the new antenna on the LCD assembly lid and route their cables underneath the adhesive tabs.
- 8 Place the LCD back on the LCD assembly lid.
- 9 Return the hinge screws to their places.
- 10 Reinstall the LCD front panel by performing steps 8–11 of the [“Replacing the LCD front panel”](#) procedure on [page 95](#).
- 11 Reinstall the LCD panel assembly by performing steps 16–23 of the [“Replacing the LCD panel assembly”](#) procedure on [page 64](#).
- 12 Turn the notebook over so the palm rest is facing up.
- 13 Reinstall the keyboard and the keyboard cover by performing steps 5–8 of the [“Replacing the keyboard”](#) procedure on [page 62](#).
- 14 Reinstall the battery.



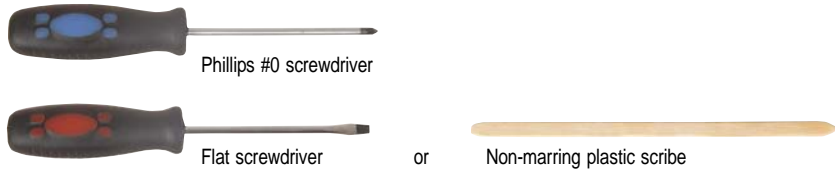

# Replacing the LCD assembly lid

Tools you need to complete this task:



Screws removed during this task:

-  1 black M2x5 (hard drive)
-  1 black M2.5x6 (optical drive)
-    3 black M2.5x6 (keyboard cover)
-   2 black M2.5x6 (LCD panel hinges - bottom)
-   2 black M2.5x6+Nylok (LCD panel hinges - top)
-     4 black M2.5x6+Nylok (LCD front panel)
-   2 chrome M2x4 (LCD hinge covers)
-     4 black M2.5x6+Nylok (LCD front panel)
-     4 black M2.5x5 (LCD panel hinges)

► To replace the antennas:

- 1 Complete the steps in [“Preparing the notebook”](#) on page 47.
- 2 Remove the LCD panel assembly by performing steps 2–15 of the [“Replacing the LCD panel assembly”](#) procedure on page 64.
- 3 Remove the LCD front panel by performing steps 3–7 of the [“Replacing the LCD front panel”](#) procedure on page 95.
- 4 Remove the LCD by performing steps 4–7 of the [“Replacing the LCD”](#) procedure on page 100.
- 5 If you are going to use the same Kensington lock cap, power button assembly, webcam, microphone and wireless antennas, remove these items from the old LCD assembly lid and attach them to the new one. Refer to the related replacement procedure on previous pages for instructions.
- 6 Place the LCD on the new LCD assembly lid.
- 7 Return the hinge screws to their places.

- 8 Reinstall the LCD front panel by performing steps 8–11 of the [“Replacing the LCD front panel”](#) procedure on [page 95](#).
- 9 Reinstall the LCD panel assembly by performing steps 16–23 of the [“Replacing the LCD panel assembly”](#) procedure on [page 64](#).
- 10 Turn the notebook over so the palm rest is facing up.
- 11 Reinstall the keyboard and the keyboard cover by performing steps 5–8 of the [“Replacing the keyboard”](#) procedure on [page 62](#).
- 12 Reinstall the battery.





# CHAPTER 4

## Troubleshooting

- Diagnosing problems
- System test procedures
- Power-On Self-Test (POST) error message
- Index of error messages
- Phoenix BIOS beep codes
- Symptom-to-FRU error messages
- Intermittent problems
- Undetermined problems

# Diagnosing problems

Use the following procedure as a guide for diagnosing notebook problems.



## Important

The diagnostic tests are intended to test only Acer products. Non-Acer products, prototype cards, or modified options can give false errors and invalid system responses.

- 1 Obtain the failing symptoms in as much detail as possible.
- 2 Verify the symptoms by attempting to re-create the failure by running the diagnostic test or by repeating the same operation.
- 3 Use the following table with the verified symptom to determine which page to go to.

Symptoms (Verified)	Go To
Power failure. (The power indicator does not go on or stay on.)	<a href="#">“Testing the power system” on page 118</a>
POST does not complete. No beep or error codes are indicated.	<ul style="list-style-type: none"> <li>▪ <a href="#">“Power-On Self-Test (POST) error message” on page 120</a></li> <li>▪ <a href="#">“Undetermined problems” on page 133</a></li> </ul>
POST detects an error and displayed messages on screen.	<a href="#">“Index of error messages” on page 121</a>
Other symptoms (LCD display problems or others).	<a href="#">“Power-On Self-Test (POST) error message” on page 120</a>
Symptoms cannot be re-created (intermittent problems).	<ul style="list-style-type: none"> <li>▪ Use the customer-reported symptoms and go to <a href="#">“Power-On Self-Test (POST) error message” on page 120</a></li> <li>▪ <a href="#">“Intermittent problems” on page 132</a></li> <li>▪ <a href="#">“Undetermined problems” on page 133</a></li> </ul>

# System test procedures

## Testing the optical drive

Use the following procedure to isolate a problem in an optical drive controller, driver, or drive.

---

 **Important**  
Make sure that the CD-ROM does not have any label attached to it. The label can cause damage to the drive or can cause the drive to fail.

---

▶ To test the optical drive:

- 1 Boot from the diagnostics diskette and start the diagnostics program.
- 2 Run the CD-ROM Test and see if the test completes successfully.
- 3 Follow the instructions in the message window.  
If an error occurs, reconnect the connector on the system board.  
If the error still remains:
- 4 Reconnect the external optical drive to a USB jack.
- 5 Replace the external optical drive.
- 6 Replace the system board.



## Testing the keyboard or auxiliary input device

If the internal keyboard does not work or an unexpected character appears, make sure that the flexible cable extending from the keyboard is correctly seated in the connector on the system board. If the keyboard cable is connected correctly, run the Keyboard Test.

---

 **Important**  
Disconnect any external keyboards before testing the built-in keyboard.

---

If the tests detect a keyboard problem, do the following one at a time.

▶ To correct the problem:

- 1 Reconnect the keyboard cable to the system board.
- 2 Replace the keyboard.
- 3 Replace the system board.



---

 **Important**  
Do not replace a non-defective FRU.

---

The following auxiliary input devices are supported by this notebook:

- Numeric keypad
- External keyboard

If any of these devices do not work, reconnect the cable connector and repeat the failing operation.

## Testing the memory

Memory errors can stop your programs, show error messages on the screen, or hang the system.

► To test the memory:

- 1 Boot from the diagnostics diskette and start the diagnostics program.
- 2 Run the Memory Test and see if the test completes successfully.
- 3 Press F2 in the test items.
- 4 Follow the instructions in the message window.



### Important

Make sure that each memory card is fully installed into the connector. A loose connection can cause an error.



## Testing the power system

► To test for a power problem:

- Turn on the notebook using each of the following power sources:
  - Remove the battery pack, connect the power adapter, then make sure that the notebook turns on using AC power.
  - Disconnect the power adapter, install a charged battery pack, then make sure that power is supplied by the battery pack.



If you suspect a power problem, complete the appropriate power supply check:

- [“Check the power adapter” on page 118](#)
- [“Check the battery pack” on page 119](#)

## Check the power adapter

Unplug the power adapter cable from the notebook and measure the output voltage at the power adapter cable plug. See the following figure.

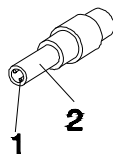

Pin 1: +19 to +20.5V  
Pin 2: 0V, Ground

- If the voltage is not correct, replace the power adapter.
- If the voltage is within the range, do the following:
  - Replace the system board.
  - If the problem is not corrected, see [“Undetermined problems” on page 133](#).
  - If the power-on indicator does not light up, check the power adapter’s power cord for correct continuity and installation.
  - If the operational charge does not work, see [“Check the battery pack” on page 119](#).



### Important

An audible noise from the power adapter does not always indicate a defect.

## Check the battery pack

- ▶ To check the battery pack using software:
  - 1 Open Power Management in the Windows Control Panel.
  - 2 In Power Meter, make sure that the parameters shown for Current Power Source and Total Battery Power Remaining are correct.
  - 3 Repeat the steps 1 and 2, for both battery and adapter. This helps you identify first the problem is on recharging or discharging.
- 
- ▶ To check the battery pack using hardware:
  - 1 Turn off the notebook.
  - 2 Remove the battery pack and measure the voltage between battery terminals 1 (+) and 6 (ground).
  - 3 If the voltage is still less than 7.5 Vdc after recharging, replace the battery.



---

### Important

To check the battery charge operation, use a discharged battery pack or a battery pack that has less than 50% of the total power remaining when installed in the notebook.

---

If the battery status indicator does not light up, remove the battery pack and let it return to room temperature. Re-install the battery pack.

If the charge indicator still does not light up, replace the battery pack. If the charge indicator still does not light up, replace the DC/DC charger board.

## Testing the touchpad

If the touchpad doesn't work, do the following actions one at a time to correct the problem.

- ▶ To test the touchpad:
  - 1 Reconnect the touchpad cables.
  - 2 Replace the touchpad.
  - 3 Replace the system board.



---

### Important

Do not replace a non-defective FRU.

---

After you use the touchpad, the pointer may drift on the screen for a short time. This self-acting pointer movement can occur when a slight, steady pressure is applied to the touchpad pointer. This symptom is not a hardware problem. No service actions are necessary if the pointer movement stops in a short period of time.

# Power-On Self-Test (POST) error message

The POST error message index lists the error message and their possible causes. The most likely cause is listed first.

**Important**

Perform the FRU replacement or actions in the sequence shown in the FRU/Action column. If the FRU replacement does not solve the problem, put the original part back in the notebook. Do not replace a non-defective FRU.

---

This index can also help you determine the next possible FRU to be replaced when servicing a notebook.

If the symptom is not listed, see [“Undetermined problems” on page 133](#).

The following lists the error messages that the BIOS displays on the screen and the error symptoms classified by function.

**Important**

Most of the error messages occur during POST. Some of them display information about a hardware device, such as the amount of memory installed. Others may indicate a problem with a device, such as the way it has been configured.

---

**Important**

If the system fails after you make changes in the BIOS Setup Utility menus, reset the notebook, enter Setup, and install Setup defaults or correct the error.

---

# Index of error messages

## Error codes

Error Codes	Error Messages
006	Equipment Configuration Error Causes: 1. CPU BIOS Update Code Mismatch 2. IDE Primary Channel Master Drive Error (The causes are shown before "Equipment Configuration Error")
010	Memory Error at xxx:xxx:xxxh (R:xxxh, W:xxxh)
070	Real Time Clock Error
071	CMOS Battery Bad
072	CMOS Checksum Error
110	System is disabled. An incorrect password was entered.
<No error code>	Battery is critically low. In this situation BIOS issues four short beeps, then shuts the system down. No message is displayed.
<No error code>	Temperature is critically high. In this situation BIOS shuts the system down. No message is displayed.

## Error messages

Error Messages	FRU/Action Sequence
Failure Fixed Disk	<ul style="list-style-type: none"> <li>▫ Reconnect the hard disk drive connector.</li> <li>▫ Run "Load Setup Defaults" using the BIOS Setup Utility, then reboot the notebook.</li> <li>▫ Test or replace the hard disk drive.</li> <li>▫ Test or replace the system board.</li> </ul>
Stuck Key	See <a href="#">"Testing the keyboard or auxiliary input device"</a> on page 117.
Keyboard error	See <a href="#">"Testing the keyboard or auxiliary input device"</a> on page 117.
Keyboard Controller Failed	See <a href="#">"Testing the keyboard or auxiliary input device"</a> on page 117.
Keyboard locked - Unlock key switch	Unlock the external keyboard.
Monitor type does not match CMOS - Run Setup	Run "Load Setup Defaults" using the BIOS Setup Utility, then reboot the notebook.
Shadow RAM Failed at offset: nnnn	<ul style="list-style-type: none"> <li>▫ Test or replace the BIOS ROM.</li> <li>▫ Test or replace the system board.</li> </ul>
System RAM Failed at offset: nnnn	<ul style="list-style-type: none"> <li>▫ Test or replace the SO-DIMM.</li> <li>▫ Test or replace the system board.</li> </ul>
Extended RAM Failed at offset: nnnn	<ul style="list-style-type: none"> <li>▫ Test or replace the SO-DIMM.</li> <li>▫ Test or replace the system board.</li> </ul>
System battery is dead - Replace and run Setup	Test or replace the CMOS battery, run the BIOS Setup Utility to reconfigure system time, then reboot the system.
System CMOS checksum bad - Default configuration used	Test or replace the CMOS battery, run the BIOS Setup Utility to reconfigure system time, then reboot the system.

## CHAPTER 4: Troubleshooting

Error Messages	FRU/Action Sequence
System timer error	<ul style="list-style-type: none"> <li>▫ Test or replace the CMOS battery, run the BIOS Setup Utility to reconfigure system time, then reboot the system.</li> <li>▫ Test or replace the system board.</li> </ul>
Real time clock error	<ul style="list-style-type: none"> <li>▫ Test or replace the CMOS battery, run the BIOS Setup Utility to reconfigure system time, then reboot the system.</li> <li>▫ Test or replace the system board.</li> </ul>
Previous boot incomplete - Default configuration used	<ul style="list-style-type: none"> <li>▫ Run "Load Setup Defaults" using the BIOS Setup Utility, then reboot the notebook.</li> <li>▫ Test or replace the CMOS battery, run the BIOS Setup Utility to reconfigure system time, then reboot the system.</li> <li>▫ Test or replace the system board.</li> </ul>
Memory size found by POST differed from CMOS	<ul style="list-style-type: none"> <li>▫ Run "Load Setup Defaults" using the BIOS Setup Utility, then reboot the notebook.</li> <li>▫ Test or replace the SO-DIMM.</li> <li>▫ Test or replace the system board.</li> </ul>
Diskette drive A error	<ul style="list-style-type: none"> <li>▫ Make sure that the drive is defined with the proper diskette type in the BIOS Setup Utility.</li> </ul>
Incorrect Drive A type - run SETUP	Make sure that the drive is defined with the proper diskette type in the BIOS Setup Utility
System cache error - Cache disabled	Test or replace the system board.
CPU ID:	Test or replace the system board.
DMA Test Failed	<ul style="list-style-type: none"> <li>▫ Test or replace the SO-DIMM.</li> <li>▫ Test or replace the system board.</li> </ul>
Software NMI Failed	<ul style="list-style-type: none"> <li>▫ Test or replace the SO-DIMM.</li> <li>▫ Test or replace the system board.</li> </ul>
Fail-Safe Timer NMI Failed	<ul style="list-style-type: none"> <li>▫ Test or replace the SO-DIMM.</li> <li>▫ Test or replace the system board.</li> </ul>
Device Address Conflict	<ul style="list-style-type: none"> <li>▫ Run "Load Setup Defaults" using the BIOS Setup Utility, then reboot the notebook.</li> <li>▫ Test or replace the CMOS battery, run the BIOS Setup Utility to reconfigure system time, then reboot the system.</li> <li>▫ Test or replace the system board.</li> </ul>
Allocation Error for device	<ul style="list-style-type: none"> <li>▫ Run "Load Setup Defaults" using the BIOS Setup Utility, then reboot the notebook.</li> <li>▫ Test or replace the CMOS battery, run the BIOS Setup Utility to reconfigure system time, then reboot the system.</li> <li>▫ Test or replace the system board.</li> </ul>
Failing Bits: nnnn	<ul style="list-style-type: none"> <li>▫ Test or replace the SO-DIMM.</li> <li>▫ Test or replace the BIOS ROM.</li> <li>▫ Test or replace the system board.</li> </ul>
Fixed Disk n	None
Invalid System Configuration Data	<ul style="list-style-type: none"> <li>▫ Test or replace the BIOS ROM.</li> <li>▫ Test or replace the system board.</li> </ul>



Error Messages	FRU/Action Sequence
I/O device IRQ conflict	<ul style="list-style-type: none"> <li>▫ Run "Load Setup Defaults" using the BIOS Setup Utility, then reboot the notebook.</li> <li>▫ Test or replace the CMOS battery, run the BIOS Setup Utility to reconfigure system time, then reboot the system.</li> <li>▫ Test or replace the system board.</li> </ul>
Operating system not found	<ul style="list-style-type: none"> <li>▫ Run the BIOS Setup Utility and see if fixed disk and drive A: are properly identified.</li> <li>▫ Test or replace the diskette drive</li> <li>▫ Test or replace the hard disk drive</li> <li>▫ Test or replace the system board</li> </ul>

## No-beep error messages

No-beep Error Messages	FRU/Action in Sequence
No beep, power-on indicator turns off and LCD is blank.	<ul style="list-style-type: none"> <li>▫ Test the power source (battery pack and power adapter). <a href="#">See "Testing the power system" on page 118.</a></li> <li>▫ Make sure that every connector is connected tightly and correctly.</li> <li>▫ Reconnect the SO-DIMM.</li> <li>▫ Test or replace the LED board.</li> <li>▫ Test or replace the system board.</li> </ul>
No beep, power-on indicator turns on and LCD is blank.	<ul style="list-style-type: none"> <li>▫ Test the power source (battery pack and power adapter). <a href="#">See "Testing the power system" on page 118.</a></li> <li>▫ Reconnect the LCD connector</li> <li>▫ Check the hard disk drive.</li> <li>▫ Check the LCD inverter ID.</li> <li>▫ Check the LCD cable.</li> <li>▫ Test or replace the LCD inverter.</li> <li>▫ Test or replace the LCD.</li> <li>▫ Test or replace the system board.</li> </ul>
No beep, power-on indicator turns on and LCD is blank. But you can see POST on an external CRT.	<ul style="list-style-type: none"> <li>▫ Reconnect the LCD connectors.</li> <li>▫ Check the LCD inverter ID.</li> <li>▫ Check the LCD cable.</li> <li>▫ Test or replace the LCD inverter.</li> <li>▫ Test or replace the LCD.</li> <li>▫ Test or replace the system board.</li> </ul>
No beep, power-on indicator turns on and a blinking cursor shown on LCD during POST.	<ul style="list-style-type: none"> <li>▫ Make sure that every connector is connected tightly and correctly.</li> <li>▫ Test or replace the system board.</li> </ul>
No beep during POST but system runs correctly.	<ul style="list-style-type: none"> <li>▫ Test or replace the speaker.</li> <li>▫ Test or replace the system board.</li> </ul>

# Phoenix BIOS beep codes

Code	Beeps	POST Routine Description
02h		Verify Real Mode
03h		Disable Non-Maskable Interrupt (NMI)
04h		Get CPU type
06h		Initialize system hardware
08h		Initialize chipset with initial POST values
09h		Set IN POST flag
0Ah		Initialize CPU registers
0Bh		Enable CPU cache
0Ch		Initialize caches to initial POST values
0Eh		Initialize I/O component
0Fh		Initialize the local bus IDE
10h		Initialize Power Management
11h		Load alternate registers with initial POST values
12h		Restore CPU control word during warm boot
13h		Initialize PCI Bus Mastering devices
14h		Initialize keyboard controller
16h	1-2-2-3	BIOS ROM checksum
17h		Initialize cache before memory autosize
18h		8254 timer initialization
1Ah		8237 DMA controller initialization
1Ch		Reset Programmable Interrupt Controller
20h	1-3-1-1	Test DRAM refresh
22h	1-3-1-3	Test 8742 Keyboard Controller
24h		Set ES segment register to 4 GB
26h		Enable A20 line
28h		Autosize DRAM
29h		Initialize POST Memory Manager
2Ah		Clear 215 KB base RAM
2Ch	1-3-4-1	RAM failure on address line xxxx
2Eh	1-3-4-3	RAM failure on data bits xxxx of low byte of memory bus
2Fh		Enable cache before system BIOS shadow

Code	Beeps	POST Routine Description
30h	1-4-1-1	RAM failure on data bits xxxx of high byte of memory bus
32h		Test CPU bus-clock frequency
33h		Initialize Phoenix Dispatch Manager
36h		Warm start shut down
38h		Shadow system BIOS ROM
3Ah		Autosize cache
3Ch		Advanced configuration of chipset registers
3Dh		Load alternate registers with CMOS values
42h		Initialize interrupt vectors
45h		POST device initialization
46h	2-1-2-3	Check ROM copyright notice
48h		Check video configuration against CMOS
49h		Initialize PCI bus and devices
4Ah		Initialize all video adapters in system
4Bh		QuietBoot start (optional)
4Ch		Shadow video BIOS ROM
4Eh		Display BIOS copyright notice
50h		Display CPU type and speed
51h		Initialize EISA board
52h		Test keyboard
54h		Set key click if enabled
58h	2-2-3-1	Test for unexpected interrupts
59h		Initialize POST display service
5Ah		Display prompt "Press F2 to enter SETUP"
5Bh		Disable CPU cache
5Ch		Test RAM between 512 and 640 KB
60h		Test extended memory
62h		Test extended memory address lines
64h		Jump to User Patch1
66h		Configure advanced cache registers
67h		Initialize Multi Processor APIC
68h		Enable external and CPU caches
69h		Setup System Management Mode (SMM) area

## CHAPTER 4: Troubleshooting

Code	Beeps	POST Routine Description
6Ah		Display external L2 cache size
6Bh		Load custom defaults (optional)
6Ch		Display shadow-area message
6Eh		Display possible high address for UMB recovery
70h		Display error messages
72h		Check for configuration errors
76h		Check for keyboard errors
7Ch		Set up hardware interrupt vectors
7Eh		Initialize coprocessor if present
80h		Disable onboard Super I/O ports and IRQs
81h		Late POST device initialization
82h		Detect and install external RS232 ports
83h		Configure non-MCD IDE controllers
84h		Detect and install external parallel ports
85h		Initialize PC-compatible PnP ISA devices
86h		Re-initialize onboard I/O ports
87h		Configure Motherboard Configurable Devices (optional)
88h		Initialize BIOS Area
89h		Enable Non-Maskable Interrupts (NMIs)
8Ah		Initialize Extended BIOS Data Area
8Bh		Test and initialize PS/2 mouse
8Ch		Initialize floppy controller
8Fh		Determine number of ATA drives (optional)
90h		Initialize hard-disk controllers
91h		Initialize local-bus hard-disk controllers
92h		Jump to UserPatch2
93h		Build MPTABLE for multi-processor boards
95h		Install CD ROM for boot
96h		Clear huge ES segment register
97h		Fixup Multi Processor table
98h	1-2	Search for option ROMs. One long, two short beeps on checksum failure.
99h		Check for SMART drive (optional)
9Ah		Shadow option ROMs

Code	Beeps	POST Routine Description
9Ch		Set up Power Management
9Dh		Initialize security engine (optional)
9Eh		Enable hardware interrupts
9Fh		Determine number of ATA and SCSI drives
A0h		Set time of day
A2h		Check key lock
A4h		Initialize Typematic rate
A8h		Erase F2 prompt
AAh		Scan for F2 key stroke
ACh		Enter SETUP
A Eh		Clear Boot flag
B0h		Check for errors
B2h		POST done- prepare to boot operating system
B4h	1	One short beep before boot
B5h		Terminate QuietBoot (optional)
B6h		Check password (optional)
B9h		Prepare Boot
BAh		Initialize DMI parameters
BBh		Initialize PnP Option ROMs
BCh		Clear parity checkers
BDh		Display MultiBoot menu
BEh		Clear screen (optional)
BFh		Check virus and backup reminders
C0h		Try to boot with INT 19
C1h		Initialize POST Error Manager (PEM)
C2h		Initialize error logging
C3h		Initialize error display function
C4h		Initialize system error handler
C5h		PnPnd dual CMOS (optional)
C6h		Initialize notebook docking (optional)
C7h		Initialize notebook docking late
C8h		Force check (optional)
C9h		Extended checksum (optional)

## CHAPTER 4: Troubleshooting

Code	Beeps	POST Routine Description
D2h		Unknown interrupt
E0h		Initialize the chipset
E1h		Initialize the bridge
E2h		Initialize the CPU
E3h		Initialize the system timer
E4h		Initialize system I/O
E5h		Check force recovery boot
E6h		Checksum BIOS ROM
E7h		Go to BIOS
E8h		Set Huge Segment
E9h		Initialize Multi Processor
EAh		Initialize OEM special code
EBh		Initialize PIC and DMA
ECh		Initialize Memory type
EDh		Initialize Memory size
EEh		Shadow Boot Block
EFh		System memory test
F0h		Initialize interrupt vectors
F1h		Initialize Run Time Clock
F2h		Initialize video
F3h		Initialize System Management Mode
F4h	1	Output one beep before boot
F5h		Boot to Mini DOS
F6h		Clear Huge Segment
F7h		Boot to Full DOS

# Symptom-to-FRU error messages

## LCD

Symptom / Error	Action in Sequence
<ul style="list-style-type: none"> <li>▫ The LCD backlight doesn't work.</li> <li>▫ The LCD is too dark.</li> <li>▫ The LCD brightness cannot be adjusted.</li> <li>▫ The LCD contrast cannot be adjusted.</li> </ul>	<ul style="list-style-type: none"> <li>▫ Run "Load Setup Defaults" using the BIOS Setup Utility, then reboot the notebook.</li> <li>▫ Reconnect the LCD connectors.</li> <li>▫ Test or replace the keyboard (if contrast and brightness function key doesn't work).</li> <li>▫ Check the LCD inverter ID.</li> <li>▫ Test or replace the LCD cable.</li> <li>▫ Test or replace the LCD inverter.</li> <li>▫ Test or replace the LCD.</li> <li>▫ Test or replace the system board.</li> </ul>
<ul style="list-style-type: none"> <li>▫ The LCD screen is unreadable.</li> <li>▫ Missing pixels in characters.</li> <li>▫ The screen appears abnormal.</li> <li>▫ The wrong color is displayed.</li> </ul>	<ul style="list-style-type: none"> <li>▫ Reconnect the LCD connector.</li> <li>▫ Check the LCD inverter ID.</li> <li>▫ Test or replace the LCD cable.</li> <li>▫ Test or replace the LCD inverter.</li> <li>▫ Test or replace the LCD.</li> <li>▫ Test or replace the system board.</li> </ul>
The LCD is displaying extra horizontal or vertical lines.	<ul style="list-style-type: none"> <li>▫ Check the LCD inverter ID.</li> <li>▫ Test or replace the LCD cable.</li> <li>▫ Test or replace the LCD inverter.</li> <li>▫ Test or replace the LCD.</li> <li>▫ Test or replace the system board.</li> </ul>

## Power

Symptom / Error	Action in Sequence
The notebook shuts down during operation.	<ul style="list-style-type: none"> <li>▫ Test the power source (battery pack and power adapter). See <a href="#">"Testing the power system" on page 118</a>.</li> <li>▫ Test or replace the battery pack.</li> <li>▫ Test or replace the power adapter.</li> <li>▫ Test or replace the system board.</li> </ul>
The notebook doesn't turn on.	<ul style="list-style-type: none"> <li>▫ Test the power source (battery pack and power adapter). See <a href="#">"Testing the power system" on page 118</a>.</li> <li>▫ Test or replace the battery pack.</li> <li>▫ Test or replace the power adapter.</li> <li>▫ Test or replace the system board.</li> </ul>
The notebook doesn't turn off.	<ul style="list-style-type: none"> <li>▫ Test the power source (battery pack and power adapter). See <a href="#">"Testing the power system" on page 118</a>.</li> <li>▫ Press and hold the power button for more than four seconds.</li> <li>▫ Test or replace the system board.</li> </ul>
The battery can't be charged.	<ul style="list-style-type: none"> <li>▫ Test the battery pack. See <a href="#">"Check the battery pack" on page 119</a>.</li> <li>▫ Test or replace the battery pack.</li> <li>▫ Test or replace the system board.</li> </ul>

## Memory

Symptom / Error	Action in Sequence
Memory count (size) appears different from actual size.	<ul style="list-style-type: none"> <li>▫ Run “Load Setup Defaults” using the BIOS Setup Utility, then reboot the notebook.</li> <li>▫ Test or replace the SO-DIMM.</li> <li>▫ Test or replace the system board.</li> </ul>

## Sound

Symptom / Error	Action in Sequence
No sound comes from the notebook when running Windows multimedia programs.	<ul style="list-style-type: none"> <li>▫ Reinstall the audio driver.</li> <li>▫ Test or replace the speakers.</li> <li>▫ Test or replace the system board.</li> </ul>
The internal speakers make noise or emit no sound.	<ul style="list-style-type: none"> <li>▫ Test or replace the speakers.</li> <li>▫ Test or replace the system board.</li> </ul>

## Power management

Symptom / Error	Action in Sequence
The notebook will not hibernate.	<ul style="list-style-type: none"> <li>▫ Test or replace the keyboard (if control is from the keyboard).</li> <li>▫ Test or replace the hard disk drive.</li> <li>▫ Test or replace the system board.</li> </ul>
The system doesn't hibernate and emits four short beeps every minute.	<ul style="list-style-type: none"> <li>▫ Press <b>Fn+O</b> and see if the notebook enters hibernation mode.</li> <li>▫ Test or replace the touchpad.</li> <li>▫ Test or replace the keyboard.</li> <li>▫ Check the hard disk connection to the system board.</li> <li>▫ Test or replace the hard disk drive.</li> <li>▫ Test or replace the system board.</li> </ul>
The notebook doesn't enter standby mode after closing the LCD.	<ul style="list-style-type: none"> <li>▫ Make sure that the magnet is in the magnet holder. For more information, see <a href="#">“Replacing the LCD” on page 100</a>.</li> <li>▫ Test or replace the system board.</li> </ul>
The system doesn't resume from hibernation mode.	<ul style="list-style-type: none"> <li>▫ Check the hard disk connection to the system board.</li> <li>▫ Test or replace the hard disk drive.</li> <li>▫ Test or replace the system board.</li> </ul>
The system doesn't resume from standby mode after opening the LCD.	<ul style="list-style-type: none"> <li>▫ Make sure that the magnet is in the magnet holder. For more information, see <a href="#">“Replacing the LCD” on page 100</a>.</li> <li>▫ Test or replace the system board.</li> </ul>
The battery fuel gauge in Windows doesn't go higher than 90%.	<ul style="list-style-type: none"> <li>▫ Remove the battery pack and let it cool for two hours.</li> <li>▫ Refresh the battery (use only battery power until the notebook turns off, then charge the battery).</li> <li>▫ Test or replace the battery pack.</li> <li>▫ Test or replace the system board.</li> </ul>
The system hangs intermittently.	<ul style="list-style-type: none"> <li>▫ Reconnect the hard disk drive and optical drive.</li> <li>▫ Check the hard disk connection to the system board.</li> <li>▫ Test or replace the system board.</li> </ul>



## Devices

Symptom / Error	Action in Sequence
System configuration does not match the installed devices.	<ul style="list-style-type: none"> <li>▫ Run "Load Setup Defaults" using the BIOS Setup Utility, then reboot the notebook.</li> <li>▫ Reconnect the hard disk drive and optical drive.</li> </ul>
The external display does not work correctly.	<ul style="list-style-type: none"> <li>▫ Press Fn+F4 repeatedly to switch between LCD, external display, and both displays.</li> <li>▫ Test or replace the system board.</li> </ul>
USB does not work correctly.	<ul style="list-style-type: none"> <li>▫ Test or replace the USB board.</li> <li>▫ Test or replace the system board.</li> </ul>
Printer problems.	<ul style="list-style-type: none"> <li>▫ Run the printer self-test.</li> <li>▫ Reinstall the printer driver.</li> <li>▫ Test or replace the printer cable.</li> <li>▫ Test or replace the printer.</li> <li>▫ Test or replace the system board.</li> </ul>

## Keyboard and touchpad

Symptom / Error	Action in Sequence
The keyboard (one or more keys) does not work.	<ul style="list-style-type: none"> <li>▫ Reconnect the keyboard cable.</li> <li>▫ Test or replace the keyboard.</li> <li>▫ Test or replace the system board.</li> </ul>
The touchpad does not work.	<ul style="list-style-type: none"> <li>▫ Reconnect the touchpad cable.</li> <li>▫ Test or replace the touchpad board.</li> <li>▫ Test or replace the system board.</li> </ul>



### Important

If you cannot find a symptom or an error in this list and the problem remains, see ["Undetermined problems" on page 133](#).

# Intermittent problems

Intermittent system hang problems can be caused by a variety of reasons that have nothing to do with a hardware defect. These reasons include: cosmic radiation, electrostatic discharge, or software errors. FRU replacement should be considered only when a recurring problem exists.

- ▶ To analyze an intermittent problem:
  - 1 Run the advanced diagnostic test for the system board in loop mode at least ten times.
    - If any error is detected, replace the FRU.
    - If no error is detected, do not replace any FRU.
  - 2 Rerun the test to verify that there are no more errors.



# Undetermined problems

If the diagnostic test may not identify which adapter or device failed, which installed devices are incorrect, whether a short circuit is suspected, or whether the system is inoperative. Use these procedures to isolate the failing FRU (do not isolate a non-defective FRU).



## Important

Verify that all attached devices are supported by the notebook.

---



## Important

Verify that the power supply being used at the time of the failure is operating correctly. (See ["Testing the power system" on page 118.](#))

---

### ► To isolate a failing FRU:

- 1 Turn off the notebook.
- 2 Visually check FRU parts for damage. If you identify any damage, replace the FRU.
- 3 Remove or disconnect all of the following devices:
  - Non-Acer devices
  - Printer, mouse, and other external devices
  - Battery pack
  - Hard disk drive(s)
  - SO-DIMM
  - Optical drive
- 4 Turn on the notebook.
- 5 Determine if the problem has changed.
  - If the problem does not recur, reconnect the removed devices one at a time until you find the failing FRU.
  - If the problem does recur, replace the following FRUs one at a time:
    - System board
    - LCD assembly



## Important

Do not replace a non-defective FRU.

---



# CHAPTER 5

## Connector locations

- [System board layout](#)

# System board layout

Top view

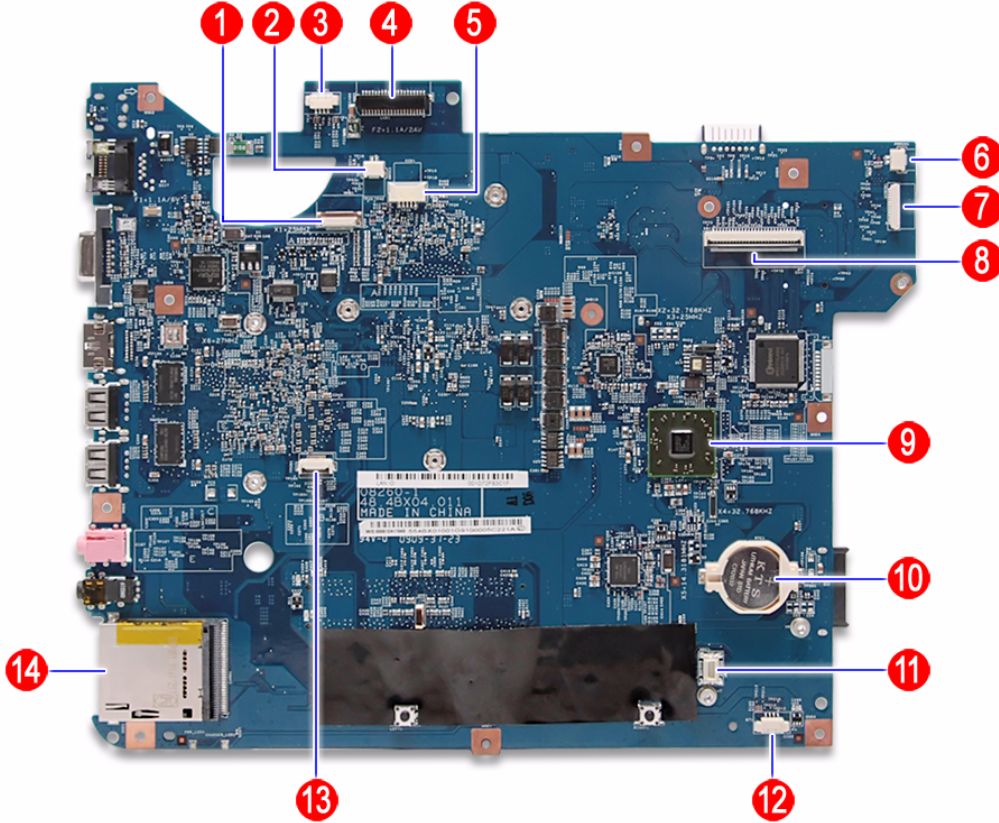

Item	Code	Component	Item	Code	Component
1	MMB1	Multimedia board cable connector	8	KB1	Keyboard cable connector
2	AMIC1	Microphone cable connector	9	ASB1	South bridge chipset
3	SPKR1	Speaker cable connector	10	RTC1	RTC battery
4	LCD1	LCD cable connector	11	MDC1	Modem card cable connector
5	CCD1	Webcam board cable connector	12	BT1	Bluetooth module cable connector
6	PWRCN1	Power button board cable connector	13	TPCN1	Touchpad / fingerprint reader board cable connector
7	USBCN1	USB board cable connector	14	CARD1	Memory card reader

## Bottom view

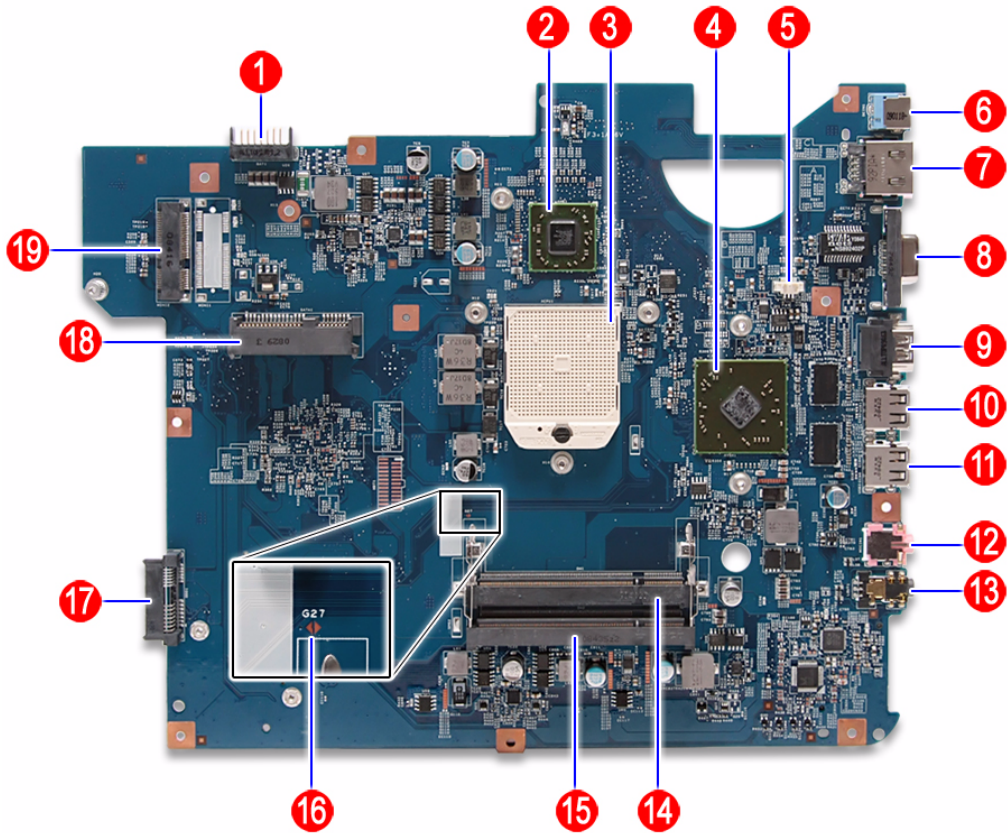

Item	Code	Component	Item	Code	Component
1	BAT1	Battery connector	11	USB3	USB port
2	ANB1	North bridge chipset	12	MICIN1	Microphone jack
3	ACPU1	Processor socket	13	LOUT1	Headphone jack
4	AVGA1	ATI RS780M chipset	14	DM1	Memory slot 1
5	FAN1	Cooling fan cable connector	15	DM2	Memory slot 2
6	DCIN1	DC power jack	16	G27	Clear password hardware gap
7	RJ45	Ethernet jack	17	ODD1	SATA optical drive connector
8	CRT1	Monitor port	18	SATA1	SATA hard drive connector
9	HDMI1	HDMI out port	19	MINI2	WLAN card slot (Mini Card)
10	USB1	USB port			





# CHAPTER 6

## FRU (Field-Replaceable Unit) list

- [Introduction](#)
- [Exploded diagram](#)
- [FRU list](#)

# Introduction

This chapter gives you the FRU (field-replaceable-unit) listing in global configurations of this model. Refer to this chapter whenever ordering for parts to repair or for RMA (Return Merchandise Authorization).

Please note that WHEN ORDERING FRU PARTS, you should check the most up-to-date information available on your regional web or channel. For whatever reasons a part number change is made, it will not be noted on the printed Service Guide. For ACER AUTHORIZED SERVICE PROVIDERS, your Acer office may have a DIFFERENT part number code from those given in the FRU list of this printed Service Guide. You MUST use the local FRU list provided by your regional Acer office to order FRU parts for repair and service of customer machines.



### Important

To scrap or to return the defective parts, you should follow the local government ordinance or regulations on how to dispose it properly, or follow the rules set by your regional Acer office on how to return it.

## Exploded diagram

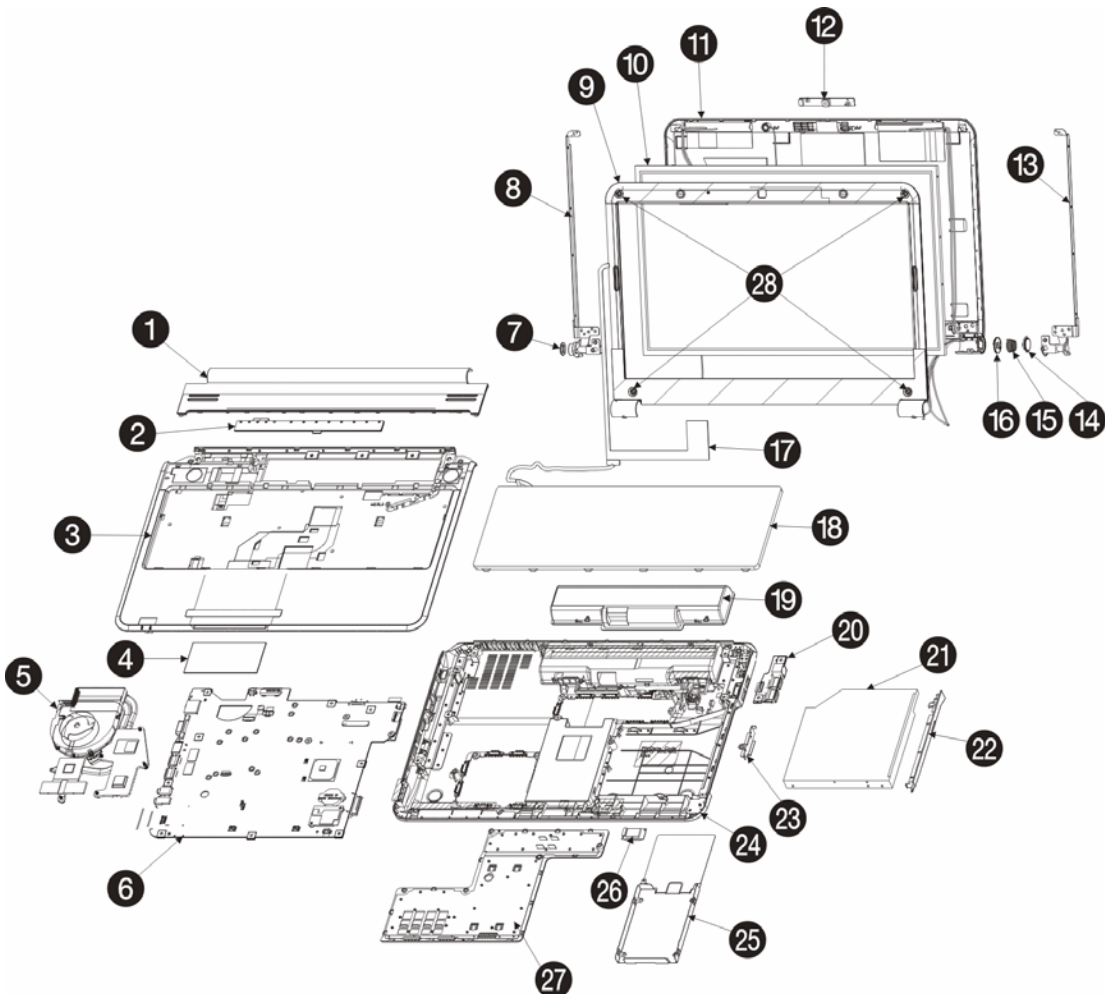

Item	Component
1	Keyboard cover
2	Multimedia board
3	Palm rest
4	Touchpad board
5	Cooling assembly
6	System board
7	Kensington lock cap
8	Left LCD panel hinge bracket
9	Front panel
10	LCD panel
11	LCD assembly lid
12	Webcam board (optional)
13	Right LCD panel hinge bracket
14	Power button board cap
15	Power button board spring
16	Power button board
17	LCD cable / LCD-webcam coaxial cable
18	Keyboard
19	Battery
20	USB board / USB-modem port board (optional)
21	Optical drive
22	Optical drive bezel
23	Optical drive bracket
24	Base enclosure
25	Hard drive
26	Bluetooth module
27	Bay cover

## FRU list

Category	Part Name	Description	OEM Part No.
ACadapter	ADAPTER 65W 19V 3PIN DELTA ADP-65JH DB A LV5 LED LF YELLOW	ADP 65W 19V 3P ADP-65JH DB A,	AP.0650A.012
	ADAPTER 65W 19V 3PIN HIPRO HP-A0652R3B 1LF LV5 LED LF YELLOW	ADP 65W 19V 3P HP-A0652R3B 1LF	AP.06501.026
	ADAPTER 90W DELTA ADP-90SB BBGE BLUE LV4 LED LF	ADP 90W 19V 3P ADP-90SB BBGE	AP.09001.027
	ADAPTER 90W 19V 3PIN DELTA ADP-90CD DB A LV5 LED LF BLUE	ADP 90W 19V 3P ADP-90CD DB A L	AP.09003.021
	ADAPTER 90W 19V 3PIN LITEON PA-1900-34AR LV5 LED LF BLUE	ADP 90W 19V 3P PA-1900-34AR LV	AP.09001.024
AC power cord	POWER CORD 10A 250V ARGENTINE	CORD ARGENTINE,10A 250V3G,1.8M	27.01518.0U1
	POWER CORD 7A 250V 2PIN KOREAN	CORD 7A250V 2P 1830 KOREAN	27.01518.531
	POWER CORD 3A 250V 3PIN UK	CODE UK 2.5A 250V 3P BK	27.03118.001
	POWER CORD 7A 125V 2PIN JAPAN	CODE JAPAN 7A 125V 2P BK	27.01518.551
	POWER CORD 10A 3PIN BK DENMARK	CODE DENMARK 2.5A 250V 3P BK	27.01518.671
	POWER CORD 10A 250V 3PIN BK SOUTH AFRICA	CODE SOUTH AFRICA 16A 250V BK	27.01518.681
	POWER CORD 10A 250V SWISS	CODE SWISS 2.5A 250V 3P BK	27.01518.691
	POWER CORD 10A 250V 3PIN CHINA	CORD CHINA 10A 250V 3P	27.01518.701
	POWER CORD 10A 250V 3PIN ITALY	CORD ITALY 10A 250V 3P BK	27.01518.711
	POWER CORD 2.5A 250V AUSTRALIA	CORD 2.5A 250V AUSTRALIA BK	27.01518.621
	POWER CORD 2.5A 250V SOUTH AFRICA BK (INDIA)	CORD 2.5A 250V SOUTH AFRICA BK	27.01518.721
	POWER CORD 10A 125V 3PIN US BK	CODE 10A 125V 3P US BK	27.01518.521
	POWER CORD 7A 125V 2PIN JAPAN BK	CODE 7A 125V 2P JAPAN BK	27.01518.661
	POWER CORD 10A 250V 3PIN DENMARK BK	CODE 10A 250V 3P DENMARK BK	27.01518.561
	POWER CORD 16A 250V SOUTH AFRICA BK	CODE 16A 250V SOUTH AFRICA BK	27.01518.571
POWER CORD 10A 250V 3PIN SWISS BK	CODE 10A 250V 3P SWISS BK	27.01518.581	

Category	Part Name	Description	OEM Part No.
AC power cord	POWER CORD 10A 250V 3PIN CHINA BK	CORD 10A 250V 3P CHINA BK	27.01518.591
	POWER CORD 10A 250V 3PIN ITALY BK	CORD 10A 250V 3P ITALY BK	27.01518.611
	POWER CORD 10A 250V SOUTH AFRICA BK (INDIA)	CORD 6A 250V SOUTH AFRICA BK	27.01518.631
	POWER CABLE 16A 250V 3PIN EUR BK	CORD 16A 250V 3P EUR BK	27.01518.601
	POWER CORD 250V 10A 3PIN ISRAEL	CORD 250V 10~16A 3P ISRAEL	27.01518.761
	POWER CORD 2.5A 125V USA	CORD USA/W CNS 2.5A 125V 8121-	27.01518.A11
	POWER CORD 2.5A 125V 1.8M BLACK TAIWANESE	POWER CORD TAIWANESE BLACK,1.8	27.01518.781
	POWER CORD 10A 250V 1.8M BRAZIL BLK	POWER CORD BRAZIL,BLK,1.8M	27.01518.A41
	POWER CORD 5A 250V 3PIN UK BK	CODE 5A 250V 3P UK BK	27.01518.541
	POWER CORD ACA / ACNZ	POWER CODE ACA / ACNZ ANNIE	27.03218.051
	POWER CORD 7.5A 250V 3P AUSTRALIA BK	CODE 7.5A 250V 3P AUSTRALIA BK	27.03218.021
	POWER CODE 7A 125V 2PIN JAPAN	CODE 7A 125V JAPAN 2PIN BK	27.03518.161
	POWER CORD 10A 125V US	CODE US 7A 125V BK	27.01518.641
	POWER CORD 250V 3PIN EUR BK	CORD EUR 250V 3P BK	27.01518.731
Battery pack	BATTERY SANYO AS-2009A LI-ION 3S2P SANYO 6 CELL 4400MAH MAIN COMMON 2.2AH(A)	BTY PACK LI+ 6C 2.2AH SANYO	BT.00607.068
	BATTERY SONY AS-2009A LI-ION 3S2P SONY 6 CELL 4400MAH MAIN COMMON 2.2AH(G6F)	BTY PACK LI+ 6C 2.2AH SONY	BT.00603.076
	BATTERY PANASONIC AS-2009A LI-ION 3S2P PANASONIC 6 CELL 4400MAH MAIN COMMON 2.2AH(CG )	BTY PACK LI+ 6C 2.2AH PANA	BT.00604.030
	BATTERY PANASONIC AS-2009A LI-ION 3S2P PANASONIC 6 CELL 5800MAH MAIN COMMON 2.9AH ( NNP )	BTY PACK LI+ 6C 2.9AH PANA	BT.00605.037
	BATTERY SAMSUNG AS-2009A LI-ION 3S2P SAMSUNG 6 CELL 4400MAH MAIN COMMON 2.2AH(F)	BTY PACK LI+ 6C 2.2AH SDI	BT.00605.036
	BATTERY SIMPLO AS-2009A LI-ION 3S2P PANASONIC 6 CELL 4400MAH MAIN COMMON PANASONIC 2.2AH ( CG )	BTY PACK PANA LI+ 6C 2.2AH SMP	BT.00606.002

CHAPTER 6: FRU (Field-Replaceable Unit) list

Category	Part Name	Description	OEM Part No.
Battery pack	BATTERY SIMPLO AS-2009A LI-ION 3S2P SAMSUNG 6 CELL 4400MAH MAIN COMMON SDI 2.2AH(F)	BTY PACK SDI LI+ 6C 2.2AH SMP	BT.00607.066
	BATTERY SIMPLO AS-2009A LI-ION 3S2P SAMSUNG 6 CELL 5600MAH MAIN COMMON SDI 2.8AH	BTY PACK SDI LI+ 6C 2.8AH SMP	BT.00607.070
	BATTERY SIMPLO AS-2009A LI-ION 3S2P LGC 6 CELL 5600MAH MAIN COMMON 2.8AH	BTY PACK LG LI+ 6C 2.8AH SMP	BT.00607.069
Boards	POWER BUTTON BOARD	SJV50MV35 POWER BD 08653-1 D	55.4BU03.001G
	POWER BUTTON BOARD	SJV50-MV PWR BD 08653-1 6L D	55.4FM03.001G
	POWER BUTTON BOARD	SJV50-TR POWER BD 08653-1 6L D	55.4EY03.001G
	TOUCHPAD BOARD SYNAPTICS TM00540-005	TOUCHPAD SYNAPTICS TM00540-005	56.17010.181
	TOUCHPAD BOARD ALPS KGDF0038A	TOUCHPAD ALPS KGDF0038A	56.17024.051
	MULTI-MEDIA BOARD	CAPACITIVE BUTTON NS-SJV50 V07	56.41010.181
	MULTI-MEDIA BOARD	CAPACITIVE BUTTON NS-SJV50-CL	56.41010.291
	USB BOARD W/MODEM CONNECTOR	SJV50-MV USB BD 08652-1M 6L D	55.4FM02.001G
	USB BOARD W/MODEM CONNECTOR	SJV50-MV35 USB BD 08652-1M D	55.4BU02.001G
	USB BOARD W/MODEM CONNECTOR	SJV50-TR USB BD 08652-1M 6L D	55.4EY02.001G
	BLUETOOTH BOARD FOXCONN BRM 2046 BT2.1 T60H928.33 F/W:861	BT MODULE FOXCONN BCM2046 V2.1	BH.21100.004
	MODEM BOARD FOXCONN T60M955.04 MDC 1.5_3.3V AUS CONEXANT	MODEM MDC FOX_CNXT RD02-D330	FX.22500.025
	WIRELESS LAN BOARD 802.11BG FOXCONN T77H121.01 Atheros AR9285(HB95)	WLAN 802.11BG Atheros AR9285(H)	NI.23600.047
WIRELESS LAN BOARD 802.11BGN LITEON Atheros AR9283 HB93 1X2 BGN WN6602AH	WLAN 802.11BGN Atheros AR9283(	NI.23600.051	
Mainboard	MAINBOARD SJV50TR DISCRETE SB710 RS880M M92XT-512MB VRAM DDRII 500 LF W/RTC BATTERY	SJV50TR DIS MB09228-1 W/SAM D	55.4FM01.011G
	MAINBOARD SJV50TR UMA SB710 RS880M LF W/RTC BATTERY	SJV50-TR UMA MB 09228-1 D	MB.WGH01.001
Camera	CAMERA 0.3M SUYIN CN0314-SN30-OV03-5	CAMERA 0.3M CN0314-SN30-OV03-5	56.18007.094
	CAMERA 0.3M CHICONY CNF701721004973L	CAMERA 0.3M CNF701721004973L	56.18012.094

Category	Part Name	Description	OEM Part No.
Cables	BLUETOOTH BOARD CABLE	C.A BT SJV50 MEC	50.4BU05.001
	BLUETOOTH BOARD CABLE	C.A BT SJV50 HT	50.4BU05.011
	POWER BUTTON BOARD CABLE	C.A. POWER SJV50 HT	50.4BU02.011
	POWER BUTTON BOARD CABLE	C.A. POWER SJV50 MEC	50.4BU02.001
	LED LCD/CAMERA CABLE	C.A. LCD CCD SJV50 HT	50.4BU01.012
	LED LCD/CAMERA CABLE	C.A. LCD CCD SJV50 MEC	50.4BU01.002
	USB BOARD CABLE	C.A. USB SJV50 MEC	50.4BU03.001
	USB BOARD CABLE	C.A. USB SJV50 MEC	50.4BU03.001
	MULTI-MEDIA BOARD CABLE	C.A. MMB FFC SJV50 JH	50.4BU07.011
	MULTI-MEDIA BOARD CABLE	C.A. MMB FFC SJV50 TR	50.4BU07.001
	MULTI-MEDIA BOARD CABLE	C.A. MMB FFC SJV50 TR	50.4BU07.001
	MODEM CABLE	C.A. RJ11 SJV50 MEC	50.4BU04.001
	TOUCHPAD BOARD CABLE	C.A. TP FFC SJV50 TR	50.4BU06.001
	TOUCHPAD BOARD CABLE	C.A. TP FFC SJV50 JH	50.4BU06.011
	Case / cover / bracket / assembly	OPTICAL BRACKET	BRKT ODD SJV50
HDD BRACKET		ASSY HDD BKT SJV50	33.WBM01.002
LED LCD BRACKET LEFT W/HINGE		LCD HINGE L SJV50 LH	34.4BU09.011
LED LCD BRACKET LEFT W/HINGE		LCD HINGE L SJV50 SZS	34.4BU09.001
LED LCD BRACKET RIGHT W/HINGE		LCD HINGE R SJV50 LH	34.4BU10.011
LED LCD BRACKET RIGHT W/HINGE		LCD HINGE R SJV50 SZS	34.4BU10.001
POWER BOARD SPRING		SPRING POWER BD SJV50	33.WBM01.005
SD DUMMY CARD		SD DUMMY CARD MYALL2	42.TKJ01.001
UNITLOAD COVER		ASSY BIG DOOR SJV50	42.WBM01.002
DVD-RW SUPER-MULTI BEZEL BLACK		ASSY ODD BEZEL 9C MUL SJV50	42.WBM01.003
BLUE-RAY COMBO BEZEL BLACK		ASSY ODD BZL BR 9C COMBO SJV50	42.WBM01.004
KEY LOCK CAP		K-LOCK COVER SJV50	42.WBM01.005
POWER BUTTON BOARD CAP BLACK		ASSY POWER BD BTN BLACK SJV50	42.WBM01.006
MIDDLE COVER BLACK W/P-KEY NONE 3G		ASSY MIDDLE CVR PU BLACK SJV50	42.WC301.001

CHAPTER 6: FRU (Field-Replaceable Unit) list

Category	Part Name	Description	OEM Part No.
Case / cover / bracket / assembly	LOWER CASE W/USB BOARD CABLE W/O MODEM CABLE&SIM CARD HOLE&MODEM HOLE (NONE 3G)	ASSY LCASE WO RJ11&SIM SJV50TR	60.BDC01.001
	UPPER CASE BLACK W/TOUCHPAD BOARD CABLE & MULTI-MEDIA BOARD CABLE & SPEAKER & LOGO PLATE FOR PACKARD BELL W/O FINGER PRINT HOLE	ASSY UCASE PB BLACK NEW SJV50	60.BDC01.002
	LED LCD COVER 15.6" IMR BLACK W/ANTENNA*2 & MICROPHONE & LOGO PLATE FOR PACKARDBELL	ASSY LCD PANEL PB BLK SJV50	60.BDC01.004
	LOWER CASE UMA W/USB BOARD CABLE & MODEM CABLE W/O SIM CARD HOLE NONE 3G	ASSY LCASE W/O SIM SJV50	60.WBM01.001
	LCD BEZEL 15.6" BLACK W/CAMERA HOLE	ASSY LCD BEZEL W CCD SJV50 BLK	60.WBM01.004
	LED LCD COVER 15.6" IMR BLUE W/ANTENNA*2 & MICROPHONE & LOGO PLATE FOR GATEWAY	ASSY LCD PANEL GTW BLUE SJV50	60.WDD01.001
	UPPER CASE BLACK W/TOUCHPAD BOARD CABLE & MULTI-MEDIA BOARD CABLE & SPEAKER & LOGO PLATE FOR GATEWAY W/O FINGER PRINT HOLE	ASSY UCASE GW BLACK NEW SJV50	60.WGH01.001
Hard disk drive	HDD 160GB 5400RPM 2.5" SATA SEAGATE WYATT ST9160314AS LF F/W:0001SDM1	HDD 160GB SEAGATE ST9160314AS	KH.16008.022
	HDD 160GB 5400RPM 2.5" SATA WD WD1600BEVT-22ZCT0 F/W:11.01A11	HDD 160GB WD WD1600BEVT-22ZCT0	KH.16001.042
	HDD 2.5" 5400RPM 250GB SEAGATE ST9250315AS WYATT SATA LF F/W:0001SDM1	HDD 250GB SEAGATE ST9250315AS	KH.25008.021
	HDD 250GB 5400RPM SATA HGST HTS545025B9A300 PANTHER-B LF	HDD 250GB HGST HTS545025B9A300	KH.25001.016
	HDD 250GB 5400RPM SATA WD WD2500BEVT-22ZCT0 F/W:11.01A11	HDD 250GB WD WD2500BEVT-22ZCT0	KH.25007.015
	HDD 320GB 5400RPM SATA HGST HTS545032B9A300 PANTHER B LF	HDD 320GB HGST HTS545032B9A300	KH.32008.013
	HDD 320GB 5400RPM SATA WD WD3200BEVT-22ZCT0 ML125 F/W:01.01A01	HDD 320GB WD WD3200BEVT-22ZCT0	KH.32007.007
	HDD 500GB 5400RPM HGST SATA HTS545050B9A300 PANTHER B LF	HDD 500GB HGST HTS545050B9A300	KH.50008.013
	HDD 500GB 5400RPM WD SATA WD5000BEVT-22ZAT0 F/W:01.01A01	HDD 500GB WD WD5000BEVT-22ZAT0	KH.50007.009
Optical drive	BLU-RAY COMBO MODULE 4X 12.7MM SATA BLACK FOR WINDOWS7	ODD NBDCB4XS (BLACK) SJV50_TRP	6M.BFD01.002
	BLU-RAY COMBO MODULE 4X 12.7MM SATA BLACK FOR WINDOWS7	ODD NBDCB4XS (BLACK) SJV50_TRM	6M.WGH01.002
	ODD PLDS BD COMBO 12.7MM TRAY DL 4X SATA DS-4E1S WINDOWS7 W/O BEZEL	BD COMBO SATA W7 PLDS DS-4E1S	KO.0040F.003



Category	Part Name	Description	OEM Part No.
Optical drive	DVD-RW SUPER-MULTI MODULE 8X 12.7MM SATA BLACK FOR WINDOWS7	ODD NSM8XS (BLACK) SJV50_TRP	6M.BFD01.001
	DVD-RW SUPER-MULTI MODULE 8X 12.7MM SATA BLACK FOR WINDOWS7	ODD NSM8XS (BLACK) SJV50_TRM	6M.WGH01.001
	ODD TOSHIBA SUPER-MULTI DRIVE 12.7MM TRAY DL 8X TS-L633C LF W/O BEZEL SATA HF+WINDOWS7	ODD SM12.7 HFW7 TSST TS-L633C	KU.00801.035
Processor	CPU AMD TURION M520 2.3G 1M 35W CASPIAN	IC CPU TURION M520 2.3G 1M 35W	KC.TM002.520
	CPU AMD TURION M600 2.4G 2M 35W CASPIAN	IC CPU TURION M600 2.4G 2M 35W	KC.TM002.600
	CPU AMD TURION M620 2.5G 2M 35W CASPIAN	IC CPU TURION M620 2.5G 2M 35W	KC.TM002.620
	CPU AMD TURION M640 2.6G 2M 35W CASPIAN	IC CPU TURION M640 2.6G 2M 35W	KC.TM002.640
Heatsink	CPU HEATSINK DISCRETE W/FAN	ASSY DIS THM CCI+FCN SJV50TR	60.4FM10.001
	CPU HEATSINK DISCRETE W/FAN	ASSY DIS THM RBN+FCN SJV50TR	60.4FM09.001
	CPU HEATSINK UMA W/FAN	ASSY UMA THM RBN+FCN SJV50PU	60.4BX07.002
	CPU HEATSINK UMA W/FAN	ASSY UMA THM CCI+FCN SJV50PU	60.4BX06.002
Memory	SODIMM 1GB DDRII 800 NANYA NT1GT64UH8D0FN-AD LF 64*16 0.07UM	SODIMM 1G NT1GT64UH8D0FN-AD	KN.1GB0G.012
	SODIMM 1GB DDRII 800 NANYA NT1GT64UH8D0FN-AD LF 64*16 0.07UM	SODIMM 1G NT1GT64UH8D0FN-AD	KN.1GB0B.033
	SODIMM 1GB DDRII667 SAMSUNG M470T2864QZ3-CE6 LF	SODIMM 1G M470T2864QZ3-CE6	KN.1GB03.025
	SODIMM 1GB DDRII667 SAMSUNG M470T2864QZ3-CE6 LF	SODIMM 1G M470T2864QZ3-CE6	KN.1GB03.025
	SODIMM 1GB DDRII 800 SAMSUNG M470T2864EH3-CF7 LF 64*16 0.055UM	SODIMM 1G M470T2864EH3-CF7	KN.1GB0B.016
	SODIMM 1GB DDRII 800 SAMSUNG M470T2864EH3-CF7 LF 64*16 0.055UM	SODIMM 1G M470T2864EH3-CF7	KN.1GB0G.016
	SODIMM 1GB DDRII667 HYNIX HYMP112S64CP6-Y5 LF	SODIMM 1G HYMP112S64CP6-Y5	KN.1GB0B.016
	SODIMM 1GB DDRII 800 HYNIX HYMP112S64CP6-S6 LF 64*16 0.065UM	SODIMM 1G HYMP112S64CP6-S6	KN.1GB0B.033
	SODIMM 1GB DDRII 800 HYNIX HYMP112S64CP6-S6 LF 64*16 0.065UM	SODIMM 1G HYMP112S64CP6-S6	KN.1GB0G.012
	SODIMM 2GB DDRII 800 NANYA NT2GT64U8HD0BN-AD LF 128*8 0.07UM	SODIMM 2G NT2GT64U8HD0BN-AD	KN.2GB0B.003
	SODIMM 2GB DDRII667 SAMSUNG M470T5663QZ3-CE6 LF	SODIMM 2G M470T5663QZ3-CE6	KN.2GB0G.004

CHAPTER 6: FRU (Field-Replaceable Unit) list

Category	Part Name	Description	OEM Part No.
Memory	SODIMM 2GB DDRII 800 SAMSUNG M470T5663EH3-CF7 LF 128*8 0.055UM	SODIMM 2G M470T5663EH3-CF7	KN.2GB03.010
	SODIMM 2GB DDRII667 HYNIX HYMP125S64CP8-Y5 LF	SODIMM 2G HYMP125S64CP8-Y5	KN.2GB0B.018
LCD	LED LCD MODULE 15.6" WXGA GLARE IMR BLACK / BLACK W/0.3M CAMERA&ANTENNA*2 & LOGO PLATE FOR PACKARDBELL	LCD NLED 15.6" WXGAG ANT*2 TTK	6M.BFD01.003
	LED LCD MODULE 15.6" WXGA GLARE IMR BULE / BLACK W/0.3M CAMERA&ANTENNA*2 & LOGO PLATE FOR GATEWAY	LCD NLED 15.6" WXGAG ANT*2 TBK	6M.WGH01.003
	LED LCD 15.6" WXGA GLARE AUO B156XW02 V0 LF 220NIT 8MS 500:1	LCD 15.6"HD AU B156XW02 V0 LED	LK.15608.002
	LED LCD 15.6" WXGA GLARE LG LP156WH2-TLE1 LF 220NIT 8MS 400:1	LCD 15.6"HD LPL LP156WH2-TLE1	LK.15605.003
Microphone	MICROPHONE	MICROPHONE XINGMENG SJV50	23.42250.001
	MICROPHONE	MICROPHONE GOERTEK SJV50	23.42249.001
	MICROPHONE	MICROPHONE HIT SJV50	23.42248.001
Speakers	SPEAKER	SPEAKER YG SJV50	23.40555.001
	SPEAKER	SPEAKER SABLE SJV50	23.40554.001
Screws	SCREW M2*L3	SCREW M2*L3 (WHITE)	86.00D45.220
	SCREW	ISO M2.5X6(H=0.7~0.8MM)	86.00E12.536
	SCREW M3 X 3 #1 NI NYLON	SCRW M3 X 3 #1 NI NYLON	86.00E78.643
	SCREW M2*L6 T=0.8	SCRW M2L6(T=0.8) BLACK	86.00F51.736
	SCREW M2*L4	SCRW M2*L4 BZN	86.00K66.324
	SCREW M2*L4 HNM	SCRW M2*L4 HNM	86.00K95.324
	SCRE M2-0.4X5ZN/BL+NY	SCRE M2-0.4X5(4,0.8)ZN/BL+NY	86.FR901.002
	SCREW M2.5*L5 BLACK ZN+NYLOK	M2.5*L5 BLACK ZN+NYLOK	86.TK501.001
Miscellaneous	NAME PLATE BLACK NV SERIES	LBL NAME PLATE_NV SERIES_BLACK	40.WBM01.001
	LCD SCREW RUBBER BLACK	RUB LCD BEZEL ROUND BLACKSJV50	47.WBM01.001

Category	Part Name	Description	OEM Part No.
Keyboard	KEYBOARD 99KEYS GP7T SJV70/SJV50 INTERNAL17 STANDARD BLACK ARABIC	KB MP-07F33A0-4424H AR 99 GP7T	KB.I170G.087
	KEYBOARD 100KEYS GP7T SJV70/SJV50 INTERNAL17 STANDARD BLACK BELGIUM	KB MP-07F36B0-4424H BE 100GP7T	KB.I170G.088
	KEYBOARD 100KEYS GP7T SJV70/SJV50 INTERNAL17 STANDARD BLACK BRAZILIAN PORTUGUESE	KB MP-07F36PA-4424H BR 100GP7T	KB.I170G.089
	KEYBOARD 100KEYS GP7T SJV70/SJV50 INTERNAL17 STANDARD BLACK CZECH/SLOVAK	KB MP-07F36CS-4424H CZK100GP7T	KB.I170G.090
	KEYBOARD 99KEYS GP7T SJV70/SJV50 INTERNAL17 STANDARD BLACK CHINESE	KB MP-07F33RC-4424H CH 99 GP7T	KB.I170G.091
	KEYBOARD 100KEYS GP7T SJV70/SJV50 INTERNAL17 STANDARD BLACK DANISH	KB MP-07F36DK-4424H DK 100GP7T	KB.I170G.092
	KEYBOARD 100KEYS GP7T SJV70/SJV50 INTERNAL17 STANDARD BLACK ARABIC FRENCH	KB MP-07F36AF-4424H FRA100GP7T	KB.I170G.093
	KEYBOARD 100KEYS GP7T SJV70/SJV50 INTERNAL17 STANDARD BLACK FRENCH	KB MP-07F36F0-4424H FR 100GP7T	KB.I170G.094
	KEYBOARD 100KEYS GP7T SJV70/SJV50 INTERNAL17 STANDARD BLACK GERMAN	KB MP-07F36D0-4424H GR 100GP7T	KB.I170G.095
	KEYBOARD 99KEYS GP7T SJV70/SJV50 INTERNAL17 STANDARD BLACK GREEK	KB MP-07F33GR-4424H GK 99 GP7T	KB.I170G.096
	KEYBOARD 100KEYS GP7T SJV70/SJV50 INTERNAL17 STANDARD BLACK HUNGARIAN	KB MP-07F36HU-4424H HU 100GP7T	KB.I170G.097
	KEYBOARD 100KEYS GP7T SJV70/SJV50 INTERNAL17 STANDARD BLACK ITALIAN	KB MP-07F36I0-4424H IT 100GP7T	KB.I170G.098
	KEYBOARD 103KEYS GP7T SJV70/SJV50 INTERNAL17 STANDARD BLACK JAPANESE	KB MP-07F30J04424 JAP 104 GP7T	KB.I170G.099
	KEYBOARD 100KEYS GP7T SJV70/SJV50 INTERNAL17 STANDARD BLACK NORDIC	KB MP-07F36DN-4424H NR 100GP7T	KB.I170G.100
	KEYBOARD 100KEYS GP7T SJV70/SJV50 INTERNAL17 STANDARD BLACK NORWEGIAN	KB MP-07F36N0-4424H NO 100GP7T	KB.I170G.101
	KEYBOARD 100KEYS GP7T SJV70/SJV50 INTERNAL17 STANDARD BLACK PORTUGUESE	KB MP-07F36P0-4424H PT 100GP7T	KB.I170G.102
	KEYBOARD 99KEYS GP7T SJV70/SJV50 INTERNAL17 STANDARD BLACK RUSSIAN	KB MP-07F33SU-4424H RU 99 GP7T	KB.I170G.103

CHAPTER 6: FRU (Field-Replaceable Unit) list

Category	Part Name	Description	OEM Part No.
Keyboard	KEYBOARD 100KEYS GP7T SJV70/SJV50 INTERNAL17 STANDARD BLACK SLO/CRO	KB MP-07F36SA-4424H SL 100GP7T	KB.I170G.104
	KEYBOARD 100KEYS GP7T SJV70/SJV50 INTERNAL17 STANDARD BLACK SPANISH	KB MP-07F36E0-4424H SP 100GP7T	KB.I170G.105
	KEYBOARD 100KEYS GP7T SJV70/SJV50 INTERNAL17 STANDARD BLACK SWEDEN	KB MP-07F36S0-4424H SE 100GP7T	KB.I170G.106
	KEYBOARD 100KEYS GP7T SJV70/SJV50 INTERNAL17 STANDARD BLACK SWISS/G	KB MP-07F36CH-4424H SW 100GP7T	KB.I170G.107
	KEYBOARD 99KEYS GP7T SJV70/SJV50 INTERNAL17 STANDARD BLACK THAILAND	KB MP-07F33T0-4424H TH 99 GP7T	KB.I170G.108
	KEYBOARD 100KEYS GP7T SJV70/SJV50 INTERNAL17 STANDARD BLACK TURKISH	KB MP-07F36TQ-4424H TR 100GP7T	KB.I170G.109
	KEYBOARD 100KEYS GP7T SJV70/SJV50 INTERNAL17 STANDARD BLACK UK	KB MP-07F36GB-4424H UK 100GP7T	KB.I170G.110
	KEYBOARD 99KEYS GP7T SJV70/SJV50 INTERNAL17 STANDARD BLACK US INTERNATIONAL	KB MP-07F33U4-4424H USI 99GP7T	KB.I170G.111
	KEYBOARD 99KEYS GP7T SJV70/SJV50 INTERNAL17 STANDARD BLACK US INTERNATIONAL W/ HEBREW	KB MP-07F33HB-4424H HE 99 GP7T	KB.I170G.112
	KEYBOARD 100KEYS GP7T SJV70/SJV50 INTERNAL17 STANDARD BLACK US W/ CANADIAN FRENCH	KB MP-07F36CU-4424H FCE100GP7T	KB.I170G.113

# APPENDIX A

## Test compatible components

- [Introduction](#)
- [Microsoft® Windows Vista® Environment Test](#)

# Introduction

This notebook's compatibility is tested and verified by Acer's internal testing department. All of its system functions are tested under Windows Vista®, Windows® XP Home, Windows® XP Pro environment.

Refer to the following lists for components, adapter cards, and peripherals which have passed these tests. Regarding configuration, combination and test procedures, please refer to the NS50 series Compatibility Test Report released by the Acer Mobile System Testing Department.

## Microsoft® Windows Vista® Environment Test

Item	Specification
<b>CRT Port Test</b>	
CRT Monitor	ViewSonic 19" CRT VCDTS23283-2G Monitor ViewSonic Professional Series G220 21" Monitor Philips 109P 19" Monitor MAG 810FT II 19" Monitor
LCD Monitor	ViewSonic 19" LCD VA1912W Monitor ViewSonic 20" LCD VA2012W Monitor Samsung 22" LCD 225DW Monitor Philips 15" 150B5 Monitor ASUS 22" LCD MW221u monitor EIZO 17" LCD FlexScan L586 monitor
<b>HDMI Port Test</b>	
LCD TV	BenQ VH3243 32" HDMI LCD TV Panasonic TC-37MPK 37" HDMI LCD TV BenQ VL3735 LCD TV
<b>USB Port Test</b>	
USB Mouse	Logitech USB 2.0 Mouse Logitech Optical Mouse Microsoft Optical Mouse Microsoft TrackBall Optical Logitech Marble Mouse Logitech Performance Optical Mouse Logitech Cordless Optical Mouse
USB Keyboard	Microsoft Natural Keyboard Pro Microsoft Digital Media Keyboard Pro Logitech Elite keyboard Logitech Cordless Desktop LX300 Keyboard IBM USB Numeric Keypad 33L3225 COMPAQ USB EAB Keyboard MICROSOFT Wireless Optical Desktop 3000
USB Printer	Samsung ML 1450 Laser Printer Epson Photo830 Printer HP Photosmart 7960 Printer Canon PIXMA IP2000 Printer Lexmark Z52 Printer HP DeskJet 840C Printer

Item	Specification
USB Speaker	JS USB Digital Speaker J-6502 JS USB speaker USBJ268 Comodow USB 3D sound (Adapter) YAMAHA USB Speaker MS35D
USB Scanner	Epson EXPRESSION 1600 Scanner Canon Canonscan CS3200F Epson USB Scanner 1660
USB Hub	D-link DU-H4 USB HUB ATEN UH-204 USB 2.0 HUB
USB Game Pad/Joystick	ALPS USB Game Pad Microsoft SideWinder Plug & Play GamePad Logitech Freedom 2.4GHz cordless Logitech WingMan USB Extreme Digital 3D Joystick Microsoft USB Side Winder Game pad Saitek P2500 Rumble Force Pad Logitech WingMan Formula (warrior) Joystick Logitech Freedom cordless joystick
USB Ethernet/Wireless LAN Adapter	Afast Ethernet Adapter USB2.0 D-Link Wireless LAN adapter,802.11a/b or b only D-Link AirPlus DWL-120+ 2.4GHz Wireless USB Adapter
USB Storage	Zynet 2.5" External Enclosure SATA/ Usb2.0 Box Sony 2.5" ExtERNAL BOX Slim Kit USB 2.0 Mass Storage 2.5" HDD combo case IO DATA 250GB eSATA HDD SanDisk Cruzer USB Flash Drive- Micro 1.0GB HP DL702 USB 128MB Digital Drive Transcend USB 512MB Flash Drive Sandisk USB 2.0 512MB Flash Drive Pioneer DVD+-R/RW Writer
USB Modem	US Robotics Courier 56K Modem
USB Bridge Cable	Z-TEK USB 2.0 Data Bridge Cable
USB FDD	NEC FDD IBM USB FDD Sony USB Floppy Disk Driver
<b>Headphone/Microphone Port Test</b>	
Headphone/Microphone	Logitech Premium Stereo Headset Headphone+Mic Sennheiser HD202 PHILIPS headphone Logitech Labtec Verse-524 MIC Panasonic Earbud Headphone with Volume Control
<b>Express Card Test</b>	
Gigabit Ethernet LAN Card	AboCom ExpressCard/34 Gigabit Ethernet PLANEX Expresscard 1000 BASE-T Gigabit LAN
Wireless LAN Card	BELKIN N1 Wireless
Card Reader Adapter	Hagiwara sys-com Compact Flash/Microdrive Adapter Express Card AboCom ExpressCard/34 5in1 Card Reader
IEEE1394 Card	AboCom ExpressCard/54 1394B-800Mbps AboCom ExpressCard/54 1394A-400Mbps
<b>Bluetooth Device Test</b>	
Bluetooth Cell Phone/Headset	Sony Ericsson Bluetooth Headset Motorola HT820 Bluetooth Stereo Headphone

APPENDIX A: Test compatible components

Item	Specification
<b>Multimedia Card Test</b>	
SD/Mini SD/Micro SD Card	SanDisk Secure Digital Card 256MB A-DATA Secure Digital Card 4GB 150X Kingston SDHC 8GB Class6 Transcend SD 512MB Transcend 150X Ultra Speed SD 4GB Transcend SD HC 4GB A-DATA 150X Turbo SD 4GB A-DATA miniSD 512MB KINGMAX mini SD Adapter+512MB Mini SD Toshiba SDHC 4GB Class4 SanDisk Micro SD 6GB TOSHIBA Micro SD 2GB
MMC/MMC Plus/MMC Pro/ RS-MMC/RS-MMC Mobile	A-DATA MultiMedia Card 256MB A-DATA MultiMedia Card plus 1GB 200X A-DATA RS-MMC 256MB Transcend MMC Plus 4GB Transcend RS-MMC 512MB Ridata Multimedia Card PRO 256MB Silicon Power RS-MMC Mobile 1GB
MS/MS PRO/MS PRO Duo	Sony Memory Stick Card 128MB Sony Memory Stick Card Pro 256MB SanDisk Memory Stick Pro Duo 256MB SanDisk Memory Stick Pro 256MB Sony Memory Stick PRO Duo Card 4GB+MS Adapter Sony Memory Stick Pro MSX -2GS 2GB SanDisk Memory Stick Pro SDMSV-512 512MB



# APPENDIX B

## Online support information

This section describes online technical support services available to help you repair your Gateway notebook.

If you are a distributor, dealer, ASP, or TPM, please refer your technical queries to your local Acer branch office. Acer branch offices and Regional Business Units may access our website. However some information sources will require a user id and password. These can be obtained directly from Acer CSD Taiwan.

Acer's website offers you convenient and valuable support resources whenever you need them. In the Technical Information section you can download information on all of Acer's Notebook, Desktop and Server models including:

- Service guides for all models
- User's manuals
- Training materials
- BIOS updates
- Software utilities
- Spare parts lists
- TABs (Technical Announcement Bulletin)

For these purposes, we have included an Acrobat File to facilitate the problem-free downloading of our technical material. Also contained on this website are:

- Detailed information on Acer's International Traveller's Warranty (ITW)
- Returned material authorization procedures
- An overview of all the support services we offer, accompanied by a list of telephone, fax and email contacts for all your technical queries.

We are always looking for ways to optimize and improve our services, so if you have any suggestions or comments, please do not hesitate to communicate these to us.

# Index

## A

- AC adapter
  - connector 16
- antennas
  - replace 111
- application key 22
- arrow keys 22
- audio
  - back button 23
  - controller 12
  - headphone jack 17
  - Increase volume 24
  - microphone jack 17
  - muting 24
  - next button 23
  - pause button 23
  - play button 23
  - resolution 12
  - stop button 23

## B

- battery
  - charge indicator 19, 21
  - latch 18
  - locating 18
  - release latch 18
  - remove 48
- bay cover
  - remove 49
- bays
  - hard drive 19
  - memory 18
- BIOS
  - password control 8
  - supported protocols 8
  - vendor 7
  - version 7
- BIOS crisis disk 38
- BIOS flash 39
- BIOS recovery
  - BIOS flash 39
  - crisis disk 38
  - precautions 38
  - procedure 38
- BIOS utility
  - access 28
  - Boot menu 36
  - Exit menu 37
  - Information menu 30
  - Main menu 31
  - navigate 29
  - Security menu 32
- Bluetooth

- chipset 12
  - module, replace 83
  - system key 23
  - turning off 23
  - turning on 23
- boot sequence 36
- buttons
  - specification 13

## C

- cable lock 16
- cable modem 16
- capacitive touch keys 20, 24
- Caps Lock indicator 21
- card reader
  - remove card 47
- cards
  - memory card slot 17
- CD
  - controlling playback 23, 24
- chipset
  - Bluetooth 12
  - USB 13
  - wired Ethernet 12
  - wireless Ethernet 13
- clicking 25
- component replacement
  - antennas 111
  - battery 48
  - bay cover 49
  - Bluetooth module 83
  - cooling assembly 80, 89
  - ESD prevention 44
  - hard drive 54
  - Kensington lock cap 107
  - keyboard 62
  - keyboard cover 58
  - LCD 100
  - LCD assembly lid 113
  - LCD front panel 95
  - LCD panel assembly 64
  - LCD panel hinge brackets 103
  - memory 50
  - microphone 109
  - modem 77
  - multimedia board 60
  - optical drive 56
  - palm rest 68
  - power button board 105
  - preparatory steps 47
  - processor 92
  - safety reminders 44

- speakers 72
- system board 86
- tape 44
- tools 46
- touchpad/fingerprint reader
  - board 74
- USB board 80
- webcam 98
- wireless card 52
- work space 45
- conductive tape 44
- connections
  - audio 17
  - broadband Internet 16
  - cable modem 16
  - dial-up modem 17
  - digital camera 17
  - DSL modem 16
  - Ethernet 16
  - external audio 17
  - external diskette drive 17
  - external speakers 17
  - flash drive 17
  - HDMI (TV) out 16
  - headphone 17
  - keyboard 17
  - microphone 17
  - modem (dial-up) 17
  - monitor (VGA) 16
  - mouse 17
  - network 16
  - power 16
  - printer 17
  - scanner 17
  - speaker 17
  - specification 13
  - USB 17
  - VGA 16
- controller
  - audio 12
  - keyboard 11
  - memory card reader 11
- cooling assembly
  - replace 80, 89
- D
- D2D Recovery 32
- dial-up modem 17
- digital camera
  - memory card reader 17
  - USB port 17
- directional keys 22
- display 6
  - switching 22

- double-clicking 26
- dragging 26
- drives
  - DVD/CD-RW 17
  - DVD±RW 17
  - hard drive 19
  - multi-format DVD±RW 17
- DSL modem 16
- DVD
  - controlling playback 23
- DVD drive
  - locating 17
- E**
- electrostatic discharge 44
- error symptom-to-spare part index 120
- ESD, *see* electrostatic discharge 44
- Ethernet
  - jack 16
- external CD-ROM drive check 117
- external monitor 16, 22
- EZ Pad touchpad
  - See* touchpad
- F**
- fan 16, 18
- features 3
- files
  - opening 26
- Fn key 22
- folders
  - opening 26
- function keys 22
- H**
- hard drive
  - bay 19
  - HDD password 33
  - indicator 21
  - replace 54
- hard drive bracket
  - remove 55
- HDD password
  - description 33
- HDMI (TV) out jack 16
- HDMI port 22
- headphone jack 17
- Hybrid Sleep
  - mode 22
  - system key 22
- I**
- indicators
  - See* status indicators
- intermittent problems 132
- Internet chat program 26
- J**
- jacks
  - See* connections
- K**
- Kensington cable lock
  - lock slot 16
- Kensington lock
  - cap, replace 107
- keyboard
  - buttons 21
  - controller 11
  - features 21
  - keys 21
  - locating 19
  - replace 62
  - USB port 17
- keyboard cover
  - replace 58
- keyboard or auxiliary input
  - device check 117
- keys
  - application 22
  - arrow 22
  - directional 22
  - Fn 22
  - function 22
  - Hybrid Sleep 22
  - LCD/CRT 22
  - navigation 22
  - Sleep 22
  - system 22
  - toggle display 22
  - Windows 22
  - wireless Ethernet 24
- L**
- latch
  - battery 18
- LCD
  - replace 100
- LCD assembly lid
  - replace 113
- LCD front panel
  - replace 95
- LCD panel
  - switching display 22
- LCD panel assembly
  - replace 64
- LCD panel hinge brackets
  - replace 103
- LCD/CRT system key 22
- lock
  - Kensington cable 16
- M**
- media reader
  - See* memory card reader
- memory
  - bay 18
  - install 50
  - remove 50
- memory card
  - remove 47
- memory card reader
  - controller 11
  - locating 17
  - supported cards 11
- memory check 118
- microphone
  - jack 17
  - replace 109
- modem
  - cable 16
  - DSL 16
  - jack (dial-up) 17
  - replace 77
- monitor
  - port 16
  - using 22
- mouse
  - USB port 17
- moving
  - pointer 25
  - screen objects 26
- multimedia board
  - replace 60
- Mute 23
- mute button 24
- muting sound 24
- MyBackup key 24
- mylar tape 44

- N
  - navigation keys 22
  - network jack 16
- O
  - opening
    - files 26
    - folders 26
    - programs 26
    - shortcut menu 26
  - optical drive
    - replace 56
  - optical drive bezel
    - remove 57
  - optical drive bracket
    - remove 57
- P
  - palm rest
    - replace 68
  - Panel
    - Bottom 18
    - left 16
  - password
    - change 34
    - clear hardware gap 40
    - guidelines 33
    - HDD, description 33
    - Password on Boot 33
    - remove 35
    - set 33
    - supervisor, description 33
  - Password on Boot 33
  - physical specifications 5
  - pointer
    - identifying 25
    - moving 25
  - power
    - button 17, 22
    - connector 16
    - Hybrid Sleep mode 22
    - indicator 19, 21
    - Sleep mode 22
    - status indicator 19, 21
  - power button board
    - replace 105
  - power system check 118
    - battery pack 119
    - power adapter 118
  - PowerSave key 24
  - printer
    - USB port 17
  - processor
    - replace 92
  - Programmable key 24
  - programs
    - opening 26
  - projector
    - port 16
    - using 22
- R
  - right-clicking 26
- S
  - scanner
    - USB port 17
  - Screen blank 23
  - screen objects
    - getting information 26
    - moving 26
    - selecting 25
  - scroll zone 25
  - security features
    - BIOS passwords 33
    - Kensington cable lock 16
  - shortcut menus
    - accessing 26
  - shortcuts
    - opening menu 26
  - Sleep
    - mode 22
    - system key 22
  - sound
    - muting 24
  - Speakers 19
  - speakers
    - jack 17
    - replace 72
  - specification
    - buttons 13
    - ports 13
    - status indicators 13
  - starting
    - programs 26
  - status indicator
    - wireless Ethernet 21
  - status indicators
    - battery charge 19, 21
    - Caps Lock 21
    - drive activity 21
    - hard drive 21
    - location 19
    - Num Lock 21
    - power 19, 21
    - specification 13
  - supervisor password
    - change 34
    - clear 40
    - description 33
    - remove 35
    - set 33
  - Suspend 22
  - system
    - block diagram 6
    - check procedures 117
  - system board
    - bottom view 137
    - replace 86
    - top view 136
  - system keys
    - locating 22
- T
  - television
    - HDMI out jack 16
  - touchpad
    - buttons 25
    - check 119
    - clicking 25
    - double-clicking 26
    - dragging screen objects 26
    - locating 20
    - moving pointer 25
    - moving screen objects 26
    - opening files, folders, and programs 26
    - opening shortcut menu 26
    - right-clicking 26
    - scroll zone 25
    - selecting screen objects 25
  - touchpad / fingerprint reader
    - board
      - replace 74
  - Touchpad toggle 24
  - turning off
    - Bluetooth 23
    - wireless network 23
  - turning on
    - Bluetooth 23
    - wireless Ethernet 24
    - wireless network 24
  - TV out (HDMI) jack 16
- U
  - undetermined problems 133
  - USB

- chipset 13
- USB board
  - replace 80
- USB port 17
- user password
  - change 34
  - clear 40
  - remove 35
  - set 34
- utilities
  - BIOS setup utility 28

## V

- ventilation 16, 18
- VGA port 16
- video
  - HDMI out jack 16
  - monitor port 16
  - projector port 16
  - VGA port 16
- view
  - left 16
  - rear 18
  - right 17
- volume
  - muting 24

## W

- webcam 20, 26
  - replace 98
- Windows
  - key 22
- Windows 2000 environment
  - test 152
- wired Ethernet
  - chipset 12
- wireless card
  - replace 52
- wireless Ethernet
  - button 24
  - chipset 13
  - status indicator 21
- wireless switch 25



MAN NV5x SVC GDE R1 04/09



8513195

TEMP  
UPC