

P-79

SERVICEGUIDE



Revision History

Please refer to the table below for the updates made on the P-79 service guide.

Date	Chapter	Updates

Service guide files and updates are available on the ACER/CSD web. For more information, refer to <http://csd.acer.com.tw>

Copyright

© 2009 Gateway, Inc. All rights reserved. Gateway, Gateway Country, the Gateway stylized logo, and the black-and-white spot design are trademarks or registered trademarks of Gateway, Inc. in the United States and other countries. All other brands and product names are trademarks or registered trademarks of their respective companies.

PRINTED IN TAIWAN

Contents

Preface	2
Features	2
System block diagram	5
Hardware specifications and configurations	6
Notebook product tour	18
BIOS Setup Utility	36
BIOS flash utility	46
Removing a password lock	47
Clearing password check and BIOS recovery	48
Preventing static electricity discharge	54
Preparing your work space	55
Tools required	56
Preparing the notebook	57
Adding or replacing memory modules	58
Replacing the main cooling assembly	60
Replacing the processor	63
Replacing the IEEE 802.11 wireless card	65
Replacing the CMOS battery	68
Replacing the hard drive	69
Replacing the optical drive	73
Replacing the keyboard cover	75
Replacing the keyboard	78
Replacing the inverter	81
Replacing the webcam	84
Replacing the lid latches	87
Replacing the LCD assembly	90
Replacing the LCD panel	94
Replacing the LCD panel hinges and bracket	98
Replacing the LCD assembly lid	102
Replacing the palm rest	104
Replacing the touchpad board	108
Replacing the touchpad button board	112
Replacing the fingerprint reader	115
Replacing the Bluetooth module	117
Replacing the modem	119
Replacing the speakers	122
Replacing the system board and VGA cooling assembly	125
Replacing the modem jack/USB board	132
Replacing the fan(s)	135
Diagnosing problems	140
System test procedures	140
Power-On Self-Test (POST) error message	143
Index of error messages	144
Phoenix BIOS beep codes	147

Contents

Symptom-to-FRU error messages	152
Intermittent problems	155
Undetermined problems	155
System board top connectors	158
System board bottom connectors	159
Introduction	162
Exploded diagram	163
FRU list	164
Introduction	182
Microsoft® Windows Vista® Environment Test	182

Contents

CHAPTER 1

System specifications

- [Preface](#)
- [Features](#)
- [System block diagram](#)
- [Hardware specifications and configurations](#)
- [Notebook product tour](#)

Preface

Conventions

The following conventions are used in this manual:



Warning

Indicates a potential for personal injury.



Caution

Indicates a potential loss of data or damage to equipment.



Important

Indicates information that is important to know for the proper completion of a procedure, choice of an option, or completing a task.

General information

Before using this information and the product it supports, read the following general information.

This service guide provides you with all technical information relating to the basic configuration decided for Acer's global product offering. To better fit local market requirements and enhance product competitiveness, your regional office may have decided to extend the functionality of a machine (such as add-on cards, modems, or extra memory capabilities). These localized features are not covered in this generic service guide. In such cases, contact your regional offices or the responsible personnel/channel to provide you with further technical details.

When ordering FRU parts: Check the most up-to-date information available on your regional web or channel. If, for whatever reason, a part number change is made, it may not be noted in this printed service guide.

Acer-authorized Service Providers: Your Acer office may have a different part number code to those given in the FRU list of this printed service guide. You must use the list provided by your regional Acer office to order FRU parts for repair and service of customer machines.

Features

Platform

- Intel® Core™2 Duo processor (2.53GHz) or Intel® Core™2 Quad processor (2.0 GHz) with 1066 MHz FSB.
- Core Logic: Intel GM45 Northbridge, Intel ICH9ME Southbridge
- Wireless: Intel WiFi Link 5100

System Memory

- Dual-Channel DDR2 SDRAM support
- Up to 8GB of DDR2 800/1066 MHz memory, upgradeable using two SO-DIMM modules

Display and graphics

- 17.1" WXGA+ TFT LCD display panel
- VGA Memory:
 - NVidia N10E-GT 1 with 1024 MB memory
- Dual independent display support
- Supported screen resolution
 - 800 x 600, 1024 x 768, 1152 x 864, 1280 x 720, 1280 x 768, 1280 x 800, 1360 x 768, 1140 x 900
- 16.7 million colors
- MPEG-2/DVD hardware-assisted capability (acceleration)
- MPEG-2/DVD decoding (for selected models)
- WMV9 (VC-1) support (acceleration)
- WMV9 (VC-1) and H.264 (AVC) decoding (for selected models)
- HDMI™ (High-Definition Multimedia Interface) with HDCP (High-bandwidth Digital Content Protection) support

Storage subsystem

- Industry standard 2.5" 120–500GB or higher 9.5mm height hard disk drive
- Optical drive options:
 - Blu-ray Disc™/DVD-Super Multi double-layer drive
 - DVD-Super Multi double-layer drive
- 5-in-1 card reader, supporting Secure Digital™ (SD), MultiMediaCard (MMC), Memory Stick® (MS), Memory Stick PRO™ (MS PRO), xD-Picture Card™ (xD)

Input devices

- 103-key keyboard, 2.5 mm (minimum) key travel
- Twelve function keys, four cursor keys, two Windows® keys
- Touchpad pointing device
- Media keys on optional multimedia panel

Audio

- Two built-in stereo speakers
- High-definition audio support
- MS-Sound compatible
- Built-in microphone on webcam

Communication

- Integrated webcam
- WLAN: Intel® WiFi Link 5100 a/b/g/n
- WPAN: Bluetooth® 2.0+EDR (Enhanced Data Rate)
- LAN: 10/100/1000 Ethernet

I/O Ports and devices

- USB (three)
- External display (VGA) port
- eSATA port
- Ethernet (RJ45)
- Headphone/SPDIF Audio Out
- Microphone in
- DC in jack for AC adapter
- PCMCIA slot (Type II)
- ExpressCard™/54 slot
- Fingerprint reader (optional)
- 5-in-1 card reader (SD™, MMC, MS, MS PRO, xD)
- HDMI™ port with HDCP support

Security

- Kensington lock slot

Environment

- Temperature:
 - Operating: 32 °F to 90 °F (0 °C to 35 °C)
 - Non-operating: -4 °F to 140 °F (-20 °C to 60 °C)
- Humidity (non-condensing):
 - Operating: 10% to 90%
 - Non-operating: 5% to 95%

Dimension and Weight

- Dimension: 400 mm x 295 mm x 42.8 mm
- Weight: 4.20 kg.

System block diagram

Godzilla-N10 Block Diagram

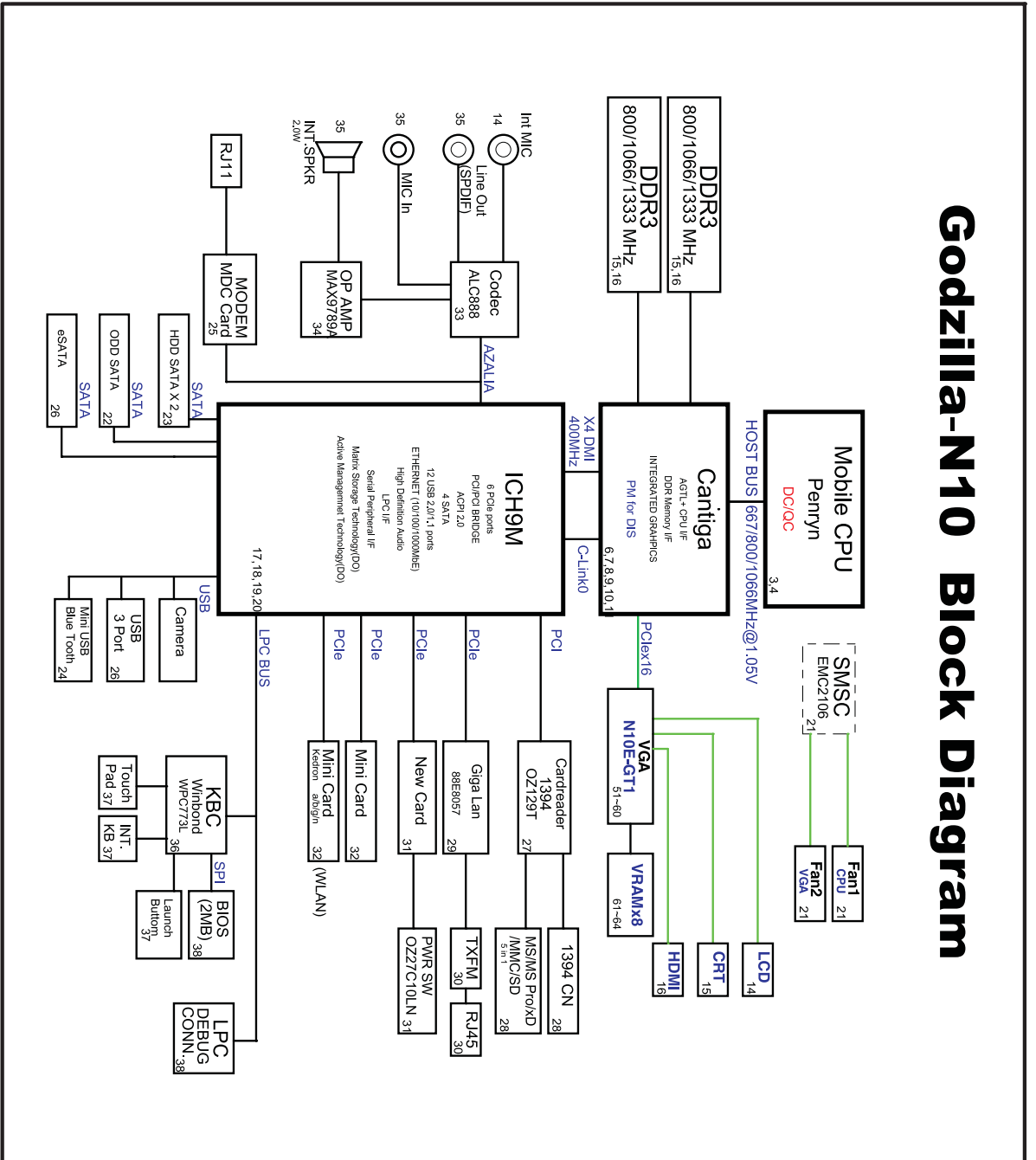

Hardware specifications and configurations

CPU

Item	Specification
CPU type	Intel Core 2 Duo or Intel Core 2 Quad Mobile Processor
Core logic	Intel GM45 + ICH9M
CPU package	Socket-P, μ FCPGA
CPU core voltage	1.0375V to 1.3V

Controllers

Item	Controller
Core logic	Intel GM45 + ICH9ME
VGA	NVidia N10E-GT 1
LAN	Marvell 88E8057
USB 2.0	Intel ICH9ME
Super I/O controller	
Bluetooth	Foxconn BRM2046
Wireless 802.11	<ul style="list-style-type: none"> ▪ Intel WiFi Link 5100
ExpressCard	Intel ICH9ME
Memory Card Reader	RTS5158
Audio Codec	Conexant CX2056-15Z Realtek ALC269X

BIOS

Item	Specification
BIOS vendor	Phoenix
BIOS Version	V1.01

Item	Specification
Supported protocols	<ul style="list-style-type: none"> ▪ ACPI 1.0b/2.0/3.0 compliance ▪ PCI 2.2 or later ▪ System/HDD Password Security Control ▪ INT 13H Extensions ▪ PnP BIOS 1.0a ▪ SMBIOS 2.4 or later ▪ BIOS Boot Specification ▪ Simple Boot Flag 1.0 ▪ Boot Block ▪ PCI Bus Power Management Interface Specification ▪ USB Specification 1.1/2.0 ▪ IEEE 1394 1.0 ▪ USB/1394 CD-ROM Boot Up support ▪ PC Card Standard 1995 (PCMCIA 3.0 Compliant Device) ▪ IrDA 1.0 ▪ Support HD audio ▪ WfM 2.0, PXE 2.1 ▪ Preboot Execution Environment (PXE) 2.1 ▪ Boot Integrity Service Application Program Interface (BIS) 1.0 ▪ PC2002/2005 compliant ▪ Intel Enhanced Speedstep Technology ▪ ASF 2.0 ▪ TPM v1.2 ▪ AHCI support ▪ iAMT 4.0 or later (for Intel platform)
BIOS password control	Manually set Supervisor and User passwords.

Memory

Item	Specification
Memory controller	Built-in
Memory size	0 MB (no on-board memory)
SO-DIMM socket number	2 sockets
Supports memory size per socket	2 GB per SO-DIMM 4 GB per SO-DIMM
Supports maximum memory size	8 GB
Supports SO-DIMM type	DDR 2 Synchronous DRAM
Supports SO-DIMM Speed	800/1066MHz
Supports SO-DIMM voltage	1.8V and 0.9V
Supports SO-DIMM package	200-pin SO-DIMM
Memory module combinations	You can install memory modules in any combination as long as they match the above specifications.

Hard Disk Drive

Item	Specification					
Vendor & Model Name	ST9120817AS MK1246GSX HTS542512K 9SA00 HT543212L9 A300 WD1200BEV S-22UST0 WD1200BEV T-22ZCT0	ST9160827AS MK1646GSX MK1652GSX HTS542516K 9SA00 HTS543216L9 A300 WD1600BEV T-22ZCT0	ST9250827AS MK2546GSX HTS542525K9S A00 HTS543225L9A 300 WD2500BEVS-2 2UST0 WD2500BEVT-2 2ZCT0	HTS543232 L9A300 WD3200BE VT-22ZCT0	ST9500325 AS WD5000BE VT-22ZAT0	ST9320421A S HTS723232L 9SA00 WD3200BEK T-22F3T0
Capacity (MB)	120000	160000	250000	320000	500000	320000
Bytes per sector	512	512	512	N/A	512	512
Data heads	3	3/4	4	N/A	2/4	2/4
Drive Format						
Disks	2	2	2	N/A	N/A	N/A
Spindle speed (RPM)	5400 RPM	5400 RPM	5400 RPM	5400 RPM	5400 RPM	7200 RPM
Performance Specifications						
Buffer size	8MB	8MB	8MB	8MB	8MB	16MB
Interface	SATA	SATA	SATA	SATA	SATA	SATA
Max. media transfer rate (disk-buffer, Mbytes/s)	540	540	540	850	3.0 GB/s (Max.) Buffer to Host	3.0 GB/s (Max.) Buffer to Host
DC Power Requirements						
Voltage tolerance	5V(DC) +/- 5%	5V(DC) +/- 5%	5V(DC) +/- 5%	5V(DC) +/- 5%	5V(DC) +/- 5%	5V(DC) +/- 5%

Optical drive

Item	Specification
Vendor & model name	TOSHIBA SUPER-MULTI DRIVE DL 8X TS-L633A LF PIONEER SUPER-MULTI DRIVE 8X DVR-TD08RS LF PANASONIC SUPER-MULTI DRIVE DL 8X UJ-870A LF HLDS SUPER-MULTI DRIVE TRAY DL 8X GSA-T50N LF SONY SUPER-MULTI DRIVE DL 8X AD-7560S LF PLDS SUPER-MULTI DRIVE DL 8X DS-8A2S LF TOSHIBA COMBO 24X TS-L463A SONY COMBO 24X CRX890S
Performance Specification	
Transfer rate (KB/sec)	Sustained: <ul style="list-style-type: none"> ▪ with CD: Max 3.6Mbytes/sec. ▪ with DVD: Max 10.08Mbytes/sec.
Buffer Memory	2MB
Interface	SATA
Applicable disc format	Applicable disc format CD: CD-DA, CD-ROM, CD-ROM XA, Photo CD (multi-session), Video CD, Cd-Extra (CD+), CD-text DVD: DVD-VIDEO, DVD-ROM, DVD-R (3.9GB, 4.7GB) DVD-R DL, DVD-RW, DVD-RAM, DVD+R, DVD+R DL, DVD+RW CD: CD-DA (Red Book) - Standard Audio CD & CD-TEXT CD-ROM (Yellow Book Mode1 & 2) - Standard Data CD-ROM XA (Mode2 Form1 & 2) - Photo CD, Multi-Session CD-I (Green Book, Mode2 Form1 & 2, Ready, Bridge) CD-Extra/ CD-Plus (Blue Book) - Audio & Text/Video Video-CD (White Book) - MPEG1 Video CD-R (Orange Book Part) CD-RW & HSRW (Orange Book Part Volume1 & Volume 2 Super Audio CD (SACD) Hybrid type US & US+ RW DVD: DVD-ROM (Book 1.02), DVD-Dual DVD-Video (Book 1.1) DVD-R (Book 1.0, 3.9G) DVD-R (Book 2.0, 4.7G) - General & Authoring DVD+R (Version 1.0) DVD+RW DVD-RW (Non CPRM & CPRM) DVD ^o R Dual
Loading mechanism	Load: Manual Release: (a) Electrical Release (Release Button) (b) Release by ATAPI command (c) Emergency Release
Power Requirement	
Input Voltage	5 V +/- 5% (Operating)

CHAPTER 1: System specifications

Item	Specification
Vendor & model name	SONY BD COMBO 12.7mm Tray DL 2X BC-5500S LF Panasonic BD COMBO 12.7mm Tray DL 2X UJ130A P08B1 PLDS BD COMBO 12.7mm Tray DL 2X DS-4E1S
Performance Specification	
Transfer rate (KB/sec)	Sustained: <ul style="list-style-type: none"> ▪ with CD: Max 3.6Mbytes/sec. ▪ with DVD: Max 10.8Mbytes/sec. ▪ with BD: Max 11Mbytes/sec.
Buffer Memory	<ul style="list-style-type: none"> ▪ for CD/DVD: 2MB ▪ for BD: 4.5MB
Interface	SATA
Applicable disc format	<p>Applicable disc format</p> <p>CD: CD-DA, CD-ROM, CD-ROM XA, Photo CD (multi-session), Video CD, Cd-Extra (CD+), CD-text</p> <p>DVD: DVD-VIDEO, DVD-ROM, DVD-R (3.9GB, 4.7GB) DVD-R DL, DVD-RW, DVD-RAM, DVD+R, DVD+R DL, DVD+RW</p> <p>CD:</p> <p>CD-DA (Red Book) - Standard Audio CD & CD-TEXT</p> <p>CD-ROM (Yellow Book Mode1 & 2) - Standard Data</p> <p>CD-ROM XA (Mode2 Form1 & 2) - Photo CD, Multi-Session</p> <p>CD-I (Green Book, Mode2 Form1 & 2, Ready, Bridge)</p> <p>CD-Extra/ CD-Plus (Blue Book) - Audio & Text/Video</p> <p>Video-CD (White Book) - MPEG1 Video</p> <p>CD-R (Orange Book Part)</p> <p>CD-RW & HSRW (Orange Book Part Volume1 & Volume 2</p> <p>Super Audio CD (SACD) Hybrid type</p> <p>US & US+ RW</p> <p>DVD:</p> <p>DVD-ROM (Book 1.02), DVD-Dual</p> <p>DVD-Video (Book 1.1)</p> <p>DVD-R (Book 1.0, 3.9G)</p> <p>DVD-R (Book 2.0, 4.7G) - General & Authoring</p> <p>DVD+R (Version 1.0)</p> <p>DVD+RW</p> <p>DVD-RW (Non CPRM & CPRM)</p> <p>DVD+/-R Dual</p> <p>Blu-Ray:</p> <p>BD-R, BD-R DL, BD-RE, BD-RE DL</p>
Loading mechanism	<p>Load: Manual</p> <p>Release:</p> <p>(a) Electrical Release (Release Button)</p> <p>(b) Release by ATAPI command</p> <p>(c) Emergency Release</p>
Power Requirement	
Input Voltage	5 V +/- 5% (Operating)

LCD

Item	Specification
Vendor & model name	AUO/LPL
Screen Diagonal (mm)	17.1 inches

Item	Specification
Display resolution (pixels)	1440 x 900 WXGA+
Pixel Pitch	0.204 x 0.204
Pixel Arrangement	R.G.B. Vertical Stripe
Display Mode	Normally White
Typical White Luminance (NIT) also called Brightness	220
Luminance Uniformity	1.25 max.
Contrast Ratio	400 typical
Response Time msec	8
Nominal Input Voltage VDD	+3.3V
Viewing Angle (degree) Horizontal: Right/Left Vertical: Upper/Lower	45/45 15/35
Temperature Range(° C) Operating Storage (shipping)	0 to +50 -40 to +60

Inverter

Item	Specification
Vendor & model name	▪ Darfon

Video subsystem

Item	Specification
Chipset	NVidia N10E-GT 1
GPU Frequency	414 MHz

Item	Specification
Memory size	1024 MB
Features	<ul style="list-style-type: none"> ▪ Unified Shader Architecture ▪ Support Microsoft® DirectX® 10 Shader Model 4 ▪ Geometry Instancing 2.0 ▪ SGI OpenGL® 2.0 optimizations and support ▪ Adaptive PCI Express interface ▪ High efficiency integrated adaptable and programmable video processor (VP2) ▪ Integrated Bit Stream Processor (BSP) ▪ NVIDIA PureVideo/Pure Video HD technology ▪ Industry video codec standard hardware acceleration ▪ Advanced Spatial Temporal De-Interlacing ▪ Vibrant Color Temperature Correction ▪ LCD Overdrive ▪ High-Quality Real-Time video recording ▪ Best quality 10-bit display pipeline ▪ NVIDIA nView Multi Display Technology ▪ SmartDimmer Technology ▪ Integrated HDMI support ▪ Support for integrated HDCP ▪ NVIDIA Digital Vibrance Control Technology ▪ Integrate HDTV encoder ▪ Dual 400MHz RAMDACs

Keyboard

Item	Specification
Keyboard controller	Winbond 8763
Total number of keypads	103-key
Windows logo key	Yes
Internal & external keyboard work simultaneously	Plug USB keyboard to the USB port directly

Pointing device

Item	Specification
Type	<ul style="list-style-type: none"> ▪ Synaptics 372 Touchpad
Buttons	Left/Right
Scrolling	Scroll zone on right side of touchpad

Memory card reader

Item	Specification
Controller	OZ129 Rev. B3 PCI-based

Item	Specification
Cards supported	Support 5-in-1 card reader (MMC, MS, MS-pro, SD, and xD)
Compliance	<ul style="list-style-type: none"> ▪ Complies to SDIO Host Interface Specification Rev 1.0 ▪ Supports MMC, MMCplus, SD Memory, and SDIO cards ▪ SDIO Version 1.10 compliant with High-Speed Mode ▪ SD Host Interface Specification v1.0 ▪ SD Host Interface Specification v2.0 ▪ SD HC (High Capacity SD memory card) ▪ Supports SD memory card, with CPRM security ▪ Complies to MultiMediaCard™ Version 4.0 ▪ Supports Memory Stick™ and MS PRO media cards ▪ Supports xD-Picture™ card and SmartMedia™ cards

Cardbus

Item	Specification
Controller	O2Micro OZ27C10LN
Cards supported	Type II

ExpressCard

Item	Specification
Controller	ICH9ME
Supports card type	Type 54
Number of slots	One
Access location	Right panel

Audio

Item	Specification
Audio Controller	Conexant CX2056-15Z Realtek ALC269X
Audio onboard or optional	Built-in
Mono or Stereo	Stereo
Resolution	<ul style="list-style-type: none"> ▪ Ten DAC channels support 16/20/24-bit PCM format for 7.1 sound playback, plus 2 channels of independent stereo sound output (multiple streaming) through the front panel output ▪ Two stereo ADCs support 16/20/24-bit PCM format, one for stereo microphone, one for legacy mixer recording
Compatibility	<ul style="list-style-type: none"> ▪ HD Audio

Item	Specification
Sampling rate	<ul style="list-style-type: none"> ▪ All DACs supports 44.1/48/96/192 kHz sample rate ▪ All ADCs support 44.1/48/96 kHz sample rate ▪ Two independent 16/20/24-bit S/PDIF-OUT converters support 44.1/48/96/192 kHz sample rate, one for nominal digital audio, the other one for digital audio output to HDMI transmitter
Internal microphone	With optional webcam
Internal speaker/quantity	2 speakers (1.5 W per channel)
Features	<ul style="list-style-type: none"> ▪ 97 dB SNR DACs & 90 dB SNR ADCs ▪ Enable VoIP function ▪ Subwoofer support

Wired LAN

Item	Specification
LAN chipset	Marvell 88E8057
Supports LAN protocol	10/100/1000 Mbps
LAN connector type	RJ45
LAN connector location	Right side
Features	<ul style="list-style-type: none"> ▪ Integrated 10/10/1000 BASE-T transceiver ▪ PCI v2.2 compliant ▪ Wake on LAN support meeting ACPI requirements

Bluetooth

Item	Specification
Chipset	Foxconn BRM2046
Data throughput	2.1 Mbit/s
Protocol	Bluetooth 2.0
Interface	USB (board level)
Connector type	Wireless via Bluetooth protocols

Wireless LAN

Item	Specification
Chipset	<ul style="list-style-type: none"> ▪ Intel WiFi Link 5100
Data throughput	11~54 Mbps, up to 270 Mbps for Draft-N

Item	Specification
Protocol	<ul style="list-style-type: none"> ▪ IEEE 802.11a ▪ IEEE 802.11b ▪ IEEE 802.11g ▪ IEEE 802.11 Draft-N
Interface	PCI bus (mini PCI socket for wireless module)

USB

Item	Specification
Chipset	Intel ICH9ME
USB compliancy level	2.0
OHCI	USB 1.1 and USB 2.0 host controller
Number of USB ports	3
Location	<ul style="list-style-type: none"> ▪ Two on the left side ▪ One on the rear

Buttons/Indicators/Ports

Item	Specification
Buttons	<ul style="list-style-type: none"> ▪ Media control buttons and capacitive volume control on media panel ▪ Power button ▪ Windows Hotstart (select models only) ▪ Wireless on/off switch
Indicators	<ul style="list-style-type: none"> ▪ Wireless on/off ▪ Caps Lock ▪ Num Lock ▪ Hard drive activity ▪ Optical drive activity ▪ Power ▪ Battery charge
Ports	<ul style="list-style-type: none"> ▪ USB (three) ▪ External display (VGA) port ▪ Modem (RJ11) (optional) ▪ Ethernet (RJ45) ▪ IEEE1394 ▪ eSATA ▪ Headphone/SPDIF Audio Out ▪ Microphone in ▪ DC in jack for AC adapter ▪ ExpressCard™/54 slot ▪ Fingerprint reader (optional) ▪ 5-in-1 card reader (SD™, MMC, MS, MS PRO, xD) ▪ HDMI™ port with HDCP support (optional)

Fingerprint reader

Item	Specification
Model	UPEK TCS4E
Interface	8-bit parallel, SPI
Resolution	High-definition 192 × 4 pixel array
Technology	CMOS active capacitive pixel-sensing
Power	3.3V
Software	Gateway Fingerprint Solution

Camera

Item	Specification
Model	▪ Chicony CNF6141
Interface	USB 2.0
Resolution	1.3M pixels (1280 x 1024)
Signal to noise ratio	42 dB
Sensor	CMOS 1/4
Power	5 V
Built-in microphone	Yes
LED	On/Off
Software	Video Web Camera

Fans

CPU Temperature (degrees C)	Fan Speed (rpm)	Acoustic Level (dBA)
45-50	0-3000	29
55-66	0-3300	33
68-74	3300-3800	38
78-83	3800-4100	40
86-91	4100-4800	40

Throttling 50%: % is controlled by operating system. Temperature point is 95°C
OS shut down at 100°C; H/W shut down at 105°C

Battery

Item	Specification
Vendor	▪ Simplo
Battery Type	Li-ion
Pack capacity	7800mAH
Number of battery cell	9
Package configuration	▪ 3 cells in series, 3 series in parallel
Normal voltage	11.1V
Charge voltage	12.6V (max)

Power supply

Item	Specification
Vendor	▪ Delta ▪
Input rating	90V AC to 264V AC, 47Hz to 63Hz
Maximum input AC current	1.5A (max)
Output rating	19V DC, 4.74A to 6.32A, 120W

Power savings

ACPI mode	Power Management
Mech. Off (G3)	All devices in the notebook are turned off completely.
Soft Off (G2/S5)	OS initiated shutdown. All devices in the notebook are turned off completely.
Working (G0/S0)	Individual devices such as the CPU and hard disc may be power managed in this state.
Suspend to RAM (S3)	<ul style="list-style-type: none"> ▪ CPU set power down ▪ VGA suspend ▪ PCMCIA suspend ▪ Audio power down ▪ Hard drive power down ▪ Optical drive power down ▪ Super I/O low power mode
Save to Disk (S4)	Also called Hibernation mode. System saves all system states and data onto the disc prior to powering off the whole system.

Notebook product tour



Important

Case color may vary from that shown in the pictures.

Front View



Component	Icon	Description
Power indicator		<ul style="list-style-type: none"> LED on - Notebook is on. LED blinking - Notebook is in Sleep or Hybrid Sleep mode. LED off - Notebook is off.
Battery charge indicator		<ul style="list-style-type: none"> LED blue - Battery is fully charged. LED purple - Battery is charging. LED blinking red - Battery charge is very low. LED solid red - Battery is malfunctioning. <p>Important: This LED only lights up when your notebook is connected to AC power or the battery charge is very low.</p>
LCD panel release latch		Press to open the LCD panel.
Wireless network switch		<p>Turn the optional IEEE 802.11 wireless network radio and optional Bluetooth radio on or off. For more information, see “Wireless Ethernet Networking” in your online <i>User Guide</i>.</p> <p>Warning: Radio frequency wireless communication can interfere with equipment on commercial aircraft. Current aviation regulations require wireless devices to be turned off while traveling in an airplane. IEEE 802.11 and Bluetooth communication devices are examples of devices that provide wireless communication.</p>

Left View

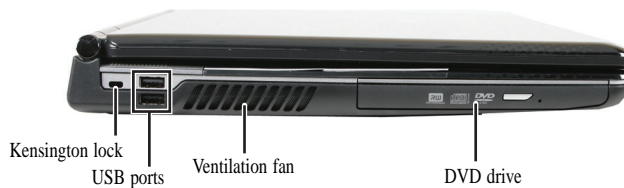

Component	Icon	Description
Kensington™ lock slot		Secure your notebook to an object by connecting a Kensington cable lock to this slot.
USB ports		Plug USB devices (such as a diskette drive, flash drive, printer, scanner, camera, keyboard, or mouse) into these ports.

Component	Icon	Description
Ventilation fan		Helps cool internal components. Warning: Do not work with the notebook resting on your lap. If the air vents are blocked, the notebook may become hot enough to harm your skin. Caution: Do not block or insert objects into these slots. If these slots are blocked, your notebook may overheat resulting in unexpected shutdown or permanent damage to the notebook. Caution: Provide adequate space around your notebook so air vents are not obstructed. Do not use the notebook on a bed, sofa, rug, or other similar surface.
DVD drive		Insert CDs, DVDs or BDs into this drive.

Right View

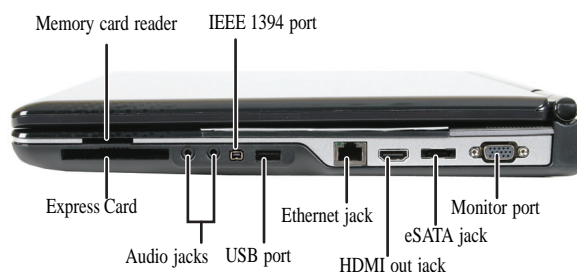



Component	Icon	Description
Memory card reader		Insert a memory card from a digital camera, MP3 player, PDA, or cellular telephone into the memory card reader. The memory card reader supports Memory Stick [®] , Memory Stick Pro [®] , Mini Secure Digital [®] , MultiMediaCard [™] , RS-MultiMediaCard [™] , Secure Digital [™] , and xD-Picture Card [™] cards.
IEEE 1394 port (optional)		Plug an IEEE 1394 (also known as Firewire [®] or i.Link [®]) device (such as a digital camcorder or MP3 player) into this optional 4-pin IEEE 1394 port.
Express Card slot		Insert one Type 54 Express Card into this slot.
Audio jacks		Headphone jack—Plug amplified speakers or headphones into this jack. The built-in speakers are turned off when speakers or headphones are plugged into this jack. Microphone jack—Plug a microphone into this jack. The built-in microphone is turned off while an external microphone is connected.
USB port		Plug a USB device (such as a diskette drive, flash drive, printer, scanner, camera, keyboard, or mouse) into this port.
Ethernet jack		Plug an Ethernet network cable into this jack. Plug the other end of the cable into a cable modem, DSL modem, or an Ethernet network jack.
HDMI out jack (optional)	HDMI	Plug an HDMI device, such as a high definition television, into this optional jack.

Component	Icon	Description
eSATA jack (optional)	eSATA	Connect an external SATA hard drive to this optional jack.
Monitor port		Plug an analog VGA monitor or projector into this port.





Rear View

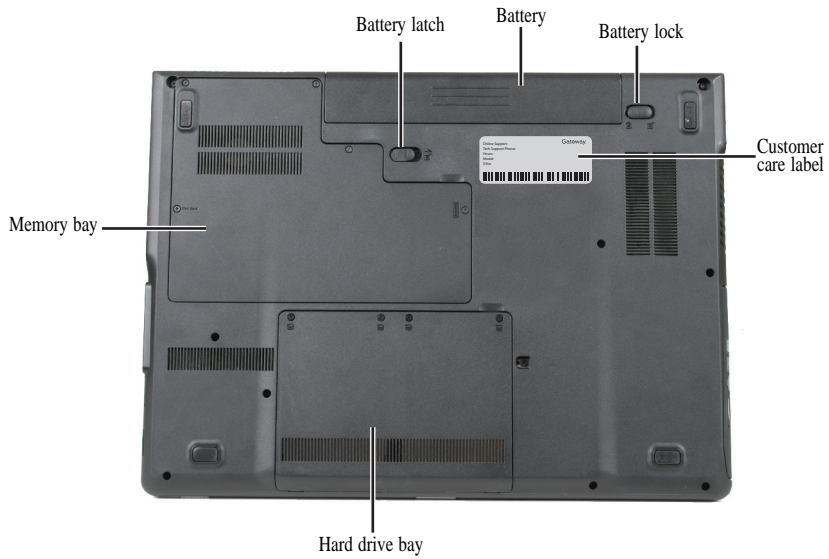

Component	Icon	Description
Ventilation fan		<p>Helps cool internal components.</p> <p>Warning: Do not work with the notebook resting on your lap. If the air vents are blocked, the notebook may become hot enough to harm your skin.</p> <p>Caution: Do not block or insert objects into these slots. If these slots are blocked, your notebook may overheat resulting in unexpected shutdown or permanent damage to the notebook.</p> <p>Caution: Provide adequate space around your notebook so air vents are not obstructed. Do not use the notebook on a bed, sofa, rug, or other similar surface.</p>
Power connector		Plug the AC adapter cable into this connector.
Modem jack (optional)		Plug a dial-up modem cable into this optional jack.

Bottom View



Component	Icon	Description
Memory bay		Memory modules are located in this bay.
Battery latch		Slide to release the battery.
Battery		Provides power when the notebook is not plugged into AC power.
Battery lock		Slide to unlock the battery.
Customer Care label		Includes the Customer Care contact information.
Hard drive bay		The hard drive(s) is (are) located in this bay.

Keyboard area

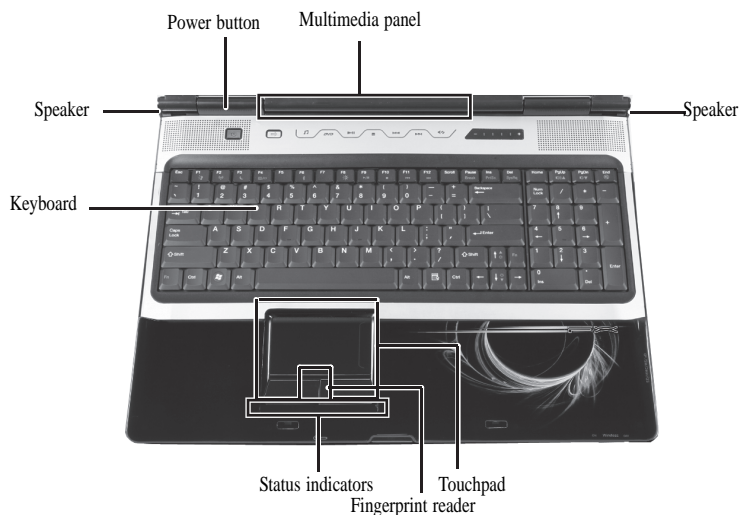

Component	Icon	Description
Keyboard		Provides all the features of a full-sized, computer keyboard.
Speakers		Provide audio output when headphones or amplified speakers are not plugged in.
Power button		Press to turn the power on or off. You can also configure the power button for Sleep/Resume mode.
Multimedia panel (optional)		Use to control playback of CDs and DVDs. The panel includes a capacitive (touch) volume control.
Touchpad		Provides all the functionality of a mouse.
Fingerprint reader (optional)		Provides enhanced security.
Status indicators		Inform you when a drive is in use or when a button has been pressed that affects how the keyboard is used.

LCD panel

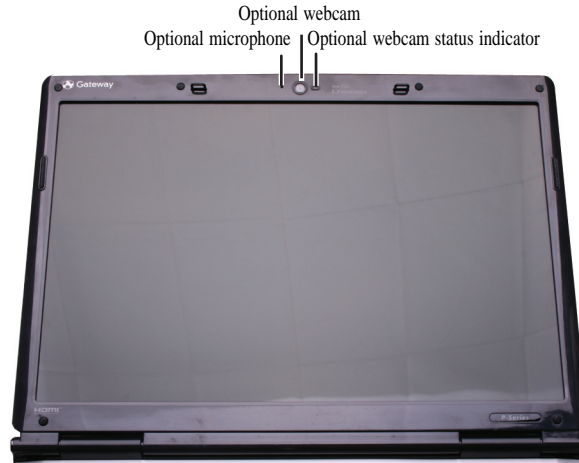

Component	Icon	Description
Microphone (optional)		Use to talk through when making Voice over Internet Protocol (VoIP) calls. Important: The optional microphone is only available when purchased with the optional webcam.
Webcam (optional)		Use to let others see who they are communicating with when making VoIP calls.
Webcam status indicator (optional)		Turns on when the webcam is turned on.

Using the status indicators



Important

If none of the indicators are on, you may need to press FN+F1 to toggle the status indicators on.

Status indicators inform you when a drive is being used or when a button has been pressed that affects how the keyboard is used. The status indicators are located below the touchpad.

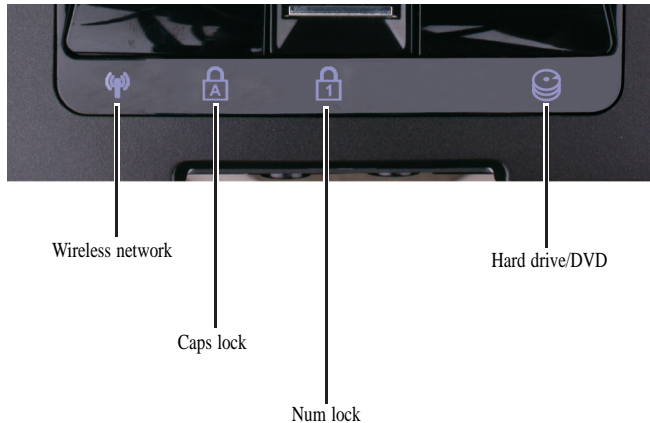

Indicator	Icon	Description
Wireless network		<ul style="list-style-type: none"> LED on - Optional wireless IEEE 802.11 radio is turned on. LED off - Optional wireless IEEE 802.11 radio is turned off.
Caps lock		<ul style="list-style-type: none"> LED on - Caps lock is turned on. LED off - Caps lock is turned off.
Num lock		<ul style="list-style-type: none"> LED on - Numeric keypad is turned on. LED off - Numeric keypad is turned off.
Hard drive/DVD		<ul style="list-style-type: none"> LED blinking - Hard drive/DVD drive is being accessed. LED off - Hard drive/DVD drive is not being accessed.

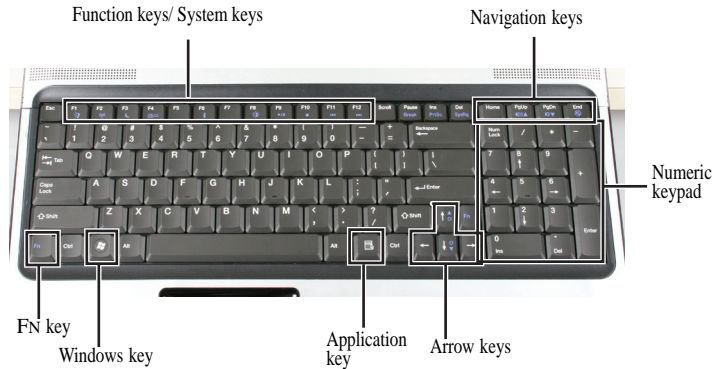

Using the keyboard

Your notebook features a full-size keyboard that functions the same as a desktop computer keyboard. Many of the keys have been assigned alternate functions, including shortcut keys for Windows and function keys for specific system operations.











Key types

The keyboard has several different types of keys. Some keys perform specific actions when pressed alone and other actions when pressed in combination with another key.

Key type	Icon	Description
Function keys		Press these keys labeled F1 to F12 to perform actions in programs. For example, pressing F1 may open help. Each program uses different function keys for different purposes. See the program documentation to find out more about the function key actions.
System keys		Press these colored keys in combination with the FN key to perform specific actions.
Navigation keys		Press these keys to move the cursor to the beginning of a line, to the end of a line, up the page, down the page, to the beginning of a document, or to the end of a document.
Numeric keypad		Use these keys to type numbers.
FN key		Press the FN key in combination with a colored system key to perform a specific action.
Windows key		Press this key to open the Windows Start menu. This key can also be used in combination with other keys to open utilities like F (Search utility), R (Run utility), and E (Computer window).
Application key		Press this key for quick access to shortcut menus and help assistants in Windows.
Arrow keys		Press these keys to move the cursor up, down, right, or left.

System key combinations

When you press the FN key and a system key at the same time, your notebook performs the action identified by the text or icon on the key.

Press and hold FN, then press this system key...	To...
	Toggle the status indicators on or off.
	Turn the optional IEEE 802.11 wireless network radio on or off. For more information, see “Wireless Ethernet Networking” in your online <i>User Guide</i> . Warning: Radio frequency wireless communication can interfere with equipment on commercial aircraft. Current aviation regulations require wireless devices to be turned off while traveling in an airplane. IEEE 802.11 communication devices are examples of devices that provide wireless communication. Important: The wireless network switch must be in the ON position for this button to work.
	Enter Sleep mode or Hybrid Sleep mode. Press the power button to leave Sleep mode.
	Toggle the notebook display in the following order: <ul style="list-style-type: none"> ▪ The LCD ▪ An external monitor or projector (a monitor or projector must be plugged into the monitor port or HDMI port on your notebook) ▪ Both displays at the same time
	Turn the optional Bluetooth radio on or off. Warning: Radio frequency wireless communication can interfere with equipment on commercial aircraft. Current aviation regulations require wireless devices to be turned off while traveling in an airplane. Bluetooth communication devices are examples of devices that provide wireless communication. Important: The wireless network switch must be in the ON position for this button to work.
	Increase the LCD panel brightness above the normal brightest setting. Use this feature in bright lighting situations, such as outside in bright sunlight. Press a second time to decrease the brightness below the normal lowest brightness setting. Use this feature in dim lighting situations. Press a third time to return the display to the normal brightness setting. Important: Using this feature will affect battery performance.
	Play or pause the CD or DVD.
	Stop playing the CD or DVD.

Press and hold FN, then press this system key...

To...



Skip back one CD track or DVD chapter.



Skip ahead one CD track or DVD chapter.



Increase the brightness of the display.



Decrease the brightness of the display.



Increase volume.



Decrease volume.



Mute the sound. Press the key combination again to restore the sound.

Using the fingerprint reader

Your notebook may include a fingerprint reader that provides enhanced security and convenience. The fingerprint reader is located between the left and right touchpad buttons.



Gateway Fingerprint Solution is a multi-purpose fingerprint software package integrated with the Microsoft Windows operating system. Utilizing the uniqueness of one's fingerprint features, Gateway Fingerprint Solution has incorporated protection against unauthorized access to your computer with centralized password management with Password vault, easy music player launching with Gateway Launch Music, secure Internet favorites via Gateway Launch Sites, and fast application/website launching and login with Gateway Launch Apps, while Gateway ProfileLaunch can launch up to three applications/websites from a single finger swipe.



Gateway Fingerprint Solution also allows you to navigate through web browsers and documents using Fingertip navigation. With Gateway Fingerprint Solution, you can now enjoy an extra layer of protection for your personal computer, as well as the convenience of accessing your daily tasks with a simple swipe of your finger!

For more information refer to the Gateway Fingerprint Solution help files.

- ▶ To run the Gateway Fingerprint Solution program:
 - 1 Click Ⓜ (Start), All Programs, Gateway, Fingerprint Solution, then click System Settings.
 - 2 Click Next to proceed through the tutorial.
 -

Using the EZ Pad touchpad

The EZ Pad™ consists of a touchpad, two buttons, and a scroll zone.

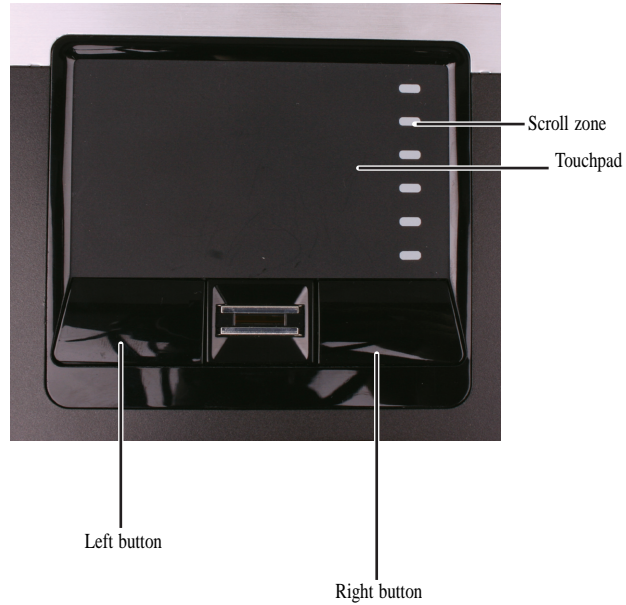

When you move your finger on the touchpad, the *pointer* (arrow) on the screen moves in the same direction. You can use the scroll zone to scroll through documents. Use of the scroll zone may vary from program to program.

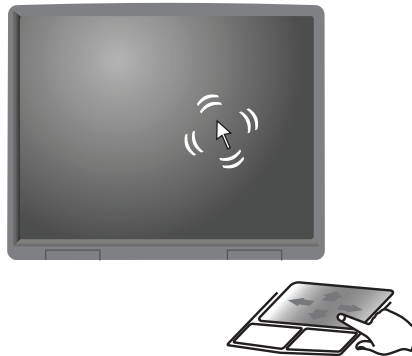

You can use the EZ Pad *left* and *right* buttons below the touchpad to select objects.

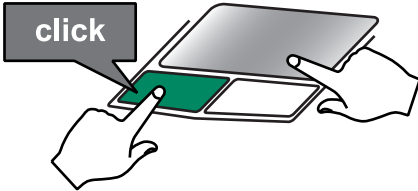
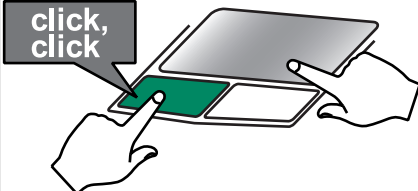
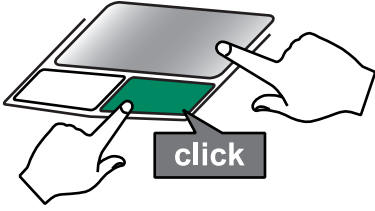
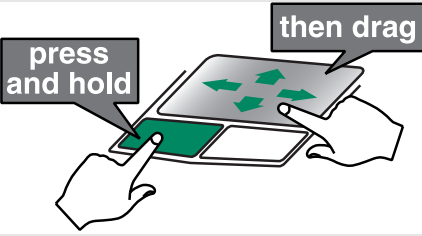
To...	Do this...	
Move the pointer on the screen.		Move your finger around on the touchpad. If you run out of space and need to move the pointer farther, lift your finger, move it to the middle of the touchpad, then continue moving your finger.
Select an object on the screen.		Position the pointer over the object. Quickly press and release the left button once. This action is called <i>clicking</i> .
Start a program or open a file or folder.		Position the pointer over the object. Press the left button twice in rapid succession. This action is called <i>double-clicking</i> .
Access a shortcut menu or find more information about an object on the screen.		Position the pointer over the object. Quickly press and release the right button once. This action is called <i>right-clicking</i> .
Move an object on the screen.		Position the pointer over the object. Press the left button and hold it down, then use the touchpad to move (drag) the object to the appropriate part of the screen. Release the button to drop the object where you want it.

Using the optional multimedia panel

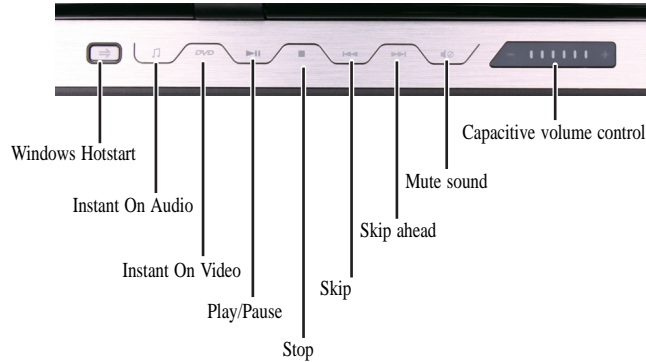

Button	Description
	Optional: Windows Hotstart—Turns on the notebook (if turned off) and opens Media Center (Windows Vista Home Premium or Windows Vista Ultimate) or Windows Media Player (Windows Vista Home Basic). Important: You can use this button if the notebook is turned on, turned off, or in Sleep or Hibernate mode. Important: You cannot use this button if you are logged on as a guest.
	Instant on Audio—Opens Media Center (Windows Vista Home Premium or Windows Vista Ultimate) or Windows Media Player (Windows Vista Home Basic).
	Instant on Video—Opens Media Center (Windows Vista Home Premium or Windows Vista Ultimate) or the DVD player program (Windows Vista Home Basic).
	Play or pause the CD or DVD.
	Stop playing the CD or DVD.
	Skip back one CD track or DVD chapter.
	Skip ahead one CD track or DVD chapter.
	Mute the sound. Press again to restore the sound.
	<p>Capacitive volume control—Swipe your finger on the volume sensor strip to change the volume. To increase volume, move from the – towards the +. To decrease volume, move from the + towards the –.</p> <p>Tip:</p> <ul style="list-style-type: none"> You can start swiping at any point on the strip. The duration of the swipe determines the amount of the change. At the end of this swipe, if you keep your finger on the strip, the volume control continues to change in the same direction. Tapping on the strip does not change the volume.

Using the webcam

You can use the optional webcam with many of the available Internet chat programs to add video and audio to your chat session. In addition, by using the software included with the webcam, you can take pictures or create video clips.

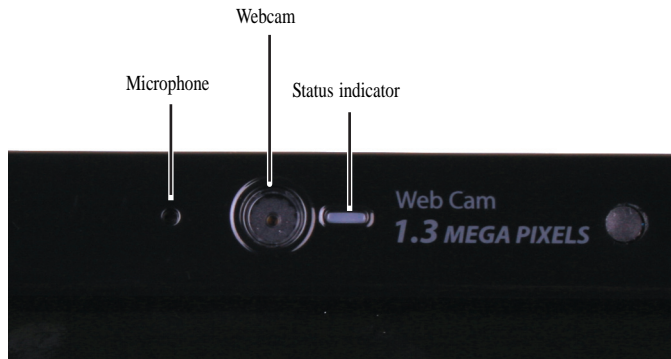





► To use the webcam:

- 1 Click  (Start), All Programs, Camera Assistant Software, then click Camera Assistant Software. The Camera Assistant Toolbar opens.

-OR-

Right-click  (Camera assistant software) on the taskbar, then click Show Toolbar. The Camera Assistant Toolbar opens.









Button	Icon	Description
Start camera		Turns on the camera and opens the preview screen.
Effects		Adds a decoration or border to your picture.
Properties		Modifies properties such as zoom, backlight compensation, brightness, and contrast.
Settings		Selects the position of the toolbar or modifies the picture, video, or audio settings.
Help		Opens online help.

- 2 Click  (Start camera). The Camera Assistant opens.



- 3 Click one of the following:

Button	Icon	Description
Snapshot		Take a picture of what is currently in the preview screen.
Video recording		Create a video recording.
Audio recording		Create an audio recording.
Functions		Change a setting or access online help.
Resolution		Change the size of the picture.
Mute		Turn audio capture on or off.
Effects		Add a decoration or border to your picture.



CHAPTER 2

System utilities

- BIOS Setup Utility
- BIOS flash utility
- Removing a password lock
- Clearing password check and BIOS recovery

BIOS Setup Utility

The BIOS Setup Utility is a hardware configuration program built into the notebook's BIOS (Basic Input/Output System). The notebook was shipped already properly configured and optimized. However, if the user encounters configuration problems, you may need to run Setup.



Important

Also see Chapter 4 “Troubleshooting” on page 139.

► To run the BIOS Setup Utility:

- 1 Turn on the notebook. You will see **Press <F2> to enter Setup** at the bottom of the screen.
- 2 Press F2. The BIOS Setup Utility opens.

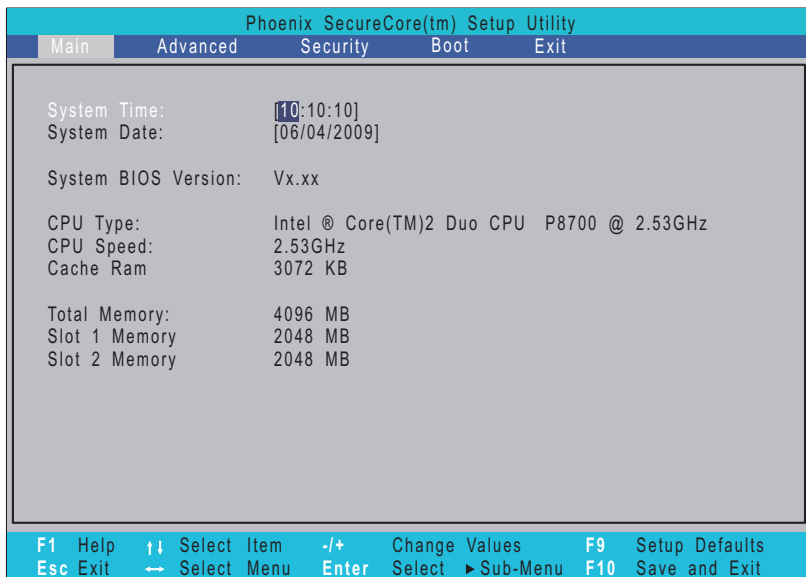

Navigating the BIOS Setup Utility

There are six menu options in the BIOS Setup Utility: Information, Main, Advanced, Intel, Security, Boot, and Exit.

► To use the BIOS Setup Utility:

- To choose a menu, use the left ← and right → arrow keys.
- To choose an item, use the up ↑ and down ↓ arrow keys.
- To change the value of a parameter, press F5 or F6.
- A plus sign (+) indicates the item has sub-items. Press ENTER to expand this item.
- Press ESC while you are in any of the menu options to go to the Exit menu.
- In any menu, you can load default settings by pressing F9. You can also press F10 to save any changes made and exit the BIOS Setup Utility.



Important

You can change the value of a parameter if it is enclosed in square brackets. Navigation keys for a particular menu are shown on the bottom of the screen. Help for parameters are found in the Item Specific Help part of the screen. Read this information carefully when making changes to parameter values. System information differs by model.

BIOS Setup Utility screens

Important

The screens shown in this section are for informational purposes only. Screen information varies by model, features ordered, and location.

Main screen

The Information screen allows the user to view a summary of your notebook hardware information.

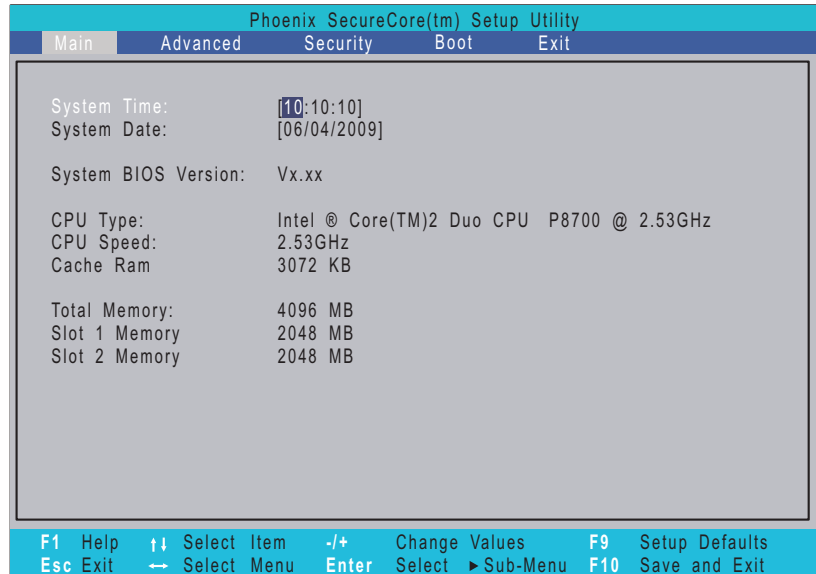

Parameter	Description
System Time	Sets the system time. The hours are displayed in a 24-hour format.
System Date	Sets the system date.
System BIOS Version	Displays system BIOS version.
CPU Type	This field shows the CPU type and speed of the system.
CPU Speed	This field shows the speed of the CPU.
Cache Ram	Display the amount of cache memory.
Total Memory	Shows the total memory of the system.
Slot 1 Memory	Shows the memory size installed in slot 1 of the system.
Slot 2 Memory	Shows the memory size installed in slot 2 of the system.
IDE0 Model Name	This field shows the model name of HDD installed on primary IDE master.
IDE0 Serial Number	This field displays the serial number of HDD installed on primary IDE master.

Advanced screen

The Advanced screen allows the user to configure advanced notebook features.

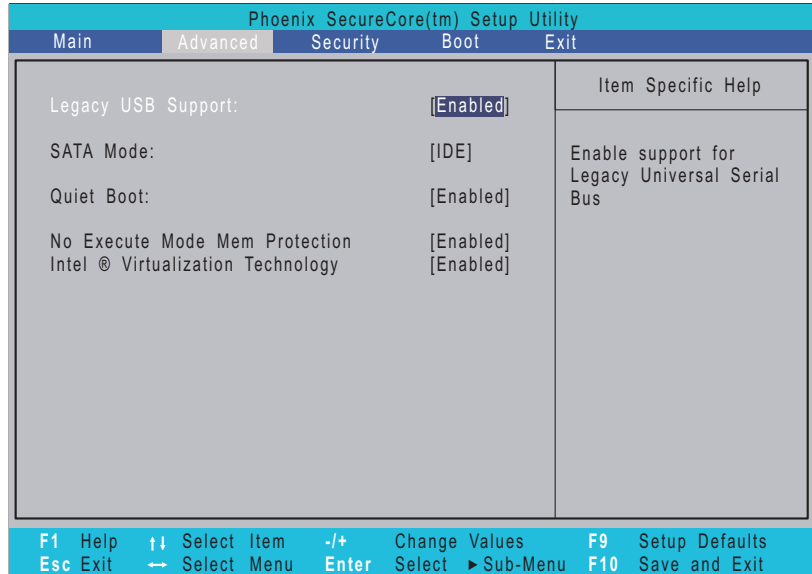

The table below describes the parameters found on this screen.

Parameter	Description	Format/Option
Legacy USB Support	Enable support for Legacy Universal Bus.	Enabled or Disabled
SATA Mode	Control the mode in which the SATA controller should operate.	IDE or AHCI
Quiet Boot	Display the logo screen during boot.	Enabled or Disabled
No Execute Mode Mem Protection	Prevent a malicious software from taking over your system by running a malicious code in protected memory area.	Enabled or Disabled
Intel Virtualization Technology	When enabled, a VMM can utilize the additional hardware virtualization capabilities provided by this technology.	Enabled or Disabled

Security screen

The Security screen contains parameters that help safeguard and protect your notebook from unauthorized use.

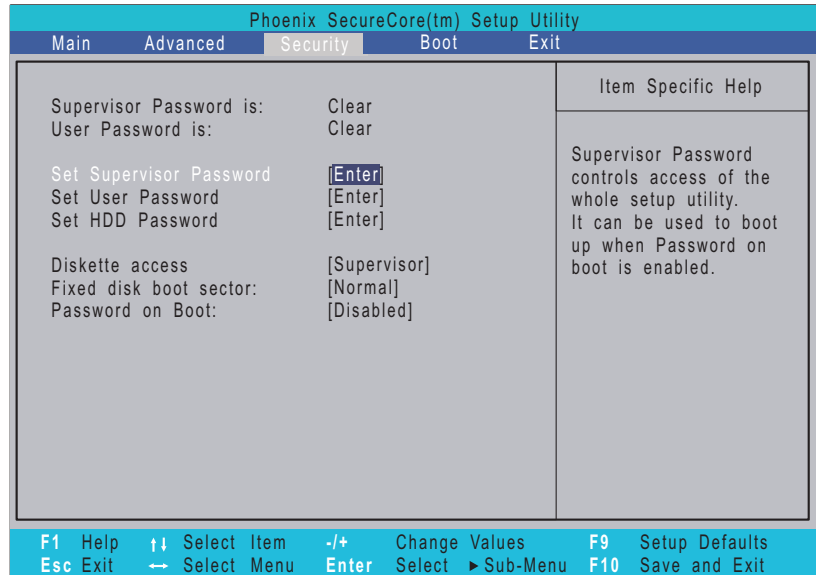

Important

Refer to [“Removing a password lock”](#) on page 47 if you need to know how to remove a Hard Drive or BIOS Password.

The table below describes the parameters in this screen. Settings in boldface are the default and suggested parameter settings.

Parameter	Description	Option
Supervisor Password Is	Shows the setting of the Supervisor password	Clear or Set
User Password Is	Shows the setting of the User password.	Clear or Set
Set Supervisor Password	Press Enter to set the supervisor password. When set, this password protects the BIOS Setup Utility from unauthorized access. The user cannot enter the Setup Utility without entering this password.	
Set User Password	Press Enter to set the user password. When a user password is set, this password protects the BIOS Setup Utility from unauthorized changes. The user can enter the Setup Utility only and does not have the right to change the value of any parameters. If Password on Boot is enabled, the user must enter the user password each time the notebook is turned on or wakes from Sleep.	
Set HDD Password	Press Enter to set the HDD password.	
Diskette access	When Supervisor or User Password is set, lets you control access to diskette drives.	Supervisor or User

Parameter	Description	Option
Fixed disk boot sector	Write protects boot sector on hard disk to protect against viruses.	Normal or Write Protect
Password on Boot	When Supervisor or User Password is set, lets you control whether to enable or disable password entry on boot up.	Disabled or Enabled

Caution When you are prompted to enter a password, you have three tries before the system halts. Don't forget your password. If you forget your password, you may have to return your notebook to your dealer to reset it.

Setting a Password

Important You must set a Supervisor password before you can set a User password.

- ▶ To set the Supervisor password:
 - 1 Press \uparrow or \downarrow to highlight Set Supervisor Password, then press ENTER. The *Set Supervisor Password* box opens.

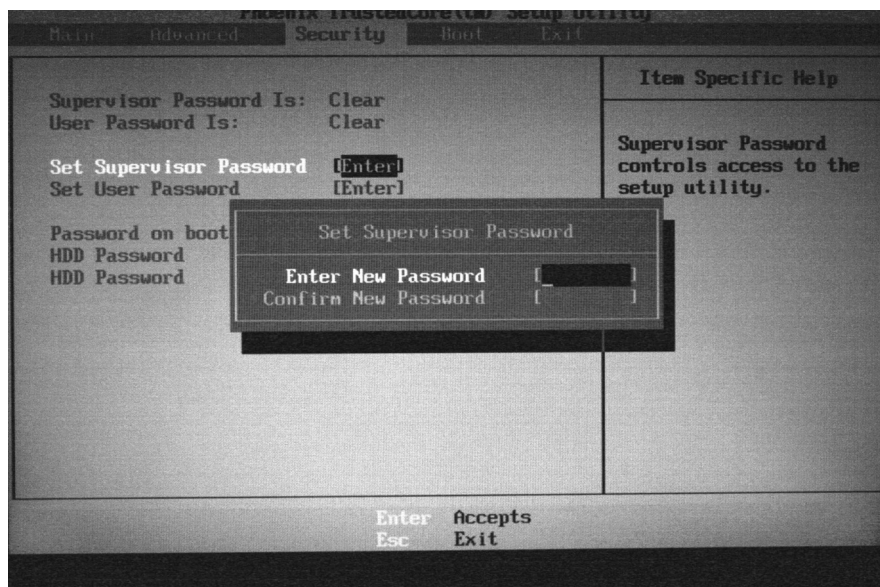

- 2 Type a password in the Enter New Password field. The password length cannot exceed eight alphanumeric characters (A-Z, a-z, 0-9). The password is not case sensitive.
- 3 Retype the password in the Confirm New Password field.

Caution Be very careful when typing your password because the characters do not appear on the screen.

- 4 Press ENTER. After setting the password, the value of Supervisor Password changes to Set.
- 5 Optional: you can enable the Password on Boot parameter.

- 6 When you are done, press F10 to save your password and exit the BIOS Setup Utility or you can proceed to setting the User password.
 -
 - ▶ To set the User password:
 - 1 Press ↑ or ↓ to highlight Set User Password, then press ENTER. The *Set User Password* box opens.
 - 2 Type a password in the Enter New Password field. The password length cannot exceed eight alphanumeric characters (A-Z, a-z, 0-9). The password is not case sensitive.
 - 3 Retype the password in the Confirm New Password field.
- ⚠ Caution**
Be very careful when typing your password because the characters do not appear on the screen.
- 4 Press ENTER. After setting the password, the value of User Password changes to Set.
 - 5 When you are done, press F10 to save your password and exit the BIOS Setup Utility.
 -

Removing a Password

- ▶ To remove a password:
 - 1 Press ↑ or ↓ to highlight Set Supervisor Password or Set User Password, then press ENTER. The *Set Supervisor Password* or *Set User Password* box opens.

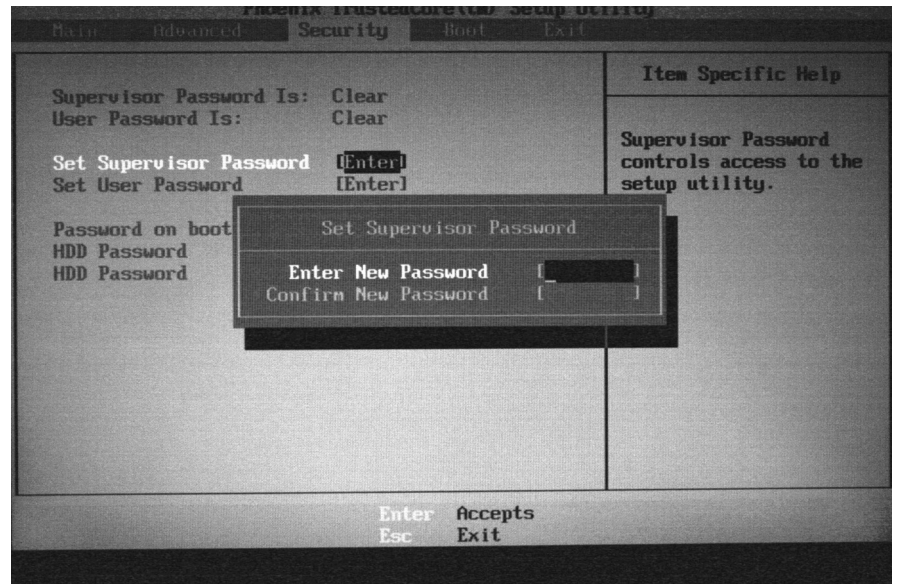

- 2 Type the current password in the Enter Current Password field, then press ENTER.
- 3 Press ENTER twice without typing anything in the Enter New Password and Confirm New Password fields. After removing the password, the value of Supervisor Password changes to Clear.
- 4 When you are done, press F10 to save your password and exit the BIOS Setup Utility.
 -

Changing a Password

► To change a password:

- 1 Press \uparrow or \downarrow to highlight Set Supervisor Password or Set User Password, then press ENTER. The *Set Supervisor Password* or *Set User Password* box opens.

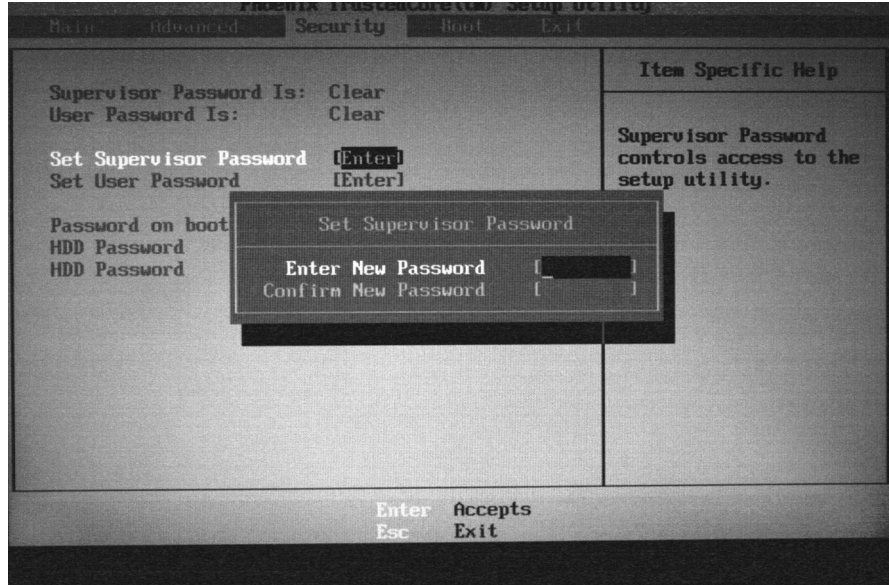

- 2 Type the current password in the Enter Current Password field, then press ENTER.

✓ Important

If you enter an incorrect current password, the screen displays the following. Press ENTER, then re-enter the current password.

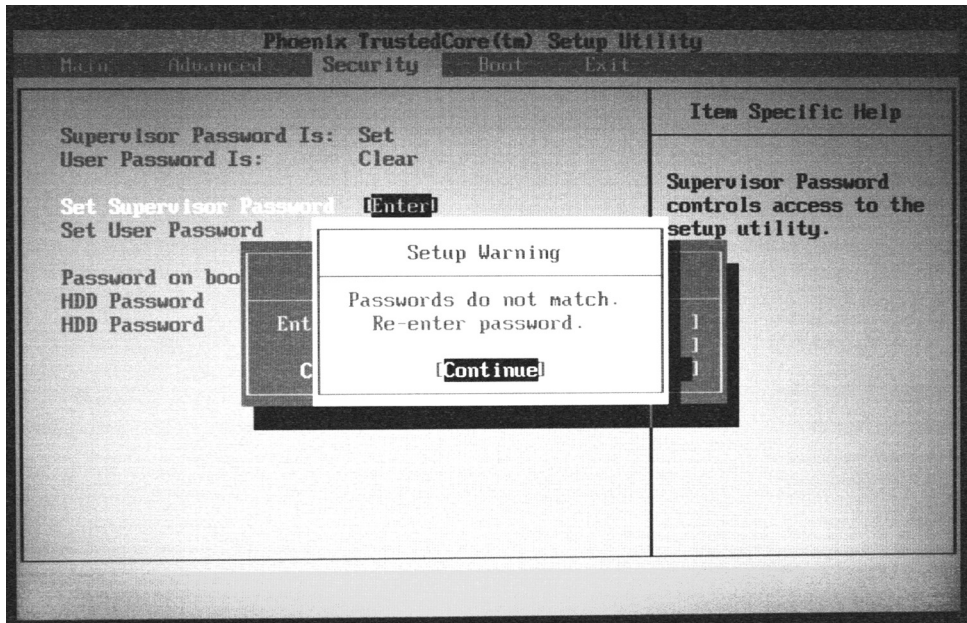

- 3 Type a password in the Enter New Password field.

- 4 Retype the password in the Confirm New Password field.

✓ Important

If you do not enter the same new password and confirm new password, the screen displays the following. Press ENTER, then re-enter the new password and confirmation password.

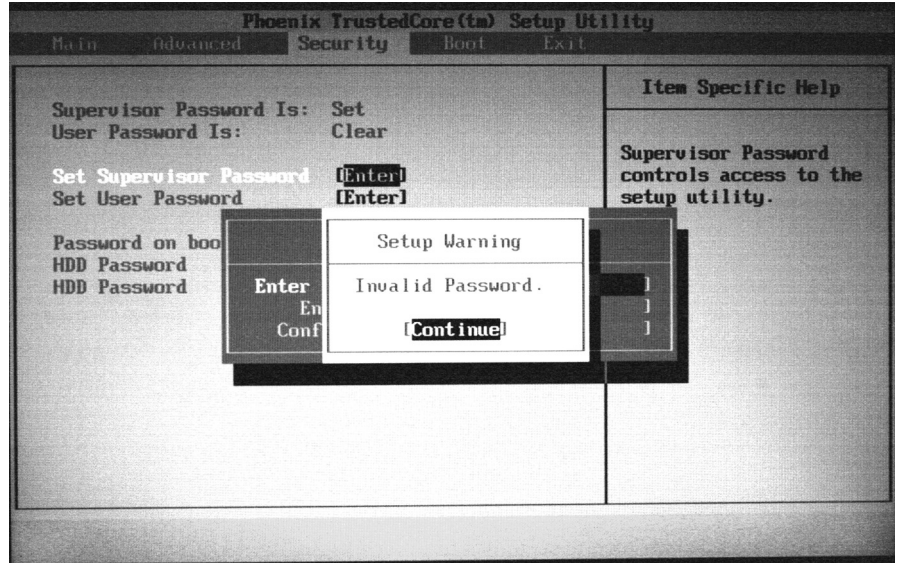

- 5 Press ENTER. The screen displays the following.

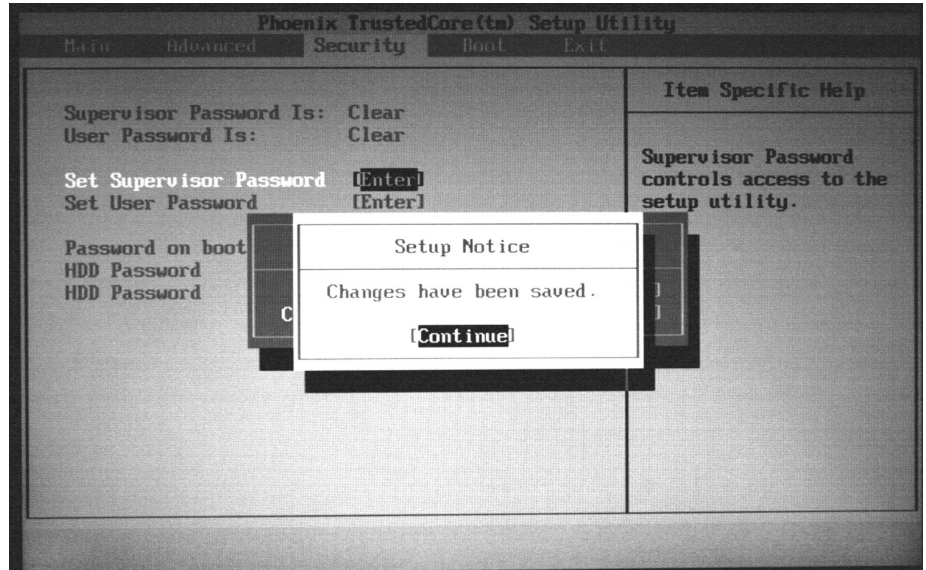

- 6 Press ENTER.
- 7 When you are done, press F10 to save your password and exit the BIOS Setup Utility.

Boot

This menu allows the user to decide the order of boot devices to load the operating system. Bootable devices include the onboard hard disk drive and the optical drive. Follow the instructions in Item Specific Help to change to boot order of the notebook devices.

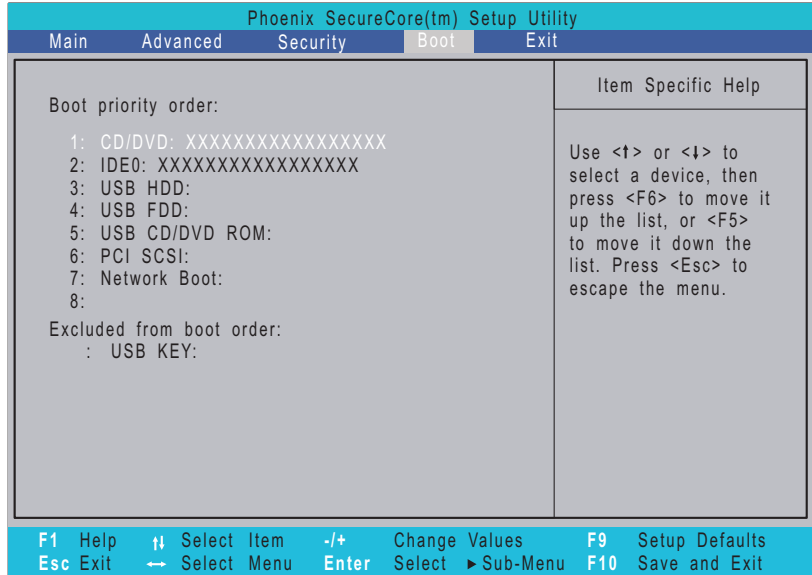

Exit

The Exit screen contains options for leaving the BIOS Setup Utility and starting Windows.

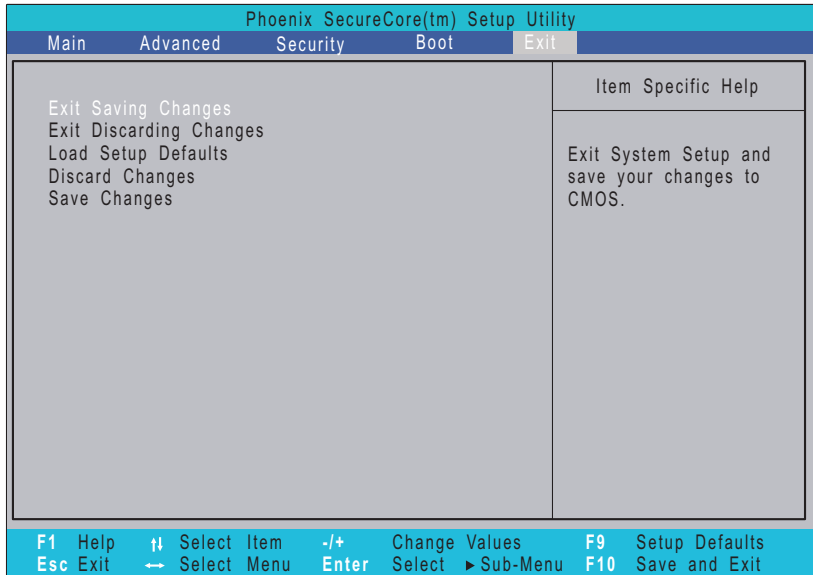

The table below describes the options on this screen.

Option	Description
Exit Saving Changes	Exit the BIOS Setup Utility and save your changes to CMOS.
Exit Discarding Changes	Exit the BIOS Setup Utility without saving your changes to CMOS.
Load Setup Default	Load default values for all SETUP items.
Discard Changes	Load previous values from CMOS for all SETUP items.
Save Changes	Save your changes to CMOS.

BIOS flash utility

Use the BIOS flash memory update for the following conditions:

- Install new versions of system programs.
- Install a new BIOS with updated features or options.
- Restore a BIOS when it becomes corrupted.

Use the Phlash utility to update the system BIOS flash ROM.



Important

Make sure that `emm386.exe` and `himem.sys` are not loaded into memory when using Phlash.



Caution

Use the AC adapter power supply when you run the Phlash or Nkbcf utility. If the battery pack does not contain enough power to finish flashing the BIOS, the notebook may not boot because the BIOS was not completely loaded.

► To use Phlash to update the BIOS:

- 1 Boot your notebook into native MS-DOS mode.
- 2 Make sure that `emm386.exe` and `himem.sys` are not loaded into system memory.
- 3 From the CD-ROM drive, type the DOS command **Phlash16** <rom-file name> /c/x/mode=3.
- 4 Press ENTER. Phlash runs automatically.



► To use Nkbcf to update the Keyboard BIOS:

- 1 Boot your notebook into native MS-DOS mode.
- 2 Make sure that `emm386.exe` and `himem.sys` are not loaded into system memory.
- 3 From the CD-ROM drive, type the DOS command **NKBCF** <kbc-file name>.
- 4 Press ENTER. Nkbcf runs automatically.



Removing a password lock

This section provides you with instructions to remove a hard drive or Supervisor password lock.

Removing a HDD password lock

If you type the wrong HDD password three times in a row, the error message **Hdd password error code** is displayed on the screen and the HDD is locked.

- ▶ To solve a HDD password locked problem, do as follows:
 - 1 Run the program unlock6.exe
 - 2 Key in **unlock6 XXXXX 00** (XXXXX is the HDD password error code).
 - 3 Select **2**.
 - 4 The master password will be displayed. Write down the master password.
 - 5 Reboot the system and key in the master password.
 -

Clearing password check and BIOS recovery

This section provides you with the standard operating procedures for clearing passwords and performing BIOS recovery on this system. This system provides one Hardware Open Gap on the mainboard for clearing password check, and one hotkey for enabling BIOS Recovery.

Clearing Password Check

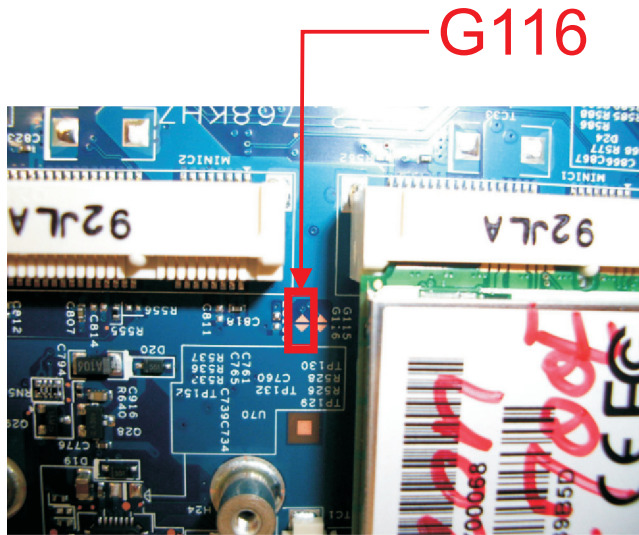

Hardware	Default Setting	Operation Description
Gap	Open (Normal)	Short (Clearing Password Check)

If users set a BIOS password (Supervisor Password and/or User Password) for security reasons, the BIOS will ask for the password during system POST or when the system enters the BIOS Setup menu. However, once it is necessary to bypass the password check, users need to short the HW Gap to clear the password.

► Follow these steps:

- 1 Power off the system, and remove the hard drive, AC adapter, and battery from the system.
- 2 Remove the memory bay cover.
- 3 The HW Gap (G116) near the wireless LAN connector.
- 4 Use an electric conductivity tool to short the two points of the HW Gap. Make sure you do not touch or damage any other components.
- 5 Plug in AC, keep the short condition on the HW Gap, and press Power Button to power on the system till BIOS POST finish. Then remove the tool from the HW Gap.
- 6 Replace the memory bay cover.
- 7 Restart system. Press F2 key to enter BIOS Setup menu.

- 8 If there is no password request, the BIOS Password is cleared. Otherwise, please follow the steps and try again.



Important

The steps are only for clearing BIOS Password (Supervisor Password and User Password).

BIOS Recovery by Crisis Disk

BIOS Recovery Boot Block is a special block of BIOS. It is used to boot up the system with minimum BIOS initialization. Users can enable this feature to restore the BIOS firmware to a successful one if the previous BIOS flashing process failed.

The system provides a function hotkey: Fn+Esc to enable BIOS Recovery process when system is powered on during BIOS POST. To use this function, it is strongly recommended to have the AC adapter and battery present. If this function is enabled, the system will force the BIOS to enter a special BIOS block, called Boot Block.

Before proceeding, prepare a Crisis Disk (refer to) and keep it ready in hand.

Steps for BIOS Recovery by Crisis Disk:

- ▶ Follow the steps below:
 - 1 Power Off system.
 - 2 Connect a removable USB storage device containing the Crisis Disk to a USB port connected to the BIOS flash failed system.
 - 3 In the power-off state, press and hold Fn+Esc, then press the power button. The system should be powered on with Crisis BIOS Recovery process.
 - 4 BIOS Boot Block starts to restore the BIOS code from the Crisis floppy disk to BIOS ROM on the failed machine.
 - 5 After the Crisis flashing process is finished, the system will restart.

After the Crisis Recovery process is finished, the system should be powered on with successful and workable BIOS. Then a person can update the latest version BIOS for this machine by regular BIOS flashing process.

Steps for Creating the Crisis Disk in Windows XP/Vista

- ▶ Follow these steps to create the Crisis Disk:
 - 1 Prepare a removable USB storage device (size greater than 10MB). Note that all data on the USB storage device will be cleared during the creation of the Crisis Disk.
 - 2 Set up another computer loaded with Windows XP or Vista operating system.

CHAPTER 2: System utilities

- Decompress the Crisis Package Source. Select **WINCRIS.EXE** and then select **Run as administrator** under Vista.

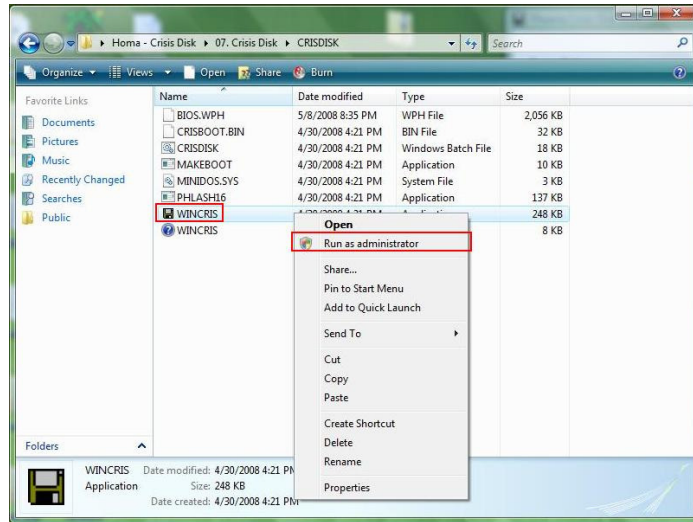

- Keep the default settings and then click on the **Start** button.

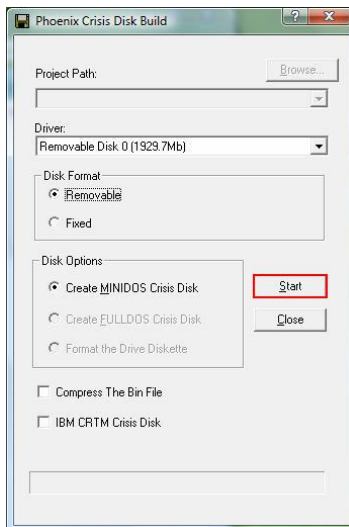

- When the pop-up warning dialog box appears, press **OK** to continue creating the Crisis Disk.

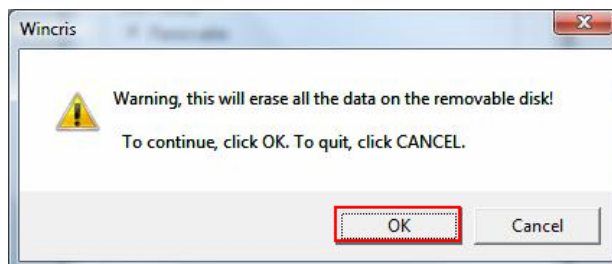

6 The Crisis Disk will be created after a few seconds.

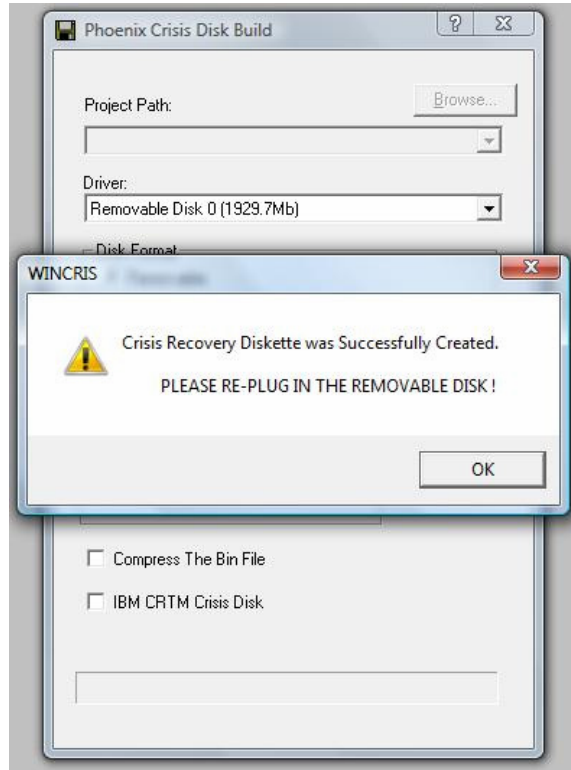

7 Press No if you do not want to create another Crisis Disk.

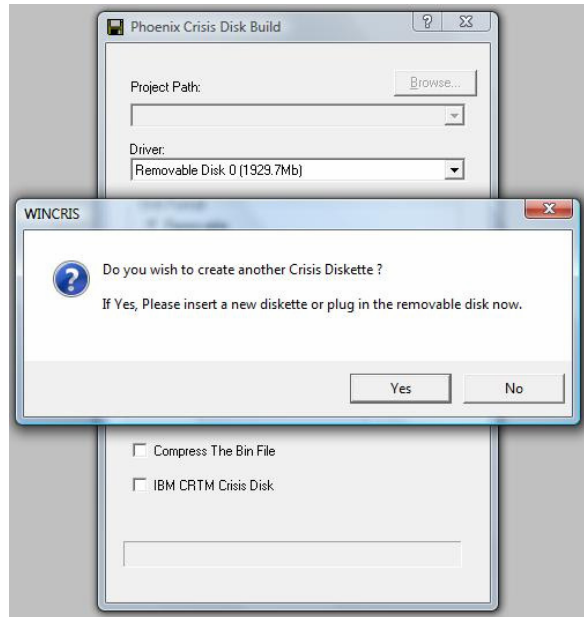

- 8 Reconnect the USB removable storage device and check if it contains the 3 files shown in the following figure.

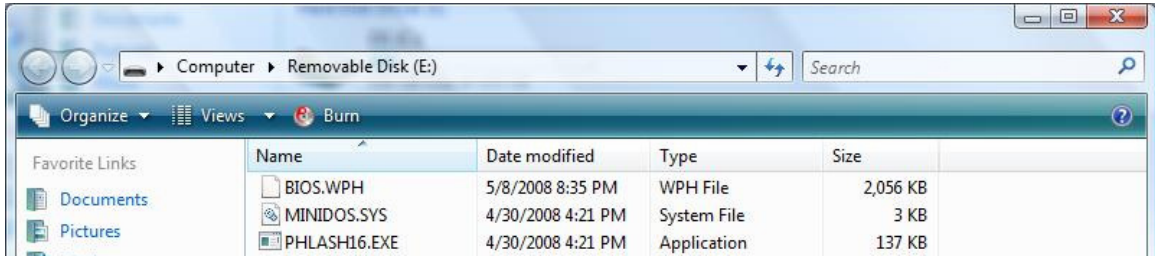

■

CHAPTER 3

Replacing notebook components

- Preventing static electricity discharge
- Preparing your work space
- Tools required
- Preparing the notebook
- Adding or replacing memory modules
- Replacing the IEEE 802.11 wireless card
- Replacing the CMOS battery
- Replacing the hard drive
- Replacing the optical drive
- Replacing the keyboard cover
- Replacing the keyboard
- Replacing the inverter
- Replacing the webcam
- Replacing the lid latches
- Replacing the LCD assembly
- Replacing the LCD panel
- Replacing the LCD panel hinges and bracket
- Replacing the LCD assembly lid
- Replacing the palm rest
- Replacing the touchpad board
- Replacing the touchpad button board
- Replacing the fingerprint reader
- Replacing the Bluetooth module
- Replacing the modem
- Replacing the speakers
- Replacing the system board and VGA cooling assembly
- Replacing the modem jack/USB board
- Replacing the fan(s)

Preventing static electricity discharge



Warning

To avoid exposure to dangerous electrical voltages and moving parts, turn off your notebook, remove the battery, and unplug the power cord, and network cable before opening the case.



Warning

To prevent risk of electric shock, do not insert any object into the vent holes of the notebook.



Important

Before performing maintenance on the notebook, you should read and understand the information in this section.

The components inside your notebook are extremely sensitive to static electricity, also known as *electrostatic discharge* (ESD).

Before performing maintenance on the notebook, follow these guidelines:

- Avoid static-causing surfaces such as carpeted floors, plastic, and packing foam.
- Remove components from their antistatic bags only when you are ready to use them. Do not lay components on the outside of antistatic bags because only the inside of the bags provide electrostatic protection.
- Always hold components by their edges. Avoid touching the edge connectors. Never slide components over any surface.
- Wear a grounding wrist strap (available at most electronics stores) and attach it to a bare metal part of your workbench or other grounded connection.
- Touch a bare metal surface on your workbench or other grounded object.

Tape

Some of the procedures in this guide involve removing tape that holds cables or components. Two types of tape are used in this notebook:

- Mylar, non-conductive tape is typically transparent, with a red or brown tint.
- Conductive tape is typically grey or silver.

If the existing tape cannot be reused, replace it with the same type (conductivity) of tape. Both types of replacement tape should be non-ESD generating tape.

Do not use cellophane tape.

Preparing your work space

Before performing maintenance on the notebook, make sure that your work space and the notebook are correctly prepared.

- Wear a grounding (ESD) wrist strap, and use a grounded or dissipative work mat.
- Use a stable and strong table, and make sure that the table top is large enough to hold each component as you remove it.
- Use bright lighting to make part identification easier.
- Keep your work surface free from clutter and dust that may damage components.
- Use a magnetized screwdriver for removing screws.
- When removing components that are attached to the notebook by a cable, unplug the cable before removing the screws, when possible, to avoid damaging the cable.
- As you remove components and screws, lay them toward the rear of your work surface (behind the notebook) or far enough to the side that your arms do not accidentally brush them onto the floor.
- To help keep track of screws, try the following:
 - Place each component's screws in their own section of a parts sorter.
 - Place each component's screws next to the component on your work surface.
 - Print the first page of each task, then place the page toward the rear of your work surface. As you remove screws, place the screws in their respective boxes on the page.
 - After loosening screws that are deeply recessed in a hole (for example, on the bottom of the base assembly), you can leave the screws in the holes if you place small pieces of masking tape over the hole openings. When reassembling the component, just remove the tape and tighten the screws.
 - When you place flat-headed screws on your work surface, stand them on their heads to prevent the screws from rolling off the table.

Tools required

To disassemble the notebook, you need the following tools:

- Wrist grounding strap and conductive mat for preventing electrostatic discharge



- Flat screwdriver



- Phillips screwdriver



- Scribe or non-marring tool



- Tweezers



Preparing the notebook

- ▶ To prepare the notebook for maintenance:
 - 1 Make sure that the disc drive is empty.
 - 2 Turn off the notebook.
 - 3 Close the LCD panel.
 - 4 Disconnect the AC adapter, and network cable.
 - 5 Disconnect all peripheral devices connected to the notebook and remove any Express Cards and memory cards.
 - 6 Remove the battery. For more information, see [“Removing the battery” on page 57](#).
 -

Removing the battery

- ▶ To remove the battery:
 - 1 Turn the notebook over so the bottom is facing up.
 - 2 Slide the battery lock to the unlocked position .

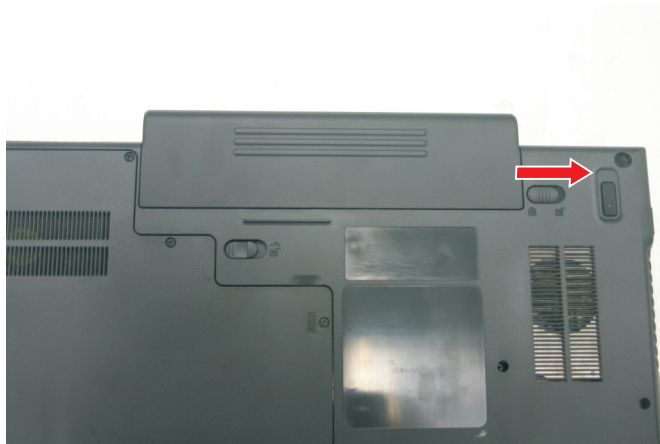

- 3 Slide the battery release latch, then slide the battery out of the notebook.

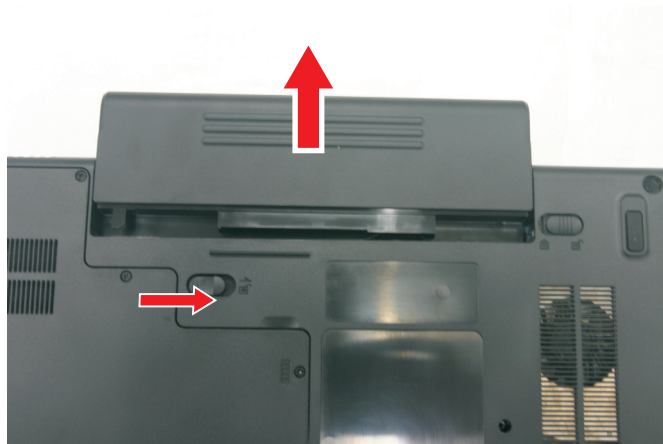

Adding or replacing memory modules



Important

Use only memory modules designed for this Gateway notebook.

Tools you need to complete this task:



Phillips #0 screwdriver

► To add or replace memory modules:

- 1 Complete the steps in [“Preparing the notebook”](#) on page 57.
- 2 Loosen the memory bay cover screws (these screws cannot be removed).

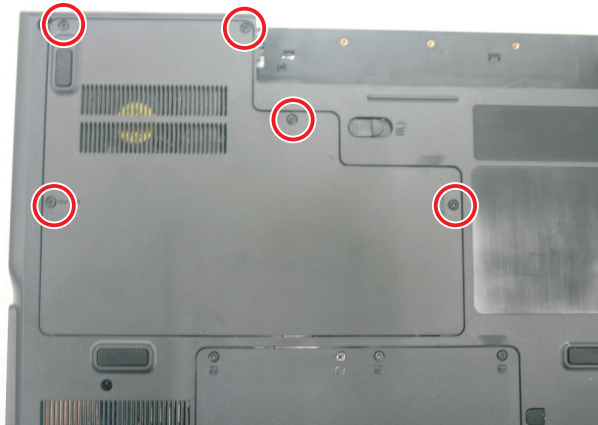

- 3 Use the thumb notch to lift the memory bay cover, then remove it. Be careful not to break off the tabs located on the end of the cover opposite the thumb notch.



- 4 If you are removing a module, gently press outward on the clip at each end of the memory module until the module tilts upward.

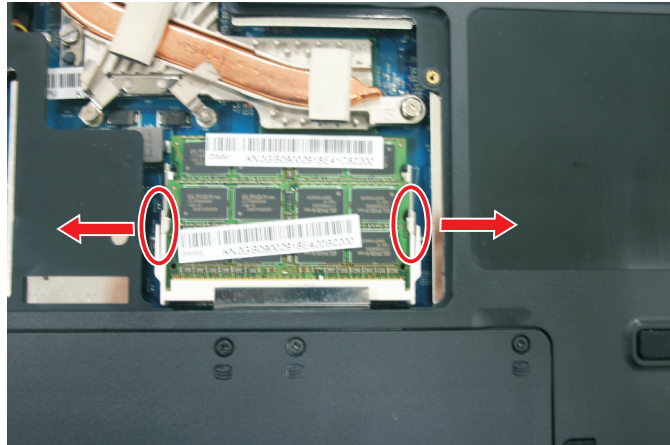

- 5 Pull the memory module out of the slot.



- 6 Hold the new or replacement module at a 30-degree angle and press it into the empty memory slot. This module is keyed so it can only be inserted in one direction. If the module does not fit, make sure that the notch in the module lines up with the tab in the memory bay.
- 7 Press the card down until it clicks into place.
- 8 Replace the memory bay cover, then tighten the cover screws.

■

Replacing the main cooling assembly

Tools you need to complete this task:



Additional materials you need to complete this task:

- X-23-7762 thermal grease

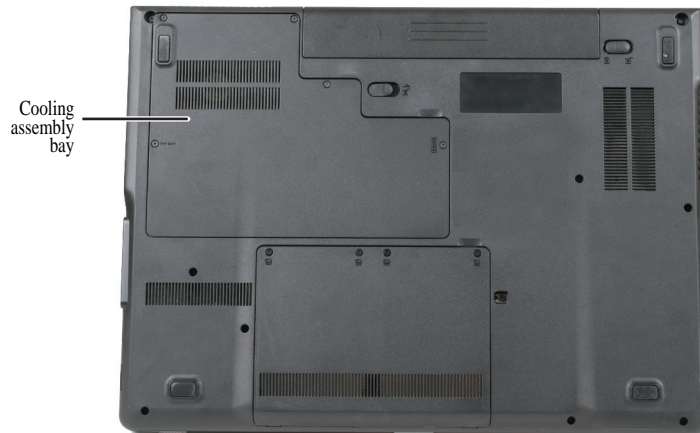

► To replace the main cooling assembly:

- 1 Complete the steps in [“Preparing the notebook”](#) on page 57.
- 2 Loosen the memory bay cover screws (these screws cannot be removed).

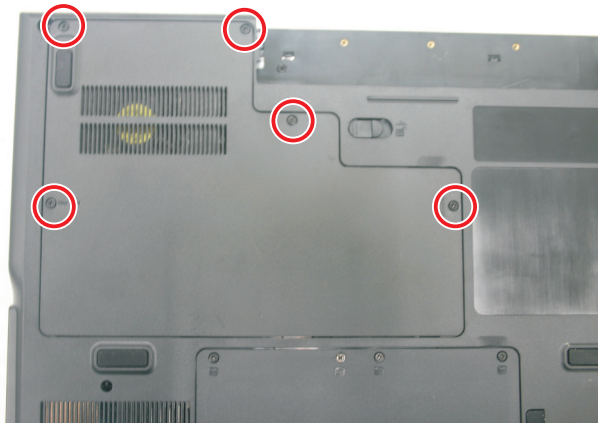

- 3 Use the thumb notch to lift the memory bay cover, then remove it. Be careful not to break off the tabs located on the end of the cover opposite the thumb notch.



- 4 Loosen or remove the screws that secure the main cooling assembly to the system board in the order shown.

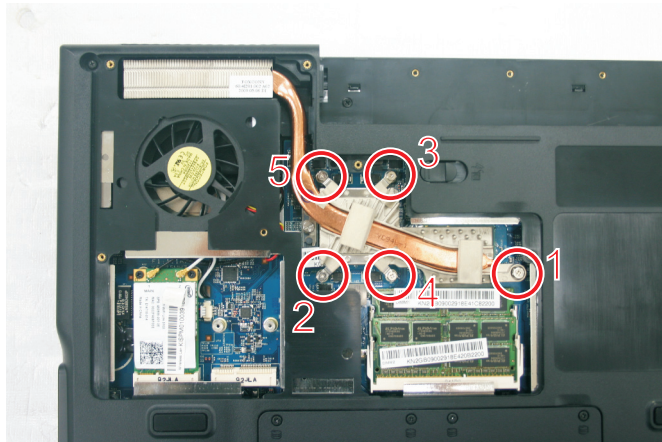

- 5 At the same time as you lift, move the main cooling assembly away from the side of the notebook, then remove the main cooling assembly.



- 6 Remove any thermal grease residue from the processor using a soft cloth and isopropyl alcohol.
- 7 Place new thermal grease on the processor. Use only enough to cover the CPU die.
- 8 Make sure a thermal pad is placed between the main cooling assembly and other components as shown.

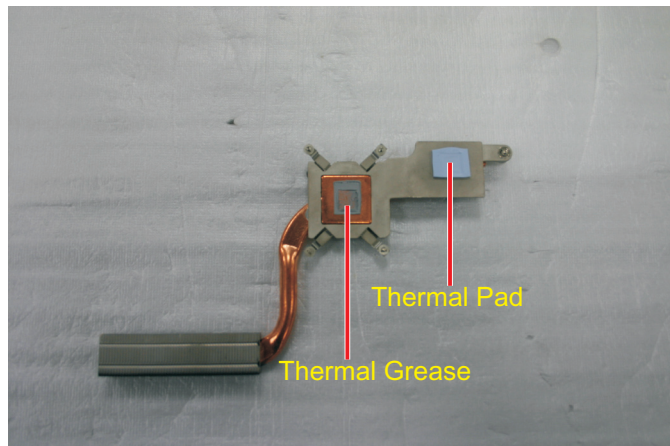

- 9 Insert the new main cooling assembly into the notebook.
- 10 Tighten the screws that secure the main cooling assembly to the system board. Reverse the order shown in Step 4.



Caution

When tightening the main cooling assembly's screws into the numbered holes, tighten them in numerical order.

- 11 Replace the cooling assembly bay cover, then tighten the cover screws.
■

Replacing the processor

Tools you need to complete this task:



Phillips #0 screwdriver



Flat-blade driver

Additional materials you need to complete this task:

- X-23-7762 thermal grease

► To replace the processor:

- 1 Complete the steps in [“Preparing the notebook”](#) on page 57.
- 2 Remove the cooling assembly by following the steps in [“Replacing the main cooling assembly”](#) on page 60.
- 3 Use a flat-blade screwdriver to turn the processor lock screw 1/4-turn counter-clockwise.



- 4 Remove the old processor from the system board.

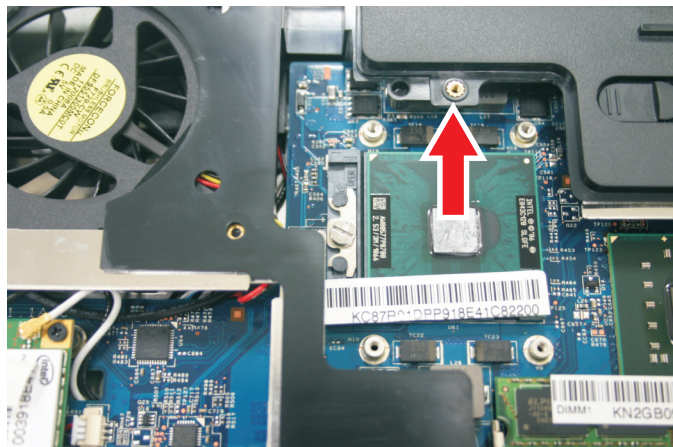

- 5 Install the new processor onto the system board making sure that Pin 1 on the processor (indicated by the silk-screened arrow on the corner of the processor) aligns with Pin 1 on the processor socket (indicated by the absence of a pin hole in the processor socket), then use a flat-blade screwdriver to turn the processor lock screw 1/4-turn clockwise.

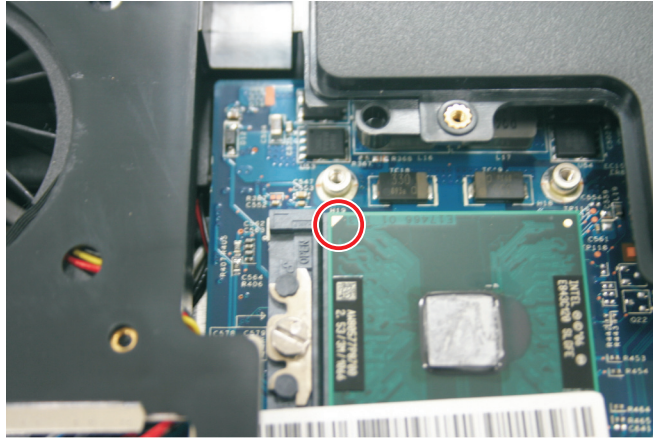

- 6 Remove any thermal grease residue from the cooling assembly using a soft cloth and isopropyl alcohol.
- 7 Place new thermal grease on the processor. Use only enough to cover the CPU die.
- 8 Make sure a thermal pad is placed between the cooling assembly and other components as shown.

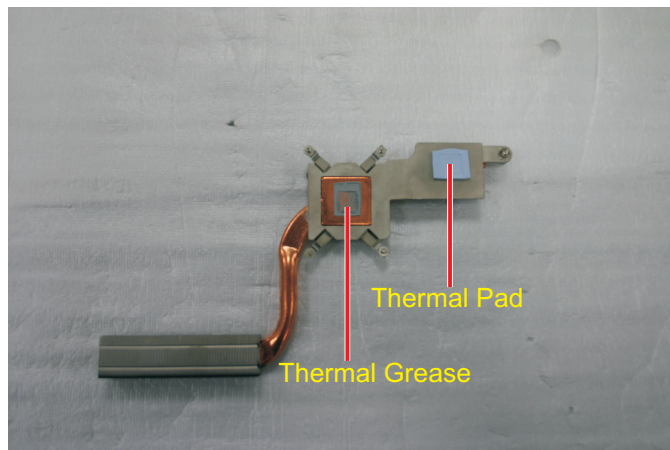

- 9 Replace the cooling assembly by following the instructions in [“Replacing the main cooling assembly”](#) on page 60.

■

Replacing the IEEE 802.11 wireless card

Tools you need to complete this task:



Screws removed during this task:

-  2 black M2x3 (IEEE 802.11 wireless card)

► To replace the IEEE 802.11 wireless card:

- 1 Complete the steps in [“Preparing the notebook”](#) on page 57.
- 2 Loosen the memory bay cover screws (these screws cannot be removed).

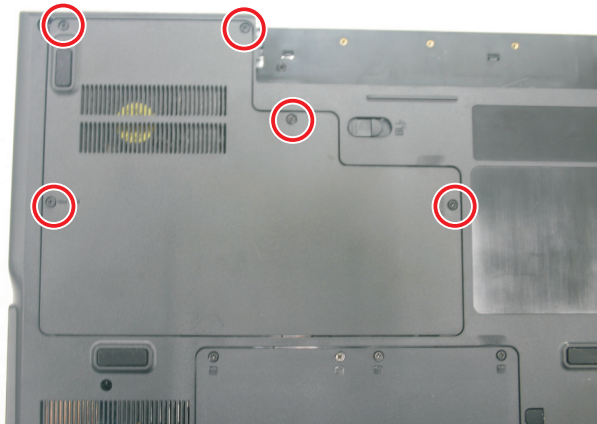

- 3 Use the thumb notch to lift the memory bay cover, then remove it. Be careful not to break off the tabs located on the end of the cover opposite the thumb notch.



- 4 Unplug the antenna cables. Note which color cable is connected to each of the connectors.



Important

The number of antenna cables varies by the type of wireless network used by the notebook. IEEE 802.11N cards typically have two antenna cables. Other types of wireless network cards typically have three antenna cables.



- 5 Remove the wireless card screws.



- 6 Pull the card out of the slot.



- 7 Move the antenna cables out of the way.
- 8 Hold the new card at a 30-degree angle and slide it into the empty slot. This card is keyed so it can only be inserted in one direction. If the card does not fit, make sure that the notch in the card lines up with the tab in the card slot.
- 9 Replace the screws removed in [Step 5](#).
- 10 Reattach the antenna cables to the connectors.
- 11 Replace the bay cover, then tighten the cover screws.
■

Replacing the CMOS battery



Important

Use only CMOS batteries designed for this Gateway notebook.

Tools you need to complete this task:

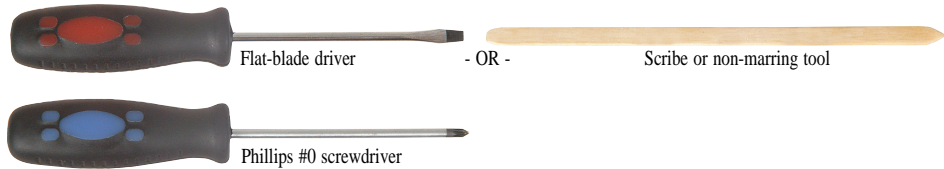

Screws removed during this task:

-  2 black M2x3 (IEEE 802.11 wireless card)

► To replace the CMOS battery:

- 1 Complete the steps in [“Preparing the notebook” on page 57](#).
- 2 Remove the optional IEEE 802.11 wireless card by following the instructions in [“Replacing the IEEE 802.11 wireless card” on page 65](#).
- 3 Disconnect the old battery from the system board.

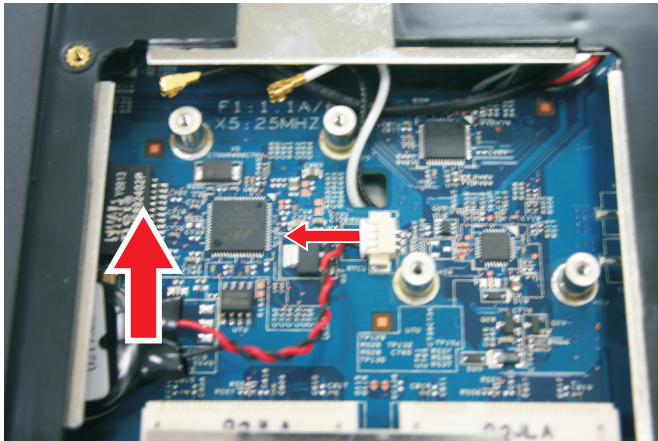

- Lift the old battery off of the system board.



Important

The battery is held in place by double-sided tape.

- Connect the new battery to the system board, then place the battery on the system board.



Important

Use double-sided tape to hold the new battery in place.

- 4 Replace the optional IEEE 802.11 wireless card by following the instructions in [“Replacing the IEEE 802.11 wireless card” on page 65](#).

Replacing the hard drive

Tools you need to complete this task:



Screws removed during this task:

-  1 chrome M3x3 (Hard drive bracket)

► To replace the hard drive:

- 1 Complete the steps in [“Preparing the notebook”](#) on page 57.
- 2 Loosen the hard drive bay cover screws (these screws cannot be removed).

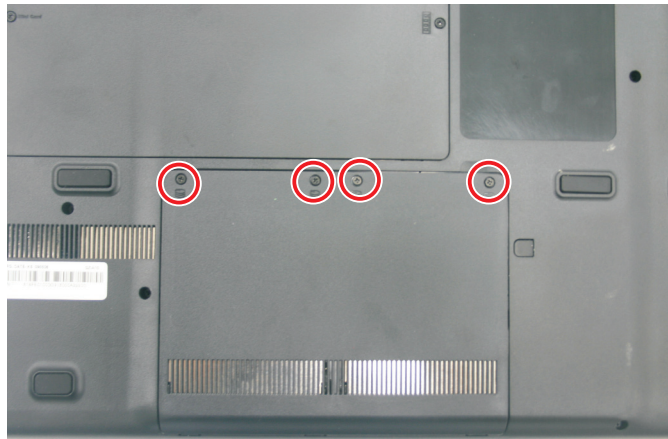

- 3 Use the thumb notch to lift the hard drive bay cover, then remove it. Be careful not to break off the tabs located on the end of the cover opposite the thumb notch.

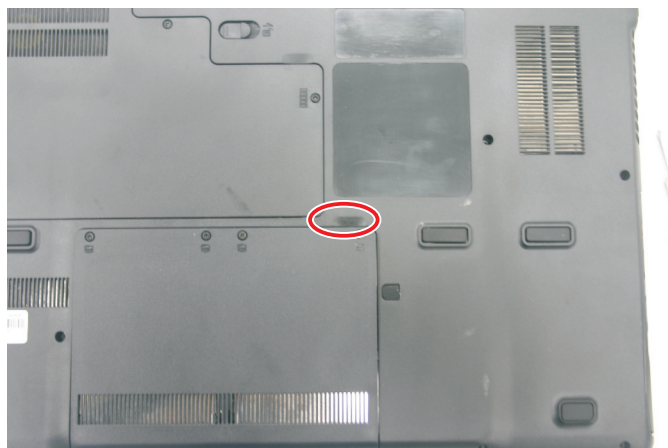

- 4 Using the plastic tab, slide the hard drive you are replacing, then remove it.

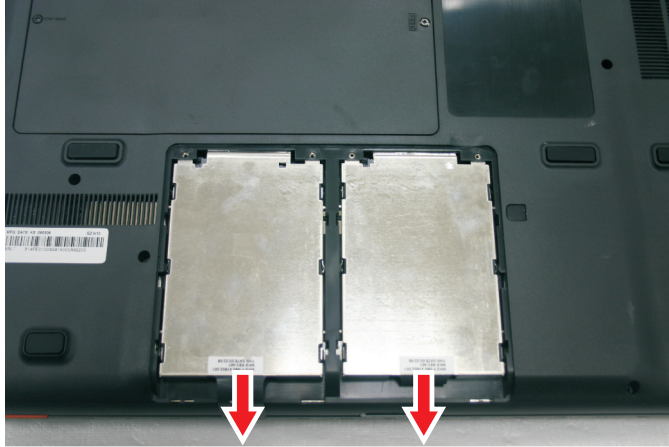

- 5 If your new hard drive already includes the hard drive bracket, go to step [Step 10](#).
-OR-
If you need to move the hard drive bracket from your old hard drive to your new hard drive, go to step [Step 6](#).

- 6 Remove the screws that secure the hard drive to the hard drive bracket.



- 7 Remove the bracket from the old drive.



- 8 Insert the new drive label side up onto the bracket so the screw holes line up.
- 9 Replace the screws that secure the bracket to the drive.

CHAPTER 3: Replacing notebook components

- 10 Slide the new hard drive kit into your notebook.
- 11 Replace the cover, then tighten the screws.
 -

Replacing the optical drive

Tools you need to complete this task:

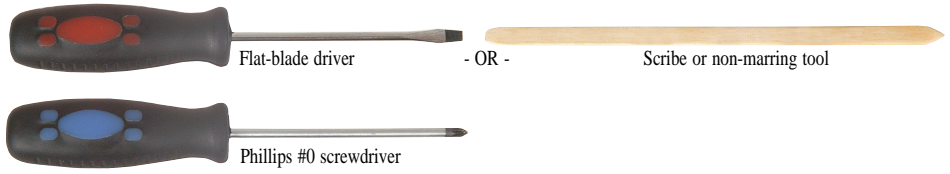

Screws removed during this task:

-  1 black M2.5×5 (Optical drive)

► To replace the optical drive:

- 1 Complete the steps in [“Preparing the notebook”](#) on page 57.
- 2 Remove the rubber insert from the bottom of the notebook.

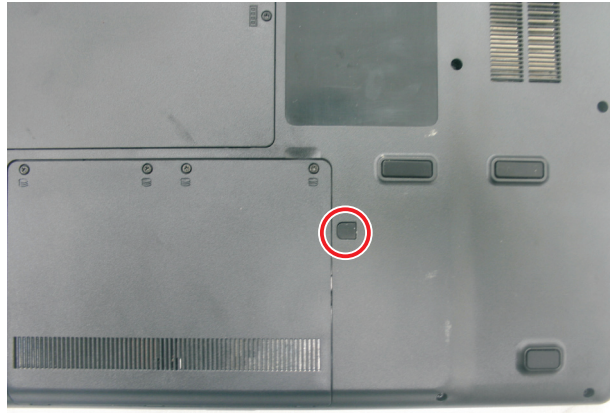

- 3 Remove the screw that secures the DVD drive to your notebook.

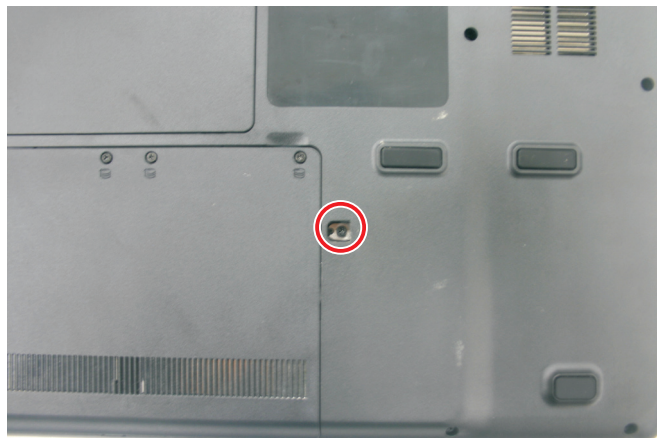

- Carefully slide the drive out of the drive bay.



Tip

Use a small screwdriver or other pointed tool to push on the DVD bracket and slide the drive out of the bay.

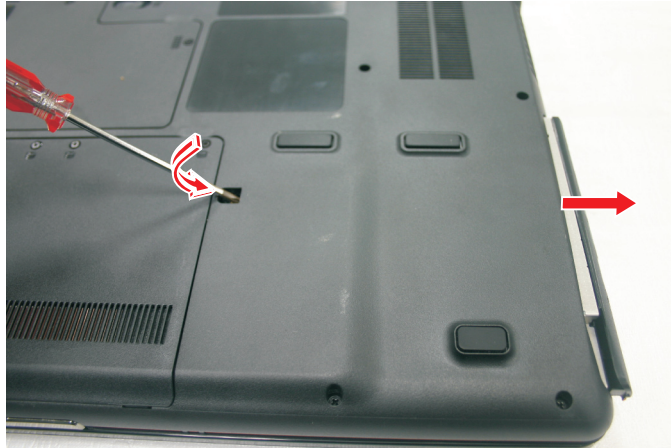

- Slide the new DVD drive into the drive bay. Make sure that the drive fits securely in the bay.
- Replace the screw removed in [Step 3](#).
 -

Replacing the keyboard cover

Tools you need to complete this task:

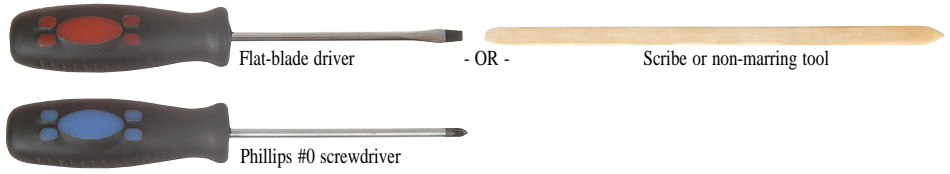

Screws removed during this task:

-  2 black M2.5×3 (Keyboard cover)
- To replace the keyboard cover:
- 1 Complete the steps in [“Preparing the notebook” on page 57](#).
 - 2 Remove the two keyboard cover screws from the inside of the battery compartment.

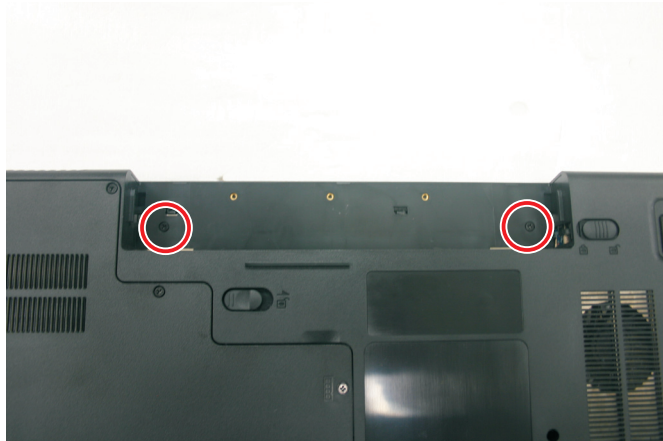

- 3 Use a plastic screw driver to release the latches.



- 4 Turn your notebook over so the top is facing up.
- 5 Open the LCD panel to the fully opened position.

- 6 Insert the small flat-blade screwdriver under each of the hinge covers and gently pry them up.



- 7 Pull the cover off the notebook by lifting the back corners of the cover. Be careful to not damage the LCD panel.



Caution

The cover is connected to the notebook by one or more cables. Do not pull on the cables.

- 8 Place the keyboard cover below the LCD screen to access the cable that need to be remove.



- Slide the black clip to the back of the notebook, then slide the cable out of the clip. Be careful not to touch or damage any other components.

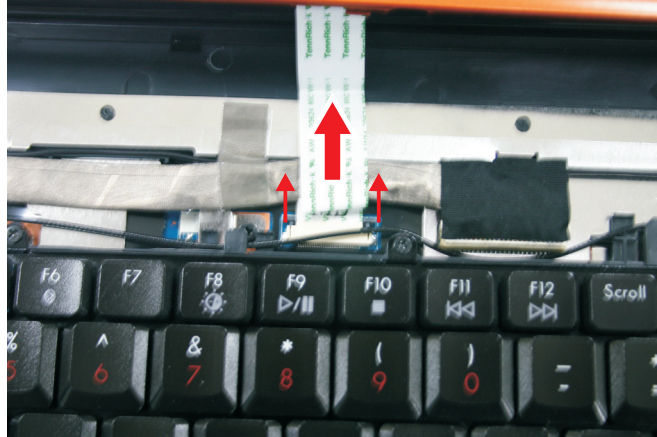

- Remove the old keyboard cover.
- Make sure the black keyboard cover connector clip is fully moved toward the back of the notebook, insert the cable into the connector, then slide the black clip forward to lock the connector in place.



Important

The cable is correctly oriented if it is not twisted.

- Replace the keyboard cover by first inserting the tabs located on the front of the cover into the slots provided, then pressing down on the back. Press down on the cover in several places until it clicks in place. The cover is correctly mounted when you can run your finger along the cover and find no loose spots. The cover should be flat all the way across.



Caution

If the cover is not correctly replaced, your notebook could be damaged when you try to close the LCD panel.

- Close the LCD panel.
- Turn your notebook over so the bottom is facing up.
- Replace the screws removed in [Step 2](#).



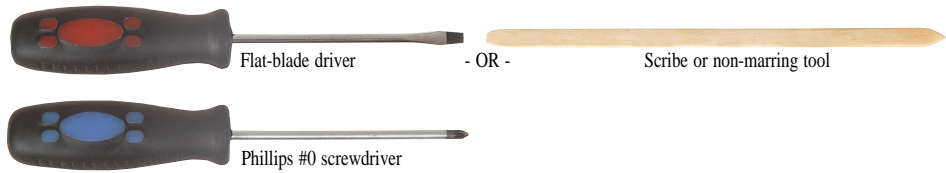

Replacing the keyboard

Tools you need to complete this task:



Screws removed during this task:

-  2 black M2.5x3 (Keyboard cover)
-  3 black M2.5x3 (Keyboard)
-  2 long black (Keyboard)

► To replace the keyboard:

- 1 Complete the steps in [“Preparing the notebook” on page 57](#).
- 2 Remove the keyboard cover by following the steps in [“Replacing the keyboard cover” on page 75](#).
- 3 Remove the five keyboard screws.



Important

Note the location of the long screw.

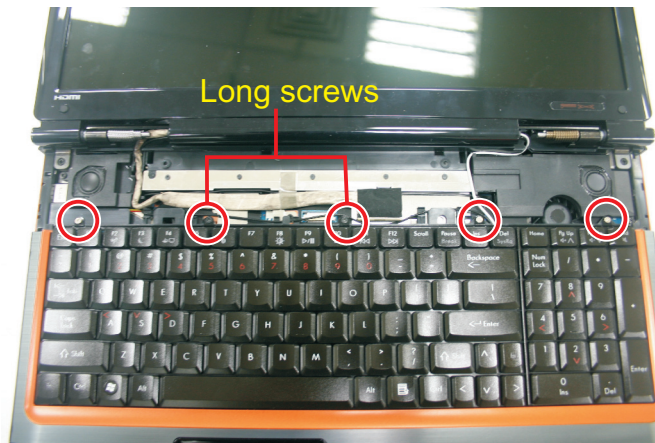

- 4 Lift the back edge of the keyboard slightly, then slowly slide it toward the LCD panel to release the keyboard retaining tabs located on the front edge of the keyboard.



- 5 Slide the keyboard connector clip to the back of the notebook or lift the connector clip off of the cable, then slide the cable out of the clip. Be careful not to touch or damage any other components.

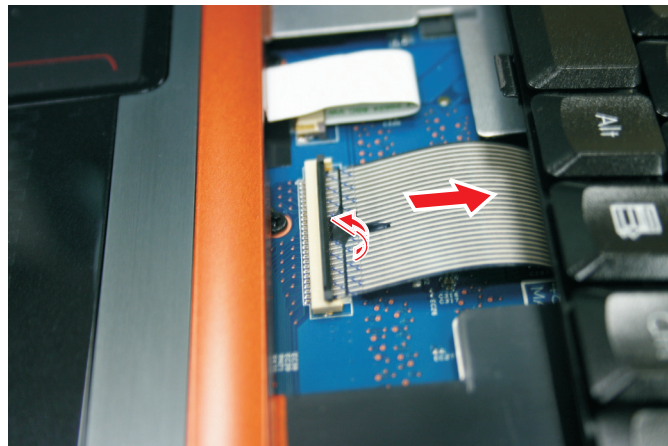

- 6 Place the new keyboard keys-up on your notebook with the space bar toward you.
- 7 Make sure the keyboard connector clip is fully moved toward the back of the notebook or lifted into the raised position, insert the cable into the connector, then slide the clip forward or downward to lock the connector in place.



Important

The keyboard cable is correctly oriented if it is not twisted.

- 8 Insert the tabs on the front edge of the keyboard into the slots under the palm rest. You may need to press down on the keyboard keys along the front edge of the keyboard to seat the retaining tabs into their corresponding slots.





- 9 Gently press the keyboard down until it is flat all the way across. The keyboard should easily fall into place. Be careful to not damage the LCD panel.
 - 10 Replace the screws removed in [Step 3](#).
 - 11 Replace the keyboard cover by following the steps in [“Replacing the keyboard cover” on page 75](#).
-

Replacing the inverter

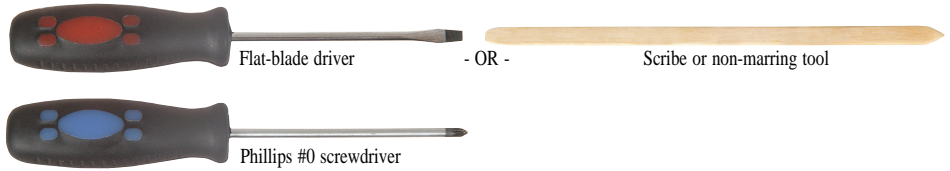
Tools you need to complete this task:



Screws removed during this task:

-  2 black M2.5×3 (Keyboard cover)
-  6 black M2.5×8 (LCD front panel)
-  2 black M2.5×5 (inverter)

► To replace the inverter:

- 1 Complete the steps in [“Preparing the notebook” on page 57](#).
- 2 Remove the keyboard cover by following the steps in [“Replacing the keyboard cover” on page 75](#).
- 3 Open the LCD panel to the fully open position.
- 4 Remove the rubber inserts from the front of the LCD panel assembly.

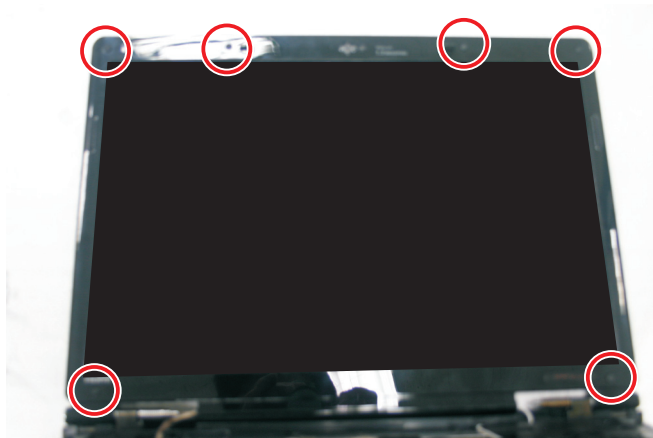

- 5 Remove the screws from the front of the LCD panel assembly.

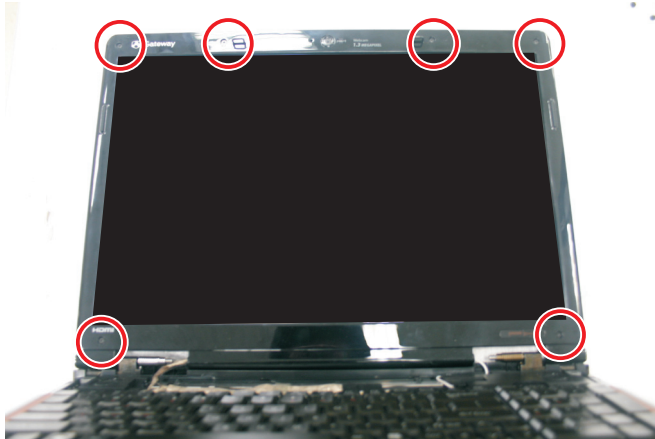

- 6 Carefully separate the front and back of the LCD panel assembly.

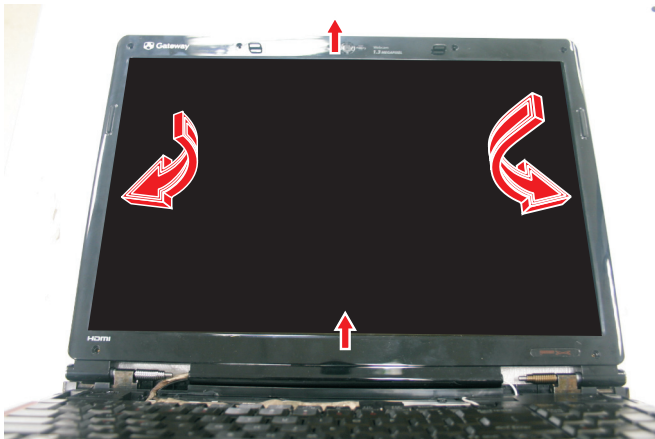

- 7 Remove the screws connecting the inverter to the LCD panel lid.

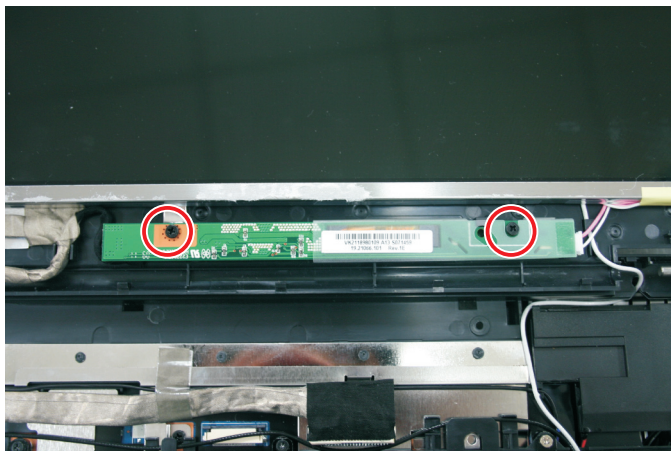

- Lift the inverter from the LCD panel assembly, then turn it over. Take note of the latch securing the inverter.

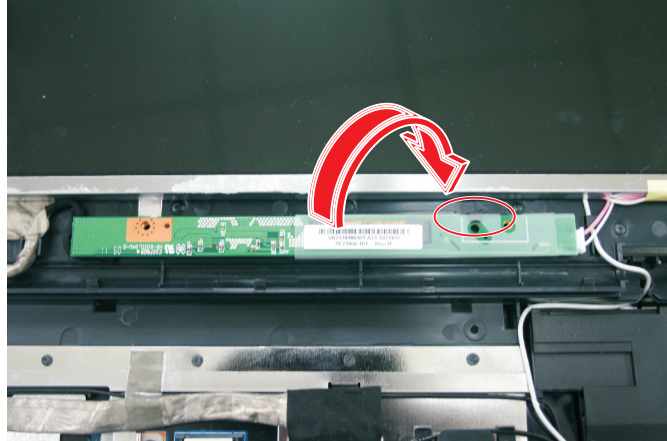

- Disconnect the connectors from the old inverter and connect them to the new inverter.



- Align the new inverter with the screw holes, then replace the screws removed in [Step 7](#).
- Press the LCD panel front and back together. Press the two halves together in several places until they click in place. You should find no loose spots or spots where the two halves do not meet.



Important

If the LCD front panel backing have a double-sided tape when removing, don't forget to replace it with a new one when putting back.

- Replace the LCD panel assembly screws removed in [Step 5](#).
- Replace the rubber inserts removed in [Step 4](#).
- Replace the keyboard cover by following the steps in “[Replacing the keyboard cover](#)” on page 75.



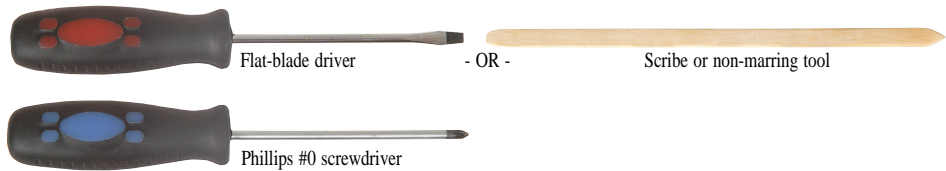

Replacing the webcam

Tools you need to complete this task:



Screws removed during this task:

-  2 black M2.5×3 (Keyboard cover)
-  6 black M2.5×8 (LCD front panel)
-  2 black M2×3 (Webcam)

► To replace the webcam:

- 1 Complete the steps in [“Preparing the notebook” on page 57](#).
- 2 Remove the keyboard cover by following the steps in [“Replacing the keyboard cover” on page 75](#).
- 3 Open the LCD panel to the fully open position.
- 4 Remove the rubber inserts from the front of the LCD panel assembly.

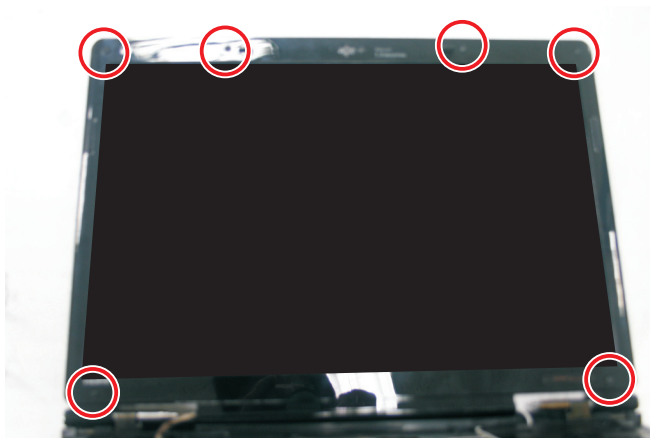

- 5 Remove the screws from the front of the LCD panel assembly.

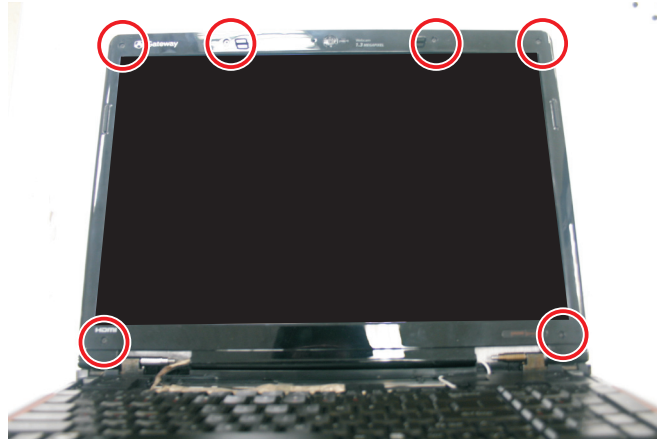

- 6 Carefully separate the front and back of the LCD panel assembly.

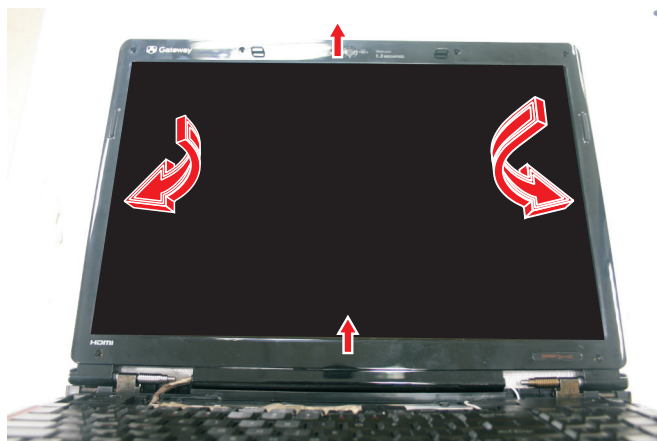

- 7 Disconnect the webcam cable from the webcam.

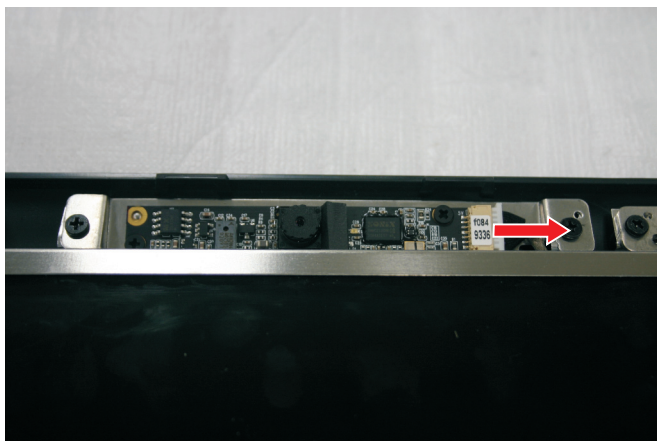

- 8 Remove the screws that connect the webcam bracket to the LCD panel assembly.

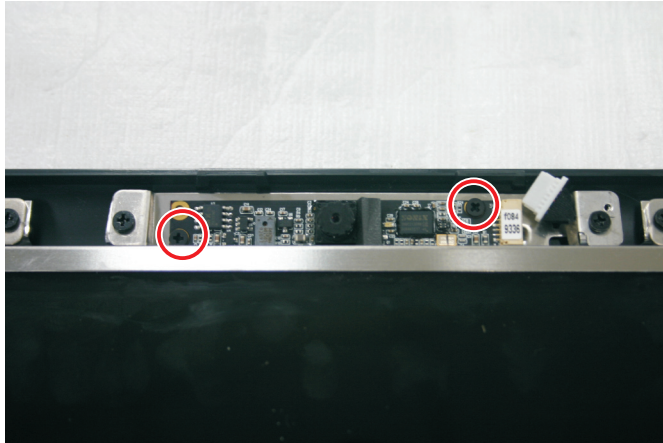

- 9 Remove the old webcam.
- 10 Install the new webcam.
- 11 Replace the screws that were removed in [Step 8](#).
- 12 Reconnect the webcam cable.
- 13 Press the LCD panel front and back together. Press the two halves together in several places until they click in place. You should find no loose spots or spots where the two halves do not meet.



Important

If the LCD front panel backing has a double-sided tape when removing, don't forget to replace it with a new one when putting back.

- 14 Replace the LCD panel assembly screws removed in [Step 5](#).
- 15 Replace the rubber inserts removed in [Step 4](#).
- 16 Replace the keyboard cover by following the steps in “[Replacing the keyboard cover](#)” on [page 75](#).



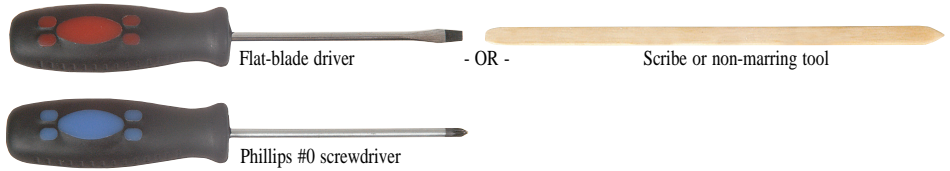

Replacing the lid latches

Tools you need to complete this task:



Screws removed during this task:

-  2 black M2.5×3 (Keyboard cover)
-  6 black M2.5×8 (LCD front panel)
-  2 black M2.5×5 (Lid latches)

► To replace the lid latches:

- 1 Complete the steps in [“Preparing the notebook”](#) on page 57.
- 2 Remove the keyboard cover by following the steps in [“Replacing the keyboard cover”](#) on page 75.
- 3 Open the LCD panel to the fully open position.
- 4 Remove the rubber inserts from the front of the LCD panel assembly.



- 5 Remove the screws from the front of the LCD panel assembly.

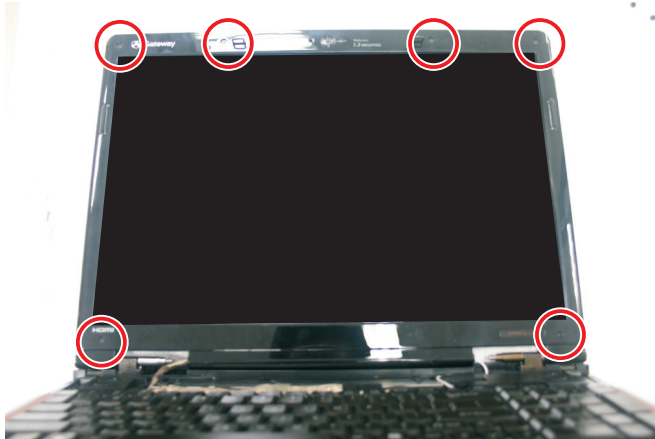

- 6 Carefully separate the front and back of the LCD panel assembly.

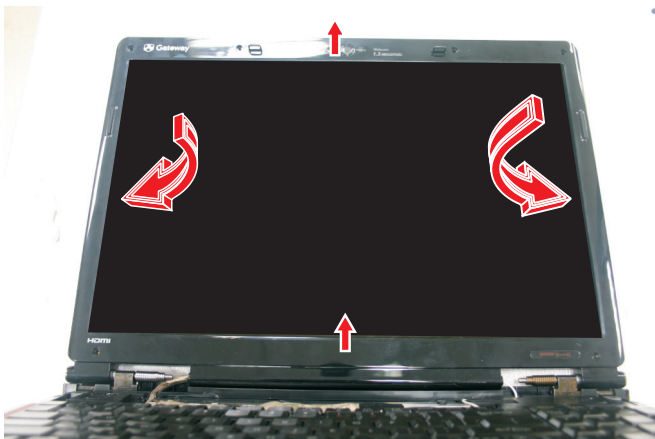

- 7 Remove the screws that connect the lid latches to the LCD panel assembly.



- 8 Remove the old lid latches.

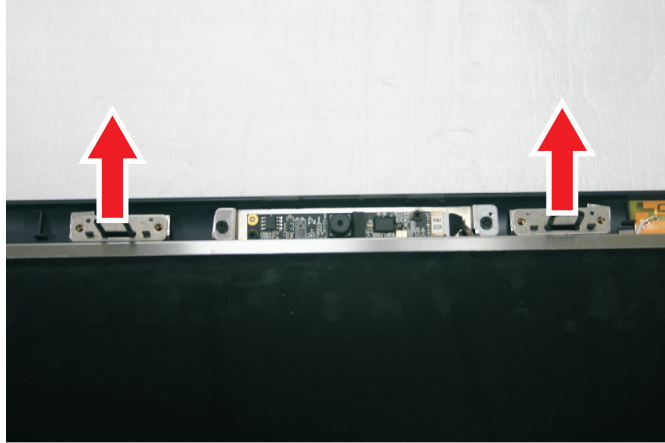

- 9 Install the new lid latches.
- 10 Replace the screws that were removed in [Step 8](#).
- 11 Press the LCD panel front and back together. Press the two halves together in several places until they click in place. You should find no loose spots or spots where the two halves do not meet.



Important

If the LCD front panel backing have a double-sided tape when removing, don't forget to replace it with a new one when putting back.

- 12 Replace the LCD panel assembly screws removed in [Step 5](#).
- 13 Replace the rubber inserts removed in [Step 4](#).
- 14 Replace the keyboard cover by following the steps in “[Replacing the keyboard cover](#)” on [page 75](#).





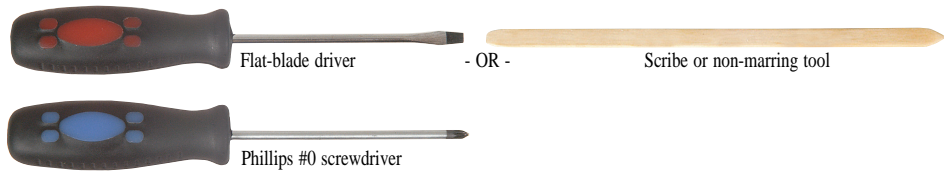

■

Replacing the LCD assembly

Tools you need to complete this task:



Screws removed during this task:

-  2 black M2.5×3 (Keyboard cover)
-  6 black M2.5×8 (LCD front panel)
-  3 black M2.5×3 (Keyboard)
-  2 long black (Keyboard)
-  2 black M2.5×8 (Hinge bottom)
-  2 black M2.5×8 (Hinge top)

► To replace the LCD assembly:

- 1 Complete the steps in [“Preparing the notebook”](#) on page 57.
- 2 If the notebook has wireless networking built in, unplug the wireless antennas by following the steps in [“Replacing the IEEE 802.11 wireless card”](#) on page 65.
- 3 Remove the keyboard cover by following the steps in [“Replacing the keyboard cover”](#) on page 75.
- 4 Remove the keyboard by following the steps in [“Replacing the keyboard”](#) on page 78.
- 5 Remove the screws on the bottom that secure the LCD panel hinges to the chassis.



- 6 Turn the notebook over so the top is facing up.
- 7 Carefully open the LCD panel to the fully-open position.

- 8 Detach the LCD cable from the system board and the tape securing it. Make sure that you grasp the plastic connector carefully and pull to unplug the LCD video cable from the notebook.



Caution

The LCD video cable connector is fragile.

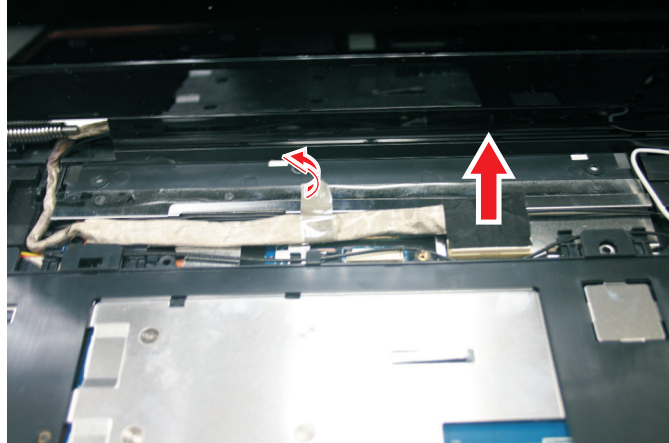

- 9 Taking care to note the cables' routing and positions as they are installed from Gateway, pull the antenna cables out from under the system board, then slide the antenna cables and LCD cables out from under the retaining clips. Release it from the latches and remove any tape that may be securing the cables.

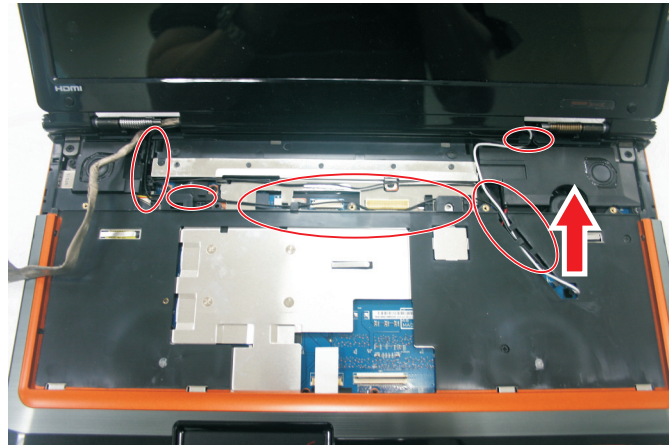

- 10 Remove the screws on the top that secure the LCD panel hinge to the chassis.

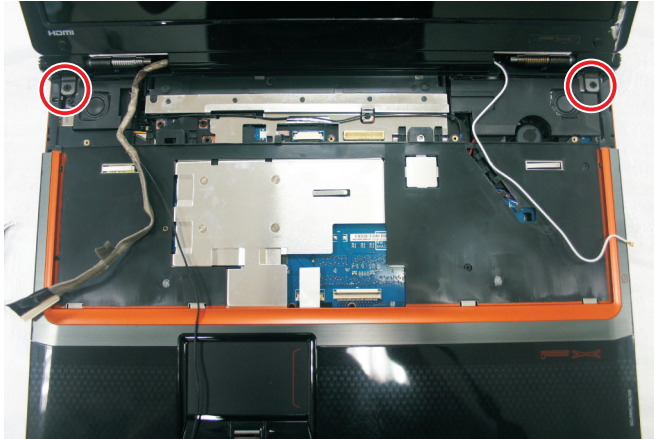

- 11 Lift the LCD panel assembly up and away from the notebook.

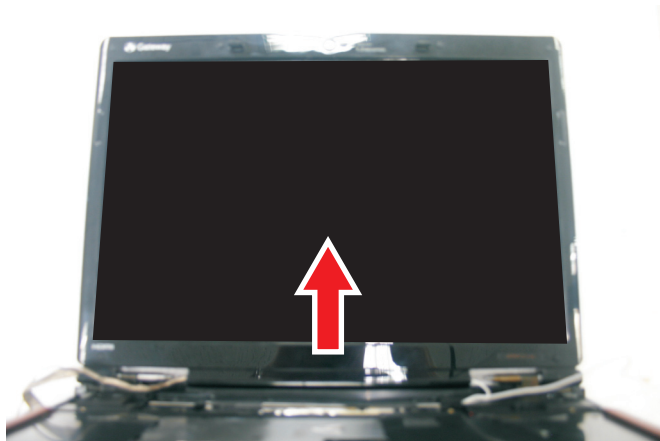

- 12 Place the new LCD panel assembly onto the notebook, then replace the hinge screws removed in [Step 10](#).
- 13 Slide the antenna cables through the retaining clips, under the system board, then into the wireless bay.
- 14 Lay the LCD cable along the flat area under the keyboard, then plug it into the notebook. Run your finger along the cable to re-stick the cable to the notebook.
- 15 Replace any tape that held the antenna wires.
- 16 Close the LCD panel, turn the notebook over so the bottom is facing up, then replace the bottom hinge screws removed in [Step 5](#).
- 17 Replace the keyboard by following the steps in [“Replacing the keyboard” on page 78](#).
- 18 Replace the keyboard cover by following the steps in [“Replacing the keyboard cover” on page 75](#).
- 19 Turn the notebook over so the bottom is facing up.
- 20 Reconnect the antenna wires to the wireless card by following the steps in [“Replacing the IEEE 802.11 wireless card” on page 65](#).

- 21 Replace the wireless bay cover by following the steps in [“Replacing the IEEE 802.11 wireless card” on page 65.](#)







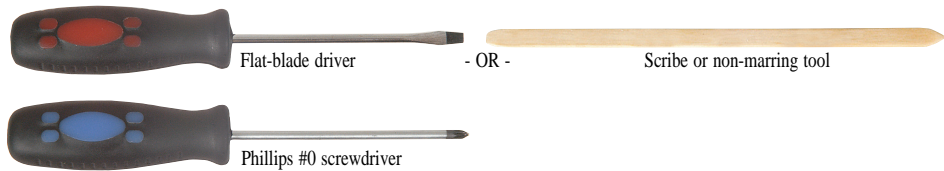





Replacing the LCD panel

Tools you need to complete this task:



Screws removed during this task:

-  2 black M2.5×3 (Keyboard cover)
-  6 black M2.5×8 (LCD front panel)
-  3 black M2.5×3 (Keyboard)
-  2 long black (Keyboard)
-  2 black M2.5×8 (Hinge bottom)
-  2 black M2.5×8 (Hinge top)
-  6 black M2.5×8 (LCD front panel)
-  4 black M2.5×5 (LCD panel to LCD panel lid)
-  2 black M2.5×5 (inverter)
-  2 black M2×3 (Webcam)
-  2 black M2.5×5 (Lid latches)

► To replace the LCD panel:

- 1 Complete the steps in [“Preparing the notebook” on page 57](#).
- 2 If the notebook has wireless networking built in, unplug the wireless antennas by following the steps in [“Replacing the IEEE 802.11 wireless card” on page 65](#).
- 3 Remove the keyboard cover by following the steps in [“Replacing the keyboard cover” on page 75](#).
- 4 Remove the keyboard by following the steps in [“Replacing the keyboard” on page 78](#).
- 5 Remove the LCD assembly by following the steps in [“Replacing the LCD assembly” on page 90](#).

- 6 Remove the rubber inserts from the front of the LCD panel assembly.

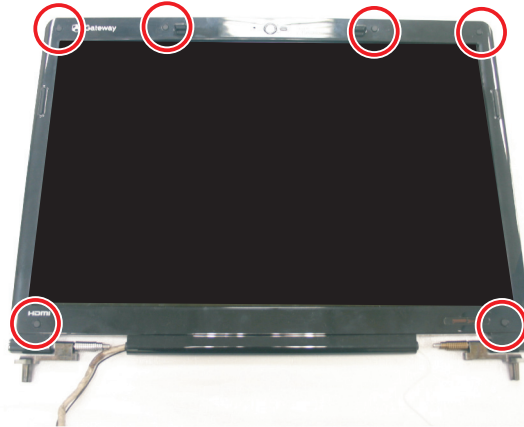

- 7 Remove the screws from the front of the LCD panel assembly.

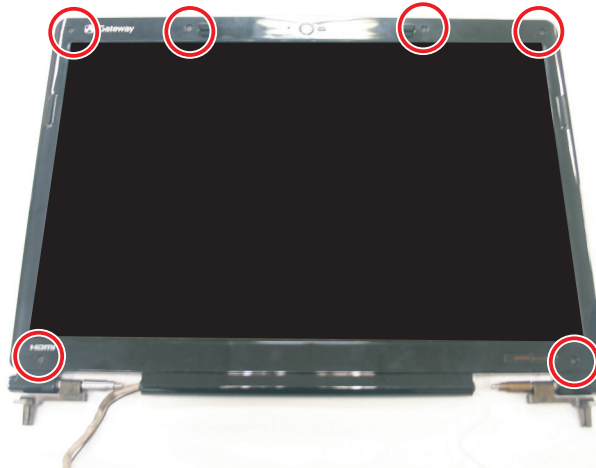

- 8 Carefully separate the front and back of the LCD panel assembly.

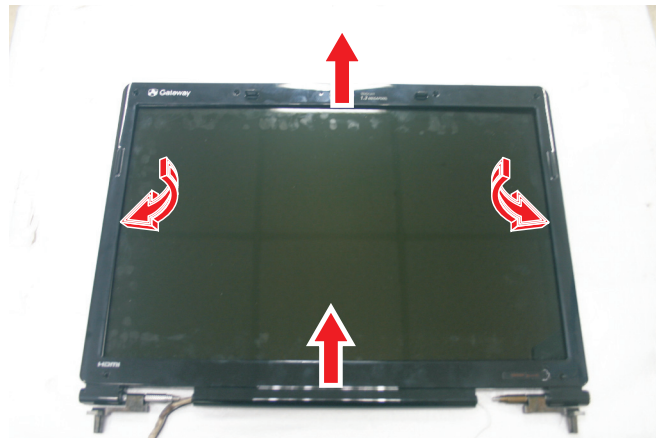

- 9 Remove the screws that secure the LCD panel to the LCD panel lid.

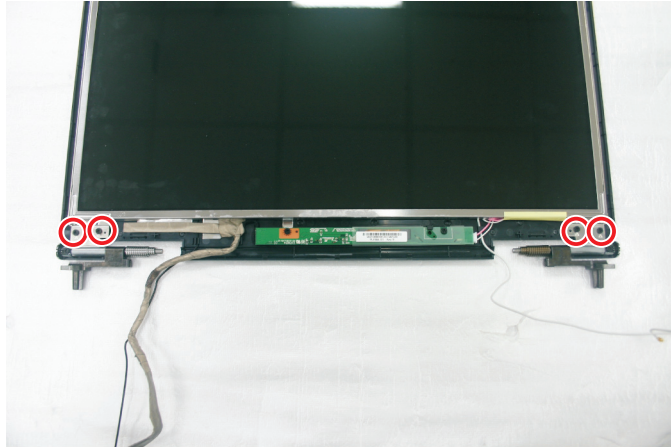

- 10 Remove the inverter by following the steps in [“Replacing the inverter”](#) on page 81.
- 11 Disconnect the web cam by following the steps in [“Replacing the webcam”](#) on page 84. You do not need to remove the web cam.
- 12 Remove the old LCD panel from the LCD panel lid.
- 13 Place the new LCD panel into the LCD panel lid.
- 14 Reconnect the web cam by following the steps in [“Replacing the webcam”](#) on page 84.
- 15 Replace the inverter by following the steps in [“Replacing the inverter”](#) on page 81.
- 16 Feed the wiring back into the hinge channels.
- 17 Replace the screws that were removed in [Step 9](#).
- 18 Make sure that the magnet has remained in the magnet bracket.

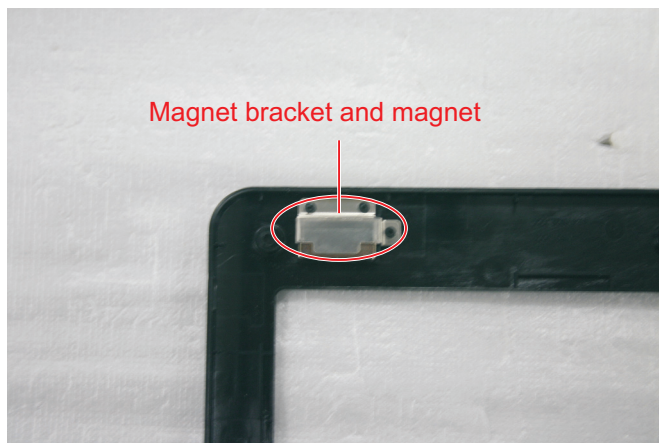

- 19 Press the LCD panel front and back together. Press the two halves together in several places until they click in place. You should find no loose spots or spots where the two halves do not meet.



Important

If the LCD front panel backing have a double-sided tape when removing, don't forget to replace it with a new one when putting back.

- 20 Replace the LCD panel assembly screws removed in [Step 7](#).
- 21 Replace the rubber inserts removed in [Step 6](#).
- 22 Replace the LCD assembly by following the steps in “[Replacing the LCD assembly](#)” on [page 90](#).
- 23 Replace the keyboard by following the steps in “[Replacing the keyboard](#)” on [page 78](#).
- 24 Replace the keyboard cover by following the steps in “[Replacing the keyboard cover](#)” on [page 75](#).
- 25 Turn the notebook over so the bottom is facing up.
- 26 Reconnect the antenna wires to the wireless card by following the steps in “[Replacing the IEEE 802.11 wireless card](#)” on [page 65](#).
- 27 Replace the wireless bay cover by following the steps in “[Replacing the IEEE 802.11 wireless card](#)” on [page 65](#).







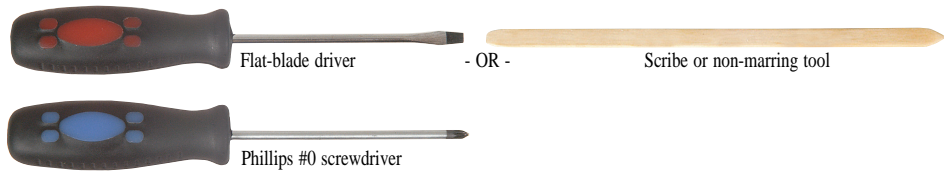





Replacing the LCD panel hinges and bracket

Tools you need to complete this task:



Screws removed during this task:

-  2 black M2.5×3 (Keyboard cover)
-  6 black M2.5×8 (LCD front panel)
-  3 black M2.5×3 (Keyboard)
-  2 long black (Keyboard)
-  2 black M2.5×8 (Hinge bottom)
-  2 black M2.5×8 (Hinge top)
-  6 black M2.5×8 (LCD front panel)
-  4 black M2.5×5 (LCD panel to LCD panel lid)
-  2 black M2.5×5 (inverter)
-  6 black M2×3 (LCD bracket to LCD panel)

► To replace the LCD panel hinges:

- 1 Complete the steps in [“Preparing the notebook” on page 57](#).
- 2 If the notebook has wireless networking built in, unplug the wireless antennas by following the steps in [“Replacing the IEEE 802.11 wireless card” on page 65](#).
- 3 Remove the keyboard cover by following the steps in [“Replacing the keyboard cover” on page 75](#).
- 4 Remove the keyboard by following the steps in [“Replacing the keyboard” on page 78](#).
- 5 Remove the LCD assembly by following the steps in [“Replacing the LCD assembly” on page 90](#).

- 6 Remove the rubber inserts from the front of the LCD panel assembly.

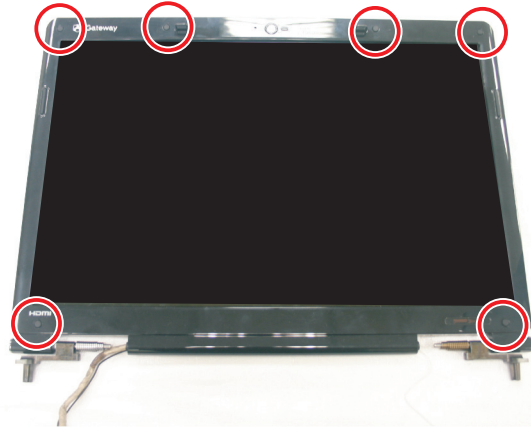

- 7 Remove the screws from the front of the LCD panel assembly.

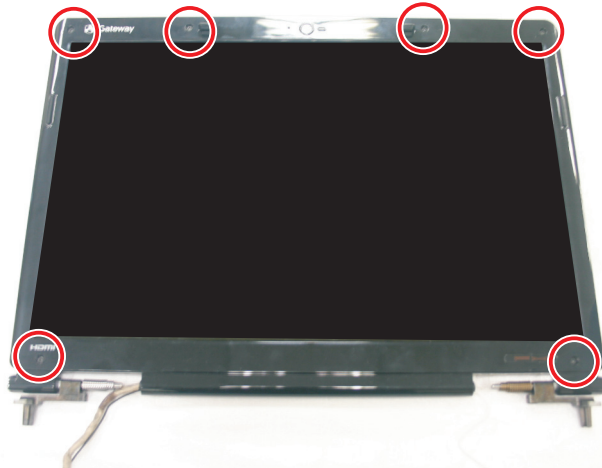

- 8 Carefully separate the front and back of the LCD panel assembly.

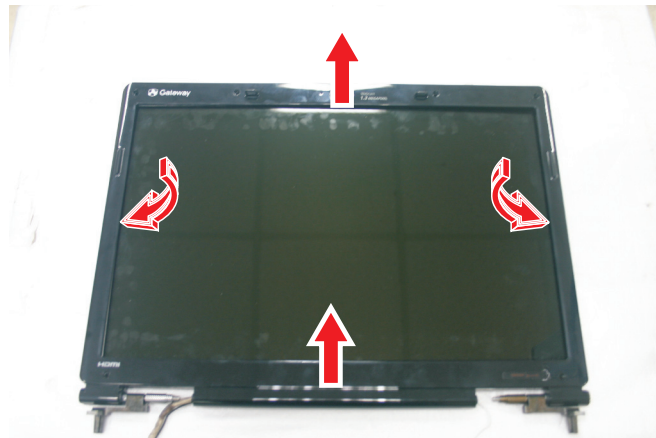

- 9 Remove the screws that secure the LCD panel to the LCD panel lid.

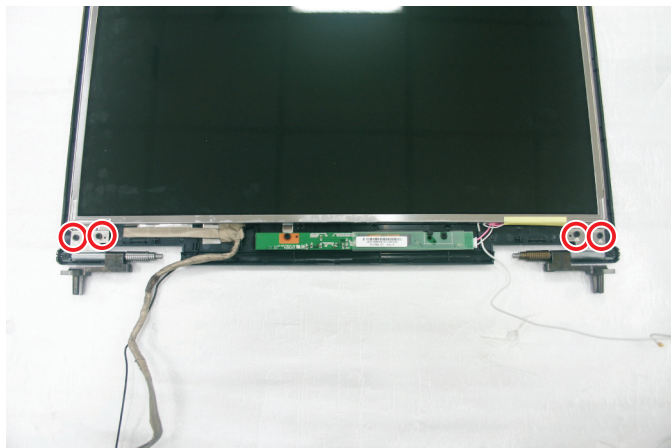

- 10 Partially lift up the LCD panel to remove the old left and right hinges.
- 11 Replace the old left and right hinges with the new ones.
- 12 Disconnect the cables from the inverter by following the steps in [“Replacing the inverter” on page 81](#).
- 13 Disconnect the web cam by following the steps in [“Replacing the webcam” on page 84](#). You do not need to remove the web cam.
- 14 Remove the old LCD panel from the LCD panel lid.
- 15 Remove the screws securing the old LCD brackets to the LCD panel.

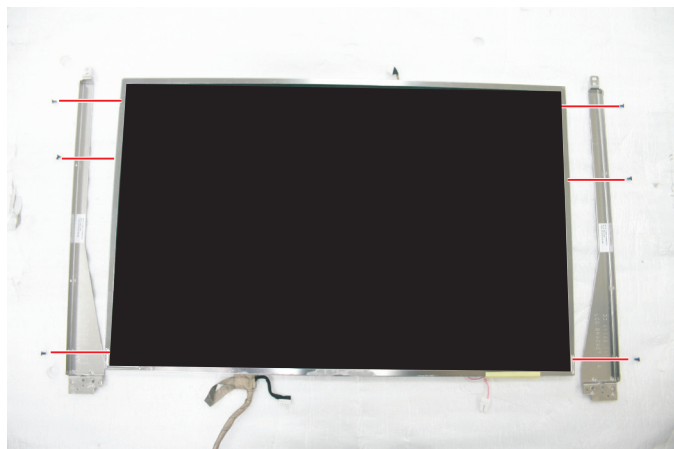

- 16 Replace the screws securing the new LCD brackets to the LCD panel.
- 17 Place the LCD panel into the LCD panel lid.
- 18 Reconnect the web cam by following the steps in [“Replacing the webcam” on page 84](#).
- 19 Replace the inverter by following the steps in [“Replacing the inverter” on page 81](#).
- 20 Feed the wiring back into the hinge channels.
- 21 Replace the screws that were removed in [Step 9](#).

- 22 Make sure that the magnet has remained in the magnet bracket.

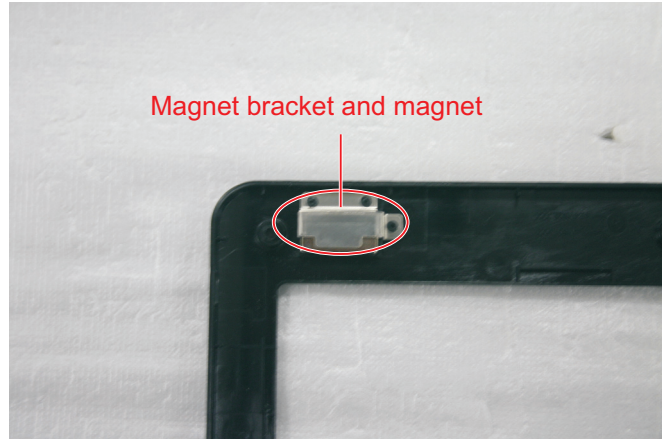

- 23 Press the LCD panel front and back together. Press the two halves together in several places until they click in place. You should find no loose spots or spots where the two halves do not meet.



Important

If the LCD front panel backing have a double-sided tape when removing, don't forget to replace it with a new one when putting back.

- 24 Replace the LCD panel assembly screws removed in [Step 7](#).
- 25 Replace the rubber inserts removed in [Step 6](#).
- 26 Replace the LCD assembly by following the steps in [“Replacing the LCD assembly” on page 90](#).
- 27 Replace the keyboard by following the steps in [“Replacing the keyboard” on page 78](#).
- 28 Replace the keyboard cover by following the steps in [“Replacing the keyboard cover” on page 75](#).
- 29 Turn the notebook over so the bottom is facing up.
- 30 Reconnect the antenna wires to the wireless card by following the steps in [“Replacing the IEEE 802.11 wireless card” on page 65](#).
- 31 Replace the wireless bay cover by following the steps in [“Replacing the IEEE 802.11 wireless card” on page 65](#).







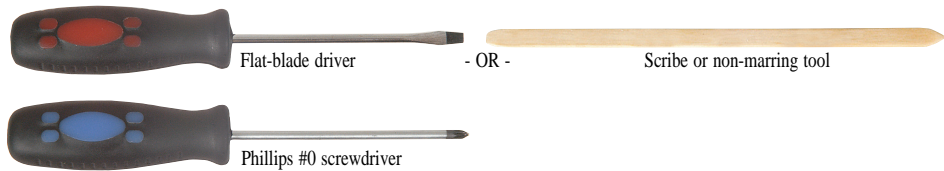





Replacing the LCD assembly lid

Tools you need to complete this task:



Screws removed during this task:

-  2 black M2.5×3 (Keyboard cover)
-  6 black M2.5×8 (LCD front panel)
-  3 black M2.5×3 (Keyboard)
-  2 long black (Keyboard)
-  2 black M2.5×8 (Hinge bottom)
-  2 black M2.5×8 (Hinge top)
-  6 black M2.5×8 (LCD front panel)
-  2 black M2.5×5 (inverter)
-  2 black M2×3 (Webcam)
-  2 black M2.5×5 (Lid latches)
-  4 black M2.5×5 (LCD panel to LCD panel lid)

► To replace the LCD assembly lid:

- 1 Complete the steps in [“Preparing the notebook”](#) on page 57.
- 2 If the notebook has wireless networking built in, unplug the wireless antennas by following the steps in [“Replacing the IEEE 802.11 wireless card”](#) on page 65.
- 3 Remove the keyboard cover by following the steps in [“Replacing the keyboard cover”](#) on page 75.
- 4 Remove the keyboard by following the steps in [“Replacing the keyboard”](#) on page 78.
- 5 Remove the LCD assembly by following the steps in [“Replacing the LCD assembly”](#) on page 90.
- 6 Remove the inverter by following the steps in [“Replacing the inverter”](#) on page 81.
- 7 Remove the web cam by following the steps in [“Replacing the webcam”](#) on page 84.
- 8 Remove the lid latches by following the steps in [“Replacing the lid latches”](#) on page 87.
- 9 Remove the LCD panel from the old LCD panel lid by following the steps in [“Replacing the LCD panel”](#) on page 94.
- 10 Remove the LCD panel brackets from the old LCD panel lid by following the steps in [“Replacing the LCD panel hinges and bracket”](#) on page 98.

- 11 Place the LCD panel brackets into the new LCD panel lid by following the steps in [“Replacing the LCD panel hinges and bracket” on page 98.](#)
- 12 Replace the LCD panel into the new LCD panel lid by following the steps in [“Replacing the LCD panel” on page 94.](#)
- 13 Replace the lid latches by following the steps in [“Replacing the lid latches” on page 87.](#)
- 14 Replace the web cam by following the steps in [“Replacing the webcam” on page 84.](#)
- 15 Replace the inverter by following the steps in [“Replacing the inverter” on page 81.](#)
- 16 Replace the LCD assembly by following the steps in [“Replacing the LCD assembly” on page 90.](#)
- 17 Replace the keyboard by following the steps in [“Replacing the keyboard” on page 78.](#)
- 18 Replace the keyboard cover by following the steps in [“Replacing the keyboard cover” on page 75.](#)
- 19 Turn the notebook over so the bottom is facing up.
- 20 Reconnect the antenna wires to the wireless card by following the steps in [“Replacing the IEEE 802.11 wireless card” on page 65.](#)
- 21 Replace the wireless bay cover by following the steps in [“Replacing the IEEE 802.11 wireless card” on page 65.](#)







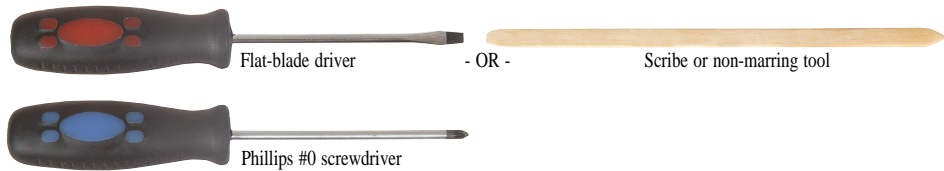



■

Replacing the palm rest

Tools you need to complete this task:



Screws removed during this task:

-  2 black M2.5×3 (Keyboard cover)
-  6 black M2.5×8 (LCD front panel)
-  3 black M2.5×3 (Keyboard)
-  2 long black (Keyboard)
-  2 black M2.5×8 (Hinge bottom)
-  2 black M2.5×8 (Hinge top)
-  8 black M2.5×8 (Palm rest-bottom)
-  6 black M2.5×8 (Palm rest-top)
-  3 black M2.5×5 (Palm rest-top)
-  4 black M2.5×3 (Touchpad board bracket)

► To replace the palm rest:

- 1 Complete the steps in [“Preparing the notebook” on page 57](#).
- 2 If the notebook has wireless networking built in, unplug the wireless antennas by following the steps in [“Replacing the IEEE 802.11 wireless card” on page 65](#).
- 3 Remove the hard drive by following the steps in [“Replacing the hard drive” on page 69](#).
- 4 Remove the keyboard cover by following the steps in [“Replacing the keyboard cover” on page 75](#).
- 5 Remove the keyboard by following the steps in [“Replacing the keyboard” on page 78](#).
- 6 Remove the LCD assembly by following the steps in [“Replacing the LCD assembly” on page 90](#).

- 7 Slide the brown touchpad connector clip to the back of the notebook, then remove the cable. Be careful not to touch or damage any other components.

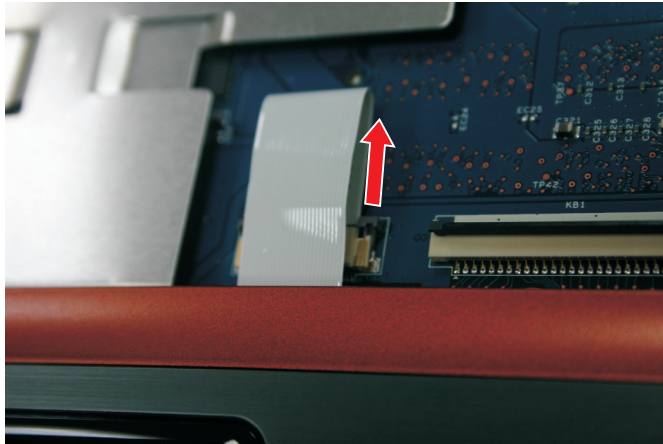
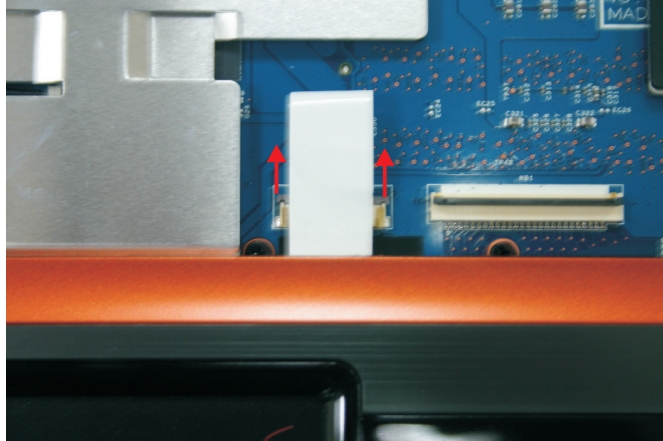

- 8 Turn the notebook over so the bottom is facing up.
- 9 Remove the screws from the bottom of the notebook.

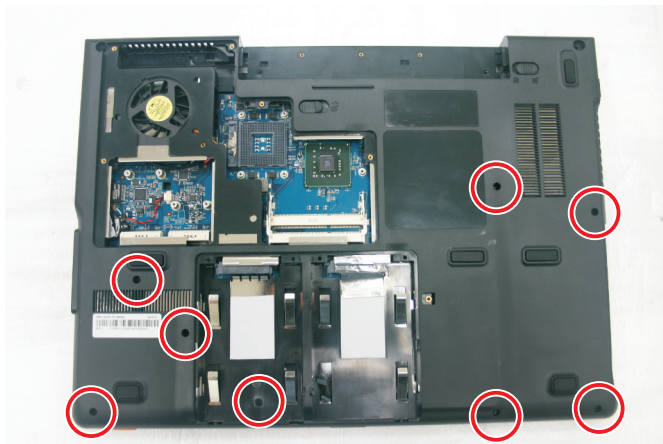

- 10 Turn the notebook over so the top is facing up.

- 11 Remove the screws from the top of the palm rest. Note the location of the screw types and sizes.

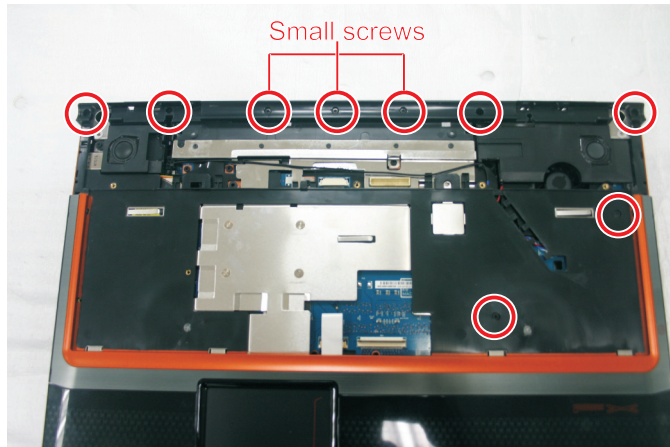

- 12 Lift the palm rest assembly up from the notebook.

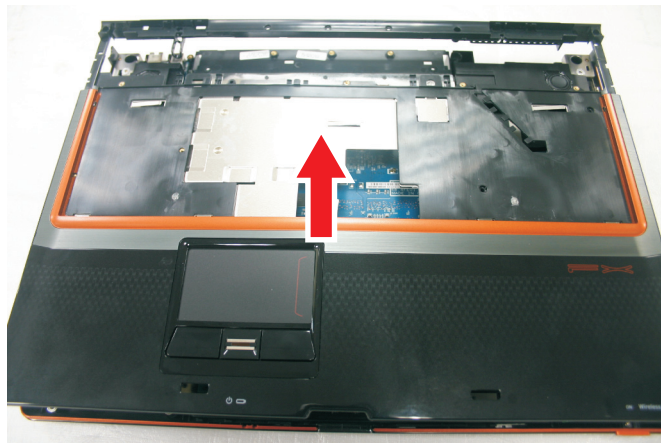

- 13 Remove the touchpad board from the old palm rest by following the instructions in [“Replacing the touchpad board” on page 108](#).
- 14 Remove the fingerprint reader from the old palm rest and install it on the new palm rest by following the instructions in [“Replacing the fingerprint reader” on page 115](#).
- 15 Install the touchpad button board on the new palm rest by following the instructions in [“Replacing the touchpad board” on page 108](#).
- 16 Install the touchpad board on the new palm rest by following the instructions in [“Replacing the touchpad board” on page 108](#).
- 17 Place the new palm rest assembly onto the notebook, then snap the assembly into place.
- 18 Replace the screws removed in [Step 11](#).
- 19 Make sure the brown touchpad connector clip is fully moved to the back of the notebook, insert the cable into the connector, then slide the brown connector clip toward the front to lock the cable in place.
- 20 Turn the notebook over so the bottom is facing up.
- 21 Replace the screws removed in [Step 9](#).

- 22 Replace the LCD assembly by following the steps in [“Replacing the LCD assembly” on page 90](#).
- 23 Replace the keyboard by following the steps in [“Replacing the keyboard” on page 78](#).
- 24 Replace the keyboard cover by following the steps in [“Replacing the keyboard cover” on page 75](#).
- 25 Replace the hard drive by following the steps in [“Replacing the hard drive” on page 69](#).
- 26 If the notebook has wireless networking built in, reconnect the wireless antennas by following the steps in [“Replacing the IEEE 802.11 wireless card” on page 65](#).
- 27 Replace the wireless bay cover by following the steps in [“Replacing the IEEE 802.11 wireless card” on page 65](#).







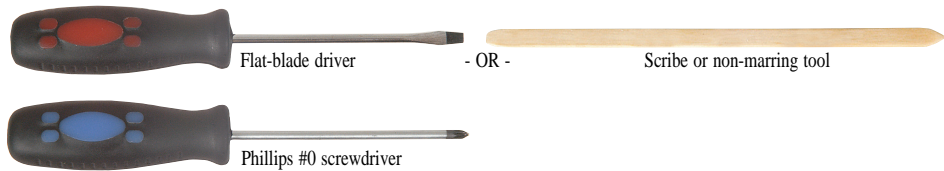



■

Replacing the touchpad board

Tools you need to complete this task:



Screws removed during this task:

-  2 black M2.5×3 (Keyboard cover)
-  6 black M2.5×8 (LCD front panel)
-  3 black M2.5×3 (Keyboard)
-  2 long black (Keyboard)
-  2 black M2.5×8 (Hinge bottom)
-  2 black M2.5×8 (Hinge top)
-  8 black M2.5×8 (Palm rest-bottom)
-  6 black M2.5×8 (Palm rest-top)
-  3 black M2.5×5 (Palm rest-top)
-  4 black M2.5×3 (Touchpad board bracket)
-  2 chrome M2×3 (Touchpad button board bracket)

► To replace the touchpad board:

- 1 Complete the steps in [“Preparing the notebook”](#) on page 57.
- 2 If the notebook has wireless networking built in, unplug the wireless antennas by following the steps in [“Replacing the IEEE 802.11 wireless card”](#) on page 65.
- 3 Remove the hard drive by following the steps in [“Replacing the hard drive”](#) on page 69.
- 4 Remove the keyboard cover by following the steps in [“Replacing the keyboard cover”](#) on page 75.
- 5 Remove the keyboard by following the steps in [“Replacing the keyboard”](#) on page 78.
- 6 Remove the LCD assembly by following the steps in [“Replacing the LCD assembly”](#) on page 90.
- 7 Remove the palm rest by following the steps in [“Replacing the palm rest”](#) on page 104.
- 8 Turn the palm rest over so the back side is facing up.

9 Remove the screws from the touchpad board bracket.

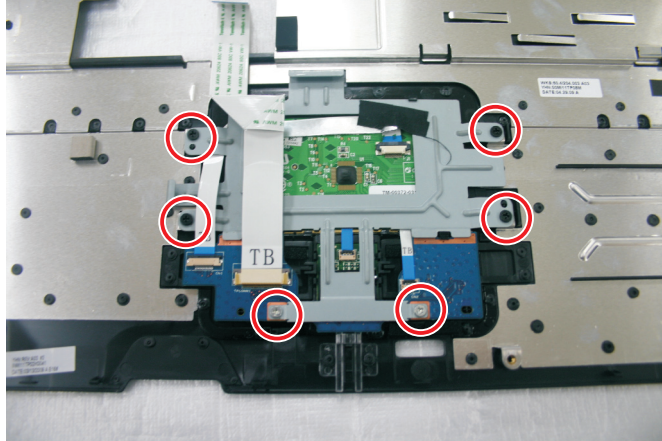

10 Remove any tape on top of the cable.

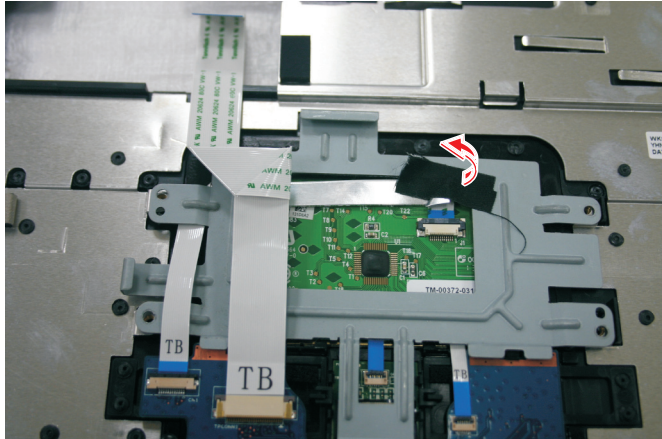

11 Swing the brown touchpad connector clip upward, then lift the cable out of the connector. Be careful not to touch or damage any other components.

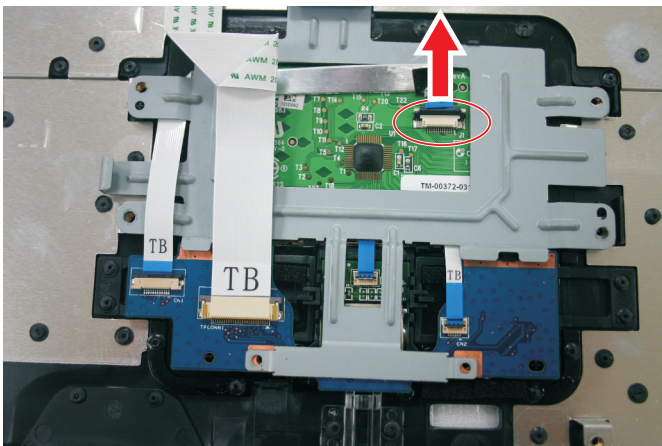

- 12 Remove the touchpad board bracket from the notebook.

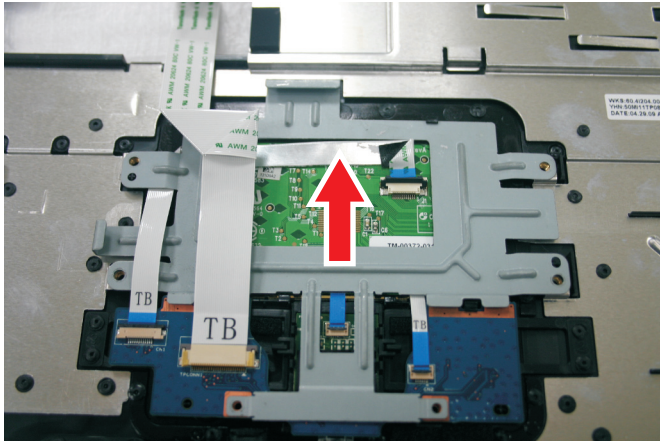

- 13 Remove the touchpad board from the notebook.

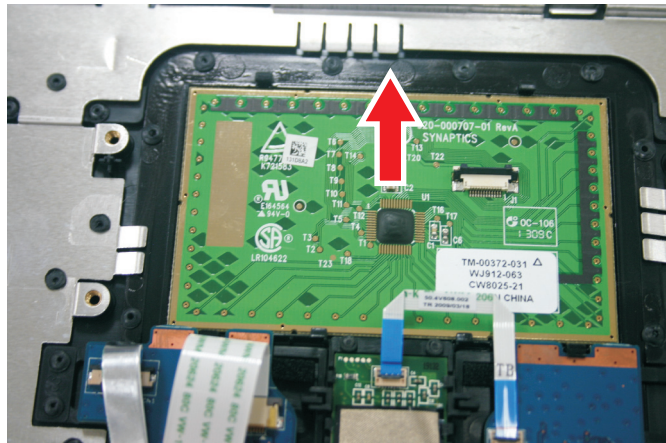

- 14 Place the new touchpad board into the notebook in the same orientation as the old board.
- 15 Replace the screws removed in [Step 9](#).
- 16 Make sure the brown touchpad connector clip is up, insert the cable into the connector, then swing the clip down to lock the connector in place.



Important

The touchpad cable is correctly oriented if the blue side is showing.

- 17 Replace the palm rest by following the steps in [“Replacing the palm rest” on page 104](#).
- 18 Replace the LCD assembly by following the steps in [“Replacing the LCD assembly” on page 90](#).
- 19 Replace the keyboard by following the steps in [“Replacing the keyboard” on page 78](#).
- 20 Replace the keyboard cover by following the steps in [“Replacing the keyboard cover” on page 75](#).
- 21 Replace the hard drive by following the steps in [“Replacing the hard drive” on page 69](#).







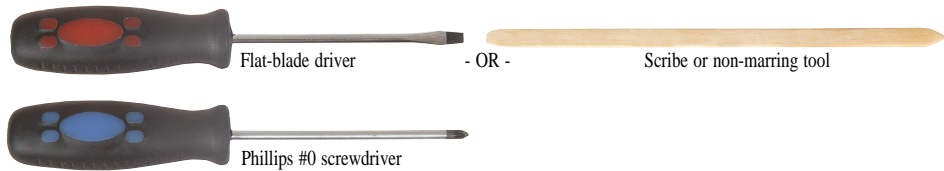



- 22 If the notebook has wireless networking built in, reconnect the wireless antennas by following the steps in [“Replacing the IEEE 802.11 wireless card”](#) on page 65.
- 23 Replace the wireless bay cover by following the steps in [“Replacing the IEEE 802.11 wireless card”](#) on page 65.
 -

Replacing the touchpad button board

Tools you need to complete this task:



Screws removed during this task:

-  2 black M2.5×3 (Keyboard cover)
-  6 black M2.5×8 (LCD front panel)
-  3 black M2.5×3 (Keyboard)
-  2 long black (Keyboard)
-  2 black M2.5×8 (Hinge bottom)
-  2 black M2.5×8 (Hinge top)
-  8 black M2.5×8 (Palm rest-bottom)
-  6 black M2.5×8 (Palm rest-top)
-  3 black M2.5×5 (Palm rest-top)
-  4 black M2.5×3 (Touchpad board bracket)
-  2 chrome M2×3 (Touchpad button board bracket)

► To replace the touchpad button board:

- 1 Complete the steps in [“Preparing the notebook” on page 57](#).
- 2 If the notebook has wireless networking built in, unplug the wireless antennas by following the steps in [“Replacing the IEEE 802.11 wireless card” on page 65](#).
- 3 Remove the hard drive by following the steps in [“Replacing the hard drive” on page 69](#).
- 4 Remove the keyboard cover by following the steps in [“Replacing the keyboard cover” on page 75](#).
- 5 Remove the keyboard by following the steps in [“Replacing the keyboard” on page 78](#).
- 6 Remove the LCD assembly by following the steps in [“Replacing the LCD assembly” on page 90](#).
- 7 Remove the palm rest by following the steps in [“Replacing the palm rest” on page 104](#).
- 8 Remove the touchpad board bracket by following the steps in [“Replacing the touchpad board” on page 108](#).

- Swing the black fingerprint reader connector clip upward, then lift the cable out of the connector. Be careful not to touch or damage any other components.

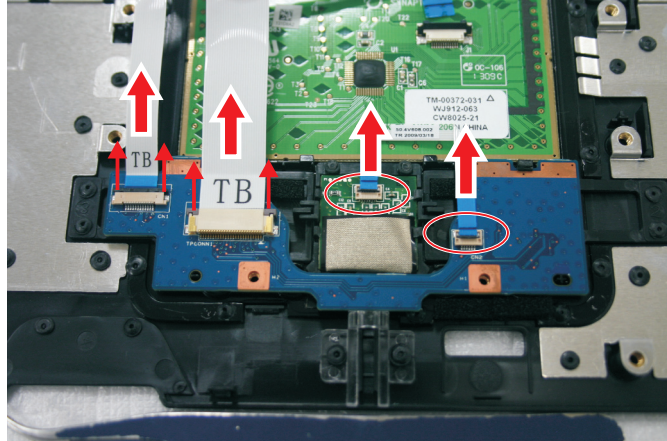

- Release from the latches and remove the touchpad button board from the palm rest.

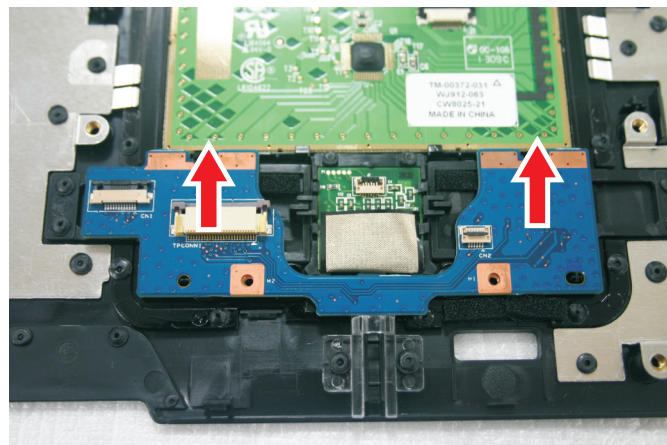

- Place the new touchpad button board into the notebook in the same orientation as the old board.
- Replace the touchpad board bracket by following the steps in [“Replacing the touchpad board” on page 108](#).
- Transfer all of the ribbon cables from the old touchpad button board to the new board.

✓ Important
The cables are correctly oriented if the blue sides are showing.

- Make sure the black fingerprint reader connector clip is up, insert the cable into the connector, then swing the clip down to lock the connector in place.

✓ Important
The touchpad cable is correctly oriented if the blue side is showing.

- Replace the palm rest by following the steps in [“Replacing the palm rest” on page 104](#).
- Replace the LCD assembly by following the steps in [“Replacing the LCD assembly” on page 90](#).







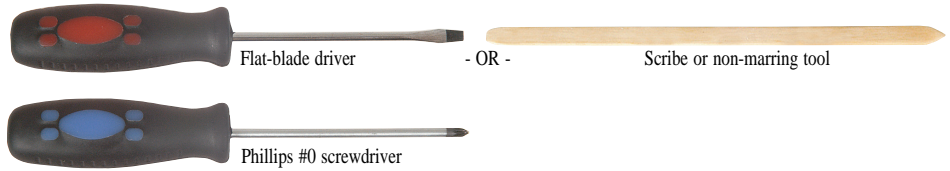



- 17 Replace the keyboard by following the steps in [“Replacing the keyboard”](#) on page 78.
- 18 Replace the keyboard cover by following the steps in [“Replacing the keyboard cover”](#) on page 75.
- 19 Replace the hard drive by following the steps in [“Replacing the hard drive”](#) on page 69.
- 20 If the notebook has wireless networking built in, reconnect the wireless antennas by following the steps in [“Replacing the IEEE 802.11 wireless card”](#) on page 65.
- 21 Replace the wireless bay cover by following the steps in [“Replacing the IEEE 802.11 wireless card”](#) on page 65.
■

Replacing the fingerprint reader

Tools you need to complete this task:



Screws removed during this task:

-  2 black M2.5×3 (Keyboard cover)
-  6 black M2.5×8 (LCD front panel)
-  3 black M2.5×3 (Keyboard)
-  2 long black (Keyboard)
-  2 black M2.5×8 (Hinge bottom)
-  2 black M2.5×8 (Hinge top)
-  8 black M2.5×8 (Palm rest-bottom)
-  6 black M2.5×8 (Palm rest-top)
-  3 black M2.5×5 (Palm rest-top)
-  4 black M2.5×3 (Touchpad board bracket)
-  2 chrome M2×3 (Touchpad button board bracket)

► To replace the fingerprint reader:

- 1 Complete the steps in [“Preparing the notebook” on page 57.](#)
- 2 If the notebook has wireless networking built in, unplug the wireless antennas by following the steps in [“Replacing the IEEE 802.11 wireless card” on page 65.](#)
- 3 Remove the hard drive by following the steps in [“Replacing the hard drive” on page 69.](#)
- 4 Remove the keyboard cover by following the steps in [“Replacing the keyboard cover” on page 75.](#)
- 5 Remove the keyboard by following the steps in [“Replacing the keyboard” on page 78.](#)
- 6 Remove the LCD assembly by following the steps in [“Replacing the LCD assembly” on page 90.](#)
- 7 Remove the palm rest by following the steps in [“Replacing the palm rest” on page 104.](#)
- 8 Remove the touchpad board bracket by following the steps in [“Replacing the touchpad board” on page 108.](#)

- 9 Release from the latches and remove the fingerprint reader from the palm rest.

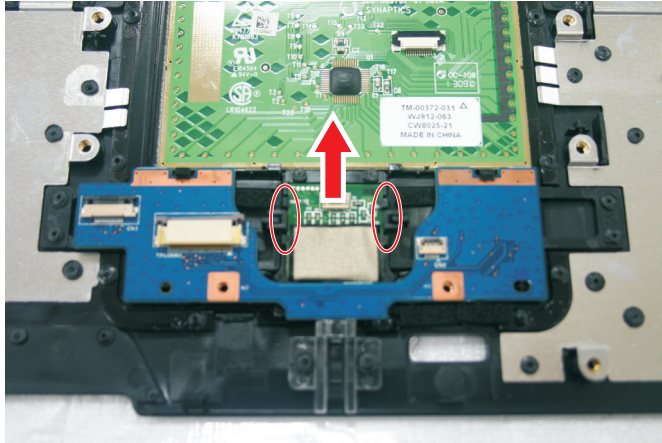

- 10 Place the new fingerprint reader into the notebook in the same orientation as the old reader.
- 11 Replace the touchpad button board by following the steps in [“Replacing the touchpad button board” on page 112.](#)
- 12 Replace the touchpad board by following the steps in [“Replacing the touchpad board” on page 108.](#)
- 13 Replace the palm rest by following the steps in [“Replacing the palm rest” on page 104.](#)
- 14 Replace the LCD assembly by following the steps in [“Replacing the LCD assembly” on page 90.](#)
- 15 Replace the keyboard by following the steps in [“Replacing the keyboard” on page 78.](#)
- 16 Replace the keyboard cover by following the steps in [“Replacing the keyboard cover” on page 75.](#)
- 17 Replace the hard drive by following the steps in [“Replacing the hard drive” on page 69.](#)
- 18 If the notebook has wireless networking built in, reconnect the wireless antennas by following the steps in [“Replacing the IEEE 802.11 wireless card” on page 65.](#)
- 19 Replace the wireless bay cover by following the steps in [“Replacing the IEEE 802.11 wireless card” on page 65.](#)







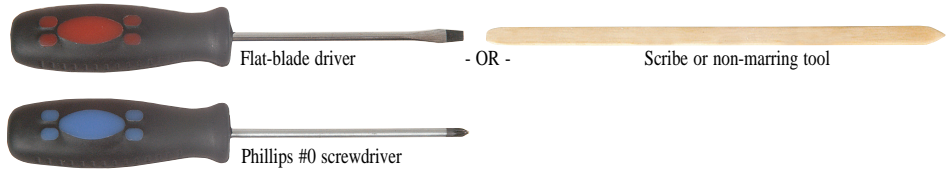

■

Replacing the Bluetooth module

Tools you need to complete this task:



Screws removed during this task:

-  2 black M2.5×3 (Keyboard cover)
-  6 black M2.5×8 (LCD front panel)
-  3 black M2.5×3 (Keyboard)
-  2 long black (Keyboard)
-  2 black M2.5×8 (Hinge bottom)
-  2 black M2.5×8 (Hinge top)
-  8 black M2.5×8 (Palm rest-bottom)
-  6 black M2.5×8 (Palm rest-top)
-  3 black M2.5×5 (Palm rest-top)

► To replace the Bluetooth module:

- 1 Complete the steps in [“Preparing the notebook” on page 57](#).
- 2 If the notebook has wireless networking built in, unplug the wireless antennas by following the steps in [“Replacing the IEEE 802.11 wireless card” on page 65](#).
- 3 Remove the hard drive by following the steps in [“Replacing the hard drive” on page 69](#).
- 4 Remove the keyboard cover by following the steps in [“Replacing the keyboard cover” on page 75](#).
- 5 Remove the keyboard by following the steps in [“Replacing the keyboard” on page 78](#).
- 6 Remove the LCD assembly by following the steps in [“Replacing the LCD assembly” on page 90](#).
- 7 Remove the palm rest by following the steps in [“Replacing the palm rest” on page 104](#).

- 8 Disconnect the cable and remove the old Bluetooth module from the notebook.

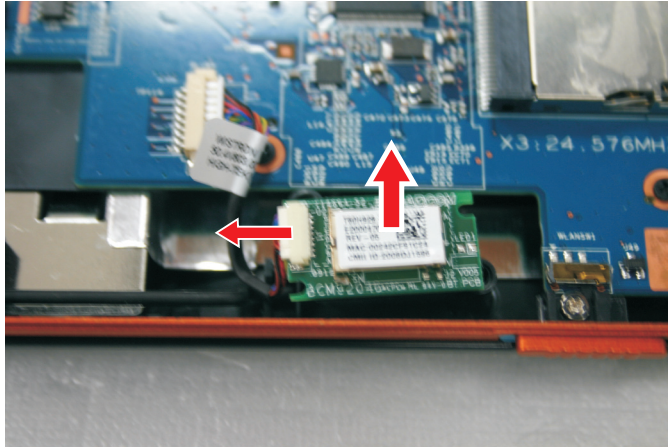

Important

The Bluetooth module is glued to a foam. Only remove the Bluetooth module if it is defective. Remember to glue the new Bluetooth module to the foam.

- 9 Connect the cable to the new Bluetooth module.
- 10 Place the new Bluetooth module into the notebook.
- 11 Replace the palm rest by following the steps in [“Replacing the palm rest” on page 104.](#)
- 12 Replace the LCD assembly by following the steps in [“Replacing the LCD assembly” on page 90.](#)
- 13 Replace the keyboard by following the steps in [“Replacing the keyboard” on page 78.](#)
- 14 Replace the keyboard cover by following the steps in [“Replacing the keyboard cover” on page 75.](#)
- 15 Replace the hard drive by following the steps in [“Replacing the hard drive” on page 69.](#)
- 16 If the notebook has wireless networking built in, reconnect the wireless antennas by following the steps in [“Replacing the IEEE 802.11 wireless card” on page 65.](#)
- 17 Replace the wireless bay cover by following the steps in [“Replacing the IEEE 802.11 wireless card” on page 65.](#)







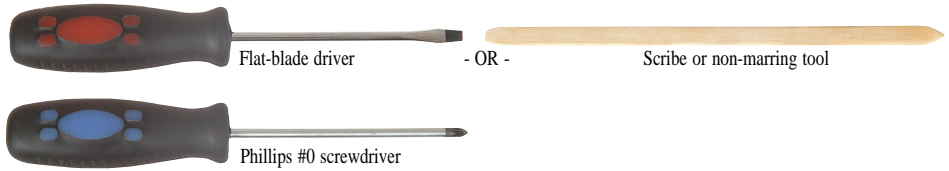





Replacing the modem

Tools you need to complete this task:



Screws removed during this task:

-  2 black M2.5×3 (Keyboard cover)
-  6 black M2.5×8 (LCD front panel)
-  3 black M2.5×3 (Keyboard)
-  2 long black (Keyboard)
-  2 black M2.5×8 (Hinge bottom)
-  2 black M2.5×8 (Hinge top)
-  8 black M2.5×8 (Palm rest-bottom)
-  6 black M2.5×8 (Palm rest-top)
-  3 black M2.5×5 (Palm rest-top)
-  2 black M2×3 (Modem)

► To replace the modem:

- 1 Complete the steps in [“Preparing the notebook” on page 57](#).
- 2 If the notebook has wireless networking built in, unplug the wireless antennas by following the steps in [“Replacing the IEEE 802.11 wireless card” on page 65](#).
- 3 Remove the hard drive by following the steps in [“Replacing the hard drive” on page 69](#).
- 4 Remove the keyboard cover by following the steps in [“Replacing the keyboard cover” on page 75](#).
- 5 Remove the keyboard by following the steps in [“Replacing the keyboard” on page 78](#).
- 6 Remove the LCD assembly by following the steps in [“Replacing the LCD assembly” on page 90](#).
- 7 Remove the palm rest by following the steps in [“Replacing the palm rest” on page 104](#).

- 8 Remove the screws securing the modem to the system board.

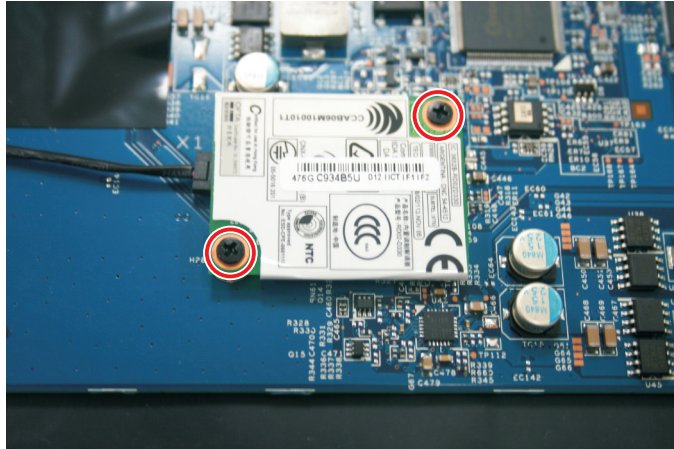

- 9 Disconnect the modem cable from the old modem and connect the cable into the new modem.

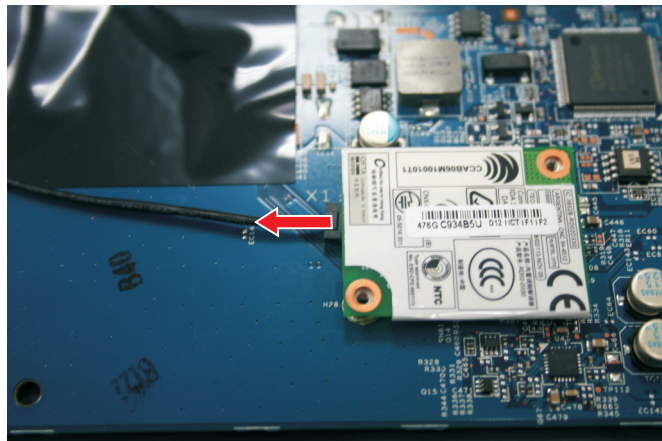

- 10 Lift the modem off of the system board.

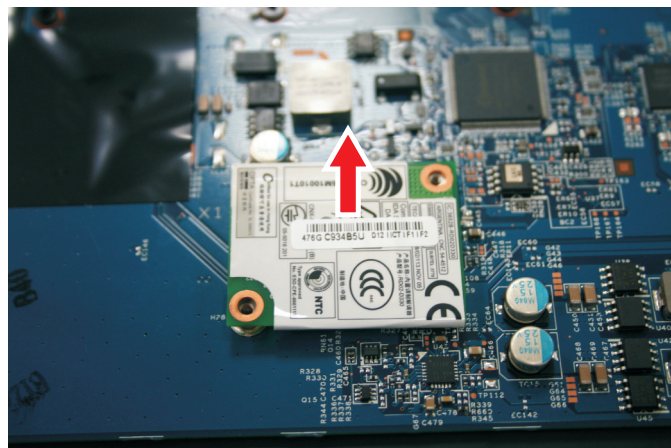







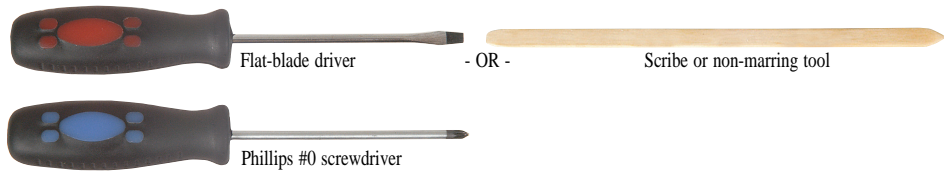



- 11 Install the new modem on the system board.
- 12 Replace the screws remove in [Step 8](#).
- 13 Replace the palm rest by following the steps in [“Replacing the palm rest” on page 104](#).
- 14 Replace the LCD assembly by following the steps in [“Replacing the LCD assembly” on page 90](#).
- 15 Replace the keyboard by following the steps in [“Replacing the keyboard” on page 78](#).
- 16 Replace the keyboard cover by following the steps in [“Replacing the keyboard cover” on page 75](#).
- 17 Replace the hard drive by following the steps in [“Replacing the hard drive” on page 69](#).
- 18 If the notebook has wireless networking built in, reconnect the wireless antennas by following the steps in [“Replacing the IEEE 802.11 wireless card” on page 65](#).
- 19 Replace the wireless bay cover by following the steps in [“Replacing the IEEE 802.11 wireless card” on page 65](#).
■

Replacing the speakers

Tools you need to complete this task:



Screws removed during this task:

-  2 black M2.5×3 (Keyboard cover)
-  6 black M2.5×8 (LCD front panel)
-  3 black M2.5×3 (Keyboard)
-  2 long black (Keyboard)
-  2 black M2.5×8 (Hinge bottom)
-  2 black M2.5×8 (Hinge top)
-  8 black M2.5×8 (Palm rest-bottom)
-  6 black M2.5×8 (Palm rest-top)
-  3 black M2.5×5 (Palm rest-top)
-  1 black M2.5×3 (Right speaker)
-  2 black M2.5×3 (Left speaker)

► To replace the speakers:

- 1 Complete the steps in [“Preparing the notebook”](#) on page 57.
- 2 If the notebook has wireless networking built in, unplug the wireless antennas by following the steps in [“Replacing the IEEE 802.11 wireless card”](#) on page 65.
- 3 Remove the hard drive by following the steps in [“Replacing the hard drive”](#) on page 69.
- 4 Remove the keyboard cover by following the steps in [“Replacing the keyboard cover”](#) on page 75.
- 5 Remove the keyboard by following the steps in [“Replacing the keyboard”](#) on page 78.
- 6 Remove the LCD assembly by following the steps in [“Replacing the LCD assembly”](#) on page 90.
- 7 Remove the palm rest by following the steps in [“Replacing the palm rest”](#) on page 104.

- 8 Disconnect the old speaker cable from the system board.

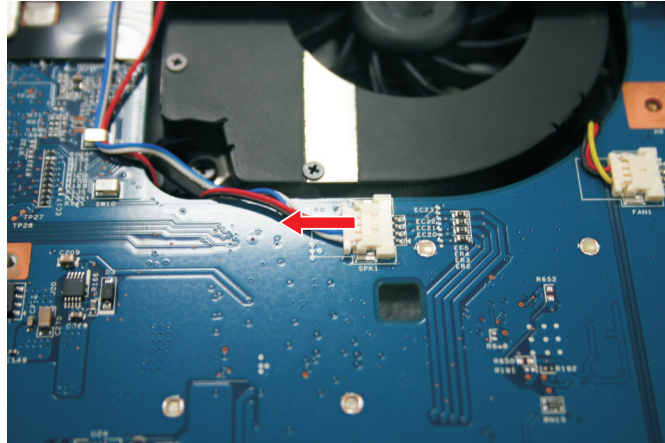

- 9 Remove the speaker screws.

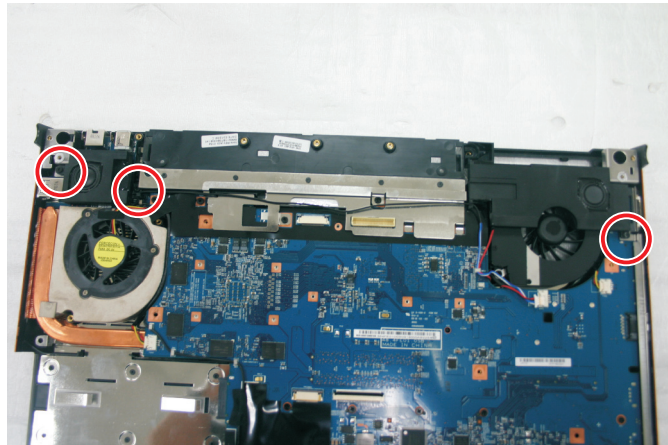

- 10 Lift the old speakers from the notebook.

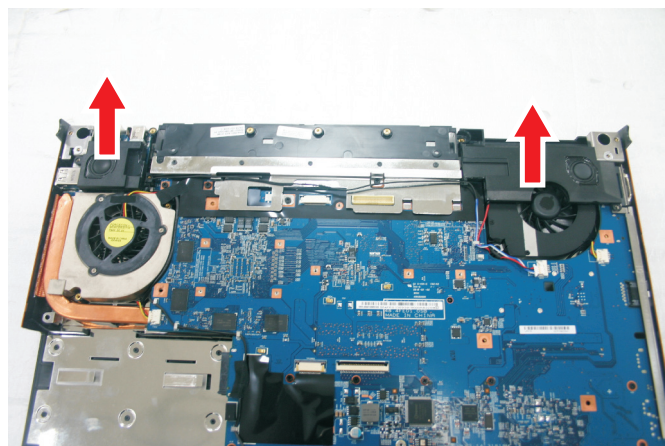

- 11 Set the new speakers into the notebook, then replace the screws removed in [Step 9](#).

- 12 Connect the cable to the system board.
- 13 Replace the palm rest by following the steps in [“Replacing the palm rest” on page 104](#).
- 14 Replace the LCD assembly by following the steps in [“Replacing the LCD assembly” on page 90](#).
- 15 Replace the keyboard by following the steps in [“Replacing the keyboard” on page 78](#).
- 16 Replace the keyboard cover by following the steps in [“Replacing the keyboard cover” on page 75](#).
- 17 Replace the hard drive by following the steps in [“Replacing the hard drive” on page 69](#).
- 18 If the notebook has wireless networking built in, reconnect the wireless antennas by following the steps in [“Replacing the IEEE 802.11 wireless card” on page 65](#).
- 19 Replace the wireless bay cover by following the steps in [“Replacing the IEEE 802.11 wireless card” on page 65](#).
■

Replacing the system board and VGA cooling assembly



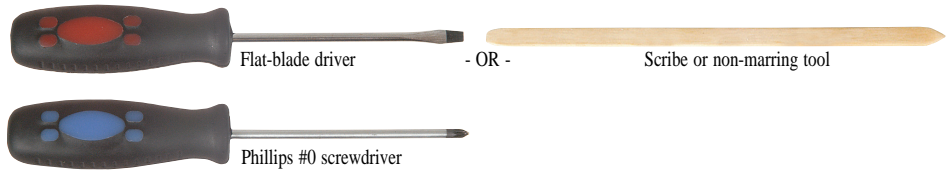











Tools you need to complete this task:



Additional materials you need to complete this task:

- X-23-7762 thermal grease

Screws removed during this task:

-  2 black M2×3 (IEEE 802.11 wireless card)
 -  1 black M2.5×5 (DVD drive)
 -  2 black M2.5×3 (Keyboard cover)
 -  6 black M2.5×8 (LCD front panel)
 -  3 black M2.5×3 (Keyboard)
 -  2 long black (Keyboard)
 -  2 black M2.5×8 (Hinge bottom)
 -  2 black M2.5×8 (Hinge top)
 -  8 black M2.5×8 (Palm rest-bottom)
 -  6 black M2.5×8 (Palm rest-top)
 -  3 black M2.5×5 (Palm rest-top)
 -  2 black M2×3 (Modem)
 -  1 black M2.5×3 (Right speaker)
 -  2 black M2.5×5 (EMI shield)
 -  4 black M2.5×5 (System board)
- To replace the system board and VGA cooling assembly:
- 1 Complete the steps in [“Preparing the notebook”](#) on page 57.
 - 2 Remove the memory from the old system board and install it on the new system board by following the instructions in [“Adding or replacing memory modules”](#) on page 58.
 - 3 Remove the cooling assembly by following the instructions in [“Replacing the IEEE 802.11 wireless card”](#) on page 65.

CHAPTER 3: Replacing notebook components

- 4 If your new system board does not include a processor, remove the processor from the old system board and install it on the new system board by following the instructions in [“Replacing the processor” on page 63](#).
- 5 Remove the optional IEEE 802.11 wireless card from the old system board and install it on the new system board by following the instructions in [“Replacing the IEEE 802.11 wireless card” on page 65](#).
- 6 Remove the hard drive by following the instructions in [“Replacing the hard drive” on page 69](#).
- 7 Remove the DVD drive by following the instructions in [“Replacing the optical drive” on page 73](#).
- 8 Remove the keyboard cover by following the steps in [“Replacing the keyboard cover” on page 75](#).
- 9 Remove the keyboard by following the steps in [“Replacing the keyboard” on page 78](#).
- 10 Remove the LCD assembly by following the steps in [“Replacing the LCD assembly” on page 90](#).
- 11 Remove the palm rest by following the steps in [“Replacing the palm rest” on page 104](#).
- 12 Unplug the Bluetooth module from the system board (one connector).

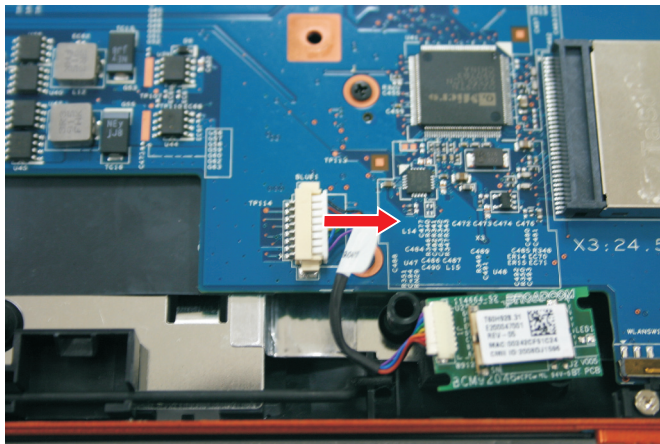

- 13 Unplug the speakers from the system board (one connector).

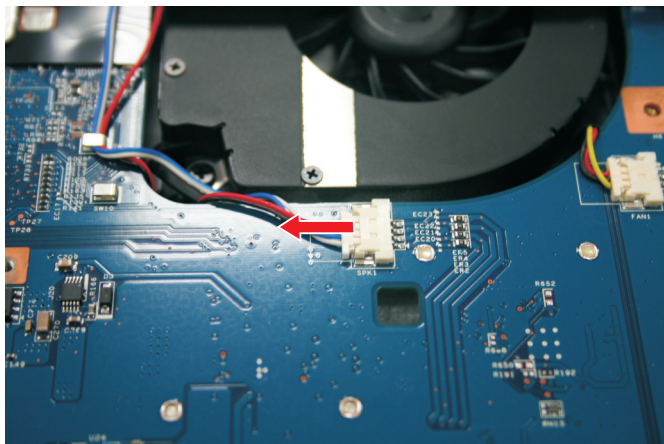

- 14 Remove the modem by following the instructions in [“Replacing the modem”](#) on page 119.
- 15 Remove the modem cable from the system board retaining clips.

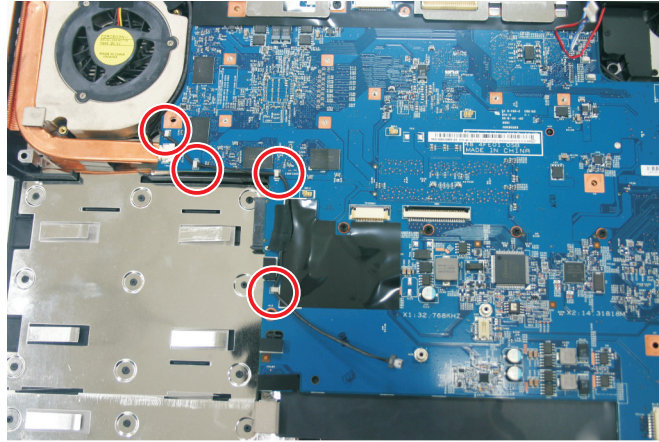

Important

Remove any tape securing the cable to the system board. Remember to replace the tape when routing the cable back to the system board.

- 16 Remove the screw holding the right speaker to the notebook, then remove the speaker.

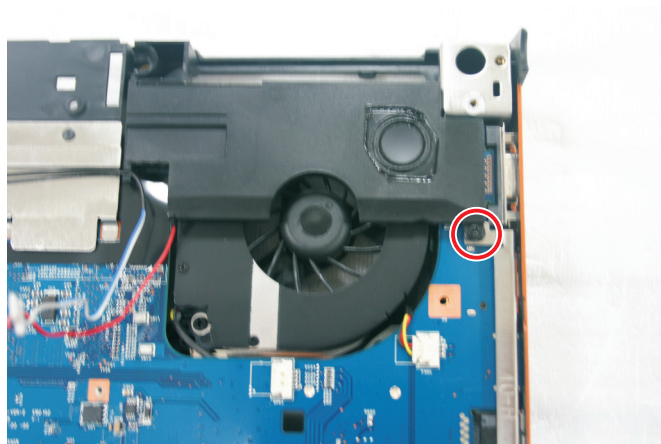

- 17 Unplug the fan(s) from the system board.

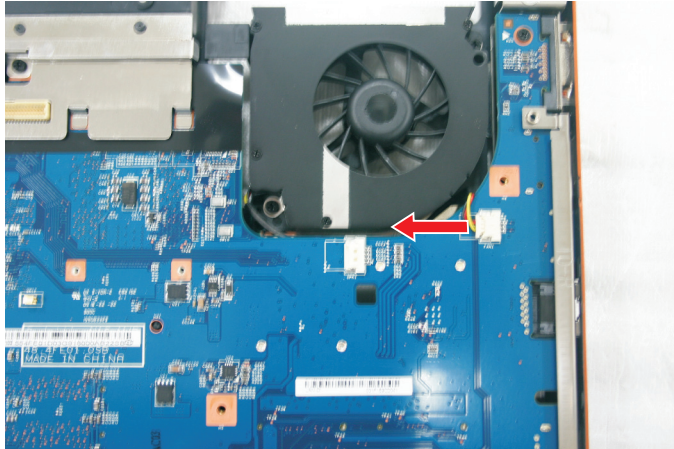

- 18 Remove the EMI shield screws. Then remove the EMI shield.

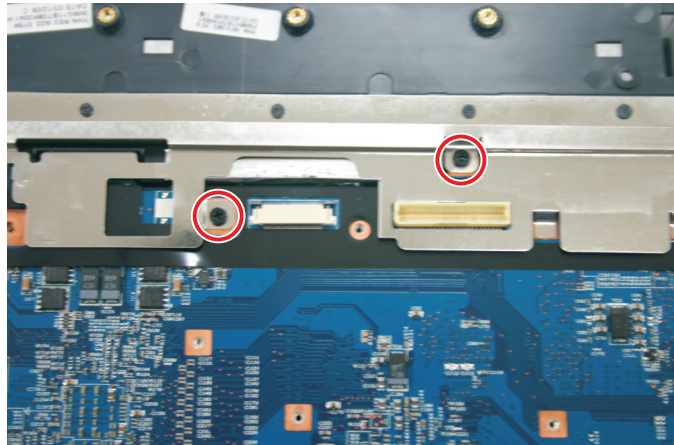

- 19 Remove the system board screws.

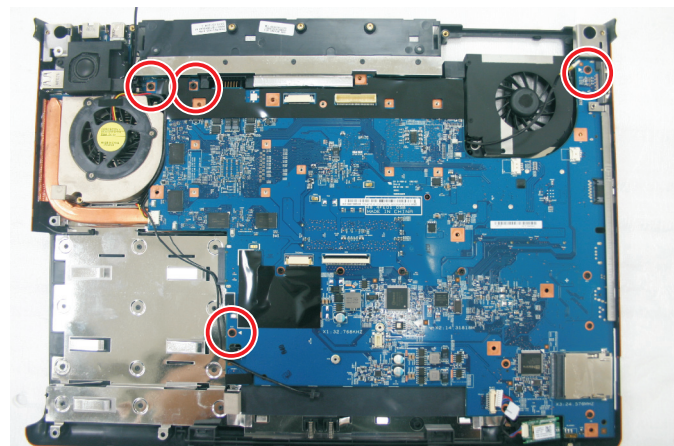

20 Carefully remove the system board.

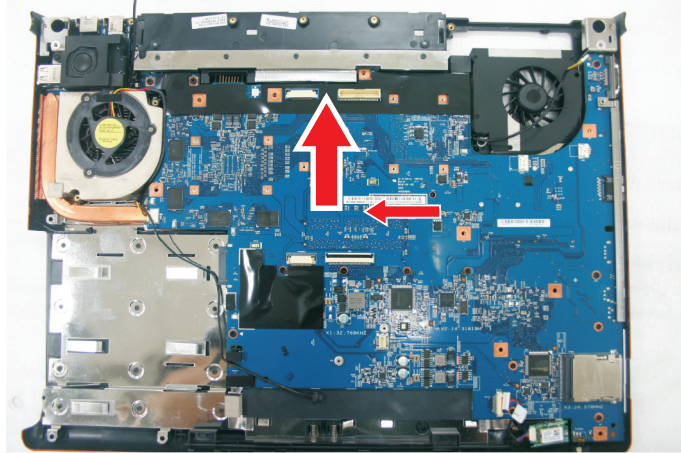

21 Disconnect the VGA cooling assembly cable from the system board.

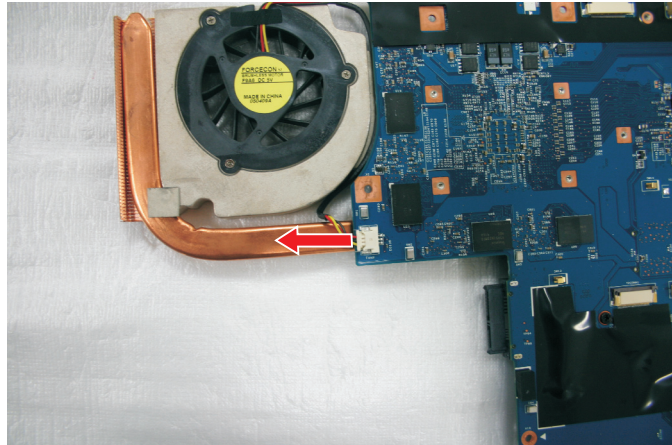

22 Turn the old system board over, then remove the VGA cooling assembly from the system board by loosening the captive screws in the order shown.

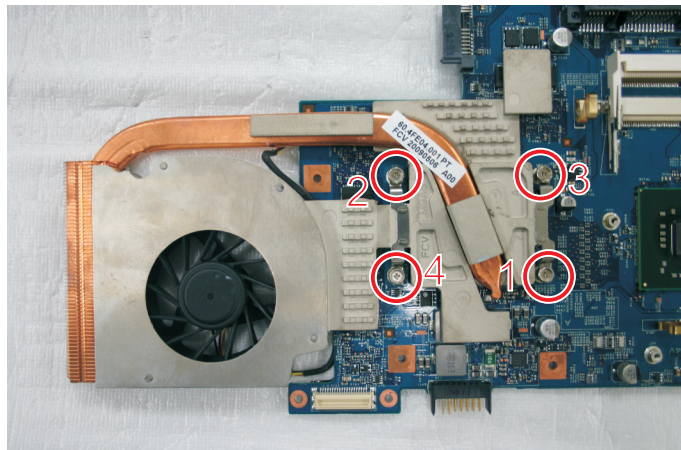

CHAPTER 3: Replacing notebook components

- 23 Remove any thermal grease residue from the second cooling assembly using a soft cloth and isopropyl alcohol.
- 24 Place thermal grease on the new system board's graphics processor. Use only enough to cover the processor die.
- 25 Replace the VGA cooling assembly on the new system board.
- 26 Place the new system board into the notebook. Make sure that:
 - The small black switch on the system board fits within the slot on the wireless network on/off switch. If it does not, the wireless network may not work.

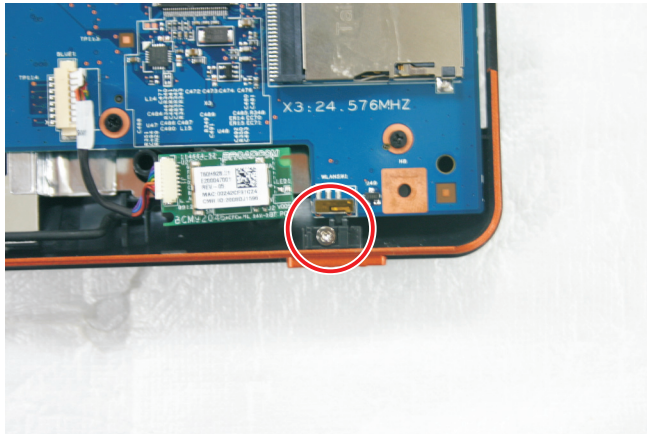

- The connector between this board and the modem jack/USB board is fully connected.

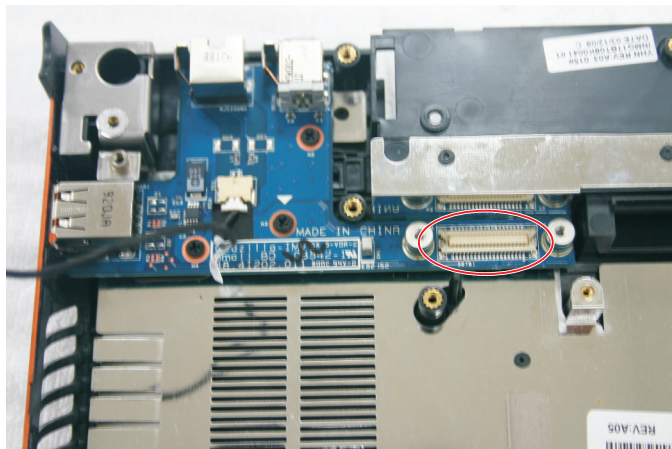

- 27 Replace the system board screws in the holes on the top of the system board removed in [Step 19](#).
- 28 Replace the modem cable into the system board retaining clips.
- 29 Replace the modem by following the instructions in [“Replacing the modem” on page 119](#).
- 30 Connect the Bluetooth module to the system board.
- 31 Connect the fan into the system board,
- 32 Replace the palm rest by following the steps in [“Replacing the palm rest” on page 104](#).

- 33 Replace the LCD assembly by following the steps in [“Replacing the LCD assembly” on page 90](#).
- 34 Replace the keyboard by following the steps in [“Replacing the keyboard” on page 78](#).
- 35 Replace the keyboard cover by following the steps in [“Replacing the keyboard cover” on page 75](#).
- 36 Replace the DVD drive by following the instructions in [“Replacing the optical drive” on page 73](#).
- 37 Replace the hard drive by following the instructions in [“Replacing the hard drive” on page 69](#).
- 38 If the notebook has wireless networking built in, reconnect the wireless antennas by following the steps in [“Replacing the IEEE 802.11 wireless card” on page 65](#).
- 39 Replace the cooling assembly by following the instructions in [“Replacing the IEEE 802.11 wireless card” on page 65](#).

■

Replacing the modem jack/USB board



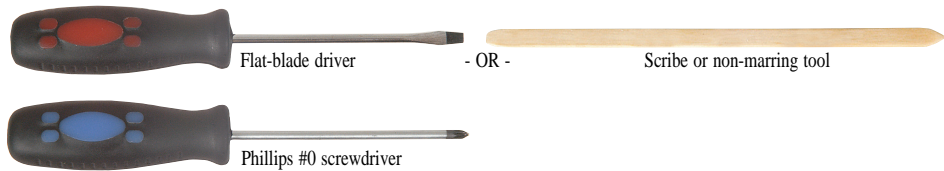













Tools you need to complete this task:



Additional materials you need to complete this task:

- X-23-7762 thermal grease

Screws removed during this task:

-  2 black M2×3 (IEEE 802.11 wireless card)
-  1 black M2.5×5 (DVD drive)
-  2 black M2.5×3 (Keyboard cover)
-  6 black M2.5×8 (LCD front panel)
-  3 black M2.5×3 (Keyboard)
-  2 long black (Keyboard)
-  2 black M2.5×8 (Hinge bottom)
-  2 black M2.5×8 (Hinge top)
-  8 black M2.5×8 (Palm rest-bottom)
-  6 black M2.5×8 (Palm rest-top)
-  3 black M2.5×5 (Palm rest-top)
-  2 black M2×3 (Modem)
-  2 black M2.5×3 (Left speaker)
-  1 black M2.5×3 (Right speaker)
-  2 black M2.5×5 (EMI shield)
-  4 black M2.5×5 (System board)
-  1 black M2.5×5 (Modem jack/USB board)

► To replace the modem jack/USB board:

- 1 Complete the steps in [“Preparing the notebook” on page 57](#).
- 2 Remove the cooling assembly by following the instructions in [“Replacing the IEEE 802.11 wireless card” on page 65](#).
- 3 If the notebook has wireless networking built in, unplug the wireless antennas by following the steps in [“Replacing the IEEE 802.11 wireless card” on page 65](#).

- 4 Remove the hard drive by following the instructions in “[Replacing the hard drive](#)” on page 69.
- 5 Remove the DVD drive by following the instructions in “[Replacing the optical drive](#)” on page 73.
- 6 Remove the keyboard cover by following the steps in “[Replacing the keyboard cover](#)” on page 75.
- 7 Remove the keyboard by following the steps in “[Replacing the keyboard](#)” on page 78.
- 8 Remove the LCD assembly by following the steps in “[Replacing the LCD assembly](#)” on page 90.
- 9 Remove the palm rest by following the steps in “[Replacing the palm rest](#)” on page 104.
- 10 Remove the speakers by following the steps in “[Replacing the speakers](#)” on page 122.
- 11 Remove the system board by following the steps in “[Replacing the system board and VGA cooling assembly](#)” on page 125.
- 12 Remove the modem jack/USB board screw.

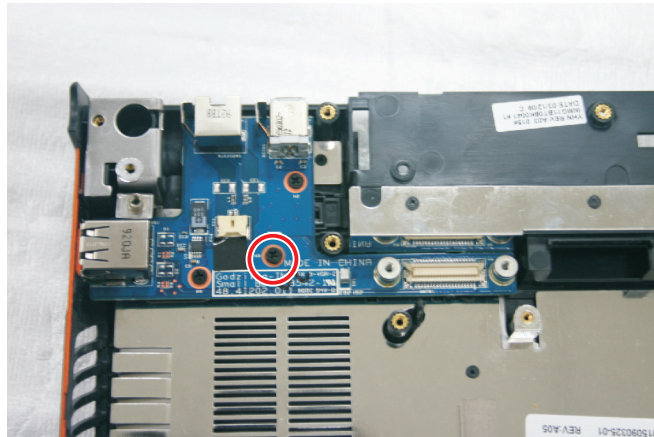

- 13 Lift the old modem jack/USB board from the notebook.

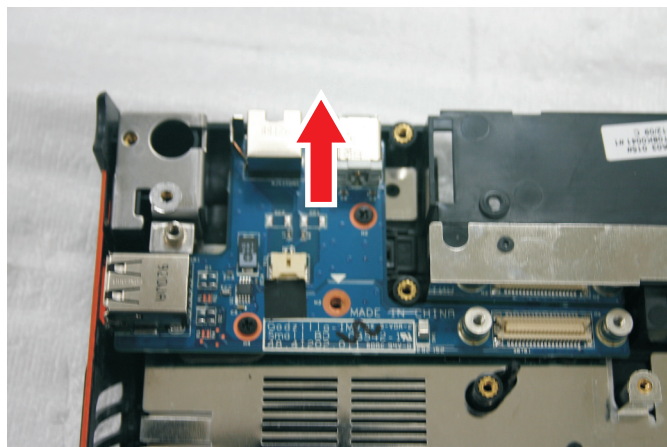

- 14 Set the new modem jack/USB board module into the notebook, then replace the screw removed in [Step 12](#).

- 15 Replace the system board by following the steps in [“Replacing the system board and VGA cooling assembly”](#) on page 125.
- 16 Replace the palm rest by following the steps in [“Replacing the palm rest”](#) on page 104.
- 17 Replace the speaker by following the steps in [“Replacing the speakers”](#) on page 122.
- 18 Replace the LCD assembly by following the steps in [“Replacing the LCD assembly”](#) on page 90.
- 19 Replace the keyboard by following the steps in [“Replacing the keyboard”](#) on page 78.
- 20 Replace the keyboard cover by following the steps in [“Replacing the keyboard cover”](#) on page 75.
- 21 Replace the DVD drive by following the instructions in [“Replacing the optical drive”](#) on page 73.
- 22 Replace the hard drive by following the instructions in [“Replacing the hard drive”](#) on page 69.
- 23 If the notebook has wireless networking built in, reconnect the wireless antennas by following the steps in [“Replacing the IEEE 802.11 wireless card”](#) on page 65.
- 24 Replace the cooling assembly by following the instructions in [“Replacing the IEEE 802.11 wireless card”](#) on page 65.
 -

Replacing the fan(s)



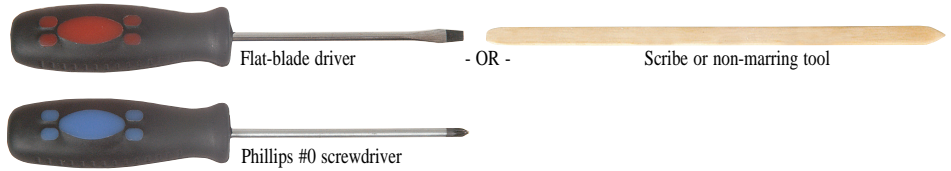













Tools you need to complete this task:



Additional materials you need to complete this task:

- X-23-7762 thermal grease

Screws removed during this task:

-  2 black M2×3 (IEEE 802.11 wireless card)
-  1 black M2.5×5 (DVD drive)
-  2 black M2.5×3 (Keyboard cover)
-  6 black M2.5×8 (LCD front panel)
-  3 black M2.5×3 (Keyboard)
-  2 long black (Keyboard)
-  2 black M2.5×8 (Hinge bottom)
-  2 black M2.5×8 (Hinge top)
-  8 black M2.5×8 (Palm rest-bottom)
-  6 black M2.5×8 (Palm rest-top)
-  3 black M2.5×5 (Palm rest-top)
-  2 black M2×3 (Modem)
-  1 black M2.5×3 (Right speaker)
-  2 black M2.5×5 (EMI shield)
-  4 black M2.5×5 (System board)
-  2 black M2.5×5 (Fans)

► To replace the fan(s):

- 1 Complete the steps in [“Preparing the notebook”](#) on page 57.
- 2 Remove the cooling assembly by following the instructions in [“Replacing the IEEE 802.11 wireless card”](#) on page 65.
- 3 If the notebook has wireless networking built in, unplug the wireless antennas by following the steps in [“Replacing the IEEE 802.11 wireless card”](#) on page 65.
- 4 Remove the hard drive by following the instructions in [“Replacing the hard drive”](#) on page 69.

- 5 Remove the DVD drive by following the steps in [“Replacing the optical drive”](#) on page 73.
- 6 Remove the keyboard cover by following the steps in [“Replacing the keyboard cover”](#) on page 75.
- 7 Remove the keyboard by following the steps in [“Replacing the keyboard”](#) on page 78.
- 8 Remove the LCD assembly by following the steps in [“Replacing the LCD assembly”](#) on page 90.
- 9 Remove the palm rest by following the steps in [“Replacing the palm rest”](#) on page 104.
- 10 Remove the system board by following the steps in [“Replacing the system board and VGA cooling assembly”](#) on page 125.
- 11 Remove the fan screws.

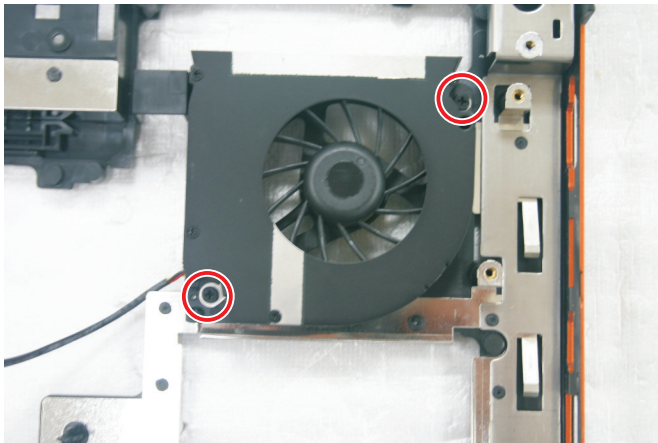

- 12 Lift the old fan from the system.

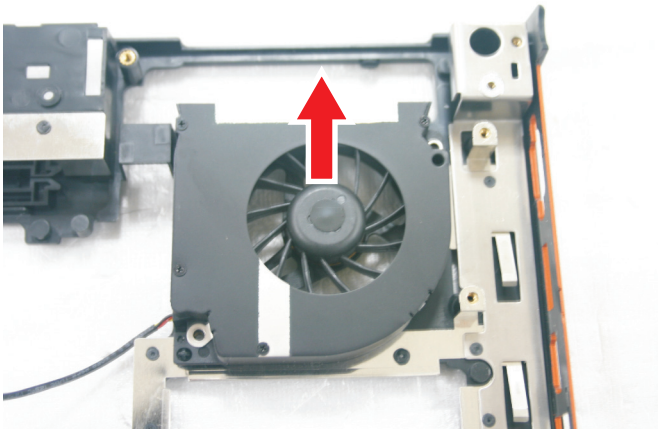

- 13 Set the new fan into the system, then replace the screws removed in [Step 11](#).
- 14 Replace the system board by following the steps in [“Replacing the system board and VGA cooling assembly”](#) on page 125.
- 15 Replace the palm rest by following the steps in [“Replacing the palm rest”](#) on page 104.

- 16 Replace the LCD assembly by following the steps in [“Replacing the LCD assembly” on page 90](#).
- 17 Replace the keyboard by following the steps in [“Replacing the keyboard” on page 78](#).
- 18 Replace the keyboard cover by following the steps in [“Replacing the keyboard cover” on page 75](#).
- 19 Replace the DVD drive by following the steps in [“Replacing the optical drive” on page 73](#).
- 20 Replace the hard drive by following the instructions in [“Replacing the hard drive” on page 69](#).
- 21 If the notebook has wireless networking built in, reconnect the wireless antennas by following the steps in [“Replacing the IEEE 802.11 wireless card” on page 65](#).
- 22 Replace the cooling assembly by following the instructions in [“Replacing the IEEE 802.11 wireless card” on page 65](#).

■

CHAPTER 4

Troubleshooting

- Diagnosing problems
- System test procedures
- Power-On Self-Test (POST) error message
- Index of error messages
- Phoenix BIOS beep codes
- Symptom-to-FRU error messages
- Intermittent problems
- Undetermined problems

Diagnosing problems

Use the following procedure as a guide for diagnosing notebook problems.



Important

The diagnostic tests are intended to test only Acer products. Non-Acer products, prototype cards, or modified options can give false errors and invalid system responses.

- 1 Obtain the failing symptoms in as much detail as possible.
- 2 Verify the symptoms by attempting to re-create the failure by running the diagnostic test or by repeating the same operation.
- 3 Use the following table with the verified symptom to determine which page to go to.

Symptoms (Verified)	Go To
Power failure. (The power indicator does not go on or stay on.)	“Testing the power system” on page 141
POST does not complete. No beep or error codes are indicated.	<ul style="list-style-type: none"> ▪ “Power-On Self-Test (POST) error message” on page 143 ▪ “Undetermined problems” on page 155
POST detects an error and displayed messages on screen.	“Index of error messages” on page 144
Other symptoms (LCD display problems or others).	“Power-On Self-Test (POST) error message” on page 143
Symptoms cannot be re-created (intermittent problems).	<ul style="list-style-type: none"> ▪ Use the customer-reported symptoms and go to “Power-On Self-Test (POST) error message” on page 143 ▪ “Intermittent problems” on page 155 ▪ “Undetermined problems” on page 155

System test procedures

Testing the optical drive

Use the following procedure to isolate a problem in an optical drive controller, driver, or drive.



Important

Make sure that the CD-ROM does not have any label attached to it. The label can cause damage to the drive or can cause the drive to fail.

- ▶ To test the optical drive:
 - 1 Boot from the diagnostics diskette and start the diagnostics program.
 - 2 Run the CD-ROM Test and see if the test completes successfully.
 - 3 Follow the instructions in the message window.
 - If an error occurs, reconnect the connector on the system board.
 - If the error still remains:
 - 4 Reconnect the external optical drive to a USB jack.
 - 5 Replace the external optical drive.

- 6 Replace the system board.



Testing the keyboard or auxiliary input device

If the internal keyboard does not work or an unexpected character appears, make sure that the flexible cable extending from the keyboard is correctly seated in the connector on the system board. If the keyboard cable is connected correctly, run the Keyboard Test.



Important

Disconnect any external keyboards before testing the built-in keyboard.

If the tests detect a keyboard problem, do the following one at a time.

► To correct the problem:

- 1 Reconnect the keyboard cable to the system board.
- 2 Replace the keyboard.
- 3 Replace the system board.



Important

Do not replace a non-defective FRU.

The following auxiliary input devices are supported by this notebook:

- Numeric keypad
- External keyboard

If any of these devices do not work, reconnect the cable connector and repeat the failing operation.

Testing the memory

Memory errors can stop your programs, show error messages on the screen, or hang the system.

► To test the memory:

- 1 Boot from the diagnostics diskette and start the diagnostics program.
- 2 Run the Memory Test and see if the test completes successfully.
- 3 Press F2 in the test items.
- 4 Follow the instructions in the message window.



Important

Make sure that each memory card is fully installed into the connector. A loose connection can cause an error.



Testing the power system

► To test for a power problem:

- Turn on the notebook using each of the following power sources:
 - Remove the battery pack, connect the power adapter, then make sure that the notebook turns on using AC power.
 - Disconnect the power adapter, install a charged battery pack, then make sure that power is supplied by the battery pack.



If you suspect a power problem, complete the appropriate power supply check:

- [“Check the power adapter” on page 142](#)
- [“Check the battery pack” on page 142](#)

Check the power adapter

Unplug the power adapter cable from the notebook and measure the output voltage at the power adapter cable plug. See the following figure.

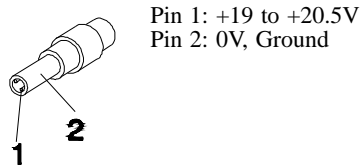

- If the voltage is not correct, replace the power adapter.
- If the voltage is within the range, do the following:
 - Replace the system board.
 - If the problem is not corrected, see [“Undetermined problems” on page 155](#).
 - If the voltage is not correct, go to [Step •](#).
 - If the power-on indicator does not light up, check the power adapter’s power cord for correct continuity and installation.
 - If the operational charge does not work, see [“Check the battery pack” on page 142](#).



Important

An audible noise from the power adapter does not always indicate a defect.

Check the battery pack

- ▶ To check the battery pack using software:
 - 1 Open Power Management in the Windows Control Panel.
 - 2 In Power Meter, make sure that the parameters shown for Current Power Source and Total Battery Power Remaining are correct.
 - 3 Repeat the steps 1 and 2, for both battery and adapter. This helps you identify first the problem is on recharging or discharging.
 -
- ▶ To check the battery pack using hardware:
 - 1 Turn off the notebook.
 - 2 Remove the battery pack and measure the voltage between battery terminals 1 (+) and 6 (ground).
 - 3 If the voltage is still less than 7.5 Vdc after recharging, replace the battery.
 -



Important

To check the battery charge operation, use a discharged battery pack or a battery pack that has less than 50% of the total power remaining when installed in the notebook.

If the battery status indicator does not light up, remove the battery pack and let it return to room temperature. Re-install the battery pack.

If the charge indicator still does not light up, replace the battery pack. If the charge indicator still does not light up, replace the DC/DC charger board.

Testing the touchpad

If the touchpad doesn't work, do the following actions one at a time to correct the problem.

- ▶ To test the touchpad:
 - 1 Reconnect the touchpad cables.
 - 2 Replace the touchpad.
 - 3 Replace the system board.
 -



Important

Do not replace a non-defective FRU.

After you use the touchpad, the pointer may drift on the screen for a short time. This self-acting pointer movement can occur when a slight, steady pressure is applied to the touchpad pointer. This symptom is not a hardware problem. No service actions are necessary if the pointer movement stops in a short period of time.

Power-On Self-Test (POST) error message

The POST error message index lists the error message and their possible causes. The most likely cause is listed first.



Important

Perform the FRU replacement or actions in the sequence shown in the FRU/Action column. If the FRU replacement does not solve the problem, put the original part back in the notebook. Do not replace a non-defective FRU.

This index can also help you determine the next possible FRU to be replaced when servicing a notebook.

If the symptom is not listed, see [“Undetermined problems” on page 155](#).

The following lists the error messages that the BIOS displays on the screen and the error symptoms classified by function.



Important

Most of the error messages occur during POST. Some of them display information about a hardware device, such as the amount of memory installed. Others may indicate a problem with a device, such as the way it has been configured.



Important

If the system fails after you make changes in the BIOS Setup Utility menus, reset the notebook, enter Setup, and install Setup defaults or correct the error.

Index of error messages

Error codes

Error Codes	Error Messages
006	Equipment Configuration Error Causes: 1. CPU BIOS Update Code Mismatch 2. IDE Primary Channel Master Drive Error (The causes are shown before “Equipment Configuration Error”)
010	Memory Error at xxxx:xxxx:xxxxh (R:xxxxh, W:xxxxh)
070	Real Time Clock Error
071	CMOS Battery Bad
072	CMOS Checksum Error
110	System is disabled. An incorrect password was entered.
<No error code>	Battery is critically low. In this situation BIOS issues four short beeps, then shuts the system down. No message is displayed.
<No error code>	Temperature is critically high. In this situation BIOS shuts the system down. No message is displayed.

Error messages

Error Messages	FRU/Action Sequence
Failure Fixed Disk	<ul style="list-style-type: none"> ▪ Reconnect the hard disk drive connector. ▪ Run “Load Setup Defaults” using the BIOS Setup Utility, then reboot the notebook. ▪ Test or replace the hard disk drive. ▪ Test or replace the system board.
Stuck Key	See “Testing the keyboard or auxiliary input device” on page 141.
Keyboard error	See “Testing the keyboard or auxiliary input device” on page 141.
Keyboard Controller Failed	See “Testing the keyboard or auxiliary input device” on page 141.
Keyboard locked - Unlock key switch	Unlock the external keyboard.
Monitor type does not match CMOS - Run Setup	Run “Load Setup Defaults” using the BIOS Setup Utility, then reboot the notebook.
Shadow RAM Failed at offset: nnnn	<ul style="list-style-type: none"> ▪ Test or replace the BIOS ROM. ▪ Test or replace the system board.
System RAM Failed at offset: nnnn	<ul style="list-style-type: none"> ▪ Test or replace the SO-DIMM. ▪ Test or replace the system board.
Extended RAM Failed at offset: nnnn	<ul style="list-style-type: none"> ▪ Test or replace the SO-DIMM. ▪ Test or replace the system board.

Error Messages	FRU/Action Sequence
System battery is dead - Replace and run Setup	Test or replace the CMOS battery, run the BIOS Setup Utility to reconfigure system time, then reboot the system.
System CMOS checksum bad - Default configuration used	Test or replace the CMOS battery, run the BIOS Setup Utility to reconfigure system time, then reboot the system.
System timer error	<ul style="list-style-type: none"> ▪ Test or replace the CMOS battery, run the BIOS Setup Utility to reconfigure system time, then reboot the system. ▪ Test or replace the system board.
Real time clock error	<ul style="list-style-type: none"> ▪ Test or replace the CMOS battery, run the BIOS Setup Utility to reconfigure system time, then reboot the system. ▪ Test or replace the system board.
Previous boot incomplete - Default configuration used	<ul style="list-style-type: none"> ▪ Run "Load Setup Defaults" using the BIOS Setup Utility, then reboot the notebook. ▪ Test or replace the CMOS battery, run the BIOS Setup Utility to reconfigure system time, then reboot the system. ▪ Test or replace the system board.
Memory size found by POST differed from CMOS	<ul style="list-style-type: none"> ▪ Run "Load Setup Defaults" using the BIOS Setup Utility, then reboot the notebook. ▪ Test or replace the SO-DIMM. ▪ Test or replace the system board.
Diskette drive A error	<ul style="list-style-type: none"> ▪ Make sure that the drive is defined with the proper diskette type in the BIOS Setup Utility.
Incorrect Drive A type - run SETUP	Make sure that the drive is defined with the proper diskette type in the BIOS Setup Utility
System cache error - Cache disabled	Test or replace the system board.
CPU ID:	Test or replace the system board.
DMA Test Failed	<ul style="list-style-type: none"> ▪ Test or replace the SO-DIMM. ▪ Test or replace the system board.
Software NMI Failed	<ul style="list-style-type: none"> ▪ Test or replace the SO-DIMM. ▪ Test or replace the system board.
Fail-Safe Timer NMI Failed	<ul style="list-style-type: none"> ▪ Test or replace the SO-DIMM. ▪ Test or replace the system board.
Device Address Conflict	<ul style="list-style-type: none"> ▪ Run "Load Setup Defaults" using the BIOS Setup Utility, then reboot the notebook. ▪ Test or replace the CMOS battery, run the BIOS Setup Utility to reconfigure system time, then reboot the system. ▪ Test or replace the system board.
Allocation Error for device	<ul style="list-style-type: none"> ▪ Run "Load Setup Defaults" using the BIOS Setup Utility, then reboot the notebook. ▪ Test or replace the CMOS battery, run the BIOS Setup Utility to reconfigure system time, then reboot the system. ▪ Test or replace the system board.
Failing Bits: nnnn	<ul style="list-style-type: none"> ▪ Test or replace the SO-DIMM. ▪ Test or replace the BIOS ROM. ▪ Test or replace the system board.
Fixed Disk n	None

Error Messages	FRU/Action Sequence
Invalid System Configuration Data	<ul style="list-style-type: none"> ▪ Test or replace the BIOS ROM. ▪ Test or replace the system board.
I/O device IRQ conflict	<ul style="list-style-type: none"> ▪ Run “Load Setup Defaults” using the BIOS Setup Utility, then reboot the notebook. ▪ Test or replace the CMOS battery, run the BIOS Setup Utility to reconfigure system time, then reboot the system. ▪ Test or replace the system board.
Operating system not found	<ul style="list-style-type: none"> ▪ Run the BIOS Setup Utility and see if fixed disk and drive A: are properly identified. ▪ Test or replace the diskette drive ▪ Test or replace the hard disk drive ▪ Test or replace the system board

No-beep error messages

No-beep Error Messages	FRU/Action in Sequence
No beep, power-on indicator turns off and LCD is blank.	<ul style="list-style-type: none"> ▪ Test the power source (battery pack and power adapter). See “Testing the power system” on page 141. ▪ Make sure that every connector is connected tightly and correctly. ▪ Reconnect the SO-DIMM. ▪ Test or replace the LED board. ▪ Test or replace the system board.
No beep, power-on indicator turns on and LCD is blank.	<ul style="list-style-type: none"> ▪ Test the power source (battery pack and power adapter). See “Testing the power system” on page 141. ▪ Reconnect the LCD connector ▪ Check the hard disk drive. ▪ Check the LCD inverter ID. ▪ Check the LCD cable. ▪ Test or replace the LCD inverter. ▪ Test or replace the LCD. ▪ Test or replace the system board.
No beep, power-on indicator turns on and LCD is blank. But you can see POST on an external CRT.	<ul style="list-style-type: none"> ▪ Reconnect the LCD connectors. ▪ Check the LCD inverter ID. ▪ Check the LCD cable. ▪ Test or replace the LCD inverter. ▪ Test or replace the LCD. ▪ Test or replace the system board.
No beep, power-on indicator turns on and a blinking cursor shown on LCD during POST.	<ul style="list-style-type: none"> ▪ Make sure that every connector is connected tightly and correctly. ▪ Test or replace the system board.
No beep during POST but system runs correctly.	<ul style="list-style-type: none"> ▪ Test or replace the speaker. ▪ Test or replace the system board.

Phoenix BIOS beep codes

Code	Beeps	POST Routine Description
02h		Verify Real Mode
03h		Disable Non-Maskable Interrupt (NMI)
04h		Get CPU type
06h		Initialize system hardware
08h		Initialize chipset with initial POST values
09h		Set IN POST flag
0Ah		Initialize CPU registers
0Bh		Enable CPU cache
0Ch		Initialize caches to initial POST values
0Eh		Initialize I/O component
0Fh		Initialize the local bus IDE
10h		Initialize Power Management
11h		Load alternate registers with initial POST values
12h		Restore CPU control word during warm boot
13h		Initialize PCI Bus Mastering devices
14h		Initialize keyboard controller
16h	1-2-2-3	BIOS ROM checksum
17h		Initialize cache before memory autosize
18h		8254 timer initialization
1Ah		8237 DMA controller initialization
1Ch		Reset Programmable Interrupt Controller
20h	1-3-1-1	Test DRAM refresh
22h	1-3-1-3	Test 8742 Keyboard Controller
24h		Set ES segment register to 4 GB
26h		Enable A20 line
28h		Autosize DRAM
29h		Initialize POST Memory Manager
2Ah		Clear 215 KB base RAM
2Ch	1-3-4-1	RAM failure on address line xxxx

CHAPTER 4: Troubleshooting

Code	Beeps	POST Routine Description
2Eh	1-3-4-3	RAM failure on data bits xxxx of low byte of memory bus
2Fh		Enable cache before system BIOS shadow
30h	1-4-1-1	RAM failure on data bits xxxx of high byte of memory bus
32h		Test CPU bus-clock frequency
33h		Initialize Phoenix Dispatch Manager
36h		Warm start shut down
38h		Shadow system BIOS ROM
3Ah		Autosize cache
3Ch		Advanced configuration of chipset registers
3Dh		Load alternate registers with CMOS values
42h		Initialize interrupt vectors
45h		POST device initialization
46h	2-1-2-3	Check ROM copyright notice
48h		Check video configuration against CMOS
49h		Initialize PCI bus and devices
4Ah		Initialize all video adapters in system
4Bh		QuietBoot start (optional)
4Ch		Shadow video BIOS ROM
4Eh		Display BIOS copyright notice
50h		Display CPU type and speed
51h		Initialize EISA board
52h		Test keyboard
54h		Set key click if enabled
58h	2-2-3-1	Test for unexpected interrupts
59h		Initialize POST display service
5Ah		Display prompt "Press F2 to enter SETUP"
5Bh		Disable CPU cache
5Ch		Test RAM between 512 and 640 KB
60h		Test extended memory
62h		Test extended memory address lines
64h		Jump to User Patch1

Code	Beeps	POST Routine Description
66h		Configure advanced cache registers
67h		Initialize Multi Processor APIC
68h		Enable external and CPU caches
69h		Setup System Management Mode (SMM) area
6Ah		Display external L2 cache size
6Bh		Load custom defaults (optional)
6Ch		Display shadow-area message
6Eh		Display possible high address for UMB recovery
70h		Display error messages
72h		Check for configuration errors
76h		Check for keyboard errors
7Ch		Set up hardware interrupt vectors
7Eh		Initialize coprocessor if present
80h		Disable onboard Super I/O ports and IRQs
81h		Late POST device initialization
82h		Detect and install external RS232 ports
83h		Configure non-MCD IDE controllers
84h		Detect and install external parallel ports
85h		Initialize PC-compatible PnP ISA devices
86h		Re-initialize onboard I/O ports
87h		Configure Motherboard Configurable Devices (optional)
88h		Initialize BIOS Area
89h		Enable Non-Maskable Interrupts (NMIs)
8Ah		Initialize Extended BIOS Data Area
8Bh		Test and initialize PS/2 mouse
8Ch		Initialize floppy controller
8Fh		Determine number of ATA drives (optional)
90h		Initialize hard-disk controllers
91h		Initialize local-bus hard-disk controllers
92h		Jump to UserPatch2
93h		Build MPTABLE for multi-processor boards

CHAPTER 4: Troubleshooting

Code	Beeps	POST Routine Description
95h		Install CD ROM for boot
96h		Clear huge ES segment register
97h		Fixup Multi Processor table
98h	1-2	Search for option ROMs. One long, two short beeps on checksum failure.
99h		Check for SMART drive (optional)
9Ah		Shadow option ROMs
9Ch		Set up Power Management
9Dh		Initialize security engine (optional)
9Eh		Enable hardware interrupts
9Fh		Determine number of ATA and SCSI drives
A0h		Set time of day
A2h		Check key lock
A4h		Initialize Typematic rate
A8h		Erase F2 prompt
AAh		Scan for F2 key stroke
ACh		Enter SETUP
AEh		Clear Boot flag
B0h		Check for errors
B2h		POST done- prepare to boot operating system
B4h	1	One short beep before boot
B5h		Terminate QuietBoot (optional)
B6h		Check password (optional)
B9h		Prepare Boot
BAh		Initialize DMI parameters
BBh		Initialize PnP Option ROMs
BCh		Clear parity checkers
BDh		Display MultiBoot menu
BEh		Clear screen (optional)
BFh		Check virus and backup reminders
C0h		Try to boot with INT 19
C1h		Initialize POST Error Manager (PEM)

Code	Beeps	POST Routine Description
C2h		Initialize error logging
C3h		Initialize error display function
C4h		Initialize system error handler
C5h		PnPnd dual CMOS (optional)
C6h		Initialize notebook docking (optional)
C7h		Initialize notebook docking late
C8h		Force check (optional)
C9h		Extended checksum (optional)
D2h		Unknown interrupt

Code	Beeps	
E0h		Initialize the chipset
E1h		Initialize the bridge
E2h		Initialize the CPU
E3h		Initialize the system timer
E4h		Initialize system I/O
E5h		Check force recovery boot
E6h		Checksum BIOS ROM
E7h		Go to BIOS
E8h		Set Huge Segment
E9h		Initialize Multi Processor
EAh		Initialize OEM special code
EBh		Initialize PIC and DMA
ECh		Initialize Memory type
EDh		Initialize Memory size
EEh		Shadow Boot Block
EFh		System memory test
F0h		Initialize interrupt vectors
F1h		Initialize Run Time Clock
F2h		Initialize video
F3h		Initialize System Management Mode

Code	Beeps	
F4h	1	Output one beep before boot
F5h		Boot to Mini DOS
F6h		Clear Huge Segment
F7h		Boot to Full DOS

Symptom-to-FRU error messages

LCD

Symptom / Error	Action in Sequence
<ul style="list-style-type: none"> ▪ The LCD backlight doesn't work. ▪ The LCD is too dark. ▪ The LCD brightness cannot be adjusted. ▪ The LCD contrast cannot be adjusted. 	<ul style="list-style-type: none"> ▪ Run “Load Setup Defaults” using the BIOS Setup Utility, then reboot the notebook. ▪ Reconnect the LCD connectors. ▪ Test or replace the keyboard (if contrast and brightness function key doesn't work). ▪ Check the LCD inverter ID. ▪ Test or replace the LCD cable. ▪ Test or replace the LCD inverter. ▪ Test or replace the LCD. ▪ Test or replace the system board.
<ul style="list-style-type: none"> ▪ The LCD screen is unreadable. ▪ Missing pels in characters. ▪ The screen appears abnormal. ▪ The wrong color is displayed. 	<ul style="list-style-type: none"> ▪ Reconnect the LCD connector. ▪ Check the LCD inverter ID. ▪ Test or replace the LCD cable. ▪ Test or replace the LCD inverter. ▪ Test or replace the LCD. ▪ Test or replace the system board.
The LCD is displaying extra horizontal or vertical lines.	<ul style="list-style-type: none"> ▪ Check the LCD inverter ID. ▪ Test or replace the LCD cable. ▪ Test or replace the LCD inverter. ▪ Test or replace the LCD. ▪ Test or replace the system board.

Power

Symptom / Error	Action in Sequence
The notebook shuts down during operation.	<ul style="list-style-type: none"> ▪ Test the power source (battery pack and power adapter). See “Testing the power system” on page 141. ▪ Test or replace the battery pack. ▪ Test or replace the power adapter. ▪ Test or replace the system board.
The notebook doesn't turn on.	<ul style="list-style-type: none"> ▪ Test the power source (battery pack and power adapter). See “Testing the power system” on page 141. ▪ Test or replace the battery pack. ▪ Test or replace the power adapter. ▪ Test or replace the system board.

Symptom / Error	Action in Sequence
The notebook doesn't turn off.	<ul style="list-style-type: none"> ▪ Test the power source (battery pack and power adapter). See “Testing the power system” on page 141. ▪ Press and hold the power button for more than four seconds. ▪ Test or replace the system board.
The battery can't be charged.	<ul style="list-style-type: none"> ▪ Test the battery pack. See “Check the battery pack” on page 142. ▪ Test or replace the battery pack. ▪ Test or replace the system board.

ExpressCard

Symptom / Error	Action in Sequence
The notebook cannot detect the ExpressCard.	<ul style="list-style-type: none"> ▪ Test or replace the system board.
ExpressCard slot pin is damaged.	<ul style="list-style-type: none"> ▪ Test or replace the system board.

Memory

Symptom / Error	Action in Sequence
Memory count (size) appears different from actual size.	<ul style="list-style-type: none"> ▪ Run “Load Setup Defaults” using the BIOS Setup Utility, then reboot the notebook. ▪ Test or replace the SO-DIMM. ▪ Test or replace the system board.

Sound

Symptom / Error	Action in Sequence
No sound comes from the notebook when running Windows multimedia programs.	<ul style="list-style-type: none"> ▪ Reinstall the audio driver. ▪ Test or replace the speakers. ▪ Test or replace the system board.
The internal speakers make noise or emit no sound.	<ul style="list-style-type: none"> ▪ Test or replace the speakers. ▪ Test or replace the system board.

Power management

Symptom / Error	Action in Sequence
The notebook will not hibernate.	<ul style="list-style-type: none"> ▪ Test or replace the keyboard (if control is from the keyboard). ▪ Test or replace the hard disk drive. ▪ Test or replace the system board.
The system doesn't hibernate and emits four short beeps every minute.	<ul style="list-style-type: none"> ▪ Press Fn+O and see if the notebook enters hibernation mode. ▪ Test or replace the touchpad. ▪ Test or replace the keyboard. ▪ Check the hard disk connection to the system board. ▪ Test or replace the hard disk drive. ▪ Test or replace the system board.

Symptom / Error	Action in Sequence
The notebook doesn't enter standby mode after closing the LCD.	<ul style="list-style-type: none"> ▪ Make sure that the magnet is in the magnet holder. For more information, see “Replacing the LCD panel” on page 94. ▪ Test or replace the system board.
The system doesn't resume from hibernation mode.	<ul style="list-style-type: none"> ▪ Check the hard disk connection to the system board. ▪ Test or replace the hard disk drive. ▪ Test or replace the system board.
The system doesn't resume from standby mode after opening the LCD.	<ul style="list-style-type: none"> ▪ Make sure that the magnet is in the magnet holder. For more information, see “Replacing the LCD panel” on page 94. ▪ Test or replace the system board.
The battery fuel gauge in Windows doesn't go higher than 90%.	<ul style="list-style-type: none"> ▪ Remove the battery pack and let it cool for two hours. ▪ Refresh the battery (use only battery power until the notebook turns off, then charge the battery). ▪ Test or replace the battery pack. ▪ Test or replace the system board.
The system hangs intermittently.	<ul style="list-style-type: none"> ▪ Reconnect the hard disk drive and optical drive. ▪ Check the hard disk connection to the system board. ▪ Test or replace the system board.

Devices

Symptom / Error	Action in Sequence
System configuration does not match the installed devices.	<ul style="list-style-type: none"> ▪ Run “Load Setup Defaults” using the BIOS Setup Utility, then reboot the notebook. ▪ Reconnect the hard disk drive and optical drive.
The external display does not work correctly.	<ul style="list-style-type: none"> ▪ Press Fn+F4 repeatedly to switch between LCD, external display, and both displays. ▪ Test or replace the system board.
USB does not work correctly.	<ul style="list-style-type: none"> ▪ Test or replace the USB board. ▪ Test or replace the system board.
Printer problems.	<ul style="list-style-type: none"> ▪ Run the printer self-test. ▪ Reinstall the printer driver. ▪ Test or replace the printer cable. ▪ Test or replace the printer. ▪ Test or replace the system board.

Keyboard and touchpad

Symptom / Error	Action in Sequence
The keyboard (one or more keys) does not work.	<ul style="list-style-type: none"> ▪ Reconnect the keyboard cable. ▪ Test or replace the keyboard. ▪ Test or replace the system board.
The touchpad does not work.	<ul style="list-style-type: none"> ▪ Reconnect the touchpad cable. ▪ Test or replace the touchpad board. ▪ Test or replace the system board.



Important

If you cannot find a symptom or an error in this list and the problem remains, see [“Undetermined problems” on page 155](#).

Intermittent problems

Intermittent system hang problems can be caused by a variety of reasons that have nothing to do with a hardware defect. These reasons include: cosmic radiation, electrostatic discharge, or software errors. FRU replacement should be considered only when a recurring problem exists.

► To analyze an intermittent problem:

- 1 Run the advanced diagnostic test for the system board in loop mode at least ten times.
 - If any error is detected, replace the FRU.
 - If no error is detected, do not replace any FRU.
- 2 Rerun the test to verify that there are no more errors.
 -

Undetermined problems

If the diagnostic test may not identify which adapter or device failed, which installed devices are incorrect, whether a short circuit is suspected, or whether the system is inoperative. Use these procedures to isolate the failing FRU (do not isolate a non-defective FRU).



Important

Verify that all attached devices are supported by the notebook.



Important

Verify that the power supply being used at the time of the failure is operating correctly. (See [“Testing the power system” on page 141](#).)

► To isolate a failing FRU:

- 1 Turn off the notebook.
- 2 Visually check FRU parts for damage. If you identify any damage, replace the FRU.
- 3 Remove or disconnect all of the following devices:

- Non-Acer devices
 - Printer, mouse, and other external devices
 - Battery pack
 - Hard disk drive(s)
 - SO-DIMM
 - Optical drive
 - Type 54 ExpressCards
- 4 Turn on the notebook.
 - 5 Determine if the problem has changed.
 - If the problem does not recur, reconnect the removed devices one at a time until you find the failing FRU.
 - If the problem does recur, replace the following FRUs one at a time:
 - System board
 - LCD assembly



Important

Do not replace a non-defective FRU.

CHAPTER 5

Connector locations

- System board top connectors
- System board bottom connectors

System board top connectors

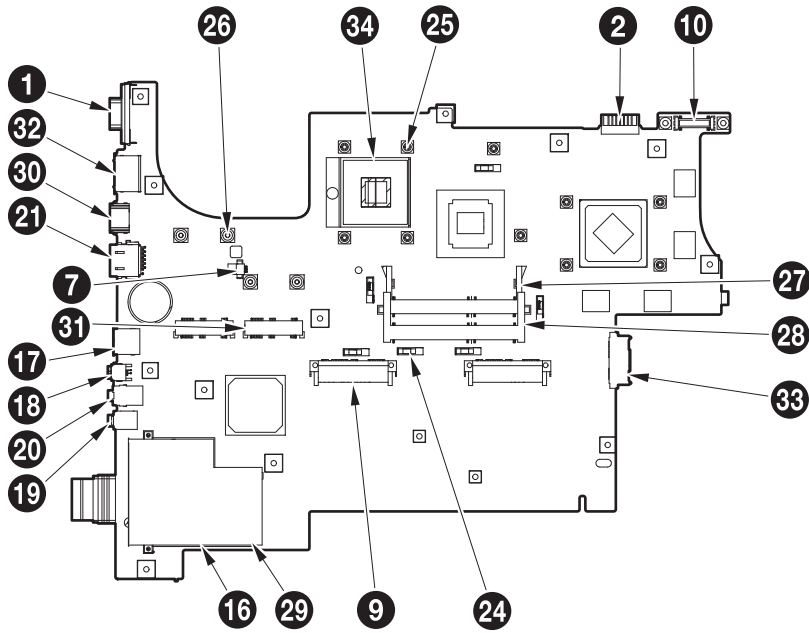

System board bottom connectors

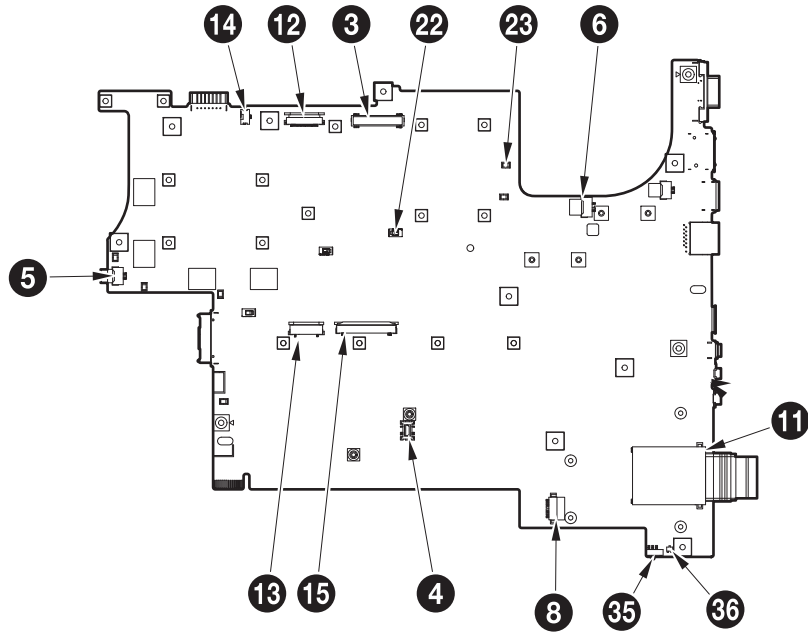

CHAPTER 5: Connector locations

NO	ACER_PN	VENDOR	VENDOR_PN	PIN	PITCH	QTY	R/S	SMT/DIP
1	20.20392.015	SUYIN	070546FR015S221ZR	15	1.145	1	Right Angle	DIP
2	20.80905.007	SUYIN	200275MR007G145ZL	7	2	1	Right Angle	DIP
3	20.F0043.050	ACES	87216-5004-02-06	50	1	1	Straight	SMT
4	20.F0582.012	AMP	1-179397-2	12	0.8	1	Straight	SMT
5	20.F0693.003	MOLEX	53780-0370	3	1.25	2	Right Angle	SMT
6	20.F0693.004	MOLEX	53780-0470	4	1.25	1	Right Angle	SMT
7	20.F0735.003	ACES	85214-030N	3	1.25	1	Right Angle	SMT
8	20.F0735.008	ACES	85204-0800N	8	1.25	1	Right Angle	SMT
9	20.F0796.022	AMP	1770871-3	22	1.27	2	Right Angle	SMT
10	20.F1122.040	ACES	88021-4001N	40	0.8	1	Right Angle	SMT
11	20.I0080.001	TAISOL	144-3000000900	36	0.8	1	Right Angle	SMT
12	20.K0116.028	52435-2871	MOLEX	28	0.5	1	Right Angle	SMT
13	20.K0228.025	ACES	87151-2507G	25	0.5	1	Right Angle	SMT
14	20.K0231.004	JST	04FLH-SM1-GB-TB(LF)(SN)	4	0.5	1	Right Angle	SMT
15	20.K0288.026	ACES	88502-2641	26	1	1	Right Angle	SMT
16	21.H0152.001	JAE	PX10AFR00NH	TBD	TBD	1	Right Angle	SMT
17	22.10218.T51	TYCO	1775562-1	4	TBD	1	Right Angle	DIP
18	22.10218.U71	SUYIN	020115FR004S536ZR	4	0.8	1	Right Angle	DIP
19	22.10263.131	SINGATRON	2SJ-R351-010	6	TBD	1	Right Angle	DIP
20	22.10270.031	SINGATRON	2SJ-A373-E01	8	TBD	1	Right Angle	DIP
21	22.10277.071	FOXCONN	JM36111-R2185-7F	8	1.02	1	Straight	SMT
22	34.41V01.001	EMI STOP	SQ-37G	TBD	TBD	3	Straight	SMT
23	34.49U01.001	EMI	SU-15S	TBD	TBD	6	Straight	SMT
24	34.4B312.002	EMI STOP	S8-130RG	TBD	TBD	6	Straight	SMT
25	34.4C408.001	TBD	TBD	TBD	TBD	12		
26	34.4G521.001	TBD	TBD	TBD	TBD	4		
27	62.10017.F81	FOXCONN	AS0A626-U2RN-7F	204	0.6	1	Right Angle	SMT
28	62.10017.F91	FOXCONN	AS0A626-UARN-7F	204	0.6	1	Right Angle	SMT
29	62.10024.911	JAE	PX10ABRB00-R1000	26	1	1	Right Angle	SMT
30	62.10027.661	MOLEX	474080001	19	0.5	1	Right Angle	SMT
31	62.10043.391	FOXCONN	AS0B226-S92N-7F	52	0.8	2	Right Angle	SMT
32	62.10065.111	MOLEX	47391-0000	7	1.27	1	Right Angle	DIP
33	62.10065.351	FOXCONN	LN21131-D409-9F	P6-S7	1.27-1	1	Right Angle	SMT
34	62.10079.001	TYCO	1674770-6	479	1.27	1	Straight	SMT
35	62.40018.211	T-MEC	NSS506-212F-AABG1T-A	3	2	1	Right Angle	SMT
36	75.03212.060	TBD	TBD	TBD	TBD	1		
37			TBD	TBD	TBD	9		

CHAPTER 6

FRU (Field-Replaceable Unit) list

- [Introduction](#)
- [Exploded diagram](#)
- [FRU list](#)

Introduction

This chapter gives you the FRU (field-replaceable-unit) listing in global configurations of P-79. Refer to this chapter whenever ordering for parts to repair or for RMA (Return Merchandise Authorization).

Please note that **WHEN ORDERING FRU PARTS**, you should check the most up-to-date information available on your regional web or channel. For whatever reasons a part number change is made, it will not be noted on the printed Service Guide. For **ACER AUTHORIZED SERVICE PROVIDERS**, your Acer office may have a **DIFFERENT** part number code from those given in the FRU list of this printed Service Guide. You **MUST** use the local FRU list provided by your regional Acer office to order FRU parts for repair and service of customer machines.



Important



To scrap or to return the defective parts, you should follow the local government ordinance or regulations on how to dispose it properly, or follow the rules set by your regional Acer office on how to return it.

Exploded diagram

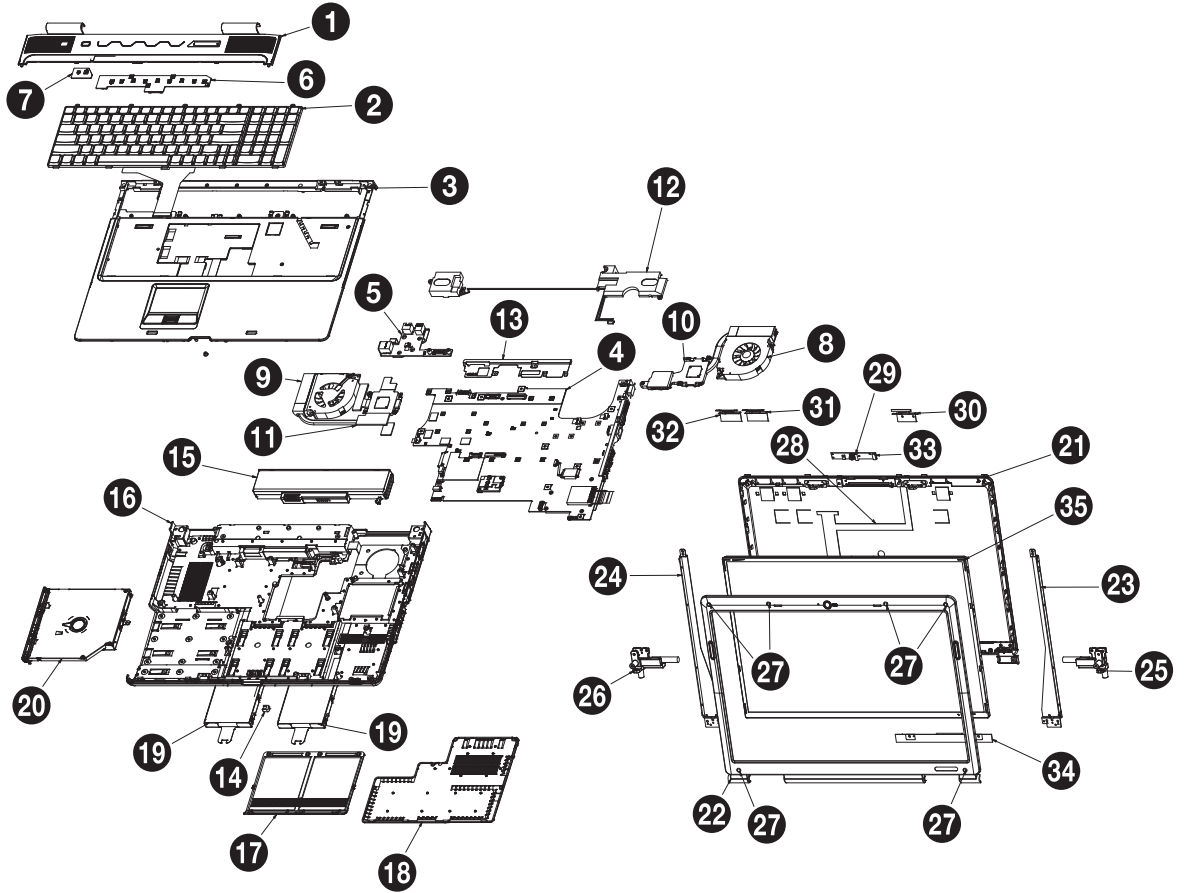
Notebook chassis

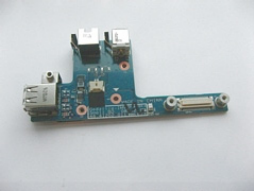
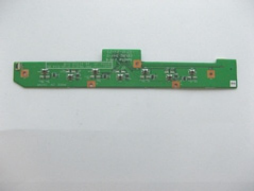
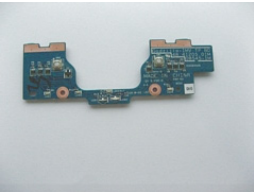

FRU list

Category	Part Name	OEM Part No.
ADAPTER		
	ADAPTER 120W 3PIN DELTA ADP-120ZB BBW	AP.12001.007
BATTERY		
	BATTERY PACK SDI LI+ 9CELL 2.6AH SMP	BT.00907.008
	BATTERY PACK LG LI+ 9CELL 2.6AH SMP	BT.00907.009
	BATTERY PACK PANA LI+ 9CELL 2.6AH SMP	BT.00907.010
BOARDS		
	I/O BOARD	55.WEJ01.001
	MEDIA HIGH-END BOARD	55.W2301.002
	TOUCH PAD BUTTON BOARD	55.WEJ01.002



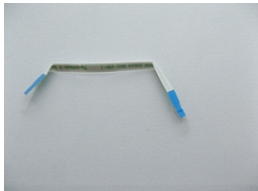

Category	Part Name	OEM Part No.
	POWER BUTTON BOARD	55.WEJ01.003
		
	TOUCHPAD SYNAPTICS TM00372-031	56.B0101.001
		
	BLUETOOTH BOARD FOXCONN BCM2046 V2.1 T60H928.31	54.W2301.005
		
	CAPACITIVE BUTTON BOARD SYNAPTICS TM-01001-003	56.W2301.001
		
	WIRELESS LAN BOARD 512AN_MMWG SHIRLEY PEAK 5100 MM#895361	KI.SPM01.003
		
	WIRELESS LAN BOARD 512AG_MMWG SHIRLEY PEAK 5100 (CENTRINO 2 WITH VPRO)	KI.SPM01.010
CABLES		
	POWER CORD 10A 125V 3PIN US BK	27.01518.641
		
	POWER CORD 10A 125V US	27.T30V1.001
	POWER CORD 10A 250V SWISS	27.01518.581
	POWER CORD 10A 250V 3PIN SWISS BK	27.01518.691
	POWER CORD 10A 250V ARGENTINE	27.01518.0U1

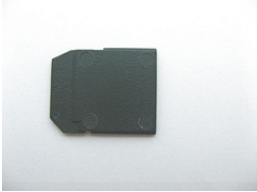
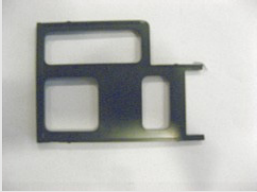

CHAPTER 6: FRU (Field-Replaceable Unit) list

Category	Part Name	OEM Part No.
	POWER CORD 7A 250V 2PIN KOREAN	27.01518.531
	POWER CORD 3A 250V 3PIN UK	27.01518.541
	POWER CORD 5A 250V 3PIN UK BK	27.03118.001
	POWER CORD 7A 125V 2PIN JAPAN	27.01518.551
	POWER CORD 10A 3PIN BK DENMARK	27.01518.561
	POWER CORD 10A 250V 3PIN DENMARK BK	27.01518.671
	POWER CORD 10A 250V 3PIN BK SOUTH AFRICA	27.01518.571
	POWER CORD 16A 250V SOUTH AFRICA BK	27.01518.681
	POWER CORD 10A 250V 3PIN CHINA	27.01518.591
	POWER CORD 10A 250V 3PIN CHINA BK	27.01518.701
	POWER CORD 250V 3PIN EUR BK	27.T30V1.004
	POWER CORD 16A 250V 3PIN EUR BK	27.01518.731
	POWER CORD 10A 250V 3PIN ITALY	27.01518.611
	POWER CORD 10A 250V 3PIN ITALY BK	27.01518.711
	POWER CORD 2.5A 250V AUSTRALIA	27.01518.621
	POWER CORD 2.5A 250V SOUTH AFRICA BK (INDIA)	27.01518.631
	POWER CORD 10A 250V SOUTH AFRICA BK (INDIA)	27.01518.721
	POWER CORD 7A 125V 2PIN JAPAN BK	27.01518.661
	POWER CORD 250V 10A 3PIN ISRAEL	27.01518.761
	POWER CORD 2.5A 125V USA	27.01518.781
POWER CORD 2.5A 125V 1.8M BLACK TAIWANESE	27.01518.A11	
POWER CORD 10A 250V 1.8M BRAZIL BLK	27.01518.A41	
POWER CORD ACA / ACNZ	27.03218.021	
POWER CORD 7.5A 250V 3P AUSTRALIA BK	27.03218.051	
POWER CORD 7A 125V 2PIN JAPAN	27.03518.161	
	POWER BUTTON BOARD CABLE	50.W2301.001

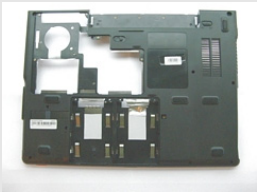
Category	Part Name	OEM Part No.
	BLUETOOTH CABLE 8PIN 50MM	50.W2301.017
	CABLE VOLUME BAR TO MULTIMEDIA BOARD 6PIN 70MM	50.W2301.016
	CABLE CONNECTED MEDIA BOARD TO MB 28PIN 30MM	50.W2301.003
	TOUCHPAD CABLE 12PIN 120MM	50.W2301.004
	TOUCHPAD BUTTON BOARD CABLE 25PIN 140MM	50.W2301.005
CASE/COVER/BRACKET ASSEMBLY		
	VOLUME PLATE	40.W2301.001

CHAPTER 6: FRU (Field-Replaceable Unit) list

Category	Part Name	OEM Part No.
	SD CARD DUMMY	42.B0101.002
	E-CARD DUMMY	42.B0101.003
	MIDDLE COVER	60.W2301.004
	LOWER CASE	60.W2301.003
	HDD COVER	60.W2301.002
	CPU COVER	60.W2301.001

Category	Part Name	OEM Part No.
	UPPER CASE PLAINING+UV W/O FINGER PRINT HOLE	60.WEJ01.001
	TOUCHPAD BRACKET	60.W2301.006
	EMI SHIELDING BRACKET	33.B0101.001
	OPTICAL BRACKET	33.W2301.001
	BLU RAY COMBO BEZEL	60.W2301.034
	DVD-RW SUPER-MULTI BEZEL	60.W4301.001
	DVD-RW SUPER-MULTI LABEL FLASH BEZEL	60.W4301.002
OPTICAL DRIVE		

CHAPTER 6: FRU (Field-Replaceable Unit) list

Category	Part Name	OEM Part No.
	BLU-RAY COMBO MODULE 2X SATA	6M.WEJ01.001
	BLU-RAY COMBO MODULE 4X SATA	6M.WEJ01.002
	DVD-RW SUPER-MULTI MODULE 8X SATA	6M.WEJ01.003
	ODD SONY BD COMBO 12.7MM TRAY DL 2X BC-5500S LF W/O BEZEL SATA	KO.0020E.002
	ODD HLDS BD COMBO 12.7MM TRAY DL 2X CT10N LF W/O BEZEL SATA	KO.0020D.001
	ODD PIONEER BD COMBO 12.7MM TRAY DL 2X BDC-TD01RS LF W/O BEZEL SATA	KO.00205.001
	ODD PIONEER BD COMBO 12.7MM TRAY DL 2X BDC-TD01RS LF W/O BEZEL FW1.02 SATA	KO.00205.002
	ODD PIONEER BD COMBO 12.7 SATA DL 4X BDC-TD01RS LF W/O BEZEL SATA	KO.00405.002
	ODD HLDS SUPER-MULTI DRIVE 12.7MM TRAY DL 8X GT10N LF W/O BEZEL SATA	KU.0080D.039
	ODD HLDS SUPER-MULTI DRIVE 12.7MM TRAY DL 8X GT10N LF W/O BEZEL FW:1.01 SATA	KU.0080D.044
	ODD SONY SUPER-MULTI DRIVE 12.7MM TRAY DL 8X AD-7580S LF W/O BEZEL SATA	KU.0080E.017
	DVD-RW SUPER-MULTI MODULE 8X SATA LABEL FLASH	6M.WEJ01.004
	ODD TSST SUPER-MULTI DRIVE 12.7MM 8X TS-L633P LF SATA LABEL FLASH W/O BEZEL	KU.00801.027
ODD HLDS SUPER-MULTI DRIVE 12.7MM TRAY 8X GSA-T50F LF SATA LABEL FLASH W/O BEZEL	KU.0080D.037	
ODD SONY SUPER-MULTI DRIVE 12.7MM TRAY 8X AD-7583S LF LABEL FLASH W/O BEZEL SATA	KU.0080E.018	
CPU/PROCESSOR		
	CPU INTEL CORE2DUAL P8700 2.53G 3M 1066 25W R-0	KC.87R01.DPP
	CPU INTEL CORE2DUAL T5800 PGA 2.0G 2M 800 MV	KC.58001.DTP
	CPU INTEL CORE2DUAL P8400 PGA 2.26G 3M 1066 25W	KC.84001.DPP
	CPU INTEL CORE2DUAL P8600 PGA 2.4G 1066 25W 3M	KC.86001.DPP
	CPU INTEL CORE2DUAL T9400 2.53G 6M 1066 35W	KC.94001.DTP
	CPU INTEL CORE2DUAL T9600 PGA 2.8G 6M 1066 35W	KC.96001.DTP

Category	Part Name	OEM Part No.
	CPU INTEL CORE2DUAL P7450 2.13G 3M 1066 TJ NOVT	KC.74501.DPP
	CPU INTEL CORE2DUAL PENRYN P8400 2.26G 3M 1066 25W R-0	KC.84R01.DPP
	CPU INTEL CORE2DUAL P9500 PGA 2.53G 6M 1066 25W	KC.95001.DPP
	CPU INTEL CORE2DUAL T5900 PGA 2.2G 2M 800 MV	KC.59001.DTP
	CPU INTEL CORE2DUAL T6400 2.0G 3M 800 35W R-0	KC.64001.DTP
	CPU INTEL CORE2DUAL T6600 2.2G 2M 800 35W R-0	KC.66001.DTP
	CPU INTEL CORE2DUAL PENRYN T9550 2.66G 6M 1066 35W E-0	KC.95501.DTP
	CPU INTEL CORE2DUAL P8600 2.4G 3M 1066 25W R-0	KC.86R01.DPP
	CPU INTEL CORE2DUAL P7550 PGA 2.26G 3M 1066 R-0	KC.75501.DPP
	CPU INTEL CORE2DUAL P8800 PGA 2.66G 3M 1066 25W R-0	KC.88R01.DPP
	CPU INTEL CORE2DUAL T6500 PGA 2.1G 2M 800 R-0	KC.65001.DTP
	CPU INTEL CORE2DUAL Q9000 PGA 2.0G 6M 1066 45W	KC.90001.QQP
	CPU INTEL CORE2QUAD Q9100 PGA 2.26G 12M 1066 45W	KC.91001.QQP

FAN

CPU FAN 23.W2301.001



HARD DISK DRIVE AND ACCESSORIES

HDD BRACKET 60.W2301.011

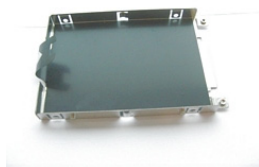

CHAPTER 6: FRU (Field-Replaceable Unit) list

Category	Part Name	OEM Part No.
	HDD 160GB 5400RPM SATA TOSHIBA LIBRA-BS MK1655GSX F/W:FG0101J 5.4	KH.16004.006
	HDD 160GB 5400RPM SATA HGST PANTHER-B PANTHER-B HTS545016B9A300 F/W:C60F	KH.16007.024
	HDD 160GB 5400RPM 2.5" SATA WD WD1600BEVT-22ZCT0 FW:11.01A11	KH.16008.022
	HDD MODULE 250G 5400RPM SATA	
	HDD BRACKET	60.W2301.011
	HDD 2.5" 5400RPM 250GB SEAGATE ST9250315AS WYATT SATA LF F/W:0001SDM1	KH.25001.016
	HDD 250GB 5400RPM SATA TOSHIBA MK2552GSX LF F/W:LV010J	KH.25004.002
	HDD 250GB 5400RPM SATA TOSHIBA LIBRA-BS MK2555GSX F/W:FG000J 5.4K	KH.25004.003
	HDD 250GB 5400RPM SATA HGST HTS543225L9A300 LF F/W:C40C	KH.25007.013
	HDD 250GB 5400RPM SATA HGST HTS545025B9A300 PANTHER-B LF	KH.25007.015
	HDD 250GB 5400RPM SATA WD WD2500BEVS-22UST0 ML125 F/W:01.01A01	KH.25008.018
	HDD 250GB 5400RPM SATA WD WD2500BEVT-22ZCT0 F/W:11.01A11	KH.25008.021
	HDD 320GB 5400RPM SATA SEAGATE WYATT ST9320325AS FW:0001SDM1	KH.32001.017
	HDD 320GB 5400RPM SATA TOSHIBA MK3252GSX F/W:LV010J	KH.32004.001
	HDD 320GB 5400RPM SATA TOSHIBA MK3255GSX LIBRA LF F/W:FG010J	KH.32004.002
	HDD 320GB 5400RPM SATA HGST HTS543232L9A300 F/W:C30C	KH.32007.004
	HDD 320GB 5400RPM SATA HGST HTS545032B9A300 PANTHER B LF	KH.32007.007
	HDD 320GB 5400RPM SATA WD WD3200BEVT-22ZCT0 ML125 F/W:01.01A01	KH.32008.013
	HDD 500GB 5400RPM WD SATA WD5000BEVT-22ZAT0 F/W:01.01A01	KH.50008.013
	HDD 500GB 5400RPM SEAGATE ST9500325AS SATA LF F/W:0001SDM1	KH.50001.011
HDD 2.5" 5400RPM 500GB TOSHIBA MK5055GSX LIBRA SATA LF F/W:FG001J	KH.50004.001	
HDD 500GB 5400RPM HGST SATA HTS545050B9A300 PANTHER B LF	KH.50007.009	

Category	Part Name	OEM Part No.
	HDD 160GB 7200RPM SATA HGST HTS723216L9A360 F/W:C30F	KH.16007.022
	HDD 200GB 7200RPM SATA SEAGATE SATA ST9200420AS FW:3.AAA 7	KH.20001.011
	HDD 250G 7200RPM SATA SEAGATE ST9250421AS LF F/W:0303	KH.25001.014
	HDD 250GB 7200RPM SATA HGST HTS723225L9A360 F/W:C30F	KH.25007.014
	HDD 320GB 7200RPM SATA HGST HTS723232L9SA00 F/W:C30F	KH.32007.005
	HDD 320GB 7200RPM SATA WD WD3200BEKT-22F3T0 FW:11.01A11 LF	KH.32008.015
	HDD 320GB 7200RPM SATA SEAGATE ST9320421AS LF F/W:0303	KH.32001.010
	HDD 500GB 7200RPM SATA SEAGATE HOLIDAY ST9500420AS F/W:0002SDM1	KH.50001.013
	HDD 320GB 5400RPM SATA SEAGATE WYATT ST9320325AS FW:0001SDM1	KH.32001.017
	HDD 320GB 5400RPM SATA TOSHIBA MK3252GSX F/W:LV010J	KH.32004.001
	HDD 320GB 5400RPM SATA TOSHIBA MK3255GSX LIBRA LF F/W:FG010J	KH.32004.002
	HDD 320GB 5400RPM SATA HGST HTS543232L9A300 F/W:C30C	KH.32007.004
	HDD 320GB 5400RPM SATA HGST HTS545032B9A300 PANTHER B LF	KH.32007.007
	HDD 320GB 5400RPM SATA WD WD3200BEVT-22ZCT0 ML125 F/W:01.01A01	KH.32008.013
HEATSINK		
	CPU HEATSINK	60.W2301.008

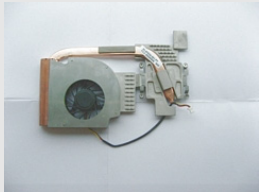

CHAPTER 6: FRU (Field-Replaceable Unit) list

Category	Part Name	OEM Part No.
	VGA HEATSINK W/FAN	60.WEJ01.002

KEYBOARD



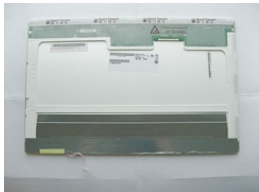

	KEYBOARD SUNREX GODZILLA_IMV P-7805U INTERNAL US INTERNATIONAL	KB.I1700.085
	KEYBOARD SUNREX GODZILLA_IMV INTERNAL US ORANGE COLOR	KB.INT0S.024
	KEYBOARD SUNREX GODZILLA_IMV INTERNAL UK	TBD
	KEYBOARD SUNREX GODZILLA_IMV INTERNAL LATIN AMERICAN	TBD
	KEYBOARD SUNREX GODZILLA_IMV INTERNAL FRENCH	TBD
	KEYBOARD SUNREX GODZILLA_IMV INTERNAL SPANISH	TBD
	KEYBOARD SUNREX GODZILLA_IMV INTERNAL US W/ CANADIAN FRENCH	KB.I1700.117
	KEYBOARD SUNREX V071930AJ3 JA JAPANESE	KB.I1700.118
	KEYBOARD SUNREX GODZILLA_IMV INTERNAL BRAZILIAN PORTUGUESE	KB.I1700.112
	KEYBOARD SUNREX GODZILLA_IMV INTERNAL THAI	KB.I1700.089

LCD AND ACCESSORIES

	LCD MODULE 17.1" WXGA+ GLARE W/1.3M CAMERA & ANTENNA*2	6M.WEJ01.005
	LCD 17.1" WXGA+ AU B170PW06 V2 GLARE LF 200NIT 8MS	LK.17105.009
	LCD SAMSUNG 17.1" WXGA+ GLARE LTN170BT07-G01 LF 220NIT 8MS 500:1	LK.17106.004
	LCD 17" WXGA+ LG LP171WP4-TLR1 GLARE LF 220NIT 8MS	LK.17108.011

Category	Part Name	OEM Part No.
	INVERTER BOARD 17" DARFON VK.21189.801	19.TK901.001
	INVERTER BOARD 17" YEC YNV-W10	19.TK901.004
	WIRELESS ANTENNA MAIN WHITE	50.W2301.008
		
	WIRELESS ANTENNA AUX WHITE	50.W2301.009
		
	LCD BRACKET RIGHT	33.W2301.002
		
	LCD BRACKET LEFT	33.W2301.003
		
	LCD HINGE PACK RIGHT	33.W2301.004
		

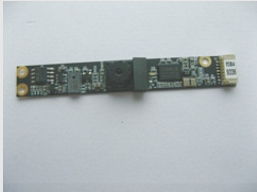
CHAPTER 6: FRU (Field-Replaceable Unit) list

Category	Part Name	OEM Part No.
	LCD HINGE PACK LEFT	33.W2301.005
	LCD/CAMERA CABLE	50.B0101.002
	CAMERA 1.3M CHICONY CNF614121004591L	57.W2301.001
	LCD COVER 17" PRINTING+UV BLACK W/HINGE CAP	60.WEJ01.003
	HINGE CAP RIGHT	60.B0101.005
	HINGE CAP LEFT	60.B0101.006
	LCD BEZEL 17" W/CAMERA HOLE	60.W2301.012
MAINBOARD AND ACCESSORIES		

Category	Part Name	OEM Part No.
	MAINBOARD GODZILLA/BLACKHILL-N10 DISCRETE PM45 ICH9ME VRAM-HYNIX1GB W/MODEM&MODEM CABLE W/O 1394&CPU&DIMM	MB.WEU01.001
	BOARDS	MODEM BOARD LITEON CONEXANT -UNIZION 1.5_3.3V AUS B85247600G
CABLES	MODEM CABLE	50.W2301.006
DIMM MEMORY		
	SODIMM 1GB DDRIII 1066MHZ ELPIDA EBJ11UE6BAU0-AE-E LF 64*16 0.07UM	KN.1GB09.009
	SODIMM 1GB DDRIII 1066MHZ SAMSUNG M471B2874DZ1-CF8	KN.1GB0B.019
	SODIMM 1GB DDRIII 1066MHZ HYNIX HMT112S6AFP6C-G7N0	KN.1GB0G.019
	SODIMM 2GB DDRIII 1066MHZ ELPIDA EBJ21UE8BAU0-AE-E	KN.2GB09.002
	SODIMM 2GB DDRIII 1066MHZ SAMSUNG M471B5673DZ1-CF8	KN.2GB0B.005
	SODIMM 2GB DDRIII 1066MHZ SAMSUNG M471B5673EH1-CF8	KN.2GB0B.012
	SODIMM 2GB DDRIII 1066MHZ HYNIX HMT125S6AFP8C-G7N0	KN.2GB0G.009
MISCELLANEOUS		
	LCD SCREW RUBBER	47.W2301.002
		ODD SCREW RUBBER

CHAPTER 6: FRU (Field-Replaceable Unit) list

Category	Part Name	OEM Part No.
	HINGE SCREW RUBBER	47.W2301.001

SCREWS

	SCREW	34.00015.081
	SCREW	86.W2301.001
	SCREW	86.00D47.630
	SCREW	86.00E34.738
	SCREW	86.W2301.002
	SCREW	86.W2301.003
	SCREW	86.W2301.004
	SCREW	86.W2301.005
	SCREW	86.W2301.006
	SCREW	86.W4301.001
	SCREW	86.W2301.007
	SPEAKER	23.W2301.003

APPENDIX A

Model definition and configuration

TBD

APPENDIX B

Test compatible components

- [Introduction](#)
- [Microsoft® Windows Vista® Environment Test](#)

Introduction

This notebook's compatibility is tested and verified by Acer's internal testing department. All of its system functions are tested under Windows Vista®, Windows® XP Home, Windows® XP Pro environment.

Refer to the following lists for components, adapter cards, and peripherals which have passed these tests. Regarding configuration, combination and test procedures, please refer to the NS50 series Compatibility Test Report released by the Acer Mobile System Testing Department.

Microsoft® Windows Vista® Environment Test

Item	Specification
CRT Port Test	
CRT Monitor	ViewSonic 19" CRT VCDTS23283-2G Monitor ViewSonic Professional Series G220 21" Monitor Philips 109P 19" Monitor MAG 810FT II 19" Monitor
LCD Monitor	
LCD Monitor	ViewSonic 19" LCD VA1912W Monitor ViewSonic 20" LCD VA2012W Monitor Samsung 22" LCD 225DW Monitor Philips 15' 150B5 Monitor ASUS 22" LCD MW221u monitor EIZO 17" LCD FlexScan L586 monitor
HDMI Port Test	
LCD TV	BenQ VH3243 32" HDMI LCD TV Panasonic TC-37MPK 37" HDMI LCD TV BenQ VL3735 LCD TV
USB Port Test	
USB Mouse	Logitech USB 2.0 Mouse Logitech Optical Mouse Microsoft Optical Mouse Microsoft TrackBall Optical Logitech Marble Mouse Logitech Performance Optical Mouse Logitech Cordless Optical Mouse
USB Keyboard	Microsoft Natural Keyboard Pro Microsoft Digital Media Keyboard Pro Logitech Elite keyboard Logitech Cordless Desktop LX300 Keyboard IBM USB Numeric Keypad 33L3225 COMPAQ USB EAB Keyboard MICROSOFT Wireless Optical Desktop 3000
USB Printer	Samsung ML 1450 Laser Printer Epson Photo830 Printer HP Photosmart 7960 Printer Canon PIXMA IP2000 Printer Lexmark Z52 Printer HP DeskJet 840C Printer

Item	Specification
USB Speaker	JS USB Digital Speaker J-6502 JS USB speaker USBJ268 Comodow USB 3D sound (Adapter) YAMAHA USB Speaker MS35D
USB Scanner	Epson EXPRESSION 1600 Scanner Canon Canonscan CS3200F Epson USB Scanner 1660
USB Hub	D-link DU-H4 USB HUB ATEN UH-204 USB 2.0 HUB
USB Game Pad/Joystick	ALPS USB Game Pad Microsoft SideWinder Plug & Play GamePad Logitech Freedom 2.4GHz cordless Logitech WingMan USB Extreme Digital 3D Joystick Microsoft USB Side Winder Game pad Saitek P2500 Rumble Force Pad Logitech WingMan Formula (warrior) Joystick Logitech Freedom cordless joystick
USB Ethernet/Wireless LAN Adapter	Afast Ethernet Adapter USB2.0 D-Link Wireless LAN adapter,802.11a/b or b only D-Link AirPlus DWL-120+ 2.4GHz Wireless USB Adapter
USB Storage	Zynet 2.5' External Enclosure SATA/ Usb2.0 Box Sony 2.5" ExtERNAL BOX Slim Kit USB 2.0 Mass Storage 2.5" HDD combo case IO DATA 250GB eSATA HDD SanDisk Cruzer USB Flash Drive- Micro 1.0GB HP DL702 USB 128MB Digital Drive Transcend USB 512MB Flash Drive Sandisk USB 2.0 512MB Flash Drive Pioneer DVD+-R/RW Writer
USB Modem	US Robotics Courier 56K Modem
USB Bridge Cable	Z-TEK USB 2.0 Data Bridge Cable
USB FDD	NEC FDD IBM USB FDD Sony USB Floppy Disk Driver
Headphone/Microphone Port Test	
Headphone/Microphone	Logitech Premium Stereo Headset Headphone+Mic Sennheiser HD202 PHILIPS headphone Logitech Labtec Verse-524 MIC Panasonic Earbud Headphone with Volume Control
Express Card Test	
Gigabit Ethernet LAN Card	AboCom ExpressCard/34 Gigabit Ethernet PLANEX Expresscard 1000 BASE-T Gigabit LAN
Wireless LAN Card	BELKIN N1 Wireless
Card Reader Adapter	Hagiwara sys-com Compact Flash/Microdrive Adapter Express Card AboCom ExpressCard/34 5in1 Card Reader
IEEE1394 Card	AboCom ExpressCard/54 1394B-800Mbps AboCom ExpressCard/54 1394A-400Mbps

APPENDIX B: Test compatible components

Item	Specification
Bluetooth Device Test	
Bluetooth Cell Phone/Headset	Sony Ericsson Bluetooth Headset Motorola HT820 Bluetooth Stereo Headphone
Multimedia Card Test	
SD/Mini SD/Micro SD Card	SanDisk Secure Digital Card 256MB A-DATA Secure Digital Card 4GB 150X Kingston SDHC 8GB Class6 Transcend SD 512MB Transcend 150X Ultra Speed SD 4GB Transcend SD HC 4GB A-DATA 150X Turbo SD 4GB A-DATA miniSD 512MB KINGMAX mini SD Adapter+512MB Mini SD Toshiba SDHC 4GB Class4 SanDisk Micro SD 6GB TOSHIBA Micro SD 2GB
MMC/MMC Plus/MMC Pro/ RS-MMC/RS-MMC Mobile	A-DATA MultiMedia Card 256MB A-DATA MultiMedia Card plus 1GB 200X A-DATA RS-MMC 256MB Transcend MMC Plus 4GB Transcend RS-MMC 512MB Ridata Multimedia Card PRO 256MB Silicon Power RS-MMC Mobile 1GB
MS/MS PRO/MS PRO Duo	Sony Memory Stick Card 128MB Sony Memory Stick Card Pro 256MB SanDisk Memory Stick Pro Duo 256MB SanDisk Memory Stick Pro 256MB Sony Memory Stick PRO Duo Card 4GB+MS Adapter Sony Memory Stick Pro MSX -2GS 2GB SanDisk Memory Stick Pro SDMSV-512 512MB

APPENDIX C

Online support information

This section describes online technical support services available to help you repair your Gateway notebook.

If you are a distributor, dealer, ASP, or TPM, please refer your technical queries to your local Acer branch office. Acer branch offices and Regional Business Units may access our website. However some information sources will require a user id and password. These can be obtained directly from Acer CSD Taiwan.

Acer's website offers you convenient and valuable support resources whenever you need them. In the Technical Information section you can download information on all of Acer's Notebook, Desktop and Server models including:

- Service guides for all models
- User's manuals
- BIOS updates
- Software utilities
- Spare parts lists
- TABs (Technical Announcement Bulletin)

For these purposes, we have included an Acrobat File to facilitate the problem-free downloading of our technical material. Also contained on this website are:

- Detailed information on Acer's International Traveller's Warranty (ITW)
- Returned material authorization procedures
- An overview of all the support services we offer, accompanied by a list of telephone, fax and email contacts for all your technical queries.

We are always looking for ways to optimize and improve our services, so if you have any suggestions or comments, please do not hesitate to communicate these to us.

Index

A

- AC adapter
 - connector 20
- AFLASH Utility 46
- application key 25
- arrow keys 25
- audio
 - adjusting volume 27
 - back button 27, 31
 - controller 13
 - headphone jack 19
 - microphone jack 19
 - muting 27, 31
 - next button 27, 31
 - pause button 26, 31
 - play button 26, 31
 - resolution 13
 - stop button 26, 31
 - volume down button 27
 - volume up button 27

B

- battery
 - charge indicator 18
 - latch 21
 - locating 21
 - release latch 21
- bays
 - hard drive 21
 - memory 21
- BIOS
 - password control 7
 - supported protocols 7
 - vendor 6
 - version 6
- BIOS Recovery by Crisis Disk steps 49
- BIOS Utility 36, 46
 - navigating 36
 - onboard device
 - configuration 40, 41
 - security 39
 - system security 44
- Bluetooth
 - chipset 14
 - system key 26
 - turning off 26
 - turning on 26
- brightness
 - adjusting 26, 27
 - system keys 27
- button

- Effects 32
- Help 32
- Properties 32
- settings 32
- Snapshot 33
- Start camera 32
- buttons
 - multimedia panel 22
 - specification 15
- C
- cable lock 18
- cable modem 19
- Camera Assistant 33
- Camera Assistant Toolbar 32
- Capacitive volume control 31
- Caps Lock indicator 24
- cards
 - Express Card slot 19
 - memory card slot 19
- CD
 - controlling playback 26, 31
- chipset
 - Bluetooth 14
 - USB 15
 - wired Ethernet 14
 - wireless Ethernet 14
- clicking 30
- connections
 - audio 19
 - broadband Internet 19
 - cable modem 19
 - dial-up modem 20
 - digital camera 18, 19
 - digital video camera 19
 - DSL modem 19
 - eSATA 20
 - Ethernet 19
 - external audio 19
 - external diskette drive 18, 19
 - external speakers 19
 - Firewire 19
 - flash drive 18, 19
 - HDMI (TV) out 19
 - headphone 19
 - i.Link 19
 - IEEE 1394 19
 - keyboard 18, 19
 - microphone 19
 - modem (dial-up) 20
 - monitor (VGA) 20
 - mouse 18, 19

- network 19
- power 20
- printer 18, 19
- scanner 18, 19
- speaker 19
- specification 15
- USB 18, 19
- VGA 20
- video camera 19
- controller
 - audio 13
 - ExpressCard 13
 - keyboard 12
 - memory card reader 12, 13
- Crisis Disk
 - creating 49
- D
- dial-up modem 20
- digital camera
 - memory card reader 19
 - USB port 18, 19
- digital video camera
 - IEEE 1394 port 19
- directional keys 25
- display 5
 - switching 26
- double-clicking 30
- dragging 30
- drives
 - DVD/CD-RW 19
 - DVD±RW 19
 - hard drive 21
 - multi-format DVD±RW 19
- DSL modem 19
- DVD
 - controlling playback 26, 31
- DVD drive
 - locating 19
- DVD player program 31
- E
- Effects button 32
- error symptom-to-spare part index 143
- eSATA
 - jack 20
- Ethernet
 - jack 19
- ExpressCard

- controller 13
- external CD-ROM drive check 140
- external monitor 20, 26
- EZ Pad touchpad
 - See* touchpad

F

- fan 19, 20
- features 2
- files
 - opening 30
- fingerprint reader
 - locating 22
 - using 27
- Firewire port 19
- flash utility 46
- Fn key 25, 26
- folders
 - opening 30
- function keys 25

H

- hard drive
 - bay 21
 - indicator 24
- HDMI (TV) out jack 19
- HDMI port 26
- headphone jack 19
- Help button 32
- Hybrid Sleep
 - mode 26
 - system key 26

I

- i.Link port 19
- IEEE 1394 port 19
- indicators
 - See* status indicators
- Instant on Audio 31
- Instant on Video 31
- intermittent problems 155
- Internet chat program 32

J

- jacks
 - See* connections
- jumper and connector locations
 - top view 158

K

- Kensington cable lock
 - lock slot 18
- keyboard
 - buttons 25
 - controller 12
 - features 25
 - keys 25
 - locating 22
 - USB port 18, 19
- keyboard or auxiliary input
 - device check 141
- keys
 - application 25
 - arrow 25
 - brightness 27
 - directional 25
 - Fn 25, 26
 - function 25
 - Hybrid Sleep 26
 - LCD brightness 27
 - LCD/CRT 26
 - navigation 25
 - numeric keypad 25
 - Sleep 26
 - system 25
 - toggle display 26
 - Windows 25
 - wireless Ethernet 26

L

- latch
 - battery 21
 - LCD panel release 18
- LCD panel
 - release latch 18
 - switching display 26
- LCD/CRT system key 26
- lock
 - Kensington cable 18

M

- Media Center 31
- memory
 - bay 21
- memory card reader
 - controller 12, 13
 - locating 19
 - supported cards 13
- memory check 141
- microphone
 - built-in 23
 - jack 19

- modem
 - cable 19
 - DSL 19
 - jack (dial-up) 20
- monitor
 - port 20
 - using 26

- mouse
 - USB port 18, 19
- moving
 - pointer 30
 - screen objects 30
- multimedia panel 22, 31
- mute button 27, 31
- muting sound 27, 31

N

- navigation keys 25
- network jack 19
- Num Lock
 - status indicator 24
 - system key 25
- numeric keypad
 - status indicator 24
 - using 25

O

- opening
 - files 30
 - folders 30
 - LCD panel 18
 - notebook 18
 - programs 30
 - shortcut menu 30

P

- Panel
 - Bottom 21
 - left 18
- pointer
 - identifying 29
 - moving 30
- power
 - button 22, 26
 - connector 20
 - Hybrid Sleep mode 26
 - indicator 18
 - Sleep mode 26
 - status indicator 18
- power system check 141
 - battery pack 142
 - power adapter 142

- printer
 - USB port 18, 19
- programs
 - opening 30
- projector
 - port 20
 - using 26
- Properties button 32
- R**
- right-clicking 30
- S**
- scanner
 - USB port 18, 19
- screen objects
 - getting information 30
 - moving 30
 - selecting 30
- scroll zone 29
- security features
 - Kensington cable lock 18
- Settings button 32
- shortcut menus
 - accessing 30
- shortcuts
 - opening menu 30
- Sleep
 - mode 26
 - system key 26
- Snapshot button 33
- sound
 - adjusting 27
 - muting 27, 31
- speakers
 - built-in 22
 - jack 19
- specification
 - buttons 15
 - ports 15
 - status indicators 15
- Start camera button 32
- starting
 - programs 30
- status indicator
 - wireless Ethernet 24
- status indicators
 - battery charge 18
 - Caps Lock 24
 - drive activity 24
 - hard drive 24
 - location 22
 - numeric keypad 24
 - Pad Lock 24
 - power 18
 - specification 15
 - toggle on or off 26
- Suspend 26
- switch
 - wireless network 18
- system
 - block diagram 5
 - check procedures 140
- system keys
 - locating 25
- T**
- television
 - HDMI out jack 19
- top 158
- touchpad
 - buttons 29
 - check 143
 - clicking 30
 - double-clicking 30
 - dragging screen objects 30
 - locating 22
 - moving pointer 29, 30
 - moving screen objects 30
 - opening files, folders, and programs 30
 - opening shortcut menu 30
 - right-clicking 30
 - scroll zone 29
 - selecting screen objects 30
- turning off
 - Bluetooth 26
 - wireless network 18, 26
- turning on
 - Bluetooth 26
 - wireless Ethernet 26
 - wireless network 18, 26
- TV out (HDMI) jack 19
- U**
- undetermined problems 155
- USB
 - chipset 15
- USB port 18, 19
- utility
 - BIOS 36, 46
 - Flash Utility 46
- V**
- VGA port 20
- video
 - chipset 11
 - features 12
 - HDMI out jack 19
 - memory 12
 - monitor port 20
 - projector port 20
 - VGA port 20
- view
 - left 18
 - rear 20
 - right 19
- volume
 - adjusting 27
 - muting 27, 31
 - system keys 27
- W**
- webcam 23, 32
- Webcam status indicator 23
- Windows
 - key 25
- Windows 2000 environment
 - test 182
- Windows Hotstart 31
- Windows Media Player 31
- wired Ethernet
 - chipset 14
- wireless Ethernet
 - button 26
 - chipset 14
 - status indicator 24
- wireless network
 - switch 18

MAN P-79 SVC GDE R1 06/09

TEMP
UPC