

SONY®

Digital HD Videocassette Recorder
HVR-M25N/M25P
HVR-M15N/M15P



HDV™

HDV 1080i

The Perfect Choice for Cost-effective HD Productions – the Sony HVR-M25 and HVR-M15 HDV 1080i VTRs

In 2004, Sony introduced affordable, yet high-performance HD recording systems adopting the HDV™ 1080i specification of the HDV format to a wide range of professional videographers. Upon that introduction, these HDV systems gained a rapid and wide acceptance due to their high picture quality, outstanding performance, and cost-effectiveness. Today, in response to the demands for greater levels of operability such as longer recording time and time-code-recording capabilities, Sony introduces its latest HDV recorders – the HVR-M25 and HVR-M15.

The HVR-M25 and HVR-M15 enable users to record and play back video in a choice of formats – HDV 1080i, DVCAM™, and DV. They also feature a down-conversion capability for 1080i recording, which provides the flexibility to record in either standard definition (SD) or high definition (HD) depending on your production needs.

One of the most powerful features of these VTRs is their compatibility with standard cassettes in addition to mini cassettes, which provides extended recording time of up to 276 minutes. In addition, these VTRs provide a convenient function to copy not just the video and audio of an original tape via an i.LINK™*1 connection, but also the time code.

Both models are optimized for use with nonlinear editing systems thanks to their highly compact size and easy operations. However, the HVR-M25 provides additional powerful features such as a built-in 2.7-inch*2 type, 16:9 LCD monitor and an HDMI (High Definition Multimedia Interface) output for more demanding production environments.

The HVR-M25 and HVR-M15 offer a highly powerful, yet cost-effective tool for nonlinear editing systems that will serve both today's production needs, as well as those of tomorrow.



HDV FORMAT

HDV 1080i Specification

The HDV 1080i specification^{*3} of the HDV format features 1,080 effective scanning lines (interlace scanning system) and 1,440 horizontal pixels. It adopts the MPEG-2 compression format (MP@H-14 for video), which uses 8-bit digital component recording with a sampling rate of 4:2:0. MPEG-1 Audio Layer II is used as the audio compression format, allowing for two-channel recording with a sampling frequency of 48 kHz/16-bit. The HDV 1080i specification provides high picture quality that can be used for HDTV program production.

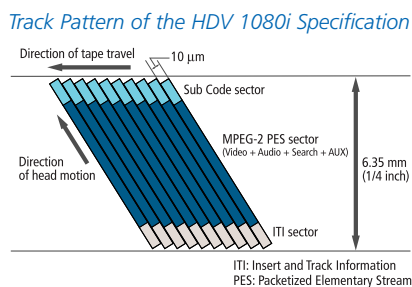

Compatible with Existing and New DV Videocassette Tape

As a member of the proven DV family of formats, the HDV format has, from the outset, been developed for compatibility with all grades of DV videocassette tape. This allows operators to use high-grade DV videocassette tapes for applications where high robustness is critical, or consumer-grade videocassette tapes for more economical operations. For heavy-duty applications, the DigitalMaster™ high-grade cassette tape has been developed. This tape is compatible with the HDV, DVCAM, and DV formats.

HVR-M25 & HVR-M15 COMMON FEATURES

Switchable Recording and Playback – HDV 1080i/DVCAM/DV SP and 60i/50i

The HVR-M25/M15 can switch between HDV 1080i, DVCAM, and DV^{*4} recording, providing full flexibility to record in either standard definition or high definition depending on your production needs. In addition, it can be switched between 60i and 50i modes (NTSC and PAL), which allows for flexible production operations, without the need for two separate VTRs of each standard.

Dual-size Cassette Mechanism

The HVR-M25/M15 has a dual-size cassette mechanism that accepts both mini- and standard-sized DigitalMaster, DVCAM, and DV cassette tapes – without using any special adaptor. This feature allows the six different types of cassette tape to be used without the cumbersome process associated with additional mechanical hardware.



Long Recording Time

The HDV format adopts the same track pitch and tape speed as the DV format, thus offering the same recording time – a maximum of 276 minutes when recording on a DigitalMaster standard cassette tape and a maximum of 63 minutes when recording on a DigitalMaster mini cassette tape.

^{*1} i.LINK is a trademark of Sony Corporation used only to designate that a product contains an IEEE 1394 connector. Not all products with an i.LINK connector will necessarily communicate with each other. For information on compatibility, operating conditions, and proper connection, please refer to the documentation supplied with any device with an i.LINK connector. For information on devices that include an i.LINK connection, please contact your nearest Sony office. ^{*2} Viewable area measured diagonally. ^{*3} The HDV format also defines the HDV 720P specification, which features 720 effective scanning lines (progressive scanning system) and 1,280 horizontal pixels. ^{*4} The HVR-M25/M15 supports DV SP mode only; no support for DV LP mode.

HVR-M25 & HVR-M15 COMMON FEATURES

Down-conversion Playback Capabilities

The HVR-M25/M15 can convert material from 1080i down to 480i and 576i, and output these video signals through its i.LINK interface. In addition, these signals can also be output via the VTR's HDMI (on the HVR-M25), analog component, S-video, or composite connector. This allows users to edit recorded material with a compatible nonlinear editing system using current DV editing software, as well as record SD signals to an external VTR. Video material can also be down-converted to 480P and 576P (as well as 720P on the HVR-M25), and output via the VTR's HDMI (on the HVR-M25) or analog component video connector. When down-converting these signals, the aspect ratio displayed can be converted from 16:9 to 4:3. Display modes can be selected from Squeeze, Letterbox*, and Edge Crop.

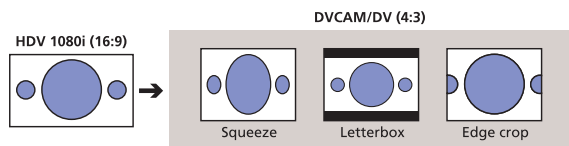

Recording, Playback and Down-conversion Formats

60i Mode

Input	Recording Format	Output						
		Playback/Down Conversion Format	Analog Component	Analog Composite	S-Video	i.LINK	HDMI*	
i.LINK	1080/60i	HDV 1080i	1080/60i	○	—	—	○	●
			720/60P	●	—	—	—	●
			480/60P	○	—	—	—	●
Analog Composite S-Video	480/60i	DVCAM/DV SP	480/60i	○	○	○	○	▲

○: Available ●: Available only for HVR-M25 ▲ Available only for HVR-M25 in playback mode

50i Mode

Input	Recording Format	Output						
		Playback/Down Conversion Format	Analog Component	Analog Composite	S-Video	i.LINK	HDMI*	
i.LINK	1080/50i	HDV 1080i	1080/50i	○	—	—	○	●
			720/50P	●	—	—	—	●
			576/50P	○	—	—	—	●
Analog Composite S-Video	576/50i	DVCAM/DV SP	576/50i	○	○	○	○	▲

○: Available ●: Available only for HVR-M25 ▲ Available only for HVR-M25 in playback mode

* The HDMI connector cannot output video and audio signals with copyright protection signals.

Edge Crop Adjust (HVR-M25 only)

When down-converting signals in the Edge Crop mode, the Edge Crop Adjust function is provided to adjust the edge crop position. By displaying the edge crop marker on the LCD monitor, operators can conveniently check the edge crop position before outputting down-converted signals.

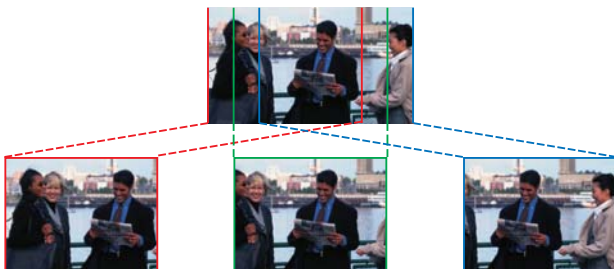

i.LINK Interface

The HVR-M25/M15 is equipped with a 4-pin i.LINK interface. This allows for one cable digital transfer*6 of video, audio, and command signals to a compatible connected VTR or nonlinear editing system in HDV, DVCAM, or DV format.

Time Code Copy from External Devices

When the HVR-M25/M15 records signals from the i.LINK port, the time code that was recorded on the original tape can be copied onto other tapes, along with the video and audio signals. This is effective when downloading edited material from nonlinear editors or creating dubs from other VTRs.

Auto Repeat and Custom Repeat

The HVR-M25/M15 has a convenient auto repeat function. This enables the VTR to automatically rewind the tape to either the beginning of the tape, the first complete blank portion, or an index point on the tape, and start playback again from there*7. In addition, the HVR-M25 has a Custom Repeat function that allows operators to set the number of repeat playbacks, the interval between each playback, and the hour at which the playback should begin.

Color Bar and 1-kHz Audio Tone Signal Output

The HVR-M25/M15 can output three types of color bar via the i.LINK, HDMI, analog component, S-video, and composite connectors, as well as an audio tone signal of 1 kHz via the i.LINK, HDMI, and analog audio connectors. These are useful when checking the system conditions.

External Control

The HVR-M25/M15 comes equipped with a Remote Commander™ unit, which enables users to control the recorder's functions wirelessly. In addition, the HVR-M25/M15 is equipped with a LANC terminal, as well as a Control S terminal to connect with the optional DSRM-10 Remote Control Unit for jog and shuttle operation.



Tape Cleaner for Reliable Operation

The HVR-M25/M15 incorporates a tape cleaner that adopts a high-grade sapphire blade. This cleaner can help prevent signal dropouts and improve the reliability of recording and playback by cleaning away particles from the tape during operation.

*5 When outputting down-converted signals in the 4:3 aspect ratio via an i.LINK connector, the Letterbox mode cannot be selected. *6 Insert and assemble editing using HDV material is not recommended with the HVR-M25/M15. When video programs in the HDV format are transferred via the i.LINK interface and edited, transitions from cut to cut may not be smooth. *7 The HVR-M25/M15 ignores any blank or index point in the first 20 seconds of the tape.

HVR-M25 FEATURES

Built-in, 2.7-inch Type, Clear Photo LCD Plus™ Monitor

The HVR-M25 is equipped with a 2.7-inch*2 type widescreen color LCD monitor with a high resolution of 211,200 dots. It adopts a newly developed Clear Photo LCD Plus panel, which provides enhanced brightness and a higher level of color reproduction than that used in the DSR-25. This LCD monitor allows operators to view the input source during recording, and check the playback picture in a 16:9 widescreen aspect ratio. Setup menus, VTR/audio settings, and audio level meters can also be displayed.

HDMI (High Definition Multimedia Interface) Output

The HVR-M25 comes equipped with a HDMI interface that is widely used in consumer electronics devices such as HDTV monitors. This interface allows the HVR-M25 to transfer non-compressed, high-definition digital video and audio to other HDMI-equipped devices via a single cable.

DUPLICATE PLUS

The DUPLICATE PLUS function makes it easy to copy video and audio from a VTR or camcorder onto the HVR-M25 – along with the original time code. Operators simply connect the two i.LINK devices together via their i.LINK interfaces and press the DUPLICATE PLUS and Play buttons on the front panel of the HVR-M25. The copying will then begin. This function can also be used for copying the content of multiple tapes onto a single tape, which is convenient when you need to compile multiple mini cassette tapes onto a single standard cassette tape. Another unique feature of DUPLICATE PLUS is the ability to selectively copy portions of material recorded in a designated format from a tape that contains mixed-format recordings. For example, you can choose to copy only HDV format recordings from a tape that includes DVCAM and DV video as well. This DUPLICATE PLUS function is available for any recordable formats (HDV/DVCAM/DV SP).

MARKER BURN

The MARKER BURN function of the HVR-M25 allows the 4:3 marker to be superimposed onto video output – whether it is displayed on the LCD monitor or output via the analog component, S-video, or composite connectors. This function is available when displaying 16:9 signals or down-converted signals in letter box or squeeze mode. It is particularly useful when making work tapes for editing in both 16:9 and 4:3 aspect ratios.

Time Counter

The HVR-M25 has a time counter display function that allows time data such as time codes, user bits, and count values of the counter to be displayed on the LCD monitor. Furthermore, operators can customize how this data appears on their display by selecting its size, position, and color via the menu. It is also possible to output video with superimposed time data via the analog component, S-video, or composite connectors.

Time Code Preset

The time code of the HVR-M25 can be preset using any number in H/M/S/F (hours/minutes/seconds/frames) to record desired tape-position information. The time code mode can be selected between “REC RUN” and “FREE RUN”. In addition to the time code, user bits can also be set.

Status Check

At the touch of the STATUS CHECK button of the HVR-M25, operators can display the menu settings for Audio Level Meter, Output Signal, Assign Button, and Custom Repeat on the LCD monitor – allowing for easy status or setting checks during recording, playback, and source feeding.

Assign Buttons

The buttons for INDEX, COUNTER RESET, and AUDIO DUB on the front panel of the HVR-M25 can be used as “Assign Buttons”, to which operators can assign another frequently used function from any of the following: HDV/DV CONVERT, HDMI/COMPONENT, END SEARCH, DATA CODE, ALLSCAN MODE, COLOR BAR, SEARCH SELECT, SEARCH +, SEARCH -, COUNTER SIZE, COUNTER COLOR, and FF/REW SPEED.

All Scan Mode

The All Scan Mode of the HVR-M25 is similar to the Under Scan Mode of ordinary monitors, in that it displays all effective scanning lines in the LCD monitor when the 1080i mode is selected. This is useful if you want to check pictures for web applications, for example. The All Scan Mode can be easily recalled at the touch of a button if you pre-assign it to one of the three “Assign Buttons”.

HVR-M15 FEATURE

Compact, Unique Design

The HVR-M15 is compact, with a small footprint that enables it to be deployed in existing work environments without disruption. It is also unique in that it can be placed either horizontally or vertically.

*HVR-M15
Cassette Compartment Lid Open*



FRONT & REAR PANELS

HVR-M25



Front Panel



Rear Panel

HVR-M15



Front Panel



Rear Panel

APPLICATIONS

Nonlinear Editing

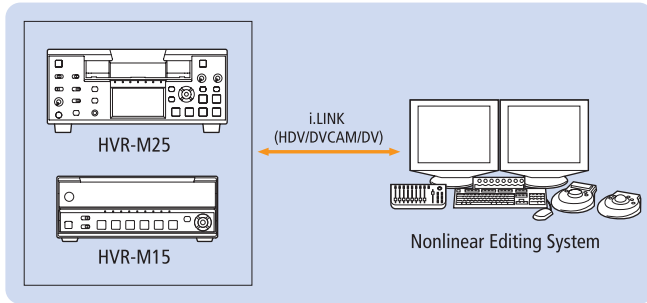

Dubbing with the Time Code Recording Capability

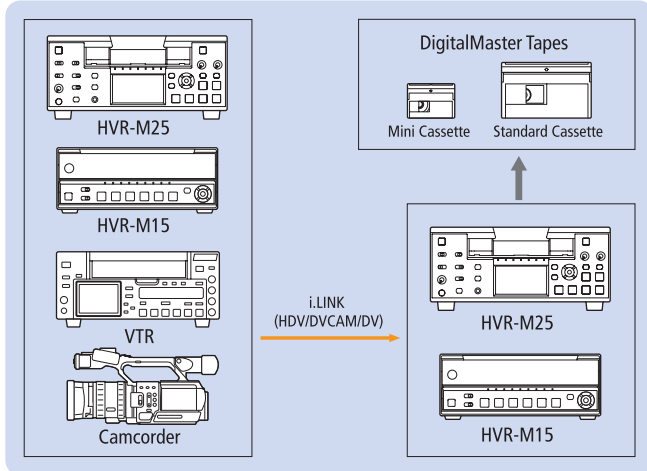

Viewing with Various Display Devices

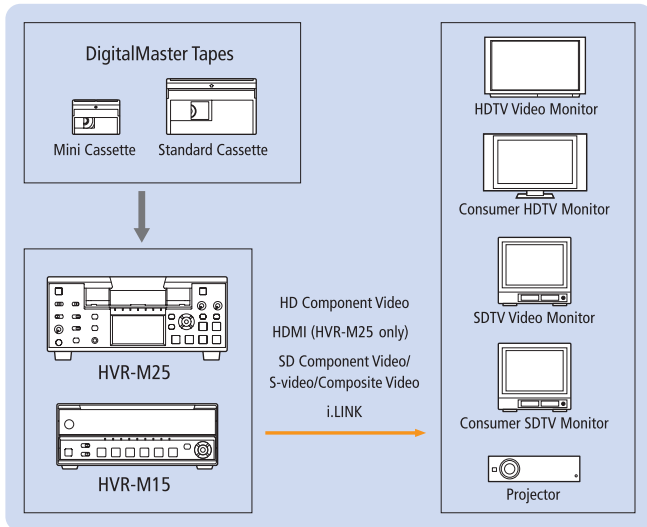

Dubbing with XDCAM™ HD Decks

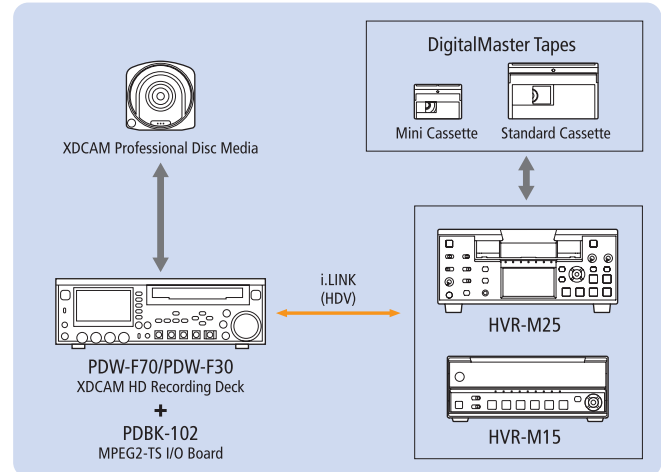

HD Camera Systems

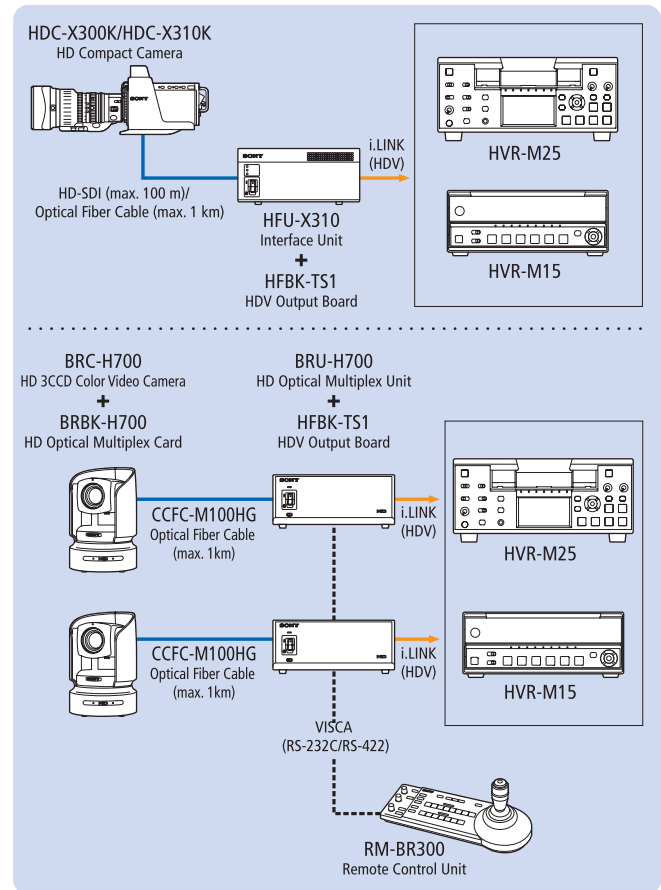

ACCESSORIES

VMC-IL4408A/IL4415/IL4435
i.LINK Cable
(4-pin to 4-pin, 0.8/1.5/3 m)

VMC-IL4615/IL4635
i.LINK Cable
(4-pin to 6-pin, 1.5/3.5 m)

DLC-HM15/HM30/HM50
HDMI Cable (1.5/3/5 m)

PHDV-276DM/186DM/124DM/64DM
DigitalMaster Standard Cassette Tape

PHDVM-63DM
DigitalMaster Mini Cassette Tape

SPECIFICATIONS

	HVR-M25	HVR-M15
Recording/playback performance		
Recording format	1080/60i, 1080/50i, 480/60i (NTSC), 576/50i (PAL)	
Playback/down conversion format	1080/60i, 1080/50i, 480/60i (NTSC), 576/50i (PAL), 480/60P, 576/50P, 720/60P, 720/50P	1080/60i, 1080/50i, 480/60i (NTSC), 576/50i (PAL), 480/60P, 576/50P
Tape speed	HDV/DV SP DVCAM	Max. 18.812 mm/s Max. 28.218 mm/s
Playback/recording time	HDV/DV SP DVCAM	Max. 276 min with PHDV-276DM cassette Max. 63 min with PHDVM-63DM cassette Max. 184 min with PHDV-276DM cassette Max. 41 min with PHDVM-63DM cassette
Fast forward/rewind time	Approx. 2 min with PHDV-276DM cassette	
Input/output connectors/devices		
Video input/output	BNC x 2 Video signal: 1 Vp-p, 75 Ω unbalanced, sync negative	RCA pin x 2 Video signal: 1 Vp-p, 75 Ω unbalanced, sync negative
S-video input/output	Mini-DIN 4-pin x 2 Y: 1 Vp-p, 75 Ω unbalanced, sync negative C: 0.286 Vp-p (NTSC), 0.3 Vp-p (PAL), 75 Ω unbalanced,	
Component video output	BNC x 3 Y: 1 Vp-p (0.3 V, sync negative) Pr/Pb (Cr/Cb): 700 mVp-p (100% color bar), input impedance 75 Ω	RCA pin x 3 Y: 1 Vp-p (0.3 V, sync negative) Pr/Pb (Cr/Cb): 700 mVp-p (100% color bar), input impedance 75 Ω
i.LINK	4-pin	
HDMI output	19-pin (type A), video: 1080/60i, 1080/50i, 480/60i (NTSC), 576/50i (PAL), 720/60P, 720/50P, 480/60P, 576/50P, audio: PCM 48 kHz/16-bit	—
Phones	Stereo minijack (φ3.5 mm), 8 Ω loading	
LANC	Stereo mini-minijack (φ2.5 mm)	
Control S	Stereo minijack (φ3.5 mm)	
Audio input	RCA pin x 2 Input level: -10/-2/+4 dBu, input impedance: min. 47 kΩ unbalanced, max. input level: -10: +18 dBu (approx. 6 Vrms), -2: +24 dBu (approx. 12.5 Vrms), +4: +30 dBu (approx. 25 Vrms)	RCA pin x 2 Input level: -10 dBu, input impedance: min. 10 kΩ unbalanced, max input level: +16 dBu (approx. 5 Vrms) in 60i mode, +14 dBu (approx. 4 Vrms) in 50i mode
Audio output	RCA pin x 2 Output level: -10 dBu (full bit -20 dB), impedance 47 kΩ, unbalanced in 60i mode, -10 dBu (full bit -18 dB), impedance 47 kΩ, unbalanced in 50i mode Impedance: max. 1 kΩ unbalanced	
LCD monitor	2.7-inch type, approx. 211,200 dots (960 x 220), Clear Photo LCD Plus	—
General		
Mass	Approx. 4.3 kg (9 lb 8 oz)	Approx. 2.3 kg (5 lb 1 oz)
Power requirements	AC 120 V, 60 Hz	
Power consumption	12 W (playback mode with LCD monitor on)	8 W (playback mode)
Operating temperature	5 to 40°C (41 to 104°F)	
Storage temperature	-20 to +60°C (-4 to 140°F)	
Supplied accessories	Remote commander (1), power cord (1), size AA batteries (2), cleaning cassette (1), operating instructions (1)	Remote commander (1), AC adaptor (1), power cord (1), stand (1), size AA batteries (2), cleaning cassette (1), operating instructions (1)

HVR-M25

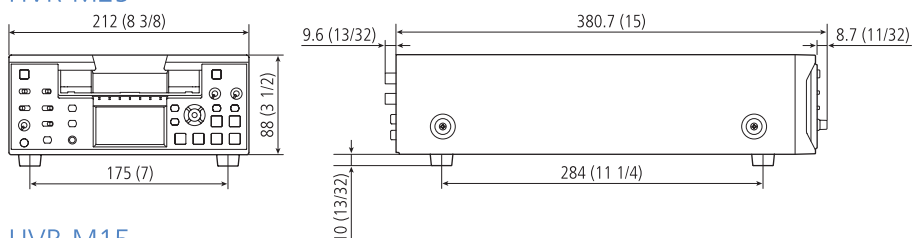

HVR-M15

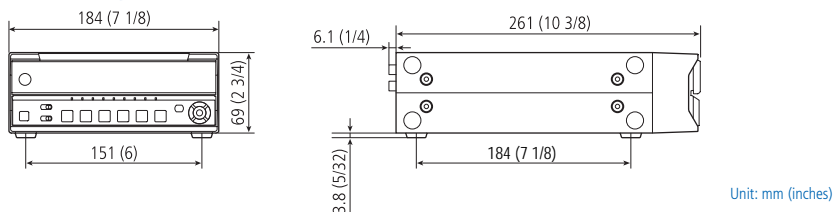

Unit: mm (inches)

Distributed by

© 2006 Sony Corporation. All rights reserved.
 Reproduction in whole or in part without permission is prohibited.
 Features and specifications are subject to change without notice.
 All non-metric weights and measurements are approximate.
 Sony, Sony logo, DVCAM, DigitalMaster, i.LINK, Clear Photo LCD Plus,
 Remote Commander, and XDCAM are trademarks of Sony Corporation.
 HDV and HDV logo are trademarks of Sony Corporation and Victor Company of Japan, Limited.