









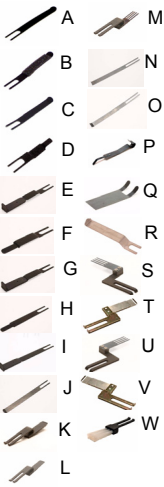

	PART #	
	<b>PUMP FILTER - Quickmaster 46</b>	P-9470
	<b>SILENCER</b>	P-9413
<b>RIBBED V-BELTS</b>		
	TOK - Drive motor (610mm)	P-3780
	TOK - Drive shaft (762mm)	P-3783
	GTO 46 - Drive motor (1168mm)	P-3785
	GTO 46 - 4 Color Drive Belt	P-3733
	GTO 46/52 - Drive motor	P-3716
	GTO 52 - Drive motor (1321mm)	P-3788
	GTO 52 Z/P, V/P - Drive motor (1016mm)	P-3790
	GTO 52 Z/P, V/P - Drive motor (1397mm)	P-3791
	Windmill 10 X 15 - Main drive (2150 mm)	P-3703
	Windmill 10 X 15 - Main drive	P-3793
	Windmill 10 X 15 - Main drive (2362 mm)	P-3893
Windmill 13 X 18 - Main drive	P-3722	
	<b>TIMING BELTS - TOK</b>	
	STACK-LOAD MASTER FEED	P-3810
	MASTER FEED TABLE	P-1697
	<b>FEED TAPE</b>	
	SPEEDMASTER 72 & 102	P-3918
	MO, SORK	P-3927
	<b>SHEET SEPARATORS</b>	
(A)	KORD (45°)	HE-KØ114
(B)	KORD (45° with pad)	HE-KØ420
(C)	KORD (90°)	HE-KØ117
(D)	K-Series	HE-KS117
(E)	K-Series w/hood	HE-KS114
(F)	GTO 46	HE-46117
(G)	GTO 46 (with hood)	HE-46114
(H)	GTO 52	HE-52117
(I)	GTO 52 (with hood)	HE-52118
(J)	GTO 52 (45°)	HE-52114
(K)	M/S Series	HE-SØ117
(L)	M/S Series	HE-SØ114
(M)	M/S Series	HE-SØ106
(N)	SB Series (90°)	HE-SB117
(O)	SB Series (45°)	HE-SB114
(P)	WINDMILL	HE-WI114
(Q)	WINDMILL	HE-WI117
(R)	Quickmaster 46/46DI	HE-46114QM
(S)	GTO (Operator side)	HE-52106
(T)	SM52/74 (Operator side)	HE-52106SM
(U)	GTO (Non-Operator side)	HE-52107
(V)	SM52/74 (Non-Operator side)	HE-52107SM
(W)	M/S/SM102 Brush	HE-SØ107
	<b>RUBBER HOOD</b> For sheet separators.	HE-46114-R
	<b>SHEET SEPARATOR BAR</b> QUICKMASTER 46 & 46DI	HE-46117QM
	<b>PLATE SPRING</b> For Quickmaster	
	4mm	HE-46099QM-4mm
	6mm	HE-46099QM-6mm
	<b>SHEET STEADIER BRUSH - GTO 46 / 52, K-Series Complete</b>	HE-46403
	Brush only	HE-46420
	Wing nut	P-3399
	Shoulder screw	P-8176

	PART #	
	<b>SHEET SEPARATOR HOLDER</b>	HE-KØR113
	KOR	
	<b>SHEET SEPARATOR HOLDER - L.H. &amp; R.H.</b> ... UNIVERSAL. WORKS ON BOTH SIDES OF FEEDER.	HE-KØRD113
	KORA, KORD, KORS	
	<b>BRUSH WHEELS</b> For feeder section.	
	K, M, S, SPEEDMASTER (white bristle)	HE-SR420
	K, M, S, SPEEDMASTER for cardboard stock (black bristle)	HE-SR500
	<b>GRIPPER FINGER</b> HE-46212	
<b>FEED GRIPPER COMPLETE - GTO 46 &amp; 52</b>		
<b>COMPLETE</b>		HE-46511
(A) Gripper finger		HE-46212
(B) Hex head screw		P-2088
(C) Needle bearing		P-3466
(D) Cam roller		P-6838
(E) Flat washer		P-595
(F) E-ring		P-2759
(G) Stud-for cam roller		P-7943
(H) Taper pin		P-431
(I) Connecting piece		P-11923
(J) Torsion spring		HE-46212-T
(K) Gripper pad		not sold alone
(L) Spring		HE-46212-E
(M) Grooved pin		P-3037
(N) Torsion Spring (not shown)		(see note)
(O) Backing Plate		HE-46212-BP
NOTE: Torsion spring "N" is obsolete. Spring "L" & grooved pin "M" are used in place of it.		
	<b>SPRING</b> For traveling feed gripper.	
	K-series	HE-KØ144
	<b>SUCKER FEET</b>	
(A)	GTO (9/32 ID x 3/4 OD gum rubber - blue)	P-5222
(A)	GTO (9/32 ID x 3/4 OD polyurethane - red)	P-7568
(B)	GTO (5/16 ID x 11/16 OD for cardboard)	P-5244
(C)	HEIDELBERG/KLUGE (7/8" O.D.)	P-5210
(C)	HEIDELBERG (1-1/16" O.D.)	P-7556
(D)	HEIDELBERG (5/32" I.D. x 1" O.D.)	P-5223
(D)	WINDMILL (5/32" I.D. x 7/8" O.D.)	P-7566
(D)	WINDMILL (1/8" I.D. x 29/32 O.D.)	P-5234
(E)	SOR (1-1/4" O.D.)	P-5236
(E)	MO/SOR (1-3/16" O.D.)	P-5240
(E)	MO/SOR (1-1/2" O.D.)	P-5243
(E)	Speedmaster 52 (6/16 I.D. x 1-3/16 O.D.)	P-7564
(F)	SORKZ For tissue paper	P-5218
(G)	TOM/TOK (1-1/4 Long)	P-5215
(G)	Quickmaster (11/16 Long)	P-7558
	<b>SPRING GUIDE (TONGUE)</b> For conveyor K- series	HE-KØR420
	<b>RETAINER SPRING</b> For GTO 52 feeder.	HE-SØ711

PART #



**HOLDER ASSEMBLY** - GTO 46/52, WINDMILL PLATENS  
**Complete** HE-WI434  
 Replacement roll pin P-2839  
 Replacement thumb screw P-2022

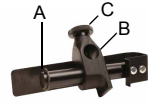

**SHEET STEADIER ASSEMBLY** - GTO 46 / 52, K-Series  
**Complete** HE-KØØ27  
 (A) Sheet steadier HE-KØR090  
 (B) Holder HE-46049  
 (C) Thumb screw P-2022

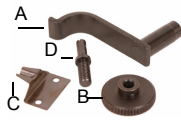

**FRONT GUIDE** - For GTO 46/52, K-Series  
 (A) Guide only HE-KØØ383  
 (B) Adjusting knob P-2932  
 (C) Retainer spring HE-KØØ257  
 (D) Adjusting screw P-2912

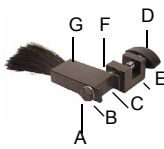

**SHEET STEADIER BRUSH** - S-SERIES  
**Complete** HE-SR467  
 (A) Hex head screw P-2077  
 (B) Flat washer P-581  
 (C) Nut P-2603  
 (D) Thumb screw P-2924  
 (E) Bracket only HE-SR485  
 (F) Spring washer P-654  
 (G) Sheet steadier brush HE-SR475

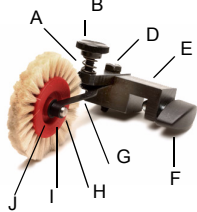

**FEEDER BRUSH WHEEL** - S-Series, Spdmst. 72/102  
**Complete** HE-SR403  
 (A) Spring P-12319  
 (B) Thumb screw P-2903  
 (C) Small bracket HE-SR498  
 (D) Hex head screw P-2043  
 (E) Large bracket HE-SR473  
 (F) Thumb screw P-2924  
 (G) Holder HE-SR492  
 (H) Pin P-4777  
 (I) Brush wheel HE-SR420  
 (J) E-Ring P-2753

**SHEET SMOOTHERS**

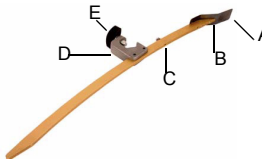

**KOR** (Complete) HE-KØR434  
**KORD/KORA** (Complete) HE-KØRD434  
**KORS** (Complete) HE-KØRS434  
 (A) Spring plate (smoother) HE-KØ779  
 (B) Screw P-2355  
 (C) Bar only (KOR) \*\* HE-KØR483  
 (C) Bar only (KORD/KORA) \*\* HE-KØRD483  
 (C) Bar only (KORS) \*\* HE-KØRS483  
 (D) Block HE-KØR359  
 (E) Thumb screw P-2924

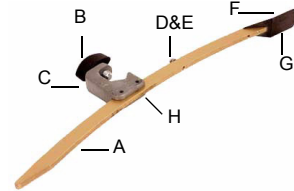

**SHEET SMOOTHER** - GTO 46 (Long)

**Complete** HE-46434  
 (A) Bar only HE-46483  
 (B) Thumb screw P-2924  
 (C) Block only HE-KØR359  
 (D) Screw P-2305  
 (E) Nut P-2600  
 (F) Pan head screw P-2355  
 (G) Plate spring HE-46779  
 (H) Roll pin P-516

PART #

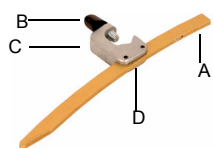

**SHEET SMOOTHER** - GTO 46 (Short)  
**Complete** HE-46352  
 (A) Bar only (Not Sold Alone) P-2924  
 (B) Thumb screw HE-KØR359  
 (C) Block only P-516  
 (D) Roll pin

*Note: \*\* bars come without holes - you must drill holes to match your existing block.*

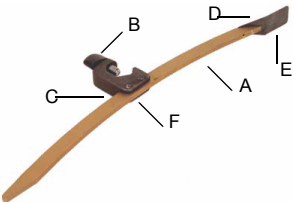

**SHEET SMOOTHER** - GTO 52  
**Complete** HE-52434  
 (A) Bar only HE-52483  
 (B) Thumb screw P-2924  
 (C) Block only HE-KØR359  
 (D) Pan head screw P-2355  
 (E) Plate spring HE-46779  
 (F) Roll pin P-516

*Note: \*\* bars come without holes - you must drill holes to match your existing block.*

**SHEET SMOOTHER PLATE SPRINGS**





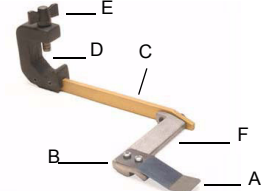

SORZ, SORDZ, SORSZ HE-SØ588  
 SORKZ, SORMZ HE-SØ924





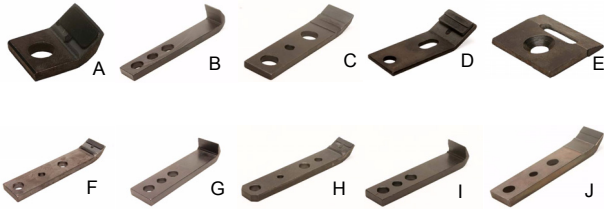





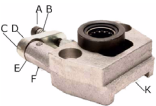

**SHEET SMOOTHER** - S-Series  
**Complete** (Operators side) HE-SØ562  
**Complete** (Drive side) HE-SØ568  
 (A) Spring plate HE-SØ779  
 (B) Screw P-10207  
 (C) Bar only \*\* HE-SØ483  
 (D) Block HE-SØ359  
 (E) Thumb screw P-2923  
 (F) Spacer piece (oper. side) HE-SØ541  
 (F) Spacer piece (drive side) HE-SØ573



**SHEET BRAKE** - GTO 46 / 52, K-Series  
**Complete** HE-52467  
 (A) Strap only HE-52500  
 (B) Block only HE-52473  
 (C) Thumb screw P-2924  
 (D) Stop nut P-2610  
 (E) Screw P-8174

	PART #
	<b>TRANSFER GRIPPER - MOZ, SPEEDMASTER, SORK</b> HE-MT225
	<p><b>GTO 46 / 52</b></p> <p>(A) Transfer and Imp. drum (urethane tip) HE-52245                      (A) Transfer and Imp. drum (plain metal tip) HE-52237                      (B) Imp.—Perfecting drum (urethane tip) HE-MØ237                      Reversing Drum (upper position) HE-521020-RU                      Reversing Drum (lower position) HE-521020-RL</p> <p><b>K-SERIES</b></p> <p>(C) Transfer and Imp. drum (metalized grit tip) HE-KØR225</p> <p><b>M-SERIES</b></p> <p>(D) Feed drum (urethane tip) HE-72225                      (A) Transfer and Imp. drum (urethane tip) HE-52245                      (A) Transfer and Imp. drum (plain metal tip) HE-52237                      (A) Transfer drum—Coating unit (metal tip) HE-52237                      (A) Imp. drum—Coating unit (urethane tip) HE-52245                      (A) Imp. drum—Coating unit (plain metal tip) HE-52237                      HE-MO1020                      HE-MO1050</p> <p><b>QUICKMASTER 46 / 46DI &amp; TOM / TOK</b></p> <p>(E) Impression drum (urethane tip) HE-46237QM</p> <p><b>S-SERIES</b></p> <p>(F) Transfer and Imp. drum (urethane tip) HE-SK237                      (F) Transfer and Imp. drum (plain metal tip) HE-SK245                      (J) Imp. cylinder gripper-SBD (urethane tip) HE-SBD237                      HE-SK1000</p> <p><b>SPEEDMASTER 72</b></p> <p>(F) Transfer and Imp. drum (urethane tip) HE-SK237                      (F) Transfer and Imp. drum (plain metal tip) HE-SK245                      (G) Imp.—Perfecting drum (plain metal tip) HE-72245S                      (G) Transfer drum (large) —Perfecting (plain metal tip) HE-72245S</p> <p><b>SPEEDMASTER 102</b></p> <p>(H) Feed drum (urethane tip) HE-102237                      (H) Feed drum (plain metal tip) HE-102245                      (H) Transfer and Imp. drum (urethane tip) HE-102237                      (H) Transfer and Imp. drum (plain metal tip) HE-102245                      (I) Imp.—Perfecting drum (plain metal tip) HE-102225</p>
	<p><b>GROOVED GRIPPER PADS - Speedmaster 72</b></p> <p>Cross groove HE-72422-CG                      Parallel groove HE-72422-PG</p> <p><b>GROOVED GRIPPER PADS - Speedmaster 102</b></p> <p>Cross groove HE-102422-CG                      Parallel groove HE-102422-PG                      Diamond groove HE-102422-DG</p>
	<p><b>Forwarding Sucker Assembly</b></p> <p>Operator Side HE-S0990-0S                      Non-Operator Side HE-S0990-DS</p>
	<p><b>GROOVED GRIPPER PADS (Cross groove)</b>                      Speedmaster 72 / 102 (after perfector)</p> <p>Drive side HE-72442-D                      Center HE-72442-C                      Operators side HE-72442-Ø</p>

	PART #
	<p><b>INK DISTRIBUTOR ADJUSTING BLOCKS - K-Series</b></p> <p><b>Drive side (complete)</b> HE-KØR494K-DS                      (consists of (A) thru (J) &amp; (K) HE-KØR494-DS.  <b>Operator side (complete)</b> HE-KØR494K-ØS                      (consists of (A) thru (J) &amp; (K) HE-KØR494-ØS.</p> <p><b>BEARING LATCH ASSEMBLY</b> (items (A) thru (F))</p> <p>(A) Screw-Cone point P-2132                      (B) Spring HE-46896                      (C) Latch HE-KØR494-L                      (D) Stud P-7164                      (E) Spring washer P-11826                      (F) Taper pin P-431</p> <p><b>JOURNAL BOX ASSEMBLY</b> (items (G) thru (J)).</p> <p>(G) Journal box HE-KØR494-JB                      (H) Retaining ring P-2771                      (I) Needle bearing P-2117                      (J) Adjusting screw P-2913                      (K) Block (drive side) HE-KØR494-DS                      (K) Block (oper. side) HE-KØR494-ØS</p> <p><b>JOURNAL BOX HOUSING ASSY.</b> (items B, G, H, I, &amp; J)                      HE-KØR494-JBC</p>
	<p><b>SPINDLE</b> For blanket cylinder                      TOM, TOK P-27744</p>
	<p><b>SHEET STOP</b> For side lays                      M-Series, S-series, Speedmaster                      HE-102100</p>
	<p><b>CLAW</b> For blanket clamp HE-46390</p>
	<p><b>THREADED BUSHING</b> For plate cylinder                      GTO 46 &amp; 52 HE-46329</p>
	<p><b>TRIP BLOCK</b> For plate cam                      GTO 52 HE-52391</p>
	<p><b>ADJUSTING SCREW - For WINDMILL LAY BAR</b></p> <p>10 X 15, 13 X 18                      (32 mm O.A.L.) HE-WI135-32                      (39 mm O.A.L.) HE-WI135-39</p>
	<p><b>CYLINDER BRUSHES</b></p> <p>KOR, KORA, KORD-62 P-7659                      KORD-64 P-7657                      KORS P-7658</p>
	<p><b>BLANKET BAR ASSEMBLY - M-Series</b></p> <p>Complete HE-MØ252                      (A) Upper clamp HE-MØ258                      (B) Lower clamp HE-MØ256                      (C) Screw (7 per assembly) P-2009                      (D) Spring (6 per assembly) (not shown) P-12319</p>
	<p><b>HOLDER ASSEMBLY - GTO 46 / 52, K-Series</b></p> <p><b>Complete</b> HE-KØ625                      Replacement roll pin P-2839                      Replacement thumb screw P-2022</p>

PART #



BLANKET BAR ASSEMBLIES

Complete (GTO 46)	HE-46252
Complete (GTO 52)	HE-52252
Complete (SM 52)	HE-52252SM
Complete (KOR)	HE-KØR252
Complete (KORD)	HE-KØRD252
Complete (KORS)	HE-KØRS252
Complete (SM 72)	HE-72252
Complete (SM 74)	HE-74252
Complete (SM 102)	HE-102252
Complete (SORZ)	HE-SØRDZ252
Complete (SORKZ)	HE-SØRKZ252
Complete (SORZ)	HE-SØRZ252



PLATE CLAMP ASSEMBLY - TAIL EDGE

GTO 46 Complete	HE-46367
GTO 52 Complete	HE-52367
(A) Upper clamp - GTO 46	HE-46359
(A) Upper clamp - GTO 52 (left hand)	HE-52359-L
(A) Upper clamp - GTO 52 (right hand)	HE-52359-R
(B) Knurled adjusting nut	P-2949
(C) Eccentric shaft - GTO 46	HE-46435
(C) Eccentric shaft - GTO 52	HE-52435
(D) Adjusting stud	P-7198
(E) Lower clamp - GTO 46	HE-46353
(E) Lower clamp - GTO 52	HE-52353
(F) Threaded stud	P-9138
(G) Spring	P-12909
(H) Screw	P-2418
(I) Metal strip - GTO 46	HE-46353-M
(I) Metal strip - GTO 52	HE-52353-M
(J) Set screw (not shown)	P-2508
(K) Rubber strip - GTO 46	HE-46353-R
(K) Rubber strip - GTO 52	HE-52353-R
(I,K) Metal & rubber strip assy. - GTO 46	HE-46353-MSR
(I,K) Metal & rubber strip assy. - GTO 52	HE-52353-MSR

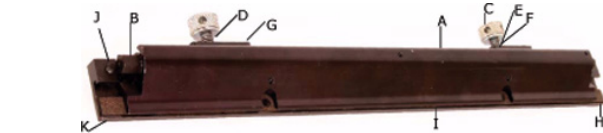

PLATE CLAMP ASSEMBLY - LEAD EDGE

GTO 46 Complete	HE-46788
(A) Upper clamp	HE-46359
(B) Eccentric shaft	HE-46435
(C) Thumb screw	P-2917
(D) Spring	HE-46896
(E) Screw	P-2101
(F) Washer	P-5519
(G) Adjusting bracket	HE-46755
(H) Lower clamp	HE-46353
(I) Spring	P-12909
(J) Screw	P-2418
(K) Metal strip	HE-46353-M
(L) Set screw (not shown)	P-2508
(M) Rubber strip - GTO 46 (not shown)	HE-46353-R
(K,M) Metal & rubber strip assy. - GTO 46	HE-46353-MSR

PART #

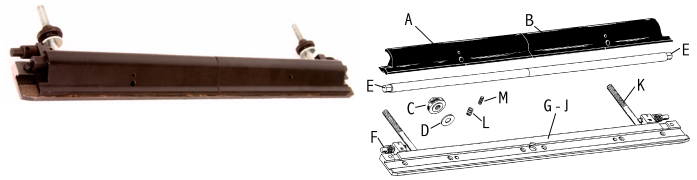

PLATE CLAMP ASSEMBLY - TAIL EDGE - For BACHER PLATE

GTO 46 Complete	HE-46367-BC
(A) Upper clamp - (L.H.)	HE-46359-L
(B) Upper clamp - (R.H.)	HE-46359-R
(C) Knurled adjusting nut	P-2949
(D) Flat washer	P-10942
(E) Eccentric shaft	HE-46435
(F) Adjusting stud	P-7198
(G) Lower clamp sub assembly	HE-46353-BC-S
(H) Lower clamp only	HE-46353-BC
(I) Rubber strip	HE-46353-R
(J) Metal strip	HE-46353-M
(K) Threaded stud	P-9138
(L) Spring	P-12909
(M) Screw	P-2418
(I,J) Metal & rubber strip assembly	HE-46353-MSR

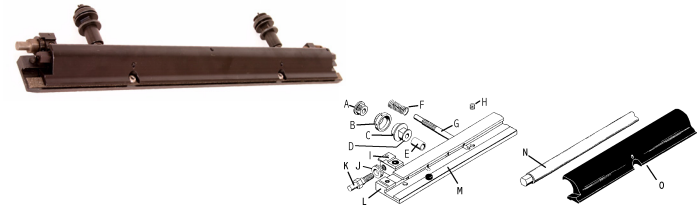

PLATE CLAMP ASSEMBLY - LEAD EDGE - For BACHER PLATE

GTO 46 Complete	HE-46788-BC
(A) Collar	P-6725
(B) Collar scale	P-6726
(C) Adjustment holder	HE-52351
(D) Washer	P-2749
(E) Spacer	P-6802
(F) Spring	P-12148
(G) Threaded stud	P-9137
(H) Spring	P-12909
(I) Adjusting block	HE-52755
(J) Ring scale	P-6724
(K) Adjusting stud	P-7199
(L) Lower clamp	HE-46353-BC
(M) Metal strip (not shown)	HE-46353-M
(N) Eccentric shaft (2 per assm)	HE-46435
(O) Upper clamp (1 per assm)	HE-46359
(P) Rubber strip (not shown)	HE-46353-R
(M,P) Metal & rubber strip assembly	HE-46353-MSR

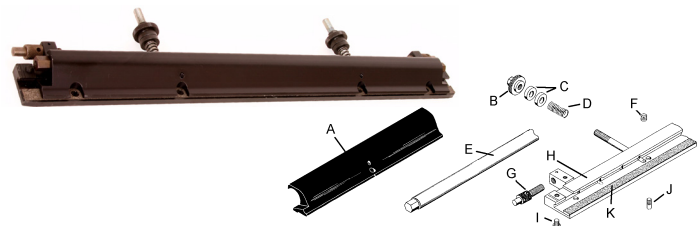
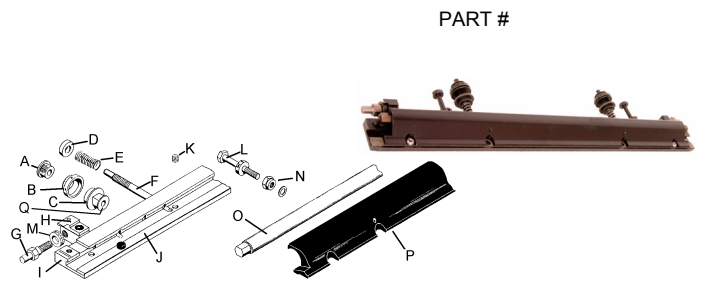

PLATE CLAMP ASSEMBLY - LEAD EDGE

GTO 52 Complete	HE-52788
(A) Clamp	HE-52359
(B) Knurled adjusting nut	P-2949
(C) Spacer	P-6843
(D) Spring	P-12148
(E) Eccentric shaft	HE-52435
(F) Spring	P-12909
(G) Adjusting stud	P-7198
(H) Lower clamp	HE-52353
(I) Screw	P-2418
(J) Set screw	P-2508
(K) Metal strip	HE-52353-M
(L) Rubber strip (not shown)	HE-52353-R
(K,L) Metal & rubber strip assembly	HE-52353-MSR



**PLATE CLAMP ASSEMBLY - LEAD EDGE - For BACHER PLATE**

<b>GTO 52 Complete</b>	HE-52788-BC
(A) Collar	P-6725
(B) Collar scale	P-6726
(C) Adjustment holder	HE-52351
(D) Spacer cam	P-6843
(E) Spring	P-12148
(F) Threaded stud	P-9137
(G) Adjusting stud	P-7199
(H) Adjusting block	HE-52755
(I) Lower clamp	HE-52353
(J) Metal strip	HE-52353-M
(K) Spring	P-12909
(L) Hex head screw	P-2089
(M) Ring scale	P-6724
(N) Nut	P-2634
(O) Eccentric shaft	HE-52435
(P) Clamp	HE-52359
(Q) Rubber strip	HE-52353-R
(J,Q) Metal & rubber strip assembly	HE-52353-MSR

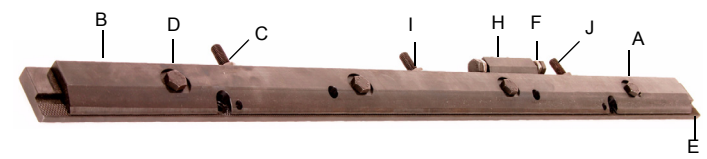

**PLATE CLAMP ASSEMBLY - KORD 64**

<b>Complete</b>	HE-KØRD367
(A) Screw (4 per assm)	P-2008
(B) Upper clamp	HE-KØRD359
(C) Flat washer	P-10942
(D) Spring (4 per assm)	P-12319
(E) Lower clamp	HE-KØRD353
(F) Screw (2 per assm)	P-2105
(G) Washer (2 per assm) (not shown)	P-5519
(H) Block	HE-KØR755
(I) Nut (3 per assm)	P-2604
(J) Set screw (3 per assm)	P-2510

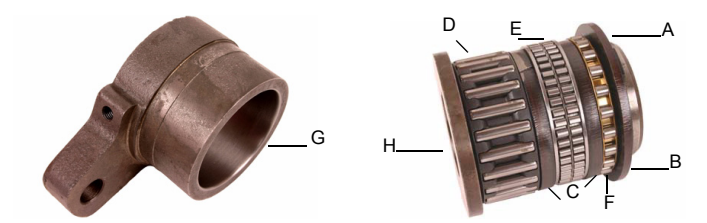

**INK UNIT OVER-RUNNING CLUTCH ASSEMBLY**

<b>COMPLETE (K-Series)</b>	HE-KØ370
<b>COMPLETE (SM 72/102)</b>	HE-72370-CON
(A) Retaining ring	P-2778
(B) Flat washer	P-2715
(C) Ring washer	P-2716
(D) Bearing cage	P-3452
(E) One-way clutch bearing	P-3447
(F) Bearing cage	P-3448
(G) Housing	Not Sold Alone
(H) Sleeve	HE-KØ370-S

	<b>ADJUSTING GEAR</b> For distributor roller.	
	KORD 64	HE-KØRD516



**• STANDARD CYLINDER JACKETS**

WINDMILL 10 X 15	10 x 14-1/4	P-30850
WINDMILL 13 X 18	12-7/8 x 17-3/4	P-30858
GTO 46	15-1/2 x 18	P-30851
GTO 52	16 x 20-3/8	P-30852
M-Series	21-1/2 x 26	P-30853
KORD 62	19-1/4 x 24-7/16	P-30854
KORD 64	19-1/2 x 25-1/2	P-30855
KOR	16-3/4 x 22-1/2	P-30859
KORA	17 x 22-1/2	P-30857
KORS	22-1/2 x 28-1/2	P-30856
Speedmaster 52	15-1/4 x 20-7/8	P-30867

**• REFINED CYLINDER JACKETS**

GTO 46	15-1/2 x 18	P-30860
GTO 52	16 x 20-3/8	P-30861
MO	21-3/4 x 26	P-30862
Speedmaster 72	21-1/16 x 29-1/4	P-30863
Speedmaster 74		P-30872
Speedmaster 102	27-15/16 x 40-3/4	P-30864

**• DIE CUTTING**

KSBZ	21-1/2 x 28-1/2	P-30865
SBB, SBBS, SBBZ	21-1/4 x 32-1/4	P-30866
KSBA	18-5/8 x 22-1/2	P-30869
S-Series	22-1/4 x 28-3/8	P-30887
SBG	24 x 30-1/4	P-30890

	<b>INK DISTRIBUTOR RUNNER</b>	
	WINDMILL 10x15	HE-WI466

---

	<b>DOG AND WORM - Quickmaster 46 / 46DI</b>	
	Dog & Worm set	HE-46464QM-K
	Worm - Ink / Water	HE-46464QM
	Dog - Water	HE-46428QM



**INK FOUNTAIN END PLATES**  
*Sold as a set of 1 Left hand & 1 Right hand.*

Quickmaster 46	HE-46566QM
Quickmaster 46DI	HE-46566QM DI
GTO 52	HE-52566
GTO 52 CPC/CPT	HE-52566CP
GTO 46/52 Numbering Unit	HE-46566-N
Speedmaster 52	HE-52566SM
Speedmaster 72	HE-72566
Speedmaster 74	HE-74566
Speedmaster 102	HE-102566
MO	HE-MØ566
Spring plate for all (O.S.)	HE-72261
Spring plate for all (N.O.S.)	HE-72082
Hickey picker for all	P-31108

PART #

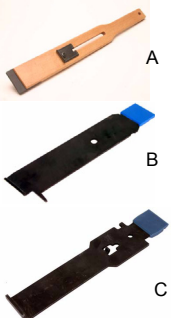

**HICKEY REMOVERS**

(A) SORS, SORD, SORM, MO P-29981  
 (B) Speedmaster 52 P-29983  
 (C) Speedmaster 74 P-29982  
 (D) Speedmaster 102 P-29980

**RUBBER REPLACEMENT** (not shown)  
 for P-29980 only. P-31336



**ADJUSTING SCREW ASSEMBLY**

Complete HE-46427  
 (A) Screw P-6530  
 (B) Brass stud P-7174  
 (C) Nut P-2601  
 (D) Lockwasher P-11830



**INK BLADE ADJUSTING SCREWS**

(A) K-Series P-2929  
 (B) GTO 46/52, M/S Series, Spdmstr 72 P-2928  
 (C) TOK P-2021



**INK ROLLER ASSEMBLY - Windmill 10x 15 (With bearings and runners.)**  
 Complete P-31999



**WATER BACK UP / FEED COLLAR ASSY - K-Series**

COMPLETE HE-KØ538  
 (A) Collar - w / "B & D" HE-KØ355  
 (B) Bearing P-3460  
 (C) Spring P-362130  
 (D) Roll pin P-10452  
 (E) Cam roller P-6838  
 (F) Stud P-7169

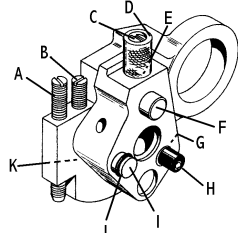



**BEARING SUPPORTS**

GTO 46 D.S. - RED / O.S. - YELLOW, GTO 52 D.S. - RED  
 -COMPLETE (w/o latch) HE-46558  
 GTO 52 O.S. - YELLOW  
 -COMPLETE (with latch) HE-52558  
 GTO 46 & 52 D.S. - YELLOW / O.S. - RED  
 -COMPLETE (w/o latch) HE-46614

(A) Set screw Not Sold Alone  
 (B) Set screw P-2538  
 (C) Shoulder screw P-8171  
 (D) Handle P-7214  
 (E) Spring (inside handle "D") Not Sold Alone  
 (F) Trunnion stud P-7173  
 (G) Set screw (to hold "H") P-2501  
 (H) Eccentric stud P-7163  
 (I) Dowel pin with o-ring P-4780  
 (J) O-ring (comes with P-4780) P-5330  
 (K) Spring (underneath "B") P-152422

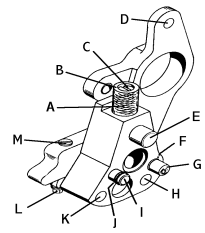
PART #

**LOWER DAMPENING BEARING SUPPORT**

GTO 46 & 52 D.S. GREEN - Complete HE-46415  
 GTO 46 & 52 O.S. GREEN - Complete HE-46400  
 (A) Spring (inside handle "B") HE-46896  
 (B) Handle P-7214  
 (C) Shoulder screw P-8171  
 (D) Dowel pin P-3132  
 (E) Trunnion stud P-7173  
 (F) Set screw (to hold "G") P-2501  
 (G) Eccentric stud P-7163  
 (H) Grooved pin P-2899  
 (I) Grooved pin with o-ring P-4780  
 (J) O-ring (comes with P-4780) P-5330  
 (K) Brass stud P-7174  
 (L) Nut P-2601  
 (M) Screw (for brass stud) P-6530

**UPPER DAMPENING BEARING SUPPORT**

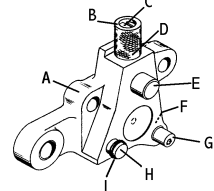
GTO 46 & 52 D.S. Complete HE-46344  
 GTO 46 & 52 O.S. Complete HE-46346  
 (A) Support only HE-46350  
 (B) Handle P-7214  
 (C) Shoulder screw P-8171  
 (D) Spring (inside handle "B") HE-46896  
 (E) Trunnion stud P-7173  
 (F) Set screw (to hold "G") P-2501  
 (G) Eccentric stud P-7163  
 (H) Dowel pin with o-ring P-4780  
 (I) O-ring (comes with P-4780) P-5330



**INK FOUNTAIN BLADES**

WINDMILL 10x15 ..... (37.6 cm x 10.1 cm) ..... HE-WI095-15  
 WINDMILL 13x18 ..... (48.0 cm x 10.1 cm) ..... HE-WI095-18  
 GTO 46 ..... (45.3 cm x 8.4 cm) ..... HE-46095  
 GTO 46 (Numbering Unit) ..... HE-46095-N  
 GTO 52 ..... (51.3 cm x 9.4 cm) ..... HE-52095  
 GTO 52 (Segmented) ..... HE-52095-S  
 GTO 52 (Numbering Unit) ..... HE-52095-N  
 KOR ..... (58 cm x 10.1 cm) ..... HE-KØR095  
 KORD 64 ..... (67.1 cm x 10.1 cm) ..... HE-KØRD095  
 KORS ..... (74.2 cm x 10.1 cm) ..... HE-KØRS095  
 M Series ..... (66.2 cm x 12.9 cm) ..... HE-MØØ95  
 SORDZ ..... (90.1 cm x 11.7 cm) ..... HE-SØRDZ095  
 SORM ..... (73.0 cm x 11.7 cm) ..... HE-SØRM095  
 SORMZ ..... (73.1 cm x 17.5 cm) ..... HE-SØRMZ095  
 SORZ ..... (83.1 cm x 11.8 cm) ..... HE-SØRZ095  
 SORKZ ..... (66.0 cm x 11.8 cm) ..... HE-SØRKZ095  
 SORSZ ..... (103.1 cm x 17.5 cm) ..... HE-SØRSZ095  
 TOK, TOM ..... (27.6 cm x 7.1 cm) ..... HE-TØ095  
 QUICKMASTER 46 ..... (33.6 cm x 7.1 cm) ..... HE-46079QM

PART #

**DAMPENING ROLLER ADJUSTMENT BLOCK**

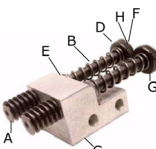

<b>Complete</b>	HE-KØR416
(A) Gear shaft	HE-KØR304
(B) Spring	HE-KØR328
(C) Bracket	HE-KØR418
(D) Knurled nut	P-2946
(E) E-ring	P-2754
(F) Decal washer	P-7464
(G) Decal washer	P-7465
(H) Nut	P-2603



**WATER TROUGH END SUPPORT**

KOR HE-KØR10102



**PLASTIC WATER FOUNTAIN ROLLER BEARING**

KOR HE-KØR10104



**WATER FOUNTAIN HOSE CLAMP**

K-Series HE-KØR347



**Spring** for M-Series Delivery Gripper

Operator Side	HE-M01081
Non-Operator Side	HE-M01080

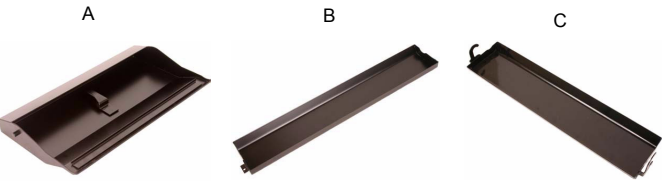

A                      B                      C

**WATER FOUNTAIN TRAYS**

(A) TOM, TOK	HE-TØ316
(B) GTO 46 Old style (ser # 650058-654211)	HE-46316-ØS
(C) GTO 46 New style (ser # 656798-698328)	HE-46316-NS



**BUFFER SPRING** - Windmill 10x15, 13x18

For roller carriage

HE-WI444



**WATER CLUTCH ASSEMBLY** - GTO 46 & 52

HE-46418

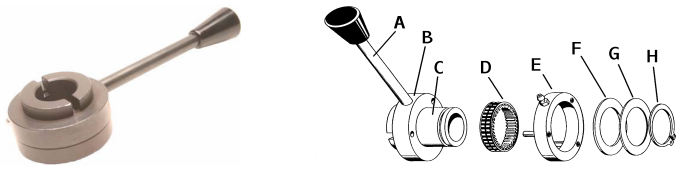

A   B   C   D   E   F   G   H

**OVER RUNNING CLUTCH LEVER ASSEMBLY** - GTO 46 & 52

<b>Complete</b> - Ink unit	HE-46259
(A) Lever & knob assembly	P-320416
(B) Collar - without pins	P-6785
(C) Bearing race	HE-46261
(D) One way clutch bearing	P-3454
(E) Collar - with pins	P-6784
(F) Washer - bearing retainer	P-2720
(G) Belleville washer	P-11833

PART #

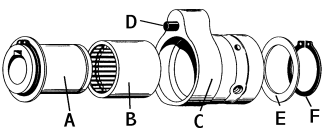
A   B   C   D   E   F

**OVER RUNNING CLUTCH ASSEMBLY** - GTO 46 & 52

<b>Complete</b> (INK)	HE-52226
<b>Complete</b> (WATER)	HE-52370
(A) Sleeve	HE-52226-S
(B) One way clutch bearing	P-3458
(C) Housing only	(Not Sold Alone)
(D) Pin	P-4792
(E) Washer	P-2720
(F) Retaining ring	P-10752



**TEFLON SEALS SETS** For Quickmaster 46 (set includes 1 ea. left / right hand)

(A) 95mm From end to end	P-31161
(B) 102 mm From end to end	P-31181

**TEFLON SEAL PACKS**

(A) Pack of 5 sets	P-31161-5
(A) Pack of 10 sets	P-31161-10
(B) Pack of 5 sets	P-31181-5
(B) Pack of 10 sets	P-31181-10



**TEFLON SEALS** - GTO 46 / 52 - For use on Varn units.

1 Pack only (2 pcs.)	P-30712
Set of 5 packs	P-31168
Set of 10 packs	P-31169

**TEFLON SEALS** - TOK / TOM - For use on Heidelberg dampening units

1 Pack only (2 pcs.)	P-30713
Set of 5 packs	P-30833
Set of 10 packs	P-30834

\*\*1 pack consists of: (1) Right hand seal and (1) Left hand seal.



**DAMPENING FELTS**

QUICKMASTER	P-11739
QUICKMASTER DI	P-11740



**ANGLE** - Paper stripper.  
GTO 46 & 52

HE-462301



**HOLD DOWN STRAPS** For HE-462301 shown at top left column, this page.

GTO 46 / 52	HE-462281
-------------	-----------



**SPRING CLIP** For HE-462281 shown above.

GTO 46 / 52	HE-462321
-------------	-----------



**GRIPPER FINGER** - GTO 46/52, K-Series

w/o Urethane	HE-521050
with Urethane	HE-521020

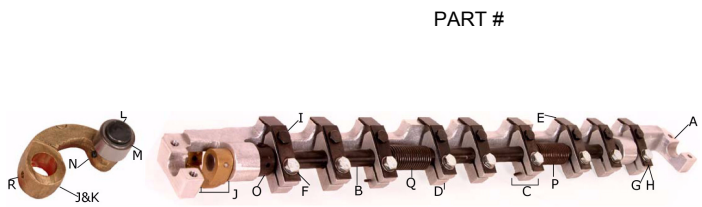

**GRIPPER BAR ASSEMBLIES - GTO 46/52, K-Series**

<b>Complete</b> (GTO 46)	HE-460990
<b>Complete</b> (GTO 52)	HE-520990
<b>Complete</b> (KOR, KORA, KORD 62)	HE-KØR0990
<b>Complete</b> (KORD 64)	HE-KØRD0990
<b>Complete</b> (KORS)	HE-KØRS0990
(A) Anvil (GTO 46)	HE-461090
Anvil (GTO 52)	HE-521090
Anvil (KOR, KORA, KORD 62)	HE-KØR1090
Anvil (KORD 64)	HE-KØRD1090
Anvil (KORS)	HE-KØRS1090
(B) Shaft (GTO 46)	HE-461060
Shaft (GTO 52)	HE-521060
Shaft (KOR, KORA, KORD 62)	HE-KØR1060
Shaft (KORD 64)	HE-KØRD1060
Shaft (KORS)	HE-KØRS1060
(C) *Holder assembly	HE-521000
(D) **Holder	HE-521061
(E) **Finger with urethane	HE-521020
(F) **Backing plate	HE-521062
(G) **Holding screw	P-2003
(H) **Belleve washer	P-651
(I) **Shoulder screw	P-8161
(J) *Arm assembly (GTO 46 & 52)	HE-521040
*Arm assembly (KOR, KORA, KORD62)	HE-KØR1040
*Arm assembly (KORS, KORD 64)	HE-KØRD1040
(K) **Arm only (GTO 46 & 52)	HE-521041
**Arm only (KOR, KORA, KORD62)	HE-KØR1041
**Arm only (KORS, KORD 64)	HE-KØRD1041
(L) **Cam roller stud (GTO 46&52)	P-7159
**Cam roller stud (K series)	P-7169
(M) **Cam roller (GTO 46 & 52)	P-11179
**Cam roller (K series)	P-6840
(N) **Pin (GTO 46 & 52)	P-373
**Pin (K series)	P-1894
(O) Collar	P-6739
(P) Spring (GTO 46 & 52)	HE-521080
(Q) Spring (GTO 52)	HE-521085
(R) Pin	P-2834
(R) Screw (K series)	P-2101

\*indicates a sub-assembly. \*\*indicates components of a sub-assembly.  
**Note:** Item (B) Shaft must be taper reamed for pins in field.

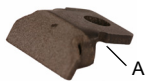

**GRIPPER PADS - SPEEDMASTER 72 & 102**

(A) For ultraviolet & infrared dryers  
 HE-721061-U



(B) For standard HE-721061



**GRIPPER PAD RAIL** For S-Series gripper bars.

HE-SK1061

**WATER OSCILLATING HOUSING ASSEMBLY**



K-Series  
 Operators side HE-KØ429  
 Drive side (shown) HE-KØ431

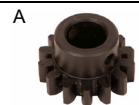

**GEAR FOR METERING ROLL - QM46**

(A) Overall Length: 13.5 mm  
 HE-46555QM



(B) Overall Length: 22 mm  
 HE-46555QM-UG

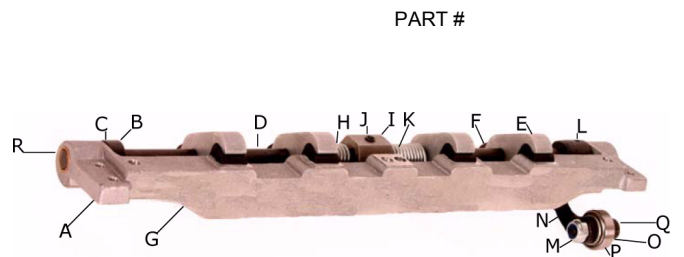

**GRIPPER BAR ASSEMBLY - TOK**

<b>Complete</b>	HE-T00990
(A) Anvil	HE-T01090
(B) Set screw	P-2506
(C) Collar	P-6728
(D) Shaft	HE-T01060
(E) Gripper finger	HE-T01020
(F) Cap screw	P-2112
(G) Gripper pad	P-11904
(H) Gripper spring	HE-T01085
(I) Tension collar	P-6734
(J) Set screw	P-2512
(K) Gripper spring	HE-T01080
(L) Taper pin	P-2810
(M) Stop nut	P-2610
(N) Gripper operating lever	HE-T01041
(O) Washer	P-580
(P) Ball bearing	P-11113
(Q) Screw	P-2103
(R) Bushing	P-3239

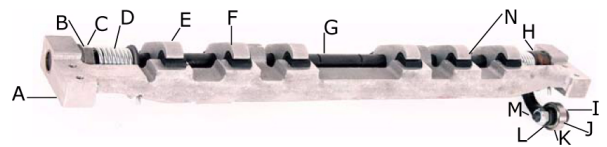

**GRIPPER BAR ASSEMBLY - QUICKMASTER 46 & 46DI**

<b>COMPLETE</b> (46)	HE-460990QM
<b>COMPLETE</b> (46DI)	HE-460990QMMDI
(A) Anvil (comes with P-11904 (Angled Pad)	HE-461090QM
(A) Anvil (comes with P-5631 (Flat Pad)	HE-461090QMMDI
(B) Set screw	P-2506
(C) Adjusting collar	P-6858
(D) Gripper spring	HE-461080QM
(E) Delivery gripper for 46	HE-461020QM
(E) Delivery gripper for 46DI	HE-461020QMMDI
(F) Screw	P-2112
(G) Gripper shaft	HE-461060QM
(H) Taper pin	P-2810

**GRIPPER LEVER ASSEMBLY**

HE-461040QM  
 (Consists of I thru M - also included with complete assembly)

- (I) Screw P-2103
- (J) Washer P-5569
- (K) Ball bearing P-11113
- (L) Gripper lever only HE-461041QM

- (M) Stop nut P-2610
- (N) Rubber pad (Flat) P-11904
- (N) Rubber pad (Angled) P-5631



**GRIPPER BAR ASSEMBLY - WINDMILL**

Complete 10 X 15	HE-WI0990-15
Complete 13 X 18	HE-WI0990-18

**SCREW** - For gripper bar operating arm HE-T1307



PART #

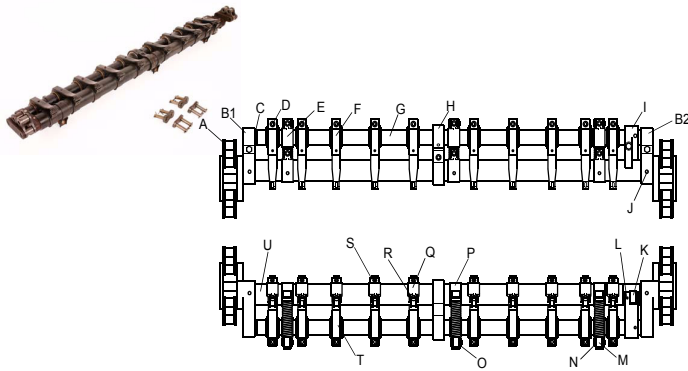

**GRIPPER BAR ASSEMBLY**

COMPLETE (Speedmaster 72)	HE-720990
COMPLETE (Speedmaster 102)	HE-1020990-U
(A) Chain link - 4 ea.	P-8715
(B-1) Carrier link assembly - operators side	HE-720991
(B-1) Carrier link assembly - operators side	HE-1020991
(B-2) Carrier link assembly - non-oper. side	HE-720992
(B-2) Carrier link assembly - non-oper. side	HE-1020992
- Link only - for (B-1)	HE-720991-L
- Link only - for (B-1)	HE-1020991-L
- Link only - for (B-2)	HE-720992-L
- Link only - for (B-2)	HE-1020992-L
- Inner chain link - 2 for each assembly	P-8715
- Needle bearing	P-3461
- Dowel pin for P-8715 - 2 for each assy.	P-2898
- Grease fitting	P-3672
(C) Washer	P-2738
(D) Screw	P-2103
(E) Clamping piece	HE-721066
(F) Finger	HE-721020
(G) Gripper supporting shaft	HE-721060
(G) Gripper supporting shaft	HE-1021060
(H) Center pivot bearing	HE-721092
(I) Gripper operating lever	HE-721040
(J) Taper pin - 3 per complete assembly	P-2865
(K) Cam roller	P-6871
(L) Set screw	P-10017
(M) Spring guide	P-2970
(N) Pin	P-4768
(O) E-Ring	P-2759
(P) Clamp	HE-721067
(Q) Clamping piece	HE-721065
- Screw	P-2103
- Nut	P-2603
- Lockwasher	P-10836
(R) Screw	P-2143
(S) Gripper pad	HE-721061-U
(T) Clamp (also in S-Series)	HE-721064
(U) Shaft	HE-721090
(U) Shaft	HE-1021090

**CARRIER LINKS - K/M/GTO Series**

(A) M-Series - wide attachment	P-8739
(B) M-Series - short attachment	P-8740
(C) K-Series - operators side	P-8732
(C) K-Series - non-operators side	P-8742
(D) Star rod carrier link (K/S)	P-8734
(E) GTO 46/52	HE-521100-A



**GRIPPER CHAIN CONNECTING LINKS**

(A) KOR, KORD, KORS / M-Series	P-8761
(B) KOR, KORD, KORS (offset link)	P-8762
(C) Connecting plate	P-8712-P

PART #

**GRIPPER CHAINS**



TOK (set)	HE-T01100
GTO 46 / 52 (set)	HE-521100
KOR (set)	HE-KØR1100
KORD (set)	HE-KØRD1100
KORS (set)	HE-KØRS1100
MO (set)	HE-M01100
SPEEDMASTER 72/102	HE-721100
SORD	HE-SØRD1100
QUICKMASTER 46 (set)	HE-461100QM
QUICKMASTER 46DI (set)	HE-461100DI

**GRIPPER BAR ASSEMBLY CARRIER LINKS  
SPEEDMASTER 72 & 102**



<b>Complete</b> (oper. side)	HE-720991
<b>Complete</b> (non-oper. side)	HE-720992
(A) Link only (oper. side)	HE-720991-L
(A) Link only (non-oper. side)	HE-720992-L
(B) Inner chain link	P-8715
(C) Needle bearing	P-3461
(D) Dowel pin	P-2898
(E) Grease fitting	P-3672

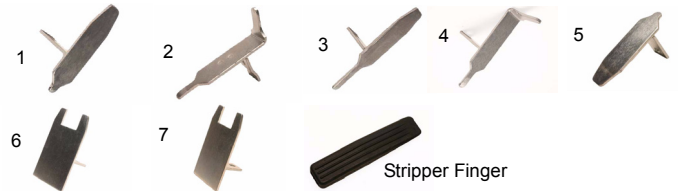

**SHEET STOPS**

- 1) KORD 62 ..... HE-KØRD2281-62  
*(for ser. #335790 & below, otherwise use HE-KØRD2282-64.)*
- 2) KORD 62 & 64 ..... HE-KØRD2282-62  
*(for ser. #335791 & above, otherwise use HE-KØRD2282-62.)*
- 3) KORD 64 ..... HE-KØRD2281-64
- 4) KORD 64 ..... HE-KØRD2282-64  
*for ser. #335791 and above, otherwise use HE-KØRD2282-62.)*
- 5) KORA, KORD-64, KORS (front - side)..... HE-KØRD2284
- 6) KORA, KORD-62 (front - center) ..... HE-KØRD2283-62
- 7) KORD-64, KORS (front - center) ..... HE-KØRD2283-64

**STRIPPER FINGER** ..... HE-KS15112

**STAR ROD BRUSH ASSY.**











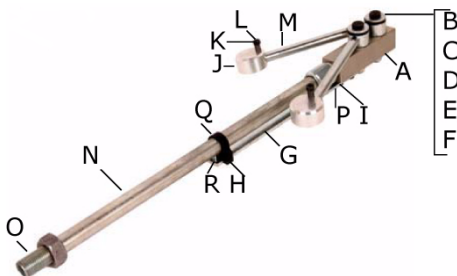











Complete	P-30842
Brush only	P-30842-B
Collar only	P-30842-C
Rubber O-ring	P-553

**STAR ROD ASSEMBLIES**

GTO 52	HE-523170
KOR, KORA, KORD 62	HE-KØRD3170-62
KORD 64	HE-KØRD3170-64
M (series)	HE-MØ3170
SORDZ	HE-SD3170
SORZ	HE-SR3170
SORKZ	HE-SK3170
SORMZ / SPEEDMASTER 72	HE-SM3170
SORSZ / SPEEDMASTER 102	HE-SS3170

NOTE: THESE DO NOT COME WITH BRUSHES OR WHEELS

		PART #
		
<b>POWDER TUBE ASSEMBLY</b>		
Complete (short tube).....	HE-KØR6030	
Complete (long tube).....	HE-KØR6040	
<b>Powder tube sub assy. (A - I).....</b>	HE-KØR6046	
(A) Manifold.....	HE-KØR6050	
(B) Screw.....	P-2044	
(C) Washer.....	P-592	
(D) Gasket.....	P-6422	
(E) Rubber washer.....	P-11036	
(F) Lock nut.....	P-2616	
(G) Powder tube guide.....	HE-KØR6051	
(H) Stop screw.....	P-2351	
(I) Screw.....	P-2082	
<b>Spray nozzle sub assy. (J - M).....</b>	HE-KØR6047	
(J) Nozzle.....	HE-KØR6056	
(K) Screw.....	P-2921	
(L) Spring.....	P-15601	
(M) Nozzle tube.....	HE-KØR6055	
<b>Powder tube sub assy. - short (N - R).....</b>	HE-KØR6035	
<b>Powder tube sub assy. - long (N - R).....</b>	HE-KØR6045	
(N) Short tube (for HE-KØR6030).....	HE-KØR6052	
(N) Long tube (for HE-KØR6040).....	HE-KØR6053	
(O) Nut.....	P-2681	
(P) Compression nut with gasket.....	P-2941	
(Q) Guide collar.....	HE-KØR6054	
(R) Set screw.....	P-2499	
<b>GUIDE WHEEL KIT - GTO 52</b>		
	Complete.....	HE-521327
	Wheel only.....	HE-521328
	O-Ring.....	P-11778
	Set screw.....	P-2580
<b>8 Watt FLOURESCENT BULB - GTO 46 / 52, TOM / TOK</b>		
		P-9743
<b>14 Watt FLOURESCENT BULB - KORD 64</b>		
		P-9726
<b>BRASS FILTER SCREENS</b>		
	Windmill Platens (24mm collar).....	P-9410
	GTO 46 & 52 (28 mm collar).....	P-9411
	GTO 46/52, Windmill (38 mm collar).....	P-9412
<b>SLIP RING BRUSHES</b>		
	K-Series (shown).....	P-9428
	S-Series.....	P-9438
	S-Series.....	P-9439
	Paired Collector Brush.....	P-9429
<b>PUMP VANE</b>		
		P-9444

		PART #
<b>CARBON BRUSHES</b>		
	Carbon Brush.....	P-9431
	Carbon Brush.....	P-9432
	S-Series.....	P-9769
	Speedmaster.....	P-9433
	Speedmaster 102Z.....	P-9434
	Speedmaster 102.....	P-9435
	Speedmaster 102V.....	P-9436
	102D+L 102V (Main motor).....	P-9437
	TOK/TOM (Motor).....	P-9440
<b>ROLLER SNAP SWITCH - All S-Series</b>		
Located on operators side outer delivery frame		
		P-9805
<b>LIMIT SWITCHES</b>		
	(A) GTO 46/52, M/S Series, Speedmaster 72/102.....	P-9836
	(B) GTO 46/52, M/S Series, Speedmaster 72/102.....	P-9837
	(C) GTO 52, M-Series, Spdmst 102 (snap action).....	P-9838
	(C) M-Series (slow action).....	P-9839
	(D) GTO 46 / 52 - Located behind blower tubes.....	P-4074
<b>VARIABLE SPEED PULLEY For K-Series</b>		
		P-4291
<b>COMPRESSION SPRING - WINDMILL 10 x 15</b>		
For variable speed control.		
		HE-WI046
<b>BOWDEN CABLE</b>		
	WINDMILL.....	HE-WI3101
<b>DELIVERY TABLE CABLE</b>		
	K-Series.....	HE-KØ971
	SB-Series.....	HE-S1539
<b>Lay Gauge Pin Kit</b>		
	Set of 5.....	P-31133
<b>Starwheel</b>		
	(A) Star/Pointed Surface (for K/S/M series).....	P-30842-0
	(B) Knurled/Dimpled Surface (GTO 46/52).....	P-30842-GT0
	(B) Knurled/Dimpled Surface (for K/S/M series).....	P-30842-K
	(C) Smooth/Plain Surface (for K/S/M series).....	P-30842-S

PART #



**PNEUMATIC SPRING** For Speedmaster 102

Safety guard (11-7/8" end to end) P-29990  
 Delivery (16-5/8" end to end) P-29991



**BLOW DOWN FAN** For Speedmaster 102 delivery

Terminal connection P-4204  
 Wire connection P-4205

**EMERGENCY KITS**



**TOK/TOM** P-31143  
 Consists of: 6 Impression gripper fingers /  
 1 Wash-up blade / 12 Sucker feet / 1 Set of teflon seals.

**QUICKMASTER 46** P-31144  
 Consists of: 8 Impression gripper fingers /  
 1 Wash-up blade / 12 Sucker feet / 1 Dampening felt / 1 Tape track

**QUICKMASTER DI46** P-31145  
 Consists of: 8 Impression gripper fingers / 1 Wash-up blade /  
 12 Sucker feet / 1 Dampening felt

**HARDWARE EMERGENCY KITS**



**HAS YOUR PRESS EVER BEEN DOWN DUE TO A SIMPLE PIN OR SPRING?  
 YOU CAN ELIMINATE COSTLY DOWN TIME IN MINUTES WITH YOUR OWN  
 EMERGENCY KIT DESIGNED TO CONVENIENTLY FIT IN YOUR DESK  
 DRAWER.**

EACH KIT COMES IN IT'S OWN MULTI-COMPARTMENT RECLOSABLE BOX  
 FOR QUICK, EASY SELECTION AND STORAGE. PART NUMBERS FOR THE  
 INDIVIDUAL ITEMS ARE ALSO INCLUDED INSIDE.

<b>MASTER KIT</b>	<b>All kits below</b>	P-30397
<b>NUT KIT</b>	43 pcs.	P-30392
<b>WASHER KIT</b>	60 pcs.	P-30396
<b>SCREW KIT</b>	168 pcs.	P-30393
<b>RING KIT</b>	47 pcs.	P-30395
<b>PIN KIT</b>	100 pcs.	P-30394

PART #

**CAM FOLLOWERS**

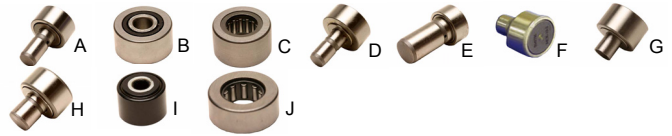

**GTO 46**  
 (A) Transfer & imp. cylinder / gripper shaft..... P-3441  
 (B) Side lay shaft..... P-4368

**GTO 52**  
 (A) Transfer & impression cylinder & storage drum  
 / gripper shaft..... P-3441

**K-SERIES**  
 (C) Imp. cyl.shaft  
 / sucker bar mechanism Outer lever..... P-6870

**M-SERIES**  
 (D) Transfer & impression cylinder & storage drum  
 / gripper shaft..... P-3416  
 (E) Reversing drum..... P-3443  
 (F) Register feed drum / gripper shaft..... P-3444

**SORZ / SORDZ / SORKZ / SORMZ / SORSZ**  
 (G) Register feed drum / gripper shaft  
 ..(cam facing cylinder O.S. & D.S.)..... P-3442  
 (H) Register feed drum / gripper shaft  
 ..(cam facing side frames O.S & D.S.)..... P-3445  
 (F) Imp. cyl. & storage drum / gripper shaft..... P-3444

**SPEEDMASTER 72 / 102**  
 (G) Register feed drum/ gripper shaft  
 ..(cam facing cylinder O.S. & D.S.)..... P-3442  
 (H) Register feed drum / gripper shaft  
 ..(cam facing side frames O.S. & D.S.)..... P-3445  
 (F) Transfer & imp. cylinder / gripper shaft..... P-3444  
 (H) Transfer gripper..... P-3445

**SPEEDMASTER 74**  
 (I) Delivery table..... P-3439

**SPEEDMASTER 102**  
 (J) Gripper opening lever on del. gripper bars. . P-6871  
 (G) On lever (OEM #71-010-110) / inking unit. . P-3442

**QUICKMASTER**  
 (A) Impression cylinder / gripper shaft. .... P-3441



**GTO 46**  
**INK ROLLER KIT** P-30457  
 Consists of:  
 (6) Blue Distributor / Ductor P-46H10B  
 (1) Red Form P-46H10R  
 (1) White Form P-46H10W  
 (1) Yellow Form P-46H10Y

**KORD 62**  
**INK ROLLER KIT** P-31656  
 Consists of:  
 (2) Blue Form / Distributor P-30916  
 (3) Red Form / Distributor / Ductor P-30918  
 (2) White Form / Distributor / Ductor P-30917  
 (2) Brown Form / Distributor / Ductor P-30919

**QUICKMASTER 46 (1ST. UNIT)**  
**INK ROLLER KIT** P-31735  
 Consists of:  
 (1) Yellow 1st. Ink Form P-34H10  
 (1) Blue 2nd. Ink Form P-34H11  
 (1) Black 3rd. Ink Form P-34H13  
 (1) Black Ink Transfer Roll #1 P-34H20  
 (1) Black Ink Transfer Roll #2 P-34H21  
 (1) Black Ink Transfer Roll #3 P-34H22  
 (1) Black Ductor P-34H30