

# Hydromassage Products

## Owner's Manual & Installation Guide

July 2011



**IMPORTANT:** Read all instructions before proceeding with installation.

**INSPECT** entire unit to ensure it is not damaged and is the correct model, size and color. Verify it has all the features and options originally ordered.

All whirlpools **MUST BE TESTED** before or during rough installation.

Please read the operating and maintenance instructions. It contains important information about how to operate and maintain your jetted bath properly and safely.

### Record your model information

Builder/Dealer/Name\_\_\_\_\_

Address\_\_\_\_\_

Phone No.\_\_\_\_\_

Model No.\_\_\_\_\_

Serial No.\_\_\_\_\_

Purchase Date\_\_\_\_\_

Hydromassage Products, 505 Nucla Way, Aurora Colorado 80011

Phone: (303) 341-1845 Fax: (303) 341-1850

[www.hydromassageproducts.com](http://www.hydromassageproducts.com)

# Congratulations

On the purchase of your Hydromassage bath tub!  
Hydromassage Products supports your purchase with strong commitment to quality and customer satisfaction.

Please read and follow all of the instructions contained in this Owner's Manual before installing, operating or maintaining your whirlpool. In addition, you should refer to these instructions during the life of your whirlpool. Failure to comply with these instructions and registration of this product may invalidate your warranty. If you have any questions concerning installation, operation, maintenance, or any other aspect of your whirlpool after reading this manual or during the life of your whirlpool, please contact us.

Hydromassage Products customer service: (303) 341-1845  
(Please be sure to consult the Troubleshooting Guide before calling)

**NOTE:** Only a qualified electrician, technician or plumber should perform the installation and service of your whirlpool.

## Table of Contents

Safety Instructions . . . . .	1
Installation Instructions . . . . .	2-5
Installations Procedures . . . . .	6
Plumbing . . . . .	7
Electrical . . . . .	8

## Operating Instructions

For all Whirlpool Bath Systems . . . . .	9-10
Bronze, Silver & Gold series . . . . .	11
Platinum series . . . . .	12
HydroClean Sanitation System . . . . .	13
For all Air Bath Systems . . . . .	13-14
Air Massage series . . . . .	15
Combination series . . . . .	15-16
Inline heater instructions . . . . .	17
Mood Light and Chromatherapy . . . . .	17
Maintenance & whirlpool cleaning . . . . .	18
Warranty . . . . .	19
Trouble shooting . . . . .	20-21
Product registration . . . . .	22

# **IMPORTANT SAFETY INSTRUCTIONS**

## **INSTRUCTIONS PERTAINING TO A RISK OF FIRE, ELECTRIC SHOCK, OR INJURY TO PERSONS**

### **WARNING:**

When using this unit, basic precautions should always be followed, including the following:

1. **READ AND FOLLOW ALL INSTRUCTIONS**
2. **DANGER** — To reduce the risk of injury, do not permit children to use this unit unless they are closely supervised at all times.
3. Use this unit only for its intended use as described in this manual. Do not use attachments not recommended by the manufacturer.
4. Never drop or insert any object into any opening.
5. Do not operate this unit without the guard over the suction fitting.
6. The unit must be connected only to a supply circuit that is protected by a ground-fault circuit-interrupter (GFCI). Such a GFCI should be provided by the installer and should interrupt power. Push the reset button. Power should be restored. If the GFCI fails to operate in this manner, the GFCI is defective. If the GFCI interrupts power to the bathtub without the test button being pushed, a ground current is flowing, indicating the possibility of an electric shock. Do not use this hydromassage bathtub. Disconnect the hydromassage bathtub and have the problem corrected by a qualified service representative before using.
7. (For permanently connected units) A green-colored terminal (or a wire connector marked 'G', 'GR', 'Ground', or 'Grounding') is provided within the terminal compartment. To reduce the risk of electric shock, connect this terminal or connector to the grounding terminal of your electric service or supply panel with a conductor equivalent in size to the circuit connectors supplying this equipment.
8. **A thermostatic mixing valve is required.** Section 414.5 of the 2009 Uniform Plumbing Codes require that the maximum hot water temperature discharging from the bathtub and/or whirlpool bathtub filler shall be limited to 120°F (49°C) by a device that conforms to ASSE 1070 or CSA B125.3. The water heater thermostat shall not be considered a control for meeting this provision.
9. **SAVE THESE INSTRUCTIONS.**

**WARNING**...The use of alcohol, drugs or medications can greatly increase the risk of fatal hypothermia.

**WARNING**...Prolonged immersions in hotter water may induce hypothermia. Hypothermia occurs when the internal temperature of the body reaches a level several degrees above the normal body temperature of 98.6 degrees F. The symptoms of hypothermia include an increase in the internal temperature of the body, dizziness, lethargy, drowsiness, and fainting. The effects of hypothermia include (1) failure to perceive heat (2) failure to recognize the need to exit the whirlpool (3) Unawareness of impending hazard (4) fetal damage in pregnant women (5) physical inability to exit whirlpool (6) Unconsciousness resulting in the danger of drowning.

## INSTALLATION INSTRUCTIONS

**WARNING:** Verification of Electrical requirements **MUST** be made before installation. Refer to the Pump label for Voltage and frequency requirements.

### INSTALLATION

1. Unpack the contents carefully and inspect the bath to verify that it is the correct model, features, and color, the pump is the correct size ordered and check for visible defects or damage. If there are problems DO NOT INSTALL. Contact the dealer / manufacturer for further instruction.
2. Construct a finish frame under the bath rim to support the bath lip and keep the deck level, which will assist water draining from the deck back into the bath. (Note: this is not required for walk-in baths with metal support structure.) An access panel **MUST** be provided for pump/control and/or blower/control to enable final electrical connections and service. The minimum recommended access panel(s) size is 18" x 18" next to the pump(s) so the unit(s) can be removed.

### **DO NOT LIFT THE HYDROMASSAGE BATH BY THE PLUMBING AT ANY TIME**

3. Drain and Overflow assembly — The plumber should connect the drain and overflow assemblies per the manufacturer's instructions. The bath may then be positioned, leveled and connected to the waste. This should be done to local building codes by qualified personnel.

**WARNING:** Verification of Electrical requirements **MUST** be made before installation. Refer to the pump and/or blower label for Voltage and frequency requirements

**DANGER — RISK OF ELECTRIC SHOCK.** Connect only to a circuit protected by a Ground-Fault Circuit-Interrupter (GFCI) with 120volt, 20amp, 60hertz electrical service with a service grounded receptacle dedicated for use by the bath.

4. Electrical Service(s) — A licensed electrician must provide the electrical service protected by a Ground-Fault Circuit-Interrupter(s) (GFCI) with 120volt, 20amp, 60hertz electrical service with a service grounded receptacle dedicated for use by the bath. Please refer to model specifications for electrical requirement.
5. GROUNDING IS REQUIRED. The units should be installed by a qualified service representative and grounded.

**ALL LOCAL AND STATE ELECTRICAL AND PLUMBING CODES MUST BE OBSERVED.** It is the responsibility of the installer/owner to determine specific code compliance prior to installation of the product.

6. Water testing — Before installing or finishing the installation, it is required that the bath be water tested and the plumbing checked for leaks. Close the drain and fill the bath with water to the overflow outlet. Check the exposed piping and especially the union connections for signs of leakage. Allow the bath to sit for an additional 60 minutes and re-inspect. Turn the pump and/or blower on and operate all features and look for signs of leakage for 60 minutes. Turn the pump and/or blower off and drain the water.

## INSTALLATION INSTRUCTIONS

[continued]

**WARNING:** Whirlpool pump and piping are factory assembled. Relocation of pump or other modifications could adversely affect the performance and safe operation of this whirlpool. Hydromassage Products shall not be liable under its warranty or otherwise for personal injury or damage caused by such unauthorized modification.

QUIETNESS OF OPERATION — Hydromassage Products has engineered their whirlpool baths from the base to the lip to ensure quality, value, functional design and maximum bathing comfort. However installations are accountable for as much as 50% of a tub's operating quietness. Please ensure the following:

Verify the floor structure is adequate to support the whirlpool with bather(s). Insulate the tub surround and leave a dead air space around the pump and tub. Leave 1/8" to 3/16" gap between tub lip and surround. Set the tub in non shrinking mortar or plaster.

## STRUCTURAL PREPARATION:

- Literature dimensions are for reference only. Installation dimensions should be taken directly from the tub. An Access panel of 18" x 18" minimum must be provided at the pump end of the whirlpool. Allowing sufficient clearance to make final connections and for servicing the pump and power panel. Access may be through the wall or platform apron at the end of the unit. In the case of sunken installations, access should be made through the ceiling below.
- The bath should remain in its shipping carton/packaging until time of installation.
- Install the drain fitting to the bath. THE DRAIN FITTING SOMETIMES WILL PROTRUDE BELOW THE BASE OF THE TUB APPROXIMATELY 1 1/2". Clearance must be provided for the drain by cutting away the subfloor (where possible) or by blocking below the tub as may be required.

WARNING: factory skirts do not allow for blocking up of the tub base. All blocking must be solid and provide uniform support to the tub base.

- Tub must rest entirely on the base.

DO NOT SUPPORT THE WEIGHT OF THE TUB BY THE RIM. Where leveling is required, and to reduce vibration noise, prepare a bed of wet mortar in area where tub is to be installed.

Carefully level unit, ensuring that uniform support is given to all areas of the base and that no portion of the lip is bearing weight. DO NOT USE MORTAR IF YOUR TUB HAS THE DELUXE AIR SYSTEMS WITH JETS ON THE BOTTOM OF THE BATH. The EZ level base will support the unit with Deluxe Air Systems.

- Frame out under the tub rim as shown in one of the illustrations below. NOTE: Due to the variety of installations possible, framing procedures other than those described may be required. Plumb in selected location using a level. Level front to back and across on both sides. A ledge under the rim, or an apron without a ledge may be constructed as required (see diagram 1A & 1B). Where installations will be against a wall, stud wall framing should run full length to the floor (see diagram 1C or 1D). Install tub firmly against sheathing as indicated with blocking below rim to prevent deflection or movement of tub. To prevent a rocking movement of tub after installation, it is important to have rim in contact, but NOT supported by blocking material.

When placing the tub on a platform or cut out (see diagram 1A), the opening should be 2" smaller than the specified rim dimensions. Extreme care must be taken in this type of installation to ensure the tub will come to rest entirely on the base. **WE DO NOT RECOMMEND DECK CUT OUT BE DONE UNTIL TUB IS ON SITE**

**IF YOU HAVE PURCHASED A WHIRLPOOL WITH AN INSTALLED TILE FLANGE, PROCEED AS FOLLOWS**

**CAUTION:** THE TILE FLANGE DOES NOT SUPPORT THE TUB! A ledger board must be provided under the bath rim as indicated in the installation instructions.

Take care to ensure the tub is not hanging from the ledger boards, as this will void your warranty.

PRE DRILL THE FLANGE and use nails or screws to secure the flange into the studs around the bath. Oversize the holes slightly to insure fastener does not damage tub flange.

Install water resistant drywall against the tile flange and 1/8"-1" above the top of the whirlpool deck. Install the tile or other finishing materials. Apply a second bead of silicone sealant between the first course of tile and the bath deck.

### TYPICAL DROPIN/ISLAND INSTALLATION

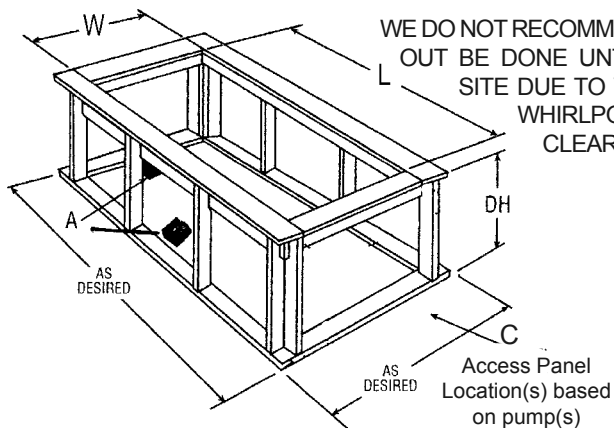

### TYPICAL ALCOVE INSTALLATION

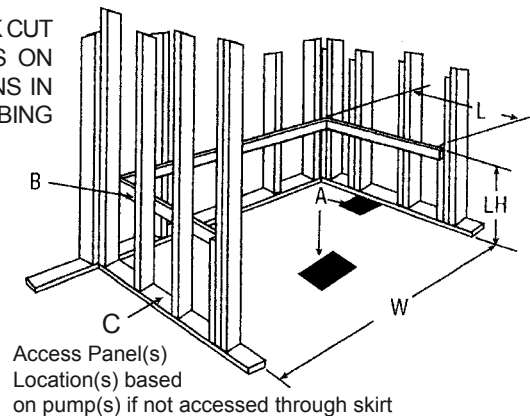

- All dimensions should be taken from tub at jobsite and adjusted as necessary. Always refer to the model specification sheet. Specifications subject to change without notice and installations vary based on model, and whirlpool plumbing systems.

L=1-1.5" s than overall length of tub  
W=1-1.5" less than overall width of tub  
DH=up to 1/2" higher than deck height  
A=6" x 12" waste and over flow cut out  
C=18" x 18" pump access 1 or 2, or 3  
to allow removal of pump(s)

L=2" less than width for ledger board  
W=1/8" - 1/4" larger than length of tub  
LH=up to 1/2" higher than deck height  
A=6" x 12" waste and over flow cut out  
B=1" x 3" leveled ledger supports  
C=18" x 18" pump access 1 or 2, or 3 to  
allow removal of pump(s)

NOTE: Before tub is used, the whirlpool system should be cleaned and disinfected. For proper procedure, please see the Maintenance section of this manual page 12.

## Typical Methods of Sealing & Finishing

### Make sure interior of tub is protected during finishing

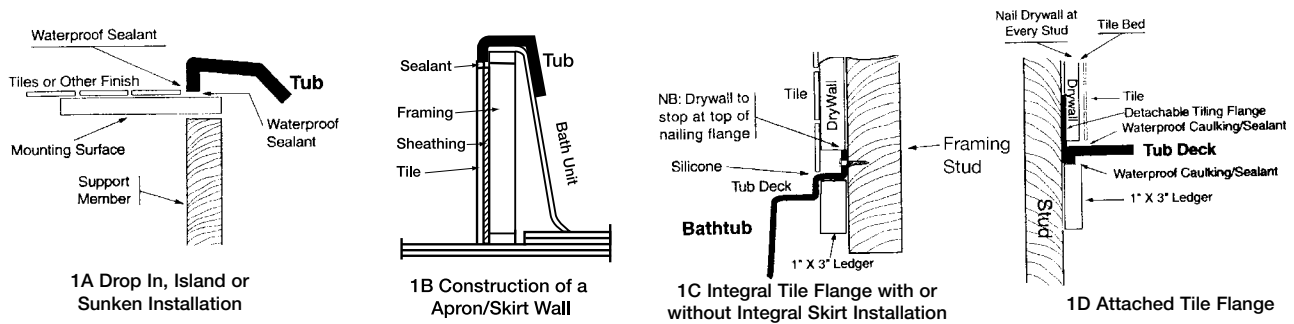

## INTEGRALLY SKIRTED AND/OR FLANGED WHIRLPOOLS

Installation Procedures:

**IMPORTANT!!!** Before installation begins, make sure that:

framed in alcove is of proper size, square and plumb; wall and floors meet fire safety requirements of local building code and/or FHA/HUD minimum property standards.

1. To avoid obstruction during installation, make sure water lines, spout pipes and valve plumbing do not project into alcove.

2. Ledger Strip: Fasten a 1" x 3" (25mm x 75mm) ledger strip along rear and both sides of alcove .

3. Mix a 3-gallon bucket of non-shrinking mortar or plaster into a paste. Place three or four mounds of plaster away from drain hole in a line or square, approximately twice as high as the cavity under the tub bottom. Place a layer of plastic on top of the mounds. Before moving unit into alcove see and follow enclosed Electrical Connection Procedures (electrical and air tube hook ups will be difficult to perform if unit is installed first).

4. Place tub into alcove with front skirt firmly on floor and depress plaster mounds. Make certain that back ledge of tub rests firmly on ledger strip

5. Pre drill flange then using 1 1/2" (40mm) galvanized roof nails or washer head screws: (a) spot fasten the two bottom corners and the two top corners of the vertical side nailing flanges. (b) fasten at each stud through the top sides flanges and back flange, working from both ends toward back center (c) complete fastening vertical side flanges. Pre drill holes through flange 1/8" larger than diameter of screw.

6. When other than scratch coat is used, furring strips as thick as nailing flanges are recommended for installation on studs above the installed tub to assure drywall will be flush.

7. Removable skirt panel for integrally skirted models: These models are sometimes offered with removable access panels. They provide a flush to wall installation (sheet rock overlaps skirt while still providing access). The skirt features a decorative removable panel enabling easy access to motor, pump and electrical hook ups. Pre mounted interlocking nylon fasteners (Velcro) or screws with caps enable simple and quick removal of skirt access panel. A small bead of color matched or clear silicone is required around the perimeter of the access panel to finish the installation.

**IMPORTANT: Before installation of the access panel, fill the unit, test the whirlpool system for proper operation and check for leaks, then drain.**

Protect interior of tub throughout installation procedures.

Framing and supports will vary according to the Model selected. Follow dimensions for your specific unit.

Plumbing connection – (spout, handles, valves, etc.) should be made after unit is installed. When mounting fittings on unit, drill holes from finished surface, using appropriate sized hole saw with fine tooth or abrasive grit cutting edge.

## INSTALLATION PROCEDURES:

1. Bathtub must be set on a solid flat surface. All six (6) adjustable feet must come in contact with the floor.
2. Plumbing hardware (faucet, hoses, and waste/overflow) should be installed prior to setting tub in-place.
3. Filler panel is used for 60" opening installations.
4. The drain body is to be installed between the drain shoe and the drain tee.

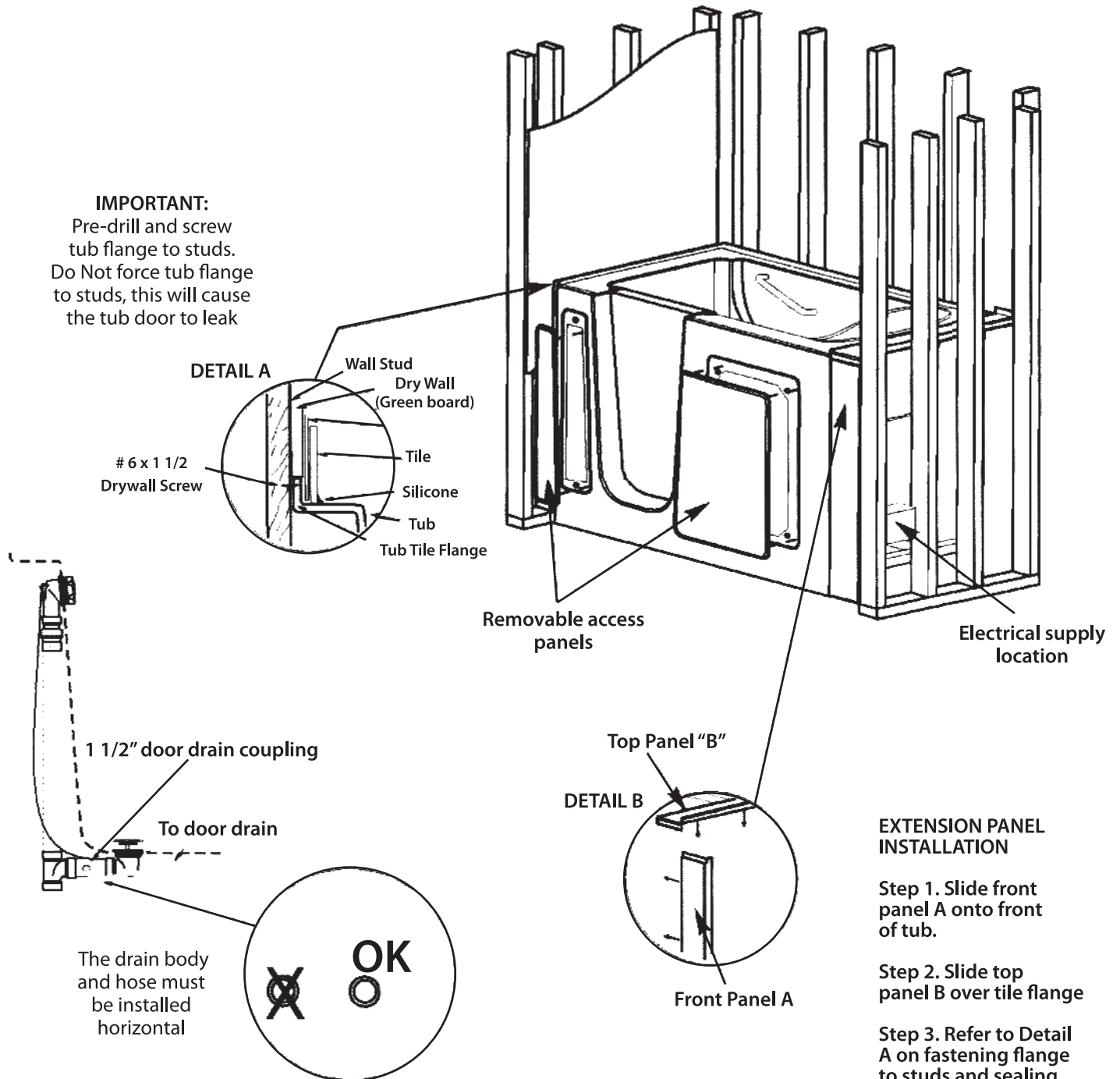



## PLUMBING:

After securing tub in place, waste and overflow, water spout and valves are installed per normal plumbing procedures, in accordance with all state and local standards.

Install standard 1 1/2" trap to drain and overflow. Before proceeding, make final operational check by filling tub with water to overflow and operate pump for 30 minutes. Check for leaks carefully both while pump is running and while turned off. Allow water to stand in tub for at least 60 minutes before draining. **HYDROMASSAGE PRODUCTS WILL NOT BE RESPONSIBLE FOR WATER DAMAGE OF ANY KIND IN CONNECTION WITH ONE OF OUR WHIRLPOOL BATHS.**

When selecting fill spout location, check to ensure that the spout is long enough to clear the tub rim from its desired location. If installation is to be on the tub deck, check the backside of the tub for adequate space for connection to water lines before drilling or cutting tub.

**WARNING:** HEATER AND ELECTRICAL  
INSTALL: A service access panel of a minimum of an 18" square must be provided adjacent to motor/pump assembly.

## Electrical Installation:

**WARNING:** ALL ELECTRICAL CONNECTIONS SHOULD BE MADE BY A LICENSED, LOCALLY CERTIFIED ELECTRICIAN. IN ACCORDANCE WITH THE REQUIREMENTS OF THE NATIONAL ELECTRICAL CODES AND PROCEDURES. REFER TO SPECIFIC SPECIFICATION SHEET FOR ELECTRICAL REQUIREMENTS.

**WARNING:** WHEN USING ELECTRICAL PRODUCTS, BASIC PRECAUTIONS SHOULD ALWAYS BE FOLLOWED, INCLUDING THE FOLLOWING:

**DANGER:** RISK OF ELECTRICAL SHOCK!! This unit REQUIRES one or more dedicated circuits, protected by a GROUND FAULT CIRCUIT INTERRUPTER (GFCI). A GFCI is not supplied, however we do specify its use. All known code authorities require a GFCI. Rough in wiring to pump(s) and/or heater on dedicated 120v 15 or 20-amp GFCI protected circuit(s). Please refer to specifications sheet for bath requirements.

**Bonding wire:** Grounding is required. The unit should be installed by a qualified Electrician and grounded as specified. For built in and custom units, install a permanent access for servicing.

**WARNING:** Risk of electrocution—All electrical connections should be performed by a licensed Electrician in compliance with local and national codes. In addition a GFCI must protect all branch circuits to the whirlpool and every electrical component must be grounded.

Run the required number of 120 volt 15 or 20 amp branch circuit(s) to a junction box within 2' (24 inches) of the whirlpool pump or heater. The branch circuit(s) MUST BE GFCI PROTECTED. Refer to the model specification sheet for the specific number and size of the GFCI circuits required.

Use copper conductors only. Insure the pump is properly grounded and the pump is bonded as required.

**CAUTION:** Before the use of the pump or heater, test the GFCI for proper operation. The pump or heater should turn off when the GFCI test button is pushed. Note: the heater will only operate if the pump is running.

## OPERATING INSTRUCTIONS

This manual contains all the information needed for the proper operation of this Whirlpool Bath.

**WARNING:** BEFORE OPERATING REFER TO THE INSTRUCTIONS PERTAINING TO THE RISK OF FIRE ELECTRICAL SHOCK OR INJURY TO PERSONS ON THE LAST PAGE OF THIS MANUAL.

**CAUTION** DO NOT OPERATE THIS UNIT WITHOUT THE GUARD COVER OVER THE SUCTION FITTING.

### TO OPERATE

1. Filling and Draining — Close the drain, fill tub with water at the desired temperature. The maximum recommended bathing temperature is 104F (40C). The water must be at least 3" above the highest jet before activating the pump. Fill the tub to use h and drain it when finished. Each bather should start their bath with fresh water.

**NEVER ATTEMPT TO RUN THE PUMP MOTOR WITHOUT ENOUGH WATER TO COVER ALL THE JETS.**

2. On/ Off Button — Your tub is equipped with a pneumatic On/off Button.

To start a tub with a pneumatic ON/OFF Button, simply depress the ON/OFF button and the pump will turn on. The button is an on/off switch. Depress the Button to turn on the pump, depress it again to turn off the pump.

3. WHIRLPOOL JETS — The direction of the jets is adjustable. Point the jets down before turning on the system. Some models have flow adjustable jets.
4. SUCTION — Never operate the whirlpool system with the guard cover over the suction fitting. Keep hair, towels, and clothing away from the suction fitting whenever the Hydromassage pump is on. The suction guard cover is a safety device designed to eliminate the potential of hair and body entrapment.

**WARNING:** Prolonged immersion in hot water may induce extremely high body temperature (hyperthermia). Hyperthermia occurs when the internal temperature of the body reaches a level several degrees above the normal body temperature of 98.6 F. The symptoms of hyperthermia include an increase in the internal temperature of the body, dizziness, lethargy, drowsiness and Fainting.

The effects of Hyperthermia include:

- a) Failure to perceive heat
- b) Failure to recognize the need to exit the Hydromassage bathtub
- c) Unawareness of impending hazard.
- d) Fetal damage in pregnant woman
- f) Physical inability to exit the hydromassage bathtub, and
- g) Unconsciousness resulting in the danger of drowning.

**WARNING** The use of alcohol, drugs, or medication can greatly increase the risk of fatal hypothermia.

**WARNING** Flush the whirlpool system periodically. See user maintenance instruction

### USER MAINTENANCE INSTRUCTIONS

#### CARE AND CLEANING

To assure a long lasting "like-new" look to your hydromassage bathtub we recommend the following easy care procedures:

1. For normal maintenance, especially after use, dew with a soft cloth or sponge and a mild soap or liquid detergent.
2. Regular use of a quality automotive wax will maintain the sparkling finish of your tub.

**DO NOT USE** abrasives such as scouring compounds, scouring pads, steel wools or harsh chemicals on your Hydromassage bathtub.

For deep stain, hard scale deposits or any other cleaning or maintenance problem, contact your dealer.

3. Flush the hydromassage bath system periodically (at least every 90 days) as follows: Fill the tub with water, add 1/2 cup household bleach, run the whirlpool system for 10 minutes and drain completely. Refill with clean water and operate the system for 10 minutes to rinse thoroughly. Drain completely and wipe dry. See page 17 for more detailed cleaning instructions.
4. It is especially **IMPORTANT** to wipe down the door seal and door jamb of the Walk-in Bath after each use in order to maintain the integrity of the water seal. In order to keep the door seal and door jamb clean and not accumulate dirt or debris of any kind, clean seal and jamb with a mild detergent and warm water using a soft cloth. The door is to remain open and unlatched when not in use.

**WARNING—** Refer all plumbing or electrical repair to a qualified service technician. **DO NOT ATTEMPT TO RESOLVE THE PROBLEM.** Attempts to repair plumbing or electrical equipment by a non-qualified service technician can result in danger of electrical shock or damage to the unit. Call your dealer for the name of the qualified service technician near you.

## Operating Instructions

For Bronze, Silver, and Gold series Whirlpools

### WHIRLPOOL USER INFORMATION – PLEASE NOTE:

The whirlpool action may cause even small amounts of bubble bath or shampoo to foam excessively. Exercise moderation in experimenting with different soap products and follow the whirlpool system cleaning instructions.

The user should do no servicing of this product. There are no user serviceable parts. All air controls and air switches are located on the lip of the tub. These are the only controls that should be used by the consumer. Do not change or alter any of these controls under any circumstances. This unit can be only be serviced by a qualified service representative.

Motors are self-lubricating and no lubrication is required. Refer to the Maintenance Instructions (page 12)

**Note: Do not start pump until all jets are submerged; water level should be 3" above highest jet**

### BATHSIDE CONTROL SYSTEMS

#### On/Off controls:

The On/Off air button for the pump/jet action  
Press button once and pump will start  
Press button again and pump will turn off



#### Three speed pump control:

(Standard on the Gold series)

To operate the 3-speed control turn the dial to change speed:

H=High M=Medium L=Low



#### Optional underwater mood light:

One on/off air button operates the pump, while the additional air Button operates the underwater mood light.

Press button once and the light will turn on

Press the button again and the light turns off

---

## AROMATHERAPY



The entire bag of beads should be put in the canister. Never put beads in separately in the canister. Always leave the beads in the bag.

The beads do not breakdown or dissolve. The fragrance just dissipates over time. Once the fragrance is gone, remove the bag of beads and replace.

# Operating Instructions

## For Platinum series whirlpools

**NOTE: Do not start pump until all jets are submerged water level should be 3" above highest jet.**

**Dual on/off air button control** operates each pump/jet action independently. Press the button once and the pump will turn on. Press the button again and the pump will turn off.

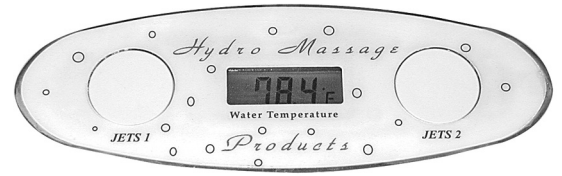

### Three speed pump control:

To operate the 3 speed control, turn the dial to change the speed. H(High) to M(Medium) to L(Low)



### Air Control volume knob:

Turning the knobs clockwise will reduce the volume of air jet pressure.

### Neck Massage pillow

Turning the dial clockwise will reduce the pillow jet pressure down to 5%  
\*Before operating the Neck Massage pillow, make sure the white lycra pillow cover is covering the gray pillow.

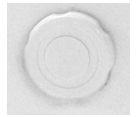
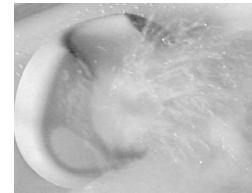

Neck  
Massage  
pillow valve  
dial

### Underwater mood light on/off air button:

Press the button once and light turns on.  
Press the button again and the light turns off.



### Bulb replacement:

See page 16 for bulb replacement and lens instructions.

### Inline heater control:

See page 16 for operating instructions.

### Microflow and Ultra Flow/Massage Soul Soother jet pressure adjustment:

Turning the *jet face* clockwise will reduce the pressure up to 95% off.



## Hydroclean Sanitation System

1. This unit meets the requirements of NSF Protocol P308 ozone sanitation systems for jetted bathtubs and pedicure footbaths.
2. The Hydroclean will operate automatically whenever the pump is running. You will notice a slight sweet smell and bubbles will be coming out of the dedicated Hydroclean jet on the side wall of the tub about 1 1/2" in diameter.
3. No maintenance or cleaning of the unit is required. The life of the unit is approximately 9000 hours of use.

# OPERATING INSTRUCTIONS

This manual contains all the information needed for the proper operation of Air Bath Systems.

**WARNING: BEFORE OPERATING REFER TO THE INSTRUCTIONS PERTAINING TO THE RISK OF FIRE ELECTRICAL SHOCK OR INJURY TO PERSONS ON THE LAST PAGE OF THIS MANUAL.**

## TO OPERATE

1. Filling and Draining — Close the drain, fill bath with water to at least 10" below the bath deck. The maximum recommended bathing temperature is 104F (40C). Turn the blower off before draining the water. Your bath is designed for fill and drain use. Fill the bath to use it and drain it when finished. Each bather should start their bath with fresh water.
2. On/Off Air Button — Your bath is equipped with a pneumatic On/Off Button that that allows the user to turn the blower On or Off and controls the blower's intensity. A timer will automatically turn off the blower after 20 minutes if it is not stopped manually.

To start a bath with a pneumatic On/Off Button, simply depress the On/Off Button and the blower will turn on.

3. Blower Speed — Once the blower is on, depressing the button again will decrease the air output to medium speed, depressing the button again will decrease the air output to low speed, depressing the button again will start the Wave mode and a final depression of the button will turn off the blower.
4. Automatic Purge Cycle — Fifteen minutes after the blower is stopped and the bath is drained, the blower will automatically start for two (2) minutes to purge and dry the air system channels or plumbing.

**WARNING:** Prolonged immersion in hot water may induce extremely high body temperature (hyperthermia). Hyperthermia occurs when the internal temperature of the body reaches a level several degrees above the normal body temperature of 98.6F, The symptoms of hyperthermia include an increase in the internal temperature of the body, dizziness, lethargy, drowsiness and fainting. The effects of Hyperthermia include:

- a) Failure to perceive heat,
- b) Failure to recognize the need to exit the Hydromassage bathtub,
- c) Unawareness of impending hazard,
- d) Fetal damage in pregnant woman,
- e) Physical inability to exit the hydromassage bathtub, and
- f) Unconsciousness resulting in the danger of drowning,

Continued

**WARNING:** The use of alcohol, drugs, or medication can greatly increase the risk of fatal hyperthermia.

**WARNING:** Flush the whirlpool system periodically. See user maintenance instructions.

## USER MAINTENANCE INSTRUCTIONS

### CARE AND CLEANING

To assure a long lasting "like-new" look to your hydromassage bathtub we recommend the following easy care procedures:

1. For normal maintenance, especially after use, clean with a soft cloth or sponge and a mild soap or liquid detergent.
2. Regular use of a quality automotive wax will maintain the sparking finish of your bath.  
**DO NOT USE abrasives such as scouring compounds, scouring pads, steel wools or harsh chemicals on your Hydromassage bathtub.**

**For deep stain, hard scale deposits or any other cleaning or maintenance problem, contact your dealer.**

3. Flush the hydromassage bath system periodically (at least every 90 days) as follows: Fill the bath with water, add 1/2 cup household bleach, run the whirlpool system for 10 minutes and drain completely. Refill with clean water and operate the system for 10 minutes to rinse thoroughly. Drain completely and wipe dry. See page 17 for more detailed cleaning instructions.

**WARNING—** Refer all plumbing or electrical repair to a qualified service technician. **DO NOT ATTEMPT TO RESOLVE THE PROBLEM.** Attempts to repair plumbing or electrical equipment by a non-qualified service technician can result in danger of electrical shock or damage to the unit. Call your dealer for the name of the qualified service technician near you.



## AIR MASSAGE SERIES AIRBATHS

- #1.1st press: The blower starts at maximum speed, LED: ON  
2nd press: The blower stops, LED: ON until the purge cycle stops. Approximately 20 minutes.
- #2.1st press: Speed goes up, LED ON when pressing  
Release pressure at the desired speed.
- #3.1st press: Speed goes down, LED: ON when pressing  
Release pressure at eh desired speed
- #4.1st press: Slow pulsation cycle ON, LED: ON  
2nd press: Quick pulsation cycle OFF, LED: flashes  
3rd press: Pulsation cycle OFF, LED: OFF

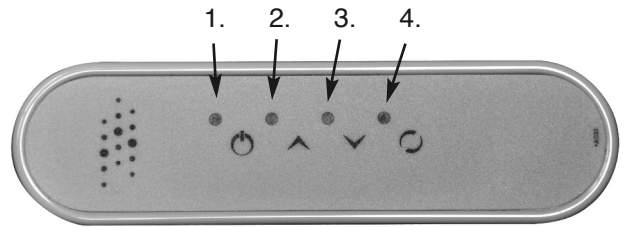

Your blower is equipped with an integrated air heating element, built in electronic control, variable speeds, pulsation cycle, a 20 minute delay and an automatic drying cycle, which will activate approximately 20 minutes after the blower has been activated. The DELUXE Aromassage system will activate an automatic drying cycle approx 20 minutes after the bath has had water in it, even if the blower was not activated.

### Operating Instructions For Combination series whirlpools

#### **NOTE: DO NOT START PUMP UNTIL ALL JETS ARE SUBMERGED**

Water level should be 3" above highest jet

- #1-1st press: The blower starts at maximum speed, LED: ON  
2nd press: The blower stops, LED: OFF
- #2-1st press: Speed goes up, LED ON when pressing  
Release pressure at the desired speed.
- #3-1st press: Speed goes down, LED: ON when pressing  
Release pressure at eh desired speed
- #4-1st press: Slow pulsation cycle OFF, LED: ON  
2nd press: Quick pulsation cycle OFF, LED: flashes  
3rd press: Pulsation cycle OFF, LED: OFF

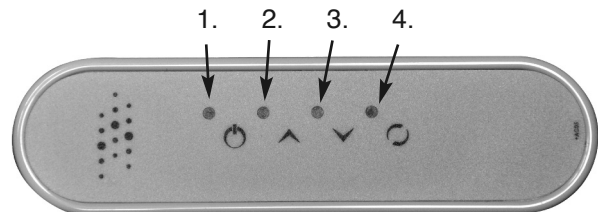

The blower will turn on automatically approximately 20 minutes after use and then for 1-3 minutes for a drying cycle

**On/off air button control** operates pump/jet action  
Press the button once and the pump will turn on  
Press the button again and the pump will turn off

#### **Three speed pump control:**

To operate the 3 speed control turn the dial to change the speed  
H(High) to M(Medium) to L(Low)



**Neck Massage pillow**

Turning the dial clockwise will reduce the pillow jet pressure down to 5%

\*Before operating the Neck Massage pillow, make sure the white lycra pillow cover is covering the gray pillow.



Neck Massage Jets & Grommets without pillow & pillow cover

**Underwater mood light on/off air button:**

Press the button once and light turns on  
Press the button again and the light turns off

**Bulb replacement:**

See page 16 for bulb replacement and lens instructions.

**Inline heater control:**

See page 16 for operating instructions.

**Soul Soother jet pressure adjustment:**

Turning the jet face clockwise will reduce the pressure  
From 5% - 95% off.

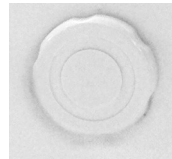

Neck Massage pillow valve diverter dial

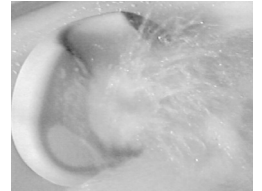

Neck Massage pillow with pillow cover

## INLINE MAINTENANCE HEATER WIRING AND OPERATING INSTRUCTIONS

The whirlpool heater is totally self-contained to insure trouble free operation. Once the whirlpool heater is wired, and the unions are tightened, operation is automatic. The heater will maintain the temperature of the water in the bathtub. As with all electrical devices, certain safety precautions should be taken during wiring and use. Please read and follow all these instructions carefully.

### FEATURES OF THE INLINE HEATER

**Hi-Limit:** Some whirlpool heaters include an exclusive "Smart Hi-Limit". This Hi-limit will not "false trip" from hot tap water. It will only turn the heater off if the thermostat fails. To reset, simply press the red button located on the heater. If the Hi-limit trips frequently, call the factory.

**Safety features:** In addition to the thermostat and Hi-limit, the whirlpool heater is equipped with a built in pressure switch. This switch will not allow the heater to turn on if the pump is not running.

**CAUTION:** Before use of the pump and heater, test the GFCI for proper operation. The pump and heater should turn off when the GFCI "TEST" button is pushed. Note: the heater will only operate if the pump is running.

**WARNING:** Prolonged immersions in hotter water may induce hyperthermia.

Hyperthermia occurs when the internal temperature of the body reaches a level several degrees above the normal body temperature of 98.6 degrees F. The symptoms of hyperthermia include an increase in the internal temperature of the body, dizziness, lethargy, drowsiness, and fainting. The effects of hyperthermia include (1) failure to perceive heat (2) failure to recognize the need to exit the whirlpool (3) Unawareness of impending hazard (4) fetal damage in pregnant women (5) physical inability to exit whirlpool (6) Unconsciousness resulting in the danger of drowning.

**WARNING:** The use of alcohol, drugs, or medication can greatly increase the risk of fatal hyperthermia

### OPTIONAL UNDERWATER LIGHT AND CHROMATHERAPY MOOD LIGHTING:

Operation:

**UNDERWATER LIGHT:** Press the on/off button once to turn on light; Press it again to turn off the light

**CHROMATHERAPY:** Press the button and the light turns on

1st press starts fast cycle off all colors	2nd press turns off
3rd press is the CLEAR color	4th press turns off
5th press is the GREEN color	6th press turns off
7th press is the YELLOW color	8th press turns off
9th press is the BLUE color	10th press turns off
11th press is the RED color	12th press turns off
13th press is the GREEN color	14th press turns off
15th press is the VOILET color	16th press turns off
17th press is BLUE to GREEN to BLUE	18th press turns off
19th press is RED to YELLOW to VOILET	20th press turns off
21st press fast cycle starts over	

### TO REPLACE THE BULB:

Disconnect the power to the bathtub.

Drain the bathtub.

Open the lens of the fixture using only the proper tool provided for that purpose.

Do not attempt to replace bulb without the proper tool. If a tool was not provided, stop here and contact the factory.

Use only a type 912 replacement lamp.

Verify "O" ring is not damaged and is properly positioned in the groove when replacing the lens. If there is damage or lens does not seal properly, do not refill bathtub. Contact factory immediately.

### NOTE: DO NOT TWIST BULB INTO SOCKET.

Use gentle pressure and push bulb into place.

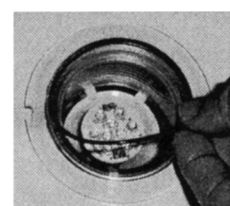
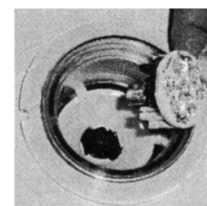
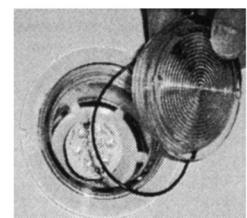

## Maintenance of Whirlpool system and acrylic surface

### Initial Cleaning

Before tub is used, the whirlpool system should be cleaned out and disinfected. Remove all debris and clean tub before putting the whirlpool into service. DO NOT USE ABRASIVE CLEANERS ON THE ACRYLIC SURFACE. Use a non-abrasive detergent that is approved for acrylic such as Mr. Clean, Fantastic, Lysol tub & Tile Cleaner and rinse well after cleaning.

- \* Fill the tub with HOT water to a level 2" above the highest jet
- \* Add 4 ounces of Hydro Cleanse whirlpool cleaner
- \* Operate whirlpool for 2 minutes; keep water in tub for 30 minutes – Drain tub

### Regular system cleaning

Hydro Cleanse should be used after each use or every 3 weeks when unit is not in use. If combined with the Hydro Clean Sanitation unit the need for Hydrocleanse and routine cleaning will be greatly reduced.

- \* Fill the tub with room temperature water
- \* Add 2 ounces of Hydrocleanse to the bath
- \* Operate whirlpool for 2 minutes. If whirlpool foams excessively shut whirlpool off.
- \* Allow water to soak in whirlpool for 30 minutes. Drain tub

This product is specifically made to be used in whirlpool and air systems. We recommend using these products to maintain a clean and sanitary whirlpool.

We recommend use of (1) teaspoon of granular chlorine during use of whirlpool if your system is not cleaned and maintained as specified.

NOTE: If your whirlpool is equipped with a Hydroclean system the use of chlorine is not recommended.

### Surface Cleaning

Use common, household NON ABRASIVE cleaners for most cleaning jobs. Rinse well and dry with clean cloth. Never use abrasive cleaners. Do not allow your acrylic surface come into contact with products such as acetone (nail polish remover), nail polish, dry cleaning solutions, lacquer thinners, gasoline, pine oil, etc. Remove dust with a wet sponge, and dry with a soft, dry cloth. Paint splashes with a quick wipe of mineral spirits followed by a rinse with water.

### Surface scratch removal

Minor scratches may be removed by polishing tub with a NON ABRASIVE car polish and then buff out.

Deeper scratches can be removed by:

Sanding with wet 400 grit sandpaper  
Sanding with wet 600 grit sandpaper  
Sanding with wet 1000 grit sandpaper  
Buff out using rubbing compound  
Polish with Automotive paste wax

## LIMITED LIFETIME WARRANTY

Hydro Massage Products, LLC ("HydroMassage") provides a limited warranty on each of its products. This warranty extends only to the original purchaser or original end user of a HydroMassage product, when such product is used only for personal, household use ("Customer"). An original end user is the person who acquires a previously unused HydroMassage product from a residential home builder, general contractor or subcontractor and who is also the first to use the HydroMassage product for personal, household use. Additional limitations apply for the commercial use of any HydroMassage product.

When properly installed, HydroMassage warrants the **fiberglass structure** of its products to be free from defects in workmanship and materials under normal use and service as follows:

- Lifetime replacement for parts and or materials for all products.

This warranty covers labor costs for two years for repairing or replacing a defective fiberglass structure at any time during the limited warranty period. This warranty does not include or cover any costs for the removal or reinstallation of the product or component. The Acrylic or Gelcoat surface of the fiberglass structure on all HydroMassage products is warranted for a period of two years only.

When properly installed, HydroMassage warrants the **whirlpool equipment, motor, pump and controls** of its products to be free from defects in workmanship and materials under normal use and service as follows:

- Ten (10) years for the HydroMassage Platinum series, Combo series and Aromassage series products;
- Five (5) years for the HydroMassage Gold series products;
- Two (2) years for the HydroMassage Silver series, and Bronze series products.

This warranty covers the cost of the defective parts only. Labor costs for repairing or replacing defective whirlpool equipment, door seals, motor, pump and controls are covered for 2 years only.

When properly installed, HydroMassage Products warrants the therapeutic plumbing parts of its products to be free from defects in workmanship and materials under normal use and service as follows:

- Ten (10) years for the HydroMassage Platinum series, Combo series and Aromassage series products;
- Five (5) years for the HydroMassage Gold series products;
- Two (2) years for the HydroMassage Silver series and Bronze series products.

This warranty covers the cost of the defective parts only. Labor costs for repairing or replacing defective therapeutic plumbing parts are covered for 2 years only.

Any products covered by the limited warranty set forth herein will be repaired to working order or replaced (with a product of equal or greater value) at the option of HydroMassage.

## LIMITED WARRANTY PERIOD AND WARRANTY REQUIREMENTS

The limited warranty period begins on the date of purchase from an authorized HydroMassage dealer or twelve (12) months from date of manufacture, whichever occurs earlier.

This warranty extends to the original purchaser or original end user only and is not transferable to a subsequent owner or user.

Customer's dated sales or delivery receipt, showing the date of purchase of the product, is Customer's proof of the purchase date. Customer may be required to provide proof of purchase as a condition of receiving warranty service.

**Warranty Service.** In order to obtain service provided under this warranty during regular business hours, contact the dealer or distributor who sold the unit, or Hydro Massage Products directly at 1-888-409-8860.

ALL WARRANTY WORK MUST BE APPROVED BY HYDROMASSAGE BEFORE THE WORK IS PERFORMED OR THE CUSTOMER MAY BE RESPONSIBLE FOR PAYING FOR THE COST OF THE WORK. IF CUSTOMER AUTHORIZES ANY REPAIR WORK TO BE PERFORMED ON THE HYDROMASSAGE PRODUCT PRIOR TO OBTAINING AUTHORIZATION FOR SUCH WORK FROM HYDROMASSAGE, THEN CUSTOMER SHALL BE RESPONSIBLE FOR PAYING FOR THE COST OF SUCH WORK.

HydroMassage reserves the right to use reconditioned parts that are equivalent or superior to original factory specifications. Replacement parts are warranted to be free from defects in materials and workmanship for thirty (30) days or for the remainder of the limited warranty period of the product in which they are installed, whichever is longer. Parts or products replaced under this limited warranty shall become the property of HydroMassage.

HydroMassage may service customer-replaceable parts by shipment of new or remanufactured replacement parts to the customer on an exchange basis.

The terms and conditions of this limited warranty constitute the complete and exclusive warranty agreement between HydroMassage and Customer for the HydroMassage product and supersede any prior agreements or representations made in any HydroMassage sales document or advice that may be provided by any authorized HydroMassage dealer in connection with Customer's purchase of the product. No change to the conditions of this limited warranty is valid unless it is made in writing and signed by an authorized representative of HydroMassage.

## DISCLAIMER AND LIMITATION OF REMEDY:

EXCEPT AS OTHERWISE PROVIDED ABOVE, HYDROMASSAGE MAKES NO OTHER WARRANTIES, EXPRESS OR IMPLIED, INCLUDING WARRANTIES OF MERCHANTABILITY AND FITNESS FOR A PARTICULAR PURPOSE OR COMPLIANCE WITH ANY CODE. HYDROMASSAGE EXPRESSLY DISCLAIMS ALL WARRANTIES NOT STATED IN THIS LIMITED WARRANTY.

CUSTOMER MUST READ AND FOLLOW ALL SET-UP AND USAGE INSTRUCTIONS IN THE APPLICABLE INSTALLATION, OPERATING AND/OR USER MANUAL(S). IF CUSTOMER FAILS TO DO SO, THE PRODUCT MAY NOT FUNCTION PROPERLY. The limited warranties herein shall not apply to damage caused by failure to adhere to any of the operating, installation or maintenance instructions stated in our manuals. The limited warranties herein shall not apply to any product following incorrect operating procedures, breakage or damages caused by the fault, carelessness, abuse, misuse, misapplication, improper maintenance, alteration or

modification of the product, as well as any chemical or natural corrosion, fire, act of God or any other casualty.

THE CUSTOMER IS ENTIRELY RESPONSIBLE FOR THE PROPER INSTALLATION OF THE PRODUCT. HydroMassage does not install or supervise the installation of its products and therefore cannot be held responsible for any default, breakage, property damage or other damage, loss or expense caused thereby or resulting therefrom, directly or indirectly.

THIS LIMITED WARRANTY DOES NOT COVER PROPERTY DAMAGE DUE TO WATER. The responsibility for water damage is solely that of the installer or Customer as we recommend a pre-install water test in the installation instructions, Owner's manual and troubleshooting guide.

The Customer user must provide an access panel to the components of the products as described in the installation guide in order for HydroMassage to provide for the warranty work specified herein. If such an access panel is not available, or additional travel is required to get to the job site, then any additional expense that is necessary to obtain access to the components will be the responsibility of the Customer.

This limited warranty does not apply to products or equipment that are not installed or operated in accordance with the instructions supplied by HydroMassage. This limited warranty does not apply to equipment or products that are not installed in accordance with all applicable rules, regulations and legislation pertaining to such installation.

This limited warranty does not apply to products or equipment installed or operated outside the continental United States.

If any product or equipment subject to this warranty that requires warranty service is not located within 100 miles of a city with a population of at least 50,000, then Customer shall be required to pay a trip charge for the service technician in advance of any work to be performed. The amount of the trip charge shall be determined and paid at the time that the warranty service is requested.

HydroMassage shall not be held liable for personal injuries or death to any person or for any direct, special, incidental or consequential damage, loss of time, loss of profits, inconvenience, incidental expenses, labor or material charges, or any other costs resulting from the use of the product or equipment or pertaining to the application of the present warranty, or resulting from the removal or replacement of any product or element or part covered by this warranty.

Manufacturer warrants the door seal for the life of the unit under normal use and conditions. This warranty shall not apply to any failure resulting from negligence, abuse, misuse, misapplication, alteration or modification or improper maintenance. The replacement door seal will be issued to the end user and it will be the responsibility of the end user to determine the means of installation. Manufacturer will not be liable for any incidental expenses or material charges in connection with removal or replacement of the door seal.

This Limited Warranty does not cover damages or defects caused by or which are a result of shipping damage.

HydroMassage reserves the right to discontinue and/or change models, colors and specifications in design together with replacement parts without notice and without incurring any obligations.

All waste and overflows, faucets, jet trim, pillows and pump seals are warranted to be free from defects at time of delivery.

This limited warranty does not include the cost of shipping the HydroMassage product or any of its components for warranty work. The cost of any such shipping charges shall be the responsibility of the Customer.

IF THE PRODUCT FAILS TO WORK AS WARRANTED ABOVE, CUSTOMER'S SOLE AND EXCLUSIVE REMEDY SHALL BE REPAIR OR REPLACEMENT. IN NO EVENT WILL HYDROMASSAGE, ITS AFFILIATES OR SUPPLIERS BE LIABLE TO THE CUSTOMER OR ANY THIRD PARTY FOR ANY DAMAGES IN EXCESS OF THE PURCHASE PRICE OF THE PRODUCT. THIS LIMITATION APPLIES TO DAMAGES OF ANY KIND WHATSOEVER, INCLUDING ANY DIRECT OR INDIRECT DAMAGES, PROPERTY DAMAGES, LOST PROFITS, LOST SAVINGS OR SPECIAL, INCIDENTAL, CONSEQUENTIAL OR EXEMPLARY DAMAGES, WHETHER FOR BREACH OF CONTRACT, WARRANTY, TORT OR OTHERWISE, OR WHETHER ARISING OUT OF THE USE OF OR INABILITY TO USE SUCH PRODUCT, EVEN IF HYDROMASSAGE HAS BEEN ADVISED OF THE POSSIBILITY OF SUCH DAMAGES OR OF ANY CLAIM BY ANY OTHER PARTY.

This limited warranty gives the Customer specific legal rights and the Customer may have other rights, which vary from one state and/or province to another.

## WHAT IS NOT COVERED BY THIS LIMITED WARRANTY?

- Service made necessary by modification of the product or by accident, misuse, abuse, neglect, improper installation, or improper maintenance. - Replacement of missing parts, the provision of retrofits, or preventive maintenance.
- Installation or removal of accessory retrofits or peripheral equipment of which the HydroMassage product may be a part.
- Service made necessary by any external cause, including fire, theft, acts of God, alteration, power failures, surges or shortages, lightning, or repairs by persons other than those authorized by HydroMassage.
- Damage caused by the use of the HydroMassage product outside the usage parameters set forth in the HydroMassage owner or users manual.
- Repair or replacement of plastics, or appearance parts such as interior or exterior finishes or trim.

**COMMERCIAL LIMITATIONS.** The limited warranty period for products installed for commercial applications or used in commercial applications or used in commercial ventures is the same as set forth above, except that the limited warranty period is reduced and limited to one (1) year from the initial date of purchase from an authorized dealer by the Customer for all parts and labor. HydroMassage is not responsible to the Customer for the loss of use or loss of profits under any circumstances. If the product is used as a display model, the unit warranty is for one year and begins from the date of manufacture.

# Troubleshooting guide

## **Pump Motor Does Not Start**

1. *GFCI or circuit breaker in off position*

Check circuit breaker panel or GFCI outlet where pump is plugged in to verify power source.

2. *Tubing disconnected from button or switch on motor*

Check to make sure it is connected and operational

3. *Fuses blown*

Replace fuses.

4. *Thermal overload on motor tripped*

Allow motor to cool down.

5. *Disconnected or defective wiring*

Call electrician.

6. *Low voltage*

Call electrician.

## **Motor Overheats**

1. *Low voltage*

Call electrician.

2. *Inadequate ventilation*

Create a large dead air space for proper air circulation.

3. *Wiring too small*

Call electrician.

## **Low Jet/Pump Pressure**

1. *3 speed control knob in low position*

Adjust knob to desired setting.

2. *Air control knobs off*

Open air control knobs.

3. *Jets are in off position*

Turn face or nozzle of jet to open or pull jet nozzle out towards inside of tub.

4. *Impeller clogged*

Contact service technician.

## **Noisy Pump and Motor**

1. *Worn motor bearings*

Contact service technician.

2. *Suction pipe partially clogged*

Contact service technician.

3. *Pump not supported properly*

Contact service technician.

4. *Pump or tube touching framing*

Contact service technician.

## **Leak at Pump**

1. *Shaft seal leaking*

Contact service technician.

2. *Leak at pump or heater unions*

Verify O-ring is in proper location and tighten the unions.

## **Mood Light/Chromotherapy Light Doesn't**

2. *Tubing disconnected*

Reattach tubing to button and or light box.

3. *Burned-out bulb*

Replace bulb. Instructions on page 16.

3. *Tubing disconnected*

Reattach tubing to button and or light box.

## **GFCI Tripping**

1. *Two components are on one circuit*

Call electrician.

2. *Incorrectly wired*

Call electrician.

## **Air Blower Starts On Its Own**

1. *The air system is designed to turn on automatically 20 minutes after use*

2. *A power outage may cause blower to purge*

## **Blower Runs, Air Is Not Coming Out of Jets**

1. *Manifold hose is disconnected*

Reconnect hose with pipe clamps.

## **Blower Runs, Not All Jets Are Working**

1. *Jets are clogged with hard water or other debris*

Fill the unit up with Plumb Klean or Hydrocleanse and let soak for 30 minutes.

## **Blower Overheats and Shuts Off**

1. *Not enough ventilation around tub*

Clear area under tub so there is a dead air space for proper ventilation.

2. *Low voltage or improper wiring*

Call electrician.

For any questions or technical support, contact us with your model and serial numbers located on plumbing pipe and label by motor at 303-341-1845.

# Troubleshooting guide

## **Walk-in Baths Door Seal Leaking**

If a small leak has been detected around the door, check closely for any accumulation of dirt or debris. Any small collection of either on the door seal or where the seal comes in contact with the door jamb could result in a minor leak through the door seal.

1. Before filling tub with water, be sure to wipe down the door seal using a damp soft cloth, as well as the surface on the door jamb that will come in contact with the seal.
2. Once the above surfaces have been wiped clean, be sure that when closing the door, the latch is completely locked forward.

NOTE: When draining the water from the tub, be sure that the door latch is in the locked position (forward). If the latch is not secure when draining the tub, as the water level lowers, the pressure on the door will be reduced, thus increasing the possibility of a leak around the door.

**Hydromassage Products**  
**Product Registration Information and Warranty Confirmation**

**ATTENTION:** To ensure that your warranty is registered and confirmed with the manufacturer, please take a few moments to complete, sign and return the Product Registration Card provided below within 30 days of the date of purchase.

**WARRANTY CONFIRMATION:** By returning this Product Registration Card, we can confirm the date of purchase for your new product. This confirmation will allow Hydromassage Products to process any warranty claims.

**PURCHASE REGISTRATION:** The information provided on the Product Registration Card such as model number, serial number and other important information will be kept on file with Hydromassage Products as your official Purchase Registration. In the event of fire, flood, or theft your product Registration card can serve as your Proof of Purchase for insurance purposes.

Your warranty will not be recognized unless this card is fully completed and returned to Hydromassage Products within 30-day time allocation.

<b>Hydromassage Products</b>	<b>Product Registration Card</b>
Name: _____ Dealer Name: _____	
Address: _____ Tub Model: _____ Color: _____	
City: _____ State: _____ Zip: _____	
Date Purchased: ___/___/___      Serial #: _____	
Phone: (    ) _____	
I have read the Owner's Manual carefully and thoroughly understand and agree that any installation, operation or maintenance of the whirlpool must be done strictly in accordance with instructions and guidelines contained in the Hydromassage Products Owner's Manual and the installation and service manuals provided.	
Signature: _____	