



HO-PSCM

Profibus Slave

Communications Module

User Manual

Manual Number HX-PSCM-M



WARNING

Thank you for purchasing automation equipment from **Automationdirect.com™**, doing business as **AutomationDirect**. We want your new **DirectLOGIC™** automation equipment to operate safely. Anyone who installs or uses this equipment should read this publication (and any other relevant publications) before installing or operating the equipment.

To minimize the risk of potential safety problems, you should follow all applicable local and national codes that regulate the installation and operation of your equipment. These codes vary from area to area and usually change with time. It is your responsibility to determine which codes should be followed, and to verify that the equipment, installation, and operation are in compliance with the latest revision of these codes.

At a minimum, you should follow all applicable sections of the National Fire Code, National Electrical Code, and the codes of the National Electrical Manufacturer's Association (NEMA). There may be local regulatory or government offices that can also help determine which codes and standards are necessary for safe installation and operation.

Equipment damage or serious injury to personnel can result from the failure to follow all applicable codes and standards. We do not guarantee the products described in this publication are suitable for your particular application, nor do we assume any responsibility for your product design, installation, or operation.

*Our products are not fault-tolerant and are not designed, manufactured or intended for use or resale as on-line control equipment in hazardous environments requiring fail-safe performance, such as in the operation of nuclear facilities, aircraft navigation or communication systems, air traffic control, direct life support machines, or weapons systems, in which the failure of the product could lead directly to death, personal injury, or severe physical or environmental damage ("High Risk Activities"). **AutomationDirect** specifically disclaims any expressed or implied warranty of fitness for High Risk Activities.*

For additional warranty and safety information, see the Terms and Conditions section of our Desk Reference. If you have any questions concerning the installation or operation of this equipment, or if you need additional information, please call us at 770-844-4200.

This publication is based on information that was available at the time it was printed. At **AutomationDirect** we constantly strive to improve our products and services, so we reserve the right to make changes to the products and/or publications at any time without notice and without any obligation. This publication may also discuss features that may not be available in certain revisions of the product.



Trademarks

This publication may contain references to products produced and/or offered by other companies. The product and company names may be trademarked and are the sole property of their respective owners. **AutomationDirect** disclaims any proprietary interest in the marks and names of others.

**Copyright 2003, Automationdirect.com™ Incorporated
All Rights Reserved**

No part of this manual shall be copied, reproduced, or transmitted in any way without the prior, written consent of **Automationdirect.com™** Incorporated. **AutomationDirect** retains the exclusive rights to all information included in this document.



AVERTISSEMENT



Nous vous remercions d'avoir acheté l'équipement d'automatisation de **Automationdirect.com™**, en faisant des affaires comme **AutomationDirect**. Nous tenons à ce que votre nouvel équipement d'automatisation **DirectLOGIC™** fonctionne en toute sécurité. Toute personne qui installe ou utilise cet équipement doit lire la présente publication (et toutes les autres publications pertinentes) avant de l'installer ou de l'utiliser.

Afin de réduire au minimum le risque d'éventuels problèmes de sécurité, vous devez respecter tous les codes locaux et nationaux applicables régissant l'installation et le fonctionnement de votre équipement. Ces codes diffèrent d'une région à l'autre et, habituellement, évoluent au fil du temps. Il vous incombe de déterminer les codes à respecter et de vous assurer que l'équipement, l'installation et le fonctionnement sont conformes aux exigences de la version la plus récente de ces codes.

Vous devez, à tout le moins, respecter toutes les sections applicables du Code national de prévention des incendies, du Code national de l'électricité et des codes de la National Electrical Manufacturer's Association (NEMA). Des organismes de réglementation ou des services gouvernementaux locaux peuvent également vous aider à déterminer les codes ainsi que les normes à respecter pour assurer une installation et un fonctionnement sûrs.

L'omission de respecter la totalité des codes et des normes applicables peut entraîner des dommages à l'équipement ou causer de graves blessures au personnel. Nous ne garantissons pas que les produits décrits dans cette publication conviennent à votre application particulière et nous n'assumons aucune responsabilité à l'égard de la conception, de l'installation ou du fonctionnement de votre produit.

Nos produits ne sont pas insensibles aux défaillances et ne sont ni conçus ni fabriqués pour l'utilisation ou la revente en tant qu'équipement de commande en ligne dans des environnements dangereux nécessitant une sécurité absolue, par exemple, l'exploitation d'installations nucléaires, les systèmes de navigation aérienne ou de communication, le contrôle de la circulation aérienne, les équipements de survie ou les systèmes d'armes, pour lesquels la défaillance du produit peut provoquer la mort, des blessures corporelles ou de graves dommages matériels ou environnementaux ("activités à risque élevé"). La société **AutomationDirect** nie toute garantie expresse ou implicite d'aptitude à l'emploi en ce qui a trait aux activités à risque élevé.

Pour des renseignements additionnels touchant la garantie et la sécurité, veuillez consulter la section Modalités et conditions de notre documentation. Si vous avez des questions au sujet de l'installation ou du fonctionnement de cet équipement, ou encore si vous avez besoin de renseignements supplémentaires, n'hésitez pas à nous téléphoner au 770-844-4200.

Cette publication s'appuie sur l'information qui était disponible au moment de l'impression. À la société **AutomationDirect**, nous nous efforçons constamment d'améliorer nos produits et services. C'est pourquoi nous nous réservons le droit d'apporter des modifications aux produits ou aux publications en tout temps, sans préavis ni quelque obligation que ce soit. La présente publication peut aussi porter sur des caractéristiques susceptibles de ne pas être offertes dans certaines versions révisées du produit.

Marques de commerce

La présente publication peut contenir des références à des produits fabriqués ou offerts par d'autres entreprises. Les désignations des produits et des entreprises peuvent être des marques de commerce et appartiennent exclusivement à leurs propriétaires respectifs. **AutomationDirect™** nie tout intérêt dans les autres marques et désignations.

Copyright 2003, **Automationdirect.com™** Incorporated

Tous droits réservés

Nulle partie de ce manuel ne doit être copiée, reproduite ou transmise de quelque façon que ce soit sans le consentement préalable écrit de la société **Automationdirect.com™** Incorporated. **AutomationDirect** conserve les droits exclusifs à l'égard de tous les renseignements contenus dans le présent document.

Manual Revisions

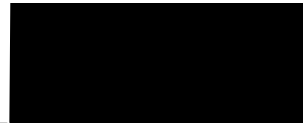

If you contact us in reference to this manual, be sure to include the revision number.

Title: H0–PSCM Profibus Slave Communications Module User Manual

Manual Number: HX–PSCM–M

Edition	Date	Description of Changes
Original	07/03	Original issue

Table of Contents

Chapter 1: Introduction

Manual Overview	1-2
Overview of this Manual	1-2
Supplemental Manuals	1-2
Who Should Read this Manual	1-2
Technical Support	1-2
Symbols Used	1-2
Key Topics for Each Chapter	1-2
H0-PSCM Module	1-3
Introduction to Profibus	1-3
PROFIBUS Concepts	1-3
PROFIBUS International	1-4
PROFIBUS Trade Organization	1-4
DP Communication Profile	1-5
Mini Glossary	1-6

Chapter 2: Installation and Setup

Installing the H0-PSCM	2-2
Remove the Slot Cover	2-2
Insert the Module	2-2
Set the Node Address	2-3
The Profibus Network	2-4
Wiring the Controller to a PROFIBUS Network	2-4
Status Indicators	2-8
Configuring the Module	2-9
GSD File	2-9
H0-PSCM Configuration	2-9
H0-PSCM Memory Map	2-9
Calculating the Power Budget for the DL06 with H0-PSCM	2-10
Managing your Power Resource	2-10
PSCM Power Specifications	2-10
Module Power Requirements	2-10
DL06 Power Consumed by Option Cards	2-11
Power Budget Calculation Example	2-12
Power Budget Calculation Worksheet	2-13

Appendix A: Specifications

H0-PSCM Profibus Slave Communications Module	A-2
---	------------

General Specifications	A-2
Cable Specifications	A-3

Appendix B: H0-PBC Profibus Base Controller GSD File

H0-PSCM Profibus Slave Communications Module GSD File	B-2
--	------------

Appendix C: DL05/06 I/O Modules

DL05/06 Discrete I/O Modules	C-2
DL05/06 Analog I/O Modules	C-2

Appendix D: Setup the SST Profibus Master PCI Card for the H0-PSCM

Setup the SST Profibus Master PCI Card for the H0-PSCM	D-2
Getting Started	D-2

Appendix E: Think & Do Profibus Network Setup with the H0-PSCM

Think & Do Profibus Network Setup with H0-PSCM	E-2
Getting the T & D Network Started	E-2
T & D Studio setup for PC control	E-2

Appendix F: Siemens Profibus Network Set up with H0-PSCM

Setup a H0-PSCM on Siemens Profibus Network	F-2
Simatic Manager	F-2

Introduction

In This Chapter. . . .

- Manual Overview
 - H0-PSCM Module
 - Introduction to PROFIBUS
-

Manual Overview

Overview of this Manual

This manual describes the installation and operation of the H0-PSCM Profibus Slave Communications Module. You will find the necessary information for installing and configuring the module for use on a Profibus network.

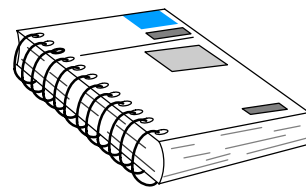

Supplemental Manuals

The following manuals are essential to the proper use of your H0 Profibus Slave Communications Module.

- **DL05/06 Options Manual** part number **D0-OPTIONS-M**
- **DL05 User Manual** part number **D0-USER-M**
- **DL06 Micro PLC User Manual** part number **D0-06USER-M**
- The PLC/PC software manual
- The PROFIBUS software (if separate) manual
- The PROFIBUS networks manual

Who Should Read this Manual

If you have a working knowledge of the PROFIBUS network, the PROFIBUS software and PLC or PC which you are using, this manual will help you configure and install your H0-PSCM Profibus Slave Communications Module.

Technical Support

We strive to make our manuals the best in the industry and rely on your feedback in reaching our goal. If you cannot find the solution to your particular application, or, if for any reason you need additional technical assistance, please call us at

770-844-4200.

Our technical support team is glad to work with you in answering your questions. They are available **weekdays from 9:00 a.m. to 6:00 p.m. Eastern Time**. We also encourage you to visit our website where you can find technical and nontechnical information about our products and our company.

www.automationdirect.com

Symbols Used



The “note pad” icon in the left-hand margin indicates a **special note**.

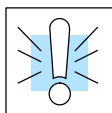

The “exclamation mark” icon in the left-hand margin indicates a **warning** or **caution**. These are very important because the information may help you prevent serious personal injury or equipment damage.

Key Topics for Each Chapter

The beginning of each chapter will list the key topics that can be found in that chapter.

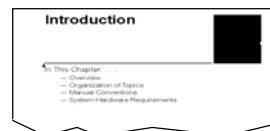

H0-PSCM Module

The H0-PSCM module is an option card that will plug into an option slot of a DL05 or a DL06 PLC. The major module components are shown below.

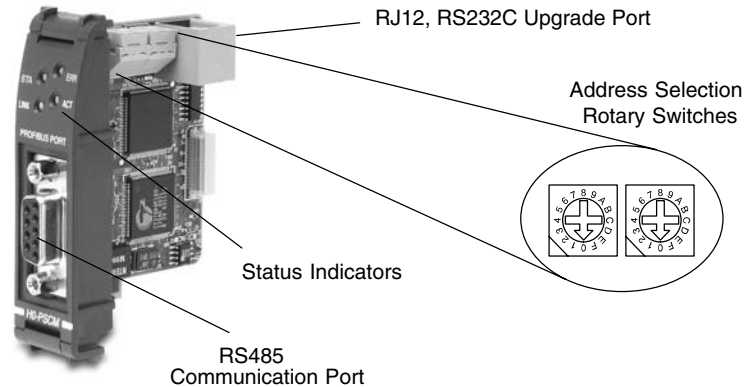

The H0-PSCM is used to transfer blocks of data between a DL05/06 PLC and a Profibus master controller. Up to four blocks of data can be chosen to be transferred. The data blocks can range in size from 1 Byte to 32 Words and can be either input or output. The data blocks can be mapped to real I/O within the PLC or user areas of memory. Once the H0-PSCM is configured, it will continually transfer the data to/from the PLC.

Introduction to Profibus

Profibus (Process Field Bus) is a vendor-independent, open field bus standard that is supported by leading manufacturers of automation products. A host of certified Profibus products are available, offering an array of products including sensors, motor drives and starters, PLCs, remote I/O systems, etc.

PROFIBUS Concepts

Here are some Profibus concepts that you may find helpful.

- Profibus offers three types of profiles.
 - Process Automation (PA)
 - Fieldbus Message Specification (FMS) communication profile
 - Decentralized Periphery (DP)
- Profibus – DP is the most frequently used communication profile.
 - The H0-PSCM is a DP slave
 - Master and slave devices, max. 126 stations on one bus
 - Connection oriented communication
 - Transmission rate up to 12 Mbps
 - Peer-to-peer (user data communication) or multicast (control commands)
 - Cyclic master-slave user data communication
 - Control commands allow synchronization of I/O
- Methods for diagnostic and error detection are built into the system

**PROFIBUS
International**

PROFIBUS International (PI) maintains the PROFIBUS standard and provides certification to EN 50170 and IEC 61158 standards for devices. The main purpose of certification is to provide users with the assurance that devices from different manufacturers will work in the same network. Certification is issued by the PROFIBUS Certification Centre in Karlsruhe, Germany.

PROFIBUS Nutzerorganisation e.V.

Haid-und-Neu-Straße 7

D-76131 Karlsruhe

Phone ++49 721 96 58 590, Fax ++49 721 96 58 589

PROFIBUS_International@compuserve.com

**PROFIBUS Trade
Organization**

The PROFIBUS Trade Organization (PTO) is a member of PROFIBUS International. For more detailed information about Profibus, visit the PTO website where technical descriptions and Profibus specifications are available.

PROFIBUS Trade Organization

16101 N. 82nd Street, Suite 3B

Scottsdale, AZ 85260

Phone 480-483-2456, Fax 480-483-7202

Their website is: www.profibus.com

DP Communication Profile

The DP Communication Profile is designed for efficient data exchange at the field level. The central automation devices, such as PLC/PC or process control systems, communicate through a fast serial connection with distributed field devices which can be I/O, drives and valves, as well as measuring transducers. Data exchange with the distributed devices is mainly cyclic.

The master controller cyclically reads the input information from the slaves and cyclically writes the output information to the slaves. The bus cycle time should be shorter than the program cycle time of the central automation system, which for many applications is approximately 10 msec. In addition to cyclic user data transmission, DP provides powerful functions for diagnostics and commissioning. Data communication is monitored by monitoring functions on both the master and slave side.

DP requires only about 1 msec at 12 Mbit/sec for the transmission of 512 bits of input data and 512 bits of output data distributed over 32 stations. The chart below shows the typical time, depending on number of stations and transmission speed. Transmitting the input and output data in a single message cycle with DP, results in a significant increase in speed compared to FMS.

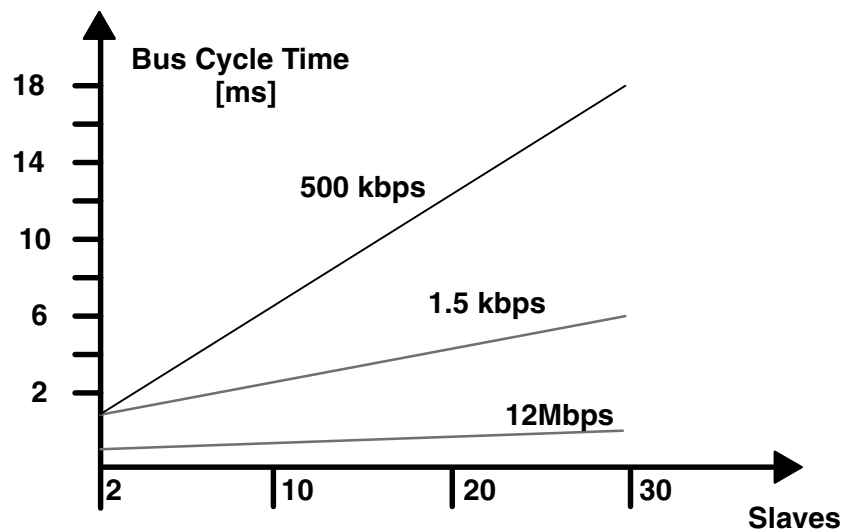

Bus cycle time of a DP mono-master system.

For a more complete description and specification of the Profibus DP communication profile, visit the Profibus Trade Organization web site, www.profibus.com.

Mini Glossary

Below is a small glossary of terms used in this manual.

Mono-Master	Only one Profibus master active on the bus during operation of the bus system of which the H0-PSCM is a slave. This can be either a PLC module or a card in your PC.
Multi-Master	Several Profibus masters are connected to one bus. These masters represent either independent subsystems or additional configuration and diagnostic devices.
Slave	a peripheral device (I/O devices, drives, HMI, valves, measuring transducers) which collects input information and sends output information to the peripherals. The H0-PSCM is a slave in a Profibus I/O sub-system.
Segment	One bus structure with a maximum of 32 stations (master or slaves) or nodes. A maximum of 9 segments is possible with the use of repeaters.
Station	A node. Can be a master or a slave.
Repeater	An RS485 device that amplifies data signals on bus lines and is the link between individual bus segments. Used to increase the number of nodes or to extend the cable length between two nodes.
Node Address	The unique device address on a Profibus network. There are a maximum of 126 (0-126). The master is usually node 0.
Token	The bus access right which is assigned to each master within a precisely defined timeframe.

Installation and Setup

In This Chapter. . . .

- Installing the H0–PSCM
 - The Profibus Network
 - Configuring the Module
-

Installing the H0-PSCM

Remove the Slot Cover

The first step in installing the option module is to remove the protective option slot cover. Remove the cover by squeezing the pinch tabs and lifting the cover off.

Installation and Setup

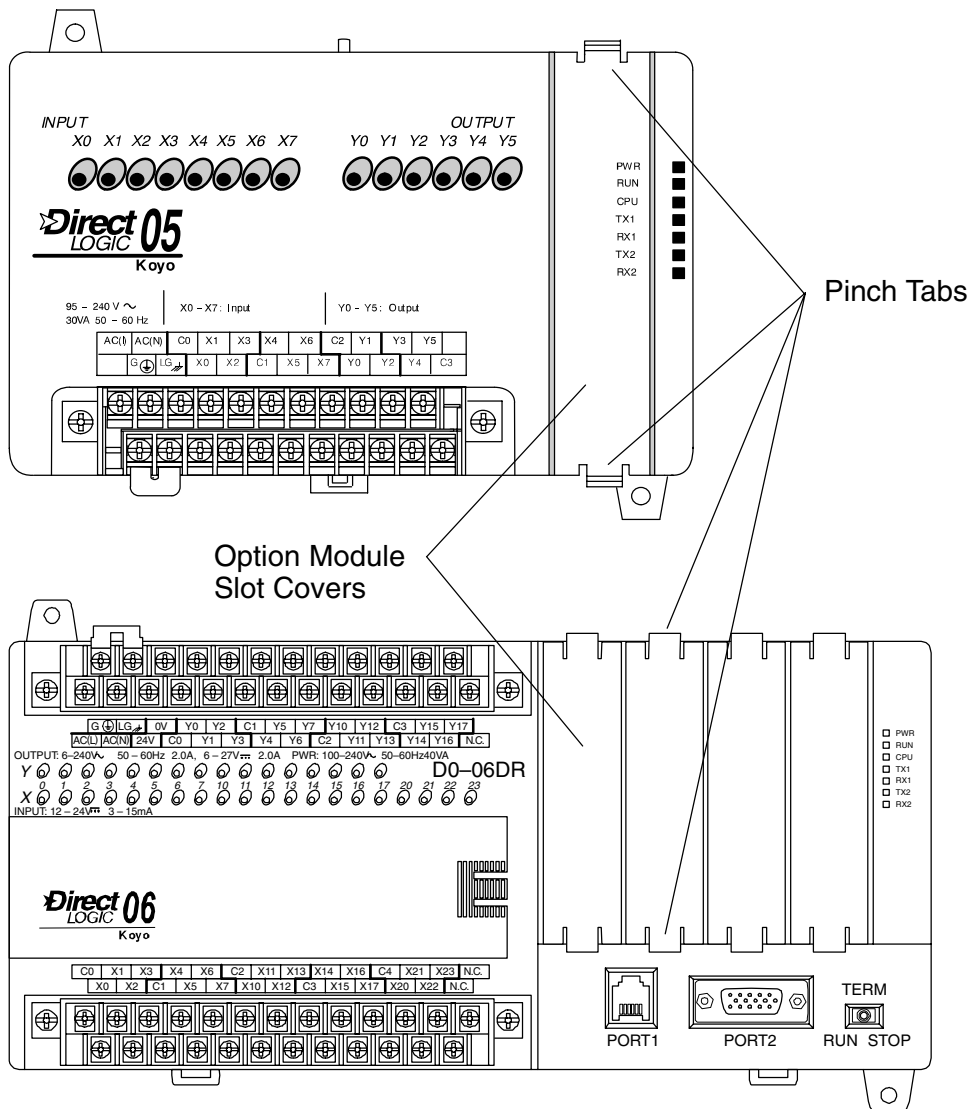

Insert the Module

Now, insert the module into the open slot. Locate the module so the printed information is oriented in the same direction as the markings on the PLC. Be careful to align the female connector on the printed circuit board of the module with the male connector on the PLC mother board. Press the module into the slot until the front of the module is flush with the front of the PLC and secure the locking tabs. Install the remaining modules in the PLC. Once the modules are in place the PLC is ready to be programmed.

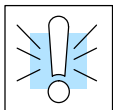

WARNING: Power to the PLCs must be disconnected before inserting or removing a module. Failure to disconnect power could result in serious damage to a module, the PLC or both.

Set the Node Address

Once the H0-PSCM is installed in the option slot, set the Node Address. The Node Address rotary switches are accessed by removing the cover located to the right of Port1 and Port2 on the DL05.

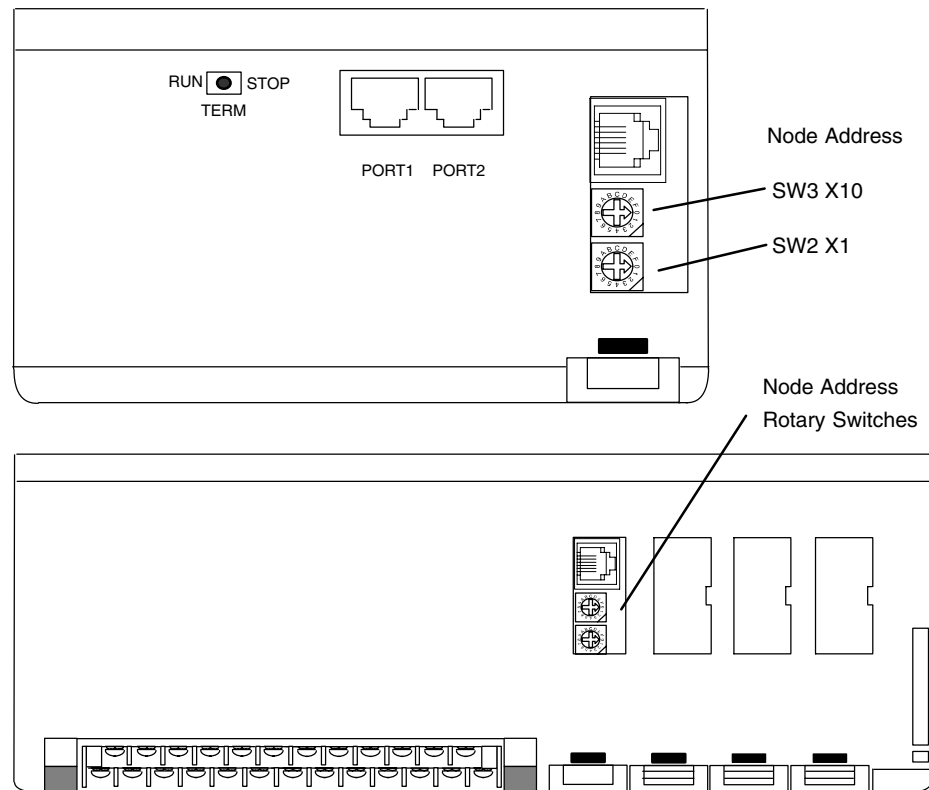

Remove the cover associated with the option slot where the H0-PSCM is installed in the DL06. Once the access cover is removed, use a small, flat, screwdriver to set the Node Address to an available address, from 3–125. Node Address 0 is normally reserved for the Profibus network master. Note that SW3 sets the tens and SW2 sets the units.

Profibus DP is usually a mono master system. Since Profibus is based on a token principle, more than one active station (masters) is allowed. The overall controlling master of the network should be node address “1”. The master should be placed at the beginning of the network. Network address “0” should be reserved for monitoring and diagnostic devices.

It is recommended that slave devices begin with address “3”. The slave devices need to be addressed in consecutive order by bus location moving away from the master.

The Profibus Network

RS-485 serial communication is most frequently used by Profibus. Twisted pair shielded copper cable with one conductor pair is the most common cable used for the Profibus network. Installation of this cable does not require expert knowledge. The bus structure permits addition and removal of stations or step-by-step commissioning of the system without interfering with the other stations. Later expansions will not effect the stations which are already in operation. It is important to follow the RS-485 installation guidelines, for 90% of the problems which occur with Profibus networks can be attributed to incorrect wiring and installation.

All devices are connected in a bus structure (line) in a Profibus network. It can be built in several segments with a segment consisting of the maximum number of stations (32) and/or the maximum length of the network. A repeater must be added if there is a need to have more than 32 stations (126 maximum). The bus is terminated by an active bus terminator at the beginning and end of each segment. See the diagram of the termination network below. Both bus terminators should be powered at all times to insure error-free operation. The bus terminator can usually be switched at the device or in the bus terminator connections.

Wiring the Controller to a PROFIBUS Network

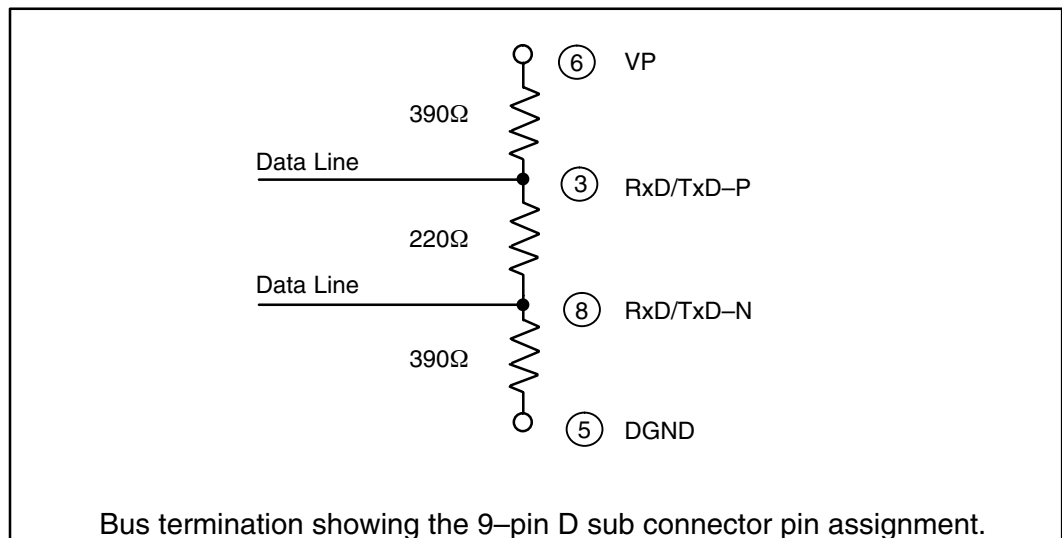

Communication speeds between 9.6 kbps and 12 Mbps are available. One unique baud rate is selected for all devices on the bus when the system is commissioned. The baud rate selected will depend upon the cable length.

The following table shows the maximum network cable lengths for the available baud rates that can be obtained with copper wire.

Baud Rate (bits per second)	Max. Segment Length	Max. Expansion
9.6k	1,000m / 3,278 feet	10,000m / 32,786 feet
19.2k	1,000m / 3,278 feet	10,000m / 32,786 feet
93.75k	1,000m / 3,278 feet	10,000m / 32,786 feet
187.5k	1,000m / 3,278 feet	10,000m / 32,786 feet
500.0k	400m / 1,311 feet	4,000m / 13,114 feet
1,500.0k	200m / 655 feet	2,000m / 6,557 feet
3,000.0k	100m / 327 feet	1,000m / 3,270 feet
6,000.0k	100m / 327 feet	1,000m / 3,270 feet
12,000.0k	100m / 327 feet	1,000m / 3,270 feet

To use baud rates greater than 1.5 Mbps, special connectors are required. The connectors have built in inductors in order to run with higher baud rates (refer to the diagram on page 2-9). Branch lines are not permitted when using baud rates greater than 1.5 Mbps. The minimum recommended cable length between two stations is 1m/3 feet.

The standard EN 50170 specifies the cable for use with Profibus. The following table specifications must be met for Profibus cables.

Cable Specification – Profibus DP	
Impedance	135 to 165 Ω / 3 to 20 MHz
Capacitance	< 30 pf / m
Resistance	< 110 Ω / km
Wire gauge	> 0.64 mm
Conductor area	> 0.34 mm ²

There are several types of Profibus cable available. The most common cable used has solid conductors for the Profibus line. Some recommended cables are: two with solid conductors, Belden Profibus 3079A and Siemens 6XV1 830 0AH10, one with flexible conductors, Bosch Comnet DP #913 548.

The Profibus network is generally connected with a shielded, twisted pair, cable. The shield must to be connected to the protective housing of the connector which is then brought to ground through the connection on the device. Care must be taken when connecting the wires to the connectors that the shield and wires are properly installed.

In many automation control systems, the I/O bus cables are the most important connections between individual components in the system. Damage to the cable or improper cable installation can lead to problems and often to a breakdown of the entire control system.

To avoid damage to the Profibus cables, install them where they will be clearly visible and separate from all other cables. This will improve EMC characteristics. Install the cables in their own cable trays or conduit separate from all A/C power wiring.

The standard Profibus cable is intended for permanent installation in buildings or in an environment which is protected from the climate. The cable should only be used in applications where there is a minimum of cable flexing and where it will not be exposed to a wet environment.

A 9-pin D-sub connector is required for connecting to Profibus networks using RS-485 for communication. The connector pin assignment and the wiring is shown in the following diagram.

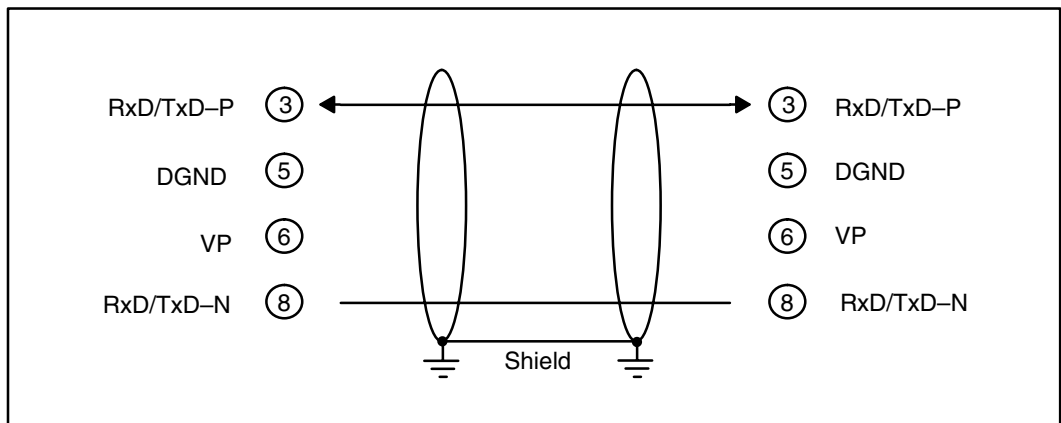

The two wires are usually color coded. Typically red and green are used. Red is used for the **B** Transmit/Receive line and Green for the **A** transmit/receive line. It is important to keep A and B line consistent throughout the network to avoid improper operation. ***This is the most common connection mistake in the field.***

It is recommended that a IP20 protective connector, such as, the Vertical Termination shown in the diagram on the next page, be used for making all terminations for the Profibus network. This is the best way for a quick and easy solution to terminating each end of your Profibus network. AutomationDirect offers two certified connectors for the Profibus Base Controller, one for a standard termination and one for a node termination.

Reverse vertical termination
AutomationDirect Part No. 103659L.

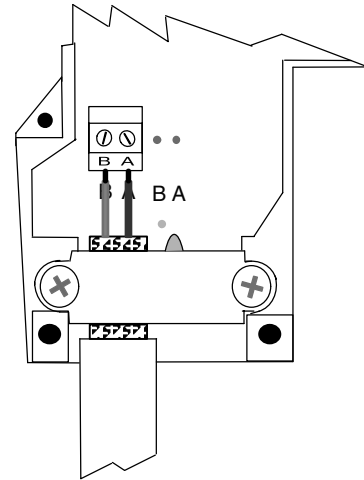

Termination showing the cable connection to points A (Red) and B (Green).

Note: The insulation has been removed exposing the shield. It is connected to ground by the metal clamp holding the cable in place.

Proper preparation of the cable is important for good Profibus network installation. When removing the cable insulation cover, make sure that the braided cable shield is not damaged. Strip the ends of the cable conductors as shown below.

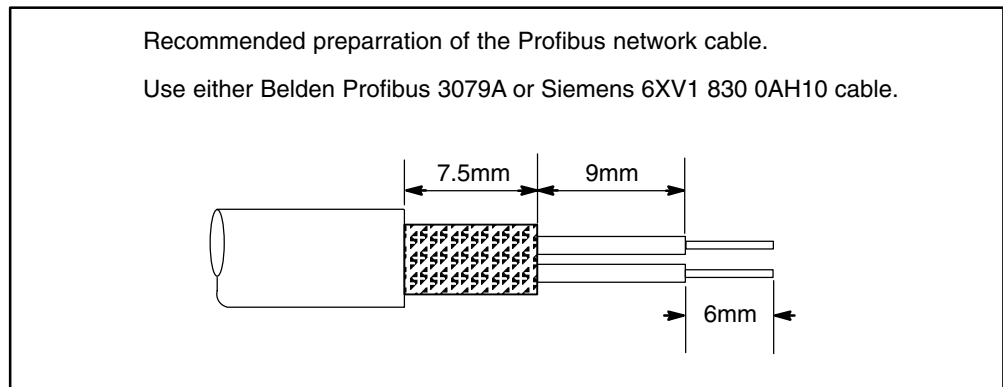

After preparing the cable, insert the green and the red conductors in the appropriate screw terminals of the bus connector.

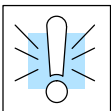

WARNING: The cable shield is not always connected to protective ground within all Profibus devices; therefore, make sure the cable shield is connected to ground before it enters the enclosure.

One important point when setting up a Profibus network is where and how to place the termination. Each Profibus peer-to-peer network, or last segment, needs to be terminated at the beginning and end of a segment (must be at the last device). The termination is usually built into the connector. Power must be supplied to the terminating resistors at the device. This means the last device needs to be powered at all times. If you have to replace the last device, the whole network could become unstable. It is preferred that the master device be installed at the beginning of the network and as a termination point.

Each segment is allowed to have a maximum of 32 stations, and a maximum of 9 segments is possible.

For installation applications where there is electromagnetic interference or to cover longer distances, fiber optic cable can be used for the Profibus field bus networks. Refer to Profibus guideline 2.022 for the specification of the Profibus fiber optic transmission method. For an overview of the fiber optic components available for Profibus, refer to a current Profibus Product Guide which can be found at the Profibus website, www.profibus.com.

Status Indicators

The H0-PSCM Profibus Slave Communication Module has four Status Indicators: STA, ERR, LINK and ACT.



Indicator	Action	Status
STA (STATUS)	ON	Powerup check passed
	OFF	Powerup check failed
ACT (ACTIVE)	ON	Connected to network
	OFF	Not connected to network or incorrect configuration
LINK	ON	Correct configuration and running
	OFF	Incorrect configuration and running
ERR (ERROR)	ON	Watchdog timer timeout

Configuring the Module

Use the Profibus configuration tool (this should come with the master unit) to configure the master and the H0-PSCM for your network. **Refer to the software Help file and/or the manual for assistance with the configuration.** Appendix D illustrates a step-by-step configuration using a SST Profibus PCI Master card.

GSD File

The actual configuration of the H0-PSCM takes place whenever the Profibus master is configured. The characteristic communication features of the H0-PSCM are defined in the form of an electronic device data sheet, GSD file. The defined file format permits the configuration system to simply read in the GSD files of the H0-PSCM and automatically use this information when configuring the bus system. The GSD file is installed in the Profibus master during the configuration of the master.

H0-PSCM Configuration

The configuration tool made available with the master controller will allow you to achieve a simple Plug and Play configuration for your Profibus network. Based on the GSD files, the network can be set up with devices from different manufacturers.

- 1. Set the module Node Address:**
Make sure that the H0-PSCM Slave module node address is set to an available node number on the Profibus network (from 3 to 125).
- 2. Configure the Profibus master:**
Configure the Profibus master with the Profibus Configuration Tool that was supplied with the master controller to configure the H0-PSCM and the DL05/06 I/O.
- 3. Add the GSD file:**
When configuring the Profibus master, add the H0-PSCM slave GSD file from the disk which came with this manual or from our web site www.automationdirect.com.
- 4. Commission the Node:**
Use the Profibus Configuration Tool used to configure the master to put the system on line.
- 5. Scan the I/O:**
Use the monitor utility that comes with the configuration tool to scan the DL05/06 I/O.
- 6. View Indicators on the H0-PSCM module:**
Refer to the Status Indicators when connecting to the network.

H0-PSCM Memory Map New H0-PSCM info goes here.

Calculating the Power Budget for the DL06 with H0-PSCM

Managing your Power Resource

When determining which I/O modules you will be using in the H0-PSCM system, it is important to remember that there is a limited amount of power available from the power supply. A table has been provided here showing the power available from the various DL06 base units and a table showing the maximum power consumed by the H0-PSCM and each of the I/O modules supported by the H0-PSCM. Following these two tables is an example of a completed power budgeting worksheet and then a blank worksheet you can use for your own calculations.

If the I/O modules you choose exceed the maximum power available from the smaller DL06 base units, you will need to adjust the configuration.

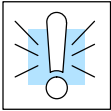

WARNING: It is *extremely* important to calculate the power budget. If you exceed the power budget, the system may operate in an unpredictable manner which may result in a risk of personal injury or equipment damage.

PSCM Power Specifications

The following table shows the amount of electrical current available at the two voltages supplied from the DL06 base unit. Use these values when calculating the power budget for you system.

The Auxiliary 24V power source mentioned in the table is available at the base terminal strip. You can connect to external devices or DL06 I/O modules that require 24VDC, but be sure not to exceed the maximum current supplied.

DL06 Power Supplied by Base Units		
Part Number	5 VDC (mA)	24 VDC (mA)
D0-06xx	<1500 mA	300 mA
	<2000 mA	200 mA
D0-06xx-D	1500 mA	none

Module Power Requirements

The chart on the next page shows the maximum amount of electrical current required to power the H0-PSCM or each I/O module. Use these values when calculating the power budget for your system.

DL06 Power Consumed by Option Cards

Part Number	5VDC	24 VDC
PBC Module		
H0-PSCM	530 mA	None
Input Modules		
D0-10ND3	35 mA	None
D0-16ND3	35 mA	None
Output Modules		
D0-10TD1	150 mA	None
D0-16TD1	200 mA	None
D0-10TD2	150 mA	None
D0-16TD2	200 mA	None
Relay Output Modules		
D0-08TR	280 mA	None
Combination Modules		
D0-07CDR	130 mA	None
D0-08CDD1	100 mA	None
Analog Modules		
F0-04AD-1	50 mA	None
F0-04AD2DA-1	100 mA	40 mA
F0-2AD2DA-2	50 mA	30 mA
F0-4AD2DA-2	100 mA	None
Specialty Modules		
H0-ECOM	25 mA	None

Power Budget Calculation Example

The following example shows how to calculate the power budget for the H0-PSCM system.

Base #	Base Unit	5 VDC (mA)	24 VDC Output (mA)
<u>1</u>			
Available Base Power	D0-06AA	<1500	300
Slot 1	D0-10TD1	150	0
Slot 2	D0-08CDD1	100	0
Slot 3	F0-2AD2DA-2	50	30
Slot 4	H0-PSCM	530	
Other			
Maximum Power Required		830	180
Remaining Power Available		1500-830= 670	300 - 170 = 120

1. Using the table on the previous page, fill in the information for the base unit, the H0-PSCM, I/O modules, and any other devices that will use system power including devices that use the 24 VDC output.
2. Add the current columns starting with the row for Slot 0 and working your way down to the "Other" category. Put the total in the row labeled "Maximum power required".
3. Subtract the row labeled "Maximum power required" from the row labeled "Available Base Power". Place the difference in the row labeled "Remaining Power Available".
4. If "Maximum Power Required" is greater than "Available Base Power" in either of the two columns, the power budget will be exceeded. It will be unsafe to use this configuration, and you will need to restructure your I/O.

Power Budget Calculation Worksheet

This blank chart is provided for you to copy and use in your power budget calculations.

Base #	Module Type	5 VDC (mA)	Auxiliary Power Source 24 VDC Output (mA)
<u>0</u>			
Available Base Power			
CPU Slot			
Slot 0			
Slot 1			
Slot 2			
Slot 3			
Slot 4			
Slot 5			
Slot 6			
Slot 7			
Other			
Total Power Required			
Remaining Power Available			

1. Using the table on the previous page, fill in the information for the base power supply, the H0-PSCM, I/O modules, and any other devices that will use system power including devices that use the 24 VDC output.
2. Add the current columns starting with the row for Slot 0 and working your way down to the "Other" category. Put the total in the row labeled "Maximum power required".
3. Subtract the row labeled "Maximum power required" from the row labeled "Available Base Power". Place the difference in the row labeled "Remaining Power Available".
4. If "Maximum Power Required" is greater than "Available Base Power" in either of the two columns, the power budget will be exceeded. It will be unsafe to use this configuration, and you will need to restructure your I/O.

Specifications

In This Appendix. . . .
— Specifications

Specifications

H0-PSCM Profibus Slave Communications Module

Module Type	Profibus Network Interface Module
Maximum Expansion	32 stations per segment, 9 repeaters max./segment, 126 stations maximum
Communications	RS-485
Auto-configuring	GSD file in Master
ProfibusProfile	DP
Profibus Port	9-pin D-shell
Node Address	3 to 125 (decimal) set by DIP switches (0 used by the Master)
Segment distance	100 meters (327 feet) to 1200 meters (3270 feet)
Baud Rate	Selectable from 9.6 kbps to 12 Mbps
LED Indicators	STA (STATUS/Module): ON = module power-up check passed OFF = module power-up check failed ACT (ACTIVE/Link): ON = Network is active OFF = Network is not active LINK (Holding): ON = PBC is configured correctly and running OFF = Incorrect I/O configuration ERR (ERROR): ON = watchdog timer timeout represents hardware, communications, or network fault; power-on reset or reset within master device software
Communications Port	RJ12, RS232C (used for firmware upgrade only)
Base Power Requirement	530mA @ 5VDC (supplied by base power supply)

General Specifications

Installation Requirements	Installs in option slot
Operating Temperature	32° F to 131° F (0° C to 55° C)
Storage Temperature	-4° F to 158° F (-20° C to 70° C)
Relative Humidity	5 to 95% (non-condensing)
Environmental Air	No corrosive gases, pollution level = 2 (UL 840)
Vibration	MIL STD 810C 514.2
Shock	MIL STD 810C 516.2
Noise Immunity	NEMA ICS3-304 Impulse noise 1 μ s, 1000V FCC class A RFI (144MHz, 430MHz, 10W, 10cm)
Manufacturer	Host Automation Products

Cable Specifications

Permitted Ambient Conditions	
Operating Temperature	32° F to 131° F (–40° C to 60° C)
Storage Temperature	–4° F to 158° F (–40° C to 60° C)
Installation Temperature	(–40° C to 60° C)
Bending Radius	
First and final bend	≥ 75 mm
Repeated bending	≥ 150 mm

H0–PSCM Profibus Slave Communication GSD File

In this Appendix. . . .
— H0-PSCM GSD File

H0-PSCM Profibus Slave Communications Module GSD File

This appendix shows the contents of the GSD file for the H0-PSCM Profibus Slave Communications Module. It is included for reference only. The electronic data diskette is included with this manual. The latest GSD file is always available for download on the www.AutomationDirect.com website. It can always be downloaded from the GSD Library located on the Profibus Trade Organization website www.profibus.com.

```

=====
; GSD File For AutomationDirect.com H0-PSCM
; using the SPC3 ASIC
; Version: V0.1
=====
#Profibus_DP
GSD_Revision=2

;General parameters
Vendor_Name   = "AutomationDirect.com"
Model_Name    = "H0-PSCM"
Revision      = "V1.0"
Ident_Number  = 0x0779
Protocol_Ident = 0
Station_Type  = 0
FMS_supp     = 0
Hardware_Release= "REV. 2"
Software_Release= "REV 1.1.11"
9.6_supp     = 1
19.2_supp    = 1
45.45_supp   = 1
93.75_supp   = 1
187.5_supp   = 1
500_supp     = 1
1.5M_supp    = 1
3M_supp      = 1
6M_supp      = 1
12M_supp     = 1
MaxTsd_9.6   = 60
MaxTsd_19.2  = 60
MaxTsd_45.45 = 250
MaxTsd_93.75 = 60
MaxTsd_187.5 = 60
MaxTsd_500   = 100
MaxTsd_1.5M  = 150

```

```

MaxTsdr_3M      = 250
MaxTsdr_6M      = 450
MaxTsdr_12M     = 800
Redundancy      = 0
Repeater_Ctrl_Sig = 0
24V_Pins        = 0
Implementation_Type = "ASIC, SPC3"
Bitmap_Device    = "Bitmap1N"
Bitmap_Diag      = "Bitmap1D"
Bitmap_SF        = "Bitmap1S"
; Slave-Specification:
Freeze_Mode_supp = 1
Sync_Mode_supp   = 1
Set_Slave_Add_Supp = 0
Auto_Baud_supp   = 1
Min_Slave_Intervall = 1
Fail_Safe        = 0
Max_Diag_Data_Len = 64
Modul_Offset     = 0
Slave_Family     = 3@DL-205
Modular_Station  = 1
Max_Input_Len    = 244
Max_Output_Len   = 244
;Max_Data_len    = 488
Max_Data_len     = 256
Max_Module       = 4

```

```

; UserPrmData: Length and Preset:

```

```

Max_User_Prm_Data_Len = 64 ; 32 Bytes reserved for profibus module + 4 bytes per slot
Ext_User_Prm_Data_Const(0) = 0x00,0x00,0x00,0x00,0x00,0x00,0x00,0x00,0x00,0x00,0x00,0x00,
0x00,0x00,0x00,0x00,0x00,0x00,0x00,0x00,0x00,0x00,0x00,0x00,0x00,0x00,0x00,0x00,0x00,0x00,
0x00,0x00,0x00,0x00,0x00,0x00

```

```

PrmText=0
Text(0)="X"
Text(1)="Y"
Text(2)="C"
Text(3)="S"
Text(4)="T"
Text(5)="CT"
Text(6)="GX"
Text(7)="GY"
Text(8)="V"
EndPrmText

```

```
ExtUserPrmData=0 "Read Address (decimal fmt)"
Unsigned16 0 0-32767
EndExtUserPrmData
```

```
ExtUserPrmData=1 "Write Address (decimal fmt)"
Unsigned16 0 0-32767
EndExtUserPrmData
```

```
ExtUserPrmData=2 "V Mem Read Addr (decimal fmt)"
Unsigned16 1024 0-32767
EndExtUserPrmData
```

```
ExtUserPrmData=3 "V Mem Write Addr (decimal fmt)"
Unsigned16 1024 0-32767
EndExtUserPrmData
```

```
ExtUserPrmData=4 "Bit Type"
Unsigned8 2 0-8
Prm_Text_Ref=0
EndExtUserPrmData
; EMPTY SLOT
Module = "Empty Slot" 0x00
EndModule
```

```
; WORD READS
Module="1 WORD READ FROM PLC" 0x41,0xC0,0x02
Ext_Module_Prm_Data_Len = 2
Ext_User_Prm_Data_Ref(0) = 2
EndModule
Module="2 WORD READ FROM PLC" 0x41,0xC1,0x02
Ext_Module_Prm_Data_Len = 2
Ext_User_Prm_Data_Ref(0) = 2
EndModule
Module="3 WORD READ FROM PLC" 0x41,0xC2,0x02
Ext_Module_Prm_Data_Len = 2
Ext_User_Prm_Data_Ref(0) = 2
EndModule
Module="4 WORD READ FROM PLC" 0x41,0xC3,0x02
Ext_Module_Prm_Data_Len = 2
Ext_User_Prm_Data_Ref(0) = 2
EndModule
```



```
Module="5 WORD READ FROM PLC" 0x41,0xC4,0x02
Ext_Module_Prm_Data_Len = 2
Ext_User_Prm_Data_Ref(0) = 2
EndModule
Module="6 WORD READ FROM PLC" 0x41,0xC5,0x02
Ext_Module_Prm_Data_Len = 2
Ext_User_Prm_Data_Ref(0) = 2
EndModule
Module="7 WORD READ FROM PLC" 0x41,0xC6,0x02
Ext_Module_Prm_Data_Len = 2
Ext_User_Prm_Data_Ref(0) = 2
EndModule

Module="8 WORD READ FROM PLC" 0x41,0xC7,0x02
Ext_Module_Prm_Data_Len = 2
Ext_User_Prm_Data_Ref(0) = 2
EndModule
Module="9 WORD READ FROM PLC" 0x41,0xC8,0x02
Ext_Module_Prm_Data_Len = 2
Ext_User_Prm_Data_Ref(0) = 2
EndModule
Module="10 WORD READ FROM PLC" 0x41,0xC9,0x02
Ext_Module_Prm_Data_Len = 2
Ext_User_Prm_Data_Ref(0) = 2
EndModule
Module="11 WORD READ FROM PLC" 0x41,0xCA,0x02
Ext_Module_Prm_Data_Len = 2
Ext_User_Prm_Data_Ref(0) = 2
EndModule
Module="12 WORD READ FROM PLC" 0x41,0xCB,0x02
Ext_Module_Prm_Data_Len = 2
Ext_User_Prm_Data_Ref(0) = 2
EndModule
Module="13 WORD READ FROM PLC" 0x41,0xCC,0x02
Ext_Module_Prm_Data_Len = 2
Ext_User_Prm_Data_Ref(0) = 2
EndModule
Module="14 WORD READ FROM PLC" 0x41,0xCD,0x02
Ext_Module_Prm_Data_Len = 2
Ext_User_Prm_Data_Ref(0) = 2
EndModule
```

```
Module="15 WORD READ FROM PLC" 0x41,0xCE,0x02
Ext_Module_Prm_Data_Len = 2
Ext_User_Prm_Data_Ref(0) = 2
EndModule
Module="16 WORD READ FROM PLC" 0x41,0xCF,0x02
Ext_Module_Prm_Data_Len = 2
Ext_User_Prm_Data_Ref(0) = 2
EndModule
Module="18 WORD READ FROM PLC" 0x41,0xD1,0x02
Ext_Module_Prm_Data_Len = 2
Ext_User_Prm_Data_Ref(0) = 2
EndModule
Module="20 WORD READ FROM PLC" 0x41,0xD3,0x02
Ext_Module_Prm_Data_Len = 2
Ext_User_Prm_Data_Ref(0) = 2
EndModule
Module="24 WORD READ FROM PLC" 0x41,0xD7,0x02
Ext_Module_Prm_Data_Len = 2
Ext_User_Prm_Data_Ref(0) = 2
EndModule
Module="30 WORD READ FROM PLC" 0x41,0xDD,0x02
Ext_Module_Prm_Data_Len = 2
Ext_User_Prm_Data_Ref(0) = 2
EndModule
Module="32 WORD READ FROM PLC" 0x41,0xDF,0x02
Ext_Module_Prm_Data_Len = 2
Ext_User_Prm_Data_Ref(0) = 2
EndModule

; WORD WRITES
Module="1 WORD WRITE TO PLC" 0x81,0xC0,0x02
Ext_Module_Prm_Data_Len = 2
Ext_User_Prm_Data_Ref(0) = 3
EndModule
Module="2 WORD WRITE TO PLC" 0x81,0xC1,0x02
Ext_Module_Prm_Data_Len = 2
Ext_User_Prm_Data_Ref(0) = 3
EndModule
Module="3 WORD WRITE TO PLC" 0x81,0xC2,0x02
Ext_Module_Prm_Data_Len = 2
Ext_User_Prm_Data_Ref(0) = 3
EndModule
```

```
Module="4 WORD WRITE TO PLC" 0x81,0xC3,0x02
Ext_Module_Prm_Data_Len = 2
Ext_User_Prm_Data_Ref(0) = 3
EndModule
```

```
Module="5 WORD WRITE TO PLC" 0x81,0xC4,0x02
Ext_Module_Prm_Data_Len = 2
Ext_User_Prm_Data_Ref(0) = 3
EndModule
```

```
Module="6 WORD WRITE TO PLC" 0x81,0xC5,0x02
Ext_Module_Prm_Data_Len = 2
Ext_User_Prm_Data_Ref(0) = 3
EndModule
```

```
Module="7 WORD WRITE TO PLC" 0x81,0xC6,0x02
Ext_Module_Prm_Data_Len = 2
Ext_User_Prm_Data_Ref(0) = 3
EndModule
```

```
Module="8 WORD WRITE TO PLC" 0x81,0xC7,0x02
Ext_Module_Prm_Data_Len = 2
Ext_User_Prm_Data_Ref(0) = 3
EndModule
```

```
Module="9 WORD WRITE TO PLC" 0x81,0xC8,0x02
Ext_Module_Prm_Data_Len = 2
Ext_User_Prm_Data_Ref(0) = 3
EndModule
```

```
Module="10 WORD WRITE TO PLC" 0x81,0xC9,0x02
Ext_Module_Prm_Data_Len = 2
Ext_User_Prm_Data_Ref(0) = 3
EndModule
```

```
Module="11 WORD WRITE TO PLC" 0x81,0xCA,0x02
Ext_Module_Prm_Data_Len = 2
Ext_User_Prm_Data_Ref(0) = 3
EndModule
```

```
Module="12 WORD WRITE TO PLC" 0x81,0xCB,0x02
Ext_Module_Prm_Data_Len = 2
Ext_User_Prm_Data_Ref(0) = 3
EndModule
```

```
Module="13 WORD WRITE TO PLC" 0x81,0xCC,0x02
Ext_Module_Prm_Data_Len = 2
Ext_User_Prm_Data_Ref(0) = 3
EndModule
```

```
Module="14 WORD WRITE TO PLC" 0x81,0xCD,0x02
Ext_Module_Prm_Data_Len = 2
Ext_User_Prm_Data_Ref(0) = 3
EndModule
Module="15 WORD WRITE TO PLC" 0x81,0xCE,0x02
Ext_Module_Prm_Data_Len = 2
Ext_User_Prm_Data_Ref(0) = 3
EndModule
Module="16 WORD WRITE TO PLC" 0x81,0xCF,0x02
Ext_Module_Prm_Data_Len = 2
Ext_User_Prm_Data_Ref(0) = 3
EndModule
Module="18 WORD WRITE TO PLC" 0x81,0xD1,0x02
Ext_Module_Prm_Data_Len = 2
Ext_User_Prm_Data_Ref(0) = 3
EndModule
Module="20 WORD WRITE TO PLC" 0x81,0xD3,0x02
Ext_Module_Prm_Data_Len = 2
Ext_User_Prm_Data_Ref(0) = 3
EndModule
Module="24 WORD WRITE TO PLC" 0x81,0xD7,0x02
Ext_Module_Prm_Data_Len = 2
Ext_User_Prm_Data_Ref(0) = 3
EndModule
Module="30 WORD WRITE TO PLC" 0x81,0xDD,0x02
Ext_Module_Prm_Data_Len = 2
Ext_User_Prm_Data_Ref(0) = 3
EndModule
Module="32 WORD WRITE TO PLC" 0x81,0xDF,0x02
Ext_Module_Prm_Data_Len = 2
Ext_User_Prm_Data_Ref(0) = 3
EndModule

; BIT READS
Module="8 BIT READ FROM PLC" 0x41,0x80,0x03
Ext_Module_Prm_Data_Len = 3
Ext_User_Prm_Data_Ref(0) = 4
Ext_User_Prm_Data_Ref(1) = 0
EndModule
```

```
Module="16 BIT READ FROM PLC" 0x41,0x81,0x03
Ext_Module_Prm_Data_Len = 3
Ext_User_Prm_Data_Ref(0) = 4
Ext_User_Prm_Data_Ref(1) = 0
EndModule
Module="24 BIT READ FROM PLC" 0x41,0x82,0x03
Ext_Module_Prm_Data_Len = 3
Ext_User_Prm_Data_Ref(0) = 4
Ext_User_Prm_Data_Ref(1) = 0
EndModule
Module="32 BIT READ FROM PLC" 0x41,0x83,0x03
Ext_Module_Prm_Data_Len = 3
Ext_User_Prm_Data_Ref(0) = 4
Ext_User_Prm_Data_Ref(1) = 0
EndModule
Module="40 BIT READ FROM PLC" 0x41,0x84,0x03
Ext_Module_Prm_Data_Len = 3
Ext_User_Prm_Data_Ref(0) = 4
Ext_User_Prm_Data_Ref(1) = 0
EndModule
Module="48 BIT READ FROM PLC" 0x41,0x85,0x03
Ext_Module_Prm_Data_Len = 3
Ext_User_Prm_Data_Ref(0) = 4
Ext_User_Prm_Data_Ref(1) = 0
EndModule
Module="56 BIT READ FROM PLC" 0x41,0x86,0x03
Ext_Module_Prm_Data_Len = 3
Ext_User_Prm_Data_Ref(0) = 4
Ext_User_Prm_Data_Ref(1) = 0
EndModule
Module="64 BIT READ FROM PLC" 0x41,0x87,0x03
Ext_Module_Prm_Data_Len = 3
Ext_User_Prm_Data_Ref(0) = 4
Ext_User_Prm_Data_Ref(1) = 0
EndModule
```

```
; BIT WRITES
Module="8 BIT WRITE TO PLC" 0x81,0x80,0x03
Ext_Module_Prm_Data_Len = 3
Ext_User_Prm_Data_Ref(0) = 4
Ext_User_Prm_Data_Ref(1) = 1
EndModule
Module="16 BIT WRITE TO PLC" 0x81,0x81,0x03
Ext_Module_Prm_Data_Len = 3
Ext_User_Prm_Data_Ref(0) = 4
Ext_User_Prm_Data_Ref(1) = 1
EndModule

Module="24 BIT WRITE TO PLC" 0x81,0x82,0x03
Ext_Module_Prm_Data_Len = 3
Ext_User_Prm_Data_Ref(0) = 4
Ext_User_Prm_Data_Ref(1) = 1
EndModule
Module="32 BIT WRITE TO PLC" 0x81,0x83,0x03
Ext_Module_Prm_Data_Len = 3
Ext_User_Prm_Data_Ref(0) = 4
Ext_User_Prm_Data_Ref(1) = 1
EndModule
Module="40 BIT WRITE TO PLC" 0x81,0x84,0x03
Ext_Module_Prm_Data_Len = 3
Ext_User_Prm_Data_Ref(0) = 4
Ext_User_Prm_Data_Ref(1) = 1
EndModule
Module="48 BIT WRITE TO PLC" 0x81,0x85,0x03
Ext_Module_Prm_Data_Len = 3
Ext_User_Prm_Data_Ref(0) = 4
Ext_User_Prm_Data_Ref(1) = 1
EndModule
Module="56 BIT WRITE TO PLC" 0x81,0x86,0x03
Ext_Module_Prm_Data_Len = 3
Ext_User_Prm_Data_Ref(0) = 4
Ext_User_Prm_Data_Ref(1) = 1
EndModule
Module="64 BIT WRITE TO PLC" 0x81,0x87,0x03
Ext_Module_Prm_Data_Len = 3
Ext_User_Prm_Data_Ref(0) = 4
Ext_User_Prm_Data_Ref(1) = 1
EndModule
```

DL05/06 I/O Modules

In This Appendix. . . .

— Supported DL05/06 I/O Modules

Supported DL05/06 I/O Modules

DL05/06 Discrete I/O Modules

Input Modules

D0-10ND3
D0-16ND3

Output Modules

D0-10TD1
D0-16TD1
D0-10TD2
D0-16TD2

Relay Output Modules

D0-08TR

Combination Modules

D0-07CDR
D0-08CDD1

DL05/06 Analog I/O Modules

Input Modules

F0-04AD-1

Combination Modules

F0-04AD2DA-1
F0-2AD2DA-2
F0-4AD2DA-2

Setup the SST Profibus Master PCI Card for the H0–PSCM

In This Appendix. . . .

— Setup SST Profibus Master PCI Card

Setup the SST Profibus Master PCI Card for the H0-PSCM

If you are adding the H0-PSCM as a slave to be used with an HMI on your network, you will need a Profibus Master for the network. Following is a step-by-step procedure for setting up a Profibus Master card for a PC.

Getting Started

As mentioned, you will need a Profibus interface card for your PC. We use the SST™ Interface Card for Profibus, produced by Woodhead Industries, Inc.. More information about the purchase of this card can be obtained from their website, www.mySST.com. The PC used for the setup procedure explained here uses this interface card. After this card has been installed, run the SST Profibus Configuration Tool, which comes with the card, to configure the H0-PSCM card.

Open the SST Profibus Configuration program.

Start > Programs > SST Profibus > SST Profibus Configuration

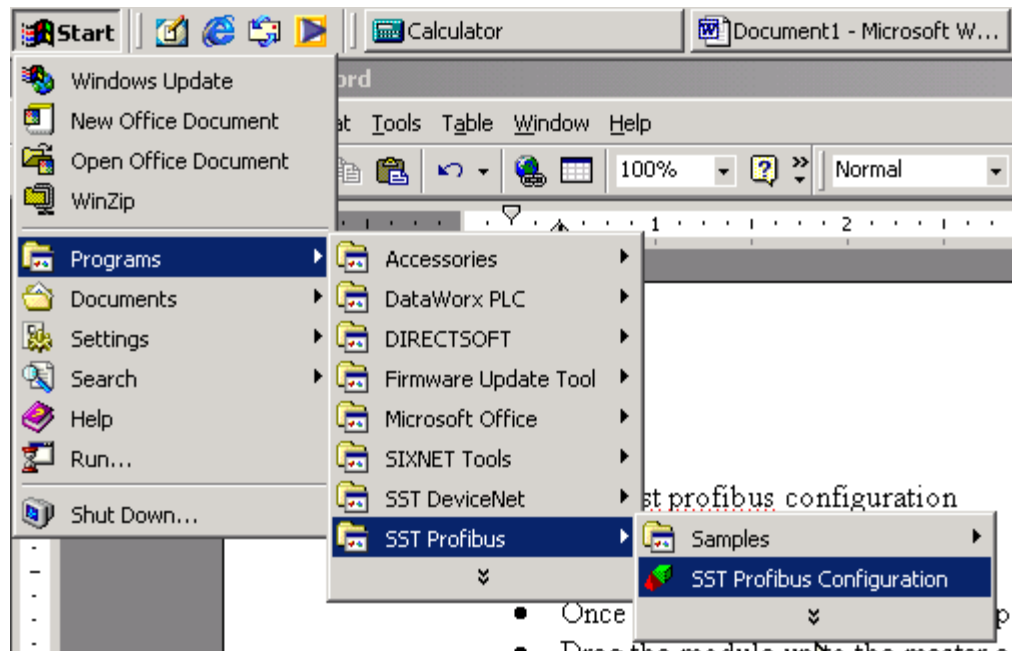

First, you must add the SST Master card that is installed in your PC to the configuration.

To select the SST Master, click on the **+** next to **Masters** at the top of the tree to open the list. Click on the **+** next to **SST** to open the list of cards. Select the card that is installed in your PC by right clicking on the card name and select **Properties**.

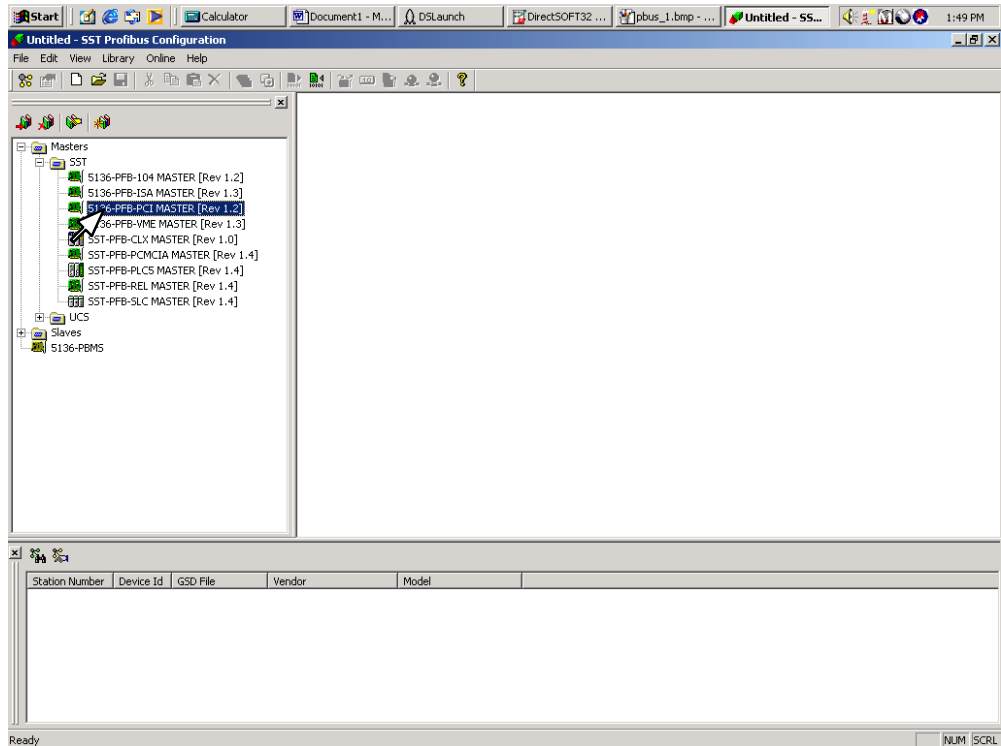

This window will come into view to verify that the correct Master has been chosen. Click **OK**.

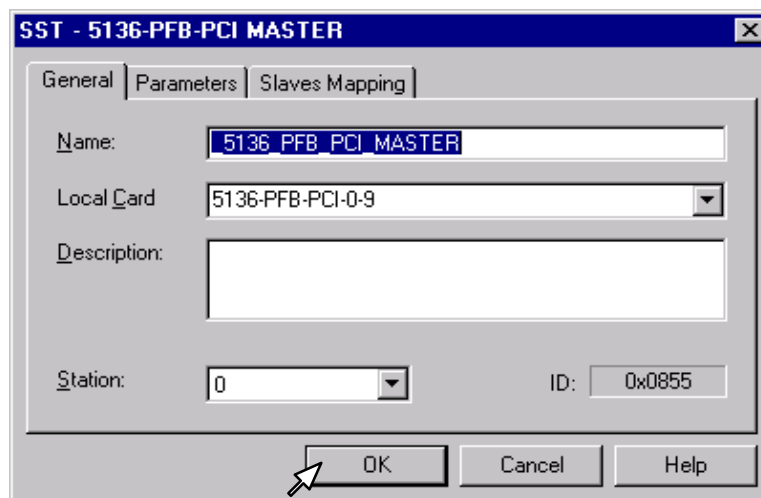

The Master card will appear on the right side of the window. Now drag the SST Master to the PROFIBUS_DP. The GSD file supplied on the floppy diskette can be added at this time. Insert the diskette into the PC drive and click on **Library** > **Add GSD**.

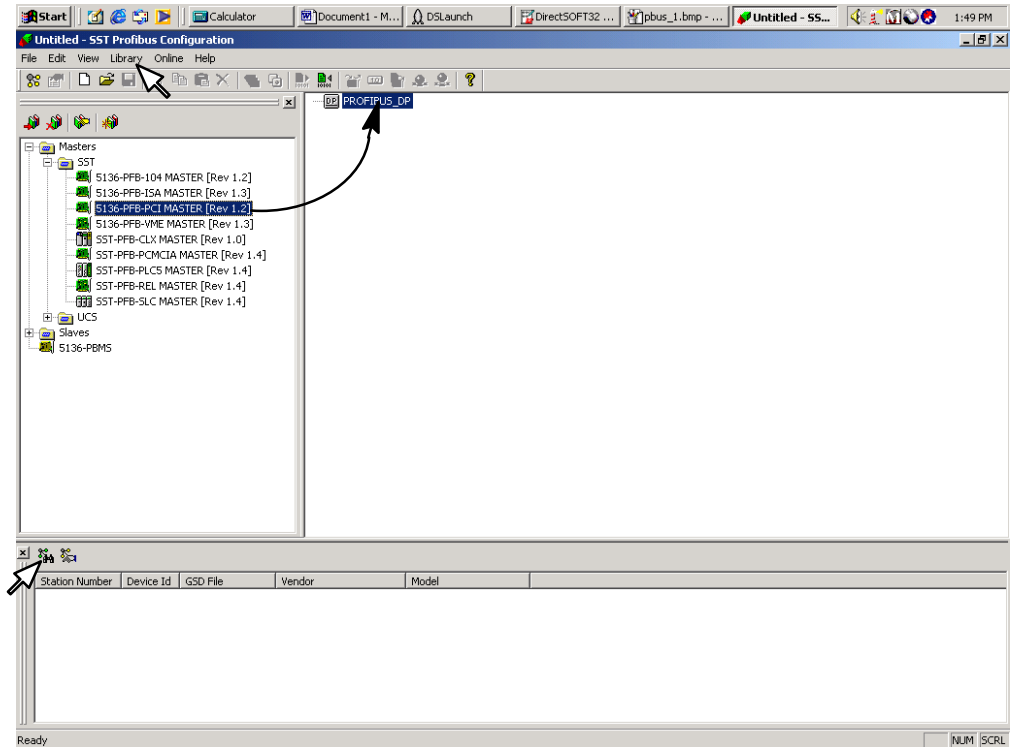

This window will appear again to verify that this is the correct Master. Click **OK**.

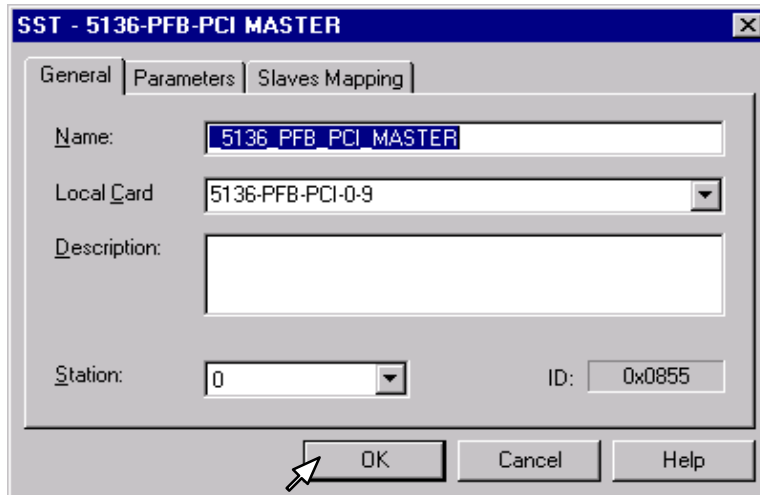

The window will show the Master configured as **[000]**. You can now scan for the slaves (nodes) on the network. In this case it will be your DL05/06. Click on the **Search for slaves** icon in the lower left of the window.

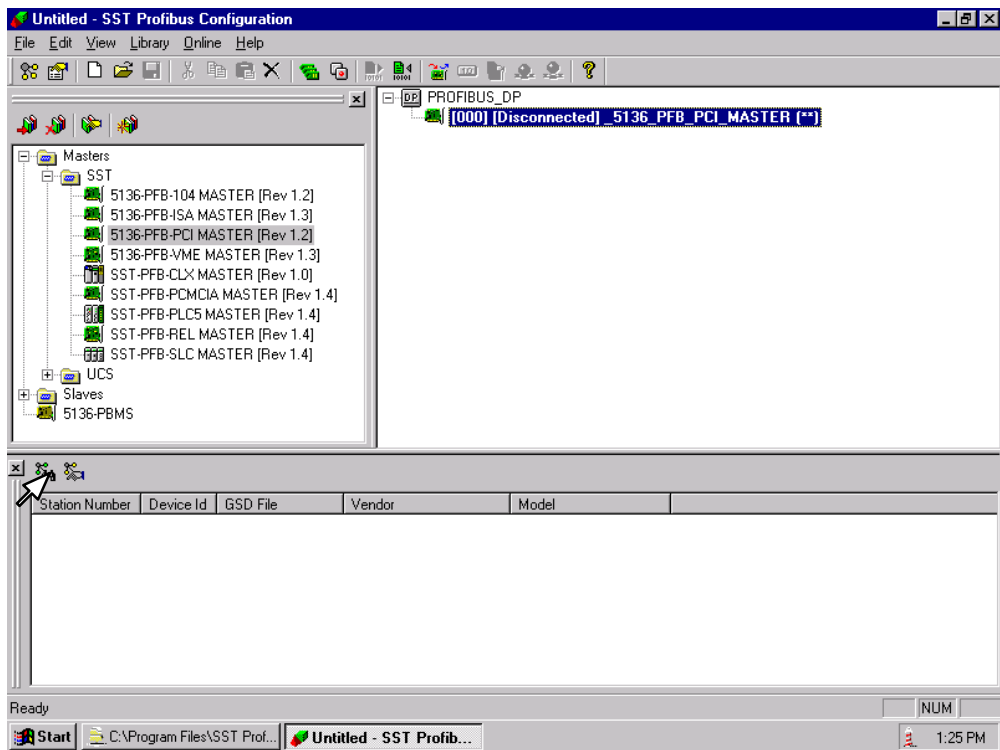

This window will come into view to verify that the correct Master to scan. Click **OK**.

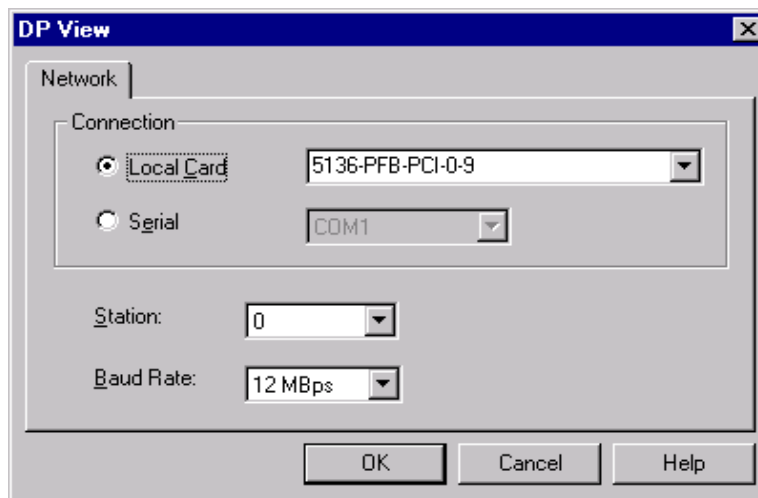

When the slave (node) is found, it will appear in the lower portion of the window as 'unknown'. Right click on the unknown label and select the GSD file which was installed earlier. If you forgot to install the GSD file, it can be installed now.

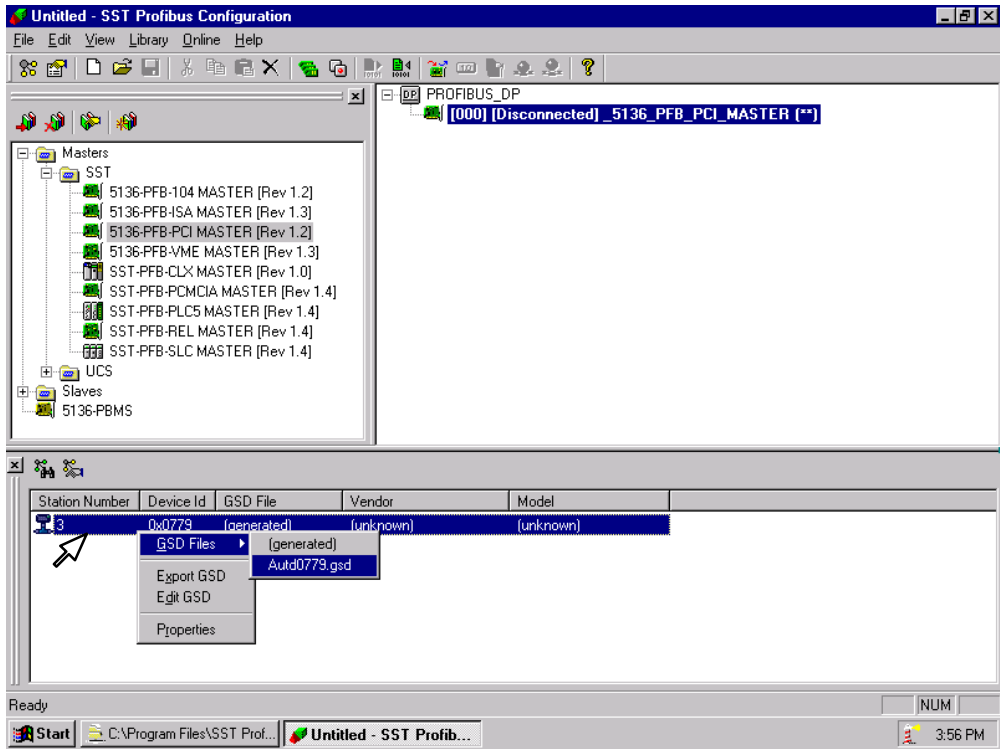

The window will now look like this. Now, drag the GSD file to the slave PLC. This will add the file to the configuration.

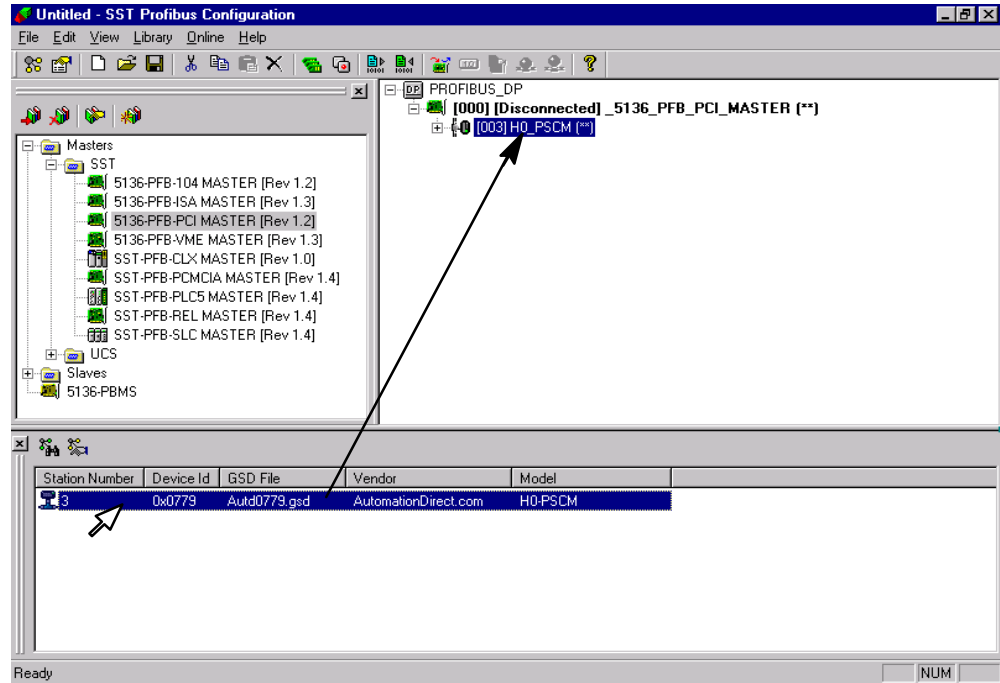

The window will look similar to the following. The In and Out 32 WORD addresses will need to be changed next. Right click on **[000] In32words** for the properties window.

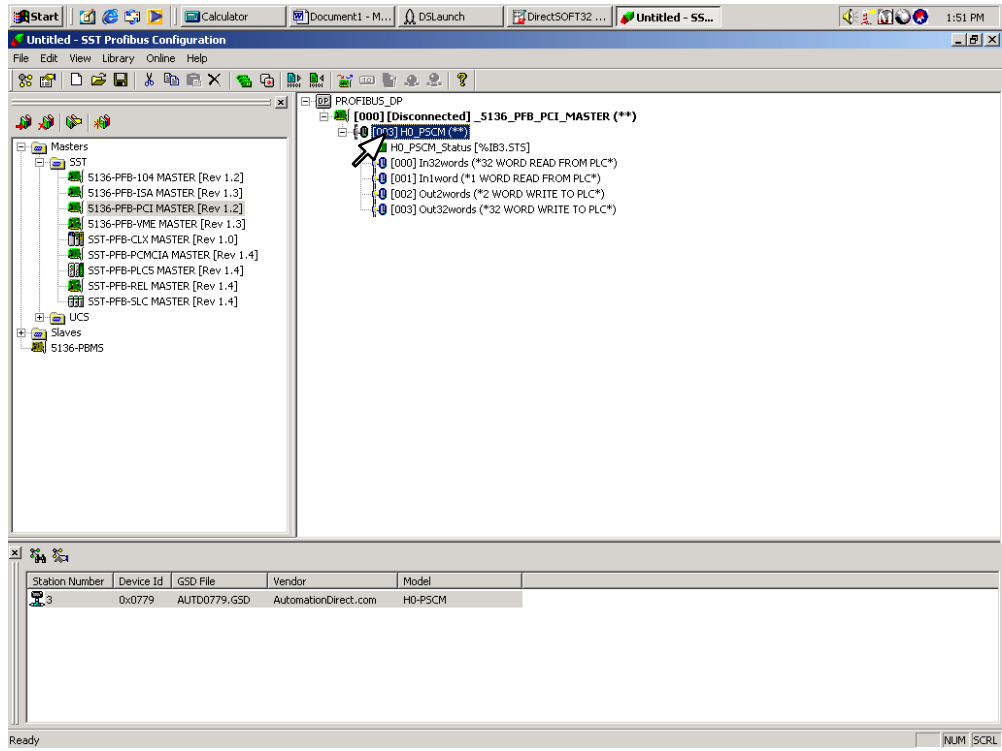

Select **Ext. Prms** and click on **Edit**. Change the **PLC** in address to 16640 (4100 hex) which is V40400.

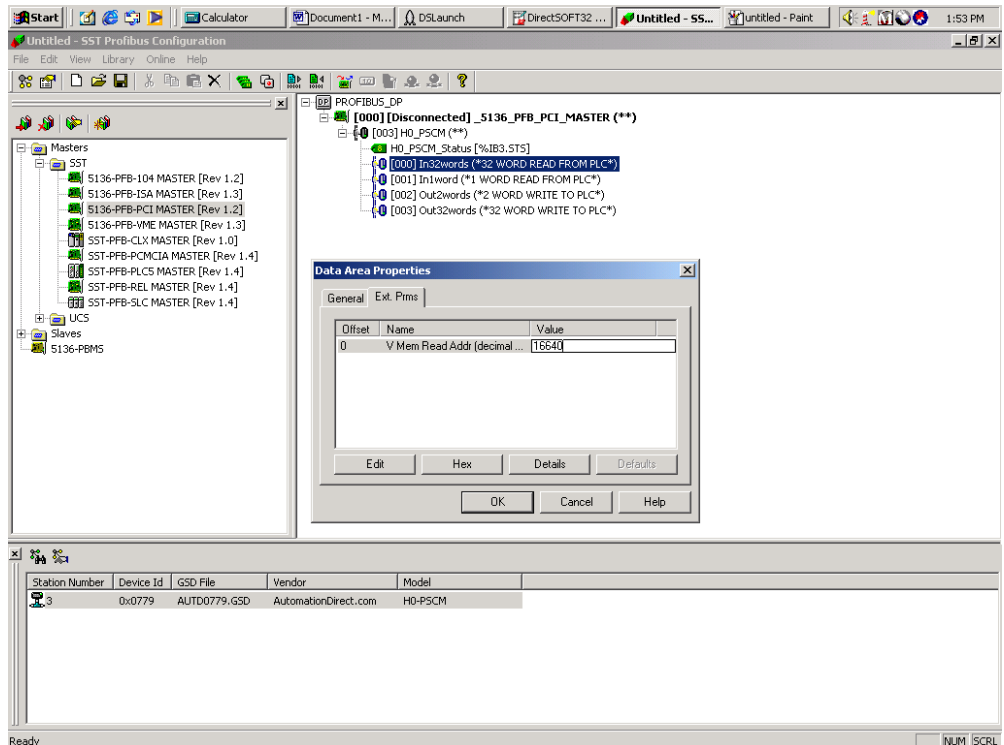

Appendix D
SST PCI Master Card

Next, select **[002] Out2words** to change the **PLC** out address to 16704 (4140 hex) which is V40500.

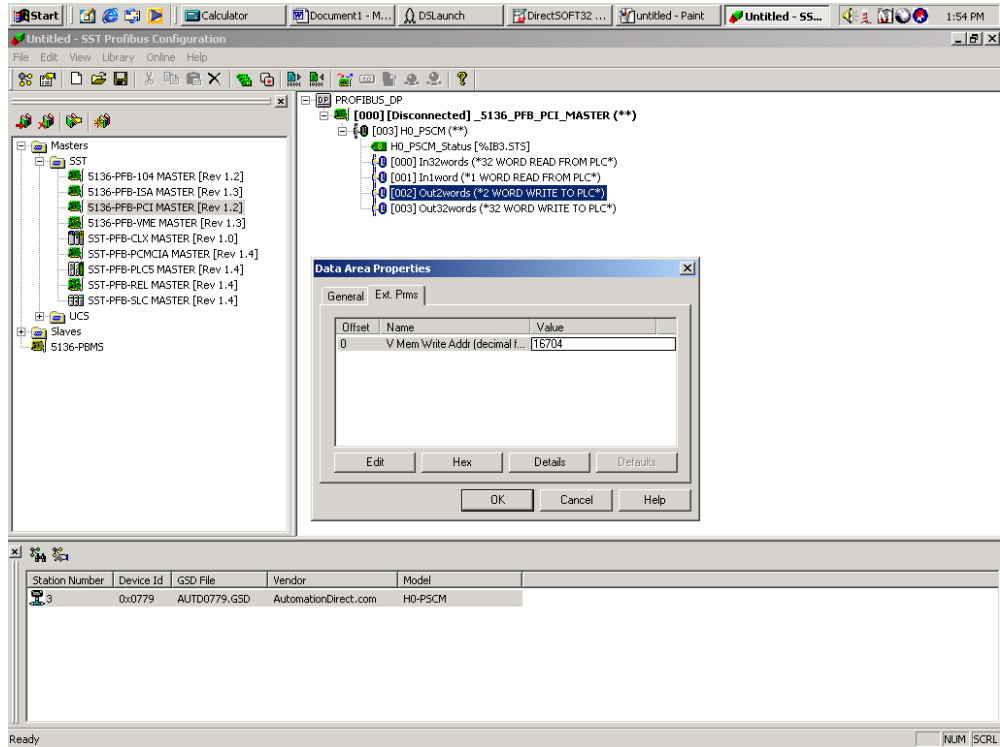

Now, connect to the SST card in the PC by right clicking on the Master icon. Select **Connect** in the drop-down window.

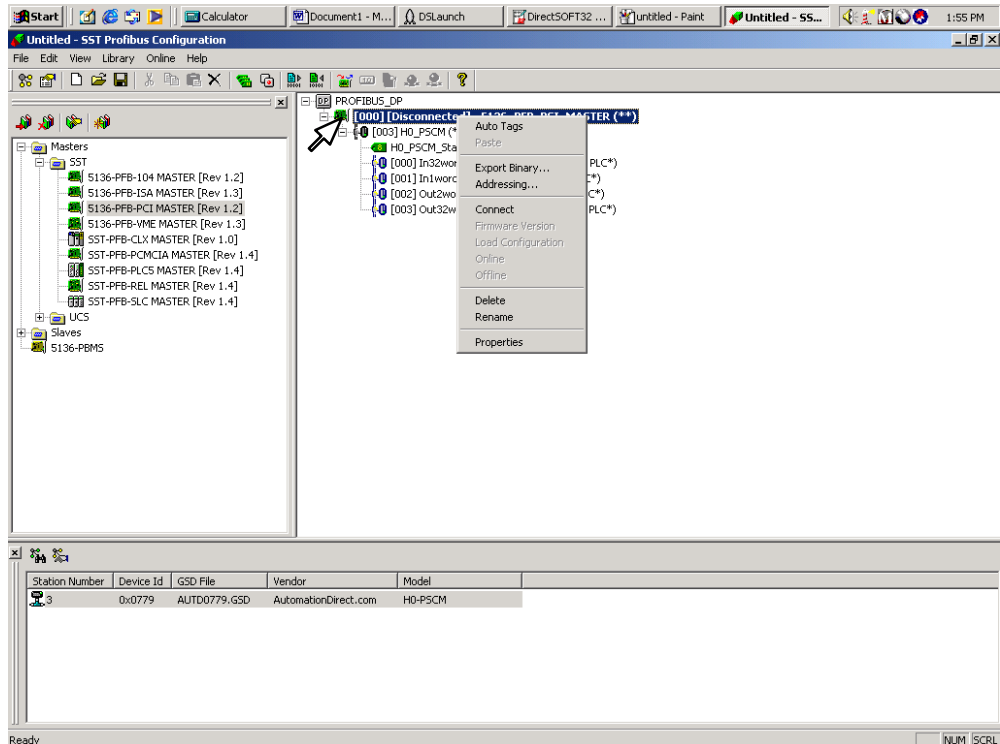

This message window will appear stating that there is a configuration mismatch, which is okay. Click **Yes** and right click on the Master again.

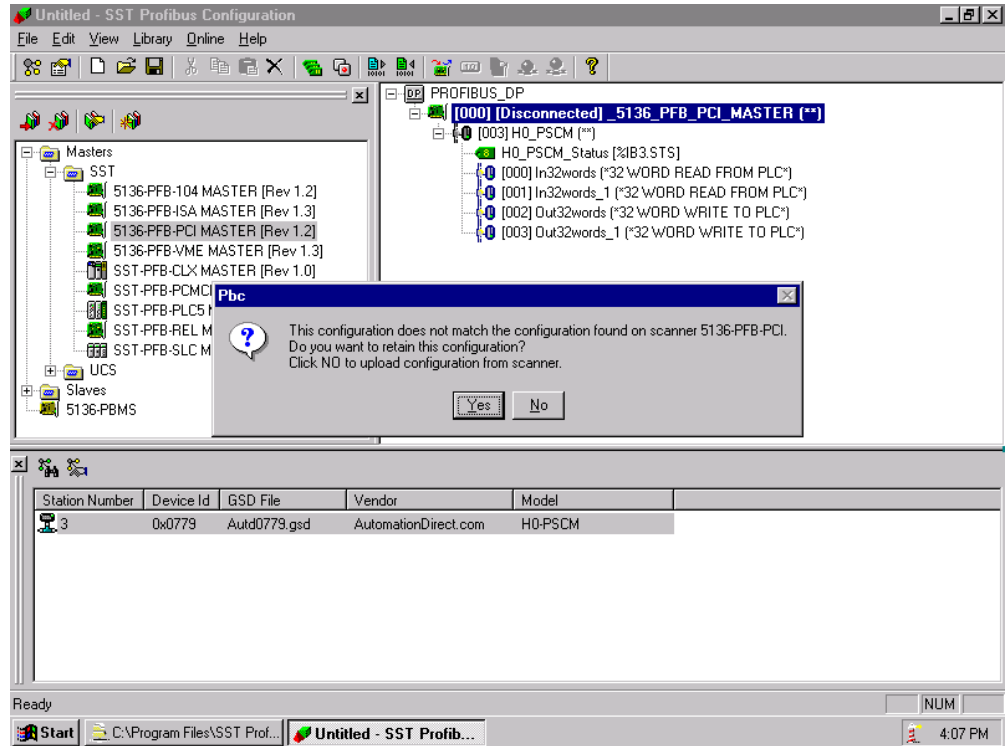

Load the configuration next by selecting **Load Configuration** in the drop-down window.

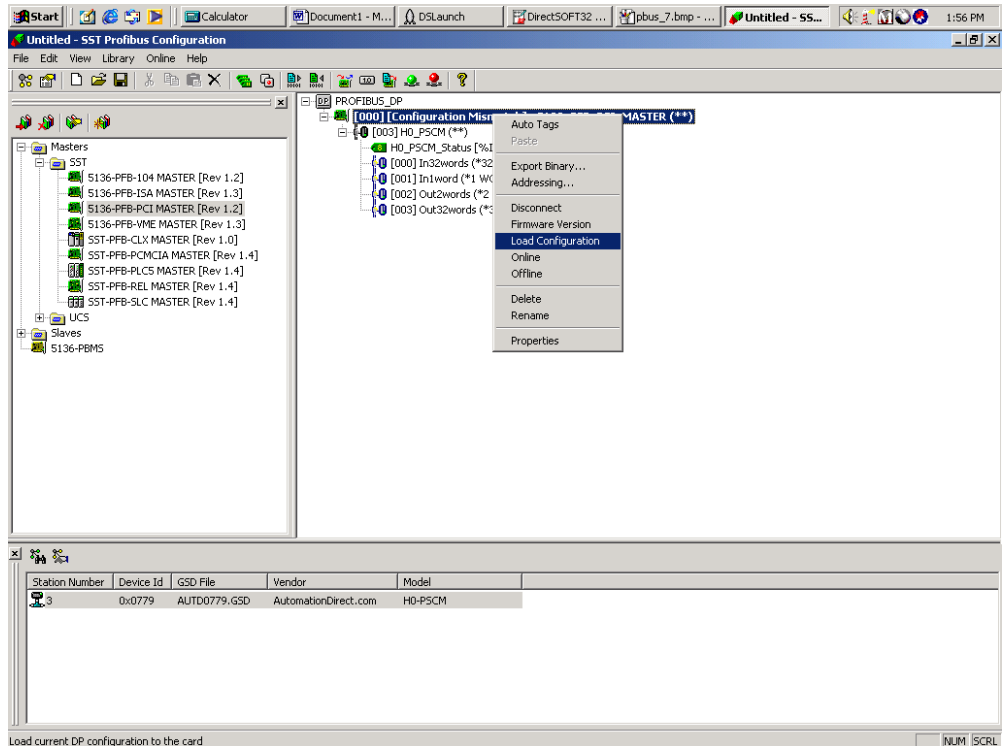

Now right click the Master icon to go on line. Select **Online** from the drop-down window.

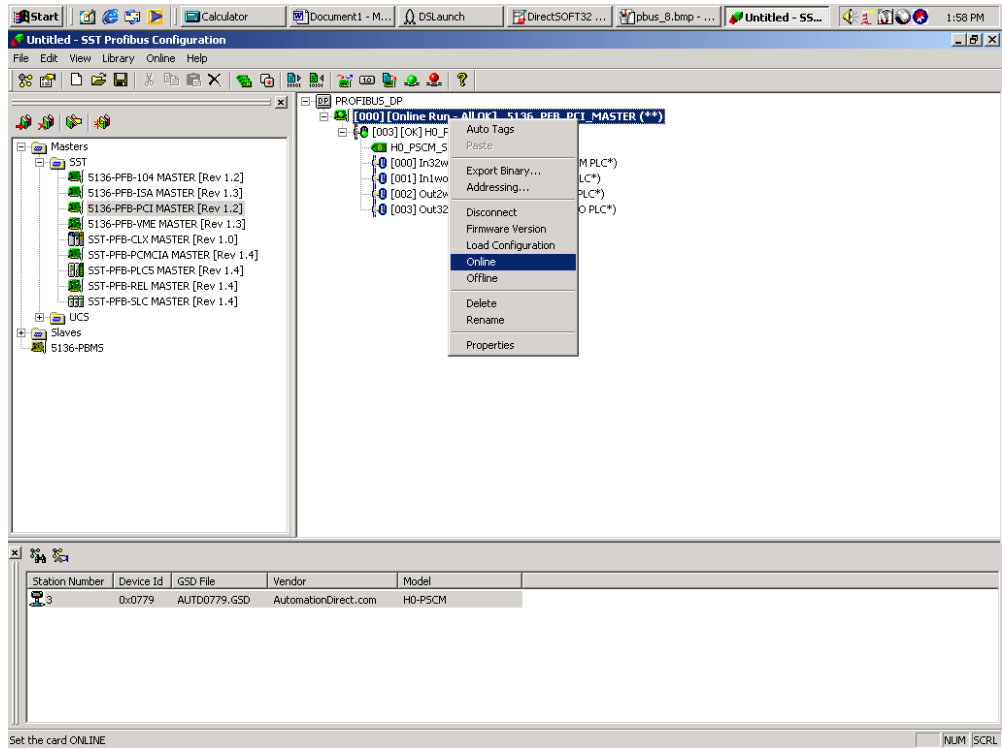

This window indicates the online status of the Profibus PCI Master Card.

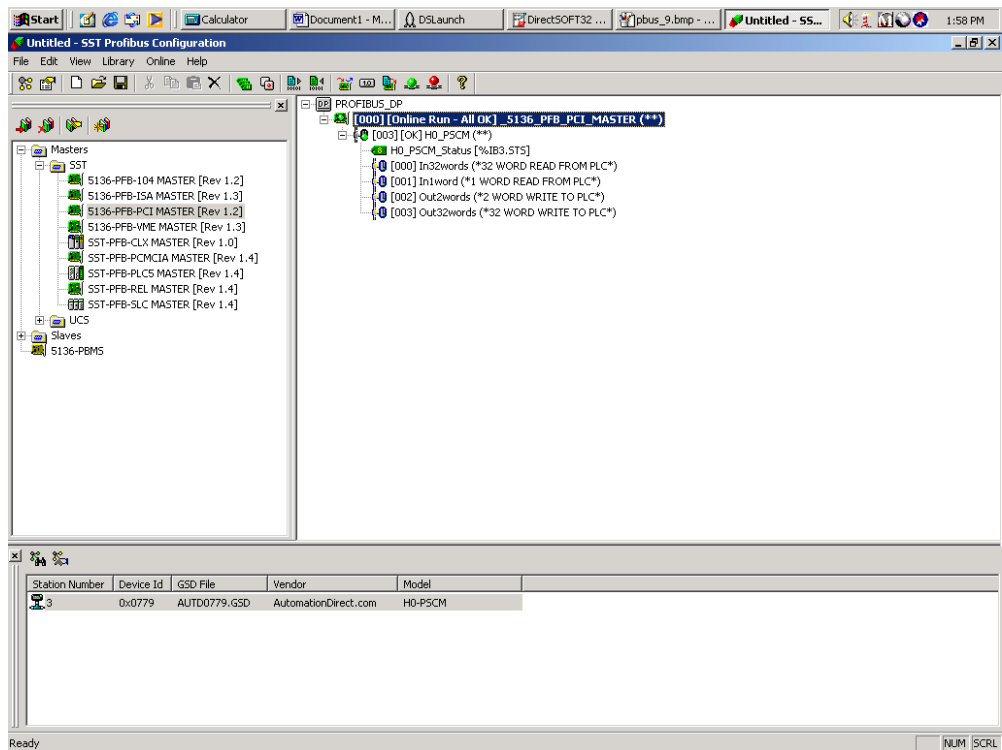

You will want to monitor the I/O next. Select **DP Monitor** to view the I/O table. To do this, click on **Start > Programs > SST Profibus > DP > DP Monitor**.

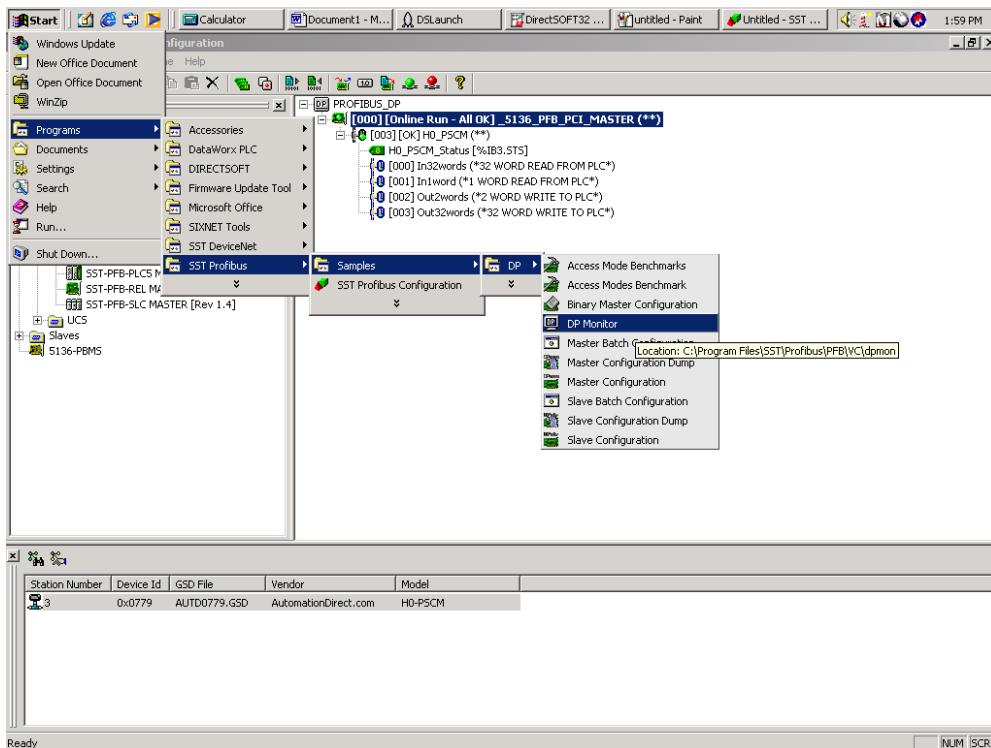

Select the Profibus PCI card in the popup window and make your selections.

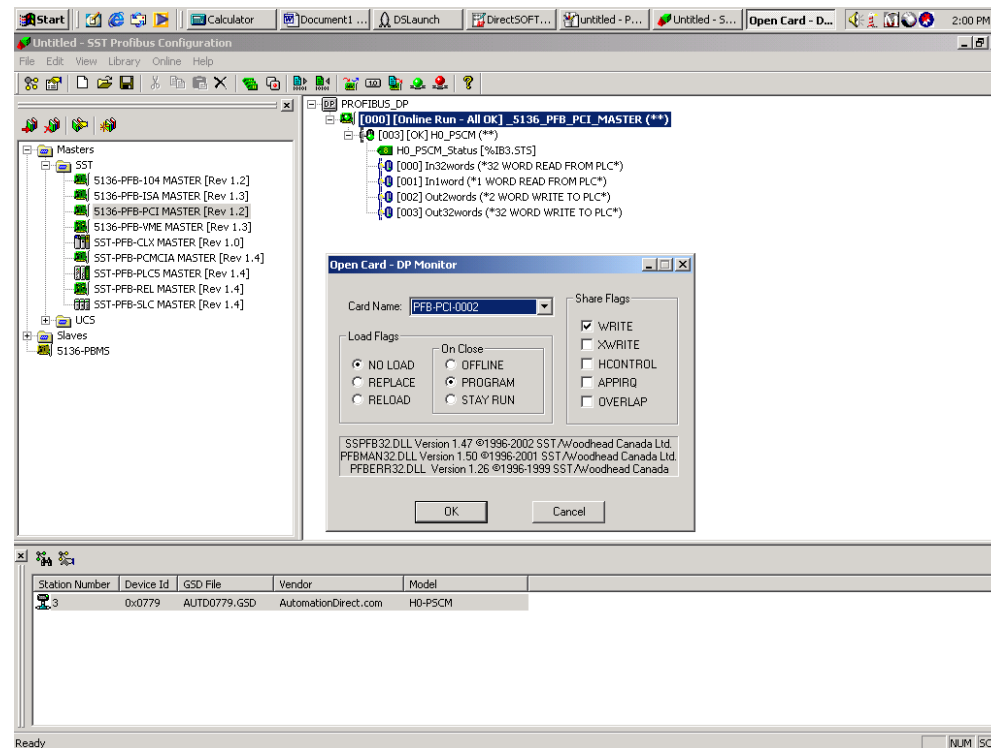

Think & Do Profibus Network Setup with the H0–PSCM

In This Appendix. . . .

— Think & Do Profibus Network Setup

Think & Do Profibus Network Setup with H0-PSCM

For those who are using the H0-PSCM as a slave with Think & Do, the following steps will guide you through the setup for your Think & Do Profibus network.

Getting the T & D Network Started

The first thing that will be needed for the Think & Do Profibus network is a Profibus interface card for your PC. We use the SST™ Interface Card for Profibus, produced by Woodhead Industries, Inc.. More information about the purchase of this card can be obtained from their website, www.mySST.com. The PC used for the setup procedure explained here uses this interface card. Whenever this card has been installed, run the SST Profibus Configuration Tool to configure the Profibus card before beginning the Think & Do setup (refer to Appendix D).

The following setup uses Think & Do Studio; however, if you have Think & Do LIVE installed on your PC, you will use I/O View instead of the Connectivity Center to setup the H0-PSCM DP Slave on the network.

T & D Studio setup for PC control

First, be sure that the Node Address has been set to a proper address (3 to 125 for the H0-PSCM). Next, open Think & Do Studio and select **File > New** in the Project Center window. Use the following procedure to setup the H0-PSCM with Think & Do Studio. The procedure assumes that the Profibus cable is connected from the SST card to your H0-PSCM Profibus Slave Communications Module.

1. Rename the project (the example name is PROFIBUS).
2. Click on the **ConnectivityCenter** button.

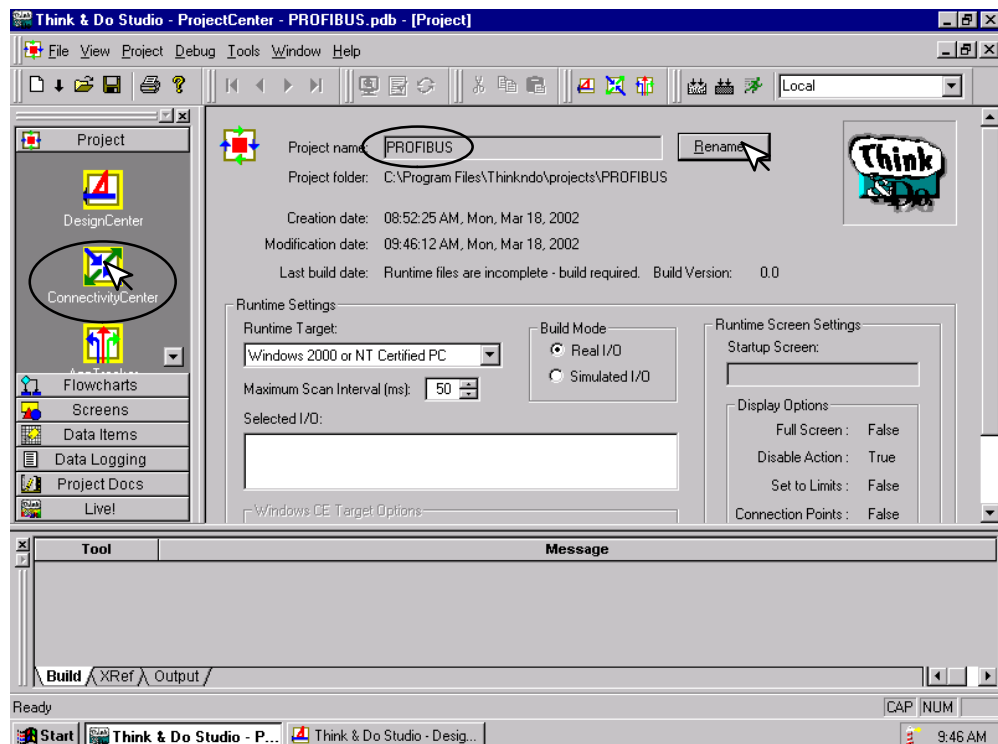

This window will appear with a note to add the I/O driver.

3. Click on **Drivers** > **Add** in the drop down window which appears.

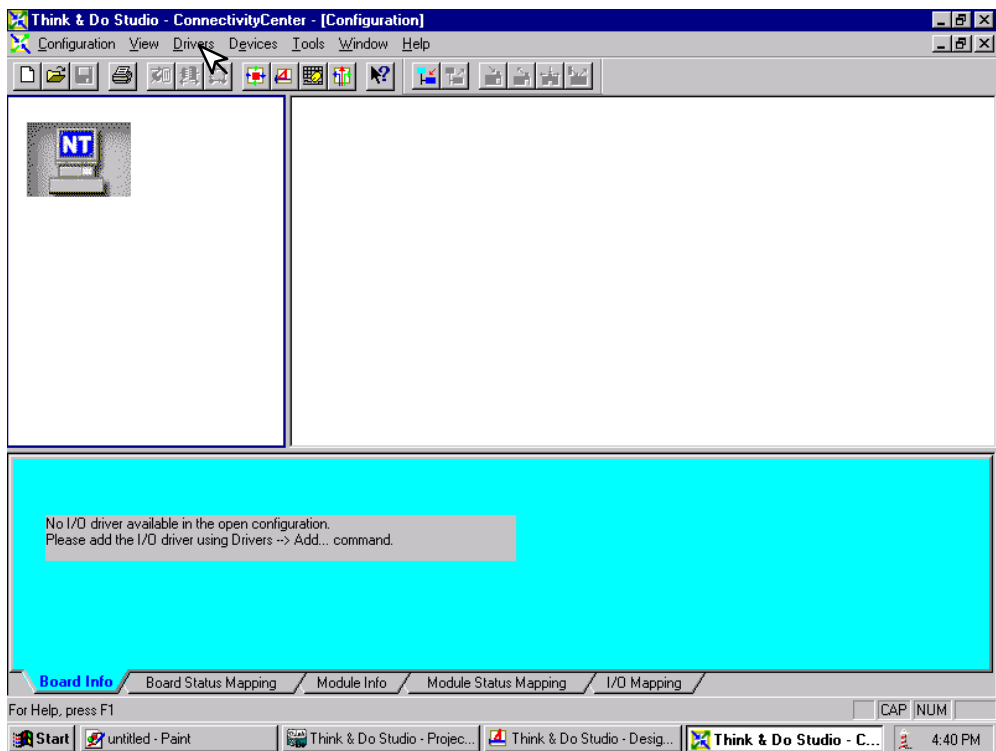

The **Add I/O Driver** window will drop down.

4. Click on the down arrow and select the Profibus driver that is installed in your PC.
5. Click **OK**.

This installs the SST driver to Think & Do configuration.

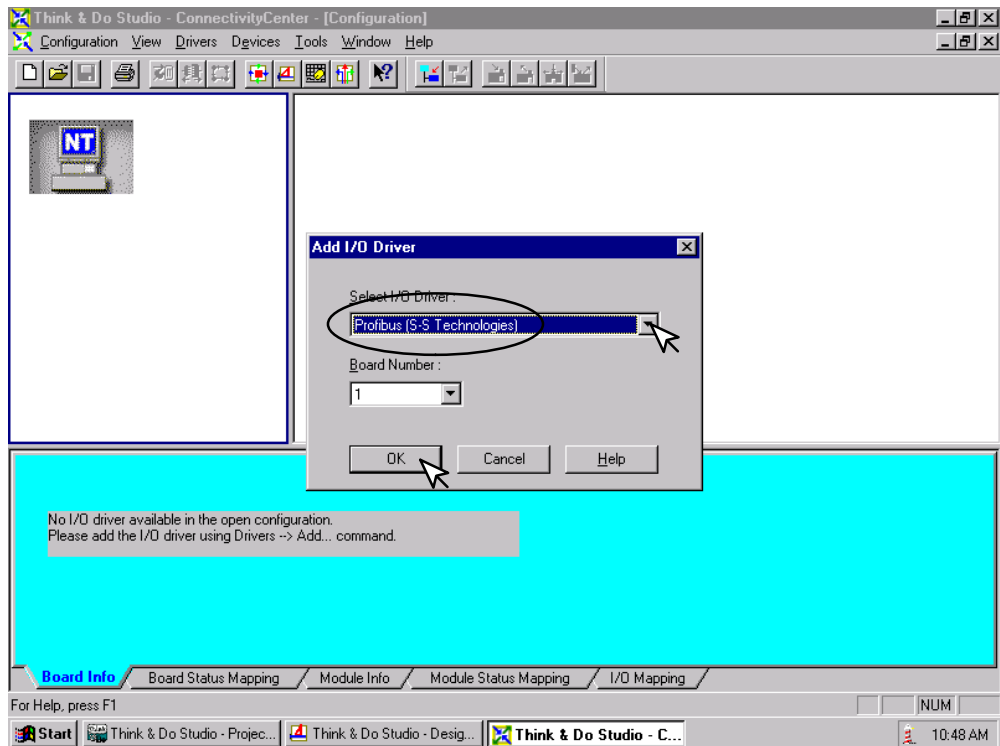

The H0-PSCM Slave must be added to the configuration next.

6. Click on **Devices** or the **Add Device** button in this window.

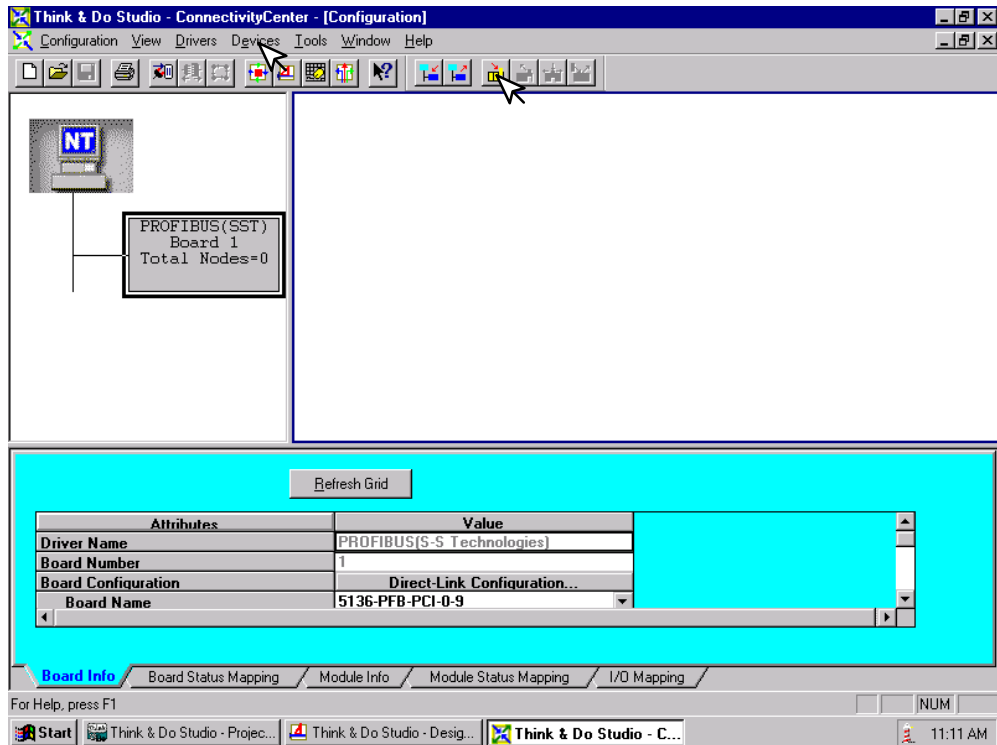

The following window will come into view. You will see a list of companies in the window on the left. Each of these have GSD files that are supported by Think & Do. If AutomationDirect is not in the list, you will need to install the GSD file from the diskette that was supplied with this manual.

7. Click the **Add** button.

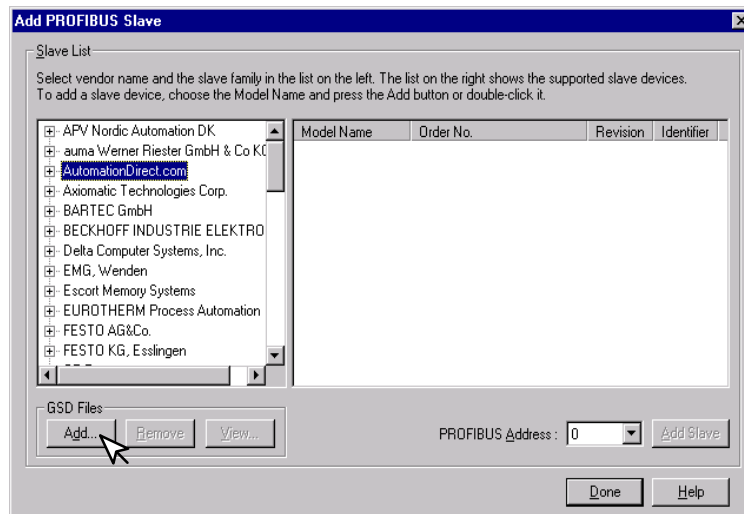

When this window comes into view, insert the diskette and select the A: drive in the **Look in:** window slot.

7. Click on **Auto0779.gsd** file to select the **File name**, then **Add**.

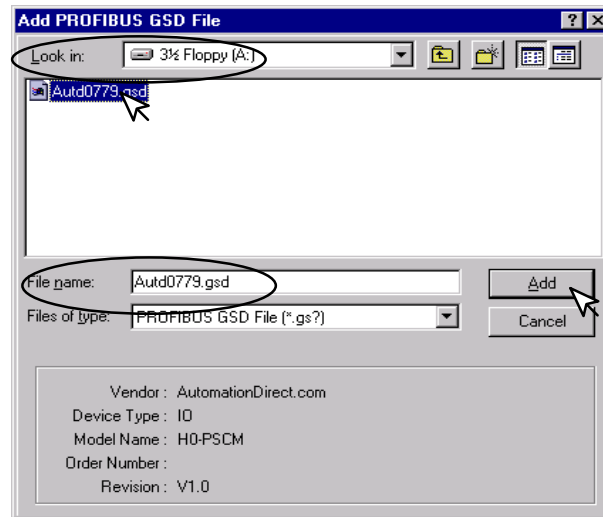

The window appears like the one shown below.

8. Click on **AutomationDirect.com**, then **IO**. This puts the available GSD file names in the window on the right.

9. Select H0-PSCM and enter the **PROFIBUS Address** set on the rotary switches.

10. Click on **Add Slave**, then **Done**.

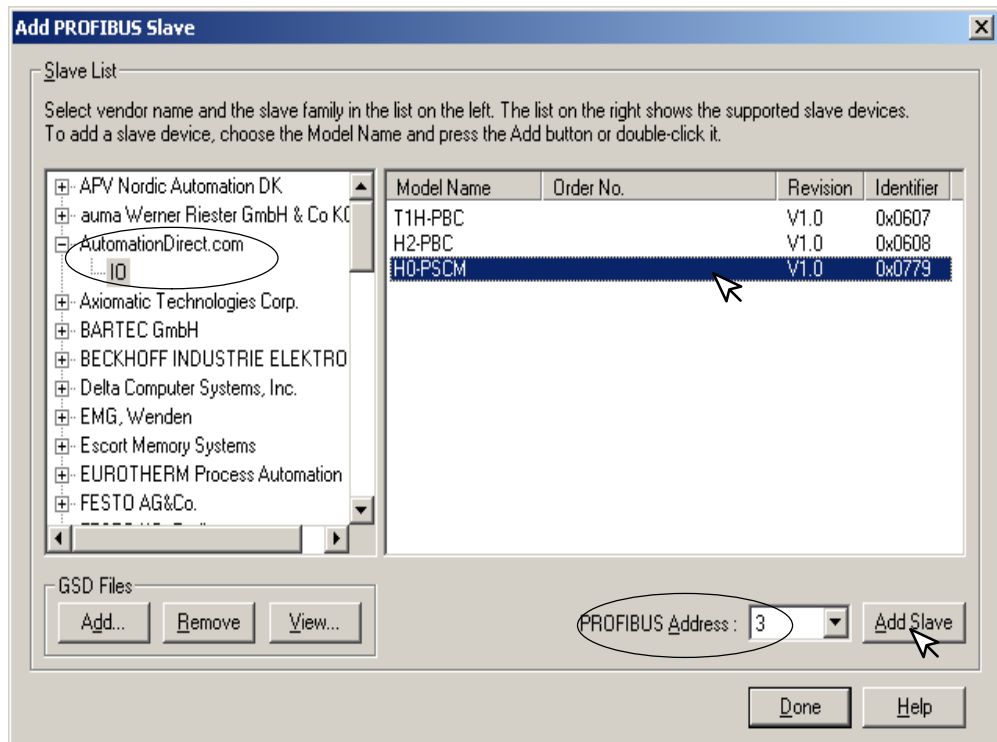



Note: Once the GSD file has been added, simply click the Connect button after installing the Profibus I/O driver the next time that a slave is configured. Think & Do Studio will search the network for all connected slaves and the modules for each slave. You will need to select the name for each module found.

The window now displays the **H0-PSCM** as a block with the name and address.

Now that the H0-PSCM Slave has been added to the configuration, add the read and write information.

11. Either click on **Devices** or on the **Add Device** button.

Attributes

Attributes	Value
PROFIBUS Address	0
Model Name	H0-PSCM
Order Number	
Description	Station000

Board Info Board Status Mapping **Module Info** Module Status Mapping I/O Mapping

For Help, press F1

The **Add I/O Module to Modular Slave** window will drop down. Select the module for Slot 1 by clicking on the down arrow next to the **I/O Module**.

12. Select **2 WORD READ FROM PLC**. Click the **OK** button.

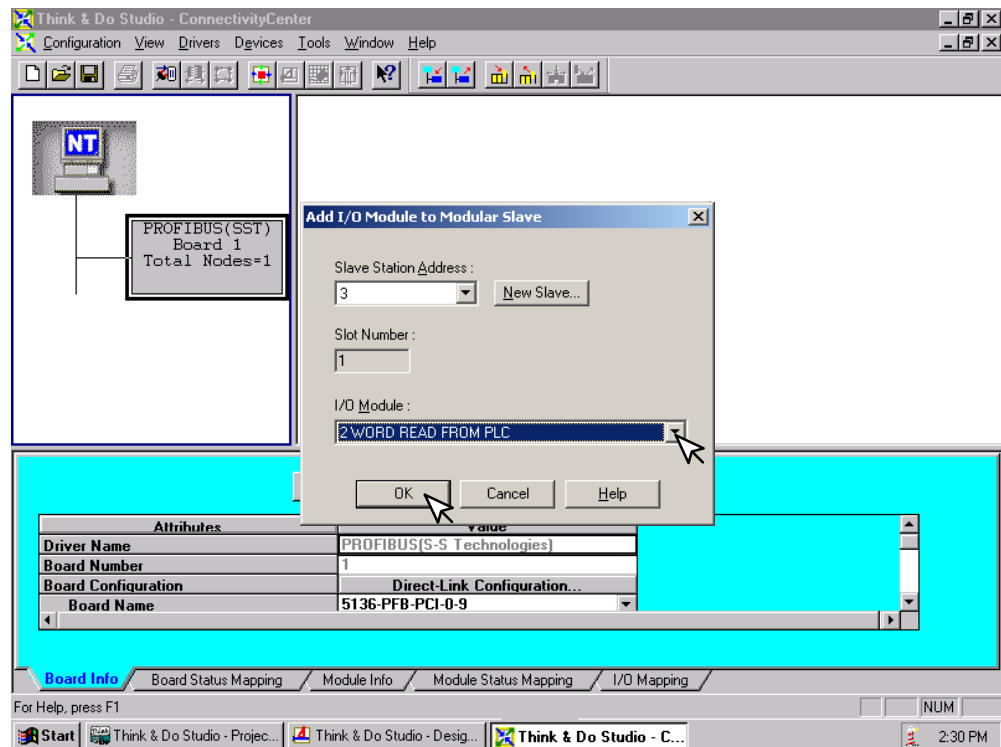

Repeat these steps for each slot with an input module installed.

The configuration window now shows the H0-PSCM Slave Communications Module with the added input module. The next step is to configure the module.

13. Click on **Configure I/O Layout**.

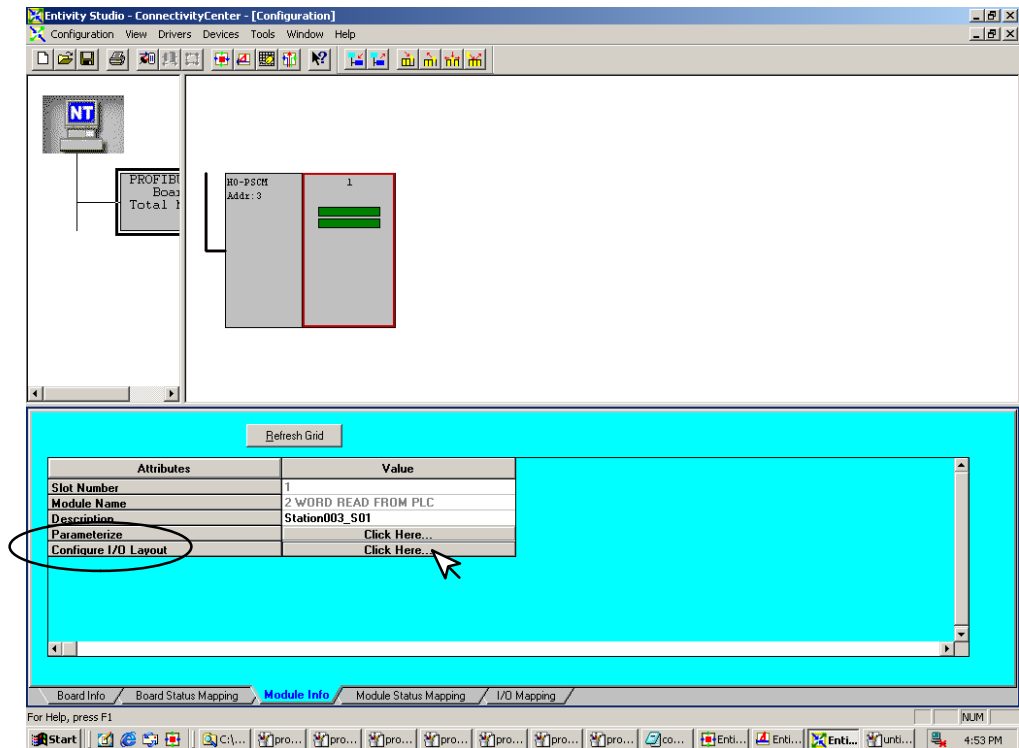

The **Configure I/O Layout** window will appear.

14. Deselect **Swap Bytes**, then click on **Apply** and **OK**.

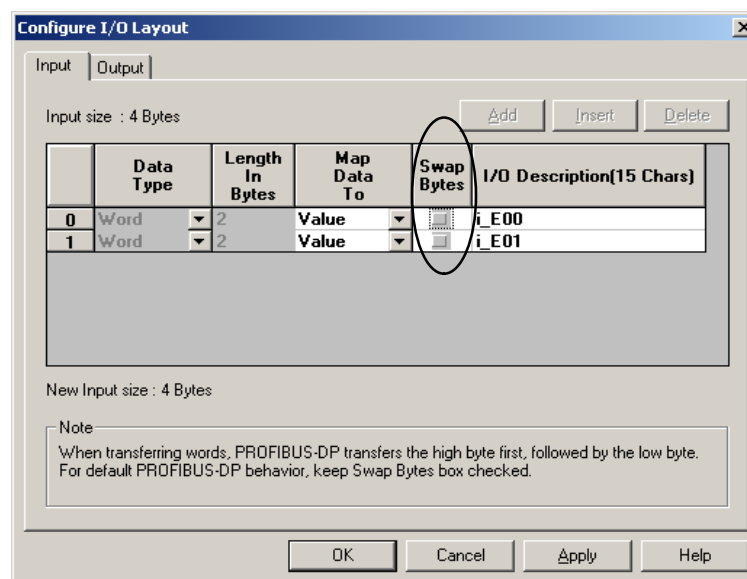

Click on **Parameterize** in the Configuration window. The Parameterize window will appear with a default value of 1024.

15. Change 1024 to **16640** (40400 octal). Click on **Apply** then **OK**.

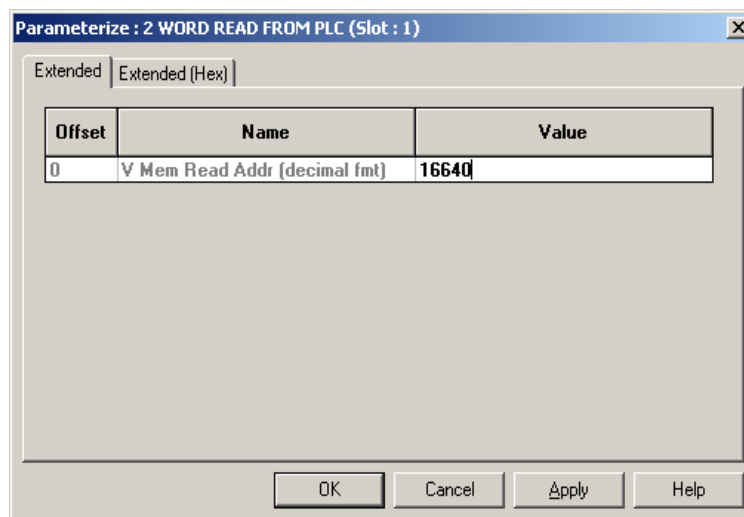

Add the output module(s) in the **Configuration** window next.

16. Click on **Devices > Add**.

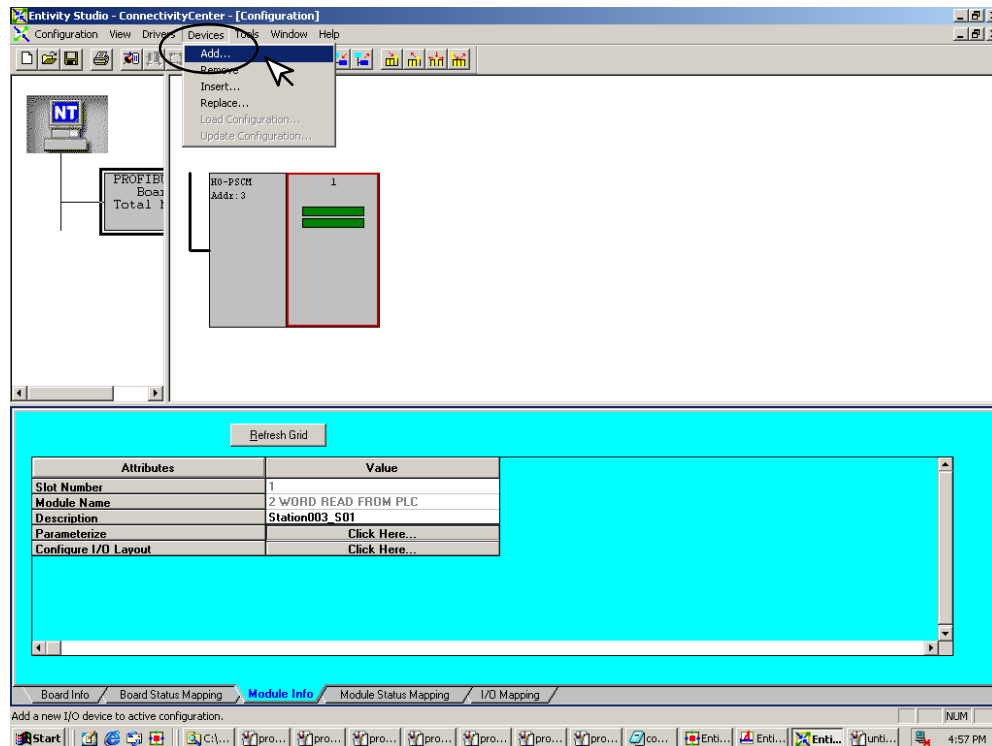

17. Select **1 WORD WRITE TO PLC** in the window that appears, then click **OK**.

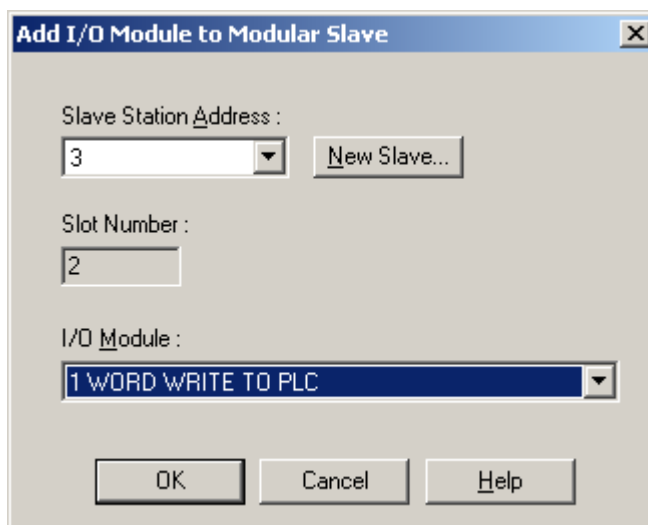

18. Now click on **Configure I/O Layout** and deselect **Swap Bytes**. Click **Apply** then **OK**.

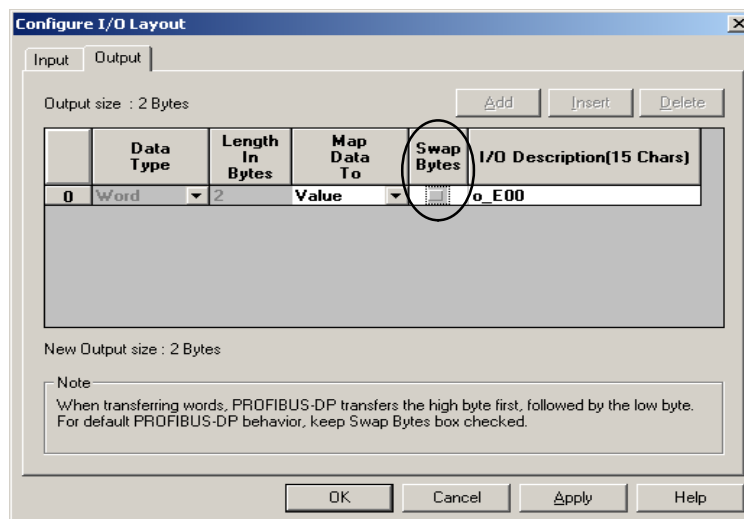

19. Click on **Parameterize** in the **Configuration** window.
- The Parameterize window will appear with a default value of 1024.
20. Change 1024 to **16704** (40500 octal). Click on **Apply** then **OK**.

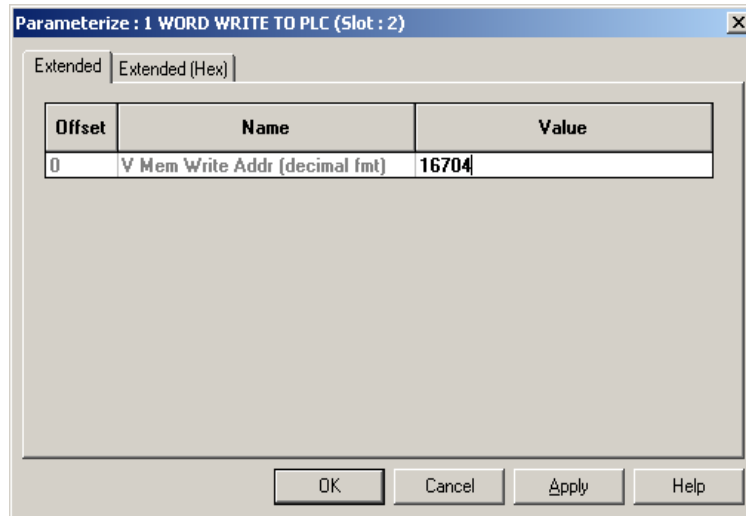

- The H0–PSCM Slave Communications Module can now be put on line.
21. Either click on **Configuration > Connect** or on the **Connect** button.
 22. After it is connected, either click on **Configuration > Scan** or on the **Scan** button.
- The system should now be running.

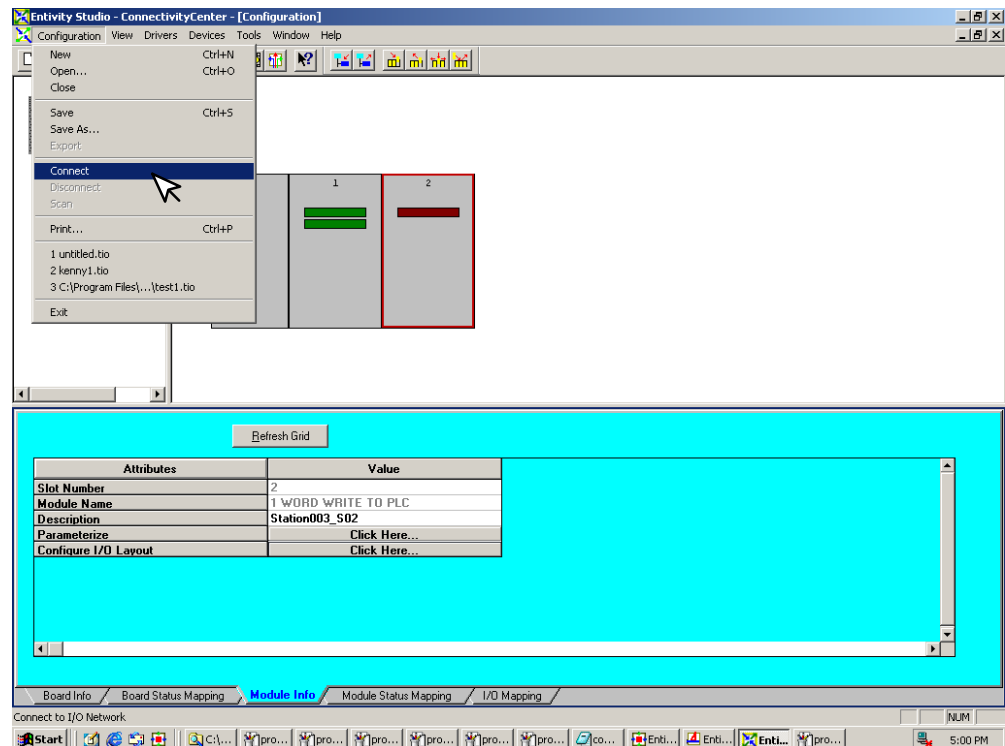

Siemens Profibus Network Set up with H0–PSCM

In This Appendix. . . .

— Siemens Profibus Network Setup with a H0–PSCM

Setup a H0-PSCM on Siemens Profibus Network

For those who are using the H0-PSCM slave on a Profibus network with a Siemens PLC, the examples on the following pages will step you through the process of setting up your network. The PLC used as the Profibus master in this example is a Simatic 300.

Simatic Manager Begin by opening your SIMATIC Manager to configure the Profibus driver.

1. Use the hardware configuration to select the PLC processor.
2. Open the catalog window by clicking on the **Catalog** button, and select the proper S7 processor.

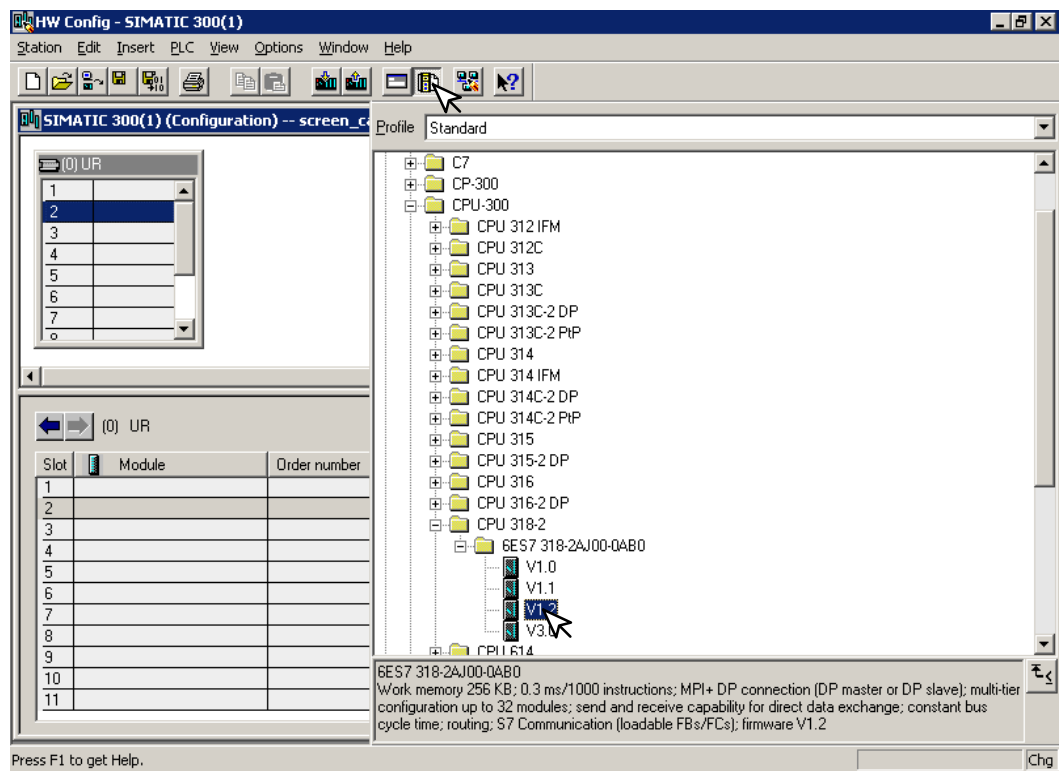

After selecting the processor, the DP interface properties window will pop-up.

3. Select **N**ew, and **O**K.

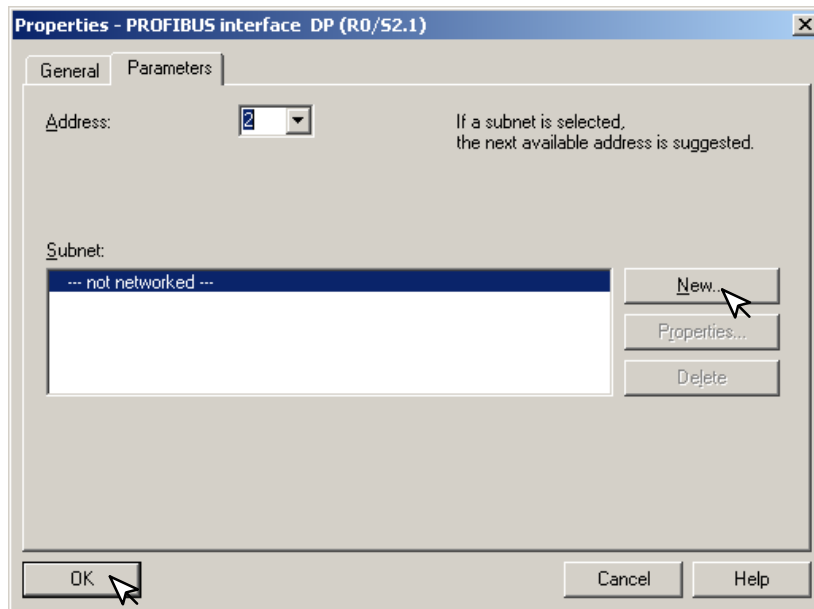

The new subnet window will appear allowing you to name the subnet. The new ID is also in the window.

4. Make the necessary entries, then click **O**K.

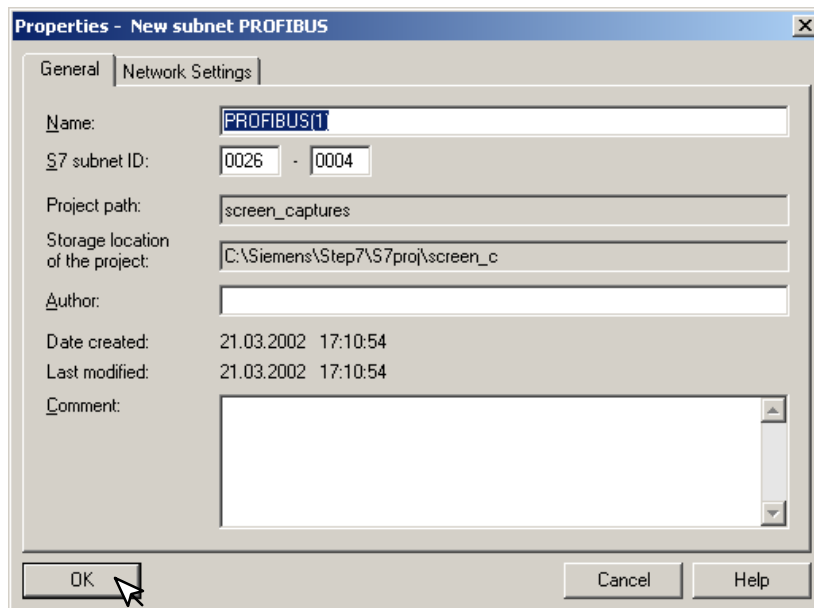

Once the processor has been selected and the DP network is enabled, the configuration window should look like the diagram below.

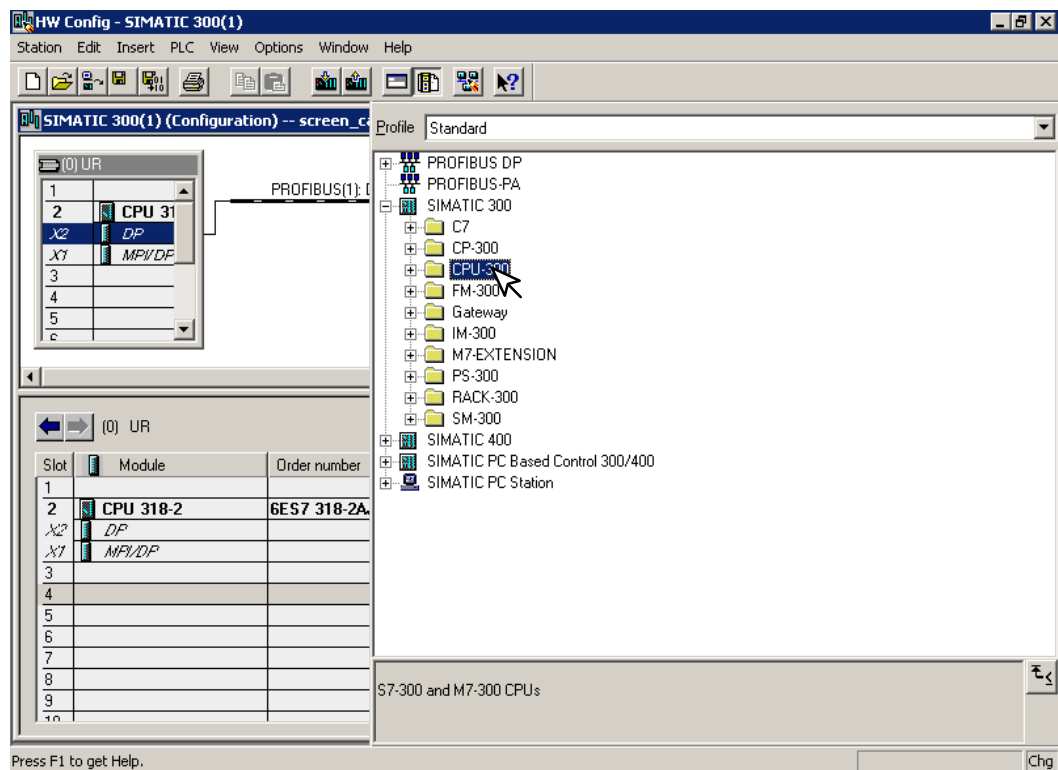

The GSD file will need to be installed now.

5. Click on **Options** and select **Install New GSD...** in the drop-down window.

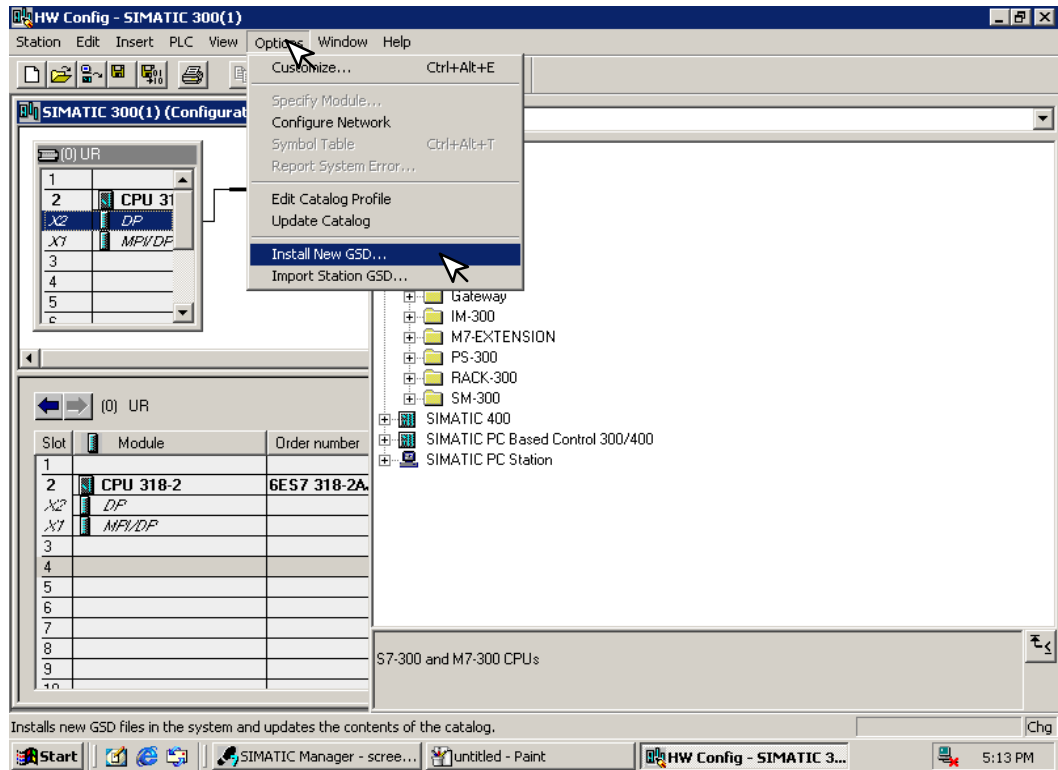

After installing the GSD file, the drop-down window will show the name of the newly installed file.

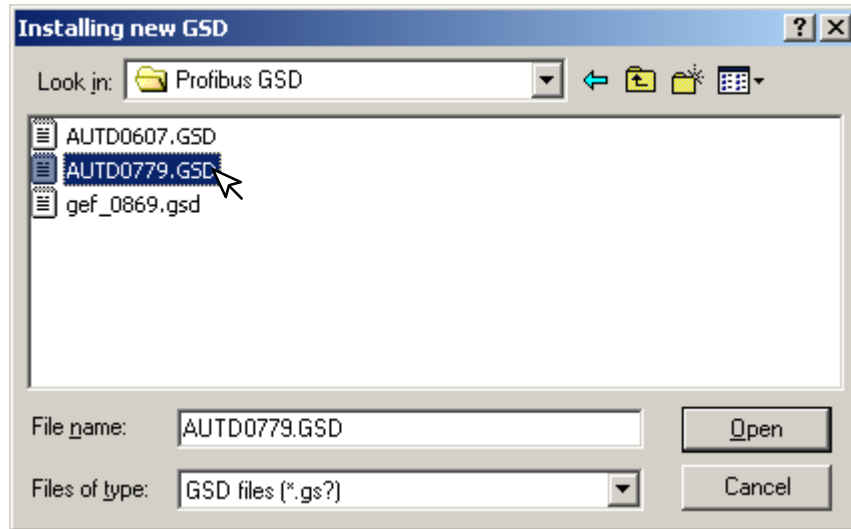

The Configuration window will look like the one below.

6. Now, click on the **H0-PSCM** and drag it to the Profibus network.

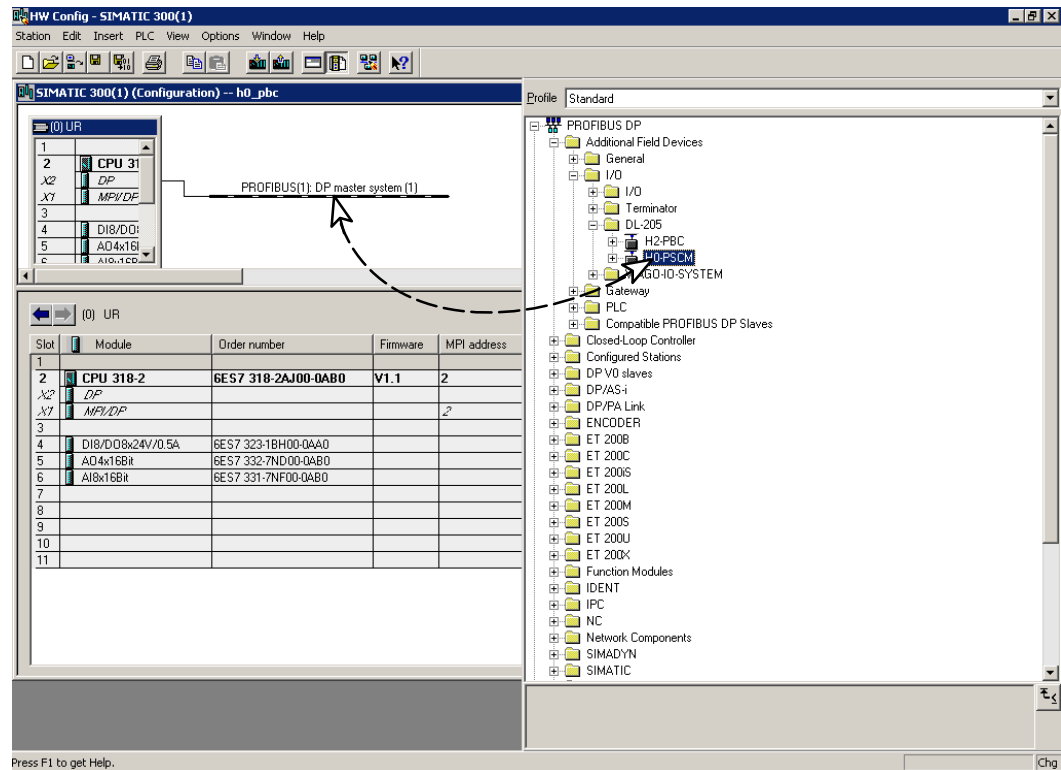

When the mouse button is released at the network node, the **Properties** window will appear so the correct node address can be entered. The transmission baud rate can be changed at this time also. Click **OK** when finished.

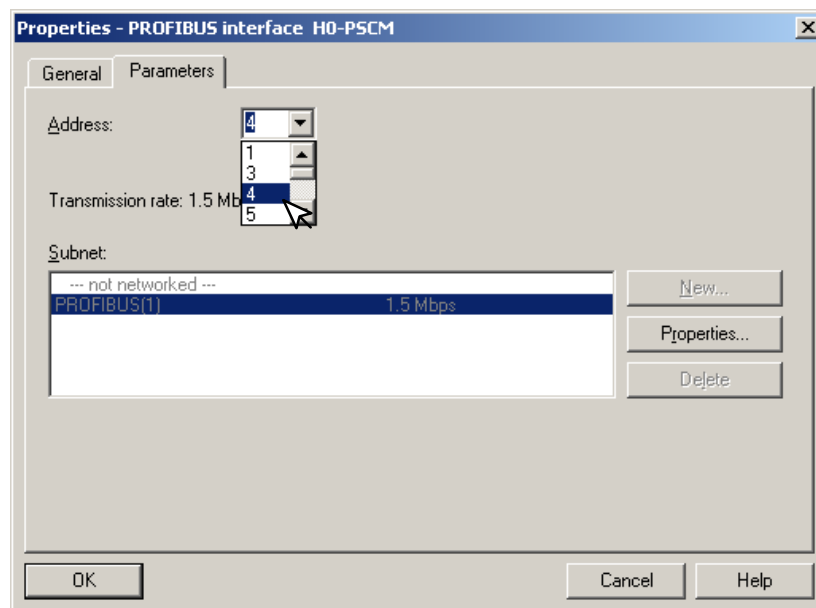

Now that the H0-PSCM is a node on the Profibus network, the WORD READ/WRITE information needs to be added to the Slave Communications Module.

- Open the H0-PSCM READ/WRITE configuration window by clicking on **H0-PSCM** at the node.

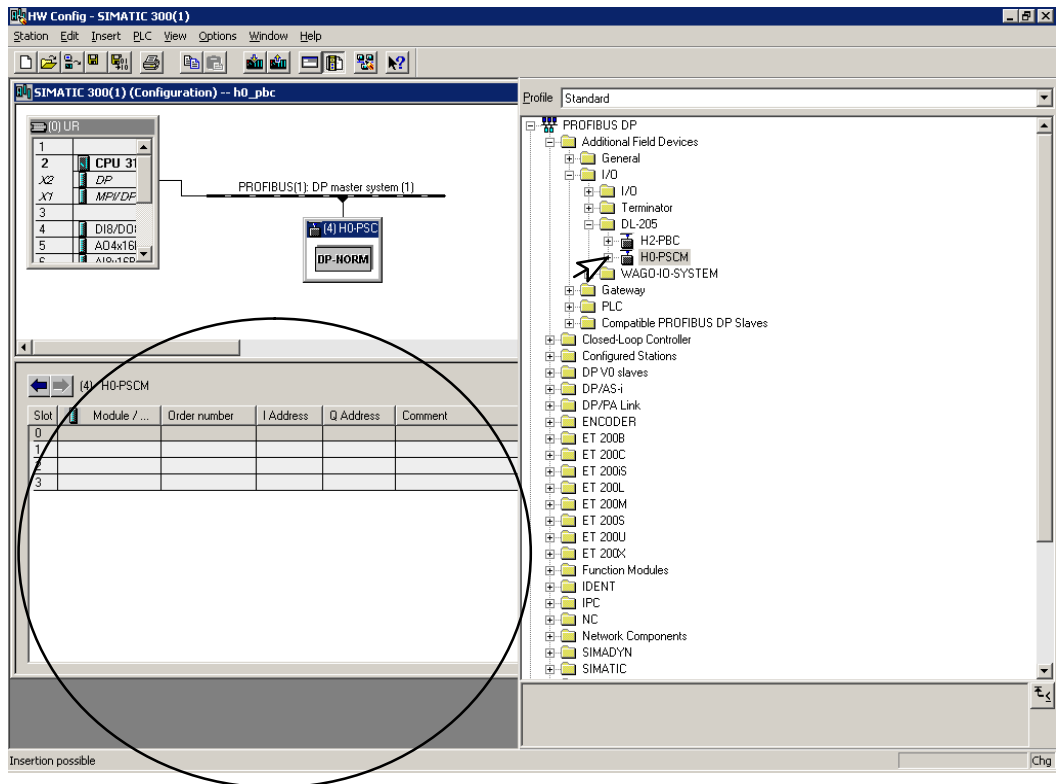

Open the H0-PSCM configuration READ/WRITE list by clicking on the + **H0-PSCM**. Make your selections to configure the Profibus Slave Communications Module.

8. Either click on the selection that you want and drag it to the configuration table to the left or double click on the selection and it will automatically be added to the configuration list.

The screenshot shows the SIMATIC Manager HW Config window for a SIMATIC 300(1) system. The rack diagram shows a CPU 31 in slot 1, DP modules in slots 2 and 3, and a DP-HORM module in slot 4. A Profibus DP master system (1) is connected to the DP-HORM module. The H0-PSCM configuration table is shown below the rack diagram, and the H0-PSCM configuration list is shown on the right.

Slot	Module / ...	Order number	I Address	Q Address	Comment
0	65	2 WORD READ	FF256..259		
1					
2					
3					

The H0-PSCM configuration list on the right includes the following options:

- Universal module
- Empty Slot
- 1 WORD READ FROM PLC
- 2 WORD READ FROM PLC
- 3 WORD READ FROM PLC
- 4 WORD READ FROM PLC
- 5 WORD READ FROM PLC
- 6 WORD READ FROM PLC
- 7 WORD READ FROM PLC
- 8 WORD READ FROM PLC
- 9 WORD READ FROM PLC
- 10 WORD READ FROM PLC
- 11 WORD READ FROM PLC
- 12 WORD READ FROM PLC
- 13 WORD READ FROM PLC
- 14 WORD READ FROM PLC
- 15 WORD READ FROM PLC
- 16 WORD READ FROM PLC
- 18 WORD READ FROM PLC
- 20 WORD READ FROM PLC
- 24 WORD READ FROM PLC
- 30 WORD READ FROM PLC
- 32 WORD READ FROM PLC
- 1 WORD WRITE TO PLC
- 2 WORD WRITE TO PLC
- 4 WORD WRITE TO PLC
- 5 WORD WRITE TO PLC
- 6 WORD WRITE TO PLC
- 7 WORD WRITE TO PLC
- 8 WORD WRITE TO PLC
- 9 WORD WRITE TO PLC
- 10 WORD WRITE TO PLC

After you have finished configuring the H0-PSCM DP Slave, the configuration window will look like the example below.

9. Next, right click on the READ and the WRITE selections, then select **Properties** to assign V Memory addresses.

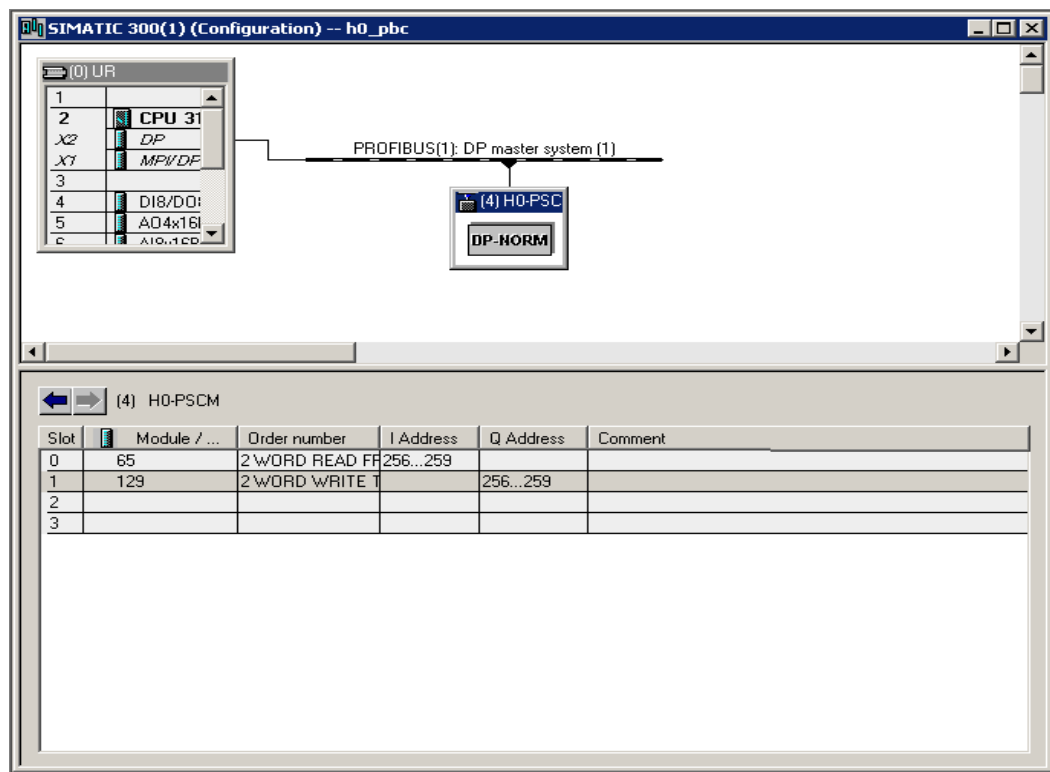

10. Select **Parameter Assignment** to enter the READ address. Enter either the decimal value of 16640 or 4100 hex, this is V40400.

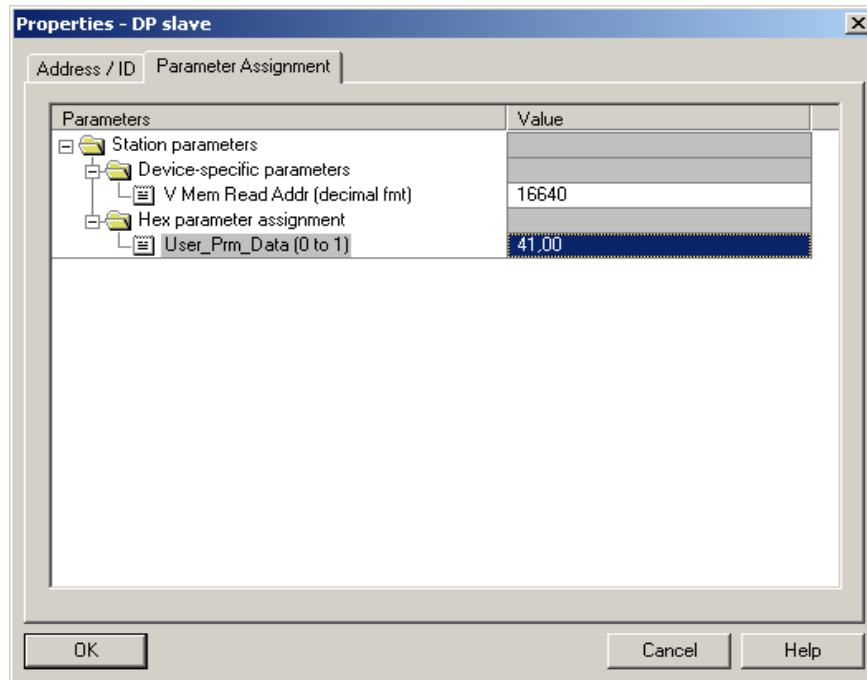

11. Enter the **Parameter Assignment** for WRITE address to either the decimal value of 16704 or 4140 hex, this is V40500.

