

Caplio^{*} R40

RICOH

Camera User Guide

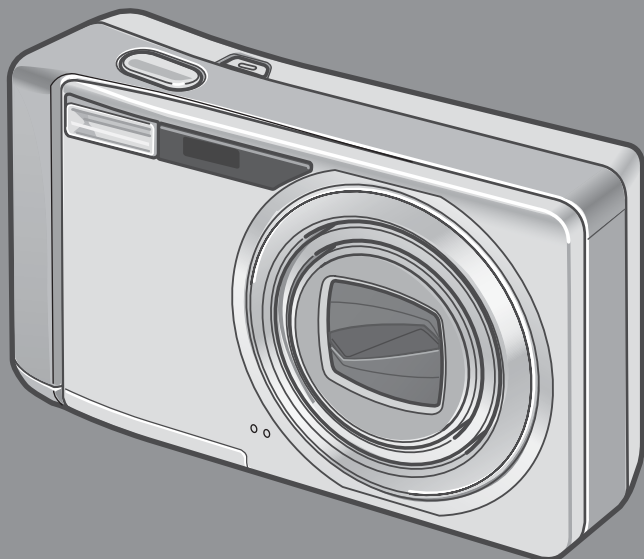

The serial number of this product is given on the bottom face of the camera.

1 Quick Guide

2 Using the Various Shooting and Playback Functions

3 Changing Camera Settings

4 Installing Software

5 Troubleshooting



Caution!

Do not connect the USB cable yet!

If you connect the camera to a computer through the USB cable before installing the provided software on the computer, the software required for connection between camera and computer may not be installed correctly.

Be sure to connect the camera to your computer after installing the provided software.

For how to install the software, see P.133.

About other documentation

Detailed explanations on how to use the provided software can be found in "Software User Guide" (PDF format file) included on the supplied CD-ROM.

For how to display the PDF file, see P.137.

The CD-ROM also contains English version of "Camera User Guide" and "Software User Guide" in PDF format.

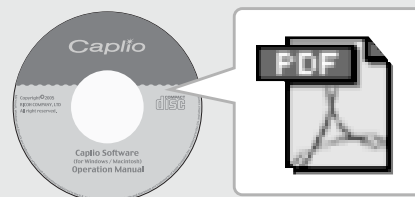

Preface

This manual provides information on how to use the shooting and playback functions of this product, as well as warnings on its use. To make the best use of this product's functions, read this manual thoroughly before use. Please keep this manual handy for ease of reference.

Ricoh Co., Ltd.

Safety Precautions	For the safe use of your camera, be sure to read the safety precautions thoroughly.
Test shooting	Please be sure to do some test shooting to make sure it is recording properly before normal use.
Copyright	Reproduction or alteration of copyrighted documents, magazines, music and other materials, other than for personal, home or similarly limited purposes, without the consent of the copyright holder is prohibited.
Exemption from Liability	Ricoh Co., Ltd. assumes no liability for failure to record or play back images caused by malfunction of this product.
Warranty	This product is manufactured to local specifications and the warranty is valid within the country of purchase. Should the product fail or malfunction while you are abroad, the manufacturer assumes no responsibility for servicing the product locally or bearing the expenditure incurred thereof.
Radio Interference	Operating this product in the vicinity of other electronic equipment may adversely affect the performance of both devices. In particular, operating the camera close to a radio or television may lead to interference. If interference occurs, follow the procedures below. <ul style="list-style-type: none">• Move the camera as far away as possible from the TV, radio or other device.• Reorient the TV or radio antenna.• Plug the devices into separate electrical outlets.

This publication may not be reproduced in whole or in part without the express written permission of Ricoh.

© 2006 RICOH CO.,LTD. All rights reserved.

The contents of this document may be changed in the future, without prior notice.

This booklet was created with thorough attention to its content. If, however, you have a question, spot an error, or find a description lacking, please refer to the end of this booklet for information on how to contact us.

Microsoft, MS, Windows and DirectX are registered trademarks of Microsoft Corporation in the United States of America and other countries.

Macintosh, Power Macintosh, and Mac OS are registered trademarks of Apple Computer, Inc. in the United States of America and other countries.

Adobe and Adobe Acrobat are trademarks of Adobe Systems Incorporated.

All trademarked company and product names mentioned in this manual are the property of their respective owners.

Key Features

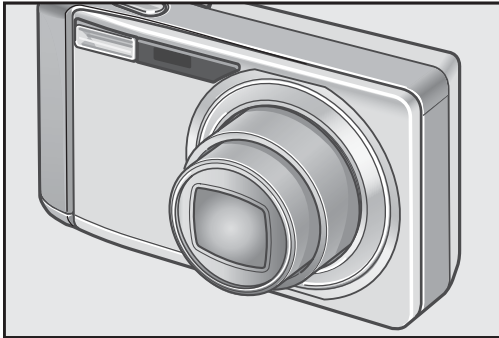

Equipped with a high magnification 5.7× wide angle zoom lens

This camera has a compact body only 26 mm thick, featuring a 28-mm (Wide-angle) to 160-mm (Telephoto)* 5.7× optical zoom lens that covers a wide range of shooting. This lens can be used to take pictures in various indoor and outdoor situations.

*Equivalent to that on a 35mm camera

Rapid shutter response enables you to capture high-speed action (P.29)

The shutter release time lag is as short as approx. 0.1 seconds.

Ricoh's patented hybrid auto focusing system technology even keeps action shots looking good.



Macro shooting at 1 cm (P.35) and close-up flash shooting at 14 cm (Telephoto) or 20 cm (Wide-angle) (P.36)

The unsurpassed macro shooting function allows you to capture details from a very close distance at only 1 cm. The camera also has a built-in flash for close-up shots at 14 cm (Telephoto) or 20 cm (Wide-angle). This combination will give you clear macro shots even under low light conditions.

AF target shift function for easy focus locking even on a tripod (P.85)

The camera is equipped with an AF target shift function. During macro shooting, the AF target shift function allows you to lock the focus with the press of a button, without moving the camera itself.

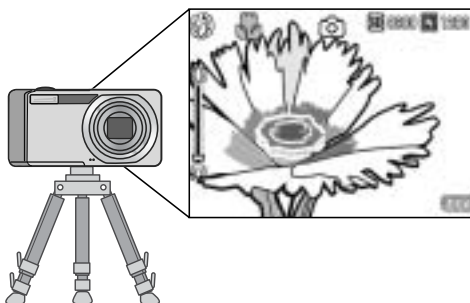

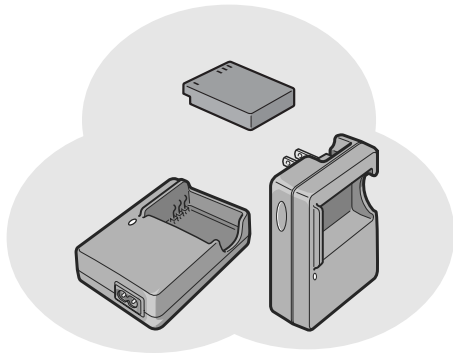

Equipped with a powerful long-lasting rechargeable battery (P.16)

This camera comes with a long-lasting, high-capacity rechargeable battery for longer periods of shooting on a trip or at work.

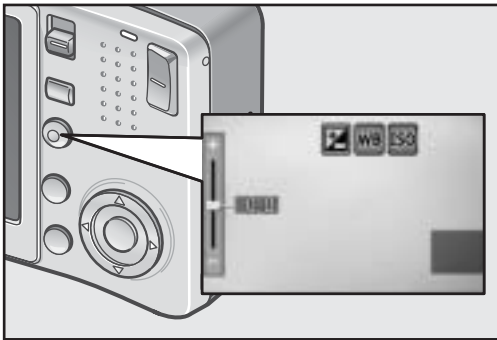

ADJ. (Adjust) button enables easy access to the most useful settings (P.57)

The ADJ. button simplifies the camera setting procedures. It allows you to make adjustments with minimum steps for settings, such as the exposure compensation and white balance. You can also assign a function as required.



30 fps or 15 fps high-quality movies with sound (P.91)

Record high-quality movies with 320 × 240 pixels at 30 frames per second and with full sound.

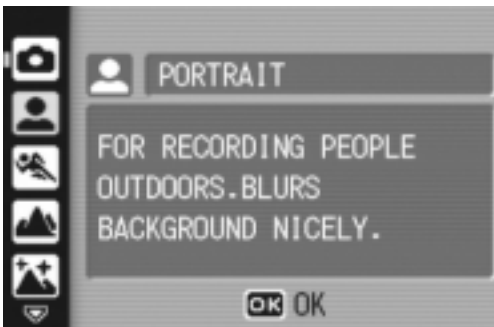

Scene Mode enables easy shooting (P.37)

In Scene Mode, you can select from among eight shooting modes to best match your shooting conditions and the camera will automatically make the optimal settings.



Skew Correction Mode helps straighten skewed images (P.37)

In Skew Correction Mode, a rectangular object shot at an angle can be straightened to look as if it were shot squarely. With the simple touch of a button, you can straighten skewed images of objects such as a message board, a display panel, or a name card.

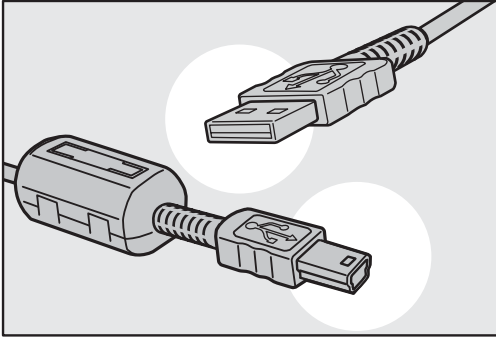

USB cable enables instant transfer of camera data to a computer

Install the provided software on your computer and then simply connect the camera to your computer with the provided USB cable to automatically transfer images to your computer.



ImageMixer software makes it easy to manage shot images in albums, edit images and sounds, create video CDs, and more

This software provides integrated handling of images with an input function to download still images, movies, and sounds from a digital camera or music CD, an album function to manage captured contents, an edit function to edit movies using MPEG-1, a layout function to create layouts using still image contents, and a disk creation function to create video CDs.

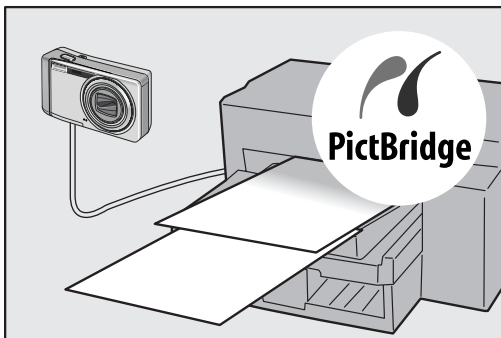

Direct printing without the use of a computer (P.52)

A Direct Print-compatible printer can be connected to the camera with the USB cable to directly transfer images to the printer. This allows for easy printing without using a computer.

You can also print reports.

Contents

Chapter 1 Quick Guide

Before Shooting	10
Packing List	10
Names of Parts.....	12
LCD Monitor Display	14
Getting Ready to Shoot	16
About the Battery.....	16
Battery Level Indication	17
SD Memory Card (available in stores)	18
Charging the Rechargeable Battery	19
Loading the Rechargeable Battery and SD Memory Card	20
Turning the Power On/Off	22
Setting the Language	23
Setting the Date and Time.....	24
Changing the Display	25
Maximizing the LCD Monitor Brightness	25
Histogram	26
Basic Shooting	27
Holding the Camera	27
Preventing Camera Shake	28
Quickly Shooting Pictures (Full-press)	29
Checking the Focus and Shooting (Half-press).....	30
When the Subject is Not Centered (Shooting with Focus Lock).....	32
Using the Zoom Function	34
Shooting Close-Ups (Macro Shooting).....	35
Using the Flash	36
Shooting with Optimal Settings According to Shooting Conditions	37
Playing Back Images	41
Reviewing the Image You Just Took (Quick Review)	41
Viewing Your Images	42
Playing Back Images in the Three-frame View	43
Thumbnail Display.....	45
Magnifying Images	46
Viewing on a Television	47
Deleting Files	49
Deleting Unwanted Files (Still Images/Movies/Sounds).....	49
Deleting Multiple Files at One Time	50

Chapter 2 Using the Various Shooting and Playback Functions

Direct Printing	52
Direct Print Function	52
Connecting the Camera to a Printer.....	52
Printing Still Images.....	53

Various Shooting Functions	57
Using the ADJ. (Adjust) Button.....	57
Shooting Setting Menu.....	58
Using the Shooting Setting Menu.....	59
Choosing Picture Quality Mode/Image Size (PIC QUALITY/SIZE).....	60
Changing the Focusing Mode (FOCUS: MULTI AF/SPOT AF).....	62
Manual Focus Shooting (FOCUS: MF).....	64
Shooting at a Fixed Distance (FOCUS: SNAP/Infinity).....	66
Changing the Light Metering (PHOTOMETRY).....	67
Changing the Edge Quality of Still Images (SHARPNESS).....	68
Setting the Color Depth (COLOR DEPTH).....	69
Shooting Consecutively with Different Exposures (AUTO BRACKET).....	70
Shooting Consecutively with Different White Balance (WB-BKT).....	71
Using Long Time Exposure (TIME EXPOSURE).....	73
Shooting Pictures Automatically at Set Intervals (INTERVAL).....	74
📷 Shooting a Still Image with Sound (IMAGE WITH SOUND).....	76
Inserting the Date into a Still Image (DATE IMPRINT).....	77
Changing the Exposure (EXPOSURE COMP.).....	78
Using Natural and Artificial Lighting (WHITE BALANCE).....	79
Changing the Sensitivity (ISO SETTING).....	81
Limiting the Shutter Speed (SLOW SHUTTER LMT).....	82
Returning the Shooting Setting Menu Settings to their Defaults (RESTORE DEFAULTS).....	83
Changing Shading for Shooting Text (DENSITY).....	84
Using the AF Target Shift Function.....	85
🕒 Using the Self-Timer.....	86
Shooting with Multi-Shot (CONT. MODE)	87
CONT.....	89
S-CONT (S Multi-Shot).....	89
M-CONT (M Multi-Shot).....	89
Viewing an S-CONT or M-CONT Still Image in Enlarged Display Mode.....	90
Shooting/Playing Back Movies	91
📹 Shooting Movies.....	91
Setting the Frame Rate.....	93
Playing Back Movies.....	94
Recording/Playing Back Sound	95
🎤 Recording Sound.....	95
Playing Back Sound.....	96
Other Functions Available in Playback Mode	97
Playback Setting Menu.....	97
Using the Playback Setting Menu.....	97
Displaying Photos in Order Automatically (SLIDE SHOW).....	98
Write-protecting Files (PROTECT).....	99
Using a Printing Service (DPOF).....	102
Changing the Image Size (RESIZE).....	105
Copying the Contents of the Internal Memory to an SD Memory Card (COPY TO CARD).....	106

Chapter 3 Changing Camera Settings

Changing Camera Settings	108
SETUP Menu.....	108
Using the SETUP Menu.....	109
Formatting the SD Memory Card (FORMAT [CARD]).....	110

Formatting the Internal Memory (FORMAT [INT. MEM.])	111
Adjusting the Brightness of the LCD Monitor (LCD BRIGHTNESS)	112
Assigning a Function to the ADJ. Button (ADJ BTN. SET.1/2)	113
Changing the Auto Power Off Setting (AUTO POWER OFF)	114
Changing the Beep Sound Setting (BEEP SOUND)	115
Changing the Beep Sound Volume (VOL. SETTINGS)	116
Changing Image Confirmation Time (LCD CONFIRM.)	117
Changing File Name Settings (SEQUENTIAL NO.)	118
Setting the Date and Time (DATE SETTINGS).....	120
Changing the Display Language (LANGUAGE/言語)	121
Changing the Playback Method for Viewing on TV (VIDEO OUT MODE)	122
Changing the Step Zooming Setting (STEP ZOOM).....	123
Displaying a Settings Change Warning (SHTG STGS WARNG.).....	124
Changing the USB Setting (USB CONNECTION)	125
Enlarging Icon Display (ENLGE PHOTO ICON)	129
Registering the Power-on Settings (REG. MY SETTINGS)	130
Changing the Startup Settings (START SETTINGS)	131

Chapter 4 Installing Software (Downloading Images to Your Computer)



Installing the Provided Software (For Windows)	134
System Requirements for Using the Provided Software	138
Installing the Software on Your Computer.....	139
Installing the DeskTopBinder Lite.....	141
Connecting the Camera to Your Computer	143
Downloading Images from an SD Memory Card	148
Installing Acrobat Reader	149
Installing DirectX	150
Uninstalling the Software.....	151
Uninstalling ImageMixer	152
Installing the Provided Software (For Macintosh)	153
System Requirements for Using the Provided Software	155
Installing the Software on Your Computer (Mac OS 8.6 to 9.2.2)	156
Installing the Software on Your Computer (Mac OS X 10.1.2 to 10.4.5).....	157

Chapter 5 Troubleshooting

Troubleshooting.....	160
Troubleshooting the Camera.....	160
Warning Messages Under Windows XP Service Pack 2	165
Appendices.....	167
A. Specifications	167
B. Optional Accessories	169
C. Using Scene Modes with Functions.....	170
D. Available Menu Items By Mode	171
E. Functions Whose Defaults are Restored When Camera is Turned Off	172
F. Number of Images That Can be Stored in Internal Memory/SD Memory Card.....	173
G. Using Your Camera Abroad	174
H. Cautions on Use	175
I. Care and Storage	176
J. Error Messages	177
K. Warranty and Servicing.....	178
Index.....	180

Using the Manuals

The following two manuals are included with your Caplio R40.

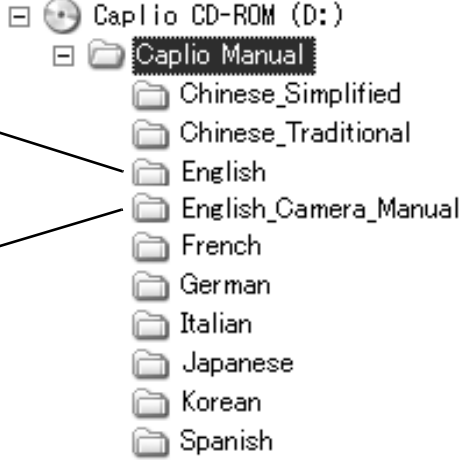
	<p>“Camera User Guide” (This booklet)</p> <p>This guide explains the usage and functions of the camera. It also explains how to install the provided software on your computer.</p> <p>* The “Camera User Guide” (English edition) is available from the provided CD-ROM as a PDF file.</p>
	<p>“Software User Guide” (PDF file)</p> <p>This guide explains how to download images from the camera to your computer and display and edit them on your computer.</p> <p>* The “Software User Guide” is available in the following folders on the provided CD-ROM.</p> <div data-bbox="906 981 1369 1440"><pre>Caplio CD-ROM (D:) ├── Caplio Manual │ ├── Chinese_Simplified │ ├── Chinese_Traditional │ ├── English │ ├── English_Camera_Manual │ ├── French │ ├── German │ ├── Italian │ ├── Japanese │ ├── Korean │ └── Spanish</pre></div> <p>Each language has its own “Software User Guide” in the respective folder.</p> <p>“Camera User Guide” (English edition) (PDF file)</p>

To copy the Software User Guide onto your hard disk

Copy the PDF file from the above folder directly to your hard disk.



Reference

The camera is provided with the ImageMixer software that allows you to display and edit images on your computer. For details on how to use ImageMixer, click the [?] button on the ImageMixer window and see the displayed manual.

For more information on ImageMixer, contact the Customer Support Center below.

North America (Los Angeles)	TEL: +1-213-341-0163
Europe (U.K.)	TEL: +44-1489-564-764
Asia (Philippines)	TEL: +63-2-438-0090
China	TEL: +86-21-5450-0391





Business hours: 9:00 AM to 5:00 PM

How to Use This Guide

Chapter 1 explains the basic operations of this camera.

If you are using the camera for the first time, read from this chapter.

The following symbols are also used in this guide:

 Caution	This indicates important notices and restrictions for using this camera.
 Note	This indicates supplementary explanations and useful tips about camera operations.
 Term	This indicates terms that are useful for understanding the explanations.
 Reference	This indicates page(s) relevant to a particular function.

The LCD monitor display examples may be different from actual display screens.

Chapter 1

Quick Guide

If you are using the camera for the first time, read from this chapter.

Before Shooting	10
Getting Ready to Shoot	16
Basic Shooting	27
Playing Back Images	41
Viewing on a Television	47
Deleting Files	49

Before Shooting

Packing List

Open the package and make sure all the items are included.

- Caplio R40

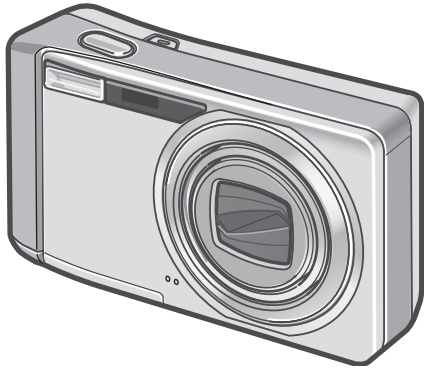

- Rechargeable Battery

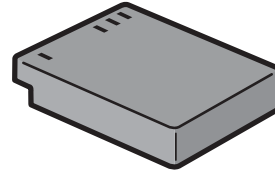

- AV Cable

Used when viewing your images on a TV.

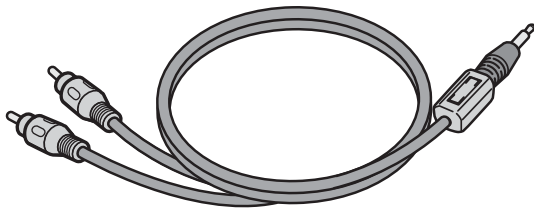

- Battery Charger

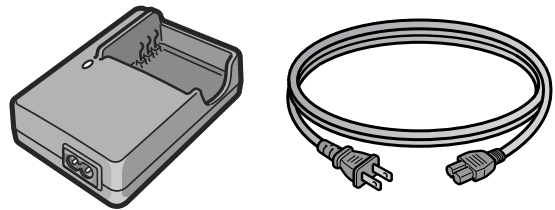

- USB Cable

Used to connect the camera to a computer or Direct Print-compatible printer.

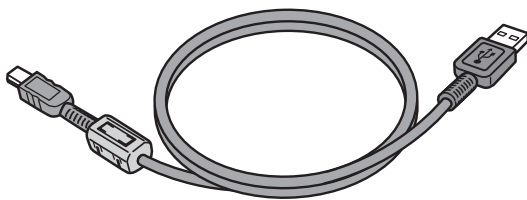

- Handstrap

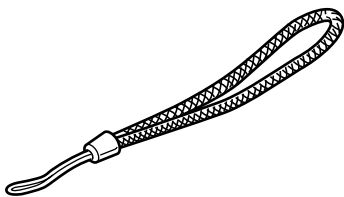

Note

Attaching the hand strap to the camera

Thread the small end of the strap through the strap eyelet on the camera and loop the ends as shown.

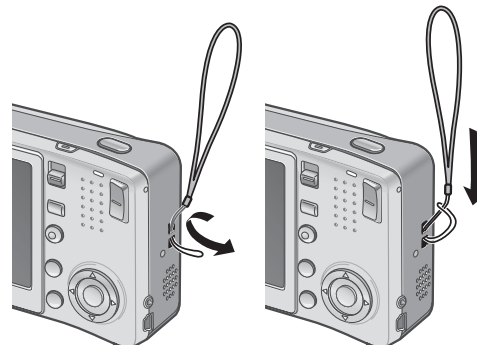

The serial number of the camera is provided on the bottom face of the camera.

- Camera User Guide (This booklet)



- Warranty

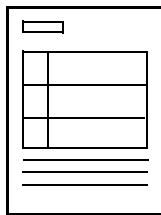

- Safety Precautions



- Caplio Software CD-ROM

The provided software and the "Software User Guide" are included on this CD-ROM.



Optional Accessories

- AC Adapter (AC-4c)

Used for power supply from a household outlet to the camera. Use this adapter for long periods of playback or when transferring images to a computer.

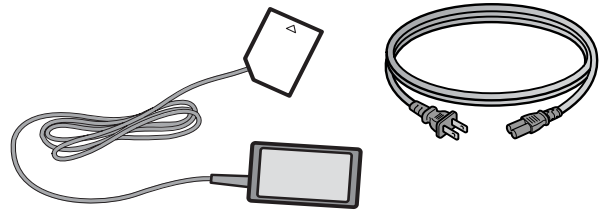

- Rechargeable Battery (DB-60)

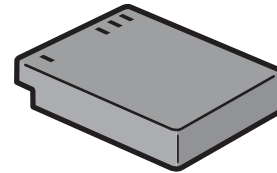

- Battery Charger (BJ-6)

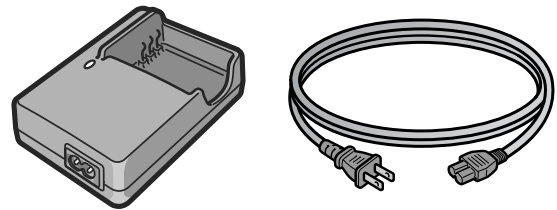

- Soft Case (SC-60)

- SD Memory Card (available in stores)



Reference

- For the latest information about accessories, visit the Ricoh website at <http://www.ricohpmmc.com>.

Names of Parts

Camera

Front View

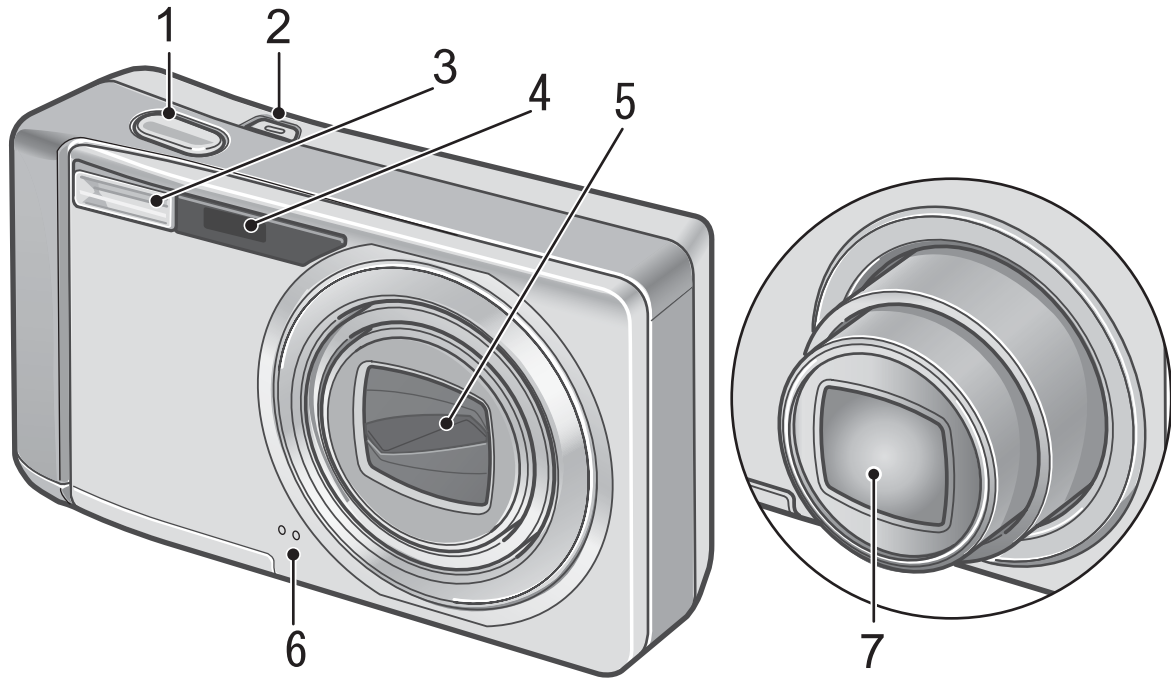

	Item Name	Refer to
1	Shutter Release Button	P.27
2	POWER Button	P.22
3	Flash	P.36
4	AF Window	-
5	Lens Cover	-
6	Microphone	P.95
7	Lens	P.27

Mode Selector

You can select one of the three modes with the mode selector.

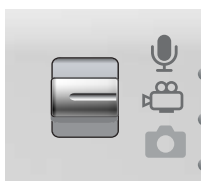

Voice Memo Mode

Allows you to record sounds.

Movie Mode

Allows you to shoot movies.

Still Image Mode

Allows you to shoot still images.

Rear View

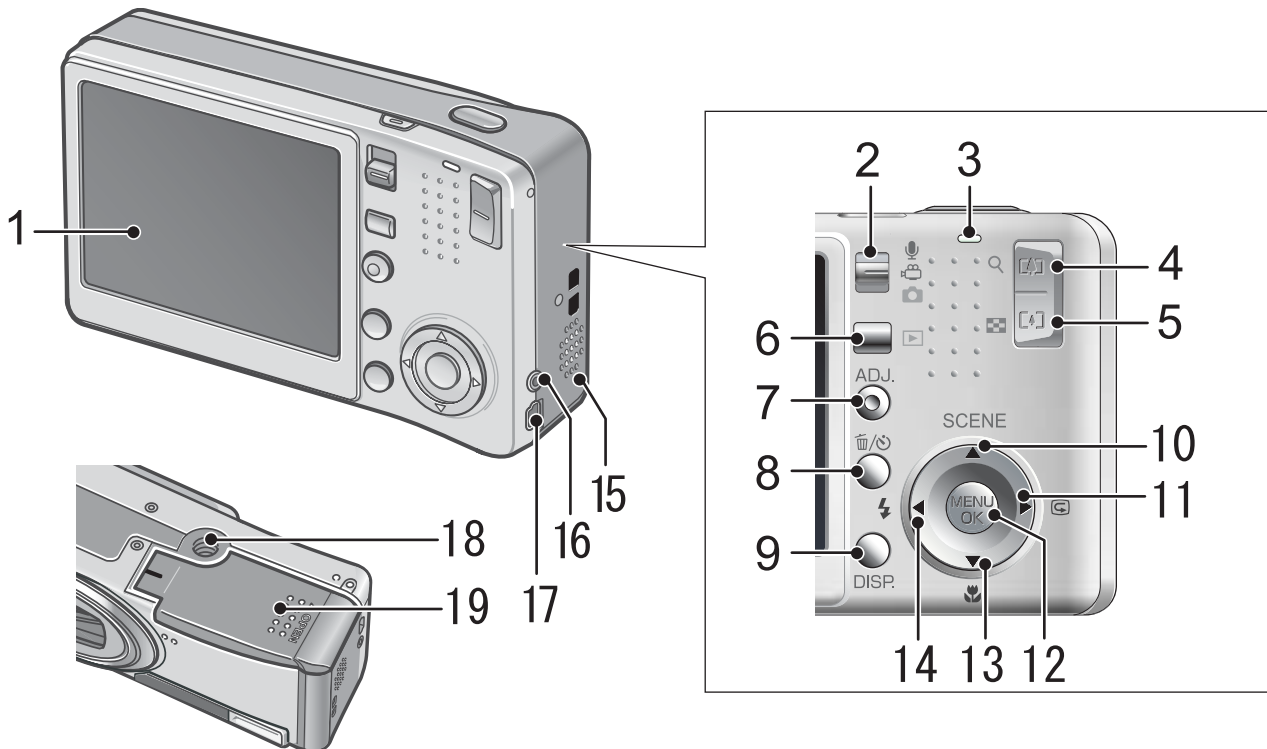

	Item Name	Refer to		Item Name	Refer to
1	LCD Monitor	P.14	11	▶/Ⓞ (Quick Review) Button	P.41
2	Mode Selector	P.12	12	MENU/OK Button	P.59 P.97 P.109
3	Auto Focus/Flash Lamp	P.30 P.36	13	▼/🌸 (Macro) Button	P.35
4	Ⓜ (Telephoto)/ Q (Enlarged View) Button	P.34 P.46	14	◀/⚡ (Flash) Button	P.36
5	Ⓜ (Wide-angle)/ 🖼 (Thumbnail Display) Button	P.34 P.45	15	Speaker	P.94 P.96
6	▶ (Playback) Button	P.42	16	AV Output Terminal	P.47
7	ADJ. Button	P.57	17	USB Terminal	P.143
8	🗑 (Delete)/ ⌚ (Self-timer) Button	P.49 P.86	18	Tripod Screw Hole (underside)	P.167
9	DISP. Button	P.25	19	Battery/Card Cover	P.20
10	▲/SCENE Button	P.37			

LCD Monitor Display

Example of LCD Monitor Display when Shooting Pictures

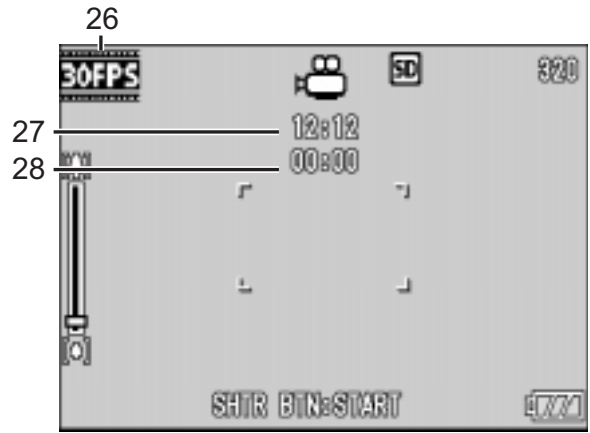
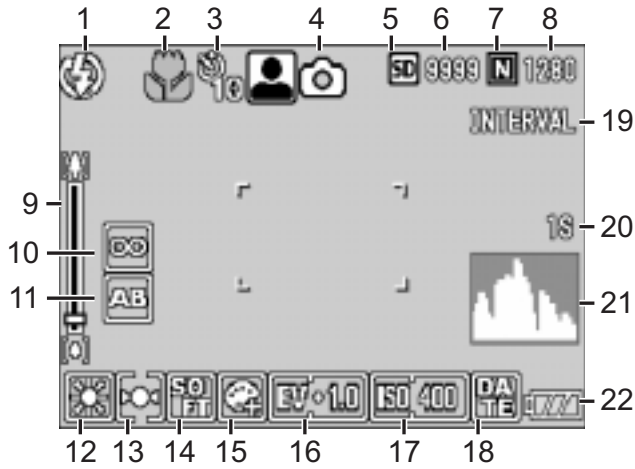

Movie Mode

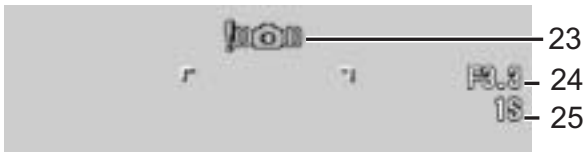

Still Image Mode

	Item Name	Refer to		Item Name	Refer to
1	Flash	P.36	15	Color Depth	P.69
2	Macro Shooting	P.35	16	Exposure Compensation	P.78
3	Self-timer	P.86	17	ISO Setting	P.81
4	Mode Types	P.12 P.37	18	Date Imprint	P.77
5	Recording Destination	P.18	19	Interval	P.74
6	Remaining Number of Still Images	P.173	20	Time Exposure	P.73
7	Picture Quality	P.60	21	Histogram	P.26
8	Image Size	P.60	22	Battery Mark	P.17
9	Zoom Bar	P.34	23	Camera Shake Warning Mark	P.28
10	Focus	P.64	24	Aperture Value	P.167
11	Auto Bracket	P.70	25	Shutter Speed	P.82
12	White Balance	P.79	26	Frame Rate	P.93
13	Photometry	P.67	27	Remaining Recording Time	P.174
14	Sharpness	P.68	28	Recording Time	P.174

Note

- The number of remaining shots available may differ from the actual number of shots, depending on the subject.
- Movie and sound recording time and the maximum number of still pictures may vary depending on the capacity of the recording destination (internal memory or SD memory card), shooting conditions, and the type and manufacturer of the SD memory card.
- When the number of remaining shots is 10,000 or more, “9999” is displayed.

Example of LCD Monitor Display During Playback

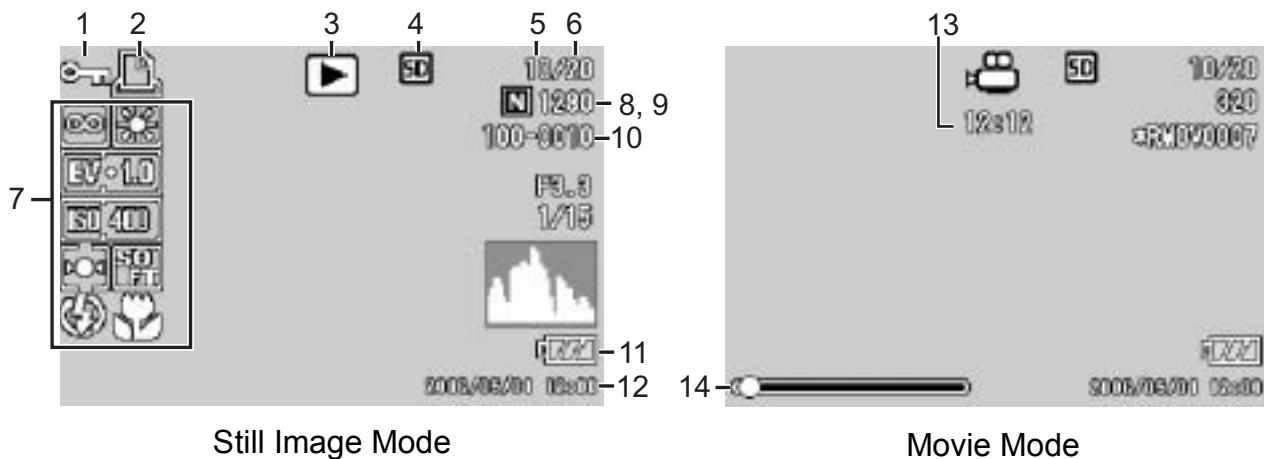

	Item Name	Refer to		Item Name	Refer to
1	Protect	P.99	8	Picture Quality	P.60
2	DPOF	P.102	9	Image Size	P.60
3	Mode Types	-	10	File No.	-
4	Playback Data Source	P.42	11	Battery Mark	P.17
5	Number of Playback Files	-	12	Date at Shooting	P.77 P.120
6	Total Number of Files	-	13	Recording Time or Lapsed Time	-
7	Setting at Shooting (Recording)	-	14	Indicator	-

Note

The LCD monitor may display messages to inform you of operational instructions or the camera's status while in use.

Getting Ready to Shoot

Turn the power on and get ready to shoot.

Note

If you have already used this camera, follow the steps below to make sure it is turned off before removing or loading the battery.

1. Make sure the LCD monitor is turned off.
2. Make sure the protective lens cover is closed.

For information on how to turn the camera off, see P.22.

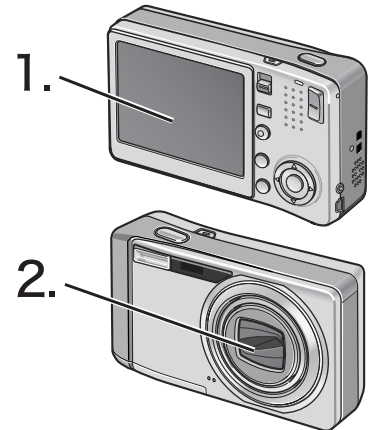

About the Battery

This camera can only be used with the following dedicated battery:

• Rechargeable Battery DB-60 (supplied)

This is a lithium-ion battery. It is economical because you can recharge it using the battery charger and use it over and over again. The battery lasts a long time, so it is convenient when traveling.

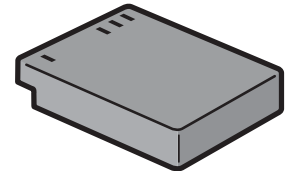

Note

Approximate number of shots you can take on a single charge: 350

- Based on CIPA standard (Temperature: 23 degrees Celsius, LCD on, 30 seconds between shots, changing the zoom setting from telephoto to wide-angle or wide-angle to telephoto for each shot, 50% flash usage, turning the power off after each 10 shots).
- Set the camera to the Power-Save or Synchro-Monitor Mode to increase the number of shots you can take.
- The number of shots is for reference only. If the camera is used for long periods of time for setting and playback, the shooting time (the number of shots) will decrease.



Reference

- For information on how to insert the Rechargeable Battery, see P.20.
- For information on how to use the AC adapter, see P.169.





Caution

- Remove the battery if you are not going to use the camera for a long period of time.
- The battery may be very hot immediately after operation. Turn the camera off and let it cool down sufficiently before removing the battery.

Battery Level Indication

A battery mark appears at the lower right of the LCD monitor to indicate the rechargeable battery level. Recharge the battery before it is depleted.

Battery Mark	Description
 Green	The battery is sufficiently charged.
	The battery level begins to drop. Recharging is recommended.
	The battery level is low. Recharge the battery.



Caution

If you are using the AC adapter,  may appear. This does not indicate malfunction and you can continue to use the camera.



SD Memory Card (available in stores)

You can store still images you have taken either in the camera's internal memory or on an SD memory card (available in stores). The internal memory capacity is 26 MB.

To record a lot of still images, movies or sounds at high resolutions, use a high-capacity SD memory card.



Note

Where images are recorded

When no SD memory card is loaded, the camera records images to the internal memory; when an SD memory card is loaded, it records images to the memory card.

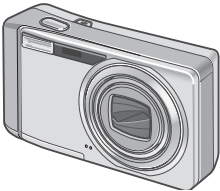
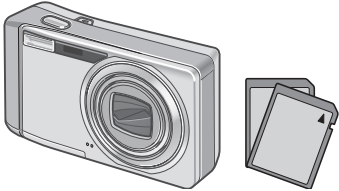
When no SD memory card is loaded	When an SD memory card is loaded
	
Records to the internal memory	Records to the SD memory card



Caution

- If an SD memory card is loaded, the camera will not record to the internal memory, even if the card is full.
- Take care not to get the contacts of the card dirty.



Note

Write-protecting your images

Move the write-protection switch on the SD memory card to LOCK to prevent your still images from being accidentally erased or the card from being formatted. If you unlock the card (by returning the switch to its original position), it is once again possible to erase images and format the card.

It is recommended to move the write-protection switch to LOCK when you have some important data recorded.

Note that you cannot shoot images on a locked card because no data can be recorded to the card. Unlock the card before shooting.

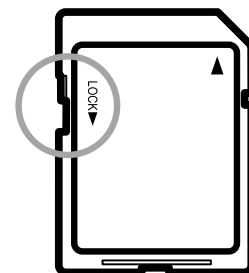

Reference

- For information on switching between the SD memory card and internal memory during playback, see P.42.
- For information on recording capacities, see P.173.
- For information on how to format an SD memory card, see P.110.

Charging the Rechargeable Battery

The rechargeable battery needs to be charged before use.

- 1. Insert the battery, making sure that the \oplus and \ominus markings on the battery match with those on the battery charger.**

The battery label should face up.



Caution

Be careful not to reverse the \oplus and \ominus sides.

- 2. Plug the battery charger into an outlet.**

Charging starts and the charger lamp indicates the progress, as shown below. Once charging has finished, unplug the power cable from the power outlet.

Depending on the battery level, the charging time differs.

Charger Lamp	Description
Lit	Charging started
Off	Charging complete
Flashing	Battery charger or battery may be faulty (unplug the battery charger from the power outlet and remove the battery from the battery charger).

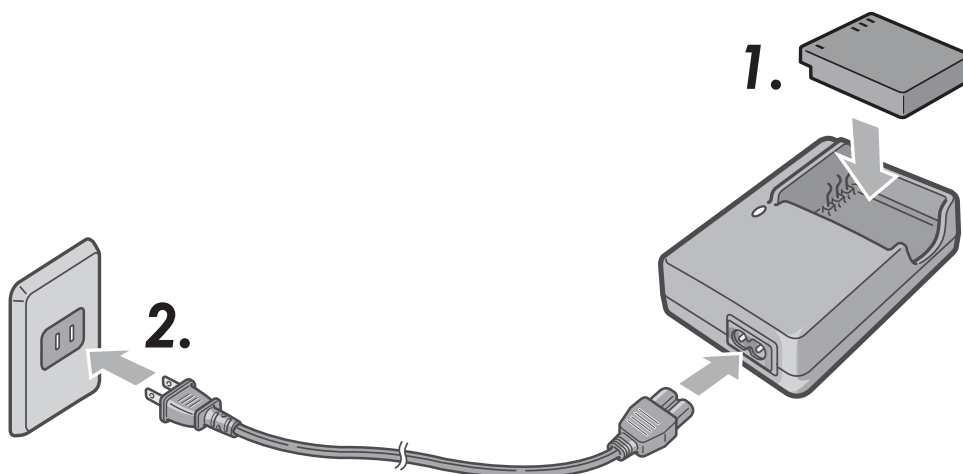

Loading the Rechargeable Battery and SD Memory Card

The rechargeable battery (DB-60) can be used to power this camera. This battery is convenient because the battery power lasts long and it can be used over and over again by recharging. If you have already used this camera, make sure it is turned off before loading the battery and card.

1. Open the battery/card cover.

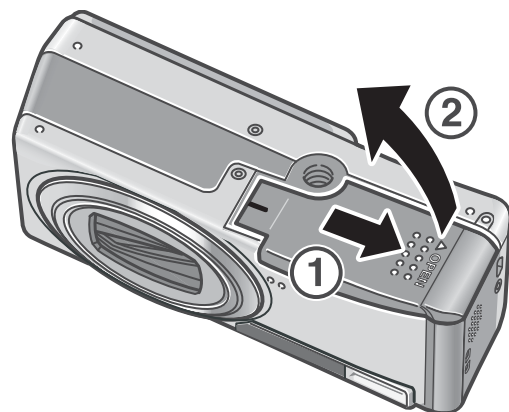

2. Make sure the SD memory card is facing the right way and then push the card all the way in until it clicks.

The rechargeable battery may be inserted first.

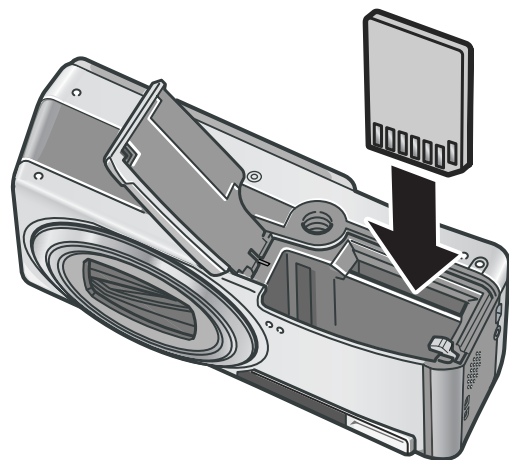

3. Insert the rechargeable battery.

When the rechargeable battery is loaded in place, it is locked with the hook shown in the figure.

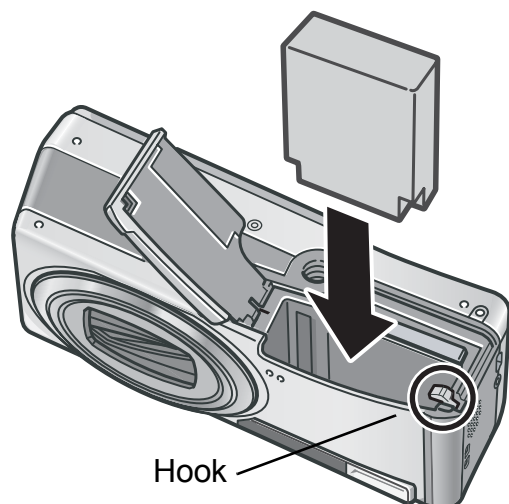

4. **Close the battery/card cover and slide it back into place.**

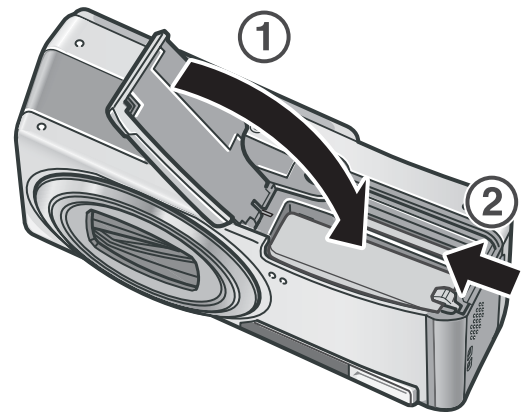

Removing the Rechargeable Battery

Open the battery/card cover. Release the hook that locks the rechargeable battery. The battery will be ejected. Pull the battery out of the camera. Be careful not to drop the battery when removing it from the camera.

Removing the SD Memory Card

Open the battery/card cover. Push in the SD Memory Card and gently release to eject it. Pull the card out of the camera.



Caution

- Remove the rechargeable battery if you are not going to use the camera for a long period of time.
- Store the removed battery in a dry cool place.
- Use the battery charger (BJ-6) to recharge the battery.

Rechargeable battery charging time

DB-60

About two hours (25°C)



Note

- Before using a new SD memory card, be sure to format it.
- When using an SD memory card previously used with another camera, be sure to back up any necessary data on the card before formatting it.



Reference

For information on how to format an SD memory card, see P.110.

Turning the Power On/Off

To turn the power on:

1. Press the **POWER** button.

After the start sound, the auto focus/flash lamp blinks for several seconds.

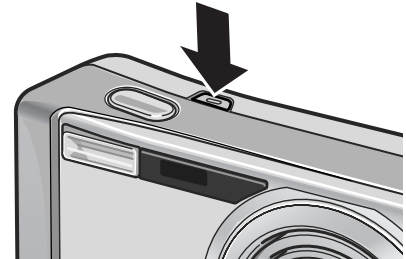

Using the Camera in Playback Mode

Pressing the  (Playback) button for more than one second turns on the camera in Playback Mode, allowing you to start playback at once.

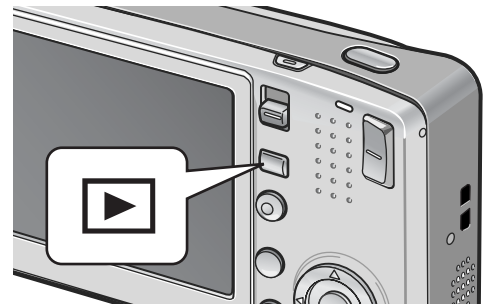

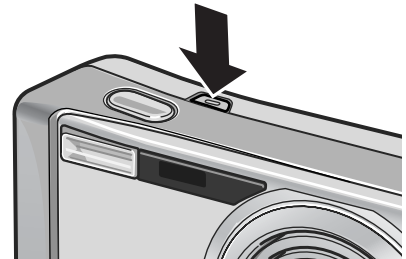

To turn the power off:

1. Press the **POWER** button.



Caution

- When the camera is turned on with the  (Playback) button, pressing the  (Playback) button again switches Playback Mode to Shooting Mode.
- After the camera is turned on, it takes longer for the camera to become ready for shooting when using the flash than when not using the flash.

Note

Auto Power Off

If the camera goes unused for a set period of time, it will automatically turn itself off to save power. (Auto Power Off)

Reference

For information on how to change the Auto Power Off setting, see P.114.

Setting the Language

When the power is turned on for the first time, the language setting screen appears (for the LCD monitor display language). After setting the language, go on to the date/time setting (for printing the date and time on your photos).

You can shoot without these settings. However, be sure to set the language, and the date/time later. Use the SETUP screen for these settings.

1. Turn the power on for the first time after purchase.

The language selection screen appears.

To skip language setting, press the MENU/OK button.

When the MENU/OK button is pressed, the language setting is cancelled and the video signal format-setting screen appears.

2. Press the ▲▼◀▶ buttons to select a language.

3. Press the MENU/OK button.

The display language is set, and the date/time setting screen appears.



Reference

For how to set the display language and date/time on the SETUP screen, see “Changing the Display Language (LANGUAGE/言語)” (P.121) and “Setting the Date and Time (DATE SETTINGS)” (P.120) in this guide.



Setting the Date and Time

When the power is turned on for the first time, the date/time setting screen appears.

1. Press the ▲▼◀▶ buttons to set the year, month, date and time.

Change the value with ▲▼ and move the frame with ◀▶.

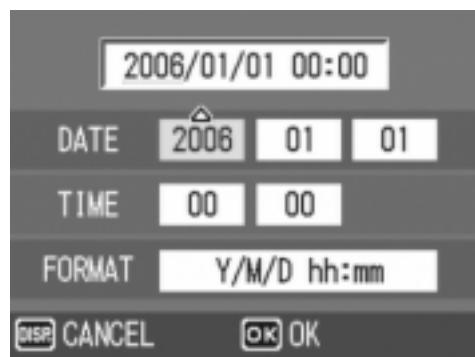

Setting at shipping

2. In [FORMAT], choose the date and time format.

Select the date and time format with ▲▼.

3. Check the display and then press the MENU/OK button.

The date is set.

Pressing the DISP. button on this screen allows you to cancel the setting.

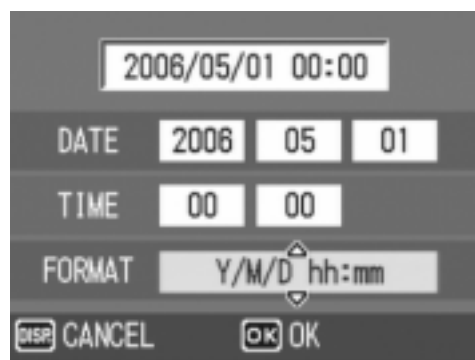

Note

- If the battery is removed for more than one week, the date and time settings will be lost. These settings must be made again.
- To retain the date and time settings, load a fully charged battery for more than two hours.



Reference

- For information on how to set the date and time, see P.120.
- For information on how to put a date stamp on each frame, see P.77.



Changing the Display

Pressing the DISP. button allows you to change the screen display mode and toggle the information displayed on the LCD monitor. Each time you press the DISP. button, the display changes in the following order: Histogram, Grid Guide, No Display, LCD Monitor Off, and Normal Symbol Display.

Normal Symbol Display



Histogram



Grid Guide

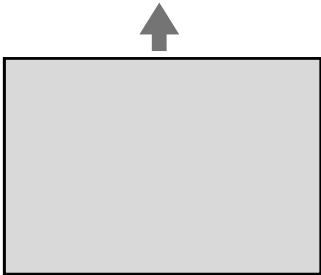
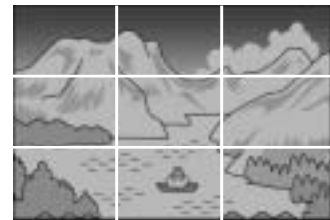

LCD Monitor Off
(Synchro-Monitor Mode)

Press the DISP. button to change the display.

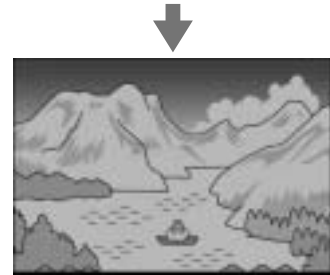

No Display

Maximizing the LCD Monitor Brightness

Hold the DISP. button down to maximize the display brightness. When the brightness is at the maximum setting, holding the DISP. button down returns the brightness to the level set in [LCD BRIGHTNESS] (P.112).

Term

Grid Guide

This displays auxiliary lines on the LCD monitor to help you compose your picture. These lines are not recorded with images.

Synchro-Monitor Mode

This turns the LCD monitor off except when the camera is operated. This mode is effective for saving power consumption. In this mode, pressing the shutter release button halfway turns the LCD monitor on. Subsequently, pressing the shutter release button fully displays the shot image on the LCD monitor and then turns the LCD monitor off.

Histogram

When Histogram is on, a histogram appears in the lower right corner on the LCD monitor. A histogram is a graph indicating the number of pixels on the vertical axis and the brightness on the horizontal axis (from left to right, shadows (dark areas), midtones, and highlights (bright areas)).

By using the histogram, you can determine the brightness of an image without being affected by the brightness around the LCD monitor. This also helps you correct for areas that are overly bright or dark.

If the histogram has only peaks on the right side without anything else, this picture is over-exposed with too many pixels only for highlight sections.



If the histogram has only peaks on the left side without anything else, this picture is under-exposed with too many pixels only for shadow sections.

Correct the exposure to an appropriate level.



Note

- The histogram displayed on the LCD monitor is for reference only. Depending on the shooting conditions (use of the flash, dark surrounding light, etc.), the exposure level indicated in the histogram may not correspond to the brightness of the shot image.
- Exposure compensation has its limitation. It does not necessarily achieve the best possible result.
- A histogram with peaks in the center may not necessarily provide the best result to suit your particular requirements.
For example, an adjustment is required if you want to underexpose or overexpose the image.



Reference

For information on how to correct the exposure compensation, see P.78.

Basic Shooting

Now you are ready.

Holding the Camera

Hold the camera as shown below for best results.

1. **Hold the camera with both hands and lightly press both elbows against your body.**

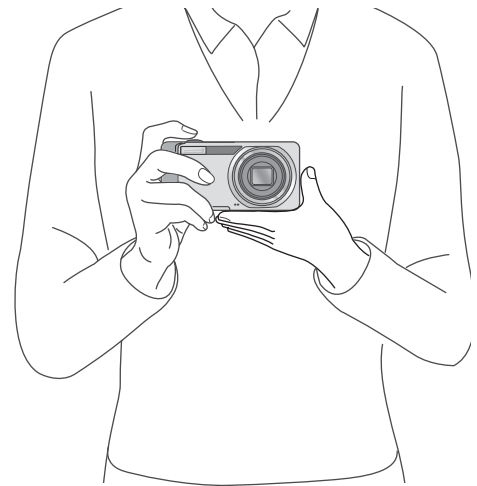

2. **Put your finger on the shutter release button.**

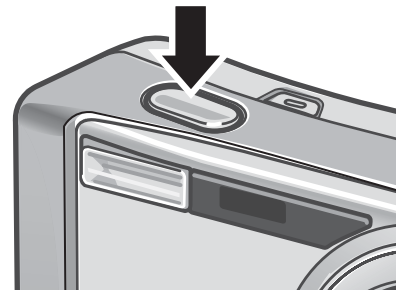

Note

When you are shooting, be careful not to obstruct the lens or flash with your fingers, hair, or the handstrap.

Preventing Camera Shake

If you move the camera when pressing the shutter release button, the still image might not come out clearly due to camera shake. The



mark displayed on the LCD monitor indicates that camera shake may occur.

To prevent camera shake, use a tripod or hold the camera securely with both hands when you shoot.

Camera shake tends to occur in the following cases:

- When shooting in a dark place without using the flash
- When shooting in Slow Sync Mode (P.36)
- When using the Zoom function
- When shooting using long time exposure (P.73)

If the camera shake warning mark () is displayed, try the following:

- Using the flash (Set the Flash Mode to [AUTO] or [FLASH ON]) (P.36).
- Raising the ISO setting (P.81).
- Using the self-timer (P.86).



Quickly Shooting Pictures (Full-press)

The shutter release button works in two steps. You can press the shutter release button halfway down (half-press) and press it all the way down (full-press). Full-press the shutter release button for quick focusing, so as not to miss a shooting opportunity.

1. Press the **POWER** button to turn the camera on.

For information on how to turn the power on, see P.22.

2. Switch the Mode Selector to .

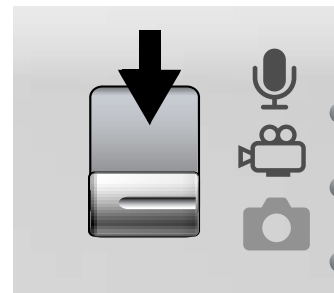

3. Compose your shot by looking at the LCD monitor.



4. Make sure the subject is centered on the screen, and gently press the shutter release button fully.

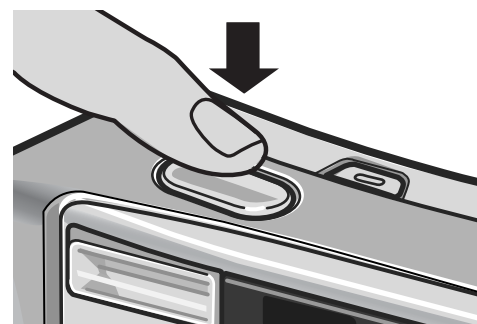

Note

- The still image you have taken freezes for a moment on the LCD monitor and is recorded. (P.117)
- Full-press is likely to cause the camera to shake. Hold the camera firmly with both hands and shoot.



Checking the Focus and Shooting (Half-press)

When you press the shutter release button halfway (half-press), the auto-focus function is triggered to determine the focal distance. Next, press it all the way down (full-press) to shoot. This is useful when the subject is not in the center of the screen (P.32).

1. Press the **POWER** button to turn the camera on.

For information on how to turn the power on, see P.22.

2. Switch the Mode Selector to .

3. Compose your shot by looking at the LCD monitor.

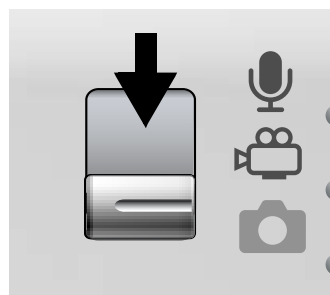

4. Since the focus is adjusted at the center of the screen, position the subject at the center of the screen and half-press the shutter release button.

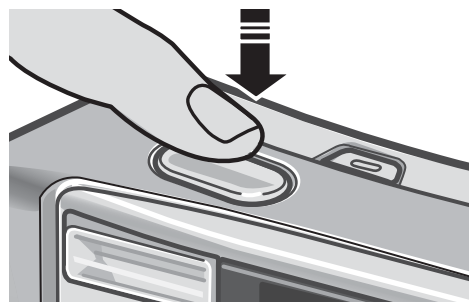

The camera focuses on the subject and the exposure is fixed.

If automatic focusing fails, the frame in the center of the LCD monitor turns red and the auto focus/flash lamp in the upper right of the LCD monitor blinks in green.

Auto Focus/Flash Lamp

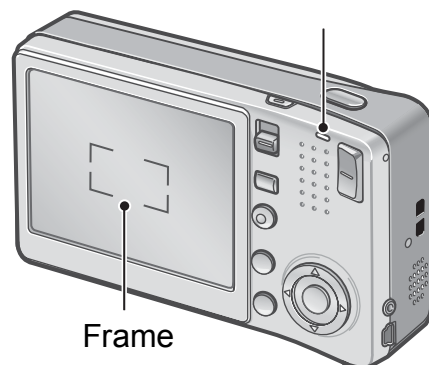

Frame

	Frame Color	Auto Focus/Flash Lamp
Before focusing	White	Off
Subject in focus	Green	On (green)
Subject not in focus	Blinks (red)	Blinks (green)

The focal distance is measured at a maximum of five points. Green frames appear to indicate the positions that are in focus.



Note

To specify a focus position during macro shooting, use the AF target shift function. (P.85)

5. Gently press the shutter release button all the way.

The still image you have taken freezes for a moment on the LCD monitor and is recorded.

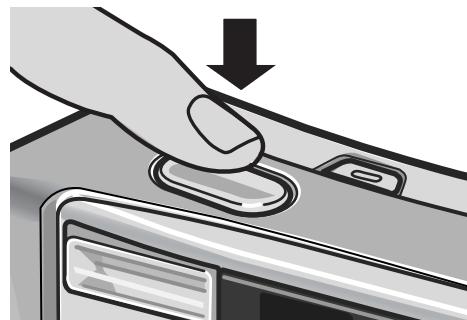

Note

- Press the shutter release button gently to prevent camera shake.
- The  mark indicates that camera shake may occur. Hold the camera still and focus the camera again.
- The flash fires twice to increase the AE/AF (Auto Exposure/Auto Focus) accuracy.
- When [LCD CONFIRM.] is set to [OFF] in the SETUP screen, the still image shot will not be displayed on the LCD monitor.

Reference

- For information on how to change the image confirmation time, see P.117.
- For information on how to change the focusing mode, see P.62.



When the Subject is Not Centered (Shooting with Focus Lock)

When your subject is not in the center of your composition, compose your photo after focusing. (Focus Lock)

Example: Taking a photograph of the castle in the background with the camera focused on a person in foreground.

Shooting range

Subject to be focused on

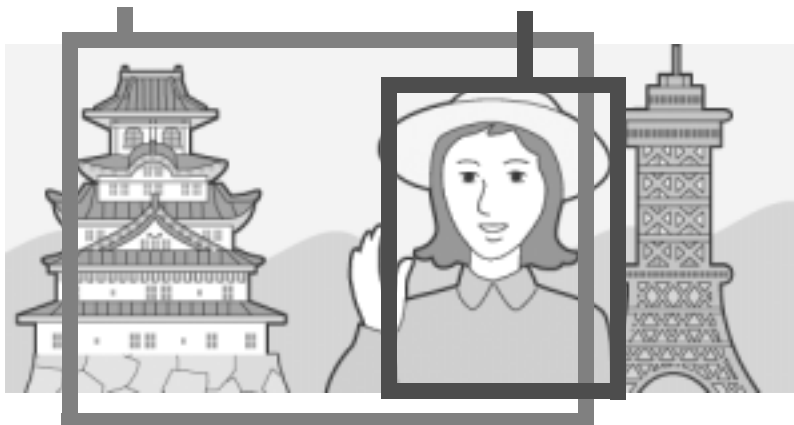

Final still image

- 1. Press the POWER button to turn the camera on.**
For information on how to turn the power on, see P.22.
- 2. Switch the Mode Selector to .**
- 3. Put the subject of your photo in the center of the screen and press the shutter release button halfway.**

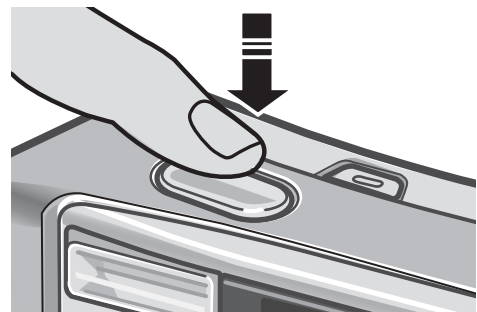

4. With the shutter half-pressed, move the camera to compose your shot.



5. Gently press the shutter release button all the way.

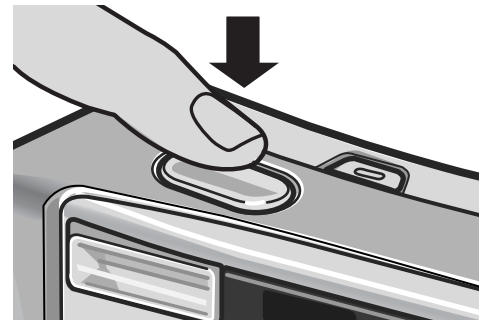

Note

During macro shooting, the AF target shift function allows you to lock the focus without moving the camera. This function is useful when using a tripod.



Reference

- For information about macro shooting, see P.35.
- For information about the AF target shift function, see P.85.



Using the Zoom Function

Pressing the [↶] (Wide-angle) button allows you to take a wide-angle picture. Pressing the [↷] (Telephoto) button allows you to take a close-up picture of the subject.

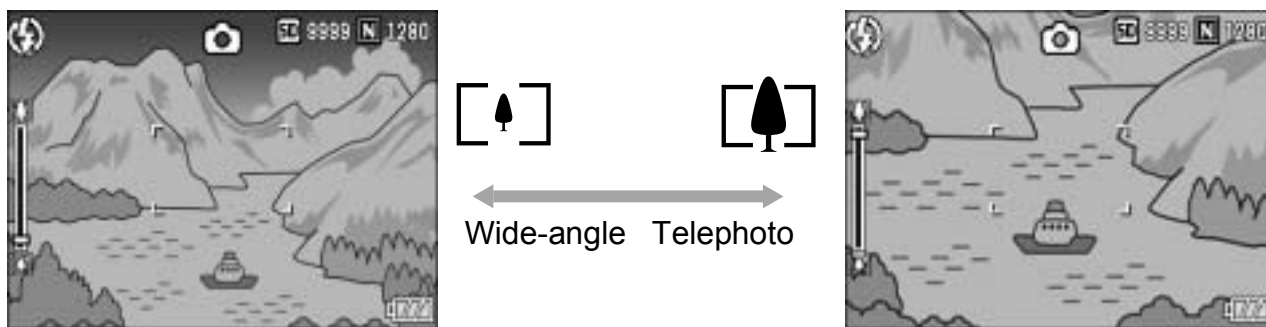

1. With the camera ready to shoot, press the [↶] (Wide-angle) button or the [↷] (Telephoto) button.

You can check the zoom status on the zoom bar of the LCD monitor.

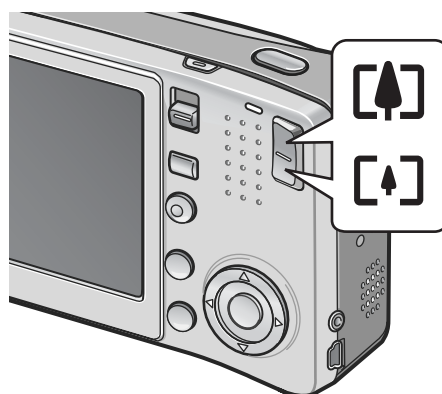

2. Compose your picture and half-press the shutter release button.
3. Full-press the shutter release button.



Note

Using the Digital Zoom

Digital zooming enables you to enlarge the subject more than the maximum magnification of the optical zoom ($\times 5.7$) specified by pressing the [↷] (Telephoto) button (up to $\times 3.6$). For digital zooming, release the [↷] button once when the zoom reaches the limit on the [↷] (Telephoto) end on the Zoom Bar, and then hold the [↷] button down again.

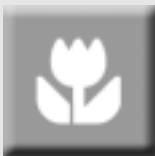



Shooting Close-Ups (Macro Shooting)

Using the  (Macro) button allows you to take a tight close-up of the subject. (Macro shooting)

This is good for shooting small subjects because you can shoot up to one centimeter (0.4 in.) away.

1. **With the camera ready to shoot, press the  (Macro) button.**

 is displayed momentarily at the center of the LCD monitor and then a  is displayed at the top of the screen.

2. **Compose your picture and half-press the shutter release button.**

3. **Full-press the shutter release button.**

To cancel Macro Mode, press the  (Macro) button again.

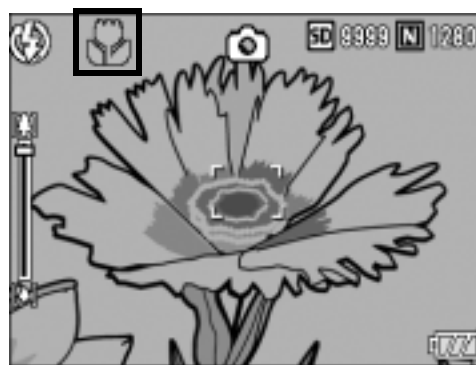
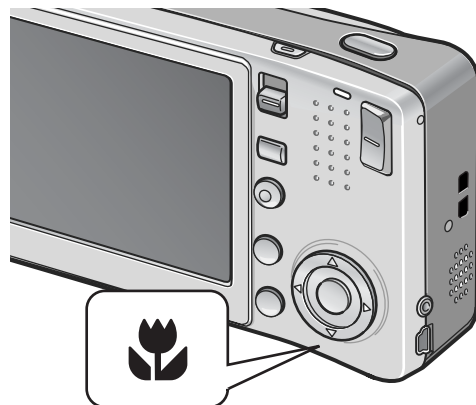

Note

- When using the zoom, you can shoot close-ups within the following distances from the front of the lens:

Wide-Angle	About 1 cm from the front of the lens	Shooting range: Approx. 28 mm × 21 mm
Telephoto	About 8 cm from the front of the lens	Shooting range: Approx. 37.5 mm × 28.2 mm (when digital zoom is not used)
		Shooting range: Approx. 10.4 mm × 7.8 mm (when 3.6× digital zoom is used)





- The AF target shift function enables you to lock the focus for macro shooting with the simple touch of a button without moving the camera. This function is useful for shooting on a tripod. (P.85)
- To take a further close-up picture during macro shooting, use [ZOOM MACRO] in Scene Mode. (P.38)





Using the Flash

Press the  (Flash) button to change the flash mode. At the time of purchase, the camera is set to [FLASH OFF]. From the front edge of the lens, the flash light reaches about 0.2 to 2.4 m (7.9 in. to 7.9 ft.) (Wide-angle) or about 0.14 to 1.85 m (5.5 in. to 6.1 ft.) (Telephoto) when the ISO setting is set to [AUTO].

Flash Modes

	FLASH OFF	The flash will not fire.
	AUTO	The flash fires automatically when the subject is poorly lit or backlit.
	RED-EYE FLASH	Reduces the red-eye phenomenon, in which people's eyes appear red in pictures.
	FLASH ON	The flash fires regardless of the lighting conditions.
	FLASH SYNCHRO.	The flash fires with the shutter speed slowed. This is useful when taking portrait pictures in a nightscape. The use of a tripod is recommended.

1. Switch the Mode Selector to .
2. Press the  (Flash) button to change the Flash Mode.

The flash mode mark is displayed momentarily at the center of the LCD monitor and then a smaller mark is displayed at the upper left of the screen. The Auto Focus/Flash Lamp blinks while the flash charges. Once the flash is charged, the lamp turns off and the camera is ready to shoot.

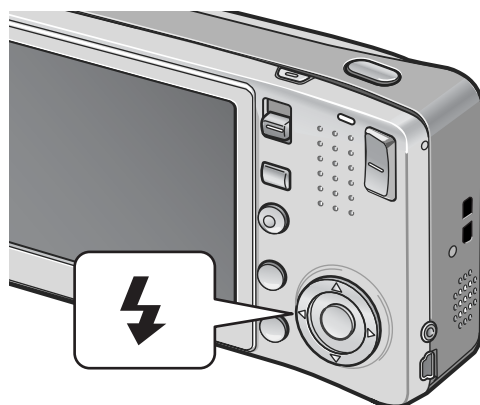





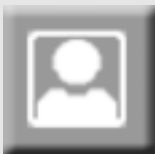



Note





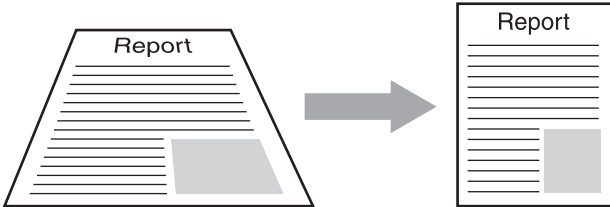

- The setting is saved until you press the  (Flash) button again.
- The flash does not fire when shooting movies or in Multi-Shot mode.
- The flash fires twice to increase the AE/AF (Auto Exposure/Auto Focus) accuracy.



Shooting with Optimal Settings According to Shooting Conditions

You can use Scene Mode to select from among eight still image modes and shoot with settings automatically optimized for shooting conditions.

	PORTRAIT	Use when taking portrait pictures.
	SPORTS	Use when taking pictures of moving objects.
	LANDSCAPE	Use when taking scenery pictures with abundant greenery or blue sky.
	NIGHTSCAPE	Use when shooting night scenes. You can also shoot with persons in the frame.  Note <ul style="list-style-type: none">• In Nightscape Mode, the flash fires when all of the following conditions are satisfied:<ul style="list-style-type: none">• The flash is set to Auto.• The flash is determined to be necessary because it is dark.• There is a figure or another object nearby.
	SKEW COR MODE	Use to straighten a rectangular object, such as a message board or business card, shot at an angle to make it look as if it were shot squarely. For detailed operations, see P.40.   Note <p>In Skew Correction Mode, choose from F1280, N1280, and N640 for the image size. (P.60)</p>

	TEXT MODE	<p>Use when capturing text images, for example notes written on a whiteboard at a meeting.</p> <p> Reference</p> <p>To change the shading of the text, see P.84.</p>
	ZOOM MACRO	<p>Use when taking a further close-up picture during macro shooting. Using the digital zoom allows you to take a larger close-up than with normal macro shooting. For detailed operations, see P.39.</p> <p> Note</p> <ul style="list-style-type: none"> • The optical zoom cannot be used in this mode. • You can shoot close-ups within the following distances from the front of the lens. <ul style="list-style-type: none"> When digital zoom is not used: About 1 cm from the front of the lens Shooting range: 23 mm × 17 mm When 3.6× digital zoom is used: About 1 cm from the front of the lens Shooting range: 6.4 mm × 4.7 mm <p> Reference</p> <ul style="list-style-type: none"> • For information on Macro Mode, see P.35. • For information about zoom operation and digital zoom, see P.34.
	HIGH SENS	<p>Use when taking pictures in dimly lit places. The LCD monitor also becomes brighter.</p>

 **Reference**

- For information about changing the picture quality and image size, see P.60.
- For the list of Shooting Setting menu items in Scene Mode, see P.171.
- For the combination of Scene Mode functions, see P.170.

1. Switch the Mode Selector to .

2. Press the SCENE button.

The Scene Mode selection screen appears.

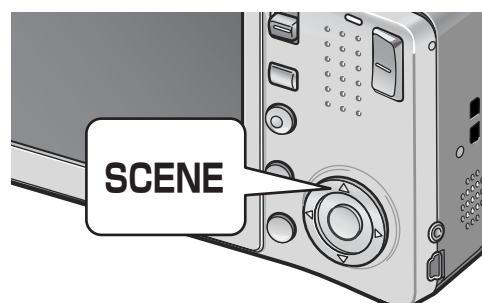

3. Press the ▲▼ buttons to select the Scene Mode.



4. Press the MENU/OK button.

The Scene Mode type is displayed at the top of the LCD monitor.

5. Press the shutter release button.



Changing Scene Mode

Press the SCENE button to return to the Scene Mode selection screen.

Returning to Normal Shooting Mode

1. Press the SCENE button to return to the Scene Mode selection screen.
2. Press the ▲▼ buttons to select [NRML SHT].
3. Press the MENU/OK button.

Shooting in Zoom Macro Mode

1. Switch the Mode Selector to .
2. Press the SCENE button.
The Scene Mode selection screen appears.
3. Press the ▲▼ buttons to select [ZOOM MACRO].
4. Press the MENU/OK button.
5. Press the [↶] (Wide-angle) or [↷] (Telephoto) button.
The zoom level appears on the LCD monitor.
6. Compose your picture and half-press the shutter release button.
7. Full-press the shutter release button.

Using the Skew Correction Mode

1. Switch the Mode Selector to .

2. Press the SCENE button.

The Scene Mode selection screen appears.

3. Press the   buttons to select [SKEW COR MODE].

4. Press the MENU/OK button.

5. Press the shutter release button to shoot the subject.

Immediately after shooting, the area recognized as the correction range is displayed with an orange frame.

Up to five areas can be recognized.

To select another correction area, move the orange frame to the target area by pressing the  button.

6. Press the MENU/OK button.

The corrected image is recorded. The image before correction is also recorded.

If the target area cannot be detected, an error message appears.

To cancel skew correction, press the  button.

Even if you cancel skew correction, the image before skew correction remains recorded.



Note

When [SKEW COR MODE] is selected, note the following:

- To shoot the subject as large as possible, position it so that the entire portion of the subject is visible on the LCD monitor.
- The camera may fail to recognize the subject in the following cases:
 - When the image is out of focus
 - When four edges of the subject are not clearly visible
 - When it is hard to distinguish between the subject and background
 - When the background is complicated
- Two images, one before correction and the other after correction, are recorded. If the number of remaining shots is less than two, you cannot shoot the subject.
- If the camera is unable to detect a correction area, the image before correction remains recorded.

Playing Back Images











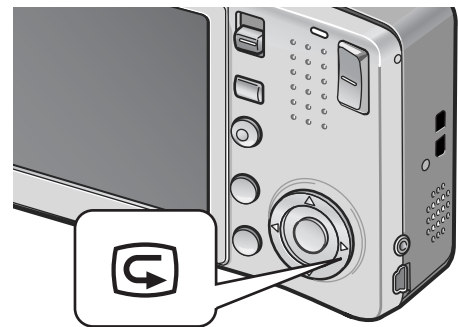



Reviewing the Image You Just Took (Quick Review)

You can view the image you just took on the LCD monitor. If you are not pleased with the way the photo came out, you can delete it then and there.

1. In Still Image Mode, press the (Quick Review) button.

The last image you took is displayed on the LCD monitor.



In Quick Review	
 Button	Returns to Shooting Mode.
 Button	Enlarges the displayed still image. You can move the displayed still image by pressing the     buttons.
 Button	Reduces the displayed still image enlarged by pressing the  button.
MENU/OK Button	Enlarges the displayed still image enlarged by pressing the  button to the maximum available magnification. Pressing this again returns the still image to its original size.
 Button	Deletes the currently displayed file. When the  button is pressed, a warning message about deleting the file appears. Select [DELETE] and press the MENU/OK button.



Note

- Once the power is turned off, the image you took cannot be displayed in Still Image Mode even if you press the  (Quick Review) button.
- If you use Quick Review to view the image taken in [TEXT MODE] of Scene Mode (P.38), the displayed image may have a slightly lower quality than the recorded one.





Viewing Your Images

In Playback Mode, you can check still images you have taken. You can also delete or zoom in on the images.

1. Press the (Playback) button.

The camera switches to Playback Mode and the last still image you took is displayed.

You can view your pictures in order by using the   buttons.

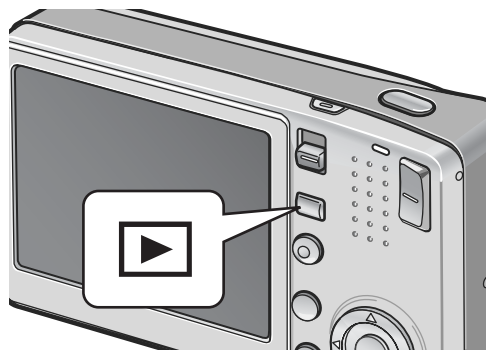

To switch the camera from Playback Mode to Still Image Mode (or Movie or Voice Memo Mode), press the  (Playback) button again.



Note

Turning on the camera in Playback Mode

When the camera is off, pressing the  (Playback) button for more than one second turns the camera on. (The camera starts up in Playback Mode.)

When the camera has been turned on with the  (Playback) button, pressing the  (Playback) button again switches Playback Mode to Shooting Mode.

Where images are played back from

When no SD memory card is loaded, the camera plays back from the internal memory.
When an SD memory card is loaded, it plays back from the SD memory card.



Reference

- For information on how to playback movies, see P.94.
- For information on how to playback sounds, see P.96.
- For information on how to playback still images with a voice memo, see P.76.



Playing Back Images in the Three-frame View

The playback screen can be divided into three frames. The three-frame view allows you to select a still image to enlarge or delete.

1. Press the (Playback) button.

The last image you took is displayed.

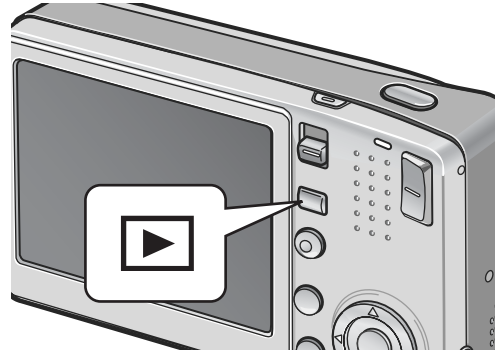

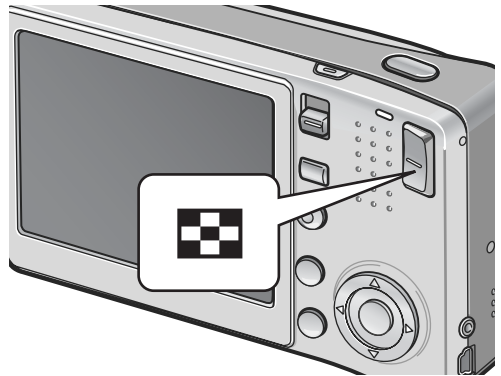

2. Press the (Thumbnail Display) button.

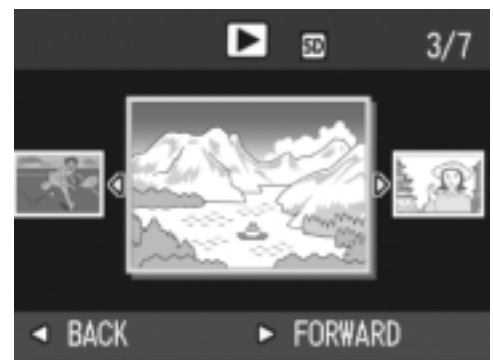

The screen changes to three-frame view. The large frame at the center of the screen displays the currently selected still image.



Switching to Single-Picture Display

1. Press the  buttons to select a still image.
2. Press the  (Enlarged View) button or the MENU/OK button.

Switching the Playback Screen

The playback screen changes as follows:



Note

If any of the following operations is performed in the three-frame view, the display returns to the ordinary playback screen (single-picture display) and the operation is executed.

- Deletion (P.49)
- Menu display (P.97)
- Movie playback (P.94)
- Sound playback (P.96)



Reference

For information on how to delete unwanted images, see P.49.



Thumbnail Display

You can view your images in sets of 12.
You can then select an image to enlarge or delete.

1. Press the  (Playback) button.

The last image you took is displayed.

2. Press the  (Thumbnail Display) button.

The screen changes to three-frame view.

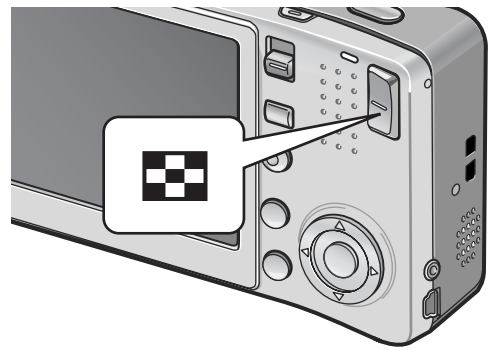

3. Press the  (Thumbnail Display) button.

The screen is divided into 12 frames and 12 still images are displayed together.

Selected still image

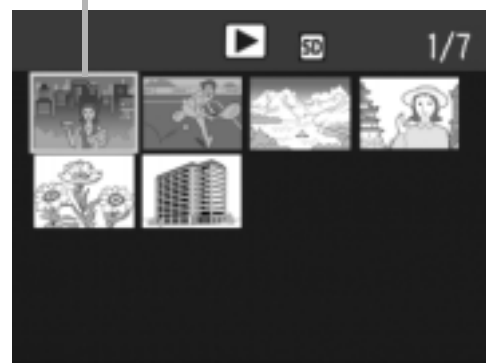

Displaying One Photo

1. Press the     buttons to select a still image.

2. Press the  (Enlarged View) button twice.



Reference

- For information on how to delete the selected image, see P.50.
- For information on how to switch to the three-frame view, see P.43.



Magnifying Images

You can enlarge a still image displayed on the LCD monitor.

2816 × 2112, 2784 × 1856, 2048 × 1536	8 times
1280 × 960	6.7 times
640 × 480	3.4 times

1. Press the  (Playback) button.

The last image you took is displayed.



2. Press the  buttons to display the still image you want to enlarge.

3. Press the  (Enlarged View) button.

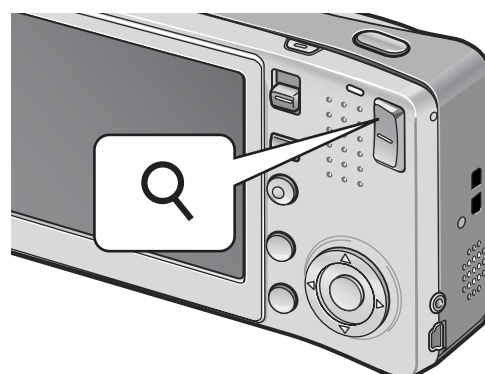
The still image is enlarged.

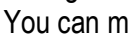

In Enlarged View

 Button	Enlarges the displayed still image. You can move the displayed still image by pressing the  buttons.
 Button	Reduces the displayed still image enlarged by pressing the  button.
MENU/OK Button	Displays the still image at the maximum magnification. Pressing this again returns the still image to its original size.



Note

Enlarged view is also available in the Quick Review Mode.

Viewing on a Television

You can view still images you have taken on a TV screen. The camera displays everything on the TV screen just as it would on the LCD monitor.

To use your television for viewing, connect your camera to the television with the AV cable that came with your camera.

To view still images on a television, follow the steps below.

1. Securely connect the AV cable to the Video In terminal on the television.

Connect the white plug of the AV cable to the audio input terminal (white) of the TV unit and the yellow plug to the video input terminal (yellow).

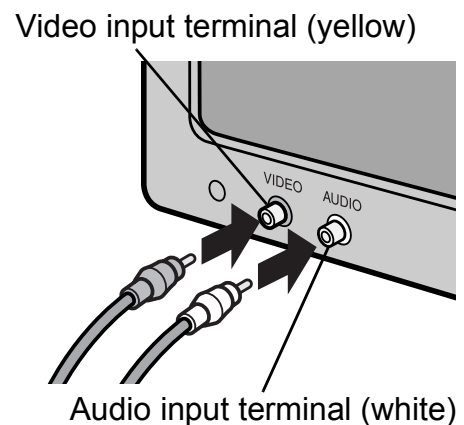

- 2. Make sure that the camera is off.**
- 3. Securely connect the AV cable to the AV Output Terminal on the camera.**

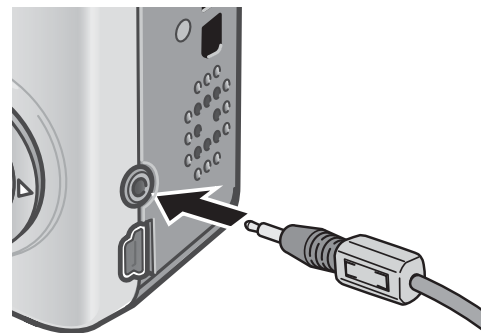

4. Set the television to Video mode. (Set the input to Video)

For details, see the documentation that came with the television.

5. Press the **POWER** button or the **▶ (Playback)** button for more than one second to turn the camera on.

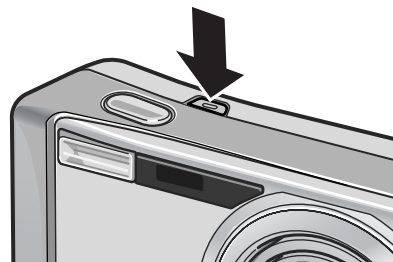

Caution

When the AV cable is connected to the camera, the LCD monitor and the speaker output turn off.

Note

- You can connect the AV cable to the Video In terminal on your television and record what you have shot to a video recorder.
- Your camera is set to NTSC playback format (used in Japan and other countries) for use with television equipment and other audiovisual equipment. If the equipment you want to connect to uses PAL format (used in Europe and elsewhere), then switch your camera to PAL format in the SETUP Menu before connecting.

Reference

For information on how to change the video out mode, see P.122.

Deleting Files



Deleting Unwanted Files (Still Images/Movies/Sounds)

You can delete unwanted or failed files from the SD memory card or internal memory.

You can delete them in the following three ways:

- Delete one file at a time
- Delete all files at once
- Select multiple frames and delete together

1. Press the (Playback) button.
2. To delete images one at a time, press the buttons to display the file you want to delete.
3. Press the (Delete) button.
4. Press the buttons to select [DELETE ONE] or [DELETE ALL].
If you select [DELETE ONE], you can change the image for deletion with the buttons.
5. Press the MENU/OK button.

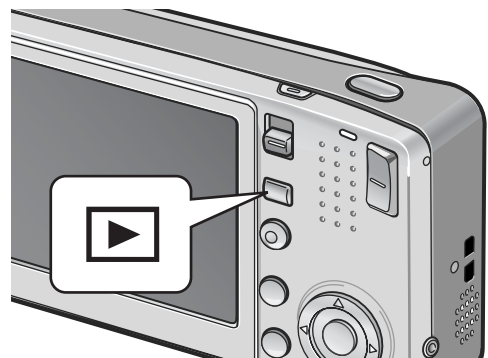

If You Selected [DELETE ONE]:

The display indicates that the files are being deleted; once finished, it returns to the screen in Step 4.

If You Selected [DELETE ALL]:



You will be prompted to confirm that you want to delete all images. If so, press the button to select [YES], and then press the MENU/OK button.

Note

In three-frame view (P.43), you can display a still image at the center of the screen and press the (Delete) button to delete it.



Deleting Multiple Files at One Time

1. Press the  (Playback) button.
2. Press the  (Thumbnail Display) button twice.

The screen is divided into 12 frames and 12 files are displayed together.

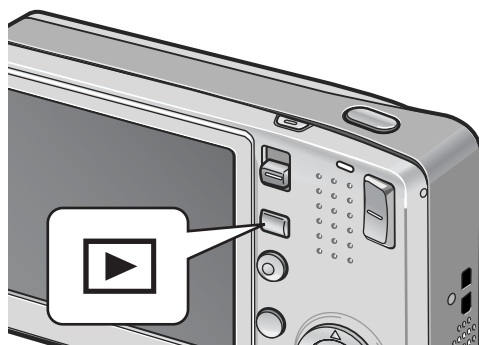

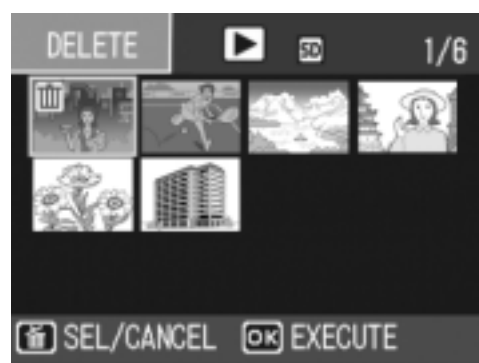

3. Press the     buttons to select the file you want to delete and press the  (Delete) button.

The trash symbol is displayed in the upper left corner of the file.



4. Repeat Step 3 to select all the files you want to delete.

If you selected a file by mistake, you can deselect it by selecting the file and pressing the  (Delete) button again.

5. Press the MENU/OK button.
6. Press the   buttons to select [YES] and then press the MENU/OK button.

The display indicates that the files are being deleted; once finished, it returns to the Thumbnail Display screen.

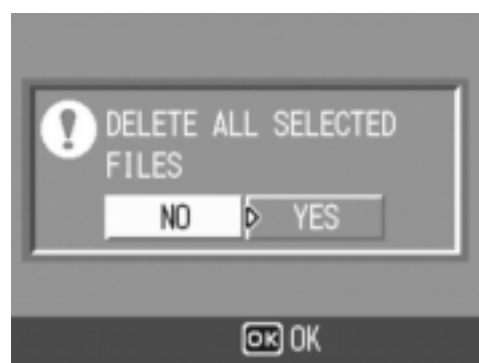

Chapter 2

Using the Various Shooting and Playback Functions

Direct Printing	52
Various Shooting Functions	57
Shooting with Multi-Shot (CONT. MODE)	87
Shooting/Playing Back Movies.....	91
Recording/Playing Back Sound	95
Other Functions Available in Playback Mode.....	97

Direct Printing

Direct Print Function

The Direct Print standard enables direct printing from a camera to a printer by connecting them via a USB cable. Photos can be printed quickly and easily from your digital camera without using a computer.



Caution

- You cannot print movies (AVI files) with this function. For still images with sounds (JPG files with WAV files), only the still images (JPG files) are printed.
- Some printers do not support images taken in Text mode (TIFF files) (P.38). Even when TIFF images are printed, their printed contents cannot be guaranteed.



Note

- This camera uses PictBridge, an industry standard for Direct Printing.
- Your printer must be compatible with PictBridge to use the Direct Print function. For support information, see the documentation that came with the printer.
- For some printers, Direct Print may not be available when [MASS STR] is selected for [USB CONNECTION] (P.125) in the SETUP menu of the camera. In such cases, select [ORIGINAL] instead.

Connecting the Camera to a Printer

Connect your camera to a printer using the USB cable provided.

- 1. Make sure that the camera is off.**
- 2. Connect your camera to a printer using the USB cable provided.**

Turn on the printer.



Note

To disconnect the camera from the printer, check that the power is off on both units before disconnecting the USB cable between them.

Printing Still Images

You can send still images from the camera to a PictBridge-compatible printer to print them.

Still images are sent from the internal memory when no SD memory card is loaded or from an SD memory card when one is loaded.



Caution

Do not disconnect the USB cable during printing.



Note

If a [PRINTER ERROR] message appears during image transfer, check the printer status and take the appropriate action.

Printing One or All Still Images

1. Check that the printer is ready to print.

The [CONNECTING...] screen appears.

2. Press the ADJ. button.

The Direct Print playback mode screen appears.

3. Press the ◀▶ buttons to select an image for printing.

4. Press the ADJ. button.

5. Press the ▲▼ buttons to select [1 FILE] or [ALL FILES].

6. Press the MENU/OK button.

The Direct Print menu appears.



7. Press the ▲▼ buttons to select an item, and then press the ► button to display the detailed options screen.

When [CONNECTING...] is displayed, the connection to the printer is not yet established. When a connection is established, [CONNECTING...] disappears and [DIRECT PRINT] appears.

Proceed with this step after the connection is established.

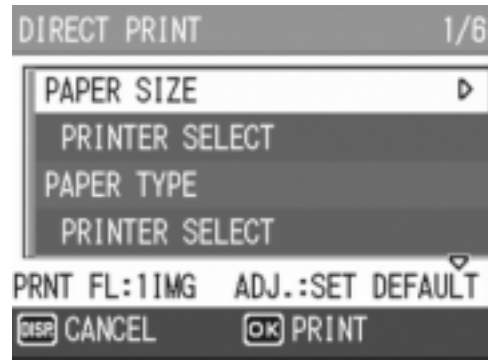

The following items can be selected. Each item appears only when supported by the printer connected to the camera.

The item marked with an asterisk (*) appears only when [REPORT PRINT] is supported by a Ricoh printer connected to the camera.

Item Name	Description
PAPER SIZE	Sets the paper size.
PAPER TYPE	Sets the paper type.
LAYOUT	Sets the number of images printed on a sheet of paper. The number of images that can be laid out on a sheet of paper varies depending on the connected printer.
DATE PRINT	Selects whether to print the date (shooting date). The date format can be set using the date/time option in the SETUP menu.
FILE NAME PRINT	Selects whether to print the file name.
OPTIMIZE IMAGE	Selects whether to optimize the image data (still image) prior to printing on the printer.
PRINT SIZE	Sets the print image size.
PRINT QUALITY	Sets the print quality.
REPORT PRINT*	Prints on forms.

8. Press the ▲▼ buttons to select the setting, and then press the MENU/OK button.

The display returns to the Direct Print menu.

9. Repeat Steps 7 and 8 to change other settings as required.



Note

To specify the setting as the default setting next time the camera is connected to the printer, press the ADJ. button when the screen in Step 7 is displayed. When the screen at the right appears, press the ◀▶ buttons to select [SET] and press the MENU/OK button. Select [CANCEL] to return the print settings to their defaults.

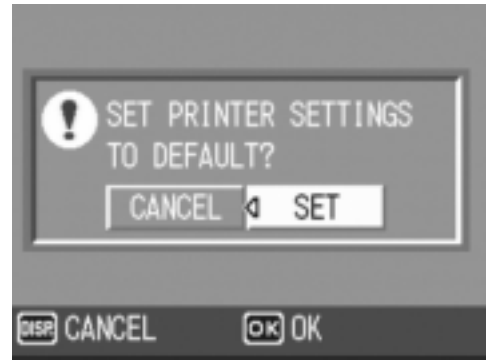

10. Press the MENU/OK button.

The selected still images are sent to the printer and the [SENDING...] screen appears.

Pressing the DISP. button cancels the operation.

When the images have been sent to the printer, the display returns to the Direct Print playback mode screen and printing starts.

Printing Several Still Images

1. Check that the printer is ready to print.

The [CONNECTING...] screen appears.

2. Press the ADJ. button.

The Direct Print playback mode screen appears.

3. Press the (Thumbnail Display) button.

The screen is divided into 12 frames and 12 still images are displayed together.

4. Press the ▲▼◀▶ buttons to select an image for printing.

5. Press the MENU/OK button.

6. Press the ▲▼ buttons to set the number of copies to print.

Press the ▲ button to increase the number of copies, or press the ▼ button to decrease the number of copies.

7. Press the ◀▶ buttons to select the next image for printing.

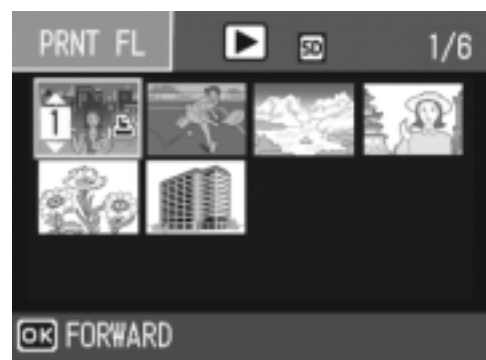
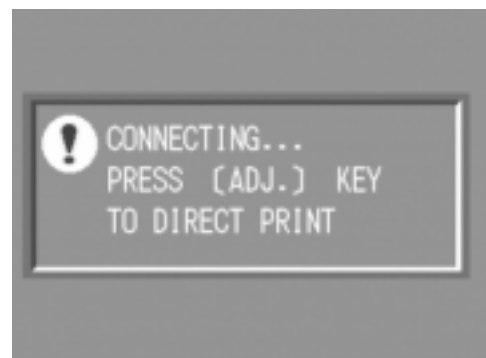

8. Press the ▲▼ buttons to set the number of copies to print.
9. Repeat Steps 7 and 8 to select all the still images to be printed and the number of copies for each.

10. Press the MENU/OK button.

The Direct Print menu appears.

11. Press the ▲▼ buttons to select an item, and then press the ► button to display the detailed options screen.

When [CONNECTING...] is displayed, the connection to the printer is not yet established.

When a connection is established, [CONNECTING...] disappears and [DIRECT PRINT] appears.

Proceed with this step after the connection is established.

For available settings, see P.54.

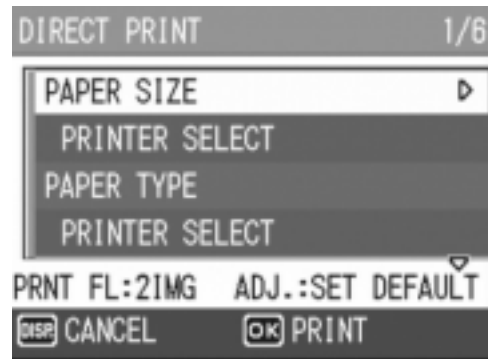

12. Press the ▲▼ buttons to select the setting, and then press the MENU/OK button.

The display returns to the Direct Print menu.

13. Repeat Steps 11 and 12 to change other settings as required.

14. Press the MENU/OK button.

The selected still images are sent to the printer and the [SENDING...] screen appears.

Pressing the DISP. button cancels the operation.

When all the selected still images have been sent from the camera to the printer, the camera display returns to the Direct Print playback mode screen.



Note

- Only images with a printer mark () are printed. If you cancel printing and then try to print again, make sure that the printer mark is on the images you want to print.
- The same still image can also be printed several times on a single sheet.
- The available items vary depending on the functions of the printer.
- To print images using the printer's default settings, select [PRINTER SELECT] on the detailed options screen.

Various Shooting Functions

Using the ADJ. (Adjust) Button

You can use the ADJ. button to adjust the exposure compensation, white balance, and ISO setting with fewer operations. Two functions other than exposure compensation and white balance can also be assigned to the ADJ. button. By assigning a frequently used function to the ADJ. button, you can more easily set that function with fewer button operations.

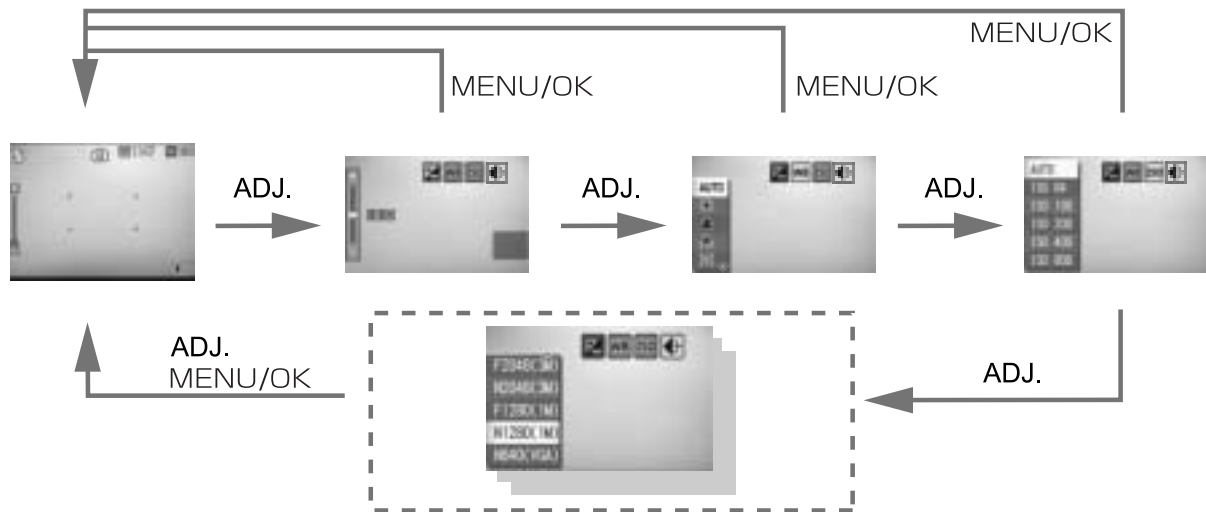

Use the SETUP menu to assign a function to the ADJ. button (P.113).

Settings Using the ADJ. Button

The settings that can be made with the ADJ. button differ between Scene Mode and Movie Mode.

Still Image Mode	ISO setting, picture quality, multi AF/spot AF/MF (focus), sharpness, photometry, auto bracket shooting, multi-shot shooting, image with sound
Movie Mode	White balance
Scene Mode ([TEXT MODE])	Text density
Scene Mode (other than [TEXT MODE])	Exposure compensation, white balance



Reference

- For information about exposure compensation, see P.78.
- For information about white balance, see P.79.
- For information about text density, see P.84.
- For information about how to assign a function to the ADJ. button, see P.113.

Shooting Setting Menu

The Shooting Setting menu enables you to shoot pictures by setting the items listed in the table below.

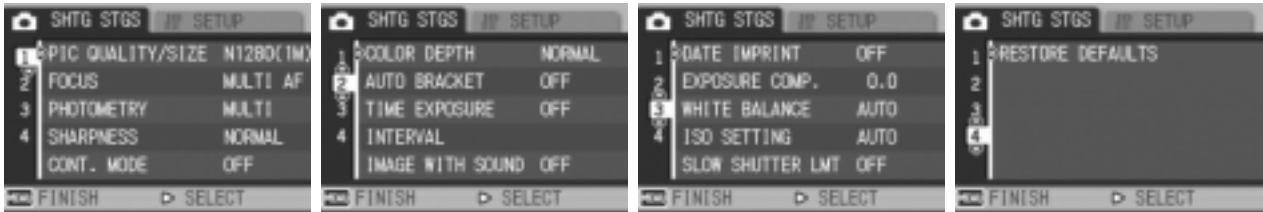

* The default values are enclosed in brackets [].

Setting	Options	Refer to
PIC QUALITY/SIZE	F2816(6M), N2816(6M), F3:2(6M), F2048(3M), N2048(3M), F1280(1M), [N1280(1M)], N640(VGA)	P.60
FOCUS	[MULTI AF], SPOT AF, MF, SNAP, ∞	P.64
PHOTOMETRY	[MULTI], CENTER, SPOT	P.67
SHARPNESS	SHARP, [NORMAL], SOFT	P.68
CONT. MODE	[OFF], CONT., S-CONT, M-CONT	P.87
COLOR DEPTH	[NORMAL], VIVID, NEUTRAL, B&W	P.69
AUTO BRACKET	[OFF], ON, WB-BKT	P.70
TIME EXPOSURE	[OFF], 1 SEC., 2 SEC., 4 SEC., 8 SEC.	P.73
INTERVAL	[0 s], 5 seconds to 3 hours	P.74
IMAGE WITH SOUND	[OFF], ON	P.76
DATE IMPRINT	[OFF], DATE, TIME	P.77
EXPOSURE COMP.	-2.0 to +2.0	P.78
WHITE BALANCE	[AUTO], (OUTDOORS), (CLOUDY), (INCANDESCENT LAMP), (INCANDESCENT LAMP2), (FLUORESCENT LAMP), [M] (MANUAL SETTINGS)	P.79
ISO SETTING	[AUTO], ISO 64, ISO 100, ISO 200, ISO 400, ISO 800	P.81
SLOW SHUTTER LMT	OFF, 1/2, 1/4, [1/8]	P.82
RESTORE DEFAULTS	_____	P.83



Note

The SETUP menu can be accessed from within the Shooting Setting menu. For details, see P.108.



Reference

For the list of Shooting Setting menu items in Movie and Scene Modes, see P.171.

Using the Shooting Setting Menu

1. **With the camera ready to shoot, press the MENU/OK button.**

The Shooting Setting menu is displayed.

2. **Press the ▲▼ buttons to select the desired menu item.**

The menu items are provided on four screens.

Press the ▼ button at the bottom item to display the next screen.

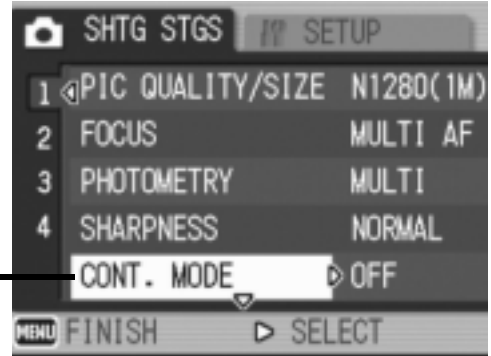

To select a screen by screen number:

1. Press the ◀ button to select a screen number on the left of the screen.
2. With the screen number selected, press the ▲▼ buttons to change screens.
3. After selecting a screen, press the ▶ button to return to the menu item selection step.

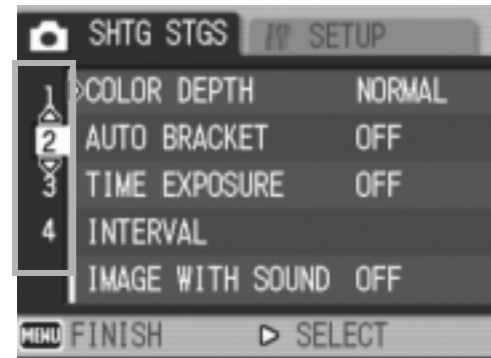

3. **After selecting a menu item, press the ▶ button.**

The menu item settings are displayed.

4. **Press the ▲▼ buttons to select the setting.**

5. **Press the MENU/OK or ◀ button.**



6. **If you pressed the ◀ button in Step 5, press also the MENU/OK button.**

The Shooting Setting menu disappears and the camera is ready to shoot.

Choosing Picture Quality Mode/Image Size (PIC QUALITY/SIZE)

The size of a stored still image depends on the Picture Quality Mode and image size settings.

There are two Picture Quality Modes: N (Normal) and F (Fine).

Picture Quality Modes		
Symbol	Mode	Description
	Normal	The compression ratio is high, resulting in a small file. Normally, shooting is done in this mode.
	Fine	The compression ratio is low, resulting in a large file, but the picture quality is better than in Normal.

Combining Picture Quality Mode and Image Size

		Size				
		2816 × 2112	2784 × 1856	2048 × 1536	1280 × 960	640 × 480
Mode	F (Fine)	F2816 (6M)	F3:2 (6M)	F2048 (3M)	F1280 (1M)	-
	N (Normal)	N2816 (6M)	-	N2048 (3M)	N1280 (1M)	N640 (VGA)
Uses		Suitable for downloading images to your computer and editing the images or printing them in large sizes.	Suitable for printing images in large sizes.	Suitable for shooting many pictures.	Capable of recording the greatest number of pictures on a single SD memory card. Suitable for attaching images to e-mail messages or using them on Web pages.	

Figures inside the bold frame indicate those shown on the screen.

In Movie Mode, you can select 320 × 240 or 160 × 120.

When Scene Mode is set to [TEXT MODE], you can select 2816 × 2112 or 2048 × 1536.



Reference

For internal memory/SD memory card recording capacities, see P.173.

1. Turn the Mode Selector to .
2. Press the MENU/OK button.
The Shooting Setting menu is displayed.
3. Press the ▼ button to select [PIC QUALITY/SIZE] and press the ► button.
4. Press the ▲▼ buttons to select a picture quality/image size.

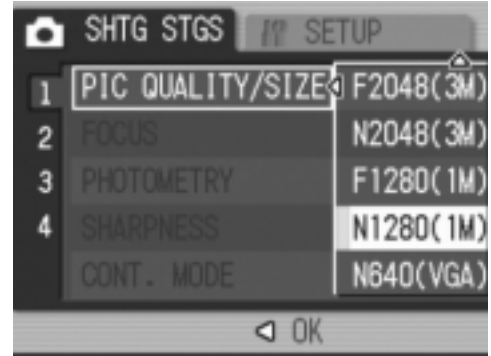

Still Image Mode

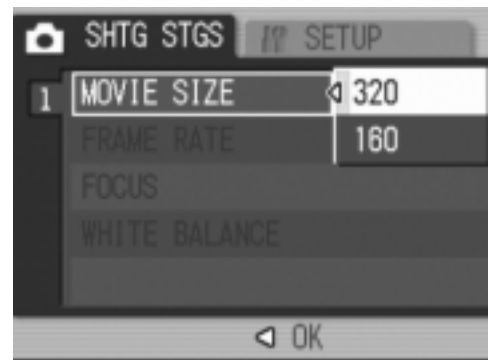

Movie Mode

5. Press the MENU/OK or ◀ button.
The Picture Quality/Image Size settings are completed.
6. If you pressed the ◀ button in Step 5, press also the MENU/OK button.
The Shooting Setting menu closes and the setting appears on the screen.
The setting is used for shooting until it is changed.



Changing the Focusing Mode (FOCUS: MULTI AF/SPOT AF)

If you shoot the subject in the default focusing mode, the camera focuses automatically with Auto Focus (AF).

The camera automatically measures the distances to a maximum of five AF areas from among 17 AF areas and focuses to the nearest AF area (MULTI AF). This prevents the center of the LCD monitor from becoming out of focus and enables you to shoot with a minimum number of out-of-focus pictures.

You can also select one AF area at the center of the picture to allow the camera to focus on this area automatically (SPOT AF).

Choose from the following five Focusing Modes.

Focusing Modes		
Symbol	Mode	Description
None	MULTI AF	Automatically measures the distances to multiple areas to adjust the focus.
None	SPOT AF	Measures the distance to the center of the picture to adjust the focus automatically.
	MF (Manual Focus)	Enables you to adjust the focus manually.
	SNAP	Fixes the shooting distance to a short distance (about 2.5 m (8.2 ft.)).
	∞ (Infinity)	Fixes the shooting distance to infinity.

Changing the Auto Focus Mode (MULTI AF/SPOT AF)

1. Switch the Mode Selector to .
2. Press the MENU/OK button.
The Shooting Setting menu is displayed.
3. Press the ▼ button to select [FOCUS] and press the ► button.
4. Press the ▲▼ buttons to select [MULTI AF] or [SPOT AF].
5. Press the MENU/OK or ◀ button.
6. If you pressed the ◀ button in Step 5, press also the MENU/OK button.

The Focus setting is completed.

The Shooting Setting menu closes.

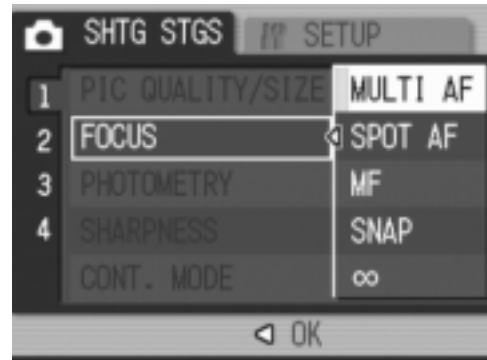

Reference

- For information about fixing the shooting distance to [SNAP] or [∞] (Infinity), see P.66.
- For information about manual focusing, see P.65.

Manual Focus Shooting (FOCUS: MF)

If the camera fails to focus automatically, you can focus manually (Manual Focus: MF).

Manual focus enables shooting at a fixed distance.

Note

- In Scene Mode, Manual Focus can be used only when [ZOOM MACRO] or [SKEW COR MODE] is selected.
- You can also use Manual Focus to focus on objects within the macro shooting range.

Setting Manual Focus

1. Switch the Mode Selector to .
2. Press the MENU/OK button.
The Shooting Setting menu is displayed.
3. Press the ▼ button to select [FOCUS] and press the ► button.
4. Press the ▲▼ buttons to select [MF].
5. Press the MENU/OK or ◀ button.
6. If you pressed the ◀ button in Step 5, press also the MENU/OK button.

The Focus setting is completed.

The Menu closes and [MF] is displayed on the screen.



Shooting with Manual Focus

1. Press the ▼ button as required.

Pressing the ▼ button enlarges the display for easy focusing.

2. Press the ► button to display the focus bar.

Each time the ► button is pressed, the focus bar and zoom bar appear alternately.



3. Press the [▲] (Telephoto) button or the [▼] (Wide-angle) button to adjust the focus.

Pressing the [▲] (Telephoto) button adjusts the focus to farther objects. Pressing the [▼] (Wide-angle) button adjusts the focus to closer objects. The manual focusing setting is used for shooting until it is changed.

4. Press the shutter release button to shoot the picture.

Note

When the zoom bar is displayed, you can operate the zoom bar with the [▲] (Telephoto) button or the [▼] (Wide-angle) button.

Reference

- For information about setting Auto Focus (MULTI AF/SPOT AF), see P.63.
- For information about fixing the shooting distance to [SNAP] or [∞] (Infinity), see P.66.

Shooting at a Fixed Distance (FOCUS: SNAP/Infinity)

The shooting distance can be set to a short distance or infinity. Infinity is useful for shooting distant scenes.

To shoot at a fixed distance, follow the steps below.

1. **Switch the Mode Selector to .**
2. **Press the MENU/OK button.**
The Shooting Setting menu is displayed.
3. **Press the ▼ button to select [FOCUS] and press the ► button.**

4. **Press the ▲▼ buttons to select [SNAP] or [∞] (Infinity).**

Selecting [SNAP] fixes the shooting distance to 2.5 meters (8.2 ft.).

Selecting [∞] fixes the shooting distance to infinity.

5. **Press the MENU/OK or ◀ button.**
6. **If you pressed the ◀ button in Step 5, press also the MENU/OK button.**

The Focus setting is completed.

The Shooting Setting menu closes and the setting appears on the screen.



The setting is used for shooting until it is changed.



Changing the Light Metering (PHOTOMETRY)

You can change the metering method (the range to use for metering) used to determine the exposure value.

There are three Light Metering Modes: MULTI, CENTER, and SPOT.

Light Metering Modes		
Symbol	Mode	Description
None	MULTI	The entire shooting range is divided into 256 partitions, and each is metered to determine the overall exposure value.
	CENTER	The entire image is metered, with emphasis on the center, to determine the exposure value. Use this when the brightness of the center and surroundings are different.
	SPOT	Only the center of the image is metered to determine the exposure value. Use this setting when you want to use the brightness at the center. This is useful if there is a marked difference in contrast or backlighting.

1. Switch the Mode Selector to .
2. Press the MENU/OK button.
The Shooting Setting menu is displayed.
3. Press the ▼ button to select [PHOTOMETRY] and press the ► button.
4. Press the ▲▼ buttons to select the desired setting.
5. Press the MENU/OK or ◀ button.
6. If you pressed the ◀ button in Step 5, press also the MENU/OK button.

The Shooting Setting menu disappears and the setting appears on the screen. The setting is used for shooting until it is changed.

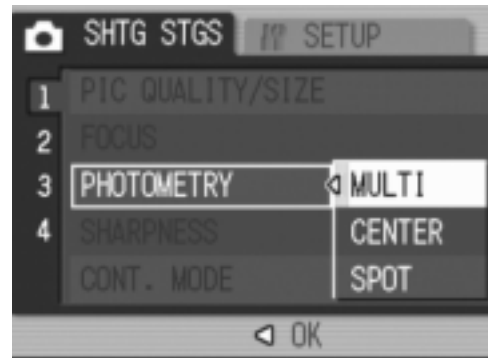

Changing the Edge Quality of Still Images (SHARPNESS)

You can change the edge quality of your still images to either sharp or soft.

1. Switch the Mode Selector to .

2. Press the MENU/OK button.

The Shooting Setting menu is displayed.

3. Press the ▼ button to select [SHARPNESS] and press the ► button.

4. Press the ▲▼ buttons to select the desired setting.

5. Press the MENU/OK or ◀ button.

The Sharpness setting is completed.

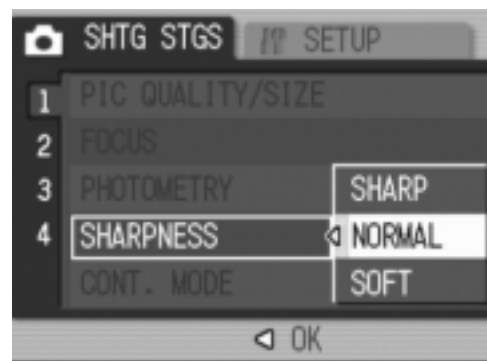







6. If you pressed the ◀ button in Step 5, press also the MENU/OK button.

The Shooting Setting menu disappears and the setting appears on the screen. The setting is used for shooting until it is changed.



Setting the Color Depth (COLOR DEPTH)

You can set the color depth of still images to [NORMAL], [VIVID], [NEUTRAL], or [B&W].

1. **Switch the Mode Selector to .**
2. **Press the MENU/OK button.**
The Shooting Setting menu is displayed.
3. **Press the  button to select [COLOR DEPTH] and press the  button.**
4. **Press the  buttons to select the color depth.**
5. **Press the MENU/OK or  button.**
The color depth setting is completed.

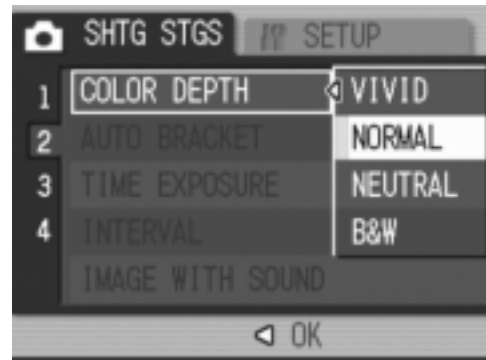

6. **If you pressed the  button in Step 5, press also the MENU/OK button.**

The Shooting Setting menu disappears. If you selected a setting other than [NORMAL], the setting appears on the screen.

The setting is used for shooting until it is changed. The setting is also reflected on the LCD monitor.



Shooting Consecutively with Different Exposures (AUTO BRACKET)

The Auto Bracketing function automatically shoots three consecutive shots at three exposure levels (-0.5EV, ± 0 , and +0.5EV) based on the set exposure level.

Note

This function is not available when shooting with sound.

- 1. Switch the Mode Selector to .**
- 2. Press the MENU/OK button.**
The Shooting Setting menu is displayed.
- 3. Press the \blacktriangledown button to select [AUTO BRACKET] and press the \blacktriangleright button.**
- 4. Press the $\blacktriangle\blacktriangledown$ buttons to select [ON].**
- 5. Press the MENU/OK or \blacktriangleleft button.**
The shooting setting menu disappears and [AB] appears on the screen.
- 6. Press the shutter release button.**
Three consecutive shots are taken at -0.5EV, ± 0 , and +0.5EV based on the set exposure compensation setting.
When shooting is completed, three still images are displayed on the LCD Monitor. They are, from left to right, at -0.5EV (darker), standard exposure compensation setting, and +0.5EV (brighter).
This setting is used for shooting until it is changed or the camera is turned off.

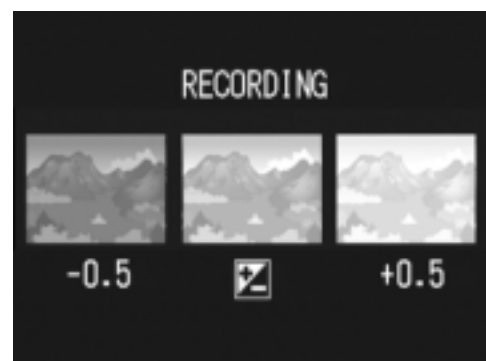

Reference

- For information on how to change the exposure compensation, see P.78.
- For information on how to change the white balance, see P.79.

Shooting Consecutively with Different White Balance (WB-BKT)

The White Balance Bracket function automatically records three images - a reddish image, a bluish image, and an image of the current white balance.

This is useful if you cannot determine the appropriate white balance.

1. **Switch the Mode Selector to .**

2. **Press the MENU/OK button.**

The Shooting Setting menu is displayed.

3. **Press the  button to select [AUTO BRACKET] and press the  button.**

4. **Press the   buttons to select [WB-BKT].**

5. **Press the MENU/OK or  button.**

6. **If you pressed the  button in Step 5, press also the MENU/OK button.**

The White Balance Bracket setting is completed.

The Shooting Setting menu disappears and [WB BKT] appears on the screen.

7. **Press the shutter release button.**

Three images (a reddish image, a bluish image, and an image equal to the current white balance) are automatically recorded. This setting is used for shooting until it is changed or the camera is turned off.

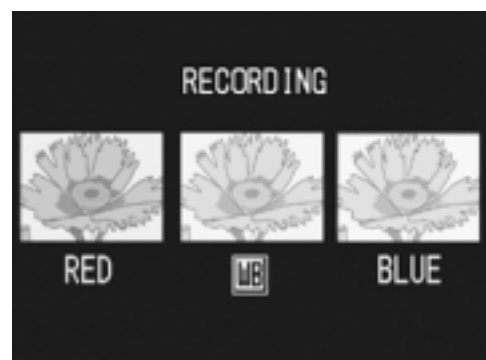
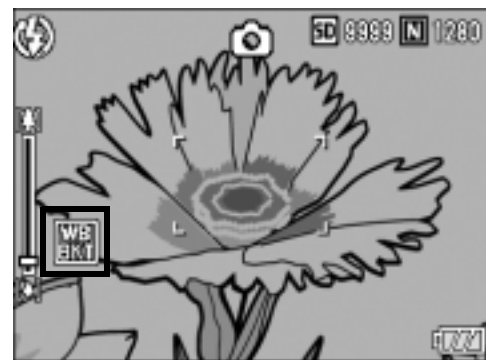
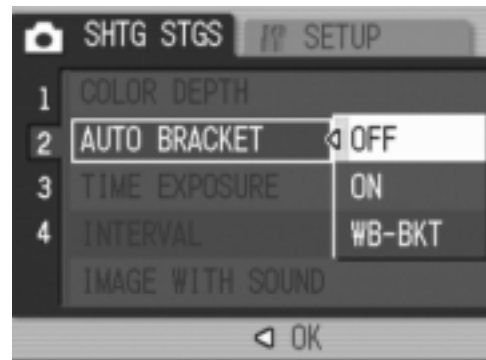



Note

- This function is not available for Multi-Shot (P.87) or Auto Bracket shooting (P.70).
- The flash cannot be used.
- Time Exposure (P.73) is set to [OFF].
- If [COLOR DEPTH] is set to [B&W], the White Balance Bracket function can be set but it does not operate.



Reference

For information on how to change the white balance, see P.79.

Using Long Time Exposure (TIME EXPOSURE)

You can select 1, 2, 4, or 8 seconds for time exposure. By using long time exposure, you can capture the movement of moving subjects such as the trail of fireworks and car lights when shooting a night scene.

1. **Switch the Mode Selector to .**
2. **Press the MENU/OK button.**
The Shooting Setting menu is displayed.
3. **Press the ▼ button to select [TIME EXPOSURE] and press the ► button.**
4. **Press the ▲▼ buttons to select the exposure time.**
5. **Press the MENU/OK or ◀ button.**
6. **If you pressed the ◀ button in Step 5, press also the MENU/OK button.**

The Time Exposure setting is completed.

The Shooting Setting menu disappears and the setting appears on the screen. The setting is used for shooting until it is changed.





Note







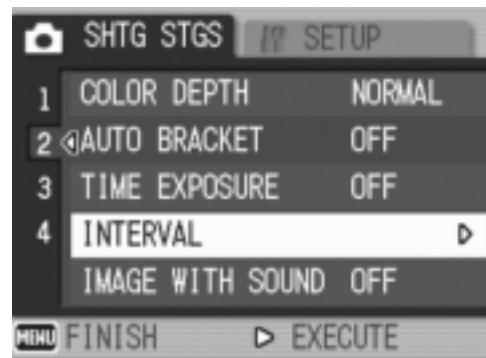

- When using long time exposure, the shutter speed may slow down and images may be blurred. Hold the camera steady by using a tripod when shooting.
- While shooting with long time exposure, the LCD monitor turns off.

Shooting Pictures Automatically at Set Intervals (INTERVAL)

You can set the camera to automatically take pictures at fixed intervals. You can set the shooting interval from 5 seconds to 3 hours in increments of 5 seconds.

1. **Switch the Mode Selector to .**
2. **Press the MENU/OK button.**
The Shooting Setting menu is displayed.
3. **Press the  button to select [INTERVAL] and press the  button.**



4. **Press the   buttons to set the hours.**
5. **Press the  button to move to the minutes setting, then use the   buttons to set the minutes.**
6. **Press the  button to move to the seconds setting, then use the   buttons to set the seconds.**
7. **Press the MENU/OK button.**

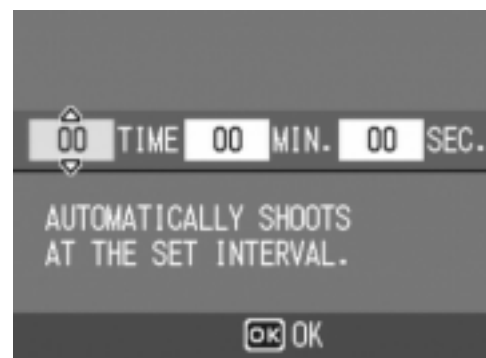

8. **Press the shutter release button.**
A picture is taken every time the fixed interval elapses.
9. **To stop shooting, press the MENU/OK button.**



The Interval Shooting setting is cleared when the camera is turned off.

Caution

The time until the next picture can be taken according to the shooting menu setting may be longer than the time set for Interval Shooting. In this case, the shooting interval becomes longer than the set time.



Note

- In Step 5, you can press and hold either the ▲▼ buttons to quickly raise or lower the minute setting.
- If the battery is not charged sufficiently, it may run down during camera operation. Use of the AC Adapter (sold separately) is recommended.
- If you press the shutter release button during Interval Shooting, the camera will shoot as usual. However, the Interval Shooting setting is unaffected. After shooting, once the time specified in Interval Shooting elapses, the next shot is taken.
- When Interval Shooting is on, consecutive shooting is automatically switched off even when Multi-Shot is set to [CONT.] or [M-CONT].

Shooting a Still Image with Sound (IMAGE WITH SOUND)

You can shoot a still image with a voice memo of up to eight seconds.

1. Switch the Mode Selector to .
2. Press the MENU/OK button.
The Shooting Setting menu is displayed.
3. Press the ▼ button to select [IMAGE WITH SOUND] and press the ► button.
4. Press the ▲▼ buttons to select [ON].
5. Press the MENU/OK or ◀ button.
6. If you pressed the ◀ button in Step 5, press also the MENU/OK button.
The Shooting Setting menu disappears.
7. Press the shutter release button to shoot the picture.
After shooting, voice recording begins.
8. Press the shutter release button to finish recording.



Note

When playing back a still image with sound, display the image in the same way as an ordinary image without sound. Pressing the ADJ. button plays back the sound.

Press the ▲▼ buttons to display the volume adjustment bar. You can adjust the volume with the ▲▼ buttons.

Reference

For information on how to display still images, see P.42.

Inserting the Date into a Still Image (DATE IMPRINT)

You can insert the date (YY/MM/DD) or the date and time (YY/MM/DD hh:mm) at the lower right of a still image.

1. Switch the Mode Selector to .
2. Press the MENU/OK button.
The Shooting Setting menu is displayed.
3. Press the ▼ button to select [DATE IMPRINT] and press the ► button.
4. Press the ▲▼ buttons to select the desired setting.
5. Press the MENU/OK or ◀ button.

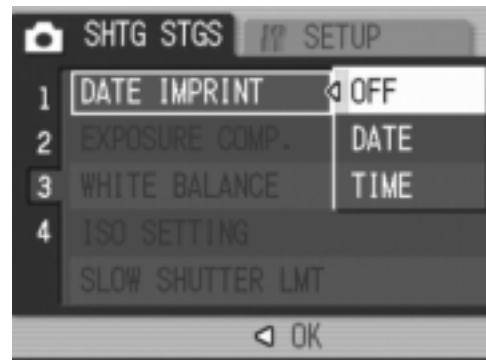

6. If you pressed the ◀ button in Step 5, press also the MENU/OK button.

The Date Imprint settings are completed. The Shooting Setting menu disappears and [DATE] appears on the screen. The setting is used for shooting until it is changed.



Note

- If the date and time have not been set, [DATE IMPRINT] cannot be used. First make the date and time settings (P.120).
- [DATE IMPRINT] cannot be used with movies.
- The date is not displayed on thumbnail images.

Changing the Exposure (EXPOSURE COMP.)

The exposure setting enables you to select the brightness level for your picture. Normally, if your subject is centered, backlight compensation is automatically activated, and you can shoot with the correct exposure.

However, in the following cases, or when you intentionally want to change the exposure, you can adjust the exposure setting. Exposure can be specified in the range from -2.0 to +2.0. Setting the level higher (+) makes the picture brighter and lower (-) makes the picture darker.

For backlighting

When the background is particularly bright, the subject will appear dark (underexposed). In this case, set the exposure level higher (+).

When your subject is whitish





The entire picture will turn out dark (underexposed). Set the exposure level higher (+).

When your subject is darkish

The entire picture will turn out bright (overexposed). Set the exposure level lower (-).

The same happens when you take a photo of a subject in a spotlight.

To change the setting, use either the Shooting Setting menu or the ADJ. button. This section explains easy ways to change the exposure setting with the ADJ. button. To use the Shooting Setting menu, see "Using the Shooting Setting Menu" (P.59).

1. **Switch the Mode Selector to .**
2. **Press the ADJ. button.**
3. **Press the   buttons until the Exposure Compensation bar appears.**
4. **Press the   buttons set the exposure setting.**

You can also press the shutter release button.

5. **Press the MENU/OK button.**

The Exposure Compensation setting is completed and the setting appears on the screen.









Note

When shooting in particularly bright places, you may not be able to correct the exposure level. In that case, the [!AE] symbol will appear on the screen.

Using Natural and Artificial Lighting (WHITE BALANCE)

Adjust the white balance so that a white subject will appear white.



At purchase, the White Balance is set to [AUTO]. Normally you do not need to change the setting, but if the camera is having difficulty determining the white balance when shooting an object of a single color or when shooting under multiple light sources, you can change the setting.

White Balance Modes		
Symbol	Mode	Description
AUTO	AUTO	Adjusts the white balance automatically.
	OUTDOORS	Select this when shooting outdoors (sunny) and white balance fails to adjust properly.
	CLOUDY	Select this when shooting in cloudy weather or shade and the white balance fails to adjust properly.
	INCANDESCENT LAMP	Select this when shooting under incandescent light and white balance fails to adjust properly.
	INCANDESCENT LAMP2	Select this when shooting under incandescent light (more reddish, compared with [INCANDESCENT LAMP])
	FLUORESCENT LAMP.	Select this when shooting under fluorescent light and white balance fails to adjust properly.
	MANUAL SETTINGS	Adjust the white balance manually.

To change the setting, use either the Shooting Setting menu or the ADJ. button.

This section explains easy ways to change the white balance setting with the ADJ. button.

To use the Shooting Setting menu, see “Using the Shooting Setting Menu” (P.59).

1. Switch the Mode Selector to .
2. Press the ADJ. button.
3. Press the ◀▶ buttons until the White Balance menu appears.
4. Press the ▲▼ buttons to select a mode other than .

You can also press the shutter release button.



5. Press the MENU/OK button.

The White Balance setting is completed and the appropriate white balance symbol appears on the screen.

The setting is used for shooting until it is changed.



Setting the White Balance Manually (MANUAL SETTING)

1. Switch the Mode Selector to .
2. Press the ADJ. button.
3. Press the ◀▶ buttons until the White Balance menu appears.
4. Press the ▲▼ buttons to select .
5. Point the camera at a piece of paper or something white under the lighting conditions for your picture.

6. Press the DISP. button.

The white balance is set.

7. Press the MENU/OK button.

The White Balance setting is completed and the appropriate white balance symbol appears on the screen.

The setting is used for shooting until it is changed.

If you press the DISP. button in Step 6, the screen refreshes to show the White Balance settings made. If the result is not as expected, press the ADJ. button and repeat Steps 5 and 6 to change the settings as many times as required.

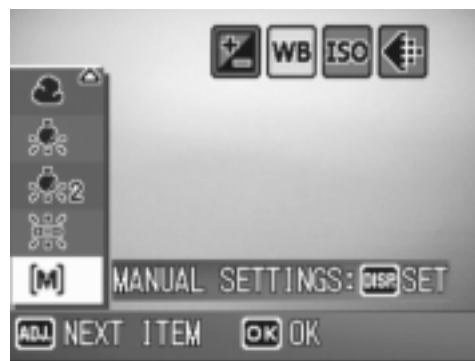

Note

When [AUTO] is selected, the white balance may not be adjusted correctly for a subject that is mostly dark. In this case, add something white to the subject.

Caution

When shooting with the flash, the white balance may not be adjusted correctly if [AUTO] is not selected. In this case, switch to [AUTO] to shoot with flash.

Changing the Sensitivity (ISO SETTING)

ISO sensitivity indicates how sensitive film is to light. A greater value means higher sensitivity. High sensitivity is suitable for shooting an object in a dark place or a fast-moving object while minimizing blurring. However, the images become grainy.

You can choose from the following six ISO settings: AUTO, ISO 64, ISO 100, ISO 200, ISO 400, and ISO 800.

When ISO setting is set to [AUTO], the camera automatically changes the sensitivity according to the distance, brightness, zoom, and macro settings. Usually, use the camera in the [AUTO] mode.

If you do not want to allow the camera to change the ISO sensitivity, select an ISO setting other than [AUTO].

1. **Switch the Mode Selector to .**
2. **Press the MENU/OK button.**
The Shooting Setting menu is displayed.
3. **Press the ▼ button to select [ISO SETTING] and press the ► button.**
4. **Press the ▲▼ buttons to select an ISO setting.**
5. **Press the MENU/OK or ◀ button.**
6. **If you pressed the ◀ button in Step 5, press also the MENU/OK button.**

The ISO setting is completed.
The Shooting Setting menu closes and the setting appears on the screen.
The setting is used for shooting until it is changed.

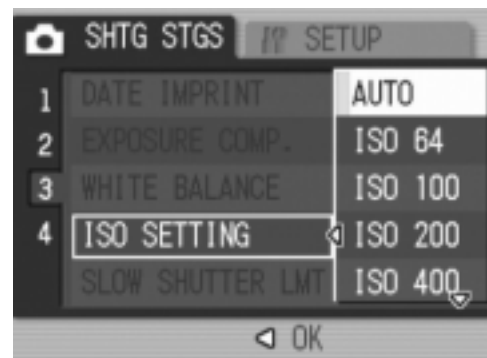

Note

At the Wide-angle zoom setting, when the ISO setting is set to [AUTO], the sensitivity is equivalent to ISO 160 with flash or ISO 100 without flash.

Limiting the Shutter Speed (SLOW SHUTTER LMT)

The maximum shutter speed can be limited to the following:
1/8 second, 1/4 second, and 1/2 second.

When this function is set to [OFF], the maximum shutter speed varies depending on the ISO setting.

1. **Switch the Mode Selector to .**
2. **Press the MENU/OK button.**
The Shooting Setting menu is displayed.
3. **Press the ▼ button to select [SLOW SHUTTER LMT] and press the ► button.**
4. **Press the ▲▼ buttons to select the maximum shutter speed.**
5. **Press the MENU/OK or ◀ button.**
6. **If you pressed the ◀ button in Step 5, press also the MENU/OK button.**

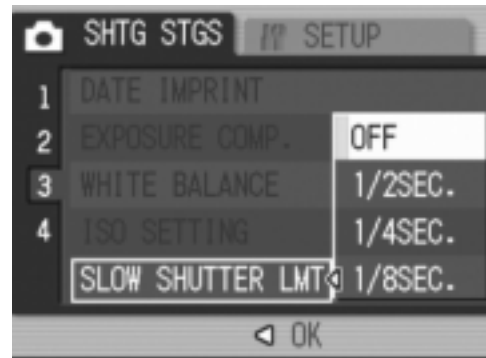

The Slow Shutter Limit setting is completed.

The Shooting Setting menu closes and the setting appears on the screen. The setting is used for shooting until it is changed.







Note

- When Time Exposure is set to [ON], priority is given to Time Exposure.
- When Scene Mode is set to [NIGHTSCAPE], priority is given to the maximum shutter speed in [NIGHTSCAPE].
- When the flash is set to [FLASH SYNCHRO.], the longest shutter speed is one second.
- When using the slow shutter limit, the light quantity may be insufficient depending on the brightness of the subject, resulting in a dark image. In this case, try the following:
 - Selecting a greater slow shutter limit.
 - Raising the ISO setting (P.81).
 - Using the flash. (P.36)

Returning the Shooting Setting Menu Settings to their Defaults (RESTORE DEFAULTS)

To return the Shooting Setting menu settings to their defaults, follow the steps below.

1. Switch the Mode Selector to .
2. Press the MENU/OK button.
The Shooting Setting menu is displayed.
3. Press the   buttons to select [RESTORE DEFAULTS] and press the  button.
4. Make sure that [YES] is selected, and then press the MENU/OK button.

The display indicates the camera is restoring the initial settings. Once it is finished, the display returns to the shooting mode screen.



Reference



For a list of functions whose settings are not reset when the camera is turned off, see P.172.

Changing Shading for Shooting Text (DENSITY)



You can change the shading of text for shooting with [TEXT MODE] in Scene Mode.

You can select from [DEEP], [NORMAL] and [LIGHT].

To change the setting, use either the Shooting Setting menu or the ADJ. button. This section explains easy ways to change the shading setting with the ADJ. button. To use the Shooting Setting menu, see “Using the Shooting Setting Menu” (P.59) and “D. Available Menu Items By Mode” (P.171).

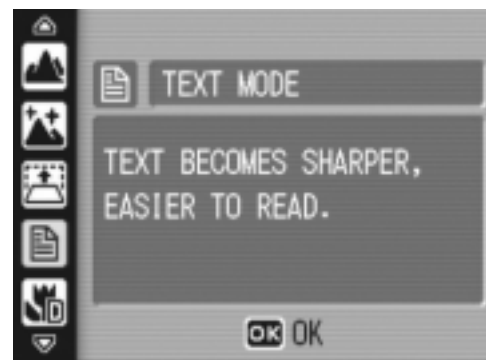
1. **Switch the Mode Selector to .**
2. **Press the SCENE button.**
The Scene Mode selection screen appears.
3. **Press the   buttons to select [TEXT MODE] and then press the MENU/OK button.**



4. **Press the ADJ. button.**
The text density menu appears.
5. **Press the   buttons to select the desired density setting.**
You can also press the shutter release button.

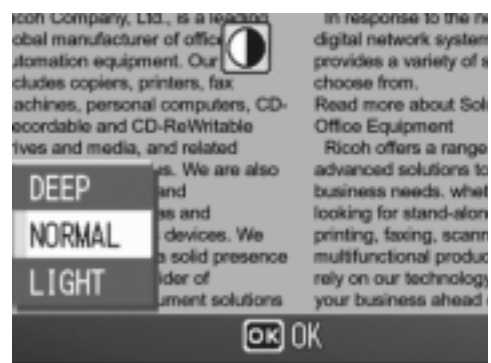

6. **Press the MENU/OK button.**

The text density setting is completed.

The text density setting does not appear on the screen. The setting is used for shooting until it is changed.



Reference

For information on how to shoot text, see P.38.

Using the AF Target Shift Function

During macro shooting, the AF target shift function allows you to lock the focus (P.32) by using the ▲▼◀▶ buttons on the camera without moving the camera.

This is useful for macro shooting on a tripod with Focus Lock.

The AF target shift function allows you to shift the cross-mark at the center of the screen to the subject you want the camera to focus on with the ▲▼◀▶ buttons.

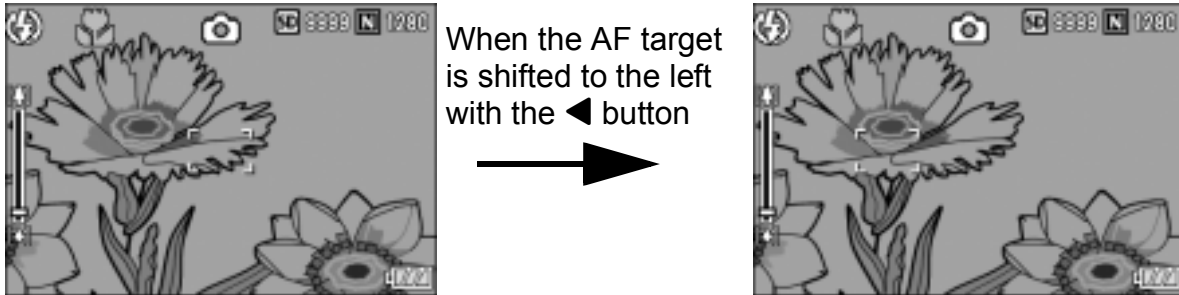

1. **With the camera ready to shoot, press the  (Macro) button.**
The Macro symbol appears at the top of the screen.

2. **Press the ADJ. button.**

3. **Press the ◀▶ buttons until the AF target shift function screen (cross-mark shown in the figure) appears.**

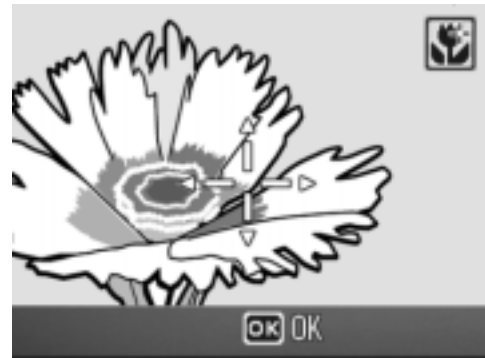

4. **Shift the cross-mark to the subject you want the camera to focus on with the ▲▼◀▶ buttons.**

5. **Press the MENU/OK button.**

6. **Half-press the shutter release button.**

The camera focuses on the area at the position of the cross-mark.



7. **Gently press the shutter release button all the way.**

The AF target shift function automatically focuses the camera on the set position until Macro Mode is canceled.

🕒 Using the Self-Timer

You can set the Self-timer to shoot after either two or ten seconds. A setting of two seconds is useful for preventing camera shake.

1. **Switch the Mode Selector to 📷.**
2. **Press the 🕒 (Self-timer) button.**

The Self-timer symbol appears on the screen.

The [10] to the right of the symbol indicates the number of seconds. In this case, if you press the shutter release button, the camera will shoot after 10 seconds.

Each press of the 🕒 (Self-timer) button changes the self-timer setting in the following order: 10 sec, 2 sec, and Self-timer Off.

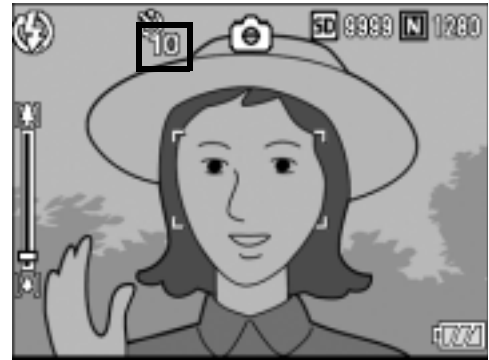

3. **Press the shutter release button.**

The focus is locked, and the flash blinks when the self-timer starts. Once the picture is taken, the self-timer turns off.

Note

- The self-timer setting is canceled when the camera is turned off.
- When the self-timer is set to 2 seconds, the flash does not blink.

Shooting with Multi-Shot (CONT. MODE)

With Multi-Shot, you can shoot consecutive images. Multi-shot has the following three modes:

CONT.

Pictures continue to be taken for as long as you hold down the shutter release button.

Still images are recorded one at a time, just as in normal shooting.

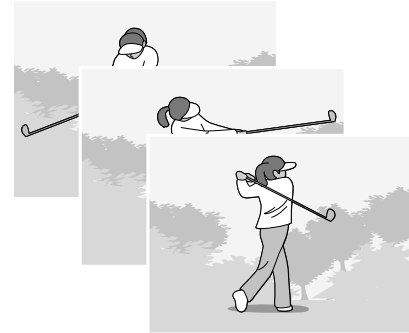

S (Stream)-CONT

With just one full-press of the shutter release button, you can take 16 consecutive shots at intervals of 1/7.5 seconds in about 2.2 seconds. The 16 still images are grouped together as a set and are recorded as one image file (2816 × 2112 pixels).

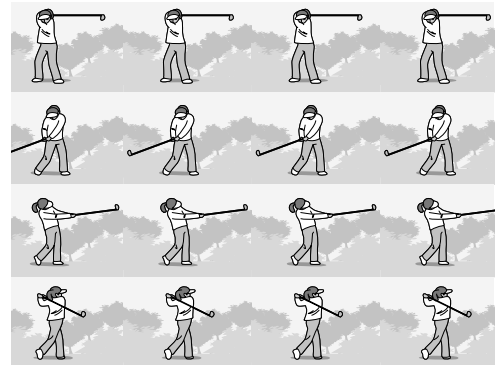

M (Memory-reversal)-CONT

The camera memorizes the scene while you hold down the shutter release button, and once you release it, the previous 2.2 seconds of shots are recorded.

The 16 still images are grouped together as a set and are recorded as one image file (2816 × 2112 pixels).

(2) The camera records for about 2.2 seconds ahead

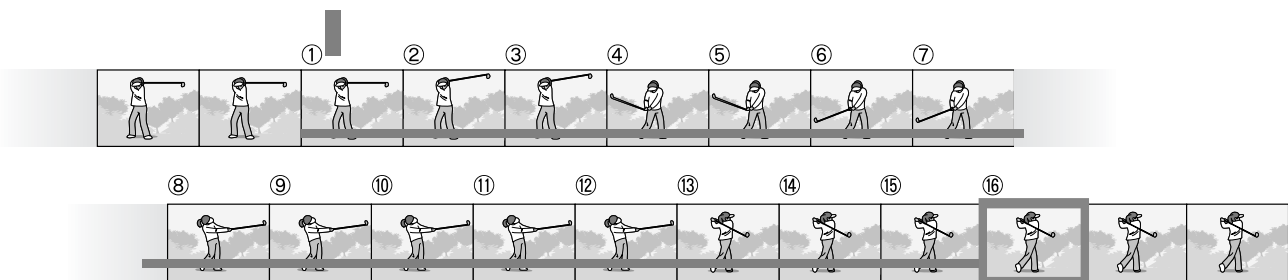

(1) If you release the shutter release button here...



Note

- When shooting with S-CONT or M-CONT, the ISO setting is fixed at [AUTO] even if it is set to [ISO 64] or [ISO 100].
- The maximum number of images that can be shot in the Multi-Shot Mode depends on the image size setting, as shown in the table below.
- The numbers of images that can be shot in the Multi-Shot Mode with the internal memory are as shown in the table below.

	F2816	N2816	F3:2	F2048	N2048	F1280	N1280	N640
Digital Zoom: Off	5	5	5	5	5	13	13	13
Digital Zoom: On	5	5	5	5	5	13	13	13

- The shot images can be recorded normally until the SD memory card becomes full. Once the number of consecutively shot images exceeds the number of images shown in the table above, however, the image recording speed becomes slow. (This depends on the image size setting.)

1. Switch the Mode Selector to .

2. Press the MENU/OK button.

The Shooting Setting menu is displayed.

3. Press the ▼ button to select [CONT. MODE] and press the ► button.

4. Press the ▲▼ buttons to select [CONT.], [S-CONT], or [M-CONT].

5. Press the MENU/OK or ◀ button.

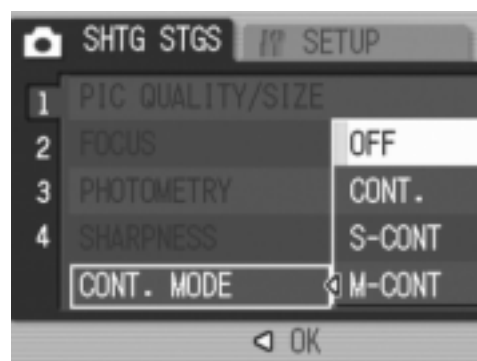

6. If you pressed the ◀ button in Step 5, press also the MENU/OK button.

The Shooting Setting menu closes and the Multi-Shot symbol appears on the screen.



CONT.

- 7. Compose your picture and then press and hold the shutter release button.**

Pictures continue to be taken for as long as you hold down the shutter release button.

- 8. Release your finger from the shutter release button to stop taking pictures.**

To playback consecutive images shot in Multi-Shot mode, switch the camera to Playback Mode (P.42) and select the still image you want to play back with the ◀▶ buttons.

S-CONT (S Multi-Shot)

- 7. Compose your picture and then press the shutter release button.**

16 pictures are taken automatically.

M-CONT (M Multi-Shot)

- 7. Compose your picture and then press and hold the shutter release button.**

The camera memorizes the scene while you hold down the shutter release button.

- 8. Release your finger from the shutter release button.**

The camera stops shooting and the 16 still images (in the previous 2.2 seconds) are recorded as one still image.

Note

- To return to normal single-image shooting, follow Steps 1 to 3, select [OFF] in Step 4, and press the MENU/OK button.
- In M-CONT Mode, if you release the shutter release button within 2.2 seconds from the time you first pressed it, the shots from the time you pressed the shutter until you released it will be recorded (the number of consecutive shots will be less than 16).
- The flash is turned off.
- During Multi-Shot Mode, the LCD monitor is turned off.

Viewing an S-CONT or M-CONT Still Image in Enlarged Display Mode

While a still image (16 frames in an image file) taken with S-CONT or M-CONT is displayed, you can enlarge any one of the 16 frames. You can also switch between frames while viewing the image in Enlarged Display Mode.

To view a frame from an S-CONT or M-CONT still image in Enlarged Display Mode, follow the steps below.

1. Press the  (Playback) button.

The last shot taken is displayed.

2. Press the   buttons to display an S-CONT or M-CONT still image.



3. Press the  (Enlarged View) button.

The first frame of the consecutive images is displayed in Enlarged Display Mode.

The frame position bar appears at the bottom of the screen.

Press the   buttons to switch frames.

To return to the 16-frame display, press the MENU/OK button.

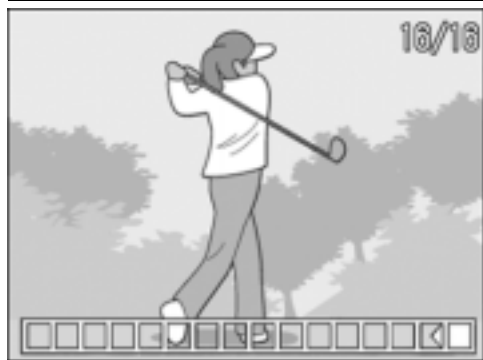

Note

Press the DISP. button to switch between displaying the bar at the bottom of the screen, displaying the grid guide, and hiding the display.

Reference

For information on how to shoot images in S-CONT or M-CONT Mode, see P.87.

Shooting/Playing Back Movies

Shooting Movies

You can shoot movies with sound.

You can set the image size to either 320 × 240 or 160 × 120 pixels.

You can set the number of frames shot per second (frame rate) to either 30 or 15.

Each movie you shoot is recorded as an AVI file.

1. **Switch the Mode Selector to  (Movie Mode).**

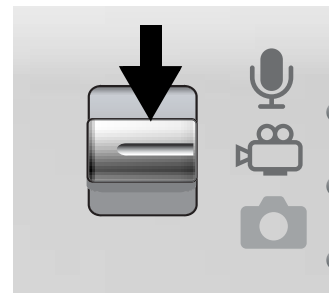

2. **Press the shutter release button.**

The camera starts recording.

Recording continues until you press the shutter release button again.

3. **Press the shutter release button to finish recording the movie.**





Caution

- While shooting movies, operation sounds may be recorded.
- The maximum recording time per shooting depends on the size of your SD memory card. (P.93)
Even if you are within the maximum recording time, recording may end depending on your card.



Note

- The flash cannot be used.
- While shooting movies, only Digital Zoom can be used.
- When the shutter release button is pressed in Step 2, the camera focuses on the subject.
- The remaining recording time may not change uniformly because it is recalculated from the remaining memory capacity during movie recording.



Reference

- For information on how to change the image size for movies, see P.60.
- For information on how to change the frame rate, see P.93.
- For information on how to use the Digital Zoom, see P.34.
- For the list of Shooting Setting menu items in Movie Mode, see P.171.

Setting the Frame Rate

You can select 30 fps or 15 fps for the number of shot frames per second (frame rate) in Movie Mode.

1. Switch the Mode Selector to .
2. Press the MENU/OK button.
The Shooting Setting menu is displayed.
3. Press the ▼ button to select [FRAME RATE] and press the ► button.
4. Press the ▲▼ button to select [30FPS] or [15FPS].
5. Press the MENU/OK or ◀ button.
6. If you pressed the ◀ button in Step 5, press also the MENU/OK button.

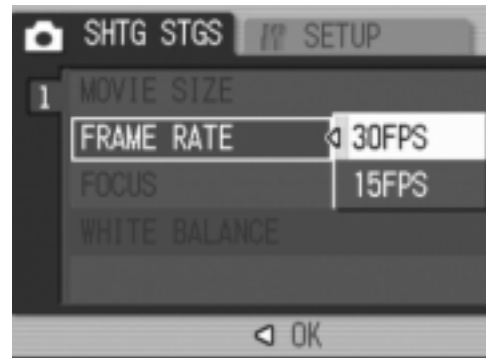

The Frame Rate setting is completed.

The Shooting Setting menu closes and the setting appears on the screen.

The setting is used for shooting until it is changed.

Note

The movie recording time depends on the capacity of the SD memory card.

The table below shows the available recording time.

	Internal Memory	32 MB	64 MB	128 MB	256 MB	512 MB	1 GB
320×240 (15FPS)	1 min 17 s	1 min 27 s	2 min 59 s	6 min 3 s	12 min 4 s	24 min 19 s	46 min 47 s
320×240 (30FPS)	39 s	44 s	1 min 31 s	3 min 4 s	6 min 7 s	12 min 19 s	23 min 42 s
160×120 (15FPS)	4 min 38 s	5 min 16 s	10 min 47 s	21 min 49 s	43 min 29 s	87 min 37 s	168 min 30 s
160×120 (30FPS)	2 min 26 s	2 min 46 s	5 min 40 s	11 min 27 s	22 min 50 s	46 min 1 s	88 min 31 s

Playing Back Movies

To playback movies, follow the steps below.

1. Press the (Playback) button.

The last shot taken is displayed.

The first frame of the movie is displayed as a still image.

2. Select to the movie you want to view using the buttons.

Press the  button to display the next file.









Press the  button to display the previous file.

3. Press the ADJ. button.

Playback begins.

The elapsed playback indicator or the elapsed time is displayed on the screen.



Fast Forward	Press the  button during playback.
Rewind	Press the  button during playback.
Pause/Playback	Press the ADJ. button.
Slow Playback	Press and hold down the  button during pause.
Slow Rewind	Press and hold down the  button during pause.
Next Frame	Press the  button during pause.
Previous Frame	Press the  button during pause.
Volume Adjustment	Press the   buttons during playback.

Term

Movie Frames

Movies consist of many frames whose images appear to be moving when displayed at high speed.

Recording/Playing Back Sound

Recording Sound

You can record sound.
Recorded data is stored as a WAV file.

1. **Switch the Mode Selector to  (Voice Memo Mode).**

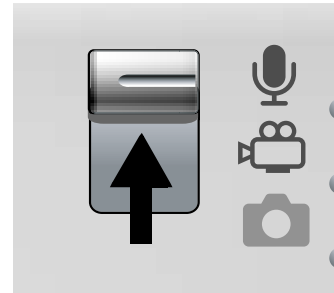

2. **Press the shutter release button.**
Sound recording starts.
3. **Press the shutter release button to stop recording.**

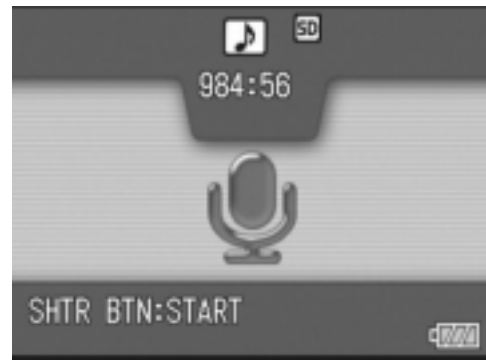

Note

The voice recording time depends on the capacity of the SD memory card.
The table below shows the available recording time.

Internal Memory	32 MB	64 MB	128 MB	256 MB	512 MB	1 GB
56 min 45 s	64 min 36 s	132 min 11 s	267 min 15 s	532 min 36 s	1073 min 00 s	2063 min 25 s

Caution

When recording sound for a long time, use of the AC adapter (AC-4c) is recommended.

Playing Back Sound

To playback sounds, follow the steps below.

1. Press the  (Playback) button.

The last shot taken is displayed.

2. Press the   buttons to select a sound file for playback (indicated with a speaker icon).

Press the  button to display the next file.





Press the  button to display the previous file.

3. Press the ADJ. button.

Playback begins.

The elapsed playback indicator or the elapsed time is displayed on the screen.



Fast Forward	Press the  button during playback.
Rewind	Press the  button during playback.
Pause/Playback	Press the ADJ. button.
Volume Adjustment	Press the   buttons during playback.

Other Functions Available in Playback Mode

Playback Setting Menu

The Playback Setting menu provides the functions shown in the table below:

Setting	Options	Refer to
SLIDE SHOW	_____	P.98
PROTECT	Select/Cancel 1 FILE, Select/Cancel ALL FILES, Select Multi-files	P.99
DPOF	Select/Cancel 1 FILE, Select/Cancel ALL FILES, Select Multi-files	P.102
RESIZE	1280, 640	P.105
COPY TO CARD	_____	P.106



Note

The SETUP menu can be accessed from within the Playback Setting menu. For details, see P.108.

Using the Playback Setting Menu

1. Press the (Playback) button to select the Playback Mode.
2. Press the MENU/OK button.
The Playback Setting menu appears.
3. Press the buttons to select the desired item.
4. After selecting a menu item, press the button.
The screen for the selected menu item appears.

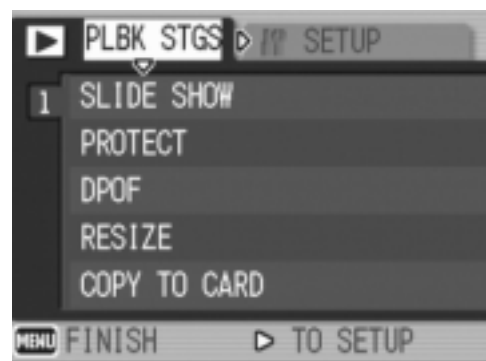

Displaying Photos in Order Automatically (SLIDE SHOW)

You can display the recorded still images, movies, and sound files sequentially on the screen. This is called a slide show.

To view a slide show, follow the steps below.

1. Press the  (Playback) button.

The last shot taken is displayed.

2. Press the MENU/OK button.

The Playback Setting menu appears.

3. Press the , select [SLIDE SHOW] and press the  button.

The slide show starts and files are played back in order.

If you want to stop the slide show in progress, press any button on the camera.

The slide show will repeat itself until stopped.

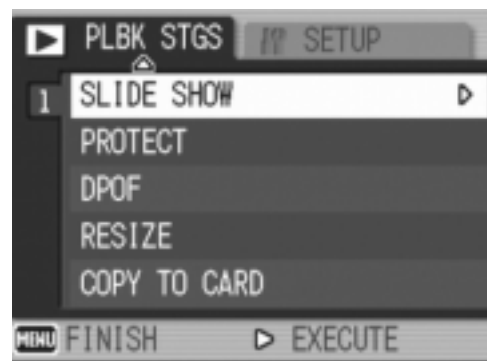

Note

- Each still image is displayed for three seconds.
- For movies, not just one frame, but the entire movie you shot is played back.
- Sound files are also played back.

Write-protecting Files (PROTECT)





You can protect files from being accidentally deleted.



Caution

Protected files cannot be deleted normally. However, they will be deleted if you format the memory where the files are stored.

Protecting Files

1. **Press the  (Playback) button.**
The last shot taken is displayed.
2. **Press the   buttons to display the file you want to protect.**
3. **Press the MENU/OK button.**
The Playback Setting menu appears.
4. **Press the  button to select [PROTECT] and press the  button.**
5. **Make sure that [1 FILE] is selected, and then press the MENU/OK button.**

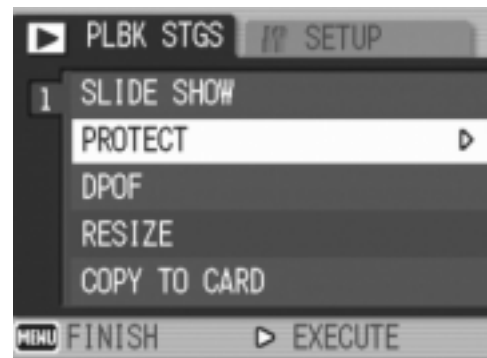

The selected file is protected and the Protect symbol appears in the upper-left corner of the screen.





Note



To unprotect a file, display the file you want to unprotect and perform Steps 3 to 5.

Protecting All Files

To protect all your files, follow the steps below.

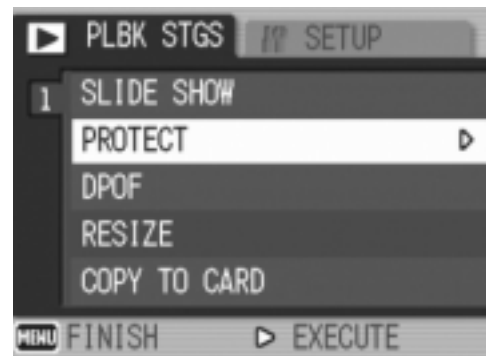
1. Press the  (Playback) button.
2. Press the MENU/OK button.
The Playback Setting menu appears.
3. Press the  button to select [PROTECT] and press the  button.



4. Press the   buttons to select [ALL FILES].
5. Make sure that [SELECT] is selected, and then press the MENU/OK button.

All files are protected and the Protect symbol appears in the upper-left corner of the screen.









Note

To cancel protection for all protected files, select [CANCEL] in Step 5.

Protecting Multiple Files at Once

To protect selected files all at once, follow the steps below.

1. **Press the  (Playback) button.**
2. **Press the  (Thumbnail Display) button twice.**
The screen is divided into 12 frames and 12 still images are displayed together.
3. **Press the  buttons to select the first file you want to protect.**
4. **Press the MENU/OK button.**
The Playback Setting menu appears.
5. **Press the  button to select [PROTECT] and press the  button.**
6. **Press the  buttons to select the next file you want to protect, and then press the MENU/OK button.**
The Protect symbol appears in the upper-right corner of the file.
7. **Repeat Step 6 to select all the files you want to protect.**
If you selected a file by mistake, you can deselect by selecting the file and pressing the MENU/OK button again.
8. **Press the DISP. button.**
The display indicates that the selected images are being processed; once finished, the display returns to the Thumbnail Display screen.

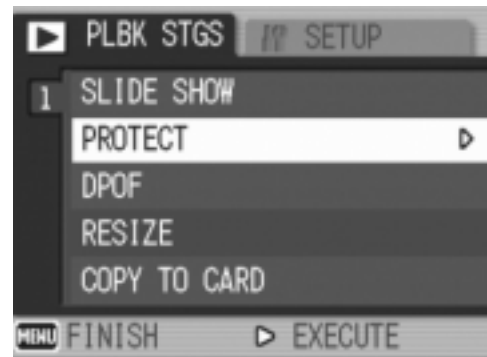

Note

To unprotect multiple files, follow the same steps described above to select the files to unprotect, and then press the DISP. button.

Reference

- For information on canceling protection for all protected files at once, see P.100.
- For information on thumbnail display, see P.45.



Using a Printing Service (DPOF)

The still images recorded on an SD memory card can be printed out if you take them to a store that offers a digital camera print service. To use a print service, you must make print settings on your camera. These settings are called Digital Print Order Format (DPOF) settings.

The DPOF setting specifies one print per still image.

However, if multiple images are selected for the DPOF setting, you can specify the number of copies to print.

Setting DPOF for the Displayed Still Image

1. Press the  (Playback) button.
2. Display the still image for which you want to make the DPOF setting.
3. Press the MENU/OK button.
The Playback Setting menu appears.
4. Press the  button to select [DPOF] and press the  button.

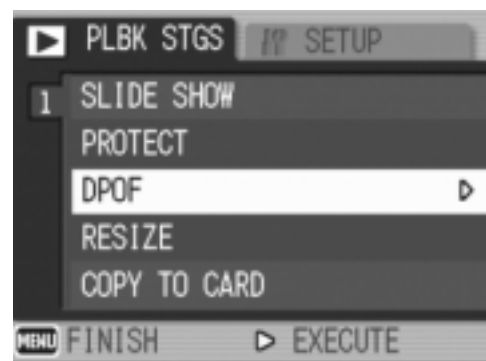

5. Make sure that [1 FILE] is selected, and then press the MENU/OK button.

Once the DPOF setting is made, the DPOF symbol appears in the upper-left corner of the screen.







Note

To remove the DPOF setting, display the still image with the DPOF setting and perform Steps 3 to 5.

Setting DPOF for All Still Images

To apply DPOF settings to all your still images, follow the steps below.

1. Press the  (Playback) button.
2. Press the MENU/OK button.
The Playback Setting menu appears.
3. Press the  button to select [DPOF] and press the  button.
4. Press the  button to select [ALL FILES].

5. Make sure that [SELECT] is selected, and then press the MENU/OK button.

Once the DPOF setting is made, the DPOF symbol appears in the upper-left corner of the screen.

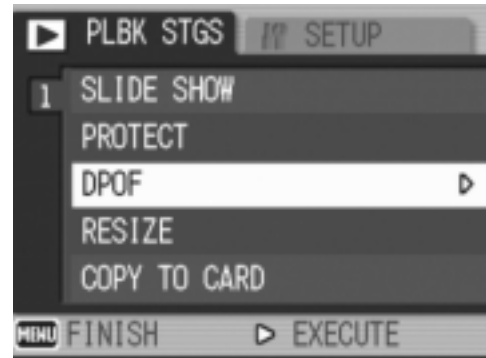







Note





To cancel the DPOF settings for all still images with DPOF settings, select [CANCEL] in Step 5.







Setting DPOF for Multiple Still Images



To make the DPOF settings for selected still images all at once, follow the steps below.

- 1. Press the  (Playback) button.**
- 2. Press the  (Thumbnail Display) button twice.**

The screen is partitioned into 12 segments to display the thumbnails of files.
- 3. Press the     buttons to select the first still image for which you want to make the DPOF setting.**
- 4. Press the MENU/OK button.**

The Playback Setting menu appears.
- 5. Press the  button to select [DPOF] and press the  button.**
- 6. Press the   buttons to set the number of copies to print.**

Press the  button to increase the number of copies, or press the  button to decrease the number of copies.
- 7. Press the   buttons to select the next still image for which you want to make the DPOF setting.**
- 8. Press the   buttons to set the number of copies to print.**

Press the  button to increase the number of copies, or press the  button to decrease the number of copies.
- 9. Repeat Steps 7 and 8 to select all the still images for which you want to make the DPOF setting.**
- 10. Press the MENU/OK button.**

The display indicates that the selected images are being processed; once finished, the display returns to the Thumbnail Display screen.

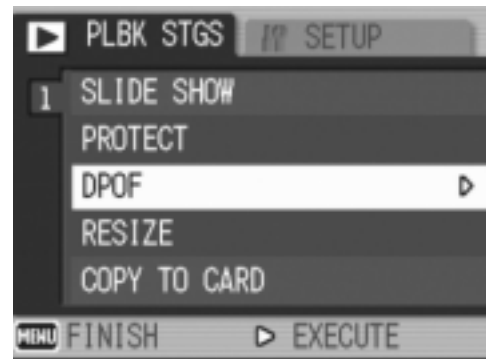

Note

To remove the DPOF settings for multiple still images, follow the same steps described above to set the number of copies to print to [0] for each image, and then press the MENU/OK button.

Reference

For information on canceling the DPOF settings for all still images with DPOF settings at once, see P.103.

Changing the Image Size (RESIZE)

You can reduce the image size of a shot still image to create a new file with a different image size.



Caution

You can resize only still images and still images with voice memos. Movies cannot be resized.







Note

- The following image sizes can be resized as shown in the table below:

Original	Resized	
F2816/N2816/F3:2/F2048/N2048	N1280	N640
F1280/N1280	N640	

- The ratio of width to height of [F3:2] images is 3:2. When an image of this type is resized, it is reduced to a 4:3 image with black borders at the top and bottom.

To change the image size, follow the steps below.

- Press the  (Playback) button.
- Press the MENU/OK button.
The Playback Setting menu appears.
- Press the  button to select [RESIZE] and press the  button.
- Press the   buttons to select [1280] or [640].
- Press the MENU/OK button.
The image size is changed and the resized still image is displayed.

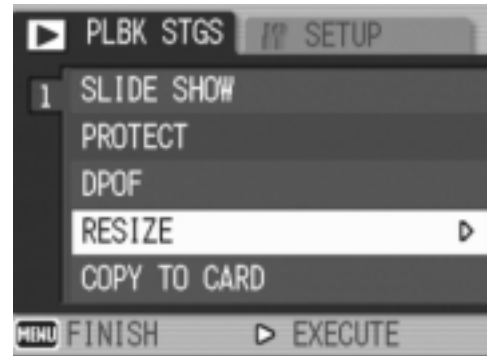



Reference

For information on how to change the image size for movies, see P.60.

Copying the Contents of the Internal Memory to an SD Memory Card (COPY TO CARD)

You can copy all movies, still images, and sound data stored in the internal memory onto an SD memory card at once.

1. Turn the camera off.
2. Insert an SD memory card.
3. Turn the camera on.
4. Press the  (Playback) button.
5. Press the MENU/OK button.
The Playback Setting menu appears.
6. Press the  button to select [COPY TO CARD] and press the  button.

The display indicates copying is in progress; once finished, the display returns to the playback screen.

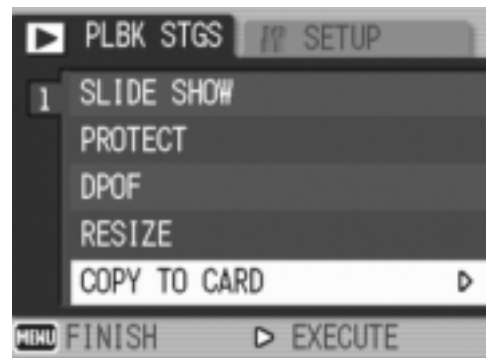

Note

- If the capacity of the SD memory card to which you are copying is insufficient, a message will be displayed indicating there is not enough capacity. To copy only the number of shots that will fit into the available capacity, select [YES] and then press the MENU/OK button. To cancel copying, select [NO] and then press the MENU/OK button.
- It is not possible to copy the contents of an SD memory card to the internal memory.

Chapter 3

Changing Camera Settings

Changing Camera Settings 108

Changing Camera Settings

SETUP Menu

You can change the camera settings by displaying the SETUP menu from the Shooting Setting menu (P.58) or Playback Setting menu (P.97).

The SETUP menu enables you to set the items listed in the table below.

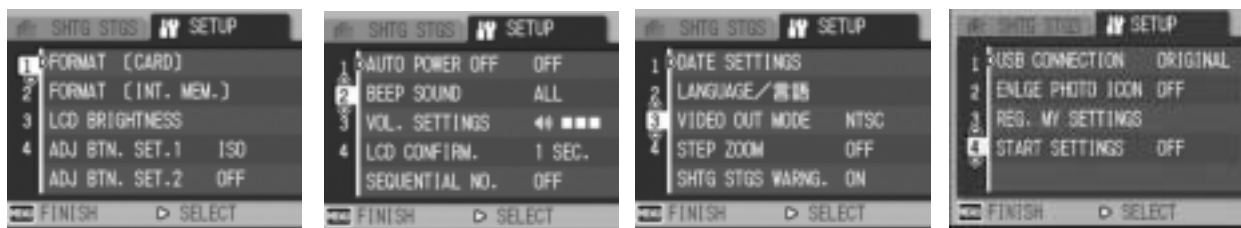

The default values are enclosed in brackets [].

Setting	Options	Refer to
FORMAT [CARD]	_____	P.110
FORMAT [INT. MEM.]	_____	P.111
LCD BRIGHTNESS	_____	P.112
ADJ BTN. SET.1* ¹ ADJ BTN. SET.2* ²	[OFF]* ² , [ISO]* ¹ , QUALITY, FOCUS, SHARP, METERING, CONT MDE, AUTO BKT, WITH SND	P.113
AUTO POWER OFF	OFF, [1 MIN.], 5 MIN., 30MIN.	P.114
BEEP SOUND	[ALL], SHUTTER	P.115
VOL. SETTINGS	□□□ (OFF), ■□□ (Small), [■ ■ □] (Medium), ■ ■ ■ (Large)	P.116
LCD CONFIRM.	OFF, [0.5SEC.], 1 SEC., 2 SEC., 3 SEC.	P.117
SEQUENTIAL NO.	ON, [OFF]	P.118
DATE SETTINGS	_____	P.120
LANGUAGE/ 言語	日本語, [ENGLISH], DEUTSCH, FRANÇAIS, ITALIANO, ESPAÑOL, 简体中文, 繁体中文, 한국어	P.121
VIDEO OUT MODE	[NTSC], PAL	P.122
STEP ZOOM	ON, [OFF]	P.123
SHTG STGS WARNG.	[ON], OFF	P.124
USB CONNECTION	MASS STR, [ORIGINAL]	P.125
ENLGE PHOTO ICON	[OFF], ON	P.129
REG. MY SETTINGS	SETTING1, SETTING2	P.130
START SETTINGS	[OFF], SETTING1, SETTING2	P.131

Using the SETUP Menu

To display and use the SETUP menu, follow the steps below.

Note

For some functions, the setting selection method may differ from what is explained here. For detailed operation, see the explanation of each function.

1. Press the MENU/OK button.

The Shooting Setting menu (or the Playback Setting menu) appears.

2. Press the ► button.

The SETUP menu appears.

3. Press the ▲▼ buttons to select the desired item.

The menu items are provided on four screens.

Press the ▼ button at the bottom item to display the next screen.

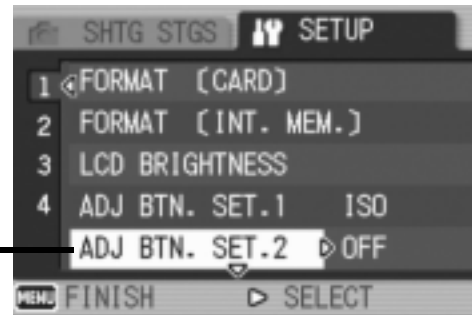

To select a screen by screen number:

1. Press the ◀ button to select a screen number on the left of the screen.
2. With the screen number selected, press the ▲▼ buttons to change screens.
3. After selecting a screen, press the ► button to return to the menu item selection step.

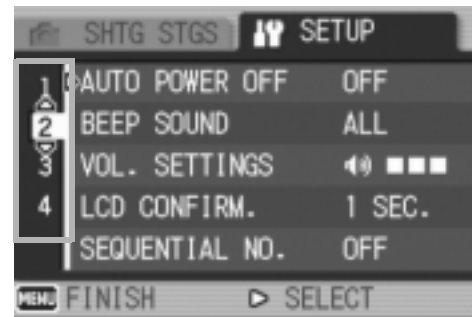

4. After selecting a menu item, press the ► button.

The menu item settings are displayed.

5. Press the ▲▼ buttons to select the setting.

6. Press the MENU/OK or ◀ button.

7. If you pressed the ◀ button in Step 6, press also the MENU/OK button.

The menu disappears and the camera is ready for shooting or playback.

Formatting the SD Memory Card (FORMAT [CARD])

If the error message [CARD ERROR] is displayed when an SD memory card is loaded into the camera or the card has been used with a computer or other device, you must format the card prior to use with this camera.

Formatting is the process of preparing a card so image data can be written on it.



Caution

If you format a card that still has images stored on it, the images will be lost.



Reference

For information on how to format the internal memory, see P.111.

To format a card, follow the steps below.

1. Display the SETUP menu.

For the operating procedure, see P.109.

2. Press the ▼ button to select [FORMAT [CARD]] and press the ► button.

A screen appears to confirm formatting.

3. Press the ◀▶ buttons to select [YES] and then press the MENU/OK button.

Formatting starts. When it is done, the display returns to the SETUP menu.

If no SD memory card is loaded, a message will be displayed.

After turning the power off, load an SD memory card and repeat the formatting process again.

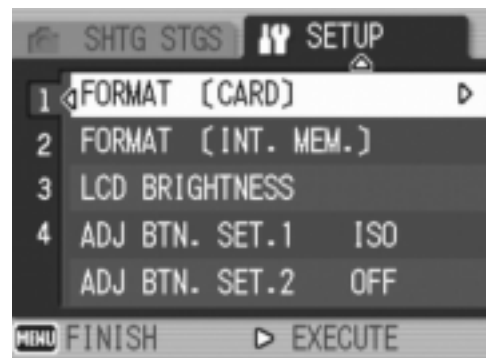

Note

Protecting your images from being deleted

Move the write-protection switch on the SD memory card to “LOCK” to prevent your still images from being accidentally erased or the card from being formatted. (P.18)

If you unlock the card (by returning the switch to its original position), it is once again possible to erase images and format the card.

Formatting the Internal Memory (FORMAT [INT. MEM.])

If the error message [FORMAT INTERNAL MEMORY] is displayed, you must format the internal memory prior to use.



Caution

Formatting the internal memory deletes all of the images recorded in the memory. If you have images in the internal memory that you do not want to delete, copy the images to the SD memory card before formatting the internal memory. (P.106)

To format the internal memory, follow the steps below.

1. Display the SETUP menu.

For the operating procedure, see P.109.

2. Press the ▼ button to select [FORMAT [INT. MEM.]] and press the ► button.

A screen appears to confirm formatting.

3. Press the ◀▶ button to select [YES] and then press the MENU/OK button.

Formatting starts. When it is done, the display returns to the SETUP menu.

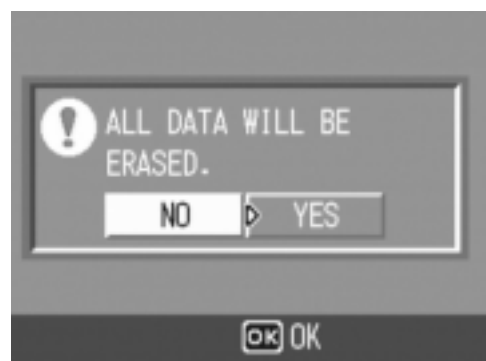
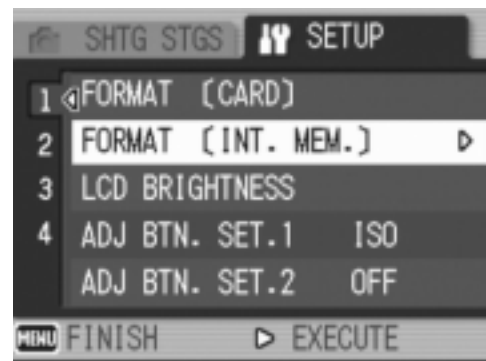

Adjusting the Brightness of the LCD Monitor (LCD BRIGHTNESS)

To adjust the brightness of the LCD monitor, follow the steps below.

1. Display the SETUP menu.

For the operating procedure, see P.109.

2. Press the ▼ button to select [LCD BRIGHTNESS] and press the ► button.

The LCD Brightness Adjustment bar appears.

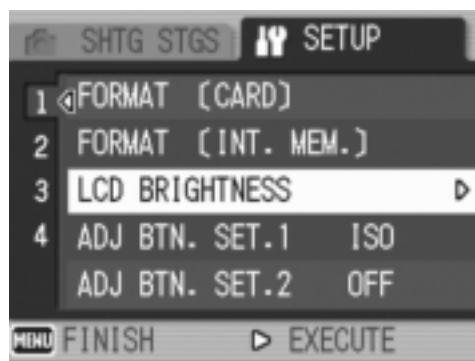

3. Press the ▲▼ buttons to adjust the brightness.

Moving it toward ☀️ makes it darker.

Moving it toward 🌙 makes it brighter. The brightness of the screen behind the bar changes as you adjust the setting.

4. When you reach the desired brightness, press the MENU/OK button.

The display returns to the SETUP screen. This setting is used until it is changed.



Note

When shooting, press and hold down the DISP. button to maximize the LCD brightness. When the brightness is at the maximum setting, holding the DISP. button down returns the brightness to the level set in [LCD BRIGHTNESS]

Assigning a Function to the ADJ. Button (ADJ BTN. SET.1/2)

Pressing the ADJ. button enables you to display the screens for setting the exposure and white balance with fewer button operations.

You can also use [ADJ BTN. SET.1] and [ADJ BTN. SET.2] to add a camera function that can be activated by pressing the ADJ. button.

Available Settings	Refer to
OFF *Default setting for [ADJ BTN. SET.2]	-
ISO (ISO SETTING) *Default setting for [ADJ BTN. SET.1]	P.81
QUALITY (PIC QUALITY/SIZE)	P.60
FOCUS	P.64
SHARP (SHARPNESS)	P.68
METERING (PHOTOMETRY)	P.67
AUTO BKT (AUTO BRACKET)	P.70
CONT MDE (CONT. MODE)	P.87
WITH SND (IMAGE WITH SOUND)	P.76

To assign a function to either [ADJ BTN. SET.1] or [ADJ BTN. SET.2], follow the steps below.

1. Display the SETUP menu.

For the operating procedure, see P.109.

2. Press the ▼ button to select [ADJ BTN. SET.1] or [ADJ BTN. SET.2], and then press the ► button.

3. Press the ▲▼ buttons to select the desired setting.

4. Press the MENU/OK or ◀ button.

5. If you pressed the ◀ button in Step 4, press also the MENU/OK button.

This setting is used until it is changed.



Reference

For information on how to use the ADJ. button, see P.57.

Changing the Auto Power Off Setting (AUTO POWER OFF)

If you do not operate the camera for a set period of time, it will shut off automatically to conserve battery power (Auto Power Off).

By default, Auto Power Off is set to one minute, but you can change this setting.

Available Settings
OFF (Auto Power Off is turned off)
1 MIN. *Default setting
5 MIN.
30MIN.

To change the Auto Power Off setting, follow the steps below.

1. Display the SETUP menu.

For the operating procedure, see P.109.

2. Press the ▼ button to select [AUTO POWER OFF] and press the ► button.

3. Press the ▲▼ buttons to select the desired setting.

4. Press the MENU/OK or ◀ button.

5. If you pressed the ◀ button in Step 4, press also the MENU/OK button.

This setting is used until it is changed.

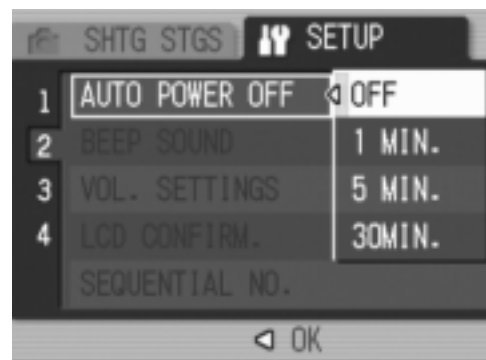

Note

- To continue using the camera after Auto Power Off turned the camera off, press the POWER button to turn the camera on again. You can also press and hold the ► (Playback) button for more than one second to turn on the camera in Playback Mode.
- Auto Power Off does not work when the camera is connected to a computer.
- When using Interval Shooting, the settings made here are not valid and Auto Power Off does not work.

Changing the Beep Sound Setting (BEEP SOUND)

During operation, the camera generates four types of sounds: start sound, shutter release sound, focus sound, and beep sound.

Start sound:	Sound when the camera is turned on.
Shutter release sound:	Sound when the shutter release button is pressed.
Focus sound:	Sound when the shutter release button is half-pressed and the camera focuses on the subject.
Beep Sound:	Error sound indicating an operation that cannot be performed.

Available Settings
SHUTTER (Shutter release sound, Beep Sound)
ALL (all sounds on) *Default setting

To change the beep sound settings, follow the steps below:

1. Display the SETUP menu.

For the operating procedure, see P.109.

2. Press the ▼ button to select [BEEP SOUND] and press the ► button.

3. Press the ▲▼ buttons to select the desired setting.

4. Press the MENU/OK or ◀ button.

5. If you pressed the ◀ button in Step 4, press also the MENU/OK button.

This setting is used until it is changed.



Reference

For information on how to adjust the volume, see P.116

Changing the Beep Sound Volume (VOL. SETTINGS)

The beep sound volume can be changed.

Available Settings
□□□ (Mute)
■□□ (Small)
■■□ (Medium) *Default setting
■■■ (Large)

To change the beep sound volume, follow the steps below:

1. Display the SETUP menu.

For the operating procedure, see P.109.

2. Press the ▼ button to select [VOL. SETTINGS] and press the ► button.

3. Press the ▲▼ buttons to select the desired setting.

4. Press the MENU/OK or ◀ button.

5. If you pressed the ◀ button in Step 4, press also the MENU/OK button.

This setting is used until it is changed.



Changing Image Confirmation Time (LCD CONFIRM.)

Immediately after you press the shutter release button, the still image taken is displayed on the screen for a moment so you can check it.

By default, the image confirmation time is set to 0.5 seconds, but this can be changed.

Available Settings
OFF (Image not displayed for confirmation)
0.5SEC. *Default setting
1 SEC.
2 SEC.
3 SEC.

To change the image confirmation time, follow the steps below.

1. Display the SETUP menu.

For the operating procedure, see P.109.

2. Press the ▼ button to select [LCD CONFIRM.] and press the ► button.

3. Press the ▲▼ buttons to select the desired setting.

4. Press the MENU/OK or ◀ button.

5. If you pressed the ◀ button in Step 4, press also the MENU/OK button.

This setting is used until it is changed.

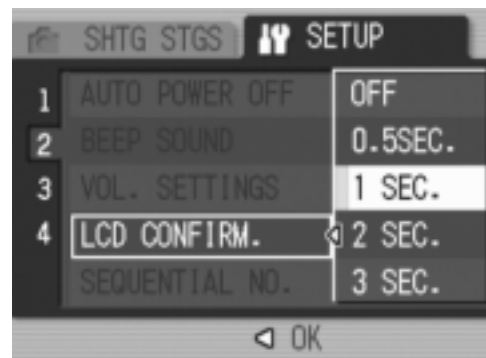

! Caution

When [LCD CONFIRM.] is set to 0.5 seconds, symbols such as the zoom bar may remain on the monitor while the image is displayed.

Changing File Name Settings (SEQUENTIAL NO.)

When you shoot a still image, it is stored on an SD memory card or in the internal memory with a consecutively numbered file name that is automatically assigned.

When you switch SD memory cards, you can set your camera to continue consecutive numbering from the previously loaded card.

Available Settings	
ON (Continue numbering)	File names are automatically assigned to still images you take, in the format of "R" followed by seven digits, from R0010001.jpg to R9999999.jpg. With this setting, file numbering is continued from one card to the next.
OFF (Do not continue numbering) *Default setting	File numbering is assigned, from RIMG0001.jpg to RIMG9999.jpg, for each SD memory card. When file name RIMG9999 is reached, no more data can be recorded to that card.

To change the file name setting, follow the steps below.

1. Display the SETUP menu.

For the operating procedure, see P.109.

2. Press the ▼ button to select [SEQUENTIAL NO.] and press the ► button.

3. Press the ▲▼ buttons to select the desired setting.

4. Press the MENU/OK or ◀ button.

5. If you pressed the ◀ button in Step 4, press also the MENU/OK button.

This setting is used until it is changed.

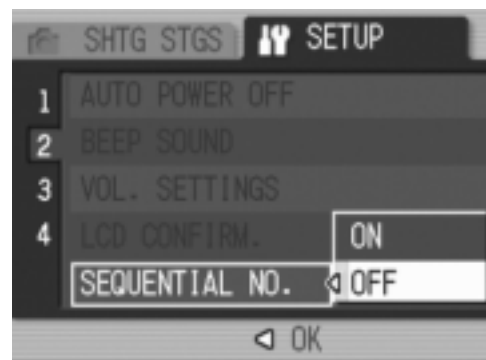



Note

- When recording data to the internal memory, files are assigned consecutively numbered file names, just as if [SEQUENTIAL NO.] is set to [OFF].
- When transferring images to a computer using RICOH Gate La (P.143), the file being transferred is renamed and saved. The file is saved with the name "RIMG****.jpg" (where **** indicates a number) even if [SEQUENTIAL NO.] is set to [ON].
- When RIMG9999 is reached, no more files can be saved. In this case, move image data from the SD memory card to the memory of the computer or a storage medium, and then format the SD memory card.

Setting the Date and Time (DATE SETTINGS)

You can take still images with the time or date stamped onto the picture.

The date/time setting on the SETUP menu is explained here.

1. Display the SETUP menu.

For the operating procedure, see P.109.

2. Press the ▼ button to select [DATE SETTINGS] and press the ► button.



3. Press the ▲▼◀▶ buttons to set the year, month, date and time.

You can press and hold down the ▲▼ button to quickly raise or lower the setting.

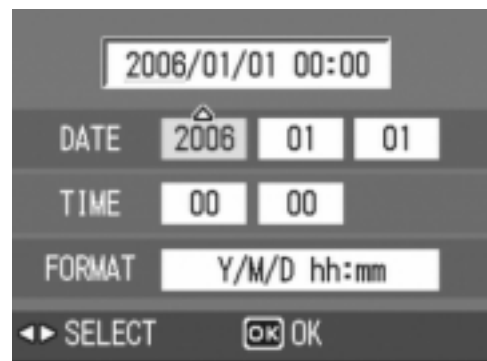

4. In [FORMAT], choose the date and time format.

5. Check the information on the screen and then press the MENU/OK button.

Once you have set the date and time, the display returns to the SETUP menu.

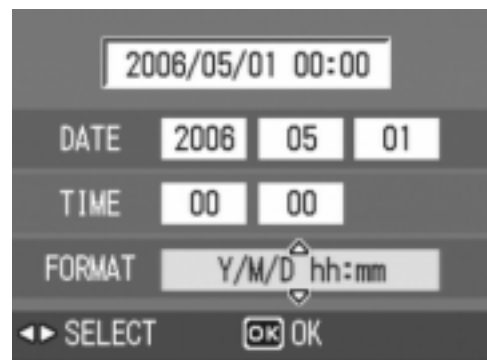

Note

- If the battery is removed for more than one week, the date and time settings will be lost. These settings must be made again.
- To retain the date and time settings, load a fully charged battery for more than two hours.

Changing the Display Language (LANGUAGE/言語)

You can change the language displayed on the screen.

Available Settings
日本語 (Japanese)
ENGLISH *Default setting
DEUTSCH (German)
FRANÇAIS (French)
ITALIANO (Italian)
ESPAÑOL (Spanish)
简体中文 (Simplified Chinese)
繁体中文 (Traditional Chinese)
한국어 (Korean)

To change the display language, follow the steps below.

1. Display the SETUP menu.

For the operating procedure, see P.109.

2. Press the ▼ button to select [LANGUAGE/言語] and press the ► button.

The language selection screen appears.



3. Press the ▲▼◀▶ buttons to select the desired setting.

4. Press the MENU/OK button.

This setting is used until it is changed.



Changing the Playback Method for Viewing on TV (VIDEO OUT MODE)

You can view your still images and movies on a television screen by connecting your camera to a television with the AV cable that came with your camera.

Your camera is set to NTSC video format (used in Japan and other countries) for use with television equipment and other audiovisual equipment. If the equipment you want to connect to uses PAL format (used in Europe and elsewhere), then switch your camera to PAL format before connecting.

Available Settings
NTSC *Default setting
PAL

To change the playback format, follow the steps below.

1. Display the **SETUP** menu.

For the operating procedure, see P.109.

2. Press the **▼** button to select **[VIDEO OUT MODE]** and press the **▶** button.

3. Press the **▲▼** buttons to select the desired setting.

4. Press the **MENU/OK** or **◀** button.

5. If you pressed the **◀** button in Step 4, press also the **MENU/OK** button.

This setting is used until it is changed.



Note

When the AV cable is connected to the camera, the LCD monitor turns off.

Reference

For information on how to view still images on your television screen, see P.47.

Changing the Step Zooming Setting (STEP ZOOM)

The focal length with optical zooming can be fixed to any of seven levels (28, 35, 50, 85, 105, 135, and 160 mm, equivalent to that on a 35mm camera) (Step Zoom).

Available Settings
OFF *Default setting
ON

To set whether to use step zooming (ON) or not (OFF), follow the steps below.

1. Display the SETUP menu.

For the operating procedure, see P.109.

2. Press the ▼ button to select [STEP ZOOM] and press the ► button.

3. Press the ▲▼ buttons to select the desired setting.

4. Press the MENU/OK or ◀ button.

5. If you pressed the ◀ button in Step 4, press also the MENU/OK button.

This setting is used until it is changed.



Note

For step zooming in Macro Mode, the focal length can be fixed to any of seven levels (31, 35, 50, 85, 105, 135, and 160 mm, equivalent to that on a 35mm camera).

Reference

For information on how to use zoom, see P.34.

Displaying a Settings Change Warning (SHTG STGS WARNG.)

If the initial settings are changed for the following functions, you can set the camera to have the icon of that function blink and to display a warning message about the function with the changed setting for about 5 seconds when the camera is turned on.

- White balance
- Focus
- ISO setting
- Exposure compensation
- Time exposure

If you operate a camera button while an icon is blinking, the icon stops blinking and lights steadily.

If you operate a camera button while the warning message is displayed, the message disappears.

Available Settings
OFF
ON *Default setting

To set whether to enable (ON) or disable (OFF) the settings change warning, follow the steps below.

- 1. Display the SETUP menu.**
For the operating procedure, see P.109.
- 2. Press the ▼ button to select [SHTG STGS WARNG.] and press the ► button.**
- 3. Press the ▲▼ buttons to select the desired setting.**
- 4. Press the MENU/OK or ◀ button.**
- 5. If you pressed the ◀ button in Step 4, press also the MENU/OK button.**

This setting is used until it is changed.

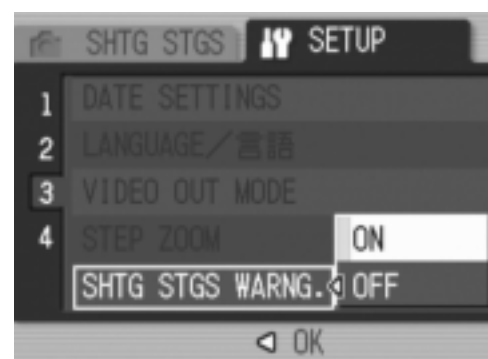

Changing the USB Setting (USB CONNECTION)

By setting [USB CONNECTION] to [MASS STR] on the SETUP menu, you can view files in the camera and transfer files from the camera to your computer using the USB cable without installing the supplied software or USB driver.

Usually, set [USB CONNECTION] to [ORIGINAL]. When set to [ORIGINAL], you can transfer images to your computer using the supplied RICOH Gate La software.

USB CONNECTION Mode	MASS STR	ORIGINAL
Downloading data	The SD memory card or internal memory of the camera can be operated directly as an external drive for file processing.	RICOH Gate La allows automatic transfer of camera data to your computer. Use the Caplio Mounter to transfer camera data to your computer. (Mac OS)
Installation from Caplio Software CD-ROM	Not required	Required
Supported Operating Systems		
Windows 98/98 SE	×	○
Windows 2000 Professional	○	○
Windows Me	○	○
Windows XP Home Edition	○	○
Windows XP Professional	○	○
Mac OS 8.6	×	○
Mac OS 9.0 to 9.2.2	○	○
Mac OS X 10.1.2 to 10.4.5	○	○
For those:	Familiar with OS file operations Not willing to install a USB driver or other programs	Willing to automate downloading to a computer Using Windows 98/98 SE Using Mac OS 8.6



Caution

- When [USB CONNECTION] is set to [MASS STR], you cannot use RICOH Gate La to transfer camera data.
- When [USB CONNECTION] is set to [MASS STR], files can only be read from the camera and cannot be written to or deleted from the camera.
- For some printers, Direct Print may not be available when [MASS STR] is selected for [USB CONNECTION] in the SETUP menu of the camera. In such cases, select [ORIGINAL] instead.

To change the USB setting, follow the steps below:

1. Display the SETUP menu.

For the operating procedure, see P.109.

2. Press the ▼ button to select [USB CONNECTION] and press the ► button.

3. Press the ▲▼ buttons to select the desired setting.

4. Press the MENU/OK or ◀ button.

5. If you pressed the ◀ button in Step 4, press also the MENU/OK button.

This setting is used until it is changed.



Reference

For information on how to transfer images using RICOH Gate La, see P.143.

To transfer images in Mass Storage Mode, follow the steps below:

1. Set [USB CONNECTION] to [MASS STR] on the SETUP menu.
2. Make sure that the camera is off.
3. Connect the supplied USB cable to a USB port on your computer.
4. Connect the USB cable to the USB terminal on your camera.

Your camera turns on.

Your computer automatically reads the file necessary for recognizing the camera as a drive.

After this preparation, the camera is displayed as a drive in [My Computer] (Windows) or Desktop (Macintosh).



Example of the display in Windows XP

5. From the displayed drive, copy the file to the desired location.

The figure at right shows the folder configuration in the drive.

The contents of the internal memory are displayed under the drive name [RICOHDCI].

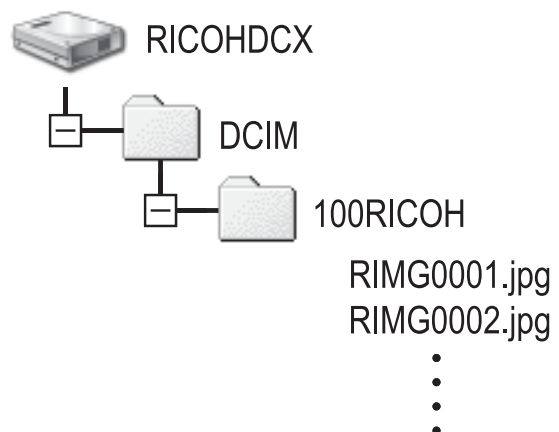

 **Caution**

- Do not disconnect the USB cable during data transfer.
- If a file with the same name already exists at the destination, it is overwritten. If you do not want the file to be overwritten, rename the file or transfer data to another folder.

 **Note**

When an SD memory card is loaded, its files are displayed. Otherwise, files in the internal memory are displayed.

Disconnecting the Camera from Your Computer (Windows)

The display is an example of Windows XP. The terms are different for other operating systems but the operations are the same.

1. Double-click the [Safely Remove Hardware] icon at the right end of the task bar.
2. Select [USB Mass Storage Device] and click [Stop].
3. Check that [USB Mass Storage Device] is selected and click [OK].
4. Click [Close].
5. Disconnect the USB cable.



Disconnecting the Camera from Your Computer (Macintosh)

1. Drag the displayed drive to the “Trash”.
2. Disconnect the USB cable.

Enlarging Icon Display (ENLGE PHOTO ICON)

You can enlarge the icons displayed on the screen during shooting. The following icons are enlarged:

- Flash
- Macro Shooting
- Self-timer
- White balance
- Focus
- Exposure compensation
- ISO setting

When the icons are enlarged, the following items are not displayed:

- Zoom Bar/Focus Bar
- Date Imprint
- Sharpness
- Color Depth

To enlarge the icons on the screen, follow the steps below:

1. Display the SETUP menu.

For the operating procedure, see P.109.

2. Press the ▼ button to select [ENLGE PHOTO ICON] and press the ► button.

3. Press the ▲▼ buttons to select [ON].

4. Press the MENU/OK or ◀ button.

5. If you pressed the ◀ button in Step 4, press also the MENU/OK button.

The Enlarging Icon Display setting is completed.

This setting is used until it is changed.



Registering the Power-on Settings (REG. MY SETTINGS)

The My Setting function allows you to make your desired settings to be used at power-on. For example, when a digital camera is used in common by multiple persons, each person can use the camera without regard to the settings made by the person who used the camera previously because the camera settings are restored to the administrator settings each time the camera is turned on.

Two types of my settings can be registered.

Registering My Settings

To register the current camera settings as my settings, follow the steps below.

- 1. Change the camera settings to the settings to be registered as my settings.**
- 2. Display the SETUP menu.**
For the operating procedure, see P.109.
- 3. Press the ▼ button to select [REG. MY SETTINGS] and press the ► button.**

A confirmation message appears.

- 4. Select [SETTING1] or [SETTING2] and press the MENU/OK button.**

The current camera settings will be registered.

If you do not want to register them, press the DISP. button.

- 5. Press the MENU/OK button.**



Changing the Startup Settings (START SETTINGS)

To change the startup settings, use one of the settings registered in [REG. MY SETTINGS].

1. Display the SETUP menu.

For the operating procedure, see P.109.

2. Press the ▼ button to select [START SETTINGS] and press the ► button.

3. Select [SETTING1] or [SETTING2] and press the MENU/OK or ◀ button.

If you do not use the My Setting function, select [OFF] in Step 3.

4. If the ◀ button was pressed in Step 3, press the MENU/OK button.

5. Turn your camera off.

The settings to be used at the next power-on will be changed.



Note

- When [START SETTINGS] is set to [OFF], settings are retained as usual.
- When [START SETTINGS] is set to [SETTING1] or [SETTING2], the camera settings made with [REG. MY SETTINGS] are used at power-on even if [RESTORE DEFAULTS] is selected.

Settings Retained by My Setting Function

PIC QUALITY	WHITE BALANCE
FOCUS	ISO SETTING
Focal distance used in Manual Focus mode	SLOW SHUTTER LMT
PHOTOMETRY	ENLGE PHOTO ICON
CONT. MODE	FLASH
COLOR DEPTH	Scene Mode
IMAGE WITH SOUND	Macro
DATE IMPRINT	DENSITY
EXPOSURE COMP.	DISP. Mode

Chapter 4

Installing Software (Downloading Images to Your Computer)

Installing the Provided Software (For Windows).....	134
Installing the Provided Software (For Macintosh).....	153



Caution

The screen images shown here may differ from the images displayed on your computer depending on your computer OS.

Installing the Provided Software (For Windows)

You need to install software for transferring images to your computer before you can download images from the camera.

Software installation is necessary for automatic image downloading from the camera to your computer.



Note

- If a file with the same name already exists at the destination, it is overwritten. If you do not want the file to be overwritten, rename the file or transfer images to another folder.
- To download images from the camera to your computer without having to install the software, change [USB CONNECTION] to [MASS STR] on the camera (P.125).



Reference

For how to download images from the camera to your computer, see the “Software User Guide” available from the Caplio Software CD-ROM. For how to display the “Software User Guide”, see P.137.



Caution

- Be sure to install the software before you connect the camera to your computer. (P.139)
- When [MASS STR] is selected on the SETUP menu of the camera, you can view the files in the camera without installing the supplied software or USB driver. At the time of purchase, [ORIGINAL] is selected.

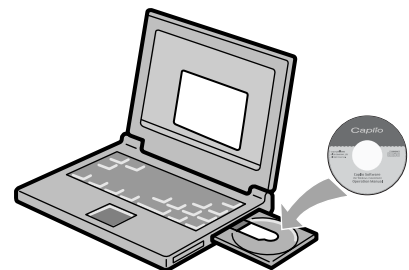

Software that can be installed from the Caplio Software CD-ROM

Once you insert the Caplio Software CD-ROM in the CD-ROM drive, the following screen appears automatically:



Item Name	Description	Refer to
Installing the Software	Use this button to install software required for handling the camera and images.	P.139
Installing DeskTopBinder Lite		P.141
Browse User's Manual (Software Version)	Click this to display the "Software User Guide" (PDF).	P.137
Browse CD-ROM Content	Click this to display the list of files contained on the CD-ROM.	P.137

When [Installing the software] is clicked: (P.139)

The following software will be installed:

Software	Windows		Description
	XP	98	
RICOH Gate La	<input type="radio"/>	<input type="radio"/>	Downloads images collectively.
ImageMixer	<input type="radio"/>	<input type="radio"/>	Shot images can be displayed or edited and video CDs can be created. DirectX (P.150) is necessary for handling movies.
USB Driver	<input type="radio"/>	<input type="radio"/>	Used to connect the camera to the computer.
WIA Driver	<input type="radio"/>	-	Used to download images.

XP: Windows XP

98: Windows 98/98SE/Me/2000



Reference

The camera is provided with ImageMixer software that allows you to display and edit images from your computer. For how to use ImageMixer, click the [?] button on the ImageMixer window and see the displayed manual.

For the latest information about ImageMixer, access the Web page of Pixela Co., Ltd. (<http://www.imagemixer.com>).



Note

The WinASPI installer starts during installation of ImageMixer. WinASPI is required when creating a Video CD using ImageMixer.

When [Installing DeskTopBinder Lite] is clicked: (P.141)

The following software will be installed:

Software	Windows		Description
	XP	98	
DeskTopBinder Lite	<input type="radio"/>	<input type="radio"/>	Software used to manage business documents. Images in the camera can be downloaded to Ridoc using the Auto Document link that monitors document updating.
USB Driver	<input type="radio"/>	<input type="radio"/>	Used to connect the camera to the computer.
WIA Driver	<input type="radio"/>	-	Used to download images.

XP: Windows XP

98: Windows 98/98SE/Me/2000



Caution

DeskTopBinder Lite is compatible with Windows 98 SE but not Windows 98.



Reference

- For details about the DeskTopBinder Lite, refer to the Read This First (PDF file), Setup Guide (PDF file), Ridoc Auto Document Link Guide (PDF file), and Help supplied with the DeskTopBinder Lite.
- For details about the Auto Document link, refer to the Ridoc Auto Document Link Guide (PDF file).

When [Browse User's Manual (Software Version)] is clicked:

The "Software User Guide" (PDF file) on the Caplio Software CD-ROM can be displayed on your computer screen. If you are a Windows user and have Acrobat Reader installed on your computer, simply click [Browse User's Manual (Software Version)].

Acrobat Reader must be installed to view the PDF file (P.149).

When [Browse CD-ROM Content] is clicked:

You can check folders and files on the CD-ROM.

The CD-ROM contains not only the Caplio software but also the following software. These software products run on Windows.

For the installation of each software product, see the reference page in the table below.

Software	Description	Refer to
Acrobat Reader	Required for viewing the "Software User Guide".	P.149
DirectX	Necessary for playing movies by the ImageMixer.	P.150



Reference

- For details about Acrobat Reader, see Help for Acrobat Reader.
- To install ImageMixer alone, double-click setup.exe in the ImageMixer folder.

System Requirements for Using the Provided Software

The following environments are necessary for using the provided software. Please check your computer, or the computer's user manual.

Operating Systems Supported	Windows 98/98 Second Edition
	Windows 2000 Professional
	Windows Me
	Windows XP Home Edition/Professional
CPU	Pentium III: 500MHz or faster
Memory	Windows 98/98SE: 128 MB or more
	Windows 2000: 128 MB or more
	Windows Me: 128 MB or more
	Windows XP: 256 MB or more
Hard drive space required for installation	Windows 98/98SE: 500 MB or more
	Windows 2000: 500 MB or more
	Windows Me: 500 MB or more
	Windows XP: 500 MB or more
Display resolution	800 × 600 pixels or greater
Display colors	65,000 colors or greater
CD-ROM drive	A CD-ROM drive compatible with the above-mentioned computer
USB port	A USB port compatible with the above-mentioned computer



Caution

- If your computer has an upgraded OS, the USB function may not work normally, so it cannot be supported.
- The provided software may not operate properly if changes are made to the operating system, such as with patches and service package releases.
- The camera does not support connection to a USB port added by using an extension function (PCI bus or other).
- If used in conjunction with a hub or other USB devices, the software may not work properly.
- When dealing with movies and other large files, a larger memory environment is recommended.



Reference

For how to download images to your computer using an SD memory card, see P.148.

Installing the Software on Your Computer



Caution

- Do not connect your camera to the computer until indicated. If you happened to connect your camera to the computer (resulting in the [Add New Hardware Wizard] screen appearing), simply click [Cancel], and after disconnecting your camera, install the software on your computer.
- If a message is displayed during installation to uninstall the old Caplio software before installing the new one, uninstall the old Caplio software once and install the new one again by following the message instructions. Even with the new Caplio software, however, the image downloading and other functions of the old model can still be used as before. (For how to uninstall the software, see P.151.)
- For Windows XP or Windows 2000, Administrator privileges are required to install the software.



Note

Here is an example of the Windows XP screen.

1. Start your computer and insert the Caplio CD-ROM in the CD-ROM drive.

The screen shown on the right appears automatically.

2. Click [Installing the software].

After a while, the [Choose Setup Language] screen appears.

3. Confirm the language, and then click [OK].

The [Welcome to the InstallShield Wizard for Caplio Software] screen appears.

4. Click [Next].

The [Choose Destination Location] screen appears.

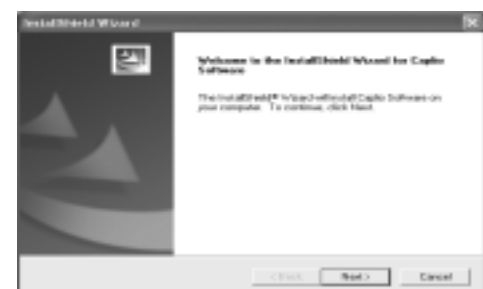

5. Confirm where you want to install and then click [Next].

The [Select Program Folder] screen appears.

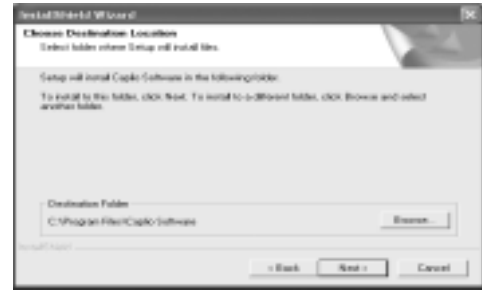

6. Confirm where you want to install and then click [Next].

The ImageMixer installer starts. Install ImageMixer following the messages displayed on the screen. When installation of ImageMixer is completed, a dialog box appears, indicating that all software applications have been installed.



7. Click [Finish].

8. Restart your computer.



Reference

For how to remove (uninstall) the software, see P.151.

Installing the DeskTopBinder Lite



Reference

For how to use DeskTopBinder Lite, refer to the Beginner's Guide, the Setup Guide, and the DeskTopBinder Lite - Auto Document Link Guide (all PDF files) that are installed with DeskTopBinder Lite.



Caution

- Do not connect your camera to the computer until indicated. If you happened to connect your camera to the computer (resulting in the [Add New Hardware Wizard] screen appearing), simply click [Cancel], and after disconnecting your camera, install the software on your computer.
- For Windows XP or Windows 2000, Administrator privileges are required to install the software.



Note

Here is an example of the Windows XP screen.

1. Start your computer and insert the Caplio CD-ROM in the CD-ROM drive.

The screen shown on the right appears automatically.

2. Click [Installing DeskTopBinder Lite].

After a few moments, the [Welcome to the InstallShield Wizard for Caplio Software S] screen appears.

3. Click [Next].

After a few moments, the [Choose Destination Location] screen appears.

4. Confirm where you want to install and then click [Next].

The [Select Program Folder] screen appears.

5. Confirm where you want to install and then click [Next].

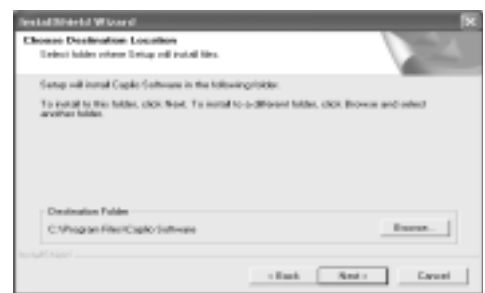

6. Click [OK].

7. Click [DeskTopBinder Lite].

The DeskTopBinder Lite installer starts.

Install DeskTopBinder Lite following the messages displayed on the screen.

When the screen where you verify digital ID is displayed, click [OK].



Caution

- When capturing images from the camera using the Auto Document link of the DeskTopBinder Lite, deselect the [Saves automatically when connected to USB] check box in the [Option settings] dialog box displayed by selecting [Option settings] on the [RICOH Gate La Settings] menu. (Refer to the “Software User Guide”.) Before capturing images from the camera, set the date and time using the [DATE SETTINGS] option of the camera. (P.120)
- If you turned the camera off and then on again while connected to the computer with DeskTopBinder Lite open, reboot the computer with the camera connected.

Connecting the Camera to Your Computer

Downloading Images Using RICOH Gate La

After installing the software on your computer, connect your camera to the computer.

The following explanation is provided assuming that [ORIGINAL] (default) is selected at [USB CONNECTION] of the camera's SETUP menu (P.125). If [MASS STR] is selected, change it to [ORIGINAL].

- 1. Make sure the camera power is off.**
- 2. Connect the USB cable to the USB port of your computer.**

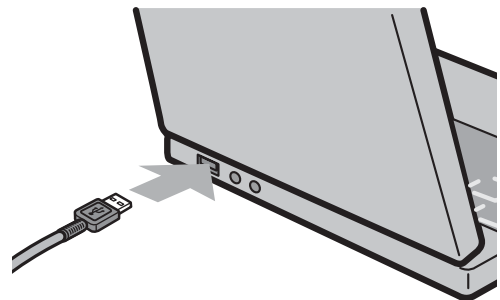

- 3. Connect the USB cable to the USB terminal of your camera.**
Your camera turns on.

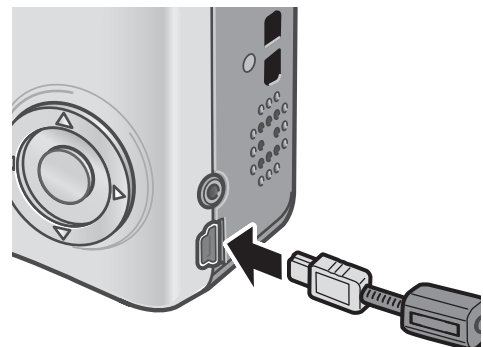

For Windows XP

The first time you connect your camera to the computer using a USB cable, the [Found New Hardware Wizard] screen will appear.

1. **Select [Install the software automatically (Recommended)].**

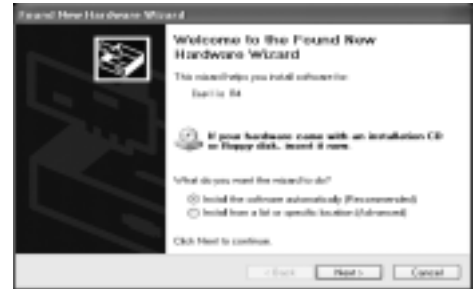

2. **Insert the Caplio Software CD-ROM into the CD-ROM drive on your computer.**

Installation of the WIA Driver automatically starts. If the CD-ROM is already on your computer when the [Found New Hardware Wizard] screen is displayed, simply click [Next] to start installation.



Reference

For how to turn the camera on/off, see P.22.



Note

By default, the WIA driver is installed in the following location:
Specify the folder if the CD-ROM is not available.

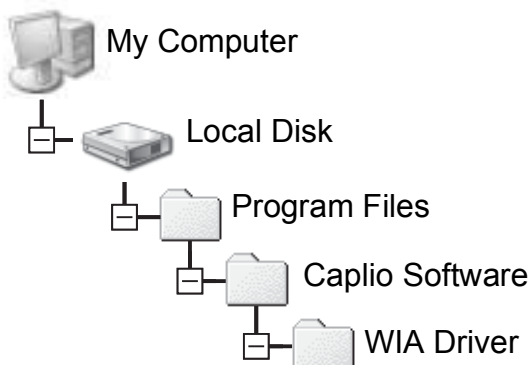

3. Select [RICOH Gate La], check [Always use this program for this action] check box, and then click [OK].

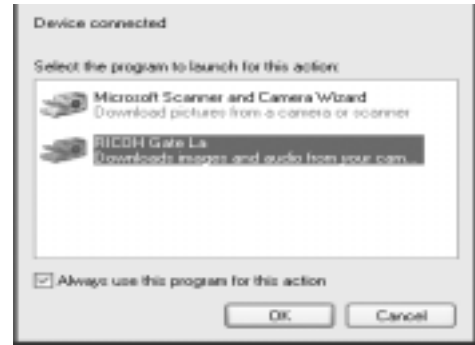

To load images from the camera with assistance from the Windows XP “Scanner and Camera Wizard”, select [Microsoft Scanner and Camera Wizard].

Leaving the [Always use this program for this action] check box unchecked will cause the [Caplio R4] screen to be displayed each time you transfer images from the camera, thereby allowing you to choose whether to use [RICOH Gate La] or the [Microsoft Scanner and Camera Wizard] for image transfers.

If your PC is installed with Windows XP Service Pack 2 and a warning message is displayed, see P.165.

Disconnecting the Camera from Your Computer:

1. Turn your camera off by pressing the POWER button.
2. Unplug the USB cable.

Note

- If the computer does not recognize the camera, uninstall the software (P.151) and install it again.
- When downloading images from your camera, be sure to use a fully charged rechargeable battery in the camera. Use of the AC adapter (sold separately) is recommended.

Reference

- For how to turn the camera on/off, see P.22.
- For details about [USB CONNECTION] (MASS STR/ORIGINAL), see P.125.

Transferring Images in Mass Storage Mode

Caution

Windows 98/98 SE and Mac OS 8.6 are not compatible with Mass Storage Mode.

1. Change [USB CONNECTION] to [MASS STR] on the Setup menu.

For more details, see P.125. At the time of purchase, [ORIGINAL] is selected.

2. Make sure that the camera power is off.

3. Connect the accessory USB cable to a USB port of your computer.

4. Connect the USB cable to the USB terminal of your camera.

Your camera turns on.

Your computer automatically reads a file necessary for recognizing the camera as a drive.

After this preparation, the camera is displayed as a drive at [My Computer] (Windows) or Desktop (Macintosh).



Example of the display in Windows XP

5. From the displayed drive, copy a file to the desired location.

The figure at right shows the folder configuration in the drive.

When the contents of the internal memory are displayed, the drive name is [RICOHDCI].

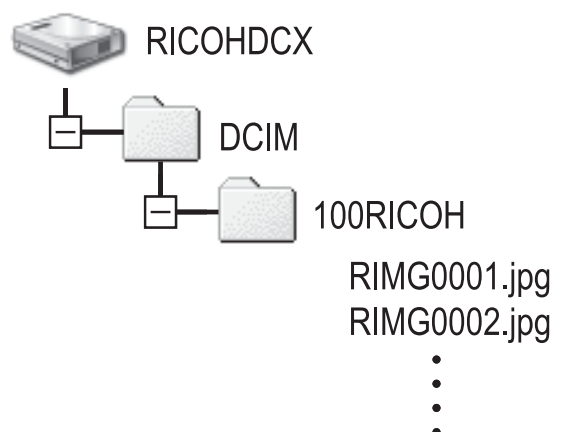

Caution

During transfer, do not disconnect the USB cable.

Note

When an SD memory card is loaded, its files are displayed. Otherwise, files in the internal memory are displayed.

Disconnecting the Camera from Your Computer (Windows)

The display is an example of Windows XP. The terms are different for other operating systems but the operations are the same.

- 1. Double-click the [Safely Remove Hardware] icon at the right end of the task bar.**
- 2. Select [USB Mass Storage Device] and click [Stop].**
- 3. Check that [USB Mass Storage Device] is selected and click [OK].**
- 4. Click [Close].**

Disconnecting the Camera from Your Computer (Macintosh)

- 1. Drag the displayed drive to the “Trash”.**

Downloading Images from an SD Memory Card

It is possible to download images from an SD memory card to the computer via a PC card slot or card reader.

Images in an SD Memory Card

Images are stored in an SD memory card in a hierarchy shown below.

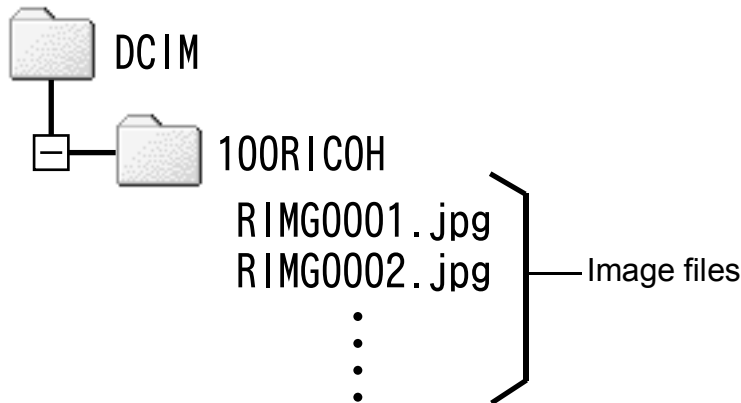

Note

Depending on the type of PC card slot or card reader, a memory card adapter may be required when using an SD memory card. If the SD memory card can be used in the PC card slot, no memory card adapter is required.



Term

Card Reader

This is a device connected to a computer to read the contents of cards. In addition to the memory card adapter-type, there are card readers compatible with various types of cards, into which you can directly load an SD memory card.

Installing Acrobat Reader

Acrobat Reader is required to display the operation manual (PDF file).

If the computer is running under Windows, Acrobat Reader can be installed.

Acrobat Reader need not be installed if already installed on your computer.



Caution

- Do not install the software when the camera is connected to your computer with a USB cable.
- For Windows XP or Windows 2000, Administrator privileges are required to install the software.

1. Start your computer, and insert the included Caplio Software CD-ROM into the CD-ROM drive.

The following screen appears automatically.

2. Click [Browse CD-ROM Content].

The files on the CD-ROM are listed.

3. Double-click the [Acrobat] folder.

4. Double-click the [English] folder.

5. Double-click [ar500enu] (ar500enu.exe).

6. Install Acrobat Reader by following the messages displayed.

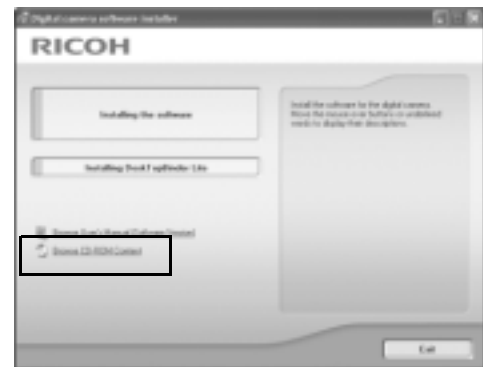

Installing DirectX

DirectX is used to play movie files with ImageMixer.

This camera requires DirectX 8.1 or later to play movie files in Windows. If you have an earlier version installed, please install the updated version available on the accompanying CD-ROM.

For Windows XP, installation of DirectX is not needed because the updated version is already installed.



Caution

- Do not install the software when the camera is connected to your computer with a USB cable.
- For Windows XP or Windows 2000, Administrator privileges are required to install the software.

- 1. Start your computer, and insert the included Caplio Software CD-ROM into the CD-ROM drive.**
- 2. Click [Browse CD-ROM Content].**
- 3. Double-click the [DirectX] folder.**
- 4. Double-click the [English] folder.**
- 5. Double-click the following file:**

Windows98/98SE/Me	[DX81xxx.exe] in the [Win98Me] folder
Windows2000	[DX81NTxxx.exe] in the [Win2000] folder

Uninstalling the Software



Caution

- For Windows 2000/XP, Administrator privileges are required to uninstall the software.
- If any other program is active or unsaved data remains, save the data and terminate the program before uninstalling.
- If you install both ImageMixer and the DeskTopBinder Lite and then uninstall either one, camera connection to the computer may fail. In this case, uninstall both [Caplio Software] and [Caplio Software S] and then install only the required one.

- 1. Click [Start] on the Windows task bar.**
- 2. Select [Settings]-[Control Panel] ([Control Panel] for XP).**
- 3. Double-click the [Add/Remove Programs] icon (or the [Add or Remove Programs] icon in Windows XP).**
- 4. Select [Caplio Software] (select [Caplio Software S] if you have installed the DeskTopBinder Lite), and then click the [Change/Remove] button.**
- 5. Confirm file deletion and click [OK].**

The [Shared File Detected] dialog box appears.
- 6. Select the [Don't display this message again.] check box, and then click [Yes].**

The uninstallation process begins. When it is finished, close the displayed window.

Uninstalling ImageMixer



Caution

- For Windows 2000/XP, Administrator privileges are required to uninstall the software.
- If any other program is active or unsaved data remains, save the data and terminate the program before uninstalling.

- 1. Click [Start] on the Windows task bar.**
- 2. Select [Settings]-[Control Panel] ([Control Panel] for XP).**
- 3. Double-click the [Add/Remove Programs] icon (or the [Add or Remove Programs] icon in Windows XP).**
- 4. Select [ImageMixer] and then click [Change/Remove].**
- 5. Confirm file deletion and click [OK].**

The uninstallation process begins. When it is finished, close the displayed window.
- 6. Restart your computer.**

Installing the Provided Software (For Macintosh)

You need to install software for transferring images to your computer before you can download images from the camera.



Reference

For how to download images from the camera into your computer, see the “Software User Guide” available from the Caplio Software CD-ROM. For how to display the “Software User Guide”, see P.154.



Caution

Be sure to install the software before you connect the camera to your computer with the cable.

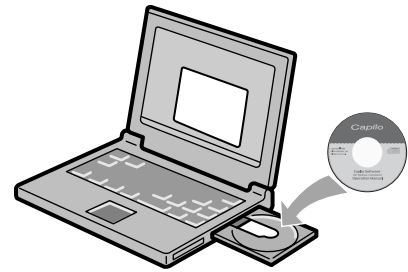

Software that can be installed from the Caplio Software CD-ROM

Software	Mac		Description
	9	X	
RICOH Gate La	<input type="radio"/>	-	Downloads images collectively.
USB Driver	<input type="radio"/>	<input type="radio"/>	Connects the camera to your computer.
Caplio Mounter	<input type="radio"/>	<input type="radio"/>	Connects the camera to your computer.

9: Mac OS 8.6 to Mac OS 9.2.2

X: Mac OS X 10.1.2 to 10.4.5

For Mac OS 8.6 to 9.2.2, double-clicking the [Installer] icon displays the screen on the right.



Item Name	Description
Installing the Software	Use this button to install software required for handling the camera and images.
Browse User's Manual (Software Version)	Use this button to display the "Software User Guide" (PDF).

When [Installing the software] is clicked:

The software will be installed.

When [Browse User's Manual (Software Version)] is clicked:

The "Software User Guide" (PDF file) on the Caplio Software CD-ROM can be displayed on your computer screen.

Acrobat Reader must be installed to view the PDF file.

System Requirements for Using the Provided Software

The following environments are necessary for using the provided software.

Please check your computer, or the computer's user manual.

Operating System	Mac OS 8.6 to 9.2.2/Mac OS X 10.1.2 to 10.4.5	
Macintosh	A USB port standard-equipped Apple Macintosh Series	
Internal Memory	Mac OS 8.6 to 9.2.2	96 MB or more (128 MB or more recommended)
	Mac OS X 10.1.2 to 10.4.5	128 MB or more (256 MB or more recommended)
Application Allocated Memory (For Mac OS 8.6 to 9.2.2)	Without using the compression utility, 16 MB or more (24 MB or more is recommended) as Application Memory	
Hard Disc Drive Capacity	Mac OS 8.6 to 9.2.2	10 MB or more (at installation)
	Mac OS X 10.1.2 to 10.4.5	100 MB or more (at installation)
	100 MB or more (at operation)	
Display resolution	800 × 600 pixels or greater	
Display colors	32,000 or greater	
CD-ROM drive	A CD-ROM drive compatible with the above-mentioned Macintosh machine	
USB port	A USB port compatible with the above-mentioned computer body	



Caution

- The provided software may not operate properly if changes are made to the operating system.
- Connection to a USB port retrofitted using an extended function (PCI bus, etc.) cannot be supported.
- If used in conjunction with a hub or other USB devices, the software may not work properly.



Note

- When dealing with movies and other large files, a larger memory environment is recommended.
- For Mac OS 8.6 to 9.2.2, use a larger memory environment, as well as allocating extra application memory.

Installing the Software on Your Computer (Mac OS 8.6 to 9.2.2)

1. Turn on your Macintosh and insert the Caplio Software CD-ROM in the CD-ROM drive.
2. Double-click the [Caplio Software] icon.
3. Double-click the [MacOS9] folder.

The [Installer] icon appears.

4. Double-click [Installer].

The “Digital camera software installer” window opens.



Installer

5. Click [Installing the software].
6. Click [OK] to update.
7. Click [Install].

When installation finishes, a message appears to inform you that it is necessary to restart your Macintosh.

8. Click [Continue].

The software is installed and after a while the Installation Complete message appears.

9. Click [Restart].

Your Macintosh restarts.



Note

To remove (uninstall) the software:

To remove (uninstall) the software from your Macintosh, drag the following files to the Trash.

File Name	Folder Name
RICOH Gate La	Control Panels
RICOH Gate La Prefs	Preferences
Caplio Mounter	Extensions
Caplio Mounter Prefs	Preferences
Caplio USB Driver	Extensions
Caplio LIB	Extensions

Installing the Software on Your Computer (Mac OS X 10.1.2 to 10.4.5)

1. Turn on your Macintosh and insert the Caplio CD-ROM in the CD-ROM drive.
2. Double-click the [Caplio Software] icon.
3. Open the Mac OS X folder.
Folders named [Mac OS X 10.1 - 10.3] and [Mac OS X 10.4] appear.

4. Click the folder for your OS.

Double click [Mac OS X 10.1 - 10.3] if you are using Mac OS X 10.1 to 10.3. Double click [Mac OS X 10.4] if you are using Mac OS X 10.4 or later. The [Caplio Mounter] icon appears.

5. Double-click [Caplio Mounter].

The Installer starts. A screen appears prompting you to enter the administrator's password.

6. Click the key icon.

An authentication window appears.

7. Enter the administrator's name and password, and then click [OK].

8. Click [Continue].

The installation Readme file appears. Click [Continue]. The screen to select the destination disk appears.



9. Click the destination disk you want, and then click [Continue].



10. Click [Install].

When installation finishes, a message appears to inform you that it is necessary to restart your Macintosh.

11. Click [Continue Installation].

The software is installed, and after a while an Installation Complete message appears.



12. Click [Restart].

Your Macintosh restarts.



Note

To remove (uninstall) the software:

1. Start [Caplio Mounter] in [Applications] folder.
2. Select [Uninstall] in [File] menu.

The uninstallation process begins.

Chapter 5

Troubleshooting

Troubleshooting	160
Appendices	167



Caution

Never use any battery other than the specified one.



Reference

For the applicable battery, see P.16.

Troubleshooting

Troubleshooting the Camera



Power Supply

Problem	Cause	Solution	Refer to
The camera does not turn on.	Battery is not loaded or is exhausted.	Load the rechargeable battery correctly. Charge the battery as required. Use the AC adapter as required.	P.19 P.20 P.169
	A (manganese dry cell or other) unacceptable battery is used.	Use the dedicated rechargeable battery. Never use any other batteries.	P.16
	The AC adapter is not connected correctly.	Reconnect it properly.	P.169
	The camera is automatically turned off by Auto Power Off.	Turn the camera back on.	P.22
	The battery is loaded in wrong direction.	Load correctly.	P.20
The camera turns off during use.	The camera was left unattended and unused, so Auto Power Off turned it off.	Press the POWER button to turn the camera on.	P.22
	Battery is running low.	Charge the rechargeable battery or use the AC adapter.	P.16
	A (manganese dry cell or other) unacceptable battery is used.	Use the dedicated rechargeable battery. Never use any other batteries.	P.16
The camera does not turn off.	Camera malfunction.	Remove the battery and load it again. Reconnect the AC adapter cable properly, if using.	P.19 P.20 P.169
Although the battery has just been charged, a battery mark is displayed to indicate a low battery level. Although the battery has just been charged, pressing the shutter release button retracts the lens. Although the battery has just been charged, pressing the shutter release button turns the power off.	A (manganese dry cell or other) unacceptable battery is used.	Use the dedicated rechargeable battery. Never use any other batteries.	P.16

Problem	Cause	Solution	Refer to
Cannot charge the battery.	Battery has reached the end of its useful life.	Replace with a new rechargeable battery.	P.16
Battery runs out quickly.	It is being used at extreme high or low temperatures.	-	-
	Many shots are being taken in dark places or other location requiring extensive use of flash.	-	-

Shooting

Problem	Cause	Solution	Refer to
The camera does not shoot even if you press the shutter release button.	Battery is not loaded or is exhausted.	Charge the rechargeable battery or use the AC adapter.	P.16 P.20 P.169
	The camera is not on.	Press the POWER button to turn the camera on.	P.22
	The camera is in Playback Mode.	Press the  (Playback) button.	P.42
	The shutter release button is not pressed all the way.	Press the shutter release button all the way.	P.29 P.30
	The SD memory card is not formatted.	Format the card.	P.110
	The SD memory card is full.	Load a new card, or delete unwanted files.	P.20 P.49
	The SD memory card has reached the end of its useful life.	Load a new memory card.	P.20
	The flash is charging.	Wait until the auto focus/flash lamp stops blinking.	P.36
	The SD memory card is locked.	Unlock the card.	P.18
	The contact surface of the SD memory card is dirty.	Wipe with a soft, dry cloth.	-
Unable to view the shot image.	The image confirmation time is too short.	Lengthen the image confirmation time.	P.117
Images do not appear on the LCD Monitor.	The camera is not on or the LCD monitor is dark.	Turn the camera on or adjust the brightness of the LCD monitor.	P.22 P.112
	The VIDEO/AV cable is connected.	Disconnect the VIDEO/AV cable.	P.47
	The screen display is in Synchro-Monitor Mode.	Press the DISP. button to change the display.	P.25
Although the camera is set to Auto Focus, it is unable to focus.	The lens or AF Window is dirty.	Wipe clean with a soft, dry cloth.	P.12
	The subject is not in the center of the shooting range.	Shoot with Focus Lock.	P.32
	It is a hard-to-focus subject.	Shoot with Focus Lock or Manual Focus.	P.32 P.64

Problem	Cause	Solution	Refer to
The picture is blurred.	You moved the camera when pressing the shutter release button.	Hold the camera with your elbows pressed against your body. Use a tripod.	P.27
	When shooting in a dark place (such as indoors), the shutter speed slows down and pictures become easily blurred.	Use the flash. Raise the ISO setting.	P.36 P.81
The flash does not fire or the flash cannot charge.	The flash cannot be used in the following cases: <ul style="list-style-type: none"> • When White Balance Bracket is set • In Continuous Shooting Mode • In Movie Mode In some Scene Modes, the flash may be disabled by default.	To shoot with the flash, change the settings or mode.	P.12 P.71 P.87 P.91 P.170
	The flash is set to Flash Off.	Use the  (Flash) button to cancel Flash Off.	P.36
	Battery is running low.	Charge the rechargeable battery or use the AC adapter.	P.16
Even though the flash fired, the picture is dark.	The distance to the subject is greater than 1.85 meters in Telephoto or greater than 2.4 meters in Wide-angle.	Get closer to your subject and shoot.	P.36
	The subject is dark.	Correct the exposure. (Exposure compensation also changes the light intensity of the flash.)	P.78
The image is too bright.	The light intensity of the flash is not appropriate.	Move a little away from the subject or illuminate the subject with another light source instead of using the flash.	P.36
	Subject is overexposed.	Correct the exposure. Cancel Exposure Time.	P.73 P.78
	The brightness of the LCD monitor is not appropriate.	Adjust the brightness of the LCD monitor.	P.112
The image is too dark.	The shot was taken in a dark place while set to  (FLASH OFF).	Use the  (Flash) button to cancel Flash Off.	P.36
	The subject is underexposed.	Correct the exposure. Set to long exposure time.	P.73 P.78
	The brightness of the LCD monitor is not appropriate.	Adjust the brightness of the LCD monitor.	P.112
The image lacks natural color.	The picture was shot in conditions that made it difficult for Auto White Balance to adjust the white balance.	Add a white object to the composition or use a White Balance setting other than Auto.	P.79
The date or recording information does not appear on the screen.	The screen display function is set to No Display.	Press the DISP. button to change the display.	P.25

Problem	Cause	Solution	Refer to
The brightness of the LCD monitor changes during AF.	You are using AF in a dark place or when the Auto Focus range and surrounding brightness are different.	This is normal.	-
There is a vertical smear on the image.	This is a phenomenon that occurs when a bright subject is shot. It is called the smear phenomenon.	This is normal.	-

Playback/Deleting

Problem	Cause	Solution	Refer to
Cannot play back, or the Playback screen does not appear.	The camera is not in Playback Mode.	Press the  (Playback) button.	P.42
	The VIDEO/AV cable is not connected properly.	Reconnect it properly.	P.47
	The VIDEO OUT MODE setting is incorrect.	Set it to the correct format.	P.122
The contents of the SD memory card cannot be played back, or the Playback screen does not appear.	No SD memory card is loaded, or an SD memory card with no stored images is loaded.	Load a card with stored images.	P.20
	You played back an SD memory card that was not formatted with this device.	Load a card that was formatted and recorded with this device.	P.20 P.110
	You played back an SD memory card that was not recorded normally.	Load a normally recorded card.	-
	The contact surface of the SD memory card is dirty.	Wipe with a soft, dry cloth.	-
	There is something wrong with the SD memory card.	Play back images from another card and if there is nothing wrong with the card, the camera is okay. There may be something wrong with the card, so do not use it.	-
The LCD monitor turned off.	Battery is running low.	Charge the rechargeable battery or use the AC adapter.	P.16
	The camera was left unattended and unused, so Auto Power Off turned it off.	Turn the camera back on.	P.22
A file cannot be deleted.	The file is protected.	Unprotect the file.	P.99
	The SD memory card is locked.	Unlock the card.	P.18
Cannot format the SD memory card.	The SD memory card is locked.	Unlock the card.	P.18

About the Software

For details about the software, refer to the “Software User Guide” (PDF file).

Other Problems

Problem	Cause	Solution	Refer to
Cannot load the SD memory card.	The card is facing the wrong way.	Load correctly.	P.20
The camera does not operate even when the buttons are pressed.	Battery is running low.	Charge the rechargeable battery or use the AC adapter.	P.16 P.19 P.169
	Camera malfunction.	Press the POWER button to turn the camera off, and then press the POWER button to turn the camera on again.	P.22
		Remove the battery and load it again. Reconnect the AC adapter cable properly, if using.	P.20 P.169
The date is incorrect.	The correct date/time are not set.	Set the correct date/time.	P.120
The set date disappeared.	The battery was removed.	If the battery is removed for about one week, the date setting will be lost. Make the settings again.	P.120
Auto Power Off does not work.	Auto Power Off is set to [OFF].	Set the time for Auto Power Off.	P.114
The beep sound cannot be heard.	The beep sound volume is turned off.	Use [VOL. SETTINGS] to set the volume to a setting other than mute.	P.116
Images do not appear on the TV.	The VIDEO OUT MODE setting is incorrect.	Set it to the correct format.	P.122
	The AV cable is not connected.	Connect the AV cable properly.	P.47
	The TV is not correctly set to VIDEO IN.	Check that the TV is correctly set to VIDEO IN.	-

Warning Messages Under Windows XP Service Pack 2

When software for your Ricoh digital camera is used on a computer with Windows XP Service Pack 2 installed, the following warning message may appear at software activation or USB connection. With this in mind, refer to the following:

When this warning message is displayed:

1. Check the information provided on the message screen to make sure that it comes from a reputable source, and then click the [Unblock] button.



Caution

If you do not recognize the program, you should block it because it may be a virus. Click the [Keep Blocking] button to prevent the program from connecting to the Internet.

If you clicked the [Keep Blocking] button:

Follow the steps below to check the Windows Firewall settings.

1. Click [Start] and then [Control Panel].

2. Double-click [Windows Firewall].

If [Windows Firewall] is not displayed, click [Switch to Classic View] at the top left of the window.



Windows Firewall

3. Click the [Exceptions] tab.

4. Check that the software is in [Programs and Services].

5. Click the [Add Program] button to add software that uses the network.



If you clicked the [Ask Me Later] button:

Each time the program is activated, the [Windows Security Alert] dialog box appears.

Appendices

A. Specifications

General

Video Signal Format	NTSC, PAL
Power Source Voltage	Rechargeable Battery (3.7 V) × 1 External (AC adapter): 3.8 V
External Dimensions	95.0 mm (W) × 53.0 mm (H) × 26.0 mm (D) (excluding projecting parts)
Weight	Camera: Approximately 135 g (excluding battery, strap) Accessories: Approximately 30 g (battery, strap)
Tripod Hole Shape	1/4-20UNC
Operating Temperature Range	0 °C to 40 °C
Operating Humidity Range	85% or less
Storage Temperature Range	-20 °C to 60 °C

Camera Parts

Image Pickup Element	Total 6.18 million pixels (effective pixels 6.04 million), 1/2.5" primary-color CCD
Lens	
• Lens	5.7× Optical Zoom Aperture: F3.3 (Wide-angle) to 4.8 (Telephoto)
• Focal Length	4.6 to 26.4 mm (equivalent to 28 to 160 mm on a 35mm camera)
• Shooting Distance	Approximately 0.3 m to ∞ (Wide-angle) or 0.84 m to ∞ (Telephoto) from the front of the lens
• Macro Shooting Distance	Approximately 0.01 m to ∞ (Wide-angle) or 0.08 m to ∞ (Telephoto) from the front of the lens
• Digital Zoom	3.6 times
Monitor Display Parts	
• Screen Size	2.5"
• Type	Transparent Amorphous Silicon TFT LCD
• Pixel Count	Approx. 153,000
White Balance	AUTO/Fixed (OUTDOORS, CLOUDY, INCAND., INCAND.2, FLUORES., MANUAL)
Exposure Adjustment	
• Light Metering Sensitivity Distribution	Multi Light Metering (256 segments), Center-weighted Light Metering, Spot Metering
• Exposure Compensation	Manual exposure compensation +/-2.0EV (1/3EV Steps)
• Metering Method	TTL-CCD Metering Method
• Flash AE	Yes (In Daylight Synchro: On)
• Shutter	Still image: 8, 4, 2, 1 to 1/2000 seconds; Movie: 1/30 to 1/2000 seconds
• ISO Sensitivity	AUTO, ISO64, ISO100, ISO200, ISO400, and ISO800

Distance Control

- AF Method Normal Shooting: External Passive/CCD method
Macro: CCD method
- AF Measurement Range Normal: approx. 0.3 m to ∞ , Macro: approx. 0.01 m to ∞

Internal Flash

- Method Flashmatic
 - Shooting Distance Approx. 0.2 to 2.4 m (Wide-angle), Approx. 0.14 to 1.85 m (Telephoto) (ISO: AUTO)
 - Operating Modes Flash Off/Auto/Red-eye reduction/Forced flash/Flash synchro
- Date Maintain Time Approx. 1 week

Image Data Record/Playback Part

Pixels

- Still Image 2816 × 2112, 2784 × 1856, 2048 × 1536, 1280 × 960, 640 × 480
- Text 2816 × 2112, 2048 × 1536
- Movie 320 × 240, 160 × 120

File Formats

- Still Image Compressed: JPEG (Exif Ver.2.21)
- Text TIFF (MMR Method ITU-T.6)
- Movie AVI (Open DML Motion JPEG Format Compliant)
- Sound WAV (Exif Ver.2.21 σ law)

Camera File System Standard DCF ("Design rule for Camera File system", a JEITA standard)

Compression Format JPEG Baseline Format Compliant (Still image, movie)

Image Size

- 2816 × 2112 N: approx. 1246 KB/Screen, F: approx. 2161 KB/Screen
- 2784 × 1856 F: approx. 1881 KB/Screen
- 2048 × 1536 N: approx. 672 KB/Screen, F: approx. 1317 KB/Screen
- 1280 × 960 N: approx. 356 KB/Screen, F: approx. 686 KB/Screen
- 640 × 480 N: approx. 83 KB/Screen

I/O Terminals

DC In 3.8 V (AC adapter)

Video Out 1.0 Vp-p (75 Ω)

USB Terminal mini-B USB Ver.1.1

Memory Cards for Recording and Playback

Memory Type SD memory card, Multi Media Card

B. Optional Accessories

The Caplio R40 can be used with the items (sold separately) listed below.

Item	Model	Remarks
AC adapter	AC-4c	Used for power supply from a household outlet to the camera.
Rechargeable battery	DB-60	Rechargeable battery for use with this camera.
Battery charger	BJ-6	Used to charge the rechargeable battery (DB-60).
Soft case	SC-60	Used to store your camera.

Using the AC Adapter (sold separately)

When shooting or viewing still images for a long time, or when connecting to your computer, use of the AC adapter (sold separately) is recommended.

If you have already used this camera, make sure it is turned off before loading the AC adapter coupler.

- 1. Open the battery/card cover.**
- 2. Insert the AC adapter coupler.**
When the AC adapter coupler is loaded in place, it is locked with the hook shown in the figure.
- 3. Plug the power cord into an outlet.**

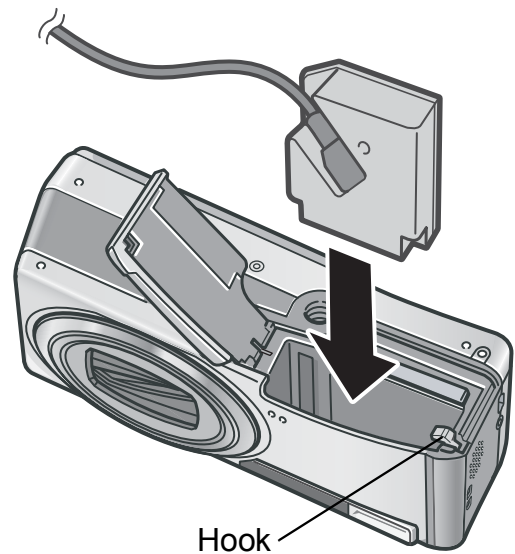



Caution

- Use the AC adapter with the battery/card cover open. Do not close the cover forcibly.
- The camera cannot be used with a tripod.
- Be sure to securely connect the AC adapter cord and plug.
- When you are not using the camera, unplug the AC adapter from the camera and the power outlet.
- If you disconnect the AC adapter from the camera or the plug from the outlet while the camera is in use, data may be lost.
- When using the AC adapter, the battery level indication may not reach the full area.

Disconnecting the AC Adapter

Make sure the camera is turned off before disconnecting the AC adapter.

- 1. Unplug the power plug from the outlet.**
- 2. Remove the AC adapter coupler from the camera.**
- 3. Close the battery/card cover and slide it back into place.**







C. Using Scene Modes with Functions

Depending on the Scene Mode, the operation of functions may differ from when in normal shooting mode. Refer to the table below.

Scene Mode	Flash	Macro Shooting
PORTRAIT	Initial setting: FLASH OFF	Disabled
SPORTS	Initial setting: FLASH OFF	Disabled
LANDSCAPE	Fixed to [FLASH OFF]	Disabled
NIGHTSCAPE	[FLASH ON] is disabled	Disabled
	Initial setting: AUTO	
TEXT MODE	Initial setting: FLASH OFF	Enabled
HIGH SENS	Initial setting: FLASH OFF	Enabled
ZOOM MACRO	Initial setting: FLASH OFF	Macro shooting only
SKEW COR MODE	Initial setting: FLASH OFF	Enabled

D. Available Menu Items By Mode

Movie Mode

Setting	Options	Refer to
MOVIE SIZE	[320], 160	P.60
FRAME RATE	15FPS, [30FPS]	P.93
FOCUS	[MULTI AF], SPOT AF, MF, SNAP, ∞	P.64
WHITE BALANCE	[AUTO],  (OUTDOORS),  (CLOUDY),  (INCANDESCENT LAMP),  (INCANDESCENT LAMP2),  (FLUORESCENT LAMP),  (MANUAL SETTINGS)	P.79

Scene Mode

Setting	PORTRAIT	SPORTS	LANDSCAPE	NIGHTSCAPE	SKEW COR MODE	TEXT MODE	ZOOM MACRO	HIGH SENSITIVITY	Refer to
PIC QUALITY/SIZE	<input type="radio"/>	<input type="radio"/>	<input type="radio"/>	<input type="radio"/>	<input type="radio"/>	-	<input type="radio"/>	<input type="radio"/>	P.60
SIZE	-	-	-	-	-	<input type="radio"/>	-	-	P.60
DENSITY	-	-	-	-	-	<input type="radio"/>	-	-	P.84
FOCUS	<input type="radio"/>	<input type="radio"/>	-	<input type="radio"/>	<input type="radio"/>	-	<input type="radio"/>	<input type="radio"/>	P.62
PHOTOMETRY	-	-	-	-	<input type="radio"/>	-	<input type="radio"/>	-	P.67
SHARPNESS	-	-	-	-	<input type="radio"/>	-	<input type="radio"/>	-	P.67
CONT. MODE	-	-	-	-	-	-	<input type="radio"/>	-	P.87
COLOR DEPTH	-	-	-	-	<input type="radio"/>	-	<input type="radio"/>	-	P.69
AUTO BRACKET	-	-	-	-	-	-	<input type="radio"/>	-	P.70
TIME EXPOSURE	-	-	-	-	-	-	<input type="radio"/>	-	P.73
IMAGE WITH SOUND	<input type="radio"/>	<input type="radio"/>	<input type="radio"/>	<input type="radio"/>	<input type="radio"/>	<input type="radio"/>	<input type="radio"/>	<input type="radio"/>	P.76
DATE IMPRINT	<input type="radio"/>	<input type="radio"/>	<input type="radio"/>	<input type="radio"/>	<input type="radio"/>	<input type="radio"/>	<input type="radio"/>	<input type="radio"/>	P.77
EXPOSURE COMP.	<input type="radio"/>	<input type="radio"/>	<input type="radio"/>	<input type="radio"/>	<input type="radio"/>	-	<input type="radio"/>	<input type="radio"/>	P.78
WHITE BALANCE	<input type="radio"/>	<input type="radio"/>	<input type="radio"/>	<input type="radio"/>	<input type="radio"/>	-	<input type="radio"/>	<input type="radio"/>	P.79
ISO SETTING	-	-	-	-	<input type="radio"/>	-	<input type="radio"/>	-	P.81
SLOW SHUTTER LMT	<input type="radio"/>	<input type="radio"/>	<input type="radio"/>	<input type="radio"/>	<input type="radio"/>	<input type="radio"/>	<input type="radio"/>	<input type="radio"/>	P.82

For details about options, see P.58.

E. Functions Whose Defaults are Restored When Camera is Turned Off

Turning the camera off may reset some function settings to their defaults.

The table below indicates whether or not the function is reset to its default when the camera is turned off.

Menu	Function	○: setting is saved, ×: setting is restored
SETUP	DATE SETTINGS	○
	AUTO POWER OFF	○
	BEEP SOUND	○
	SEQUENTIAL NO.	○
	LCD CONFIRM.	○
	VOL. SETTINGS	○
	LCD BRIGHTNESS	○
	LANGUAGE/言語	○
	VIDEO OUT MODE	○
	ADJ BTN. SET.1 ADJ BTN. SET.2	○
	STEP ZOOM	○
	USB CONNECTION	○
	ENLGE PHOTO ICON	○
	SHTG STGS WARNG.	○
	REG. MY SETTINGS	○
	START SETTINGS	○
Shooting	CONT. MODE	×
	EXPOSURE COMP.	○
	WHITE BALANCE	○
	COLOR DEPTH	○
	PIC QUALITY/SIZE	○
	FOCUS	○
	PHOTOMETRY	○
	ISO SETTING	○
	SHARPNESS	○
	AUTO BRACKET	×
	TIME EXPOSURE	○
	INTERVAL	×
	DATE IMPRINT	○

Menu	Function	○: setting is saved, ×: setting is restored
	IMAGE WITH SOUND	×
	Self-timer	×
	Flash	○
	Macro shooting	×
	DENSITY (TEXT MODE)	○
	SLOW SHUTTER LMT	○
	MOVIE SIZE (Movie Mode)	○
	FRAME RATE	○
	SIZE (TEXT MODE)	○
	Maximum brightness	○
Playback	VOL. SETTINGS	○

F. Number of Images That Can be Stored in Internal Memory/SD Memory Card

The following table shows the approximate number of images that can be recorded in the internal memory and onto an SD memory card at various image size and picture quality settings.

Mode	Picture Quality	Image Size	Internal Memory	32 MB	64 MB	128 MB	256 MB	512 MB	1 GB
Still Image	F	2816 × 2112	11	12	26	52	105	212	408
	N	2816 × 2112	19	22	45	91	181	365	702
	F	2784 × 1856	12	14	30	60	120	243	468
	F	2048 × 1536	18	21	43	87	173	349	671
	N	2048 × 1536	36	41	84	170	339	683	1314
	F	1280 × 960	33	38	79	159	318	641	1233
	N	1280 × 960	63	72	148	301	600	1209	2324
	N	640 × 480	277	315	645	1304	2599	5237	10072
TEXT MODE		2816 × 2112	59	67	138	279	557	1122	2158
		2048 × 1536	87	99	203	412	821	1654	3181

Mode	Picture Quality	Image Size	Internal Memory	32 MB	64 MB	128 MB	256 MB	512 MB	1 GB
Movie	15FPS 320 × 240		1 min 17 s	1 min 27 s	2 min 59 s	6 min 3 s	12 min 4 s	24 min 19 s	46 min 47 s
	30FPS 320 × 240		39 s	44 s	1 min 31 s	3 min 4 s	6 min 7 s	12 min 19 s	23 min 42 s
	15FPS 160 × 120		4 min 38 s	5 min 16 s	10 min 47 s	21 min 49 s	43 min 29 s	87 min 37 s	168 min 30 s
	30FPS 160 × 120		2 min 26 s	2 min 46 s	5 min 40 s	11 min 27 s	22 min 50 s	46 min 1 s	88 min 31 s
Sound			56 min 45 s	64 min 36 s	132 min 11 s	267 min 15 s	532 min 36 s	1073 min 0 s	2063 min 25 s



Note

- The number of remaining shots displayed on the LCD monitor may differ from the actual number of shots, depending on the subject.
- Movie and sound recording time and the maximum number of still pictures may vary depending on the capacity of the recording destination (internal memory or SD memory card), shooting conditions, and the type and manufacturer of the SD memory card.

G. Using Your Camera Abroad

AC Adapter (Model AC-4c)

This AC adapter can be used in regions with a current of 100-240V, 50Hz/60Hz.

If you are going to travel to a country that uses a different shaped wall outlet/plug, please consult your travel agent on a plug adapter suitable for wall outlets in your country of destination.

Warranty

This product was manufactured for use in the country in which it was purchased. The warranty is only valid in the country in which the camera was purchased.

Should the product fail or malfunction while you are abroad, the manufacturer assumes no responsibility for servicing the product locally or bearing the expenditure incurred therefore.

Playback on Television in Other Regions

Playback is possible on televisions (or monitors) equipped with a video input terminal. Please use the AV cable provided.

This camera is compatible with both NTSC and PAL television formats. Set the video format on the camera to match that of the television you are using.

When you go abroad, set your camera to the local video format.

H. Cautions on Use

- This product was manufactured for use in the country in which it was purchased. The warranty is only valid in the country in which the camera was purchased.
- Should the product fail or malfunction while you are abroad, the manufacturer assumes no responsibility for servicing the product locally or bearing the expenditure incurred therefore.
- Be sure not to drop or apply any sudden force to the camera.
- Firing the flash consecutively may heat the firing unit. Do not fire it consecutively more than necessary.
- Do not fire the flash near eyes. It could cause visual impairment (particularly for infants).
- Do not fire the flash near the driver of a vehicle to avoid causing accidents.
- The batteries may become hot after extended use. Touching the batteries immediately after use could result in burns to your fingers.
- If the LCD monitor or panel is exposed to sunlight, they may become washed out and images may become hard to view.
- The LCD monitor and panel may contain some pixels that do not remain lit up continually in part or at all. Also, the brightness may become uneven because of the characteristics of LCDs. These are not failures.
- While you are carrying the camera, be careful not to hit it against other objects.
- In an environment where the temperature changes suddenly, condensation may occur in the camera, resulting in troubles such as fogging of the glass surface or malfunctions of the camera. If this occurs, place the camera in a bag to slow the temperature change as much as possible. Take it out of the bag after the temperature difference from the atmosphere has decreased to a fairly small amount.
- To avoid damaging the connectors, do not put any objects into the camera's microphone or speaker holes.



Note

Conditions in which condensation may easily occur:

- When the camera is moved to an environment where the temperature differs greatly.
- In humid places
- In a room immediately after being heated, or when the camera is exposed directly to cooled air from an air-conditioner or another similar appliance

I. Care and Storage

Care

- Please note that if fingerprints, dirt, etc. get onto the lens, picture quality will suffer.
- When dust or dirt does get on the lens, do not touch it directly with your fingers, and either use a blower (available in stores) to blow it off, or a soft cloth to gently dust it off.
- After use at the beach or around chemicals, wipe it off particularly carefully.
- In the unlikely event that your camera fails to work properly, please consult your Ricoh Repair Center.

There are high voltage circuits in this camera. As this is dangerous, do not dismantle this camera under any circumstances.

- Do not get volatile substances, such as thinner, benzene, or pesticides on your camera. This may cause a change in quality, paint to peel, etc.
- As the surface of the LCD Monitor is easily scratched, do not rub hard objects against it.
- Clean the surface of the LCD monitor by wiping gently with a soft cloth containing a small amount of display cleaner sold in stores.

Use and Storage

- Please avoid using or storing your camera in the following kinds of places, as this may damage the camera.
 - In high heat and humidity, or where there is severe change in temperature or humidity.
 - Places with a lot of dust, dirt or sand.
 - Places with severe vibration.
 - Places where it is in direct contact with vinyl or rubber products or chemicals, including mothballs or other insect repellent, for long periods of time.
 - Places with strong magnetic fields (monitors, next to strong magnets, etc.).
- If you are using a battery or batteries, remove them if you are not going to use the camera for a long period of time.

Precautions regarding care of your camera

1. Be sure to turn the power off.
2. Remove the batteries or AC Adapter before caring for your camera.

J. Error Messages

If an error message is displayed on the screen, take the corresponding action.

Error Message	Cause and Action	Page
INSERT CARD	No card is loaded. Insert a card.	P.20
SET DATE.	The date is not set. Set the date.	P.120
FILE NUMBER OVER LIMIT	The file number limit has been exceeded. Use another card.	P.118
UNMATCHED FILE	The camera cannot display this file. Check the file contents on your computer, and then delete the file.	-
INSUFFICIENT MEMORY. CONTINUE?	Because there is not sufficient capacity on the card, all the files cannot be copied. Use another card.	P.18
PROTECTED	You are trying to delete a protected file.	P.99
CARD IS WRITE-PROTECTED.	The card is "Locked (write-protected)". Unlock the card.	P.18
PRINT SETTINGS CANNOT BE SET FOR THIS FILE.	This file (movie or other file) cannot be selected for printing.	-
INSUFFICIENT MEMORY	Files cannot be stored. Make sure there is enough free space or delete unwanted files.	P.49 P.110 P.111
	The image print number limit has been exceeded. Select an image and set the number to 0.	-
FORMAT INTERNAL MEMORY	You must format the internal memory.	P.111
FORMAT CARD	The card is not formatted. Format the card.	P.110
CARD ERROR	Reformat the card. If, after doing so, the error message still appears, the card may be faulty. Do not use the card.	P.110
WRITING TO CARD	Writing file to memory. Wait until writing finishes.	-
NO FILE	There are no files that can be played back.	-
CANNOT RECORD	The number of remaining shots is 0. Switch to another card or the internal memory.	-

K. Warranty and Servicing

1. This product is backed by a limited warranty. During the warranty period mentioned in the Warranty supplied with your camera, any defective parts will be repaired free of charge. In the event of a camera malfunction, contact the dealer from which you purchased the camera or your nearest Ricoh service office. Please note that you will be not be reimbursed for the cost of bringing the camera to the Ricoh service office.
2. This warranty does not cover any damage resulting from:
 - 1) failure to follow the instructions in the instruction manual;
 - 2) repair, modification or overhaul not conducted by an authorized service center listed in the instruction manual;
 - 3) fire or natural disaster;
 - 4) Improper storage, such as exposing the camera to high temperatures, humidity, or moth-balls; storing it with a leaking battery; storing the camera in a dirty condition so that it becomes moldy; or otherwise insufficiently caring for the camera;
 - 5) Submergence; exposure to floods or spilled alcohol or other beverages; allowing sand or mud to enter the camera; exposure to physical shocks; or dropping the camera.
3. After the warranty period has passed, you will be liable for all repair fees, including those incurred at an authorized service center.
4. You will be liable for all repair fees, even within the warranty period, if the warranty card is not attached or if the distributor's name or the purchase date have been changed or are not indicated on the card.
5. Expenses for overhaul and thorough inspection by special request of the customer will be charged to the customer, whether or not they are incurred during the warranty period.
6. This warranty only applies to the camera and not to the accessories, such as the case and strap, nor does it apply to the battery and other consumables provided.
7. Any consequential damages arising from failure of the camera, such as expenses incurred in taking pictures or loss of expected profit, will not be reimbursed whether they occur during the warranty period or not.
8. The warranty is only valid in the country in which the camera was purchased.
 - * The above provisions refer to repairs offered free of charge, and do not limit your legal rights.
 - * The intention of the above provisions is also described in the warranty card provided with this camera.
9. Parts essential to the servicing of the camera (that is, components required to maintain the functions and quality of the camera) will be available for a period of five years after the camera is discontinued.
10. Please note that if the camera is seriously damaged by flooding, submergence, infiltration of sand or mud, violent shocks or dropping, it may not be repairable, and restoration to its original condition may be impossible.



Note

- Before sending the camera in for repair, check the battery and read the instruction manual again to ensure proper operation.
- Some repairs require a significant amount of time to be completed.
- When sending the camera to a service center, please include a note which describes the defective part and the problem as precisely as possible.
- Remove all accessories not related to the problem before sending the camera to the service center.
- Before taking any important pictures (such as at weddings, on trips abroad, etc.), test the camera to check operation and ensure proper functioning. We recommend that you keep this manual and spare battery on hand.
- This warranty does not apply to data stored on an SD Memory Card or in internal memory.

INFORMATION TO THE USER

USA FCC Part15 Class B

The equipment has been tested and found to comply with the limits for a Class B digital device, pursuant to part 15 of the FCC Rules. These limits are designed to provide reasonable protection against harmful interference in a residential installation. This equipment generates, uses, and can radiate radio frequency energy and if not installed and used in accordance with the instructions, may cause harmful interference to radio communications. However, there is no guarantee that interference will not occur in a particular installation. If this equipment does cause harmful interference to radio or television reception, which can be determined by turning the equipment off and on, then user is encouraged to try to correct the interference by one or more of the following measures:

- Reorient or relocate the receiving antenna.
- Increase the separation between the equipment and receiver.
- Connect the equipment to an outlet on a circuit different from that to which the receiver is connected.
- Consult the dealer or an experienced radio/TV technician for help. (FCC 15.105B)

Changes or modifications not expressly approved by the party responsible for compliance could void the user's authority to operate the equipment. (FCC 15.21)

Properly shielded and grounded cables and connectors must be used for connection to a host computer in order to comply with FCC emission limits. (FCC 15.27)

An AC adapter with a ferrite core must be used for RF interference suppression.

COMPLIANCE INFORMATION STATEMENT

Product Name: DIGITAL CAMERA

Model Number: Caplio R40

This device complies with Part 15 of the FCC Rules.

Operation is subject to the following two conditions:

- (1) This device may cause harmful interference, and
- (2) This device must accept any interference received, including interference that may cause undesired operation.

RICOH CORPORATION

5 Dedrick Place, West Caldwell NJ, 07006 Tel.: 1-800-225-1899

Note to Users in Canada

Note: This Class B digital apparatus complies with Canadian ICES-003

Remarque Concernant les Utilisateurs au Canada

Avertissement: Cet appareil numérique de la classe Best conforme a la norme NMB-003 du Canada

IMPORTANT SAFETY INSTRUCTIONS-SAVE THESE INSTRUCTIONS

DANGER-TO REDUCE THE RISK OF FIRE OR ELECTRIC SHOCK, CAREFULLY FOLLOW THESE INSTRUCTIONS.



Declaration of Conformity

"The Product complies with the requirements of the EMC Directive 89/336/EEC."

Index

A

AC Adapter 11, 169
Acrobat Reader 137
ADJ BTN. SET. 1/2 113
ADJ. Button 13, 57, 94
AF target shift 85
AF Window 12
AUTO BRACKET 70
Auto Focus (AF) 62
Auto Focus/Flash Lamp 13, 30, 36
AUTO POWER OFF 114
AV Cable 10, 47
AV Output Terminal 13, 47

B

Backlighting 78
Battery 16
Battery Charger 10, 19
Battery Level Indication 17
Battery/Card Cover 13, 20
BEEP SOUND 115

C

Camera shake 28
Caplio Mounter 153
Caplio Software CD-ROM 11, 135, 153
Card Reader 148
Charging 19
COLOR DEPTH 69
CONT 87
COPY TO CARD 106

D

DATE IMPRINT 77
DATE SETTINGS 24, 120
Delete 49
Delete/Self-timer Button 13, 49, 86
DENSITY 84
DeskTopBinder Lite 136
Digital Zoom 34
Direct Print 52
DirectX 137
DISP. Button 13, 25
DPOF 102

E

Enlarged View 46
ENLGE PHOTO ICON 129
Error Messages 177
EXPOSURE COMP. 78

F

Flash 12, 36, 86
Flash Button 13, 36
FOCUS 64
Focus Lock 32
FORMAT [CARD] 110

FORMAT [INT. MEM.] 111
FRAME RATE 93
Full-press 29

G

Grid Guide 25

H

Half-press 30
Handstrap 10
HIGH SENS 38
Histogram 26

I

IMAGE WITH SOUND 76
ImageMixer 135, 137, 152
Internal Memory 18, 42
INTERVAL 74
ISO SETTING 81

L

LANDSCAPE 37
LANGUAGE/言語 121
LCD BRIGHTNESS 112
LCD CONFIRM. 117
LCD Monitor 13, 14
Lens 12
Lens Cover 12

M

M (Memory-reversal)-CONT 87
Macro Button 13, 35
Manual Focus (MF) 64
MENU/OK Button 13, 59, 97, 109
Microphone 12
Mode Selector 12, 13
Movie Mode 12, 91
MOVIE SIZE 60

N

NIGHTSCAPE 37
Number of images that can be stored 173
Number of shots you can take 16

P

PHOTOMETRY 67
PIC QUALITY/SIZE 60
PictBridge 52
Playback Button 13, 42
Playback Mode 22, 42, 97
Playback Setting menu 97
PORTRAIT 37
POWER Button 12
Printing 52
PROTECT 99

Q

Quick Review Button 13, 41

R

Rechargeable Battery 10, 19, 20
REG. MY SETTINGS 130
REPORT PRINT 54
RESIZE 105

RESTORE DEFAULTS.....	83
RICOH Gate La.....	135, 153
S	
S (Stream)-CONT	87
SCENE Button	13, 38
Scene Mode.....	37
SD Memory Card	18, 20, 42
Self-Timer	86
SEQUENTIAL NO.....	118
SETUP menu	108
SHARPNESS.....	68
Shooting Setting Menu.....	58
SHTG STGS WARNG.	124
Shutter Release Button.....	12, 27
SKEW COR MODE.....	37, 40
SLIDE SHOW	98
SLOW SHUTTER LMT	82
Speaker.....	13
SPORTS	37
START SETTINGS	131
STEP ZOOM.....	123
Still Image Mode	12
Synchro-Monitor Mode.....	25
T	
Telephoto/Enlarged View Button.....	13, 34, 45
TEXT MODE	38
Three-frame View	43
Thumbnail Display	45
TIME EXPOSURE	73
Tripod Screw Hole	13
U	
USB Cable	10, 52
USB CONNECTION	125
USB Driver	135, 136, 153
USB Terminal.....	13, 143
V	
VIDEO OUT MODE	122
Voice Memo Mode.....	12, 95
VOL. SETTINGS.....	116
W	
WAV file	95
WHITE BALANCE.....	79
White Balance Bracket.....	71
WIA Driver.....	135, 136
Wide-angle/Thumbnail Display Button.....	13, 34, 45
Z	
Zoom.....	34
ZOOM MACRO.....	38, 39

Telephone Support Numbers in Europe

UK	(from within the UK)	02073 656 580
	(from outside of the UK)	+44 2073 656 580
Deutschland	(innerhalb Deutschlands)	06331 268 438
	(außerhalb Deutschlands)	+49 6331 268 438
France	(à partir de la France)	0800 91 4897
	(en dehors de la France)	+49 6331 268 409
Italia	(dall'Italia)	02 696 33 451
	(dall'estero)	+39 02 696 33 451
España	(desde España)	91 406 9148
	(desde fuera de España)	+34 91 406 9148

<http://www.service.ricohpmmc.com/>

From environmental friendliness to environmental conservation and to environmental management

Ricoh is aggressively promoting environment-friendly activities and also environment conservation activities to solve the great subject of management as one of the citizens on our precious earth.



To reduce the environmental loads of digital cameras, Ricoh is also trying to solve the great subjects of "Saving energy by reducing power consumption" and "Reducing environment-affecting chemical substances contained in products".

If a problem arises

First of all, see "Troubleshooting" (P.159) in this manual. If the issues still persist, please contact a Ricoh office.

Ricoh Offices	
Ricoh Company, Ltd.	3-2-3, Shin-Yokohama Kouhoku-ku, Yokohama City, Kanagawa 222-8530, Japan http://www.ricoh.co.jp/r_dc
Ricoh Corporation	5 Dedrick Place, West Caldwell, New Jersey 07006, U.S.A. 1-800-22RICOH http://www.ricoh-usa.com
RICOH EUROPE B.V. (EPMMC)	(innerhalb Deutschlands) 06331 268 438 (außerhalb Deutschlands) +49 6331 268 438 http://www.ricohpmmc.com
RICOH UK LTD. (PMMC UK)	(from within the UK) 02073 656 580 (from outside of the UK) +44 2073 656 580
RICOH FRANCE S.A. (PMMC FRANCE)	(à partir de la France) 0800 91 4897 (en dehors de la France) +49 6331 268 409
RICOH ESPANA, S.A. (PMMC SPAIN)	(desde España) 91 406 9148 (desde fuera de España) +34 91 406 9148
Ricoh Italia S.p.A. (PMMC ITALY)	(dall'Italia) 02 696 33 451 (dall'estero) +39 02 696 33 451
RICOH HONG KONG LIMITED Personal Multimedia Products Center	21/F., Tai Yau Building, 181 Johnston Road, Wan Chai, Hong Kong
Ricoh Australia Pty. Ltd.	8 Rodborough Road, Frenchs Forest, NSW 2086, Australia http://www.ricoh.com.au
About ImageMixer	North America (Los Angeles): TEL: +1-213-341-0163 Europe (U.K.): TEL: +44-1489-564-764 Asia (Philippines): TEL: +63-2-438-0090 China: TEL: +86-21-5450-0391 Business hours: 9:00 AM to 5:00 PM

Ricoh Company, Ltd.
Ricoh Building, 8-13-1, Ginza, Chuo-ku, Tokyo
104-8222, Japan
2006 March



Printed in China



* L 7 3 5 2 9 7 1 *