

Intermec

**User's
Manual**

JANUS™ 2050
Vehicle-Mount Computer (4MB)

P/N 065716-001

Intermec

**User's
Manual**

JANUS™ 2050
Vehicle-Mount Computer (4MB)

P/N 065716-001

Intermec® Corporation
6001 36th Avenue West
P.O. Box 4280
Everett, WA 98203-9280

U.S. service and technical support: 1-800-755-5505
U.S. media supplies ordering information: 1-800-227-9947

Canadian service and technical support: 1-800-688-7043
Canadian media supplies ordering information: 1-800-268-6936

Outside U.S. and Canada: Contact your local Intermec service supplier.

The information contained herein is proprietary and is provided solely for the purpose of allowing customers to operate and/or service Intermec manufactured equipment and is not to be released, reproduced, or used for any other purpose without written permission of Intermec.

Information and specifications in this manual are subject to change without notice.

© 1997 by Intermec Corporation
All Rights Reserved

The word Intermec, the Intermec logo, JANUS, IRL, TRAKKER, Antares, Duratherm, Precision Print, PrintSet, Virtual Wedge, and CrossBar are either trademarks or registered trademarks of Intermec Corporation.

CardID™ and *CardSoft™* are trademarks of SystemSoft Corporation. Some of the information in this manual is based on copyrighted material contained in the *CardSoft™ 3.1 Software User's Guide*, published by SystemSoft Corporation, 1992-1994, Natick, Massachusetts.

Throughout this manual, trademarked names may be used. Rather than put a trademark (™ or ®) symbol in every occurrence of a trademarked name, we state that we are using the names only in an editorial fashion, and to the benefit of the trademark owner, with no intention of infringement.

Contents

Before You Begin xv
 Warranty Information xv
 Safety Summary xv
 Warnings and Cautions xvi
 Terms and Conventions xvii
 Suggested Reading xix

1

Getting Started

Overview of the JANUS 2050 1-3

Starting the JANUS 2050 for the First Time 1-6

Unpacking the JANUS 2050 1-6

Mounting the JANUS 2050 on a Vehicle 1-6

Connecting the JANUS 2050 to the Vehicle Power Supply 1-9

Attaching the Antenna 1-10

Connecting a Scanning Device to the JANUS 2050 1-11

Turning On the JANUS 2050 for the First Time 1-13

Turning the JANUS 2050 On and Off 1-13

Setting the Time and Date 1-14

Entering Data 1-14

Using a Laser Scanner 1-15

Scanning Techniques 1-16

JANUS 2050 Accessories 1-17

Where Do You Go From Here? 1-17

2

Operating the JANUS 2050

Using the JANUS 2050 Features 2-3

The JANUS 2050 Keypad 2-5

How to Type the Characters Printed on the Keypad 2-6

Using the Keypad 2-6

Ctrl, Alt, and Shift Keys 2-6

Compound Function Key 2-7

Additional Keys 2-7

Cursor Keypad 2-7

Numeric Keypad 2-7

Entering ASCII Characters 2-8

JANUS 2050 Vehicle-Mount Computer User's Manual (4MB)

- International Keypads 2-9*
 - DOS Code Pages 2-9*
 - Alpha Keys With Multiple Characters 2-9*
 - Numeric Keys With Multiple Characters 2-9*
 - Alt and Shift Keys 2-9*
 - Special Characters 2-10*
 - International Keypad Examples 2-10*
- Terminal Emulation (TE) Keypads 2-14*
 - Accessing TE Commands on the Keypad 2-15*
 - Shift Key 2-15*
 - Ctrl and Alt Keys 2-15*
 - Compound Function Key 2-15*

Booting the JANUS 2050 2-16

- Performing a Cold Boot 2-16*
- Performing a Warm Boot 2-16*

Understanding the Status LEDs 2-17

Display Modes 2-19

Understanding Audio Signals and Beep Sequences 2-20

Estimating Power Usage 2-21

Recharging the Backup Battery 2-21

Defining JANUS 2050 Drives 2-22

- Drive C 2-22*
- Drive D 2-22*
- Drive E 2-23*
- PC Card Drive (G) 2-23*

Memory Management 2-24

3

Using the JANUS Software

Software Provided With the JANUS 2050 3-3

What Software Is Provided on the Companion Disks? 3-4

Using DOS Commands 3-5

- Defining the Startup Files 3-6*
- AUTOEXEC.BAT File 3-6*
- CONFIG.SYS File 3-8*

- MS-DOS Startup Menu 3-10**
- Learning How to Change the Contents of Drive C 3-10**
- Creating a RAM Drive 3-11**
- Changing Drive C and Configuring for International Languages 3-13**
- Using Auto-Loader to Change Drive C 3-14**
 - Installing Auto-Loader 3-14
 - Creating and Loading an Image File 3-16
 - Creating an Image File 3-18
 - Loading an Existing Image File 3-20
- Using MakeDisk and PutDisk to Change Drives C or D 3-21**
 - Deciding Where to Run MakeDisk 3-21
 - Creating and Filling the Working Source Directory 3-22
 - Creating the New Image File 3-23
 - Loading the New Image File 3-23
 - Examples of Using MakeDisk and PutDisk 3-24
- Using Reader Services 3-28**
- Understanding the Bar Code Wedge 3-29**
 - Enabling Direct Hardware Wedge Functions 3-30
 - Using the Wedge Configuration Program 3-30

4

Configuring the JANUS 2050

- Overview of Configuration Parameters 4-3**
 - Configuring for Bar Code Symbolologies 4-3
 - Defining Communications Parameters 4-4
 - Modifying Operations Parameters 4-5
- Different Ways to Configure the JANUS 2050 4-6**
- Using the Configuration Application 4-7**
 - Entering ASCII Control Characters 4-9
 - Communications Protocol Characters 4-9
 - Operation Preambles and Postambles 4-9
 - Using Multiple Configuration Files 4-10
 - Configuring the JANUS 2050 From the DOS Prompt 4-11
 - Loading a New Configuration File 4-11
 - Automatically Loading a Configuration File 4-11
 - Saving a New Configuration File 4-12
 - Loading the Factory Default Configuration 4-12

Editing a Configuration File Using the Host Computer 4-13

Configuring With Bar Code Labels 4-14

Configuring Using IRL Z Commands 4-15

Configuring Through a User Application 4-15

5

Using PC Cards

Learning About PC Cards 5-3

What Is PCMCIA? 5-3

Supported PC Cards 5-3

Which Memory Cards Are Recommended? 5-4

Which Expansion Cards Are Recommended? 5-4

Accessing the PC Card Drive 5-5

Configuring, Formatting, and Using PC Cards 5-9

Preparing to Use ATA Cards 5-10

Initializing and Formatting an ATA Card 5-10

Using the ATA Card 5-11

Preparing to Use Flash Cards 5-12

Initializing and Formatting a Flash Card 5-12

Erasing a Previously Formatted Flash PC Card 5-14

Preparing to Use I/O Cards 5-15

Configuring the JANUS device to Use an I/O Card 5-15

Resetting the PC Card Drive for I/O Cards 5-16

Preparing to Use SRAM Cards 5-16

Formatting an SRAM PC card 5-17

Using the SRAM PC Card 5-17

Managing the Power on the PC Card Drive 5-17

Managing the PC Card Drivers in the Startup Files 5-18

Drivers in CONFIG.SYS 5-19

Drivers in AUTOEXEC.BAT 5-19

Tips for Enabling PC Card Drivers 5-20

6

Communicating With the JANUS 2050

Planning the Network Connection 6-3

Choosing a Communications Application 6-4

Choosing a Communications Protocol 6-4

Choosing a Protocol Handler 6-5

Setting Up the JANUS 2050 for Communications	6-7
Configuring the JANUS 2050 for Communications	6-7
Loading and Unloading Protocol Handlers	6-8
Loading/Unloading Protocol Handlers at the DOS Prompt	6-8
Loading/Unloading Protocol Handlers With a Batch File	6-9
Loading/Unloading Protocol Handlers With IRL Desktop or Communications Manager	6-10
Specifying a Value for the FIFO Control Register	6-10
Different Ways to Communicate With the JANUS 2050	6-13
Communicating Using the InterInk/Intersvr Utilities	6-13
InterInk/Intersvr System Requirements	6-15
Installing InterInk/Intersvr	6-15
Running InterInk on the Host Computer	6-16
Running InterInk on the JANUS 2050	6-17
InterInk/Intersvr Status	6-18
Redirecting Drives	6-18
Exiting InterInk/Intersvr	6-18
Restarting InterInk/Intersvr	6-19
Communicating Using Communications Manager	6-19
Using the Communications Manager Menus	6-19
Using a Command Line	6-21
Downloading Applications Across the Network	6-22
Examples of Using BFT	6-23
Examining a Typical BFT Session	6-25
Preparing the Device and Host Computer for BFT	6-26
Differentiating Between Client and Server	6-27
Starting an Application When the FTA Terminates	6-29
Using FTA Commands on the Device	6-29
Typing FTA Commands on the Device	6-29
Learning the Syntax of FTA Commands	6-30
Editing the FTA Initialization File	6-32

7

Working With IRL

<i>What Is IRL?</i>	7-3
<i>Using IRL on the JANUS 2050</i>	7-4
Working With Files	7-4
Specifying Data and Program Paths	7-5
Using the Desktop	7-5
<i>Using Commands in the IRL Desktop</i>	7-8
Starting an IRL Program	7-8

JANUS 2050 Vehicle-Mount Computer User's Manual (4MB)

Exiting an IRL Program 7-9
Downloading an IRL Program 7-10
Transmitting IRL Files 7-10
Receiving IRL Files 7-11
Clearing IRL Files 7-11

Types of Error Messages 7-12

Resuming IRL Programs 7-13

Exiting a Program So You Can Resume It Later 7-13
Exiting Directly to DOS 7-14
Resuming a Program From the DOS Prompt 7-14
Resuming a Program From the IRL Desktop 7-14

Using the IRL Z Command 7-15

IRL File, Clear 7-16

IRL File, Receive 7-17

IRL File, Transmit 7-17

IRL Program, Download 7-18

IRL Program, Exit 7-18

IRL Program, Resume 7-19

IRL Program, Run 7-19

8

Troubleshooting

Troubleshooting the JANUS 2050 8-3

Powering Up or Booting the JANUS 2050 8-3

Operating the JANUS 2050 8-7

Running IRL 8-9

Using PC Cards 8-10

Using DOS 8-13

Using Configuration Manager 8-16

Using MakeDisk 8-17

Using PutDisk 8-19

Scanning Bar Code Labels 8-22

Resetting the JANUS 2050 8-23

Returning to the Default Configuration 8-23

Performing a Cold Boot 8-23

Forcing the JANUS 2050 to Turn Off 8-24

Saving Data and Loading Flash Memory 8-24

Saving JANUS 2050 Data 8-24

Loading Flash Memory 8-25

9

Command Reference

Using JANUS 2050 Commands 9-3

Enter/Exit Accumulate 9-4

Enter Accumulate 9-4

Exit Accumulate 9-5

Backspace, Destructive 9-5

Change Configuration 9-6

Clear 9-6

Command Override 9-7

Enter 9-8

Prepare for Reboot 9-8

Reboot 9-9

10

Configuration Commands

Using Configuration Commands 10-3

Variable Data 10-4

Address, Multi-Drop 10-5

AFF (Affirmative Acknowledge) 10-6

Baud Rate 10-7

JANUS 2050 Vehicle-Mount Computer User's Manual (4MB)

Beep Duration 10-9

Beep Frequency 10-11

Beep Volume 10-13

Codabar 10-14

Code 11 10-16

Code 16K 10-17

Code 2 of 5 10-18

Code 39 10-20

Code 49 10-24

Code 93 10-26

Code 128 10-27

Command Processing 10-28

Communications Port, Select 10-33

Communications Port, Choosing Scanner or COM2 10-34

Communications Port, UART Restore 10-35

Communications Protocol 10-37

Configure 10-37

Activate 10-40

Multi-Drop, User-Defined 10-41

Data Bits 10-42

Decode Security 10-43

Display Mode, IRL 10-44

Display Setup 10-45

EOF (End of File) 10-47

EOM (End of Message) 10-48

EOR (End of Record) 10-50

Flow Control 10-51



Intercharacter Delay 10-52

Interleaved 2 of 5 10-54

IRL BAK (Bad Program Acknowledge) 10-56

IRL END Program Block 10-57

IRL EOP (End of Program) 10-58

IRL PAK (Program Acknowledge) 10-59

IRL PSS (Program Statement Separator) 10-60

IRL RUN 10-61

IRL SOP (Start of Program) 10-62

Key Code Lookup Table 10-63

Keypad Caps Lock 10-64

Keypad Clicker 10-65

Keypad Ctrl Key Functions 10-66

LRC 10-67

MSI 10-68

NEG (Negative Acknowledge) 10-70

Parity 10-71

Plessey 10-72

POL 10-73

Postamble 10-74

Preamble 10-75

Records Per Block 10-76

REQ (Request for Acknowledge) 10-78

RES (Reset) 10-79

Scan Ahead 10-80

Scanner Devices 10-81

Scanner Mode 10-82
Scanner Redundancy 10-83
Scanner Timeout 10-84
Scanner Trigger 10-85
SEL (Select) 10-86
SOM (Start of Message) 10-87
Stop Bits 10-88
Timeout Delay 10-89
Transmit Abort Timeout 10-91
Turnaround Delay 10-93
UPC/EAN 10-94

11

Advanced Operations

Making More RAM Available on the JANUS 2050 11-3
Not Installing the PC Card Drivers 11-3
Unloading the Reader Wedge TSR 11-3

Accessing the Boot Loader Menu 11-4
Changing the Password 11-6
Putting the JANUS 2050 in Storage Mode 11-6
Exiting Storage Mode 11-7

A

Configuration and Full ASCII Charts

Entering ASCII Control Characters A-3
Entering Escape Sequences A-4
User-Defined Protocol Character Combinations A-5
Multi-Drop POL and SEL Combinations A-6
Key Codes A-7
Keypad Charts A-13

Full ASCII Table A-16

Full ASCII Bar Code Chart A-19

Bar Code Chart for Moving Around in Menus A-22

Default Configuration A-23

Configuration Command by Syntax A-27

B

Specifications**Physical and Environmental Specifications B-3****Connecting Devices to the JANUS 2050 B-4**

COM Port Connector B-4

Input Device Connector B-6

Types of Memory Used in the JANUS 2050 B-8

Conventional Memory (0 Through 640K) B-9

Upper Memory Area B-9

RAM Drive B-10

Extended Memory B-10

Expanded Memory B-10

High Memory Area (HMA) B-11

User Flash Memory B-11

Application Flash Memory B-11

C

Software Utility Reference**Interlnk C-3**

INTERLNK.EXE C-4

Intersvr C-7

POWER.EXE C-9

Auto-Loader Batch Files C-10

Learning How to Use Auto-Loader C-10

Using LOAD_USA C-11

USING LOADLANG C-11

Using LOADADD C-11

Using LOADIMG C-13

Using LOADNEW C-13

Using LOADXIMG C-14

Using MAKE_USA C-14

Using MAKELANG C-14

Using MAKENEW C-15



Glossary



Index



Before You Begin

This section introduces you to standard warranty provisions, safety precautions, warnings and cautions, document formatting conventions, and sources of additional product information.

Warranty Information

To receive a copy of the standard warranty provision for this product, contact your local Intermec support services organization. In the U.S. call 1-800-755-5505, and in Canada call 1-800-688-7043. Otherwise, refer to the Worldwide Sales & Service list that ships with this manual for the address and telephone number of your Intermec sales organization.

Safety Summary

Your safety is extremely important. Read and follow all warnings and cautions in this book before handling and operating Intermec equipment. You can be seriously injured, and equipment and data can be damaged if you do not follow the safety warnings and cautions.

Do not repair or adjust alone Do not repair or adjust energized equipment alone under any circumstances. Someone capable of providing first aid must always be present for your safety.

First aid Always obtain first aid or medical attention immediately after an injury. Never neglect an injury, no matter how slight it seems.

Resuscitation Begin resuscitation immediately if someone is injured and stops breathing. Any delay could result in death. To work on or near high voltage, you should be familiar with approved industrial first aid methods.

Energized equipment Never work on energized equipment unless authorized by a responsible authority. Energized electrical equipment is dangerous. Electrical shock from energized equipment can cause death. If you must perform authorized emergency work on energized equipment, be sure that you comply strictly with approved safety regulations.

Warnings and Cautions

The warnings and cautions in this manual use this format.



Warning

A warning warns you of an operating procedure, practice, condition, or statement that must be strictly observed to avoid death or serious injury to the persons working on the equipment.

Avertissement

Un avertissement vous alerte d'une procédure de fonctionnement, d'une méthode, d'un état ou d'un rapport qui doit être strictement respecté pour éviter l'occurrence de mort ou de blessures graves aux personnes manipulant l'équipement.



Caution

A caution alerts you to an operating procedure, practice, condition, or statement that must be strictly observed to prevent equipment damage or destruction, or corruption or loss of data.

Conseil



Une précaution vous alerte d'une procédure de fonctionnement, d'une méthode, d'un état ou d'un rapport qui doit être strictement respecté pour empêcher l'endommagement ou la destruction de l'équipement, ou l'altération ou la perte de données.









Terms and Conventions

This manual refers to the JANUS 2050 RF Vehicle-Mount Data Collection Computer as “the JANUS 2050,” “the computer,” or “the device.” The following conventions are used to emphasize keypad and bar code input, screen messages, command syntax, and warnings and cautions.

JANUS 2050 Keypad Input

Key icons represent keystrokes you enter on the JANUS 2050. For example, “press ” directs you to press the key labeled “” on the JANUS 2050 keypad.

When you must press a series of keys in order, the keys are shown in order without connectors. For example, “press    ” to boot the JANUS 2050” directs you to press and release each key in the order shown.

When you must press more than one key simultaneously, the keys are shown separated by a dash. For example, “press  - ” to enter control mode.” When keys are separated by a dash, you must press and hold them in the order shown.

Bar Code Input

You can scan the bar codes listed in this manual to enter data or perform a command. Each bar code includes the name and human-readable interpretation. For example:

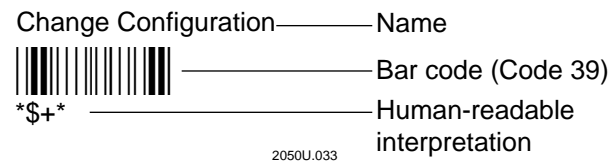

Screen Messages

When discussing messages displayed on the JANUS 2050 screen, the messages are shown as in this example.

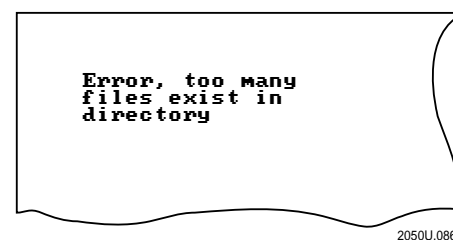

Commands

- Command syntax is shown in the text as it should be entered into the JANUS 2050. For example, to see a listing of directories on the JANUS 2050, type the following command and press .

```
dir
```

- Commands may be shown with special characters that are not part of the command. Do not include the special characters when you type or scan the command. These characters indicate information about each part of the command.

Braces { } enclose a parameter that is required. For example, you format an SRAM card with this command:

```
format {drive:}
```

where you replace {drive:} with the letter designation of the drive where the SRAM card is located.

- Configuration commands use the convention *data* to indicate variable data. For example, the configuration command for beep volume is:

```
BVdata
```

where *data* can be a number from 0 through 4. Replace the term *data* with one of the options listed with the command syntax. For example, the configuration command to turn the beep volume off is BV0.

- Bold type is used when keystrokes that you enter are included within textual information. For example, “To load the protocol handler for COM1, you would use **1**” indicates you would press 1 on your keypad.



Suggested Reading

You may need to refer to the manuals listed below. To order additional manuals, contact your local Intermec representative or distributor.

Manual	Intermec Part No.
<i>0100 Access Point User's Manual</i>	062367
<i>0110 Access Point User's Manual</i>	065053
<i>The Bar Code Book</i>	051241
<i>Data Communications Reference Manual</i>	044737
DOS user's manual	064673
<i>IRL Programming Reference Manual</i>	048609
<i>JANUS 2.4 GHz Installation Utility (4MB) User's Manual</i>	064673
<i>JANUS 2.4 GHz Terminal Emulation Quick Reference Guide</i>	063682
<i>JANUS 2.4 GHz Radio Frequency Quick Reference Guide</i>	064819
<i>JANUS 900 MHz Radio Frequency Quick Reference Guide</i>	060207
<i>JANUS Application Simulator User's Manual</i>	062778
<i>JANUS PSK for Ada Reference Manual</i>	062038
<i>JANUS PSK for Basic Reference Manual</i>	063191
<i>JANUS PSK for C++ Reference Manual</i>	062133
<i>PC-IRL Reference Manual</i>	049212
<i>RF System/9180 User's Manual</i>	054292

If you are using the JANUS PSK, you may have one or more of the JANUS PSK manuals listed above, depending on the programming language you use. Refer to your PSK manual when you see these instructions:

“For help, see your JANUS PSK reference manual.”



Getting Started

This chapter describes how to unpack, set up, and start the JANUS 2050 RF Vehicle-Mount Data Collection Computer.

Overview of the JANUS 2050

The JANUS™ 2050 RF Vehicle-Mount Data Collection Computer is a rugged data collection device that collects, sends, and receives information through radio frequencies. The JANUS 2050 can be mounted on a forklift or other vehicle and is powered by the vehicle's power supply. The vehicle can move anywhere within transmission range of the Intermec 9181 Base Radio Unit or access point, and transmit to and receive information from the host computer. The JANUS 2050 gives you tremendous flexibility in developing your data collection system.

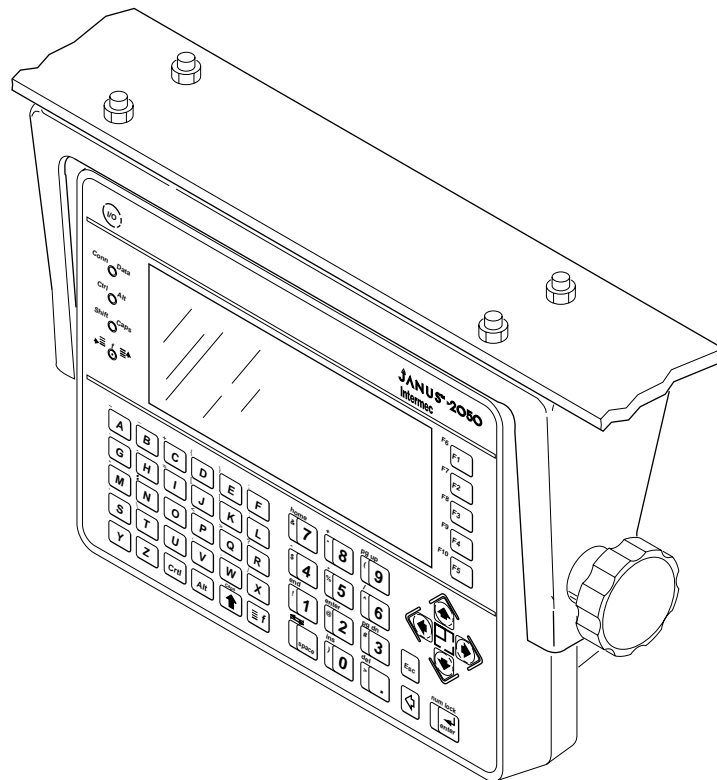

2050U.021

You can enter data into the JANUS 2050 using the keypad or a laser scanner. The JANUS 2050 transmits this data to the base radio unit. From there, the data is communicated to a network controller that is connected to a host computer. Data may also be transmitted from the host computer to the JANUS 2050 using the same path.

Typical 900 MHz Configuration

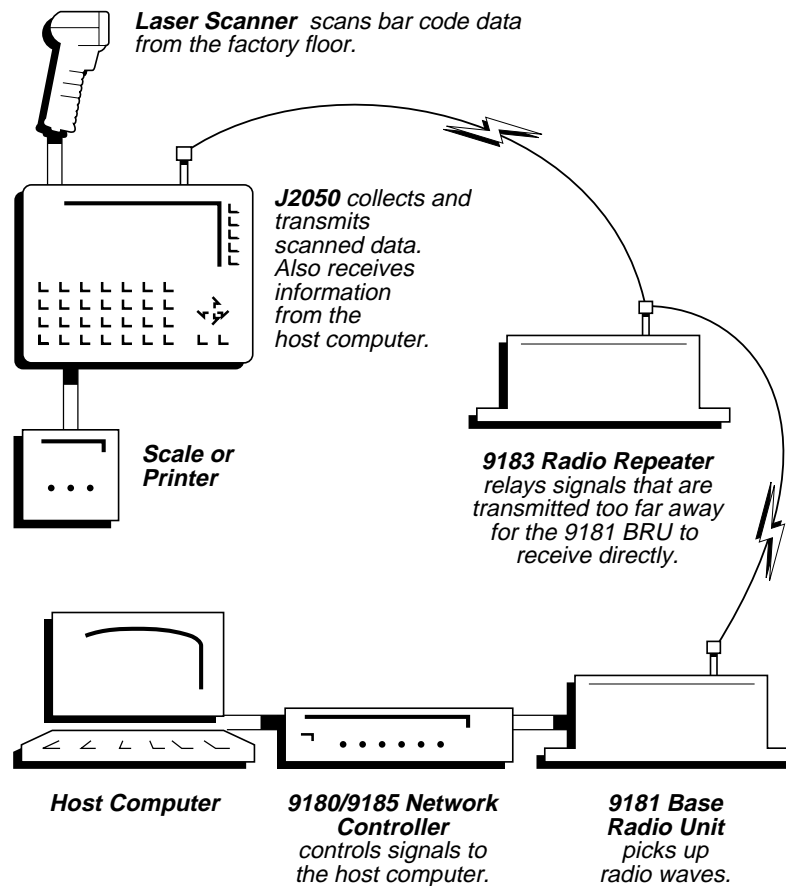

2050U.001

One of the major benefits of the JANUS 2050 is that you can transmit data as soon as it is collected. Without radio frequency (RF) capability, a portable data collection device must store the collected data until the device can be physically connected to the host by a cable, modem, or communications dock. With RF, the JANUS 2050 continuously transmits data to the host as it is collected. This feature reduces data collection time considerably.

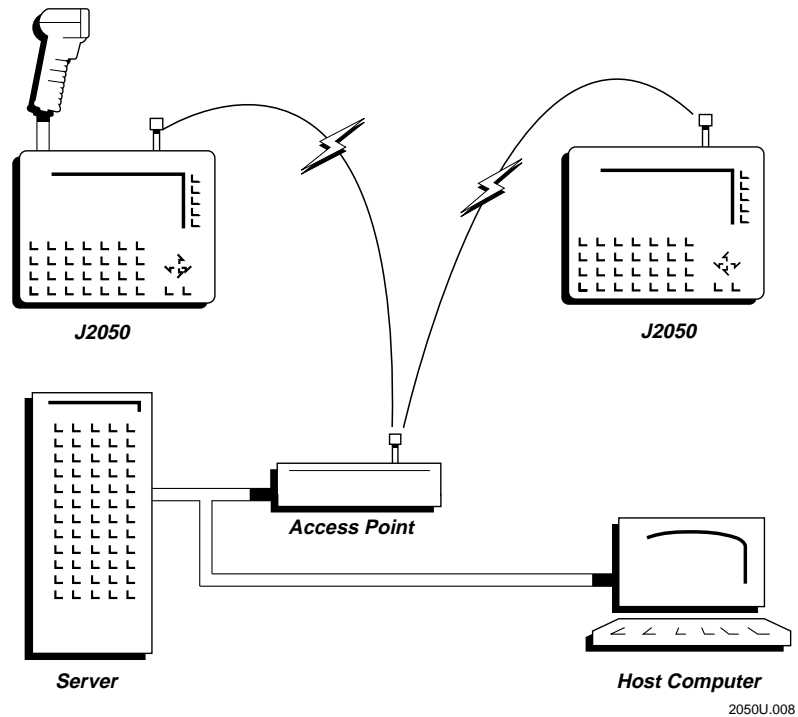
Typical 2.4 GHz Configuration

The JANUS 2050 is a rugged data collection computer that can:

- Operate in warehouse conditions 24 hours a day. It is watertight and shock resistant and can operate in a wide range of temperatures and moisture conditions.
- Connect to a scale, printer, or portable reader using its auxiliary RS-232 port. The JANUS 2050 can be configured to automatically communicate with the device when it is connected.
- Run your custom data-collection programs using Intermec's Interactive Reader Language (IRL) or using a high-level, PC-based language such as Basic, C, or C++.

Starting the JANUS 2050 for the First Time

To prepare and start the JANUS 2050 for the first time, you will need to:

- Unpack the JANUS 2050 and check the contents against the order invoice.
- Mount the JANUS 2050 on a vehicle using the mounting bracket.
- Connect the JANUS 2050 to the vehicle's power supply.
- Install the radio antenna.
- Connect a scanning device to the JANUS 2050.
- Turn on the JANUS 2050 for the first time.
- Set the date and time.
- At the DOS prompt, enter data from the keypad or by using a scanning device.

These steps are described in detail in the following pages.

Unpacking the JANUS 2050

When you remove the JANUS 2050 from its box, save the box and shipping material in case you need to ship or store the JANUS 2050. A set of disks is included in the box with the JANUS 2050. Check the contents against the invoice for completeness and contact your Intermec representative if there is a problem.

Note: A README file is included on companion disk 1 that is shipped with the JANUS 2050. README.DOC contains additional information about the JANUS 2050 and its operation. You can view or print this file using any text editor.

Mounting the JANUS 2050 on a Vehicle

The JANUS 2050 is designed to be mounted on a vertical or horizontal surface. Use the following instructions as guidelines for installation.

- In most cases, you will need to weld or bolt a flat mounting plate to the vehicle to secure the JANUS 2050 mounting bracket.
- Mount the JANUS 2050 where the operator can easily see the display and use the keyboard. If possible, you should mount the unit in a location that avoids glare from overhead lighting and sunlight.

The mounting position should provide adequate access to the front panel so that the operator can easily see and use the JANUS 2050.

- Allow space to access the back panel connectors and the ON/OFF switch. When you mount the JANUS 2050 on metal surfaces, the minimum reinforced thickness should be 10-gage (3.4mm) steel.
- Intermec recommends fastening a bolt (3/8-inch/10mm) with a flat washer, lock washer, and nut (3/8-16 UNC-2B) to each of the four corner holes on the mounting bracket. The bolt length will depend on the thickness of the mounting surface.
- Attach the power cable to the JANUS 2050 and leave a 6-inch service loop in the cable. Use plastic tie-wraps to secure the cable all the way to the power connection. Make sure the cable will not be pinched or rubbed by any moving parts on the vehicle. In some applications, you may need to sheath the cable to prevent it from being pinched.

Note: *Mounting hardware (bolts, nuts, and washers) is not supplied with the JANUS 2050.*

To attach the mounting bracket to the vehicle

1. Using the mounting bracket as a template, mark and drill four holes in the mounting surface.
2. Attach the bracket using a bolt (3/8-inch/10mm) with a flat washer, lock washer, and nut (3/8-16 UNC-2B) through each of the four holes in the mounting bracket and the mounting surface.

After you secure the mounting bracket to the vehicle, attach the JANUS 2050 to the mounting bracket.

To attach the JANUS 2050 to the mounting bracket

1. Place the split lock washers on the knobs.
2. Insert the knobs through the mounting bracket and thread into the JANUS 2050.
3. Secure the grounding cable to the mounting bracket with a nut (8-32 UNC-2B).

Mounting Bracket Assembly

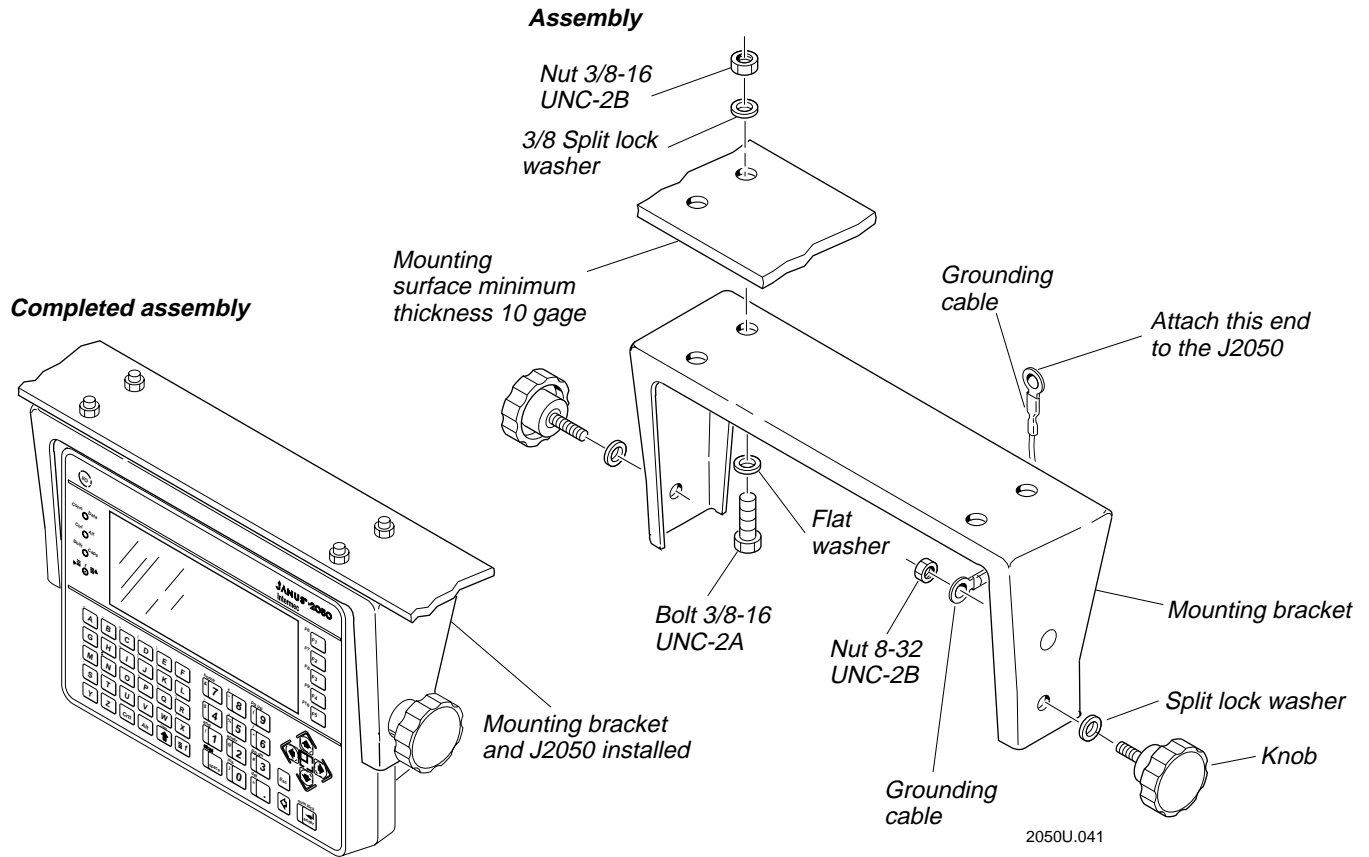

Connecting the JANUS 2050 to the Vehicle Power Supply

Use the following guidelines to connect the JANUS 2050 to a vehicle power supply.

- The power connection should be as close as possible to the vehicle battery. Battery vendors have recommended using sheet metal screws to connect the JANUS 2050 power cable connections directly to the lead battery terminal.

If it is not possible to attach the JANUS 2050 power cable directly to the battery, attach the cable to the point immediately past the battery connector. After the connection has been made, test for the correct voltage and polarity at each pin of the connector.

The connections should be made as follows:

JANUS 2050 Power Connector Pin	Wire Color in Cable (P/N 058527)	Vehicle Connection Point
A	Red	Battery (+) positive terminal
B	White	Vehicle chassis ground
C	Black	Battery (-) negative terminal
Shell	Shield	Vehicle chassis ground

Note: The power connection must supply constant power to the JANUS 2050 whether the vehicle is operating or not.

- If you connect the JANUS 2050 to the dashboard power, check that ample power is available and remains within the specified DC input range before making a connection.

Note: It takes approximately 15 hours to fully charge the internal battery when the JANUS 2050 is not operating or 30 hours when it is operating. The JANUS 2050 can function before the battery is charged, but it will not have full data retention capability when there is a power loss. The JANUS 2050 internal battery must be fully charged to retain data with a power loss.



Caution

Turn off the JANUS 2050 before connecting or disconnecting the power.

Conseil

Eteignez la JANUS 2050 avant de connecter ou déconnecter une source de courant.

Attaching the Antenna

The antenna picks up radio signals from or sends signals to the Intermec 9181 Base Radio Unit, 9183 Radio Repeater, or 0100 Access Point. Attach the antenna to the connector on the top of the JANUS 2050. Keep each JANUS 2050 at least 2 feet away from another JANUS 2050 or any other radio. Two antennas within 2 feet of each other may damage the radio receivers.



Caution

The antenna must be attached before turning on the JANUS 2050. The internal radio could be damaged if the antenna is not attached.

Conseil

Si l'antenna n'est pas attachée avant que la JANUS 2050 soit mise sous tension, la radio interne peut être endommagée.

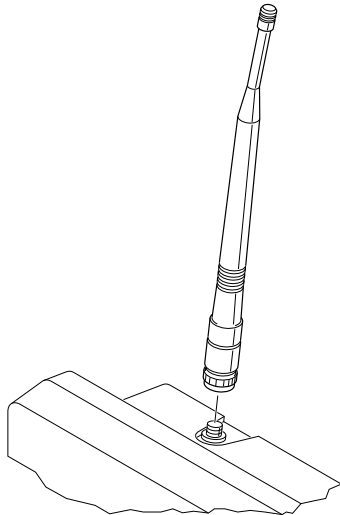

2050U.009

Connecting a Scanning Device to the JANUS 2050

The JANUS 2050 can use one of several input devices to scan bar codes:

- 151X laser scanner
- 1545 laser scanner
- 1550 laser scanner

Before using a scanning device with the JANUS 2050, read the manual that comes with the equipment to ensure proper operation and safety.

To connect a laser scanner to the JANUS 2050, locate the input device connector on the back of the JANUS 2050. The connector is keyed so that the input device cable can be inserted only one way.



Caution

To prevent loss of data and/or internal component damage, always turn off the JANUS 2050 before plugging in any cable or accessory or disconnecting the power cable. As an added precaution, always turn off the JANUS 2050 using the power switch on the rear when it is not in use.

Conseil

Pour éviter la perte fortuite de données et/ou l'endommagement de pièces internes, éteignez toujours la JANUS 2050 avant d'y brancher tout câble ou accessoire ou avant de faire la déconnexion entre la source de courant. Comme précaution supplémentaire, éteignez toujours la JANUS 2050 lorsqu'elle n'est pas en service.

Connecting a Laser Scanner

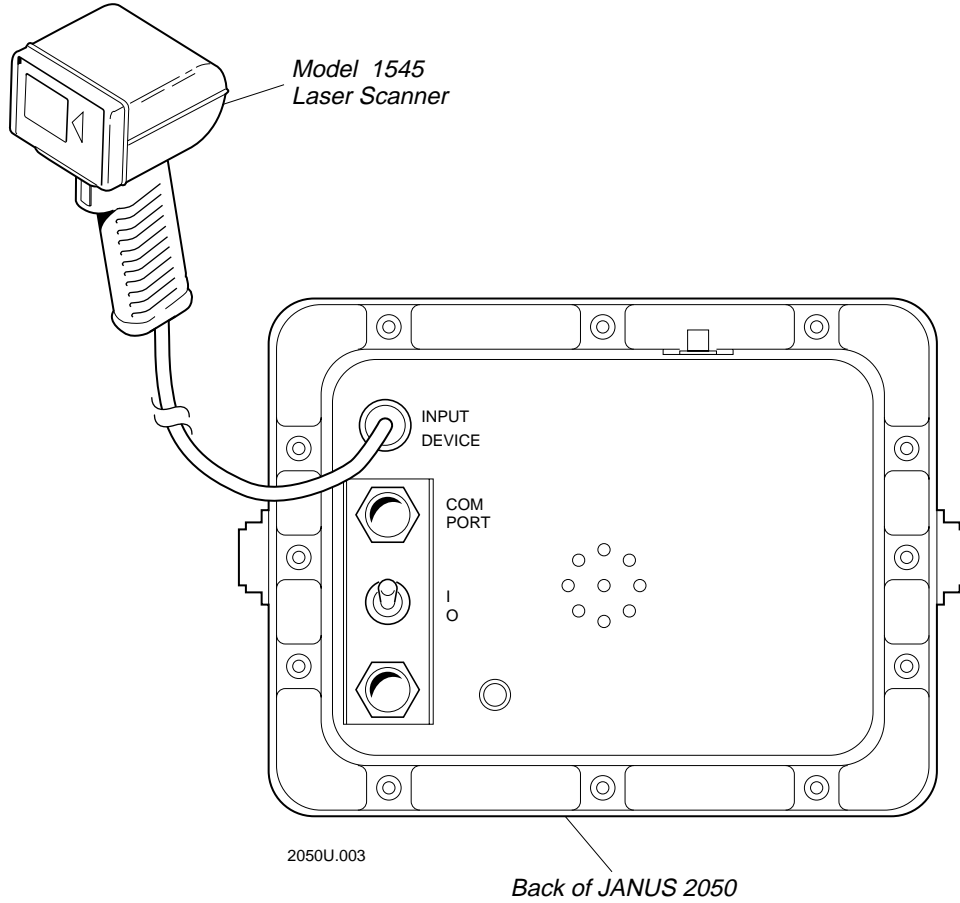

Turning On the JANUS 2050 for the First Time

The first time you turn on the JANUS 2050, you need to go through an initialization sequence to prepare the JANUS 2050 for operation. If you do not press a key within 60 seconds after a screen displays, the JANUS 2050 automatically shuts off and you have to start over at Step 1.

To turn on the JANUS 2050

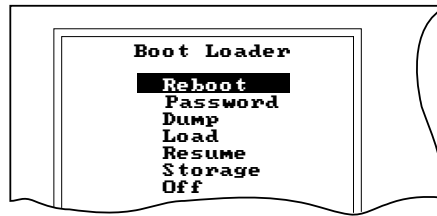

2050U.067

1. When you have connected the JANUS 2050 to the vehicle's power supply and switched the rear power switch to on, press the ⓪ button to turn the JANUS 2050 on. The password screen appears if the internal battery is dead. Press ↵ for the next screen.
2. The Boot Loader menu appears with the highlight on Reboot. Press ↵ to cold boot the JANUS 2050.
3. The backup battery status displays. Press ↵ to exit Storage mode and continue booting the JANUS 2050.

The JANUS 2050 then runs through a boot sequence similar to a PC and displays the DOS prompt when it finishes booting.

Note: To learn more about the Boot Loader menu and storage mode, see Chapter 11, "Advanced Operations."

Turning the JANUS 2050 On and Off

The On/Off toggle switch located on the back of the JANUS 2050 controls power to the unit. This switch must be in the On position for the unit to operate and to charge the internal battery.

The yellow ⓪ button on the front panel does not shut off the unit, but puts the JANUS 2050 into a suspend state. In the suspend state, the JANUS 2050 saves all memory and turns off the power to most hardware, including the CPU.

When you press ⓪ to turn on the JANUS 2050, operation resumes exactly where it was when the JANUS 2050 was turned off. If a program was running when the JANUS 2050 was turned off, the program continues at the same point when you turn the JANUS 2050 on again.

Setting the Time and Date

To set the date and time

1. At the DOS prompt, scan the following bar code to set the time:



TIME

2. Enter the current time in the format HH:MM:SS. Press to enter the colons. When you have typed in the time, press .
3. Scan the following bar code to set the date:



DATE

4. Enter the current date in the format MM-DD-YY. Press to enter the dashes. When you have typed in the date, press .

Note: You can type the *TIME* and *DATE* commands at the DOS prompt if you have not connected a scanner to the JANUS 2050.

Entering Data

You can enter data using the JANUS 2050 keypad or by scanning bar code labels. For example, the `dir` command lists the contents of a drive. At the DOS prompt, type the following command using the keypad:

```
dir
```

Then, press to execute the command.

Or, scan the following bar code:



DIR

The directory of the current drive displays on the JANUS 2050 screen.

Using a Laser Scanner

1. Connect the laser scanner to the JANUS 2050 using an interface cable as described in “Connecting a Scanning Device to the JANUS 2050” earlier in this chapter.
2. Press the  button to turn on the JANUS 2050.
3. Press the trigger once to position the spotting beam in the center of a bar code.
4. Continue to press the trigger to scan the bar code. The JANUS 2050 beeps when it correctly reads a bar code.



Caution

Do not look directly into the window of the laser scanner while it is scanning. Long-term exposure to the laser beam can damage your vision.

Conseil

Ne regardez pas directement la réflexion d'un rayon laser ou dans la fenêtre du laser lorsque celui-ci est en opération. Si vous regardez trop longtemps un rayon laser, cela peut endommager votre vision.

Scanning Techniques

The best scanning results are obtained by using the scanning angles shown in the figure below. If the bar code is scanned straight on, the scan is reflected directly back from the bar code and cannot be read by the scanner. This area is called the dead zone.

Optimum Scanning Angles

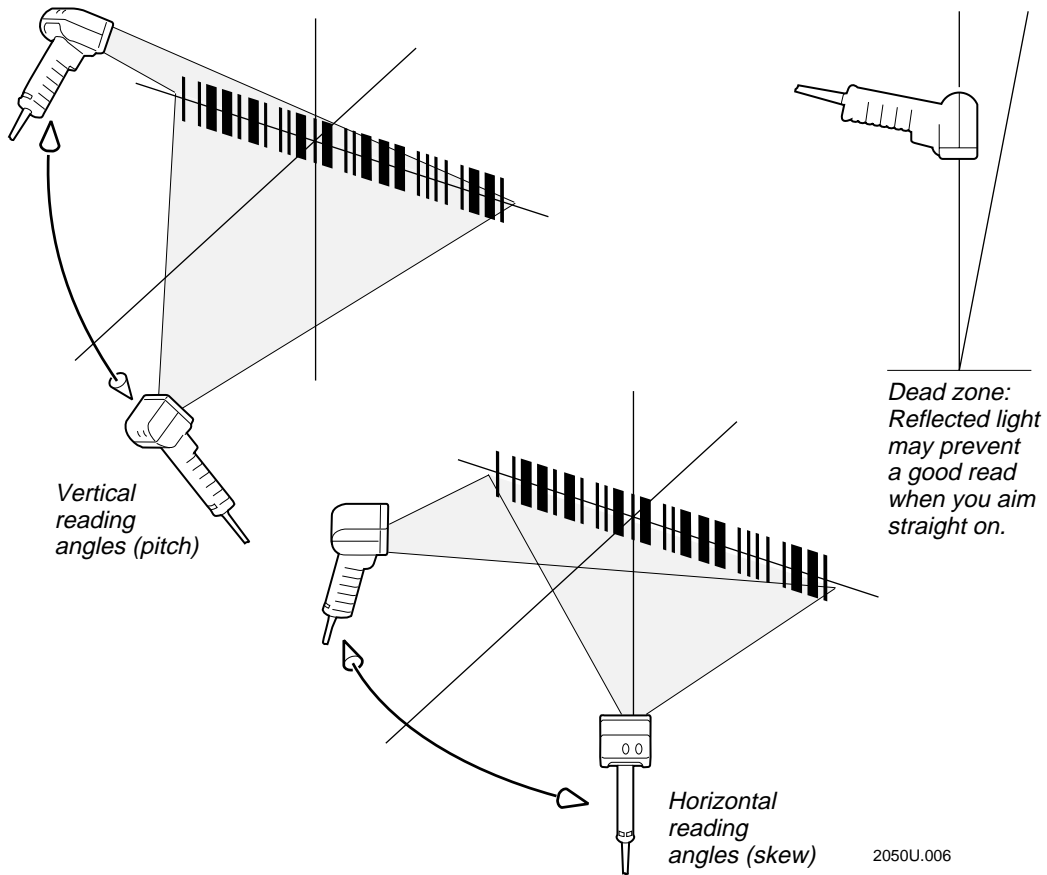

JANUS 2050 Accessories

The following accessories are available for the JANUS 2050. For information on ordering any of these accessories, contact your local Intermec representative.

Description	Part Number	Use
1517 Long-Range Laser Scanner	1517	Bar code scanner.
1518 High-Visibility Laser Scanner	1518	Bar code scanner.
1519 High-Density Laser Scanner	1519	Bar code scanner.
1545 Laser Scanner	1545	Bar code scanner.
1550 Laser Scanner	1550	Bar code scanner.
Cable for 1517/1518/1519 scanners (6 ft)	583403-013	Cable for 151X scanner.
Cable for 1517/1518/1519 scanners (15 ft)	582403-014	Cable for 151X scanner.
1545 cable (6 ft)	062798	Cable for the 1545 scanner.
1545 cable (15 ft)	062799	Cable for the 1545 scanner.
1550 cable (6 ft)	064051	Cable for the 1550 scanner.
1550 cable (15 ft)	064052	Cable for the 1550 scanner.
Printer Cable	055001	COM port cable for printer.
Battery power cable	058527	Connects the JANUS 2050 to the vehicle power supply. Shipped with JANUS 2050.
Null modem adapter cable	063092	Connects JANUS 2050 to host computer DB-9 connector.
Scanner mount stand	061063	Holds laser scanner.

Where Do You Go From Here?

This manual provides easy reference for the tasks you want to perform:

- For a detailed description of JANUS 2050 hardware, including the keypad, display, status lights, audio signals, and drives, see Chapter 2, “Operating the JANUS 2050.”
- For an overview of the software provided with the JANUS 2050, see Chapter 3, “Using the JANUS 2050 Software.”
- To configure the JANUS 2050, see Chapter 4, “Configuring the JANUS 2050.”

- To learn about PC cards and how they are used with the JANUS 2050, see Chapter 5, "Using PC Cards."
- To connect the JANUS 2050 to a host computer to download programs or transfer data, see Chapter 6, "Communicating With the JANUS 2050."
- To download and run an IRL program, see Chapter 7, "Working With IRL."
- To solve basic problems with the JANUS 2050, see Chapter 8, "Troubleshooting."
- To learn about JANUS 2050 operation commands, including descriptions, bar codes, keypad and host input, and IRL formats for the commands, see Chapter 9, "Command Reference."
- To find a detailed description of configuration commands, including bar codes and keypad and host input, see Chapter 10, "Configuration Commands."
- To learn about JANUS 2050 memory, accessing the boot loader screen, and setting the password, see Chapter 11, "Advanced Operations."
- To find reference tables you can use when configuring communications protocols and the key code lookup table on the reader, See Appendix A, "Configuration and Full ASCII Charts."
- For information on specifications, the default configuration, and types of available memory, see Appendix B, "Specifications."
- For information on the syntax for Interlnk, POWER.EXE, and the Auto-Loader batch files, see Appendix C, "Software Utility Reference."
- To learn how to configure your JANUS 2050 to operate in a 2.4 GHz radio environment, refer to the *JANUS 2.4 GHz Installation Utility User's Manual (4MB)*.
- To configure the JANUS 2050 for RF communications, refer to the *JANUS 900 MHz Radio Frequency Quick Reference Guide* or the *JANUS 2.4 GHz Radio Frequency Quick Reference Guide*.

2

Operating the JANUS 2050

This chapter gives you a detailed description of the JANUS 2050 including the keypad, display, status lights, audio signals, device connectors, backup battery, and drives.

Using the JANUS 2050 Features

Your JANUS 2050 shares many features with a personal computer. A personal computer has a 102-key keyboard, 80 character by 25 row display, disk and hard drives, a beeper, a communications port, and a power supply.

The JANUS 2050 has three drives and one PC card drive, a beeper, and a serial port. The JANUS 2050 keypad, status display, and controls are described in the following sections.

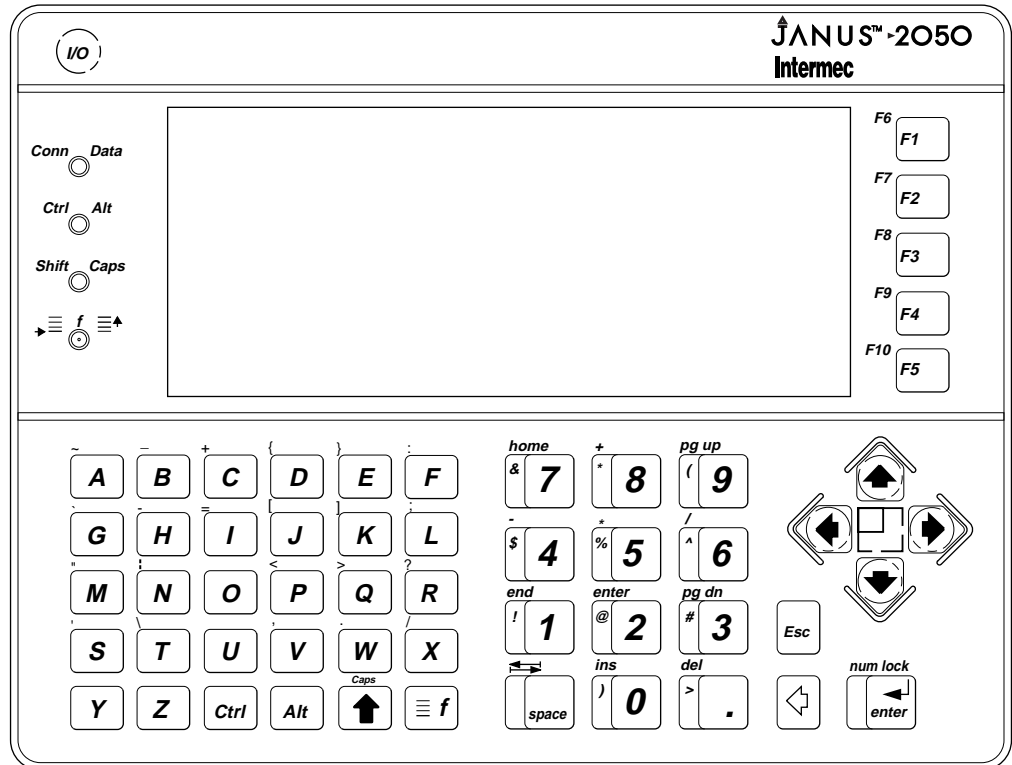

2050U.027

You can adjust the viewing angle of the display by loosening the knobs on the side of the JANUS 2050, tilting the unit, and then tightening the knobs.

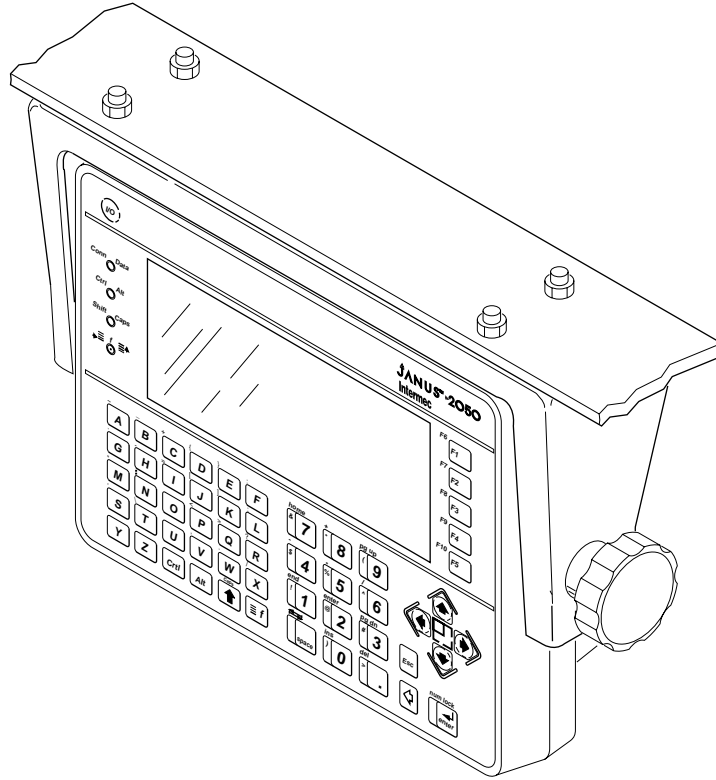

2050U.021

The JANUS 2050 Keypad

The JANUS 2050 has an all-purpose alphanumeric keypad. In addition to the U.S. version, it is available in four international languages: French, German, Italian, and Spanish. The keypads support the same keys as a 102-key PC keyboard.

Optional terminal emulation (TE) keypads support the same keys that are used on 3270 and 5250 terminals. The TE keypads are described later in this chapter.

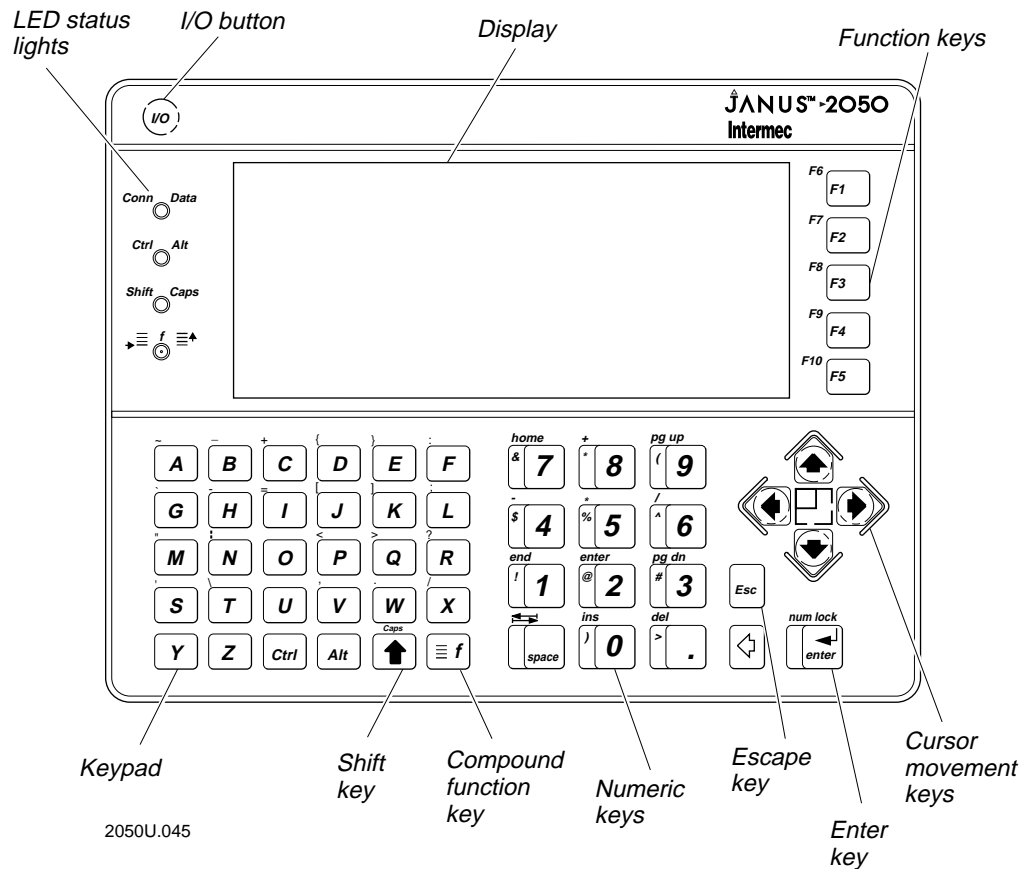

How to Type the Characters Printed on the Keypad

There are three types of characters and symbols printed on the keypad:



Character	Description	To Type the Character
First	The first character is the one in the middle of the key. If two characters are printed on the key, it is the larger character.	Press the key the character appears on.
Second	The second character is the one in the upper left of the key. The alphabetic keys (A through Z) do not show the secondary key, but it is the uppercase version of the letter.	<ul style="list-style-type: none"> • Press and release it. • Press the key the character appears on.
Third	The third character is the one that appears just above the key. Some keys (such as Y and Z) do not have a third character.	<ul style="list-style-type: none"> • Press and release it. • Press the key the character appears on.



Using the Keypad





Appendix A contains a keypad chart illustrating how you can access all 102 keys on the keypad. You enter alphabetic and numeric characters by pressing the key with the desired letter or number on it. For example:

To enter	Press
a	
A	
1	
!	



Ctrl, Alt, and Shift Keys

You enter the , , and keys on the JANUS 2050 differently than on a PC keyboard. On a PC keyboard, you hold down the Ctrl, Alt, or Shift keys when pressing another key to enter that key combination. On the JANUS 2050, you do not have to hold down these keys. When you press the Ctrl, Alt, or Shift key, it is held in a buffer until you press another key. When you press a second key, you enter the combination into the JANUS 2050.



There are LEDs for each of these keys at the left of the JANUS 2050 display. When you press the , , or  key, it is held in the buffer and the LED for that key lights up. When you press a second key, you enter the combination into the JANUS 2050 and the LED turns off.









For example, to do a warm boot of the JANUS 2050, you press and release the  key, press and release the  key, press and release the  key, and then press the  (period) key. This sequence is the same as entering **Ctrl-Alt-Del** on a PC.

There are right and left Ctrl, Alt, and Shift keys on a PC 102-key keyboard. You can also enter a right and left Ctrl, Alt, or Shift on the JANUS 2050.

The keys are held in a buffer until you press another key. You can also enter just Ctrl, Alt, or Shift by repeating the keystroke(s) a second time. For example, to enter a Ctrl, press  .

Compound Function Key

The Compound Function key  is a special key on the JANUS 2050 keypad. You use the  key to access characters of perform functions that do not have an actual key on the keypad. The compound function status LED illuminates when you select this key.

The  key works like the , , and  keys. When you press , it is held in a buffer. When you press a key other than , the key combination is entered into the JANUS 2050. For example, you use the  key to type the question mark (?) character printed above the  key.

For a complete list of key combinations, see the “Keypad Charts” in Appendix A.

Additional Keys



A PC keyboard has two small keypads in addition to the alphanumeric keypad. They are the cursor keypad and the numeric keypad. These keys are also supported on the JANUS 2050 as described next.



Cursor Keypad

Use the cursor keypad  to move the cursor around the screen. The cursor or arrow keys on a PC keyboard correspond to the diamond-shaped arrow key on the JANUS 2050 keypad.

Numeric Keypad

Use the numeric keypad to enter mathematical symbols (*, +, -, /, enter), move the cursor on the display, or enter numbers. You can also use the numeric keypad to enter any ASCII character.

The mathematical symbols, which are listed above the number keys, are always available. However, to access the cursor keys and numeric keys of the numeric keypad, you must first enable the numeric keypad by pressing   . When you enable the numeric keypad, the set of numeric keys on the JANUS 2050 act like a PC numeric keypad.



The numeric keypad has two states: Num Lock on and Num Lock off. You toggle the Num Lock on and off by pressing  . Switching between states changes the function of the numeric keys.

Num Lock On With the Num Lock on, numbers are accessed by pressing the desired numeric key. You can access the cursor functions (page up, page down, etc.) by pressing , and then the numeric key.

Num Lock Off With the Num Lock off, you access the cursor functions by pressing the desired key. You access numbers by pressing  and then the desired key.

To exit and disable the numeric keypad, press   .

You can check if the numeric keypad is enabled or disabled by trying to enter the shift character on a numeric key.











For example, if you press   and the JANUS 2050 displays:

- | | |
|---------|---|
| % | The numeric keypad is disabled. |
| 5 | The numeric keypad is enabled and the Num Lock is turned on. |
| nothing | The numeric keypad is enabled and the Num Lock is turned off. |

Entering ASCII Characters

You can enter ASCII characters from the ASCII extended character set using the numeric keypad. For help, see the “Full ASCII Table” in Appendix A for the values you can enter.

To enter an ASCII character



1. If you do not have the numeric keypad enabled, press   .
2. If you do not have the Num Lock turned on, press  .
3. Press and hold the  key.
4. Enter the three-digit decimal ASCII value for the character. The value cannot be larger than 255.
5. Release the  key.
6. To exit and disable the numeric keypad, press   .

International Keypads

Entering characters on the four international keypads (French, German, Italian, and Spanish) is the same as it is for the U.S. keypad. However, there are some additional rules you need to know to use the JANUS 2050 international keypads.

DOS Code Pages

You can translate all international keypads using an installed DOS code page. DOS code pages contain the standard ASCII character set and a set of national language characters specific to the language the code page supports. You can find more information on DOS code pages in any DOS 5.0 manual. You can switch DOS code pages on the JANUS 2050 using the following key sequences:

-  to change to U.S. key translations (default DOS configuration).
-  to change to the key translations based on the code page installed for the JANUS 2050 (French, German, Italian, and Spanish).

Alpha Keys With Multiple Characters



The alpha keys on the JANUS 2050 have an additional character printed above the key. To enter the character printed above the key, press and release the  key, and then press the key below the desired symbol or function.

Numeric Keys With Multiple Characters

The numeric keys on the JANUS 2050 have three characters printed on the key.



pg dn





- To enter the left character on the key, press and release the  key followed by the desired key.
- To enter the lower character on the key, press the desired key.
- To enter the character printed above the key, press and release the  key, and then press the key below the desired symbol or function.

When you enable the numeric keypad, only the numeric keys are available. The Shift and Alt characters listed on the numeric keys cannot be accessed. Characters listed above the numeric keys are always accessible regardless of whether the numeric keypad is enabled or disabled.



Alt and Shift Keys

On all versions of the JANUS 2050 international keypads, the right Alt key is identical to the Alt Gr key on PC international (non-U.S.) keyboards. To enter a left-Alt, press and release the  key followed by the  key.

For many DOS NLS languages, pressing the Shift key causes the Caps Lock to clear if it is active. For other DOS NLS languages, pressing Caps Lock ( ), does not cause the Caps Lock key to clear if it is already active.

Special Characters

Modifiers (^, ~, ¨, etc.) to certain vowels and consonants produce no character until a second key is pressed. These modifiers are commonly referred to as *dead keys*. If you want to generate just the modifier, press  as the second key. If you press a dead key followed by a key to which the modifier does not apply, the JANUS 2050 sounds an error beep and the modifier displays followed by the incorrect character.

The characters above  and  constitute the 102nd key on a 101/102 enhanced PC keyboard. Both characters produce scan code 56H.

International Keypad Examples

The following pages illustrate the international keypads available on the JANUS 2050 computer.

French Keypad

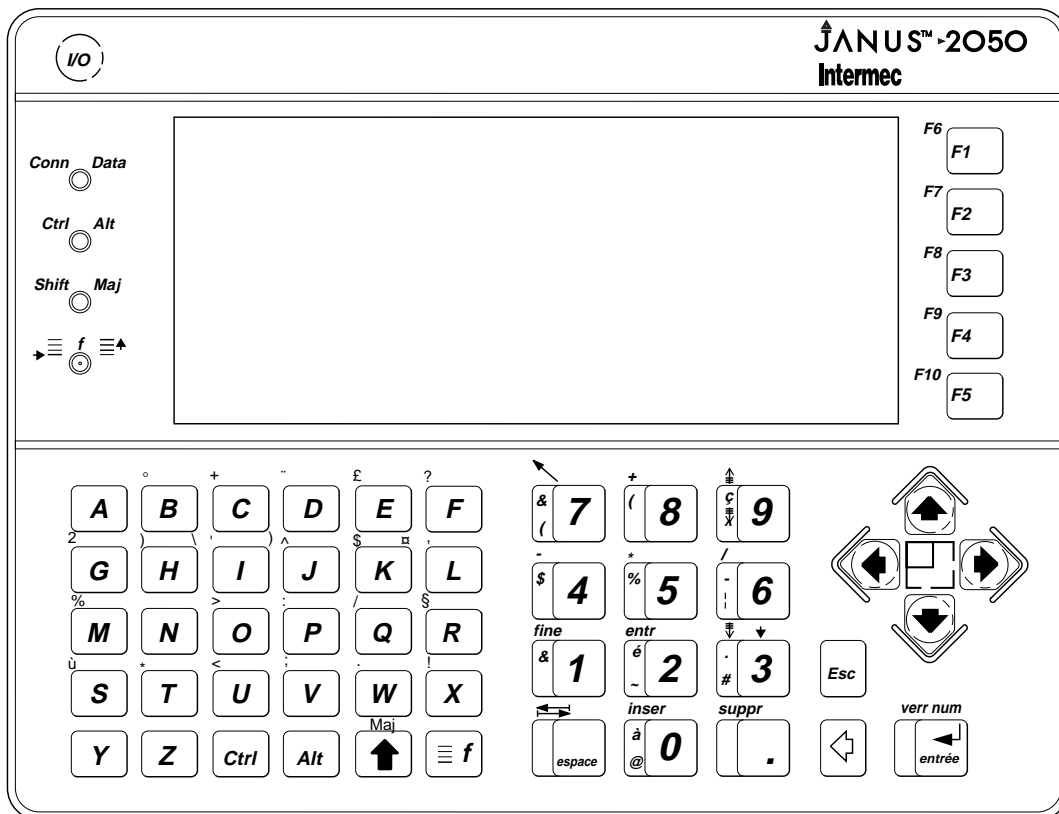

German Keypad

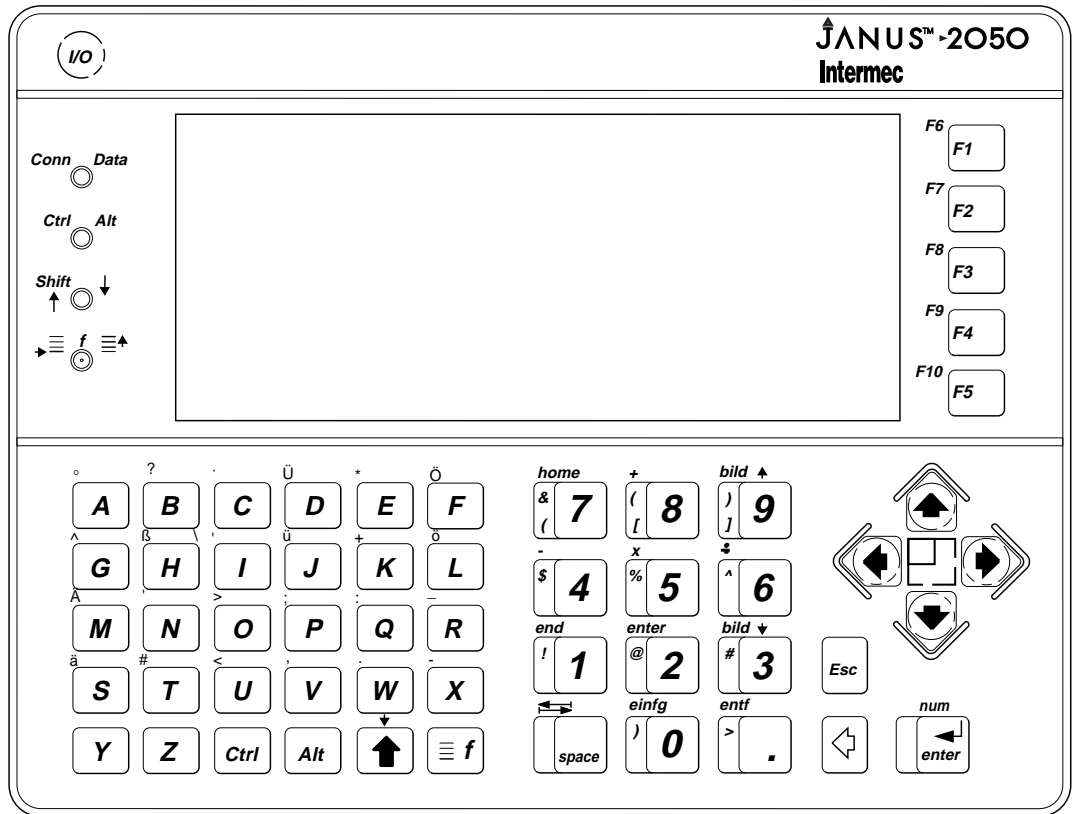

2050U.046

Italian Keypad

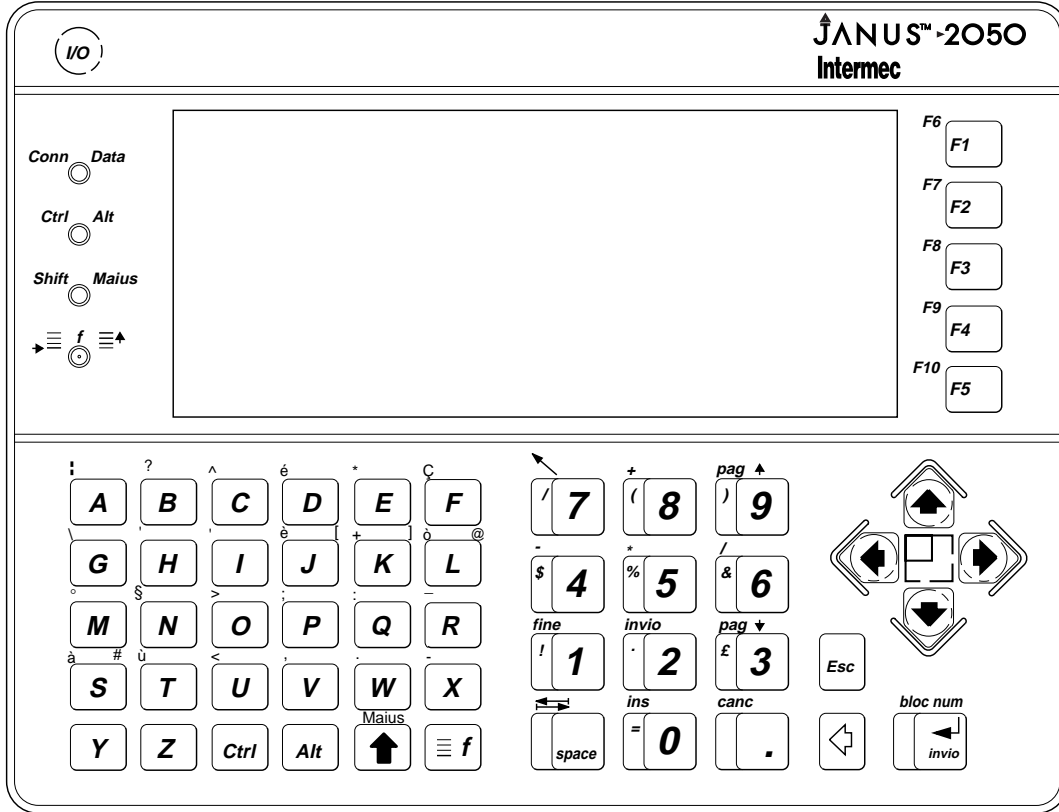

2050U.048

Spanish Keypad

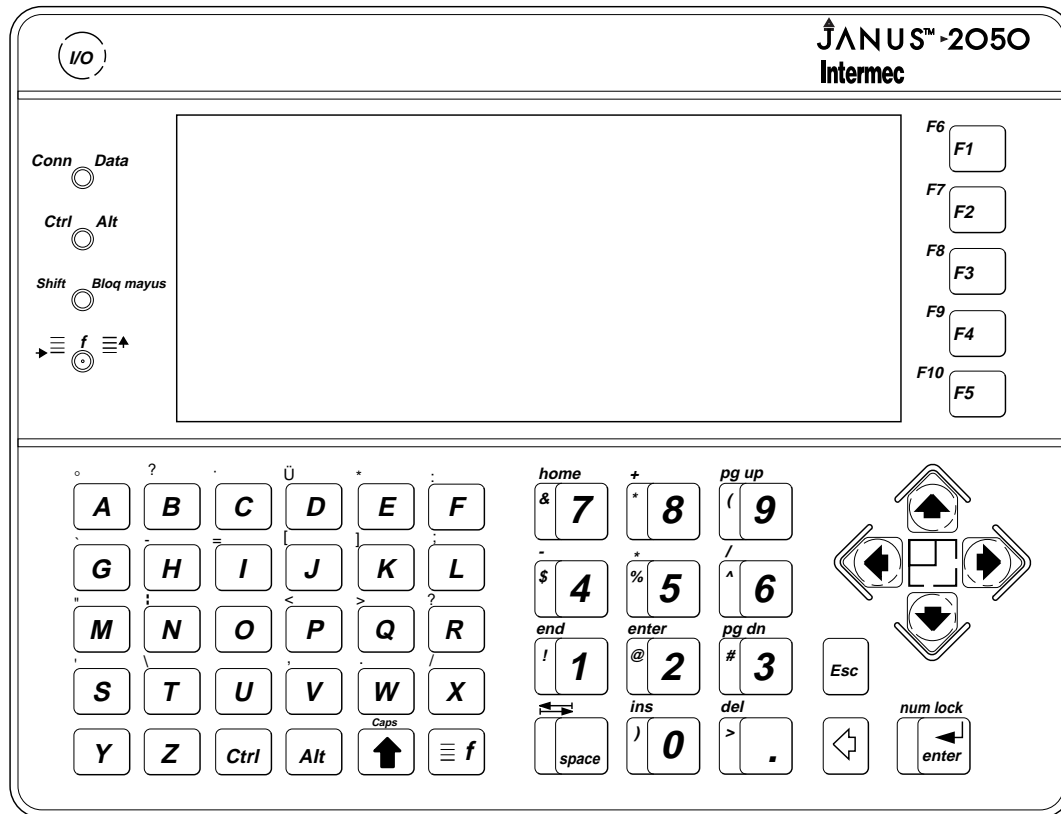

2050U.047

Terminal Emulation (TE) Keypads

A JANUS 2050 configured for terminal emulation comes with a keypad that contains most of the keys available on an IBM 3270 or 5250 keyboard. The TE keypads are similar to the regular JANUS 2050 keypads, but have additional commands that are specific to IBM 3270 or 5250 systems.

The following illustration shows the 3270 and 5250 keypads.

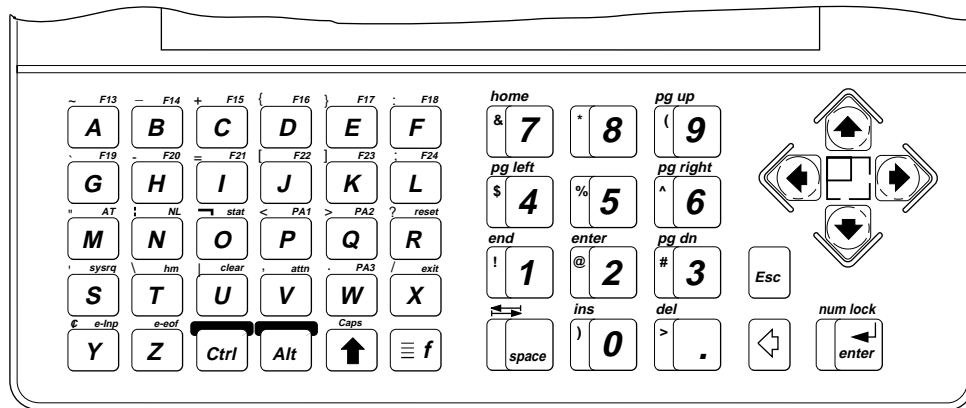

3270

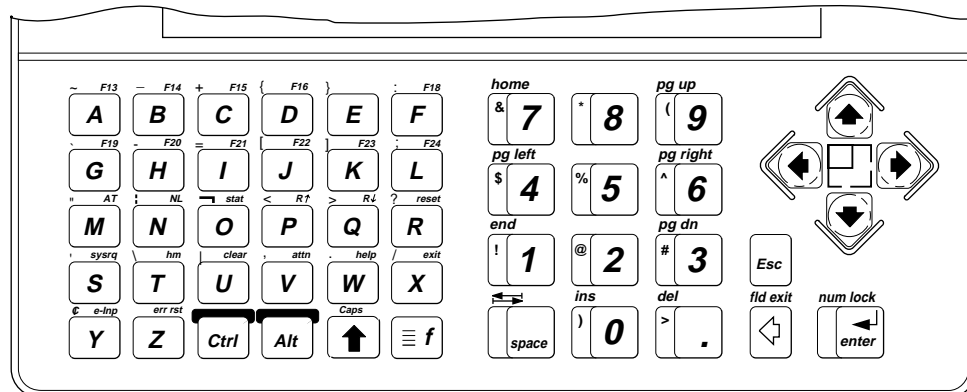





5250



2050U.019

Accessing TE Commands on the Keypad





As on all terminal keyboards, the keys on the JANUS 2050 TE keypad have their main function marked directly on the key itself. To access that character or function, just press the key. Your JANUS 2050 TE provides access to additional keys and commands. These keys are described below.





Note: When entering a key combination on the JANUS 2050, you do not need to press and hold the , , , or  keys. Once you press a key, the JANUS 2050 stores the keystroke in memory and uses it with the next keystroke as a key combination.



Shift Key

The  key accesses uppercase letters. For example, for the letter “A” you press  . This key also accesses the mathematical symbols printed on the number keys.



Ctrl and Alt Keys

The  and  keys let you access characters or commands on the keypad that are printed above the letter keys and function keys. The  key has the color green above it and activates the commands printed in green. Similarly, the  key activates commands printed in blue.

To use the  and  keys, simply press and release the key, and then press the corresponding key that has the desired command or character printed above it. For example, to create an equal sign (=), press  and then press .

Note: When you exit TE and return to the DOS prompt, the  key will no longer be accessing the characters printed above the letter keys. Use the  key instead.

Compound Function Key

On a regular JANUS 2050 keypad, the  key can be pressed multiple times to access even more sets of commands. You can press the  key up to three times to access different sets of commands. These commands are not available when you are using terminal emulation software.

Booting the JANUS 2050





You can perform a cold boot or warm boot on the JANUS 2050.

Performing a Cold Boot

A cold boot invokes the BIOS boot sequence, the bootstrap verifies that the 256K system flash is not corrupt, clears all memory, and does a complete power-on-self-test (POST) to ensure that the hardware and peripherals are operational.

It also initializes the system hardware for subsequent use by the system software, loads the configuration file JANUS.INI if present (otherwise, it loads the default configuration), runs AUTOEXEC.BAT and CONFIG.SYS, and brings up DOS. Drive E is initialized on a cold boot and all files on the drive are lost. To perform a cold boot, select Reboot from the Boot Loader menu. The Boot Loader menu is described later in this chapter.

Performing a Warm Boot

A warm boot goes through POST, and runs CONFIG.SYS and AUTOEXEC.BAT, and then goes to the DOS prompt. Memory remains intact on a warm boot. You initiate a warm boot when you press    .



Caution

Do not press any keys while the JANUS 2050 is performing a warm boot or you may lose data.









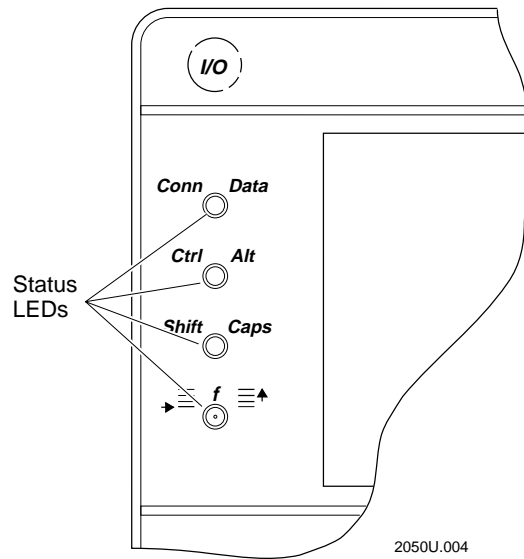

Conseil

N'appuyez pas sur des touches pendant que le lecteur se réamorce, sinon vous pouvez perdre des données.











Understanding the Status LEDs

The four LEDs located to the left of the screen display the status of the following JANUS 2050 functions.

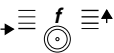

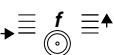
Status LEDs	Color	Description
	Yellow	Indicates communication with the network controller is established.
	Red/Orange	Data is buffered in the JANUS 2050 RF interface.
<p>Note: Do not turn off the JANUS 2050 when the Conn/Data light is on. When you power up, the JANUS 2050 attempts to send any data in the radio buffer. Depending on the time between power down and power up, this data could be meaningless and/or disrupt the host application. The operator who turns on the unit could also be confused by a display screen containing instructions or data unrelated to his or her work.</p>		
	Green	A connection is established with the network controller and data transfer is taking place.
	Yellow	Ctrl  function is enabled.
	Red/Orange	Alt  function is enabled.
	Green	Both Ctrl  and Alt  functions are enabled.

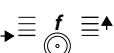
Status Lights (continued)

Status LEDs	Color	Description
Shift  Caps	Yellow	Shift function is enabled.
Shift  Caps	Red/Orange	Caps  function is enabled.
Shift  Caps	Green	Both Shift and Caps  functions are enabled.
 f 	Yellow	Compound function  1 is enabled.
 f 	Red/Orange	Compound function  2 is enabled.
 f 	Green	Compound function  3 is enabled.



Caution

Always wait for the Conn/Data light to go off before changing protocols, turning off the unit, or inserting a cable. The data light will go off when all data is transferred from the JANUS 2050.

Conseil

Attendez toujours que le voyant des données s'éteigne avant de changer de protocole, d'éteindre l'unité ou d'insérer un câble. Le voyant des données s'éteindra lorsque toutes les données seront transférées de la JANUS 2050.

Display Modes

The JANUS 2050 display is CGA compatible with enhanced features for DOS code page support. The default configuration for the JANUS 2050 display is 25 rows by 80 characters.

You can use the JANUS 2050 in Text or Graphics mode. When the JANUS 2050 is in Text mode, you can set the display size to 25 x 80, 13 x 80, 25 x 40, or 13 x 40. You also have the option of doubling the character height or width without reducing the display area. You can change the display setup in the JANUS 2050's configuration. The JANUS 2050 also supports two character attributes: blinking and reverse video.

To use Graphics mode, your application needs to set Graphics mode when you start the application on the JANUS 2050. As you exit the application, set Text mode again before returning to the DOS prompt. When you use the JANUS 2050 in graphics mode, it has a 640 x 200 pixel display.

For help on programming the JANUS 2050 or setting Graphics mode, see the JANUS PSK reference manual set.

Understanding Audio Signals and Beep Sequences



The JANUS 2050 has a beeper to indicate status. The following table indicates the purpose of each beep sequence or audio signal. You can change the beep volume in the JANUS 2050's configuration.

Signal/Beep Sequence	Meaning
L	Valid command or data accumulated.
H	Valid data entered, label decoded, last row of a two dimensional symbology decoded, or the power-on-self-test (POST) passed on a cold boot.
LH	Valid PC card inserted.
HL	Valid PC card removed.
LLL	Invalid command or data, or an IRL syntax error was found while compiling.
LHL	IRL runtime error (a nonfatal error).
HLH	Input/output (I/O) error.
HHH	Configuration error or a fatal IRL error.
LLHH	Updating JANUS 2050 configuration.
C	Key pressed.
C	One row of a two-dimensional symbology decoded (Code 16K and Code 49).
Chirp (continual)	Battery is low. Chirp sounds every 15 seconds.
Shadow or double beep/click	Battery is low. The second beep or click is a lower tone that shadows the first.

C=click, L=low beep, H=high beep

Estimating Power Usage

You can use the following information as a guideline for estimating typical power usage.

Internal combustion vehicles A typical battery has a capacity of 60 Amp-hours (Ah). The JANUS 2050 typically draws 1.8A at 12V. To find the length of time the JANUS 2050 can operate before recharging the vehicle battery, divide the capacity of your battery by the amount of power drawn hourly. Your calculation should be similar to the following:

$$60\text{Ah}/1.8\text{A} = 33.3 \text{ hours or } 1.4 \text{ days}$$

If you start with a fully charged battery, the JANUS 2050 can operate for 33.3 hours or approximately 1.4 days before draining the vehicle battery.

Electric vehicles Electric vehicles have higher capacity batteries than internal combustion vehicles. The standard electric vehicle battery is so large that leaving the JANUS 2050 powered on for long periods of time has no noticeable effect on the vehicle battery.

Recharging the Backup Battery

The JANUS 2050 is normally powered by the batteries of the vehicle to which it is attached. The internal NiCad battery supplies power to the real-time clock and processor RAM when you remove or discharge the vehicle. The NiCad battery must be replaced by an Intermec service technician.

If you turn on the JANUS 2050 when the battery charge is low, the JANUS 2050 beeps and displays a "Backup Battery Low" message. You should recharge the battery immediately.

To recharge the backup battery

1. Press the  button to suspend the JANUS 2050 while input power is connected and the rear power switch is in the ON position.
2. The backup battery will charge enough to operate the unit normally on an external power supply within 20 minutes. To be fully functional, the backup battery should charge for approximately 10 hours.

Note: *If you continue to operate the JANUS 2050 without charging the backup battery, the JANUS 2050 beeps every 15 seconds for 1 minute and then turns off.*

Defining JANUS 2050 Drives

The JANUS 2050 contains three onboard drives and one PC card drive to run applications and store data.

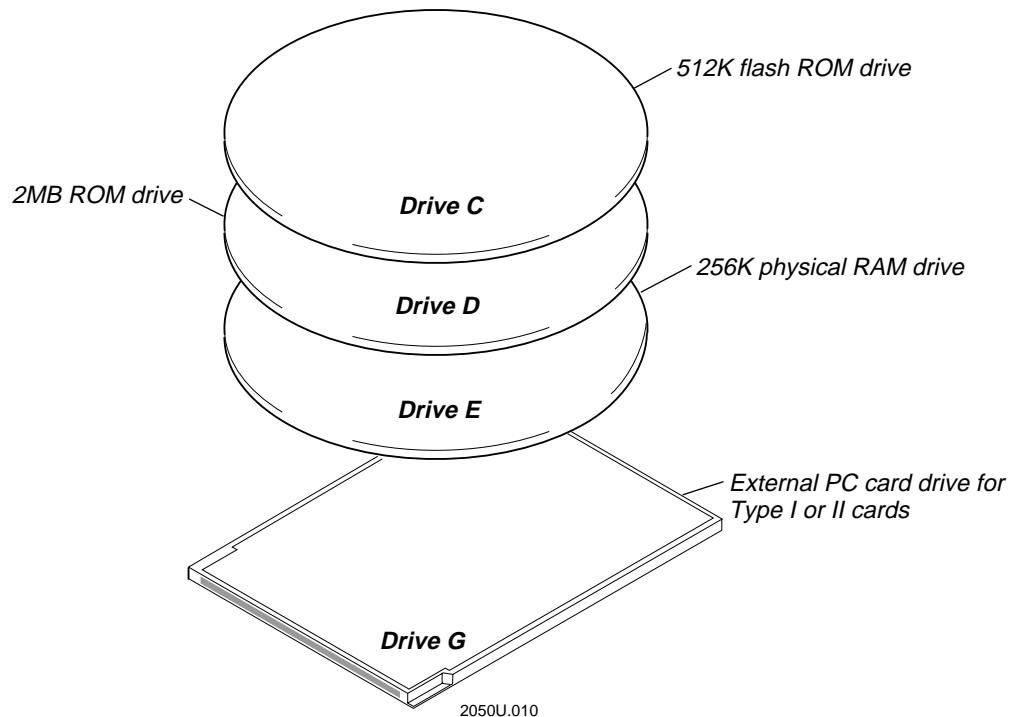

Drive C

Drive C is a flash drive in a File Allocation Table (FAT) type format. It contains the AUTOEXEC.BAT and CONFIG.SYS files that execute when the JANUS 2050 boots. You can use this drive to store user-executable files. The drive requires a special utility to write to it, but can be read using standard DOS procedures. You can add, change, or delete files on drive C using the Auto-Loader utility or the MakeDisk/PutDisk utilities. See Chapter 3, "Using the JANUS 2050 Software," for instructions on how to add and remove files on drive C.

Drive D

Drive D is a ROM drive that uses a FAT-type format. It contains the system files for DOS, along with the resident functions of the JANUS 2050. See Chapter 3, "Using the JANUS 2050 Software," for instructions on how to add and remove files on drive D.

Drive E

Drive E is a RAM drive and uses a FAT-based file format. It can be used to store data files and user applications.

The device driver for drive E is SRAMDISK.SYS, which requires HIMEM.SYS to execute. This drive can be reduced or eliminated and the freed memory used as extended memory by an application. Creating and reconfiguring the RAM drive is discussed in Chapter 3, “Using the JANUS 2050 Software.”

PC Card Drive (G)

The PC card drive on the JANUS 2050 is similar to a disk drive on a PC. Use a PC card, which is like a floppy disk, to store data and transfer information to other computers.

You access the PC card drive as drive G on the JANUS 2050. This external drive is located on the bottom side of the JANUS 2050. When a card is properly formatted, you can access it directly from the JANUS 2050. The JANUS 2050 uses memory and input/output cards that comply with the PCMCIA 2.1 standards for Type I and II cards. See Chapter 5, “Using PC Cards,” for more information.

Note: *If you have a new PC card, it must be formatted before you can use it in the JANUS 2050. See “Configuring, Formatting, and Using PC Cards” in Chapter 5 for information on formatting ATA, SRAM, I/O, and flash cards.*

Note: *JANUS 2050s equipped with a 2.4 GHz radio use the PC card slot for the radio controller.*

Memory Management

The best use of memory depends on the application that is using it, and the types of memory available to the application.

Data storage Drive E is recommended for data storage if less than 256K is required. 1MB, 2MB, or 4MB SRAM PC cards are recommended if more memory is required.

Applications and lookup tables Drive E is recommended for storing all applications and lookup tables. If more memory for applications is required, an Intel flash block-erasable card, available in sizes of 1, 4, 10, and 20MB, is recommended.

Large applications If you develop a large application that requires more conventional memory to run in than is presently available, remove any device drivers and TSRs, such as ANSI.SYS or SRAMDISK.SYS, that are not required by your application. If that still does not provide enough conventional memory, then you might consider using HIMEM.SYS and EMM386 and load some device drivers or TSRs into the upper memory blocks and high memory area. Another possibility is purchasing a DOS extender and developing your application so it can run using both conventional and extended memory.

See Chapter 11, "Advanced Operations," for information on making more conventional memory available on the JANUS 2050.

Using the JANUS 2050 Software

This chapter describes the software that is shipped with the JANUS 2050, tells you how to update files on drive C, and explains how to use the PC card drive.

Software Provided With the JANUS 2050

The JANUS 2050 has a number of applications that assist you in running the computer and collecting bar code data.

DOS Your 4MB JANUS device comes with MS-DOS 6.2 and supports many standard MS-DOS 6.2 commands. Use DOS commands and utilities to transfer files, create and run programs, create a RAM drive, and access files on PC cards. For help using MS-DOS commands, see any MS-DOS manual.

DOS also has a communications program called Interlnk/Intersvr that allows the JANUS 2050 to access the drives on a host computer as if they were on the JANUS 2050 and vice versa. Use the **/b** switch on the JANUS 2050 command line with Interlnk/Intersvr to make optimum use of the monochromatic display. Chapter 6, "Communicating With the JANUS 2050," discusses this program.

Configuration application You can use the configuration application to configure the JANUS 2050 with pull-down menus and dialog boxes. This application lets you modify the JANUS 2050 for your specific needs, such as decoding bar code symbologies, defining communications protocols, and setting JANUS 2050 operations. You can run the configuration application by entering the **ic** command from the DOS prompt. For more information on configuration, refer to Chapter 4, "Configuring the JANUS 2050."

Communications Manager You can use the Communications Manager utility to transmit and receive files, and request status. Companion Disk 3, shipped with the JANUS 2050, contains the Communications Manager utility. You need to load the Communications Manager files on the JANUS 2050 before running the utility. Chapter 6, "Communicating With the JANUS 2050," discusses Communications Manager in more detail.

IRL or IRL Desktop You can use the IRL or IRL Desktop to transmit, clear, and receive files, and download and run IRL programs. You can run the IRL Desktop by entering the **irl** command from the DOS prompt. For more information on IRL, refer to Chapter 7, "Working With IRL."

Boot utilities You can use this set of programs to reload or upgrade the JANUS 2050 system software. Chapter 8, "Troubleshooting," discusses these programs in more detail.

Auto-Loader utility You can use this program to replace the CONFIG.SYS and AUTOEXEC.BAT files on drive C, and configure the JANUS 2050 for international languages. You can also use it to store additional files on drive C. The Auto-Loader utility is discussed in more detail later in this chapter.

LDKEYTAB.EXE This program along with a .KTB file is used to load the alphanumeric keypad or oversized-numeric keys keypad scan code table. These files should only be used by an Intermec service technician.

Binary file transfer (BFT) Use BFT in a 900 MHz CrossBar or RF network to connect a host computer to one or more readers in order to transfer binary files or change the contents of the reader's drive C. For help, see "Communicating With the JANUS 2050" in Chapter 6.

MakeDisk and PutDisk MakeDisk creates an image file containing the files you want on the drive, and PutDisk places the new image on the JANUS drive. MakeDisk supports the creation of subdirectories on drives C and D. For more information, see "Using MakeDisk and PutDisk to Change Drives C or D" later in this chapter.

Direct Hardware Wedge The Direct Hardware Wedge is a new feature of JANUS 4.0 software that provides hardware level PC compatibility. It provides bar code data to PC applications that directly access the hardware. The existing Virtual Wedge is a software wedge that is ten times faster than going through the PC hardware. Use the Virtual Wedge for maximum performance. Use the Direct Hardware Wedge for maximum PC compatibility.

What Software Is Provided on the Companion Disks?

You receive a set of companion disks with your JANUS device. The disks contain files that may help you use the reader more efficiently. You can use Interlnk to copy files from the companion disks to the JANUS 2050.

You can use a PC and the DOS DIR command to learn exactly what files are stored on the companion disks. Here are general descriptions of each disk:

Companion disk 1 The Boot Utilities companion disk contains the files you need to load or upgrade the system software. This disk also contains the README.DOC, a text file that describes important information about the reader that was unavailable when this manual was published. This disk also contains a batch file, INSTALL.BAT, that you can use to install Auto-Loader onto a host computer. Auto-Loader lets you change the contents of drive C.

Companion disk 2 The MS-DOS Programs companion disk contains commands and device drivers. Some of these commands and drivers are already installed on the device. This disk also contains applications, such as INTERLNK.EXE, MakeDisk, and PutDisk.

Companion disk 3 The Application companion disk contains applications such as Communications Manager and IRLXDESK.EXE. This disk also contains PC card drivers and utilities that control the reader's operation, prepare the reader to use the different types of PC cards, customize the reader to use the PC card software, and provide you with helpful tools.

Note: Companion disk 3 also contains LDKEYTAB.EXE and a .KTB file. Only an authorized Intermec service technician should use these files to load the keypad scan code table.

Using DOS Commands

Your JANUS device uses the MS-DOS operating system, and you can use DOS commands on the JANUS device just as you do on a PC. From the DOS prompt, you type a DOS command and press  to execute the command. For example:

```
dir
```

Or, you can create and scan bar code labels that contain DOS commands:

DIR Command



DIR

For help using DOS commands, see any DOS manual.

All DOS commands provided with the JANUS device are available on the MS-DOS Programs companion disk 2. The most commonly used commands are also stored on drive D. See the README.DOC for a list of the files on drive D.

Note: The DOS commands available on drive D are a subset of the DOS commands that are available on the MS-DOS companion disk. You can add or replace DOS commands on drive D as needed.

Your 4MB JANUS device supports these commands, but you cannot use them on drives C or D because they are ROM (read only memory) drives:

CHKDSK (You can analyze, but not fix, drives C and D with CHKDSK)

DISKCOMP

DISKCOPY

SCANDISK (You can analyze, but not fix, drives C and D with SCANDISK)

DEFRAG (DEFRAG will not work on drives C and D)

Defining the Startup Files

JANUS devices use two startup files to control how DOS uses hardware, memory, and files: AUTOEXEC.BAT and CONFIG.SYS. AUTOEXEC.BAT loads programs and defines paths. CONFIG.SYS loads device drivers and reserves memory for processing information. The commands in the startup files execute when you warm boot or cold boot the JANUS device.

You may modify the startup files for a variety of reasons:

- To change the default JANUS Startup menu.
- To support applications you will run on your JANUS device.
- To load drivers for your PC cards.
- To create physical RAM drives.
- To configure your JANUS device to operate in another language.

Because AUTOEXEC.BAT and CONFIG.SYS are stored on drives C or D, you must use Auto-Loader, binary file transfer (BFT), or MakeDisk and PutDisk to replace them.

The next sections illustrate what the two startup files may contain when your 4MB JANUS device arrives from the factory.

AUTOEXEC.BAT File

The AUTOEXEC.BAT file on your 4MB JANUS device should look like this one:

Command Line	Definition
<code>echo off</code>	The AUTOEXEC.BAT commands are not displayed on the screen as they are executed.
<code>cls</code>	Clears the screen.
<code>if not exist autoinst.bat goto T2 call autoinst goto T3</code>	These commands call the AUTOINST.BAT file, enabling you to update drives C or D with Auto-Loader.
<code>:T2</code>	Do not remove these commands.
<code>if exist d:\autoinst.bat call d:\autoinst</code>	Do not delete AUTOINST.BAT from drives C or D.
<code>:T3</code>	
<code>set prompt=\$p\$g</code>	Sets the DOS prompt to display the current drive and directory, followed by the > symbol.
<code>set path=c:\;d:\;e\;</code>	Directs DOS to look for commands and programs in the root directories of drives C, D, and E. Do not add drive G to the path, or else errors will occur when you do not have a PC card installed.

AUTOEXEC.BAT File (continued)

Command Line	Definition
set temp=e:\	A temp directory is required for MORE.COM to work correctly on ROM drives.
set im_errpath=e:\	Tells the JANUS device to write the configuration error file JANUS.ERR to drive E. The JANUS device must execute this command before it calls LOADUMA.EXE.
d:	
d:\ipm_4m.exe REM d:\apm_4m.exe	IPM_4M and APM_4M work with card services to manage the power on the PC card drive when you suspend and resume the JANUS device. Note: Do not load both at the same time, but you must load one.
if exist d:\loaduma.exe d:\loaduma	Loads Reader Services, Configuration Manager TSR, and the decode and scanner utilities that let the JANUS device operate as a bar code reader.
d:\im_disp.exe	Loads software required for the display.
d:\ic /0 e:\janus.ini	Loads the JANUS.INI configuration file if it exists.
d:\kwc.com 0	Sets the bar code wedge options. The default configuration is 0. Configuration parameters are: <ul style="list-style-type: none"> 0 Virtual wedge and expanded keyboard enabled. 1 Direct Hardware wedge and expanded keyboard enabled. 2 Direct Hardware wedge enabled and expanded keyboard disabled. 3 Virtual Wedge enabled and expanded keyboard disabled. 4 Display status.
rfph 4	Loads the RF protocol handler for COM4 only if you are using a JANUS RF device.

AUTOEXEC.BAT File(continued)

Command Line	Definition
<pre>if not exist c:\fta.exe goto DOS_PROMPT e: fta.exe checkhost; exit</pre>	Runs the FTSERVER batch file if it is on drives C or D. FTSERVER runs FTA.EXE, which provides binary file transfer (BFT) on the JANUS device. If a host is trying to initiate a BFT session, FTA continues running; if not, FTA stops running.
<pre>%IM_APPLICATION% :DOS_PROMPT</pre>	After FTA terminates, %IM_APPLICATION% runs any application identified by the DOS environment variable IM_APPLICATION.
<pre>c:</pre>	Resets the JANUS device to drive C or D.
<pre>cls</pre>	Clears the screen.

CONFIG.SYS File

The CONFIG.SYS file on your 4MB JANUS device should look like this one:

Command Line	Definition
<pre>[menu] menuitem=sram, Load PCCard menuitem=ata, ATA PCCard menuitem=flash, Flash PCCard menuitem=io, I/O PCCard menuitem=no, No PCCard menucolor=15,0 menudefault=sram, 20 shell=command.com /e:2000 /p</pre>	Creates the Startup menu. Increases the size of the environment space to 2000 bytes. This line is required for Auto-Loader.
<pre>device=d:\himem.sys /testmem:off dos=high</pre>	Loads the DOS extended memory manager, HIMEM.SYS. You must load HIMEM before you load device drivers.
<pre>device=d:\power.exe /low</pre>	Loads APM power management.
<pre>device=d:\sramdisk.sys 256 512 /e</pre>	Creates the 256K RAM drive E.
<pre>install=d:\card_sr.exe</pre>	Loads software required for the PC card drives.

CONFIG.SYS File (continued)**Command Line**

```
[sram]
device=d:\cs.exe /poll:1
device=d:\csalloc.exe
    d:\csalloc.ini
device=mtsram.ext
device=mtddrv.exe

[ata]
device=d:\cs.exe /poll:1
device=d:\csalloc.exe
    d:\csalloc.ini
device=\atadriv.exe /s:2
device=mtddrv.exe
device=d:\cardid.exe

[flash]
device=d:\cs.exe /poll:1
device=d:\csalloc.exe
    d:\csalloc.ini
device=d:\mti1.exe
device=d:\mti2p.exe
device=mtddrv.exe
device=d:\ftl.exe

[io]
device=d:\cs.exe /poll:1
device=d:\csalloc.exe
    d:\csalloc.ini
device=mtsram.exe
device=mtddrv.exe
device=d:\cardid.exe

[no]

[common]
device=d:\interlnk.exe /drives:7
    /noprinter /com:1 /auto

buffers=10

files=50

stacks=9,256
```

Definition

Loads software required for PC cards. CSALLOC is a DOS program that scans the system for available memory, I/O port, and interrupt request queue (IRQ) resources.

Loads software required for ATA cards.

Loads software required for flash cards.

Loads software required for SRAM and I/O cards.

Loads Interlnk as a resident device driver only if Intersvr is executing on a host computer that is connected to the JANUS device. Do not remove. Auto-Loader uses this line.

Sets the amount of memory that DOS reserves for data transferred to and from a disk.

Sets the number of files that can be open at one time. You need this command for IRL support.

Sets the amount of memory that DOS reserves to process hardware interrupts.

MS-DOS Startup Menu

The default JANUS startup menu is defined in the menu configuration block in the CONFIG.SYS file. It defines several different PC Card configurations that you can enable on your JANUS device. You can modify or disable the JANUS startup menu by removing or changing parameters in the menu configuration. Refer to any MS-DOS 6.2 manual for more information on setting up or changing the startup menu.

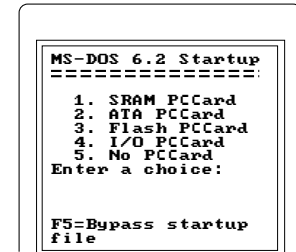

20X0A.002

Learning How to Change the Contents of Drive C

Drive C contains the AUTOEXEC.BAT and CONFIG.SYS startup files, as well as software for the PC card drive. You can use the remaining space on drive C to store applications and data files. In general, drive C should contain files that you often read or execute, but do not often write to or replace.

Drive C is a 512K ROM drive implemented in flash memory. It is upgradeable, but has limited write capability. You can use DOS commands to read from drive C, but you cannot use DOS commands to write to drive C.

To write to drive C, you must use one of these special utilities:

- Auto-Loader
- MakeDisk and PutDisk
- Binary file transfer (BFT)

These utilities let you create an image file that contains an “image” or “snapshot” of all the files you want on drive C.

Then you use the utilities to load the image file to drive C.

Once you load the image file to drive C, the image file becomes transparent. For example, when you use the DOS DIR command for a directory listing on drive C, all you see are the individual files that were contained in the image file.

You cannot directly add, edit, or delete individual files on drive C. Instead, you must replace the entire image.

You can use these utilities to create an image file and copy it to drive C:

Auto-Loader Auto-Loader creates an image file that contains the files you want placed on drive C, and then replaces the old drive C image file with the new one. You run Auto-Loader on a host computer connected to the COM1 port on the JANUS device.

Binary file transfer (BFT) Use BFT in a 900 MHz CrossBar or RF network to connect a host computer to one or more devices in order to transfer binary files or change the contents of drive C. For help, see “Communicating With the JANUS 2050” in Chapter 6.

MakeDisk and PutDisk MakeDisk creates an image file containing the files you want on the drive, and PutDisk places the new image on the JANUS drive. MakeDisk supports the creation of subdirectories on drives C and D. For more information, see “Using MakeDisk and PutDisk to Change Drives C or D” later in this chapter.

When deciding which utility to use, you should consider these facts:

- Auto-Loader and BFT require you to use a host computer. MakeDisk and PutDisk do not require you to use a host computer.
- You must install Auto-Loader onto the host computer. MakeDisk and PutDisk are already on the reader’s drive D.
- You must create a BFT application for the host computer using Data Collection Manager (DCM) or Interface Software (IS). Also, you must create BFT-ready applications for the reader using BFT functions provided in the PSK. For help, see your DCM, IS, or PSK documentation.
- If you run MakeDisk on the reader’s RAM drive, the image file must be less than 256K.

Creating a RAM Drive

The device driver SRAMDISK.SYS is used to create an SRAM (static random access memory) drive E on the JANUS 2050. SRAM disks are faster than hard disk drives because the data is always loaded into RAM. The number of SRAM disks you set up is only limited by the amount of memory in the JANUS 2050.

SRAMDISK.SYS only works in extended memory (above 1MB). It cannot use conventional or expanded memory. For SRAMDISK.SYS to use extended memory, HIMEM.SYS or another extended memory manager that conforms to XMS must be installed. In the CONFIG.SYS file, the device command that installs the XMS extended memory manager must precede the command that installs the SRAM disk. SRAMDISK is compatible with all DOS commands and Norton utilities.

An SRAM disk is specified in the factory installed CONFIG.SYS file. If you reconfigure SRAMDISK.SYS or change the RAM size, the RAM drive initializes and destroys any previous drive. Before reconfiguring this drive save all important data files.

Note: Files on the RAM drive are not retained when you execute a cold boot on the JANUS 2050.

To create or change the SRAM drive

1. Verify that HIMEM.SYS or another extended memory manager is loaded in the CONFIG.SYS file.
2. Edit the JANUS 2050 CONFIG.SYS file. It is easier to edit the CONFIG.SYS file on your host computer and then replace the file on the JANUS 2050. For more information on how to update files on drive C, see "Changing Drive C and Configuring for International Languages" later in this chapter.
3. Include a separate SRAMDISK.SYS command line in your CONFIG.SYS file for each SRAM disk you want to add. The SRAMDISK.SYS command line(s) must be added after the line that loads the extended memory manager. The command syntax is:

```
device={drive:}{path}sramdisk.sys {DiskSize SectorSize  
NumEntries}
```





where:

drive:path specifies the location of the SRAMDISK.SYS file.

DiskSize specifies the size in kilobytes (K) of the SRAM disk. The size can range from 16K to 256K. The default is 64K.

SectorSize specifies the disk sector size in bytes. The size can be 128, 256, or 512 bytes. The default is 512. If you include a SectorSize value, you also need to include the DiskSize value.

NumEntries specifies the number of files and directories that can be created in the SRAM disk directory. You can specify from 2 to 1024 files and/or directories. The default is 64. If you include a NumEntries value, you must also include the SectorSize and DiskSize values.

4. Initiate a warm boot on the JANUS 2050 by pressing     in sequence.



Caution

Do not press any keys while the JANUS 2050 is performing a warm boot or you may lose data.

Conseil

N'appuyez pas sur des touches pendant que le lecteur se réamorce, sinon vous pouvez perdre des données.

Creating additional SRAM disks

The first SRAM disk is called drive E. If you create additional SRAM disks, they would be called drive F, G, H, and so forth.

- To create an SRAM disk and allocate 64K of extended memory to the disk, add the following line to the CONFIG.SYS file:

```
device=d:\sramdisk.sys
```

DOS searches for the SRAMDISK.SYS utility on drive D in the root directory.

- To create an SRAM disk and allocate 256K of extended memory to the disk, add the following line to the CONFIG.SYS file:

```
device=d:\sramdisk.sys 256
```

- To create an SRAM disk and allocate 256K of extended memory to the disk with 128-byte sectors and only a maximum of 16 entries in its root directory, add the following line to the CONFIG.SYS file:

```
device=d:\sramdisk.sys 256 128 16
```

Note: 256K is the maximum amount of memory that can be allocated for the RAM disk. If you exceed 256K, Reader Services cannot execute. Reader Services are described later in this chapter.

Changing Drive C and Configuring for International Languages

Drive C contains the AUTOEXEC.BAT and CONFIG.SYS files for the JANUS 2050. You can modify these startup files to define how DOS uses the JANUS 2050 hardware, memory, and application files. You can also use the startup files to configure the JANUS 2050 to operate in an international language.

You can use the remaining space on drive C to store applications and tables. Drive C is a flash memory drive that requires special procedures for writing to it. There are two utilities you can use to add, change, or delete files on drive C:

- Auto-Loader
- MakeDisk and PutDisk

The Auto-Loader utility is an automated process that creates an image file containing the files you want placed on drive C. The image file is used to replace the old drive C image file with the new one. The Auto-Loader utility also allows you to easily configure your JANUS 2050 for any DOS-supported national language. The Auto-Loader utility is run from a host computer that is connected to a JANUS 2050.

MakeDisk and PutDisk provide you with an alternative method for modifying drive C. MakeDisk allows you to create an image file containing the files you want placed on drive C. PutDisk replaces the old drive C image file with the new one. MakeDisk can be executed on the host computer or the JANUS 2050 RAM drive. PutDisk must be executed on the JANUS 2050.

You can use either the Auto-Loader utility or the MakeDisk/PutDisk utilities to update drive C. To configure for international languages, you must use the Auto-Loader utility. Once you load a new drive image, you can read from drive C using standard DOS methods.

Using Auto-Loader to Change Drive C

The Auto-Loader utility is located on companion disk 1, which was shipped with the JANUS 2050. With this utility, you can add, change, or delete files on drive C, or modify the JANUS 2050 to support a different DOS National Language Support (NLS) language.

To modify the JANUS 2050 drive C

1. Install the Auto-Loader utility on your host computer.
2. Create an image file and load it on the JANUS 2050 drive C.

Each procedure is explained in the following pages.

Installing Auto-Loader

To install Auto-Loader on your host computer, you need:

- DOS 3.3 or later.
- To increase the environment space reserved by the host computer's CONFIG.SYS *shell=* command. It should be configured to allow environment space at least four times the length of the pathname, to which the INSTALL procedure will copy the required files.
- The JANUS 2050 companion disk 1.

To install Auto-Loader on your host computer

1. Make the directory where you want to install Auto-Loader your current working directory.

Note: Do not use the drive C root directory or install Auto-Loader on a pseudo drive that has been created with the use of a third-party file compression software utility.

2. At the DOS prompt on the host computer, enter the command:

```
{source}:install {country} -{port}
```

where:

source specifies the disk drive where the JANUS 2050 companion disk 1 is inserted.

country specifies in what language you want the JANUS 2050 to operate. Enter the name of the country. It must be one supported by DOS National Language Support (NLS). This parameter is optional; the default is USA.

port specifies the host computer's serial COM port that the JANUS 2050 is connected to. This parameter is optional; the default is COM1.

For example, if Companion Disk 1 is in drive A, and the JANUS 2050 is connected to COM1 on the host computer, enter the following command to make the JANUS 2050 operate in English:

```
A:install
```

If Companion Disk 1 is in drive B, and the JANUS 2050 is connected to COM2 on the host computer, enter the following command to make the JANUS 2050 operate in French:

```
B:install france -com2
```

3. Wait for the installation procedure to finish, and follow any instructions on the host computer's display.

The install procedure creates a subdirectory C_FILES\COMMON on your host computer that contains the factory default startup files AUTOEXEC.BAT and CONFIG.SYS. You can edit these files before loading them onto the JANUS 2050, but be careful not to remove or alter clearly commented statements that are used to support the Auto-Loader utility. Any files added to the subdirectory \COMMON are ignored when the startup files are loaded on the JANUS 2050.

The install procedure also creates the following batch files on the host computer.

LOADC.BAT This is a master file that is called by the following batch files.

LOAD_USA.BAT or **LOADLANG.BAT** Creates an image file that contains only the new startup files. It then loads the drive image onto the JANUS 2050 drive C and overwrites all existing files. Any non-startup files are deleted from drive C. Which batch file you use depends on whether you specified USA or another country when loading the Auto-Loader utility.

LOADADD.BAT Creates an image file that contains additional files you specify, and loads the drive image onto the JANUS 2050 drive C without replacing the existing JANUS 2050 AUTOEXEC.BAT and CONFIG.SYS. All existing files on drive C remain intact unless they are replaced by new files with the same name.

LOADNEW.BAT Creates an image file that contains the new startup files plus any additional files you specify. It then loads the drive image onto the JANUS 2050 drive C and overwrites all existing files. If a file is not included in the image file when you use the Loadnew command, it is deleted from drive C when the new image file is loaded.

LOADXIMG.BAT Loads the existing drive C image file that was created when you used one of the LOAD or MAKE batch files.

MAKE_USA.BAT or **MAKELANG.BAT** Creates an image file that contains the new startup files and saves the image file on the host computer. This file allows you to create one or more image files that contain different AUTOEXEC.BAT and CONFIG.SYS files.

MAKENEW.BAT Creates an image file that contains the new startup files plus any additional files you specify and saves the image file on the host computer. This file allows you to create one or more application-specific image files.

LOADIMG.BAT Loads a drive image that you specify onto the JANUS 2050. The drive image is created using one of the MAKE batch files. This file allows you to load an image file onto multiple JANUS 2050s.

There are two different methods you can use to create and load an image file on the JANUS 2050 drive C:

- Use the Load_USA, Loadlang, Loadadd, or Loadnew batch files to create and load an image file in a single step. For these instructions, see the next section, "Creating and Loading an Image File."
- Use the Make_USA, Makelang, or Makenew batch files to create the image file and store it on a host computer. Next, use the Loading or Loadximg to load the image file on the JANUS 2050. For these instructions, see "Creating an Image File" and "Loading an Existing Image File" later in this chapter.

Creating and Loading an Image File

You can use the Auto-Loader LOAD batch files to create an image file and load it on the JANUS 2050 in a single step. All files are placed in the root directory on the JANUS 2050 drive C; no subdirectories are allowed. Be sure to back up any drive C files before you load a new drive C to prevent losing any information. To update drive C with the LOAD batch files, connect the JANUS 2050 to the host computer.

Note: *The Auto-Loader batch files must be installed on your host computer before you create an image file. For instructions and more information, see "Installing Auto-Loader" earlier in this chapter.*

To create an image file

1. The default startup files are installed on your host computer in the subdirectory C_FILES\COMMON. You can create an image file that contains only the startup files, other files in addition to the startup files, or specific files. Use one of the following commands on the host computer to create and load the image file:

- To create an image file containing the startup files in the subdirectory C_FILES\COMMON and load the image file on the JANUS 2050 drive C, type one of the following commands on the host computer.

Note: Any files residing on drive C are overwritten.

If the JANUS 2050 is going to operate in English, type:

```
load_usa
```

If the JANUS 2050 is going to operate in a language other than English, type:

```
loadlang
```

- To create an image file containing the startup files in the subdirectory C_FILES\COMMON plus any additional files and load it on the JANUS 2050 drive C, type the following command on the host computer:

```
loadnew {[path\[filename1]} [path\[filename2]} ...
```

Note: Any files residing on drive C are overwritten.

- To create an image file containing specific files and load it on the JANUS 2050 drive C without replacing the JANUS 2050s current files, type the following command on the host computer:



```
loadadd {[path\[filename1]} [path\[filename2]} ...
```

where:

path \ is the drive and directory of the file(s) you want loaded.

filename is the name of the file(s) you want to load. You can specify more than one file, or use **path***. * to load all the files from a specified directory.

Note: All existing files on drive C remain intact, unless they are replaced by new files with the same name.

2. Once you have typed in one of the LOAD commands, press  and follow any instructions displayed on the host computer's screen. The auto-load procedure uses the Interlnk/Intersvr utilities to communicate with the JANUS 2050.
3. When the Intersvr screen appears on the host computer, perform a warm boot on the JANUS 2050 to begin executing Interlnk.
4. The JANUS 2050 drive C is updated with the files contained in the image file. After drive C is updated, the JANUS 2050 reboots automatically.
5. Press  -  to exit Intersvr on the host computer. Interlnk will still be loaded in memory on the JANUS 2050. If you need the memory, perform a warm boot on the JANUS 2050.

The auto-load process saves all the files included in the drive C image file to the subdirectory NEWDRV_C\C_FINAL on the host computer. This subdirectory is overwritten each time a LOAD or MAKE batch file executes.

The auto-load process also creates a copy of the new drive C image file and saves it in the file NEWDRV_C\IMAGE\DRIVEC.IMG on the host computer. You can load this image file onto another JANUS 2050. Enter the following command on the host computer:

```
loadximg
```

Follow Steps 2 through 5 above to use Interlnk/Intersvr and load the image file on the JANUS 2050 drive C.

Note: Any files residing on drive C are overwritten.

Creating an Image File

You use the Auto-Loader MAKE batch files to create an image file and save it on the host computer. You do not have to connect the JANUS 2050 to the host computer when using the MAKE batch files. The image file is saved to NEWDRV_C\IMAGE\DRIVEC.IMG. Once you have created the image file, you can load the same image on one or more JANUS 2050s at a later date.

All of the MAKE and LOAD batch files save the image file to the file NEWDRV_C\IMAGE\DRIVEC.IMG. This file allows you to create multiple drive C image files for two or more JANUS 2050s. If you are going to create more than one image file, you need to rename each image file after you create it. Otherwise, it is overwritten the next time you create a LOAD or MAKE batch file.

Note: The Auto-Loader batch files must be installed on your host computer before you create an image file. For instructions and more information, see “Installing Auto-Loader” earlier in this chapter.

To create an image file

1. The default startup files are installed on your host computer in the subdirectory C_FILES\COMMON. You can create an image file that contains only the startup files, or an image file that contains other files in addition to the startup files. Use one of the following commands on the host computer to create the image file:
 - To create an image file containing the startup files in the subdirectory C_FILES\COMMON and save it on the host computer, type one of the following commands on the host computer.

If the JANUS 2050 is going to operate in English, type:

```
make_usa
```

If the JANUS 2050 is going to operate in a language other than English, type:

```
makelang
```
 - To create an image file containing the startup files in the subdirectory C_FILES\COMMON plus any additional files you specify, type the following command on the host computer:

```
makenew {[path\[filename1] [path\[filename2]} ...
```

where:

path is the drive and directory of the file(s) you want to include in the image file.

filename is the name of the file(s) you want to include in the image file. You can specify more than one file or use **path*.*** to load all the files from the specified directory.
2. Once you have typed in one of the MAKE commands, press . The image file is saved to the file DRIVEC.IMG on the subdirectory NEWDRV_C\IMAGE on your host computer.
3. To create another image file, rename the file DRIVEC.IMG. Then repeat Steps 1 and 2 to create a different image file.

To load the image file on the JANUS 2050 drive C, continue with the next instructions for "Loading an Existing Image File."

Loading an Existing Image File

Once you have created an image file and stored it on your host computer, you can load the image file on the JANUS 2050 drive C. This procedure allows you to load an image file onto multiple JANUS 2050s. To create an image file, see the instructions for "Creating an Image File" earlier in this chapter.

Before loading an existing image file, connect the JANUS 2050 to the host computer.

Note: Any files residing on drive C are overwritten.

To load an existing image file

1. Use one of the following commands to load an existing image file:

- To load an image file you have created with one of the MAKE batch files or by running a previous LOAD batch file, type the following command on the host computer:

```
loading {[path\[filename]}
```



where:

path is the drive and directory of the file you want to load.

filename is the name of the file you want to load.

- To load the image file NEWDRV_C\IMAGE\DRIVEC.IMG, type the following command on the host computer:

```
loadximg
```

2. Once you have typed in one of the LOAD commands, press  and follow any instructions displayed on the host computer's screen. The auto-load procedure uses Interlnk/Intersvr to communicate with the JANUS 2050.
3. When the Intersvr screen appears on the host computer, perform a warm boot on the JANUS 2050 to begin executing Interlnk.
4. The JANUS 2050 drive C is updated with the files contained in the image file. After drive C is updated, the JANUS 2050 reboots automatically.
5. Press  -  to exit Intersvr on the host computer. Interlnk will still be loaded in memory on the JANUS 2050. If you need the memory, perform a warm boot on the JANUS 2050.

Using MakeDisk and PutDisk to Change Drives C or D

You can use the MakeDisk and PutDisk utilities to perform these tasks on your 4MB JANUS device:

- Adding or editing files on drives C or D.
- Replacing some files on drives C or D.
- Replacing all of the files on drives C or D.
- Deleting files from drives C or D.

Follow these steps, which the next sections describe in detail:

1. Create a working directory and fill it with files for drive C or D.
2. Create the new image file with MakeDisk.
3. Load the new image file onto the JANUS device with PutDisk.

Note: Due to its large size, MakeDisk is not loaded on drive D. You must copy the self-expanding executable C_MAKE.EXE from the Boot Utilities companion disk to a drive on the host PC and run C_MAKE.EXE. After running C_MAKE.EXE, delete all of the extracted files except for MAKEDISK.EXE.



Caution

Do not run any Intermec-provided JANUS application programs (such as IC.EXE) on your PC. Also, do not run any .EXE programs that use Intermec interrupt extensions or libraries on your PC. These programs will lock up your PC and may corrupt the PC BIOS.

Conseil

N'exécutez pas sur votre PC de programmes d'application JANUS fournis par Intermec (tels que IC.EXE). N'exécutez pas non plus sur votre PC de programmes .EXE qui utilisent des bibliothèques ou des extensions d'interruption car ces programmes bloqueront votre PC et pourraient corrompre le BIOS du PC.

Deciding Where to Run MakeDisk

You can run MakeDisk:

- on the RAM drive.
If you want to make images larger than 256K on the RAM drive, you need to change your CONFIG.SYS file to enlarge the drive. Use the following to estimate the amount of space needed to create a RAM drive for running MakeDisk.

Note: On drive C you need to allocate space for your files, plus 15K, plus 512 bytes overhead per file, and 135K for the MS-DOS system files.

Note: On drive D you can omit the 135K for the MS-DOS system files.

- on a PC card inserted into the JANUS device.
- on a host computer with or without Interlnk.

With Interlnk You can use Interlnk to copy files from drives C or D to the host's working directory and then copy MAKEDISK.EXE to a working directory on the host computer. You can then run MakeDisk on the host computer. For more information on using Interlnk, see your JANUS user's manual.

Without Interlnk You can run MakeDisk on the host computer without Interlnk if you copy MAKEDISK.EXE to a working directory on the host computer. You can also use the DOS COPY commands to copy additional files from the companion disks instead of from drives C or D.

Creating and Filling the Working Source Directory

1. Create a working source directory where you will store the files you want on drives C or D.

Since the use of subdirectories is fully supported by MakeDisk, you can create and populate subdirectories in the working source directory.

2. Create or copy files to the working directory.

You can create or copy a maximum of 125 files to the drive C root directory or 128 files to drive D root directory. You can create or copy an infinite number of files to subdirectories below the root directory, provided they can fit in the allocated drive space.

- If you are adding new files to drives C or D, copy all files currently on drives C or D as well as the new files to the working directory and its subdirectories.
- If you are changing or replacing some of the existing files on drives C or D, copy all files currently on drives C or D to the working directory and its subdirectories. Edit the files you want to change or replace.
- If you are replacing all files on drives C or D, copy the files you want on drives C or D to the working directory and its subdirectories.
- If you are deleting files from drives C or D, copy all files currently on drives C or D to the working directory and its subdirectories. Delete the files you want to remove from drives C or D.

You can use the DOS COPY command to copy files from the companion disks, or you can use Interlnk to copy files from the JANUS drives C or D.

Creating the New Image File

Create the image file by typing the command:

```
makedisk /s=[path] [/o=[output file] /d=[drvletter]}
```

where:

path specifies the directory that contains the files for the image file. This directory is called the source directory.

The *path* parameter is **required**. You may choose to include the drive letter if the source directory resides on another drive. For example, you could enter A:\JANUS\IMAGE as the path. If you do not specify the path correctly, the command fails.

output file specifies the full path and name of the image file to create. If you do not include this parameter, the image file is called DRIVE_C.IMG (DRIVE_D.IMG if you specified /d=d) and is placed in the current working directory.

The *output file* parameter is **optional**.

drvletter specifies the target JANUS drive, either C or D. The default is drive C.

The *drvletter* parameter is **optional**.

All files in the source directory are placed into the image file, including hidden and read-only files. If subdirectories exist, they are also incorporated in the image file.

Note: *If you have problems running MakeDisk or PutDisk, see Chapter 8 “Troubleshooting.”*

Loading the New Image File

Note: *When you run PutDisk, all files on drives C or D are overwritten. Be sure to back up any files you want to keep before you continue.*

1. Connect the JANUS device to the host computer.
2. If you created the image file on the host computer and want to load it to the JANUS device from the host, start Interlnk now (with the host as server, and the JANUS device as client).

Note: *You can simply reboot the JANUS device after the connected host has Interlnk installed.*

You do not have to start Interlnk if you followed one of these strategies:

- You created the image file on the JANUS device.
- You created the image file on the host computer, copied the file to a PC card, and inserted the PC card into the JANUS device.

3. Type this command on the JANUS device:

```
putdisk /d=[drvletter] /i=[image filename]
```

where:

drvletter is the target JANUS drive to be updated. The default is drive C.

image filename is the name of the drives C or D image file created by MakeDisk. If you do not specify a path and filename, PutDisk looks for DRIVE_C.IMG.

You may receive error messages in the following conditions:

- If the specified file does not exist, PutDisk displays an error message and terminates.
- If you specify a path without a file name, PutDisk also displays an error message.
- PutDisk generates an error message if you attempt to put a DRIVE_C.IMG on drive D or a DRIVE_D.IMG on drive C.

Note: PutDisk will overwrite all files on drives C or D.

For example, to copy the C-ATA.IMG image file from a PC card on the JANUS device to the JANUS drive C, type this command:

```
putdisk /i=g:\c-ata.img
```

PutDisk tries to determine if there is adequate power before replacing the drive image. If a power problem exists, PutDisk displays an error message and terminates.

You see messages on the JANUS device as PutDisk updates drives C or D, erases flash memory, and copies the DOS and new drives C or D image file to the JANUS device, and warm boots the JANUS device. If an error occurs, see Chapter 8, "Troubleshooting."

Examples of Using MakeDisk and PutDisk

Following are three examples of how you can use MakeDisk and PutDisk to change the contents of drives C or D:

- In the first example, you run MakeDisk on the host, transfer the image file to the JANUS device on a PC card, and run PutDisk on the JANUS device to load the image file to drive C.

- In the second example, you run MakeDisk on the host, use Interlnk to make the image file appear as if it were on the JANUS device, and run PutDisk on the JANUS device.
- In the third example, you run MakeDisk on the host, transfer the image file to the JANUS device on a PC card, and run PutDisk on the JANUS device to load the image file to drive D.

Example 1

In this example, the resulting image file will be larger than 256K, so you must create the image file on the host computer if the JANUS RAM drive is configured at 256K (factory default). This example assumes that the host computer and the JANUS device can share a PC card.

1. Connect the JANUS device to a host computer using an appropriate serial connection.
2. Create a source directory on the host computer by typing this command at the host computer's DOS prompt:

```
mkdir c:\drivec
```
3. Fill the source directory with all the files you want to include in the new image file:
 - a. Copy the files from the current drive C to the source directory. Because the host computer and JANUS device can share a PC card, you can insert the card into the JANUS PC card drive and copy all files from drive C to drive G. Then insert the card into the host computer's PC card drive and copy all the files to the source directory.
 - b. Add any other files and/or subdirectories to the working directory that you want on drive C. These files may include source read-only data files and applications for your JANUS device.
 - c. Edit AUTOEXEC.BAT, CONFIG.SYS, and other files in the source directory as necessary.
4. Insert the JANUS Boot Utilities companion disk into a drive on the host PC.
5. Copy the self-expanding executable C_MAKE.EXE to drive C on the host PC by typing:

```
copy a:\c_make.exe c:\
```
6. Run C_MAKE.EXE and delete all of the extracted files except for MAKEDISK.EXE.
7. Type this command at the host computer's DOS prompt:

```
makedisk /s=c:\drivec /o=newdrv.img
```

An image file, NEWDRV.IMG, is created in the working directory of the host computer's drive C.

Note: Do not create the image file in the directory where the source files reside.

8. Copy the image file from the host computer to the PC card and then insert the PC card into the JANUS PC card drive, drive G.

Note: It is recommended that you provide an external power supply for the JANUS device before you execute PutDisk.

9. At the DOS prompt on the JANUS device, type this command to load the new image file onto drive C.

```
putdisk /i=g:\newdrv.img
```

Example 2

In this example, you create the image file on the host computer, use Interlnk to make the image file appear as if it were on the JANUS device, and use PutDisk to load the image file to drive C.

1. Connect the JANUS device to a host computer using an appropriate serial connection.
2. Create a source directory on the host computer by typing this command at the host computer's DOS prompt:

```
mkdir c:\drivec
```

3. Fill the source directory with all the files you want to include in the new image file:
 - a. Copy the files from the current JANUS drive C to the source directory on the host PC. Use Interlnk with the host computer as the client and the JANUS device as the server.
 - b. Add any other files to the source directory that you want on drive C. These files may include read-only data files and applications for your JANUS device.

Note: Do not create the image file in the directory where the source files reside.

- c. Edit AUTOEXEC.BAT, CONFIG.SYS, and other files in the source directory as necessary.
4. Insert the JANUS Boot Utilities companion disk into a drive on the host PC.
 5. Copy the self-expanding executable C_MAKE.EXE to drive C on the host PC by typing:

```
copy a:\c_make.exe c:\
```

6. Run C_MAKE.EXE and delete all of the extracted files except for MAKEDISK.EXE.

7. Type this command at the host computer's DOS prompt:

```
makedisk /s=c:\drivec /o=newdrv.img
```

MakeDisk creates an image file, NEWDRV.IMG, in the working directory of the host computer's drive C.

8. Restart Interlnk. Make the JANUS device the client, and the host computer the server. The new image file, NEWDRV.IMG, appears on the drive H root directory.
9. At the DOS prompt on the JANUS device, type this command to load the image file to drive C.

```
putdisk /i=h:\newdrv.img
```

Example 3

In this example, the resulting image file will update drive D. Since the image file will be larger than 256K, you must create the image file on the host computer if the JANUS RAM drive is configured at 256K (factory default). This example assumes that the host computer and your JANUS device can share a PC card.

1. Connect the JANUS device to a host computer using an appropriate serial connection.
2. Create a source directory on the host computer by typing this command at the host computer's DOS prompt:

```
mkdir c:\drived
```
3. Fill the source directory with all the files you want to include in the new image file:
 - a. Copy the files from the current drive D to the source directory. Because the host computer and your JANUS device can share a PC card, you can insert the card into the JANUS PC card drive and copy all files from drive D to drive G. Then insert the card into the host computer's PC card drive and copy all the files to the source directory.
 - b. Add any other files and/or subdirectories to the source directory that you want on drive D. These files may include read-only data files and applications for your JANUS device.
4. Insert the JANUS Boot Utilities companion disk into a drive on the host PC.
5. Copy the self-expanding executable C_MAKE.EXE to drive C on the host PC by typing:

```
copy a:\c_make.exe c:\
```
6. Run C_MAKE.EXE and delete all of the extracted files except for MAKEDISK.EXE.

7. Create the drive image by typing this command at the host computer's DOS prompt:

```
makedisk /s=c:\drived /o=newdrvd.img /d=d
```

An image file, NEWDRVD.IMG, is created in the working directory of the host computer's drive C.

Note: Do not create the image file in the directory where the source files reside.

8. Copy the image file from the host computer to the PC card and then insert the PC card into the JANUS PC card drive (drive G).

Note: It is recommended that you provide an external power supply for the JANUS device before you execute PutDisk.

9. At the DOS prompt on the JANUS device, type this command to load the new image file onto drive D.

```
putdisk /i=g:\newdrvd.img /d=d
```

Using Reader Services

Reader Services are programs that decode bar codes, process data input and output (I/O), configure the reader, and handle all power management for the reader. AUTOEXEC.BAT loads Reader Services when you boot the reader. You do not interact directly with Reader Services because they operate as part of the reader's system software. You can create applications that use Reader Services. For help, see your JANUS PSK reference manual.

Reader Services include these programs:

Communications Utilities Communications Utilities are transmit and receive functions that you can call with PSK functions or software interrupts. Communications Utilities let the reader transmit and receive buffers or bytes of data regardless of the communications protocol that you use.

Configuration Manager Configuration Manager maintains the reader's current configuration file (such as JANUS.INI), ensures that the reader operates according to that configuration, and lets you change the reader's configuration file. Configuration Manager is a terminate and stay resident program (TSR) that loads into the reader's memory during a warm or cold boot. For help, see "Unloading and Loading Configuration Manager TSR" later in this chapter.

Input Manager Using software interrupts and library functions, your reader applications can use Input Manager as an interface for all data I/O from the reader's COM ports, wand, scanner, and keypad. Input Manager also handles all power management during data I/O. For help with software interrupts and library functions, see your JANUS PSK reference manual.

You can use Input Manager to customize how the reader handles data from the keypad, wand, or scanner. The reader can display all input, beep when labels are scanned, and parse reader commands. For example, when you scan a bar code label, Input Manager can identify the symbology and if the label includes reader commands.

Virtual Wedge The Virtual Wedge decodes and manages bar code input, making the reader functionally equivalent to a wedge reader connected to a PC. This program facilitates rapid porting of PC applications to the reader. When you scan a bar code label, the Virtual Wedge inserts the data into the keyboard buffer as if it had been typed. The Virtual Wedge sends configuration commands to Configuration Manager. The Virtual Wedge also recognizes and implements reader commands.

Direct Hardware Wedge The Direct Hardware Wedge is a new feature of JANUS 4.0 software that allows bar code data to emulate keystrokes on the keypad. For more information on the Virtual Wedge and Direct Hardware Wedge, see “Understanding the Bar Code Wedge,” in the following section.

Understanding the Bar Code Wedge

The Bar Code Wedge is a Reader Services feature that enables your JANUS device to decode bar codes, making it functionally equivalent to a wedge reader connected to a PC. Prior to JANUS 4.0 software, the only wedge option was the Virtual Wedge. With the 4.0 software release, the Reader Services wedge feature has a second option, the Direct Hardware Wedge.

When you scan a bar code with the Virtual Wedge Option enabled, data is inserted directly into the keyboard buffer as if it had been typed. The Direct Hardware Wedge provides hardware level PC compatibility and processes the scanned data directly as individual keystrokes.

The Direct Hardware Wedge provides bar code data to applications that directly access the hardware, it is the option to select when working with applications (for example, Attachmate, FTP, Zstem for DOS, PC-TCP for DOS, and others) that require keystroke interrupts to occur when data is received. The Virtual Wedge option, which is up to 10 times faster than going through the PC hardware, is the option you should select when you need maximum performance.

If you have developed advanced applications for your JANUS device, you need to customize how the reader and application handle data from the keypad, wand, or scanner. Refer to the JANUS Programmer’s Software Kit and reference manuals for instructions.

The Virtual Wedge is the default configuration. You can enable the Direct Hardware Wedge by using the KWC.COM program. For more information, see “Using the Wedge Configuration Program,” later in this chapter.

Enabling Direct Hardware Wedge Functions

When you enable the Direct Hardware Wedge function, you disable the portion of the Virtual Wedge that inserts data directly into the keyboard buffer. With the Direct Hardware Wedge function enabled, data is inserted into the hardware to be processed as actual keystrokes. The processing of Reader Services commands and configuration bar codes is not affected by the wedge option you select.

Intermec recommends that you enable the Direct Hardware Wedge if you experience any of the following problems using off-the-shelf PC software on your 4MB JANUS device.

- You scan a bar code and get a “read beep,” but the data isn’t received by your application.
- You scan a bar code and characters are dropped.
- Your application uses bar codes to manipulate screen functions and the screen doesn’t respond correctly.

Note: If you attempt to run the wedge configuration program on a JANUS device running version 3.0 or earlier software, the Direct Hardware Wedge feature will not be available. The Direct Hardware Wedge feature requires a software modification and a new KSCPU chip.

Using the Wedge Configuration Program

You can use the wedge configuration program (KWC.COM) to set wedge options on your 4MB JANUS device. To start KWC.COM, type this command at the DOS prompt and press .

kwc

Or, scan this bar code.



KWC

The main menu appears, displaying five configuration options.



```
C:\>KWC
Keyboard Control
Copyright 1996
Intermec Corp.
Version 1.00

Usage: KWC x
0 - KW off , XKBD on
1 - KW on , XKBD on
2 - KW on , XKBD off
3 - KW off , XKBD off
4 - status only

C:\>
```

20X0A.004

Option 0 Option 0 is the default configuration. Select Option 0 to enable the Virtual Wedge and the expanded keyboard. To select this option, type the following command at the DOS prompt and press .

kwc 0

Or, scan this bar code.



KWC 0

```
C:\ >kwc 0
Keyboard Control
Copyright 1996
Intermec Corp.
Version 1.00

KW Disabled
XKB Enabled

C:\ >_
```

20X0A.005

Note: The AUTOEXEC.BAT on your 4MB JANUS device is set to Option 0 (Virtual Wedge enabled/extended keyboard enabled). To permanently change this option, you will need to modify your AUTOEXEC.BAT file and load a new image to drive C.

Option 1 Select Option 1 to enable the Direct Hardware Wedge and the expanded keyboard. To select this option, type the following command at the DOS prompt and press .

kwc 1

Or, scan this bar code.



KWC 1

```
C:\ >kwc 1
Keyboard Control
Copyright 1996
Intermec Corp.
Version 1.00

KW Enabled
XKB Enabled

C:\ >_
```

20X0A.006

Note: The following two options disable the expanded keyboard buffer. The expanded keyboard buffer allows the JANUS device to consistently process bar codes that are longer than 15 characters. Do not disable the expanded keyboard unless your application continues to experience compatibility problems.

Option 2 Select Option 2 to enable the Direct Hardware Wedge and disable the expanded keyboard. To select this option, type the following command at the DOS prompt and press .

kwc 2

Or, scan this bar code.



KWC 2

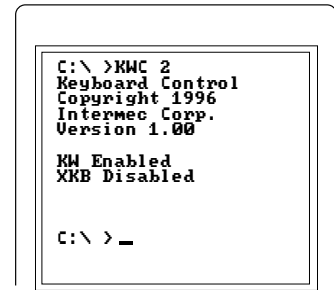

20X0A.007

Option 3 Select Option 3 to disable the Virtual Wedge and the expanded keyboard. To select this option, type the following command at the DOS prompt and press .

kwc 3

Or, scan this bar code.



KWC 3

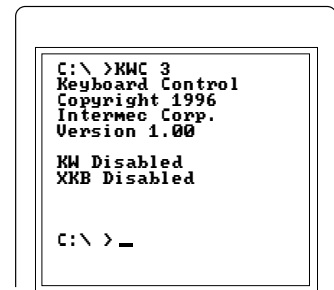

20X0A.008

Option 4 Select Option 4 to display the current wedge configuration status. To select this option, type the following command at the DOS prompt and press .

kwc 4

Or, scan this bar code.



KWC 4

4

Configuring the JANUS 2050

This chapter discusses the various ways you can configure the JANUS 2050, lists all the configuration options, and identifies the default setting for each option.

Overview of Configuration Parameters

Configuration options let you fine-tune the JANUS 2050 to work efficiently in your system.

- You determine what bar code symbologies the JANUS 2050 should decode.
- You tell the JANUS 2050 what communication standards to use when talking to a host computer or other devices.
- You also modify the JANUS 2050 to work efficiently in your particular work environment.

Configuring for Bar Code Symbologies

The bar code symbologies configuration parameters include all the types of bar codes the JANUS 2050 can decode. You should enable the bar code symbologies that you are going to scan. For some symbologies, you also need to tell the JANUS 2050 what type of check digit the bar code will include or the length of the bar code label.

The JANUS 2050 reads and decodes the following symbologies:

- Codabar
- Code 11
- Code 39
- Code 49
- Code 93
- Code 128
- Code 16K
- Interleaved 2 of 5
- MSI
- Plessey
- Code 2 of 5
- UPC/EAN

The JANUS 2050 automatically recognizes and decodes as many of these symbologies as needed by your application. This feature is called *autodiscrimination*.

Note: *The fewer symbologies you enable the JANUS 2050 to decode, the faster it can decode a bar code label.*

When you enable multiple symbologies, the JANUS 2050 may, on rare occasions, decode bar code labels in a symbology other than the label's actual symbology. Row clicks may also occur, indicating that the label was decoded as a row in a two-dimensional symbology. To avoid this problem, only enable the JANUS 2050 to decode the bar code symbologies that you are using. If the problem does occur, scan the label again. MSI and Plessey configurations are disabled by default.

Defining Communications Parameters

The communications configuration parameters include the communications ports, protocols, and the parameters that define the individual protocols. The communications port designates the port for which you are configuring the protocol. The communications protocol and its parameters determine how the JANUS 2050 talks to the device to which it is connected.

You can configure more than one protocol for a port. However, only one protocol at a time can be active for each port. The JANUS 2050 can communicate using the following protocols and parameters. Each protocol has certain parameters that can be set for that protocol.

Communications Parameters

Protocol	Parameter
User-Defined	<ul style="list-style-type: none">• Baud rate, parity, data, and stop bits• Flow control, LRC• Intercharacter, turnaround, and timeout delay• Transmit abort timeout• SOM, EOM• POL, SEL, RES, REQ, AFF, NEG• EOF, EOR, and number of records per block• IRL PAK, IRL BAK, IRL SOP, IRL EOP, IRL RUN, IRL END, and IRL PSS
User-Defined Multi-Drop	<ul style="list-style-type: none">• Baud rate, parity, data, and stop bits• Flow control, LRC• Intercharacter, turnaround, and timeout delay• Transmit abort timeout• SOM, EOM• POL, SEL, RES, REQ, AFF, NEG• EOF, EOR, and number of records per block• IRL PAK, IRL BAK, IRL SOP, IRL EOP, IRL RUN, IRL END, and IRL PSS

Communications Parameters (continued)

Protocol	Parameter
Point-to-Point	<ul style="list-style-type: none">• Baud rate, parity, data, and stop bits• Flow control• Intercharacter, turnaround, and timeout delay• Transmit abort timeout
Polling Mode D	<ul style="list-style-type: none">• Baud rate• Flow control• Transmit abort timeout
Multi-Drop	<ul style="list-style-type: none">• Baud rate, parity, data bits• Transmit abort timeout• Address, Multi-Drop
PC Standard	<ul style="list-style-type: none">• Baud rate, parity, data, and stop bits

Modifying Operations Parameters

The operations configuration parameters include all areas that assist you in using the JANUS 2050. The JANUS 2050 can be configured to:

- Modify data from bar code labels using preambles, postambles, and the key code lookup table.
- Disable specified commands.
- Modify the beeper duration, frequency, and volume.
- Modify the display mode and setup.
- Modify the keypad clicker,  key functions, and numeric keypad.
- Modify scanner operation with scanner data buffering, modes, redundancy, timeout, trigger, and decode security.

Different Ways to Configure the JANUS 2050

You can configure the JANUS 2050 in several ways:

Using the Configuration Application The configuration application program is run on the JANUS 2050. The menus and dialog boxes list all of the configuration options available on the JANUS 2050 and indicate what parameters are currently enabled. You can create various configuration files for different situations and load the necessary configuration file for each application.

Editing a Configuration File Using the Host Computer The configuration application uses the configuration files to display the current configuration. You can edit a configuration file without using the configuration application program by uploading the file to the host computer.

On the host computer, you can edit the file or create new configuration files. When you download the file to the JANUS 2050, you make the file the active configuration by loading it in the configuration application program and making it the online configuration. When the JANUS 2050 boots, the configuration file (JANUS.INI) is used to set the initial configuration. If the configuration file does not exist, the JANUS 2050 is set to the default configuration.

Scanning Bar Code Labels You can scan bar code labels to quickly change the JANUS 2050's configuration. You can scan the bar code labels listed in this manual if you just want to change one or two configuration settings, or you can create your own bar code labels to configure a large number of JANUS 2050s.

Using IRL Z Commands Z commands are included in IRL programs to modify the JANUS 2050's configuration for that specific program. You can automatically configure the JANUS 2050 each time an IRL program is executed by including Z commands in the program statements. This feature is useful if the JANUS 2050 needs to be configured a certain way when running the IRL program.

Through a User Application You can also configure the JANUS 2050 by sending a configuration command string down from a host computer when the JANUS 2050 is running a user application. This method is similar to configuring from an IRL program. The JANUS 2050 must be running a user application that accepts the configuration commands. You can configure the JANUS 2050 by sending configuration command strings when using the IRL Desktop, or an application that specifically uses the Reader Services input manager. You cannot configure the JANUS 2050 by sending configuration command strings when the JANUS 2050 is at the DOS prompt.

Note: *The configuration commands are listed alphabetically in Chapter 10, "Configuration Commands." This reference includes a description of the purpose, options, and command syntax for each command.*

Using the Configuration Application

The configuration application is a menu-driven application that lets you configure the JANUS 2050 and view system information. To open the configuration application from the DOS prompt, type:

```
ic
```

Then press .

Or, scan the following bar code:



IC

In the menu bar, there are four drop-down menus:

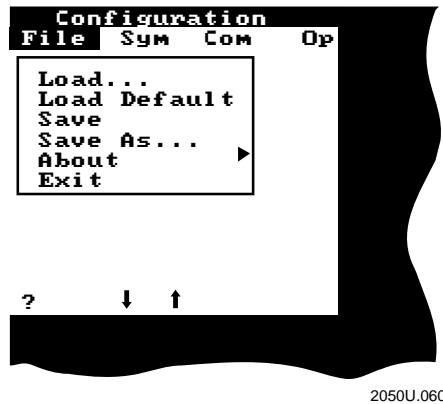

File Select the File menu to load or save configuration files, or return to the default configuration. You can also display software versions, equipment information, and available memory. You quit the configuration application by selecting Exit from this menu.

Sym Select the Sym menu to enable or disable decoding of bar code symbologies. Some of the symbologies also allow you to determine the check digit and label length.

Com Select the Com menu to set the communications protocol for each of the JANUS 2050's COM ports and to define the parameters for each selected protocol.

Op Select the Op menu to change the operating parameters for the JANUS 2050. You can modify parameters and options for turning the JANUS 2050 on and off, data manipulation, JANUS 2050 display, beeper control, keypad, and scanner operation.

Note: When you are configuring the JANUS 2050 using the drop-down menus, press  for online help.

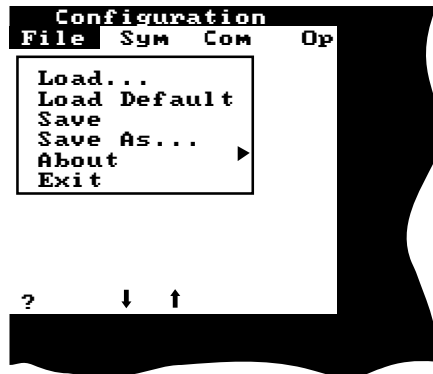

2050U.060

To select a menu in the menu bar, press **◀** or **▶** to move the highlight to the desired menu. To view the drop-down menu, press **↵** or **▼**.

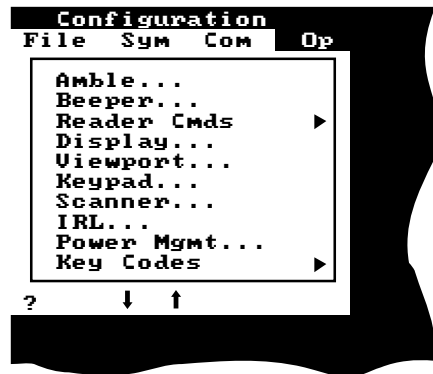

2050U.062

The Sym, Com, and Op drop-down menus list the various configuration selections. An asterisk (*) on the Sym or Com protocol drop-down menu indicates that the symbology or protocol is active. When a drop-down menu is displayed, select a command by pressing **▲** or **▼** to move the highlight to the desired command, and then press **↵** to choose the command. Press **Esc** to exit a menu.

The dialog boxes list the options for the configuration parameters. The field below the option will be either a toggle or an entry field. When a dialog box displays, press **▲** or **▼** or **Tab/BackTab** to move the highlight to the desired field. In a highlighted field, either enter a value or press **◀** or **▶** to view the options for that field.

A few dialog boxes contain check boxes. Check boxes are used when more than one option can be selected at a time. Press **space** to mark or clear check boxes.

- Pressing **↵** is the same as choosing OK. It exits the dialog box and saves the changes.
- Pressing **Esc** is the same as choosing Cancel in single screen configurations only. It exits the dialog box without saving the changes.
- When you set parameters on multiple screens, such as communications protocol, use the Next and Prev commands to move between the screens.

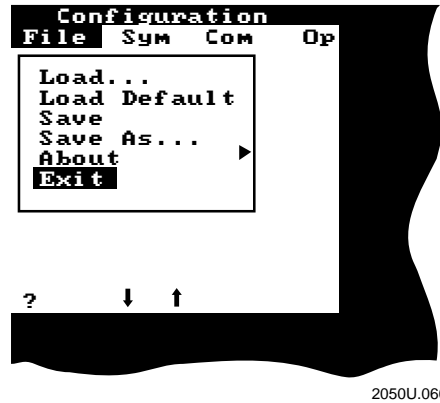

To exit the configuration application, select Exit in the File drop-down menu and press .

Instead of pressing keys on the keypad, you can scan the bar code labels listed in Appendix A to move the cursor through the configuration menus.

Entering ASCII Control Characters

There are two types of configuration parameters that you can use to enter ASCII control characters for the settings. They are communications protocol characters, and operation preambles and postambles.

Communications Protocol Characters

Some communications protocols require you to set the protocol character to an ASCII control character. To enter an ASCII control character for one of the protocol characters in the dialog box, such as EOR and EOM, press followed by a letter, number, or symbol key. For example, to enter the ASCII character STX, press and the word <STX> appears in the protocol character field. The ASCII control characters and their corresponding keys are listed in Appendix A.

If you want to disable the protocol character, highlight the space next to the protocol character you want to disable and press .

Operation Preambles and Postambles

You can include ASCII control characters in the preamble or postamble fields in the dialog box using an escape sequence. For example, to set the postamble to Carriage Return Line Feed, enter:

```
\r\n
```

The escape sequences for the ASCII control characters are listed in Appendix A. If there is not an abbreviation for the ASCII control character, enter the two-digit hexadecimal number (`\xnn` where `nn` is the hex value) for the ASCII control character. The hex numbers are listed in the full ASCII chart in Appendix A. For example, to enter the value for ETX, enter:

```
\x03
```

If you enter the hex number for ASCII characters above 7F hex (128 decimal), the JANUS 2050 displays the extended ASCII character instead of its numerical value in the dialog box.

Using Multiple Configuration Files

When you change the JANUS 2050's configuration, you can save the configuration under a filename with the extension .INI. It is similar to a word processor where you can load, edit, and save the files as many times as you want.

For example, if you change the JANUS 2050 configuration and exit the configuration application, the JANUS 2050 asks if you want to update the online configuration before exiting. If you press , the changes you made in the application are now used by the JANUS 2050.

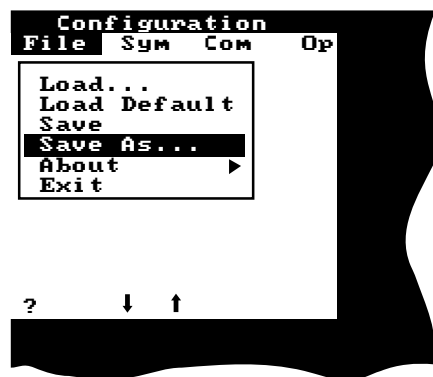

2050U.063

You can then go back into the configuration application and reconfigure the JANUS 2050. Instead of exiting the configuration application, choose the command Save As from the File drop-down menu and enter a filename, such as EXAMPLE.INI.

When exiting the configuration application, the JANUS 2050 asks if you want to update the online configuration. If you choose yes, the configuration settings in the EXAMPLE.INI file apply to the JANUS 2050 upon exiting the configuration application. If you choose no, the configuration settings before the changes you just made remain active. The EXAMPLE.INI file has already been saved and can be made active at any time.

If you do not make EXAMPLE.INI the active configuration, you can return at any time to the configuration application and choose Load from the File drop-down menu. Select EXAMPLE.INI from the list of filenames and press . EXAMPLE.INI is loaded into the configuration application. When exiting the configuration, the JANUS 2050 asks if you want to update the online configuration. If you choose yes, EXAMPLE.INI is now the active configuration.

Configuring the JANUS 2050 From the DOS Prompt

You can create, load, and save configuration files by using switches with the `ic` command at the DOS prompt. The switches are:

Command	Description
<code>ic /l {path\filename}</code>	Loads a configuration file.
<code>ic /s {path\filename}</code>	Saves a configuration file.
<code>ic /d</code>	Loads the factory default configuration.

where *path* is the drive and directory that contains the file, and *filename* is the name of the configuration file.

These commands do not execute the menu-driven configuration application (IC.EXE). The menu-driven application executes when you type the `ic` command without any switches or parameters.

Loading a New Configuration File

You can make any configuration file active by typing this command at the DOS prompt:

```
ic /l {path\filename}
```

When you type this command, the JANUS 2050 displays this message:

```
Loading Reader  
Configuration from  
{path\filename}
```

The configuration file specified in the message is now active.

Automatically Loading a Configuration File

You can make any configuration file load automatically whenever you boot the JANUS 2050 by adding this command to the AUTOEXEC.BAT file:

```
ic /l {path\filename}
```

The JANUS 2050 will automatically load the configuration file whenever the AUTOEXEC.BAT file executes.

Saving a New Configuration File

If you modified your configuration or loaded a new file, you can save the current configuration under a new filename by typing this command at the DOS prompt:

```
ic /s {path\filename}
```

When you type this command, the JANUS 2050 checks to see if the filename already exists. If it does, this prompt appears:

```
Overwrite (Yes/No)? N
```

Choose your response:

- Press **N** or **enter** if you do not want to overwrite the file. The changes stay in effect only until the JANUS 2050 is powered off or rebooted.
- Press **Y** to overwrite the contents of the file with your changes.

As the JANUS 2050 saves the changes, it displays this message:

```
Saving Reader  
Configuration to  
{path\filename}
```

The JANUS 2050's configuration is now saved to the specified file.

Loading the Factory Default Configuration

You can load the factory default configuration without rebooting by typing this command at the DOS prompt:

```
ic /d
```

Editing a Configuration File Using the Host Computer

If you want to edit configuration files on the host computer, you can upload configuration files and edit the file using any standard text editor. All configuration files have the extension *.INI. When the JANUS 2050 performs a reboot, if JANUS.INI is present, the JANUS 2050 loads the configuration settings from JANUS.INI. Otherwise, it loads the default configuration.

A configuration file contains lines similar to the command line column:



Command Line	Definition
AD""	Preamble disabled
AE"\x0D"	Postamble set to CR
BD"00050L"BD"00050H"	Beep duration set to 50 ms for low and high beeps
BF"01200L"BF"02400H"	Beep frequency set to 1200 Hz for low beeps and 2400 Hz for high beeps
BV"1"	Beep volume set to quiet
CA"99"	Interleaved 2 of 5 set to variable length with a check digit

The configuration commands must be in uppercase for the JANUS 2050 to recognize the commands. You should enclose the command options in quotes (for example, BV"1") when you are editing the configuration file. Quotes are used to designate the end of a configuration command. Use double quotes to enter a quote in the command line. For example, AD""4 is interpreted as AD"4.

Appendix A contains a configuration command syntax cross-reference. To determine the definition of each command line in your configuration file and learn the available options, see Chapter 10, "Configuration Commands."

Once you have made the changes to a configuration file and downloaded it to the JANUS 2050, you can make the configuration file active by following these steps.

To activate the configuration file

1. Type **ic** to start the configuration application program.
2. Select File and then Load.
3. Enter the name of the modified configuration file including the path and press .
4. Select File, then Exit, and press  to update the online configuration.

The edited configuration file is now active. If there are any errors in the configuration file, the JANUS 2050 generates an error file called JANUS.ERR. This file lists the line numbers with the incorrect syntax and the reason for the error. The command SET IM_ERRPATH=E:\ listed in the AUTOEXEC.BAT specifies that the error file is written to drive E. To view the error file, change to drive E on the JANUS 2050 and enter the following:

```
type janus.err
```

If your edited configuration file contains errors, use the configuration application to enter the correct option for the configuration parameter that caused the error.

Configuring With Bar Code Labels

You can configure the JANUS 2050 by scanning bar code labels listed in this manual, or by creating your own bar code labels. Creating your own bar code labels is useful when configuring a number of JANUS 2050s.

You can create bar code labels that contain more than one configuration command. For example, configuring a JANUS 2050 for User-Defined protocol (PS0) on COM1 (IS1), with a baud rate of 2400 (IA4), even parity (IB1), 8 data bits (II8), and 2 stop bits (IC2) can be done with three bar codes. Each bar code starts with \$+ (the change configuration command), followed by the syntax and option for each parameter.

Configure for COM1, Configure User-Defined Protocol



\$+IS1PS0

2400 Baud, Even Parity, 8 Data Bits, and 2 Stop Bits



\$+IA4IB1II8IC2

Activate User-Defined Protocol



\$+PA0

Note: You must enclose parameter options with quotation marks if those options conflict with reader configuration commands. For example, you may want to set the postamble to the letters "BV", which happen to be the beep volume command. You can enter this command by using \$+AE"BV". If you leave out the quotation marks (\$+ADBV), the JANUS 2050 mistakes the command as setting the preamble (AD) to no characters, and changing the beep volume command (BV).

Configuring Using IRL Z Commands

You can automatically configure the JANUS 2050 each time an IRL program is executed by including Z commands in the program statements. These configuration changes are saved in the online configuration file. For example, if you want to change the display mode from buffered to transparent, you would insert the following Z command in your IRL program:

```
Z "$+DM1 "
```

When the IRL program reaches this command statement, it would configure the JANUS 2050 and continue executing the program.

Configuring Through a User Application

When creating an application to run on the JANUS 2050, you can program the JANUS 2050 to accept configuration command strings from the host computer using Reader Services. These configuration changes are saved in the online configuration file. For example, to configure the JANUS 2050 to decode Code 93, the computer would send the following command string to a user application:

```
$+CF1
```

The user application must be designed to accept command syntax from the host. The JANUS 2050 cannot accept command strings when it is at the DOS prompt.

For information on using Reader Services, refer to the JANUS PSK reference manual set.

5

Using PC Cards

This chapter introduces PC cards and explains how you can use them in your JANUS 2050.

Learning About PC Cards

The JANUS 2050 comes equipped with a PC card drive to expand the computer's memory and input/output capabilities. The PC card provides the mechanism for storing and transferring information to other computers that have PC card drives. A PC card drive is similar to a disk drive on a PC, and the PC card is similar to a floppy disk.

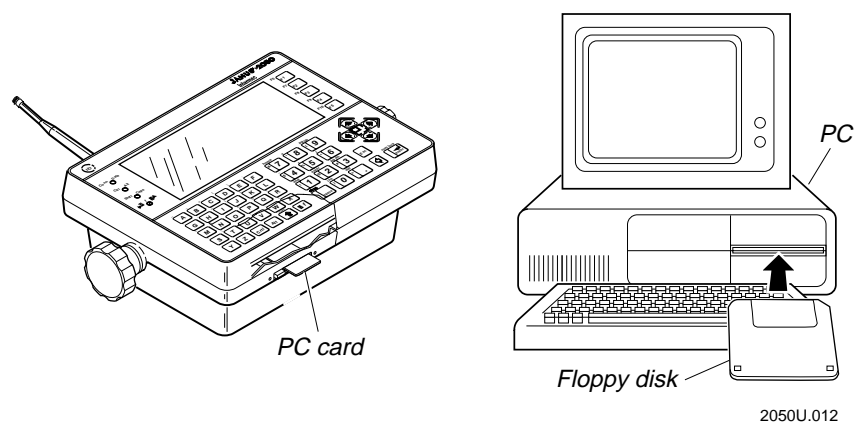

Note: JANUS 2050s equipped with a 2.4 GHz radio use the PC card slot for the radio controller.

What Is PCMCIA?

PCMCIA (Personal Computer Memory Card International Association) defines a set of hardware and software standards for memory and expansion cards that are available for personal computers. The JANUS 2050 uses PC cards that comply with PCMCIA Standard 2.1

The JANUS 2050 comes with an external PC card drive for Type I or Type II memory and expansion cards.

Supported PC Cards

The JANUS 2050 uses PC cards that comply with Intel ExCA or PCMCIA Standards 1.0, 2.0, and 2.1. There are three types of PC cards; you can identify them according to their physical size:

Type I These cards are 3.3mm thick.

Type II These cards are 5mm thick.

Type III These cards are 10.5mm thick.

You can use Type I or Type II cards in the JANUS 2050 to add memory or connect an I/O device. You cannot use Type III cards in a JANUS 2050.



Which Memory Cards Are Recommended?

You can use Type I or Type II memory cards that have up to 64MB of memory formatted with a DOS file allocation table (FAT). There are many types of PC memory cards available:

- ATA (PC Card AT Attached)
- EPROM (Erasable Programmable Read Only Memory)
- EEPROM (Electrically Erasable Programmable Read Only Memory)
- Flash (Nonvolatile Memory)
- OTPROM (One-Time Programmable Read Only Memory)
- ROM (Read Only Memory)
- SRAM (Static Random Access Memory)

Intermec recommends using ATA, flash, or SRAM cards in your JANUS 2050. Choose the type of memory card that meets your data storage needs:

Memory Card	Type of Data Storage
ATA	Use an ATA flash card to store large amounts of data (up to 64MB) that change frequently. ATA cards retain their data without the use of a backup battery and are available in larger memory sizes.
Flash	Use a flash card to store data (1MB to 32MB) that does not change as frequently. Flash cards retain their data without the use of a backup battery.
SRAM	Use an SRAM card to store data (up to 4MB) that changes frequently. An SRAM card has a lithium battery to back up data for the life of the battery.

Note: Intermec recommends ATA and SRAM cards for most data storage needs. You should only use a flash card as a low-cost alternative. If you decide to use a flash card, Intermec recommends flash cards that store 1MB or more of data.

Which Expansion Cards Are Recommended?

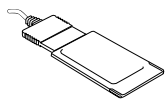

You can use expansion or input/output (I/O) cards to connect the JANUS 2050 to I/O devices. Modem cards and network cards are examples of I/O cards.

For a complete list of Intermec-supported PC cards, contact your Intermec sales representative.

Accessing the PC Card Drive

The PC card drive on the JANUS 2050 is located on the underside of the case. The PC card drive is in a sealed unit to protect the PC card and drive from possible contamination from the operating environment. You can use a Type I or Type II PC card in the drive.

To insert a PC card

1. Make sure the JANUS 2050 is on. Press the  button to turn the JANUS 2050 on.

Note: The JANUS 2050 must be turned on when you insert a card into the external drive or it may not recognize the card.

2. Using a straight-slot screwdriver, remove the two self-locking screws (6 - 32 x 0.375) and two sealing washers on the PC card access door.

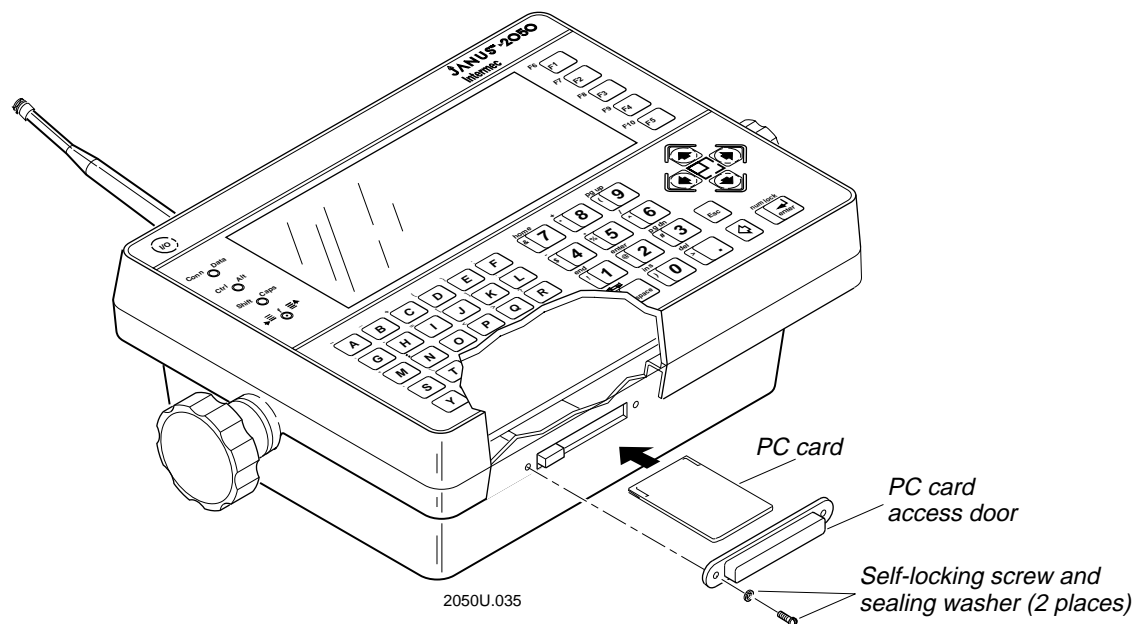

3. Lift off the PC card access door.
4. Identify the two notches on the edges of the PC card. Look at the connector end of the card. There is a single-walled notch on one side, and a double-walled notch on the other side.

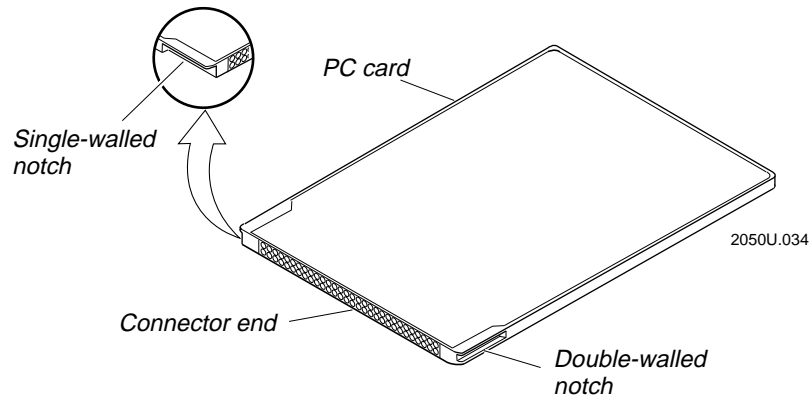

5. Insert the card into the drive slot, connector end first with the single-walled notch on the right edge of the card.

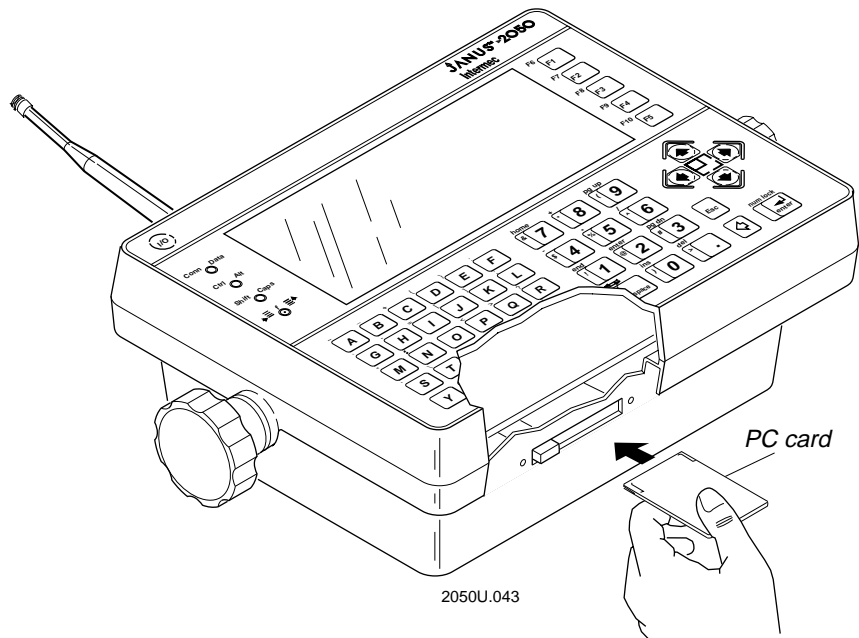

6. Push the card into the drive slot until it seats and the eject button pops out.

Note: Do not force a PC card into the drive slot. If the card does not fit easily, remove it and make sure you have the card oriented correctly. Then try again.

Approximately 5 seconds after you insert the card, the JANUS 2050 sounds an audible low-high beep tone to indicate it recognized the card. For a description of the beep tones, see “Understanding Audio Signals and Beep Sequences” in Chapter 2.

7. Install the PC card access door using the sealing washers and self-locking screws. Use the torque driver with a straight-slot screwdriver bit to torque the self-locking screws to 11 in-lb.

Note: If you are using a card with an external cable, do not install the drive door.

To remove a PC card

1. Make sure the JANUS 2050 is finished writing to the PC card. You can remove the card with the JANUS 2050 turned on or off.
2. Using a straight-slot screwdriver, remove the two self-locking screws (6 - 32 x 0.375) and two sealing washers on the PC card access door.

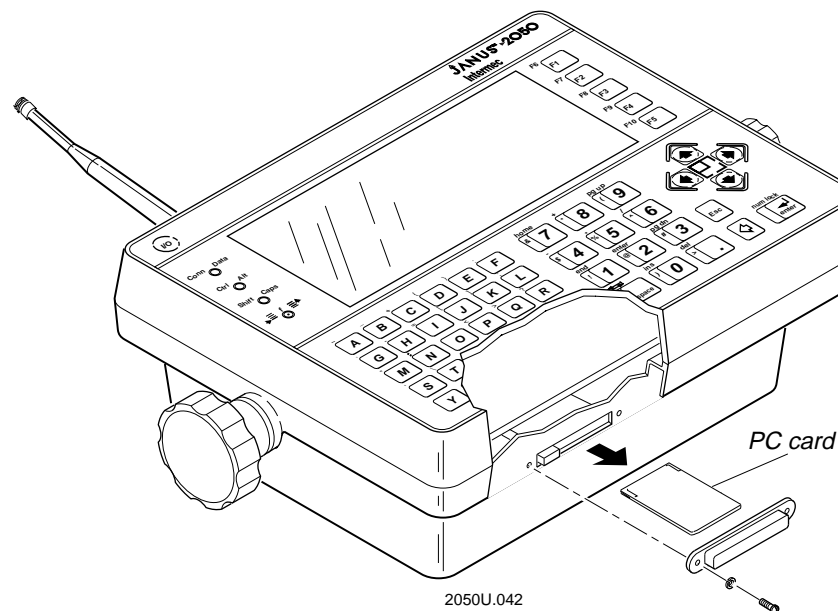

3. Lift off the PC card access door.

4. Press the PC card eject button to eject the card.

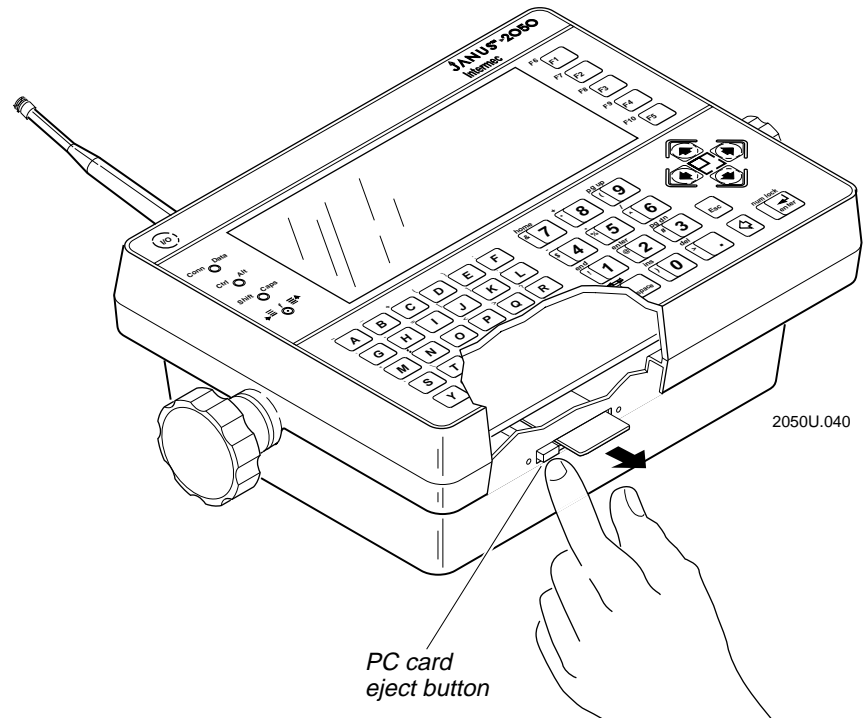

5. Remove the card from the drive slot. The JANUS 2050 sounds an audible high-low beep tone when the PC card is removed.
6. Replace the PC card access door using the sealing washers and self-locking screws. Use the torque driver with a straight-slot screwdriver bit to torque the self-locking screws to 11 in-lb.

Configuring, Formatting, and Using PC Cards

You need to configure the JANUS 2050 and format a PC card before you can use a card in your JANUS 2050. The next table shows a brief overview of the process for each type of PC card. After you scan this overview, you may want to read the following sections for more details.

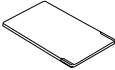
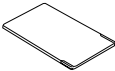
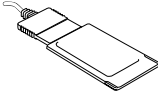
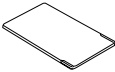
Type of Card	Step 1: Configure the JANUS 2050	Step 2: Format the Card	Step 3: Use the Card
ATA 	Edit the AUTOEXEC.BAT and CONFIG.SYS files and activate or add card drivers and utilities.	Use ATAINIT.EXE and FORMAT.COM: atainit {drive:} format {drive:}	Use DOS commands, for example: copy delete move
Flash 	Edit the CONFIG.SYS file and activate or add card drivers and utilities.	Use MCFORMAT.EXE: mcformat	Use DOS commands, for example: copy delete move
I/O (Modem) 	Edit the AUTOEXEC.BAT and CONFIG.SYS files and activate or add card drivers and utilities.	No formatting is required.	Use a commercially available communications program.
SRAM 	Edit the CONFIG.SYS file and activate or add card drivers and utilities. <i>Note: SRAM card is the default in the JANUS 2050 CONFIG.SYS file.</i>	Use FORMAT.COM: format {drive:}	Use DOS commands, for example: copy delete move

The next sections give you detailed instructions to configure, format, and use ATA, flash, I/O, and SRAM PC cards.

Preparing to Use ATA Cards

To use an ATA flash card you need to:

1. Configure the JANUS 2050 to use an ATA card by selecting the ATA card option on the MS-DOS startup menu.
2. Initialize and format the ATA card.
3. Use the ATA card

Initializing and Formatting an ATA Card

Follow these steps to initialize and format the ATA card:

1. Insert the ATA card in the PC card drive.
2. Type this command and press  :

```
atainit {drive:}
```

where *drive:* is the PC card drive.

Note: *ATAINIT only works with ATA cards that are supported by the ATADRV.EXE driver. If you are unable to use your ATA card, it may be an unsupported card. Check the documentation that is shipped with the ATA card.*



Caution

Make sure you enter the correct drive letter when you initialize the ATA card or you may erase the wrong drive.

Conseil

Assurez-vous de ne pas faire d'erreur en tapant la lettre identifiant le lecteur pour le formatage de la carte ATA. Sinon, vous risquez d'effacer un lecteur incorrect.

The program displays the parameters (Fixed Cylinders, Heads, and Physical Sectors) for your ATA card. The next prompt is:

```
Here are the parameters that were returned, examine them  
carefully to ensure they match what was expected.  
Press ENTER to accept and continue or <P> to prompt.
```

Note: *You can press the d key at any time to abort and exit the initialization program.*

3. Press  to accept the values that are displayed. The next prompt is:
Do you wish a compact format?

4. If your ATA card is 4MB or less, press Y . If your ATA card is greater than 4MB, press N . ATAINIT begins initializing the card and displays these messages.

```
Partition table successfully written.  
BPB Boot sector successfully wiped.  
Proceed with a DOS "FORMAT" command.
```

5. Type this command and press enter :

```
format {drive:}
```

where *drive*: is the PC card drive.



Caution

Make sure you enter the correct drive letter when you format the ATA card or you may erase the wrong drive.

Conseil

Assurez-vous de ne pas faire d'erreur en tapant la lettre identifiant le lecteur pour le formatage de la carte ATA. Sinon, vous risquez d'effacer un lecteur incorrect.

The program displays the next message.

```
WARNING: ALL DATA ON NON-REMOVABLE DISK  
DRIVE G: WILL BE LOST!  
Proceed with format (Y/N)?
```

6. Press Y to continue. When the card is formatted, the next prompt is displayed.

```
Volume label (11 characters, ENTER for none)?
```

7. Press enter if you do not want to enter a label for the card, or type a label name (up to 11 characters long) and press enter . The program displays the card's capacity and other drive statistics. You are ready to use the ATA card.

Using the ATA Card

You can use standard DOS commands to copy, delete, and move files, and to create and remove directories on an ATA card. If you need more information about DOS commands, refer to any book that describes DOS commands.

Preparing to Use Flash Cards

To use a flash card you need to:

1. Configure the JANUS 2050 to use a flash card by selecting the Flash Card option on the MS-DOS Startup menu.
2. Erase the flash card if it has been formatted already. If you have an unformatted card, proceed to Step 3.
3. Format the flash card using the MCFORMAT utility.

Note: Intermec recommends using flash cards that store 1MB or more of data.

Initializing and Formatting a Flash Card

Note: If you have an unformatted card, continue with Step 1. If you have a previously formatted card, you must first erase the card. For help, see the instructions "To erase a flash PC card" later in this section.

1. Insert the flash card in the PC card drive.
2. Type this command and press  :

```
mcformat
```

The MCFORMAT main menu appears.

```
PC Memory Card Formatter
(C) 1994 INTEL Corporation
Copyright 1994 SystemSoft Corp. All Rights Reserved
Version 1.01 (241 3-05)F

MCFORMAT options
Choose one of the following:

  1. Create and format a new partition.
  2. Format an existing partition.
  3. Erase a partition.
  4. Display partition information.

Enter your choice. [4]

To quit MCFORMAT, press [ESC].
```

2050U.013

3. Press **[1]** to select Option 1. You will see the following information.

```

Create and format a new partition.
-----
Drive  Beg address  End address  Type  Status  Size
-----
  G           0      4194303   Free Unformatted 4096K
-----
Which drive would you like to select?
Drive =

```

2050U.014

4. Press **[G]**, the letter of the PC card drive. The program displays the next prompt:

```

Would you like to format entire card with FLASH(1)or
FTL(2) (1/2)?

```

5. Press **[1]** to format the entire card in an MS-Flash format, or press **[2]** to format the entire card in an FTL flash format. The program displays the next prompt:

```

Are you ready to format drive G: with FTL format
(Y/N)?

```

Note: For most applications, Intermec recommends that you format a flash card in FTL (File Translation Layer) flash format. You should use the MS-Flash format when you are using the flash card in a JANUS 2050 and also in another PC card slot that supports MS-Flash format, but not FTL flash format.

6. Press **[Y]** to begin formatting the card. The program begins formatting the flash card and displays the percent complete as it is working. Do not remove the flash card while the program is formatting the card.

The next prompt is:

```

100% complete
Format Complete
Please input a volume label. (11 Characters, Press
enter for no label)
Label =

```

7. Press **[enter]** if you do not want to enter a label for the card, or type a label name (up to 11 characters long) and press **[enter]**. The program displays the current card status followed by the next prompt.

```

Press return for main menu.

```

8. Press **[enter]** to return to the MCFORMAT main menu.

9. Press **Esc** to exit MCFORMAT. You are ready to use the flash card.

Note: If you have trouble formatting the flash card, or the JANUS 2050 will not recognize the card, you may need to install additional flash card drivers. For help, see "Using PC Cards," in Chapter 8.

Erasing a Previously Formatted Flash PC Card

If your flash card has already been formatted, you must erase the card and clear its memory before you can format the card again.

Note: If your flash card has never been formatted, proceed to the next section.

1. Insert the flash card in the PC card drive.
2. Type this command and press **Enter** :

```
mcformat
```

The MCFORMAT main menu appears.

```
PC Memory Card Formatter
(C) 1994 INTEL Corporation
Copyright 1994 SystemSoft Corp. All Rights Reserved
Version 1.01 (241 3-05)F

MCFORMAT options

Choose one of the following:

1. Create and format a new partition.
2. Format an existing partition.
3. Erase a partition.
4. Display partition information.

Enter your choice. [4]

To quit MCFORMAT, press [ESC].
```

2050U.015

3. Press **3** to select Option 3. You will see the following information.

```
Erase a partition.

Drive Beg address End address Type Status Size
-----
G      0      4194303  FTL  Formatted  4096K

Which drive would you like to select?
Drive =
```

2050U.016

4. Press **[G]**, the letter of the PC card drive. The program displays the next prompt:
This command will erase drive G: entirely.
Do you want to continue (Y/N)?
5. Press **[Y]** to begin erasing the flash card. The program displays the next message and the percent complete as it erases the card. Do not remove the flash card while the program is erasing the card.
DO NOT REMOVE CARD WHILE ERASING!
Erasing card.
100% complete
Press return for main menu.
6. Press **[enter]** to return to the MCFORMAT main menu.
7. Press **[Esc]** to exit MCFORMAT. You are ready to format the flash card.

Preparing to Use I/O Cards

You can use I/O expansion cards in the PC card drive. To use an I/O card in the drive, you need to add the I/O card drivers and utilities to AUTOEXEC.BAT and CONFIG.SYS.

Note: Before you use an I/O card in your JANUS device, read the documentation shipped with the PC card for any instructions on using your card. Some cards may need to be configured before they can be used in the PC card drive.

Configuring the JANUS device to Use an I/O Card

Follow these steps to configure the JANUS device for an I/O card:

1. Edit the AUTOEXEC.BAT file, which is stored on the drive C.
2. Search for this line in the AUTOEXEC.BAT file:
d:\apm_4m.exe
If the line is remarked out, delete the REM characters. If you cannot find this line, add it to the AUTOEXEC.BAT file.
3. Remark out this line:
d:\ipm_4m.exe
Note: Do not load both IPM_4M.EXE or APM_4M.EXE at the same time.
4. Save your changes to the AUTOEXEC.BAT file.
5. Edit the CONFIG.SYS file on the JANUS drive C.

6. Search for this line in the CONFIG.SYS file:

```
device=d:\cardid.exe d:\cardid.ini
```

If the line is remarked out, delete the REM characters. If you cannot find this line, add it to the CONFIG.SYS file.

7. To save conventional memory, remark out any lines that load drivers for ATA, flash, or SRAM cards.
8. Save your changes to the CONFIG.SYS file.
9. Replace the AUTOEXEC.BAT and CONFIG.SYS files on the JANUS drive C.

Resetting the PC Card Drive for I/O Cards

By default, the PC card drive is not reset when you suspend or resume the JANUS device. Therefore, you can keep files open when you suspend and resume without losing data.

However, if you have an I/O card in the PC card drive, you must reset the drive when you resume the device. You can configure the device to reset the drive after a suspend/resume cycle by running the APM_4M.EXE program.

To load APM_4M.EXE into memory

- Type this command at the DOS prompt:

```
d:\apm_4m
```

Or scan this bar code:



```
*D:\APM_4M*
```

You can add this command to your AUTOEXEC.BAT file to start APM_4M.EXE whenever you boot the reader:

```
d:\apm_4m.exe
```

Note: APM_4M.EXE is also available on the Application companion disk 3.

Preparing to Use SRAM Cards

To use an SRAM card you need to:

1. Configure the JANUS 2050 to use an SRAM card by selecting the SRAM card option on the MS-DOS Startup menu.
2. Format the SRAM card.
3. Use the SRAM card.

Formatting an SRAM PC card

1. Insert the SRAM card in the PC card drive.
2. Type this command and press  :
`format {drive:}`
where *drive:* is the PC card drive.
3. You are ready to use the SRAM card.

Using the SRAM PC Card

You can use standard DOS commands to copy, delete, and move files, and to create and remove directories on an SRAM card. To learn which DOS commands are available on the reader, see the MS-DOS Programs companion disk 2. For help using DOS commands, see any DOS manual.

For example, to copy all the files from drive C to drive G (PC card drive), type this command at the DOS prompt:

```
copy c:\*.* g:
```

To delete all the files on the SRAM card in drive G, type this command at the DOS prompt:

```
del g:\*.*
```

Managing the Power on the PC Card Drive

You can use a utility called CARDINFO.EXE to manage the power on the PC card drive and to get information about the card currently inserted in your JANUS 2050.

You can run CARDINFO at any time to:

- Display information about the type of card that is currently inserted in each PC card drive.
- Turn off or on the power to a PC card drive when a PC card is installed in the drive.
- Display the drive letter designation for your ATA PC card.
- Display detailed information about the PC card and drive configuration, including the I/O ports, Interrupt Request Queue (IRQ) resources, and memory areas that are being used by each card.
- Display the latest error that occurred for a PC card that is installed in a drive.

To run CARDINFO on the JANUS 2050

Type one of these commands at the DOS prompt and press .

Command	Option
<code>cardinfo</code>	Displays information about the card inserted in the PC card drive, including the type of card, size, card manufacturer, and product name.
<code>cardinfo /off</code>	Turns off the power to the PC card drive.
<code>cardinfo /on</code>	Turns on the power to the PC card drive.
<code>cardinfo /c</code>	Displays information about the card inserted in the PC card drive, including the type of card, size, card manufacturer, product name, and Card Services.
<code>cardinfo /v more</code>	Displays extensive information about the card inserted in the PC card drive, including the type of card, size, card manufacturer, product name, Card Services, client, and card configuration. Use the DOS More switch with this command since the information is usually more than one screen long.
<code>cardinfo /?</code>	Displays information about the CARDINFO options.

You can use the CARDINFO utility to manage JANUS 2050 power when an I/O card is installed in the PC card drive.

To turn off the power to the PC card drive, type this command and press :

```
cardinfo /off
```

When you are ready to use the modem card, type this command and press :

```
cardinfo /on
```

Managing the PC Card Drivers in the Startup Files

The PC card drivers and utilities are stored on the JANUS reader and the Application companion disk 3. These files control how the PC card drives operate, customize the reader to use the PC card software, and provide you with helpful tools.

Note: Your reader is customized to use the PC card drivers and cards as efficiently as possible. For help with advanced card configuration and power management, see the SystemSoft CardSoft 3.1 Software User's Guide, which is stored as the executable zipped file `CSUG_DOC.EXE` on companion disk 3. The guide is in Microsoft Word 2.0 format.

This section covers these topics:

- Drivers in CONFIG.SYS
- Drivers in AUTOEXEC.BAT
- Tips for Enabling PC Card Drivers

Drivers in CONFIG.SYS

Your CONFIG.SYS must contain these lines to support the PC card drive:

```
device=d:\cs.exe /poll 1
device=d:\csalloc.exe d:\csalloc.ini
install=d:\card_sr.exe
```

Note: *If you delete or remark out these lines, you cannot use the PC card drives.*

CONFIG.SYS also contains lines that support specific types of PC cards, such as ATA cards. To save conventional memory, you can comment out all the drivers except for the ones that apply to the type of card (or cards) currently installed in the reader.

Type of Card	Lines You Need to Activate the Device Drivers
ATA	<pre>device=c:\atadv.exe /s:2 device=c:\mtddrv.exe device=d:\cardid.exe d:\cardid.ini</pre>
Flash	<pre>device=c:\mti1.exe device=c:\mti2p.exe device=c:\mtddrv.exe device=c:\ftl.exe (or: c:\ms-flash.sys)</pre>
I/O	<pre>device=d:\cardid.exe d:\cardid.ini</pre>
SRAM	<pre>device=c:\mtsram.exe device=c:\mtddrv.exe</pre>

Drivers in AUTOEXEC.BAT

The AUTOEXEC.BAT file loads one of these drivers:

- IPM_4M.EXE for ATA, flash, and SRAM cards
- APM_4M.EXE for I/O cards

You load one or the other, but not both drivers at the same time. If you need to install both, install APM_4M.EXE because it does everything IPM_4M.EXE does.

Tips for Enabling PC Card Drivers

Consider these guidelines:

- If you are using two different types of PC cards in your JANUS 2010 reader, make sure you enable all the drivers in CONFIG.SYS for both types. Otherwise, one or both cards may not operate correctly.
- If you use several types of PC cards, you can expect to edit the CONFIG.SYS file often to activate and deactivate these device drivers. You may consider creating several versions of the CONFIG.SYS file, each of which supports a different type of card.
- If you are having trouble or if you want to customize your system, you can use the CONFIG.EXE configuration utility, which is stored on companion disk 3.

For instructions, read the *SystemSoft CardSoft 3.1 Software User's Guide*. The guide is in Microsoft Word 2.0 format and stored as the executable zipped file CSUG_DOC.EXE on companion disk 3.

Note: You must run CONFIG.EXE on a PC, not on a JANUS reader.

6

Communicating With the JANUS 2050

This chapter discusses communications protocols, explains how to set up the JANUS 2050 to communicate with another device, and describes the different methods you can use to communicate with the JANUS 2050. For information on radio frequency communication (RF), refer to the Radio Frequency Quick Reference Guide that ships with this manual for information about 900MHz RF communication, or to the documentation in your 2.4 GHz Installation Utility kit for information about 2.4GHz RF communication.

Planning the Network Connection

In most networking and data communications situations, the JANUS 2050 uses a communications application, communications protocol, and protocol handler to talk to the network.

What is a communications application? A communications application is a software program that lets the JANUS 2050 communicate with another computer device. Many specialized communications applications are available because there are many specialized data communications tasks to be performed. For example, a communications application may establish a connection with another computer, transfer files, and perform error checking—or it may make remote directories and files available to the local user.

Communications applications usually require communications protocols and protocol handlers to handle the actual transmission of data. However, you do not need a communications protocol or protocol handler if the application will access the COM port directly.

What is a communications protocol? Communications protocols determine exactly how data is transmitted between the JANUS 2050 and the connected device. Each protocol has parameters you can set, such as baud rate and parity. Both the JANUS 2050 and the connected device must use the same protocol and parameter settings to communicate properly.

What is a protocol handler? Protocol handlers are programs you run only on the JANUS 2050. The protocol handler transmits and receives data in the manner specified by the communications protocol. Each protocol handler is used with a specific communications protocol.

The next sections describe the communications protocols and protocol handlers available for your JANUS 2050.

Choosing a Communications Application

You can use one of the three communications applications shipped with your JANUS 2050, you can create a JANUS PSK communications application, or you can purchase a third-party communications application:

IRL Desktop You can use the IRL Desktop to transfer IRL programs and IRL data files between the JANUS 2050 and a host computer. For help, see Chapter 7, "Working With IRL."

Interlnk/Intersvr You can use the DOS utilities Interlnk and Intersvr to access the drives in the host computer as if they existed in the JANUS 2050, and vice versa. For help, see "Communicating Using the Interlnk/Intersvr Utilities" later in this chapter.

Communications Manager You can use the Communications Manager utility to transmit and receive data files, and to request COM port and protocol status. For help, see "Communicating Using Communications Manager" later in this chapter.

JANUS PSK communications application You can create your own communications application using the software libraries provided with the JANUS Programmer's Software Kit. For help, see the JANUS PSK reference manual set.

Third-Party communications application You can use a third-party communications application that conforms to the requirements of the JANUS 2050.

Choosing a Communications Protocol

The device can communicate in any of seven configurable protocols. The protocols are introduced briefly here. For details about their characteristics and parameters, see "Communications Protocol, Configure" in Chapter 10.

User-Defined protocol User-Defined is a powerful protocol because you can configure the protocol to your own requirements. For example, you can configure User-Defined for a Point-to-Point like protocol, but with an LRC and an acknowledgment from the receiver being required. You can also define communications characters such as SOM, POL, or SEL, or disable these characters by setting them to zero.

User-Defined protocol is also used to define User-Defined Multi-Drop protocol. In User-Defined Multi-Drop, the POL and SEL protocol characters must be set in a predetermined combination. See Appendix A for the correct POL and SEL combinations.

Point-to-Point protocol Point-to-Point is an unsolicited protocol in which the JANUS 2050 transmits data whenever it has something to transmit. The data is followed by a CR LF as the EOM character. It is always in a receiving state and does not wait for select commands. This protocol does not perform any error checking or acknowledgment handshaking.

Point-to-Point protocol is typically used to connect the JANUS 2050 to a CRT terminal or host computer. Since it is an unsolicited protocol, the transmit command can be initiated from the JANUS 2050 or the host.

Polling Mode D protocol Polling Mode D requires the host to ask the JANUS 2050 for data it might have (polling) and to request to send data to the JANUS 2050 (selecting). PC-IRL uses this protocol.

Multi-Drop protocol Multi-Drop follows the same protocol sequences as Polling Mode D with the extension of device addressing, which allows up to 32 devices on one 4-wire RS-485 twisted pair line. Due to timeout parameters, the baud rate must be 2400 or higher.

Multi-Drop protocol is typically used in CrossBar networks.

PC Standard protocol PC Standard handles data transfer on a character-by-character basis or by either filling a receive buffer or transmitting a buffer of data. This protocol is designed to be compatible with the standard PC BIOS functions. The one exception is that the PC Standard protocol is capable of buffering data that is received, which avoids losing characters if a program has not checked for data recently.

RF protocol RF protocol is for use in radio frequency (RF) networks only. For details, see the *JANUS 900 MHz Radio Frequency Quick Reference Guide*.

No protocol No protocol is for communications programs, such as Interlnk/Intersvr, that directly access the COM port instead of using a protocol handler, which allows you to switch between direct COM port access and using a protocol handler.

Choosing a Protocol Handler

There are three protocol handlers:

PHIMEC The Intermec protocol handler. PHIMEC lets you communicate with other Intermec devices such as concentrators.

PHPCSTD The PC Standard protocol handler. PHPCSTD provides low-level communications abilities and protocol services at the DOS level for non-communications software. This includes byte-by-byte transfer and status information.

RFPH The RF protocol handler. RFPH lets you communicate with devices in an RF network.

You will use each protocol handler with a specific communications protocol:

Use this protocol handler:	With this communications protocol:
PHIMEC	User-Defined protocol Point-to-Point protocol Polling Mode D protocol Multi-Drop protocol
PHPCSTD	PC Standard protocol
RFPH	RF Communications protocol

Note: *You do not load a protocol handler if you choose No protocol as your communications protocol. For example, if you decide to use the Interlnk/Intersvr communications application, you do not need a communications protocol or protocol handler, so you choose No protocol and do not load a protocol handler.*

Instructions for loading and unloading protocol handlers are presented later in this chapter. When you load a protocol handler that corresponds to the active protocol, the active protocol tells the protocol handler how to communicate.

Setting Up the JANUS 2050 for Communications

1. Select and configure the communications port and protocol.
2. Load the corresponding protocol handler, if necessary.
3. If you are not loading a protocol handler, set the configuration parameters for communications port UART (Universal Asynchronous Receiver/Transmitter).
4. Connect the JANUS 2050 to the device it will communicate with.

Each step is explained in the following pages.

Configuring the JANUS 2050 for Communications

When configuring the JANUS 2050 to talk to another device, it is important that the JANUS 2050 and connecting device are set to the same communications protocol and parameters. The communications protocols have one or more parameters that must be configured for that protocol.

To configure the JANUS 2050 for communications

1. Select the communications port for which you are configuring the protocol. Your selection tells the JANUS 2050 to apply all further communication configurations to the selected port. (See “Communications Port, Select” in Chapter 10.)
2. Select the protocol you want to configure. Your selection tells the JANUS 2050 to apply all further communications parameter configurations to the selected protocol. (See “Communications Protocol, Configure” in Chapter 10.)
3. Set the parameters for that protocol. (See “Communications Protocol, Configure” in Chapter 10 for a list of parameters for each protocol.)
4. Activate the selected protocol. The port cannot use the communications protocol until it is active. (See “Communications Protocol, Activate” in Chapter 10.)

You can configure the JANUS 2050 port for more than one communications protocol, but the port can only use one protocol at a time. You designate what protocol a port should have by “activating” it in the JANUS 2050’s configuration. When you are using a communications program on the JANUS 2050, the RF port is designated as COM4.

Note: *If you are using a CrossBar network, configure the JANUS 2050 for Multi-Drop protocol.*

Loading and Unloading Protocol Handlers

There are several ways to load protocol handlers:

- Manually load them from the DOS command line.
- Include them in a batch file that also executes your program.
- Load the protocol handlers whenever you execute the Communications Manager utility or IRL Desktop.

If you are using an off-the-shelf communications program that directly accesses the COM port, you can maximize memory by not loading a protocol handler. You activate No protocol in the JANUS 2050 configuration. You cannot download JANUS 2050 configuration commands from the host computer when using off-the-shelf software.

Note: For the protocol handler to be active when it is loaded, its corresponding communications protocol must be active. For example, if PC Standard protocol is loaded, it will not become active until the PC Standard protocol is made the active protocol in the JANUS 2050's configuration.

Loading/Unloading Protocol Handlers at the DOS Prompt

When you are using communications from the DOS command line, you can load the protocol handlers from the command line as needed. If you load a protocol handler from the command line, it is recommended that you unload the protocol handler when you are finished to maximize memory.

To load a protocol handler, enter this command at the JANUS 2050 DOS prompt

```
{protocol handler} {port}
```

To unload a protocol handler, enter this command at the JANUS 2050 DOS prompt

```
unload {protocol handler} {port}
```

where:

protocol handler is the name of the protocol handler you want to load or unload. For the Intermec protocol handler, enter **phimec**. For the PC standard protocol handler, enter **phpcstd**. For the RF protocol handler, enter **rfph**.

port indicates the port for which you are loading or unloading the protocol handler. To load or unload the protocol handler for COM1, enter **1**.

For example, to load the Intermec protocol handler on COM1, enter the following command at the JANUS 2050 DOS prompt:

```
phimec 1
```

Loading/Unloading Protocol Handlers With a Batch File

If you are creating your own application or using software that does not have built-in protocol handlers, you can create a batch file that automatically loads and unloads the protocol handler whenever you enter and exit the application.

An example batch file is listed next. The batch file loads the Intermec and PC Standard protocol handlers, executes the Communications Manager utility, and then unloads the protocol handlers when the Communications Manager is exited. You can modify the example batch file to load only one protocol handler to maximize memory for the application.

If a protocol handler is loaded before you run the batch file, that protocol handler will not be unloaded when you exit your application.

Note: *COMMAND.COM* executes files in the order *.COM*, *.EXE*, *.BAT*. Therefore, the batch file that loads the protocol handlers for your program should have a different filename than the executable. If the batch file and the executable have the same filename, the executable is run instead of the batch file.

Example Batch File

Command Line	Definition
set CMPCST=	Clear the environment variables used by this batch file.
set CMUSER=	
phimec 1	Load the Intermec protocol handler for COM port 1. If the Intermec protocol handler is already loaded, an error is returned and the variable is not set.
if not errorlevel 1 set CMUSER=1	
phpcstd 1	Load PC Standard protocol handler for COM port 1. If the PC Standard protocol handler is already loaded, an error is returned and the variable is not set.
if not errorlevel 1 set CMPCSTD=1	
cmanager %1 %2 %3	Executes the Communications Manager utility. You can replace this with your application executable.
if not "%cpcstd%"=="1" goto :nopcstd unload phpcstd 1	If the PC Standard protocol handler was loaded by this batch file, unload the PC standard protocol handler.
if errorlevel 1 echo unload failure on pcstd :nopcstd	Check for failure to unload the PC standard protocol handler.
if not "%CMUSER%"=="1" goto :nouser unload phimec 1	If the Intermec protocol handler was loaded by this batch file, unload the Intermec protocol handler.
if errorlevel 1 echo unload failure on userdef :nouser	Check for failure to unload the Intermec protocol handler.

If you want a protocol handler to always be present, you can include the command line in your AUTOEXEC.BAT file. However, this requires more memory to operate the JANUS 2050.

Loading/Unloading Protocol Handlers With IRL Desktop or Communications Manager

You can load a protocol handler for a designated port when you execute the IRL Desktop or the Communications Manager utility. When you exit the program, the protocol handler is unloaded. To load a protocol handler when executing IRL Desktop or Communications Manager, you enter the following command at the DOS prompt:

```
{application} -[ {port} {ph} ]
```

where:

application is the application you are executing. For IRL Desktop, enter **irl**. For the Communications Manager, enter **cmgr**.

port indicates the port for which you are loading the protocol handler. To load the protocol handler for COM1, enter **1**.

ph is the notation for the protocol handler you want to load. For the Intermec protocol handler, enter **i**. For the PC Standard protocol handler, enter **p**.

For example, to load the Intermec protocol handler on COM1 and execute the IRL Desktop, you enter the following command at the JANUS 2050 DOS prompt:

```
irl -1i
```

Specifying a Value for the FIFO Control Register

The First In First Out (FIFO) control register contains a hex value that controls the Universal Asynchronous Receiver/Transmitter (UART) buffer. For example, the FIFO control register can enable UART 16x550 mode and require the buffer to receive four bytes of data before generating a receive interrupt.

If you turn off your JANUS device while running a communications application, the device cannot save the contents of the UART FIFO control register. When you turn the device back on, the device sets the FIFO control register to its default value, 0 hex, unless you have already specified a value that the device can use to restore the FIFO control register. You should specify another value if the default is not appropriate for the JANUS 2050 UART FIFO control register.

To determine if you should specify a value, what value to specify, and how to do it

1. Decide if you need to specify a value that the device will use to reset the FIFO control register after a Suspend/Resume. You must specify a hex value if you plan to perform either of these activities:
 - You run a communications application on COM1 without loading an Intermec protocol handler into memory.
 - You run a communications application on COM2 that changes the COM2 UART FIFO control register to use UART 16x550 mode. (Many communications applications change the COM2 UART FIFO control register to use UART 16x550 mode. To learn if your application uses UART 16x550 mode, see its manual.)
2. Calculate which two digit hexadecimal value will correctly restore your UART FIFO control register. Use this illustration as a guide:

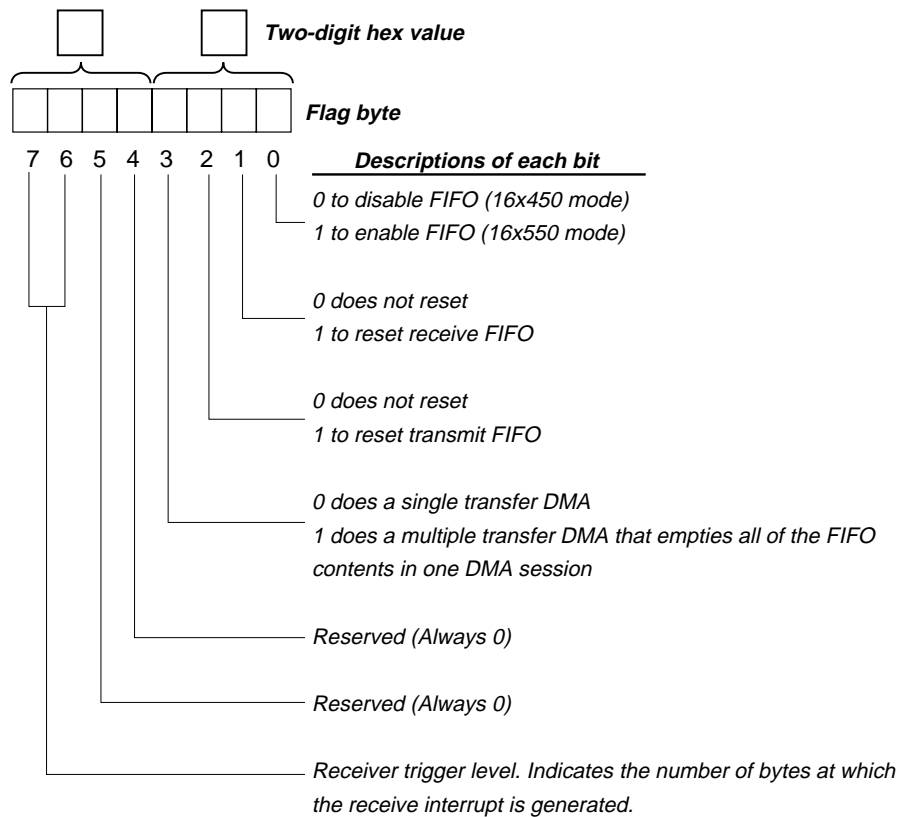

		Number of bytes that generate a receive interrupt
7	6	
0	0	1
1	0	4
0	1	8
1	1	14

2050U.097

Follow these steps:

- Choose 1 or 0 for each bit in the flag byte. Read the descriptions for each bit carefully to decide whether to enable or disable each bit.
- Convert the bytes to hexadecimal numbers. The resulting two hex numbers are the value you will specify (in Step 3) to restore the UART FIFO control register.

For example, a two-digit value of 81 enables UART 16x550 mode, requires the buffer to receive four bytes of data before generating a receive interrupt, and leaves all other parameters disabled.

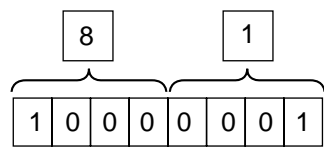

2050U.044

3. Specify the value for the UART FIFO control register using one of these methods:
 - Start the configuration application (IC.EXE), choose the COM port from the COM menu, and type the value into the FIFO CONTROL REGISTER parameter. For help using IC.EXE, see Chapter 4, "Configuring the JANUS 2050."
 - Scan the Communications Port, UART Restore command in Chapter 10, "Configuration Commands."
 - Use software interrupts. For help, see the JANUS PSK reference manual set.

Different Ways to Communicate With the JANUS 2050

There are a number of ways for the JANUS 2050 to communicate with other devices:

IRL Desktop You can use the IRL Desktop to transfer IRL programs and data files between the JANUS 2050 and the host computer using menus. IRL Desktop is discussed in more detail in Chapter 7, “Working With IRL.”

Interlnk/Intersvr You can use the DOS utilities Interlnk/Intersvr to access the drives in the host computer as if they existed in the JANUS 2050 and vice versa. Use the /b switch on the JANUS 2050 command line with Interlnk/Intersvr to make optimum use of the monochromatic display. Interlnk/Intersvr are discussed in more detail later in this chapter.

Communications Manager You can use the Communications Manager utility to transmit and receive data files, and request port and protocol status. Communications Manager is discussed in more detail later in this chapter.

Communicating Using the Interlnk/Intersvr Utilities

You can easily transfer files between the JANUS 2050 and a host computer by using the JANUS 2050 Interlnk program. Through Interlnk, the host computer can run programs located on the JANUS 2050, and the JANUS 2050 can access information from the host computer without having to copy files.

For example, you can create a QBasic program on the computer. Once you develop the program, you can run it on the JANUS 2050 by having the JANUS 2050 call up the computer and access its drives.

The device that you enter commands from is called the client. The device connected to the client is the server. You use the client to control both it and the server. The server's drives and printers look as if they are on the client. The server screen displays the status of the connection. The JANUS 2050 will most likely be used as a server when creating programs, and as a client when uploading data files and running programs.

Because Interlnk does not work with redirected drives when the JANUS 2050 is the server, the host computer (client) will not be able to access the JANUS 2050 PC card drive when it has a flash memory card installed.

Example

Suppose the host computer is the client and has two hard drives (C and D) and one disk drive (A). The JANUS 2050 is the server and has four drives: three simulated drives (C, D, and E) and a PC card drive (G).

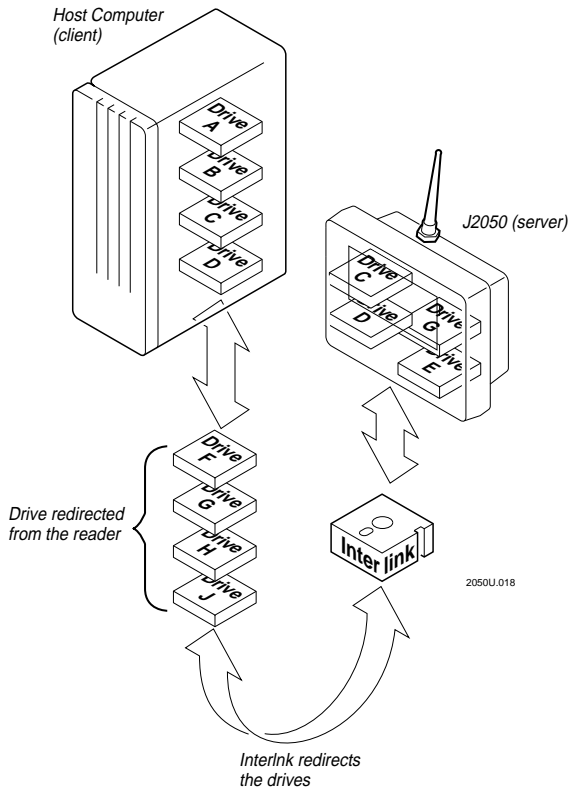

When the JANUS 2050 and host computer are connected through Interlnk, drives on the JANUS 2050 (server) appear as additional drives on the host computer (client). In addition to drives A, C, and D, the host computer now has drives F, G, H, and J.

Client Drives		Server Drives
A		
B		
C		
D		
F	redirected from	C
G	redirected from	D
H	redirected from	E
I	placeholder for internal PC card drive	F
J	redirected from	G

The client's drive G is redirected from the server's (JANUS 2050) drive C. If you type the command **dir g:** on the client, a list of files located in the root directory of the JANUS 2050 drive C is displayed.

The following sections describe what hardware and software you need to use Interlnk/Intersvr, how to get Interlnk/Intersvr running, and several procedures for using Interlnk/Intersvr.

Interlnk/Intersvr System Requirements

The following hardware, software, and memory are necessary to use Interlnk on your host computer:

- A serial port
- DOS 3.0 or later
- 16K of free memory on the client device and 130K of free memory on the server device

Installing Interlnk/Intersvr

There are two files necessary to run Interlnk: INTERLNK.EXE and INTERSVR.EXE. INTERLNK.EXE is a device driver that you install on the device designated as the client. INTERSVR.EXE is a program that you run on the device designated as the server. It is recommended that you run Interlnk on the host computer (make it the client) and run Intersvr on the JANUS 2050 (make it the server) to optimize memory use. You do not need to load protocol handlers to use Interlnk/Intersvr.

To install Interlnk/Intersvr on the host computer

1. Connect the JANUS 2050 to the host computer.
2. Make the directory where the Interlnk files on the host computer will reside your current working directory.
3. Copy the INTERLNK.EXE file and INTERSVR.EXE file from companion disk 2, shipped with the JANUS 2050, to the host computer.

If you do not have companion disk 2 containing the Interlnk and Intersvr files, you can enter the following command at the JANUS 2050 DOS prompt:

```
intersvr /rcopy
```

The Interlnk/Intersvr files will be copied to the host computer. Follow any instructions on the JANUS 2050 display. If the host computer locks up after the files have been copied over, reboot the host computer.

Note: You must run Interlnk on the JANUS 2050 if you want to access a flash card in the PC card drive.

Running Interlnk on the Host Computer

If you are going to make the host computer the client and make the JANUS 2050 the server, follow these instructions:

1. On the host computer, add a device command for INTERLNK.EXE to the CONFIG.SYS file. The command should specify the location of the file and how many drives are on the server. For example:

```
device=c:\interlnk.exe /drives:7
```

This specifies that INTERLNK.EXE is located in the root directory on drive C and that INTERLNK.EXE redirects all drives. If **/drives:** is not specified, Interlnk redirects three drives. Refer to Appendix D, "Software Utility Reference," for more information on the options you can specify for the Interlnk device driver command.





2. If COM1 on the host computer is connected to the JANUS 2050, go to the next step. If you are not using COM1 on the host computer and are using the DOS command SHARE.EXE on that computer, remove the Share command from the AUTOEXEC.BAT or CONFIG.SYS file.
3. Start the Interlnk server by entering the following command at the JANUS 2050 DOS prompt:

```
intersvr /com1 /b
```

A screen appears displaying information on the redirected drives and printer ports.

If you do not include **/com1** in the command line, Intersvr defaults to COM3 and you will receive two error messages. You need to specify **/b** switch or black and white mode is not visible on the JANUS 2050. Press  after each message is displayed and Intersvr will then go to COM1.

4. To restart the host computer to load Interlnk from CONFIG.SYS, press

 -  -  - .

Interlnk is now connected to the server and you are ready for operation. For example, if the client's (host computer) drive G is redirected from the server's drive C, enter the following command:

g:

Now any commands entered at the drive G prompt will affect the JANUS 2050 drive C.

Running Interlnk on the JANUS 2050

If you are going to make the JANUS 2050 the client and make the host computer the server, follow these instructions:

1. Start the Interlnk server by entering at the host computer's command prompt:

```
intersvr
```

If you are using a port other than COM1, specify that port in the command line (for example, `intersvr /com2`).

A screen appears displaying information on the redirected drives and printer ports.

2. Reboot the JANUS 2050 to start Interlnk by pressing    .

Note: *It is not necessary to modify the JANUS 2050 CONFIG.SYS file. The JANUS 2050 factory default CONFIG.SYS file installs Interlnk automatically (using the /auto option) when the JANUS 2050 is connected to a host computer that is running Intersvr.*



Caution

Do not press any keys while the JANUS 2050 is performing a warm boot or you may lose data.

Conseil

N'appuyez pas sur des touches pendant que le lecteur se réamorçe, sinon vous pouvez perdre des données.

Interlnk is now connected to the server and you are ready for operation. For example, if the client's (JANUS 2050) drive G is redirected from the server's drive A, enter the following command:

```
g:
```

Now any commands entered at the drive G prompt will affect the host computer's drive A.

Interlnk\Intersvr can also be executed on two JANUS 2050s using the steps listed above.

Interlnk/Intersvr Status

When Intersvr is started, it displays a status screen.

Microsoft Interlnk version 1.00			
This Computer (Server)		Other Computer (Client)	
A:	equals	D:	
B:	equals	E:	
C:	equals	F:	
D:	equals	G:	
E:	equals	H:	
LPT3:	equals	LPT1	
Transfer:	Port = Com 1	Speed:	Alt + F4 = Exit

This Computer This column lists all drives and printer ports on the server. The screen also displays the size of the hard disk drives on the server.

Other Computer This column lists the server's redirected drive designations.

2050U.103

When the client is reading from or writing to the server, the word *Transfer* flashes at the bottom of the screen and an asterisk (*) is displayed next to the server drive that is being accessed. The status bar also shows which server port is connected to the client and the baud rate.

Redirecting Drives

You can redirect a client drive to a different server drive using the Interlnk command. For example, if the client drives F and G are set to server drives C and D respectively, you can redirect the client drive F to server drive D and client drive G to server drive E by entering the following command:

```
interlnk f=d g=e
```

To cancel the redirection of client drive F, do not specify a server drive as shown:

```
interlnk f=
```

Note: The client cannot access a server's drive that was redirected before Interlnk was started, such as a network drive.

Exiting Interlnk/Intersvr

Use the server's keyboard to break the Interlnk connection between computers. Press Alt - F4 to break the connection.

Restarting Interlnk/Intersvr

You can restart the connection at any time by entering the following command on the server:

```
intersvr /com1
```

This command tells the server which communications port you are using. On the client, make one of the redirected drives the active drive. For example, if the client's drive G is redirected from the server's drive C, enter:

```
g:
```

If Interlnk/Intersvr will not restart, repeat the steps listed in the section "Running Interlnk on the Host Computer" or "Running Interlnk on the JANUS 2050" earlier in this chapter.

Communicating Using Communications Manager

The Communications Manager utility lets you transmit and receive ASCII files, and request port and protocol status. The files to execute Communications Manager are shipped on Companion disk 3 and can be loaded on the JANUS 2050 drive C or a PC card. The following files need to be loaded on the JANUS 2050 to execute Communications Manager:

- CMANAGER.EXE
- CMGR.BAT
- CO001.DAT

Once it is loaded on the JANUS 2050 or a PC card, you can run Communications Manager by using menus or by entering commands at the DOS prompt as described in the following pages.

Using the Communications Manager Menus

To open the Communications Manager utility from the DOS prompt, type:

```
cmgr
```

and then press .

Or, scan the following bar code:



CMGR

If you want to load a protocol handler for a designated port and execute Communications Manager, you can include an argument in the command line. To load a protocol handler, enter the following command at the DOS prompt:

```
cmgr -[port]{ph}
```

where:

port indicates the port for which you are loading the protocol handler. To load the protocol handler for COM1, enter **1**.

ph is the notation for the protocol handler you want to load. For the Intermec protocol handler, enter **i**. For the PC Standard protocol handler, enter **p**.

For example, to load the PC Standard protocol handler on COM1 and execute Communications Manager, enter the following command at the DOS prompt:

```
cmgr -1p
```

Note: When Communications Manager is used with the PC Standard protocol handler, it automatically sets EOR to <CR><LF>, and EOF to <SOH> for file transfers.

In the menu bar, there are three pull-down menus:

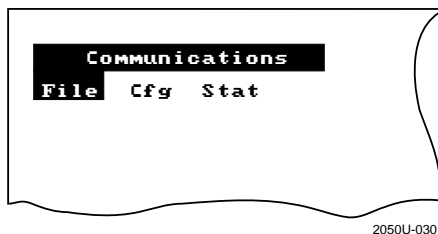

File Select the File menu to designate which port to communicate through, and transmit or receive ASCII files. It also has a section that displays the software version. You quit Communications Manager by choosing Exit from this menu.

Cfg Select the Cfg menu to set the communications protocol for each of the JANUS 2050 COM ports and define the parameters for each selected protocol. For a list of the communications protocols and their parameters, see Chapter 10, "Configuration Commands."

Stat Select the Stat menu to view the status of the selected COM port, such as the protocol and parameters being used and whether the port is active or inactive.

The commands listed in the File menu are described next:

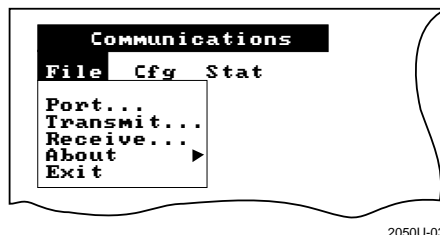

Port This command lets you select which port to communicate through. COM1 is the optical serial port.

Transmit Transmits the selected file through the designated COM port. A screen displays the status of the transfer.

Receive Stores the file it receives from the designated COM port under the selected filename. A screen displays the status of the transfer.

About Displays the software version.

Exit Exits the Communications Manager.

Use the following instructions to move around in the menus and select commands

- When a pull-down menu is displayed, select a command by pressing **▲** or **▼** to move the highlight to the desired command, and then press **↵** to choose the command.
- The dialog boxes list the options for that menu. When a dialog box is displayed, press **▲** or **▼** or **Tab/BackTab** to move to the desired field.
- Pressing **↵** is the same as choosing OK. It exits the dialog box and saves the changes.
- Pressing **Esc** is the same as choosing CANCEL. It exits the dialog box without saving changes.
- To exit Communications Manager, select Exit in the File pull-down menu and press **↵**.

You can scan the bar code labels listed in Appendix A to move the cursor through the communications menus instead of pressing keys.

Using a Command Line

You can use a DOS command line instead of the menu system to transmit and receive files with the Communications Manager utility. The syntax for the command is:

```
cmgr -[ {port}{ph} ] -p{port} -s{direction}
-f[path\]{filename}
```

where:

[*{port}{ph}*] indicates the port and protocol handler you are loading. To load the protocol handler for COM1, enter **1**. You enter **i** to load the Intermec protocol handler, and **p** to load the PC Standard protocol handler. For example, to load the PC Standard protocol handler for COM1, enter **-1p**.

port is the communications port. For example, to specify COM port 1 enter **-p1**.

direction indicates whether you are transmitting (T) or receiving (R). For example, to receive a file, enter **-sr**.

path \ indicates the directory for the file you are transmitting or receiving. If no directory is entered, the current working directory is used.

filename indicates the file you are transmitting or receiving.

For example, to load the PC Standard protocol handler on COM1 and transmit a file called TEST.DAT from COM1, you enter the following command at the DOS prompt:

```
cmgr -1p -p1 -st ftest.dat
```

Downloading Applications Across the Network

You can use binary file transfer (BFT) to download applications to JANUS devices in 900 MHz RF and CrossBar networks. BFT can perform these tasks with or without assistance from the person operating the device:

- Interrupt any PSK application, reboot the device, and start the file transfer application (FTA) on the device
- Transfer binary files (for example, an application) with error detection
- Change the contents of the JANUS drive C by loading a new image file
- Run any program on the device when the transfer or update is complete

Note: *The BFT functionality is provided by the file transfer application (FTA.EXE), which is stored on the Application companion disk 3.*

Examples of Using BFT

The next two examples illustrate how you can use BFT to update applications on networked JANUS devices by transferring new binary files to the devices.

Example 1: Updating Several JANUS Devices From a Host Computer

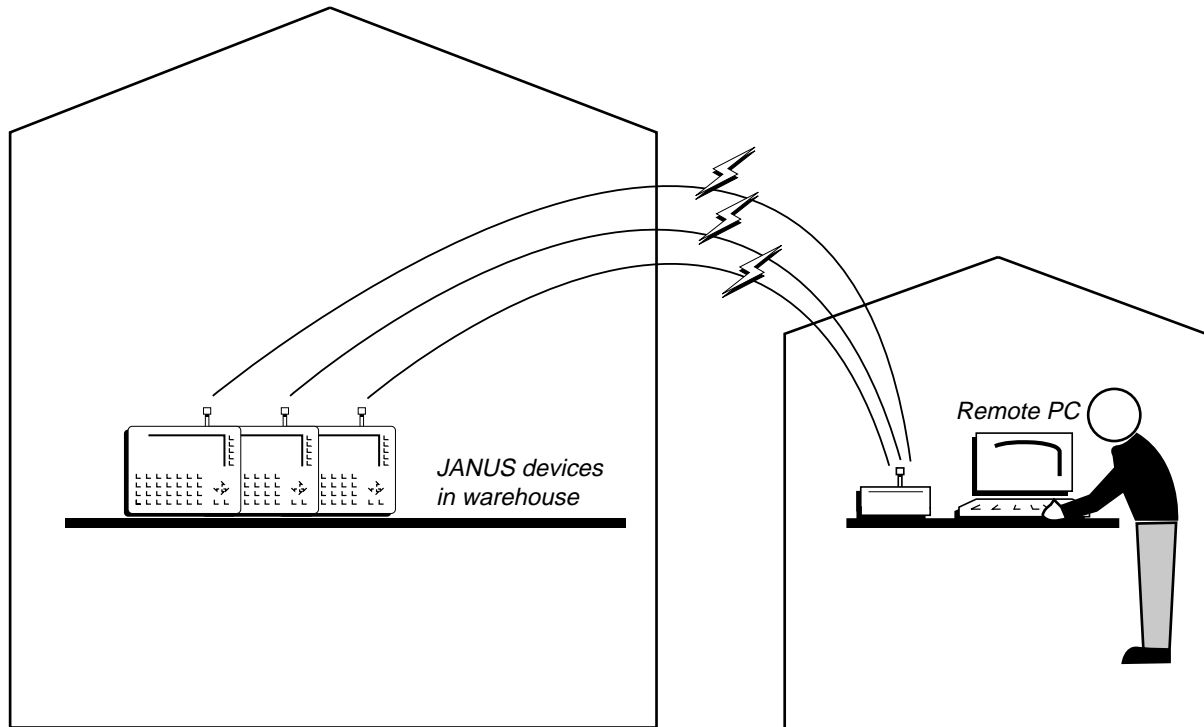

2050U.023

From a single host computer, a system administrator uses BFT to download a new version of a data collection application simultaneously (using group queues) to every device on the RF network in the warehouse while the operators are on their lunch break.

Example 2: Downloading an Executable File From a Host Computer

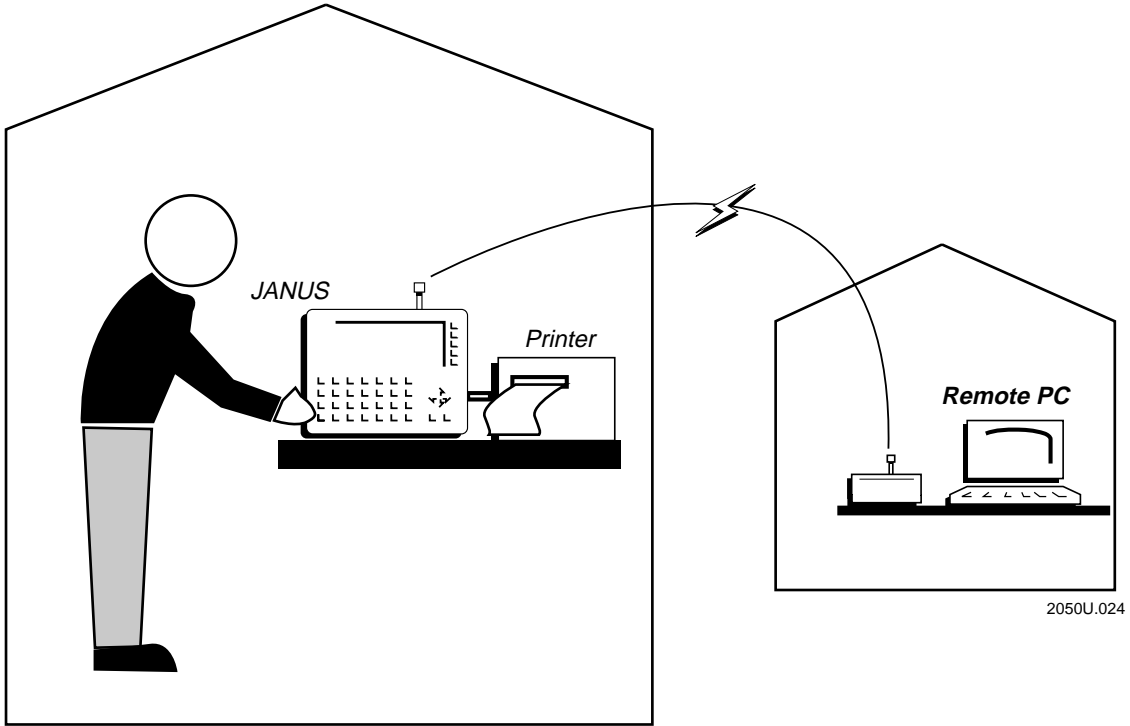

A service technician is using a JANUS device to diagnose problems with a printer in the RF network. The technician may decide to use a test application that is stored on another computer in the RF network. Using BFT, the technician can download the application to the device—without walking back to the computer, connecting the device to the host computer, and using Interlnk to transfer the application.

Examining a Typical BFT Session

A typical BFT session, with the host computer acting as the client and the JANUS device acting as the server, includes these activities:

- The host computer and devices are connected with a CrossBar or 900 MHz RF network.
- The operator starts a BFT-ready PSK application on the device and either continues working or stops working.

Note: A BFT-ready PSK application has been programmed to accept the host's Prepare for Reboot command, call a Prepare for Reboot PSK function, and notify the PSK library and host computer when the device is ready to be rebooted. For help creating BFT-ready PSK applications, see your JANUS PSK reference manual.

- From the host computer, an administrator starts the Data Collection Manager (DCM) or Interface Software (IS) application that manages the BFT process. This application sends a Prepare for Reboot command to a single device or a group of devices.
- The PSK application on the device accepts the Prepare for Reboot command, optionally performs housekeeping tasks (such as closing files), and sends a Ready for Reboot message to the host. This ensures that the host computer has received all data queued in the controllers, as well as indicates that the device is ready to be rebooted.
- The host computer sends a Reboot command to the device or devices. The device reboots, and a command in AUTOEXEC.BAT starts FTSERVER.BAT if there is a copy of FTSERVER.BAT on drive C.

FTSERVER.BAT starts the file transfer application (FTA.EXE). If FTA detects that a host computer rebooted the device to initiate a BFT session, FTA continues running. Otherwise, it terminates.

- The host computer can begin sending commands to the FTA:
 - The host computer may transfer binary files to and from the device.
 - The host computer may update the device's drive C with a 512K image.
 - The host computer may set the IM_APPLICATION DOS environment variable to an application on the device that will be run when the FTA terminates.
- When the FTA terminates, the device executes the command identified by the IM_APPLICATION DOS environment variable.

Preparing the Device and Host Computer for BFT

To take advantage of BFT, you must set up your device, host computer, and network as described in this checklist:

- Make sure the host computer and devices are connected through a CrossBar or 900 MHz RF network.

To use BFT in a CrossBar network, you must use the Multi-Drop communications protocol. You cannot, for example, use the User-Defined or Polling Mode D communications protocols.

- If you use Multi-Drop with BFT, do not set the baud rate higher than 9600 bps.

BFT transmits packets larger than 30 bytes to the device. If you set the baud rate to 19.2 kbps, the device cannot handle large incoming packets at that speed. An error condition develops: the communications application times out or waits indefinitely on a receive request, and the 9154 Multi-Drop Line Controller's fault light turns on.

- If you are using a 9180 Network Controller or 9154 Multi-Drop Line Controller, find out the version of the controller's firmware. You may need to modify the controller's asynchronous host computer parameters if the controller has an older version of firmware:

9180 If the 9180 firmware version is 2.1 or greater, you do not have to adjust the configuration to support BFT. However, if the version is less than 2.1, you must change the asynchronous host computer parameters to 8 data bits, rather than the default 7 data bits.

9154 If the 9154 firmware version is 2.6 or greater, you do not have to adjust the configuration to support BFT. However, if the version is less than 2.5, you must change the asynchronous host computer parameters to 8 data bits, rather than the default 7 data bits.

Note: *Intermec does not recommend using Binary File Transfer (BFT) to transfer large files in a CrossBar network with a 9154 Multi-Drop Line Controller.*

You can contact your Intermec service representative to learn how to order a firmware upgrade for the 9180 and 9154.

- The 9161 Multi-Drop and Port Concentrators do not support BFT.
- Create a DCM or IS application that will run on the host computer and communicate with the FTA on the device. For help creating this application, read your DCM or IS documentation.

- ❑ Enable the Prepare for Reboot and Reboot commands with the Command Processing command (\$+DC) on the device. These commands allow the device to respond when the host computer initiates a BFT session. In the default configuration, these commands are enabled. For help, see “Configuration Commands” in Chapter 10.
- ❑ Copy FTA.EXE and FTA.INI from the Application companion disk 3 to drive C on the JANUS 2050. For help adding new files to drive C, see “Learning How to Change the Contents of Drive C” in Chapter 3.
- ❑ Run a BFT-ready PSK application on the device so that when the host computer requests that the device prepare for reboot, the device can respond correctly. The PSK application must be programmed to expect the Prepare for Reboot command.

Differentiating Between Client and Server

BFT is a client/server application, and you must decide which device (host computer or device) is to be the client or server. The difference between client and server is a simple one: the client is the device from which you enter all commands. In this example, the host computer is the client:

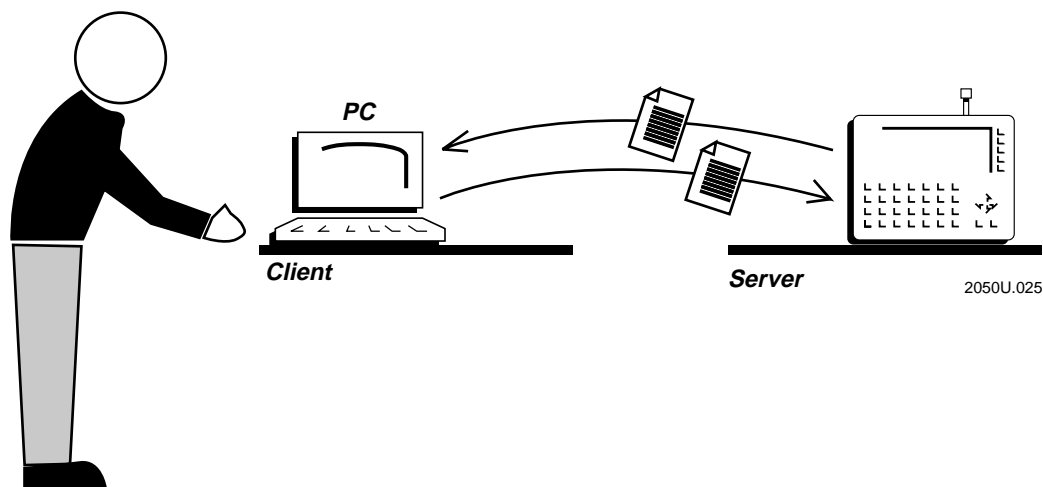

The way you start the FTA on the device determines whether the device will be the client or server.

To make the device the client

1. Type this command at the device's DOS prompt to start the FTA:
fta
2. Type this command at the FTA prompt to open a BFT session:
open
3. From the device, type the commands to transfer binary files or update the device's drive C.

To make the device the server

There are two ways to make the device the server:

1. Type this command at the device's DOS prompt to start the FTA:
fta
2. Type this command at the FTA prompt to make the device the server:
server
3. From the host computer, type the commands to transfer binary files or update the device's drive C.

Or,

1. Send the Prepare for Reboot command from the host computer to start the FTA on the device.
2. When you receive the Ready For Reboot message from the device, send the Reboot command from the host computer to the device. This command reboots the device and opens the BFT session.
3. From the host computer, type the commands to transfer binary files or update the device's drive C.

Note: Because you cannot display the server's directories from the client, you must already know where each target file is located on the server.

Starting an Application When the FTA Terminates

When the host computer is the client, the host computer can identify an application that will be started automatically on the device when the FTA is terminated on the device.

For example, you finish transferring binary files to the device, close the connection between the host computer and device, and terminate the FTA on the device. Next, you may want to restart the PSK application that was running on the device when the host computer issued the Prepare for Reboot command.

To automatically start an application when the FTA terminates

1. From the host computer, issue a command that sets the device's DOS environment variable `IM_APPLICATION` to an application on the device. For help, see your DCM or IS documentation.
2. Terminate the FTA on the device. The `%IM_APPLICATION%` command in the device's `AUTOEXEC.BAT` executes, running the specified command on the device. For help, see "Defining the Startup Files" in Chapter 3.

Using FTA Commands on the Device

When the device is the client, you can use these FTA commands:

CHECKHOST	LUPGRADE
CLOSE	OPEN
EXIT	PUT
GET	RUPGRADE
HELP	SERVER

Typing FTA Commands on the Device

You can use the FTA commands on the device by:

- typing a command at the FTA prompt. (The FTA prompt appears when you run the FTA by typing `fta` at the device's DOS prompt.)
- typing one or more commands in a batch file.
- typing one or more commands on the DOS command line. Use a semicolon (;) between each command. For example, type this command and press  to open an FTA session, get a file from the host, and exit the session:

```
e:\> fta o; g filename; e
```

where *filename* is the path and name of the file to be transferred.

Learning the Syntax of FTA Commands

This section describes each FTA command and its syntax. You can abbreviate the command names as shown in the Syntax column of the next table. Also, you do not have to capitalize the commands; the commands are not case sensitive.

FTA Command Descriptions and Syntax

Command	Description	Syntax
CHECKHOST	Checks if the host computer rebooted the device and is ready to proceed with the device as the server and the host computer as the client. You can type this command only from the device's DOS command line.	<p>ch [<i>port</i>]</p> <p>where:</p> <p><i>port</i> is the COM port for the connection. If you do not specify a port, the application uses the first port with an active protocol handler.</p>
CLOSE	Terminates the connection with the host computer. You can abbreviate this command as CL.	c
EXIT	Terminates the FTA program and returns you to the DOS prompt on the device.	e
GET	Copies a file from the host computer to the device.	<p>g <i>hfile</i> [<i>rfile</i>]</p> <p>where:</p> <p><i>hfile</i> is the path and filename of the file to be transferred from the host computer to the device.</p> <p><i>rfile</i> is the destination path and filename on the device. If you do not specify a <i>rfile</i> name, the <i>hfile</i> name is used.</p>
HELP	Displays a description of the FTA commands, syntax, and parameters.	h
LUPGRADE	Upgrades the device's drive C from the device. Stands for "local upgrade."	<p>l <i>file</i> c</p> <p>where:</p> <p><i>file</i> is the path and filename of the image file on the JANUS device, and C is the drive to be updated.</p>

FTA Command Descriptions and Syntax (continued)

Command	Description	Syntax
OPEN	Establishes a connection with the host computer.	o [<i>port</i>] where: <i>port</i> can be the COM port for the connection. If you do not specify a port, the application uses the first port with an active protocol handler. Once a connection is open, you can type other FTA commands or type <input type="checkbox"/> to exit.
PUT	Copies a file from the device to the host computer.	p <i>rfile</i> [<i>hfile</i>] where: <i>rfile</i> is the path and filename of the file to be transferred from the device to the host. <i>hfile</i> is the destination path and filename on the host. If you do not specify an <i>hfile</i> name, the <i>rfile</i> name is used.
RUPGRADE	Upgrades the device's drive C from the host. Stands for "remote upgrade."	r <i>file</i> c where: <i>file</i> is the path and filename of the image file on the host computer, and C is the drive to be upgraded.
SERVER	Identifies the device as the server, not the client. You will type all subsequent FTA commands at the host.	s [<i>port</i>] where: <i>port</i> is the COM port for the connection. If you do not specify a port, the application uses the first port with an active protocol handler.

Editing the FTA Initialization File

The FTA initialization file (FTA.INI) controls how the FTA operates. You may need to modify INI parameters to match the timeouts with the speed of your network. You can use a standard ASCII text editor to edit the file. This table describes the parameters in the default FTA.INI file, which is stored on Application companion disk 3:

Parameter in FTA.INI	Description
HostOpenSessionTimeout=10000	Milliseconds FTA waits for the host to respond to an open session request in which the device is the client.
HostStartServerTimeout=10000	Milliseconds FTA waits for the host to respond to an open session request in which the device is the server.
ReceiveRecordTimeout=10000	Milliseconds FTA waits for the host to send the next data record while downloading a file to the device.
StartUploadTimeout=10000	Milliseconds FTA waits for the host to respond to a request to begin uploading a file from the device.
StartDownloadTimeout=10000	Milliseconds FTA waits for the host to respond to a request to begin downloading a file to the device.
HostServerReadTimeout=10000	Milliseconds FTA waits for the host to send a command to the device when the host is the client.
HostClientReadTimeout=65535	Milliseconds FTA waits for the host to send a command to the device when the host is the server.
SendRecordTimeout=10000	Milliseconds FTA waits for the device to transmit a record to the host.
JobRecoverAttempts=1	Number of times FTA attempts to recover a session with the host after that session has been lost.
EndTransmitTimeout=65535	Milliseconds FTA waits for the host to acknowledge that a file upload is complete.
TransmitResponseDelay=5000	Milliseconds FTA allows to elapse before it starts to upload a file from the device to the host after the host sent the command to begin uploading the file.
ClearChannelTimeout=10000	Milliseconds FTA waits for data when the communications channel is being cleared.



Working With IRL

This chapter provides an overview of Intermec's Interactive Reader Language (IRL). It includes information on using the IRL Desktop on the JANUS 2050 and differences in IRL that are exclusive to the JANUS 2050. Use this chapter in conjunction with the IRL Programming Reference Manual or the PC-IRL Reference Manual. These manuals provide information on creating IRL programs.

What Is IRL?

Interactive Reader Language (IRL) is a high-level programming language used to develop custom application programs for the JANUS 2050. Using IRL, you can program the JANUS 2050 to display messages that prompt the operator for information and provide feedback.

IRL programs are stored as text files on the JANUS 2050 drives or on the host computer. They can be created in any DOS-based text editor and saved as an ASCII text file. IRL features include:

- backward compatibility with previous versions of IRL.
- creation by integrated tools or PC-IRL.
- advanced bar code input capabilities.
- automatic and transparent power management.
- efficient memory use.
- simple and easy to use, for rapid application development.

IRL programs can be written directly on the JANUS 2050 or on a PC and then downloaded to the JANUS 2050. Intermec recommends that you write the programs on a PC and download them to the JANUS 2050. Intermec developed PC-IRL to help write IRL programs on an IBM-compatible PC. PC-IRL also downloads IRL programs to the JANUS 2050 using Polling Mode D protocol.

Using IRL on the JANUS 2050

The IRL operating environment on the JANUS 2050 is called the IRL Desktop. The IRL Desktop is a menu-driven application that lets you download IRL programs, transmit files, receive files, and execute IRL programs.

Working With Files

Because IRL version 4.0 uses the DOS file structure, you can store more than one IRL program on the JANUS 2050. You should exercise care in naming and using data files, since you can use the same data file for multiple programs. If more than one program uses the same data file, your data may be overwritten when the next program is run.

Disk space, not internal memory, limits the size of the data files. If insufficient disk space exists when the program begins to fill the data files, an error message is given and the program terminates execution.

Files may be dimensioned or undimensioned. An undimensioned file has the same characteristics as the default data file (file 0) in that only actual data is stored. Opening an existing dimensioned data file with different dimensions generates an error message. If a data file is opened but no data is entered when the program ends, the data file is deleted.

All IRL program filenames must end with the extension .IRL, and all IRL data filenames must end with the extension .IRD. Otherwise, the IRL Desktop does not recognize them. The default filenames are as follows:

{IRL-0}.IRD	IRL default data file (file 0)
{IRL-1}.IRL	IRL default program file (file 1)
{IRL-A}.IRD	IRL data file A
•	
•	
•	
{IRL-Z}.IRD	IRL data file Z

These files continue to be accessed as 0, 1, and A through Z in the IRL commands as they have in previous versions of IRL. You can read from and write to File 0. The default program {IRL-1}.IRL is executed when you scan the Run Program bar code label or download the command from the host computer. When you use the IRL Desktop, you can select which program to execute.

Specifying Data and Program Paths

The directory that is current when the IRL Desktop is run becomes the path for the data and program files. An exception is if the current drive is C or D. In this case, the first drive the JANUS 2050 can write to becomes the path. You can change the directory or view the current paths using the menus in the IRL Desktop.

You can specify a default directory path for your IRL program and data files in your AUTOEXEC.BAT file. This feature lets you control where files are stored. To specify the default path, include the following lines in your AUTOEXEC.BAT file.

To set the path for IRL programs

- Enter the following command:

```
set IM_IRLPROG=[drive][directory]
```

To set the path for IRL data files

- Enter the following command:

```
set IM_IRLDATA=[drive][directory]
```

If you set IM_IRLDATA path to a drive that cannot be written to, the JANUS 2050 defaults to drive G if a PC card is present; otherwise, it writes to drive E.

Data paths can also be specified in the IRL program by declaring the path in the open statement for files A through Z. File 0 is the only file that cannot have its path specified in an IRL program.

Using the Desktop

You can use the IRL Desktop to transfer and execute IRL programs. To open the IRL Desktop from the DOS prompt, type:

```
irl
```

Then press .

Or scan the bar code:



IRL

If you want to load a protocol handler for a designated port and execute the IRL Desktop, you can include an argument in the command line. To load a protocol handler, enter the following command at the JANUS 2050 DOS prompt:

```
irl -[ {port} ] {ph}
```

where:

port indicates the port for which you are loading the protocol handler. Use **1** to load the protocol handler for COM1.

ph is the notation for the protocol handler you want to load. Use **i** for the Intermec protocol handler. Use **p** for the PC standard protocol handler.

For example, to load the Intermec protocol handler on COM1 and execute the IRL Desktop, enter the following command at the JANUS 2050 DOS prompt:

```
irl -li
```

In the menu bar, there are two pull-down menus:

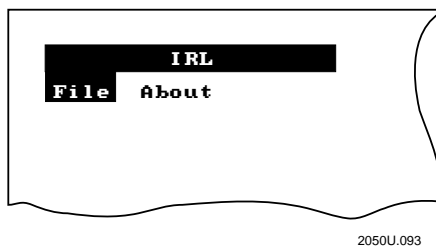

File Select the File menu to transfer files, change directories, review file status, and begin executing an IRL program. You quit the IRL Desktop by choosing Exit from this menu.

About Lists the amount of RAM and disk space available and displays your current directory.

The commands listed in the File menu are described next:



Run Executes the selected IRL program.

Resume Resumes running a program that was previously halted.

Directory Lists all IRL files in the current directory.

Change Dir Changes the current drive and directory.

File Stats Indicates if the selected data file is dimensioned or undimensioned and the number of records entered. If the file is dimensioned, it will also list the dimensions.









Clear Data Deletes the default IRL data files {IRL-0}.IRD, {IRL-A}.IRD to {IRL-Z}.IRD. Data files that you specifically create are not deleted.

Receive Stores the file it receives from the designated communications port under the selected filename.

Transmit Transmits the selected file through the designated communications port.

Exit Exits the IRL Desktop.

To move around in the menus and select commands

- To select a menu in the menu bar, press ◀ or ▶ to move the highlight to the desired menu. To view the pull-down menu, press  or ▼.
- When a pull-down menu is displayed, select a command by pressing ▲ or ▼ to move the highlight to the desired command. Then press  to choose the command.
- The dialog boxes list the options for that menu. When a dialog box is displayed, press ▲ or ▼, or  or  to move the highlight to the desired field. In dialog boxes that contain a list of filenames, highlight the file you want to execute and press  to execute the file.
- Highlight the OK button and press  to exit the dialog box and save the changes.
- Highlight the CANCEL button and press  to exit the dialog box without saving the changes.
- To exit the IRL Desktop, select Exit in the File pull-down menu and press .

You can scan the bar code labels listed in Appendix A to move the cursor through the configuration menus instead of pressing keys.

Using Commands in the IRL Desktop

In addition to choosing a command from the desktop, you can also scan a bar code label or download the command from the host computer. You must be in the IRL Desktop to execute the commands listed in the following pages.

Starting an IRL Program

To run an IRL program from the IRL Desktop, do one of the following:

- Choose the Run command from the File menu. The Run dialog box displays a list of program files in the current directory. Use the ▲ ▼ keys to highlight the program you want to run and press .
- End an IRL program download with the RUN command (//) from the host computer.
- Enter the RUN command from the host computer, or scan the bar code label.

From the host computer, enter the command:

//

Or, scan the following label:

Run Program



//

The program begins at the first program statement. The IRL Desktop executes the default file named {IRL-1}.IRL when you scan the Run bar code or enter the Run command from the host computer.

Note: If you need more memory to run your IRL program, you can execute an IRL program without the IRL Desktop using IRLXDESK.EXE. To use IRLXDESK, you need to load it on one of the JANUS 2050 drives from companion disk 3. Once it is loaded on the JANUS 2050, enter the following command to begin executing your IRL program:

```
irlxdesk filename
```

When you execute IRLXDESK, none of the protocol handlers are automatically loaded.

If there are any syntax errors, the JANUS 2050 emits three low pitched beeps and the desktop displays the line number(s) of the errors along with a message describing the error(s). Correct the program and run it again. During a syntax check, OK and Cancel buttons are displayed along with any error messages. Choose OK to continue the syntax check. Choose Cancel to terminate it.

If you switch the JANUS 2050 off when an IRL program is running, it will resume running when the JANUS 2050 is turned on again.

Exiting an IRL Program

To exit an IRL program when the IRL desktop is open, do one of the following:

- Include the IRL Exit command (E) with a modifier in the program statements.
- Enter an Exit IRL command (/S) from the host computer.
- Scan the following label:

Exit IRL Program



/S

The program completes any housekeeping functions, such as closing open files, and returns to the calling function whether it is the IRL Desktop or DOS.

- Enter the application break sequence from the keypad to break out of an IRL program that is locked in an infinite loop.
 1. Press the I/O button to turn off the JANUS 2050.
 2. Press F3 - 2 - \blacktriangleleft simultaneously.
 3. Press 1 to set the application break bit in the JANUS 2050.
 4. Press the I/O button to turn on the JANUS 2050. The program will not resume running. You can resume normal operation.

Downloading an IRL Program

To download an IRL program, send a Start of Program <SOP> character followed by the program to be downloaded from the host computer.

The <SOP> character can be set in the JANUS 2050's configuration. The default is <SI>.

The file is stored as the default IRL program named, {IRL-1}.IRL. If there is an {IRL-1}.IRL program already in the same directory, it is overwritten. If an error is detected, an error message is displayed and control is returned to the IRL Desktop. You can also use PC-IRL, Collect, DCM/2, DFM, or Interscan to download IRL programs. For more information on downloading IRL programs from the host computer to the JANUS 2050, see the *PC-IRL Reference Manual*.

Transmitting IRL Files

To transmit an IRL program or data file, do one of the following:

- Choose Transmit from the IRL Desktop File menu.
- Enter an IRL Transmit File command from the host computer, or scan the bar code label.

From the host computer, enter the command:

`%%filename`

where *filename* can be any character from A to Z, 0, or 1.

Or, scan the following label:



The Transmit dialog box displays a list of all of the files. Select the file to be transmitted and press .

For more information on transmitting IRL programs and files from the host computer to the JANUS 2050, see the *PC-IRL Reference Manual*.

Receiving IRL Files

To receive a file from the host computer and store it under a specified filename, do one of the following:

- Choose Receive from the IRL Desktop File menu.
- Enter an IRL Receive File command from the host computer, or scan the bar code label.

From the host computer, enter the command:

```
.%filename
```

where *filename* can be any character from A to Z, 0, or 1.

Or, scan the following label:

Receive File



.%

The Receive dialog box is displayed. Enter the filename to be received.

For more information on receiving IRL files from the host computer, see the *PC-IRL Reference Manual*.

Clearing IRL Files

To delete one or all of the IRL data files with default filenames {IRL-0}.IRD and {IRL-A}.IRD to {IRL-Z}.IRD when the IRL Desktop is open, do one of the following:

- Choose Clear Data from the IRL Desktop File menu. A message stating the data files will be deleted is displayed. Press  to delete the files.
- Enter an IRL Clear File command from the host computer:

```
.$filename
```

where *filename* can be any character from A to Z, or 0. If you do not include a filename, all files are deleted.

- Or, scan one of the following labels:

Clear All IRL Data Files



.S

Clear {IRL-0}.IRD



.S0

Clear{IRL-A}.IRD



.SA

Clear{IRL-B}.IRD



.SB

Clear {IRL-C}.IRD



.SC

Clear {IRL-D}.IRD



.SD

Note: You can create bar code labels to delete {IRL-E}.IRD through {IRL-Z}.IRD.

When you scan the Clear All IRL Data Files command, a message lists the data files to be deleted as well as the directory where the files are located. Choose OK to delete the data files.

If you choose to clear one data file, IRL deletes the file without displaying the message or prompt.



Caution

When the clear file command is sent from the host without data, all data is cleared and all files are deleted.

Conseil

Lorsque la commande d'effacement de fichier (clear file) est envoyée de l'hôte sans préciser les données à effacer, toutes les données sont effacées et tous les fichiers sont supprimés.

Types of Error Messages

When an error occurs, the JANUS 2050 responds by emitting an error beep and displaying an error message. Press  to clear the message and continue. The types of messages are:

Receive error This error occurs when the JANUS 2050 is receiving a message or protocol characters from the host.

Transmit error This error occurs when the JANUS 2050 is transmitting a message or protocol characters to the host.

Syntax error This error occurs when the JANUS 2050 does a syntax check on a program before running the program. If a program statement is invalid, the error message lists the program statement and the problem. Edit the program for syntax errors and run it again.

Runtime error This error occurs when the JANUS 2050 is executing a program. The program ignores nonfatal errors. If it is a fatal error, the JANUS 2050 exits the program and returns to the IRL Desktop or DOS prompt.

The following table lists the error beep sequences and their meanings.

Sequence	Meaning
LLL	Syntax or compile error
LHL	Nonfatal runtime error
HHH	Fatal runtime error

L=low beep H=high beep

Resuming IRL Programs

You can exit an IRL program, perform other functions with your JANUS 2050, and then resume the IRL program exactly where you left off. Other functions you can perform before resuming the program include executing DOS commands, running other IRL programs, and putting the JANUS 2050 in suspend mode.

Exiting a Program So You Can Resume It Later

You will be able to resume an IRL program later if you exit it using one of these methods:

- The Exit IRL command
- An application break sequence
- The ED command (The E command has a D modifier, which instructs IRL to exit to DOS.)

You can exit multiple programs that can all be resumed later. IRL creates a separate FILENAME.RSM file in the current data path directory for each program (where FILENAME is the corresponding program name). The .RSM file contains parameters that allow IRL to resume the program exactly where you left off. The .RSM file is deleted when you run or resume the program.

IRL also saves the name of the last program that was exited as described previously into the {LATEST}.RSM file. Every time IRL saves the filename to this file, it overwrites the last filename; therefore, the file always identifies the last IRL program that can be resumed. This file is deleted when you run or resume the program.

Exiting Directly to DOS

The E command has a modifier, D, that is used to exit an IRL program, bypass the IRL Desktop, and go directly to DOS.

IRL sets the exit code to a nonzero value if the ED command caused the program to exit to DOS. IRL sets the exit code to zero if the program is terminated normally. You can create a batch file using the exit code to determine if the JANUS 2050 exited an IRL program and returned to DOS.

The Exit IRL command and the application break sequence return to the IRL Desktop. You can resume the program from the DOS prompt or from the IRL Desktop as described next.

Resuming a Program From the DOS Prompt

To resume an IRL program from the DOS prompt, type a command that follows this syntax:

```
irl -rX filename
```

where -r instructs IRL to resume, X is the value to be placed into the status register (#0), and *filename* is the name of the program.

Note: Make sure there is no space between the -r and X, or the value will not be placed into the status register (#0).

You can omit parts of the irl -rX *filename* command:

- If you do not include the -r argument, IRL starts the program from the beginning and deletes the .RSM file.
- If you do not supply an X value for the status register, IRL sets the register to 0. If the value you supply is invalid, IRL sets the register to 999999999. IRL sets the status register only when the ED command is issued.
- If you do not specify a *filename* and you do include the -r, IRL resumes the last program exited, as identified in the {LATEST}.RSM file.

Resuming a Program From the IRL Desktop

You can choose the Resume command from the File menu and select a program to resume.

You can also scan the IRL Program, Resume command (\$.) from the IRL Desktop:

IRL Resume



\$.

Using the IRL Z Command

To execute JANUS 2050 commands from an IRL program, use the IRL Z command. When the IRL program reaches a Z command, it is executed and the program continues with the next program statement. If the Z command is not valid, nothing will happen. The JANUS 2050 commands that can be executed in IRL are shown in the following table.

Command	IRL Z Command
Change configuration	Z"\$+command"
Backlight control	Z"%data"
Laser on	Z"/."
Laser off	Z"/%"
Protected field	Z"\x09message"
Set clock	Z"/+ time"

Descriptions of these commands are included in Chapter 9, "Command Reference."

The change configuration command allows you to change any of the JANUS 2050 configuration settings. For example, if you wanted to set the beep volume to high (BV4) in an IRL program, the command is:

```
Z "$+BV4 "
```

Note: \$- is not required but is supported at the end of change configuration commands for backward compatibility.

For a description and syntax of the configuration commands that the JANUS 2050 supports, see Chapter 10, "Configuration Commands."

Note: U and V without an Edit (E) modifier do not parse for JANUS 2050 commands. The two exceptions are when Set Clock or Exit Program are sent from the host computer.

IRL File, Clear

Purpose: Delete one or all of the IRL data files with default filenames: {IRL-0}.IRD and {IRL-A}.IRD to {IRL-Z}.IRD.

From host: *.\$filename*

where *filename* is 0 or any character from A to Z. If you do not include a filename, all IRL data files (0, A to Z) are deleted.



Caution

When the clear file command is sent from the host computer without data, all data is cleared and all files are deleted.

Conseil

Lorsque la commande d'effacement de fichier (clear file) est envoyée de l'hôte sans préciser les données à effacer, toutes les données sont effacées et tous les fichiers sont supprimés.

Keypad: Use the Clear Data option on the File menu.

IRL command: Not supported

Scan: Or, scan one of the following labels.

Clear All IRL Data Files



.\$

Clear {IRL-0}.IRD



.\$0

Clear{IRL-A}.IRD



.\$A

Clear{IRL-B}.IRD



.\$B

Clear {IRL-C}.IRD



.\$C

Clear {IRL-D}.IRD



.\$D

Note: You can create bar code labels to delete {IRL-E}.IRD through {IRL-Z}.IRD.

When you scan the Clear All IRL Data Files command, a message lists the data files to be deleted as well as the directory where the files are located. Choose OK to delete the data files.

If you choose to clear one data file, IRL deletes the file without displaying the message or prompt.

IRL File, Receive

Purpose:	Accepts a file from the host computer and saves it under the specified filename. If the filename is not included, the JANUS 2050 will display the Receive screen, which allows you to select a COM port and a filename.
From host:	.% <i>filename</i>
Keypad:	Use the Receive option on the File menu.
IRL command:	Not supported
Scan:	Receive IRL File  *.*

IRL File, Transmit

Purpose:	Sends the specified file to the host computer. If the filename is not included, the JANUS 2050 will display the Transmit screen, which will list all .IRL and .IRD files in the current directory.
From host:	%% <i>filename</i>
Keypad:	Use the transmit option on the File menu.
IRL command:	Not supported
Scan:	Transmit IRL File  *%%*

IRL Program, Download

Purpose:	Downloads an IRL program from the host computer. The <SOP> character can be set in the JANUS 2050's configuration. The default is <SI>. The default IRL program filename is {IRL-1}.IRL. If there is an {IRL-1}.IRL program already on the JANUS 2050, it is overwritten.
From host:	<SOP>
Keypad:	Not supported
IRL command:	Not supported
Scan:	Not supported

IRL Program, Exit

Purpose:	Exits an executing IRL program.
From host:	/\$
Keypad:	Not supported (Refer to application break sequence information earlier in this chapter.)
IRL command:	Not supported
Scan:	Exit Program  */\$*

IRL Program, Resume

Purpose: Resumes execution of a suspended IRL program.

From host: \$.

Keypad: Use the Resume option on the File menu.

IRL command: Not supported

Scan: IRL Resume

\$.

IRL Program, Run

Purpose: Executes the default IRL program named {IRL-1}.IRL.

From host: //

Keypad: Use the Run option on the File menu.

IRL command: Not supported

Scan: Run IRL Program

//

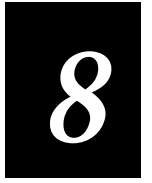

Troubleshooting

This chapter lists problems that may occur when you operate the JANUS 2050 and provides possible solutions to those problems. It also provides different options for resetting the JANUS 2050, and describes how to save data and update flash memory.

Troubleshooting the JANUS 2050

If you have problems operating the JANUS 2050, review the following tables listing problems and their possible solutions. Problems are grouped into common areas for easier reference. For example, problems you might see while running an IRL program are grouped in one table.

Powering Up or Booting the JANUS 2050

This table lists problems that may occur when turning the JANUS 2050 on or off, or when booting the JANUS 2050.

Problem

When you turn on or cold boot the reader, the Boot Loader menu appears. The menu may not list all the Boot Loader commands, and the screen may include a status message. For example, the partial Boot Loader menu may look like this:

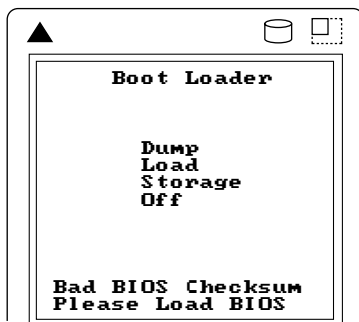

20X0A.003

Solution

The bootstrap checks the system flash when doing a resume or cold boot. If the system flash is corrupt or there are bad checksum error messages, it brings up the Boot Loader menu. Read the status messages at the bottom of the menu.

If you see “Bad BIOS Checksum” or a message that indicates the system flash is corrupt, you could save the contents of conventional memory using the Dump menu selection, but you must reload the system flash.

If the system flash memory is corrupt, you can dump memory and reload the system flash. For more information about reloading flash memory, see “Saving Data and Loading Flash Memory” later in this chapter.

Powering Up or Booting the JANUS 2050 (continued)

Problem

Other Boot Loader menu messages may look like this:

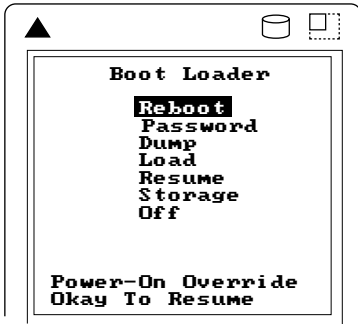

20X0A.001

Solution

If you see "Bad Saved State," the device may have been in Storage mode. Press to reboot. If you are prompted to exit Storage mode, press again.

You may also see the "Bad Saved State" message if you press to suspend the device while it is booting. Press to reboot the device. You may be able to save the contents of the physical RAM drive.

Other self-explanatory messages may display on bottom of the Boot Loader menu.

For messages in the following group, choose Reboot on the Boot Loader menu and press .

- "System Has Reset
Please Reboot"
- "Bad CMOS Checksum, Errors
Please Reboot"
- "DRAM Check Failed
Please Reboot"

For the messages in the following group, choose Resume or Reboot on the Boot Loader menu and press .

- "Keypad Fault Found
Okay to Resume"
- "Power-On Override
Okay to Resume"
- "Power-Off Timeout, Errors
Okay to Resume"
- "Power-Off Forced
Okay to Resume"

Powering Up or Booting the JANUS 2050 (continued)**Problem**

During a warm boot, the JANUS 2050 cannot finish booting and displays an error message.

Solution

If you press a key (especially the Ctrl, Alt, Shift, Caps Lock, or Compound function keys) before the JANUS 2050 has finished booting, you may see the message, “FA Keyboard Error, Press F1 or F2.” Press **F2** to exit the error screen and the JANUS 2050 will continue booting.

If the JANUS 2050 appears to be locked up, press **q** to suspend the JANUS 2050. When you turn the JANUS 2050 back on, the Boot Loader menu displays the message, “Bad Saved State.” Press **enter** to reboot the JANUS 2050.

**Caution**

Do not press any keys while the JANUS 2050 is performing a warm boot or you may lose data.

Conseil

N'appuyez pas sur des touches pendant que le lecteur se réamorce, sinon vous pouvez perdre des données.

When the JANUS 2050 is turned on, it goes to the Boot Loader menu.

If the JANUS 2050 was in storage mode, it will display a “Bad Saved State” message. Press **enter** to reboot the JANUS 2050. When the next screen is displayed, press **enter** again to exit storage mode.

You can also see the “Bad Saved State” message if you press the **⌘** key to suspend the JANUS 2050 while it is booting. Press **enter** to reboot the JANUS 2050.

**Caution**

When the JANUS 2050 performs a cold boot, all data on the RAM disk is destroyed.

Conseil



Lorsque le lecteur s'amorce à froid, les données se trouvant sur le disque RAM sont détruites.

Powering Up or Booting the JANUS 2050 (continued)

Problem

The JANUS 2050 does not turn off when you press the  button.

Solution

The JANUS 2050 is locked up. Press  -  -  to turn off the JANUS 2050. When you turn the JANUS 2050 on, the JANUS 2050 displays the Boot Loader menu. From the menu, you can try dumping memory to a host computer or you can do a cold boot.



Caution







When the JANUS 2050 performs a cold boot, all data on the RAM disk is destroyed.

Conseil

Lorsque le lecteur s'amorçe à froid, les données se trouvant sur le disque RAM sont détruites.

Operating the JANUS 2050

The next table lists problems that may occur when operating the JANUS 2050. For example, if you have problems entering or scanning data, some possible solutions are listed in the following table.

Problem	Solution
You cannot tell if the numeric keypad is enabled or disabled.	<p>You can check if the numeric keypad is enabled or disabled by entering the shift character on a numeric key. For example, if you press   and the JANUS 2050 displays:</p> <p>% The numeric keypad is disabled.</p> <p>5 The numeric keypad is enabled and the Num Lock is turned on.</p> <p>nothing The numeric keypad is enabled and the Num Lock is turned off.</p>
JANUS 2050 commands are not working properly.	<p>The JANUS 2050 commands are disabled. Scan the Enable Override command shown below to temporarily enable all of the JANUS 2050 commands. You can also enable or disable JANUS 2050 commands in the configuration application (IC.EXE) program.</p> <p>Enable Override</p>  <p>*\$+DC3*</p>
Bar code labels will not scan.	Refer to “Scanning Bar Code Labels” later in this chapter.
The JANUS 2050 beeps every 10 seconds and cannot be turned off when you press the  button.	The JANUS 2050 is locked up. Press  -  -  simultaneously to turn off the JANUS 2050. When you turn the JANUS 2050 on, it displays the Boot Loader menu. Reboot the JANUS 2050.
The JANUS 2050 decodes a bar code label in a symbology other than the label’s actual symbology.	Try scanning the bar code label again. Make sure you scan the entire label. When multiple symbologies are enabled, the JANUS 2050 may decode bar code labels in a symbology other than the label’s actual symbology. Only enable the JANUS 2050 to decode the bar code symbologies that you are using.

Operating the JANUS 2050 (continued)

Problem

The user-application program is not receiving the bar code input properly.

Solution

Reader Services may have been unloaded. Verify that the command IF EXIST D:\RDG.BAT CALL D:\RDG.BAT is listed in the AUTOEXEC.BAT file, and then perform a warm boot to reload Reader Services. If Reader Services is not loaded, the JANUS 2050 will not read the label at all.







Caution

Do not press any keys while the JANUS 2050 is performing a warm boot or you may lose data.

Conseil

Lorsque le lecteur s'amorçe à froid, les données se trouvant sur le disque RAM sont détruites.

You want to return to the default (out of the box) condition.

Load the default configuration from the configuration application (IC.EXE). At the DOS prompt, type the command `ic` and press . Using the arrow keys, choose File on the main menu and press . In the File drop-down menu, choose Load Default and press . To exit the configuration application, choose Exit and press .

The JANUS 2050 may sound an error beep and display an error message such as "Bad command or filename" when you attempt to scan a bar code label that contains a valid configuration command. Or, the JANUS 2050 may reject configuration commands sent over an RF link.









Make sure the Configuration Manager TSR is loaded into the JANUS 2050's memory. A JANUS 2050 accepts configuration commands only if the TSR is loaded.

To load the Configuration Manager TSR, type the following command and press .

```
cfgmgr
```

Running IRL

This table lists problems that may occur when you run IRL programs on the JANUS 2050. For more information, see Chapter 7, “Working With IRL.”

Problem	Solution
<p>The JANUS 2050 displays “Executing...” on power up or prompts you for data on power up.</p>	<p>An IRL program is running. Enter or scan the Exit IRL program command shown below.</p> <p>Exit IRL Program</p>  <p>*/S*</p>
<p>There is not enough memory to run your IRL program.</p>	<p>Use IRLXDESK.EXE to execute the IRL program without the IRL Desktop. You need to load IRLXDESK.EXE onto one of the JANUS 2050 drives from the Boot companion disk. Once it is loaded on the JANUS 2050, type the following command and press .</p> <pre>irlxdesk filename</pre> <p>No protocol handlers are loaded.</p>
<p>The JANUS 2050 is locked up in an IRL program.</p>	<p>To break out of the IRL program, execute the application break sequence:</p> <ol style="list-style-type: none"> 1. Press the  button to turn the JANUS 2050 off. 2. Press  -  - . 3. Press . 4. Press the  button to turn the JANUS 2050 on.
<p>The JANUS 2050 displays “Insufficient memory” when you try to run an IRL program from the IRL Desktop (IRLDESK.EXE).</p>	<p>You may be able to free up more conventional memory by following the suggestions in “Making More RAM Available on the JANUS 2050” in Chapter 11, “Advanced Operations.”</p> <p>Use the IRLXDESK utility, instead of the IRL Desktop, to run the IRL program. IRLXDESK uses less conventional memory than the IRL Desktop and does not provide the IRL Desktop menu environment.</p>

Using PC Cards

This table lists problems that may occur when you use a PC card in the JANUS 2050.

Problem

The JANUS 2050 beeps twice when you insert a card in the PC card drive.

The JANUS 2050 locks up when you are accessing a PC card in drive G while using Interlnk/Intersvr.

The JANUS 2050 locks up frequently when you are accessing the PC card in the PC card drive.

You are trying to access the JANUS 2050 PC card drive and you see the message "Invalid media type reading drive G."

You are trying to access the JANUS 2050 PC card drive and you see the message, "Not ready reading drive G. Abort, Retry, Fail?"

You are trying to access the JANUS 2050 PC drive and you see the message, "Bad command or file."

Solution

The JANUS 2050 cannot read the PC card in drive G. You need to format the PC card.

You cannot access a flash card in the JANUS 2050 PC card drive if you are running Interlnk on the host computer. Run Interlnk on the JANUS 2050 and Intersvr on the host computer if you want to access a flash card in the JANUS 2050 PC card drive.

The PC card may not be formatted correctly. If you formatted the PC card on your PC or host computer, try formatting the card in the JANUS 2050 PC card drive.

Press **A** to abort. The JANUS 2050 cannot read the PC card in the drive. Use the CARDINFO utility to verify the type of card you are using (ATA, flash, I/O, or SRAM).

Check the JANUS 2050 CONFIG.SYS file. Make sure you have the correct drivers installed for the type of card you are using. Format the PC card.

Press **A** to abort. The JANUS 2050 cannot read the PC card in the drive. Use the CARDINFO utility to verify the type of card you are using (ATA, flash, I/O, or SRAM).

Check the JANUS 2050 CONFIG.SYS file. Make sure you have the correct drivers installed for the type of card you are using. Format the PC card.

You may also see this message if you are using the Substitute command and you do not have a PC card in the PC card drive. Insert a PC card in each drive and try using the Substitute command again.

Check the command you entered and make sure it is a valid command. Try entering the command again.

Using PC Cards (continued)

Problem

You hear the JANUS 2050 sound a single low tone beep when you insert a PC card in the PC card drive.

Solution

The JANUS 2050 cannot read the card in the PC card drive. You need to format the card.

If you followed all the instructions to format a flash PC card and the JANUS 2050 still does not recognize the card, you may need to install two other flash card drivers, MTAA.EXE and MTAB.EXE to use AMD Type A or B flash cards.

Copy the two drivers from the Application companion disk to drive C on the JANUS 2050 (using Auto-Loader or MakeDisk and PutDisk). Edit the CONFIG.SYS file and add these lines after the line that installs the MTI2P.EXE driver:

```
device=c:\mtaa.exe  
device=c:\mtab.exe
```

When you have placed the revised CONFIG.SYS file on the JANUS 2050 drive C, reboot the device and then try formatting the flash card again.

You are trying to load APM_4M.EXE or IPM_4M.EXE and you see the message "CS PM already loaded."

You cannot load APM_4M.EXE and IPM_4M.EXE at the same time. If you see this message, one of the utilities is already loaded. Load APM_4M only for I/O cards; otherwise use IPM_4M.

Check the AUTOEXEC.BAT file to see which utility is loaded. If you are loading the wrong one, edit the AUTOEXEC.BAT file or load the utility from the DOS prompt.

You are deleting files from a 512K flash card and it does not appear that there is any additional space available on the card.

If you are using a 512K flash card with an MS-Flash file format, the card is formatted as a WORM (Write Once Read Many) drive. A 512K flash card does not have room for more than one separately erasable block of memory. You can delete individual files using the DOS delete command, but the memory the files were using is not available to be used again. To reclaim the memory from deleted files, you need to erase the entire card and then reformat the card.

Note: Intermec recommends using flash cards that store 1MB or more of data.

You are accessing the PC card in the PC card drive and the JANUS 2050 locks up frequently.

The PC card may not be formatted correctly. If you formatted the PC card on your PC or host computer, try formatting the card in the JANUS 2050 PC card drive. Use the CARDINFO utility to verify the current format and status of the card.

Using PC Cards (continued)

Problem

You are trying to format a flash PC card with the MCFORMAT utility and you see the message "You must erase G: before creating a new partition."

After you load your Novell network software, you are using a network PC card and run an application that does not work properly after making a system call.

Solution

If a flash card has been formatted before, you must first erase the card before you can format it. Use the MCFORMAT utility and select Option **3** from the MCFORMAT main menu to erase a flash card.

If you erase the flash card and still see this message when you try to format the card or the card will not format, check the JANUS 2050 CONFIG.SYS file. Make sure you have the flash card drivers installed. Once the flash card drivers are active in the CONFIG.SYS file, try erasing the flash card. Then format the card.

If you notice a problem with an application trying to execute a system call, your Novell network software may have modified the COMSPEC environment variable to add a drive specifier to the path. DOS uses the COMSPEC environment variable to find the COMMAND.COM file, and COMMAND.COM must be loaded in order for DOS to execute a system command. The JANUS 2050 uses ROM DOS 5.0, which expects COMSPEC to be set to:

```
comspec=command
```

To eliminate this problem, you must run a special utility named INITENV.EXE before you log in your JANUS 2050 to a NetWare server. Use the INITENV.EXE application on the JANUS 2050 drive C and create a login batch file similar to the following generic example:

```
@echo off
c:\initenv
f:\login %1 %2
set comspec=command
```

Use the new login file instead of your Novell login file when you log in your JANUS 2050 to the server. If you do not run INITENV.EXE before you log in, your DOS environment table will be corrupted and it may cause your JANUS application to fail. You can set COMSPEC correctly to fix part of the problem, however you need to reboot the JANUS 2050 to clear embedded garbage characters from the environment table.

To check the COMSPEC environment variable, type **set** and press . All the environment variables are displayed. If COMSPEC is set to anything other than COMMAND, it has been changed by the login process.

Using DOS

This table lists problems that may occur when you run DOS-based applications on the JANUS 2050.

Problem	Solution
The JANUS 2050 displays a "Write Fault Error Writing Device PRN message."	A <DLE> or Ctrl-P was entered into the JANUS 2050. There may be a conflict because <DLE> is both the Intermec command override command and the DOS printer redirection command. Press Ctrl - P to turn off console echo to the printer, and then press A to abort.
There is not enough memory to load a program.	You need to free up memory by removing unused programs and files.
The JANUS 2050 displays a warning message that the specified range overlaps.	If you used EMM386 with the following statement, <pre>device=d:\emm386.exe noems i=a000-afff x=b000-ffff</pre> the JANUS 2050 displays a warning message because EMM386 automatically excludes the area f000-ffff. The above statement directs EMM386 to exclude an area that is already excluded. Therefore, use the following statement to install EMM386 to load device drivers high: <pre>device=d:\emm386.exe noems i=a000-afff x=b000-ffff</pre>
The JANUS 2050 locks up when running the Auto-Loader utility and you cannot reboot the JANUS 2050.	Use the Boot Loader menu to reload the system flash as described in "Saving Data and Loading Flash Memory" later in this chapter.
You enter a DOS command and it does not work on a drive.	The following DOS commands are not supported on the JANUS 2050: DOSSHELL DOSSWAP.EXE DRIVER.SYS EGA EGAMONO.GRB FDISK.EXE FORMAT.COM GORILLA.BAS HERC MONEY.BAS MONO MSHER.COM NIBBLE.BAS REMLINE.BAS UNFORMAT.COM VGA VGAMONO.GRB

Using DOS (continued)

Problem

You cannot access a drive while using the Interlnk utility.

Solution

Interlnk does not redirect network drives, CD-ROM drives, or any other device that uses a redirection interface. If the JANUS 2050 is designated as a server, you will not be able to access a flash card in the reader's PC card drive from the host computer.

The following commands do not work with the Interlnk device driver:

CHKDSK	MIRROR
DISKCOMP	SYS
DISKCOPY	UNDELETE
FORMAT	UNFORMAT

You do not have the Companion Disk(s) and need to use Interlnk/Intersvr.

If you do not have the DOS companion disk that contains the Interlnk and Intersvr files, you can enter the following command on the JANUS 2050:

```
ntersvr /rcopy
```

The command copies the Interlnk and Intersvr files to the host computer. Before entering this command, you must connect the JANUS 2050 and host computer with a 3-wire RS-232 cable when working with Interlnk/Intersvr. The Mode command must be available on the host computer where you are installing Interlnk.

The host computer locks up after you enter the command intersvr /rcopy on the JANUS 2050.

When the Intersvr and Interlnk files are downloaded to the host computer, the host computer may lock up. Reboot the host computer.

After you type the command intersvr on the JANUS 2050, you see an error message about COM3.

You did not include the switch /com1 in your command line and Intersvr defaulted to COM3. Press to continue. When the message regarding COM4 is displayed, press again. Intersvr will now access COM1.

The JANUS 2050 does not boot after you modified the CONFIG.SYS file.

Correct the error in CONFIG.SYS. Use Auto-Loader, BFT, or MakeDisk and PutDisk to load the new CONFIG.SYS on the device.

Boot the JANUS 2050. The device should boot with the corrected CONFIG.SYS file.

*Using DOS (continued)***Problem**

While running the Auto-Loader utility, the JANUS 2050 locks up just after the DOS boot banner message is displayed.

If the JANUS 2050 displays this error message after you type the Interlnk command, DO NOT follow the instructions in the message: "Install Interlnk, add the following line to your CONFIG.SYS file and reboot..."

Solution

Press **Alt** - **F4** on the host computer and then perform a warm boot on the JANUS 2050.

A lockup may occur under the following conditions:

- An active Intersvr connection to the JANUS 2050 exists when the JANUS 2050 reboots. The JANUS 2050 factory default CONFIG.SYS file installs Interlnk automatically (using the /auto option) when the JANUS 2050 is connected to COM1 of the host computer and the host computer is running Intersvr.
- Conventional memory space (that is, the lower 640K) is full and there is not enough space for your software configuration to coexist with the Interlnk device driver. This condition means that your modifications to CONFIG.SYS and AUTOEXEC.BAT are installing a combination of device drivers, DOS options, TSRs, and/or applications that together absorb the majority of available conventional memory.

To prevent any future lockups on the JANUS 2050 when you are using the Auto-Loader utility, press **Alt** - **F4** on the host computer or break the serial connection between the JANUS 2050 and host computer BEFORE the JANUS 2050 reaches the DOS initialization step of the warm boot.

You do not need to modify the CONFIG.SYS file. To run Interlnk on the JANUS 2050, connect the JANUS 2050 to a host computer, execute Intersvr on the host, and warm boot the JANUS 2050. The factory default CONFIG.SYS on the JANUS 2050 installs Interlnk automatically using the /auto option when the JANUS 2050 is connected to a host computer running Intersvr.

Using Configuration Manager

This table lists problems that may occur when you load or unload the Configuration Manager TSR.

Problem

When you try to start the configuration application or IRL Desktop, the JANUS 2050 displays an error message indicating that there is not enough memory available to run the Configuration Manager.

You see the message "Configuration Manager TSR is not loaded."

You see the message "Configuration Manager TSR already loaded."

Solution

If the Configuration Manager TSR is unloaded when you start Configuration Manager or the IRL Desktop, the JANUS 2050 automatically loads the TSR for you.

If there is not enough RAM available for the Configuration Manager TSR, the JANUS 2050 displays an error message. Make sure at least 50K of RAM is available.

You typed **cfgmgr -d** to unload the Configuration Manager TSR from memory, but it has already been unloaded. No action is required.

You typed **cfgmgr** to load the Configuration Manager TSR into memory, but it has already been loaded. No action is required.

Using MakeDisk

This table lists messages that you may see when you use MakeDisk to create a new image file for drives C or D.

Message	Explanation/Solution
A source path has been specified that contains no files.	You cannot attempt to create an image file from a source directory that contains no files. MakeDisk will not let you create an empty drive image.
An invalid path and/or file name has been specified for the image file.	MakeDisk was unable to create the image file based on the "/o=[path\filename]" argument given. This error can be caused by either an invalid path name (for example, a path that doesn't exist or a "not ready" drive), or a <i>path\filename</i> that contains characters that DOS does not recognize as valid characters for filenames.
An invalid path name has been specified.	MakeDisk could not find the source directory path you specified on the command line. Please specify a valid subdirectory for the "/s=[path]" argument.
<ul style="list-style-type: none"> • Corrupt BPB in suffix: Unable to create a drive image. • Corrupt suffix: Unable to create a drive image. 	If either of these messages persist after further attempts, it may indicate a corrupted MAKEDISK.EXE file. Get a fresh copy of MAKEDISK.EXE from the Boot Utilities companion disk.
Drive full: Unable to write a complete image file to the output drive. Remove some files or specify a different output path and file name.	The drive where the image file is being written has insufficient free space available to contain the entire image file.
ERROR, unknown or incomplete command, or too many characters: [<i>bad command line argument shown here</i>].	You have entered a command line argument that MakeDisk does not recognize (as shown in the error message). Run MakeDisk again with the command line argument corrected.
Insufficient memory, unable to create a complete image file. Try again after removing device drivers, TSRs, or other applications that are occupying conventional memory.	There is not enough conventional DOS memory available on the computer running MakeDisk to complete the MakeDisk process. You may need to unload (terminate) some applications, device drivers, or TSRs in order to free the needed memory. Another approach is to reduce the number of nested subdirectories in the longest directory chain below your source directory.
Invalid drive letter specified. Please specify either drive C or D only.	MakeDisk will only create image files for drives C and D on your 4MB JANUS device.

Using MakeDisk (continued)

Message

Makedisk was unable to complete the drive image. Try again.

Explanation/Solution

You may receive this message for several types of general faults such as:

- One or more of the files in the source directory could not be accessed. This could indicate a corrupt file or a bad disk.
- A network error occurred when DOS attempted to retrieve a remote file.
- DOS was unable to read the source directory for any number of reasons.

Please specify a source path where your drive image can get its files from.

Enter a valid subdirectory name where your source files reside that will be used to create the drive image. (This is the `/s=[path]` argument).

The root directory can only contain [n] files; your source files exceed this count. Place some of your root files in a subdirectory as an alternative.

Your source directory (first level) contains more than the maximum number of files and/or subdirectories permitted for the target drive's root directory. One approach to solve this is to place some of the first-level files in a subdirectory below your source directory.

The system has too many files open; unable to create a drive image. Increase the 'FILES=' setting in your CONFIG.SYS file or terminate other applications that may be running.

MakeDisk needs to open several files during the image file creation process, but is unable to do so. You may need to terminate other applications or close some files in order to complete the MakeDisk process.

Your source files would create a [n] byte image file which is [n] bytes in excess of drive [C: or D:]'s capacity.

The total size of the files and subdirectories in your source directory, including the overhead space required to emulate a DOS compatible drive, exceeds the storage capacity of the JANUS drive you have targeted.

Using PutDisk

This table lists messages that you may see when you use PutDisk to load a new image file to drives C or D.

Message	Explanation/Solution
Attempt to allocate memory failed, unable to proceed.	This indicates that there is not enough conventional DOS memory available for PutDisk to complete the flash update process. You may need to unload (terminate) some applications, device drivers, or TSR programs to free the needed memory.
Attempted to upgrade a ROM drive, unable to proceed.	PutDisk has determined that the target JANUS drive is comprised of ROM (read-only memory, which cannot be written to by PutDisk) instead of flash memory. Other kinds of system faults can lead PutDisk to make this determination in error, such as a flash programming voltage fault or address decoding problems.
Attempted upgrade in a RAM region, unable to proceed.	PutDisk has determined that the target JANUS drive is comprised of RAM (random access memory, which cannot support a non-volatile drive) instead of flash memory. Other kinds of system faults can lead PutDisk to make this determination in error, such as faulty flash memory or address decoding problems. You may need technical support to solve this type of error.
Cannot upgrade an unsupported drive.	Attempts to update a JANUS drive other than C or D are unsupported. Restart PutDisk, and specify the drive /d=[drvletter] as either C or D.
<ul style="list-style-type: none"> Fault has occurred during attempt to erase flash memory. Fault has occurred during attempt to write flash memory. 	If either of these messages persist after retrying PutDisk with a fresh battery or charging source, it may indicate a flash memory hardware failure on the JANUS device.
Image checksum failed comparison with checksum of received data.	This may indicate that the flash memory update was incomplete. You will need to restart PutDisk using the same image file.
Image file error: Drive image file is larger than the drive's BPB capacity.	The size of the drive image file is larger than is declared valid by the formatting portion of the image file. You will have to reconstruct the drive image file by using the MakeDisk utility.
Image file error: Drive image file is larger than the flash media capacity.	The size of the image file is larger than the targeted drive's flash memory on the JANUS device. You must reduce the total file content (total size) of the drive image file by rebuilding it with the MakeDisk utility using fewer or smaller files.

Using PutDisk (continued)

Message

Image file error: Drive image file is too small to be valid.

Explanation/Solution

You have attempted to write an image file to a JANUS drive that is smaller than the minimum permitted size for an image file. The minimum image file size is unique for each JANUS drive (for example, the image file may target a JANUS drive other than the one you attempted to write it to).

Image file error: Drive image type is not compatible with reader's DOS version.

You have attempted to write a drive image intended for a 1MB JANUS device to a 4MB JANUS device, or vice versa.

Image file error: Image is not compatible with the specified drive.

If the image file you attempted to write to drive C, was created for drive D, it must only be written to drive D.

Image file error: Received image data has exceeded the specified image file size.

This generally indicates a communications error or a DOS file I/O error. You should retry PutDisk to see if the problem persists. If the problem is related to the use of Intersvr/Interlnk or a remote drive that is networked using another method, you need to determine if a communications problem exists before proceeding.

- Image file error: Unrecognized drive image type.
- Image file error: Drive image contains an invalid or unsupported BPB.

These messages indicate that the image file you attempted to write to a JANUS drive is either corrupt, or is an invalid image file format for the JANUS device. Build a fresh image file using the MakeDisk utility.

Image file not found.

PutDisk was unable to find the image file you specified on the command line as the /i=[imagefile] argument.

Power management fault has occurred on reader.

PutDisk attempts to cooperate with JANUS power management processes; however, rare circumstances may cause a temporary fault. The best remedy for this problem is to reboot the JANUS device after PutDisk completes. If a flash update was not completed due to this fault, restart PutDisk after rebooting.

Reader's programming voltage failed during flash operation.

This message will likely occur if the battery level is borderline. You will need to restart PutDisk after installing a fresh battery or connecting the JANUS device to a charging source. If the drive being updated was drive C, it is unlikely that you will be able to reboot to the MS-DOS prompt, however you may be able to continue by rerunning PutDisk from the current MS-DOS session (without rebooting). If this method fails, you will need to enter the boot screen and use LOADER.EXE to update the JANUS drive C.

Using PutDisk (continued)

Message	Explanation/Solution
Reader's programming voltage has failed operational limits.	The flash programming voltage source has exceeded the acceptable current limit. This may be due to other PC Cards that use flash programming voltage. Retry PutDisk after removing all PC Cards other than SRAM cards.
Specified image file path is not valid.	This error can be caused by either an invalid path name (for example, a path that doesn't exist or a "not ready" drive), or a path\filename that contains characters that DOS does not recognize as valid characters in filenames.
The reader's battery is too low to proceed with flash operations.	You must install a fresh battery or connect the JANUS device to either a charger via the optical link adapter or a communications dock before proceeding with the flash update.
Unable to activate Reader's A20 signal.	This may indicate either a conflict with other software that controls the A20 signal, or a hardware problem on the JANUS device. Try using PutDisk again, after terminating any suspect applications or utility programs. Another alternative is to enter the boot screen and attempt the use of LOADER.EXE to update the drives C or D.
Unable to activate reader's programming voltage, cannot proceed.	This message indicates that flash memory cannot be updated due to flash programming voltage problems. If the problem persists after installing a fresh battery or connecting the JANUS device to a charging source, there may be a hardware problem that requires service.
Unable to assert PM control due to concurrent PM host running on reader.	In this context, PM refers to protected mode which is used to access the extended memory regions assigned to the flash memory for JANUS drives. If another application is running that uses PM, it will likely introduce a conflict with PutDisk. You need to terminate (or uninstall) the application that is causing the conflict. Programs in this category include DOS extenders and EMM386 (which is not supported on the JANUS device).
Unable to engage reader's programming voltage, cannot proceed.	This may indicate a conflict with another process or device that uses flash programming voltage. Remove any PC Cards (other than SRAM cards) from the JANUS device.
Unable to resume flash drive upgrade; must be restarted.	PutDisk was unable to continue the flash update process that was interrupted with a power-down suspend/resume cycle. You need to restart PutDisk. First attempt to rerun PutDisk in the current MS-DOS session. If this fails, you will need to reboot to the MS-DOS prompt before restarting PutDisk. If the target drive was C and the JANUS device will no longer boot to the MS-DOS prompt, you will need to enter the boot screen and use LOADER.EXE to update drive C.

Using PutDisk (continued)

Message	Explanation/Solution
Upgrade failed, but original drive contents have been preserved.	This message may be displayed in conjunction with another specific fault message showing the cause of PutDisk interruption. It means that although the drive update was attempted, the original files on the target drive have not been altered and are therefore safe to use.

Scanning Bar Code Labels

If you have trouble operating the laser scanner, perform the following checks:

- Make sure the JANUS 2050 is turned on. Press the $\text{\textcircled{I/O}}$ button on the keypad to turn the JANUS 2050 on.
- Inspect the print quality of the bar code label. Try scanning a known-good bar code label for comparison.
- Try scanning the bar code label again, but vary the scanning angle and distance.
- Clean the scanning window with a solution of ammonia and water. Wipe dry. Do not allow abrasive material to touch the window.
- Verify that the JANUS 2050 is configured to read the bar code symbology you are scanning. Use the configuration application (IC.EXE) program to verify the bar code symbology you have configured on the JANUS 2050.
- Verify the correct scanner type is enabled using the configuration application.
- Verify that IF EXIST D:\RDG.BAT CALL D:\RDG.BAT is loaded from the AUTOEXEC.BAT file.
- Try using another scanner.

Note: To prevent data loss, do not scan both multiread labels and regular labels when you are at the DOS prompt.

Resetting the JANUS 2050

This section describes how to reset the JANUS 2050 by returning to the default configuration, performing a cold boot to initialize the JANUS 2050, and forcing the JANUS 2050 to shut down if the JANUS 2050 is not responding to the  button.

Note: Turning off the JANUS 2050 does not clear memory. When you turn on the JANUS 2050, it returns to the same place the JANUS 2050 was before it was turned off.

Returning to the Default Configuration

1. Start the configuration application. Type the following command at the DOS prompt:

```
ic
```
2. From the File drop-down menu, choose Load Default.
3. From the File drop-down menu, choose Exit.
4. When the JANUS 2050 asks if you want to update the online configuration, select Yes.

The JANUS 2050 exits the configuration application and returns to the default configuration.

Performing a Cold Boot

Before you perform a cold boot, attempt a warm boot. If a warm boot does not clear the problem, then perform a cold boot.



Caution

When the JANUS 2050 performs a cold boot, all data on the RAM disk is destroyed.

Conseil

Lorsque le lecteur s'amorce à froid, les données se trouvant sur le disque RAM sont détruites.

To perform a cold boot

1. Turn off the JANUS 2050 by pressing the I/O button.
2. Press F3 - 2 - \blacktriangleleft at the same time.
3. Press 2 . This is a bootstrap request.
4. Turn the JANUS 2050 on by pressing the I/O button.
5. If the password is set, the JANUS 2050 displays the Password screen. Type in the password, press enter , and the Boot Loader menu is displayed.
6. Choose Reboot and press enter . Reboot clears the internal RAM and all of its contents.

If you do not want to reset the JANUS 2050, you can also select Resume and press enter . The JANUS 2050 will continue executing the program.

Forcing the JANUS 2050 to Turn Off

If the JANUS 2050 does not turn off when you press I/O , you can force it to turn off by pressing I/O - 5 - \blacktriangledown at the same time.

When you turn on the JANUS 2050 again, the Boot Loader menu is displayed. From the menu, you can try dumping memory or you can do a cold boot. A cold boot clears the internal RAM and all of its contents.

Saving Data and Loading Flash Memory

If the JANUS 2050 cannot resume operation, you can save the JANUS 2050's data and then use a program on the Boot Utilities companion disk to reload the system, application, and user flash memory. You can also use this same program on an upgrade disk to upgrade the JANUS 2050's software.

Saving JANUS 2050 Data

When the JANUS 2050 cannot resume, the power management software displays an error message. You can turn the JANUS 2050 off without losing data provided there is sufficient battery power. The next time the JANUS 2050 is turned on, it repeats the error sequence and returns to the Boot Loader menu. If you reboot the JANUS 2050, the data is lost.

You can save the data from the JANUS 2050's 640K memory by dumping the data to the host computer. The host computer must be running a communication program that is capable of receiving and storing the data from the JANUS 2050's memory.

To save data from the JANUS 2050 to the host computer

1. Connect the JANUS 2050 to a host computer using the communications port. The JANUS 2050 transmits and receives data at 4800 baud, no parity, 8 data bits, and 1 stop bit.
2. Run a communications program, such as Crosstalk, that saves data on the host computer. This program is not provided with the JANUS 2050.
3. If the Boot Loader menu is not already displayed, request the menu by turning the JANUS 2050 off. Press **F3** - **2** - **◀** at the same time. Release the keys and then press **2**. Turn the JANUS 2050 on by pressing the **⏻** button.
4. Choose Dump on the Boot Loader menu, and then press **↵**.

The JANUS 2050 downloads data from low memory (640K and below) through COM1 to the host computer. The data is transmitted in Intel hexadecimal file format.

5. A record counter on the JANUS 2050 display counts the data as it is transmitted to the host computer. The record counter stops updating when the JANUS 2050 is finished downloading the data. When the download is completed, you can reboot the JANUS 2050 or reload the JANUS 2050's flash memory.

If the system flash memory is corrupt, reload the JANUS 2050 flash memory as described in the next section.

Loading Flash Memory

If the JANUS 2050 Boot Loader menu displays a checksum error message or if you need to upgrade the JANUS 2050 software, you can download all of the JANUS 2050 flash memory from a host computer. Before replacing the memory, upload any data you want saved from the JANUS 2050 to the host computer.



Caution

If the Load System flash option is selected, all system data will be lost.

Conseil

Si l'option de chargement du flash système (Load System Flash) est sélectionnée, toutes les données système seront perdues.

The files you need to update the JANUS 2050 flash memory are located in the self-extracting compressed file IMGx_x.EXE on the JANUS 2050 Boot Utilities companion disk. The IMGx_x.EXE file contains four files:

LOADER.EXE This is the program that updates the flash memory. LOADER.EXE supports a baud rate of 38400 bps or 57600 bps. Loader updates the JANUS 2050 flash memory.

To run the program at 38400 bps, you must type the Loader command on the host computer and include the /b38400 option on the command line. Here is the command syntax:

```
loader {filenames} /comn /b38400
```

If you omit the /b38400 option, Loader operates at the default baud rate, 57600 bps. For details about the Loader command syntax, type this command on your host computer and press  :

```
loader /?
```

Note: To upgrade drive C at 38400 bps, you must enter the Loader commands manually.

SYSTEM_x.x This is the 256K system flash that includes PC BIOS and part of MS ROM DOS.

OTP2MEGx.x This file is for the 2MB flash that includes 80K of MS ROM DOS and the 1.9MB drive D. Drive D contains programs like Intermec's protocol handler, IRL, Configuration Manager, and Reader Services.

USER_x.x This is the 512K default drive C. It contains the factory default AUTOEXEC.BAT and CONFIG.SYS files.

Note: x.x represents the software version number.

9

Command Reference

This chapter provides an alphabetical listing of commands that can be executed when operating the JANUS 2050. The information for each command includes a description of the command, the syntax for the command, and a bar code label containing the command syntax.

Using JANUS 2050 Commands

A command causes the JANUS 2050 to perform a task. Commands can be scanned from a bar code label, entered from the keypad, sent from a host computer, or executed in an IRL program. JANUS 2050 commands can be grouped together (concatenated) into one string. For example, the command to switch the backlight on is `%.1`, and the command to raise the beep volume is `$+BV9`. These two commands can be concatenated as shown here and downloaded from a host computer:

```
%.1$+BV9
```

By adding start/stop codes, you can create a bar code that does the same thing:

Backlight On/Raise Beep Volume



```
*%.1$+BV9*
```

Concatenated commands are executed in the order in which they appear in the string. If the JANUS 2050 encounters an incorrect command, it performs the valid commands preceding the invalid command and ignores the remainder of the string. When there is an error, the JANUS 2050 emits three low beeps.

Note: *JANUS 2050 commands from the keypad and host computer work only when an application is using Reader Services. IRL-related commands work only when the IRL Desktop is running.*

Enter/Exit Accumulate

Accumulate mode is used to accumulate all scanned data in the JANUS 2050 data buffer. When accumulate mode is exited, the accumulated data is "entered" as a data record into the JANUS 2050. The buffer is cleared by one of the following commands:

- An Exit accumulate command
- An Enter command
- A Clear command
- Any type of reset

Up to 250 characters can be held in the buffer. If the data record count exceeds 250 characters, the last bar code read is rejected, and the JANUS 2050 sounds an error beep.





Enter Accumulate

Purpose:	Enters accumulate mode. Do not press any keys when using the enter accumulate command; they are not entered into the JANUS 2050.
From host:	Not supported
Keypad:	+ /
IRL command:	Not supported
Scan:	Enter Accumulate  *+/*

Exit Accumulate

Purpose:	Exits accumulate mode and transmits the current data record. If no data has been accumulated, an empty data record is transmitted.
From host:	Not supported
Keypad:	- /
IRL command:	Not supported
Scan:	Exit Accumulate  *_/*

Backspace, Destructive

Purpose:	Deletes the last character from the current data record. If there is no data in the buffer, the JANUS 2050 emits three low beeps.
From host:	Not supported
Keypad:	 or  
IRL command:	Not supported
Scan:	Backspace, Destructive  *\$H*

Change Configuration

Purpose: Must precede any configuration command parameter. If a valid string is entered, the JANUS 2050 configuration parameters are modified and the JANUS 2050 sounds a high beep. The configuration parameters and their options are listed in Chapter 10, "Configuration Commands."

From host: \$+command

Keypad: \$+command

IRL command: Z"\$+command"

Scan: Change Configuration



\$+

Enter a configuration command or scan a bar code label containing a configuration command.

Note: The Exit Configuration command (\$+command\$-) is not required, but is allowed for backward compatibility.

Clear

Purpose: Deletes the entire data record being accumulated. The Clear command can also be used on preamble and postamble buffers.

From host: Not supported

Keypad: Not supported

IRL command: Not supported

Scan: Clear



_ _

Command Override

Purpose: Causes the character that follows it to be treated as data. This command allows for the use of control characters in preambles, data strings, and configuration command strings.

From host: <DLE>

Keypad:  

^P is also the ASCII Data Link Exception character (DLE). ^P causes the character that follows it to be received as data, even if it is a protocol character. Therefore, to interpret a Command Override command from the host, the command must be preceded by DLE.





For example, when “^P^P^M” is sent from the host, it is interpreted as “^P^M”, where ^P is acknowledged allowing the following command (^M) to be interpreted as data and passed on to the application. When “^P^M” is sent from the host, it is interpreted as ^M, the display is not affected, and the Carriage Return command is executed.





IRL command: Z“^P”

Scan: Command Override



<DLE>

The JANUS 2050 uses  -  as the Command Override command; however, the DOS printer redirection command ( - ) is also supported on the JANUS 2050. This dual purpose may cause some conflicts.

If you have Reader Services loaded and scan the bar code label <DLE>, the first scan is interpreted as a JANUS 2050 command. The next <DLE> entered causes a  -  to be entered into the expanded key buffer. DOS takes this  -  and enables printer-redirection.

If no printer is connected, all subsequent entries cause an error and the following message is displayed:

```
Write fault error writing device PRN
Abort, Retry?
```

Enter

Purpose: Causes the JANUS 2050 to enter the current data record. It completes the entry of a command. If no data exists, a null string is entered.

From host: Not supported





Keypad: 

IRL command: Not supported

Scan: Enter



**

DOS shuts off the printer echo for the duration of the error, which allows it to display the error. As long as the printer echo has been requested (by entering a  - ), DOS turns the printer echo back on after the critical error is corrected. You can exit the critical error by pressing  -  (to turn off console echo to the printer), and then pressing  (to abort).

Prepare for Reboot

Purpose: Causes the PSK library to notify the BFT-ready PSK application that the host wants to reboot the system and establish a binary file transfer (BFT) session. The PSK application accepts the Prepare for Reboot command and sends a Ready for Reboot message to the host. For help, see "Communicating With the JANUS 2050" in Chapter 6.

From Host: ..+%1 Prepare for Reboot

..+%0 Cancel the Prepare for Reboot command

Keypad: Not supported

IRL command: Not supported

Scan: Not supported

Reboot

Purpose:	Causes the JANUS reader to warm boot and establish a binary file transfer (BFT) session with a host computer. The host must have already sent a Prepare for Reboot command and the BFT-ready PSK application has responded with a Ready for Reboot message. For help, see “Communicating With the JANUS 2050” in Chapter 6.
From Host:	..%\$1 Reboot ..%\$0 Cancel the Reboot command
Keypad:	Not supported
IRL command:	Not supported
Scan:	Not supported

10

Configuration Commands

This chapter provides an alphabetical list of all the configuration commands supported on the JANUS 2050.

Using Configuration Commands

A configuration command modifies JANUS 2050 operation. You can scan configuration commands from a bar code label, execute them in an IRL program, and enter them from the JANUS 2050 keypad to a user application, or send them from a host computer to a user application.

Note: *Configuration commands from the keypad and host computer can only be sent to an application designed to accept the command syntax.*

This chapter provides the following information on each configuration parameter:

- Command description
- Default setting
- Command syntax and options
- Bar codes containing the configuration parameters

The commands appear alphabetically by command name. If you want to look up a command by its syntax, refer to the “Configuration Command by Syntax” table in Appendix A.

The following JANUS configuration commands have no effect on the JANUS 2050, and are not included in this manual.

- Display Backlight Timeout (\$+DF)
- Display Contrast (\$+DJ)
- Viewport Movement Keys (\$+DV)
- Viewport Movement Steps (\$+DY)
- Communication Dock Port Select (\$+IP)

Variable Data

You must enter commands that require variable data in the following sequence. For example, you can set the EOF character to any ASCII character. If you want to set the EOF character to SOH:

1. Scan the following bar code to enter Accumulate mode and change the configuration (\$+) for EOF (FA):

Enter Accumulate / Set EOF



+/\$+FA

2. Scan a bar code from the full ASCII chart in Appendix A. SOH has been included here as an example:

SOH



<SOH>

3. Scan the Exit Accumulate bar code:

Exit Accumulate



-/

When the Exit Accumulate label is scanned, the JANUS 2050 updates the configuration for EOF.

Address, Multi-Drop

Purpose: Defines the address of the communications port when using Multi-Drop protocol. Each address has unique POL and SEL characters that are automatically set when the address is configured. Refer to Appendix A for the POL and SEL values that correspond to each address.

***Note:** You must select the communications port and protocol before setting the parameters to define that protocol. For help, see "Communications Protocol, Configure" later in this chapter.*

Default: A

Syntax: HCdata
data can be A through Z or 0 through 5.

Scan: 1. Scan the following bar code:

Enter Accumulate / Address



+/\$+HC

2. Scan a bar code for *data* from the full ASCII chart in Appendix A.
3. Scan the following bar code:

Exit Accumulate



-/

AFF (Affirmative Acknowledge)

Purpose: Enables or disables the handshake event that is an affirmative acknowledge to a message. AFF and NEG must both be enabled to have a valid configuration.

Note: You must select the communications port and protocol before setting the parameters to define that protocol. Refer to the configuration command "Communications Protocol, Configure" later in this chapter for more information on defining protocols.

Default: AFF disabled

Syntax: PGdata
data can be any ASCII character.

Scan: To disable AFF, scan the following bar code:

Disable AFF



\$+PG

Or: To set AFF to an ASCII character:

1. Scan the following bar code:

Enter Accumulate / AFF



+/\$+PG

2. Scan a bar code for *data* from the full ASCII chart in Appendix A.
3. Scan the following bar code:

Exit Accumulate



_/

Baud Rate

Purpose: Sets the baud rate for the selected communications port on the JANUS 2050. It must match the baud rate of the device (for example, the host computer) that the JANUS 2050 is communicating with.

Note: You must select the communications port and protocol before setting the parameters to define that protocol. Refer to the configuration command “Communications Protocol, Configure” later in this chapter for more information on defining protocols.

For Polling Mode D protocol, the baud rate must be 1200 or higher. For Multi-Drop protocol, the baud rate must be 2400 or higher.

Default: 9600 baud

Syntax: IAdata
Acceptable values for *data* are:

0	110 baud
1	300 baud
2	600 baud
3	1200 baud
4	2400 baud
5	4800 baud
6	9600 baud
7	19200 baud
8	38400 baud

Scan: One of the following labels:

110 Baud



S+IA0

300 Baud



S+IA1

600 Baud



S+IA2

Baud Rate (continued)

1200 Baud



\$+IA3

2400 Baud



\$+IA4

4800 Baud



\$+IA5

9600 Baud



\$+IA6

19200 Baud



\$+IA7

38400 Baud



\$+IA8

Beep Duration

Purpose: Defines the individual beep duration of the default/IRL JANUS 2050 beeps. There are two types of beeps: high/IRL1 and low/IRL0.

Default: 50 ms for both high and low beeps

Syntax: *BDdata*
Acceptable values for *data* are: from 1 ms to 60000 ms (60 seconds).

Scan: 1. Scan the following bar code:

Enter Accumulate / Beep Duration



+/\$+BD

2. Scan a numeric value for *data* in ms from the following bar codes:



0



1



2



3



4



5



6



7



8



9

Beep Duration (continued)

3. Scan one of the following bar codes to designate whether the setting is for a low or high beep:

Low Beep



L

High Beep



H

4. Scan the following bar code:

Exit Accumulate



-/

Beep Frequency

Purpose: Defines the individual frequencies of the default/IRL JANUS 2050 beeps. There are two types of beep: high/IRL 1 and low/IRL 0.

Default: 1000 Hz for low beeps
2000 Hz for high beeps

Syntax: BFdata
Acceptable values for *data* are: from 20 to 20,000 Hz (20 KHz).

Note: Setting the frequency outside the range of 100 Hz to 10,000 Hz makes the beeps inaudible.

Scan: 1. Scan the following bar code:

Enter Accumulate / Beep Frequency



+/\$+BF

2. Scan a numeric value for *data* in Hz from the following bar codes:



0



1



2



3



4



5



6



7



8



9

Beep Frequency (continued)

3. Scan one of the following bar codes to designate whether the setting is for a low or high beep:

Low Beep



L

High Beep



H

4. Scan the following bar code:

Exit Accumulate



_/

Beep Volume

Purpose: Adjusts the volume of the beeps emitted by the JANUS 2050. The beep patterns are defined in Chapter 2, “Operating the JANUS 2050.” Set the beep volume according to operator preference and work environment.

Default: Normal

Syntax: *BVdata*

Acceptable values for *data* are:

0	Off
1	Quiet
2	Normal
3	Loud
4	Very loud
8	Lower volume
9	Raise volume

Scan: One of the following labels:

Off



\$+BV0

Quiet



\$+BV1

Normal



\$+BV2

Loud



\$+BV3

Very Loud



\$+BV4

Or: Scan one of these bar codes repeatedly to achieve the desired volume:

Raise Beep Volume



\$+BV9

Lower Beep Volume



\$+BV8

Codabar

Purpose: Enables/disables decoding of Codabar symbology. Codabar is a self-checking, discrete symbology having 16 characters in its set: 0-9, dollar sign (\$), colon (:), slash (/), period (.), plus (+), and minus (-). Codabar is commonly used in libraries, blood banks, and air-parcel express applications. American Blood Commission (ABC) Codabar requires that start/stop code representations be retained. As a result, configuration CD10 is an illegal configuration.

Default: Standard Codabar, ABCD start/stop transmitted

Syntax: CD*data*

Acceptable values for *data* must be two digits, corresponding to:

<i>First digit:</i>	0	Disabled
	1	ABC
	2	Standard
	3	Concatenated
<i>Second digit:</i>	0	Discard start/stop
	1	ABCD start/stop transmitted
	2	DC1-DC4 start/stop transmitted

Scan: One of the following labels:

Codabar Disabled, Discard Start/Stop



\$+CD00

ABC, ABCD Start/Stop



\$+CD11

ABC, DC1-DC4 Start/Stop



\$+CD12

Standard, Discard Start/Stop



\$+CD20

Codabar(continued)

Standard, ABCD Start/Stop



\$+CD21

Standard, DC1-DC4 Start/Stop



\$+CD22

Concatenated, Discard Start/Stop



\$+CD30

Concatenated, ABCD Start/Stop



\$+CD31

Concatenated, DC1-DC4 Start/Stop



\$+CD32

Code 11

Purpose: Enables/disables decoding of Code 11 symbology. Code 11 is a very high density discrete numeric bar code. It is most extensively used in labeling telecommunications components and equipment.

Default: Enabled with two check digits

Syntax: *CGdata*

Acceptable values for *data* are:

- 0 Disabled
- 1 One check digit
- 2 Two check digits

Scan: One of the following labels:

Disable Code 11



\$+CG0

Code 11 With One Check Digit



\$+CG1

Code 11 With Two Check Digits



\$+CG2

Code 16K

Purpose: Enables/disables decoding of Code 16K symbology. Code 16K is a two-dimensional (stacked rows), ultra-high density bar code. It is based on Code 128 and is used widely in labeling unit-dose packaging for the healthcare industry.

Default: Standard

Syntax: *CPdata*

Acceptable values for *data* are:

0	Disabled
1	Standard
2	With function code 1

When you enable Code 16K with Function Code 1, the reader decodes the bar code label and checks for a Function Code 1 in the first data character position. If a Function Code 1 is the first character, the reader substitutes this Code 16K symbology identifier string for the Function Code 1 character.

Scan: One of the following labels:

Disable Code 16K



\$+CP0

Code 16K, Standard



\$+CP1

Code 16K With Function Code 1



\$+CP2

Code 2 of 5

Purpose: Enables\disables decoding of Code 2 of 5 symbology. Code 2 of 5 uses the bars to encode information and the spaces to separate the individual bars. This code is discrete and self-checking. Decoding for Code 2 of 5 code can only be enabled if decoding for the Interleaved 2 of 5 code is disabled. If Interleaved 2 of 5 is enabled, Code 2 of 5 code is automatically disabled.

Default: Disabled

Syntax: *CCdata*

data consists of three digits as follows:

<i>First digit:</i>	0	3 bar start/stop
	1	2 bar start/stop

<i>Second and third digits:</i>	00	Disable 2 of 5
	01-32	Label length

Scan: To disable 2 of 5, scan the following bar code:

Disable 2 of 5



\$+CC00

Or: To enable 2 of 5 decoding:

1. Scan one of the following bar codes:

2 of 5, 3 Bar Start / Stop



+/\$+CC0

2 of 5, 2 Bar Start / Stop



+/\$+CC1

Code 2 of 5 (continued)

2. Scan a two-digit numeric value for the label length (01 to 32) from the following bar codes.



3. Scan the following bar code:



Code 39

Purpose: Enables/disables decoding of Code 39 symbology. Code 39 is discrete, variable length, and self-checking. The character set is A-Z uppercase, 0-9, dollar sign (\$), period (.), slash (/), percent (%), space (), plus (+), and minus (-).

There are three types of ASCII decoded by the JANUS 2050: non-full ASCII, full ASCII and mixed-full ASCII.

Code 39 non-full ASCII uses a one character encoding scheme. Therefore, the data "READER" is encoded as follows:



READER

This label decodes as *READER*.

In Code 39 full ASCII, the character set is extended to 128 characters using a two-character encoding scheme. This extension is accomplished by using the dollar sign (\$), slash (/), percent (%), and plus (+) as preceding characters followed by an uppercase letter. Lowercase letters must be encoded as a plus sign (+) followed by their uppercase equivalent. The ASCII characters and their Code 39 representations are listed in Appendix A.

Thus in full ASCII Code 39, the data "reader" is encoded as follows:



+R+E+A+D+E+R

The label decodes as *+R+E+A+D+E+R* when the JANUS 2050 is configured for non-full ASCII Code 39. But, it decodes as *reader* when the JANUS 2050 is configured for full ASCII Code 39.

Code 39 full ASCII is used to enter ASCII control characters or lowercase characters as data. It should also be enabled to allow the use of ASCII command characters.

The Code 39 mixed-full ASCII configuration is used when printers encode the same label two different ways. For example, if you have a bar code with the data \$%a, some printers encode the data as:



/D/E+A

Code 39 (continued)

According to the full ASCII table in Appendix A, \$ is represented by /D and % is represented by /E. This data is decoded as \$%a if the JANUS 2050 is configured for full ASCII, because all the data is represented by valid full ASCII characters pairs.

Other printers encode the data \$%a as:



\$%+A

The \$ and % are valid Code 39 characters in the non-full ASCII character set. However, this label will NOT be decoded by the JANUS 2050 if it is configured for full ASCII, because the data is NOT represented by valid full ASCII character pairs. To decode the label correctly, configure the JANUS 2050 for mixed-full ASCII.

When configured for mixed-full ASCII, the JANUS 2050 will decode both of the labels above as \$%a.

Mixed-full ASCII interprets any valid full ASCII character pairs that appear in the label, but does not require that all data be encoded with a valid full ASCII character pair. If you are uncertain how your labels are encoded, configure the JANUS 2050 for mixed-full ASCII, which decodes all valid Code 39 labels.

If you are configuring the JANUS 2050 for Code 39 full ASCII, you should check for mixed-full ASCII. Mixed-full ASCII does not apply when you are configuring the JANUS 2050 for non-full ASCII.

Note: *The interpretive text found under bar code labels does not always accurately reflect the data that is encoded in the label. The interpretive text represents how the label should be decoded.*

The following table can aid you in configuring your JANUS 2050.

JANUS 2050	Bar Code	Decode
Non-full ASCII	\$%+A /D/E+A	\$%+A /D/E+A
Full ASCII	\$%+A /D/E+A	No decode \$%a
Mixed-full ASCII	\$%+A /D/E+A	\$%a \$%a

Default: Enable full ASCII with no check digit (111)

Code 39 (continued)

Syntax: CBdata

Acceptable values for *data* must be three digits, corresponding to:

<i>First digit:</i>	0	Disabled
	1	Enabled with no check digit
	2	Enabled with check digit
	3	HIBC (health industry bar code)
	4	With AIAG check digit
<i>Second digit:</i>	0	Discard check digit
	1	Transmit check digit
<i>Third digit:</i>	0	Non-full ASCII
	1	Full ASCII
	2	Mixed-full ASCII

Note: Selecting HIBC Code 39 automatically sets the configuration to non-full ASCII with the check digit transmitted.

Scan: To disable Code 39:

Disable Code 39



\$+CB0

Or: To set Code 39:

1. Scan the following bar code:

Enter Accumulate / Code 39



+/\$+CB

2. Scan one of the following for the first digit:

Without a Check Digit



1

With a Check Digit



2

HIBC Code 39



3

With AIAG Check Digit



4

Code 39 (continued)

3. Scan one of the following for the second digit:

Discard Check Digit



0

Transmit Check Digit



1

4. Scan one of the following for the third digit:

Non-Full ASCII



0

Full ASCII



1

Mixed-Full



2

5. Scan the following bar code:

Exit Accumulate



-/

Code 49

Purpose: Enables/disables decoding of Code 49 symbology. Code 49 is a multirow symbology for high data density. The last character in each row is used for row checking and the last two characters of the symbol are used for overall checking.

Function codes designate where to place the predefined data string in a Code 49 label. Whenever a JANUS 2050 encounters a function code, it replaces the function code with the defined string before transmitting the data to the workstation. This defined string allows a single Code 49 symbol to contain several different variable length data fields. Function code 1 (F1) is used to identify a data system. Function code 2 (F2) is used to indicate the end of a data field.

Default: Code 49 enabled, function code 1 disabled, function Code 2 set to CR LF, and Function Code 3 disabled.

Syntax:

<i>CJdata</i>	Code 49
<i>CKdata</i>	Function code 1
<i>CLdata</i>	Function code 2
<i>CMdata</i>	Function code 3

Acceptable values for *data* are:

Code 49: 0 Disabled
 1 Enabled

Function code 1: Any two ASCII characters.

Function code 2: Any four ASCII characters

Function code 3: Any two ASCII characters

Scan: One of the following labels:

Disable Code 49



\$+CJ0

Enable Code 49



\$+CJ1

Code 49 (continued)

To disable any of the function codes, scan the appropriate label:

Disable Function Code 1



\$+CK

Disable Function Code 2



\$+CL

Disable Function Code 3



\$+CM

Or:

To set one of the function codes to a character string:

1. Scan the appropriate bar code:

Enter Accumulate / Function Code 1



+/\$+CK

Enter Accumulate / Function Code 2



+/\$+CL

Enter Accumulate / Function Code 3



+/\$+CM

2. Scan any character from the full ASCII chart in Appendix A. Two characters each are allowed for function code 1 and 3. Four characters are allowed for function code 2.
3. Scan the following bar code:

Exit Accumulate



-/

Code 93

Purpose: Enables/disables decoding of Code 93 symbology. Code 93 is a variable length, continuous symbology employing four element widths. It is designed to complement Code 39.

Default: Enabled

Syntax: CF*data*

Acceptable values for *data* are:

0 Disabled

1 Enabled

Scan: One of the following labels:

Disable Code 93



\$+CF0

Enable Code 93



\$+CF1

Code 128

Purpose: Enables/disables decoding of Code 128 symbology. Code 128 is a very high density alphanumeric symbology. It is a variable length, continuous code employing multiple element widths. Code 128 symbology can be configured to Standard or UCC/EAN, which affects how function code 1 characters are decoded. Function code 1 characters are decoded as follows:

- If Code 128 is configured to Standard, the reader will not decode function code 1 characters in bar code labels.
- If Code 128 is configured to UCC/EAN, the reader will decode the bar code label as standard Code 128 unless the first two characters are a start character and a function code 1. If the first two characters are a start character and a function code 1:
 1. The first two characters are not transmitted.
 2. The three symbology ID characters,]C1, are transmitted.
 3. The remaining Code 128 characters are decoded as standard Code 128.
 4. Any subsequent function code 1 characters are translated to the ASCII GS character as a separator for variable length fields.

Default: Standard

Syntax: CHdata
Acceptable values for *data* are:

- 0 Disabled
- 1 Standard
- 2 UCC/EAN - 128

Scan: One of the following labels:

Disable Code 128



S+CH0

Standard Code 128



S+CH1

UCC/EAN - 128



S+CH2

Command Processing

Purpose: Command processing allows you to disable JANUS 2050 commands. For example, you can disable multiple-read labels (labels starting with a blank space), which then causes them to be processed as regular labels with the leading space treated as data.

The override option is a temporary setting that allows you to enable all the JANUS 2050 commands for as long as you need them. When you want to return to the previous setting, you disable the override.

Default: All commands enabled

Note: Viewport movement commands have no effect on the JANUS 2050.

Syntax: DCdata

Acceptable values for *data* are:

0	Disable all JANUS 2050 commands
1	Enable all JANUS 2050 commands
2	Disable override
3	Enable override
<command> 0	Disable command
<command> 1	Enable command

Note: If all JANUS 2050 commands are disabled (\$+DC0), you cannot change the JANUS 2050's configuration or exit from an IRL program. To enable the JANUS 2050 commands you need to enter the configuration application, or edit the configuration "*.ini" file.

Scan: To enable all the JANUS 2050 commands or override the current settings, scan one of the following bar codes:

Enable All Commands



\$+DC1

Disable Override



\$+DC2

Enable Override



\$+DC3

Command Processing (continued)

Or: To disable/enable specific commands, complete the following steps:

1. Scan the following bar code:

Enter Accumulate / Command Processing



+/\$+DC

2. Scan the label combination to build the command that is being enabled/disabled.

Enter Accumulate



+



/

Exit Accumulate



_



/

Backspace



_



+

Clear



_



_

Backlight



%



_

Change Config



3



+

Laser On



/



_

Command Processing (continued)

Laser Off



/



%

Viewport Up



%



/

Viewport Down



%



+

Viewport Right



.



_

Viewport Left



%



_

Viewport Page Up



.



.



%



+

Viewport Page Down



.



.



%



_

Command Processing (continued)

Viewport Home



.



.



%



/

Viewport End



.



.



%



.

Cursor to Viewport



.



.



%



%

Viewport to Cursor



/



_

Enter Key Code Entry



.



.

Transmit File



%



%

Set Clock



/



+

Command Processing (continued)

Run Program



/



/

Exit Program



/



\$

Download Program



<SI>

Multiple-Read



* *

Clear File



.



\$

Receive File



.



%

Prepare for Reboot



..+%

Reboot



..%\$

3. Scan one of the following bar codes:

Disable the Command



0

Enable the Command



1

4. Repeat Steps 2 and 3 if more than one command is being disabled/enabled.
5. Scan the following bar code:

Exit Accumulate



-/

Communications Port, Select

Purpose: Assigns all subsequent communications port and protocol configurations to the selected port.

Default: COM port 1

Syntax: *ISdata*

Acceptable values for *data* are:

- 1 COM port 1
- 2 COM port 2
- 3 COM port 3
- 4 COM port 4

Scan: One of the following labels:

COM Port 1



\$+IS1

COM Port 2



\$+IS2

COM Port3



\$+IS3

COM Port 4



\$+IS4

Communications Port, Choosing Scanner or COM2

Purpose: The scanner and COM2 share the same internal hardware port, as a result, scanner port usage and host port COM2 usage are mutually exclusive. The JANUS 2050 will be undamaged, but neither port will function with the other connected.

The scanner port is a Fischer connector on the back of the JANUS 2050. You should scan commands to configure COM2 before enabling COM2.

Note: *To set serial communications parameters (such as baud rate and parity) for COM2, you must use off-the-shelf software. For example, you can execute the Mode command from the DOS prompt, or an application using COM2 can execute standard DOS commands. You cannot set serial communications parameters for COM2 with IC.EXE. Also, you cannot scan configuration commands because you have disabled the scanner port.*

Default: Scanner

Syntax: IXdata

Acceptable values for *data* are:

0 for scanner
1 for COM2

Scan: This label to change from scanner to COM2:



Set Scanner Port to COM2



\$+IX1

You cannot scan a command to change from COM2 to scanner because you have changed the function of the scanner port.

Communications Port, UART Restore

- Purpose:** Defines the hex value used to restore the COM UART FIFO control registers when you suspend and resume the reader.
- You must set the FIFO control register value for the reader's UART device if you plan to perform either of the following tasks:
- Run a communications program on COM1 without loading an Intermec protocol handler such as PHIMEC into memory.
 - Run a communications program on COM2 that changes the COM2 UART FIFO control register to use UART 16x550 mode.
- Otherwise, you can use the default value (00 hex) for this parameter. For more information, see "Specifying a Value for the FIFO Control Register" in Chapter 6.
- Note:** *If your application uses UART 16x550 mode to its fullest extent, you will need to determine the appropriate setting.*
- Default:** 00
- Syntax:** For COM1: *IVdata*
For COM2: *IWdata*
- Acceptable values for *data* are:
- 00 0 Hex
XX Two characters representing the hex value that the UART FIFO control register is set to when the JANUS 2050 is turned on
- Scan:** To set the hex value default, scan the following bar code:
- | | |
|---|--|
| COM1: 0 Hex | COM2: 0 Hex |
|  |  |
| *S+IV00* | *S+IW00* |

Communications Port, UART Restore (continued)

Or: To set the hex value:

1. Scan one of the following bar code:

Enter Accumulate/Change Configuration/COM1



+/\$+IV

Enter Accumulate/Change Configuration/COM2



+/\$+IW

2. Scan two bar codes for *data* from the full ASCII chart in Appendix A.
3. Scan the following bar code:

End Accumulate



-/

Repeat Steps 1 through 3 for a second COM port if necessary.

Communications Protocol

Protocol determines how the JANUS 2050 communicates with the host through the DTE interface of the selected communications port. A different protocol can be configured for each communications port. Even if you are using the same protocol for each port, each communications port must be configured separately. One advantage of this is that you can have a different protocol configured and active for each communications port.

Before configuring a protocol, you need to select the communications port to which it applies with Communications Port, Select (IS). Once the protocol is configured, you need to *activate* the protocol.

Configure

Purpose:

This command assigns all subsequent protocol configuration changes (for example, baud rate and data bits) to the selected communications protocol. Each protocol has a list of parameters that can be configured for that protocol:

*Note: Some of the protocol characters for User-Defined cannot be reconfigured if User-Defined is active. If User-Defined is the active protocol, set the active protocol to **None**. Once you are finished configuring User-Defined protocol, then reactivate the protocol.*

The following characters are used with IRL and Communications Manager and are not directly supported by the Intermec protocol handler.

- EOF, EOR, and # of Records per Block
- PAK, BAK, SOP, EOP, RUN, END, and PSS

If you want to configure the JANUS 2050 for User-Defined Multi-Drop protocol, select User-Defined protocol and then go to the configuration command “Communications Protocol, Multi-Drop, User-Defined” later in this chapter.

Configure (continued)

Protocol	Parameter
User-Defined	<ul style="list-style-type: none">• Baud rate, parity, data, and stop bits• Flow control, LRC• Intercharacter, turnaround, and timeout delay• Transmit abort timeout• SOM, EOM• POL, SEL, RES, REQ, AFF, NEG• EOF, EOR, and number of records per block• IRL PAK, IRL BAK, IRL SOP, IRL EOP, IRL RUN, IRL END, and IRL PSS
User-Defined Multi-Drop	<ul style="list-style-type: none">• Baud rate, parity, data, and stop bits• Flow control, LRC• Intercharacter, turnaround, and timeout delay• Transmit abort timeout• SOM, EOM• POL, SEL, RES, REQ, AFF, NEG• EOF, EOR, and number of records per block• IRL PAK, IRL BAK, IRL SOP, IRL EOP, IRL RUN, IRL END, and IRL PSS
Point-to-Point	<ul style="list-style-type: none">• Baud rate, parity, data, and stop bits• Flow control• Intercharacter, turnaround, and timeout delay• Transmit abort timeout
Polling Mode D	<ul style="list-style-type: none">• Baud rate• Flow control• Transmit abort timeout
Multi-Drop	<ul style="list-style-type: none">• Baud rate, parity, data bits• Transmit abort timeout• Address, Multi-Drop
PC Standard	<ul style="list-style-type: none">• Baud rate, parity, data, and stop bits

Configure (continued)

Default: Point-to-Point

Syntax: *PSdata*

Acceptable values for *data* are:

0	User-Defined
1	Point-to-Point
2	Polling Mode D
3	Multi-Drop
7	PC Standard

Scan: One of the following labels:

User-Defined



\$+PS0

Point-to-Point



\$+PS1

Polling Mode D



\$+PS2

Multi-Drop



\$+PS3

PC Standard



\$+PS7

Activate

Purpose: Enables the selected protocol to be used for the preselected communications port. Each port can only have one active protocol at a time.

Note: *The selected protocol does not become active until the corresponding protocol handler is loaded.*

Default: Point-to-Point

Syntax: PAdata

Acceptable values for *data* are:

- 0 User-Defined
- 1 Point-to-Point
- 2 Polling Mode D
- 3 Multi-Drop
- 7 PC Standard
- 9 None

Scan: One of the following labels:

User-Defined Protocol



\$+PA0

Point-to-Point Protocol



\$+PA1

Polling Mode D Protocol



\$+PA2

Multi-Drop Protocol



\$+PA3

PC Standard Protocol



\$+PA7

No Protocol



\$+PA9

Multi-Drop, User-Defined

Purpose: An option of User-Defined protocol. You must set the POL and SEL characters to define a unique device address. Refer to Appendix A for the correct POL and SEL combinations.

Note: You must select User-Defined protocol before you can enable User-Defined Multi-Drop protocol. Refer to the configuration command “Communications Protocol, Configure” earlier in this chapter for more information on defining protocols. To activate User-Defined Multi-Drop protocol, select User-Defined in the configuration command Communications Protocol, Activate.

Default: Disabled

Syntax: *PMdata*
Acceptable values for *data* are:
0 Disabled
1 Enabled

Scan: One of the following labels:

Disable User-Defined Multi-Drop



S+PM0

Enable User-Defined Multi-Drop



S+PM1

Data Bits

Purpose: Sets the number of data bits the JANUS 2050 uses when communicating with another device (for example, the host computer).

Note: You must select the communications port and protocol before setting the parameters to define that protocol. Refer to the configuration command "Communications Protocol, Configure" earlier in this chapter for more information on defining protocols.

Default: 7

Syntax: `IIdata`

Acceptable values for *data* are:

7 7 data bits
8 8 data bits

Scan: One of the following labels:

7 Data Bits



\$+II7

8 Data Bits



\$+II8

Decode Security

Purpose: Defines the security level to use when decoding bar code labels. When a lower decode security level is selected, it allows bar code labels with poorer print quality to be decoded.

Note: The low parameter should only be used as a temporary solution until label print quality can be improved.

Default: Moderate

Syntax: CSdata

Acceptable values for *data* are:

0	Low
1	Moderate
2	High

Scan: One of the following labels:

Low



\$+CS0

Moderate



\$+CS1

High



\$+CS2

Display Mode, IRL

Purpose: Determines how IRL displays and handles data. The JANUS 2050 has two IRL display modes: buffered and transparent.

Buffered display A buffered display formats the display text with a full block character and a Carriage Return Line Feed (CR LF) after each data record. When running an IRL program, the CR LF is actually executed before the next IRL prompt.

Transparent display A transparent display does not add a CR LF after each data record. Scanned data records are concatenated together.

Autowrap and autoscroll features are disabled. When the cursor gets to the end of a line, it does not wraparound. When the cursor reaches the bottom of the display, it does not scroll up. You must use control codes to format the display and move the cursor around. These control codes must be included in IRL programs. For example, a CR LF sequence can be used to move down one display row or to scroll the display after the last row. Error messages are not displayed.

Default: Buffered

Syntax: DM*data*

Acceptable values for *data* are:

0 Buffered
1 Transparent

Scan: One of the following labels:

Buffered Display Mode



\$+DM0

Transparent Display Mode



\$+DM1

Display Setup

- Purpose:** Defines the number of columns and rows in the display image, the video mode, at what row the display scrolls, and the character height.
The JANUS 2050 video modes are used in the same way as on a PC.
- Default:** Display size 80 columns x 25 rows, video mode 3, scrolls at row 25, and normal character height.

Syntax: DSdata
Acceptable values for *data* are four digits corresponding to:

<i>First digit:</i>	0	80 x 25
<i>Second digit:</i>	0	Video mode 0 (double character width)
	1	Video mode 1 (double character width)
	2	Video mode 2 (normal character width)
	3	Video mode 3 (normal character width)
<i>Third digit:</i>	0	Scroll at row 25
	3	Scroll at row 13
<i>Fourth digit:</i>	0	Normal character height
	1	Double character height

Note: When you scan a label that changes the video mode, the screen goes blank. To bring the screen back, begin entering data.

Scan: One of the following labels to set display options:

25 x 40, Video Mode 0, Scroll at Row 25, Normal Height



\$+DS0000

25 x 40, Video Mode 0, Scroll at Row 13, Double Height



\$+DS0031

25 x 40, Video Mode 1, Scroll at Row 25, Normal Height



\$+DS0100

Display Setup (continued)

25 x 40, Video Mode 1, Scroll at Row 13, Double Height



\$+DS0131

25 x 80, Video Mode 2, Scroll at Row 25, Normal Height



\$+DS0200

25 x 80, Video Mode 2, Scroll at Row 13, Double Height



\$+DS0231

25 x 80, Video Mode 3, Scroll at Row 25, Normal Height



\$+DS0300

25 x 80, Video Mode 3, Scroll at Row 13, Double Height



\$+DS0331

EOF (End of File)

Purpose: Defines the end of file character for the communications port when transmitting a file from the JANUS 2050.

Note: You must select the communications port and protocol before setting the parameters to define that protocol. Refer to the configuration command “Communications Protocol, Configure” earlier in this chapter for more information on defining protocols.

The configured option may be overridden when used with certain communications protocols. It will not be overridden when used with User-Defined protocol.

Default: Disabled

Syntax: FAdata
data can be any ASCII character.

Scan: To disable EOF, scan the following bar code:

Disable EOF



\$+FA

Or: To set EOF to an ASCII character:

1. Scan the following bar code:

Enter Accumulate / EOF



+/\$+FA

2. Scan a bar code for *data* from the full ASCII chart in Appendix A.
3. Scan the following bar code:

Exit Accumulate



-/

EOM (End of Message)

Purpose: Attaches an EOM to the end of a data block to indicate the end of data transmission to and from a JANUS 2050. You can disable the EOM transmit and receive characters, define EOM transmit and receive to the same characters, or define EOM transmit and receive to different characters.

Note: You must select the communications port and protocol before setting the parameters to define that protocol. For help, see the configuration command "Communications Protocol, Configure" earlier in this chapter.

Default: EOM Transmit and Receive are set to CR (0DH) and LF (0AH) (carriage return line feed)

Syntax: PF Disable transmit and receive EOM
PFdata Enable transmit and receive EOM

PI Disable transmit EOM only
PIdata Enable transmit EOM only

PJ Disable receive EOM only
PJdata Enable receive EOM only

data can be one or two ASCII characters.

Scan: To disable EOM, scan one of these bar codes:

Disable EOM, Transmit and Receive



\$+PF

Disable EOM, Transmit Only



\$+PI

Disable EOM, Receive Only



\$+PJ

Or: To set EOM transmit and receive to the same ASCII character:

1. Scan this bar code:

Enter Accumulate / Enable EOM, Transmit and Receive



+/\$+PF

EOM (End of Message continued)

- 2. Scan one or two bar codes for *data* from the full ASCII chart in Appendix A.
- 3. Scan this bar code:

Exit Accumulate



-/

Or: To set EOM transmit and receive to different ASCII characters:

Note: You can enable an EOM transmit character and disable the EOM receive character, or vice versa.

- 1. Scan this bar code to set the EOM transmit character:

Enter Accumulate / Enable EOM, Transmit Only



+/\$+PI

- 2. Scan one or two bar codes for *data* from the full ASCII chart in Appendix A.
- 3. Scan this bar code:

Exit Accumulate



-/

- 4. Scan this bar code to set the EOM receive character:

Enter Accumulate / Enable EOM, Receive Only



+/\$+PJ

- 5. Scan one or two bar codes for *data* from the full ASCII chart in Appendix A.
- 6. Scan this bar code:

Exit Accumulate



-/

EOR (End of Record)

Purpose: Attaches an EOR to the end of every record of a file transmit.

Note: You must select the communications port and protocol before setting the parameters to define that protocol. Refer to the configuration command "Communications Protocol, Configure" earlier in this chapter for more information on defining protocols.

The configured option may be overridden when used with certain communications protocols. It will not be overridden when used with User-Defined protocol.

Default: Disabled

Syntax: FBdata

data can be one or two ASCII characters.

Scan: To disable EOR, scan the following bar code:

Disable EOR



\$+FB

Or: To set the EOR character to an ASCII character(s):

1. Scan the following bar code:

Enter Accumulate / EOR



+/\$+FB

2. Scan one or two bar codes for data from the full ASCII chart in Appendix A.
3. Scan the following bar code:

Exit Accumulate



-/

Flow Control

Purpose: Regulates the data transmission through the communications port. The JANUS 2050 is a DTE device.

Clear To Send/Request To Send (CTS/RTS) is a hardware signal flow control. RTS is set high by the JANUS 2050 when it is ready to transmit. CTS is checked by the JANUS 2050 when trying to transmit data.

XON/XOFF response causes the JANUS 2050 to respond to XON/XOFF characters received while transmitting. XON/XOFF control specifies that XON/XOFF characters are transmitted by the JANUS 2050 to control the incoming data flow. XON/XOFF response and control specify that the JANUS 2050 responds to and transmits XON/XOFF characters.

Note: You must select the communications port and protocol before setting the parameters that define the protocol. Refer to the configuration command “Communications Protocol, Configure” earlier in this chapter for more information on defining protocols.

Default: None

Syntax: *ILdata*

Acceptable values for *data* are:

- 0 None
- 1 CTS checking/RTS control
- 2 XON/XOFF response
- 3 XON/XOFF control
- 4 XON/XOFF response and control

Scan: One of the following labels:

No Flow Control



S+IL0

CTS Checking/RTS Control



S+IL1

XON/XOFF Response



S+IL2

XON/XOFF Control



S+IL3

XON/XOFF Response and Control



S+IL4

Intercharacter Delay

Purpose: Defines the amount of time the JANUS 2050 waits before sending each character to the host. It modifies outgoing data only by slowing the speed of transmission. A character delay can be useful when communicating with a controller through modems using full-duplex operation.

Note: You must select the communications port and protocol before setting the parameters that define the protocol. Refer to the configuration command "Communications Protocol, Configure" earlier in this chapter for more information on defining protocols.

Default: 0 sec

Syntax: IDdata

Acceptable values for *data* are:

0	0 ms
1	1 ms
2	2 ms
3	5 ms
4	10 ms
5	20 ms
6	50 ms
7	100 ms

Scan: One of the following labels:

0 ms Intercharacter Delay



\$+ID0

1 ms Intercharacter Delay



\$+ID1

2 ms Intercharacter Delay



\$+ID2

5 ms Intercharacter Delay



\$+ID3

Intercharacter Delay (continued)

10 ms Intercharacter Delay



\$+ID4

20 ms Intercharacter Delay



\$+ID5

50 ms Intercharacter Delay



\$+ID6

100 ms Intercharacter Delay



\$+ID7

Interleaved 2 of 5

Purpose: Enables/disables decoding of Interleaved 2 of 5 symbology. Interleaved 2 of 5 is a high-density, self-checking, continuous numeric symbology. It is mainly used in inventory distribution.

Enabling Interleaved 2 of 5 automatically disables 2 of 5.

Default: Variable length with a check digit

Syntax: *CAdata*

Acceptable values for *data* are:

- 0 Disabled
- 2-32 Fixed length (even number only)
- 97 Variable length without a check digit
- 98 Case code (6 or 14) with a check digit
- 99 Variable length with a check digit



Caution

Using the variable length without a check digit configuration option can cause substitution errors.

Conseil

Des erreurs de substitution peuvent survenir si vous utilisez la longueur variable sans option de vérification de configuration de chiffres.

Scan: One of the following labels:

Disable Interleaved 2 of 5



\$+CA0

Variable Length With a Check Digit



\$+CA99

Variable Length Without a Check Digit



\$+CA97

Interleaved 2 of 5, Case Code



\$+CA98

Interleaved 2 of 5 (continued)

Or: To set Interleaved 2 of 5 to fixed length:

1. Scan the following bar code:

Enter Accumulate / Fixed Length



+/\$+CA

2. Scan a numeric value for *data* from the following bar codes (even numbers 2 through 32 only):



0



1



2



3



4



6



8

3. Scan the following bar code:

Exit Accumulate



-/

IRL BAK (Bad Program Acknowledge)

Purpose: A BAK is sent from the JANUS 2050 to indicate that an IRL program cannot be successfully downloaded.

Note: You must select the communications port and protocol before setting the parameters to define that protocol. Refer to the configuration command "Communications Protocol, Configure" earlier in this chapter for more information on defining protocols.

Default: BEL

Syntax: ZBdata
data can be any ASCII character.

Scan: To disable BAK, scan the following bar code:

Disable BAK



\$+ZB

Or: To set BAK to an ASCII character:

1. Scan the following bar code:

Enter Accumulate / BAK



+/\$+ZB

2. Scan a bar code for *data* from the full ASCII chart in Appendix A.
3. Scan the following bar code:

Exit Accumulate



_/

IRL END Program Block

Purpose: Indicates the last block of an IRL program when downloading a program to the JANUS 2050.

Note: You must select the communications port and protocol before setting the parameters to define that protocol. Refer to the configuration command “Communications Protocol, Configure” earlier in this chapter for more information on defining protocols.

Default: SO (shift out)

Syntax: XDdata
data can be any ASCII characters.

Scan: To disable END, scan the following bar code:

Disable END



\$+XD

Or: To set END to an ASCII character:

1. Scan the following bar code:

Enter Accumulate / End of IRL Program Block



+/\$+XD

2. Scan a bar code for *data* from the full ASCII chart in Appendix A.

3. Scan the following bar code:

Exit Accumulate



_/

IRL EOP (End of Program)

Purpose: An EOP indicates the end of an IRL program block when downloading a program to the JANUS 2050.

Note: You must select the communications port and protocol before setting the parameters to define that protocol. Refer to the configuration command "Communications Protocol, Configure" earlier in this chapter for more information on defining protocols.

Default: SYN (synchronous idle)

Syntax: XBdata
data can be any ASCII character.

Scan: To disable EOP, scan the following bar code:

Disable EOP



\$+XB

Or: To set EOP to an ASCII character:

1. Scan the following bar code:

Enter Accumulate / EOP



+/\$+XB

2. Scan a bar code for *data* from the full ASCII chart in Appendix A.
3. Scan the following bar code:

Exit Accumulate



-/

IRL PAK (Program Acknowledge)

Purpose: This character is sent by the JANUS 2050 to the host computer to acknowledge a received IRL program.

Note: You must select the communications port and protocol before setting the parameters that define the protocol. Refer to the configuration command “Communications Protocol, Configure” earlier in this chapter for more information on defining protocols.

Default: RS (record separator)

Syntax: *Z**A**data*
data can be any ASCII character.

Scan: To disable PAK, scan the following bar code:

Disable PAK



\$+ZA

Or: To set the PAK to an ASCII character:

1. Scan the following bar code:

Enter Accumulate / PAK



+/\$+ZA

2. Scan a bar code for *data* from the full ASCII chart in Appendix A.

3. Scan the following bar code:

Exit Accumulate



_/

IRL PSS (Program Statement Separator)

Purpose: Separates individual IRL program statements from each other.

Note: You must select the communications port and protocol before setting the parameters that define the protocol. Refer to the configuration command "Communications Protocol, Configure" earlier in this chapter for more information on defining protocols.

Do not define PSS as the same character used for EOM.

Default: CR (carriage return)

Syntax: XEdata
data can be any ASCII character.

Scan: To disable PSS, scan the following bar code:

Disable PSS



\$+XE

Or: To set the PSS to an ASCII character:

1. Scan the following bar code:

Enter Accumulate / PSS



+/\$+XE

2. Scan a bar code for *data* from the full ASCII chart in Appendix A.

3. Scan the following bar code:

Exit Accumulate



-/

IRL RUN

Purpose: Designates the end of an IRL program download and causes the JANUS 2050 to execute the program. RUN takes the place of the last EOP character in the downloaded program.

Note: You must select the communications port and protocol before setting the parameters that define the protocol. Refer to the configuration command “Communications Protocol, Configure” earlier in this chapter for more information on defining protocols.

Default: DC2

Syntax: XCdata
data can be any ASCII character.

Scan: To disable RUN, scan the following bar code:

Disable RUN



\$+XC

Or: To set RUN to an ASCII character:

1. Scan the following bar code:

Enter Accumulate / RUN



+/\$+XC

2. Scan a bar code for *data* from the full ASCII chart in Appendix A.
3. Scan the following bar code:

Exit Accumulate



-/

IRL SOP (Start of Program)

Purpose: Defines the beginning of an IRL program download from the host computer.

Note: You must select the communications port and protocol before setting the parameters that define the protocol. Refer to the configuration command "Communications Protocol, Configure" earlier in this chapter for more information on defining protocols.

Default: SI (shift in)

Syntax: XAdata
data can be any ASCII character.

Scan: To disable SOP, scan the following bar code:

Disable SOP



\$+XA

Or: To set SOP to an ASCII character:

1. Scan the following bar code:

Enter Accumulate / SOP



+/\$+XA

2. Scan a bar code for *data* from the full ASCII chart in Appendix A.

3. Scan the following bar code:

Exit Accumulate



./

Key Code Lookup Table

Purpose: Allows scanned characters to be remapped to keystroke equivalents. Up to 20 characters can be redefined.

Default: 102-key PC keyboard (no modifications)

Syntax: WMdata
Acceptable values for *data* are any ASCII character.

Scan: To reset the lookup table to the default setting, scan the following bar code:

Clear Lookup Table



\$+WN

Or: To modify any scanned character, complete the following steps:

1. Scan the following bar code:

Modify Lookup Table



+/\$+WM

2. Enter data by scanning the ASCII character you wish to redefine from the full ASCII chart in Appendix A.
3. Enter the new key by scanning the four-digit hex value from the full ASCII chart in Appendix A. Refer to the Key Codes table in Appendix A for the key's hex value.

Note: The redefined character and ASCII value should be enclosed in quotes to prevent the JANUS 2050 from interpreting the option as a JANUS 2050 or configuration command. For example, `+$+WM"A1A5B"` is interpreted as, redefine A to [(hex value 1A5B).

4. Scan the Exit Accumulate bar code:

Exit Accumulate



_/

Keypad Caps Lock

Purpose: Sets the caps lock on and off. By default, the JANUS 2050 sets caps lock off when it boots. This command lets you modify the configuration file (such as JANUS.INI) to enable caps lock after the JANUS 2050 boots.

Default: Caps lock off

Syntax: *KAdata*

Acceptable values for *data* are:

0 Caps lock off

1 Caps lock on

Scan: Scan one of the following labels:

Caps Lock Off



\$+KA0

Caps Lock On



\$+KA1

Keypad Clicker

Purpose: Enables/disables the keypad clicks. Every time a key is pressed or a two-dimensional symbology is decoded, the JANUS 2050 emits a click.

Default: Clicker enabled

Syntax: *KCdata*
Acceptable values for *data* are:

- 0 Disable keypad clicker
- 1 Enable keypad clicker

Scan: One of the following labels:

Disable Keypad Clicker



S+KC0

Enable Keypad Clicker



S+KC1

Keypad Ctrl Key Functions

Purpose: Defines the functionality of the control (Ctrl) key.

Default: Ctrl key permitted

Syntax: *KBdata*

Acceptable values for *data* are:

- 0 Ctrl key permitted
- 1 Ctrl-Alt-Del sequence (warm reboot) prohibited
- 2 Ctrl key combinations prohibited

Scan: One of the following labels:

Ctrl Key Permitted



\$+KB0

Ctrl-Alt-Del Prohibited



\$+KB1

Ctrl Key Combinations Prohibited



\$+KB2

LRC

Purpose: The Longitudinal Redundancy Check character is an error-checking character that can be appended to transmitted and received blocks of data.

Note: You must select the communications port and protocol before setting the parameters that define the protocol. Refer to the configuration command “Communications Protocol, Configure” earlier in this chapter for more information on defining protocols.

Default: Disabled

Syntax: IFdata
Acceptable values for data are:

- 0 LRC disabled
- 1 LRC enabled

Scan: One of the following labels:

Disable LRC



S+IF0

Enable LRC



S+IF1

MSI

Purpose: Enables/disables decoding of MSI symbology. MSI code is similar to Plessey code. It includes a start pattern, data characters, one or two check digits, and a stop pattern. MSI code requires two parameters.

Default: Disabled

Syntax: CN*data*

Acceptable values for *data* are:

<i>First digit:</i>	0	Disabled
	1	No check digits
	2	1 modulus 10 check digit
	3	2 modulus 10 check digit
<i>Second digit:</i>	0	Discard check digit
	1	Transmit check digit

Scan: One of the following labels:

Disable MSI



\$+CN00

MSI Without Check Digits



\$+CN10

MSI With 1 Modulus 10 Check Digit, Discard Check Digit



\$+CN20

MSI With 1 Modulus 10 Check Digit, Transmit Check Digit



\$+CN21

MSI (continued)

MSI With 2 Modulus 10 Check Digits, Discard Check Digits



\$+CN30

MSI With 2 Modulus 10 Check Digits, Transmit Check Digits



\$+CN31

NEG (Negative Acknowledge)

Purpose: Indicates a negative acknowledgment to a transmitted message. NEG and AFF must both be enabled to have a valid configuration.

Note: You must select the communications port and protocol before setting the parameters that define the protocol. Refer to the configuration command "Communications Protocol, Configure" earlier in this chapter for more information on defining protocols.

Default: Disabled

Syntax: PHdata
data can be any ASCII character.

Scan: To disable NEG, scan the following bar code:

Disable NEG



\$+PH

Or: To set the NEG to an ASCII character:

1. Scan the following bar code:

Enter Accumulate / NEG



+/\$+PH

2. Scan a bar code for *data* from the full ASCII chart in Appendix A.
3. Scan the following bar code:

Exit Accumulate



_/

Parity

Purpose: Sets the parity of the selected communications port. Parity is used for error checking in data transmissions.

Note: You must select the communications port and protocol before setting the parameters that define the protocol. Refer to the configuration command “Communications Protocol, Configure” earlier in this chapter for more information on defining protocols.

Default: Even

Syntax: `IBdata`

Acceptable values for *data* are:

- 0 None
- 1 Even
- 2 Odd
- 3 Mark
- 4 Space

Scan: One of the following labels:

No Parity



\$+IB0

Even Parity



\$+IB1

Odd Parity



\$+IB2

Mark Parity



\$+IB3

Space Parity



\$+IB4

Plessey

Purpose: Enables/disables decoding of Plessey symbology. Plessey code is pulse-width-modulated. It includes a start character, data characters, an eight-bit cyclic check digit, a termination bar, and usually a reverse start character. The code is continuous and not self-checking. Plessey code has two parameters that need to be configured: start code and check digit.

Default: Disabled

Syntax: *CIdata*

Acceptable values for *data* are:

- 00 Disabled
- 10 Plessey with reverse start code
- 30 Transmit check digit
- 31 Discard check digit

Scan: To disable Plessey:

Disable Plessey



\$+CI00

Or: To set Plessey, complete the following steps:

1. Scan the following bar code:

Plessey With Reverse Start Code



\$+CI10

2. Scan one of the following bar codes to transmit or retain the check digit:

Transmit Check Digit



\$+CI30

Discard Check Digit



\$+CI31

POL

Purpose: Solicits or requests data from a polled device.

Note: You must select the communications port and protocol before setting the parameters that define the protocol. Refer to the configuration command “Communications Protocol, Configure” earlier in this chapter for more information on defining protocols.

Default: Disabled

Syntax: HBdata
data can be any ASCII character.

Scan: To disable POL, scan the following bar code:

Disable POL



\$+HB

Or: To set POL to an ASCII character:

1. Scan the following bar code:

Enter Accumulate / POL



+/\$+HB

2. Scan a bar code for *data* from the full ASCII chart in Appendix A.

3. Scan the following bar code:

Exit Accumulate



./

Postamble

Purpose: Sets the postamble that is appended to any data scanned by the JANUS 2050. Common postambles include cursor controls, such as tabs or carriage return line feeds.

Note: Postambles are not added to scanned data when running IRL programs.

Default: <CR>

Syntax: AE*data*

Acceptable values for *data* are up to 25 ASCII characters. When no data is included, the postamble is disabled. You must enclose the *data* within quotation marks if the *data* is a reserved word, such as a configuration command.

Scan: To disable the postamble, scan the following bar code:

Disable Postamble



\$+AE

Or: To set the postamble to an ASCII character string:

1. Scan the following bar code:

Enter Accumulate / Postamble / Start of Data



+/\$+AE

2. Scan a value for *data* from the ASCII chart in Appendix A. The postamble can be from 1 to 25 characters.
3. Scan the following bar code:

End of Data / Exit Accumulate



-/

Preamble

Purpose: Sets the preamble that precedes any data scanned by the JANUS 2050. Common preambles include a data location number or an operator number.

Note: Preambles are not added to scanned data when running IRL programs.

Default: Disabled

Syntax: AD*data*

Acceptable values for *data* are up to 25 ASCII characters. When no data is included, the preamble is disabled. You must enclose the *data* within quotation marks if the *data* is a reserved word, such as a configuration command.

Scan: To disable the preamble, scan the following bar code:

Disable Preamble



\$+AD

Or: To set the preamble to an ASCII character string:

1. Scan the following bar code:

Enter Accumulate / Preamble / Start of Data



+/\$+AD

2. Scan a value for *data* from the ASCII chart in Appendix A. The preamble can be from 1 to 25 characters.
3. Scan the following bar code:

End of Data / Exit Accumulate



-/

Records Per Block

Purpose: Defines the maximum number of data records transmitted per block of data. Usually files are transmitted record by record. This configuration allows multiple records to be transmitted per data block. A block of data is transmitted during a single transmission, like an individual data record is normally.

***Note:** The configured option may be overridden when used with certain communications protocols. It will not be overridden when used with User-Defined protocol.*

You must select the communications port and protocol before setting the parameters that define the protocol. Refer to the configuration command "Communications Protocol, Configure" earlier in this chapter for more information on defining protocols.

Default: 1 record transmitted per block

Syntax: FCdata

Acceptable values for *data* are:

- 0 All records are transmitted in one block
- 01-99 Records transmitted per block

Scan: To have all records transmitted in one block, scan the following bar code:

All Records = 1 Block



\$+FC0

Or: To set the records per block:

1. Scan the following bar code:

Enter Accumulate / Number of Records Per Block



+/\$+FC

Records Per Block (continued)

2. Scan a two-digit numeric value for *data* from the following bar codes:



0



1



2



3



4



5



6



7



8



9

3. Scan the following bar code:

Exit Accumulate



/

REQ (Request for Acknowledge)

Purpose: Enables/disables a request for a repeat handshake event. If REQ is enabled, AFF and NEG must also be enabled to have a valid configuration.

Note: You must select the communications port and protocol before setting the parameters that define the protocol. Refer to the configuration command "Communications Protocol, Configure" earlier in this chapter for more information on defining protocols.

Default: Disabled

Syntax: PDdata
data can be any ASCII character.

Scan: To disable REQ, scan the following bar code:

Disable REQ



\$+PD

Or: To set REQ to an ASCII character:

1. Scan the following bar code:

Enter Accumulate / REQ



+/\$+PD

2. Scan a bar code for *data* from the full ASCII chart in Appendix A.
3. Scan the following bar code:

Exit Accumulate



-/

RES (Reset)

Purpose: Enables/disables a reset event.

Note: You must select the communications port and protocol before setting the parameters that define the protocol. Refer to the configuration command “Communications Protocol, Configure” earlier in this chapter for more information on defining protocols.

Default: Disabled

Syntax: PCdata
data can be any ASCII character.

Scan: To disable RES, scan the following bar code:

Disable RES

 \$+PC

Or: To set RES to an ASCII character:

1. Scan the following bar code:

Enter Accumulate / RES

 +/\$+PC

2. Scan a bar code for *data* from the full ASCII chart in Appendix A.

3. Scan the following bar code:

Exit Accumulate

 ./

Scan Ahead

Purpose: Enables/disables scan ahead. When this parameter is enabled, you can scan a number of labels that are held in a stack until the JANUS 2050 can process the data. When this parameter is disabled, you scan a label and the JANUS 2050 processes the data before the next label can be scanned.

Default: Enabled

Syntax: *SDdata*

Acceptable values for *data* are:

- 0 Disable - one label at a time
- 1 Enable - many labels at a time

Scan: One of the following labels:

Disable



\$+SD0

Enable



\$+SD1

Scanner Devices

Purpose: Specifies the the scanner type, this allows the JANUS 2050 to optimize performance when connected to that scanner.

Note: When a specific scanner is selected, other scanners may not function properly.

Default: All compatible scanners

Syntax: *SSdata*

Acceptable values for *data* are:

- 0 All compatible scanners (use for 1517 scanner)
- 1 1461 CCD (not currently supported)
- 2 1500 (not currently supported)
- 3 1515 (not currently supported)
- 4 1545

Scan: One of the following labels

All Compatible Scanners



\$+SS0

1461 CCD



\$+SS1

1500



\$+SS2

1515



\$+SS3

1545



\$+SS4

Symbol Scanner



\$+SS5

1550



\$+SS6

Scanner Mode

- Purpose:** Defines how the scanner operates when you pull the trigger. Two scanner modes are available:
- One-shot mode requires you to pull the trigger each time you want to scan a bar code. Once the bar code is scanned, the scanner turns off.
 - Automatic mode allows you to pull the trigger once and scan a series of bar codes. Releasing the trigger turns the scanner off. To scan the same bar code more than once, you must release the trigger or scan a different bar code before attempting a second scan.

Note: This configuration is applicable only when using a scanner with the reader.

Default: One-shot mode

Syntax: SBdata

Acceptable values for *data* are:

0	One-shot mode
1	1461 Automatic mode

Scan: One of the following labels:

One-Shot Mode

\$+SB0

Automatic Mode

\$+SB1

Scanner Redundancy

Purpose: Defines the number of scans (voting) the scanner takes of the same label that must be decoded correctly for a good read of the label. Voting allows the JANUS 2050 to decode the same bar code label multiple times during a single-trigger event, and to compare the decoded information a specific number of times before signaling a good read. Setting the redundancy configuration to *low* allows the JANUS 2050 to accept the first good read, which speeds up performance. This setting is recommended for good quality bar code labels.

When configured to *normal*, the JANUS 2050 decodes the bar code label a minimum number of times in each trigger event. When configured to *high*, the JANUS 2050 scans and decodes the bar code label a maximum number of times in each trigger event. The specific number of comparisons depends on each bar code symbology.

For example, when you are scanning Code 39 labels and voting is configured to *moderate*, two successive matching decodes in a single-trigger event are required. When voting is configured to *high*, three successive matching decodes in a single-trigger event are required.

Setting the redundancy configuration to *high* is important when scanning poor quality labels that may cause substitution errors.

Default: Normal

Syntax: *SRdata*
Acceptable values for *data* are:

- 0 None
- 1 Normal
- 2 High

Scan: One of the following labels:

None



\$+SR0

Normal



\$+SR1

High



\$+SR2

Scanner Timeout

Purpose: Defines the maximum length of time the scanner stays on following each trigger pull.

Default: No timeout

Syntax: SAdata

Acceptable values for *data* are:

0 Disabled

1-60 Shutoff time in seconds

Scan: 1. Scan the following bar code:

Enter Accumulate / Scanner Timeout



+/\$+SA

2. Scan a numeric value for *data* from the following bar codes:



0



1



2



3



4



5



6



7



8



9

3. Scan the following bar code:

Exit Accumulate



-/

Scanner Trigger

Purpose: Scanner trigger allows you to set the triggering to level or edge triggering.

- With level triggering, you pull the trigger and the laser turns on and stays on until you release the trigger.
- In edge triggering, you pull the trigger and the laser turns on and stays on. When you pull the trigger a second time, the laser turns off. Simply releasing the trigger does not turn the laser off. If the laser is left on, the scanner timeout turns the laser off.

Default: Level

Syntax: *SCdata*

Acceptable values for *data* are:

0 Level
1 Edge

Scan: One of the following labels:

Level Trigger



\$+SC0

Edge Trigger



\$+SC1

SEL (Select)

Purpose: Defines the character that requests permission for the controller to send data to the polled device.

Note: You must select the communications port and protocol before setting the parameters that define the protocol. Refer to the configuration command "Communications Protocol, Configure" earlier in this chapter for more information on defining protocols.

Default: Disabled

Syntax: HAdata
data can be any ASCII character

Scan: To disable SEL, scan the following bar code:

Disable SEL



\$+HA

Or: To set SEL to an ASCII character:

1. Scan the following bar code:

Enter Accumulate / SEL



+/\$+HA

2. Scan a bar code for *data* from the full ASCII chart in Appendix A.
3. Scan the following bar code:

Exit Accumulate



_/

SOM (Start of Message)

Purpose: SOM is the first character in a message sent to or received from the host computer.

Note: You must select the communications port and protocol before setting the parameters that define the protocol. Refer to the configuration command “Communications Protocol, Configure” earlier in this chapter for more information on defining protocols.

Default: Disabled

Syntax: PEdata
data can be any ASCII character

Scan: To disable SOM, scan the following bar code:

Disable SOM



\$+PE

Or: To set SOM to an ASCII character:

1. Scan the following bar code:

Enter Accumulate / SOM



+/\$+PE

2. Scan a bar code for *data* from the full ASCII chart in Appendix A.
3. Scan the following bar code:

Exit Accumulate



_/

Stop Bits

Purpose: Sets the number of stop bits on the communications port.

Note: You must select the communications port and protocol before setting the parameters that define the protocol. Refer to the configuration command "Communications Protocol, Configure" earlier in this chapter for more information on defining protocols.

Default: 1 stop bit

Syntax: ICdata

Acceptable values for *data* are:

- 1 One stop bit
- 2 Two stop bits

Scan: One of the following labels:

1 Stop Bit



\$+IC1

2 Stop Bits



\$+IC2

Timeout Delay

Purpose: Defines the length of time the JANUS 2050 waits between characters when receiving a message. When the timeout expires, an I/O error occurs.

If you are using the JANUS 2050 to use a User-Defined protocol or a Point-to-Point protocol, you should use Timeout Delay only at baud rates of 9600 or lower. You should disable Timeout Delay (IE=8) at baud rates of 19200 or higher to avoid losing incoming data.

Note: You must select the communications port and protocol before setting the parameters that define the protocol. Refer to the configuration command “Communications Protocol, Configure” earlier in this chapter for more information on defining protocols.

Default: 10 sec

Syntax: IEdata

Acceptable values for *data* are:

0	5 ms
1	100 ms
2	500 ms
3	2 sec
4	10 sec
5	20 sec
6	40 sec
7	60 sec
8	No timeout

Scan: One of the following labels:

No Timeout Delay



S+IE8

Timeout Delay, 5 ms



S+IE0

Timeout Delay, 100 ms



S+IE1

Timeout Delay, 500 ms



S+IE2

Timeout Delay, 2 sec



S+IE3

Timeout Delay, 10 sec



S+IE4

Timeout Delay (continued)

Timeout Delay, 20 sec



\$+IE5

Timeout Delay, 40 sec



\$+IE6

Timeout Delay, 60 sec



\$+IE7

Transmit Abort Timeout

Purpose: Defines the length of time the JANUS 2050 waits to receive a message if one of the following conditions is true:

- CTS is continuously false for the timeout period.
- XOFF condition does not change within the timeout period.
- POL not received (polling protocol) within the timeout period.

This is similar to the Timeout Delay configuration, but it only applies to the three conditions listed above.

Note: You must select the communications port and protocol before setting the parameters that define the protocol. Refer to the configuration command “Communications Protocol, Configure” earlier in this chapter for more information on defining protocols.

Default: Disabled

Syntax: IHdata

Acceptable values for *data* are:

0	Disabled
1-65000	Timeout in ms

1. Scan the following bar code:

Enter Accumulate / Transmit Abort Timeout



+/\$+IH

2. Scan a numeric value of one to five digits for *data* from the following bar codes:



0



1



2



3

Transmit Abort Timeout (continued)



4



5



6



7



8



9

3. Scan the following bar code:

Exit Accumulate



/

Turnaround Delay

Purpose: Defines the length of time the JANUS 2050 waits to respond after receiving data from the host computer.

Note: You must select the communications port and protocol before setting the parameters that define the protocol. Refer to the configuration command “Communications Protocol, Configure” earlier in this chapter for more information on defining protocols.

Default: 0 sec

Syntax: IGdata

Acceptable values for data are:

0	0 ms
1	1 ms
2	2 ms
3	5 ms
4	10 ms
5	20 ms
6	50 ms
7	100 ms

Scan: One of the following labels:

No Turnaround Delay



S+IG0

Turnaround Delay, 1 ms



S+IG1

Turnaround Delay, 2 ms



S+IG2

Turnaround Delay, 5 ms



S+IG3

Turnaround Delay, 10 ms



S+IG4

Turnaround Delay, 20 ms



S+IG5

Turnaround Delay, 50 ms



S+IG6

Turnaround Delay, 100 ms



S+IG7

UPC/EAN

Purpose: Enables/disables the decoding of Universal Product Code (UPC)/European Article Numbering (EAN) symbology. UPC/EAN are fixed length, numeric, continuous symbologies that use four element widths. An EAN-configured JANUS 2050 can decode UPC, but the reverse is not true. UPC code is a subset of EAN code.

The fifth, sixth, and seventh digits are optional. Setting the sixth digit to 0 strips one leading digit from UPC-A, UPC-E, and EAN-8 and two leading digits from EAN-13. If you want to set the sixth digit, you must also set the fifth digit.

Default: UPC-A/EAN-13, UPC-E, and EAN-8 enabled, supplementals allowed, transmit check digit, transmit number system digit, and retain UPC-A leading zero

Syntax: *CEdata*

data must be 4 to 7 digits selected from the following list:

<i>First digit:</i>	0	UPC-A/EAN-13 disabled
	1	UPC-A/EAN-13 enabled
	2	UPC-A only
<i>Second digit:</i>	0	UPC-E disabled
	1	UPC-E enabled
<i>Third digit:</i>	0	EAN-8 disabled
	1	EAN-8 enabled
<i>Fourth digit</i>	0	Supplementals not allowed
	1	Supplementals allowed
<i>Fifth digit:</i>	0	Discard check digit
	1	Transmit check digit
<i>Sixth digit:</i>	0	Discard number system digit
	1	Transmit number system digit
<i>Seventh digit:</i>	0	Discard UPC-A leading zero
	1	Retain UPC-A leading zero

Scan: To disable UPC/EAN, scan the following bar code:

Disable UPC/EAN



\$+CE000000

UPC/EAN (continued)

Or: To enable UPC/EAN:

1. Scan the following bar code:

Enter Accumulate / UPC/EAN



+/\$+CE

2. Scan one of the following for the first digit:

Disable

UPC/EAN-13



0

Enable

UPC/EAN-13



1

UPC-A only



2

3. Scan one of the following for the second digit:

Disable UPC-E



0

Enable UPC-E



1

4. Scan one of the following for the third digit:

Disable EAN-8



0

Enable EAN-8



1

5. Scan one of the following for the fourth digit:

Supplementals

Not Allowed



0

Supplementals

Allowed



1

6. (Optional) Scan one of the following for the fifth digit:

Discard Check Digit



0

Transmit Check Digit



1

7. (Optional) Scan one of the following for the sixth digit:

Discard Number

System Digit



0

Transmit Number

System Digit



1

8. (Optional) Scan one of the following for the seventh digit:

Discard UPC-A

Leading Zero



0

Retain UPC-A

Leading Zero



1

9. Scan the following bar code:

Exit Accumulate



_/

11

Advanced Operations

This chapter explains how to make more memory available for applications, how to access and use the boot loader screen, how to set the password, and how to put the JANUS 2050 in Storage mode.

Making More RAM Available on the JANUS 2050

Your JANUS 2050 may not have enough conventional memory (RAM) available for the JANUS applications you want to run. If so, you can free up some conventional memory by not installing the PC card drivers and by unloading two TSR programs (TSRs) from your JANUS 2050's memory.

The next sections describe how and when to perform these tasks:

- Not installing the PC card drivers to free up about 60K.
- Unloading the Reader Wedge TSR to free up about 80K.

Note: *If you do not need to free up more conventional memory on your JANUS 2050, you do not have to perform these tasks.*

Not Installing the PC Card Drivers

You do not need to install PC card drivers if you are not using PC cards in your reader. You may be able to save up to 60K in conventional memory by not installing the drivers. Choose the No PC Card option on the MS-DOS startup menu and PC card drivers will not be installed when you boot the reader.

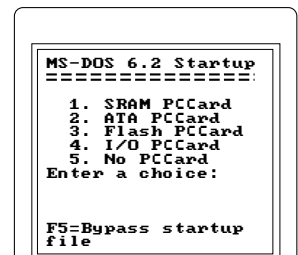

20X0A.002

Unloading the Reader Wedge TSR

The Reader Wedge TSR (RWTSR.EXE) must be loaded in memory before you can call Reader Wedge PSK functions such as `im_receive_input`. However, when you finish your PSK application, you no longer need RWTSR.EXE in memory.

You can save about 80K by unloading RWTSR.EXE with this command:

```
rwtsr -d
```

You can load RWTSR.EXE with this command:

```
rwtsr
```

Accessing the Boot Loader Menu

The Boot Loader menu appears when you enter a designated key combination, the system flash is corrupt, the BIOS checksums fail, or if the JANUS 2050 cannot resume. From the Boot Loader menu you can perform a cold boot, change the password, put the JANUS 2050 in Storage mode, load system flash, or perform a memory dump.

To request the Boot Loader menu

Note: If you do not press a key within 60 seconds after a screen is displayed, the JANUS 2050 automatically shuts off and you have to start over at Step 1.

1. Turn off the JANUS 2050 by pressing the I/O button.
2. Press F3 - 2 - \blacktriangleleft at the same time.
3. Press 2 .
4. Press I/O to turn the JANUS 2050 on.
5. If the password is not set, you immediately go to the Boot Loader menu.

If the password is set, the Password screen is displayed and you must type in the password. You are allowed three tries to enter the password.

Note: The JANUS 2050 is shipped from the factory with the password disabled.

The Boot Loader menu lists the options available and displays status messages or checksums at the bottom of the screen.

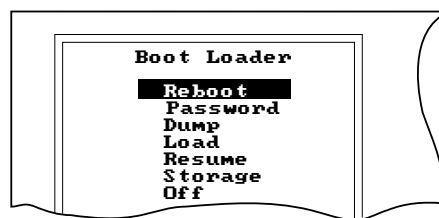

2050U.067

Reboot This option performs a cold boot of the JANUS 2050. A cold boot clears the internal conventional memory and destroys all buffered data.



Caution

When the JANUS 2050 performs a cold boot, data on the RAM disk is destroyed.

Conseil

Lorsque le lecteur s'amorce à froid, les données se trouvant sur le disque RAM sont détruites.

Password Select this option to set, change, or disable the current password. When the password is set, you must enter a password before you can go to the Boot Loader menu.

Dump This selection transmits the lower 640K of memory across the serial port. It is used when the JANUS 2050 is not functioning and you need to save the data.

Before selecting this option, the host computer must be connected to the JANUS 2050 and executing a program that expects the 640K of data. For more information about dumping data, see Chapter 8, “Troubleshooting.”

Load Select this option to receive a program across the serial port. The program may be a transient loader capable of programming the flash, a program to reload a corrupted keypad table, or execute diagnostics. For more information about loading programs, see Chapter 8, “Troubleshooting.”



Caution

If the load system flash option is selected, all system data will be lost.

Conseil

Si l'option de chargement du flash système (load system flash) est sélectionnée, toutes les données système seront perdues.

Resume This selection exits the Boot Loader menu and returns the JANUS 2050 to where it was before it was turned off. If the JANUS 2050 was executing a program, the program continues. If there is a bad checksum or the flash is corrupt, the JANUS 2050 cannot resume.

Storage This selection puts the JANUS 2050 in Storage mode to preserve the life of the backup battery. You should put the JANUS 2050 in Storage mode whenever the JANUS 2050 is not going to be used for a couple of months. However, all RAM data is lost.

Off This selection exits the Boot Loader menu and puts the JANUS 2050 into the suspend state. When the JANUS 2050 is turned on again, it resumes normal operation.

Changing the Password

The password is used to limit access to the Boot Loader menu. If the password is set, you cannot access the options in the Boot Loader menu without the password. Also, if you put the JANUS 2050 in Storage mode, you cannot exit Storage mode without the password. If you lose the password, call your Intermec service representative.

To set or change the password

1. If the Boot Loader menu is not already displayed on the JANUS 2050, request the menu by turning the JANUS 2050 off. Then press **F3** - **2** - **4** followed by **2** followed by **0**.

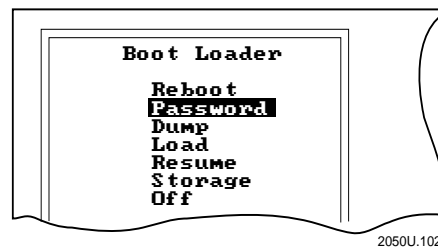

2. Using **↓**, select Password.
3. Press **enter**.
4. Type the new password and press **enter**. The password can be up to seven characters.

To disable the password, press **enter** twice without typing in a password.

5. Type the new password again for verification and press **enter**.

If you enter it incorrectly the second time, you receive an error message and you need to repeat Steps 4 and 5 again.

6. Select Resume from the Boot Loader menu.

Putting the JANUS 2050 in Storage Mode

If you are not going to use the JANUS 2050 for the next couple of months, you should put it in Storage mode to preserve the life of the internal battery.



Caution

Any data stored in the JANUS 2050's memory is lost when you enter Storage mode.

Conseil

Toutes les données stockées dans la mémoire du lecteur sont perdues lorsque vous entrez en mode de stockage.

To put the JANUS 2050 in Storage mode

1. If the Boot Loader menu is not already displayed on the JANUS 2050, request the menu by turning the JANUS 2050 off. Then press **F3** - **2** - **↓** followed by **2** followed by **↻**.

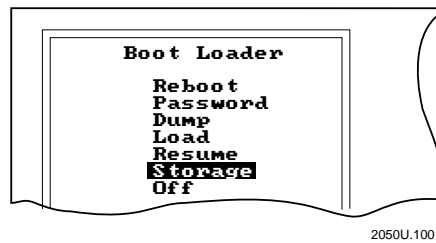

2. Using **↓**, select Storage.
3. Press **↵**. The JANUS 2050 automatically shuts off and is placed in Storage mode.

Exiting Storage Mode

If you turn on the JANUS 2050 while it is in Storage mode, you will need to exit Storage mode.

To exit Storage mode

1. If the password is set, the JANUS 2050 will request the password.
2. Once the password is entered, the Boot Loader menu is displayed.
3. From the menu, select Reboot. The JANUS 2050 will execute POST and then ask if you want to exit Storage mode.
4. Press **↵** to exit Storage mode and continue booting the JANUS 2050.

Or,

Press **Esc** to turn off the JANUS 2050 and remain in Storage mode.



Configuration and Full ASCII Charts

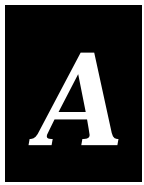

This appendix includes reference tables you can use when configuring communications protocols and the key code lookup table on the reader. Appendix A also contains a full ASCII chart and charts of Code 39 bar code labels that you can scan with the JANUS 2050. A keypad chart showing how to enter all characters on the alphanumeric keypad is also provided.

Entering ASCII Control Characters

You use ASCII control characters when setting the protocol parameters. You can enter ASCII control characters into the JANUS 2050 using key combinations. The following table lists the key combinations and the ASCII character that is entered for that combination.

Key Sequence	ASCII Control Character	Key Sequence	ASCII Control Character	Key Sequence	ASCII Control Character
	SOH		FF		ETB
	STX		CR		CAN
	ETX		SO		EM
	EOT		SI		SUB
	ENQ		DLE		FS
	ACK		DC1		GS
	BEL		DC2		RS
	BS		DC3		US
	HT		DC4		NUL
	LF		NAK		ESC
	VT		SYN		

Note: These key sequences for the ASCII control characters FS, GS, RS, US, and NUL are not used in IRL. They are only used in the configuration application or Communications Manager.

Entering Escape Sequences

You use escape sequences when entering ASCII control characters for preambles and postambles in the configuration application, or to edit a configuration file. You can represent non-graphic characters and some ASCII control characters using the backslash and a letter. This table lists escape sequences you enter and the corresponding ASCII control characters.

Escape Sequence	ASCII Control Character
<code>\n</code>	LF Line Feed
<code>\t</code>	HT Horizontal Tab
<code>\b</code>	BS Backspace
<code>\r</code>	CR Carriage Return
<code>\f</code>	FF Form Feed
<code>\a</code>	BEL Bell
<code>\\</code>	\ Slash
<code>\xhh</code>	hh is the two-digit hexadecimal number for the ASCII control character

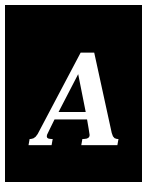

User-Defined Protocol Character Combinations

User-Defined protocol supports 24 configurations. The six key parameters that determine the User-Defined configuration are POL, SEL, RES, REQ, AFF, and NEG. This table lists the valid combinations for these parameters.

POL	SEL	RES	REQ	AFF	NEG
—	—	—	—	—	—
—	—	—	—	<i>data</i>	<i>data</i>
—	—	—	<i>data</i>	<i>data</i>	<i>data</i>
—	—	<i>data</i>	—	—	—
—	—	<i>data</i>	—	<i>data</i>	<i>data</i>
—	—	<i>data</i>	<i>data</i>	<i>data</i>	<i>data</i>
—	<i>data</i>	—	—	—	—
—	<i>data</i>	—	—	<i>data</i>	<i>data</i>
—	<i>data</i>	—	<i>data</i>	<i>data</i>	<i>data</i>
—	<i>data</i>	<i>data</i>	—	—	—
—	<i>data</i>	<i>data</i>	—	<i>data</i>	<i>data</i>
—	<i>data</i>	<i>data</i>	<i>data</i>	<i>data</i>	<i>data</i>
<i>data</i>	—	—	—	—	—
<i>data</i>	—	—	—	<i>data</i>	<i>data</i>
<i>data</i>	—	—	<i>data</i>	<i>data</i>	<i>data</i>
<i>data</i>	—	<i>data</i>	—	—	—
<i>data</i>	—	<i>data</i>	—	<i>data</i>	<i>data</i>
<i>data</i>	—	<i>data</i>	<i>data</i>	<i>data</i>	<i>data</i>
<i>data</i>	<i>data</i>	—	—	—	—
<i>data</i>	<i>data</i>	—	—	<i>data</i>	<i>data</i>
<i>data</i>	<i>data</i>	—	<i>data</i>	<i>data</i>	<i>data</i>
<i>data</i>	<i>data</i>	<i>data</i>	—	—	—
<i>data</i>	<i>data</i>	<i>data</i>	—	<i>data</i>	<i>data</i>
<i>data</i>	<i>data</i>	<i>data</i>	<i>data</i>	<i>data</i>	<i>data</i>

data Means the parameter is set to a character.

— Means the parameter is disabled.

Multi-Drop POL and SEL Combinations

The POL and SEL character combinations are used when you are configuring User-Defined Multi-Drop protocol. The POL and SEL protocol characters must be assigned in a predetermined combination. The following table lists the device address and the corresponding POL and SEL combinations. When you configure for the Intermec Multi-Drop protocol, the POL and SEL combinations are predefined when you select the device address.

Device Address	POL	SEQ	Device Address	POL	SEQ
A	FS	GS	Q	<	=
B	RS	US	R	>	?
C	SP	!	S	@	A
D	"	#	T	B	C
E	\$	%	U	D	E
F	&	'	V	F	G
G	()	W	H	I
H	*	+	X	J	K
I	,	-	Y	L	M
J	.	/	Z	N	O
K	0	1	0	P	Q
L	2	3	1	R	S
M	4	5	2	T	U
N	6	7	3	V	W
O	8	9	4	X	Y
P	:	;	5	Z	[

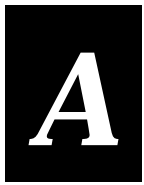

Key Codes

You use the key codes to redefine scanned characters to a keystroke equivalent. Use the Key Code table to find each key's four-digit hexadecimal value that you enter to change the JANUS 2050's key-code lookup table. For help, see the "Key Code Lookup Table" in Chapter 10.





Key Lists each key on a regular PC keyboard.











Normal Lists the key code value for each key.

Shift Lists the key code value for the  key plus the key.





















Control Lists the key code for the  key plus the key.

Alt Lists the key code for the  key plus the key.

For example, the key code for   is 1E41. The key code for   is 1E00.

Key	Normal	Shift	Control	Alt
	3B00	5400	5E00	6800
	4000	5900	6300	6D00
	8500	8700	8900	8B00
	3C00	5500	5F00	6900
	4100	5A00	6400	6E00
	8600	8800	8A00	8C00
	3D00	5600	6000	6A00
	4200	5B00	6500	6F00
	—	—	—	—
	3E00	5700	6100	6B00
	4300	5C00	6600	7000

Key Codes Table (continued)

















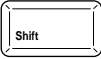

Key	Normal	Shift	Control	Alt
	—	—	0000	—
	3F00	5800	6200	6C00
	4400	5D00	6700	7100
	—	—	7200	—
	1E61	1E41	1E01	1E00
	3062	3042	3002	3000
	2E63	2E43	2E03	2E00
	2064	2044	2004	2000
	1265	1245	1205	1200
	2166	2146	2106	2100
	2267	2247	2207	2200
	2960	297E	—	2900
	2368	2348	2308	2300
	0C2D	0C5F	0C1F	8200
	1769	1749	1709	1700
	0D3D	0D2B	—	8300
	246A	244A	240A	2400
	1A5B	1A7B	1A1B	1A00
	256B	254B	250B	2500
	1B5D	1B7D	1B1D	1B00



Key Codes Table (continued)

Key	Normal	Shift	Control	Alt
	266C	264C	260C	2600
	273B	273A	—	2700
	326D	324D	320D	3200
	316E	314E	310E	3100
	186F	184F	180F	1800
	1970	1950	1910	1900
	1071	1051	1011	1000
	1372	1352	1312	1300
	1F73	1F53	1F13	1F00
	2827	2822	—	2800
	1474	1454	1414	1400
	2B5C	2B7C	2B1C	2B00
	1675	1655	1615	1600
	2F76	2F56	2F16	2F00
	332C	333C	—	3300
	1177	1157	1117	1100
	342E	343E	—	3400
	2D78	2D58	2D18	2D00
	352F	353F	—	3500
	1579	1559	1519	1500

Key Codes Table (continued)



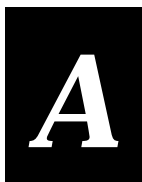







Key	Normal	Shift	Control	Alt
	2C7A	2C5A	2C1A	2C00
 (right)	—	—	—	—
 (left)	—	—	—	—
 (right)	—	—	—	—
 (left)	—	—	—	—
 (right)	—	—	—	—
 (left)	—	—	—	—
	—	—	—	—
	0837	0826	—	7E00
	47E0	47E0	77E0	9700
	4700	4737	7700	<i>See Note</i>
	0938	092A	—	7F00
	4E2B	4E2B	9000	4E00
	4800	4838	8D00	<i>See Note</i>
	0A39	0A28	—	8000
	49E0	49E0	84E0	9900
	4900	4939	8400	<i>See Note</i>
 (backspace)	0E08	0E08	0E7F	0E00
	011B	011B	011B	0100

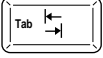

Key Codes Table (continued)

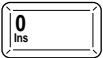
Key	Normal	Shift	Control	Alt
	0534	0524	—	7B00
	4A2D	4A2D	8E00	4A00
	4B00	4B34	7300	See Note
	0635	0625	—	7C00
	372A	372A	9600	3700
	4C00	4C35	8F00	See Note
	0736	075E	071E	7D00
	E02F	E02F	9500	A400
	4D00	4D36	7400	See Note
(left arrow)	4BE0	4BE0	73E0	9B00
	48E0	48E0	8DE0	9800
	0231	0221	—	7800
	4FE0	4FE0	75E0	9F00
	4F00	4F31	7500	See Note
	0332	0340	0300	7900
	E00D	E00D	E00A	A600
	5000	5032	9100	See Note
	0433	0423	—	7A00
	51E0	51E0	76E0	A100

Key Codes Table (continued)

Key	Normal	Shift	Control	Alt
	5100	5133	7600	<i>See Note</i>
	50E0	50E0	91E0	A000
	4DE0	4DE0	74E0	9D00
	3920	3920	3920	3920
	0F09	0F00	9400	A500
	0B30	0B29	—	8100
	52E0	52E0	92E0	A200
	5300	532E	9200	—
	5300	532E	9300	—
	1C0D	1C0D	1C0A	1C00
	—	—	—	—

Note: You use a numeric keypad to enter these key code values by pressing the Alt key plus a three-digit number from 0 to 255. You must enable the number pad on the JANUS 2050 to enter these hexadecimal key codes. For help, see “Using the Keypad” in Chapter 2.

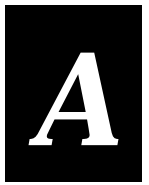

Keypad Charts

These charts list the keystroke sequences for entering all 102 PC-keys on the JANUS 2050's alphanumeric (U.S. version) keypad.

Note: Viewport movement keys have no effect on the JANUS 2050.

U.S. Alphanumeric Keypad

To Enter	Press the Key(s):	To Enter	Press the Key(s):
resume/suspend		backspace	
a to z	to	escape	
A to Z	to	enter	
0 to 9	to	space	
compound function		. (period)	
right ctrl		cursor up	
left ctrl	or 	cursor down	
right alt		cursor left	
left alt	or 	cursor right	
right shift		viewport up	
left shift		viewport down	
caps lock		viewport left	
viewport right		viewport end	
viewport home		viewport page up	
viewport page down		viewport to cursor	
cursor to viewport		tab	
backtab		F1 to F5	
F6 to F10	to	F11	
F12		!	
@		#	

U.S. Alphanumeric Keypad (continued)

To Enter	Press the Key(s):	To Enter	Press the Key(s):
\$	4	%	5
^	6	&	7
*	8	(9
)	0	[J
]	K	{	D
}	E	<	P
>	Q	'	G
,	V	;	L
:	F	,	S
"	M	~	A
-	H	_	B
	N	\	T
/	X	?	R
+	C	=	I
<i>scroll lock</i>	F3	<i>insert</i>	0
<i>pause</i>	F4	<i>delete</i>	.
<i>ctrl break</i>	F4	<i>enter</i>	2
<i>print screen</i>	F5	<i>pg dn</i>	4
<i>home</i>	7	*	5
<i>end</i>	1	/	6
<i>page up</i>	9	+	8
<i>page down</i>	3	-	4

Note: The numeric keypad must be disabled to use the 0 to 9 key combinations shown above.



U.S. Alphanumeric Keypad (continued)

To enter the numeric keypad, press:

To turn Num Lock on and off, press:

To exit the numeric keypad, press:

With Num Lock on:

To Enter	Press the Key(s):
<i>0 to 9</i>	to
<i>space</i>	
<i>.</i>	
<i>end</i>	
<i>cursor down</i>	
<i>page down</i>	
<i>cursor left</i>	
<i>cursor right</i>	
<i>home</i>	
<i>cursor up</i>	
<i>page up</i>	
<i>insert</i>	
<i>delete</i>	

With Num Lock off:

To Enter	Press the Key(s):
<i>end</i>	
<i>cursor down</i>	
<i>page down</i>	
<i>cursor left</i>	
<i>cursor right</i>	
<i>home</i>	
<i>cursor up</i>	
<i>page up</i>	
<i>insert</i>	
<i>delete</i>	
<i>space</i>	
<i>0 to 9</i>	to
<i>.</i>	

Full ASCII Table

The following table lists the ASCII codes and control characters and their binary, hexadecimal, decimal, and Code 39 equivalents.

U.S. ASCII Codes

Binary ⁰	Hex ¹	Dec ²	C39 ³	Char ⁴	Binary ⁰	Hex ¹	Dec ²	C39 ³	Char ⁴
00000000	00	00	%U	NUL	00100000	20	32	SP	SP ⁵
00000001	01	01	\$A	SOH	00100001	21	33	/A	!
00000010	02	02	\$B	STX	00100010	22	34	/B	"
00000011	03	03	\$C	ETX	00100011	23	35	/C	#
00000100	04	04	\$D	EOT	00100100	24	36	/D	\$
00000101	05	05	\$E	ENQ	00100101	25	37	/E	%
00000110	06	06	\$F	ACK	00100110	26	38	/F	&
00000111	07	07	\$G	BEL	00100111	27	39	/G	'
00001000	08	08	\$H	BS	00101000	28	40	/H	(
00001001	09	09	\$I	HT	00101001	29	41	/I)
00001010	0A	10	\$J	LF	00101010	2A	42	/J	*
00001011	0B	11	\$K	VT	00101011	2B	43	/K	+
00001100	0C	12	\$L	FF	00101100	2C	44	/L	,
00001101	0D	13	\$M	CR	00101101	2D	45	/M	-
00001110	0E	14	\$N	SO	00101110	2E	46	/N	.
00001111	0F	15	\$O	SI	00101111	2F	47	/O	/
00010000	10	16	\$P	DLE	00110000	30	48	/P ⁶	0
00010001	11	17	\$Q	DC1	00110001	31	49	/Q	1
00010010	12	18	\$R	DC2	00110010	32	50	/R	2
00010011	13	19	\$S	DC3	00110011	33	51	/S	3
00010100	14	20	\$T	DC4	00110100	34	52	/T	4
00010101	15	21	\$U	NAK	00110101	35	53	/U	5
00010110	16	22	\$V	SYN	00110110	36	54	/V	6
00010111	17	23	\$W	ETB	00110111	37	55	/W	7
00011000	18	24	\$X	CAN	00111000	38	56	/X	8
00011001	19	25	\$Y	EM	00111001	39	57	/Y	9
00011010	1A	26	\$Z	SUB	00111010	3A	58	/Z	:
00011011	1B	27	%A	ESC	00111011	3B	59	%F	;
00011100	1C	28	%B	FS	00111100	3C	60	%G	<
00011101	1D	29	%C	GS	00111101	3D	61	%H	=
00011110	1E	30	%D	RS	00111110	3E	62	%I	>
00011111	1F	31	%E	US	00111111	3F	63	%J	?



U.S. ASCII Codes (continued)

Binary ⁰	Hex ¹	Dec ²	C39 ³	Char ⁴	Binary ⁰	Hex ¹	Dec ²	C39 ³	Char ⁴
01000000	40	64	%V	@	01100000	60	96	%W	`
01000001	41	65	A	A	01100001	61	97	+A	a
01000010	42	66	B	B	01100010	62	98	+B	b
01000011	43	67	C	C	01100011	63	99	+C	c
01000100	44	68	D	D	01100100	64	100	+D	d
01000101	45	69	E	E	01100101	65	101	+E	e
01000110	46	70	F	F	01100110	66	102	+F	f
01000111	47	71	G	G	01100111	67	103	+G	g
01001000	48	72	H	H	01101000	68	104	+H	h
01001001	49	73	I	I	01101001	69	105	+I	i
01001010	4A	74	J	J	01101010	6A	106	+J	j
01001011	4B	75	K	K	01101011	6B	107	+K	k
01001100	4C	76	L	L	01101100	6C	108	+L	l
01001101	4D	77	M	M	01101101	6D	109	+M	m
01001110	4E	78	N	N	01101110	6E	110	+N	n
01001111	4F	79	O	O	01101111	6F	111	+O	o
01010000	50	80	P	P	01110000	70	112	+P	p
01010001	51	81	Q	Q	01110001	71	113	+Q	q
01010010	52	82	R	R	01110010	72	114	+R	r
01010011	53	83	S	S	01110011	73	115	+S	s
01010100	54	84	T	T	01110100	74	116	+T	t
01010101	55	85	U	U	01110101	75	117	+U	u
01010110	56	86	V	V	01110110	76	118	+V	v
01010111	57	87	W	W	01110111	77	119	+W	w
01011000	58	88	X	X	01111000	78	120	+X	x
01011001	59	89	Y	Y	01111001	79	121	+Y	y
01011010	5A	90	Z	Z	01111010	7A	122	+Z	z
01011011	5B	91	%K	[01111011	7B	123	%P	{
01011100	5C	92	%L	\	01111100	7C	124	%Q	
01011101	5D	93	%M]	01111101	7D	125	%R	}
01011110	5E	94	%N	^	01111110	7E	126	%S	~
01011111	5F	95	%O	_	01111111	7F	127	%T ⁷	n ⁸

Notes:

- 0 Bit positions are 76543210
- 1 Hexadecimal value
- 2 Decimal value
- 3 Code 39 character(s)
- 4 ASCII character

- 5 SP is the SPACE character
- 6 The Code 39 characters /P through /Y may be interchanged with the numbers 0 through 9
- 7 May be interchanged with %X or %Y or %Z
- 8 n is the DELETE character

ASCII Control Characters

Control	Character Definitions	Control	Character Definitions
NUL	Null, or all zeroes	DC1	Device Control 1 (XON)
SOH	Start of Heading	DC2	Device Control 2
STX	Start of Text	DC3	Device Control 3 (XOFF)
ETX	End of Text	DC4	Device Control
EOT	End of Transmission	NAK	Negative Acknowledge
ENQ	Enquiry	SYN	Synchronous Idle
ACK	Acknowledgment	ETB	End Transmission Block
BEL	Bell	CAN	Cancel
BS	Backspace	EM	End of Medium
HT	Horizontal Tab	SUB	Substitute
LF	Line Feed	ESC	Escape
VT	Vertical Tab	FS	File Separator
FF	Form Feed	GS	Group Separator
CR	Carriage Return	RS	Record Separator
SO	Shift Out	US	Unit Separator
SI	Shift In	SP	Space
DLE	Data Link Escape	DEL	Delete

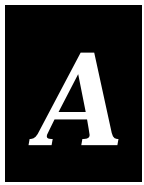

Full ASCII Bar Code Chart

This chart lists the Code 39 bar code labels for all of the ASCII characters.

NUL

SOH

STX

ETX

EOT

ENQ

ACK

BEL

BS

HT

LF

VT

FF

CR

SO

SI

DLE

DC1

DC2

DC3

DC4

NAK

SYN

ETB

CAN

EM

SUB

ESC

FS

GS

RS

US

SP

!

"

#

\$

%

&

'

(

)

*

+

,

-

.











/

Full ASCII Bar Code Chart (continued)

 0	 1	 2	 3
 4	 5	 6	 7
 8	 9	 :	 ;
 <	 =	 >	 ?
 @	 A	 B	 C
 D	 E	 F	 G
 H	 I	 J	 K
 L	 M	 N	 O
 P	 Q	 R	 S
 T	 U	 V	 W
 X	 Y	 Z	 [
 \	]	 ^	 _



Full ASCII Bar Code Chart (continued)

			
\	a	b	c
			
d	e	f	g
			
h	i	j	k
			
l	m	n	o
			
p	q	r	s
			
t	u	v	w
			
x	y	z	{
			
	}	~	DEL

Bar Code Chart for Moving Around in Menus

You can use this chart of bar code labels to move through the menus in the configuration application, Communications Manager, and IRL Desktop. The labels use the syntax:

. .*hhhh*

where *hhhh* is the four hex digits representing the key code hex value.

You can create your own bar codes for all 102 PC-keys by using the same syntax. The key code hex values are listed in "Key Codes" earlier in this chapter.

Note: The commands in this bar code chart are only intended for use when the key code lookup table configuration will not work with bar code input.

Enter



..1C0D

Esc



..011B

Cursor Up



..48E0

Cursor Down



..50E0

Cursor Left



..4BE0

Cursor Right



..4DE0

Page Up



..49E0

Page Down



..51E0

Home



..47E0

End



..4FE0

Insert



..52E0

Delete



..53E0

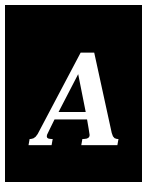

Bar Code Chart for Moving Around in Menus (continued)

Tab

 ..0F09

Shift-Tab

 ..0F00

Backspace

 ..0E08

F1

 ..3B00

Default Configuration

The following tables show the default configuration of the JANUS 2050. You can use the configuration application (IC.EXE) program to set the JANUS 2050 to the default configuration. For help, see “Returning to the Default Configuration” in Chapter 8.

Bar Code Symbolologies

Parameter	Default
Codabar	Standard, ABCD start/stop retained
Code 11	Enabled with two check digits
Code 39	Full ASCII enabled with no check digit
Code 49	Enabled, function code 1 and 3 disabled, function code 2 set to CR LF
Code 93	Enabled
Code 128	Standard
Code 16K	Standard
MSI	Disabled
Plessey	Disabled
Code 2 of 5	Disabled
Interleaved 2 of 5	Variable length with a check digit
UPC/EAN	UPC-A/EAN-13, UPC-E, and EAN-8 enabled, supplementals allowed, transmit check digit, transmit number system digit, and retain UPC-A leading zero

Communications

Parameter	Default
Communication protocol	
configure	Point-to-Point
activate	Point-to-Point
User-Defined Multi-Drop	Disabled
Communication port	COM port 1
COM1 FIFO control register restore	00 Hex
COM2 FIFO control register restore	00 Hex
Address, Multi-Drop	A
Baud rate	9600 baud
Data bits	7 bits
Flow control	None
Parity	Even
Stop bits	1 stop bit
Intercharacter delay	0 sec
Turnaround delay	0 sec
Timeout delay	10 sec
LRC	Disabled
AFF	Disabled
EOF	Disabled
IRL BAK	BEL
IRL END Program Block	SO (shift out)
IRL EOP	SYN (synchronous idle)
IRL PAK	RS (record separator)
IRL PSS	CR (carriage return)
IRL RUN	DC2 (device control 2)
IRL SOP	SI (shift in)
EOR	Disabled
NEG	Disabled
POL	Disabled
REQ	Disabled

Communications (continued)

Parameter	Default
RES	Disabled
SEL	Disabled
SOM	Disabled
EOM TX	CR and LF
EOM RX	CR and LF
Records per block	1 record transmitted per block

Operations

Parameter	Default
Automatic shutoff	Disabled
Beep duration	50 ms
Beep frequency	1000 Hz for low, 2000 Hz for high
Beep volume	Normal
Command processing	All commands enabled
Decode security	Moderate
Display mode	Buffered
Display size	25 x 80, video mode 3, scroll at row 25, normal character height
Keypad Caps Lock	Caps Lock Off
Keypad clicker	Enabled
Keypad Ctrl key functions	All Ctrl functions enabled
Keypad, numeric	Permit entering numeric keypad mode
Key code lookup table	No modifications
Preamble	Disabled (No characters)
Postamble	<CR>
Scan ahead	Enabled
Scanner modes	One-shot trigger
Scanner redundancy	Normal
Scanner port selection	Scanner
Scanner selection	All
Scanner timeout	Disabled (0)

RF Communications

Parameter	Default
Scanner trigger	Level
Acknowledgement delay	100 ms
Broadcast receipt	Enabled
Channel allow	All channels are excluded from the search pattern
Channel select	924 MHz
Device Address	0 (turned off)
Duty cycle percent	100%
Duty cycle period	1 second
Loopback	Disabled
Network ID	Channel search disabled
Repeat count	No repeaters
Retry limit	0 (optimized setting)
RF protocol	Enabled
RFNC address	RFNC 0

Configuration Command by Syntax

The following table lists each configuration command and its syntax.

Syntax	Command
<i>ADdata</i>	Preamble
<i>AEdata</i>	Postamble
<i>BDdata</i>	Beep duration
<i>BFdata</i>	Beep frequency
<i>BVdata</i>	Beep volume
<i>CAdata</i>	Interleaved Two of Five Code (1 2 of 5)
<i>CBdata</i>	Code 39
<i>CCdata</i>	Two of Five Code (2 of 5)
<i>CDdata</i>	Codabar
<i>CEdata</i>	UPC/EAN
<i>CFdata</i>	Code 93
<i>CGdata</i>	Code 11
<i>CHdata</i>	Code 128
<i>CIdata</i>	Plessey Code
<i>CJdata</i>	Code 49
<i>CKdata</i>	Code 49 Function Code 1
<i>CLdata</i>	Code 49 Function Code 2
<i>CMdata</i>	Code 49 Function Code 3
<i>CNdata</i>	MSI Code
<i>CPdata</i>	Code 16K
<i>CSdata</i>	Decode security
<i>DCdata</i>	Command Processing
<i>DFdata</i>	Display backlight timeout
<i>DJdata</i>	Display contrast
<i>DMdata</i>	Display mode, IRL
<i>DSdata</i>	Display setup
<i>DVdata</i>	Viewport movement keys
<i>DYdata</i>	Viewport movement steps
<i>EZdata</i>	Automatic shutoff
<i>FAdata</i>	EOF (End of File)
<i>FBdata</i>	EOR (End of Record)
<i>FCdata</i>	Records per block
<i>HAdata</i>	SEL (Select)
<i>HBdata</i>	POL
<i>HCdata</i>	Address, Multi-Drop
<i>IAdata</i>	Baud rate
<i>IBdata</i>	Parity
<i>ICdata</i>	Stop bits
<i>IDdata</i>	Intercharacter delay

Configuration Commands by Syntax (continued)

Syntax	Command
IEdata	Timeout delay
IFdata	LRC
IGdata	Turnaround delay
IHdata	Transmit abort timeout
IIdata	Data bits
ILdata	Flow control
ISdata	Communications port, select
IVdata	Communications port 1, UART restore FIFO control register
IWdata	Communications port 2, UART restore FIFO control register
IXdata	Communications port, scanner on COM2
KAdata	Keypad Caps Lock
KBdata	Keypad Ctrl key functions
KCdata	Keypad click
KDdata	Keypad, numeric
NM02data	RF loopback
NM03data	RF broadcast receipt
PAdata	Communications protocol, activate
PCdata	RES (Reset)
PDdata	REQ (Request for Acknowledge)
PEdata	SOM (Start of Message)
PFdata	EOM (End of Message)
PGdata	AFF (Affirmative Acknowledge)
PHdata	NEG (Negative Acknowledge)
PIdata	Transmit EOM
PJdata	Receive EOM
PMdata	Communications protocol, User-Defined Multi-Drop
PSdata	Communications protocol, select
R<channel>data	RF channel allow
RFdata	RF protocol
RHdata	RF device address
RLdata	RF retry limit
RMdata	RF acknowledgment delay
RTdata	RFNC (RF network controller) address
RUdata	RF repeat count
RVdata	RF channel select
RWdata	RF network ID
RXdata	RF duty cycle period
RYdata	RF duty cycle percent
SAdata	Scanner timeout
SBdata	Scanner mode
SCdata	Scanner trigger

Configuration Commands by Syntax (continued)

Syntax	Command
<i>SDdata</i>	Scan ahead
<i>SRdata</i>	Scanner redundancy
<i>SSdata</i>	Scanner devices
<i>WMdata</i>	Key code lookup table
<i>XAdata</i>	IRL SOP (Start of Program)
<i>XBdata</i>	IL EOP (End of Program)
<i>XCdata</i>	IRL RUN
<i>XDdata</i>	IRL END program block
<i>XEdata</i>	IRL PSS (Program Statement Separator)
<i>ZAdata</i>	IRL PAK (Program Acknowledge)
<i>ZBdata</i>	IRL BAK (Bad Program Acknowledge)



Specifications

This appendix lists the physical and environmental specifications, and describes how to connect devices to the JANUS 2050. This appendix also describes the types of memory available on the JANUS 2050.

Physical and Environmental Specifications

Physical Characteristics	Width	13.85 in	(35.18 cm)
	Depth	5.5 in	(13.97 cm)
	Height	10.25 in	(26.04 cm)
	Weight	18 lb	(8.18 kg)
Power	Primary	Nominal 12 to 48 VDC Universal Power Supply with surge, over voltage, and reversal protection.	
	Backup	NiCad battery, constantly recharged for memory and data retention.	
Temperature			
Battery Charging	+50°F to +104°F	(+10°C to +40°C)	
Operating	-4°F to +122°F	(-20°C to +50°C)	
Storage	-4°F to +158°F	(-20°C to +70°C)	
Environmental	<ul style="list-style-type: none"> • Operating and storage range of 10% to 90% relative humidity • Sealed against dust and moisture to IP54 • Vibration for use on industrial vehicles. 		
Display	<ul style="list-style-type: none"> • Bright electroluminescent CGA display • Full-screen (25 lines x 80 characters) or configurable oversized characters including 13 x 80, 24 x 40, or 13 x 40 		

Physical and Environmental Specifications (continued)

Memory	<ul style="list-style-type: none">• 4MB battery backed RAM, 512K flash drive C, 2MB ROM drive D• Type I/II PC card drive for additional program or data storage (not available with 2.4 GHz radio option)
Keypad Options	<ul style="list-style-type: none">• Full alphanumeric U.S.• French, German, Italian, Spanish• IBM 3270 and 5250

Connecting Devices to the JANUS 2050

The JANUS 2050 has two RS-232 serial ports for communications. The JANUS 2050 can communicate through these ports with the following devices:

- Terminal
- DCE and DTE RS-232 device
- Host computer
- Portable readers
- Port concentrator
- Modem

Chapter 6, "Communicating With the JANUS 2050," discusses the different programs that can be used to communicate with the JANUS 2050 and transfer data.

COM Port Connector

The COM1 and COM2 interfaces on the COM port are completely separate and need to be configured separately. The correct cables must be used to attach Data Communications Equipment (DCE) or Data Terminal Equipment (DTE) devices to each COM port. For a list of standard connector cables, see "JANUS 2050 Accessories" in Chapter 1.

The scanner port (COM1) and COM2 share the same internal hardware port. As a result, communications on COM2 and simultaneous use of a scanner or other device is not supported. For detailed information on configuring the COM2 port, see "Communications Port, Choosing Scanner or COM2" in Chapter 10.

Refer to the COM Port Pin Assignment Diagram and Input Device Pin Assignment diagrams if you need to construct special cables to connect to your applications. Use the following Intermec parts to build a connector that attaches to the JANUS 2050 COM port.

Intermec Part Number	Connector
581780	10 position sealed plug (contacts supplied with the connector)
581838	Circular backshell with band

Communications on COM2 and simultaneous use of a scanner is not supported. For detailed information on configuring the COM2 port, see “Communications Port, Choosing Scanner or COM2” in Chapter 10.

The COM port also supports RS-232 devices. Because the DCE interface does not interfere with radio communications, you can attach a device to the DCE interface and still communicate with the network controller.

COM Port Pin Assignment

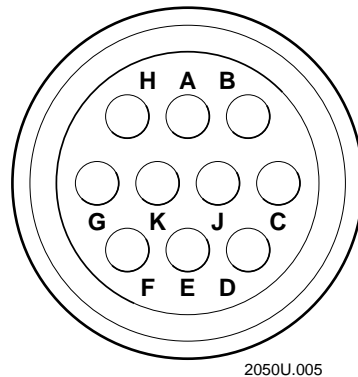

Pin Number	Function
A	Ground
B	COM1 TXD (out)
C	COM1 RXD (in)
D	COM1 RTS (out)
E	COM1 CTS (in)
F	Not Used
G	COM2 TXD (out)
H	COM2 RXD (in)
J	COM2 RTS (out)
K	COM2 CTS (in)

Input Device Connector

The JANUS 2050 can use several input devices to scan bar codes. For a list of input devices that you can use, see “JANUS 2050 Accessories” in Chapter 1. Before using optional equipment such as a laser scanner with the JANUS 2050, be sure to read the manual that comes with the device to ensure proper operation and safety.

To connect a laser scanner to the JANUS 2050, attach a connector cable to the input device connector on the back of the JANUS 2050. The connector is keyed so that the input device cable can only be inserted one way.

The input device port on the JANUS 2050 is shared with COM2. Only one device at a time can be configured to use this port. For detailed information on configuring the COM2 port see “Communications Port, Choosing Scanner or COM2” in Chapter 10. The default settings configure this port for a scanner.

Note: *The cable used to connect 151X or 1545 scanners with a 9450 VMU are not compatible with the JANUS 2050. For a list of standard connector cables, see “JANUS 2050 Accessories” in Chapter 1.*

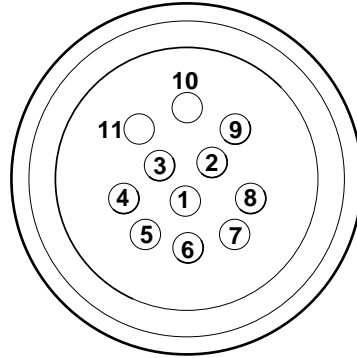
Input Device Pin Assignment

Wire Number	Function
1	VEXT+
2	GOOD READ
3	NC
4	SOS
5	TRIG
6	VIDEO
7	NC
8	NC
9	GND
10	VBAT+
11	STOP

Types of Memory Used in the JANUS 2050

The JANUS 2050 uses the types of memory described in this section. Memory in the reader is similar to that of a PC in some ways, and very different in other ways. One major difference is that the reader uses memory to simulate disk drives. This memory map shows how the reader uses memory.

Address	Contents	Description
FFFFFF E00000	No Physical Memory	End of 386SX Address Space
C00000	APPLICATION DISK Drive D	2MB Flash
880000	Unused Address Space No Physical Memory	(3.5MB)
800000	USER FLASH Drive C	512K Flash
400000	No Physical Memory	(4MB)
110000	3MB DRAM Extended Memory Contains 256K Drive E:	HIMEM is included in this 3MB
100000	HIMEM, 64K MS-DOS 6.2 Loaded	1MB Real Mode Boundary
FFFFF FFFF0	RESET VECTOR (10H Bytes)	Bootstrap Vector 10H ASIC BANKED
F2000	BIOS & PM (56K)	BIOS Flash, Shadowed
F0000	INT13/19 (4K, 8K allowed)	
E0000	BIOS Extensions (64K)	BIOS Extensions, Shadowed
D0000	Scanner/Decodes (64K)	Upper memory block
C0000	PC Card Window (64K)	Can be used for optional upper memory

Memory Map (continued)

Address	Contents	Description
B8000	VIDEO Memory (32K)	Video SRAM, DRAM Masked Out
A0000	Reader Services and Configuration Manager Code and Data (95k)	32K BANKED Bootstrap ROM
9A800	BIOS Extension Data (22K)	End of 640K DRAM
16AA0	Conventional Memory (527K)	User Memory <i>Note: This area also contains any additional needed drivers.</i>
700	MS-DOS and PC card Data and Drivers (89K)	Includes MS-DOS data and IO.SYS, POWER, HIMEM, SRAMDISK, CS, CSALLOC, MTSRAM, MTDDRV, CARD_SR, and COMMAND.COM stub.
0	BIOS GDT MS-DOS Data Area BIOS Data Area Vector Table	Reserved for BIOS/MS-DOS (1.8K)

Conventional Memory (0 Through 640K)

Your 4MB JANUS device has 4MB of battery-backed dynamic RAM. The first 640K is conventional memory and is virtually the same as that of a PC. You can use this memory to run applications. The MS-DOS 6.2 operating system loads at 0 (zero) and works up, followed by the statements and drivers in the CONFIG.SYS file, then COMMAND.COM, TSR (terminate and stay resident) programs, and commands in the AUTOEXEC.BAT file just like a PC.

Upper Memory Area

The area between the 640K and 1024K is known as the upper memory area. The upper memory area is physically composed of a 256K flash ROM chip (system flash) and the video memory chip under the DRAM memory. Like a PC, this area contains the BIOS and video buffers. The upper memory area also contains PC card memory and Intermec JANUS driver software. The 384K upper memory area maps just above 640K conventional memory.

RAM Drive

Part of extended memory is configured as a RAM drive (drive E) on the 4MB JANUS device. The default CONFIG.SYS file loads HIMEM.SYS and uses the SRAMDISK.SYS device driver to create the RAM drive.

You can use the RAM drive to store files just like a disk drive on your PC. File access is usually faster on a RAM drive than a physical disk drive. Unlike a PC, the JANUS device saves any files on the RAM drive during a warm boot. However, the JANUS device clears any files on the RAM drive on a cold boot.

The RAM drive uses 256K of extended memory. If you are not using a PC card, Intermec recommends that you use the RAM drive for data files that you save or update frequently. The RAM drive is not as secure as a PC card since the drive is erased when you cold boot the JANUS device (unless you press during memory test).

Extended Memory

The JANUS device is initially configured with 2.75MB of extended memory available, which is allocated for use by Intermec applications (IC.EXE and IRL). To remove the RAM drive and use the available extended memory, you need to change or delete the SRAMDISK statement in the CONFIG.SYS file. You can also use extended memory for overlay memory.

The JANUS device provides extended memory for control and access to RAM above 1MB. The extended memory conforms to XMS specification 2.0. The HIMEM.SYS driver initializes and manages extended memory. HIMEM.SYS looks at all the memory in the system and takes control of everything above 1024K. You must load all drivers in extended memory through the HIMEM.SYS interface. If a driver is not compatible with HIMEM.SYS, you cannot load it in high memory.

Some applications may require you to exclude memory from HIMEM.SYS management, leaving some extended memory available. If this is necessary, you should reconfigure the RAM drive (E) to use the available extended memory. DOS drivers must check in with HIMEM.SYS for their memory assignments within the XMS managed by HIMEM.SYS. Currently, the RAM drive uses the XMS interface through HIMEM.SYS.

Expanded Memory

When you install more than 1MB of memory on a PC, it can be used as expanded memory and is a way for the system to access memory beyond the 1MB barrier. To use expanded memory on a PC, you need an expanded memory board and an expanded memory manager.

Expanded memory is not available on 4MB JANUS devices.

High Memory Area (HMA)

The high memory area (HMA) is a 64K block of memory, starting 16 bytes below the 1024K mark, and is the first 64K of extended memory.

Since HMA can only hold one item, the first program that requests HMA uses it, regardless of the size of the program. The DOS=HIGH statement in CONFIG.SYS loads MS-DOS into high memory.

User Flash Memory

User flash memory contains the 512K ROM drive C. It is mapped to 800000H. Drive C is similar to the hard drive C on your PC and contains the MS-DOS startup files, CONFIG.SYS, and AUTOEXEC.BAT.

Since drive C is a ROM drive that resides in flash memory, you cannot write files to this drive as you would on your PC. You must use the Auto-Loader or MakeDisk and PutDisk to modify the startup files or change other files on drive C.

Application Flash Memory

Application flash memory is the 2MB ROM drive D. It is mapped to C00000H. DOS files and utilities are stored on drive D.

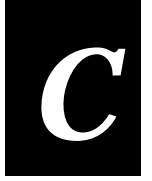

Software Utility Reference

This appendix describes Interlnk, INTERLNK.EXE, INTERSVR.EXE, POWER.EXE, and the Auto-Loader batch files.

Interlnk

With Interlnk, you can easily transfer files between your JANUS device and a host computer or another JANUS device. You can also make all the drives on one computer appear as if they are physically located on the other, so that you have unrestricted access to the contents of all the drives.

The device running Interlnk is the client and is used to enter commands. The device responding to commands is the server. For help installing and running Interlnk, see “Different Ways to Communicate With the JANUS 2050” in Chapter 6.

The command to begin running Interlnk is:

Syntax:

```
interlnk [client:=][server:]
```

where:

- client* specifies the letter of the client drive that is redirected to a drive on the server. The drive must be one that was redirected when you started Interlnk.
- server* specifies the letter of the drive on the Interlnk server that is redirected. The drive must be one listed under *This Computer (Server)* in the Interlnk Server Status screen.

Notes:

Installing the INTERLNK.EXE device driver You must load the INTERLNK.EXE device driver into memory before you can use the Interlnk command. For help, see the next section.

Displaying the status To display Interlnk’s current status, type the command on the client without including the *client:=server:* parameter.

Canceling redirection on a drive To cancel redirection of a client drive to a server drive, specify only the client drive and the equal sign (=) in the Interlnk command.

Examples:

To redirect drive F and G on the client to drive D and E on the server:

```
interlnk f=d g=e
```

To cancel the redirection of client drive G:

```
interlnk g=
```

INTERLNK.EXE

This device driver redirects requests for operations on Interlnk drives or printer ports to Intersvr drives or printer ports. You must load this device driver in the CONFIG.SYS file of the device running Interlnk (the client).

Add a command to the client's CONFIG.SYS that follows this syntax:

Syntax:

```
device=[drive:][path\]interlnk.exe [/drives:n] [/noprinter]
        [/com[:][n | address]] [/auto] [/noscan] [/low ]
        /baud:rate[/v]
```

where:

<i>drive:path</i>	specifies the location of the INTERLNK.EXE file
<i>/drives:n</i>	specifies the number of drives to redirect: 0 to redirect printers only 1 to redirect one drive 2 to redirect two drives 3 to redirect three drives (default) and so on.
<i>/noprinter</i>	specifies not to redirect printers. By default, Interlnk redirects all available printer ports.
<i>/com:n</i> <i>/com:address</i>	identifies the serial COM port that is connected to the server by specifying either the number (<i>n</i>) or address (<i>address</i>) of the port. If you omit <i>n</i> and <i>address</i> , Intersvr searches all serial ports and uses the first port that it finds connected to the client. If you specify the <i>/com</i> switch, the server searches only for serial ports. By default, all serial ports are scanned.
<i>/auto</i>	loads the INTERLNK.EXE device driver in memory only if the client can establish a connection with the server when the client starts up. By default, Interlnk is loaded even if the client cannot establish a connection with the server.
<i>/noscan</i>	loads the INTERLNK.EXE device driver in memory, but prevents a connection between client and server from being established. By default, the client tries to establish a connection with the server as soon as you load INTERLNK.EXE.
<i>/low</i>	loads the INTERLNK.EXE device driver into conventional memory even if upper memory is available.

Syntax: (cont.)

<code>/baud:rate</code>	sets a maximum baud rate for serial communication. Type 9600, 19200, 38400, 57600, or 115200. The default is 115200.
<code>/v</code>	prevents conflicts with a computer's timer. Include this switch if you have a serial connection between computers and one of them stops running when you use Interlnk to access a drive or printer port.

Notes: **Position of the Interlnk command in the CONFIG.SYS file** The position of the device command that loads INTERLNK.EXE in the CONFIG.SYS can affect pre-existing drive assignments.

For example, suppose your computer includes a floppy disk drive (A), two hard disk drives (C and D), and two RAM drives (E and F). If you load the INTERLNK.EXE device driver before creating the RAM drives and you choose to redirect three drives, Interlnk assigns letters E, F, and G to the redirected drives, and letters H and I to the RAM drives. To prevent this situation from happening, load INTERLNK.EXE last in your CONFIG.SYS file.

Calculating the number of drives to redirect When you add the INTERLNK.EXE command to the host computer's CONFIG.SYS, you should set the `/drives` option to at least seven drives. The JANUS device contains five default drives (C, D, E, F, G), and Interlnk assumes two more (A and B). If you specify fewer than seven drives, Interlnk will not redirect all the device drives. You need more than seven drives if the device contains more than one physical RAM drive.

Saving memory The Interlnk device driver loads all of its code into memory. You can save memory by specifying the `/noprinter` or `/com` switch. If you specify the `/noprinter` switch, the Interlnk program does not load code that redirects printers. If you specify the `/com` switch, the program does not load code that supports parallel ports. Intermec recommends using the `/noprinter` and `/com` switches when INTERLNK.EXE is loaded on the device.

Using a serial mouse with Microsoft Windows If you are using a serial mouse with Microsoft Windows, specify the `/com` switch to designate a COM port other than the one the mouse is using.

DOS version Some features of DOS may not be available to the client computer if you are running a different DOS version on your Interlnk server. For example, if you have large partitions on the server and are running DOS 3.0 on the client, the partitions are not available to the client because DOS 3.0 does not support them.

Running an application located on the server If you use Interlnk to run an application located on the server, make sure the application is configured for the computer you have designated as the client.

INTERLNK.EXE (continued)

Notes: (cont.) **Limitations** These commands do not work on devices running Interlnk:

CHKDSK	FORMAT	UNDELETE
DISKCOMP	MIRROR	UNFORMAT
DISKCOPY	SYS	

Interlnk does not redirect network, CD-ROM drives, or any other device that uses a redirection interface. For example, you cannot access a network drive that was redirected before Interlnk was started.

Examples:

If the Interlnk files are located in the INTERLNK directory on the host computer's drive C and you need to specify seven drives so that drives C through G on the device will be redirected, add this line to the CONFIG.SYS file on the device:

```
device=c:\interlnk\interlnk.exe /drives:7
```

If the Interlnk files are located in the root directory on drive D of the reader, you used the serial port to connect to another computer, and you want to start Interlnk without having the printers redirected, add this line to the CONFIG.SYS file on the reader:

```
device=d:\interlnk.exe /com /noprinter /drives:7
```

To make Interlnk use a non-standard COM port whose address is 3F8, add this line to your CONFIG.SYS file on the reader:

```
device=d:\interlnk.exe /com:3F8 /drives:7
```

Intersvr

Interlnk is loaded on the device designated as the client. The device running Intersvr is called the server. The server responds to commands typed on the client. When you run Intersvr in conjunction with Interlnk, it provides serial file transfer capability through redirected drives, and printing through redirected printer ports. For help installing and running Intersvr, see “Different Ways to Communicate With the JANUS 2050” in Chapter 6.

Type this command to begin running Intersvr:

Syntax: `intersvr [drive:] [/x=drive:] [/com:n | address]
[/baud:rate][/b][/v]`

where:

- | | |
|--------------------------------------|---|
| <i>drive:</i> | specifies the letter of a drive to be redirected. By default, all drives are redirected. |
| <i>/x=drive</i> | specifies a drive that is not redirected. By default, all drives are redirected. |
| <i>/com:n</i>
<i>/com:address</i> | identifies the serial COM port that is connected to the server by specifying either the number (<i>n</i>) or address (<i>address</i>) of the port.

If you omit <i>n</i> and <i>address</i> , Intersvr searches all serial ports and uses the first port that it finds connected to the client. If you specify the <i>/com</i> switch, the server searches only for serial ports. By default, all serial ports are scanned. |
| <i>/baud:rate</i> | sets a maximum serial baud rate. Type 9600, 19200, 38400, 57600, or 115200. The default is 115200. |
| <i>/b</i> | displays the Interlnk Server Status screen in black and white. Use this switch if you are having problems reading your monochrome monitor. |
| <i>/v</i> | prevents conflicts with a computer's timer. Specify this switch if you have a serial connection between computers and one of them stops running when you use Interlnk to access a drive or printer port. |

Notes: **Specifying the order of drives** Interlnk redirects drives in the order you specify. The first server drive specified is redirected to the first available client drive, the second server drive specified is redirected to the second available client drive, and so forth.

Intersvr (continued)

Notes: (cont.) Copying the files from the reader If you do not have the MS-DOS Programs companion disk, which contains the Interlnk and Intersvr files, you can copy the files from the reader. You need to connect the host computer to the reader using a 7-wire, null-modem serial cable and the Mode command must be available on the host computer where you are installing Interlnk. To copy the files to the host computer, type this command on the reader:

```
intersvr /rcopy
```

Using a serial mouse with Microsoft Windows If you are using a serial mouse with Microsoft Windows, and you start Intersvr while Windows is running, specify the /com switch to designate a COM port other than the one the mouse is using.

Using Interlnk in a task-switching or multitasking environment If you start Intersvr in a task-switching or multitasking environment, task-switching and key combinations that switch you out of your current task are disabled. To restore these functions, quit the server.

Limitations These commands do not work on the device running Intersvr:

CHKDSK	FORMAT	UNDELETE
DISKCOMP	MIRROR	UNFORMAT
DISKCOPY	SYS	

Interlnk does not redirect network, CD-ROM drives, or any other device that uses a redirection interface. For example, you cannot access a network drive that was redirected before Interlnk was started.

Examples: If you have two computers and each contains drives A, B, and C, you can start Intersvr and direct server drive C to client drive D, and A to E, and B to F, by typing this command on the server:

```
intersvr c: a: b:
```

To redirect all server drives except drive A and use COM4 to connect to the client, type this command on the server:

```
intersvr /x=a /com4
```

POWER.EXE

POWER.EXE lets you adjust the JANUS 2050 power management at the DOS prompt. It provides power-saving features and an application program interface (API) that applications can use. POWER.EXE works through the Advanced Power Management (APM) interface. IRL programs and programs that use Reader Services do not require POWER.EXE.

To change the level of power management, type this command at the JANUS 2050 DOS prompt:

Syntax:

```
[drive:][path]power.exe [adv[:max | reg | min] |  
std | off][low]
```

where:

<i>drive:path</i>	specifies the location of the POWER.EXE file.
adv:max	conserves the reader's power when applications and hardware devices are idle. Performance may be affected if an application is active instead of idle. Use max for maximum power conservation. Use reg to balance power conservation with performance. Use min (default) if performance is not satisfactory with max or reg.
adv:reg	
adv:min	
std	conserves the reader's power. Use std to conserve power by using only the power management features of your hardware. Use off to turn off POWER.EXE. If POWER.EXE is off, the date is not updated when you turn off the reader. If you use your own APM interface, it should be able to update the date each time the reader is turned on and the date has changed.
off	
low	loads POWER.EXE into conventional memory, even if the upper memory area is available. By default, POWER.EXE is loaded into upper memory if it is available.

Notes:

To display the current power setting, type the command:

```
power
```

You can view the power settings screen with the viewport or use Interlnk to view the settings on the host.

POWER.EXE is embedded in the software and is set by default to adv:min. The JANUS 2050 has its own power management for maximum efficiency.

Auto-Loader Batch Files

When you install Auto-Loader onto your host computer, eight batch files are copied to your host computer. You will use these batch files to change the contents of drive C on the JANUS 2050:

- LOAD_USA.BAT or LOADLANG.BAT
- LOADADD.BAT
- LOADC.BAT
- LOADIMG.BAT
- LOADNEW.BAT
- LOADXIMG.BAT
- MAKE_USA.BAT or MAKELANG.BAT
- MAKENEW.BAT

Note: *The LOADC.BAT file is a master batch file called by the other batch files.*

This section covers these topics:

- Learning How to Use Auto-Loader
- How to Use Each Batch File

Learning How to Use Auto-Loader

Follow either of these methods to create an image file, which contains the files you want on drive C, and then load it onto the device:

- Use LOAD_USA, LOADLANG, LOADADD, or LOADNEW to create and load the image file in a single step.
- Use MAKE_USA, MAKELANG, or MAKENEW to create the image file and store it on a host computer. Then use LOADIMG or LOADXIMG to load the image file onto the device. This two-step method helps you create an image file to be loaded onto multiple JANUS devices.

Using **LOAD_USA**

LOAD_USA creates an image file that contains only the three startup files in the C_FILES\COMMON directory: AUTOEXEC.BAT, AUTOINST.BAT, and CONFIG.SYS. Then LOAD_USA loads the image file onto drive C, deleting all the files currently on drive C.

Here is the syntax for LOAD_USA:

```
load_usa
```

Note: If you installed Auto-Loader for a DOS NLS country, the LOAD_USA batch file is not installed.

USING **LOADLANG**

LOADLANG creates an image file that contains only the three startup files in the C_FILES\COMMON directory. Then LOADLANG loads the image file onto drive C, deleting all the files currently on drive C.

The LOADLANG command also edits AUTOEXEC.BAT and CONFIG.SYS to support the DOS NLS language you specified when you installed Auto-Loader.

Here is the syntax for LOADLANG:

```
loadlang
```

Note: If you installed Auto-Loader for a DOS NLS country, the LOADLANG batch file is installed instead of the LOAD_USA batch file.

Using **LOADADD**

LOADADD adds or replaces files on drive C without overwriting all of the files of drive C. You can also use LOADADD to configure the device to operate in a DOS NLS language.

There are two LOADADD commands:

- loadadd nls
- loadadd *path\filename* [*path\filename path\filename...*]

where:

path is the drive and directory of the file to load.

filename is the name of the file to load.

You can specify more than one file or use *path*.** to load all the files from a directory.

The next tables describe how the two LOADADD commands work depending on the information you include in the command and whether you installed Auto-Loader for a DOS NLS country.

Command: `loadadd nls`

DOS NLS Support?	Description
No	<ul style="list-style-type: none"> • Creates an image file that contains the three startup files in C_FILES\COMMON and all files currently on drive C. • Loads the image file on drive C. • Overwrites only the startup files on drive C.
Yes	<ul style="list-style-type: none"> • Creates an image file that contains the three startup files in C_FILES\COMMON and all files currently on drive C. • Appends commands to AUTOEXEC.BAT and CONFIG.SYS to support the DOS NLS language. • Loads the image file on drive C. • Overwrites only the startup files on drive C.

Command: `loadadd path\filename [path\filename...]`

DOS NLS Support?	Description
No	<ul style="list-style-type: none"> • Creates an image file that contains files you specify in the command and all files currently on drive C. • Loads the image file on drive C. • Overwrites files on drive C only if the command contains a file with the same name.
Yes	<ul style="list-style-type: none"> • Creates an image file that contains files you specify in the command, all files currently on drive C, and the three startup files in C_FILES\COMMON unless you specify startup files in the command. • Appends commands to AUTOEXEC.BAT and CONFIG.SYS to support the DOS NLS language. • Loads the image file on drive C. • Overwrite files on drive C only if the command contains a file with the same name.

Using **LOADIMG**

LOADIMG loads the image file that you specify on the command line on drive C. LOADIMG overwrites all files currently on drive C.

You must have created the image file already with the MAKENEW, MAKE_USA, LOADADD, LOADNEW, LOADLANG, or LOAD_USA. You may have renamed the image file from its default name, NEWDRV_C\DRIVEC.IMG.

LOADIMG is useful when you are loading an image file onto multiple JANUS devices.

Here is the syntax for LOADIMG:

```
loading path\filename
```

where:

path is the drive and directory of the image file to load.

filename is the name of the image file to load.

Using **LOADNEW**

LOADNEW creates an image file that contains any files you include in the command line. If you do not specify startup files in the command line, LOADNEW adds the three default startup files in C_FILES\COMMON to the image file. Then LOADNEW loads the image file onto the reader's drive C, deleting all the files currently on drive C.

If you specified a DOS NLS country when you installed Auto-Loader on the host computer, LOADNEW appends commands to the AUTOEXEC.BAT and CONFIG.SYS files to support that DOS NLS language.

Here is the syntax for LOADNEW:

```
loadnew path\filename [path\filename path\filename...]
```

where:

path is the drive and directory of the file to load.

filename is the name of the file to load.

You can specify more than one file or use *path*.** to load all the files from a directory.

Using LOADXIMG

LOADXIMG loads the default image file, NEWDRV_C\DRIVEC.IMG, to drive C. LOADXIMG overwrites all files currently on drive C.

You must have created the image file already with the MAKENEW, MAKE_USA, LOADADD, LOADNEW, LOADLANG, or LOAD_USA commands.

LOADXIMG is useful when you are loading an image file onto multiple JANUS devices. Here is the syntax for LOADXIMG:

```
loadximg
```

Using MAKE_USA

MAKE_USA creates an image file that contains only the three startup files in C_FILES\COMMON. No other files are included in the image file.

You must use LOADXIMG or LOADIMG to load the image file to drive C. The Make commands offer the advantage of allowing you to create an image file on the host that you can use to update multiple readers.

Here is the syntax for MAKE_USA:

```
make_usa
```

Note: If you installed Auto-Loader for a DOS NLS country, the MAKE_USA batch file is not installed.

Using MAKELANG

MAKELANG creates an image file that contains only the three startup files in C_FILES\COMMON. No other files are included in the image file.

The MAKELANG command also edits AUTOEXEC.BAT and CONFIG.SYS to support the DOS NLS language you specified when you installed Auto-Loader.

You must use LOADXIMG or LOADIMG to load the image file to drive C. The Make commands offer the advantage of allowing you to create an image file on the host that you can use to update multiple JANUS devices.

Here is the syntax for MAKELANG:

```
makelang
```

Note: If you installed Auto-Loader for a DOS NLS country, the MAKELANG batch file is installed instead of the MAKE_USA batch file.

Using MAKENEW

MAKENEW creates an image file that contains any files you include in the command line. If you do not specify startup files in the command line, MAKENEW adds the three default startup files in C_FILES\COMMON to the image file.

If you specified a DOS NLS country when you installed Auto-Loader on the host computer, MAKENEW appends commands to the AUTOEXEC.BAT and CONFIG.SYS files to support that DOS NLS language.

You must use LOADXIMG or LOADIMG to load the image file to drive C. The Make commands offer the advantage of allowing you to create an image file on the host that you can use to update multiple JANUS devices.

Here is the syntax for MAKENEW:

```
makenew path\filename [path\filename path\filename...]
```

where:

path is the drive and directory of the file to include in the image file.

filename is the name of the file to include in the image file.

You can specify more than one file or use *path**.* to load all the files from a directory.



Glossary

Accumulate mode

Operating mode in which the device stores scanned information in the data buffer until the device receives a enter command.

acknowledgment delay

Specifies the maximum amount of time that may elapse before the controller determines that a device did not receive the message.

AFF

Affirmative Acknowledge character. This character enables or disables the handshake event that is an affirmative acknowledge to a message.

alphanumeric keypad

The alphanumeric keypad is an all-purpose keypad with 52 keys. Although the keypad is smaller than a regular PC keyboard, you use special keys on the keypad and press key combinations to access all 102 keys that are available on a PC keyboard. The alphanumeric keypad is available in English, French, German, Italian, and Spanish.

application break bit

A flag in the device that an application checks when you turn on the device. If the bit is not set to 1, the application will resume running. If the bit is set to 1, the application will not resume. You press the application break sequence to set the application break bit.

application break sequence

A series of keys you press to stop an application from resuming after you turn the device off and then on again. Usually you use these keys when an application is locked up and you do not want to cold boot the device to clear the memory.

Application companion disk

One of the disks that Intermec ships with your JANUS device. This disk contains applications such as Communications Manager and IRLXDESK.EXE. This disk also contains PC card drivers and utilities that control operation, prepare the device to use the different types of PC cards, customize the device to use the PC card software, and provide you with helpful tools.

ASCII

American Standard Code for Information Interchange. A standard 7-bit code almost always transmitted with a parity bit for a total of 8 bits per character.

ASCII control character

One of the first 32 characters (0 through 31 in decimal representation) in the ASCII character set. Each of these characters has a standard control function, such as backspace or carriage return.

ATA flash PC card

A type of memory PC card that provides additional disk storage space, not more executable conventional memory, on a JANUS device.

audio signals

The device has a beeper and a clicker that produce audio signals that indicate device status. You can change the beep volume and enable or disable the keypad clicker with configuration commands.

Auto-Loader

A DOS utility used to change the contents of drive C. You can also use it to configure the device to operate in any language supported by DOS NLS (National Language Support). You run Auto-Loader on a host computer connected to the COM1 port.

automatic shutoff

A device configuration feature that defines the maximum length of time the device stays on when there is no activity. At automatic shutoff, the contents of device memory are saved and the device resumes where it left off when it is turned on again.

backlight

A light built into the device display to make it easier to view the device display in dimly lit environments.

BAK

Bad Program Acknowledgment character. This character is sent from the device to indicate that the IRL program received from the host could not be successfully compiled.

bar code density

Number of data characters that can be represented in a linear unit of measure. Often expressed in characters per inch.

bar code label

A label that contains a bar code symbol.

bar code symbology

A scheme for encoding data as bar code. Code 39, Interleaved 2 of 5, and Codabar are examples of different symbologies.

battery pack

See NiCad battery pack.

baud rate

The number of discreet conditions or signal events per second. In RS-232 and RS-422/485 systems, baud rate is the same as bits per second (bps).

binary file

A file that contains a sequence of 8-bit data characters or executable code. Compare to ASCII text file. Binary files require special software for transmission. See also binary file transfer.

binary file transfer (BFT)

The process or method for transmitting a binary file (such as an executable file) from one computer device to another.

boot

Usually means to invoke a bootstrap process, which involves building up a system from some simple preliminary instructions or information.

Boot Loader menu

The menu on the device used to reboot the device, to dump the RAM, to reload or upgrade the software, or to use Storage mode.

Boot Utilities companion disk

One of the disks that Intermec ships with your JANUS device. This disk contains the files you need to load or upgrade the system software. This disk also contains the README.DOC, a text file that describes important information about the device that was unavailable when this manual was published. This disk also contains a batch file, INSTALL.BAT, that you can use to install Auto-Loader onto a host computer.

bps

Bits per second. The unit of measure used to describe the rate of data transmission. For example, 1200 bits per second means that there are 1200 data bits transmitted per second.

BRU

Base radio unit. A device that transmits messages over radio frequency (RF) waves between a controller and data collection devices.

CGA

Abbreviation for Color/Graphics Adapter. CGA is a video adapter board.

check character

A character included within a message for the purpose of performing a check to ensure the accuracy of the message.

check digit

A character included in a bar code whose value is used to do a mathematical check on the value of the decoded bar code to retain accuracy.

client

The computer from which you will access drives, directories, files, and programs that are stored on the server. See also server.

Codabar

A self-checking, discrete bar code symbology that has these 16 characters in its set: 0 to 9, dollar sign (\$), colon (:), slash (/), period (.), plus (+), and minus (-). Codabar is commonly used in libraries, blood banks, and air-parcel express applications. The American Blood Commission (ABC) Codabar requires that you retain the start/stop code digits when processing a Codabar symbol. The maximum density for a Codabar symbol is 12.8 characters per inch.

Code 2 of 5 (2 of 5)

A discrete, self-checking code for encoding numeric data only. The bars encode information and the spaces separate individual bars. It can achieve densities of 15 characters per inch.

Code 11

A very high density, discrete, numeric bar code developed by Intermec. The character set includes the numbers 0 through 9 and the dash character (-). Each character is represented by a standalone group of three bars with two included spaces. This code is not self-checking. One or two check digits provide data security. Code 11 is most extensively used in labeling telecommunications components and equipment. Its maximum density is 15 characters per inch.

Code 128

A very high density alphanumeric symbology that supports the extended ASCII character set. It is a variable length, continuous code that uses multiple element widths. Code 128's high density makes it useful when printing data in a limited space. Its maximum density is 12.1 alphanumeric characters per inch or 24.2 numeric characters per inch.

Code 16K

A two-dimensional (stacked rows), ultra-high density bar code symbology. It is based on Code 128 and is used widely to label unit-dose packaging for the healthcare industry.

Code 39

A discrete, variable length, and self-checking bar code symbology. The character set is uppercase A to Z, 0 to 9, dollar sign (\$), period (.), slash (/), percent (%), space (), plus (+), and minus (-). Code 39 can be extended to the full 128 ASCII character set by use of a two-character encoding scheme (see full ASCII). Its maximum density is 9.8 characters per inch.

Code 49

A multirow symbology for high data density. The last character in each row is used for row checking and the last two characters of the symbol are used for overall checking. The character set includes all 128 ASCII characters. Its maximum density is 93.3 alphanumeric characters per inch or 154.3 numeric characters per inch.

Code 93

A variable length, continuous bar code symbology using four element widths. It can be used interchangeably with Code 39 when higher density printing is required. The character set is the same as Code 39. Its maximum density is 14.8 characters per inch.

cold boot

One of two ways to boot the device; compare to warm boot. A cold boot invokes the BIOS boot sequence, which verifies that the 256K flash system image is not corrupt, clears all memory, and performs a complete power-on self test (POST) to ensure that the hardware and peripherals are operational. The cold boot initializes the system hardware for use by system software, loads the default configuration, runs AUTOEXEC.BAT and CONFIG.SYS, and loads DOS. Because the physical RAM drive is initialized, all files on drive E are lost. You may cold boot the device to clear the conventional memory, break out of an application that is locked in an infinite loop, or recover from an error condition.

COM port

Commonly used short form of communications port. Locations from which data can be passed into and out of the device. COM ports offer serial communications, which means that data is transmitted one bit at a time over a single line from one computer to another.

Communications Manager

An application on the device that lets you transmit and receive files, and see the status of the COM port. This application is available on the Application companion disk 3.



communications protocol

A set of rules or standards designed to enable computers to connect with each other and exchange data. An example of a communications protocol is Point-to-Point protocol.

Communications Utilities

Transmit and receive functions that you can call with PSK functions or software interrupts. Included in the Reader Services programs.

Compound Function key

The Compound Function key is a special key on the JANUS keypad. You use the  key to access characters or perform functions that do not have an actual key on the keypad. When you press , the key is held in a buffer and the Compound Function key icon appears on the display. Once you press a key other than , the key combination is entered into the device and the icon disappears from the display.

configuration

The selected parameters that determine the operating characteristics of an electronic device.

configuration command

A configuration command changes the way the device operates. You can enter a configuration command by typing on the keypad, by scanning a bar code label, or by sending a command from the host computer.

configuration file

A configuration file is an ASCII text file that contains settings for some or all of the configuration parameters.

Configuration Manager

A Reader Services program on the device that maintains the current configuration file, ensures that the device operates according to that configuration, and lets you change the configuration file.

Control mode

A mode you use to temporarily change some of the display parameters at the DOS prompt or when running an application. The parameters are reset when you boot the device.

conventional memory

The device has 4MB of battery-backed dynamic RAM. The first 640K is conventional memory and is virtually the same as that of a PC. You can use this memory to run applications.

cursor keypad

A set of keys on the device that allows you to move the cursor around the screen.

data bits

The number of bits the device uses when communicating with another device (i.e., host computer). Generally set at seven or eight.

default configuration

The values set for each configuration parameter when the device is shipped.

device driver

A software component that controls an external device. For example, a PC card device driver controls how the device accesses the PC card.

DLE

The ASCII Data Link Exception character. It causes the character that follows it to be received as data, even if it is a protocol character. It allows for the use of control characters in preambles, data strings, and configuration command strings.

DOS code pages

A code page is a table that relates binary character codes used by a program to keys on the keypad or to characters on the display. All international keypads are translated using an installed DOS code page that contains the standard ASCII character set and a set of national language characters specific to the language the code page supports.

downline

When devices are connected to a computer, they are connected in a "line." Downline is a direction relative to the computer. If more than one computer is connected in a line, the upline computers usually handle data processing and the downline computers usually handle data collection and sometimes some data preprocessing. Contrast with upline.

DRAM

Abbreviation for dynamic random access memory. A type of RAM that stores information in integrated circuits containing capacitors. Since capacitors lose their charge over time, DRAM boards include logic to recharge, or "refresh," the RAM chips continuously. Since their internal circuitry is simple, DRAMs are more commonly used than static RAMs, even though they are slower. DRAM can hold approximately four times as much data as a static RAM chip of the same complexity. The JANUS 2050 has 4MB of battery-backed DRAM.

drive

An electromechanical device that reads from and writes to disks. The three types of common disk drives are floppy disk drives, hard disk drives, and PC card drives.

driver

See device driver.

EAN

European Article Numbering. International standard bar code for retail food packages corresponding to the Universal Product Code (UPC) in the United States. A device that is configured to decode EAN bar codes can decode UPC, but the reverse is not true. UPC code is a subset of EAN code.

edge triggering

A scanner trigger configuration that makes the laser turn on after you pull the trigger and stay on until you pull it a second time. Simply releasing the trigger does not turn the laser off. If the laser is left on, the scanner timeout turns the laser off. Contrast with level triggering.

EMM

Expanded Memory Manager. Software that makes expanded memory available to EMS-compatible DOS programs.

end device

The device in the data collection system that collects and inputs data.

environment variable

A specification in a program that defines an operating parameter, such as the command path.

EOF

End of File character. Attached to the last record transmitted in a block of records and after the End of Record (EOR), if the EOF character field is enabled.

EOM

End of Message character. Sent at the end of device and host messages. The transmitted and received EOM characters can be defined separately.

EOP

End of Program block character. Sent by the host after a block of IRL program statements to tell the device that another block of IRL statements is coming.

EOR

End of Record character. Attached to the end of every record transmitted by the polled device if the EOR character field is enabled.

error message

A message from a device or program advising the user of an error that requires intervention to solve. For example, if you receive the error message “Error, incorrect number of parameters” while creating a drive image with MakeDisk, you should verify that the command line is correct and then try again.

extended memory

System memory above 1MB. The device is initially configured with 3MB of extended memory available, which is allocated for use by Intermec applications (IC.EXE and IRL). The device provides extended memory for control and access to RAM above 1MB. The extended memory conforms to XMS specification 2.0. Extended memory is initialized and managed by the HIMEM.SYS driver.

extended memory manager

Software that makes extended memory available to DOS programs. For example, you must run an extended memory manager such as HIMEM.SYS on the device to create and use a physical RAM drive.

FIFO control register (FCR)

First in/first out control register. The FCR contains a hex value that controls how the UART buffer operates. You may need to configure the JANUS to restore a hex value for the FCR in case you turn off the device while running a communications application that uses UART 16x550 mode.

fixed length

Characteristic of a bar code symbology in which the number of characters per symbol is predetermined. Opposite of variable length.

flash PC card

A type of memory PC card that provides additional disk storage space, not more executable conventional memory, on the device. Flash cards retain their data without the use of a backup battery.

flash ROM drive

Drives C and D on the device are ROM drives that are implemented in flash memory. Flash ROM drives are upgradeable, but have limited write capability. Both drives use a file allocation table (FAT) type format.

flow control

A method for controlling the flow of data between the device and the serial port. It stops the transmitting device from sending data when the receiving device buffer fills up and starts it again when the buffer empties. Flow control can be done through software (XON/XOFF) or hardware (CTS/RTS).

full ASCII

An operating mode that sets the device to properly decode Code 39 or Code 93 labels containing data that includes any of the 128 ASCII characters.

Graphics mode

One of two display modes on the device. When the device is set to use Graphics mode, you see a 128 x 160 pixel display size. You can use the CGA display as a viewport to move around and see a 200 x 640 pixel virtual display. Contrast with Text mode.

handshake event

A communications event that signifies the completion of a data block transmission. The exchange signifies either an affirmative acknowledge (AFF) or a negative acknowledge (NEG). The handshake event is enabled by defining the AFF character to be other than NULL. Some computers use the characters XON and XOFF as handshaking characters.

HIBC

Health Industry Bar Code standard. A modified version of Code 39 that has 43 characters, uses the Modulus 43 check character, and reserves some character combinations for special usage.

high memory area (HMA)

HMA is a 64K block of memory, starting 16 bytes below the 1024K mark, and is the first 64K of extended memory. Since HMA can only hold one item, the first program that requests HMA uses it, regardless of the size of the program.

home

The viewport's home position is the upper left corner of the virtual display.

horizontal reading angle

The horizontal angle of a laser scanner to a bar code label. The optimum horizontal reading angle is near zero degrees.

host computer

A PC or other computer connected to the JANUS device. Also called the host.

human-readable

A character printed in a font that can be read by a human, as opposed to bar code symbology that can only be read by a machine.

image file

An image file contains all the files you want to load onto the ROM drives. Because ROM drives are implemented in flash memory, you can use DOS commands to read from drive C or D, but you must use special utilities to write to them.

input/output (I/O) PC card

A type of PC card, such as a modem card, that can be used to connect the device to another device for communications. I/O cards comply with PCMCIA Standard 2.1.

Input Manager

A Reader Services program that you use as an interface for all data input and output from the COM ports, scanner, and keypad. The Input Manager handles all power management tasks during data input and output.

Interactive Configuration application (IC.EXE)

A menu-driven application that lets you view the current configuration, modify parameters, create configuration files, and configure the device with any configuration file.

intercharacter delay

Amount of time between transmitting successive characters.

Interleaved 2 of 5 Code (I 2 of 5)

A high-density, self-checking, continuous numeric bar code symbology. A bar code developed by Intermec that encodes the digits 0 through 9. The name Interleaved 2 of 5 is derived from the method used to encode two characters. In this symbol, two characters are paired, using bars to represent the first character and the interleaved spaces to represent the second character. Each character has two wide elements and three narrow elements, for a total of five elements. It is mainly used in inventory distribution and the automobile industry. It can achieve a maximum density of 7.8 characters per inch.

Interlnk

A DOS communications program on the device that you use to access the drives on a host computer as if they were on the device, and vice versa.

Intersvr

A companion application to Interlnk that runs on the computer that acts as the server while Interlnk runs on the computer that is the client.

IRL (Interactive Reader Language)

A high-level programming language developed by Intermec for the JANUS device.

IRL Desktop

The IRL operating environment on the JANUS device is called the IRL Desktop. This application lets you use the device to transmit, receive, and clear data files, and to download and run IRL programs.

IRQ

Interrupt request. Hardware lines over which devices such as the input/output ports, the keypad, and disk drivers can send request-attention signals (commonly called "interrupts"). IRQs suspend current operations, save current work, and transfer control to a routine called an interrupt handler, which causes a specific set of instructions to be carried out by the computer's microprocessor.

keypad buffer

An area of memory that saves a limited number of operator keystrokes.

keypad clicker

A feature that makes the device produce an audible click every time a key is pressed. This feature can be enabled or disabled with the Keypad Clicker configuration command.

large numeric keypad

One of the keypads available on the device. The large numeric keypad has 34 keys and is available in English. The number keys are larger to make it easier to enter a lot of numeric data. See also alphanumeric keypad.

laser scanner

An optical bar code reading device that uses a low energy laser light beam to examine a spatial pattern, one part after another. It then generates analog or digital signals corresponding to the pattern. Laser scanners are often used in mark sensing, pattern recognition, character recognition, and bar code recognition. The laser scanner converts bar code symbols to electrical signals for input to a bar code decoder for processing and subsequent output through a data communications interface.

level triggering

A scanner trigger configuration that makes the laser turn on after you pull the trigger and stay on until you release the trigger. Contrast with edge triggering.

LRC

Longitudinal redundancy check character. This character is an error-checking character that is optionally appended to transmitted blocks of data and optionally checked on received blocks of data.

memory cards

See PC cards.

MakeDisk

One of two programs you can use to change the contents of ROM drives. MakeDisk creates an image file containing the files you want on a ROM drive. You can run MakeDisk on a host computer, on the PC card drive, or on the RAM drive.

Modulus 43 check character

Check character derivation method for Code 39.

modem card

A Type II PC card that converts one form of a signal to another, which is suitable for transmission over communications circuits, typically from digital to analog and then from analog to digital.

MS-DOS Programs companion disk

One of the disks that Intermec ships with your JANUS device. This disk contains commands and device drivers. Some of these commands and drivers are already installed on the device. This disk also contains applications, such as INTERLNK.EXE, MakeDisk, and PutDisk.

MSI code

Similar to Plessey code. MSI code includes a start pattern, data characters, one or two check digits, and a stop pattern. It is fixed length, continuous, and non self-checking. This code is used to mark retail shelves for inventory reordering. The character set is 0 to 9 plus additional symbols.

Multi-Drop address

The address of the COM port when you are using Multi-Drop communications protocol. Each Multi-Drop address has unique POL and SEL characters that are automatically set when you configure the address.

Multi-Drop protocol

Communications protocol similar to Polling Mode D, used when connecting multiple devices to a port concentrator. In Multi-Drop, each device on the line must be assigned a unique POL and SEL character. Due to timeout parameters, the baud rate must be 2400 or higher.

multiple-read label

A bar code label that has a space as the first character after the start code. The device stores a multiple-read label in the buffer until you execute a command to transmit the label or scan a regular label. Contrast with regular label.

NEG

Negative Acknowledgment character. Indicates a negative acknowledgment to a solicitation event or a data transmission event.

network

A collection of devices that can store and manipulate electronic data, interconnected in such a way that their users can store, retrieve, and share information with each other.

NLS

National Language Support. A DOS feature that provides country-specific information and character set (code page) switching for international language support.

nonvolatile

Refers to memory that is saved when power is lost or turned off.

null modem cable

A cable that connects two computers and allows transmission of data between them without requiring a modem.

number pad

A set of keys on the device that allows you to move the cursor around the screen and to type numbers and mathematical symbols. The number pad is designed to work like the number pad on a regular PC keyboard.

One-Shot mode

See Scanner mode.

PAK

Program Acknowledgment character. Sent from the device when the received IRL program compiles with no errors.

parameter

See configuration command.

parity

A system for encoding characters with odd or even bar code patterns. Parity provides a self-checking feature in bar codes and other data transmission techniques. Even parity characters have an odd number of binary ones in their structure.

PC card

A PC card is similar to a floppy disk. You can use Type I or II memory PC cards and Type II expansion PC cards. Memory cards provide additional disk storage space, not more executable conventional memory. Expansion cards (also called I/O cards) allow you to connect the device to I/O devices. PC cards were previously called PCMCIA cards.

PCMCIA

Personal Computer Memory Card International Association. This group of manufacturers has defined a set of hardware and software standards for memory and expansion PC cards that are available for personal computers.

PC Standard communications protocol

A communications protocol that handles data transfer on a character-by-character basis or by either filling a receive buffer or transmitting a buffer of data. This protocol is designed to be compatible with the standard PC BIOS functions. The one exception is that the PC Standard protocol can buffer data that is received to avoid losing characters if a program has not checked for data recently.

physical RAM drive

See RAM drive.

Plessey Code

A fixed length, continuous, and not self-checking bar code symbology. Plessey code is pulse-width modulated. It includes a start character, data characters, an eight-bit cyclic check digit, a termination bar, and usually a reverse start character.

Point-to-Point protocol

Point-to-Point is an unsolicited protocol in which the device transmits data whenever it has something to transmit. The data is followed by a CR LF as the EOM characters. The device is always in a receiving state and does not wait for select commands. This protocol does not perform any error checking or acknowledgment handshaking. Point-to-Point protocol is typically used to connect the device to a CRT terminal or host computer.

POL

Poll character. Sent by the host to request device data. For User-Defined Multi-Drop protocol, you must define a unique character for each device on a data line.

Polling Mode D

Polling Mode D is a communications protocol that requires the host computer to ask the device for data it might have (polling) and to request to send data to the device (selecting). Polling Mode D is used to connect multiple devices to a single multiport controller. PC-IRL uses this protocol.

POST

Power-on self test. This test runs when you warm or cold boot the device. The test ensures that the hardware and peripherals are operational.

postamble

A field of data that is sent after the data in a message. It is typically used to tag transactions rapid processing by the host, and it expands the data field (record) length. Similar to the preamble.

preamble

Predefined data that is automatically appended to the beginning of entered data. Similar to postamble.

protocol character

See ASCII control character.

protocol handler

A protocol handler provides communications services that let a device send data to other devices by transmitting and receiving data as specified by the communications protocol.

PSK

JANUS Programmer's Software Kit. A library of software functions for creating applications on the JANUS.

PSS

Program Statement Separator character. The PSS indicates the end of an IRL program statement. It separates individual IRL program statements from one another in a block of IRL program statements. PSS must not be defined the same as the EOM.

PutDisk

One of two programs you can use to change the contents of the ROM drives. PutDisk places an image file created with MakeDisk on the device. You can run PutDisk only on the device.

RAM

Random access memory. Memory that can be written into, or read, by locating any data address.

RAM drive

A disk drive that exists only in extended memory. You create, read, write, and delete files on a RAM drive the same way you can on a hard disk drive. RAM drives are faster than hard disk drives because the contents of a RAM drive are, by definition, always resident in RAM. The contents are destroyed when you cold boot the device.

Reader Services

A collection of programs on the device that decode bar codes, process data input and output, configure the device, and handle power management.

records per block

The maximum number of data records transmitted per block of data. A block of data is transmitted during a single transmission event.

regular label

A bar code label that takes the form of <start code data stop code>. A regular bar code label is executed as soon as you scan it. Contrast with multiple-read label.

remark out

When you add a REM statement (short for REMark) at the beginning of a command line in a batch file, DOS treats the line as a remark instead of as a command. Any statement beginning with the characters REM will be ignored by the command processor. Typically, users will remark out device drivers in AUTOEXEC.BAT and CONFIG.SYS startup files.

REQ

Request for Acknowledgment character. Sent by the device to the host to request a retransmission of an acknowledgment to a message.

RES

Reset character. Sent by the device to end communications with the host. The RES character enables or disables the reset event, or resets the data transmission event to the solicitation event.

resume

When you press $\text{\textcircled{V}}$ to turn the device back on, the device resumes exactly where it was when you turned it off. If a program was running when you turned off the device, the program continues running from the same point when you turn the device back on.

RF data collection system

Radio frequency data collection system in which the individual components communicate with each other by radio signals.

RFPH

The RF protocol handler, which enables a JANUS device to communicate as an end device in an RF network. RFPH lets the device transmit and receive data as specified by the RF communications protocol.

ROM

Read only memory. Usually a small memory that contains often-used instructions, such as microprograms or system software. ROM is programmed during memory fabrication and cannot be reprogrammed.

ROM drive

A read-only memory drive. Drives C and D are ROM drives implemented in flash memory on the device.

scanner timeout

Maximum time the laser is on. The laser will automatically turn off if timeout occurs before the trigger is released.

SEL

Select character. The character that requests permission for the controller to send data to the polled device.

serial communications

With serial communications, data is transmitted one bit at a time over a single line from one computer to another. Often serial communications link host computers to terminals and PCs to printers.

serial communications parameters

Parameters that control serial communications from one computer to another, such as baud rate and parity.

server

The computer that contains the drives, directories, files, and programs you want to access. See also client.

SOM

Start of Message character. The first character in messages sent to or received from the host.

SOP

Start of Program Block character. Sent by the host at the beginning of a block of IRL program statements.

spotting beam

An aiming feature of a laser scanner. A small beam of light briefly shines on the object being scanned, allowing the operator to position the scanner correctly for a good read.

SRAM drive

Static RAM. See RAM drive.

SRAM PC card

A type of memory PC card that provides additional disk storage space, not more executable conventional memory, on the device. An SRAM card has a lithium battery to back up data for the life of the battery.

stop bits

A bit that signals the end of a character. One of the serial communications parameters.

Suspend mode

The mode the JANUS device enters when you press I/O to turn off the device. In Suspend mode, the device saves all memory and turns off the power to most hardware, including the CPU.

symbology

See bar code symbology.

timeout

A defined time allowed for an event after which an alternative action is taken.

timeout delay

The time the device waits between received characters before an I/O (input/output) error occurs.

TSR program

Terminate and stay resident program. A DOS program that remains loaded in conventional memory after you have terminated it. You must explicitly unload the TSR if you want to free the conventional memory it is using.

UART buffer

Universal Asynchronous Receiver/Transmitter buffer. The UART buffer contains bytes of data being sent or received by the device. The FIFO control register controls how the UART buffer operates.

UPC/EAN Code

A fixed length, numeric, continuous bar code symbology that uses four element widths. A device that is configured to decode EAN bar codes can decode UPC, but the reverse is not true. UPC code is a subset of EAN code. It is a numeric, 12-digit bar code symbology used extensively in retail, particularly the grocery industry. The character set is 0 to 9. Its maximum character density is 13.8 numeric characters per inch.

upline

A device that is at the computer end of a connection between a computer and a device is referred to as being upline. When devices are connected to a computer, they are connected in a "line." Upline is a direction relative to the device, in contrast to downline.

upper memory area

The area between the 640K and 1024K. The upper memory area is physically composed of a 256K flash ROM chip (system flash) and the video memory chip. Like a PC, this area contains the BIOS and video buffers. The upper memory area also contains PC card memory and ROM DOS. The 384K upper memory area maps just above 640K conventional memory.

User-Defined protocol

A custom communications protocol that can be modified to meet specific host requirements. For example, you can configure User-Defined to act like a Point-to-Point protocol, except that it requires an LRC and an acknowledgment from the receiver. You can also define the communications characters such as SOM, POL, or SEL, or disable these characters by setting them to null.

vertical reading angle

The vertical angle of a laser scanner to a bar code label. The optimum vertical reading angle is near 20 degrees.

Virtual Wedge

A Reader Services feature that lets the device decode bar codes, making the device functionally equivalent to a wedge device connected to a PC.

volatile

Refers to memory that is not saved when power is lost or turned off.

warm boot

One of two ways to boot the device; compare to cold boot. A warm boot performs the power-on self test (POST) to ensure that the hardware and peripherals are operational, runs CONFIG.SYS and AUTOEXEC.BAT, and displays the DOS prompt. The contents of both conventional memory and the physical RAM drive (drive E) remain intact. You may warm boot the device to execute startup files, such as AUTOEXEC.BAT, that have changed. You may also warm boot to start Interlnk.

XON/XOFF

A type of software flow control for communications between digital devices. It stops the host from sending data when the device buffer fills up (XOFF) and starts it again when the buffer empties (XON).



Index

Numbers

9154 Multi-Drop Line Controller for BFT, 6-26
9180 Network Controller for BFT, 6-26

A

Adding files to drive C, 3-16
Address, Multi-Drop, 10-5, A-6
advanced power management, using, C-9
AFF, 10-6
Alt
 key, 2-6
APM_4M.EXE
 defined, 3-7
 loading, 3-7, 5-16
 troubleshooting, 8-11
Application storage, 2-24
applications
 downloading with BFT, 6-22-6-32
ASCII
 bar code chart, A-19
 Code 39
 full, 10-20
 mixed-full, 10-20
 non-full, 10-20
 control characters, 9-7
 configuring preamble/postamble, 4-9, A-4
 configuring protocol characters, 4-9, A-3
 Data Link Exception (DLE), 9-7
 entering characters (0 to 255), 2-8
 equivalents, A-16
ASCII GS character, 10-27
ATA card
 defined, 5-4
 initializing and formatting, 5-10
ATADRV.EXE, 5-10
ATAINIT.EXE, 5-10
Audio signals, 2-20
Audio signals, when inserting a PC card, 2-20
AUTOEXEC.BAT
 defined, 3-6
 editing on drive C, 3-10, 3-13
 I/O cards, configuring, 5-15
 loading a configuration file with IC.EXE, 4-11
Auto-Loader
 batch files
 reference information, C-10-C-15
 drive C
 using Auto-Loader to change, 3-11, C-10
Auto-Loader utility, 3-4, 3-14
 creating and loading a new drive C, 3-16
 creating image files, 3-18
 installing, 3-14
 loading image files, 3-20
 overview, 3-13

reader locks up, 8-13

B

Backspace, destructive, 9-5
Backup battery, 2-21
 charging, 2-21
 time for full charge, 2-21
Bad BIOS Checksum error message, 8-3
Bad command or filename, 8-10
Bad Saved State, 8-4
BAK, IRL, 10-56
Bar code
 ASCII chart, A-19
 configuration overview, 4-3
 configuring with, 4-6
 creating configuration labels, 4-14
 decode security, 10-43
 Enable override, 8-7
 Exit IRL program, 8-9
 moving the cursor with bar codes, A-22
 symbolologies
 Codabar, 10-14
 Code 11, 10-16
 Code 128, 10-27
 Code 16K, 10-17
 Code 39, 10-20
 Code 49, 10-24
 Code 93, 10-26
 function code 1, 10-24
 function code 2, 10-24
 Interleaved Two of Five, 10-54
 MSI, 10-68
 Plessey, 10-72
 Two of Five, 10-18
 UPC/EAN, 10-94
Bar code symbolologies
 default settings, A-23
bar code wedge
 configuring, 3-30
 default configuration, 3-31
Bar codes
 problems scanning, 8-22
batch file
 for Auto-Loader, C-10-C-15
 to install Auto-Loader, 3-4
battery pack
 power status, displaying, C-9
baud rate, 10-7
 38400 bps, 8-26
 57600 bps, 8-26
 for BFT, 6-26
 for Loader, 8-26
Beep
 duration, 10-9
 frequency, 10-11

- status indication, 2-20
- volume, 10-13
- BFT
 - application, starting automatically, 6-29
 - baud rate restrictions, 6-26
 - Cancel the Prepare for Reboot command, 9-8
 - Cancel the Reboot command, 9-9
 - client, using the device as, 6-27
 - defining a typical session, 6-25
 - downloading applications, 6-22-6-32
 - drive C, using to change, 3-11
 - example, illustrated, 6-23, 6-24
 - FTA commands, using, 6-29
 - FTA initialization file, editing, 6-32
 - Prepare for Reboot command, using, 9-8
 - preparing the device and host computer, 6-26
 - Reboot command, using, 9-9
 - server, using the device as, 6-28
- Binary File Transfer
 - defined, 3-4
- Boot Loader menu, 11-4
 - dump, 11-5
 - load, 11-5
 - off (exiting), 11-5
 - password, 11-5
 - setting, 11-6
 - reboot, 11-4
 - resume, 11-5
 - storage mode, 11-5
 - entering, 11-6
 - exiting, 11-7
 - system flash corrupt, 8-3
 - troubleshooting, 8-3
- Boot utilities, 3-3
- Booting the JANUS 2050, 2-16, 11-4
- booting the reader, 4-11
- Buffered display, 10-44
- C**
 - Cancel the Prepare for Reboot command, 9-8
 - Cancel the Reboot command, 9-9
 - Card. *See* PC card
 - CARDINFO.EXE, 5-17
 - Cards
 - overview, PC cards, 5-9
 - Cfg menu in Communications Manager, 6-20
 - changing drive C
 - learning how to, Error! Not a valid bookmark in entry on page 3-10, C-10
 - changing drive C or D, using MakeDisk and PutDisk, 3-21
 - CHECKHOST, FTA command, 6-30
 - Clear command, 9-6
 - Clicker, keypad, 10-65
 - Client, making Interlnk the, 6-13
 - client/server
 - BFT, illustrated, 6-27
 - Interlnk, using, C-3-C-6, C-7
 - CLOSE, FTA command, 6-30
 - Codabar, 10-14
 - Code 11, 10-16
 - Code 128, 10-27
 - Code 16K, 10-17
 - Code 39, 10-20
 - Code 49, 10-24
 - Code 93, 10-26
 - Code pages, switching in DOS, 2-9
 - Cold boot, 2-16, 11-4
 - Com menu in configuration application, 4-7
 - COM port connector, B-4
 - COM port pin assignments, B-5
 - Command
 - concatenated, 9-3
 - configuration command syntax listing, A-27
 - override command, 9-7
 - Command processing, 10-28
 - Command, configuration
 - multiple-read labels, 10-28
 - Command, configuration, 4-14, 9-6
 - address, Multi-Drop, 10-5
 - AFF, 10-6
 - BAK, IRL, 10-56
 - baud rate, 10-7
 - beep
 - duration, 10-9
 - frequency, 10-11
 - volume, 10-13
 - Codabar, 10-14
 - Code 11, 10-16
 - Code 128, 10-27
 - Code 16K, 10-17
 - Code 39, 10-20
 - Code 49, 10-24
 - Code 93, 10-26
 - COM1 Port
 - UART - Restore, 10-35
 - COM2 Port
 - UART - Restore, 10-34
 - command processing, 10-28
 - communication port
 - UART, 6-11
 - communications port, 10-33
 - communications protocol, 10-37
 - activate, 10-40
 - User-Defined Multi-Drop, 10-41
 - data bits, 10-42
 - decode security, 10-43
 - display
 - mode, IRL, 10-44
 - setup, 10-45

- END, IRL, 10-57
- EOF, 10-47
- EOM, 10-48
- EOP, IRL, 10-58
- EOR, 10-50
- flow control, 10-51
- function code 1, 10-24
- function code 2, 10-24
- intercharacter delay, 10-52
- Interleaved Two of Five, 10-54
- key code lookup table, 10-63, A-7
- keypad
 - clicker, 10-65
 - Ctrl key functions, 10-66
- Keypad Caps Lock, 10-64
- LRC, 10-67
- MSI, 10-68
- NEG, 10-70
- overview, 10-3
- PAK, IRL, 10-59
- parity, 10-71
- Plessey, 10-72
- POL, 10-73
- postamble, 10-74
- preamble, 10-75
- PSS, IRL, 10-60
- records per block, 10-76
- REQ, 10-78
- RES, 10-79
- RUN, IRL, 10-61
- scan ahead, 10-80
- scanner
 - devices, 10-81
 - mode, 10-82
 - redundancy, 10-83
 - timeout, 10-84
 - trigger, 10-85
- SEL, 10-86
- SOM, 10-87
- SOP, IRL, 10-62
- stop bits, 10-88
- syntax cross-reference, A-27
- timeout delay, 10-89
- transmit abort timeout, 10-91
- turnaround delay, 10-93
- Two of Five, 10-18
- UPC/EAN, 10-94
- variable data, working with, 10-4
- Command, JANUS 2050
 - backspace, destructive, 9-5
 - change configuration, 9-6
 - clear, 9-6
 - command override, 9-7
 - enter, 9-8
 - Enter/Exit Accumulate, 9-4
 - Prepare for Reboot, 9-8
- Command, reader, 9-3
 - disabling commands, 10-28
- COMMAND.COM, 8-12
- Commands, JANUS 2050
 - Reboot, 9-9
- Communication parameters
 - address, Multi-Drop, 10-5
 - AFF, 10-6
 - baud rate, 10-7
 - data bits, 10-42
 - EOF, 10-47
 - EOM, 10-48
 - EOR, 10-50
 - flow control, 10-51
 - intercharacter delay, 10-52
 - IRL BAK, 10-56
 - IRL END, 10-57
 - IRL EOP, 10-58
 - IRL PAK, 10-59
 - IRL PSS, 10-60
 - IRL RUN, 10-61
 - IRL SOP, 10-62
 - LRC, 10-67
 - NEG, 10-70
 - parity, 10-71
 - POL, 10-73
 - records per block, 10-76
 - REQ, 10-78
 - RES, 10-79
 - SEL, 10-86
 - SOM, 10-87
 - stop bits, 10-88
 - timeout delay, 10-89
 - transmit abort timeout, 10-91
 - turnaround delay, 10-93
- Communication port
 - UART, 6-11
- Communication protocol
 - disabling protocol characters, 4-9
 - User-defined, 6-4
- Communications
 - configuration overview, 4-4
 - configuring for, 6-7
 - configuring protocol characters, 4-9
 - CrossBar, Multi-Drop protocol, 6-5, 6-7
 - Exiting Interlnk/Intersvr, 6-18
 - Interlnk, 6-4, 6-13
 - executing on the host computer, 6-16
 - executing on the JANUS 2050, 6-17
 - Interlnk, using to transfer files, C-3-C-6
 - Interlnk/Intersvr
 - status, 6-18
 - Intersvr, defined, C-7
 - IRL Desktop, 6-4, 6-13

- manager, 3-3, 6-4, 6-13
 - entering commands from the DOS prompt, 6-21
 - executing the menu application, 6-19
 - exiting, 6-21
 - loading protocol handlers, 6-20
 - with PC standard protocol handler, 6-20
- restarting Interlnk/Intersvr, 6-19
- utilities, using, 3-28
- Communications parameters
 - default settings, A-24
 - POL, A-6
 - SEL, A-6
- Communications port, 10-33
 - UART setting the FIFO control register, 10-35
- Communications protocol, 10-37
 - activate, 10-40
 - Multidrop, 6-5, 10-5, 10-7
 - None, 6-5
 - parameters
 - address, Multi-Drop, 10-5
 - AFF, 10-6
 - baud rate, 10-7
 - data bits, 10-42
 - EOF, 10-47
 - EOM, 10-48
 - EOR, 10-50
 - flow control, 10-51
 - intercharacter delay, 10-52
 - IRL BAK, 10-56
 - IRL END, 10-57
 - IRL EOP, 10-58
 - IRL PAK, 10-59
 - IRL PSS, 10-60
 - IRL RUN, 10-61
 - IRL SOP, 10-62
 - LRC, 10-67
 - NEG, 10-70
 - parity, 10-71
 - POL, 10-73, A-6
 - records per block, 10-76
 - REQ, 10-78
 - RES, 10-79
 - SEL, 10-86, A-6
 - SOM, 10-87
 - stop bits, 10-88
 - timeout delay, 10-89
 - transmit abort timeout, 10-91
 - turnaround delay, 10-93
 - using ASCII characters, A-3
 - PC standard, 6-5
 - Point-to-point, 6-5
 - Polling Mode D, 6-5, 10-7
 - protocol handler, 6-5, 6-8, 6-10
 - Intermec, 6-8
 - loading/unloading, 6-8, 6-10
 - PC standard, 6-8
 - RF, 6-5
 - User-defined
 - Multi-Drop, A-6
 - POL/SEL character combinations, A-5
 - User-defined Multi-Drop, 6-4, 10-37, 10-41
 - Companion Disk
 - Auto-Loader utility, 3-4, 3-14
 - boot utilities, 3-3
 - LDKEYTAB.EXE, 3-4
 - companion disks, summary of contents, 3-4
 - Compound Function LED, 2-18
 - COMSPEC environment variable, 8-12
 - Concatenated commands, 9-3
 - CONFIG.EXE, PC card utility, 5-20
 - CONFIG.SYS
 - ATA cards, configuring, 3-9
 - defined, 3-8
 - editing on drive C, 3-10, 3-13
 - failure to boot, 8-14
 - flash cards, configuring, 3-9
 - I/O cards, configuring, 3-9, 5-15
 - INTERLNK.EXE device driver, C-3, C-4
 - SRAM cards, configuring, 3-9
 - Configuration
 - application, 3-3
 - bar code symbologies, 4-3
 - command, 9-6
 - communications, 4-4, 6-7
 - default settings, A-23
 - editing a file, 4-13
 - error file, 4-14
 - help, 4-7
 - menus, 4-7
 - operations, 4-5
 - overview, 4-3
 - preamble/postamble, 4-9
 - protocol characters, 4-9
 - using an application, 4-15
 - using bar code, 4-6, 4-14
 - using IRL, 4-6, 4-15
 - using the host computer, 4-6
 - Configuration application, 4-6, 4-7
 - example, 4-10
 - exiting, 4-9
 - starting, 4-7
 - configuration application, starting, 4-11
 - configuration file
 - loading, 4-11
 - loading automatically, 4-11
 - saving, 4-12
 - configuring
 - bar code wedge, default, 3-31
 - Direct Hardware Wedge, 3-32
 - overview, PC cards, 5-9

- serial communications parameters, 10-34
- UART FIFO control register, 6-11
- Virtual Wedge, 3-32
- configuring the reader
 - Configuration Manager, defined, 3-28
- configuring the bar code wedge, 3-30
- Conn/Data LED, 2-17
- Connector end, PC card, 5-6
- conventional memory
 - ways to free memory, 5-16
 - ways to free up memory, 11-3
- conventional memory, described, B-9
- copying files
 - drive C or D, 3-21
 - SRAM cards, 5-17
- Creating
 - image file, 3-18
 - RAM drive
 - DiskSize, 3-12
 - examples, 3-13
 - NumEntries, 3-12
 - SectorSize, 3-12
- CrossBar, 6-7
- CrossBar network
 - using BFT, 6-26
- CrossBar, Multi-Drop protocol, 6-5
- Ctrl
 - key, 2-6
 - functions enable/disable, 10-66
- Ctrl/Alt LED, 2-17
- CTS/RTS, 10-51
- Cursor
 - keypad, 2-7
 - moving through menus with bar codes, A-22

D

- Data
 - storage, 2-24
 - variable
 - working with configuration commands, 10-4
- Data bits, 10-42
- DCM, using with BFT, 3-11, 6-25
- Decode security, 10-43
- Default configuration
 - returning to, 8-23
 - settings, A-23
- Deleting files
 - on drive C, 3-16
 - SRAM cards, 5-17
 - troubleshooting, 8-11
- Device driver
 - HIMEM.SYS, 2-23, 3-11
 - SRAMDISK.SYS, 2-23, 3-11
- device drivers
 - HIMEM.SYS, B-10

- I/O cards, configuring, 5-16
- INTERLNK.EXE, C-3, C-4
- list of, 5-18
- SRAMDISK.SYS, B-10
- troubleshooting for flash cards, 8-11
- Dialog box, 6-21
 - exiting, 4-8
 - using, 4-8
- Direct Hardware Wedge
 - configuring, 3-30
 - defined, 3-4, 3-32
 - enabling, 3-32
- DiskSize, 3-12
- Display
 - buffered, 10-44
 - graphics mode, 2-19
 - mode, IRL, 10-44
 - setup, 10-45
 - size, 2-19
 - text mode, 2-19
 - transparent, 10-44
 - video modes, 10-45
- DLE, 9-7
- documentation
 - from SystemSoft, 5-18
- DOS
 - code pages, switching, 2-9
 - defined, 3-3
 - Interlnk, 6-4
 - Interlnk, unsupported commands, C-6
 - international languages, customizing for, 3-6, 3-13
 - Intersvr, 6-13
 - Intersvr, unsupported commands, C-8
 - Mode command, 10-34
 - National Language Support (NLS), 3-15
 - SRAMDISK, 3-11
 - using on the reader, 3-5
- DOS commands
 - not used with Interlnk driver, 8-14
 - unsupported, 8-14
- DOS commands, adding or replacing, 3-5
- drive C
 - adding or editing files, C-11
 - BFT, changing with, 6-22
 - changing, learning about, 3-10, C-10
 - creating a drive C image file, 3-23
 - MakeDisk and PutDisk, using to change, 3-21
 - memory, defined, B-11
 - PC card files, list of, 5-18
- drive C or D
 - loading an image file, 3-23
 - MakeDisk and PutDisk
 - examples, 3-24
- drive D,
 - creating a drive D image file, 3-23

- PC card files, list of, 5-18
- drive E, memory, defined, B-10

- DRIVEC.IMG, 3-23

- DRIVED.IMG, 3-23

- Drives

- C, 2-22

- adding, changing, deleting files, 3-13, 3-16

- D, 2-22

- defining, 2-22

- E, 2-23

- F, recommended uses, 2-24

- G, 2-23

- PC card, 2-23

- Drives C

- using Loader, 8-26

- Dump data, 11-5

E

- Edge triggering, scanner, 10-85

- EMM386, 8-13

- END, IRL, 10-57

- Enter command, 9-8

- Enter/Exit Accumulate, 9-4

- environment space, allocating, 3-8

- environment variable

- IM_APPLICATION, 6-29

- EOF, 10-47

- EOM, 10-48

- EOP, IRL, 10-58

- EOR, 10-50

- Erasing flash cards, 5-14

- Error

- JANUS.ERR, 4-14

- error messages

- Bad BIOS Checksum, 8-3

- Bad Saved State, 8-4

- JANUS.ERR file, 3-7

- EXIT, FTA command, 6-30

- Exiting

- Communications Manager menu, 6-21

- configuration application menu, 4-9

- dialog box, 4-8

- Interlnk/Intersvr, 6-18

- expanded memory, B-10

- Extended memory, 3-11, B-10

- External PC card drive

- inserting a card, 5-5

- location on the JANUS 2050, 5-3

F

- Factory default configuration

- loading without rebooting, 4-12

- File

- LOAD_USA.BAT, 3-15

- LOADADD.BAT, 3-15

- LOADC.BAT, 3-15

- LOADIMG.BAT, 3-16

- LOADLANG.BAT, 3-15

- LOADNEW.BAT, 3-16

- LOADXIMG.BAT, 3-16

- MAKE_USA.BAT, 3-16

- MAKELANG.BAT, 3-16

- MAKENEW.BAT, 3-16

- naming conventions

- configuration, 4-10

- file transfer application. See FTA files

- APM_4M.EXE, 5-16

- ATADRV.EXE, 5-10

- ATAINIT.EXE, 5-10

- AUTOEXEC.BAT, 3-6, 4-11

- CARDINFO.EXE, 5-17

- CONFIG.SYS, 3-8

- EXAMPLE.INI, 4-10

- FORMAT.COM, 5-9, 5-11, 5-17

- FTA.EXE, 6-22

- FTSERVER.BAT, 6-25

- INITENV.EXE, 8-12

- IRLDESK.EXE, 8-16

- JANUS.INI, 3-28

- LOADER.EXE, 8-26

- MCFORMAT.EXE, 5-12, 5-14

- PC cards, list of, 5-18

- RWTSR.EXE, 11-3

- Flash card

- defined, 5-4

- erasing, 5-14

- formatting, 5-12

- troubleshooting, 8-11, 8-12

- Flash memory

- loading, 8-26

- flash memory, described, B-11

- Flash memory, updating with loader, 8-26

- Flow control, 10-51

- Forcing turn off, 8-24

- Formatting

- ATA cards, 5-10

- flash cards, 5-12

- overview, PC cards, 5-9

- SRAM cards, 5-17

- troubleshooting, 8-11

- French keypad, 2-10

- FTA

- application, starting, 6-29

- commands, description and syntax, 6-30

- commands, using on the device, 6-29

- defined, 6-22

- initialization file, editing, 6-32

- starting, 6-27

- FTA.EXE, 6-22
 - FTA.INI, 6-27, 6-32
 - FTL, formatting flash cards, 5-13
 - FTSERVER.BAT, 6-25
 - Full ASCII, Code 39, 10-20
 - Function code 1, 10-24
 - Function code 2, 10-24
- G**
- German keypad, 2-11
 - GET, FTA command, 6-30
 - Graphics mode, 2-19
- H**
- Help, configuration, 4-7
 - HELP, FTA command, 6-30
 - Hexadecimal value, 6-11
 - high memory area, described, B-11
 - HIMEM.SYS, 2-23, 3-11, B-10
 - Host computer, communicating with JANUS 2050, 8-26
- I**
- I/O card
 - configuring, 5-15
 - device drivers, 5-16
 - managing power on the PC card drive, 5-18
 - resetting the PC card drive, 5-16
 - troubleshooting, 8-12
 - types recommended, 5-4
 - IC command, new switches, 4-11
 - IM_APPLICATION environment variable, 6-25, 6-29
 - Image file
 - creating, 3-16, 3-18
 - DRIVEC.IMG, 3-23
 - DRIVED.IMG, 3-23
 - loading, 3-16, 3-20
 - MakeDisk, creating, 3-23
 - PutDisk, loading with, 3-23
 - INI file. *See* configuration file
 - INTENV.EXE, 8-12
 - initializing, ATA cards, 5-10
 - Input device connector, B-6
 - Input device pin assignments, B-7
 - Input Manager, defined, 3-28
 - Inserting
 - cards, 5-5
 - cards, understanding audio signals, 2-20
 - Installing
 - Auto-Loader utility, 3-14
 - Interlnk/Intersvr, 6-15
 - insufficient memory
 - to run the Configuration Manager TSR, 8-16
 - Intel ExCA standards, 5-3
 - Intercharacter delay, 10-52
 - Interface Software (IS), using with BFT, 3-11, 6-25
 - Interleaved Two of Five, 10-54
 - Interlnk, 6-13
 - breaking the connection, 6-18
 - client, 6-13
 - example, 6-14
 - exiting, 6-18
 - installing, 6-15
 - INTERLNK.EXE, syntax defined, C-4-C-6
 - redirecting drives, 6-18, C-3-C-6
 - reference information, C-3-C-6
 - requirements, 6-15
 - restarting, 6-19
 - running on the host computer, 6-16
 - running on the JANUS 2050, 6-17
 - status, 6-18
 - Interlnk, running with MakeDisk, 3-21
 - Intermec protocol handler
 - loading/unloading
 - with a batch file, 6-9
 - with an application, 6-10
 - Internal battery, 2-21
 - International keypads, 2-9
 - international languages, customizing for, 3-6, 3-13
 - Intersvr, 6-13
 - DOS commands not supported, C-6, C-8
 - example, 6-14
 - installing, 6-15
 - rcopy, using, 6-15
 - redirecting drives, C-7
 - reference information, C-7
 - requirements, 6-15
 - running on the device, 6-16
 - running on the host computer, 6-17
 - server, 6-13
 - status, 6-18
 - IPM_4M.EXE
 - defined, 3-7
 - loading, 3-7
 - troubleshooting, 8-11
- IRL**
- BAK, 10-56
 - configuring the JANUS 2050, 4-15
 - configuring the reader, 4-6
 - desktop, 3-3, 6-4, 6-13
 - display mode, 10-44
 - END, 10-57
 - EOP, 10-58
 - IRL Desktop, 8-16
 - PAK, 10-59
 - PSS, 10-60
 - RUN, 10-61
 - SOP, 10-62
- IRQ**, 5-17
- Italian keypad, 2-12

J

JANUS 2050

- Auto-Loader utility, 3-4
 - backup battery, 2-21
 - beep sequences, 2-20
 - Boot utilities, 3-3
 - cold boot, 2-16
 - COM port connector, B-4
 - Communications Manager, 3-3
 - configuration
 - application, 3-3
 - command overview, 10-3
 - overview, 4-3
 - connecting devices, B-4
 - constructing special cables, B-5
 - defining drives, 2-22
 - display modes, 2-19
 - entering keystrokes, A-13
 - estimating power usage, 2-21
 - input device connector, B-6
 - inserting cards into the external drive, 5-5
 - IRL Desktop, 3-3
 - keypad described, 2-5
 - PC card drives illustrated, 5-3
 - power-on self-test, 2-16
 - removing PC cards, 5-7
 - specifications, B-3
 - status lights, 2-17
 - warm boot, 2-16
- JANUS.ERR file, 3-7, 4-14
- JANUS.INI, 3-28, 10-64

K

- Key code lookup table, 10-63
- Key codes, A-7
- Keypad, 2-5
 - clicker, 10-65
 - Ctrl key functions, 10-66
 - cursor keypad, 2-7
 - French, 2-10
 - German, 2-11
 - international, 2-9
 - Italian, 2-12
 - numeric keypad, 2-7
 - entering ASCII characters, 2-8
 - Num Lock on/off, 2-8
 - Spanish, 2-13
 - TE, 2-14
- Keypad Caps Lock, 10-64
- Keystrokes
 - Alt, 2-6, 2-7
 - Ctrl, 2-6, 2-7
 - entering, A-13
 - Shift, 2-6, 2-7

KWC.COM, 3-30

L

- languages
 - configuring the device for, C-10
 - configuring with LOADADD, C-11
 - configuring with LOADLANG, C-11
 - configuring with LOADNEW, C-13
- LDKEYTAB.EXE, 3-4, 3-5
- LEDs
 - status display, 2-17
- Level triggering, scanner, 10-85
- Load, Boot Loader menu, 11-5
- LOAD_USA, C-11
- LOAD_USA.BAT, 3-15
- LOADADD, C-11
- LOADADD.BAT, 3-15
- LOADC.BAT, 3-15, C-10
- LOADIMG, C-13
- LOADIMG.BAT, 3-16
- Loading
 - drive C image, 3-20
 - files onto drive C, 3-16
 - flash, 11-5
 - protocol handlers
 - at the DOS prompt, 6-8
 - with a batch file, 6-9
 - with an application, 6-10, 6-20
- Loading flash memory, 8-26
 - IMGx_x.EXE file, 8-26
 - LOADER.EXE, 8-26
 - OTP2MEGx.x, 8-26
 - SYSTEM_x.x, 8-26
 - USER_x.x, 8-26
- LOADLANG, C-11
- LOADLANG.BAT, 3-15
- LOADNEW, C-13
- LOADNEW.BAT, 3-16
- LOADXIMG, C-14
- LOADXIMG.BAT, 3-16
- Locked-up JANUS 2050, 8-11
- LRC, 10-67
- LUPGRADE, FTA command, 6-30

M

- MAKE_USA, C-14
- MAKE_USA.BAT, 3-16
- MakeDisk
 - defined, 3-4
 - drives C or D, adding, editing, deleting files, 3-21
 - examples of using, 3-24
 - image file, creating, 3-23
 - messages, 8-17
 - output file, defining, 3-23

- overview, 3-14
- path parameter, defining, 3-23
- target drive parameter, defining, 3-23
- where to run, 3-21
- working directory, creating, 3-22
- working source directory, creating, 3-22
- MAKELANG, C-14
- MAKELANG.BAT, 3-16
- MAKENEW, C-15
- MAKENEW.BAT, 3-16
- MCFORMAT.EXE, 5-12, 5-14
- Memory
 - conventional, described, B-9
 - expanded, described, B-10
 - extended, 3-11, B-10
 - flash, described, B-11
 - high memory area, described, B-11
 - recommended uses for storage, 2-24
 - upper memory block, described, B-9
- Memory card
 - types recommended, 5-4
- Menu
 - Cfg in Communications Manager, 6-20
 - Com in configuration application, 4-7
 - configuration, 4-7
 - exiting, Communications Manager, 6-21
 - Op in configuration application, 4-7
 - selecting a pull-down menu
 - communications manager, 6-21
 - configuration application, 4-8
 - Stat in Communications Manager, 6-20
- Menu, MCFORMAT, 5-12, 5-14
- menu, Startup, 3-10, 11-3
- messages
 - Bad BIOS Checksum, 8-3
 - Bad Saved State, 8-4, 8-5
 - PRN, 8-13
- Mixed-full ASCII, Code 39, 10-20
- Mode
 - Suspend, 6-11
- Mode, DOS command, 10-34
- MS-DOS. *See* DOS
- MS-Flash, formatting flash cards, 5-13
- MSI, 10-68
- MTAA.EXE, 8-11
- MTAB.EXE, 8-11
- Multi-Drop protocol, 6-5
- Multi-Drop protocol, 10-5, 10-7

N

- National Language Support, 3-15
- NEG, 10-70
- networking
 - BFT, downloading applications, 6-22-6-32
- No protocol, 6-5

- Non-full ASCII, Code 39, 10-20, 10-23
- Notches, on PC cards, 5-6
- NumEntries, 3-12
- Numeric keypad, 2-7
 - determining status of, 2-8
 - entering ASCII characters, 2-8
- Num Lock, 2-8

O

- Off, Boot Loader menu, 11-5
- Op menu in configuration application, 4-7
- OPEN, FTA command, 6-31
- Operations
 - configuration overview, 4-5
- Operations parameters
 - default settings, A-25
- Overview
 - configuring, formatting, and using PC cards, 5-9

P

- PAK, IRL, 10-59
- Parity, 10-71
- Password, Boot Loader menu, 11-5
 - setting, 11-6
- PC card
 - audio signals when inserting, 2-20
 - displaying information about, 5-17
 - drive, 2-23
 - erasing flash cards, 5-14
 - formatting flash cards, 5-12
 - formatting SRAM cards, 5-17
 - I/O cards recommended, 5-4
 - initializing and formatting ATA cards, 5-10
 - inserting, 5-5
 - learning about, 5-3
 - memory cards recommended, 5-4
 - overview of configuring, formatting, and using, 5-9
 - removing from the drive, 5-7
 - types supported, 5-3
- PC card drive
 - compared to PC disk drive, 5-3
 - location on the JANUS 2050, 5-3
 - resetting, 5-16
 - turning the power on and off, 5-17
- PC cards
 - files, list of, 5-18
 - I/O cards
 - configuring, 5-15
 - SRAM cards
 - using, 5-17
- PC cards, using MakeDisk for, 3-21
- PC standard protocol, 6-5, 6-20

PC standard protocol handler
 loading/unloading
 with a batch file, 6-9
 with an application, 6-10

PCMCIA
 Standard 2.1, 5-3. See also PC card

Physical and environmental specification, B-3

Plessey, 10-72

Point-to-Point protocol, 6-5

POL, 10-73
 POL/SEL character combinations, A-5

Polling Mode D protocol, 6-5, 10-7

Postamble, 10-74
 entering ASCII control characters, 4-9, A-4

power management
 for PC card drives, 5-17
 POWER.EXE, using, C-9

Power usage, estimating
 estimating power usage, 2-21

POWER.EXE
 reference information, C-9

Power-on-self-test, 2-16

Preamble, 10-75
 entering ASCII control characters, 4-9, A-4

Prepare for Reboot reader command, 9-8

Programs
 IC.EXE, 8-7, 8-8
 IRLXDESK.EXE, 8-9

Protocol character
 disabling in configuration, 4-9
 entering ASCII control characters, 4-9

Protocol handler, 6-5
 Intermec, 6-8
 loading/unloading
 at the DOS prompt, 6-8
 with a batch file, 6-9
 with an application, 6-10, 6-20
 PC standard, 6-8, 6-20

PSK
 BFT-ready applications, preparing, 6-25
 communications utilities, using, 3-28

PSK functions
 im_receive_input, 11-3

PSS, IRL, 10-60

PUT, FTA command, 6-31

PutDisk
 defined, 3-4
 examples of using, 3-24
 image file name, defining, 3-24
 image file, loading a drive C or D, 3-23
 overview, 3-14
 target drive, defining, 3-24

R

RAM drive, 3-11

 described, B-10
 examples for creating a drive, 3-13
 files, saving during cold boot, 8-4
 MakeDisk, using for, 3-21

RAM, making more available, 11-3

Rcopy, Intersvr, 6-15

Reader Services
 high memory area, using, B-11
 overview, 3-28

Reader Wedge TSR, unloading to save memory, 11-3

README.DOC file, 3-5

Reboot reader command, 9-9

Records per block, 10-76

Redirecting drives, 6-18, C-3-C-6, C-7

Removing
 cards from the drive, 5-7

REQ, 10-78

RES, 10-79

Resume
 Boot Loader menu, 11-5

RF communications
 BFT, using, 6-26

RF communications parameters
 default settings, A-26

RF protocol, 6-5

RUN, IRL, 10-61

RUPGRADE, FTA command, 6-31

S

Saving data, 8-24
 Boot Loader menu, 8-24
 dumping data to host, 8-24

Saving memory, 11-5

Scan ahead, 10-80

Scanner
 redundancy, 10-83
 timeout, 10-84
 trigger, 10-85

Scanner devices, 10-81

Scanner mode, 10-82

Scanning problems, 8-22

SectorSize, 3-12

SEL, 10-86
 POL/SEL character combinations, A-5

Selecting a pull-down menu
 Communications Manager, 6-21
 configuration application, 4-8

serial communications parameters for COM ports, 10-34

Server, 6-13
 server, defined, C-3, C-7

SERVER, FTA command, 6-31

Shift
 key, 2-6

Shift/Caps LED, 2-18

software, provided on companion disks, 3-4

SOM, 10-87
 SOP, IRL, 10-62
 Spanish keypad, 2-13
 Special characters, entering, 2-10
 SRAM card
 defined, 5-4
 formatting, 5-17
 using, 5-17
 SRAMDISK.SYS, 2-23, 3-11, B-10
 standards
 Intel ExCA, 5-3
 PCMCIA, 5-3
 Starting Communications Manager, 6-19
 startup files
 editing on drive C, 3-10, 3-13
 startup files, defined, 3-6
 Startup menu
 configuring, 3-8
 defined, 3-10, 11-3
 Stat menu in Communications Manager, 6-20
 Status lights, 2-17
 Compound function, 2-18
 Conn/Data, 2-17
 Ctrl/Alt, 2-17
 Shift/Caps, 2-18
 Stop bits, 10-88
 Storage mode, 11-5
 entering, 11-6
 exiting, 11-7
 Storing data, 2-24
 Suspend mode, 6-11
 system flash corrupt, 8-3
 SystemSoft documentation, 5-18

T

Table storage, 2-24
 TE keypad, 2-14
 Terminate-and-stay-resident. *See* TSR
 Text mode, 2-19
 Timeout delay, 10-89
 Transmit abort timeout, 10-91
 Transparent display, 10-44
 Troubleshooting, 8-3
 beeps/turns off, 8-3
 Boot Loader menu, 8-3
 DOS, 8-13
 IRL, 8-9
 MakeDisk, using, 8-17
 Operating the JANUS 2050, 8-7
 beeps and cannot be turned off, 8-7
 check numeric keypad status, 8-7
 commands not working, 8-7
 error reading bar code, 8-7
 load default configuration, 8-8
 program not receiving input, 8-8

Powering Up or Booting the JANUS 2050
 error message displayed, 8-5
 will not boot, 8-3
 powering up or booting the reader, 8-3
 Running IRL
 exit IRL program, 8-9
 not enough memory, 8-9
 Using DOS
 boot failure after CONFIG.SYS change, 8-14
 COM3 error message, 8-14
 drive access problems, 8-14
 failure of DOS command, 8-13
 host computer locks up, 8-14
 Interlink/Intersvr, 8-14
 not enough memory, 8-13
 range overlaps, 8-13
 reader locks up, 8-13
 write fault error, 8-13
 Using PC cards
 beep when card inserted, 8-10
 reader locks when accessing card, 8-10

TSR
 Reader Wedge, 11-3
 Turnaround delay, 10-93
 Two of Five, 10-18
 Type I card, dimensions, 5-3
 Type II card, dimensions, 5-3
 Type III card, dimensions, 5-3

U

UART
 configure FIFO control register, 10-35
 UART restore, COM1
 FIFO control register, 6-11
 Unloading protocol handlers
 at the DOS prompt, 6-8
 UPC/EAN, 10-94
 Updating flash memory, 8-26
 upper memory block, described, B-9
 US ASCII codes, A-16
 user flash memory, described, B-11
 User-defined
 Multi-Drop, A-6
 protocol
 POL/SEL character combinations, A-5
 User-defined Multi-Drop protocol, 6-4, 10-37, 10-41
 User-defined protocol, 6-4

V

Video modes, 10-45
 Virtual Wedge
 configuring, 3-30
 disabling, 3-32
 enabling, 3-31

JANUS 2050 Vehicle-Mount Computer User's Manual (4MB)

W

Warm boot, 2-16

X

XON/XOFF, 10-51

Z

Z commands, configuring the reader, 4-6