

# JINMA 200 Series DOCUMENTATION



Edited by:

Steve Bradshaw  
Malacat Enterprises  
Cobble Hill, B.C.

## Table of Contents

INTRODUCTION.....	7
Sources of data .....	7
PARTS.....	7
Yancheng Tractor Factory.....	8
THE RULES.....	9
Preventing Farm Machine Hazards.....	11
AEX-593-91.....	11
Shear and Cutting Points.....	11
Pinch Points .....	12
Wrap Points .....	12
Crush Points .....	12
Free-Wheeling Parts.....	13
Springs.....	13
Burn Points.....	13
Hydraulic Systems.....	13
MATERIAL SAFETY DATA SHEETS.....	15
DISPOSAL OF POL WASTE.....	16
ENVIROMENTAL LAW.....	16
Controls and Instruments.....	17
Instruments (Standard).....	17
Amp meter.....	17
Water Temperature Gauge.....	17
Oil Pressure Gauge.....	17
Tachometer.....	17
Turning Signal Switch.....	17
Work Light Switch.....	17
Horn Button.....	17
Headlight Switch.....	17
Starting Switch.....	18
Instruments (Optional).....	18
Amp meter.....	18
Water Temperature Gauge.....	18
Tachometer/Hour Meter.....	18
Oil Pressure Gauge.....	18
Fuel Gauge.....	18
OPERATING CONTROLS.....	19
Engine Shutoff Handle.....	19
Compression Release.....	19
Hand Throttle.....	19
Clutch Pedal.....	19
4WD Selector.....	19

Transmission Gear Selector.....	19
Hi-Lo Range Gear Shifting Lever.....	20
Left and Right Brake Pedals.....	20
Foot Throttle Pedal.....	20
Parking Brake Lock Pawl.....	20
Creeper Shifting Lever.....	20
Hydraulic Control Lever.....	20
Differential Lock Lever.....	20
Hydraulic Speed Regulator.....	20
Control and Operation of the Tractor.....	21
Starting Engine.....	21
Warm weather over 32 Degrees F.....	21
Cold weather below 32 Degrees F .....	21
Operating the Tractor.....	21
Driving the Tractor.....	22
Proper speed should be selected for best productivity. ....	22
Stopping the Tractor.....	22
Tractor Operation Safety.....	22
Control and Operation of the Working Devices.....	23
Control and Operation of PTO.....	23
Control and Operation of Hydraulic Hitch System.....	24
Position Control.....	24
Floating Control.....	24
Control of the Lowering Speed of the Implement.....	24
Operation of Hitch System.....	24
Adjusting of Longitudinal Level.....	24
Adjusting of Lateral Level.....	25
Use of the Electrical Equipment.....	26
Battery.....	26
The Starter.....	26
Maintenance Schedule for the Tractor.....	27
Daily Maintenance.....	27
50 Hour Maintenance (Every 50 Hours).....	27
250 Hour Maintenance (Every 250 Hours).....	27
500 Hour Maintenance (Every 500 Hours).....	27
1000 Hour Maintenance (Every 1000 Hours).....	28
Maintenance for Long Term Storage.....	28
Tractor Adjustments.....	29
Adjustment of clutch.....	29
Adjustment of brake.....	30
Adjustment of disc brake.....	31
Free state adjustment of disc brake .....	31
Travel adjustment of brake pedal.....	31
Troubleshooting guide for Diesel Engines.....	32
SERVICE ADVISORIES.....	34

50 hour, Head Re-torque.....	34
18-28 HP Jinma Tractor Hydraulic Fluid Intake Filter .....	36
Backhoe Hydraulic Fluid Intake Filter .....	38
Injector Pump Oil .....	40
Oil Drains .....	41
Ignition Switch Retrofit .....	42
Jinma 254 Specifications.....	43
Jinma Crate Tractor Assembly .....	46
Jinma JW-03 Backhoe Info .....	50
PIVET PINS.....	50
Enlarge outrigger pads. ....	51
Strengthen lower sub-frame. ....	51
Stiffen up rear mount .....	52

## Index of Illustrations, drawings and photos.

Figure 1. A 254 at the factory.....	8
Figure 2. Yancheng City.....	8
Figure 3. Old Factory with dirt floors.....	8
Figure 4. New factory machine shop.....	8
Figure 5. Engine assembly in the new plant.....	8
Figure 6. Map of Jiansu Province .....	8
Figure 7. Shear Point.....	11
Figure 8. Pinch Points.....	12
Figure 9. Crush Points.....	13
Figure 10. Spring dangers.....	13
Figure 11. Old style instrument panel.....	17
Figure 12. Old style lower dash switches .....	17
Figure 13. New style electronic instrument cluster.....	18
Figure 14. New style lower dash switches.....	18
Figure 15. Driving Controls.....	19
Figure 16. Ignition Switch .....	21
Figure 17. Clutch cut away diagram.....	29
Figure 18. Brake cut away diagram.....	30
Figure 19. TY-290 Engine.....	34
Figure 20. JM204 TY29 Engine with valve cover removed.....	34
Figure 21. Close-up of JM-204 TY290 engine head.....	34
Figure 22. Y385 Torque Sequence, used for JM254/284.....	35
Figure 23. TY20 Torque Sequence, used in JM184/204/224.....	35
Figure 24. Hydraulic Filter Assembly.....	36
Figure 25. Hydraulic filter disassembly.....	37
Figure 26. Hydraulic Filter Parts.....	37
Figure 27. Hoe Hydraulic Oil Filter.....	38
Figure 28. Hoe Hydraulic Filter o-ring.....	38
Figure 29. Fuel Injector Oil filler (A) & Drain (C).....	40
Figure 30. Fuel Injector Breather (A) and Cap (B).....	40
Figure 31. Fuel Injector Assembly.....	40
Figure 32. Fuel Injector Steel Balls.....	40
Figure 33. Transmission Oil Drain.....	41
Figure 34. Engine Oil Drain.....	41
Figure 35. Hydraulic System Oil Drain.....	41
Figure 36. JW-03 Backhoe showing modification points.....	50
Figure 37. Flat bar details.....	50
Figure 38. JW-03 Pivot pins.....	50
Figure 39. Enlarged Outrigger Pads.....	51
Figure 40. Hoe Frame showing heavy reinforcement .....	51
Figure 41. Hoe frame damage.....	51

Figure 42. Hoe frame reinforcement fwd view.....51  
Figure 43. Hoe frame reinforcement after view.....51  
Figure 44. Hoe frame top link stabilizer.....52

## INTRODUCTION

This manual is a general guide to provide the user with general information with respect to personnel and equipment safety, operational procedures and maintenance of your machine.

This manual was developed to fill the requirement for a JINMA specific operations and maintenance manual. While Jinma tractors come with a set of 4 manuals, some of the language syntax is a little hard to follow.

### Sources of data

Sources of data for this manual come from many places. They include , but are not limited to the following:

<http://www.johnstractor.homestead.com/>, <http://www.emerybuilt.com/>  
<http://www.tractor-outlet.com/> <http://www.china-tractors.com/>  
<http://www.tractorpages.com/>, <http://chinabestproducts.com>

Factory Engine Operations Manual,  
Factory Tractor Operations and Maintenance Manual,  
Factory Tractor Illustrated Parts Breakdown Manual,  
Factory Engine Illustrated Parts Breakdown Manual.

The Chinese Tractor Owner Association is a good place to lurk, ask questions and get/give support from/to others.

<http://www.ctoa.net>



Please read this manual carefully and keep in a convenient place for future reference.



Do not hesitate to contact your local dealer for any questions concerning the tractor. Even if you obtained this tractor as a crate assembly project, a tractor dealer can provide skilled personnel, spare parts and all tools and equipment necessary for your service requirements. Most of all, a dealer will have the experience of working with tractors and small diesel engines.

### PARTS

Parts are readily available for JINMA series tractors. The Internet is a good place to find sources of parts. <http://www.jinmaparts.com> is but one company selling parts for your machine.

Any suggestions and or comments about this manuals contents, errors or omissions are most welcome. Please email or mail:

Steven Bradshaw  
1033 Braithwaite Drive  
Cobble Hill, BC  
Canada. V0R-1L0  
brads@malacat.ca

## Yancheng Tractor Factory

The Yancheng Tractor Factory is located, as you may guess, in the city of Yancheng, Jiangsu province, China, and is about 100 miles north of Shanghai. Yancheng is one of thirteen municipalities of Jiangsu province.

Yancheng is situated by the Yellow sea. With the coastal marshland covering an area of 453,000 ha with rich resources, Yancheng is an important production center for clams, prawns and eels. The two natural protection regions of red-crowned cranes and David' clear have been set up in Yancheng. The



Figure 1. A 254 at the factory

development of agricultural economy of the city is in full swing, making the city a new commodity grain and cotton base in China. The local industrial structure has been completed in Yancheng with industries like textiles, machinery, electronics, chemical, pharmaceutical, food processing and construction materials **industries** as its backbone. The arts and crafts, native and special products of the city are of unique styles.



Figure 2. Yancheng City



Figure 4. New factory machine shop

The tractor factory was originally built about 50 years ago. As you can see from figure 3, this factory was a less than ideal environment in which to build. As of the spring of 2002 all tractors were being built in a new factory.



Figure 3. Old Factory with dirt floors



Figure 6. Map of Jiangsu Province

Average wage per person in Jiangsu Prov for 2003 was 9200 Yuan (Cdn \$1400).

Pop. 70.2 Million

Area: 1.03 x 10<sup>5</sup> Km<sup>2</sup>



Figure 5. Engine assembly in the new plant





Read these safety rules and follow them closely. Failure to obey these rules could result in loss of control of vehicle, severe personal injury to yourself or bystanders, or damage to property or equipment. The triangle  in the text signifies important cautions or warnings which must be followed.

## THE RULES

- Know the controls and how to stop quickly. READ THIS MANUAL and instructions furnished with attachments.
- Do not allow children to operate the machine. Do not allow adults to operate the machine without proper instructions.
- Do not carry passengers. Don' mow when children and others are around.
- Clear the work area of objects (wire, rocks, etc.) that might be picked up and thrown.
- Disengage PTO and shift into neutral before attempting to start the engine.
- Disengage PTO and stop the engine before leaving the operators position.
- Disengage PTO and stop the engine before making any repairs or adjustments.
- Disengage PTO and lower all attachments when not in use.
- Take all possible precautions when leaving the vehicle unattended, such as disengaging the PTO, lowering all hydraulic attachments, setting the parking brake, stopping the engine and removing the key.
- Do not stop or start suddenly when going uphill or downhill. Mow up and down the face of slopes; never across the face.
- Reduce speed and exercise extreme caution on slopes and in sharp turns to prevent tipping or loss of control. Be especially cautious when changing direction on slopes.
- Stay alert for holes, rocks, and roots in the terrain and other hidden hazards. Keep away from drop-offs.
- Use care when pulling loads or using heavy equipment.
  - a) Use only approved draw bar hitch points.
  - b) Limit loads to those you can safely control.
  - c) Do not turn sharply. Use care when backing.
  - d) Use counterweights or wheel weights when suggested in this manual.
- Watch out for traffic when crossing or near roadways.
- When using any attachments, never direct discharge of material toward bystanders or allow anyone near the vehicle when in operation.
- Handle fuel with care.
  - a) Use approved container.
  - b) Never remove the fuel cap of, or add to a running or hot engine.

- Open doors if the engine is run a confined space – exhaust fumes are dangerous. Do not run the engine indoors.
- Keep the vehicle and attachments in good operating condition, and keep safety devices in place and in working condition.
- Keep all nuts, bolts and screws tight to be sure the equipment is safe to operate.
- To reduce the risk of fire, keep the engine and exhaust system free of grass, leaves or excessive grease.
- The vehicle and attachments should be stopped and inspected for damage after striking a foreign object, and damage should be repaired before restarting and operating the equipment.
- Do not change the speed governor setting or over speed the engine.
- When welding, make sure that hoses are properly protected as sparks or molten material may puncture or weaken the tubes and sleeves, resulting in leakage or of oil, cooling liquid, etc.
- Avoid using unsuitable, pressurized filling systems or fuel cans when filling tanks, as these may cause considerable spillage and leakage of liquids.
- As a general rule, do not allow liquid fuels, lubricants, acids, solvents, etc. to come into contact with the skin. The majority of these products contain substances that are potential health hazards.
- Modern lubricants contain additives. Do not burn contaminated fuel oils and/or oils used in conventional heating systems.
- Avoid spillage when transferring used engine cooling liquids, engine and transmission lubricants, hydraulic oils, etc. Never mix used fuel oil with lubricants. Store safely until suitable disposal can be arranged according to national legislation or local regulations.
- Modern anti-freeze liquids and solutions, e.g.: anti-freeze and other additives must be replaced every two years. They must not be left to be absorbed into the ground, but must be collected and disposed of in a suitable manner.
- Any leakage or defect in the engine cooling or hydraulic systems must be repaired immediately.
- Do not increase the pressure in pressurized systems, as this may cause component parts to burst.
- When welding, make sure that hoses are properly protected as sparks or molten material may puncture or weaken the tubes and sleeves, resulting in leakage or of oil, cooling liquid, etc.

## Preventing Farm Machine Hazards

### AEX-593-91

#### Thomas L. Bean

Each year, 2,600 farm residents are killed and 230,000 disabled in farm-related injuries, many due to farm machinery. Farm machinery uses mechanical power to do work. This creates a number of possible hazards for both operators and bystanders. Even though manufacturers take many steps to make machinery safe, all hazards cannot be removed. Some machine parts cannot be completely shielded and still do their job. For instance, a totally enclosed cutting blade could not cut.

Many machinery-related accidents result from human error. The operator either forgot something, took a shortcut or a risk, ignored a warning, wasn't paying close attention, or failed to follow safety rules. In addition, guards removed for maintenance often aren't replaced.

There are many different kinds of farm machinery: mowers, tractors, shredders, harvesters, grinders, blowers, augers, balers, etc. They all have similar characteristics and hazards. You can be cut, crushed, pulled in or struck by an object thrown by these machines. They have cutting edges, gears, chains, revolving shafts, rotating blades, pinch points and other hazards. You can also be injured if you fall while working on or near any of these machines.

Accidents with farm machinery are often serious, even fatal. It is important to recognize and be alert for machine hazards and to take precautions to avoid injury.

### Shear and Cutting Points

Shear points (Fig. 1) are created when the edges of two objects are moved together closely enough to cut a soft material, as with a pair of shears or an auger. Cutting points are created when a single object moves forcefully or rapidly enough to cut, as with a rotary mower blade.

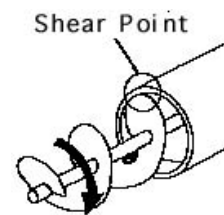

Figure 7. Shear Point

Both shear and cutting points are created on machinery designed to cut, such as harvesters, and on those that are not designed to cut, such as augers. They are hazardous because of their cutting force and they often move so rapidly that they may not be visible, so it is easy to forget they are operating or to underestimate the hazard.

Because some shear and cutting points cannot be guarded, it is important to be aware of their hazard and stay alert when they are operating. It is also important to warn others and to look out for their safety. This is especially true if there is a danger of thrown objects while using cutting-type equipment.

## Pinch Points

Pinch points are another hazard of farm machinery (Fig. 2). Pinch points (which should be more appropriately named mangled or maimed points) are formed when two rotating objects move together and at least one of them moves in a circle. For example, the point at which a belt runs into a pulley is a pinch point. Belt drives, chain drives, and gear drives are other sources of pinch points in power transmission devices. Feed rolls, gathering chains and similar equipment designed to draw crops into the machine also create pinch points.

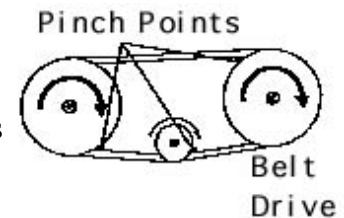

Figure 8. Pinch Points

Fingers, hands and feet can be caught directly in pinch points, or they may be drawn into the pinch points by the inertia of the moving part or loose clothing that becomes entangled. Contact may be made by falling or brushing against unshielded parts. You can become entangled in pinch points if you take chances and reach or work near rotating parts. Machines move too fast to get out of a pinch point once you become caught.

To avoid injury from pinch points, be aware where pinch points occur and avoid them. Wear clothing that fits well and is not loose or floppy. Never reach over or work near rotating parts. Turn off machinery to work on it. Always replace shields removed for maintenance.

## Wrap Points

Rotating shafts are the most common source of wrap-point accidents, although any exposed machine part that rotates can be a wrap point. A cuff, sleeve, pant leg, long hair or just a thread can catch a rotating part and result in serious injury. Entanglement with a wrap point can pull you into the machine, or clothing may become so tightly wrapped that you are crushed or suffocated. In other cases, you could be thrown off balance and fall into other machinery parts.

Even a perfectly round shaft can be hazardous if there is enough pressure to hold clothing against the shaft. Hazards increase with shafts that are not round. Clothing is more likely to catch if there is dried mud or manure on the shaft, or if the shaft is nicked. Ends of shafts that protrude beyond bearings are also dangerous. Universal joints, keys and fastening devices can also snag clothing.

Check all equipment for potential wrap points and, if possible, shield those that can be shielded. Replace any damaged manufacturer-installed warning labels and place warnings on equipment parts not previously labeled. In addition, consider painting them a bright color, perhaps with wide stripes. Be aware of wrap points and be alert to their danger.

## Crush Points

Crush points are created when two objects move toward each other or one object moves toward a stationary object. For example, hitching tractors to implements (Fig. 3) creates a potential crush point.

Hitch accidents most commonly occur to fingers placed at the hitching point. Wait until the tractor has

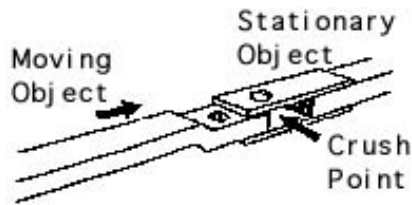

stopped before stepping into the hitching position. If possible, arrange the hitch point so that the tractor can be backed into position without anyone between. Always know what the other person is doing.

Figure 9. Crush Points

Failure to safely block up equipment can result in a fatal crushing injury. A jack may slip, a hose or overhead support may break, or the equipment may roll. Take extra precautions when working with machinery that is raised for any reason. The operator's head or chest can be crushed between the equipment and a low beam or other part of a farm building. These accidents usually occur when the machine is being operated in reverse. Tree limbs are also potential hazards when working with tractors and other machinery.

To prevent being crushed or pinned, recognize and avoid potentially dangerous situations. Block all machinery securely if you must work under it. If an implement can roll freely, block its wheels so it cannot roll.

## Free-Wheeling Parts

Many machine parts continue to spin after the power is shut off, including cutter heads of forage harvesters, hammer mills of feed grinders, rotary mower blades, fans and flywheels. Never touch these parts until they have stopped moving. This could take 2 to 2 1/2 minutes.

## Springs

Compressed springs (Fig. 4) will expand with great force when released, and springs that are stretched will contract rapidly when released. Know what direction a spring will move and how it might affect another machine part when released, and stay out of its path.

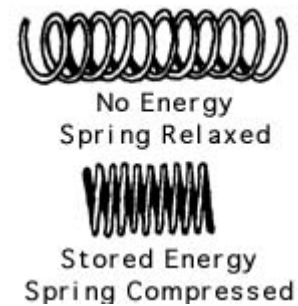

Figure 10. Spring dangers

## Burn Points

Be aware of burn points: mufflers, manifolds and even gear cases under adverse climatic conditions. They may not be severe enough to seriously maim, but they can startle the operator enough to cause him or her to "jump" into more deadly danger.

## Hydraulic Systems

Hydraulic systems contain fluid under extreme pressure. Before loosening, tightening, removing or otherwise working with any fittings or parts, relieve this pressure. Jet streams from even pinhole leaks can penetrate flesh. In addition, the liquid is often hot.

Before attempting any service on hydraulic systems, shut off the engine that powers the hydraulic pump. Lower the implement to the ground and relieve the pressure. Follow instructions in the operator' s manual because the specific procedures for servicing the systems are very important to your safety.

Funded in whole or in part from Grant Number U05/CCU506070-01, "Cooperative Agreement Program for Agricultural Health Promotion Systems," National Institute for Occupational Safety and Health.

Reviewed by Dr. Randall Wood and Dr. Warren Roller

---











## MATERIAL SAFETY DATA SHEETS.

MSDS is a widely used abbreviation for Material Safety Data Sheet. A MSDS contains details of the hazards associated with a chemical, and gives information on its safe use. MSDS helps with the electronic management of the material safety data sheets.

You will be using many different types of petroleum, oils and lubricants during the operation and maintenance of your machine.



The MSDS sheet will provide you with technical information about the product including but not limited to Product and Company Identification

- Information on ingredients.
- Emergency overview.  What the material is.
- Stability and Reactivity.  What not to mix it with.
- Toxicological Information.  What it will do to you if you touch, breath, ingest this material.
- Accidental Release Measures.  What to do if you release it into the environment.
- Handling and Storage. 
- Personal Protective Equipment.   Do as it says.
- Immediate Health Effects. 
- First Aid Measures, and  
- Firefighting measures. 

You can find MSDS information on any product sold in North America. Vendors MUST provide them on request. The following is an example of a MSDS sheet for Simple Antifreeze.

**SECTION 2 COMPOSITION/ INFORMATION ON INGREDIENTS**

COMPONENTS	CAS NUMBER	AMOUNT
EthyleneGlycol	107-21-1	80 - 95 %weight
Diethyleneglycol	111-46-6	1 - 5 %weight
Sodium2-ethylhexanoate	19766-89-3	1 - 5 %weight

**SECTION 3 HAZARDS IDENTIFICATION****EMERGENCY OVERVIEW**

- HARMFUL OR FATAL IF SWALLOWED
- CAUSES EYE IRRITATION
- CONTAINS MATERIAL THAT MAY CAUSE ADVERSE REPRODUCTIVE EFFECTS BASED ON ANIMAL DATA
- POSSIBLE BIRTH DEFECT HAZARD - CONTAINS MATERIAL THAT MAY CAUSE BIRTH DEFECTS BASED ON ANIMAL DATA
- MAY CAUSE DAMAGE TO:
- KIDNEY

**SECTION 4 FIRST AID MEASURES**

**Eye:** Flush eyes with water immediately while holding the eyelids open. Remove contact lenses, if worn, after initial flushing, and continue flushing for at least 15 minutes. Get medical attention if irritation persists.

**Skin:** To remove the material from skin, use soap and water. Discard contaminated clothing and shoes or thoroughly clean before reuse.

**Ingestion:** If swallowed, get immediate medical attention. Do not induce vomiting. Never give anything by mouth to an unconscious person.

**Inhalation:** Move the exposed person to fresh air. If not breathing, give artificial respiration. If breathing is difficult, give oxygen. Get medical attention if breathing difficulties continue.

**DISPOSAL OF POL WASTE**

Do not dispose used oil, coolant by dumping it onto the ground. The effect on the environment is cumulative over time. Return used oil and glycol to your local recycling depot.

**ENVIROMENTAL LAW**

You can be held accountable for the pollution you cause by improper disposal of POL and other materials hazardous to the environment. **THE BUCK STOPS WITH YOU.**



## Controls and Instruments

### Instruments (Standard)

In order to operate the tractor correctly, it is necessary to familiarize the functions of all controls and instruments as well as their positions on the tractor.



Figure 11. Old style instrument panel

- **Amp meter:** Indicates the current intensity of battery while being charged or discharged. If the pointer deflects to "+" side, it means that the battery is being charged. If the pointer deflects to the "-" side, it is being discharged.
- **Water Temperature Gauge:** Indicates the water temperature of the engine cooling system.
- **Oil Pressure Gauge:** Indicates the oil pressure of the engine. Normal oil pressure is 2-4 kgf/cm<sup>2</sup> (0.2-0.4Mpa).
- **Tachometer:** Indicates engine speed and records the accumulated running time of the engine.

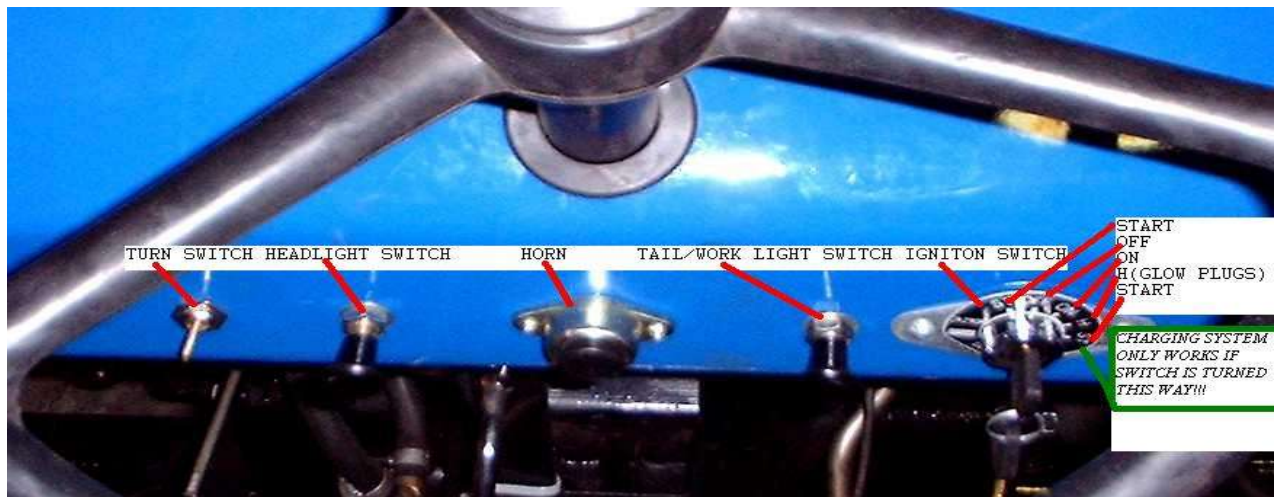

Figure 12. Old style lower dash switches

- **Turning Signal Switch:** Turn the switch to the left to engage signal light for left turn. Turn switch to the right to engage signal light for a right turn.
- **Work Light Switch:** Pull the switch out to turn on the rear work light. Push the switch in to turn it off.
- **Horn Button:** Press the button to sound the horn.
- **Headlight Switch:** Pull the switch to the first position to operate the headlights. Pull switch to the second

position to operate the headlights and taillights.

- **Starting Switch:** Turn to first notch clockwise, and power is supplied to the lights and charging system. This is the "on" position. Turn switch further clockwise, (you will feel spring tension,) to next notch, (you will notice amp gage show discharge,) and hold for about 20 seconds to operate glow plugs in very cold weather. Turn switch full clockwise, and starter will engage to start engine. Release key when engine starts. Use glow plugs only when temperature is freezing or below. Tractor may also be started by turning key counter-clockwise. This will start the tractor, but will not allow alternator system or lights to operate. This position should not be used in normal operation. NOTE: Clutch pedal must be pushed down all the way for starter to operate.

## Instruments (Optional)

The optional Instrument Panel has the same lower switches (turn signals, work light, horn, headlights, and start switch) along with an enhanced gauge package.

- **Amp meter:** Indicates the current intensity of battery while being charged or discharged. If the pointer deflects to "+" side, it means that the battery is being charged. If the pointer deflects to the "-" side, it is being discharged.
- **Water Temperature Gauge:** Indicates the water temperature of the engine cooling system.
- **Tachometer/Hour Meter:** Display Engine RPM and the accumulated running time of the engine.
- **Oil Pressure Gauge:** Indicates the oil pressure of the engine. Normal oil pressure is 2-4 kg/cm<sup>2</sup> (0.2-0.4Mpa).
- **Fuel Gauge:** Indicates the remaining fuel in tank.



Figure 13. New style electronic instrument cluster



Figure 14. New style lower dash switches

## OPERATING CONTROLS

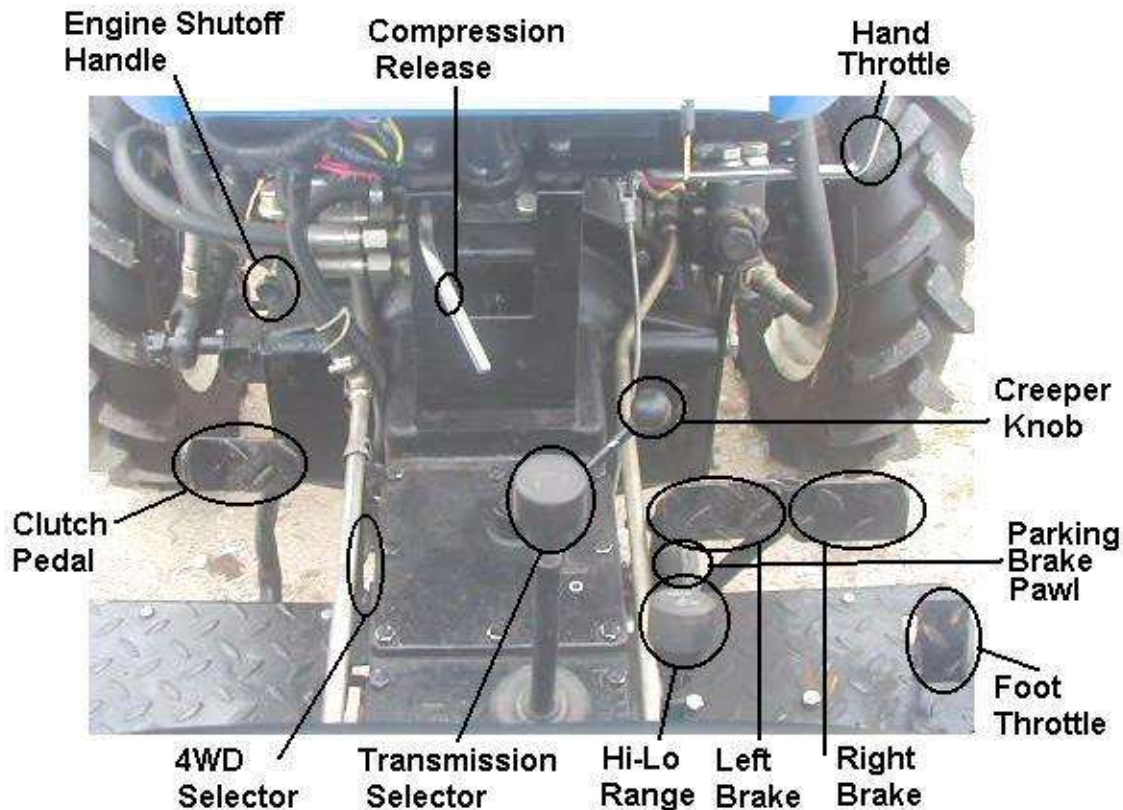

Figure 15. Driving Controls

- **Engine Shutoff Handle: (Fuel Cut-Off Rod):** Makes the engine stop. Pull out lever and hold until the engine completely stops.
- **Compression Release:** Reduces the pressure in the cylinders to make the engine start easier in extremely cold weather or with weak battery.
- **Hand Throttle:** Pull the hand throttle backward, the RPM will decrease. Pushing it forward will increase engine speed.
- **Clutch Pedal:** Depress the pedal to disengage the clutch. Pushing clutch partially in disengages the transmission, all the way in disengages the PTO. Always use clutch when moving gear selectors or PTO control.
- **4WD Selector:** Engage or disengage the power to front drive axle to achieve 4 wheel drive or 2-wheel drive. Do not operate tractor on hard surface while 4 wheel drive is engaged.
- **Transmission Gear Selector:** To control the main speed gearbox. Standard H pattern – 3 fwd and 1 rev.

- **Hi-Lo Range Gear Shifting Lever:** To control the auxiliary speed gearbox. Pull up for **hi** range and down for **low** range.
- **Left and Right Brake Pedals:** Move the braking lock plate right to lock both brake pedals together in order to apply both brakes at the same time. Separate the braking lock plate to achieve left or right one-side braking. This is used to make sharp turns.
- **Foot Throttle Pedal:** Depress the pedal down to increase engine speed.
- **Parking Brake Lock Pawl:** Use lever to lock pawl (located on the left brake pedal) to lock brakes in the applied position (parking brake). Release brake lock pawl before moving tractor.
- **Creeper Shifting Lever:** To exchange the normal speed with the creeper speed range.
- **Hydraulic Control Lever:** When the lever is pulled backward the hitch is lifted. When pushed forward, the hitch is lowered. When moved into vertical position, the hitch is in neutral/hold position. Always return lever to neutral position when desired height of attachment is obtained.
- **Differential Lock Lever:** Used to engage or disengage differential lock. If disengaged the two driving wheels may have different speeds. If engaged, the two driving wheels operate at the same speed. Do not use on hard surface or make turns.
- **Hydraulic Speed Regulator:** Used to control how fast or slow the hitch moves down.
- **PTO Control Lever:** Engage or disengage PTO power. Forward is 540 rpm, rearward is 1000 rpm.

## Control and Operation of the Tractor

### Starting Engine

Before starting the engine, check fuel, lubricating oil and coolant level. Put gear-shifting lever in neutral position.

**Note:** The ignition switch must be in the ON position for the alternator to charge the battery.

#### Warm weather over 32 Degrees F

1. Turn the starting switch clockwise to "start" position. The starter drives the engine. The starter must not be operated more than 5-10 seconds for each start. Only after an interval of at least 2 minutes should the engine be started again.
2. When the engine starts, release the key and it will return to the on position.

#### Cold weather below 32 Degrees F

Turn key clockwise to first position past "on" for approximately 20 seconds to operate glow plugs. In this position, you will notice the amp gage will show discharge. This will let you know that the glow plugs are operating. Then proceed to start as in warm weather. In extreme cold conditions or if battery is low, you may use the decompression lever to ease starting.



Figure 16. Ignition Switch

### Operating the Tractor

After the engine is started, run it at moderate speed for 5-10 minutes to allow the engine to warm up. After the water temperature reaches 70 degrees Celsius the tractor can be operated by the following steps:

1. Lift any attached implements.
2. Depress the clutch pedal, put the gear-shifting lever into the desired gear, and release the parking brake lock pawl of the brake pedal.
3. Observe your environment - make sure there are no obstructions or persons are in the way.
4. Gradually release clutch pedal and the tractor will start off smoothly.
5. During operation make sure all readings on gauges are indicating in the normal range.
6. **DO NOT RIDE THE CLUTCH.**  Remove your foot from the clutch pedal when tractor is in motion. Failure to do this will cause premature clutch failure.

## Driving the Tractor

1. When transiting between job sites or running on highway, lock the left and the right brake pedals together with brake lock plate.
2. In field operation, one-side braking can be used to reduce turning radius.  DO NOT use one-side braking for sharp turning when the tractor is running at high speed or is being used for transportation on highway. If one-sided braking is used in these conditions, overturning and/or damage to components is possible.

Proper speed should be selected for best productivity.

## Stopping the Tractor

- Throttle the engine down to lower the speed of the tractor.
- Depress the clutch pedal quickly and shift the gear-shifting lever to neutral position.
- Release the clutch pedal and let engine run at idle.
- Depress the brake pedals to stop the tractor, then lock the pedals with the parking brake locking pawl.



**Note:** In case the tractor has to be stopped suddenly, clutch pedals and brake pedals should be depressed simultaneously. DO NOT depress the brake pedals only. Depression of only brake pedals will result in damage to the tractor.

- If the tractor is to be parked for quite a while, the engine should be stopped. After the engine has been unloaded, it should run at low speed until the cooling water temperature drops to 70 degrees Celsius or lower. Pull out fuel cut-off rod to bring the engine to a stop.



**Note:** Never stop the engine when its temperature is very high. Do not stop the engine with decompression mechanism.

- Turn the key switch to "O" (off) and remove key. If the tractor is going to be stored, turn off the fuel tank valve.

## Tractor Operation Safety



The following safety regulations are very important for protecting operator and tractor from hazards. They should must be strictly followed during operation.

- Carefully inspect the working condition of the engine and main components, and listen for any abnormal sound or noise. Be sure to check the adjustments of the clutch and brake. Check and tighten any loose nuts and bolts on main components of the tractor.
- Make sure there are no people or obstacles around the tractor before starting and operating tractor.
- Do not get on or off the tractor while it is running. NEVER check, adjust or repair any part of tractor or attachment with the engine running.

- Before going up or down a slope, proper speed should be selected. Do not coast, turn sharply or shift gears while driving down a slope.
- During transiting between job sites, lock the brake pedals together. One-side braking should not be used for sharp turning when the tractor is running at high speed or with a full load.
- If front end of the tractor rises up in operation, throttle down the engine, disengage the clutch and reduce the load immediately to protect the tractor and operator from longitudinal overturning.
- **If the engine runs away, immediately pull out the fuel cut-off rod, move decompression lever to "decompressing" position or plug up fresh air into the engine instead of disengaging clutch.**



**Diesel runaway can be caused by fuel oil dilution of the engine lube oil. If the engine runs away, find out why and repair the fault(s) before attempting to use the machine.**

- Lighting equipment must be serviceable during operating at night or on public roads.
- Transmission lever should be placed in the neutral position when the tractor is running idle.
- Passengers should never be allowed to ride on tractor or attachments.
- Never get under any implement or attachments while raised with hydraulic lift, without first using safety stands to support weight of attachment.

## Control and Operation of PTO driven Devices

### Control and Operation of PTO

PTO can be engaged and disengaged by using the PTO control lever on the right side of the transmission box. Push clutch pedal all the way down when engaging or disengaging PTO. To engage PTO, push down the control lever from the front and upper side for 1000 rpm and up for 740 rpm. To disengage, put the control lever in the middle position. The operation steps are as follows:

- Unscrew the PTO safety shield and couple the desired driven machine to the PTO shaft.
- Put the gear-shifting lever at the neutral position.
- Depress the clutch pedal fully then shift the PTO control lever to the proper "engaged" position.
- Release the clutch pedal slowly and the driven machine will run. First let the driven machine run at slightly open throttle to ensure that nothing is wrong with the driven machine. Then run with open throttle, and put the driven machine into operation.
- Care should be taken when operating the PTO. On some attachments, the drive shaft may hit or come in contact with tractor or attachment when in the raised position.



**Note:** When the tractor implement travels for a long distance, the control lever should be shifted to the neutral position to cut off the power so as to avoid damaging the implement and causing physical damage.

## Control and Operation of Hydraulic Hitch System

The hydraulic hitch system serves to attach, lift and lower implement, as well as adjust and maintain the working position of the implement in order to meet different requirements of various implements and operations. To raise and lower the implement, simply move the control lever of the distributor.

Depending on the type of work to be done, type of implement used and/or field conditions, the hydraulic hitch system provides various functions to obtain satisfactory work quality.

### Position Control

The position of the implement can be adjusted by moving the control lever of the distributor. When the desired position of the implement has been obtained set the position of the stopper on the return rod to limit the control lever. Tighten the stopper on the rod with the screw, so that the lever can be pushed to the same position every time. Adjustments may be made for different implements.

### Floating Control

Floating control is suitable for field plowing. In floating control, the supporting wheel is needed for implement. During plowing, hold the control lever of distributor at "lowering" position (i.e. push the control lever of distributor forward with the return stopper. Do not return the control lever to the neutral position). The hydraulic circuit is then in "floating" control. Using floating control, the plowing depth is controlled by the change in height of the supporting wheel. The uniform plowing depth will be obtained in the field with changes of soil resistance.

### Control of the Lowering Speed of the Implement

Turn the lowering speed adjusting valve to control the lowering speed of the implement. The lowering speed should be selected properly according to the weight of the implement and hardness of soil surface in order to prevent the implement from being seriously impacted and damaged. To reduce the lowering speed, turn the lowering speed adjusting valve clockwise. To increase the lowering speed, turn the valve counterclockwise.

## Operation of Hitch System

Adjust the implement according to the Implement Operation Manual before attaching the implements to the hitch system of the tractor. In plowing, adjust longitudinal and lateral level of plow in order to get the implement square to the ground.

### Adjusting of Longitudinal Level

Adjust the length of the upper link of the hitch. Keep the plow frame horizontal in longitudinal level, so as to keep each share in the same plowing depth. If the front share plows deeper than the rear one, or heel of plow goes out from bottom of furrow, extend the upper link; if the front share plows shallower than the rear one, or rear heel sinks into the bottom of furrow, shorten the upper link.



### **Adjusting of Lateral Level**

Adjust length of right lifting rod to keep plow frame horizontal in lateral level. When the right lifting rod is extended, the right side of the implement is lowered. As the right lifting rod is shortened, the right side of the implement is raised. Usually, the left lifting rod should not require any adjustment. Only if the right lifting rod is adjusted to its limits will the left lifting rod need to be adjusted to obtain correct implement placement.

The check chains can make the integral unit have good maneuverability in the field. The check chains also prevent the implement from hitting the rear wheels when turning the tractor or lifting the implement in the field. The check chains are normally loosened when the implement is in the plowing position. NEVER tighten the check chains to adjust the deviation traction of the implement during plowing.

While using implements of driving type, check the length of universal joint shaft; after attachment, there should be about 10mm axial clearance between PTO shaft and universal shaft.

### **Using the Differential Lock**

In tractor operation, if one drive wheel slips greatly and the tractor can not move forward, operate differential lock according to the following steps:

- Depress the clutch pedal, move the gear shifting lever to the low range gear position and hold.
- Depress down the differential lock lever under the right side of the seat, gradually release the clutch pedal to engage the clutch, so that two drive wheels rotate in same speed, then there is a possibility to drive the tractor through the slippery area.
- After the tractor passes through the slippery area, stop and disengage the differential lock. Do not turn the tractor with the differential lock engaged otherwise damage to tractor may occur.

Note: Release differential lock lever and let it return to the original position after the differential lock is engaged.

### **Use of the Electrical Equipment**

The electrical equipment of the tractor is used to start the engine, generate power to run all auxiliary electrical equipment and keep the battery charged. This tractor uses a negative ground 12 volt alternator.

#### **Battery**

The battery size is Group 24, 12V and its rated capacity is 66 AH. In routine use, the battery should be checked often and maintained in accordance with the technical maintenance regulations of the battery manufacture. Dust and dirt on the outside of the battery should be cleaned away often to prevent electrical leakages. Check the battery for cracks and electrolyte leaks. Keep the terminals and all contacts in clean, corrosion free condition. Be sure to keep the air hole on the plastic cover clear. This will protect the battery from explosion which can be caused by a build up of gas in the battery. Never allow any open flame or sparks near the battery.

**The Starter**

Keep the starter clean and the wire connection lugs in clean and free of corrosion. Do not engage the starter for longer than 10 seconds at any given time. The shortest interval between two attempts at starting must be no less than 2 minutes. If the engine can not be started after several attempts, the trouble should be found and corrected. If the engine is started in cold weather, it should be preheated with the block heater before starting.

---

## Maintenance Schedule for the Tractor

In order to keep the tractor in excellent condition, prolong its service life and reduce troubles, the users must often check the mechanical condition of the tractor and strictly carry out recommended maintenance.

### Daily Maintenance

1. Clean dirt and sludge on the tractor and implements. Under the extremely dusty circumstances, the air filter should be cleaned more often.
2. Check all fastening bolts and nuts on the tractor, especially front and rear wheel nuts. Tighten if necessary.
3. Check the level in engine crankcase, radiator, fuel tank and hydraulic system; refill if necessary. Only after the engine has stopped for more than 15 minutes should the oil levels be checked.
4. Check for any leaking of oil, water, and repair if necessary.
5. Check the tire pressure and inflate if necessary.

### 50 Hour Maintenance (Every 50 Hours)

1. Carry out the maintenance items in daily maintenance.
2. All grease fittings should be wiped clean and greased with the recommended grease.
3. Check air filter and clean or replace as needed.
4. Check the fan belt tension (When pressing the middle part of the longer side of the belt, the belt drops about 15-25mm under the force of about 10N, then the tension is suitable). Adjust if necessary.
5. Check and adjust the free travel of clutch pedal and brake pedals.
6. Check the oil level in transmission box and front drive axle. Refill if necessary.
7. Wipe the battery with a piece of cloth. Check the electrolyte level. Smear the terminals with grease to avoid corrosion.

### 250 Hour Maintenance (Every 250 Hours)

1. Complete daily and 50 hour maintenance items.
2. Change the engine oil and oil filter.

### 500 Hour Maintenance (Every 500 Hours)

1. Complete daily, 50 hour and 250 hour maintenance items.
2. Check and adjust inlet and exhaust valve clearance.
3. Clean fuel tank and fuel cartridge.
4. Flush transmission box. And replace lubricating oil.
5. Clean the filter of hydraulic lifter, check the oil for cleanliness. Flush the inside of lifter housing and replace with fresh oil if necessary.
6. Check and adjust front wheel toe-in (The toe-in should be 4-10mm).

## **1000 Hour Maintenance (Every 1000 Hours)**

1. Complete daily, 50 hour, 250 hour, and, 500 hour maintenance.
2. Clean the gathered carbon in the silencer and exhaust manifold.
3. Clean the oil filter in the hydraulic lifting system, replace the oil in the system with fresh oil.
4. After the maintenance has been done, run the tractor for a short time for trial to make sure that every part is in normal operating condition.

## **Maintenance for Long Term Storage**

If the tractor is to be in long term storage, you should fully examine mechanical condition and follow the steps listed below.

1. Store the tractor in dry shelter; support the front and rear wheels so weight is not on the tires. If storing in the open air for limited time, cover the tractor with tarp.
2. Clean the outside of the tractor, wax painted surfaces and lubricate each lubrication point with grease.
3. Check anti-freeze level and protection in the cooling system, remove the battery for storage and cover the exhaust system to keep out all water and critters.
4. Start the engine to run for 20 minutes every three months to insure the proper lubrication of internal engine parts.

## Tractor Adjustments

1. flywheel
2. PTO clutch driven plate
3. Pull rod
4. PTO clutch pressure plate
5. Belleville spring.
6. Adjusting nut
7. Nut
8. Belleville spring
9. Clutch cover
10. Nut
11. Adjusting bolt
12. Release rock arm
13. Release yoke
14. Nut
15. Release yoke push rod
16. Clutch pedal
17. Release fork
18. Release bearing
19. Release lever
20. Fixed pressure
21. Main clutch driven plate
22. Main clutch pressure plate.
23. Nut
24. Adjusting bolt .

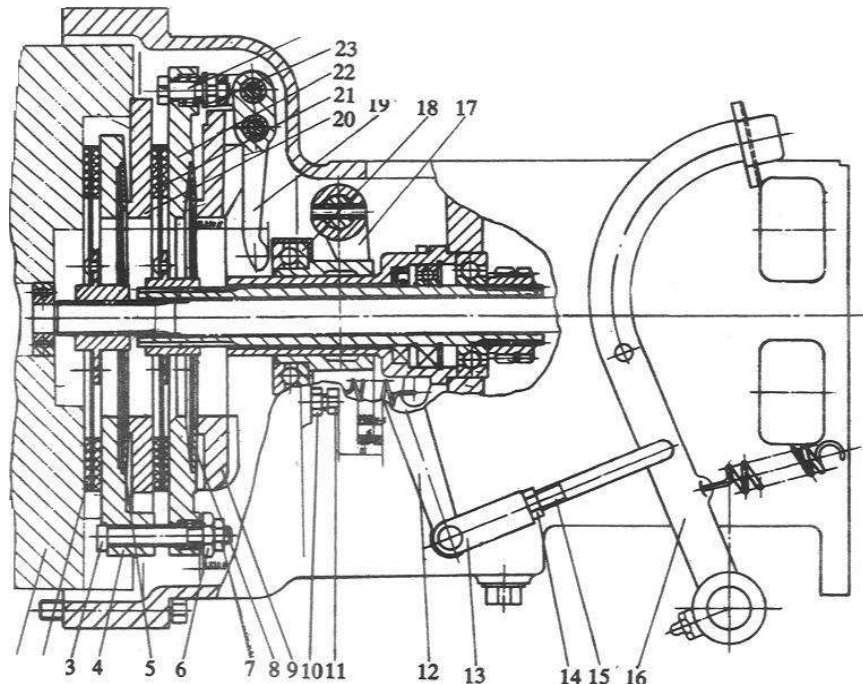

Figure 17. Clutch cut away diagram

### Adjustment of clutch

Due to continuous wear of parts during operation of the clutch, clutch slip and clutch incomplete disengagement will happen, which can cause the tractor operate incorrectly. Therefore, timely adjustment of the clutch should be made.

Connection – controlled part dual storage clutch. It mainly consists of three parts: driving part, driven part and controlling part. Driving part rotates with the engine flywheel; only when the clutch engages can the driven part rotate with the engine.

Dual stage clutch should be adjusted on fixture. The adjusting steps are as follows: Adjust the length of adjusting bolt (11) to make the distance difference between 3 release levers and PTO clutch pressure plate is no more than 0.1 mm; after adjustment, tighten it with nut M10x1.

When adjusting the free travel of the clutch pedal ( fig. 4 – 1 ), first adjust the length of clutch push rod ( 15 ) to ensure that the clearance between end faces of three release levers and release bearing is  $2.5 + 0.5$  mm and the idle travel of release rock arm is 3.5 – 5 mm; after adjustment tighten it with nut M10.

Position limit adjustment of working travel of clutch pedal: loosen nut ( 10 ), then turn adjusting bolt ( 11 ) to make the working travel under release rock arm ( 12 ) is 25 mm, then tighten nut ( 10 ).

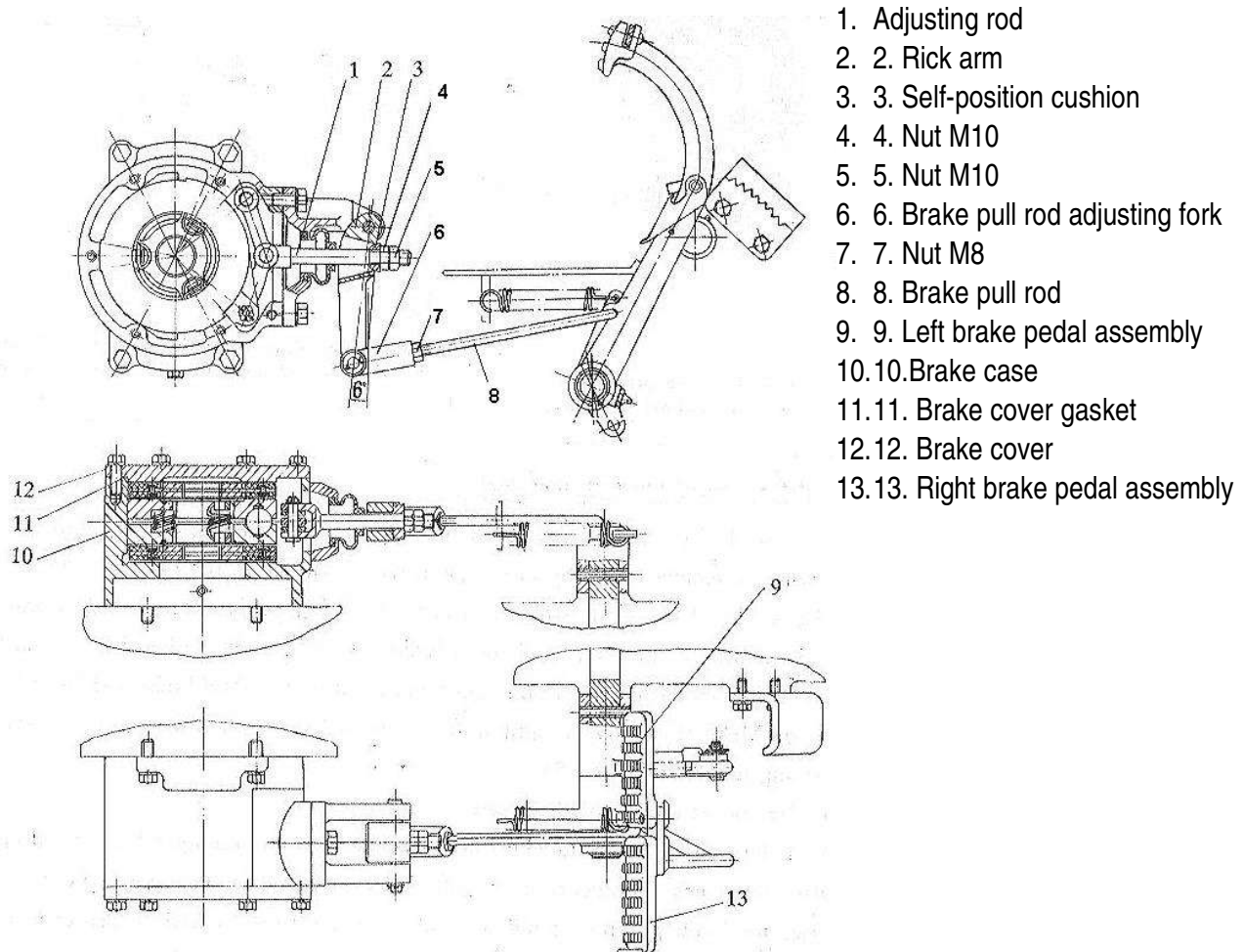

Figure 18. Brake cut away diagram

## Adjustment of brake

After the tractor has worked for a period, the wear of the friction disc of the brake makes the gap between friction disc and brake drum or friction disc and brake case and brake cover increase and effect the brake performance. Excessive free travel will cause break ineffectiveness. So the brakes should be regularly checked and adjusted to ensure the safe operation of the tractor. When one of the following conditions of the brake appears, adjustment should be done.

- Free travel of brake pedal is excessive and causes brake ineffectiveness.
- Free travel of break pedal is too small and keeps the break in a semi – braking state; the brake case also generates heat.
- Left and right braking force are unequal.

## **Adjustment of disc brake**

### **Free state adjustment of disc brake**

1. Loosen the outer locking nut M10 (5) on adjusting rod (1)
2. Turn the inner nut M10 (4) to change the mounting angle of the rock arm (2) through the longitudinal motion of the shelf
3. Position cushion (3) and ensure the central connecting line of the upper and lower holes inclines to rear from the plumb line.
4. After adjustment, lock it with locking nut (5).

### **Travel adjustment of brake pedal**

1. Loosen the locking nut (7) on pull rod adjusting fork (6)
2. Pull brake pull rod adjusting fork to change the length of the pull rod (8) until the displacement (from the highest position of the brake pedal to friction disc assembly being completely braked) of the brake pedal in 85 - 95 mm.
3. When the left right pedal are locked together, stepping on the pedals can simultaneously brake the left and right wheels
4. After adjustment, lock it with nut (7).

If the above adjusting range can not perfectly make the free state and brake state out, they can be adjusted through increasing or reducing the brake cover gaskets (11) between brake cover (12) and brake case (10). If the brake travel is too small, increase the gaskets; if the break travel is too big, reduce or remove the gaskets.

## Troubleshooting guide for Diesel Engines

The following is a general diesel engine diagnostic guide. It may not be 100% effective for Jinma series of diesel engines.

Symptom	Cause	Remedy
<b>Black or Dark Gray Smoke</b>		
Smokes under load, especially at high and medium speed. Engine is quieter than normal.	Injector pump timing retarded	Set timing
Smokes under load, especially at low and medium speed. Engine is noisier than normal.	Injector pump timing advanced	Set timing
Smokes under load at all speeds, but most apparent at low and medium speeds. Engine may be difficult to start.	Weak cylinder compression	Repair engine
Smokes under load, especially at high speed.	Restricted air cleaner	Clean/replace air filter element
Smokes under load, especially at high and medium speed. Power may be down.	Dirty injector nozzle(s)	Clean/replace injector(s)
Smokes under load, especially at low and medium speed. Power may be down.	Clogged/restricted fuel lines	Clean/replace fuel lines
Puffs of black smoke, sometimes with blue or white component. Engine may knock.	Sticking injectors	Clean/replace injector(s)
<b>Blue, blue-gray, or gray-white smoke</b>		
Whitish or blue smoke at high speed and light load, especially when engine is cold. As temperature rises smoke color changes to black. Power loss across the full RPM band, especially at full throttle.	Injector pump timing retarded	Set timing
Whitish or blue smoke under light load, after engine reaches operating temperature. Knocking may be present.	Leaking injector(s)	Repair/replace injector(s)
Blue smoke on acceleration after a prolonged period at idle. Smoke may disappear under steady throttle.	Leaking valve seals.	Replace seals. Check valve guide/stems.
Persistent blue smoke at all speeds and loads, and operating temperatures.	Worn rings/cylinders.	Overhaul/rebuild engine.
Light blue or whitish smoke at high speed under light load. Pungent odor.	Over-cooling	Replace thermostat
Engine cranks slowly but does not start.	Cranking system malfunction	Check battery, cable terminators, and starter motor
	Crankshaft bound, viscosity	Bar engine over by hand. If it appears tight, check oil for ethylene glycol leaks into sump.
	Faulty injectors	Check injector opening pressure.
Cranking speed erratic, engine does not start.	Valves out of time	Check valve timing
Engine cranks normally, but does not start.	Glow plug inoperable	Check glow plugs, control circuitry
	Incorrect or contaminated fuel	Check fuel supply
	No fuel to cylinders	Trace the supply forward from tank to transfer pump, transfer pump to high pressure pump (which may be the same unit), high pressure pump to injectors, injectors to nozzles.
	Incorrect pump timing	Check timing
	Air intake restriction	Check filter element
	Exhaust system restriction	Check system
	Low compression	Test cylinder compression



Engine does not idle	Incorrect idle adjustment	Correct adjustment
	Air in fuel system	Bleed system, tighten connections.
	Clogged fuel filter(s)	Replace filter(s)
	Fuel return line restricted	Disconnect line to verify restriction and remove obstruction
	Air inlet restriction	Replace filter element
	Exhaust system restriction	Repair system
Engine runs erratically at low speed	Any of the idle malfunctions above.	Check as indicated
	Loss of compression in one or more cylinders	Test cylinder compression
Engine does not develop normal power	Insufficient fuel supply	Check filters, transfer pump, cap vent, for possible air leaks into system.
	Incorrect or contaminated fuel	check fuel supply
	Injection timing error	Check timing
	Air inlet restriction	Check filter element
	High pressure fuel system malfunction	Check high pressure system, beginning with leaks and concluding with pump calibration
	Loss of engine compression	Test cylinder compression
Engine knocks excessively	Defective injector(s)	Test by substitution
	Restricted fuel return line	Open line to verify, remove obstruction
	Injection pump malfunction	Test pump
	Bearing knock	Verify and repair engine.

## SERVICE ADVISORIES

### 50 hour, Head Re-torque

Mike Stuart, a defacto expert on Chinese tractors, recommends to check the head bolt torque on Jinma tractors when the (1<sup>st</sup>) 50 hour service is performed. It is simple procedure to perform, and should not take more than an hour or two. The general procedure is outlined below:

1. Let engine cool to ambient air temp. Locate all valve cover bolts. The 2cyl engine has 6 bolts located around the cover edge. The 3 cyl has three bolts located in the center of the cover. Hood bracket and electrical items, maybe attached to some of the bolts. **Note orientation and which bolts have the items.** Unscrew and remove all valve cover bolts. Move electrical items and brackets aside.
2. Remove valve cover. The valve cover gasket may break into several pieces, some attached to cover and rest to head. Use a putty knife to scrape free of cover and head. Vacuum up the loose pieces. Locate all head bolts. There are 10 bolts for the 2 cyl engine and 8 for the 3 cyl engine.



Figure 19. TY-290 Engine

3. Check the torque sequence pictures, further down, to verify you found all the bolts.



Figure 20. JM204 TY29 Engine with valve cover removed

4. Using the correct torque sequence for your engine, torque each bolt to 95-105 ft lbs. Note: Do not loosen the bolts first. You are only tightening them.
5. If you have a new gasket, lightly coat the surfaces with Permatex Blue RTV Silicone gasket maker, or equivalent. Align gasket on head, making sure all holes and edges are aligned. The RTV will hold the gasket from slipping.



Figure 21. Close-up of JM-204 TY290 engine head

6. If you do not have a new gasket, you can place a small continuous bead of the RTV gasket maker around the valve cover mating surface of the head. Don't over do the RTV such that it will be squeezed and fall into the top of the head.

7. Align the valve cover over the head. Carefully set it on the head. Use a couple of the valve cover bolts and just get them started, to keep the cover in position.
8. Get all valve cover bolts started. Make sure you have mounted any bracket or electrical items. Tighten the valve cover bolts evenly. Start at the center, and work toward the ends. Don't have a torque spec for the valve cover bolts, but 3/8" socket wrench tight, should do.
9. Start engine, and bring up to operating temperature. Carefully check valve cover for oil leaks.

### Engine Head Torque Sequences

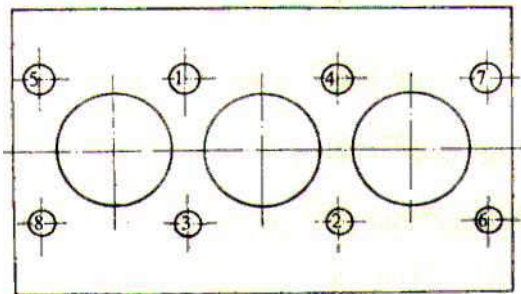

Figure 22. Y385 Torque Sequence, used for JM254/284

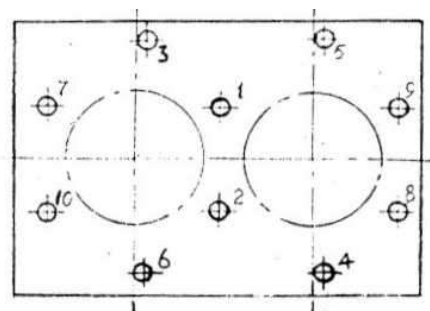

Figure 23. TY20 Torque Sequence, used in JM184/204/224

Torque sequence, torque spec, and info provided by Mike @ Maverick Tractor  
JM204 head photos provided by Glenn @ Coastal Tractor and Equipment

**Service Advisory 1:****18-28 HP Jinma Tractor Hydraulic Fluid Intake Filter**

Approximate Time Needed for Service is 1 hour.

Keeping the hydraulic pump pre-filter clean is very important to the operation of your tractors hydraulic system. This filter is located under the drivers seat, feeds the pump that is located on the right side of the engine which in turn produces pressure for the FEL, Power Steering, and 3 Point system. This pump is cooled and lubricated by the same oil it pumps and therefor a starvation of the pump due to restricted flow will most likely cause complete failure or at the very least cause improper wear, early failure and/or reduced pressure and flow. Indications that your filter is dirty would be either, no or sluggish loader or power steering operation especially during first start up or cold temperatures. The manufacturing process can and will allow a significant amount of metal filings or contaminates to be in the system. Just draining and replacing the oil will not clean the filter. It is our highest recommendation that this bulletin be followed immediately before any further operation is attempted no matter what hours are on the engine. Virtually no oil is lost during this procedure. The bulletin is specifically written for the Q18-28 and is not valid for the 30-35 HP Jinma tractor - See Advisory #2

1. If you have a front end loader make sure it is on the ground and no pressure is in the system. With tractor turned off move all control valves back and forth to neutralize any pressure.
2. Remove the 4 bolts than hold down the operator seat assembly and remove the seat.
3. Unscrew the nut which holds the steel suction line to the cover/adaptor plate atop the reservoir. This line feeds the inlet side of the hydraulic pump which is located on the forward/right side of the engine.
4. Remove 3 bolts that hold the cover/adaptor plate to the top of the reservoir.
5. Gently, without harming the gasket lift this entire assembly up and out of the well. Oil should be near the top of the housing. Do not re-install a damaged gasket - make a new one from bulk gasket material available at any auto parts store.
6. Disassemble this filter assembly completely. Wash all metal components in solvent, and use compressed air to blow from the inside out, this will clean the wire mesh screen. Do not crush or deform the wire mesh. **If you have damaged this filter or broken the 3 bolt housing then call us for a replacement - we normally stock these items.** Wipe off two rubber gaskets and re-assemble. (hint; a small amount of axle grease on the gaskets will hold them in place while you reassemble it). Firmly tighten the bolt into the bottom of the filter assembly and carefully inspect the wire mesh to confirm it does not have any gaps around the outside on either end. Drop the filter assembly back into the housing and tighten the 3 bolts and re-attach the suction line.



Figure 24. Hydraulic Filter Assembly

1. The pump must be primed and will not normally pickup oil from the filter due to air which is now in the intake line. To aid in priming connect the 2 mid ship hydraulic quick connects together by disconnecting the FEL and butt connect them together. This is the same way your tractor was shipped prior to installing the FEL. If you do not have an FEL then this is not necessary.
2. Start tractor for approximately 1 minute and check for leaks. If you listen carefully you should hear the pump pick up oil almost immediately and prime itself. Shut off the tractor after 1 minute.



Figure 25. Hydraulic filter disassembly



Figure 26. Hydraulic Filter Parts

3. Re-hook the quick connects in and out of the FEL, start up the tractor and operate your loader. Shut down and re-check your oil level. Re-install the drivers seat.

<http://www.tractor-outlet.com/toservice.html>

Service advisory # 2 omitted (for 35 HP and larger)

**Service Advisory 3:****Backhoe Hydraulic Fluid Intake Filter**

Approximate Time Needed for Service is 1 hour.

Easy - no special tools required.

Your JW03 Backhoe has been designed with the same filter system as the tractor. This filter is located on the left side of the BH oil reservoir, and is also held on by 3 bolts. On this system you will need a clean bucket to catch the just under 3 gallons of oil so it will not leak out onto the ground. It is best to drive the right side of your tractor up on blocks prior to unbolting the filter assembly as this will aid in getting all the old oil out of the tank. Check the oil, if it smells burnt, or is extremely milky then you should replace it. If your oil looks good and you don't find many contaminants then you can strain the oil prior to putting it back in the reservoir. A paint filter works good for this and helps to remove debris and contaminants that may be in the system.



Figure 27. Hoe Hydraulic Oil Filter



Figure 28. Hoe Hydraulic Filter o-ring

1. As always when working with any hydraulics. Shut down the tractor. Move all control levers to minimize pressure.
2. Lower the left stabilization pad to make access easier.
3. Remove the nut holding the hydraulic hose going to the filter housing. Check for compound washer either in the nut or in a groove located on the opposite fitting. Remove it and set aside.

4. Loosen and remove the 3 bolts holding the housing in place. Remember the bucket to catch oil.

5. Remove the filter assembly. Disassemble this filter assembly completely. Wash all metal components in solvent, and use compressed air to blow from the inside out, this will clean the wire mesh screen. Do not crush or deform the wire mesh. **If you have damaged this filter or broken the 3 bolt housing then call us for a replacement - we normally stock these items.** Wipe off two rubber gaskets and re-assemble. (hint; a small amount of axle grease on the gaskets will hold them in place while you reassemble it). Firmly tighten the bolt into the bottom of the filter assembly and carefully inspect the wire mesh to confirm it does not have any gaps around the outside on either end.
  
6. Reinstall the filter assembly (don't forget the gasket) back into the tank and tighten the 3 bolts. Now put the compound washer back into the groove of the threaded fitting. If you didn't have one to begin with then a properly fitted rubber O-ring will suffice or you can purchase them from our parts stock. Be sure to coat an O-ring with grease to prevent pinching. Grease also works good to keep the compound washer in place while assembling. This washer is necessary to prevent air intake and leaks to the otherwise closed system. This same compound washer is used in many of your hydraulic fittings so is best to keep some spares around.

<http://www.tractor-outlet.com/toservice.html>

### Service Advisory 4: Injector Pump Oil

Approximate Time Needed for Service is 20 min.

Easy - no special tools required. <http://www.tractor-outlet.com/toservice.html>

You should check your fuel injection pump oil regularly and change it yearly. The oil is for splash lubrication of the steel balls and other moving parts inside the mechanical governor. We have found that hydraulic or engine oil is acceptable for use.

The fill plug (A) is toward the rear of the injector pump and is mounted on top with a breather. The drain (C) is on the bottom. Total oil volume is about 4 oz. or 1/4 of a pint if completely empty.

To fill and check, first remove the (A) breather on top, then remove the rubber cap (not always included) from bottom of (B) and **add oil very slowly, one ounce at a time**. When oil comes out (B) then it is full. Wait a full 15 minutes for excess oil to run out prior to starting engine. Once oil has stopped then replace rubber cap (B) and breather (A).



Figure 29. Fuel Injector Oil filler (A) & Drain (C)



Figure 30. Fuel Injector Breather (A) and Cap (B)



Figure 32. Fuel Injector Steel Balls



Figure 31. Fuel Injector Assembly



**Service Advisory 5:****Oil Drains**

Easy - no special tools required.



Figure 33. Transmission Oil Drain



Figure 34. Engine Oil Drain



Figure 35. Hydraulic System Oil Drain

Draining and Changing your oils is fairly straight forward and easy. Above we have shown you the drain locations for each system. Your engine uses standard weight oils. We use HD 30 but 10-40 and other weights will work also. Use what ever weight oil you are running in your vehicles which would be appropriate for your local temperature conditions. The transmission and hydraulic system use the same oil. Choose a quality hydraulic oil such as #303 from New Holland.

**Service Advisory 6:****Ignition Switch Retrofit**

Easy - no special tools required. <http://www.tractor-outlet.com/toservice.html>

The ignition switch that came with your Jinma 18-28 HP tractor is multifunction and can present some problems after significant use. It can have intermittent faults where the momentary glow plugs and starter are immediately on when you turn the key to the first position (lights). In other words, all three posts are hot, #2 for lights, #3 for glow plugs, and #4 for starter solenoid. This will cause your 30 amp fuse to blow consistently. A replacement switch is available through your local New Holland dealer and was used on Ford Series 2000-9000 tractors from about 1965 on. Ask for Ford Part # D 5NN11N501A. If you would still like to use a direct replacement that requires nothing other than wire for wire exchange then we normally stock them. Ask for Jinma part number #TY290

**© Tractor Outlet**

**P.O. Box 147**

**83548 Bowens Lane**

**Christmas Valley, Oregon 97641**

## Jinma 254 Specifications

Note: This spec sheet is for the JM 254 compact tractor fitted with turf tires, JM/ZL-20 Front end Loader, JM/JW-03 Back hoe, JM9GX-1.5A Finish mower and the 1GX-120 Rototiller

### JM-254 Compact Tractor General Specifications

Crate Shipping Size	L 7.57' x W 4.73' x H 3.7'
Gross Weight	3168 Lbs
Overall Dimensions w/o attachments:	L 9.97' x W 4.3' x H 4.79'
Overall Dimensions with FEL and Backhoe	L 19.62' x W 5.2' x H 7.5'
Wheelbase	F 4.16'                      R 4.6'
Ground Clearance	13" (11" with backhoe support assy)
Tires	F 600x16                      R 9.5x24

**Note: AG and Turf Tires are NOT interchangeable on a JM254**



Jinma 254 in racing red

Tractor Weight W/O Attachments	2375	Lbs Net
<b>Tractor Weight with Hoe and FEL</b>	<b>4525</b>	<b>Lbs Net</b>
Mower Weight	400	Lbs Net
Rototiller Weight	740	Lbs Net

Rated Traction Force (tractor only with ?AG tires?)	1600	Lbs
PTO Speed	540/1000	RPM
3 Point Hitch	Category 1	
Clutch	Dual Stage	(live PTO)

Engine	Type	3 Cylinder, 4 cycle water cooled diesel	
	Bore	3.35	In
	Stroke	3.54	In
	Compression	22:1	
	Firing Order	1-3-2	
	Horsepower	25 @ 2300 RPM	
	Torque	64 ft lbs @ 1850 RPM	
	Lubrication	Gear operated oil pump and spin on filter	
Fuel	Injection pump model T7B with governor, spin on filter		

Electrical	Starter	12 Volt solenoid operated with key switch	
	Alternator	12 volt 25 amp with electronic voltage regulator	
	Glow Plugs	3 operated by ignition switch	
	Battery	Type 24C 12 volt	

Hydraulic	Type	Half remote	
	Pump	Gear type	
	Cylinder	2.48" x 3.93"	
	Distributor	Slide valve regulating type	
	Safety Valve	Direct acting type	
	Pressure	2200	Psi
	Lift Capacity 27 in behind lift point	875	Lbs
	Safety Valve release	2770	Psi
PTO	540/1000	RPM	

Fluids	Fuel	Diesel
	Engine Oil	15W/40 API Service CF4 or higher
	Transmission/Differential	Hydraulic Tractor Fluid
	Fuel Injection Pump	Hydraulic Tractor Fluid

Capacities	Fuel	20	Liters
	Engine Crankcase	6.5	Liters
	Front Drive Axle	4.75	Liters
	Transmission	15	Liters
	Hydraulic System	9.5	Liters
	Cooling System	8.5	Liters
	Injector Pump	4	Oz

		Normal Mode	Range	Creep Mode
SPEED (Km/Mi per Hr)	FORWARD	1.73 / 1.08	Low	0.32 / 0.20
		3.42 / 2.13	Low	0.64 / 0.40
		5.70 / 3.54	Low	1.06 / 0.65
		7.99 / 4.96	High	1.40 / 0.87
		15.79 / 9.81	High	2.94 / 1.83
	26.35 / 16.37	High	4.91 / 3.05	
	REVERSE	1.37 / 0.85	Low	0.26 / 0.16
		6.34 / 3.94	High	1.18 / 0.73

**JM/ZL-20 Front End Loader Detailed Specifications**

Bucket Width	50	In
Bucket Capacity	7.06	Ft <sup>3</sup>
Maximum Lift Height	98	In
Reach at maximum height (Fig 2-C)	16	In
Maximum Dump Angle (Fig 2-D)	16	Deg
Reach with bucket on ground (Fig 2-C)	59	In
Bucket Roll Back (Fig 2-F)	17	Deg
Digging Depth below grade (Fig 2-G)	6	In
High in Carry Position (Fig 2-H)	61	In
Lift Capacity to full height	875	Lbs
Break Away Capacity	2200	Lbs
Weight less Mounts	675	Lbs
Raising Time	6.5	Sec
Lowering Time	5	Sec
Bucket Dump Time	4	Sec
Hydraulic Control Valve	Two spool selective control	
Bucket and Lift Cylinders (2 each)	Double Acting 2" bore x 23 " stroke	

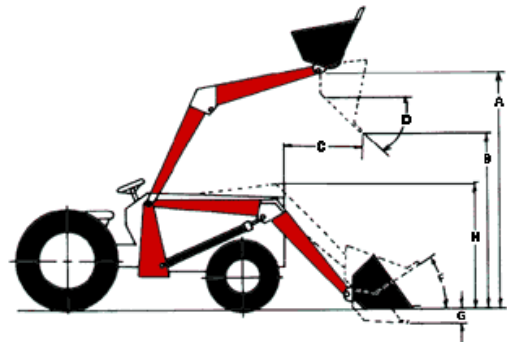
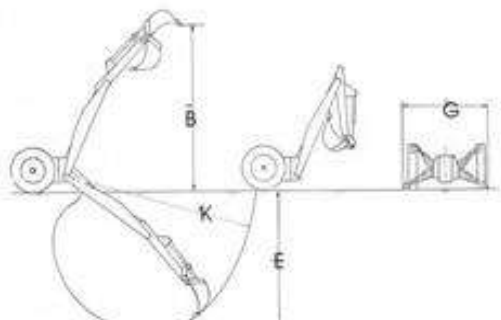

Figure 2 – JM/ZL-20 FEL dimensions

**JM/JW-03 Backhoe Detailed Specifications**

Bucket Width	12	In
Bucket Capacity	1.06	Ft <sup>3</sup>
Overall Dimensions during transportation		
Maximum Digging Depth (Fig 3-E)	5.9	Ft
Maximum Digging Radius (Fig 3-K)	9.8	Ft
Bucket Rotating angle	160	Deg
Discharge Height (Fig 3-B)	8.2	Ft
Extension width with legs deployed (Fig 3-G)	5.9	Ft
Weight	1340	Lbs



**Note: This hoe is mounted directly to tractor frame, not the 3 point hitch**

**JM9GX Finish mower Detailed Specifications**

Cutting Width	58.25	In
Overall Width	64	In
Overall Hight	35	In
Cutting Hight Range	1 5/9 - 3 35/64	In
Required Horse Power	17-30	Hp
PTO Speed	540	RPM
Blade Tip speed	207	Ft/Sec
Blade Overlap	1 1/9	In
Blades	3	Updraft
Blade Spindles (Greased from top)	3	
Suspension Linkage	3	Point
Deck Thickness	3/16	In
Side Skirts	3/16x4 53/64	In
Weight	400	Lbs



Figure 4- JM9GX-1.5A Finish Mower

## Jinma Crate Tractor Assembly





















The Crate tractor assembly process can be broken down into 10 stages.

- All factory tractor, engine and accessory manuals.
- Spare filters, lights, gaskets, tools and more-
- You will need; 1 gallon antifreeze, 2 gallons electrolyte, jack and stands / blocks, crescent wrench, good wire cutters (the tractor and parts are held in place by bolts and lots of wire), a safe work area and diesel. Save all bolts, nuts and washers as you take the crate apart. You may be able to use them.

Each of the 10 stages has an estimated operation time of one hour.

For assembled Tractors please see Jinma Page.

Stage	Description
1	Unpack crate, check contents, read manuals and fill battery with electrolyte.
2	Check tire pressure. Move tractor chassis from crate and bolt on 4 wheels.
3	Attach rear fenders, roll bar and seat belt anchor points.
4	Attach front weight frame. Insert battery.
5	Attach fuel tank. Connect electrical connections and cables. (See TractorConnection wiring guide)
6	Attach engine exhaust, hood and steering wheel.
7	Attach 3 point linkage trailing arms and top link.
8	Apply grease, lubricants and coolant. Fill fuel tank with diesel. Check all bolts for tightness and fluid connections for leaks.
9	Connect battery terminals, prime injector pump, start engine.
10	Check operation and for leaks.

			
<p>As Shipped</p>	<p>All the pieces</p>	<p>Main Tractor Assembly</p>	<p>Rolling Chassis</p>
			
<p>Tool Box</p>	<p>Tires</p>	<p>Hood &amp; Front Weight Bracket</p>	<p>Ready for Town</p>
			
<p>Battery Bracket</p>	<p>Battery Hold-down</p>	<p>Battery, Need your own Electrolyte</p>	
			
<p>Steering Wheel</p>	<p>Rear Fenders &amp; Roll Bar</p>	<p>Muffler</p>	
			
<p>Hood</p>	<p>Front Weights / NA with FEL</p>	<p>Air Cleaner</p>	
			
<p>Drawbar</p>	<p>Three Point Hitch / Class 1</p>	<p>PTO Shield</p>	

Before you start assembling your ‘Crate’ tractor, please take some time to look over the owners manual and illustrated parts manual that is in the Blue “tool and spare parts” box. Decades of hands on work on foreign equipment has taught me some rules that I would like to pass along.

- Positive Mental Attitude
- Do not be looking for “problems” because it is Chinese. Most tractors arrive with none and the minor ones you encounter are NORMAL for any new equipment.
- Part A was scratched in shipment!!!
- Brand name Orange, Green and Blue tractors are assembled from “Crate” parts and minor imperfections are repaired and the tractor is sent to a dealer. A traditional dealer inspects the tractor and fixes any additional operational, fit and finish defects before the customer sees the equipment. You are the DEALER AND ASSEMBLY FACILITY. This is part of why you are saving a LOT of money. A missing bolt, a bent line or a scratch are items you will take care of for your customer (YOU) to make sure that his machine is as good as it can be.
- Don' t overlook the small stuff
- Take your time assembling and checking your tractor. The more items you check during assembly the fewer problems you will have later. Check that the bolts everywhere are tight. A wire tie to secure hoses and wires now means less leaks and electrical problems for the life of your tractor.
- The D\*@N \*%@~ does not work!

Relax. I know the frustration after waiting so long for your tractor to arrive when something does not work or is really broken.

- If it does not work have you read the owners manual? It may have bad English but it does have good trouble shooting help.
- Defective Parts have a factory one year parts warranty. If we do not have the parts in stock we may,
- Buy part from another dealer.  
Repair your part.  
Get part from factory.

You will get your tractor running.



I can't stress enough that you should relax, take your time, read and look at the pictures in the parts and owners manuals and have fun. Get help when you need it and DO IT SAFE. When you are done you will know more about your tractor than most owners and some DEALERS. I hope you will have pride in knowing that the best assembly facility put your tractor together.

Copyright © 2002 Nelson Equipment Corporation

**Nelson Equipment Corporation**

38544 Hwy. 99W

Corvallis, OR 97330

Phone 541-745-5589 Fax: 541-745-5589

EMAIL: [TractorConnection@HotMail.com](mailto:TractorConnection@HotMail.com)

## Jinma JW-03 Backhoe Info

The following info has been provided by Schmalts, Jay, and Jeff. JW-03 Backhoe owners and frequent contributors to the CTOA board.

### PIVET PINS

The hoe is great! If you don't plan to use it for any really heavy duty digging, it would be fine as is. But, who the heck is going to do that??? If you do these mods you will have a hoe that **BLOWS AWAY** any competitors, for less than half the price. These mods will not take **very** long, if you have a welder and metal cutter of some kind. These hoes have a huge bucket and rams, they are too strong for the sub-frame setup, from the factory. Even with these issues, I recommend one to anyone looking for a hoe.

- 1). Prevent pivot pins from popping out. The existing middle section pins can pop out when a twisting force is applied. Get some 1/2" x 1/4" bar stock and weld a piece of it across the open part of the booms, near the pivot pins, in the center section. (see yellow arrows)



Figure 36. JW-03 Backhoe showing modification

There is one pin that needs it the most. If you look at the pins, you will see the one that is in the mid-section joint does not go through very far. It barely protrudes out the other side and does not have a snap ring holding it in, just a S-<sup>points</sup>

shaped hook. I put the little piece of metal across the open area on top of the boom to keep it from spreading, and tacked in the pin, with a few small welds. If you have to remove the pin latter, a quick pass with a grinder will take of the tack welds.



Figure 38. JW-03 Pivot pins



Figure 37. Flat bar details

### Enlarge outrigger pads.

- The small pads that come with the hoe are no good for soft soil and sink easily. (see circle diagram) This intern puts stress on the tractor frame.

Weld 4- 5"x 5"x 1/4" plates to the underside corners of each pad. Eight in all. If you go to a metal supplier this should cost around \$20 to have it sheared to size.



Figure 39. Enlarged Outrigger Pads

### Strengthen lower sub-frame.

- The lower sub-frame of the hoe will bend if you try to lift the whole tractor off the ground with the hoe. (see what can happen in picture below) Weld some square tubing along the bottom of the frame to stiffen it up.



Figure 40. Hoe Frame showing heavy reinforcement

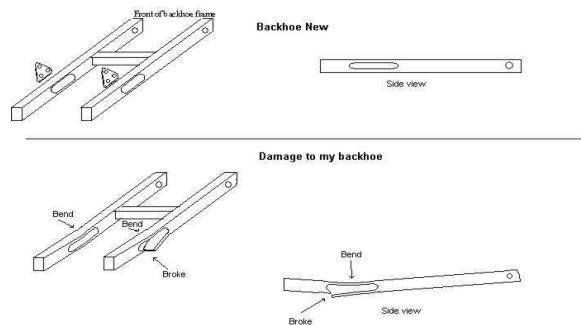

Figure 41. Hoe frame damage



Figure 42. Hoe frame reinforcement fwd view



Figure 43. Hoe frame reinforcement after view

**Note:** New JM hoe frames are said to be improved in this area. Square tubing below the oval cut-out has been added. Still not as strong as the mod shown here.

## Stiffen up rear mount

4. Make a link that goes to the upper 3pt link.  
Great job! This guy can start his own  
Implement company!



*Figure 44. Hoe frame top link stabilizer*

## Credits

The following info has been provided by Schmalts, Jay, and Jeff, JW-03 Backhoe owners and frequent contributors to the CTOA board.