

JVC

SERVICE MANUAL

FLAT COLOUR TELEVISION

AV-29SS26, AV-29SX76/G

BASIC CHASSIS

CW3

InterArt
MaxxBass®

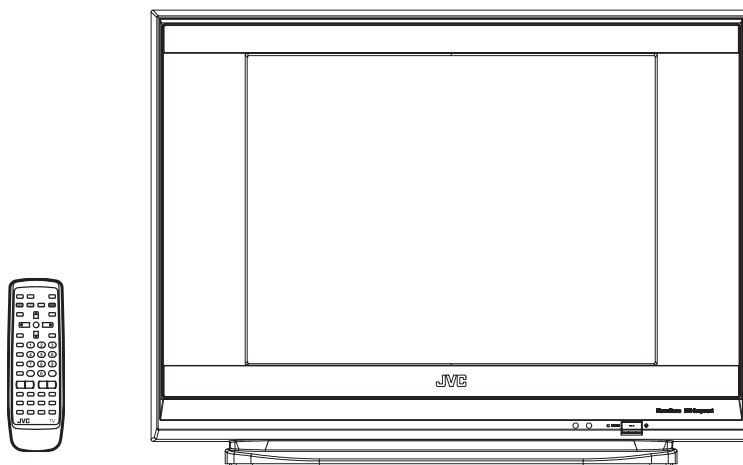

TABLE OF CONTENTS

1	PRECAUTION.....	1-3
2	SPECIFIC SERVICE INSTRUCTIONS.....	1-4
3	DISASSEMBLY.....	1-6
4	ADJUSTMENT.....	1-12
5	TROUBLESHOOTING.....	1-32

SPECIFICATION

Items	Contents	
	AV-29SS26	AV-29SX76/G
Dimensions (W × H × D)	81.0 cm × 61.6 cm × 39.4 cm	
Mass	44 kg	
TV RF System	B, G, I, D, K, M	
Colour System	PAL / SECAM / NTSC 3.58 / NTSC 4.43	
Stereo System	A2 (B/G) / NICAM (B/G, I, D/K)	PB STEREO
Teletext System	FLOF (Fastext) WST (World Standard System)	
Receiving Frequency	VHF Low	46.25MHz - 140.25MHz (AS0 - S6)
	VHF High	147.25MHz - 423.25MHz (S7 - S36)
	UHF	431.25MHz - 863.25MHz (S37 - C57)
	CATV	Mid (X - Z+2, S1 - S10) / Super (S11 - S20) / Hyper (S21 - S41) bands
Intermediate Frequency	VIF	38.0MHz (B, G, I, D, K, M)
	SIF	32.26 MHz (5.74 MHz: B), 32.15MHz (5.85 MHz: G), 31.45 MHz (6.55 MHz: I) 31.75 MHz (6.5 MHz: D), 32.15MHz (5.85 MHz: K), 33.5MHz (4.5MHz : M)
Colour Sub Carrier	PAL	4.43 MHz
	SECAM	4.40625 MHz / 4.25 MHz
	NTSC	3.58 MHz / 4.43 MHz
Power Input	AC110 V - AC240 V, 50 Hz/60 Hz	
Power Consumption	191W (Max) / 129W (Avg)	
Picture Tube	29-inch, aspect ratio 4 : 3, flat square type, tinted	
High Voltage	30.5 kV +1 kV / -1.5kV	
Speaker	6.5 cm × 13 cm, oval type × 2	
Audio Power Output	10 W + 10 W (Rated power output)	
Aerial Input	75 Ω unbalanced, coaxial	
Video / Audio Input-1/2/3	Component Video [VIDEO-2]	RCA pin jack × 3 Y:1V(p-p), positive (negative sync), 75Ω Cb/Cr:0.7V(p-p), 75Ω
	S-Video [VIDEO-1]	Mini-DIN 4 pin × 1 Y: 1V(p-p), positive (negative sync provided), 75Ω C: 0.286V(p-p) (Burst signal), 75Ω
	Video	1V(p-p), negative sync, 75Ω, RCA pin jack × 3
	Audio	500mV(rms) (-4dBs), high impedance, RCA pin jack × 6
Video / Audio Output	Video	1V(p-p), 75Ω, RCA pin jack × 1
	Audio	500mV(rms)(-4dBs), Low impedance, RCA pin jack × 2
Headphone jack	3.5 mm stereo mini jack × 1	
Remote Control Unit	RM-C1286 (UM-3/AA/R6 dry cell battery × 2)	RM-C1285 (UM-3/AA/R6 dry cell battery × 2)

Design and specifications subject to change without notice.

SECTION 1 PRECAUTION

1.1 SAFETY PRECAUTIONS

- (1) The design of this product contains special hardware, many circuits and components specially for safety purposes. For continued protection, no changes should be made to the original design unless authorized in writing by the manufacturer. Replacement parts must be identical to those used in the original circuits. Service should be performed by qualified personnel only.
- (2) Alterations of the design or circuitry of the products should not be made. Any design alterations or additions will void the manufacturer's warranty and will further relieve the manufacturer of responsibility for personal injury or property damage resulting therefrom.
- (3) Many electrical and mechanical parts in the products have special safety-related characteristics. These characteristics are often not evident from visual inspection nor can the protection afforded by them necessarily be obtained by using replacement components rated for higher voltage, wattage, etc. Replacement parts which have these special safety characteristics are identified in the parts list of Service manual. **Electrical components having such features are identified by shading on the schematics and by (Δ) on the parts list in Service manual.** The use of a substitute replacement which does not have the same safety characteristics as the recommended replacement part shown in the parts list of Service manual may cause shock, fire, or other hazards.
- (4) **Don't short between the LIVE side ground and ISOLATED (NEUTRAL) side ground or EARTH side ground when repairing.**
Some model's power circuit is partly different in the GND. The difference of the GND is shown by the LIVE : (\perp) side GND, the ISOLATED (NEUTRAL) : ($\frac{\perp}{\text{---}}$) side GND and EARTH : (\oplus) side GND.
Don't short between the LIVE side GND and ISOLATED (NEUTRAL) side GND or EARTH side GND and never measure the LIVE side GND and ISOLATED (NEUTRAL) side GND or EARTH side GND at the same time with a measuring apparatus (oscilloscope etc.). If above note will not be kept, a fuse or any parts will be broken.
- (5) If any repair has been made to the chassis, it is recommended that the B1 setting should be checked or adjusted (See B1 VOLTAGE).
- (6) The high voltage applied to the picture tube must conform with that specified in Service manual. Excessive high voltage can cause an increase in X-Ray emission, arcing and possible component damage, therefore operation under excessive high voltage conditions should be kept to a minimum, or should be prevented. If severe arcing occurs, remove the AC power immediately and determine the cause by visual inspection (incorrect installation, cracked or melted high voltage harness, poor soldering, etc.). To maintain the proper minimum level of soft X-Ray emission, components in the high voltage circuitry including the picture tube must be the exact replacements or alternatives approved by the manufacturer of the complete product.
- (7) Do not check high voltage by drawing an arc. Use a high voltage meter or a high voltage probe with a VTVM. Discharge the picture tube before attempting meter connection, by connecting a clip lead to the ground frame and connecting the other end of the lead through a 10k Ω 2W resistor to the anode button.

- (8) When service is required, observe the original lead dress. Extra precaution should be given to assure correct lead dress in the high voltage circuit area. Where a short circuit has occurred, those components that indicate evidence of overheating should be replaced. Always use the manufacturer's replacement components.
- (9) **Isolation Check (Safety for Electrical Shock Hazard)**
After re-assembling the product, always perform an isolation check on the exposed metal parts of the cabinet (antenna terminals, video/audio input and output terminals, Control knobs, metal cabinet, screw heads, earphone jack, control shafts, etc.) to be sure the product is safe to operate without danger of electrical shock.
 - a) **Dielectric Strength Test**
The isolation between the AC primary circuit and all metal parts exposed to the user, particularly any exposed metal part having a return path to the chassis should withstand a voltage of 3000V AC (r.m.s.) for a period of one second. (. . . Withstand a voltage of 1100V AC (r.m.s.) to an appliance rated up to 120V, and 3000V AC (r.m.s.) to an appliance rated 200V or more, for a period of one second.) This method of test requires a test equipment not generally found in the service trade.
 - b) **Leakage Current Check**
Plug the AC line cord directly into the AC outlet (do not use a line isolation transformer during this check.). Using a "Leakage Current Tester", measure the leakage current from each exposed metal part of the cabinet, particularly any exposed metal part having a return path to the chassis, to a known good earth ground (water pipe, etc.). Any leakage current must not exceed 0.5mA AC (r.m.s.). However, in tropical area, this must not exceed 0.2mA AC (r.m.s.).

Alternate Check Method

Plug the AC line cord directly into the AC outlet (do not use a line isolation transformer during this check.). Use an AC voltmeter having 1000 Ω per volt or more sensitivity in the following manner. Connect a 1500 Ω 10W resistor paralleled by a 0.15 μ F AC-type capacitor between an exposed metal part and a known good earth ground (water pipe, etc.). Measure the AC voltage across the resistor with the AC voltmeter. Move the resistor connection to each exposed metal part, particularly any exposed metal part having a return path to the chassis, and measure the AC voltage across the resistor. Now, reverse the plug in the AC outlet and repeat each measurement. Any voltage measured must not exceed 0.75V AC (r.m.s.). This corresponds to 0.5mA AC (r.m.s.). However, in tropical area, this must not exceed 0.3V AC (r.m.s.). This corresponds to 0.2mA AC (r.m.s.).

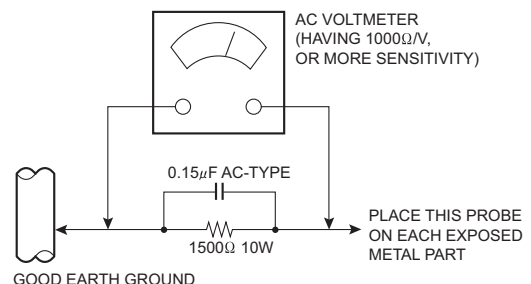

SECTION 2

SPECIFIC SERVICE INSTRUCTIONS

2.1 FEATURES

DVD PICTURE MODE

This function can enhance the picture quality of DVD. The screen can be made sharp or soft by this setting.

AUTO SIGNAL DETECT

When input DVD signal to VIDEO-2, detect the input signal and change the input mode to VIDEO-2 automatically.

CINEMA SURROUND

This function can enjoy an enhanced sound for wider audience.

PICTURE MODE

This function can adjust the picture settings automatically. There are BRIGHT, STANDARD and SOFT in the PICTURE MODE.

RETURN +

This function can set a channel frequently view to the Return Channel and you can view that channel at any time with one-touch.

AI ECO SENSOR

This function can adjust TV screen contrast according to the brightness of your room.

MaxxBass

MaxxBass enhances bass sound that cannot be reproduced by normal speakers to be heard by our ears.

2.2 MAIN DIFFERENCE LIST

Item	AV-29SS26	AV-29SX76/G
OSD Language	Eng, Chi, Rus, Mal, Ind	Eng, Ara, Fre, Per, Rus
PIP Function	NO	YES
MAIN PWB	SCW-1941A-H2	SCW-1947A-H2
REMOTE CONTROL UNIT	RM-C1286	RM-C1285

2.3 REMOTE CONTROL UNIT

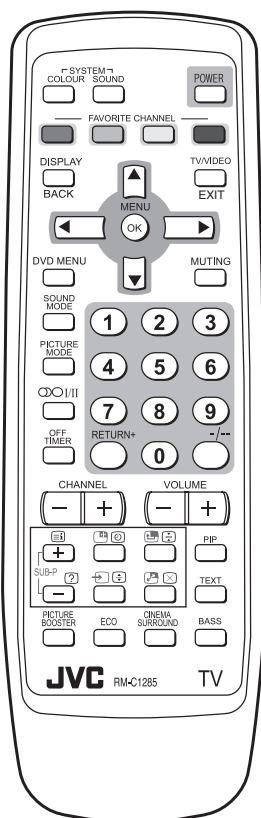

<RM-C1285>

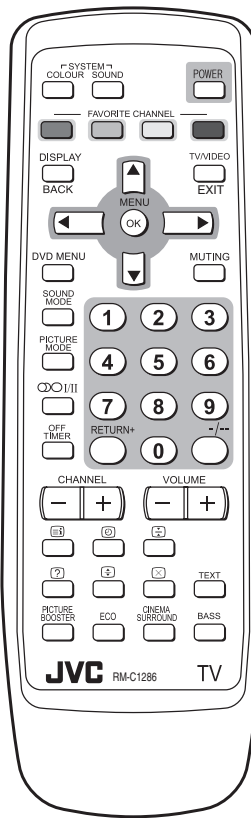

<RM-C1286>

2.4 TECHNICAL INFORMATION

2.4.1 MAIN MI-COM (CPU) PIN FUNCTION

Pin No.	Pin name	I/O	Function	Pin No.	Pin name	I/O	Function
1	VssP2	-	GND	65	SVM	O	Not used
2	VssC4	-	GND	66	FbiSo	I	Flyback input/sandcastle output
3	V1.8C4	I	1.8V (Digital)	67	Hout	O	Horizontal output
4	V3.3A3	I	3.3V	68	VssComb	-	GND
5	VrefP_Sdac	I	3.3V (Positive)	69	V5Comb	I	5V
6	VrefN_Sdac	-	GND	70	Vin/R2/Pr	I	PIP R input
7	VrefP_Sdac	I	3.3V (Negative)	71	Uin/B2/Pb	I	PIP B input
8	VrefN_Sdac	-	GND	72	Yin/G2/Y	I	PIP G input
9	VrefP_Sdac	I	3.3V (Positive)	73	Ysync	I	Not used
10	Xtalln	I	24.576MHz for system clock	74	Yout	O	Not used
11	XtalOut	O	24.576MHz for system clock	75	Uout/INSSW2	I	YUV insertion input
12	VssA1	-	GND	76	NC	O	Not used
13	NECK	I	V-guard input/ I/O switch	77	INSSW3	I	YUV insertion input
14	CONT	I	1.8V regulator control	78	R3/Pr	I	Component PR input (Video-2)
15	V5P1	I	+5V	79	G3/Y	I	Component Y input (Video-2)
16	Ph2	-	Phase-2 filter	80	B3/Pb	I	Component PB input (Video-2)
17	Ph1	-	Phase-1 filter	81	Gnd3	-	GND
18	Gnd1	-	GND	82	V5P3	I	5V
19	SecPll	-	SECAM PLL decoupling	83	BCL	I	Beam current limiter input
20	Dec8G	-	Bandgap decoupling	84	BLKIN	I	Black current input
21	EW	O	East-West drive output	85	Rout	O	R output
22	VDRB-	O	Vertical drive B output	86	Gout	O	G output
23	VDRA+	O	Vertical drive A output	87	Bout	O	B output
24	Vif1	I	Video IF input 1	88	V3.3A1	I	3.3V
25	Vif2	I	Video IF input 2	89	RefAdN	-	GND
26	Vsc	-	Vertical sawtooth capacitor	90	V3.3RefAdP	I	3.3V (Positive)
27	Iref	I	Reference current input	91	RefAd	I	3.3/2V
28	GndIF	-	GND	92	GndA	-	GND
29	Sif1	I	Sound IF input 1	93	V1.8A	I	1.8V
30	Sif2	I	Sound IF input 2	94	V3.3A2	I	3.3V
31	AGC	O	Tuner AGC output	95	VssADC	-	GND
32	EHT	I	EHT/overvoltage protection input	96	V1.8ADC	I	1.8V
33	Ssif/RefIn/Avl/RefOut	O	Automatic Volume Levelling/ sound IF input / subcarrier reference output / external reference signal input for I signalmixer for DVB operation	97	REMOTE	I	Remote control
34	L3	I	Audio-L3 input (left signal)	98	PW_LED	I	POWER LED control
35	R3	I	Audio-R3 input (right signal)	99	PW_LED	I	POWER LED control
36	L-OUT	O	Audio L output	100	V1.8C2	I	1.8V
37	R-OUT	O	Audio R output	101	VssC2	-	GND
38	DecsDem	-	Decoupling sound demodulator	102	TIMER	-	Not used
39	QssO/AmO/AudeEm	O	QSS intercarrier output / AM output / deemphasis / (front-end audio out)	103	TIMER	-	Not used
40	Gnd2	-	GND	104	VER_PROTECT	O	X-ray protect
41	PllIf	-	IF-PLL loop filter	105	S_REDUCE	O	Sound control
42	SifAgc	-	AGC sound IF	106	P00/I2SDI1	O	Not used
43	IfVo/FmRo/DvbO	O	Not used	107	POWER	O	SUB POWER control
44	NC	O	Not used	108	SCL1	I	I2C bus clock
45	V8AudioSwitches	I	8V	109	SDA1	I/O	I2C bus data
46	AgcSsif	-	AGC capacitor second sound IF	110	V3.3P	I	3.3V
47	V5P2	I	5V	111	ROTATION	O	Rotation
48	V-OUT	O	Video output	112	3.58/OTHER	O	NTSC 3.58 detection
49	L1	I	Audio-L1 input	113	A_MUTE	O	Audio muting
50	R1	I	Audio-R1 input	114	4.5/OTHER	O	NTSC 4.43 detection
51	V3	I	Video V3 input	115	PROT	I	Protect
52	C4	I	Not used	116	ECO_IN	I	ECO sensor level detection
53	Audio2InL	I	Not used	117	V1.8C1	I	1.8V (Digital)
54	Audio2InR	I	Not used	118	DecV1V8	I	1.8V
55	V2/Y	I	Video V2 input	119	KEY_IN	I	Key scan data
56	L2	I	Audio L2 input (Left signal)	120	VDO-DET	I	Video DET input
57	R2	I	Audio R2 input (right signal)	121	VSSC1+P1	-	Digital GND
58	Y3/Cvbs	I	S-Video Y1 input	122	S_V_DET	I	S-Video DET input
59	C1	I	S-Video C1 input	123	P25/PWM4	O	GTVA_reset
60	AudioLsL	O	Audio L output for audio power amplifier	124	V1.8C3	I	1.8V (Digital)
61	AudioLsR	O	Audio R output for audio power amplifier	125	VssC3	-	GND
62	HP-L	O	Not used	126	P12/Int2	I	External interrupt
63	HP-R	O	Not used	127	SDA0	I/O	I2C bus data (for memory)
64	CVBSO/PIP	O	CVBS / PIP output	128	SCL0	I	I2C bus clock (for memory)

SECTION 3

DISASSEMBLY

3.1 DISASSEMBLY PROCEDURE

3.1.1 REMOVING THE REAR COVER

- Unplug the power cord.
 - (1) Remove the 15 screws [A] as shown in Fig.1.
 - (2) Withdraw the REAR COVER toward you.

CAUTION:

When reinstalling the rear cover, carefully push it inward after inserting the MAIN PWB into the REAR COVER groove.

3.1.2 REMOVING THE CHASSIS (CHASSIS BASE AND CONTROL BASE)

- Remove the REAR COVER.
 - (1) Slightly raise the both sides of the CHASSIS by hand and remove the 2 claws [B] under the CHASSIS from the front cabinet as shown in Fig.1.
 - (2) Withdraw the CHASSIS backward.
(If necessary, take off the wire clamp, connectors etc.)

NOTE:

When conducting a check with power supplied, be sure to confirm that the CRT earth wire is connected to the CRT SOCKET PWB and the MAIN PWB.

3.1.3 REMOVING THE AV BOARD

- Remove the REAR COVER.
 - (1) Remove the 2 screws [C] as shown in Fig.1.
 - (2) When you pull out the AV BOARD in the direction of arrow [D] as shown in Fig.1, it can be removed.

3.1.4 REMOVING THE CONTROL BASE

- Remove the REAR COVER.
- Remove the CHASSIS.
 - (1) While pushing down the 1 claw [E] as shown in Fig. 2 and pull out the CONTROL BASE in the direction of arrow [F] as shown in Fig. 2, the control base can be removed.
(If necessary, take off the wire, connectors etc.)

3.1.5 REMOVING THE SPEAKER

- Remove the REAR COVER.
 - (1) Remove the 2 screws [G] as shown in Fig.1.
 - (2) Withdraw the SPEAKER backward.
 - (3) Follow the same steps when removing the other hand SPEAKER.

3.1.6 REMOVING THE FRONT CONTROL PWB(2/2)

- Remove the REAR COVER.
 - (1) Remove the 4 screws [H] as shown in Fig1.
 - (2) Withdraw the FRONT CONTROL PWB(2/2).

3.1.7 CHECKING THE MAIN PW BOARD

- To check the back side of the MAIN PWB.
 - (1) Pull out the CHASSIS and CONTROL BASE. (Refer to the procedure described in REMOVING THE CHASSIS)
 - (2) Put the CHASSIS in upright position with the MAIN PWB's solderside faced to the right. The FBT must be positioned on top. (Viewed from the rear)
 - (3) Put the CONTROL PWBs in an appropriate position, taking care not giving tension to the ribbon cables that connect to the MAIN PWB.

CAUTIONS:

- Use insulating materials, if necessary, to avoid possible electrical contacts between PWBs and expose terminals, etc.
- Before turning on power, make sure that the CRT earth wire and other connectors are properly connected.
- When repairing, connect the DEG. COIL to the DEG. connector on the MAIN PWB.

3.1.8 WIRE CLAMPING AND CABLE TYING

- (1) Be sure to clamp the wire.
- (2) Never remove the cable tie used for tying the wires together.
Should it be inadvertently removed, be sure to tie the wires with a new cable tie.

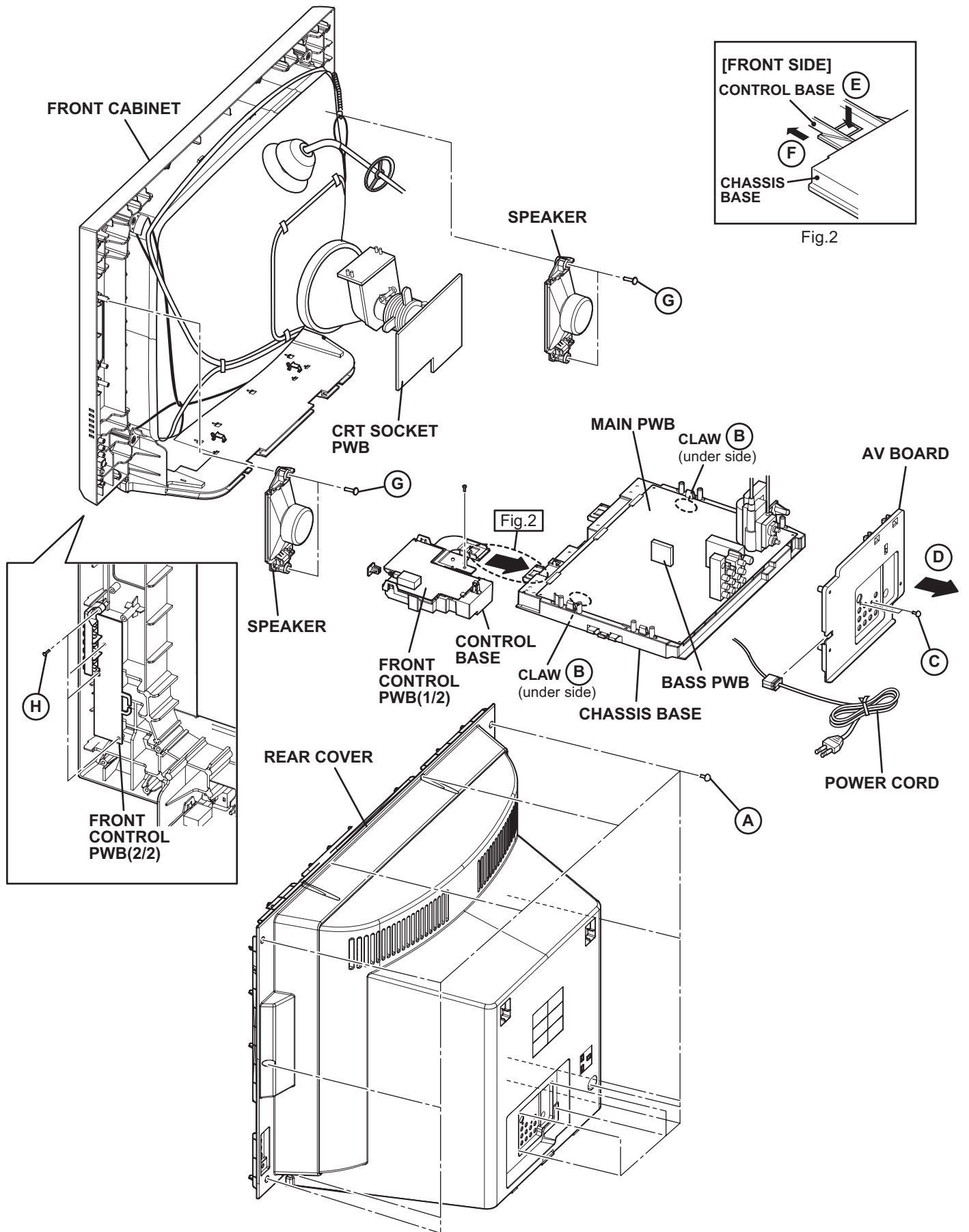

3.2 MEMORY IC REPLACEMENT

- This model uses the memory IC.

Memory IC: IC702 on MAIN PWB

The memory IC memorizes data for correctly operating the video and deflection circuits. When replacing the memory IC, be sure to use the same type IC written with the initial values of data. In other words, use the specific IC listed in "PRINTED WIRING BOARD PARTS LIST". For its mounting location, refer to "ADJUSTMENT LOCATIONS".

3.2.1 MEMORY IC REPLACEMENT PROCEDURE

1. Power off

Switch off the power and disconnect the power plug from the AC outlet.

2. Replace the memory IC

Be sure to use the memory IC written with the initial setting values.

3. Power on

Connect the power plug to the AC outlet and switch on the power.

4. System constant check and setting

* It must not adjust without signal.

- (1) Press the **[DISPLAY]** key and the **[PICTURE MODE]** key of the REMOTE CONTROL UNIT simultaneously.
- (2) The SERVICE MODE screen of Fig. 1 will be displayed.
- (3) While the SERVICE MODE is displayed, press the **[DISPLAY]** key and the **[PICTURE MODE]** key simultaneously, and the SYSTEM CONSTANT SET screen of Fig. 2 will be displayed.
- (4) Check the setting values of the SYSTEM CONSTANT SET. If the value is different, select the setting item with the **[MENU ▲/▼]** key, and set the correct value with the **[MENU ◀/▶]** key.
- (5) Press the **[OK]** key to memorize the setting value.
- (6) Press the **[DISPLAY]** key twice, and return to the normal screen.

5. Receiving channel setting

Refer to the OPERATING INSTRUCTIONS and set the receive channels (Channels Preset) as described.

6. User settings

Check the user setting items according to the given in page later.

Where these do not agree, refer to the OPERATING INSTRUCTIONS and set the items as described.

7. SERVICE MODE setting

Verify what to set in the SERVICE MODE, and set whatever is necessary (Fig.1).

Refer to the SERVICE ADJUSTMENT for setting.

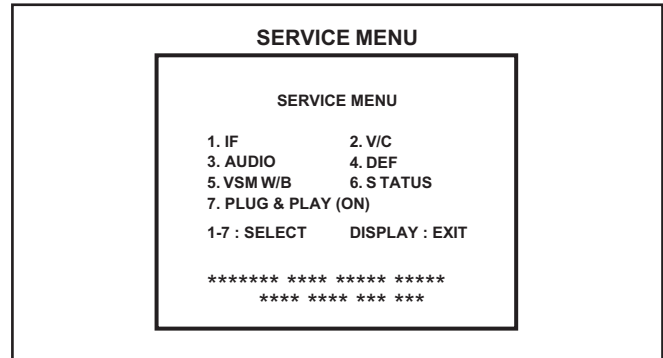

Fig.1

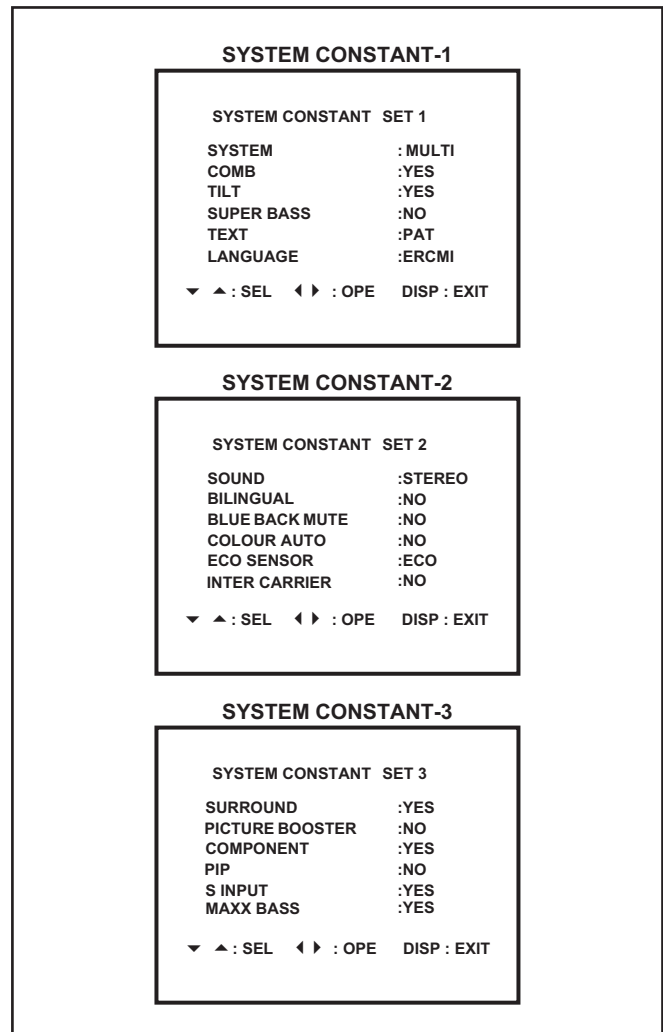
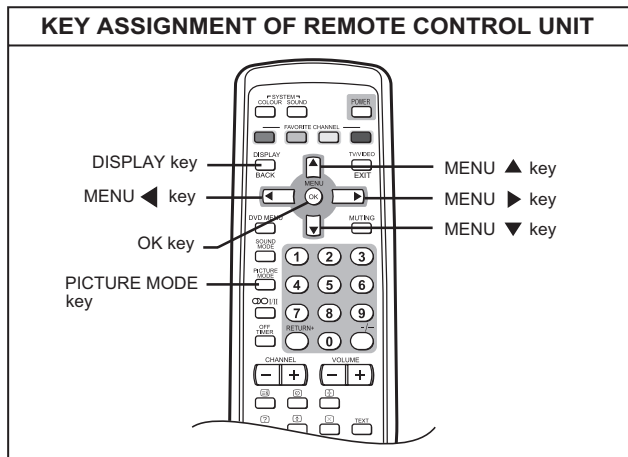

Fig.2



3.2.2 SYSTEM CONSTANT SETTING

Setting item	Setting value	
	AV-29SS26	AV-29SX76/G
SYSTEM	MULTI	←
COMB	YES	←
TILT	YES	←
SUPER BASS	NO	←
TEXT	PAT	←
LANGUAGE	E/R/C/M/I	E/R/A/P/F
SOUND	STEREO	PB
BILINGUAL	NO	←
BLUE BACK MUTE	NO	←
COLOUR AUTO	NO	YES
ECO SENSOR	ECO	←
INTER CARRIER	NO	←
SURROUND	YES	←
PICTURE BOOSTER	NO	←
COMPONENT	YES	←
PIP	NO	YES
S INPUT	YES	←
MAXX BASS	YES	←

3.2.3 SETTINGS OF FACTORY SHIPMENT

3.2.3.1 BUTTON OPERATION

Setting item	Setting position
POWER	Off
CHANNEL	PR 1
VOLUME	15

3.2.3.2 REMOTE CONTROL DIRECT OPERATION

Setting item	Setting position
CHANNEL	PR1
VOLUME	15
PICTURE MODE	BRIGHT
DISPLAY	Indicated
TV/VIDEO	TV
CINEMA SURROUND	OFF

3.2.3.3 REMOTE CONTROL MENU OPERATION

(1) PICTURE SETTING

Setting item	Setting position
PICTURE MODE	BRIGHT
CONTRAST / BRIGHT / SHARP / COLOUR / TINT	Centre
WHITE BALANCE	COOL
VNR	AUTO

(2) SOUND SETTING

Setting item	Setting position
STEREO I/II	STEREO SOUND
AI VOLUME	OFF
SOUND MODE	MUSIC
BALANCE	Centre
CINEMA SURROUND	OFF
MAXX BASS	OFF

(3) FEATURE SETTING

Setting item	Setting position
DVD MENU	
AUTO SIGNAL DETECT	ON
DVD PICTURE MODE	OFF
DVD THEATER STATUS	OFF
DVD SOUND MODE	THEATER
ON TIMER	OFF
OFF TIMER	OFF
CHILD LOCK	OFF
COMPRESS (16:9)	OFF
AI ECO SENSOR	OFF

(4) INSTALL SETTING

Setting item	Setting position
AUTO PROGRAM	TV channel automatically set
EDIT/MANUAL	PRESET CH only
COLOUR SYSTEM	PAL
LANGUAGE	ENGLISH
TEXT LANGUAGE	GROUP1 [AV-29SS26] GROUP4 [AV-29SX76/G]
VIDEO-2 SETTING	COMPONENT
BLUE BACK	ON
BEEP	ON

3.2.4 SERVICE MODE SETTING ITEMS

Setting item	Setting value
1. IF	1. VCO 2. DELAY POINT
2. V / C	1.SCREEN (READ DATA) 2.CUTOFF / CUT OFF THEATER (B/G) 3.WDR (R/G/B) 4.BRIGHT (TV/VDO 1/2/3) 5.CONT. (TV/VDO 1/2/3) 6.COLOUR (TV/VDO 1/2/3) 7.TINT (TV/VDO 1/2/3 /THEATER) 8.SHARP (TV/VDO 1/2/3) 9.Y DELAY (TV/VDO 1/2/3/S-VDO) 10.TINT DVD (TV/VDO/THEATER) 11.AMP T.SHARP (TV/VDO) 12.TWIN CONT (TV/VDO)
3. AUDIO [Do not adjust]	1. DCXO ADJ 2. NICAM lower ERR LIM 3. NICAM upper ERR LIM 4. A2 ID THR 5. MENU EQUALIZER
4. DEF	1. V-SHIFT 2. V-SLOPE 3. V-SIZE 4. H-CENT 5. H-SIZE 6. TRAPEZ 7. EW-PIN 8. COR-UP 9. COR-LO 10. ANGLE 11. BOW 12. V-S.CR 13. V-LIN 14. V-ZOOM
5. VSM PRESET	1. BRIGHT 2. CONT 3. COLOUR 4. SHARP 5. HUE 1. R DRIVE 2. G DRIVE 3. B DRIVE
6. STATUS [Display only]	---
7. PLUG & PLAY(ON) [Display only]	---

3.3 REPLACEMENT OF CHIP COMPONENT

3.3.1 CAUTIONS

- (1) Avoid heating for more than 3 seconds.
- (2) Do not rub the electrodes and the resist parts of the pattern.
- (3) When removing a chip part, melt the solder adequately.
- (4) Do not reuse a chip part after removing it.

3.3.2 SOLDERING IRON

- (1) Use a high insulation soldering iron with a thin pointed end of it.
- (2) A 30w soldering iron is recommended for easily removing parts.

3.3.3 REPLACEMENT STEPS

1. How to remove Chip parts

[Resistors, capacitors, etc.]

- (1) As shown in the figure, push the part with tweezers and alternately melt the solder at each end.

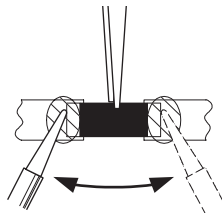

- (2) Shift with the tweezers and remove the chip part.

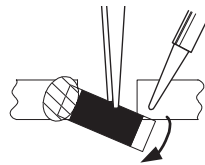

[Transistors, diodes, variable resistors, etc.]

- (1) Apply extra solder to each lead.



- (2) As shown in the figure, push the part with tweezers and alternately melt the solder at each lead. Shift and remove the chip part.

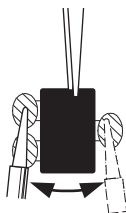

NOTE :

After removing the part, remove remaining solder from the pattern.

2. How to install Chip parts

[Resistors, capacitors, etc.]

- (1) Apply solder to the pattern as indicated in the figure.

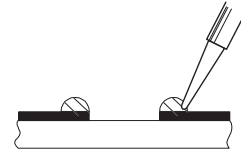

- (2) Grasp the chip part with tweezers and place it on the solder. Then heat and melt the solder at both ends of the chip part.

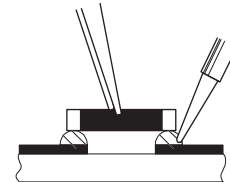

[Transistors, diodes, variable resistors, etc.]

- (1) Apply solder to the pattern as indicated in the figure.
- (2) Grasp the chip part with tweezers and place it on the solder.
- (3) First solder lead **A** as indicated in the figure.

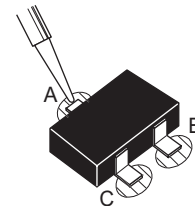

- (4) Then solder leads **B** and **C**.

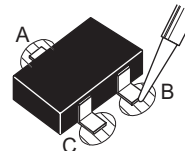

SECTION 4 ADJUSTMENT

4.1 ADJUSTMENT PREPARATION

- (1) There are 2 ways of adjusting this TV : One is with the **REMOTE CONTROL UNIT** and the other is the conventional method using adjustment parts and components.
- (2) The adjustment using the **REMOTE CONTROL UNIT** is made on the basis of the initial setting values. The setting values which adjust the screen to the optimum condition can be different from the initial setting values.
- (3) Make sure that connection is correctly made AC to AC power source.
- (4) Turn on the power of the TV and measuring instruments for warming up for at least 30 minutes before starting adjustments.
- (5) If the receive or input signal is not specified, use the most appropriate signal for adjustment.
- (6) Never touch the parts (such as variable resistors, transformers and condensers) not shown in the adjustment items of this service adjustment.

4.2 PRESET SETTING BEFORE ADJUSTMENT

Unless otherwise specified in the adjustment items, preset the following functions with the **REMOTE CONTROL UNIT**.

Item	Preset value
PICTURE MODE(VSM)	BRIGHT
VNR	OFF
AI ECO SENSOR	OFF
BALANCE	Centre
BASS / TREBLE / BALANCE	Centre
CINEMA SURROUND	OFF

4.3 MEASURING INSTRUMENT AND FIXTURES

- (1) DC voltmeter (or digital voltmeter)
- (2) Oscilloscope
- (3) HV voltmeter
- (4) Signal generator
(Pattern generator : PAL/NTSC)
- (5) Remote control unit

4.4 ADJUSTMENT ITEMS

■ CHECK ITEMS

- B1 VOLTAGE check
- HIGH VOLTAGE check
- IF VCO check

■ TUNER / IF CIRCUIT

- DELAY POINT (AGC) adjustment

■ FOCUS

- FOCUS adjustment

■ DEFLECTION CIRCUIT

- V.SLOPE adjustment
- V.POSITION adjustment
- V.SIZE adjustment
- H.POSITION adjustment
- H.SIZE adjustment
- SIDE PIN adjustment
- TRAPEZIUM adjustment
- V. LINEARITY adjustment
- CORNER adjustment
- H. PARALLEL adjustment
- H.BOW adjustment

■ VIDEO CIRCUIT

- WHITE BALANCE adjustment
- SUB BRIGHT adjustment
- SUB CONTRAST adjustment
- SUB COLOUR adjustment
- SUB TINT adjustment

■ VSM PRESET SETTING

- VSM PRESET

■ PURITY AND CONVERGENCE

- PURITY adjustment
- STATIC CONVERGENCE adjustment
- DYNAMIC CONVERGENCE adjustment

4.5 ADJUSTMENT LOCATION

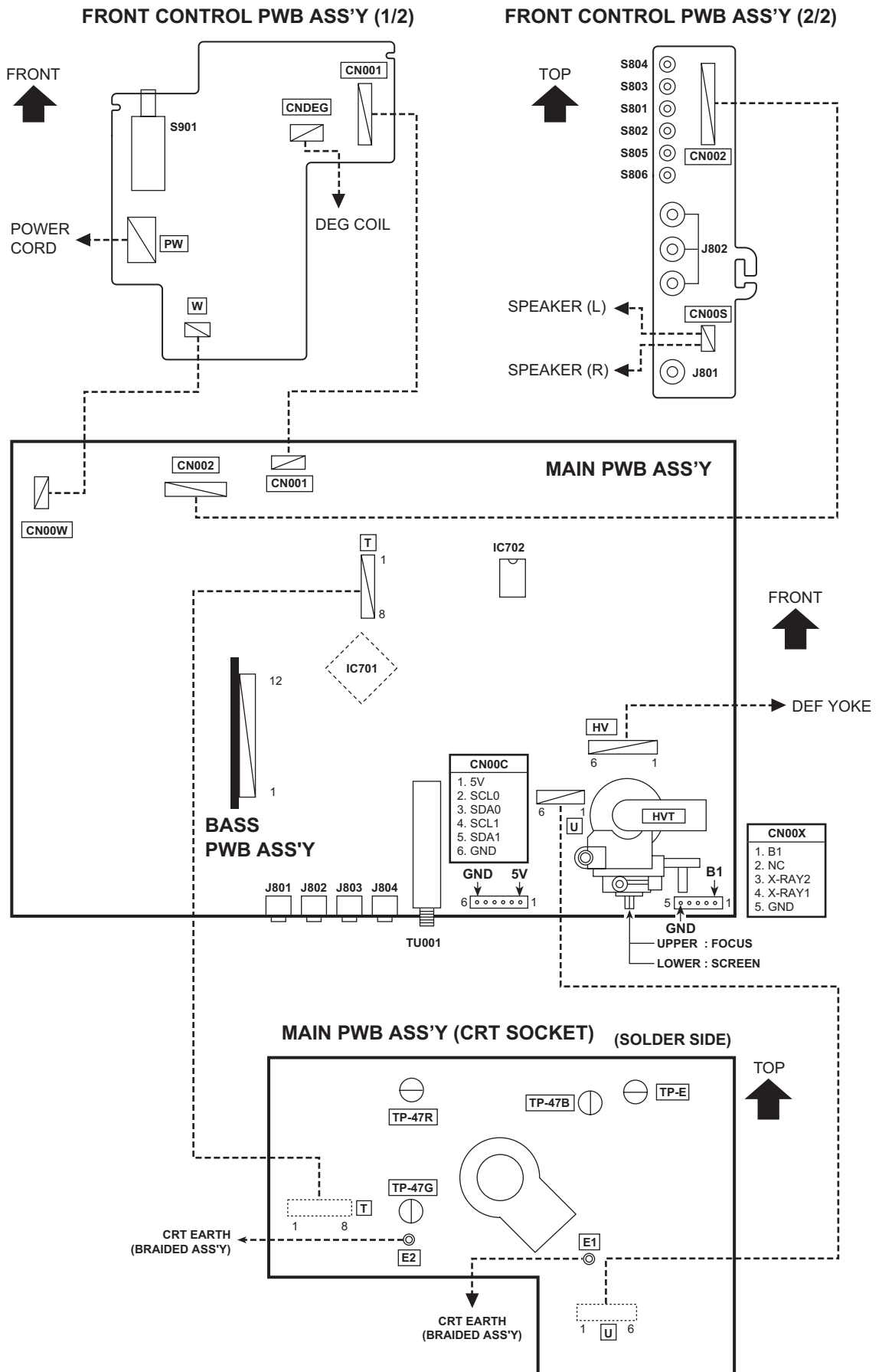

4.6 BASIC OPERATION OF SERVICE MODE

4.6.1 TOOL OF SERVICE MODE OPERATION

Operate the SERVICE MODE with the REMOTE CONTROL UNIT.

4.6.2 SERVICE MODE ITEMS

With the SERVICE MODE, various adjustments can be made, and they are broadly classified in the following items of settings.

1.IF	This mode adjusts the setting values of the IF circuit.
2. V/C	This mode adjusts the setting values of the VIDEO circuit.
3.AUDIO	This mode adjusts the setting values of the multiplicity AUDIO circuit. [Do not adjust]
4. DEF	This mode adjusts the setting values of the DEFLECTION circuit for each aspect mode given below.
5.VSM PRESET	This mode adjusts the initial setting values of BRIGHT, STANDARD and SOFT. (VSM : Video Status Memory)
6.STATUS	It is no requirement to adjustment. [Do not adjust]
7.PLUG & PLAY (ON)	This mode adjusts the setting values of the PIP circuit. [Do not adjust]

4.6.3 BASIC OPERATION IN SERVICE MODE

4.6.3.1 HOW TO ENTER THE SERVICE MODE

- (1) Press the **[DISPLAY]** key and the **[PICTURE MODE]** key simultaneously, then enter the SERVICE MODE.
- (2) When the main menu is displayed, press any key of the [7] to [9] key to enter the corresponding sub menu mode.

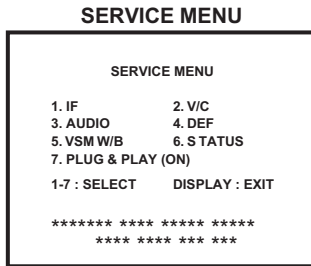

Fig.1

4.6.3.2 SETTING METHOD

■ 1.IF

- [1. VCO] : It must not adjust without signal
 - (1) **[1]** key
Select 1.IF.
 - (2) **[1]** key
Select 1.VCO(CW).
Check the arrow position between the ABOVE REF. and BELOW REF.
 - (3) **[DISPLAY]** key
Return to the SERVICE MODE main manu screen.

■ 2. V/C, 4. DEF

- (1) **[2], [4]** key
Select one from 2. V/C, 4. DEF.
- (2) **[MENU ▲/▼]** key
Select setting items.
- (3) **[MENU ◀/▶]** key
Set the setting values of the setting items.

■ 5.VSM W/B

- (1) **[5]** key
Select 5.VSM W/B.
- (2) **[OK]** key
Select setting items.
- (3) **[MENU ▲/▼]** key
Set the setting values of the setting items.

4.6.3.3 MEMORIZE THE ADJUSTMENT DATA

When Mnt is completed, press the **[OK]** key to memorize the adjustment value. If not to do so, the data is not memorized to the memory IC. And if exit the adjustment mode before to memorize the data, the adjustment value which you have changed will be canceled.

4.6.3.4 RELEASE OF SERVICE MODE

After completing the setting, return to the SERVICE MODE, then again press the **[DISPLAY]** key.

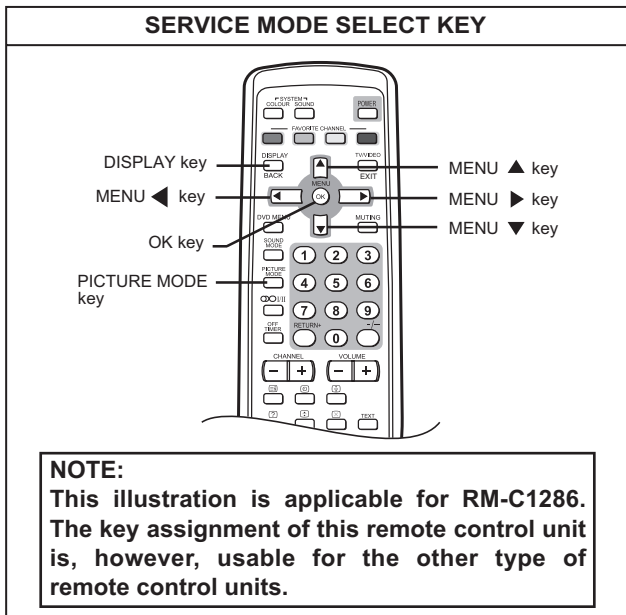

Fig.2

4.6.4 SERVICE MODE FLOW CHART

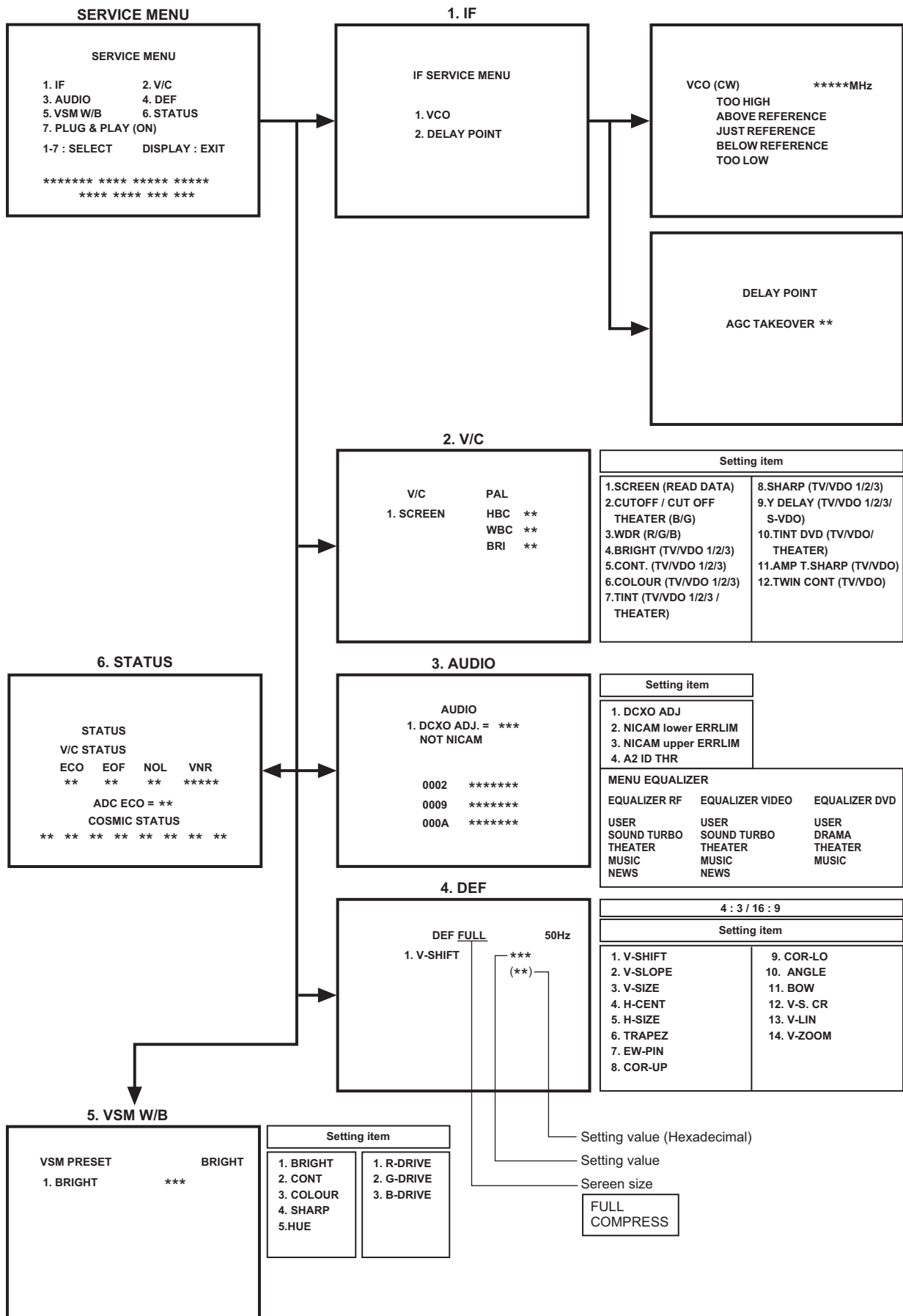

Fig.3

4.7 INITIAL SETTING VALUE OF SERVICE MODE

- (1) Adjustment of the SERVICE MODE is made on the basis of the initial setting values; however, the new setting values which set the screen in its optimum condition may differ from the initial setting value.
- (2) Do not change the initial setting values of the setting items not listed in "ADJUSTMENT PROCEDURE".
- (3) The " --- " means adjustment is not possible.
- (4) " 12.TWIN CONT " is displayed only in the models with PIP function.

[2. V/C] * is variable values for adjustment.

Adjustment item		Variable range	Initial setting value							
			PAL	SECAM	NTSC3. 58	NTSC4. 43	VIDEO 2	COMPONENT (V-2)		
								525i	625i	
1. SCREEN	BRI	0 ~ 63	32*	32*	32*	32*	---	32*	32*	
2. CUT OFF	B	0 ~ 63(-32 ~ +31)	37*	37*	37*	37*	---	-3*	-3*	
		G	18*	18*	18*	18*	---	(-5)*	(-5)*	
	CUT OFF THEATER	B	0 ~ 63(-32 ~ +31)	---	---	---	---	+6	+5	+5
		G	0 ~ 63(-32 ~ +31)	---	---	---	---	+4	+8	+8
3. WDR	R	0 ~ 63(-32 ~ +31)	32*	32*	32*	32*	---	0	0	
	G	0 ~ 63(-32 ~ +31)	32	32	32	32	---	0	0	
	B	0 ~ 63(-32 ~ +31)	45*	45*	45*	45*	---	0	0	
4. BRIGHT	RF	0 ~ 63	39*	39*	39*	39*	---	---	---	
	VIDEO-1(COMPOSITE/S)	(-32 ~ +31)	(+1)	(+1)	(+1)	(+1)	---	---	---	
	VIDEO-2(COMPONENT)	(-32 ~ +31)	(+1)	(+1)	(+1)	(+1)	---	(+2)	(+2)	
	VIDEO-3(COMPOSITE)	(-32 ~ +31)	(+2)	(+2)	(+2)	(+2)	---	---	---	
5. CONT.	RF	0 ~ 63	32*	32*	32*	32*	---	---	---	
	VIDEO	(-32 ~ +31)	(-2)	(-2)	(-2)	(-2)	---	(-2)	(-2)	
6. COLOUR	RF	0 ~ 63(-32 ~ +31)	42*	28*	30*	+1	---	---	---	
	VIDEO-1(COMPOSITE/S)	(-32 ~ +31)	+6	+3	+3	+2	---	---	---	
	VIDEO-2(COMPONENT)	(-32 ~ +31)	+6	+3	+3	+2	---	(+9)	(+5)	
	VIDEO-3(COMPOSITE)	(-32 ~ +31)	+6	+3	+3	+2	---	---	---	
7. TINT	RF	0 ~ 63(-32 ~ +31)	---	---	+27*	+2	---	---	---	
	VIDEO	(-32 ~ +31)	---	---	(+4)	(+2)	---	---	---	
	THEATER	(-32 ~ +31)	---	---	(+3)	(+0)	---	---	---	
8. SHARP	RF	0 ~ 63	28	28	28	28	---	---	---	
	VIDEO	0 ~ 63	53	53	53	53	---	15	15	
9. Y DELAY	RF	0 ~ 15	11	9	12	5	---	---	---	
	VIDEO	0 ~ 15	9	8	11	10	---	---	---	
	S-VIDEO	0 ~ 15	7	7	7	7	---	---	---	
10. TINT DVD	RF	0 ~ 63(-32 ~ +31)	37*	-7	+0	+0	---	---	---	
	VIDEO	(-32 ~ +31)	+1	-8	+0	+0	---	+5	+0	
	THEATER	(-32 ~ +31)	-2	+0	---	---	---	+3	+3	
11. AMP T.SHARP	RF VIDEO	0 ~ 63	0	0	0	0	---	0	0	
12. TWIN CONT.	TWIN (RF)	---	-15	-15	-15	-15	---	---	---	
	TWIN (VIDEO)	---	---	---	---	---	---	---	---	

[3. AUDIO] *This submenu is for display only, no adjustment is required.

Function	Item	Setting value
AUDIO	1. DC XO ADJ	12H*
	2. NICAM LOWER ERR LIM	6FH
	3. NICAM UPPER ERR LIM	B0H
	4. A2 ID THR	00H

Function	MODE	Item	100Hz	300Hz	1kHz	3kHz	8kHz
MENU EQUALIZER	RF	SOUND TURBO	+11	+8	+4	+7	+9
		THEATER	+8	+5	-7	+4	+4
		MUSIC	+10	+6	-5	+4	+10
		NEWS	-1	-1	+1	-4	-6
		USER	+0	+0	+0	+0	+0
	VIDEO	SOUND TURBO	+11	+8	+4	+7	+9
		THEATER	+8	+5	-7	+4	+4
		MUSIC	+10	+6	-5	+4	+10
		NEWS	-1	-1	+1	-4	-6
		USER	+0	+0	+0	+0	+0
	DVD	THEATER	+8	+5	-7	+4	+4
		MUSIC	+10	+6	-5	+4	+10
		DRAMA	+2	+3	+4	+1	+0
		USER	+0	+0	+0	+0	+0

[4. DEF]

Adjustment item	Variable range		Initial setting value			
			4:3		COMPRESS (16:9)	
	4:3 50Hz	Others	50Hz	60Hz	50Hz	60Hz
1. V-SHIFT	0 ~ 63	-32 ~ +31	0*	0*	0*	0*
2. V-SLOPE	0 ~ 63	-32 ~ +31	0*	0*	0*	0*
3. V-SIZE	0 ~ 63	-32 ~ +31	+30*	0*	-4*	-2*
4. H-CENT	0 ~ 63	-32 ~ +31	+35*	0*	0*	0*
5. H-SIZE	0 ~ 63	-32 ~ +31	+45*	0*	0*	0*
6. TRAPEZ	0 ~ 63	-32 ~ +31	0*	0*	0*	0*
7. EW-PIN	0 ~ 63	-32 ~ +31	-12*	0*	0*	0*
8. COR-UP	0 ~ 63	-32 ~ +31	0*	0*	0*	0*
9. COR-LO	0 ~ 63	-32 ~ +31	0*	0*	0*	0*
10. ANGLE	0 ~ 63	-32 ~ +31	0*	0*	0*	0*
11. BOW	0 ~ 63	-32 ~ +31	0*	0*	0*	0*
12. V-S.CR	0 ~ 63	-32 ~ +31	0*	0*	0*	0*
13. V-LIN	0 ~ 63	-32 ~ +31	0*	0*	0*	0*
14. V-ZOOM	0 ~ 63	-32 ~ +31	+20	(0)	-23*	+3*

NOTE: The value with an asterisk * is variable for adjustment. The values in parenthesis () are fixed values.
V-ZOOM DATA can adjust follow data range in case measurement line power on is appeared.

[5. VSM W/B]

Setting item	Variable range	Setting value			
		BRIGHT	SOFT	STANDARD	THEATER
1. BRIGHT	-16 - 16	0	0	0	-4
2. CONT.	-16 - 16	+15	+5	+10	+5
3. COLOUR	-16 - 16	0	0	-4	-8
4. SHARP	-16 - 16	0	-10	-5	0
5. HUE	-16 - 16	0	0	0	-1

Setting item	Variable range	Setting value			
		COOL	WARM	NORMAL	THEATER
1. R DRIVE	-64 - 63	0	+10	0	+9
2. G DRIVE	-64 - 63	0	-4	+2	0
3. B DRIVE	-64 - 63	0	-12	-10	-27

4.8 ADJUSTMENT PROCEDURE

4.8.1 CHECK ITEM

Item	Measuring instrument	Test point	Adjustment part	Description
B1 VOLTAGE	DC voltmeter Remote control unit	CN00X connector 1-pin:TP-B1 5-pin:TP-E [MAIN PWB]		(1) Receive any broadcast. (2) Connect a DC voltmeter to 1-pin and 5-pin of CN00X connector. (3) Make sure that the voltage is DC134.5V ±2.0V .
HIGH VOLTAGE	HV voltmeter Remote control unit	CRT anode Chassis GND		(1) Receive any broadcast. (2) Connect the earth clip of HV voltmeter to chassis GND. (3) Connect the probe of HV voltmeter to CRT anode. (4) Make sure that the voltage is DC30.5kV +1kV/-1.5kV . NOTE: <ul style="list-style-type: none"> Remove the probe before removing the earth clip.
IF VCO	Remote control unit		[1.IF] 1.VCO	<ul style="list-style-type: none"> Under normal conditions, no adjustment is required. Confirmation adjustment. <ol style="list-style-type: none"> Select 1.IF from the SERVICE MODE. Select <1.VCO> Receive any broadcast. Check the ←(Arrow) position between the ABOVE REF. and BELOW REF.
<div style="text-align: center;"> <p>Receiving frequency</p> </div>				

4.8.2 TUNER / IF CIRCUIT

Item	Measuring instrument	Test point	Adjustment part	Description
DELAY POINT (AGC)	Signal generator		[1. IF] 2. DELAY POINT (AGC TAKE-OVER)	(1) Receive a black and white signal (colour off). (2) Select 1. IF. (3) Select <2. DELAY POINT>. (4) Set the setting values of the setting items as shown below table. (5) Then adjust the [MENU - / +] keys until video noise disappears. (6) Turn to other channels and make sure that there are no irregularities.
	Remote control unit			
Setting Item		Variable range	Initial setting value	
DELAY POINT (AGC TAKE-OVER)	NTSC3.58	0 - 127	28	
	OTHER		28	

4.8.3 FOCUS

Item	Measuring instrument	Test point	Adjustment part	Description
FOCUS	Signal generator		FOCUS VR [In HVT]	(1) Receive the cross hatch signal. (2) While looking at the screen, adjust the FOCUS VR to the vertical and horizontal lines will be thinnest and sharpest. (3) Make sure that the picture is in focus even when the screen gets darkened.

4.8.4 DEFLECTION CIRCUIT

- The setting (adjustment) using the remote control unit is made on the basis of the initial setting values.
- The setting values which adjust the screen to the optimum condition can be different from the initial setting values.
- When performing deflection circuit adjustment, adjusts PAL signal (fv: 50 Hz) in 4:3 mode and 16:9 mode respectively, and adjust the NTSC signal (fv: 60 Hz) similarly.

NOTE:

Proceed to the following adjustment after having completed the adjustments of SUB BRIGHT and SUB PICTURE.

■ COMPRESS: OFF (4:3)

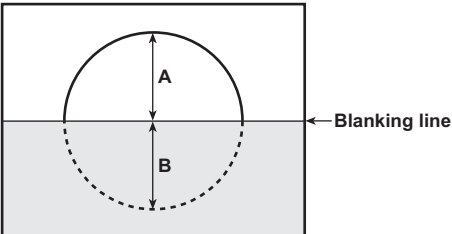
Item	Measuring instrument	Test point	Adjustment part	Description
V. SLOPE	Signal generator		[4. DEF] 2. V-SLOPE	<p>PAL V. SLOPE</p> (1) Receive a circle pattern signal of vertical frequency 50Hz (PAL). (2) Select 4. DEF from the SERVICE MODE. (3) Select <2. V-SLOPE>. (4) Set the initial setting value of <2. V-SLOPE>. (5) Adjust <2. V-SLOPE> to make "A = B". (6) Press the [OK] key to memorize the set values. <p>NTSC V. SLOPE</p> (1) Receive a circle pattern signal of vertical frequency 60Hz (NTSC). (2) Follow the same step 2 to 6 as in PAL V. SLOPE.
	Remote control unit			
				

Item	Measuring instrument	Test point	Adjustment part	Description
V. POSITION	Signal generator Remote control unit		[4. DEF] 1. V-SHIFT	<p>PAL V. POSITION</p> <ol style="list-style-type: none"> (1) Receive a circle pattern signal of vertical frequency 50Hz (PAL). (2) Select 4. DEF from the SERVICE MODE. (3) Select <1. V-SHIFT>. (4) Set the initial setting value of <1. V-SHIFT>. (5) Adjust <1. V-SHIFT> to make "A = B". (6) Press the [OK] key to memorize the set values. <p>NTSC V. POSITION</p> <ol style="list-style-type: none"> (1) Receive a circle pattern signal of vertical frequency 60Hz (NTSC). (2) Follow the same step 2 to 6 as in PAL V. POSITION.
V. SIZE	Signal generator Remote control unit		[4. DEF] 3. V-SIZE	<p>PAL V. SIZE</p> <ol style="list-style-type: none"> (1) Receive a PAL crosshatch signal. (2) Select 4. DEF from the SERVICE MODE. (3) Select <3. V-SIZE>. (4) Set the initial setting value of <3. V-SIZE>. (5) Adjust <3. V-SIZE> to make the vertical screen size to 92% of the picture size. (6) Press the [OK] key to memorize the set values. <p>NTSC V. SIZE</p> <ol style="list-style-type: none"> (1) Receive a NTSC crosshatch signal. (2) Follow the same step 2 to 6 as in PAL V. SIZE.
H. POSITION	Signal generator Remote control unit		[4. DEF] 4. H-CENT	<p>PAL H. POSITION</p> <ol style="list-style-type: none"> (1) Receive a PAL circle pattern signal. (2) Select 4. DEF from the SERVICE MODE. (3) Select <4. H-CENT>. (4) Set the initial setting value of <4. H-CENT>. (5) Adjust <4. H-CENT> to make "C = D". (6) Press the [OK] key to memorize the set values. <p>NTSC H. POSITION</p> <ol style="list-style-type: none"> (1) Receive a NTSC circle pattern signal. (2) Follow the same step 2 to 6 as in PAL H. POSITION.

Item	Measuring instrument	Test point	Adjustment part	Description
H. SIZE	Signal generator		[4.DEF] 5. H-SIZE	<p>PAL H. SIZE</p> <ol style="list-style-type: none"> (1) Receive a PAL crosshatch signal. (2) Select 4. DEF from the SERVICE MODE. (3) Select <5. H-SIZE>. (4) Set the initial setting value of <5. H-SIZE>. (5) Adjust <5. H-SIZE> to make the horizontal screen size to 91% of the picture size. (6) Press the [OK] key to memorize the set values. <p>NTSC H. SIZE</p> <ol style="list-style-type: none"> (1) Receive a NTSC crosshatch signal. (2) Follow the same step 2 to 6 as in PAL H. SIZE.
	Remote control unit			
SIDE PIN	Signal generator		[4. DEF] 7. EW-PIN	<p>PAL SIDE PIN</p> <ol style="list-style-type: none"> (1) Receive a PAL crosshatch signal. (2) Select 4. DEF from the SERVICE MODE. (3) Select <7. EW-PIN>. (4) Set the initial setting value of <7. EW-PIN>. (5) Adjust <7. EW-PIN> so that the first vertical lines at the left and right edges on the screen are straight. (6) Press the [OK] key to memorize the set values. <p>NTSC SIDE PIN</p> <ol style="list-style-type: none"> (1) Receive a NTSC crosshatch signal. (2) Follow the same step 2 to 6 as in PAL SIDE PIN.
	Remote control unit			
TRAPEZIUM	Signal generator		[4.DEF] 6. TRAPEZ	<p>PAL TRAPEZIUM</p> <ol style="list-style-type: none"> (1) Receive a PAL crosshatch signal. (2) Select 4. DEF from the SERVICE MODE. (3) Select <6. TRAPEZ>. (4) Set the initial setting value of 6. TRAPEZ. (5) Adjust <6. TRAPEZ> so that the vertical lines at the left and right edges on the screen are in parallel. (6) Press the [OK] key to memorize the set values. <p>NTSC TRAPEZIUM</p> <ol style="list-style-type: none"> (1) Receive a NTSC crosshatch signal. (2) Follow the same step 2 to 6 as in PAL TRAPEZIUM.
	Remote control unit			

Item	Measuring instrument	Test point	Adjustment part	Description
V.LINEARITY	Signal generator Remote control unit		[4. DEF] 12. V-S. CR 13. V-LIN	<p>PAL V. LINEARITY</p> <ol style="list-style-type: none"> (1) Receive a PAL crosshatch signal. (2) Select 4. DEF from the SERVICE MODE. (3) Select <12. V-S.CR>. (4) Set the initial setting value of <12. V-S. CR>. (5) Select <13. V-LIN>. (6) Set the initial setting value of <13. V-LIN>. (7) Adjust <12. V-S. CR> and <13. V-LIN> so that the spaces of each line on TOP, CENTRE and BOTTOM become uniform. (8) Press the [OK] key to memorize the set values. <p>NTSC V. LINEARITY</p> <ol style="list-style-type: none"> (1) Receive a NTSC crosshatch signal. (2) Follow the same step 2 to 8 as in PAL V-S. CR.
CORNER PIN	Signal generator Remote control unit		[4. DEF] 8. COR-UP 9. COR-LO	<p>PAL CORNER PIN</p> <ol style="list-style-type: none"> (1) Receive a PAL crosshatch signal. (2) Select 4. DEF from the SERVICE MODE. (3) Select <8. COR-UP>. (4) Set the initial setting value of <8. COR-UP>. (5) Select <9. COR-LO>. (6) Set the initial setting value of <9. COR-LO>. (7) Adjust <8. COR-UP> and <9. COR-LO> so that the vertical lines at the four corners on the screen are straight. (8) Press the [OK] key to memorize the set values. <p>NTSC CORNER PIN</p> <ol style="list-style-type: none"> (1) Receive a NTSC crosshatch signal. (2) Follow the same step 2 to 8 as in PAL CORNER.
H. PARALLEL	Signal generator Remote control unit		[4. DEF] 10. ANGLE	<p>PAL H. PARALLEL</p> <ol style="list-style-type: none"> (1) Receive a PAL crosshatch signal. (2) Select 4. DEF from the SERVICE MODE. (3) Select <10. ANGLE>. (4) Set the initial setting value of <10. ANGLE>. (5) Adjust <10. ANGLE> to optimize the trapezium distortion at the centre of the screen. (6) Press the [OK] key to memorize the set values. <p>NTSC H. PARALLEL</p> <ol style="list-style-type: none"> (1) Receive a NTSC crosshatch signal. (2) Follow the same step 2 to 6 as in PAL H. PARALLEL.

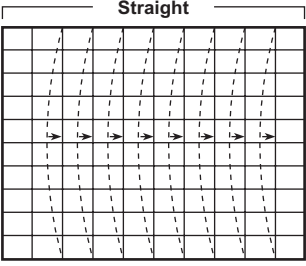
Item	Measuring instrument	Test point	Adjustment part	Description
H. BOW	Signal generator Remote control unit		[4.DEF] 11. BOW	<p>PAL H. BOW</p> <ol style="list-style-type: none"> Receive a PAL crosshatch signal. Select 4. DEF from the SERVICE MODE. Select <11. BOW>. Set the initial setting value of <11. BOW>. Adjust <11. BOW> to optimize the horizontal arc distortion. Press the [OK] key to memorize the set values. <p>NTSC H. BOW</p> <ol style="list-style-type: none"> Receive a NTSC crosshatch signal. Follow the same step 2 to 6 as in PAL H. BOW.
				

■ COMPRESS : ON (16:9)

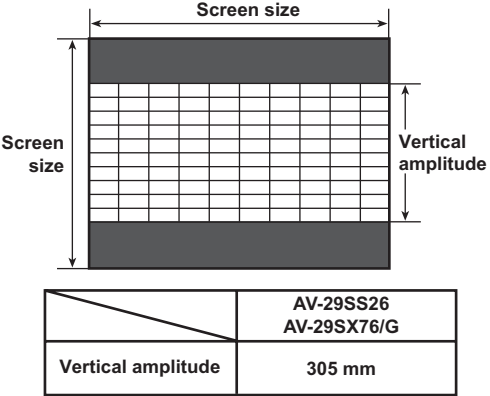
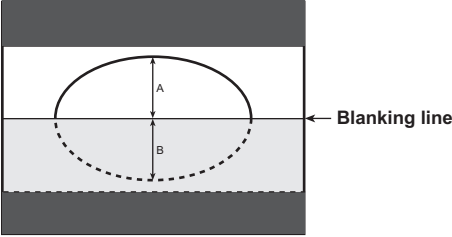
Item	Measuring instrument	Test point	Adjustment part	Description				
V. SIZE	Signal generator Remote control unit		[4.DEF] 14. V. ZOOM 3. V-SIZE	<p>PAL V. SIZE</p> <ol style="list-style-type: none"> Receive a circle pattern signal of vertical frequency 50Hz (PAL). Set the COMPRESS(16 : 9) to ON. Select 4. DEF from the SERVICE MODE. Set the initial setting value of <14. V. ZOOM>. Select <3. V-SIZE>. Set the initial setting value of <3. V-SIZE>. Adjust <3. V-SIZE> to set the vertical amplitude of the image to the value shown in the left hand side list. Press the [OK] key to memorize the set values. <p>NTSC V. SIZE</p> <ol style="list-style-type: none"> Receive a crosshatch signal of vertical frequency 60Hz (NTSC). Follow the same step 2 to 8 as in PAL V. SIZE. 				
 <table border="1" data-bbox="266 1262 678 1367"> <tr> <td></td> <td>AV-29SS26 AV-29SX76/G</td> </tr> <tr> <td>Vertical amplitude</td> <td>305 mm</td> </tr> </table>					AV-29SS26 AV-29SX76/G	Vertical amplitude	305 mm	
	AV-29SS26 AV-29SX76/G							
Vertical amplitude	305 mm							
V. SLOPE	Signal generator Remote control unit		[4.DEF] 2. V-SLOPE	<p>PAL V. SLOPE</p> <ol style="list-style-type: none"> Receive a circle pattern signal of vertical frequency 50Hz (PAL). Set the COMPRESS(16 : 9) to ON. Select 4. DEF from the SERVICE MODE. Select <2. V-SLOPE>. Set the initial setting value of <2. V-SLOPE>. Adjust <2. V-SLOPE> to make "A = B". Press the [OK] key to memorize the set values. <p>NTSC V. SLOPE</p> <ol style="list-style-type: none"> Receive a circle pattern signal of vertical frequency 60Hz (NTSC). Follow the same step 2 to 7 as in PAL V-SLOPE. 				
								

Item	Measuring instrument	Test point	Adjustment part	Description
SIDE PIN	Signal generator		[4. DEF] 7. EW-PIN	<p>PAL SIDE PIN</p> <ol style="list-style-type: none"> (1) Receive a PAL crosshatch signal. (2) Set the COMPRESS(16 : 9) to ON. (3) Select 4. DEF from the SERVICE MODE. (4) Select <7. EW-PIN>. (5) Set the initial setting value of <7. EW-PIN>. (6) Adjust <7. EW-PIN> so that the first vertical lines at the left and right edges on the screen are straight. (7) Press the [OK] key to memorize the set values. <p>NTSC SIDE PIN</p> <ol style="list-style-type: none"> (1) Receive a NTSC crosshatch signal. (2) Follow the same step 2 to 7 as in PAL SIDE PIN.
	Remote control unit			
TRAPEZIUM	Signal generator		[4. DEF] 6. TRAPEZ	<p>PAL TRAPEZIUM PIN</p> <ol style="list-style-type: none"> (1) Receive a PAL crosshatch signal. (2) Set the COMPRESS(16 : 9) to ON. (3) Select 4. DEF from the SERVICE MODE. (4) Select <6. TRAPEZ>. (5) Set the initial setting value of <6. TRAPEZ>. (6) Adjust <6. TRAPEZ> so that the vertical lines at the left and right edges on the screen are in parallel. (7) Press the [OK] key to memorize the set values. <p>NTSC TRAPEZIUM PIN</p> <ol style="list-style-type: none"> (1) Receive a NTSC crosshatch signal. (2) Follow the same step 2 to 7 as in PAL TRAPEZIUM.
	Remote control unit			
CORNER PIN	Signal generator		[4. DEF] 8. COR-UP 9. COR-LO	<p>PAL CORNER PIN</p> <ol style="list-style-type: none"> (1) Receive a PAL crosshatch signal. (2) Set the COMPRESS(16 : 9) to ON. (3) Select 4. DEF from the SERVICE MODE. (4) Select <8. COR-UP>. (5) Set the initial setting value of <8. COR-UP>. (6) Select <9. COR-LO>. (7) Set the initial setting value of <9. COR-LO>. (8) Adjust <8. COR-UP> and <9. COR-LO> so that the vertical lines at the four corners on the screen are straight. (9) Press the [OK] key to memorize the set values. <p>NTSC CORNER PIN</p> <ol style="list-style-type: none"> (1) Receive a NTSC crosshatch signal. (2) Follow the same step 2 to 9 as in PAL CORNER PIN.
	Remote control unit			

■ VIDEO - 2 SET: COMPONENT

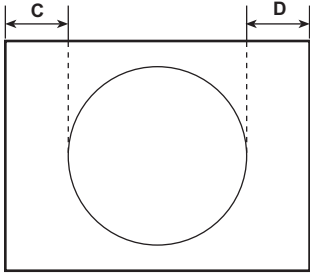
Item	Measuring instrument	Test point	Adjustment part	Description
H. POSITION	Signal generator Remote control unit		[4. DEF] 4. H-CENT	(1) Receive a PAL circle pattern signal to VIDEO-2 component terminal. (2) Select VIDEO-2 SET from the MENU and set VIDEO-2 SET to COMPONENT. (3) Select 4. DEF from the SERVICE MODE. (4) Select <4. H-CENT> . (5) Set the initial setting value of <4. H-CENT> . (6) Adjust <4. H-CENT> to make "C=D". (7) Press the [OK] key to memorize the set values.
				

4.8.5 VIDEO CIRCUIT

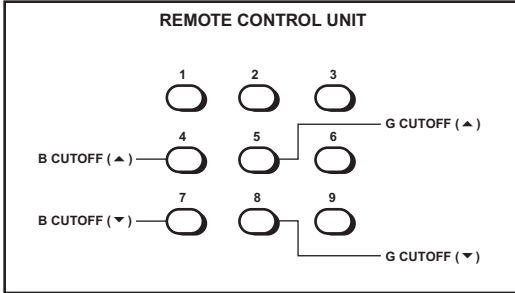
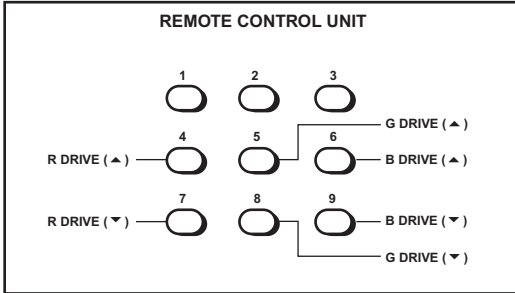
Item	Measuring instrument	Test point	Adjustment part	Description
WHITE BALANCE (Low light)	Signal generator Remote control unit		[2. V/C] 2. CUTOFF (B) 2. CUTOFF (G) SCREEN VR [In HVT]	COMPOSITE WHITE BALANCE (1) Receive a PAL black and white signal (colour off). (2) Set the PICTURE MODE to BRIGHT . (3) Select 2. V/C from the SERVICE MODE. (4) Select <2. CUTOFF> (B) and (G). (5) Set each value to initial setting value with the [4] / [7] keys and [5] / [8] keys. (6) Turn the SCREEN VR fully counterclockwise, then slowly turn it clockwise to where a red, blue or green colour is faintly visible. (7) Use the [4] / [7] and [5] / [8] keys to adjust so that the other 2 colours appear white. (8) Turn the SCREEN VR to where the single horizontal line glows faintly. (9) Press the [OK] key to memorize the set values. COMPONENT WHITE BALANCE (1) Receive a PAL component black and white signal (colour off). (2) Select VIDEO-2 SET from the MENU and set VIDEO-2 SET to COMPONENT. (3) Adjust COMPONENT WHITE BALANCE in the same way as "COMPOSITE WHITE BALANCE".
				
WHITE BALANCE (High light)	Signal generator Remote control unit		[2. V/C] 3. WDR (R) 3. WDR (G) 3. WDR (B)	(1) Receive a PAL black and white signal (colour off). (2) Set the PICTURE MODE to BRIGHT . (3) Select 2. V/C from the SERVICE MODE. (4) Select <3. WDR> (R), (G) and (B). (5) Set each value to initial setting value with the [4] to [9] keys. (6) Use the [4] to [9] keys to produce a white screen. (7) Press the [OK] key to memorize the set values.
				

Item	Measuring instrument	Test point	Adjustment part	Description
SUB BRIGHT	Remote control unit		[2. V/C] 4. BRIGHT	(1) Receive a NTSC broadcast. (2) Set the PICTURE MODE to BRIGHT . (3) Select 2. V/C from the SERVICE MODE. (4) Select <4. BRIGHT> . (5) Set the initial setting value of <4. BRIGHT> . (6) If the brightness is not best with the initial setting value, make fine adjustment until you get the best brightness. (7) Press the [OK] key to memorize the set values.
SUB CONTRAST	Remote control unit		[2. V/C] 5. CONT	(1) Receive a NTSC broadcast. (2) Set the PICTURE MODE to BRIGHT . (3) Select 2. V/C from the SERVICE MODE. (4) Select <5. CONT> . (5) Set the initial setting value of <5. CONT> . (6) If the contrast is not best with the initial setting value, make fine adjustment until you get the best contrast. (7) Press the [OK] key to memorize the set values.
SUB COLOUR	Remote control unit		[2. V/C] 6. COLOUR	[Method of adjustment without measuring instrument] PAL COLOUR (1) Receive a PAL M broadcast. (2) Set the PICTURE MODE to BRIGHT . (3) Select 2. V/C from the SERVICE MODE. (4) Select <6. COLOUR> . (5) Set the initial setting value of <6. COLOUR> . (6) If the colour is not the best with the initial set value, make fine adjustment until you get the best colour. (7) Press the [OK] key to memorize the set values. SECAM COLOUR (1) Receive a SECAM broadcast. (2) Follow the same step 2 to 7 as in PAL COLOUR. NTSC 3.58 COLOUR (1) Receive a NTSC 3.58MHz broadcast. (2) Follow the same step 2 to 7 as in PAL COLOUR. NTSC 4.43 COLOUR • When NTSC 3.58 COLOUR is set, NTSC 4.43 COLOUR will be automatically set.
	Signal generator Oscilloscope Remote control unit	TP-47B TP-E [CRT SOCKET PWB]	[2. V/C] 6. COLOUR	[Method of adjustment using measuring instrument] PAL COLOUR (1) Receive a PAL M colour bar signal (full field colour bar 75% white). (2) Connect the oscilloscope between TP-47B and TP-E. (3) Set the PICTURE MODE to BRIGHT . (4) Select 2. V/C from the SERVICE MODE. (5) Select <6. COLOUR> . (6) Set the initial setting value of <6. COLOUR> . (7) Adjust the value of (A) to the value in the voltage table in the left. (8) Press the [OK] key to memorize the set values. SECAM COLOUR (1) Receive a SECAM colour bar signal (full field colour bar 75% white) (2) Follow the same step 2 to 8 as in PAL COLOUR. NTSC 3.58 COLOUR (1) Receive a NTSC 3.58MHz broadcast. (2) Follow the same step 2 to 8 as in PAL COLOUR. NTSC 4.43 COLOUR • When NTSC 3.58 COLOUR is set, NTSC 4.43 COLOUR will be automatically set.

VOLTAGE (W-B)	Voltage setting		
	PAL	NTSC	SECAM
AV-29SS26	38V	26V	6V
AV-29SX76/G	38V	26V	6V

Item	Measuring instrument	Test point	Adjustment part	Description
SUB TINT	Remote control unit		[2. V/C] 7. TINT	<p>[Method of adjustment without measuring instrument]</p> <p>PAL TINT</p> <ol style="list-style-type: none"> Receive a PAL broadcast. Set the PICTURE MODE to BRIGHT. Select 2. V/C from the SERVICE MODE. Select <7. TINT>. Set the initial setting value of <7. TINT>. If you cannot get the best HUE with the initial setting value, make fine adjustment until you get the best TINT. Press the [OK] key to memorize the best values. <p>NTSC 3.58 TINT</p> <ol style="list-style-type: none"> Receive a NTSC 3.58 broadcast. Follow the same step 2 to 8 as in PAL TINT. <p>NTSC 4.43 TINT</p> <ul style="list-style-type: none"> When NTSC 3.58 TINT is set, NTSC 4.43 TINT will be automatically set. <p>PAL TINT (DVD)</p> <ol style="list-style-type: none"> Receive a PAL broadcast. Set the PICTURE MODE to BRIGHT. Select 2. V/C from the SERVICE MODE. Select <10. TINT DVD>. Set the initial setting value of <10. TINT DVD>. If you cannot get the best HUE with the initial setting value, make fine adjustment until you get the best TINT. Press the [OK] key to memorize the best values.
	Signal generator Oscilloscope Remote control unit	TP-47B TP-E [CRT SOCKET PWB]	[2. V/C] 7. TINT	<p>[Method of adjustment using measuring instrument]</p> <p>PAL TINT</p> <ol style="list-style-type: none"> Receive a PAL colour bar signal (full field colour bar 75% white). Connect the oscilloscope to TP-47B and TP-E. Set the PICTURE MODE to BRIGHT. Select 2. V/C from the SERVICE MODE. Select <7. TINT>. Set the initial setting value of <7. TINT>. If you cannot get the best HUE with the initial setting value, make fine adjustment until you get the best TINT. Press the [OK] key to memorize the best values. <p>NTSC 3.58 TINT</p> <ol style="list-style-type: none"> Receive a NTSC 3.58 colour bar signal (full field colour bar 75% white). Follow the same step 2 to 8 as in PAL TINT. <p>NTSC 4.43 TINT</p> <ul style="list-style-type: none"> When NTSC 3.58 TINT is set, NTSC 4.43 TINT will be automatically set. <p>PAL TINT (DVD)</p> <ol style="list-style-type: none"> Receive a PAL colour bar signal (full field colour bar 75% white). Connect the oscilloscope to TP-47B and TP-E. Set the PICTURE MODE to BRIGHT. Select 2. V/C from the SERVICE MODE. Select <10. TINT DVD>. Set the initial setting value of <10. TINT>. If you cannot get the best HUE with the initial setting value, make fine adjustment until you get the best TINT. Press the [OK] key to memorize the best values.

VOLTAGE (W-B)	Voltage setting	
	NTSC 3.58 (TINT)	PAL TINT (DVD)
AV-29SS26	+14V	+27V
AV-29SX76/G	+14V	+27V

4.8.6 VSM PRESET SETTING

Item	Measuring instrument	Test point	Adjustment part	Description																																																												
VSM PRESET	Remote control unit		[5.VSM W/B] 1. BRIGHT 2. CONT 3. COLOUR 4. SHARP 5. HUE 1. R-DRIVE 2. G-DRIVE 3. B-DRIVE	(1) Select 5.VSM W/B from the SERVICE MODE. (2) Select the BRIGHT with the [OK] key. (3) Adjust the [MENU ◀ / ▶] key to bring the set values of <1. BRIGHT> - <5. HUE> to the values shown in the table. (4) Press the [OK] key to memorize the set values. (5) Respectively select the VSM PRESET mode for STANDARD, SOFT and THEATER . (6) Select COOL with the [OK] key. (7) Adjust the [MENU ◀ / ▶] key to bring the set values of <1. R DRIVE> to <3. B DRIVE> to the values shown in the table. (8) Press the [OK] key to memorize the set values. (9) Respectively select the WWHITE BALANCE mode for WARM and NORMAL .																																																												
					<table border="1"> <thead> <tr> <th rowspan="2">Setting item</th> <th rowspan="2">Variable range</th> <th colspan="4">Setting value</th> </tr> <tr> <th>BRIGHT</th> <th>SOFT</th> <th>STANDARD</th> <th>THEATER</th> </tr> </thead> <tbody> <tr> <td>1. BRIGHT</td> <td>-16 - 16</td> <td>0</td> <td>0</td> <td>0</td> <td>-4</td> </tr> <tr> <td>2. CONT.</td> <td>-16 - 16</td> <td>+15</td> <td>+5</td> <td>+10</td> <td>+5</td> </tr> <tr> <td>3. COLOUR</td> <td>-16 - 16</td> <td>0</td> <td>+0</td> <td>-4</td> <td>-8</td> </tr> <tr> <td>4. SHARP</td> <td>-16 - 16</td> <td>0</td> <td>-10</td> <td>-5</td> <td>0</td> </tr> <tr> <td>5. HUE</td> <td>-16 - 16</td> <td>0</td> <td>0</td> <td>0</td> <td>-1</td> </tr> </tbody> </table> <table border="1"> <thead> <tr> <th rowspan="2">Setting item</th> <th colspan="4">W/B preset</th> </tr> <tr> <th>COOL</th> <th>NORMAL</th> <th>WARM</th> <th>THEATER</th> </tr> </thead> <tbody> <tr> <td>1. RDRIVE</td> <td>0</td> <td>0</td> <td>+10</td> <td>+9</td> </tr> <tr> <td>2. G DRIVE</td> <td>0</td> <td>+2</td> <td>-4</td> <td>0</td> </tr> <tr> <td>3. B DRIVE</td> <td>0</td> <td>-10</td> <td>-12</td> <td>-27</td> </tr> </tbody> </table>	Setting item	Variable range	Setting value				BRIGHT	SOFT	STANDARD	THEATER	1. BRIGHT	-16 - 16	0	0	0	-4	2. CONT.	-16 - 16	+15	+5	+10	+5	3. COLOUR	-16 - 16	0	+0	-4	-8	4. SHARP	-16 - 16	0	-10	-5	0	5. HUE	-16 - 16	0	0	0	-1	Setting item	W/B preset				COOL	NORMAL	WARM	THEATER	1. RDRIVE	0	0	+10	+9	2. G DRIVE	0	+2	-4	0
Setting item	Variable range	Setting value																																																														
		BRIGHT	SOFT	STANDARD	THEATER																																																											
1. BRIGHT	-16 - 16	0	0	0	-4																																																											
2. CONT.	-16 - 16	+15	+5	+10	+5																																																											
3. COLOUR	-16 - 16	0	+0	-4	-8																																																											
4. SHARP	-16 - 16	0	-10	-5	0																																																											
5. HUE	-16 - 16	0	0	0	-1																																																											
Setting item	W/B preset																																																															
	COOL	NORMAL	WARM	THEATER																																																												
1. RDRIVE	0	0	+10	+9																																																												
2. G DRIVE	0	+2	-4	0																																																												
3. B DRIVE	0	-10	-12	-27																																																												

4.8.7 PURITY AND CONVERGENCE

■ PURITY ADJUSTMENT

NOTE:

The final adjustment of CONVERGENCE must be done after the FOCUS adjustment. (CONVERGENCE is changed by FOCUS adjustment.)
When makes difference by FOCUS adjustment, should be reconfirming PURITY adjustment.

- (1) Demagnetize CRT with the demagnetizer.
- (2) Loosen the retainer screw of the deflection yoke.
- (3) Remove the wedges.
- (4) Input a green raster signal from the signal generator, and turn the screen to green raster.
- (5) Move the deflection yoke backward.
- (6) Bring the long lug of the purity magnets on the short lug and position them horizontally. (Fig.2)
- (7) Adjust the gap between two lugs so that the GREEN RASTER will come into the centre of the screen. (Fig.3)
- (8) Move the deflection yoke forward, and fix the position of the deflection yoke so that the whole screen will become green.
- (9) Insert the wedge to the top side of the deflection yoke so that it will not move.
- (10) Input a crosshatch signal.
- (11) Verify that the screen is horizontal.
- (12) Input red and blue raster signals, and make sure that purity is properly adjusted.

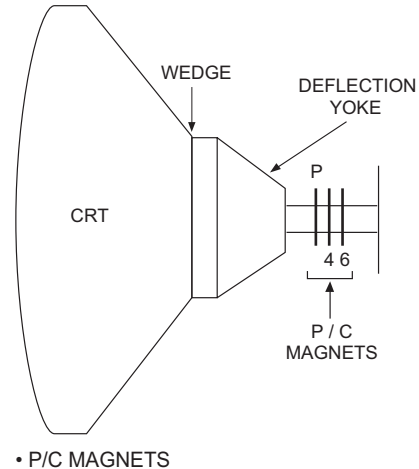

- P/C MAGNETS
- P : PURITY MAGNET
- 4 : 4 POLES (convergence magnets)
- 6 : 6 POLES (convergence magnets)

Fig.1

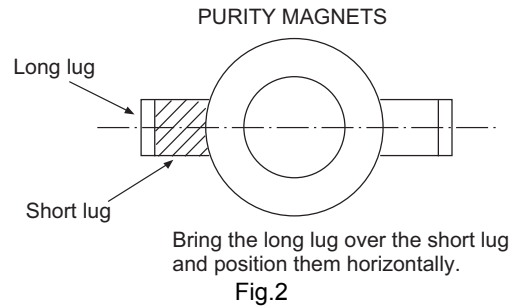
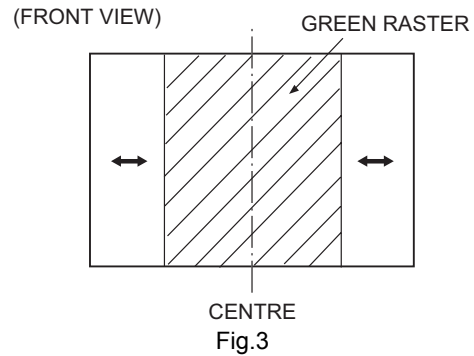
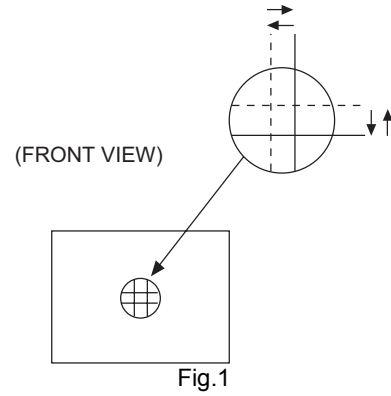

Fig.2



■ STATIC CONVERGENCE ADJUSTMENT

- (1) Input a crosshatch signal.
- (2) Using 4-pole convergence magnets, overlap the red and blue lines in the centre of the screen (Fig.1) and turn them to magenta (red/blue).
- (3) Using 6-pole convergence magnets, overlap the magenta (red/blue) and green lines in the centre of the screen and turn them to white.
- (4) Repeat 2 and 3 above, and make best convergence.



■ DYNAMIC CONVERGENCE ADJUSTMENT

- (1) Move the deflection yoke up and down and overlap the lines in the periphery. (Fig. 2)
 - (2) Move the deflection yoke left to right and overlap the lines in the periphery. (Fig. 3)
 - (3) Repeat 1 and 2 above, and make best convergence.
 - (4) Adjust XV by XV coil. (Fig.4)
- After adjustment, fix the wedge at the original position. Fasten the retainer screw of the deflection yoke. Fix the P/C magnets with glue.

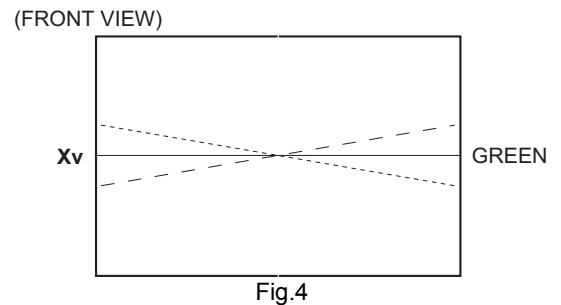
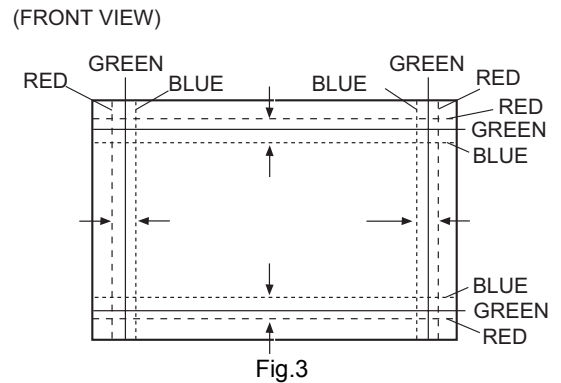
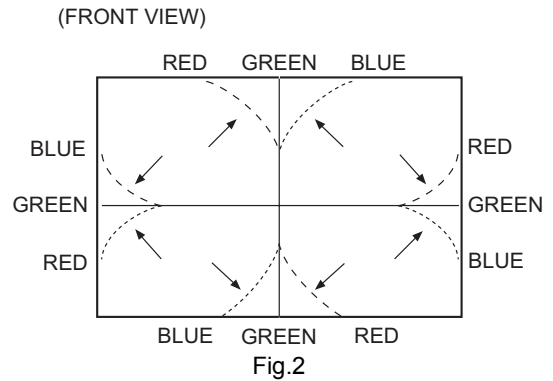

SECTION 5 TROUBLESHOOTING

5.1 SELF CHECK FUNCTIONS

5.1.1 OUTLINE

This model has self check functions given below. When an abnormality has been detected, the SUB POWER is turned off and POWER LED flashes to inform of the failure. An abnormality is detected by the signal input state of the control line connected to the microcomputer.

5.1.2 SELF CHECK ITEMS

Check item	Details of detection	Method of detection	State of abnormality
B1 over-current protection	An over-current on the low B1 line is detected.	The main microcomputer detects the possible abnormality at 24-msec. intervals and judges the results in every 16 time. Of the 16 times, if NG is detected more than 9 times, it is judged that there is an abnormality.	When an abnormality has been detected, the SUB-POWER is turned off. While the SUB-POWER is being turned off, the POWER key on the remote control unit is not operational until the power cord is disconnected and connected again.
CRT neck broken protection	Operation of CRT neck protection circuit.		

5.1.3 SELF CHECK INDICATING FUNCTION

When an abnormality has been detected at about 5 seconds after the power was turned on, the SUB POWER is turned off immediately and the POWER LED flashes.

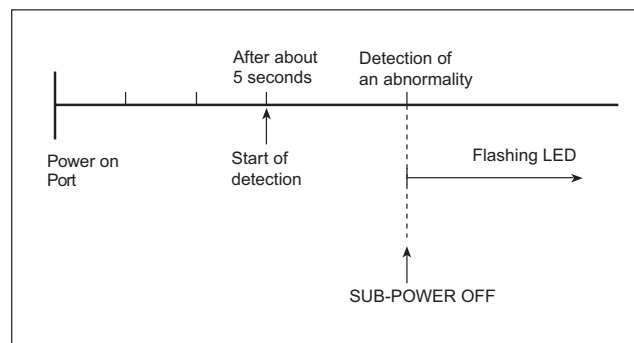

[INDICATION BY THE POWER LED]

Item	LED flashing intervals
B1 over-current protection / CRT neck broken protection	0.3 seconds



JVC

Victor Company of Japan, Limited
Display Category 12, 3-chome, Moriya-cho, Kanagawa-ku, Yokohama-city, Kanagawa-prefecture, 221-8528, Japan

(No.YA449)



COLOUR TELEVISION

AV-29BS26

AV-29BX16

AV-29MS26

AV-29MX16

AV-29MX56

AV-29MX76

AV-29SS26

AV-29SX56

AV-29SX76

AV-25MS26

AV-25MX16

AV-25MX56

AV-25MX76

AV-21BS26

AV-21BX16

AV-21BX16B

AV-21MS26

AV-21MX16

AV-21MX56

AV-21MX76

EQUALIZER • CINEMA SURROUND • COMPONENT INPUT

Contents

Knowing your TV's features	3
Remote control buttons and basic functions	4
TV buttons and functions.....	6
Setting up your TV.....	7
Basic setting for picture	9
Advanced setting for picture.....	11
Original features for picture	12
Basic setting for sound	14
Advanced setting for sound.....	15
DVD Menu	16
Customized setting	17
TV channel presetting	19
Additional preparation	22
Troubleshooting.....	23
Specifications	Back cover

INSTRUCTIONS

Thank you for buying this JVC colour television.
To make sure you understand how to use your new TV, please read this manual thoroughly before you begin.

WARNING: TO PREVENT FIRE OR SHOCK HAZARD, DO NOT EXPOSE THIS APPLIANCE TO RAIN OR MOISTURE.

CAUTION: TO ENSURE PERSONAL SAFETY, OBSERVE THE FOLLOWING RULES REGARDING THE USE OF THIS TV.

- 1 Operate only from the power source indicated on the rear of the TV.
- 2 Avoid damaging the power cord and mains plug. When unplugging the TV, grasp the mains plug. Do not pull on the power cord.
- 3 Never block or cover the ventilation openings.
Never install the TV where good ventilation is unattainable.
When installing this TV, leave spaces for ventilation around the TV of more than the minimum distances as shown.

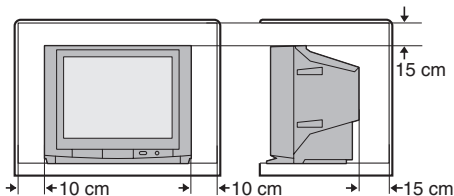

- 4 Do not allow objects or liquid into the cabinet openings.
- 5 In the event of a fault, unplug the unit and call a service technician.
Do not attempt to repair it yourself or remove the rear cover.
- 6 The surface of the TV screen is easily damaged. Be very careful with it when handling the TV. Should the TV screen become soiled, wipe it with a soft dry cloth. Never rub it forcefully. Never use any cleaner or detergent on it.

- 7 This TV can be turned on/off power by connecting/disconnecting the AC plug into AC outlet. While this TV is being installed, enough space should be reserved for connection/disconnecting the AC plug into AC outlet by hand.
- 8 The apparatus shall not be exposed to dripping or splashing and that no objects filled with liquids, such as vases, shall be placed on the apparatus.

**WARNING: <AV-21M, AV-25M, AV-29M, AV-21B, AV-29B Series>
YOU CAN DETACH THE PROTECT SHEET ON THE TOP AND BOTTOM OF FRONT FRAME IF YOU NEEDED.
THE FRONT BUTTON DOOR OF THE TV SHOULD BE PULLED OUT FROM ITS BOTTOM. DO NOT PRESS THE UPPER PART, OR YOUR FINGER MAY BE PINCHED.**

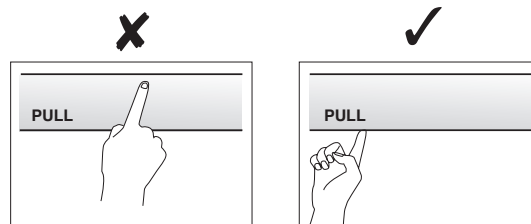

Knowing your TV's features

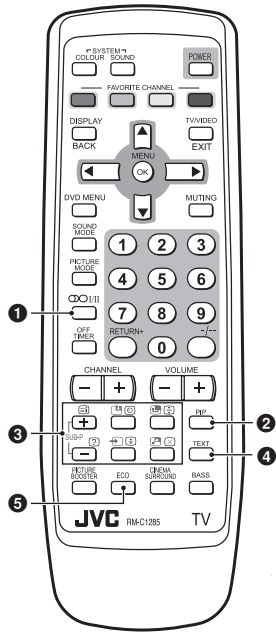

Main features

DVD MENU	Just connect DVD player to the television. The television will detect DVD signal and display picture on the screen automatically and you can adjust pictures and sound while you are watching DVD as your desire. When disconnect DVD player, the television will display the previous channel.
MaxxBass	MaxxBass enhances bass sound that cannot be reproduced by normal speakers to be heard by our ears.
PIP (Picture In Picture)	You can view two screens (Main picture and Sub picture) at the same time.
TELETEXT	You can view teletext programmes which are broadcasted by some TV channels. Teletext programme is an information in text form.
FAVORITE CH (Channel)	You can register up to four favorite channels for quick recall with one press.
A2/NICAM (STEREO / I-II)	You can listen the stereo sound or bilingual sound from TV programme broadcasting by A2 or NICAM Sound-multiplex system.
AI ECO SENSOR	TV detects the brightness of your room and automatically adjust the picture brightness to a suitable level for a better eyecare.
ECO MODE	You can adjust TV screen contrast according to the brightness of your room to suitable level for a better eyecare.
AI VOLUME	TV adjusts the volume automatically to the same level for all TV channels to avoid sudden change of the volume when selecting different TV channels or selecting Video Mode.
TINT	You can adjust TINT setting for all colour systems, including PAL.

Confirm your TV's functions

Some functions written in this instruction manual may not be available for your TV.

Please see the chart below and check the functions that are equipped for your TV's model number.

The model number is indicated at the rear of your TV. When you press a button concerned to a function that is not available for your TV, it does not work and the logo "Ø" appears on the screen.

NO.	Function	Model No.																				
		AV-29BS26	AV-29BX16	AV-29MX16	AV-29MS26	AV-29SS26	AV-29MX56	AV-29SX56	AV-29MX76	AV-29SX76	AV-25MS26	AV-25MX16	AV-25MX56	AV-25MX76	AV-21BS26	AV-21BX16	AV-21BX16B	AV-21MS26	AV-21MX16	AV-21MX56	AV-21MX76	
1	OO I/II (STEREO/I-II)	Ø	—	—	Ø	—	—	—	Ø	—	Ø	—	—	Ø	—	—	—	Ø	—	—	—	—
2 3	PIP control buttons (Green label)	—	—	—	—	—	—	—	Ø	Ø	—	—	Ø	Ø	—	—	—	—	—	—	Ø	Ø
4 3	TELETEXT control buttons (Black label)	Ø	—	—	Ø	—	—	—	Ø	Ø	—	—	Ø	Ø	—	—	—	—	—	—	—	Ø
—	PICTURE TILT	Ø	Ø	Ø	Ø	Ø	Ø	Ø	Ø	—	—	—	—	—	—	—	—	—	—	—	—	—
—	MaxxBass	—	—	Ø	Ø	Ø	Ø	Ø	Ø	Ø	Ø	Ø	Ø	—	—	—	—	Ø	Ø	Ø	Ø	Ø
5	AI ECO SENSOR	—	—	Ø	Ø	Ø	Ø	Ø	Ø	Ø	Ø	Ø	Ø	—	—	—	—	Ø	Ø	Ø	Ø	Ø
5	ECO MODE	Ø	Ø	—	—	—	—	—	—	—	—	—	—	Ø	Ø	—	—	—	—	—	—	—

Remote control buttons and basic functions

No.	Press	To
①	POWER	Turn on or off the TV from standby mode.
②	MENU/OK	Display menu and confirm selected function.
③	▲ / ▼ / ◀ / ▶	Select and adjust menu function.
④	CHANNEL +/-	Select the desired channel number.
⑤	VOLUME +/-	Adjust the volume level.
⑥	TV/VIDEO EXIT	Select TV or video terminal input. On the other hand, you can use this button to EXIT from the menu.
⑦	MUTING	Turn off the volume. Press this button again to resume the volume.
⑧	DISPLAY /BACK	Display the programme number or video terminal number, stereo/bilingual broadcast system and PR list (channel list) on the screen. You can select the channel using the PR list. 1 Press the DISPLAY button once to display the PR list. 2 Press ▲ / ▼ / ◀ / ▶ buttons to choose a channel, then press the MENU/OK button. You can confirm the favorite channels in the PR list. The channels set to favorite channels are indicated with coloured mark. On the other hand, you can use this button to return to the previous menu.
⑨	0~9, -/--	Select the programme number. For two digits programme number, press -/--, then press the number button.
⑩	RETURN+	a) Return to the frequently view channel with one touch. 1 Choose the channel you want to register. 2 Press and hold RETURN+ button until "RETURN PLUS PROGRAMMED!" appears. To cancel, press and hold RETURN+ button until "RETURN PLUS CANCELED!" appears. b) Return to the previously viewed channel, if you have not set or have cancelled the Return channel as above.
⑪	FAVORITE CHANNEL (colour buttons: red, green, yellow, blue)	Register and recall 4 favorite channels. 1. Choose the TV channel you want to register then press and hold a colour button until "PROGRAMMED! ■" appears. 2. To register other favorite channels, repeat step 1. To recall the favorite channel, press the corresponding colour button. When the TV is in Text function or MENU mode, the favorite channel function is not available. When the TV is in PIP function, the favorite channel function cannot register but can recall the favorite channel.

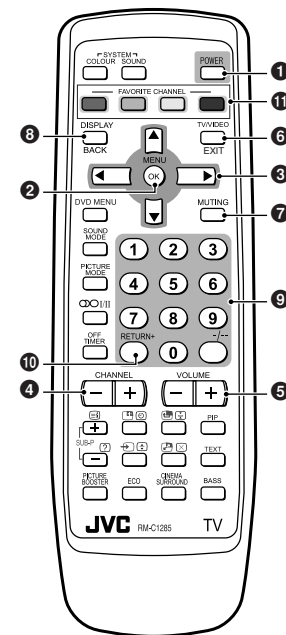

Remote control buttons and basic functions (continued)

How to operate menus and menus locations

To	Operation	Note
Display the MENU	Press the MENU/OK button ②. PICTURE MENU is displayed on first press.	To exit the MENU, press the DISPLAY/BACK button ③ or choose EXIT menu or TV/VIDEO/EXIT button ⑥.
Choose a Top menu	Press ◀/▶ buttons ③ to choose a menu title when the cursor is pointing at MENU.	—
Choose a 2nd menu	Press ▲/▼ buttons ③ to choose a 2nd menu title.	Press ▼ button ③ to display the next functions.
Display the 3rd menu	Press ▲/▼ buttons ③ to choose a 2nd menu title. Then press MENU/OK button ②.	
Return to the previous menu	Press the DISPLAY/BACK button ③.	—
Choose the setting of a function	Press ▲/▼ buttons ③ to choose a function. Then press the ◀/▶ buttons ③ to change the setting.	Press the TV/VIDEO/EXIT button ⑥ to exit from the menu.
Adjust the effect level of a function	Press ▲/▼ buttons ③ to choose a function. Then press the ◀/▶ buttons ③ to adjust the effect level.	
Display the sub menu of a function.	Press the ▲/▼ buttons ③ to choose a function. Then press MENU/OK button ② to display the sub menu.	—

The following chart shows locations of functions in menus. In this manual, location of a function is described as follows:

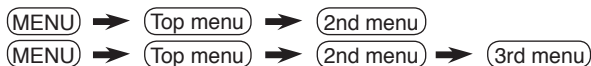

Note: Some functions have the 4th menus as the sub-menus.

	Top menu	2nd menu	Location	3rd menu	Location	
MENU	PICTURE	PICTURE MODE	P.9	—	—	
		PICTURE SETTING	P.10	CONTRAST	P.10	
				BRIGHT	P.10	
				SHARP	P.10	
				COLOUR	P.10	
		TINT	P.10			
	WHITE BALANCE	P.10	—	—		
	VNR	P.17	—	—		
	SOUND		STEREO/HI	P.15	—	—
			AI VOLUME	P.15	—	—
			SOUND MODE	P.14	—	—
			EQUALIZER	P.15	—	—
			BALANCE	P.14	—	—
			CINEMA SURROUND	P.15	—	—
			MaxxBass	P.15	—	—
	FEATURES	DVD MENU	P.16	AUTO SIGNAL DETECT	P.16	
				DVD PICTURE MODE	P.16	
				DVD THEATER STATUS	P.16	
				DVD SOUND MODE	P.16	
		ON TIMER	P.17	PR	P.17	
		ON TIMER	P.17	—	—	
		CHILD LOCK	P.17	—	—	
		COMPRESS (16:9)	P.11	—	—	
AI ECO SENSOR/ECO MODE		P.11	—	—		
INSTALL		AUTO PROGRAM	P.19	—	—	
	EDIT/MANUAL	P.19	DELETE, MOVE, MANUAL, INSERT	P.19-P.20		
	COLOUR SYSTEM	P.9	—	—		
	LANGUAGE	P.17	LANGUAGE	P.17		
	TEXT LANGUAGE	P.13	TEXT LANGUAGE	P.13		
	VIDEO-2 SETTING	P.18	—	—		
	BLUE BACK	P.11	—	—		
	PICTURE TILT	P.11	—	—		
BEEP	P.18	—	—			

TV buttons and functions

The illustrations shown below is for AV-21BS26 and AV-29SS26 only, which are used for explanation purpose.

Your TV may not look exactly the same as illustrated.

Front of the TV

AV-29SS26

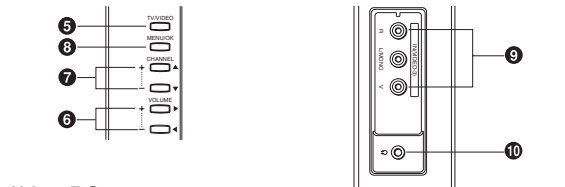
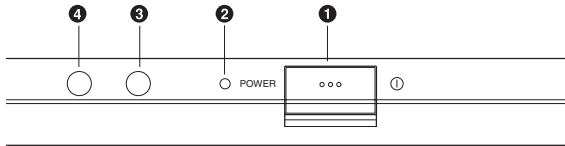

AV-21BS26

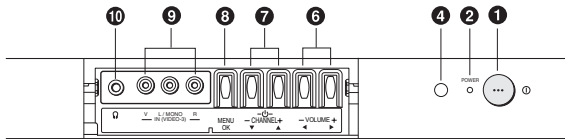

No. Button/terminal	Description	Page
① ① (main power)	Press to turn on or turn off the TV's main power.	-
② POWER lamp	Indicate the TV's status. No colour : TV's main power is being turned off. Red : TV's main power is being turned on. Blink : While the TV is in standby mode, ON TIMER function is in used. While the TV is in turn on mode, OFF TIMER function is in used. Note: When you turn off the power switch while TV is in standby mode, the power lamp will go off in 10 -15 seconds. When you operate the TV, POWER Lamp will be blink.	-
③ ECO sensor		-
④ Remote control sensor		-
⑤ TV/VIDEO	Press to select TV or Video terminal input or exit from menu.	-
⑥ VOLUME +/-	Press to adjust the volume level.	-
⑦ CHANNEL +/-	Press to select the desired channel (Both of RF and Video input.)	-
⑧ MENU/OK	Press to display the menu.	-
⑨ IN (VIDEO-3)	Video and audio input jacks for VIDEO-3 mode.	22
⑩	Headphone jack.	22
⑪	Aerial socket.	7
⑫ OUTPUT	Video and audio output jacks. (The component video signal cannot be output.)	22
⑬ COMPONENT (VIDEO-2) INPUT	Video or component video, and audio input jacks for VIDEO-2 mode. You can select the input signal by setting the "VIDEO-2 SETTING" function (see page 18).	22
⑭ VIDEO-1 INPUT	Video or S-VIDEO, and audio input jacks for VIDEO-1 mode.	7

How to operate the menus with the TV button

TV button	Work as same as the button on the remote control unit	Note
MENU	MENU/OK button	To display main menu and exit menu after finish setting.
CHANNEL +/-	▼/▲ button	To select menu function.
VOLUME +/-	◀▶ button	To choose a Top menu and adjust the desired menu function.

Rear of the TV

AV-29SS26

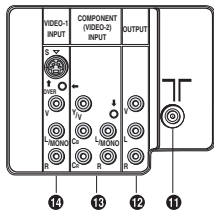

Setting up your TV

CAUTION

- Turn off the equipment including the TV before connecting.

1 Connecting the aerial cable.

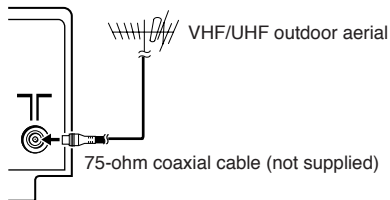

If you connect a VCR, connect the aerial output jack of your VCR and the aerial jack on the TV with aerial cable. Then connect the output jacks of your VCR and the VIDEO-1 input jacks of the TV with the video cable (or S-VIDEO cable if available) and audio cables. For details, see the manual of your VCR.

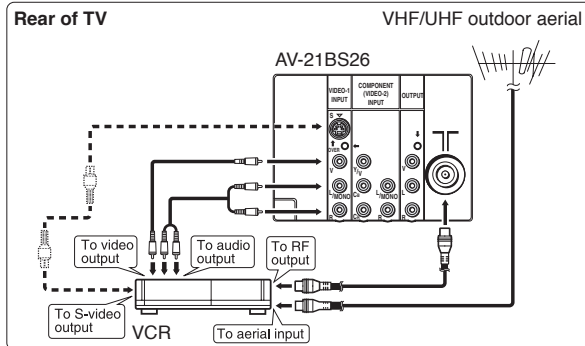

The illustration shown is just a sample. It may not be same as your TV.

2 Connecting the main plug to the AC outlet.

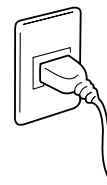

3 Inserting batteries into the remote control.

Insert two batteries by following the ⊕ and ⊖ polarities and inserting the ⊖ end first.

CAUTION:

Follow the cautions printed on the batteries.

Notes:

- Use AA/R6/UM-3 dry cell batteries.
- If the remote control does not work properly, fit new batteries. The supplied batteries are for testing, not regular use.

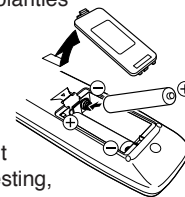

4 Turn on the TV by pressing the main power button.

JVC logo appears on the screen.



JVC logo will appear on the screen again at the phase of "SETUP TOUR RESTART?" function. Then the initial setting can be performed according to page 8.

Note:

While in the INSTALL menu with the cursor pointing at INSTALL, pressing the blue button will also display the JVC logo.

Setting up your TV (continued)

5 Making the initial settings

Set up your TV by pressing MENU/OK button or waiting for 15 seconds, then operate the TV by following the steps below:



- Press ▲/▼ button to select your desired language*.

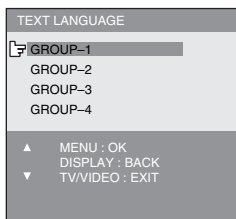

- Press ▲/▼ button to select your desired Teletext language group*. For details, see page 13. (For BS26/MS26/SS26/MX76/SX76 series only)

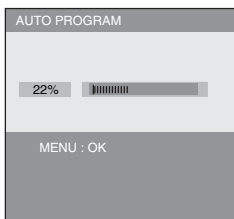

- TV will start searching for the channels.

To stop AUTO PROGRAM, press MENU/OK button.

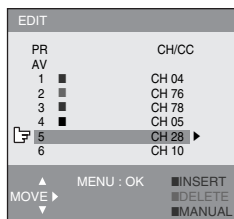

- To complete the initial setting, press the MENU/OK button. To edit the channel list, see page 19.

When turn on the TV at the next time

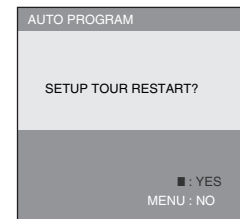

- “SETUP TOUR RESTART?” will be displayed. Press the MENU/OK button to cancel the SETUP TOUR RESTART function. If you want to make initial settings again when the next time you turn on the TV, press the Red button to activate the SETUP TOUR RESTART function.

* If the TEXT function is available for your TV and the LANGUAGE shown follow as ENGLISH/РУССКИЙ/عربي / فارسی / FRANÇAIS, you can select the TEXT LANGUAGE group from GROUP-1 to GROUP-4.

If the TEXT function is available for your TV and the LANGUAGE shown follow as ENGLISH/РУССКИЙ/中文/MELAYU/INDONESIA, you can select the TEXT LANGUAGE group from GROUP-1 to GROUP-3.

Basic setting for picture

COLOUR SYSTEM

You can select the appropriate colour system when the picture is not clear or no colour appears.

Press the COLOUR SYSTEM button to select a setting.

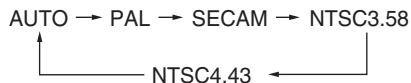

To operate this function with a menu:

* (MENU) ➔ (INSTALL menu) ➔ (COLOUR SYSTEM)

For the colour system in each country or region, see the table below:

Area	Country or Region	System
Asia, Middle East	Bahrain, Kuwait, Oman, Qatar, United Arab Emirates, Yemen, etc.	PAL
	Indonesia, Malaysia, Singapore, Thailand, India, etc.	PAL
	China, Vietnam, etc.	PAL
	Hong Kong, etc.	PAL
	Islamic Republic of Iran, Lebanon, Saudi Arabia, etc.	SECAM
Europe	Philippines, Taiwan, Myanmar, etc.	NTSC
	Russia, etc.	SECAM
	Czech Republic, Poland, etc.	PAL
	Germany, Holland, Belgium, etc.	PAL
Oceania	UK, etc.	PAL
	Australia, New Zealand, etc.	PAL
Africa	Republic of South Africa, etc.	PAL
	Nigeria, etc.	PAL
	Egypt, Morocco, etc.	SECAM

PICTURE MODE

You can choose the desired picture setting with one-touch.

Press the PICTURE MODE button to select a setting.

SOFT	Softens contrast and sharpness.
BRIGHT	Heightens contrast and sharpness.
STANDARD	Standard picture setting.
USER	You can change this picture setting as you like. Select USER and adjust following items in the PICTURE SETTING menu. (CONTRAST, BRIGHT, SHARP, COLOUR, TINT)

When you select VIDEO-2 Mode, you cannot adjust SHARP.

When you set DVD THEATER STATUS in DVD MENU to ON, you cannot adjust PICTURE MODE.

To operate this function with a menu:

* (MENU) ➔ (PICTURE menu) ➔ (PICTURE MODE)

To return the USER setting to default, press the blue button when the PICTURE SETTING menu is displayed.

* About the basic operations of the menu, please see the “How to operate menus and menus locations” on page 5.

Basic setting for picture (continued)

PICTURE SETTING

You can adjust the desired picture setting when selecting USER in PICTURE MODE.

1 Select USER in PICTURE MODE under PICTURE menu.

* (MENU) → (PICTURE menu) → (PICTURE MODE)
→ (USER)

2 Select PICTURE SETTING in PICTURE menu, then adjust the setting.

* (MENU) → (PICTURE menu) → (PICTURE SETTING)

CONTRAST	◀ : Lower contrast	▶ : Higher contrast
BRIGHT	◀ : Darker	▶ : Brighter
SHARP	◀ : Softer	▶ : Higher
COLOUR	◀ : Lighter	▶ : Deeper
TINT	◀ : Reddish	▶ : Greenish

When you select VIDEO-2 Mode, you cannot adjust SHARP.

WHITE BALANCE

You can change the white balance of the picture to better match the type of video being viewed.

Select WHITE BALANCE in the PICTURE menu, then choose the desired setting.

* (MENU) → (PICTURE menu) → (WHITE BALANCE)

NORMAL	Normal white balance.
COOL	Bluish white.
WARM	Reddish white.

When you set DVD THEATER STATUS in DVD MENU to ON, you cannot adjust WHITE BALANCE.

* About the basic operations of the menu, please see the “How to operate menus and menu locations” on page 5.

Advanced setting for picture

AI ECO SENSOR (ECO)/ECO MODE

You can adjust TV screen contrast according to the brightness of your room.

Press the ECO button to select the desired mode.

OFF	Cancel the function.
MODE-1/ECO-1	Mild contrast (recommended.)
MODE-2/ECO-2	Even contrast.
DISPLAY (for AI ECO SENSOR only)	Display the graphic of the function.

To operate this function with a menu:

* (MENU) → (FEATURES menu)
→ (AI ECO SENSOR / ECO MODE)

When you set DVD THEATER STATUS in DVD MENU to ON, you cannot adjust AI ECO SENSOR / ECO MODE.

Note : AI ECO SENSOR for M and S series.
ECO MODE for B series.

Correcting the Slanting Picture (PICTURE TILT)

You can correct the picture tilt caused by the earth's magnetic force.

1 Select PICTURE TILT in the INSTALL menu, then press MENU/OK button.

* (MENU) → (INSTALL menu) → (PICTURE TILT)

The following display appears.



2 Press the ▲/▼ buttons until the picture becomes level. Then press the MENU/OK button.

COMPRESS (16:9)

You can convert a normal picture (4:3 aspect ratio) into a wide picture (16:9 aspect ratio).

Select COMPRESS (16:9) in the FEATURES menu, then choose ON or OFF.

* (MENU) → (FEATURES menu) → (COMPRESS (16:9))

BLUE BACK

You can set the TV to automatically change to a blue screen and mute the sound if the signal is weak or absent, or when there is no input from an antenna.

Select BLUE BACK in the INSTALL menu, then choose ON or OFF.

* (MENU) → (INSTALL menu) → (BLUE BACK)

If you wish to continue viewing the poor picture, off the BLUE BACK function.

* About the basic operations of the menu, please see the "How to operate menus and menus locations" on page 5.

Original features for picture

PIP

You can display a sub picture within the main picture on the screen. Press the PIP operation buttons to display and change the sub picture setting.





PIP Display the sub picture.
To cancel, press the PIP button again.

Notes:

- You can hear the sound from the main picture only.
- When main picture and sub picture are the same TV channel.

Press SUB-P +/-	Main picture will be changed TV channel follow as sub picture.
Press  (Input)	To change sub picture to video mode.

Press CHANNEL +/-	Sub picture will be changed TV channel follow as Main picture.
Press CHANNEL +/-	Until main picture change to video mode.

SUB-P +/-	Select the desired TV channel for sub picture.
 (Input)	Select the input source for the sub picture.
 (Swap)	Swap between the main picture and sub picture.
 (Position)	Change the sub picture position. Each time you press the  (Position) button, the sub picture position will change as follows: lower right → lower left → upper left ↑ upper right ←
 (Freeze)	Freeze the sub picture.

When VIDEO-2 is set to component, you cannot select VIDEO-2 for sub picture. If the main picture input source is VIDEO-2 with component, the PIP function is disabled.

TELETEXT

You can watch the Teletext broadcast channel with TEXT function.













1 Press the TEXT button to select the desired mode as follows:



2 Press the CHANNEL +/- buttons, number buttons or colour buttons to select other Teletext pages.

3 Press TEXT or TV/VIDEO button to return to TV mode.

You can also operate the teletext using the following buttons:

 (Hold)	Hold a teletext page. The  (Hold) icon is displayed at the top left of the screen. To cancel, press  (Hold) button again.
 (Reveal)	Display the hidden text (e.g. answers to a quiz). To cancel, press  (Reveal) button again.
 (Size)	Enlarge the teletext display.
 (Index)	Return to the index page instantly.
 (Cancel)	Watch TV programme while waiting for a teletext page. When the teletext page is found, a page number appears at the upper left of the screen. Press  (Cancel) button to view the teletext page.
 (Sub-page)	Operate the  (Sub-page) function. Sub-page numbers are displayed at the left of the screen. To cancel sub-page function, press  (Sub-page) button again.

Original features for picture (continued)

TEXT LANGUAGE

You can set the Teletext language group that corresponds to the programmes.

Select TEXT LANGUAGE in the INSTALL menu, then choose the desired language group.

* (MENU) → (INSTALL menu) → (TEXT LANGUAGE)

GROUP-1	English, German, Swedish, Finnish, Danish, Hungarian, Italian, French, Spanish, Portuguese, Turkish
GROUP-2	Polish, German, Estonian, Slovenian, Czech, Slovakian, Rumanian
GROUP-3	Polish, German, Estonian, Lettish, Russian, Ukrainian
GROUP-4	English, Polish, French, Turkish, Arabic, Farsi

Depending on the broadcast, the language set may not display properly. For details, refer to page 8.

* About the basic operations of the menu, please see the “How to operate menus and menus locations” on page 5.

Basic setting for sound

SOUND SYSTEM

You can select an appropriate sound system when abnormal sound occurs even when the picture appears normally. Press the SOUND SYSTEM button to select a setting.

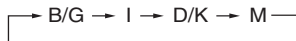

This function is not available in video mode.
For the sound system in each country or region, see the table below:

Area	Country or Region	System
Asia, Middle East	Bahrain, Kuwait, Oman, Qatar, United Arab Emirates, Yemen, etc. Indonesia, Malaysia, Singapore, Thailand, India, etc.	B/G
	China, Vietnam, etc.	D/K
	Hong Kong, etc.	I
	Islamic Republic of Iran, Lebanon, Saudi Arabia, etc.	B/G
	Philippines, Taiwan, Myanmar, etc.	M
Europe	Russia, etc.	D/K
	Czech Republic, Poland, etc.	D/K
	Germany, Holland, Belgium, etc.	B/G
	UK, etc.	I
Oceania	Australia, New Zealand, etc.	B/G
Africa	Republic of South Africa, etc.	I
	Nigeria, etc.	B/G
	Egypt, Morocco, etc.	B/G

SOUND MODE

You can choose the desired sound setting. Select the SOUND MODE in SOUND menu, then choose the setting.

* (MENU) → (SOUND menu) → (SOUND MODE)

USER You can change this sound setting as you like.
Select USER and adjust the frequencies in EQUALIZER (100, 300, 1K, 3K, 8K Hz).
For details, see "EQUALIZER" on page 15.

SOUND TURBO Emphasize on low and high frequency levels.

THEATER Emphasize on movie sound.

MUSIC Emphasize on music effect.

NEWS Emphasize on vocal sound.

When you select VIDEO-2, you cannot adjust SOUND MODE function. You can adjust it in DVD Menu.

When SOUND MODE is set to SOUND TURBO, EQUALIZER, CINEMA SURROUND and MaxxBass functions are not available.

BALANCE

You can adjust the volume balance between the left and right speakers.

Select BALANCE in SOUND menu, then adjust the setting.

* (MENU) → (SOUND menu) → (BALANCE)

* About the basic operations of the menu, please see the "How to operate menus and menus locations" on page 5.

Advanced setting for sound

CINEMA SURROUND

You can enjoy an enhanced sound for wider audience.
Press the CINEMA SURROUND button to select a setting.

OFF	Cancel the function.
ON	Listen to sound with wider audience effect.



This function is not available when SOUND MODE is set to SOUND TURBO.

To operate this function with a menu:

* (MENU) → (SOUND menu) → (CINEMA SURROUND)

STEREO / I-II (I/II)

You can enjoy the stereo and bilingual broadcasted programmes.
Press the  I/II button to select the desired mode.

	Select stereo sound.
	Select monaural sound.
I	Select bilingual I (sub I).
II	Select bilingual II (sub II).

This function is not available in video mode.

To operate this function with a menu:

* (MENU) → (SOUND menu) → (STEREO / I-II)

MaxxBass

You can enjoy an enhanced bass sound which cannot be reproduced by normal speakers.

Select MaxxBass in SOUND menu, then choose the desired setting.

* (MENU) → (SOUND menu) → (MaxxBass)

OFF	MaxxBass is turned off.
HIGH	MaxxBass effect is high.
LOW	MaxxBass effect is low.

This function is not available when SOUND MODE is set to SOUND TURBO.

“MaxxBass” is a registered trademark of Waves Audio Ltd. in the USA, Japan and other countries.

EQUALIZER

You can adjust the sound level of each frequencies when selecting USER mode in SOUND MODE.

1 Select USER in SOUND MODE under SOUND menu.

* (MENU) → (SOUND menu) → (SOUND MODE) → (USER)

2 Select EQUALIZER in SOUND menu.

* (MENU) → (SOUND menu) → (EQUALIZER)

The following display appears.

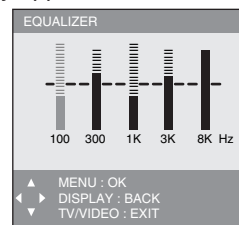

3 Select and adjust the desired frequencies.

4 Press the MENU/OK button to exit the menu.

Adjust high frequency will affect higher pitch sound and vice versa.
When you select VIDEO-2, you cannot adjust EQUALIZER.

AI VOLUME

You can adjust the volume of all the channels and video inputs to the same level automatically depends on the strength of signal of the sources.

Select AI VOLUME in SOUND menu, then choose ON or OFF.

* (MENU) → (SOUND menu) → (AI VOLUME)

* About the basic operations of the menu, please see the “How to operate menus and menus locations” on page 5.

DVD Menu

AUTO SIGNAL DETECT

When the DVD input signal is detected, the input mode will be changed to VIDEO-2 automatically. And when the DVD input signal is not detected, the input mode will be changed to RF previous input mode.

Select AUTO SIGNAL DETECT in DVD MENU under FEATURES menu then choose ON or OFF (Factory setting is ON).

* (MENU) → (FEATURES menu) → (DVD MENU)
→ (AUTO SIGNAL DETECT)

Press the "POWER ON" button on the DVD players or VCRs (follow by the "PLAY" button for VCRs) so that the signal can be detected.

DVD PICTURE MODE

You can enhance the picture quality of the DVD or VIDEO-2.

Select DVD PICTURE MODE in DVD MENU under FEATURES menu, then choose the desired setting.

* (MENU) → (FEATURES menu) → (DVD MENU)
→ (DVD PICTURE MODE)

OFF	Cancel the function.
CLEAR-1	Select when the disc is with lots of noise (To soften the picture).
CLEAR-2	Select when the disc is with less noise (To sharpen the picture).

DVD THEATER STATUS

You can enjoy an enhanced picture quality for movie playback in a dark room, like watching a movie in the theater.

Select DVD THEATER STATUS in DVD MENU under FEATURES menu, then choose ON or OFF.

* (MENU) → (FEATURES menu) → (DVD MENU)
→ (DVD THEATER STATUS)

ON	Enjoy movie playback with suitable colour temperature, sharp subtitles and improved gradation for black, like in a theater.
OFF	Cancel the function.

When you set DVD THEATER STATUS to ON, PICTURE MODE, WHITE BALANCE and AI ECO SENSOR / ECO MODE functions are not available.

DVD SOUND MODE

You can choose different sound setting for viewing different types of DVD content.

Select DVD SOUND MODE in DVD MENU under FEATURES menu, then choose the desired setting.

* (MENU) → (FEATURES menu) → (DVD MENU)
→ (DVD SOUND MODE)

MUSIC	Select when watching a music concert.
USER	Select if you want to adjust the sound setting to your preference.
THEATER	Select when watching an action movie.
DRAMA	Select when watching a drama movie.

* About the basic operations of the menu, please see the "How to operate menus and menu locations" on page 5.

Customized setting

VNR

You can reduce the picture noise.

Select VNR in PICTURE menu, then choose a setting of VNR function.

* (MENU) → (PICTURE menu) → (VNR)

OFF	VNR is turned off.
AUTO	Effect of VNR is automatically controlled.
MIN	Effect of VNR becomes minimum level.
MAX	Effect of VNR becomes maximum level.

If you select MAX, the picture becomes softer even if the original picture is sharp.

When you select VIDEO-2, you cannot adjust VNR function.

LANGUAGE

You can choose your desired on screen display language.

Select LANGUAGE in the INSTALL menu, then choose a language.

* (MENU) → (INSTALL menu) → (LANGUAGE)

CHILD LOCK

You can disable the front control buttons of the TV.

Select CHILD LOCK in the FEATURES menu, then choose ON or OFF.

* (MENU) → (FEATURES menu) → (CHILD LOCK)

ON TIMER

You can set the TV to turn on automatically from standby mode at a set channel and time.

1 Select ON TIMER in the FEATURE menu.

* (MENU) → (FEATURES menu)
→ (ON TIMER)

The following display appears.

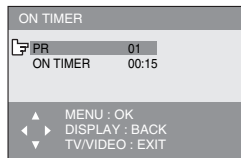

2 Choose the PR (channel) by pressing the ◀/▶ button.

External input, AV position and any un-preset channel cannot be chosen for PR.

3 Set the ON TIMER to your desired period of time by pressing the ◀/▶ button. ON TIMER starts. You can set the period of time to a maximum of 12 hours in 15-minute intervals.

To off the ON TIMER, set the ON TIMER to OFF.

Note : If TV is not in standby mode when ON TIMER is reach the setting time, this case is not available.

OFF TIMER

You can set the TV to turn off automatically to standby mode after a set time.

Press the OFF TIMER button to select a desired period of time.

You can set the period of time to a maximum of 120 minutes in 10 minute intervals.

To operate this function with a menu:

* (MENU) → (FEATURES menu) → (OFF TIMER)

When the remaining elapse time is one minute, "GOOD NIGHT!" appears on the screen.

You can display the OFF TIMER menu again to confirm or change the remaining time.

* About the basic operations of the menu, please see the "How to operate menus and menus locations" on page 5.

Customized setting (continued)

VIDEO-2 SETTING

You can set the VIDEO-2 SETTING according to the video signal output from external devices connected to the VIDEO-2 terminal. Select VIDEO-2 SETTING in INSTALL menu, then choose a setting (Factory setting is COMPONENT).

* (MENU) → (INSTALL menu) → (VIDEO-2 SETTING)

VIDEO	If a normal video signal (composite video signal) is input.
COMPONENT	If a component video signal (Y/C _B /C _R) is input.

You must choose a setting according to the signal that you input to VIDEO-2. (If you input the VIDEO Signal or VCR Signal to VIDEO-2, you must set VIDEO-2 SETTING to VIDEO.)

For connecting methods, see “Additional Preparation” on page 22.

BEEP

You can use the BEEP function to alert you during DVD AUTO SIGNAL DETECT, AI ECO SENSOR Detect, Stereo Detect, ON TIMER/OFF TIMER operations and when some buttons on the remote control are pressed.

Select BEEP in the INSTALL menu, then choose ON or OFF.

* (MENU) → (INSTALL menu) → (BEEP)

When the volume is level 0, then BEEP function is not available.

DISPLAY

You can display the programme number, video terminal number and PR list on the screen.

Press the DISPLAY button to select the desired mode:

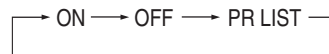

Choose a TV channel or a VIDEO terminal.

- 1 Press the DISPLAY button to display the PR LIST.
- 2 Select a programme number or video terminal by pressing the ▲/▼ button to move up/down on the programme number or press the ◀▶ button to skip for each 7 programme numbers, then press MENU/OK button.

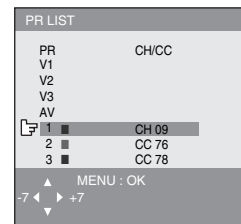

* About the basic operations of the menu, please see the “How to operate menus and menu locations” on page 5.

TV channel presetting

To register the TV channels automatically (AUTO PROGRAM)

You can register the TV channels into the TV's channel list automatically.

- 1 Display the INSTALL menu.

* (MENU) ➔ (INSTALL menu)

- 2 Choose AUTO PROGRAM, then press the MENU/OK button. AUTO PROGRAM function starts, and the channels received are registered in the channel list (PR LIST) automatically.

- 3 The EDIT menu appears.

To edit the channel list	Proceed to Step 3 of "To edit the channel list (PR LIST)" on page 20.
If a channel is not registered	Proceed to Step 3 of "To register the TV channels manually" on this page.
To exit the menu	Press the MENU/OK button.

To register the TV channels manually (MANUAL in the EDIT menu)

You can register the TV channels into the TV's channel list manually.

- 1 Display the INSTALL menu.

* (MENU) ➔ (INSTALL menu)

- 2 Choose EDIT/MANUAL, then press the MENU/OK button. EDIT menu appears.

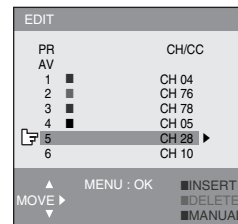

- 3 Choose the channel which you want to register.
- 4 Press the blue button to activate the MANUAL function. The sound system of the channel appears at the right of the CH/CC number.
- 5 Press the ► button to choose an appropriate sound system. For details, see "SOUND SYSTEM" on page 14.
- 6 Press the green or red button to search for the TV channel. Searching stops when a channel is found and displayed.
- 7 Repeat step 5 until your desired TV channel appears.

If the reception is poor	Press the blue or yellow button to fine tune the TV channel.
If noisy sound is heard	Press the ► button to choose an appropriate sound system.

- 8 Press the MENU/OK button to exit the menu.

* About the basic operations of the menu, please see the "How to operate menus and menu locations" on page 5.

TV channel presetting (continued)

To edit the channel list (PR LIST) (MOVE and DELETE in the EDIT menu)

You can edit the TV channel list as you like.

Note: After this operation, other channel's PR numbers will be changed.

- 1 Display the INSTALL menu.

* (MENU) ➔ (INSTALL menu)

- 2 Choose EDIT/MANUAL, then press the MENU/OK button.
EDIT menu appears.

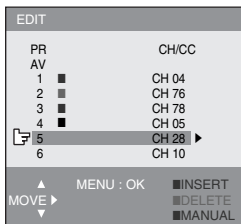

- 3 Choose the channel which you want to change its PR number, or delete.

- 4 Do the following action:

To change the PR number (MOVE)	Press the ► button. Then move it to the new PR number you want to use for the channel by pressing the ▲/▼ button. Finally press the ◀ button.
--------------------------------	-----------------------------------------------------------------------------------------------------------------------------------------------

To delete the channel (DELETE)	Press the yellow button.
--------------------------------	--------------------------

- 5 Press the MENU/OK button to exit the menu.

To add in the new channel (INSERT in the EDIT menu)

You can add in new channels in the TV channel list as you like.

You need to find the “CH/CC” number for the TV channel. Find the “CH/CC” number corresponding to the channel number of the TV channel from “CH/CC number list” on page 21.

- 1 Display the INSTALL menu.

* (MENU) ➔ (INSTALL menu)

- 2 Choose EDIT/MANUAL, then press the MENU/OK button.
EDIT menu appears.

- 3 Choose the PR number for which you will register a new TV channel. When you add a new TV channel of NTSC-M system, press the SOUND SYSTEM button to change the sound system to M. Then proceed to the next step.

- 4 Press the green button, then press ► button to choose “CC” or “CH”.

- 5 Press the number button to enter the CH/CC number for the TV channel you wish to add.

The TV starts to search the TV channel, and the picture of the TV channel appears. If the TV finds no TV channel, a noisy picture appears.

When a TV channel has already been registered in PR99, using the INSERT function deletes that TV channel.

* About the basic operations of the menu, please see the “How to operate menus and menus locations” on page 5.

TV channel presetting (continued)

CH/CC number

When you want to use the INSERT function on page 20, find the CH/CC number corresponding to the channel number of the TV channel from this table.

Channel No.	Country
US	United States, Philippines, etc..
CCIR	Middle East, Southeast Asia, etc..
OIRT	Eastern Europe, Russia, Vietnam, etc..
AUSTRALIA	Australia, etc..

Channel

CH	US	CCIR	OIRT	AUSTRALIA
CH 02	US-2	E2	R1	AU-0
CH 03	US-3	E3		AU-1
CH 04	US-4	E4	R2	AU-2
CH 05	US-5	E5	R6	AU-6
CH 06	US-6	E6	R7	AU-7
CH 07	US-7	E7	R8	AU-8
CH 08	US-8	E8	R9	AU-9
CH 09	US-9	E9		
CH 10	US-10	E10	R10	AU-10
CH 11	US-11	E11	R11	AU-11
CH 12	US-12	E12	R12	
CH 13	US-13			
CH 14	US-14, W+29			
CH 15	US-15, W+30			
CH 16	US-16, W+31			
CH 17	US-17, W+32			
CH 18	US-18, W+33			
CH 19	US-19, W+34			
CH 20	US-20, W+35			
CH 21	US-21, W+36	E21		
CH 22	US-22, W+37	E22		
CH 23	US-23, W+38	E23		
CH 24	US-24, W+39	E24		
CH 25	US-25, W+40	E25		
CH 26	US-26, W+41	E26		
CH 27	US-27, W+42	E27		
CH 28	US-28, W+43	E28		AU-28
CH 29	US-29, W+44	E29		AU-29
CH 30	US-30, W+45	E30		AU-30
CH 31	US-31, W+46	E31		AU-31/AU-32
CH 32	US-32, W+47	E32		AU-33

CH	US	CCIR	OIRT	AUSTRALIA
CH 33	US-33, W+48	E33		AU-34
CH 34	US-34, W+49	E34		AU-35
CH 35	US-35, W+50	E35		AU-36
CH 36	US-36, W+51	E36		AU-37
CH 37	US-37, W+52	E37		AU-38
CH 38	US-38, W+53	E38		AU-39/AU-40
CH 39	US-39, W+54	E39		AU-41
CH 40	US-40, W+55	E40		AU-42
CH 41	US-41, W+56	E41		AU-43
CH 42	US-42, W+57	E42		AU-44
CH 43	US-43, W+58	E43		AU-45
CH 44	US-44, W+59	E44		AU-46
CH 45	US-45, W+60	E45		AU-47/AU-48
CH 46	US-46, W+61	E46		AU-49
CH 47	US-47, W+62	E47		AU-50
CH 48	US-48, W+63	E48		AU-51
CH 49	US-49, W+64	E49		AU-52
CH 50	US-50, W+65	E50		AU-53
CH 51	US-51, W+66	E51		AU-54
CH 52	US-52, W+67	E52		AU-55/AU-56
CH 53	US-53, W+68	E53		AU-57
CH 54	US-54, W+69	E54		AU-58
CH 55	US-55, W+70	E55		AU-59
CH 56	US-56, W+71	E56		AU-60
CH 57	US-57, W+72	E57		AU-61
CH 58	US-58, W+73	E58		AU-62
CH 59	US-59, W+74	E59		AU-63/AU-64
CH 60	US-60, W+75	E60		AU-65
CH 61	US-61, W+76	E61		AU-66
CH 62	US-62, W+77	E62		AU-67
CH 63	US-63, W+78	E63		AU-68
CH 64	US-64, W+79	E64		AU-69
CH 65	US-65, W+80	E65		
CH 66	US-66, W+81	E66		
CH 67	US-67, W+82	E67		
CH 68	US-68, W+83	E68		
CH 69	US-69, W+84	E69		

CC	US	CCIR	OIRT	AUSTRALIA
CC 01		S-1		AU-5
CC 02		S-2		
CC 03		S-3		
CC 04		S-4		
CC 05		S-5		
CC 06		S-6		AU-5A
CC 07		S-7		
CC 08		S-8		
CC 09		S-9		
CC 10		S-10		
CC 11		S-11		
CC 12		S-12		
CC 13		S-13		
CC 14	A	S-14		
CC 15	B	S-15		
CC 16	C	S-16		
CC 17	D	S-17		

CC	US	CCIR	OIRT	AUSTRALIA
CC 18	E	S-18		
CC 19	F	S-19		
CC 20	G	S-20		
CC 21	H	S-21		
CC 22	I	S-22		
CC 23	J	S-23		
CC 24	K	S-24		
CC 25	L	S-25		
CC 26	M	S-26		
CC 27	N	S-27		
CC 28	O	S-28		
CC 29	P	S-29		
CC 30	Q	S-30		
CC 31	R	S-31		
CC 32	S	S-32		
CC 33	T	S-33		
CC 34	U	S-34		
CC 35	V	S-35		
CC 36	W	S-36		
CC 37	W+1	S-37		
CC 38	W+2	S-38		
CC 39	W+3	S-39		
CC 40	W+4	S-40		
CC 41	W+5	S-41		
CC 42	W+6			
CC 43	W+7			
CC 44	W+8			
CC 45	W+9			
CC 46	W+10			
CC 47	W+11			
CC 48	W+12			
CC 49	W+13			
CC 50	W+14			
CC 51	W+15			
CC 52	W+16			
CC 53	W+17			
CC 54	W+18			
CC 55	W+19			
CC 56	W+20			
CC 57	W+21			
CC 58	W+22			
CC 59	W+23			
CC 60	W+24			
CC 61	W+25			
CC 62	W+26			
CC 63	W+27			
CC 64	W+28			
CC 75		X		
CC 76		Y	R3	
CC 77		Z	R4	AU-3
CC 78		Z+1	R5	
CC 79		Z+2		AU-4
CC 95	A-5			
CC 96	A-4			
CC 97	A-3			
CC 98	A-2			
CC 99	A-1			

Additional preparation

The illustrations shown in this section are for AV-21BS26 and AV-29SS26 only, which are used for explanation purpose. Your TV may not look exactly the same as illustrated.

Before connecting

- Read the manuals provided with the devices for the proper connection.
- Turn off all the devices including the TV.
- Note that connecting cables are not supplied.

Connecting to front video input terminals

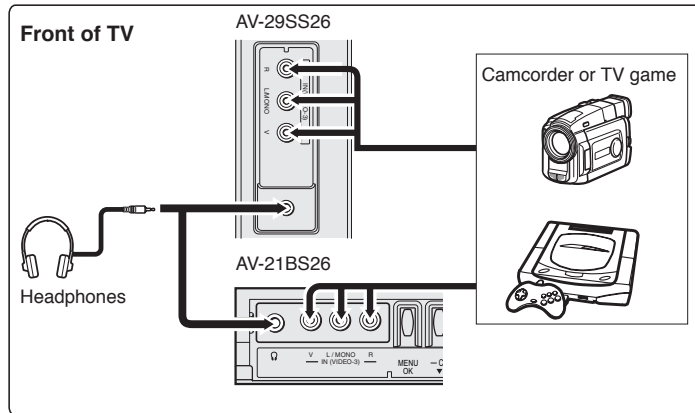

Connecting to rear component/video input terminals and output terminals

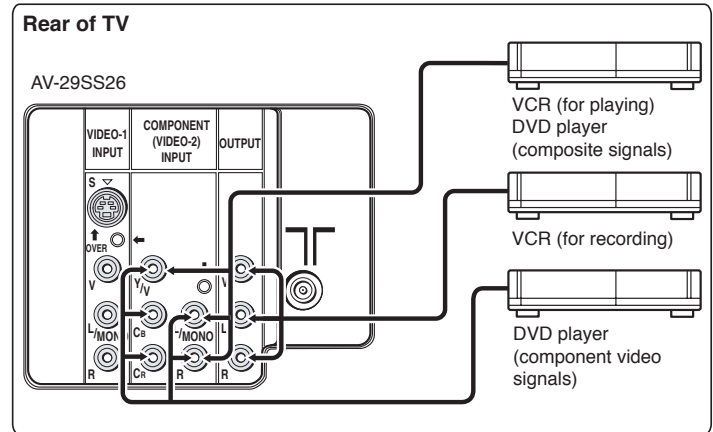

When connecting to COMPONENT (VIDEO-2) input, depending on the connection, choose the appropriate video input using the menu (see "VIDEO-2 SETTING" on page 18)

Troubleshooting

If a problem occurs when you are using the TV, check the below troubleshooting guide before calling for repair.

• No picture, no sound	• Deactivate the BLUE BACK function if it is turned on. • Choose the appropriate sound system. Refer to "SOUND SYSTEM" on page 14.
• Snowy picture	• Check the aerial cable and its connection with the TV.
• Stripes appear on the picture	• Interference occurs caused by other devices such as an amplifier, personal computer, or a hair drier. Move such devices away from your TV.
• Double-pictures (ghosting) occur	• Interference occurs caused by signal reflecting from mountains or building. Try to adjust the aerial's direction or use a better directionality antenna.
• Poor picture	• Choose the appropriate colour system. Refer to "COLOUR SYSTEM" on page 9. • Adjust the COLOUR or BRIGHT setting. Refer to "PICTURE SETTING" on page 10.
• White and bright still image look as if it were coloured	• Inevitable phenomenon due to the nature of the picture tube. This is not a malfunction.
• Top of the image from software products or video tape is distorted	• This is due to the condition of the video signal whereby the image was not recorded properly. This is not a malfunction.
• Poor sound	• Adjust the sound frequency properly. Refer to "EQUALIZER" on page 15.
• Stereo or bilingual sound is unclear	• TV channel reception is poor. Change the stereo/bilingual mode to mono sound (see page 15).
• Cannot operate the remote control	• The batteries may be exhausted. Replace with new batteries (see page 7). • Ensure that you are operating the remote control at less than seven meters from the front of your TV.
• Cannot operate the menus	• Press TV/VIDEO button to return to TV mode and try operating the menus.
• Cannot operate the front control buttons	• Deactivate the CHILD LOCK function if it is turned on (see page 17).

• Colour patches appear at the corner of the screen	• This may due to the magnetized device such as a speaker near to your TV. Keep the device apart from your TV. Alternately, you can also use the magnetic-shielded speaker.
• Picture is tilted	• This may due to the earth magnetism. Refer to "PICTURE TILT" on page 11 to correct the tilt.
• Image takes a short period to be displayed	• Image required time to stabilize before display. This is not a malfunction.
• TV may emit crackling sound	• This is due to a sudden change in temperature and it is not a malfunction. If the crackling sound is too frequent, request your service technician for inspection.
• Feel a slight electric shock when touching the TV screen	• This is due to the static electricity of the picture tube and it will not harm the human body. This is not a malfunction.
• The Auto Signal Detect function does not work	• Please check that the AUTO SIGNAL DETECT function is on or off. • Turn the VCR or DVD player off, wait a while, then turn it on again. • Inspect the video cable connection on VIDEO-2 that they are connected properly.
• Suddenly, a channel or input was changed to VIDEO-2 inputs.	• Some VCRs and DVD players can trigger Auto Signal Detect even after you choose a different input. • Please turn off the AUTO SIGNAL DETECT function.
• "PLEASE DISCONNECT VIDEO-1 CABLE!" appears on the screen.	• Please disconnect either S-VIDEO cable or video input cable from Video-1 input.

Specifications

TV RF systems

B, G, I, D, K, M

Colour systems

PAL, SECAM, NTSC 3.58 MHz, NTSC 4.43 MHz

Receiving channels

VHF low channel (VL), VHF high channel (VH), UHF channel (U)
Receives cable channels in mid band, super band and hyper band.

Power requirements

For Australia: AC 220 to 240 V, 50 Hz / 60 Hz
For others: AC 110 to 240 V, 50 Hz / 60 Hz

External input / output

VIDEO-1: S-video input, VIDEO input, AUDIO L/R input
VIDEO-2/COMPONENT: VIDEO input, AUDIO L/R input, COMPONENT VIDEO (Y/C_B/C_R) input
VIDEO-3: VIDEO input, AUDIO L/R input
OUTPUT: VIDEO output, AUDIO L/R output
Headphone jack: Stereo mini jack (3.5 mm diameter)

**Sound-multiplex systems

A2 (B/G) or NICAM (B/G, I, D/K)

**Teletext system

FLOF (Fastext), WST (World Standard Text)

**Language displayed by teletext

Please see the table in the description "TEXT LANGUAGE" on page 13.

**Depends on the models, STEREO/II function for the Sound-multiplex systems or Teletext function may not be available.
Please confirm with the chart on page 3.

Design and specifications subject to change without notice.

JVC

PARTS LIST

CAUTION

- The parts identified by the Δ symbol are important for the safety . Whenever replacing these parts, be sure to use specified ones to secure the safety.
- The parts not indicated in this Parts List and those which are filled with lines --- in the Parts No. columns will not be supplied.
- P.W. BOARD Ass'y will not be supplied, but those which are filled with the Parts No. in the Parts No. columns will be supplied.

ABBREVIATIONS OF RESISTORS, CAPACITORS AND TOLERANCES

RESISTORS		CAPACITORS	
CR	Carbon Resistor	C CAP.	Ceramic Capacitor
FR	Fusible Resistor	E CAP.	Electrolytic Capacitor
PR	Plate Resistor	M CAP.	Mylar Capacitor
VR	Variable Resistor	CH CAP.	Chip Capacitor
HV R	High Voltage Resistor	HV CAP.	High Voltage Capacitor
MF R	Metal Film Resistor	MF CAP.	Metalized Film Capacitor
MG R	Metal Glazed Resistor	MM CAP.	Metalized Mylar Capacitor
MP R	Metal Plate Resistor	MP CAP.	Metalized Polystyrol Capacitor
OM R	Metal Oxide Film Resistor	PP CAP.	Polypropylene Capacitor
CMF R	Coating Metal Film Resistor	PS CAP.	Polystyrol Capacitor
UNF R	Non-Flammable Resistor	TF CAP.	Thin Film Capacitor
CH V R	Chip Variable Resistor	MPP CAP.	Metalized Polypropylene Capacitor
CH MG R	Chip Metal Glazed Resistor	TAN. CAP.	Tantalum Capacitor
COMP. R	Composition Resistor	CH C CAP.	Chip Ceramic Capacitor
LPTC R	Linear Positive Temperature Coefficient Resistor	BP E CAP.	Bi-Polar Electrolytic Capacitor
		CH AL E CAP.	Chip Aluminum Electrolytic Capacitor
		CH AL BP CAP.	Chip Aluminum Bi-Polar Capacitor
		CH TAN. E CAP.	Chip Tantalum Electrolytic Capacitor
		CH AL BP E CAP.	Chip Tantalum Bi-Polar Electrolytic Capacitor

RESISTORS									
F	G	J	K	M	N	R	H	Z	P
±1%	±2%	±5%	±10%	±20%	±30%	+30% -10%	+50% -10%	+80% -20%	+100% -0%

CONTENTS

USING P.W. BOARD & REMOTE CONTROL UNIT	3-3
EXPLODED VIEW PARTS LIST -1	3-3
EXPLODED VIEW -1	3-4
PRINTED WIRING BOARD PARTS LIST [AV-29SS26]	3-5
MAIN P.W. BOARD ASS'Y (SCW-1941A-H2)	3-5
CRT SOCKET P.W. BOARD ASS'Y (SCW-3038A-H2)	3-8
FRONT CONTROL P.W. BOARD ASS'Y (SCW-8020A-H2)	3-9
BASS P.W. BOARD ASS'Y (SCW-6003A-H2)	3-9
PRINTED WIRING BOARD PARTS LIST [AV-29SX76/G]	3-10
MAIN P.W. BOARD ASS'Y (SCW-1947A-H2)	3-10
CRT SOCKET P.W. BOARD ASS'Y (SCW-3038A-H2)	3-13
FRONT CONTROL P.W. BOARD ASS'Y (SCW-8020A-H2)	3-13
BASS P.W. BOARD ASS'Y (SCW-6003A-H2)	3-13
REMOTE CONTROL UNIT PARTS LIST (RM-C1286-1H) [AV-29SS26]	3-14
REMOTE CONTROL UNIT PARTS LIST (RM-C1285-1H) [AV-29SX76/G]	3-14
PACKING	3-15
PACKING PARTS LIST	3-15

USING P.W. BOARD & REMOTE CONTROL UNIT

P.W.B ASS'Y	AV-29SS26	AV-29SX76/G
MAIN P.W.B	SCW-1941A-H2	SCW-1947A-H2
CRT SOCKET P.W.B	SCW-3038A-H2	←
FRONT CONTROL P.W.B	SCW-8020A-H2	←
BASS P.W.B	SCW-6003A-H2	←
REMOTE CONTROL UNIT	RM-C1286-1H	RM-C1285-1H

EXPLODED VIEW PARTS LIST -1

△ Ref.No.	Part No.	Part Name	Description	Local
△ V01	A68ERS870X04KD	PICTURE TUBE(ITC)	Inc.DEF YOKE, PC MAGNET	
△ L01	QQW0214-001	DEG COIL		
△ T522	QQH0216-001	FB TRANSF		
1	GG30155-001A-H	LED LENS		
11	QYSBSFG4016ZA	TAP SCREW	M4 x 16mm(x15)	
12	GG20132-001B-H	OPERATION SHEET		
△ 13	GG10425-001B-H	REAR COVER		
14	QYSBSFG3010ZA	TAP SCREW	M3 x 10mm(x2)	
△ 15	GG10441-001B-H	AV BOARD		
△ 16	CM23167-A01-H	POWER CORD CLAMP		
△ 17	QMPR340-165-K2	POWER CORD	1.65m BLACK	
△ 18	LC11061-002C-H	CHASSIS BASE		
19	GG10428-001A-H	CONTROL BASE		
20	CM48241-001-H	KNOB CAP		
21	A48457-3-H	SPRING		
22	WJY0018-001A-E	BRAIDED ASSY		
23	WJY0013-003A-E	BRAIDED ASS'Y	(x2)	
△ 24	LC30103-003A-H	CHASSIS ADAPTER	(x2)	
25	GG40046-001A-H	TAP SCREW	(x4)	
26	LC40226-005A-H	SPACER	(x4)	
27	GG20057-002A-H	SPEAKER HOLDER	(x4)	
28	QAS0348-001	SPEAKER	(x2) SP01,SP02	AV-29SS26
28	QAS0139-001	SPEAKER	(x2) SP01,SP02	AV-29SX76G
29	QYSBSFG3008ZA	TAP SCREW	M3 x 8mm(x4)	
30	GG30154-001B-H	CONTROL KNOB		
△ 40	SCW-1941A-H2	MAIN PWB		AV-29SS26
△ 40	SCW-1947A-H2	MAIN PWB		AV-29SX76G
△ 41	SCW-3038A-H2	CRT SOCKET PWB		
△ 42	SCW-8020A-H2	FRONT CONTROL PWB		
△ 43	SCW-6003A-H2	BASS PWB		
△ 100	GG10423-001B-H	FRONT CABINET ASS'Y	Inc.101,102	
101	GG30153-001B-H	POWER KNOB		
102	CM35235-009-H	SPRING		

EXPLODED VIEW -1

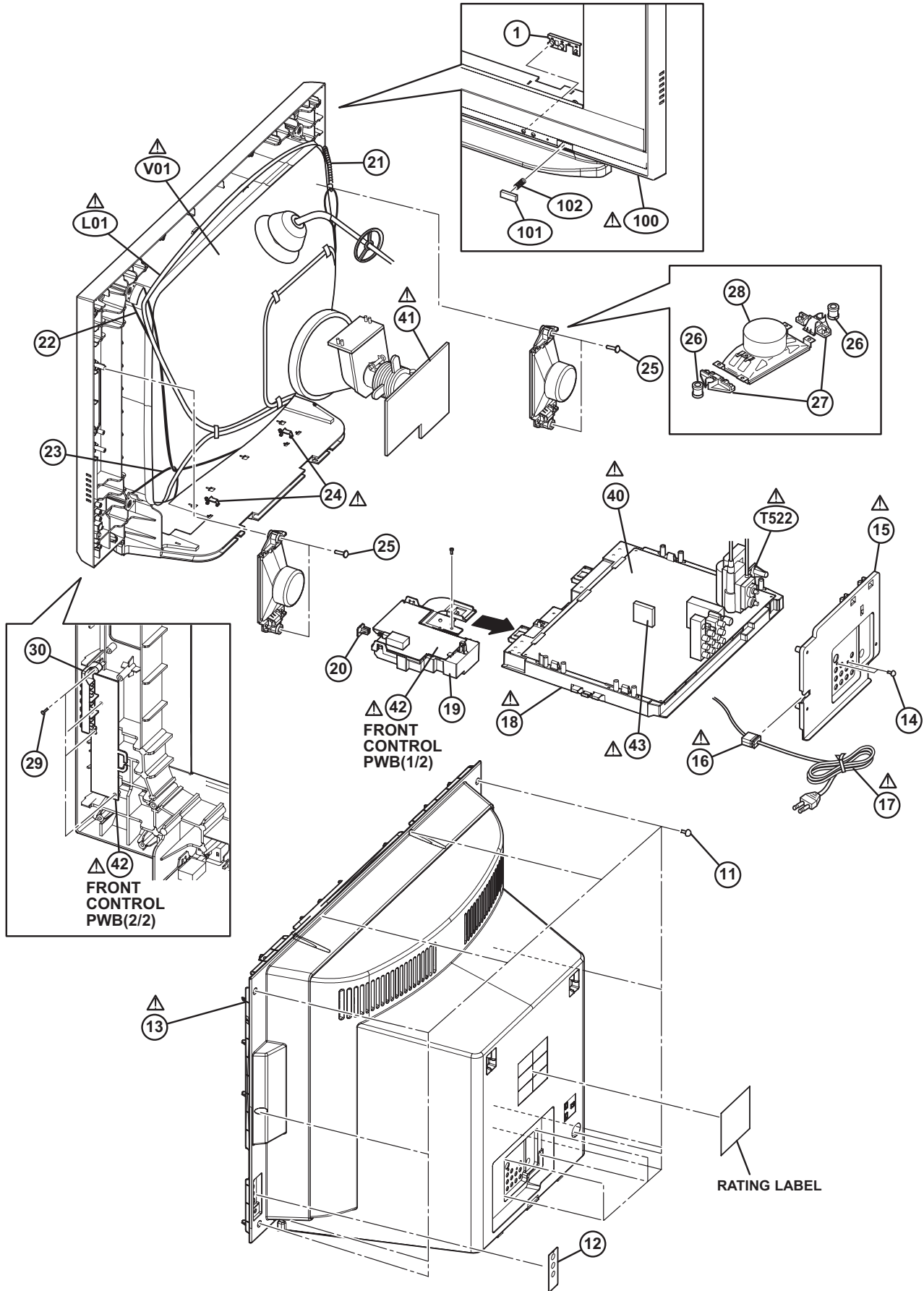

PRINTED WIRING BOARD PARTS LIST [AV-29SS26]

MAIN P.W. BOARD ASS'Y (SCW-1941A-H2)

△Ref No.	Part No.	Part Name	Description Local	△Ref No.	Part No.	Part Name	Description Local
				D706	MA8036-X	Z DIODE	
IC401	AN15526A	IC		D707	MA111-X	SI DIODE	
IC481	LA6515	IC		D708	MA111-X	SI DIODE	
IC601	AN5277	IC		D709	MA111-X	SI DIODE	
IC701	TDA12021-ERC3-F	IC(MCU)	(SERVICE)	D710	MA8091/H/-X	Z DIODE	
IC702	ATE16-29MS26	IC	(SERVICE)	D711	MA111-X	SI DIODE	
IC921	STR-W6556A-F5	IC		D712	MA111-X	SI DIODE	
IC951	SE135N	IC		D713	MA8039/H/-X	Z DIODE	
IC972	PQ033RDA1SSH	IC		D714	MA8039/H/-X	Z DIODE	
IC973	PQ120RDA1SZ	IC		D715	MA111-X	SI DIODE	
IC975	PQ050RDA1SZ	IC		D716	MA111-X	SI DIODE	
				D717	MA111-X	SI DIODE	
Q101	2SC5397/CD/-T	TRANSISTOR		D751	MA8091/H/-X	Z DIODE	
Q102	UN2212-X	DIGI TRANSISTOR		D753	MA8091/H/-X	Z DIODE	
Q103	UN2212-X	DIGI TRANSISTOR		D810	MA8091/H/-X	Z DIODE	
Q341	2SA1530A/QR/-X	TRANSISTOR		D811	MA8091/H/-X	Z DIODE	
Q421	2SC3928A/QR/-X	TRANSISTOR		D812	MA8091/H/-X	Z DIODE	
Q422	2SC3928A/QR/-X	TRANSISTOR		D813	MA8091/H/-X	Z DIODE	
Q461	RDN050N20	POWER MOS FET		D814	MA8091/H/-X	Z DIODE	
Q481	2SC3928A/QR/-X	TRANSISTOR		D815	MA8091/H/-X	Z DIODE	
Q482	2SA1530A/QR/-X	TRANSISTOR		D901	GSIB460-S1	BRIDGE DIODE	
Q483	2SA562TM/Y/-T	TRANSISTOR		D921	FR105GT-T3	SI DIODE	
Q484	2SA1530A/QR/-X	TRANSISTOR		D922	MTZJ36A-T2	Z DIODE	
Q521	BSN304-T	TRANSISTOR		D923	MTZJ9.1B-T2	Z DIODE	
△Q522	TT2202-YD	POW TRANSISTOR		D924	MTZJ9.1B-T2	Z DIODE	
Q571	2SA1208/ST/Z1-T	TRANSISTOR		D925	MTZJ9.1B-T2	Z DIODE	
Q572	UN2212-X	DIGI TRANSISTOR		D926	FR105GT-T3	SI DIODE	
Q601	2SA1530A/QR/-X	TRANSISTOR		D927	MTZJ27B-T2	Z DIODE	
Q602	2SA1530A/QR/-X	TRANSISTOR		D929	MA8330/M/-X	Z DIODE	
Q603	UN2226-X	DIGI TRANSISTOR		D930	MA111-X	SI DIODE	
Q605	UN2226-X	DIGI TRANSISTOR		D931	MA8200/M/-X	Z DIODE	
Q607	2SC3928A/QR/-X	TRANSISTOR		D932	MA111-X	SI DIODE	
Q608	2SC3928A/QR/-X	TRANSISTOR		D933	MTZJ9.1B-T2	Z DIODE	
Q609	UN2226-X	DIGI TRANSISTOR		D951	RU4AM-LFM1	SI DIODE	
Q611	UN2226-X	DIGI TRANSISTOR		D952	FMX-G12S	SI DIODE	
Q612	2SC3928A/QR/-X	TRANSISTOR		D953	FR105GT-T3	SI DIODE	
Q702	2SC3928A/QR/-X	TRANSISTOR		D954	FR105GT-T3	SI DIODE	
Q704	2SC3928A/QR/-X	TRANSISTOR		D955	FMX-G12S	SI DIODE	
Q705	SSM3K02F-X	MOS FET		D957	MA8039/H/-X	Z DIODE	
Q706	SSM3K02F-X	MOS FET		D958	1SR35-400A-T2	SI DIODE	
Q707	2SC3928A/QR/-X	TRANSISTOR		D962	MA8330/M/-X	Z DIODE	
Q708	2SA1530A/QR/-X	TRANSISTOR		D970	MA8082/M/-X	Z DIODE	
Q791	2SC3928A/QR/-X	TRANSISTOR		D971	MA111-X	SI DIODE	
Q801	KTA1267/YG/-T	TRANSISTOR		D972	MA111-X	SI DIODE	
Q803	UN2226-X	DIGI TRANSISTOR		D973	MA111-X	SI DIODE	
Q804	UN2226-X	DIGI TRANSISTOR		D975	MA111-X	SI DIODE	
Q805	2SA1530A/QR/-X	TRANSISTOR		D977	1SR124-400A-T2	SI DIODE	
Q921	2SC3852A	POW TRANSISTOR		D981	UDZS2.0B-X	Z DIODE	
Q951	2SC3928A/QR/-X	TRANSISTOR		D982	UDZS2.0B-X	Z DIODE	
Q952	2SC3928A/QR/-X	TRANSISTOR		△PC901	PS2581AL1/QW/	PHOTO COUPLER	
Q957	2SC3928A/QR/-X	TRANSISTOR		C001	NCB31HK-103X	C CAPACITOR	0.01uF 50V K
Q958	2SA1013/RO/-T	TRANSISTOR		C002	QETN1HM-106Z	E CAPACITOR	10uF 50V M
Q981	2SA562TM/Y/-T	TRANSISTOR		C003	NCB31CK-104X	C CAPACITOR	0.1uF 16V K
Q982	2SC3928A/QR/-X	TRANSISTOR		C004	QETN1AM-477Z	E CAPACITOR	470uF 10V M
Q983	2SA562TM/Y/-T	TRANSISTOR		C005	NCB31HK-222X	C CAPACITOR	2200pF 50V K
Q984	2SC3928A/QR/-X	TRANSISTOR		C006	QETN1HM-336Z	E CAPACITOR	33uF 50V M
D101	1SS356-X	SI DIODE		C007	NDC31HJ-560X	C CAPACITOR	56pF 50V J
D102	1SS356-X	SI DIODE		C008	NDC31HJ-560X	C CAPACITOR	56pF 50V J
D341	MA111-X	SI DIODE		C101	NCB31HK-472X	C CAPACITOR	4700pF 50V K
D342	MA111-X	SI DIODE		C102	NCB31HK-472X	C CAPACITOR	4700pF 50V K
D343	MA111-X	SI DIODE		C103	NCB31HK-472X	C CAPACITOR	4700pF 50V K
D345	MA111-X	SI DIODE		C104	QETN1HM-106Z	E CAPACITOR	10uF 50V M
D423	1N4003SG-T2	SI DIODE		C105	NCB31HK-472X	C CAPACITOR	4700pF 50V K
D424	1SR35-400A-T2	SI DIODE		C106	NDC31HJ-180X	C CAPACITOR	18pF 50V J
D481	MA111-X	SI DIODE		C107	NCB31HK-103X	C CAPACITOR	0.01uF 50V K
D521	RH3G-F1	SI DIODE		C108	NCB31HK-472X	C CAPACITOR	4700pF 50V K
D522	RU4AM-LFM1	SI DIODE		C109	NCB31HK-472X	C CAPACITOR	4700pF 50V K
D523	FR105GT-T3	SI DIODE		C110	NCB31CK-104X	C CAPACITOR	0.1uF 16V K
D524	MA8091/H/-X	Z DIODE		C111	QETN1CM-477Z	E CAPACITOR	470uF 16V M
D530	FR105GT-T3	SI DIODE		C341	QETN1CM-227Z	E CAPACITOR	220uF 16V M
D551	FR105GT-T3	SI DIODE		C422	QCS32HJ-560Z	C CAPACITOR	56pF 500V J
D552	FR105GT-T3	SI DIODE		C423	NDC31HJ-102X	C CAPACITOR	1000pF 50V J
D554	MA8051/L/-X	Z DIODE		C424	QFLC2AJ-683Z	M CAPACITOR	0.068uF 100V J
D571	MA8075/H/-X	Z DIODE		C427	QETN1VM-108Z	E CAPACITOR	1000uF 35V M
D581	FR105GT-T3	SI DIODE		C428	QETN1VM-107Z	E CAPACITOR	100uF 35V M
D601	MA111-X	SI DIODE		C430	QFLC2AJ-563Z	M CAPACITOR	0.056uF 100V J
D603	MA111-X	SI DIODE		C431	NCB31HK-104X	C CAPACITOR	0.1uF 50V K
D607	MA111-X	SI DIODE		C435	NCF21HZ-334X	C CAPACITOR	0.33uF 50V Z
D701	MA111-X	SI DIODE		C436	NCF21HZ-334X	C CAPACITOR	0.33uF 50V Z
D702	MA8091/H/-X	Z DIODE		C471	QETN1HM-226Z	E CAPACITOR	22uF 50V M
D703	MA8091/H/-X	Z DIODE		C481	NCB31CK-224X	C CAPACITOR	0.22uF 16V K
D704	MA8091/H/-X	Z DIODE		C482	NCB31CK-224X	C CAPACITOR	0.22uF 16V K

△Ref No.	Part No.	Part Name	Description Local	△Ref No.	Part No.	Part Name	Description Local
C483	NCB31CK-224X	C CAPACITOR	0.22uF 16V K	C743	QETN1HM-106Z	E CAPACITOR	10uF 50V M
C484	NCB31CK-224X	C CAPACITOR	0.22uF 16V K	C744	NCB31CK-104X	C CAPACITOR	0.1uF 16V K
C485	QETN1VM-476Z	E CAPACITOR	47uF 35V M	C745	NCB31CK-104X	C CAPACITOR	0.1uF 16V K
C487	QETN1VM-226Z	E CAPACITOR	22uF 35V M	C746	NCB31CK-104X	C CAPACITOR	0.1uF 16V K
C488	NDC31HJ-561X	C CAPACITOR	560pF 50V J	C751	NCB31CK-104X	C CAPACITOR	0.1uF 16V K
C489	QETN1HM-226Z	E CAPACITOR	22uF 50V M	C752	NCB31CK-104X	C CAPACITOR	0.1uF 16V K
C490	QETN1CM-477Z	E CAPACITOR	470uF 16V M	C753	NCB31CK-104X	C CAPACITOR	0.1uF 16V K
C520	NRSA63J-222X	MG RESISTOR	2.2kΩ 1/16W J	C754	NCB31CK-104X	C CAPACITOR	0.1uF 16V K
C521	QCB31HK-332Z	C CAPACITOR	3300pF 50V K	C755	QETN1CM-227Z	E CAPACITOR	220uF 16V M
C522	QFLC1HJ-223Z	M CAPACITOR	0.022uF 50V J	C756	NCB31HK-104X	C CAPACITOR	0.1uF 50V K
C523	QETN1VM-476Z	E CAPACITOR	47uF 35V M	C757	NDC31HJ-561X	C CAPACITOR	560pF 50V J
△C524	QFZO196-302	MPP CAPACITOR	3000pF 1.5kV H	C758	NCB31CK-224X	C CAPACITOR	0.22uF 16V K
C525	QFZO196-143	MPP CAPACITOR	0.014uF 1.5kV H	C760	NCB31CK-224X	C CAPACITOR	0.22uF 16V K
C526	QFZO196-302	MPP CAPACITOR	3000pF 1.5kV H	C761	NCB31CK-104X	C CAPACITOR	0.1uF 16V K
C527	QFZO197-184	MPP CAPACITOR	0.18uF 250V J	C762	QETN1CM-107Z	E CAPACITOR	100uF 16V M
C528	QFP32GJ-393	PP CAPACITOR	0.039uF 400V J	C764	NCB31CK-104X	C CAPACITOR	0.1uF 16V K
C529	QENC2AM-225Z	BP E CAPACITOR	2.2uF 100V M	C766	NCB31CK-224X	C CAPACITOR	0.22uF 16V K
C530	QCB32HK-561Z	C CAPACITOR	560pF 500V K	C767	NCB31CK-224X	C CAPACITOR	0.22uF 16V K
C531	QEZ0195-475Z	BP E CAPACITOR	4.7uF 50V M	C768	NCB31CK-224X	C CAPACITOR	0.22uF 16V K
C532	QETN2EM-106Z	E CAPACITOR	10uF 250V M	C769	NCB31CK-104X	C CAPACITOR	0.1uF 16V K
C533	QFZO197-434	MPP CAPACITOR	0.43uF 250V J	C770	NCB31CK-104X	C CAPACITOR	0.1uF 16V K
C542	QFZO197-254	MPP CAPACITOR	0.25uF 250V J	C772	NCB31CK-224X	C CAPACITOR	0.22uF 16V K
C551	QCB32HK-561Z	C CAPACITOR	560pF 500V K	C775	NCB31CK-224X	C CAPACITOR	0.22uF 16V K
C552	QCB32HK-561Z	C CAPACITOR	560pF 500V K	C776	NCB31CK-104X	C CAPACITOR	0.1uF 16V K
C553	QETN1EM-108Z	E CAPACITOR	1000uF 25V M	C777	NCB31CK-104X	C CAPACITOR	0.1uF 16V K
C554	QETN1EM-108Z	E CAPACITOR	1000uF 25V M	C778	QETN1VM-476Z	E CAPACITOR	47uF 35V M
C555	QFLC2AJ-103Z	M CAPACITOR	0.01uF 100V J	C779	QETN1HM-106Z	E CAPACITOR	10uF 50V M
C571	QETM2CM-227	E CAPACITOR	220uF 160V M	C780	NCB31CK-104X	C CAPACITOR	0.1uF 16V K
C572	QETN1CM-107Z	E CAPACITOR	100uF 16V M	C781	NCB31CK-105X	C CAPACITOR	1uF 16V K
C573	QETN1VM-476Z	E CAPACITOR	47uF 35V M	C782	NCB31CK-105X	C CAPACITOR	1uF 16V K
C581	QFVF1HJ-104Z	MF CAPACITOR	0.1uF 50V J	C783	QETN1HM-105Z	E CAPACITOR	1uF 50V M
C582	QFZO197-204	MPP CAPACITOR	0.2uF 250V J	C785	QETN1HM-105Z	E CAPACITOR	1uF 50V M
C601	QETN1HM-106Z	E CAPACITOR	10uF 50V M	C786	NCB31CK-104X	C CAPACITOR	0.1uF 16V K
C602	QETN1HM-106Z	E CAPACITOR	10uF 50V M	C787	NCB31CK-104X	C CAPACITOR	0.1uF 16V K
C603	NCB31CK-224X	C CAPACITOR	0.22uF 16V K	C788	NCB31CK-104X	C CAPACITOR	0.1uF 16V K
C604	NCB31CK-224X	C CAPACITOR	0.22uF 16V K	C790	NDC31HJ-270X	C CAPACITOR	27pF 50V J
C605	NCB31CK-224X	C CAPACITOR	0.22uF 16V K	C792	NCB31CK-104X	C CAPACITOR	0.1uF 16V K
C606	NCB31CK-224X	C CAPACITOR	0.22uF 16V K	C793	QETN1HM-475Z	E CAPACITOR	4.7uF 50V M
C607	QETN1CM-227Z	E CAPACITOR	220uF 16V M	C802	QETN1HM-106Z	E CAPACITOR	10uF 50V M
C608	QETN1CM-227Z	E CAPACITOR	220uF 16V M	C803	QETN1HM-106Z	E CAPACITOR	10uF 50V M
C609	QETN1HM-336Z	E CAPACITOR	33uF 50V M	C804	QETN1CM-477Z	E CAPACITOR	470uF 16V M
C610	QETN1HM-107Z	E CAPACITOR	100uF 50V M	C821	NCB21HK-152X	C CAPACITOR	1500pF 50V K
C613	QETN1HM-106Z	E CAPACITOR	10uF 50V M	C822	NCB21HK-152X	C CAPACITOR	1500pF 50V K
C615	QETN1EM-108Z	E CAPACITOR	1000uF 25V M	C823	NCB21HK-152X	C CAPACITOR	1500pF 50V K
C616	QETN1EM-108Z	E CAPACITOR	1000uF 25V M	C824	NCB21HK-152X	C CAPACITOR	1500pF 50V K
C656	QETN1HM-107Z	E CAPACITOR	100uF 50V M	C827	NRSA63J-OR0X	MG RESISTOR	0Ω 1/16W J
C661	QETN1CM-107Z	E CAPACITOR	100uF 16V M	C828	NRSA63J-OR0X	MG RESISTOR	0Ω 1/16W J
C662	QETN1HM-106Z	E CAPACITOR	10uF 50V M	C829	NRSA63J-OR0X	MG RESISTOR	0Ω 1/16W J
C701	NCB31CK-224X	C CAPACITOR	0.22uF 16V K	C830	NRSA63J-OR0X	MG RESISTOR	0Ω 1/16W J
C702	NCB31CK-224X	C CAPACITOR	0.22uF 16V K	C901	QFZ9072-224	MM CAPACITOR	0.22uF AC250V K
C703	QETN1AM-477Z	E CAPACITOR	470uF 10V M	△C903	QCZ9015-102Z	C CAPACITOR	1000pF AC250V Z
C704	NCB31CK-104X	C CAPACITOR	0.1uF 16V K	△C904	QCZ9015-102Z	C CAPACITOR	1000pF AC250V Z
C705	NDC31HJ-7R0X	C CAPACITOR	7pF 50V J	△C905	QCZ9015-102Z	C CAPACITOR	1000pF AC250V Z
C706	NDC31HJ-7R0X	C CAPACITOR	7pF 50V J	C906	QEZ0371-397	E CAPACITOR	390uF 400V M
C707	NCB31CK-104X	C CAPACITOR	0.1uF 16V K	C915	QCB32HK-392Z	C CAPACITOR	3900pF 500V K
C708	QETN1CM-107Z	E CAPACITOR	100uF 16V M	C921	QCZ0364-102	C CAPACITOR	1000pF 2kV K
C709	NCB31HK-103X	C CAPACITOR	0.01uF 50V K	C922	QFLC1HJ-103Z	M CAPACITOR	0.01uF 50V J
C710	NCB31HK-682X	C CAPACITOR	6800pF 50V K	C923	QFLC1HJ-102Z	M CAPACITOR	1000pF 50V J
C711	QETN1HM-225Z	E CAPACITOR	2.2uF 50V M	C924	QFLC1HJ-104Z	M CAPACITOR	0.1uF 50V J
C712	QFVF1HJ-224Z	MF CAPACITOR	0.22uF 50V J	C925	QETN2AM-226Z	E CAPACITOR	22uF 100V M
C713	QETN1HM-106Z	E CAPACITOR	10uF 50V M	C926	QETN1HM-226Z	E CAPACITOR	22uF 50V M
C714	NCB31HK-223X	C CAPACITOR	0.022uF 50V K	C950	NCB31HK-104X	C CAPACITOR	0.1uF 50V K
C715	NCB31HK-102X	C CAPACITOR	1000pF 50V K	C951	QCZ0364-152	C CAPACITOR	1500pF 2kV K
C716	NCB31HK-102X	C CAPACITOR	1000pF 50V K	C952	QCB32HK-471Z	C CAPACITOR	470pF 500V K
C717	QETN1HM-105Z	E CAPACITOR	1uF 50V M	C953	QCB32HK-471Z	C CAPACITOR	470pF 500V K
C718	QFZO229-154Z	MF CAPACITOR	0.15uF 63V K	C954	QCB32HK-471Z	C CAPACITOR	470pF 500V K
C719	NCB31HK-103X	C CAPACITOR	0.01uF 50V K	C955	QCB32HK-471Z	C CAPACITOR	470pF 500V K
C720	NCB31HK-102X	C CAPACITOR	1000pF 50V K	C956	QEZ0203-227	E CAPACITOR	220uF 160V M
C723	NCB31CK-105X	C CAPACITOR	1uF 16V K	C957	QETN1AM-228Z	E CAPACITOR	2200uF 10V M
C724	NCB31CK-105X	C CAPACITOR	1uF 16V K	C958	QETN1EM-477Z	E CAPACITOR	470uF 25V M
C725	NCB31CK-104X	C CAPACITOR	0.1uF 16V K	C959	QETN1VM-107Z	E CAPACITOR	100uF 35V M
C726	QETN1HM-106Z	E CAPACITOR	10uF 50V M	C960	QETM1VM-228	E CAPACITOR	2200uF 35V M
C727	NCB31HK-332X	C CAPACITOR	3300pF 50V K	C962	NRSA63J-OR0X	MG RESISTOR	0Ω 1/16W J
C728	NCB31CK-104X	C CAPACITOR	0.1uF 16V K	C963	QCZ0121-102	C CAPACITOR	1000pF 3.15kV Z
C729	QETN1HM-225Z	E CAPACITOR	2.2uF 50V M	C967	QETN1AM-108Z	E CAPACITOR	1000uF 10V M
C730	QETN1CM-227Z	E CAPACITOR	220uF 16V M	C975	QETN1EM-108Z	E CAPACITOR	1000uF 25V M
C731	NCB31CK-104X	C CAPACITOR	0.1uF 16V K	C977	QETN1VM-476Z	E CAPACITOR	47uF 35V M
C732	QETN1HM-225Z	E CAPACITOR	2.2uF 50V M	C980	QETN1CM-107Z	E CAPACITOR	100uF 16V M
C734	NCB31CK-104X	C CAPACITOR	0.1uF 16V K	C982	QETN1AM-227Z	E CAPACITOR	220uF 10V M
C735	NCB31CK-104X	C CAPACITOR	0.1uF 16V K	△C991	QCZ9079-471	C CAPACITOR	470pF AC250V K
C736	NCB31HK-103X	C CAPACITOR	0.01uF 50V K	△C992	QCZ9079-471	C CAPACITOR	470pF AC250V K
C737	NCB31CK-104X	C CAPACITOR	0.1uF 16V K	△C993	QCZ9079-681	C CAPACITOR	680pF AC250V K
C738	NCB31CK-105X	C CAPACITOR	1uF 16V K	R001	NRSA63J-221X	MG RESISTOR	220Ω 1/16W J
C739	NCB31CK-105X	C CAPACITOR	1uF 16V K	R002	NRSA63J-221X	MG RESISTOR	220Ω 1/16W J
C740	NCB31CK-104X	C CAPACITOR	0.1uF 16V K	R003	NRSA63J-392X	MG RESISTOR	3.9kΩ 1/16W J
C741	NCB31CK-104X	C CAPACITOR	0.1uF 16V K	R004	NRSA63J-273X	MG RESISTOR	27kΩ 1/16W J
C742	QETN1HM-106Z	E CAPACITOR	10uF 50V M				

△Ref No.	Part No.	Part Name	Description Local	△Ref No.	Part No.	Part Name	Description Local
R005	NRSA63J-750X	MG RESISTOR	75Ω 1/16W J	R624	NRSA63J-683X	MG RESISTOR	68kΩ 1/16W J
R101	NRSA63J-100X	MG RESISTOR	10Ω 1/16W J	R626	NRSA02J-271X	MG RESISTOR	270Ω 1/10W J
R102	NRSA63J-682X	MG RESISTOR	6.8kΩ 1/16W J	R628	NRSA02J-271X	MG RESISTOR	270Ω 1/10W J
R103	NRSA63J-272X	MG RESISTOR	2.7kΩ 1/16W J	R629	NRSA63J-222X	MG RESISTOR	2.2kΩ 1/16W J
R104	NRSA63J-181X	MG RESISTOR	180Ω 1/16W J	R630	NRSA63J-222X	MG RESISTOR	2.2kΩ 1/16W J
R105	NRSA63J-220X	MG RESISTOR	22Ω 1/16W J	R632	NRSA63J-102X	MG RESISTOR	1kΩ 1/16W J
R106	NRSA63J-101X	MG RESISTOR	100Ω 1/16W J	R701	NRSA63J-123X	MG RESISTOR	12kΩ 1/16W J
R107	NRSA63J-472X	MG RESISTOR	4.7kΩ 1/16W J	R702	NRSA63J-471X	MG RESISTOR	470Ω 1/16W J
R108	NRSA63J-222X	MG RESISTOR	2.2kΩ 1/16W J	R703	NRSA63J-101X	MG RESISTOR	100Ω 1/16W J
R109	NRSA63J-222X	MG RESISTOR	2.2kΩ 1/16W J	R704	NRSA63J-101X	MG RESISTOR	100Ω 1/16W J
R110	NRSA63J-222X	MG RESISTOR	2.2kΩ 1/16W J	R705	NRSA63J-393X	MG RESISTOR	39kΩ 1/16W J
R341	NRSA63J-0R0X	MG RESISTOR	0Ω 1/16W J	R706	NRSA63J-221X	MG RESISTOR	220Ω 1/16W J
R344	NRSA63J-220X	MG RESISTOR	22Ω 1/16W J	R707	NRSA63J-273X	MG RESISTOR	27kΩ 1/16W J
R345	NRSA63J-102X	MG RESISTOR	1kΩ 1/16W J	R708	NRSA63J-473X	MG RESISTOR	47kΩ 1/16W J
R411	NRSA63J-222X	MG RESISTOR	2.2kΩ 1/16W J	R709	NRSA63J-105X	MG RESISTOR	1MΩ 1/16W J
R412	NRSA63J-222X	MG RESISTOR	2.2kΩ 1/16W J	R711	QRE141J-562Y	C RESISTOR	5.6kΩ 1/4W J
R421	NRSA63J-103X	MG RESISTOR	10kΩ 1/16W J	R712	NRSA63J-103X	MG RESISTOR	10kΩ 1/16W J
R426	NRSA63J-123X	MG RESISTOR	12kΩ 1/16W J	R713	QRE141J-562Y	C RESISTOR	5.6kΩ 1/4W J
R427	NRSA63J-682X	MG RESISTOR	6.8kΩ 1/16W J	R714	NRSA63J-103X	MG RESISTOR	10kΩ 1/16W J
R430	NRSA63J-123X	MG RESISTOR	12kΩ 1/16W J	R715	NRSA63J-391X	MG RESISTOR	390Ω 1/16W J
R431	QRE121J-4R7Y	C RESISTOR	4.7Ω 1/2W J	R716	NRSA63J-562X	MG RESISTOR	5.6kΩ 1/16W J
R432	QRX01GJ-2R2	MF RESISTOR	2.2Ω 1W J	R717	NRSA63J-103X	MG RESISTOR	10kΩ 1/16W J
R433	QRE121J-3R3Y	C RESISTOR	3.3Ω 1/2W J	R718	NRSA63J-562X	MG RESISTOR	5.6kΩ 1/16W J
R434	NRSA63J-682X	MG RESISTOR	6.8kΩ 1/16W J	R719	NRSA63J-103X	MG RESISTOR	10kΩ 1/16W J
R438	NRSA63J-105X	MG RESISTOR	1MΩ 1/16W J	R720	QRE141J-0R0Y	C RESISTOR	0Ω 1/4W J
R440	QRG01GJ-331	OMF RESISTOR	330Ω 1W J	R722	NRSA63J-471X	MG RESISTOR	470Ω 1/16W J
R448	QRE121J-1R0Y	C RESISTOR	1Ω 1/2W J	R723	NRSA63J-471X	MG RESISTOR	470Ω 1/16W J
R461	QRE121J-683Y	C RESISTOR	68kΩ 1/2W J	R724	NRSA63J-102X	MG RESISTOR	1kΩ 1/16W J
R462	QRL039J-150	OMF RESISTOR	15Ω 3W J	R725	NRSA63J-470X	MG RESISTOR	47Ω 1/16W J
R471	NRSA63J-274X	MG RESISTOR	270kΩ 1/16W J	R726	NRSA63J-273X	MG RESISTOR	27kΩ 1/16W J
R472	NRSA63J-103X	MG RESISTOR	10kΩ 1/16W J	R727	NRSA63J-103X	MG RESISTOR	10kΩ 1/16W J
R473	NRSA63J-683X	MG RESISTOR	68kΩ 1/16W J	R728	QRE141J-101Y	C RESISTOR	100Ω 1/4W J
R474	NRSA63J-224X	MG RESISTOR	220kΩ 1/16W J	R730	QRE141J-151Y	C RESISTOR	150Ω 1/4W J
R481	NRSA63J-124X	MG RESISTOR	120kΩ 1/16W J	R731	NRSA63J-102X	MG RESISTOR	1kΩ 1/16W J
R482	NRSA63J-683X	MG RESISTOR	68kΩ 1/16W J	R732	NRSA63J-102X	MG RESISTOR	1kΩ 1/16W J
R483	NRSA63J-682X	MG RESISTOR	6.8kΩ 1/16W J	R733	NRSA63J-101X	MG RESISTOR	100Ω 1/16W J
R484	NRSA63J-562X	MG RESISTOR	5.6kΩ 1/16W J	R734	NRSA63J-101X	MG RESISTOR	100Ω 1/16W J
R485	NRSA63J-333X	MG RESISTOR	33kΩ 1/16W J	R735	NRSA63J-101X	MG RESISTOR	100Ω 1/16W J
R486	NRSA63J-332X	MG RESISTOR	3.3kΩ 1/16W J	R736	QRE141J-101Y	C RESISTOR	100Ω 1/4W J
R487	NRSA63J-154X	MG RESISTOR	150kΩ 1/16W J	R737	NRSA63J-101X	MG RESISTOR	100Ω 1/16W J
R488	NRSA63J-104X	MG RESISTOR	100kΩ 1/16W J	R738	NRSA63J-101X	MG RESISTOR	100Ω 1/16W J
R490	NRSA63J-103X	MG RESISTOR	10kΩ 1/16W J	R739	NRSA63J-101X	MG RESISTOR	100Ω 1/16W J
R491	NRSA63J-683X	MG RESISTOR	68kΩ 1/16W J	R740	NRSA63J-153X	MG RESISTOR	15kΩ 1/16W J
R492	NRSA63J-152X	MG RESISTOR	1.5kΩ 1/16W J	R741	NRSA63J-221X	MG RESISTOR	220Ω 1/16W J
R493	NRSA63J-223X	MG RESISTOR	22kΩ 1/16W J	R742	NRSA63J-221X	MG RESISTOR	220Ω 1/16W J
R494	NRSA63J-562X	MG RESISTOR	5.6kΩ 1/16W J	R743	NRSA63J-332X	MG RESISTOR	3.3kΩ 1/16W J
R496	NRSA63J-472X	MG RESISTOR	4.7kΩ 1/16W J	R744	NRSA63J-221X	MG RESISTOR	220Ω 1/16W J
R497	NRSA63J-222X	MG RESISTOR	2.2kΩ 1/16W J	R745	NRSA63J-332X	MG RESISTOR	3.3kΩ 1/16W J
R498	NRSA63J-223X	MG RESISTOR	22kΩ 1/16W J	R746	NRSA63J-103X	MG RESISTOR	10kΩ 1/16W J
R499	NRSA63J-473X	MG RESISTOR	47kΩ 1/16W J	R747	NRSA63J-101X	MG RESISTOR	100Ω 1/16W J
R520	NRSA63J-471X	MG RESISTOR	470Ω 1/16W J	R748	NRSA63J-272X	MG RESISTOR	2.7kΩ 1/16W J
R521	NRSA63J-104X	MG RESISTOR	100kΩ 1/16W J	R749	QRE141J-102Y	C RESISTOR	1kΩ 1/4W J
R522	QRE121J-220Y	C RESISTOR	22Ω 1/2W J	R750	NRSA63J-103X	MG RESISTOR	10kΩ 1/16W J
R523	QRL029J-271	OMF RESISTOR	270Ω 2W J	R751	NRSA63J-102X	MG RESISTOR	1kΩ 1/16W J
R524	QRL039J-221	OMF RESISTOR	220Ω 3W J	R752	QRE141J-101Y	C RESISTOR	100Ω 1/4W J
R525	QRL039J-221	OMF RESISTOR	220Ω 3W J	R753	NRSA63J-122X	MG RESISTOR	1.2kΩ 1/16W J
R527	QRL039J-103	OMF RESISTOR	10kΩ 3W J	R754	NRSA63J-221X	MG RESISTOR	220Ω 1/16W J
R528	QRE121J-471Y	C RESISTOR	470Ω 1/2W J	R755	NRSA63J-122X	MG RESISTOR	1.2kΩ 1/16W J
△R530	QRZ9017-4R7	FUSI RESISTOR	4.7Ω 1/4W J	R756	NRSA63J-103X	MG RESISTOR	10kΩ 1/16W J
△R533	QRZ9017-4R7	FUSI RESISTOR	4.7Ω 1/4W J	R757	NRSA63J-472X	MG RESISTOR	4.7kΩ 1/16W J
R551	QRZ9021-1R5	FUSI RESISTOR	1.5Ω 1W J	R758	NRSA63J-332X	MG RESISTOR	3.3kΩ 1/16W J
R552	QRZ9021-1R5	FUSI RESISTOR	1.5Ω 1W J	R759	NRSA63J-332X	MG RESISTOR	3.3kΩ 1/16W J
R554	NRSA63J-182X	MG RESISTOR	1.8kΩ 1/16W J	R760	NRSA63J-101X	MG RESISTOR	100Ω 1/16W J
R571	QRZ0225-2R2	UNF RESISTOR	2.2Ω 7W K	R761	NRSA63J-101X	MG RESISTOR	100Ω 1/16W J
R572	QRA14CF-1202Y	CMF RESISTOR	12kΩ 1/4W F	R762	NRSA63J-221X	MG RESISTOR	220Ω 1/16W J
R573	NRSA63J-332X	MG RESISTOR	3.3kΩ 1/16W J	R763	NRSA63J-221X	MG RESISTOR	220Ω 1/16W J
R574	QRE121J-183Y	C RESISTOR	18kΩ 1/2W J	R764	NRSA63J-221X	MG RESISTOR	220Ω 1/16W J
R575	NRSA63J-222X	MG RESISTOR	2.2kΩ 1/16W J	R765	NRSA63J-221X	MG RESISTOR	220Ω 1/16W J
R581	QRE121J-822Y	C RESISTOR	8.2kΩ 1/2W J	R768	NRSA63J-101X	MG RESISTOR	100Ω 1/16W J
R582	QRE121J-104Y	C RESISTOR	100kΩ 1/2W J	R769	NRSA63J-103X	MG RESISTOR	10kΩ 1/16W J
R583	QRE121J-184Y	C RESISTOR	180kΩ 1/2W J	R771	QRE141J-102Y	C RESISTOR	1kΩ 1/4W J
R601	NRSA63J-0R0X	MG RESISTOR	0Ω 1/16W J	R772	QRE141J-562Y	C RESISTOR	5.6kΩ 1/4W J
R602	NRSA63J-0R0X	MG RESISTOR	0Ω 1/16W J	R773	NRSA63J-103X	MG RESISTOR	10kΩ 1/16W J
R603	NRSA63J-102X	MG RESISTOR	1kΩ 1/16W J	R774	NRSA63J-562X	MG RESISTOR	5.6kΩ 1/16W J
R604	NRSA02J-123X	MG RESISTOR	12kΩ 1/10W J	R775	NRSA63J-103X	MG RESISTOR	10kΩ 1/16W J
R606	QRE121J-2R2Y	C RESISTOR	2.2Ω 1/2W J	R776	NRSA63J-153X	MG RESISTOR	15kΩ 1/16W J
R607	QRE121J-2R2Y	C RESISTOR	2.2Ω 1/2W J	R777	NRSA63J-101X	MG RESISTOR	100Ω 1/16W J
R609	NRSA63J-273X	MG RESISTOR	27kΩ 1/16W J	R779	NRSA63J-101X	MG RESISTOR	100Ω 1/16W J
R610	NRSA63J-104X	MG RESISTOR	100kΩ 1/16W J	R780	NRSA63J-101X	MG RESISTOR	100Ω 1/16W J
R611	NRSA63J-103X	MG RESISTOR	10kΩ 1/16W J	R781	NRSA63J-101X	MG RESISTOR	100Ω 1/16W J
R612	NRSA63J-104X	MG RESISTOR	100kΩ 1/16W J	R782	NRSA63J-122X	MG RESISTOR	1.2kΩ 1/16W J
R614	NRSA63J-104X	MG RESISTOR	100kΩ 1/16W J	R783	NRSA63J-103X	MG RESISTOR	10kΩ 1/16W J
R618	NRSA02J-123X	MG RESISTOR	12kΩ 1/10W J	R784	NRSA63J-103X	MG RESISTOR	10kΩ 1/16W J
R620	NRSA63J-103X	MG RESISTOR	10kΩ 1/16W J	R785	NRSA63J-103X	MG RESISTOR	10kΩ 1/16W J
R621	NRSA63J-222X	MG RESISTOR	2.2kΩ 1/16W J	R786	NRSA63J-750X	MG RESISTOR	75Ω 1/16W J
R622	NRSA63J-103X	MG RESISTOR	10kΩ 1/16W J	R787	NRSA63J-472X	MG RESISTOR	4.7kΩ 1/16W J
R623	NRSA63J-333X	MG RESISTOR	33kΩ 1/16W J	R788	NRSA63J-0R0X	MG RESISTOR	0Ω 1/16W J

△Ref No.	Part No.	Part Name	Description Local	△Ref No.	Part No.	Part Name	Description Local
R790	NRSA63J-102X	MG RESISTOR	1kΩ 1/16W J	K702	QQR1114-001Z	FERRITE BEADS	
R792	QRE141J-330Y	C RESISTOR	33Ω 1/4W J	K703	QQR1113-001Z	FERRITE BEADS	
R793	NRSA63J-101X	MG RESISTOR	100Ω 1/16W J	K921	QQR1114-001Z	FERRITE BEADS	
R794	NRSA63J-222X	MG RESISTOR	2.2kΩ 1/16W J	K951	QQR1114-001Z	FERRITE BEADS	
R795	NRSA63J-104X	MG RESISTOR	100kΩ 1/16W J	K952	QQR1113-001Z	FERRITE BEADS	
R796	NRSA63J-102X	MG RESISTOR	1kΩ 1/16W J	K953	QQR1113-001Z	FERRITE BEADS	
R797	NRSA63J-683X	MG RESISTOR	68kΩ 1/16W J	K954	QQR1113-001Z	FERRITE BEADS	
R798	NRSA63J-473X	MG RESISTOR	47kΩ 1/16W J	K955	QQR1113-001Z	FERRITE BEADS	
R801	NRSA63J-750X	MG RESISTOR	75Ω 1/16W J	K957	QQR1114-001Z	FERRITE BEADS	
R802	NRSA63J-0R0X	MG RESISTOR	0Ω 1/16W J	LC801	QQR1199-002	EMI FILTER	
R803	NRSA63J-0R0X	MG RESISTOR	0Ω 1/16W J	LC802	QQR1199-002	EMI FILTER	
R804	NRSA63J-750X	MG RESISTOR	75Ω 1/16W J	LC803	QQR1199-002	EMI FILTER	
R805	NRSA63J-750X	MG RESISTOR	75Ω 1/16W J	LC804	QQR1199-002	EMI FILTER	
R806	NRSA63J-750X	MG RESISTOR	75Ω 1/16W J	△LF902	QQR1433-001	LINE FILTER	
R807	QRE121J-101Y	C RESISTOR	100Ω 1/2W J	SF101	QAX0872-001	SAW FILTER	
R809	NRSA63J-221X	MG RESISTOR	220Ω 1/16W J	SF102	QAX0731-001	SAW FILTER	
R810	NRSA63J-391X	MG RESISTOR	390Ω 1/16W J	TU001	QAU0383-002	TUNER	
R811	NRSA63J-823X	MG RESISTOR	82kΩ 1/16W J	X701	QAX0799-001Z	CRYSTAL	2457600MHz
R812	NRSA63J-391X	MG RESISTOR	390Ω 1/16W J				
R813	NRSA63J-823X	MG RESISTOR	82kΩ 1/16W J				
R814	NRSA63J-104X	MG RESISTOR	100kΩ 1/16W J				
R815	NRSA63J-750X	MG RESISTOR	75Ω 1/16W J				
R816	NRSA63J-750X	MG RESISTOR	75Ω 1/16W J				
R901	QRF154K-1R8	UNF WW RESISTOR	1.8Ω 15W K				
R902	QRL029J-683	OMF RESISTOR	68kΩ 2W J				
R921	QRL029J-473	OMF RESISTOR	47kΩ 2W J				
R922	QRE141J-391Y	C RESISTOR	390Ω 1/4W J	IC351	TDA6107AJF/N1	IC	
R923	QRE141J-273Y	C RESISTOR	27kΩ 1/4W J				
R924	QRA14CF-3902Y	CMF RESISTOR	39kΩ 1/4W F	Q203	KTC3199/YG-T	TRANSISTOR	
R926	QRE121J-220Y	C RESISTOR	22Ω 1/2W J	Q204	KTC3199/YG-T	TRANSISTOR	
R927	NRSA63J-222X	MG RESISTOR	2.2kΩ 1/16W J	Q206	KTA1267/YG-T	TRANSISTOR	
R928	QRE121J-103Y	C RESISTOR	10kΩ 1/2W J	Q208	2SA2140/QP/	POW TRANSISTOR	
R929	QRE141J-220Y	C RESISTOR	22Ω 1/4W J	Q209	2SC5993/QP/	POW TRANSISTOR	
R951	QRE121J-332Y	C RESISTOR	3.3kΩ 1/2W J	Q371	2SC3928A/QR-X	TRANSISTOR	
R952	QRE121J-153Y	C RESISTOR	15kΩ 1/2W J	Q372	2SC3928A/QR-X	TRANSISTOR	
R953	QRE121J-103Y	C RESISTOR	10kΩ 1/2W J	Q373	2SC3928A/QR-X	TRANSISTOR	
R957	NRSA63J-153X	MG RESISTOR	15kΩ 1/16W J	Q374	2SA1530A/QR-X	TRANSISTOR	
R958	NRSA63J-183X	MG RESISTOR	18kΩ 1/16W J				
R959	NRSA63J-153X	MG RESISTOR	15kΩ 1/16W J	D201	MA111-X	SI DIODE	
R960	QRE121J-223Y	C RESISTOR	22kΩ 1/2W J	D202	MA111-X	SI DIODE	
R962	QRL029J-223	OMF RESISTOR	22kΩ 2W J	D203	RGP10J-5025-T3	SI DIODE	
R963	QRE121J-332Y	C RESISTOR	3.3kΩ 1/2W J	D204	RGP10J-5025-T3	SI DIODE	
R965	QRX029J-1R0	MF RESISTOR	1Ω 2W J	D350	MA8075/M-X	Z DIODE	
R970	QRE121J-182Y	C RESISTOR	1.8kΩ 1/2W J	D354	EU01N-T2	SI DIODE	
R975	QRE141J-122Y	C RESISTOR	1.2kΩ 1/4W J	D355	EU01N-T2	SI DIODE	
R976	NRSA63J-391X	MG RESISTOR	390Ω 1/16W J	D356	EU01N-T2	SI DIODE	
R980	NRSA63J-562X	MG RESISTOR	5.6kΩ 1/16W J	D357	EU01N-T2	SI DIODE	
R981	QRE121J-3R9Y	C RESISTOR	3.9Ω 1/2W J	D371	MA111-X	SI DIODE	
R982	NRSA63J-473X	MG RESISTOR	47kΩ 1/16W J	D372	MA111-X	SI DIODE	
R983	QRE121J-3R9Y	C RESISTOR	3.9Ω 1/2W J				
R984	NRSA63J-473X	MG RESISTOR	47kΩ 1/16W J	C201	QETN1CM-227Z	E CAPACITOR	220uF 16V M
R985	NRSA63J-472X	MG RESISTOR	4.7kΩ 1/16W J	C203	QETN1HM-106Z	E CAPACITOR	10uF 50V M
R986	NRSA63J-472X	MG RESISTOR	4.7kΩ 1/16W J	C204	NDC31HJ-471X	C CAPACITOR	470pF 50V J
△R991	QRZ9046-825Z	C RESISTOR	8.2MΩ 1/2W K	C205	NCB31HK-561X	C CAPACITOR	560pF 50V K
				C206	QETN1HM-335Z	E CAPACITOR	3.3uF 50V M
L001	QQL244K-8R2Z	PEAKING COIL	8.2uH K	C207	QCS31HJ-5R0Z	C CAPACITOR	5pF 50V J
L002	QQL244J-4R7Z	PEAKING COIL	4.7uH J	C209	QETN1CM-107Z	E CAPACITOR	100uF 16V M
L003	QQL244J-4R7Z	PEAKING COIL	4.7uH J	C211	NDC31HJ-821X	C CAPACITOR	820pF 50V J
L101	QQL244K-1R0Z	PEAKING COIL	1uH K	C212	QCB32HK-472Z	C CAPACITOR	4700pF 500V K
L401	QQL244K-820Z	PEAKING COIL	82uH K	C213	NCB31HK-102X	C CAPACITOR	1000pF 50V K
L521	QQLZ036-821	COIL	820uH K	C214	QETN2CM-106Z	E CAPACITOR	10uF 160V M
L522	QQR1243-002	LINIARITY COIL		C215	QCB32HK-472Z	C CAPACITOR	4700pF 500V K
L523	QQLZ036-101	COIL	100uH K	C216	QETN2CM-106Z	E CAPACITOR	10uF 160V M
L530	QQL244K-220Z	PEAKING COIL	22uH K	C217	QETN1AM-107Z	E CAPACITOR	100uF 10V M
L701	QQL231J-5R6Y	P COIL	5.6uH J	C218	QETN1AM-107Z	E CAPACITOR	100uF 10V M
L702	QQL231J-5R6Y	P COIL	5.6uH J	C219	QETN1AM-337Z	E CAPACITOR	330uF 10V M
L703	NQL812K-100X	P COIL	10uH K	C220	QCS32HJ-680Z	C CAPACITOR	68pF 500V J
L706	NQL812K-100X	P COIL	10uH K	C351	NDC31HJ-102X	C CAPACITOR	1000pF 50V J
L716	NQL812K-100X	P COIL	10uH K	C352	QETN2EM-475Z	E CAPACITOR	4.7uF 250V M
L718	NQL812K-100X	P COIL	10uH K	C353	QFKC2EK-104Z	MM CAPACITOR	0.1uF 250V K
L951	QQLZ026-480	COIL	48uH ±7%	C358	QFZ0196-103	MPP CAPACITOR	0.01uF 1.5kV H
△T521	QQR1229-001	DRIVE TRANSF		C371	QETN1CM-227Z	E CAPACITOR	220uF 16V M
T523	QQR1732-001	PIN TRANSF					
T921	QQS0388-001	SW TRANSF		R207	NRSA63J-0R0X	MG RESISTOR	0Ω 1/16W J
				R208	NRSA63J-153X	MG RESISTOR	15kΩ 1/16W J
△CP650	ICP-N38-T	IC PROTECTOR	1.5A	R209	NRSA63J-152X	MG RESISTOR	1.5kΩ 1/16W J
△CP951	QMFZ034-4R0Z-J1	FUSE	4A 125V	R210	NRSA63J-272X	MG RESISTOR	2.7kΩ 1/16W J
△CP952	ICP-N38-T	IC PROTECTOR	1.5A	R211	NRSA63J-152X	MG RESISTOR	1.5kΩ 1/16W J
△CP953	ICP-N38-T	IC PROTECTOR	1.5A	R212	NRSA63J-151X	MG RESISTOR	150Ω 1/16W J
△CP954	ICP-N38-T	IC PROTECTOR	1.5A	R213	NRSA63J-221X	MG RESISTOR	220Ω 1/16W J
△CP955	ICP-N75-T	IC PROTECTOR	2.7A	R214	QRJ146J-100X	UNF C RESISTOR	10Ω 1/4W J
J801	QNZ0454-002	PIN JACK	VIDEO1/S-VIDEO IN	R219	NRSA63J-470X	MG RESISTOR	47Ω 1/16W J
J802	QNN0349-002	PIN JACK	VIDEO2/COMP IN	R220	NRSA63J-470X	MG RESISTOR	47Ω 1/16W J
J803	QNN0348-001	PIN JACK	VIDEO2/COMP IN	R221	NRSA63J-122X	MG RESISTOR	1.2kΩ 1/16W J
J804	QNN0349-001	PIN JACK	VIDEO OUT	R222	QRE121J-563Y	C RESISTOR	56kΩ 1/2W J
K107	QQR1114-001Z	FERRITE BEADS		R223	QRE121J-563Y	C RESISTOR	56kΩ 1/2W J
K601	QQR1114-001Z	FERRITE BEADS		R224	NRSA63J-122X	MG RESISTOR	1.2kΩ 1/16W J

CRT SOCKET P.W. BOARD ASS'Y (SCW-3038A-H2)

△Ref No.	Part No.	Part Name	Description Local	△Ref No.	Part No.	Part Name	Description Local
R225	NRSA63J-390X	MG RESISTOR	39Ω 1/16W J	LC801	QQR1199-002	EMI FILTER	
R226	QRE121J-2R7Y	C RESISTOR	2.7Ω 1/2W J	△LRF901	QQR1433-001	LINE FILTER	
R227	QRE121J-2R7Y	C RESISTOR	2.7Ω 1/2W J	△RY901	QSK0061-002	RELAY	
R228	NRSA63J-390X	MG RESISTOR	39Ω 1/16W J	S801	QSW0619-003Z	PUSH SWITCH	CH+
R229	QRE121J-121Y	C RESISTOR	120Ω 1/2W J	S802	QSW0619-003Z	PUSH SWITCH	CH-
R232	QRL029J-391	OMF RESISTOR	390Ω 2W J	S803	QSW0619-003Z	PUSH SWITCH	MENU
R351	NRSA63J-101X	MG RESISTOR	100Ω 1/16W J	S804	QSW0619-003Z	PUSH SWITCH	TV/VIDEO
R352	NRSA63J-101X	MG RESISTOR	100Ω 1/16W J	S805	QSW0619-003Z	PUSH SWITCH	VOL+
R353	NRSA63J-101X	MG RESISTOR	100Ω 1/16W J	S806	QSW0619-003Z	PUSH SWITCH	VOL-
R354	NRSA63J-101X	MG RESISTOR	100Ω 1/16W J	△S901	QSW0750-001	PUSH SWITCH	POWER
R355	QRC121K-561Z	COMP RESISTOR	560Ω 1/2W K	TH901	QAD0145-2R3	P THERMISTOR	2.3Ω
R356	QRC121K-561Z	COMP RESISTOR	560Ω 1/2W K	△VA901	QAF0060-621	VARISTOR	620V
R357	QRC121K-561Z	COMP RESISTOR	560Ω 1/2W K		GG30138-001A-H	EE HOLDER	
R358	QRZ0107-152Z	C RESISTOR	1.5kΩ 1/2W K		LC30349-001A-H	LED HOLDER	
R359	QRZ0107-152Z	C RESISTOR	1.5kΩ 1/2W K				
R360	QRZ0107-152Z	C RESISTOR	1.5kΩ 1/2W K				
△R369	QRZ9023-1R0	FUSI RESISTOR	1Ω 2W J				
R371	NRSA63J-333X	MG RESISTOR	33kΩ 1/16W J				
R372	NRSA63J-333X	MG RESISTOR	33kΩ 1/16W J				
R373	NRSA63J-333X	MG RESISTOR	33kΩ 1/16W J				
R374	QRZ0107-474Z	C RESISTOR	470kΩ 1/2W K				
R376	NRSA63J-562X	MG RESISTOR	5.6kΩ 1/16W J				
R377	NRSA63J-123X	MG RESISTOR	12kΩ 1/16W J				
L351	QQL244J-5R6Z	COIL	5.6uH J				
△FR201	QRZ9021-561	FUSI RESISTOR	560Ω 1W J				
K201	QQR1114-001Z	FERRITE BEADS					
K202	QQR1114-001Z	FERRITE BEADS					
K203	QQR1114-001Z	FERRITE BEADS					
K204	QRL029J-271	OMF RESISTOR	270Ω 2W J				
K205	QQR1114-001Z	FERRITE BEADS					
K206	QQR1114-001Z	FERRITE BEADS					
K208	QQR1113-001Z	FERRITE BEADS					
△SK351	QNZ0536-002	CRT SOCKET					

BASS P.W. BOARD ASS'Y (SCW-6003A-H2)

△Ref No.	Part No.	Part Name	Description Local
IC671	MX3000DS-X	IC	
C671	QETN1HM-474Z	E CAPACITOR	0.47uF 50V M
C672	NDC31HJ-330X	C CAPACITOR	33pF 50V J
C673	NDC31HJ-330X	C CAPACITOR	33pF 50V J
C674	NDC31HJ-330X	C CAPACITOR	33pF 50V J
C675	NDC31HJ-330X	C CAPACITOR	33pF 50V J
C676	NDC31HJ-330X	C CAPACITOR	33pF 50V J
C677	QETN1HM-105Z	E CAPACITOR	1uF 50V M
C678	NCB31HK-153X	C CAPACITOR	0.015uF 50V K
C679	QETN1CM-107Z	E CAPACITOR	100uF 16V M
C680	NCB31HK-104X	C CAPACITOR	0.1uF 50V K
C681	NDC31HJ-330X	C CAPACITOR	33pF 50V J
C682	NDC31HJ-330X	C CAPACITOR	33pF 50V J
C683	NCB31HK-104X	C CAPACITOR	0.1uF 50V K
C684	QETN1HM-106Z	E CAPACITOR	10uF 50V M
C685	NCB21CK-105X	C CAPACITOR	1uF 16V K
C686	NCB21CK-105X	C CAPACITOR	1uF 16V K
C688	NCF21AZ-475X	C CAPACITOR	4.7uF 10V Z
C689	NCF21AZ-475X	C CAPACITOR	4.7uF 10V Z
C690	NDC31HJ-680X	C CAPACITOR	68pF 50V J
C691	NDC31HJ-680X	C CAPACITOR	68pF 50V J
R671	NRSA63J-472X	MG RESISTOR	4.7kΩ 1/16W J
R672	NRSA63J-472X	MG RESISTOR	4.7kΩ 1/16W J
R673	NRSA63J-123X	MG RESISTOR	12kΩ 1/16W J
R674	NRSA63J-123X	MG RESISTOR	12kΩ 1/16W J
R675	NRSA63J-103X	MG RESISTOR	10kΩ 1/16W J
R676	NRSA63J-104X	MG RESISTOR	100kΩ 1/16W J
R677	NRSA63J-472X	MG RESISTOR	4.7kΩ 1/16W J
R678	NRSA63J-472X	MG RESISTOR	4.7kΩ 1/16W J
R679	NRSA63J-100X	MG RESISTOR	10Ω 1/16W J
R682	NRSA63J-221X	MG RESISTOR	220Ω 1/16W J
R683	NRSA63J-221X	MG RESISTOR	220Ω 1/16W J

FRONT CONTROL P.W. BOARD ASS'Y (SCW-8020A-H2)

△Ref No.	Part No.	Part Name	Description Local
IC301	S9648	PHOTO CONDUCTOR	
IC801	GP1UE281QKVF	IR DETECT UNIT	
Q955	2SC3928A/QR-X	TRANSISTOR	
D801	LH22440-T16	LED	POWER(RED)
D803	MA8091/H-X	Z DIODE	
D956	MA111-X	SI DIODE	
D957	MA111-X	SI DIODE	
C301	QETN1HM-475Z	E CAPACITOR	4.7uF 50V M
C801	NCB31HK-104X	C CAPACITOR	0.1uF 50V K
C802	QETN1CM-107Z	E CAPACITOR	100uF 16V M
C803	NRSA63J-0R0X	MG RESISTOR	0Ω 1/16W J
C806	NCB31HK-152X	C CAPACITOR	1500pF 50V K
C807	NCB31HK-152X	C CAPACITOR	1500pF 50V K
△C901	QFZ9072-224	MM CAPACITOR	0.22uF AC250V K
△C902	QFZ9072-224	MM CAPACITOR	0.22uF AC250V K
C965	QETN1CM-107Z	E CAPACITOR	100uF 16V M
R302	NRSA63J-823X	MG RESISTOR	82kΩ 1/16W J
R601	QRE121J-271Y	C RESISTOR	270Ω 1/2W J
R602	NRSA63J-102X	MG RESISTOR	1kΩ 1/16W J
R603	NRSA63J-102X	MG RESISTOR	1kΩ 1/16W J
R604	QRE121J-271Y	C RESISTOR	270Ω 1/2W J
R801	NRSA63J-102X	MG RESISTOR	1kΩ 1/16W J
R802	NRSA63J-470X	MG RESISTOR	47Ω 1/16W J
R803	NRSA63J-471X	MG RESISTOR	470Ω 1/16W J
R806	NRSA63J-0R0X	MG RESISTOR	0Ω 1/16W J
R809	NRSA63J-0R0X	MG RESISTOR	0Ω 1/16W J
R812	NRSA63J-181X	MG RESISTOR	180Ω 1/16W J
R813	NRSA63J-221X	MG RESISTOR	220Ω 1/16W J
R814	NRSA63J-331X	MG RESISTOR	330Ω 1/16W J
R815	NRSA63J-471X	MG RESISTOR	470Ω 1/16W J
R816	NRSA63J-821X	MG RESISTOR	820Ω 1/16W J
△R901	QRZ0107-474Z	C RESISTOR	470kΩ 1/2W K
R960	NRSA63J-223X	MG RESISTOR	22kΩ 1/16W J
R961	NRSA63J-223X	MG RESISTOR	22kΩ 1/16W J
△F901	QMF51E2-4R0-S	FUSE	4A AC250V
J801	QMS3001-C01	3.5 JACK	HEADPHONE
J802	QNN0797-001	PIN JACK	VIDEO3 IN
K801	QQR1114-001Z	FERRITE BEADS	

PRINTED WIRING BOARD PARTS LIST [AV-29SX76/G]

MAIN P.W. BOARD ASS'Y (SCW-1947A-H2)

△Ref No.	Part No.	Part Name	Description Local	△Ref No.	Part No.	Part Name	Description Local
IC301	PVP9390A-QG-A1	IC		D607	MA111-X	SI DIODE	
IC401	AN15526A	IC		D701	MA111-X	SI DIODE	
IC481	LA6515	IC		D702	MA8091/H/-X	Z DIODE	
IC601	AN5277	IC		D703	MA8091/H/-X	Z DIODE	
IC701	TDA12021-ERA3-F	IC(MCU)	(SERVICE)	D704	MA8091/H/-X	Z DIODE	
IC702	ATE16-29MX76G	IC	(SERVICE)	D706	MA8036-X	Z DIODE	
IC921	STR-W6556A-F5	IC		D707	MA111-X	SI DIODE	
IC951	SE135N	IC		D708	MA111-X	SI DIODE	
IC972	PQ033RDA1SSH	IC		D709	MA111-X	SI DIODE	
IC973	PQ120RDA1SZ	IC		D710	MA8091/H/-X	Z DIODE	
IC975	PQ050RDA1SZ	IC		D711	MA111-X	SI DIODE	
Q101	2SC5397/CDI-T	TRANSISTOR		D712	MA111-X	SI DIODE	
Q102	UN2212-X	DIGI TRANSISTOR		D713	MA8039/H/-X	Z DIODE	
Q103	UN2212-X	DIGI TRANSISTOR		D714	MA8039/H/-X	Z DIODE	
Q305	2SC3928A/QR/-X	TRANSISTOR		D715	MA111-X	SI DIODE	
Q306	2SC3928A/QR/-X	TRANSISTOR		D716	MA111-X	SI DIODE	
Q307	2SA1530A/QR/-X	TRANSISTOR		D717	MA111-X	SI DIODE	
Q341	2SA1530A/QR/-X	TRANSISTOR		D751	MA8091/H/-X	Z DIODE	
Q421	2SC3928A/QR/-X	TRANSISTOR		D753	MA8091/H/-X	Z DIODE	
Q422	2SC3928A/QR/-X	TRANSISTOR		D810	MA8091/H/-X	Z DIODE	
Q461	RDN050N20	POWER MOS FET		D811	MA8091/H/-X	Z DIODE	
Q481	2SC3928A/QR/-X	TRANSISTOR		D812	MA8091/H/-X	Z DIODE	
Q482	2SA1530A/QR/-X	TRANSISTOR		D813	MA8091/H/-X	Z DIODE	
Q483	2SA562TM/Y/-T	TRANSISTOR		D814	MA8091/H/-X	Z DIODE	
Q484	2SA1530A/QR/-X	TRANSISTOR		D815	MA8091/H/-X	Z DIODE	
Q521	BSN304-T	TRANSISTOR		D901	GSIB460-S1	BRIDGE DIODE	
△Q522	TT2202-YD	POW TRANSISTOR		D921	FR105GT-T3	SI DIODE	
Q571	2SA1208/ST/Z1-T	TRANSISTOR		D922	MTZJ36A-T2	Z DIODE	
Q572	UN2212-X	DIGI TRANSISTOR		D923	MTZJ9.1B-T2	Z DIODE	
Q601	2SA1530A/QR/-X	TRANSISTOR		D924	MTZJ9.1B-T2	Z DIODE	
Q602	2SA1530A/QR/-X	TRANSISTOR		D925	MTZJ9.1B-T2	Z DIODE	
Q603	UN2226-X	DIGI TRANSISTOR		D926	FR105GT-T3	SI DIODE	
Q605	UN2226-X	DIGI TRANSISTOR		D927	MTZJ27B-T2	Z DIODE	
Q607	2SC3928A/QR/-X	TRANSISTOR		D929	MA8330/M/-X	Z DIODE	
Q608	2SC3928A/QR/-X	TRANSISTOR		D930	MA111-X	SI DIODE	
Q609	UN2226-X	DIGI TRANSISTOR		D931	MA8200/M/-X	Z DIODE	
Q611	UN2226-X	DIGI TRANSISTOR		D932	MA111-X	SI DIODE	
Q612	2SC3928A/QR/-X	TRANSISTOR		D933	MTZJ9.1B-T2	Z DIODE	
Q702	2SC3928A/QR/-X	TRANSISTOR		D951	RU4AM-LFM1	SI DIODE	
Q704	2SC3928A/QR/-X	TRANSISTOR		D952	FMX-G12S	SI DIODE	
Q705	SSM3K02F-X	MOS FET		D953	FR105GT-T3	SI DIODE	
Q706	SSM3K02F-X	MOS FET		D954	FR105GT-T3	SI DIODE	
Q707	2SC3928A/QR/-X	TRANSISTOR		D955	FMX-G12S	SI DIODE	
Q708	2SA1530A/QR/-X	TRANSISTOR		D957	MA8039/H/-X	Z DIODE	
Q791	2SC3928A/QR/-X	TRANSISTOR		D958	1SR35-400A-T2	SI DIODE	
Q801	KTA1267/YG-T	TRANSISTOR		D962	MA8330/M/-X	Z DIODE	
Q803	UN2226-X	DIGI TRANSISTOR		D970	MA8082/M/-X	Z DIODE	
Q804	UN2226-X	DIGI TRANSISTOR		D971	MA111-X	SI DIODE	
Q805	2SA1530A/QR/-X	TRANSISTOR		D972	MA111-X	SI DIODE	
Q921	2SC3852A	POW TRANSISTOR		D973	MA111-X	SI DIODE	
Q951	2SC3928A/QR/-X	TRANSISTOR		D975	MA111-X	SI DIODE	
Q952	2SC3928A/QR/-X	TRANSISTOR		D977	1SR124-400A-T2	SI DIODE	
Q957	2SC3928A/QR/-X	TRANSISTOR		D981	UDZS2.0B-X	Z DIODE	
Q958	2SA1013/RO/-T	TRANSISTOR		D982	UDZS2.0B-X	Z DIODE	
Q981	2SA562TM/Y/-T	TRANSISTOR		△PC901	PS2581AL1/QW/	PHOTO COUPLER	
Q982	2SC3928A/QR/-X	TRANSISTOR		C001	NCB31HK-103X	C CAPACITOR	0.01uF 50V K
Q983	2SA562TM/Y/-T	TRANSISTOR		C002	QETN1HM-106Z	E CAPACITOR	10uF 50V M
Q984	2SC3928A/QR/-X	TRANSISTOR		C003	NCB31CK-104X	C CAPACITOR	0.1uF 16V K
D101	1SS356-X	SI DIODE		C004	QETN1AM-477Z	E CAPACITOR	470uF 10V M
D102	1SS356-X	SI DIODE		C005	NCB31HK-222X	C CAPACITOR	2200pF 50V K
D301	MA111-X	SI DIODE		C006	QETN1HM-336Z	E CAPACITOR	33uF 50V M
D341	MA111-X	SI DIODE		C007	NDC31HJ-560X	C CAPACITOR	56pF 50V J
D342	MA111-X	SI DIODE		C008	NDC31HJ-560X	C CAPACITOR	56pF 50V J
D343	MA111-X	SI DIODE		C101	NCB31HK-472X	C CAPACITOR	4700pF 50V K
D345	MA111-X	SI DIODE		C102	NCB31HK-472X	C CAPACITOR	4700pF 50V K
D423	1N4003SG-T2	SI DIODE		C103	NCB31HK-472X	C CAPACITOR	4700pF 50V K
D424	1SR35-400A-T2	SI DIODE		C104	QETN1HM-106Z	E CAPACITOR	10uF 50V M
D481	MA111-X	SI DIODE		C105	NCB31HK-472X	C CAPACITOR	4700pF 50V K
D521	RH3G-F1	SI DIODE		C106	NDC31HJ-180X	C CAPACITOR	18pF 50V J
D522	RU4AM-LFM1	SI DIODE		C107	NCB31HK-103X	C CAPACITOR	0.01uF 50V K
D523	FR105GT-T3	SI DIODE		C108	NCB31HK-472X	C CAPACITOR	4700pF 50V K
D524	MA8091/H/-X	Z DIODE		C109	NCB31HK-472X	C CAPACITOR	4700pF 50V K
D530	FR105GT-T3	SI DIODE		C110	NCB31CK-104X	C CAPACITOR	0.1uF 16V K
D551	FR105GT-T3	SI DIODE		C111	QETN1CM-477Z	E CAPACITOR	470uF 16V M
D552	FR105GT-T3	SI DIODE		C302	NDC31HJ-270X	C CAPACITOR	27pF 50V J
D554	MA8051/L/-X	Z DIODE		C303	NDC31HJ-270X	C CAPACITOR	27pF 50V J
D571	MA8075/H/-X	Z DIODE		C304	QETN1HM-106Z	E CAPACITOR	10uF 50V M
D581	FR105GT-T3	SI DIODE		C305	NCB31HK-103X	C CAPACITOR	0.01uF 50V K
D601	MA111-X	SI DIODE		C306	QETN1HM-106Z	E CAPACITOR	10uF 50V M
D603	MA111-X	SI DIODE		C307	NCB31HK-103X	C CAPACITOR	0.01uF 50V K
				C308	QETN1HM-106Z	E CAPACITOR	10uF 50V M
				C309	NCB31HK-103X	C CAPACITOR	0.01uF 50V K

△Ref No.	Part No.	Part Name	Description Local	△Ref No.	Part No.	Part Name	Description Local
C310	QETN1HM-106Z	E CAPACITOR	10uF 50V M	C719	NCB31HK-103X	C CAPACITOR	0.01uF 50V K
C311	NCB31HK-103X	C CAPACITOR	0.01uF 50V K	C720	NCB31HK-102X	C CAPACITOR	1000pF 50V K
C312	QETN1HM-106Z	E CAPACITOR	10uF 50V M	C723	NCB31CK-105X	C CAPACITOR	1uF 16V K
C313	NCB31HK-103X	C CAPACITOR	0.01uF 50V K	C724	NCB31CK-105X	C CAPACITOR	1uF 16V K
C314	NCB30JK-225X	C CAPACITOR	2.2uF 6.3V K	C725	NCB31CK-104X	C CAPACITOR	0.1uF 16V K
C315	NCB31HK-473X	C CAPACITOR	0.047uF 50V K	C726	QETN1HM-106Z	E CAPACITOR	10uF 50V M
C316	QETN1CM-107Z	E CAPACITOR	100uF 16V M	C727	NCB31HK-332X	C CAPACITOR	3300pF 50V K
C318	NDC31HJ-270X	C CAPACITOR	27pF 50V J	C728	NCB31CK-104X	C CAPACITOR	0.1uF 16V K
C341	QETN1CM-227Z	E CAPACITOR	220uF 16V M	C729	QETN1HM-225Z	E CAPACITOR	2.2uF 50V M
C422	QCS32HJ-560Z	C CAPACITOR	56pF 500V J	C730	QETN1CM-227Z	E CAPACITOR	220uF 16V M
C423	NDC31HJ-102X	C CAPACITOR	1000pF 50V J	C731	NCB31CK-104X	C CAPACITOR	0.1uF 16V K
C424	QFLC2AJ-683Z	M CAPACITOR	0.068uF 100V J	C732	QETN1HM-225Z	E CAPACITOR	2.2uF 50V M
C427	QETN1VM-108Z	E CAPACITOR	1000uF 35V M	C734	NCB31CK-104X	C CAPACITOR	0.1uF 16V K
C428	QETN1VM-107Z	E CAPACITOR	100uF 35V M	C735	NCB31CK-104X	C CAPACITOR	0.1uF 16V K
C430	QFLC2AJ-563Z	M CAPACITOR	0.056uF 100V J	C736	NCB31HK-103X	C CAPACITOR	0.01uF 50V K
C431	NCB31HK-104X	C CAPACITOR	0.1uF 50V K	C737	NCB31CK-104X	C CAPACITOR	0.1uF 16V K
C435	NCF21HZ-334X	C CAPACITOR	0.33uF 50V Z	C738	NCB31CK-105X	C CAPACITOR	1uF 16V K
C436	NCF21HZ-334X	C CAPACITOR	0.33uF 50V Z	C739	NCB31CK-105X	C CAPACITOR	1uF 16V K
C471	QETN1HM-226Z	E CAPACITOR	22uF 50V M	C740	NCB31CK-104X	C CAPACITOR	0.1uF 16V K
C481	NCB31CK-224X	C CAPACITOR	0.22uF 16V K	C741	NCB31CK-104X	C CAPACITOR	0.1uF 16V K
C482	NCB31CK-224X	C CAPACITOR	0.22uF 16V K	C742	QETN1HM-106Z	E CAPACITOR	10uF 50V M
C483	NCB31CK-224X	C CAPACITOR	0.22uF 16V K	C743	QETN1HM-106Z	E CAPACITOR	10uF 50V M
C484	NCB31CK-224X	C CAPACITOR	0.22uF 16V K	C744	NCB31CK-104X	C CAPACITOR	0.1uF 16V K
C485	QETN1VM-476Z	E CAPACITOR	47uF 35V M	C745	NCB31CK-104X	C CAPACITOR	0.1uF 16V K
C487	QETN1VM-226Z	E CAPACITOR	22uF 35V M	C746	NCB31CK-104X	C CAPACITOR	0.1uF 16V K
C488	NDC31HJ-561X	C CAPACITOR	560pF 50V J	C748	NCB31CK-104X	C CAPACITOR	0.1uF 16V K
C489	QETN1HM-226Z	E CAPACITOR	22uF 50V M	C749	NCB31CK-104X	C CAPACITOR	0.1uF 16V K
C490	QETN1CM-477Z	E CAPACITOR	470uF 16V M	C750	NCB31CK-104X	C CAPACITOR	0.1uF 16V K
C520	NRSA63J-222X	MG RESISTOR	2.2kΩ 1/16W J	C751	NCB31CK-104X	C CAPACITOR	0.1uF 16V K
C521	QCB31HK-332Z	C CAPACITOR	3300pF 50V K	C752	NCB31CK-104X	C CAPACITOR	0.1uF 16V K
C522	QFLC1HJ-223Z	M CAPACITOR	0.022uF 50V J	C753	NCB31CK-104X	C CAPACITOR	0.1uF 16V K
C523	QETN1VM-476Z	E CAPACITOR	47uF 35V M	C754	NCB31CK-104X	C CAPACITOR	0.1uF 16V K
△C524	QFZ0196-302	MPP CAPACITOR	3000pF 1.5kV H	C755	QETN1CM-227Z	E CAPACITOR	220uF 16V M
C525	QFZ0196-143	MPP CAPACITOR	0.014uF 1.5kV H	C756	NCB31HK-104X	C CAPACITOR	0.1uF 50V K
C526	QFZ0196-302	MPP CAPACITOR	3000pF 1.5kV H	C757	NDC31HJ-561X	C CAPACITOR	560pF 50V J
C527	QFZ0197-184	MPP CAPACITOR	0.18uF 250V J	C758	NCB31CK-224X	C CAPACITOR	0.22uF 16V K
C528	QFP32GJ-393	PP CAPACITOR	0.039uF 400V J	C760	NCB31CK-224X	C CAPACITOR	0.22uF 16V K
C529	QENC2AM-225Z	BP E CAPACITOR	2.2uF 100V M	C761	NCB31CK-104X	C CAPACITOR	0.1uF 16V K
C530	QCB32HK-561Z	C CAPACITOR	560pF 500V K	C762	QETN1CM-107Z	E CAPACITOR	100uF 16V M
C531	QEZO195-475Z	BP E CAPACITOR	4.7uF 50V M	C764	NCB31CK-104X	C CAPACITOR	0.1uF 16V K
C532	QETN2EM-106Z	E CAPACITOR	10uF 250V M	C766	NCB31CK-224X	C CAPACITOR	0.22uF 16V K
C533	QFZ0197-434	MPP CAPACITOR	0.43uF 250V J	C767	NCB31CK-224X	C CAPACITOR	0.22uF 16V K
C542	QFZ0197-254	MPP CAPACITOR	0.25uF 250V J	C768	NCB31CK-224X	C CAPACITOR	0.22uF 16V K
C551	QCB32HK-561Z	C CAPACITOR	560pF 500V K	C769	NCB31CK-104X	C CAPACITOR	0.1uF 16V K
C552	QCB32HK-561Z	C CAPACITOR	560pF 500V K	C770	NCB31CK-104X	C CAPACITOR	0.1uF 16V K
C553	QETN1EM-108Z	E CAPACITOR	1000uF 25V M	C772	NCB31CK-224X	C CAPACITOR	0.22uF 16V K
C554	QETN1EM-108Z	E CAPACITOR	1000uF 25V M	C775	NCB31CK-224X	C CAPACITOR	0.22uF 16V K
C555	QFLC2AJ-103Z	M CAPACITOR	0.01uF 100V J	C776	NCB31CK-104X	C CAPACITOR	0.1uF 16V K
C571	QETM2CM-227	E CAPACITOR	220uF 160V M	C777	NCB31CK-104X	C CAPACITOR	0.1uF 16V K
C572	QETN1CM-107Z	E CAPACITOR	100uF 16V M	C778	QETN1VM-476Z	E CAPACITOR	47uF 35V M
C573	QETN1VM-476Z	E CAPACITOR	47uF 35V M	C779	QETN1HM-106Z	E CAPACITOR	10uF 50V M
C581	QFVF1HJ-104Z	MF CAPACITOR	0.1uF 50V J	C780	NCB31CK-104X	C CAPACITOR	0.1uF 16V K
C582	QFZ0197-204	MPP CAPACITOR	0.2uF 250V J	C781	NCB31CK-105X	C CAPACITOR	1uF 16V K
C601	QETN1HM-106Z	E CAPACITOR	10uF 50V M	C782	NCB31CK-105X	C CAPACITOR	1uF 16V K
C602	QETN1HM-106Z	E CAPACITOR	10uF 50V M	C783	QETN1HM-105Z	E CAPACITOR	1uF 50V M
C603	NCB31CK-224X	C CAPACITOR	0.22uF 16V K	C785	QETN1HM-105Z	E CAPACITOR	1uF 50V M
C604	NCB31CK-224X	C CAPACITOR	0.22uF 16V K	C790	NDC31HJ-270X	C CAPACITOR	27pF 50V J
C605	NCB31CK-224X	C CAPACITOR	0.22uF 16V K	C792	NCB31CK-104X	C CAPACITOR	0.1uF 16V K
C606	NCB31CK-224X	C CAPACITOR	0.22uF 16V K	C793	QETN1HM-475Z	E CAPACITOR	4.7uF 50V M
C607	QETN1CM-227Z	E CAPACITOR	220uF 16V M	C802	QETN1HM-106Z	E CAPACITOR	10uF 50V M
C608	QETN1CM-227Z	E CAPACITOR	220uF 16V M	C803	QETN1HM-106Z	E CAPACITOR	10uF 50V M
C609	QETN1HM-336Z	E CAPACITOR	33uF 50V M	C804	QETN1CM-477Z	E CAPACITOR	470uF 16V M
C610	QETN1HM-107Z	E CAPACITOR	100uF 50V M	C821	NCB21HK-152X	C CAPACITOR	1500pF 50V K
C613	QETN1HM-106Z	E CAPACITOR	10uF 50V M	C822	NCB21HK-152X	C CAPACITOR	1500pF 50V K
C615	QETN1EM-108Z	E CAPACITOR	1000uF 25V M	C823	NCB21HK-152X	C CAPACITOR	1500pF 50V K
C616	QETN1EM-108Z	E CAPACITOR	1000uF 25V M	C824	NCB21HK-152X	C CAPACITOR	1500pF 50V K
C656	QETN1HM-107Z	E CAPACITOR	100uF 50V M	C827	NRSA63J-0R0X	MG RESISTOR	0Ω 1/16W J
C661	QETN1CM-107Z	E CAPACITOR	100uF 16V M	C828	NRSA63J-0R0X	MG RESISTOR	0Ω 1/16W J
C662	QETN1HM-106Z	E CAPACITOR	10uF 50V M	C829	NRSA63J-0R0X	MG RESISTOR	0Ω 1/16W J
C701	NCB31CK-224X	C CAPACITOR	0.22uF 16V K	C830	NRSA63J-0R0X	MG RESISTOR	0Ω 1/16W J
C702	NCB31CK-224X	C CAPACITOR	0.22uF 16V K	C901	QFZ9072-224	MM CAPACITOR	0.22uF AC250V Z
C703	QETN1AM-477Z	E CAPACITOR	470uF 10V M	△C903	QCZ9015-102Z	C CAPACITOR	1000pF AC250V Z
C704	NCB31CK-104X	C CAPACITOR	0.1uF 16V K	△C904	QCZ9015-102Z	C CAPACITOR	1000pF AC250V Z
C705	NDC31HJ-7R0X	C CAPACITOR	7pF 50V J	△C905	QCZ9015-102Z	C CAPACITOR	1000pF AC250V Z
C706	NDC31HJ-7R0X	C CAPACITOR	7pF 50V J	C906	QEZO371-397	E CAPACITOR	390uF 400V M
C707	NCB31CK-104X	C CAPACITOR	0.1uF 16V K	C915	QCB32HK-392Z	C CAPACITOR	3900pF 500V K
C708	QETN1CM-107Z	E CAPACITOR	100uF 16V M	C921	QCZ0364-102	C CAPACITOR	1000pF 2kV K
C709	NCB31HK-103X	C CAPACITOR	0.01uF 50V K	C922	QFLC1HJ-103Z	M CAPACITOR	0.01uF 50V J
C710	NCB31HK-682X	C CAPACITOR	6800pF 50V K	C923	QFLC1HJ-102Z	M CAPACITOR	1000pF 50V J
C711	QETN1HM-225Z	E CAPACITOR	2.2uF 50V M	C924	QFLC1HJ-104Z	M CAPACITOR	0.1uF 50V J
C712	QFVF1HJ-224Z	MF CAPACITOR	0.22uF 50V J	C925	QETN2AM-226Z	E CAPACITOR	22uF 100V M
C713	QETN1HM-106Z	E CAPACITOR	10uF 50V M	C926	QETN1HM-226Z	E CAPACITOR	22uF 50V M
C714	NCB31HK-223X	C CAPACITOR	0.022uF 50V K	C950	NCB31HK-104X	C CAPACITOR	0.1uF 50V K
C715	NCB31HK-102X	C CAPACITOR	1000pF 50V K	C951	QCZ0364-152	C CAPACITOR	1500pF 2kV K
C716	NCB31HK-102X	C CAPACITOR	1000pF 50V K	C952	QCB32HK-471Z	C CAPACITOR	470pF 500V K
C717	QETN1HM-105Z	E CAPACITOR	1uF 50V M	C953	QCB32HK-471Z	C CAPACITOR	470pF 500V K
C718	QFZ0229-154Z	MF CAPACITOR	0.15uF 63V K	C954	QCB32HK-471Z	C CAPACITOR	470pF 500V K

△Ref No.	Part No.	Part Name	Description Local	△Ref No.	Part No.	Part Name	Description Local
C955	QCB32HK-471Z	C CAPACITOR	470pF 500V K	R521	NRSA63J-104X	MG RESISTOR	100kΩ 1/16W J
C956	QEZO203-227	E CAPACITOR	220uF 160V M	R522	QRE121J-220Y	C RESISTOR	22Ω 1/2W J
C957	QETN1AM-228Z	E CAPACITOR	2200uF 10V M	R523	QRL029J-271	OMF RESISTOR	270Ω 2W J
C958	QETN1EM-477Z	E CAPACITOR	470uF 25V M	R524	QRL039J-221	OMF RESISTOR	220Ω 3W J
C959	QETN1VM-107Z	E CAPACITOR	100uF 35V M	R525	QRL039J-221	OMF RESISTOR	220Ω 3W J
C960	QETM1VM-228	E CAPACITOR	2200uF 35V M	R527	QRL039J-103	OMF RESISTOR	10kΩ 3W J
C962	NRSA63J-0R0X	MG RESISTOR	0Ω 1/16W J	R528	QRE121J-471Y	C RESISTOR	470Ω 1/2W J
C963	QCZO121-102	C CAPACITOR	1000pF 3.15kV Z	△R530	QRZ9017-4R7	FUSI RESISTOR	4.7Ω 1/4W J
C967	QETN1AM-108Z	E CAPACITOR	1000uF 10V M	△R533	QRZ9017-4R7	FUSI RESISTOR	4.7Ω 1/4W J
C975	QETN1EM-108Z	E CAPACITOR	1000uF 25V M	R551	QRZ9021-1R5	FUSI RESISTOR	1.5Ω 1W J
C977	QETN1VM-476Z	E CAPACITOR	47uF 35V M	R552	QRZ9021-1R5	FUSI RESISTOR	1.5Ω 1W J
C980	QETN1CM-107Z	E CAPACITOR	100uF 16V M	R554	NRSA63J-182X	MG RESISTOR	1.8kΩ 1/16W J
C982	QETN1AM-227Z	E CAPACITOR	220uF 10V M	R571	QRZ0225-2R2	UNF RESISTOR	2.2Ω 7W K
△C991	QCZ9079-471	C CAPACITOR	470pF AC250V K	R572	QRA14CF-1202Y	CMF RESISTOR	12kΩ 1/4W F
△C992	QCZ9079-471	C CAPACITOR	470pF AC250V K	R573	NRSA63J-332X	MG RESISTOR	3.3kΩ 1/16W J
△C993	QCZ9079-681	C CAPACITOR	680pF AC250V K	R574	QRE121J-183Y	C RESISTOR	18kΩ 1/2W J
				R575	NRSA63J-222X	MG RESISTOR	2.2kΩ 1/16W J
R001	NRSA63J-221X	MG RESISTOR	220Ω 1/16W J	R581	QRE121J-822Y	C RESISTOR	8.2kΩ 1/2W J
R002	NRSA63J-221X	MG RESISTOR	220Ω 1/16W J	R582	QRE121J-104Y	C RESISTOR	100kΩ 1/2W J
R003	NRSA63J-392X	MG RESISTOR	3.9kΩ 1/16W J	R583	QRE121J-184Y	C RESISTOR	180kΩ 1/2W J
R004	NRSA63J-273X	MG RESISTOR	27kΩ 1/16W J	R601	NRSA63J-0R0X	MG RESISTOR	0Ω 1/16W J
R005	NRSA63J-750X	MG RESISTOR	75Ω 1/16W J	R602	NRSA63J-0R0X	MG RESISTOR	0Ω 1/16W J
R101	NRSA63J-100X	MG RESISTOR	10Ω 1/16W J	R603	NRSA63J-102X	MG RESISTOR	1kΩ 1/16W J
R102	NRSA63J-682X	MG RESISTOR	6.8kΩ 1/16W J	R604	NRSA02J-123X	MG RESISTOR	12kΩ 1/10W J
R103	NRSA63J-272X	MG RESISTOR	2.7kΩ 1/16W J	R606	QRE121J-2R2Y	C RESISTOR	2.2Ω 1/2W J
R104	NRSA63J-181X	MG RESISTOR	180Ω 1/16W J	R607	QRE121J-2R2Y	C RESISTOR	2.2Ω 1/2W J
R105	NRSA63J-220X	MG RESISTOR	22Ω 1/16W J	R609	NRSA63J-273X	MG RESISTOR	27kΩ 1/16W J
R106	NRSA63J-101X	MG RESISTOR	100Ω 1/16W J	R610	NRSA63J-104X	MG RESISTOR	100kΩ 1/16W J
R107	NRSA63J-472X	MG RESISTOR	4.7kΩ 1/16W J	R611	NRSA63J-103X	MG RESISTOR	10kΩ 1/16W J
R108	NRSA63J-222X	MG RESISTOR	2.2kΩ 1/16W J	R612	NRSA63J-104X	MG RESISTOR	100kΩ 1/16W J
R109	NRSA63J-222X	MG RESISTOR	2.2kΩ 1/16W J	R614	NRSA63J-104X	MG RESISTOR	100kΩ 1/16W J
R110	NRSA63J-222X	MG RESISTOR	2.2kΩ 1/16W J	R618	NRSA02J-123X	MG RESISTOR	12kΩ 1/10W J
R307	NRSA63J-223X	MG RESISTOR	22kΩ 1/16W J	R620	NRSA63J-103X	MG RESISTOR	10kΩ 1/16W J
R308	NRSA63J-333X	MG RESISTOR	33kΩ 1/16W J	R621	NRSA63J-222X	MG RESISTOR	2.2kΩ 1/16W J
R309	NRSA63J-221X	MG RESISTOR	220Ω 1/16W J	R622	NRSA63J-103X	MG RESISTOR	10kΩ 1/16W J
R310	NRSA63J-472X	MG RESISTOR	4.7kΩ 1/16W J	R623	NRSA63J-333X	MG RESISTOR	33kΩ 1/16W J
R311	NRSA63J-472X	MG RESISTOR	4.7kΩ 1/16W J	R624	NRSA63J-683X	MG RESISTOR	68kΩ 1/16W J
R312	NRSA63J-221X	MG RESISTOR	220Ω 1/16W J	R626	NRSA02J-271X	MG RESISTOR	270Ω 1/10W J
R313	NRSA63J-823X	MG RESISTOR	82kΩ 1/16W J	R628	NRSA02J-271X	MG RESISTOR	270Ω 1/10W J
R314	NRSA63J-223X	MG RESISTOR	22kΩ 1/16W J	R629	NRSA63J-222X	MG RESISTOR	2.2kΩ 1/16W J
R315	NRSA63J-103X	MG RESISTOR	10kΩ 1/16W J	R630	NRSA63J-222X	MG RESISTOR	2.2kΩ 1/16W J
R316	NRSA63J-103X	MG RESISTOR	10kΩ 1/16W J	R632	NRSA63J-102X	MG RESISTOR	1kΩ 1/16W J
R317	NRSA63J-103X	MG RESISTOR	10kΩ 1/16W J	R701	NRSA63J-123X	MG RESISTOR	12kΩ 1/16W J
R318	NRSA63J-472X	MG RESISTOR	4.7kΩ 1/16W J	R702	NRSA63J-471X	MG RESISTOR	470Ω 1/16W J
R319	NRSA63J-472X	MG RESISTOR	4.7kΩ 1/16W J	R703	NRSA63J-101X	MG RESISTOR	100Ω 1/16W J
R320	NRSA63J-123X	MG RESISTOR	12kΩ 1/16W J	R704	NRSA63J-101X	MG RESISTOR	100Ω 1/16W J
R321	NRSA63J-472X	MG RESISTOR	4.7kΩ 1/16W J	R705	NRSA63J-393X	MG RESISTOR	39kΩ 1/16W J
R341	NRSA63J-0R0X	MG RESISTOR	0Ω 1/16W J	R706	NRSA63J-221X	MG RESISTOR	220Ω 1/16W J
R344	NRSA63J-220X	MG RESISTOR	22Ω 1/16W J	R707	NRSA63J-273X	MG RESISTOR	27kΩ 1/16W J
R345	NRSA63J-102X	MG RESISTOR	1kΩ 1/16W J	R708	NRSA63J-473X	MG RESISTOR	47kΩ 1/16W J
R411	NRSA63J-222X	MG RESISTOR	2.2kΩ 1/16W J	R709	NRSA63J-105X	MG RESISTOR	1MΩ 1/16W J
R412	NRSA63J-222X	MG RESISTOR	2.2kΩ 1/16W J	R711	QRE141J-562Y	C RESISTOR	5.6kΩ 1/4W J
R421	NRSA63J-103X	MG RESISTOR	10kΩ 1/16W J	R712	NRSA63J-103X	MG RESISTOR	10kΩ 1/16W J
R426	NRSA63J-123X	MG RESISTOR	12kΩ 1/16W J	R713	QRE141J-562Y	C RESISTOR	5.6kΩ 1/4W J
R427	NRSA63J-682X	MG RESISTOR	6.8kΩ 1/16W J	R714	NRSA63J-103X	MG RESISTOR	10kΩ 1/16W J
R430	NRSA63J-123X	MG RESISTOR	12kΩ 1/16W J	R715	NRSA63J-391X	MG RESISTOR	390Ω 1/16W J
R431	QRE121J-4R7Y	C RESISTOR	4.7Ω 1/2W J	R716	NRSA63J-562X	MG RESISTOR	5.6kΩ 1/16W J
R432	QRX01GJ-2R2	MF RESISTOR	2.2Ω 1W J	R717	NRSA63J-103X	MG RESISTOR	10kΩ 1/16W J
R433	QRE121J-3R3Y	C RESISTOR	3.3Ω 1/2W J	R718	NRSA63J-562X	MG RESISTOR	5.6kΩ 1/16W J
R434	NRSA63J-682X	MG RESISTOR	6.8kΩ 1/16W J	R719	NRSA63J-103X	MG RESISTOR	10kΩ 1/16W J
R438	NRSA63J-105X	MG RESISTOR	1MΩ 1/16W J	R720	QRE141J-0R0Y	C RESISTOR	0Ω 1/4W J
R440	QRG01GJ-331	OMF RESISTOR	330Ω 1W J	R722	NRSA63J-471X	MG RESISTOR	470Ω 1/16W J
R448	QRE121J-1R0Y	C RESISTOR	1Ω 1/2W J	R723	NRSA63J-471X	MG RESISTOR	470Ω 1/16W J
R461	QRE121J-683Y	C RESISTOR	68kΩ 1/2W J	R724	NRSA63J-102X	MG RESISTOR	1kΩ 1/16W J
R462	QRL039J-150	OMF RESISTOR	15Ω 3W J	R725	NRSA63J-470X	MG RESISTOR	47Ω 1/16W J
R471	NRSA63J-274X	MG RESISTOR	270kΩ 1/16W J	R726	NRSA63J-273X	MG RESISTOR	27kΩ 1/16W J
R472	NRSA63J-103X	MG RESISTOR	10kΩ 1/16W J	R727	NRSA63J-103X	MG RESISTOR	10kΩ 1/16W J
R473	NRSA63J-683X	MG RESISTOR	68kΩ 1/16W J	R728	QRE141J-101Y	C RESISTOR	100Ω 1/4W J
R474	NRSA63J-224X	MG RESISTOR	220kΩ 1/16W J	R729	NRSA63J-472X	MG RESISTOR	4.7kΩ 1/16W J
R481	NRSA63J-124X	MG RESISTOR	120kΩ 1/16W J	R730	QRE141J-151Y	C RESISTOR	150Ω 1/4W J
R482	NRSA63J-683X	MG RESISTOR	68kΩ 1/16W J	R731	NRSA63J-102X	MG RESISTOR	1kΩ 1/16W J
R483	NRSA63J-682X	MG RESISTOR	6.8kΩ 1/16W J	R732	NRSA63J-102X	MG RESISTOR	1kΩ 1/16W J
R484	NRSA63J-562X	MG RESISTOR	5.6kΩ 1/16W J	R733	NRSA63J-101X	MG RESISTOR	100Ω 1/16W J
R485	NRSA63J-333X	MG RESISTOR	33kΩ 1/16W J	R734	NRSA63J-101X	MG RESISTOR	100Ω 1/16W J
R486	NRSA63J-332X	MG RESISTOR	3.3kΩ 1/16W J	R735	NRSA63J-101X	MG RESISTOR	100Ω 1/16W J
R487	NRSA63J-154X	MG RESISTOR	150kΩ 1/16W J	R736	QRE141J-101Y	C RESISTOR	100Ω 1/4W J
R488	NRSA63J-104X	MG RESISTOR	100kΩ 1/16W J	R737	NRSA63J-101X	MG RESISTOR	100Ω 1/16W J
R490	NRSA63J-103X	MG RESISTOR	10kΩ 1/16W J	R738	NRSA63J-101X	MG RESISTOR	100Ω 1/16W J
R491	NRSA63J-683X	MG RESISTOR	68kΩ 1/16W J	R739	NRSA63J-101X	MG RESISTOR	100Ω 1/16W J
R492	NRSA63J-152X	MG RESISTOR	1.5kΩ 1/16W J	R740	NRSA63J-153X	MG RESISTOR	15kΩ 1/16W J
R493	NRSA63J-223X	MG RESISTOR	22kΩ 1/16W J	R741	NRSA63J-221X	MG RESISTOR	220Ω 1/16W J
R494	NRSA63J-562X	MG RESISTOR	5.6kΩ 1/16W J	R742	NRSA63J-221X	MG RESISTOR	220Ω 1/16W J
R496	NRSA63J-472X	MG RESISTOR	4.7kΩ 1/16W J	R743	NRSA63J-332X	MG RESISTOR	3.3kΩ 1/16W J
R497	NRSA63J-222X	MG RESISTOR	2.2kΩ 1/16W J	R744	NRSA63J-221X	MG RESISTOR	220Ω 1/16W J
R498	NRSA63J-223X	MG RESISTOR	22kΩ 1/16W J	R745	NRSA63J-332X	MG RESISTOR	3.3kΩ 1/16W J
R499	NRSA63J-473X	MG RESISTOR	47kΩ 1/16W J	R746	NRSA63J-103X	MG RESISTOR	10kΩ 1/16W J
R520	NRSA63J-471X	MG RESISTOR	470Ω 1/16W J	R747	NRSA63J-101X	MG RESISTOR	100Ω 1/16W J

△Ref No.	Part No.	Part Name	Description Local	△Ref No.	Part No.	Part Name	Description Local
R748	NRSA63J-272X	MG RESISTOR	2.7kΩ 1/16W J	R984	NRSA63J-473X	MG RESISTOR	47kΩ 1/16W J
R749	QRE141J-102Y	C RESISTOR	1kΩ 1/4W J	R985	NRSA63J-472X	MG RESISTOR	4.7kΩ 1/16W J
R750	NRSA63J-103X	MG RESISTOR	10kΩ 1/16W J	R986	NRSA63J-472X	MG RESISTOR	4.7kΩ 1/16W J
R751	NRSA63J-102X	MG RESISTOR	1kΩ 1/16W J	△R991	QRZ9046-825Z	C RESISTOR	8.2MΩ 1/2W K
R752	QRE141J-101Y	C RESISTOR	100Ω 1/4W J	L001	QQL244K-8R2Z	PEAKING COIL	8.2uH K
R753	NRSA63J-122X	MG RESISTOR	1.2kΩ 1/16W J	L002	QQL244J-4R7Z	PEAKING COIL	4.7uH J
R754	NRSA63J-221X	MG RESISTOR	220Ω 1/16W J	L003	QQL244J-4R7Z	PEAKING COIL	4.7uH J
R755	NRSA63J-122X	MG RESISTOR	1.2kΩ 1/16W J	L101	QQL244K-1R0Z	PEAKING COIL	1uH K
R756	NRSA63J-103X	MG RESISTOR	10kΩ 1/16W J	L301	QQL244K-100Z	PEAKING COIL	10uH K
R757	NRSA63J-472X	MG RESISTOR	4.7kΩ 1/16W J	L302	QQL244K-100Z	PEAKING COIL	10uH K
R758	NRSA63J-332X	MG RESISTOR	3.3kΩ 1/16W J	L303	QQL244K-100Z	PEAKING COIL	10uH K
R759	NRSA63J-332X	MG RESISTOR	3.3kΩ 1/16W J	L304	QQL244J-221Z	PEAKING COIL	220uH J
R760	NRSA63J-101X	MG RESISTOR	100Ω 1/16W J	L305	QQL244K-100Z	PEAKING COIL	10uH K
R761	NRSA63J-101X	MG RESISTOR	100Ω 1/16W J	L306	QQL244K-100Z	PEAKING COIL	10uH K
R762	NRSA63J-221X	MG RESISTOR	220Ω 1/16W J	L401	QQL244K-820Z	PEAKING COIL	82uH K
R763	NRSA63J-221X	MG RESISTOR	220Ω 1/16W J	L521	QQL2036-821	COIL	820uH K
R764	NRSA63J-221X	MG RESISTOR	220Ω 1/16W J	L522	QQR1243-002	LINIARITY COIL	
R765	NRSA63J-221X	MG RESISTOR	220Ω 1/16W J	L523	QQL2036-101	COIL	100uH K
R766	NRSA63J-101X	MG RESISTOR	100Ω 1/16W J	L530	QQL244K-220Z	PEAKING COIL	22uH K
R769	NRSA63J-103X	MG RESISTOR	10kΩ 1/16W J	L701	QQL231J-5R6Y	P COIL	5.6uH J
R771	QRE141J-102Y	C RESISTOR	1kΩ 1/4W J	L702	QQL231J-5R6Y	P COIL	5.6uH J
R772	QRE141J-562Y	C RESISTOR	5.6kΩ 1/4W J	L703	NQL812K-100X	P COIL	10uH K
R773	NRSA63J-103X	MG RESISTOR	10kΩ 1/16W J	L706	NQL812K-100X	P COIL	10uH K
R774	NRSA63J-562X	MG RESISTOR	5.6kΩ 1/16W J	L716	NQL812K-100X	P COIL	10uH K
R775	NRSA63J-103X	MG RESISTOR	10kΩ 1/16W J	L718	NQL812K-100X	P COIL	10uH K
R776	NRSA63J-153X	MG RESISTOR	15kΩ 1/16W J	L951	QQLZ026-480	COIL	48uH ±7%
R777	NRSA63J-101X	MG RESISTOR	100Ω 1/16W J	△T521	QQR1229-001	DRIVE TRANSF	
R779	NRSA63J-101X	MG RESISTOR	100Ω 1/16W J	T523	QQR1732-001	PIN TRANSF	
R780	NRSA63J-101X	MG RESISTOR	100Ω 1/16W J	T921	QQS0388-001	SW TRANSF	
R781	NRSA63J-101X	MG RESISTOR	100Ω 1/16W J	△CP650	ICP-N38-T	IC PROTECTOR	1.5A
R782	NRSA63J-122X	MG RESISTOR	1.2kΩ 1/16W J	△CP951	QMFZ034-4R0Z-J1	FUSE	4A 125V
R783	NRSA63J-103X	MG RESISTOR	10kΩ 1/16W J	△CP952	ICP-N38-T	IC PROTECTOR	1.5A
R784	NRSA63J-103X	MG RESISTOR	10kΩ 1/16W J	△CP953	ICP-N38-T	IC PROTECTOR	1.5A
R785	NRSA63J-103X	MG RESISTOR	10kΩ 1/16W J	△CP954	ICP-N38-T	IC PROTECTOR	1.5A
R786	NRSA63J-750X	MG RESISTOR	75Ω 1/16W J	△CP955	ICP-N75-T	IC PROTECTOR	1.5A
R787	NRSA63J-472X	MG RESISTOR	4.7kΩ 1/16W J	J801	QNZ0454-002	PIN JACK	VIDEO1/S-VIDEO IN
R788	NRSA63J-0R0X	MG RESISTOR	0Ω 1/16W J	J802	QNN0349-002	PIN JACK	VIDEO2/COMP IN
R790	NRSA63J-102X	MG RESISTOR	1kΩ 1/16W J	J803	QNN0348-001	PIN JACK	VIDEO2/COMP IN
R792	QRE141J-330Y	C RESISTOR	33Ω 1/4W J	J804	QNN0349-001	PIN JACK	VIDEO OUT
R793	NRSA63J-101X	MG RESISTOR	100Ω 1/16W J	K107	QQR1114-001Z	FERRITE BEADS	
R794	NRSA63J-222X	MG RESISTOR	2.2kΩ 1/16W J	K601	QQR1114-001Z	FERRITE BEADS	
R795	NRSA63J-104X	MG RESISTOR	100kΩ 1/16W J	K702	QQR1114-001Z	FERRITE BEADS	
R796	NRSA63J-102X	MG RESISTOR	1kΩ 1/16W J	K703	QQR1113-001Z	FERRITE BEADS	
R797	NRSA63J-683X	MG RESISTOR	68kΩ 1/16W J	K921	QQR1114-001Z	FERRITE BEADS	
R798	NRSA63J-473X	MG RESISTOR	47kΩ 1/16W J	K951	QQR1114-001Z	FERRITE BEADS	
R801	NRSA63J-750X	MG RESISTOR	75Ω 1/16W J	K952	QQR1113-001Z	FERRITE BEADS	
R802	NRSA63J-0R0X	MG RESISTOR	0Ω 1/16W J	K953	QQR1113-001Z	FERRITE BEADS	
R803	NRSA63J-0R0X	MG RESISTOR	0Ω 1/16W J	K954	QQR1113-001Z	FERRITE BEADS	
R804	NRSA63J-750X	MG RESISTOR	75Ω 1/16W J	K955	QQR1113-001Z	FERRITE BEADS	
R805	NRSA63J-750X	MG RESISTOR	75Ω 1/16W J	K957	QQR1114-001Z	FERRITE BEADS	
R806	NRSA63J-750X	MG RESISTOR	75Ω 1/16W J	LC801	QQR1199-002	EMI FILTER	
R807	QRE121J-101Y	C RESISTOR	100Ω 1/2W J	LC802	QQR1199-002	EMI FILTER	
R809	NRSA63J-221X	MG RESISTOR	220Ω 1/16W J	LC803	QQR1199-002	EMI FILTER	
R810	NRSA63J-391X	MG RESISTOR	390Ω 1/16W J	LC804	QQR1199-002	EMI FILTER	
R811	NRSA63J-823X	MG RESISTOR	82kΩ 1/16W J	△LF902	QQR1433-001	LINE FILTER	
R812	NRSA63J-391X	MG RESISTOR	390Ω 1/16W J	SF101	QAX0663-001	SAW FILTER	
R813	NRSA63J-823X	MG RESISTOR	82kΩ 1/16W J	SF102	QAX0731-001	SAW FILTER	
R814	NRSA63J-104X	MG RESISTOR	100kΩ 1/16W J	TU001	QAU0383-002	TUNER	
R815	NRSA63J-750X	MG RESISTOR	75Ω 1/16W J	X301	QAX0775-001Z	CRYSTAL	20.250000MHz
R816	NRSA63J-750X	MG RESISTOR	75Ω 1/16W J	X701	QAX0799-001Z	CRYSTAL	2457600MHz
R901	QRF154K-1R8	UNF WW RESISTOR	1.8Ω 15W K				
R902	QRL029J-683	OMF RESISTOR	68kΩ 2W J				
R921	QRL029J-473	OMF RESISTOR	47kΩ 2W J				
R922	QRE141J-391Y	C RESISTOR	390Ω 1/4W J				
R923	QRE141J-273Y	C RESISTOR	27kΩ 1/4W J				
R924	QRA14CF-3902Y	CMF RESISTOR	39kΩ 1/4W F				
R926	QRE121J-220Y	C RESISTOR	22Ω 1/2W J				
R927	NRSA63J-222X	MG RESISTOR	2.2kΩ 1/16W J				
R928	QRE121J-103Y	C RESISTOR	10kΩ 1/2W J				
R929	QRE141J-220Y	C RESISTOR	22Ω 1/4W J				
R951	QRE121J-332Y	C RESISTOR	3.3kΩ 1/2W J				
R952	QRE121J-153Y	C RESISTOR	15kΩ 1/2W J				
R953	QRE121J-103Y	C RESISTOR	10kΩ 1/2W J				
R957	NRSA63J-153X	MG RESISTOR	15kΩ 1/16W J				
R958	NRSA63J-183X	MG RESISTOR	18kΩ 1/16W J				
R959	NRSA63J-153X	MG RESISTOR	15kΩ 1/16W J				
R960	QRE121J-223Y	C RESISTOR	22kΩ 1/2W J				
R962	QRL029J-223	OMF RESISTOR	22kΩ 2W J				
R963	QRE121J-332Y	C RESISTOR	3.3kΩ 1/2W J				
R965	QRX029J-1R0	MF RESISTOR	1Ω 2W J				
R970	QRE121J-182Y	C RESISTOR	1.8kΩ 1/2W J				
R975	QRE141J-122Y	C RESISTOR	1.2kΩ 1/4W J				
R976	NRSA63J-391X	MG RESISTOR	390Ω 1/16W J				
R980	NRSA63J-562X	MG RESISTOR	5.6kΩ 1/16W J				
R981	QRE121J-3R9Y	C RESISTOR	3.9Ω 1/2W J				
R982	NRSA63J-473X	MG RESISTOR	47kΩ 1/16W J				
R983	QRE121J-3R9Y	C RESISTOR	3.9Ω 1/2W J				

CRT SOCKET P.W. BOARD ASS'Y (SCW-3038A-H2)

REFER TO PARTS LIST IN PAGE 3-8 FOR THIS P.W. BOARD.

FRONT CONTROL P.W. BOARD ASS'Y (SCW-8020A-H2)

REFER TO PARTS LIST IN PAGE 3-9 FOR THIS P.W. BOARD.

BASS P.W. BOARD ASS'Y (SCW-6003A-H2)

REFER TO PARTS LIST IN PAGE 3-9 FOR THIS P.W. BOARD.

REMOTE CONTROL UNIT PARTS LIST (RM-C1286-1H) [AV-29SS26]

△ Ref No.	Part No.	Part Name	Description	Local
	R25-8566	BATTERY COVER		

REMOTE CONTROL UNIT PARTS LIST (RM-C1285-1H) [AV-29SX76/G]

△ Ref No.	Part No.	Part Name	Description	Local
	R25-8566	BATTERY COVER		

PACKING

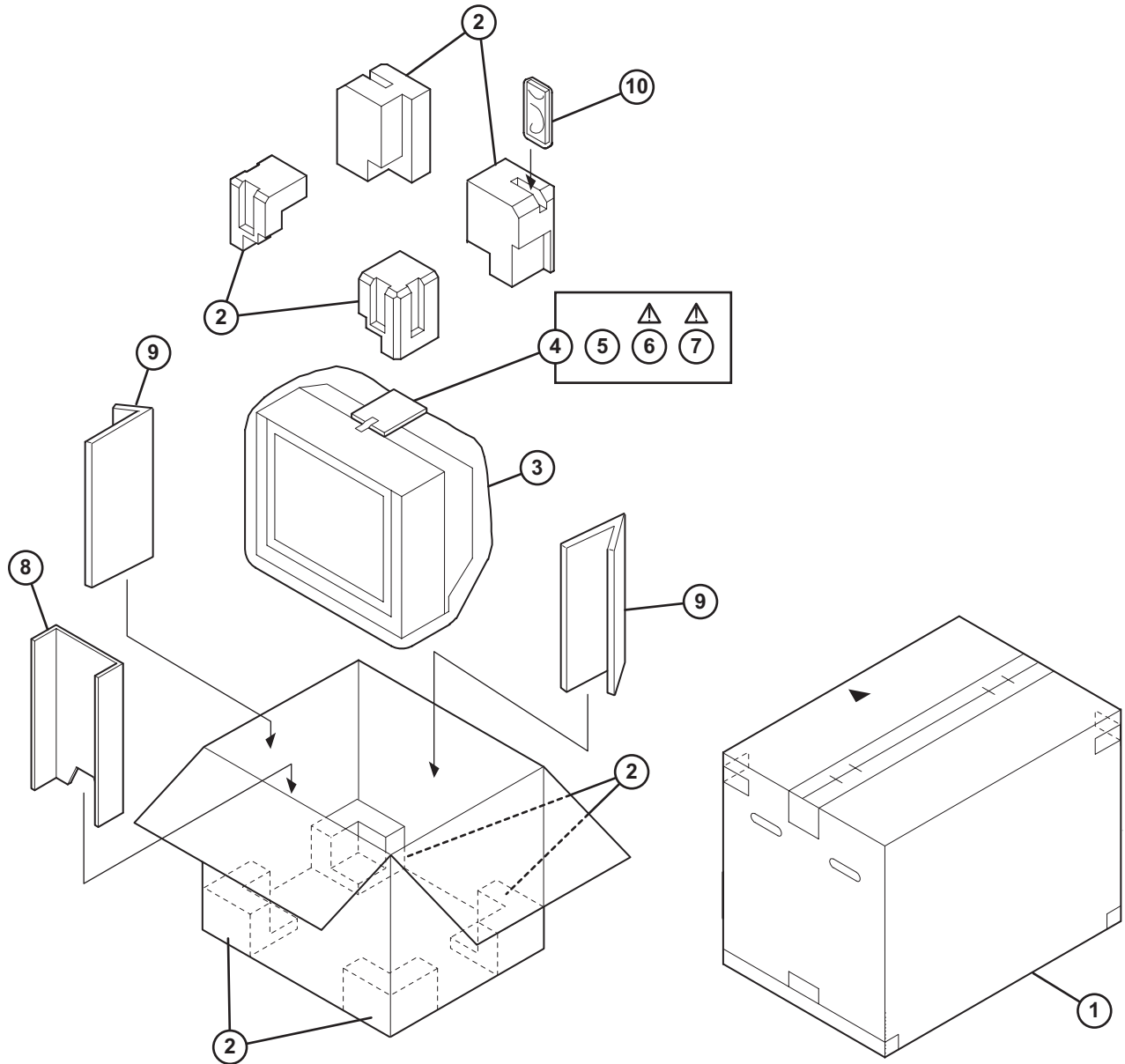

PACKING PARTS LIST

△	Ref.No.	Part No.	Part Name	Description	Local
	1	GG10285-014A-H	PACKING CASE		AV-29SS26
	1	GG10282-042A-H	PACKING CASE		AV-29SX76G
	2	GG10427-001A-H	CUSHION ASS'Y	8pcs in 1set	
	3	GG30097-004A-H	POLY BAG		
	4	GG30096-001A-H	POLY BAG		
	5	-----	BATTERY	AA/R6 1.5V(x2)	
△	6	GGT0116-001A-H	INST BOOK		
△	7	GGT0117-001A-H	DIGEST MANUAL		AV-29SX76G
	8	GG20011-015A-H	SUPPORT PAD		AV-29SS26
	9	GG20011-016A-H	SUPPORT PAD	(x2)	AV-29SS26
	10	RM-C1286-1H	REMOTE CONTROL UNIT		AV-29SS26
	10	RM-C1285-1H	REMOTE CONTROL UNIT		AV-29SX76G

JVC

SCHEMATIC DIAGRAMS

FLAT COLOUR TELEVISION

AV-29SS26, AV-29SX76/G

CD-ROM No.SML200609

BASIC CHASSIS

CW3

InteriArt
MaxxBass®

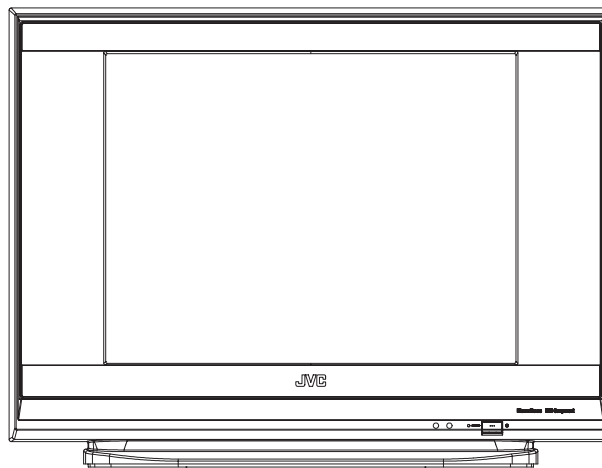

AV-29SS26, AV-29SX76/G

STANDARD CIRCUIT DIAGRAM

NOTE ON USING CIRCUIT DIAGRAMS

1.SAFETY

The components identified by the \triangle symbol and shading are critical for safety. For continued safety replace safety critical components only with manufactures recommended parts.

2.SPECIFIED VOLTAGE AND WAVEFORM VALUES

The voltage and waveform values have been measured under the following conditions.

- (1)Input signal : Colour bar signal
- (2)Setting positions of each knob/button and variable resistor : Original setting position when shipped
- (3)Internal resistance of tester : DC 20k Ω /V
- (4)Oscilloscope sweeping time : H \Rightarrow 20 μ s / div
: V \Rightarrow 5ms / div
: Others \Rightarrow Sweeping time is specified
- (5)Voltage values : All DC voltage values

* Since the voltage values of signal circuit vary to some extent according to adjustments, use them as reference values.

3.INDICATION OF PARTS SYMBOL [EXAMPLE]

- In the PW board : R209 \rightarrow R209

4.INDICATIONS ON THE CIRCUIT DIAGRAM

(1)Resistors

● Resistance value

- No unit : [Ω]
- K : [k Ω]
- M : [M Ω]

● Rated allowable power

- No indication : 1/16 [W]
- Others : As specified

● Type

- No indication : Carbon resistor
- OMR : Oxide metal film resistor
- MFR : Metal film resistor
- MPR : Metal plate resistor
- UNFR : Uninflammable resistor
- FR : Fusible resistor

* Composition resistor 1/2 [W] is specified as 1/2S or Comp.

(2)Capacitors

● Capacitance value

- 1 or higher : [pF]
- less than 1 : [μ F]

● Withstand voltage

- No indication : DC50[V]
- Others : DC withstand voltage [V]
- AC indicated : AC withstand voltage [V]

* Electrolytic Capacitors

47/50[Example]: Capacitance value [μ F]/withstand voltage[V]

● Type

- No indication : Ceramic capacitor
- MM : Metalized mylar capacitor
- PP : Polypropylene capacitor
- MPP : Metalized polypropylene capacitor
- MF : Metalized film capacitor
- TF : Thin film capacitor
- BP : Bipolar electrolytic capacitor
- TAN : Tantalum capacitor

(3)Coils

- No unit : [μ H]
- Others : As specified

(4)Power Supply



* Respective voltage values are indicated

(5)Test point



(6)Connecting method

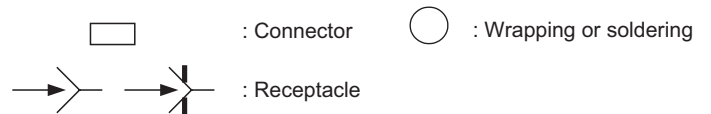

(7)Ground symbol

- \perp : LIVE side ground
- ∇ : ISOLATED(NEUTRAL) side ground
- \equiv : EARTH ground
- ∇ : DIGITAL ground

5.NOTE FOR REPAIRING SERVICE

This model's power circuit is partly different in the GND. The difference of the GND is shown by the LIVE (\perp) side GND and the ISOLATED(NEUTRAL) (∇) side GND. Therefore, care must be taken for the following points.

- (1)Do not touch the LIVE side GND or the LIVE side GND and the ISOLATED(NEUTRAL) side GND simultaneously. If the above caution is not respected, an electric shock may be caused. Therefore, make sure that the power cord is surely removed from the receptacle when, for example, the chassis is pulled out.
- (2)Do not short between the LIVE side GND and ISOLATED(NEUTRAL) side GND or never measure with a measuring apparatus with a measuring apparatus (oscilloscope, etc.) the LIVE side GND and ISOLATED(NEUTRAL) side GND at the same time. If the above precaution is not respected, a fuse or any parts will be broken.

◆ Since the circuit diagram is a standard one, the circuit and circuit constants may be subject to change for improvement without any notice.

NOTE

◆ Due improvement in performance, some part numbers show in the circuit diagram may not agree with those indicated in the part list.

When ordering parts, please use the numbers that appear in the Parts List.

CONTENTS

SEMICONDUCTOR SHAPES	2-2
BLOCK DIAGRAM	2-3
CIRCUIT DIAGRAMS	2-5
MAIN PWB CIRCUIT DIAGRAM [AV-29SS26] (1/2), (2/2)	2-5
MAIN PWB CIRCUIT DIAGRAM [AV-29SX76/G] (1/2), (2/2)	2-9
CRT SOCKET PWB CIRCUIT DIAGRAM	2-13
FRONT CONTROL PWB CIRCUIT DIAGRAM	2-15
BASS PWB CIRCUIT DIAGRAM	2-17
PATTERN DIAGRAMS	2-19
MAIN PWB PATTERN	2-19
CRT SOCKET PWB PATTERN	2-21
FRONT CONTROL PWB PATTERN	2-22
BASS PWB PATTERN	2-23
VOLTAGE CHATRS	2-25
WAVEFORMS	2-26

USING P.W. BOARD

P.W.B ASS'Y name	AV-29SS26	AV-29SX76/G
MAIN P.W. BOARD	SCW-1941A-H2	SCW-1947A-H2
CRT SOCKET P.W. BOARD	SCW-3038A-H2	←
FRONT CONTROL P.W. BOARD	SCW-8020A-H2	←
BASS P.W. BOARD	SCW-6003A-H2	←

SEMICONDUCTOR SHAPES

TRANSISTOR

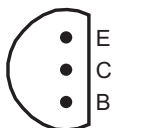
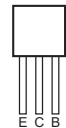
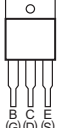
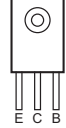
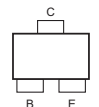
BOTTOM VIEW	FRONT VIEW			TOP VIEW
				CHIP TR 

IC

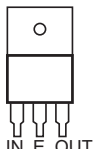
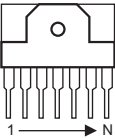
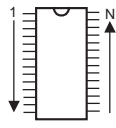
BOTTOM VIEW	FRONT VIEW		TOP VIEW
			

CHIP IC

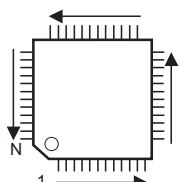
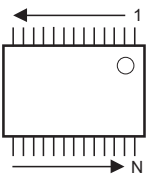
TOP VIEW	
	

BLOCK DIAGRAM

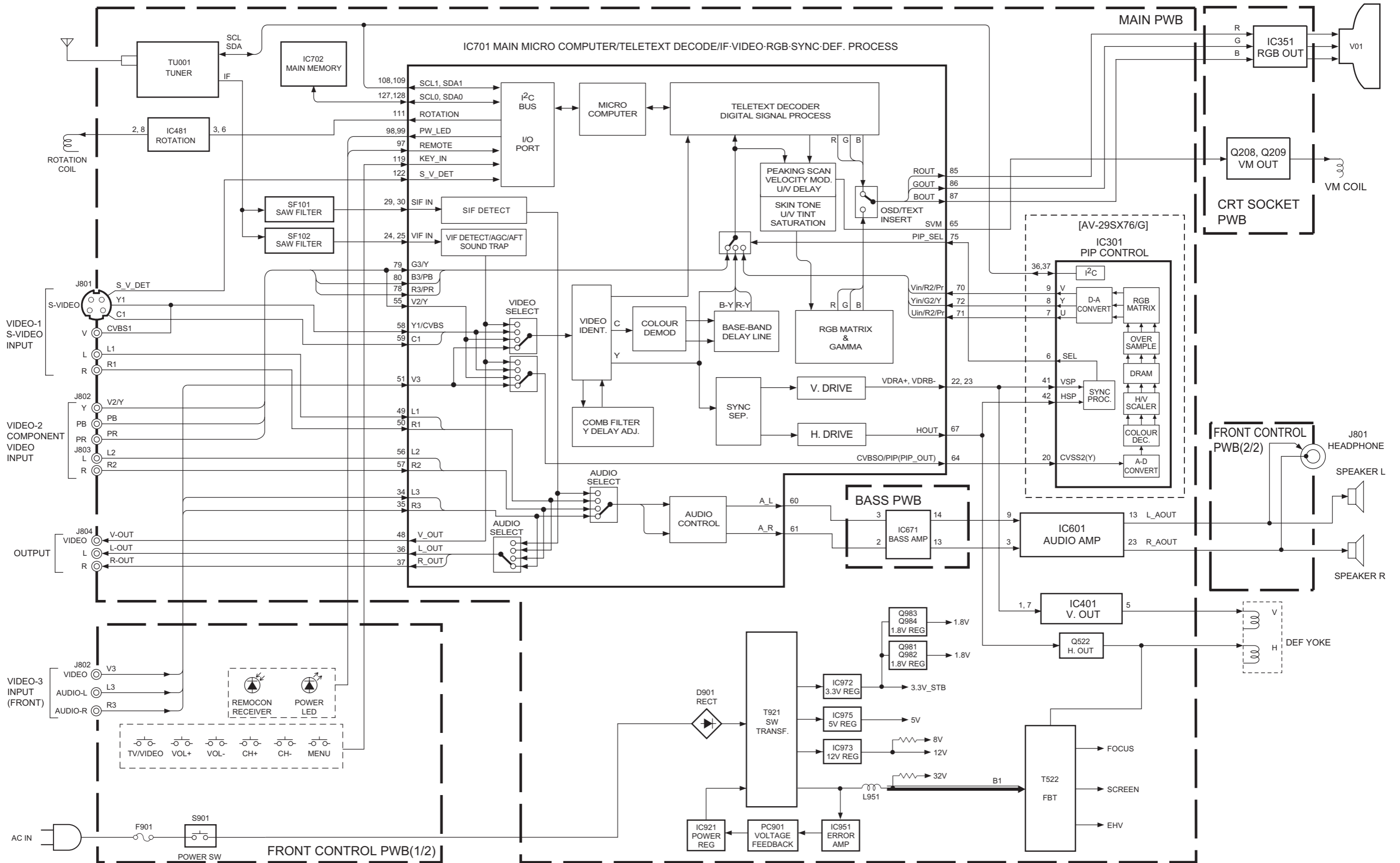

CIRCUIT DIAGRAMS

MAIN PWB CIRCUIT DIAGRAM [AV-29SS26] (1/2) SHEET 1

ADJUSTMENT
CONNECTOR

FRONT CONTROL PWB
SHEET6 CN001

FRONT CONTROL PWB
SHEET6 CN002

CRT SOCKET PWB
SHEET5 CN00T

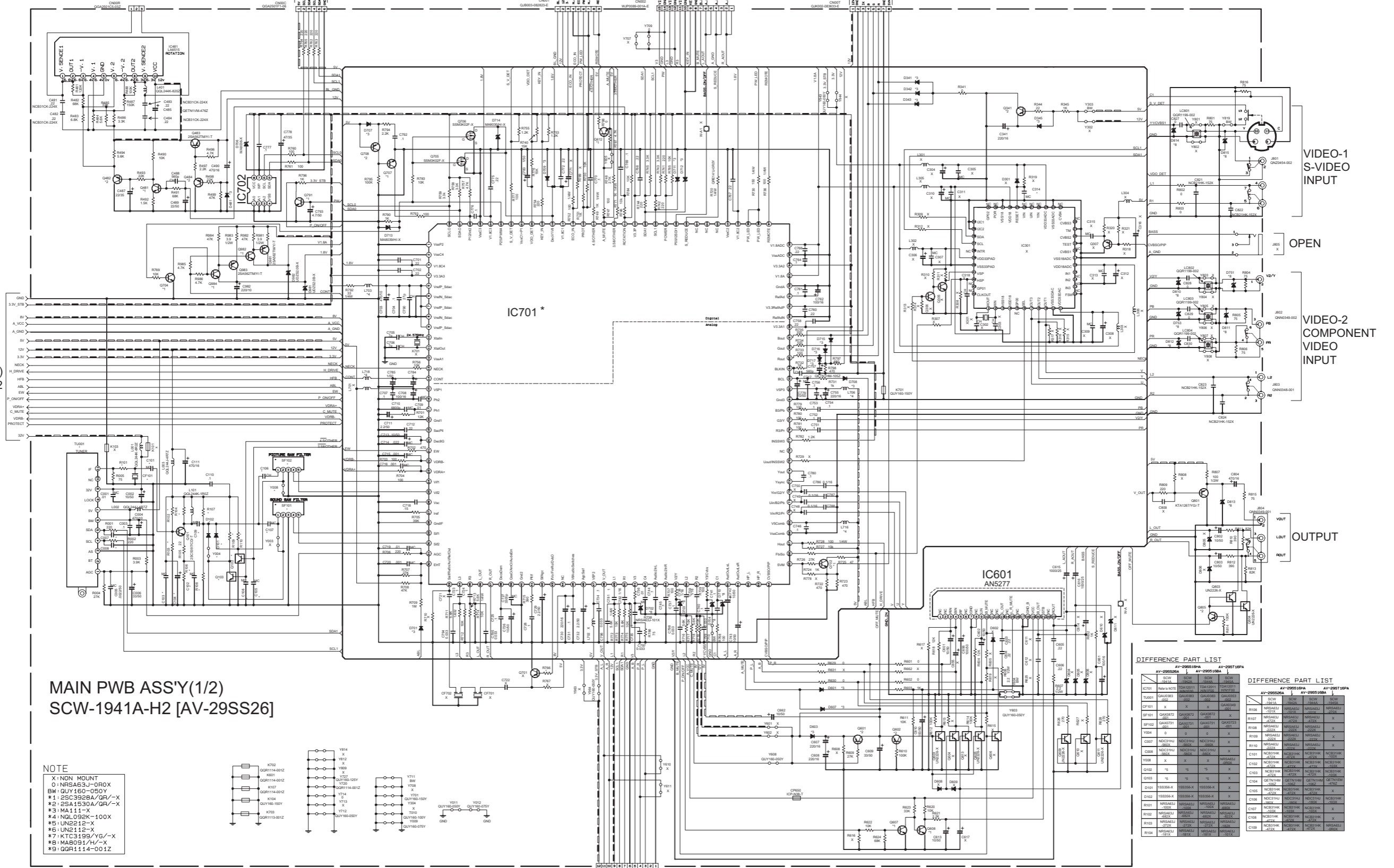

MAIN PWB ASS'Y(1/2)
SCW-1941A-H2 [AV-29SS26]

NOTE
X: NON MOUNT
0: NRS463J-0ROX
BW: QUY150-050Y
#1: 2SC3928A/QR/-X
#2: 2SA1530A/QR/-X
#3: MA111-X
#4: NOL092K-100X
#5: UN2212-X
#6: UN2112-X
#7: KTC3199/YG/-X
#8: MAB091/Y/-X
#9: QBR1114-001Z

DIFFERENCE PART LIST

AV-29SS26A	AV-29SS19HA	AV-29SS16HA
IC701	QBR1114-001Z	QBR1114-001Z
IC702	QBR1114-001Z	QBR1114-001Z
IC601	AN527	AN527
RESISTORS	RESISTORS	RESISTORS
CAPACITORS	CAPACITORS	CAPACITORS

DIFFERENCE PART LIST

AV-29SS26A	AV-29SS19HA	AV-29SS16HA
RESISTORS	RESISTORS	RESISTORS
CAPACITORS	CAPACITORS	CAPACITORS
DIODES	DIODES	DIODES
TRANSISTORS	TRANSISTORS	TRANSISTORS

NOTE) 1. Refer to the part list for the part number of IC701 and IC702.
2. Refer to page 2-25 for voltages of this circuit diagram.
3. Refer to page 2-26 for waveforms of this circuit diagram.

BASS PWB
SHEET7
CN00M

c21259001a.001_1/2

MAIN PWB(1/2)
SHEET1

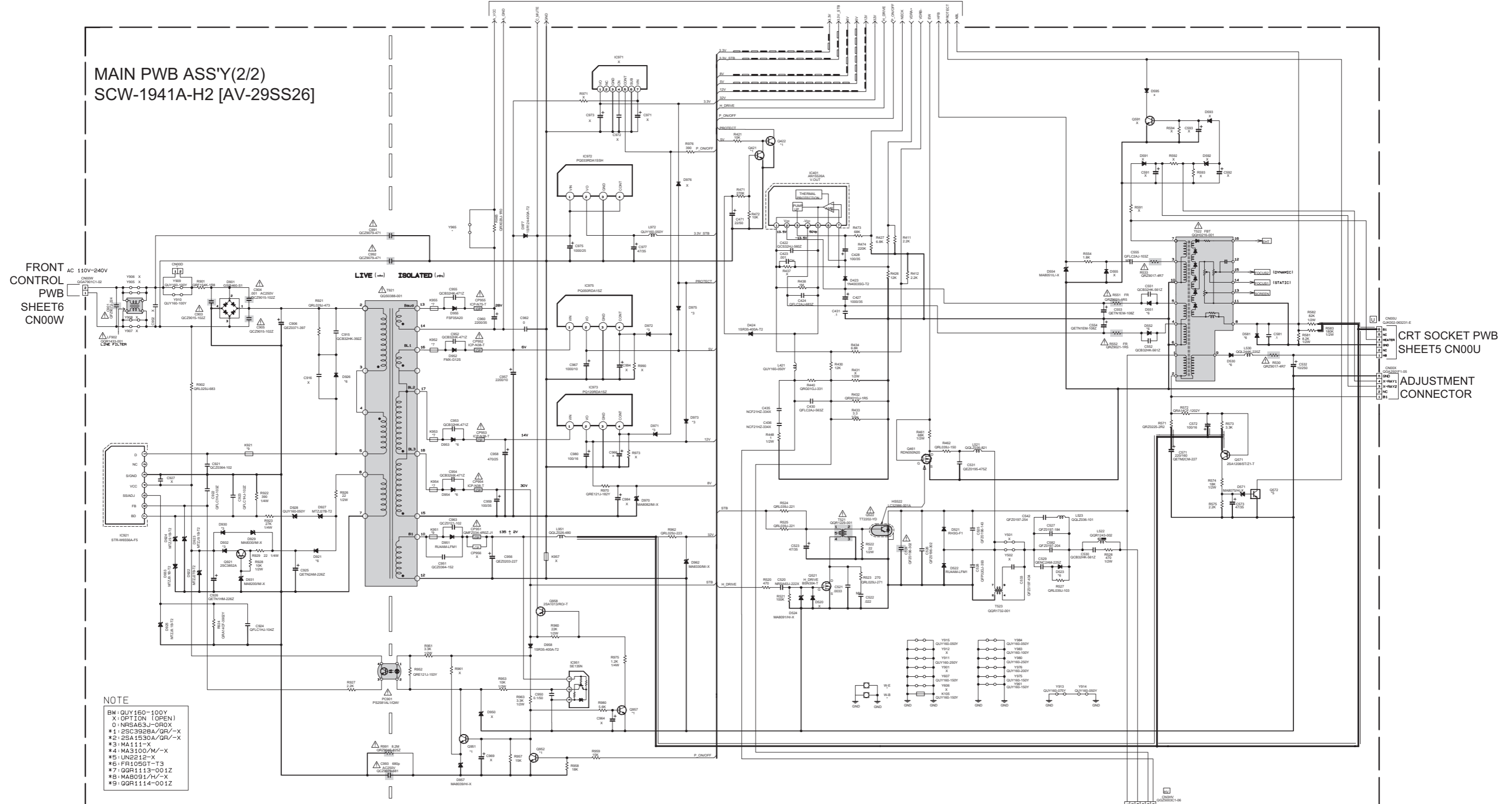

c21259001a.001_2/2

△ DEF YOKE

NOTE) 1. Refer to page 2-25 for voltages of this circuit diagram.
2. Refer to page 2-26 for waveforms of this circuit diagram.

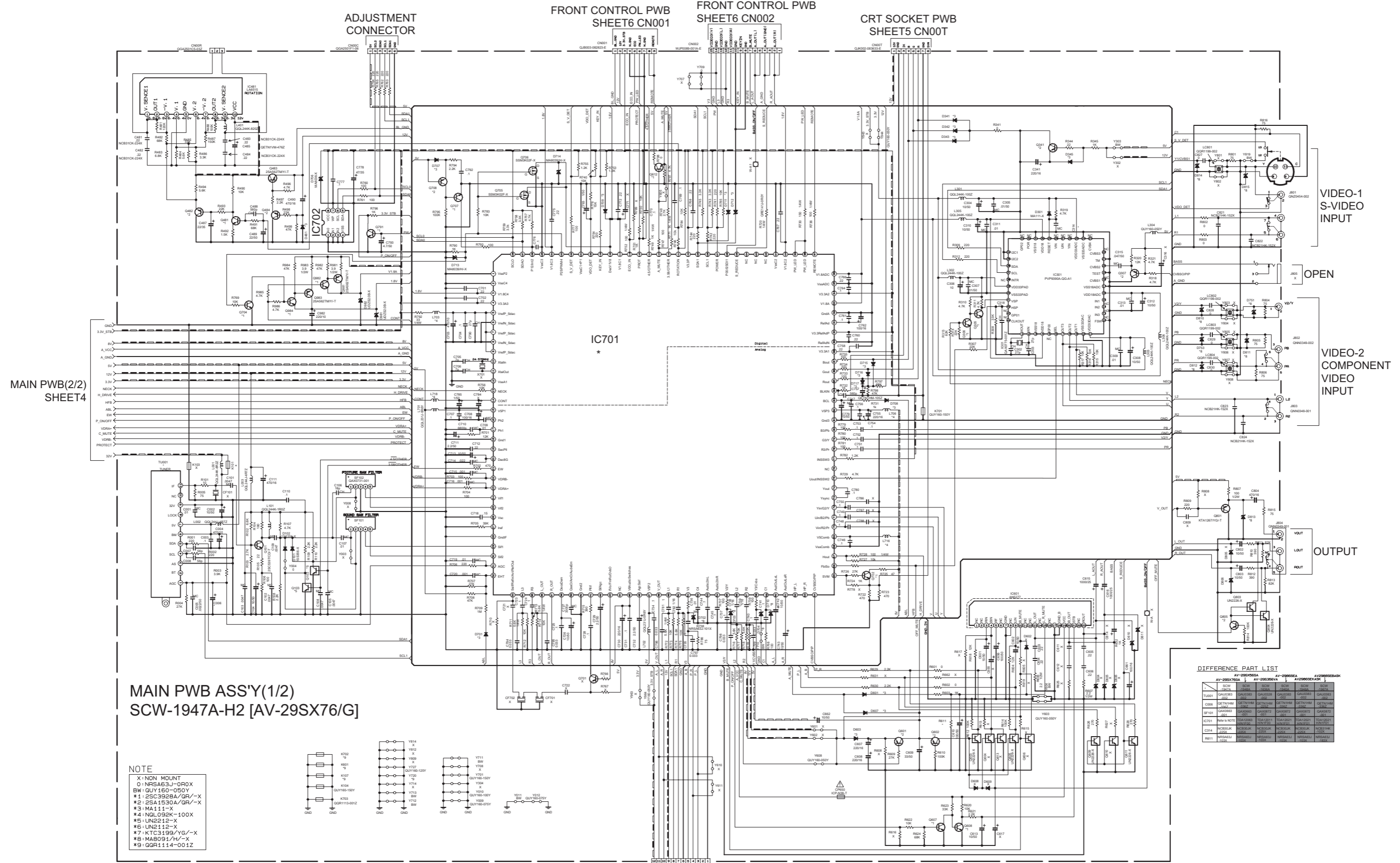

MAIN PWB ASS'Y(1/2)
SCW-1947A-H2 [AV-29SX76/G]

NOTE
 X: NON MOUNT
 O: NRS463J-OROX
 B: QY150-050Y
 *1: 2SC392BA/GR/-X
 *2: 2SA1530A/GR/-X
 *3: MA111-X
 *4: NGL092K-100X
 *5: UN2212-X
 *6: UN2112-X
 *7: KTC3199/YG/-X
 *8: MAB03/H/-X
 *9: GGR1114-001Z

DIFFERENCE PART LIST

AV-29SX76/G	AV-29SX76/G	AV-29SX76/G	AV-29SX76/G	AV-29SX76/G	AV-29SX76/G
TU001	GAU038	GAU038	GAU038	GAU038	GAU038
C006	GET198	GET198	GET198	GET198	GET198
BF101	GAU066	GAU066	GAU066	GAU066	GAU066
CT011	Ref to NOTE	Ref to NOTE	Ref to NOTE	Ref to NOTE	Ref to NOTE
C214	NCE214	NCE214	NCE214	NCE214	NCE214
RE11	NRS463	NRS463	NRS463	NRS463	NRS463

NOTE) 1. Refer to the part list for the part number of IC701 and IC702.
 2. Refer to page 2-25 for voltages of this circuit diagram.
 3. Refer to page 2-26 for waveforms of this circuit diagram.

BASS PWB
SHEET7
CN00M

c21261001a.001_1/2

MAIN PWB(1/2)
SHEET3

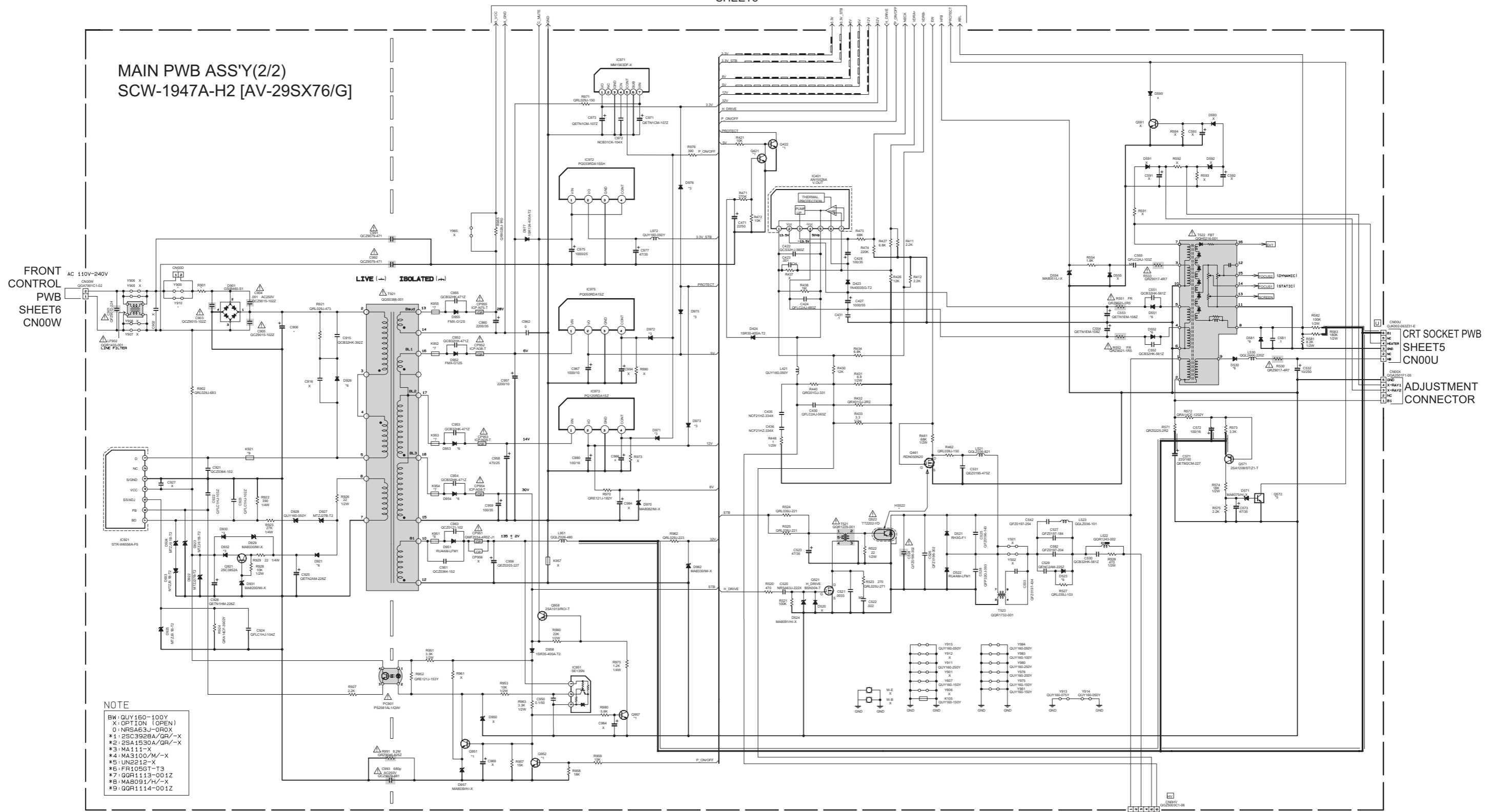

MAIN PWB ASS'Y(2/2)
SCW-1947A-H2 [AV-29SX76/G]

FRONT CONTROL
PWB
SHEET6
CN00W

CRT SOCKET PWB
SHEET5
CN00U
ADJUSTMENT
CONNECTOR

NOTE
BW: QUY160-100Y
X: OPTION (OPEN)
O: NRS A63J-OROX
*1: 2SC392BA/QR/-X
*2: 2SA1530A/QR/-X
*3: MA111-X
*4: MA3100/M/-X
*5: UN2212-X
*6: FR105GT-T3
*7: QGR1113-001Z
*8: MAB091/H/-X
*9: QGR1114-001Z

DIFFERENCE PART LIST

AV-29SX76A	AV-29SX76A	AV-29SX76A	AV-29SX76A	AV-29SX76A	AV-29SX76A
CN000	X				
R801	QRP154K	QRP154K	QRP154K	QRP154K	QRP154K
C806	QZ2071	QZ2071	QZ2071	QZ2071	QZ2071
Y900	QUY180	QUY180	QUY180	QUY180	QUY180
Y910	QUY180	QUY180	QUY180	QUY180	QUY180
H9522	LC1843	LC1843	LC1843	LC1843	LC1843

NOTE) 1. Refer to page 2-25 for voltages of this circuit diagram.
2. Refer to page 2-26 for waveforms of this circuit diagram.

c21261001a.001_2/2

CRT SOCKET PWB ASS'Y
SCW-3038A-H2

DIFFERENCE PART LIST

AV-29862EA	AV-29862EA	AV-29862EA	AV-29862EA	AV-29862EA	AV-29862EA	AV-29862EA	AV-29862EA	AV-29862EA	AV-29862EA	AV-29862EA
SCW-3037A	SCW-3037A	SCW-3037A	SCW-3037A	SCW-3037A	SCW-3037A	SCW-3037A	SCW-3037A	SCW-3037A	SCW-3037A	SCW-3037A
Y01	Y01	Y01	Y01	Y01	Y01	Y01	Y01	Y01	Y01	Y01
CN0VM	CN0VM	CN0VM	CN0VM	CN0VM	CN0VM	CN0VM	CN0VM	CN0VM	CN0VM	CN0VM
R369	R369	R369	R369	R369	R369	R369	R369	R369	R369	R369

NOTE
 BW: QUY160-050Y
 X: OPTION (NON MOUNTED)
 O: NRS A63J-OROX
 *1: 2SC3928A/QR/-X
 *2: 2SA1530A/QR/-X
 *3: MA111-X
 *4: MA3100/M/-X
 *5: UN2212-X
 *6: KTC319B/YG/-T
 *7: KTA1267/YG/-T
 *8: CE41492-001Z

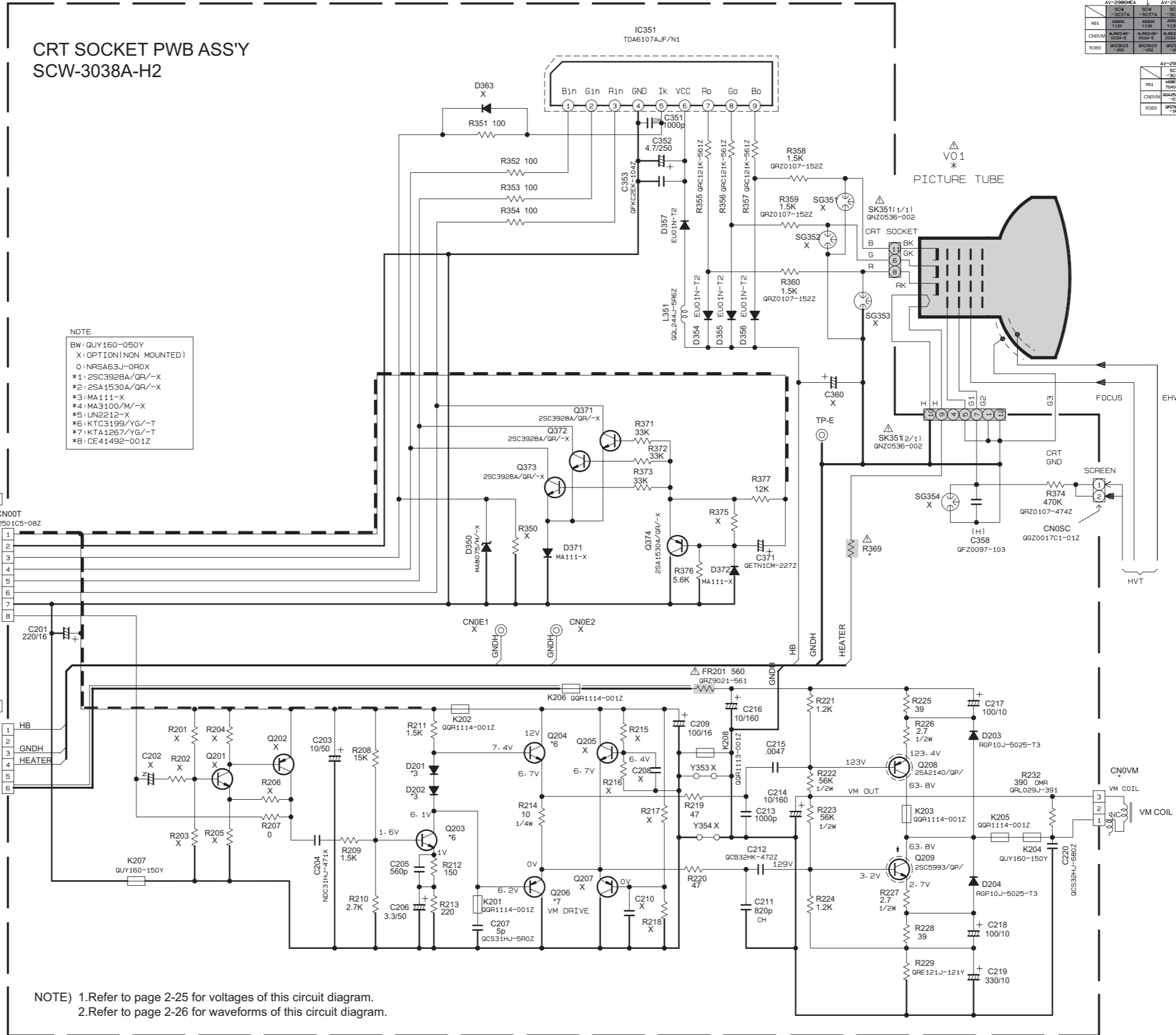
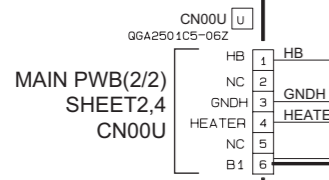
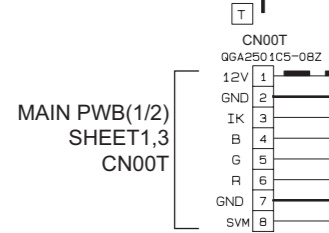

NOTE) 1. Refer to page 2-25 for voltages of this circuit diagram.
 2. Refer to page 2-26 for waveforms of this circuit diagram.

FRONT CONTROL PWB ASS'Y
SCW-8020A-H2

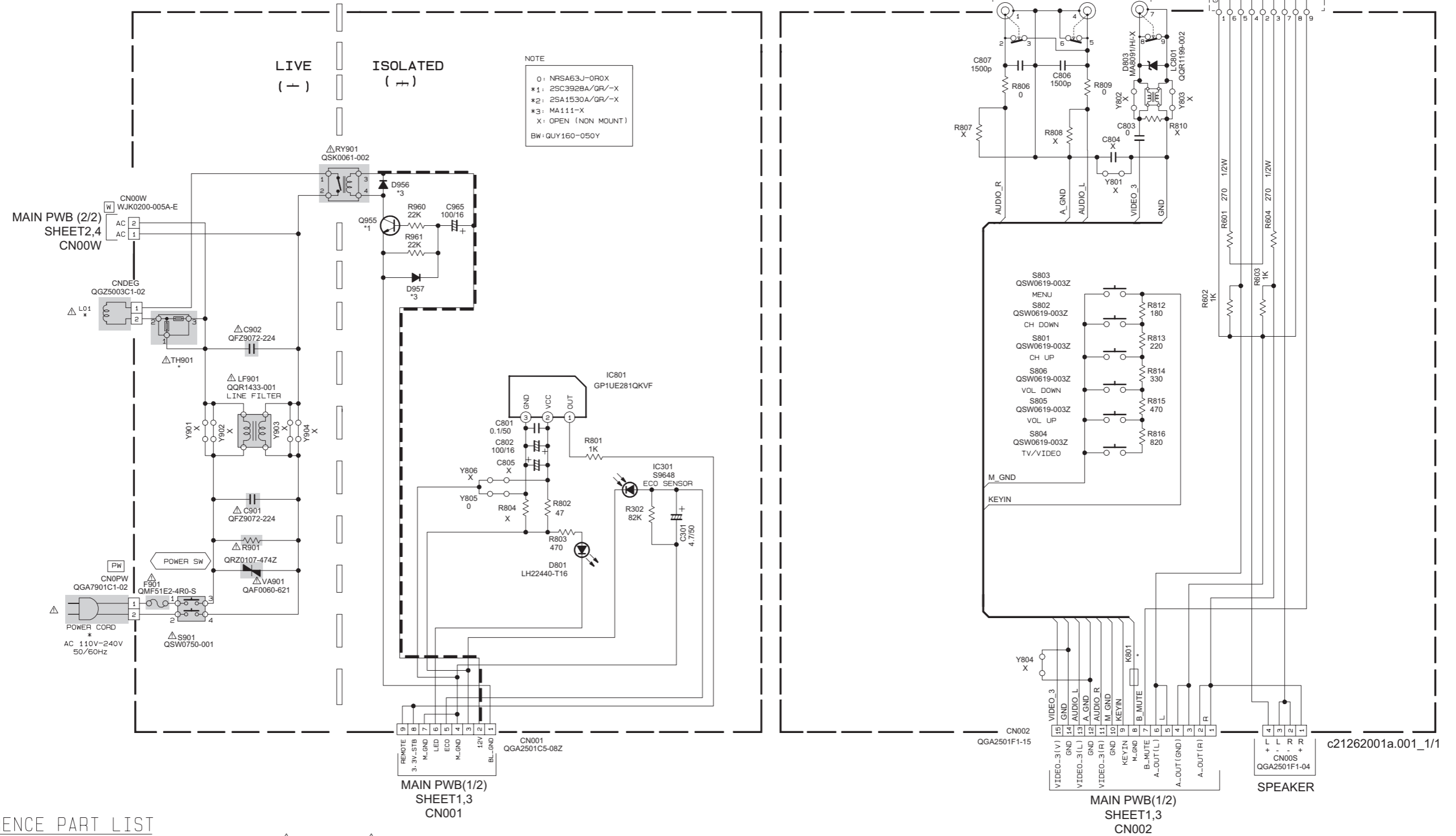

DIFFERENCE PART LIST

	AV-295X766A	AV-295S26A	AV-295X56SA	AV-295S16HA	AV-295T16PA	AV-295S16BA	AV-295S36VA	AV-296S5EA	AV296S5EASK	
POWER CORD	QMPR340-165-K2	QMPR340-165-K2	QMPR650-165-JC	QMPR650-165-JC	QMPR380-165-K2	QMPR420-165-K2	QMPR500-200-JC	QMPR340-165-K2	QMPR340-165-K2	QMPR340-165-K2
L01	QGW0214-001	QGW0214-001	QGW0214-001	QGW0214-001	QGW0214-001	QGW0214-001	QGW0214-001	QGW0213-001	QGW0213-001	QGW0213-001
K801	QQR1114-001Z	QQR1114-001Z	QQR1114-001Z	QQR1114-001Z	QQR1114-001Z	QQR1113-001Z	QQR1113-001Z	QQR1113-001Z	QQR1113-001Z	QQR1113-001Z
TH901	QAD0145-2R3	QAD0145-2R3	QAD0145-2R3	QAD0145-2R3	QAD0145-2R3	QAD0145-2R3	QAD0145-2R3	QAD0134-4R5	QAD0134-4R5	QAD0134-4R5

NOTE) 1.Refer to page 2-25 for voltages of this circuit diagram.
2.Refer to page 2-26 for waveforms of this circuit diagram.

BASS PWB ASS'Y
SCW-6003A-H2

CN00M
GG30161-001A-H

L671
QQL244J-4R7Z

DIFFERENCE PART LIST

	21' . 25' MODEL	29' VT MODEL	29' MODEL	21' 25' VT MODEL
	SCW -6001A	SCW -6002A	SCW -6003A	SCW -6004A
R671	NRSA63J -562X	NRSA63J -472X	NRSA63J 472X	NRSA63J -562X
R672	NRSA63J -562X	NRSA63J -472X	NRSA63J 472X	NRSA63J -562X

- NOTE
- X: OPTION
 - 0: NRSA63J-0R0X
 - *1: 2SC3928A/QR/-X
 - *2: 2SA1530A/QR/-X
 - *3: MA111-X
 - *4: MA3100/M/-X
 - *5: UN2212-X
 - *6: EU01N-T3
 - *7: KTA1267/YG/-T
 - *8: CE41492-001Z
 - *9: RGP10J-5025-T3

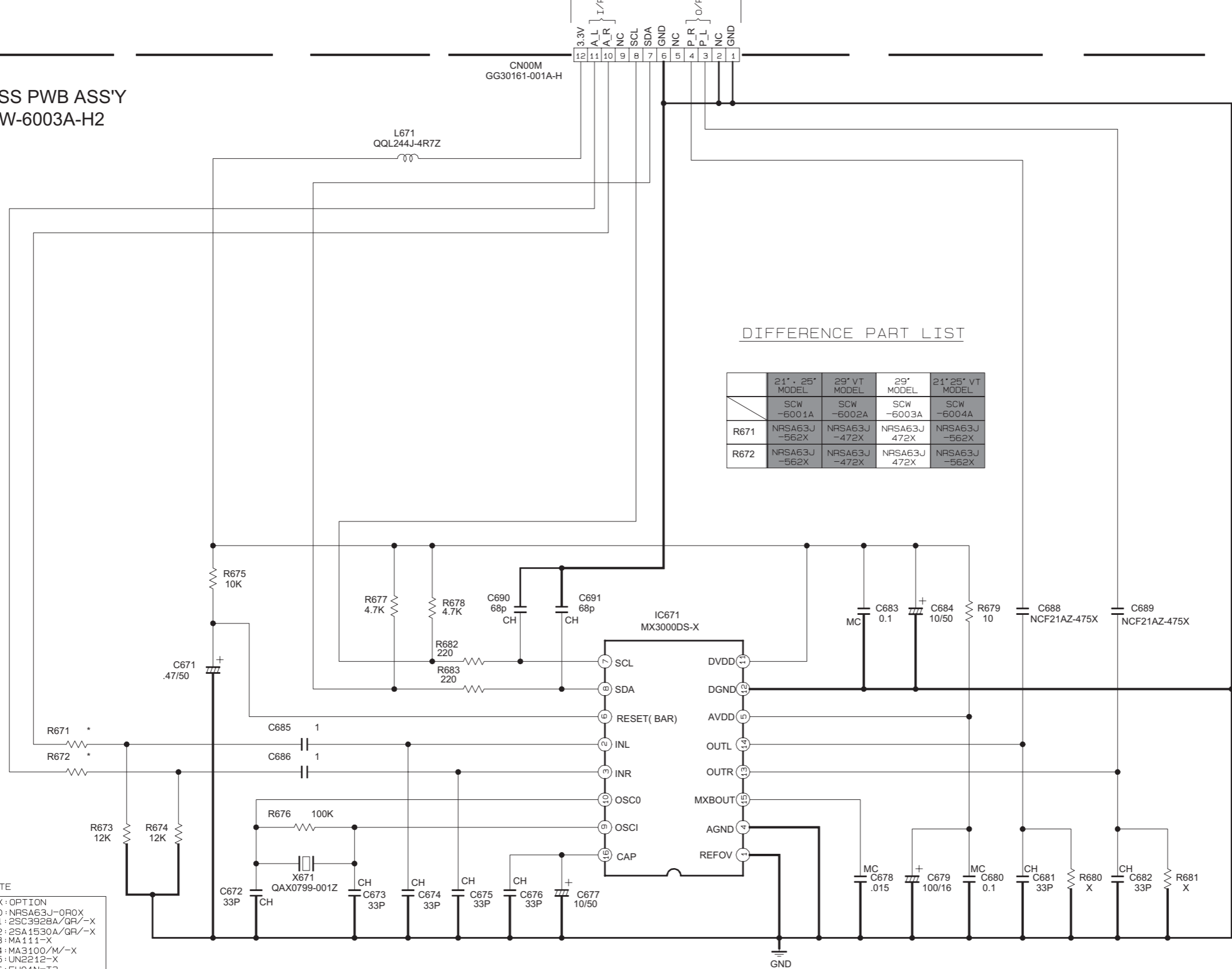

NOTE) 1.Refer to page 2-25 for voltages of this circuit diagram.
2.Refer to page 2-26 for waveforms of this circuit diagram.

PATTERN DIAGRAMS
MAIN PWB PATTERN

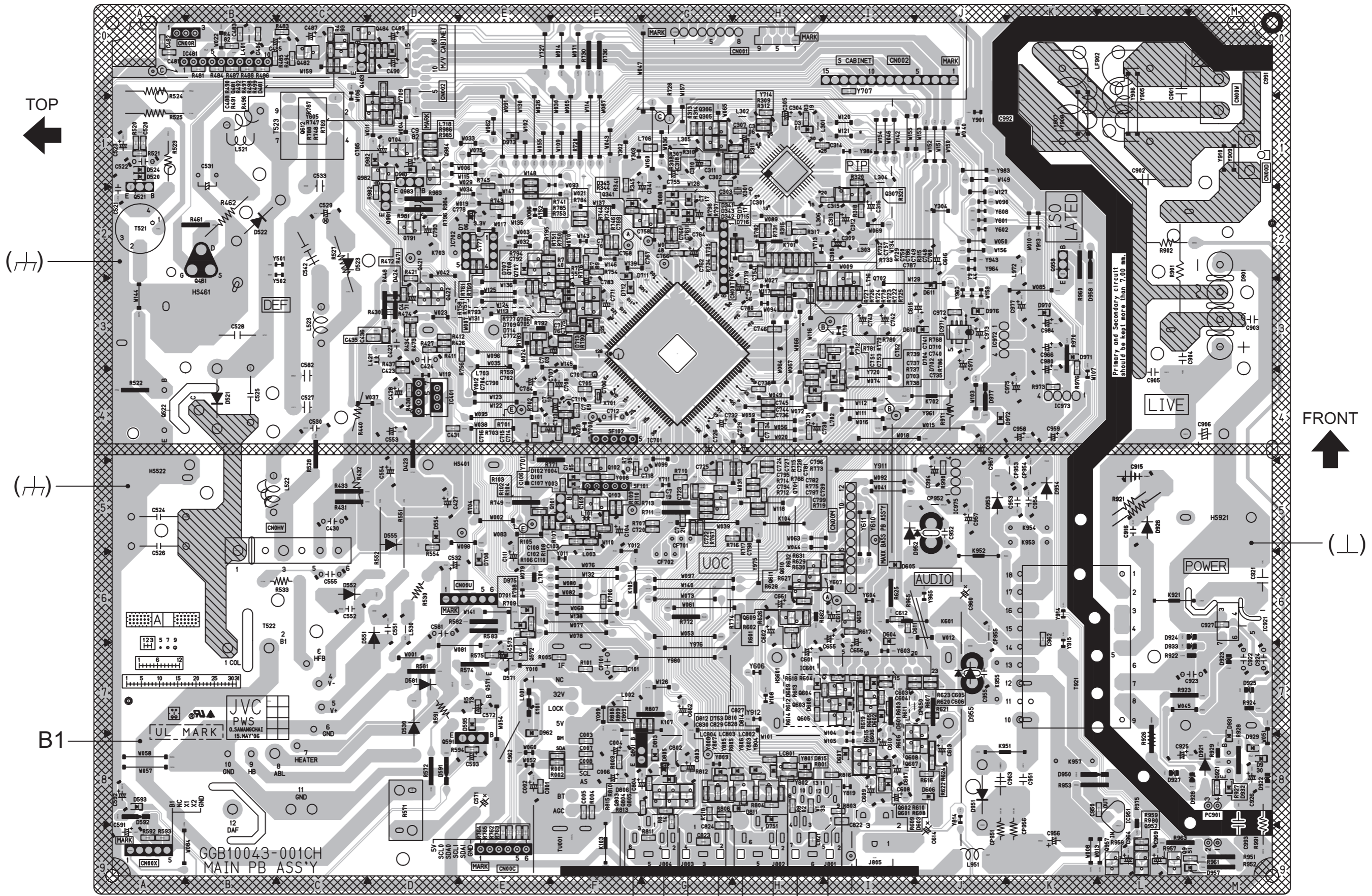

CRT SOCKET PWB PATTERN

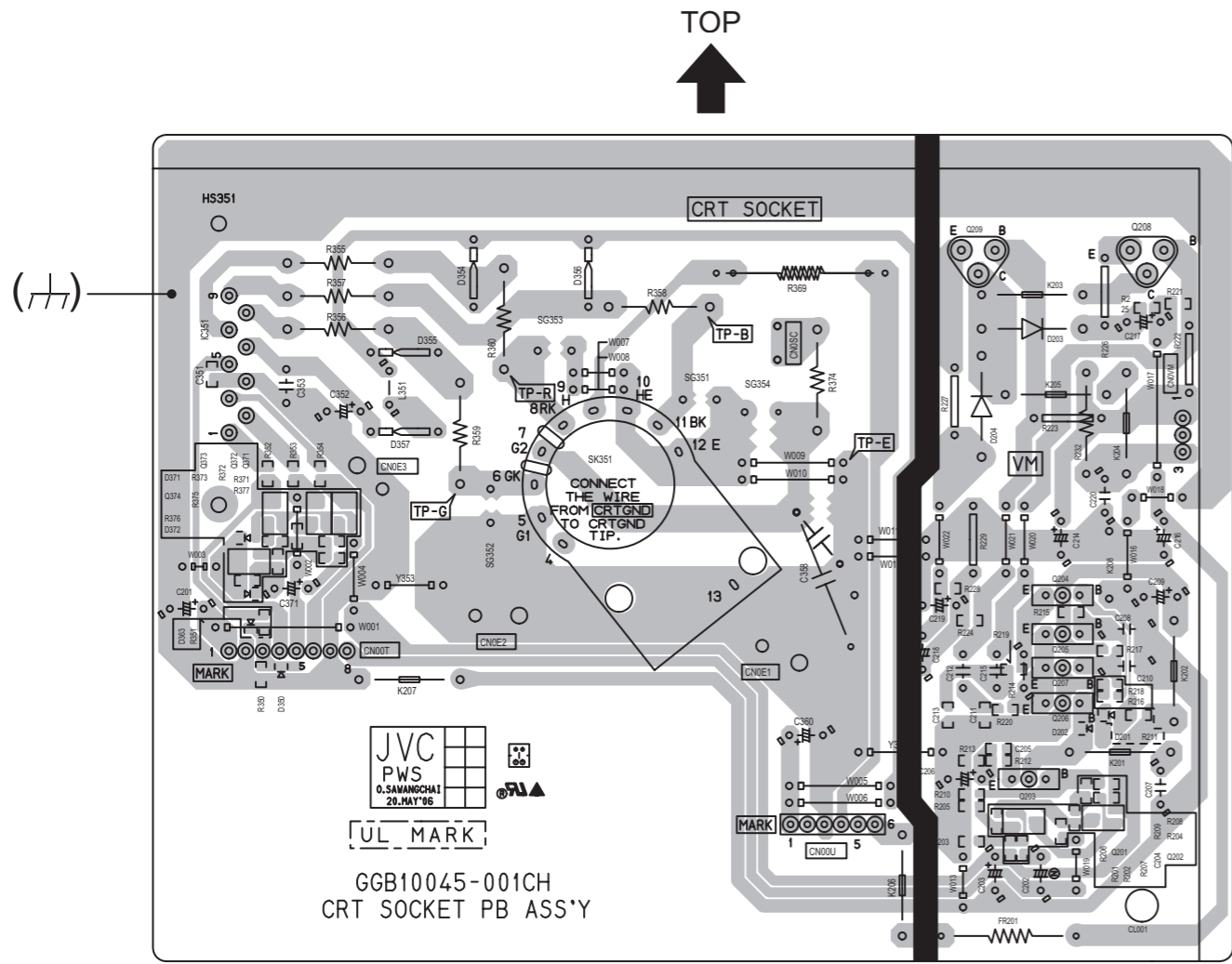

FRONT CONTROL PWB PATTERN

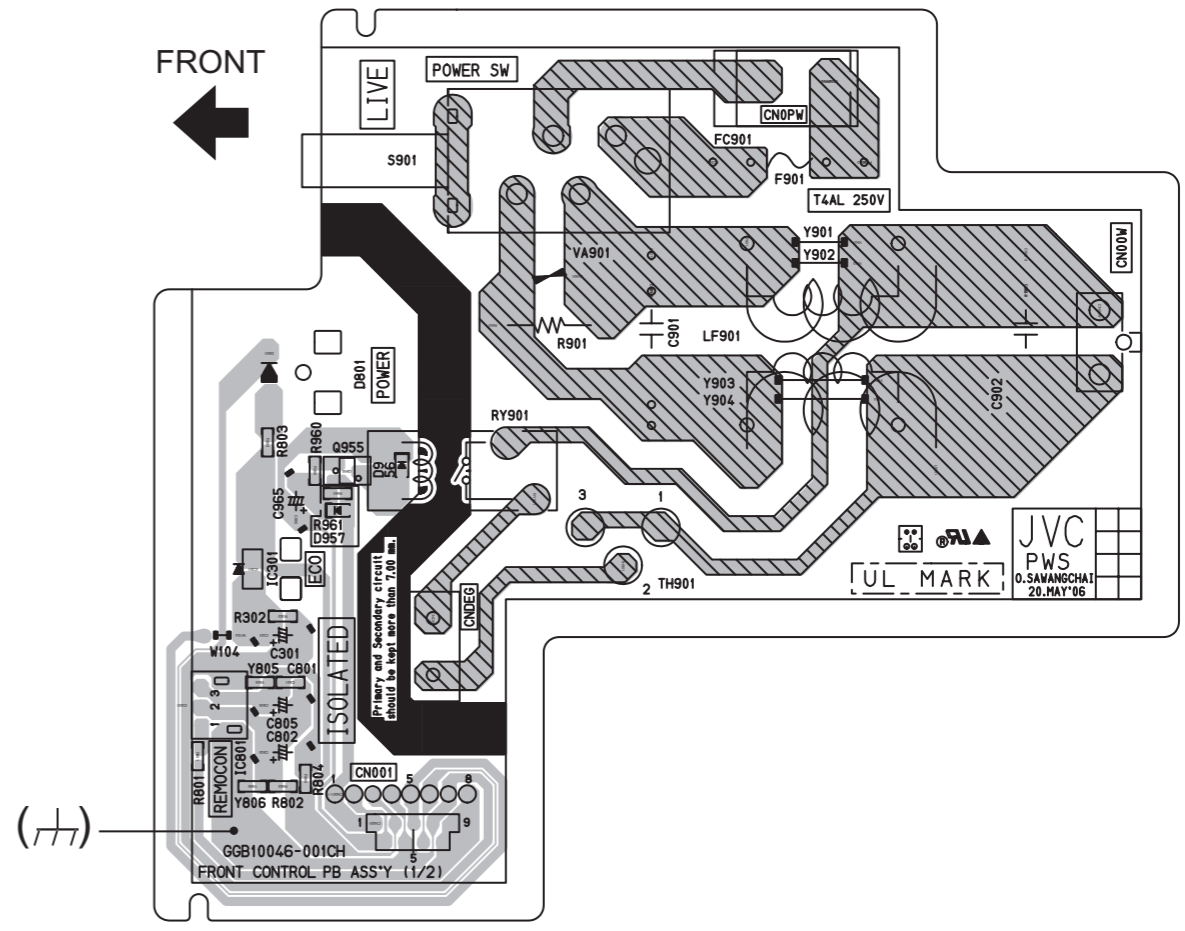

FRONT CONTROL PWB PATTERN

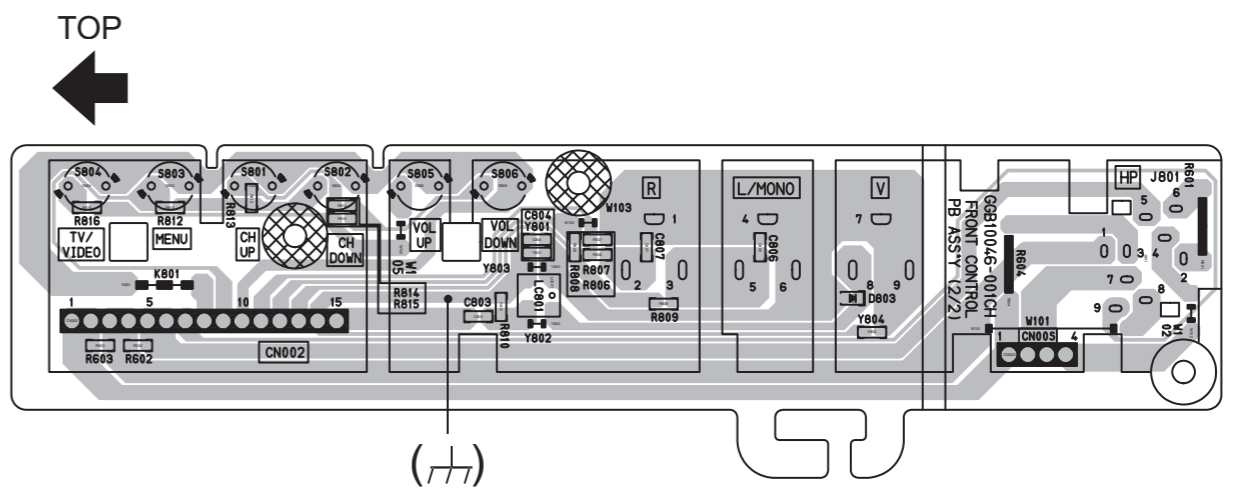

BASS PWB PATTERN [SOLDER SIDE]

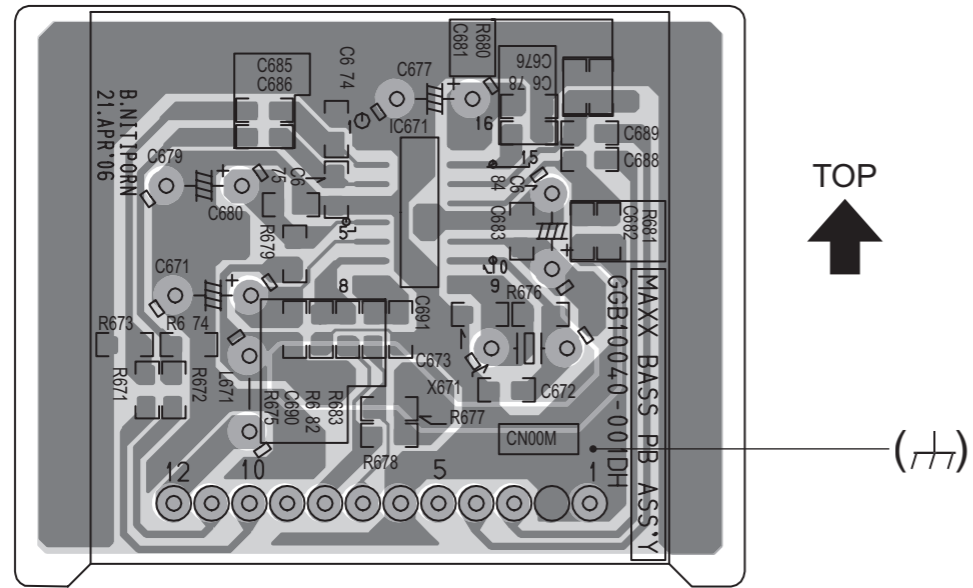

BASS PWB PATTERN [PARTS SIDE]

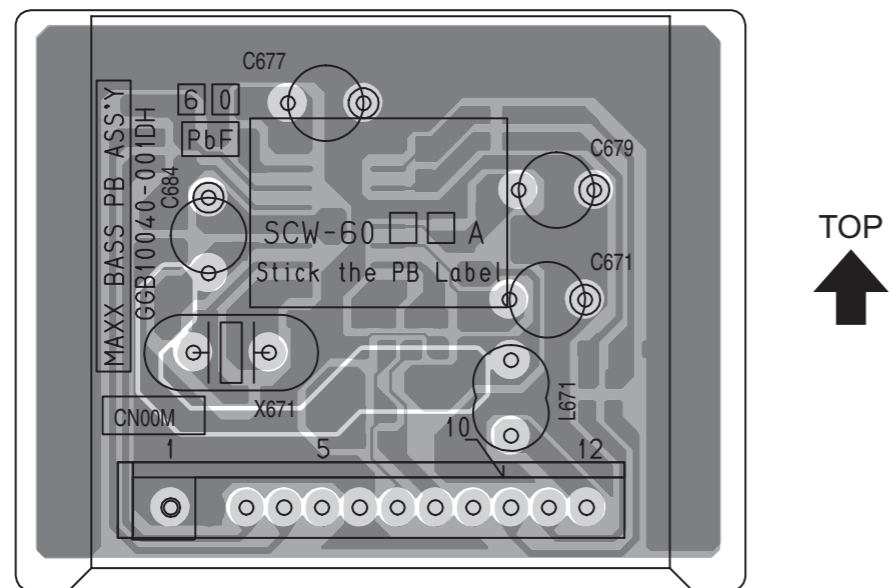

VOLTAGE CHARTS

<MAIN PWB>		<MAIN PWB>		<MAIN PWB>		<MAIN PWB>		<MAIN PWB>		<MAIN PWB>	
MODE PIN NO.	DC (V)	MODE PIN NO.	DC (V)	MODE PIN NO.	DC (V)	MODE PIN NO.	DC (V)	MODE PIN NO.	DC (V)	MODE PIN NO.	DC (V)
IC401		65	2.0	IC972		Q612		IC351		IC351	
1	0.3	66	0.3	1	6.7	E	0	1	2.0	1	0
2	13.9	67	1.6	2	0	C	4.9	2	2.1	2	1.2
3	-10.8	68	0	3	3.1	B	0	3	2.0	3	1.2
4	-13.3	69	4.9	4		Q702		4	0.1	4	0
5	0	70	1.3	IC973		E	1.3	5	5.1	5	3.2
6	14.4	71	1.2	1	16.4	C	4.7	6	196.3	6	1.9
7	0.5	72	1.2	2	11.8	B	2.0	7	123.9	7	0.7
IC601		73	2.0	3	0	Q704		8	118.2	8	11.8
1	0	74	1.7	4	3.1	E	0	9	125.7	9	11.8
2	NC	75	0.3	IC975		C	2.5	Q203		E	1.1
3	0	76	0	1	7.5	B	0	E	1.1	C	6.2
4	NC	77	3.2	2	4.9	Q705		C	6.2	B	1.8
5	25.9	78	1.2	3	0	S	0	Q204		E	6.8
6	NC	79	1.1	4	3.2	D	0	C	11.8	B	7.4
7	0	80	1.2	Q101		G	1.9	E	6.8	C	0
8	NC	81	0	E	2.2	Q706		C	11.8	B	6.1
9	0	82	4.9	C	11.8	S	0	Q206		E	6.8
10	NC	83	2.4	B	2.9	D	0	C	0	B	6.1
11	0.5	84	3.7	Q102		G	1.9	Q208		E	124.7
12	NC	85	2.0	E	0	Q707		C	63.8	B	124.1
13	12.9	86	2.1	C	7.5	E	0	Q209		E	2.7
14	NC	87	2.0	B	0	C	3.2	C	63.8	B	3.2
15	0.7	88	3.1	Q103		B	0	Q371		E	0.2
16	NC	89	0	E	0	Q708		C	2.0	B	0.4
17	0	90	3.1	C	0	E	4.7	E	0.2	C	2.0
18	NC	91	1.6	B	3.0	C	0	Q372		E	0.2
19	27.2	92	0.2	Q307		B	4.9	C	2.0	B	0.4
20	NC	93	1.7	E	3.3	Q791		E	0.2	C	2.0
21	16.7	94	3.2	C	0.2	E	0	C	2.0	B	0.4
22	NC	95	0	B	2.7	C	3.9	Q373		E	0.2
23	12.8	96	1.8	Q341		B	0	E	0.2	C	2.0
IC701		97	3.0	E	4.8	Q801		C	2.0	B	0.4
1	0	98	0	C	-0.2	E	2.1	Q372		E	0.2
2	0	99	0	B	4.9	C	0	C	2.0	B	0.4
3	1.9	100	1.9	Q421		B	1.4	E	0.2	C	2.0
4	3.2	101	0	E	0	Q803		C	2.0	B	0.4
5	3.1	102	1.5	C	0	E	0	Q373		E	0.2
6	0	103	0	B	0.5	C	0	E	0.2	C	2.1
7	3.0	104	0	Q422		B	-0.5	B	0.3	E	0.6
8	0	105	3.1	E	0	Q804		C	0.2	B	0.2
9	3.0	106	3.2	C	3.1	E	0	Q374		E	0.6
10	1.4	107	0	B	0	C	0	E	0.6	C	0.2
11	1.4	108	2.0	Q461		B	-0.5	B	0.2	B	0.2
12	0.3	109	1.9	S	17.6	Q805		E	0.2	B	0.2
13	0.1	110	3.2	D	0	E	0.2	C	-0.4	B	0.2
14	2.8	111	1.7	G	3.6	C	-0.4	B	0	B	0.2
15	4.8	112	0	Q521		B	0	IC301		1	2.7
16	1.9	113	0	E	0	Q951		2	3.3	2	3.3
17	2.2	114	3.1	C	25.8	E	0.7	IC801		1	2.9
18	0	115	3.1	B	1.5	C	21.9	2	0	2	0
19	2.3	116	2.6	Q522		B	0	3	3.2	3	3.2
20	2.2	117	1.9	E	0	Q952		Q955		E	0
21	3.5	118	1.9	C	130.0	E	0	E	0	C	11.8
22	1.2	119	3.1	B	0	C	0	B	0	B	0
23	1.3	120	3.0	Q571		B	0.7	Q957		E	29.2
24	1.9	121	0	E	135.0	Q957		E	0	C	6.7
25	1.9	122	3.1	C	0	E	0	B	29.1	B	29.1
26	2.3	123	0	B	134.7	C	29.1	Q958		E	2.7
27	1.9	124	1.9	Q572		B	0	E	29.2	C	1.9
28	0	125	0	E	0	Q958		C	6.7	B	1.9
29	1.9	126	3.2	C	3.1	E	29.2	Q982		E	1.9
30	1.9	127	3.1	B	0	C	2.0	B	2.5	C	2.0
31	4.3	128	3.1	Q601		B	2.5	Q983		E	1.9
32	1.8	IC702		E	8.7	Q981		E	2.7	C	2.0
33	2.1	1	0	C	0.3	E	2.7	C	2.0	B	2.0
34	2.2	2	0	B	8.9	C	1.9	B	2.0	E	1.9
35	2.2	3	0	Q602		B	1.9	Q984		E	1.9
36	3.6	4	0	E	0.2	Q982		E	1.9	C	2.0
37	3.5	5	3.2	C	-0.4	E	1.9	C	2.0	B	2.5
38	2.4	6	3.2	B	0	C	2.0	TU001		1	4.3
39	2.5	7	0	Q603		B	2.5	2	3.8	3	0
40	0	8	3.2	E	0	Q983		4	2.1	4	2.1
41	2.9	IC921		C	0	E	2.7	5	2.0	5	2.0
42	1.6	1	125.4	B	-0.6	C	2.0	6	4.9	6	4.9
43	2.6	2	NC	Q605		B	2.0	7	4.9	7	4.9
44	2.8	3	0	E	0	Q984		E	0	E	0
45	8.2	4	19.7	C	0	E	1.9	9	35.0	B	2.4
46	2.2	5	4.0	B	-0.7	C	2.0	11	0	E	0
47	4.8	6	1.7	Q607		B	2.5	12	0	C	0
48	1.4	7	0.3	E	0	TU001		13	1.6	B	2.4
49	2.2	IC951		C	0	1	4.3	14	1.6	E	0
50	2.1	1	135.1	B	0.6	2	3.8	15	0.1	C	0
51	1.4	2	21.9	Q608		3	0	16	1.2	B	2.4
52	1.6	3	0	E	0	4	2.1			E	0
53	2.2	IC971		C	22.7	5	2.0			C	0
54	2.2	1	3.2	B	0	6	4.9			B	2.4
55	1.4	2	0.2	Q609		7	4.9			E	0
56	2.1	3	0	E	0	8	0			C	0
57	2.2	4	1.9	C	0	9	35.0			B	2.4
58	1.8	5	3.7	B	2.4	11	0			E	0
59	1.5	6	0	Q611						C	0
60	3.7	7	6.1	E	0					B	2.4
61	3.7			C	0						
62	3.5			B	2.4						
63	3.5										
64	0.5										

WAVEFORMS

-MAIN PWB-

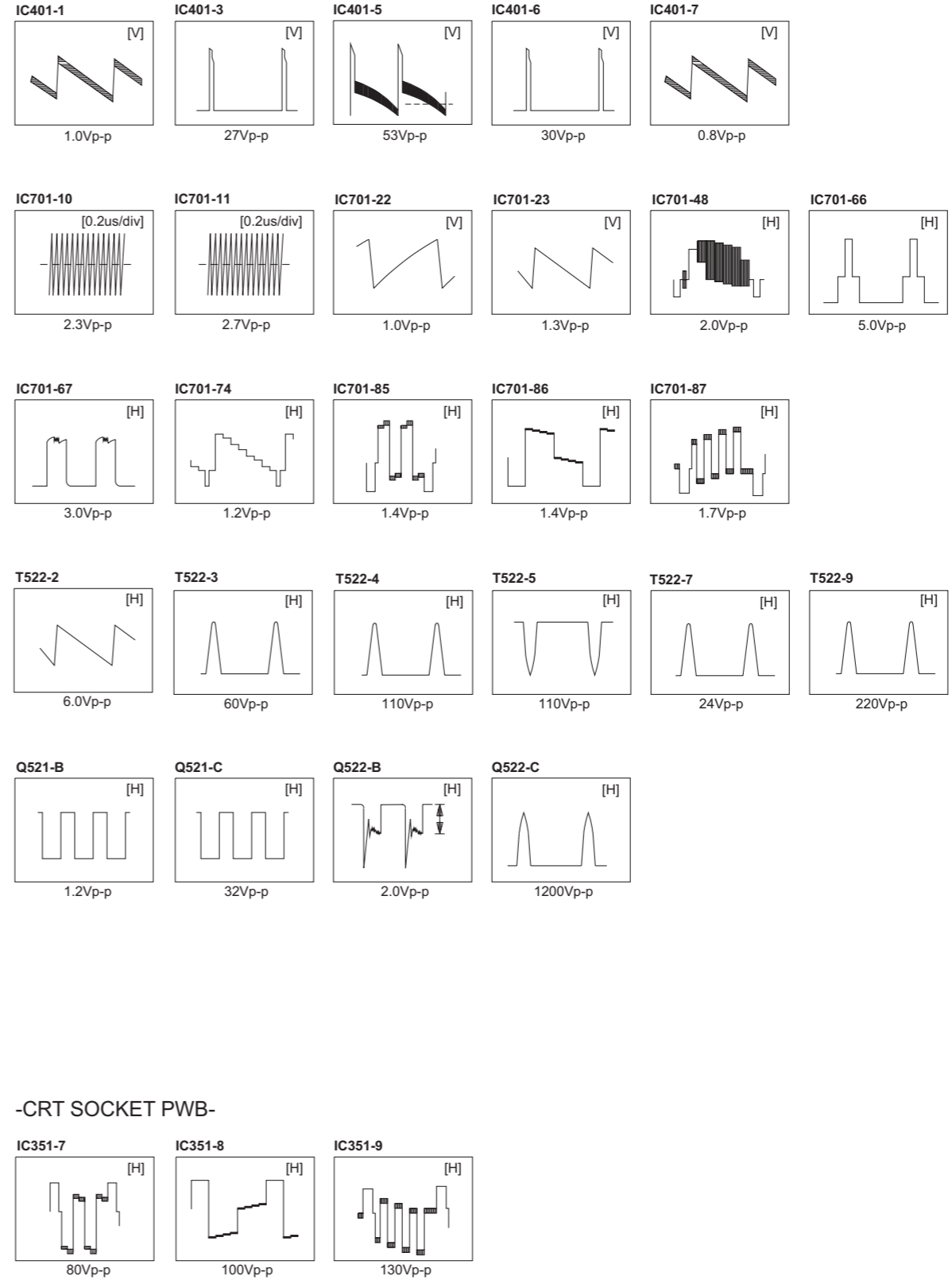

-CRT SOCKET PWB-



JVC

Victor Company of Japan, Limited
Display Category 12, 3-chome, Moriya-cho, Kanagawa-ku, Yokohama-city, Kanagawa-prefecture, 221-8528, Japan

(No.YA449)