

10. CIRCUIT DIAGRAM

10.1 BB Circuit

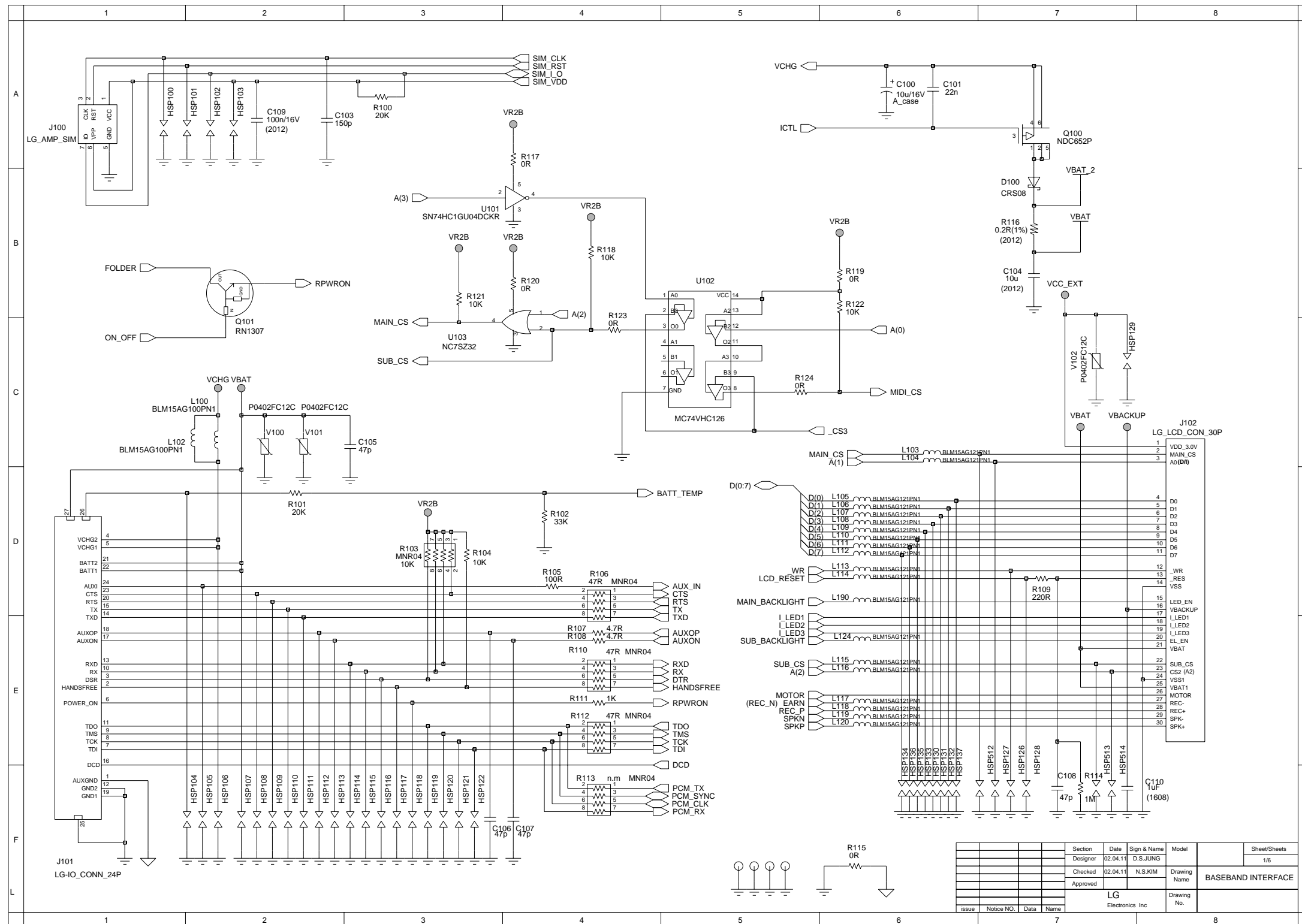

10. CIRCUIT DIAGRAM

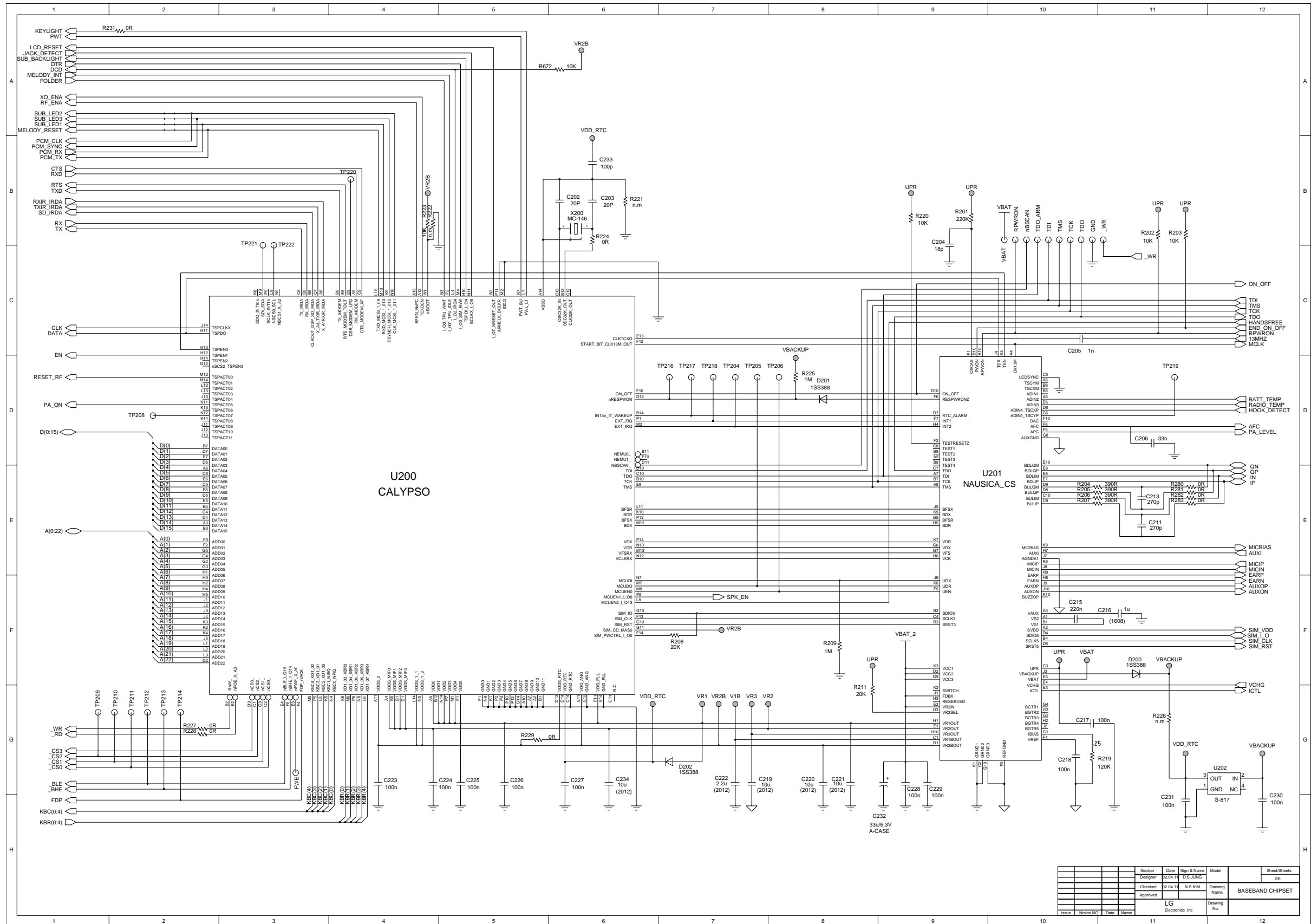

Section	Date	Sign & Name	Model	Sheet/Sheets
Designer	02.04.11	D.S.JUNG		2/6
Checked	02.04.11	N.S.KIM	Drawing Name	
Approved			BASEBAND CHIPSET	
Issue	Notice No.	Date	Name	
			LG Electronics Inc.	

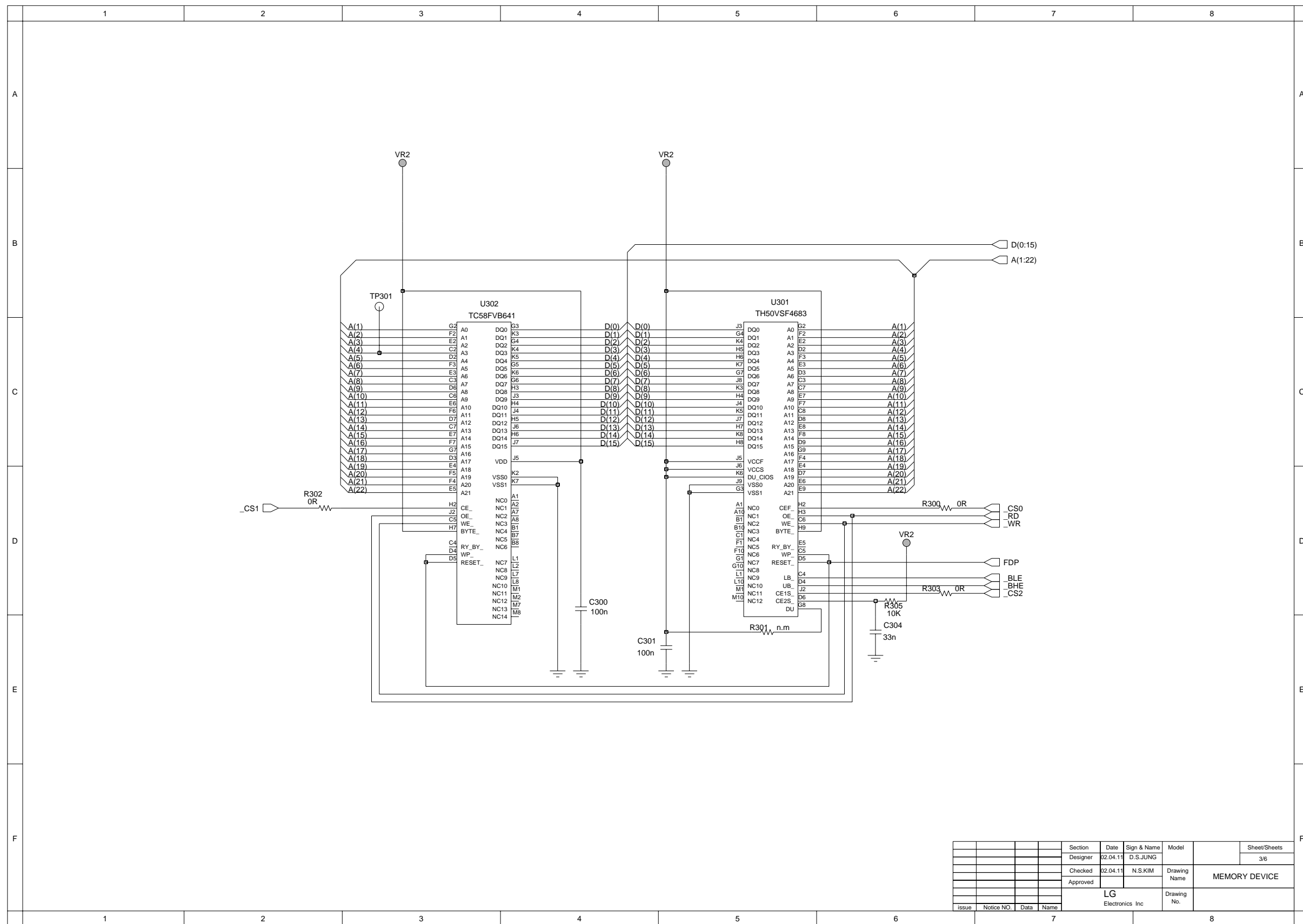

Section	Date	Sign & Name	Model	Sheet/Sheets
Designer	02.04.11	D.S.JUNG		3/6
Checked	02.04.11	N.S.KIM	Drawing Name	MEMORY DEVICE
Approved			Drawing No.	
LG Electronics Inc				
Issue	Notice NO.	Data	Name	

10. CIRCUIT DIAGRAM

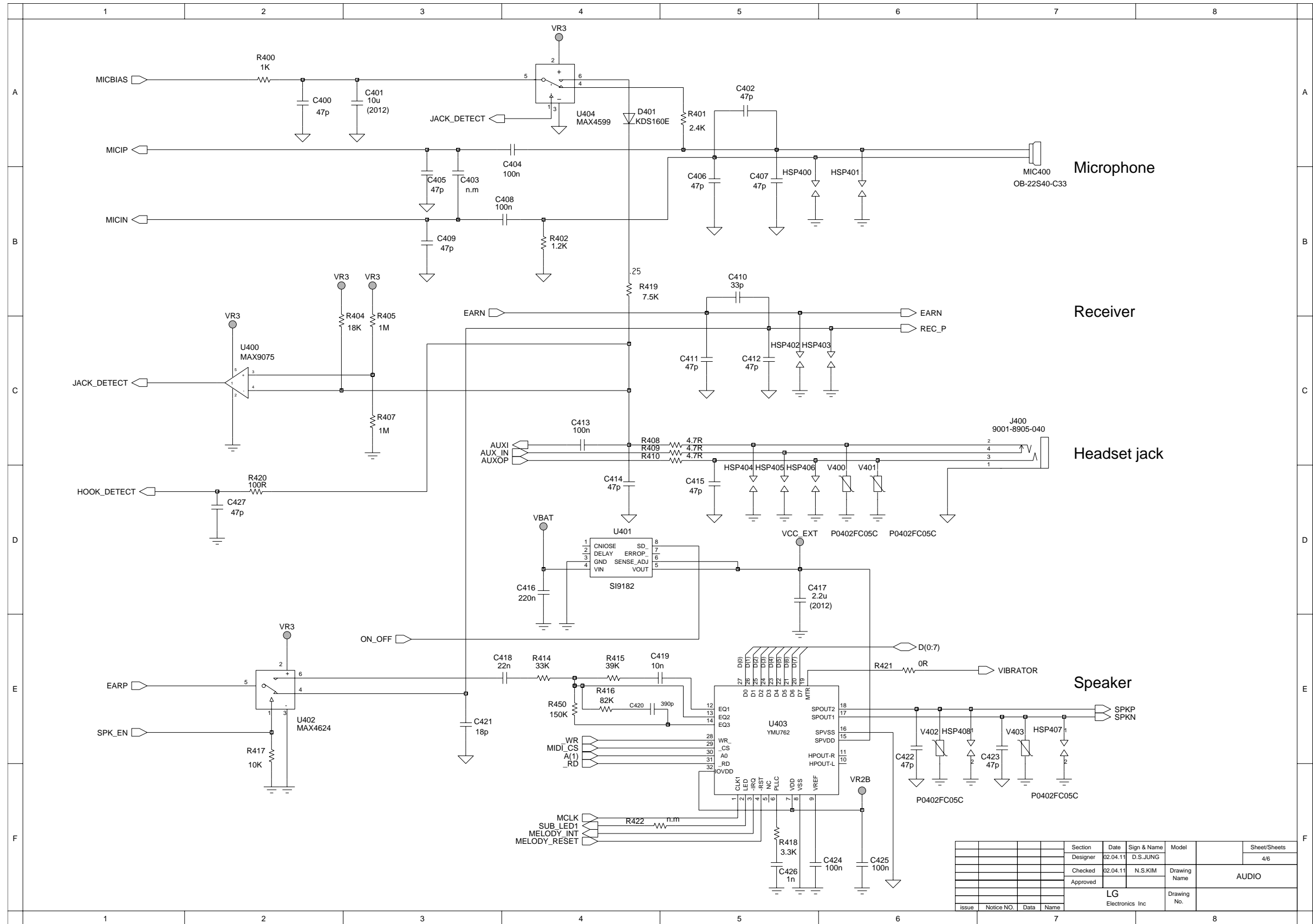

Section	Date	Sign & Name	Model	Sheet/Sheets
Designer	02.04.11	D.S.JUNG		4/6
Checked	02.04.11	N.S.KIM	Drawing Name	AUDIO
Approved		LG	Drawing No.	
Issue	Notice NO.	Date	Name	

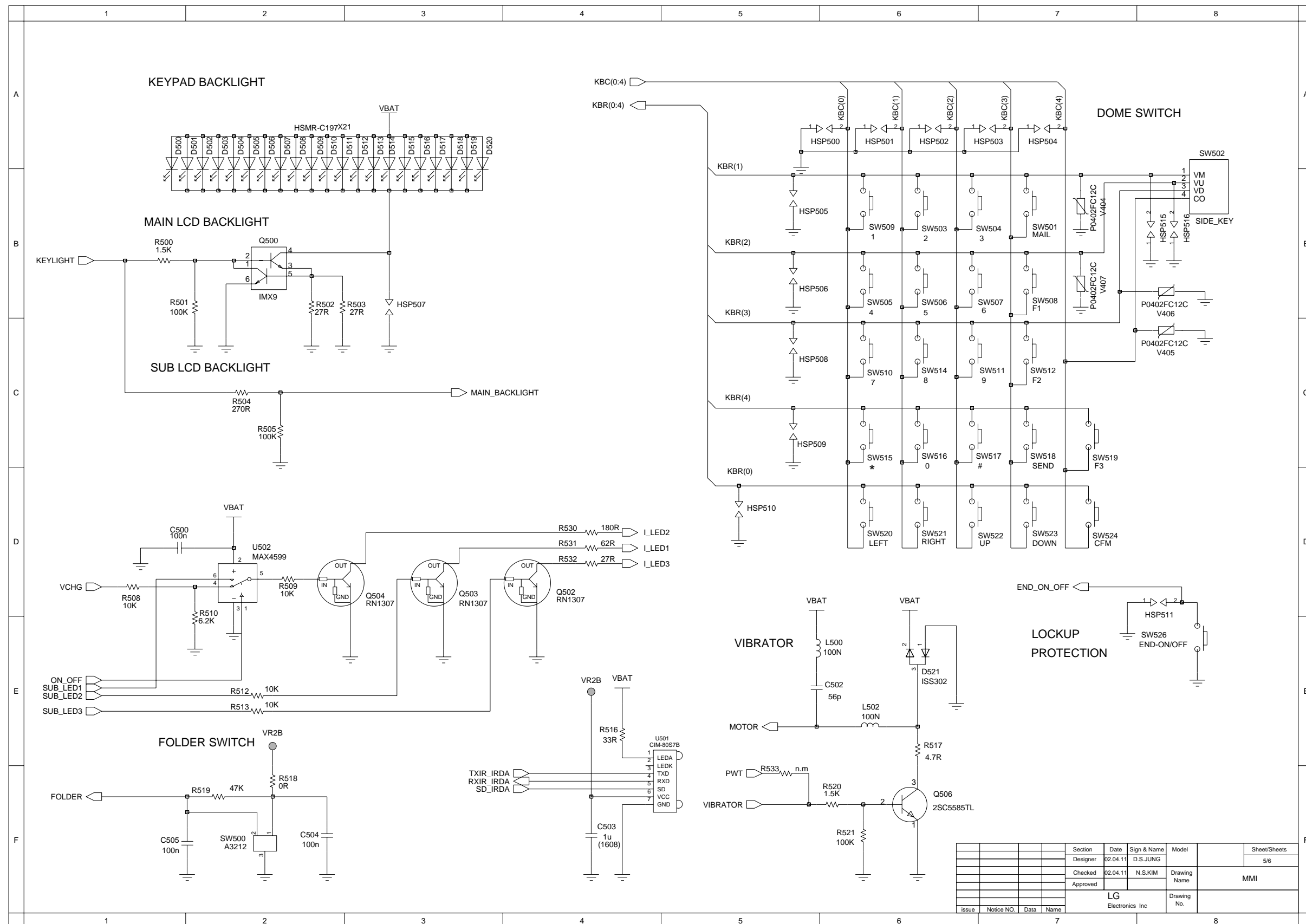

Section	Date	Sign & Name	Model	Sheet/Sheets
Designer	02.04.11	D.S.JUNG		5/6
Checked	02.04.11	N.S.KIM	Drawing Name	
Approved				MMI
LG Electronics Inc			Drawing No.	

10. CIRCUIT DIAGRAM

10.2 RF Circuit

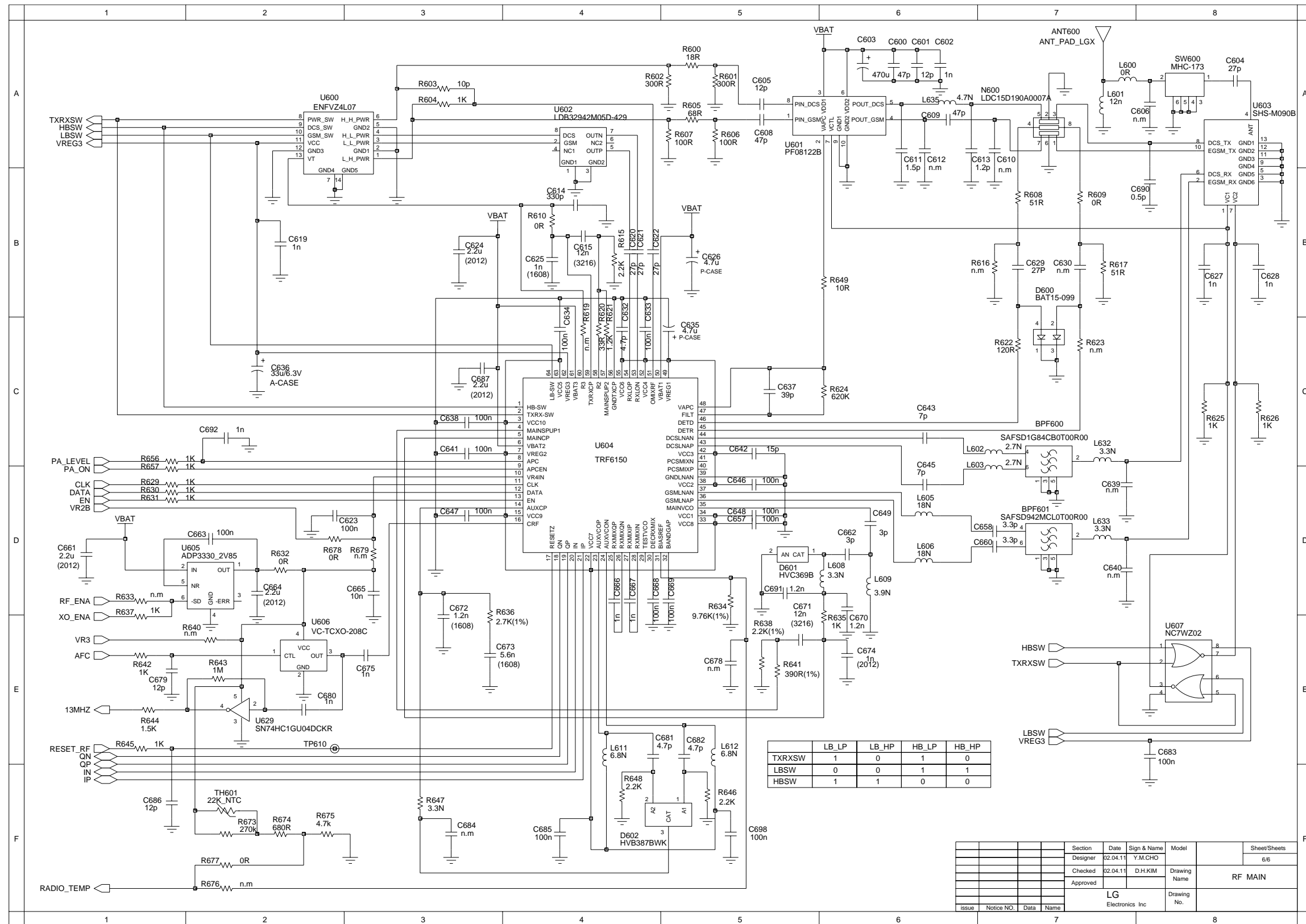

11. PCB LAYOUT

11.1 TOP

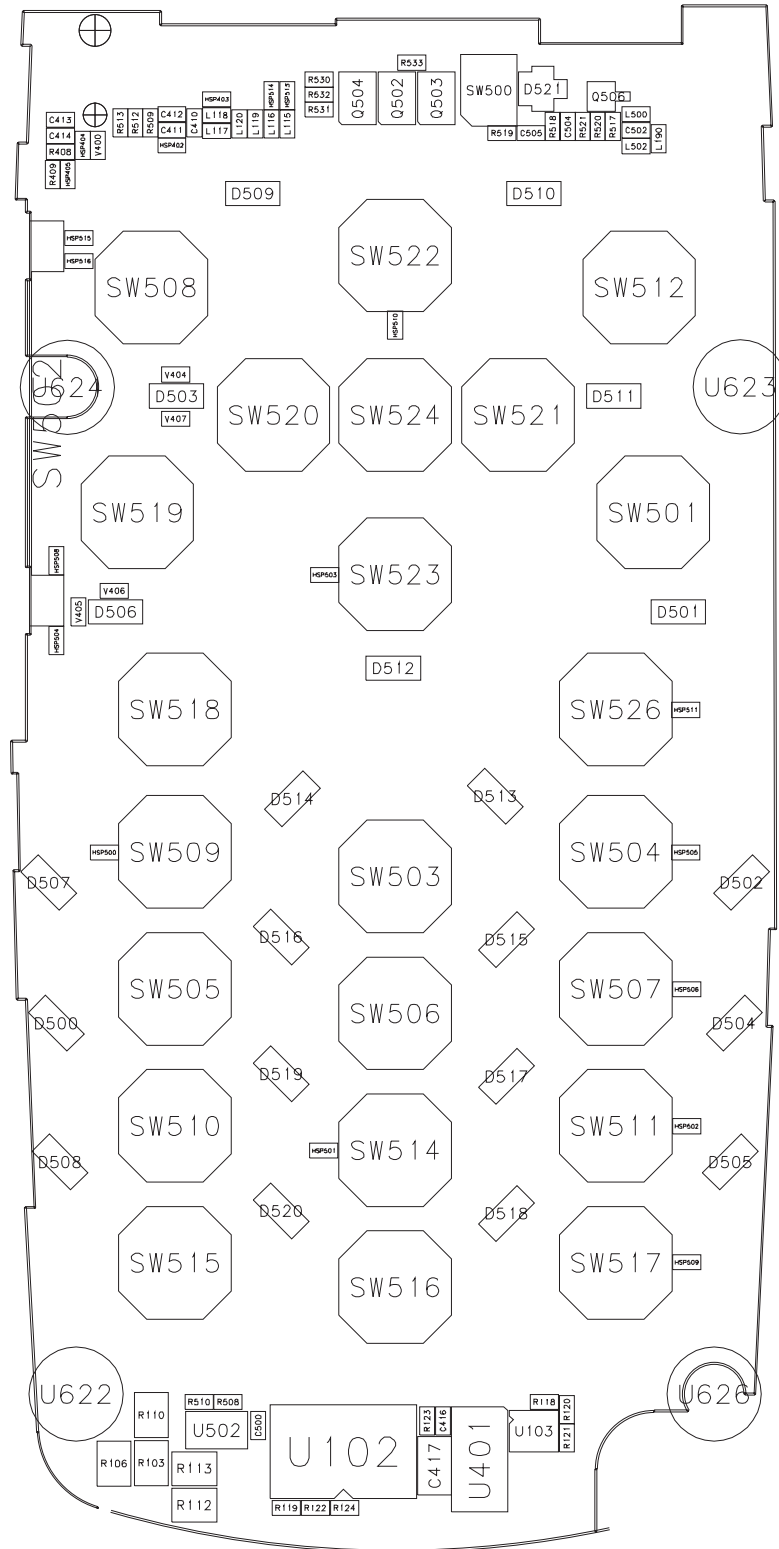

www.s-manuals.com