



Thunder n3600B



S2927

Version 1.0

Copyright

Copyright © TYAN Computer Corporation, 2006. All rights reserved. No part of this manual may be reproduced or translated without prior written consent from TYAN Computer Corp.

Trademark

All registered and unregistered trademarks and company names contained in this manual are property of their respective owners including, but not limited to the following.

TYAN, Thunder n3600B are trademarks of TYAN Computer Corporation.
AMD, Opteron, and combinations thereof are trademarks of AMD Corporation.
AMI, AMI BIOS are trademarks of AMI Technologies.
Microsoft, Windows are trademarks of Microsoft Corporation.
SuSE, is a trademark of SuSE AG.
Marvell[®] is a trademark of Broadcom Corporation and/or its subsidiaries
XGI and XG20 are trademarks of XGI Corporation
nVIDIA, nForce are trademarks of NVIDIA Corporation.





Notice

Information contained in this document is furnished by TYAN Computer Corporation and has been reviewed for accuracy and reliability prior to printing. TYAN assumes no liability whatsoever, and disclaims any express or implied warranty, relating to sale and/or use of TYAN products including liability or warranties relating to fitness for a particular purpose or merchantability. TYAN retains the right to make changes to product descriptions and/or specifications at any time, without notice. In no event will TYAN be held liable for any direct or indirect, incidental or consequential damage, loss of use, loss of data or other malady resulting from errors or inaccuracies of information contained in this document.

Table of Contents

Check the box contents!	Page 3
Chapter 1: Introduction	
1.1 Congratulations	Page 5
1.2 Hardware Specifications	Page 5
Chapter 2: Board Installation	
2.1 Board Image	Page 8
2.2 Block Diagram	Page 9
2.3 Board Parts, Jumpers and Connectors	Page 10
2.4 Tips on Installing Motherboard in Chassis	Page 22
2.5 Installing the Processor(s)	Page 23
2.6 Installing the Memory	Page 28
2.7 Attaching Drive Cables	Page 31
2.8 Installing Add-In Cards	Page 33
2.9 Installing Graphic Cards and SLI Bridge	Page 34
2.10 Connecting External Devices	Page 35
2.11 Installing the Power Supply	Page 36
2.12 Finishing Up	Page 36
Chapter 3: BIOS Setup	
3.1 About the BIOS	Page 37
3.2 BIOS Menu Bar	Page 37
3.3 Setup Basics	Page 38
3.4 Getting Help	Page 38
3.5 In Case of Problems	Page 38
3.6 BIOS Main Menu	Page 39
3.7 Advanced Menu	Page 40
3.8 PCI/PnP Menu	Page 61
3.9 Boot Menu	Page 63
3.10 Security Menu	Page 67
3.11 Chipset Menu	Page 68
3.12 Exit Menu	Page 70
Chapter 4: Diagnostics	
4.1 Beep Codes	Page 71
4.2 Flash Utility	Page 71
4.3 AMIBIOS Post Code	Page 77
Appendix: SMDC Information	Page 79
Glossary	Page 81
Technical Support	Page 87

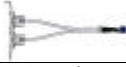
Check the box contents!

Item	S2927
	1x S2927 motherboard
	1x 34-Pin floppy drive cable
	6 x SATA cable
	3 x SATA Drive Power Adapter
	1 x Ultra-DMA-100/66 IDE cable
	1 x IEEE1394a Cable (S2927A2NRF only)
	1 x USB2.0 cable
	1 x S2927 User's Manual
	1 x S2927 Quick Reference guide
	1 x TYAN driver CD
	1 x I/O shield
	1 x SLI bridge (S2927A2NRF only)
	2 x CPU Retention Frame and Back Plate

Chapter 1: Introduction

1.1 - Congratulations

You have purchased one of the most powerful server solutions. The Thunder n3600B (S2927) is a flexible AMD64 platform for multiple applications, based on NVIDIA nForce Pro3600 and SMSC SCH5017 chipsets.

Designed to support AMD® Opteron™ 2000 series processors and DDRII-667 memory, the S2927 with integrated Dual Gigabit Ethernet LAN, built-in 16MB XGI XG20™ video and six serial ATA ports, is ideal for CPU, memory, and video intensive applications such as CAD, Graphics Design, and High Bandwidth Video Editing, etc.

Remember to visit TYAN's Website at <http://www.TYAN.com>. There you can find information on all of TYAN's products with FAQs, online manuals and BIOS upgrades.

1.2 - Hardware Specifications

Processor

- Dual 1207-pin ZIF sockets
- Supports up to two AMD Socket F Opteron 2000 series processors
- Up to 1.0GHz Hyper-Transport link support

Expansion Slots

- One (1) x16 PCI-E (PCI-E1)
- One (1) x16 PCI-E with x8 bandwidth (PCI-E2)
- Three 32-bit, 33MHz PCI v2.3 slots (PCI1~PCI3)
- Total five usable expansion slots

Chipset

- nVIDIA nForce Pro 3600
- SMSC SCH5017

Memory

- Dual memory channels
- Supports 8x DDRII-667/533/400 registered, ECC DIMMs

Integrated LAN Controllers

- Two nForce Pro 3600 integrated MAC with two Marvell 88E1116 single port Gigabit Ethernet PHY
- Integrated TCP offload Engine (TOE)
- IEEE802.3 compliant, WOL/PXE support
- Pin header for front panel LAN LED

Integrated Audio (S2927A2NRF only)

- Realtek ALC262 audio CODEC
- HD Audio 1.0 compliant
- 2 x 5 pin header for front panel audio connector
- CD_IN connector

Integrated PCI 1394 (S2927A2NRF only)

- VIA VT6307/6308 PCI FireWire (1394) controller
- Two IEEE1394 ports (via cable)

System Management

- SMSC SCH5017 w/ 2x EMC6D103
- 2x CPU FAN & 2x 4-pin system Fan headers, w/ tachometer input and w/ auto fan control
- Temperature and voltage monitoring
- Watchdog timer
- Port 80 code display LED

Integrated PCI IDE

- Single channel master mode support up to two IDE devices
- Support for ATA-133/100/66/33 IDE drives and ATAPI compliant devices

Integrated 2D/3D PCI Graphics (S2927G2NR only)

- XGI Volari (XG20)
- 16MB frame buffer memory

Integrated Serial ATA II

- Three serial ATA II Host controllers embedded
- Supports up to 6 serial ports running at 3.0Gb/s per direction per channel
- Serial ATA II specification compliant
- nVIDIA MediaShield™ supports for RAID 0, 1, 0+1, 5, JBOD
- HDD LED connector

Integrated I/O Interface

- One (1) floppy connector
- Four (4) USB 2.0 ports (via cable)
- One (1) COM port (via cable)
- Tyan 2x9 front panel pin header
- One (1) parallel pin header

Form Factor

- ATX footprint, 10.2" x 12.0" (259mmx305mm)

Back Panel I/O Ports

- Stacked PS/2 mouse & keyboard ports
- One (1) COM1 connector
- One (1) 15-pin VGA port
- 3 audio jacks (from bottom: line out <green>, line in <blue>, MIC <pink>) (S2927A2NRF version only)
- 2 double-decked USB2.0 ports and one RJ45 (2x Marvell 88E1116 single port GbE PHY + nVIDIA MAC) 10/100/1000 Base-T port with link/activity LED

Server Management

- M3291, IPMI 2.0 Remote System Mgmt card
- Renasas H8S2167 BMC controller
- BT, KCS, Logging support
- IPMI-over-LAN
- Remote power on/off and reset

BIOS

- AMI BIOS 8Mbit Flash
- Supports ACPI 2.0
- PnP, DMI2.0, WfM 2.0 power management

Power

- EPS12V support, on board 4-phase VRD
- Universal 24-pin + 8-pin power connectors
- 4-pin auxiliary power connector

Regulatory

- FCC Class B (Declaration of Conformity)
- CE (Declaration of Conformity)

Chapter 2: Board Installation

You are now ready to install your motherboard. The mounting hole pattern of the Thunder n3600B S2927 matches the ATX specification. Before continuing with installation, confirm that your chassis supports an ATX motherboard.

How to install our products right... the first time

The first thing you should do is reading this user's manual. It contains important information that will make configuration and setup much easier. Here are some precautions you should take when installing your motherboard:

- (1) Ground yourself properly before removing your motherboard from the antistatic bag. Unplug the power from your computer power supply and then touch a safely grounded object to release static charge (i.e. power supply case). For the safest conditions, TYAN recommends wearing a static safety wrist strap.
- (2) Hold the motherboard by its edges and do not touch the bottom of the board, or flex the board in any way.
- (3) Avoid touching the motherboard components, IC chips, connectors, memory modules, and leads.
- (4) Place the motherboard on a grounded antistatic surface or on the antistatic bag that the board was shipped in.
- (5) Inspect the board for damage.

The following pages include details on how to install your motherboard into your chassis, as well as installing the processor, memory, disk drives and cables.

NOTE	DO NOT APPLY POWER TO THE BOARD IF IT HAS BEEN DAMAGED
-------------	---

2.1- Board Image

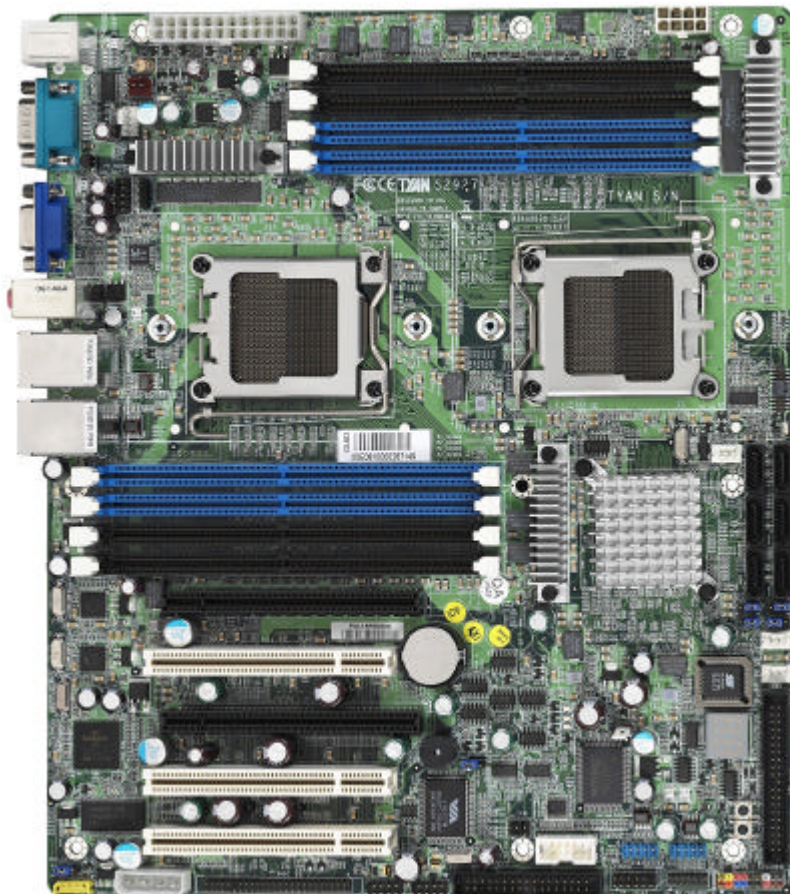

This picture is representative of the latest board revision available at the time of publishing. The board you receive may or may not look exactly like the above picture.

2.2 - Block Diagram

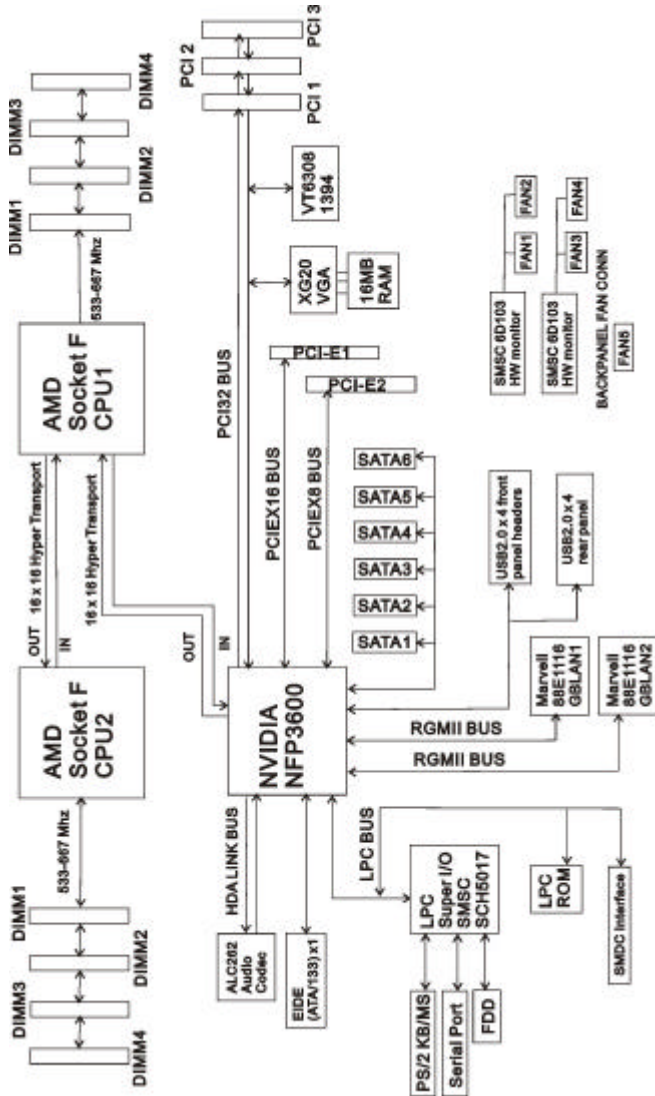

Thunder n3600B S2927 Block Diagram

2.3 - Board Parts, Jumpers and Connectors

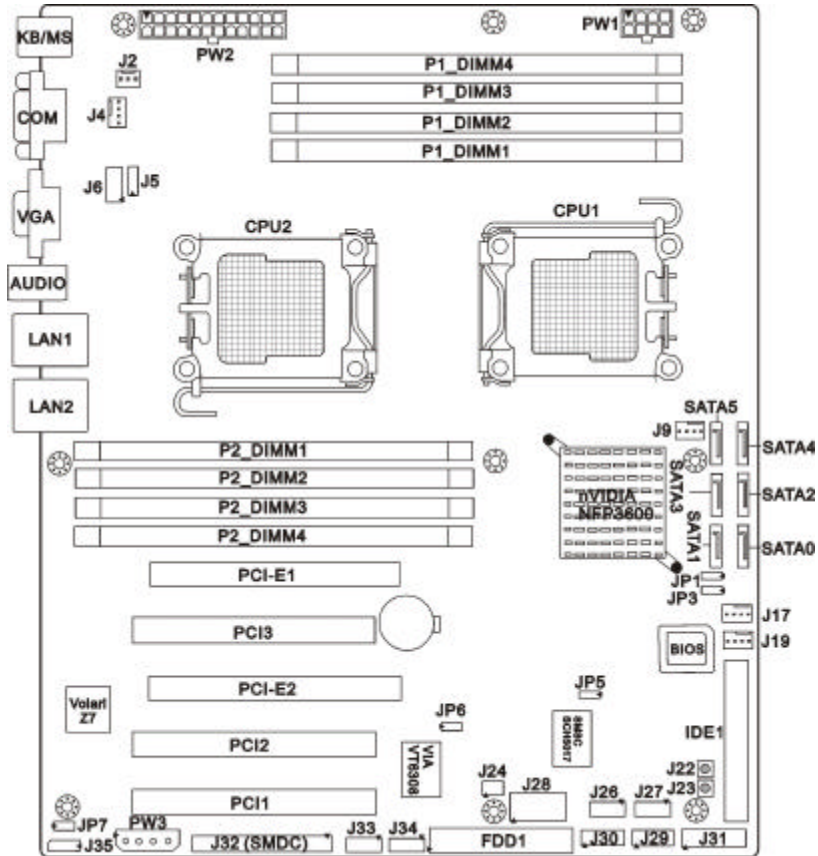

Jumper Legend

	OPEN - Jumper OFF, without jumper cover
	CLOSED – Jumper ON, with jumper cover

Jumper/Connector	Function
J2	3-pin Fan Connector
J4/J9/J17/J19	4-pin Fan Connector with Speed Control
J5	CD_IN Pin Header
J6	Audio Pin Header
J26/J27	Front USB Connector
J28	COM Port Pin Header
J33/J34	IEEE1394 Connector
J35	IPMB Connector
J22	RESET Button
J23	POWER ON Button
JP6	1394 Disable Jumper
JP7	VGA Disable Jumper
JP1/JP3	ASF2.0/SMDC Select Jumper
JP5	Clear CMOS Jumper
J32	SMDC Connector
J31	Front Panel Header
J24/J29/J30	Reserved for OEM only

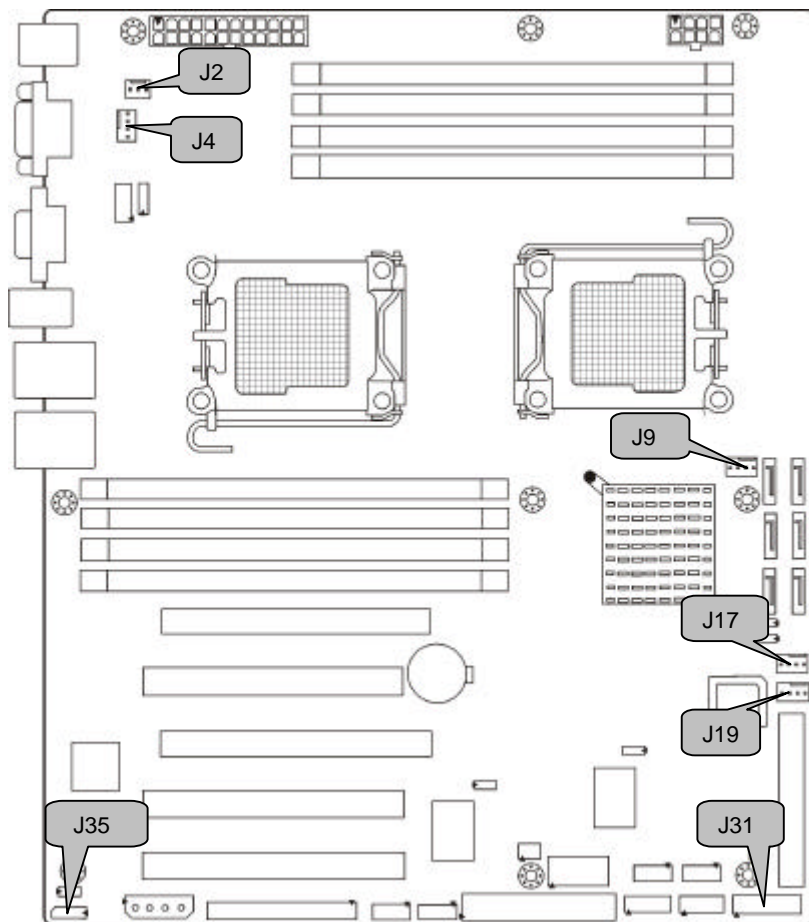

J2: 3-pin Fan Connector

	<p>Use this header to connect the chassis cooling fan to your motherboard to keep the system stable and reliable.</p> <table border="1"> <tr> <th>Pin 1</th> <th>Pin 2</th> <th>Pin 3</th> </tr> <tr> <td>GND</td> <td>+12V</td> <td>NC</td> </tr> </table>	Pin 1	Pin 2	Pin 3	GND	+12V	NC
Pin 1	Pin 2	Pin 3					
GND	+12V	NC					

J4/J9/J17/J19: 4-pin FAN Connector with speed control

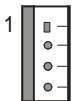
<p>J9/J17/J19</p> 	<p>Use these headers to connect the cooling fans to your motherboard to keep the system stable and reliable.</p> <table border="1"> <tr> <th>Pin 1</th> <th>Pin 2</th> <th>Pin 3</th> <th>Pin 4</th> </tr> <tr> <td>GND</td> <td>+12V</td> <td>Tachometer</td> <td>Speed Control</td> </tr> </table>	Pin 1	Pin 2	Pin 3	Pin 4	GND	+12V	Tachometer	Speed Control
Pin 1	Pin 2	Pin 3	Pin 4						
GND	+12V	Tachometer	Speed Control						
<p>J4</p> 	<p>This connector supports the tachometer monitoring and auto fan speed control.</p>								

J35: IPMB Pin Header

	<p>Use this header to connect to the IPMB device.</p> <table border="1"> <tr> <th>Pin 1</th> <th>Pin 2</th> <th>Pin 3</th> <th>Pin 4</th> </tr> <tr> <td>IPMB DATA</td> <td>GND</td> <td>IPMB CLK</td> <td>NC</td> </tr> </table>	Pin 1	Pin 2	Pin 3	Pin 4	IPMB DATA	GND	IPMB CLK	NC
Pin 1	Pin 2	Pin 3	Pin 4						
IPMB DATA	GND	IPMB CLK	NC						

J31: Front Panel Header

The motherboard provides one front panel header for electrical connection to the front panel switches and LED's.

PWR LED+	PWR LED-	PWR SW#		Warning LED		KEY	GND	INTRUDER
2	4	6	8	10	12	14	16	18
1	3	5	7	9	11	13	15	17
HDD LED+	HDD LED-	Reset		NMI		+5VSB	SMBUS Data	SMBUS Clock

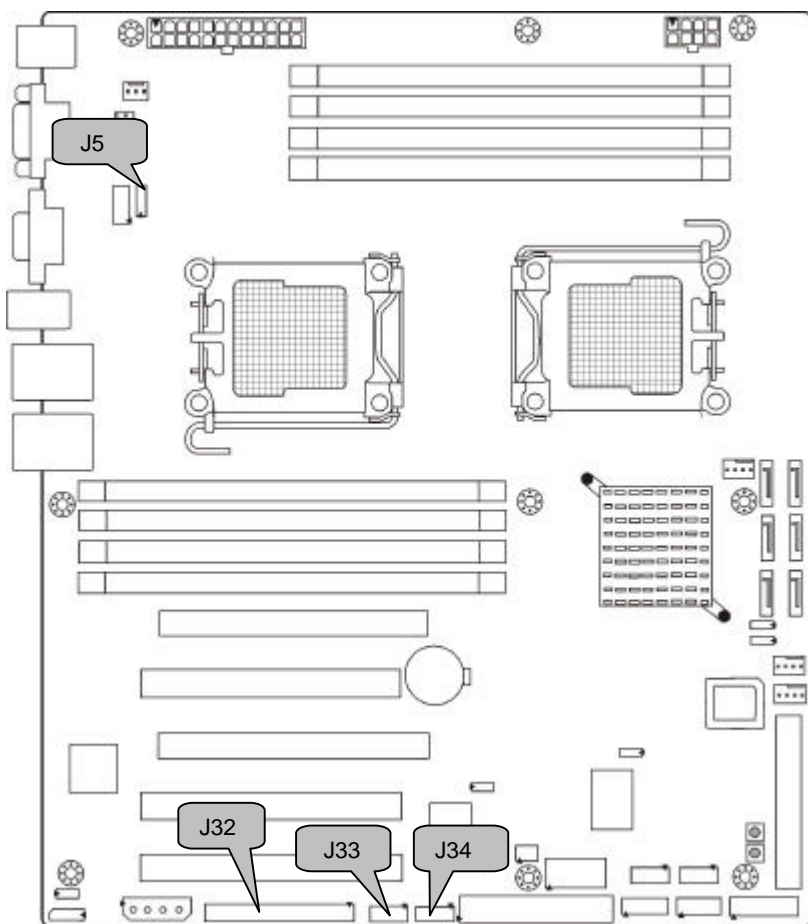

J33/J34: IEEE1394 Pin Header

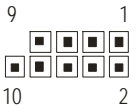

J33: F1394-1
J34: F1394-2

Use these headers to connect to the external devices of IEEE 1394.

Pin 1	XTPA 0/1 P	Pin 2	XTPA 0/1 M
Pin 3	GND	Pin 4	GND
Pin 5	XTPB0P	Pin 6	XTPB0M
Pin 7	1394PWR 1/2	Pin 8	1394PWR 1/2
Pin 9	KEY	Pin 10	GND

J5: CD_IN Pin Header



Use this header to connect to the external CD_IN device.

Pin 1	Pin 2	Pin 3	Pin 4
CD-IN-L	GND	GND	CD-IN-R

J32: SMDC Connector

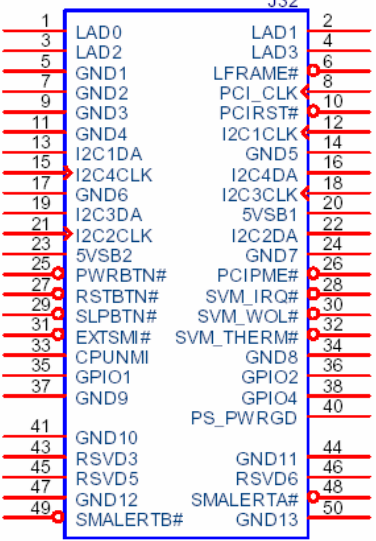

CON25X2_SVM_A

The SMDC connector allows you to connect with Tyan Server Management Daughter Card (SMDC). The S2927 supports Tyan SMDC M3291. See Appendix for more information on SMDC.

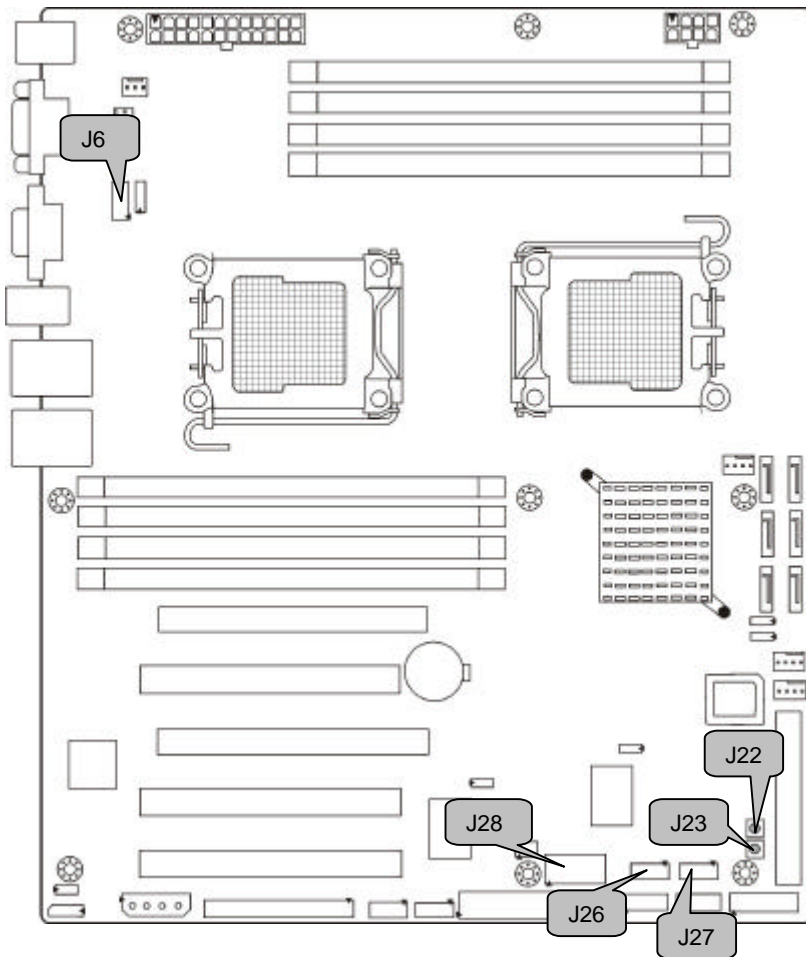

J28: COM Port Pin Header

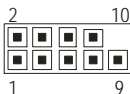

Use these pin definitions to connect a port to COM2.
 *TYAN does not provide cable for this header. It is designed for OEM use only.

Pin 1	DCD	Pin 2	DSR
Pin 3	RXD	Pin 4	RTS
Pin 5	TXD	Pin 6	CTS
Pin 7	DTR	Pin 8	RI
Pin 9	GND	Pin 10	KEU

J26/J27: Front Panel USB2.0 Connectors



J27: USB3
 J26: USB4

Use these headers to connect to the USB devices via the enclosed USB cable.

Pin 1	USBPWR	Pin 2	USBPWR
Pin 3	USB 4/5-	Pin 4	USB 6/7-
Pin 5	USB 4/5+	Pin 6	USB 6/7+
Pin 7	GND	Pin 8	GND
Pin 9	KEY	Pin 10	GND

J6: Audio Pin Header

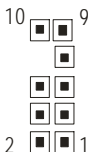

Pin 1	MIC-L-IN	Pin 2	GND
Pin 3	MIC-R-IN	Pin 4	NC
Pin 5	LINE-R-IN	Pin 6	MIC-JD
Pin 7	I/O SENSE	Pin 8	KEY
Pin 9	LINE-L-IN	Pin 10	LINE-JD

J22: RESET Button



Pin 1	Pin 2	Pin 3	Pin 4
RSTSW-	RSTSW-	GND	GND

J23: POWER ON Button



Pin 1	Pin 2	Pin 3	Pin 4
PWRSW-	PWRSW-	GND	GND

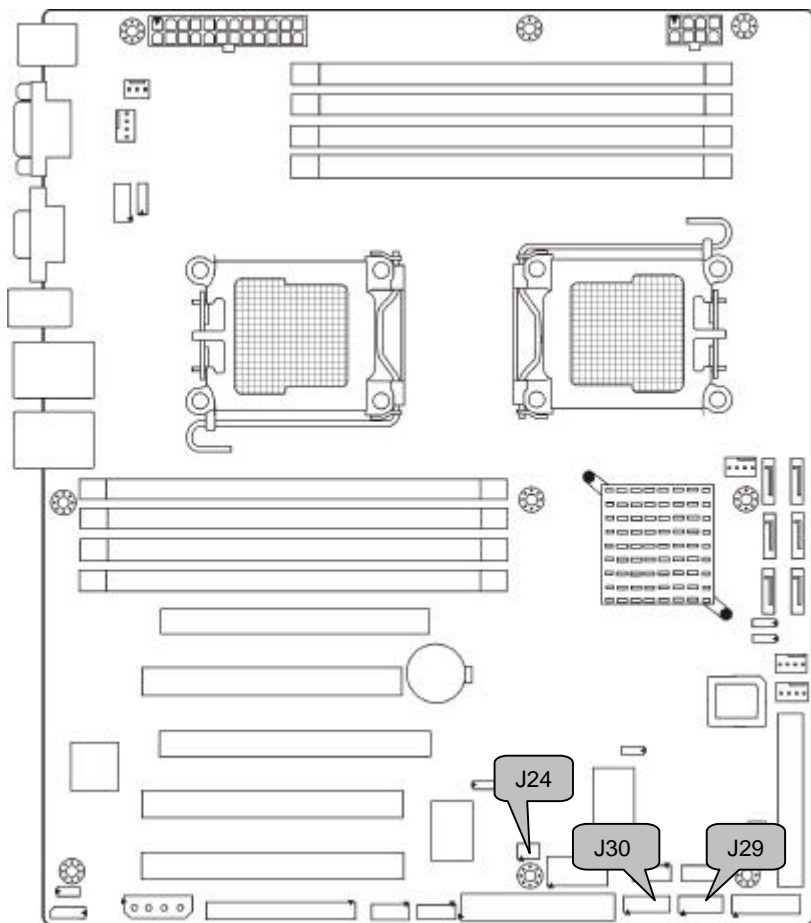

J24: LCM Connector (reserved for OEM only)

	Use this header to connect the LCM module with system monitoring function. This header is reserved for barebone use.		
Pin 1	VCC	Pin 2	RXD2
Pin 3	KEY	Pin 4	GND
Pin 5	+5VSB	Pin 6	TXD2

J29: Fan Tachometer Pin Header (reserved for OEM only)

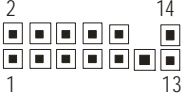

	This header is reserved for barebone use.		
Pin 1	FAN1_TACH	Pin 2	FAN6_TACH
Pin 3	FAN2_TACH	Pin 4	FAN7_TACH
Pin 5	FAN3_TACH	Pin 6	FAN8_TACH
Pin 7	FAN4_TACH	Pin 8	FAN9_TACH
Pin 9	FAN5_TACH	Pin 10	FAN10_TACH
Pin 11	GND	Pin 12	KEY
Pin 13	GND	Pin 14	PWM1

J30: TYAN FP2 Pin Header (reserved for OEM only)

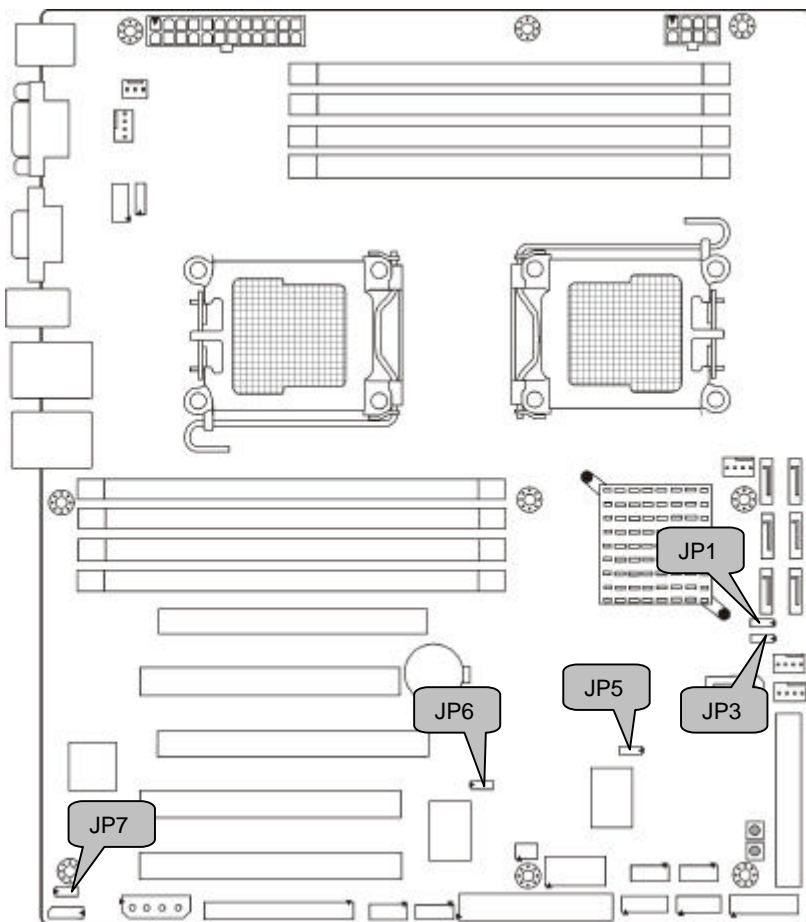

	This header is reserved for barebone use.		
Pin 1	LAN1 LED+	Pin 2	LAN1 LED-
Pin 3	LAN2 LED+	Pin 4	LAN2 LED-
Pin 5	NC	Pin 6	GND
Pin 7	ID LED+	Pin 8	ID LED-
Pin 9	ID_LED S/W+	Pin 10	ID_LED S/W-
Pin 11	NC	Pin 12	KEY





JP5: Clear CMOS Jumper

 <p>Normal (Default)</p>	Use this jumper when you forgot your system/setup password or need to clear system BIOS setting.
 <p>Clear</p>	How to clear the CMOS data - Power off system and disconnect power supply from AC source - Use jumper cap to close Pin_2 and 3 for several seconds to Clear CMOS - Replace jumper cap to close Pin_1 and 2 - Reconnect power supply to AC source Power on system



JP7: VGA Enable/Disable Jumper

 <p>Enable the onboard VGA function. (Default)</p>	
 <p>Disable the onboard VGA function.</p>	

JP6: 1394 Enable/Disable Jumper

 <p>Enable the integrated 1394a function of VT6308 PCI FireWire controller. (Default)</p>	
 <p>Disable the integrated 1394a function of VT6308 PCI FireWire controller.</p>	

JP1/JP3: SMDC/ASF2.0 Select Header

 <p>Support ASF2.0 (Default)</p>	
 <p>Support SMDC card</p>	

2.4 - Tips on Installing Motherboard in Chassis

Before installing your motherboard, make sure your chassis has the necessary motherboard support studs installed. These studs are usually metal and are gold in color. Usually, the chassis manufacturer will pre-install the support studs. If you are unsure of stud placement, simply lay the motherboard inside the chassis and align the screw holes of the motherboard to the studs inside the case. If there are any studs missing, you will know right away since the motherboard will not be able to be securely installed.

Some chassis' include plastic studs instead of metal. Although the plastic studs are usable, TYAN recommends using metal studs with screws that will fasten the motherboard more securely in place.

Below is a chart detailing what the most common motherboard studs look like and how they should be installed.

Mounting the Motherboard

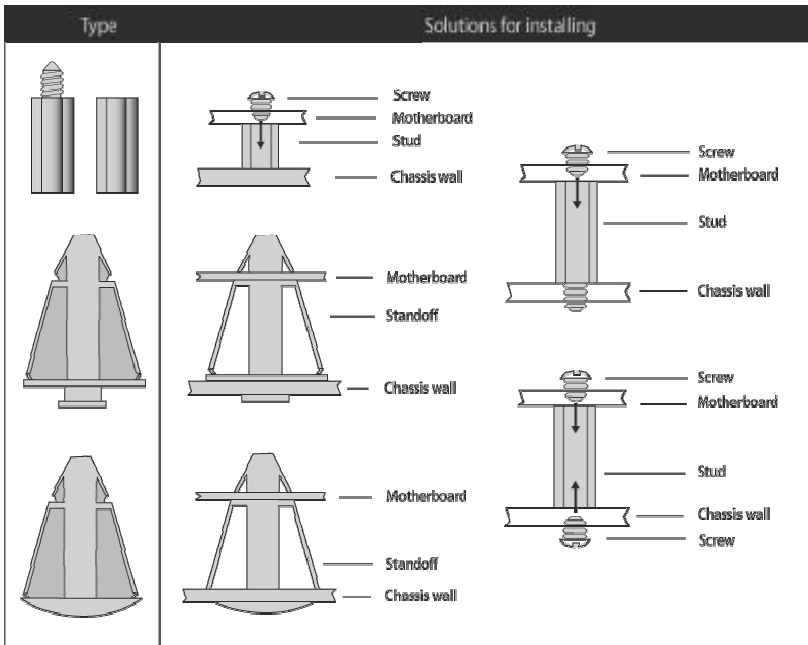

2.5 - Installing the Processor(s)

Your S2927 ports the latest processor technologies from AMD. Check the TYAN website for latest processor support:

<http://www.tyan.com>

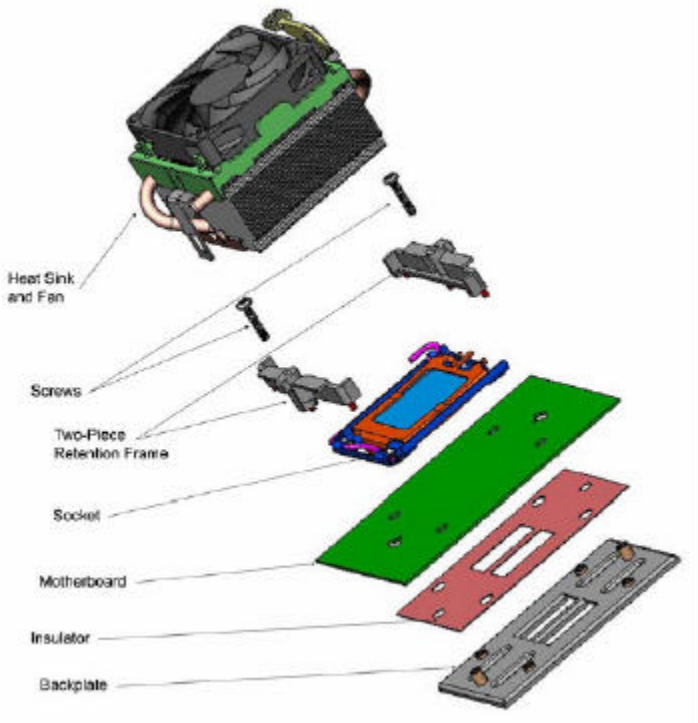

Figure 1. Exploded View of Thermal Solution AMD PIB Platforms based on AMD Socket F Processor

Back plate Assembly

The back plate is mounted on the backside of the motherboard and enhances local stiffness to support shock and vibration loads acting on the heat sink. The back plate assembly prevents excessive motherboard warpage in the area near the processor. Without a back plate, excessive warpage could cause serious damage to electrical connections of the processor socket and integrated circuit packages surrounding the processor. The back plate also serves as a stiffener plate for the LGA socket.

While doing the installation, be careful in holding the components. Follow these instructions to install your back plate:

1. Remove the release liner from the back plate.
2. Align the PEM nuts on the back plate to the holes on the reverse side of the PCB.
3. First, insert the taller upper & lower middle PEM nuts through the holes of the PCB. The remaining four shorter PEM nuts should automatically fit the 4 holes on the PCB as shown in the following pictures.

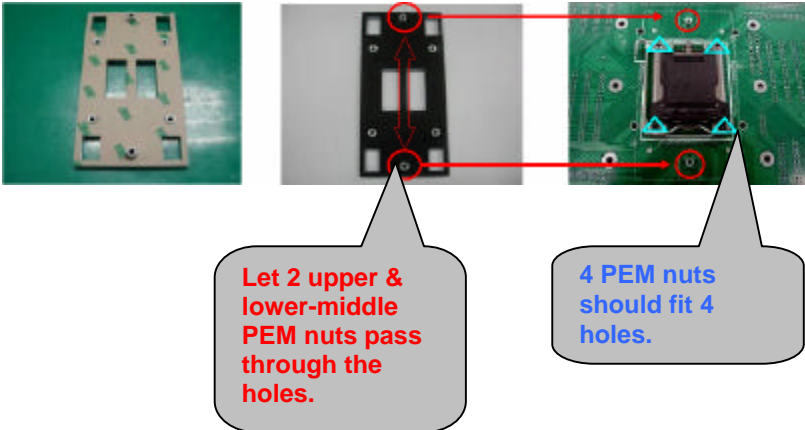

4. Locate four screw holes on socket and screw the socket to the PCB board.

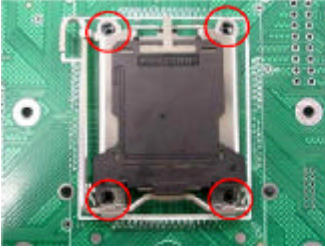

NOTE: Do not assemble CPU before securing socket with screws.

5. Inspect Socket F assembly to PCB. The Socket F must be tightly attached onto the PCB. There must NOT be any gap between stand off the PCB.

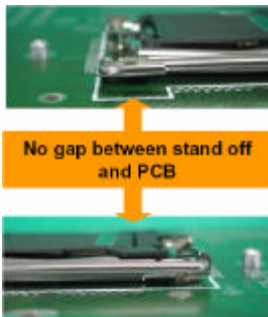

Processor Installation

The processor should be installed carefully. Make sure you are wearing an antistatic strap and handle the processor as little as possible. Follow these instructions to install your processor:

1. Place the PCB such that the socket cam side faces you. Make sure the lever hook is on your top-left side.
2. Use your left thumb and forefinger to hold the lever hook, then pull it to the left side to clear the retention tab.
3. Rotate the lever to a fully open position.

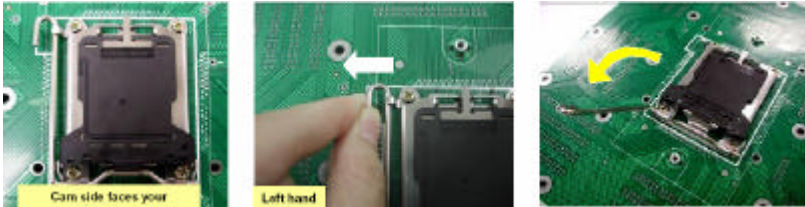

4. Lift the load plate to a fully open position.

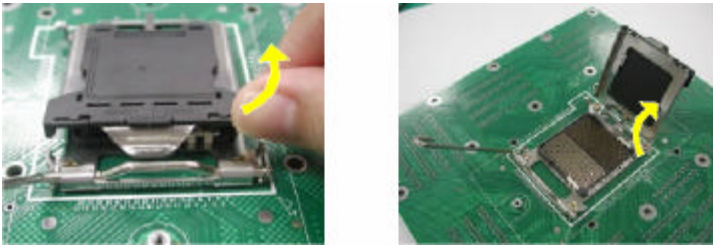

5. Locate the Pin 1 indicator of the package. Align the package with the socket and carefully insert the package into the socket with vertical motion only. Vertically check if the CPU is seated well in the socket housing. If not, take out the CPU, with vertical motion only, and repeat the above steps.

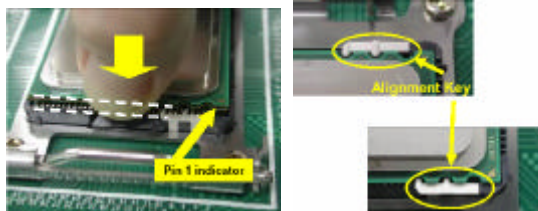

NOTE: The alignment keys must be located in the notches of the package.

6. Remove the PnP cap. Use your left hand to hold the load plate. Then use your right thumb to remove the PnP cap from the load plate. With the package in the socket, the PnP cap removal process will not damage the contacts.

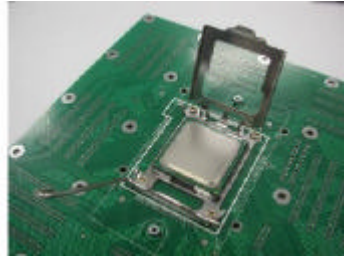
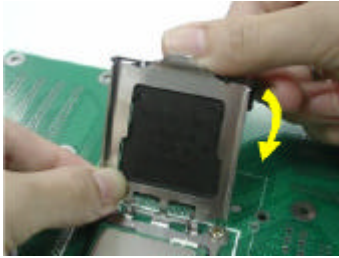

7. Close the socket. Rotate the load plate onto the package lid. Engage the load lever while pressing down lightly onto the load plate. Secure the lever near the hook end under the retention tab.

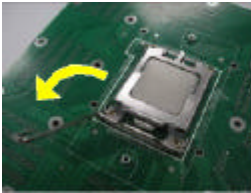

8. Repeat this procedure for the second processor if necessary.

2.6 - Installing the Memory

Before installing memory, ensure that the memory you have is compatible with the motherboard and processor. Only DDR2-667/533/400 DIMM modules are required. Check the TYAN Web site at: www.tyan.com for details of the type of memory recommended for your motherboard.

The following diagram shows common types of DDR2 memory modules.

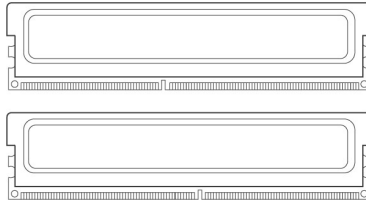

Key points to note before installing memory:

- Only **DDR2 667/533 /400 Registered ECC** memory modules are supported.
- All installed memory will automatically be detected and no jumpers or settings need changing.

For optimal dual-channel DDR2 operation, always install memory in pairs beginning with P1_DIMM1 and P1_DIMM3. Memory modules of the same type and density are required for dual-channel DDR2 Operation. Mismatched memory may cause system instability.

Refer to the following table for supported DDR2 populations.
 (Note: X indicates a populated DIMM slot)

DDR2 DIMM population is always from back to front (black slot first).

DIMM slot	64bit-support							
P1_DIMM1			x			x		x
P1_DIMM3	x		x	x		x	x	x
P2_DIMM1					x		x	x
P2_DIMM3		x		x	x	x	x	x

Population order for 64-bit mode is **DIMM3** first, then **DIMM1**.

DIMM slot	128bit-support							
P1_DIMM1				x		x		x
P1_DIMM2				x		x		x
P1_DIMM3	x		x	x		x	x	x
P1_DIMM4	x		x	x		x	x	x
P2_DIMM1					x		x	x
P2_DIMM2					x		x	x
P2_DIMM3		x	x		x	x	x	x
P2_DIMM4		x	x		x	x	x	x

Population order for 128-bit mode is **DIMM3** and **DIMM4**, then **DIMM1** and **DIMM2**.

Memory Installation Procedure

Follow these instructions to install memory modules into the S2927

1. Press the locking levers in the direction shown in the following illustration.

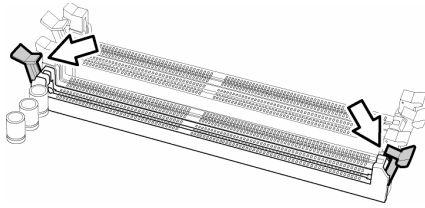

2. Align the memory module with the socket. The memory module is keyed to fit only one way in the socket.

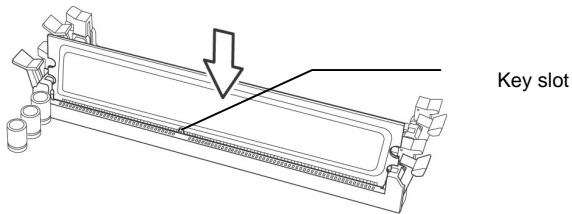

3. Seat the module firmly into the socket by gently pressing down until it sits flush with the socket. The locking levers pop up into place.

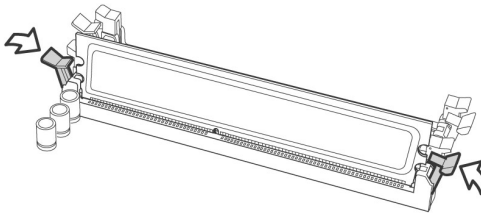

2.7 - Attaching Drive Cables

Attaching IDE Drive Cable

Attaching the IDE drive cable is simple. These cables are “keyed” to only allow them to be connected in the correct manner. TYAN motherboards have two on-board IDE channels, each supporting two drives. **The black connector designates the Primary channel, while the white connector designates the Secondary channel.**

Attaching IDE cables to the IDE connectors is illustrated below:

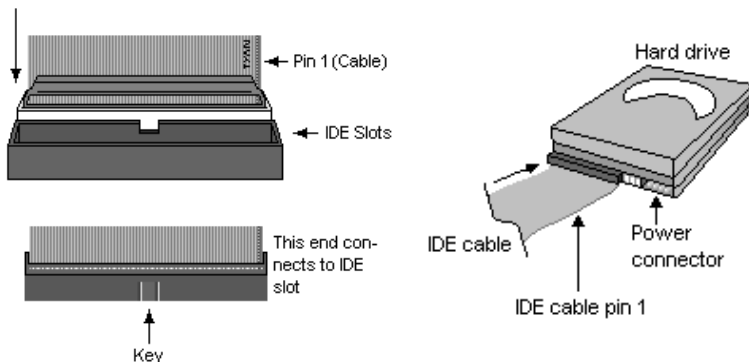

Simply plug in the BLUE END of the IDE cable into the motherboard IDE connector, and the other end(s) into the drive(s). Each standard IDE cable has three connectors, two of which are closer together. The BLUE connector that is furthest away from the other two is the end that connects to the motherboard. The other two connectors are used to connect to drives.

NOTE: Always remember to properly set the drive jumpers. If only using one device on a channel, it must be set as Master for the BIOS to detect it.

TIP: Pin 1 on the IDE cable (usually designated by a colored wire) faces the drive's power connector.

Attaching Serial ATA Cables

The Thunder n3600B S2927 is equipped with 6 Serial ATA (SATA) channels. Connections for these drives are very simple.

There is no need to set Master/Slave jumpers on SATA drives.

Tyan has supplied two SATA cables and one SATA power adapter. If you are in need of other cables or power adapters please contact your place of purchase.

The following pictures illustrate how to connect an SATA drive

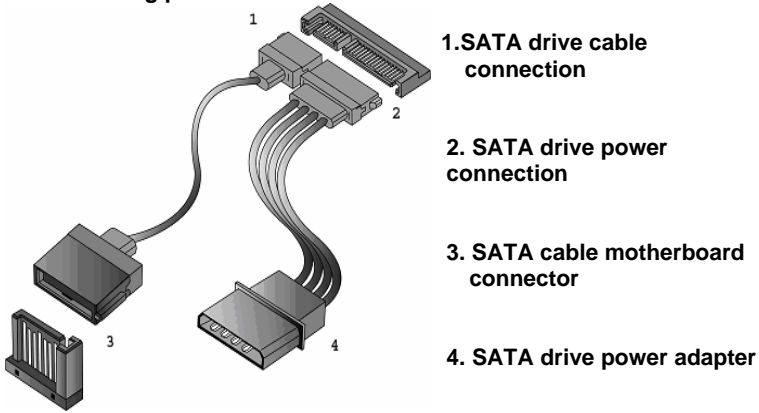

Attaching Floppy Drive Cables

Attaching floppy diskette drives are done in a similar manner to hard drives. See the picture below for an example of a floppy cable. Most of the current floppy drives on the market require that the cable be installed with the colored stripe positioned next to the power connector. In most cases, there will be a key pin on the cable which will force a proper connection of the cable.

Twist at the end of the ribbon cable

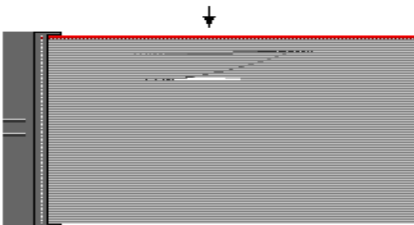

Attach first floppy drive (drive **A:**) to the end of the cable with the twist in it. Drive **B:** is usually connected to the next possible connector on the cable (the second or third connector after you install Drive **A:**).

2.8 - Installing Add-In Cards

Before installing add-in cards, it's helpful to know if they are fully compatible with your motherboard. For this reason, we've provided the diagrams below, showing the most common slots that may appear on your motherboard. Not all of the slots shown will necessarily appear on your motherboard.

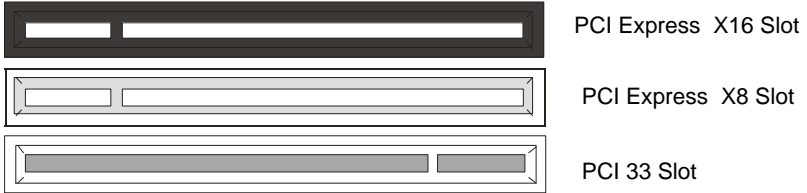

Simply find the appropriate slot for your add-in card and insert the card firmly. Do not force any add-in cards into any slots if they do not seat in place. It is better to try another slot or return the faulty card rather than damaging both the motherboard and the add-in card.

NOTE

YOU MUST ALWAYS unplug the power connector from the motherboard before performing system hardware changes. Otherwise you may damage the board and/or expansion device.

2.9 – Installing Graphic Cards & SLI Bridge (for S2927A2NRF only)

The S2927 supports the NVIDIA SLI technology. The SLI (Scalable Link Interface) technology is a revolutionary approach to scalability and increased performance. Taking advantage of the increased bandwidth of the PCI Express™ bus architecture, the SLI technology features hardware and software innovation within NVIDIA GPUs (graphic processing units) and NVIDIA MCPs (media and communications processors). Combining two NVIDIA SLI-certified graphics cards in a single system allows you to highly increase your graphic performance.

Installing Graphic Card

Locate the SLI bridge. After installing two graphic cards, put the SLI Bridge onto two graphic cards to make the connection.



2.10 - Connecting External Devices

Your motherboard supports a number of different interfaces through connecting peripherals. See the following diagrams for the details.

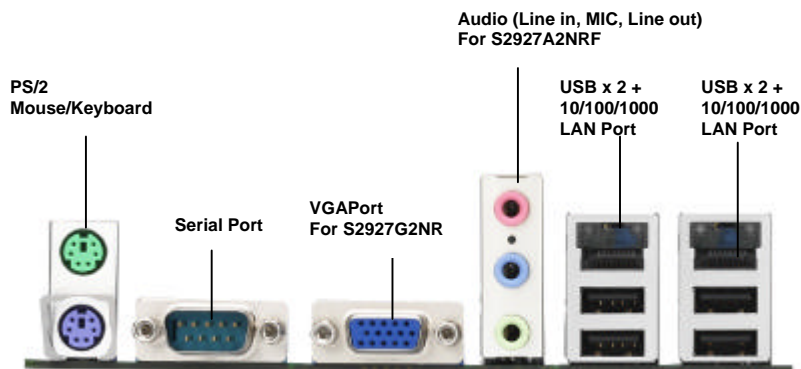

NOTE: Peripheral devices can be plugged straight into any of these ports but software may be required to complete the installation.

Onboard LAN LED Color Definition

The three onboard Ethernet ports have green and yellow LEDs to indicate LAN status. The chart below illustrates the different LED states.

10/100/1000 Mbps LAN Link/Activity LED Scheme			
LEFT RIGHT		Left LED	Right LED
10 Mbps	Link	Green	Off
	Active	Blinking Green	Off
100 Mbps	Link	Green	Green
	Active	Blinking Green	Green
1000 Mbps	Link	Green	Orange
	Active	Blinking Green	Orange
No Link		Off	Off

2.11 - Installing the Power Supply

There are three power connectors on your Thunder n3600B S2927. The S2927 requires that you have an EPS12V power supply that has a 24-pin, an 8-pin and a 4-pin (optional) power connector.

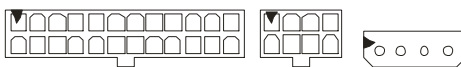

Applying power to the board

1. Connect the EPS 12V 8-pin power connector.
2. Connect the EPS 12V 24-pin power connector.
3. Connect the EPS 12V 4-pin power connector (optional).
4. Connect power cable to power supply and power outlet

NOTE

YOU MUST unplug the power supply before plugging the power cables to motherboard connectors.

2.12 – Finishing Up

Congratulations on making it this far! You're finished setting up the hardware aspect of your computer. Before closing up your chassis, make sure that all cables and wires are connected properly, especially IDE cables and most importantly, jumpers. You may have difficulty powering on your system if the motherboard jumpers are not set correctly.

In the rare circumstance that you have experienced difficulty, you can find help by asking your vendor for assistance. If they are not available for assistance, please find setup information and documentation online at our website or by **calling your vendor's support line**.

Chapter 3: BIOS Setup

3.1 About the BIOS

The BIOS is the basic input/output system, the firmware on the motherboard that enables your hardware to interface with your software. The BIOS determines what a computer can do without accessing programs from a disk. The BIOS contains all the code required to control the keyboard, display screen, disk drives, serial communications, and a number of miscellaneous functions. This chapter describes the various BIOS settings that can be used to configure your system.

The BIOS section of this manual is subject to change without notice and is provided for reference purposes only. The settings and configurations of the BIOS are current at the time of print and are subject to change, and therefore may not match exactly what is displayed on screen.

This section describes the BIOS setup program. The setup program lets you modify basic configuration settings. The settings are then stored in a dedicated, battery-backed memory (called NVRAM) that retains the information even when the power is turned off.

To start the BIOS setup utility:

1. Turn on or reboot your system.
2. Press during POST (<Tab> on remote console) to start the BIOS setup utility.

3.2 – BIOS Menu Bar

The menu bar at the top of the windows lists these selections:

Main	To configure basic system setups
Advanced	To configure the advanced chipset features
PCI/PnP	To configure legacy Plug & Play or PCI settings
Boot	To configure system boot order
Security	To configure user and supervisor passwords
Chipset	To configure chipset management features
Exit	To exit setup utility

3.3 Setup Basics

The table below shows how to navigate in the setup program using the keyboard.

Key	Function
<F1>	General help window
<ESC>	Exit current menu
← → arrow keys	Select a different menu
↑ or ↓ arrow keys	Move cursor up/down
<Tab> or <Shift-Tab>	Cycle cursor up/down
<Home> or <End>	Move cursor to top/bottom of the window
<PgUp> or <PgDn>	Move cursor to next/previous page
<->	Select the previous value/setting of the field
<+>	Select the next value/setting of the field
<F8>	Load Fail Safe default configuration values of the menu
<F9>	Load the Optimal default configuration values of the menu
<F10>	Save and exit
<Enter>	Execute command or select submenu

3.4 Getting Help

Pressing [F1] will display a small help window that describes the appropriate keys to use and the possible selections for the highlighted item. To exit the Help Window, press [ESC].

3.5 In Case of Problems

If you have trouble booting your computer after making and saving the changes with the BIOS setup program, you can restart the computer by holding the power button down until the computer shuts off (usually within 4 seconds); resetting by pressing CTRL-ALT-DEL; or clearing the CMOS.

The best advice is to only alter settings that you thoroughly understand. In particular, do not change settings in the Chipset section unless you are absolutely sure of what you are doing. The Chipset defaults have been carefully chosen either by TYAN or your system manufacturer for best performance and reliability. Even a seemingly small change to the Chipset setup options may cause the system to become unstable or unusable.

NOTE: The following pages provide the details of BIOS menu. Please be noticed that the BIOS menu are continually changing due to the BIOS updating. The BIOS menu provided are the most updated when this manual is written. Please visit Tyan's website at <http://www.tyan.com> for the information of BIOS updating.

3.6 BIOS Main Menu

The Main BIOS Menu is the first screen that you can navigate. The Main BIOS setup menu screen has two main frames. The left frame displays all the options that can be configured. "Grayed-out" options cannot be configured, options in blue can be changed.

The right frame displays the key legend. Above the key legend is an area reserved for a text message. When an option is selected in the left frame, it is highlighted in white. Often, a text message will accompany it.

BIOS Setup Utility	
Main	Advanced PCI/PnP Boot Security Chipset Exit
System Overview	Use [ENTER], [TAB] or [SHIFT-TAB] to select a field
AMIBIOS Version : 08.00.xx Build Date : 06/21/06 ID : 0AAAA000 Processor Dual-Core AMD Opteron™ Processor 2214 Speed : xxxx MHz Count : x System Memory Size : xxxx MB System Time [22:21:21] System Date [Tue 01/01/2002]	Use [+] or [-] to configure system time. Select Screen Select Item Enter Go to Sub Screen F1 General Help F10 Save and Exit ESC Exit

Feature	Option	Description
Main		
System Time	HH : MM : SS	Set the system time
System Date	MM : DD : YYYY	Set the system date

3.7 Advanced Menu

You can select any of the items in the left frame of the screen, such as Super I/O Configuration, to go to the sub menu for that item. You can display an Advanced BIOS Setup option by highlighting it using the <Arrow> keys. All Advanced BIOS Setup options are described in this section. The Advanced BIOS Setup screen is shown below. The sub menus are described on the following pages.

BIOS Setup Utility	
Main	Advanced
Advanced Settings	Configure CPU
WARNING: Setting wrong values in below sections may cause system to malfunction. ▶ CPU Configuration ▶ IDE Configuration ▶ Floppy Configuration ▶ Super IO Configuration ▶ ACPI Configuration ▶ APM Configuration ▶ Event Log Configuration ▶ Hardware Health Configuration ▶ Remote Access Configuration ▶ USB Configuration ▶ AMD PowerNow Configuration ▶ Onboard Devices Configuration	Select Screen Select Item Enter Go to Sub Screen F1 General Help F10 Save and Exit ESC Exit

Feature	Option	Description
Advanced Settings		
CPU Configuration	Menu Item	Configure CPU
IDE Configuration	Menu Item	Configure the IDE device(s)
Floppy Configuration	Menu Item	Configure the Floppy drive(s)
Super IO Configuration	Menu Item	Configures Super IO Chipset Nat417
ACPI Configuration	Menu Item	Section for Advanced ACPI Configuration
APM Configuration	Menu Item	Section for APM configuration
Event Log Configuration	Menu Item	Mark as read, Clear or View Event Log statistics
Hardware Health Configuration	Menu Item	Configure/monitor the Hardware Health

Feature	Option	Description
Advanced Settings		
Remote Access Configuration	Menu Item	Configure Remote Access
USB Configuration	Menu Item	Configure the USB support
AMD PowerNow Configuration	Menu Item	Configure AMD PowerNow support
Onboard Devices Configuration	Menu Item	Configure onboard devices

3.7.1 CPU Configuration

You can use this screen to view CPU Configuration Menu. Use the up and down arrow (↑/↓) keys to select an item. Use the Plus and Minus (+/-) keys to change the value of the selected option. The settings are described on the following pages.

BIOS Setup Utility		
Main	Advanced	Chipset
CPU Configuration Module Version : XX.XX AGESA Version : XXXXXX Physical Count : X Logical Count : X		This option should remain disabled for normal operation. The driver developer may disable it for testing purpose. Select Screen Select Item +/- Change Option F1 General Help F10 Save and Exit ESC Exit
Dual Core AMD Opteron (tm) Processor xxxxxxxx Revision : xx Cache L1: xxxx Cache L2: xxxx Speed: xxxx Current FSB Multiplier : xxxx Maximum FSB Multiplier: xxxx Able to change Freq.: Yes uCode Patch Level: None required GART Error Reporting [Disabled] MTRR Mapping [Continuous]		

Feature	Option	Description
CPU Configuration		
Module Version	Read only	Displays information about CPU
AGESA Version		
Physical Count		
Logical Count		
Revision	Read only	Displays information about CPU
Cache L1		
Cache L2		
Speed		
Current FSB Multiplier		
Maximum FSB Multiplier		
Able to change Freq.		
uCode Patch Level		

Feature	Option	Description
CPU Configuration		
GART Error Reporting	Disabled	This option should remain disabled for normal operation. The driver developer may enable it for the purpose of testing.
	Enabled	
MTRR Mapping	Continuous	This option determines the method used for programming CPU MTRRs when 4GB or more of memory is preset. Discrete leaves the PCI hole below the 4GB boundary undescribed. Continuous explicitly describes the PCI hole as non-cacheable.
	Discrete	

3.7.2 IDE Configuration Sub-Menu

You can use this screen to select options for the IDE Configuration Settings. Use the up and down <Arrow> keys to select an item. Use the <Plus> and <Minus> keys to change the value of the selected option.

BIOS Setup Utility		
Main	Advanced	PCI/PnP Boot Security Chipset Exit
IDE Configuration		While entering setup, BIOS auto detects the presence of IDE devices. This displays the status of auto detection of IDE devices. Select Screen Select Item +/- Change Option F1 General Help F10 Save and Exit ESC Exit
Onboard IDE Controller	[Enabled]	
Serial-ATA Devices	[Device 0/1/2]	
▶ nVidia RAID Setup ▶ Primary IDE Master ▶ Primary IDE Slave ▶ SATA0 (Dev5, Func0) ▶ SATA1 (Dev5, Func0) ▶ SATA2 (Dev5, Func1) ▶ SATA3 (Dev5, Func1) ▶ SATA4 (Dev5, Func2) ▶ SATA5 (Dev5, Func2)		
Hard Disk Write Protect	[Disabled]	
IDE Detect Time Out (Sec)	[35]	

Feature	Option	Description
IDE Configuration		
Onboard IDE Controller	Enabled	Enable/Disable onboard IDE controller.
	Disabled	
Serial-ATA Devices	Device 0/1/2	Configure serial ATA devices.
	Disabled	
	Device 0	
	Device 1/1	
Hard Disk Write Protect	Disabled	Enable/Disable device write protection. This will be effective only if device is accessed through BIOS.
	Enabled	
IDE Detect Time Out (Sec)	0~35 (at 5 interval)	Select the time out value for detecting ATA/ATAPI device(s).

3.7.2.1 nVidia RAID Setup

BIOS Setup Utility	
Main	Advanced PCI/PnP Boot Security Chipset Exit
RAID Setup	While entering setup, BIOS auto detects the presence of IDE devices. This displays the status of auto detection of IDE devices. Select Screen Select Item +/- Change Option F1 General Help F10 Save and Exit ESC Exit
nVidia RAID Function	

Feature	Option	Description
nVidia RAID Setup		
nVidia RAID Function	Disabled	While entering setup, you can choose enabled/disabled RAID mode for each ATA channel.
	Enabled	

3.7.2.2 Primary IDE Master/Slave Sub-Menu

BIOS Setup Utility	
Main	Advanced PCI/PnP Boot Security Chipset Exit
Primary IDE Master	
Device: Not Detected	Select Screen Select Item
Type [Auto]	+/- Change Option
LBA /Large Mode [Auto]	Tab Select Field
Block (Multi-Sector Transfer) [Auto]	F1 General Help
PIO Mode [Auto]	F10 Save and Exit
DMA Mode [Auto]	ESC Exit
S.M.A.R.T. [Auto]	
32 Bit Data Transfer [Enabled]	

Feature	Option	Description
Primary IDE Master/Slave		
Type	Auto	Selects the type of device connected to the system.
	Not Installed	
	CD/DVD	
	ARMD	
LBA/Large Mode	Auto	Auto: Enabled LBA Mode if the device supports it and the device is not already formatted with LBA Mode disabled.
	Disabled	Disabled: Disabled LBA Mode.
Block (Multi-Sector Transfer)	Auto	Disabled: The Data transfer from and to the device occurs one sector at a time.
	Disabled	Auto: The Data transfer from and to the device occurs multiple sectors at a time if the device supports it.
PIO Mode	Auto	Selects the PIO Mode. Select Auto to enhance hard disk performance by optimizing the hard disk timing.
	0~4 (at 1 interval)	
DMA Mode	Auto	Selects DMA Mode. Auto: Auto detected.
S.M.A.R.T.	Auto	S.M.A.R.T. (Self-Monitoring Analysis and Reporting Technology) is a utility that monitors your disk status to predict hard disk failure.
	Disabled	
	Enabled	
32Bit Data Transfer	Enabled	Enables 32-bit to maximize the IDE hard disk data transfer rate.
	Disabled	

3.7.2.3 SATA0/1/2/3/4/5 Sub-Menu

BIOS Setup Utility	
Main	Advanced PCI/PnP Boot Security Chipset Exit
Third IDE Master	
Device: Not Detected	
LBA /Large Mode [Auto]	Select Screen Select Item +/- Change Option Tab Select Field F1 General Help F10 Save and Exit ESC Exit
Block (Multi-Sector Transfer) [Auto]	
PIO Mode [Auto]	
DMA Mode [Auto]	
S.M.A.R.T. [Auto]	
32 Bit Data Transfer [Enabled]	

Feature	Option	Description
SATA 0/1/2/3/4/5		
LBA/Large Mode	Auto	Auto: Enabled LBA Mode if the device supports it and the device is not already formatted with LBA Mode disabled.
	Disabled	Disabled: Disabled LBA Mode.
Block (Multi-Sector Transfer)	Auto	Disabled: The Data transfer from and to the device occurs one sector at a time.
	Disabled	Auto: The Data transfer from and to the device occurs multiple sectors at a time if the device supports it.
PIO Mode	Auto	Selects the PIO Mode. Select Auto to enhance hard disk performance by optimizing the hard disk timing.
	0-4 (at 1 interval)	
DMA Mode	Auto	Selects DMA Mode. Auto: Auto detected.
S.M.A.R.T.	Auto	S.M.A.R.T (Self-Monitoring Analysis and Reporting Technology) is a utility that monitors your disk status to predict hard disk failure.
	Disabled	
	Enabled	
32Bit Data Transfer	Enabled	Enables 32-bit to maximize the IDE hard disk data transfer rate.
	Disabled	

3.7.3 Floppy Configuration Sub-Menu

You can use this screen to specify options for the Floppy Configuration Settings. Use the up and down <Arrow> keys to select an item. Use the <Plus> and <Minus> keys to change the value of the selected option. The settings are described on the following pages.

BIOS Setup Utility		
Main	Advanced	PCI/PnP Boot Security Chipset Exit
Floppy Configuration		Select the type of floppy drive connected to the system.
Floppy A	[1.44MB 31/2"]	Select Screen Select Item +/- Change Option F1 General Help F10 Save and Exit ESC Exit
Floppy B	[Disabled]	

Feature	Option	Description
Floppy Configuration		
Floppy A	Disabled	Selects the type of floppy drive connected to the system.
	360 KB 51/4"	
	1.2 MB 51/4"	
	720 KB 31/2"	
	1.44 MB 31/2"	
2.88 MB 31/2"		
Floppy B	Disabled	Selects the type of floppy drive connected to the system.
	360 KB 51/4"	
	1.2 MB 51/4"	
	720 KB 31/2"	
	1.44 MB 31/2"	
2.88 MB 31/2"		

3.7.4 Super IO Configuration Sub-Menu

You can use this screen to select options for the Super I/O settings. Use the up and down arrow (↑/↓) keys to select an item. Use the Plus and Minus (+/-) keys to change the value of the selected option

BIOS Setup Utility		
Main	Advanced	PCI/PnP Boot Security Chipset Exit
Configure SCH5017 Super IO Chipset		Allows BIOS to enable or disable Floppy Controller.
Onboard Floppy Controller	[Enabled]	Select Screen
Serial Port1 Address	[3F8/IRQ4]	Select Item
Serial Port2 Address	[2F8/IRQ3]	+/- Change Option
Chassis Intrusion Detect	[Disabled]	F1 General Help
Watchdog Mode	[Disabled]	F10 Save and Exit
		ESC Exit

Feature	Option	Description
Configure SCH5017 Super IO Chipset		
Onboard Floppy Controller	Disabled	Allow BIOS to enable or disable the floppy controller.
	Enabled	
Serial Port1 Address	3F8 IRQ4	Allow BIOS to select Serial Port1 Base Addresses.
	3E8 IRQ4	
	2E8 IRQ3	
	Disabled	
Serial Port2 Address	2F8 IRQ3	Allow BIOS to select Serial Part2 Base Addresses.
	3F8 IRQ4	
	2E8 IRQ3	
	Disabled	
Chassis Intrusion Detect	Disabled	Enable/Disable the function of chassis intrusion detection. When chassis open event is detected, BIOS will record the event.
	Enabled	
Watchdog Mode	Disabled	Enable/Disable watchdog mode.
	Enabled	

3.7.5 ACPI Configuration Sub-Menu

Use this screen to select options for ACPI. Use the up and down arrow (↑/↓) keys to select an item. Use the Plus and Minus (+/-) keys to change the value of the selected option. A description of the selected item appears on the right side of the screen. The settings are described on this page. The screen is shown below.

BIOS Setup Utility						
Main	Advanced	PCI/PnP	Boot	Security	Chipset	Exit
ACPI Settings		Advanced ACPI Configuration settings				
▶ Advanced ACPI Configuration		Use this section to configure additional ACPI options. Select Screen Select Item +/- Change Option F1 General Help F10 Save and Exit ESC Exit				

3.7.5.1 Advanced ACPI Configuration Sub-Menu

BIOS Setup Utility	
Main	Advanced PCI/PnP Boot Security Chipset Exit
Advanced ACPI Configuration	Enable RSDP pointers to 64-bit Fixed System Description Tables. Di ACPI version has some
ACPI Version Features ACPI APIC support AMI OEMB table Headless mode	[ACPI v2.0] [Enabled] [Enabled] [Disabled]
	Select Screen Select Item +/- Change Option F1 General Help F10 Save and Exit ESC Exit

Feature	Option	Description
Advanced ACPI Configuration		
ACPI Version Features	ACPI v3.0	Set this value to allow or prevent the system to be complaint with the ACPI 2.0 specification.
	ACPI v2.0	
	ACPI v1.0	
ACPI APIC Support	Enabled	This option allows you to define whether or not to enable APIC features.
	Disabled	
AMI OEMB table	Enabled	Set this value to allow the ACPI BIOS to add a pointer to an OEMB table in the Root System Description Table (RSDT) table. Note: OEMB table is used to pass POST data to the AMI code during ACPI O/S operations.
	Disabled	
Headless mode	Enabled	Enable or disable Headless operation mode through ACPI.
	Disabled	

3.7.6 APM Configuration

BIOS Setup Utility		
Main	Advanced	PCI/PnP Boot Security Chipset Exit
Resume On PME#	[Disabled]	Disable/Enable PME to generate a wake event. Select Screen Select Item +/- Change Option F1 General Help F10 Save and Exit ESC Exit
Resume On PCIE Wake#	[Disabled]	
Resume On LAN (MAC)	[Disabled]	
Resume On PS/2 Keyboard	[Disabled]	
Resume On RTC Alarm	[Disabled]	
Restore on AC Power Loss	[Last State]	

Feature	Option	Description
APM Configuration		
Resume On PME#	Disabled	Disable/Enable PME to generate a wake event.
	Enabled	
Resume On PCIE Wake#	Disabled	Disable/Enable PME to generate a wake event.
	Enabled	
Resume On LAN (MAC)	Disabled	Enable/Disable LAN (MAC) to generate a wake event.
	Enabled	
Resume On PS/2 Keyboard	Disabled	Enable/Disable PS/2 keyboard to generate a wake event
	Enabled	
Resume On RTC Alarm	Disabled	Enable/Disable RTC event to wake after a power failure.
	Enabled	
Restore on AC Power Loss	Last State	
	Power on	
	Power off	

3.7.7 Event Log Configuration Sub-Menu

You can use this screen to view the Event Log Control Menu. This logs system events (such as CMOS clear, ECC memory errors, etc) and writes the log into NVRAM. Use the up and down arrow (↑/↓) keys to select an item. Use the Plus and Minus (+/-) keys to change the value of the selected option. The settings are described on the following pages.

BIOS Setup Utility	
Main	Advanced PCI/PnP Boot Security Chipset Exit
Event Logging details	View all unread events on the Event Log.
View Event Log Mark All Events as Read Clear Event Log	Select Screen Select Item +/- Change Option Enter Go to Sub Screen F1 General Help F10 Save and Exit ESC Exit

Feature	Option	Description
Event Logging details		
View Event Log	—	Views all unread events on the Event Log.
Mark All Events as Read	OK	Marks all unread events as read.
	Cancel	
Clear Event Log	OK	Erases all of events.
	Cancel	

3.7.8 Hardware Health Configuration Sub-Menu

You can use this screen to view the Hardware Health Configuration Settings. Use the up and down arrow (↑/↓) keys to select an item. Use the Plus and Minus (+/-) keys to change the value of the selected option. The settings are described on the following pages.

BIOS Setup Utility		
Main	Advanced	Chipset
Hardware Health Configuration		
H/W Health Function		[Enabled]
CPUFAN1, CPUFAN2 PWR Control		[Disabled]
FAN3, FAN4 PWR Control		[Disabled]
FAN Fail LED Indicator		[Disabled]
Hardware Health Event Monitoring		
▶ Mainboard Voltages Report		
CPU1 Temperature	:xx C/ xxx F	Select Screen Select Item +/- Change Option Tab Select Field F1 General Help F10 Save and Exit ESC Exit
CPU2 Temperature	:xx C/ xxx F	
Ambient (Near SuperIO) Temp	:xx C/ xxx F	
Ambient (Near VGA) Temp	:xx C/ xxx F	
Ambient (Near MCP55) Temp	:xx C/ xxx F	
CPU1 FAN1 Speed (TACH1)	:xxxx RPM	
CPU2 FAN2 Speed (TACH2)	:xxxx RPM	
FAN3 Speed (TACH5)	:xxxx RPM	
FAN4 Speed (TACH6)	:xxxx RPM	

Feature	Option	Description
Hardware Health Configuration		
H/W Health Function	Enabled	Enables Hardware Health Monitoring Device.
	Disabled	
CPUFAN1, CPUFAN2 PWR Control	Enabled	FAN power duty cycle is auto dynamic programmed in selected temperature range. Disabled: Fan Power On. Enabled: Fan Power Duty Cycle=30%(40°C)-100%(60°C), see max (CPU1, CPU2, SuperIO)
	Disabled	
FAN3, FAN4 PWR Control	Enabled	FAN power duty cycle is auto dynamic programmed in selected temperature range. Disabled: Fan Power On. Enabled: Fan Power Duty Cycle=30%(40°C)-100%(60°C), see max (VGA, MCP55)
	Disabled	
FAN Fail LED Indicator	Enabled	Enabled: Any FAN speed less than 800 RPM, the FAN Fail LED will be lighted.
	Disabled	

3.7.8.1 Mainboard Voltages Report Sub-Menu

You can use this screen to monitor mainboard's voltages. Use the up and down arrow (↑/↓) keys to select an item. Use the Plus and Minus (+/-) keys to change the value of the selected option.

BIOS Setup Utility						
Main	Advanced	PCI/PnP	Boot	Security	Chipset	Exit
--Board Voltages Event Monitoring--						
CPU1 Vdimm						: x.xxx V
CPU2 Vdimm						: x.xxx V
CPU1 Vcore						: x.xxx V
CPU2 Vcore						: x.xxx V
+3.3V (SB)						: x.xxx V
3VDU						: x.xxx V
+5V (SB)						: x.xxx V
VCC						: x.xxx V
+12V (for cpu1 vcore)						: x.xxx V
+12V (for cpu2 vcore)						: x.xxx V

The mainboard voltage report submenu is **read only**.

3.7.9 Remote Access Configuration Sub-Menu

You can use this screen to view the Remote Access Configuration Menu. This feature allows access to the Server remotely via serial port. Use the up and down arrow (↑/↓) keys to select an item. Use the Plus and Minus (+/-) keys to change the value of the selected option. The settings are described on the following pages.

BIOS Setup Utility		
Main	Advanced	PCI/PnP Boot Security Chipset Exit
Configure Remote Access type and parameters		Select remote access type.
Remote Access	[Disabled]	Select Screen Select Item +/- Change Field F1 General Help F10 Save and Exit ESC Exit
Serial Port Number	[COM1]	
Base Address, IRQ	[3F8h, 4]	
Serial Port Mode	[115200 8, n, 1]	
Flow Control	[None]	
Redirection After BIOS POST	[Always]	
Terminal Type	[ANSI]	
VT-UTF8 Combo Key Support	[Enabled]	
Sredir Memory Display Delay	[No Delay]	

Feature	Option	Description
Configure Remote Access type and parameters		
Remote Access	Enabled	Enables remote access to system through serial port.
	Disabled	
Serial Port Number	COM1	Select Serial Port for console redirection. Make sure the selected port is enabled.
	COM2	
Base Address, IRQ	Read only	
Serial Port Mode	115200 8,n,1	Select Serial Port settings.
	57600 8,n,1	
	19200 8,n,1	
	9600 8,n,1	
Flow Control	None	Select Flow Control for console redirection.
	Hardware	
	Software	

Feature	Option	Description
Configure Remote Access type and parameters		
Redirection After BIOS POST	Disabled	Disable: Turns off the redirection after POST
	Boot Loader	Boot Loader: Redirection is active during POST and during Boot Loader.
	Always	Always: Redirection is always active. <Some OSs may not work if set to Always>
Terminal Type	ANSI	Select the target terminal type.
	VT100	
	VT-UTF8	
VT-UTF8 Combo Key Support	Enabled	Enable VT-UTF8 Combination key Support for ANSI/VT100 terminals.
	Disabled	
Sredir Memory Display Delay	No Delay	Gives the delay in seconds to display memory information
	Delay 1 Sec	
	Delay 2 Sec	
	Delay 4 Sec	

3.7.10 USB Configuration Sub-Menu

You can use this screen to view the USB Configuration Menu. Use the up and down arrow (↑/↓) keys to select an item. Use the Plus and Minus (+/-) keys to change the value of the selected option. The settings are described on the following pages.

BIOS Setup Utility	
Main	Advanced PCI/PnP Boot Security Chipset Exit
USB Configuration	Enables USB host controllers.
Module Version – X.XX.X-XX.X	Select Screen
USB Devices Enabled: None	Select Item
Legacy USB Support	+/- Change Option
USB 2.0 Controller Mode	F1 General Help
BIOS EHCI Hand-Off	F10 Save and Exit
	ESC Exit
	[Enabled]
	[HiSpeed]
	[Enabled]

Feature	Option	Description
USB Configuration		
Legacy USB Support	Disabled	Enables support for legacy USB.
	Enabled	
USB 2.0 Controller Mode	Hi Speed	Configure the USB 2.0 controller in Hi Speed (480Mbps) or Full Speed (12Mbps).
	Full Speed	
BIOS EHCI Hand-Off	Enabled	This is a work around for OSes without EHCI hand-off support. The EHCI ownership change should claim by EHCI driver.
	Disabled	

3.7.11 AMD PowerNow Configuration Sub-Menu

You can use this screen to view the AMD PowerNow Configuration Menu. Use the up and down arrow (↑/↓) keys to select an item. Use the Plus and Minus (+/-) keys to change the value of the selected option. The settings are described on the following pages.

BIOS Setup Utility		
Main	Advanced	PCI/PnP Boot Security Chipset Exit
AMD PowerNow Configuration		Enabled/Disabled PowerNow
PowerNow	[Enabled]	Select Screen Select Item +/- Change Option F1 General Help F10 Save and Exit ESC Exit

Feature	Option	Description
AMD PowerNow Configuration		
PowerNow	Enabled	Enabled/Disabled PowerNow
	Disabled	

3.7.12 Onboard Devices Configuration Sub-Menu

You can use this screen to view the Onboard Devices Configuration Menu. Use the up and down arrow (↑/↓) keys to select an item. Use the Plus and Minus (+/-) keys to change the value of the selected option. The settings are described on the following pages.

BIOS Setup Utility						
Main	Advanced	PCI/PnP	Boot	Security	Chipset	Exit
Onboard Device and PCI Slots Configuration				If NO display exist, ACPI Headless Mode need [Enabled].		
Onboard VGA				[Enabled]		
Primary Graphics Adapter		[PCI Express	PCI]			
USB 1.1 Controller		[Enabled]		Select Screen		
USB 2.0 Controller		[Enabled]		Select Item		
HD AUDIO		[Auto]		+/- Change Field		
LAN1		[Auto]		F1 General Help		
LAN2		[Auto]		F10 Save and Exit		
				ESC Exit		

Feature	Option	Description
MPS Configuration		
Onboard VGA	Disabled	Enabled/Disabled VGA controller
	Enabled	
Primary Graphics Adapter	PCI Express	Configure primary graphics adapter.
	PCI	
	PCI PCI Express	
USB 1.1/2.0 Controller	Disabled	Enabled/Disabled LAN controller
	Enabled	
HD AUDIO	Auto	Configure HD audio.
	Disabled	
LAN1/LAN2	Auto	Configure LAN1/LAN2
	Disabled	

3.8 PCI/PnP Menu

You can use this screen to view PnP (Plug & Play) BIOS Configuration Menu. This menu allows the user to configure how the BIOS assigns resources & resolves conflicts. Use the up and down arrow (↑/↓) keys to select an item. Use the Plus and Minus (+/-) keys to change the value of the selected option. The settings are described on the following pages.

BIOS Setup Utility	
Main	Advanced PCI/PnP Boot Security Chipset Exit
Advanced PCI/PnP Settings	Clear NVRAM during System Boot.
WARNING: Setting wrong values in below sections may cause system to malfunction. Clear NVRAM [No] Plug & Play O/S [No] PCI Latency Timer [64] Allocate IRQ to PCI VGA [Yes] Palette Snooping [Disabled] PCI IDE BusMaster [Disabled]	Select Screen Select Item +/- Change Option F1 General Help F10 Save and Exit ESC Exit

Feature	Option	Description
Advanced PCI/PnP Settings		
Clear NVRAM	No	Clears NVRAM during system Boot.
	Yes	
Plug & Play OS	Yes	No: lets the BIOS configure all the devices in the system. Yes: lets the operating system configure Plug and Play (PnP) devices not required for boot if your system has a Plug and Play operating system.
	No	
PCI Latency Timer	32	This setting controls how many PCI clocks each PCI device can hold the bus before another PCI device takes over. When set to higher values, every PCI device can conduct transactions for a longer time and thus improve the effective PCI bandwidth. Values in units of PCI clocks for PCI device latency timer register.
	64	
	96	
	128	
	160	
	192	
	224	
	248	
Allocate IRQ to PCI VGA	Yes	Yes: assigns IRQ to PCI VGA card if card requests IRQ.
	No	
Palette Snooping	Disabled	This is the default setting and should not be changed unless the VGA card manufacturer requires Palette Snooping to be Enabled. Enabled: informs the PCI devices that an ISA graphics device is installed in the system so the card will function correctly.
	Enabled	
PCI IDE BusMaster	Disabled	Enabled: BIOS uses PCI bus mastering for reading / writing to IDE drives.
	Enabled	
	Reserved	

3.9 Boot Menu

You can display Boot Setup option by highlighting it using the Arrow (↑/↓) keys and pressing Enter. The settings are described on the following pages.

BIOS Setup Utility						
Main	Advanced	PCI/PnP	Boot	Security	Chipset	Exit
Boot Settings				Configures settings during System Boot.		
<ul style="list-style-type: none"> ▶ Boot Settings Configuration ▶ Boot Device Priority ▶ Removable Drives 				Select Screen Select Item Enter Go to Sub Screen F1 General Help F10 Save and Exit ESC Exit		

3.9.1 Boot Settings Configuration Sub-Menu

Use this screen to select options for the Boot Settings Configuration. Use the up and down arrow (↑/↓) keys to select an item. Use the Plus and Minus (+/-) keys to change the value of the selected option.

BIOS Setup Utility						
Main	Advanced	PCI/PnP	Boot	Security	Chipset	Exit
Boot Settings Configuration				Allows BIOS to skip certain tests while booting. This will decrease the time needed to boot the system.		
<ul style="list-style-type: none"> Quick Boot [Disabled] Quiet Boot [Disabled] Add On ROM Display Mode [Force BIOS] Boot up Num-Lock [On] PS/2 Mouse Support [Auto] Wait for 'F1' if Error [Enabled] Hit 'DEL' Message Display [Enabled] Interrupt 19 Capture [Enabled] Endless Boot [Disabled] 				Select Screen Select Item +/- Change Option F1 General Help F10 Save and Exit ESC Exit		

Feature	Option	Description
Boot Settings Configuration		
Quick Boot	Enabled	This option allows user bypass BIOS self test during POST.
	Disabled	
Quiet Boot	Disabled	Disabled: displays normal POST messages.
	Enabled	Enabled: displays OEM log instead of POST messages.
Add On ROM Display Mode	Force BIOS	Allows user to force BIOS/Option ROM of add-on cards to be displayed during quiet boot.
	Keep Current	
Boot up Num-Lock	On	Selects Power-on state for Numlock.
	Off	
PS/2 Mouse Support	Enabled	Selects support for PS/2 Mouse.
	Disabled	
	Auto	
Wait for 'F1' If Error	Enabled	Waits for F1 key to be present if error occurs.
	Disabled	
Hit 'DEL' Message Display	Enabled	Displays "Press DEL to run Setup" in POST.
	Disabled	
Interrupt 19 Capture	Disabled	Enabled: allows option ROMs to trap interrupt 19.
	Enabled	
Endless Boot	Disabled	Endless loop boot from BBS table.
	Enabled	

3.9.2 Boot Device Priority

Use this screen to select options for the Boot Device Priority. Use the up and down arrow (↑/↓) keys to select an item. Use the Plus and Minus (+/-) keys to change the value of the selected option.

BIOS Setup Utility	
Main	Advanced PCI/PnP Boot Security Chipset Exit
Boot Device Priority	Specifies the boot sequence from the available devices.
1st Boot Device	[xx,xxx-xxxxx:xxx]
2nd Boot Device	[xx,xxx-xxxxx:xxx]
3rd Boot Device	[xx,xxx-xxxxx:xxx]
	<p>A device enclosed in parenthesis has been disabled in the corresponding type menu.</p> <p>Select Screen Select Item +/- Change Option F1 General Help F10 Save and Exit ESC Exit</p>

Feature	Option	Description
Boot Device Priority		
1st Boot Device	xx,xxx-xxxxx:xxx	Settings for boot priority. These can be customized depending on your preference.
2nd Boot Device	xx,xxx-xxxxx:xxx	
3rd Boot Device	Disabled	

3.9.3 Removable Drives

Use this screen to select options for the Boot Device Priority. Use the up and down arrow (↑/↓) keys to select an item. Use the Plus and Minus (+/-) keys to change the value of the selected option.

BIOS Setup Utility	
Main	Advanced PCI/PnP Boot Security Chipset Exit
Removable Drives	Specifies the boot sequence from the available devices.
1st Drive	[xx,xxx-xxxxx:xxx]
	Select Screen Select Item +/- Change Option F1 General Help F10 Save and Exit ESC Exit

Feature	Option	Description
Removable Drives		
1st Drive	xx,xxx-xxxxx:xxx	Specifies the boot sequence from the available devices. These can be customized depending on your preference.
	xx,xxx-xxxxx:xxx	
	Disabled	

3.10 Security Menu

The system can be configured so that all users must enter a password every time the system boots or when BIOS Setup is entered, using either the Supervisor password or User password. The Supervisor and User passwords activate two different levels of password security. If you select password support, you are prompted for a one to six character password. Type the password on the keyboard. The password does not appear on the screen when typed. Make sure you write it down. If you forget it, you must clear CMOS and reconfigure.

BIOS Setup Utility						
Main	Advanced	PCI/PnP	Boot	Security	Chipset	Exit
Security Settings				Install or change the password.		
Supervisor Password : Not Installed User Password : Not Installed				Select Screen Select Item		
Change Supervisor Password Change User Password				+/- Change Option F1 General Help F10 Save and Exit ESC Exit		
Boot Sector Virus Protection			[Disabled]			

Feature	Option	Description
Security Settings		
Supervisor Password:	Not Installed	If the password has been set, Installed displays. If no password is set, Not Installed displays.
	Installed	
User Password:	Not Installed	If the password has been set, Installed displays. If no password is set, Not Installed displays.
	Installed	
Change Supervisor Password	—	Selects this option to change or install Supervisor Password.
Change User Password	—	Selects this option to change or install User Password.
Boot Sector Virus Protection	Disabled	When it is set to [Enabled], BIOS will issue a virus warning message and beep if a write to the boot sector or the partition table of the HDD is attempted.
	Enabled	

3.11 Chipset Menu

This menu allows the user to customize functions of the AMD Chipsets. North Bridge configuration contains options for Memory & CPU settings. South Bridge configuration contains options for SM Bus & USB. Additional configuration for the AMD8131 PCI-X Tunnel is available in the PCI-X Configuration Menu. Select a menu by highlighting it using the Arrow (↑/↓) keys and pressing Enter. The settings are described on the following pages.

BIOS Setup Utility							
Main	Advanced	PCI/PnP	Boot	Security	Chipset	Exit	
Advanced Chipset Settings					Options for NB		
WARNING: Setting wrong values in below sections may cause system to malfunction.					Select Screen		
▶ Northbridge Configuration					Select Item		
					Enter Go to Sub Screen		
					F1 General Help		
					F10 Save and Exit		
					ESC Exit		

3.11.1 Northbridge Configuration Sub-Menu

This menu gives options for customizing memory & Hypertransport settings. Select a menu by highlighting it using the Arrow (↑/↓) keys and pressing Enter. The settings are described on the following pages.

BIOS Setup Utility	
Main	Advanced PCI/PnP Boot Security Chipset Exit
NorthBridge Chipset Configuration	
<ul style="list-style-type: none"> ▶ Memory Configuration ▶ ECC Configuration ▶ IOMMU Option Menu Power Down Control [Auto] Alternate VID [0.050.V] 	Select Screen Select Item Enter Go to Sub Screen F1 General Help F10 Save and Exit ESC Exit
Memory Timing Parameters	[CPU Node 0]
Memory CLK	:XXX MHz
CAS latency (Tcl)	:XX
RAS/CAS Delay (Trcd)	:X CLK
Min Active RAS (Tras)	:X CLK
Row Precharge Time (Trp)	:X CLK
RAS/RAS Delay (Trrd)	:X CLK
Row Cycle (Trc)	:XX CLK
Asynchronous Latency	:X ns

Feature	Option	Description
NorthBridge Chipset Configuration		
Power Down Control	Auto	Allow DIMMs to enter power down mode by deasserting the clock enable signal when DIMMs are not in use.
	Disable	
Alternate VID	0.850V	Specify the alternate VID while in low power status.
	1.050V	
	1.025V	
	1.000V	
	0.975V	
	0.950V	
	0.925V	
	0.900V	
	0.875V	
	0.825V	
0.800V		

Feature	Option	Description
NorthBridge Chipset Configuration		
Memory Timing Parameters	CPU Node 0	Reports CPU1 or CPU2 DRAM timing.
	CPU Node 1	
Memory CLK	Read only	It shows the clock frequency of the installed SDRAM.
CAS Latency (Tcl)	Read only	This controls the timing delay (in clock cycles) before SDRAM starts a read command after receiving it.
RAS/CAS Delay (Trcd)	Read only	When DRAM is refreshed, both rows and columns are addressed separately. This setup item allows you to determine the timing of the transition from RAS (row address strobe) to CAS (column address strobe). The less the clock cycles, the faster the DRAM performance.
Min Active RAS (Tras)	Read only	This setting allows you to select the number of clock cycles allotted for the RAS pulse width, according to DRAM specifications. The less the clock cycles, the faster the DRAM performance.
Row Precharge Time (Trp)	Read only	This item controls the number of cycles for Row Address Strobe (RAS) to be allowed to precharge. If insufficient time is allowed for the RAS to accumulate its charge before DRAM refresh, refresh may be incomplete and DRAM may fail to retain data. This item applies only when synchronous DRAM is installed in the system.
RAS/RAS Delay (Trrd)	Read only	Auto uses hardware compensation values. Other values add to or subtract from hardware generated value. Recommended setting is Auto.
Row Cycle (Trc)	Read only	Bits 7-4. RAS#-active to RAS#-active or auto refresh of the same bank.
Asynchronous Latency	Read only	Bits 3-0. This field should be loaded with a 4-bit value equal to the maximum asynchronous latency in the DRAM read round-trip loop.

3.11.1.1 Memory Configuration Sub-Menu

This menu has options for memory speed & latency. Use the up and down arrow (↑/↓) keys to select an item. Use the Plus and Minus (+/-) keys to change the value of the selected option.

BIOS Setup Utility	
Main	Advanced
PCI/PnP	Boot
Security	Chipset
	Exit
Memory Configuration	
MEMCLK can be set by the code using AUTO, or if you use LIMIT, you can set one of the standard values.	
Memclock Mode	[Auto]
MCT Timing Mode	[Auto]
Bank Interleaving	[Auto]
MemClk Tristate C3/ATLVID	[Disabled]
Memory Hole Remapping	[Enabled]
Select Screen Select Item +/- Change Option F1 General Help F10 Save and Exit ESC Exit	

Feature	Option	Description
Memory Configuration		
Memclock Mode	Limit	Select the DRAM Frequency programming method. If Auto, the DRAM speed will be based on SPDs. If Limit, the DRAM speed will not exceed the specified value. If Manual, the DRAM speed specified will be programmed by users.
	Auto	
	Manual	
MCT Timing Mode	Manual	Allows user to configure the MCT Timing Mode manually.
	Auto	
Bank Interleaving	Disabled	Enable Bank Memory Interleaving
	Auto	
MemClk Tristate C3/ATLVID	Disabled	Enable/Disable MemClk Tri-Stating during C3 and Alt VID
	Enabled	
Memory Hole Remapping	Enabled	Enable Memory Remapping around Memory Hole
	Disabled	

3.11.1.2 ECC Configuration Sub-Menu

This menu allows the user to configure ECC setup for system & DRAM. Use the up and down arrow (↑/↓) keys to select an item. Use the Plus and Minus (+/-) keys to change the value of the selected option.

BIOS Setup Utility			
Main	Advanced	PCI/PnP	Boot Security
ECC Configuration		Chipset	Exit
DRAM ECC Enable		DRAM ECC allows hardware to report and correct memory errors automatically maintaining system integrity.	
4-Bit ECC Mode		[Enabled]	
DRAM SCRUB REDIRECT		[Disabled]	
DRAM BG Scrub		[Disabled]	
L2 Cache BG Scrub		[Disabled]	
Data Cache BG Scrub		[Disabled]	
		Select Screen	
		Select Item	
		+/- Change Option	
		F1 General Help	
		F10 Save and Exit	
		ESC Exit	

Feature	Option	Description
ECC Configuration		
DRAM ECC Enable	Enabled	DRAM ECC allows hardware to report and correct memory errors automatically maintaining system integrity.
	Disabled	
4-Bit ECC Mode	Disabled	Enable 4-Bit ECC Mode. Note: Also known as CHIPKILL ECC Mode
	Enabled	
DRAM SCRUB REDIRECT	Disabled	DRAM SCRUB REDIRECT allows the system to correct DRAM ECC errors immediately when they occur, even if background scrubbing is on.
	Enabled	
DRAM BG Scrub	Disabled	DRAM scrubbing corrects memory errors so later reads are correct. Doing this while memory is not being used improves performance. Note: When AMD's node interleave feature is enabled, BIOS will force DRAM scrub off.
	40ns	
	80ns	
	160ns	
	320ns	
	640ns	
	1.28us	
	2.56us	
	5.12us	
	10.2us	
20.5us		
41.0us		

Feature	Option	Description
ECC Configuration		
	81.9us	
	163.8us	
	327.7us	
	655.4us	
L2 Cache BG Scrub	Disabled	Allows the L2 Data Cache RAM to be corrected while idle.
	40ns	
	80ns	
	160ns	
	320ns	
	640ns	
	1.28us	
	2.56us	
	5.12us	
	10.2us	
	20.5us	
	41.0us	
	81.9us	
	163.8us	
327.7us		
655.4us		
Data Cache BG Scrub	Disabled	Allows the L1 Data Cache RAM to be corrected while idle.
	40ns	
	80ns	
	160ns	
	320ns	
	640ns	
	1.28us	
	2.56us	
	5.12us	
	10.2us	
	20.5us	
	41.0us	
	81.9us	
	163.8us	
327.7us		
655.4us		

3.11.1.3 IOMMU Option Menu

This menu has options for IOMMU. Use the up and down arrow (↑/↓) keys to select an item. Use the Plus and Minus (+/-) keys to change the value of the selected option.

BIOS Setup Utility			
Main	Advanced	PCI/PnP	Boot Security
			Chipset Exit
IOMMU Mode		[128MB]	<p>Set GART size in systems without AGP, or disable altogether. Some OSes require valid GART for proper operation. If AGP is present, select appropriate option to ensure proper AGP operation.</p> <p>Select Screen Select Item +/- Change Option F1 General Help F10 Save and Exit ESC Exit</p>

Feature	Option	Description
IOMMU Configuration		
IOMMU Mode	AGP Present	Set GART size in systems without AGP, or disable altogether. Some OSes require valid GART for proper operation. If AGP is present, select appropriate option to ensure proper AGP operation.
	Disabled	
	32 MB	
	64 MB	
	128 MB	
	256 MB	
	512 MB	
1 GB		

3.12 Exit Menu

You can display an Exit BIOS Setup option by highlighting it Arrow (↑/↓) keys and pressing Enter.

BIOS Setup Utility						
Main	Advanced	PCI/PnP	Boot	Security	Chipset	Exit
Exit Options					Exit system setup after saving the changes.	
Save Changes and Exit Discard Changes and Exit Discard Charges					F10 key can be used for this operation.	
Load Optimal Defaults Load Failsafe Defaults					Select Screen Select Item Enter Go to Sub Screen F1 General Help F10 Save and Exit ESC Exit	

Save Changes and Exit

Use this option to exit setup utility and re-boot.
All new selections you have made are stored into CMOS.
System will use the new settings to boot up.

Discard Changes and Exit

Use this option to exit setup utility and re-boot.
All new selections you have made are not stored into CMOS.
System will use the old settings to boot up.

Discard Changes

Use this option to restore all new setup values that you have made but not saved into CMOS.

Load Optimal Defaults

Use this option to load default performance setup values.
Use this option when system CMOS values have been corrupted or modified incorrectly.

Load Failsafe Defaults

Use this option to load all default failsafe setup values.
Use this option when troubleshooting.

Chapter 4: Diagnostics

Note: if you experience problems with setting up your system, always check the following things in the following order:

Memory, Video, CPU

By checking these items, you will most likely find out what the problem might have been when setting up your system. For more information on troubleshooting, check the TYAN website at: <http://www.tyan.com>.

4.1 Beep Codes

Fatal errors, which halt the boot process, are communicated through two kinds of audible beeps.

- A single long beep followed by two short beeps: It indicates that a video error has occurred.
- A single long beep repeatedly: It indicates that a DRAM error has occurred.

The most common type of error is a memory error.

Before contacting your vendor or TYAN Technical Support, be sure that you note as much as you can about the beep code length and order that you experience. Also, be ready with information regarding add-in cards, drives and O/S to speed the support process and come to a quicker solution.

4.2 Flash Utility

Every BIOS file is unique for the motherboard it was designed for. For Flash Utilities, BIOS downloads, and information on how to properly use the Flash Utility with your motherboard, please check the TYAN web site: <http://www.tyan.com/>

Note: Please be aware that by flashing your BIOS, you agree that in the event of a BIOS flash failure, you must contact your dealer for a replacement BIOS. There are no exceptions. TYAN does not have a policy for replacing BIOS chips directly with end users. In no event will TYAN be held responsible for damages done by the end user.

4.3 AMIBIOS Post Code

The POST code checkpoints are the largest set of checkpoints during the BIOS pre-boot process. The following table describes the type of checkpoints that may occur during the POST portion of the BIOS:

Checkpoint	Description
03	Disable NMI, Parity, video for EGA, and DMA controllers. Initialize BIOS, POST, Runtime data area. Also initialize BIOS modules on POST entry and GPNV area. Initialized CMOS as mentioned in the Kernel Variable "wCMOSFlags."
04	Check CMOS diagnostic byte to determine if battery power is OK and CMOS checksum is OK. Verify CMOS checksum manually by reading storage area. If the CMOS checksum is bad, update CMOS with power-on default values and clear passwords. Initialize status register A. Initializes data variables that are based on CMOS setup questions. Initializes both the 8259 compatible PICs in the system
05	Initializes the interrupt controlling hardware (generally PIC) and interrupt vector table.
06	Do R/W test to CH-2 count reg. Initialize CH-0 as system timer. Install the POSTINT1Ch handler. Enable IRQ-0 in PIC for system timer interrupt. Traps INT1Ch vector to "POSTINT1ChHandlerBlock."
08	Initializes the CPU. The BAT test is being done on KBC. Program the keyboard controller command byte is being done after Auto detection of KB/MS using AMI KB-5.
0A	Initializes the 8042 compatible Key Board Controller.
0B	Detects the presence of PS/2 mouse.
0C	Detects the presence of Keyboard in KBC port.
0E	Testing and initialization of different Input Devices. Also, update the Kernel Variables. Traps the INT09h vector, so that the POST INT09h handler gets control for IRQ1. Uncompress all available language, BIOS logo, and Silent logo modules.
13	Early POST initialization of chipset registers.
24	Uncompress and initialize any platform specific BIOS modules.
30	Initialize System Management Interrupt.
2A	Initializes different devices through DIM. See <i>DIM Code Checkpoints</i> section of document for more information.
2C	Initializes different devices. Detects and initializes the video adapter installed in the system that have optional ROMs.
2E	Initializes all the output devices.
31	Allocate memory for ADM module and uncompress it. Give control to ADM module for initialization. Initialize language and font modules for ADM. Activate ADM module.
33	Initializes the silent boot module. Set the window for displaying text information.

Checkpoint	Description
37	Displaying sign-on message, CPU information, setup key message, and any OEM specific information.
38	Initializes different devices through DIM. See <i>DIM Code Checkpoints</i> section of document for more information.
39	Initializes DMAC-1 & DMAC-2.
3A	Initialize RTC date/time.
3B	Test for total memory installed in the system. Also, Check for DEL or ESC keys to limit memory test. Display total memory in the system.
3C	Mid POST initialization of chipset registers.
40	Detect different devices (Parallel ports, serial ports, and coprocessor in CPU, ... etc.) successfully installed in the system and update the BDA, EBDA...etc.
50	Programming the memory hole or any kind of implementation that needs an adjustment in system RAM size if needed.
52	Updates CMOS memory size from memory found in memory test. Allocates memory for Extended BIOS Data Area from base memory.
60	Initializes NUM-LOCK status and programs the KBD typematic rate.
75	Initialize Int-13 and prepare for IPL detection.
78	Initializes IPL devices controlled by BIOS and option ROMs.
7A	Initializes remaining option ROMs.
7C	Generate and write contents of ESCD in NVRam.
84	Log errors encountered during POST.
85	Display errors to the user and gets the user response for error.
87	Execute BIOS setup if needed / requested.
8C	Late POST initialization of chipset registers.
8E	Program the peripheral parameters. Enable/Disable NMI as selected
90	Late POST initialization of system management interrupt.
A0	Check boot password if installed.
A1	Clean-up work needed before booting to OS.
A2	Takes care of runtime image preparation for different BIOS modules. Fill the free area in F000h segment with 0FFh. Initializes the Microsoft IRQ Routing Table. Prepares the runtime language module. Disables the system configuration display if needed.
A4	Initialize runtime language module.
A7	Displays the system configuration screen if enabled. Initialize the CPU's before boot, which includes the programming of the MTRR's.
A8	Prepare CPU for OS boot including final MTRR values.
A9	Wait for user input at config display if needed.
AA	Uninstall POST INT1Ch vector and INT09h vector. Deinitializes the ADM module.
AB	Prepare BBS for Int 19 boot.
AC	End of POST initialization of chipset registers.
B1	Save system context for ACPI.
00	Passes control to OS Loader (typically INT19h).

Appendix: SMDC Information

Overview

Tyan Server Management Daughter Card (SMDC) is a powerful yet cost-efficient solution for high-end server management hardware packages. Tyan's goal is to provide remote system monitoring and control even when the operating system is absent or simply fails. This empowers Tyan's server board with advanced industrial-standard features.

Tyan SMDC is a snap-in card that provides essential server management solution. It enables any IT Manager by providing multi-interfaces to access the hardware remotely and perform **monitor**, **control** and **diagnose** activities effectively.

Tyan SMDC is not a peripheral card. Unlike regular peripheral card such as AGP card, Network card or SCSI card, SMDC does not require any hardware specific driver. As long as a standby power comes into the system, SMDC will begin looking after the system.

Tyan SMDC provides diversified methods to communicate with the hardware. IT manager has the flexibility to choose among *Keyboard Controller Style* (KCS), *Block Transfer* (BT) style, Intelligent Chassis Management Bus (ICMB), Intelligent Platform Management Bus (IPMB), Emergency Management Port (EMP) and standard IPMI-Over-LAN communication as defined in latest IPMI 1.5 specification.

Tyan SMDC is compatible with all IPMI-compliance software as well as Tyan System Operator™ (TSO) software package.

By adding SMDC, Tyan's server board becomes a highly manageable and IPMI compatible system with all the advanced features suggesting in IPMI Spec.

More detailed information on Tyan's SMDC card can be found on our website: <http://www.tyan.com>

Features of Tyan Server Management



Monitor various system components remotely
-such as fans, processor temperature, and more



Remote power on and power off



Console redirect
-the ability to view system remotely



Alert and error actions
-such as audible beep, e-mail, power down and reboot



SMDC runs on stand-by power
-the SMDC will continue to function, even if the system is not powered on

How SMDC and TSO Work

The brief descriptions below will help explain how these items function.

	<p>Agent – a system with SMDC installed The SMDC is installed in the Agent system that uses a compatible/supported Tyan motherboard.</p>
	<p>Manager – manages the Agent The Manger is set up to manage the Agent that has the SMDC. The Manager and Agent should be located in the same place.</p>
	<p>Console – communicates with Manager The Console is used to monitor and control the Agent through the Manager.</p>

Glossary

ACPI (Advanced Configuration and Power Interface): a power management specification that allows the operating system to control the amount of power distributed to the computer's devices. Devices not in use can be turned off, reducing unnecessary power expenditure.

AGP (Accelerated Graphics Port): a PCI-based interface which was designed specifically for demands of 3D graphics applications. The 32-bit AGP channel directly links the graphics controller to the main memory. While the channel runs only at 66 MHz, it supports data transmission during both the rising and falling ends of the clock cycle, yielding an effective speed of 133 MHz.

ATAPI (AT Attachment Packet Interface): also known as IDE or ATA; a drive implementation that includes the disk controller on the device itself. It allows CD-ROMs and tape drives to be configured as master or slave devices, just like HDDs.

ATX: the form factor designed to replace the AT form factor. It improves on the AT design by rotating the board 90 degrees, so that the IDE connectors are closer to the drive bays, and the CPU is closer to the power supply and cooling fan. The keyboard, mouse, USB, serial, and parallel ports are built-in.

Bandwidth: refers to carrying capacity. The greater the bandwidth, the more data the bus, phone line, or other electrical path can carry. Greater bandwidth results in greater speed.

BBS (BIOS Boot Specification): a feature within the BIOS that creates, prioritizes, and maintains a list of all Initial Program Load (IPL) devices, and then stores that list in NVRAM. IPL devices have the ability to load and execute an OS, as well as provide the ability to return to the BIOS if the OS load process fails. At that point, the next IPL device is called upon to attempt loading of the OS.

BIOS (Basic Input/Output System): the program that resides in the ROM chip, which provides the basic instructions for controlling your computer's hardware. Both the operating system and application software use BIOS routines to ensure compatibility.

Buffer: a portion of RAM which is used to temporarily store data; usually from an application though it is also used when printing and in most keyboard drivers. The CPU can manipulate data in a buffer before copying it to a disk drive. While this improves system performance (reading to or writing from a disk drive a single time is much faster than doing so repeatedly) there is the possibility of

losing your data should the system crash. Information in a buffer is temporarily stored, not permanently saved.

Bus: a data pathway. The term is used especially to refer to the connection between the processor and system memory, and between the processor and PCI or ISA local buses.

Bus mastering: allows peripheral devices and IDEs to access the system memory without going through the CPU (similar to DMA channels).

Cache: a temporary storage area for data that will be needed often by an application. Using a cache lowers data access times since the information is stored in SRAM instead of slower DRAM. Note that the cache is also much smaller than your regular memory: a typical cache size is 512KB, while you may have as much as 4GB of regular memory.

Closed and open jumpers: jumpers and jumper pins are active when they are "on" or "closed", and inactive when they are "off" or "open".

CMOS (Complementary Metal-Oxide Semiconductors): chips that hold the basic startup information for the BIOS.

COM port: another name for the serial port, which is called as such because it transmits the eight bits of a byte of data along one wire, and receives data on another single wire (that is, the data is transmitted in serial form, one bit after another). Parallel ports transmit the bits of a byte on eight different wires at the same time (that is, in parallel form, eight bits at the same time).

DDR (Double Data Rate): a technology designed to double the clock speed of the memory. It activates output on both the rising and falling edge of the system clock rather than on just the rising edge, potentially doubling output.

DIMM (Dual In-line Memory Module): faster and more capacious form of RAM than SIMMs, and do not need to be installed in pairs.

DIMM bank: sometimes called DIMM socket because the physical slot and the logical unit are the same. That is, one DIMM module fits into one DIMM socket, which is capable of acting as a memory bank.

DMA (Direct Memory Access): channels that are similar to IRQs. DMA channels allow hardware devices (like soundcards or keyboards) to access the main memory without involving the CPU. This frees up CPU resources for other tasks. As with IRQs, it is vital that you do not double up devices on a single line. Plug-n-Play devices will take care of this for you.

DRAM (Dynamic RAM): widely available, very affordable form of RAM which loses data if it is not recharged regularly (every few milliseconds). This refresh requirement makes DRAM three to ten times slower than non-recharged RAM such as SRAM.

ECC (Error Correction Code or Error Checking and Correcting): allows data to be checked for errors during run-time. Errors can subsequently be corrected at the same time that they're found.

EEPROM (Electrically Erasable Programmable ROM): also called Flash BIOS, it is a ROM chip which can, unlike normal ROM, be updated. This allows you to keep up with changes in the BIOS programs without having to buy a new chip. TYAN's BIOS updates can be found at <http://www.tyan.com>

ESCD (Extended System Configuration Data): a format for storing information about Plug-n-Play devices in the system BIOS. This information helps properly configure the system each time it boots.

Firmware: low-level software that controls the system hardware.

Form factor: an industry term for the size, shape, power supply type, and external connector type of the Personal Computer Board (PCB) or motherboard. The standard form factors are the AT and ATX.

Global timer: onboard hardware timer, such as the Real-Time Clock (RTC).

HDD: stands for Hard Disk Drive, a type of fixed drive.

H-SYNC: controls the horizontal synchronization/properties of the monitor.

HyperTransport™: a high speed, low latency, scalable point-to-point link for interconnecting ICs on boards. It can be significantly faster than a PCI bus for an equivalent number of pins. It provides the bandwidth and flexibility critical for today's networking and computing platforms while retaining the fundamental programming model of PCI.

IC (Integrated Circuit): the formal name for the computer chip.

IDE (Integrated Device/Drive Electronics): a simple, self-contained HDD interface. It can handle drives up to 8.4 GB in size. Almost all IDEs sold now are in fact Enhanced IDEs (EIDEs), with maximum capacity determined by the hardware controller.

IDE INT (IDE Interrupt): a hardware interrupt signal that goes to the IDE.

I/O (Input/Output): the connection between your computer and another piece of hardware (mouse, keyboard, etc.)

IRQ (Interrupt Request): an electronic request that runs from a hardware device to the CPU. The interrupt controller assigns priorities to incoming requests and delivers them to the CPU. It is important that there is only one device hooked up to each IRQ line; doubling up devices on IRQ lines can lock up your system. Plug-n-Play operating systems can take care of these details for you.

Latency: the amount of time that one part of a system spends waiting for another part to catch up. This occurs most commonly when the system sends data out to a peripheral device and has to wait for the peripheral to spread (peripherals tend to be slower than onboard system components).

NVRAM: ROM and EEPROM are both examples of Non-Volatile RAM, memory that holds its data without power. DRAM, in contrast, is volatile.

Parallel port: transmits the bits of a byte on eight different wires at the same time.

PCI (Peripheral Component Interconnect): a 32 or 64-bit local bus (data pathway) which is faster than the ISA bus. Local buses are those which operate within a single system (as opposed to a network bus, which connects multiple systems).

PCI PIO (PCI Programmable Input/Output) modes: the data transfer modes used by IDE drives. These modes use the CPU for data transfer (in contrast, DMA channels do not). PCI refers to the type of bus used by these modes to communicate with the CPU.

PCI-to-PCI bridge: allows you to connect multiple PCI devices onto one PCI slot.

Pipeline burst SRAM: a fast secondary cache. It is used as a secondary cache because SRAM is slower than SDRAM, but usually larger. Data is cached first to the faster primary cache, and then, when the primary cache is full, to the slower secondary cache.

PnP (Plug-n-Play): a design standard that has become ascendant in the industry. Plug-n-Play devices require little set-up to use. Devices and operating systems that are not Plug-n-Play require you to reconfigure your system each time you add or change any part of your hardware.

PXE (Preboot Execution Environment): one of four components that together make up the Wired for Management 2.0 baseline specification. PXE was designed to define a standard set of preboot protocol services within a client with the goal of allowing networked-based booting to boot using industry standard protocols.

RAID (Redundant Array of Independent Disks): a way for the same data to be stored in different places on many hard drives. By using this method, the data is stored redundantly and multiple hard drives will appear as a single drive to the operating system. RAID level 0 is known as striping, where data is striped (or overlapped) across multiple hard drives, but offers no fault-tolerance. RAID level 1 is known as mirroring, which stores the data within at least two hard drives, but does not stripe. RAID level 1 also allows for faster access time and fault-tolerance, since either hard drive can be read at the same time. RAID level 0+1 is both striping and mirroring, providing fault-tolerance, striping, and faster access all at the same time.

RAIDIOS: RAID I/O Steering (Intel)

RAM (Random Access Memory): technically refers to a type of memory where any byte can be accessed without touching the adjacent data and is often referred to the system's main memory. This memory is available to any program running on the computer.

ROM (Read-Only Memory): a storage chip which contains the BIOS; the basic instructions required to boot the computer and start up the operating system.

SDRAM (Synchronous Dynamic RAM): called as such because it can keep two sets of memory addresses open simultaneously. By transferring data alternately from one set of addresses and then the other, SDRAM cuts down on the delays associated with non-synchronous RAM, which must close one address bank before opening the next.

Serial port: called as such because it transmits the eight bits of a byte of data along one wire, and receives data on another single wire (that is, the data is transmitted in serial form, one bit after another).

SCSI Interrupt Steering Logic (SISL): Architecture that allows a RAID controller, such as AcceleRAID 150, 200 or 250, to implement RAID on a system board-embedded SCSI bus or a set of SCSI busses. SISL: SCSI Interrupt Steering Logic (LSI) (only on LSI SCSI boards)

Sleep/Suspend mode: in this mode, all devices except the CPU shut down.

SDRAM (Static RAM): unlike DRAM, this type of RAM does not need to be refreshed in order to prevent data loss. Thus, it is faster and more expensive.

SLI (Scalable Link Interface): NVIDIA SLI technology links two graphics cards together to provide scalability and increased performance. NVIDIA SLI takes advantage of the increased bandwidth of the PCI Express bus architecture, and features hardware and software innovations within NVIDIA GPUs (graphics processing units) and NVIDIA MCPs (media and communications processors). Depending on the application, NVIDIA SLI can deliver as much as two times the performance of a single GPU configuration.

Standby mode: in this mode, the video and hard drives shut down; all other devices continue to operate normally.

UltraDMA-33/66/100: a fast version of the old DMA channel. UltraDMA is also called UltraATA. Without a proper UltraDMA controller, your system cannot take advantage of higher data transfer rates of the new UltraDMA/UltraATA hard drives.

USB (Universal Serial Bus): a versatile port. This one port type can function as a serial, parallel, mouse, keyboard or joystick port. It is fast enough to support video transfer, and is capable of supporting up to 127 daisy-chained peripheral devices.

VGA (Video Graphics Array): the PC video display standard

V-SYNC: controls the vertical scanning properties of the monitor.

ZCR (Zero Channel RAID): PCI card that allows a RAID card to use the onboard SCSI chip, thus lowering cost of RAID solution

ZIF Socket (Zero Insertion Force socket): these sockets make it possible to insert CPUs without damaging the sensitive CPU pins. The CPU is lightly placed in an open ZIF socket, and a lever is pulled down. This shifts the processor over and down, guiding it into the board and locking it into place.

Technical Support

If a problem arises with your system, you should turn to your dealer for help first. Your system has most likely been configured by them, and they should have the best idea of what hardware and software your system contains. Furthermore, if you purchased your system from a dealer near you, you can bring your system to them to have it serviced instead of attempting to do so yourself (which can have expensive consequences).

If these options are not available for you then Tyan Computer Corporation can help. Besides designing innovative and quality products for over a decade, Tyan has continuously offered customers service beyond their expectations. Tyan's website (www.tyan.com) provides easy-to-access resources such as in-depth Linux Online Support sections with downloadable Linux drivers and comprehensive compatibility reports for chassis, memory and much more. With all these convenient resources just a few keystrokes away, users can easily find the latest software and operating system components to keep their systems running as powerful and productive as possible. Tyan also ranks high for its commitment to fast and friendly customer support through email. By offering plenty of options for users, Tyan serves multiple market segments with the industry's most competitive services to support them.

"Tyan's tech support is some of the most impressive we've seen, with great response time and exceptional organization in general" - Anandtech.com

Please feel free to contact us directly for this service at techsupport@tyan.com

Help Resources:

1. See the beep codes section of this manual.
2. See the TYAN website for FAQ's, bulletins, driver updates, and other information: <http://www.tyan.com>
3. Contact your dealer for help BEFORE calling TYAN.
4. Check the TYAN user group:
alt.comp.periphs.mainboard.TYAN

Returning Merchandise for Service

During the warranty period, contact your distributor or system vendor FIRST for any product problems. This warranty only covers normal customer use and does not cover damages incurred during shipping or failure due to the alteration, misuse, abuse, or improper maintenance of products.

NOTE: A receipt or copy of your invoice marked with the date of purchase is required before any warranty service can be rendered. You may obtain service by calling the manufacturer for a Return Merchandise Authorization (RMA) number. The RMA number should be prominently displayed on the outside of the shipping carton and the package should be mailed prepaid. TYAN will pay to have the board shipped back to you.



Notice for the USA

Compliance Information Statement (Declaration of Conformity Procedure) DoC
FCC Part 15: This device complies with part 15 of the FCC Rules

Operation is subject to the following conditions:

This device may not cause harmful interference, and
This device must accept any interference received including interference that may cause undesired operation. If this equipment does cause harmful interference to radio or television reception, which can be determined by turning the equipment off and on, the user is encouraged to try one or more of the following measures:

- Reorient or relocate the receiving antenna.
- Increase the separation between the equipment and the receiver.
- Plug the equipment into an outlet on a circuit different from that of the receiver.
- Consult the dealer on an experienced radio/television technician for help.

Notice for Canada

This apparatus complies with the Class B limits for radio interference as specified in the Canadian Department of Communications Radio Interference Regulations. (Cet appareil est conforme aux normes de Classe B d'interference radio tel que specifie par le Ministere Canadien des Communications dans les reglements d'ineteferece radio.)



Notice for Europe (CE Mark)

This product is in conformity with the Council Directive 89/336/EEC, 92/31/EEC (EMC).

CAUTION: Lithium battery included with this board. Do not puncture, mutilate, or dispose of battery in fire. Danger of explosion if battery is incorrectly replaced. Replace only with the same or equivalent type recommended by manufacturer. Dispose of used battery according to manufacturer instructions and in accordance with your local regulations.

Document #: D1820-100