



Tempest i5400XT



S5396

Version 1.2

Copyright

Copyright © TYAN Computer Corporation, 2007. All rights reserved. No part of this manual may be reproduced or translated without prior written consent from TYAN Computer Corp.

Trademark

All registered and unregistered trademarks and company names contained in this manual are property of their respective owners including, but not limited to the following.

TYAN, S5396 are trademarks of TYAN Computer Corporation.

Intel, Seaburg, and combinations thereof are trademarks of Intel Corporation.

Phoenix, Phoenix-Award BIOS are trademarks of Phoenix Technologies.













Notice

Information contained in this document is furnished by TYAN Computer Corporation and has been reviewed for accuracy and reliability prior to printing. TYAN assumes no liability whatsoever, and disclaims any express or implied warranty, relating to sale and/or use of TYAN products including liability or warranties relating to fitness for a particular purpose or merchantability. TYAN retains the right to make changes to product descriptions and/or specifications at any time, without notice. In no event will TYAN be held liable for any direct or indirect, incidental or consequential damage, loss of use, loss of data or other malady resulting from errors or inaccuracies of information contained in this document.

Table of Contents

Check the box contents!	3
Chapter 1: Introduction	
1.1 Congratulations.....	5
1.2 Hardware Specifications.....	5
Chapter 2: Board Installation	
2.1 Board Image.....	7
2.2 Block Diagram.....	8
2.3 Board Parts, Jumpers and Connectors.....	9
2.4 Jumper settings.....	10
2.5 Tips on Installing Motherboard in Chassis.....	21
2.6 Installing the Processor(s).....	23
2.7 Installing the Memory.....	26
2.8 Attaching Drive Cables.....	28
2.9 Installing Add-in Cards.....	30
2.10 Connecting External Devices.....	31
2.11 Installing the Power Supply.....	32
2.12 Finishing up.....	33
Chapter 3: BIOS Setup	
3.1 About the BIOS.....	34
3.2 BIOS Main Menu.....	36
3.3 Advanced Menu.....	42
3.4 Security Menu.....	59
3.5 TPM State.....	60
3.6 Power Menu.....	61
3.7 Boot Menu.....	62
3.8 Exit Menu.....	64
Chapter 4: Diagnostics	
4.1 Beep Codes.....	65
4.2 Flash Utility.....	65
4.3 BIOS Post Code.....	66
Appendix I: SMDC Information	69
Appendix II: How to Make a Driver Diskette	71
Glossary	73
Technical Support	79

Check the box contents!

	1x S5396 motherboard
	1x 34-Pin floppy drive cable
	1 x Ultra-DMA-100/66/33 IDE cable
	3 x Serial ATA power cable
	6 x Serial ATA Cable
	1x Cable set: 9-pin Serial and 25-pin Parallel
	1 x USB2.0 cable
	2 x SAS cable
	1 x S5396 user's manual
	1 x S5396 Quick Reference guide
	1 x TYAN driver CD
	1 x I/O shield

If any of these items are missing, please contact your vendor/dealer for replacement before continuing with the installation process.

Chapter 1: Introduction

1.1 - Congratulations

You have purchased one of the most powerful workstation solutions. The S5396 is a flexible Intel® platform for multiple applications, based on the Intel® 5400 (Seaburg) MCH and 6321ESB chipsets.

Designed with the Dual LGA771 sockets, the S5396 supports Intel® Xeon® Dual/Quad core processors and 32/64GB DDR2-533/667 FB-DIMM memory. The S5396 is also featured with an integrated Dual Gigabit Ethernet LAN, six SATA ports and eight SAS/SATA ports based on the integrated LSI SAS controller. It's ideally designed to provide a versatile workstation platform.

Remember to visit TYAN's Website at <http://www.TYAN.com>. There you can find information on all of TYAN's products with FAQs, online manuals and BIOS upgrades.

1.2 - Hardware Specifications

Processors

- Dual LGA771 sockets
- Supports up to two Intel® Xeon® Woodcrest Processors(5000/5100 Series Dual-core);Clovertown Processors (5300 Series, Quad-core); Wolfdale-DP Processors (45nm, dual-core); Harpertown Processors (45nm, quad-core)
- 1.33 / 1.06GHz FSB
- VRD 11.0

Chipset

- Intel 5400 MCH + 6321ESB Chipset support for 1.33 / 1.06GHz FSB
- Winbond W83627EHG Super I/O Chip

Expansion Slots

- Two (2) PCI Express x16 slots (X16 Gen2 signal from MCH)
- One (1) PCI Express x8 slot (x8 signal from 6321ESB)
- Two (2) PCI-X 133/100MHz slots from 6321ESB
- One (1) PCI 32-bit 33MHz slot

Total six expansion slots

System Management

- ADI Hardware Monitor with PECL circuit
- CPU thermal & voltage monitor support
- Five (5) fan headers (4-pin configuration)

Integrated I/O Interfaces

- Two USB 2.0 headers
- Six standard/integrated SATA-II connectors
- One IDE and one Floppy CON
- Eight SAS Ports
- One 4-pin CD-in and one 4-pin Aux header
- One 9-pin front panel audio header

Integrated LAN controllers

- Intel Gigabit from 6321ESB (w/ dual ports "Gilgal" 82563)
- Two RJ-45 ports with LEDs

Integrated Audio

- HDA link
- RealTek ALC888 controller (High Definition Audio)
- Line-in, Line-out, Mic-in rear ports
- Front panel audio header
- CD-in, Aux headers (4-pin configuration)
- SPDIF in/out connector in rear

Integrated PCI 1394

- TI TSB43AB22 1394a controller
- 1394a channel for rear (connector)
- 1394a channel for front (header)

Memory

- Eight 240-pin DDR2 FB-DIMM sockets
- 4 memory channels
- Supports ECC DIMMs
- Maximum of 64/32 GB DDR2-533/667

Integrated Serial ATA II

- Six (6) SATA-II ports running at 3.0 Gb/s
- RAID 0, 1, 5, 10 support in Windows

Integrated SAS

- LSI 1068E SAS Controller
- PCI-E x4 interface to 6321ESB
- Eight SAS Ports

Back Panel I/O Ports

- Stacked PS/2 keyboard and mouse connectors
- One SPDIF in and one SPDIF out
- Stacked Serial (one) and parallel (one) connectors
- Two stacked dual USB ports w/ GbE RJ-45 connectors
- FireWire (1394a) connector
- Stacked Line-in, Line-out, Mic-in audio connectors

Trusted Platform Management (TPM)

- Infineon SLB9635TT 1.2

Server Management

- Baseboard Management Controller (BMC) from daughter card M3291
- Tailored for IPMI 2.0 specification
- Supports remote power on/off and reset (IPMI-over-LAN)
- Server Management Daughter card via built-in 2x25 header

BIOS

- PhoenixBIOS® on 8Mbit Flash ROM
- Support APM 1.2, ACPI 2.0
- Serial Console Redirect
- PXE via Ethernet, USB device boot
- PnP, DMI 2.0, WfM 2.0 Power Management
- User-configurable H/W monitoring
- Auto-configuration of hard disk types
- Multiple boot options
- 48-bit LBA support

Power

- EPS12V/SSI (24+8+2X2 pin) power connectors
- Note: If Slot6 (PCI-E X16 slot, the one closest to the memory slots) is used, 4X1 pin power connector must be plugged in)

Form Factor

- SSI / Extended ATX (12" x 13")

Regulatory

- FCC Class B (DoC)
- European Community CE (DoC)

Software Specifications

OS (Operating System) Support

Windows XP Pro 32-bit + Sp2
Windows XP Pro 64-bit + Sp1
Windows 2003 Server
Windows Vista
RedHat Enterprise Linux 5
SUSE Enterprise Server 10.2

TYAN reserves the right to add support or discontinue support for any OS with or without notice.

Chapter 2: Board Installation

You are now ready to install your motherboard. The mounting hole pattern of the S5396 matches the Extended ATX specification. Before continuing with installation, confirm that your chassis supports an Extended ATX motherboard.

How to install our products right... the first time

The first thing you should do is reading this user's manual. It contains important information that will make configuration and setup much easier. Here are some precautions you should take when installing your motherboard:

- (1) Ground yourself properly before removing your motherboard from the antistatic bag. Unplug the power from your computer power supply and then touch a safely grounded object to release static charge (i.e. power supply case). For the safest conditions, TYAN recommends wearing a static safety wrist strap.
- (2) Hold the motherboard by its edges and do not touch the bottom of the board, or flex the board in any way.
- (3) Avoid touching the motherboard components, IC chips, connectors, memory modules, and leads.
- (4) Place the motherboard on a grounded antistatic surface or on the antistatic bag that the board was shipped in.
- (5) Inspect the board for damage.

The following pages include details on how to install your motherboard into your chassis, as well as installing the processor, memory, disk drives and cables.

NOTE	DO NOT APPLY POWER TO THE BOARD IF IT HAS BEEN DAMAGED
-------------	---

2.1– Board Image

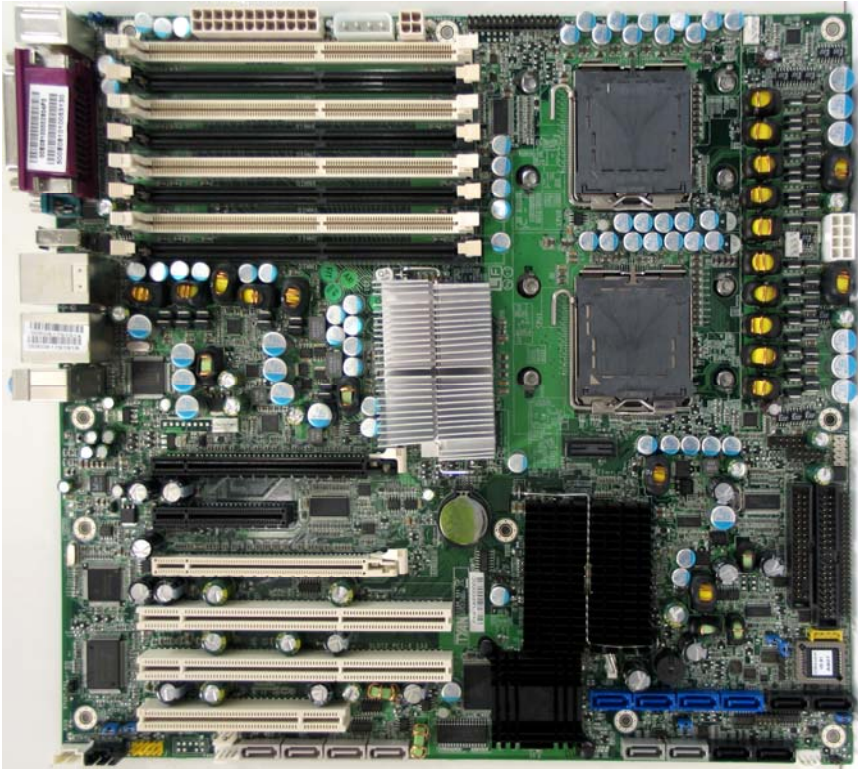

This picture is representative of the latest board revision available at the time of publishing. The board you receive may or may not look exactly like the above picture.

2.2 – Block Diagram

S5396 Block Diagram

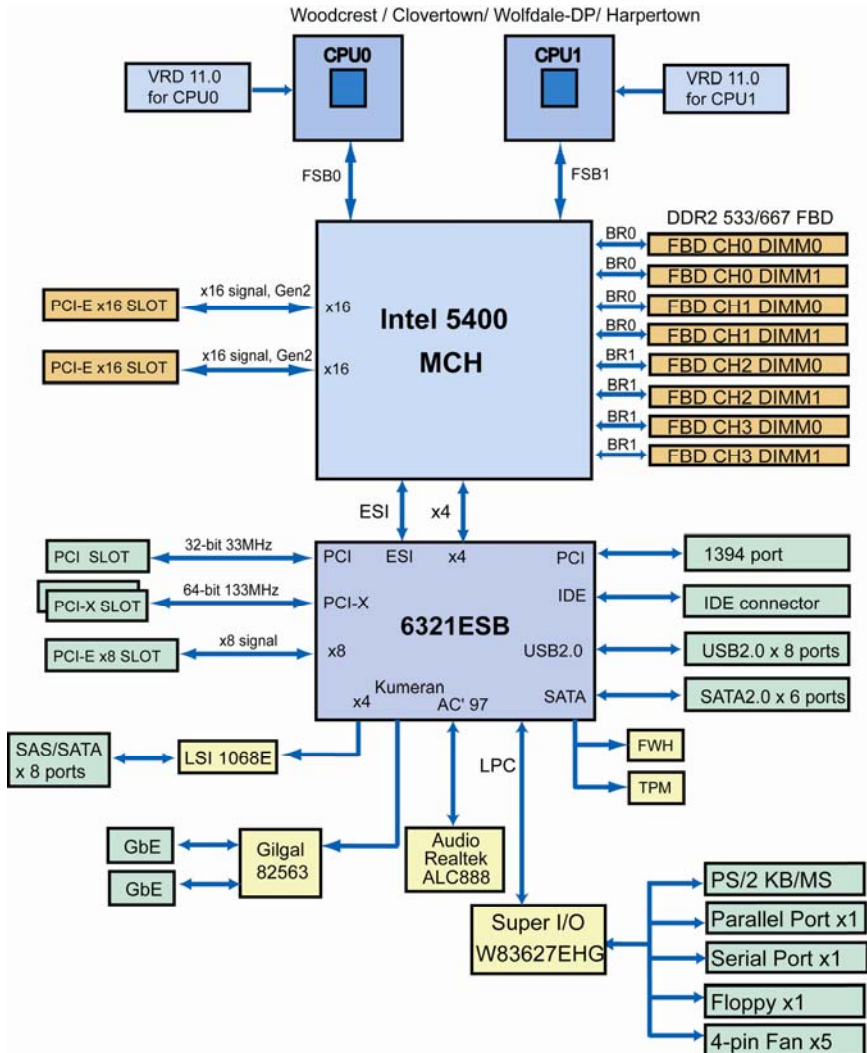

2.3 – Board Parts, Jumpers and Connectors

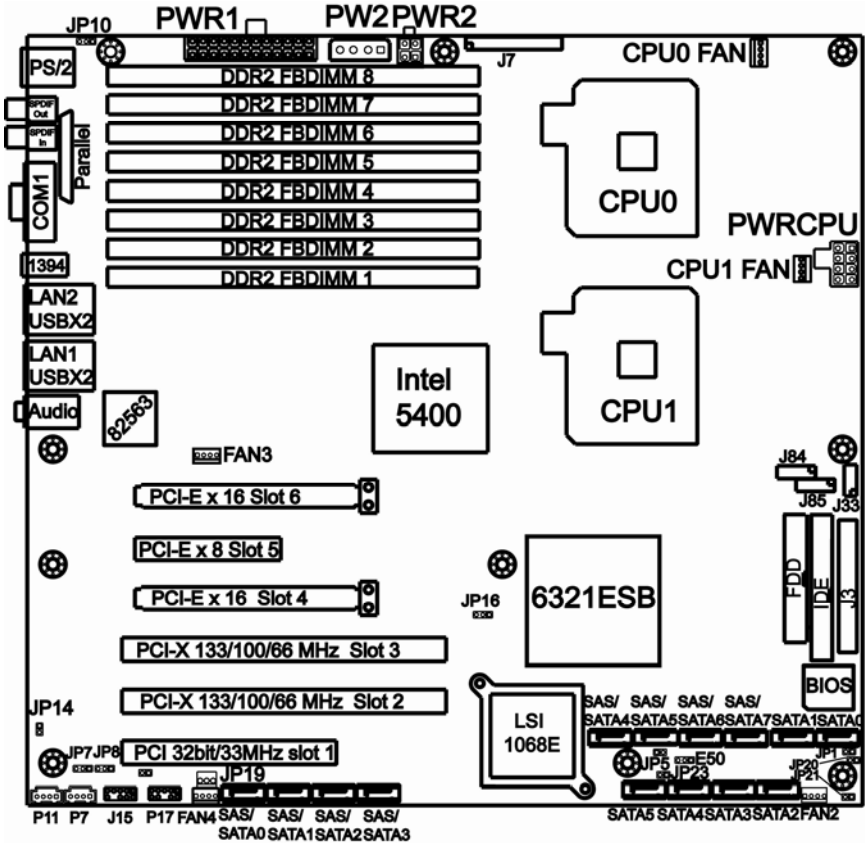





This diagram is representative of the latest board revision available at the time of publishing. The board you receive may not look exactly like the above diagram.

2.4 – Jumper settings

Jumper/Connector	Function	Settings
E50	CMOS Clear Jumper	See Page11-12
JP1	Internal buzzer Enable/Disable Jumper	
JP19	Chassis Intrusion Jumper	
JP14	FWH Write Protect Jumper	
JP23	BIOS Recovery Jumper	
JP5	SAS Enable/Disable Jumper	See Page13-14
JP10	PS/2 Wake up Jumper	
JP16	PCI-X Frequency Setting Jumper	
JP7/JP8	LAN11/LAN2 Enable/Disable Jumper	See Page15
JP20/21	LAN1/LAN2 Link and Active LED Header	
P7	CD_IN Header	See Page16-17
P11	AUX_IN Header	
J15	Audio Front Panel Header	
P17	Intel HD Audio Digital Header	
J7	LED Interface Connector	
J33	1394 Front Panel Header	See Page18
J3	SMDC Connector_M3291	
J84/J85	Front Panel USB2.0 Connectors	See Page19
CPU0FAN/CPU1FAN/ FAN3/ FAN4	4-pin FAN Header	See Page20

Jumper Legend

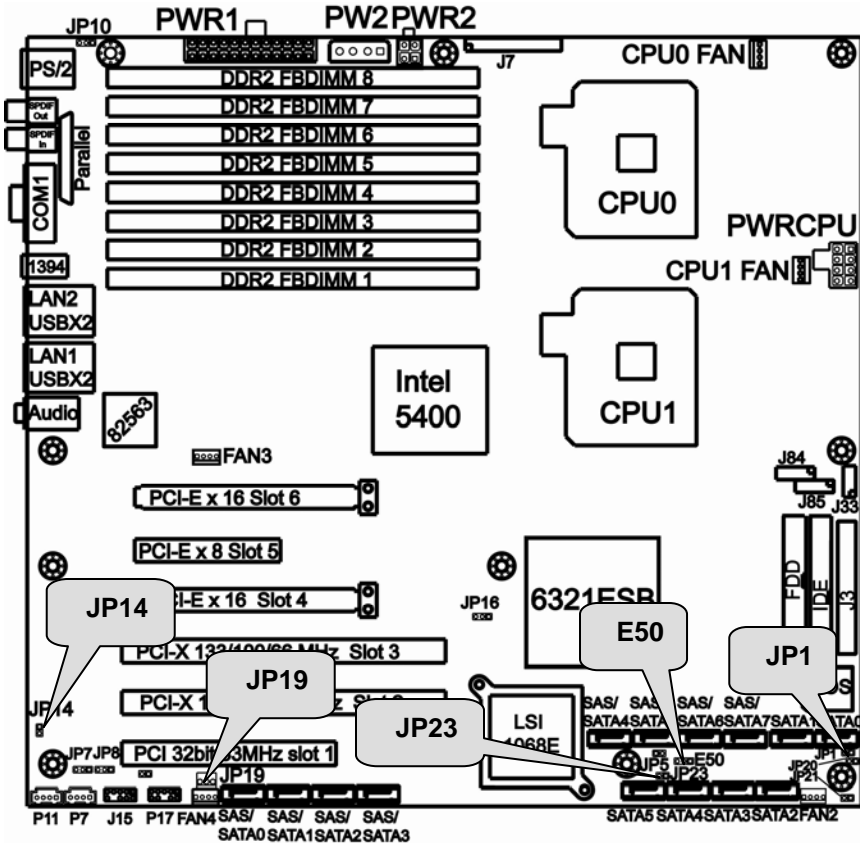

	OPEN - Jumper OFF	Without jumper cover
	CLOSED - Jumper ON	With jumper cover
	To indicate the location of pin-1	
	To indicate the location of pin-1	





E50: CMOS Clear Jumper

 <p>Normal (Default)</p>	<p>Use this jumper when you have forgotten your system/setup password or need to clear the system BIOS settings.</p> <p>How to clear the CMOS data</p> <ul style="list-style-type: none"> - Power off system and disconnect the power supply from the AC source - Use jumper cap to close pin_2 and 3 for several seconds to clear the CMOS - Replace the jumper cap to close pin_1 and pin_2 <p>Reconnect the power supply to the AC source and power on the system</p>
--	--

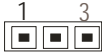

JP1: Internal Buzzer Enable/Disable Jumper

 <p>1</p>	Use this jumper to disable the onboard internal Buzzer.
 <p>1</p> <p>(Default)</p>	Use this jumper to enable the onboard internal Buzzer.



JP19: Chassis Intrusion Jumper

 <p>1 3</p> <p>(Default)</p>	Use this jumper to disable the system chassis intrusion alarm.
 <p>1 3</p>	Use this jumper to trigger the system chassis intrusion alarm.

JP14: FWH Write Protect Jumper



 <p>1</p> <p>(Default)</p>	Use this jumper to disable the FWH write protect.
 <p>1</p>	Use this jumper to enable the FWH write protect.

JP23: BIOS Recovery Jumper

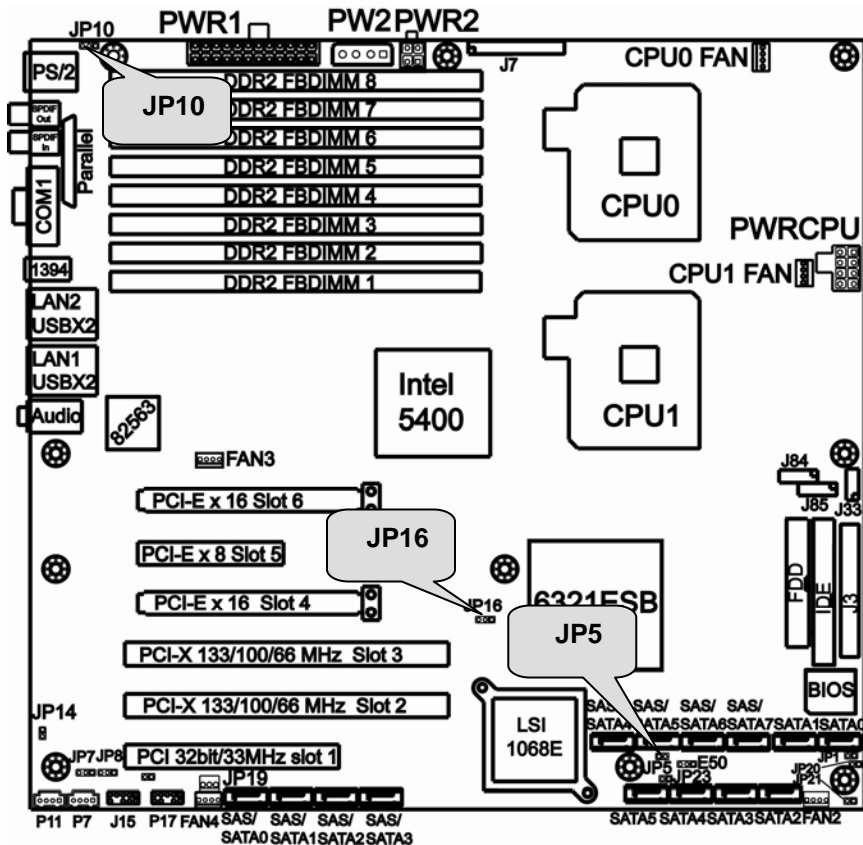



 <p>1</p> <p>(Default)</p>	No BIOS recovery function
 <p>1</p>	BIOS will be forced into recovery. BIOS image will be loaded from floppy.









JP5: SAS Enable/Disable jumper

 <p>1 (Default)</p>	<p>Use this jumper to enable onboard SAS.</p>
 <p>1</p>	<p>Use this jumper to disable onboard SAS.</p>

JP10: PS/2 Wake Up Jumper

 3  1	1-2 Close: Use this jumper to disable the PS/2 devices from waking up.
 3  1 (Default)	2-3 Close: Use this jumper to enable the waking up of the PS/2 devices. (Default)

JP16: PCI-X Frequency Setting Jumper

 3  1	1-2 close: 100MHz
 3  1 (Default)	2 close: 133MHz (Default)
 3  1	2-3 close: 66MHz

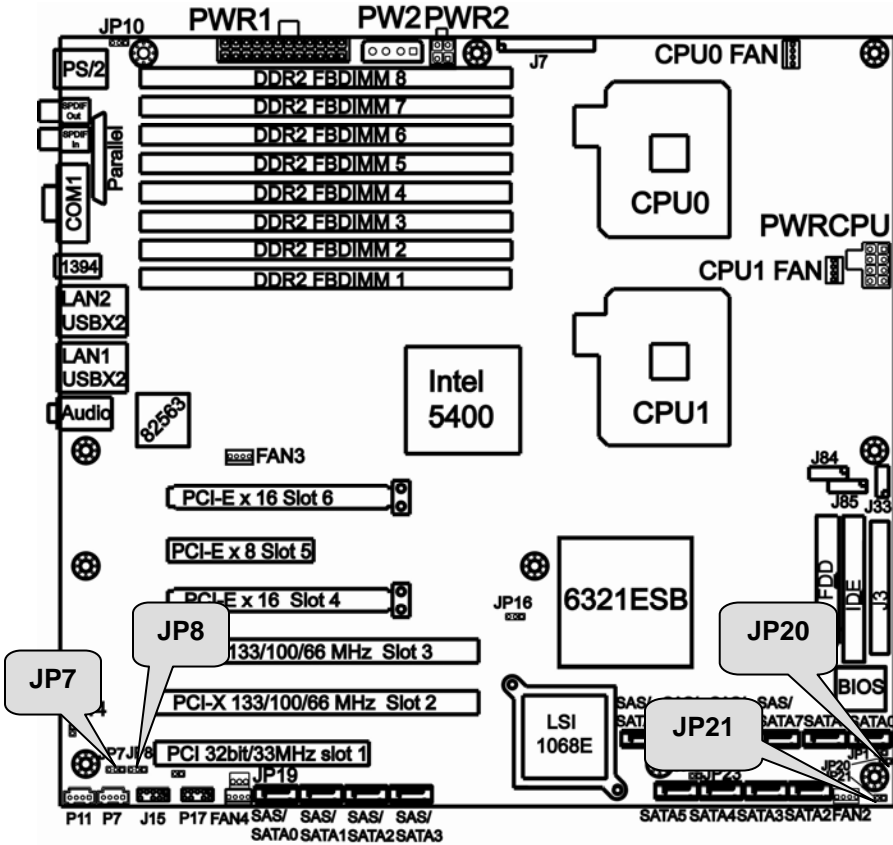

JP7/JP8: LAN Enable/Disable Jumper

<p>(Default)</p>	<p>JP7: Enable the 1st LAN port JP8: Enable the 2nd LAN port</p>
	<p>JP7: Disable the 1st LAN port JP8: Disable the 2nd LAN port</p>

JP20/JP21: LAN1/LAN2 Link and Active LED Header

	<p>JP20/JP21 is for connecting an external LED to indicate LAN1/LAN2 <i>LINK</i> and <i>ACTIVITY</i>. The behavior of this LED is the same as LAN1/LAN2 RJ45 LED: Pin 1: LINK Pin 2: ACT</p>
--	--

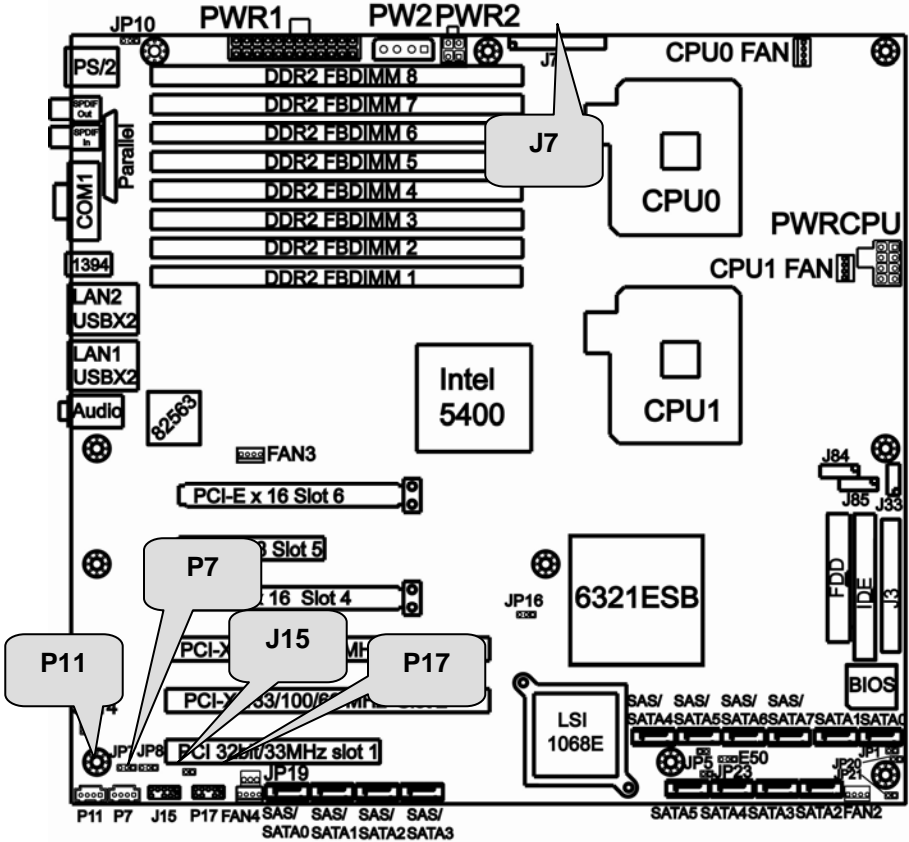

P7: CD IN Header

1	■	CD_L
2	■	CD_GND
3	■	CD_GND
4	■	CD_R

P11: AUX IN Header

1	■	AUX_L
2	■	GND
3	■	GND
4	■	AUX_R

J15: Audio Front Panel Header

MIC_L	1	2	GND
MIC_R	3	4	PRESENCE#
LINE_OUT_R	5	6	MIC_SENSE_RETURN
SENSE_SEND	7	8	KEY
LINE_OUT_L	9	10	LINEOUT_SENSE_RETURN

P17: Intel HD Audio Digital Header

Intel HD Audio Digital Header is used to support one HD Codec on a cabled up card.

BCLK	1	2	GND
RST#	3	4	DVDD_IO
SYNC	5	6	GND
SDO	7	8	3.3V_DVDD_CORE
SDI	9	10	12V
RSVD	11	12	KEY
RSVD	13	14	3.3V_DUAL
RSVD	15	16	GND

J7: LED Interface Connector

LED Interface Connector is used to connect some control or signal wires from motherboard to chassis, such as HDD LED, power LED, power button, and reset button.

GND	1	2	SPKR_OUT_L
SLP_LED +	3	4	KEY
KEY	5	6	GND
PWR_LED +_0	7	8	SPKR_OUT_H
PWR_LED +_1	9	10	NC1
GND	11	12	NC2
3.3V	13	14	KEY
MSG_LED	15	16	NC3
KEY	17	18	SCSI_LED -_0
3.3V	19	20	SCSI_LED -_1
HDD_LED -	21	22	NC4
GND	23	24	KEY
PWRBTN_N	25	26	GND
SLPBTN_N	27	28	GND
RESET_N	29	30	GND

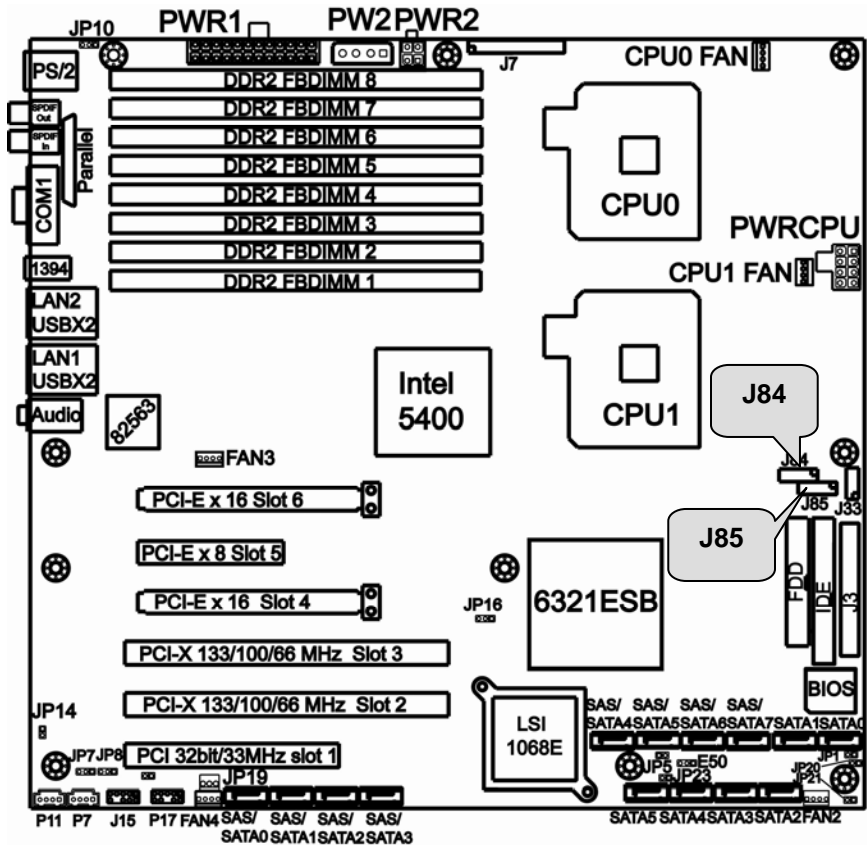

J84/J85: Front Panel USB 2.0 Connectors

	<p>Use these two headers to connect the USB devices via the enclosed USB cable.</p>
--	---

KEY	1	■	■	2	CCR_SYSTEM_ON_L
USB_CCR_VCC	3	■	■	4	USB_CCR_VCC
USB_CCR_DAT1_L	5	■	■	6	USB_CCR_DAT2_L
USB_CCR_DAT1_H	7	■	■	8	USB_CCR_DAT2_H
GND	9	■	■	10	GND
KEY	11	■	■	12	NC

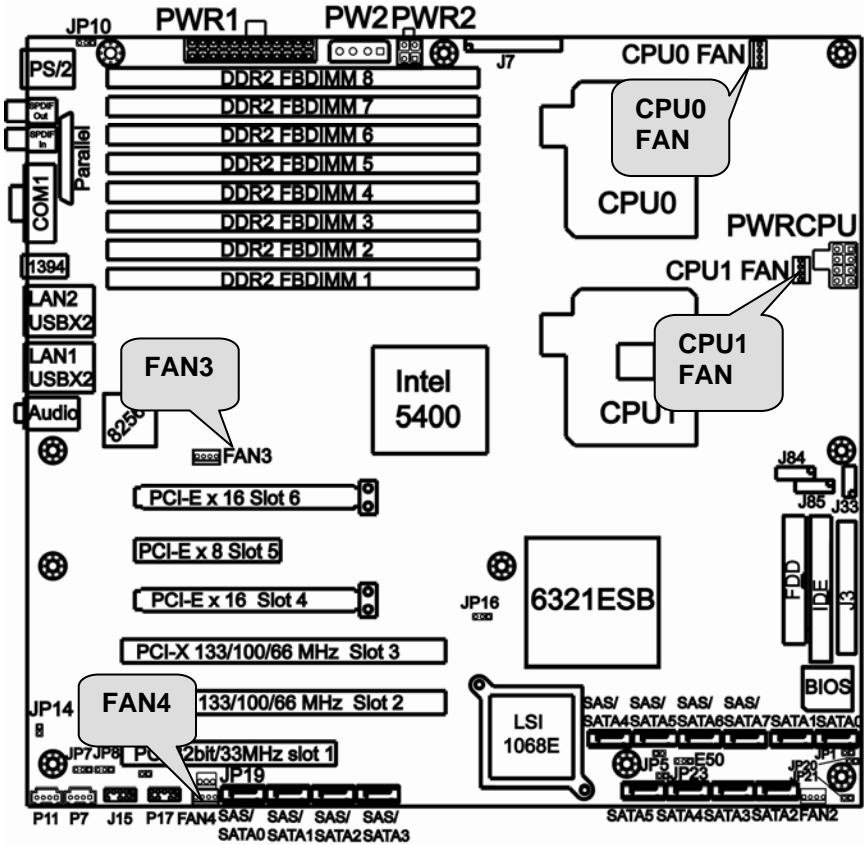

CPU0FAN/ CPU1FAN/ FAN3/ FAN4: 4-pin FAN Header

FAN1/FAN2/FAN3:

FAN0/FAN4:

Use these headers to connect the cooling fans to the motherboard to keep the system stable and reliable.

Pin 1	Pin 2	Pin 3	Pin 4
GND	+12V	Tachometer	Fan PWM (speed) Control

2.5 - Tips on Installing Motherboard in Chassis

Before installing your motherboard, make sure your chassis has the necessary motherboard support studs installed. These studs are usually metal and are gold in color. Usually, the chassis manufacturer will pre-install the support studs. If you are unsure of stud placement, simply lay the motherboard inside the chassis and align the screw holes of the motherboard to the studs inside the case. If there are any studs missing, you will know right away since the motherboard will not be able to be securely installed.

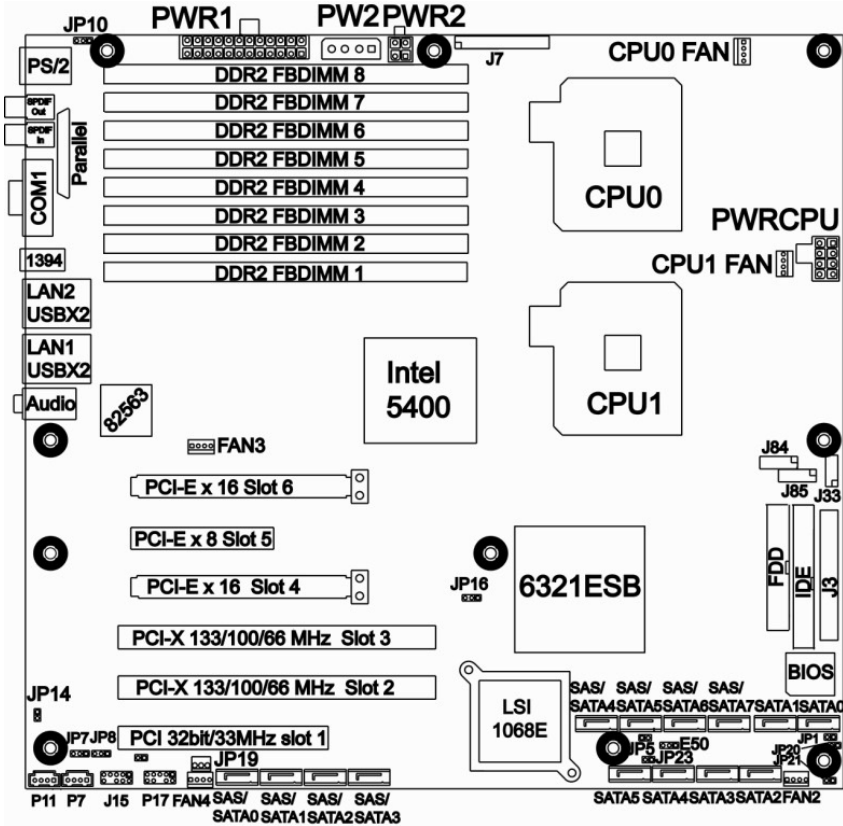

Some chassis' include plastic studs instead of metal. Although the plastic studs are usable, TYAN recommends using metal studs with screws that will fasten the motherboard more securely in place.

Below is a chart detailing what the most common motherboard studs look like and how they should be installed.

Mounting the Motherboard

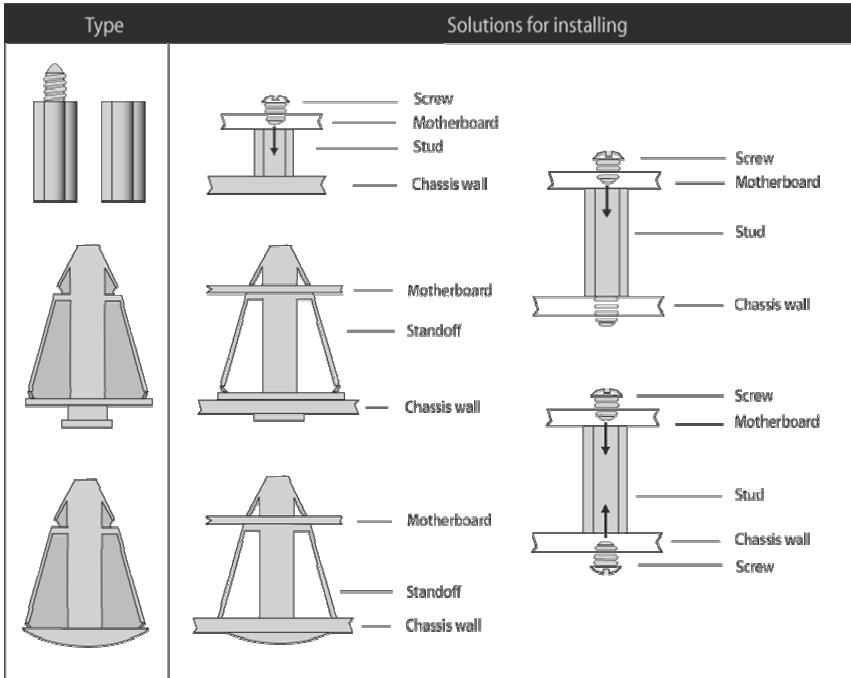

2.6 - Installing the Processor(s)

Your S5396 supports the latest processor technologies from Intel. Check the TYAN website for latest processor support:

<http://www.tyan.com>

Processor Installation

The processor should be installed carefully. Make sure you are wearing an antistatic strap and handle the processor as little as possible.

Follow these instructions to install your processor

1. Locate the processor socket on the motherboard and lift the protective cover off as shown.

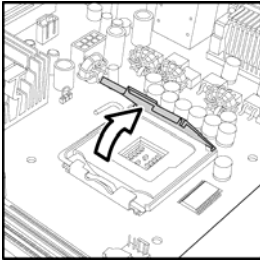

WARNING:

This new processor socket designed by Intel is easily damaged. The processor has to be installed very carefully to prevent the contact pins in the socket from breaking. It is strongly recommended that the processor installation process should be handled by an experienced technician.

2. Pull the locking lever out of its locked position and let it spring into the open position.

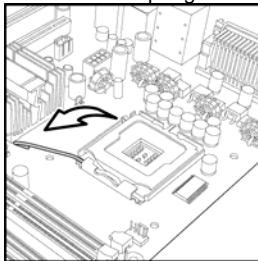
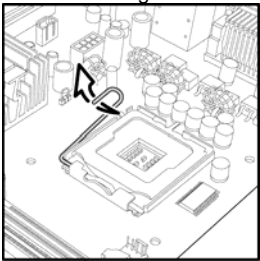

3. Lift the metal cover to expose the socket interior and place the socket in as shown.

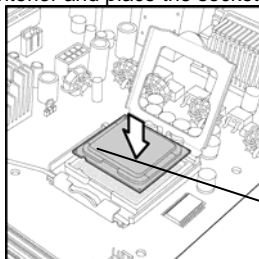
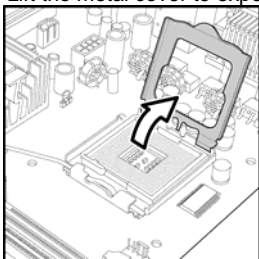

Pin 1

4. Close the cover and return the locking lever to its locked position.

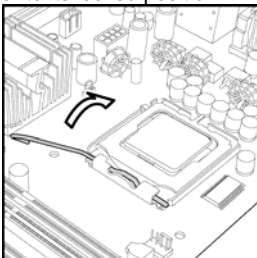
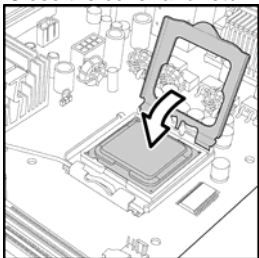

5. Repeat this procedure for the second processor socket.
6. Turn the board upside down and insert the heat sink spring mechanism as shown. The heat sink spring may be already pre-installed by the manufacturer.

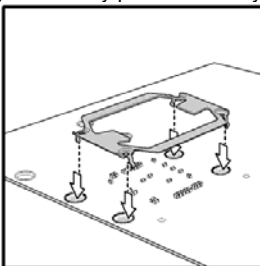

7. Turn the board the right way up again and screw the heat sink into place.

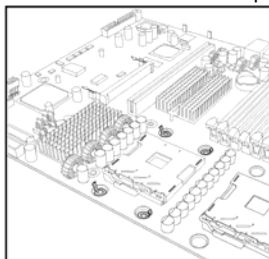
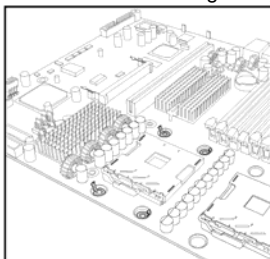

8. Repeat this procedure for the second processor.

Cooling Fan Installation

After you have installed the processor, the heatsink should be installed to ensure that the processor runs efficiently and does not overheat. Use heatsink for best results.

Follow these instructions to install the heatsink shown.

1. Align the heatsink with the four holes around the processor socket.
2. Press the heatsink down until the four screws are securely seated in the holes.
3. Use screw drive to secure the four screws.



Remember to connect the power supply for the fan to complete the installation.

Because there are many different types of heatsinks available from many different manufacturers, a lot of them have their own method of installation. For the safest method of installation and information on choosing the appropriate heatsink, please refer to Intel's website at <http://www.Intel.com>.

Finishing Installing the Cooling Fan

After you finish installing the heatsink onto the processor and socket, attach the end wire of the fan (which should already be attached to the heatsink) to the motherboard. The following diagram illustrates how to connect fans onto the motherboard.

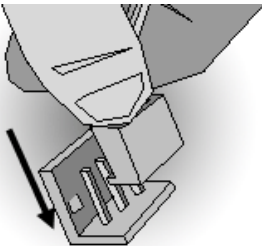

After you have finished installing all the fans you can connect your drives (hard drives, CD-ROM drives, etc) to the motherboard.

2.7 - Installing the Memory

Before installing memory, ensure that the memory you have is compatible with the motherboard and processor. Only DDR2-533/667 FB-DIMM modules are required. Check the TYAN Web site at: www.tyan.com for details of the type of memory recommended for your motherboard.

The following diagram shows common types of FBD memory modules.



Key points to note before installing memory:

- Only **DDR2 533/667 FB-DIMM** ECC memory modules are supported.
- All installed memory will automatically be detected and no jumpers or settings need changing.
- The S5396 supports up to 64GB of memory.

The following chart outlines the suggested rules for populating memory.

Memory Population Rules

DIMM \ Channel	Single	Dual	Four	Four
DDR2 FBDIMM1	x	x	x	x
DDR2 FBDIMM2				x
DDR2 FBDIMM3		x	x	x
DDR2 FBDIMM4				x
DDR2 FBDIMM5			x	x
DDR2 FBDIMM6				x
DDR2 FBDIMM7			x	x
DDR2 FBDIMM8				x

Notes



S5396 only supports Registered ECC DDR2 FB-DIMM

Memory Installation Procedure

Follow these instructions to install memory modules into the S5396.

1. Press the locking levers in the direction shown in the following illustration.

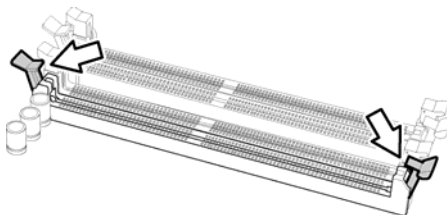

2. Align the memory module with the socket. The memory module is keyed to fit only one way in the socket.

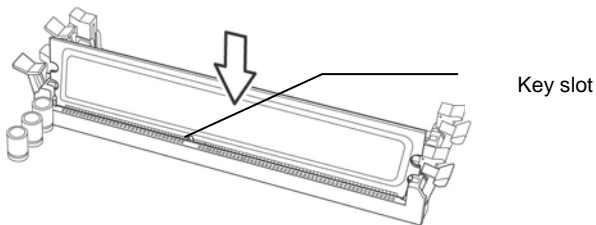

3. Seat the module firmly into the socket by gently pressing down until it sits flush with the socket. The locking levers pop up into place.

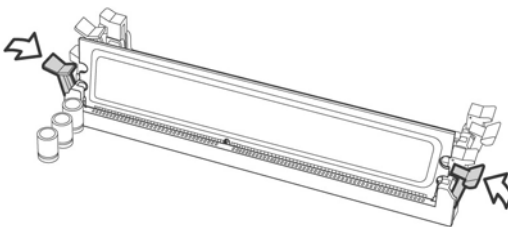

2.8 - Attaching Drive Cables

Attaching IDE Drive Cable

Attaching the IDE drive cable is simple. These cables are “keyed” to only allow them to be connected in the correct manner. TYAN motherboards have two on-board IDE channels, each supporting two drives. **The black connector designates the Primary channel, while the white connector designates the Secondary channel.**

Attaching IDE cables to the IDE connectors is illustrated below:

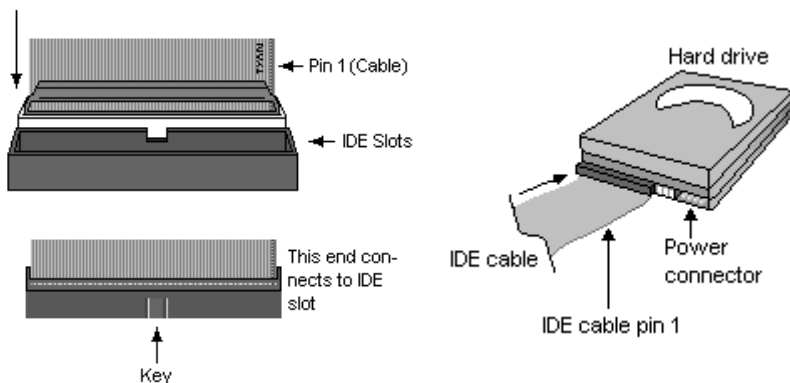

Simply plug in the BLUE END of the IDE cable into the motherboard IDE connector, and the other end(s) into the drive(s). Each standard IDE cable has three connectors, two of which are closer together. The BLUE connector that is furthest away from the other two is the end that connects to the motherboard. The other two connectors are used to connect to drives.

NOTE: Always remember to properly set the drive jumpers. If only using one device on a channel, it must be set as Master for the BIOS to detect it.

TIP: Pin 1 on the IDE cable (usually designated by a colored wire) faces the drive's power connector.

Attaching Serial ATA Cables

The S5396 is also equipped with 6 Serial ATA (SATA) channels. Connections for these drives are also very simple.

There is no need to set Master/Slave jumpers on SATA drives.

Tyan has supplied two SATA cables and one SATA power adapter. If you are in need of other cables or power adapters please contact your place of purchase.

The following pictures illustrate how to connect an SATA drive

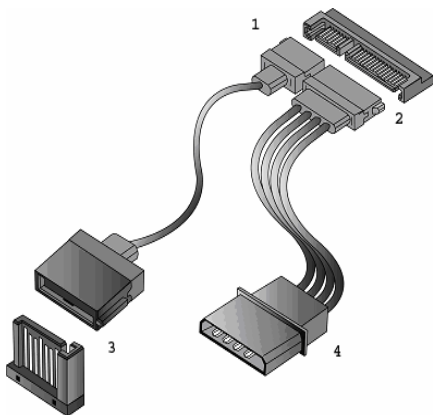

1. SATA drive cable connection
2. SATA drive power connection
3. SATA cable motherboard connector
4. SATA drive power adapter

Attaching Floppy Drive Cables

Attaching floppy diskette drives are done in a similar manner to hard drives. See the picture below for an example of a floppy cable. Most of the current floppy drives on the market require that the cable be installed with the colored stripe positioned next to the power connector. In most cases, there will be a key pin on the cable which will force a proper connection of the cable.

Twist at the end of the ribbon cable

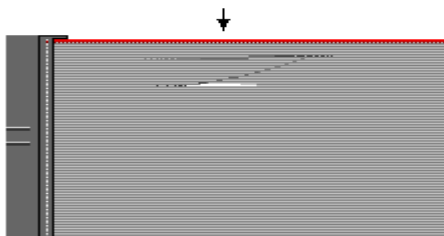

Attach first floppy drive (drive **A:**) to the end of the cable with the twist in it. Drive **B:** is usually connected to the next possible connector on the cable (the second or third connector after you install Drive **A:**).

2.9 - Installing Add-In Cards

Before installing add-in cards, it's helpful to know if they are fully compatible with your motherboard. For this reason, we've provided the diagrams below, showing the slots that appear on your motherboard.

PCI-E x16 slot



PCI-E x8 slot

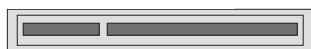

PCI-X 64bit 133/100/66MHz slot

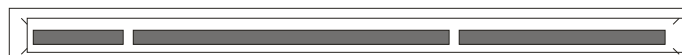

PCI 32-bit 33MHz slot

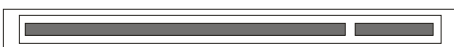

Simply find the appropriate slot for your add-in card and insert the card firmly. Do not force any add-in cards into any slots if they do not seat in place. It is better to try another slot or return the faulty card rather than damaging both the motherboard and the add-in card.

PCI IDESELs and IRQ Assignments

Slot or Device	IDSEL#	PIRQ 0 (INT A)	PIRQ 1 (INT B)	PIRQ 2 (INT C)	IRQ 3 (INT D)
PCI X1 (J25)	ESB2 PCIX_AD25	ESB2 PCIX_IRQ_N4	ESB2 PCIX_IRQ_N5	ESB2 PCIX_IRQ_N6	ESB2 PCIX_IRQ_N7
PCI X2 (J28)	ESB2 PCIX_AD26	ESB2 PCIX_IRQ_N8	ESB2 PCIX_IRQ_N9	ESB2 PCIX_IRQ_N10	ESB2 PCIX_IRQ_N11
PCI (J20)	ESB2 P_AD20	ESB2 PCI_IRQ_N E	ESB2 PCI_IRQ_N F	ESB2 PCI_IRQ_N G	ESB2 PCI_IRQ_N H
Onboard 1394(U)	ESB2 P_AD21	ESB2 PCI_IRQ_N A			

NOTE

YOU MUST ALWAYS unplug the power connector from the motherboard before performing system hardware changes. Otherwise you may damage the board and/or expansion device.

2.10 - Connecting External Devices

The following diagrams will detail the rear port stack for the S5396 motherboard:

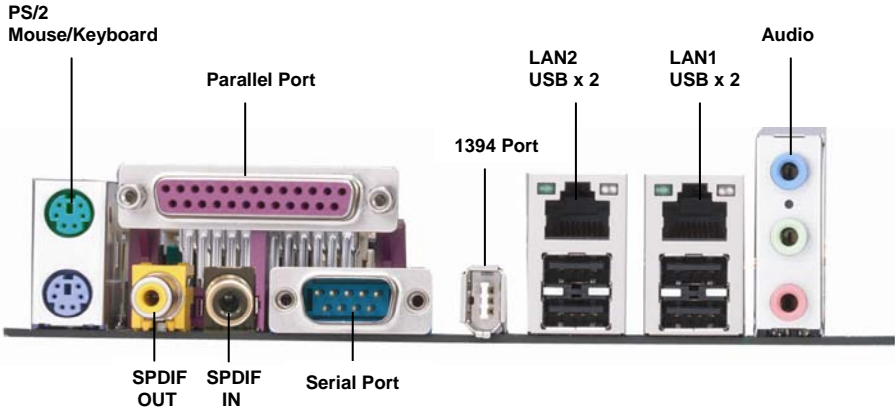

NOTE: Peripheral devices can be plugged straight into any of these ports but software may be required to complete the installation.

Onboard LAN LED Color Definition

The three onboard Ethernet ports have green and yellow LEDs to indicate LAN status. The chart below illustrates the different LED states.

10/100/1000 Mbps LAN Link/Activity LED Scheme			
		Left LED	Right LED
10 Mbps	Link	Green	Off
	Active	Blinking Green	Off
100 Mbps	Link	Green	Green
	Active	Blinking Green	Green
1000 Mbps	Link	Green	Yellow
	Active	Blinking Green	Yellow
No Link		Off	Off

2.11 - Installing the Power Supply

There are three power connectors on your S5396. The S5396 requires that you have an EPS12V power supply that has a 24-pin, an 8-pin power connector, a 2x2-pin 12V power connector and a 4x1-pin IDE power connector. Please be aware that ATX 2.x, ATX12V and ATXGES power supplies may **not** be compatible with the board and can damage the motherboard and/or CPU(s).

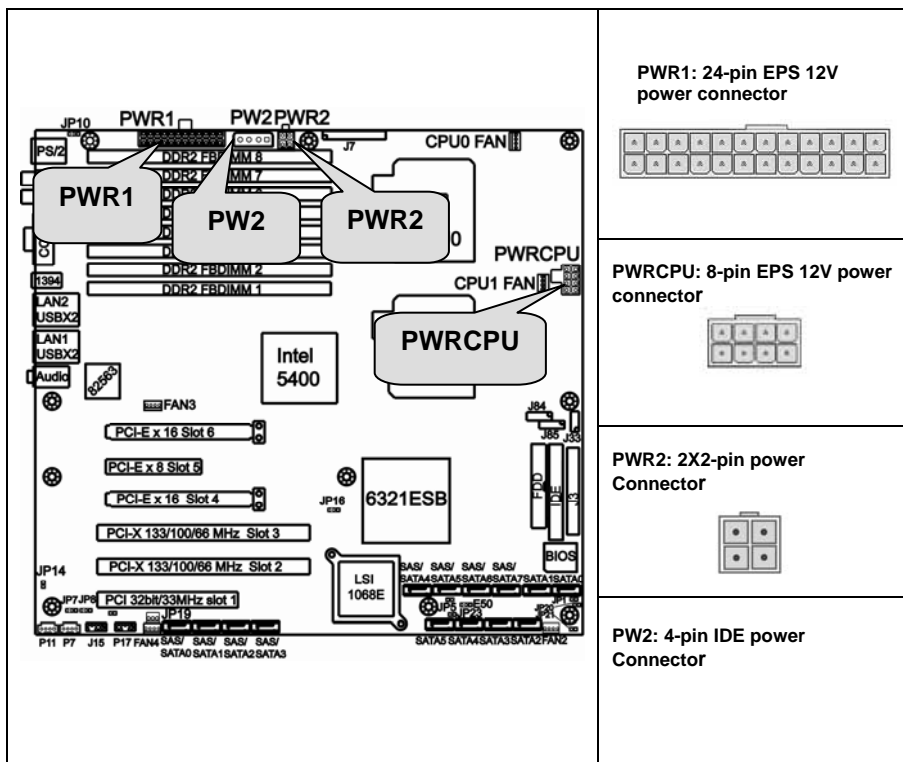

Applying power to the board

1. Connect the EPS 12V 8-pin power connector.
2. Connect the EPS 12V 24-pin power connector.
3. Connect the EPS 12V 2X2-pin power connector.
4. Connect power cable to power supply and power outlet

Note: If Slot6 (PCI-E X16 slot, the one closest to the memory slots) is used, PW2 4X1 pin IDE power connector must be plugged in)

We suggest using a 750W or higher power supply; this is of course dependent on how many devices you attach. A 750W power is sufficient for systems without many devices (i.e. 1 hard drive, 1 optical drive, and 1 or 2 expansion cards) however a higher wattage solution may be needed if the system is fully loaded. Refer to the www.tyan.com website for further information.

NOTE: The Tempest i5400XT (S5396) peripheral drive power connector must be independent of any other devices. A device such as a DVD/CD-ROM drive, hard drive, or any other devices cannot be attached onto the same power line. If connected, system stability is compromised.

NOTE

YOU MUST unplug the power supply before plugging the power cables to motherboard connector s.

2.12 - Finishing up

Congratulations on making it this far! You're finished setting up the hardware aspect of your computer. Before closing up your chassis, make sure that all cables and wires are connected properly, especially IDE cables and most importantly, jumpers. You may have difficulty powering on your system if the motherboard jumpers are not set correctly.

In the rare circumstance that you have experienced difficulty, you can find help by asking your vendor for assistance. If they are not available for assistance, please find setup information and documentation online at our website or by **calling your vendor's support line.**

Chapter 3: BIOS Setup

3.1. About the BIOS

The BIOS is the basic input/output system, the firmware on the motherboard that enables your hardware to interface with your software. The BIOS determines what a computer can do without accessing programs from a disk. The BIOS contains all the code required to control the keyboard, display screen, disk drives, serial communications, and a number of miscellaneous functions. This chapter describes the various BIOS settings that can be used to configure your system.

The BIOS section of this manual is subject to change without notice and is provided for reference purposes only. The settings and configurations of the BIOS are current at the time of print and are subject to change, and therefore may not match exactly what is displayed on screen.

This section describes the BIOS setup program. The setup program lets you modify basic configuration settings. The settings are then stored in a dedicated, battery-backed memory (called NVRAM) that retains the information even when the power is turned off.

To start the BIOS setup utility:

1. Turn on or reboot your system.
2. Press <F2> during POST to start the BIOS setup utility.

3.1.1 Setup Basics

The table below shows how to navigate in the setup program using the keyboard.

Key	Function
Tab	Moves from one selection to the next
Left/Right Arrow Keys	Changes from one menu to the next
Up/Down Arrow Keys	Moves between selections
Enter	Opens highlighted section
PgUp/PgDn Keys	Changes settings.

3.1.2 Getting Help

Pressing [F1] will display a small help window that describes the appropriate keys to use and the possible selections for the highlighted item. To exit the Help Window, press [ESC] or the [F1] key again.

3.1.3 In Case of Problems

If you have trouble booting your computer after making and saving the changes with the BIOS setup program, you can restart the computer by holding the power button down until the computer shuts off (usually within 4 seconds); resetting by pressing CTRL-ALT-DEL; or clearing the CMOS.

The best advice is to only alter settings that you thoroughly understand. In particular, do not change settings in the Chipset section unless you are absolutely sure of what you are doing. The Chipset defaults have been carefully chosen either by TYAN or your system manufacturer for best performance and reliability. Even a seemingly small change to the Chipset setup options may cause the system to become unstable or unusable.

3.1.4 Setup Variations

Not all systems have the same BIOS setup layout or options. While the basic look and function of the BIOS setup remains more or less the same for most systems, the appearance of your Setup screen may differ from the charts shown in this section. Each system design and chipset combination requires a custom configuration. In addition, the final appearance of the Setup program depends on the system designer. Your system designer may decide that certain items should not be available for user configuration, and remove them from the BIOS setup program.

NOTE: The following pages provide the details of BIOS menu. Please be noticed that the BIOS menu are continually changing due to the BIOS updating. The BIOS menu provided are the most updated ones when this manual is written. Please visit Tyan's website at <http://www.tyan.com> for the information of BIOS updating.

3.2 BIOS Main Menu

In this section, you can alter general features such as the date and time, as well as access to the IDE configuration options. Note that the options listed below are for options that can directly be changed within the Main Setup screen.

PhoenixBIOS Setup Utility						
Main	Advanced	Security	TPM State	Power	Boot	Exit
System Time:		[xx:xx:xx]			Item Specific Help	
System Date:		[xxxx-xx-xx]				
Legacy Diskette A:		[1.44/1.25 MB 3½"]				
<ul style="list-style-type: none"> ▶ IDE Channel 0 Master ▶ IDE Channel 0 Slave ▶ SATA Port 1 ▶ SATA Port 2 ▶ SATA Port 3 ▶ SATA Port 4 ▶ Memory Cache ▶ Board Information 						
System Memory:		[xxxx KB]				
Extended Memory:		[xxxx KB]				
					[Tab], [Shift-Tab], or [Enter] selects field.	
F1	Help	↑ ↓	Select Item	-/+	Change Values	F9 Setup Defaults
Esc	Exit	← →	Select Menu	Enter	Select ▶ Sub-Menu	F10 Save and Exit

System Time / Date setup

System Time: Adjusts the system clock.

HH Hours (24hr. format)
 MM Minutes
 SS Seconds

System Date: Adjusts the system date.

MM Months
DD Days
YYYY Years

Legacy Diskette A

Defines the floppy drive type NONE / 360K, 5.25 in / 1.2 M, 5.25 in / 720 K, 3.5 in / 1.44 M, 3.5 in / 2.88 M, 3.5 in

System Memory

This display allows you to change the amount of system memory present on the system.

Extended Memory

This displays/allows you to change the amount of extended memory present on the system.

3.2.1 IDE Channel 0/1 Setup

Computer detects IDE drive type from drive C to drive F.

Press **Enter** on any of the Channel 0, Channel 1 options to view advanced details of the corresponding drive. The system displays advanced details like the number of heads/cylinders/sectors on the detected disk and the maximum storage capacity of the disk.

PhoenixBIOS Setup Utility						
Main	Advanced	Security	TPM State	Power	Boot	Exit
Type:		[Auto]			Item Specific Help	
Multi-Sector Transfers:		[Disabled]			User = your enter parameters of hard-disk drive installed at this connection.	
LBA Mode Control:		[Disabled]			Auto = autotypes hard-disk drive installed here.	
32 Bit I/O:		[Disabled]			1-39 = you select pre-determined type of hard-disk drive installed here.	
Transfer Mode:		[Standard]			CD-ROM = a CD-ROM drive is installed here.	
Ultra DMA Mode:		[Disabled]			ATAPI Removable = removable disk drive is installed here.	
F1 Help	↑ ↓ Select Item	-/+ Change Values	F9 Setup Defaults			
Esc Exit	← → Select Menu	Enter Select	▶ Sub-Menu	F10 Save and Exit		

The system displays advanced details like the number of heads/cylinders/sectors on the detected disk and the maximum storage capacity of the disk.

This option lets you set the following hard disk parameters:

Type

Selects the type of device connected to the system.

Auto / CD/DVD / Not Installed / ARMD

Multi-Sector Transfers

This option allows you to specify the number of sectors per block for multiple sector transfers.

Disabled / 2 Sectors / 4 Sectors / 8 Sectors / 16 Sectors

LBA Mode Control

Enables or disables LBA Mode.

When LBA is turned on, the BIOS will enable geometry translation. This translation may be done in the same way that it is done in Extended CHS or large mode, or it may be done using a different algorithm called LBA-assist translation. The translated geometry is still what is presented to the operating system for use in Int 13h calls. The difference between LBA and ECHS is that when using ECHS the BIOS translates the parameters used by these calls from the translated geometry to the drive's logical geometry. With LBA, it translates from the translated geometry directly into a logical block (sector) number.

Disabled / Enabled

32 Bit I/O

Enables or disables 32 bit data transfer mode.

Enabling this option causes the PCI hard disk interface controller to bundle together two 16-bit chunks of data from the drive into a 32-bit group, which is then transmitted to the processor or memory. This results in a small performance increase.

Disabled / Enabled

Transfer Mode

These modes determine the speed at which data is transferred to and from the drive. The Auto option automatically determines the correct transfer rates.

Standard / Fast PIO 1 / Fast PIO 2 / Fast PIO 3 / Fast PIO 4 / FPIO 3 / DMA 1 / FPIO 4 / DMA 2

Ultra DMA Mode

Enables or disables Ultra DMA Mode.

Ultra DMA (UDMA, or, more accurately, Ultra DMA/33) is a protocol for transferring data between a hard disk drive through the computer's data paths (or bus) to the computer's random access memory (RAM). The Ultra DMA/33 protocol transfers data in burst mode at a rate of 33.3 MBps (megabytes per second), twice as fast as the previous Direct Memory Access (DMA) interface. Ultra DMA support in your computer means that it will boot (start) and open new applications more quickly. It will also help users of graphics-intensive and other applications that require large amounts of access to data on the hard drive. Ultra DMA uses Cyclical Redundancy Checking (CRC), offering a new level of data protection.

Disabled / Mode 0 / Mode 1 / Mode 2 / Mode 3 / Mode 4 / Mode 5 / Mode 6

3.2.2 Memory Cache

This setting allows you to tweak the various cache settings for optimal performance of your system. Press Enter to display the various cache settings.

PhoenixBIOS Setup Utility						
Main	Advanced	Security	TPM State	Power	Boot	Exit
Memory Cache					Item Specific Help	
Cache System BIOS area:					[Write Protect]	
Cache Video BIOS area:					[Write Protect]	
Cache Base 0-512K:					[Write Back]	
Cache Base 512K-640K:					[Write Back]	
Cache Extended Memory Area:					[Write Back]	
Cache A000 – AFFF:					[Disabled]	
Cache B000 – BFFF:					[Disabled]	
Cache C800 – CBFF:					[Write Protect]	
Cache CC00 – CFFF:					[Write Protect]	
Cache D000 – D3FF:					[Disabled]	
Cache D400 – D7FF:					[Disabled]	
Cache D800 – DBFF:					[Disabled]	
Cache DC00 – DFFF:					[Disabled]	
Cache E000 – E3FF:					[Write Protect]	
Cache E400 – E7FF:					[Write Protect]	
Cache E800 – EBFF:					[Write Protect]	
Cache EC00 – EFFF:					[Write Protect]	
F1 Help		↑ ↓ Select Item		-/+ Change Values		F9 Setup Defaults
Esc Exit		← → Select Menu		Enter Select		▶ Sub-Menu F10 Save and Exit

Cache System BIOS Area

This feature is only available when the system BIOS is shadowed. It enables or disables the caching of the system BIOS ROM at F0000h-FFFFFh via the L2 cache. This greatly speeds up accesses to the system BIOS. However, this

does not necessarily make the system perform better because the OS does not need to access the system BIOS often.

As such, it would be a waste of L2 cache bandwidth to cache the system BIOS instead of data that are more critical to the system's performance. In addition, if any program writes into this memory area, it will result in a system crash. So, it is recommended that you write protect this area for optimal system performance.

Uncached / **Write Protect**

Cache Video BIOS Area

This feature is only valid when the video BIOS is shadowed. It enables or disables the caching of the video BIOS ROM at C0000h-C7FFFh via the L2 cache. This greatly speeds up accesses to the video BIOS. However, this does not necessarily make the system perform better because the OS bypasses the BIOS and uses the graphics driver to access the video card's hardware directly. As such, it would be a waste of L2 cache bandwidth to cache the video BIOS instead of data that are more critical to the system's performance. In addition, if any program writes into this memory area, it will result in a system crash. So, it is recommended that you write protect this area for optimal system performance.

Uncached / **Write Protect**

Cache Base 0-512K

This feature allows you to control caching of 512K base memory.

Uncached / Write Through / Write Protect / **Write Back**

Cache Base 512K-640K

This feature allows you to control caching of 512K 640K base memory.

Uncached / Write Through / Write Protect / **Write Back**

Cache Extended Memory Area

This feature allows you to control caching of system memory above one megabyte.

Uncached / Write Through / Write Protect / **Write Back**

Cache A000-AFFF/B000-BFFF

These features allow you to control caching of A000-AFFF/B000-BFFF memory.

Disabled / USMC Caching / Write Through / Write Protect / Write Back

Cache C800-CBFF/Cache CC00-CFFF

These features allow you to control caching of C800-CBFF/CC00-CFFF memory.

Disabled / Write Through / **Write Protect** / Write Back

Cache D000-D3FF/Cache D400-D7FF/Cache D800-DBFF/Cache DC00-DFFF

These features allow you to control caching of D000-D3FF/D400-D7FF/D800-D8FF/DC00-DFFF memory.

Disabled / Write Through / Write Protect / Write Back

Cache E000-E3FF/Cache E400-E7FF / Cache E8000-EBFF / Cache EC00-EFFF

These features allow you to control caching of C8000-CBFF/CC00-CFFF/Cache E8000-EBFF / Cache EC00-EFFF memory.

Disabled / Write Through / **Write Protect** / Write Back

3.2.3 Board Information

This displays motherboard and BIOS version information.

PhoenixBIOS Setup Utility						
Main	Advanced	Security	TPM State	Power	Boot	Exit
Board Information				Item Specific Help		
Bios Version Bios Build Date Board Mfg Board						
F1 Help	↑ ↓ Select Item	-/+ Change Values	F9 Setup Defaults			
Esc Exit	← → Select Menu	Enter Select	▶ Sub-Menu	F10 Save and Exit		

3.3 Advanced Menu

This section facilitates configuring advanced BIOS options for your system.

PhoenixBIOS Setup Utility						
Main	Advanced	Security	TPM State	Power	Boot	Exit
<ul style="list-style-type: none"> ▶ Hardware Monitoring ▶ BIOS Event Logging ▶ Advanced Chipset Control ▶ Advanced Processor Options ▶ Diskette Controller ▶ ATA Controller ▶ LSI SAS Interface ▶ Integrated Network Interface ▶ Integrated Audio [Auto] ▶ Integrated 1394: [Enable] ▶ Integrated USB ▶ I/O Device Configuration ▶ PCI Configuration 					Item Specific Help	
					Hardware monitoring configuration	
Reset Configuration Data			[No]			
Route Port 80h cycles to			[PCI]			
F1	Help	↑ ↓	Select Item	-/+	Change Values	F9 Setup Defaults
Esc	Exit	← →	Select Menu	Enter	Select ▶ Sub-Menu	F10 Save and Exit

Integrated Audio

This feature is used to configure the audio controller.

Disabled / **Auto**

Integrated 1394

This feature is used to enable the integrated 1394 controller.

Enabled / Disabled

Reset Configuration Data

If you install a new piece of hardware or modify your computer's hardware configuration, the BIOS will automatically detect the changes and reconfigure the ESCD (Extended System Configuration Data). Therefore, there is usually no need to manually force the BIOS to reconfigure the ESCD.

However, sometimes, the BIOS may not be able to detect the hardware changes. A serious resource conflict may occur and the operating system may not even boot as a result. This is where the Reset Configuration Data BIOS feature comes in.

This BIOS feature allows you to manually force the BIOS to clear the previously saved ESCD data and reconfigure the settings. All you need to do is enable this BIOS feature and then reboot your computer. The new ESCD should resolve the conflict and allow the operating system to load normally. Please note that the BIOS will automatically reset it to the default setting of No after reconfiguring the new ESCD. So, there is no need for you to manually disable this feature after rebooting.

No / Yes

Route Port 80h cycles to

LPC---Route Port 80h I/O cycles to the LPC bus.

PCI---- Route Port 80h I/O cycles to the LPC bus.

3.3.1 Hardware Monitoring

This displays critical system parameters like CPU speed, fan speeds, voltage levels and CPU temperature.

PhoenixBIOS Setup Utility					
Main	Advanced	Security	TPM State	Power	Boot Exit
Hardware Monitoring				Item Specific Help	
FAN Speed Control		[Full Speed]			
CPU Temp Reading		[Auto]			
▶Realtime sensors					
F1 Help	↑ ↓ Select Item	-/+ Change Values	F9 Setup Defaults		
Esc Exit	← → Select Menu	Enter Select ▶ Sub-Menu	F10 Save and Exit		

FAN Speed Control

This feature is used to control the fan speed.

Auto: Optimum temperature control at maximum CPU performance

Full Speed: All fans are working at full speed.

CPU Temp Reading

This item is used to configure the CPU temperature reading.

Auto / Diode / PECI

3.3.1.1 Realtime Sensors

This screen contains the information from motherboard hardware monitor sensors, such as temperature and fan speed.

PhoenixBIOS Setup Utility						
Main	Advanced	Security	TPM State	Power	Boot	Exit
Realtime Sensors					Item Specific Help	
CPU0 Temperature	xxx		C			
CPU1 Temperature	xxx		C			
CPU0 Fan (Fan0)	xxxx		RPM			
CPU1 Fan (Fan1)	xxxx		RPM			
Rear Fan (Fan3)	xxxx		RPM			
Front Fan (Fan2)	xxxx		RPM			
PCI Area Fan (Fan4)	xxxx		RPM			
CPU0 Core voltage	xxxx		V			
CPU1 VCore voltage	xxxx		V			
CPU VTT	xxxx		V			
VCC 1.5V	xxxx		V			
VCC 3.3V	xxxx		V			
VCC 5V	xxxx		V			
VCC12V	xxxx		V			
F1 Help	↑ ↓ Select Item	-/+ Change Values	F9 Setup Defaults			
Esc Exit	← → Select Menu	Enter Select	▶ Sub-Menu	F10 Save and Exit		

3.3.2 BIOS Event Logging

PhoenixBIOS Setup Utility									
Main	Advanced	Security	TPM State	Power	Boot	Exit			
BIOS Event Logging					Item Specific Help				
BIOS Event Logging:		[Enabled]							
View BIOS event log:		[Enter]							
Clear BIOS Event Log:		[Disabled]							
F1	Help	↑ ↓	Select Item	-/+	Change Values	F9	Setup Defaults		
Esc	Exit	← →	Select Menu	Enter	Select	▶	Sub-Menu	F10	Save and Exit

BIOS Event Logging

When set to [Enabled], errors will be logged to BIOS event log.

Disabled / **Enabled**

View BIOS event log

Press [Enter] to view BIOS event log

Clear BIOS Event log

When set to [Enabled], BIOS event log will be cleared.

Disabled / Enabled

3.3.3 Advanced Chipset Control

PhoenixBIOS Setup Utility						
Main	Advanced	Security	TPM State	Power	Boot	Exit
Advanced Chipset Control					Item Specific Help	
Intel VT for Directed I/O (VT-d) Crystal Beach Configure Enable: [Disabled] Force PCI-E Gen2 slot to Gen1 mode [Auto] SERR signal condition: [Single bit] 4GB PCI Hole Granularity: [1.0 GB] Memory Branch Mode: [Interleave] Branch 0 Rank Interleave: [4:1] Branch 0 Rank Sparing: [Disabled] Branch 1 Rank Interleave: [4:1] Branch 1 Rank Sparing: [Disabled] Enhanced x8 Detection: [Enabled] Force ITK Config Clocking: [Disabled] Reserved Branch FOR ITK [Branch 1] High Precision Event Timer: [Yes] Snoop filter: [Disabled]						
F1	Help	↑ ↓	Select Item	-/+	Change Values	F9 Setup Defaults
Esc	Exit	← →	Select Menu	Enter	Select ▶ Sub-Menu	F10 Save and Exit

Force PCI-E Gen2 slot to Gen1 mode

Force PCI-E Gen2 slot operate at Gen1 mode. Some PCI-E Gen1 Cards may work abnormally on PCI-E Gen2 slot. You may use this option to select the right mode you need when you encounter such problem.

Auto / **PCI-E Gen2** / PCI-E Gen1

SERR signal condition

Select ECC error conditions that SERR# be asserted.

None / **Single bit** / Multiple bit/ Both

4GB PCI Hole Granularity

This feature is used to select the granularity of PCI hole for PCI resource. If MTRRs are not enough, we may use this option to reduce the MTRR occupation.

256MB / 512MB / 1.0GB / 2.0GB

Memory Branch Mode

This option is used to select the type of memory operation mode.
Sequential / **Interleave** / Mirror / Single Channel 0

Branch 0/1 Rank Sparring

This option is used to enable/disable Branch 0 rank/DIMM sparing feature.
Disabled / Enabled

Enhanced x8 Detection

This feature is used to enable/disable enhanced x8 DRAM UC error detection.
Disabled / **Enabled**

Force ITK Config Clocking

This feature is used to enable/disable FBD configuration for ITK test suite.
Disabled / Enabled

High Precision Event Timer:

This feature is used to enable/disable Multimedia Timer support.
Disabled / Enabled

Snoop filter

This item is used to enable the snoop filter.
Enabled / Disabled

3.3.3.1 Intel VT for Directed I/O (VT-d)

Enable/Disable Intel Virtualization Technology for Directed I/O (VT-d) by reporting the I/O device assignment to VMM through DMAR ACPI tables

PhoenixBIOS Setup Utility						
Main	Advanced	Security	TPM State	Power	Boot	Exit
Intel VT for Directed I/O (VT-d) [Disabled]					Item Specific Help	
VT-d for Port0 (ESI)		[Enabled]				
VT-d for Port1		[Enabled]				
VT-d for Port5		[Enabled]				
VT-d for Port9		[Enabled]				
VT-d for DMI Port		[Enabled]				
F1 Help	↑ ↓ Select Item	-/+ Change Values	F9 Setup Defaults			
Esc Exit	← → Select Menu	Enter Select	▶ Sub-Menu	F10 Save and Exit		

3.3.4 Advanced Processor Options

This section allows you to fine-tune the processor options.

PhoenixBIOS Setup Utility						
Main	Advanced	Security	TPM State	Power	Boot	Exit
Advanced Processor Options					Item Specific Help	
Hyperthreading		[Enabled]				
Intel® Virtualization Technology		[Enabled]				
Machine Checking		[Enabled]				
Fast String operations		[Enabled]				
C1 Enhanced Mode		[Disabled]				
Discrete MTRR Allocation		[Enabled]				
▶CPU Cache Control		[Disabled]				
F1	Help	↑ ↓	Select Item	-/+	Change Values	F9 Setup Defaults
Esc	Exit	← →	Select Menu	Enter	Select ▶ Sub-Menu	F10 Save and Exit

PhoenixBIOS Setup Utility						
Main	Advanced	Security	Boot	Exit		
CPU Cache Control			Item Specific Help			
DCU Prefetcher		[Disabled]				
Hardware Prefetcher		[Enabled]				
IP Prefetcher		[Enabled]				
Adjacent Cache Line Prefetcher		[Enabled]				
Direct Cache Access		[Disabled]				
F1	Help	↑ ↓	Select Item	-/+	Change Values	F9 Setup Defaults
Esc	Exit	← →	Select Menu	Enter	Select ▶ Sub-Menu	F10 Save and Exit

Hyperthreading

Enable this only if you have an Intel Hyper Threading processor.

Hyper-Threading Technology enables multi-threaded software applications to execute threads in parallel. Hyper-Threading Technology provides thread-level-parallelism (TLP) on each processor resulting in increased utilization of processor execution resources. As

a result, resource utilization yields higher processing throughput. Hyper-Threading Technology is a form of simultaneous multi-threading technology (SMT) where multiple threads of software applications can be run simultaneously on one processor. This is achieved by duplicating the architectural state on each processor, while sharing one set of processor execution resources. Hyper-Threading Technology also delivers faster response times for multi-tasking workload environments. By allowing the processor to use on-die resources that would otherwise have been idle, Hyper-Threading Technology provides a performance boost on multi-threading and multi-tasking operations for the Intel NetBurst® microarchitecture.

Disabled / **Enabled**

C1 Enhanced Mode

This feature is used to enable the C1 Enhanced mode.

Enabled / **Disabled**

Discrete MTRR Allocation

This feature is used to configure the MTRR method. Disabling the feature will set the MTRR method in continuous status.

Disabled / Enabled

3.3.5 Diskette Controller

PhoenixBIOS Setup Utility						
Main	Advanced	Security	TPM State	Power	Boot	Exit
Diskette Controller					Item Specific Help	
Floppy disk controller			[Enabled]			
F1	Help	↑ ↓	Select Item	-/+	Change Values	F9 Setup Defaults
Esc	Exit	← →	Select Menu	Enter	Select ▶ Sub-Menu	F10 Save and Exit

Floppy Disk Controller

This defines how the floppy disk controller is detected and configured.

Disabled / **Enabled** / Auto / OS Controlled

3.3.6 ATA Controller

This screen contains the configuration of the ATA controller.

PhoenixBIOS Setup Utility						
Main	Advanced	Security	TPM State	Power	Boot	Exit
ATA Controller					Item Specific Help	
Parallel ATA:		[Enabled]				
Serial ATA:		[Enabled]				
SATA Controller Mode Option:		[Enhanced]				
SATA RAID Enable:		[Disabled]				
SATA AHCI Enabel:		[Disabled]				
F1	Help	↑ ↓	Select Item	-/+	Change Values	F9 Setup Defaults
Esc	Exit	← →	Select Menu	Enter	Select	▶ Sub-Menu F10 Save and Exit

Parallel ATA

This feature is used to enable the PATA function.

Disabled / **Enabled**

Serial ATA

This feature is used to enable the SATA function.

Enabled / Disabled

SATA Controller Mode Option

This feature is used to select SATA controller mode. In "compatible mode", SATA and PATA drives are auto-detected and placed in Legacy mode. In "Enhanced (non-AHCI) mode", SATA and PATA drives are auto-detected and placed in Native IDE mode.

Compatible / Enhanced (non-AHCI)

SATA RAID Enable

This item allows you to enable the SATA RAID functionality.

Disabled / Enabled

SATA AHCI Enable

This item allows you to enable the SATA AHCI functionality.

Disabled / **Enabled**

If you do not want to install SATA AHCI driver, please set the SATA AHCI mode to Disabled.

3.3.7 LSI SAS Interface

This screen contains the configuration of the LSI SAS interface.

PhoenixBIOS Setup Utility									
Main	Advanced	Security	TPM State	Power	Boot	Exit			
LSI SAS Interface					Item Specific Help				
LSI SAS Controller:		[Enabled]							
Option ROM Scan:		[Enabled]							
F1	Help	↑ ↓	Select Item	-/+	Change Values	F9	Setup Defaults		
Esc	Exit	← →	Select Menu	Enter	Select	▶	Sub-Menu	F10	Save and Exit

Integrated SAS Interface

This feature is used to enable the LSI SAS controller.

Enabled / Disabled

Option ROM Scan

This feature is used to initialize the device expansion ROM.

Enabled / Disabled

3.3.8 Integrated Network Interface

This screen contains the configuration of the integrated network interface.

PhoenixBIOS Setup Utility						
Main	Advanced	Security	TPM State	Power	Boot	Exit
Integrated Network Interface					Item Specific Help	
LAN Port0:		[Enabled]				
LAN Port1:		[Enabled]				
Option ROM Scan		[Disabled]				
F1	Help	↑ ↓	Select Item	-/+	Change Values	F9 Setup Defaults
Esc	Exit	← →	Select Menu	Enter	Select ▶ Sub-Menu	F10 Save and Exit

LAN Port0/1

These two features are used to configure the onboard LAN controllers.

Enabled / Disabled

Option ROM Scan

This feature is used to initialize the device expansion ROM.

Enabled / Disabled

3.3.9 Integrated Audio

PhoenixBIOS Setup Utility						
Main	Advanced	Security	TPM State	Power	Boot	Exit
Integrated Audio					Item Specific Help	
Integrated Audio					[Auto]	
F1	Help	↑ ↓	Select Item	-/+	Change Values	F9 Setup Defaults
Esc	Exit	← →	Select Menu	Enter	Select ▶ Sub-Menu	F10 Save and Exit

3.3.10 Integrated 1394

PhoenixBIOS Setup Utility						
Main	Advanced	Security	Power	Boot	Exit	
Integrated 1394					Item Specific Help	
Integrated 1394					[Enabled]	
F1	Help	↑ ↓	Select Item	-/+	Change Values	F9 Setup Defaults
Esc	Exit	← →	Select Menu	Enter	Select ▶ Sub-Menu	F10 Save and Exit

3.3.11 Integrated USB

This screen contains the configuration of the integrated USB.

PhoenixBIOS Setup Utility						
Main	Advanced	Security	TPM State	Power	Boot	Exit
Integrated USB					Item Specific Help	
Integrated USB1.1		[Enabled]				
Integrated USB2.0		[Enabled]				
Legacy USB Support		[Enabled]				
F1	Help	↑ ↓	Select Item	-/+	Change Values	F9 Setup Defaults
Esc	Exit	← →	Select Menu	Enter	Select ▶ Sub-Menu	F10 Save and Exit

Integrated USB1.1

Enable or Disable all USB devices by setting item to the desired value.

Enabled / Disabled

Integrated USB2.0

Control USB 2.0 functionality through this Setup Item.

Enabled / Disabled

Legacy USB Support

This option is used to enable the support for legacy USB.

Enabled / Disabled

3.3.10 I/O Device Configuration

PhoenixBIOS Setup Utility						
Main	Advanced	Security	TPM State	Power	Boot	Exit
I/O Device Configuration					Item Specific Help	
Serial port A:		[Enabled]				
Base I/O Address:		[3F8]				
Interrupt:		[IRQ 3]				
Parallel port:		[Enabled]				
Mode:		[ECP]				
Base I/O Address		[378]				
Interrupt:		[IRQ 7]				
DMA channel:		[DMA 3]				
F1	Help	↑ ↓	Select Item	-/+	Change Values	F9 Setup Defaults
Esc	Exit	← →	Select Menu	Enter	Select	▶ Sub-Menu F10 Save and Exit

Serial Port A

This defines how the first serial port is detected and configured.

Disabled / **Enabled** / Auto / OS Controlled

Base I/O Address:

Set the base I/O address for serial port A/B.

3F8

Interrupt:

Set the interrupt for serial port A/B.

IRQ3

Parallel Port

This defines how the parallel port is detected and configured.

Disabled / **Enabled** / Auto / OS Controlled

Mode

This field allows the user to select the parallel port mode.

In addition to “Output only” and “Bi-directional”, there are two faster bidirectional modes available - the ECP (Extended Capabilities Port) and EPP (Enhanced Parallel Port) modes.

ECP uses the DMA protocol to achieve data transfer rates of up to 2.5 Mb/s and provides symmetric bidirectional communication. On the other hand, EPP uses existing parallel port signals to provide asymmetric bidirectional communication.

Generally, because of its FIFOs and the DMA channel it uses, ECP is good for large data transfers (useful for scanners and printers). On the other hand, EPP is better with links that switch directions frequently (like parallel port drives).

Output only / Bi-directional / EPP / **ECP**

Base I/O Address

Set the base I/O address for parallel port.

378

Interrupt

Set the interrupt for parallel port

IRQ7

DMA Channel

This BIOS feature determines which DMA channel the parallel port should use when it is in ECP mode.

The ECP mode uses the DMA protocol to achieve data transfer rates of up to 2.5 Mbits/s and provides symmetric bidirectional communications. For all this, it requires the use of a DMA channel.

By default, the parallel port uses DMA Channel 3 when it is in ECP mode. This works fine in most situations.

This feature is provided just in case one of your add-on cards requires the use of DMA Channel 3. In such a case, you can use this BIOS feature to force the parallel port to use the alternate DMA Channel 1.

Please note that there is no performance advantage in choosing DMA Channel 3 over DMA Channel 1 or vice versa. As long as either Channel 3 or Channel 1 is available for your parallel port to use, the parallel port will be able to function properly in ECP mode.

DMA 3

3.3.11 PCI Configuration

This screen contains the additional setup menus to configure PCI devices.

PhoenixBIOS Setup Utility						
Main	Advanced	Security	TPM State	Power	Boot	Exit
PCI Configuration					Item Specific Help	
<ul style="list-style-type: none">▶ PCI Device, Slot #1▶ PCI Device, Slot #2▶ PCI Device, Slot #3▶ PCI Device, Slot #4▶ PCI Device, Slot #5▶ PCI Device, Slot #6						
F1	Help	↑ ↓	Select Item	-/+	Change Values	F9 Setup Defaults
Esc	Exit	← →	Select Menu	Enter	Select ▶ Sub-Menu	F10 Save and Exit

3.3.11.1 PCI Device, Slot # 1/2/3/4/5/6 Sub-Menu

These screens contain the setup items for configuring the specific PCI device.

PhoenixBIOS Setup Utility						
Main	Advanced	Security	TPM State	Power	Boot	Exit
PCI Device, Slot #1/2/3/4/5/6					Item Specific Help	
Option ROM Scan		[Enabled]				
Latency Timer		[Default]				
F1	Help	↑ ↓	Select Item	-/+	Change Values	F9 Setup Defaults
Esc	Exit	← →	Select Menu	Enter	Select ▶ Sub-Menu	F10 Save and Exit

Option ROM Scan

This feature is used to initialize the device expansion ROM.

Enabled / Disabled

Latency Timer

This feature is used to configure the minimum guaranteed time slice allotted for bus master in units of PCI bus clocks.

Default / 0020h / 0040h / 0060h / 0080h / 00A0h / 00C0h / 00E0h

3.4 Security Menu

These settings allow you to configure the security options for your system.

PhoenixBIOS Setup Utility						
Main	Advanced	Security	TPM State	Power	Boot	Exit
Supervisor Password Is:					Clear	Item Specific Help
User Password Is:					Clear	
Set Setup Password					[Enter]	
Set User Password					[Enter]	
Fixed disk boot sector					[Normal]	
Password on boot:					[Disabled]	
Trusted Platform Support					[Enabled]	
Write on Flexible Disks:					[Unlocked]	
BIOS Write Protect:					[Disabled]	
Cabinet Monitoring					[Disabled]	
F1	Help	↑ ↓	Select Item	-/+	Change Values	F9 Setup Defaults
Esc	Exit	← →	Select Menu	Enter	Select	▶ Sub-Menu F10 Save and Exit

The system displays the current supervisor and user passwords.

Set Supervisor Password

This option allows the supervisor to set the supervisor password to restrict access to the BIOS settings.

Set User Password

This option allows the user to set the user password.

Password on boot

When enabled, the system will ask for a password at every boot. The system will continue booting only if the correct password is entered. If the wrong password is entered three times, the system will automatically shut down.

Disabled / Enabled

Write on Flexible Disks

This item is used to configure the data written to floppy disk

Unlocked: Data can be written to floppy disk

Locked: No data can be written to floppy disk.

Unlocked / Locked

BIOS Write Protect

This item is used to configure the writing protection of BIOS flash memory. When set to enabled, the BIOS flash memory will be written protected.

Disabled / Enabled

Cabinet Monitoring

This item is used to configure the monitoring of system's housing. When enabled, the system's housing is monitored.

Disabled / Enabled

3.5 TPM State

PhoenixBIOS Setup Utility						
Main	Advanced	Security	TPM State	Power	Boot	Exit
Current TPM State					Item Specific Help	
Change TPM State						
F1	Help	↑ ↓	Select Item	-/+	Change Values	F9 Setup Defaults
Esc	Exit	← →	Select Menu	Enter	Select ▶ Sub-Menu	F10 Save and Exit

3.6 Power Menu

PhoenixBIOS Setup Utility						
Main	Advanced	Security	TPM State	Power	Boot	Exit
ACPI Save to RAM: [Enabled]					Item Specific Help	
After Power Failure: [Last State]						
F1	Help	↑ ↓	Select Item	-/+	Change Values	F9 Setup Defaults
Esc	Exit	← →	Select Menu	Enter	Select ▶ Sub-Menu	F10 Save and Exit

Enabled ACPI_Sx

This feature is used to select one of the ACPI power states: S1 or S3. If selected, the corresponding power state will be disabled.

Disabled / Enabled

After Power Failure

This option is used to specify the mode of operation after the system recovers from a power loss.

Stay off / Power on / **Last State**

3.7 Boot Menu

Use this screen to select options for the Boot Settings Configuration.

PhoenixBIOS Setup Utility						
Main	Advanced	Security	TPM State	Power	Boot	Exit
Error Halt in POST:					[All Errors]	Item Specific Help
Summary screen:					[Disabled]	
Quiet Boot:					[Enabled]	
QuickBoot Mode:					[Enabled]	
▶ Boot Device Priority						
F1	Help	↑ ↓	Select Item	-/+	Change Values	F9 Setup Defaults
Esc	Exit	← →	Select Menu	Enter	Select ▶ Sub-Menu	F10 Save and Exit

Error Halt in POST

This item is used to pauses and displays the setup entry or resume boot prompt if error occurs at boot.

All Errors / No Errors/ All, but Keyboard

Summary Screen

This feature is used to display the system configuration on boot.

Enabled / Disabled

Quick Boot

This feature is used to configure the boot message.

Enabled: Displays OEM log instead of POST messages.

Disabled: Displays normal POST messages

Enabled / Disabled

QuickBoot Mode

This feature allows the system to skip certain tests while booting.

Enabled / Disabled

3.7.1 Boot Device Priority

Use this screen to select options for the Boot Settings Configuration.

PhoenixBIOS Setup Utility						
Main	Advanced	Security	Power	Boot	Exit	
Boot Device Priority				Item Specific Help		
1: Legacy Floppy Drives 2: 3: 4: 5: 6: 7: 8: : Legacy Network Card				Keys used to view or configure devices: <Enter> expands or collapses devices with a + or - <Ctrl + Enter> expands all <Shift + 1> enables or disables a device. <+> and <-> moves the device up or down. <n> May move removable device between Hard Disk or Removable Disk. <d> Remove a device that is not installed.		
F1	Help	↑ ↓	Select Item	-/+	Change Values	F9 Setup Defaults
Esc	Exit	← →	Select Menu	Enter	Select ▶ Sub-Menu	F10 Save and Exit

The boot menu will list all bootable devices. Use <Enter> to expand or collapses devices with a '+' or '-'. Use <+> or <-> to arrange the priorities of all bootable devices.

3.8 Exit Menu

These settings set the exit options on your system.

PhoenixBIOS Setup Utility						
Main	Advanced	Security	TPM State	Power	Boot	Exit
Exit Saving Changes Exit Discarding Changes Load Setup Defaults Discard Changes Save Changes					Item Specific Help Exit system Setup and save your changes to CMOS.	
F1	Help	↑ ↓	Select Item	-/+	Change Values	F9 Setup Defaults
Esc	Exit	← →	Select Menu	Enter	Select ▶ Sub-Menu	F10 Save and Exit

Exit Saving Changes

This exits BIOS setup after saving the changes made.

Exit Discarding Changes

This exits BIOS setup after discarding the changes made.

Load Setup Defaults

Loads the factory default values.

Discard Changes

Discards all changes made without exiting BIOS setup.

Save Changes

Saves all changes made without exiting BIOS.

Chapter 4: Diagnostics

NOTE: If you experience problems with setting up your system, always check the following things in the following order:

Memory, Video, CPU

By checking these items, you will most likely find out what the problem might have been when setting up your system. For more information on troubleshooting, check the TYAN website at: <http://www.tyan.com>.

4.1 Beep Codes

Fatal errors, which halt the boot process, are communicated through two kinds of audible beeps.

- A single long beep followed by two short beeps: It indicates that a video error has occurred and the BIOS can't initialize the video screen to display and additional info.
- A single long beep repeatedly: This indicates that a DRAM error has occurred.

The most common type of error is a memory error.

Before contacting your vendor or TYAN Technical Support, be sure that you note as much as you can about the beep code length and order that you experience. Also, be ready with information regarding add-in cards, drives and O/S to speed the support process and come to a quicker solution.

4.2 Flash Utility

Every BIOS file is unique for the motherboard it was designed for. For Flash Utilities, BIOS downloads, and information on how to properly use the Flash Utility with your motherboard, please check the TYAN web site: <http://www.tyan.com/>

Note



Please be aware that by flashing your BIOS, you agree that in the event of a BIOS flash failure, you must contact your dealer for a replacement BIOS. There are no exceptions. TYAN does not have a policy for replacing BIOS chips directly with end users. In no event will TYAN be held responsible for damages done by the end user.

4.3 - BIOS Post Code

Code	Beeps / Description	Code	Beeps / Description
02h	Verify Real Mode	32h	Test CPU bus-clock frequency
03h	Disable Non-Maskable Interrupt (NMI)	33h	Initialize Phoenix Dispatch Manager
04h	Get CPU type	36h	Warm start shut down
06h	Initialize system hardware	38h	Shadow system BIOS ROM
08h	Initialize chipset with initial POST values	3Ah	Autosize cache
09h	Set IN POST flag	3Ch	Advanced configuration of chipset registers
0Ah	Initialize CPU registers	3Dh	Load alternate registers with CMOS values
0Bh	Enable CPU cache	42h	Initialize interrupt vectors
0Ch	Initialize caches to initial POST values	45h	POST device initialization
0Eh	Initialize I/O component	46h	2-1-2-3. Check ROM copyright notice
0Fh	Initialize the local bus IDE	48h	Check video configuration against CMOS
10h	Initialize Power Management	49h	Initialize PCI bus and devices
11h	Load alternate registers with initial POST values	4Ah	Initialize all video adapters in system
12h	Restore CPU control word during warm boot	4Bh	QuietBoot start (optional)
13h	Initialize PCI Bus Mastering devices	4Ch	Shadow video BIOS ROM
14h	Initialize keyboard controller	4Eh	Display BIOS copyright notice
16h	1-2-2-3. BIOS ROM checksum	50h	Display CPU type and speed
17h	Initialize cache before memory autosize	51h	Initialize EISA board
18h	8254 timer initialization	52h	Test keyboard
1Ah	8237 DMA controller initialization	54h	Set key click if enabled
1Ch	Reset Programmable Interrupt Controller	58h	2-2-3-1. Test for unexpected interrupts
20h	1-3-1-1. Test DRAM refresh	59h	Initialize POST display service
22h	1-3-1-3. Test 8742 KBD Controller	5Ah	Display prompt "Press F2 to enter SETUP"
24h	Set ES segment register to 4 GB	5Bh	Disable CPU cache
26h	Enable A20 line	5Ch	Test RAM between 512 and 640 KB
28h	Autosize DRAM	60h	Test extended memory
29h	Initialize POST Memory Manager	62h	Test extended memory address lines
2Ah	Clear 512 KB base RAM	64h	Jump to UserPatch1
2Ch	1-3-4-1. RAM failure on address	66h	Configure advanced cache registers
2Eh	1-3-4-3. RAM failure on data bits of low byte of memory bus	67h	Initialize Multi Processor APIC
2Fh	Enable cache before system BIOS shadow	68h	Enable external and CPU caches
30h	1-4-1-1. RAM failure on data bits of high byte of memory bus	69h	Setup System Management Mode (SMM) area
Code	Beeps / Description	Code	Beeps / Description
6Ah	Display external L2 cache size	A2h	Check key lock
6Bh	Load custom defaults (optional)	A4h	Initialize Typematic rate

6Ch	Display shadow-area message	A8h	Erase F2 prompt
6Eh	Display possible high address for UMB recovery	AAh	Scan for F2 key stroke
70h	Display error messages	ACh	Enter SETUP
72h	Check for configuration errors	AEh	Clear Boot flag
76h	Check for keyboard errors	B0h	Check for errors
7Ch	Set up hardware interrupt vectors	B2h	POST done - prepare to boot operating system
7Eh	Initialize coprocessor if present	B4h	One short beep before boot
80h	Disable onboard Super I/O ports and IRQs	B5h	Terminate QuietBoot (optional)
81h	Late POST device initialization	B6h	Check password (optional)
82h	Detect and install external RS232 ports	B9h	Prepare Boot
83h	Configure non-MCD IDE controllers	BAh	Initialize DMI parameters
84h	Detect and install external parallel ports	BBh	Initialize PnP Option ROMs
85h	Initialize PC-compatible PnP ISA devices	BCh	Clear parity checkers
86h	Re-initialize onboard I/O ports.	BDh	Display MultiBoot menu
87h	Configure Motherboard Devices	BEh	Clear screen (optional)
88h	Initialize BIOS Data Area	BFh	Check virus and backup reminders
89h	Enable Non-Maskable Interrupts (NMI)	C0h	Try to boot with INT 19
8Ah	Initialize Extended BIOS Data Area	C1h	Initialize POST Error Manager (PEM)
8Bh	Test and initialize PS/2 mouse	C2h	Initialize error logging
8Ch	Initialize floppy controller	C3h	Initialize error display function
8Fh	Determine number of ATA drives (optional)	C4h	Initialize system error handler
90h	Initialize hard-disk controllers	C5h	PnPnd dual CMOS (optional)
91h	Initialize local-bus hard-disk controllers	C6h	Initialize notebook docking (optional)
92h	Jump to UserPatch2	C7h	Initialize notebook docking late
93h	Build MPTABLE for multi-processor boards	C8h	Force check (optional)
95h	Install CD ROM for boot	C9h	Extended checksum (optional)
96h	Clear huge ES segment register	D2h	BIOS Boot Block
97h	Fixup Multi Processor table	E0h	BIOS Boot Block
98h	1-2. Search for option ROMs.	E1h	BIOS Boot Block
99h	Check for SMART Drive (optional)	E2h	Initialize the CPU
9Ah	Shadow option ROMs	E3h	Initialize system timer
9Ch	Set up Power Management	E4h	Initialize system I/O
9Dh	Initialize security engine (optional)	E5h	Check force recovery boot
9Eh	Enable hardware interrupts	E6h	Checksum BIOS ROM
9Fh	Determine number of ATA and SCSI drives	E7h	Go to BIOS
A0h	Set time of day	E8h	Set Huge Segment
Code	Beeps / Description	Code	Beeps / Description
E9h	Initialize Multi Processor	F1h	Initialize Run Time Clock
EAh	Initialize OEM special code	F2h	Initialize video
EBh	Initialize PIC and DMA	F3h	Initialize System Management Mode
ECh	Initialize Memory type	F4h	Output one beep before boot

EDh	Initialize Memory size	F5h	Boot to Mini DOS
EEh	Shadow Boot Block	F6h	Clear Huge Segment
EFh	System memory test	F7h	Boot to Full DOS
F0h	Initialize interrupt vectors		

Appendix I: SMDC Information

Overview

Tyan Server Management Daughter Card (SMDC) is a powerful yet cost-efficient solution for high-end server management hardware packages. Tyan's goal is to provide remote system monitoring and control even when the operating system is absent or simply fails. This empowers Tyan's server board with advanced industrial-standard features.

Tyan SMDC is a snap-in card that provides essential server management solution. It enables any IT Manager by providing multi-interfaces to access the hardware remotely and perform **monitor**, **control** and **diagnose** activities effectively.

Tyan SMDC is not a peripheral card. Unlike regular peripheral card such as AGP card, Network card or SCSI card, SMDC does not require any hardware specific driver. As long as a standby power comes into the system, SMDC will begin looking after the system.

Tyan SMDC provides diversified methods to communicate with the hardware. IT manager has the flexibility to choose among *Keyboard Controller Style (KCS)*, *Block Transfer (BT)* style, Intelligent Chassis Management Bus (ICMB), Intelligent Platform Management Bus (IPMB), Emergency Management Port (EMP) and standard IPMI-Over-LAN communication as defined in latest IPMI 1.5 specification.

Tyan SMDC is compatible with all IPMI-compliance software as well as Tyan System Operator™ (TSO) software package.

By adding SMDC, Tyan's server board becomes a highly manageable and IPMI compatible system with all the advanced features suggesting in IPMI Spec.

More detailed information on Tyan's SMDC card can be found on our website:
<http://www.tyan.com>

Features of Tyan Server Management



Monitor various system components remotely
-such as fans, processor temperature, and more



Remote power on and power off



Console redirect
-the ability to view system remotely



Alert and error actions
-such as audible beep, e-mail, power down and reboot



SMDC runs on stand-by power
-the SMDC will continue to function, even if the system is not powered on

How SMDC and TSO Work

The brief descriptions below will help explain how these items function.

	<p>Agent – a system with SMDC installed The SMDC is installed in the Agent system that uses a compatible/supported Tyan motherboard.</p>
	<p>Manager – manages the Agent The Manger is set up to manage the Agent that has the SMDC. The Manager and Agent should be located in the same place.</p>
	<p>Console – communicates with Manager The Console is used to monitor and control the Agent through the Manager.</p>

Appendix II: How to Make a Driver Diskette

Follow the steps below to make a driver diskette from the TYAN driver CD provided.

1. Start the system and insert the TYAN CD into the CD-ROM drive to boot from CD. You will see the following menu. Then press [1] and [Enter] to boot the system to Tyan diskette maker. (If you would like to boot from hard disk, press 0 and Enter or just wait for 10 seconds to boot automatically from hard disk.).

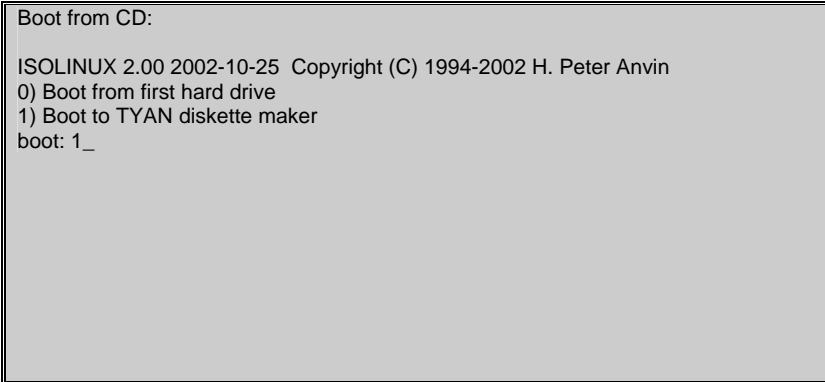

2. Choose the chipset vendor which you need from the main menu.

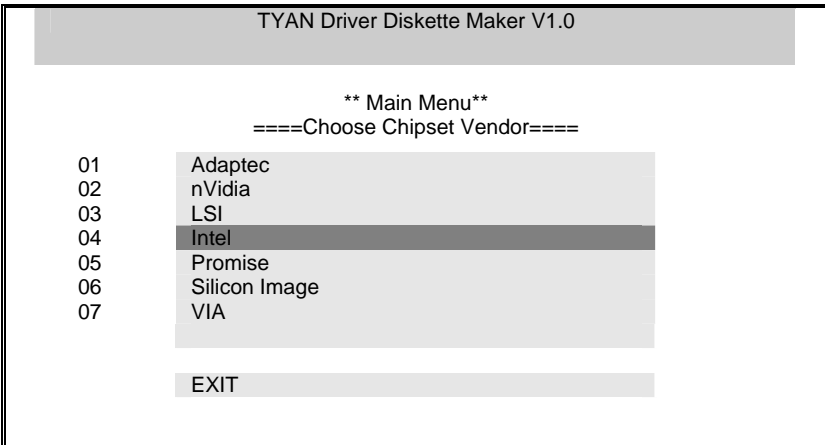

3. The following picture pops up after selecting the chipset model.

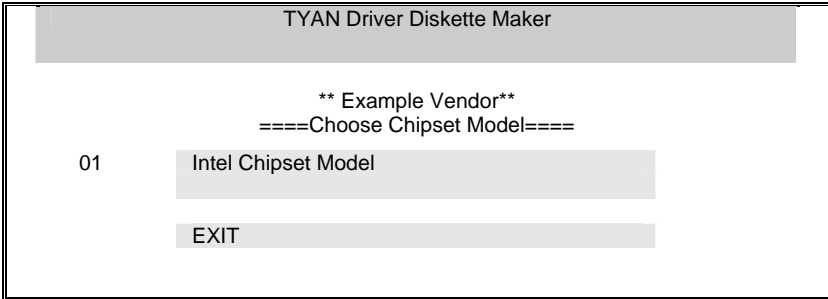

4. After selecting the chipset model, select the OS to start the diskette making.

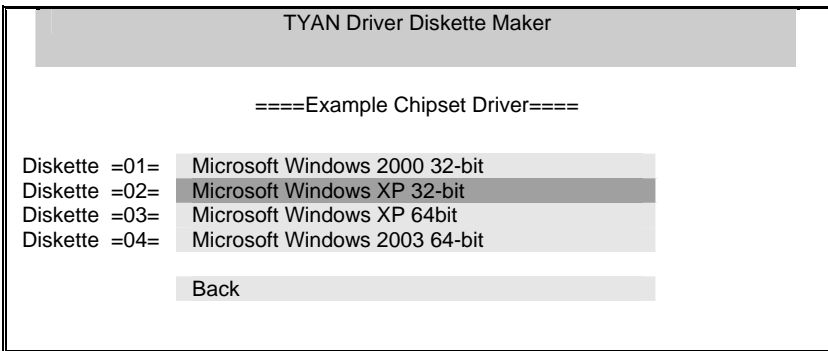

5. Follow the instruction on menu to insert a diskette and press [ENTER].

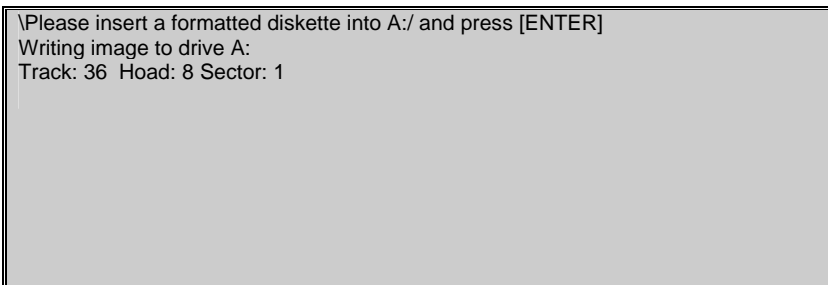

6. Using "ESC" key to quit the Tyan diskette maker. The system will automatically restart.

Glossary

ACPI (Advanced Configuration and Power Interface): a power management specification that allows the operating system to control the amount of power distributed to the computer's devices. Devices not in use can be turned off, reducing unnecessary power expenditure.

AGP (Accelerated Graphics Port): a PCI-based interface which was designed specifically for demands of 3D graphics applications. The 32-bit AGP channel directly links the graphics controller to the main memory. While the channel runs at only 66 MHz, it supports data transmission during both the rising and falling ends of the clock cycle, yielding an effective speed of 133 MHz.

ATAPI (AT Attachment Packet Interface): also known as IDE or ATA; a drive implementation that includes the disk controller on the device itself. It allows CD-ROMs and tape drives to be configured as master or slave devices, just like HDDs.

ATX: the form factor designed to replace the AT form factor. It improves on the AT design by rotating the board 90 degrees, so that the IDE connectors are closer to the drive bays, and the CPU is closer to the power supply and cooling fan. The keyboard, mouse, USB, serial, and parallel ports are built-in.

Bandwidth: refers to carrying capacity. The greater the bandwidth, the more data the bus, phone line, or other electrical path, can carry. Greater bandwidth, then, also results in greater speed.

BBS (BIOS Boot Specification): is a feature within the BIOS that creates, prioritizes, and maintains a list of all Initial Program Load (IPL) devices, and then stores that list in NVRAM. IPL devices have the ability to load and execute an OS, as well as provide the ability to return to the BIOS if the OS load process fails for some reason. At that point, the next IPL device is called upon to attempt loading of the OS.

BIOS (Basic Input/Output System): the program that resides in the ROM chip, and provides the basic instructions for controlling your computer's hardware. Both the operating system and application software use BIOS routines to ensure compatibility.

Buffer: a portion of RAM which is used to temporarily store data, usually from an application, though it is also used when printing, and in most keyboard drivers. The CPU can manipulate data in a buffer before copying it, all at once, to a disk drive. While this improves system performance --- reading to or writing from a disk drive a single time is much faster than doing so repeatedly --- there is also the possibility of losing your data should the system crash. Information stored in a buffer is temporarily stored, not permanently saved.

Bus: a data pathway. The term is used especially to refer to the connection between the processor and system memory, and between the processor and PCI or ISA local buses.

Bus mastering: allows peripheral devices and IDEs to access the system memory without going through the CPU (similar to DMA channels).

Cache: a temporary storage area for data that will be needed often by an application. Using a cache lowers data access times, since the needed information is stored in the SRAM instead of in the slow DRAM. Note that the cache is also much smaller than your regular memory: a typical cache size is 512KB, while you may have as much as 4GB of regular memory.

Cache size: refers to the physical size of the cache onboard. This should not be confused with the cacheable area, which is the total amount of memory which can be scanned by the system in search of data to put into the cache. A typical setup would be a cache size of 512KB, and a cacheable area of 512MB. In this case, up to 512KB of the main memory onboard is capable of being cached. However, only 512KB of this memory will be in the cache at any given moment. Any main memory above 512MB could never be cached.

Closed and open jumpers: jumpers and jumper pins are active when they are “on” or “closed”, and inactive when they are “off” or “open”.

CMOS (Complementary Metal-Oxide Semiconductors): chips that hold the basic startup information for the BIOS.

COM port: another name for the serial port, which is called as such because it transmits the eight bits of a byte of data along one wire, and receives data on another single wire (that is, the data is transmitted in serial form, one bit after another). Parallel ports transmit the bits of a byte on eight different wires at the same time (that is, in parallel form, eight bits at the same time).

DDR (Double Data Rate): is a technology designed to double the clock speed of the memory. It activates output on both the rising and falling edge of the system clock rather than on just the rising edge, potentially doubling output.

DIMM (Dual In-line Memory Module): faster and more capacious form of RAM than SIMMs, and do not need to be installed in pairs.

DIMM bank: sometimes called DIMM sockets, because the physical slot and the logical unit are the same. That is, one DIMM module fits into one DIMM socket, which is capable of acting as a memory bank.

DMA (Direct Memory Access): channels that are similar to IRQs. DMA channels allow hardware devices (like soundcards or keyboards) to access the main memory without involving the CPU. This frees up CPU resources for other tasks. As with IRQs, it is vital that you do not double up devices on a single line. Plug-n-Play devices will take care of this for you.

Doze mode: in this mode, only the CPU's speed is slowed.

DRAM (Dynamic RAM): widely available, very affordable form of RAM which has the unfortunate tendency to lose data if it is not recharged regularly (every few milliseconds). This refresh requirement makes DRAM three to ten times slower than non-recharged RAM such as SRAM.

ECC (Error Correction Code or Error Checking and Correcting): allows data to be checked for errors during run-time. Errors can subsequently be corrected at the same time that they're found.

EEPROM (Electrically Erasable Programmable ROM): also called Flash BIOS, is a ROM chip which can, unlike normal ROM, be updated. This allows you to keep up with changes in the BIOS programs without having to buy a new chip. TYAN's BIOS updates can be found at <http://www.tyan.com>

EMRL: Embedded RAID Logic. An Adaptec specific RAID technology.

ESCD (Extended System Configuration Data): a format for storing information about Plug-n-Play devices in the system BIOS. This information helps properly configure the system each time it boots.

Fault-tolerance: a term describing a system where one component can quickly be replaced without causing a loss of service, such as in a RAID system.

Firmware: low-level software that controls the system hardware.

Form factor: an industry term for the size, shape, power supply type, and external connector type of the Personal Computer Board (PCB) or motherboard. The standard form factors are the AT and ATX, although TYAN also makes some Baby-AT and ATX Footprint boards.

Global timer: onboard hardware timer, such as the Real-Time Clock (RTC).

Handshaking: a process where two devices initiate communications. One device, typically the server, sends a message to another device, typically a client, in order to request establishment of a communications channel. The two devices will then exchange messages back and forth in order to settle on a communications protocol.

HDD: stands for Hard Disk Drive, a type of fixed drive.

H-SYNC: controls the horizontal synchronization/properties of the monitor.

IC (Integrated Circuit): the formal name for the computer chip.

IDE (Integrated Device/Drive Electronics): a simple, self-contained HDD interface. It can handle drives up to 8.4 GB in size. Almost all IDEs sold now are in fact Enhanced IDEs (EIDEs), with maximum capacity determined by the hardware controller.

IDE INT (IDE Interrupt): a hardware interrupt signal that goes to the IDE.

I/O (Input/Output): the connection between your computer and another piece of hardware (mouse, keyboard, etc.)

Initial Program Load (IPL): a feature built into BBS-compliant devices, describing those devices as capable of loading and executing an OS, as well as being able to provide control back to the BIOS if the loading attempt fails.

IPL: see Initial Program Load.

IRQ (Interrupt Request): an electronic request that runs from a hardware device to the CPU. The interrupt controller assigns priorities to incoming requests and delivers them to the CPU. It is important that there is only one device hooked up to each IRQ line; doubling up devices on IRQ lines can lock up your system. Plug-n-Play operating systems can take care of these details for you.

ISA (Industry Standard Architecture): a slower 8- or 16-bit bus (data pathway).

Latency: the amount of time that one part of a system spends waiting for another part to catch up. This is most common when the system sends data out to a peripheral device, and it waiting for the peripheral to send some data back (peripherals tend to be slower than onboard system components).

Mirroring: see RAID.

NVRAM: ROM and EEPROM are both examples of Non-Volatile RAM, memory that holds its data without power. DRAM, in contrast, is volatile.

OEMs (Original Equipment Manufacturers): Compaq or IBM package other companies' motherboards and hardware inside their case and sell them.

Parallel port: transmits the bits of a byte on eight different wires at the same time (that is, in parallel form, eight bits at the same time).

PCI (Peripheral Component Interconnect): a 32 or 64-bit local bus (data pathway) which is faster than the ISA bus. Local buses are those which operate within a single system (as opposed to a network bus, which connects multiple systems).

PCI PIO (PCI Programmable Input/Output) modes: the data transfer modes used by IDE drives. These modes use the CPU for data transfer (in contrast, DMA channels do not). PCI refers to the type of bus used by these modes to communicate with the CPU.

PCI-to-PCI bridge: allows you to connect multiple PCI devices onto one PCI slot.

Pipeline burst SRAM: a type of RAM that can maintain its data as long as power is provided to the memory chips. In this configuration, SRAM requests are pipelined, which means that larger packets of data are sent to the memory at one time, and acted upon quickly. This type of SRAM operates at bus speeds higher than 66MHz.

Pipelining: improves system performance by allowing the CPU to begin executing a second instruction before the first is completed. A pipeline can be likened to an assembly line, with a given part of the pipeline repeatedly executing a set part of an operation on a series of instructions.

PM timers (Power Management timers): software timers that count down the number of seconds or minutes until the system times out and enters sleep, suspend, or doze mode.

PnP (Plug-n-Play): a design standard that has become ascendant in the industry. Plug-n-Play devices require little set-up to use. Novice end users can simply plug them into a computer that is running on a Plug-n-Play aware operating system (such as Windows 98), and go to work. Devices and operating systems that are not Plug-n-Play require you to reconfigure your system each time you add or change any part of your hardware.

PXE (Preboot Execution Environment): one of four components that together make up the Wired for Management 2.0 baseline specification. PXE was designed to define a standard set of preboot protocol services within a client, towards the goal of allowing networked-based booting to boot using industry standard protocols.

RAID (Redundant Array of Independent Disks): a way for the same data to be stored in different places on many hard drives. By using this method, the data is stored redundantly, also the multiple hard drives will appear as a single drive to the operating system. RAID level 0 is known as striping, where data is striped (or overlapped) across multiple hard drives, but offers no fault-tolerance. RAID level 1 is known as mirroring, which stores the data within at least two hard drives, but does not stripe. RAID level 1 also allows for faster access time and fault-tolerance, since either hard drive can be read at the same time. RAID level 0+1 is both striping and mirroring, providing fault-tolerance, striping, and faster access all at the same time.

RAIDIOS: stands for RAID I/O Steering, a type of RAID technology from Intel. RAIDIOS is a specification used to enable an embedded I/O controller, embedded on the motherboard, to be used as just an I/O controller or to be the I/O component of a hardware RAID subsystem. The RAIDIOS circuit allows an I/O Processor (either embedded on the motherboard or on an add-in card) to configure the I/O controller and service the I/O controller's interrupts. The I/O controller and the I/O Processor together are two of the primary components of a hardware RAID subsystem.

RAM (Random Access Memory): technically refers to a type of memory where any byte can be accessed without touching the adjacent data, is often used to refer to the system's main memory. This memory is available to any program running on the computer.

ROM (Read-Only Memory): a storage chip which contains the BIOS; the basic instructions required to boot the computer and start up the operating system.

SATA (Serial ATA): is an evolutionary replacement for the Parallel ATA physical storage interface. Serial ATA is a drop-in solution in that it is compatible with today's software and operating systems. It will provide for systems which are easier to design, with cables that are simpler to route and install, smaller cable connectors, and lower voltage requirements.

SDRAM (Synchronous Dynamic RAM): called as such because it can keep two sets of memory addresses open simultaneously. By transferring data alternately from one set of addresses and then the other, SDRAM cuts down on the delays associated with non-synchronous RAM, which must close one address bank before opening the next.

Serial port: called as such because it transmits the eight bits of a byte of data along one wire, and receives data on another single wire (that is, the data is transmitted in serial form, one bit after another).

SCSI Interrupt Steering Logic (SISL): Architecture that allows a RAID controller, such as AcceleRAID 150, 200 or 250, to implement RAID on a system board-embedded SCSI bus or a set of SCSI busses. SISL: SCSI Interrupt Steering Logic (LSI) (only on LSI SCSI boards)

SIMM (Single In-line Memory Module): formally the most common form of RAM for motherboards. They must be installed in pairs, and do not have the carrying capacity or the speed of DIMM modules.

Sleep/Suspend mode: in this mode, all devices except the CPU shut down.

SRAM (Static RAM): unlike DRAM, this type of RAM does not need to be refreshed in order to prevent data loss. Thus, it is faster and more expensive.

SSI (Server System Infrastructure): an industry initiative intended to provide ready-to-use design specifications for common server hardware elements (chassis, power supplies, and racks) to promote and support server industry growth.

Standby mode: in this mode, the video and hard drives shut down; all other devices continue to operate normally.

Striping: see RAID

UltraDMA-33/66/100: a fast version of the old DMA channel. UltraDMA is also called UltraATA. Without proper UltraDMA controller, your system cannot take advantage of higher data transfer rates of the new UltraDMA/UltraATA hard drives.

USB (Universal Serial Bus): a versatile port. This one port type can function as a serial, parallel, mouse, keyboard or joystick port. It is fast enough to support video transfer, and is capable of supporting up to 127 daisy-chained peripheral devices.

VGA (Video Graphics Array): the PC video display standard

V-SYNC: controls the vertical scanning properties of the monitor.

ZCR: Zero Channel RAID. PCI card that allows a RAID card to use the onboard SCSI chip, thus lowering cost of RAID solution

ZIF Socket (Zero Insertion Force socket): these sockets make it possible to insert CPUs without damaging the sensitive CPU pins. The CPU is lightly placed in an open ZIF socket, and a lever is pulled down. This shifts the processor over and down, guiding it into the board and locking it into place.

Technical Support

If a problem arises with your system, you should turn to your dealer for help first. Your system has most likely been configured by them, and they should have the best idea of what hardware and software your system contains. Furthermore, if you purchased your system from a dealer near you, you can bring your system to them to have it serviced instead of attempting to do so yourself (which can have expensive consequences).

Help Resources:

1. See the beep codes section of this manual.
2. See the TYAN website for FAQ's, bulletins, driver updates, and other information: <http://www.tyan.com>
3. Contact your dealer for help BEFORE calling TYAN.
4. Check the TYAN user group: alt.comp.periphs.mainboard.TYAN

Returning Merchandise for Service

During the warranty period, contact your distributor or system vendor FIRST for any product problems. This warranty only covers normal customer use and does not cover damages incurred during shipping or failure due to the alteration, misuse, abuse, or improper maintenance of products.

NOTE: A receipt or copy of your invoice marked with the date of purchase is required before any warranty service can be rendered. You may obtain service by calling the manufacturer for a Return Merchandise Authorization (RMA) number. The RMA number should be prominently displayed on the outside of the shipping carton and the package should be mailed prepaid. TYAN will pay to have the board shipped back to you.



Notice for the USA

Compliance Information Statement (Declaration of Conformity Procedure) DoC

FCC Part 15: This device complies with part 15 of the FCC Rules

Operation is subject to the following conditions:

This device may not cause harmful interference, and

This device must accept any interference received including interference that may cause undesired operation. If this equipment does cause harmful interference to radio or television reception, which can be determined by turning the equipment off and on, the user is encouraged to try one or more of the following measures:

Reorient or relocate the receiving antenna.

Increase the separation between the equipment and the receiver.

Plug the equipment into an outlet on a circuit different from that of the receiver.

Consult the dealer on an experienced radio/television technician for help.

Notice for Canada

This apparatus complies with the Class B limits for radio interference as specified in the Canadian Department of Communications Radio Interference Regulations. (Cet appareil est conforme aux norms de Classe B d'interference radio tel que specifie par le Ministere Canadien des Communications dans les reglements d'interference radio.)



Notice for Europe (CE Mark)

This product is in conformity with the Council Directive 89/336/EEC, 92/31/EEC (EMC).

CAUTION: Lithium battery included with this board. Do not puncture, mutilate, or dispose of battery in fire. Danger of explosion if battery is incorrectly replaced. Replace only with the same or equivalent type recommended by manufacturer. Dispose of used battery according to manufacturer instructions and in accordance with your local regulations.

Document #: D1930 - 100