

# NEWMAR<sup>®</sup>

## DC Power Onboard<sup>SM</sup>



and shoes ■ Battery Chargers ■ DC Converters ■ Inverters ■ Power Supplies ■ Power Stabilizers ■ Inter  
ors ■ DC Power Conditioners ■ Electrical Panels ■ Meters ■ Digital Instruments ■ Installation Acces

# Battery Chargers - Phase Three Series



## Three Stage "Smart" Chargers

Phase Three "Smart" battery charging technology is now available in a wide range of power levels, allowing you to select the right size, features and flexibility you require for virtually any application from small recreational craft to large live-aboards, workboats and other commercial vessels. These chargers interact with batteries to put them through the optimum three stage charge process which provides for fastest recovery and ideal conditioning, maximizing battery performance and extending battery life.

A selector switch adjusts output voltage to adapt for gel-cell/flooded lead-acid/AGM battery types. An optional temperature compensation sensor also adjusts output for ideal voltage based on changes in the batteries' ambient temperature. All models are housed in a rugged stainless steel case with a durable white powder coat finish, and the internal circuitry is polyurethane coated for maximum corrosion resistance.

## Features

- "Smart" circuitry provides three stage charging—bulk, absorption, float.
- Wide model range covers battery system ratings from 14-950 amp-hours
- Gel-Cell/Flooded Lead-acid/AGM battery type switch selects optimum charge/float voltages.
- Multiple isolated output banks; ammeter indicates total output current. (except PT-7)
- Optional sensor adjusts output voltage based on battery temperature. (except PT-7)
- Current limiting-prevents damage from overloading.
- Charger status clearly displayed with L.E.D. and/or audible indicators or optional remote panel.
- Use as a power supply; can power loads without a battery in line.
- Built to last—rugged stainless steel case with a durable white powder coat finish with an optional drip shield and maritized internal circuitry.
- Numerous Safety and EMC Compliances
- Two year parts and labor warranty

## Models

12 Volt	24 Volt	32 Volt
PT-7	PT-24-8W	PT-32-25W
PT-14W	PT-24-13W	
PT-25W	PT-24-20W	
PT-40W	PT-24-45U	
PT-80	PT-24-60W	
	PT-24-95U	

See next page for detailed specifications.



## Optional Accessories

**Remote Indicator Panel.** Model: RP (Not available for all models - refer to Specifications on following page)

**DC Energy Monitor,** reads Volts, Amps, Amp Hours (See page 20 for details)

**Temperature Compensation Sensor,** Model: TCS-12/24 shown (see next page for applicable sensor depending on charger model)

## Phase Three Monitor/Control Unit For ABS Installation

This unit, when used in conjunction with certain PT Chargers\* creates a system which is fully compliant with American Bureau of Shipping (ABS) Battery Charging standards for commercial installations

\* For use with all models except PT-7, PT-24-60W, PT-24-95U, and PT-32-25.

## Incorporates

- Digital readout of float voltage to 1/10th volt
- Output float voltage adjustment pot; permits fine tuning from -4% to +5%
- AC circuit breaker; provides overcurrent protection and manual disconnect
- AC power ON indicator light
- 10' wiring harness for easy connection of PT Series charger

**Model:** PT-MCU

**Size (HxWxD):** 8.7"x4.6"x5.5"

**Weight:** 3.5 lbs.



DC Power Onboard

# Battery Chargers - Phase Three Series

## Specifications

	12 Volt Models					24 Volt Models					32 Volt	
	PT-7	PT-14W	PT-25W	PT-40W	PT-80	PT-24-8W	PT-24-13W	PT-24-20W	PT-24-45U	PT-24-60W	PT-24-95U	PT-32-25W
<b>Input VAC (50-60 Hz.)</b>	88-132 or 176-264	85-264	90-132 or 180-264	85-135 or 170-270	90-264	85-264	90-132 or 180-264	85-135 or 170-270	90-264	207-253	90-264	104-126
<b>Input Amps @ Full Load</b>												
@ 115 VAC	2	2.8	6.5	8.5	12	2.8	6.5	8.5	12	NA	26	15
@ 230 VAC	1	1.4	4	4.3	7	1.4	4	4.3	7	13	14	N/A
<b>P.F. Rating</b>	>.65	.93@230V .98@115V	.7	.7	.95@230V .98@115V	.93@230V .98@115V	.7	.7	.95@230V .98@115V	.7	.95@230V .98@115V	.7
<b>Max Output Amps</b>	7	14	25	40	80	8	13	20	45	60	95	25
<b>Output Banks</b>	2	3	3	3	3	3	3	3	3	3	3	3
<b>Battery Capacity (Amp-Hours)</b>	14-70	28-140	50-250	80-400	160-800	16-80	26-130	40-200	90-450	120-600	180-950	50-250
<b>Operating Temp. Rating Reference</b>	T-1	T-2	T-4	T-5	T-7	T-2	T-3	T-5	T-8	T-6	T-8	T-6
<b>Case Size Ref.</b>	A-1	A-2	A-2	A-3	A-5	A-2	A-2	A-3	A-5	A-6	A-6	A-4
<b>Weight; Lbs./Kg.</b>	3.2/1.5	8/4	8.2/4	12/6	15.2/7	8/4	8.2/4	12/6	12.2/6	24.1/11	24.5/11	12.2/6
<b>Optional Temp. Sensor Model</b>	N/A	TCS-12/24	TCS-12/24	TCS-12/24	TCS-12/24	TCS-12/24	TCS-12/24	TCS-12/24	TCS-12/24	TP	TCS-12/24	TP
<b>Remote Panel Model</b>	N/A	RP	RP	RP	RP	RP	RP	RP	RP	N/A	RP	N/A
<b>Equalize Option</b>	No	Yes	Yes	Yes	Yes	Yes	Yes	Yes	Yes	No	Yes	No
<b>Output Indicator Ref.</b>	M-1	M-3	M-3	M-3	M-3	M-3	M-3	M-3	M-3	M-2	M-3	M-2
<b>Compliance Ref.</b>	CG, CE	CG, CE	CG	CG, CE	CE	CG, CE	CG	CG, CE	EN, CE	EN, CE	EN, CE	EN, CE

**Case Size:**

Ref	Inches			Centimeters		
	H	W	D	H	W	D
A-1	10.5	5.0	2.8	26.7	12.7	7.1
A-2	12.5	7.7	4.3	31.8	19.6	10.9
A-3	13.85 <sup>*</sup>	9.5	4.8 <sup>*</sup>	35.2 <sup>*</sup>	24.1	12.2 <sup>*</sup>
A-4	13.8 <sup>A</sup>	9.8	5 <sup>A</sup>	35 <sup>A</sup>	24.9	12.7 <sup>A</sup>
A-5	14.8 <sup>B</sup>	9.6	5.6 <sup>B</sup>	37.6 <sup>B</sup>	24.4	14.2 <sup>B</sup>
A-6	17.5 <sup>C</sup>	12	7.2 <sup>C</sup>	44.5 <sup>C</sup>	30.5	18.3 <sup>C</sup>

*\* Add .75" (1.9 cm) to height and 1.35" (3.4 cm) to depth  
A Add 1.27" (3.2 cm) to height and 1.1" (2.8 cm) to depth  
B Add 1" (2.54 cm) to height and .5" (1.27 cm) to depth  
C Add 2" (5.08 cm) to height and 1" (2.54 cm) to depth*

## Compliance References\*:

See matrix for applicable models  
**CG** USCG CFR 183.410 (Ignition protected)  
**EN** EN 60335-1, EN 60335-2-29

**CE** Carries the CE Mark  
 \* Numerous other Safety and EMC compliances may also apply. Contact factory if further compliance information is required.

## Output Indicator References:

**M-1** Charge/Float L.E.D.  
**M-2** Total output ammeter and charger status L.E.D.'s/Alarms  
**M-3** Total output ammeter and power-on L.E.D.

## Typical Charge Curve

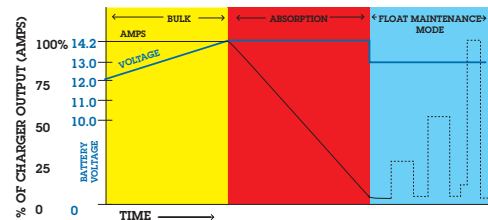

## Temperature Rating References:

**T-1** -10°C to +45°C; Derate linearly from 100% @ 0°C to 80% @ -10°C  
**T-2** -10°C to +60°C; Derate linearly from 100% @ 40°C to 60% @ 60°C  
**T-3** -10°C to +60°C; Derate linearly from 100% @ 50°C to 60% @ 60°C  
**T-4** -10°C to +60°C; Derate linearly from 100% @ 40°C to 60% @ 60°C  
**T-5** -40°C to +60°C; Derate linearly from 100% @ 50°C to 75% @ 60°C  
**T-6** -20°C to +50°C; Full output  
**T-7** -20°C to +70°C; Derate linearly from 100% @ 45°C to 50% @ 70°C  
**T-8** -20°C to +70°C; Derate linearly from 100% @ 50°C to 50% @ 70°C

## Nominal Output Voltages at Gel/Flooded Switch Settings

(without Temperature Compensation option installed or at 22.2°C (72°F) with Temperature Compensation option installed.)

Setting	12 Volt Models		24 Volt Models		32 Volt Model	
	Charge @ 50 % load	Float @ .5 amp load	Charge @ 50 % load	Float @ .5 amp load	Charge @ 50 % load	Float @ .5 amp load
Gel-Cell	14.0 VDC	13.6 VDC	28.0 VDC	27.2 VDC	37.3	36.2
Flooded/AGM	14.2 VDC	13.4 VDC	28.4 VDC	26.8 VDC	37.8	35.7

**Temperature Compensation:** - 5 mV per cell per °C. Sensor supplied with 25' cable (40' cable optional) and plug-in connector

**Protection (all models):** Input/Output Fuses, Current Limiting, Thermal Protection, Forced Air Cooling, Drip Shield

**Remote Panel, Model RP:** LED's indicate charger output stage. Manual reset button reinitializes three stage charge cycle. Supplied with 25' cable and plug-in connector. Panel dimensions: 3" H x 4.75" W



DC Power Onboard

# Battery Chargers - Phase Three Modular

Go to  
Webpage!

## *A Battery Charging System with Redundant, Easily Replaced Charge Modules Providing High Reliability and Serviceability*

### Reliability

- Redundant, independent, charger modules increase reliability – a malfunction of one does not disable the charging system; remaining modules continue to operate.

### Serviceability

- Module change-out takes only minutes, while the system continues to operate
- Technical personnel not required
- No need to remove the charger case from the boat or disconnect any wiring
- No inconvenience of power interruption to the boat

### Features

- Three stage "smart" charging; bulk, absorption, float
- Battery type selector switch; gel-cell, lead-acid, AGM
- Temperature compensated output option
- Numerous diagnostic and system status indicators
- 12 Volt; 33-100 amps or 24 Volt; 22-67 amps
- "Universal" input of 90-264 VAC, 50-60 Hz. – can be used anywhere in the world
- Powder coated stainless steel case

### The Phase Three Modular (PTM) Concept

Super yachts and commercial vessels have complex electrical systems that support equipment essential to safe operation. These boats are frequently in transit or in remote locations where repair/service is not readily available. Down-time can be very costly and severely impact sailing schedules.

Recognizing that all equipment has a finite service life and random component failure can occur at any time, system reliability can be improved by reducing the number of single points of failure, thus diminishing the impact of a solitary fault on the overall system. The PTM series applies this "fault-tolerant" concept to battery chargers, by using multiple independent charger modules within the unit.

The PTM consists of a case which serves as connection point to AC input and battery bank output, as well as three front-facing power bays, each accommodating a 550 watt charger module which slides and locks in place. If a module fault occurs, a front panel indicator is activated and the system continues operating.

Captains and owners will appreciate this system approach to reliability. A dead charger and dead batteries can disable a vessel, but with the PTM redundant charging system a fault in one of the modules is easily identified and it can be quickly replaced with an on-hand spare or an exchange unit from the factory, while the charging system continues to operate.



# Battery Chargers - Phase Three Modular

The Phase Three Modular (PTM) Series is a battery charging system consisting of a wall mount case, which serves as a connection point for AC input and battery bank output that accommodate up to three charging modules which slide and lock into front access power bays. Its redundant charger modules increase reliability, as the system remains operational in the event of a charger module fault. The system is easily and quickly restored to full output by simple module replacement.

The system features three stage charging for rapid recharge and optimal battery life. See pages 2 & 3 for a complete description of the three stage charging process.

## Specifications

System Model	Modules Installed*	Max Output Amps	Max Input Amps @ 115/230 VAC
PTMS-12-100	3	100 @ 12 V	18/9
PTMS-24-67	3	67 @ 24 V	18/9

## General System Specifications

**Input Voltage/Frequency:** 90-264 VAC, 47-63 Hz, single phase; derate linearly from 100% output @ 105 VAC to 80% output @ 90 VAC

**Power Factor:** .96-.99

**Efficiency:** 85% typical

**Nominal Charge/Float Voltages:** Refer to chart on page 3

**Temperature Compensation (Option):** - 5 mV per cell per °C (typical)

**Temperature Rating:** 0-60° C; derate linearly from 100% output @ 50° C to 80% output @ 60° C

**Recommended Battery Type/Capacity:** Gel-Cell, Flooded or Sealed Lead-Acid;

12 Volt Systems: 6 Cell, 80-400 A-H (per installed module); 240-1200 A-H (per system)

24 Volt Systems: 12 Cell, 40-200 A-H (per installed module); 120-600 A-H (per system)

**Output Battery Banks:** 3

**Module Bays:** 3\*

**Status Indicators:** Output OK, No Output, Check System, Battery Too Hot, Total Output Bar Graph, Output Voltage Test Points, Contacts for Optional Remote Alarm

**Case Material:** Powder Coated Stainless Steel

**Case Size:** Refer to diagram at right

**Weight:** Empty: 16 lbs/7.3 kg. - With three modules installed: 34 lbs/15.5 kg.

\* Note: Charge modules are shipped in the same carton as the PTM case and are then placed in position by the installer.

## Individual Module Specifications

**Models:** PTM -12-33 (12 volt); PTM-24-22 (24 volt)

**Input Voltage/Frequency:** 90-264 VAC; 47-63 Hz; derate linearly from 100% output @ 105 VAC to 80% output @ 90 VAC

**Input Current:** 3 amps @ 230VAC; 6 amps @ 115 VAC

**Power Factor:** .96-.99

**Efficiency:** 85% typical

**Protection Features:** Input Fuse, Output Fuse, Current Limiting, Over Voltage Protection, Cooling Fan, Automatic Thermal Shutdown/Recovery

**Compliances:**

CE Mark, UL Recognized; E183223, Level 3

Safety: EN60950-1 USA, Canada, Europe

EMI Radiated and Conducted: FCC Part 15 Level A; EN55022 Class A

**Status Indicators:** Output OK/FAULT

**Weight:** 6 lbs.

**Output Current:**

PTM-12-33: 33 amps max

PTM-24-22: 22.5 amps max in Bulk Phase;  
20 amps max in Absorption/Float Phases

## Optional

Temperature Compensation Sensor - Model TCS-12/24: See pages 2 & 3 for details

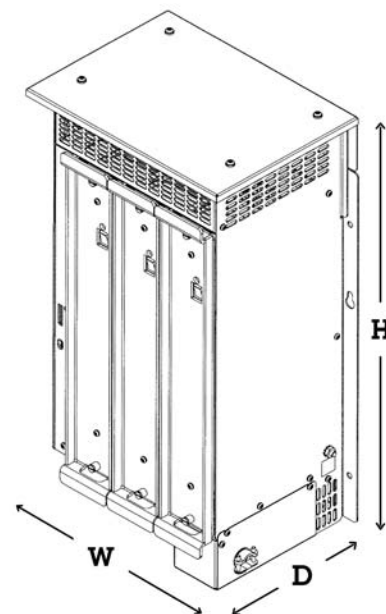

## Case Size

Inches			Centimeters		
H	W	D	H	W	D
20.9	10.9	8.8	53.1	27.7	22.4



DC Power Onboard

# Inverter-Chargers

## A Complete Line of High Power DC-AC Inverters with Built-in Battery Chargers.

The circuitry of these Inverter/Chargers incorporates a technology which is field-proven and was carefully refined for years in both harsh industrial and sensitive utility applications. Now this rugged design is offered for marine applications where reliability and performance are paramount, and low noise operation has become a critical factor in the boat owner's choice of power products.

While incorporating numerous important features these inverter/chargers are engineered with a high functionality approach that installers will appreciate. All connectors and mounts are heavy duty commercial grade.

Ten models are available for use with 12, 24 or 32 volt battery systems and provide continuous rated AC power ranging from 1800 to 4800 watts at 115 VAC-60 Hz. The dual voltage models are a new addition to the line, ideal for large yachts and commercial vessels with power requirements for both 115 and 230 VAC equipment.

Called the "Perfect Wave" Series, these inverter-chargers deliver pure, sinusoidal\* AC for flawless operation of all appliances and sensitive electronics. They are ideal for entertainment systems and micro-processor-based equipment such as computers which are intolerant to AC wave distortion.

*\* except model 2500IC, which produces quasi-sine wave*



All models incorporate a built-in automatic transfer switch which activates multi-stage battery charger for rapid and safe replenishment of the inverter battery bank whenever shore or generator AC power is available.

All models feature numerous circuit and safety protections, such as thermally controlled cooling fans, low voltage cutout, thermal and overload protection and ground fault interruption, and are housed in rugged powder coated aluminum cases suitable for permanent horizontal or bulkhead mounting. An optional remote indicator and control panel is available for all models.

### Features

- Rugged hostile environment-proven circuitry generates "Perfect Wave" AC for powering any appliance, from wattage-hungry refrigeration to highly input-sensitive computers, electronic controllers/processors.
- Built-in high output charger for rapid battery bank replenishment— all models feature three stage, temperature compensated charger with output programmable for gel-cell, flooded lead-acid or AGM battery type, and amp-hour capacity selector for proper charging in various applications.
- Internal charger is activated by an automatic transfer relay via remote sensor whenever external AC power is available. Optional Battery Integrator permits charging of multiple banks (see page 14)
- Designed for maximum ease of installation and operation— installer and user-friendly. Large DC input terminal blocks and front panel GFCI protected outlet receptacles. AC output from the inverter may also be hard-wired.
- All important aspects of inverter and charger operation clearly displayed with front panel status indicators - optional remote panel available.
- Numerous safety and circuit protections: short circuit, overload, over-temperature, ground fault protection, output circuit breaker

- Thermally controlled cooling fan prolongs life of components
- Automatic low voltage shutdown circuit prevents damage to batteries due to over-discharge when using inverter function.
- Heavy duty powder coated aluminum construction and polyurethane coated internal circuitry—built to last in the harsh marine environment.
- UL listed with full two year warranty

### Options/Accessories

- Remote control and indicator panel; ICR-2-25 provided with 25' of cable and ICR-2-50 provided with 50' of cable.
- Duplicates all status indicators found on unit front panel and allows remote ON/OFF capability
- Battery Integrator, Models BI-100, BI-200, and BI-24-100, enables of multiple isolated battery banks. (See page 14)
- AC and DC energy monitors. (See page 20)
- Inverter info center panel blanks. (See opposite page)
- High current fuse assembly. (See page 22)



Model: ICR-2-25 & ICR-2-50



DC Power Onboard

# Inverter-Chargers

## Specifications

Model	12-1800IC	12-2500IC	12-3000IC*	12-3000IC-DV*
<b>Inverter Output:</b>				
VAC	115V, 60 Hz.	115V, 60 Hz.	115V, 60 Hz.	115/230V, 60 Hz.
Watts (Surge)	4000	5500	6500	6500
Watts (Cont.)	1800	2500	3000	3000
Wave Type	PS	QS	PS	PS
<b>Inverter Input:</b>				
VDC	11-14	11-14	11-14	11-14
Max Amps	180	250	300	300
<b>Charger Input:</b>				
VAC	115V, 60 Hz.	115V, 60 Hz.	115V, 60 Hz.	230V, 60 Hz.
Max Amps	15	15	20	10
<b>Charger Output:</b>				
Max Amps@V	85A@12V	100A@12V	105A@12V	105A@12V
Type	three stage	three stage	three stage	three stage
<b>Case:</b>				
Size Reference	I-2	I-2	I-3	I-3
Weight: Lbs./Kg.	54/25	54/25	75/35	80/37
Model	24-2200IC	24-4800IC	24-4800IC-DV*	32-2400IC
<b>Inverter Output:</b>				
VAC	115V, 60 Hz.	115V, 60Hz.	115/230V, 60 Hz.	115V, 60 Hz.
Watts (Surge)	6500	14,000	14,000	6500
Watts (Cont.)	2200	4800	4800	2400
Wave Type	PS	PS	PS	PS
<b>Inverter Input:</b>				
VDC	22-28	22-28	22-28	29-38
Max Amps	110	240	240	100
<b>Charger Input:</b>				
VAC	115V, 60 Hz.	115V, 60 Hz.	230V, 60 Hz.	115V, 60 Hz.
Max Amps	15	40	15	15
<b>Charger Output:</b>				
Max Amps@V	40A@24V	105A@24V	105A@24V	30A@32V
Type	three stage	three stage	three stage	three stage
<b>Case:</b>				
Size Reference	I-2	I-3	I-3	I-2
Weight: Lbs./Kg.	57/26	95/43	80/37	59/27

\*Special Order Only – Contact Factory

## Charger Characteristics:

Three stage "smart charger"; programmable via selector switch for gel, flooded lead-acid or AGM battery type; temperature compensated. Output voltage temperature compensated via provided battery temp sensor with 20' cable

## Case Size References:

Case	Inches			Centimeters		
	H	W	D	H	W	D
I-2	7.5	16.0	15.5	19.1	40.6	39.4
I-3	10	17	16	25.4	43.2	40.6



## Protection Features (all models):

- Automatic low battery shutdown
- Output circuit breaker
- Auto high temperature shutdown/recovery
- Short circuit protection
- Overload protection

## Mechanical Features (all models):

- Thermally controlled cooling fan
- Dual GFCI protected duplex outlet
- AC hard-wire (optional)
- Powder coated aluminum case with shelf or bulkhead mounting flanges
- Polyurethane coated printed circuit boards

## Wave Type:

PS = Pure Sine QS = Quasi Sine

## Operating Temperature (all models):

-22° C to +40° C (0° F to 104°F)

**Inverter Regulation:** 120 VAC RMS (110V-127V)



# Battery Chargers - ABC Series

**Go to Webpage!**



ABC 12-25



ABC 12-8

## ABC Series

The ABC Series chargers have been in the Newmar line for 30 years. They utilize time tested SCR charging circuitry, individually sensing and regulating each of 2 isolated battery banks, allowing the user to leave the charger operating indefinitely, even under no-load conditions without fear of overcharging. These chargers are ideal for vessels or vehicles which have an intermittent demand for battery power.

(For battery systems which require high continuous output, see our Phase Three Chargers on pages 2-3)

These chargers are housed in a rugged, black anodized aluminum, heat-sink case which extracts heat without introducing dust and moisture to the inside of the unit.

The rugged and reliable ABC charger is employed in hostile environments throughout the world in recreation and commercial marine applications, off-shore oil platforms, in mining equipment, emergency service vehicles and rugged off-road applications.

They feature a total output ammeter, on-off power switch, power "on" indicator light, 115/230 VAC input selector switch, factory installed AC power cord with molded plug and shock-resistant rubber mounting grommets. Circuit boards are polyurethane conformal coated for corrosion resistance and all are protected against overheating by an automatically resetting thermal switch.

## Features

- Total output ammeter
- Dual independently regulated output banks
- On-off switch and power "on" indicator light
- Vibration absorbing mounting grommets
- Anodized aluminum case
- 115/230 VAC input selector switch
- Auto-reset thermal breaker
- Conformal coating of circuit board

## Specifications

Model	Input	Amps @ F. L.	Output			Inches			Centimeters			Weight	
			Volts	Banks	Amps	H	W	D	H	W	D	(Lbs)	(Kg)
ABC 12-8	105-125 VAC or 210-250 VAC	1.5/.75	12	2	8	8.0	6.0	4.2	20.3	15.2	10.6	9	4.1
ABC 12-25	50-60Hz	5/2.5	12	2	25	11.9	4.7	6.2	30.2	11.9	15.8	14	6.4

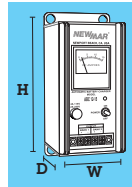

## Typical Charge Curves ABC Series

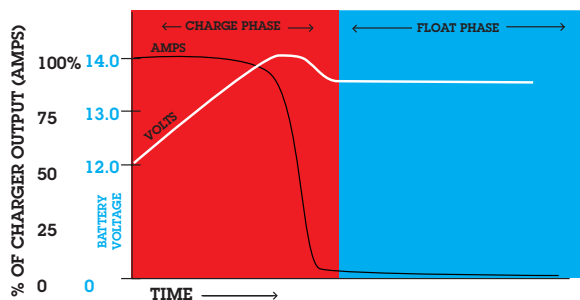

**Duty Cycle Ratings:** Rated Charging Output 20 min., derate to 50% for continuous output

**Operating Temperature:** 0-40°C

**Float Voltage:** 13.4 VDC

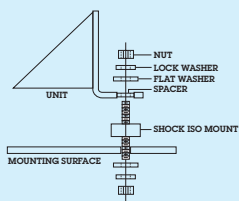

### Option: Extreme Vibration Mounting Kit

The Extreme Vibration Mounting Kit is available to protect NEWMAR power converters from the extreme stresses of shock and vibration when mounted on high-vibration vehicles.

The kit (pictured here) replaces the standard vibration kit provided with the unit and fits into the unit's mounting flange to act as a "super shock absorber" for electronics in high-vibe applications. It is available to fit all NEWMAR units from 2 to 70 lbs. Specify KIT-L for units which weigh 2-15 lbs. and Kit-H for units which weigh 16-70 lbs.



# DC-DC Converters - Standard & Isolated Series

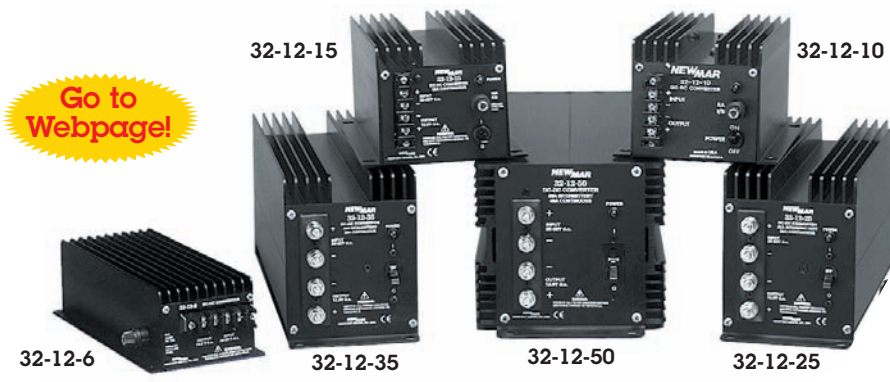

## Standard Series

Convert 20-50 VDC to 12 or 24 VDC output for powering communication/navigation equipment, on negative ground systems. (See Isolated Series, below for positive ground applications.) Ideal for powering voice, data and navigation transceivers in mobile and marine applications.

- Excellent Regulation: Output voltage maintained within 1% under all line and load conditions within rating.
- Heat generated by semi-conductors is extracted and dissipated by large heat sink fins that maximize air contact for cool operation and long life of components.
- Polyurethane conformal coating on PC boards and corrosion-resistant anodized aluminum case with heavy duty shock mounts assure survival in hostile environments.
- Numerous converter and load protection circuits: Current limiting\*; automatic thermal shutdown; short circuit proof\*; reverse polarity and overvoltage protection\*.
- \* Except 3 Amp. Model.
- Carries the CE mark

## Isolated Series

Same features as Standard Series, but with the additional capability of permitting connection of negative ground gear to positive or floating ground battery systems, or vice-versa. Many models may also be used as 12 or 24 volt stabilizers for highly input voltage sensitive equipment (see page 13).

**Input range:** 10-56 VDC; positive, negative or floating ground.

**Output:** 12 or 24 VDC, 3 to 35 amps.

## Options

- 24 VDC output (see specs at left)
- Operation as battery charger or parallel redundant operation\* – derate to continuous duty rating (contact factory)
- Extreme vibration mounting kit. (See page 10)

\* Except Model: 24-12-3

## Case Size

Ref.	Inches			Centimeters		
	H	W	D	H	W	D
C-1	2.7	4.5	6.0	6.9	11.4	15.2
C-2	4.5	5.9	11.0	11.4	15.0	27.9
C-3	6.0	4.7	14.0	15.2	11.9	35.6
C-4	6.0	4.7	16.0	15.2	11.9	40.6
C-5	6.2	6.8	18.1	15.7	17.3	46.0
C-7	4.25	5.9	7.7	10.8	15.0	19.6
C-8	4.25	5.9	14.0	10.8	15.0	35.6
C-9	6.0	6.8	16.5	15.2	17.3	41.9
C-10	2.8	4.2	10.4	7.1	10.7	26.4
C-11	3.5	3.5	1.75	8.9	8.9	4.5

NEW

Model	Input voltage	Output voltage	Output Amps		Case Size	Weight	
			Intermittent	Continuous		(Lbs)	(Kg.)
<b>Standard Series</b>							
24-12-3	17-32	13.6	3	3	C-11	1	.45
32-12-6	20-50	13.6	6	6	C-10	2.5	.9
32-24-6	32-50	24.5	6	6	C-10	2.5	.9
32-12-10	20-50	13.6	10	10	C-2	4	1.8
32-24-10	32-50	24.5	10	10	C-2	4	1.8
32-12-15	20-50	13.6	15	15	C-2	5	2.3
32-24-15	32-50	24.5	15	15	C-2	5	2.3
32-12-25	20-50	13.6	25	20	C-3	7.5	3.4
32-24-25	32-50	24.5	25	20	C-3	7.5	3.4
32-12-35	20-50	13.6	35	30	C-4	12	5.5
32-24-35	32-50	24.5	35	30	C-4	12	5.5
32-12-50	20-50	13.6	50	40	C-5	16	7.3
32-24-50	32-50	24.5	50	40	C-5	16	7.3
<b>Isolated Series</b>							
12-12-12I	10-16*	13.6	12	8	C-8	6	2.7
12-24-6I	10-16*	24.5	6	4	C-8	6	2.7
12-12-35I	10-16*	13.6	35	20	C-9	12	5.5
12-24-18I	10-16*	24.5	18	10	C-9	12	5.5
48-12-6I	20-56	13.6	6	6	C-7	7	2.7
48-24-3I	20-56	24.5	3	3	C-7	7	2.7
48-12-12I	20-56	13.6	12	8	C-8	6	2.7
48-24-6I	20-56	24.5	6	4	C-8	6	2.7
48-12-18I	20-56	13.6	18	10	C-8	8	3.6
48-24-9I	20-56	24.5	9	5	C-8	8	3.6
48-12-35I	20-56	13.6	35	20	C-9	12	5.5
48-24-18I	20-56	24.5	18	10	C-9	12	5.5

\*11.5 VDC minimum start-up voltage, then operates @ 10-16 VDC from 1 amp minimum to full load

## Performance Specifications – Standard & Isolated Series

**Output:** 13.6 VDC (internally adjustable 12.6-14.5) or 24.5 VDC (or specify) - except 24-12-3

**Ripple:** 150 mV P-P maximum

**Regulation:** Standard: 1% Line/Load  
Isolated: 2% Line/Load

### Duty Cycle Ratings\*

Intermittent - 20 minutes max on 20% duty. Current limit set at approx. 105% of intermittent rating

\*24-12-3: 2 minute max. on time

Continuous - 24 hours, 100% duty

**Idle Current:** Standard Series: Less than 100 mA (including power "ON" light)  
Isolated Series: approx. 50 mA

**Operating Temp:** 0-50° C,  
Derate Linearly From 100% @ 40° C to 50% @ 50° C Thermal shutdown @ 70° C Case Temperature

**Model 24-12-3I:** Full Output -25° C to +30° C; Derate linearly from 100% @ +30° C to 45% @ +50° C

**Switching Frequency:** Standard: 40 Khz  
Isolated: 70Khz

**Efficiency:** 85% - Typical.

### Isolation -

**Output/Chassis: Input/Chassis:** 250 VDC  
**Input/Output:** 250 VDC (Isolated Series only)

**Certification:** Carries the CE mark (Standard Series only)



# Power Supplies - Heavy Duty Series

Go to Webpage!



## Specifications

Model	Nominal Input VAC	Output Amperage		Case Size Ref.	Weight	
		Intermittent	Continuous		Lbs.	Kg.
<b>12 Volt Output</b>						
115-12-8	115/230	8	5	P-2	10	4.5
115-12-20A	115/230	20	8	P-3	20	9.1
115-12-35CD	115/230	35	35	P-5	32	14.6
<b>24-Volt Output</b>						
115-24-10	115/230	10	4	P-3	20	9.1
115-24-18CD	115/230	18	18	P-5	32	14.6
115-24-35CD	115/230	35	35	P-6	60	27.3

## Case Size

	Inches			Centimeters		
	H	W	D	H	W	D
<b>P-2</b>	6.0	4.6	8.5	15.2	11.7	21.6
<b>P-3</b>	5.7	4.8	16.3	14.5	12.2	41.4
<b>P-5</b>	6.5	9.5	14.0	16.5	24.1	35.6
<b>P-6</b>	6.5	13.0	18.75	16.5	33.0	47.6

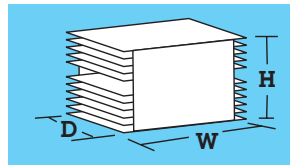

## Output Voltage

### 12 V Models:

13.6 VDC (Internally adjustable 12.6-14.5 VDC)  
Ripple: 40mV P-P (@ 110-125/220-250 VAC input)

### 24 V Models:

24.5 VDC (Internally adjustable 21-27.5 VDC)

Note: When modified for battery charger operation output voltage is factory set at 27.2 VDC

Ripple: 70mV P-P (@ 110-125/220-250 VAC input)

**Regulation All Models:** 1% Line and Load (@ 110-125 / 220-250 VAC input)

## Heavy Duty Series

- Designed for powering 12 and 24 VDC communication/navigation equipment aboard commercial vessels where reliability is the primary consideration.
- Input voltage 115 or 230 VAC selected by slide switch on the front panel.
- Excellent Regulation and Ripple Spec: Output voltage maintained within 1% under all line and load conditions within rating; Ripple is less than 40 mV P-P. (12 volt) or 70 mV P-P (24-volt).
- Polyurethane conformal coated PC board and corrosion resistant heavy duty aluminum case with integral shock mounts assures survival in hostile environments.
- Heat generated by semi-conductors is extracted and dissipated by large heat sink fins that maximize air contact for cool operation and long life of components.
- Supply and Load Circuit Protection: overvoltage, current limit; (set @ 105% of intermittent rating), thermal overload and input/output fusing.
- Thermally activated cooling fan on "CD" units.

## Input Range

105-125/210-250 VAC (selectable), 50-60 Hz  
Derate to 50% output below 110 and 220 VAC

## Operating Temperature

### Standard Units

0-50°C, Derate Linearly From 100% @ 40°C  
To 50% @ 50°C Thermal shutdown @ 85°C  
Case temperature

### C.D. Units

0-65°C, Derate Linearly From 100% @ 50°C  
To 50% @ 65°C Thermal Shutdown @ 85°C  
Case temperature

## Duty Cycle

**Intermittent:** 20 minutes max on time,  
20% duty

**Continuous:** 24 Hours/Day 100% Duty

## Options

- Use as a Battery Charger
- Output voltage adjust (see Output Voltage for range)
- Transfer relay for back up battery in event of power failure (ERC option see page 15)

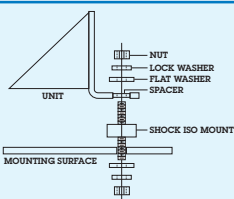

### Option: Extreme Vibration Mounting Kit

The Extreme Vibration Mounting Kit is available to protect NEWMAR power converters from the extreme stresses of shock and vibration when mounted on high-vibration vehicles.

The kit (pictured here) replaces the standard vibration kit provided with the unit and fits into the unit's mounting flange to act as a "super shock absorber" for electronics in high-vibe applications. It is available to fit all NEWMAR units from 2 to 70 lbs. Specify KIT-L for units which weigh 2-15 lbs. and Kit-H for units which weigh 16-70 lbs.

# Power Supplies with Built-In Battery Back-up

## Power-Pac

Designed for critical applications such as VHF shore stations that must remain on the air, even during a power outage. The 12 volt supply features built-in back-up batteries which are charged during normal operation and then continue to power radios even when AC power is lost.

- Highly regulated, low ripple output for noise-free radio operation
- Battery automatically comes on-line if AC fails
- Low battery alarm and disconnect, with override switch for emergency power

## General Specifications

- Input:** 115/230 VAC, 50-60 Hz.
- Output:** 13.6 VDC @ 5A cont., 10A Int.
- Regulation:** 1% line and load
- Ripple:** 1% P-P
- Operating Temp:** 0-40° C

## Models:

- Power-Pac 7 A/H** (w/7 amp/hour battery), 18 lbs.
- Power-Pac 14 A/H** (w/14 amp/hour battery), 24 lbs.
- Dimensions** (both models): 5.3" H x 9.0" W x 10.5" D

## Options:

- External battery packs available, contact factory for information on BM Series
- Also available without batteries installed; contact factory (subtract 15 lbs. from unit weight)



## Integrated Power System

Precision-regulated power supply with built-in batteries, status indicators, alarms and low voltage disconnect. Ideal for GMDSS consoles and base stations. Rear terminals provided to expand back-up capacity by wiring additional batteries. 19" or 23" rackmount standard. Bulkhead/shelf mounting bracket optional. 115/230 VAC, 50-60 Hz input all models.

Model	Output		Internal Battery Capacity	Ground Reference	Weight		Case Size Inches H x W x D
	VDC	Amps Continuous			Lbs	Kg.	
IPS 12-40	13.6	40	16 A-H	Negative	32	14.6	3.5 x 17 x 19.5
IPS 24-22	27.2	22	8 A-H	Negative	32	14.6	3.5 x 17 x 19.5
IPS 48-11	54.4	11	4 A-H	Positive	32	14.6	3.5 x 17 x 19.5

# Power Modules & Power Function Manager

## Power Modules

Power Modules function as power supply or battery charger; 12, 24 or 48 volts; positive, negative floating ground. Wire in parallel to create systems from 500-6,000 watts. Optional quick connect wiring kit allows swap-out of modules without system shutdown. 115/230 VAC, 50-60 Hz input. 19" or 23" rackmount standard. Bulkhead/shelf mounting bracket optional.



Model	Input Amps @ F.L. 115/230V	Output		Weight	
		VDC V OUT	Amps Cont. +	Lbs	Kg.
PM-12-40	8.5/4.3	13.6	40	12.2	5.5
PM-12-70	16/8	13.6	70	15.2	6.9
PM-24-20	8.5/4.3	27.2	20	12.2	5.5
PM-24-35	16/8	27.2	35	15.2	6.9
PM-24-80	*/22	27.2	80	34	15
PM-48-10	8.5/4.3	54.4	10	12.2	5.5
PM-48-18	16/8	54.4	18	14.0	6.4
PM-48-50	*/22	54.4	50	34	15

+ For parallel configuration/load sharing derate output 10%

## Power Function Manager



Power Function Manager converts ordinary power supplies (or Power Modules, at left) into a fully integrated and ideally functional complete power system. The unit provides control, monitoring, paralleling and protection of 12, 24 or 48 VDC, positive, negative or floating ground power sources.

- Heavy duty (400 amp) input power parallel tie point
- Digital output monitoring of system voltage and amperage
- System status lights
- Five distribution circuit breaker capacity
- Auto low voltage or manual battery disconnect
- Summary alarm contacts

## Model: PFM-400

19" or 23" rackmount only; 2 RU (3.5") high

## Case Size - PM and PFM

Inches			Centimeters		
H	W*	D	H	W*	D
3.5	17	20.5	13.5	43.2	52.1

\*19" and 23" mounting brackets provided



DC Power Onboard

# DC Power Conditioners

Go to  
Webpage!

## StartGuard

The abrupt DC system voltage drop that accompanies engine starting can cause microprocessor-driven communication and navigation electronics to "dump" programmed memory.



StartGuard solves this problem by providing supplemental voltage to sensitive electronics while the engine is cranked. It contains a sealed rechargeable battery which is switched on-line to electronics when the starter switch or solenoid is engaged. When the engine is running StartGuard automatically goes off-line and the internal battery is recharged by the alternator.

## Specifications

**Input Voltage:** 13.8 - 14.8 VDC nominal, 15.5 VDC max.

**Relay Activation Input Voltage:** 7-15 VDC

**Output:** 20 amps max.

**Battery:** 12 VDC, sealed rechargeable,

5 - 7 year life (typical)

5 amp-hour capacity

Certified by DOT and IATA for shipment by air

Replacement battery P/N: 591-0412-0

**Back-up Capacity (Fully Charged):** (See matrix below)

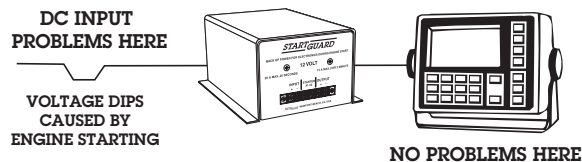

Model	Input	Back-Up Capacity		Dimensions		Weight	
		1 Minute	2 Minutes	Inches	Centimeters	Lbs	Kg.
NS-12-20	13.8-14.8 VDC Nominal 15.5 VDC Max	20 amps	15 amps	8.25 x 4.9 x 3.5	20.1 x 12.5 x 8.9	5.5	2.5



## NAV-PAC®

Marine communication/navigation electronics such as programmable data transceivers, GPS and other microprocessor-controlled devices require clean and steady DC input power. Their sensitive circuitry is highly vulnerable to voltage drop from engine start, noise and line spikes from alternators and motors, and conducted noise from various other electronic devices. NAV-PAC prevents these conditions from affecting electronics.

- Prevents voltage "drop-out" to electronics during engine start
- Absorbs line "spikes"
- Filters out electrical interference
- Provides supplemental voltage/battery back-up for up to 15 min.
- Remote monitor panel included.

U.S. PATENT #: 5172292

**Model:** NP-12

**Input Voltage:** 13.8-14.8 VDC nominal, 15.5 VDC max.

**Output:** 20 amps Max. @ 12 Volt

**Back-Up Power:**

7 Amps for fifteen (15) minutes

10 Amps for eight (8) minutes

15 Amps for two (2) minutes

20 Amps for one (1) minute

**Battery:** Sealed Rechargeable 5.0 Amp-Hour, 5-7 years typical life, can be replaced. Low-voltage disconnect circuit protects battery from total discharge. Certified by DOT and IATA for shipment by air. Replacement battery P/N: 591-0412-0

**Noise Filtering:** Audio through 200 MHZ

**Voltage Spike Protection:**

Transient energy capability; 100 Joules, 4,000 amps Max (8 x 20 micro seconds)

**Size ( H x W x D):**

5.25" x 6.2" x 7.4"

13.3 x 15.7 x 18.8 cm

**Weight**

5.9 lbs.,

2.7 Kg.,

**Panel Dimensions:** 3.5" W x 2" H (8.9 x 5.1 cm)

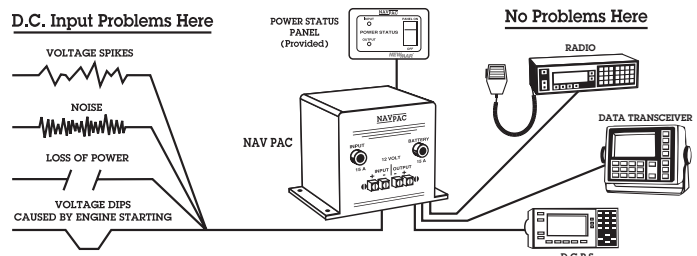

**NEWMAR**

DC Power Onboard

# DC Power Stabilizers

**New**



12-12-31



24-24-71

**Go to Webpage!**



12-12-12I

## 12 & 24 Volt Stabilizing Converters

Feed sensitive electronics with proper voltage regardless of battery condition. These stabilizing converters provide continuous, precisely regulated output over the entire range of a battery's usable voltage. This prevents subjecting loads to fluctuating input voltage which can cause shutdown, diminish performance and possibly damage sensitive circuitry.

### Application Benefits Include:

- Operate electronics at optimal input voltage, even from nearly drained batteries
- Boost voltage to compensate for voltage drops in long wire runs from batteries
- Eliminate voltage drops during momentary high current drain from batteries, as during engine start
- Eliminate voltage fluctuation from charge sources
- Eliminate voltage overshoot due to sudden removal of high current load

These converters provide total input/output isolation, virtually eliminating conducted line noise and permitting connection of negative ground gear to positive or floating ground systems, or vice versa. The rugged anodized aluminum case is ideal for marine and mobile applications.

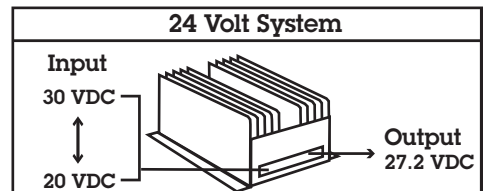
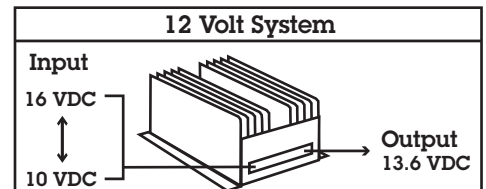

Model	Input voltage	Output voltage	Output Amps Intermittent	Case Size	Weight (Lbs) (Kg.)
12-12-3I	10-16	13.6	3	C-4	1 .45
12-12-6I	10-16	13.6	6	C-4	1 .45
12-12-12I	10-16*	13.6	12	C-2	6 2.7
12-12-35I	10-16*	13.6	35	C-3	12 5.5
24-24-3I	20-32	27.2	3	C-3	12 5.5
24-24-7I	20-32	27.2	7	C-5	2 .9
48-24-9I	20-56	24.5	9	C-2	8 3.6
48-24-18I	20-56	24.5	18	C-3	12 5.5

\*11.5 VDC minimum start-up voltage, then operates @ 10-16 VDC from 1 amp minimum to full load

### Case Size

Ref.	Inches			Centimeters		
	H	W	D	H	W	D
C-1	4.25	5.9	7.7	10.8	15.0	19.6
C-2	4.25	5.9	14.0	10.8	15.0	35.6
C-3	6.0	6.8	16.5	15.2	17.3	41.9
C-4	3.5	3.5	1.75	8.9	8.9	4.5
C-5	7.0	3.5	1.75	17.8	8.9	4.5



DC Power Onboard



## Battery Isolators

These heavy duty isolators allow charging multiple batteries automatically from one or two alternators, and prevent discharge or "dumping" of one battery into another. Each battery is charged according to its need without overcharging. Rated for 12-48 volt negative ground DC systems. Feature conservatively rated diodes and a rustproof anodized aluminum heat sink case. Models are available for 70, 120 and 165 amp alternators.

Model	Alternator Sources	Battery Bank	Max Amperage Input	Weight		Dimensions		
				Lbs	Kg	L	W	H
1-2-70	1	2	70	2	.9	3.25	4.5	3.1 in
						8.3	11.4	7.9 cm
1-3-70	1	3	70	2	.9	3.25	4.5	3.1 in
						8.3	11.4	7.9 cm
2-3-70	2	3	70	4	1.8	6.5	4.5	3.1 in
						16.5	11.4	7.9 cm
1-2-120	1	2	120	3	1.4	6.5	4.5	3.1 in
						16.5	11.4	8.0 cm
1-3-120	1	3	120	3	1.4	6.5	4.5	3.1 in
						16.5	11.4	8.0 cm
2-3-120	2	3	120	5	2.3	12.5	4.5	3.1 in
						30.5	11.4	7.9 cm
1-3-165	1	3	165	5	2.3	9	4.5	3.1 in
						22.9	11.4	8.0 cm

Application Note: Battery Isolators may also be used to facilitate N+1 parallel/redundant operation of power supplies. Contact factory.

## Features:

- Heavy duty construction
- Rated for systems up to 48 volts DC, negative ground
- Rust-proof anodized aluminum case
- Stainless steel mounting hardware provided
- Protective covers provided for terminals

## Performance Specifications

**Operating temperature:** -40 to +80° C

**Duty cycle:** Continuous rating to 50° C

Derate linearly to 70% @ 80° C

**Temp. rise:** 95° C at full rated current (mount vertically for optimum cooling)

**Voltage drop:** 0.7V @ 50% load  
0.9V @ full load

*Note: These battery isolators are not compatible with self exciting alternators. Please consult the manufacturer of your alternator if you are unsure of your configuration.*



## Battery Integrator

Charging multiple battery banks without use of diode isolators dictates that the batteries be connected or "integrated" only

whenever a charge voltage is present so that they

may be charged simultaneously, then disconnected or "isolated" when in use to allow for selective discharge and avoid having the secondary or standby battery drain into the primary battery.

Battery Integrators perform this function automatically, acting as a "smart" switch to connect independent battery banks only when a charging voltage is present. Otherwise, they are isolated, and discharge between banks is prevented.

## Features

- Enables charging of two separate banks without voltage drop, yet maintains 100% isolation at all other times. For systems of three banks or more, an additional unit must be installed for each additional bank
- Heavy duty silver-plated contactor, continuous duty rated
- Voltage sense circuit, epoxy encapsulated and heavy duty continuous rated solenoid are all designed for use in marine environments
- 12 volt model has ignition protection rating
- Easy three-wire hook up for two bank systems (BATT +, BATT +, GROUND)
- Terminal for optional wiring of remote light indicating when battery banks are integrated
- Optional internal connection can be wired though key starter or manual override switch, tying battery banks together for extra boost during engine start

## Specifications

**Models:** BI-100; BI-200; BI-24-100

**Battery Integration Connect Point:**

13.2 VDC (approx.)

26.4 VDC (approx.)

**Battery Disconnect Point:**

12.8 VDC (approx.)

25.6 VDC (approx.)

**Maximum Continuous Current:**

100 amps (100 amp models)

200 amps (200 amp model)

**Peak Maximum Current:**

400 amps (100 amp models)

600 amps (200 amp model)

**Operating Temperature:**

Control: -40 to +85° C

Solenoid: -28 to +48° C

**Terminals:** Battery Connections:

5/16" copper alloy stud

**Dimensions (H x W x D):**

3" x 3.25" x 2.5"

**Weight:** 1 lb.

## Automatic Power Selector

The Automatic Power Selector (APS) is a solid state device which enables installation of a seamless, redundant power system for critical electronic loads. It selects the higher voltage of two isolated DC power sources and routes power to the load. Should one source falter or fail, the other will automatically supply the load with no transfer delay, operation continues uninterrupted.

Easy installation, two independent power sources are wired to the APS and routed in a single output to the vital load. Rugged, rust-proof anodized aluminum case.

## Models:

**APS-70** Max. Load 70 amps, 3.25" x 4.5" x 3.1", 2 lbs..

**APS-160** Max. Load 160 amps, 9.0" x 4.5" x 3.1", 5 lbs.

**Voltage Rating:** 6-50 VDC, neg. ground



APS-70

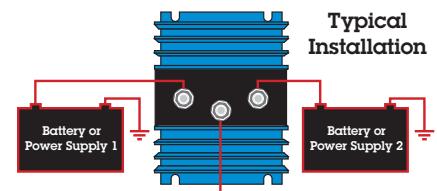

Critical Electronics

## Low Voltage Disconnect - LVD

Discharging batteries beyond a critical low voltage can damage the batteries and/or load, and require a longer recharge interval. A low voltage disconnect prevents this condition.

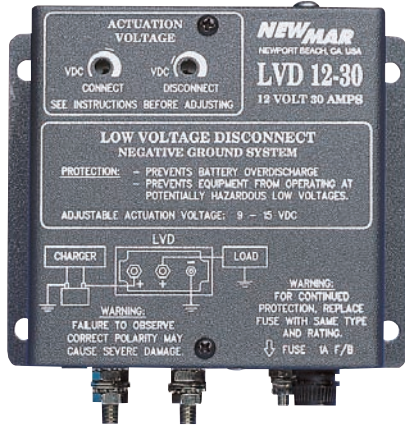

The LVD contains a sense and control circuit housed in a compact, rugged, vinyl-clad aluminum case. It is installed in-line between the battery and the load. The unit continually monitors battery voltage and if it falls below a preset voltage threshold, the load is automatically disconnected. When batteries are recharged past another pre-set voltage the load is reconnected. Connect and disconnect points are user adjustable.

### Models:

- LVD 12-30, LVD 12-75 (Neg. Ground)
- LVD 24-50 (Neg. Ground)
- LVD 48-30 (Pos. Ground)

### Specifications

Factory Set Actuation Voltages:	12 VOLT	24 VOLT	48 VOLT
Disconnect	10.4 VDC	21.0 VDC	42.0VDC
Connect	12.2 VDC	24.5 VDC	49.0VDC

### Voltage and Contact Current Ratings:

Indicated By Model Number  
(i.e., LVD 12-30 = 12 Volts, 30 Amps Continuous)

**Dimensions** (Mounted vertically, all models): 5.25" H x 5.25" W x 3.5" D  
**Weight:** (All models): 1 LB.

### Typical LVD Installation

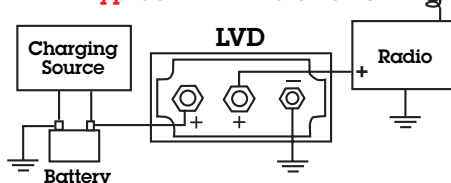

## Emergency Relay/Charger - ERC

The E.R.C. allows emergency battery tie-in to a radio system that is normally operated by a power supply.



Under normal conditions the radio is connected through the ERC to the power supply and the back-up battery receives only a trickle charge to keep it in peak condition.

In the event of AC power failure a relay automatically connects the radio to the back-up battery, restoring the system within one second. When AC power is restored the radio is automatically reconnected to the power supply and the trickle charge resumes to the battery.

Available in 12 or 24 VDC, 15 or 35 Amp ratings, (not ignition protected.)

### Application notes:

- 1 sec. switch over delay may not be suitable for data transceivers, use instead a system where the battery is floated on output of power supply – see Power-Pac or IPS (pg 11) or APS (pg 14).
- Trickle charge current will maintain a back up battery and will slowly restore a deeply discharged battery. A separate high current charging source is recommended for deep discharge recovery.

### Specifications

ERC Model	Amps Int.Cont.	Size-inches H	Size-inches W	Size-inches D	Lbs	Kg
12-15	15	10	2.25	2.875	4	1.5
24-15	15	10	2.25	2.875	4	1.5
12-35	35	30	3.875	2.875	4	2.9
24-35*	35	30	3.875	2.875	4	2.9

\*Built to order

### Typical Trickle Charge Current:

1.5 amps – will vary depending on power supply voltage and battery condition.

### Optimal Power Supply Voltage:

12 volt systems: 13.4 - 14.0 VDC  
24 volt systems: 26.8 - 28.0 VDC

### Typical ERC Installation

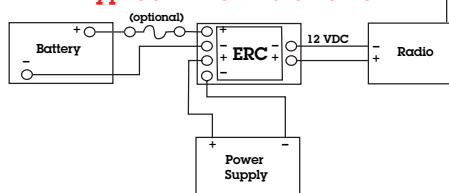

## Lamp Dimmer System

Adjust DC lights to ease eye strain and enhance night vision. Light intensity is easily regulated by remote panel.



### Control Panel - LDP

5000 Ohm dimmer control panel adjusts brightness between Off and 85% of full voltage. Black anodized aluminum panel.  
**Size:** 3" x 3" (7.6 x 7.6 cm)



### Dimmer Unit - LD

100 watt capacity, for 12, 24, and 32 VDC systems. Rugged anodized aluminum heat sink case.

**Size:** 9" x 4.5" x 2.75"; 2 lbs.  
22.9 x 11.4 x 7cm. .9 Kg.

### Model: LD Panel

Control Panel

### Model: LD

Dimmer only (no panel)

### Typical LD Installation

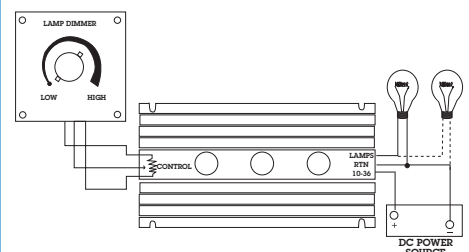



ES-1

## ES-1 DC Master Panel

This DC master control panel offers a large DC circuit capacity and full metering.

### Features:

- Analog DC volt and ammeter, back illuminated with dimmer.
- 4 battery bank test switch.
- DC master breaker (100 Amp standard; 50 or 75 amp optional)
- 22 branch circuit capacity, 20 installed standard; 3-5A, 5-10A, 6-15A, 6-20A or specify
- Red circuit "on" indicator lights.
- LS-III Label set included.
- Multiple position ground Bus Bar included.
- Size: 10"W x 15"H x 4" D, (25.4 X 38.1 X 10.2 CM), Weight 8 lbs., (3.6 Kg.)

Because of their exact height match and style compatibility, the panels below are ideal companions for expanding circuit capacity of the ES-1 or ES-5, or they may be used as stand-alone load centers.



ES-6

## ES-6 DC Load Center

### Features:

- Accommodates one meter; analog standard. (DC 0-50A ammeter standard), or specify DC volts
- Master breaker (DC-75 amp standard; 50 or 100 amp optional, single pole)
- 10 branch circuit capacity, 8 installed standard:  
1-5A, 2-10A, 4-15A, 1-20A
- Indicator lights on every circuit.
- LS-III set included.
- Multiple position ground Bus Bar included.
- Size: 5 1/4" W x 15" H x 4" D, (13.3 x 38.1 x 10.2 cm)

## ES-7 AC or DC Accessory Panel

### Features:

- AC or DC master breaker (AC 50 amp\* standard, 30 amp optional, double pole or DC 100 amp standard; 50 or 75 amp optional, single pole.)
- 16 branch circuit capacity, 12 installed standard:  
ES-7A: 2-10A, 5-15A, 5-20A  
ES-7D: 2-5A, 3-10A, 5-15A, 2-20A
- Indicator lights on every circuit.
- LS-III label set included.
- Multiple position ground Bus Bar included.
- Size: 5 1/4" W x 15" H x 4" D, (13.3 x 38.1 x 10.2 cm)  
Weight: 7 lbs., (3.2 Kg.)

\* Note 50 amp master OK for use on 230 VAC line-to-line systems. For 230 VAC line-to-neutral systems 30 amp is maximum master breaker value.



ES-7

## Options

### Meters:

Standard installed voltmeters are for 12 VDC or 115 VAC applications. (Ammeter range depends on master breaker value.) Optional voltmeters may be installed for 24 VDC or 230 VAC applications. Contact the factory for a complete list of metering options

### Alternate Circuit Breaker

#### Configurations:

Changing circuit breaker value mix or location is never a problem! Simply advise us of the breaker arrangement you need. (Panel specific illustrated order forms listing all options are available at [www.newmarpower.com](http://www.newmarpower.com).) Please allow 3-5 days additional lead time to complete the modification.

Note: There is a mod. fee for special configurations – contact factory.

### Installation Cut-Out Dimensions

Model	Inches (H x W)	Centimeters (H x W)
ES-1	9 X 14	22.9 X 35.6
ES-3	13 X 8.8	33 X 22.4
ES-4	16.8 X 10.8	42.7 X 27.4
ES-5	19 X 13	48.3 X 33
ES-6D	4.5 X 13	11.4 X 33
ES-7A & 7D	4 X 13.8	10.2 X 35.1



# Electrical Panels – Elite Series

## AC-DC Master Control

Locating all AC and DC functions on one panel provides a vessel with a central load distribution and monitoring center. Features common to all models include:

- Complete metering of voltage and current on AC and DC systems. Back-lit analog meters are standard.
- AC master breaker(s) with reverse polarity warning light.
- Power "on" indicator lights on all circuits.
- Four battery bank voltage test switch
- Deluxe label set (LS-III) included, 206 functions.
- Multiple position ground bus bar
- Rating 115/230 VAC, 65 VDC

## ES-4

Large 3 1/2" scale meters and an ample circuit breaker capacity makes this the panel of choice for boats in the 35'-45' range. Circuit specifications listed at bottom of page. 17" W X 12" H X 4" D, 12 lbs (43.2 X 30.5 X 10.2 cm 5.5 Kg.)



ES-4



### Option

For vessels with an onboard generator, the panel may be fitted with a 7.5 kW ship-shore AC source selector switch. Specify **ES-4SS** option when ordering.

Note: There is a modification fee for special configurations - contact factory.

## ES-3

This panel combines AC and DC control into one compact panel. See list of specifications at bottom of page. 13.7" W X 10" H X 4" D, 10 lbs (34.8 X 25.4 X 10.2 cm, 4.5Kg.)

ES-3



## ES-5

Exceptional yachts require an extraordinary panel which incorporates all the aspects of the vessel's electrical system. The ES-5 is such a panel. In addition to its large DC circuit capacity, the AC section includes two load groups and a source selector switch for two shore power lines and a 15kW generator. Pre-heat and start-stop controls are standard. Additional system capacity can be obtained by incorporating model ES-6 or ES-7 (listed on page 16). 20" W x 15" H x 6" D, 20 Lbs. (50.8 X 38.1 X 15.2 cm, 9.1Kg.)

ES-5



Model	DC Circuits	AC Circuits
ES-3	16 Breaker capacity, 12 Installed standard; 2-5A, 3-10A, 4-15A, 3-20A or specify	Master (D.P.) 30 amp standard 50 amp* optional, plus 6 S.P. branch capacity, 5 installed standard; 1-10A, 15A, 2-20A or specify
ES-4	20 Breaker capacity, 16 Installed standard; 3-5A, 3-10A, 5-15A, 5-20A or specify	Master (D.P.) 50 amp* standard plus 8S.P. branch capacity, 6 installed standard; 1-10A, 3-15A, 2-20A or specify
ES-4SS	Same as above with 7.5 kW, three position (Shore-Off-Gen) ship shore selector switch installed. <i>Special Order Only.</i>	
ES-5	Master plus 24 breaker capacity, 20 installed standard; 3-5A, 4-10A, 7-15A, 6-20A or specify	Two load groups each consisting of: Master breaker (D.P.) 50 amp* standard plus 10 S.P. branch capacity, 8 installed standard; 2-10A, 3-15A, 3-20A or specify

\*Note (For panels used in 230 VAC applications): 50 amp Master OK for use on 230 VAC line-to-line systems. Not for 230 VAC line-to-neutral systems.



# Electrical Panels



NEWMAR offers a wide range of stylishly engineered electrical panels to provide control, protection and monitoring for on-board electrical circuits, ranging from basic meter panels to full-function AC/DC master distribution centers.

The panels are manufactured with 1/8" strong black anodized aluminum, feature elegant graphics, and their modular design allows integration of multiple units for a "custom" installation. All panels are pre-wired with bus bars and ground strips for easy installation, and come with extensive circuit identification label sets.

The circuit breakers use a "trip-free" magnetic-hydraulic mechanism and are UL recognized and CSA listed.

Individual circuit "ON" indicator lights are now standard for all distribution branch circuit breakers. Many models of meter panels and distribution panels are also available as blanks with bus bar, breaker mounting screws, labels and indicator light mounting hardware, allowing the installer to select from a wide array of components for maximum options in electrical system design.

## Accessory Panels

These versatile panels are ideal for smaller vessels with only a limited number of electrical circuits, or for larger systems where their modular design makes for an easy and attractive expansion of existing system capacity.

Stock panels with breakers installed come standard with DC indicator lights, but may be factory modified with AC indicator lights instead. Blank versions of the panels come with all necessary hardware to install lights and breakers. All panels are provided with a circuit identification label set of 22 common on-board electrical functions (see below).



**ACCY-IX:** 8 breaker capacity, 5 installed standard; 2-5A, 1-10A, 1-15A, 1-20A or specify. 8 DC circuit "ON" indicator lights installed standard, AC lights optional. Size: 7 1/2" x 5 1/4", Weight: 2 lbs.

**ACCY-IBX:** Blank version of ACCY-IX above. No breakers provided. Label set, light and breaker mounting hardware provided. Weight: 1 lb.

**ACCY-III:** Half-height version of ACCY-IX at left. 3 breaker capacity, 3 installed standard; 3 DC "ON" indicator lights installed standard - AC optional. 1-5A, 1-10A 1-15A or specify. Size: 3 3/4" x 5 1/4", Weight: 1 lb.

**ACCY-IIBX:** Blank version of ACCY-III above. No breakers or lights provided. Label set, light and breaker mounting hardware provided. Weight: 1 lb.



See page 22 for Panel Back Enclosures.

## Typical Accessory Panel Wiring Diagram

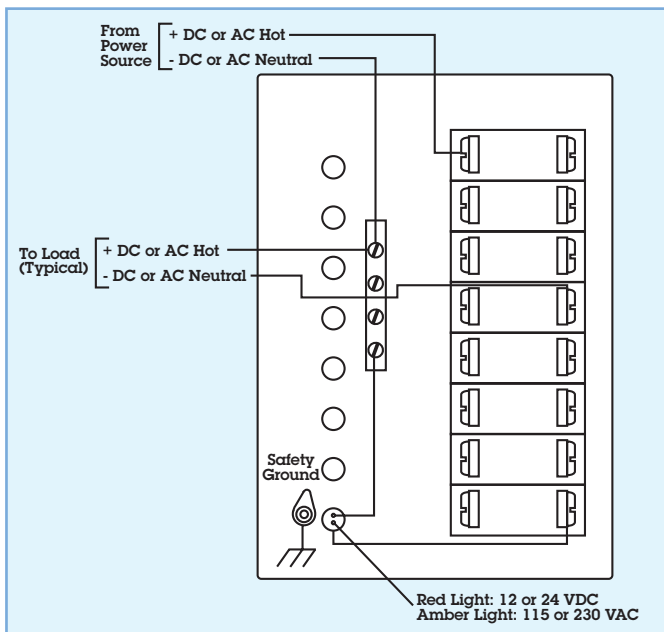

## Installation Cut-Out Dimensions\*

	Inches (W x H)	Centimeters (W x H)
<b>ACCY-IX</b>	4 X 6	10.2 X 15.2
<b>ACCY-IBX</b>	4 X 6	10.2 X 15.2
<b>ACCY-III</b>	4 X 2.5	10.2 X 6.4
<b>ACCY-IIBX</b>	4 X 2.5	10.2 X 6.4

\* Allow approximately 3" depth clearance for all panels on this page.

## Label Set Provided

Each panel is provided with a basic set of the following functions listed. Other more extensive label sets (up to 206 functions) are also available separately. To see the complete list, visit [www.newmarpower.com](http://www.newmarpower.com) and click on Electrical Panel Accessories.

## LS-I Standard Set 22 Labels

ACCESSORY	FORE CABIN	SPARE
AFT CABIN	MAIN CABIN	SPREADER
ANCHOR	MAST	SUMP PUMP
BILGE PUMP	NAV/COM	WATER HEATER
BOW	OUTLETS	WATER PRESSURE
CABIN LIGHTS	REFRIGERATOR	WINDLASS
ENGINE ROOM	RUNNING	WINDSHIELD

## DC Master Panel

DC monitor, protection, and control. Dimensional compatibility allows easy expansion of the system by incorporating additional accessory or monitor panels (see pages 18 and 21, respectively). Features an illuminated, expanded scale DC voltmeter with dual battery bank test switch and individual "ON" indicator lights. A label set of common on-board circuits is provided (see page 18, LS-I, for label list).

**DC-IX:** Voltmeter with dual battery bank test switch; 11 circuit breaker capacity, 9 installed standard 2-5A, 3-10A, 4-15A or specify.  
Panel size: 10 1/2" x 7 1/2", (26.7 X 19 cm.); Weight: 4 lbs., (1.8Kg.)



## Installation Cut-Out Dimensions

	Inches	Centimeters
DC-IX	8.3 X 6.3	21.1 X 16

## AC Master Panels

Essential control/protection whenever AC from shorepower or generators is on board. A double pole master breaker with power on indicator light protects both hot and neutral legs of the AC circuit. A reverse polarity light provides clear warning when wiring is reversed and poses a shock hazard. Single pole branch circuit breakers (Model AC-IX) and individual "ON" indicator lights provide control and protection of various AC loads. For 115/230 VAC applications – see ratings note. A label set of common on-board circuits is provided (see page 18, LS-I, for label list).

**AC-IX:** 30 amp master breaker (15A or 50 A\* optional), 5 branch circuit capacity 4 installed standard 1-10A, 2-15A, 1-20A, or specify. LS-I Label set included. Panel size: 5 1/4" x 7 1/2", (13.3 X 9.5 cm.)  
Weight: 2 lbs., (.9 Kg.)

**AC-II:** 30 Amp master breaker (15A or 50A\* optional).  
Panel size: 5 1/4" x 3 3/4" (13.3 X 9.5 cm.),  
Weight: 1 lb (.5 Kg.)

\*50A option rating note: OK for use on 230 VAC line-to-line systems. *Not* rated for 230 VAC line-to-neutral systems.



See pg 23 for AC Source Selector Switch.

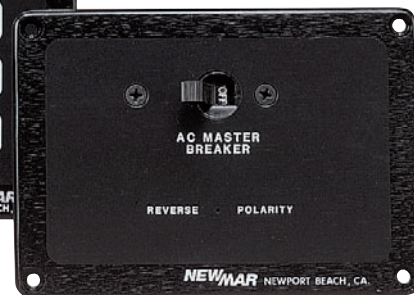

## Typical AC Panel Wiring Diagram

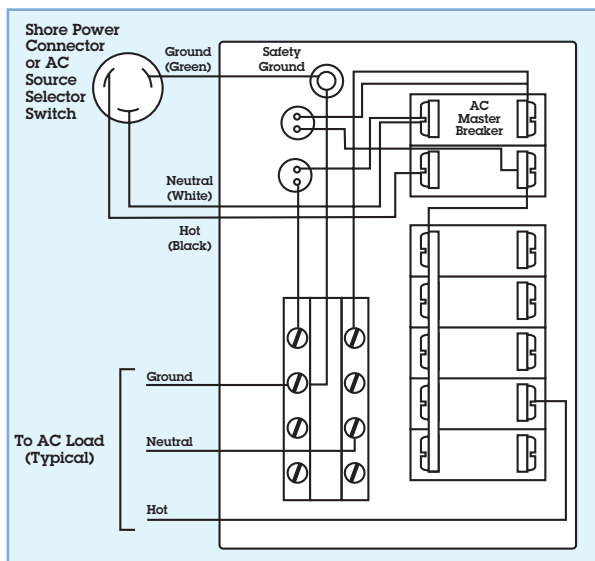

## Installation Cut-Out Dimensions

	Inches	Centimeters
AC-IX	4 X 6	10.2 X 15.2
AC-II	4 X 2.5	10.2 X 6.4

## Alternate Circuit Breaker Amperage Ratings

Changing circuit breaker value mix or location for any panel shown on these pages is no problem! Simply advise us of the breaker arrangement you need. (Panel specific illustrated order forms listing all options are available at [www.newmarpower.com](http://www.newmarpower.com).) Please allow 3-5 days additional lead time to complete the modification. *Note: There is a modification fee for special configurations – contact factory.*

# Digital Instruments for AC/DC Systems

These highly versatile and sleekly designed digital instruments provide comprehensive monitoring of onboard AC and DC electrical systems. They give quick, accurate, up-to-the moment information on all important aspects of electrical system status – voltage, current, power consumed, power available, AC frequency, abnormal system conditions, and more.

All read-outs and programming of these multiple functions are easily controlled via touch-pads on the instrument face. LCD displays are easily read in bright sunlight and feature five level adjustable red back-lighting for conservation of night vision. High/low voltage and frequency alarms are standard, and DC monitors are NMEA 0183 compatible. Typical accuracy is +/- 1%.

These instruments are waterproof and are suitable for installation in exposed above deck areas, such as open cockpits and flybridges (provided there is no water ingress to the rear of the mounting surface). The meter/touch-pad and surrounding bezel are fully waterproof and the ABS housing is UV stabilized.

All models are designed for through-bulkhead mounting; 2 1/2" models may also be installed in NEWMAR's Single Universal Series panel (see page 21).

All instruments are pre-calibrated for typical use settings at the factory prior to shipment, however they may be recalibrated via touch pad after installation to suit the special needs or conditions of any particular vessel.



DCE

## DCE: DC Energy Monitor

Displays volts, amps, energy used and remaining for 12 or 24 volt systems up to 500 amps and up to 3,000 amp-hour capacity. Makes DC energy management a breeze. Monitor voltage on up to three separate banks. House bank (or battery bank of choice) may be also be programmed for the following functions: 1) Monitor charge/discharge amperage. 2) Total energy monitor can be set for amp-hours or percent-of-charge. 3) High/low voltage alarm, plus alarm set-point for low amp-hours remaining. 500 amp shunt included. NMEA 0183 compatible output for data logging. Available in 2 1/2" or 4 1/4" square face.

Available in 2 Sizes



ACE

## ACE: AC Energy Monitor

For 115/230 volt systems. Reads: 90-300 VAC (True RMS), 0-150 amps, frequency from 40-70 Hz and power from 0-45 kW. Features alarm circuits for high/low voltage and high/low frequency. Can be programmed to provide automatic generator shutdown (see Remote Alarm Option below) in the event that voltage or frequency exceed predetermined range. Current and voltage transformers are included. 12 or 24 volt source required to power meter. Available in 2 1/2" or 4 1/4" square face.

Available in 2 Sizes



DCV

## DCV: DC Voltmeter

For three battery banks, 12 and/or 24 volt systems. Reads to the nearest 1/10 volt. Features a programmable high/low voltage alarm circuit for each bank. NMEA 0183 compatible for PC interface. Only available in 2 1/2" version.



DCE-VAH-110

Go to Webpage!

## Large Scale Models Now Available

Our DCE and ACE Digital Instruments are now offered in a large LCD read-out design. Digits are an easy-to-read 1 1/4" tall, allowing monitoring from a distance. Large button keypads make programming and function selection a breeze!

All instrument ratings and functions are identical to standard scale instruments described at left. Mounting hole requirements and hardware are also identical to standard scale models. Instrument face dimensions: 4 1/4" x 4 1/4" (110 mm x 110 mm)

## Models

**DCE-VAH-110** Large scale version of DCE shown at left  
**ACE-VAF-110** Large scale version of ACE shown at left

## Remote Alarm Relay Option

All instruments shown on this page have programmable alarms. A relay is now available that activates from the instrument alarm signal output terminal allowing remote activation and/or connection to the vessel's 12 or 24 volt alarm panel.

## Model:

**DIR** Digital Instrument Relay  
**Input Signal:** 5 VDC  
**Relay Rating:** 12/24 VDC, 10 amps  
**Size:** 2.4" x 1.4" x 1.5"



Model: DIR

## Instrument Drawings & Mounting Options

2 1/2" model depicted: Large Scale Instruments use identical size mounting hole and hardware configuration

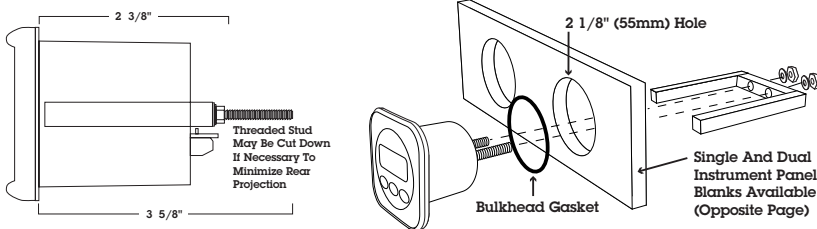

# Metering

Go to  
Webpage!



Assemble an electrical monitoring system using these meters and the panel blanks shown below. Meters are now available in Digital and Analog format in 2 1/2" and 3 1/2" sizes. One pre-fab meter panel accommodates the 2 1/2" meters and digital instruments (see page 20).

## Analog Meters

Easy to read graphics with unit divisions give precise readouts at a glance. Designed for easy front or rear panel mounting. See below for meter panel blanks.

## AC Meters

AC Volt 0-150  
AC Volt 0-300  
AC Amp 0-50 w/current transformer  
AC Amp 0-100 w/current transformer

## DC Meters

DC Volt 8-16  
DC Volt 16-32  
DC Amp 0-50 w/shunt  
DC Amp 0-100 w/shunt

## Replacement Shunts/Current Transformers For Analog Meters

- Shunt for 0-50 DC ammeter
- Shunt for 0-100 DC ammeter
- Current transformer for 0-50 AC ammeter
- Current transformer for 0-100 AC ammeter

## Meter Face Measurements

**3.5" scale:** 3 3/4" W x 2 7/8"H (9.5 X 7.3 cm)  
**2.5" scale:** 2.1/2" W x 2 3/8"H (6.3 X 6.0 cm)

## Meter Panel Blanks

### Universal Series

**MPB-SU:** Single Universal Panel; accommodates one 2 1/2" meter or one Digital Instrument in front-mount configuration; can be oriented for either horizontal or vertical mounting. Panel dimensions: 3 3/4" x 5 1/4"



# Electrical Panel Accessories

## Circuit Breakers

All circuit breakers offered by NEWMAR are UL recognized and CSA listed for AC and DC systems and meet USCG requirements as a qualified circuit protection device.

### Standard Series: Single and Double Pole

Fit all NEWMAR electrical panels, as well as most other brands

- Feature magnetic-hydraulic "trip-free" mechanism
- 5-30 amp rated to 65 VDC or 277 VAC; 40 and 50 amp rated to 32 VDC or 120 VAC (See rating note below).
- Mounting screws not provided order separately
- #10 screw terminals on rear for wiring

### Options

- Red, white or black toggle handles
- Single pole values: 5, 10, 15, 20, 25, 30, 40 or 50 amp.
- Double pole values: 15, 20, 30 or 50 amp

**Important Circuit Breaker Rating Note:** Standard series breakers shown on this page which are rated higher than 30 amps are acceptable for use in 230 VAC Line-to-Line systems (where each leg is 115 VAC - to - neutral), but are not rated for 230 VAC line-to-neutral systems.



**Go to Webpage!**

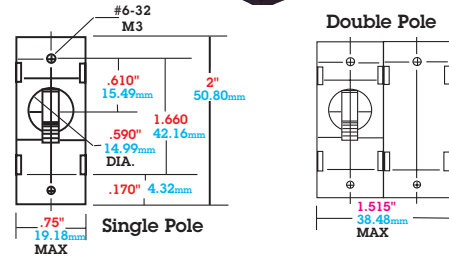

### High Amperage Series: Single Pole

Rated for up to 65 VDC or 120/240 VAC service

- Feature auxiliary contacts for optional remote monitoring of circuit breaker status
- "Trip-free" mechanism

### Options

- Current rating of 75 or 100 amps
- Black or white toggle

Note:

Square cut-out mounting configuration fits Elite Series Panel (manufactured 1995 or later) DC master breaker position only.

- 1/4" studs on rear for wiring
- Two 6-32 screws required for mounting; not included w/bulk pack - order separately
- Auxiliary alarm contacts (form C)

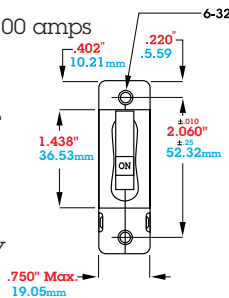

## Label Sets

Ideal for custom labeling of switch or circuit breaker positions on any NEWMAR or similarly constructed electrical panel. White lettering on black peel-and-stick mylar. Label size: 1.75" W x .5" H

### Models:

- LS-I Standard Set - 22 labels
  - LS-II Electronic Set - 55 labels
  - LS-III Deluxe Set - 206 labels
- (Visit [www.newmarpower.com](http://www.newmarpower.com) for a complete list of Label Sets)



## Panel Back Enclosures

Secure to the rear of many common electrical panels to protect crew against injury or panel against damage from accidental contact. Heavy duty ABS plastic. May be cut or drilled to suit wiring needs. (Intermediate mounting surface between panel and enclosure required)

Model	Size (H x W x D)	Fits these NEWMAR Panels
BE-432	4.5" x 3.2" x 2"	ACCY-IIX, AC-II, METER-II
BE-855	8" x 5" x 5"	ACCY-IX, AC-IX
BE-1085	10" x 8" x 5"	DC-II

## High Current Fuses / Fuseblocks

Essential safety item for all inverter installations and other high amperage DC circuit over-current protection.

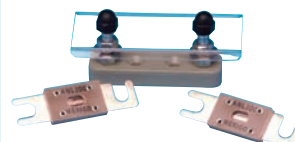

- Heavy duty 500 amp, insulated, compact fuse block with corrosion-resistant 5/16" studs
- Secures to surface with two #10 flat head screws or bolts (not included)
- Clear lexan cover insulates conductive parts, per ABYC/USCG requirements
- Accepts industry standard ANL tin-plated copper fuses. Purchase separately.
- See-through mica element for easy identification of blown fuse

**Fuseblock Model:** AFB-500

**Fuse Models** (numeral indicates amperage): ANL-50, ANL-100, ANL-150, ANL-200, ANL-250, ANL-300, ANL-350, ANL-400, ANL-500 (All rated to 80 VDC)

## Indicator Lights

Use as "circuit on" or service indicator light on AC or DC systems. Snap-in panel mount in 5/16" hole, 6", 18 AWG leads.



### Models:

- 115/230 VAC Amber\*
- 115/230 VAC Red
- 115/230 VAC Green

- 12/24 VDC Red\*
- 12/24 VDC Green

\* standard replacement light for Newmar panels available in skin pack or bulk pack

# AC Source Switches



SS-3.0



SS-7.5 INV

Go to  
Webpage!

An AC source selector switch is an essential item for any boat with an onboard AC generator and/or inverter. The switch eliminates the safety hazard and/or damage that can occur if two AC sources are applied to the same circuit simultaneously.

These switches are fitted with a compact escutcheon plate with engraved switch position nomenclature (mounting dimensions below).

The switches carry UL and CSA approval, are CE marked, and feature heavy duty contacts and a positive step cam mechanism for low resistance contact closure. May be installed in panel with thickness up to 1/4".

## Standard Switches

Model	Amperage @ 115/230	Number of Poles	Switch Positions	Standard Plate Markings**
SS-3.0	30	2	2 + "OFF"	SHIP-OFF-SHORE
SS-7.5	63	2	2 + "OFF"	SHIP-OFF-SHORE
SS-7.5 INV†	63	2	3 + "OFF"	OFF-GEN-INV-SHORE
SS-15*	126	2	2 + "OFF"	SHIP-OFF-SHORE

\*May be configured as a 63 amp, 4 pole switch

† For vessels with onboard generator and inverter

## Mounting Flange Dimensions

All standard switches, plus 63 and 80 amp special order switches. 100 and 125 amp special order switches only.

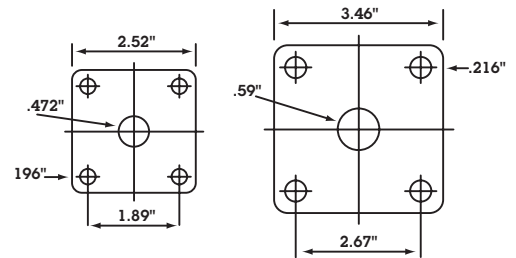

## Special Order Switches

If none of the standard switches listed above meet your requirements, NEWMAR will custom configure an AC selector switch for you. Please allow 2 weeks for shipment. Contact factory for pricing.

### 1) Determine the following:

- Amperage/kW rating required
- Number of switch positions required
- Number of poles required

### 2) Use the chart below to determine model number:

Amperage/kw Rating @ 120 VAC	2 Position Plus Off		3 Position Plus Off		4 Position Plus Off	
	2 Pole	3 Pole	2 Pole	3 Pole	2 Pole	3 Pole
63 Amp (7.5 kw)	S-622	S-632	S-623	S-633	S-624	S-634
80 Amp (10 kw)	S-822	S-832	S-823	S-833	S-824	S-834
100 Amp (12.5 kw)	S-1022	S-1032	S-1023	S-1033	S-1024	S-1034
125 Amp (15.5 kw)	S-1222	S-1232	S-1223	S-1233	S-1224	S-1234

### Depth Dimensions

SS-3.0	2 1/8"
SS-7.5	2 3/8"
SS-7.5 INV	3 1/2"
SS-15	4"

### 3) Select the desired switch selector position labeling from the following list:

SHORE GEN PORT SHORE PORT GEN  
 SHORE 1 GEN 1 STBD SHORE STBD GEN  
 SHORE 2 GEN 2 INV  
 or specify the position labeling you require.

If you have need for a specific arrangement of the switch selector position labels, please mention this at the time of ordering. Note: Combination switches similar to one used in our ES-5 panel, (see page 17) also available. Contact factory for more information.



# AC Shore Power Accessories



GI-100

## Galvanic Isolator

Sacrificial zincs corrode away as they protect metal thru hulls, shafts and props from damaging electrolysis. Stray, low voltage current flowing between the AC safety ground and DC bonding system is a principal cause of this "galvanic" action.

Installing the Galvanic Isolator between the AC safety ground and DC bonding system (see diagram), blocks a majority of the low voltage currents and corrosive action on the zincs is significantly reduced (while the integrity of the critical safety ground path is maintained.) This means a significant savings in boat haul-out fees and zinc replacement costs.

For additional safety, all units feature a large capacitor, providing a secondary low impedance path for sending AC current to ground.

Three models are offered; rated for 30 amp, 50 amp or 100 amp shorepower.

Model	SHORE POWER VAC, Hz	Shore Power Rating, Amps	Dimensions			Weight		
			H	W	D	Lb.	Kg.	
GI-30	115/230, 50-60	30	2.7	4.8	7.3	in.	2.45	1.1
GI-50	115/230, 50-60	50	4.5	4.7	8.9	in.	3.2	1.5
GI-100*	115/230, 50-60	100	15	7.25	7.2	in.	13.35	6

\*Special order item.  
Allow 2-3 weeks for delivery



Go to  
Webpage!

## Typical Wiring

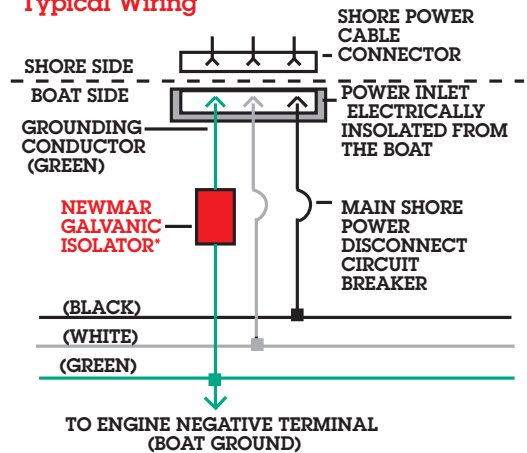

## AC Panels

These panels provide essential control and protection for shore and on-board AC sources. Two pole breakers with single toggle provide maximum protection with easy fingertip disconnect. All models feature a reverse polarity warning.

**AC-IX:** 30 amp double pole master breaker (15A or 50A optional) plus 5 single pole branch capacity, 4 installed standard; 1-10A, 2-15A, 1-20A. Master and branch circuit "ON" and reverse polarity warning indicator lights installed. Label set of 22 common shipboard circuits provided. Size: 7.5" x 5.25", Weight: 2 lbs.

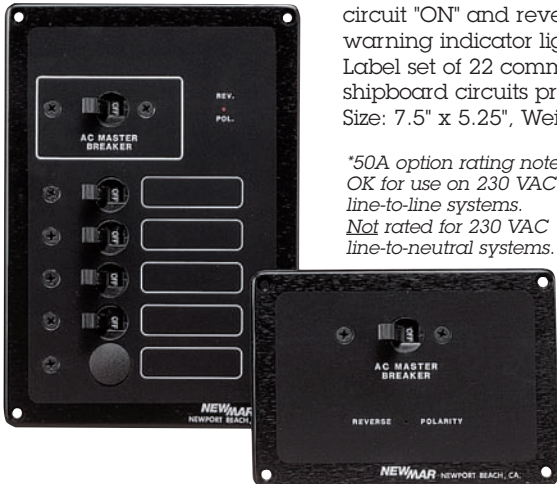

\*50A option rating note:  
OK for use on 230 VAC  
line-to-line systems.  
Not rated for 230 VAC  
line-to-neutral systems.

light to provide clear indication when hot/neutral wiring is reversed and presents a shock hazard. Master and branch circuit breakers have power "ON" indicator lights. For 115 or 230 VAC applications.

**AC-II:** 30 amp double pole master breaker only (15A or 50A optional). Master AC circuit "ON" and reverse polarity warning indicator lights installed. Size: 3.75" x 5.25", Weight: 1 lb.

## AC Source Selector Switches



Wide range of sizes and styles available. See page 23.



# Terminal Strips & Bus Bars

## Terminal Strips

- Use as a common negative/neutral bus for AC or DC systems. Dual terminal strips in 4 or 8 screw positions on 3/4" centers are secured to a high density insulated base. All hardware, bus material and fasteners are nickel-plated brass.
- #8 screws accommodate various size ring terminals and each terminal strip is rated for 100 amps.
- Interlocking bases allow use of multiple terminal strips and bus bars (described below) to produce secure and neat wiring assemblies. The terminal strip bases have provisions for either #8 or #10 mounting screws, and no conductive parts in the base are exposed to the mounting surface.
- A clear plastic insulating cover is provided with skin packed units. Specify bulk or skin pack when ordering.

Go to Webpage!

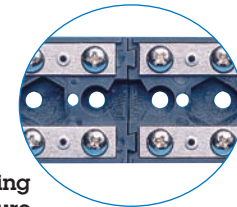

Interlocking Feature

Model	Total # of Base Terminals	Size
TS-2x4	8	3 1/16" x 1 1/2"
TS-2x8	16	6 1/16" x 1 1/2"

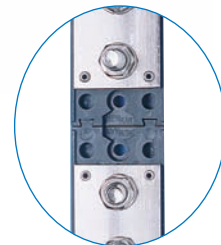
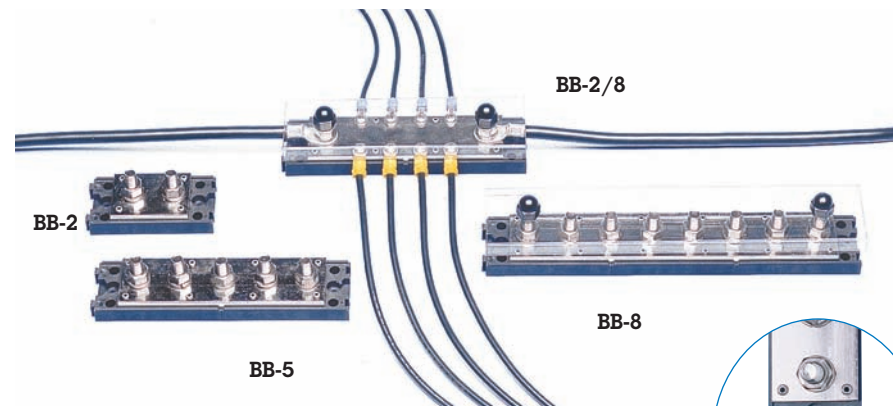

Interlocking Feature

Model	Qty. of 5/16" Studs	Base Size
BB-2	2	3 1/16" x 1 1/2"
BB-2/8	2 plus 8 - #8 screws	6 1/16" x 1 1/2"
BB-5	5	6 1/16" x 1 1/2"
BB-8	8	9 1/16" x 1 1/2"

## Bus Bars

- Ideal as a DC ground tie point or positive bus, these heavy duty, 500 amp rated bus bar assemblies feature 5/16" studs on 1" centers in 1/4" thick copper bar for common connection/distribution of large wire gauges and accommodate 5/16" ring terminals.
- One combination model features two 5/16" studs and eight #8 screws, accommodating multiple size wire terminals.
- All bus material is nickel-plated copper.
- A clear insulating protective cover is provided to prevent short circuits and provide visibility of lugs.
- The mounting bases are keyed for interlocking and may be mated with the terminal strips (described above). Conductive parts are captured and recessed away from the mounting surface. Use #8 or #10 screws for mounting.

## Connector Strips

- Molded nylon encases 6 or 12 pairs of connectors that use screw compression to secure wires without use of lugs. Ideal for electronic installations. Brass barrels capture wires and are held in place with a stainless steel "finger" compressed by a screw. The screw does not make contact with the wires, protecting the copper strands from cuts and breakage - Meets ABYC standards. (Same connector strip used in BX Series boxes - see page 26.)
- 3 Sizes: ranging from 6 to 16 gauge
- Strips are easily cut to meet wiring requirements and space limitations.
- All models clamshell packed for attractive retail display, or bulk packed for contractor use.

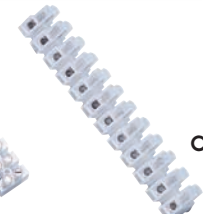
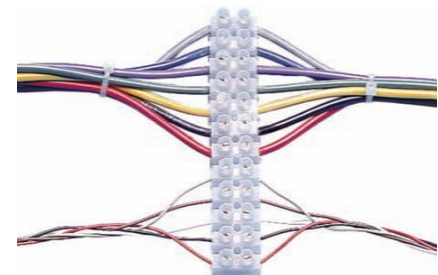

CS-1

CS-2

Model	# of Terminal Pairs	Max Wire Gauge	Max Amps*	Size L X W X H
CS-1	12	16	6	3.75" x .675" x .5"
CS-2	12	14	10	4.5" x .75" x .75"
CS-3	12	12	16	5.5" x .875" x .8"

\*Per set of terminals



DC Power Onboard

# Thru-Dex® – Waterproof Boxes

## Waterproof Junction Boxes

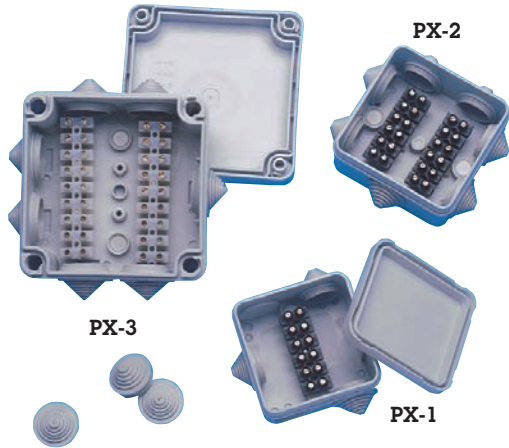

### PX Series

- Ideal for making wiring connections above or below decks, even in areas subject to occasional spray
- Similar to BX Series junction boxes, but made from rugged, non-corrosive, high impact polypropylene
- Snap-on cover provides watertight seal
- "Universal" cut-to-fit (see diagram) graduated diameter cable entries accommodate wide cable range
- Multiple position connector strips with "captive" screw compression wire terminals installed – meets ABYC standards (same type as CS-1, page 25)
- Multiple knockouts provided for conduit access (in addition to cable entries)
- IEC Waterproof Rating: IP54 – "Water projected in jets against the enclosure from any direction shall have no harmful effects."

### Graduated Diameter, Flexible Cut-to-fit Cable Entries

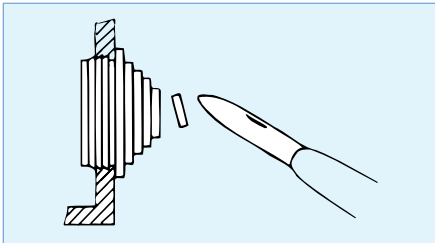

Model	PX-1	PX-2	PX-3
Number of Connector Strips	1	2	2
Positions per Strip	6	6	9
Max Wire Gauge	16	16	16
Number of Cable Entry Ports	5	7	7
Number of Cable Entries Installed	3	7	7
Spare Cable Entries Provided	2	0	0
Cable Diameter Range (inches)	.14-.81	.14-.81	.14-.99
Cable Diameter Range (mm)	3.5-20.5	3.5-20.5	3.5-25.5
Box Size (inches)	2.95 x 2.95 x 1.66	3.35 x 3.35 x 1.66	4.45 x 4.45 x 2.29
Box Size (cm)	7.5 x 7.5 x 4.2	8.5 x 8.5 x 4.2	11.3 x 11.3 x 5.8

## Splashproof Junction Boxes

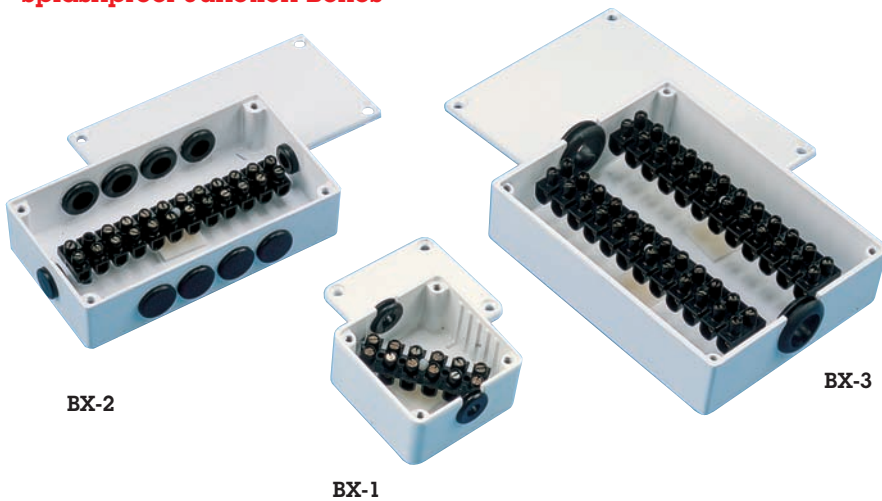

### BX Series

- Provides for secure, protected below-deck wiring connections, IP rating 54
- Rugged cast aluminum box with white enamel finish
- Easy wiring access through multiple grommeted cable entries
- Supplied with high quality connector strips - secure wires w/compression fittings – no terminals required (See CS-1 and CS-2, on opposite page for full description – see matrix below for number/gauge of terminals)

Model	BX-1	BX-2	BX-3
Number of Connector Strips	1	1	2
Positions per Strip	6	12	11
Max Wire Gauge	16	16	14
Max amps (Per Position)	6	6	10
Cable Entries	2	8	2
Max Cable Diameter	.25"	.37"	.59"
Box Size (inches)	2 x 2 x 1.2	4.4 x 2.4 x 1.2	4.7 x 3.7 x 1.3
Box Size (cm)	5.1 x 5.1 x 3.1	11.2 x 6.1 x 3.1	11.9 x 9.4 x 3.3

Go to  
Webpage!

# Electrical Enclosures, Cable Entries

## EX Series Electrical Enclosures

These enclosures provide functional and professional protective cases for wire connectors, terminal blocks, relays, solenoids, fuses, etc. The corrosion-resistant polycarbonate cases are ideal for marine applications, and the deep cavity design leaves room for securing wiring and components and making connections. In addition, instruments, switches and panels can be surface mounted to the cover, as there is ample space for rear projection and wiring.

The enclosures have gasketed covers with captured non-corrosive securing screws and offer various levels of water resistant integrity per installer option, depending on type of cable entry used (see below). Waterproof entries provide IP68 protection while the splash-proof entries are rated at IP54. Two splash-proof entries are (model SPF-1) included with the enclosures.



Application example - EX-474 shown with digital instruments mounted in cover



Enclosure mounting points are located in the bottom of the box and caps for waterproof sealing of the mounting holes are provided. Also supplied is an internal base plate with stand-off mounts for securing components inside the enclosure.

Knock-outs in numerous sizes are positioned on all four sides of the enclosures, giving the installer many options on cable entry type and location for convenient, professional wiring. (See choices of Cable Entries below.)

Enclosure Model	Size L x W x D (inches)	Knock-Outs (size cross-reference below)
EX-373	7.09 x 3.7 x 3.19	14 ea. PG-16
EX-474	7.09 x 4.33 x 4.37	16 ea. PG-16, 4 ea. PG-21, 2 ea. PG-29
EX-1074	7.09 x 10.0 x 4.37	24 ea. PG-16, 8 ea. PG-21, 4 ea. PG-29

## Cable Entries

Choose from waterproof or splash-proof enclosure cable entries in various sizes.

### Waterproof Fittings

For complete waterproof assembly (IP68) use these compression fittings. Retaining nut secures fitting to enclosures, compression hub creates waterproof seal around wires. Various sizes are available in a wide range of cable diameters.



Model	Cable Diameter Range	Mounting Hole Diameter	EX Enclosure Knock-Out Size Ref.
WPF-1	.2"-.47"	.91" (22.5 mm)	PG-16
WPF-2	.35"-.71"	1.14" (29.0 mm)	PG-21
WPF-3	.55"-.98"	1.48" (37.5 mm)	PG-29



### Splash-Proof Fittings

Flexible fittings snap into access holes on enclosures. Graduated diameter, cut-to-fit sizing accommodates a wide range of cable diameters. Can also function as a splash-proof plug on knocked-out enclosure access hole. Sold in pairs.



Graduated Diameter, Flexible Cut-to-fit Cable Entries

Model	Cable Diameter Range	Mounting Hole Diameter	EX Enclosure Knock-Out Size Ref.
SPF-1	.14"-.81"	.91" (22.5 mm)	PG-16
SPF-2	.14"-.99"	1.14" (29.0 mm)	PG-21

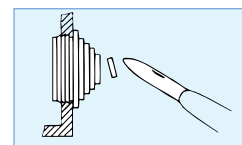

## Waterproof Fittings

- Create a 100% waterproof seal when routing cables through decks and bulkhead
- Allow installation and/or removal of cable with connector still attached
- Accommodate wide range of cables
- Rugged, weatherproof glass-filled nylon
- Available in two series:

**CCX Series** – Entry hole pre-drilled in seal with slit to edge allowing feed thru of cable with factory-installed connector attached; multiple glands cover a wide range of cable sizes; one CCX fitting required for each cable.



Model	Cable Diameter Range	Max Connector Diameter	Typical Connector
CCX-R	.47"-.59"	1.57"	Large Radar Plug
CCX-S	.35"-.55"	.83"	Small Radar Plugs
CCX-T	.18"-.35"	.83"	PL-259, BNC, Wind Instrument Plugs

**DX Series** – Drill holes and slit cable gland as required to accommodate cable with or without factory-installed connector. Multiple cables may be passed through a single fitting.



Model	Drill Thru Aperture	Max. Connector Dia.
DX-2	1.18" Diameter	1.18"
DX-3	1.57" Diameter	1.57"
DX-5*	1.9" Diameter	1.9"

\* Aluminum Housing

## RailFast® Antenna Mounts

Quick, easy installation of antenna on 1" or 7/8" railing. Ideal for G.P.S., VHF radio, and whip antennas, has direct feed-thru hole for coax cable. Ratchet surface permits 360° rotation for adjustment/lay-down. Holds antennas up to 8' (2.4 meters) in length. No drilling required; all necessary hardware provided. (US Patent #4546949)

- **Model 311-N**  
Strong, fiberglass filled nylon rail mount for permanent antenna installation with hex-key vertical adjustment. Smooth spherical shape won't catch lines or clothing.
- **Model 311-NLH**  
Similar to 311-N (listed above), but has lay-down handle that permits quick, easy lay-down of antenna.



## Antenna/Coax Switches



### Manual

**Model:** CS-201  
Two position switch allows manual selection of one of two antennas with a single radio or one of 2 radios with a single antenna. Die cast aluminum case.

**Power:** 1.5 kW peak  
1 kW continuous  
**Impedance:** 50 ohm  
**Connectors:** SO-239/UHF  
**Weight:** 1Lb., .5 Kg.



### Remote

**Model:** RCS  
Operates on 12 VDC, single pole, double throw. Permits remote selection of two antennas with a single radio.

**Power:** 1 Kw.  
**Impedance:** 48 ohm  
**Coil Current:** 250 mA  
**Connectors:** SO-239/UHF  
**Weight:** 1 Lb., .5 Kg.

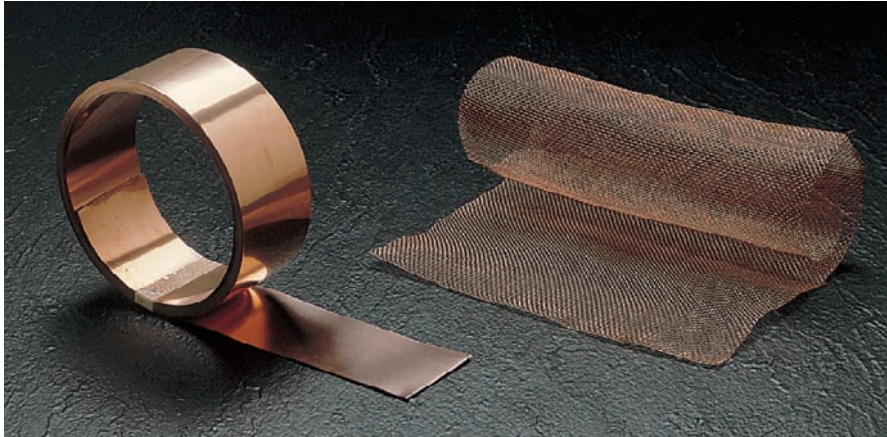

## Copper Strap & Copper Screen Sizes

Model	Width	Length	Weight
<b>GS-2-25</b>	2" 5.1 cm	25' 8 meters	3 lbs. 1.4 kg
<b>GS-2-50</b>	2" 5.1 cm	50' 17 meters	5 lbs. 2.3 kg
<b>GS-2-100</b>	2" 5.1 cm	100' 33 meters	8 lbs. 3.6 kg
<b>GS-4-100</b>	4" 10.2 cm	100' 33 meters	16 lbs. 7.3 kg
<b>Screen-25</b>	4" 1.2 meters	25' 8 meters	16 lbs. 7.3 kg

### Copper Strap

- Ideal conductor for RF grounding of SSB radios and other noise sensitive transceivers or for bonding of thru-hulls, etc.
- Flexible – easily conforms to vessel contours
- .01" (25mm) thick – see matrix for available lengths and widths

### Copper Screen

- Tight copper mesh (.05" x .01" wire spacing) ideal for creating a ground plane in hull. Length: 25'; Width: 4'
- May be placed into electronics enclosures to provide an RF barrier.

### Ground Shoes

- Provide an excellent noise-free RF ground by making direct contact with water outside hull.
- Porous copper construction magnifies contact area – see matrix for surface area equivalent
- Silicon bronze hardware provided (Not intended for lightning protection)

Model	Dimensions		Ground Area		Weight	
	Inches	Centimeters	Equivalent	Lbs	Kg	
<b>8A</b>	8 x 2 .5 x .5	20.3 x 6.3 x 1.3	20 sq. ft. 6.1 M <sup>2</sup>	3	1.4	
<b>12C</b>	12 x 3 x .5	30.5 x 7.6 x 1.3	40 sq. ft. 12.2 M <sup>2</sup>	4	1.8	
<b>18E</b>	18 x 6 x .5	45.7 x 15.2 x 1.3	100 sq. ft. 30.5 M <sup>2</sup>	11	5	



### Noise Filters

The interference or electronic "noise" generated by alternators, ignition systems, motors, etc., can render a vehicle or vessel's radio or other electronic equipment virtually useless. This interference takes the form of popping or static on radios or audio gear and garbled images or "hash" on video displays.

These specialized filters can be used singly or in combination to attenuate conducted line noise, either at the affected equipment or at the noise source.

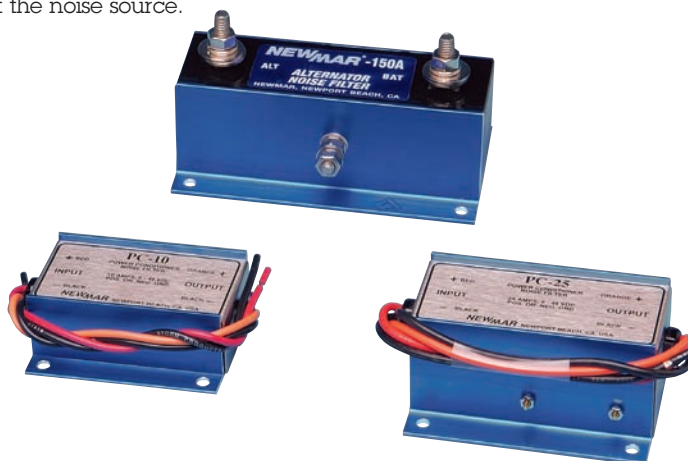

Model	Rating	Installation Location	Size			Weight
			H	W	D	
<b>150-A</b>	150 Amp	In the alternator output lead	3.25" (8.2)	5.75" 14.6	3.25" 8.2cm	3 lbs. 1.4Kg.)
<b>PC-10</b>	10 Amp	In the + and - power leads close to affected equipment	1.25" (3.2)	4.25" 10.8	3" 8.2cm	1 lb. .5Kg.)
<b>PC-25</b>	25 Amp	Same as PC-10	2" (5.1)	4.25" 10.8	3.25" 8.2cm	2 lbs. .9 Kg.)

#### Filter Features:

- Heavy duty aluminum construction
- Operate on 6-48 VDC systems
- Integral mounting flanges for secure installation
- Brass stud connectors on alternator filters accommodate high current cables and terminals
- Color coded wire leads on all other models make in-line installation easy

#### Filtered Frequencies

- Model 150A: 70 kHz – 100 MHz
- Models PC-10 and PC-25: Audio – 200 MHz

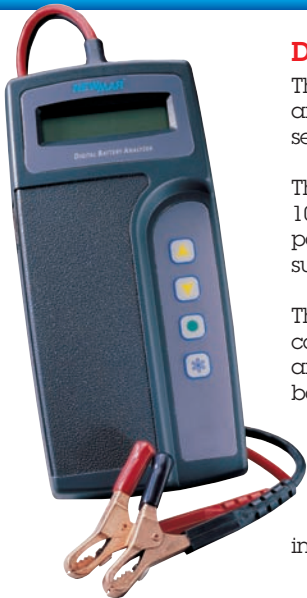

## Digital Battery Analyzer

The **Digital Battery Analyzer** (model DBA) is an essential tool for all DC system installers, technicians and battery dealers. Simple to use, it performs a complete analysis of battery condition in mere seconds, then displays conclusive data on a large clear LCD readout.

The DBA analyzes 12 and 6 volt lead-acid, gel-cell and AGM batteries of all types with ratings from 100-1400 CCA. It provides information on battery voltage, battery condition and available battery power. This gives you empirical data to assure your customers that their batteries are fine, or to support your recommendation that they be replaced.

The unit is housed in rugged ABS plastic, yet is light-weight and compact for use in cramped battery compartments and portability in tool kits. It comes equipped with 32" polarity color-coded test leads and quick-connect clamps. The DBA indicates whether the clamps have proper contact with battery posts.

Single-battery banks or batteries connected singly in series may be tested without disconnection. Parallel batteries must be disconnected prior to testing.

No internal battery nor external AC power source is required. Clear and concise operating instructions are provided.

### Features:

- Analyzes 12 volt and 6 volt lead-acid batteries of all types: flooded, gel-cell or AGM; deep-cycle or gen/engine start
- Simple three step test procedure provides a comprehensive analysis of batteries in seconds. (See Inset.)
- No need to recharge batteries prior to testing; accurate results for batteries in any state of charge down to 5.5 volts
- Uses sophisticated conductance technology; will not harm or discharge batteries
- Rugged, compact, light-weight case; easy to use even in hard-to-access battery compartments
- Temperature compensation setting when testing batteries below 32°F (0°C)
- Handy water-resistant carry-case with shoulder strap provided

### Specifications:

**Model:** DBA - Digital Battery Analyzer

**Battery Type:** 12 or 6 VDC nominal, lead-acid (flooded, gel or AGM), deep-cycle or gen/engine start

**Battery Capacity:** 100-1400 CCA (Cold Cranking Amps)

**Operating Range:** 5.5 - 14.0 VDC

**Input Power:** Operates on power of battery under test, down to 5.5 VDC

**Display Type:** LCD

**Temp. Range:** 32-120°F (0-50°C); temperature compensation provided below 32°F

**Protection:** Will not be harmed by accidental reverse polarity connection

**Case Material:** Acid resistant ABS plastic

**Size:** 9" x 4" x 2.5"

**Weight:** .9 lb., .4 kg.

**Warranty:** Two Years

### Simple Testing Procedure

1. Clip DBA leads to battery terminals
  2. Using touch pad, select battery CCA rating from display menu
  3. Press start test button.
- In less than a minute, the unit analyzes then displays:**

1. Battery voltage
2. Available power (in CCA)
3. One of the following battery condition readouts:

**GOOD BATTERY**

**GOOD-RECHARGE**

**CHARGE & RETEST**

**REPLACE BATTERY**

**BAD CELL-REPLACE BATTERY**

## Electrical System Analyzer

An essential tool for any marine electrical system installer or surveyor, the Electrical System Analyzer provides extremely accurate data on all major AC and DC electrical functions in a convenient hand-held device with large easy-to-read LCD display.

### Measures and Displays:

- AC Voltage up to 400 VAC
- AC Current up to 200 Amps
- Frequency at 50-100,000 Hz
- DC Voltage up to 400 VDC
- DC Current up to 200 Amps
- Electrical Continuity

### Features:

- Clamping sensor allows current measurement without disconnecting wiring or shunt installation
- Long easy-grip color coded needle-type test probes
- Operates on two AA batteries (provided)
- Protective carry-case included

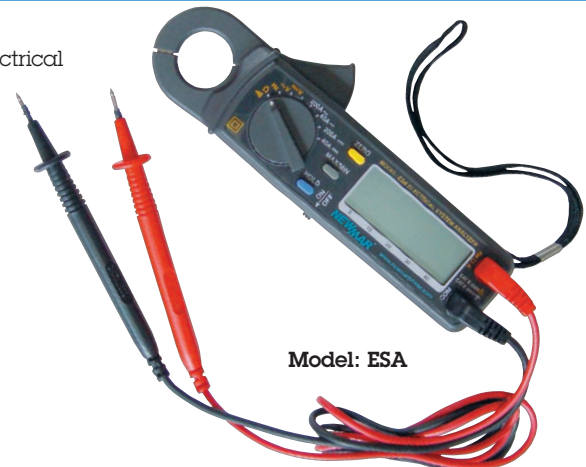

Model: ESA

# Phone-Com Systems

Go to  
Webpage!



PI-10

The Phone-Com intercom system provides direct, wired, point-to-point communication anywhere on the vessel. Voice contact to any phone in the system is as easy as lifting the receiver and pressing the call button. Phone-Com operates on 12 VDC. They are constructed of high-impact plastic and are available in either bright white or traditional black. Bulkhead mounting bracket is provided. Two versions are available:

**PI-2:** Designed for communication between only two points. A single call button sounds a buzzer and illuminates an indicator lamp on the companion phone. Available singly or as a set with 40' of interconnect wire, fuse, terminal lugs and mounting hardware.

**PI-10:** For multiple station calling capability. Up to 10 phones may be interconnected, and each phone has 10 call buttons. Sold individually-- see wiring requirements below.

**Phone-Com Wiring:** Color-coded multi-conductor interconnect wire (22 AWG) is available from NEWMAR at any length desired with 5, 10 or 15 conductors. For PI-2, use 5 conductor wire. For PI-10, add 3 to the total number of stations to determine minimum number of conductors required.

**Note:** Phones are not waterproof and should be installed in a protected location.

**PI-2:** Two station phone with single call button; sold individually; 2 lbs.

**PI-2 SET:** Two station phone set, 40' interconnect wire, fuse, lugs, mounting hardware; 5 lbs.

**PI-10:** Multi-station phone with 10 call buttons, sold individually; 2 lbs.

**22 AWG Wire:** 5, 10 or 15 conductor; sold per foot.

**BUZZER:** External buzzer for use in high-noise areas, 1 lb.

(Specify White or Black when ordering)



PI-2

PI-10

## AQ Series Waterproof Radio Covers



AQ-10L/R

Hand-held radios can be taken anywhere without being damaged by water, dust or sand when the AQ Series waterproof cover is used for protection. Even total immersion will not harm the radio. These covers are certified waterproof to a depth of 33 feet.

The case is made of super-tough, UV resistant PVC, which is engineered with enough flexibility to facilitate easy operation of knobs and keypads. Transparent design allows easy reading of digital displays. Sound is virtually unimpeded and RF transmission is unaffected.

A quick release clip allows easy insertion and removal of the radio and a handy lanyard provides extra security when hands are wet. But if the radio falls into deep water, no problem! Safely inside the AQ case, it will float! Weight (all models): 1 lb.

### Models

**AQ-10L/R** For compact hand-held radios. New reversible design accommodates both left and right hand antennas; Replaces AQ-10

**AQ-20L/R** For standard size hand-helds. New reversible design accommodates both left and right hand antennas; Replaces AQ-20L and AQ-20R

**AQ-2MXL** Larger and longer than AQ-20 for high power radios with large battery packs

### Dimensions in inches

**A**=Overall height of radio/phone with antenna extended  
**B**=Height of radio/phone body  
**C**=Combined width and depth of radio/phone body

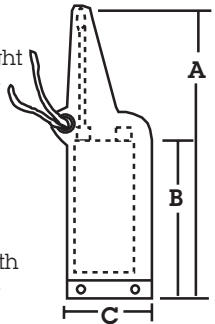

Model	A	B	C
AQ-20L/R	15.7"	7.8"	5"
AQ-2MXL	21.2"	10.6"	5.3"
AQ-10L/R	13"	6.1"	4.1"

## Deck Horns/Hailers

Clear, distortion free, waterproof deck horns are ideal for shipboard paging, hailing, fog horn and alarm systems. High impact plastic with hook-up wire provided. 8 Ohm. Assembled with stainless steel hardware.



PA-60/40  
Heavy Duty  
Commercial

Model	Output Nominal/Peak	Weight
PA-8W	8 watts / 12 watts	1 lb.
PA-30/20	30 watts / 20 watts	3 lbs.
PA-40/30	40 watts / 30 watts	5 lbs.
PA-60/40	60 watts / 40 watts	8 lbs.

Note: Model PA-60/40 is a commercial grade horn which also features excellent sensitivity as a microphone for use in talk-back systems.

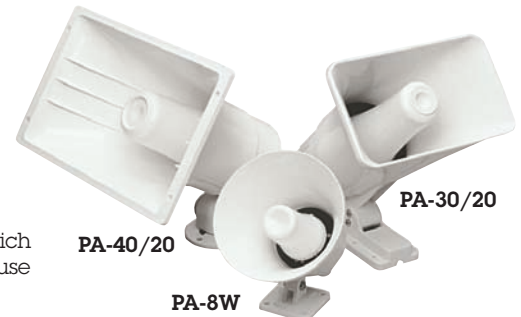

PA-40/20

PA-30/20

PA-8W

NEWMAR

DC Power Onboard



[www.newmarpower.com](http://www.newmarpower.com)

ABC Chargers.....	8	Digital Instruments.....	20	NAV-PAC.....	12
AC/DC Monitors.....	20-21	Dimmer, Lighting.....	15	Noise Filters.....	29
AC Source Switches.....	23	Distribution Panels.....	16-19, 24	Paging Speakers.....	31
Ammeters.....	20-21	Enclosures, Panel.....	22	Panel Blanks.....	18-19, 21
ANL Fuses.....	22	Electrical Panels.....	16-19, 24	Panel Enclosures.....	22
Antenna Mounts.....	28	Electrical System Analyzer.....	30	Phase Three Chargers.....	2-3
Antenna Switches.....	28	Electronic Filters.....	29	Phase Three Modular Chargers.....	4-5
AQ Series Waterproof Covers.....	31	Emergency Relay/Charger.....	15	Phone Intercoms.....	31
Automatic Power Selector.....	14	Feed-Thru Fittings.....	27-28	Power Conditioners.....	12-13
Battery Analyzer.....	30	Fuses, Fuseblocks.....	22	Power Function Manager.....	11
Battery Chargers.....	2-5, 8	Galvanic Isolators.....	24	Power Modules.....	11
Battery Integrators.....	14	Ground Shoes.....	29	Power-Pac.....	11
Battery Isolators.....	14	Ground Strap.....	29	Power Supply, Bench.....	11
Bus Bars.....	25	Hailer Horns.....	31	Power Supplies, Heavy Duty.....	10
Cable Fittings/Feed-Thrus.....	27-28	Indicator Lights.....	22	Power Supplies with Battery.....	11
Circuit Breakers.....	22	Instruments, Digital.....	20	Railfast Antenna Mounts.....	28
Clamshell Fittings.....	28	Integrated Power Systems.....	11	Ship-Shore Switches.....	23
Coax Switches.....	28	Inverter-Chargers.....	6-7	Speakers, Paging.....	31
Connector Strips.....	25	Intercoms.....	31	StartGuard.....	12
Copper Strap.....	29	Junction Boxes.....	26-27	Terminal Strips.....	25
DC-DC Converters.....	9, 13	Label Sets.....	22	Voltage Stabilizers.....	13
DC Power Conditioners.....	12-13	Lamp Dimmer.....	15	Voltmeters.....	20-21
DC Voltage Stabilizers.....	13	Low Voltage Disconnects.....	15	Waterproof Fittings.....	27-28
Deck Fittings.....	28	Meters, AC/DC.....	20-21	Waterproof Junction Boxes.....	26-27
Deck Horns.....	31	Meter Panels.....	21	Waterproof Radio Covers.....	31
Digital Battery Analyzer.....	30	Microphone Clips.....	28	Waterproof Speakers.....	31

Distributed By: