

NOKIA 6680

RM-36

**Transceiver characteristics:**

- Dual mode WCDMA/GSM operation and tri-band GSM coverage on up to five continents (GSM 900/1800/1900 and WCDMA 2100 networks)
- Two integrated digital cameras: 1.3 megapixel and VGA
- Experience two-way video calls and see face-to-face as you talk in real time
- Video sharing capability
- High-resolution display with 262,144-colors
- Capture quality images and video
- Nokia XpressPrint printing solution: PictBridge, Bluetooth wireless technology, MultiMediaCard (MMC)
- Fast WCDMA and EDGE connections for broadband-speed browsing plus tri-band GSM phone with global roaming capability
- Convenient email access with automatic download to send images and view documents
- Calendar, contacts, and other personal information management features plus data printing
- Music player with stereo audio

Transceiver with BL-5C 900mAh Li-Ion battery pack

Talk time	Standby	Note
2,2h –3,3h (WCDMA) 3h-6h (GSM)	6-11 days	Depends on network parameters

Environmental characteristics:

- Lead-free soldered

SERVICE MANUAL

Service Level 1&2

TABLE OF CONTENT

	Page
1. INTRODUCTION.....	3
2. GENERAL REPAIR INFORMATION.....	4
3. PATHFINDER FOR WORKSHOP STAFF.....	5
4. EXPLODED VIEW AND COMPONENT DISPOSAL.....	6
5. SPARE PARTS OVERVIEW.....	7
6. SPARE PARTS LIST.....	8
7. SERVICE TOOLS.....	9
8. SW-UPDATE.....	11
9. DISASSEMBLY INSTRUCTIONS.....	12
10. REMOVAL OF SHIELDING LIDS.....	17
11. LEGEND FOR QUICK TROUBLE SHOOTER.....	18
12. QUICK TROUBLE SHOOTER PART 1.....	19
13. QUICK TROUBLE SHOOTER PART 2.....	20
14. QUICK TROUBLE SHOOTER PART 3.....	21
15. CAMERA GONOGO TEST.....	22
16. BLUETOOTH.....	23
17. GONOGO TEST.....	24
18. BATTERY TEST.....	24
19. FORWARDING OF REPAIRS.....	25
20. ESD PROTECTION REQUIREMENTS.....	26

CHANGE HISTORY

Status	Version No.	Date	Comments
Draft	0.1	19.10.2004	Initial draft
Approved	1.0	22.02.2005	Approval

1. INTRODUCTION

The purpose of this document is to help Nokia service levels 1 and 2 workshop technicians to carry out service to Nokia products. This Service Manual is to be used **only** by authorized Nokia service suppliers, and the content of it is **confidential**. Please note that Nokia provides also other guidance documents (e.g. Service Bulletins) for service suppliers, follow these regularly and comply with the given instructions.

While every endeavor has been made to ensure the accuracy of this document, some errors may exist. If you find any errors or if you have further suggestions, please notify Nokia using the address below:

<mailto:cc-ts-rc.documentation@nokia.com>

Please keep in mind also that this documentation is continuously being updated and modified, so watch always out for the newest version.

Warnings and Cautions

Please refer to the phone's user guide for instructions relating to operation, care and maintenance including important safety information. Note also the following:

Warnings:

1. CARE MUST BE TAKEN ON INSTALLATION IN VEHICLES FITTED WITH ELECTRONIC ENGINE MANAGEMENT SYSTEMS AND ANTI-SKID BRAKING SYSTEMS. UNDER CERTAIN FAULT CONDITIONS, EMITTED RF ENERGY CAN AFFECT THEIR OPERATION. IF NECESSARY, CONSULT THE VEHICLE DEALER/MANUFACTURER TO DETERMINE THE IMMUNITY OF VEHICLE ELECTRONIC SYSTEMS TO RF ENERGY.
2. THE HANDPORTABLE TELEPHONE MUST NOT BE OPERATED IN AREAS LIKELY TO CONTAIN POTENTIALLY EXPLOSIVE ATMOSPHERES EG PETROL STATIONS (SERVICE STATIONS), BLASTING AREAS ETC.
3. OPERATION OF ANY RADIO TRANSMITTING EQUIPMENT, INCLUDING CELLULAR TELEPHONES, MAY INTERFERE WITH THE FUNCTIONALITY OF INADEQUATELY PROTECTED MEDICAL DEVICES. CONSULT A PHYSICIAN OR THE MANUFACTURER OF THE MEDICAL DEVICE IF YOU HAVE ANY QUESTIONS. OTHER ELECTRONIC EQUIPMENT MAY ALSO BE SUBJECT TO INTERFERENCE.

Cautions:

1. Servicing and alignment must be undertaken by qualified personnel only.
2. Ensure all work is carried out at an anti-static workstation and that an anti-static wrist strap is worn.
3. Use only approved components as specified in the parts list.
4. Ensure all components, modules screws and insulators are correctly re-fitted after servicing and alignment.
Ensure all cables and wires are repositioned correctly.



Electrostatic discharge can easily damage the sensitive components of electronic products. Therefore every Service Supplier has to take care of all precautions, which are mentioned in the service level related "Service Partner Requirements", available on Nokia Online. Also see ESD Protection Requirements in this Service Manual.

2. GENERAL REPAIR INFORMATION

In this section the technician will get some general hints how to carry out repairs:

- To familiarize oneself with Nokia product read the tutorials or user guide on www.nokia.com -->Support--> Phones, by selecting the Phone Model.
- Before starting the repair you must take care of ESD precautions like being in your ESD Protected Area and connecting your wristband.
- Use gloves to avoid corrosion and fingerprints.
- Protect windows and displays with a film to avoid dust and scratches.
- When cleaning the LCD Module any lint-free cloth can be used (e.g. Micro-Fibre cloth).
- When cleaning the pads you have to use a soft cloth/ESD brush and Isopropanol. It is not allowed to use a glass fiber pencil because it scratches the surface and will lead later on to corrosion.
- Mechanical parts (except shielding lids and bent parts), which didn't repair the failure, can be reused, if they are not soldered.
- When removing the shielding lids make sure to replace them with new ones, otherwise the high-frequency leakage can have an influence on the device.
- Always use original Nokia spare parts.
- Check the soldering joints of the parts, which are concerned regarding the indicated error (e.g. soldered connectors or switches) and resolder them if necessary (Level 2 only).
- Remove redundant soldering flux after repair.
- Meet the torque requirements when assembling the unit (see also the document "torques for transceiver assembly" on Nokia Online).
- Always use your own equipment for testing where you are sure that it works. E.g. if the customer complains about charger function, please test the phone with your own charger to be sure if phone or charger causes the malfunction.
- A SIM card is needed for all GoNoGo tests.
- When doing the fault log entries, always note the Item code, which caused the malfunction. Also, fill in the appropriate part code from the assembly, if needed.
- Please be aware that some malfunctions could be software related and solved by an update.

- There are several documents available on NOL, which have to be followed:
- First, take care for the latest content pages of Service Bulletins, which are always available for each folder on Nokia Online. This is also important to recognize, if existing documents have become invalid.
- The service level indicator at the bottom of each document tells the appropriate destination.

Downloads > Support Library >

1. Instructions
 2. General Service Bulletins
 3. Product related documents
 4. Spare Part Service Bulletins
 5. Service Tools Service Bulletins
 6. Common Software Service Bulletins
- etc,...

Use General SB-217 as a reference or overview.

Please also check Nokia Online (NOL) for latest news and files on a regular basis.

3. PATHFINDER FOR WORKSHOP STAFF

In addition to the information in this Service Manual, there are several instructions and information, which have to be followed. Main documentation database is [NOKIA Online](#) with the purpose of serving different multimedia content, like video clips or interactive tutorials.

It is mandatory to watch for newest technical and organizational information on a daily basis to be updated as required (see “**Latest files in Support Library**”). Every new information has to be processed and implemented as soon as possible.

When logged into NOL you can also find needed information in different folder like:

Support Library

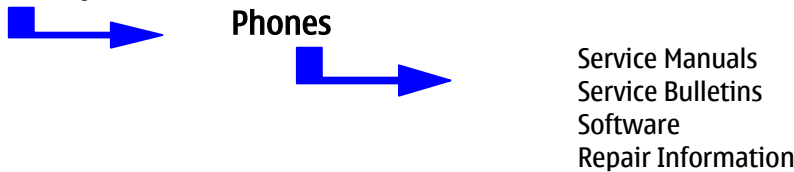

Level 1&2 e-learning (former NOKIA CarePoint) on NOKIA Online

Former NOKIA CarePoint content, such as	<ul style="list-style-type: none"> • Online Troubleshooting • Product information • Videos – Disassembly/Assembly 	can be found on NOKIA Online
		<p>NOKIA Online</p> <p>↓</p> <p>Care Services</p> <p>↓</p> <p>Training</p> <p>↓</p> <p>Phone Models</p>

Level 1&2 e-learning courses offer a quick overview of the NOKIA phone and support for how to repair and use the phone:

<p>Overview & Guides Basic information about the phone, features and technologies</p>	<p>Disassembly & Assembly Instructions to disassemble and assemble the phone</p>	<p>Troubleshooting Step-by-step instructions on how to locate and repair the most common problems with the phone</p>
---	--	--

To reduce the server traffic it is recommended to download newest version of huge files like videos, Phoenix packages or Service Manuals only once and distribute it internally for further use.

4. EXPLODED VIEW AND COMPONENT DISPOSAL

Recommendation for the ecologically friendly disposal of components. Colorized components show the different categories. See corresponding ITEM/CIRCUIT REF in the Spare Parts Service Bulletins on NOL.

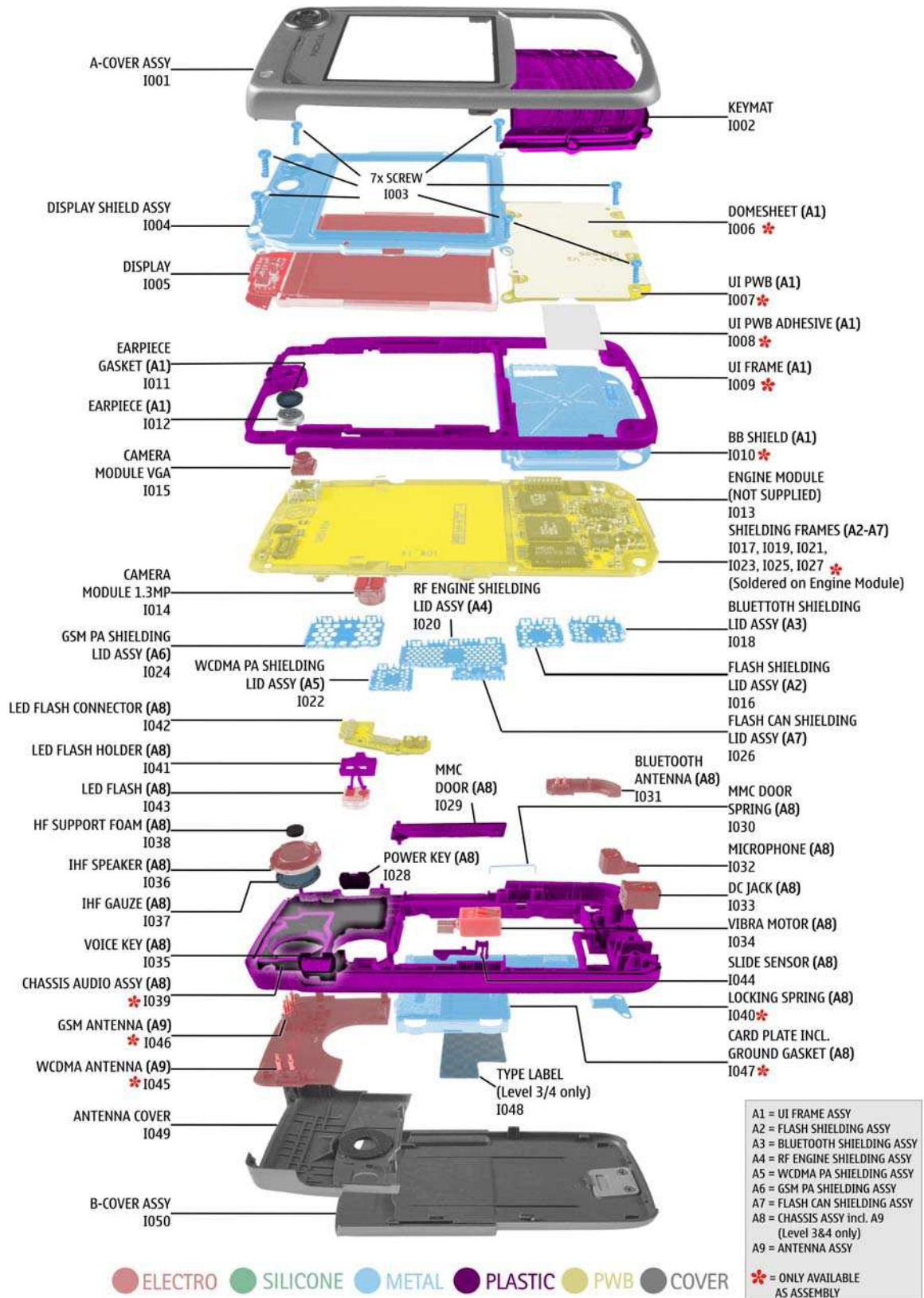

5. SPARE PARTS OVERVIEW

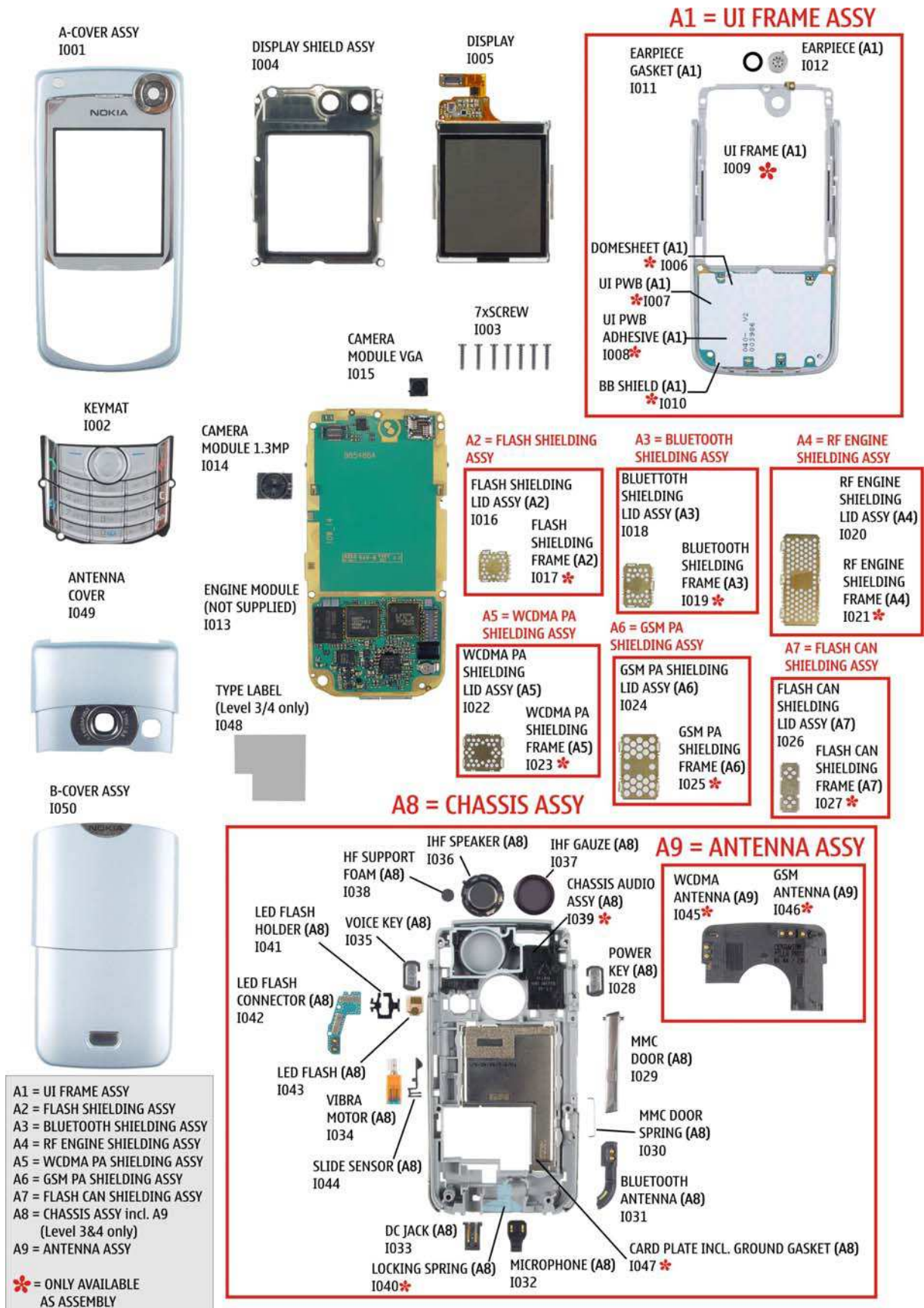

6. SPARE PARTS LIST

Please exchange this page (placeholder) with latest corresponding Service Bulletins (spare parts, SWAP units and service tools) from Nokia Online!

This will ensure, that you are using up-to-date order codes only.

Therefore Service Bulletins have to be checked from NOL on daily basis.

7. SERVICE TOOLS

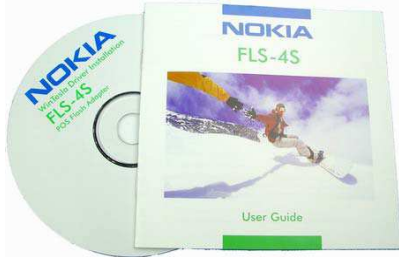
**FLS-4S incl. ACF-8, Driver and User Guide**

Dongle and flash device incorporated into one package, developed specifically for POS use.

**ACF-8**

Universal Power Supply is used to power FLS-4S.

**Internal Battery BL-5C**

Inserted under the back cover, this Li-Ion 900 mAh battery provides power in a lightweight package.

**DKU-2**

USB Flash Cable

**Travel Charger ACP-12**

Small and lightweight charger for fast charging of your phone battery.

**Headset HDS-3**

Small and lightweight stereo headset for handsfree functionality and listening to FM radio.

**SS-15**

Camera removal tool. One side is for disassembly, the other side for assembly.



SS-51
 Camera Removal Tool



SS-68
 Antenna Cover Opening Tool.



RJ-74
 Soldering Jig



Lead-free Solder Wire
 Mandatory for lead-free products (Level 2 only).

0772040 NMP Standard Toolkit



- Nokia opening tool SRT-6 Nokia No. 0770431
- Tonichi torque driver Nokia No. 6901525
- [Hoya](#) micro fibre cloth MX304
- [Dastex](#) gloves S, M, XL
- [Artlux](#) goggles AH166
- [Wera](#) bit T5 867/4TX 5x50
- Wera 867/4 6IP; 50mm (Torx 6 PLUS®)
- Wera bit T6 867/4TX 6x50
- Wera 867/1 5IP; 25mm (Torx 5 PLUS®)
- Wera bit T6 PLUS® 867/4TX 6IP
- [Facom](#) side cutter 416E
- Facom T5 driver SP.14032
- Facom T6 driver SP.14033
- Facom slot screwdriver AEF. 2x35.E
- [Wetec](#) tweezers 7abb SA-ESD
- Wetec tweezers 22 SA-ESD
- Wetec tweezers 13 SA-SMD ESD
- Wetec tweezers PSF SA-ESD
- Wetec ESD brush E1211
- [Kaiser](#) Fototechnik airbrush 6315
- Wetec dental tool DEM83266/0
- [RS](#) Components Scissors 323-5732

8. SW-UPDATE

To use FLS-4S Flash Dongle you have to follow the user guide inside the sales package. Please check always for the latest version of flash software, which is available on [Nokia Online](#).

Flash Concept – (Point of Sales)



9. DISASSEMBLY INSTRUCTIONS



1.) Protect the window with a film.

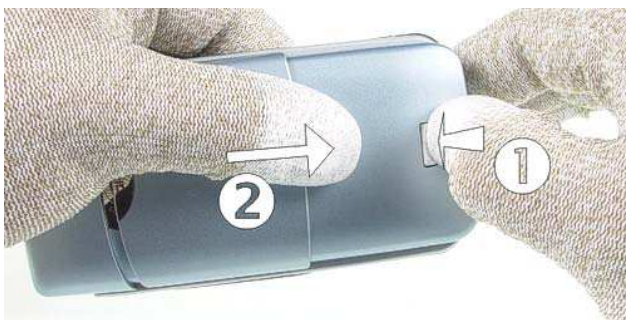

2.) Press the release button and remove the **B-Cover**.



3.) Place the SS-68 into the openings.



4.) Pull up the **Antenna Cover** carefully.



5.) Release the booth clips of the **A-Cover** with SRT-6.



6.) Remove the **A-Cover** by turning it as shown in the picture carefully. Replace the **A-Cover** if it is necessary.



7.) Remove the **Keymat**.



8.) Unscrew the seven Torx Plus® size 6 screws in the shown order. **For assembly, the reverse order and a torque driver with a torque of 25Ncm has to be used.**

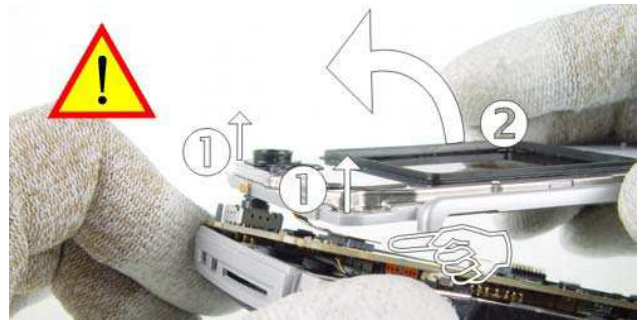

9.) Lift the UI FRAME ASSY a bit and flip it up carefully.

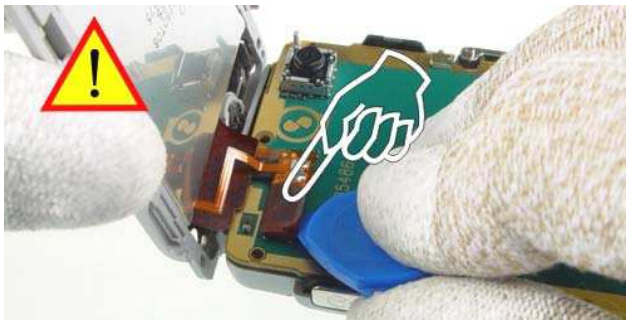

10.) Open the display connector with SRT-6 carefully. Take care about the surrounding components.



11.) The Display Shield is locked to the UI-Frame in the shown places.



12.) Release the Display Shield with a slotted screwdriver.



13.) Remove the Display Shield.

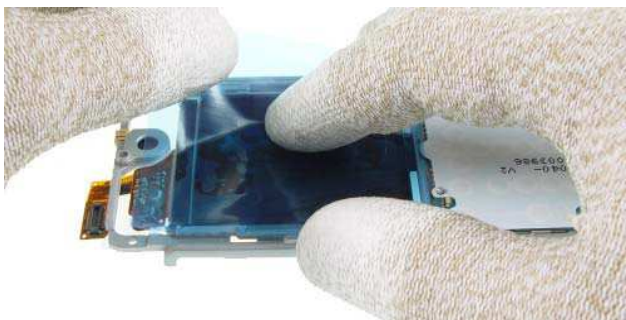

14.) Protect the Display with a film.



15.) Remove the Display.



16.) Use the dental tool as a lever to remove the Earpiece.

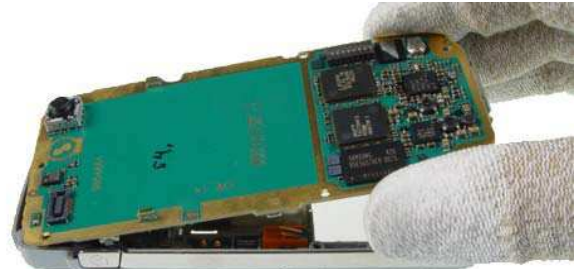

17.) Remove the Engine Module.

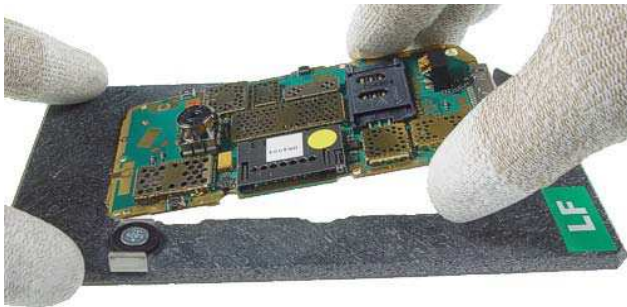

18.) Use always the Rework Jig as a support when working on the Engine Module.

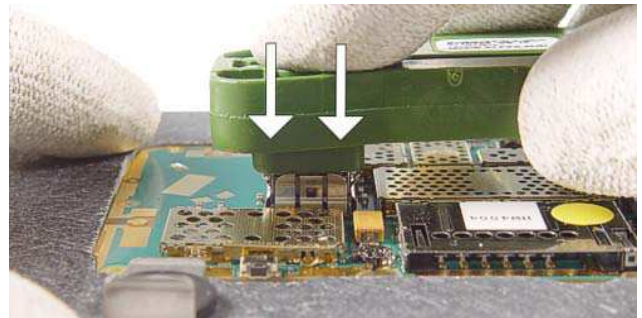

19.) Use the SS-15 Camera Removal Tool when removing the Camera Module 1.3MP.

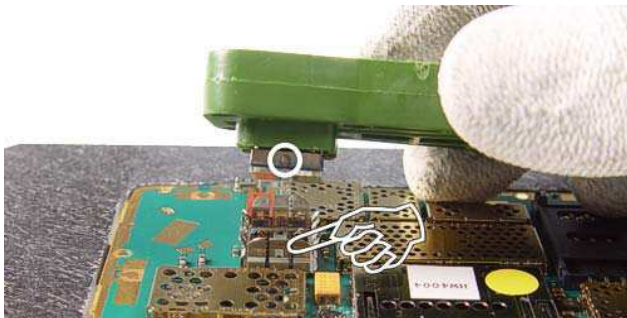

20.) Note the Camera guide pins when re-assembling.

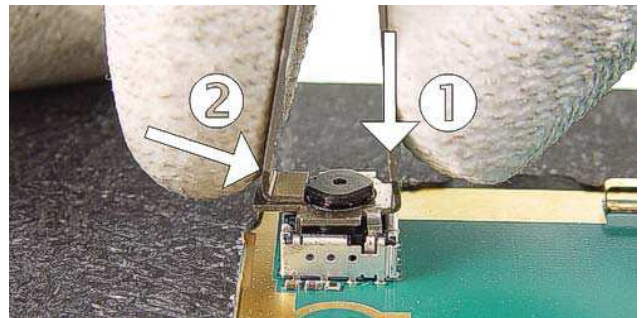

21.) Use the SS-51 when removing the Camera Module VGA.

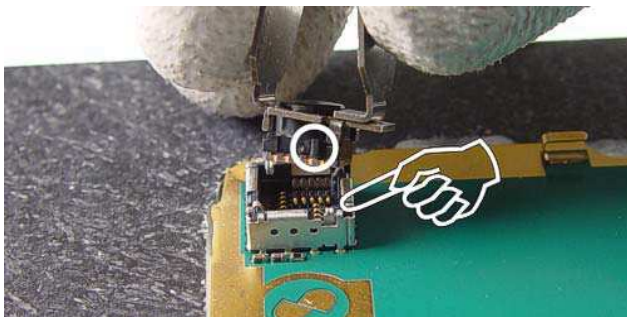

22.) Also note the camera guiding when re-assembly.

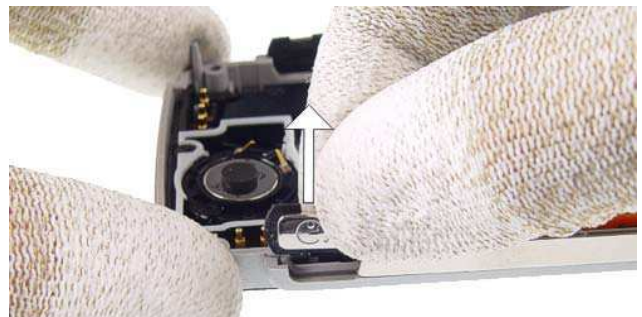

23.) Remove the Voice Key

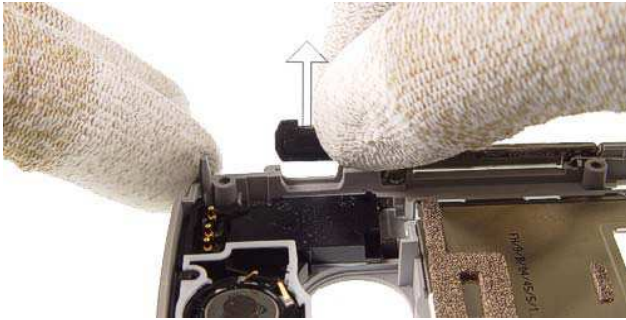

24.) Remove the **Power Key**..

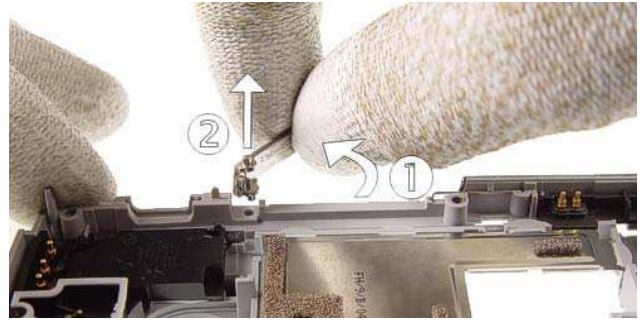

25.) Open the **MMC Door** and remove it from its holder.

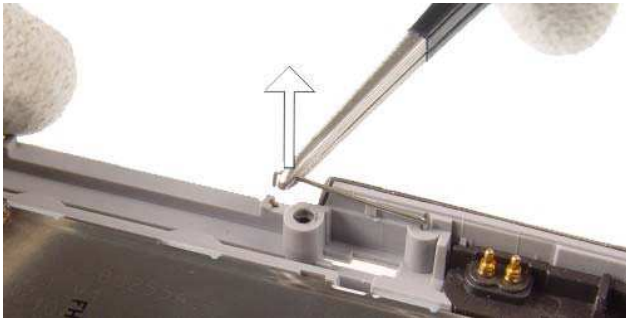

26.) Remove the **MMC Door Spring** with tweezers.

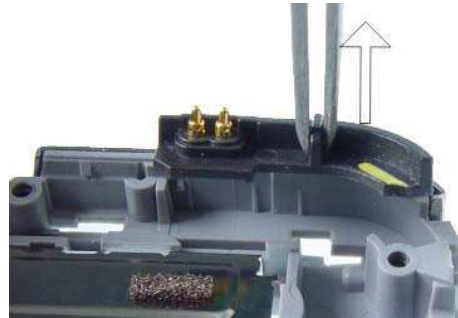

27.) Remove the **Bluetooth Antenna**.

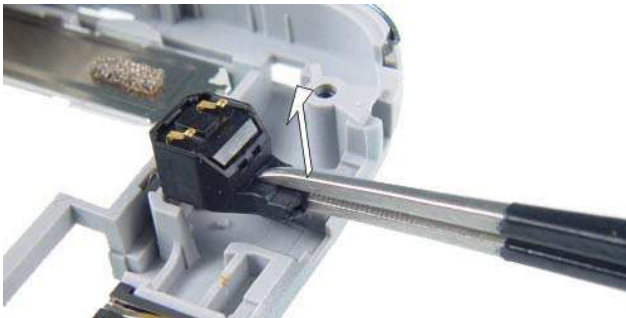

28.) Remove the **Microphone**.



29.) Use the DC plug when removing the **DC-Jack**.

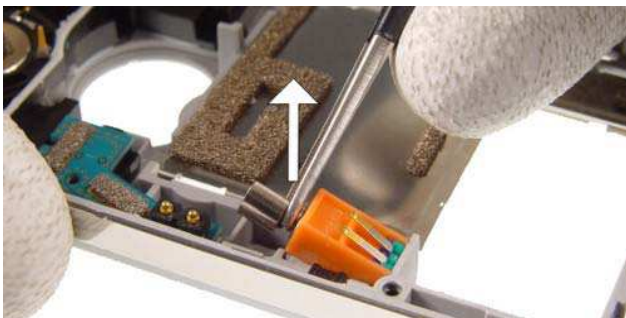

30.) Remove the **Vibra Motor** with Tweezers.

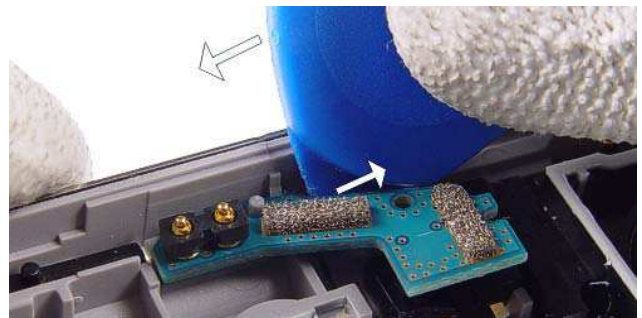

31.) Unlock the **LED Flash Connector** with SRT-6.

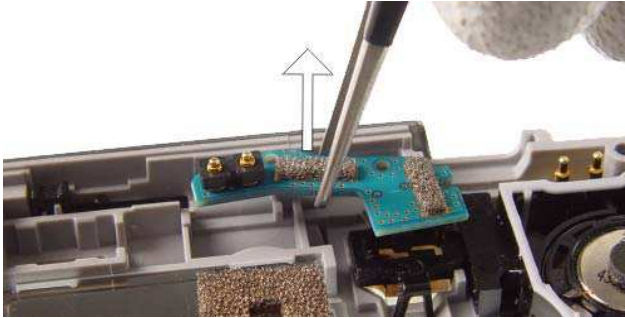
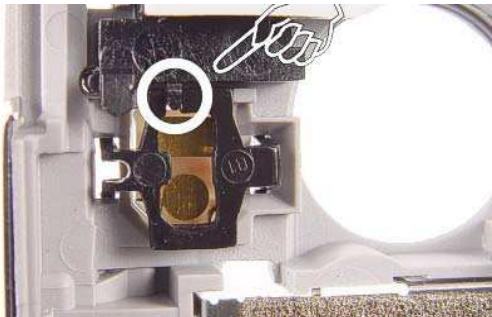
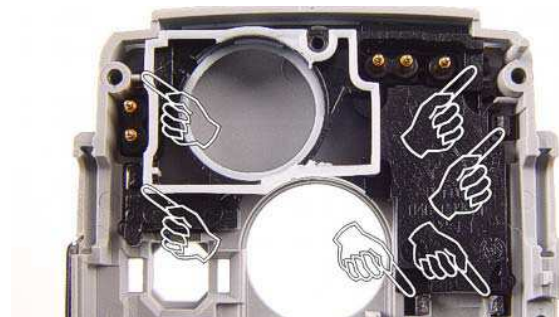
32.) Remove the **LED Flash Connector**.33.) Use tweezers to unlock the snaps of the **LED Flash Holder**.34.) Note! Take care to the right position of the **LED Flash Holder** when re-assembling.35.) Push out the **LED Flash** with SRT-6.36.) Use tweezers as a lever when removing the **IHF-Speaker**.37.) The **Antenna Assy** is attached with four snaps to the **Chassis Assy**.

38.) Unlock the snaps with a slotted screwdriver carefully.

39.) Remove the **Antenna Assy**.



40.) Push out the **Slide Sensor** with tweezers.

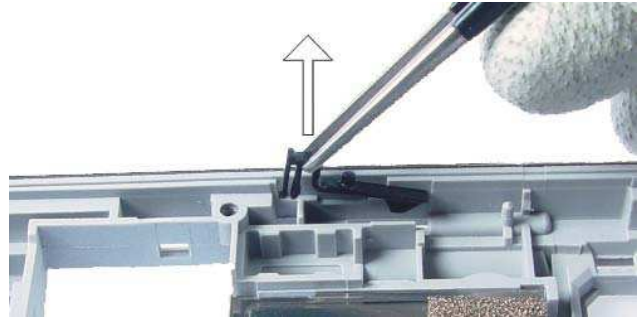

41.) Now, remove the **Slide Sensor**. Note the right position when re-assembling.

10. REMOVAL OF SHIELDING LIDS

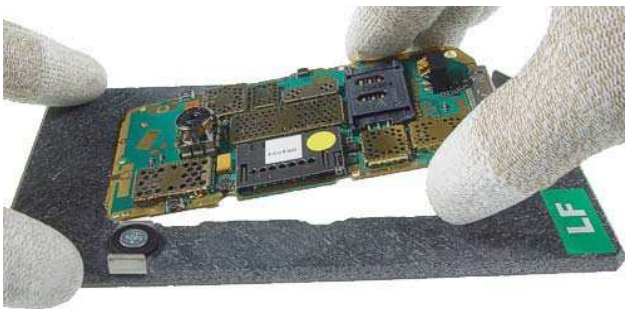

1.) Use always the Soldering Jig as a support when working on the **Engine Module**.

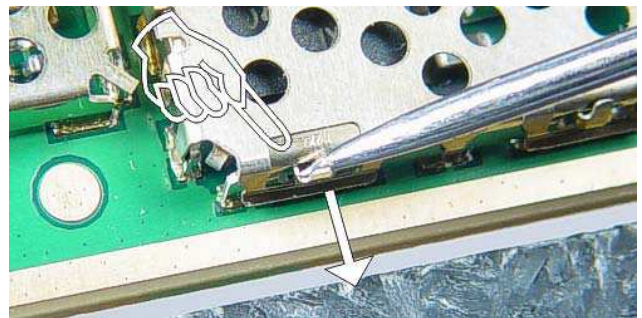

2.) Open the clips of the **Shielding Lids** with the dental tool.

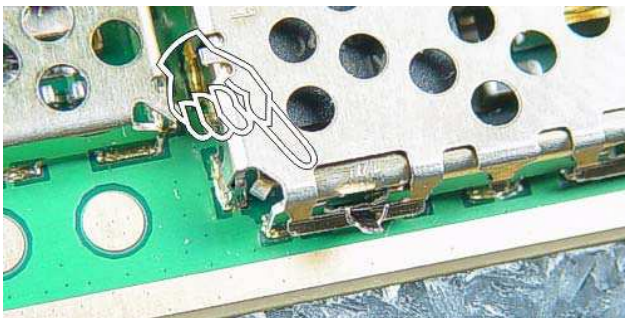



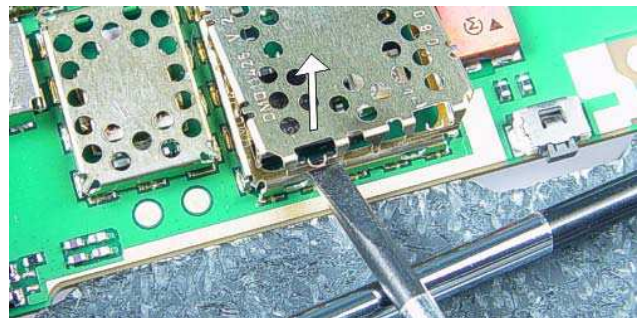





3.) The lid can be removed, if all clips of the **Shielding Lid** are in the shown position.



4.) Use a slotted screwdriver as a lever to lift the **Shielding Lids**. **Always use new Shielding Lids for re-assembly.**

11. LEGEND FOR QUICK TROUBLE SHOOTER

This legend is valid for all parts of the **Quick Trouble Shooter**

Follow the steps until the problem is solved. If this doesn't help, you are not authorized to go forward.	
	Only marked components (e.g. I002 ) can be changed.
	The start point of repair activities regarding the appeared fault symptoms.
	Follow the arrows step by step
	Pads or contacts: Check optical and mechanical condition particularly regarding to corrosion. Clean if necessary.
	Measure component for electrical functionality and change, if needed. (Level 2 only)
	Pads or contacts: Check optical and mechanical condition particularly regarding to corrosion. Clean with ESD brush only, if necessary.
	No more actions possible send product to the appropriate service supplier with higher service level.

12. QUICK TROUBLE SHOOTER PART 1

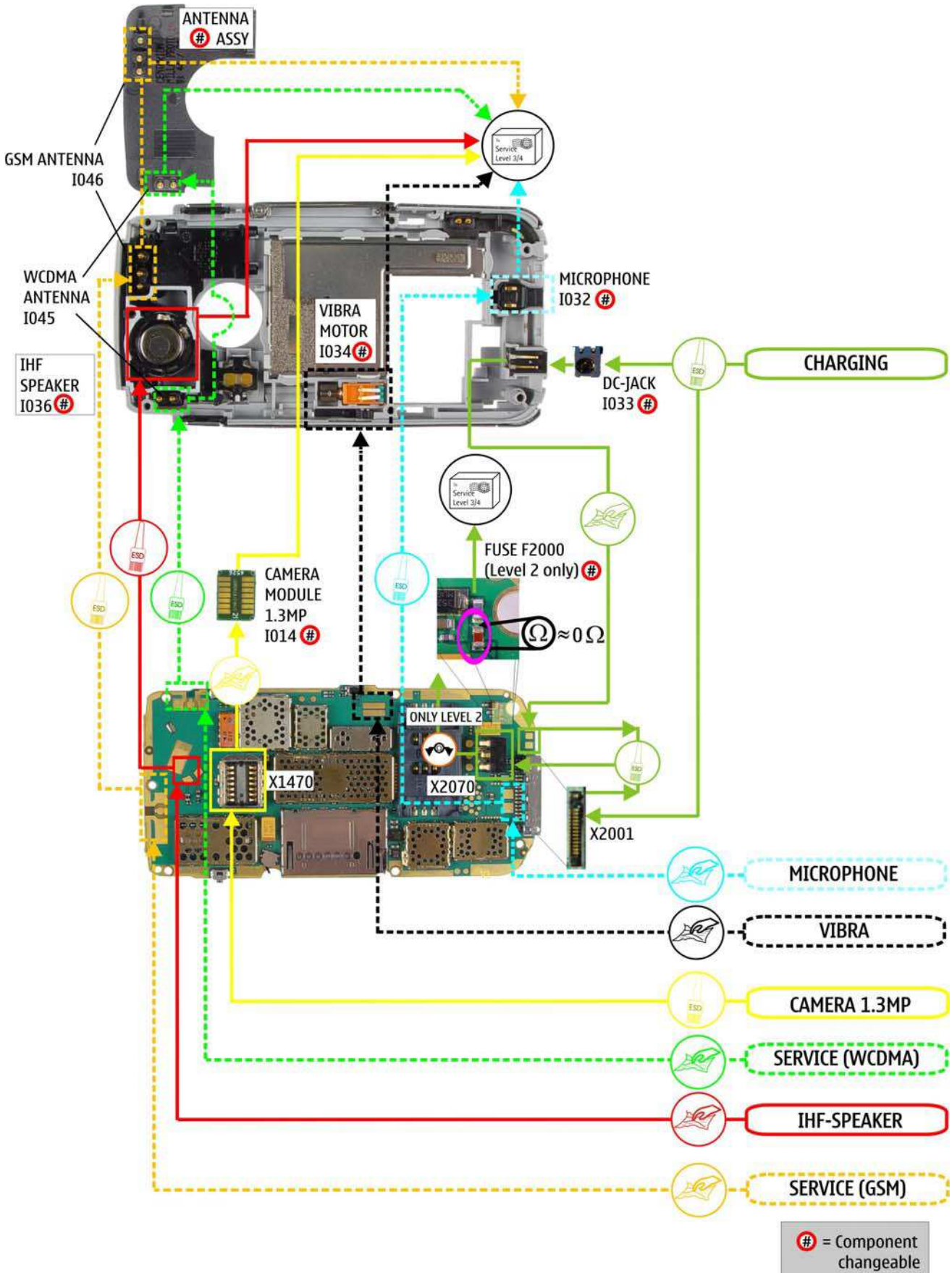

13. QUICK TROUBLE SHOOTER PART 2

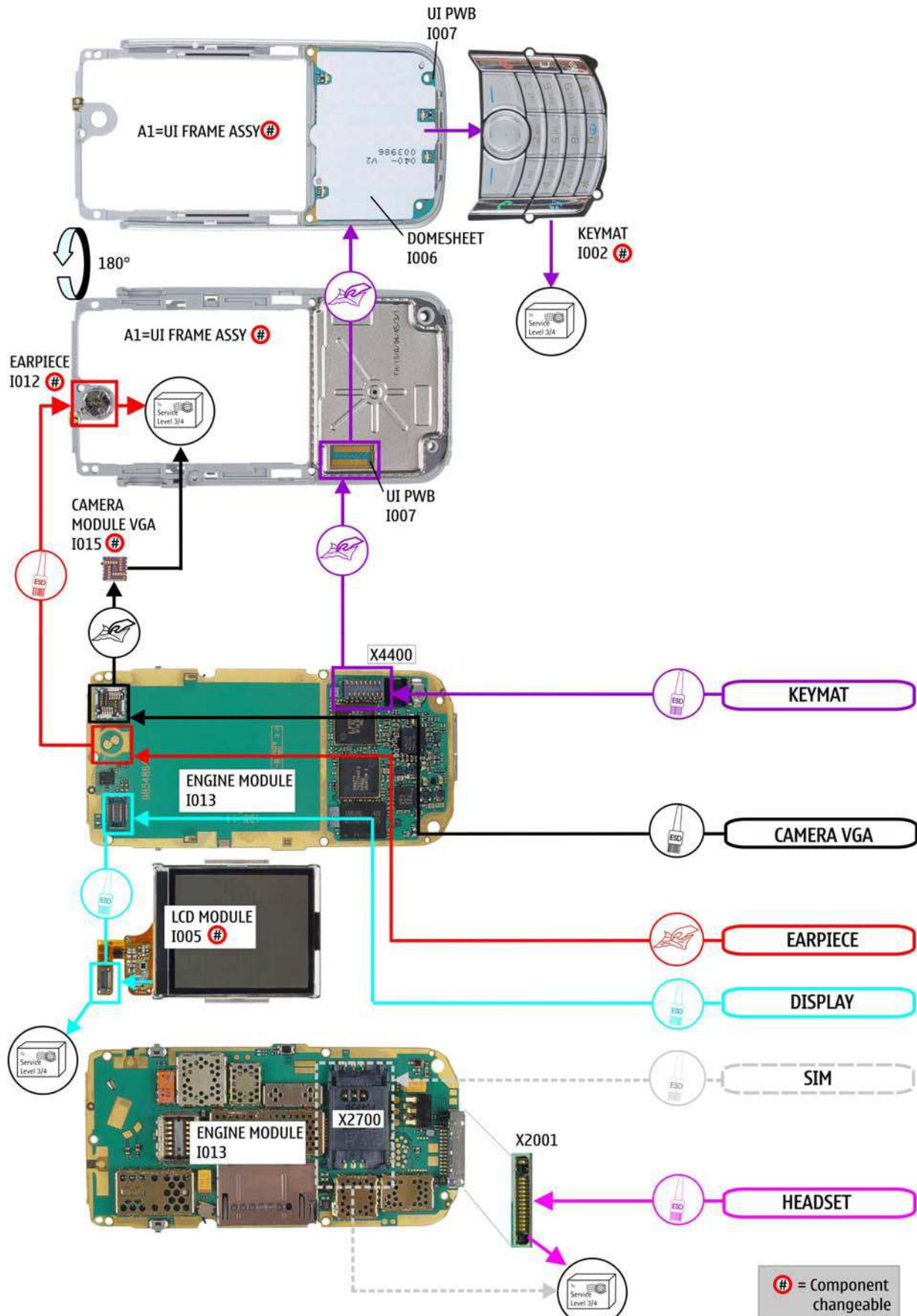

14. QUICK TROUBLE SHOOTER PART 3

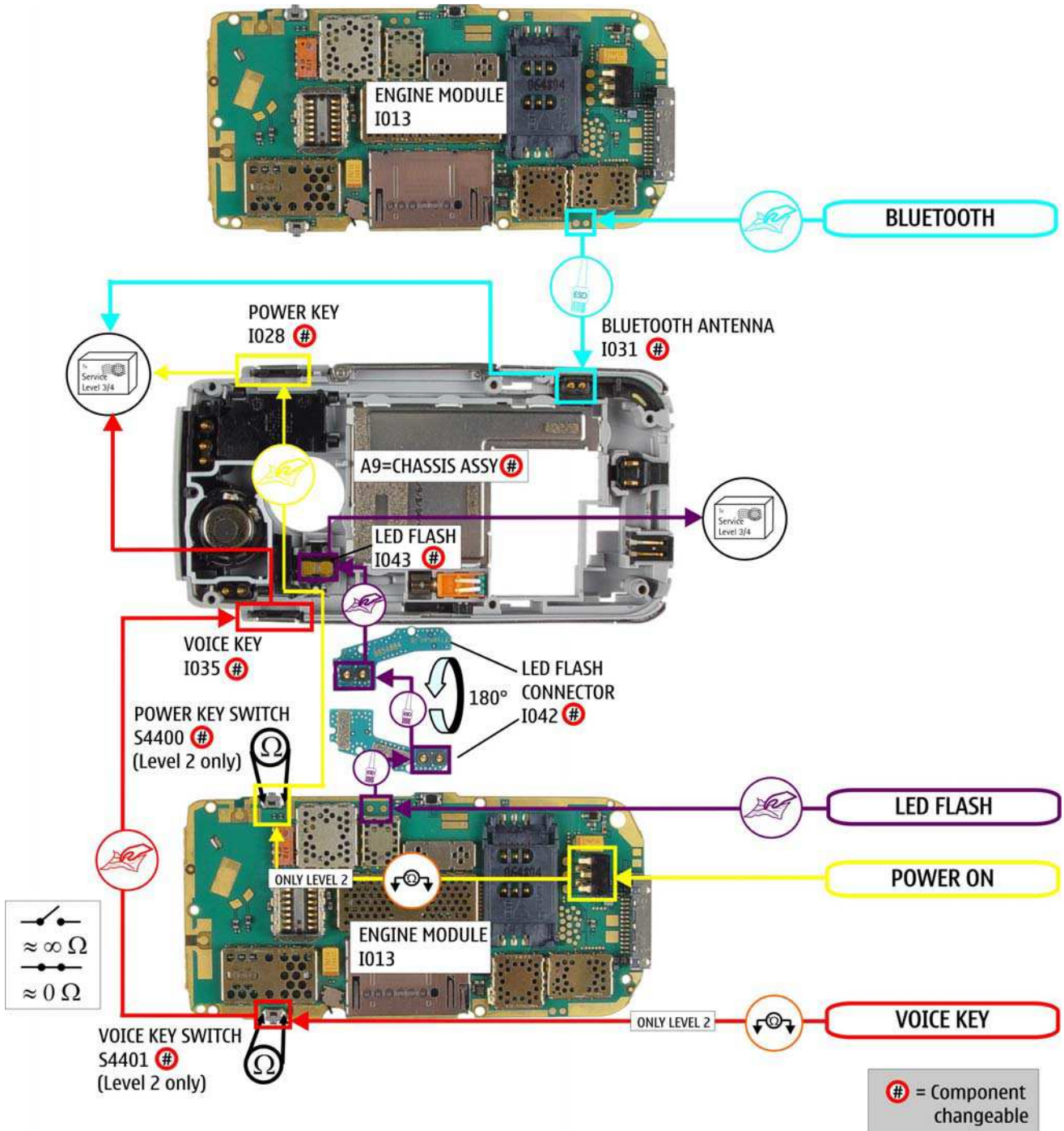

15. CAMERA GONOGO TEST

Before starting the GoNoGo test, check that camera window is clean. If not, clean the window with cloth.



1.3 Mega Pixel Camera



VGA Camera

1.3 Mega Pixel Camera GoNoGo test:

- Press the red receiver button to reach the Home Menu
- Open the **Slide Cover**
- Press  to take a photo
This Image will be saved to Gallery into the Photos folder automatically.
Test was successful, if the Image appears on your Display. The camera is ok.
- Select **Options**
- Select **Delete**
- Select **Yes**
- Close the **Slide Cover**

VGA Camera GoNoGo test:

- **Slide Cover** must be closed
- Press the red receiver button to reach the Home Menu
- Select **Camera**
- Press  to take a photo
This Image will be saved to Gallery into the Photos folder automatically.
Test was successful, if the Image appears on your Display. The camera is ok.
- Select **Options**
- Select **Delete**
- Select **Yes**
- Press the red receiver button to reach the Home Menu

If the test is failed see Quick Trouble Shooter.

16. BLUETOOTH

Bluetooth test

You need another Bluetooth device (e.g. 6230) to do a GoNoGo test.

Make sure that Bluetooth is activated in the reference unit. The distance of the devices should be not more than 5m from each other.



Reference unit, Bluetooth



Test unit

Settings on the test unit:

- Press the red **End** key to reach the Home Menu



- Press  and select one entry.
If phone and SIM memory is empty, create one new entry.
- Select **Options**
- Select **Send**
- Select **Bluetooth**
If needed (for e.g. after a sw-update), enter a name for this device
- Search window appears, if all Bluetooth devices in range will be displayed, the test is successful!
- Press red **End** key to reach the Home Menu

Note: If the Bluetooth is activated, switch it off!

17. GONOGO TEST

After the optical check, a GoNoGo test has to be carried out if the unit has been unscrewed to guarantee the functionality of the phone.

**Please refer to the actual information on Nokia Online. When using delivered tester support files, take care of the right setup according to the tester type and product type.
Please refer to “Recommended Service Equipment” on Nokia Online.**

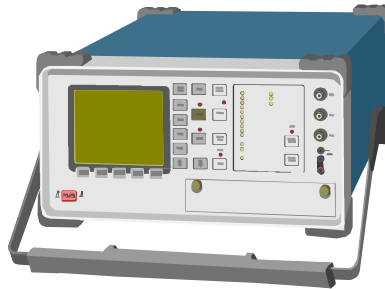

Mobile Phone Tester

18. BATTERY TEST

A battery tester lets you test the capacity of Nokia batteries.

Please refer to the actual information on Nokia Online.



<http://www.astratec.co.uk/>



<http://www.cadex.com/>

19. FORWARDING OF REPAIRS

When it is necessary to forward of repairs to appropriate service supplier with higher service level we recommend using the offered swap phone cartons as described in Spare Parts SB-004.

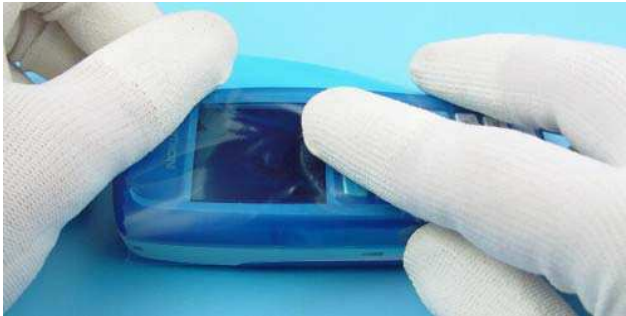

Always Protect the window with a protection film.



Put the unit under the stretch film.



Add repair documentation e.g. filled-in service note into the swap carton.



There are two different sizes of swap cartons for common mobile phones.

20. ESD PROTECTION REQUIREMENTS

Please refer to the Nokia Online document [Service Supplier Requirements](#) in folder General instructions.

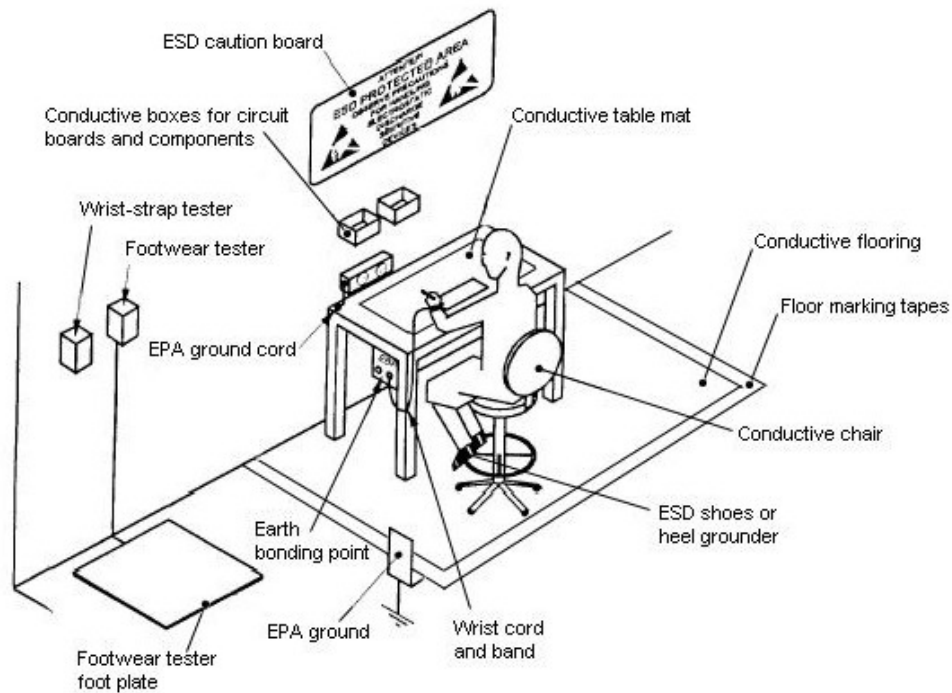

- USE** Conductive bags and boxes
- USE** ESD compatible service tools
- USE** Conductive wastebaskets
- USE** ESD gloves when handling PWBs/PCBs
- USE** Cleaning material without changing el. Characteristics
- USE** Grounded service equipment, i.e. soldering station
- USE** ESD clothes such as coat or frock

- NO** Smoking
- NO** Drinking
- NO** Eating
- NO** Dust
- NO** Useless Items
- NO** Normal pressured air for cleaning modules/displays



The video covers general issues concerning Electro-Static Discharge (ESD)

www.s-manuals.com