

# The Open Master Hearing Aid (openMHA)

4.8.0

## Plugin Developers' Manual



**HörTech**

Kompetenzzentrum für  
Hörgeräte-Systemtechnik

**The Open Master Hearing Aid (openMHA) – Plugin Developers' Manual**  
HörTech gGmbH  
Marie-Curie-Str. 2  
D-26129 Oldenburg

## LICENSE AGREEMENT

This file is part of the HörTech Open Master Hearing Aid (openMHA)  
Copyright © 2005 2006 2007 2008 2009 2010 2012 2013 2014 2015 2016 HörTech gGmbH.  
Copyright © 2017 2018 2019 HörTech gGmbH.

openMHA is free software: you can redistribute it and/or modify it under the terms of the GNU Affero General Public License as published by the Free Software Foundation, version 3 of the License.

openMHA is distributed in the hope that it will be useful, but WITHOUT ANY WARRANTY; without even the implied warranty of MERCHANTABILITY or FITNESS FOR A PARTICULAR PURPOSE. See the GNU Affero General Public License, version 3 for more details.

You should have received a copy of the GNU Affero General Public License, version 3 along with openMHA. If not, see <<http://www.gnu.org/licenses/>>.

# Contents

<b>1</b>	<b>Overview</b>	<b>1</b>
1.1	Structure . . . . .	1
1.2	Platform Services and Conventions . . . . .	2
<b>2</b>	<b>Todo List</b>	<b>4</b>
<b>3</b>	<b>Module Documentation</b>	<b>4</b>
3.1	Concept of Variables and Data Exchange in the openMHA . . . . .	4
3.2	The openMHA Plugins (programming interface) . . . . .	7
3.3	Writing openMHA Plugins. A step-by-step tutorial . . . . .	11
3.4	The MHA Framework interface . . . . .	27
3.5	Communication between algorithms . . . . .	28
3.6	Error handling in the openMHA . . . . .	32
3.7	The openMHA configuration language . . . . .	34
3.8	The openMHA Toolbox library . . . . .	35
3.9	Vector and matrix processing toolbox . . . . .	37
3.10	Complex arithmetics in the openMHA . . . . .	61
3.11	Fast Fourier Transform functions . . . . .	71
<b>4</b>	<b>Namespace Documentation</b>	<b>78</b>
4.1	ac2Isl Namespace Reference . . . . .	78
4.2	acmon Namespace Reference . . . . .	78
4.3	acsave Namespace Reference . . . . .	79
4.4	addsndfile Namespace Reference . . . . .	79
4.5	ADM Namespace Reference . . . . .	80
4.6	AuditoryProfile Namespace Reference . . . . .	81
4.7	coherence Namespace Reference . . . . .	82
4.8	dc Namespace Reference . . . . .	82
4.9	dc_simple Namespace Reference . . . . .	83
4.10	delay Namespace Reference . . . . .	84
4.11	delaysum Namespace Reference . . . . .	84
4.12	DynComp Namespace Reference . . . . .	85
4.13	fader_wave Namespace Reference . . . . .	86
4.14	fftfbpow Namespace Reference . . . . .	86
4.15	fftfilterbank Namespace Reference . . . . .	87
4.16	fshift Namespace Reference . . . . .	87
4.17	fshift_hilbert Namespace Reference . . . . .	88
4.18	gain Namespace Reference . . . . .	88
4.19	gtfb_analyzer Namespace Reference . . . . .	88
4.20	matrixmixer Namespace Reference . . . . .	89
4.21	MHA_AC Namespace Reference . . . . .	89
4.22	mha_error_helpers Namespace Reference . . . . .	90
4.23	MHA_TCP Namespace Reference . . . . .	91
4.24	mhachain Namespace Reference . . . . .	93
4.25	MHAEvents Namespace Reference . . . . .	93
4.26	MHAFilter Namespace Reference . . . . .	94
4.27	MHAIOJack Namespace Reference . . . . .	98
4.28	MHAIOJackdb Namespace Reference . . . . .	98
4.29	MHAIOPortAudio Namespace Reference . . . . .	98
4.30	MHAJack Namespace Reference . . . . .	99

4.31	MHAKernel Namespace Reference	101
4.32	MHAMultiSrc Namespace Reference	101
4.33	MHAOvIFilter Namespace Reference	102
4.34	MHAOvIFilter::barkscale Namespace Reference	103
4.35	MHAOvIFilter::FreqScaleFun Namespace Reference	103
4.36	MHAOvIFilter::ShapeFun Namespace Reference	106
4.37	MHAParser Namespace Reference	107
4.38	MHAParser::StrCnv Namespace Reference	112
4.39	MHAPLugin Namespace Reference	116
4.40	MHAPLugin_Resampling Namespace Reference	117
4.41	MHAPLugin_Split Namespace Reference	117
4.42	MHASignal Namespace Reference	118
4.43	MHASndFile Namespace Reference	125
4.44	MHATableLookup Namespace Reference	125
4.45	MHAWindow Namespace Reference	125
4.46	multibandcompressor Namespace Reference	127
4.47	noisePowProposedScale Namespace Reference	127
4.48	overlapadd Namespace Reference	127
4.49	plingploing Namespace Reference	128
4.50	PluginLoader Namespace Reference	128
4.51	route Namespace Reference	129
4.52	shadowfilter_begin Namespace Reference	129
4.53	shadowfilter_end Namespace Reference	129
4.54	smoothgains_bridge Namespace Reference	130
4.55	testplugin Namespace Reference	130
<b>5</b>	<b>Class Documentation</b>	<b>130</b>
5.1	ac2Isl::ac2Isl_t Class Reference	130
5.2	ac2Isl::cfg_t Class Reference	133
5.3	ac2Isl::save_var_base_t Class Reference	136
5.4	ac2Isl::save_var_t< T > Class Template Reference	137
5.5	ac2Isl::save_var_t< mha_complex_t > Class Template Reference	140
5.6	ac2Isl::type_info Struct Reference	143
5.7	ac2osc_t Class Reference	144
5.8	ac2wave_if_t Class Reference	148
5.9	ac2wave_t Class Reference	150
5.10	acConcat_wave Class Reference	151
5.11	acConcat_wave_config Class Reference	154
5.12	acmon::ac_monitor_t Class Reference	155
5.13	acmon::acmon_t Class Reference	157
5.14	acPooling_wave Class Reference	160
5.15	acPooling_wave_config Class Reference	163
5.16	acsave::acsave_t Class Reference	165
5.17	acsave::cfg_t Class Reference	168
5.18	acsave::mat4head_t Struct Reference	169
5.19	acsave::save_var_t Class Reference	170
5.20	acSteer Class Reference	172
5.21	acSteer_config Class Reference	174
5.22	acTransform_wave Class Reference	176
5.23	acTransform_wave_config Class Reference	178
5.24	addsndfile::addsndfile_if_t Class Reference	180
5.25	addsndfile::level_adapt_t Class Reference	183

5.26	<a href="#">addsndfile::resampled_soundfile_t Class Reference</a>	184
5.27	<a href="#">addsndfile::sndfile_t Class Reference</a>	186
5.28	<a href="#">addsndfile::waveform_proxy_t Class Reference</a>	187
5.29	<a href="#">ADM::ADM&lt; F &gt; Class Template Reference</a>	188
5.30	<a href="#">ADM::Delay&lt; F &gt; Class Template Reference</a>	191
5.31	<a href="#">ADM::Linearphase_FIR&lt; F &gt; Class Template Reference</a>	193
5.32	<a href="#">adm_if_t Class Reference</a>	195
5.33	<a href="#">adm_rtconfig_t Class Reference</a>	197
5.34	<a href="#">algo_comm_t Struct Reference</a>	201
5.35	<a href="#">alsa_base_t Class Reference</a>	206
5.36	<a href="#">alsa_dev_par_parser_t Class Reference</a>	208
5.37	<a href="#">alsa_t&lt; T &gt; Class Template Reference</a>	210
5.38	<a href="#">altplugs_t Class Reference</a>	213
5.39	<a href="#">analysepath_t Class Reference</a>	217
5.40	<a href="#">analysispath_if_t Class Reference</a>	219
5.41	<a href="#">AuditoryProfile::fmap_t Class Reference</a>	221
5.42	<a href="#">AuditoryProfile::parser_t Class Reference</a>	222
5.43	<a href="#">AuditoryProfile::parser_t::ear_t Class Reference</a>	223
5.44	<a href="#">AuditoryProfile::parser_t::fmap_t Class Reference</a>	224
5.45	<a href="#">AuditoryProfile::profile_t Class Reference</a>	226
5.46	<a href="#">AuditoryProfile::profile_t::ear_t Class Reference</a>	227
5.47	<a href="#">bbcalib_interface_t Class Reference</a>	228
5.48	<a href="#">calibrator_runtime_layer_t Class Reference</a>	229
5.49	<a href="#">calibrator_t Class Reference</a>	231
5.50	<a href="#">calibrator_variables_t Class Reference</a>	233
5.51	<a href="#">cfg_t Class Reference</a>	235
5.52	<a href="#">coherence::cohflt_if_t Class Reference</a>	237
5.53	<a href="#">coherence::cohflt_t Class Reference</a>	239
5.54	<a href="#">coherence::vars_t Class Reference</a>	241
5.55	<a href="#">combc_if_t Class Reference</a>	243
5.56	<a href="#">combc_t Class Reference</a>	244
5.57	<a href="#">comm_var_t Struct Reference</a>	246
5.58	<a href="#">cpuload_t Class Reference</a>	247
5.59	<a href="#">db_if_t Class Reference</a>	249
5.60	<a href="#">db_t Class Reference</a>	251
5.61	<a href="#">dc::dc_if_t Class Reference</a>	253
5.62	<a href="#">dc::dc_t Class Reference</a>	255
5.63	<a href="#">dc::dc_vars_t Class Reference</a>	257
5.64	<a href="#">dc::dc_vars_validator_t Class Reference</a>	260
5.65	<a href="#">dc::wb_inhib_cfg_t Class Reference</a>	260
5.66	<a href="#">dc::wideband_inhib_vars_t Class Reference</a>	261
5.67	<a href="#">dc_simple::dc_if_t Class Reference</a>	263
5.68	<a href="#">dc_simple::dc_t Class Reference</a>	266
5.69	<a href="#">dc_simple::dc_t::line_t Class Reference</a>	268
5.70	<a href="#">dc_simple::dc_vars_t Class Reference</a>	269
5.71	<a href="#">dc_simple::dc_vars_validator_t Class Reference</a>	270
5.72	<a href="#">dc_simple::level_smoother_t Class Reference</a>	271
5.73	<a href="#">delay::interface_t Class Reference</a>	273
5.74	<a href="#">delaysum::delaysum_if_t Class Reference</a>	274
5.75	<a href="#">delaysum::delaysum_t Class Reference</a>	277
5.76	<a href="#">doasvm_classification Class Reference</a>	279

5.77	doasvm_classification_config Class Reference	281
5.78	doasvm_feature_extraction Class Reference	283
5.79	doasvm_feature_extraction_config Class Reference	285
5.80	droptect_t Class Reference	287
5.81	ds_t Class Reference	290
5.82	dynamiclib_t Class Reference	291
5.83	DynComp::dc_afterburn_rt_t Class Reference	292
5.84	DynComp::dc_afterburn_t Class Reference	294
5.85	DynComp::dc_afterburn_vars_t Class Reference	296
5.86	DynComp::gaintable_t Class Reference	298
5.87	example1_t Class Reference	303
5.88	example2_t Class Reference	305
5.89	example3_t Class Reference	308
5.90	example4_t Class Reference	312
5.91	example5_t Class Reference	315
5.92	example6_t Class Reference	316
5.93	expression_t Class Reference	318
5.94	fader_if_t Class Reference	318
5.95	fader_wave::fader_wave_if_t Class Reference	320
5.96	fader_wave::level_adapt_t Class Reference	322
5.97	fftfbpow::fftfbpow_interface_t Class Reference	323
5.98	fftfbpow::fftfbpow_t Class Reference	326
5.99	fftfilterbank::fftfb_interface_t Class Reference	328
5.100	fftfilterbank::fftfb_plug_t Class Reference	330
5.101	fshift::fshift_config_t Class Reference	332
5.102	fshift::fshift_t Class Reference	334
5.103	fshift_hilbert::frequency_translator_t Class Reference	337
5.104	fshift_hilbert::hilbert_shifter_t Class Reference	339
5.105	fw_t Class Reference	343
5.106	fw_vars_t Class Reference	348
5.107	gain::gain_if_t Class Reference	350
5.108	gain::scaler_t Class Reference	352
5.109	gtfb_analyzer::gtfb_analyzer_cfg_t Struct Reference	352
5.110	gtfb_analyzer::gtfb_analyzer_t Class Reference	355
5.111	hanning_ramps_t Class Reference	358
5.112	identity_t Class Reference	359
5.113	iirfilter_t Class Reference	360
5.114	io_alsa_t Class Reference	361
5.115	io_file_t Class Reference	365
5.116	io_lib_t Class Reference	369
5.117	io_parser_t Class Reference	372
5.118	io_tcp_fwcb_t Class Reference	375
5.119	io_tcp_parser_t Class Reference	378
5.120	io_tcp_sound_t Class Reference	384
5.121	io_tcp_sound_t::float_union Union Reference	388
5.122	io_tcp_t Class Reference	389
5.123	latex_doc_t Class Reference	391
5.124	lpc Class Reference	395
5.125	lpc_bl_predictor Class Reference	398
5.126	lpc_bl_predictor_config Class Reference	400
5.127	lpc_burglattice Class Reference	402

5.128	<a href="#">lpc_burglattice_config Class Reference</a>	405
5.129	<a href="#">lpc_config Class Reference</a>	406
5.130	<a href="#">matrixmixer::cfg_t Class Reference</a>	408
5.131	<a href="#">matrixmixer::matmix_t Class Reference</a>	410
5.132	<a href="#">MHA_AC::ac2matrix_helper_t Class Reference</a>	412
5.133	<a href="#">MHA_AC::ac2matrix_t Class Reference</a>	413
5.134	<a href="#">MHA_AC::acspace2matrix_t Class Reference</a>	415
5.135	<a href="#">MHA_AC::double_t Class Reference</a>	418
5.136	<a href="#">MHA_AC::float_t Class Reference</a>	420
5.137	<a href="#">MHA_AC::int_t Class Reference</a>	421
5.138	<a href="#">MHA_AC::spectrum_t Class Reference</a>	422
5.139	<a href="#">MHA_AC::stat_t Class Reference</a>	424
5.140	<a href="#">MHA_AC::waveform_t Class Reference</a>	425
5.141	<a href="#">mha_audio_descriptor_t Struct Reference</a>	427
5.142	<a href="#">mha_audio_t Struct Reference</a>	428
5.143	<a href="#">mha_channel_info_t Struct Reference</a>	429
5.144	<a href="#">mha_complex_t Struct Reference</a>	431
5.145	<a href="#">mha_complex_test_array_t Struct Reference</a>	431
5.146	<a href="#">mha_dblbuf_t&lt; FIFO &gt; Class Template Reference</a>	432
5.147	<a href="#">mha_direction_t Struct Reference</a>	438
5.148	<a href="#">mha_drifter_fifo_t&lt; T &gt; Class Template Reference</a>	439
5.149	<a href="#">MHA_Error Class Reference</a>	445
5.150	<a href="#">mha_fifo_lw_t&lt; T &gt; Class Template Reference</a>	447
5.151	<a href="#">mha_fifo_posix_threads_t Class Reference</a>	450
5.152	<a href="#">mha_fifo_t&lt; T &gt; Class Template Reference</a>	452
5.153	<a href="#">mha_fifo_thread_guard_t Class Reference</a>	456
5.154	<a href="#">mha_fifo_thread_platform_t Class Reference</a>	457
5.155	<a href="#">mha_real_test_array_t Struct Reference</a>	460
5.156	<a href="#">mha_rt_fifo_element_t&lt; T &gt; Class Template Reference</a>	460
5.157	<a href="#">mha_rt_fifo_t&lt; T &gt; Class Template Reference</a>	462
5.158	<a href="#">mha_spec_t Struct Reference</a>	465
5.159	<a href="#">mha_stash_environment_variable_t Class Reference</a>	466
5.160	<a href="#">MHA_TCP::Async_Notify Class Reference</a>	468
5.161	<a href="#">MHA_TCP::Client Class Reference</a>	469
5.162	<a href="#">MHA_TCP::Connection Class Reference</a>	471
5.163	<a href="#">MHA_TCP::Event_Watcher Class Reference</a>	478
5.164	<a href="#">MHA_TCP::OS_EVENT_TYPE Struct Reference</a>	480
5.165	<a href="#">MHA_TCP::Server Class Reference</a>	481
5.166	<a href="#">MHA_TCP::sock_init_t Class Reference</a>	483
5.167	<a href="#">MHA_TCP::Sockaccept_Event Class Reference</a>	484
5.168	<a href="#">MHA_TCP::Sockread_Event Class Reference</a>	485
5.169	<a href="#">MHA_TCP::Sockwrite_Event Class Reference</a>	486
5.170	<a href="#">MHA_TCP::Thread Class Reference</a>	486
5.171	<a href="#">MHA_TCP::Timeout_Event Class Reference</a>	490
5.172	<a href="#">MHA_TCP::Timeout_Watcher Class Reference</a>	491
5.173	<a href="#">MHA_TCP::Wakeup_Event Class Reference</a>	493
5.174	<a href="#">mha_tictoc_t Struct Reference</a>	495
5.175	<a href="#">mha_wave_t Struct Reference</a>	496
5.176	<a href="#">mhachain::chain_base_t Class Reference</a>	497
5.177	<a href="#">mhachain::mhachain_t Class Reference</a>	500
5.178	<a href="#">mhachain::plugs_t Class Reference</a>	501



5.179 mhaconfig_t Struct Reference . . . . .	504
5.180 MHAEvents::connector_base_t Class Reference . . . . .	506
5.181 MHAEvents::connector_t< receiver_t > Class Template Reference . . . . .	508
5.182 MHAEvents::emitter_t Class Reference . . . . .	510
5.183 MHAEvents::patchbay_t< receiver_t > Class Template Reference . . . . .	512
5.184 MHAFilter::adapt_filter_param_t Class Reference . . . . .	513
5.185 MHAFilter::adapt_filter_state_t Class Reference . . . . .	514
5.186 MHAFilter::adapt_filter_t Class Reference . . . . .	515
5.187 MHAFilter::blockprocessing_polyphase_resampling_t Class Reference . . . . .	517
5.188 MHAFilter::complex_bandpass_t Class Reference . . . . .	520
5.189 MHAFilter::diff_t Class Reference . . . . .	522
5.190 MHAFilter::fftfiler_t Class Reference . . . . .	523
5.191 MHAFilter::fftfilerbank_t Class Reference . . . . .	527
5.192 MHAFilter::filter_t Class Reference . . . . .	531
5.193 MHAFilter::gammaflt_t Class Reference . . . . .	535
5.194 MHAFilter::iir_filter_state_t Class Reference . . . . .	538
5.195 MHAFilter::iir_filter_t Class Reference . . . . .	539
5.196 MHAFilter::iir_ord1_real_t Class Reference . . . . .	542
5.197 MHAFilter::o1_ar_filter_t Class Reference . . . . .	545
5.198 MHAFilter::o1flt_lowpass_t Class Reference . . . . .	548
5.199 MHAFilter::o1flt_maxtrack_t Class Reference . . . . .	551
5.200 MHAFilter::o1flt_mintrack_t Class Reference . . . . .	552
5.201 MHAFilter::partitioned_convolution_t Class Reference . . . . .	554
5.202 MHAFilter::partitioned_convolution_t::index_t Struct Reference . . . . .	558
5.203 MHAFilter::polyphase_resampling_t Class Reference . . . . .	559
5.204 MHAFilter::resampling_filter_t Class Reference . . . . .	564
5.205 MHAFilter::smoothspec_t Class Reference . . . . .	565
5.206 MHAFilter::thirdoctave_analyzer_t Class Reference . . . . .	568
5.207 MHAFilter::transfer_function_t Struct Reference . . . . .	570
5.208 MHAFilter::transfer_matrix_t Struct Reference . . . . .	573
5.209 MHAIOJack::io_jack_t Class Reference . . . . .	574
5.210 MHAIOJackdb::io_jack_t Class Reference . . . . .	578
5.211 MHAIOPortAudio::device_info_t Class Reference . . . . .	583
5.212 MHAIOPortAudio::io_portaudio_t Class Reference . . . . .	585
5.213 MHAJack::client_avg_t Class Reference . . . . .	588
5.214 MHAJack::client_noncont_t Class Reference . . . . .	591
5.215 MHAJack::client_t Class Reference . . . . .	593
5.216 MHAJack::port_t Class Reference . . . . .	599
5.217 MHAKernel::algo_comm_class_t Class Reference . . . . .	603
5.218 MHAKernel::comm_var_map_t Class Reference . . . . .	606
5.219 MHAMultiSrc::base_t Class Reference . . . . .	607
5.220 MHAMultiSrc::channel_t Class Reference . . . . .	608
5.221 MHAMultiSrc::channels_t Class Reference . . . . .	609
5.222 MHAMultiSrc::spectrum_t Class Reference . . . . .	610
5.223 MHAMultiSrc::waveform_t Class Reference . . . . .	611
5.224 MHAOvIFilter::band_descriptor_t Class Reference . . . . .	612
5.225 MHAOvIFilter::barkscale::bark2hz_t Class Reference . . . . .	613
5.226 MHAOvIFilter::barkscale::hz2bark_t Class Reference . . . . .	614
5.227 MHAOvIFilter::fftfb_ac_info_t Class Reference . . . . .	615
5.228 MHAOvIFilter::fftfb_t Class Reference . . . . .	616
5.229 MHAOvIFilter::fftfb_vars_t Class Reference . . . . .	619

5.230 MHAOvFilter::fscale_bw_t Class Reference	622
5.231 MHAOvFilter::fscale_t Class Reference	623
5.232 MHAOvFilter::fspacing_t Class Reference	625
5.233 MHAOvFilter::overlap_save_filterbank_analytic_t Class Reference	627
5.234 MHAOvFilter::overlap_save_filterbank_t Class Reference	628
5.235 MHAOvFilter::overlap_save_filterbank_t::vars_t Class Reference	630
5.236 MHAOvFilter::scale_var_t Class Reference	632
5.237 MHAParser::base_t Class Reference	634
5.238 MHAParser::base_t::replace_t Class Reference	643
5.239 MHAParser::bool_mon_t Class Reference	644
5.240 MHAParser::bool_t Class Reference	645
5.241 MHAParser::c_ifc_parser_t Class Reference	648
5.242 MHAParser::commit_t< receiver_t > Class Template Reference	650
5.243 MHAParser::complex_mon_t Class Reference	652
5.244 MHAParser::complex_t Class Reference	654
5.245 MHAParser::entry_t Class Reference	656
5.246 MHAParser::expression_t Class Reference	657
5.247 MHAParser::float_mon_t Class Reference	658
5.248 MHAParser::float_t Class Reference	659
5.249 MHAParser::int_mon_t Class Reference	662
5.250 MHAParser::int_t Class Reference	664
5.251 MHAParser::keyword_list_t Class Reference	666
5.252 MHAParser::kw_t Class Reference	669
5.253 MHAParser::mcomplex_mon_t Class Reference	672
5.254 MHAParser::mcomplex_t Class Reference	674
5.255 MHAParser::mfloat_mon_t Class Reference	676
5.256 MHAParser::mfloat_t Class Reference	677
5.257 MHAParser::mhaconfig_mon_t Class Reference	680
5.258 MHAParser::mhapluginloader_t Class Reference	682
5.259 MHAParser::mint_mon_t Class Reference	685
5.260 MHAParser::monitor_t Class Reference	686
5.261 MHAParser::parser_t Class Reference	688
5.262 MHAParser::range_var_t Class Reference	693
5.263 MHAParser::string_mon_t Class Reference	696
5.264 MHAParser::string_t Class Reference	697
5.265 MHAParser::variable_t Class Reference	700
5.266 MHAParser::vcomplex_mon_t Class Reference	702
5.267 MHAParser::vcomplex_t Class Reference	704
5.268 MHAParser::vfloat_mon_t Class Reference	707
5.269 MHAParser::vfloat_t Class Reference	709
5.270 MHAParser::vint_mon_t Class Reference	711
5.271 MHAParser::vint_t Class Reference	713
5.272 MHAParser::vstring_mon_t Class Reference	715
5.273 MHAParser::vstring_t Class Reference	717
5.274 MHAParser::window_t Class Reference	719
5.275 mhaplug_cfg_t Class Reference	722
5.276 MHAPLugin::cfg_chain_t< runtime_cfg_t > Class Template Reference	722
5.277 MHAPLugin::config_t< runtime_cfg_t > Class Template Reference	723
5.278 MHAPLugin::plugin_t< runtime_cfg_t > Class Template Reference	728
5.279 MHAPLugin_Resampling::resampling_if_t Class Reference	733
5.280 MHAPLugin_Resampling::resampling_t Class Reference	735

5.281 MHAPlugin_Split::domain_handler_t Class Reference . . . . .	736
5.282 MHAPlugin_Split::dummy_threads_t Class Reference . . . . .	741
5.283 MHAPlugin_Split::posix_threads_t Class Reference . . . . .	743
5.284 MHAPlugin_Split::split_t Class Reference . . . . .	747
5.285 MHAPlugin_Split::splitted_part_t Class Reference . . . . .	751
5.286 MHAPlugin_Split::thread_platform_t Class Reference . . . . .	756
5.287 MHAPlugin_Split::uni_processor_t Class Reference . . . . .	759
5.288 mhaserver_t Class Reference . . . . .	760
5.289 MHASignal::async_rmslevel_t Class Reference . . . . .	763
5.290 MHASignal::delay_spec_t Class Reference . . . . .	765
5.291 MHASignal::delay_t Class Reference . . . . .	766
5.292 MHASignal::delay_wave_t Class Reference . . . . .	768
5.293 MHASignal::doublebuffer_t Class Reference . . . . .	769
5.294 MHASignal::fft_t Class Reference . . . . .	772
5.295 MHASignal::hilbert_fftw_t Class Reference . . . . .	775
5.296 MHASignal::hilbert_t Class Reference . . . . .	776
5.297 MHASignal::loop_wavefragment_t Class Reference . . . . .	778
5.298 MHASignal::matrix_t Class Reference . . . . .	782
5.299 MHASignal::minphase_t Class Reference . . . . .	790
5.300 MHASignal::quantizer_t Class Reference . . . . .	792
5.301 MHASignal::ringbuffer_t Class Reference . . . . .	793
5.302 MHASignal::schroeder_t Class Reference . . . . .	797
5.303 MHASignal::spectrum_t Class Reference . . . . .	800
5.304 MHASignal::stat_t Class Reference . . . . .	805
5.305 MHASignal::subsample_delay_t Class Reference . . . . .	806
5.306 MHASignal::uint_vector_t Class Reference . . . . .	809
5.307 MHASignal::waveform_t Class Reference . . . . .	812
5.308 MHASndFile::sf_t Class Reference . . . . .	822
5.309 MHASndFile::sf_wave_t Class Reference . . . . .	823
5.310 MHATableLookup::linear_table_t Class Reference . . . . .	824
5.311 MHATableLookup::table_t Class Reference . . . . .	828
5.312 MHATableLookup::xy_table_t Class Reference . . . . .	830
5.313 MHAWindow::bartlett_t Class Reference . . . . .	834
5.314 MHAWindow::base_t Class Reference . . . . .	835
5.315 MHAWindow::blackman_t Class Reference . . . . .	837
5.316 MHAWindow::fun_t Class Reference . . . . .	838
5.317 MHAWindow::hamming_t Class Reference . . . . .	839
5.318 MHAWindow::hanning_t Class Reference . . . . .	840
5.319 MHAWindow::rect_t Class Reference . . . . .	841
5.320 MHAWindow::user_t Class Reference . . . . .	842
5.321 mon_t Class Reference . . . . .	844
5.322 multibandcompressor::fftfb_plug_t Class Reference . . . . .	845
5.323 multibandcompressor::interface_t Class Reference . . . . .	847
5.324 multibandcompressor::plugin_signals_t Class Reference . . . . .	849
5.325 nlms_t Class Reference . . . . .	851
5.326 noise_t Class Reference . . . . .	853
5.327 noisePowProposedScale::interface_t Class Reference . . . . .	855
5.328 noisePowProposedScale::noisePowProposed Class Reference . . . . .	857
5.329 overlapadd::overlapadd_if_t Class Reference . . . . .	859
5.330 overlapadd::overlapadd_t Class Reference . . . . .	862
5.331 parser_int_dyn Class Reference . . . . .	864

5.332 plingploing::if_t Class Reference . . . . .	865
5.333 plingploing::plingploing_t Class Reference . . . . .	868
5.334 plug_t Class Reference . . . . .	870
5.335 plugin_interface_t Class Reference . . . . .	872
5.336 pluginbrowser_t Class Reference . . . . .	873
5.337 plugindescription_t Class Reference . . . . .	875
5.338 PluginLoader::config_file_splitter_t Class Reference . . . . .	876
5.339 PluginLoader::fourway_processor_t Class Reference . . . . .	877
5.340 PluginLoader::mhapluginloader_t Class Reference . . . . .	880
5.341 pluginloader_t Class Reference . . . . .	885
5.342 prediction_error Class Reference . . . . .	886
5.343 prediction_error_config Class Reference . . . . .	889
5.344 rmslevel_if_t Class Reference . . . . .	892
5.345 rmslevel_t Class Reference . . . . .	894
5.346 route::interface_t Class Reference . . . . .	895
5.347 route::process_t Class Reference . . . . .	897
5.348 rt_nlms_t Class Reference . . . . .	898
5.349 save_spec_t Class Reference . . . . .	901
5.350 save_wave_t Class Reference . . . . .	902
5.351 shadowfilter_begin::cfg_t Class Reference . . . . .	903
5.352 shadowfilter_begin::shadowfilter_begin_t Class Reference . . . . .	905
5.353 shadowfilter_end::cfg_t Class Reference . . . . .	906
5.354 shadowfilter_end::shadowfilter_end_t Class Reference . . . . .	908
5.355 sine_cfg_t Struct Reference . . . . .	909
5.356 sine_t Class Reference . . . . .	910
5.357 smoothgains_bridge::overlapadd_if_t Class Reference . . . . .	912
5.358 smoothgains_bridge::smoothspec_wrap_t Class Reference . . . . .	914
5.359 softclip_t Class Reference . . . . .	916
5.360 softclipper_t Class Reference . . . . .	917
5.361 softclipper_variables_t Class Reference . . . . .	919
5.362 spec2wave_if_t Class Reference . . . . .	920
5.363 spec2wave_t Class Reference . . . . .	922
5.364 spec_fader_t Class Reference . . . . .	923
5.365 spechnoise_t Class Reference . . . . .	924
5.366 steerbf Class Reference . . . . .	926
5.367 steerbf_config Class Reference . . . . .	928
5.368 testplugin::ac_parser_t Class Reference . . . . .	930
5.369 testplugin::config_parser_t Class Reference . . . . .	932
5.370 testplugin::if_t Class Reference . . . . .	934
5.371 testplugin::signal_parser_t Class Reference . . . . .	936
5.372 timo_AC Class Reference . . . . .	937
5.373 timo_params Class Reference . . . . .	939
5.374 timoConfig Class Reference . . . . .	940
5.375 timoSmooth Class Reference . . . . .	944
5.376 us_t Class Reference . . . . .	947
5.377 wave2spec_if_t Class Reference . . . . .	949
5.378 wave2spec_t Class Reference . . . . .	951
5.379 wavrec_t Class Reference . . . . .	953
5.380 wavwriter_t Class Reference . . . . .	955
5.381 windowselector_t Class Reference . . . . .	957
<b>6 File Documentation</b>	<b>960</b>

6.1	ac2Isl.cpp File Reference	960
6.2	ac2osc.cpp File Reference	960
6.3	ac2wave.cpp File Reference	960
6.4	ac_monitor_type.cpp File Reference	961
6.5	ac_monitor_type.hh File Reference	961
6.6	acConcat_wave.cpp File Reference	961
6.7	acConcat_wave.h File Reference	961
6.8	acmon.cpp File Reference	961
6.9	acPooling_wave.cpp File Reference	962
6.10	acPooling_wave.h File Reference	962
6.11	acsave.cpp File Reference	962
6.12	acSteer.cpp File Reference	963
6.13	acSteer.h File Reference	963
6.14	acTransform_wave.cpp File Reference	964
6.15	acTransform_wave.h File Reference	964
6.16	addsndfile.cpp File Reference	964
6.17	adm.cpp File Reference	965
6.18	adm.hh File Reference	966
6.19	altplugs.cpp File Reference	967
6.20	analysemhaplugin.cpp File Reference	967
6.21	analysispath.cpp File Reference	967
6.22	auditory_profile.cpp File Reference	968
6.23	auditory_profile.h File Reference	968
6.24	browsemhaplugins.cpp File Reference	968
6.25	coherence.cpp File Reference	969
6.26	combinechannels.cpp File Reference	969
6.27	compiler_id.cpp File Reference	970
6.28	compiler_id.hh File Reference	970
6.29	complex_filter.cpp File Reference	970
6.30	complex_filter.h File Reference	970
6.31	cpupload.cpp File Reference	971
6.32	db.cpp File Reference	971
6.33	dc.cpp File Reference	971
6.34	dc_afterburn.cpp File Reference	972
6.35	dc_afterburn.h File Reference	972
6.36	dc_simple.cpp File Reference	973
6.37	delay.cpp File Reference	973
6.38	delaysum.cpp File Reference	974
6.39	doasvm_classification.cpp File Reference	974
6.40	doasvm_classification.h File Reference	974
6.41	doasvm_feature_extraction.cpp File Reference	974
6.42	doasvm_feature_extraction.h File Reference	975
6.43	doc_appendix.h File Reference	975
6.44	doc_examples.h File Reference	975
6.45	doc_frameworks.h File Reference	975
6.46	doc_general.h File Reference	975
6.47	doc_kernel.h File Reference	975
6.48	doc_matlab.h File Reference	975
6.49	doc_mhamain.h File Reference	975
6.50	doc_parser.h File Reference	975
6.51	doc_plugif.cpp File Reference	975

6.52	<a href="#">doc_plugins.h File Reference</a>	975
6.53	<a href="#">doc_system.h File Reference</a>	975
6.54	<a href="#">doc_toolbox.h File Reference</a>	975
6.55	<a href="#">downsample.cpp File Reference</a>	975
6.56	<a href="#">droptect.cpp File Reference</a>	976
6.57	<a href="#">example1.cpp File Reference</a>	976
6.58	<a href="#">example2.cpp File Reference</a>	976
6.59	<a href="#">example3.cpp File Reference</a>	976
6.60	<a href="#">example4.cpp File Reference</a>	976
6.61	<a href="#">example5.cpp File Reference</a>	976
6.62	<a href="#">example6.cpp File Reference</a>	977
6.63	<a href="#">fader_spec.cpp File Reference</a>	977
6.64	<a href="#">fader_wave.cpp File Reference</a>	977
6.65	<a href="#">fftfbpow.cpp File Reference</a>	978
6.66	<a href="#">fftfilterbank.cpp File Reference</a>	978
6.67	<a href="#">fshift.cpp File Reference</a>	979
6.68	<a href="#">fshift.hh File Reference</a>	979
6.69	<a href="#">fshift_hilbert.cpp File Reference</a>	979
6.70	<a href="#">gain.cpp File Reference</a>	979
6.71	<a href="#">gaintable.cpp File Reference</a>	980
6.72	<a href="#">gaintable.h File Reference</a>	980
6.73	<a href="#">generatemhaplugindoc.cpp File Reference</a>	981
6.74	<a href="#">gtfb_analyzer.cpp File Reference</a>	982
6.75	<a href="#">hann.cpp File Reference</a>	984
6.76	<a href="#">hann.h File Reference</a>	985
6.77	<a href="#">identity.cpp File Reference</a>	985
6.78	<a href="#">ifftshift.cpp File Reference</a>	985
6.79	<a href="#">ifftshift.h File Reference</a>	986
6.80	<a href="#">iirfilter.cpp File Reference</a>	986
6.81	<a href="#">lpc.cpp File Reference</a>	986
6.82	<a href="#">lpc.h File Reference</a>	987
6.83	<a href="#">lpc_bl_predictor.cpp File Reference</a>	987
6.84	<a href="#">lpc_bl_predictor.h File Reference</a>	987
6.85	<a href="#">lpc_burg-lattice.cpp File Reference</a>	988
6.86	<a href="#">lpc_burg-lattice.h File Reference</a>	988
6.87	<a href="#">matrixmixer.cpp File Reference</a>	988
6.88	<a href="#">mha.cpp File Reference</a>	989
6.89	<a href="#">mha.hh File Reference</a>	989
6.90	<a href="#">mha_algo_comm.cpp File Reference</a>	994
6.91	<a href="#">mha_algo_comm.h File Reference</a>	995
6.92	<a href="#">mha_algo_comm.hh File Reference</a>	996
6.93	<a href="#">mha_defs.h File Reference</a>	997
6.94	<a href="#">mha_errno.c File Reference</a>	998
6.95	<a href="#">mha_errno.h File Reference</a>	999
6.96	<a href="#">mha_error.cpp File Reference</a>	1000
6.97	<a href="#">mha_error.hh File Reference</a>	1001
6.98	<a href="#">mha_event_emitter.h File Reference</a>	1002
6.99	<a href="#">mha_events.cpp File Reference</a>	1002
6.100	<a href="#">mha_events.h File Reference</a>	1002
6.101	<a href="#">mha_fftfb.cpp File Reference</a>	1002
6.102	<a href="#">mha_fftfb.hh File Reference</a>	1004

6.103 mha_fifo.cpp File Reference	.1005
6.104 mha_fifo.h File Reference	.1005
6.105 mha_filter.cpp File Reference	.1005
6.106 mha_filter.hh File Reference	.1006
6.107 mha_generic_chain.cpp File Reference	.1007
6.108 mha_generic_chain.h File Reference	.1008
6.109 mha_io_ifc.h File Reference	.1008
6.110 mha_multisrc.cpp File Reference	.1009
6.111 mha_multisrc.h File Reference	.1010
6.112 mha_os.cpp File Reference	.1010
6.113 mha_os.h File Reference	.1012
6.114 mha_parser.cpp File Reference	.1015
6.115 mha_parser.hh File Reference	.1017
6.116 mha_plugin.hh File Reference	.1022
6.117 mha_profiling.c File Reference	.1024
6.118 mha_profiling.h File Reference	.1024
6.119 mha_ruby.cpp File Reference	.1025
6.120 mha_signal.cpp File Reference	.1026
6.121 mha_signal.hh File Reference	.1029
6.122 mha_signal_fft.h File Reference	.1038
6.123 mha_tablelookup.cpp File Reference	.1038
6.124 mha_tablelookup.hh File Reference	.1038
6.125 mha_tcp.cpp File Reference	.1039
6.126 mha_tcp.hh File Reference	.1040
6.127 mha_toolbox.h File Reference	.1042
6.128 mha_windowparser.cpp File Reference	.1042
6.129 mha_windowparser.h File Reference	.1042
6.130 mhachain.cpp File Reference	.1043
6.131 mhafw_lib.cpp File Reference	.1043
6.132 mhafw_lib.h File Reference	.1043
6.133 MHAIOalsa.cpp File Reference	.1044
6.134 MHAIOFile.cpp File Reference	.1046
6.135 MHAIOJack.cpp File Reference	.1049
6.136 MHAIOJackdb.cpp File Reference	.1052
6.137 MHAIOParser.cpp File Reference	.1055
6.138 MHAIOPortAudio.cpp File Reference	.1057
6.139 MHAIOTCP.cpp File Reference	.1060
6.140 mhajack.cpp File Reference	.1064
6.141 mhajack.h File Reference	.1064
6.142 mhamain.cpp File Reference	.1066
6.143 mhapluginloader.cpp File Reference	.1067
6.144 mhapluginloader.h File Reference	.1067
6.145 mhasndfile.cpp File Reference	.1068
6.146 mhasndfile.h File Reference	.1068
6.147 multibandcompressor.cpp File Reference	.1069
6.148 nlms_wave.cpp File Reference	.1069
6.149 noise.cpp File Reference	.1070
6.150 noisePowProposedScale.cpp File Reference	.1070
6.151 overlapadd.cpp File Reference	.1071
6.152 plingploing.cpp File Reference	.1071
6.153 pluginbrowser.cpp File Reference	.1072

6.154 pluginbrowser.h File Reference	.1072
6.155 prediction_error.cpp File Reference	.1072
6.156 prediction_error.h File Reference	.1072
6.157 resampling.cpp File Reference	.1073
6.158 rmslevel.cpp File Reference	.1073
6.159 route.cpp File Reference	.1073
6.160 save_spec.cpp File Reference	.1073
6.161 save_wave.cpp File Reference	.1073
6.162 shadowfilter_begin.cpp File Reference	.1074
6.163 shadowfilter_end.cpp File Reference	.1074
6.164 sine.cpp File Reference	.1074
6.165 smoothgains_bridge.cpp File Reference	.1074
6.166 softclip.cpp File Reference	.1075
6.167 spec2wave.cpp File Reference	.1075
6.168 spechnoise.cpp File Reference	.1075
6.169 spechnoise.h File Reference	.1078
6.170 split.cpp File Reference	.1078
6.171 steerbf.cpp File Reference	.1079
6.172 steerbf.h File Reference	.1080
6.173 testalsadevice.c File Reference	.1080
6.174 testplugin.cpp File Reference	.1080
6.175 timoconfig.cpp File Reference	.1081
6.176 timoconfig.h File Reference	.1081
6.177 timoSmooth.cpp File Reference	.1081
6.178 timosmooth.h File Reference	.1082
6.179 transducers.cpp File Reference	.1082
6.180 upsample.cpp File Reference	.1083
6.181 wave2spec.cpp File Reference	.1083
6.182 wavrec.cpp File Reference	.1083
6.183 windowselector.cpp File Reference	.1084
6.184 windowselector.h File Reference	.1084
<b>Index</b>	<b>1085</b>



## 1 Overview

The HörTech Open Master Hearing Aid (openMHA), is a development and evaluation software platform that is able to execute hearing aid signal processing in real-time on standard computing hardware with a low delay between sound input and output.

### 1.1 Structure

The openMHA can be split into four major components :

- **The openMHA command line application (MHA)** (p. 34)
- **Signal processing plugins** (p. 7)
- Audio input-output (IO) plugins (see **io\_file\_t** (p. 365), **MHAIOJack** (p. 98), **io\_parser\_t** (p. 372), **io\_tcp\_parser\_t** (p. 378))
- **The openMHA toolbox library** (p. 35)

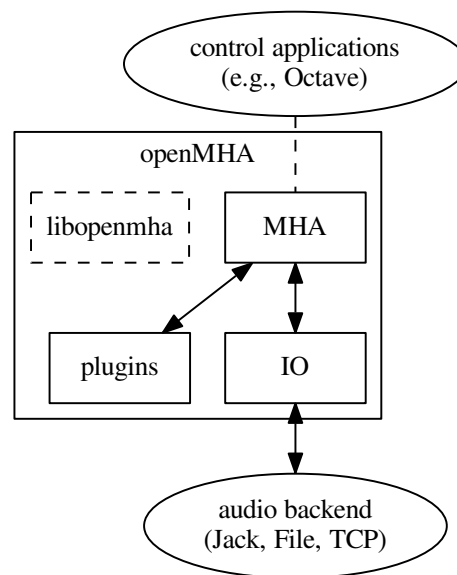

**Figure 1 openMHA structure**

**The openMHA command line application (MHA)** (p. 34) acts as a plugin host. It can load signal processing plugins as well as audio input-output (IO) plugins. Additionally, it provides the command line configuration interface and a TCP/IP based configuration interface. Several IO plugins exist: For real-time signal processing, commonly the openMHA **MHAIOJack** (p. 98) plugin (see plugins' manual) is used, which provides an interface to the Jack Audio Connection Kit (JACK). Other IO plugins provide audio file access or TCP/IP-based processing.

**openMHA plugins** (p. 7) provide the audio signal processing capabilities and audio signal handling. Typically, one openMHA plugin implements one specific algorithm. The complete virtual hearing aid signal processing can be achieved by a combination of several openMHA plugins.

## 1.2 Platform Services and Conventions

The openMHA platform offers some services and conventions to algorithms implemented in plugins, that make it especially well suited to develop hearing aid algorithms, while still supporting general-purpose signal processing.

### 1.2.1 Audio Signal Domains

As in most other plugin hosts, the audio signal in the openMHA is processed in audio chunks. However, plugins are not restricted to propagate audio signal as blocks of audio samples in the time domain another option is to propagate the audio signal in the short time Fourier transform (STFT) domain, i.e. as spectra of blocks of audio signal, so that not every plugin has to perform its own STFT analysis and synthesis. Since STFT analysis and re-synthesis of acceptable audio quality always introduces an algorithmic delay, sharing STFT data is a necessity for a hearing aid signal processing platform, because the overall delay of the complete processing has to be as short as possible.

Similar to some other platforms, the openMHA allows also arbitrary data to be exchanged between plugins through a mechanism called **algorithm communication variables** (p. 28) or short "AC vars". This mechanism is commonly used to share data such as filter coefficients or filter states.

### 1.2.2 Real-Time Safe Complex Configuration Changes

Hearing aid algorithms in the openMHA can export configuration settings that may be changed by the user at run time.

To ensure real-time safe signal processing, the audio processing will normally be done in a signal processing thread with real-time priority, while user interaction with configuration parameters would be performed in a configuration thread with normal priority, so that the audio processing does not get interrupted by configuration tasks. Two types of problems may occur when the user is changing parameters in such a setup:

- The change of a simple parameter exposed to the user may cause an involved recalculation of internal runtime parameters that the algorithm actually uses in processing. The duration required to perform this recalculation may be a significant portion of (or take even longer than) the time available to process one block of audio signal. In hearing aid usage, it is not acceptable to halt audio processing for the duration that the recalculation may require.
- If the user needs to change multiple parameters to reach a desired configuration state of an algorithm from the original configuration state, then it may not be acceptable that processing is performed while some of the parameters have already been changed while others still retain their original values. It is also not acceptable to interrupt signal processing until all pending configuration changes have been performed.

The openMHA provides a mechanism in its toolbox library to enable real-time safe configuration changes in openMHA plugins:

Basically, existing runtime configurations are used in the processing thread until the work of creating an updated runtime configuration has been completed in the configuration thread.

In hearing aids, it is more acceptable to continue to use an outdated configuration for a few more milliseconds than blocking all processing.

The openMHA toolbox library provides an easy-to-use mechanism to integrate real-time safe runtime configuration updates into every plugin.

### 1.2.3 Plugins can Themselves Host Other Plugins

An openMHA plugin can itself act as a plugin host. This allows to combine analysis and re-synthesis methods in a single plugin. We call plugins that can themselves load other plugins "bridge plugins" in the openMHA.

When such a bridge plugin is then called by the openMHA to process one block of signal, it will first perform its analysis, then invoke (as a function call) the signal processing in the loaded plugin to process the block of signal in the analysis domain, wait to receive a processed block of signal in the analysis domain back from the loaded plugin when the signal processing function call to that plugin returns, then perform the re-synthesis transform, and finally return the block of processed signal in the original domain back to the caller of the bridge plugin.

### 1.2.4 Central Calibration

The purpose of hearing aid signal processing is to enhance the sound for hearing impaired listeners. Hearing impairment generally means that people suffering from it have increased hearing thresholds, i.e. soft sounds that are audible for normal hearing listeners may be imperceptible for hearing impaired listeners. To provide accurate signal enhancement for hearing impaired people, hearing aid signal processing algorithms have to be able to determine the absolute physical sound pressure level corresponding to a digital signal given to any openMHA plugin for processing. Inside the openMHA, we achieve this with the following convention: The single-precision floating point time-domain sound signal samples, that are processed inside the openMHA plugins in blocks of short durations, have the physical pressure unit Pascal ( $1\text{Pa} = 1\text{N}/\text{m}^2$ ). With this convention in place, all plugins can determine the absolute physical sound pressure level from the sound samples that they process. A derived convention is employed in the spectral domain for STFT signals. Due to the dependency of the calibration on the hardware used, it is the responsibility of the user of the openMHA to perform calibration measurements and adapt the openMHA settings to make sure that this calibration convention is met. We provide the plugin `transducers` which can be configured to perform the necessary signal adjustments.

## 2 Todo List

### **Class `AuditoryProfile::profile_t` (p. 226)**

Give more documentation; implement all parts of the auditory profile.

### **Class `mha_stash_environment_variable_t` (p. 466)**

Move to collection of unit-test support classes when we have one.

### **Class `mhaconfig_t` (p. 504)**

Add information on number of bands and on center frequencies, or replace by `mha_audio↔_descriptor_t` (p. 427).

### **Class `MHAFilter::filter_t` (p. 531)**

Implement a more robust filter form.

### **Member `MHAFilter::polyphase_resampling_t::now_index` (p. 563)**

Index into what? What is the meaning of now?

### **Class `MHAPlugin::plugin_t < runtime_cfg_t >` (p. 728)**

Describe all services provided by this class, so that the reason why it is recommended that all plugins use this class as their base is evident. Document all relevant methods and fields.

## 3 Module Documentation

### 3.1 Concept of Variables and Data Exchange in the openMHA

Accessibility of configuration variables and data exchange between plugins (processing blocks) are an important issue in the openMHA.

Accessibility of configuration variables and data exchange between plugins (processing blocks) are an important issue in the openMHA.

In general, variable types in the openMHA are distinguished by their different access methods. The variable types in the openMHA are:

- **Configuration variables** : Read and write accesses are possible through the openM↔HA configuration language interface. Configuration variables are implemented as C++ classes with a public data member of the underlying C type. Configuration variables can be read and modified from "outside" using the configuration language. The plugin which provides the configuration variable can use the exposed data member directly. All accesses through the openMHA configuration language are checked for data type, valid range, and access restrictions.
- **Monitor variables** : Read access is possible through the openMHA configuration language. Write access is only possible from the C++ code. Internally, monitor variables have a similar C++ class interface as configuration variables.

- **AC variables (algorithm communication variables (p. 28))**: Any C or C++ data structure can be shared within an openMHA chain. Access management and name space is realised in openMHA chain plugin ('mhachain'). AC variables are not available to the openMHA configuration language interface, although a read-only converter plugin `acmon` is available.
- **Runtime configuration** : Algorithms usually derive more parameters (runtime configuration) from the openMHA configuration language variables. When a configuration variable changes through configuration language write access, then the runtime configuration has to be recomputed. Plugin developers are encouraged to encapsulate the runtime configuration in a C++ class, which recomputes the runtime configuration from configuration variables in the constructor. The openMHA supports lock-free and thread-safe replacement of the runtime configuration instance (see **example5.cpp** (p. 21) and references therein).

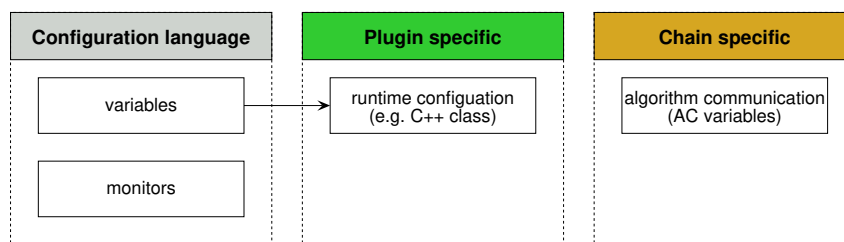

Figure 2 Variable types in the openMHA

The C++ data types are shown in the figure below. These variables can be accessed via the openMHA host application using the openMHA configuration language. For more details see 'Application engineers' manual'.



Figure 3 MHParse elements

## 3.2 The openMHA Plugins (programming interface)

An openMHA plugin is the signal processing unit, usually an algorithm.

### Classes

- class **MHAPLugin::plugin\_t< runtime\_cfg\_t >**  
*The template class for C++ openMHA plugins.*

### Macros

- #define **MHAPLUGIN\_CALLBACKS\_PREFIX**(prefix, classname, indom, outdom)  
*C++ wrapper macro for the plugin interface.*
- #define **MHAPLUGIN\_CALLBACKS**(plugname, classname, indom, outdom) **MHAPLUGIN\_CALLBACKS\_PREFIX**(MHA\_STATIC\_ ## plugname ## \_,classname,indom,outdom)  
*C++ wrapper macro for the plugin interface.*
- #define **MHAPLUGIN\_DOCUMENTATION**(plugname, cat, doc) **MHAPLUGIN\_DOCUMENTATION\_PREFIX**(MHA\_STATIC\_ ## plugname ## \_,cat,doc)  
*Wrapper macro for the plugin documentation interface.*

### 3.2.1 Detailed Description

An openMHA plugin is the signal processing unit, usually an algorithm.

openMHA plugins can be combined into processing chains. One of the configured chains can be selected for output which allows direct comparison of single algorithms or complex signal processing configurations. Algorithms within one chain can communicate with each other by sharing some of their variables, see section **Communication between algorithms** (p. 28).

The openMHA plugins can use the openMHA configuration language for their configuration. If they do so, the configuration can be changed through the framework even at run time. A description of this language can be found in section **The openMHA configuration language** (p. 34). If the algorithms should make use of the openMHA configuration language, they need to be written in C++ rather than pure C.

In the openMHA package a set of example plugins is included. These examples are the base of a step by step tutorial on how to write an openMHA plugin. See section **Writing openMHA Plugins. A step-by-step tutorial** (p. 11) for details.

openMHA plugins communicate with the openMHA using a simple C language interface. This way it is easy to mix plugins compiled with different C++ compilers. For convenience, we provide C++ classes which can be connected to the C++ interface. We strongly recommend the usage of these C++ wrappers. They include out-of-the box support exporting variables to the configuration interface and for thread safe configuration update.

The openMHA C++ plugin interface consists of a few number of method prototypes:

The output domain (spectrum or waveform) of an openMHA plugin will typically be the same as the input domain:

- `mha_wave_t` (p. 496) \* `process(mha_wave_t (p. 496) *)`: pure waveform processing
- `mha_spec_t` (p. 465) \* `process(mha_spec_t (p. 465) *)`: pure spectral processing

But it is also possible to implement domain transformations (from the time domain into spectrum or vice versa). The corresponding method signatures are:

- `mha_spec_t` (p. 465) \* `process(mha_wave_t (p. 496) *)`: Domain transformation from waveform to spectrum
- `mha_wave_t` (p. 496) \* `process(mha_spec_t (p. 465) *)`: Domain transformation from spectrum to waveform

For preparation and release of a plugin, the methods

- `void prepare(mhaconfig_t (p. 504) &)` and
- `void release(void)`

have to be implemented. The openMHA will call the `process()` method only after the `prepare` method has returned and before `release()` is invoked. It is guaranteed by the openMHA framework that signal processing is performed only between calls of `prepare()` and `release()`. Each call of `prepare()` is followed by a call of `release()` (after some optional signal processing).

For configuration purposes, the plugin class has to export a method called `parse()` which implements the openMHA configuration language. We strongly recommend that you do not implement this method yourself, but by inheriting from the class `MHAParser::parser_t` (p. 688) from the openMHA toolbox, directly or indirectly (inheriting from a class that itself inherits from `MHAParser::parser_t` (p. 688)).

### 3.2.2 Connecting the C++ class with the C Interface

A C++ class which provides the appropriate methods can be used as an openMHA Plugin by connecting it to the C interface using the `MHAPLUGIN_CALLBACKS` (p. 10) macro.

The openMHA Toolbox library provides a base class `MHAPlugin::plugin_t` (p. 728)<T> (a template class) which can be used as the base class for a plugin class. This base class implements some necessary features for openMHA plugin developers like integration into the openMHA configuration language environment (it inherits from `MHAParser::parser_t` (p. 688)) and thread-safe runtime configuration update.



### 3.2.3 Error reporting

When your plugin detects a situation that it cannot handle, like input signal of the wrong signal domain at preparation time, unsupported number of input channels at preparation time, unsupported combinations of values in the plugin's variables during configuration, it should throw a C++ exception. The exception should be of type `MHAError`. Exceptions of this type are caught by the **MHAPLUGIN\_CALLBACKS** (p. 10) macro for further error Reporting.

Throwing exceptions in response to unsupported configuration changes does not stop the signal processing. The openMHA configuration language parser will restore the previous value of that variable and report an error to the configurator, while the signal processing continues. Throwing exceptions from the signal processing thread will terminate the signal processing. Therefore, you should generally avoid throwing exceptions from the process method. Only do this if you detected a defect in your plugin, and then you should include enough information in the error message to be able to fix the defect.

### 3.2.4 Contents of the openMHA Plugin programming interface

#### 3.2.5 Macro Definition Documentation

##### 3.2.5.1 #define MHAPLUGIN\_CALLBACKS\_PREFIX(

```
prefix,
classname,
indom,
outdom )
```

C++ wrapper macro for the plugin interface.

##### Parameters

<i>classname</i>	The name of the plugin class
<i>indom</i>	Input domain ( <i>wave</i> or <i>spec</i> )
<i>outdom</i>	Output domain ( <i>wave</i> or <i>spec</i> )

This macro defines all required openMHA Plugin interface functions and passes calls of these functions to the corresponding member functions of the class '*classname*'. The parameters '*indom*' and '*outdom*' specify the input and output domain of the processing method. The `MHAInit()` and `MHADestroy()` functions will create or destroy an instance of the class. The appropriate member functions have to be defined in the class. It is suggested to make usage of the **MHAPlugin::plugin\_t** (p. 728) template class. Exceptions of type **MHA\_Error** (p. 445) are caught and transformed into appropriate error codes with their corresponding error messages.

```

3.2.5.2 #define MHAPLUGIN_CALLBACKS(
        plugname,
        classname,
        indom,
        outdom ) MHAPLUGIN_CALLBACKS_PREFIX(MHA_STATIC_ ## plugname
        ## _,classname,indom,outdom)

```

C++ wrapper macro for the plugin interface.

#### Parameters

<i>plugname</i>	The file name of the plugin without the .so or .dll extension
<i>classname</i>	The name of the plugin class
<i>indom</i>	Input domain ( <i>wave</i> or <i>spec</i> )
<i>outdom</i>	Output domain ( <i>wave</i> or <i>spec</i> )

This macro defines all required openMHA Plugin interface functions and passes calls of these functions to the corresponding member functions of the class 'classname'. The parameters 'indom' and 'outdom' specify the input and output domain of the processing method. The `MHAInit()` and `MHADestroy()` functions will create or destroy an instance of the class. The appropriate member functions have to be defined in the class. It is suggested to make usage of the `MHAPlugin::plugin_t` (p. 728) template class. Exceptions of type `MHA_Error` (p. 445) are caught and transformed into appropriate error codes with their corresponding error messages.

```

3.2.5.3 #define MHAPLUGIN_DOCUMENTATION(
        plugname,
        cat,
        doc ) MHAPLUGIN_DOCUMENTATION_PREFIX(MHA_STATIC_ ##
        plugname ## _,cat,doc)

```

Wrapper macro for the plugin documentation interface.

#### Parameters

<i>plugin</i>	The file name of the plugin without the .so or .dll extension
<i>cat</i>	Space separated list of categories to which belong the plugin (as const char*)
<i>doc</i>	Documentation of the plugin (as const char*)

This macro defines the openMHA Plugin interface function for the documentation. The categories can be any space separated list of category names. An empty string will categorize the plugin in the category 'other'.

The documentation should contain a description of the plugin including a description of the underlying models, and a paragraph containing hints for usage. The text should be LaTeX compatible (e.g., avoid or quote underscores in the text part); equations should be formatted as LaTeX.

### 3.3 Writing openMHA Plugins. A step-by-step tutorial

A step-by-step tutorial on writing openMHA plugins.

A step-by-step tutorial on writing openMHA plugins.

openMHA contains a small number of example plugins as C++ source code. They are meant to help developers in understanding the concepts of openMHA plugin programming starting from the simplest example and increasing in complexity. This tutorial explains the basic parts of the example files.

#### 3.3.1 example1.cpp

The example plugin file `example1.cpp` (p. 976) demonstrates the easiest way to implement an openMHA Plugin. It attenuates the sound signal in the first channel by multiplying the sound samples with a factor. The plugin class `MHAPlugin::plugin_t` (p. 728) exports several methods, but only two of them need a non-empty implementation: `prepare()` method is a pure virtual function and `process()` is called when signal processing starts.

```
#include "mha_plugin.hh"

class example1_t : public MHAPlugin::plugin_t<int> {
public:
    example1_t(algo_comm_t & ac,
              const std::string & chain_name,
              const std::string & algo_name)
        : MHAPlugin::plugin_t<int>("", ac)
    { /* Do nothing in constructor */ }

    void release(void)
    { /* Do nothing in release */ }
};
```

Every plugin implementation should include the '`mha_plugin.hh` (p. 1022)' header file. C++ helper classes for plugin development are declared in this header file, and most header files needed for plugin development are included by `mha_plugin.hh` (p. 1022).

The class `plugin1_t` inherits from the class `MHAPlugin::plugin_t` (p. 728), which then inherits from `MHAParser::parser_t` (p. 688) – the configuration language interface in the method "parse". Our plugin class therefore exports the working "parse" method inherited from `MHAParser::parser_t` (p. 688), and the plugin is visible in the openMHA configuration tree.

The constructor has to accept 3 parameters of correct types. In this simple example, we do not make use of them.

The `release()` method is used to free resources after signal processing. In this simple example, we do not allocate resources, so there is no need to free them.

##### 3.3.1.1 The prepare method

```
void prepare(mhaconfig_t & signal_info)
{
    if (signal_info.domain != MHA_WAVEFORM)
        throw MHA_Error(__FILE__, __LINE__,
                        "This plugin can only process waveform signals.");
    if (signal_info.channels < 1)
        throw MHA_Error(__FILE__, __LINE__,
                        "This plugin requires at least one input channel.");
}
```

## Parameters

<i>signal_info</i>	Contains information about the input signal's parameters, see <b>mhaconfig_t</b> (p. 504).
--------------------	--

The `prepare()` method of the plugin is called before the signal processing starts, when the input signal parameters like domain, number of channels, frames per block, and sampling rate are known. The `prepare()` method can check these values and raise an exception if the plugin cannot cope with them, as is done here. The plugin can also change these values if the signal processing performed in the plugin results in an output signal with different parameters. This plugin does not change the signal's parameters, therefore they are not modified here.

### 3.3.1.2 The signal processing method

```
mha_wave_t * process(mha_wave_t * signal)
{
    unsigned int channel = 0; // channels and frames counting starts with 0
    float factor = 0.1f;
    unsigned int frame;

    // Scale channel number "channel" by "factor":
    for(frame = 0; frame < signal->num_frames; frame++) {
        // Waveform channels are stored interleaved.
        signal->buf[signal->num_channels * frame + channel] *= factor;
    }
    // Algorithms may process data in-place and return the input signal
    // structure as their output signal:
    return signal;
}
};
```

## Parameters

<i>signal</i>	Pointer to the input signal structure <b>mha_wave_t</b> (p. 496).
---------------	---

## Returns

Pointer to the output signal structure. The input signal structure may be reused if the signal has the same domain and dimensions.

The plugin works with time domain input signal (indicated by the data type **mha\_wave\_t** (p. 496) of the process method's parameter). It scales the first channel by a factor of 0.1. The output signal reuses the structure that previously contained the input signal (in-place processing).

### 3.3.1.3 Connecting the C++ class with the C plugin interface

Plugins have to export C functions as their interface (to avoid C++ name-mangling issues and other incompatibilities when mixing plugins compiled with different C++ compilers).

```
MHAPLUGIN_CALLBACKS (example1, example1_t, wave, wave)
```

This macro takes care of accessing the C++ class from the C functions required as the plugin's interface. It implements the C functions and calls the corresponding C++ instance methods. Plugin classes should be derived from the template class `MHAPlugin::plugin_t` (p. 728) to be compatible with the C interface wrapper.

This macro also catches C++ exceptions of type `MHA_Error` (p. 445), when raised in the methods of the plugin class, and reports the error using an error flag as the return value of the underlying C function. It is therefore important to note that only C++ exceptions of type `MHA_Error` (p. 445) may be raised by your plugin. If your code uses different Exception classes, you will have to catch them yourself before control leaves your plugin class, and maybe report the error by throwing an instance of `MHA_Error` (p. 445). This is important, because: (1) C++ exceptions cannot cross the plugin interface, which is in C, and (2) there is no error handling code for your exception classes in the openMHA framework anyways.

### 3.3.2 example2.cpp

This is another simple example of openMHA plugin written in C++. This plugin also scales one channel of the input signal, working in the time domain. The scale factor and which channel to scale (index number) are made accessible to the configuration language.

The algorithm is again implemented as a C++ class.

```
class example2_t : public MHAPlugin::plugin_t<int> {
    MHAParser::int_t scale_ch;
    MHAParser::float_t factor;
public:
    example2_t(algo_comm_t & ac,
               const std::string & chain_name,
               const std::string & algo_name);

    void prepare(mhaconfig_t & signal_info);

    void release(void);

    mha_wave_t * process(mha_wave_t * signal);
};
```

#### Parameters

<i>scale_ch</i>	– the channel number to be scaled
<i>factor</i>	– the scale factor of the scaling.

This class again inherits from the template class `MHAPlugin::plugin_t` (p. 728) for integration with the openMHA configuration language. The two data members serve as externally visible configuration variables. All methods of this class have a non-empty implementation.

#### 3.3.2.1 Constructor

```
example2_t::example2_t(algo_comm_t & ac,
                       const std::string & chain_name,
```

```

        const std::string & algo_name)
: MHAPlugin::plugin_t<int>("This plugin multiplies the sound signal"
    " in one audio channel by a factor",ac),
  scale_ch("Index of audio channel to scale. Indices start from 0.",
    "0",
    "[0,["),
  factor("The scaling factor that is applied to the selected channel.",
    "0.1",
    "[0,[")
{
  insert_item("channel", &scale_ch);
  insert_item("factor", &factor);
}

```

The constructor invokes the superclass constructor with a string parameter. This string parameter serves as the help text that describes the functionality of the plugin. The constructor registers configuration variables with the openMHA configuration tree and sets their default values and permitted ranges. The minimum permitted value for both variables is zero, and there is no maximum limit (apart from the limitations of the underlying C data type). The configuration variables have to be registered with the parser node instance using the **MHAParser::parser←\_t::insert\_item** (p. 690) method.

### 3.3.2.2 The prepare method

```

void example2_t::prepare(mhaconfig_t & signal_info)
{
  if (signal_info.domain != MHA_WAVEFORM)
    throw MHA_Error(__FILE__, __LINE__,
      "This plugin can only process waveform signals.");
  // The user may have configured scale_ch before prepare is called.
  // Check that the configured channel is present in the input signal.
  if (signal_info.channels <= unsigned(scale_ch.data))
    throw MHA_Error(__FILE__, __LINE__,
      "This plugin requires at least %d input channels.",
      scale_ch.data + 1);
  // Adjust the range of the channel configuration variable so that it
  // cannot be set to an out-of-range value during processing.
  using MHAParser::StrCnv::val2str;
  scale_ch.set_range("[0," + val2str(int(signal_info.channels)) + "[");
}

```

#### Parameters

<i>signal_info</i>	– contains information about the input signal's parameters, see <b>mhaconfig_t</b> (p. 504).
--------------------	--

The user may have changed the configuration variables before preparing the openMHA plugin. A consequence of this is that it is not sufficient any more to check if the input signal has at least 1 audio channel.

Instead, this prepare method checks that the input signal has enough channels so that the current value of `scale_ch.data` is a valid channel index, i.e.  $0 \leq \text{scale\_ch.data} < \text{signal\_info.channels}$ . The prepare method does not have to check that  $0 \leq \text{scale\_ch.data}$ , since this is guaranteed by the valid range setting of the configuration variable.

The prepare method then modifies the valid range of the `scale_ch` variable, it modifies the upper bound so that the user cannot set the variable to a channel index higher than the available channels. Setting the range is done using a string parameter. The prepare method concatenates a string of the form "[0,n[". `n` is the number of channels in the input signal, and is used here as an exclusive upper boundary. To convert the number of channels into a string, a helper function for string conversion from the openMHA Toolbox is used. This function is overloaded and works for several data types.

It is safe to assume that the value of configuration variables does not change while the prepare method executes, since openMHA preparation is triggered from a configuration language command, and the openMHA configuration language parser is busy and cannot accept other commands until all openMHA plugins are prepared (or one of them stops the process by raising an exception). As we will see later in this tutorial, the same assumption cannot be made for the process method.

### 3.3.2.3 The release method

```
void example2_t::release(void)
{
    scale_ch.set_range("[0,[" );
}
```

The release method should undo the state changes that were performed by the prepare method. In this example, the prepare method has reduced the valid range of the `scale_ch`, so that only valid channels could be selected during signal processing.

The release method reverts this change by setting the valid range back to its original value, "[0,[".

### 3.3.2.4 The signal processing method

```
mha_wave_t * example2_t::process(mha_wave_t * signal)
{
    unsigned int frame;
    for(frame = 0; frame < signal->num_frames; frame++)
        value(signal, frame, scale_ch.data) *= factor.data;
    return signal;
}
```

The processing function uses the current values of the configuration variables to scale every frame in the selected audio channel.

Note that the value of each configuration variable can change while the processing method executes, since the process method usually executes in a different thread than the configuration interface.

For this simple plugin, this is not a problem, but for more advanced plugins, it has to be taken into consideration. The next section takes a closer look at the problem.

## Consistency

Assume that one thread reads the value stored in a variable while another thread writes a new value to that variable concurrently. In this case, you may have a consistency problem. You would perhaps expect that the value retrieved from the variable either (a) the old value, or (b) the new value, but not (c) something else. Yet generally case (c) is a possibility.

Fortunately, for some data types on PC systems, case (c) cannot happen. These are 32bit wide data types with a 4-byte alignment. Therefore, the values in **MHAParser::int\_t** (p. 664) and **MHAParser::float\_t** (p. 659) are always consistent, but this is not the case for vectors, strings, or complex values. With these, you can get a mixture of the bit patterns of old and new values, or you can even cause a memory access violation in case a vector or string grows and has to be reallocated to a different memory address.

There is also a consistency problem if you take the combination of two "safe" datatypes. The openMHA provides a mechanism that can cope with these types of problems. This thread-safe runtime configuration update mechanism is introduced in example 5.

### 3.3.3 example3.cpp

This example introduces the openMHA Event mechanism. Plugins that provide configuration variable can receive a callback from the parser base class when a configuration variable is accessed through the configuration language interface.

The third example performs the same processing as before, but now only even channel indices are permitted when selecting the audio channel to scale. This restriction cannot be ensured by setting the range of the channel index configuration variable. Instead, the event mechanism of openMHA configuration variables is used. Configuration variables emit 4 different events, and your plugin can connect callback methods that are called when the events are triggered. These events are:

#### **writeaccess**

- triggered on write access to a configuration variable.

#### **valuechanged**

- triggered when write access to a configuration variable actually changes the value of this variable.

#### **readaccess**

- triggered after the value of the configuration variable has been read.

#### **preadaccess**

- triggered before the value of a configuration variable is read, i.e. the value of the requested variable can be changed by the callback to implement computation on demand.

All of these callbacks are executed in the configuration thread. Therefore, the callback implementation does not have to be realtime-safe. No other updates of configuration language variables through the configuration language can happen in parallel, but your processing method can execute in parallel and may change values.



### 3.3.3.1 Data member declarations

```
class example3_t : public MHAPlugin::plugin_t<int> {
    MHAParser::int_t scale_ch;
    MHAParser::float_t factor;
    MHAParser::int_mon_t prepared;

    MHAEvents::patchbay_t<example3_t> patchbay;
```

This plugin exposes another configuration variable, "prepared", that keeps track of the prepared state of the plugin. This is a read-only (monitor) integer variable, i.e. its value can only be changed by your plugin's C++ code. When using the configuration language interface, the value of this variable can only be read, but not changed.

The patchbay member is an instance of a connector class that connects event sources with callbacks.

### 3.3.3.2 Method declarations

```
    /* Callbacks triggered by Events */
    void on_scale_ch_writeaccess();
    void on_scale_ch_valuechanged();
    void on_scale_ch_readaccess();
    void on_prereadaccess();
public:
    example3_t(algo_comm_t & ac,
              const std::string & chain_name,
              const std::string & algo_name);

    void prepare(mhaconfig_t & signal_info);

    void release(void);

    mha_wave_t * process(mha_wave_t * signal);
};
```

This plugin exposes 4 callback methods that are triggered by events. Multiple events (from the same or different configuration variables) can be connected to the same callback method, if desired.

This example plugin uses the `valuechanged` event to check that the `scale_ch` configuration variable is only set to valid values.

The other callbacks only cause log messages to stdout, but the comments in the logging callbacks give a hint when listening on the events would be useful.

### 3.3.3.3 Example 3 constructor

```
example3_t::example3_t(algo_comm_t & ac,
                      const std::string & chain_name,
                      const std::string & algo_name)
: MHAPlugin::plugin_t<int>("This plugin multiplies the sound signal"
                          " in one audio channel by a factor", ac),
  scale_ch("Index of audio channel to scale. Indices start from 0."
           " Only channels with even indices may be scaled.",
           "0",
           "[0, [",
           factor("The scaling factor that is applied to the selected channel.",
                 "0.1",
                 "[0, [",
           prepared("State of this plugin: 0 = unprepared, 1 = prepared")
{
  insert_item("channel", &scale_ch);
  insert_item("factor", &factor);
  prepared.data = 0;
  insert_item("prepared", &prepared);

  patchbay.connect(&scale_ch.writeaccess, this,
                  &example3_t::on_scale_ch_writeaccess);
  patchbay.connect(&scale_ch.valuechanged, this,
                  &example3_t::on_scale_ch_valuechanged);
  patchbay.connect(&scale_ch.readaccess, this,
                  &example3_t::on_scale_ch_readaccess);
  patchbay.connect(&scale_ch.prereadaccess, this,
                  &example3_t::on_prereadaccess);
  patchbay.connect(&factor.prereadaccess, this,
                  &example3_t::on_prereadaccess);
  patchbay.connect(&prepared.prereadaccess, this,
                  &example3_t::on_prereadaccess);
}
```

The constructor of monitor variables does not take a parameter for setting the initial value. The single parameter here is the help text describing the contents of the read-only variable. If the initial value should differ from 0, then the `.data` member of the configuration variable has to be set to the initial value in the plugin constructor's body explicitly, as is done here for demonstration although the initial value of this monitor variable is 0.

Events and callback methods are then connected using the `patchbay` member variable.

### 3.3.3.4 The prepare method

```
void example3_t::prepare(mhaconfig_t & signal_info)
{
  if (signal_info.domain != MHA_WAVEFORM)
    throw MHA_Error(__FILE__, __LINE__,
                  "This plugin can only process waveform signals.");
  // The user may have configured scale_ch before prepare is called.
  // Check that the configured channel is present in the input signal.
  if (signal_info.channels <= unsigned(scale_ch.data))
    throw MHA_Error(__FILE__, __LINE__,
                  "This plugin requires at least %d input channels.",
                  scale_ch.data + 1);

  // bookkeeping
  prepared.data = 1;
}
```

The prepare method checks whether the current setting of the `scale_ch` variable is possible with the input signal dimension. It does not adjust the range of the variable, since the range alone is not sufficient to ensure all future settings are also valid: The scale channel index has to be even.

### 3.3.3.5 The release method

```
void example3_t::release(void)
{
    prepared.data = 0;
}
```

The release method is needed for tracking the prepared state only in this example.

### 3.3.3.6 The signal processing method

```
mha_wave_t * example3_t::process(mha_wave_t * signal)
{
    unsigned int frame;
    for(frame = 0; frame < signal->num_frames; frame++)
        value(signal,frame,scale_ch.data) *= factor.data;
    return signal;
}
```

The signal processing member function is the same as in example 2.

### 3.3.3.7 The callback methods

```
void example3_t::on_scale_ch_writeaccess()
{
    printf("Write access: Attempt to set scale_ch=%d.\n", scale_ch.data);
    // Can be used to track any writeaccess to the configuration, even
    // if it does not change the value. E.g. setting the name of the
    // sound file in a string configuration variable can cause a sound
    // file player plugin to start playing the sound file from the
    // beginning.
}
void example3_t::on_scale_ch_valuechanged()
{
    if (scale_ch.data & 1)
        throw MHA_Error(__FILE__, __LINE__,
            "Attempt to set scale_ch to non-even value %d",
            scale_ch.data);
    // Can be used to recompute a runtime configuration only if some
    // configuration variable actually changed.
}
void example3_t::on_scale_ch_readaccess()
{
    printf("scale_ch has been read.\n");
    // A configuration variable used as an accumulator can be reset
    // after it has been read.
}
void example3_t::on_prereadaccess()
{
    printf("A configuration language variable is about to be read.\n");
    // Can be used to compute the value on demand.
}

MHAPLUGIN_CALLBACKS(example3,example3_t,wave,wave)
```

When the `writeaccess` or `valuechanged` callbacks throw an `MHAError` exception, then the change made to the value of the configuration variable is reverted.

If multiple event sources are connected to a single callback method, then it is not possible to determine which event has caused the callback to execute. Often, this information is not crucial, i.e. when the answer to a change of any variable in a set of variables is the same, e.g. the recomputation of a new runtime configuration that takes all variables of this set as input.

### 3.3.4 example4.cpp

This plugin is the same as example 3 except that it works on the spectral domain (STFT).

#### 3.3.4.1 The Prepare method

```
void example4_t::prepare(mhaconfig_t & signal_info)
{
    if (signal_info.domain != MHA_SPECTRUM)
        throw MHA_Error(__FILE__, __LINE__,
            "This plugin can only process spectrum signals.");
    // The user may have configured scale_ch before prepare is called.
    // Check that the configured channel is present in the input signal.
    if (signal_info.channels <= unsigned(scale_ch.data))
        throw MHA_Error(__FILE__, __LINE__,
            "This plugin requires at least %d input channels.",
            scale_ch.data + 1);

    // bookkeeping
    prepared.data = 1;
}
```

The prepare method now checks that the signal domain is MHA\_SPECTRUM.

#### 3.3.4.2 The signal processing method

```
mha_spec_t * example4_t::process(mha_spec_t * signal)
{
    unsigned int bin;
    // spectral signal is stored non-interleaved.
    mha_complex_t * channeldata =
        signal->buf + signal->num_frames * scale_ch.data;
    for(bin = 0; bin < signal->num_frames; bin++)
        channeldata[bin] *= factor.data;
    return signal;
}
```

The signal processing member function works on the spectral signal instead of the wave signal as before.

The **mha\_spec\_t** (p. 465) instance stores the complex (**mha\_complex\_t** (p. 431)) spectral signal for positive frequencies only (since the waveform signal is always real). The `num_frames` member of **mha\_spec\_t** (p. 465) actually denotes the number of STFT bins.

Please note that different from **mha\_wave\_t** (p. 496), a multichannel signal in **mha\_spec\_t** (p. 465) is stored non-interleaved in the signal buffer.

Some arithmetic operations are defined on struct **mha\_complex\_t** (p. 431) to facilitate efficient complex computations. The `*=` operator used here (defined for real and for complex arguments) is one of them.

#### 3.3.4.3 Connecting the C++ class with the C plugin interface

```
MHAPLUGIN_CALLBACKS(example4, example4_t, spec, spec)
```

When connecting a class that performs spectral processing with the C interface, use `spec` instead of `wave` as the domain indicator.

## 3.3.5 example5.cpp

Many algorithms use complex operations to transform the user space variables into run time configurations. If this takes a noticeable time (e.g. more than 100-500  $\mu$  sec), the update of the runtime configuration can not take place in the real time processing thread. Furthermore, the parallel access to complex structures may cause unpredictable results if variables are read while only parts of them are written to memory (cf. section **Consistency** (p. 16)). To handle these situations, a special C++ template class **MHAPLugin::plugin\_t** (p. 728) was designed. This class helps keeping all access to the configuration language variables in the **configuration** thread rather than in the **processing** thread.

The runtime configuration class **example5\_t** (p. 315) is the parameter of the template class **MHAPLugin::plugin\_t** (p. 728). Its constructor converts the user variables into a runtime configuration. Because the constructor executes in the configuration thread, there is no harm if the constructor takes a long time. All other member functions and data members of the runtime configurations are accessed only from the signal processing thread (real-time thread).

```
class example5_t {
public:
    example5_t(unsigned int,unsigned int,mha_real_t);
    mha_spec_t* process(mha_spec_t*);
private:
    unsigned int channel;
    mha_real_t scale;
};
```

The plugin interface class inherits from the plugin template class **MHAPLugin::plugin\_t** (p. 728), parameterised by the runtime configuration. Configuration changes (write access to the variables) will emit a write access event of the changed variables. These events can be connected to member functions of the interface class by the help of a **MHAEvents::patchbay\_t** (p. 512) instance.

```
class plugin_interface_t : public MHAPLugin::plugin_t<example5_t> {
public:
    plugin_interface_t(const algo_comm_t&,const std::string&,const std::string&);
    mha_spec_t* process(mha_spec_t*);
    void prepare(mhaconfig_t&);
private:
    void update_cfg();
    /* integer variable of MHA-parser: */
    MHAParser::int_t scale_ch;
    /* float variable of MHA-parser: */
    MHAParser::float_t factor;
    /* patch bay for connecting configuration parser
       events with local member functions: */
    MHAEvents::patchbay_t<plugin_interface_t> patchbay;
};
```

The constructor of the runtime configuration analyses and validates the user variables. If the configuration is invalid, an exception of type **MHA\_Error** (p. 445) is thrown. This will cause the openMHA configuration language command which caused the change to fail: The modified configuration language variable is then reset to its original value, and the error message will contain the message string of the **MHA\_Error** (p. 445) exception.

```

example5_t::example5_t(unsigned int ichannel,
                      unsigned int numchannels,
                      mha_real_t iscale)
: channel(ichannel), scale(iscale)
{
    if( channel >= numchannels )
        throw MHA_Error(__FILE__, __LINE__,
                        "Invalid channel number %d (only %d channels configured).",
                        channel, numchannels);
}

```

In this example, the run time configuration class `example5_t` (p. 315) has a signal processing member function. In this function, the selected channel is scaled by the given scaling factor.

```

mha_spec_t* example5_t::process(mha_spec_t* spec)
{
    /* Scale channel number "scale_ch" by "factor": */
    for(unsigned int fr = 0; fr < spec->num_frames; fr++){
        spec->buf[fr + channel * spec->num_frames].re *= scale;
        spec->buf[fr + channel * spec->num_frames].im *= scale;
    }
    return spec;
}

```

The constructor of the example plugin class is similar to the previous examples. A callback triggered on write access to the variables is registered using the `MHAEvents::patchbay_t` (p. 512) instance.

```

plugin_interface_t::plugin_interface_t(
    const algo_comm_t& iac,
    const std::string&, const std::string&)
: MHAPlugin::plugin_t<example5_t>("example plugin configuration structure", iac),
  /* initializing variable 'scale_ch' with MHAParser::int_t(char* name, ... ) */
  scale_ch("channel number to be scaled", "0", "[0, [",
  /* initializing variable 'factor' with MHAParser::float_t(char* name, ... ) */
  factor("scale factor", "1.0", "[0,2]")
{
    /* Register variables to the configuration parser: */
    insert_item("channel", &scale_ch);
    insert_item("factor", &factor);
    /*
     * On write access to the parser variables a notify callback of
     * this class will be called. That function will update the runtime
     * configuration.
     */
    patchbay.connect(&scale_ch.writeaccess, this, &plugin_interface_t::update_cfg);
    patchbay.connect(&factor.writeaccess, this, &plugin_interface_t::update_cfg);
}

```

The processing function can gather the latest valid runtime configuration by a call of `poll_↔ config`. On success, the class member `cfg` points to this configuration. On error, if there is no usable runtime configuration instance, an exception is thrown. In this example, the `prepare` method ensures that there is a valid runtime configuration, so that in this example, no error can be raised at this point. The `prepare` method is always executed before the `process` method is called. The runtime configuration class in this example provides a signal processing method. The `process` method of the plugin interface calls the `process` method of this instance to perform the actual signal processing.

```

mha_spec_t* plugin_interface_t::process(mha_spec_t* spec)
{
    poll_config();
    return cfg->process(spec);
}

```

The prepare method ensures that a valid runtime configuration exists by creating a new runtime configuration from the current configuration language variables. If the configuration is invalid, then an exception of type **MHA\_Error** (p. 445) is raised and the preparation of the openMHA fails with an error message.

```

void plugin_interface_t::prepare(mhaconfig_t& tfcfg)
{
    if( tfcfg.domain != MHA_SPECTRUM )
        throw MHA_Error(__FILE__, __LINE__,
            "Example5: Only spectral processing is supported.");
    /* remember the transform configuration (i.e. channel numbers): */
    tftype = tfcfg;
    /* make sure that a valid runtime configuration exists: */
    update_cfg();
}

```

The update\_cfg member function is called when the value of a configuration language variable changes, or from the prepare method. It allocates a new runtime configuration and registers it for later access from the real time processing thread. The function **push\_config** (p. 726) stores the configuration in a FiFo queue of runtime configurations. Once they are inserted in the FiFo, the **MHAPlugin::plugin\_t** (p. 728) template is responsible for deleting runtime configuration instances stored in the FiFo. You don't need to keep track of the created instances, and you must not delete them yourself.

```

void plugin_interface_t::update_cfg()
{
    if( tftype.channels )
        push_config(new example5_t(scale_ch.data,tftype.channels,factor.data));
}

```

In the end of the example code file, the macro **MHAPLUGIN\_CALLBACKS** (p. 10) defines all ANSI-C interface functions and passes them to the corresponding C++ class member functions (partly defined by the **MHAPlugin::plugin\_t** (p. 728) template class). All exceptions of type **MHA\_Error** (p. 445) are caught and transformed into an appropriate error code and error message.

```

MHAPLUGIN_CALLBACKS(example5,plugin_interface_t,spec,spec)

```

### 3.3.6 example6.cpp

This last example is the same as the previous one, but it additionally creates an 'Algorithm Communication Variable' (AC variable). It calculates the RMS level of a given channel and stores it into this variable. The variable can be accessed by any other algorithm in the same chain. To store the data onto disk, the 'acsave' plugin can be used. 'acmon' is a plugin which converts AC variables into parsable monitor variables.

In the constructor of the plugin class the variable `rmsdb` is registered under the name `example6_rmslev` as a one-dimensional AC variable of type float. For registration of other types, read access and other detailed informations please see **Communication between algorithms** (p. 28).

```
example6_t::example6_t(const algo_comm_t& iac,
                      const std::string&, const std::string&)
: MHAPLugin::plugin_t<cfg_t>("example plugin configuration structure", iac),
  /* initializing variable 'channel_no' with MHAParser::int_t(char* name, ....) */
  channel_no("channel in which the RMS level is measured", "0", "[0, [")
{
  /* Register variables to the configuration parser: */
  insert_item("channel", &channel_no);
  /*
   * On write access to the parser variables a notify callback of
   * this class will be called. That function will update the runtime
   * configuration.
   */
  patchbay.connect(&channel_no.writeaccess, this, &example6_t::update_cfg);
  /*
   * Propagate the level variable to all algorithms in the
   * processing chain. If multiple instances of this algorithm are
   * required, than it is necessary to use different names for this
   * variable (i.e. prefixing the name with the algorithm name
   * passed to MHAInit).
   */
  ac.insert_var_float( ac.handle, "example6_rmslev", &rmsdb );
}
```



### 3.3.7 Debugging openMHA plugins

Suppose you would want to step through the code of your openMHA plugin with a debugger. This example details how to use the linux gdb debugger to inspect the `example6_t::prepare()` (p. 317) and `example6_t::process()` (p. 317) routines of `example6.cpp` (p. 24) example 6.

First, make sure that your plugin is compiled with the compiler option to include debugging symbols: Apply the `-g` switch to all gcc, g++ invocations.

Once the plugin is compiled, with debugging symbols, create a test configuration. For example 6, assuming there is an audio file named `input.wav` in your working directory, you could create a configuration file named `'debugexample6.cfg'`, with the following content:

```
# debugexample6.cfg
fragsize = 64
srate = 44100
nchannels_in = 2
iolib = MHAIOFile

io.in = input.wav
io.out = output.wav
mhalib = example6
mha.channel = 1
cmd=start
```

Assuming all your binaries and shared-object libraries are in your `'bin'` directory (see `README.md`), you could start gdb using

```
$ export MHA_LIBRARY_PATH=$PWD/bin
$ gdb $MHA_LIBRARY_PATH/mha
```

Set breakpoints in `prepare` and `process` methods, and start execution. Note that specifying the breakpoint by symbol (`example6_t::prepare` (p. 317)) does not yet work, as the symbol lives in the openMHA plugin that has not yet been loaded. Specifying by line number works, however. Specifying the breakpoint by symbol also works once the plugin is loaded (i.e. when the debugger stops in the first breakpoint). You can set the breakpoints like this (example shown here is run in gdb version 7.11.1):

```
(gdb) run ?read:debugexample6.cfg
Starting program: {openMHA_directory}/bin/mha ?read:debugexample6.cfg
[Thread debugging using libthread_db enabled]
Using host libthread_db library "/lib/x86_64-linux-gnu/libthread_db.so.1".
The Open Master Hearing Aid (openMHA) server
Copyright (c) 2005-2019 HoerTech gGmbH, D-26129 Oldenburg, Germany
```

```
This program comes with ABSOLUTELY NO WARRANTY; for details see file COPYING.
This is free software, and you are welcome to redistribute it
under the terms of the GNU AFFERO GENERAL PUBLIC LICENSE, Version 3;
for details see file COPYING.
```

```
Breakpoint 1, example6_t::prepare (this=0x6478b0, tfcfg=...)
  at example6.cpp:192
192         if( tfcfg.domain != MHA_WAVEFORM )
(gdb) b example6.cpp:162
Breakpoint 2 at 0x7ffff589744a: file example6.cpp, line 162.
(gdb) c
Continuing.
```

Where '{openMHA\_directory}' is the directory where openMHA is located (which should also be your working directory in this case). Next step is the `process()` method. You can now examine and change the variables, step through the program as needed (using, for example 'n' to step in the next line):

```
Breakpoint 2, example6_t::process (this=0x7ffff6a06c0d, wave=0x10a8b550)
  at example6.cpp:162
162     {
(gdb) n
163     poll_config();
(gdb)
```

**3.4 The MHA Framework interface**

### 3.5 Communication between algorithms

Algorithms within one chain can share variables for communication with other algorithms.

Collaboration diagram for Communication between algorithms:

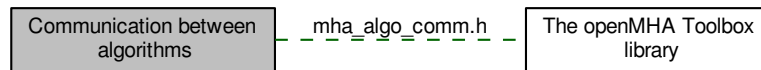

#### Files

- file **mha\_algo\_comm.h**  
*Header file for Algorithm Communication.*

#### Namespaces

- **MHA\_AC**  
*Functions and classes for Algorithm Communication (AC) support.*

#### Classes

- class **MHA\_AC::spectrum\_t**  
*Insert a **MHASignal::spectrum\_t** (p. 800) class into the AC space.*
- class **MHA\_AC::waveform\_t**  
*Insert a **MHASignal::waveform\_t** (p. 812) class into the AC space.*
- class **MHA\_AC::int\_t**  
*Insert a integer variable into the AC space.*
- class **MHA\_AC::float\_t**  
*Insert a float point variable into the AC space.*
- class **MHA\_AC::double\_t**  
*Insert a double precision floating point variable into the AC space.*
- class **MHA\_AC::ac2matrix\_t**  
*Copy AC variable to a matrix.*
- class **MHA\_AC::acspace2matrix\_t**  
*Copy all or a subset of all numeric AC variables into an array of matrixes.*
- struct **algo\_comm\_t**  
*A reference handle for algorithm communication variables.*
- struct **comm\_var\_t**  
*Algorithm communication variable structure.*

## Functions

- **mha\_spec\_t MHA\_AC::get\_var\_spectrum** (**algo\_comm\_t** ac, const std::string &name)  
*Convert an AC variable into a spectrum.*
- **mha\_wave\_t MHA\_AC::get\_var\_waveform** (**algo\_comm\_t** ac, const std::string &name)  
*Convert an AC variable into a waveform.*
- **int MHA\_AC::get\_var\_int** (**algo\_comm\_t** ac, const std::string &name)  
*Return value of an integer scalar AC variable.*
- **float MHA\_AC::get\_var\_float** (**algo\_comm\_t** ac, const std::string &name)  
*Return value of an floating point scalar AC variable.*
- **std::vector< float > MHA\_AC::get\_var\_vfloat** (**algo\_comm\_t** ac, const std::string &name)  
*Return value of an floating point vector AC variable as standard vector of floats.*

### 3.5.1 Detailed Description

Algorithms within one chain can share variables for communication with other algorithms.

This mechanism allows interaction between algorithms (i.e. separation of noise estimation and noise reduction algorithms, combination of dynamic compression and noise estimation). Through a set of simple C functions, algorithms can propagate variables of any type, even C++ classes, to other algorithms.

An algorithm communication handle (**algo\_comm\_t** (p. 201)) is passed at initialisation time to the constructor of each plugin class **constructor** (p. 728). This handle contains a reference handle, **algo\_comm\_t::handle** (p. 201), and a number of function pointers, **algo\_comm\_t::insert\_var** (p. 201) etc.. An algorithm communication variable is an object of type **comm\_var\_t** (p. 246).

For AC variables of numeric types, openMHA Plugins for conversion into parsable monitor variables, **acmon**, and storage into Matlab or text files, **acsave**, are available.

### 3.5.2 Function Documentation

#### 3.5.2.1 **mha\_spec\_t MHA\_AC::get\_var\_spectrum** ( **algo\_comm\_t** ac, const std::string & name )

Convert an AC variable into a spectrum.

This function reads an AC variable and tries to convert it into a valid spectrum. The Spectrum variable is granted to be valid only for one call of the processing function.

**Parameters**

<i>ac</i>	AC handle
<i>name</i>	Name of the variable

**Returns**

Spectrum structure

```
3.5.2.2 mha_wave_t MHA_AC::get_var_waveform (
        algo_comm_t ac,
        const std::string & name )
```

Convert an AC variable into a waveform.

This function reads an AC variable and tries to convert it into a valid waveform. The waveform variable is granted to be valid only for one call of the processing function.

**Parameters**

<i>ac</i>	AC handle
<i>name</i>	Name of the variable

**Returns**

waveform structure

```
3.5.2.3 int MHA_AC::get_var_int (
        algo_comm_t ac,
        const std::string & name )
```

Return value of an integer scalar AC variable.

**Parameters**

<i>ac</i>	AC handle
<i>name</i>	Name of the variable

**Returns**

Variable value

```
3.5.2.4 float MHA_AC::get_var_float (
        algo_comm_t ac,
        const std::string & name )
```

Return value of an floating point scalar AC variable.

#### Parameters

<i>ac</i>	AC handle
<i>name</i>	Name of the variable

#### Returns

Variable value

```
3.5.2.5 std::vector< float > MHA_AC::get_var_vfloat (
        algo_comm_t ac,
        const std::string & name )
```

Return value of an floating point vector AC variable as standard vector of floats.

#### Parameters

<i>ac</i>	AC handle
<i>name</i>	Name of the variable

#### Returns

Variable value

### 3.6 Error handling in the openMHA

Errors are reported to the user via the **MHA\_Error** (p. 445) exception.

Collaboration diagram for Error handling in the openMHA:

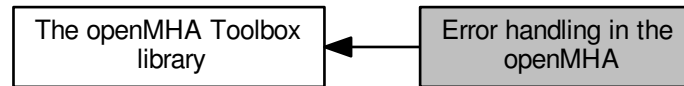

#### Classes

- class **MHA\_Error**  
*Error reporting exception class.*

#### Macros

- #define **MHA\_ErrorMsg**(x) **MHA\_Error**(\_\_FILE\_\_, \_\_LINE\_\_, "%s", x)  
*Throw an openMHA error with a text message.*
- #define **MHA\_assert**(x) if(!(x)) throw **MHA\_Error**(\_\_FILE\_\_, \_\_LINE\_\_, "\"%s\" is false.", #x)  
*Assertion macro, which throws an **MHA\_Error** (p. 445).*
- #define **MHA\_assert\_equal**(a, b) if( a != b ) throw **MHA\_Error**(\_\_FILE\_\_, \_\_LINE\_\_, "\"%s == %s\" is false (%s = %g, %s = %g).", #a, #b, #a, (double)(a), #b, (double)(b))  
*Equality assertion macro, which throws an **MHA\_Error** (p. 445) with the values.*

#### Functions

- void **mha\_debug** (const char \*fmt,...)  
*Print an info message (stderr on Linux, OutputDebugString in Windows).*

#### 3.6.1 Detailed Description

Errors are reported to the user via the **MHA\_Error** (p. 445) exception.

#### 3.6.2 Macro Definition Documentation

##### 3.6.2.1 #define MHA\_ErrorMsg(x) MHA\_Error(\_\_FILE\_\_, \_\_LINE\_\_, "%s", x)

Throw an openMHA error with a text message.



## Parameters

<i>x</i>	Text message.
----------	---------------

```
3.6.2.2 #define MHA_assert(
           x ) if(!x) throw MHA_Error(__FILE__,__LINE__,"\"%s\" is false.",#x)
```

Assertion macro, which throws an **MHA\_Error** (p. 445).

## Parameters

<i>x</i>	Boolean expression which should be true.
----------	--

```
3.6.2.3 #define MHA_assert_equal(
           a,
           b ) if( a != b ) throw MHA_Error(__FILE__,__LINE__,"\"%s == %s\" is false (%s =
           %g, %s = %g).",#a,#b,#a,(double)(a),#b,(double)(b))
```

Equality assertion macro, which throws an **MHA\_Error** (p. 445) with the values.

## Parameters

<i>a</i>	Numeric expression which can be converted to double (for printing).
<i>b</i>	Numeric expression which should be equal to a

## 3.6.3 Function Documentation

```
3.6.3.1 void mha_debug (
           const char * fmt,
           ... )
```

Print an info message (stderr on Linux, OutputDebugString in Windows).

### 3.7 The openMHA configuration language

openMHA Plugins that should use the openMHA configuration language for their configuration have to be implemented in C++ and need to include **mha\_parser.hh** (p. 1017).

openMHA Plugins that should use the openMHA configuration language for their configuration have to be implemented in C++ and need to include **mha\_parser.hh** (p. 1017).

All required classes and functions for parser access are declared in the namespace **MH↔AParser** (p. 107). The plugin class should be derived from the class **MHAParser::parser\_t** (p. 688) (or **MHAPLugin::plugin\_t** (p. 728)), which symbolises a sub-parser node in the open↔MHA script hierarchy. Variables of many types can be registered to the sub-parser node by calling the member function **insert\_item** (p. 690).

The openMHA Plugin template class **MHAPLugin::plugin\_t** (p. 728) together with the Plugin macro **MHAPLUGIN\_CALLBACKS** (p. 10) provide the callback mappings and correct inheritance. If your plugin is based on that template class, you simply have to use the **insert\_item** command to give access to your variables, everything else is managed internally.

A complete list of all openMHA script items is given in the description of the **MHAParser** (p. 107) namespace.

### 3.8 The openMHA Toolbox library

The openMHA toolbox is a static C++ library which makes it more comfortable to develop openMHA plugins.

Collaboration diagram for The openMHA Toolbox library:

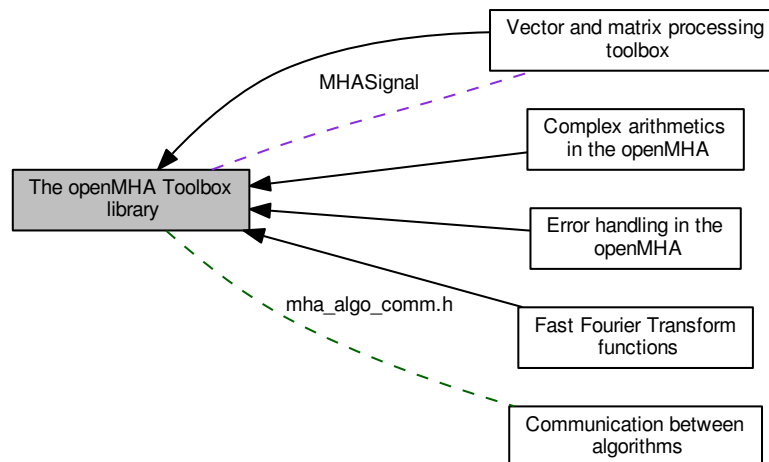

#### Modules

- **Error handling in the openMHA**

*Errors are reported to the user via the **MHA\_Error** (p. 445) exception.*

- **Vector and matrix processing toolbox**

*The vector and matrix processing toolbox consists of a number of classes defined in the namespace **MHASignal** (p. 118), and many functions and operators for use with the structures **mha\_wave\_t** (p. 496) and **mha\_spec\_t** (p. 465).*

- **Complex arithmetics in the openMHA**

- **Fast Fourier Transform functions**

#### Files

- file **mha\_algo\_comm.h**

*Header file for Algorithm Communication.*

- file **mha\_filter.hh**

*Header file for IIR filter classes.*

- file **mha\_signal.hh**

*Header file for audio signal handling and processing classes.*

- file **mha\_tablelookup.hh**

*Header file for table lookup classes.*

## Namespaces

- **MHAOvIFilter**  
*Namespace for overlapping FFT based filter bank classes and functions.*
- **MHAFilter**  
*Namespace for IIR and FIR filter classes.*
- **MHAParser**  
*Name space for the openMHA-Parser configuration language.*
- **MHASignal**  
*Namespace for audio signal handling and processing classes.*
- **MHATableLookup**  
*Namespace for table lookup classes.*

### 3.8.1 Detailed Description

The openMHA toolbox is a static C++ library which makes it more comfortable to develop openMHA plugins.

It contains the openMHA script language classes.

### 3.9 Vector and matrix processing toolbox

The vector and matrix processing toolbox consists of a number of classes defined in the namespace **MHASignal** (p. 118), and many functions and operators for use with the structures **mha\_wave\_t** (p. 496) and **mha\_spec\_t** (p. 465).

Collaboration diagram for Vector and matrix processing toolbox:

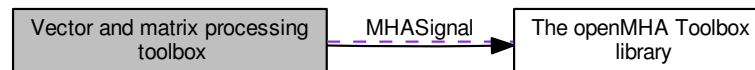

#### Namespaces

- **MHASignal**  
*Namespace for audio signal handling and processing classes.*
- **MHAWindow**  
*Collection of Window types.*

#### Classes

- struct **mha\_wave\_t**  
*Waveform signal structure.*
- struct **mha\_spec\_t**  
*Spectrum signal structure.*
- struct **mha\_audio\_descriptor\_t**  
*Description of an audio fragment (planned as a replacement of **mhaconfig\_t** (p. 504)).*
- struct **mha\_audio\_t**  
*An audio fragment in the openMHA (planned as a replacement of **mha\_wave\_t** (p. 496) and **mha\_spec\_t** (p. 465)).*
- class **MHASignal::spectrum\_t**  
*a signal processing class for spectral data (based on **mha\_spec\_t** (p. 465))*
- class **MHASignal::waveform\_t**  
*signal processing class for waveform data (based on **mha\_wave\_t** (p. 496))*
- class **MHASignal::doublebuffer\_t**  
*Double-buffering class.*
- class **MHASignal::hilbert\_t**  
*Hilbert transformation of a waveform segment.*
- class **MHASignal::minphase\_t**  
*Minimal phase function.*
- class **MHASignal::uint\_vector\_t**

*Vector of unsigned values, used for size and index description of n-dimensional matrixes.*

- class **MHASignal::matrix\_t**  
*n-dimensional matrix with real or complex floating point values.*
- class **MHAParser::window\_t**  
*MHA configuration interface for a window function generator.*
- class **MHASignal::delay\_wave\_t**  
*Delayline containing wave fragments.*
- class **MHASignal::async\_rmslevel\_t**  
*Class for asynchronous level metering.*

## Typedefs

- typedef float **mha\_real\_t**  
*openMHA type for real numbers*

## Functions

- **mha\_wave\_t range** (**mha\_wave\_t** s, unsigned int k0, unsigned int len)  
*Return a time interval from a waveform chunk.*
- **mha\_spec\_t channels** (**mha\_spec\_t** s, unsigned int ch\_start, unsigned int nch)  
*Return a channel interval from a spectrum.*
- void **MHASignal::for\_each** (**mha\_wave\_t** \*s, **mha\_real\_t**(\*fun)(**mha\_real\_t**))  
*Apply a function to each element of a **mha\_wave\_t** (p. 496).*
- **mha\_real\_t MHASignal::lin2db** (**mha\_real\_t** x)  
*Conversion from linear scale to dB (no SPL reference)*
- **mha\_real\_t MHASignal::db2lin** (**mha\_real\_t** x)  
*Conversion from dB scale to linear (no SPL reference)*
- **mha\_real\_t MHASignal::pa2dbspl** (**mha\_real\_t** x)  
*Conversion from linear Pascal scale to dB SPL.*
- **mha\_real\_t MHASignal::pa2dbspl** (**mha\_real\_t** x, **mha\_real\_t** eps=1e-20f)  
*Conversion from squared Pascal scale to dB SPL.*
- **mha\_real\_t MHASignal::dbspl2pa** (**mha\_real\_t** x)  
*Conversion from dB SPL to linear Pascal scale.*
- **mha\_real\_t MHASignal::smp2sec** (**mha\_real\_t** n, **mha\_real\_t** srate)  
*conversion from samples to seconds*
- **mha\_real\_t MHASignal::sec2smp** (**mha\_real\_t** sec, **mha\_real\_t** srate)  
*conversion from seconds to samples*
- **mha\_real\_t MHASignal::bin2freq** (**mha\_real\_t** bin, unsigned fftlen, **mha\_real\_t** srate)  
*conversion from fft bin index to frequency*
- **mha\_real\_t MHASignal::freq2bin** (**mha\_real\_t** freq, unsigned fftlen, **mha\_real\_t** srate)  
*conversion from frequency to fft bin index*
- **mha\_real\_t MHASignal::smp2rad** (**mha\_real\_t** samples, unsigned bin, unsigned fftlen)  
*conversion from delay in samples to phase shift*

- **mha\_real\_t MHASignal::rad2smp** (**mha\_real\_t** phase\_shift, unsigned bin, unsigned fftlen)  
*conversion from phase shift to delay in samples*
- `template<class elem_type >`  
`std::vector< elem_type > MHASignal::dupvec` (`std::vector< elem_type > vec`, unsigned n)  
*Duplicate last vector element to match desired size.*
- `template<class elem_type >`  
`std::vector< elem_type > MHASignal::dupvec_chk` (`std::vector< elem_type > vec`, unsigned n)  
*Duplicate last vector element to match desired size, check for dimension.*
- **bool equal\_dim** (`const mha_wave_t &a`, `const mha_wave_t &b`)  
*Test for equal dimension of waveform structures.*
- **bool equal\_dim** (`const mha_wave_t &a`, `const mhaconfig_t &b`)  
*Test for match of waveform dimension with mhaconfig structure.*
- **bool equal\_dim** (`const mha_spec_t &a`, `const mha_spec_t &b`)  
*Test for equal dimension of spectrum structures.*
- **bool equal\_dim** (`const mha_spec_t &a`, `const mhaconfig_t &b`)  
*Test for match of spectrum dimension with mhaconfig structure.*
- **bool equal\_dim** (`const mha_wave_t &a`, `const mha_spec_t &b`)  
*Test for equal dimension of waveform/spectrum structures.*
- **bool equal\_dim** (`const mha_spec_t &a`, `const mha_wave_t &b`)  
*Test for equal dimension of waveform/spectrum structures.*
- **void integrate** (`mha_wave_t &s`)  
*Numeric integration of a signal vector (real values)*
- **void integrate** (`mha_spec_t &s`)  
*Numeric integration of a signal vector (complex values)*
- **unsigned int size** (`const mha_wave_t &s`)  
*Return size of a waveform structure.*
- **unsigned int size** (`const mha_spec_t &s`)  
*Return size of a spectrum structure.*
- **unsigned int size** (`const mha_wave_t *s`)  
*Return size of a waveform structure.*
- **unsigned int size** (`const mha_spec_t *s`)  
*Return size of a spectrum structure.*
- **void clear** (`mha_wave_t &s`)  
*Set all values of waveform to zero.*
- **void clear** (`mha_wave_t *s`)  
*Set all values of waveform to zero.*
- **void clear** (`mha_spec_t &s`)  
*Set all values of spectrum to zero.*
- **void clear** (`mha_spec_t *s`)  
*Set all values of spectrum to zero.*
- **void assign** (`mha_wave_t self`, `mha_real_t val`)  
*Set all values of waveform 'self' to 'val'.*

- void **assign** (**mha\_wave\_t** self, const **mha\_wave\_t** &val)  
*Set all values of waveform 'self' to 'val'.*
- void **assign** (**mha\_spec\_t** self, const **mha\_spec\_t** &val)  
*Set all values of spectrum 'self' to 'val'.*
- void **timeshift** (**mha\_wave\_t** &self, int shift)  
*Time shift of waveform chunk.*
- **mha\_real\_t** & **value** (**mha\_wave\_t** \*s, unsigned int fr, unsigned int ch)  
*Access an element of a waveform structure.*
- const **mha\_real\_t** & **value** (const **mha\_wave\_t** \*s, unsigned int fr, unsigned int ch)  
*Constant access to an element of a waveform structure.*
- **mha\_complex\_t** & **value** (**mha\_spec\_t** \*s, unsigned int fr, unsigned int ch)  
*Access to an element of a spectrum.*
- const **mha\_complex\_t** & **value** (const **mha\_spec\_t** \*s, unsigned int fr, unsigned int ch)  
*Constant access to an element of a spectrum.*
- **mha\_real\_t** & **value** (**mha\_wave\_t** &s, unsigned int fr, unsigned int ch)  
*Access to an element of a waveform structure.*
- const **mha\_real\_t** & **value** (const **mha\_wave\_t** &s, unsigned int fr, unsigned int ch)  
*Constant access to an element of a waveform structure.*
- **mha\_complex\_t** & **value** (**mha\_spec\_t** &s, unsigned int fr, unsigned int ch)  
*Access to an element of a spectrum.*
- const **mha\_complex\_t** & **value** (const **mha\_spec\_t** &s, unsigned int fr, unsigned int ch)  
*Constant access to an element of a spectrum.*
- std::vector< float > **std\_vector\_float** (const **mha\_wave\_t** &)  
*Converts a **mha\_wave\_t** (p. 496) structure into a std::vector<float> (interleaved order).*
- std::vector< std::vector< float > > **std\_vector\_vector\_float** (const **mha\_wave\_t** &)  
*Converts a **mha\_wave\_t** (p. 496) structure into a std::vector< std::vector<float> > (outer vector represents channels).*
- std::vector< std::vector< **mha\_complex\_t** > > **std\_vector\_vector\_complex** (const **mha\_spec\_t** &)  
*Converts a **mha\_spec\_t** (p. 465) structure into a std::vector< std::vector<mha\_complex\_t> > (outer vector represents channels).*
- **mha\_wave\_t** & **operator+=** (**mha\_wave\_t** &, const **mha\_real\_t** &)  
*Addition operator.*
- **mha\_wave\_t** & **operator+=** (**mha\_wave\_t** &, const **mha\_wave\_t** &)  
*Addition operator.*
- **mha\_wave\_t** & **operator-=** (**mha\_wave\_t** &, const **mha\_wave\_t** &)  
*Subtraction operator.*
- **mha\_spec\_t** & **operator-=** (**mha\_spec\_t** &, const **mha\_spec\_t** &)  
*Subtraction operator.*
- **mha\_wave\_t** & **operator\*=** (**mha\_wave\_t** &, const **mha\_real\_t** &)  
*Element-wise multiplication operator.*
- **mha\_wave\_t** & **operator\*=** (**mha\_wave\_t** &, const **mha\_wave\_t** &)  
*Element-wise multiplication operator.*
- **mha\_spec\_t** & **operator\*=** (**mha\_spec\_t** &, const **mha\_real\_t** &)  
*Element-wise multiplication operator.*



- **mha\_spec\_t & operator\*=(mha\_spec\_t &, const mha\_wave\_t &)**  
*Element-wise multiplication operator.*
- **mha\_spec\_t & operator\*=(mha\_spec\_t &, const mha\_spec\_t &)**  
*Element-wise multiplication operator.*
- **mha\_spec\_t & operator/=(mha\_spec\_t &, const mha\_spec\_t &)**  
*Element-wise division operator.*
- **mha\_wave\_t & operator/=(mha\_wave\_t &, const mha\_wave\_t &)**  
*Element-wise division operator.*
- **mha\_spec\_t & operator+=(mha\_spec\_t &, const mha\_spec\_t &)**  
*Addition operator.*
- **mha\_spec\_t & operator+=(mha\_spec\_t &, const mha\_real\_t &)**  
*Addition operator.*
- **mha\_wave\_t & operator^=(mha\_wave\_t &self, const mha\_real\_t &arg)**  
*Exponent operator.*
- **void MHASignal::copy\_channel(mha\_spec\_t &self, const mha\_spec\_t &src, unsigned sch, unsigned dch)**  
*Copy one channel of a source signal.*
- **void MHASignal::copy\_channel(mha\_wave\_t &self, const mha\_wave\_t &src, unsigned src\_channel, unsigned dest\_channel)**  
*Copy one channel of a source signal.*
- **mha\_real\_t MHASignal::rmslevel(const mha\_spec\_t &s, unsigned int channel, unsigned int fftlen)**  
*Return RMS level of a spectrum channel.*
- **mha\_real\_t MHASignal::colored\_intensity(const mha\_spec\_t &s, unsigned int channel, unsigned int fftlen, mha\_real\_t sqfreq\_response[])**  
*Colored spectrum intensity.*
- **mha\_real\_t MHASignal::maxabs(const mha\_spec\_t &s, unsigned int channel)**  
*Find maximal absolute value.*
- **mha\_real\_t MHASignal::rmslevel(const mha\_wave\_t &s, unsigned int channel)**  
*Return RMS level of a waveform channel.*
- **mha\_real\_t MHASignal::maxabs(const mha\_wave\_t &s, unsigned int channel)**  
*Find maximal absolute value.*
- **mha\_real\_t MHASignal::maxabs(const mha\_wave\_t &s)**  
*Find maximal absolute value.*
- **mha\_real\_t MHASignal::max(const mha\_wave\_t &s)**  
*Find maximal value.*
- **mha\_real\_t MHASignal::min(const mha\_wave\_t &s)**  
*Find minimal value.*
- **mha\_real\_t MHASignal::sumsqr\_channel(const mha\_wave\_t &s, unsigned int channel)**  
*Calculate sum of squared values in one channel.*
- **mha\_real\_t MHASignal::sumsqr\_frame(const mha\_wave\_t &s, unsigned int frame)**  
*Calculate sum over all channels of squared values.*
- **void conjugate(mha\_spec\_t &self)**  
*Replace (!) the value of this **mha\_spec\_t** (p. 465) with its conjugate.*

### 3.9.1 Detailed Description

The vector and matrix processing toolbox consists of a number of classes defined in the namespace **MHASignal** (p. 118), and many functions and operators for use with the structures **mha\_↔\_wave\_t** (p. 496) and **mha\_spec\_t** (p. 465).

### 3.9.2 Typedef Documentation

#### 3.9.2.1 typedef float mha\_real\_t

openMHA type for real numbers

This type is expected to be always the C-type 'float' (IEEE 754 single).

### 3.9.3 Function Documentation

#### 3.9.3.1 mha\_wave\_t range ( mha\_wave\_t *s*, unsigned int *k0*, unsigned int *len* )

Return a time interval from a waveform chunk.

A waveform chunk containing a time interval of a larger waveform chunk is returned. The number of channels remains constant. The data of the output waveform structure points to the data of the input structure, i.e., write access to the output waveform chunk modifies the corresponding entries in the input chunk.

#### Parameters

<i>s</i>	Waveform structure
<i>k0</i>	Index of first value in output
<i>len</i>	Number of frames in output

#### Returns

Waveform structure representing the sub-interval.

#### 3.9.3.2 mha\_spec\_t channels ( mha\_spec\_t *s*, unsigned int *ch\_start*, unsigned int *nch* )

Return a channel interval from a spectrum.

## Parameters

<i>s</i>	Input spectrum
<i>ch_start</i>	Index of first channel in output
<i>nch</i>	Number of channels in output

## Returns

Spectrum structure representing the sub-interval.

```
3.9.3.3 void MHASignal::for_each (
    mha_wave_t * s,
    mha_real_t (*)(mha_real_t) fun ) [inline]
```

Apply a function to each element of a **mha\_wave\_t** (p. 496).

## Parameters

<i>s</i>	Pointer to a <b>mha_wave_t</b> (p. 496) structure
<i>fun</i>	Function to be applied (one argument)

```
3.9.3.4 mha_real_t MHASignal::lin2db (
    mha_real_t x ) [inline]
```

Conversion from linear scale to dB (no SPL reference)

## Parameters

<i>x</i>	Linear input.
----------	---------------

```
3.9.3.5 mha_real_t MHASignal::db2lin (
    mha_real_t x ) [inline]
```

Conversion from dB scale to linear (no SPL reference)

## Parameters

<i>x</i>	dB input.
----------	-----------

```
3.9.3.6 mha_real_t MHASignal::pa2dbspl (
    mha_real_t x ) [inline]
```

Conversion from linear Pascal scale to dB SPL.

**Parameters**

<i>x</i>	Linear input.
----------	---------------

**3.9.3.7** `mha_real_t MHASignal::pa22dbspl (`  
`mha_real_t x,`  
`mha_real_t eps = 1e-20f ) [inline]`

Conversion from squared Pascal scale to dB SPL.

**Parameters**

<i>x</i>	squared pascal input
<i>eps</i>	minimum squared-pascal value

**3.9.3.8** `mha_real_t MHASignal::dbspl2pa (`  
`mha_real_t x ) [inline]`

Conversion from dB SPL to linear Pascal scale.

**Parameters**

<i>x</i>	Linear input.
----------	---------------

**3.9.3.9** `mha_real_t MHASignal::smp2sec (`  
`mha_real_t n,`  
`mha_real_t srate ) [inline]`

conversion from samples to seconds

**Parameters**

<i>n</i>	number of samples
<i>srate</i>	sampling rate / Hz

**3.9.3.10** `mha_real_t MHASignal::sec2smp (`  
`mha_real_t sec,`  
`mha_real_t srate ) [inline]`

conversion from seconds to samples

**Parameters**

<i>sec</i>	time in seconds
<i>srate</i>	sampling rate / Hz

**Returns**

number of samples, generally has non-zero fractional part

```
3.9.3.11 mha_real_t MHASignal::bin2freq (
    mha_real_t bin,
    unsigned fftlen,
    mha_real_t srate ) [inline]
```

conversion from fft bin index to frequency

**Parameters**

<i>bin</i>	index of fft bin, index 0 has dc
<i>fftlen</i>	FFT length
<i>srate</i>	sampling frequency / Hz

**Returns**

frequency of fft bin / Hz

```
3.9.3.12 mha_real_t MHASignal::freq2bin (
    mha_real_t freq,
    unsigned fftlen,
    mha_real_t srate ) [inline]
```

conversion from frequency to fft bin index

**Parameters**

<i>freq</i>	frequency / Hz
<i>fftlen</i>	FFT length
<i>srate</i>	sampling frequency / Hz

**Returns**

0-based index of fft bin, generally has non-zero fractional part

```
3.9.3.13 mha_real_t MHASignal::smp2rad (
    mha_real_t samples,
    unsigned bin,
    unsigned fftlen ) [inline]
```

conversion from delay in samples to phase shift

Compute phase shift that needs to be applied to fft spectrum to achieve the desired delay.

**Parameters**

<i>samples</i>	delay in samples. Positive delay: shift current signal to future.
<i>bin</i>	index of fft bin, index 0 has dc (index 0 and nyquist bin cannot be delayed)
<i>fftlen</i>	FFT length

**Returns**

The phase shift in radiant that needs to be applied to fft bin to achieve the desired delay. A positive delay requires a negative phase shift. If required phase shift is  $>\pi$  or  $<-\pi$ , then the desired delay cannot be applied in the fft domain with given parameters. Required phase shifts close to  $\pi$  should not be used. If bin is 0 or nyquist, returns 0 phase shift.

```
3.9.3.14 mha_real_t MHASignal::rad2smp (
           mha_real_t phase_shift,
           unsigned bin,
           unsigned fftlen ) [inline]
```

conversion from phase shift to delay in samples

Compute delay in samples that is achieved by a phase shift.

**Parameters**

<i>phase_shift</i>	phase shift in radiant
<i>bin</i>	index of fft bin, index 0 has dc (index 0 and nyquist bin cannot be delayed)
<i>fftlen</i>	FFT length

**Returns**

The delay in samples achieved by applying the phase shift. A negative phase shift causes a positive delay: shifts current signal to future.

```
3.9.3.15 template<class elem_type > std::vector<elem_type> MHASignal::dupvec (
           std::vector< elem_type > vec,
           unsigned n )
```

Duplicate last vector element to match desired size.

**Parameters**

<i>vec</i>	Input vector.
<i>n</i>	Target number of elements.

## Return values

<i>Resized</i>	vector.
----------------	---------

```
3.9.3.16  template<class elem_type > std::vector<elem_type> MHASignal::dupvec_chk (
            std::vector< elem_type > vec,
            unsigned n )
```

Duplicate last vector element to match desired size, check for dimension.

The input dimension can be either 1 or the target length.

## Parameters

<i>vec</i>	Input vector.
<i>n</i>	Target number of elements.

## Return values

<i>Resized</i>	vector.
----------------	---------

```
3.9.3.17  bool equal_dim (
            const mha_wave_t & a,
            const mha_wave_t & b ) [inline]
```

Test for equal dimension of waveform structures.

```
3.9.3.18  bool equal_dim (
            const mha_wave_t & a,
            const mhaconfig_t & b ) [inline]
```

Test for match of waveform dimension with mhaconfig structure.

```
3.9.3.19  bool equal_dim (
            const mha_spec_t & a,
            const mha_spec_t & b ) [inline]
```

Test for equal dimension of spectrum structures.

```
3.9.3.20  bool equal_dim (
            const mha_spec_t & a,
            const mhaconfig_t & b ) [inline]
```

Test for match of spectrum dimension with mhaconfig structure.

```
3.9.3.21 bool equal_dim (
    const mha_wave_t & a,
    const mha_spec_t & b ) [inline]
```

Test for equal dimension of waveform/spectrum structures.

#### Warning

Waveform structures **mha\_wave\_t** (p. 496) use interleaved data order, while spectrum structures **mha\_spec\_t** (p. 465) use non-interleaved.

```
3.9.3.22 bool equal_dim (
    const mha_spec_t & a,
    const mha_wave_t & b ) [inline]
```

Test for equal dimension of waveform/spectrum structures.

#### Warning

Waveform structures **mha\_wave\_t** (p. 496) use interleaved data order, while spectrum structures **mha\_spec\_t** (p. 465) use non-interleaved.

```
3.9.3.23 void integrate (
    mha_wave_t & s )
```

Numeric integration of a signal vector (real values)

#### Parameters

s	Input signal vector
---	---------------------

```
3.9.3.24 void integrate (
    mha_spec_t & s )
```

Numeric integration of a signal vector (complex values)

#### Parameters

s	Input signal vector
---	---------------------

```
3.9.3.25 unsigned int size (
    const mha_wave_t & s ) [inline]
```

Return size of a waveform structure.



3.9.3.26 unsigned int size (  
                   const mha\_spec\_t & s ) [inline]

Return size of a spectrum structure.

3.9.3.27 unsigned int size (  
                   const mha\_wave\_t \* s ) [inline]

Return size of a waveform structure.

3.9.3.28 unsigned int size (  
                   const mha\_spec\_t \* s ) [inline]

Return size of a spectrum structure.

3.9.3.29 void clear (  
                   mha\_wave\_t & s ) [inline]

Set all values of waveform to zero.

3.9.3.30 void clear (  
                   mha\_wave\_t \* s ) [inline]

Set all values of waveform to zero.

3.9.3.31 void clear (  
                   mha\_spec\_t & s ) [inline]

Set all values of spectrum to zero.

3.9.3.32 void clear (  
                   mha\_spec\_t \* s ) [inline]

Set all values of spectrum to zero.

3.9.3.33 void assign (  
                   mha\_wave\_t self,  
                   mha\_real\_t val ) [inline]

Set all values of waveform 'self' to 'val'.

#### Parameters

<i>self</i>	Waveform to be modified.
<i>val</i>	Value to be assigned to all entries of waveform.

3.9.3.34 void assign (  
           **mha\_wave\_t self,**  
           **const mha\_wave\_t & val )**

Set all values of waveform 'self' to 'val'.

**Parameters**

<i>self</i>	Waveform to be modified.
<i>val</i>	Source waveform structure.

3.9.3.35 void assign (  
           **mha\_spec\_t self,**  
           **const mha\_spec\_t & val )**

Set all values of spectrum 'self' to 'val'.

**Parameters**

<i>self</i>	Spectrum to be modified.
<i>val</i>	Source spectrum.

3.9.3.36 void timeshift (  
           **mha\_wave\_t & self,**  
           **int shift )**

Time shift of waveform chunk.

Shifted areas are filled with zeros.

**Parameters**

<i>self</i>	Waveform chunk to be shifted
<i>shift</i>	Shift amount, positive values shift to later times

3.9.3.37 **mha\_real\_t& value (**  
           **mha\_wave\_t \* s,**  
           **unsigned int fr,**  
           **unsigned int ch ) [inline]**

Access an element of a waveform structure.

**Parameters**

<i>s</i>	Waveform structure
<i>fr</i>	Frame number
<i>ch</i>	Channel number

**Returns**

Reference to element

```
3.9.3.38  const mha_real_t& value (
           const mha_wave_t * s,
           unsigned int fr,
           unsigned int ch ) [inline]
```

Constant access to an element of a waveform structure.

**Parameters**

<i>s</i>	Waveform structure
<i>fr</i>	Frame number
<i>ch</i>	Channel number

**Returns**

Reference to element

```
3.9.3.39  mha_complex_t& value (
           mha_spec_t * s,
           unsigned int fr,
           unsigned int ch ) [inline]
```

Access to an element of a spectrum.

**Parameters**

<i>s</i>	Spectrum structure
<i>fr</i>	Bin number
<i>ch</i>	Channel number

**Returns**

Reference to element

```
3.9.3.40  const mha_complex_t& value (
           const mha_spec_t * s,
           unsigned int fr,
           unsigned int ch ) [inline]
```

Constant access to an element of a spectrum.

**Parameters**

<i>s</i>	Spectrum structure
<i>fr</i>	Bin number
<i>ch</i>	Channel number

**Returns**

Reference to element

```
3.9.3.41 mha_real_t& value (
           mha_wave_t & s,
           unsigned int fr,
           unsigned int ch ) [inline]
```

Access to an element of a waveform structure.

**Parameters**

<i>s</i>	Waveform structure
<i>fr</i>	Frame number
<i>ch</i>	Channel number

**Returns**

Reference to element

```
3.9.3.42 const mha_real_t& value (
           const mha_wave_t & s,
           unsigned int fr,
           unsigned int ch ) [inline]
```

Constant access to an element of a waveform structure.

**Parameters**

<i>s</i>	Waveform structure
<i>fr</i>	Frame number
<i>ch</i>	Channel number

**Returns**

Reference to element

```
3.9.3.43 mha_complex_t& value (
           mha_spec_t & s,
           unsigned int fr,
           unsigned int ch ) [inline]
```

Access to an element of a spectrum.

#### Parameters

<i>s</i>	Spectrum structure
<i>fr</i>	Bin number
<i>ch</i>	Channel number

#### Returns

Reference to element

```
3.9.3.44 const mha_complex_t& value (
           const mha_spec_t & s,
           unsigned int fr,
           unsigned int ch ) [inline]
```

Constant access to an element of a spectrum.

#### Parameters

<i>s</i>	Spectrum structure
<i>fr</i>	Bin number
<i>ch</i>	Channel number

#### Returns

Reference to element

```
3.9.3.45 std::vector<float> std_vector_float (
           const mha_wave_t & )
```

Converts a **mha\_wave\_t** (p. 496) structure into a `std::vector<float>` (interleaved order).

#### Warning

This function is not real-time safe. Do not use in signal processing thread.

3.9.3.46 `std::vector<std::vector<float>> std_vector_vector_float ( const mha_wave_t & )`

Converts a **mha\_wave\_t** (p. 496) structure into a `std::vector< std::vector<float>>` (outer vector represents channels).

#### Warning

This function is not real-time safe. Do not use in signal processing thread.

3.9.3.47 `std::vector<std::vector<mha_complex_t>> std_vector_vector_complex ( const mha_spec_t & )`

Converts a **mha\_spec\_t** (p. 465) structure into a `std::vector< std::vector<mha_complex_t>>` (outer vector represents channels).

#### Warning

This function is not real-time safe. Do not use in signal processing thread.

3.9.3.48 `mha_wave_t& operator+= ( mha_wave_t & , const mha_real_t & )`

Addition operator.

3.9.3.49 `mha_wave_t& operator+= ( mha_wave_t & , const mha_wave_t & )`

Addition operator.

3.9.3.50 `mha_wave_t& operator-= ( mha_wave_t & , const mha_wave_t & )`

Subtraction operator.

3.9.3.51 `mha_spec_t& operator-= ( mha_spec_t & , const mha_spec_t & )`

Subtraction operator.

3.9.3.52 `mha_wave_t& operator*=(`  
    `mha_wave_t &` ,  
    `const mha_real_t & )`

Element-wise multiplication operator.

3.9.3.53 `mha_wave_t& operator*=(`  
    `mha_wave_t &` ,  
    `const mha_wave_t & )`

Element-wise multiplication operator.

3.9.3.54 `mha_spec_t& operator*=(`  
    `mha_spec_t &` ,  
    `const mha_real_t & )`

Element-wise multiplication operator.

3.9.3.55 `mha_spec_t& operator*=(`  
    `mha_spec_t &` ,  
    `const mha_wave_t & )`

Element-wise multiplication operator.

3.9.3.56 `mha_spec_t& operator*=(`  
    `mha_spec_t &` ,  
    `const mha_spec_t & )`

Element-wise multiplication operator.

3.9.3.57 `mha_spec_t& operator/=(`  
    `mha_spec_t &` ,  
    `const mha_spec_t & )`

Element-wise division operator.

3.9.3.58 `mha_wave_t& operator/=(`  
    `mha_wave_t &` ,  
    `const mha_wave_t & )`

Element-wise division operator.

3.9.3.59 `mha_spec_t& operator+=(`  
    `mha_spec_t &` ,  
    `const mha_spec_t & )`

Addition operator.

```
3.9.3.60 mha_spec_t& operator+= (
        mha_spec_t &,
        const mha_real_t & )
```

Addition operator.

```
3.9.3.61 mha_wave_t& operator^= (
        mha_wave_t & self,
        const mha_real_t & arg )
```

Exponent operator.

#### Warning

This overwrites the xor operator!

```
3.9.3.62 void MHASignal::copy_channel (
        mha_spec_t & self,
        const mha_spec_t & src,
        unsigned sch,
        unsigned dch )
```

Copy one channel of a source signal.

#### Parameters

<i>self</i>	Destination.
<i>src</i>	Source
<i>sch</i>	Source channel number
<i>dch</i>	Destination channel number

```
3.9.3.63 void MHASignal::copy_channel (
        mha_wave_t & self,
        const mha_wave_t & src,
        unsigned src_channel,
        unsigned dest_channel )
```

Copy one channel of a source signal.

#### Parameters

<i>self</i>	Destination.
<i>src</i>	Source
<i>src_channel</i>	Source channel number
<i>dest_channel</i>	Destination channel number



```
3.9.3.64 mha_real_t MHASignal::rmslevel (
           const mha_spec_t & s,
           unsigned int channel,
           unsigned int fftlen )
```

Return RMS level of a spectrum channel.

#### Parameters

<i>s</i>	Input spectrum
<i>channel</i>	Channel number to be tested
<i>fftlen</i>	FFT length (to correctly count the level of the Nyquist bin)

#### Returns

RMS level in Pa

```
3.9.3.65 mha_real_t MHASignal::colored_intensity (
           const mha_spec_t & s,
           unsigned int channel,
           unsigned int fftlen,
           mha_real_t sqfreq_response[] )
```

Colored spectrum intensity.

computes the squared sum of the spectrum after filtering with the frequency response

#### Parameters

<i>s</i>	Input spectrum
<i>channel</i>	Channel number to be tested
<i>fftlen</i>	FFT length (to correctly count the level of the Nyquist bin)
<i>sqfreq_response</i>	A squared weighting factor for every fft bin.

#### Returns

sum of squares. Root of this is the colored level in Pa

```
3.9.3.66 mha_real_t MHASignal::maxabs (
           const mha_spec_t & s,
           unsigned int channel )
```

Find maximal absolute value.

**Parameters**

<i>s</i>	Input signal
<i>channel</i>	Channel to be tested

**Returns**

maximum absolute value

**3.9.3.67** `mha_real_t MHASignal::rmslevel (`  
`const mha_wave_t & s,`  
`unsigned int channel )`

Return RMS level of a waveform channel.

**Parameters**

<i>s</i>	Input waveform signal
<i>channel</i>	Channel number to be tested

**Returns**

RMS level in Pa

**3.9.3.68** `mha_real_t MHASignal::maxabs (`  
`const mha_wave_t & s,`  
`unsigned int channel )`

Find maximal absolute value.

**Parameters**

<i>s</i>	Input signal
<i>channel</i>	Channel to be tested

**Returns**

maximum absolute value

**3.9.3.69** `mha_real_t MHASignal::maxabs (`  
`const mha_wave_t & s )`

Find maximal absolute value.

**Parameters**

<code>s</code>	Input signal
----------------	--------------

**Returns**

maximum absolute value

**3.9.3.70** `mha_real_t MHASignal::max (`  
`const mha_wave_t & s )`

Find maximal value.

**Parameters**

<code>s</code>	Input signal
----------------	--------------

**Returns**

maximum absolute value

**3.9.3.71** `mha_real_t MHASignal::min (`  
`const mha_wave_t & s )`

Find minimal value.

**Parameters**

<code>s</code>	Input signal
----------------	--------------

**Returns**

maximum absolute value

**3.9.3.72** `mha_real_t MHASignal::sumsqr_channel (`  
`const mha_wave_t & s,`  
`unsigned int channel )`

Calculate sum of squared values in one channel.

**Parameters**

<code>s</code>	Input signal
<code>channel</code>	Channel

**Returns**

$$\sum x^2$$

**3.9.3.73** `mha_real_t MHASignal::sumsqr_frame (`  
    `const mha_wave_t & s,`  
    `unsigned int frame )`

Calculate sum over all channels of squared values.

**Parameters**

<code>s</code>	Input signal
<code>frame</code>	Frame number

**Returns**

$$\sum x^2$$

**3.9.3.74** `void conjugate (`  
    `mha_spec_t & self ) [inline]`

Replace (!) the value of this `mha_spec_t` (p. 465) with its conjugate.

## 3.10 Complex arithmetics in the openMHA

Collaboration diagram for Complex arithmetics in the openMHA:

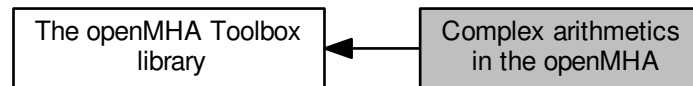

## Classes

- struct **mha\_complex\_t**  
*Type for complex floating point values.*

## Functions

- **mha\_complex\_t & set (mha\_complex\_t &self, mha\_real\_t real, mha\_real\_t imag=0)**  
*Assign real and imaginary parts to a **mha\_complex\_t** (p. 431) variable.*
- **mha\_complex\_t mha\_complex (mha\_real\_t real, mha\_real\_t imag=0)**  
*Create a new **mha\_complex\_t** (p. 431) with specified real and imaginary parts.*
- **mha\_complex\_t & set (mha\_complex\_t &self, const std::complex< mha\_real\_t > &stdcomplex)**  
*Assign a **mha\_complex\_t** (p. 431) variable from a **std::complex**.*
- **std::complex< mha\_real\_t > stdcomplex (const mha\_complex\_t &self)**  
*Create a **std::complex** from **mha\_complex\_t** (p. 431).*
- **mha\_complex\_t & expi (mha\_complex\_t &self, mha\_real\_t angle)**  
*replaces the value of the given **mha\_complex\_t** (p. 431) with  $\exp(i*b)$ .*
- **double angle (const mha\_complex\_t &self)**  
*Computes the angle of a complex number in the complex plane.*
- **mha\_complex\_t & operator+= (mha\_complex\_t &self, const mha\_complex\_t &other)**  
*Addition of two complex numbers, overwriting the first.*
- **mha\_complex\_t operator+ (const mha\_complex\_t &self, const mha\_complex\_t &other)**  
*Addition of two complex numbers, result is a temporary object.*
- **mha\_complex\_t & operator+= (mha\_complex\_t &self, mha\_real\_t other\_real)**  
*Addition of a complex and a real number, overwriting the complex.*
- **mha\_complex\_t operator+ (const mha\_complex\_t &self, mha\_real\_t other\_real)**  
*Addition of a complex and a real number, result is a temporary object.*
- **mha\_complex\_t & operator-= (mha\_complex\_t &self, const mha\_complex\_t &other)**  
*Subtraction of two complex numbers, overwriting the first.*

- **mha\_complex\_t operator-** (const **mha\_complex\_t** &self, const **mha\_complex\_t** &other)
 

*Subtraction of two complex numbers, result is a temporary object.*
- **mha\_complex\_t & operator-=** (**mha\_complex\_t** &self, **mha\_real\_t** other\_real)
 

*Subtraction of a complex and a real number, overwriting the complex.*
- **mha\_complex\_t operator-** (const **mha\_complex\_t** &self, **mha\_real\_t** other\_real)
 

*Subtraction of a complex and a real number, result is a temporary object.*
- **mha\_complex\_t & operator\*=**\***** (**mha\_complex\_t** &self, const **mha\_complex\_t** &other)
 

*Multiplication of two complex numbers, overwriting the first.*
- **mha\_complex\_t operator\***\***** (const **mha\_complex\_t** &self, const **mha\_complex\_t** &other)
 

*Multiplication of two complex numbers, result is a temporary object.*
- **mha\_complex\_t & operator\*=**\***** (**mha\_complex\_t** &self, **mha\_real\_t** other\_real)
 

*Multiplication of a complex and a real number, overwriting the complex.*
- **mha\_complex\_t & expi** (**mha\_complex\_t** &self, **mha\_real\_t** angle, **mha\_real\_t** factor)
 

*replaces (!) the value of the given **mha\_complex\_t** (p. 431) with  $a * \exp(i*b)$*
- **mha\_complex\_t operator\***\***** (const **mha\_complex\_t** &self, **mha\_real\_t** other\_real)
 

*Multiplication of a complex and a real number, result is a temporary object.*
- **mha\_real\_t abs2** (const **mha\_complex\_t** &self)
 

*Compute the square of the absolute value of a complex value.*
- **mha\_real\_t abs** (const **mha\_complex\_t** &self)
 

*Compute the absolute value of a complex value.*
- **mha\_complex\_t & operator/=** (**mha\_complex\_t** &self, **mha\_real\_t** other\_real)
 

*Division of a complex and a real number, overwriting the complex.*
- **mha\_complex\_t operator/** (const **mha\_complex\_t** &self, **mha\_real\_t** other\_real)
 

*Division of a complex and a real number, result is a temporary object.*
- **mha\_complex\_t & safe\_div** (**mha\_complex\_t** &self, const **mha\_complex\_t** &other, **mha\_real\_t** eps, **mha\_real\_t** eps2)
 

*Safe division of two complex numbers, overwriting the first.*
- **mha\_complex\_t & operator/=** (**mha\_complex\_t** &self, const **mha\_complex\_t** &other)
 

*Division of two complex numbers, overwriting the first.*
- **mha\_complex\_t operator/** (const **mha\_complex\_t** &self, const **mha\_complex\_t** &other)
 

*Division of two complex numbers, result is a temporary object.*
- **mha\_complex\_t operator-** (const **mha\_complex\_t** &self)
 

*Unary minus on a complex results in a negative temporary object.*
- **bool operator==** (const **mha\_complex\_t** &x, const **mha\_complex\_t** &y)
 

*Compare two complex numbers for equality.*
- **bool operator!=** (const **mha\_complex\_t** &x, const **mha\_complex\_t** &y)
 

*Compare two complex numbers for inequality.*
- **void conjugate** (**mha\_complex\_t** &self)
 

*Replace (!) the value of this **mha\_complex\_t** (p. 431) with its conjugate.*
- **mha\_complex\_t \_conjugate** (const **mha\_complex\_t** &self)
 

*Compute the conjugate of this complex value.*
- **void reciprocal** (**mha\_complex\_t** &self)

*Replace the value of this complex with its reciprocal.*

- **mha\_complex\_t \_reciprocal** (const **mha\_complex\_t** &self)  
*compute the reciprocal of this complex value.*
- void **normalize** (**mha\_complex\_t** &self)  
*Divide a complex by its absolute value, thereby normalizing it (projecting onto the unit circle).*
- void **normalize** (**mha\_complex\_t** &self, **mha\_real\_t** margin)  
*Divide a complex by its absolute value, thereby normalizing it (projecting onto the unit circle), with a safety margin.*
- bool **almost** (const **mha\_complex\_t** &self, const **mha\_complex\_t** &other, **mha\_real\_t** times\_epsilon=1e2)  
*Compare two complex numbers for equality except for a small relative error.*
- bool **operator<** (const **mha\_complex\_t** &x, const **mha\_complex\_t** &y)  
*Compares the absolute values of two complex numbers.*

### 3.10.1 Detailed Description

### 3.10.2 Function Documentation

3.10.2.1 **mha\_complex\_t& set** (  
     **mha\_complex\_t** & self,  
     **mha\_real\_t** real,  
     **mha\_real\_t** imag = 0 ) [inline]

Assign real and imaginary parts to a **mha\_complex\_t** (p. 431) variable.

#### Parameters

<i>self</i>	The <b>mha_complex_t</b> (p. 431) variable whose value is about to change.
<i>real</i>	The new real part.
<i>imag</i>	The new imaginary part.

#### Returns

A reference to the changed variable.

3.10.2.2 **mha\_complex\_t mha\_complex** (  
     **mha\_real\_t** real,  
     **mha\_real\_t** imag = 0 ) [inline]

Create a new **mha\_complex\_t** (p. 431) with specified real and imaginary parts.

#### Parameters

<i>real</i>	The real part.
<i>imag</i>	The imaginary part.

**Returns**

The new value.

```
3.10.2.3 mha_complex_t& set (
    mha_complex_t & self,
    const std::complex< mha_real_t > & stdcomplex ) [inline]
```

Assign a **mha\_complex\_t** (p. 431) variable from a `std::complex`.

**Parameters**

<i>self</i>	The <b>mha_complex_t</b> (p. 431) variable whose value is about to change.
<i>stdcomplex</i>	The new complex value.

**Returns**

A reference to the changed variable.

```
3.10.2.4 std::complex<mha_real_t> stdcomplex (
    const mha_complex_t & self ) [inline]
```

Create a `std::complex` from **mha\_complex\_t** (p. 431).

```
3.10.2.5 mha_complex_t& expi (
    mha_complex_t & self,
    mha_real_t angle ) [inline]
```

replaces the value of the given **mha\_complex\_t** (p. 431) with  $\exp(i*b)$ .

**Parameters**

<i>self</i>	The <b>mha_complex_t</b> (p. 431) variable whose value is about to change.
<i>angle</i>	The angle in the complex plane [rad].

**Returns**

A reference to the changed variable.

```
3.10.2.6 double angle (
    const mha_complex_t & self ) [inline]
```

Computes the angle of a complex number in the complex plane.



## Parameters

<i>self</i>	The complex number whose angle is needed.
-------------	---

## Returns

The angle of a complex number in the complex plane.

```
3.10.2.7 mha_complex_t& operator+=(
    mha_complex_t & self,
    const mha_complex_t & other ) [inline]
```

Addition of two complex numbers, overwriting the first.

```
3.10.2.8 mha_complex_t operator+(
    const mha_complex_t & self,
    const mha_complex_t & other ) [inline]
```

Addition of two complex numbers, result is a temporary object.

```
3.10.2.9 mha_complex_t& operator+=(
    mha_complex_t & self,
    mha_real_t other_real ) [inline]
```

Addition of a complex and a real number, overwriting the complex.

```
3.10.2.10 mha_complex_t operator+(
    const mha_complex_t & self,
    mha_real_t other_real ) [inline]
```

Addition of a complex and a real number, result is a temporary object.

```
3.10.2.11 mha_complex_t& operator-=(
    mha_complex_t & self,
    const mha_complex_t & other ) [inline]
```

Subtraction of two complex numbers, overwriting the first.

```
3.10.2.12 mha_complex_t operator-(
    const mha_complex_t & self,
    const mha_complex_t & other ) [inline]
```

Subtraction of two complex numbers, result is a temporary object.

```
3.10.2.13 mha_complex_t& operator-= (
           mha_complex_t & self,
           mha_real_t other_real ) [inline]
```

Subtraction of a complex and a real number, overwriting the complex.

```
3.10.2.14 mha_complex_t operator- (
           const mha_complex_t & self,
           mha_real_t other_real ) [inline]
```

Subtraction of a complex and a real number, result is a temporary object.

```
3.10.2.15 mha_complex_t& operator*=(
           mha_complex_t & self,
           const mha_complex_t & other ) [inline]
```

Multiplication of two complex numbers, overwriting the first.

```
3.10.2.16 mha_complex_t operator* (
           const mha_complex_t & self,
           const mha_complex_t & other ) [inline]
```

Multiplication of two complex numbers, result is a temporary object.

```
3.10.2.17 mha_complex_t& operator*=(
           mha_complex_t & self,
           mha_real_t other_real ) [inline]
```

Multiplication of a complex and a real number, overwriting the complex.

```
3.10.2.18 mha_complex_t& expi (
           mha_complex_t & self,
           mha_real_t angle,
           mha_real_t factor ) [inline]
```

replaces (!) the value of the given **mha\_complex\_t** (p. 431) with  $a * \exp(i*b)$

#### Parameters

<i>self</i>	The <b>mha_complex_t</b> (p. 431) variable whose value is about to change.
<i>angle</i>	The imaginary exponent.
<i>factor</i>	The absolute value of the result.

**Returns**

A reference to the changed variable.

```
3.10.2.19 mha_complex_t operator* (
    const mha_complex_t & self,
    mha_real_t other_real ) [inline]
```

Multiplication of a complex and a real number, result is a temporary object.

```
3.10.2.20 mha_real_t abs2 (
    const mha_complex_t & self ) [inline]
```

Compute the square of the absolute value of a complex value.

**Returns**

The square of the absolute value of self.

```
3.10.2.21 mha_real_t abs (
    const mha_complex_t & self ) [inline]
```

Compute the absolute value of a complex value.

**Returns**

The absolute value of self.

```
3.10.2.22 mha_complex_t& operator/= (
    mha_complex_t & self,
    mha_real_t other_real ) [inline]
```

Division of a complex and a real number, overwriting the complex.

```
3.10.2.23 mha_complex_t operator/ (
    const mha_complex_t & self,
    mha_real_t other_real ) [inline]
```

Division of a complex and a real number, result is a temporary object.

```
3.10.2.24 mha_complex_t& safe_div (
    mha_complex_t & self,
    const mha_complex_t & other,
    mha_real_t eps,
    mha_real_t eps2 ) [inline]
```

Safe division of two complex numbers, overwriting the first.

If  $\text{abs}(\text{divisor}) < \text{eps}$ , then divisor is replaced by eps.  $\text{eps2} = \text{eps} * \text{eps}$ .

```
3.10.2.25 mha_complex_t& operator/= (
           mha_complex_t & self,
           const mha_complex_t & other ) [inline]
```

Division of two complex numbers, overwriting the first.

```
3.10.2.26 mha_complex_t operator/ (
           const mha_complex_t & self,
           const mha_complex_t & other ) [inline]
```

Division of two complex numbers, result is a temporary object.

```
3.10.2.27 mha_complex_t operator- (
           const mha_complex_t & self ) [inline]
```

Unary minus on a complex results in a negative temporary object.

```
3.10.2.28 bool operator== (
           const mha_complex_t & x,
           const mha_complex_t & y ) [inline]
```

Compare two complex numbers for equality.

```
3.10.2.29 bool operator!= (
           const mha_complex_t & x,
           const mha_complex_t & y ) [inline]
```

Compare two complex numbers for inequality.

```
3.10.2.30 void conjugate (
           mha_complex_t & self ) [inline]
```

Replace (!) the value of this **mha\_complex\_t** (p. 431) with its conjugate.

```
3.10.2.31 mha_complex_t conjugate (
           const mha_complex_t & self ) [inline]
```

Compute the conjugate of this complex value.

#### Returns

A temporary object holding the conjugate value.

```
3.10.2.32 void reciprocal (
           mha_complex_t & self ) [inline]
```

Replace the value of this complex with its reciprocal.

```
3.10.2.33 mha_complex_t_reciprocal (
           const mha_complex_t & self ) [inline]
```

compute the reciprocal of this complex value.

#### Returns

A temporary object holding the reciprocal value.

```
3.10.2.34 void normalize (
           mha_complex_t & self ) [inline]
```

Divide a complex by its absolute value, thereby normalizing it (projecting onto the unit circle).

```
3.10.2.35 void normalize (
           mha_complex_t & self,
           mha_real_t margin ) [inline]
```

Divide a complex by its absolute value, thereby normalizing it (projecting onto the unit circle), with a safety margin.

```
3.10.2.36 bool almost (
           const mha_complex_t & self,
           const mha_complex_t & other,
           mha_real_t times_epsilon = 1e2 ) [inline]
```

Compare two complex numbers for equality except for a small relative error.

#### Parameters

<i>self</i>	The first complex number.
<i>other</i>	The second complex number.
<i>times_epsilon</i>	Permitted relative error is this number multiplied with the machine accuracy for this Floating point format ( <code>std::numeric_limits&lt;mha_real_t&gt;::epsilon</code> )

#### Returns

true if the relative difference is below `times_epsilon * std::numeric_limits<mha_real_t>::epsilon`

3.10.2.37 `bool operator< (`  
    `const mha_complex_t & x,`  
    `const mha_complex_t & y ) [inline]`

Compares the absolute values of two complex numbers.

## 3.11 Fast Fourier Transform functions

Collaboration diagram for Fast Fourier Transform functions:

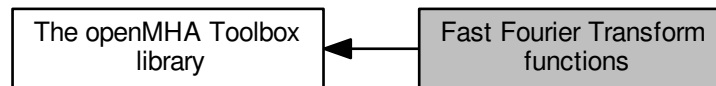

## Typedefs

- typedef void \* **mha\_fft\_t**  
*Handle for an FFT object.*

## Functions

- **mha\_fft\_t mha\_fft\_new** (unsigned int n)  
*Create a new FFT handle.*
- void **mha\_fft\_free** (mha\_fft\_t h)  
*Destroy an FFT handle.*
- void **mha\_fft\_wave2spec** (mha\_fft\_t h, const mha\_wave\_t \*in, mha\_spec\_t \*out)  
*Transform waveform segment into spectrum.*
- void **mha\_fft\_wave2spec** (mha\_fft\_t h, const mha\_wave\_t \*in, mha\_spec\_t \*out, bool swaps)  
*Transform waveform segment into spectrum.*
- void **mha\_fft\_spec2wave** (mha\_fft\_t h, const mha\_spec\_t \*in, mha\_wave\_t \*out)  
*Transform spectrum into waveform segment.*
- void **mha\_fft\_spec2wave** (mha\_fft\_t h, const mha\_spec\_t \*in, mha\_wave\_t \*out, unsigned int offset)  
*Transform spectrum into waveform segment.*
- void **mha\_fft\_forward** (mha\_fft\_t h, mha\_spec\_t \*sIn, mha\_spec\_t \*sOut)  
*Complex to complex FFT (forward).*
- void **mha\_fft\_backward** (mha\_fft\_t h, mha\_spec\_t \*sIn, mha\_spec\_t \*sOut)  
*Complex to complex FFT (backward).*
- void **mha\_fft\_forward\_scale** (mha\_fft\_t h, mha\_spec\_t \*sIn, mha\_spec\_t \*sOut)  
*Complex to complex FFT (forward).*
- void **mha\_fft\_backward\_scale** (mha\_fft\_t h, mha\_spec\_t \*sIn, mha\_spec\_t \*sOut)  
*Complex to complex FFT (backward).*
- void **mha\_fft\_wave2spec\_scale** (mha\_fft\_t h, const mha\_wave\_t \*in, mha\_spec\_t \*out)  
*Transform waveform segment into spectrum.*
- void **mha\_fft\_spec2wave\_scale** (mha\_fft\_t h, const mha\_spec\_t \*in, mha\_wave\_t \*out)  
*Transform spectrum into waveform segment.*

### 3.11.1 Detailed Description

### 3.11.2 Typedef Documentation

#### 3.11.2.1 typedef void\* mha\_fft\_t

Handle for an FFT object.

This FFT object is used by the functions `mha_fft_wave2spec` and `mha_fft_spec2wave`. The F↔FT back-end is the FFTW library. The back-end is completely hidden, including external header files or linking external libraries is not required.

### 3.11.3 Function Documentation

#### 3.11.3.1 `mha_fft_t mha_fft_new ( unsigned int n )`

Create a new FFT handle.

##### Parameters

<i>n</i>	FFT length.
----------	-------------

Create a new FFT handle.

##### Parameters

<i>n</i>	FFT length
----------	------------

##### Return values

<i>FFT</i>	object
------------	--------

#### 3.11.3.2 `void mha_fft_free ( mha_fft_t h )`

Destroy an FFT handle.

##### Parameters

<i>h</i>	Handle to be destroyed.
----------	-------------------------

Destroy an FFT handle.



## Parameters

<i>h</i>	FFT object to be removed
----------	--------------------------

```
3.11.3.3 void mha_fft_wave2spec (
           mha_fft_t h,
           const mha_wave_t * in,
           mha_spec_t * out )
```

Transform waveform segment into spectrum.

## Parameters

<i>h</i>	FFT handle.
<i>in</i>	Input waveform segment.
<i>out</i>	Output spectrum.

Transform waveform segment into spectrum.

## Parameters

<i>h</i>	FFT object handle
<i>in</i>	pointer to input waveform signal
<i>out</i>	pointer to output spectrum signal (has to be allocated)

```
3.11.3.4 void mha_fft_wave2spec (
           mha_fft_t h,
           const mha_wave_t * in,
           mha_spec_t * out,
           bool swaps )
```

Transform waveform segment into spectrum.

Like normal wave2spec, but swaps wave buffer halves before transforming if the swaps parameter is true.

Warning: These openMHA FFTs adopt a nonstandard scaling scheme in which the forward transform scales by 1/N and the backward does not scale. We would recommend using the '\_scale' methods instead.

## Parameters

<i>h</i>	FFT handle.
<i>in</i>	Input waveform segment.
<i>out</i>	Output spectrum.
<i>swaps</i>	Function swaps the first and second half of the waveform buffer before the FFT transform when this parameter is set to true.

```
3.11.3.5 void mha_fft_spec2wave (
           mha_fft_t h,
           const mha_spec_t * in,
           mha_wave_t * out )
```

Tranform spectrum into waveform segment.

Warning: These openMHA FFTs adopt a nonstandard scaling scheme in which the forward transform scales by 1/N and the backward does not scale. We would recommend using the '\_scale' methods instead.

#### Parameters

<i>h</i>	FFT handle.
<i>in</i>	Input spectrum.
<i>out</i>	Output waveform segment.

Tranform spectrum into waveform segment.

#### Parameters

<i>h</i>	FFT object handle
<i>in</i>	pointer to input spectrum
<i>out</i>	pointer to output waveform signal (has to be allocated)

```
3.11.3.6 void mha_fft_spec2wave (
           mha_fft_t h,
           const mha_spec_t * in,
           mha_wave_t * out,
           unsigned int offset )
```

Tranform spectrum into waveform segment.

out may have fewer number of frames than needed for a complete iFFT. Only as many frames are written into out as fit, starting with offset offset of the complete iFFT.

Warning: These openMHA FFTs adopt a nonstandard scaling scheme in which the forward transform scales by 1/N and the backward does not scale. We would recommend using the '\_scale' methods instead.

#### Parameters

<i>h</i>	FFT handle.
<i>in</i>	Input spectrum.
<i>out</i>	Output waveform segment.
<i>offset</i>	Offset into iFFT wave buffer

Transform spectrum into waveform segment.

Only part of the iFFT is transferred into the out buffer.

Out may have fewer number of frames than needed for a complete iFFT. Only as many frames are written into out as fit, starting with offset offset of the complete iFFT.

#### Parameters

<i>h</i>	FFT object handle
<i>in</i>	pointer to input spectrum
<i>out</i>	pointer to output waveform signal (has to be allocated)
<i>offset</i>	Offset into complete iFFT buffer.

```
3.11.3.7 void mha_fft_forward (
    mha_fft_t h,
    mha_spec_t * sIn,
    mha_spec_t * sOut )
```

Complex to complex FFT (forward).

sIn and sOut need to have nfft bins (please note that **mha\_spec\_t** (p. 465) typically has nfft/2+1 bins for half-complex representation).

Warning: These openMHA FFTs adopt a nonstandard scaling scheme in which the forward transform scales by 1/N and the backward does not scale. We would recommend using the '\_scale' methods instead.

#### Parameters

<i>h</i>	FFT handle.
<i>sIn</i>	Input spectrum.
<i>sOut</i>	Output spectrum.

```
3.11.3.8 void mha_fft_backward (
    mha_fft_t h,
    mha_spec_t * sIn,
    mha_spec_t * sOut )
```

Complex to complex FFT (backward).

sIn and sOut need to have nfft bins (please note that **mha\_spec\_t** (p. 465) typically has nfft/2+1 bins for half-complex representation).

Warning: These openMHA FFTs adopt a nonstandard scaling scheme in which the forward transform scales by 1/N and the backward does not scale. We would recommend using the '\_scale' methods instead.

**Parameters**

<i>h</i>	FFT handle.
<i>sIn</i>	Input spectrum.
<i>sOut</i>	Output spectrum.

```
3.11.3.9 void mha_fft_forward_scale (
           mha_fft_t h,
           mha_spec_t * sIn,
           mha_spec_t * sOut )
```

Complex to complex FFT (forward).

*sIn* and *sOut* need to have *nfft* bins (please note that **mha\_spec\_t** (p. 465) typically has *nfft*/2+1 bins for half-complex representation).

The *\_scale* methods use standard DFT scaling: There is no scaling in the forward transformation, and 1/*N* scaling for the backward.

**Parameters**

<i>h</i>	FFT handle.
<i>sIn</i>	Input spectrum.
<i>sOut</i>	Output spectrum.

```
3.11.3.10 void mha_fft_backward_scale (
           mha_fft_t h,
           mha_spec_t * sIn,
           mha_spec_t * sOut )
```

Complex to complex FFT (backward).

*sIn* and *sOut* need to have *nfft* bins (please note that **mha\_spec\_t** (p. 465) typically has *nfft*/2+1 bins for half-complex representation).

The *\_scale* methods use standard DFT scaling: There is no scaling in the forward transformation, and 1/*N* scaling for the backward.

**Parameters**

<i>h</i>	FFT handle.
<i>sIn</i>	Input spectrum.
<i>sOut</i>	Output spectrum.

```
3.11.3.11 void mha_fft_wave2spec_scale (
           mha_fft_t h,
           const mha_wave_t * in,
           mha_spec_t * out )
```

Transform waveform segment into spectrum.

The `_scale` methods use standard DFT scaling: There is no scaling in the forward transformation, and 1/N scaling for the backward.

#### Parameters

<i>h</i>	FFT handle.
<i>in</i>	Input waveform segment.
<i>out</i>	Output spectrum.

```
3.11.3.12 void mha_fft_spec2wave_scale (
           mha_fft_t h,
           const mha_spec_t * in,
           mha_wave_t * out )
```

Transform spectrum into waveform segment.

The `_scale` methods use standard DFT scaling: There is no scaling in the forward transformation, and 1/N scaling for the backward.

#### Parameters

<i>h</i>	FFT handle.
<i>in</i>	Input spectrum.
<i>out</i>	Output waveform segment.

## 4 Namespace Documentation

### 4.1 ac2lsl Namespace Reference

All types for the **ac2lsl** (p. 78) plugins live in this namespace.

#### Classes

- class **ac2lsl\_t**  
*Plugin class of **ac2lsl** (p. 78).*
- class **cfg\_t**  
*Runtime configuration class of the **ac2lsl** (p. 78) plugin.*
- class **save\_var\_base\_t**  
*Interface for ac to lsl bridge variable.*
- class **save\_var\_t**  
*Implementation for all ac to lsl bridges except complex types.*
- class **save\_var\_t<mha\_complex\_t>**  
*Template specialization of the **ac2lsl** (p. 78) bridge to take care of complex numbers.*
- struct **type\_info**

#### Variables

- const std::map< int, **type\_info** > **types**

#### 4.1.1 Detailed Description

All types for the **ac2lsl** (p. 78) plugins live in this namespace.

#### 4.1.2 Variable Documentation

##### 4.1.2.1 const std::map<int, type\_info> ac2lsl::types

### 4.2 acmon Namespace Reference

Namespace for displaying ac variables as parser monitors.

#### Classes

- class **ac\_monitor\_t**  
*A class for converting AC variables to Parser monitors of correct type.*
- class **acmon\_t**

#### 4.2.1 Detailed Description

Namespace for displaying ac variables as parser monitors.

### 4.3 acsave Namespace Reference

#### Classes

- class **acsave\_t**
- class **cfg\_t**
- struct **mat4head\_t**
- class **save\_var\_t**

### 4.4 addsndfile Namespace Reference

#### Classes

- class **addsndfile\_if\_t**
- class **level\_adapt\_t**
- class **resampled\_soundfile\_t**  
*Reads sound from file and resamples it if necessary and wanted.*
- class **sndfile\_t**
- class **waveform\_proxy\_t**  
*Class helps to specify which instance of `MHASignal_waveform_t` parent instance is meant in `resampled_soundfile_t` (p. 184).*

#### Typedefs

- typedef **MHAPLugin::config\_t**< level\_adapt\_t > **level\_adaptor**
- typedef **MHAPLugin::plugin\_t**< sndfile\_t > **wave\_reader**

#### Enumerations

#### Functions

- static unsigned **resampled\_num\_frames** (unsigned num\_source\_frames, float source\_rate, float target\_rate, **addsndfile\_resampling\_mode\_t** resampling\_mode)

#### 4.4.1 Typedef Documentation

4.4.1.1 `typedef MHAPlugin::config_t<level_adapt_t> addsndfile::level_adaptor`

4.4.1.2 `typedef MHAPlugin::plugin_t<sndfile_t> addsndfile::wave_reader`

#### 4.4.2 Enumeration Type Documentation

4.4.2.1 `enum addsndfile::addsndfile_resampling_mode_t`

Specifies the resampling mode in `resampled_soundfile_t` (p. 184).

##### Enumerator

***DONT\_RESAMPLE\_PERMISSIVE***

***DONT\_RESAMPLE\_STRICT*** Do not resample, if the sample rate of the MHA differs from the sample rate of the sound file, raise an error.

***DO\_RESAMPLE*** Resample.

#### 4.4.3 Function Documentation

4.4.3.1 `static unsigned addsndfile::resampled_num_frames ( unsigned num_source_frames, float source_rate, float target_rate, addsndfile_resampling_mode_t resampling_mode ) [static]`

### 4.5 ADM Namespace Reference

#### Classes

- class **ADM**  
*Adaptive differential microphone, working for speech frequency range.*
- class **Delay**  
*A delay-line class which can also do subsample-delays for a limited frequency range below fs/4.*
- class **Linearphase\_FIR**  
*An efficient linear-phase fir filter implementation.*

#### Functions

- static double **subsampledelay\_coeff** (double samples, double f\_design, double fs=1.0)  
*compute IIR coefficient for subsample delay*



## Variables

- const double **PI** = 3.14159265358979312
- const double **C** = 340
- const double **DELAY\_FREQ** = 2000
- const double **START\_BETA** = 0.5

## 4.5.1 Function Documentation

4.5.1.1 static double ADM::subsampledelay\_coeff (  
double *samples*,  
double *f\_design*,  
double *fs* = 1.0 ) [static]

compute IIR coefficient for subsample delay

## Parameters

<i>samples</i>	Constraint: 0.0 <= samples < 1.0; Amount of sub-sample delay
<i>f_design</i>	design frequency (subsample delay is accurate for this frequency)
<i>fs</i>	sampling rate

## Returns

IIR coefficient for subsample delay

## 4.5.2 Variable Documentation

4.5.2.1 const double ADM::PI = 3.14159265358979312

4.5.2.2 const double ADM::C = 340

4.5.2.3 const double ADM::DELAY\_FREQ = 2000

4.5.2.4 const double ADM::START\_BETA = 0.5

## 4.6 AuditoryProfile Namespace Reference

Namespace for classes and functions around the auditory profile (e.g., audiogram handling)

## Classes

- class **fmap\_t**  
*A class to store frequency dependent data (e.g., HTL and UCL).*
- class **parser\_t**  
*Class to make the auditory profile accessible through the parser interface.*
- class **profile\_t**  
*The Auditory Profile class.*

### 4.6.1 Detailed Description

Namespace for classes and functions around the auditory profile (e.g., audiogram handling)

The auditory profile as defined by HearCom or BMBF Modellbasierte Hoergeraete is stored in the class **AuditoryProfile::profile\_t** (p. 226). Until a complete definition is available, only the currently needed elements are implemented.

## 4.7 coherence Namespace Reference

### Classes

- class **cohflt\_if\_t**
- class **cohflt\_t**
- class **vars\_t**

### Functions

- void **getcipd** (**mha\_complex\_t** &c, **mha\_real\_t** &a, const **mha\_complex\_t** &xl, const **mha\_complex\_t** &xr)

### 4.7.1 Function Documentation

4.7.1.1 void coherence::getcipd (  
                   **mha\_complex\_t** & c,  
                   **mha\_real\_t** & a,  
                   const **mha\_complex\_t** & xl,  
                   const **mha\_complex\_t** & xr ) [inline]

## 4.8 dc Namespace Reference

### Classes

- class **dc\_if\_t**
- class **dc\_t**
- class **dc\_vars\_t**
- class **dc\_vars\_validator\_t**
- class **wb\_inhib\_cfg\_t**
- class **wideband\_inhib\_vars\_t**

## Functions

- unsigned int **get\_audiochannels** (unsigned int totalchannels, std::string acname, **algo\_←\_comm\_t ac**)

### 4.8.1 Function Documentation

4.8.1.1 unsigned int dc::get\_audiochannels ( unsigned int *totalchannels*, std::string *acname*, algo\_comm\_t *ac* )

## 4.9 dc\_simple Namespace Reference

### Classes

- class **dc\_if\_t**
- class **dc\_t**
- class **dc\_vars\_t**
- class **dc\_vars\_validator\_t**
- class **level\_smoother\_t**

### Typedefs

- typedef **MHAPlugin::plugin\_t< dc\_t > DC**
- typedef **MHAPlugin::config\_t< level\_smoother\_t > LEVEL**

### Functions

- void **test\_fail** (const std::vector< float > &v, unsigned int s, const std::string &name)
- std::vector< float > **force\_resize** (const std::vector< float > &v, unsigned int s, const std::string &name)
- **mha\_real\_t not\_zero** (**mha\_real\_t** x, const std::string &comment="")

#### 4.9.1 Typedef Documentation

4.9.1.1 `typedef MHAPlugin::plugin_t<dc_t> dc_simple::DC`

4.9.1.2 `typedef MHAPlugin::config_t<level_smoother_t> dc_simple::LEVEL`

#### 4.9.2 Function Documentation

4.9.2.1 `void dc_simple::test_fail (`  
     `const std::vector< float > & v,`  
     `unsigned int s,`  
     `const std::string & name )`

4.9.2.2 `std::vector<float> dc_simple::force_resize (`  
     `const std::vector< float > & v,`  
     `unsigned int s,`  
     `const std::string & name )`

4.9.2.3 `mha_real_t dc_simple::not_zero (`  
     `mha_real_t x,`  
     `const std::string & comment = " " )`

#### 4.10 delay Namespace Reference

##### Classes

- class **interface\_t**

#### 4.11 delaysum Namespace Reference

This namespace contains the delaysum plugin.

##### Classes

- class **delaysum\_if\_t**  
*Interface class for the delaysum plugin.*
- class **delaysum\_t**  
*Runtime configuration of the delaysum plugin.*

##### 4.11.1 Detailed Description

This namespace contains the delaysum plugin.

## 4.12 DynComp Namespace Reference

dynamic compression related classes and functions

### Classes

- class **dc\_afterburn\_rt\_t**  
*Real-time class for after burn effect.*
- class **dc\_afterburn\_t**  
*Afterburn class, to be defined as a member of compressors.*
- class **dc\_afterburn\_vars\_t**  
*Variables for **dc\_afterburn\_t** (p. 294) class.*
- class **gaintable\_t**  
*Gain table class.*

### Functions

- **mha\_real\_t interp1** (const std::vector< **mha\_real\_t** > &vX, const std::vector< **mha\_real\_t** > &vY, **mha\_real\_t** X)  
*One-dimensional linear interpolation.*
- **mha\_real\_t interp2** (const std::vector< **mha\_real\_t** > &vX, const std::vector< **mha\_real\_t** > &vY, const std::vector< std::vector< **mha\_real\_t** > > &mZ, **mha\_real\_t** X, **mha\_real\_t** Y)  
*Linear interpolation in a two-dimensional field.*

#### 4.12.1 Detailed Description

dynamic compression related classes and functions

#### 4.12.2 Function Documentation

4.12.2.1 **mha\_real\_t DynComp::interp1** (  
    const std::vector< **mha\_real\_t** > & vX,  
    const std::vector< **mha\_real\_t** > & vY,  
    **mha\_real\_t** X )

One-dimensional linear interpolation.

#### Parameters

vX	Vector with input samples.
vY	Vector with values at input samples.
X	Input value to be interpolated.

## Return values

<i>Interpolated</i>	value Y(X) at position X.
---------------------	---------------------------

```
4.12.2.2 mha_real_t DynComp::interp2 (
    const std::vector< mha_real_t > & vX,
    const std::vector< mha_real_t > & vY,
    const std::vector< std::vector< mha_real_t > > & mZ,
    mha_real_t X,
    mha_real_t Y )
```

Linear interpolation in a two-dimensional field.

## Parameters

<i>vX</i>	Vector with input samples, first dimension.
<i>vY</i>	Vector with input samples, second dimension.
<i>mZ</i>	Field with values at input samples.
<i>X</i>	First dimension of input value to be interpolated.
<i>Y</i>	Second dimension of input value to be interpolated.

## Return values

<i>Interpolated</i>	value Z(X,Y) at position X,Y.
---------------------	-------------------------------

## 4.13 fader\_wave Namespace Reference

## Classes

- class **fader\_wave\_if\_t**
- class **level\_adapt\_t**

## Typedefs

- typedef **MHAPLugin::plugin\_t< level\_adapt\_t > level\_adaptor**

## 4.13.1 Typedef Documentation

4.13.1.1 typedef MHAPLugin::plugin\_t<level\_adapt\_t> fader\_wave::level\_adaptor

## 4.14 fftfbpow Namespace Reference

Namespace for the fftfbpow plugin.

### Classes

- class **fftfbpow\_interface\_t**  
*Interface class for fftfbpow plugin.*
- class **fftfbpow\_t**  
*Run time configuration for the fftfbpow plugin.*

#### 4.14.1 Detailed Description

Namespace for the fftfbpow plugin.

## 4.15 fftfilterbank Namespace Reference

### Classes

- class **fftfb\_interface\_t**
- class **fftfb\_plug\_t**

## 4.16 fshift Namespace Reference

All types for the fshift plugin live in this namespace.

### Classes

- class **fshift\_config\_t**  
*fshift runtime config class*
- class **fshift\_t**  
*fshift plugin interface class*

### Functions

- int **fft\_find\_bin** (**mha\_real\_t** frequency, unsigned **fftl**, **mha\_real\_t** srate)  
*Finds bin number of FFT bin nearest to the given frequency.*

#### 4.16.1 Detailed Description

All types for the fshift plugin live in this namespace.

#### 4.16.2 Function Documentation

4.16.2.1 int fshift::fft\_find\_bin (  
                  **mha\_real\_t** frequency,  
                  unsigned **fftl**,  
                  **mha\_real\_t** srate )

Finds bin number of FFT bin nearest to the given frequency.

**Parameters**

<i>frequency</i>	The frequency for which to look. Has to be in range $[-\text{srate}/2, +\text{srate}/2]$
<i>ftlen</i>	Length of the FFT.
<i>srate</i>	Sampling rate of the waveform from which the FFT originates.

**Returns**

Bin number of the FFT bin corresponding to frequency

**4.17 fshift\_hilbert Namespace Reference**

All types for the hilbert frequency shifter live in this namespace.

**Classes**

- class **frequency\_translator\_t**
- class **hilbert\_shifter\_t**

**4.17.1 Detailed Description**

All types for the hilbert frequency shifter live in this namespace.

**4.18 gain Namespace Reference****Classes**

- class **gain\_if\_t**
- class **scaler\_t**

**4.19 gtfb\_analyzer Namespace Reference****Classes**

- struct **gtfb\_analyzer\_cfg\_t**  
*Configuration for Gammatone Filterbank Analyzer.*
- class **gtfb\_analyzer\_t**  
*Gammatone Filterbank Analyzer Plugin.*



## 4.20 matrixmixer Namespace Reference

## Classes

- class **cfg\_t**
- class **matmix\_t**

## 4.21 MHA\_AC Namespace Reference

Functions and classes for Algorithm Communication (AC) support.

## Classes

- class **ac2matrix\_helper\_t**
- class **ac2matrix\_t**  
*Copy AC variable to a matrix.*
- class **acspace2matrix\_t**  
*Copy all or a subset of all numeric AC variables into an array of matrixes.*
- class **double\_t**  
*Insert a double precision floating point variable into the AC space.*
- class **float\_t**  
*Insert a float point variable into the AC space.*
- class **int\_t**  
*Insert a integer variable into the AC space.*
- class **spectrum\_t**  
*Insert a **MHASignal::spectrum\_t** (p. 800) class into the AC space.*
- class **stat\_t**
- class **waveform\_t**  
*Insert a **MHASignal::waveform\_t** (p. 812) class into the AC space.*

## Functions

- **mha\_spec\_t get\_var\_spectrum (algo\_comm\_t ac, const std::string &name)**  
*Convert an AC variable into a spectrum.*
- **mha\_wave\_t get\_var\_waveform (algo\_comm\_t ac, const std::string &name)**  
*Convert an AC variable into a waveform.*
- **int get\_var\_int (algo\_comm\_t ac, const std::string &name)**  
*Return value of an integer scalar AC variable.*
- **float get\_var\_float (algo\_comm\_t ac, const std::string &name)**  
*Return value of an floating point scalar AC variable.*
- **std::vector< float > get\_var\_vfloat (algo\_comm\_t ac, const std::string &name)**  
*Return value of an floating point vector AC variable as standard vector of floats.*

### 4.21.1 Detailed Description

Functions and classes for Algorithm Communication (AC) support.

## 4.22 mha\_error\_helpers Namespace Reference

### Functions

- unsigned **digits** (unsigned *n*)  
*Compute number of decimal digits required to represent an unsigned integer.*
- unsigned **snprintf\_required\_length** (const char \**formatstring*,...)  
*snprintf\_required\_length Compute the number of bytes (excluding the terminating nul) required to store the result of an snprintf.*

### 4.22.1 Function Documentation

#### 4.22.1.1 unsigned mha\_error\_helpers::digits ( unsigned *n* )

Compute number of decimal digits required to represent an unsigned integer.

#### Parameters

<i>n</i>	The unsigned integer that we want to know the number of required decimal digits for. return The number of decimal digits in <i>n</i> .
----------	---

#### 4.22.1.2 unsigned mha\_error\_helpers::snprintf\_required\_length ( const char \* *formatstring*, ... )

*snprintf\_required\_length* Compute the number of bytes (excluding the terminating nul) required to store the result of an *snprintf*.

#### Parameters

<i>formatstring</i>	The format string with standard printf <i>formatstring</i>
---------------------	--

#### Returns

the number of bytes required by printf without the terminating nul

## 4.23 MHA\_TCP Namespace Reference

A Namespace for TCP helper classes.

### Classes

- class **Async\_Notify**  
*Portable Multiplexable cross-thread notification.*
- class **Client**  
*A portable class for a tcp client connections.*
- class **Connection**  
**Connection** (p. 471) handles Communication between client and server, is used on both sides.
- class **Event\_Watcher**  
*OS-independent event watcher, uses select on Unix and WaitForMultipleObjects on Windows.*
- struct **OS\_EVENT\_TYPE**
- class **Server**
- class **sock\_init\_t**
- class **Sockaccept\_Event**
- class **Sockread\_Event**  
*Watch socket for incoming data.*
- class **Sockwrite\_Event**
- class **Thread**  
*A very simple class for portable threads.*
- class **Timeout\_Event**
- class **Timeout\_Watcher**  
*OS-independent event watcher with internal fixed-end-time timeout.*
- class **Wakeup\_Event**  
*A base class for asynchronous wakeup events.*

### Typedefs

- typedef int **SOCKET**

### Functions

- std::string **STRERROR** (int err)  
*Portable conversion from error number to error string.*
- std::string **HSTRERROR** (int err)  
*Portable conversion from hostname error number to error string.*
- int **N\_ERRNO** ()  
*Portable access to last network error number.*
- int **H\_ERRNO** ()  
*Portable access to last hostname error number.*

- int **G\_ERRNO** ()  
*Portable access to last non-network error number.*
- double **dtime** ()  
*Time access function for system's high resolution time, retrieve current time as double.*
- double **dtime** (const struct timeval &tv)  
*Time access function for unix' high resolution time, converts struct timeval to double.*
- struct timeval **stime** (double d)  
*Time access function for unix' high resolution time, converts time from double to struct timeval.*

## Variables

- class **MHA\_TCP::sock\_init\_t sock\_initializer**

### 4.23.1 Detailed Description

A Namespace for TCP helper classes.

### 4.23.2 Typedef Documentation

#### 4.23.2.1 typedef int MHA\_TCP::SOCKET

### 4.23.3 Function Documentation

#### 4.23.3.1 std::string MHA\_TCP::STRERROR ( int *err* )

Portable conversion from error number to error string.

#### 4.23.3.2 std::string MHA\_TCP::HSTRERROR ( int *err* )

Portable conversion from hostname error number to error string.

#### 4.23.3.3 int MHA\_TCP::N\_ERRNO ( )

Portable access to last network error number.

#### 4.23.3.4 int MHA\_TCP::H\_ERRNO ( )

Portable access to last hostname error number.

## 4.23.3.5 int MHA\_TCP::G\_ERRNO ( )

Portable access to last non-network error number.

## 4.23.3.6 double MHA\_TCP::dtime ( )

Time access function for system's high resolution time, retrieve current time as double.

4.23.3.7 double MHA\_TCP::dtime (   
const struct timeval & tv )

Time access function for unix' high resolution time, converts struct timeval to double.

4.23.3.8 struct timeval MHA\_TCP::stime (   
double d )

Time access function for unix' high resolution time, converts time from double to struct timeval.

## 4.23.4 Variable Documentation

## 4.23.4.1 class MHA\_TCP::sock\_init\_t MHA\_TCP::sock\_initializer

## 4.24 mhachain Namespace Reference

## Classes

- class **chain\_base\_t**
- class **mhachain\_t**
- class **plugs\_t**

## 4.25 MHAEvents Namespace Reference

Collection of event handling classes.

## Classes

- class **connector\_base\_t**
- class **connector\_t**
- class **emitter\_t**  
*Class for emitting openMHA events.*
- class **patchbay\_t**  
*Patchbay which connects any event emitter with any member function of the parameter class.*

#### 4.25.1 Detailed Description

Collection of event handling classes.

#### 4.26 MHAFilter Namespace Reference

Namespace for IIR and FIR filter classes.

##### Classes

- class **adapt\_filter\_param\_t**
- class **adapt\_filter\_state\_t**
- class **adapt\_filter\_t**  
*Adaptive filter.*
- class **blockprocessing\_polyphase\_resampling\_t**  
*A class that does polyphase resampling and takes into account block processing.*
- class **complex\_bandpass\_t**  
*Complex bandpass filter.*
- class **diff\_t**  
*Differentiator class (non-normalized)*
- class **fftfilter\_t**  
*FFT based FIR filter implementation.*
- class **fftfilterbank\_t**  
*FFT based FIR filterbank implementation.*
- class **filter\_t**  
*Generic IIR filter class.*
- class **gamma\_ft\_t**  
*Class for gammatone filter.*
- class **iir\_filter\_state\_t**
- class **iir\_filter\_t**  
*IIR filter class wrapper for integration into parser structure.*
- class **iir\_ord1\_real\_t**  
*First order recursive filter.*
- class **o1\_ar\_filter\_t**  
*First order attack-release lowpass filter.*
- class **o1flt\_lowpass\_t**  
*First order low pass filter.*
- class **o1flt\_maxtrack\_t**  
*First order maximum tracker.*
- class **o1flt\_mintrack\_t**  
*First order minimum tracker.*
- class **partitioned\_convolution\_t**  
*A filter class for partitioned convolution.*

- class **polyphase\_resampling\_t**  
*A class that performs polyphase resampling.*
- class **resampling\_filter\_t**  
*Hann shaped low pass filter for resampling.*
- class **smoothspec\_t**  
*Smooth spectral gains, create a windowed impulse response.*
- class **thirdoctave\_analyzer\_t**
- struct **transfer\_function\_t**  
*a structure containing a source channel number, a target channel number, and an impulse response.*
- struct **transfer\_matrix\_t**  
*A sparse matrix of transfer function partitionss.*

## Functions

- void **make\_friendly\_number** (**mha\_real\_t** &x)
- void **make\_friendly\_number** (**mha\_complex\_t** &x)
- void **make\_friendly\_number** (double &x)
- void **o1\_lp\_coeffs** (const **mha\_real\_t** tau, const **mha\_real\_t** fs, **mha\_real\_t** &c1, **mha\_real\_t** &c2)  
*Set first order filter coefficients from time constant and sampling rate.*
- void **butter\_stop\_ord1** (double \*A, double \*B, double f1, double f2, double fs)  
*Setup a first order butterworth band stop filter.*
- **MHASignal::waveform\_t** \* **spec2fir** (const **mha\_spec\_t** \*spec, const unsigned int fftlen, const **MHAWindow::base\_t** &window, const bool minphase)  
*Create a windowed impulse response/FIR filter coefficients from a spectrum.*
- unsigned **gcd** (unsigned a, unsigned b)  
*greatest common divisor*
- double **sinc** (double x)  
*sin(x)/x function, coping with x=0.*
- std::pair< unsigned, unsigned > **resampling\_factors** (float source\_sampling\_rate, float target\_sampling\_rate, float factor=1.0f)  
*Computes rational resampling factor from two sampling rates.*

### 4.26.1 Detailed Description

Namespace for IIR and FIR filter classes.

## 4.26.2 Function Documentation

4.26.2.1 void MHAFilter::make\_friendly\_number ( mha\_real\_t & x ) [inline]

4.26.2.2 void MHAFilter::make\_friendly\_number ( mha\_complex\_t & x ) [inline]

4.26.2.3 void MHAFilter::make\_friendly\_number ( double & x ) [inline]

4.26.2.4 void MHAFilter::o1\_lp\_coeffs ( const mha\_real\_t tau, const mha\_real\_t fs, mha\_real\_t & c1, mha\_real\_t & c2 )

Set first order filter coefficients from time constant and sampling rate.

### Parameters

<i>tau</i>	Time constant
<i>fs</i>	Sampling rate

### Return values

<i>c1</i>	Recursive filter coefficient
<i>c2</i>	Non-recursive filter coefficient

4.26.2.5 void MHAFilter::butter\_stop\_ord1 ( double \* A, double \* B, double f1, double f2, double fs )

Setup a first order butterworth band stop filter.

This function calculates the filter coefficients of a first order butterworth band stop filter.

### Return values

<i>A</i>	recursive filter coefficients
<i>B</i>	non recursive filter coefficients



## Parameters

<i>f1</i>	lower frequency
<i>f2</i>	upper frequency
<i>fs</i>	sample frequency

```
4.26.2.6 MHAFilter::spec2fir (
    const mha_spec_t * spec,
    const unsigned int fftlen,
    const MHAWindow::base_t & window,
    const bool minphase )
```

Create a windowed impulse response/FIR filter coefficients from a spectrum.

## Parameters

<i>spec</i>	Input spectrum
<i>fftlen</i>	FFT length of spectrum
<i>window</i>	Window shape (with length, e.g. initialized with MHAWindow::hanning(54)).
<i>minphase</i>	Flag, true if original phase should be discarded and replaced by a minimal phase function.

```
4.26.2.7 unsigned MHAFilter::gcd (
    unsigned a,
    unsigned b ) [inline]
```

greatest common divisor

```
4.26.2.8 double MHAFilter::sinc (
    double x )
```

sin(x)/x function, coping with x=0.

This is the historical sinc function, not the normalized sinc function.

```
4.26.2.9 std::pair< unsigned, unsigned > MHAFilter::resampling_factors (
    float source_sampling_rate,
    float target_sampling_rate,
    float factor = 1.0f )
```

Computes rational resampling factor from two sampling rates.

The function will fail if either `sampling_rate * factor` is not an integer

**Parameters**

<i>source_sampling_rate</i>	The original sampling rate
<i>target_sampling_rate</i>	The desired sampling rate
<i>factor</i>	A helper factor to use for non-integer sampling rates

**Returns**

a pair that contains first the upsampling factor and second the downsampling factor required for the specified resampling.

**Exceptions**

<b><i>MHA_Error</i></b> (p. 445)	if no rational resampling factor can be found.
----------------------------------	--

**4.27 MHAIOJack Namespace Reference**

JACK IO.

**Classes**

- class **io\_jack\_t**  
*Main class for JACK IO.*

**4.27.1 Detailed Description**

JACK IO.

**4.28 MHAIOJackdb Namespace Reference****Classes**

- class **io\_jack\_t**  
*Main class for JACK IO.*

**4.29 MHAIOPortAudio Namespace Reference****Classes**

- class **device\_info\_t**
- class **io\_portaudio\_t**  
*Main class for Portaudio sound IO.*

## Functions

- static std::string **parserFriendlyName** (const std::string &in)

### 4.29.1 Function Documentation

4.29.1.1 static std::string MHAIOPortAudio::parserFriendlyName (const std::string &in) [static]

## 4.30 MHAJack Namespace Reference

Classes and functions for openMHA and JACK interaction.

### Classes

- class **client\_avg\_t**  
*Generic JACK client for averaging a system response across time.*
- class **client\_noncont\_t**  
*Generic client for synchronous playback and recording of waveform fragments.*
- class **client\_t**  
*Generic asynchronous JACK client.*
- class **port\_t**  
*Class for one channel/port.*

### Functions

- void **io** (**mha\_wave\_t** \*s\_out, **mha\_wave\_t** \*s\_in, const std::string &name, const std::vector< std::string > &p\_out, const std::vector< std::string > &p\_in, float \*srate=NULL, unsigned int \*fragsize=NULL, bool use\_jack\_transport=false)  
*Functional form of generic client for synchronous playback and recording of waveform fragments.*
- std::vector< unsigned int > **get\_port\_capture\_latency** (const std::vector< std::string > &ports)  
*Return the JACK port latency of ports.*
- std::vector< int > **get\_port\_capture\_latency\_int** (const std::vector< std::string > &ports)  
*Return the JACK port latency of ports.*
- std::vector< unsigned int > **get\_port\_playback\_latency** (const std::vector< std::string > &ports)  
*Return the JACK port latency of ports.*
- std::vector< int > **get\_port\_playback\_latency\_int** (const std::vector< std::string > &ports)

### 4.30.1 Detailed Description

Classes and functions for openMHA and JACK interaction.

### 4.30.2 Function Documentation

4.30.2.1 void MHAJack::io (   
     *mha\_wave\_t* \* *s\_out*,   
     *mha\_wave\_t* \* *s\_in*,   
     const std::string & *name*,   
     const std::vector< std::string > & *p\_out*,   
     const std::vector< std::string > & *p\_in*,   
     float \* *srate* = NULL,   
     unsigned int \* *fragsize* = NULL,   
     bool *use\_jack\_transport* = false )

Functional form of generic client for synchronous playback and recording of waveform fragments.

4.30.2.2 std::vector< unsigned int > MHAJack::get\_port\_capture\_latency (   
     const std::vector< std::string > & *ports* )

Return the JACK port latency of ports.

#### Parameters

<i>ports</i>	Ports to be tested
--------------	--------------------

#### Returns

Latency vector (one entry for each port)

4.30.2.3 std::vector< int > MHAJack::get\_port\_capture\_latency\_int (   
     const std::vector< std::string > & *ports* )

Return the JACK port latency of ports.

#### Parameters

<i>ports</i>	Ports to be tested
--------------	--------------------

**Returns**

Latency vector (one entry for each port)

4.30.2.4 `std::vector< unsigned int > MHAJack::get_port_playback_latency ( const std::vector< std::string > & ports )`

Return the JACK port latency of ports.

**Parameters**

<i>ports</i>	Ports to be tested
--------------	--------------------

**Returns**

Latency vector (one entry for each port)

4.30.2.5 `std::vector< int > MHAJack::get_port_playback_latency_int ( const std::vector< std::string > & ports )`

**4.31 MHAKernel Namespace Reference****Classes**

- class **algo\_comm\_class\_t**
- class **comm\_var\_map\_t**

**Functions**

- **algo\_comm\_class\_t \* algo\_comm\_safe\_cast** (void \*)

**4.31.1 Function Documentation**

4.31.1.1 `MHAKernel::algo_comm_class_t * MHAKernel::algo_comm_safe_cast ( void * h )`

**4.32 MHAMultiSrc Namespace Reference**

Collection of classes for selecting audio chunks from multiple sources.

## Classes

- class **base\_t**  
*Base class for source selection.*
- class **channel\_t**
- class **channels\_t**
- class **spectrum\_t**
- class **waveform\_t**

### 4.32.1 Detailed Description

Collection of classes for selecting audio chunks from multiple sources.

## 4.33 MHAOvIFilter Namespace Reference

Namespace for overlapping FFT based filter bank classes and functions.

## Namespaces

- **barkscale**
- **FreqScaleFun**  
*Transform functions from linear scale in Hz to new frequency scales.*
- **ShapeFun**  
*Shape functions for overlapping filters.*

## Classes

- class **band\_descriptor\_t**
- class **fftfb\_ac\_info\_t**
- class **fftfb\_t**  
*FFT based overlapping filter bank.*
- class **fftfb\_vars\_t**  
*Set of configuration variables for FFT-based overlapping filters.*
- class **fscale\_bw\_t**
- class **fscale\_t**
- class **fspacing\_t**  
*Class for frequency spacing, used by filterbank shape generator class.*
- class **overlap\_save\_filterbank\_analytic\_t**
- class **overlap\_save\_filterbank\_t**  
*A time-domain minimal phase filter bank with frequency shapes from **MHAOvIFilter::fftfb\_t** (p. 616).*
- class **scale\_var\_t**

## Typedefs

- typedef **mha\_real\_t**( **scale\_fun\_t**) (**mha\_real\_t**)

### 4.33.1 Detailed Description

Namespace for overlapping FFT based filter bank classes and functions.

### 4.33.2 Typedef Documentation

4.33.2.1 typedef **mha\_real\_t**( MHAOvFilter::**scale\_fun\_t**) (**mha\_real\_t**)

## 4.34 MHAOvFilter::barkscale Namespace Reference

### Classes

- class **bark2hz\_t**
- class **hz2bark\_t**

### Variables

- **mha\_real\_t** **vfreq** [**BARKSCALE\_ENTRIES**]
- **mha\_real\_t** **vbark** [**BARKSCALE\_ENTRIES**]

### 4.34.1 Variable Documentation

4.34.1.1 **mha\_real\_t** MHAOvFilter::barkscale::**vfreq**

4.34.1.2 **mha\_real\_t** MHAOvFilter::barkscale::**vbark**

## 4.35 MHAOvFilter::FreqScaleFun Namespace Reference

Transform functions from linear scale in Hz to new frequency scales.

## Functions

- **mha\_real\_t hz2hz (mha\_real\_t x)**  
*Dummy scale transformation Hz to Hz.*
- **mha\_real\_t hz2khz (mha\_real\_t x)**
- **mha\_real\_t hz2octave (mha\_real\_t x)**
- **mha\_real\_t hz2third\_octave (mha\_real\_t x)**
- **mha\_real\_t hz2bark (mha\_real\_t x)**  
*Transformation to bark scale.*
- **mha\_real\_t hz2bark\_analytic (mha\_real\_t)**
- **mha\_real\_t hz2erb (mha\_real\_t)**
- **mha\_real\_t hz2erb\_glasberg1990 (mha\_real\_t)**
- **mha\_real\_t hz2log (mha\_real\_t x)**  
*Third octave frequency scale.*
- **mha\_real\_t inv\_scale (mha\_real\_t, mha\_real\_t(\*) (mha\_real\_t))**

### 4.35.1 Detailed Description

Transform functions from linear scale in Hz to new frequency scales.

### 4.35.2 Function Documentation

#### 4.35.2.1 mha\_real\_t MHAOvFilter::FreqScaleFun::hz2hz (mha\_real\_t x)

Dummy scale transformation Hz to Hz.

This function implements a dummy scale transformation (linear frequency scale).

#### Parameters

$x$	Input frequency in Hz
-----	-----------------------

#### Returns

Frequency in Hz

#### 4.35.2.2 mha\_real\_t MHAOvFilter::FreqScaleFun::hz2khz (mha\_real\_t x)

#### 4.35.2.3 mha\_real\_t MHAOvFilter::FreqScaleFun::hz2octave (mha\_real\_t x)



4.35.2.4 `mha_real_t MHAOvFilter::FreqScaleFun::hz2third_octave ( mha_real_t x )`

4.35.2.5 `mha_real_t MHAOvFilter::FreqScaleFun::hz2bark ( mha_real_t x )`

Transformation to bark scale.

This function implements a critical band rate (bark) scale.

#### Parameters

<code>x</code>	Input frequency in Hz
----------------	-----------------------

#### Returns

Critical band rate in Bark

4.35.2.6 `mha_real_t MHAOvFilter::FreqScaleFun::hz2bark_analytic ( mha_real_t x )`

4.35.2.7 `mha_real_t MHAOvFilter::FreqScaleFun::hz2erb ( mha_real_t x )`

4.35.2.8 `mha_real_t MHAOvFilter::FreqScaleFun::hz2erb_glasberg1990 ( mha_real_t x )`

4.35.2.9 `mha_real_t MHAOvFilter::FreqScaleFun::hz2log ( mha_real_t x )`

Third octave frequency scale.

This function implements a third octave scale. Frequencies below 16 Hz are mapped to 16 Hz.

#### Parameters

<code>x</code>	Frequency in Hz
----------------	-----------------

#### Returns

Third octaves relative to 1000 Hz

4.35.2.10 `mha_real_t MHAOvFilter::FreqScaleFun::inv_scale ( mha_real_t y, mha_real_t (*)(mha_real_t) fun )`

## 4.36 MHAOvIFilter::ShapeFun Namespace Reference

Shape functions for overlapping filters.

### Functions

- **mha\_real\_t rect** (mha\_real\_t x)  
*Filter shape function for rectangular filters.*
- **mha\_real\_t linear** (mha\_real\_t x)  
*Filter shape function for sawtooth filters.*
- **mha\_real\_t hann** (mha\_real\_t x)  
*Filter shape function for hanning shaped filters.*
- **mha\_real\_t expflt** (mha\_real\_t)
- **mha\_real\_t gauss** (mha\_real\_t)

### 4.36.1 Detailed Description

Shape functions for overlapping filters.

### 4.36.2 Function Documentation

#### 4.36.2.1 mha\_real\_t MHAOvIFilter::ShapeFun::rect ( mha\_real\_t x )

Filter shape function for rectangular filters.

This function creates rectangular filter shapes. The edge is exactly half way between two center frequencies (on a given scale).

#### Parameters

x	Input value in the range [-1,1].
---	----------------------------------

#### Returns

Weight function in the range [0,1]

#### 4.36.2.2 mha\_real\_t MHAOvIFilter::ShapeFun::linear ( mha\_real\_t x )

Filter shape function for sawtooth filters.

This function creates sawtooth filter shapes. They rise linearly from 0 to 1 in the interval from the lower neighbor center frequency to the band center frequency and from 1 to 0 in the interval from the band center frequency to the upper neighbour band center frequency. Linear means linear on a given frequency scale.

#### Parameters

x	Input value in the range [-1,1].
---	----------------------------------

#### Returns

Weight function in the range [0,1]

4.36.2.3 `mha_real_t MHAOvFilter::ShapeFun::hann ( mha_real_t x )`

Filter shape function for hanning shaped filters.

This function creates hanning window shaped filters.

#### Parameters

x	Input value in the range [-1,1].
---	----------------------------------

#### Returns

Weight function in the range [0,1]

4.36.2.4 `mha_real_t MHAOvFilter::ShapeFun::expflt ( mha_real_t x )`

4.36.2.5 `mha_real_t MHAOvFilter::ShapeFun::gauss ( mha_real_t x )`

## 4.37 MHAParser Namespace Reference

Name space for the openMHA-Parser configuration language.

#### Namespaces

- **StrCnv**

*String converter namespace.*

## Classes

- class **base\_t**  
*Base class for all parser items.*
- class **bool\_mon\_t**  
*Monitor with string value.*
- class **bool\_t**  
*Variable with a boolean value ("yes"/"no")*
- class **c\_ifc\_parser\_t**
- class **commit\_t**  
*Parser variable with event-emission functionality.*
- class **complex\_mon\_t**  
*Monitor with complex value.*
- class **complex\_t**  
*Variable with complex value.*
- class **entry\_t**
- class **expression\_t**
- class **float\_mon\_t**  
*Monitor with float value.*
- class **float\_t**  
*Variable with float value.*
- class **int\_mon\_t**  
*Monitor variable with int value.*
- class **int\_t**  
*Variable with integer value.*
- class **keyword\_list\_t**  
*Keyword list class.*
- class **kw\_t**  
*Variable with keyword list value.*
- class **mcomplex\_mon\_t**  
*Matrix of complex numbers monitor.*
- class **mcomplex\_t**  
*Matrix variable with complex value.*
- class **mfloat\_mon\_t**  
*Matrix of floats monitor.*
- class **mfloat\_t**  
*Matrix variable with float value.*
- class **mhaconfig\_mon\_t**
- class **mhapluginloader\_t**  
*Class to create a plugin loader in a parser, including the load logic.*
- class **mint\_mon\_t**  
*Matrix of ints monitor.*
- class **monitor\_t**  
*Base class for monitors and variable nodes.*
- class **parser\_t**

*Parser node class.*

- class **range\_var\_t**  
*Base class for all variables with a numeric value range.*
- class **string\_mon\_t**  
*Monitor with string value.*
- class **string\_t**  
*Variable with a string value.*
- class **variable\_t**  
*Base class for variable nodes.*
- class **vcomplex\_mon\_t**  
*Monitor with vector of complex values.*
- class **vcomplex\_t**  
*Vector variable with complex value.*
- class **vfloat\_mon\_t**  
*Vector of floats monitor.*
- class **vfloat\_t**  
*Vector variable with float value.*
- class **vint\_mon\_t**  
*Vector of ints monitor.*
- class **vint\_t**  
*Variable with vector<int> value.*
- class **vstring\_mon\_t**  
*Vector of monitors with string value.*
- class **vstring\_t**  
*Vector variable with string values.*
- class **window\_t**  
*MHA configuration interface for a window function generator.*

## Typedefs

- typedef std::string(base\_t::\* **opact\_t**) (**expression\_t** &)
- typedef std::string(base\_t::\* **query\_t**) (const std::string &)
- typedef std::map< std::string, **opact\_t** > **opact\_map\_t**
- typedef std::map< std::string, **query\_t** > **query\_map\_t**
- typedef std::list< **entry\_t** > **entry\_map\_t**
- typedef int(\* **c\_parse\_cmd\_t**) (void \*, const char \*, char \*, unsigned int)
- typedef const char \*(\* **c\_parse\_err\_t**) (void \*, int)

## Functions

- int **get\_precision** ()
- std::string **commentate** (const std::string &s)
- void **trim** (std::string &s)
- std::string **cfg\_dump** (**base\_t** \*, const std::string &)
- std::string **cfg\_dump\_short** (**base\_t** \*, const std::string &)
- std::string **all\_dump** (**base\_t** \*, const std::string &)
- std::string **mon\_dump** (**base\_t** \*, const std::string &)
- std::string **all\_ids** (**base\_t** \*, const std::string &, const std::string &="")
- void **strreplace** (std::string &, const std::string &, const std::string &)
- string replace function*
- void **envreplace** (std::string &s)

### 4.37.1 Detailed Description

Name space for the openMHA-Parser configuration language.

This namespace contains all classes which are needed for the implementation of the openMHA configuration language. For details on the script language itself please see section **The openMHA configuration language** (p. 34).

### 4.37.2 List of valid MHAParser items

- **Sub-parser:** **parser\_t** (p. 688)
- **Variables:**  
 Numeric variables: **int\_t** (p. 664), **vint\_t** (p. 713), **float\_t** (p. 659), **vfloat\_t** (p. 709), **mfloat\_t** (p. 677)  
 Other variables: **string\_t** (p. 697), **vstring\_t** (p. 717), **kw\_t** (p. 669), **bool\_t** (p. 645)
- **Monitors:**  
 Numeric monitors: **int\_mon\_t** (p. 662), **vint\_mon\_t** (p. 711), **float\_mon\_t** (p. 658), **vfloat\_mon\_t** (p. 707), **mfloat\_mon\_t** (p. 676), **mcomplex\_mon\_t** (p. 672)  
 Other monitors: **bool\_mon\_t** (p. 644), **string\_mon\_t** (p. 696), **vstring\_mon\_t** (p. 715)

Members can be inserted into the configuration namespace by using `MHAParser::insert_item()` or the **insert\_member()** (p. 1021) macro.

## 4.37.3 Typedef Documentation

4.37.3.1 `typedef std::string(base_t::* MHAParser::opact_t) (expression_t &)`

4.37.3.2 `typedef std::string(base_t::* MHAParser::query_t) (const std::string &)`

4.37.3.3 `typedef std::map<std::string,opact_t> MHAParser::opact_map_t`

4.37.3.4 `typedef std::map<std::string,query_t> MHAParser::query_map_t`

4.37.3.5 `typedef std::list<entry_t> MHAParser::entry_map_t`

4.37.3.6 `typedef int(* MHAParser::c_parse_cmd_t) (void *, const char *, char *, unsigned int)`

4.37.3.7 `typedef const char>(* MHAParser::c_parse_err_t) (void *, int)`

## 4.37.4 Function Documentation

4.37.4.1 `int MHAParser::get_precision ( )`

4.37.4.2 `std::string MHAParser::commentate ( const std::string & s )`

4.37.4.3 `void MHAParser::trim ( std::string & s )`

4.37.4.4 `std::string MHAParser::cfg_dump ( base_t * p, const std::string & pref )`

4.37.4.5 `std::string MHAParser::cfg_dump_short ( base_t * p, const std::string & pref )`

4.37.4.6 `std::string MHAParser::all_dump ( base_t * p, const std::string & pref )`

4.37.4.7 `std::string MHAParser::mon_dump ( base_t * p, const std::string & pref )`

4.37.4.8 `std::string MHAParser::all_ids ( base_t * p, const std::string & pref, const std::string & id = " " )`

4.37.4.9 `void MHAParser::strreplace ( std::string & s, const std::string & arg, const std::string & rep )`

string replace function

## Parameters

<i>s</i>	target string
<i>arg</i>	search pattern
<i>rep</i>	replace pattern

4.37.4.10 void MHAParser::envreplace (  
std::string & s )

## 4.38 MHAParser::StrCnv Namespace Reference

String converter namespace.

## Functions

- int **num\_brackets** (const std::string &s)  
*Return number of brackets at beginning and end of string.*
- int **bracket\_balance** (const std::string &s)
- void **str2val** (const std::string &, bool &)  
*Convert from string.*
- void **str2val** (const std::string &, float &)  
*Convert from string.*
- void **str2val** (const std::string &, **mha\_complex\_t** &)  
*Convert from string.*
- void **str2val** (const std::string &, int &)  
*Convert from string.*
- void **str2val** (const std::string &, **keyword\_list\_t** &)  
*Convert from string.*
- void **str2val** (const std::string &, std::string &)  
*Convert from string.*
- template<class arg\_t >  
void **str2val** (const std::string &s, std::vector< arg\_t > &val)  
*Converter for vector types.*
- template<>  
void **str2val**< **mha\_real\_t** > (const std::string &s, std::vector< **mha\_real\_t** > &v)  
*Converter for vector<mha\_real\_t> with Matlab-style expansion.*
- template<class arg\_t >  
void **str2val** (const std::string &s, std::vector< std::vector< arg\_t > > &val)  
*Converter for matrix types.*
- std::string **val2str** (const bool &)  
*Convert to string.*
- std::string **val2str** (const float &)  
*Convert to string.*
- std::string **val2str** (const **mha\_complex\_t** &)



- Convert to string.*
- `std::string val2str` (const int &)  
*Convert to string.*
- `std::string val2str` (const `keyword_list_t` &)  
*Convert to string.*
- `std::string val2str` (const std::string &)  
*Convert to string.*
- `std::string val2str` (const std::vector< float > &)  
*Convert to string.*
- `std::string val2str` (const std::vector< `mha_complex_t` > &)  
*Convert to string.*
- `std::string val2str` (const std::vector< int > &)  
*Convert to string.*
- `std::string val2str` (const std::vector< std::vector< int > > &)  
*Convert to string.*
- `std::string val2str` (const std::vector< std::string > &)  
*Convert to string.*
- `std::string val2str` (const std::vector< std::vector< float > > &)  
*Convert to string.*
- `std::string val2str` (const std::vector< std::vector< `mha_complex_t` > > &)  
*Convert to string.*

#### 4.38.1 Detailed Description

String converter namespace.

The functions defined in this namespace manage the conversions from C++ variables to strings and back. It was tried to keep a matlab compatible string format for vectors and vectors of vectors.

#### 4.38.2 Function Documentation

##### 4.38.2.1 `int MHAParser::StrCnv::num_brackets (const std::string & s )`

Return number of brackets at beginning and end of string.

##### Parameters

s	String
---	--------

**Returns**

Number of brackets, or -1 for empty string

**4.38.2.2** `int MHAParser::StrCnv::bracket_balance (`  
`const std::string & s )`

**4.38.2.3** `void MHAParser::StrCnv::str2val (`  
`const std::string & s,`  
`bool & v )`

Convert from string.

**4.38.2.4** `void MHAParser::StrCnv::str2val (`  
`const std::string & s,`  
`float & v )`

Convert from string.

**4.38.2.5** `void MHAParser::StrCnv::str2val (`  
`const std::string & s,`  
`mha_complex_t & v )`

Convert from string.

**4.38.2.6** `void MHAParser::StrCnv::str2val (`  
`const std::string & s,`  
`int & v )`

Convert from string.

**4.38.2.7** `void MHAParser::StrCnv::str2val (`  
`const std::string & s,`  
`MHAParser::keyword_list_t & v )`

Convert from string.

**4.38.2.8** `void MHAParser::StrCnv::str2val (`  
`const std::string & s,`  
`std::string & v )`

Convert from string.

**4.38.2.9** `template<class arg_t > void MHAParser::StrCnv::str2val (`  
`const std::string & s,`  
`std::vector< arg_t > & val )`

Converter for vector types.

```
4.38.2.10  template<> void MHAParser::StrCnv::str2val< mha_real_t > (
            const std::string & s,
            std::vector< mha_real_t > & v )
```

Converter for vector<mha\_real\_t> with Matlab-style expansion.

```
4.38.2.11  template<class arg_t > void MHAParser::StrCnv::str2val (
            const std::string & s,
            std::vector< std::vector< arg_t > > & val )
```

Converter for matrix types.

```
4.38.2.12  std::string MHAParser::StrCnv::val2str (
            const bool & v )
```

Convert to string.

```
4.38.2.13  std::string MHAParser::StrCnv::val2str (
            const float & v )
```

Convert to string.

```
4.38.2.14  std::string MHAParser::StrCnv::val2str (
            const mha_complex_t & v )
```

Convert to string.

```
4.38.2.15  std::string MHAParser::StrCnv::val2str (
            const int & v )
```

Convert to string.

```
4.38.2.16  std::string MHAParser::StrCnv::val2str (
            const keyword_list_t & v )
```

Convert to string.

```
4.38.2.17  std::string MHAParser::StrCnv::val2str (
            const std::string & v )
```

Convert to string.

```
4.38.2.18  std::string MHAParser::StrCnv::val2str (
            const std::vector< float > & v )
```

Convert to string.

4.38.2.19 `std::string MHAParser::StrCnv::val2str (`  
`const std::vector< mha_complex_t > & v )`

Convert to string.

4.38.2.20 `std::string MHAParser::StrCnv::val2str (`  
`const std::vector< int > & v )`

Convert to string.

4.38.2.21 `std::string MHAParser::StrCnv::val2str (`  
`const std::vector< std::vector< int > > & v )`

Convert to string.

4.38.2.22 `std::string MHAParser::StrCnv::val2str (`  
`const std::vector< std::string > & v )`

Convert to string.

4.38.2.23 `std::string MHAParser::StrCnv::val2str (`  
`const std::vector< std::vector< float > > & v )`

Convert to string.

4.38.2.24 `std::string MHAParser::StrCnv::val2str (`  
`const std::vector< std::vector< mha_complex_t > > & v )`

Convert to string.

## 4.39 MHAPlugin Namespace Reference

Namespace for openMHA plugin class templates and thread-safe runtime configurations.

### Classes

- class **cfg\_chain\_t**
- class **config\_t**  
*Template class for thread safe configuration.*
- class **plugin\_t**  
*The template class for C++ openMHA plugins.*

#### 4.39.1 Detailed Description

Namespace for openMHA plugin class templates and thread-safe runtime configurations.

### 4.40 MHAPlugin\_Resampling Namespace Reference

#### Classes

- class **resampling\_if\_t**
- class **resampling\_t**

### 4.41 MHAPlugin\_Split Namespace Reference

#### Classes

- class **domain\_handler\_t**  
*Handles domain-specific partial input and output signal.*
- class **dummy\_threads\_t**  
*Dummy specification of a thread platform: This class implements everything in a single thread.*
- class **posix\_threads\_t**  
*Posix threads specification of thread platform.*
- class **split\_t**  
*Implements split plugin.*
- class **splitted\_part\_t**  
*The **splitted\_part\_t** (p. 751) instance manages the plugin that performs processing on the reduced set of channels.*
- class **thread\_platform\_t**  
*Basic interface for encapsulating thread creation, thread priority setting, and synchronization on any threading platform (i.e., pthreads or win32threads).*
- class **uni\_processor\_t**  
*An interface to a class that sports a process method with no parameters and no return value.*

#### Enumerations

#### 4.41.1 Detailed Description

A namespace for the split plugin. Helps testability and documentation.

## 4.41.2 Enumeration Type Documentation

### 4.41.2.1 anonymous enum

Invalid thread priority.

Enumerator

***INVALID\_THREAD\_PRIORITY***

## 4.42 MHASignal Namespace Reference

Namespace for audio signal handling and processing classes.

### Classes

- class **async\_rmslevel\_t**  
*Class for asynchronous level metering.*
- class **delay\_spec\_t**
- class **delay\_t**  
*Class to realize a simple delay of waveform streams.*
- class **delay\_wave\_t**  
*Delayline containing wave fragments.*
- class **doublebuffer\_t**  
*Double-buffering class.*
- class **fft\_t**
- class **hilbert\_fftw\_t**
- class **hilbert\_t**  
*Hilbert transformation of a waveform segment.*
- class **loop\_wavefragment\_t**  
*Copy a fixed waveform fragment to a series of waveform fragments of other size.*
- class **matrix\_t**  
*n-dimensional matrix with real or complex floating point values.*
- class **minphase\_t**  
*Minimal phase function.*
- class **quantizer\_t**  
*Simple simulation of fixpoint quantization.*
- class **ringbuffer\_t**  
*A ringbuffer class for time domain audio signal, which makes no assumptions with respect to fragment size.*
- class **schroeder\_t**  
*Schroeder tone complex class.*
- class **spectrum\_t**  
*a signal processing class for spectral data (based on **mha\_spec\_t** (p. 465))*

- class **stat\_t**
- class **subsample\_delay\_t**  
*implements subsample delay in spectral domain.*
- class **uint\_vector\_t**  
*Vector of unsigned values, used for size and index description of n-dimensional matrixes.*
- class **waveform\_t**  
*signal processing class for waveform data (based on **mha\_wave\_t** (p. 496))*

## Functions

- void **for\_each** (**mha\_wave\_t** \*s, **mha\_real\_t**(\*fun)(**mha\_real\_t**))  
*Apply a function to each element of a **mha\_wave\_t** (p. 496).*
- **mha\_real\_t** **lin2db** (**mha\_real\_t** x)  
*Conversion from linear scale to dB (no SPL reference)*
- **mha\_real\_t** **db2lin** (**mha\_real\_t** x)  
*Conversion from dB scale to linear (no SPL reference)*
- **mha\_real\_t** **pa2dbspl** (**mha\_real\_t** x)  
*Conversion from linear Pascal scale to dB SPL.*
- **mha\_real\_t** **pa22dbspl** (**mha\_real\_t** x, **mha\_real\_t** eps=1e-20f)  
*Conversion from squared Pascal scale to dB SPL.*
- **mha\_real\_t** **dbspl2pa** (**mha\_real\_t** x)  
*Conversion from dB SPL to linear Pascal scale.*
- **mha\_real\_t** **smp2sec** (**mha\_real\_t** n, **mha\_real\_t** srate)  
*conversion from samples to seconds*
- **mha\_real\_t** **sec2smp** (**mha\_real\_t** sec, **mha\_real\_t** srate)  
*conversion from seconds to samples*
- **mha\_real\_t** **bin2freq** (**mha\_real\_t** bin, unsigned fftlen, **mha\_real\_t** srate)  
*conversion from fft bin index to frequency*
- **mha\_real\_t** **freq2bin** (**mha\_real\_t** freq, unsigned fftlen, **mha\_real\_t** srate)  
*conversion from frequency to fft bin index*
- **mha\_real\_t** **smp2rad** (**mha\_real\_t** samples, unsigned bin, unsigned fftlen)  
*conversion from delay in samples to phase shift*
- **mha\_real\_t** **rad2smp** (**mha\_real\_t** phase\_shift, unsigned bin, unsigned fftlen)  
*conversion from phase shift to delay in samples*
- template<class elem\_type >  
std::vector< elem\_type > **dupvec** (std::vector< elem\_type > vec, unsigned n)  
*Duplicate last vector element to match desired size.*
- template<class elem\_type >  
std::vector< elem\_type > **dupvec\_chk** (std::vector< elem\_type > vec, unsigned n)  
*Duplicate last vector element to match desired size, check for dimension.*
- void **copy\_channel** (**mha\_spec\_t** &self, const **mha\_spec\_t** &src, unsigned sch, unsigned dch)  
*Copy one channel of a source signal.*
- void **copy\_channel** (**mha\_wave\_t** &self, const **mha\_wave\_t** &src, unsigned src\_↔ channel, unsigned dest\_channel)

- Copy one channel of a source signal.*
- **mha\_real\_t rmslevel** (const **mha\_spec\_t** &s, unsigned int channel, unsigned int fftlen)  
*Return RMS level of a spectrum channel.*
  - **mha\_real\_t colored\_intensity** (const **mha\_spec\_t** &s, unsigned int channel, unsigned int fftlen, **mha\_real\_t** sqfreq\_response[])  
*Colored spectrum intensity.*
  - **mha\_real\_t maxabs** (const **mha\_spec\_t** &s, unsigned int channel)  
*Find maximal absolute value.*
  - **mha\_real\_t rmslevel** (const **mha\_wave\_t** &s, unsigned int channel)  
*Return RMS level of a waveform channel.*
  - **mha\_real\_t maxabs** (const **mha\_wave\_t** &s, unsigned int channel)  
*Find maximal absolute value.*
  - **mha\_real\_t maxabs** (const **mha\_wave\_t** &s)  
*Find maximal absolute value.*
  - **mha\_real\_t max** (const **mha\_wave\_t** &s)  
*Find maximal value.*
  - **mha\_real\_t min** (const **mha\_wave\_t** &s)  
*Find minimal value.*
  - **mha\_real\_t sumsqr\_channel** (const **mha\_wave\_t** &s, unsigned int channel)  
*Calculate sum of squared values in one channel.*
  - **mha\_real\_t sumsqr\_frame** (const **mha\_wave\_t** &s, unsigned int frame)  
*Calculate sum over all channels of squared values.*
  - void **scale** (**mha\_spec\_t** \*dest, const **mha\_wave\_t** \*src)
  - void **limit** (**mha\_wave\_t** &s, const **mha\_real\_t** &min, const **mha\_real\_t** &max)  
*Limit the signal in the waveform buffer to the range [min, max].*
  - template<class elem\_type >  
elem\_type **kth\_smallest** (elem\_type array[], unsigned n, unsigned k)  
*Fast search for the kth smallest element of an array.*
  - template<class elem\_type >  
elem\_type **median** (elem\_type array[], unsigned n)  
*Fast median search.*
  - template<class elem\_type >  
elem\_type **mean** (const std::vector< elem\_type > &data, elem\_type start\_val)  
*Calculate average of elements in a vector.*
  - template<class elem\_type >  
std::vector< elem\_type > **quantile** (std::vector< elem\_type > data, const std::vector< elem\_type > &p)  
*Calculate quantile of elements in a vector.*
  - void **saveas\_mat4** (const **mha\_spec\_t** &data, const std::string &varname, FILE \*fh)  
*Save an openMHA spectrum as a variable in a Matlab4 file.*
  - void **saveas\_mat4** (const **mha\_wave\_t** &data, const std::string &varname, FILE \*fh)  
*Save an openMHA waveform as a variable in a Matlab4 file.*
  - void **saveas\_mat4** (const std::vector< **mha\_real\_t** > &data, const std::string &varname, FILE \*fh)  
*Save a float vector as a variable in a Matlab4 file.*
  - void **copy\_permuted** (**mha\_wave\_t** \*dest, const **mha\_wave\_t** \*src)  
*Copy contents of a waveform to a permuted waveform.*



## Variables

- unsigned long int **signal\_counter** = 0  
*Signal counter to produce signal ID strings.*

## 4.42.1 Detailed Description

Namespace for audio signal handling and processing classes.

## 4.42.2 Function Documentation

4.42.2.1 void MHASignal::scale (  
    mha\_spec\_t \* *dest*,  
    const mha\_wave\_t \* *src* )

4.42.2.2 void MHASignal::limit (  
    mha\_wave\_t & *s*,  
    const mha\_real\_t & *min*,  
    const mha\_real\_t & *max* )

Limit the signal in the waveform buffer to the range [min, max].

## Parameters

<i>s</i>	The signal to limit. The signal in this wave buffer is modified.
<i>min</i>	lower limit
<i>max</i>	upper limit

4.42.2.3 template<class elem\_type > elem\_type MHASignal::kth\_smallest (  
    elem\_type *array*[],  
    unsigned *n*,  
    unsigned *k* )

Fast search for the kth smallest element of an array.

The order of elements is altered, but not completely sorted. Using the algorithm from N. Wirth, published in "Algorithms + data structures = programs", Prentice-Hall, 1976

## Parameters

<i>array</i>	Element array
--------------	---------------

**Postcondition**

The order of elements in the array is altered. `array[k]` then holds the result.

**Parameters**

$n$	number of elements in array
-----	-----------------------------

**Precondition**

$n \geq 1$

**Parameters**

$k$	The $k$ 'th smallest element is returned: $k = 0$ returns the minimum, $k = (n-1)/2$ returns the median, $k=(n-1)$ returns the maximum
-----	--

**Precondition**

$k < n$

**Returns**

The  $k$ th smallest array element

```
4.42.2.4 template<class elem_type > elem_type MHASignal::median (
    elem_type array[],
    unsigned n ) [inline]
```

Fast median search.

The order of elements is altered, but not completely sorted.

**Parameters**

<code>array</code>	Element array
--------------------	---------------

**Postcondition**

The order of elements in the array is altered. `array[(n-1)/2]` then holds the median.

**Parameters**

$n$	number of elements in array
-----	-----------------------------

**Precondition**

$n \geq 1$

**Returns**

The median of the array elements

```
4.42.2.5 template<class elem_type > elem_type MHASignal::mean (
    const std::vector< elem_type > & data,
    elem_type start_val ) [inline]
```

Calculate average of elements in a vector.

**Parameters**

<i>data</i>	Input vector
<i>start_val</i>	Value for initialization of the return value before sum.

**Returns**

The average of the vector elements

```
4.42.2.6 template<class elem_type > std::vector<elem_type> MHASignal::quantile (
    std::vector< elem_type > data,
    const std::vector< elem_type > & p ) [inline]
```

Calculate quantile of elements in a vector.

**Parameters**

<i>data</i>	Input vector
<i>p</i>	Vector of probability values.

**Returns**

Vector of quantiles of input data, one entry for each probability value.

```
4.42.2.7 void MHASignal::saveas_mat4 (
    const mha_spec_t & data,
    const std::string & varname,
    FILE * fh )
```

Save a openMHA spectrum as a variable in a Matlab4 file.

## Parameters

<i>data</i>	openMHA spectrum to be saved.
<i>varname</i>	Matlab variable name (Matlab4 limitations on maximal length are not checked).
<i>fh</i>	File handle to Matlab4 file.

```
4.42.2.8 void MHASignal::saveas_mat4 (
           const mha_wave_t & data,
           const std::string & varname,
           FILE * fh )
```

Save a openMHA waveform as a variable in a Matlab4 file.

## Parameters

<i>data</i>	openMHA waveform to be saved.
<i>varname</i>	Matlab variable name (Matlab4 limitations on maximal length are not checked).
<i>fh</i>	File handle to Matlab4 file.

```
4.42.2.9 void MHASignal::saveas_mat4 (
           const std::vector< mha_real_t > & data,
           const std::string & varname,
           FILE * fh )
```

Save a float vector as a variable in a Matlab4 file.

## Parameters

<i>data</i>	Float vector to be saved.
<i>varname</i>	Matlab variable name (Matlab4 limitations on maximal length are not checked).
<i>fh</i>	File handle to Matlab4 file.

```
4.42.2.10 void MHASignal::copy_permuted (
           mha_wave_t * dest,
           const mha_wave_t * src )
```

Copy contents of a waveform to a permuted waveform.

## Parameters

<i>dest</i>	Destination waveform
<i>src</i>	Source waveform

The total size of src and dest must be the same, num\_frames and num\_channels must be

exchanged in dest.

#### 4.42.3 Variable Documentation

##### 4.42.3.1 unsigned long int MHASignal::signal\_counter = 0

Signal counter to produce signal ID strings.

#### 4.43 MHASndFile Namespace Reference

##### Classes

- class **sf\_t**
- class **sf\_wave\_t**

#### 4.44 MHATableLookup Namespace Reference

Namespace for table lookup classes.

##### Classes

- class **linear\_table\_t**  
*Class for interpolation with equidistant x values.*
- class **table\_t**
- class **xy\_table\_t**  
*Class for interpolation with non-equidistant x values.*

##### 4.44.1 Detailed Description

Namespace for table lookup classes.

#### 4.45 MHASndFile Namespace Reference

Collection of Window types.

## Classes

- class **bartlett\_t**  
*Bartlett window.*
- class **base\_t**  
*Common base for window types.*
- class **blackman\_t**  
*Blackman window.*
- class **fun\_t**  
*Generic window based on a generator function.*
- class **hamming\_t**  
*Hamming window.*
- class **hanning\_t**  
*von-Hann window*
- class **rect\_t**  
*Rectangular window.*
- class **user\_t**  
*User defined window.*

## Functions

- float **rect** (float)  
*Rectangular window function.*
- float **bartlett** (float)  
*Bartlett window function.*
- float **hanning** (float)  
*Hanning window function.*
- float **hamming** (float)  
*Hamming window function.*
- float **blackman** (float)  
*Blackman window function.*

### 4.45.1 Detailed Description

Collection of Window types.

### 4.45.2 Function Documentation

#### 4.45.2.1 float MHAWindow::rect (float x )

Rectangular window function.

4.45.2.2 float MHAWindow::bartlett (  
float x )

Bartlett window function.

4.45.2.3 float MHAWindow::hanning (  
float x )

Hanning window function.

4.45.2.4 float MHAWindow::hamming (  
float x )

Hamming window function.

4.45.2.5 float MHAWindow::blackman (  
float x )

Blackman window function.

## 4.46 multibandcompressor Namespace Reference

### Classes

- class **fftfb\_plug\_t**
- class **interface\_t**
- class **plugin\_signals\_t**

## 4.47 noisePowProposedScale Namespace Reference

### Classes

- class **interface\_t**
- class **noisePowProposed**

## 4.48 overlapadd Namespace Reference

### Classes

- class **overlapadd\_if\_t**
- class **overlapadd\_t**

## 4.49 plingploing Namespace Reference

All classes for the plingploing music generator live in this namespace.

### Classes

- class **if\_t**  
*Plugin class of the plingploing music generator.*
- class **plingploing\_t**  
*Run-time configuration of the plingploing music generator.*

### Functions

- double **drand** (double a, double b)

### 4.49.1 Detailed Description

All classes for the plingploing music generator live in this namespace.

### 4.49.2 Function Documentation

4.49.2.1 double plingploing::drand (  
double a,  
double b )

## 4.50 PluginLoader Namespace Reference

### Classes

- class **config\_file\_splitter\_t**
- class **fourway\_processor\_t**  
*This abstract class defines the interface for classes that implement all types of signal domain processing supported by the MHA: wave2wave, spec2spec, wave2spec, and spec2wave.*
- class **mhapluginloader\_t**

### Functions

- const char \* **mhastrdomain** (**mha\_domain\_t**)
- void **mhaconfig\_compare** (const **mhaconfig\_t** &req, const **mhaconfig\_t** &avail, const std::string &pref="")  
*Compare two **mhaconfig\_t** (p. 504) structures, and report differences as an error.*



## 4.50.1 Function Documentation

4.50.1.1 `const char * PluginLoader::mhastrdomain ( mha_domain_t d )`

4.50.1.2 `void PluginLoader::mhaconfig_compare ( const mhaconfig_t & req, const mhaconfig_t & avail, const std::string & pref = " " )`

Compare two **mhaconfig\_t** (p. 504) structures, and report differences as an error.

## Parameters

<i>req</i>	Expected <b>mhaconfig_t</b> (p. 504) structure
<i>avail</i>	Available <b>mhaconfig_t</b> (p. 504) structure
<i>pref</i>	Prefix for error messages

## 4.51 route Namespace Reference

## Classes

- class **interface\_t**
- class **process\_t**

## 4.52 shadowfilter\_begin Namespace Reference

## Classes

- class **cfg\_t**
- class **shadowfilter\_begin\_t**

## 4.53 shadowfilter\_end Namespace Reference

## Classes

- class **cfg\_t**
- class **shadowfilter\_end\_t**

#### 4.54 smoothgains\_bridge Namespace Reference

##### Classes

- class **overlapadd\_if\_t**
- class **smoothspec\_wrap\_t**

#### 4.55 testplugin Namespace Reference

##### Classes

- class **ac\_parser\_t**
- class **config\_parser\_t**
- class **if\_t**
- class **signal\_parser\_t**

## 5 Class Documentation

### 5.1 ac2lsl::ac2lsl\_t Class Reference

Plugin class of **ac2lsl** (p. 78).

Inheritance diagram for ac2lsl::ac2lsl\_t:

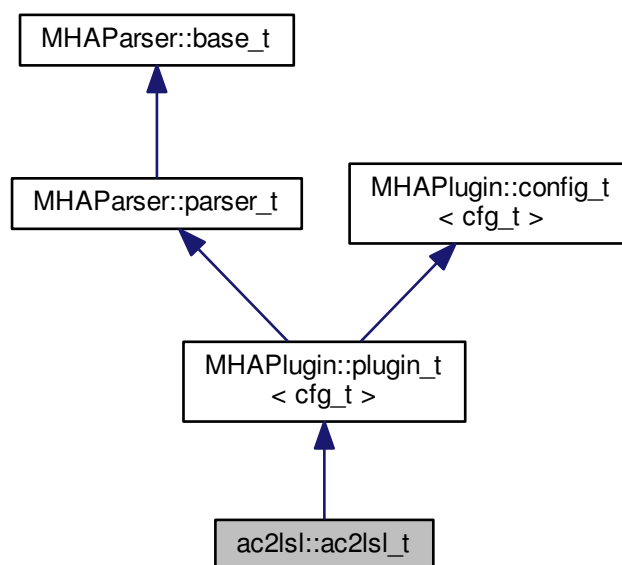

## Public Member Functions

- **ac2lsl\_t** (**algo\_comm\_t** iac, const char \*chain, const char \*algo)
- void **prepare** (**mhaconfig\_t** &)  
*Prepare constructs the vector of bridge variables and locks the configuration, then calls **update()** (p. 133).*
- **mha\_wave\_t** \* **process** (**mha\_wave\_t** \*s)  
*Processing fct for waveforms.*
- **mha\_spec\_t** \* **process** (**mha\_spec\_t** \*s)  
*Processing fct for spectra.*
- void **process** ()  
*Process function.*
- void **release** ()  
*Release fct.*

## Private Member Functions

- std::vector< std::string > **get\_all\_names\_from\_ac\_space** (const **algo\_comm\_t** &ac)  
const  
*Retrieves all variable names from the AC space.*
- void **update** ()  
*Construct new runtime configuration.*

## Private Attributes

- **MHAParser::vstring\_t** vars
- **MHAParser::string\_t** source\_id
- **MHAParser::bool\_t** rt\_strict
- **MHAParser::bool\_t** activate
- **MHAParser::int\_t** skip
- **MHAEvents::patchbay\_t**< **ac2lsl\_t** > patchbay
- bool is\_first\_run

## Additional Inherited Members

### 5.1.1 Detailed Description

Plugin class of **ac2lsl** (p. 78).

## 5.1.2 Constructor & Destructor Documentation

5.1.2.1 `ac2lsl::ac2lsl_t::ac2lsl_t (`  
     `algo_comm_t iac,`  
     `const char * chain,`  
     `const char * algo )`

## 5.1.3 Member Function Documentation

5.1.3.1 `void ac2lsl::ac2lsl_t::prepare (`  
     `mhaconfig_t & cf ) [virtual]`

Prepare constructs the vector of bridge variables and locks the configuration, then calls **update()** (p. 133).

Implements **MHAPIugin::plugin\_t< cfg\_t >** (p. 730).

5.1.3.2 `mha_wave_t* ac2lsl::ac2lsl_t::process (`  
     `mha_wave_t* s ) [inline]`

Processing fct for waveforms.

Calls **process(void)** (p. 132).

5.1.3.3 `mha_spec_t* ac2lsl::ac2lsl_t::process (`  
     `mha_spec_t* s ) [inline]`

Processing fct for spectra.

Calls **process(void)** (p. 132).

5.1.3.4 `void ac2lsl::ac2lsl_t::process (`  
     `void )`

Process function.

Checks once if the plugin is run in a real-time thread and throws if `rt_strict` is true, then forwards to **cfg\_t::process()** (p. 135).

5.1.3.5 `void ac2lsl::ac2lsl_t::release ( ) [virtual]`

Release fct.

Unlocks variable name list

Reimplemented from **MHAPIugin::plugin\_t< cfg\_t >** (p. 731).

5.1.3.6 `std::vector< std::string > ac2lsl::ac2lsl_t::get_all_names_from_ac_space (`  
     `const algo_comm_t & ac ) const [private]`

Retrieves all variable names from the AC space.

## Parameters

<i>ac</i>	AC space
-----------	----------

## Returns

Vector of variable names

5.1.3.7 void ac2lsl::ac2lsl\_t::update ( ) [private]

Construct new runtime configuration.

## 5.1.4 Member Data Documentation

5.1.4.1 MHAParser::vstring\_t ac2lsl::ac2lsl\_t::vars [private]

5.1.4.2 MHAParser::string\_t ac2lsl::ac2lsl\_t::source\_id [private]

5.1.4.3 MHAParser::bool\_t ac2lsl::ac2lsl\_t::rt\_strict [private]

5.1.4.4 MHAParser::bool\_t ac2lsl::ac2lsl\_t::activate [private]

5.1.4.5 MHAParser::int\_t ac2lsl::ac2lsl\_t::skip [private]

5.1.4.6 MHAEvents::patchbay\_t<ac2lsl\_t> ac2lsl::ac2lsl\_t::patchbay [private]

5.1.4.7 bool ac2lsl::ac2lsl\_t::is\_first\_run [private]

The documentation for this class was generated from the following file:

- **ac2lsl.cpp**

## 5.2 ac2lsl::cfg\_t Class Reference

Runtime configuration class of the **ac2lsl** (p. 78) plugin.

## Public Member Functions

- **cfg\_t** (const **algo\_comm\_t** &ac\_, unsigned skip\_, const std::string &source\_id, const std::vector< std::string > &varnames\_, double rate)  
*C'tor of ac2lsl* (p. 78) run time configuration.
- void **process** ()

### Private Member Functions

- void **create\_or\_replace\_var** (const std::string &name, const **comm\_var\_t** &v)
- void **check\_vars** ()
- void **update\_varlist** ()

### Private Attributes

- std::map< std::string, std::unique\_ptr< **save\_var\_base\_t** > > **varlist**  
*Maps variable name to unique ptr's of ac to lsl bridges.*
- unsigned **skipcnt**  
*Counter of frames to skip.*
- const unsigned **skip**  
*Number of frames to skip after each send.*
- const double **srate**  
*Sampling rate of the stream.*
- const std::string **source\_id**  
*User configurable source id.*
- const **algo\_comm\_t** & **ac**  
*Handle to the ac space.*

## 5.2.1 Detailed Description

Runtime configuration class of the **ac2lsl** (p. 78) plugin.

## 5.2.2 Constructor & Destructor Documentation

### 5.2.2.1 `cfg_t::cfg_t (`

```
const algo_comm_t & ac_,
unsigned skip_,
const std::string & source_id,
const std::vector< std::string > & varnames_,
double rate )
```

C'tor of **ac2lsl** (p. 78) run time configuration.

### Parameters

<code>ac_</code>	AC space, source of data to send over LSL
<code>skip_</code>	Number of frames to skip after each send
<code>source_id_↔</code>	LSL identifier for this data stream
<code>varnames_↔</code>	Names of AC variables to send over LSL
<code>rate</code>	Rate with which chunks of data are sent to the LSL stream. Usually the rate with which process calls happen, but may be lower due to time-subsampling caused by <code>skip_</code>

### 5.2.3 Member Function Documentation

5.2.3.1 void `cfg_t::create_or_replace_var` (  
    const std::string & *name*,  
    const comm\_var\_t & *v* ) [private]

5.2.3.2 void `ac2lsl::cfg_t::check_vars` ( ) [private]

5.2.3.3 void `cfg_t::update_varlist` ( ) [private]

5.2.3.4 void `cfg_t::process` (  
    void )

### 5.2.4 Member Data Documentation

5.2.4.1 std::map<std::string, std::unique\_ptr<save\_var\_base\_t> > `ac2lsl::cfg_t::varlist`  
[private]

Maps variable name to unique ptr's of ac to lsl bridges.

5.2.4.2 unsigned `ac2lsl::cfg_t::skipcnt` [private]

Counter of frames to skip.

5.2.4.3 const unsigned `ac2lsl::cfg_t::skip` [private]

Number of frames to skip after each send.

5.2.4.4 const double `ac2lsl::cfg_t::srate` [private]

Sampling rate of the stream.

5.2.4.5 const std::string `ac2lsl::cfg_t::source_id` [private]

User configurable source id.

5.2.4.6 const algo\_comm\_t& `ac2lsl::cfg_t::ac` [private]

Handle to the ac space.

The documentation for this class was generated from the following file:

- **ac2lsl.cpp**

### 5.3 ac2lsl::save\_var\_base\_t Class Reference

Interface for ac to lsl bridge variable.

Inheritance diagram for ac2lsl::save\_var\_base\_t:

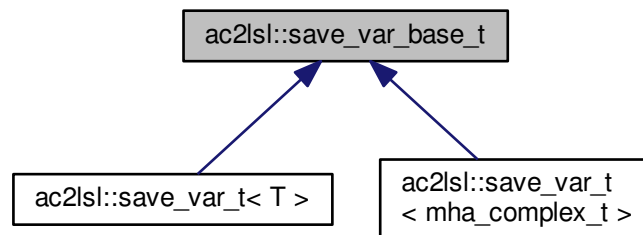

#### Public Member Functions

- virtual void **send\_frame** ()=0
- virtual void \* **get\_buf\_address** () const noexcept=0
- virtual void **set\_buf\_address** (void \*data)=0
- virtual lsl::stream\_info **info** () const noexcept=0
- virtual unsigned **data\_type** () const noexcept=0
- virtual unsigned **num\_entries** () const noexcept=0
- virtual **~save\_var\_base\_t** ()=default

#### 5.3.1 Detailed Description

Interface for ac to lsl bridge variable.

#### 5.3.2 Constructor & Destructor Documentation

5.3.2.1 virtual ac2lsl::save\_var\_base\_t::~save\_var\_base\_t( ) [virtual],[default]

#### 5.3.3 Member Function Documentation

5.3.3.1 virtual void ac2lsl::save\_var\_base\_t::send\_frame( ) [pure virtual]

Implemented in `ac2lsl::save_var_t< mha_complex_t >` (p. 143), and `ac2lsl::save_var_t< T >` (p. 140).



5.3.3.2 `virtual void* ac2lsl::save_var_base_t::get_buf_address ( ) const` [pure virtual],  
[noexcept]

Implemented in `ac2lsl::save_var_t< mha_complex_t >` (p. 142), and `ac2lsl::save_var_t< T >` (p. 139).

5.3.3.3 `virtual void ac2lsl::save_var_base_t::set_buf_address ( void * data )` [pure virtual]

Implemented in `ac2lsl::save_var_t< mha_complex_t >` (p. 142), and `ac2lsl::save_var_t< T >` (p. 139).

5.3.3.4 `virtual lsl::stream_info ac2lsl::save_var_base_t::info ( ) const` [pure virtual],  
[noexcept]

Implemented in `ac2lsl::save_var_t< mha_complex_t >` (p. 142), and `ac2lsl::save_var_t< T >` (p. 139).

5.3.3.5 `virtual unsigned ac2lsl::save_var_base_t::data_type ( ) const` [pure virtual],  
[noexcept]

Implemented in `ac2lsl::save_var_t< mha_complex_t >` (p. 142), and `ac2lsl::save_var_t< T >` (p. 140).

5.3.3.6 `virtual unsigned ac2lsl::save_var_base_t::num_entries ( ) const` [pure virtual],  
[noexcept]

Implemented in `ac2lsl::save_var_t< mha_complex_t >` (p. 142), and `ac2lsl::save_var_t< T >` (p. 139).

The documentation for this class was generated from the following file:

- `ac2lsl.cpp`

## 5.4 ac2lsl::save\_var\_t< T > Class Template Reference

Implementation for all ac to lsl bridges except complex types.

Inheritance diagram for `ac2lsl::save_var_t< T >`:

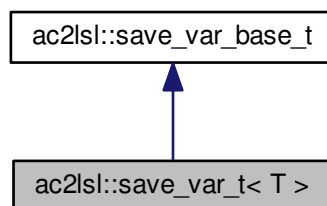

## Public Member Functions

- **save\_var\_t** (const std::string &name\_, const std::string &type\_, unsigned num\_entries\_, const **mha\_real\_t** rate\_, const lsl::channel\_format\_t format\_, const std::string &source\_id\_, void \*data\_, const unsigned **data\_type\_**)  
*C'tor of generic ac to lsl bridge.*
- virtual void \* **get\_buf\_address** () const noexcept override  
*Get buffer address as void pointer.*
- virtual void **set\_buf\_address** (void \*data) override  
*Cast the input pointer to the appropriate type and set the buffer address.*
- virtual lsl::stream\_info **info** () const noexcept override  
*Get stream info object from stream outlet.*
- virtual unsigned **num\_entries** () const noexcept override  
*Get number of entries in the stream object.*
- virtual unsigned **data\_type** () const noexcept override  
*Get data type id according MHA convention.*
- virtual ~**save\_var\_t** ()=default
- virtual void **send\_frame** () override  
*Send a frame to lsl.*

## Private Attributes

- lsl::stream\_outlet **stream**  
*LSL stream outlet.*
- T \* **buf**  
*Pointer to data buffer of the ac variable.*
- const unsigned **data\_type\_**  
*Data type id according to MHA convention.*

### 5.4.1 Detailed Description

```
template<typename T>
class ac2lsl::save_var_t< T >
```

Implementation for all ac to lsl bridges except complex types.

### 5.4.2 Constructor & Destructor Documentation

```
5.4.2.1 template<typename T > ac2lsl::save_var_t< T >::save_var_t (
    const std::string & name_,
    const std::string & type_,
    unsigned num_entries_,
    const mha_real_t rate_,
    const lsl::channel_format_t format_,
    const std::string & source_id_,
    void * data_,
    const unsigned data_type_ ) [inline]
```

C'tor of generic ac to lsl bridge.

## Parameters

<i>info</i>	LSL stream info object containing metadata
<i>data</i>	Pointer to data buffer of the ac variable
<i>data_type</i>	Type id of the stream, in mha convention. Should be set to one if not a vector.

5.4.2.2 `template<typename T > virtual ac2lsl::save_var_t< T >::~~save_var_t( )` [virtual], [default]

## 5.4.3 Member Function Documentation

5.4.3.1 `template<typename T > virtual void* ac2lsl::save_var_t< T >::get_buf_address ( ) const` [inline], [override], [virtual], [noexcept]

Get buffer address as void pointer.

## Returns

Adress of the data buffer

Implements `ac2lsl::save_var_base_t` (p. 137).

5.4.3.2 `template<typename T > virtual void ac2lsl::save_var_t< T >::set_buf_address ( void * data )` [inline], [override], [virtual]

Cast the input pointer to the appropriate type and set the buffer address.

## Parameters

<i>data</i>	New buffer address
-------------	--------------------

Implements `ac2lsl::save_var_base_t` (p. 137).

5.4.3.3 `template<typename T > virtual lsl::stream_info ac2lsl::save_var_t< T >::info ( ) const` [inline], [override], [virtual], [noexcept]

Get stream info object from stream outlet.

Implements `ac2lsl::save_var_base_t` (p. 137).

5.4.3.4 `template<typename T > virtual unsigned ac2lsl::save_var_t< T >::num_entries ( ) const` [inline], [override], [virtual], [noexcept]

Get number of entries in the stream object.

Implements `ac2lsl::save_var_base_t` (p. 137).

**5.4.3.5** `template<typename T > virtual unsigned ac2lsl::save_var_t< T >::data_type ( ) const`  
`[inline], [override], [virtual], [noexcept]`

Get data type id according MHA convention.

Implements `ac2lsl::save_var_base_t` (p. 137).

**5.4.3.6** `template<typename T > virtual void ac2lsl::save_var_t< T >::send_frame ( ) [inline],`  
`[override], [virtual]`

Send a frame to lsl.

Implements `ac2lsl::save_var_base_t` (p. 136).

#### 5.4.4 Member Data Documentation

**5.4.4.1** `template<typename T > lsl::stream_outlet ac2lsl::save_var_t< T >::stream [private]`

LSL stream outlet.

Interface to lsl

**5.4.4.2** `template<typename T > T* ac2lsl::save_var_t< T >::buf [private]`

Pointer to data buffer of the ac variable.

**5.4.4.3** `template<typename T > const unsigned ac2lsl::save_var_t< T >::data_type_`  
`[private]`

Data type id according to MHA convention.

The documentation for this class was generated from the following file:

- `ac2lsl.cpp`

#### 5.5 `ac2lsl::save_var_t< mha_complex_t >` Class Template Reference

Template specialization of the `ac2lsl` (p. 78) bridge to take care of complex numbers.

Inheritance diagram for `ac2lsl::save_var_t< mha_complex_t >`:

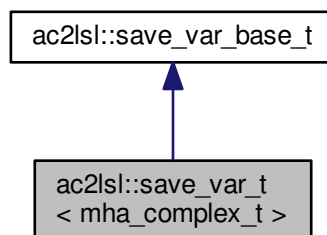

### Public Member Functions

- **save\_var\_t** (const std::string &name\_, const std::string &type\_, const unsigned num\_↵ entries\_, const **mha\_real\_t** rate\_, const lsl::channel\_format\_t format\_, const std::string &source\_id\_, void \*data\_)  
*C'tor of specialization for complex types.*
- virtual void \* **get\_buf\_address** () const noexcept override
- virtual void **set\_buf\_address** (void \*data) override
- virtual lsl::stream\_info **info** () const noexcept override  
*Get buffer address as void pointer.*
- virtual unsigned **num\_entries** () const noexcept override  
*Get number of entries in the stream object.*
- virtual unsigned **data\_type** () const noexcept override  
*Cast the input pointer to the appropriate type and set the buffer address.*
- virtual ~**save\_var\_t** ()=default
- virtual void **send\_frame** () override  
*Send a frame of complex types.*

### Private Attributes

- lsl::stream\_outlet **stream**  
*LSL stream outlet.*
- **mha\_complex\_t** \* **buf**  
*Pointer to data buffer of the ac variable.*

#### 5.5.1 Detailed Description

```
template<>
class ac2lsl::save_var_t< mha_complex_t >
```

Template specialization of the **ac2lsl** (p. 78) bridge to take care of complex numbers.

This specialization is needed because lsl does not support complex numbers. Order is [re(0), im(0), re(1), im(1), ...]

#### 5.5.2 Constructor & Destructor Documentation

```
5.5.2.1 ac2lsl::save_var_t< mha_complex_t >::save_var_t(
    const std::string & name_,
    const std::string & type_,
    const unsigned num_entries_,
    const mha_real_t rate_,
    const lsl::channel_format_t format_,
    const std::string & source_id_,
    void * data_ ) [inline]
```

C'tor of specialization for complex types.

See generic c'tor for details.

5.5.2.2 `virtual ac2lsl::save_var_t< mha_complex_t >::~~save_var_t ( ) [virtual], [default]`

### 5.5.3 Member Function Documentation

5.5.3.1 `virtual void* ac2lsl::save_var_t< mha_complex_t >::get_buf_address ( ) const [inline], [override], [virtual], [noexcept]`

Implements `ac2lsl::save_var_base_t` (p. 137).

5.5.3.2 `virtual void ac2lsl::save_var_t< mha_complex_t >::set_buf_address ( void * data ) [inline], [override], [virtual]`

Implements `ac2lsl::save_var_base_t` (p. 137).

5.5.3.3 `virtual lsl::stream_info ac2lsl::save_var_t< mha_complex_t >::info ( ) const [inline], [override], [virtual], [noexcept]`

Get buffer address as void pointer.

#### Returns

Adress of the data buffer

Implements `ac2lsl::save_var_base_t` (p. 137).

5.5.3.4 `virtual unsigned ac2lsl::save_var_t< mha_complex_t >::num_entries ( ) const [inline], [override], [virtual], [noexcept]`

Get number of entries in the stream object.

Implements `ac2lsl::save_var_base_t` (p. 137).

5.5.3.5 `virtual unsigned ac2lsl::save_var_t< mha_complex_t >::data_type ( ) const [inline], [override], [virtual], [noexcept]`

Cast the input pointer to the appropriate type and set the buffer address.

#### Parameters

<i>data</i>	New buffer address
-------------	--------------------

Implements `ac2lsl::save_var_base_t` (p. 137).

5.5.3.6 virtual void **ac2lsl::save\_var\_t**< **mha\_complex\_t** >::**send\_frame** ( ) [*inline*],  
[*override*], [*virtual*]

Send a frame of complex types.

Complex numbers are stored as alternating real and imaginary parts. An array of complex numbers in memory can be reinterpreted as a vector of real numbers that correspond to real and imaginary parts. LSL does not support complex types directly. Send one vector containing {buf[0].re,buf[0].im,buf[1].re,buf[1].im,...} instead.

Implements **ac2lsl::save\_var\_base\_t** (p. 136).

#### 5.5.4 Member Data Documentation

5.5.4.1 **lsl::stream\_outlet** **ac2lsl::save\_var\_t**< **mha\_complex\_t** >::**stream** [*private*]

LSL stream outlet.

Interface to lsl

5.5.4.2 **mha\_complex\_t\*** **ac2lsl::save\_var\_t**< **mha\_complex\_t** >::**buf** [*private*]

Pointer to data buffer of the ac variable.

The documentation for this class was generated from the following file:

- **ac2lsl.cpp**

## 5.6 ac2lsl::type\_info Struct Reference

### Public Attributes

- const std::string **name**
- const lsl::channel\_format\_t **format**

#### 5.6.1 Member Data Documentation

5.6.1.1 const std::string **ac2lsl::type\_info::name**

5.6.1.2 const lsl::channel\_format\_t **ac2lsl::type\_info::format**

The documentation for this struct was generated from the following file:

- **ac2lsl.cpp**

## 5.7 ac2osc\_t Class Reference

Plugin class of the ac2osc plugin.

Inheritance diagram for ac2osc\_t:

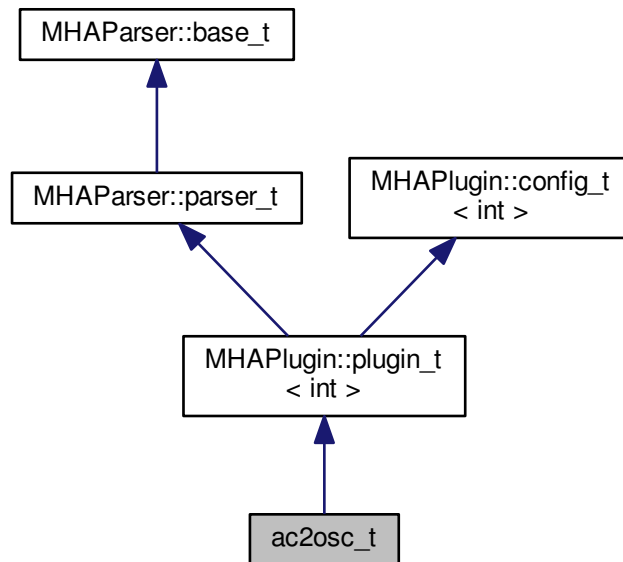

### Public Member Functions

- **ac2osc\_t** (**algo\_comm\_t** iac, const char \*chain, const char \*algo)  
*C'tor of plugin class.*
- void **prepare** (**mhaconfig\_t** &)
- **mha\_wave\_t** \* **process** (**mha\_wave\_t** \*s)  
*Processing fct for waveforms.*
- **mha\_spec\_t** \* **process** (**mha\_spec\_t** \*s)  
*Processing fct for spectra.*
- void **process** ()  
*Process function.*
- void **release** ()  
*Release frees osc related memory, does cleanup.*

### Private Member Functions

- void **send\_osc\_float** ()
- void **update\_mode** ()  
*Start/Stop sending of messages.*



## Private Attributes

- **MHAParser::string\_t host**  
*OSC server host name.*
- **MHAParser::string\_t port**  
*OSC server port.*
- **MHAParser::int\_t ttl**  
*Time-to-live of UDP packages.*
- **MHAParser::vstring\_t vars**  
*List of AC variables to be saved, empty for all.*
- **MHAParser::kw\_t mode**  
*Record mode.*
- **MHAParser::int\_t skip**  
*number of frames to skip after sending*
- **MHAParser::bool\_t rt\_strict**  
*abort if used in real-time thread?*
- **MHA\_AC::acspace2matrix\_t \* acspace**
- **MHAEvents::patchbay\_t < ac2osc\_t > patchbay**
- bool **b\_record**
- uint8\_t \* **rtmem**
- float **framerate**
- int **skipcnt**
- lo\_address **lo\_addr**
- bool **is\_first\_run**

## Additional Inherited Members

## 5.7.1 Detailed Description

Plugin class of the ac2osc plugin.

## 5.7.2 Constructor &amp; Destructor Documentation

```
5.7.2.1 ac2osc_t::ac2osc_t (
    algo_comm_t iac,
    const char * chain,
    const char * algo )
```

C'tor of plugin class.

### 5.7.3 Member Function Documentation

5.7.3.1 `void ac2osc_t::prepare ( mhaconfig_t & cf ) [virtual]`

Implements **MHAPLugin::plugin\_t< int >** (p. 730).

5.7.3.2 `mha_wave_t* ac2osc_t::process ( mha_wave_t* s ) [inline]`

Processing fct for waveforms.

Calls **process(void)** (p. 146).

5.7.3.3 `mha_spec_t* ac2osc_t::process ( mha_spec_t* s ) [inline]`

Processing fct for spectra.

Calls **process(void)** (p. 146).

5.7.3.4 `void ac2osc_t::process ( void )`

Process function.

Checks once if the plugin is run in a real-time thread and throws if `rt_strict` is true, sends osc messages according to config.

5.7.3.5 `void ac2osc_t::release ( void ) [virtual]`

Release frees osc related memory, does cleanup.

Reimplemented from **MHAPLugin::plugin\_t< int >** (p. 731).

5.7.3.6 `void ac2osc_t::send_osc_float ( ) [private]`

5.7.3.7 `void ac2osc_t::update_mode ( ) [private]`

Start/Stop sending of messages.

### 5.7.4 Member Data Documentation

5.7.4.1 `MHAParser::string_t ac2osc_t::host [private]`

OSC server host name.

**5.7.4.2 MHAParser::string\_t ac2osc\_t::port** [private]

OSC server port.

**5.7.4.3 MHAParser::int\_t ac2osc\_t::ttl** [private]

Time-to-live of UDP packages.

**5.7.4.4 MHAParser::vstring\_t ac2osc\_t::vars** [private]

List of AC variables to be saved, empty for all.

**5.7.4.5 MHAParser::kw\_t ac2osc\_t::mode** [private]

Record mode.

**5.7.4.6 MHAParser::int\_t ac2osc\_t::skip** [private]

number of frames to skip after sending

**5.7.4.7 MHAParser::bool\_t ac2osc\_t::rt\_strict** [private]

abort if used in real-time thread?

**5.7.4.8 MHA\_AC::acspace2matrix\_t\* ac2osc\_t::acspace** [private]**5.7.4.9 MHAEvents::patchbay\_t<ac2osc\_t> ac2osc\_t::patchbay** [private]**5.7.4.10 bool ac2osc\_t::b\_record** [private]**5.7.4.11 uint8\_t\* ac2osc\_t::rtmem** [private]**5.7.4.12 float ac2osc\_t::framerate** [private]**5.7.4.13 int ac2osc\_t::skipcnt** [private]**5.7.4.14 lo\_address ac2osc\_t::lo\_addr** [private]**5.7.4.15 bool ac2osc\_t::is\_first\_run** [private]

The documentation for this class was generated from the following file:

- **ac2osc.cpp**

## 5.8 ac2wave\_if\_t Class Reference

Inheritance diagram for ac2wave\_if\_t:

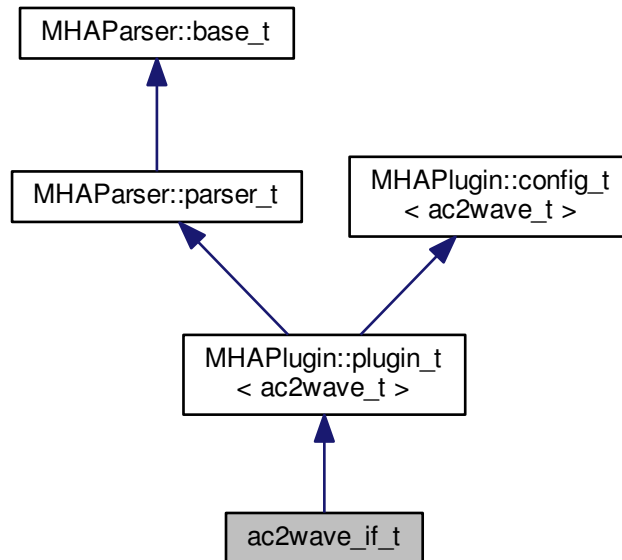

### Public Member Functions

- **ac2wave\_if\_t** (const **algo\_comm\_t** &, const std::string &, const std::string &)
- **mha\_wave\_t \* process** (**mha\_spec\_t \***)
- **mha\_wave\_t \* process** (**mha\_wave\_t \***)
- void **prepare** (**mhaconfig\_t** &)
- void **release** ()

### Private Member Functions

- void **update** ()

### Private Attributes

- **MHAParser::string\_t** name
- **MHAParser::float\_t** gain\_in
- **MHAParser::float\_t** gain\_ac
- **MHAParser::int\_t** delay\_in
- **MHAParser::int\_t** delay\_ac
- **MHASignal::waveform\_t \* zeros**
- bool **prepared**
- **MHAEvents::patchbay\_t < ac2wave\_if\_t >** patchbay

## Additional Inherited Members

### 5.8.1 Constructor & Destructor Documentation

5.8.1.1 `ac2wave_if_t::ac2wave_if_t (`  
    `const algo_comm_t & iac,`  
    `const std::string & ith,`  
    `const std::string & ial )`

### 5.8.2 Member Function Documentation

5.8.2.1 `mha_wave_t * ac2wave_if_t::process (`  
    `mha_spec_t * )`

5.8.2.2 `mha_wave_t * ac2wave_if_t::process (`  
    `mha_wave_t * s )`

5.8.2.3 `void ac2wave_if_t::prepare (`  
    `mhaconfig_t & tf ) [virtual]`

Implements `MHAPLugin::plugin_t< ac2wave_t >` (p. 730).

5.8.2.4 `void ac2wave_if_t::release (`  
    `void ) [virtual]`

Reimplemented from `MHAPLugin::plugin_t< ac2wave_t >` (p. 731).

5.8.2.5 `void ac2wave_if_t::update ( ) [private]`

### 5.8.3 Member Data Documentation

5.8.3.1 `MHAParser::string_t ac2wave_if_t::name [private]`

5.8.3.2 `MHAParser::float_t ac2wave_if_t::gain_in [private]`

5.8.3.3 `MHAParser::float_t ac2wave_if_t::gain_ac [private]`

5.8.3.4 `MHAParser::int_t ac2wave_if_t::delay_in [private]`

5.8.3.5 `MHAParser::int_t ac2wave_if_t::delay_ac [private]`

5.8.3.6 `MHASignal::waveform_t* ac2wave_if_t::zeros [private]`

5.8.3.7 `bool ac2wave_if_t::prepared [private]`

5.8.3.8 `MHAEvents::patchbay_t<ac2wave_if_t> ac2wave_if_t::patchbay [private]`

The documentation for this class was generated from the following file:

- `ac2wave.cpp`

## 5.9 ac2wave\_t Class Reference

### Public Member Functions

- **ac2wave\_t** (unsigned int frames\_, unsigned int channels\_, **algo\_comm\_t** ac\_, std::string name\_, float gain\_in\_, float gain\_ac\_, unsigned int delay\_in\_, unsigned int delay\_ac\_)
- **mha\_wave\_t \* process** (**mha\_wave\_t \***)

### Private Attributes

- unsigned int **frames**
- unsigned int **channels**
- **mha\_wave\_t w**
- **algo\_comm\_t ac**
- std::string **name**
- **MHASignal::delay\_wave\_t delay\_in**
- **MHASignal::delay\_wave\_t delay\_ac**
- **mha\_real\_t gain\_in**
- **mha\_real\_t gain\_ac**

### 5.9.1 Constructor & Destructor Documentation

5.9.1.1 ac2wave\_t::ac2wave\_t (  
     unsigned int *frames\_*,  
     unsigned int *channels\_*,  
     **algo\_comm\_t** *ac\_*,  
     std::string *name\_*,  
     float *gain\_in\_*,  
     float *gain\_ac\_*,  
     unsigned int *delay\_in\_*,  
     unsigned int *delay\_ac\_* )

### 5.9.2 Member Function Documentation

5.9.2.1 **mha\_wave\_t \* ac2wave\_t::process** (  
     **mha\_wave\_t \* s** )

### 5.9.3 Member Data Documentation

5.9.3.1 unsigned int **ac2wave\_t::frames** [private]

5.9.3.2 unsigned int **ac2wave\_t::channels** [private]

5.9.3.3 **mha\_wave\_t ac2wave\_t::w** [private]

5.9.3.4 algo\_comm\_t ac2wave\_t::ac [private]

5.9.3.5 std::string ac2wave\_t::name [private]

5.9.3.6 MHASignal::delay\_wave\_t ac2wave\_t::delay\_in [private]

5.9.3.7 MHASignal::delay\_wave\_t ac2wave\_t::delay\_ac [private]

5.9.3.8 mha\_real\_t ac2wave\_t::gain\_in [private]

5.9.3.9 mha\_real\_t ac2wave\_t::gain\_ac [private]

The documentation for this class was generated from the following file:

- ac2wave.cpp

## 5.10 acConcat\_wave Class Reference

Inheritance diagram for acConcat\_wave:

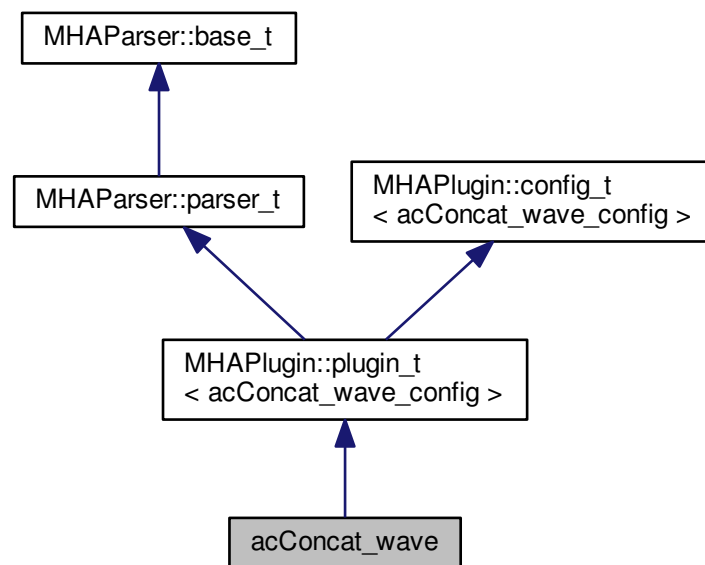

## Public Member Functions

- **acConcat\_wave** (**algo\_comm\_t** &**ac**, const std::string &**chain\_name**, const std::string &**algo\_name**)  
*Constructs our plugin.*
- **~acConcat\_wave** ()
- **mha\_wave\_t \* process** (**mha\_wave\_t \***)  
*Checks for the most recent configuration and defers processing to it.*
- void **prepare** (**mhaconfig\_t** &)  
*Plugin preparation.*
- void **release** (void)

## Public Attributes

- **MHAParser::int\_t num\_AC**
- **MHAParser::string\_t prefix\_names\_AC**
- **MHAParser::vint\_t samples\_AC**
- **MHAParser::string\_t name\_con\_AC**
- **MHAParser::int\_t numchannels**

## Private Member Functions

- void **update\_cfg** ()

## Private Attributes

- **MHAEvents::patchbay\_t< acConcat\_wave > patchbay**

## Additional Inherited Members

### 5.10.1 Constructor & Destructor Documentation

- 5.10.1.1 **acConcat\_wave::acConcat\_wave** (  
     **algo\_comm\_t** & *ac*,  
     const std::string & *chain\_name*,  
     const std::string & *algo\_name* )

Constructs our plugin.



5.10.1.2 `acConcat_wave::~~acConcat_wave ( )`

## 5.10.2 Member Function Documentation

5.10.2.1 `mha_wave_t* acConcat_wave::process ( mha_wave_t* signal )`

Checks for the most recent configuration and defers processing to it.

5.10.2.2 `void acConcat_wave::prepare ( mhaconfig_t & signal_info ) [virtual]`

Plugin preparation.

An opportunity to validate configuration parameters before instantiating a configuration.

### Parameters

<i>signal_info</i>	Structure containing a description of the form of the signal (domain, number of channels, frames per block, sampling rate).
--------------------	---

Implements `MHAPlugin::plugin_t< acConcat_wave_config >` (p. 730).

5.10.2.3 `void acConcat_wave::release ( void ) [inline], [virtual]`

Reimplemented from `MHAPlugin::plugin_t< acConcat_wave_config >` (p. 731).

5.10.2.4 `void acConcat_wave::update_cfg ( ) [private]`

## 5.10.3 Member Data Documentation

5.10.3.1 `MHAParser::int_t acConcat_wave::num_AC`

5.10.3.2 `MHAParser::string_t acConcat_wave::prefix_names_AC`

5.10.3.3 `MHAParser::vint_t acConcat_wave::samples_AC`

5.10.3.4 `MHAParser::string_t acConcat_wave::name_con_AC`

5.10.3.5 `MHAParser::int_t acConcat_wave::numchannels`

5.10.3.6 `MHAEvents::patchbay_t<acConcat_wave> acConcat_wave::patchbay [private]`

The documentation for this class was generated from the following files:

- `acConcat_wave.h`
- `acConcat_wave.cpp`

## 5.11 acConcat\_wave\_config Class Reference

### Public Member Functions

- **acConcat\_wave\_config** (**algo\_comm\_t** &**ac**, const **mhaconfig\_t** *in\_cfg*, **acConcat\_wave** \**\_concat*)
- **~acConcat\_wave\_config** ()
- **mha\_wave\_t** \* **process** (**mha\_wave\_t** \*)

### Public Attributes

- **algo\_comm\_t** & **ac**
- **std::vector**< **std::string** > **strNames\_AC**
- **std::vector**< **int** > **numSamples\_AC**
- **mha\_wave\_t** **vGCC**
- **MHA\_AC::waveform\_t** \* **vGCC\_con**

### 5.11.1 Constructor & Destructor Documentation

5.11.1.1 **acConcat\_wave\_config::acConcat\_wave\_config** (  
     **algo\_comm\_t** & *ac*,  
     const **mhaconfig\_t** *in\_cfg*,  
     **acConcat\_wave** \* *\_concat* )

5.11.1.2 **acConcat\_wave\_config::~~acConcat\_wave\_config** ( )

### 5.11.2 Member Function Documentation

5.11.2.1 **mha\_wave\_t** \* **acConcat\_wave\_config::process** (  
     **mha\_wave\_t** \* *wave* )

### 5.11.3 Member Data Documentation

5.11.3.1 **algo\_comm\_t** & **acConcat\_wave\_config::ac**

5.11.3.2 **std::vector**< **std::string** > **acConcat\_wave\_config::strNames\_AC**

5.11.3.3 **std::vector**< **int** > **acConcat\_wave\_config::numSamples\_AC**

5.11.3.4 **mha\_wave\_t** **acConcat\_wave\_config::vGCC**

5.11.3.5 **MHA\_AC::waveform\_t** \* **acConcat\_wave\_config::vGCC\_con**

The documentation for this class was generated from the following files:

- **acConcat\_wave.h**
- **acConcat\_wave.cpp**

## 5.12 acmon::ac\_monitor\_t Class Reference

A class for converting AC variables to Parser monitors of correct type.

### Public Member Functions

- **ac\_monitor\_t** (**MHAParser::parser\_t** &parent, const std::string &name\_, **algo\_comm**↔  
\_t ac, bool use\_matrix)  
*Converts AC variable to parser monitor.*
- void **getvar** (**algo\_comm\_t** ac)  
*Update values of monitor.*

### Public Attributes

- std::string **name**  
*name of AC variable and parser monitor*
- std::string **dimstr**  
*columns x rows*
- **MHAParser::vfloat\_mon\_t** **mon**  
*Monitor used for real vectors.*
- **MHAParser::mfloat\_mon\_t** **mon\_mat**  
*Monitor used for real matrices.*
- **MHAParser::vcomplex\_mon\_t** **mon\_complex**  
*monitor used for complex vectors*
- **MHAParser::mcomplex\_mon\_t** **mon\_mat\_complex**  
*monitor used for complex matrices*
- **MHAParser::parser\_t** & **p\_parser**  
*parent parser to insert monitor into*

### Private Attributes

- bool **use\_mat**  
*if true, use matrix monitor, else use vector monitor*

#### 5.12.1 Detailed Description

A class for converting AC variables to Parser monitors of correct type.

#### 5.12.2 Constructor & Destructor Documentation

5.12.2.1 acmon::ac\_monitor\_t::ac\_monitor\_t (  
**MHAParser::parser\_t** & parent,  
 const std::string & name\_,  
**algo\_comm\_t** ac,  
 bool use\_matrix )

Converts AC variable to parser monitor.

**Parameters**

<i>parent</i>	The parser to insert a monitor into
<i>name_</i>	The name of the AC variable and the monitor variable
<i>ac</i>	Handle to algorithm communication space
<i>use_matrix</i>	Indicates if a matrix monitor type should be used.

**5.12.3 Member Function Documentation****5.12.3.1 void acmon::ac\_monitor\_t::getvar ( algo\_comm\_t ac )**

Update values of monitor.

**Parameters**

<i>ac</i>	Handle to algorithm communication space
-----------	---

**5.12.4 Member Data Documentation****5.12.4.1 std::string acmon::ac\_monitor\_t::name**

name of AC variable and parser monitor

**5.12.4.2 std::string acmon::ac\_monitor\_t::dimstr**

columns x rows

**5.12.4.3 MHAParser::vfloat\_mon\_t acmon::ac\_monitor\_t::mon**

Monitor used for real vectors.

**5.12.4.4 MHAParser::mfloat\_mon\_t acmon::ac\_monitor\_t::mon\_mat**

Monitor used for real matrices.

**5.12.4.5 MHAParser::vcomplex\_mon\_t acmon::ac\_monitor\_t::mon\_complex**

monitor used for complex vectors

## 5.12.4.6 MHAParser::mcomplex\_mon\_t acmon::ac\_monitor\_t::mon\_mat\_complex

monitor used for complex matrices

## 5.12.4.7 MHAParser::parser\_t&amp; acmon::ac\_monitor\_t::p\_parser

parent parser to insert monitor into

## 5.12.4.8 bool acmon::ac\_monitor\_t::use\_mat [private]

if true, use matrix monitor, else use vector monitor

The documentation for this class was generated from the following files:

- **ac\_monitor\_type.hh**
- **ac\_monitor\_type.cpp**

## 5.13 acmon::acmon\_t Class Reference

Inheritance diagram for acmon::acmon\_t:

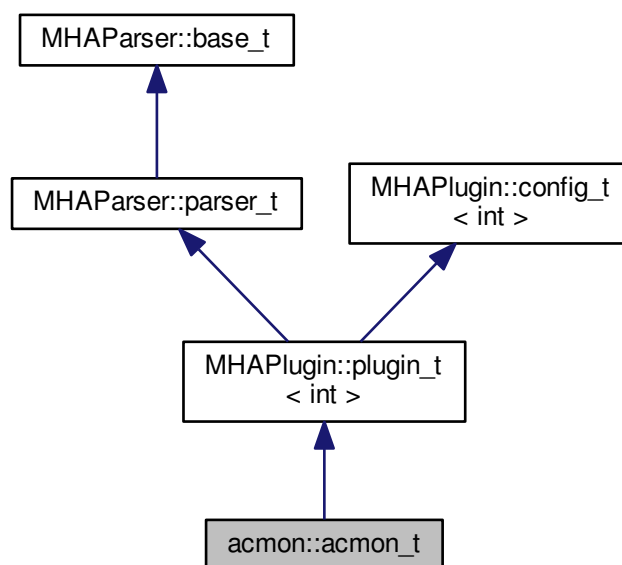

### Public Member Functions

- **acmon\_t** (const **algo\_comm\_t** &, const std::string &, const std::string &)
- **~acmon\_t** ()
- void **prepare** (**mhaconfig\_t** &)
- void **release** ()
- **mha\_spec\_t** \* **process** (**mha\_spec\_t** \*)
- **mha\_wave\_t** \* **process** (**mha\_wave\_t** \*)

### Private Member Functions

- void **save\_vars** ()
- void **update\_recmode** ()

### Private Attributes

- **algo\_comm\_t** **ac**
- **MHAParser::vstring\_mon\_t** **varlist**
- **MHAParser::vstring\_mon\_t** **dimensions**
- **MHAParser::kw\_t** **dispmode**
- **MHAParser::kw\_t** **recmode**
- std::vector< **ac\_monitor\_t** \* > **vars**
- **MHAEvents::patchbay\_t**< **acmon\_t** > **patchbay**
- std::string **chain**
- std::string **algo**
- bool **b\_cont**
- bool **b\_snapshot**

### Additional Inherited Members

#### 5.13.1 Constructor & Destructor Documentation

5.13.1.1 **acmon::acmon\_t::acmon\_t** (  
     const **algo\_comm\_t** & *iac*,  
     const std::string & *ith*,  
     const std::string & *ial* )

5.13.1.2 **acmon::acmon\_t::~~acmon\_t** (  
     void )

#### 5.13.2 Member Function Documentation

5.13.2.1 void **acmon::acmon\_t::prepare** (  
     **mhaconfig\_t** & *tf* ) [virtual]

Implements **MHAPlugin::plugin\_t**< int > (p. 730).

5.13.2.2 void acmon::acmon\_t::release ( void ) [inline],[virtual]

Reimplemented from **MHAPIugin::plugin\_t**< int > (p. 731).

5.13.2.3 mha\_spec\_t\* acmon::acmon\_t::process ( mha\_spec\_t\* s )

5.13.2.4 mha\_wave\_t\* acmon::acmon\_t::process ( mha\_wave\_t\* s )

5.13.2.5 void acmon::acmon\_t::save\_vars ( ) [private]

5.13.2.6 void acmon::acmon\_t::update\_recmode ( ) [private]

### 5.13.3 Member Data Documentation

5.13.3.1 algo\_comm\_t acmon::acmon\_t::ac [private]

5.13.3.2 MHAParser::vstring\_mon\_t acmon::acmon\_t::varlist [private]

5.13.3.3 MHAParser::vstring\_mon\_t acmon::acmon\_t::dimensions [private]

5.13.3.4 MHAParser::kw\_t acmon::acmon\_t::dispmode [private]

5.13.3.5 MHAParser::kw\_t acmon::acmon\_t::recmode [private]

5.13.3.6 std::vector<ac\_monitor\_t\*> acmon::acmon\_t::vars [private]

5.13.3.7 MHAEvents::patchbay\_t<acmon\_t> acmon::acmon\_t::patchbay [private]

5.13.3.8 std::string acmon::acmon\_t::chain [private]

5.13.3.9 std::string acmon::acmon\_t::algo [private]

5.13.3.10 bool acmon::acmon\_t::b\_cont [private]

5.13.3.11 bool acmon::acmon\_t::b\_snapshot [private]

The documentation for this class was generated from the following file:

- **acmon.cpp**

## 5.14 acPooling\_wave Class Reference

Inheritance diagram for acPooling\_wave:

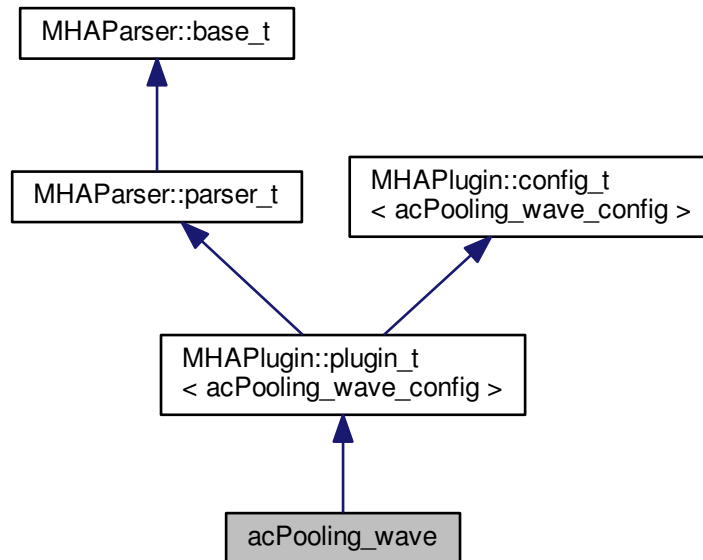

### Public Member Functions

- **acPooling\_wave** (**algo\_comm\_t** &ac, const std::string &chain\_name, const std::string &algo\_name)  
*Constructs our plugin.*
- **~acPooling\_wave** ()
- **mha\_wave\_t \* process** (**mha\_wave\_t \***)  
*Checks for the most recent configuration and defers processing to it.*
- void **prepare** (**mhaconfig\_t** &)  
*Plugin preparation.*
- void **release** (void)

### Public Attributes

- **MHAParser::int\_t** numsamples
- **MHAParser::int\_t** pooling\_wndlen
- **MHAParser::kw\_t** pooling\_type
- **MHAParser::float\_t** upper\_threshold
- **MHAParser::float\_t** lower\_threshold
- **MHAParser::int\_t** neighbourhood



- **MHAParser::float\_t** alpha
- **MHAParser::string\_t** p\_name
- **MHAParser::string\_t** p\_biased\_name
- **MHAParser::string\_t** pool\_name
- **MHAParser::string\_t** max\_pool\_ind\_name
- **MHAParser::string\_t** like\_ratio\_name
- **MHAParser::vfloat\_t** prob\_bias

#### Private Member Functions

- void **update\_cfg** ()

#### Private Attributes

- **MHAEvents::patchbay\_t**< **acPooling\_wave** > patchbay

#### Additional Inherited Members

##### 5.14.1 Constructor & Destructor Documentation

5.14.1.1 **acPooling\_wave::acPooling\_wave** (  
     **algo\_comm\_t** & *ac*,  
     const std::string & *chain\_name*,  
     const std::string & *algo\_name* )

Constructs our plugin.

5.14.1.2 **acPooling\_wave::~~acPooling\_wave** ( )

##### 5.14.2 Member Function Documentation

5.14.2.1 **mha\_wave\_t\*** **acPooling\_wave::process** (  
     **mha\_wave\_t\*** *signal* )

Checks for the most recent configuration and defers processing to it.

5.14.2.2 void **acPooling\_wave::prepare** (  
     **mhaconfig\_t** & *signal\_info* ) [virtual]

Plugin preparation.

An opportunity to validate configuration parameters before instantiating a configuration.

## Parameters

<i>signal_info</i>	Structure containing a description of the form of the signal (domain, number of channels, frames per block, sampling rate).
--------------------	---

Implements **MHAPLugin::plugin\_t< acPooling\_wave\_config >** (p. 730).

5.14.2.3 void acPooling\_wave::release ( void ) [inline],[virtual]

Reimplemented from **MHAPLugin::plugin\_t< acPooling\_wave\_config >** (p. 731).

5.14.2.4 void acPooling\_wave::update\_cfg ( ) [private]

### 5.14.3 Member Data Documentation

5.14.3.1 MHAParser::int\_t acPooling\_wave::numsamples

5.14.3.2 MHAParser::int\_t acPooling\_wave::pooling\_wndlen

5.14.3.3 MHAParser::kw\_t acPooling\_wave::pooling\_type

5.14.3.4 MHAParser::float\_t acPooling\_wave::upper\_threshold

5.14.3.5 MHAParser::float\_t acPooling\_wave::lower\_threshold

5.14.3.6 MHAParser::int\_t acPooling\_wave::neighbourhood

5.14.3.7 MHAParser::float\_t acPooling\_wave::alpha

5.14.3.8 MHAParser::string\_t acPooling\_wave::p\_name

5.14.3.9 MHAParser::string\_t acPooling\_wave::p\_biased\_name

5.14.3.10 MHAParser::string\_t acPooling\_wave::pool\_name

5.14.3.11 MHAParser::string\_t acPooling\_wave::max\_pool\_ind\_name

5.14.3.12 MHAParser::string\_t acPooling\_wave::like\_ratio\_name

5.14.3.13 MHAParser::vfloat\_t acPooling\_wave::prob\_bias

5.14.3.14 MHAEvents::patchbay\_t<acPooling\_wave> acPooling\_wave::patchbay [private]

The documentation for this class was generated from the following files:

- acPooling\_wave.h
- acPooling\_wave.cpp

## 5.15 acPooling\_wave\_config Class Reference

## Public Member Functions

- **acPooling\_wave\_config** (algo\_comm\_t &ac, const mhaconfig\_t in\_cfg, acPooling\_wave \* \_pooling)
- **~acPooling\_wave\_config** ( )
- **mha\_wave\_t \* process** (mha\_wave\_t \*)
- **void insert** ( )

## Public Attributes

- **algo\_comm\_t & ac**
- **std::string raw\_p\_name**
- **MHA\_AC::waveform\_t p**
- **MHA\_AC::waveform\_t p\_biased**
- **MHA\_AC::waveform\_t p\_max**
- **MHA\_AC::waveform\_t like\_ratio**
- **mha\_wave\_t c**
- **unsigned int pooling\_ind**
- **unsigned int pooling\_option**
- **unsigned int pooling\_size**
- **float up\_thresh**
- **float low\_thresh**
- **int neigh**
- **float alpha**
- **MHASignal::waveform\_t pool**
- **MHASignal::waveform\_t prob\_bias\_func**

## 5.15.1 Constructor &amp; Destructor Documentation

5.15.1.1 **acPooling\_wave\_config::acPooling\_wave\_config** (  
     algo\_comm\_t & ac,  
     const mhaconfig\_t in\_cfg,  
     acPooling\_wave \* \_pooling )

5.15.1.2 **acPooling\_wave\_config::~~acPooling\_wave\_config** ( )

## 5.15.2 Member Function Documentation

5.15.2.1 **mha\_wave\_t \* acPooling\_wave\_config::process** (  
     mha\_wave\_t \* wave )

5.15.2.2 **void acPooling\_wave\_config::insert** ( )

### 5.15.3 Member Data Documentation

5.15.3.1 `algo_comm_t& acPooling_wave_config::ac`

5.15.3.2 `std::string acPooling_wave_config::raw_p_name`

5.15.3.3 `MHA_AC::waveform_t acPooling_wave_config::p`

5.15.3.4 `MHA_AC::waveform_t acPooling_wave_config::p_biased`

5.15.3.5 `MHA_AC::waveform_t acPooling_wave_config::p_max`

5.15.3.6 `MHA_AC::waveform_t acPooling_wave_config::like_ratio`

5.15.3.7 `mha_wave_t acPooling_wave_config::c`

5.15.3.8 `unsigned int acPooling_wave_config::pooling_ind`

5.15.3.9 `unsigned int acPooling_wave_config::pooling_option`

5.15.3.10 `unsigned int acPooling_wave_config::pooling_size`

5.15.3.11 `float acPooling_wave_config::up_thresh`

5.15.3.12 `float acPooling_wave_config::low_thresh`

5.15.3.13 `int acPooling_wave_config::neigh`

5.15.3.14 `float acPooling_wave_config::alpha`

5.15.3.15 `MHASignal::waveform_t acPooling_wave_config::pool`

5.15.3.16 `MHASignal::waveform_t acPooling_wave_config::prob_bias_func`

The documentation for this class was generated from the following files:

- `acPooling_wave.h`
- `acPooling_wave.cpp`

## 5.16 acsave::acsave\_t Class Reference

Inheritance diagram for acsave::acsave\_t:

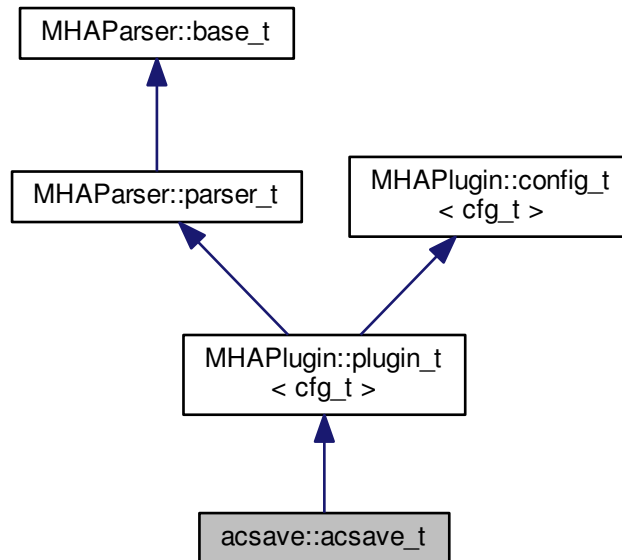

## Public Member Functions

- **acsave\_t** (const **algo\_comm\_t** &, const std::string &, const std::string &)
- void **prepare** (**mhaconfig\_t** &)
- void **release** ()
- **mha\_spec\_t** \* **process** (**mha\_spec\_t** \*)
- **mha\_wave\_t** \* **process** (**mha\_wave\_t** \*)
- void **event\_start\_recording** ()
- void **event\_stop\_and\_flush** ()

## Private Types

- typedef std::vector< **save\_var\_t** \* > **varlist\_t**

## Private Member Functions

- void **process** ()

## Private Attributes

- **MHAParser::bool\_t bflush**
- **MHAParser::kw\_t fileformat**
- **MHAParser::string\_t fname**
- **MHAParser::float\_t reclen**
- **MHAParser::vstring\_t variables**
- **varlist\_t varlist**
- **std::string chain**
- **std::string algo**
- **bool b\_prepared**
- **bool b\_flushed**
- **MHAEvents::patchbay\_t< acsave\_t > patchbay**

## Additional Inherited Members

### 5.16.1 Member Typedef Documentation

5.16.1.1 `typedef std::vector<save_var_t*> acsave::acsave_t::varlist_t` [private]

### 5.16.2 Constructor & Destructor Documentation

5.16.2.1 `acsave::acsave_t::acsave_t (`  
     `const algo_comm_t & iac,`  
     `const std::string & ith,`  
     `const std::string & ial )`

### 5.16.3 Member Function Documentation

5.16.3.1 `void acsave::acsave_t::prepare (`  
     `mhaconfig_t & tf )` [virtual]

Implements **MHAPlugin::plugin\_t< cfg\_t >** (p. 730).

5.16.3.2 `void acsave::acsave_t::release (`  
     `void )` [virtual]

Reimplemented from **MHAPlugin::plugin\_t< cfg\_t >** (p. 731).

5.16.3.3 `mha_spec_t * acsave::acsave_t::process ( mha_spec_t * s )`

5.16.3.4 `mha_wave_t * acsave::acsave_t::process ( mha_wave_t * s )`

5.16.3.5 `void acsave::acsave_t::event_start_recording ( )`

5.16.3.6 `void acsave::acsave_t::event_stop_and_flush ( )`

5.16.3.7 `void acsave::acsave_t::process ( void ) [private]`

#### 5.16.4 Member Data Documentation

5.16.4.1 `MHAParser::bool_t acsave::acsave_t::bflush [private]`

5.16.4.2 `MHAParser::kw_t acsave::acsave_t::fileformat [private]`

5.16.4.3 `MHAParser::string_t acsave::acsave_t::fname [private]`

5.16.4.4 `MHAParser::float_t acsave::acsave_t::reclen [private]`

5.16.4.5 `MHAParser::vstring_t acsave::acsave_t::variables [private]`

5.16.4.6 `varlist_t acsave::acsave_t::varlist [private]`

5.16.4.7 `std::string acsave::acsave_t::chain [private]`

5.16.4.8 `std::string acsave::acsave_t::algo [private]`

5.16.4.9 `bool acsave::acsave_t::b_prepared [private]`

5.16.4.10 `bool acsave::acsave_t::b_flushed [private]`

5.16.4.11 `MHAEvents::patchbay_t<acsave_t> acsave::acsave_t::patchbay [private]`

The documentation for this class was generated from the following file:

- `acsave.cpp`

## 5.17 acsave::cfg\_t Class Reference

### Public Member Functions

- **cfg\_t** (const **algo\_comm\_t** &iac, unsigned int imax\_frames, std::vector< std::string > &var\_names)
- **~cfg\_t** ()
- void **store\_frame** ()
- void **flush\_data** (const std::string &, unsigned int)

### Private Attributes

- **algo\_comm\_t** ac
- unsigned int **nvars**
- **save\_var\_t** \*\* varlist
- unsigned int **rec\_frames**
- unsigned int **max\_frames**

### 5.17.1 Constructor & Destructor Documentation

5.17.1.1 **cfg\_t::cfg\_t** (  
           const **algo\_comm\_t** & iac,  
           unsigned int *imax\_frames*,  
           std::vector< std::string > & *var\_names* )

5.17.1.2 **cfg\_t::~~cfg\_t** ( )

### 5.17.2 Member Function Documentation

5.17.2.1 void **cfg\_t::store\_frame** ( )

This function is called in the processing thread.

5.17.2.2 void **cfg\_t::flush\_data** (  
           const std::string & *filename*,  
           unsigned int *fmt* )

This function is called in the configuration thread.

#### Parameters

<i>filename</i>	Output file name
<i>fmt</i>	Output file format



### 5.17.3 Member Data Documentation

5.17.3.1 `algo_comm_t` `acsave::cfg_t::ac` [private]

5.17.3.2 `unsigned int` `acsave::cfg_t::nvars` [private]

5.17.3.3 `save_var_t**` `acsave::cfg_t::varlist` [private]

5.17.3.4 `unsigned int` `acsave::cfg_t::rec_frames` [private]

5.17.3.5 `unsigned int` `acsave::cfg_t::max_frames` [private]

The documentation for this class was generated from the following file:

- `acsave.cpp`

## 5.18 `acsave::mat4head_t` Struct Reference

### Public Attributes

- `int32_t` `t`
- `int32_t` `rows`
- `int32_t` `cols`
- `int32_t` `imag`
- `int32_t` `namelen`

### 5.18.1 Member Data Documentation

5.18.1.1 `int32_t` `acsave::mat4head_t::t`

5.18.1.2 `int32_t` `acsave::mat4head_t::rows`

5.18.1.3 `int32_t` `acsave::mat4head_t::cols`

5.18.1.4 `int32_t` `acsave::mat4head_t::imag`

5.18.1.5 `int32_t` `acsave::mat4head_t::namelen`

The documentation for this struct was generated from the following file:

- `acsave.cpp`

## 5.19 `acsave::save_var_t` Class Reference

### Public Member Functions

- `save_var_t` (const std::string &, int, const `algo_comm_t` &)
- `~save_var_t` ()
- void `store_frame` ()
- void `save_txt` (FILE \*, unsigned int)
- void `save_mat4` (FILE \*, unsigned int)
- void `save_m` (FILE \*, unsigned int)

### Public Attributes

- double \* `data`

### Private Attributes

- std::string `name`
- unsigned int `nframes`
- unsigned int `ndim`
- unsigned int `maxframe`
- `algo_comm_t` `ac`
- unsigned int `framecnt`
- bool `b_complex`

### 5.19.1 Constructor & Destructor Documentation

5.19.1.1 `acsave::save_var_t::save_var_t` (  
     const std::string & *nm*,  
     int *n*,  
     const `algo_comm_t` & *iac* )

5.19.1.2 `acsave::save_var_t::~~save_var_t` ( )

### 5.19.2 Member Function Documentation

5.19.2.1 void `acsave::save_var_t::store_frame` ( )

5.19.2.2 void `acsave::save_var_t::save_txt` (  
     FILE \* *fh*,  
     unsigned int *writeframes* )

5.19.2.3 `void acsave::save_var_t::save_mat4 (`  
    `FILE * fh,`  
    `unsigned int writeframes )`

5.19.2.4 `void acsave::save_var_t::save_m (`  
    `FILE * fh,`  
    `unsigned int writeframes )`

### 5.19.3 Member Data Documentation

5.19.3.1 `double* acsave::save_var_t::data`

5.19.3.2 `std::string acsave::save_var_t::name` [private]

5.19.3.3 `unsigned int acsave::save_var_t::nframes` [private]

5.19.3.4 `unsigned int acsave::save_var_t::ndim` [private]

5.19.3.5 `unsigned int acsave::save_var_t::maxframe` [private]

5.19.3.6 `algo_comm_t acsave::save_var_t::ac` [private]

5.19.3.7 `unsigned int acsave::save_var_t::framecnt` [private]

5.19.3.8 `bool acsave::save_var_t::b_complex` [private]

The documentation for this class was generated from the following file:

- `acsave.cpp`

## 5.20 acSteer Class Reference

Inheritance diagram for acSteer:

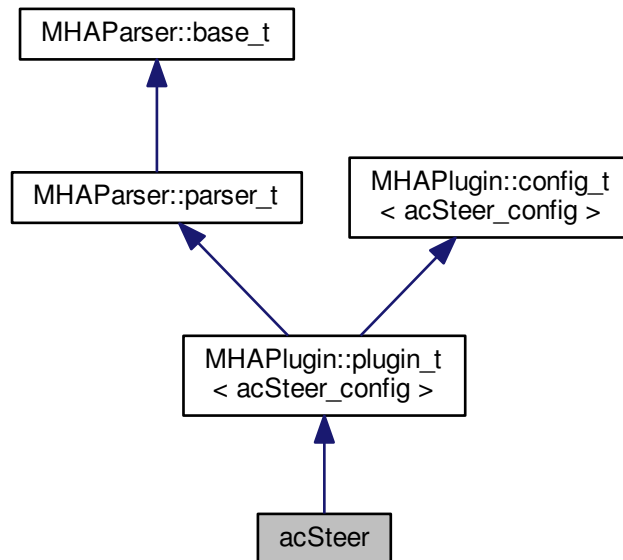

### Public Member Functions

- **acSteer** (**algo\_comm\_t** &**ac**, const std::string &chain\_name, const std::string &algo\_name)
  - Constructs our plugin.*
- **~acSteer** ()
- **mha\_spec\_t \* process** (**mha\_spec\_t \***)
  - This method is a NOOP.*
- void **prepare** (**mhaconfig\_t** &)
- void **release** (void)

### Public Attributes

- **MHAParser::string\_t** steerFile
- **MHAParser::string\_t** acSteerName1
- **MHAParser::string\_t** acSteerName2
- **MHAParser::int\_t** nsteerchan
- **MHAParser::int\_t** nrefmic

## Private Member Functions

- void **update\_cfg** ()

## Private Attributes

- **MHAEvents::patchbay\_t**< **acSteer** > **patchbay**

## Additional Inherited Members

## 5.20.1 Constructor &amp; Destructor Documentation

5.20.1.1 **acSteer::acSteer** (  
     **algo\_comm\_t** & *ac*,  
     const std::string & *chain\_name*,  
     const std::string & *algo\_name* )

Constructs our plugin.

5.20.1.2 **acSteer::~~acSteer** ( )

## 5.20.2 Member Function Documentation

5.20.2.1 **mha\_spec\_t**\* **acSteer::process** (  
     **mha\_spec\_t**\* *signal* )

This method is a NOOP.

5.20.2.2 void **acSteer::prepare** (  
     **mhaconfig\_t** & *signal\_info* ) [virtual]

Plugin preparation.

An opportunity to validate configuration parameters before instantiating a configuration.

## Parameters

<i>signal_info</i>	Structure containing a description of the form of the signal (domain, number of channels, frames per block, sampling rate).
--------------------	---

Implements **MHAPlugin::plugin\_t**< **acSteer\_config** > (p. 730).

5.20.2.3 void `acSteer::release` (  
     void ) [`inline`],[`virtual`]

Reimplemented from `MHAPLugin::plugin_t< acSteer_config >` (p. 731).

5.20.2.4 void `acSteer::update_cfg` ( ) [`private`]

## 5.20.3 Member Data Documentation

5.20.3.1 `MHAParser::string_t` `acSteer::steerFile`

5.20.3.2 `MHAParser::string_t` `acSteer::acSteerName1`

5.20.3.3 `MHAParser::string_t` `acSteer::acSteerName2`

5.20.3.4 `MHAParser::int_t` `acSteer::nsteerchan`

5.20.3.5 `MHAParser::int_t` `acSteer::nrefmic`

5.20.3.6 `MHAEvents::patchbay_t<acSteer>` `acSteer::patchbay` [`private`]

The documentation for this class was generated from the following files:

- `acSteer.h`
- `acSteer.cpp`

## 5.21 `acSteer_config` Class Reference

### Public Member Functions

- `acSteer_config` (`algo_comm_t` &`ac`, const `mhaconfig_t` `in_cfg`, `acSteer` \*`acSteer`)
- `~acSteer_config` ()
- void `insert` ()

### Public Attributes

- unsigned int `nchan`
- unsigned int `nfreq`
- unsigned int `nsteerchan`
- unsigned int `nrefmic`
- unsigned int `nangle`
- `MHA_AC::spectrum_t` `specSteer1`
- `MHA_AC::spectrum_t` `specSteer2`

### 5.21.1 Constructor & Destructor Documentation

5.21.1.1 `acSteer_config::acSteer_config ( algo_comm_t & ac, const mhaconfig_t in_cfg, acSteer * acSteer )`

5.21.1.2 `acSteer_config::~acSteer_config ( )`

### 5.21.2 Member Function Documentation

5.21.2.1 `void acSteer_config::insert ( )`

### 5.21.3 Member Data Documentation

5.21.3.1 `unsigned int acSteer_config::nchan`

5.21.3.2 `unsigned int acSteer_config::nfreq`

5.21.3.3 `unsigned int acSteer_config::nsteerchan`

5.21.3.4 `unsigned int acSteer_config::nrefmic`

5.21.3.5 `unsigned int acSteer_config::nangle`

5.21.3.6 `MHA_AC::spectrum_t acSteer_config::specSteer1`

5.21.3.7 `MHA_AC::spectrum_t acSteer_config::specSteer2`

The documentation for this class was generated from the following files:

- `acSteer.h`
- `acSteer.cpp`

## 5.22 acTransform\_wave Class Reference

Inheritance diagram for acTransform\_wave:

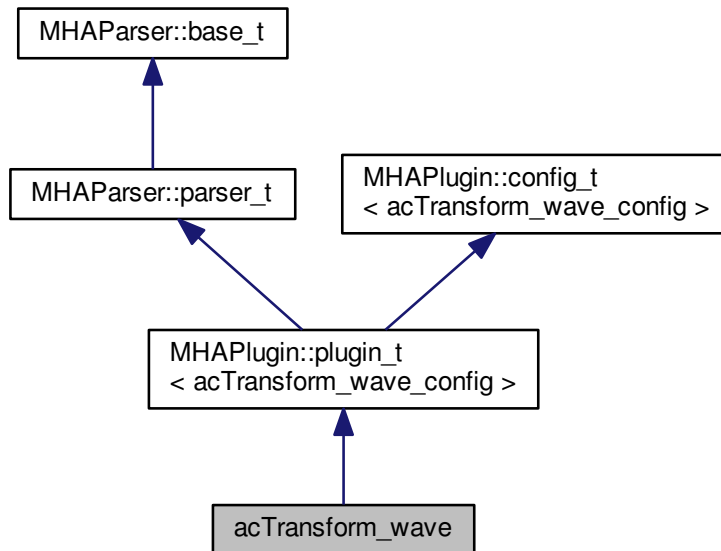

### Public Member Functions

- **acTransform\_wave** (algo\_comm\_t &ac, const std::string &chain\_name, const std::string &algo\_name)  
*Constructs our plugin.*
- **~acTransform\_wave** ()
- **mha\_wave\_t \* process** (mha\_wave\_t \*)  
*Checks for the most recent configuration and defers processing to it.*
- void **prepare** (mhaconfig\_t &)  
*Plugin preparation.*
- void **release** (void)

### Public Attributes

- **MHAParser::string\_t ang\_name**
- **MHAParser::string\_t raw\_p\_name**
- **MHAParser::string\_t raw\_p\_max\_name**
- **MHAParser::string\_t rotated\_p\_name**
- **MHAParser::string\_t rotated\_p\_max\_name**
- **MHAParser::int\_t numsamples**
- **MHAParser::bool\_t to\_from**



## Private Member Functions

- void **update\_cfg** ()

## Private Attributes

- **MHAEvents::patchbay\_t**< acTransform\_wave > **patchbay**

## Additional Inherited Members

## 5.22.1 Constructor &amp; Destructor Documentation

5.22.1.1 acTransform\_wave::acTransform\_wave (   
                   algo\_comm\_t & ac,   
                   const std::string & chain\_name,   
                   const std::string & algo\_name )

Constructs our plugin.

5.22.1.2 acTransform\_wave::~acTransform\_wave ( )

## 5.22.2 Member Function Documentation

5.22.2.1 mha\_wave\_t \* acTransform\_wave::process (   
                   mha\_wave\_t \* signal )

Checks for the most recent configuration and defers processing to it.

5.22.2.2 void acTransform\_wave::prepare (   
                   mhaconfig\_t & signal\_info ) [virtual]

Plugin preparation.

An opportunity to validate configuration parameters before instantiating a configuration.

## Parameters

<i>signal_info</i>	Structure containing a description of the form of the signal (domain, number of channels, frames per block, sampling rate).
--------------------	---

Implements **MHAPlugin::plugin\_t**< acTransform\_wave\_config > (p. 730).

5.22.2.3 `void acTransform_wave::release ( void ) [inline],[virtual]`

Reimplemented from `MHAPLugin::plugin_t< acTransform_wave_config >` (p. 731).

5.22.2.4 `void acTransform_wave::update_cfg ( ) [private]`

### 5.22.3 Member Data Documentation

5.22.3.1 `MHAParser::string_t acTransform_wave::ang_name`

5.22.3.2 `MHAParser::string_t acTransform_wave::raw_p_name`

5.22.3.3 `MHAParser::string_t acTransform_wave::raw_p_max_name`

5.22.3.4 `MHAParser::string_t acTransform_wave::rotated_p_name`

5.22.3.5 `MHAParser::string_t acTransform_wave::rotated_p_max_name`

5.22.3.6 `MHAParser::int_t acTransform_wave::numsamples`

5.22.3.7 `MHAParser::bool_t acTransform_wave::to_from`

5.22.3.8 `MHAEvents::patchbay_t<acTransform_wave> acTransform_wave::patchbay [private]`

The documentation for this class was generated from the following files:

- `acTransform_wave.h`
- `acTransform_wave.cpp`

## 5.23 `acTransform_wave_config` Class Reference

### Public Member Functions

- `acTransform_wave_config (algo_comm_t &ac, const mhaconfig_t in_cfg, acTransform_wave *_transform)`
- `~acTransform_wave_config ()`
- `mha_wave_t * process (mha_wave_t *)`

## Public Attributes

- **algo\_comm\_t** & **ac**
- std::string **ang\_name**
- std::string **raw\_p\_name**
- std::string **raw\_p\_max\_name**
- **MHA\_AC::waveform\_t** **rotated\_p**
- **MHA\_AC::int\_t** **rotated\_i**
- unsigned int **offset**
- unsigned int **resolution**
- unsigned int **to\_from**

## 5.23.1 Constructor & Destructor Documentation

5.23.1.1 `acTransform_wave_config::acTransform_wave_config ( algo_comm_t & ac, const mhaconfig_t in_cfg, acTransform_wave * _transform )`

5.23.1.2 `acTransform_wave_config::~~acTransform_wave_config ( )`

## 5.23.2 Member Function Documentation

5.23.2.1 `mha_wave_t * acTransform_wave_config::process ( mha_wave_t * wave )`

## 5.23.3 Member Data Documentation

5.23.3.1 `algo_comm_t& acTransform_wave_config::ac`

5.23.3.2 `std::string acTransform_wave_config::ang_name`

5.23.3.3 `std::string acTransform_wave_config::raw_p_name`

5.23.3.4 `std::string acTransform_wave_config::raw_p_max_name`

5.23.3.5 `MHA_AC::waveform_t acTransform_wave_config::rotated_p`

5.23.3.6 `MHA_AC::int_t acTransform_wave_config::rotated_i`

5.23.3.7 `unsigned int acTransform_wave_config::offset`

5.23.3.8 `unsigned int acTransform_wave_config::resolution`

5.23.3.9 `unsigned int acTransform_wave_config::to_from`

The documentation for this class was generated from the following files:

- **acTransform\_wave.h**
- **acTransform\_wave.cpp**

## 5.24 addsndfile::addsndfile\_if\_t Class Reference

Inheritance diagram for addsndfile::addsndfile\_if\_t:

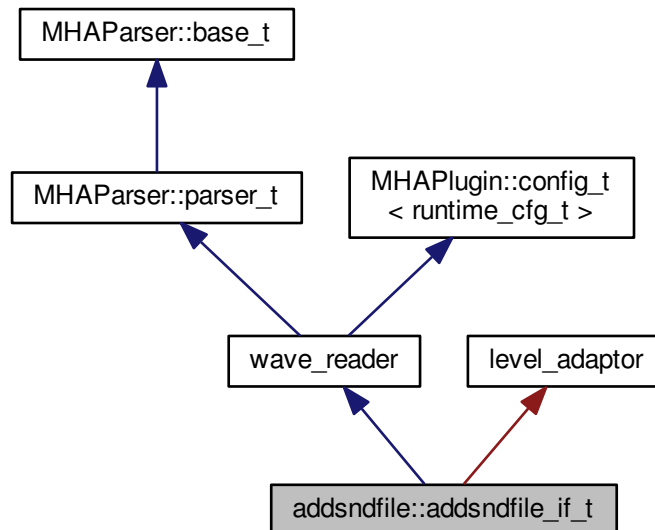

### Public Member Functions

- **addsndfile\_if\_t** (**algo\_comm\_t**, const char \*, const char \*)
- **mha\_wave\_t \* process** (**mha\_wave\_t \***)
- void **prepare** (**mhaconfig\_t &**)
- void **release** ()

### Private Member Functions

- void **update** ()
- void **change\_mode** ()
- void **set\_level** ()
- void **scan\_dir** ()

### Private Attributes

- **MHAParser::string\_t** filename
- **MHAParser::string\_t** path
- **MHAParser::bool\_t** loop
- **MHAParser::float\_t** level

- **MHAParser::kw\_t levelmode**
- **MHAParser::kw\_t resamplingmode**
- **MHAParser::vint\_t channels**
- **MHAParser::kw\_t mode**
- **MHAParser::float\_t ramplen**
- **MHAParser::int\_t startpos**
- **MHAParser::vint\_mon\_t mapping**
- **MHAParser::int\_mon\_t numchannels**
- **MHAParser::int\_mon\_t mhachannels**
- **MHAParser::int\_mon\_t active**
- **MHAParser::string\_t search\_pattern**
- **MHAParser::vstring\_mon\_t search\_result**
- unsigned int **uint\_mode**
- **MHAEvents::patchbay\_t** < **addsndfile\_if\_t** > **patchbay**

#### Additional Inherited Members

#### 5.24.1 Constructor & Destructor Documentation

5.24.1.1 **addsndfile::addsndfile\_if\_t::addsndfile\_if\_t** (  
    **algo\_comm\_t iac**,  
    **const char \***,  
    **const char \*** )

#### 5.24.2 Member Function Documentation

5.24.2.1 **mha\_wave\_t \*** **addsndfile::addsndfile\_if\_t::process** (  
    **mha\_wave\_t \* s** )

5.24.2.2 **void** **addsndfile::addsndfile\_if\_t::prepare** (  
    **mhaconfig\_t & tf** ) [*virtual*]

Implements **MHAPlugin::plugin\_t** < **runtime\_cfg\_t** > (p. 730).

5.24.2.3 **void** **addsndfile::addsndfile\_if\_t::release** (  
    **void** ) [*virtual*]

Reimplemented from **MHAPlugin::plugin\_t** < **runtime\_cfg\_t** > (p. 731).

- 5.24.2.4 void addsndfile::addsndfile\_if\_t::update ( ) [private]
- 5.24.2.5 void addsndfile::addsndfile\_if\_t::change\_mode ( ) [private]
- 5.24.2.6 void addsndfile::addsndfile\_if\_t::set\_level ( ) [private]
- 5.24.2.7 void addsndfile::addsndfile\_if\_t::scan\_dir ( ) [private]
- 5.24.3 Member Data Documentation
  - 5.24.3.1 MHAParser::string\_t addsndfile::addsndfile\_if\_t::filename [private]
  - 5.24.3.2 MHAParser::string\_t addsndfile::addsndfile\_if\_t::path [private]
  - 5.24.3.3 MHAParser::bool\_t addsndfile::addsndfile\_if\_t::loop [private]
  - 5.24.3.4 MHAParser::float\_t addsndfile::addsndfile\_if\_t::level [private]
  - 5.24.3.5 MHAParser::kw\_t addsndfile::addsndfile\_if\_t::levelmode [private]
  - 5.24.3.6 MHAParser::kw\_t addsndfile::addsndfile\_if\_t::resamplingmode [private]
  - 5.24.3.7 MHAParser::vint\_t addsndfile::addsndfile\_if\_t::channels [private]
  - 5.24.3.8 MHAParser::kw\_t addsndfile::addsndfile\_if\_t::mode [private]
  - 5.24.3.9 MHAParser::float\_t addsndfile::addsndfile\_if\_t::ramplen [private]
  - 5.24.3.10 MHAParser::int\_t addsndfile::addsndfile\_if\_t::startpos [private]
  - 5.24.3.11 MHAParser::vint\_mon\_t addsndfile::addsndfile\_if\_t::mapping [private]
  - 5.24.3.12 MHAParser::int\_mon\_t addsndfile::addsndfile\_if\_t::numchannels [private]
  - 5.24.3.13 MHAParser::int\_mon\_t addsndfile::addsndfile\_if\_t::mhachannels [private]
  - 5.24.3.14 MHAParser::int\_mon\_t addsndfile::addsndfile\_if\_t::active [private]
  - 5.24.3.15 MHAParser::string\_t addsndfile::addsndfile\_if\_t::search\_pattern [private]
  - 5.24.3.16 MHAParser::vstring\_mon\_t addsndfile::addsndfile\_if\_t::search\_result [private]
  - 5.24.3.17 unsigned int addsndfile::addsndfile\_if\_t::uint\_mode [private]
  - 5.24.3.18 MHAEvents::patchbay\_t<addsndfile\_if\_t> addsndfile::addsndfile\_if\_t::patchbay [private]

The documentation for this class was generated from the following file:

- **addsndfile.cpp**

## 5.25 addsndfile::level\_adapt\_t Class Reference

Inheritance diagram for addsndfile::level\_adapt\_t:

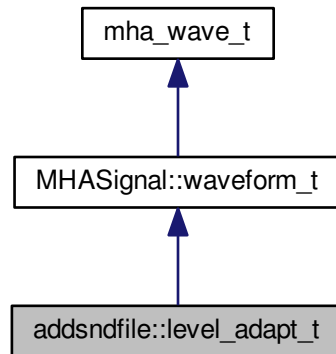

## Public Member Functions

- **level\_adapt\_t** (*mhaconfig\_t* cf, *mha\_real\_t* adapt\_len, *mha\_real\_t* l\_new\_, *mha\_real\_t* l\_old\_)
- void **update\_frame** ()
- *mha\_real\_t* **get\_level** () const
- bool **can\_update** () const

## Private Attributes

- unsigned int **ilen**
- unsigned int **pos**
- **MHAWindow::fun\_t** wnd
- *mha\_real\_t* l\_new
- *mha\_real\_t* l\_old

## Additional Inherited Members

## 5.25.1 Constructor &amp; Destructor Documentation

5.25.1.1 addsndfile::level\_adapt\_t::level\_adapt\_t (  
*mhaconfig\_t* cf,  
*mha\_real\_t* adapt\_len,  
*mha\_real\_t* l\_new\_,  
*mha\_real\_t* l\_old\_ )

## 5.25.2 Member Function Documentation

5.25.2.1 `void addsndfile::level_adapt_t::update_frame ( )`

5.25.2.2 `mha_real_t addsndfile::level_adapt_t::get_level ( ) const` [inline]

5.25.2.3 `bool addsndfile::level_adapt_t::can_update ( ) const` [inline]

## 5.25.3 Member Data Documentation

5.25.3.1 `unsigned int addsndfile::level_adapt_t::ilen` [private]

5.25.3.2 `unsigned int addsndfile::level_adapt_t::pos` [private]

5.25.3.3 `MHAWindow::fun_t addsndfile::level_adapt_t::wnd` [private]

5.25.3.4 `mha_real_t addsndfile::level_adapt_t::l_new` [private]

5.25.3.5 `mha_real_t addsndfile::level_adapt_t::l_old` [private]

The documentation for this class was generated from the following file:

- `addsndfile.cpp`

## 5.26 `addsndfile::resampled_soundfile_t` Class Reference

Reads sound from file and resamples it if necessary and wanted.

Inheritance diagram for `addsndfile::resampled_soundfile_t`:

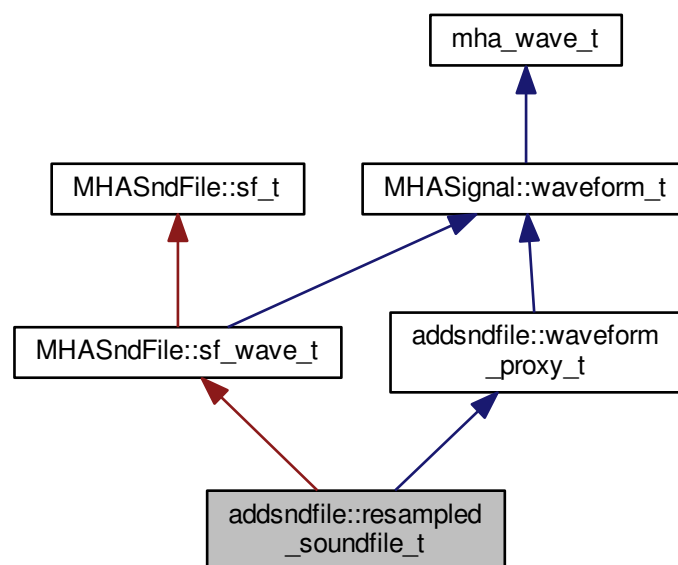



## Public Member Functions

- **resampled\_soundfile\_t** (const std::string &name, float mha\_sampling\_rate, **addsndfile\_↔  
\_resampling\_mode\_t** resampling\_mode)

*Reads sound from file and resamples if necessary and wanted.*

## Additional Inherited Members

## 5.26.1 Detailed Description

Reads sound from file and resamples it if necessary and wanted.

Sound data can then be used by addsndfile.

## 5.26.2 Constructor &amp; Destructor Documentation

5.26.2.1 **addsndfile::resampled\_soundfile\_t::resampled\_soundfile\_t** (  
     const std::string & name,  
     float mha\_sampling\_rate,  
     **addsndfile\_resampling\_mode\_t** resampling\_mode )

Reads sound from file and resamples if necessary and wanted.

If the sound file does not specify a sampling rate, then the sound data is always used without resampling.

## Parameters

<i>name</i>	Sound file name
<i>mha_sampling_rate</i>	The sampling rate of the MHA signal processing at the point of the addsndfile plugin
<i>resampling_mode</i>	DONT_RESAMPLE_STRICT: Do not resample, just use the samples from the sound file at the current sample rate, even if the sample rate of the sound file differs. DONT_RESAMPLE_PERMISSIVE: Do not resample, if the sample rate of the MHA differs from the sample rate of the sound file, raise an error. DO_RESAMPLE: Resample.

## Exceptions

<b>MHA_Error</b> (p. 445)	If the sampling rate of the file does not match the sampling rate of the MHA and DONT_RESAMPLE_STRICT was requested. If resampling failed (e.g. due to non-rational quotient of MHA sampling rate and sound file sampling rate).
---------------------------	--

The documentation for this class was generated from the following file:

- **addsndfile.cpp**

## 5.27 addsndfile::sndfile\_t Class Reference

Inheritance diagram for addsndfile::sndfile\_t:

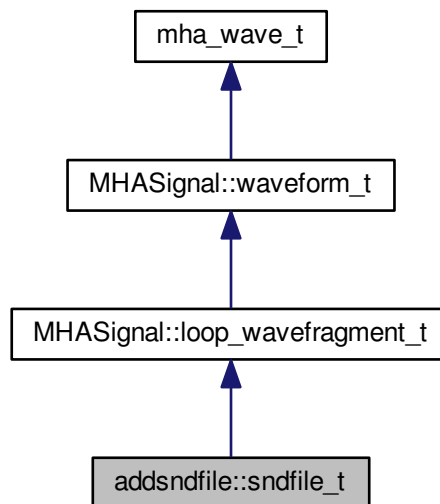

### Public Member Functions

- **sndfile\_t** (const std::string &name, bool loop, unsigned int level\_mode, std::vector< int > channels\_, unsigned int nchannels, std::vector< int > &mapping, int &numchannels, unsigned int startpos, float mha\_sampling\_rate, **addsndfile\_resampling\_mode\_t** resampling\_mode)

### Additional Inherited Members

#### 5.27.1 Constructor & Destructor Documentation

```

5.27.1.1 addsndfile::sndfile_t::sndfile_t (
    const std::string & name,
    bool loop,
    unsigned int level_mode,
    std::vector< int > channels_,
    unsigned int nchannels,
    std::vector< int > & mapping,
    int & numchannels,
    unsigned int startpos,
    float mha_sampling_rate,
    addsndfile_resampling_mode_t resampling_mode )

```

The documentation for this class was generated from the following file:

- **addsndfile.cpp**

## 5.28 addsndfile::waveform\_proxy\_t Class Reference

Class helps to specify which instance of MHASignal\_waveform\_t parent instance is meant in **resampled\_soundfile\_t** (p. 184).

Inheritance diagram for addsndfile::waveform\_proxy\_t:

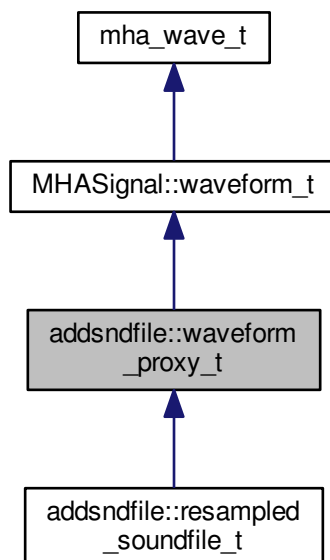

### Public Member Functions

- **waveform\_proxy\_t** (unsigned frames, unsigned **channels**)

## Additional Inherited Members

### 5.28.1 Detailed Description

Class helps to specify which instance of `MHASignal_waveform_t` parent instance is meant in `resampled_soundfile_t` (p. 184).

### 5.28.2 Constructor & Destructor Documentation

5.28.2.1 `addsndfile::waveform_proxy_t::waveform_proxy_t( unsigned frames, unsigned channels ) [inline]`

The documentation for this class was generated from the following file:

- `addsndfile.cpp`

## 5.29 `ADM::ADM< F >` Class Template Reference

Adaptive differential microphone, working for speech frequency range.

### Public Member Functions

- **ADM** (F fs, F dist, unsigned lp\_order, const F \*lp\_alphas, unsigned decomb\_order, const F \*decomb\_alphas, F tau\_beta=F(50e-3), F mu\_beta=F(1e-4))  
*Create Adaptive Differential Microphone.*
- F **process** (const F &front, const F &back, const F &external\_beta=F(-1))  
*ADM* (p. 188) *processes one frame.*
- F **beta** () const

### Private Attributes

- `Delay< F > m_delay_front`
- `Delay< F > m_delay_back`
- `Linearphase_FIR< F > m_lp_bf`
- `Linearphase_FIR< F > m_lp_result`
- `Linearphase_FIR< F > m_decomb`
- F `m_beta`
- F `m_mu_beta`
- F `m_powerfilter_coeff`
- F `m_powerfilter_norm`
- F `m_powerfilter_state`

## 5.29.1 Detailed Description

```
template<class F>
class ADM::ADM< F >
```

Adaptive differential microphone, working for speech frequency range.

## 5.29.2 Constructor &amp; Destructor Documentation

```
5.29.2.1 template<class F > ADM::ADM< F >::ADM (
    F fs,
    F dist,
    unsigned lp_order,
    const F * lp_alphas,
    unsigned decomb_order,
    const F * decomb_alphas,
    F tau_beta = F (50e-3),
    F mu_beta = F (1e-4) )
```

Create Adaptive Differential Microphone.

## Parameters

<i>fs</i>	Sampling rate / Hz
<i>dist</i>	Distance between physical microphones / m
<i>lp_order</i>	Filter order of FIR lowpass filter used for adaptation
<i>lp_alphas</i>	Pointer to array of alpha coefficients for the lowpass filter used for adaptation. Since this class uses linear phase FIR filters only, only the first half ( $order/2 + 1$ ) of the coefficients will be read (coefficients for linear-phase FIR filters are symmetric).
<i>decomb_order</i>	Filter order of FIR compensation filter (compensates for comb filter characteristic)
<i>decomb_alphas</i>	Pointer to array of alpha coefficients for the compensation filter used to compensate for the comb filter characteristic. Since this class uses linear phase FIR filters only, only the first half ( $order/2 + 1$ ) of the coefficients will be read (coefficients for linear-phase FIR filters are symmetric).
<i>tau_beta</i>	Time constant of the lowpass filter used for averaging the power of the output signal
<i>mu_beta</i>	adaption speed

## 5.29.3 Member Function Documentation

```
5.29.3.1 template<class F> F ADM::ADM<F>::process (
    const F & front,
    const F & back,
    const F & external_beta = F(-1) ) [inline]
```

**ADM** (p. 188) processes one frame.

#### Parameters

<i>front</i>	The current front input signal sample
<i>back</i>	The current rear input signal sample
<i>external_beta</i>	If $\geq 0$ , this is used as the "beta" parameter for direction to filter out. Else, the beta parameter is adapted to filtered out a direction so that best reduction of signal intensity from the back hemisphere is achieved.

#### Returns

The computed output sample

```
5.29.3.2 template<class F> F ADM::ADM<F>::beta ( ) const [inline]
```

#### 5.29.4 Member Data Documentation

```
5.29.4.1 template<class F> Delay<F> ADM::ADM<F>::m_delay_front [private]
```

```
5.29.4.2 template<class F> Delay<F> ADM::ADM<F>::m_delay_back [private]
```

```
5.29.4.3 template<class F> Linearphase_FIR<F> ADM::ADM<F>::m_lp_bf [private]
```

```
5.29.4.4 template<class F> Linearphase_FIR<F> ADM::ADM<F>::m_lp_result [private]
```

```
5.29.4.5 template<class F> Linearphase_FIR<F> ADM::ADM<F>::m_decomb [private]
```

```
5.29.4.6 template<class F> F ADM::ADM<F>::m_beta [private]
```

```
5.29.4.7 template<class F> F ADM::ADM<F>::m_mu_beta [private]
```

```
5.29.4.8 template<class F> F ADM::ADM<F>::m_powerfilter_coeff [private]
```

```
5.29.4.9 template<class F> F ADM::ADM<F>::m_powerfilter_norm [private]
```

```
5.29.4.10 template<class F> F ADM::ADM<F>::m_powerfilter_state [private]
```

The documentation for this class was generated from the following file:

- **adm.hh**

### 5.30 ADM::Delay< F > Class Template Reference

A delay-line class which can also do subsample-delays for a limited frequency range below  $fs/4$ .

#### Public Member Functions

- **Delay** (F samples, F f\_design, F fs)  
*Create a signal delay object.*
- **~Delay** ()
- F **process** (const F &in\_sample)  
*Apply delay to signal.*

#### Private Attributes

- unsigned **m\_fullsamples**  
*Integer part of delay.*
- F **m\_coeff**  
*coefficient for 1st order IIR lowpass filter which does the subsample delay*
- F **m\_norm**  
*normalization for the IIR subsample delay filter*
- F \* **m\_state**  
*Ringbuffer: Delayline.*
- unsigned **m\_now\_in**  
*current position for inserting new samples into m\_state ringbuffer*

#### 5.30.1 Detailed Description

```
template<class F>
class ADM::Delay< F >
```

A delay-line class which can also do subsample-delays for a limited frequency range below  $fs/4$ .

#### 5.30.2 Constructor & Destructor Documentation

```
5.30.2.1 template<class F > ADM::Delay< F >::Delay (
                F samples,
                F f_design,
                F fs )
```

Create a signal delay object.

**Parameters**

<i>samples</i>	number of samples to delay (may be non-integer)
<i>f_design</i>	subsampledelay is exact for this frequency
<i>fs</i>	sampling frequency

5.30.2.2 `template<class F> ADM::Delay< F >::~~Delay ( )`

**5.30.3 Member Function Documentation**

5.30.3.1 `template<class F> F ADM::Delay< F >::process ( const F & in_sample ) [inline]`

Apply delay to signal.

**Parameters**

<i>in_sample</i>	The current input signal sample
------------------	---------------------------------

**Returns**

The computed output sample

**5.30.4 Member Data Documentation**

5.30.4.1 `template<class F> unsigned ADM::Delay< F >::m_fullsamples [private]`

Integer part of delay.

5.30.4.2 `template<class F> F ADM::Delay< F >::m_coeff [private]`

coefficient for 1st order IIR lowpass filter which does the subsample delay

5.30.4.3 `template<class F> F ADM::Delay< F >::m_norm [private]`

normalization for the IIR subsample delay filter

5.30.4.4 `template<class F> F* ADM::Delay< F >::m_state [private]`

Ringbuffer: Delayline.



5.30.4.5 `template<class F> unsigned ADM::Delay< F >::m_now_in` [private]

current position for inserting new samples into m\_state ringbuffer

The documentation for this class was generated from the following file:

- **adm.hh**

## 5.31 ADM::Linearphase\_FIR< F > Class Template Reference

An efficient linear-phase fir filter implementation.

### Public Member Functions

- **Linearphase\_FIR** (unsigned order, const F \*alphas)  
*Create linear-phase FIR filter.*
- **~Linearphase\_FIR** ()
- F **process** (const F &in\_sample)  
*Filter one sample with this linear-phase FIR filter.*

### Private Attributes

- unsigned **m\_order**  
*The filter order of this linear-phase FIR filter.*
- F \* **m\_alphas**  
*FIR filter coefficients.*
- F \* **m\_output**  
*Ringbuffer for building future output.*
- unsigned **m\_now**  
*current start of ringbuffer*

### 5.31.1 Detailed Description

```
template<class F>
class ADM::Linearphase_FIR< F >
```

An efficient linear-phase fir filter implementation.

### 5.31.2 Constructor & Destructor Documentation

```
5.31.2.1 template<class F> ADM::Linearphase_FIR< F >::Linearphase_FIR (
    unsigned order,
    const F * alphas )
```

Create linear-phase FIR filter.

**Parameters**

<i>order</i>	filter order of this FIR filter. restriction: must be even.
<i>alphas</i>	pointer to Array of alpha coefficients. Since this class is for linear phase FIR filters only, only $(order / 2 + 1)$ coefficients will be read. (Coefficients for linear-phase FIR filters are symmetric.)

5.31.2.2 `template<class F > ADM::Linearphase_FIR< F >::~~Linearphase_FIR ( )`

**5.31.3 Member Function Documentation**

5.31.3.1 `template<class F > F ADM::Linearphase_FIR< F >::process ( const F & in_sample ) [inline]`

Filter one sample with this linear-phase FIR filter.

**Parameters**

<i>in_sample</i>	the current input sample
------------------	--------------------------

**Returns**

the computed output sample

**5.31.4 Member Data Documentation**

5.31.4.1 `template<class F > unsigned ADM::Linearphase_FIR< F >::m_order [private]`

The filter order of this linear-phase FIR filter.

5.31.4.2 `template<class F > F* ADM::Linearphase_FIR< F >::m_alphas [private]`

FIR filter coefficients.

Only  $m\_order / 2 + 1$  coefficients need to be stored since coefficients of linear-phase FIR filters are symmetric

5.31.4.3 `template<class F > F* ADM::Linearphase_FIR< F >::m_output [private]`

Ringbuffer for building future output.

5.31.4.4 `template<class F> unsigned ADM::Linearphase_FIR< F >::m_now` [private]

current start of ringbuffer

The documentation for this class was generated from the following file:

- **adm.hh**

## 5.32 adm\_if\_t Class Reference

Inheritance diagram for adm\_if\_t:

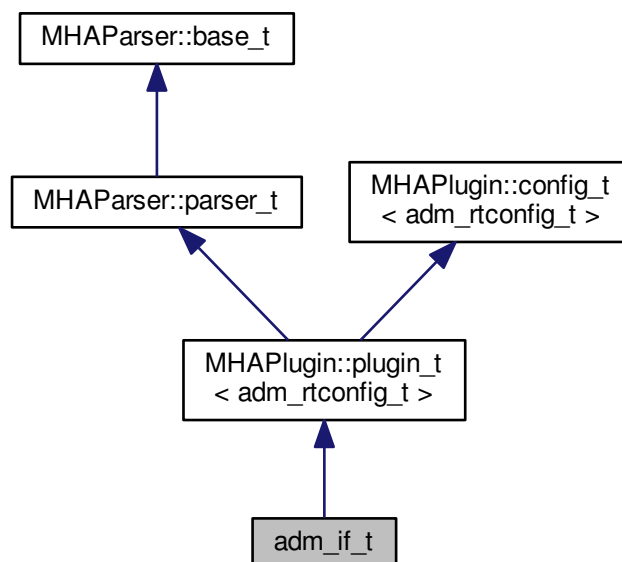

### Public Member Functions

- **adm\_if\_t** (const **algo\_comm\_t** &ac, const std::string &thread\_name, const std::string &algo\_name)
- **mha\_wave\_t \* process** (mha\_wave\_t \*in)
- virtual void **prepare** (mhaconfig\_t &)
- virtual void **release** ()

### Private Member Functions

- void **update** ()
- bool **is\_prepared** ()

## Private Attributes

- **MHASignal::waveform\_t \* out**
- **MHAParser::vint\_t front\_channels**
- **MHAParser::vint\_t rear\_channels**
- **MHAParser::vfloat\_t distances**
- **MHAParser::int\_t lp\_order**
- **MHAParser::int\_t decomb\_order**
- **MHAParser::int\_t bypass**
- **MHAParser::float\_t beta**
- **MHAParser::vfloat\_t mu\_beta**
- **MHAParser::vfloat\_t tau\_beta**
- **MHAParser::vfloat\_mon\_t coeff\_lp**
- **MHAParser::vfloat\_mon\_t coeff\_decomb**
- unsigned **input\_channels**
- **mha\_real\_t srate**
- **MHAEvents::patchbay\_t< adm\_if\_t > patchbay**

## Additional Inherited Members

### 5.32.1 Constructor & Destructor Documentation

5.32.1.1 `adm_if_t::adm_if_t (`  
                   `const algo_comm_t & ac,`  
                   `const std::string & thread_name,`  
                   `const std::string & algo_name )`

### 5.32.2 Member Function Documentation

5.32.2.1 `mha_wave_t * adm_if_t::process (`  
                   `mha_wave_t * in )`

5.32.2.2 `void adm_if_t::prepare (`  
                   `mhaconfig_t & cfg ) [virtual]`

Implements **MHAPlugin::plugin\_t< adm\_rtconfig\_t >** (p. 730).

5.32.2.3 `void adm_if_t::release (`  
                   `void ) [virtual]`

Reimplemented from **MHAPlugin::plugin\_t< adm\_rtconfig\_t >** (p. 731).

5.32.2.4 void adm\_if\_t::update ( ) [private]

5.32.2.5 bool adm\_if\_t::is\_prepared ( ) [inline],[private]

### 5.32.3 Member Data Documentation

5.32.3.1 MHASignal::waveform\_t\* adm\_if\_t::out [private]

5.32.3.2 MHAParser::vint\_t adm\_if\_t::front\_channels [private]

5.32.3.3 MHAParser::vint\_t adm\_if\_t::rear\_channels [private]

5.32.3.4 MHAParser::vfloat\_t adm\_if\_t::distances [private]

5.32.3.5 MHAParser::int\_t adm\_if\_t::lp\_order [private]

5.32.3.6 MHAParser::int\_t adm\_if\_t::decomb\_order [private]

5.32.3.7 MHAParser::int\_t adm\_if\_t::bypass [private]

5.32.3.8 MHAParser::float\_t adm\_if\_t::beta [private]

5.32.3.9 MHAParser::vfloat\_t adm\_if\_t::mu\_beta [private]

5.32.3.10 MHAParser::vfloat\_t adm\_if\_t::tau\_beta [private]

5.32.3.11 MHAParser::vfloat\_mon\_t adm\_if\_t::coeff\_lp [private]

5.32.3.12 MHAParser::vfloat\_mon\_t adm\_if\_t::coeff\_decomb [private]

5.32.3.13 unsigned adm\_if\_t::input\_channels [private]

5.32.3.14 mha\_real\_t adm\_if\_t::srate [private]

5.32.3.15 MHAEvents::patchbay\_t<adm\_if\_t> adm\_if\_t::patchbay [private]

The documentation for this class was generated from the following file:

- **adm.cpp**

## 5.33 adm\_rtconfig\_t Class Reference

### Public Types

- typedef **ADM::ADM**< mha\_real\_t > **adm\_t**

## Public Member Functions

- **adm\_rtconfig\_t** (unsigned nchannels\_in, unsigned nchannels\_out, const std::vector< int > &**front\_channels**, const std::vector< int > &**rear\_channels**, const **mha\_real\_t** fs, const std::vector< **mha\_real\_t** > &distances, const int lp\_order, const int decomb\_order, const std::vector< **mha\_real\_t** > &tau\_beta, const std::vector< **mha\_real\_t** > &mu\_beta)
  - Construct new ADMs.*
- virtual ~**adm\_rtconfig\_t** ()
- size\_t **num\_adms** () const
- **adm\_t** & **adm** (unsigned index)
  - Returns adm object number index.*
- int **front\_channel** (unsigned index) const
  - Returns index of front channel for adm number index.*
- int **rear\_channel** (unsigned index) const
  - Returns index of rear channel for adm number index.*

## Private Member Functions

- void **check\_index** (unsigned index) const
  - Index checking for all internal arrays.*

## Private Attributes

- std::vector< int > **front\_channels**
  - Indices of channels containing the signals from the front microphones.*
- std::vector< int > **rear\_channels**
  - Indices of channels containing the signals from the rear microphones.*
- **MHASignal::waveform\_t \* lp\_coefs**
  - Lowpass filter coefficients.*
- std::vector< **MHASignal::waveform\_t \* > decomb\_coefs**
  - Decomb-Filter coefficients.*
- std::vector< **adm\_t \* > adms**
  - ADMs.*

### 5.33.1 Member Typedef Documentation

#### 5.33.1.1 typedef **ADM::ADM**<mha\_real\_t> **adm\_rtconfig\_t::adm\_t**

### 5.33.2 Constructor & Destructor Documentation

```

5.33.2.1 adm_rtconfig_t::adm_rtconfig_t (
    unsigned nchannels_in,
    unsigned nchannels_out,
    const std::vector< int > & front_channels,
    const std::vector< int > & rear_channels,
    const mha_real_t fs,
    const std::vector< mha_real_t > & distances,
    const int lp_order,
    const int decomb_order,
    const std::vector< mha_real_t > & tau_beta,
    const std::vector< mha_real_t > & mu_beta )

```

Construct new ADMs.

Used when configuration changes.

#### Parameters

<i>nchannels_in</i>	Number of input channels
<i>nchannels_out</i>	Number of output channels
<i>front_channels</i>	Parser's front_channels setting
<i>rear_channels</i>	Parser's front_channels setting
<i>fs</i>	Sampling rate / Hz
<i>distances</i>	Distances between microphones / m
<i>lp_order</i>	Filter order of FIR lowpass filter for adaptation
<i>decomb_order</i>	Filter order of FIR compensation filter (compensates for comb filter characteristic)
<i>tau_beta</i>	Time constants of the lowpass filter used for averaging the power of the output signal used for adaptation
<i>mu_beta</i>	Adaptation step sizes

```

5.33.2.2 adm_rtconfig_t::~~adm_rtconfig_t ( ) [virtual]

```

#### 5.33.3 Member Function Documentation

```

5.33.3.1 void adm_rtconfig_t::check_index (
    unsigned index ) const [inline], [private]

```

Index checking for all internal arrays.

#### Exceptions

<b><i>MHA_Error</i></b> (p. 445)	if index out of range.
----------------------------------	------------------------

5.33.3.2 `size_t adm_rtconfig_t::num_adms ( ) const [inline]`

5.33.3.3 `adm_t& adm_rtconfig_t::adm ( unsigned index ) [inline]`

Returns adm object number index.

5.33.3.4 `int adm_rtconfig_t::front_channel ( unsigned index ) const [inline]`

Returns index of front channel for adm number index.

5.33.3.5 `int adm_rtconfig_t::rear_channel ( unsigned index ) const [inline]`

Returns index of rear channel for adm number index.

#### 5.33.4 Member Data Documentation

5.33.4.1 `std::vector<int> adm_rtconfig_t::front_channels [private]`

Indices of channels containing the signals from the front microphones.

5.33.4.2 `std::vector<int> adm_rtconfig_t::rear_channels [private]`

Indices of channels containing the signals from the rear microphones.

5.33.4.3 `MHASignal::waveform_t* adm_rtconfig_t::lp_coeffs [private]`

Lowpass filter coefficients.

5.33.4.4 `std::vector<MHASignal::waveform_t*> adm_rtconfig_t::decomb_coeffs [private]`

Decomb-Filter coefficients.

5.33.4.5 `std::vector<adm_t*> adm_rtconfig_t::adms [private]`

ADMs.

The documentation for this class was generated from the following file:

- **adm.cpp**



## 5.34 algo\_comm\_t Struct Reference

A reference handle for algorithm communication variables.

### Public Attributes

- void \* **handle**  
*AC variable control handle.*
- int(\* **insert\_var**)(void \*, const char \*, **comm\_var\_t**)  
*Register an AC variable.*
- int(\* **insert\_var\_int**)(void \*, const char \*, int \*)  
*Register an int as an AC variable.*
- int(\* **insert\_var\_float**)(void \*, const char \*, float \*)  
*Register a float as an AC variable.*
- int(\* **remove\_var**)(void \*, const char \*)  
*Remove an AC variable.*
- int(\* **remove\_ref**)(void \*, void \*)  
*Remove all AC variable which refer to address.*
- int(\* **is\_var**)(void \*, const char \*)  
*Test if an AC variable exists.*
- int(\* **get\_var**)(void \*, const char \*, **comm\_var\_t** \*)  
*Get the variable handle of an AC variable.*
- int(\* **get\_var\_int**)(void \*, const char \*, int \*)  
*Get the value of an int AC variable.*
- int(\* **get\_var\_float**)(void \*, const char \*, float \*)  
*Get the value of a float AC variable.*
- int(\* **get\_entries**)(void \*, char \*, unsigned int)  
*Return a space separated list of all variable names.*
- const char \*(\* **get\_error**)(int)  
*Convert AC error codes into human readable error messages.*

### 5.34.1 Detailed Description

A reference handle for algorithm communication variables.

This structure contains a control handle and a set of function pointers for sharing variables within one processing chain. See also section **Communication between algorithms** (p. 28).

### 5.34.2 Member Data Documentation

#### 5.34.2.1 algo\_comm\_t::handle

AC variable control handle.

#### 5.34.2.2 algo\_comm\_t::insert\_var

Register an AC variable.

This function can register a variable to be shared within one chain. If a variable of this name exists it will be overwritten.

**Parameters**

<i>h</i>	AC handle
<i>n</i>	name of variable. May not be empty. Must not contain space character. The name is copied, therefore it is allowed that the char array pointed to gets invalid after return.
<i>v</i>	variable handle of type <b>comm_var_t</b> (p. 246)

**Returns**

Error code or zero on success

**5.34.2.3 algo\_comm\_t::insert\_var\_int**

Register an int as an AC variable.

This function can register an int variable to be shared with other algorithms. It behaves similar to `ac.insert_var`.

**Parameters**

<i>h</i>	AC handle
<i>n</i>	name of variable
<i>v</i>	pointer on the variable

**Returns**

Error code or zero on success

**5.34.2.4 algo\_comm\_t::insert\_var\_float**

Register a float as an AC variable.

This function can register a float variable to be shared with other algorithms. It behaves similar to `ac.insert_var`.

**Parameters**

<i>h</i>	AC handle
<i>n</i>	name of variable
<i>v</i>	pointer on the variable

**Returns**

Error code or zero on success

## 5.34.2.5 algo\_comm\_t::remove\_var

Remove an AC variable.

Remove (unregister) an AC variable. After calling this function, the variable is not available to `ac.is_var` or `ac.get_var`. The data pointer is not affected.

**Parameters**

<i>h</i>	AC handle
<i>n</i>	name of variable to be removed

**Returns**

Error code or zero on success

## 5.34.2.6 algo\_comm\_t::remove\_ref

Remove all AC variable which refer to address.

This function removes all AC variables whos data field points to the given address.

**Parameters**

<i>h</i>	AC handle
<i>p</i>	address which should not be referred to any more

**Returns**

Error code or zero on success

## 5.34.2.7 algo\_comm\_t::is\_var

Test if an AC variable exists.

This function tests if an AC variable of a given name exists. Use `ac.get_var` to get information about the variables type and dimension.

**Parameters**

<i>h</i>	AC handle
<i>n</i>	name of variable

**Returns**

1 if the variable exists, 0 otherwise

**5.34.2.8 algo\_comm\_t::get\_var**

Get the variable handle of an AC variable.

This function returns the variable handle **comm\_var\_t** (p. 246) of a variable of the given name. If no variable of that name exists, an error code is returned.

**Parameters**

<i>h</i>	AC handle
<i>n</i>	name of variable
<i>v</i>	pointer to a AC variable object

**Returns**

Error code or zero on success

**5.34.2.9 algo\_comm\_t::get\_var\_int**

Get the value of an int AC variable.

This function returns the value of an int AC variable of the given name. If no variable exists, the variable type is mismatching or more than one entry is registered, a corresponding error code is returned. This is a special version of `ac.get_var`.

**Parameters**

<i>h</i>	AC handle
<i>n</i>	name of variable
<i>v</i>	pointer on an int variable to store the result

**Returns**

Error code or zero on success

**5.34.2.10 algo\_comm\_t::get\_var\_float**

Get the value of a float AC variable.

This function returns the value of a float AC variable of the given name. If no variable exists, the variable type is mismatching or more than one entry is registered, a corresponding error code is returned. This is a special version of `ac.get_var`.

**Parameters**

<i>h</i>	AC handle
<i>n</i>	name of variable
<i>v</i>	pointer on a float variable to store the result

**Returns**

Error code or zero on success

**5.34.2.11 algo\_comm\_t::get\_entries**

Return a space separated list of all variable names.

This function returns the names of all registered variables, separated by a single space.

**Parameters**

<i>h</i>	AC handle
----------	-----------

**Return values**

<i>ret</i>	Character buffer for return value
------------	-----------------------------------

**Parameters**

<i>len</i>	length of character buffer
------------	----------------------------

**Returns**

Error code or zero on success. -1: invalid ac handle. -3: not enough room in character buffer to store all variable names.

**5.34.2.12 algo\_comm\_t::get\_error**

Convert AC error codes into human readable error messages.

**Parameters**

<i>e</i>	Error code
----------	------------

## Returns

Error message

The documentation for this struct was generated from the following files:

- **mha.hh**
- **mha\_algo\_comm.cpp**

## 5.35 `alsa_base_t` Class Reference

Inheritance diagram for `alsa_base_t`:

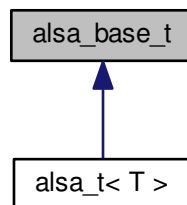

## Public Member Functions

- **alsa\_base\_t** ()
- virtual **~alsa\_base\_t** ()=default
- virtual void **start** ()=0  
*start puts alsa device in usable state*
- virtual void **stop** ()=0  
*stop informs alsa device that we do not need any more samples / will not provide any more samples*
- virtual int **read** (**mha\_wave\_t** \*\*)=0  
*read audio samples from the device into an internal **mha\_wave\_t** (p. 496) buffer, then update the pointer given as parameter to point to the internal structure.*
- virtual int **write** (**mha\_wave\_t** \*)=0  
*write audio samples from the given waveform buffer to the sound device.*

## Public Attributes

- `snd_pcm_t *` **pcm**  
*The underlying alsa handle to this sound card.*

### 5.35.1 Constructor & Destructor Documentation

5.35.1.1 `alsa_base_t::alsa_base_t( )` [inline]

5.35.1.2 `virtual alsa_base_t::~~alsa_base_t( )` [virtual],[default]

### 5.35.2 Member Function Documentation

5.35.2.1 `virtual void alsa_base_t::start( )` [pure virtual]

start puts alsa device in usable state

Implemented in `alsa_t< T >` (p. 211).

5.35.2.2 `virtual void alsa_base_t::stop( )` [pure virtual]

stop informs alsa device that we do not need any more samples / will not provide any more samples

Implemented in `alsa_t< T >` (p. 212).

5.35.2.3 `virtual int alsa_base_t::read ( mha_wave_t** )` [pure virtual]

read audio samples from the device into an internal `mha_wave_t` (p. 496) buffer, then update the pointer given as parameter to point to the internal structure.

Converts sound samples from the integer data type provided by the sound card to floating-point values needed by the MHA in the range [-1.0,1.0]

Implemented in `alsa_t< T >` (p. 212).

5.35.2.4 `virtual int alsa_base_t::write ( mha_wave_t* )` [pure virtual]

write audio samples from the given waveform buffer to the sound device.

converts the floating point values coming from the MHA to the integer samples required by the sound card.

Implemented in `alsa_t< T >` (p. 212).

### 5.35.3 Member Data Documentation

#### 5.35.3.1 `snd_pcm_t*` `alsa_base_t::pcm`

The underlying alsa handle to this sound card.

The documentation for this class was generated from the following file:

- **MHAIOalsa.cpp**

### 5.36 `alsa_dev_par_parser_t` Class Reference

Parser variables corresponding to one alsa device.

Inheritance diagram for `alsa_dev_par_parser_t`:

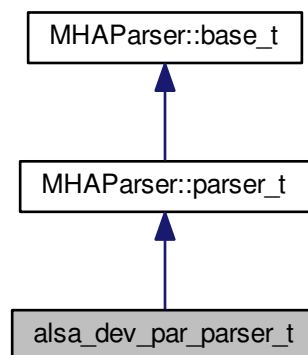

#### Public Member Functions

- **`alsa_dev_par_parser_t`** (`snd_pcm_stream_t` **`stream_dir`**)  
*Constructor inserts the parser variables into this sub-parser.*

#### Public Attributes

- **`MHAParser::string_t`** **`device`**  
*Name of the device in the alsa world, like "hw:0.0", "default", etc.*
- **`MHAParser::int_t`** **`nperiods`**  
*Number of buffers of fragsize to hold in the alsa buffer.*
- `snd_pcm_stream_t` **`stream_dir`**  
*Remember the direction (capture/playback) of this device.*



## Additional Inherited Members

### 5.36.1 Detailed Description

Parser variables corresponding to one alsa device.

ALSA separates audio capture and audio playback into two different devices that have to be opened separately. This class encapsulates the parser variables that pertain to one such direction.

### 5.36.2 Constructor & Destructor Documentation

#### 5.36.2.1 `alsa_dev_par_parser_t::alsa_dev_par_parser_t (snd_pcm_stream_t stream_dir )`

Constructor inserts the parser variables into this sub-parser.

#### Parameters

<code><i>stream_dir</i></code>	capture or playback
--------------------------------	---------------------

### 5.36.3 Member Data Documentation

#### 5.36.3.1 `MHAParser::string_t alsa_dev_par_parser_t::device`

Name of the device in the alsa world, like "hw:0.0", "default", etc.

#### 5.36.3.2 `MHAParser::int_t alsa_dev_par_parser_t::nperiods`

Number of buffers of fragsize to hold in the alsa buffer.

Usually 2, the minimum possible.

#### 5.36.3.3 `snd_pcm_stream_t alsa_dev_par_parser_t::stream_dir`

Remember the direction (capture/playback) of this device.

The documentation for this class was generated from the following file:

- `MHAIOalsa.cpp`

### 5.37 `alsa_t< T >` Class Template Reference

Our representation of one alsa device.

Inheritance diagram for `alsa_t< T >`:

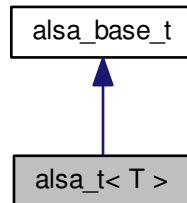

#### Public Member Functions

- **`alsa_t`** (`const alsa_dev_par_parser_t &par`, unsigned int `rate`, unsigned int **`fragsize`**, unsigned int **`channels`**)  
*Constructor receives the parameters for this device.*
- **`~alsa_t`** ()  
*Destructor closes the sound device.*
- void **`start`** () override  
*start puts alsa device in usable state*
- void **`stop`** () override  
*stop informs alsa device that we do not need any more samples / will not provide any more samples*
- int **`read`** (`mha_wave_t **`) override  
*read audio samples from the device into an internal `mha_wave_t` (p. 496) buffer, then update the pointer given as parameter to point to the internal structure.*
- int **`write`** (`mha_wave_t *`) override  
*write audio samples from the given waveform buffer to the sound device.*

#### Private Attributes

- unsigned int **`channels`**
- unsigned int **`fragsize`**
- T \* **`buffer`**
- `std::vector< mha_real_t >` **`frame_data`**
- **`MHASignal::waveform_t`** `wave`  
*internal buffer to store sound samples coming from the sound card.*
- const `mha_real_t` **`gain`**
- const `mha_real_t` **`invgain`**
- const `mha_real_t` **`val_min`**
- const `mha_real_t` **`val_max`**
- `snd_pcm_format_t` **`pcm_format`**

## Additional Inherited Members

### 5.37.1 Detailed Description

```
template<typename T>
class alsa_t< T >
```

Our representation of one alsa device.

We can start and stop the device, and depending on the direction, read or write samples.

### 5.37.2 Constructor & Destructor Documentation

```
5.37.2.1 template<typename T > alsa_t< T >::alsa_t (
    const alsa_dev_par_parser_t & par,
    unsigned int rate,
    unsigned int fragsize,
    unsigned int channels )
```

Constructor receives the parameters for this device.

It opens the sound device using the alsa library and selects the given parameters, but does not yet start the sound device to perform real I/O.

#### Parameters

<i>par</i>	our parser variable aggregator (containing direction, device name, and number of periods to place in alsa buffer)
<i>rate</i>	sampling rate in Hz
<i>fragsize</i>	samples per block per channel
<i>channels</i>	number of audio channels to open

```
5.37.2.2 template<typename T > alsa_t< T >::~~alsa_t ( )
```

Destructor closes the sound device.

### 5.37.3 Member Function Documentation

```
5.37.3.1 template<typename T > void alsa_t< T >::start ( ) [override], [virtual]
```

start puts alsa device in usable state

Implements `alsa_base_t` (p. 207).

5.37.3.2 `template<typename T> void alsa_t< T >::stop ( )` [override],[virtual]

stop informs alsa device that we do not need any more samples / will not provide any more samples

Implements **alsa\_base\_t** (p. 207).

5.37.3.3 `template<typename T> int alsa_t< T >::read ( mha_wave_t** s )` [override],[virtual]

read audio samples from the device into an internal **mha\_wave\_t** (p. 496) buffer, then update the pointer given as parameter to point to the internal structure.

Converts sound samples from the integer data type provided by the sound card to floating-point values needed by the MHA in the range [-1.0,1.0]

Implements **alsa\_base\_t** (p. 207).

5.37.3.4 `template<typename T> int alsa_t< T >::write ( mha_wave_t* s )` [override],[virtual]

write audio samples from the given waveform buffer to the sound device.

converts the floating point values coming from the MHA to the integer samples required by the sound card.

Implements **alsa\_base\_t** (p. 207).

#### 5.37.4 Member Data Documentation

5.37.4.1 `template<typename T> unsigned int alsa_t< T >::channels` [private]

5.37.4.2 `template<typename T> unsigned int alsa_t< T >::fragsize` [private]

5.37.4.3 `template<typename T> T* alsa_t< T >::buffer` [private]

5.37.4.4 `template<typename T> std::vector<mha_real_t> alsa_t< T >::frame_data` [private]

5.37.4.5 `template<typename T> MHASignal::waveform_t alsa_t< T >::wave` [private]

internal buffer to store sound samples coming from the sound card.

5.37.4.6 `template<typename T> const mha_real_t alsa_t< T>::gain` [private]

5.37.4.7 `template<typename T> const mha_real_t alsa_t< T>::invgain` [private]

5.37.4.8 `template<typename T> const mha_real_t alsa_t< T>::val_min` [private]

5.37.4.9 `template<typename T> const mha_real_t alsa_t< T>::val_max` [private]

5.37.4.10 `template<typename T> snd_pcm_format_t alsa_t< T>::pcm_format` [private]

The documentation for this class was generated from the following file:

- **MHAIOalsa.cpp**

## 5.38 altplugs\_t Class Reference

Inheritance diagram for altplugs\_t:

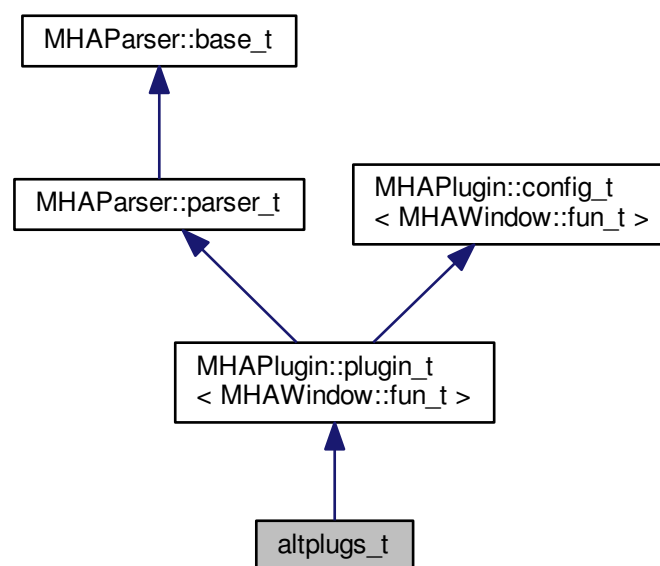

### Public Member Functions

- **altplugs\_t** (**algo\_comm\_t** iac, const char \*chain, const char \*algo)
- void **prepare** (**mhaconfig\_t** &)
- void **release** ()
- void **process** (**mha\_wave\_t** \*, **mha\_wave\_t** \*\*)
- void **process** (**mha\_spec\_t** \*, **mha\_wave\_t** \*\*)
- void **process** (**mha\_wave\_t** \*, **mha\_spec\_t** \*\*)
- void **process** (**mha\_spec\_t** \*, **mha\_spec\_t** \*\*)
- virtual std::string **parse** (const std::string &arg)
- virtual void **parse** (const char \*a1, char \*a2, unsigned int a3)

### Private Member Functions

- void **event\_set\_plugs** ()
- void **event\_add\_plug** ()
- void **event\_delete\_plug** ()
- void **event\_select\_plug** ()
- void **update\_selector\_list** ()
- void **update\_ramplen** ()
- void **proc\_ramp** (mha\_wave\_t \*s)

### Private Attributes

- **MHAParser::bool\_t use\_own\_ac**
- **MHAParser::vstring\_t parser\_plugs**
- **MHAParser::string\_t add\_plug**
- **MHAParser::string\_t delete\_plug**
- **MHAParser::float\_t ramplen**
- **MHAParser::kw\_t select\_plug**
- **MHAParser::parser\_t current**
- **MHAParser::vstring\_mon\_t nondefault\_labels**
- **std::vector< mhaplug\_cfg\_t \* > plugs**
- **mhaplug\_cfg\_t \* selected\_plug**
- **MHAEvents::patchbay\_t< altplugs\_t > patchbay**
- **MHASignal::waveform\_t \* fallback\_wave**
- **MHASignal::spectrum\_t \* fallback\_spec**
- **mhaconfig\_t cfin**
- **mhaconfig\_t cfout**
- **bool prepared**
- **bool added\_via\_plugs**
- **unsigned int ramp\_counter**
- **unsigned int ramp\_len**

### Additional Inherited Members

#### 5.38.1 Constructor & Destructor Documentation

5.38.1.1 **altplugs\_t::altplugs\_t** (  
     **algo\_comm\_t iac**,  
     **const char \* chain**,  
     **const char \* algo** )

#### 5.38.2 Member Function Documentation

5.38.2.1 **void altplugs\_t::prepare** (  
     **mhaconfig\_t & cf** ) [virtual]

Implements **MHAPugin::plugin\_t< MHAWindow::fun\_t >** (p. 730).

5.38.2.2 void altplugs\_t::release (   
 void ) [virtual]

Reimplemented from **MHAPLugin::plugin\_t** < **MHAWindow::fun\_t** > (p. 731).

5.38.2.3 void altplugs\_t::process (   
 mha\_wave\_t \* *sIn*,   
 mha\_wave\_t \*\* *sOut* )

5.38.2.4 void altplugs\_t::process (   
 mha\_spec\_t \* *sIn*,   
 mha\_wave\_t \*\* *sOut* )

5.38.2.5 void altplugs\_t::process (   
 mha\_wave\_t \* *sIn*,   
 mha\_spec\_t \*\* *sOut* )

5.38.2.6 void altplugs\_t::process (   
 mha\_spec\_t \* *sIn*,   
 mha\_spec\_t \*\* *sOut* )

5.38.2.7 std::string altplugs\_t::parse (   
 const std::string & *arg* ) [virtual]

Reimplemented from **MHAParser::base\_t** (p. 637).

5.38.2.8 virtual void altplugs\_t::parse (   
 const char \* *a1*,   
 char \* *a2*,   
 unsigned int *a3* ) [inline],[virtual]

Reimplemented from **MHAParser::base\_t** (p. 638).

5.38.2.9 void altplugs\_t::event\_set\_plugs ( ) [private]

5.38.2.10 void altplugs\_t::event\_add\_plug ( ) [private]

5.38.2.11 void altplugs\_t::event\_delete\_plug ( ) [private]

5.38.2.12 void altplugs\_t::event\_select\_plug ( ) [private]

5.38.2.13 void altplugs\_t::update\_selector\_list ( ) [private]

5.38.2.14 void altplugs\_t::update\_ramplen ( ) [private]

- 5.38.2.15 `void altplugs_t::proc_ramp ( mha_wave_t* s )` [private]
- 5.38.3 Member Data Documentation
  - 5.38.3.1 `MHAParser::bool_t altplugs_t::use_own_ac` [private]
  - 5.38.3.2 `MHAParser::vstring_t altplugs_t::parser_plugs` [private]
  - 5.38.3.3 `MHAParser::string_t altplugs_t::add_plug` [private]
  - 5.38.3.4 `MHAParser::string_t altplugs_t::delete_plug` [private]
  - 5.38.3.5 `MHAParser::float_t altplugs_t::ramplen` [private]
  - 5.38.3.6 `MHAParser::kw_t altplugs_t::select_plug` [private]
  - 5.38.3.7 `MHAParser::parser_t altplugs_t::current` [private]
  - 5.38.3.8 `MHAParser::vstring_mon_t altplugs_t::nondefault_labels` [private]
  - 5.38.3.9 `std::vector<mhaplug_cfg_t*> altplugs_t::plugs` [private]
  - 5.38.3.10 `mhaplug_cfg_t* altplugs_t::selected_plug` [private]
  - 5.38.3.11 `MHAEvents::patchbay_t<altplugs_t> altplugs_t::patchbay` [private]
  - 5.38.3.12 `MHASignal::waveform_t* altplugs_t::fallback_wave` [private]
  - 5.38.3.13 `MHASignal::spectrum_t* altplugs_t::fallback_spec` [private]
  - 5.38.3.14 `mhaconfig_t altplugs_t::cfin` [private]
  - 5.38.3.15 `mhaconfig_t altplugs_t::cfout` [private]
  - 5.38.3.16 `bool altplugs_t::prepared` [private]
  - 5.38.3.17 `bool altplugs_t::added_via_plugs` [private]
  - 5.38.3.18 `unsigned int altplugs_t::ramp_counter` [private]
  - 5.38.3.19 `unsigned int altplugs_t::ramp_len` [private]

The documentation for this class was generated from the following file:

- **altplugs.cpp**



## 5.39 analysepath\_t Class Reference

## Public Member Functions

- **analysepath\_t** (unsigned int *nchannels\_in*, unsigned int *outer\_fragsize*, unsigned int *inner\_fragsize*, int **priority**, **MHAProc\_wave2wave\_t** *inner\_proc\_wave2wave*, **MHAProc\_wave2spec\_t** *inner\_proc\_wave2spec*, void \**ilibdata*, **algo\_comm\_t** *outer\_ac*, const **MHA\_AC::acspace2matrix\_t** &*acspace\_template*, **mha\_domain\_t** *inner\_out\_domain*, unsigned int *fifo\_len\_blocks*)
- virtual **~analysepath\_t** ()
- void **rt\_process** (**mha\_wave\_t** \*)
- virtual int **svc** ()

## Private Attributes

- **MHAProc\_wave2wave\_t** *inner\_process\_wave2wave*
- **MHAProc\_wave2spec\_t** *inner\_process\_wave2spec*
- **MHASignal::waveform\_t** *inner\_input*
- void \* *libdata*
- **mha\_fifo\_t**< **mha\_real\_t** > *wave\_fifo*
- **mha\_fifo\_t**< **MHA\_AC::acspace2matrix\_t** > *ac\_fifo*
- **MHA\_AC::acspace2matrix\_t** *inner\_ac\_copy*
- **MHA\_AC::acspace2matrix\_t** *outer\_ac\_copy*
- **algo\_comm\_t** *outer\_ac*
- **mha\_domain\_t** *inner\_out\_domain*
- **MHA\_Error** *inner\_error*
- bool *has\_inner\_error*
- bool *flag\_terminate\_inner\_thread*
- int *input\_to\_process*
- **pthread\_mutex\_t** *ProcessMutex*
- **pthread\_attr\_t** *attr*
- struct **sched\_param** *priority*
- int *scheduler*
- **pthread\_t** *thread*
- **pthread\_cond\_t** *cond\_to\_process*

## 5.39.1 Constructor &amp; Destructor Documentation

5.39.1.1 **analysepath\_t::analysepath\_t** (  
     unsigned int *nchannels\_in*,  
     unsigned int *outer\_fragsize*,  
     unsigned int *inner\_fragsize*,  
     int *priority*,  
     **MHAProc\_wave2wave\_t** *inner\_proc\_wave2wave*,  
     **MHAProc\_wave2spec\_t** *inner\_proc\_wave2spec*,  
     void \* *ilibdata*,  
     **algo\_comm\_t** *outer\_ac*,  
     const **MHA\_AC::acspace2matrix\_t** & *acspace\_template*,  
     **mha\_domain\_t** *inner\_out\_domain*,  
     unsigned int *fifo\_len\_blocks* )

- 5.39.1.2 `analysepath_t::~analysepath_t( )` [virtual]
- 5.39.2 Member Function Documentation
  - 5.39.2.1 `void analysepath_t::rt_process ( mha_wave_t * outer_input )`
  - 5.39.2.2 `int analysepath_t::svc( )` [virtual]
- 5.39.3 Member Data Documentation
  - 5.39.3.1 `MHAProc_wave2wave_t analysepath_t::inner_process_wave2wave` [private]
  - 5.39.3.2 `MHAProc_wave2spec_t analysepath_t::inner_process_wave2spec` [private]
  - 5.39.3.3 `MHASignal::waveform_t analysepath_t::inner_input` [private]
  - 5.39.3.4 `void* analysepath_t::libdata` [private]
  - 5.39.3.5 `mha_fifo_t<mha_real_t> analysepath_t::wave_fifo` [private]
  - 5.39.3.6 `mha_fifo_t<MHA_AC::acspace2matrix_t> analysepath_t::ac_fifo` [private]
  - 5.39.3.7 `MHA_AC::acspace2matrix_t analysepath_t::inner_ac_copy` [private]
  - 5.39.3.8 `MHA_AC::acspace2matrix_t analysepath_t::outer_ac_copy` [private]
  - 5.39.3.9 `algo_comm_t analysepath_t::outer_ac` [private]
  - 5.39.3.10 `mha_domain_t analysepath_t::inner_out_domain` [private]
  - 5.39.3.11 `MHA_Error analysepath_t::inner_error` [private]
  - 5.39.3.12 `bool analysepath_t::has_inner_error` [private]
  - 5.39.3.13 `bool analysepath_t::flag_terminate_inner_thread` [private]
  - 5.39.3.14 `int analysepath_t::input_to_process` [private]
  - 5.39.3.15 `pthread_mutex_t analysepath_t::ProcessMutex` [private]
  - 5.39.3.16 `pthread_attr_t analysepath_t::attr` [private]
  - 5.39.3.17 `struct sched_param analysepath_t::priority` [private]
  - 5.39.3.18 `int analysepath_t::scheduler` [private]
  - 5.39.3.19 `pthread_t analysepath_t::thread` [private]
  - 5.39.3.20 `pthread_cond_t analysepath_t::cond_to_process` [private]

The documentation for this class was generated from the following file:

- **analysispath.cpp**

## 5.40 analysispath\_if\_t Class Reference

Inheritance diagram for analysispath\_if\_t:

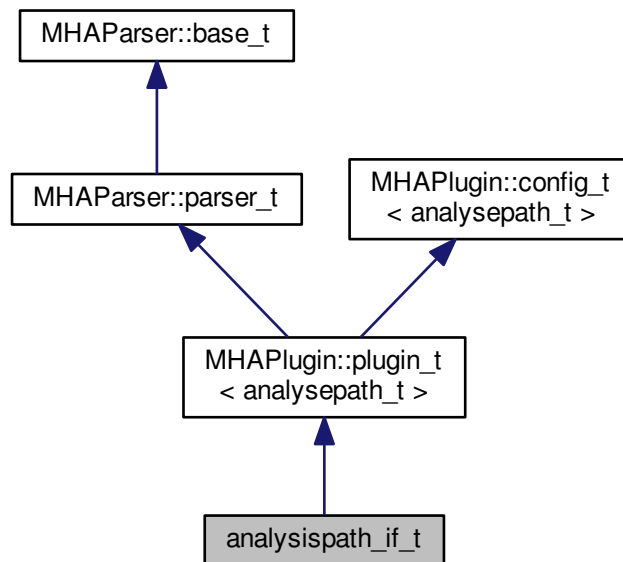

## Public Member Functions

- **analysispath\_if\_t** (**algo\_comm\_t**, std::string, std::string)
- **mha\_wave\_t \* process** (**mha\_wave\_t \***)
- void **prepare** (**mhaconfig\_t &**)
- void **release** ()
- **~analysispath\_if\_t** ()

## Private Member Functions

- void **loadlib** ()

## Private Attributes

- **MHAEvents::patchbay\_t< analysispath\_if\_t > patchbay**
- **MHAParser::string\_t libname**
- **MHAParser::int\_t fragsize**
- **MHAParser::int\_t fifolen**
- **MHAParser::int\_t priority**
- **MHAParser::vstring\_t vars**
- **plug\_t \* plug**
- std::string **chain**
- std::string **algo**
- **MHA\_AC::acspace2matrix\_t \* acspace\_template**

## Additional Inherited Members

### 5.40.1 Constructor & Destructor Documentation

5.40.1.1 `analysispath_if_t::analysispath_if_t (`  
     `algo_comm_t iac,`  
     `std::string th,`  
     `std::string al )`

5.40.1.2 `analysispath_if_t::~analysispath_if_t ( )`

### 5.40.2 Member Function Documentation

5.40.2.1 `mha_wave_t * analysispath_if_t::process (`  
     `mha_wave_t * s )`

5.40.2.2 `void analysispath_if_t::prepare (`  
     `mhaconfig_t & conf ) [virtual]`

Implements **MHAPLugin::plugin\_t< analysepath\_t >** (p. 730).

5.40.2.3 `void analysispath_if_t::release (`  
     `void ) [virtual]`

Reimplemented from **MHAPLugin::plugin\_t< analysepath\_t >** (p. 731).

5.40.2.4 `void analysispath_if_t::loadlib ( ) [private]`

### 5.40.3 Member Data Documentation

5.40.3.1 **MHAEvents::patchbay\_t< analysispath\_if\_t > analysispath\_if\_t::patchbay**  
     [private]

5.40.3.2 **MHAParser::string\_t analysispath\_if\_t::libname** [private]

5.40.3.3 **MHAParser::int\_t analysispath\_if\_t::fragsize** [private]

5.40.3.4 **MHAParser::int\_t analysispath\_if\_t::fifolen** [private]

5.40.3.5 **MHAParser::int\_t analysispath\_if\_t::priority** [private]

5.40.3.6 **MHAParser::vstring\_t analysispath\_if\_t::vars** [private]

5.40.3.7 **plug\_t\* analysispath\_if\_t::plug** [private]

5.40.3.8 **std::string analysispath\_if\_t::chain** [private]

5.40.3.9 **std::string analysispath\_if\_t::algo** [private]

5.40.3.10 **MHA\_AC::acspace2matrix\_t\* analysispath\_if\_t::acspace\_template** [private]

The documentation for this class was generated from the following file:

- **analysispath.cpp**

## 5.41 AuditoryProfile::fmap\_t Class Reference

A class to store frequency dependent data (e.g., HTL and UCL).

Inherits `map< mha_real_t, mha_real_t >`.

### Public Member Functions

- `std::vector< mha_real_t > get_frequencies () const`  
*Return configured frequencies.*
- `std::vector< mha_real_t > get_values () const`  
*Return stored values corresponding to the frequencies.*
- `bool isempty () const`

### 5.41.1 Detailed Description

A class to store frequency dependent data (e.g., HTL and UCL).

### 5.41.2 Member Function Documentation

#### 5.41.2.1 `std::vector< mha_real_t > AuditoryProfile::fmap_t::get_frequencies ( ) const`

Return configured frequencies.

#### 5.41.2.2 `std::vector< mha_real_t > AuditoryProfile::fmap_t::get_values ( ) const`

Return stored values corresponding to the frequencies.

#### 5.41.2.3 `bool AuditoryProfile::fmap_t::isempty ( ) const` `[inline]`

The documentation for this class was generated from the following files:

- `auditory_profile.h`
- `auditory_profile.cpp`

## 5.42 AuditoryProfile::parser\_t Class Reference

Class to make the auditory profile accessible through the parser interface.

Inheritance diagram for AuditoryProfile::parser\_t:

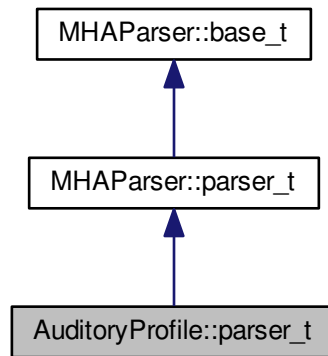

### Classes

- class `ear_t`
- class `fmap_t`

### Public Member Functions

- `parser_t ()`
- `AuditoryProfile::profile_t get_current_profile ()`

### Private Attributes

- `AuditoryProfile::parser_t::ear_t L`
- `AuditoryProfile::parser_t::ear_t R`

### Additional Inherited Members

#### 5.42.1 Detailed Description

Class to make the auditory profile accessible through the parser interface.

## 5.42.2 Constructor &amp; Destructor Documentation

## 5.42.2.1 AuditoryProfile::parser\_t::parser\_t ( )

## 5.42.3 Member Function Documentation

## 5.42.3.1 AuditoryProfile::profile\_t AuditoryProfile::parser\_t::get\_current\_profile ( )

## 5.42.4 Member Data Documentation

## 5.42.4.1 AuditoryProfile::parser\_t::ear\_t AuditoryProfile::parser\_t::L [private]

## 5.42.4.2 AuditoryProfile::parser\_t::ear\_t AuditoryProfile::parser\_t::R [private]

The documentation for this class was generated from the following files:

- **auditory\_profile.h**
- **auditory\_profile.cpp**

## 5.43 AuditoryProfile::parser\_t::ear\_t Class Reference

Inheritance diagram for AuditoryProfile::parser\_t::ear\_t:

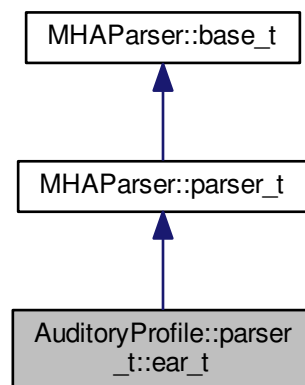

## Public Member Functions

- **ear\_t ( )**
- **AuditoryProfile::profile\_t::ear\_t get\_ear ( ) const**

### Private Attributes

- **AuditoryProfile::parser\_t::fmap\_t HTL**
- **AuditoryProfile::parser\_t::fmap\_t UCL**

### Additional Inherited Members

#### 5.43.1 Constructor & Destructor Documentation

##### 5.43.1.1 AuditoryProfile::parser\_t::ear\_t( )

#### 5.43.2 Member Function Documentation

##### 5.43.2.1 AuditoryProfile::profile\_t::ear\_t AuditoryProfile::parser\_t::ear\_t::get\_ear( ) const

#### 5.43.3 Member Data Documentation

##### 5.43.3.1 AuditoryProfile::parser\_t::fmap\_t AuditoryProfile::parser\_t::ear\_t::HTL [private]

##### 5.43.3.2 AuditoryProfile::parser\_t::fmap\_t AuditoryProfile::parser\_t::ear\_t::UCL [private]

The documentation for this class was generated from the following files:

- **auditory\_profile.h**
- **auditory\_profile.cpp**

### 5.44 AuditoryProfile::parser\_t::fmap\_t Class Reference

Inheritance diagram for AuditoryProfile::parser\_t::fmap\_t:

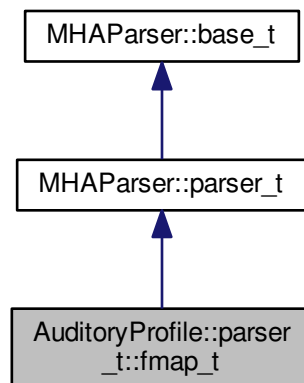



### Public Member Functions

- **fmap\_t** (const std::string &name, const std::string &help)
- **AuditoryProfile::fmap\_t get\_fmap** () const

### Private Member Functions

- void **validate** ()

### Private Attributes

- **MHAEvents::patchbay\_t**< **AuditoryProfile::parser\_t::fmap\_t** > patchbay
- **MHAParser::vfloat\_t** f
- **MHAParser::vfloat\_t** value
- std::string **name\_**

### Additional Inherited Members

#### 5.44.1 Constructor & Destructor Documentation

5.44.1.1 **AuditoryProfile::parser\_t::fmap\_t** (  
    const std::string & *name*,  
    const std::string & *help* )

#### 5.44.2 Member Function Documentation

5.44.2.1 **AuditoryProfile::fmap\_t** **AuditoryProfile::parser\_t::fmap\_t::get\_fmap** ( ) const

5.44.2.2 void **AuditoryProfile::parser\_t::fmap\_t::validate** ( ) [private]

#### 5.44.3 Member Data Documentation

5.44.3.1 **MHAEvents::patchbay\_t**< **AuditoryProfile::parser\_t::fmap\_t** >  
**AuditoryProfile::parser\_t::fmap\_t::patchbay** [private]

5.44.3.2 **MHAParser::vfloat\_t** **AuditoryProfile::parser\_t::fmap\_t::f** [private]

5.44.3.3 **MHAParser::vfloat\_t** **AuditoryProfile::parser\_t::fmap\_t::value** [private]

5.44.3.4 std::string **AuditoryProfile::parser\_t::fmap\_t::name\_** [private]

The documentation for this class was generated from the following files:

- **auditory\_profile.h**
- **auditory\_profile.cpp**

## 5.45 AuditoryProfile::profile\_t Class Reference

The Auditory Profile class.

### Classes

- class **ear\_t**  
*Class for ear-dependent parameters, e.g., audiograms or unilateral loudness scaling.*

### Public Member Functions

- **AuditoryProfile::profile\_t::ear\_t get\_ear** (unsigned int channel) const  
*Return ear information of channel number.*

### Public Attributes

- **AuditoryProfile::profile\_t::ear\_t L**  
*Left ear data.*
- **AuditoryProfile::profile\_t::ear\_t R**  
*Right ear data.*

### 5.45.1 Detailed Description

The Auditory Profile class.

See definition of auditory profile

**Todo** Give more documentation; implement all parts of the auditory profile.

Currently only the audiogram data is stored.

### 5.45.2 Member Function Documentation

#### 5.45.2.1 AuditoryProfile::profile\_t::ear\_t AuditoryProfile::profile\_t::get\_ear ( unsigned int *channel* ) const `[inline]`

Return ear information of channel number.

### 5.45.3 Member Data Documentation

#### 5.45.3.1 AuditoryProfile::profile\_t::ear\_t AuditoryProfile::profile\_t::L

Left ear data.

#### 5.45.3.2 AuditoryProfile::profile\_t::ear\_t AuditoryProfile::profile\_t::R

Right ear data.

The documentation for this class was generated from the following file:

- **auditory\_profile.h**

## 5.46 AuditoryProfile::profile\_t::ear\_t Class Reference

Class for ear-dependent parameters, e.g., audiograms or unilateral loudness scaling.

### Public Member Functions

- void **convert\_empty2normal** ()

### Public Attributes

- **AuditoryProfile::fmap\_t HTL**
- **AuditoryProfile::fmap\_t UCL**

### 5.46.1 Detailed Description

Class for ear-dependent parameters, e.g., audiograms or unilateral loudness scaling.

### 5.46.2 Member Function Documentation

#### 5.46.2.1 void AuditoryProfile::profile\_t::ear\_t::convert\_empty2normal ( )

### 5.46.3 Member Data Documentation

#### 5.46.3.1 AuditoryProfile::fmap\_t AuditoryProfile::profile\_t::ear\_t::HTL

#### 5.46.3.2 AuditoryProfile::fmap\_t AuditoryProfile::profile\_t::ear\_t::UCL

The documentation for this class was generated from the following files:

- **auditory\_profile.h**
- **auditory\_profile.cpp**

## 5.47 bbcalib\_interface\_t Class Reference

Inheritance diagram for bbcalib\_interface\_t:

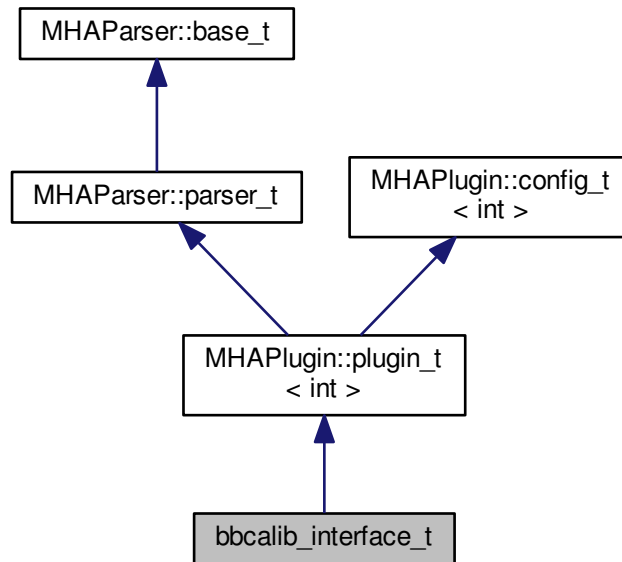

### Public Member Functions

- **bbcalib\_interface\_t** (const **algo\_comm\_t** &, const std::string &, const std::string &)
- **~bbcalib\_interface\_t** ()
- **mha\_wave\_t \* process** (mha\_wave\_t \*)
- void **prepare** (mhaconfig\_t &)
- void **release** ()

### Private Attributes

- **calibrator\_t calib\_in**
- **calibrator\_t calib\_out**
- **MHAParser::mhapuginloader\_t plugloader**

## Additional Inherited Members

## 5.47.1 Constructor &amp; Destructor Documentation

5.47.1.1 `bbcalib_interface_t::bbcalib_interface_t ( const algo_comm_t & iac, const std::string & , const std::string & )`

5.47.1.2 `bbcalib_interface_t::~bbcalib_interface_t ( )`

## 5.47.2 Member Function Documentation

5.47.2.1 `mha_wave_t * bbcalib_interface_t::process ( mha_wave_t * s )`

5.47.2.2 `void bbcalib_interface_t::prepare ( mhaconfig_t & tf ) [virtual]`

Implements `MHAPLugin::plugin_t< int >` (p. 730).

5.47.2.3 `void bbcalib_interface_t::release ( void ) [virtual]`

Reimplemented from `MHAPLugin::plugin_t< int >` (p. 731).

## 5.47.3 Member Data Documentation

5.47.3.1 `calibrator_t bbcalib_interface_t::calib_in [private]`

5.47.3.2 `calibrator_t bbcalib_interface_t::calib_out [private]`

5.47.3.3 `MHAParser::mhapluginloader_t bbcalib_interface_t::plugloader [private]`

The documentation for this class was generated from the following file:

- `transducers.cpp`

5.48 `calibrator_runtime_layer_t` Class Reference

## Public Member Functions

- `calibrator_runtime_layer_t` (bool is\_input, const `mhaconfig_t` &tf, `calibrator_variables_t` &vars)
- `mha_real_t process (mha_wave_t **)`

### Static Private Member Functions

- static unsigned int **firfirrlen** (const std::vector< std::vector< float > > &)
- static unsigned int **firfir2fftl** (unsigned int, const std::vector< std::vector< float > > &)

### Private Attributes

- **MHAFilter::fftfilter\_t** fir
- **MHASignal::quantizer\_t** quant
- **MHASignal::waveform\_t** gain
- **softclipper\_t** softclip
- bool **b\_is\_input**
- bool **b\_use\_fir**
- bool **b\_use\_clipping**
- **MHASignal::loop\_wavefragment\_t** spechnoise
- **MHASignal::loop\_wavefragment\_t::playback\_mode\_t** pmode

### 5.48.1 Constructor & Destructor Documentation

5.48.1.1 `calibrator_runtime_layer_t::calibrator_runtime_layer_t (`  
     `bool is_input,`  
     `const mhaconfig_t & tf,`  
     `calibrator_variables_t & vars )`

### 5.48.2 Member Function Documentation

5.48.2.1 `mha_real_t calibrator_runtime_layer_t::process (`  
     `mha_wave_t ** s )`

5.48.2.2 `unsigned int calibrator_runtime_layer_t::firfirlen (`  
     `const std::vector< std::vector< float > > & fir )` [static], [private]

5.48.2.3 `unsigned int calibrator_runtime_layer_t::firfir2fftl (`  
     `unsigned int fragsize,`  
     `const std::vector< std::vector< float > > & fir )` [static], [private]

### 5.48.3 Member Data Documentation

5.48.3.1 `MHAFilter::fftfilter_t calibrator_runtime_layer_t::fir` [private]

5.48.3.2 `MHASignal::quantizer_t calibrator_runtime_layer_t::quant` [private]

5.48.3.3 `MHASignal::waveform_t calibrator_runtime_layer_t::gain` [private]

5.48.3.4 `softclipper_t` `calibrator_runtime_layer_t::softclip` [private]

5.48.3.5 `bool` `calibrator_runtime_layer_t::b_is_input` [private]

5.48.3.6 `bool` `calibrator_runtime_layer_t::b_use_fir` [private]

5.48.3.7 `bool` `calibrator_runtime_layer_t::b_use_clipping` [private]

5.48.3.8 `MHASignal::loop_wavefragment_t` `calibrator_runtime_layer_t::speechnoise` [private]

5.48.3.9 `MHASignal::loop_wavefragment_t::playback_mode_t` `calibrator_runtime_layer_t::pmode` [private]

The documentation for this class was generated from the following file:

- `transducers.cpp`

## 5.49 calibrator\_t Class Reference

Inheritance diagram for `calibrator_t`:

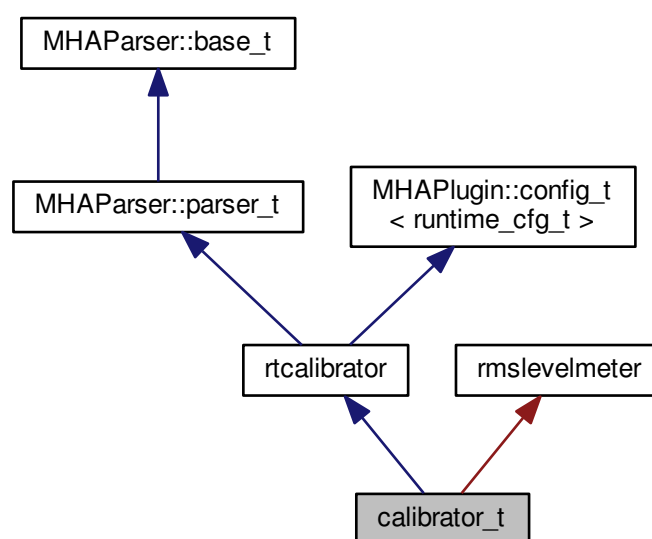

### Public Member Functions

- **calibrator\_t** (**algo\_comm\_t**, bool *is\_input*)
- void **prepare** (**mhaconfig\_t** &*tf*)
- void **release** ()
- **mha\_wave\_t** \* **process** (**mha\_wave\_t** \**s*)

### Private Member Functions

- void **update** ()
- void **update\_tau\_level** ()
- void **read\_levels** ()

### Private Attributes

- bool **b\_is\_input**
- **MHAEvents::patchbay\_t** < **calibrator\_t** > **patchbay**
- **calibrator\_variables\_t** **vars**
- bool **prepared**

### Additional Inherited Members

#### 5.49.1 Constructor & Destructor Documentation

5.49.1.1 **calibrator\_t::calibrator\_t** (  
           **algo\_comm\_t** *iac*,  
           bool *is\_input* )

#### 5.49.2 Member Function Documentation

5.49.2.1 void **calibrator\_t::prepare** (  
           **mhaconfig\_t** & *tf* ) [*inline*],[*virtual*]

Implements **MHAPlugin::plugin\_t** < **runtime\_cfg\_t** > (p. 730).

5.49.2.2 void **calibrator\_t::release** (  
           void ) [*inline*],[*virtual*]

Reimplemented from **MHAPlugin::plugin\_t** < **runtime\_cfg\_t** > (p. 731).



5.49.2.3 mha\_wave\_t \* calibrator\_t::process ( mha\_wave\_t \* s )

5.49.2.4 void calibrator\_t::update ( ) [private]

5.49.2.5 void calibrator\_t::update\_tau\_level ( ) [private]

5.49.2.6 void calibrator\_t::read\_levels ( ) [private]

### 5.49.3 Member Data Documentation

5.49.3.1 bool calibrator\_t::b\_is\_input [private]

5.49.3.2 MHAEvents::patchbay\_t<calibrator\_t> calibrator\_t::patchbay [private]

5.49.3.3 calibrator\_variables\_t calibrator\_t::vars [private]

5.49.3.4 bool calibrator\_t::prepared [private]

The documentation for this class was generated from the following file:

- **transducers.cpp**

## 5.50 calibrator\_variables\_t Class Reference

### Public Member Functions

- **calibrator\_variables\_t** (bool is\_input, **MHAParser::parser\_t** &parent)

### Public Attributes

- **MHAParser::vfloat\_t** peaklevel
- **MHAParser::mfloat\_t** fir
- **MHAParser::int\_t** nbits
- **MHAParser::float\_t** tau\_level
- **MHAParser::kw\_t** spnoise\_mode
- **MHAParser::vint\_t** spnoise\_channels
- **MHAParser::float\_t** spnoise\_level
- **MHAParser::vfloat\_mon\_t** rmslevel
- **MHAParser::parser\_t** spnoise\_parser
- **MHAParser::float\_mon\_t** srates
- **MHAParser::int\_mon\_t** fragsize
- **MHAParser::int\_mon\_t** num\_channels
- **MHAParser::parser\_t** config\_parser
- **softclipper\_variables\_t** softclip
- **MHAParser::bool\_t** do\_clipping

## 5.50.1 Constructor & Destructor Documentation

5.50.1.1 `calibrator_variables_t::calibrator_variables_t (`  
    `bool is_input,`  
    `MHAParser::parser_t & parent )`

## 5.50.2 Member Data Documentation

5.50.2.1 `MHAParser::vfloat_t calibrator_variables_t::peaklevel`

5.50.2.2 `MHAParser::mfloat_t calibrator_variables_t::fir`

5.50.2.3 `MHAParser::int_t calibrator_variables_t::nbits`

5.50.2.4 `MHAParser::float_t calibrator_variables_t::tau_level`

5.50.2.5 `MHAParser::kw_t calibrator_variables_t::spnoise_mode`

5.50.2.6 `MHAParser::vint_t calibrator_variables_t::spnoise_channels`

5.50.2.7 `MHAParser::float_t calibrator_variables_t::spnoise_level`

5.50.2.8 `MHAParser::vfloat_mon_t calibrator_variables_t::rmslevel`

5.50.2.9 `MHAParser::parser_t calibrator_variables_t::spnoise_parser`

5.50.2.10 `MHAParser::float_mon_t calibrator_variables_t::srate`

5.50.2.11 `MHAParser::int_mon_t calibrator_variables_t::fragsize`

5.50.2.12 `MHAParser::int_mon_t calibrator_variables_t::num_channels`

5.50.2.13 `MHAParser::parser_t calibrator_variables_t::config_parser`

5.50.2.14 `softclipper_variables_t calibrator_variables_t::softclip`

5.50.2.15 `MHAParser::bool_t calibrator_variables_t::do_clipping`

The documentation for this class was generated from the following file:

- `transducers.cpp`

5.51 `cfg_t` Class Reference

## Public Member Functions

- `cfg_t` (unsigned int, unsigned int)
- `cfg_t` (`mhaconfig_t` *chcfg*, `mha_real_t` *newlev*, bool *replace*, `mha_real_t` *len*)
- void `process` (`mha_wave_t` \*)
- void `process` (`mha_spec_t` \*)
- `cfg_t` (`mha_real_t` *tau\_attack*, `mha_real_t` *tau\_decay*, unsigned int *nch*, `mha_real_t` *start\_limit*, `mha_real_t` *slope\_db*, `mha_real_t` *fs*)

## Public Attributes

- unsigned int `channel`
- `mha_real_t` `start_lin`
- `mha_real_t` `alpha`
- `MHAFilter::o1flt_lowpass_t` `attack`
- `MHAFilter::o1flt_maxtrack_t` `decay`

## Private Attributes

- `mha_real_t` `gain_wave_`
- `mha_real_t` `gain_spec_`
- bool `replace_`
- bool `use_frozen_`
- `MHASignal::waveform_t` `frozen_noise_`
- unsigned int `pos`

## 5.51.1 Constructor &amp; Destructor Documentation

5.51.1.1 `cfg_t::cfg_t` (  
           unsigned int *ichannel*,  
           unsigned int *numchannels* )

5.51.1.2 `cfg_t::cfg_t` (  
           `mhaconfig_t` *chcfg*,  
           `mha_real_t` *newlev*,  
           bool *replace*,  
           `mha_real_t` *len* )

5.51.1.3 `cfg_t::cfg_t` (  
           `mha_real_t` *tau\_attack*,  
           `mha_real_t` *tau\_decay*,  
           unsigned int *nch*,  
           `mha_real_t` *start\_limit*,  
           `mha_real_t` *slope\_db*,  
           `mha_real_t` *fs* )

## 5.51.2 Member Function Documentation

5.51.2.1 void `cfg_t::process ( mha_wave_t * s )` [inline]

5.51.2.2 void `cfg_t::process ( mha_spec_t * s )` [inline]

## 5.51.3 Member Data Documentation

5.51.3.1 unsigned int `cfg_t::channel`

5.51.3.2 `mha_real_t cfg_t::gain_wave_` [private]

5.51.3.3 `mha_real_t cfg_t::gain_spec_` [private]

5.51.3.4 `bool cfg_t::replace_` [private]

5.51.3.5 `bool cfg_t::use_frozen_` [private]

5.51.3.6 `MHASignal::waveform_t cfg_t::frozen_noise_` [private]

5.51.3.7 unsigned int `cfg_t::pos` [private]

5.51.3.8 `mha_real_t cfg_t::start_lin`

5.51.3.9 `mha_real_t cfg_t::alpha`

5.51.3.10 `MHAFilter::o1flt_lowpass_t cfg_t::attack`

5.51.3.11 `MHAFilter::o1flt_maxtrack_t cfg_t::decay`

The documentation for this class was generated from the following files:

- `example6.cpp`
- `noise.cpp`
- `softclip.cpp`

## 5.52 coherence::cohflt\_if\_t Class Reference

Inheritance diagram for coherence::cohflt\_if\_t:

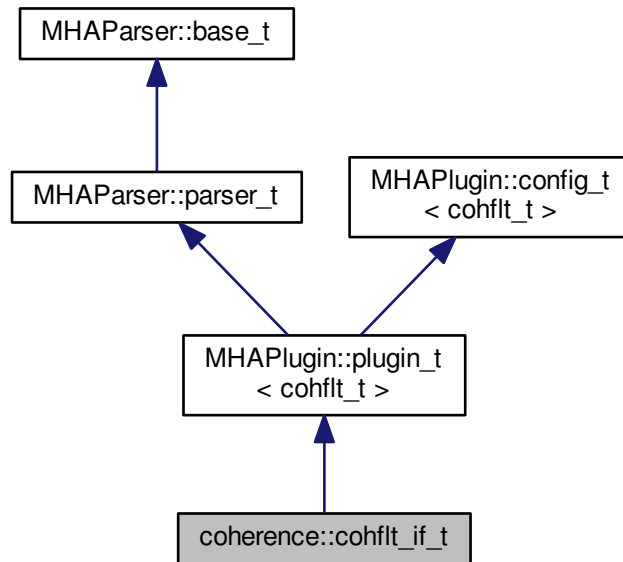

### Public Member Functions

- `cohflt_if_t` (const `algo_comm_t` &, const `std::string` &, const `std::string` &)
- void `prepare` (`mhaconfig_t` &)
- void `release` ()
- `mha_spec_t` \* `process` (`mha_spec_t` \*)

### Private Member Functions

- void `update` ()

### Private Attributes

- `MHAEvents::patchbay_t < cohflt_if_t >` `patchbay`
- `vars_t` `vars`
- const `std::string` `algo`

## Additional Inherited Members

### 5.52.1 Constructor & Destructor Documentation

5.52.1.1 `coherence::cohflt_if_t::cohflt_if_t (`  
    `const algo_comm_t & ac,`  
    `const std::string & th,`  
    `const std::string & al )`

### 5.52.2 Member Function Documentation

5.52.2.1 `void coherence::cohflt_if_t::prepare (`  
    `mhaconfig_t & tf ) [virtual]`

Implements **MHAPlugin::plugin\_t< cohflt\_t >** (p. 730).

5.52.2.2 `void coherence::cohflt_if_t::release (`  
    `void ) [virtual]`

Reimplemented from **MHAPlugin::plugin\_t< cohflt\_t >** (p. 731).

5.52.2.3 `mha_spec_t * coherence::cohflt_if_t::process (`  
    `mha_spec_t * s )`

5.52.2.4 `void coherence::cohflt_if_t::update ( ) [private]`

### 5.52.3 Member Data Documentation

5.52.3.1 `MHAEvents::patchbay_t<cohflt_if_t> coherence::cohflt_if_t::patchbay [private]`

5.52.3.2 `vars_t coherence::cohflt_if_t::vars [private]`

5.52.3.3 `const std::string coherence::cohflt_if_t::algo [private]`

The documentation for this class was generated from the following file:

- **coherence.cpp**

## 5.53 coherence::cohflt\_t Class Reference

Inheritance diagram for coherence::cohflt\_t:

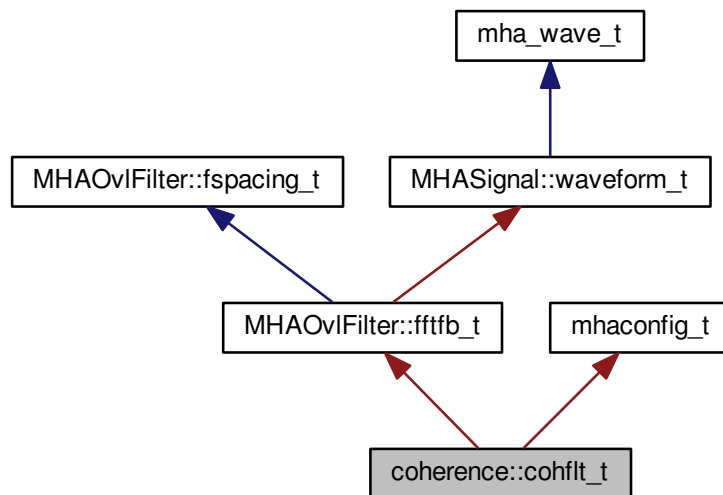

## Public Member Functions

- **cohflt\_t** (**vars\_t** &v, const **mhaconfig\_t** &icf, **algo\_comm\_t** iac, const std::string &name)
- **mha\_spec\_t \* process** (**mha\_spec\_t** \*)
- void **insert** ()

## Private Attributes

- unsigned int **nbands**
- bool **avg\_ipd**
- **mha\_complex\_t cg**
- float **g**
- float **c\_scale**
- float **c\_min**
- **MHASignal::waveform\_t alpha**
- float **limit**
- **MHAFilter::o1flt\_lowpass\_t lp1r**
- **MHAFilter::o1flt\_lowpass\_t lp1i**
- **MHA\_AC::spectrum\_t coh\_c**
- **MHA\_AC::waveform\_t coh\_rlp**
- **MHASignal::waveform\_t gain**
- **MHASignal::delay\_wave\_t gain\_delay**

- **MHASignal::spectrum\_t s\_out**
- bool **blinvert**
- **MHAFilter::o1flt\_lowpass\_t lp1ltg**
- bool **b\_ltg**
- std::vector< float > **staticgain**

#### Additional Inherited Members

#### 5.53.1 Constructor & Destructor Documentation

5.53.1.1 coherence::cohflt\_t::cohflt\_t (   
     vars\_t & v,   
     const mhaconfig\_t & icf,   
     algo\_comm\_t iac,   
     const std::string & name )

#### 5.53.2 Member Function Documentation

5.53.2.1 mha\_spec\_t \* coherence::cohflt\_t::process (   
     mha\_spec\_t \* s )

5.53.2.2 void coherence::cohflt\_t::insert ( )

#### 5.53.3 Member Data Documentation

5.53.3.1 unsigned int coherence::cohflt\_t::nbands [private]

5.53.3.2 bool coherence::cohflt\_t::avg\_ipd [private]

5.53.3.3 mha\_complex\_t coherence::cohflt\_t::cg [private]

5.53.3.4 float coherence::cohflt\_t::g [private]

5.53.3.5 float coherence::cohflt\_t::c\_scale [private]

5.53.3.6 float coherence::cohflt\_t::c\_min [private]

5.53.3.7 MHASignal::waveform\_t coherence::cohflt\_t::alpha [private]

5.53.3.8 float coherence::cohflt\_t::limit [private]

5.53.3.9 MHAFilter::o1flt\_lowpass\_t coherence::cohflt\_t::lp1r [private]



- 5.53.3.10 MHAFilter::o1flt\_lowpass\_t coherence::cohflt\_t::lp1i [private]
- 5.53.3.11 MHA\_AC::spectrum\_t coherence::cohflt\_t::coh\_c [private]
- 5.53.3.12 MHA\_AC::waveform\_t coherence::cohflt\_t::coh\_rlp [private]
- 5.53.3.13 MHASignal::waveform\_t coherence::cohflt\_t::gain [private]
- 5.53.3.14 MHASignal::delay\_wave\_t coherence::cohflt\_t::gain\_delay [private]
- 5.53.3.15 MHASignal::spectrum\_t coherence::cohflt\_t::s\_out [private]
- 5.53.3.16 bool coherence::cohflt\_t::blinvert [private]
- 5.53.3.17 MHAFilter::o1flt\_lowpass\_t coherence::cohflt\_t::lp1ltg [private]
- 5.53.3.18 bool coherence::cohflt\_t::b\_ltg [private]
- 5.53.3.19 std::vector<float> coherence::cohflt\_t::staticgain [private]

The documentation for this class was generated from the following file:

- coherence.cpp

## 5.54 coherence::vars\_t Class Reference

Inheritance diagram for coherence::vars\_t:

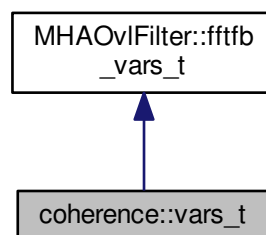

### Public Member Functions

- vars\_t (MHAParser::parser\_t \*)

## Public Attributes

- **MHAParser::kw\_t tau\_unit**
- **MHAParser::vfloat\_t tau**
- **MHAParser::vfloat\_t alpha**
- **MHAParser::float\_t limit**
- **MHAParser::vfloat\_t mapping**
- **MHAParser::kw\_t average**
- **MHAParser::bool\_t invert**
- **MHAParser::bool\_t ltgcomp**
- **MHAParser::vfloat\_t ltgtau**
- **MHAParser::vfloat\_t staticgain**
- **MHAParser::int\_t delay**

### 5.54.1 Constructor & Destructor Documentation

5.54.1.1 **coherence::vars\_t::vars\_t ( MHAParser::parser\_t \* p )**

### 5.54.2 Member Data Documentation

5.54.2.1 **MHAParser::kw\_t coherence::vars\_t::tau\_unit**

5.54.2.2 **MHAParser::vfloat\_t coherence::vars\_t::tau**

5.54.2.3 **MHAParser::vfloat\_t coherence::vars\_t::alpha**

5.54.2.4 **MHAParser::float\_t coherence::vars\_t::limit**

5.54.2.5 **MHAParser::vfloat\_t coherence::vars\_t::mapping**

5.54.2.6 **MHAParser::kw\_t coherence::vars\_t::average**

5.54.2.7 **MHAParser::bool\_t coherence::vars\_t::invert**

5.54.2.8 **MHAParser::bool\_t coherence::vars\_t::ltgcomp**

5.54.2.9 **MHAParser::vfloat\_t coherence::vars\_t::ltgtau**

5.54.2.10 **MHAParser::vfloat\_t coherence::vars\_t::staticgain**

5.54.2.11 **MHAParser::int\_t coherence::vars\_t::delay**

The documentation for this class was generated from the following file:

- **coherence.cpp**

5.55 `combc_if_t` Class Reference

Inheritance diagram for `combc_if_t`:

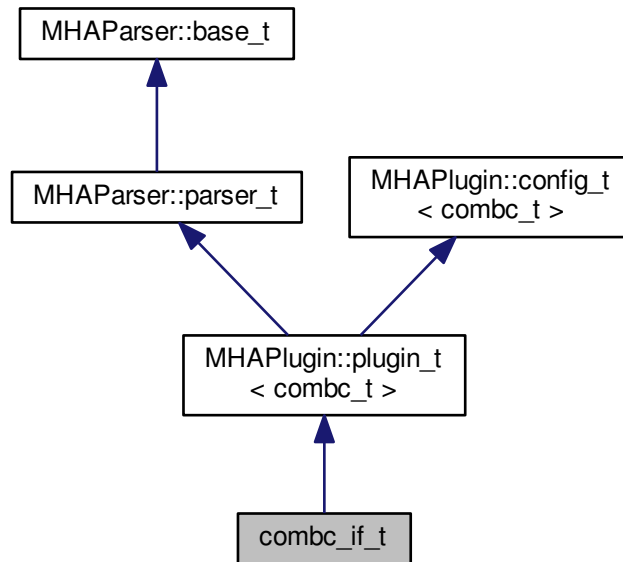

### Public Member Functions

- `combc_if_t` (const `algo_comm_t` &, const `std::string` &, const `std::string` &)
- void `prepare` (`mhaconfig_t` &)
- `mha_wave_t * process` (`mha_wave_t *`)
- `mha_spec_t * process` (`mha_spec_t *`)

### Private Attributes

- `MHAParser::int_t` `outchannels`
- `MHAParser::bool_t` `interleaved`
- `MHAParser::string_t` `channel_gain_name`
- `MHAParser::string_t` `element_gain_name`

## Additional Inherited Members

### 5.55.1 Constructor & Destructor Documentation

5.55.1.1 `combc_if_t::combc_if_t (`  
     `const algo_comm_t & iac,`  
     `const std::string & ,`  
     `const std::string & )`

### 5.55.2 Member Function Documentation

5.55.2.1 `void combc_if_t::prepare (`  
     `mhaconfig_t & chcfg )` [virtual]

Implements `MHAParser::plugin_t< combc_t >` (p. 730).

5.55.2.2 `mha_wave_t * combc_if_t::process (`  
     `mha_wave_t * s )`

5.55.2.3 `mha_spec_t * combc_if_t::process (`  
     `mha_spec_t * s )`

### 5.55.3 Member Data Documentation

5.55.3.1 `MHAParser::int_t combc_if_t::outchannels` [private]

5.55.3.2 `MHAParser::bool_t combc_if_t::interleaved` [private]

5.55.3.3 `MHAParser::string_t combc_if_t::channel_gain_name` [private]

5.55.3.4 `MHAParser::string_t combc_if_t::element_gain_name` [private]

The documentation for this class was generated from the following file:

- `combinechannels.cpp`

## 5.56 `combc_t` Class Reference

### Public Member Functions

- `combc_t (algo_comm_t ac, mhaconfig_t cfg_input, mhaconfig_t cfg_output, std::vector< float > channel_gains, const std::string &element_gain_name, bool interleaved)`
- `mha_wave_t * process (mha_wave_t *s)`
- `mha_spec_t * process (mha_spec_t *s)`

## Private Attributes

- `algo_comm_t ac_`
- `bool interleaved_`
- `unsigned int nbands`
- `MHASignal::waveform_t w_out`
- `MHASignal::spectrum_t s_out`
- `std::vector< mha_real_t > channel_gains_`
- `std::string element_gain_name_`

## 5.56.1 Constructor &amp; Destructor Documentation

5.56.1.1 `combc_t::combc_t (`  
    `algo_comm_t ac,`  
    `mhaconfig_t cfg_input,`  
    `mhaconfig_t cfg_output,`  
    `std::vector< float > channel_gains,`  
    `const std::string & element_gain_name,`  
    `bool interleaved )`

## 5.56.2 Member Function Documentation

5.56.2.1 `mha_wave_t * combc_t::process (`  
    `mha_wave_t * s )`

5.56.2.2 `mha_spec_t * combc_t::process (`  
    `mha_spec_t * s )`

## 5.56.3 Member Data Documentation

5.56.3.1 `algo_comm_t combc_t::ac_` [private]

5.56.3.2 `bool combc_t::interleaved_` [private]

5.56.3.3 `unsigned int combc_t::nbands` [private]

5.56.3.4 `MHASignal::waveform_t combc_t::w_out` [private]

5.56.3.5 `MHASignal::spectrum_t combc_t::s_out` [private]

5.56.3.6 `std::vector<mha_real_t> combc_t::channel_gains_` [private]

5.56.3.7 `std::string combc_t::element_gain_name_` [private]

The documentation for this class was generated from the following file:

- `combinechannels.cpp`

## 5.57 comm\_var\_t Struct Reference

Algorithm communication variable structure.

### Public Attributes

- unsigned int **data\_type**  
*Type of data.*
- unsigned int **num\_entries**  
*Number of entries.*
- unsigned int **stride**  
*length of one row (C interpretation) or of one column (Fortran interpretation)*
- void \* **data**  
*Pointer to variable data.*

### 5.57.1 Detailed Description

Algorithm communication variable structure.

Algorithm communication variables (AC variables) are objects of this type. The member data is a pointer to the variable 'data'. This pointer has to be valid for the lifetime of this AC variable. The member 'data\_type' can be one of the predefined types or any user defined type. The member 'num\_entries' describes the number of elements of this base type stored at the pointer address.

An AC variable can be registered with the `\ref algo_comm_t::insert_var "insert_var"` function.

### 5.57.2 Member Data Documentation

#### 5.57.2.1 comm\_var\_t::data\_type

Type of data.

This can be one of the predefined types

- MHA\_AC\_CHAR
- MHA\_AC\_INT
- MHA\_AC\_MHAREAL
- MHA\_AC\_FLOAT
- MHA\_AC\_DOUBLE
- MHA\_AC\_MHACOMPLEX
- MHA\_AC\_VEC\_FLOAT or any user defined type with a value greater than
- MHA\_AC\_USER

## 5.57.2.2 comm\_var\_t::num\_entries

Number of entries.

## 5.57.2.3 comm\_var\_t::stride

length of one row (C interpretation) or of one column (Fortran interpretation)

## 5.57.2.4 comm\_var\_t::data

Pointer to variable data.

The documentation for this struct was generated from the following files:

- **mha.hh**
- **mha\_algo\_comm.cpp**

## 5.58 cpuload\_t Class Reference

Inheritance diagram for cpuload\_t:

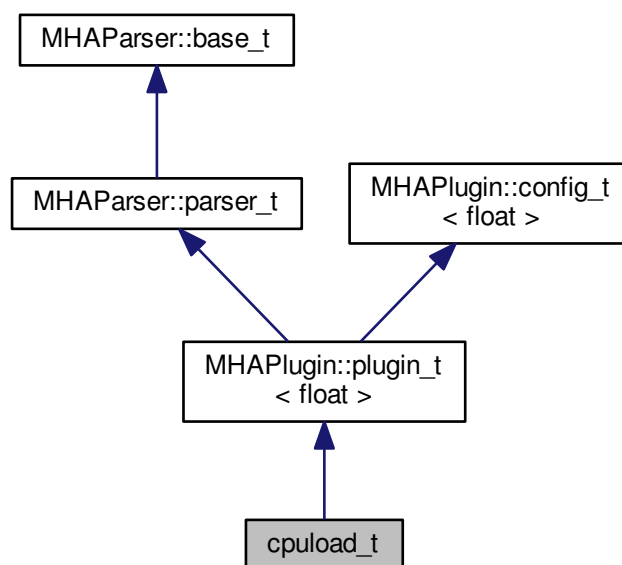

### Public Member Functions

- **cpuload\_t** (**algo\_comm\_t**, const char \*, const char \*)
- **mha\_spec\_t \* process** (**mha\_spec\_t \***)
- **mha\_wave\_t \* process** (**mha\_wave\_t \***)
- void **prepare** (**mhaconfig\_t &**)

### Private Member Functions

- void **compute\_something** ()
- void **compute\_something\_else** ()

### Private Attributes

- **MHAParser::float\_t factor**
- **MHAParser::bool\_t use\_sine**
- float **phase**
- volatile float **result**
- std::vector< float > **table**

### Additional Inherited Members

#### 5.58.1 Constructor & Destructor Documentation

5.58.1.1 **cpuload\_t::cpuload\_t** (  
           **algo\_comm\_t iac**,  
           const char \*,  
           const char \* )

#### 5.58.2 Member Function Documentation

5.58.2.1 **mha\_spec\_t \* cpuload\_t::process** (  
           **mha\_spec\_t \* s** )

5.58.2.2 **mha\_wave\_t \* cpuload\_t::process** (  
           **mha\_wave\_t \* s** )

5.58.2.3 void **cpuload\_t::prepare** (  
           **mhaconfig\_t & cf** ) [virtual]

Implements **MHAPLugin::plugin\_t< float >** (p. 730).



5.58.2.4 void cpuload\_t::compute\_something ( ) [inline],[private]

5.58.2.5 void cpuload\_t::compute\_something\_else ( ) [inline],[private]

### 5.58.3 Member Data Documentation

5.58.3.1 MHAParser::float\_t cpuload\_t::factor [private]

5.58.3.2 MHAParser::bool\_t cpuload\_t::use\_sine [private]

5.58.3.3 float cpuload\_t::phase [private]

5.58.3.4 volatile float cpuload\_t::result [private]

5.58.3.5 std::vector<float> cpuload\_t::table [private]

The documentation for this class was generated from the following file:

- cpuload.cpp

## 5.59 db\_if\_t Class Reference

Inheritance diagram for db\_if\_t:

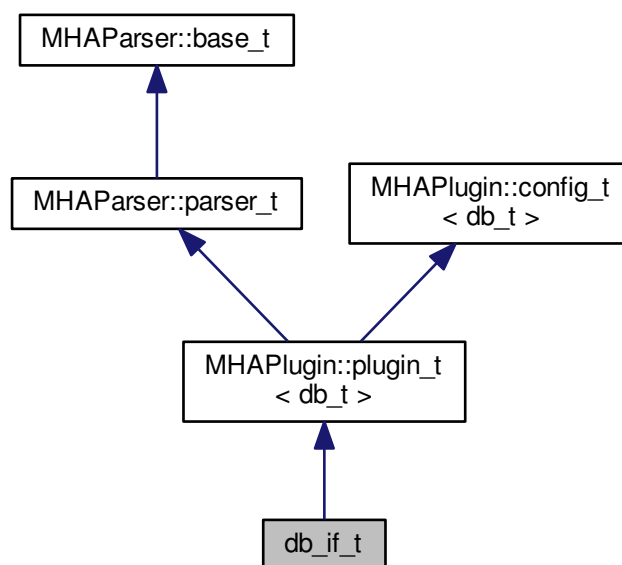

## Public Member Functions

- **db\_if\_t** (**algo\_comm\_t**, std::string, std::string)
- **mha\_wave\_t \* process** (**mha\_wave\_t \***)
- void **prepare** (**mhaconfig\_t &**)
- void **release** ()
- **~db\_if\_t** ()

## Private Attributes

- **MHAEvents::patchbay\_t< db\_if\_t > patchbay**
- **MHAParser::int\_t fragsize**
- **MHAParser::mhapluginloader\_t plugloader**
- std::string **chain**
- std::string **algo**
- bool **bypass**

## Additional Inherited Members

### 5.59.1 Constructor & Destructor Documentation

5.59.1.1 **db\_if\_t::db\_if\_t** (  
                   **algo\_comm\_t iac,**  
                   **std::string th,**  
                   **std::string al** )

5.59.1.2 **db\_if\_t::~~db\_if\_t** ( )

### 5.59.2 Member Function Documentation

5.59.2.1 **mha\_wave\_t \* db\_if\_t::process** (  
                   **mha\_wave\_t \* s** )

5.59.2.2 void **db\_if\_t::prepare** (  
                   **mhaconfig\_t & conf** ) [virtual]

Implements **MHAPlugin::plugin\_t< db\_t >** (p. 730).

5.59.2.3 void **db\_if\_t::release** (  
                   **void** ) [virtual]

Reimplemented from **MHAPlugin::plugin\_t< db\_t >** (p. 731).

## 5.59.3 Member Data Documentation

5.59.3.1 `MHAEvents::patchbay_t< db_if_t > db_if_t::patchbay` [private]5.59.3.2 `MHAParser::int_t db_if_t::fragsize` [private]5.59.3.3 `MHAParser::mhapluginloader_t db_if_t::plugloader` [private]5.59.3.4 `std::string db_if_t::chain` [private]5.59.3.5 `std::string db_if_t::algo` [private]5.59.3.6 `bool db_if_t::bypass` [private]

The documentation for this class was generated from the following file:

- **db.cpp**

## 5.60 db\_t Class Reference

Inheritance diagram for db\_t:

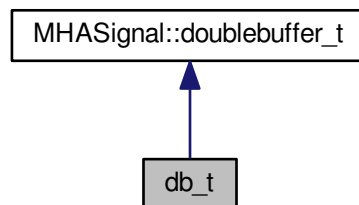

## Public Member Functions

- **db\_t** (unsigned int outer\_fragsize, unsigned int inner\_fragsize, unsigned int nch\_in, unsigned int nch\_out, **MHAParser::mhapluginloader\_t** &plug)
- **mha\_wave\_t \* inner\_process** (**mha\_wave\_t \***)

## Private Attributes

- **MHAParser::mhapluginloader\_t & plugloader**

## Additional Inherited Members

### 5.60.1 Constructor & Destructor Documentation

5.60.1.1 `db_t::db_t (`  
    unsigned int *outer\_fragsize*,  
    unsigned int *inner\_fragsize*,  
    unsigned int *nch\_in*,  
    unsigned int *nch\_out*,  
    MHAParser::mhapluginloader\_t & *plug* )

### 5.60.2 Member Function Documentation

5.60.2.1 `mha_wave_t * db_t::inner_process (`  
    *mha\_wave\_t \* s* ) [*virtual*]

Implements **MHASignal::doublebuffer\_t** (p. 771).

### 5.60.3 Member Data Documentation

5.60.3.1 `MHAParser::mhapluginloader_t & db_t::plugloader` [*private*]

The documentation for this class was generated from the following file:

- **db.cpp**

## 5.61 dc::dc\_if\_t Class Reference

Inheritance diagram for dc::dc\_if\_t:

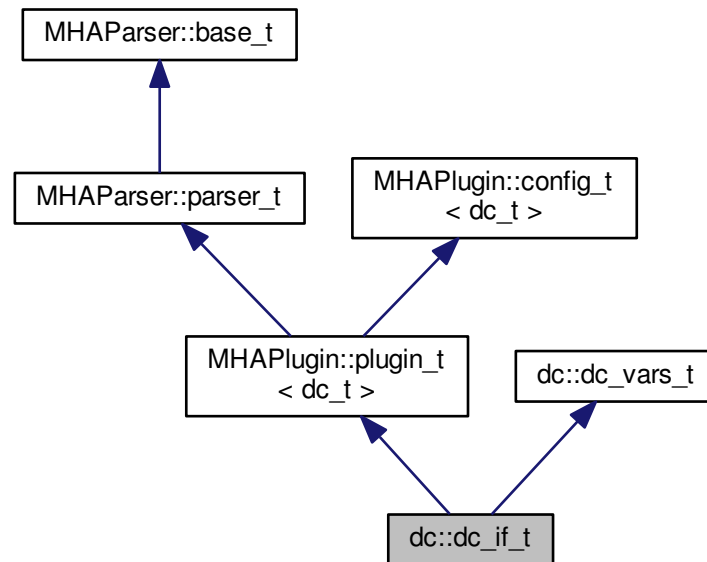

### Public Member Functions

- **dc\_if\_t** (const **algo\_comm\_t** &ac\_, const std::string &th\_, const std::string &al\_)
- void **prepare** (**mhaconfig\_t** &tf)
- **mha\_wave\_t** \* **process** (**mha\_wave\_t** \*)
- **mha\_spec\_t** \* **process** (**mha\_spec\_t** \*)

### Private Member Functions

- void **update\_monitors** ()  
*Called from within the processing routines: updates the monitor variables.*
- void **update** ()  
*Called by MHA configuration change event mechanism: creates new runtime configuration.*

### Private Attributes

- std::string **algo**
- **wideband\_inhib\_vars\_t** **wbinhib**
- **MHAEvents::patchbay\_t** < **dc\_if\_t** > **patchbay**

## Additional Inherited Members

### 5.61.1 Constructor & Destructor Documentation

5.61.1.1 `dc::dc_if_t::dc_if_t (`  
                   `const algo_comm_t & ac_,`  
                   `const std::string & th_,`  
                   `const std::string & al_ )`

### 5.61.2 Member Function Documentation

5.61.2.1 `void dc::dc_if_t::prepare (`  
                   `mhaconfig_t & tf ) [virtual]`

Implements **MHAPlugin::plugin\_t< dc\_t >** (p. 730).

5.61.2.2 `mha_wave_t * dc::dc_if_t::process (`  
                   `mha_wave_t * s_in )`

5.61.2.3 `mha_spec_t * dc::dc_if_t::process (`  
                   `mha_spec_t * s_in )`

5.61.2.4 `void dc::dc_if_t::update_monitors ( ) [private]`

Called from within the processing routines: updates the monitor variables.

5.61.2.5 `void dc::dc_if_t::update ( ) [private]`

Called by MHA configuration change event mechanism: creates new runtime configuration.

### 5.61.3 Member Data Documentation

5.61.3.1 `std::string dc::dc_if_t::algo [private]`

5.61.3.2 `wideband_inhib_vars_t dc::dc_if_t::wbinhib [private]`

5.61.3.3 `MHAEvents::patchbay_t<dc_if_t> dc::dc_if_t::patchbay [private]`

The documentation for this class was generated from the following file:

- **dc.cpp**

## 5.62 dc::dc\_t Class Reference

Inheritance diagram for dc::dc\_t:

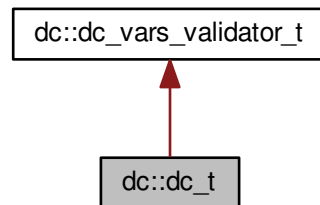

## Public Member Functions

- `dc_t` (`dc_vars_t` vars, `mha_real_t` filter\_rate, unsigned int nch, `algo_comm_t` ac, `mha_↔_domain_t` domain, unsigned int fftlen, std::string algo)
- `mha_wave_t * process` (`mha_wave_t *`)
- `mha_spec_t * process` (`mha_spec_t *`, `wb_inhib_cfg_t *wb_inhib`)
- void `explicit_insert` ()
- unsigned `get_nbands` () const  
*Number of frequency bands accessor.*
- const `MHASignal::waveform_t & get_level_in_db` () const
- const `MHASignal::waveform_t & get_level_in_db_adjusted` () const

## Private Attributes

- std::vector< `MHATableLookup::linear_table_t` > `gt`
- `MHAFilter::o1flt_lowpass_t` `rmslevel`
- `MHAFilter::o1flt_lowpass_t` `attack`
- `MHAFilter::o1flt_maxtrack_t` `decay`
- bool `powersum`
- bool `bypass`
- unsigned int `naudiochannels`
- unsigned int `nbands`
- `MHA_AC::waveform_t` `level_in_db`
- `MHA_AC::waveform_t` `level_in_db_adjusted`
- `MHA_AC::waveform_t` `inhib_gain`
- `MHASignal::waveform_t` `max_level_difference`
- unsigned int `k_nyquist`

## Additional Inherited Members

### 5.62.1 Constructor & Destructor Documentation

5.62.1.1 `dc::dc_t::dc_t (`  
     `dc_vars_t vars,`  
     `mha_real_t filter_rate,`  
     `unsigned int nch,`  
     `algo_comm_t ac,`  
     `mha_domain_t domain,`  
     `unsigned int fftlen,`  
     `std::string algo )`

### 5.62.2 Member Function Documentation

5.62.2.1 `mha_wave_t * dc::dc_t::process (`  
     `mha_wave_t * s )`

5.62.2.2 `mha_spec_t * dc::dc_t::process (`  
     `mha_spec_t * s,`  
     `wb_inhib_cfg_t * wbinhib )`

5.62.2.3 `void dc::dc_t::explicit_insert ( )`

5.62.2.4 `unsigned dc::dc_t::get_nbands ( ) const` `[inline]`

Number of frequency bands accessor.

5.62.2.5 `const MHASignal::waveform_t & dc::dc_t::get_level_in_db ( ) const` `[inline]`

5.62.2.6 `const MHASignal::waveform_t & dc::dc_t::get_level_in_db_adjusted ( ) const`  
`[inline]`

### 5.62.3 Member Data Documentation

5.62.3.1 `std::vector<MHATableLookup::linear_table_t> dc::dc_t::gt` `[private]`

5.62.3.2 `MHAFilter::o1flt_lowpass_t dc::dc_t::rmslevel` `[private]`

5.62.3.3 `MHAFilter::o1flt_lowpass_t dc::dc_t::attack` `[private]`

5.62.3.4 `MHAFilter::o1flt_maxtrack_t dc::dc_t::decay` `[private]`

5.62.3.5 `bool dc::dc_t::powersum` `[private]`



5.62.3.6 `bool dc::dc_t::bypass` [private]

5.62.3.7 `unsigned int dc::dc_t::naudiochannels` [private]

5.62.3.8 `unsigned int dc::dc_t::nbands` [private]

5.62.3.9 `MHA_AC::waveform_t dc::dc_t::level_in_db` [private]

5.62.3.10 `MHA_AC::waveform_t dc::dc_t::level_in_db_adjusted` [private]

5.62.3.11 `MHA_AC::waveform_t dc::dc_t::inhib_gain` [private]

5.62.3.12 `MHASignal::waveform_t dc::dc_t::max_level_difference` [private]

5.62.3.13 `unsigned int dc::dc_t::k_nyquist` [private]

The documentation for this class was generated from the following file:

- `dc.cpp`

## 5.63 dc::dc\_vars\_t Class Reference

Inheritance diagram for `dc::dc_vars_t`:

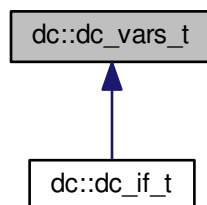

### Public Member Functions

- `dc_vars_t (MHAParser::parser_t &)`

## Public Attributes

- **MHAParser::bool\_t powersum**
- **MHAParser::mfloat\_t gtdata**
- **MHAParser::vfloat\_t gtmin**
- **MHAParser::vfloat\_t gtstep**
- **MHAParser::vfloat\_t taurmslevel**
- **MHAParser::vfloat\_t tauattack**
- **MHAParser::vfloat\_t taudecay**
- **MHAParser::string\_t filterbank**
- **std::string cf\_name**
- **std::string ef\_name**
- **std::string bw\_name**
- **MHAParser::string\_t cname**
- **MHAParser::bool\_t bypass**
- **MHAParser::string\_t clientid**
- **MHAParser::string\_t gainrule**
- **MHAParser::string\_t preset**
- **MHAParser::int\_mon\_t modified**
- **MHAParser::mfloat\_t max\_level\_difference**
- **MHAParser::vfloat\_mon\_t input\_level**
- **MHAParser::vfloat\_mon\_t filtered\_level**
- **MHAParser::vfloat\_mon\_t center\_frequencies**
- **MHAParser::vfloat\_mon\_t edge\_frequencies**
- **MHAParser::vfloat\_mon\_t band\_weights**
- **MHAParser::bool\_t use\_wbinhib**

## 5.63.1 Constructor &amp; Destructor Documentation

5.63.1.1 `dc::dc_vars_t::dc_vars_t ( MHAParser::parser_t & p )`

## 5.63.2 Member Data Documentation

5.63.2.1 `MHAParser::bool_t dc::dc_vars_t::powersum`

5.63.2.2 `MHAParser::mfloat_t dc::dc_vars_t::gtdata`

5.63.2.3 `MHAParser::vfloat_t dc::dc_vars_t::gtmin`

5.63.2.4 `MHAParser::vfloat_t dc::dc_vars_t::gtstep`

5.63.2.5 `MHAParser::vfloat_t dc::dc_vars_t::taurmslevel`

- 5.63.2.6 MHAParser::vfloat\_t dc::dc\_vars\_t::tauattack
- 5.63.2.7 MHAParser::vfloat\_t dc::dc\_vars\_t::taudecay
- 5.63.2.8 MHAParser::string\_t dc::dc\_vars\_t::filterbank
- 5.63.2.9 std::string dc::dc\_vars\_t::cf\_name
- 5.63.2.10 std::string dc::dc\_vars\_t::ef\_name
- 5.63.2.11 std::string dc::dc\_vars\_t::bw\_name
- 5.63.2.12 MHAParser::string\_t dc::dc\_vars\_t::chname
- 5.63.2.13 MHAParser::bool\_t dc::dc\_vars\_t::bypass
- 5.63.2.14 MHAParser::string\_t dc::dc\_vars\_t::clientid
- 5.63.2.15 MHAParser::string\_t dc::dc\_vars\_t::gainrule
- 5.63.2.16 MHAParser::string\_t dc::dc\_vars\_t::preset
- 5.63.2.17 MHAParser::int\_mon\_t dc::dc\_vars\_t::modified
- 5.63.2.18 MHAParser::mfloat\_t dc::dc\_vars\_t::max\_level\_difference
- 5.63.2.19 MHAParser::vfloat\_mon\_t dc::dc\_vars\_t::input\_level
- 5.63.2.20 MHAParser::vfloat\_mon\_t dc::dc\_vars\_t::filtered\_level
- 5.63.2.21 MHAParser::vfloat\_mon\_t dc::dc\_vars\_t::center\_frequencies
- 5.63.2.22 MHAParser::vfloat\_mon\_t dc::dc\_vars\_t::edge\_frequencies
- 5.63.2.23 MHAParser::vfloat\_mon\_t dc::dc\_vars\_t::band\_weights
- 5.63.2.24 MHAParser::bool\_t dc::dc\_vars\_t::use\_wbinhib

The documentation for this class was generated from the following file:

- **dc.cpp**

## 5.64 dc::dc\_vars\_validator\_t Class Reference

Inheritance diagram for dc::dc\_vars\_validator\_t:

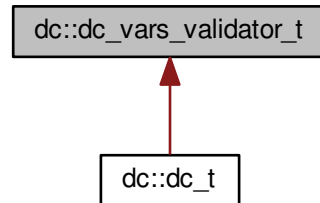

### Public Member Functions

- `dc_vars_validator_t` (`dc_vars_t` &*v*, unsigned int *s*, `mha_domain_t` *domain*)

### 5.64.1 Constructor & Destructor Documentation

5.64.1.1 `dc::dc_vars_validator_t::dc_vars_validator_t (`  
`dc_vars_t & v,`  
`unsigned int s,`  
`mha_domain_t domain )`

The documentation for this class was generated from the following file:

- `dc.cpp`

## 5.65 dc::wb\_inhib\_cfg\_t Class Reference

### Public Member Functions

- `wb_inhib_cfg_t` (const `wideband_inhib_vars_t` &*vars*)

### Public Attributes

- `std::vector< float >` `weights`
- float `dl_map_min`
- float `dl_map_max`
- float `dl_diff`
- float `l_min`
- `std::vector< std::vector< float > >` `g_scale`

## 5.65.1 Constructor &amp; Destructor Documentation

5.65.1.1 dc::wb\_inhib\_cfg\_t::wb\_inhib\_cfg\_t (   
 const wideband\_inhib\_vars\_t & vars )

## 5.65.2 Member Data Documentation

5.65.2.1 std::vector<float> dc::wb\_inhib\_cfg\_t::weights

5.65.2.2 float dc::wb\_inhib\_cfg\_t::dl\_map\_min

5.65.2.3 float dc::wb\_inhib\_cfg\_t::dl\_map\_max

5.65.2.4 float dc::wb\_inhib\_cfg\_t::dl\_diff

5.65.2.5 float dc::wb\_inhib\_cfg\_t::l\_min

5.65.2.6 std::vector<std::vector<float> > dc::wb\_inhib\_cfg\_t::g\_scale

The documentation for this class was generated from the following file:

- **dc.cpp**

## 5.66 dc::wideband\_inhib\_vars\_t Class Reference

Inheritance diagram for dc::wideband\_inhib\_vars\_t:

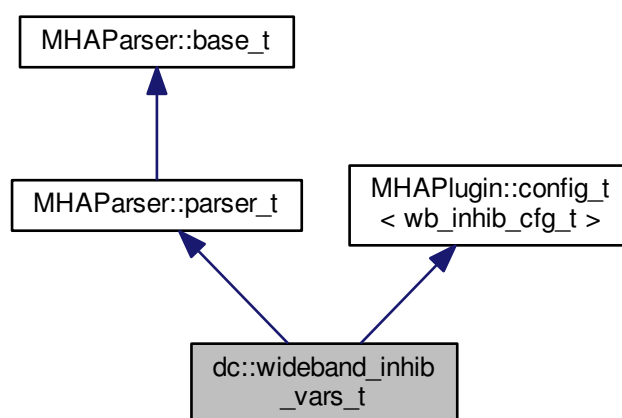

## Public Member Functions

- **wideband\_inhib\_vars\_t** ( )
- void **setchannels** (unsigned int *ch*, unsigned int *bnds*)
- **wb\_inhib\_cfg\_t** \* **current** ( )
- void **update** ( )

## Public Attributes

- **MHAParser::vfloat\_t** **weights**
- **MHAParser::float\_t** **dl\_map\_min**
- **MHAParser::float\_t** **dl\_map\_max**
- **MHAParser::float\_t** **l\_min**
- **MHAParser::mfloat\_t** **g\_scale**
- **MHAEvents::patchbay\_t** < **wideband\_inhib\_vars\_t** > **patchbay**
- unsigned int **channels**
- unsigned int **bands**

## Additional Inherited Members

### 5.66.1 Constructor & Destructor Documentation

5.66.1.1 `dc::wideband_inhib_vars_t::wideband_inhib_vars_t ( )`

### 5.66.2 Member Function Documentation

5.66.2.1 `void dc::wideband_inhib_vars_t::setchannels ( unsigned int ch, unsigned int bnds ) [inline]`

5.66.2.2 `wb_inhib_cfg_t* dc::wideband_inhib_vars_t::current ( ) [inline]`

5.66.2.3 `void dc::wideband_inhib_vars_t::update ( )`

### 5.66.3 Member Data Documentation

5.66.3.1 `MHAParser::vfloat_t dc::wideband_inhib_vars_t::weights`

5.66.3.2 `MHAParser::float_t dc::wideband_inhib_vars_t::dl_map_min`

5.66.3.3 `MHAParser::float_t dc::wideband_inhib_vars_t::dl_map_max`

5.66.3.4 `MHAParser::float_t dc::wideband_inhib_vars_t::l_min`

5.66.3.5 MHAParser::mfloat\_t dc::wideband\_inhib\_vars\_t::g\_scale

5.66.3.6 MHAEvents::patchbay\_t<wideband\_inhib\_vars\_t> dc::wideband\_inhib\_vars\_t↔  
::patchbay

5.66.3.7 unsigned int dc::wideband\_inhib\_vars\_t::channels

5.66.3.8 unsigned int dc::wideband\_inhib\_vars\_t::bands

The documentation for this class was generated from the following file:

- **dc.cpp**

## 5.67 dc\_simple::dc\_if\_t Class Reference

Inheritance diagram for dc\_simple::dc\_if\_t:

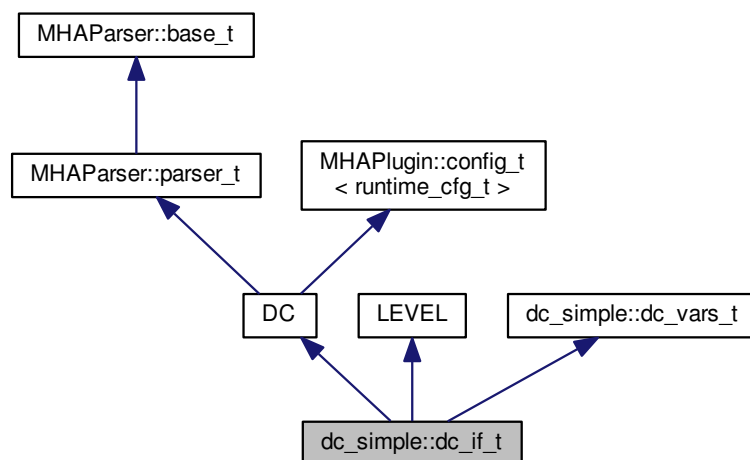

### Public Member Functions

- **dc\_if\_t** (const **algo\_comm\_t** &ac\_, const std::string &th\_, const std::string &al\_)
- void **prepare** (**mhaconfig\_t** &tf)
- void **release** ()
- **mha\_spec\_t** \* **process** (**mha\_spec\_t** \*)
- **mha\_wave\_t** \* **process** (**mha\_wave\_t** \*)

### Private Member Functions

- void **update\_dc** ()
- void **update\_level** ()
- void **has\_been\_modified** ()
- void **read\_modified** ()
- void **update\_level\_mon** ()
- void **update\_gain\_mon** ()

### Private Attributes

- **MHAParser::string\_t** clientid
- **MHAParser::string\_t** gainrule
- **MHAParser::string\_t** preset
- **MHAParser::int\_mon\_t** modified
- **MHAParser::vfloat\_mon\_t** mon\_l
- **MHAParser::vfloat\_mon\_t** mon\_g
- **MHAParser::string\_t** filterbank
- **MHAParser::vfloat\_mon\_t** center\_frequencies
- **MHAParser::vfloat\_mon\_t** edge\_frequencies
- **MHAEvents::patchbay\_t**< **dc\_if\_t** > patchbay
- bool **prepared**

### Additional Inherited Members

#### 5.67.1 Constructor & Destructor Documentation

5.67.1.1 `dc_simple::dc_if_t::dc_if_t (`  
     `const algo_comm_t & ac_,`  
     `const std::string & th_,`  
     `const std::string & al_ )`

#### 5.67.2 Member Function Documentation

5.67.2.1 `void dc_simple::dc_if_t::prepare (`  
     `mhaconfig_t & tf ) [virtual]`

Implements **MHAPlugin::plugin\_t**< **runtime\_cfg\_t** > (p. 730).

5.67.2.2 `void dc_simple::dc_if_t::release (`  
     `void ) [virtual]`

Reimplemented from **MHAPlugin::plugin\_t**< **runtime\_cfg\_t** > (p. 731).



5.67.2.3 mha\_spec\_t \* dc\_simple::dc\_if\_t::process ( mha\_spec\_t \* s )

5.67.2.4 mha\_wave\_t \* dc\_simple::dc\_if\_t::process ( mha\_wave\_t \* s )

5.67.2.5 void dc\_simple::dc\_if\_t::update\_dc ( ) [private]

5.67.2.6 void dc\_simple::dc\_if\_t::update\_level ( ) [private]

5.67.2.7 void dc\_simple::dc\_if\_t::has\_been\_modified ( ) [inline],[private]

5.67.2.8 void dc\_simple::dc\_if\_t::read\_modified ( ) [inline],[private]

5.67.2.9 void dc\_simple::dc\_if\_t::update\_level\_mon ( ) [private]

5.67.2.10 void dc\_simple::dc\_if\_t::update\_gain\_mon ( ) [private]

### 5.67.3 Member Data Documentation

5.67.3.1 MHAParser::string\_t dc\_simple::dc\_if\_t::clientid [private]

5.67.3.2 MHAParser::string\_t dc\_simple::dc\_if\_t::gainrule [private]

5.67.3.3 MHAParser::string\_t dc\_simple::dc\_if\_t::preset [private]

5.67.3.4 MHAParser::int\_mon\_t dc\_simple::dc\_if\_t::modified [private]

5.67.3.5 MHAParser::vfloat\_mon\_t dc\_simple::dc\_if\_t::mon\_l [private]

5.67.3.6 MHAParser::vfloat\_mon\_t dc\_simple::dc\_if\_t::mon\_g [private]

5.67.3.7 MHAParser::string\_t dc\_simple::dc\_if\_t::filterbank [private]

5.67.3.8 MHAParser::vfloat\_mon\_t dc\_simple::dc\_if\_t::center\_frequencies [private]

5.67.3.9 MHAParser::vfloat\_mon\_t dc\_simple::dc\_if\_t::edge\_frequencies [private]

5.67.3.10 MHAEvents::patchbay\_t<dc\_if\_t> dc\_simple::dc\_if\_t::patchbay [private]

5.67.3.11 bool dc\_simple::dc\_if\_t::prepared [private]

The documentation for this class was generated from the following file:

- **dc\_simple.cpp**

## 5.68 dc\_simple::dc\_t Class Reference

Inheritance diagram for dc\_simple::dc\_t:

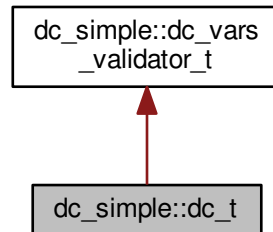

### Classes

- class **line\_t**

### Public Member Functions

- **dc\_t** (const **dc\_vars\_t** &vars, **mha\_real\_t** filter\_rate, unsigned int nch, unsigned int fftlen)
- **mha\_spec\_t** \* **process** (**mha\_spec\_t** \*, **mha\_wave\_t** \*level\_db)
- **mha\_wave\_t** \* **process** (**mha\_wave\_t** \*, **mha\_wave\_t** \*level\_db)

### Public Attributes

- std::vector< float > **mon\_l**
- std::vector< float > **mon\_g**

### Private Attributes

- std::vector< **mha\_real\_t** > **expansion\_threshold**
- std::vector< **mha\_real\_t** > **limiter\_threshold**
- std::vector< **line\_t** > **compression**
- std::vector< **line\_t** > **expansion**
- std::vector< **line\_t** > **limiter**
- std::vector< **mha\_real\_t** > **maxgain**
- unsigned int **nbands**

## Additional Inherited Members

### 5.68.1 Constructor & Destructor Documentation

5.68.1.1 dc\_simple::dc\_t::dc\_t (  
    const dc\_vars\_t & vars,  
    mha\_real\_t filter\_rate,  
    unsigned int nch,  
    unsigned int fftlen )

### 5.68.2 Member Function Documentation

5.68.2.1 mha\_spec\_t \* dc\_simple::dc\_t::process (  
    mha\_spec\_t \* s,  
    mha\_wave\_t \* level\_db )

5.68.2.2 mha\_wave\_t \* dc\_simple::dc\_t::process (  
    mha\_wave\_t \* s,  
    mha\_wave\_t \* level\_db )

### 5.68.3 Member Data Documentation

5.68.3.1 std::vector<mha\_real\_t> dc\_simple::dc\_t::expansion\_threshold [private]

5.68.3.2 std::vector<mha\_real\_t> dc\_simple::dc\_t::limiter\_threshold [private]

5.68.3.3 std::vector<line\_t> dc\_simple::dc\_t::compression [private]

5.68.3.4 std::vector<line\_t> dc\_simple::dc\_t::expansion [private]

5.68.3.5 std::vector<line\_t> dc\_simple::dc\_t::limiter [private]

5.68.3.6 std::vector<mha\_real\_t> dc\_simple::dc\_t::maxgain [private]

5.68.3.7 unsigned int dc\_simple::dc\_t::nbands [private]

5.68.3.8 std::vector<float> dc\_simple::dc\_t::mon\_l

5.68.3.9 std::vector<float> dc\_simple::dc\_t::mon\_g

The documentation for this class was generated from the following file:

- **dc\_simple.cpp**

## 5.69 dc\_simple::dc\_t::line\_t Class Reference

### Public Member Functions

- `line_t (mha_real_t x1, mha_real_t y1, mha_real_t x2, mha_real_t y2)`
- `line_t (mha_real_t x1, mha_real_t y1, mha_real_t slope)`
- `mha_real_t operator() (mha_real_t x)`

### Private Attributes

- `mha_real_t m`
- `mha_real_t y0`

### 5.69.1 Constructor & Destructor Documentation

5.69.1.1 `dc_simple::dc_t::line_t::line_t (`  
    `mha_real_t x1,`  
    `mha_real_t y1,`  
    `mha_real_t x2,`  
    `mha_real_t y2 )`

5.69.1.2 `dc_simple::dc_t::line_t::line_t (`  
    `mha_real_t x1,`  
    `mha_real_t y1,`  
    `mha_real_t slope )`

### 5.69.2 Member Function Documentation

5.69.2.1 `mha_real_t dc_simple::dc_t::line_t::operator() (`  
    `mha_real_t x ) [inline]`

### 5.69.3 Member Data Documentation

5.69.3.1 `mha_real_t dc_simple::dc_t::line_t::m [private]`

5.69.3.2 `mha_real_t dc_simple::dc_t::line_t::y0 [private]`

The documentation for this class was generated from the following file:

- `dc_simple.cpp`

## 5.70 dc\_simple::dc\_vars\_t Class Reference

Inheritance diagram for dc\_simple::dc\_vars\_t:

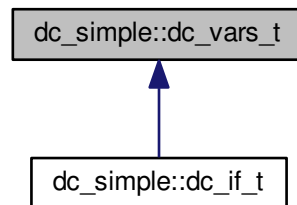

#### Public Member Functions

- **dc\_vars\_t (MHAParser::parser\_t &)**

#### Public Attributes

- **MHAParser::vfloat\_t g50**
- **MHAParser::vfloat\_t g80**
- **MHAParser::vfloat\_t maxgain**
- **MHAParser::vfloat\_t expansion\_threshold**
- **MHAParser::vfloat\_t expansion\_slope**
- **MHAParser::vfloat\_t limiter\_threshold**
- **MHAParser::vfloat\_t tauattack**
- **MHAParser::vfloat\_t taudecay**
- **MHAParser::bool\_t bypass**

#### 5.70.1 Constructor & Destructor Documentation

5.70.1.1 **dc\_simple::dc\_vars\_t::dc\_vars\_t (MHAParser::parser\_t & p )**

#### 5.70.2 Member Data Documentation

5.70.2.1 **MHAParser::vfloat\_t dc\_simple::dc\_vars\_t::g50**

5.70.2.2 **MHAParser::vfloat\_t dc\_simple::dc\_vars\_t::g80**

- 5.70.2.3 `MHAParser::vfloat_t dc_simple::dc_vars_t::maxgain`
- 5.70.2.4 `MHAParser::vfloat_t dc_simple::dc_vars_t::expansion_threshold`
- 5.70.2.5 `MHAParser::vfloat_t dc_simple::dc_vars_t::expansion_slope`
- 5.70.2.6 `MHAParser::vfloat_t dc_simple::dc_vars_t::limiter_threshold`
- 5.70.2.7 `MHAParser::vfloat_t dc_simple::dc_vars_t::tauattack`
- 5.70.2.8 `MHAParser::vfloat_t dc_simple::dc_vars_t::taudecay`
- 5.70.2.9 `MHAParser::bool_t dc_simple::dc_vars_t::bypass`

The documentation for this class was generated from the following file:

- `dc_simple.cpp`

## 5.71 `dc_simple::dc_vars_validator_t` Class Reference

Inheritance diagram for `dc_simple::dc_vars_validator_t`:

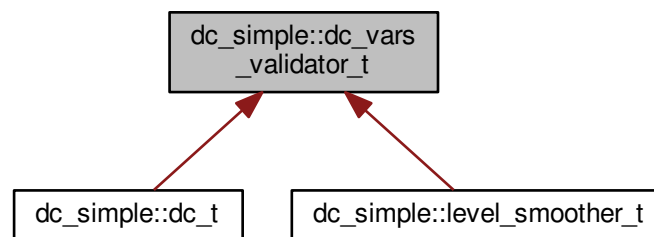

### Public Member Functions

- `dc_vars_validator_t` (const `dc_vars_t` &`v`, unsigned int `s`)

## 5.71.1 Constructor &amp; Destructor Documentation

5.71.1.1 dc\_simple::dc\_vars\_validator\_t::dc\_vars\_validator\_t (  
    const dc\_vars\_t & v,  
    unsigned int s )

The documentation for this class was generated from the following file:

- **dc\_simple.cpp**

## 5.72 dc\_simple::level\_smoother\_t Class Reference

Inheritance diagram for dc\_simple::level\_smoother\_t:

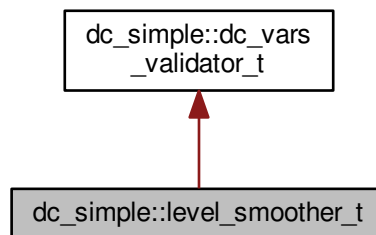

## Public Member Functions

- **level\_smoother\_t** (const dc\_vars\_t &vars, mha\_real\_t filter\_rate, mhaconfig\_t buscfg)
- **mha\_wave\_t \* process** (mha\_spec\_t \*)
- **mha\_wave\_t \* process** (mha\_wave\_t \*)

## Private Attributes

- **MHAFilter::o1flt\_lowpass\_t** attack
- **MHAFilter::o1flt\_maxtrack\_t** decay
- unsigned int **nbands**
- unsigned int **fftlens**
- **MHASignal::waveform\_t** level\_wave
- **MHASignal::waveform\_t** level\_spec

## Additional Inherited Members

### 5.72.1 Constructor & Destructor Documentation

5.72.1.1 `dc_simple::level_smoother_t::level_smoother_t (`  
     `const dc_vars_t & vars,`  
     `mha_real_t filter_rate,`  
     `mhaconfig_t buscfg )`

### 5.72.2 Member Function Documentation

5.72.2.1 `mha_wave_t * dc_simple::level_smoother_t::process (`  
     `mha_spec_t * s )`

5.72.2.2 `mha_wave_t * dc_simple::level_smoother_t::process (`  
     `mha_wave_t * s )`

### 5.72.3 Member Data Documentation

5.72.3.1 `MHAFilter::o1flt_lowpass_t dc_simple::level_smoother_t::attack` [private]

5.72.3.2 `MHAFilter::o1flt_maxtrack_t dc_simple::level_smoother_t::decay` [private]

5.72.3.3 `unsigned int dc_simple::level_smoother_t::nbands` [private]

5.72.3.4 `unsigned int dc_simple::level_smoother_t::ffflen` [private]

5.72.3.5 `MHASignal::waveform_t dc_simple::level_smoother_t::level_wave` [private]

5.72.3.6 `MHASignal::waveform_t dc_simple::level_smoother_t::level_spec` [private]

The documentation for this class was generated from the following file:

- `dc_simple.cpp`



## 5.73 delay::interface\_t Class Reference

Inheritance diagram for delay::interface\_t:

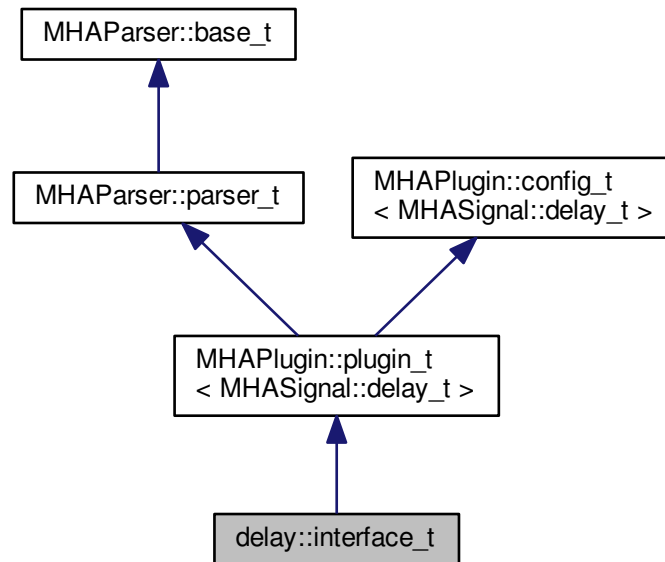

#### Public Member Functions

- **interface\_t** (const **algo\_comm\_t** &, const std::string &, const std::string &)
- void **prepare** (**mhaconfig\_t** &)
- **mha\_wave\_t** \* **process** (**mha\_wave\_t** \*)

#### Private Member Functions

- void **update** ()

#### Private Attributes

- **MHAParser::vint\_t** **delays**
- **MHAEvents::patchbay\_t** < **interface\_t** > **patchbay**

## Additional Inherited Members

### 5.73.1 Constructor & Destructor Documentation

5.73.1.1 `delay::interface_t::interface_t (`  
           `const algo_comm_t & iac,`  
           `const std::string & ,`  
           `const std::string & )`

### 5.73.2 Member Function Documentation

5.73.2.1 `void delay::interface_t::prepare (`  
           `mhaconfig_t & tf ) [virtual]`

Implements `MHAParser::plugin_t< MHASignal::delay_t >` (p. 730).

5.73.2.2 `mha_wave_t * delay::interface_t::process (`  
           `mha_wave_t * s )`

5.73.2.3 `void delay::interface_t::update ( ) [private]`

### 5.73.3 Member Data Documentation

5.73.3.1 `MHAParser::vint_t delay::interface_t::delays [private]`

5.73.3.2 `MHAEvents::patchbay_t<interface_t> delay::interface_t::patchbay [private]`

The documentation for this class was generated from the following file:

- `delay.cpp`

## 5.74 `delaysum::delaysum_if_t` Class Reference

Interface class for the `delaysum` plugin.

Inheritance diagram for delaysum::delaysum\_if\_t:

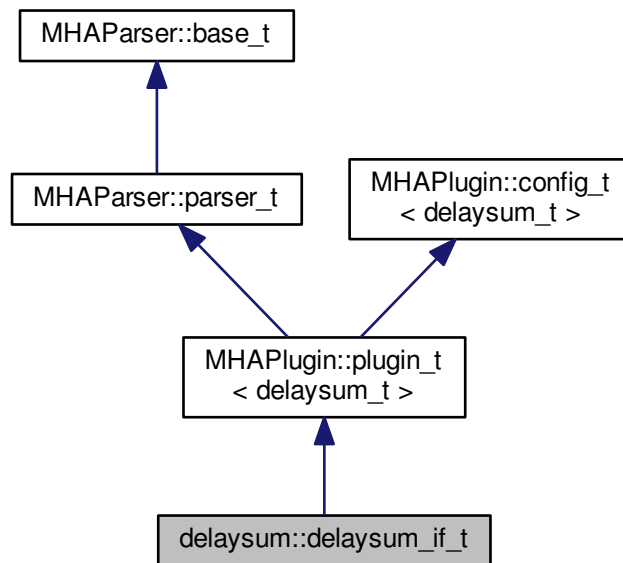

### Public Member Functions

- **delaysum\_if\_t** (const **algo\_comm\_t** &, const std::string &, const std::string &)
- **mha\_wave\_t \* process** (mha\_wave\_t \*)
- void **prepare** (mhaconfig\_t &)
- void **release** ()

### Private Member Functions

- void **update\_cfg** ()

### Private Attributes

- **MHAParser::vfloat\_t weights**  
*Linear weights to be multiplied with the audio signal, one factor for each channel.*
- **MHAParser::vint\_t delay**  
*vector of channel-specific delays, in samples.*
- **MHAEvents::patchbay\_t < delaysum\_if\_t > patchbay**  
*The patchbay to react to config changes.*

## Additional Inherited Members

### 5.74.1 Detailed Description

Interface class for the delaysum plugin.

This plugin allows to delay and sum multiple input channels using individual delays and weights. After each channel gets delayed it is multiplied with the given weight and then added to the single outout channel.

### 5.74.2 Constructor & Destructor Documentation

5.74.2.1 `delaysum::delaysum_if_t::delaysum_if_t ( const algo_comm_t & iac, const std::string & , const std::string & )`

### 5.74.3 Member Function Documentation

5.74.3.1 `mha_wave_t * delaysum::delaysum_if_t::process ( mha_wave_t * wave )`

5.74.3.2 `void delaysum::delaysum_if_t::prepare ( mhaconfig_t & tcfg ) [virtual]`

Implements `MHAPLugin::plugin_t< delaysum_t >` (p. 730).

5.74.3.3 `void delaysum::delaysum_if_t::release ( void ) [virtual]`

Reimplemented from `MHAPLugin::plugin_t< delaysum_t >` (p. 731).

5.74.3.4 `void delaysum::delaysum_if_t::update_cfg ( ) [private]`

### 5.74.4 Member Data Documentation

5.74.4.1 `MHAParser::vfloat_t delaysum::delaysum_if_t::weights [private]`

Linear weights to be multiplied with the audio signal, one factor for each channel.

Order is [chan0, chan1, ...]

5.74.4.2 `MHAParser::vint_t delaysum::delaysum_if_t::delay [private]`

vector of channel-specific delays, in samples.

### 5.74.4.3 MHAEvents::patchbay\_t<delaysum\_if\_t> delaysum::delaysum\_if\_t::patchbay [private]

The patchbay to react to config changes.

The documentation for this class was generated from the following file:

- **delaysum.cpp**

## 5.75 delaysum::delaysum\_t Class Reference

Runtime configuration of the delaysum plugin.

Inheritance diagram for delaysum::delaysum\_t:

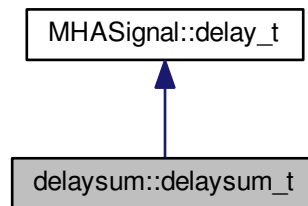

### Public Member Functions

- **delaysum\_t** (unsigned int nch, unsigned int fragsize, const std::vector< **mha\_real\_t** > &weights\_, const std::vector< int > &delays\_)  
*Constructor of the runtime configuration.*
- **mha\_wave\_t \* process** (**mha\_wave\_t \***)

### Private Attributes

- std::vector< **mha\_real\_t** > **weights**  
*Relative weights for each channel. Order is [chan0, chan1, ...].*
- **MHASignal::waveform\_t out**  
*Output waveform.*

### 5.75.1 Detailed Description

Runtime configuration of the delaysum plugin.

Inherits from the already present `delay_t` class. The constructor initializes and validates the runtime configuration and forwards the delay vector to the `delay_t` class. The process function first calls `delay_t::process` and then multiplies every output channel with its weight and adds them into the output channel.

### 5.75.2 Constructor & Destructor Documentation

5.75.2.1 `delaysum::delaysum_t::delaysum_t (`  
     unsigned int *nch*,  
     unsigned int *fragsize*,  
     const std::vector< *mha\_real\_t* > & *weights\_*,  
     const std::vector< int > & *delays\_* )

Constructor of the runtime configuration.

#### Parameters

<i>nch</i>	Number of input channels.
<i>fragsize</i>	Size of one input fragment in frames.
<i>weights_</i> ↔	Vector of weights for each channel.
<i>delays_</i> ↔	Vector of delays, one entry per channel.

### 5.75.3 Member Function Documentation

5.75.3.1 `mha_wave_t * delaysum::delaysum_t::process (`  
     *mha\_wave\_t \* signal* )

### 5.75.4 Member Data Documentation

5.75.4.1 `std::vector<mha_real_t> delaysum::delaysum_t::weights` [private]

Relative weights for each channel. Order is [chan0, chan1, ...].

5.75.4.2 `MHASignal::waveform_t delaysum::delaysum_t::out` [private]

Output waveform.

The documentation for this class was generated from the following file:

- `delaysum.cpp`

## 5.76 doasvm\_classification Class Reference

Inheritance diagram for doasvm\_classification:

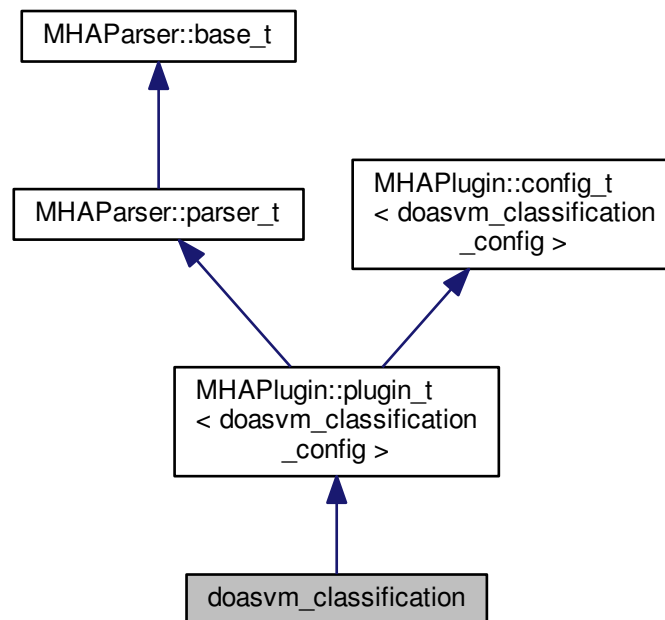

## Public Member Functions

- **doasvm\_classification** (**algo\_comm\_t** &ac, const std::string &chain\_name, const std::string &algo\_name)  
*Constructs our plugin.*
- **~doasvm\_classification** ()
- **mha\_wave\_t \* process** (**mha\_wave\_t \***)  
*Checks for the most recent configuration and defers processing to it.*
- void **prepare** (**mhaconfig\_t** &)  
*Plugin preparation.*
- void **release** (void)

## Public Attributes

- **MHAParser::vfloat\_t** angles
- **MHAParser::mfloat\_t** w
- **MHAParser::vfloat\_t** b
- **MHAParser::vfloat\_t** x
- **MHAParser::vfloat\_t** y
- **MHAParser::string\_t** p\_name
- **MHAParser::string\_t** max\_p\_ind\_name
- **MHAParser::string\_t** vGCC\_name

### Private Member Functions

- void **update\_cfg** ()

### Private Attributes

- **MHAEvents::patchbay\_t**< **doasvm\_classification** > **patchbay**

### Additional Inherited Members

#### 5.76.1 Constructor & Destructor Documentation

5.76.1.1 **doasvm\_classification::doasvm\_classification** (  
     **algo\_comm\_t** & *ac*,  
     const std::string & *chain\_name*,  
     const std::string & *algo\_name* )

Constructs our plugin.

5.76.1.2 **doasvm\_classification::~~doasvm\_classification** ( )

#### 5.76.2 Member Function Documentation

5.76.2.1 **mha\_wave\_t**\* **doasvm\_classification::process** (  
     **mha\_wave\_t**\* *signal* )

Checks for the most recent configuration and defers processing to it.

5.76.2.2 void **doasvm\_classification::prepare** (  
     **mhaconfig\_t** & *signal\_info* ) [virtual]

Plugin preparation.

An opportunity to validate configuration parameters before instantiating a configuration.

#### Parameters

<i>signal_info</i>	Structure containing a description of the form of the signal (domain, number of channels, frames per block, sampling rate).
--------------------	---

Implements **MHAPlugin::plugin\_t**< **doasvm\_classification\_config** > (p. [730](#)).



5.76.2.3 void doasvm\_classification::release (  
void ) [inline],[virtual]

Reimplemented from **MHAPugin::plugin\_t**< **doasvm\_classification\_config** > (p. 731).

5.76.2.4 void doasvm\_classification::update\_cfg ( ) [private]

### 5.76.3 Member Data Documentation

5.76.3.1 **MHAParser::vfloat\_t** doasvm\_classification::angles

5.76.3.2 **MHAParser::mfloat\_t** doasvm\_classification::w

5.76.3.3 **MHAParser::vfloat\_t** doasvm\_classification::b

5.76.3.4 **MHAParser::vfloat\_t** doasvm\_classification::x

5.76.3.5 **MHAParser::vfloat\_t** doasvm\_classification::y

5.76.3.6 **MHAParser::string\_t** doasvm\_classification::p\_name

5.76.3.7 **MHAParser::string\_t** doasvm\_classification::max\_p\_ind\_name

5.76.3.8 **MHAParser::string\_t** doasvm\_classification::vGCC\_name

5.76.3.9 **MHAEvents::patchbay\_t**<**doasvm\_classification**> doasvm\_classification::patchbay  
[private]

The documentation for this class was generated from the following files:

- **doasvm\_classification.h**
- **doasvm\_classification.cpp**

## 5.77 doasvm\_classification\_config Class Reference

### Public Member Functions

- **doasvm\_classification\_config** (**algo\_comm\_t** &ac, const **mhaconfig\_t** in\_cfg, **doasvm\_classification** \*\_doasvm)
- **~doasvm\_classification\_config** ()
- **mha\_wave\_t** \* **process** (**mha\_wave\_t** \*)

## Public Attributes

- **algo\_comm\_t & ac**
- **doasvm\_classification \* doasvm**
- **MHA\_AC::waveform\_t p**
- **MHA\_AC::int\_t p\_max**
- **mha\_wave\_t c**

## 5.77.1 Constructor &amp; Destructor Documentation

5.77.1.1 **doasvm\_classification\_config::doasvm\_classification\_config (**  
     **algo\_comm\_t & ac,**  
     **const mhaconfig\_t in\_cfg,**  
     **doasvm\_classification \* \_doasvm )**

5.77.1.2 **doasvm\_classification\_config::~doasvm\_classification\_config ( )**

## 5.77.2 Member Function Documentation

5.77.2.1 **mha\_wave\_t \* doasvm\_classification\_config::process (**  
     **mha\_wave\_t \* wave )**

## 5.77.3 Member Data Documentation

5.77.3.1 **algo\_comm\_t& doasvm\_classification\_config::ac**

5.77.3.2 **doasvm\_classification\* doasvm\_classification\_config::doasvm**

5.77.3.3 **MHA\_AC::waveform\_t doasvm\_classification\_config::p**

5.77.3.4 **MHA\_AC::int\_t doasvm\_classification\_config::p\_max**

5.77.3.5 **mha\_wave\_t doasvm\_classification\_config::c**

The documentation for this class was generated from the following files:

- **doasvm\_classification.h**
- **doasvm\_classification.cpp**

## 5.78 doasvm\_feature\_extraction Class Reference

Inheritance diagram for doasvm\_feature\_extraction:

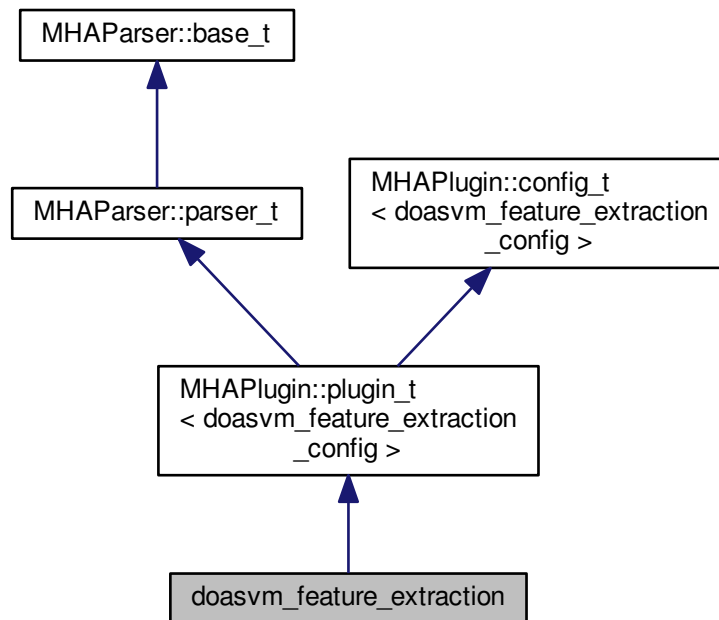

## Public Member Functions

- **doasvm\_feature\_extraction** (**algo\_comm\_t** &ac, const std::string &chain\_name, const std::string &algo\_name)  
*Constructs our plugin.*
- **~doasvm\_feature\_extraction** ()
- **mha\_wave\_t \* process** (**mha\_wave\_t \***)  
*Checks for the most recent configuration and defers processing to it.*
- void **prepare** (**mhaconfig\_t** &)  
*Plugin preparation.*
- void **release** (void)

## Public Attributes

- **MHAParser::int\_t** fftlen
- **MHAParser::int\_t** max\_lag
- **MHAParser::int\_t** nupsample
- **MHAParser::string\_t** vGCC\_name

### Private Member Functions

- void **update\_cfg** ()

### Private Attributes

- **MHAEvents::patchbay\_t**< **doasvm\_feature\_extraction** > **patchbay**

### Additional Inherited Members

#### 5.78.1 Constructor & Destructor Documentation

5.78.1.1 **doasvm\_feature\_extraction::doasvm\_feature\_extraction** (  
     **algo\_comm\_t** & *ac*,  
     const std::string & *chain\_name*,  
     const std::string & *algo\_name* )

Constructs our plugin.

5.78.1.2 **doasvm\_feature\_extraction::~doasvm\_feature\_extraction** ( )

#### 5.78.2 Member Function Documentation

5.78.2.1 **mha\_wave\_t** \* **doasvm\_feature\_extraction::process** (  
     **mha\_wave\_t** \* *signal* )

Checks for the most recent configuration and defers processing to it.

5.78.2.2 void **doasvm\_feature\_extraction::prepare** (  
     **mhaconfig\_t** & *signal\_info* ) [virtual]

Plugin preparation.

An opportunity to validate configuration parameters before instantiating a configuration.

#### Parameters

<i>signal_info</i>	Structure containing a description of the form of the signal (domain, number of channels, frames per block, sampling rate).
--------------------	---

Implements **MHAPlugin::plugin\_t**< **doasvm\_feature\_extraction\_config** > (p. [730](#)).

5.78.2.3 void doasvm\_feature\_extraction::release ( void ) [inline],[virtual]

Reimplemented from **MHAPlugin::plugin\_t< doasvm\_feature\_extraction\_config >** (p. 731).

5.78.2.4 void doasvm\_feature\_extraction::update\_cfg ( ) [private]

### 5.78.3 Member Data Documentation

5.78.3.1 **MHAParser::int\_t doasvm\_feature\_extraction::fftl**

5.78.3.2 **MHAParser::int\_t doasvm\_feature\_extraction::max\_lag**

5.78.3.3 **MHAParser::int\_t doasvm\_feature\_extraction::nupsample**

5.78.3.4 **MHAParser::string\_t doasvm\_feature\_extraction::vGCC\_name**

5.78.3.5 **MHAEvents::patchbay\_t<doasvm\_feature\_extraction> doasvm\_feature\_extraction::patchbay** [private]

The documentation for this class was generated from the following files:

- **doasvm\_feature\_extraction.h**
- **doasvm\_feature\_extraction.cpp**

## 5.79 doasvm\_feature\_extraction\_config Class Reference

### Public Member Functions

- **doasvm\_feature\_extraction\_config** (algo\_comm\_t &ac, const mhaconfig\_t in\_cfg, doasvm\_feature\_extraction \*\_doagcc)
- **~doasvm\_feature\_extraction\_config** ()
- **mha\_wave\_t \* process** (mha\_wave\_t \*)

### Public Attributes

- **doasvm\_feature\_extraction \* doagcc**
- unsigned int **wndlen**
- unsigned int **fftl**
- unsigned int **G\_length**
- unsigned int **GCC\_start**
- unsigned int **GCC\_end**
- **MHA\_AC::waveform\_t vGCC\_ac**
- **mha\_fft\_t fft**
- **mha\_fft\_t ifft**
- double **hifftwin\_sum**
- **MHASignal::waveform\_t proc\_wave**
- **MHASignal::waveform\_t hwin**
- **MHASignal::waveform\_t hifftwin**
- **MHASignal::waveform\_t vGCC**
- **MHASignal::spectrum\_t in\_spec**
- **MHASignal::spectrum\_t G**

### 5.79.1 Constructor & Destructor Documentation

5.79.1.1 `doasvm_feature_extraction_config::doasvm_feature_extraction_config ( algo_comm_t & ac, const mhaconfig_t in_cfg, doasvm_feature_extraction * _doagcc )`

5.79.1.2 `doasvm_feature_extraction_config::~doasvm_feature_extraction_config ( )`

### 5.79.2 Member Function Documentation

5.79.2.1 `mha_wave_t * doasvm_feature_extraction_config::process ( mha_wave_t * wave )`

### 5.79.3 Member Data Documentation

5.79.3.1 `doasvm_feature_extraction* doasvm_feature_extraction_config::doagcc`

5.79.3.2 `unsigned int doasvm_feature_extraction_config::wndlen`

5.79.3.3 `unsigned int doasvm_feature_extraction_config::fftl`

5.79.3.4 `unsigned int doasvm_feature_extraction_config::G_length`

5.79.3.5 `unsigned int doasvm_feature_extraction_config::GCC_start`

5.79.3.6 `unsigned int doasvm_feature_extraction_config::GCC_end`

5.79.3.7 `MHA_AC::waveform_t doasvm_feature_extraction_config::vGCC_ac`

5.79.3.8 `mha_fft_t doasvm_feature_extraction_config::fft`

5.79.3.9 `mha_fft_t doasvm_feature_extraction_config::ifft`

5.79.3.10 `double doasvm_feature_extraction_config::hifftwin_sum`

5.79.3.11 `MHASignal::waveform_t doasvm_feature_extraction_config::proc_wave`

5.79.3.12 `MHASignal::waveform_t doasvm_feature_extraction_config::hwin`

5.79.3.13 `MHASignal::waveform_t doasvm_feature_extraction_config::hifftwin`

5.79.3.14 `MHASignal::waveform_t doasvm_feature_extraction_config::vGCC`

5.79.3.15 `MHASignal::spectrum_t doasvm_feature_extraction_config::in_spec`

5.79.3.16 `MHASignal::spectrum_t doasvm_feature_extraction_config::G`

The documentation for this class was generated from the following files:

- `doasvm_feature_extraction.h`
- `doasvm_feature_extraction.cpp`

## 5.80 droptect\_t Class Reference

Detect dropouts in a signal with a constant spectrum.

Inheritance diagram for droptect\_t:

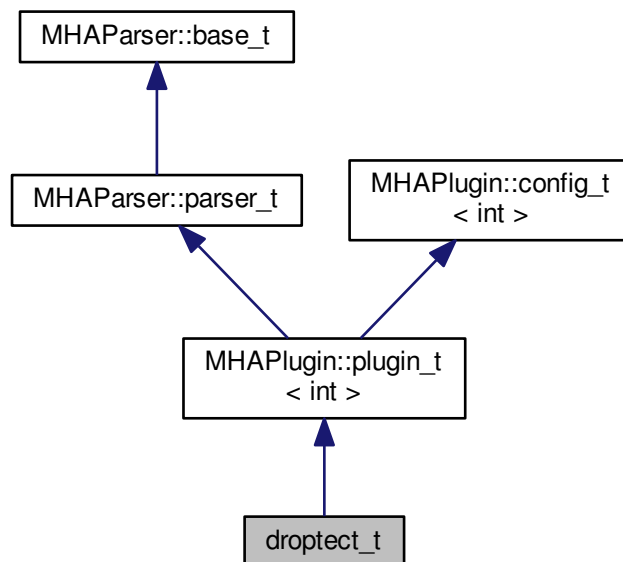

## Public Member Functions

- **droptect\_t** (**algo\_comm\_t** &ac, const std::string &chain\_name, const std::string &algo\_name)
 

*This constructor initializes the configuration language variables and inserts them into the MHA configuration tree.*
- void **prepare** (**mhaconfig\_t** &signal\_info)
- void **release** (void)
- **mha\_spec\_t** \* **process** (**mha\_spec\_t** \*signal)

## Private Attributes

- **MHAParser::vint\_mon\_t** dropouts
- **MHAParser::vint\_mon\_t** consecutive\_dropouts
- **MHAParser::int\_mon\_t** blocks
- **MHAParser::bool\_t** reset
- **MHAParser::float\_t** threshold
- **MHASignal::waveform\_t** \* current\_powspec

- **MHASignal::waveform\_t \* filtered\_powspec**
- **MHAParser::float\_t tau**
- **std::vector< bool > filter\_activated**
- **float period**  
*The period of the process callback.*
- **MHAParser::mfloat\_mon\_t filtered\_powspec\_mon**  
*User access to filtered spectrum.*
- **MHAParser::float\_mon\_t level\_mon**

### Additional Inherited Members

#### 5.80.1 Detailed Description

Detect dropouts in a signal with a constant spectrum.

#### 5.80.2 Constructor & Destructor Documentation

5.80.2.1 `droptect_t::droptect_t (`  
     `algo_comm_t & ac,`  
     `const std::string & chain_name,`  
     `const std::string & algo_name )`

This constructor initializes the configuration language variables and inserts them into the MHA configuration tree.

#### 5.80.3 Member Function Documentation

5.80.3.1 `void droptect_t::prepare (`  
     `mhaconfig_t & signal_info ) [virtual]`

Implements **MHAPlugin::plugin\_t< int >** (p. 730).

5.80.3.2 `void droptect_t::release (`  
     `void ) [virtual]`

Reimplemented from **MHAPlugin::plugin\_t< int >** (p. 731).



5.80.3.3 `mha_spec_t * droptect_t::process ( mha_spec_t * signal )`

#### 5.80.4 Member Data Documentation

5.80.4.1 `MHAParser::vint_mon_t droptect_t::dropouts` [private]

5.80.4.2 `MHAParser::vint_mon_t droptect_t::consecutive_dropouts` [private]

5.80.4.3 `MHAParser::int_mon_t droptect_t::blocks` [private]

5.80.4.4 `MHAParser::bool_t droptect_t::reset` [private]

5.80.4.5 `MHAParser::float_t droptect_t::threshold` [private]

5.80.4.6 `MHASignal::waveform_t * droptect_t::current_powspec` [private]

5.80.4.7 `MHASignal::waveform_t * droptect_t::filtered_powspec` [private]

5.80.4.8 `MHAParser::float_t droptect_t::tau` [private]

5.80.4.9 `std::vector<bool> droptect_t::filter_activated` [private]

5.80.4.10 `float droptect_t::period` [private]

The period of the process callback.

5.80.4.11 `MHAParser::mfloat_mon_t droptect_t::filtered_powspec_mon` [private]

User access to filtered spectrum.

5.80.4.12 `MHAParser::float_mon_t droptect_t::level_mon` [private]

The documentation for this class was generated from the following file:

- **droptect.cpp**

## 5.81 ds\_t Class Reference

Inheritance diagram for ds\_t:

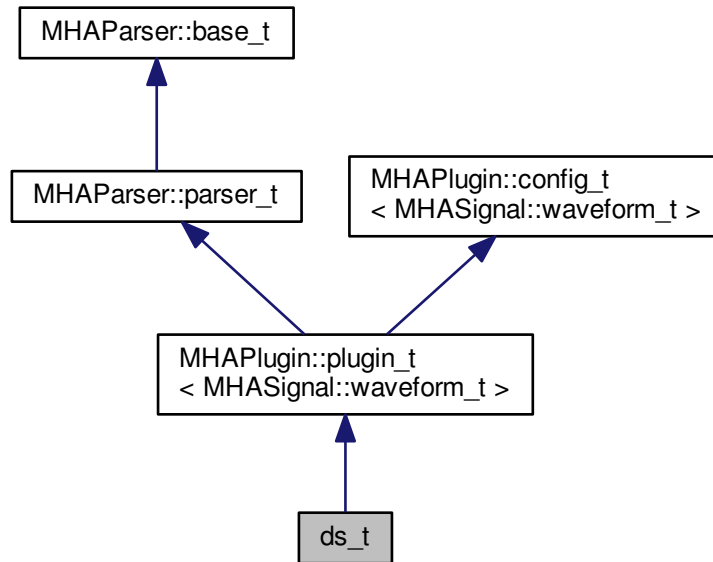

### Public Member Functions

- **ds\_t** (**algo\_comm\_t**, std::string, std::string)
- **mha\_wave\_t \* process** (**mha\_wave\_t \***)
- void **prepare** (**mhaconfig\_t &**)
- void **release** ()

### Private Attributes

- **MHAParser::int\_t ratio**
- **MHAFilter::iir\_filter\_t antialias**

### Additional Inherited Members

#### 5.81.1 Constructor & Destructor Documentation

5.81.1.1 `ds_t::ds_t (`  
    `algo_comm_t iac,`  
    `std::string ,`  
    `std::string )`

## 5.81.2 Member Function Documentation

5.81.2.1 `mha_wave_t * ds_t::process (`  
    `mha_wave_t * s )`

5.81.2.2 `void ds_t::prepare (`  
    `mhaconfig_t & cf ) [virtual]`

Implements `MHAPLugin::plugin_t< MHASignal::waveform_t >` (p. 730).

5.81.2.3 `void ds_t::release (`  
    `void ) [virtual]`

Reimplemented from `MHAPLugin::plugin_t< MHASignal::waveform_t >` (p. 731).

## 5.81.3 Member Data Documentation

5.81.3.1 `MHAParser::int_t ds_t::ratio` [private]

5.81.3.2 `MHAFilter::iir_filter_t ds_t::antialias` [private]

The documentation for this class was generated from the following file:

- `downsample.cpp`

## 5.82 dynamiclib\_t Class Reference

### Public Member Functions

- `dynamiclib_t` (const std::string &)
- `void * resolve` (const std::string &)
- `void * resolve_checked` (const std::string &)
- `~dynamiclib_t` ()
- `const std::string & getmodulename` () const
- `const std::string & getname` () const

## Private Attributes

- `std::string fullname`
- `std::string modulename`
- `mha_libhandle_t h`

## 5.82.1 Constructor & Destructor Documentation

5.82.1.1 `dynamiclib_t::dynamiclib_t ( const std::string & n )`

5.82.1.2 `dynamiclib_t::~dynamiclib_t ( )`

## 5.82.2 Member Function Documentation

5.82.2.1 `void * dynamiclib_t::resolve ( const std::string & n )`

5.82.2.2 `void * dynamiclib_t::resolve_checked ( const std::string & n )`

5.82.2.3 `const std::string& dynamiclib_t::getmodulename ( ) const [inline]`

5.82.2.4 `const std::string& dynamiclib_t::getname ( ) const [inline]`

## 5.82.3 Member Data Documentation

5.82.3.1 `std::string dynamiclib_t::fullname [private]`

5.82.3.2 `std::string dynamiclib_t::modulename [private]`

5.82.3.3 `mha_libhandle_t dynamiclib_t::h [private]`

The documentation for this class was generated from the following files:

- `mha_os.h`
- `mha_os.cpp`

## 5.83 DynComp::dc\_afterburn\_rt\_t Class Reference

Real-time class for after burn effect.

## Public Member Functions

- **dc\_afterburn\_rt\_t** (const std::vector< float > &cf, unsigned int **channels**, float srate, const **dc\_afterburn\_vars\_t** &vars)
- void **burn** (float &Gin, float Lin, unsigned int band, unsigned int channel)  
*gain modifier method (afterburn).*

## Private Attributes

- std::vector< float > **drain\_inv**
- std::vector< float > **conflux**
- std::vector< float > **maxgain**
- std::vector< float > **mpo\_inv**
- std::vector< **MHAFilter::o1flt\_lowpass\_t** > **lp**

## 5.83.1 Detailed Description

Real-time class for after burn effect.

The constructor processes the parameters and creates pre-processed variables for efficient realtime processing.

## 5.83.2 Constructor &amp; Destructor Documentation

5.83.2.1 DynComp::dc\_afterburn\_rt\_t::dc\_afterburn\_rt\_t (  
const std::vector< float > &cf,  
unsigned int channels,  
float srate,  
const dc\_afterburn\_vars\_t &vars )

## 5.83.3 Member Function Documentation

5.83.3.1 void DynComp::dc\_afterburn\_rt\_t::burn (  
float &Gin,  
float Lin,  
unsigned int band,  
unsigned int channel ) [inline]

gain modifier method (afterburn).

## Parameters

<i>Gin</i>	Linear gain.
<i>Lin</i>	Input level (Pascal).
<i>band</i>	Filter band number.
<i>channel</i>	Channel number.

Output level for MPO is estimated by  $Gin * Lin$ .

#### 5.83.4 Member Data Documentation

5.83.4.1 `std::vector<float> DynComp::dc_afterburn_rt_t::drain_inv` [private]

5.83.4.2 `std::vector<float> DynComp::dc_afterburn_rt_t::conflux` [private]

5.83.4.3 `std::vector<float> DynComp::dc_afterburn_rt_t::maxgain` [private]

5.83.4.4 `std::vector<float> DynComp::dc_afterburn_rt_t::mpo_inv` [private]

5.83.4.5 `std::vector<MHAFilter::o1flt_lowpass_t> DynComp::dc_afterburn_rt_t::lp` [private]

The documentation for this class was generated from the following files:

- `dc_afterburn.h`
- `dc_afterburn.cpp`

#### 5.84 DynComp::dc\_afterburn\_t Class Reference

Afterburn class, to be defined as a member of compressors.

Inheritance diagram for `DynComp::dc_afterburn_t`:

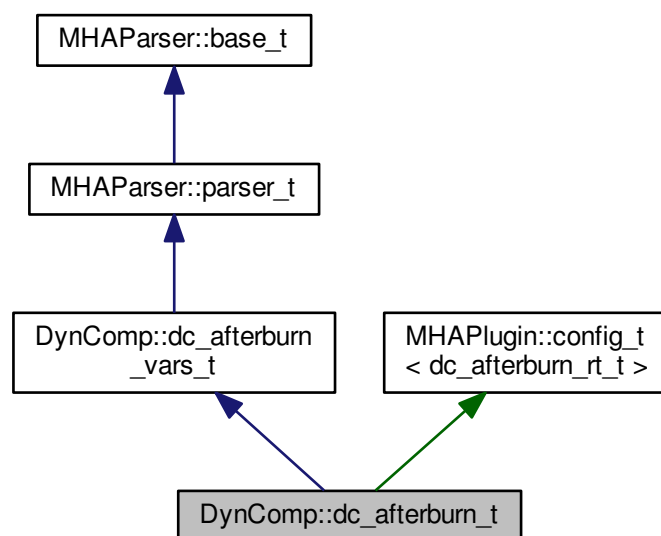

### Public Member Functions

- **dc\_afterburn\_t** ()
- void **set\_fb\_pars** (const std::vector< float > &cf, unsigned int **channels**, float *srate*)
- void **unset\_fb\_pars** ()
- void **update\_burner** ()
- void **burn** (float &Gin, float Lin, unsigned int band, unsigned int channel)

### Private Member Functions

- void **update** ()

### Private Attributes

- **MHAEvents::patchbay\_t**< **dc\_afterburn\_t** > **patchbay**
- std::vector< float > **\_cf**
- unsigned int **\_channels**
- float **\_srate**
- bool **commit\_pending**
- bool **fb\_pars\_configured**

### Additional Inherited Members

#### 5.84.1 Detailed Description

Afterburn class, to be defined as a member of compressors.

#### 5.84.2 Constructor & Destructor Documentation

##### 5.84.2.1 DynComp::dc\_afterburn\_t::dc\_afterburn\_t ( )

#### 5.84.3 Member Function Documentation

##### 5.84.3.1 void DynComp::dc\_afterburn\_t::set\_fb\_pars ( const std::vector< float > &cf, unsigned int *channels*, float *srate* )

##### 5.84.3.2 void DynComp::dc\_afterburn\_t::unset\_fb\_pars ( )

##### 5.84.3.3 void DynComp::dc\_afterburn\_t::update\_burner ( ) [inline]

5.84.3.4 void DynComp::dc\_afterburn\_t::burn (   
float & *Gin*,   
float *Lin*,   
unsigned int *band*,   
unsigned int *channel* ) [inline]

5.84.3.5 void DynComp::dc\_afterburn\_t::update ( ) [private]

#### 5.84.4 Member Data Documentation

5.84.4.1 MHAEvents::patchbay\_t<dc\_afterburn\_t> DynComp::dc\_afterburn\_t::patchbay [private]

5.84.4.2 std::vector<float> DynComp::dc\_afterburn\_t::\_cf [private]

5.84.4.3 unsigned int DynComp::dc\_afterburn\_t::\_channels [private]

5.84.4.4 float DynComp::dc\_afterburn\_t::\_srate [private]

5.84.4.5 bool DynComp::dc\_afterburn\_t::commit\_pending [private]

5.84.4.6 bool DynComp::dc\_afterburn\_t::fb\_pars\_configured [private]

The documentation for this class was generated from the following files:

- **dc\_afterburn.h**
- **dc\_afterburn.cpp**

#### 5.85 DynComp::dc\_afterburn\_vars\_t Class Reference

Variables for **dc\_afterburn\_t** (p. 294) class.



Inheritance diagram for DynComp::dc\_afterburn\_vars\_t:

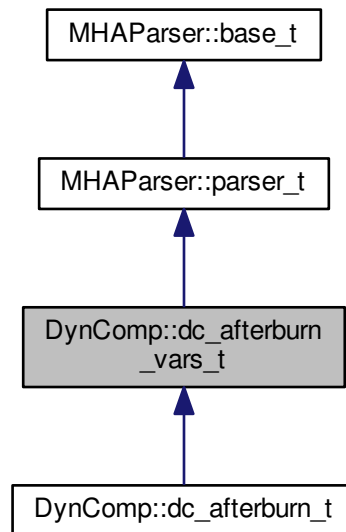

#### Public Member Functions

- **dc\_afterburn\_vars\_t** ()

#### Public Attributes

- **MHAParser::vfloat\_t** f
- **MHAParser::vfloat\_t** drain
- **MHAParser::vfloat\_t** conflux
- **MHAParser::vfloat\_t** maxgain
- **MHAParser::vfloat\_t** mpo
- **MHAParser::float\_t** taugain
- **MHAParser::kw\_t** commit
- **MHAParser::bool\_t** bypass

#### Additional Inherited Members

##### 5.85.1 Detailed Description

Variables for **dc\_afterburn\_t** (p. 294) class.

## 5.85.2 Constructor & Destructor Documentation

5.85.2.1 `DynComp::dc_afterburn_vars_t::dc_afterburn_vars_t( )`

## 5.85.3 Member Data Documentation

5.85.3.1 `MHAParser::vfloat_t DynComp::dc_afterburn_vars_t::f`

5.85.3.2 `MHAParser::vfloat_t DynComp::dc_afterburn_vars_t::drain`

5.85.3.3 `MHAParser::vfloat_t DynComp::dc_afterburn_vars_t::conflux`

5.85.3.4 `MHAParser::vfloat_t DynComp::dc_afterburn_vars_t::maxgain`

5.85.3.5 `MHAParser::vfloat_t DynComp::dc_afterburn_vars_t::mpo`

5.85.3.6 `MHAParser::float_t DynComp::dc_afterburn_vars_t::taugain`

5.85.3.7 `MHAParser::kw_t DynComp::dc_afterburn_vars_t::commit`

5.85.3.8 `MHAParser::bool_t DynComp::dc_afterburn_vars_t::bypass`

The documentation for this class was generated from the following files:

- `dc_afterburn.h`
- `dc_afterburn.cpp`

## 5.86 `DynComp::gaintable_t` Class Reference

Gain table class.

## Public Member Functions

- **gaintable\_t** (const std::vector< **mha\_real\_t** > &LInput, const std::vector< **mha\_real\_t** > &FCenter, unsigned int **channels**)  
*Constructor.*
- **~gaintable\_t** ()
- void **update** (std::vector< std::vector< std::vector< **mha\_real\_t** > > > newGain)  
*Update gains from an external table.*
- **mha\_real\_t get\_gain** (**mha\_real\_t** Lin, **mha\_real\_t** Fin, unsigned int channel)  
*Read Gain from gain table.*
- **mha\_real\_t get\_gain** (**mha\_real\_t** Lin, unsigned int band, unsigned int channel)  
*Read Gain from gain table.*
- void **get\_gain** (const **mha\_wave\_t** &Lin, **mha\_wave\_t** &Gain)  
*Read Gains from gain table.*
- unsigned int **nbands** () const  
*Return number of frequency bands.*
- unsigned int **nchannels** () const  
*Return number of audio channels.*
- std::vector< std::vector< **mha\_real\_t** > > **get\_iofun** () const  
*Return current input-output function.*
- std::vector< **mha\_real\_t** > **get\_vL** () const
- std::vector< **mha\_real\_t** > **get\_vF** () const

## Private Attributes

- unsigned int **num\_L**
- unsigned int **num\_F**
- unsigned int **num\_channels**
- std::vector< **mha\_real\_t** > **vL**
- std::vector< **mha\_real\_t** > **vF**
- std::vector< **mha\_real\_t** > **vFlog**
- std::vector< std::vector< std::vector< **mha\_real\_t** > > > **data**

## 5.86.1 Detailed Description

Gain table class.

This gain table is intended to efficient table lookup, i.e, interpolation of levels, and optional interpolation of frequencies. Sample input levels and sample frequencies are given in the constructor. The gain entries can be updated with the **update()** (p. 301) member function via a gain prescription rule from an auditory profile.

## 5.86.2 Constructor & Destructor Documentation

5.86.2.1 `gaintable_t::gaintable_t (`  
    `const std::vector< mha_real_t > & LInput,`  
    `const std::vector< mha_real_t > & FCenter,`  
    `unsigned int channels )`

Constructor.

## Parameters

<i>LInput</i>	Input level samples, in equivalent LTASS_combined dB SPL.
<i>FCenter</i>	Frequency samples in Hz (e.g., center frequencies of filterbank).
<i>channels</i>	Number of audio channels (typically 2).

## 5.86.2.2 gaintable\_t::~~gaintable\_t ( )

## 5.86.3 Member Function Documentation

5.86.3.1 void gaintable\_t::update (   
 `std::vector< std::vector< std::vector< mha_real_t > > > newGain )`

Update gains from an external table.

## Parameters

<i>newGain</i>	New gain table entries.
----------------	-------------------------

Dimension change is not allowed. The number of entries are checked.

5.86.3.2 mha\_real\_t gaintable\_t::get\_gain (   
 `mha_real_t Lin,`  
`mha_real_t Fin,`  
`unsigned int channel )`

Read Gain from gain table.

## Parameters

<i>Lin</i>	Input level
<i>Fin</i>	Input frequency (no match required)
<i>channel</i>	Audio channel

5.86.3.3 mha\_real\_t gaintable\_t::get\_gain (   
 `mha_real_t Lin,`  
`unsigned int band,`  
`unsigned int channel )`

Read Gain from gain table.

## Parameters

<i>Lin</i>	Input level
------------	-------------

**Parameters**

<i>band</i>	Input frequency band
<i>channel</i>	Audio channel

5.86.3.4 `void gaintable_t::get_gain (`  
`const mha_wave_t & Lin,`  
`mha_wave_t & Gain )`

Read Gains from gain table.

**Parameters**

<i>Lin</i>	Input levels.
<i>Gain</i>	Output gain.

The number of channels in Lin and Gain must match the number of bands times number of channels in the gaintable.

5.86.3.5 `unsigned int DynComp::gaintable_t::nbands ( ) const [inline]`

Return number of frequency bands.

5.86.3.6 `unsigned int DynComp::gaintable_t::nchannels ( ) const [inline]`

Return number of audio channels.

5.86.3.7 `std::vector< std::vector< mha_real_t > > gaintable_t::get_iofun ( ) const`

Return current input-output function.

5.86.3.8 `std::vector<mha_real_t> DynComp::gaintable_t::get_vL ( ) const [inline]`

5.86.3.9 `std::vector<mha_real_t> DynComp::gaintable_t::get_vF ( ) const [inline]`

**5.86.4 Member Data Documentation**

5.86.4.1 `unsigned int DynComp::gaintable_t::num_L [private]`

5.86.4.2 `unsigned int DynComp::gaintable_t::num_F [private]`

5.86.4.3 `unsigned int DynComp::gaintable_t::num_channels [private]`

5.86.4.4 `std::vector<mha_real_t> DynComp::gaintable_t::vL` [private]

5.86.4.5 `std::vector<mha_real_t> DynComp::gaintable_t::vF` [private]

5.86.4.6 `std::vector<mha_real_t> DynComp::gaintable_t::vFlog` [private]

5.86.4.7 `std::vector<std::vector<std::vector<mha_real_t>>> DynComp::gaintable_t::data`  
[private]

The documentation for this class was generated from the following files:

- **gaintable.h**
- **gaintable.cpp**

## 5.87 example1\_t Class Reference

This C++ class implements the simplest example plugin for the step-by-step tutorial.

Inheritance diagram for example1\_t:

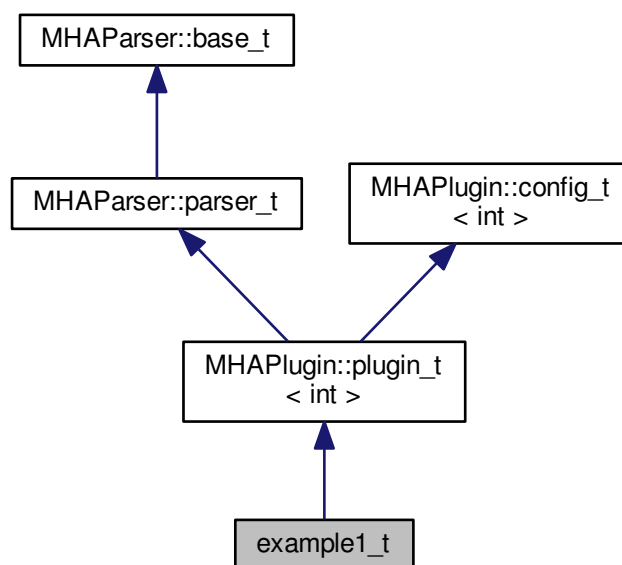

## Public Member Functions

- **example1\_t** (**algo\_comm\_t** &ac, const std::string &chain\_name, const std::string &algo\_name)  
*Do-nothing constructor.*
- void **release** (void)  
*Release may be empty.*
- void **prepare** (**mhaconfig\_t** &signal\_info)  
*Plugin preparation.*
- **mha\_wave\_t \* process** (**mha\_wave\_t** \*signal)  
*Signal processing performed by the plugin.*

## Additional Inherited Members

### 5.87.1 Detailed Description

This C++ class implements the simplest example plugin for the step-by-step tutorial.

It inherits from **MHAPLugin::plugin\_t** (p. 728) for correct integration in the configuration language interface.

### 5.87.2 Constructor & Destructor Documentation

5.87.2.1 **example1\_t::example1\_t** (  
    **algo\_comm\_t** &ac,  
    const std::string &chain\_name,  
    const std::string &algo\_name ) [inline]

Do-nothing constructor.

The constructor has to take these three arguments, but it does not have to use them. However, the base class has to be initialized.

### 5.87.3 Member Function Documentation

5.87.3.1 **void example1\_t::release** (  
    void ) [inline],[virtual]

Release may be empty.

Reimplemented from **MHAPLugin::plugin\_t< int >** (p. 731).

5.87.3.2 **void example1\_t::prepare** (  
    **mhaconfig\_t** &signal\_info ) [inline],[virtual]

Plugin preparation.

This plugin checks that the input signal has the waveform domain and contains at least one channel



**Parameters**

<i>signal_info</i>	Structure containing a description of the form of the signal (domain, number of channels, frames per block, sampling rate).
--------------------	---

Implements **MHAPlugin::plugin\_t**< int > (p. 730).

```
5.87.3.3 mha_wave_t* example1_t::process (  
        mha_wave_t* signal ) [inline]
```

Signal processing performed by the plugin.

This plugin multiplies the signal in the first audio channel by a factor 0.1.

**Parameters**

<i>signal</i>	Pointer to the input signal structure.
---------------	--

**Returns**

Returns a pointer to the input signal structure, with a the signal modified by this plugin.  
(In-place processing)

The documentation for this class was generated from the following file:

- **example1.cpp**

**5.88 example2\_t Class Reference**

This C++ class implements the second example plugin for the step-by-step tutorial.

Inheritance diagram for example2\_t:

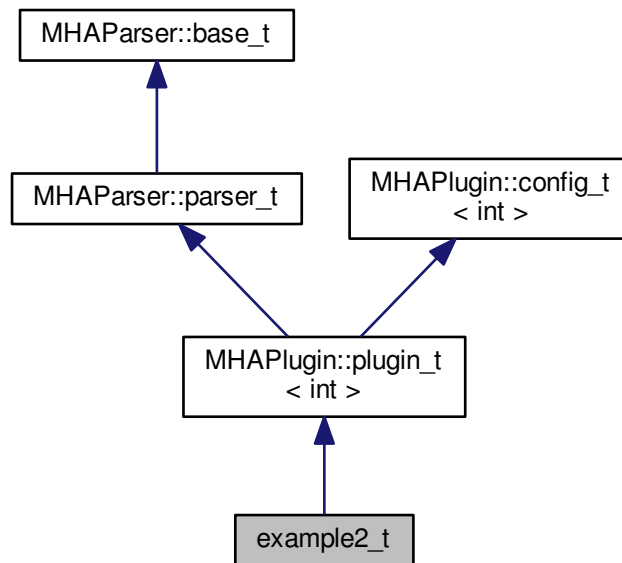

### Public Member Functions

- **example2\_t** (**algo\_comm\_t** &ac, const std::string &chain\_name, const std::string &algo\_name)  
*This constructor initializes the configuration language variables and inserts them into the openMHA configuration tree.*
- void **prepare** (**mhaconfig\_t** &signal\_info)  
*Plugin preparation.*
- void **release** (void)  
*Undo restrictions posed in prepare.*
- **mha\_wave\_t** \* **process** (**mha\_wave\_t** \*signal)  
*Signal processing performed by the plugin.*

### Private Attributes

- **MHAParser::int\_t** **scale\_ch**  
*Index of audio channel to scale.*
- **MHAParser::float\_t** **factor**  
*The scaling factor applied to the selected channel.*

## Additional Inherited Members

### 5.88.1 Detailed Description

This C++ class implements the second example plugin for the step-by-step tutorial.

It extends the first example by using configuration language variables to influence the processing.

### 5.88.2 Constructor & Destructor Documentation

5.88.2.1 `example2_t::example2_t (`  
     `algo_comm_t & ac,`  
     `const std::string & chain_name,`  
     `const std::string & algo_name )`

This constructor initializes the configuration language variables and inserts them into the openMHA configuration tree.

### 5.88.3 Member Function Documentation

5.88.3.1 `void example2_t::prepare (`  
     `mhaconfig_t & signal_info ) [virtual]`

Plugin preparation.

This plugin checks that the input signal has the waveform domain and contains enough channels.

#### Parameters

<i>signal_info</i>	Structure containing a description of the form of the signal (domain, number of channels, frames per block, sampling rate).
--------------------	---

Implements **MHAPlugin::plugin\_t< int >** (p. 730).

5.88.3.2 `void example2_t::release (`  
     `void ) [virtual]`

Undo restrictions posed in prepare.

Reimplemented from **MHAPlugin::plugin\_t< int >** (p. 731).

### 5.88.3.3 `mha_wave_t * example2_t::process ( mha_wave_t * signal )`

Signal processing performed by the plugin.

This plugin multiplies the signal in the selected audio channel by the configured factor.

#### Parameters

<code>signal</code>	Pointer to the input signal structure.
---------------------	--

#### Returns

Returns a pointer to the input signal structure, with a the signal modified by this plugin. (In-place processing)

## 5.88.4 Member Data Documentation

### 5.88.4.1 `MHAParser::int_t example2_t::scale_ch` [private]

Index of audio channel to scale.

### 5.88.4.2 `MHAParser::float_t example2_t::factor` [private]

The scaling factor applied to the selected channel.

The documentation for this class was generated from the following file:

- `example2.cpp`

## 5.89 `example3_t` Class Reference

A Plugin class using the openMHA Event mechanism.

Inheritance diagram for example3\_t:

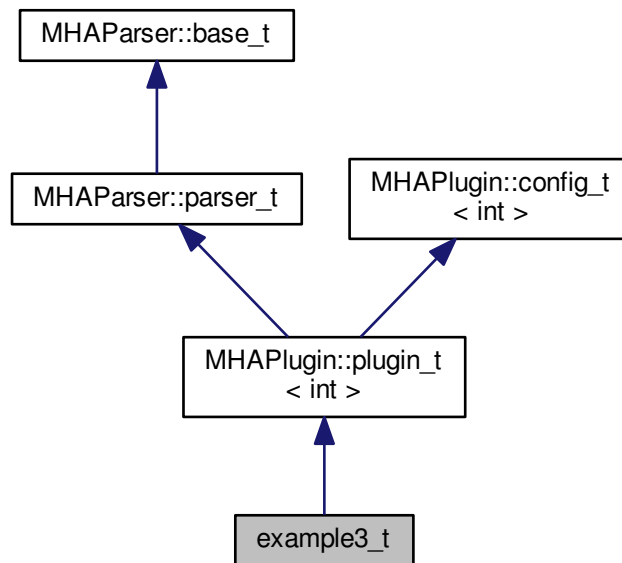

### Public Member Functions

- **example3\_t** (**algo\_comm\_t** &ac, const std::string &chain\_name, const std::string &algo\_name)  
*This constructor initializes the configuration language variables and inserts them into the openMHA configuration tree.*
- void **prepare** (**mhaconfig\_t** &signal\_info)  
*Plugin preparation.*
- void **release** (void)  
*Bookkeeping only.*
- **mha\_wave\_t** \* **process** (**mha\_wave\_t** \*signal)  
*Signal processing performed by the plugin.*

### Private Member Functions

- void **on\_scale\_ch\_writeaccess** ()
- void **on\_scale\_ch\_valuechanged** ()
- void **on\_scale\_ch\_readaccess** ()
- void **on\_prereadaccess** ()

## Private Attributes

- **MHAParser::int\_t scale\_ch**  
*Index of audio channel to scale.*
- **MHAParser::float\_t factor**  
*The scaling factor applied to the selected channel.*
- **MHAParser::int\_mon\_t prepared**  
*Keep Track of the prepare/release calls.*
- **MHAEvents::patchbay\_t < example3\_t > patchbay**  
*The Event connector.*

## Additional Inherited Members

### 5.89.1 Detailed Description

A Plugin class using the openMHA Event mechanism.

This is the third example plugin for the step-by-step tutorial.

### 5.89.2 Constructor & Destructor Documentation

5.89.2.1 `example3_t::example3_t (`  
`algo_comm_t & ac,`  
`const std::string & chain_name,`  
`const std::string & algo_name )`

This constructor initializes the configuration language variables and inserts them into the openMHA configuration tree.

It connects the openMHA Events triggered by these configuration variables to the respective callbacks.

### 5.89.3 Member Function Documentation

5.89.3.1 `void example3_t::on_scale_ch_writeaccess ( ) [private]`

5.89.3.2 `void example3_t::on_scale_ch_valuechanged ( ) [private]`

5.89.3.3 `void example3_t::on_scale_ch_readaccess ( ) [private]`

5.89.3.4 `void example3_t::on_prereadaccess ( ) [private]`

5.89.3.5 `void example3_t::prepare (`  
`mhaconfig_t & signal_info ) [virtual]`

Plugin preparation.

This plugin checks that the input signal has the waveform domain and contains enough channels.

## Parameters

<i>signal_info</i>	Structure containing a description of the form of the signal (domain, number of channels, frames per block, sampling rate).
--------------------	---

Implements **MHAPLugin::plugin\_t**< **int** > (p. 730).

5.89.3.6 **void example3\_t::release (**  
**void )** [virtual]

Bookkeeping only.

Reimplemented from **MHAPLugin::plugin\_t**< **int** > (p. 731).

5.89.3.7 **mha\_wave\_t \* example3\_t::process (**  
**mha\_wave\_t \* signal )**

Signal processing performed by the plugin.

This plugin multiplies the signal in the selected audio channel by the configured factor.

## Parameters

<i>signal</i>	Pointer to the input signal structure.
---------------	--

## Returns

Returns a pointer to the input signal structure, with a the signal modified by this plugin.  
(In-place processing)

## 5.89.4 Member Data Documentation

5.89.4.1 **MHAParser::int\_t example3\_t::scale\_ch** [private]

Index of audio channel to scale.

5.89.4.2 **MHAParser::float\_t example3\_t::factor** [private]

The scaling factor applied to the selected channel.

5.89.4.3 **MHAParser::int\_mon\_t example3\_t::prepared** [private]

Keep Track of the prepare/release calls.

#### 5.89.4.4 MHAEvents::patchbay\_t<example3\_t> example3\_t::patchbay [private]

The Event connector.

The documentation for this class was generated from the following file:

- **example3.cpp**

### 5.90 example4\_t Class Reference

A Plugin class using the spectral signal.

Inheritance diagram for example4\_t:

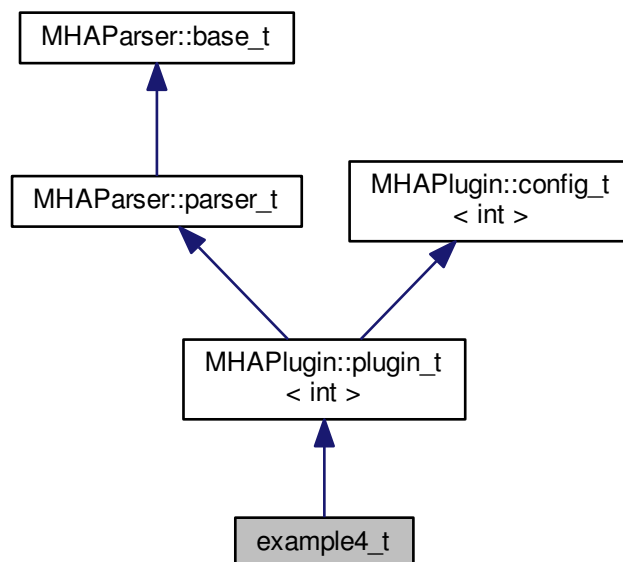

#### Public Member Functions

- **example4\_t** (**algo\_comm\_t** &ac, const std::string &chain\_name, const std::string &algo\_name)  
*This constructor initializes the configuration language variables and inserts them into the openMHA configuration tree.*
- void **prepare** (**mhaconfig\_t** &signal\_info)  
*Plugin preparation.*
- void **release** (void)  
*Bookkeeping only.*
- **mha\_spec\_t** \* **process** (**mha\_spec\_t** \*signal)  
*Signal processing performed by the plugin.*



### Private Member Functions

- void **on\_scale\_ch\_writeaccess** ()
- void **on\_scale\_ch\_valuechanged** ()
- void **on\_scale\_ch\_readaccess** ()
- void **on\_prereadaccess** ()

### Private Attributes

- **MHAParser::int\_t scale\_ch**  
*Index of audio channel to scale.*
- **MHAParser::float\_t factor**  
*The scaling factor applied to the selected channel.*
- **MHAParser::int\_mon\_t prepared**  
*Keep Track of the prepare/release calls.*
- **MHAEvents::patchbay\_t < example4\_t > patchbay**  
*The Event connector.*

### Additional Inherited Members

#### 5.90.1 Detailed Description

A Plugin class using the spectral signal.

This is the fourth example plugin for the step-by-step tutorial.

#### 5.90.2 Constructor & Destructor Documentation

##### 5.90.2.1 example4\_t::example4\_t (     **algo\_comm\_t** & *ac*,     const std::string & *chain\_name*,     const std::string & *algo\_name* )

This constructor initializes the configuration language variables and inserts them into the openMHA configuration tree.

It connects the openMHA Events triggered by these configuration variables to the respective callbacks.

### 5.90.3 Member Function Documentation

5.90.3.1 `void example4_t::on_scale_ch_writeaccess ( ) [private]`

5.90.3.2 `void example4_t::on_scale_ch_valuechanged ( ) [private]`

5.90.3.3 `void example4_t::on_scale_ch_readaccess ( ) [private]`

5.90.3.4 `void example4_t::on_prereadaccess ( ) [private]`

5.90.3.5 `void example4_t::prepare ( mhaconfig_t & signal_info ) [virtual]`

Plugin preparation.

This plugin checks that the input signal has the waveform domain and contains enough channels.

#### Parameters

<i>signal_info</i>	Structure containing a description of the form of the signal (domain, number of channels, frames per block, sampling rate).
--------------------	---

Implements **MHAPIugin::plugin\_t< int >** (p. 730).

5.90.3.6 `void example4_t::release ( void ) [virtual]`

Bookkeeping only.

Reimplemented from **MHAPIugin::plugin\_t< int >** (p. 731).

5.90.3.7 `mha_spec_t * example4_t::process ( mha_spec_t * signal )`

Signal processing performed by the plugin.

This plugin multiplies the spectral signal in the selected audio channel by the configured factor.

#### Parameters

<i>signal</i>	Pointer to the input signal structure.
---------------	--

## Returns

Returns a pointer to the input signal structure, with a the signal modified by this plugin.  
(In-place processing)

### 5.90.4 Member Data Documentation

#### 5.90.4.1 `MHAParser::int_t example4_t::scale_ch` [private]

Index of audio channel to scale.

#### 5.90.4.2 `MHAParser::float_t example4_t::factor` [private]

The scaling factor applied to the selected channel.

#### 5.90.4.3 `MHAParser::int_mon_t example4_t::prepared` [private]

Keep Track of the prepare/release calls.

#### 5.90.4.4 `MHAEvents::patchbay_t<example4_t> example4_t::patchbay` [private]

The Event connector.

The documentation for this class was generated from the following file:

- **example4.cpp**

### 5.91 example5\_t Class Reference

#### Public Member Functions

- **example5\_t** (unsigned int, unsigned int, **mha\_real\_t**)
- **mha\_spec\_t \* process** (**mha\_spec\_t \***)

#### Private Attributes

- unsigned int **channel**
- **mha\_real\_t scale**

### 5.91.1 Constructor & Destructor Documentation

5.91.1.1 `example5_t::example5_t (`  
     `unsigned int ichannel,`  
     `unsigned int numchannels,`  
     `mha_real_t iscale )`

### 5.91.2 Member Function Documentation

5.91.2.1 `mha_spec_t * example5_t::process (`  
     `mha_spec_t * spec )`

### 5.91.3 Member Data Documentation

5.91.3.1 `unsigned int example5_t::channel [private]`

5.91.3.2 `mha_real_t example5_t::scale [private]`

The documentation for this class was generated from the following file:

- **example5.cpp**

## 5.92 example6\_t Class Reference

Inheritance diagram for example6\_t:

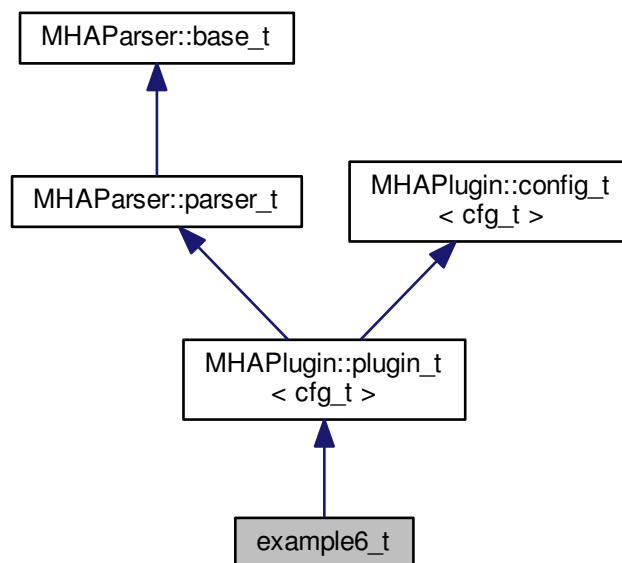

### Public Member Functions

- **example6\_t** (const **algo\_comm\_t** &, const std::string &, const std::string &)
- **mha\_wave\_t \* process** (**mha\_wave\_t \***)
- void **prepare** (**mhaconfig\_t** &)

### Private Member Functions

- void **update\_cfg** ()

### Private Attributes

- **MHAParser::int\_t channel\_no**
- float **rmsdb**
- **MHAEvents::patchbay\_t< example6\_t > patchbay**

### Additional Inherited Members

#### 5.92.1 Constructor & Destructor Documentation

5.92.1.1 **example6\_t::example6\_t** (  
    const **algo\_comm\_t** & *iac*,  
    const std::string & ,  
    const std::string & )

#### 5.92.2 Member Function Documentation

5.92.2.1 **mha\_wave\_t \* example6\_t::process** (  
    **mha\_wave\_t \* wave** )

5.92.2.2 void **example6\_t::prepare** (  
    **mhaconfig\_t & tcfg** ) [virtual]

Implements **MHAPlugin::plugin\_t< cfg\_t >** (p. 730).

5.92.2.3 void **example6\_t::update\_cfg** ( ) [private]

#### 5.92.3 Member Data Documentation

5.92.3.1 **MHAParser::int\_t example6\_t::channel\_no** [private]

5.92.3.2 float **example6\_t::rmsdb** [private]

5.92.3.3 **MHAEvents::patchbay\_t<example6\_t> example6\_t::patchbay** [private]

The documentation for this class was generated from the following file:

- **example6.cpp**

### 5.93 expression\_t Class Reference

Class for separating a string into a left hand value and a right hand value.

#### 5.93.1 Detailed Description

Class for separating a string into a left hand value and a right hand value.

A list of valid operators can be provided. After construction, the class members lval, rval and op contain the appropriate contents.

The documentation for this class was generated from the following file:

- **mha\_parser.cpp**

### 5.94 fader\_if\_t Class Reference

Inheritance diagram for fader\_if\_t:

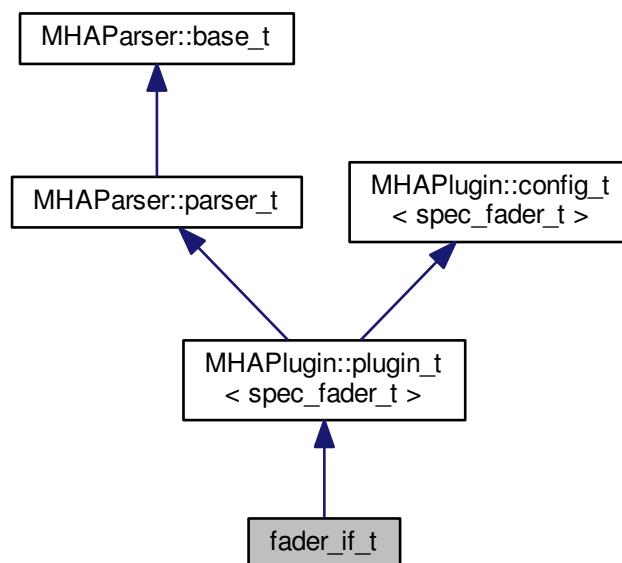

#### Public Member Functions

- **fader\_if\_t** (const **algo\_comm\_t** &, const std::string &, const std::string &)
- **mha\_spec\_t \* process** (mha\_spec\_t \*)
- void **prepare** (mhaconfig\_t &)

## Private Member Functions

- void **update\_cfg** ()

## Private Attributes

- **MHAEvents::patchbay\_t**< **fader\_if\_t** > **patchbay**
- **MHAParser::float\_t** **tau**
- **MHAParser::vfloat\_t** **newgains**
- **mha\_real\_t** \* **actgains**

## Additional Inherited Members

## 5.94.1 Constructor &amp; Destructor Documentation

5.94.1.1 **fader\_if\_t::fader\_if\_t** (  
                   const **algo\_comm\_t** & *iac*,  
                   const std::string & ,  
                   const std::string & )

## 5.94.2 Member Function Documentation

5.94.2.1 **mha\_spec\_t** \* **fader\_if\_t::process** (  
                   **mha\_spec\_t** \* *s* )

5.94.2.2 void **fader\_if\_t::prepare** (  
                   **mhaconfig\_t** & *tf* ) [virtual]

Implements **MHAPlugin::plugin\_t**< **spec\_fader\_t** > (p. 730).

5.94.2.3 void **fader\_if\_t::update\_cfg** (  
                   void ) [private]

## 5.94.3 Member Data Documentation

5.94.3.1 **MHAEvents::patchbay\_t**<**fader\_if\_t**> **fader\_if\_t::patchbay** [private]

5.94.3.2 **MHAParser::float\_t** **fader\_if\_t::tau** [private]

5.94.3.3 **MHAParser::vfloat\_t** **fader\_if\_t::newgains** [private]

5.94.3.4 **mha\_real\_t**\* **fader\_if\_t::actgains** [private]

The documentation for this class was generated from the following file:

- **fader\_spec.cpp**

## 5.95 fader\_wave::fader\_wave\_if\_t Class Reference

Inheritance diagram for fader\_wave::fader\_wave\_if\_t:

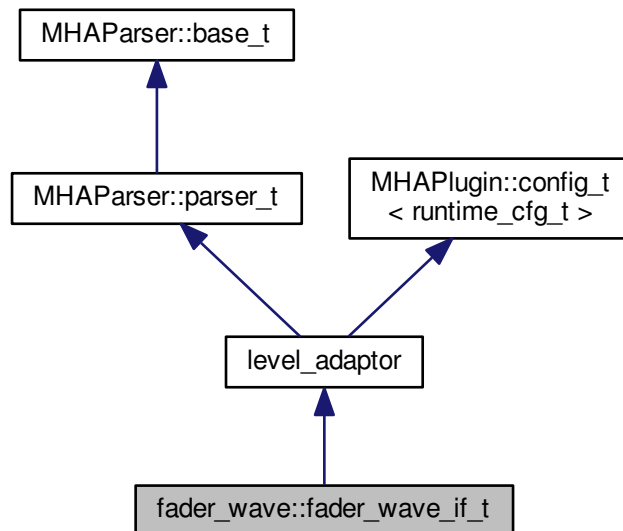

### Public Member Functions

- **fader\_wave\_if\_t** (**algo\_comm\_t**, const char \*, const char \*)
- **mha\_wave\_t \* process** (**mha\_wave\_t \***)
- void **prepare** (**mhaconfig\_t &**)
- void **release** ()

### Private Member Functions

- void **set\_level** ()

### Private Attributes

- **MHAParser::vfloat\_t** gain
- **MHAParser::float\_t** ramplen
- **MHAEvents::patchbay\_t** < **fader\_wave\_if\_t** > patchbay
- bool **prepared**



## Additional Inherited Members

### 5.95.1 Constructor & Destructor Documentation

5.95.1.1 `fader_wave::fader_wave_if_t::fader_wave_if_t (`  
    `algo_comm_t iac,`  
    `const char *,`  
    `const char * )`

### 5.95.2 Member Function Documentation

5.95.2.1 `mha_wave_t * fader_wave::fader_wave_if_t::process (`  
    `mha_wave_t * s )`

5.95.2.2 `void fader_wave::fader_wave_if_t::prepare (`  
    `mhaconfig_t & tf ) [virtual]`

Implements `MHAPlugin::plugin_t< runtime_cfg_t >` (p. 730).

5.95.2.3 `void fader_wave::fader_wave_if_t::release (`  
    `void ) [virtual]`

Reimplemented from `MHAPlugin::plugin_t< runtime_cfg_t >` (p. 731).

5.95.2.4 `void fader_wave::fader_wave_if_t::set_level ( ) [private]`

### 5.95.3 Member Data Documentation

5.95.3.1 `MHAParser::vfloat_t fader_wave::fader_wave_if_t::gain [private]`

5.95.3.2 `MHAParser::float_t fader_wave::fader_wave_if_t::ramplen [private]`

5.95.3.3 `MHAEvents::patchbay_t<fader_wave_if_t> fader_wave::fader_wave_if_t::patchbay`  
    `[private]`

5.95.3.4 `bool fader_wave::fader_wave_if_t::prepared [private]`

The documentation for this class was generated from the following file:

- `fader_wave.cpp`

## 5.96 fader\_wave::level\_adapt\_t Class Reference

Inheritance diagram for fader\_wave::level\_adapt\_t:

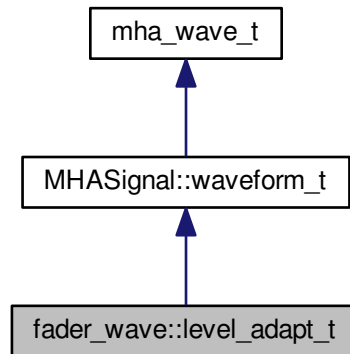

### Public Member Functions

- **level\_adapt\_t** (**mhaconfig\_t** cf, **mha\_real\_t** adapt\_len, std::vector< float > l\_new\_↔, std::vector< float > l\_old\_)
- void **update\_frame** ()
- std::vector< float > **get\_level** () const
- bool **can\_update** () const

### Private Attributes

- unsigned int **ilen**
- unsigned int **pos**
- **MHAWindow::fun\_t** wnd
- std::vector< float > **l\_new**
- std::vector< float > **l\_old**

### Additional Inherited Members

#### 5.96.1 Constructor & Destructor Documentation

- ##### 5.96.1.1 fader\_wave::level\_adapt\_t::level\_adapt\_t (
- ```

    mhaconfig_t cf,
    mha_real_t adapt_len,
    std::vector< float > l_new_,
    std::vector< float > l_old_ )

```

## 5.96.2 Member Function Documentation

5.96.2.1 void fader\_wave::level\_adapt\_t::update\_frame ( )

5.96.2.2 std::vector&lt;float&gt; fader\_wave::level\_adapt\_t::get\_level ( ) const [inline]

5.96.2.3 bool fader\_wave::level\_adapt\_t::can\_update ( ) const [inline]

## 5.96.3 Member Data Documentation

5.96.3.1 unsigned int fader\_wave::level\_adapt\_t::ilen [private]

5.96.3.2 unsigned int fader\_wave::level\_adapt\_t::pos [private]

5.96.3.3 MHASWindow::fun\_t fader\_wave::level\_adapt\_t::wnd [private]

5.96.3.4 std::vector&lt;float&gt; fader\_wave::level\_adapt\_t::l\_new [private]

5.96.3.5 std::vector&lt;float&gt; fader\_wave::level\_adapt\_t::l\_old [private]

The documentation for this class was generated from the following file:

- **fader\_wave.cpp**

## 5.97 fftfbpow::fftfbpow\_interface\_t Class Reference

Interface class for fftfbpow plugin.

Inheritance diagram for fftfbpow::fftfbpow\_interface\_t:

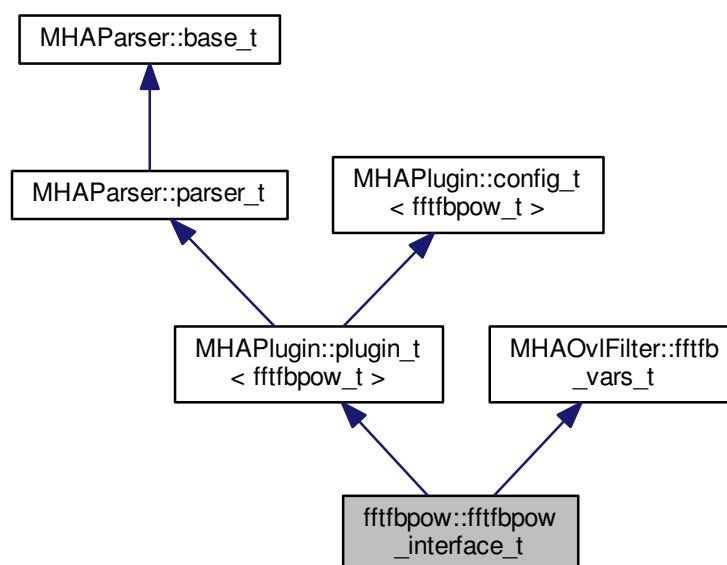

## Public Member Functions

- **fffbpow\_interface\_t** (const **algo\_comm\_t** &**ac**, const std::string &, const std::string &algo\_name)  
*Constructor with standard MHA constructor parameters.*
- void **prepare** (**mhaconfig\_t** &tf)  
*Standard MHA plugin prepare function.*
- **mha\_spec\_t** \* **process** (**mha\_spec\_t** \*s)  
*Standard MHA plugin process fct.*

## Private Member Functions

- void **update\_cfg** ()  
*Constructs new runtime configuration in thread-safe manner.*

## Private Attributes

- std::string **name**  
*Configured name of this plugin instance.*
- **MHAEvents::patchbay\_t**< **fffbpow\_interface\_t** > **patchbay**  
*Patchbay to connect to MHA configuration interface.*

## Additional Inherited Members

### 5.97.1 Detailed Description

Interface class for fffbpow plugin.

### 5.97.2 Constructor & Destructor Documentation

5.97.2.1 **fffbpow::fffbpow\_interface\_t::fffbpow\_interface\_t** (  
    const **algo\_comm\_t** & *ac*,  
    const std::string & ,  
    const std::string & *algo\_name* )

Constructor with standard MHA constructor parameters.

#### Parameters

|                  |                                                  |
|------------------|--------------------------------------------------|
| <i>ac</i>        | Handle to algorithm communication variable space |
| <i>algo_name</i> | Configured name of this plugin instance          |

### 5.97.3 Member Function Documentation

5.97.3.1 `void fftfbpow::fftfbpow_interface_t::prepare ( mhaconfig_t & tf ) [virtual]`

Standard MHA plugin prepare function.

Ensures that the input is in the frequency domain, calls `update_cfg()` (p. 325) and inserts fbpow into the AC space.

#### Parameters

|                 |                                                                               |
|-----------------|-------------------------------------------------------------------------------|
| <code>tf</code> | Incoming mha configuration structure, contains information about input signal |
|-----------------|-------------------------------------------------------------------------------|

Implements `MHAPlugin::plugin_t< fftfbpow_t >` (p. 730).

5.97.3.2 `mha_spec_t * fftfbpow::fftfbpow_interface_t::process ( mha_spec_t * s )`

Standard MHA plugin process fct.

Polls new config and calls `process()` (p. 325) of the runtime configuration.

#### Parameters

|                |                |
|----------------|----------------|
| <code>s</code> | Input spectrum |
|----------------|----------------|

#### Returns

Unchanged input spectrum

5.97.3.3 `void fftfbpow::fftfbpow_interface_t::update_cfg ( void ) [private]`

Constructs new runtime configuration in thread-safe manner.

### 5.97.4 Member Data Documentation

5.97.4.1 `std::string fftfbpow::fftfbpow_interface_t::name [private]`

Configured name of this plugin instance.

#### 5.97.4.2 MHAEvents::patchbay\_t<fftfbpow\_interface\_t> fftfbpow::fftfbpow\_interface\_t↔ ::patchbay [private]

Patchbay to connect to MHA configuration interface.

The documentation for this class was generated from the following file:

- **fftfbpow.cpp**

### 5.98 fftfbpow::fftfbpow\_t Class Reference

Run time configuration for the fftfbpow plugin.

Inheritance diagram for fftfbpow::fftfbpow\_t:

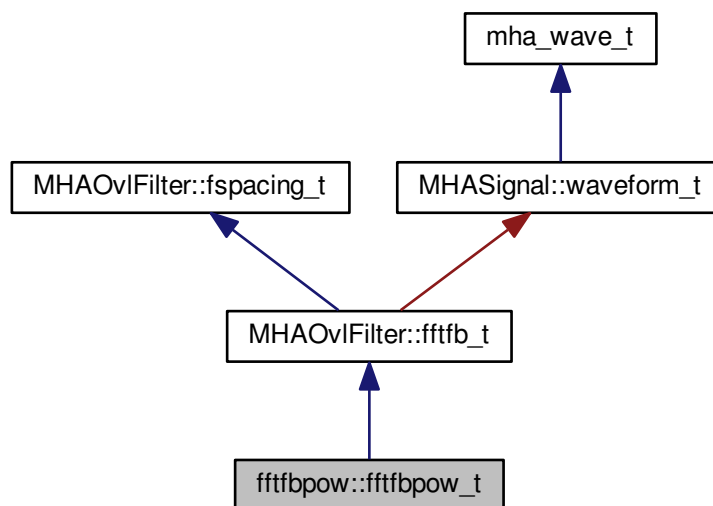

#### Public Member Functions

- **fftfbpow\_t (MHAOvIFilter::fftfb\_vars\_t &vars, unsigned int nch, unsigned int nfft, mha↔  
\_real\_t fs, algo\_comm\_t ac, std::string name)**  
*Constructor of the run time configuration.*

#### Public Attributes

- **MHA\_AC::waveform\_t fbpow**  
*AC variable containing the estimated power in each frequency band.*

## Additional Inherited Members

### 5.98.1 Detailed Description

Run time configuration for the fftfbpow plugin.

### 5.98.2 Constructor & Destructor Documentation

5.98.2.1 `fftfbpow::fftfbpow_t::fftfbpow_t ( MHAOviFilter::fftfb_vars_t & vars, unsigned int nch, unsigned int nfft, mha_real_t fs, algo_comm_t ac, std::string name )`

Constructor of the run time configuration.

#### Parameters

|             |                                                                           |
|-------------|---------------------------------------------------------------------------|
| <i>vars</i> | Set of configuration variables for FFT-based overlapping filters          |
| <i>nch</i>  | Number of audio input channels                                            |
| <i>nfft</i> | Length of FFT                                                             |
| <i>fs</i>   | Sampling rate                                                             |
| <i>ac</i>   | AC space                                                                  |
| <i>name</i> | Configured name of plugin interface, used as prefix for AC variable names |

### 5.98.3 Member Data Documentation

5.98.3.1 `MHA_AC::waveform_t fftfbpow::fftfbpow_t::fbpow`

AC variable containing the estimated power in each frequency band.

The documentation for this class was generated from the following file:

- `fftfbpow.cpp`

## 5.99 fftfilterbank::fftfb\_interface\_t Class Reference

Inheritance diagram for fftfilterbank::fftfb\_interface\_t:

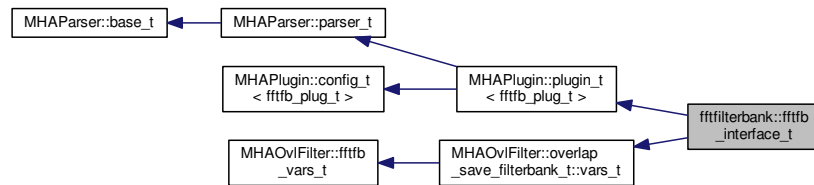

### Public Member Functions

- **fftfb\_interface\_t** (const **algo\_comm\_t** &ac, const std::string &th, const std::string &al)  
*Default values are set and MHA configuration variables registered into the parser.*
- void **prepare** (**mhaconfig\_t** &)  
*Prepare all variables for processing.*
- void **release** ()
- **mha\_spec\_t** \* **process** (**mha\_spec\_t** \*)
- **mha\_wave\_t** \* **process** (**mha\_wave\_t** \*)

### Private Member Functions

- void **update\_cfg** ()

### Private Attributes

- **MHAParser::bool\_t** return\_imag
- **MHAEvents::patchbay\_t** < **fftfb\_interface\_t** > patchbay
- **MHA\_AC::int\_t** nchannels
- std::string algo
- bool prepared
- unsigned int nbands

### Additional Inherited Members

#### 5.99.1 Constructor & Destructor Documentation

5.99.1.1 **fftfilterbank::fftfb\_interface\_t::fftfb\_interface\_t** (  
     const **algo\_comm\_t** & ac,  
     const std::string & th,  
     const std::string & al )

Default values are set and MHA configuration variables registered into the parser.



## Parameters

|           |                                |
|-----------|--------------------------------|
| <i>ac</i> | algorithm communication handle |
| <i>th</i> | chain name                     |
| <i>al</i> | algorithm name                 |

## 5.99.2 Member Function Documentation

5.99.2.1 void fftfilterbank::fftfb\_interface\_t::prepare (  
mhaconfig\_t & tf ) [virtual]

Prepare all variables for processing.

In this function, all variables are initialised and the filter shapes for each band are calculated. The filter shapes  $W(f)$  are defined as

$$W(f) = W(T(S(f))) = W(x), \quad x = T(S(f)) = T(\hat{f}),$$

$W(x)$  being a symmetric window function in the interval  $[-1, 1]$  and  $S(f)$  the transformation from the linear scale to the given frequency scale (see functions in FreqScaleFun). The function  $T(\hat{f})$  transforms the frequency range between the center frequencies  $[\hat{f}_{k-1}, \hat{f}_k]$  and  $[\hat{f}_k, \hat{f}_{k+1}]$  into the interval  $[-1, 0]$  and  $[0, 1]$ , respectively. This function is realised by the function linscale().

## Parameters

|           |                       |
|-----------|-----------------------|
| <i>tf</i> | Channel configuration |
|-----------|-----------------------|

Implements **MHAPlugin::plugin\_t**< **fftfb\_plug\_t** > (p. 730).

5.99.2.2 void fftfilterbank::fftfb\_interface\_t::release (  
void ) [virtual]

Reimplemented from **MHAPlugin::plugin\_t**< **fftfb\_plug\_t** > (p. 731).

5.99.2.3 mha\_spec\_t \* fftfilterbank::fftfb\_interface\_t::process (  
mha\_spec\_t \* s )5.99.2.4 mha\_wave\_t \* fftfilterbank::fftfb\_interface\_t::process (  
mha\_wave\_t \* s )5.99.2.5 void fftfilterbank::fftfb\_interface\_t::update\_cfg (  
void ) [private]

### 5.99.3 Member Data Documentation

5.99.3.1 `MHAParser::bool_t fftfilterbank::fftfb_interface_t::return_imag` [private]

5.99.3.2 `MHAEvents::patchbay_t<fftfb_interface_t> fftfilterbank::fftfb_interface_t::patchbay` [private]

5.99.3.3 `MHA_AC::int_t fftfilterbank::fftfb_interface_t::nchannels` [private]

5.99.3.4 `std::string fftfilterbank::fftfb_interface_t::algo` [private]

5.99.3.5 `bool fftfilterbank::fftfb_interface_t::prepared` [private]

5.99.3.6 `unsigned int fftfilterbank::fftfb_interface_t::nbands` [private]

The documentation for this class was generated from the following file:

- `fftfilterbank.cpp`

### 5.100 `fftfilterbank::fftfb_plug_t` Class Reference

Inheritance diagram for `fftfilterbank::fftfb_plug_t`:

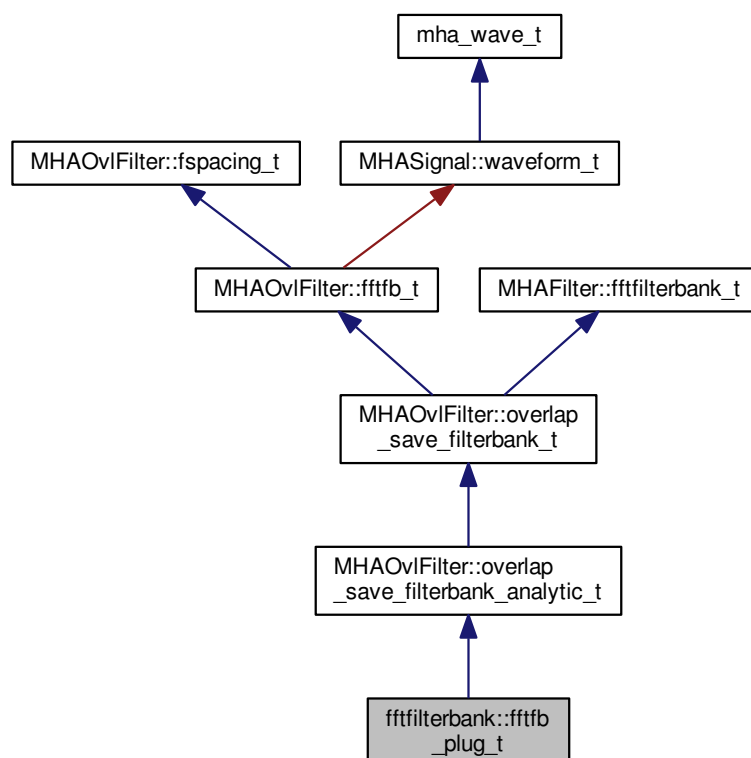

## Public Member Functions

- **fftfb\_plug\_t** (MHAOvIFilter::overlap\_save\_filterbank\_t::vars\_t &, mhaconfig\_t chcfg, algo\_comm\_t ac, std::string alg, bool return\_imag)
- **mha\_spec\_t \* process** (mha\_spec\_t \*)
- **mha\_wave\_t \* process** (mha\_wave\_t \*)
- void **insert** ()

## Private Attributes

- MHAOvIFilter::fftfb\_ac\_info\_t **fb\_acinfo**
- MHASignal::spectrum\_t **s\_out**
- MHA\_AC::waveform\_t **imag**
- bool **return\_imag\_**

## Additional Inherited Members

## 5.100.1 Constructor &amp; Destructor Documentation

5.100.1.1 **fftfilterbank::fftfb\_plug\_t::fftfb\_plug\_t** (MHAOvIFilter::overlap\_save\_filterbank\_t::vars\_t & vars, mhaconfig\_t chcfg, algo\_comm\_t ac, std::string alg, bool return\_imag )

## 5.100.2 Member Function Documentation

5.100.2.1 **mha\_spec\_t \* fftfilterbank::fftfb\_plug\_t::process** (mha\_spec\_t \* s )

5.100.2.2 **mha\_wave\_t \* fftfilterbank::fftfb\_plug\_t::process** (mha\_wave\_t \* s )

5.100.2.3 void **fftfilterbank::fftfb\_plug\_t::insert** ( )

## 5.100.3 Member Data Documentation

5.100.3.1 **MHAOvIFilter::fftfb\_ac\_info\_t** **fftfilterbank::fftfb\_plug\_t::fb\_acinfo** [private]

5.100.3.2 **MHASignal::spectrum\_t** **fftfilterbank::fftfb\_plug\_t::s\_out** [private]

5.100.3.3 **MHA\_AC::waveform\_t** **fftfilterbank::fftfb\_plug\_t::imag** [private]

5.100.3.4 bool **fftfilterbank::fftfb\_plug\_t::return\_imag\_** [private]

The documentation for this class was generated from the following file:

- **fftfilterbank.cpp**

## 5.101 fshift::fshift\_config\_t Class Reference

fshift runtime config class

### Public Member Functions

- **fshift\_config\_t** (**fshift\_t** const \*const *plug*)  
*C'tor of the fshift plugin runtime configuration class.*
- ~**fshift\_config\_t** ()=default
- **mha\_spec\_t** \* **process** (**mha\_spec\_t** \*)

### Private Attributes

- const unsigned int **kmin**  
*FFT bin corresponding to fmin.*
- const unsigned **kmax**  
*FFT bin corresponding to fmax.*
- const int **df**  
*Frequency shift expressed in FFT bins.*
- const **mha\_complex\_t** **delta\_phi**  
*Phase advance per fft frame.*
- **mha\_complex\_t** **delta\_phi\_total**  
*Sum of all phase advances.*

### 5.101.1 Detailed Description

fshift runtime config class

### 5.101.2 Constructor & Destructor Documentation

5.101.2.1 fshift::fshift\_config\_t::fshift\_config\_t (  
fshift\_t const \*const *plug* ) [explicit]

C'tor of the fshift plugin runtime configuration class.

#### Parameters

|             |                                                                                                                 |
|-------------|-----------------------------------------------------------------------------------------------------------------|
| <i>plug</i> | ptr to the plugin interface class. Configuration information is given this way to keep the argument list small. |
|-------------|-----------------------------------------------------------------------------------------------------------------|

5.101.2.2 fshift::fshift\_config\_t::~fshift\_config\_t( ) [default]

### 5.101.3 Member Function Documentation

5.101.3.1 mha\_spec\_t \* fshift::fshift\_config\_t::process ( mha\_spec\_t \* in )

### 5.101.4 Member Data Documentation

5.101.4.1 const unsigned int fshift::fshift\_config\_t::kmin [private]

FFT bin corresponding to fmin.

5.101.4.2 const unsigned fshift::fshift\_config\_t::kmax [private]

FFT bin corresponding to fmax.

5.101.4.3 const int fshift::fshift\_config\_t::df [private]

Frequency shift expressed in FFT bins.

5.101.4.4 const mha\_complex\_t fshift::fshift\_config\_t::delta\_phi [private]

Phase advance per fft frame.

5.101.4.5 mha\_complex\_t fshift::fshift\_config\_t::delta\_phi\_total [private]

Sum of all phase advances.

The documentation for this class was generated from the following files:

- **fshift.hh**
- **fshift.cpp**

## 5.102 fshift::fshift\_t Class Reference

fshift plugin interface class

Inheritance diagram for fshift::fshift\_t:

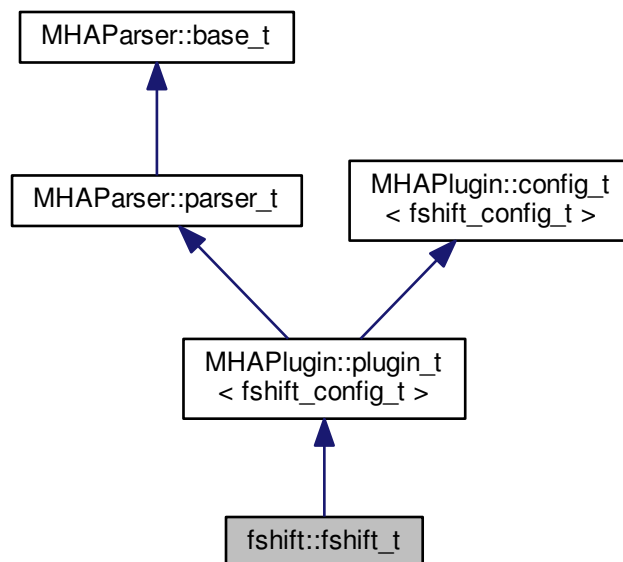

### Public Member Functions

- **fshift\_t** (**algo\_comm\_t** &**ac**, const std::string &chain\_name, const std::string &algo\_name)
  - Constructs our plugin.*
- **~fshift\_t** ()
- **mha\_spec\_t \* process** (**mha\_spec\_t \***)
  - Checks for the most recent configuration and defers processing to it.*
- void **prepare** (**mhaconfig\_t** &)
  - Plugin preparation.*
- void **release** (void)
- **mha\_real\_t fmin** () const
- **mha\_real\_t fmax** () const
- **mha\_real\_t df** () const

### Private Member Functions

- void **update\_cfg** ()

## Private Attributes

- **MHAEvents::patchbay\_t** < fshift\_t > **patchbay**  
*patch bay for connecting configuration parser events with local member functions:*
- **MHAParser::float\_t** **m\_fmin**
- **MHAParser::float\_t** **m\_fmax**  
*upper boundary for frequency shifter*
- **MHAParser::float\_t** **m\_df**  
*Shift frequency in Hz.*

## Additional Inherited Members

## 5.102.1 Detailed Description

fshift plugin interface class

## 5.102.2 Constructor &amp; Destructor Documentation

5.102.2.1 **fshift::fshift\_t::fshift\_t (**  
     **algo\_comm\_t & ac,**  
     **const std::string & chain\_name,**  
     **const std::string & algo\_name )**

Constructs our plugin.

5.102.2.2 **fshift::fshift\_t::~~fshift\_t ( )**

## 5.102.3 Member Function Documentation

5.102.3.1 **mha\_spec\_t \* fshift::fshift\_t::process (**  
     **mha\_spec\_t \* signal )**

Checks for the most recent configuration and defers processing to it.

5.102.3.2 **void fshift::fshift\_t::prepare (**  
     **mhaconfig\_t & signal\_info )** [virtual]

Plugin preparation.

An opportunity to validate configuration parameters before instantiating a configuration.

## Parameters

|                    |                                                                                                                             |
|--------------------|-----------------------------------------------------------------------------------------------------------------------------|
| <i>signal_info</i> | Structure containing a description of the form of the signal (domain, number of channels, frames per block, sampling rate). |
|--------------------|-----------------------------------------------------------------------------------------------------------------------------|

Implements **MHAPugin::plugin\_t< fshift\_config\_t >** (p. 730).

5.102.3.3 `void fshift::fshift_t::release ( void ) [inline], [virtual]`

Reimplemented from **MHAPugin::plugin\_t< fshift\_config\_t >** (p. 731).

5.102.3.4 `mha_real_t fshift::fshift_t::fmin ( ) const [inline]`

5.102.3.5 `mha_real_t fshift::fshift_t::fmax ( ) const [inline]`

5.102.3.6 `mha_real_t fshift::fshift_t::df ( ) const [inline]`

5.102.3.7 `void fshift::fshift_t::update_cfg ( void ) [private]`

#### 5.102.4 Member Data Documentation

5.102.4.1 `MHAEvents::patchbay_t<fshift_t> fshift::fshift_t::patchbay [private]`

patch bay for connecting configuration parser events with local member functions:

5.102.4.2 `MHAParser::float_t fshift::fshift_t::m_fmin [private]`

5.102.4.3 `MHAParser::float_t fshift::fshift_t::m_fmax [private]`

upper boundary for frequency shifter

5.102.4.4 `MHAParser::float_t fshift::fshift_t::m_df [private]`

Shift frequency in Hz.

The documentation for this class was generated from the following files:

- **fshift.hh**
- **fshift.cpp**



## 5.103 fshift\_hilbert::frequency\_translator\_t Class Reference

Inheritance diagram for fshift\_hilbert::frequency\_translator\_t:

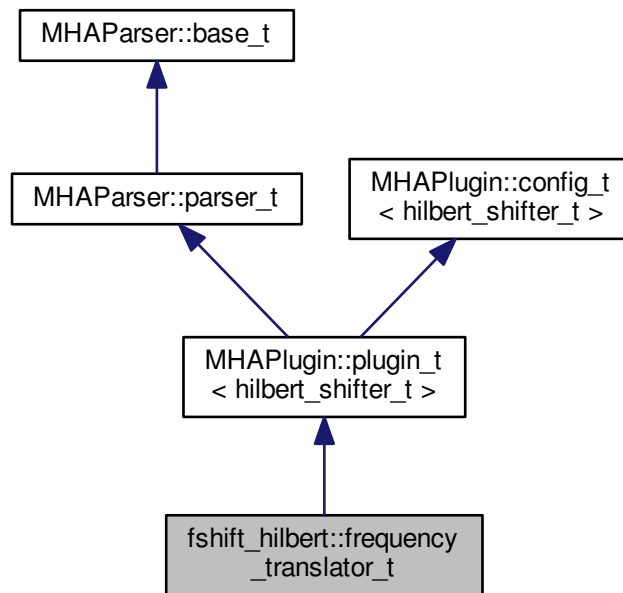

## Public Member Functions

- **frequency\_translator\_t** (const **algo\_comm\_t** &, const std::string &, const std::string &)
- **mha\_spec\_t \* process** (mha\_spec\_t \*)
- void **prepare** (mhaconfig\_t &)
- void **release** ()

## Private Member Functions

- void **update** ()

## Private Attributes

- **MHAEvents::patchbay\_t** < frequency\_translator\_t > **patchbay**
- **MHAParser::vfloat\_t** **df**  
*Vector containing the shift frequencies in Hz.*
- **MHAParser::float\_t** **fmin**  
*Lower boundary for frequency shifter.*

- **MHAParser::float\_t fmax**  
*Upper boundary for frequency shifter.*
- **MHAParser::int\_t irslen**  
*Maximum length of cut off filter response.*
- **MHAParser::kw\_t phasemode**  
*Mode of gain smoothing.*

### Additional Inherited Members

#### 5.103.1 Constructor & Destructor Documentation

5.103.1.1 **fshift\_hilbert::frequency\_translator\_t::frequency\_translator\_t** (  
     const algo\_comm\_t & iac,  
     const std::string & ith,  
     const std::string & ial )

#### 5.103.2 Member Function Documentation

5.103.2.1 **mha\_spec\_t \* fshift\_hilbert::frequency\_translator\_t::process** (  
     mha\_spec\_t \* s )

5.103.2.2 **void fshift\_hilbert::frequency\_translator\_t::prepare** (  
     mhaconfig\_t & tf ) [virtual]

Implements **MHAPLugin::plugin\_t< hilbert\_shifter\_t >** (p. 730).

5.103.2.3 **void fshift\_hilbert::frequency\_translator\_t::release** (  
     void ) [virtual]

Reimplemented from **MHAPLugin::plugin\_t< hilbert\_shifter\_t >** (p. 731).

5.103.2.4 **void fshift\_hilbert::frequency\_translator\_t::update** ( ) [private]

#### 5.103.3 Member Data Documentation

5.103.3.1 **MHAEvents::patchbay\_t<frequency\_translator\_t> fshift\_hilbert::frequency\_↔  
 translator\_t::patchbay** [private]

5.103.3.2 **MHAParser::vfloat\_t fshift\_hilbert::frequency\_translator\_t::df** [private]

Vector containing the shift frequencies in Hz.

**5.103.3.3 MHAParser::float\_t fshift\_hilbert::frequency\_translator\_t::fmin** [private]

Lower boundary for frequency shifter.

**5.103.3.4 MHAParser::float\_t fshift\_hilbert::frequency\_translator\_t::fmax** [private]

Upper boundary for frequency shifter.

**5.103.3.5 MHAParser::int\_t fshift\_hilbert::frequency\_translator\_t::irslen** [private]

Maximum length of cut off filter response.

**5.103.3.6 MHAParser::kw\_t fshift\_hilbert::frequency\_translator\_t::phasemode** [private]

Mode of gain smoothing.

The documentation for this class was generated from the following file:

- **fshift\_hilbert.cpp**

**5.104 fshift\_hilbert::hilbert\_shifter\_t Class Reference**

Inheritance diagram for fshift\_hilbert::hilbert\_shifter\_t:

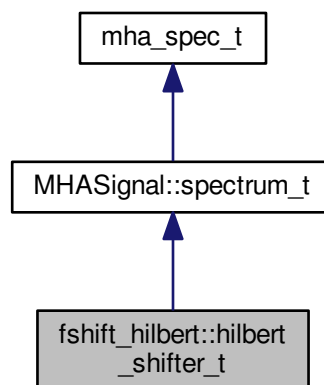

## Public Member Functions

- **hilbert\_shifter\_t** (unsigned int fftlen, unsigned int **channels**, **mha\_real\_t** srate, unsigned int **kmin**, unsigned int **kmax**, std::vector< **mha\_real\_t** > dphi, unsigned int **frameshift**, unsigned int maxirslen, unsigned int phasemode)
- **~hilbert\_shifter\_t** ()
- void **process** (**mha\_spec\_t** \*)

## Private Attributes

- **MHASignal::spectrum\_t fullspec**  
*Part of the spectrum to be frequency shifted.*
- **MHASignal::spectrum\_t analytic**  
*Analytic signal, defined as  $a(t)=x(t)+i*H(x(t))$*
- **MHASignal::waveform\_t shifted**  
*The frequency shifted signal in the time domain.*
- **MHASignal::spectrum\_t mixw\_shift**  
*Helper variable containing the coefficients used to split the spectrum.*
- **MHASignal::spectrum\_t mixw\_ref**  
*Helper variable containing the coefficients used to split the spectrum.*
- **fftw\_plan plan\_spec2analytic**  
*FFT plan for the transformation of fullspec into the time domain.*
- **mha\_fft\_t mhafft**  
*MHA wrapper object for fftw.*
- **MHASignal::waveform\_t df**  
*Vector holding one delta f value for every channel.*
- unsigned int **kmin**  
*FFT frame that corresponds to  $f_{min}$ .*
- unsigned int **kmax**  
*FFT frame that corresponds to  $f_{max}$ .*
- unsigned int **frameshift**  
*Total phase advance within one fragment.*
- std::vector< **mha\_complex\_t** > **delta\_phi**  
*Phase advance per frame.*
- std::vector< **mha\_complex\_t** > **delta\_phi\_total**  
*Sum of all phase advances.*

## Additional Inherited Members

### 5.104.1 Constructor & Destructor Documentation

5.104.1.1 fshift\_hilbert::hilbert\_shifter\_t::hilbert\_shifter\_t (   
     unsigned int *ftlen*,   
     unsigned int *channels*,   
     mha\_real\_t *srate*,   
     unsigned int *kmin*,   
     unsigned int *kmax*,   
     std::vector< mha\_real\_t > *dphi*,   
     unsigned int *frameshift*,   
     unsigned int *maxirslen*,   
     unsigned int *phasemode* )

5.104.1.2 fshift\_hilbert::hilbert\_shifter\_t::~~hilbert\_shifter\_t ( )

## 5.104.2 Member Function Documentation

5.104.2.1 void fshift\_hilbert::hilbert\_shifter\_t::process (   
     mha\_spec\_t \* *s* )

## 5.104.3 Member Data Documentation

5.104.3.1 MHASignal::spectrum\_t fshift\_hilbert::hilbert\_shifter\_t::fullspec [private]

Part of the spectrum to be frequency shifted.

5.104.3.2 MHASignal::spectrum\_t fshift\_hilbert::hilbert\_shifter\_t::analytic [private]

Analytic signal, defined as  $a(t)=x(t)+i*H(x(t))$

5.104.3.3 MHASignal::waveform\_t fshift\_hilbert::hilbert\_shifter\_t::shifted [private]

The frequency shifted signal in the time domain.

5.104.3.4 MHASignal::spectrum\_t fshift\_hilbert::hilbert\_shifter\_t::mixw\_shift [private]

Helper variable containing the coefficients used to split the spectrum.

Contains 1 for every fft bin to be frequency shifted, 0 for all others

5.104.3.5 MHASignal::spectrum\_t fshift\_hilbert::hilbert\_shifter\_t::mixw\_ref [private]

Helper variable containing the coefficients used to split the spectrum.

Contains 0 for every fft bin to be frequency shifted, 1 for all others

5.104.3.6 `fftw_plan fshift_hilbert::hilbert_shifter_t::plan_spec2analytic` [private]

FFT plan for the transformation of fullspec into the time domain.

5.104.3.7 `mha_fft_t fshift_hilbert::hilbert_shifter_t::mhafft` [private]

MHA wrapper object for fftw.

5.104.3.8 `MHASignal::waveform_t fshift_hilbert::hilbert_shifter_t::df` [private]

Vector holding one delta f value for every channel.

5.104.3.9 `unsigned int fshift_hilbert::hilbert_shifter_t::kmin` [private]

FFT frame that corresponds to `f_min`.

5.104.3.10 `unsigned int fshift_hilbert::hilbert_shifter_t::kmax` [private]

FFT frame that corresponds to `f_max`.

5.104.3.11 `unsigned int fshift_hilbert::hilbert_shifter_t::frameshift` [private]

Total phase advance within one fragment.

5.104.3.12 `std::vector<mha_complex_t> fshift_hilbert::hilbert_shifter_t::delta_phi` [private]

Phase advance per frame.

5.104.3.13 `std::vector<mha_complex_t> fshift_hilbert::hilbert_shifter_t::delta_phi_total`  
[private]

Sum of all phase advances.

The documentation for this class was generated from the following file:

- `fshift_hilbert.cpp`

## 5.105 fw\_t Class Reference

Inheritance diagram for fw\_t:

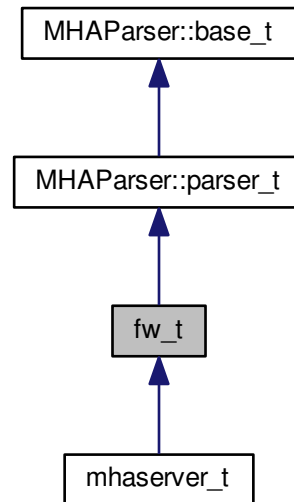

#### Public Member Functions

- `fw_t ()`
- `~fw_t ()`
- `bool exit_request () const`

#### Protected Attributes

- `int proc_error`
- `int io_error`

#### Private Types

#### Private Member Functions

- `void prepare ()`  
*preparation for processing*
- `void start ()`  
*start of processing*
- `void stop ()`

- stop/pause of processing*
- void **release** ()
  - release of IO device*
- void **quit** ()
  - controlled quit*
- void **stopped** (int, int)
- void **started** ()
- int **process** (mha\_wave\_t \*, mha\_wave\_t \*\*)
- void **exec\_fw\_command** ()
- void **load\_proc\_lib** ()
- void **load\_io\_lib** ()
- void **fw\_sleep\_cmd** ()
- void **fw\_until\_cmd** ()
- void **get\_input\_signal\_dimension** ()
- void **async\_read** ()
- void **async\_poll\_msg** ()
- void **get\_parserstate** ()

#### Static Private Member Functions

- static void **stopped** (void \*h, int proc\_err, int io\_err)
- static void **started** (void \*h)
- static int **process** (void \*h, mha\_wave\_t \*sIn, mha\_wave\_t \*\*sOut)

#### Private Attributes

- fw\_vars\_t prepare\_vars
- MHAParser::int\_mon\_t nchannels\_out
- MHAParser::string\_t proc\_name
- MHAParser::string\_t io\_name
- MHAParser::bool\_t exit\_on\_stop
- MHAParser::int\_t fw\_sleep
- MHAParser::string\_t fw\_until
- MHAParser::kw\_t fw\_cmd
- MHAParser::string\_mon\_t parserstate
- MHAParser::string\_t errorlog
- MHAParser::string\_t fatallog
- MHAParser::vstring\_t plugins
- MHAParser::vstring\_t plugin\_paths
- MHAParser::bool\_t dump\_mha
- MHAParser::string\_t inst\_name
  - A variable for naming MHA instances.*
- MHAKernel::algo\_comm\_class\_t ac
- PluginLoader::mhapluginloader\_t \* proc\_lib
- io\_lib\_t \* io\_lib



- **mhaconfig\_t cfin**
- **mhaconfig\_t cfout**
- **state\_t state**
- **bool b\_exit\_request**
- **MHAParser::string\_mon\_t proc\_error\_string**
- **MHAEvents::patchbay\_t< fw\_t > patchbay**

#### Additional Inherited Members

#### 5.105.1 Member Enumeration Documentation

##### 5.105.1.1 enum fw\_t::state\_t [private]

#### Enumerator

*fw\_unprepared*

*fw\_stopped*

*fw\_starting*

*fw\_running*

*fw\_stopping*

*fw\_exiting*

#### 5.105.2 Constructor & Destructor Documentation

##### 5.105.2.1 fw\_t::fw\_t( )

##### 5.105.2.2 fw\_t::~~fw\_t( )

#### 5.105.3 Member Function Documentation

##### 5.105.3.1 bool fw\_t::exit\_request( ) const [inline]

##### 5.105.3.2 void fw\_t::prepare ( void ) [private]

preparation for processing

##### 5.105.3.3 void fw\_t::start ( ) [private]

start of processing

5.105.3.4 void fw\_t::stop ( ) [private]

stop/pause of processing

5.105.3.5 void fw\_t::release ( ) [private]

release of IO device

5.105.3.6 void fw\_t::quit ( ) [private]

controlled quit

5.105.3.7 static void fw\_t::stopped (   
 void \* *h*,   
 int *proc\_err*,   
 int *io\_err* ) [inline],[static],[private]

5.105.3.8 static void fw\_t::started (   
 void \* *h* ) [inline],[static],[private]

5.105.3.9 static int fw\_t::process (   
 void \* *h*,   
 mha\_wave\_t \* *sIn*,   
 mha\_wave\_t \*\* *sOut* ) [inline],[static],[private]

5.105.3.10 void fw\_t::stopped (   
 int *proc\_err*,   
 int *io\_err* ) [private]

5.105.3.11 void fw\_t::started ( ) [private]

5.105.3.12 int fw\_t::process (   
 mha\_wave\_t \* *s\_in*,   
 mha\_wave\_t \*\* *s\_out* ) [private]

5.105.3.13 void fw\_t::exec\_fw\_command ( ) [private]

5.105.3.14 void fw\_t::load\_proc\_lib ( ) [private]

5.105.3.15 void fw\_t::load\_io\_lib ( ) [private]

5.105.3.16 void fw\_t::fw\_sleep\_cmd ( ) [private]

5.105.3.17 void fw\_t::fw\_until\_cmd ( ) [private]

5.105.3.18 void fw\_t::get\_input\_signal\_dimension ( ) [private]

5.105.3.19 void fw\_t::async\_read ( ) [inline],[private]

5.105.3.20 void fw\_t::async\_poll\_msg ( ) [private]

5.105.3.21 void fw\_t::get\_parserstate ( ) [private]

#### 5.105.4 Member Data Documentation

5.105.4.1 fw\_vars\_t fw\_t::prepare\_vars [private]

5.105.4.2 MHAParser::int\_mon\_t fw\_t::nchannels\_out [private]

5.105.4.3 MHAParser::string\_t fw\_t::proc\_name [private]

5.105.4.4 MHAParser::string\_t fw\_t::io\_name [private]

5.105.4.5 MHAParser::bool\_t fw\_t::exit\_on\_stop [private]

5.105.4.6 MHAParser::int\_t fw\_t::fw\_sleep [private]

5.105.4.7 MHAParser::string\_t fw\_t::fw\_until [private]

5.105.4.8 MHAParser::kw\_t fw\_t::fw\_cmd [private]

5.105.4.9 MHAParser::string\_mon\_t fw\_t::parserstate [private]

5.105.4.10 MHAParser::string\_t fw\_t::errorlog [private]

5.105.4.11 MHAParser::string\_t fw\_t::fatallog [private]

5.105.4.12 MHAParser::vstring\_t fw\_t::plugins [private]

5.105.4.13 MHAParser::vstring\_t fw\_t::plugin\_paths [private]

5.105.4.14 MHAParser::bool\_t fw\_t::dump\_mha [private]

5.105.4.15 MHAParser::string\_t fw\_t::inst\_name [private]

A variable for naming MHA instances.

- 5.105.4.16 `MHAKernel::algo_comm_class_t fw_t::ac` [private]
- 5.105.4.17 `PluginLoader::mhapluginloader_t* fw_t::proc_lib` [private]
- 5.105.4.18 `io_lib_t* fw_t::io_lib` [private]
- 5.105.4.19 `mhaconfig_t fw_t::cfin` [private]
- 5.105.4.20 `mhaconfig_t fw_t::cfout` [private]
- 5.105.4.21 `state_t fw_t::state` [private]
- 5.105.4.22 `bool fw_t::b_exit_request` [private]
- 5.105.4.23 `int fw_t::proc_error` [protected]
- 5.105.4.24 `int fw_t::io_error` [protected]
- 5.105.4.25 `MHAParser::string_mon_t fw_t::proc_error_string` [private]
- 5.105.4.26 `MHAEvents::patchbay_t<fw_t> fw_t::patchbay` [private]

The documentation for this class was generated from the following files:

- `mhafw_lib.h`
- `mhafw_lib.cpp`

## 5.106 `fw_vars_t` Class Reference

### Public Member Functions

- `fw_vars_t (MHAParser::parser_t &)`
- `void lock_srate_fragmentsize ()`
- `void lock_channels ()`
- `void unlock_srate_fragmentsize ()`
- `void unlock_channels ()`

### Public Attributes

- `MHAParser::int_t pinchannels`
- `MHAParser::int_t pfragmentsize`
- `MHAParser::float_t psrate`

### 5.106.1 Constructor & Destructor Documentation

5.106.1.1 fw\_vars\_t::fw\_vars\_t (  
                  MHAParser::parser\_t & p )

### 5.106.2 Member Function Documentation

5.106.2.1 void fw\_vars\_t::lock\_srate\_fragsize ( )

5.106.2.2 void fw\_vars\_t::lock\_channels ( )

5.106.2.3 void fw\_vars\_t::unlock\_srate\_fragsize ( )

5.106.2.4 void fw\_vars\_t::unlock\_channels ( )

### 5.106.3 Member Data Documentation

5.106.3.1 MHAParser::int\_t fw\_vars\_t::pinchannels

5.106.3.2 MHAParser::int\_t fw\_vars\_t::pfragmentsize

5.106.3.3 MHAParser::float\_t fw\_vars\_t::psrate

The documentation for this class was generated from the following files:

- mhafw\_lib.h
- mhafw\_lib.cpp

## 5.107 gain::gain\_if\_t Class Reference

Inheritance diagram for gain::gain\_if\_t:

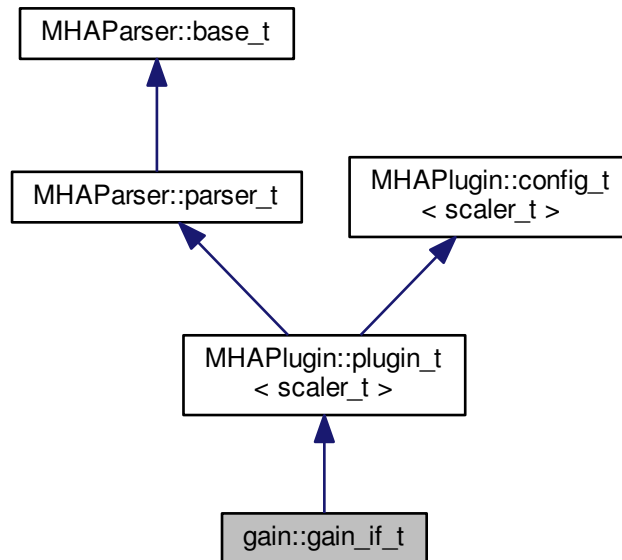

### Public Member Functions

- **gain\_if\_t** (const **algo\_comm\_t** &, const std::string &, const std::string &)
- **mha\_wave\_t \* process** (**mha\_wave\_t \***)
- **mha\_spec\_t \* process** (**mha\_spec\_t \***)
- void **prepare** (**mhaconfig\_t** &)
- void **release** ()

### Private Member Functions

- void **update\_gain** ()
- void **update\_bbgain** ()
- void **update\_minmax** ()

### Private Attributes

- **MHAEvents::patchbay\_t < gain\_if\_t > patchbay**
- **MHAParser::vfloat\_t gains**
- **MHAParser::float\_t bbgain**
- **MHAParser::float\_t vmin**
- **MHAParser::float\_t vmax**

## Additional Inherited Members

### 5.107.1 Constructor & Destructor Documentation

5.107.1.1 `gain::gain_if_t (`  
    `const algo_comm_t & iac,`  
    `const std::string & ,`  
    `const std::string & )`

### 5.107.2 Member Function Documentation

5.107.2.1 `mha_wave_t * gain::gain_if_t::process (`  
    `mha_wave_t * s )`

5.107.2.2 `mha_spec_t * gain::gain_if_t::process (`  
    `mha_spec_t * s )`

5.107.2.3 `void gain::gain_if_t::prepare (`  
    `mhaconfig_t & tf ) [virtual]`

Implements **MHAPLugin::plugin\_t< scaler\_t >** (p. 730).

5.107.2.4 `void gain::gain_if_t::release (`  
    `void ) [virtual]`

Reimplemented from **MHAPLugin::plugin\_t< scaler\_t >** (p. 731).

5.107.2.5 `void gain::gain_if_t::update_gain ( ) [private]`

5.107.2.6 `void gain::gain_if_t::update_bbgain ( ) [private]`

5.107.2.7 `void gain::gain_if_t::update_minmax ( ) [private]`

### 5.107.3 Member Data Documentation

5.107.3.1 `MHAEvents::patchbay_t<gain_if_t> gain::gain_if_t::patchbay [private]`

5.107.3.2 `MHAParser::vfloat_t gain::gain_if_t::gains [private]`

5.107.3.3 `MHAParser::float_t gain::gain_if_t::bbgain [private]`

5.107.3.4 `MHAParser::float_t gain::gain_if_t::vmin [private]`

5.107.3.5 `MHAParser::float_t gain::gain_if_t::vmax [private]`

The documentation for this class was generated from the following file:

- **gain.cpp**

## 5.108 gain::scaler\_t Class Reference

Inheritance diagram for gain::scaler\_t:

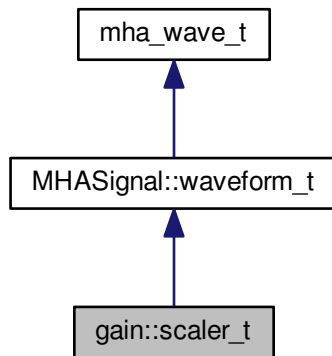

### Public Member Functions

- **scaler\_t** (const unsigned int &channels, const **MHAParser::vfloat\_t** &gains)

### Additional Inherited Members

#### 5.108.1 Constructor & Destructor Documentation

- 5.108.1.1 gain::scaler\_t::scaler\_t (const unsigned int & channels, const **MHAParser::vfloat\_t** & gains )

The documentation for this class was generated from the following file:

- **gain.cpp**

## 5.109 gtfb\_analyzer::gtfb\_analyzer\_cfg\_t Struct Reference

Configuration for Gammatone Filterbank Analyzer.



## Public Member Functions

- unsigned **bands** () const  
*Each band is split into this number of bands.*
- unsigned **channels** () const  
*The number of separate audio channels.*
- unsigned **frames** () const  
*The number of frames in one chunk.*
- **mha\_complex\_t** \* **states** (unsigned channel, unsigned band)  
*Returns pointer to filter states for that band.*
- **gtfb\_analyzer\_cfg\_t** (unsigned ch, unsigned **frames**, unsigned ord, const std::vector< **mha\_complex\_t** > &\_coeff, const std::vector< **mha\_complex\_t** > &\_norm\_phase)  
*Create a configuration for Gammatone Filterbank Analyzer.*
- ~**gtfb\_analyzer\_cfg\_t** ()
- **mha\_complex\_t** & **cvalue** (unsigned frame, unsigned channel, unsigned band)

## Public Attributes

- unsigned **order**  
*The order of the gammatone filters.*
- std::vector< **mha\_complex\_t** > **coeff**  
*The complex coefficients of the gammatone filter bands.*
- std::vector< **mha\_complex\_t** > **norm\_phase**  
*Combination of normalization and phase correction factor.*
- **mha\_wave\_t** **s\_out**  
*Storage for the (complex) output signal.*
- std::vector< **mha\_complex\_t** > **state**  
*Storage for Filter state.*

## 5.109.1 Detailed Description

Configuration for Gammatone Filterbank Analyzer.

## 5.109.2 Constructor &amp; Destructor Documentation

```
5.109.2.1 gtfb_analyzer::gtfb_analyzer_cfg_t::gtfb_analyzer_cfg_t (
    unsigned ch,
    unsigned frames,
    unsigned ord,
    const std::vector< mha_complex_t > &_coeff,
    const std::vector< mha_complex_t > &_norm_phase ) [inline]
```

Create a configuration for Gammatone Filterbank Analyzer.

## Parameters

|                    |                                             |
|--------------------|---------------------------------------------|
| <i>ch</i>          | Number of Audio channels.                   |
| <i>frames</i>      | Number of Audio frames per chunk.           |
| <i>ord</i>         | The order of the gammatone filters.         |
| <i>_coeff</i>      | Complex gammatone filter coefficients.      |
| <i>_norm_phase</i> | Normalization and phase correction factors. |

5.109.2.2 `gtfb_analyzer::gtfb_analyzer_cfg_t::~~gtfb_analyzer_cfg_t( )` [inline]

## 5.109.3 Member Function Documentation

5.109.3.1 `unsigned gtfb_analyzer::gtfb_analyzer_cfg_t::bands( ) const` [inline]

Each band is split into this number of bands.

5.109.3.2 `unsigned gtfb_analyzer::gtfb_analyzer_cfg_t::channels( ) const` [inline]

The number of separate audio channels.

5.109.3.3 `unsigned gtfb_analyzer::gtfb_analyzer_cfg_t::frames( ) const` [inline]

The number of frames in one chunk.

5.109.3.4 `mha_complex_t* gtfb_analyzer::gtfb_analyzer_cfg_t::states( unsigned channel, unsigned band )` [inline]

Returns pointer to filter states for that band.

5.109.3.5 `mha_complex_t& gtfb_analyzer::gtfb_analyzer_cfg_t::cvalue( unsigned frame, unsigned channel, unsigned band )` [inline]

## 5.109.4 Member Data Documentation

5.109.4.1 `unsigned gtfb_analyzer::gtfb_analyzer_cfg_t::order`

The order of the gammatone filters.

5.109.4.2 `std::vector<mha_complex_t> gtfb_analyzer::gtfb_analyzer_cfg_t::coeff`

The complex coefficients of the gammatone filter bands.

5.109.4.3 `std::vector<mha_complex_t> gtfb_analyzer::gtfb_analyzer_cfg_t::norm_phase`

Combination of normalization and phase correction factor.

5.109.4.4 `mha_wave_t gtfb_analyzer::gtfb_analyzer_cfg_t::s_out`

Storage for the (complex) output signal.

Each of the real input audio channels is split into frequency bands with complex time signal output. The split complex time signal is again stored in a `mha_wave_t` (p. 496) buffer. Each complex time signal is stored as adjacent real and imaginary channels. Complex output from one source channel is stored in adjacent complex output channels.

Example: If the input has 2 channels `ch0 ch1`, and `gtfb_analyzer` (p. 88) splits into 3 bands `b0 b1 b2`, then the order of output channels in `s_out` is: `ch0_b0_real ch0_b0_imag ch0_b1_real ch0_b1_imag ch0_b2_real ch0_b2_imag ch1_b0_real ch1_b1_imag ch1_b1_real ch1_b1_imag ch1_b2_real ch1_b2_imag`

5.109.4.5 `std::vector<mha_complex_t> gtfb_analyzer::gtfb_analyzer_cfg_t::state`

Storage for Filter state.

Holds `channels()` (p. 354) \* `bands()` (p. 354) \* order complex filter states. Layout↔  
: state[(`bands()` (p. 354)\*channel+band)\*order+stage]

The documentation for this struct was generated from the following file:

- `gtfb_analyzer.cpp`

5.110 `gtfb_analyzer::gtfb_analyzer_t` Class Reference

Gammatone Filterbank Analyzer Plugin.

Inheritance diagram for `gtfb_analyzer::gtfb_analyzer_t`:

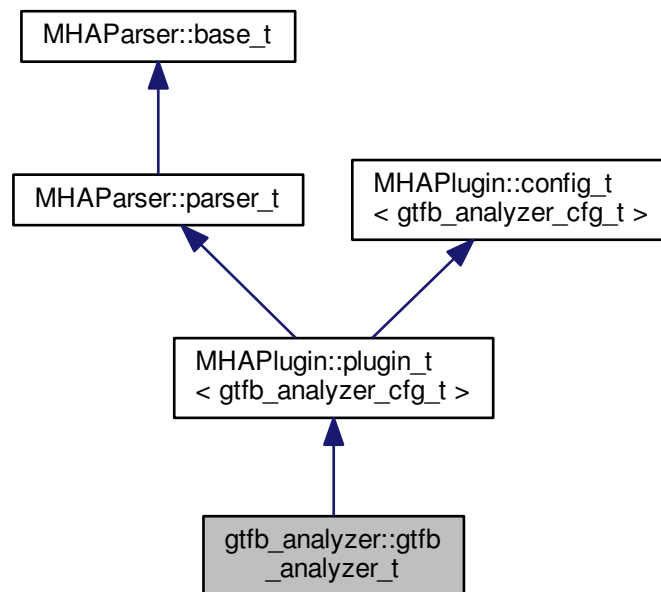

### Public Member Functions

- **gtfb\_analyzer\_t** (const **algo\_comm\_t** &, const std::string &thread\_name, const std::string &algo\_name)
- **mha\_wave\_t \* process** (mha\_wave\_t \*)
- void **prepare** (mhaconfig\_t &)

### Private Member Functions

- void **update\_cfg** ()

### Private Attributes

- **MHAEvents::patchbay\_t < gtfb\_analyzer\_t > patchbay**
- bool **prepared**
- **MHAParser::int\_t order**
- **MHAParser::vcomplex\_t coeff**
- **MHAParser::vcomplex\_t norm\_phase**

## Additional Inherited Members

### 5.110.1 Detailed Description

Gammatone Filterbank Analyzer Plugin.

### 5.110.2 Constructor & Destructor Documentation

5.110.2.1 `gtfb_analyzer::gtfb_analyzer_t::gtfb_analyzer_t ( const algo_comm_t & iac, const std::string & thread_name, const std::string & algo_name )`

### 5.110.3 Member Function Documentation

5.110.3.1 `mha_wave_t * gtfb_analyzer::gtfb_analyzer_t::process ( mha_wave_t * s )`

5.110.3.2 `void gtfb_analyzer::gtfb_analyzer_t::prepare ( mhaconfig_t & tf ) [virtual]`

Implements `MHAPLugin::plugin_t< gtfb_analyzer_cfg_t >` (p. 730).

5.110.3.3 `void gtfb_analyzer::gtfb_analyzer_t::update_cfg ( void ) [private]`

### 5.110.4 Member Data Documentation

5.110.4.1 `MHAEvents::patchbay_t<gtfb_analyzer_t> gtfb_analyzer::gtfb_analyzer_t::patchbay [private]`

5.110.4.2 `bool gtfb_analyzer::gtfb_analyzer_t::prepared [private]`

5.110.4.3 `MHAParser::int_t gtfb_analyzer::gtfb_analyzer_t::order [private]`

5.110.4.4 `MHAParser::vcomplex_t gtfb_analyzer::gtfb_analyzer_t::coeff [private]`

5.110.4.5 `MHAParser::vcomplex_t gtfb_analyzer::gtfb_analyzer_t::norm_phase [private]`

The documentation for this class was generated from the following file:

- `gtfb_analyzer.cpp`

## 5.111 hanning\_ramps\_t Class Reference

### Public Member Functions

- **hanning\_ramps\_t** (unsigned int, unsigned int)
- **~hanning\_ramps\_t** ()
- void **operator()** (MHASignal::waveform\_t &)

### Private Attributes

- unsigned int **len\_a**
- unsigned int **len\_b**
- **mha\_real\_t** \* **ramp\_a**
- **mha\_real\_t** \* **ramp\_b**

### 5.111.1 Constructor & Destructor Documentation

5.111.1.1 **hanning\_ramps\_t::hanning\_ramps\_t** (  
           unsigned int *la*,  
           unsigned int *lb* )

5.111.1.2 **hanning\_ramps\_t::~~hanning\_ramps\_t** (  
           void )

### 5.111.2 Member Function Documentation

5.111.2.1 void **hanning\_ramps\_t::operator()** (  
           MHASignal::waveform\_t & *b* )

### 5.111.3 Member Data Documentation

5.111.3.1 unsigned int **hanning\_ramps\_t::len\_a** [private]

5.111.3.2 unsigned int **hanning\_ramps\_t::len\_b** [private]

5.111.3.3 **mha\_real\_t**\* **hanning\_ramps\_t::ramp\_a** [private]

5.111.3.4 **mha\_real\_t**\* **hanning\_ramps\_t::ramp\_b** [private]

The documentation for this class was generated from the following file:

- **spec2wave.cpp**

## 5.112 identity\_t Class Reference

Inheritance diagram for identity\_t:

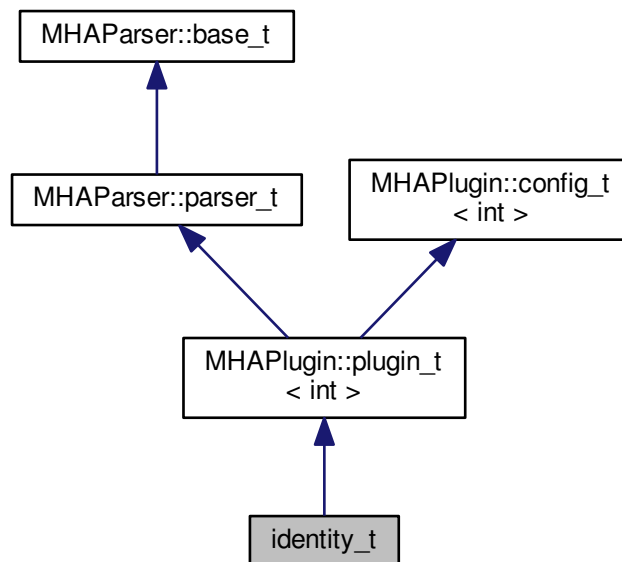

## Public Member Functions

- **identity\_t** (const **algo\_comm\_t** &, const std::string &, const std::string &)
- **mha\_wave\_t** \* **process** (mha\_wave\_t \*)
- **mha\_spec\_t** \* **process** (mha\_spec\_t \*)
- void **prepare** (mhaconfig\_t &)
- void **release** ()

## Additional Inherited Members

## 5.112.1 Constructor &amp; Destructor Documentation

5.112.1.1 identity\_t::identity\_t (  
     const **algo\_comm\_t** & *iac*,  
     const std::string & ,  
     const std::string & )

## 5.112.2 Member Function Documentation

5.112.2.1 `mha_wave_t * identity_t::process ( mha_wave_t * s )`

5.112.2.2 `mha_spec_t * identity_t::process ( mha_spec_t * s )`

5.112.2.3 `void identity_t::prepare ( mhaconfig_t & tf ) [virtual]`

Implements `MHAPLugin::plugin_t< int >` (p. 730).

5.112.2.4 `void identity_t::release ( void ) [virtual]`

Reimplemented from `MHAPLugin::plugin_t< int >` (p. 731).

The documentation for this class was generated from the following file:

- `identity.cpp`

## 5.113 iirfilter\_t Class Reference

Inheritance diagram for `iirfilter_t`:

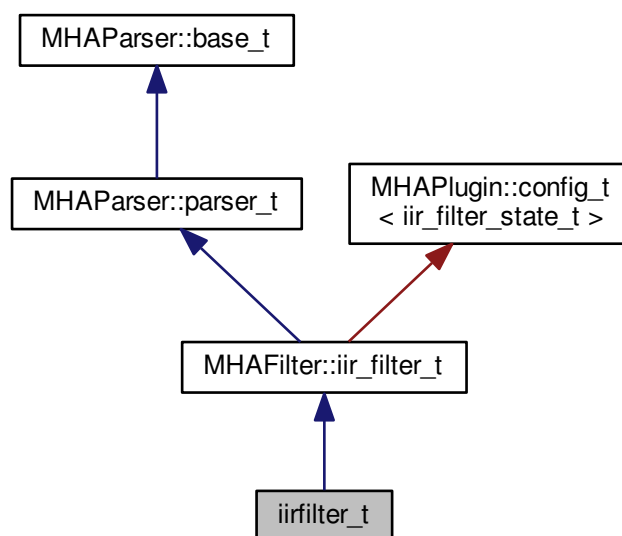



### Public Member Functions

- **iirfilter\_t** (const **algo\_comm\_t** &, const std::string &, const std::string &)
- void **prepare\_** (**mhaconfig\_t** &)
- void **release\_** ()
- **mha\_wave\_t** \* **process** (**mha\_wave\_t** \*)

### Additional Inherited Members

#### 5.113.1 Constructor & Destructor Documentation

5.113.1.1 **iirfilter\_t::iirfilter\_t** (  
    const **algo\_comm\_t** & *ac*,  
    const std::string & *th*,  
    const std::string & *al* )

#### 5.113.2 Member Function Documentation

5.113.2.1 void **iirfilter\_t::prepare\_** (  
    **mhaconfig\_t** & *tf* )

5.113.2.2 void **iirfilter\_t::release\_** ( ) [inline]

5.113.2.3 **mha\_wave\_t** \* **iirfilter\_t::process** (  
    **mha\_wave\_t** \* *s* )

The documentation for this class was generated from the following file:

- **iirfilter.cpp**

## 5.114 io\_alsa\_t Class Reference

MHA IO interface class for ALSA IO.

Inheritance diagram for io\_alsa\_t:

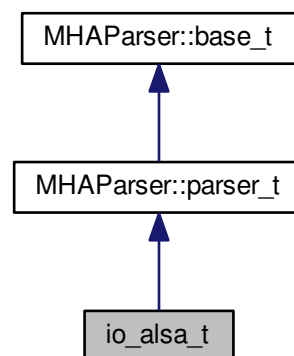

### Public Member Functions

- **io\_alsa\_t** (unsigned int fragsize, float samplerate, **IOProcessEvent\_t** proc\_event, void \*proc\_handle, **IOStartedEvent\_t** start\_event, void \*start\_handle, **IOStoppedEvent\_t** stop\_event, void \*stop\_handle)  
*Constructor, receives the callback handles to interact with the MHA framework.*
- template<typename T = void>  
**void prepare** (int, int)  
*Called after the framework has prepared the processing plugins and the number of input and output channels are fixed.*
- **void release** ()  
*MHA framework leaves prepared state.*
- **void start** ()  
*MHA framework calls this function when signal processing should start.*
- **void stop** ()  
*MHA framework calls this function when signal processing should stop.*
- template<>  
**void prepare** (int nch\_in, int nch\_out)

### Static Public Member Functions

- static void \* **thread\_start** (void \*h)  
*MHAIOAlsa uses a separate thread that calls the alsa read and write functions to read and write audio samples, these functions are blocking until samples can be read or written.*

### Private Member Functions

- **void process** ()

### Private Attributes

- bool **b\_process**
- unsigned int **fw\_fragsize**
- unsigned int **fw\_samplerate**
- **IOProcessEvent\_t** proc\_event
- void \* **proc\_handle**
- **IOStartedEvent\_t** start\_event
- void \* **start\_handle**
- **IOStoppedEvent\_t** stop\_event
- void \* **stop\_handle**
- **alsa\_base\_t** \* dev\_in
- **alsa\_base\_t** \* dev\_out
- pthread\_t **proc\_thread**
- **alsa\_dev\_par\_parser\_t** p\_in
- **alsa\_dev\_par\_parser\_t** p\_out
- **MHAParser::bool\_t** pcmLink
- **MHAParser::int\_t** priority
- **MHAParser::kw\_t** format
- **MHAParser::int\_mon\_t** alsa\_start\_counter
- **MHAEvents::patchbay\_t**< io\_alsa\_t > patchbay

## Additional Inherited Members

### 5.114.1 Detailed Description

MHA IO interface class for ALSA IO.

### 5.114.2 Constructor & Destructor Documentation

5.114.2.1 `io_alsa_t::io_alsa_t (`  
    unsigned int *fragsize*,  
    float *samplerate*,  
    IOProcessEvent\_t *proc\_event*,  
    void \* *proc\_handle*,  
    IOStartedEvent\_t *start\_event*,  
    void \* *start\_handle*,  
    IOStoppedEvent\_t *stop\_event*,  
    void \* *stop\_handle* )

Constructor, receives the callback handles to interact with the MHA framework.

### 5.114.3 Member Function Documentation

5.114.3.1 `template<typename T > void io_alsa_t::prepare (`  
    int *nch\_in*,  
    int *nch\_out* )

Called after the framework has prepared the processing plugins and the number of input and output channels are fixed.

open pcm streams

5.114.3.2 `void io_alsa_t::release (`  
    void )

MHA framework leaves prepared state.

5.114.3.3 `void io_alsa_t::start ( )`

MHA framework calls this function when signal processing should start.

5.114.3.4 `void io_alsa_t::stop ( )`

MHA framework calls this function when signal processing should stop.

5.114.3.5 `void * io_alsa_t::thread_start (`  
`void * h ) [static]`

MHAIOAlsa uses a separate thread that calls the alsa read and write functions to read and write audio samples, these functions are blocking until samples can be read or written.

This is the start function of that thread.

5.114.3.6 `void io_alsa_t::process (`  
`void ) [private]`

5.114.3.7 `template<> void io_alsa_t::prepare (`  
`int nch_in,`  
`int nch_out )`

#### 5.114.4 Member Data Documentation

5.114.4.1 `bool io_alsa_t::b_process [private]`

5.114.4.2 `unsigned int io_alsa_t::fw_fragsize [private]`

5.114.4.3 `unsigned int io_alsa_t::fw_samplerate [private]`

5.114.4.4 `IOProcessEvent_t io_alsa_t::proc_event [private]`

5.114.4.5 `void* io_alsa_t::proc_handle [private]`

5.114.4.6 `IOStartedEvent_t io_alsa_t::start_event [private]`

5.114.4.7 `void* io_alsa_t::start_handle [private]`

5.114.4.8 `IOStoppedEvent_t io_alsa_t::stop_event [private]`

5.114.4.9 `void* io_alsa_t::stop_handle [private]`

5.114.4.10 `alsa_base_t* io_alsa_t::dev_in [private]`

5.114.4.11 `alsa_base_t* io_alsa_t::dev_out [private]`

5.114.4.12 `pthread_t io_alsa_t::proc_thread [private]`

5.114.4.13 `alsa_dev_par_parser_t io_alsa_t::p_in [private]`

5.114.4.14 `alsa_dev_par_parser_t io_alsa_t::p_out [private]`

5.114.4.15 `MHAParser::bool_t io_alsa_t::pcmlink [private]`

5.114.4.16 `MHAParser::int_t io_alsa_t::priority [private]`

5.114.4.17 `MHAParser::kw_t io_alsa_t::format [private]`

5.114.4.18 `MHAParser::int_mon_t io_alsa_t::alsa_start_counter [private]`

5.114.4.19 `MHAEvents::patchbay_t<io_alsa_t> io_alsa_t::patchbay [private]`

The documentation for this class was generated from the following file:

- **MHAIOalsa.cpp**

## 5.115 io\_file\_t Class Reference

File IO.

Inheritance diagram for io\_file\_t:

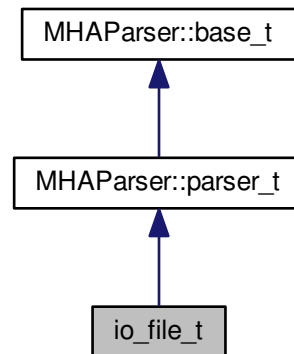

### Public Member Functions

- `io_file_t` (int **fragsize**, float **samplerate**, `IOProcessEvent_t` **proc\_event**, void \***proc\_**↔**handle**, `IOStartedEvent_t` **start\_event**, void \***start\_**↔**handle**, `IOStoppedEvent_t` **stop\_**↔**\_event**, void \***stop\_**↔**handle**)
- `~io_file_t` ()
- void **prepare** (int, int)  
*Allocate buffers, activate FILE client and install internal ports.*
- void **start** ()
- void **stop** ()
- void **release** ()  
*Remove FILE client and deallocate internal ports and buffers.*

### Private Member Functions

- void **stopped** (int, int)
- void **setlock** (bool locked)  
*lock or unlock all parser variables.*

### Private Attributes

- int **fragsize**
- float **samplerate**
- int **nchannels\_in**
- int **nchannels\_file\_in**
- int **nchannels\_out**
- **IOProcessEvent\_t proc\_event**
- void \* **proc\_handle**
- **IOStartedEvent\_t start\_event**
- void \* **start\_handle**
- **IOStoppedEvent\_t stop\_event**
- void \* **stop\_handle**
- **MHAParser::string\_t filename\_input**
- **MHAParser::string\_t filename\_output**
- **MHAParser::kw\_t output\_sample\_format**
- **MHAParser::int\_t startsample**
- **MHAParser::int\_t length**
- **MHAParser::bool\_t strict\_channel\_match**
- **MHAParser::bool\_t strict\_srate\_match**
- **MHASignal::waveform\_t \* s\_in**
- **MHASignal::waveform\_t \* s\_file\_in**
- **mha\_wave\_t \* s\_out**
- bool **b\_prepared**
- SNDFILE \* **sf\_in**
- SNDFILE \* **sf\_out**
- SF\_INFO **sfinf\_in**
- SF\_INFO **sfinf\_out**
- sf\_count\_t **total\_read**

### Additional Inherited Members

#### 5.115.1 Detailed Description

File IO.

#### 5.115.2 Constructor & Destructor Documentation

- 5.115.2.1 **io\_file\_t::io\_file\_t (**  
     **int fragsize,**  
     **float samplerate,**  
     **IOProcessEvent\_t proc\_event,**  
     **void \* proc\_handle,**  
     **IOStartedEvent\_t start\_event,**  
     **void \* start\_handle,**  
     **IOStoppedEvent\_t stop\_event,**  
     **void \* stop\_handle )**

5.115.2.2 io\_file\_t::~io\_file\_t ( )

### 5.115.3 Member Function Documentation

5.115.3.1 void io\_file\_t::prepare (  
    int *nch\_in*,  
    int *nch\_out* )

Allocate buffers, activate FILE client and install internal ports.

5.115.3.2 void io\_file\_t::start ( )

5.115.3.3 void io\_file\_t::stop ( )

5.115.3.4 void io\_file\_t::release (  
    void )

Remove FILE client and deallocate internal ports and buffers.

5.115.3.5 void io\_file\_t::stopped (  
    int *proc\_err*,  
    int *io\_err* ) [private]

5.115.3.6 void io\_file\_t::setlock (  
    bool *locked* ) [private]

lock or unlock all parser variables.

Used in prepare/release.

#### Parameters

|               |                                        |
|---------------|----------------------------------------|
| <i>locked</i> | When true, locks. When false, unlocks. |
|---------------|----------------------------------------|

### 5.115.4 Member Data Documentation

5.115.4.1 int io\_file\_t::fragsize [private]

5.115.4.2 float io\_file\_t::samplerate [private]

5.115.4.3 int io\_file\_t::nchannels\_in [private]

5.115.4.4 int io\_file\_t::nchannels\_file\_in [private]

- 5.115.4.5 `int io_file_t::nchannels_out` [private]
- 5.115.4.6 `IOProcessEvent_t io_file_t::proc_event` [private]
- 5.115.4.7 `void* io_file_t::proc_handle` [private]
- 5.115.4.8 `IOStartedEvent_t io_file_t::start_event` [private]
- 5.115.4.9 `void* io_file_t::start_handle` [private]
- 5.115.4.10 `IOStoppedEvent_t io_file_t::stop_event` [private]
- 5.115.4.11 `void* io_file_t::stop_handle` [private]
- 5.115.4.12 `MHAParser::string_t io_file_t::filename_input` [private]
- 5.115.4.13 `MHAParser::string_t io_file_t::filename_output` [private]
- 5.115.4.14 `MHAParser::kw_t io_file_t::output_sample_format` [private]
- 5.115.4.15 `MHAParser::int_t io_file_t::startsample` [private]
- 5.115.4.16 `MHAParser::int_t io_file_t::length` [private]
- 5.115.4.17 `MHAParser::bool_t io_file_t::strict_channel_match` [private]
- 5.115.4.18 `MHAParser::bool_t io_file_t::strict_srate_match` [private]
- 5.115.4.19 `MHASignal::waveform_t* io_file_t::s_in` [private]
- 5.115.4.20 `MHASignal::waveform_t* io_file_t::s_file_in` [private]
- 5.115.4.21 `mha_wave_t* io_file_t::s_out` [private]
- 5.115.4.22 `bool io_file_t::b_prepared` [private]
- 5.115.4.23 `SNDFILE* io_file_t::sf_in` [private]
- 5.115.4.24 `SNDFILE* io_file_t::sf_out` [private]
- 5.115.4.25 `SF_INFO io_file_t::sfin_in` [private]
- 5.115.4.26 `SF_INFO io_file_t::sfin_out` [private]
- 5.115.4.27 `sf_count_t io_file_t::total_read` [private]

The documentation for this class was generated from the following file:

- **MHAIOFile.cpp**



## 5.116 io\_lib\_t Class Reference

Class for loading MHA sound IO module.

Inheritance diagram for io\_lib\_t:

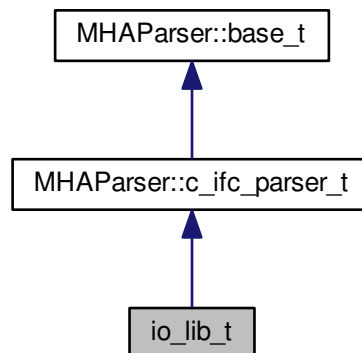

### Public Member Functions

- **io\_lib\_t** (int fragsize, float samplerate, **IOProcessEvent\_t** proc\_event, void \*proc\_↔ handle, **IOStartedEvent\_t** start\_event, void \*start\_handle, **IOStoppedEvent\_t** stop\_↔ event, void \*stop\_handle, std::string libname)  
*load and initialize MHA sound io module.*
- **~io\_lib\_t** ()  
*Deinitialize and unload this MHA sound io module.*
- void **prepare** (unsigned int inch, unsigned int outch)  
*Prepare the sound io module.*
- void **start** ()  
*Tell the sound io module to start sound processing.*
- void **stop** ()
- void **release** ()
- std::string **lib\_str\_error** (int err)

### Protected Member Functions

- void **test\_error** ()

### Protected Attributes

- int **lib\_err**
- **dynamiclib\_t lib\_handle**
- void \* **lib\_data**
- **IOInit\_t IOInit\_cb**
- **IOPrepare\_t IOPrepare\_cb**
- **IOStart\_t IOStart\_cb**
- **IOStop\_t IOStop\_cb**
- **IORelease\_t IORelease\_cb**
- **IOSetVar\_t IOSetVar\_cb**
- **IOStrError\_t IOStrError\_cb**
- **IODestroy\_t IODestroy\_cb**

### Additional Inherited Members

#### 5.116.1 Detailed Description

Class for loading MHA sound IO module.

#### 5.116.2 Constructor & Destructor Documentation

5.116.2.1 `io_lib_t::io_lib_t (`  
     int *fragsize*,  
     float *samplerate*,  
     IOProcessEvent\_t *proc\_event*,  
     void \* *proc\_handle*,  
     IOStartedEvent\_t *start\_event*,  
     void \* *start\_handle*,  
     IOStoppedEvent\_t *stop\_event*,  
     void \* *stop\_handle*,  
     std::string *libname* )

load and initialize MHA sound io module.

5.116.2.2 `io_lib_t::~~io_lib_t ( )`

Deinitialize and unload this MHA sound io module.

#### 5.116.3 Member Function Documentation

5.116.3.1 `void io_lib_t::prepare (`  
     unsigned int *inch*,  
     unsigned int *outch* )

Prepare the sound io module.

After preparation, the sound io module may start the sound processing at any time (external trigger). When the sound processing is started, the sound io module will call the `start_event` callback.

## Parameters

|              |                           |
|--------------|---------------------------|
| <i>inch</i>  | number of input channels  |
| <i>outch</i> | number of output channels |

## 5.116.3.2 void io\_lib\_t::start ( )

Tell the sound io module to start sound processing.

Some io modules need this, for others that wait for external events this method might do nothing.

## 5.116.3.3 void io\_lib\_t::stop ( )

## 5.116.3.4 void io\_lib\_t::release ( )

5.116.3.5 std::string io\_lib\_t::lib\_str\_error ( int *err* )

## 5.116.3.6 void io\_lib\_t::test\_error ( ) [protected]

## 5.116.4 Member Data Documentation

## 5.116.4.1 int io\_lib\_t::lib\_err [protected]

## 5.116.4.2 dynamiclib\_t io\_lib\_t::lib\_handle [protected]

## 5.116.4.3 void\* io\_lib\_t::lib\_data [protected]

## 5.116.4.4 IOInit\_t io\_lib\_t::IOInit\_cb [protected]

## 5.116.4.5 IOPrepare\_t io\_lib\_t::IOPrepare\_cb [protected]

## 5.116.4.6 IOStart\_t io\_lib\_t::IOStart\_cb [protected]

## 5.116.4.7 IOStop\_t io\_lib\_t::IOStop\_cb [protected]

## 5.116.4.8 IORelease\_t io\_lib\_t::IORelease\_cb [protected]

## 5.116.4.9 IOSetVar\_t io\_lib\_t::IOSetVar\_cb [protected]

## 5.116.4.10 IOStrError\_t io\_lib\_t::IOStrError\_cb [protected]

## 5.116.4.11 IODestroy\_t io\_lib\_t::IODestroy\_cb [protected]

The documentation for this class was generated from the following files:

- mhafw\_lib.h
- mhafw\_lib.cpp

## 5.117 io\_parser\_t Class Reference

Main class for Parser IO.

Inheritance diagram for io\_parser\_t:

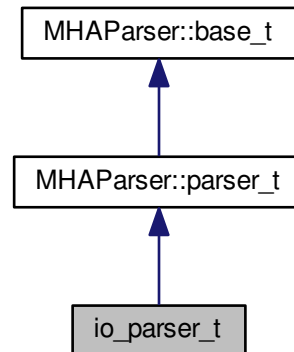

### Public Member Functions

- **io\_parser\_t** (unsigned int **fragsize**, **IOProcessEvent\_t** **proc\_event**, void \***proc\_handle**, **IOStartedEvent\_t** **start\_event**, void \***start\_handle**, **IOStoppedEvent\_t** **stop\_event**, void \***stop\_handle**)
- **~io\_parser\_t** ()
- void **prepare** (int, int)  
*Allocate buffers, activate JACK client and install internal ports.*
- void **start** ()
- void **stop** ()
- void **release** ()  
*Remove JACK client and deallocate internal ports and buffers.*

### Private Member Functions

- void **stopped** (int, int)
- void **started** ()
- void **process\_frame** ()

### Private Attributes

- unsigned int **fragsize**
- unsigned int **nchannels\_in**
- unsigned int **nchannels\_out**
- **IOProcessEvent\_t proc\_event**
- void \* **proc\_handle**
- **IOStartedEvent\_t start\_event**
- void \* **start\_handle**
- **IOStoppedEvent\_t stop\_event**
- void \* **stop\_handle**
- **MHAParser::mfloat\_t input**
- **MHAParser::mfloat\_mon\_t output**
- **MHASignal::waveform\_t \* s\_in**
- **mha\_wave\_t \* s\_out**
- bool **b\_fw\_started**
- bool **b\_stopped**
- bool **b\_prepared**
- bool **b\_starting**
- **MHAEvents::patchbay\_t< io\_parser\_t > patchbay**

### Additional Inherited Members

#### 5.117.1 Detailed Description

Main class for Parser IO.

#### 5.117.2 Constructor & Destructor Documentation

5.117.2.1 io\_parser\_t::io\_parser\_t (   
     unsigned int *fragsize*,   
     IOProcessEvent\_t *proc\_event*,   
     void \* *proc\_handle*,   
     IOStartedEvent\_t *start\_event*,   
     void \* *start\_handle*,   
     IOStoppedEvent\_t *stop\_event*,   
     void \* *stop\_handle* )

5.117.2.2 io\_parser\_t::~io\_parser\_t ( )

#### 5.117.3 Member Function Documentation

5.117.3.1 void io\_parser\_t::prepare (   
     int *nch\_in*,   
     int *nch\_out* )

Allocate buffers, activate JACK client and install internal ports.

5.117.3.2 void io\_parser\_t::start ( )

5.117.3.3 void io\_parser\_t::stop ( )

5.117.3.4 void io\_parser\_t::release ( void )

Remove JACK client and deallocate internal ports and buffers.

5.117.3.5 void io\_parser\_t::stopped ( int *proc\_err*, int *io\_err* ) [private]

5.117.3.6 void io\_parser\_t::started ( ) [private]

5.117.3.7 void io\_parser\_t::process\_frame ( ) [private]

#### 5.117.4 Member Data Documentation

5.117.4.1 unsigned int io\_parser\_t::fragsize [private]

5.117.4.2 unsigned int io\_parser\_t::nchannels\_in [private]

5.117.4.3 unsigned int io\_parser\_t::nchannels\_out [private]

5.117.4.4 IOProcessEvent\_t io\_parser\_t::proc\_event [private]

5.117.4.5 void\* io\_parser\_t::proc\_handle [private]

5.117.4.6 IOStartedEvent\_t io\_parser\_t::start\_event [private]

5.117.4.7 void\* io\_parser\_t::start\_handle [private]

5.117.4.8 IOStoppedEvent\_t io\_parser\_t::stop\_event [private]

5.117.4.9 void\* io\_parser\_t::stop\_handle [private]

5.117.4.10 MHAParser::mfloat\_t io\_parser\_t::input [private]

5.117.4.11 MHAParser::mfloat\_mon\_t io\_parser\_t::output [private]

5.117.4.12 MHASignal::waveform\_t\* io\_parser\_t::s\_in [private]

5.117.4.13 mha\_wave\_t\* io\_parser\_t::s\_out [private]

5.117.4.14 bool io\_parser\_t::b\_fw\_started [private]

5.117.4.15 bool io\_parser\_t::b\_stopped [private]

5.117.4.16 bool io\_parser\_t::b\_prepared [private]

5.117.4.17 bool io\_parser\_t::b\_starting [private]

5.117.4.18 MHAEvents::patchbay\_t<io\_parser\_t> io\_parser\_t::patchbay [private]

The documentation for this class was generated from the following file:

- **MHAIOParser.cpp**

## 5.118 io\_tcp\_fwcb\_t Class Reference

TCP sound-io library's interface to the framework callbacks.

## Public Member Functions

- **io\_tcp\_fwcb\_t** (IOProcessEvent\_t proc\_event, void \*proc\_handle, IOStartedEvent\_t start\_event, void \*start\_handle, IOStoppedEvent\_t stop\_event, void \*stop\_handle)
  - Constructor stores framework handles and initializes error numbers to 0.*
- virtual ~**io\_tcp\_fwcb\_t** ()
  - Do-nothing destructor.*
- virtual void **start** ()
  - Call the framework's start callback.*
- virtual int **process** (mha\_wave\_t \*sIn, mha\_wave\_t \*&sOut)
  - Call the frameworks processing callback.*
- virtual void **set\_errnos** (int proc\_err, int io\_err)
  - Save error numbers to use during.*
- virtual void **stop** ()
  - Call the frameworks stop callback.*

## Private Attributes

- **IOProcessEvent\_t proc\_event**
  - Pointer to signal processing callback function.*
- **IOStartedEvent\_t start\_event**
  - Pointer to start notification callback function.*
- **IOStoppedEvent\_t stop\_event**
  - Pointer to stop notification callback function.*
- void \* **proc\_handle**
  - Handles belonging to framework.*
- void \* **start\_handle**
- void \* **stop\_handle**
- int **proc\_err**
  - Errors from the processing callback and from the TCP IO itself are stored here before closing Network handles.*
- int **io\_err**

## 5.118.1 Detailed Description

TCP sound-io library's interface to the framework callbacks.

### 5.118.2 Constructor & Destructor Documentation

```
5.118.2.1 io_tcp_fwcb_t::io_tcp_fwcb_t (
    IOProcessEvent_t proc_event,
    void * proc_handle,
    IOStartedEvent_t start_event,
    void * start_handle,
    IOStoppedEvent_t stop_event,
    void * stop_handle )
```

Constructor stores framework handles and initializes error numbers to 0.

```
5.118.2.2 virtual io_tcp_fwcb_t::~io_tcp_fwcb_t ( ) [inline],[virtual]
```

Do-nothing destructor.

### 5.118.3 Member Function Documentation

```
5.118.3.1 void io_tcp_fwcb_t::start ( ) [virtual]
```

Call the framework's start callback.

```
5.118.3.2 int io_tcp_fwcb_t::process (
    mha_wave_t * sIn,
    mha_wave_t *& sOut ) [virtual]
```

Call the frameworks processing callback.

#### Parameters

|             |                                                                                                         |
|-------------|---------------------------------------------------------------------------------------------------------|
| <i>sIn</i>  | The input sound data just received from TCP.                                                            |
| <i>sOut</i> | A pointer to output sound data. Will point to the output sound data storage when the callback finishes. |

#### Returns

Status, an error number from the signal processing callback. If this is != 0, then the connection should be closed.

```
5.118.3.3 void io_tcp_fwcb_t::set_ernnos (
    int proc_err,
    int io_err ) [virtual]
```

Save error numbers to use during.



See also

**stop** (p. 377)

Parameters

|                 |                           |
|-----------------|---------------------------|
| <i>proc_err</i> | The error number from the |
|-----------------|---------------------------|

See also

**process** (p. 376) callback.

Parameters

|               |                                              |
|---------------|----------------------------------------------|
| <i>io_err</i> | The error number from the io library itself. |
|---------------|----------------------------------------------|

5.118.3.4 void io\_tcp\_fwcb\_t::stop ( ) [virtual]

Call the frameworks stop callback.

Uses the error numbers set previously with

See also

**set\_errnos** (p. 376).

5.118.4 Member Data Documentation

5.118.4.1 IOProcessEvent\_t io\_tcp\_fwcb\_t::proc\_event [private]

Pointer to signal processing callback function.

5.118.4.2 IOStartedEvent\_t io\_tcp\_fwcb\_t::start\_event [private]

Pointer to start notification callback function.

Called when a new TCP connection is established or the user issues the start command while there is a connection.

5.118.4.3 IOStoppedEvent\_t io\_tcp\_fwcb\_t::stop\_event [private]

Pointer to stop notification callback function.

Called when the connection is closed.

5.118.4.4 `void* io_tcp_fwcb_t::proc_handle` [private]

Handles belonging to framework.

5.118.4.5 `void * io_tcp_fwcb_t::start_handle` [private]

5.118.4.6 `void * io_tcp_fwcb_t::stop_handle` [private]

5.118.4.7 `int io_tcp_fwcb_t::proc_err` [private]

Errors from the processing callback and from the TCP IO itself are stored here before closing Network handles.

MHAIOTCP is notified by the server when the connection has been taken down, and calls

See also

**stop** (p. 377) from that callback. Within **stop** (p. 377), these error numbers are read again and transmitted to the framework.

5.118.4.8 `int io_tcp_fwcb_t::io_err` [private]

The documentation for this class was generated from the following file:

- **MHAIOTCP.cpp**

## 5.119 `io_tcp_parser_t` Class Reference

The parser interface of the IOTCP library.

Inheritance diagram for `io_tcp_parser_t`:

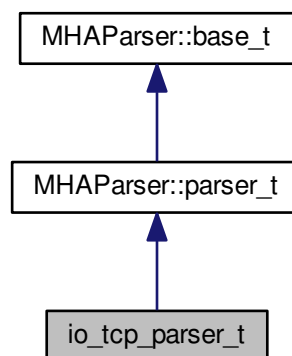

## Public Member Functions

- virtual const std::string & **get\_local\_address** () const  
*Read parser variable local\_address, this is the address of the network interface that should listen for incoming connections.*
- virtual unsigned short **get\_local\_port** () const  
*Read parser variable local\_port, this is the TCP port that should be used for incoming connections.*
- virtual void **set\_local\_port** (unsigned short port)  
*Set parser variable local\_port.*
- virtual bool **get\_server\_port\_open** () const  
*Return the status of the server port as it is known to the parser.*
- virtual void **set\_server\_port\_open** (bool open)  
*Inform the parser of the current status of the server socket.*
- virtual bool **get\_connected** () const  
*Return the parser's knowledge concerning whether there currently exists an established sound data TCP connection or not.*
- virtual void **set\_connected** (bool connected)  
*Inform the parser about the existence of a sound data connection.*
- virtual void **set\_new\_peer** (unsigned short port, const std::string &host)  
*Set parser monitor variables peer\_port and peer\_address, and calls set\_connected(true).*
- **io\_tcp\_parser\_t** ()  
*Constructor initializes parser variables.*
- virtual ~**io\_tcp\_parser\_t** ()  
*Do-nothing destructor.*
- virtual void **debug** (const std::string &message)

## Private Attributes

- **MHAParser::string\_t local\_address**  
*Lets the user set the local network interface to listen on.*
- **MHAParser::int\_t local\_port**  
*Lets the user choose the local tcp port to listen on.*
- **MHAParser::int\_mon\_t server\_port\_open**  
*Indicates whether the TCP server socket is currently open.*
- **MHAParser::int\_mon\_t connected**  
*Indicator if there currently is a sound data connection over TCP.*
- **MHAParser::string\_mon\_t peer\_address**  
*Display the ip address of the currently connected sound data client.*
- **MHAParser::int\_mon\_t peer\_port**  
*Display the tcp port used by the current sound data client.*
- **MHAParser::string\_t debug\_filename**  
*filename to write debugging info to (if non-empty)*
- FILE \* **debug\_file**  
*file handle to write debugging info to*

## Additional Inherited Members

### 5.119.1 Detailed Description

The parser interface of the IOTCP library.

### 5.119.2 Constructor & Destructor Documentation

#### 5.119.2.1 `io_tcp_parser_t::io_tcp_parser_t( )`

Constructor initializes parser variables.

#### 5.119.2.2 `virtual io_tcp_parser_t::~io_tcp_parser_t( ) [inline], [virtual]`

Do-nothing destructor.

### 5.119.3 Member Function Documentation

#### 5.119.3.1 `virtual const std::string& io_tcp_parser_t::get_local_address( ) const [inline], [virtual]`

Read parser variable `local_address`, this is the address of the network interface that should listen for incoming connections.

#### Returns

A string containing the address of the local interface as it was set by the user.

#### 5.119.3.2 `unsigned short io_tcp_parser_t::get_local_port( ) const [virtual]`

Read parser variable `local_port`, this is the TCP port that should be used for incoming connections.

#### Returns

The local tcp port to listen on as it was chosen by the user. The port number is between `MIN_TCP_PORT` and `MAX_TCP_PORT`.

#### 5.119.3.3 `void io_tcp_parser_t::set_local_port( unsigned short port ) [virtual]`

Set parser variable `local_port`.

This is needed when it was set to 0 before: In this case, the OS chooses a free port for the TCP server socket, and the port that it chose has to be published to the user via the parser interface.

### Parameters

|             |                                                                                                     |
|-------------|-----------------------------------------------------------------------------------------------------|
| <i>port</i> | The TCP port number that is currently used. In the range [MIN_TCP_PORT, MAX_TCP_PORT], excluding 0. |
|-------------|-----------------------------------------------------------------------------------------------------|

### Precondition

**get\_local\_port()** (p. 380) currently returns 0.

#### 5.119.3.4 bool io\_tcp\_parser\_t::get\_server\_port\_open ( ) const [virtual]

Return the status of the server port as it is known to the parser.

### Returns

false after initialization, or the value most recently set via

### See also

**set\_server\_port\_open** (p. 381).

#### 5.119.3.5 void io\_tcp\_parser\_t::set\_server\_port\_open ( bool open ) [virtual]

Inform the parser of the current status of the server socket.

### Parameters

|             |                                                                     |
|-------------|---------------------------------------------------------------------|
| <i>open</i> | Indicates whether the server socket has just been opened or closed. |
|-------------|---------------------------------------------------------------------|

### Precondition

*open* may only have the value true if **get\_server\_port\_open()** (p. 381) currently returns false.

### Postcondition

### See also

**get\_server\_port\_open** (p. 381) returns the **value** (p. 53) of *open*.

### 5.119.3.6 `bool io_tcp_parser_t::get_connected ( ) const` [virtual]

Return the parser's knowledge concerning whether there currently exists an established sound data TCP connection or not.

#### Returns

false after initialization, or the value most recently set via

#### See also

`set_connected` (p. 382).

### 5.119.3.7 `void io_tcp_parser_t::set_connected ( bool connected )` [virtual]

Inform the parser about the existence of a sound data connection.

#### Parameters

|                  |                                                           |
|------------------|-----------------------------------------------------------|
| <i>connected</i> | Indicates whether there currently is a connection or not. |
|------------------|-----------------------------------------------------------|

#### Precondition

`connected` must not have the same value that is currently returned by

#### See also

`get_connected` (p. 382).

#### Postcondition

#### See also

`get_connected` (p. 382) returns the **value** (p. 53) of `open`.

### 5.119.3.8 `void io_tcp_parser_t::set_new_peer ( unsigned short port, const std::string & host )` [virtual]

Set parser monitor variables `peer_port` and `peer_address`, and calls `set_connected(true)`.

This method should be called when a new connection is established.

## Parameters

|             |                                              |
|-------------|----------------------------------------------|
| <i>port</i> | The TCP port number used by the peer.        |
| <i>host</i> | The Internet host where the peer is located. |

## Precondition

## See also

**get\_connected** (p. 382) currently returns false.

## Postcondition

## See also

**get\_connected** (p. 382) returns true.

5.119.3.9 virtual void io\_tcp\_parser\_t::debug (   
                   const std::string & *message* ) [inline],[virtual]

## 5.119.4 Member Data Documentation

5.119.4.1 MHAParser::string\_t io\_tcp\_parser\_t::local\_address [private]

Lets the user set the local network interface to listen on.

5.119.4.2 MHAParser::int\_t io\_tcp\_parser\_t::local\_port [private]

Lets the user choose the local tcp port to listen on.

5.119.4.3 MHAParser::int\_mon\_t io\_tcp\_parser\_t::server\_port\_open [private]

Indicates wether the TCP server socket is currently open.

5.119.4.4 MHAParser::int\_mon\_t io\_tcp\_parser\_t::connected [private]

Indicator if there currently is a sound data connection over TCP.

#### 5.119.4.5 **MHAParser::string\_mon\_t io\_tcp\_parser\_t::peer\_address** [private]

Display the ip address of the currently connected sound data client.

#### 5.119.4.6 **MHAParser::int\_mon\_t io\_tcp\_parser\_t::peer\_port** [private]

Display the tcp port used by the current sound data client.

#### 5.119.4.7 **MHAParser::string\_t io\_tcp\_parser\_t::debug\_filename** [private]

filename to write debugging info to (if non-empty)

#### 5.119.4.8 **FILE\* io\_tcp\_parser\_t::debug\_file** [private]

file handle to write debugging info to

The documentation for this class was generated from the following file:

- **MHAIOTCP.cpp**

### 5.120 **io\_tcp\_sound\_t** Class Reference

Sound data handling of io tcp library.

#### Classes

- union **float\_union**

*This union helps in conversion of floats from host byte order to network byte order and back again.*

#### Public Member Functions

- **io\_tcp\_sound\_t** (int **fragsize**, float **samplerate**)  
*Initialize sound data handling.*
- virtual **~io\_tcp\_sound\_t** ()  
*Do-nothing destructor.*
- virtual void **prepare** (int **num\_inchannels**, int **num\_outchannels**)  
*Called during prepare, sets number of audio channels and allocates sound data storage.*
- virtual void **release** ()  
*Called during release.*
- virtual int **chunkbytes\_in** () const  
*Number of bytes that constitute one input sound chunk.*
- virtual std::string **header** () const  
*Create the tcp sound header lines.*
- virtual **mha\_wave\_t \* ntoh** (const std::string &data)  
*Copy data received from tcp into **mha\_wave\_t** (p. 496) structure.*
- virtual std::string **hton** (const **mha\_wave\_t \*s\_out**)  
*Copy sound data from the output sound structure to a string.*



### Static Private Member Functions

- static void **check\_sound\_data\_type** ()  
*Check if mha\_real\_t is a usable 32-bit floating point type.*

### Private Attributes

- int **fragsize**  
*Number of sound samples in each channel expected and returned from processing callback.*
- float **samplerate**  
*Sampling rate.*
- int **num\_inchannels**  
*Number of input channels.*
- int **num\_outchannels**
- **MHASignal::waveform\_t \* s\_in**  
*Storage for input signal.*

#### 5.120.1 Detailed Description

Sound data handling of io tcp library.

#### 5.120.2 Constructor & Destructor Documentation

5.120.2.1 io\_tcp\_sound\_t::io\_tcp\_sound\_t (  
    int *fragsize*,  
    float *samplerate* )

Initialize sound data handling.

Checks sound data type by calling

See also

**check\_sound\_data\_type** (p. [386](#)).

#### Parameters

|                   |                                                                                         |
|-------------------|-----------------------------------------------------------------------------------------|
| <i>fragsize</i>   | Number of sound samples in each channel expected and returned from processing callback. |
| <i>samplerate</i> | Number of samples per second in each channel.                                           |

5.120.2.2 `virtual io_tcp_sound_t::~io_tcp_sound_t( ) [inline],[virtual]`

Do-nothing destructor.

### 5.120.3 Member Function Documentation

5.120.3.1 `void io_tcp_sound_t::check_sound_data_type( ) [static],[private]`

Check if `mha_real_t` is a usable 32-bit floating point type.

#### Exceptions

|                                  |                                                               |
|----------------------------------|---------------------------------------------------------------|
| <b><i>MHA_Error</i></b> (p. 445) | if <code>mha_real_t</code> is not compatible to 32-bit float. |
|----------------------------------|---------------------------------------------------------------|

5.120.3.2 `void io_tcp_sound_t::prepare (`  
`int num_inchannels,`  
`int num_outchannels ) [virtual]`

Called during prepare, sets number of audio channels and allocates sound data storage.

#### Parameters

|                              |                                  |
|------------------------------|----------------------------------|
| <code>num_inchannels</code>  | Number of input audio channels.  |
| <code>num_outchannels</code> | Number of output audio channels. |

5.120.3.3 `void io_tcp_sound_t::release (`  
`void ) [virtual]`

Called during release.

Deletes sound data storage.

5.120.3.4 `int io_tcp_sound_t::chunkbytes_in( ) const [virtual]`

Number of bytes that constitute one input sound chunk.

#### Returns

Number of bytes to read from TCP connection before invoking signal processing.

5.120.3.5 `std::string io_tcp_sound_t::header( ) const [virtual]`

Create the tcp sound header lines.

5.120.3.6 `mha_wave_t * io_tcp_sound_t::ntoh (`  
`const std::string & data ) [virtual]`

Copy data received from tcp into **mha\_wave\_t** (p. 496) structure.

Doing network-to-host byte order swapping in the process.

#### Parameters

|             |             |
|-------------|-------------|
| <i>data</i> | One chunk ( |
|-------------|-------------|

#### See also

**chunkbytes\_in** (p. 386)) of sound data to process.

#### Returns

Pointer to the sound data storage.

5.120.3.7 `std::string io_tcp_sound_t::hton (`  
`const mha_wave_t * s_out ) [virtual]`

Copy sound data from the output sound structure to a string.

Doing host-to-network byte order swapping while at it.

#### Parameters

|              |                                                 |
|--------------|-------------------------------------------------|
| <i>s_out</i> | Pointer to the storage of the sound to put out. |
|--------------|-------------------------------------------------|

#### Returns

The sound data in network byte order.

### 5.120.4 Member Data Documentation

5.120.4.1 `int io_tcp_sound_t::fragsize [private]`

Number of sound samples in each channel expected and returned from processing callback.

5.120.4.2 `float io_tcp_sound_t::samplerate [private]`

Sampling rate.

Number of samples per second in each channel.

#### 5.120.4.3 `int io_tcp_sound_t::num_inchannels` [private]

Number of input channels.

Number of channels expected from and returned by signal processing callback.

#### 5.120.4.4 `int io_tcp_sound_t::num_outchannels` [private]

#### 5.120.4.5 `MHASignal::waveform_t* io_tcp_sound_t::s_in` [private]

Storage for input signal.

The documentation for this class was generated from the following file:

- **MHAIOTCP.cpp**

### 5.121 `io_tcp_sound_t::float_union` Union Reference

This union helps in conversion of floats from host byte order to network byte order and back again.

#### Public Attributes

- float **f**
- unsigned int **i**
- char **c** [4]

#### 5.121.1 Detailed Description

This union helps in conversion of floats from host byte order to network byte order and back again.

#### 5.121.2 Member Data Documentation

##### 5.121.2.1 `float io_tcp_sound_t::float_union::f`

##### 5.121.2.2 `unsigned int io_tcp_sound_t::float_union::i`

##### 5.121.2.3 `char io_tcp_sound_t::float_union::c[4]`

The documentation for this union was generated from the following file:

- **MHAIOTCP.cpp**

## 5.122 io\_tcp\_t Class Reference

The tcp sound io library.

## Public Member Functions

- **io\_tcp\_t** (int fragsize, float samplerate, **IOProcessEvent\_t** proc\_event, void \*proc\_↔ handle, **IOStartedEvent\_t** start\_event, void \*start\_handle, **IOStoppedEvent\_t** stop\_↔ event, void \*stop\_handle)
- void **prepare** (int num\_inchannels, int num\_outchannels)  
*Allocate server socket and start thread waiting for sound data exchange.*
- void **start** ()  
*Call frameworks start callback if there is a sound data connection at the moment.*
- void **stop** ()  
*Close the current connection if there is one.*
- void **release** ()  
*Close the current connection and close the server socket.*
- virtual void **accept\_loop** ()  
*IO thread executes this method.*
- virtual void **connection\_loop** (**MHA\_TCP::Connection** \*c)  
*IO thread executes this method for each connection.*
- virtual void **parse** (const char \*cmd, char \*retval, unsigned int len)  
*Parser interface.*
- virtual ~**io\_tcp\_t** ()

## Private Attributes

- **io\_tcp\_parser\_t** parser
- **io\_tcp\_sound\_t** sound
- **io\_tcp\_fwcb\_t** fwcb
- **MHA\_TCP::Server** \* server
- **MHA\_TCP::Thread** \* thread
- **MHA\_TCP::Async\_Notify** notify\_start
- **MHA\_TCP::Async\_Notify** notify\_stop
- **MHA\_TCP::Async\_Notify** notify\_release

## 5.122.1 Detailed Description

The tcp sound io library.

## 5.122.2 Constructor & Destructor Documentation

5.122.2.1 `io_tcp_t::io_tcp_t (`  
     `int fragsize,`  
     `float samplerate,`  
     `IOProcessEvent_t proc_event,`  
     `void * proc_handle,`  
     `IOStartedEvent_t start_event,`  
     `void * start_handle,`  
     `IOStoppedEvent_t stop_event,`  
     `void * stop_handle )`

5.122.2.2 `virtual io_tcp_t::~io_tcp_t ( ) [inline],[virtual]`

## 5.122.3 Member Function Documentation

5.122.3.1 `void io_tcp_t::prepare (`  
     `int num_inchannels,`  
     `int num_outchannels )`

Allocate server socket and start thread waiting for sound data exchange.

prepare opens the tcp server socket and starts the io thread that listens for audio data on the tcp socket after doing some sanity checks

5.122.3.2 `void io_tcp_t::start ( )`

Call frameworks start callback if there is a sound data connection at the moment.

5.122.3.3 `void io_tcp_t::stop ( )`

Close the current connection if there is one.

stop IO thread

5.122.3.4 `void io_tcp_t::release (`  
     `void )`

Close the current connection and close the server socket.

Stop IO thread and close server socket.

5.122.3.5 `void io_tcp_t::accept_loop ( ) [virtual]`

IO thread executes this method.

5.122.3.6 `void io_tcp_t::connection_loop (`  
     `MHA_TCP::Connection * c ) [virtual]`

IO thread executes this method for each connection.

## Parameters

|                |                                                                                        |
|----------------|----------------------------------------------------------------------------------------|
| <code>c</code> | pointer to connection. <code>connection_loop</code> deletes connection before exiting. |
|----------------|----------------------------------------------------------------------------------------|

```
5.122.3.7 virtual void io_tcp_t::parse (
    const char * cmd,
    char * retval,
    unsigned int len ) [inline],[virtual]
```

Parser interface.

## 5.122.4 Member Data Documentation

5.122.4.1 `io_tcp_parser_t io_tcp_t::parser` [private]

5.122.4.2 `io_tcp_sound_t io_tcp_t::sound` [private]

5.122.4.3 `io_tcp_fwcb_t io_tcp_t::fwcb` [private]

5.122.4.4 `MHA_TCP::Server* io_tcp_t::server` [private]

5.122.4.5 `MHA_TCP::Thread* io_tcp_t::thread` [private]

5.122.4.6 `MHA_TCP::Async_Notify io_tcp_t::notify_start` [private]

5.122.4.7 `MHA_TCP::Async_Notify io_tcp_t::notify_stop` [private]

5.122.4.8 `MHA_TCP::Async_Notify io_tcp_t::notify_release` [private]

The documentation for this class was generated from the following file:

- **MHAIOTCP.cpp**

## 5.123 latex\_doc\_t Class Reference

Class to access the information stored in the plugin source code's `MHAPLUGIN_DOCUMENTATION` macro.

## Public Member Functions

- **latex\_doc\_t** (const std::string &**plugname**, const std::string &**plugin\_macro**)  
*Constructor loads the plugin into this process.*
- std::string **get\_latex\_doc** ()  
*This method accesses the compiled-in contents of the MHAPLUGIN\_DOCUMENTATION macro and the exported interface functions of the loaded plugin to produce latex documentation for the plugin.*
- std::string **get\_main\_category** () const
- std::vector< std::string > **get\_categories** () const

## Private Member Functions

- std::string **strdom** (**mha\_domain\_t** d) const
- std::string **get\_ac** (**MHAKernel::algo\_comm\_class\_t** &ac, std::string txt) const
- std::string **parsername** (std::string s) const
- std::string **get\_parser\_var** (**MHAParser::base\_t** \*p, std::string name) const
- std::string **get\_parser\_tab** (**MHAParser::base\_t** \*p, const std::string &prefix, const std::string &latex\_macro) const

## Private Attributes

- const std::string **plugname**
- const std::string **latex\_plugname**
- **MHAKernel::algo\_comm\_class\_t** ac
- **PluginLoader::mhapluginloader\_t** loader
- const std::string **plugin\_macro**

### 5.123.1 Detailed Description

Class to access the information stored in the plugin source code's MHAPLUGIN\_DOCUMENTATION macro.

### 5.123.2 Constructor & Destructor Documentation

5.123.2.1 **latex\_doc\_t::latex\_doc\_t** (  
    const std::string & *plugname*,  
    const std::string & *plugin\_macro* )

Constructor loads the plugin into this process.



**Parameters**

|                     |                                                                                                                     |
|---------------------|---------------------------------------------------------------------------------------------------------------------|
| <i>plugname</i>     | Name of the MHA plugin to process                                                                                   |
| <i>plugin_macro</i> | name of the LaTeX section macro that documents a single plugin (e.g. "section", "subsection", "subsubsection", ...) |

**5.123.3 Member Function Documentation****5.123.3.1 std::string latex\_doc\_t::get\_latex\_doc ( )**

This method accesses the compiled-in contents of the MHAPLUGIN\_DOCUMENTATION macro and the exported interface functions of the loaded plugin to produce latex documentation for the plugin.

It tentatively prepares the plugin for processing and checks the AC variables registered by the plugin.

**Returns**

the complete latex documentation for this plugin

**5.123.3.2 std::string latex\_doc\_t::get\_main\_category ( ) const****Returns**

the first word of the categories string in the MHAPLUGIN\_DOCUMENTATION macro

**5.123.3.3 std::vector< std::string > latex\_doc\_t::get\_categories ( ) const****Returns**

a vector of all words in the categories string in the MHAPLUGIN\_DOCUMENTATION macro

- 5.123.3.4 `std::string latex_doc_t::strdom ( mha_domain_t d ) const` [private]
- 5.123.3.5 `std::string latex_doc_t::get_ac ( MHAKernel::algo_comm_class_t & ac, std::string txt ) const` [private]
- 5.123.3.6 `std::string latex_doc_t::parsername ( std::string s ) const` [private]
- 5.123.3.7 `std::string latex_doc_t::get_parser_var ( MHAParser::base_t * p, std::string name ) const` [private]
- 5.123.3.8 `std::string latex_doc_t::get_parser_tab ( MHAParser::base_t * p, const std::string & prefix, const std::string & latex_macro ) const` [private]
- 5.123.4 Member Data Documentation
  - 5.123.4.1 `const std::string latex_doc_t::plugname` [private]
  - 5.123.4.2 `const std::string latex_doc_t::latex_plugname` [private]
  - 5.123.4.3 `MHAKernel::algo_comm_class_t latex_doc_t::ac` [private]
  - 5.123.4.4 `PluginLoader::mhapluginloader_t latex_doc_t::loader` [private]
  - 5.123.4.5 `const std::string latex_doc_t::plugin_macro` [private]

The documentation for this class was generated from the following file:

- `generatemhaplugin.doc.cpp`

## 5.124 Ipc Class Reference

Inheritance diagram for Ipc:

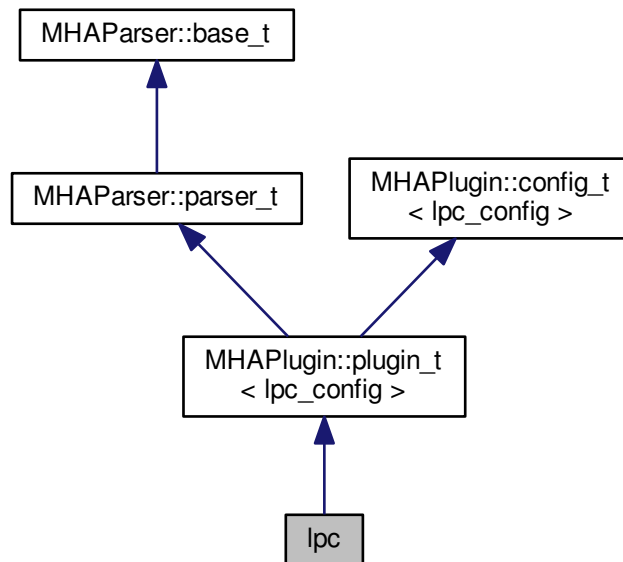

## Public Member Functions

- **Ipc** (**algo\_comm\_t** &**ac**, const std::string &chain\_name, const std::string &algo\_name)  
*Constructs our plugin.*
- ~**Ipc** ()
- **mha\_wave\_t** \* **process** (**mha\_wave\_t** \*)  
*Checks for the most recent configuration and defers processing to it.*
- void **prepare** (**mhaconfig\_t** &)  
*Plugin preparation.*
- void **release** (void)

## Private Member Functions

- void **update\_cfg** ()

### Private Attributes

- `std::string algo_name`
- `MHAParser::int_t lpc_order`
- `MHAParser::int_t lpc_buffer_size`
- `MHAParser::bool_t shift`
- `MHAParser::int_t comp_each_iter`
- `MHAParser::bool_t norm`
- `MHAEvents::patchbay_t< lpc > patchbay`

### Additional Inherited Members

#### 5.124.1 Constructor & Destructor Documentation

5.124.1.1 `lpc::lpc (`  
     `algo_comm_t & ac,`  
     `const std::string & chain_name,`  
     `const std::string & algo_name )`

Constructs our plugin.

5.124.1.2 `lpc::~~lpc ( )`

#### 5.124.2 Member Function Documentation

5.124.2.1 `mha_wave_t * lpc::process (`  
     `mha_wave_t * signal )`

Checks for the most recent configuration and defers processing to it.

5.124.2.2 `void lpc::prepare (`  
     `mhaconfig_t & signal_info ) [virtual]`

Plugin preparation.

An opportunity to validate configuration parameters before instantiating a configuration.

#### Parameters

|                    |                                                                                                                             |
|--------------------|-----------------------------------------------------------------------------------------------------------------------------|
| <i>signal_info</i> | Structure containing a description of the form of the signal (domain, number of channels, frames per block, sampling rate). |
|--------------------|-----------------------------------------------------------------------------------------------------------------------------|

Implements `MHAPlugin::plugin_t< lpc_config >` (p. 730).

5.124.2.3 void Ipc::release (  
void ) [inline],[virtual]

Reimplemented from **MHAPugin::plugin\_t< Ipc\_config >** (p. 731).

5.124.2.4 void Ipc::update\_cfg (  
void ) [private]

### 5.124.3 Member Data Documentation

5.124.3.1 std::string Ipc::algo\_name [private]

5.124.3.2 MHAParser::int\_t Ipc::lpc\_order [private]

5.124.3.3 MHAParser::int\_t Ipc::lpc\_buffer\_size [private]

5.124.3.4 MHAParser::bool\_t Ipc::shift [private]

5.124.3.5 MHAParser::int\_t Ipc::comp\_each\_iter [private]

5.124.3.6 MHAParser::bool\_t Ipc::norm [private]

5.124.3.7 MHAEvents::patchbay\_t<Ipc> Ipc::patchbay [private]

The documentation for this class was generated from the following files:

- Ipc.h
- Ipc.cpp

## 5.125 ipc\_bl\_predictor Class Reference

Inheritance diagram for ipc\_bl\_predictor:

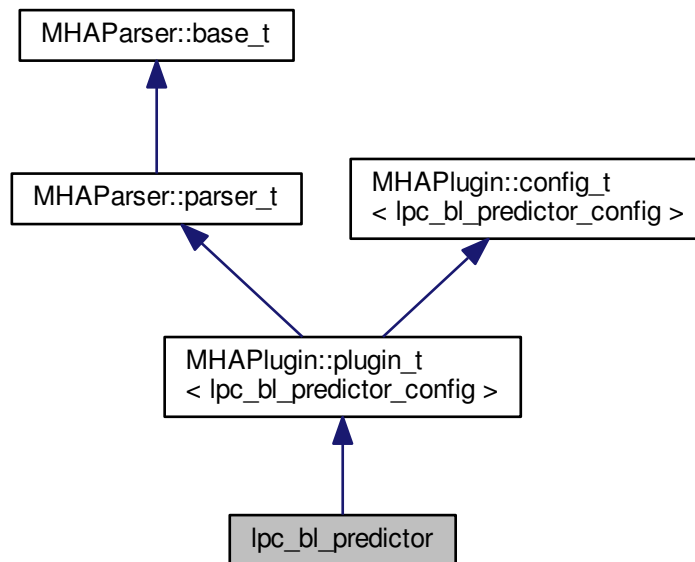

### Public Member Functions

- **ipc\_bl\_predictor** (**algo\_comm\_t** &ac, const std::string &chain\_name, const std::string &algo\_name)  
*Constructs our plugin.*
- **~ipc\_bl\_predictor** ()
- **mha\_wave\_t \* process** (**mha\_wave\_t \***)  
*Checks for the most recent configuration and defers processing to it.*
- void **prepare** (**mhaconfig\_t** &)  
*Plugin preparation.*
- void **release** (void)

### Public Attributes

- **MHAParser::int\_t** ipc\_order
- **MHAParser::string\_t** name\_kappa
- **MHAParser::string\_t** name\_lpc\_f
- **MHAParser::string\_t** name\_lpc\_b
- **MHAParser::string\_t** name\_f
- **MHAParser::string\_t** name\_b

## Private Member Functions

- void **update\_cfg** ()

## Private Attributes

- **MHAEvents::patchbay\_t**< `lpc_bl_predictor` > **patchbay**

## Additional Inherited Members

## 5.125.1 Constructor &amp; Destructor Documentation

5.125.1.1 `lpc_bl_predictor::lpc_bl_predictor` (  
     `algo_comm_t & ac`,  
     `const std::string & chain_name`,  
     `const std::string & algo_name` )

Constructs our plugin.

5.125.1.2 `lpc_bl_predictor::~~lpc_bl_predictor` ( )

## 5.125.2 Member Function Documentation

5.125.2.1 `mha_wave_t * lpc_bl_predictor::process` (  
     `mha_wave_t * signal` )

Checks for the most recent configuration and defers processing to it.

5.125.2.2 `void lpc_bl_predictor::prepare` (  
     `mhaconfig_t & signal_info` ) [virtual]

Plugin preparation.

An opportunity to validate configuration parameters before instantiating a configuration.

## Parameters

|                    |                                                                                                                             |
|--------------------|-----------------------------------------------------------------------------------------------------------------------------|
| <i>signal_info</i> | Structure containing a description of the form of the signal (domain, number of channels, frames per block, sampling rate). |
|--------------------|-----------------------------------------------------------------------------------------------------------------------------|

Implements **MHAPlugin::plugin\_t**< `lpc_bl_predictor_config` > (p. 730).

5.125.2.3 `void lpc_bl_predictor::release (`  
`void ) [inline],[virtual]`

Reimplemented from `MHAPLugin::plugin_t< lpc_bl_predictor_config >` (p. 731).

5.125.2.4 `void lpc_bl_predictor::update_cfg (`  
`void ) [private]`

### 5.125.3 Member Data Documentation

5.125.3.1 `MHAParser::int_t lpc_bl_predictor::lpc_order`

5.125.3.2 `MHAParser::string_t lpc_bl_predictor::name_kappa`

5.125.3.3 `MHAParser::string_t lpc_bl_predictor::name_lpc_f`

5.125.3.4 `MHAParser::string_t lpc_bl_predictor::name_lpc_b`

5.125.3.5 `MHAParser::string_t lpc_bl_predictor::name_f`

5.125.3.6 `MHAParser::string_t lpc_bl_predictor::name_b`

5.125.3.7 `MHAEvents::patchbay_t<lpc_bl_predictor> lpc_bl_predictor::patchbay`  
`[private]`

The documentation for this class was generated from the following files:

- `lpc_bl_predictor.h`
- `lpc_bl_predictor.cpp`

## 5.126 `lpc_bl_predictor_config` Class Reference

### Public Member Functions

- `lpc_bl_predictor_config (algo_comm_t &iac, const mhaconfig_t in_cfg, lpc_bl_↔  
predictor *_lpc)`
- `~lpc_bl_predictor_config ()`
- `mha_wave_t * process (mha_wave_t *)`



## Private Attributes

- `algo_comm_t ac`
- `MHA_AC::waveform_t f_est`
- `MHA_AC::waveform_t b_est`
- `MHASignal::waveform_t forward`
- `MHASignal::waveform_t backward`
- `int lpc_order`
- `std::string name_km`
- `std::string name_f`
- `std::string name_b`
- `mha_wave_t km`
- `mha_wave_t s_f`
- `mha_wave_t s_b`

## 5.126.1 Constructor &amp; Destructor Documentation

5.126.1.1 `lpc_bl_predictor_config::lpc_bl_predictor_config (`  
    `algo_comm_t & iac,`  
    `const mhaconfig_t in_cfg,`  
    `lpc_bl_predictor * _lpc )`

5.126.1.2 `lpc_bl_predictor_config::~~lpc_bl_predictor_config ( )`

## 5.126.2 Member Function Documentation

5.126.2.1 `mha_wave_t * lpc_bl_predictor_config::process (`  
    `mha_wave_t * wave )`

## 5.126.3 Member Data Documentation

5.126.3.1 `algo_comm_t lpc_bl_predictor_config::ac` [private]

5.126.3.2 `MHA_AC::waveform_t lpc_bl_predictor_config::f_est` [private]

5.126.3.3 `MHA_AC::waveform_t lpc_bl_predictor_config::b_est` [private]

5.126.3.4 `MHASignal::waveform_t lpc_bl_predictor_config::forward` [private]

5.126.3.5 `MHASignal::waveform_t lpc_bl_predictor_config::backward` [private]

5.126.3.6 `int lpc_bl_predictor_config::lpc_order` [private]

5.126.3.7 `std::string lpc_bl_predictor_config::name_km` [private]

5.126.3.8 `std::string lpc_bl_predictor_config::name_f` [private]

5.126.3.9 `std::string lpc_bl_predictor_config::name_b` [private]

5.126.3.10 `mha_wave_t lpc_bl_predictor_config::km` [private]

5.126.3.11 `mha_wave_t lpc_bl_predictor_config::s_f` [private]

5.126.3.12 `mha_wave_t lpc_bl_predictor_config::s_b` [private]

The documentation for this class was generated from the following files:

- `lpc_bl_predictor.h`
- `lpc_bl_predictor.cpp`

## 5.127 `lpc_burglattice` Class Reference

Inheritance diagram for `lpc_burglattice`:

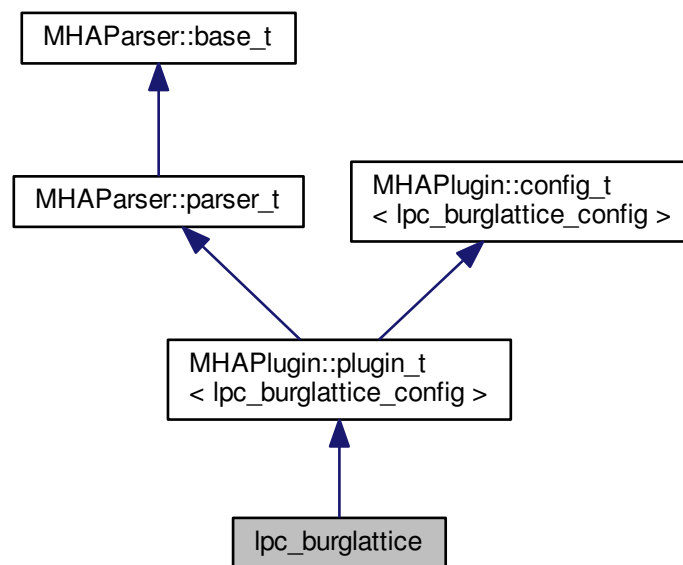

### Public Member Functions

- **`lpc_burglattice`** (`algo_comm_t &ac`, `const std::string &chain_name`, `const std::string &algo_name`)  
*Constructs our plugin.*
- **`~lpc_burglattice`** ()
- **`mha_wave_t * process`** (`mha_wave_t *`)  
*Checks for the most recent configuration and defers processing to it.*
- `void` **`prepare`** (`mhaconfig_t &`)  
*Plugin preparation.*
- `void` **`release`** (`void`)

### Public Attributes

- `MHAParser::int_t` `lpc_order`
- `MHAParser::string_t` `name_kappa`
- `MHAParser::string_t` `name_f`
- `MHAParser::string_t` `name_b`
- `MHAParser::float_t` `lambda`

### Private Member Functions

- `void` **`update_cfg`** ()

### Private Attributes

- `MHAEvents::patchbay_t` `< lpc_burglattice > patchbay`

### Additional Inherited Members

#### 5.127.1 Constructor & Destructor Documentation

5.127.1.1 `lpc_burglattice::lpc_burglattice` (  
    `algo_comm_t &ac`,  
    `const std::string &chain_name`,  
    `const std::string &algo_name` )

Constructs our plugin.

5.127.1.2 `lpc_burglattice::~~lpc_burglattice ( )`

## 5.127.2 Member Function Documentation

5.127.2.1 `mha_wave_t * lpc_burglattice::process ( mha_wave_t * signal )`

Checks for the most recent configuration and defers processing to it.

5.127.2.2 `void lpc_burglattice::prepare ( mhaconfig_t & signal_info ) [virtual]`

Plugin preparation.

An opportunity to validate configuration parameters before instantiating a configuration.

### Parameters

|                    |                                                                                                                             |
|--------------------|-----------------------------------------------------------------------------------------------------------------------------|
| <i>signal_info</i> | Structure containing a description of the form of the signal (domain, number of channels, frames per block, sampling rate). |
|--------------------|-----------------------------------------------------------------------------------------------------------------------------|

Implements `MHAPLugin::plugin_t< lpc_burglattice_config >` (p. 730).

5.127.2.3 `void lpc_burglattice::release ( void ) [inline], [virtual]`

Reimplemented from `MHAPLugin::plugin_t< lpc_burglattice_config >` (p. 731).

5.127.2.4 `void lpc_burglattice::update_cfg ( void ) [private]`

## 5.127.3 Member Data Documentation

5.127.3.1 `MHAParser::int_t lpc_burglattice::lpc_order`

5.127.3.2 `MHAParser::string_t lpc_burglattice::name_kappa`

5.127.3.3 `MHAParser::string_t lpc_burglattice::name_f`

5.127.3.4 `MHAParser::string_t lpc_burglattice::name_b`

5.127.3.5 `MHAParser::float_t lpc_burglattice::lambda`

5.127.3.6 `MHAEvents::patchbay_t<lpc_burglattice> lpc_burglattice::patchbay [private]`

The documentation for this class was generated from the following files:

- `lpc_burg-lattice.h`
- `lpc_burg-lattice.cpp`

5.128 `lpc_burglattice_config` Class Reference

## Public Member Functions

- `lpc_burglattice_config` (`algo_comm_t` &*iac*, const `mhaconfig_t` *in\_cfg*, `lpc_burglattice` \**lpc*)
- `~lpc_burglattice_config` ()
- `mha_wave_t` \* `process` (`mha_wave_t` \*)

## Private Attributes

- `algo_comm_t` *ac*
- `MHASignal::waveform_t` *forward*
- `MHASignal::waveform_t` *backward*
- `MHASignal::waveform_t` *kappa*
- `MHA_AC::waveform_t` *kappa\_block*
- `MHASignal::waveform_t` *dm*
- `MHASignal::waveform_t` *nm*
- `mha_real_t` *lambda*
- int *lpc\_order*
- `std::string` *name\_f*
- `std::string` *name\_b*
- `mha_wave_t` *s\_f*
- `mha_wave_t` *s\_b*

## 5.128.1 Constructor &amp; Destructor Documentation

5.128.1.1 `lpc_burglattice_config::lpc_burglattice_config` (  
     `algo_comm_t` &*iac*,  
     const `mhaconfig_t` *in\_cfg*,  
     `lpc_burglattice` \**lpc* )

5.128.1.2 `lpc_burglattice_config::~~lpc_burglattice_config` ( )

## 5.128.2 Member Function Documentation

5.128.2.1 `mha_wave_t` \* `lpc_burglattice_config::process` (  
     `mha_wave_t` \* *wave* )

## 5.128.3 Member Data Documentation

5.128.3.1 `algo_comm_t` `lpc_burglattice_config::ac` [private]

- 5.128.3.2 `MHASignal::waveform_t lpc_burglattice_config::forward` [private]
- 5.128.3.3 `MHASignal::waveform_t lpc_burglattice_config::backward` [private]
- 5.128.3.4 `MHASignal::waveform_t lpc_burglattice_config::kappa` [private]
- 5.128.3.5 `MHA_AC::waveform_t lpc_burglattice_config::kappa_block` [private]
- 5.128.3.6 `MHASignal::waveform_t lpc_burglattice_config::dm` [private]
- 5.128.3.7 `MHASignal::waveform_t lpc_burglattice_config::nm` [private]
- 5.128.3.8 `mha_real_t lpc_burglattice_config::lambda` [private]
- 5.128.3.9 `int lpc_burglattice_config::lpc_order` [private]
- 5.128.3.10 `std::string lpc_burglattice_config::name_f` [private]
- 5.128.3.11 `std::string lpc_burglattice_config::name_b` [private]
- 5.128.3.12 `mha_wave_t lpc_burglattice_config::s_f` [private]
- 5.128.3.13 `mha_wave_t lpc_burglattice_config::s_b` [private]

The documentation for this class was generated from the following files:

- `lpc_burg-lattice.h`
- `lpc_burg-lattice.cpp`

## 5.129 `lpc_config` Class Reference

### Public Member Functions

- `lpc_config` (`algo_comm_t &ac`, const `mhaconfig_t` `in_cfg`, `std::string` `&algo_name`, unsigned int `_order`, unsigned int `_lpc_buffer_size`, bool `_shift`, unsigned int `_comp_each`, unsigned int `_iter`, bool `_norm`)
- `~lpc_config` ()
- `mha_wave_t * process` (`mha_wave_t *`)
- void `insert` ()

### Private Attributes

- bool **norm**
- bool **shift**
- unsigned int **comp\_each\_iter**
- unsigned int **order**
- unsigned int **lpc\_buffer\_size**
- unsigned int **N**
- unsigned int **comp\_iter**
- **mha\_wave\_t** **sample**
- std::vector< **mha\_real\_t** > **R**
- std::vector< **mha\_real\_t** > **A**
- **MHASignal::ringbuffer\_t** **inwave**
- **MHA\_AC::waveform\_t** **lpc\_out**
- **MHA\_AC::waveform\_t** **corr\_out**

### 5.129.1 Constructor & Destructor Documentation

5.129.1.1 `lpc_config::lpc_config (`  
    `algo_comm_t & ac,`  
    `const mhaconfig_t in_cfg,`  
    `std::string & algo_name,`  
    `unsigned int _order,`  
    `unsigned int _lpc_buffer_size,`  
    `bool _shift,`  
    `unsigned int _comp_each_iter,`  
    `bool _norm )`

5.129.1.2 `lpc_config::~lpc_config ( )`

### 5.129.2 Member Function Documentation

5.129.2.1 `mha_wave_t * lpc_config::process (`  
    `mha_wave_t * wave )`

5.129.2.2 `void lpc_config::insert ( )`

### 5.129.3 Member Data Documentation

5.129.3.1 `bool lpc_config::norm` [private]

5.129.3.2 `bool lpc_config::shift` [private]

5.129.3.3 `unsigned int lpc_config::comp_each_iter` [private]

- 5.129.3.4 unsigned int `lpc_config::order` [private]
- 5.129.3.5 unsigned int `lpc_config::lpc_buffer_size` [private]
- 5.129.3.6 unsigned int `lpc_config::N` [private]
- 5.129.3.7 unsigned int `lpc_config::comp_iter` [private]
- 5.129.3.8 `mha_wave_t` `lpc_config::sample` [private]
- 5.129.3.9 `std::vector<mha_real_t>` `lpc_config::R` [private]
- 5.129.3.10 `std::vector<mha_real_t>` `lpc_config::A` [private]
- 5.129.3.11 `MHASignal::ringbuffer_t` `lpc_config::inwave` [private]
- 5.129.3.12 `MHA_AC::waveform_t` `lpc_config::lpc_out` [private]
- 5.129.3.13 `MHA_AC::waveform_t` `lpc_config::corr_out` [private]

The documentation for this class was generated from the following files:

- `lpc.h`
- `lpc.cpp`

## 5.130 `matrixmixer::cfg_t` Class Reference

### Public Member Functions

- `cfg_t` (`std::vector< std::vector< float > >` `imixer`, unsigned int `ci`, unsigned int `co`, unsigned int `fragsize`, unsigned int `nfft`)
- `mha_wave_t * process (mha_wave_t *)`
- `mha_spec_t * process (mha_spec_t *)`

### Private Attributes

- `MHASignal::waveform_t` `m`
- `MHASignal::waveform_t` `wout`
- `MHASignal::spectrum_t` `sout`



### 5.130.1 Constructor & Destructor Documentation

5.130.1.1 `cfg_t::cfg_t (`  
    `std::vector< std::vector< float > > imixer,`  
    `unsigned int ci,`  
    `unsigned int co,`  
    `unsigned int fragsize,`  
    `unsigned int nfft )`

### 5.130.2 Member Function Documentation

5.130.2.1 `mha_wave_t * cfg_t::process (`  
    `mha_wave_t * s )`

5.130.2.2 `mha_spec_t * cfg_t::process (`  
    `mha_spec_t * s )`

### 5.130.3 Member Data Documentation

5.130.3.1 `MHASignal::waveform_t matrixmixer::cfg_t::m` [private]

5.130.3.2 `MHASignal::waveform_t matrixmixer::cfg_t::wout` [private]

5.130.3.3 `MHASignal::spectrum_t matrixmixer::cfg_t::sout` [private]

The documentation for this class was generated from the following file:

- `matrixmixer.cpp`

### 5.131 matrixmixer::matmix\_t Class Reference

Inheritance diagram for matrixmixer::matmix\_t:

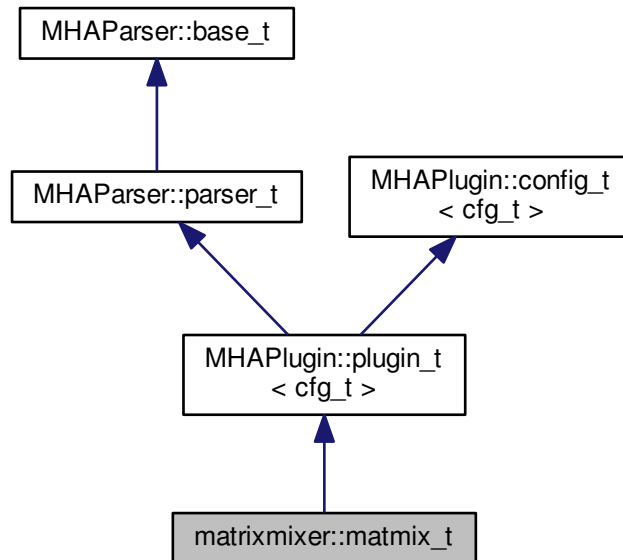

#### Public Member Functions

- **matmix\_t** (const **algo\_comm\_t** &, const std::string &, const std::string &)
- void **prepare** (**mhaconfig\_t** &)
- **mha\_wave\_t** \* **process** (**mha\_wave\_t** \*)
- **mha\_spec\_t** \* **process** (**mha\_spec\_t** \*)

#### Private Member Functions

- void **update\_m** ()

#### Private Attributes

- **MHAEvents::patchbay\_t** < **matmix\_t** > **patchbay**
- **MHAParser::mfloat\_t** **mixer**
- unsigned int **ci**
- unsigned int **co**

## Additional Inherited Members

### 5.131.1 Constructor & Destructor Documentation

5.131.1.1 `matrixmixer::matmix_t::matmix_t (`  
    `const algo_comm_t & iac,`  
    `const std::string & ,`  
    `const std::string & )`

### 5.131.2 Member Function Documentation

5.131.2.1 `void matrixmixer::matmix_t::prepare (`  
    `mhaconfig_t & tf )` [virtual]

Implements `MHAPugin::plugin_t< cfg_t >` (p. 730).

5.131.2.2 `mha_wave_t * matrixmixer::matmix_t::process (`  
    `mha_wave_t * s )`

5.131.2.3 `mha_spec_t * matrixmixer::matmix_t::process (`  
    `mha_spec_t * s )`

5.131.2.4 `void matrixmixer::matmix_t::update_m (`  
    `void )` [private]

### 5.131.3 Member Data Documentation

5.131.3.1 `MHAEvents::patchbay_t<matmix_t> matrixmixer::matmix_t::patchbay` [private]

5.131.3.2 `MHAParser::mfloat_t matrixmixer::matmix_t::mixer` [private]

5.131.3.3 `unsigned int matrixmixer::matmix_t::ci` [private]

5.131.3.4 `unsigned int matrixmixer::matmix_t::co` [private]

The documentation for this class was generated from the following file:

- `matrixmixer.cpp`

### 5.132 MHA\_AC::ac2matrix\_helper\_t Class Reference

Inheritance diagram for MHA\_AC::ac2matrix\_helper\_t:

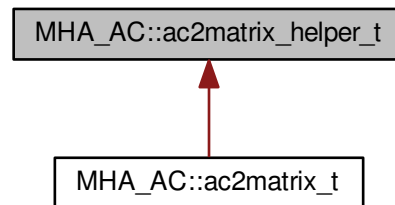

#### Public Member Functions

- **ac2matrix\_helper\_t** (**algo\_comm\_t**, const std::string &)
- void **getvar** ()

#### Public Attributes

- **algo\_comm\_t** **ac**
- std::string **name**
- std::string **username**
- **MHASignal::uint\_vector\_t** **size**
- bool **is\_complex**

#### Protected Attributes

- **comm\_var\_t** **acvar**

#### 5.132.1 Constructor & Destructor Documentation

5.132.1.1 MHA\_AC::ac2matrix\_helper\_t::ac2matrix\_helper\_t (**algo\_comm\_t** *iac*, const std::string & *iname* )

#### 5.132.2 Member Function Documentation

5.132.2.1 void MHA\_AC::ac2matrix\_helper\_t::getvar ( )

## 5.132.3 Member Data Documentation

5.132.3.1 algo\_comm\_t MHA\_AC::ac2matrix\_helper\_t::ac

5.132.3.2 std::string MHA\_AC::ac2matrix\_helper\_t::name

5.132.3.3 std::string MHA\_AC::ac2matrix\_helper\_t::username

5.132.3.4 MHASignal::uint\_vector\_t MHA\_AC::ac2matrix\_helper\_t::size

5.132.3.5 bool MHA\_AC::ac2matrix\_helper\_t::is\_complex

5.132.3.6 comm\_var\_t MHA\_AC::ac2matrix\_helper\_t::acvar [protected]

The documentation for this class was generated from the following files:

- mha\_algo\_comm.h
- mha\_algo\_comm.cpp

## 5.133 MHA\_AC::ac2matrix\_t Class Reference

Copy AC variable to a matrix.

Inheritance diagram for MHA\_AC::ac2matrix\_t:

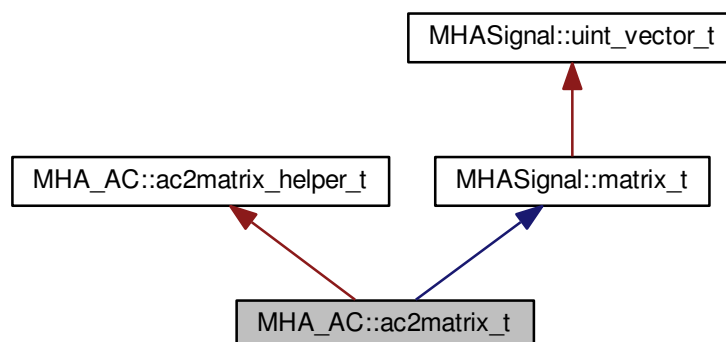

## Public Member Functions

- **ac2matrix\_t** (**algo\_comm\_t ac**, const std::string &**name**)  
*Constructor.*
- void **update** ()  
*Update contents of the matrix from the AC space.*
- const std::string & **getname** () const  
*Return name of AC variable/matrix.*
- const std::string & **getusername** () const  
*Return user specified name of AC variable/matrix.*
- void **insert** (**algo\_comm\_t ac**)  
*Insert matrix into an AC space (other than source AC space)*

## Additional Inherited Members

### 5.133.1 Detailed Description

Copy AC variable to a matrix.

This class constructs a matrix of same size as an AC variable and can copy the AC variable to itself. The **update()** (p. 414) function is real-time safe.

### 5.133.2 Constructor & Destructor Documentation

#### 5.133.2.1 MHA\_AC::ac2matrix\_t::ac2matrix\_t (     **algo\_comm\_t ac**,     const std::string & *name* )

Constructor.

#### Parameters

|             |                                  |
|-------------|----------------------------------|
| <i>ac</i>   | AC handle                        |
| <i>name</i> | Name of AC variable to be copied |

### 5.133.3 Member Function Documentation

#### 5.133.3.1 void MHA\_AC::ac2matrix\_t::update ( )

Update contents of the matrix from the AC space.

This function is real-time safe. The copy operation performance is of the order of the number of elements in the matrix.

5.133.3.2 `const std::string& MHA_AC::ac2matrix_t::getname ( ) const` `[inline]`

Return name of AC variable/matrix.

5.133.3.3 `const std::string& MHA_AC::ac2matrix_t::getusername ( ) const` `[inline]`

Return user specified name of AC variable/matrix.

5.133.3.4 `void MHA_AC::ac2matrix_t::insert (`  
`algo_comm_t ac )`

Insert matrix into an AC space (other than source AC space)

#### Parameters

|                 |                                |
|-----------------|--------------------------------|
| <code>ac</code> | AC space handle to insert data |
|-----------------|--------------------------------|

#### Note

The AC variable data buffer points to the data of the matrix. Modifications of the AC variable directly modify the data of the matrix; after deletion of the matrix, the data buffer is invalid.

The documentation for this class was generated from the following files:

- `mha_algo_comm.h`
- `mha_algo_comm.cpp`

## 5.134 MHA\_AC::acspace2matrix\_t Class Reference

Copy all or a subset of all numeric AC variables into an array of matrixes.

#### Public Member Functions

- `acspace2matrix_t (algo_comm_t ac, const std::vector< std::string > &names)`  
*Constructor.*
- `acspace2matrix_t (const MHA_AC::acspace2matrix_t &src)`  
*Constructor with initialization from an instance.*
- `~acspace2matrix_t ()`
- `MHA_AC::acspace2matrix_t & operator= (const MHA_AC::acspace2matrix_t &src)`  
*Copy all contents (deep copy).*
- `MHA_AC::ac2matrix_t & operator[] (unsigned int k)`  
*Access operator.*

- const **MHA\_AC::ac2matrix\_t** & **operator[]** (unsigned int k) const  
*Constant access operator.*
- void **update** ()  
*Update function.*
- unsigned int **size** () const  
*Number of matrixes in AC space.*
- unsigned int **frame** () const  
*Actual frame number.*
- void **insert** (**algo\_comm\_t** ac)  
*Insert AC space copy into an AC space (other than source AC space)*

#### Private Attributes

- unsigned int **len**
- **MHA\_AC::ac2matrix\_t** \*\* **data**
- unsigned int **frameno**

#### 5.134.1 Detailed Description

Copy all or a subset of all numeric AC variables into an array of matrixes.

#### 5.134.2 Constructor & Destructor Documentation

5.134.2.1 **MHA\_AC::acspace2matrix\_t::acspace2matrix\_t** (  
    **algo\_comm\_t** ac,  
    const std::vector< std::string > & *names* )

Constructor.

Scan all given AC variables and allocate corresponding matrixes.

#### Parameters

|              |                                          |
|--------------|------------------------------------------|
| <i>ac</i>    | AC handle.                               |
| <i>names</i> | Names of AC variables, or empty for all. |

5.134.2.2 **MHA\_AC::acspace2matrix\_t::acspace2matrix\_t** (  
    const **MHA\_AC::acspace2matrix\_t** & *src* )

Constructor with initialization from an instance.



## Parameters

|            |                        |
|------------|------------------------|
| <i>src</i> | Instance to be copied. |
|------------|------------------------|

## 5.134.2.3 MHA\_AC::acspace2matrix\_t::~~acspace2matrix\_t( )

## 5.134.3 Member Function Documentation

5.134.3.1 MHA\_AC::acspace2matrix\_t & MHA\_AC::acspace2matrix\_t::operator=(  
const MHA\_AC::acspace2matrix\_t & *src* )

Copy all contents (deep copy).

## Parameters

|            |                                 |
|------------|---------------------------------|
| <i>src</i> | Array of matrixes to be copied. |
|------------|---------------------------------|

5.134.3.2 MHA\_AC::ac2matrix\_t& MHA\_AC::acspace2matrix\_t::operator[](  
unsigned int *k* ) [inline]

Access operator.

## Parameters

|          |                                                               |
|----------|---------------------------------------------------------------|
| <i>k</i> | index into array; should not exceed <b>size()</b> (p. 418)-1. |
|----------|---------------------------------------------------------------|

## Return values

|                  |            |
|------------------|------------|
| <i>Reference</i> | to matrix. |
|------------------|------------|

5.134.3.3 const MHA\_AC::ac2matrix\_t& MHA\_AC::acspace2matrix\_t::operator[](  
unsigned int *k* ) const [inline]

Constant access operator.

## Parameters

|          |                                                               |
|----------|---------------------------------------------------------------|
| <i>k</i> | index into array; should not exceed <b>size()</b> (p. 418)-1. |
|----------|---------------------------------------------------------------|

## Return values

|                 |                      |
|-----------------|----------------------|
| <i>Constant</i> | reference to matrix. |
|-----------------|----------------------|

5.134.3.4 void MHA\_AC::acspace2matrix\_t::update ( ) [inline]

Update function.

This function updates all matrixes from their corresponding AC variables. It can be called from the MHA Framework prepare function or in the processing callback.

5.134.3.5 unsigned int MHA\_AC::acspace2matrix\_t::size ( ) const [inline]

Number of matrixes in AC space.

5.134.3.6 unsigned int MHA\_AC::acspace2matrix\_t::frame ( ) const [inline]

Actual frame number.

5.134.3.7 void MHA\_AC::acspace2matrix\_t::insert (   
 algo\_comm\_t ac )

Insert AC space copy into an AC space (other than source AC space)

Parameters

|           |                                |
|-----------|--------------------------------|
| <i>ac</i> | AC space handle to insert data |
|-----------|--------------------------------|

#### 5.134.4 Member Data Documentation

5.134.4.1 unsigned int MHA\_AC::acspace2matrix\_t::len [private]

5.134.4.2 MHA\_AC::ac2matrix\_t\*\* MHA\_AC::acspace2matrix\_t::data [private]

5.134.4.3 unsigned int MHA\_AC::acspace2matrix\_t::frameno [private]

The documentation for this class was generated from the following files:

- mha\_algo\_comm.h
- mha\_algo\_comm.cpp

#### 5.135 MHA\_AC::double\_t Class Reference

Insert a double precision floating point variable into the AC space.

## Public Member Functions

- **double\_t** (**algo\_comm\_t**, std::string, double=0)
- **~double\_t** ()

## Public Attributes

- double **data**  
*Floating point value variable.*

## Private Attributes

- **algo\_comm\_t ac**

### 5.135.1 Detailed Description

Insert a double precision floating point variable into the AC space.

The variable is automatically removed on destruction.

### 5.135.2 Constructor & Destructor Documentation

5.135.2.1 MHA\_AC::double\_t::double\_t (  
    **algo\_comm\_t iac**,  
    std::string *n*,  
    double *v = 0* )

5.135.2.2 MHA\_AC::double\_t::~~double\_t ( )

### 5.135.3 Member Data Documentation

5.135.3.1 double MHA\_AC::double\_t::data

Floating point value variable.

5.135.3.2 **algo\_comm\_t MHA\_AC::double\_t::ac** [private]

The documentation for this class was generated from the following files:

- **mha\_algo\_comm.h**
- **mha\_algo\_comm.cpp**

### 5.136 MHA\_AC::float\_t Class Reference

Insert a float point variable into the AC space.

#### Public Member Functions

- **float\_t** (**algo\_comm\_t**, std::string, float=0)  
*Constructor.*
- **~float\_t** ()

#### Public Attributes

- float **data**  
*Floating point value variable.*

#### Private Attributes

- **algo\_comm\_t ac**

#### 5.136.1 Detailed Description

Insert a float point variable into the AC space.

The variable is automatically removed on destruction.

#### 5.136.2 Constructor & Destructor Documentation

5.136.2.1 MHA\_AC::float\_t::float\_t (  
    **algo\_comm\_t** *iac*,  
    std::string *n*,  
    float *v = 0* )

Constructor.

5.136.2.2 MHA\_AC::float\_t::~~float\_t ( )

#### 5.136.3 Member Data Documentation

5.136.3.1 float MHA\_AC::float\_t::data

Floating point value variable.

## 5.136.3.2 algo\_comm\_t MHA\_AC::float\_t::ac [private]

The documentation for this class was generated from the following files:

- mha\_algo\_comm.h
- mha\_algo\_comm.cpp

## 5.137 MHA\_AC::int\_t Class Reference

Insert a integer variable into the AC space.

## Public Member Functions

- int\_t (algo\_comm\_t, std::string, int=0)
- ~int\_t ()

## Public Attributes

- int **data**  
*Integer value variable.*

## Private Attributes

- **algo\_comm\_t ac**

## 5.137.1 Detailed Description

Insert a integer variable into the AC space.

The variable is automatically removed on destruction.

## 5.137.2 Constructor &amp; Destructor Documentation

5.137.2.1 MHA\_AC::int\_t::int\_t (  
                    **algo\_comm\_t iac,**  
                    **std::string n,**  
                    **int v = 0 )**

5.137.2.2 MHA\_AC::int\_t::~~int\_t ( )

## 5.137.3 Member Data Documentation

5.137.3.1 int MHA\_AC::int\_t::data

Integer value variable.

### 5.137.3.2 algo\_comm\_t MHA\_AC::int\_t::ac [private]

The documentation for this class was generated from the following files:

- **mha\_algo\_comm.h**
- **mha\_algo\_comm.cpp**

### 5.138 MHA\_AC::spectrum\_t Class Reference

Insert a **MHASignal::spectrum\_t** (p. 800) class into the AC space.

Inheritance diagram for MHA\_AC::spectrum\_t:

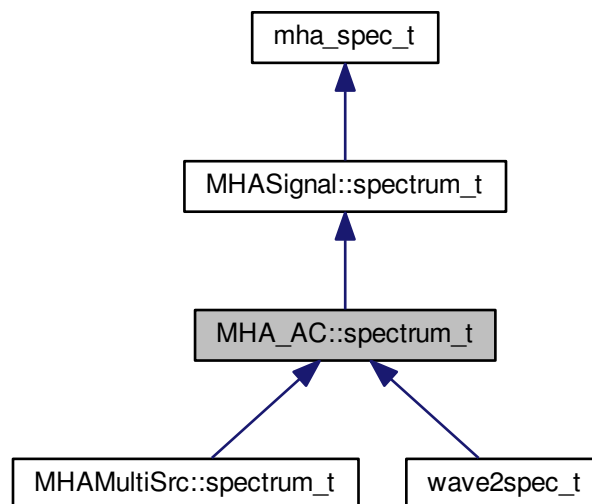

#### Public Member Functions

- **spectrum\_t** (**algo\_comm\_t ac**, std::string **name**, unsigned int bins, unsigned int **channels**, bool insert\_now)  
*Create the AC variable.*
- **~spectrum\_t** ()
- void **insert** ()  
*Insert AC variable into AC space.*

#### Protected Attributes

- **algo\_comm\_t ac**
- std::string **name**

## Additional Inherited Members

### 5.138.1 Detailed Description

Insert a **MHASignal::spectrum\_t** (p. 800) class into the AC space.

The variable is automatically removed on destruction.

### 5.138.2 Constructor & Destructor Documentation

5.138.2.1 **MHA\_AC::spectrum\_t::spectrum\_t** (  
     **algo\_comm\_t** *ac*,  
     std::string *name*,  
     unsigned int *bins*,  
     unsigned int *channels*,  
     bool *insert\_now* )

Create the AC variable.

#### Parameters

|                   |                                                                                                            |
|-------------------|------------------------------------------------------------------------------------------------------------|
| <i>ac</i>         | AC handle                                                                                                  |
| <i>name</i>       | Name of variable in AC space                                                                               |
| <i>bins</i>       | Number of FFT bins in the <b>waveform_t</b> (p. 425) class                                                 |
| <i>channels</i>   | Number of audio channels in the <b>waveform_t</b> (p. 425) class                                           |
| <i>insert_now</i> | Insert implicitly in the constructor (true) or explicitly in the <b>insert()</b> (p. 423) function (false) |

5.138.2.2 **MHA\_AC::spectrum\_t::~~spectrum\_t** (  
     void ) [virtual]

Reimplemented from **MHASignal::spectrum\_t** (p. 802).

### 5.138.3 Member Function Documentation

5.138.3.1 void **MHA\_AC::spectrum\_t::insert** ( )

Insert AC variable into AC space.

### 5.138.4 Member Data Documentation

5.138.4.1 `algo_comm_t MHA_AC::spectrum_t::ac` [protected]

5.138.4.2 `std::string MHA_AC::spectrum_t::name` [protected]

The documentation for this class was generated from the following files:

- `mha_algo_comm.h`
- `mha_algo_comm.cpp`

### 5.139 MHA\_AC::stat\_t Class Reference

Inheritance diagram for `MHA_AC::stat_t`:

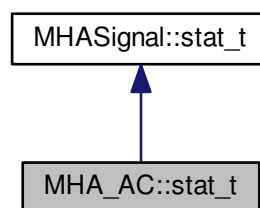

#### Public Member Functions

- `stat_t (algo_comm_t ac, const std::string &name, const unsigned int &frames, const unsigned int &channels, bool insert_now)`
- `void update ()`
- `void insert ()`

#### Private Attributes

- `MHA_AC::waveform_t mean`
- `MHA_AC::waveform_t std`



## 5.139.1 Constructor &amp; Destructor Documentation

5.139.1.1 MHA\_AC::stat\_t::stat\_t (  
     **algo\_comm\_t** *ac*,  
     const std::string & *name*,  
     const unsigned int & *frames*,  
     const unsigned int & *channels*,  
     bool *insert\_now* )

## 5.139.2 Member Function Documentation

5.139.2.1 void MHA\_AC::stat\_t::update ( )

5.139.2.2 void MHA\_AC::stat\_t::insert ( )

## 5.139.3 Member Data Documentation

5.139.3.1 MHA\_AC::waveform\_t MHA\_AC::stat\_t::mean [private]

5.139.3.2 MHA\_AC::waveform\_t MHA\_AC::stat\_t::std [private]

The documentation for this class was generated from the following files:

- **mha\_algo\_comm.h**
- **mha\_algo\_comm.cpp**

## 5.140 MHA\_AC::waveform\_t Class Reference

Insert a **MHASignal::waveform\_t** (p. 812) class into the AC space.

Inheritance diagram for MHA\_AC::waveform\_t:

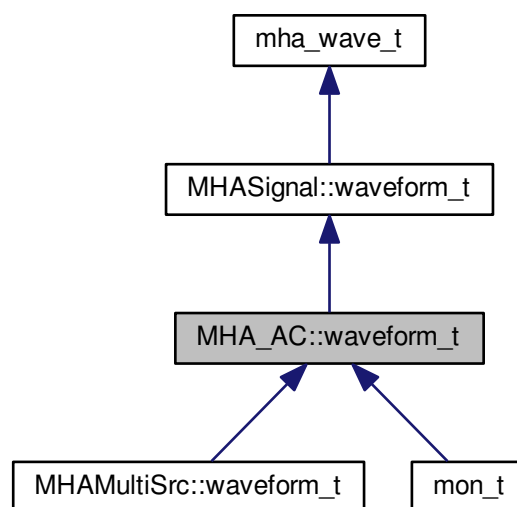

## Public Member Functions

- **waveform\_t** (**algo\_comm\_t ac**, std::string **name**, unsigned int **frames**, unsigned int **channels**, bool **insert\_now**)  
*Create the AC variable.*
- **~waveform\_t** ()
- void **insert** ()  
*Insert AC variable into AC space.*

## Protected Attributes

- **algo\_comm\_t ac**
- std::string **name**

## Additional Inherited Members

### 5.140.1 Detailed Description

Insert a **MHASignal::waveform\_t** (p. 812) class into the AC space.

The variable is automatically removed on destruction.

### 5.140.2 Constructor & Destructor Documentation

5.140.2.1 **MHA\_AC::waveform\_t::waveform\_t** (  
**algo\_comm\_t ac**,  
 std::string **name**,  
 unsigned int **frames**,  
 unsigned int **channels**,  
 bool **insert\_now** )

Create the AC variable.

#### Parameters

|                   |                                                                                                            |
|-------------------|------------------------------------------------------------------------------------------------------------|
| <i>ac</i>         | AC handle                                                                                                  |
| <i>name</i>       | Name of variable in AC space                                                                               |
| <i>frames</i>     | Number of frames in the <b>waveform_t</b> (p. 425) class                                                   |
| <i>channels</i>   | Number of audio channels in the <b>waveform_t</b> (p. 425) class                                           |
| <i>insert_now</i> | Insert implicitly in the constructor (true) or explicitly in the <b>insert()</b> (p. 427) function (false) |

5.140.2.2 MHA\_AC::waveform\_t::~~waveform\_t ( void ) [virtual]

Reimplemented from **MHASignal::waveform\_t** (p. 815).

### 5.140.3 Member Function Documentation

5.140.3.1 void MHA\_AC::waveform\_t::insert ( )

Insert AC variable into AC space.

### 5.140.4 Member Data Documentation

5.140.4.1 algo\_comm\_t MHA\_AC::waveform\_t::ac [protected]

5.140.4.2 std::string MHA\_AC::waveform\_t::name [protected]

The documentation for this class was generated from the following files:

- **mha\_algo\_comm.h**
- **mha\_algo\_comm.cpp**

## 5.141 mha\_audio\_descriptor\_t Struct Reference

Description of an audio fragment (planned as a replacement of **mhaconfig\_t** (p. 504)).

### Public Attributes

- unsigned int **n\_samples**  
*Number of samples.*
- unsigned int **n\_channels**  
*Number of audio channels.*
- unsigned int **n\_freqs**  
*Number of frequency bands.*
- unsigned int **is\_complex**  
*Flag about sample type.*
- **mha\_real\_t dt**  
*Time distance between samples (only equidistant samples allowed)*
- **mha\_real\_t \* cf**  
*Center frequencies of frequency bands.*
- **mha\_real\_t \* chdir**  
*Hint on source direction of channel, values below zero is left, values above zero is right, zero means unknown.*

### 5.141.1 Detailed Description

Description of an audio fragment (planned as a replacement of **mhaconfig\_t** (p. 504)).

### 5.141.2 Member Data Documentation

#### 5.141.2.1 unsigned int mha\_audio\_descriptor\_t::n\_samples

Number of samples.

#### 5.141.2.2 unsigned int mha\_audio\_descriptor\_t::n\_channels

Number of audio channels.

#### 5.141.2.3 unsigned int mha\_audio\_descriptor\_t::n\_freqs

Number of frequency bands.

#### 5.141.2.4 unsigned int mha\_audio\_descriptor\_t::is\_complex

Flag about sample type.

#### 5.141.2.5 mha\_real\_t mha\_audio\_descriptor\_t::dt

Time distance between samples (only equidistant samples allowed)

#### 5.141.2.6 mha\_real\_t\* mha\_audio\_descriptor\_t::cf

Center frequencies of frequency bands.

#### 5.141.2.7 mha\_real\_t\* mha\_audio\_descriptor\_t::chdir

Hint on source direction of channel, values below zero is left, values above zero is right, zero means unknown.

The documentation for this struct was generated from the following file:

- **mha.hh**

### 5.142 mha\_audio\_t Struct Reference

An audio fragment in the openMHA (planned as a replacement of **mha\_wave\_t** (p. 496) and **mha\_spec\_t** (p. 465)).

## Public Attributes

- **mha\_audio\_descriptor\_t descriptor**  
*Dimension and description of the data.*
- **mha\_real\_t \* rdata**  
*Data pointer if flag `mha_audio_descriptor_t::is_complex` (p. 428) is unset.*
- **mha\_complex\_t \* cdata**  
*Data pointer if flag `mha_audio_descriptor_t::is_complex` (p. 428) is set.*

### 5.142.1 Detailed Description

An audio fragment in the openMHA (planned as a replacement of **mha\_wave\_t** (p. 496) and **mha\_spec\_t** (p. 465)).

The data alignment is  $(t_0, c_0, f_0), (t_0, c_0, f_1), \dots, (t_0, c_0, f_{freqs}), (t_0, c_1, f_0), \dots$ . This allows a direct cast of the current **mha\_wave\_t** (p. 496) and **mha\_spec\_t** (p. 465) data pointers into corresponding **mha\_audio\_t** (p. 428) objects.

### 5.142.2 Member Data Documentation

#### 5.142.2.1 mha\_audio\_descriptor\_t mha\_audio\_t::descriptor

Dimension and description of the data.

#### 5.142.2.2 mha\_real\_t\* mha\_audio\_t::rdata

Data pointer if flag **mha\_audio\_descriptor\_t::is\_complex** (p. 428) is unset.

#### 5.142.2.3 mha\_complex\_t\* mha\_audio\_t::cdata

Data pointer if flag **mha\_audio\_descriptor\_t::is\_complex** (p. 428) is set.

The documentation for this struct was generated from the following file:

- **mha.hh**

## 5.143 mha\_channel\_info\_t Struct Reference

Channel information structure.

## Public Attributes

- int **id**  
*channel id*
- char **idstr** [32]  
*channel id*
- unsigned int **side**  
*side (left/right)*
- **mha\_direction\_t dir**  
*source direction*
- **mha\_real\_t peaklevel**  
*Peak level corresponds to this SPL (dB) level.*

### 5.143.1 Detailed Description

Channel information structure.

### 5.143.2 Member Data Documentation

#### 5.143.2.1 int mha\_channel\_info\_t::id

channel id

#### 5.143.2.2 char mha\_channel\_info\_t::idstr[32]

channel id

#### 5.143.2.3 unsigned int mha\_channel\_info\_t::side

side (left/right)

#### 5.143.2.4 mha\_direction\_t mha\_channel\_info\_t::dir

source direction

#### 5.143.2.5 mha\_real\_t mha\_channel\_info\_t::peaklevel

Peak level corresponds to this SPL (dB) level.

The documentation for this struct was generated from the following file:

- **mha.hh**

## 5.144 `mha_complex_t` Struct Reference

Type for complex floating point values.

### Public Attributes

- `mha_real_t re`  
*Real part.*
- `mha_real_t im`  
*Imaginary part.*

### 5.144.1 Detailed Description

Type for complex floating point values.

### 5.144.2 Member Data Documentation

#### 5.144.2.1 `mha_real_t mha_complex_t::re`

Real part.

#### 5.144.2.2 `mha_real_t mha_complex_t::im`

Imaginary part.

The documentation for this struct was generated from the following file:

- `mha.hh`

## 5.145 `mha_complex_test_array_t` Struct Reference

Several places in MHA rely on the fact that you can cast an array of `mha_complex_t` (p. 431) `c[]` to an array of `mha_real_t r[]` with `r[0] == c[0].re` `r[1] == c[0].im` `r[2] == c[1].re` ...

### Public Attributes

- `mha_complex_t c [2]`

### 5.145.1 Detailed Description

Several places in MHA rely on the fact that you can cast an array of **mha\_complex\_t** (p. 431) `c[]` to an array of `mha_real_t r[]` with `r[0] == c[0].re` `r[1] == c[0].im` `r[2] == c[1].re` ...

Check these expectations in static asserts.

### 5.145.2 Member Data Documentation

#### 5.145.2.1 `mha_complex_t mha_complex_test_array_t::c[2]`

The documentation for this struct was generated from the following file:

- **mha.hh**

### 5.146 `mha_dblbuf_t< FIFO >` Class Template Reference

The doublebuffer adapts block sizes between an outer process, which provides input data and takes output data, and an inner process, which processes the input signal and generates output data using a different block size than the outer process.

#### Public Types

- typedef `FIFO::value_type` **value\_type**  
*The datatype exchanged by the FIFO and this doublebuffer.*

#### Public Member Functions

- virtual unsigned **get\_inner\_size** () const
- virtual unsigned **get\_outer\_size** () const
- virtual unsigned **get\_delay** () const
- virtual unsigned **get\_fifo\_size** () const
- virtual unsigned **get\_input\_channels** () const
- virtual unsigned **get\_output\_channels** () const
- virtual unsigned **get\_input\_fifo\_fill\_count** () const
- virtual unsigned **get\_output\_fifo\_fill\_count** () const
- virtual unsigned **get\_input\_fifo\_space** () const
- virtual unsigned **get\_output\_fifo\_space** () const
- virtual **MHA\_Error** \* **get\_inner\_error** () const
- virtual void **provoke\_inner\_error** (const **MHA\_Error** &)
- virtual void **provoke\_outer\_error** (const **MHA\_Error** &)



- **mha\_dbdbuf\_t** (unsigned **outer\_size**, unsigned **inner\_size**, unsigned **delay**, unsigned **input\_channels**, unsigned **output\_channels**, const **value\_type** &delay\_data)  
*Constructor creates FIFOs with specified delay.*
- virtual **~mha\_dbdbuf\_t** ()
- virtual void **process** (const **value\_type** \*input\_signal, **value\_type** \*output\_signal, unsigned count)  
*The outer process has to call this method to propagate the input signal to the inner process, and receives back the output signal.*
- virtual void **input** (**value\_type** \*input\_signal)  
*The inner process has to call this method to receive its input signal.*
- virtual void **output** (const **value\_type** \*output\_signal)  
*The outer process has to call this method to deliver its output signal.*

#### Private Attributes

- unsigned **outer\_size**  
*The block size used by the outer process.*
- unsigned **inner\_size**  
*The block size used by the inner process.*
- unsigned **delay**  
*The delay introduced by bidirectional buffer size adaptation.*
- unsigned **fifo\_size**  
*The size of each of the FIFOs.*
- unsigned **input\_channels**  
*The number of input channels.*
- unsigned **output\_channels**  
*The number of output channels.*
- FIFO **input\_fifo**  
*The FIFO for transporting the input signal from the outer process to the inner process.*
- FIFO **output\_fifo**  
*The FIFO for transporting the output signal from the inner process to the outer process.*
- **MHA\_Error** \* **inner\_error**  
*Owned copy of exception to be thrown in inner thread.*
- **MHA\_Error** \* **outer\_error**  
*Owned copy of exception to be thrown in outer thread.*

#### 5.146.1 Detailed Description

```
template<class FIFO>
class mha_dbdbuf_t< FIFO >
```

The doublebuffer adapts block sizes between an outer process, which provides input data and takes output data, and an inner process, which processes the input signal and generates output data using a different block size than the outer process.

This class introduces the channels concept. Input and output may have different channel counts.

## 5.146.2 Member Typedef Documentation

### 5.146.2.1 `template<class FIFO > typedef FIFO::value_type mha_dbdbuf_t< FIFO >::value_type`

The datatype exchanged by the FIFO and this doublebuffer.

## 5.146.3 Constructor & Destructor Documentation

### 5.146.3.1 `template<class FIFO > mha_dbdbuf_t< FIFO >::mha_dbdbuf_t ( unsigned outer_size, unsigned inner_size, unsigned delay, unsigned input_channels, unsigned output_channels, const value_type & delay_data )`

Constructor creates FIFOs with specified delay.

#### Warning

The doublebuffer may block or raise an exception if the delay is too small. To avoid this, the delay should be

$$delay \geq (inner\_size - gcd(inner\_size, outer\_size))$$

#### Parameters

|                        |                                             |
|------------------------|---------------------------------------------|
| <i>outer_size</i>      | The block size used by the outer process.   |
| <i>inner_size</i>      | The block size used by the inner process.   |
| <i>delay</i>           | The total delay                             |
| <i>input_channels</i>  | Number of input channels                    |
| <i>output_channels</i> | Number of output channels                   |
| <i>delay_data</i>      | The delay consists of copies of this value. |

### 5.146.3.2 `template<class FIFO > mha_dbdbuf_t< FIFO >::~~mha_dbdbuf_t ( ) [virtual]`

## 5.146.4 Member Function Documentation

### 5.146.4.1 `template<class FIFO > virtual unsigned mha_dbdbuf_t< FIFO >::get_inner_size ( ) const [inline], [virtual]`

- 5.146.4.2 `template<class FIFO > virtual unsigned mha_dblbuf_t< FIFO >::get_outer_size ( ) const`  
[inline],[virtual]
- 5.146.4.3 `template<class FIFO > virtual unsigned mha_dblbuf_t< FIFO >::get_delay ( ) const`  
[inline],[virtual]
- 5.146.4.4 `template<class FIFO > virtual unsigned mha_dblbuf_t< FIFO >::get_fifo_size ( ) const`  
[inline],[virtual]
- 5.146.4.5 `template<class FIFO > virtual unsigned mha_dblbuf_t< FIFO >::get_input_channels ( )`  
`const` [inline],[virtual]
- 5.146.4.6 `template<class FIFO > virtual unsigned mha_dblbuf_t< FIFO >::get_output_channels ( )`  
`const` [inline],[virtual]
- 5.146.4.7 `template<class FIFO > virtual unsigned mha_dblbuf_t< FIFO >::get_input_fifo_fill_count ( )`  
`const` [inline],[virtual]
- 5.146.4.8 `template<class FIFO > virtual unsigned mha_dblbuf_t< FIFO >::get_output_fifo_fill_count ( )`  
`const` [inline],[virtual]
- 5.146.4.9 `template<class FIFO > virtual unsigned mha_dblbuf_t< FIFO >::get_input_fifo_space ( )`  
`const` [inline],[virtual]
- 5.146.4.10 `template<class FIFO > virtual unsigned mha_dblbuf_t< FIFO >::get_output_fifo_space ( )`  
`const` [inline],[virtual]
- 5.146.4.11 `template<class FIFO > virtual MHA_Error* mha_dblbuf_t< FIFO >::get_inner_error ( )`  
`const` [inline],[virtual]
- 5.146.4.12 `template<class FIFO > void mha_dblbuf_t< FIFO >::provoke_inner_error (`  
`const MHA_Error & error )` [virtual]
- 5.146.4.13 `template<class FIFO > void mha_dblbuf_t< FIFO >::provoke_outer_error (`  
`const MHA_Error & error )` [virtual]
- 5.146.4.14 `template<class FIFO > void mha_dblbuf_t< FIFO >::process (`  
`const value_type * input_signal,`  
`value_type * output_signal,`  
`unsigned count )` [virtual]

The outer process has to call this method to propagate the input signal to the inner process, and receives back the output signal.

## Parameters

|                      |                                                                                                               |
|----------------------|---------------------------------------------------------------------------------------------------------------|
| <i>input_signal</i>  | Pointer to the input signal array.                                                                            |
| <i>output_signal</i> | Pointer to the output signal array.                                                                           |
| <i>count</i>         | The number of data instances provided and expected, lower or equal to <i>inner_size</i> given to constructor. |

## Exceptions

|                                  |                                                                                                                          |
|----------------------------------|--------------------------------------------------------------------------------------------------------------------------|
| <b><i>MHA_Error</i></b> (p. 445) | When <i>count</i> is > <i>outer_size</i> as given to constructor or the underlying fifo implementation detects an error. |
|----------------------------------|--------------------------------------------------------------------------------------------------------------------------|

5.146.4.15 `template<class FIFO > void mha_dblbuf_t< FIFO >::input ( value_type * input_signal ) [virtual]`

The inner process has to call this method to receive its input signal.

## Parameters

|                     |                                                    |
|---------------------|----------------------------------------------------|
| <i>input_signal</i> | Array where the doublebuffer can store the signal. |
|---------------------|----------------------------------------------------|

## Exceptions

|                                  |                                                           |
|----------------------------------|-----------------------------------------------------------|
| <b><i>MHA_Error</i></b> (p. 445) | When the underlying fifo implementation detects an error. |
|----------------------------------|-----------------------------------------------------------|

5.146.4.16 `template<class FIFO > void mha_dblbuf_t< FIFO >::output ( const value_type * output_signal ) [virtual]`

The outer process has to call this method to deliver its output signal.

## Parameters

|                      |                                                   |
|----------------------|---------------------------------------------------|
| <i>output_signal</i> | Array from which doublebuffer reads outputsignal. |
|----------------------|---------------------------------------------------|

## Exceptions

|                                  |                                                           |
|----------------------------------|-----------------------------------------------------------|
| <b><i>MHA_Error</i></b> (p. 445) | When the underlying fifo implementation detects an error. |
|----------------------------------|-----------------------------------------------------------|

## 5.146.5 Member Data Documentation

5.146.5.1 `template<class FIFO > unsigned mha_dblbuf_t< FIFO >::outer_size` [private]

The block size used by the outer process.

5.146.5.2 `template<class FIFO > unsigned mha_dblbuf_t< FIFO >::inner_size` [private]

The block size used by the inner process.

5.146.5.3 `template<class FIFO > unsigned mha_dblbuf_t< FIFO >::delay` [private]

The delay introduced by bidirectional buffer size adaptation.

5.146.5.4 `template<class FIFO > unsigned mha_dblbuf_t< FIFO >::fifo_size` [private]

The size of each of the FIFOs.

5.146.5.5 `template<class FIFO > unsigned mha_dblbuf_t< FIFO >::input_channels` [private]

The number of input channels.

5.146.5.6 `template<class FIFO > unsigned mha_dblbuf_t< FIFO >::output_channels` [private]

The number of output channels.

5.146.5.7 `template<class FIFO > FIFO mha_dblbuf_t< FIFO >::input_fifo` [private]

The FIFO for transporting the input signal from the outer process to the inner process.

5.146.5.8 `template<class FIFO > FIFO mha_dblbuf_t< FIFO >::output_fifo` [private]

The FIFO for transporting the output signal from the inner process to the outer process.

5.146.5.9 `template<class FIFO > MHA_Error* mha_dblbuf_t< FIFO >::inner_error` [private]

Owned copy of exception to be thrown in inner thread.

5.146.5.10 `template<class FIFO > MHA_Error* mha_dblbuf_t< FIFO >::outer_error`  
[private]

Owned copy of exception to be thrown in outer thread.

The documentation for this class was generated from the following files:

- **mha\_fifo.h**
- **mha\_fifo.cpp**

## 5.147 mha\_direction\_t Struct Reference

Channel source direction structure.

### Public Attributes

- **mha\_real\_t azimuth**  
*azimuth in radians*
- **mha\_real\_t elevation**  
*elevation in radians*
- **mha\_real\_t distance**  
*distance in meters*

### 5.147.1 Detailed Description

Channel source direction structure.

### 5.147.2 Member Data Documentation

#### 5.147.2.1 mha\_real\_t mha\_direction\_t::azimuth

azimuth in radians

#### 5.147.2.2 mha\_real\_t mha\_direction\_t::elevation

elevation in radians

#### 5.147.2.3 mha\_real\_t mha\_direction\_t::distance

distance in meters

The documentation for this struct was generated from the following file:

- **mha.hh**

## 5.148 mha\_drifter\_fifo\_t&lt; T &gt; Class Template Reference

A FIFO class for blocksize adaptation without Synchronization.

Inheritance diagram for mha\_drifter\_fifo\_t< T >:

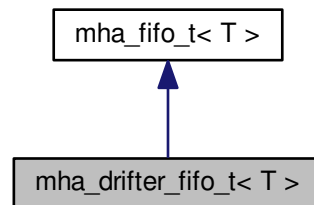

## Public Member Functions

- virtual void **write** (const T \*data, unsigned count)  
*write data to fifo*
- virtual void **read** (T \*buf, unsigned count)  
*Read data from fifo.*
- virtual unsigned **get\_fill\_count** () const  
*Return fill\_count, adding mha\_drifter\_fifo\_t<T>::startup\_zeros (p. 445) to the number of samples actually in the fifo's buffer.*
- virtual unsigned **get\_available\_space** () const  
*Return available space, subtracting number of mha\_drifter\_fifo\_t<T>::startup\_zeros (p. 445) from the available\_space actually present in the fifo's buffer.*
- virtual unsigned **get\_des\_fill\_count** () const  
*The desired fill count of this fifo.*
- virtual unsigned **get\_min\_fill\_count** () const  
*The minimum fill count of this fifo.*
- virtual void **stop** ()  
*Called by mha\_drifter\_fifo\_t<T>::read (p. 441) or mha\_drifter\_fifo\_t<T>::write (p. 441) when their xrun in succession counter exceeds its limit.*
- virtual void **starting** ()  
*Called by mha\_drifter\_fifo\_t<T>::read (p. 441) or mha\_drifter\_fifo\_t<T>::write (p. 441) when the respective flag (mha\_drifter\_fifo\_t<T>::reader\_started (p. 443) or mha\_drifter\_fifo\_t<T>::writer\_started (p. 443)) is about to be toggled from false to true.*
- **mha\_drifter\_fifo\_t** (unsigned min\_fill\_count, unsigned **desired\_fill\_count**, unsigned **max\_fill\_count**)  
*Create drifter FIFO.*
- **mha\_drifter\_fifo\_t** (unsigned min\_fill\_count, unsigned **desired\_fill\_count**, unsigned **max\_fill\_count**, const T &t)  
*Create drifter FIFO where all (initially unused) copies of T are initialized as copies of t.*

## Private Attributes

- const unsigned **minimum\_fill\_count**  
*The minimum fill count of this fifo.*
- const unsigned **desired\_fill\_count**  
*The desired fill count of the fifo.*
- bool **writer\_started**  
*Flag set to true when write is called the first time.*
- bool **reader\_started**  
*Flag set to true when read is called for the first time.*
- unsigned **writer\_xruns\_total**  
*The number of xruns seen by the writer since object instantiation.*
- unsigned **reader\_xruns\_total**  
*The number of xruns seen by the reader since object instantiation.*
- unsigned **writer\_xruns\_since\_start**  
*The number of xruns seen by the writer since the last start of processing.*
- unsigned **reader\_xruns\_since\_start**  
*The number of xruns seen by the reader since the last start of processing.*
- unsigned **writer\_xruns\_in\_succession**  
*The number of xruns seen by the writer in succession.*
- unsigned **reader\_xruns\_in\_succession**  
*The number of xruns seen by the reader in succession.*
- unsigned **maximum\_writer\_xruns\_in\_succession\_before\_stop**  
*A limit to the number of xruns seen in succession during write before the data transmission through the FIFO is stopped.*
- unsigned **maximum\_reader\_xruns\_in\_succession\_before\_stop**  
*A limit to the number of xruns seen in succession during read before the data transmission through the FIFO is stopped.*
- **mha\_fifo\_t< T >::value\_type null\_data**  
*The value used in place of missing data.*
- unsigned **startup\_zeros**  
*When processing starts, that is when both **mha\_drifter\_fifo\_t<T>::reader\_started** (p. 443) and **mha\_drifter\_fifo\_t<T>::writer\_started** (p. 443) are true, then first **mha\_drifter\_fifo\_t<T>::desired\_fill\_count** (p. 443) instances of **mha\_drifter\_fifo\_t<T>::null\_data** (p. 444) are delivered to the reader.*

## Additional Inherited Members

### 5.148.1 Detailed Description

```
template<class T>
class mha_drifter_fifo_t< T >
```

A FIFO class for blocksize adaptation without Synchronization.

Features: delay concept (desired, minimum and maximum delay), drifting support by throwing away data or inserting zeroes.



## 5.148.2 Constructor &amp; Destructor Documentation

5.148.2.1 `template<class T > mha_drifter_fifo_t< T >::mha_drifter_fifo_t ( unsigned min_fill_count, unsigned desired_fill_count, unsigned max_fill_count )`

Create drifter FIFO.

5.148.2.2 `template<class T > mha_drifter_fifo_t< T >::mha_drifter_fifo_t ( unsigned min_fill_count, unsigned desired_fill_count, unsigned max_fill_count, const T & t )`

Create drifter FIFO where all (initially unused) copies of T are initialized as copies of t.

## 5.148.3 Member Function Documentation

5.148.3.1 `template<class T > void mha_drifter_fifo_t< T >::write ( const T * data, unsigned count ) [virtual]`

write data to fifo

Sets **writer\_started** (p. 443) to true.

When processing has started, i.e. both **reader\_started** (p. 443) and **writer\_started** (p. 443) are true, write specified ammount of data to the fifo. If there is not enough space available, then the exceeding data is lost and the writer xrun counters are increased.

Processing is stopped when **writer\_xruns\_in\_succession** (p. 444) exceeds **maximum\_↔ writer\_xruns\_in\_succession\_before\_stop** (p. 444).

## Parameters

|              |                             |
|--------------|-----------------------------|
| <i>data</i>  | Pointer to source data.     |
| <i>count</i> | Number of instances to copy |

Reimplemented from **mha\_fifo\_t< T >** (p. 454).

5.148.3.2 `template<class T > void mha_drifter_fifo_t< T >::read ( T * buf, unsigned count ) [virtual]`

Read data from fifo.

Sets **reader\_started** (p. 443) to true.

When processing has started, i.e. both **reader\_started** (p. 443) and **writer\_started** (p. 443) are true, then read specified amount of data from the fifo. As long as **startup\_zeros** (p. 445) is  $> 0$ , **null\_data** (p. 444) is delivered to the reader and **startup\_zeros** (p. 445) is diminished. Only when **startup\_zeros** (p. 445) has reached 0, data is actually read from the fifo's buffer.

If the read would cause the fifo's fill count to drop below **minimum\_fill\_count** (p. 443), then only so much data are read that **minimum\_fill\_count** (p. 443) entries remain in the fifo, the missing data is replaced with **null\_data** (p. 444), and the reader xrun counters are increased.

Processing is stopped when **reader\_xruns\_in\_succession** (p. 444) exceeds **maximum\_reader\_xruns\_in\_succession\_before\_stop** (p. 444).

#### Parameters

|              |                              |
|--------------|------------------------------|
| <i>buf</i>   | Pointer to the target buffer |
| <i>count</i> | Number of instances to copy  |

Reimplemented from **mha\_fifo\_t< T >** (p. 455).

```
5.148.3.3 template<class T > unsigned mha_drifter_fifo_t< T >::get_fill_count ( ) const
        [virtual]
```

Return **fill\_count**, adding **mha\_drifter\_fifo\_t<T>::startup\_zeros** (p. 445) to the number of samples actually in the fifo's buffer.

Reimplemented from **mha\_fifo\_t< T >** (p. 455).

```
5.148.3.4 template<class T > unsigned mha_drifter_fifo_t< T >::get_available_space ( ) const
        [virtual]
```

Return available space, subtracting number of **mha\_drifter\_fifo\_t<T>::startup\_zeros** (p. 445) from the **available\_space** actually present in the fifo's buffer.

TODO: uncertain if this is a good idea.

Reimplemented from **mha\_fifo\_t< T >** (p. 455).

```
5.148.3.5 template<class T > virtual unsigned mha_drifter_fifo_t< T >::get_des_fill_count ( )
        const [inline],[virtual]
```

The desired fill count of this fifo.

```
5.148.3.6 template<class T > virtual unsigned mha_drifter_fifo_t< T >::get_min_fill_count ( )
        const [inline],[virtual]
```

The minimum fill count of this fifo.

5.148.3.7 `template<class T> void mha_drifter_fifo_t< T >::stop ( ) [virtual]`

Called by `mha_drifter_fifo_t<T>::read` (p. 441) or `mha_drifter_fifo_t<T>::write` (p. 441) when their xrun in succession counter exceeds its limit.

Called by `read` (p. 441) or `write` (p. 441) when their xrun in succession counter exceeds its limit.

May also be called explicitly.

5.148.3.8 `template<class T> void mha_drifter_fifo_t< T >::starting ( ) [virtual]`

Called by `mha_drifter_fifo_t<T>::read` (p. 441) or `mha_drifter_fifo_t<T>::write` (p. 441) when the respective flag (`mha_drifter_fifo_t<T>::reader_started` (p. 443) or `mha_drifter_fifo_t<T>::writer_started` (p. 443)) is about to be toggled from false to true.

The fifo's buffer is emptied, this method resets `startup_zeros` (p. 445) to `desired_fill_count` (p. 443), and it also resets `reader_xruns_since_start` (p. 444) and `writer_xruns_since_start` (p. 444) to 0.

#### 5.148.4 Member Data Documentation

5.148.4.1 `template<class T> const unsigned mha_drifter_fifo_t< T >::minimum_fill_count [private]`

The minimum fill count of this fifo.

5.148.4.2 `template<class T> const unsigned mha_drifter_fifo_t< T >::desired_fill_count [private]`

The desired fill count of the fifo.

The fifo is initialized with this ammount of data when data transmission starts.

5.148.4.3 `template<class T> bool mha_drifter_fifo_t< T >::writer_started [private]`

Flag set to true when write is called the first time.

5.148.4.4 `template<class T> bool mha_drifter_fifo_t< T >::reader_started [private]`

Flag set to true when read is called for the first time.

5.148.4.5 `template<class T> unsigned mha_drifter_fifo_t< T >::writer_xruns_total [private]`

The number of xruns seen by the writer since object instantiation.

**5.148.4.6** `template<class T> unsigned mha_drifter_fifo_t< T >::reader_xruns_total` [private]

The number of xruns seen by the reader since object instantiation.

**5.148.4.7** `template<class T> unsigned mha_drifter_fifo_t< T >::writer_xruns_since_start`  
[private]

The number of xruns seen by the writer since the last start of processing.

**5.148.4.8** `template<class T> unsigned mha_drifter_fifo_t< T >::reader_xruns_since_start`  
[private]

The number of xruns seen by the reader since the last start of processing.

**5.148.4.9** `template<class T> unsigned mha_drifter_fifo_t< T >::writer_xruns_in_succession`  
[private]

The number of xruns seen by the writer in succession.

Reset to 0 every time a write succeeds without xrun.

**5.148.4.10** `template<class T> unsigned mha_drifter_fifo_t< T >::reader_xruns_in_succession`  
[private]

The number of xruns seen by the reader in succession.

Reset to 0 every time a read succeeds without xrun.

**5.148.4.11** `template<class T> unsigned mha_drifter_fifo_t< T >::maximum_writer_xruns_in_↔  
succession_before_stop` [private]

A limit to the number of xruns seen in succession during write before the data transmission through the FIFO is stopped.

**5.148.4.12** `template<class T> unsigned mha_drifter_fifo_t< T >::maximum_reader_xruns_in_↔  
succession_before_stop` [private]

A limit to the number of xruns seen in succession during read before the data transmission through the FIFO is stopped.

**5.148.4.13** `template<class T> mha_fifo_t<T>::value_type mha_drifter_fifo_t< T >::null_data`  
[private]

The value used in place of missing data.

5.148.4.14 `template<class T> unsigned mha_drifter_fifo_t<T>::startup_zeros` [private]

When processing starts, that is when both `mha_drifter_fifo_t<T>::reader_started` (p. 443) and `mha_drifter_fifo_t<T>::writer_started` (p. 443) are true, then first `mha_drifter_fifo_t<T>::desired_fill_count` (p. 443) instances of `mha_drifter_fifo_t<T>::null_data` (p. 444) are delivered to the reader.

These `null_data` (p. 444) instances are not transmitted through the fifo because filling the fifo with enough `null_data` (p. 444) might not be realtime safe and this filling has to be initiated by `starting` (p. 443) or `stop` (p. 443) (this implementation: `starting` (p. 443)) which are be called with realtime constraints.

The documentation for this class was generated from the following file:

- `mha_fifo.h`

## 5.149 MHA\_Error Class Reference

Error reporting exception class.

Inherits exception.

### Public Member Functions

- `MHA_Error` (const char \*file, int line, const char \*fmt,...)  
*Create an instance of a **MHA\_Error** (p. 445).*
- `MHA_Error` (const `MHA_Error` &)
- `MHA_Error` & `operator=` (const `MHA_Error` &)
- `~MHA_Error` () throw ()
- const char \* `get_msg` () const  
*Return the error message without source position.*
- const char \* `get_longmsg` () const  
*Return the error message with source position.*
- const char \* `what` () const throw ()  
*overwrite `std::exception::what()`*

### Private Attributes

- char \* `msg`
- char \* `longmsg`

### 5.149.1 Detailed Description

Error reporting exception class.

This class is used for error handling in the openMHA. It is used by the openMHA kernel and by the openMHA toolbox library. Please note that exceptions should not be used accross ANSI-C interfaces. It is necessary to catch exceptions within the library.

The **MHA\_Error** (p. 445) class holds source file name, line number and an error message.

### 5.149.2 Constructor & Destructor Documentation

5.149.2.1 **MHA\_Error::MHA\_Error** (  
     const char \* *s\_file*,  
     int *l*,  
     const char \* *fmt*,  
     ... )

Create an instance of a **MHA\_Error** (p. 445).

#### Parameters

|               |                                                |
|---------------|------------------------------------------------|
| <i>s_file</i> | source file name ( <b>FILE</b> )               |
| <i>l</i>      | source line ( <b>LINE</b> )                    |
| <i>fmt</i>    | format string for error message (as in printf) |

5.149.2.2 **MHA\_Error::MHA\_Error** (  
     const **MHA\_Error** & *p* )

5.149.2.3 **MHA\_Error::~~MHA\_Error** ( ) throw )

### 5.149.3 Member Function Documentation

5.149.3.1 **MHA\_Error & MHA\_Error::operator=** (  
     const **MHA\_Error** & *p* )

5.149.3.2 const char\* **MHA\_Error::get\_msg** ( ) const [inline]

Return the error message without source position.

5.149.3.3 const char\* **MHA\_Error::get\_longmsg** ( ) const [inline]

Return the error message with source position.

5.149.3.4 `const char* MHA_Error::what ( ) const throw )` `[inline]`

overwrite `std::exception::what()`

#### 5.149.4 Member Data Documentation

5.149.4.1 `char* MHA_Error::msg` `[private]`

5.149.4.2 `char* MHA_Error::longmsg` `[private]`

The documentation for this class was generated from the following files:

- `mha_error.hh`
- `mha_error.cpp`

## 5.150 mha\_fifo\_lw\_t< T > Class Template Reference

This FIFO uses locks to synchronize access.

Inheritance diagram for `mha_fifo_lw_t< T >`:

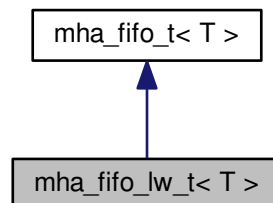

### Public Member Functions

- virtual void **write** (`const T *data`, unsigned count)  
*write specified ammount of data to the fifo.*
- virtual void **read** (`T *buf`, unsigned count)  
*read data from fifo.*
- **mha\_fifo\_lw\_t** (unsigned **max\_fill\_count**)  
*Create FIFO with fixed buffer size.*
- virtual **~mha\_fifo\_lw\_t** ()  
*release synchronization object*
- virtual void **set\_error** (unsigned index, **MHA\_Error \*error**)  
*Process waiting for more data or space should bail out, throwing this error.*

## Private Attributes

- **mha\_fifo\_thread\_platform\_t \* sync**  
*platform specific thread synchronization*
- **MHA\_Error \* error [2]**  
*If waiting for synchronization should be aborted then exception to be thrown by reader process (index 0) or writer process (index 1) has to be placed here.*

## Additional Inherited Members

### 5.150.1 Detailed Description

```
template<class T>
class mha_fifo_lw_t< T >
```

This FIFO uses locks to synchronize access.

Reading and writing can block until the operation can be executed.

### 5.150.2 Constructor & Destructor Documentation

```
5.150.2.1 template<class T > mha_fifo_lw_t< T >::mha_fifo_lw_t (
    unsigned max_fill_count ) [explicit]
```

Create FIFO with fixed buffer size.

```
5.150.2.2 template<class T > mha_fifo_lw_t< T >::~~mha_fifo_lw_t( ) [virtual]
```

release synchronization object

### 5.150.3 Member Function Documentation

```
5.150.3.1 template<class T > void mha_fifo_lw_t< T >::write (
    const T * data,
    unsigned count ) [virtual]
```

write specified ammount of data to the fifo.

If there is not enough space, then wait for more space.



## Parameters

|              |                              |
|--------------|------------------------------|
| <i>data</i>  | Pointer to source data.      |
| <i>count</i> | Number of instances to copy. |

## Exceptions

|                                  |                                      |
|----------------------------------|--------------------------------------|
| <b><i>MHA_Error</i></b> (p. 445) | when detecting a deadlock situation. |
|----------------------------------|--------------------------------------|

Reimplemented from **mha\_fifo\_t< T >** (p. 454).

```
5.150.3.2  template<class T> void mha_fifo_lw_t< T >::read (
            T * buf,
            unsigned count ) [virtual]
```

read data from fifo.

If there is not enough data, then wait for more data.

## Parameters

|              |                               |
|--------------|-------------------------------|
| <i>buf</i>   | Pointer to the target buffer. |
| <i>count</i> | Number of instances to copy.  |

## Exceptions

|                                  |                                      |
|----------------------------------|--------------------------------------|
| <b><i>MHA_Error</i></b> (p. 445) | when detecting a deadlock situation. |
|----------------------------------|--------------------------------------|

Reimplemented from **mha\_fifo\_t< T >** (p. 455).

```
5.150.3.3  template<class T> void mha_fifo_lw_t< T >::set_error (
            unsigned index,
            MHA_Error * error ) [virtual]
```

Process waiting for more data or space should bail out, throwing this error.

## Parameters

|              |                                                         |
|--------------|---------------------------------------------------------|
| <i>index</i> | Use 0 for terminating reader, 1 for terminating writer. |
| <i>error</i> | <b><i>MHA_Error</i></b> (p. 445) to be thrown           |

## 5.150.4 Member Data Documentation

5.150.4.1 `template<class T> mha_fifo_thread_platform_t* mha_fifo_lw_t< T >::sync`  
`[private]`

platform specific thread synchronization

5.150.4.2 `template<class T> MHA_Error* mha_fifo_lw_t< T >::error[2]` `[private]`

If waiting for synchronization should be aborted then exception to be thrown by reader process (index 0) or writer process (index 1) has to be placed here.

The documentation for this class was generated from the following files:

- **mha\_fifo.h**
- **mha\_fifo.cpp**

## 5.151 mha\_fifo\_posix\_threads\_t Class Reference

Inheritance diagram for `mha_fifo_posix_threads_t`:

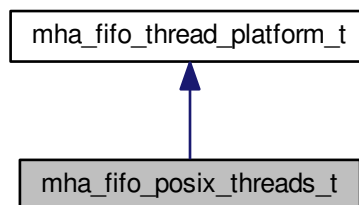

### Public Member Functions

- **mha\_fifo\_posix\_threads\_t ()**
- virtual void **acquire\_mutex ()**
- virtual void **release\_mutex ()**
- virtual void **wait\_for\_decrease ()**
- virtual void **wait\_for\_increase ()**
- virtual void **increment ()**
- virtual void **decrement ()**
- virtual **~mha\_fifo\_posix\_threads\_t ()**

## Private Attributes

- pthread\_mutex\_t **mutex**
- pthread\_cond\_t **decrease\_condition**
- pthread\_cond\_t **increase\_condition**

### 5.151.1 Constructor & Destructor Documentation

5.151.1.1 mha\_fifo\_posix\_threads\_t::mha\_fifo\_posix\_threads\_t( ) [inline]

5.151.1.2 virtual mha\_fifo\_posix\_threads\_t::~~mha\_fifo\_posix\_threads\_t( ) [inline],  
[virtual]

### 5.151.2 Member Function Documentation

5.151.2.1 virtual void mha\_fifo\_posix\_threads\_t::acquire\_mutex( ) [inline], [virtual]

Implements [mha\\_fifo\\_thread\\_platform\\_t](#) (p. 459).

5.151.2.2 virtual void mha\_fifo\_posix\_threads\_t::release\_mutex( ) [inline], [virtual]

Implements [mha\\_fifo\\_thread\\_platform\\_t](#) (p. 459).

5.151.2.3 virtual void mha\_fifo\_posix\_threads\_t::wait\_for\_decrease( ) [inline], [virtual]

Implements [mha\\_fifo\\_thread\\_platform\\_t](#) (p. 459).

5.151.2.4 virtual void mha\_fifo\_posix\_threads\_t::wait\_for\_increase( ) [inline], [virtual]

Implements [mha\\_fifo\\_thread\\_platform\\_t](#) (p. 459).

5.151.2.5 virtual void mha\_fifo\_posix\_threads\_t::increment( ) [inline], [virtual]

Implements [mha\\_fifo\\_thread\\_platform\\_t](#) (p. 459).

5.151.2.6 virtual void mha\_fifo\_posix\_threads\_t::decrement( ) [inline], [virtual]

Implements [mha\\_fifo\\_thread\\_platform\\_t](#) (p. 460).

### 5.151.3 Member Data Documentation

5.151.3.1 `pthread_mutex_t mha_fifo_posix_threads_t::mutex` [private]

5.151.3.2 `pthread_cond_t mha_fifo_posix_threads_t::decrease_condition` [private]

5.151.3.3 `pthread_cond_t mha_fifo_posix_threads_t::increase_condition` [private]

The documentation for this class was generated from the following file:

- `mha_fifo.h`

### 5.152 `mha_fifo_t< T >` Class Template Reference

A FIFO class for blocksize adaptation Synchronization: None.

Inheritance diagram for `mha_fifo_t< T >`:

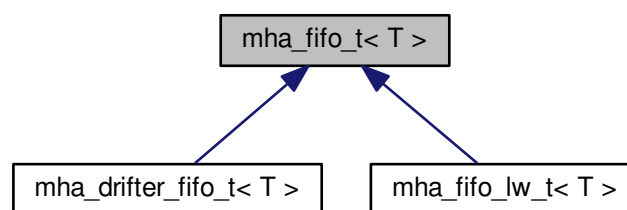

#### Public Types

- `typedef T value_type`

*The data type exchanged by this fifo.*

**Public Member Functions**

- virtual void **write** (const T \*data, unsigned count)  
*write specified ammount of data to the fifo.*
- virtual void **read** (T \*buf, unsigned count)  
*read data from fifo*
- virtual unsigned **get\_fill\_count** () const  
*Read-only access to fill\_count.*
- virtual unsigned **get\_available\_space** () const  
*Read-only access to available\_space.*
- virtual unsigned **get\_max\_fill\_count** () const  
*The capacity of this fifo.*
- **mha\_fifo\_t** (unsigned **max\_fill\_count**)  
*Create FIFO with fixed buffer size.*
- **mha\_fifo\_t** (unsigned **max\_fill\_count**, const T &t)  
*Create FIFO with fixed buffer size, where all (initially unused) copies of T are initialized as copies of t.*
- **mha\_fifo\_t** (const **mha\_fifo\_t** &src)  
*Copy constructor.*
- virtual ~**mha\_fifo\_t** ()  
*Destroy FIFO.*
- **mha\_fifo\_t**< T > & **operator=** (const **mha\_fifo\_t**< T > &)  
*Assignment operator.*

**Protected Member Functions**

- void **clear** ()  
*Empty the fifo at once.*

**Private Attributes**

- const unsigned **max\_fill\_count**  
*The maximum fill count of this FIFO.*
- T \* **buf**  
*The memory allocated to store the data.*
- T \* **write\_ptr**  
*points to location where to write next*
- const T \* **read\_ptr**  
*points to location where to read next*
- bool **buf\_uses\_placement\_new**  
*wether buf was allocated using placement new or array new.*

### 5.152.1 Detailed Description

```
template<class T>
class mha_fifo_t< T >
```

A FIFO class for blocksize adaptation Synchronization: None.

Use external synchronisation or synchronization in inheriting class.

### 5.152.2 Member Typedef Documentation

#### 5.152.2.1 `template<class T> typedef T mha_fifo_t< T >::value_type`

The data type exchanged by this fifo.

### 5.152.3 Constructor & Destructor Documentation

#### 5.152.3.1 `template<class T > mha_fifo_t< T >::mha_fifo_t ( unsigned max_fill_count ) [explicit]`

Create FIFO with fixed buffer size.

#### 5.152.3.2 `template<class T > mha_fifo_t< T >::mha_fifo_t ( unsigned max_fill_count, const T & t )`

Create FIFO with fixed buffer size, where all (initially unused) copies of T are initialized as copies of t.

#### 5.152.3.3 `template<class T > mha_fifo_t< T >::mha_fifo_t ( const mha_fifo_t< T > & src )`

Copy constructor.

#### 5.152.3.4 `template<class T > mha_fifo_t< T >::~~mha_fifo_t( ) [virtual]`

Destroy FIFO.

### 5.152.4 Member Function Documentation

#### 5.152.4.1 `template<class T > void mha_fifo_t< T >::write ( const T * data, unsigned count ) [virtual]`

write specified ammount of data to the fifo.

## Parameters

|              |                             |
|--------------|-----------------------------|
| <i>data</i>  | Pointer to source data.     |
| <i>count</i> | Number of instances to copy |

## Exceptions

|                                  |                                           |
|----------------------------------|-------------------------------------------|
| <b><i>MHA_Error</i></b> (p. 445) | when there is not enough space available. |
|----------------------------------|-------------------------------------------|

Reimplemented in **mha\_fifo\_lw\_t< T >** (p. 448), and **mha\_drifter\_fifo\_t< T >** (p. 441).

5.152.4.2 `template<class T> void mha_fifo_t< T >::read (`  
`T * buf,`  
`unsigned count ) [virtual]`

read data from fifo

## Parameters

|              |                              |
|--------------|------------------------------|
| <i>buf</i>   | Pointer to the target buffer |
| <i>count</i> | Number of instances to copy  |

## Exceptions

|                                  |                                          |
|----------------------------------|------------------------------------------|
| <b><i>MHA_Error</i></b> (p. 445) | when there is not enough data available. |
|----------------------------------|------------------------------------------|

Reimplemented in **mha\_fifo\_lw\_t< T >** (p. 449), and **mha\_drifter\_fifo\_t< T >** (p. 441).

5.152.4.3 `template<class T> unsigned mha_fifo_t< T >::get_fill_count ( ) const [virtual]`

Read-only access to `fill_count`.

Reimplemented in **mha\_drifter\_fifo\_t< T >** (p. 442).

5.152.4.4 `template<class T> unsigned mha_fifo_t< T >::get_available_space ( ) const`  
`[virtual]`

Read-only access to `available_space`.

Reimplemented in **mha\_drifter\_fifo\_t< T >** (p. 442).

5.152.4.5 `template<class T> virtual unsigned mha_fifo_t< T >::get_max_fill_count ( ) const`  
`[inline], [virtual]`

The capacity of this fifo.

5.152.4.6 `template<class T> mha_fifo_t< T > & mha_fifo_t< T >::operator= ( const mha_fifo_t< T > & src )`

Assignment operator.

5.152.4.7 `template<class T> void mha_fifo_t< T >::clear ( ) [inline],[protected]`

Empty the fifo at once.

Should be called by the reader, or when the reader is inactive.

### 5.152.5 Member Data Documentation

5.152.5.1 `template<class T> const unsigned mha_fifo_t< T >::max_fill_count [private]`

The maximum fill count of this FIFO.

5.152.5.2 `template<class T> T* mha_fifo_t< T >::buf [private]`

The memory allocated to store the data.

`max_fill_count + 1` locations are allocated: At least one location is always unused, because we have `max_fill_count + 1` possible fillcounts `[0:max_fill_count]` that we need to distinguish.

5.152.5.3 `template<class T> T* mha_fifo_t< T >::write_ptr [private]`

points to location where to write next

5.152.5.4 `template<class T> const T* mha_fifo_t< T >::read_ptr [private]`

points to location where to read next

5.152.5.5 `template<class T> bool mha_fifo_t< T >::buf_uses_placement_new [private]`

wether buf was allocated using placement new or array new.

The documentation for this class was generated from the following file:

- **mha\_fifo.h**

### 5.153 mha\_fifo\_thread\_guard\_t Class Reference

Simple Mutex Guard Class.



## Public Member Functions

- `mha_fifo_thread_guard_t(mha_fifo_thread_platform_t *sync)`
- `~mha_fifo_thread_guard_t()`

## Private Attributes

- `mha_fifo_thread_platform_t * sync`

## 5.153.1 Detailed Description

Simple Mutex Guard Class.

## 5.153.2 Constructor &amp; Destructor Documentation

5.153.2.1 `mha_fifo_thread_guard_t::mha_fifo_thread_guard_t(mha_fifo_thread_platform_t * sync)` `[inline]`

5.153.2.2 `mha_fifo_thread_guard_t::~~mha_fifo_thread_guard_t()` `[inline]`

## 5.153.3 Member Data Documentation

5.153.3.1 `mha_fifo_thread_platform_t * mha_fifo_thread_guard_t::sync` `[private]`

The documentation for this class was generated from the following file:

- `mha_fifo.h`

## 5.154 mha\_fifo\_thread\_platform\_t Class Reference

Abstract base class for synchronizing multithreaded (producer/consumer) fifo operations.

Inheritance diagram for `mha_fifo_thread_platform_t`:

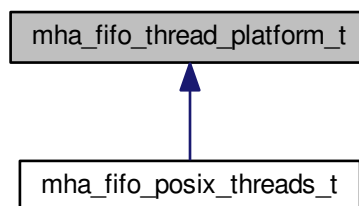

## Public Member Functions

- virtual void **acquire\_mutex** ()=0  
*Calling thread waits until it acquires the lock.*
- virtual void **release\_mutex** ()=0  
*Calling thread releases the lock.*
- virtual void **wait\_for\_decrease** ()=0  
*Calling producer thread must own the lock.*
- virtual void **wait\_for\_increase** ()=0  
*Calling consumer thread must own the lock.*
- virtual void **increment** ()=0  
*To be called by producer thread after producing.*
- virtual void **decrement** ()=0  
*To be called by consumer thread after consuming.*
- virtual **~mha\_fifo\_thread\_platform\_t** ()  
*Make destructor virtual.*
- **mha\_fifo\_thread\_platform\_t** ()  
*Make default constructor accessible.*

## Private Member Functions

- **mha\_fifo\_thread\_platform\_t** (const **mha\_fifo\_thread\_platform\_t** &)
- **mha\_fifo\_thread\_platform\_t** & **operator=** (const **mha\_fifo\_thread\_platform\_t** &)

### 5.154.1 Detailed Description

Abstract base class for synchronizing multithreaded (producer/consumer) fifo operations.

Works only with single producer and single consumer.

### 5.154.2 Constructor & Destructor Documentation

5.154.2.1 `virtual mha_fifo_thread_platform_t::~~mha_fifo_thread_platform_t( ) [inline], [virtual]`

Make destructor virtual.

5.154.2.2 `mha_fifo_thread_platform_t::mha_fifo_thread_platform_t( const mha_fifo_thread_platform_t & ) [private]`

5.154.2.3 `mha_fifo_thread_platform_t::mha_fifo_thread_platform_t( ) [inline]`

Make default constructor accessible.

### 5.154.3 Member Function Documentation

#### 5.154.3.1 virtual void mha\_fifo\_thread\_platform\_t::acquire\_mutex ( ) [pure virtual]

Calling thread waits until it acquires the lock.

Must not be called when the lock is already acquired.

Implemented in **mha\_fifo\_posix\_threads\_t** (p. 451).

#### 5.154.3.2 virtual void mha\_fifo\_thread\_platform\_t::release\_mutex ( ) [pure virtual]

Calling thread releases the lock.

May only be called when lock is owned.

Implemented in **mha\_fifo\_posix\_threads\_t** (p. 451).

#### 5.154.3.3 virtual void mha\_fifo\_thread\_platform\_t::wait\_for\_decrease ( ) [pure virtual]

Calling producer thread must own the lock.

Method releases lock, and waits for consumer thread to call decrease(). Then reacquires lock and returns

Implemented in **mha\_fifo\_posix\_threads\_t** (p. 451).

#### 5.154.3.4 virtual void mha\_fifo\_thread\_platform\_t::wait\_for\_increase ( ) [pure virtual]

Calling consumer thread must own the lock.

Method releases lock, and waits for producer thread to call increase(). Then reacquires lock and returns

Implemented in **mha\_fifo\_posix\_threads\_t** (p. 451).

#### 5.154.3.5 virtual void mha\_fifo\_thread\_platform\_t::increment ( ) [pure virtual]

To be called by producer thread after producing.

Producer thread needs to own the lock to call this method.

Implemented in **mha\_fifo\_posix\_threads\_t** (p. 451).

5.154.3.6 `virtual void mha_fifo_thread_platform_t::decrement ( ) [pure virtual]`

To be called by consumer thread after consuming.

Consumer thread needs to own the lock to call this method.

Implemented in `mha_fifo_posix_threads_t` (p. 451).

5.154.3.7 `mha_fifo_thread_platform_t& mha_fifo_thread_platform_t::operator= ( const mha_fifo_thread_platform_t & ) [private]`

The documentation for this class was generated from the following file:

- `mha_fifo.h`

## 5.155 `mha_real_test_array_t` Struct Reference

### Public Attributes

- `mha_real_t r [4]`

### 5.155.1 Member Data Documentation

5.155.1.1 `mha_real_t mha_real_test_array_t::r[4]`

The documentation for this struct was generated from the following file:

- `mha.hh`

## 5.156 `mha_rt_fifo_element_t< T >` Class Template Reference

Object wrapper for `mha_rt_fifo_t` (p. 462).

### Public Member Functions

- `mha_rt_fifo_element_t (T *data)`  
*Constructor.*
- `~mha_rt_fifo_element_t ()`

## Public Attributes

- `mha_rt_fifo_element_t< T > * next`  
Pointer to next fifo element. `NULL` for the last (newest) fifo element.
- `bool abandoned`  
Indicates that this element will no longer be used and may be deleted.
- `T * data`  
Pointer to user data.

## 5.156.1 Detailed Description

```
template<class T>
class mha_rt_fifo_element_t< T >
```

Object wrapper for `mha_rt_fifo_t` (p. 462).

## 5.156.2 Constructor &amp; Destructor Documentation

```
5.156.2.1 template<class T > mha_rt_fifo_element_t< T >::mha_rt_fifo_element_t(
           T * data ) [inline]
```

Constructor.

This element assumes ownership of user data.

## Parameters

|                   |                                                                                                                                               |
|-------------------|-----------------------------------------------------------------------------------------------------------------------------------------------|
| <code>data</code> | User data. Has to be allocated on the heap with standard operator <code>new</code> , because it will be deleted in this element's destructor. |
|-------------------|-----------------------------------------------------------------------------------------------------------------------------------------------|

```
5.156.2.2 template<class T > mha_rt_fifo_element_t< T >::~~mha_rt_fifo_element_t( )
           [inline]
```

## 5.156.3 Member Data Documentation

```
5.156.3.1 template<class T > mha_rt_fifo_element_t<T>* mha_rt_fifo_element_t< T >::next
```

Pointer to next fifo element. `NULL` for the last (newest) fifo element.

```
5.156.3.2 template<class T > bool mha_rt_fifo_element_t< T >::abandoned
```

Indicates that this element will no longer be used and may be deleted.

### 5.156.3.3 `template<class T> T* mha_rt_fifo_element_t< T >::data`

Pointer to user data.

The documentation for this class was generated from the following file:

- **mha\_fifo.h**

## 5.157 `mha_rt_fifo_t< T >` Class Template Reference

Template class for thread safe, half real time safe fifo without explicit locks.

### Public Member Functions

- **mha\_rt\_fifo\_t ()**  
*Construct empty fifo.*
- **~mha\_rt\_fifo\_t ()**  
*Destructor will delete all data currently in the fifo.*
- **T \* poll ()**  
*Retrieve the latest element in the Fifo.*
- **T \* poll\_1 ()**  
*Retrieve the next element in the Fifo, if there is one, and mark the previous element as abandoned.*
- **void push (T \*data)**  
*Add element to the Fifo.*

### Private Member Functions

- **void remove\_abandoned ()**  
*Deletes abandoned elements.*
- **void remove\_all ()**  
*Deletes all elements.*

### Private Attributes

- **mha\_rt\_fifo\_element\_t< T > \* root**  
*The first element in the fifo. Deleting elements starts here.*
- **mha\_rt\_fifo\_element\_t< T > \* current**  
*The element most recently returned by **poll** (p. 463) or **poll\_1** (p. 464).*

### 5.157.1 Detailed Description

```
template<class T>  
class mha_rt_fifo_t< T >
```

Template class for thread safe, half real time safe fifo without explicit locks.

Reading from this fifo is realtime safe, writing to it is not. This fifo is designed for objects that were constructed on the heap. It assumes ownership of these objects and calls delete on them when they are no longer used. Objects remain inside the Fifo while being used by the reader.

A new fifo element is inserted by using **push** (p. 464). The push operation is not real time safe, it allocates and deallocates memory. The latest element is retrieved by calling **poll** (p. 463). This operation will skip fifo elements if more than one **push** (p. 464) has been occurred since the last poll. To avoid skipping, call the **poll\_1** (p. 464) operation instead.

### 5.157.2 Constructor & Destructor Documentation

5.157.2.1 `template<class T > mha_rt_fifo_t< T >::mha_rt_fifo_t( ) [inline]`

Construct empty fifo.

5.157.2.2 `template<class T > mha_rt_fifo_t< T >::~~mha_rt_fifo_t( ) [inline]`

Destructor will delete all data currently in the fifo.

### 5.157.3 Member Function Documentation

5.157.3.1 `template<class T > T* mha_rt_fifo_t< T >::poll( ) [inline]`

Retrieve the latest element in the Fifo.

Will skip fifo elements if more than one element has been added since last poll invocation. Will return the same element as on last call if no elements have been added in the mean time. Marks former elements as abandoned.

#### Returns

The latest element in this Fifo. Returns NULL if the Fifo is empty.

5.157.3.2 `template<class T> T* mha_rt_fifo_t< T >::poll_1 ( ) [inline]`

Retrieve the next element in the Fifo, if there is one, and mark the previous element as abandoned.

Else, if there is no newer element, returns the same element as on last `poll()` (p. 463) or `poll_1()` (p. 464) invocation.

#### Returns

The next element in this Fifo, if there is one, or the same as before. Returns NULL if the Fifo is empty.

5.157.3.3 `template<class T> void mha_rt_fifo_t< T >::push ( T* data ) [inline]`

Add element to the Fifo.

Deletes abandoned elements in the fifo.

#### Parameters

|             |                                                                                                                                                                                                                                    |
|-------------|------------------------------------------------------------------------------------------------------------------------------------------------------------------------------------------------------------------------------------|
| <i>data</i> | The new user data to place at the end of the fifo. After this invocation, the fifo is the owner of this object and will delete it when it is no longer used. data must have been allocated on the heap with standard operator new. |
|-------------|------------------------------------------------------------------------------------------------------------------------------------------------------------------------------------------------------------------------------------|

5.157.3.4 `template<class T> void mha_rt_fifo_t< T >::remove_abandoned ( ) [inline], [private]`

Deletes abandoned elements.

5.157.3.5 `template<class T> void mha_rt_fifo_t< T >::remove_all ( ) [inline], [private]`

Deletes all elements.

#### 5.157.4 Member Data Documentation

5.157.4.1 `template<class T> mha_rt_fifo_element_t<T>* mha_rt_fifo_t< T >::root [private]`

The first element in the fifo. Deleting elements starts here.



5.157.4.2 `template<class T > mha_rt_fifo_element_t<T>* mha_rt_fifo_t< T >::current`  
`[private]`

The element most recently returned by **poll** (p. 463) or **poll\_1** (p. 464).

Searching for new elements starts here.

The documentation for this class was generated from the following file:

- **mha\_fifo.h**

## 5.158 mha\_spec\_t Struct Reference

Spectrum signal structure.

Inheritance diagram for `mha_spec_t`:

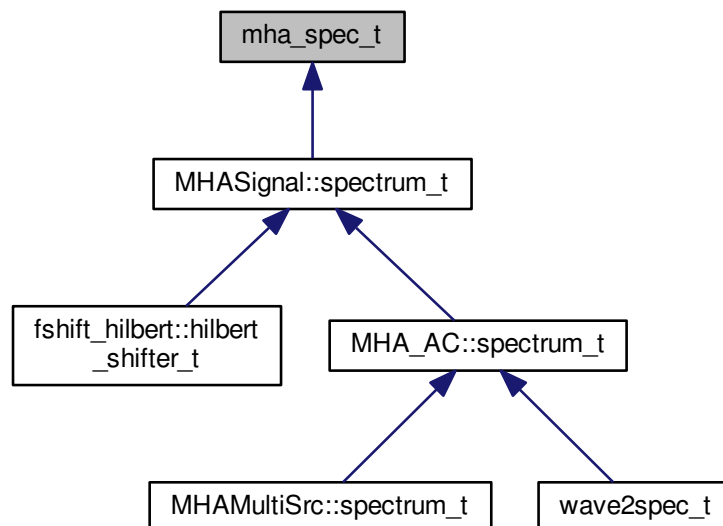

### Public Attributes

- **mha\_complex\_t \* buf**  
*signal buffer*
- unsigned int **num\_channels**  
*number of channels*
- unsigned int **num\_frames**  
*number of frames in each channel*
- **mha\_channel\_info\_t \* channel\_info**  
*detailed channel description*

### 5.158.1 Detailed Description

Spectrum signal structure.

This structure contains the short time fourier transform output of the windowed input signal. The member `num_frames` describes the number of frequency bins in each channel. For an even FFT length  $N$ , this is  $N/2 + 1$ . With odd FFT lengths, it is  $(N + 1)/2$ . The imaginary part of the first bin is zero. For even FFT lengths, also the imaginary part at the Nyquist frequency is zero.

|                        |         |         |         |         |         |     |             |           |
|------------------------|---------|---------|---------|---------|---------|-----|-------------|-----------|
| <code>buf[k].re</code> | $Re(0)$ | $Re(1)$ | $Re(2)$ | $Re(3)$ | $Re(4)$ | ... | $Re(n/2-1)$ | $Re(n/2)$ |
| <code>buf[k].im</code> |         | $Im(1)$ | $Im(2)$ | $Im(3)$ | $Im(4)$ | ... | $Im(n/2-1)$ |           |
| <code>k</code>         | 0       | 1       | 2       | 3       | 4       |     | $n/2-1$     | $n/2$     |

**Figure 4 Data order of FFT spectrum.**

### 5.158.2 Member Data Documentation

#### 5.158.2.1 `mha_complex_t* mha_spec_t::buf`

signal buffer

#### 5.158.2.2 `unsigned int mha_spec_t::num_channels`

number of channels

#### 5.158.2.3 `unsigned int mha_spec_t::num_frames`

number of frames in each channel

#### 5.158.2.4 `mha_channel_info_t* mha_spec_t::channel_info`

detailed channel description

The documentation for this struct was generated from the following file:

- `mha.hh`

### 5.159 `mha_stash_environment_variable_t` Class Reference

This class changes the value of an environment variable when constructed and restores the original state of the environment variable when destroyed.

## Public Member Functions

- **mha\_stash\_environment\_variable\_t** (const std::string &**variable\_name**, const std::string &**new\_content**)
- **~mha\_stash\_environment\_variable\_t** ()

## Private Attributes

- const bool **existed\_before**  
*Flag indicates if the environment variable existed before constructor.*
- const std::string **variable\_name**  
*Name of environment variable.*
- const std::string **original\_content**  
*Content of environment variable before constructor executed.*

### 5.159.1 Detailed Description

This class changes the value of an environment variable when constructed and restores the original state of the environment variable when destroyed.

Can be used for testing functionality related to environment variables.

**Todo** Move to collection of unit-test support classes when we have one.

### 5.159.2 Constructor & Destructor Documentation

5.159.2.1 **mha\_stash\_environment\_variable\_t::mha\_stash\_environment\_variable\_t** (const std::string & *variable\_name*, const std::string & *new\_content* ) [inline]

5.159.2.2 **mha\_stash\_environment\_variable\_t::~mha\_stash\_environment\_variable\_t** ( ) [inline]

### 5.159.3 Member Data Documentation

5.159.3.1 const bool **mha\_stash\_environment\_variable\_t::existed\_before** [private]

Flag indicates if the environment variable existed before constructor.

5.159.3.2 const std::string **mha\_stash\_environment\_variable\_t::variable\_name** [private]

Name of environment variable.

5.159.3.3 `const std::string mha_stash_environment_variable_t::original_content` [private]

Content of environment variable before constructor executed.

The documentation for this class was generated from the following file:

- `mha_os.h`

## 5.160 MHA\_TCP::Async\_Notify Class Reference

Portable Multiplexable cross-thread notification.

Inheritance diagram for MHA\_TCP::Async\_Notify:

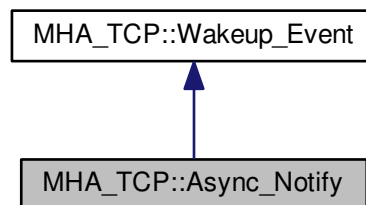

### Public Member Functions

- `Async_Notify ()`
- virtual void `reset ()`
- virtual void `set ()`
- virtual `~Async_Notify ()`

### Private Attributes

- int `pipe` [2]

### Additional Inherited Members

#### 5.160.1 Detailed Description

Portable Multiplexable cross-thread notification.

## 5.160.2 Constructor &amp; Destructor Documentation

5.160.2.1 Async\_Notify::Async\_Notify ( )

5.160.2.2 Async\_Notify::~Async\_Notify ( ) [virtual]

## 5.160.3 Member Function Documentation

5.160.3.1 void Async\_Notify::reset ( ) [virtual]

Reimplemented from **MHA\_TCP::Wakeup\_Event** (p. 495).

5.160.3.2 void Async\_Notify::set ( ) [virtual]

## 5.160.4 Member Data Documentation

5.160.4.1 int MHA\_TCP::Async\_Notify::pipe[2] [private]

The documentation for this class was generated from the following files:

- **mha\_tcp.hh**
- **mha\_tcp.cpp**

## 5.161 MHA\_TCP::Client Class Reference

A portable class for a tcp client connections.

Inheritance diagram for MHA\_TCP::Client:

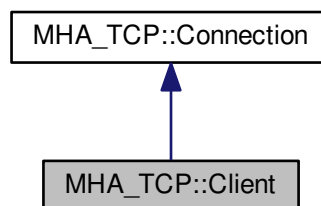

## Public Member Functions

- **Client** (const std::string &host, unsigned short port)  
*Constructor connects to host, port via TCP.*
- **Client** (const std::string &host, unsigned short port, **Timeout\_Watcher** &timeout\_↔  
watcher)  
*Constructor connects to host, port via TCP, using a timeout.*

## Additional Inherited Members

### 5.161.1 Detailed Description

A portable class for a tcp client connections.

### 5.161.2 Constructor & Destructor Documentation

#### 5.161.2.1 Client::Client ( const std::string & host, unsigned short port )

Constructor connects to host, port via TCP.

#### Parameters

|             |                                                 |
|-------------|-------------------------------------------------|
| <i>host</i> | The hostname of the TCP <b>Server</b> (p. 481). |
| <i>port</i> | The port or the TCP <b>Server</b> (p. 481).     |

#### 5.161.2.2 Client::Client ( const std::string & host, unsigned short port, **Timeout\_Watcher** & timeout\_watcher )

Constructor connects to host, port via TCP, using a timeout.

#### Parameters

|                        |                                                 |
|------------------------|-------------------------------------------------|
| <i>host</i>            | The hostname of the TCP <b>Server</b> (p. 481). |
| <i>port</i>            | The port or the TCP <b>Server</b> (p. 481).     |
| <i>timeout_watcher</i> | an Event watcher that implements a timeout.     |

The documentation for this class was generated from the following files:

- **mha\_tcp.hh**

- `mha_tcp.cpp`

## 5.162 MHA\_TCP::Connection Class Reference

**Connection** (p. 471) handles Communication between client and server, is used on both sides.

Inheritance diagram for MHA\_TCP::Connection:

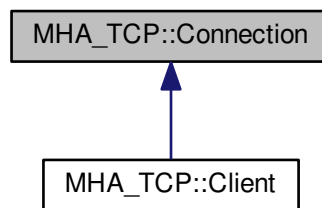

### Public Member Functions

- **Socketread\_Event \* get\_read\_event ()**
- **Socketwrite\_Event \* get\_write\_event ()**
- `std::string get_peer_address ()`  
*Get peer's IP Address.*
- `unsigned short get_peer_port ()`  
*Get peer's TCP port.*
- **SOCKET get\_fd () const**  
*Return the (protected) file descriptor of the connection.*
- `virtual ~Connection ()`  
*Destructor closes the underlying file descriptor.*
- `bool eof ()`  
*Checks if the peer has closed the connection.*
- `bool can_read_line (char delim= '\n')`  
*Checks if a full line of text has arrived by now.*
- `bool can_read_bytes (unsigned howmany)`  
*Checks if the specified ammount of data can be read.*
- `std::string read_line (char delim= '\n')`  
*Reads a single line of data from the socket.*
- `std::string read_bytes (unsigned howmany)`  
*Reads the specified ammount of dat from the socket.*
- `void try_write (const std::string &data="")`

*Adds data to the internal "outgoing" buffer, and then tries to write as much data from that buffer to the socket as possible without blocking.*

- void **write** (const std::string &data="")

*Adds data to the internal "outgoing" buffer, and then writes that that buffer to the socket, regardless of blocking.*

- bool **needs\_write** ()

*Checks if the internal "outgoing" buffer contains data.*

- unsigned **buffered\_incoming\_bytes** () const

*Returns the number of bytes in the internal "incoming" buffer.*

- unsigned **buffered\_outgoing\_bytes** () const

*Returns the number of bytes in the internal "outgoing" buffer.*

### Protected Member Functions

- **Connection (SOCKET \_fd)**

*Create a connection instance from a socket filedescriptor.*

### Protected Attributes

- **SOCKET fd**

*The file descriptor of the TCP Socket.*

### Private Member Functions

- void **init\_peer\_data** ()

*determine peer address and port*

- bool **can\_sysread** ()

*Determine wether at least 1 byte can be read without blocking.*

- bool **can\_syswrite** ()

*Determine wether at least 1 byte can be written without blocking.*

- std::string **sysread** (unsigned bytes)

*Call the system's read function and try to read bytes.*

- std::string **syswrite** (const std::string &data)

*Call the system's write function and try to write all characters in the string data.*

### Private Attributes

- std::string **outbuf**
- std::string **inbuf**
- **Sockread\_Event \* read\_event**
- **Sockwrite\_Event \* write\_event**
- bool **closed**
- struct sockaddr\_in **peer\_addr**



## 5.162.1 Detailed Description

**Connection** (p. 471) handles Communication between client and server, is used on both sides.

## 5.162.2 Constructor &amp; Destructor Documentation

5.162.2.1 MHA\_TCP::Connection::Connection (   
 SOCKET\_fd ) [protected]

Create a connection instance from a socket filedescriptor.

## Parameters

|                      |                                                                                                |
|----------------------|------------------------------------------------------------------------------------------------|
| ↔<br>_↔<br><i>fd</i> | The file descriptor of the TCP Socket. This file descriptor is closed again in the destructor. |
|----------------------|------------------------------------------------------------------------------------------------|

## Exceptions

|                           |                                |
|---------------------------|--------------------------------|
| <b>MHA_Error</b> (p. 445) | If the file descriptor is < 0. |
|---------------------------|--------------------------------|

## 5.162.2.2 Connection::~~Connection ( ) [virtual]

Destructor closes the underlying file descriptor.

## 5.162.3 Member Function Documentation

## 5.162.3.1 void MHA\_TCP::Connection::init\_peer\_data ( ) [private]

determine peer address and port

## 5.162.3.2 bool Connection::can\_sysread ( ) [private]

Determine whether at least 1 byte can be read without blocking.

## 5.162.3.3 bool Connection::can\_syswrite ( ) [private]

Determine whether at least 1 byte can be written without blocking.

5.162.3.4 std::string Connection::sysread (   
 unsigned bytes ) [private]

Call the system's read function and try to read bytes.

This will block in a situation where can\_sysread returns false.

**Parameters**

|              |                                   |
|--------------|-----------------------------------|
| <i>bytes</i> | The desired number of characters. |
|--------------|-----------------------------------|

**Returns**

The characters read from the socket. The result may have fewer characters than specified by bytes. If the result is an empty string, then the socket has been closed by the peer.

**5.162.3.5** `std::string Connection::syswrite (`  
`const std::string & data ) [private]`

Call the system's write function and try to write all characters in the string data.

May write fewer characters, but will at least write one character.

**Parameters**

|             |                                                |
|-------------|------------------------------------------------|
| <i>data</i> | A string of characters to write to the socket. |
|-------------|------------------------------------------------|

**Returns**

The rest of the characters that have not yet been written.

**5.162.3.6** `Socketread_Event * Connection::get_read_event ( )`

**5.162.3.7** `Socketwrite_Event * Connection::get_write_event ( )`

**5.162.3.8** `std::string Connection::get_peer_address ( )`

Get peer's IP Address.

**5.162.3.9** `unsigned short Connection::get_peer_port ( )`

Get peer's TCP port.

**5.162.3.10** `SOCKET MHA_TCP::Connection::get_fd ( ) const [inline]`

Return the (protected) file descriptor of the connection.

Will be required for SSL.

### 5.162.3.11 bool Connection::eof ( )

Checks if the peer has closed the connection.

As a side effect, this method fills the internal "incoming" buffer if it was empty and the socket is readable and not eof.

### 5.162.3.12 bool Connection::can\_read\_line ( char *delim* = '\n' )

Checks if a full line of text has arrived by now.

This method reads data from the socket into the internal "incoming" buffer if it can be done without blocking.

#### Parameters

|              |                     |
|--------------|---------------------|
| <i>delim</i> | The line delimiter. |
|--------------|---------------------|

#### Returns

true if at least one full line of text is present in the internal buffer after this method call, false otherwise.

### 5.162.3.13 bool Connection::can\_read\_bytes ( unsigned *howmany* )

Checks if the specified amount of data can be read.

This method reads data from the socket into an internal "incoming" buffer if it can be done without blocking.

#### Parameters

|                |                                                            |
|----------------|------------------------------------------------------------|
| <i>howmany</i> | The number of bytes that the caller wants to have checked. |
|----------------|------------------------------------------------------------|

#### Returns

true if at least the specified amount of data is present in the internal buffer after this method call, false otherwise

### 5.162.3.14 std::string Connection::read\_line ( char *delim* = '\n' )

Reads a single line of data from the socket.

Blocks if necessary.

**Parameters**

|              |                     |
|--------------|---------------------|
| <i>delim</i> | The line delimiter. |
|--------------|---------------------|

**Returns**

The string of characters in this line, including the trailing delimiter. The delimiter may be missing if the last line before EOF does not have a delimiter.

**5.162.3.15** `std::string Connection::read_bytes ( unsigned howmany )`

Reads the specified amount of data from the socket.

Blocks if necessary.

**Parameters**

|                |                              |
|----------------|------------------------------|
| <i>howmany</i> | The number of bytes to read. |
|----------------|------------------------------|

**Returns**

The string of characters read. The string may be shorter if EOF is encountered.

**5.162.3.16** `void Connection::try_write ( const std::string & data = " " )`

Adds data to the internal "outgoing" buffer, and then tries to write as much data from that buffer to the socket as possible without blocking.

**Parameters**

|             |                               |
|-------------|-------------------------------|
| <i>data</i> | data to send over the socket. |
|-------------|-------------------------------|

**5.162.3.17** `void Connection::write ( const std::string & data = " " )`

Adds data to the internal "outgoing" buffer, and then writes that that buffer to the socket, regardless of blocking.

**Parameters**

|             |                               |
|-------------|-------------------------------|
| <i>data</i> | data to send over the socket. |
|-------------|-------------------------------|

#### 5.162.3.18 `bool Connection::needs_write ( )`

Checks if the internal "outgoing" buffer contains data.

#### 5.162.3.19 `unsigned Connection::buffered_incoming_bytes ( ) const`

Returns the number of bytes in the internal "incoming" buffer.

#### 5.162.3.20 `unsigned Connection::buffered_outgoing_bytes ( ) const`

Returns the number of bytes in the internal "outgoing" buffer.

### 5.162.4 Member Data Documentation

#### 5.162.4.1 `std::string MHA_TCP::Connection::outbuf` [private]

#### 5.162.4.2 `std::string MHA_TCP::Connection::inbuf` [private]

#### 5.162.4.3 `Socketread_Event* MHA_TCP::Connection::read_event` [private]

#### 5.162.4.4 `Socketwrite_Event* MHA_TCP::Connection::write_event` [private]

#### 5.162.4.5 `bool MHA_TCP::Connection::closed` [private]

#### 5.162.4.6 `struct sockaddr_in MHA_TCP::Connection::peer_addr` [private]

#### 5.162.4.7 `SOCKET MHA_TCP::Connection::fd` [protected]

The file descriptor of the TCP Socket.

The documentation for this class was generated from the following files:

- `mha_tcp.hh`
- `mha_tcp.cpp`

### 5.163 MHA\_TCP::Event\_Watcher Class Reference

OS-independent event watcher, uses select on Unix and WaitForMultipleObjects on Windows.

Inheritance diagram for MHA\_TCP::Event\_Watcher:

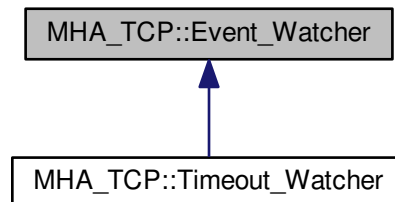

#### Public Types

- typedef **std::set**< **Wakeup\_Event** \* > **Events**
- typedef **std::set**< **Wakeup\_Event** \* >::iterator **iterator**

#### Public Member Functions

- void **observe** (**Wakeup\_Event** \*event)  
*Add an event to this observer.*
- void **ignore** (**Wakeup\_Event** \*event)  
*Remove an event from this observer.*
- **std::set**< **Wakeup\_Event** \* > **wait** ()  
*Wait for some event to occur.*
- virtual **~Event\_Watcher** ()

#### Private Attributes

- **std::set**< **Wakeup\_Event** \* > **events**  
*The list of events to watch.*

#### 5.163.1 Detailed Description

OS-independent event watcher, uses select on Unix and WaitForMultipleObjects on Windows.

### 5.163.2 Member Typedef Documentation

5.163.2.1 `typedef std::set<Wakeup_Event*> MHA_TCP::Event_Watcher::Events`

5.163.2.2 `typedef std::set<Wakeup_Event*>::iterator MHA_TCP::Event_Watcher::iterator`

### 5.163.3 Constructor & Destructor Documentation

5.163.3.1 `Event_Watcher::~Event_Watcher ( ) [virtual]`

### 5.163.4 Member Function Documentation

5.163.4.1 `void Event_Watcher::observe ( Wakeup_Event * event )`

Add an event to this observer.

5.163.4.2 `void Event_Watcher::ignore ( Wakeup_Event * event )`

Remove an event from this observer.

5.163.4.3 `std::set< Wakeup_Event * > Event_Watcher::wait ( )`

\ Wait for some event to occur.

Return all events that are ready

### 5.163.5 Member Data Documentation

5.163.5.1 `std::set<Wakeup_Event*> MHA_TCP::Event_Watcher::events [private]`

The list of events to watch.

The documentation for this class was generated from the following files:

- `mha_tcp.hh`
- `mha_tcp.cpp`

## 5.164 MHA\_TCP::OS\_EVENT\_TYPE Struct Reference

### Public Types

### Public Attributes

- enum MHA\_TCP::OS\_EVENT\_TYPE:: { ... } **mode**
- union {
  - int **fd**
  - double **timeout**

### 5.164.1 Member Enumeration Documentation

#### 5.164.1.1 anonymous enum

#### Enumerator

***R***

***W***

***X***

***T***

### 5.164.2 Member Data Documentation

#### 5.164.2.1 enum { ... } MHA\_TCP::OS\_EVENT\_TYPE::mode

#### 5.164.2.2 int MHA\_TCP::OS\_EVENT\_TYPE::fd

#### 5.164.2.3 double MHA\_TCP::OS\_EVENT\_TYPE::timeout

#### 5.164.2.4 union { ... }

The documentation for this struct was generated from the following file:

- **mha\_tcp.hh**



## 5.165 MHA\_TCP::Server Class Reference

## Public Member Functions

- **Server** (unsigned short **port**=0, const std::string &**iface**="0.0.0.0")  
*Create a TCP server socket.*
- **Server** (const std::string &**iface**, unsigned short **port**=0)  
*Create a TCP server socket.*
- **~Server** ()  
*Close the TCP server socket.*
- std::string **get\_interface** () const  
*Get the name given in the constructor for the network interface.*
- unsigned short **get\_port** () const  
*Get the port that the TCP server socket currently listens to.*
- **SocketAccept\_Event \* get\_accept\_event** ()  
*Produces an event that can be observed by an **Event\_Watcher** (p. 478).*
- **Connection \* accept** ()  
*Accept an incoming connection.*
- **Connection \* try\_accept** ()  
*Accept an incoming connection if it can be done without blocking.*

## Private Member Functions

- void **initialize** (const std::string &**iface**, unsigned short **port**)

## Private Attributes

- sockaddr\_in **sock\_addr**
- **SOCKET serversocket**
- std::string **iface**
- unsigned short **port**
- **SocketAccept\_Event \* accept\_event**

## 5.165.1 Constructor &amp; Destructor Documentation

5.165.1.1 **Server::Server** (  
    unsigned short **port** = 0,  
    const std::string & **iface** = "0.0.0.0" )

Create a TCP server socket.

**Parameters**

|              |                                   |
|--------------|-----------------------------------|
| <i>port</i>  | The TCP port to listen to.        |
| <i>iface</i> | The network interface to bind to. |

**5.165.1.2** `Server::Server (`  
     `const std::string & iface,`  
     `unsigned short port = 0 )`

Create a TCP server socket.

**Parameters**

|              |                                   |
|--------------|-----------------------------------|
| <i>port</i>  | The TCP port to listen to.        |
| <i>iface</i> | The network interface to bind to. |

**5.165.1.3** `Server::~~Server ( )`

Close the TCP server socket.

**5.165.2 Member Function Documentation**

**5.165.2.1** `void Server::initialize (`  
     `const std::string & iface,`  
     `unsigned short port ) [private]`

**5.165.2.2** `std::string Server::get_interface ( ) const`

Get the name given in the constructor for the network interface.

**5.165.2.3** `unsigned short Server::get_port ( ) const`

Get the port that the TCP server socket currently listens to.

**5.165.2.4** `Sockaccept_Event * Server::get_accept_event ( )`

Produces an event that can be observed by an **Event\_Watcher** (p. 478).

This event signals incoming connections that can be accepted.

### 5.165.2.5 Connection \* Server::accept ( )

Accept an incoming connection.

blocks if necessary.

#### Returns

The new TCP connection. The connection has to be deleted by the caller.

### 5.165.2.6 Connection \* Server::try\_accept ( )

Accept an incoming connection if it can be done without blocking.

#### Returns

The new TCP connection or 0 if there is no immediate connection. The connection has to be deleted by the caller.

## 5.165.3 Member Data Documentation

5.165.3.1 sockaddr\_in MHA\_TCP::Server::sock\_addr [private]

5.165.3.2 SOCKET MHA\_TCP::Server::serversocket [private]

5.165.3.3 std::string MHA\_TCP::Server::iface [private]

5.165.3.4 unsigned short MHA\_TCP::Server::port [private]

5.165.3.5 Sockaccept\_Event\* MHA\_TCP::Server::accept\_event [private]

The documentation for this class was generated from the following files:

- mha\_tcp.hh
- mha\_tcp.cpp

## 5.166 MHA\_TCP::sock\_init\_t Class Reference

### Public Member Functions

- sock\_init\_t ()

### 5.166.1 Constructor & Destructor Documentation

#### 5.166.1.1 MHA\_TCP::sock\_init\_t::sock\_init\_t( ) [inline]

The documentation for this class was generated from the following file:

- **mha\_tcp.cpp**

### 5.167 MHA\_TCP::Sockaccept\_Event Class Reference

Inheritance diagram for MHA\_TCP::Sockaccept\_Event:

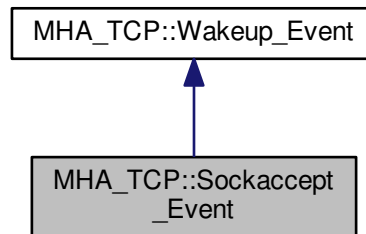

#### Public Member Functions

- **Sockaccept\_Event (SOCKET)**

#### Additional Inherited Members

### 5.167.1 Constructor & Destructor Documentation

#### 5.167.1.1 MHA\_TCP::Sockaccept\_Event::Sockaccept\_Event (SOCKET s )

The documentation for this class was generated from the following files:

- **mha\_tcp.hh**
- **mha\_tcp.cpp**

## 5.168 MHA\_TCP::Sockread\_Event Class Reference

Watch socket for incoming data.

Inheritance diagram for MHA\_TCP::Sockread\_Event:

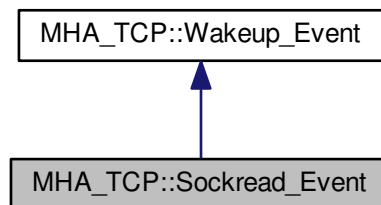

#### Public Member Functions

- **Sockread\_Event (SOCKET s)**

*Set socket to watch for.*

#### Additional Inherited Members

##### 5.168.1 Detailed Description

Watch socket for incoming data.

##### 5.168.2 Constructor & Destructor Documentation

###### 5.168.2.1 MHA\_TCP::Sockread\_Event::Sockread\_Event (SOCKET s )

Set socket to watch for.

#### Parameters

|   |                                         |
|---|-----------------------------------------|
| s | The socket to observe incoming data on. |
|---|-----------------------------------------|

The documentation for this class was generated from the following files:

- **mha\_tcp.hh**
- **mha\_tcp.cpp**

### 5.169 MHA\_TCP::Sockwrite\_Event Class Reference

Inheritance diagram for MHA\_TCP::Sockwrite\_Event:

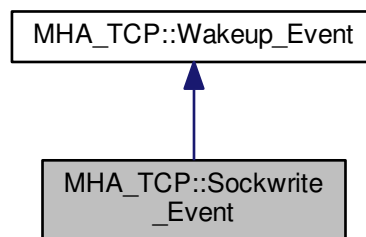

#### Public Member Functions

- **Sockwrite\_Event (SOCKET s)**

#### Additional Inherited Members

#### 5.169.1 Constructor & Destructor Documentation

##### 5.169.1.1 MHA\_TCP::Sockwrite\_Event::Sockwrite\_Event (SOCKET s)

The documentation for this class was generated from the following files:

- **mha\_tcp.hh**
- **mha\_tcp.cpp**

### 5.170 MHA\_TCP::Thread Class Reference

A very simple class for portable threads.

## Public Types

- typedef void (\*)(**thr\_f**) (void \*)  
*The thread function signature to use with this class.*

## Public Member Functions

- **Thread** (**thr\_f** func, void \***arg**=0)  
*Constructor starts a new thread.*
- virtual ~**Thread** ()  
*The destructor should only be called when the **Thread** (p. 486) is finished.*
- virtual void **run** ()  
*The internal method that delegated the new thread to the registered **Thread** (p. 486) function.*

## Public Attributes

- **Async\_Notify thread\_finish\_event**  
*Event will be triggered when the thread exits.*
- enum MHA\_TCP::Thread:: { ... } **state**  
*The current state of the thread.*
- **thr\_f thread\_func**  
*The thread function that the client has registered.*
- void \* **thread\_arg**  
*The argument that the client wants to be handed through to the thread function.*
- **MHA\_Error \* error**  
*The **MHA\_Error** (p. 445) that caused the thread to abort, if any.*

## Protected Member Functions

- **Thread** ()  
*Default constructor may only be used by derived classes that want to start the thread themselves.*

## Protected Attributes

- void \* **arg**  
*The argument for the client's thread function.*
- void \* **return\_value**  
*The return value from the client's thread function is stored here When that function returns.*

## Private Attributes

- `pthread_t` **thread\_handle**  
*The posix thread handle.*
- `pthread_attr_t` **thread\_attr**  
*The posix thread attribute structure.*

### 5.170.1 Detailed Description

A very simple class for portable threads.

### 5.170.2 Member Typedef Documentation

#### 5.170.2.1 `typedef void*(* MHA_TCP::Thread::thr_f)(void *)`

The thread function signature to use with this class.

Derive from this class and call protected standard constructor to start threads differently.

### 5.170.3 Member Enumeration Documentation

#### 5.170.3.1 anonymous enum

The current state of the thread.

#### Enumerator

***PREPARED***  
***RUNNING***  
***FINISHED***

### 5.170.4 Constructor & Destructor Documentation

#### 5.170.4.1 `MHA_TCP::Thread::Thread ( )` [protected]

Default constructor may only be used by derived classes that want to start the thread themselves.

#### 5.170.4.2 `Thread::Thread (` `Thread::thr_f func,` `void * arg = 0 )`

Constructor starts a new thread.



## Parameters

|             |                                                    |
|-------------|----------------------------------------------------|
| <i>func</i> | The function to be executed by the thread.         |
| <i>arg</i>  | The argument given to pass to the thread function. |

## 5.170.4.3 Thread::~~Thread ( ) [virtual]

The destructor should only be called when the **Thread** (p. 486) is finished.

There is preliminary support for forceful thread cancellation in the destructor, but probably not very robust or portable..

## 5.170.5 Member Function Documentation

## 5.170.5.1 void Thread::run ( ) [virtual]

The internal method that delegated the new thread to the registered **Thread** (p. 486) function.

## 5.170.6 Member Data Documentation

## 5.170.6.1 pthread\_t MHA\_TCP::Thread::thread\_handle [private]

The posix thread handle.

## 5.170.6.2 pthread\_attr\_t MHA\_TCP::Thread::thread\_attr [private]

The posix thread attribute structure.

Required for starting a thread in detached state. Detachment is required to eliminate the need for joining this thread.

## 5.170.6.3 void\* MHA\_TCP::Thread::arg [protected]

The argument for the client's thread function.

## 5.170.6.4 void\* MHA\_TCP::Thread::return\_value [protected]

The return value from the client's thread function is stored here When that function returns.

## 5.170.6.5 Async\_Notify MHA\_TCP::Thread::thread\_finish\_event

Event will be triggered when the thread exits.

#### 5.170.6.6 `enum { ... } MHA_TCP::Thread::state`

The current state of the thread.

#### 5.170.6.7 `thr_f MHA_TCP::Thread::thread_func`

The thread function that the client has registered.

#### 5.170.6.8 `void* MHA_TCP::Thread::thread_arg`

The argument that the client wants to be handed through to the thread function.

#### 5.170.6.9 `MHA_Error* MHA_TCP::Thread::error`

The **MHA\_Error** (p. 445) that caused the thread to abort, if any.

The documentation for this class was generated from the following files:

- `mha_tcp.hh`
- `mha_tcp.cpp`

### 5.171 MHA\_TCP::Timeout\_Event Class Reference

Inheritance diagram for MHA\_TCP::Timeout\_Event:

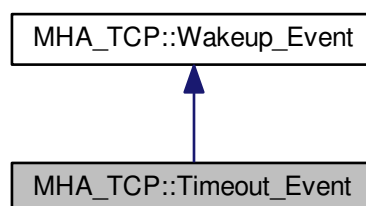

#### Public Member Functions

- **Timeout\_Event** (double interval)
- virtual **OS\_EVENT\_TYPE get\_os\_event** ()

### Private Attributes

- double **end\_time**

### Additional Inherited Members

#### 5.171.1 Constructor & Destructor Documentation

5.171.1.1 Timeout\_Event::Timeout\_Event (   
double *interval* )

#### 5.171.2 Member Function Documentation

5.171.2.1 OS\_EVENT\_TYPE Timeout\_Event::get\_os\_event ( ) [virtual]

Reimplemented from **MHA\_TCP::Wakeup\_Event** (p. 494).

#### 5.171.3 Member Data Documentation

5.171.3.1 double MHA\_TCP::Timeout\_Event::end\_time [private]

The documentation for this class was generated from the following files:

- **mha\_tcp.hh**
- **mha\_tcp.cpp**

## 5.172 MHA\_TCP::Timeout\_Watcher Class Reference

OS-independent event watcher with internal fixed-end-time timeout.

Inheritance diagram for MHA\_TCP::Timeout\_Watcher:

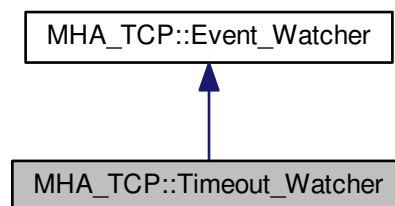

## Public Member Functions

- **Timeout\_Watcher** (double interval)
- virtual **~Timeout\_Watcher** ()

## Private Attributes

- **Timeout\_Event** timeout

## Additional Inherited Members

### 5.172.1 Detailed Description

OS-independent event watcher with internal fixed-end-time timeout.

### 5.172.2 Constructor & Destructor Documentation

5.172.2.1 **Timeout\_Watcher::Timeout\_Watcher** (  
    double *interval* ) [explicit]

5.172.2.2 **Timeout\_Watcher::~~Timeout\_Watcher** ( ) [virtual]

### 5.172.3 Member Data Documentation

5.172.3.1 **Timeout\_Event** MHA\_TCP::Timeout\_Watcher::timeout [private]

The documentation for this class was generated from the following files:

- **mha\_tcp.hh**
- **mha\_tcp.cpp**

## 5.173 MHA\_TCP::Wakeup\_Event Class Reference

A base class for asynchronous wakeup events.

Inheritance diagram for MHA\_TCP::Wakeup\_Event:

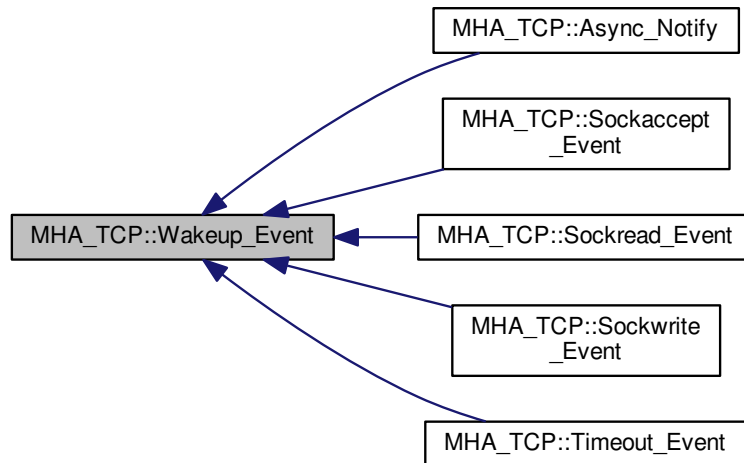

## Public Member Functions

- **Wakeup\_Event ()**  
*Event Constructor.*
- virtual void **observed\_by (Event\_Watcher \*observer)**  
*Called by the **Event\_Watcher** (p. 478) when this event is added to its list of observed events.*
- virtual void **ignored\_by (Event\_Watcher \*observer)**  
*Called by the **Event\_Watcher** (p. 478) when this event is removed from its list of observed events.*
- virtual **~Wakeup\_Event ()**  
*Destructor deregisters from observers.*
- virtual **OS\_EVENT\_TYPE get\_os\_event ()**  
*Get necessary information for the Event Watcher.*
- virtual void **reset ()**  
*For pure notification events, reset the "signalled" status.*
- virtual bool **status ()**  
*Query whether the event is in signalled state now.*

## Protected Attributes

- **OS\_EVENT\_TYPE os\_event**
- bool **os\_event\_valid**

## Private Attributes

- **std::set**< class **Event\_Watcher** \* > **observers**

*A list of all **Event\_Watcher** (p. 478) instances that this **Wakeup\_Event** (p. 493) is observed by (stored here for proper deregistering).*

### 5.173.1 Detailed Description

A base class for asynchronous wakeup events.

### 5.173.2 Constructor & Destructor Documentation

#### 5.173.2.1 **Wakeup\_Event::Wakeup\_Event** ( )

Event Constructor.

The new event has invalid state.

#### 5.173.2.2 **Wakeup\_Event::~~Wakeup\_Event** ( ) [virtual]

Destructor deregisters from observers.

### 5.173.3 Member Function Documentation

#### 5.173.3.1 **void Wakeup\_Event::observed\_by** ( **Event\_Watcher** \* *observer* ) [virtual]

Called by the **Event\_Watcher** (p. 478) when this event is added to its list of observed events.

#### 5.173.3.2 **void Wakeup\_Event::ignored\_by** ( **Event\_Watcher** \* *observer* ) [virtual]

Called by the **Event\_Watcher** (p. 478) when this event is removed from its list of observed events.

#### 5.173.3.3 **OS\_EVENT\_TYPE Wakeup\_Event::get\_os\_event** ( ) [virtual]

Get necessary information for the Event Watcher.

Reimplemented in **MHA\_TCP::Timeout\_Event** (p. 491).

5.173.3.4 void Wakeup\_Event::reset ( ) [virtual]

For pure notification events, reset the "signalled" status.

Reimplemented in **MHA\_TCP::Async\_Notify** (p. 469).

5.173.3.5 bool Wakeup\_Event::status ( ) [virtual]

Query whether the event is in signalled state now.

#### 5.173.4 Member Data Documentation

5.173.4.1 std::set<class Event\_Watcher \*> MHA\_TCP::Wakeup\_Event::observers [private]

A list of all **Event\_Watcher** (p. 478) instances that this **Wakeup\_Event** (p. 493) is observed by (stored here for proper deregistering).

5.173.4.2 OS\_EVENT\_TYPE MHA\_TCP::Wakeup\_Event::os\_event [protected]

5.173.4.3 bool MHA\_TCP::Wakeup\_Event::os\_event\_valid [protected]

The documentation for this class was generated from the following files:

- **mha\_tcp.hh**
- **mha\_tcp.cpp**

## 5.174 mha\_tictoc\_t Struct Reference

### Public Attributes

- struct timeval **tv1**
- struct timeval **tv2**
- struct timezone **tz**
- float **t**

#### 5.174.1 Member Data Documentation

5.174.1.1 struct timeval mha\_tictoc\_t::tv1

5.174.1.2 struct timeval mha\_tictoc\_t::tv2

5.174.1.3 struct timezone mha\_tictoc\_t::tz

5.174.1.4 float mha\_tictoc\_t::t

The documentation for this struct was generated from the following file:

- **mha\_profiling.h**

## 5.175 mha\_wave\_t Struct Reference

Waveform signal structure.

Inheritance diagram for mha\_wave\_t:

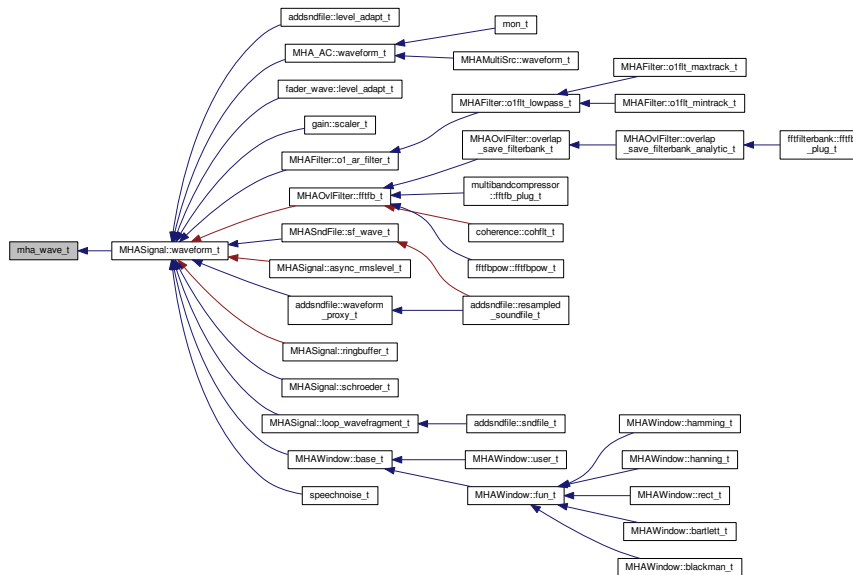

### Public Attributes

- **mha\_real\_t \* buf**  
*signal buffer*
- unsigned int **num\_channels**  
*number of channels*
- unsigned int **num\_frames**  
*number of frames in each channel*
- **mha\_channel\_info\_t \* channel\_info**  
*detailed channel description*

### 5.175.1 Detailed Description

Waveform signal structure.

This structure contains one fragment of a waveform signal. The member num\_frames describes the number of audio samples in each audio channel.

The field channel\_info must be an array of num\_channels entries or NULL.



## 5.175.2 Member Data Documentation

## 5.175.2.1 mha\_real\_t\* mha\_wave\_t::buf

signal buffer

## 5.175.2.2 unsigned int mha\_wave\_t::num\_channels

number of channels

## 5.175.2.3 unsigned int mha\_wave\_t::num\_frames

number of frames in each channel

## 5.175.2.4 mha\_channel\_info\_t\* mha\_wave\_t::channel\_info

detailed channel description

The documentation for this struct was generated from the following file:

- **mha.hh**

## 5.176 mhachain::chain\_base\_t Class Reference

Inheritance diagram for mhachain::chain\_base\_t:

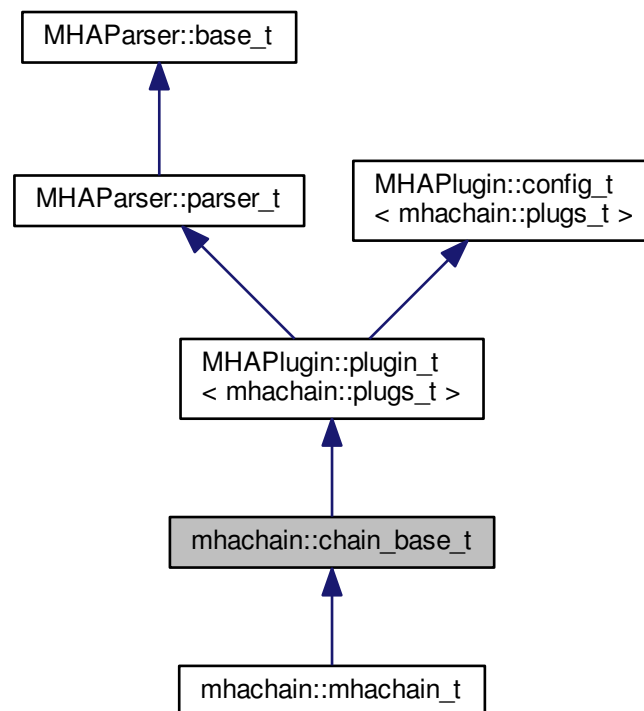

## Public Member Functions

- **chain\_base\_t** (**algo\_comm\_t**, const std::string &, const std::string &)
- void **process** (**mha\_wave\_t** \*, **mha\_wave\_t** \*\*)
- void **process** (**mha\_spec\_t** \*, **mha\_wave\_t** \*\*)
- void **process** (**mha\_wave\_t** \*, **mha\_spec\_t** \*\*)
- void **process** (**mha\_spec\_t** \*, **mha\_spec\_t** \*\*)
- void **prepare** (**mhaconfig\_t** &)
- void **release** ()

## Protected Attributes

- **MHAParser::bool\_t** **bprofiling**
- **MHAParser::vstring\_t** **algos**

## Private Member Functions

- void **update** ()

## Private Attributes

- std::vector< std::string > **old\_algos**
- **MHAEvents::patchbay\_t**< **mhachain::chain\_base\_t** > **patchbay**
- **mhaconfig\_t** **cfin**
- **mhaconfig\_t** **cfout**
- bool **b\_prepared**
- std::string **chain**

## Additional Inherited Members

### 5.176.1 Constructor & Destructor Documentation

5.176.1.1 **mhachain::chain\_base\_t::chain\_base\_t** (  
     **algo\_comm\_t** *iac*,  
     const std::string & *ichain*,  
     const std::string & *ialgo* )

### 5.176.2 Member Function Documentation

5.176.2.1 void **mhachain::chain\_base\_t::process** (  
     **mha\_wave\_t** \* *sin*,  
     **mha\_wave\_t** \*\* *sout* )

5.176.2.2 void mhachain::chain\_base\_t::process (   
 mha\_spec\_t \* *sin*,   
 mha\_wave\_t \*\* *sout* )

5.176.2.3 void mhachain::chain\_base\_t::process (   
 mha\_wave\_t \* *sin*,   
 mha\_spec\_t \*\* *sout* )

5.176.2.4 void mhachain::chain\_base\_t::process (   
 mha\_spec\_t \* *sin*,   
 mha\_spec\_t \*\* *sout* )

5.176.2.5 void mhachain::chain\_base\_t::prepare (   
 mhaconfig\_t & *cf* ) [virtual]

Implements **MHAPLugin::plugin\_t**< **mhachain::plugs\_t** > (p. 730).

5.176.2.6 void mhachain::chain\_base\_t::release (   
 void ) [virtual]

Reimplemented from **MHAPLugin::plugin\_t**< **mhachain::plugs\_t** > (p. 731).

5.176.2.7 void mhachain::chain\_base\_t::update ( ) [private]

### 5.176.3 Member Data Documentation

5.176.3.1 **MHAParser::bool\_t** mhachain::chain\_base\_t::bprofiling [protected]

5.176.3.2 **MHAParser::vstring\_t** mhachain::chain\_base\_t::algos [protected]

5.176.3.3 **std::vector<std::string>** mhachain::chain\_base\_t::old\_algos [private]

5.176.3.4 **MHAEvents::patchbay\_t**< **mhachain::chain\_base\_t** >   
 mhachain::chain\_base\_t::patchbay [private]

5.176.3.5 **mhaconfig\_t** mhachain::chain\_base\_t::cfin [private]

5.176.3.6 **mhaconfig\_t** mhachain::chain\_base\_t::cfout [private]

5.176.3.7 **bool** mhachain::chain\_base\_t::b\_prepared [private]

5.176.3.8 **std::string** mhachain::chain\_base\_t::chain [private]

The documentation for this class was generated from the following files:

- **mha\_generic\_chain.h**
- **mha\_generic\_chain.cpp**

## 5.177 mhachain::mhachain\_t Class Reference

Inheritance diagram for mhachain::mhachain\_t:

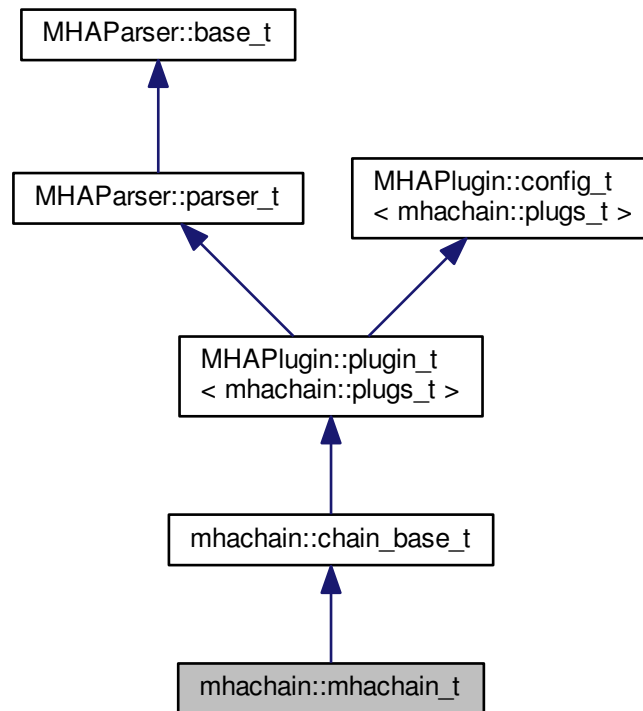

### Public Member Functions

- **mhachain\_t** (**algo\_comm\_t** iac, const std::string &ichain, const std::string &ialgo)

### Additional Inherited Members

#### 5.177.1 Constructor & Destructor Documentation

5.177.1.1 mhachain::mhachain\_t::mhachain\_t (  
**algo\_comm\_t** iac,  
 const std::string & *ichain*,  
 const std::string & *ialgo* )

The documentation for this class was generated from the following file:

- **mhachain.cpp**

## 5.178 mhachain::plugs\_t Class Reference

## Public Member Functions

- **plugs\_t** (std::vector< std::string > **algos**, **mhaconfig\_t** cfin, **mhaconfig\_t** cfout, bool do\_prepare, **MHAParser::parser\_t** &p, **algo\_comm\_t** iac, std::string ichain, bool use\_↔profiling)
- ~**plugs\_t** ()
- void **prepare** (**mhaconfig\_t** &)
- void **release** ()
- void **process** (**mha\_wave\_t** \*, **mha\_spec\_t** \*, **mha\_wave\_t** \*\*, **mha\_spec\_t** \*\*)
- bool **prepared** () const

## Private Member Functions

- void **alloc\_plugs** (std::vector< std::string > **algos**)
- void **cleanup\_plugs** ()
- void **update\_proc\_load** ()

## Private Attributes

- bool **b\_prepared**
- std::vector< **PluginLoader::mhapluginloader\_t** \* > **algos**
- **MHAParser::parser\_t** & **parser**
- **algo\_comm\_t** **ac**
- std::string **chain**
- **MHAParser::parser\_t** **profiling**
- **MHAParser::vstring\_mon\_t** **prof\_algos**
- **MHAParser::vfloat\_mon\_t** **prof\_init**
- **MHAParser::vfloat\_mon\_t** **prof\_prepare**
- **MHAParser::vfloat\_mon\_t** **prof\_release**
- **MHAParser::vfloat\_mon\_t** **prof\_process**
- **MHAParser::float\_mon\_t** **prof\_process\_tt**
- **MHAParser::vfloat\_mon\_t** **prof\_process\_load**
- unsigned int **proc\_cnt**
- **mhaconfig\_t** **prof\_cfg**
- **MHAEvents::connector\_t**< **mhachain::plugs\_t** > **prof\_load\_con**
- **MHAEvents::connector\_t**< **mhachain::plugs\_t** > **prof\_tt\_con**
- bool **b\_use\_profiling**
- **mha\_platform\_tictoc\_t** **tictoc**

### 5.178.1 Constructor & Destructor Documentation

5.178.1.1 `mhachain::plugs_t::plugs_t (`  
     `std::vector< std::string > algos,`  
     `mhaconfig_t cfin,`  
     `mhaconfig_t cfout,`  
     `bool do_prepare,`  
     `MHAParser::parser_t & p,`  
     `algo_comm_t iac,`  
     `std::string ichain,`  
     `bool use_profiling )`

5.178.1.2 `mhachain::plugs_t::~~plugs_t ( )`

### 5.178.2 Member Function Documentation

5.178.2.1 `void mhachain::plugs_t::prepare (`  
     `mhaconfig_t & tf )`

5.178.2.2 `void mhachain::plugs_t::release (`  
     `void )`

5.178.2.3 `void mhachain::plugs_t::process (`  
     `mha_wave_t * win,`  
     `mha_spec_t * sin,`  
     `mha_wave_t ** wout,`  
     `mha_spec_t ** sout )`

5.178.2.4 `bool mhachain::plugs_t::prepared ( ) const` [inline]

5.178.2.5 `void mhachain::plugs_t::alloc_plugs (`  
     `std::vector< std::string > algos )` [private]

5.178.2.6 `void mhachain::plugs_t::cleanup_plugs ( )` [private]

5.178.2.7 `void mhachain::plugs_t::update_proc_load ( )` [private]

### 5.178.3 Member Data Documentation

5.178.3.1 `bool mhachain::plugs_t::b_prepared` [private]

5.178.3.2 `std::vector< PluginLoader::mhapluginloader_t* > mhachain::plugs_t::alogs`  
     [private]

5.178.3.3 `MHAParser::parser_t & mhachain::plugs_t::parser` [private]

- 5.178.3.4 `algo_comm_t` `mhachain::plugs_t::ac` [private]
- 5.178.3.5 `std::string` `mhachain::plugs_t::chain` [private]
- 5.178.3.6 `MHAParser::parser_t` `mhachain::plugs_t::profiling` [private]
- 5.178.3.7 `MHAParser::vstring_mon_t` `mhachain::plugs_t::prof_algos` [private]
- 5.178.3.8 `MHAParser::vfloat_mon_t` `mhachain::plugs_t::prof_init` [private]
- 5.178.3.9 `MHAParser::vfloat_mon_t` `mhachain::plugs_t::prof_prepare` [private]
- 5.178.3.10 `MHAParser::vfloat_mon_t` `mhachain::plugs_t::prof_release` [private]
- 5.178.3.11 `MHAParser::vfloat_mon_t` `mhachain::plugs_t::prof_process` [private]
- 5.178.3.12 `MHAParser::float_mon_t` `mhachain::plugs_t::prof_process_tt` [private]
- 5.178.3.13 `MHAParser::vfloat_mon_t` `mhachain::plugs_t::prof_process_load` [private]
- 5.178.3.14 `unsigned int` `mhachain::plugs_t::proc_cnt` [private]
- 5.178.3.15 `mhaconfig_t` `mhachain::plugs_t::prof_cfg` [private]
- 5.178.3.16 `MHAEvents::connector_t<mhachain::plugs_t>` `mhachain::plugs_t::prof_load_con`  
[private]
- 5.178.3.17 `MHAEvents::connector_t<mhachain::plugs_t>` `mhachain::plugs_t::prof_tt_con`  
[private]
- 5.178.3.18 `bool` `mhachain::plugs_t::b_use_profiling` [private]
- 5.178.3.19 `mha_platform_tictoc_t` `mhachain::plugs_t::tictoc` [private]

The documentation for this class was generated from the following files:

- `mha_generic_chain.h`
- `mha_generic_chain.cpp`

## 5.179 mhaconfig\_t Struct Reference

MHA prepare configuration structure.

Inheritance diagram for mhaconfig\_t:

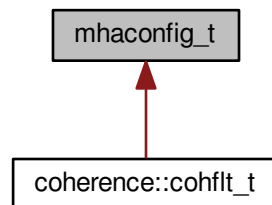

### Public Attributes

- unsigned int **channels**  
*Number of audio channels.*
- unsigned int **domain**  
*Signal domain (MHA\_WAVEFORM or MHA\_SPECTRUM)*
- unsigned int **fragsize**  
*Fragment size of waveform data.*
- unsigned int **wndlen**  
*Window length of spectral data.*
- unsigned int **ftlen**  
*FFT length of spectral data.*
- **mha\_real\_t srate**  
*Sampling rate in Hz.*

### 5.179.1 Detailed Description

MHA prepare configuration structure.

This structure contains information about channel number and domain for input and output signals of a openMHA Plugin. Each plugin can change any of these parameters, e.g. by resampling of the signal. The only limitation is that the callback frequency is fixed (except for the plugins `db` and `dbasync`).

**Todo** Add information on number of bands and on center frequencies, or replace by **mha\_↔ audio\_descriptor\_t** (p. 427).



## 5.179.2 Member Data Documentation

### 5.179.2.1 unsigned int mhaconfig\_t::channels

Number of audio channels.

### 5.179.2.2 unsigned int mhaconfig\_t::domain

Signal domain (MHA\_WAVEFORM or MHA\_SPECTRUM)

### 5.179.2.3 unsigned int mhaconfig\_t::fragsize

Fragment size of waveform data.

### 5.179.2.4 unsigned int mhaconfig\_t::wndlen

Window length of spectral data.

### 5.179.2.5 unsigned int mhaconfig\_t::fftl

FFT length of spectral data.

### 5.179.2.6 mha\_real\_t mhaconfig\_t::srate

Sampling rate in Hz.

The documentation for this struct was generated from the following file:

- **mha.hh**

## 5.180 MHAEvents::connector\_base\_t Class Reference

Inheritance diagram for MHAEvents::connector\_base\_t:

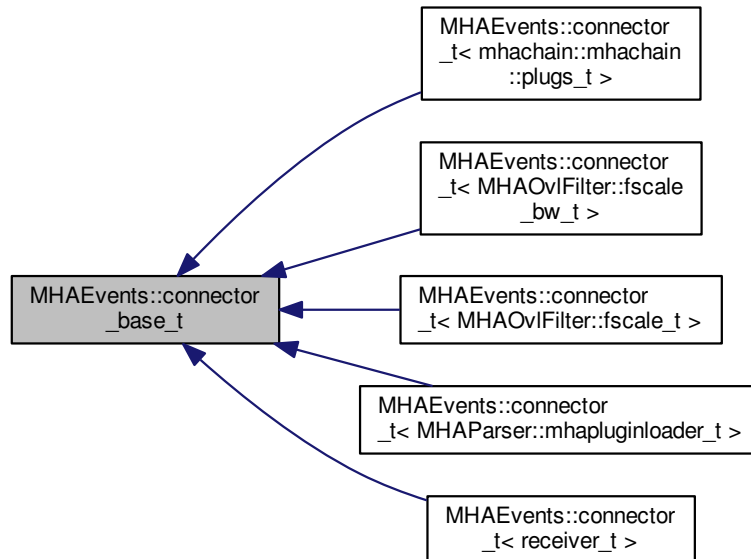

### Public Member Functions

- **connector\_base\_t** ()
- virtual **~connector\_base\_t** ()
- virtual void **emit\_event** ()
- virtual void **emit\_event** (const std::string &)
- virtual void **emit\_event** (const std::string &, unsigned int, unsigned int)
- void **emitter\_die** ()

### Protected Attributes

- bool **emitter\_is\_alive**

### 5.180.1 Constructor & Destructor Documentation

5.180.1.1 MHAEvents::connector\_base\_t::connector\_base\_t ( )

5.180.1.2 MHAEvents::connector\_base\_t::~~connector\_base\_t ( ) [virtual]

## 5.180.2 Member Function Documentation

### 5.180.2.1 void MHAEvents::connector\_base\_t::emit\_event ( ) [virtual]

Reimplemented in **MHAEvents::connector\_t< receiver\_t >** (p. 509), **MHAEvents::connector\_t< MHAOvIFilter::fscale\_bw\_t >** (p. 509), **MHAEvents::connector\_t< MHAParser::mhapluginloader\_t >** (p. 509), **MHAEvents::connector\_t< mhachain::mhachain::plugs\_t >** (p. 509), and **MHAEvents::connector\_t< MHAOvIFilter::fscale\_t >** (p. 509).

### 5.180.2.2 void MHAEvents::connector\_base\_t::emit\_event ( const std::string & ) [virtual]

Reimplemented in **MHAEvents::connector\_t< receiver\_t >** (p. 509), **MHAEvents::connector\_t< MHAOvIFilter::fscale\_bw\_t >** (p. 509), **MHAEvents::connector\_t< MHAParser::mhapluginloader\_t >** (p. 509), **MHAEvents::connector\_t< mhachain::mhachain::plugs\_t >** (p. 509), and **MHAEvents::connector\_t< MHAOvIFilter::fscale\_t >** (p. 509).

### 5.180.2.3 void MHAEvents::connector\_base\_t::emit\_event ( const std::string & , unsigned int , unsigned int ) [virtual]

Reimplemented in **MHAEvents::connector\_t< receiver\_t >** (p. 509), **MHAEvents::connector\_t< MHAOvIFilter::fscale\_bw\_t >** (p. 509), **MHAEvents::connector\_t< MHAParser::mhapluginloader\_t >** (p. 509), **MHAEvents::connector\_t< mhachain::mhachain::plugs\_t >** (p. 509), and **MHAEvents::connector\_t< MHAOvIFilter::fscale\_t >** (p. 509).

### 5.180.2.4 void MHAEvents::connector\_base\_t::emitter\_die ( )

## 5.180.3 Member Data Documentation

### 5.180.3.1 bool MHAEvents::connector\_base\_t::emitter\_is\_alive [protected]

The documentation for this class was generated from the following files:

- **mha\_event\_emitter.h**
- **mha\_events.cpp**

## 5.181 MHAEvents::connector\_t< receiver\_t > Class Template Reference

Inheritance diagram for MHAEvents::connector\_t< receiver\_t >:

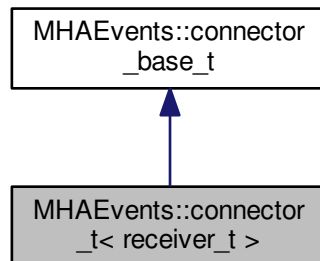

### Public Member Functions

- **connector\_t** (**emitter\_t** \*, receiver\_t \*, void(receiver\_t::\*)())
- **connector\_t** (**emitter\_t** \*, receiver\_t \*, void(receiver\_t::\*)(const std::string &))
- **connector\_t** (**emitter\_t** \*, receiver\_t \*, void(receiver\_t::\*)(const std::string &, unsigned int, unsigned int))
- **~connector\_t** ()

### Private Member Functions

- void **emit\_event** ()
- void **emit\_event** (const std::string &)
- void **emit\_event** (const std::string &, unsigned int, unsigned int)

### Private Attributes

- **emitter\_t** \* **emitter**
- receiver\_t \* **receiver**
- void(receiver\_t::\* **eventhandler** )()
- void(receiver\_t::\* **eventhandler\_s** )(const std::string &)
- void(receiver\_t::\* **eventhandler\_suu** )(const std::string &, unsigned int, unsigned int)

Additional Inherited Members

5.181.1 Constructor & Destructor Documentation

5.181.1.1 `template<class receiver_t> MHAEvents::connector_t< receiver_t >::connector_t ( emitter_t * e, receiver_t * r, void(receiver_t::*)() rfun )`

5.181.1.2 `template<class receiver_t> MHAEvents::connector_t< receiver_t >::connector_t ( emitter_t * e, receiver_t * r, void(receiver_t::*)(const std::string &) rfun )`

5.181.1.3 `template<class receiver_t> MHAEvents::connector_t< receiver_t >::connector_t ( emitter_t * e, receiver_t * r, void(receiver_t::*)(const std::string &, unsigned int, unsigned int) rfun )`

5.181.1.4 `template<class receiver_t> MHAEvents::connector_t< receiver_t >::~~connector_t ( )`

5.181.2 Member Function Documentation

5.181.2.1 `template<class receiver_t> void MHAEvents::connector_t< receiver_t >::emit_event ( ) [private],[virtual]`

Reimplemented from **MHAEvents::connector\_base\_t** (p. 507).

5.181.2.2 `template<class receiver_t> void MHAEvents::connector_t< receiver_t >::emit_event ( const std::string & arg ) [private],[virtual]`

Reimplemented from **MHAEvents::connector\_base\_t** (p. 507).

5.181.2.3 `template<class receiver_t> void MHAEvents::connector_t< receiver_t >::emit_event ( const std::string & arg, unsigned int arg2, unsigned int arg3 ) [private],[virtual]`

Reimplemented from **MHAEvents::connector\_base\_t** (p. 507).

### 5.181.3 Member Data Documentation

- 5.181.3.1 `template<class receiver_t> emitter_t* MHAEvents::connector_t< receiver_t >::emitter` [private]
- 5.181.3.2 `template<class receiver_t> receiver_t* MHAEvents::connector_t< receiver_t >::receiver` [private]
- 5.181.3.3 `template<class receiver_t> void(receiver_t::* MHAEvents::connector_t< receiver_t >::eventhandler) ()` [private]
- 5.181.3.4 `template<class receiver_t> void(receiver_t::* MHAEvents::connector_t< receiver_t >::eventhandler_s) (const std::string &)` [private]
- 5.181.3.5 `template<class receiver_t> void(receiver_t::* MHAEvents::connector_t< receiver_t >::eventhandler_suu) (const std::string &, unsigned int, unsigned int)` [private]

The documentation for this class was generated from the following file:

- **mha\_events.h**

### 5.182 MHAEvents::emitter\_t Class Reference

Class for emitting openMHA events.

#### Public Member Functions

- `~emitter_t ()`
- `void operator() ()`  
*Emit an event without parameter.*
- `void operator() (const std::string &)`  
*Emit an event with string parameter.*
- `void operator() (const std::string &, unsigned int, unsigned int)`  
*Emit an event with string parameter and two unsigned int parameters.*
- `void connect (connector_base_t *)`
- `void disconnect (connector_base_t *)`

#### Private Attributes

- `std::list< connector_base_t * > connections`

### 5.182.1 Detailed Description

Class for emitting openMHA events.

Use the template class **MHAEvents::patchbay\_t** (p. 512) for connecting to an emitter.

### 5.182.2 Constructor & Destructor Documentation

#### 5.182.2.1 MHAEvents::emitter\_t::~emitter\_t ( )

### 5.182.3 Member Function Documentation

#### 5.182.3.1 void MHAEvents::emitter\_t::operator() ( )

Emit an event without parameter.

#### 5.182.3.2 void MHAEvents::emitter\_t::operator() ( const std::string & arg )

Emit an event with string parameter.

#### 5.182.3.3 void MHAEvents::emitter\_t::operator() ( const std::string & arg, unsigned int arg2, unsigned int arg3 )

Emit an event with string parameter and two unsigned int parameters.

#### 5.182.3.4 void MHAEvents::emitter\_t::connect ( connector\_base\_t \* c )

#### 5.182.3.5 void MHAEvents::emitter\_t::disconnect ( connector\_base\_t \* c )

### 5.182.4 Member Data Documentation

#### 5.182.4.1 std::list<connector\_base\_t\*> MHAEvents::emitter\_t::connections [private]

The documentation for this class was generated from the following files:

- **mha\_event\_emitter.h**
- **mha\_events.cpp**

### 5.183 MHAEvents::patchbay\_t< receiver\_t > Class Template Reference

Patchbay which connects any event emitter with any member function of the parameter class.

#### Public Member Functions

- `~patchbay_t()`
- `void connect (emitter_t *, receiver_t *, void(receiver_t::*)())`  
*Connect a receiver member function void (receiver\_t::\*)() with an event emitter.*
- `void connect (emitter_t *, receiver_t *, void(receiver_t::*)(const std::string &))`  
*Connect a receiver member function void (receiver\_t::\*)(const std::string&) with an event emitter.*
- `void connect (emitter_t *, receiver_t *, void(receiver_t::*)(const std::string &, unsigned int, unsigned int))`

#### Private Attributes

- `std::list< connector_t< receiver_t > * > cons`

#### 5.183.1 Detailed Description

```
template<class receiver_t>
class MHAEvents::patchbay_t< receiver_t >
```

Patchbay which connects any event emitter with any member function of the parameter class.

The connections created by the `connect()` (p. 512) function are hold until the destructor is called. To avoid access to invalid function pointers, it is required to destruct the patchbay before the receiver, usually by declaring the patchbay as a member of the receiver.

The receiver can be any class or structure; the event callback can be either a member function without arguments or with `const std::string&` argument.

#### 5.183.2 Constructor & Destructor Documentation

5.183.2.1 `template<class receiver_t > MHAEvents::patchbay_t< receiver_t >::~~patchbay_t ( )`

#### 5.183.3 Member Function Documentation

5.183.3.1 `template<class receiver_t> void MHAEvents::patchbay_t< receiver_t >::connect ( emitter_t * e, receiver_t * r, void(receiver_t::*)() rfun )`

Connect a receiver member function void (receiver\_t::\*)() with an event emitter.

Create a connection.

The connection is removed when the patchbay is destructed.



## Parameters

|             |                                                    |
|-------------|----------------------------------------------------|
| <i>e</i>    | Pointer to an event emitter                        |
| <i>r</i>    | Pointer to the receiver                            |
| <i>rfun</i> | Pointer to a member function of the receiver class |

5.183.3.2 `template<class receiver_t> void MHAEvents::patchbay_t< receiver_t >::connect ( emitter_t * e, receiver_t * r, void(receiver_t::*)(const std::string &) rfun )`

Connect a receiver member function void (receiver\_t::\*)(const std::string&) with an event emitter.

Create a connection.

The connection is removed when the patchbay is destructed.

## Parameters

|             |                                                    |
|-------------|----------------------------------------------------|
| <i>e</i>    | Pointer to an event emitter                        |
| <i>r</i>    | Pointer to the receiver                            |
| <i>rfun</i> | Pointer to a member function of the receiver class |

5.183.3.3 `template<class receiver_t> void MHAEvents::patchbay_t< receiver_t >::connect ( emitter_t * e, receiver_t * r, void(receiver_t::*)(const std::string &, unsigned int, unsigned int) rfun )`

## 5.183.4 Member Data Documentation

5.183.4.1 `template<class receiver_t> std::list<connector_t<receiver_t>*> MHAEvents::patchbay_t< receiver_t >::cons [private]`

The documentation for this class was generated from the following file:

- `mha_events.h`

## 5.184 MHAFilter::adapt\_filter\_param\_t Class Reference

## Public Member Functions

- `adapt_filter_param_t (mha_real_t imu, bool ierr_in)`

## Public Attributes

- **mha\_real\_t mu**
- **bool err\_in**

### 5.184.1 Constructor & Destructor Documentation

5.184.1.1 **MHAFilter::adapt\_filter\_param\_t::adapt\_filter\_param\_t ( mha\_real\_t imu, bool ierr\_in )**

### 5.184.2 Member Data Documentation

5.184.2.1 **mha\_real\_t MHAFilter::adapt\_filter\_param\_t::mu**

5.184.2.2 **bool MHAFilter::adapt\_filter\_param\_t::err\_in**

The documentation for this class was generated from the following files:

- **mha\_filter.hh**
- **mha\_filter.cpp**

### 5.185 MHAFilter::adapt\_filter\_state\_t Class Reference

#### Public Member Functions

- **adapt\_filter\_state\_t (int ntaps, int nchannels)**
- **void filter (mha\_wave\_t y, mha\_wave\_t e, mha\_wave\_t x, mha\_wave\_t d, mha\_real\_t mu, bool err\_in)**

#### Private Attributes

- **int ntaps**
- **int nchannels**
- **MHASignal::waveform\_t W**
- **MHASignal::waveform\_t X**
- **MHASignal::waveform\_t od**
- **MHASignal::waveform\_t oy**

## 5.185.1 Constructor &amp; Destructor Documentation

5.185.1.1 MHAFilter::adapt\_filter\_state\_t::adapt\_filter\_state\_t (  
     int *ntaps*,  
     int *nchannels* )

## 5.185.2 Member Function Documentation

5.185.2.1 void MHAFilter::adapt\_filter\_state\_t::filter (  
     mha\_wave\_t *y*,  
     mha\_wave\_t *e*,  
     mha\_wave\_t *x*,  
     mha\_wave\_t *d*,  
     mha\_real\_t *mu*,  
     bool *err\_in* )

## 5.185.3 Member Data Documentation

5.185.3.1 int MHAFilter::adapt\_filter\_state\_t::ntaps [private]

5.185.3.2 int MHAFilter::adapt\_filter\_state\_t::nchannels [private]

5.185.3.3 MHASignal::waveform\_t MHAFilter::adapt\_filter\_state\_t::W [private]

5.185.3.4 MHASignal::waveform\_t MHAFilter::adapt\_filter\_state\_t::X [private]

5.185.3.5 MHASignal::waveform\_t MHAFilter::adapt\_filter\_state\_t::od [private]

5.185.3.6 MHASignal::waveform\_t MHAFilter::adapt\_filter\_state\_t::oy [private]

The documentation for this class was generated from the following files:

- **mha\_filter.hh**
- **mha\_filter.cpp**

## 5.186 MHAFilter::adapt\_filter\_t Class Reference

Adaptive filter.

Inheritance diagram for MHAFilter::adapt\_filter\_t:

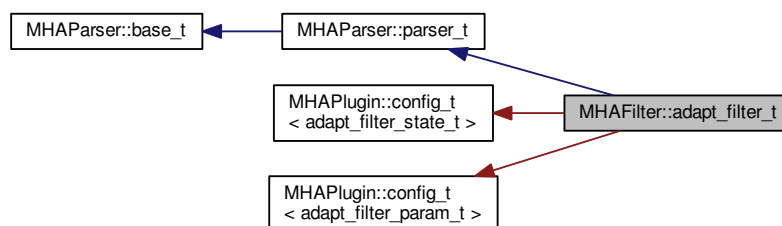

### Public Member Functions

- **adapt\_filter\_t** (std::string)
- void **filter** (**mha\_wave\_t** y, **mha\_wave\_t** e, **mha\_wave\_t** x, **mha\_wave\_t** d)
- void **set\_channelcnt** (unsigned int)

### Private Member Functions

- void **update\_mu** ()
- void **update\_ntaps** ()

### Private Attributes

- **MHAParser::float\_t** mu
- **MHAParser::int\_t** ntaps
- **MHAParser::bool\_t** err\_in
- **MHAEvents::patchbay\_t** < **adapt\_filter\_t** > connector
- unsigned int **nchannels**

### Additional Inherited Members

#### 5.186.1 Detailed Description

Adaptive filter.

#### 5.186.2 Constructor & Destructor Documentation

5.186.2.1 **MHAFilter::adapt\_filter\_t::adapt\_filter\_t** (  
std::string *help* )

#### 5.186.3 Member Function Documentation

5.186.3.1 void **MHAFilter::adapt\_filter\_t::filter** (  
**mha\_wave\_t** y,  
**mha\_wave\_t** e,  
**mha\_wave\_t** x,  
**mha\_wave\_t** d )

5.186.3.2 void **MHAFilter::adapt\_filter\_t::set\_channelcnt** (  
unsigned int *nch* )

5.186.3.3 void **MHAFilter::adapt\_filter\_t::update\_mu** ( ) [private]

5.186.3.4 void MHAFilter::adapt\_filter\_t::update\_ntaps ( ) [private]

#### 5.186.4 Member Data Documentation

5.186.4.1 MHAParser::float\_t MHAFilter::adapt\_filter\_t::mu [private]

5.186.4.2 MHAParser::int\_t MHAFilter::adapt\_filter\_t::ntaps [private]

5.186.4.3 MHAParser::bool\_t MHAFilter::adapt\_filter\_t::err\_in [private]

5.186.4.4 MHAEvents::patchbay\_t<adapt\_filter\_t> MHAFilter::adapt\_filter\_t::connector [private]

5.186.4.5 unsigned int MHAFilter::adapt\_filter\_t::nchannels [private]

The documentation for this class was generated from the following files:

- **mha\_filter.hh**
- **mha\_filter.cpp**

## 5.187 MHAFilter::blockprocessing\_polyphase\_resampling\_t Class Reference

A class that does polyphase resampling and takes into account block processing.

### Public Member Functions

- **blockprocessing\_polyphase\_resampling\_t** (float source\_srate, unsigned source\_fragsize, float target\_srate, unsigned target\_fragsize, float nyquist\_ratio, float irslen, unsigned nchannels, bool add\_delay)  
*Constructs a polyphase resampling filter that can be used for blockprocessing with the given parameters.*
- virtual ~**blockprocessing\_polyphase\_resampling\_t** ()
- void **write** (**mha\_wave\_t** &signal)  
*Write signal to the ringbuffer.*
- void **read** (**mha\_wave\_t** &signal)  
*Read resampled signal.*
- bool **can\_read** () const  
*Checks if the resampling ring buffer can produce another output signal block.*

### Private Attributes

- **polyphase\_resampling\_t** \* **resampling**
- unsigned **fragsize\_in**
- unsigned **fragsize\_out**
- unsigned **num\_channels**

### 5.187.1 Detailed Description

A class that does polyphase resampling and takes into account block processing.

### 5.187.2 Constructor & Destructor Documentation

#### 5.187.2.1 MHAFilter::blockprocessing\_polyphase\_resampling\_t::blockprocessing\_polyphase\_resampling\_t (

```
float source_srate,
unsigned source_frgsize,
float target_srate,
unsigned target_frgsize,
float nyquist_ratio,
float irslen,
unsigned nchannels,
bool add_delay )
```

Constructs a polyphase resampling filter that can be used for blockprocessing with the given parameters.

#### Parameters

|                       |                                                                                                                                                                                                                                                                                                                                                                                                                        |
|-----------------------|------------------------------------------------------------------------------------------------------------------------------------------------------------------------------------------------------------------------------------------------------------------------------------------------------------------------------------------------------------------------------------------------------------------------|
| <i>source_srate</i>   | Source sampling rate / Hz                                                                                                                                                                                                                                                                                                                                                                                              |
| <i>source_frgsize</i> | Fragment size of incoming audio blocks / frames at source_srate                                                                                                                                                                                                                                                                                                                                                        |
| <i>target_srate</i>   | Target sampling rate / Hz                                                                                                                                                                                                                                                                                                                                                                                              |
| <i>target_frgsize</i> | Fragment size of produced audio blocks / frames at target_srate                                                                                                                                                                                                                                                                                                                                                        |
| <i>nyquist_ratio</i>  | Low pass filter cutoff frequency relative to the nyquist frequency of the smaller of the two sampling rates. Example values: 0.8, 0.9                                                                                                                                                                                                                                                                                  |
| <i>irslen</i>         | Impulse response length used for low pass filtering / s                                                                                                                                                                                                                                                                                                                                                                |
| <i>nchannels</i>      | Number of audio channels                                                                                                                                                                                                                                                                                                                                                                                               |
| <i>add_delay</i>      | To avoid underruns, a delay is generally necessary for round trip block size adaptations. It is only necessary to add this delay to one of the two resampling chains. Set this parameter to true for the first resampling object of a round trip pair. It will add the necessary delay, and calculate the size of the ring buffer appropriately, When set to false, only the ringbuffer size will be set sufficiently. |

#### 5.187.2.2 virtual MHAFilter::blockprocessing\_polyphase\_resampling\_t::~~blockprocessing\_polyphase\_resampling\_t ( ) [inline],[virtual]

### 5.187.3 Member Function Documentation

#### 5.187.3.1 void MHAFilter::blockprocessing\_polyphase\_resampling\_t::write ( mha\_wave\_t & signal )

Write signal to the ringbuffer.

#### Parameters

|               |                                        |
|---------------|----------------------------------------|
| <i>signal</i> | input signal in original sampling rate |
|---------------|----------------------------------------|

#### Exceptions

|                           |                                                                                                                                                                            |
|---------------------------|----------------------------------------------------------------------------------------------------------------------------------------------------------------------------|
| <b>MHA_Error</b> (p. 445) | Raises exception if there is not enough room, if the number of channels does not match, or if the number of frames is not equal to the number specified in the constructor |
|---------------------------|----------------------------------------------------------------------------------------------------------------------------------------------------------------------------|

5.187.3.2 void MHAFilter::blockprocessing\_polyphase\_resampling\_t::read ( mha\_wave\_t & *signal* )

Read resampled signal.

Will perform the resampling and remove no longer needed samples from the input buffer.

#### Parameters

|               |                                          |
|---------------|------------------------------------------|
| <i>signal</i> | buffer to write the resampled signal to. |
|---------------|------------------------------------------|

#### Exceptions

|                           |                                                                                                           |
|---------------------------|-----------------------------------------------------------------------------------------------------------|
| <b>MHA_Error</b> (p. 445) | Raises exception if there is not enough input signal, if the number of channels of frames does not match. |
|---------------------------|-----------------------------------------------------------------------------------------------------------|

5.187.3.3 bool MHAFilter::blockprocessing\_polyphase\_resampling\_t::can\_read ( ) const [inline]

Checks if the resampling ring buffer can produce another output signal block.

#### 5.187.4 Member Data Documentation

5.187.4.1 polyphase\_resampling\_t\* MHAFilter::blockprocessing\_polyphase\_resampling\_t↔::resampling [private]

5.187.4.2 unsigned MHAFilter::blockprocessing\_polyphase\_resampling\_t::fragsize\_in [private]

5.187.4.3 unsigned MHAFilter::blockprocessing\_polyphase\_resampling\_t::fragsize\_out [private]

5.187.4.4 unsigned MHAFilter::blockprocessing\_polyphase\_resampling\_t::num\_channels [private]

The documentation for this class was generated from the following files:

- mha\_filter.hh
- mha\_filter.cpp

## 5.188 MHAFilter::complex\_bandpass\_t Class Reference

Complex bandpass filter.

### Public Member Functions

- **complex\_bandpass\_t** (std::vector< **mha\_complex\_t** > A, std::vector< **mha\_↵  
complex\_t** > B)  
*Constructor with filter coefficients (one per channel)*
- void **set\_state** (**mha\_real\_t** val)
- void **set\_state** (std::vector< **mha\_real\_t** > val)
- void **set\_state** (**mha\_complex\_t** val)
- void **set\_weights** (std::vector< **mha\_complex\_t** > new\_B)  
*Allow to modify the input weights at a later stage.*
- std::vector< **mha\_complex\_t** > **get\_weights** () const
- void **filter** (const **mha\_wave\_t** &X, **mha\_spec\_t** &Y)  
*Filter method for real value input.*
- void **filter** (const **mha\_wave\_t** &X, **mha\_wave\_t** &Yre, **mha\_wave\_t** &Yim)  
*Filter method for real value input.*
- void **filter** (const **mha\_spec\_t** &X, **mha\_spec\_t** &Y)  
*Filter method for complex value input.*
- void **filter** (const **mha\_wave\_t** &Xre, const **mha\_wave\_t** &Xim, **mha\_wave\_t** &Yre, **mha\_wave\_t** &Yim)  
*Filter method for complex value input.*
- std::string **inspect** () const

### Static Public Member Functions

- static std::vector< **mha\_complex\_t** > **creator\_A** (std::vector< **mha\_real\_t** > cf, std↵  
::vector< **mha\_real\_t** > bw, **mha\_real\_t** srate, unsigned int order)
- static std::vector< **mha\_complex\_t** > **creator\_B** (std::vector< **mha\_complex\_t** > A, unsigned int order)

### Private Attributes

- std::vector< **mha\_complex\_t** > **A\_**
- std::vector< **mha\_complex\_t** > **B\_**
- std::vector< **mha\_complex\_t** > **Yn**

#### 5.188.1 Detailed Description

Complex bandpass filter.



## 5.188.2 Constructor &amp; Destructor Documentation

5.188.2.1 MHAFilter::complex\_bandpass\_t::complex\_bandpass\_t (   
                   std::vector< mha\_complex\_t > *A*,   
                   std::vector< mha\_complex\_t > *B* )

Constructor with filter coefficients (one per channel)

## Parameters

|          |                                           |
|----------|-------------------------------------------|
| <i>A</i> | complex filter coefficients, one per band |
| <i>B</i> | complex weights                           |

## 5.188.3 Member Function Documentation

5.188.3.1 std::vector< mha\_complex\_t > MHAFilter::complex\_bandpass\_t::creator\_A (   
                   std::vector< mha\_real\_t > *cf*,   
                   std::vector< mha\_real\_t > *bw*,   
                   mha\_real\_t *state*,   
                   unsigned int *order* ) [static]

5.188.3.2 std::vector< mha\_complex\_t > MHAFilter::complex\_bandpass\_t::creator\_B (   
                   std::vector< mha\_complex\_t > *A*,   
                   unsigned int *order* ) [static]

5.188.3.3 void MHAFilter::complex\_bandpass\_t::set\_state (   
                   mha\_real\_t *val* )

5.188.3.4 void MHAFilter::complex\_bandpass\_t::set\_state (   
                   std::vector< mha\_real\_t > *val* )

5.188.3.5 void MHAFilter::complex\_bandpass\_t::set\_state (   
                   mha\_complex\_t *val* )

5.188.3.6 void MHAFilter::complex\_bandpass\_t::set\_weights (   
                   std::vector< mha\_complex\_t > *new\_B* )

Allow to modify the input weights at a later stage.

5.188.3.7 std::vector< mha\_complex\_t > MHAFilter::complex\_bandpass\_t::get\_weights ( ) const   
                   [inline]

5.188.3.8 void MHAFilter::complex\_bandpass\_t::filter (   
                   const mha\_wave\_t & *X*,   
                   mha\_spec\_t & *Y* ) [inline]

Filter method for real value input.

```
5.188.3.9 void MHAFilter::complex_bandpass_t::filter (
           const mha_wave_t & X,
           mha_wave_t & Yre,
           mha_wave_t & Yim ) [inline]
```

Filter method for real value input.

```
5.188.3.10 void MHAFilter::complex_bandpass_t::filter (
            const mha_spec_t & X,
            mha_spec_t & Y ) [inline]
```

Filter method for complex value input.

```
5.188.3.11 void MHAFilter::complex_bandpass_t::filter (
            const mha_wave_t & Xre,
            const mha_wave_t & Xim,
            mha_wave_t & Yre,
            mha_wave_t & Yim ) [inline]
```

Filter method for complex value input.

```
5.188.3.12 std::string MHAFilter::complex_bandpass_t::inspect ( ) const [inline]
```

#### 5.188.4 Member Data Documentation

```
5.188.4.1 std::vector<mha_complex_t> MHAFilter::complex_bandpass_t::A_ [private]
```

```
5.188.4.2 std::vector<mha_complex_t> MHAFilter::complex_bandpass_t::B_ [private]
```

```
5.188.4.3 std::vector<mha_complex_t> MHAFilter::complex_bandpass_t::Yn [private]
```

The documentation for this class was generated from the following files:

- **complex\_filter.h**
- **complex\_filter.cpp**

#### 5.189 MHAFilter::diff\_t Class Reference

Differentiator class (non-normalized)

Inheritance diagram for MHAFilter::diff\_t:

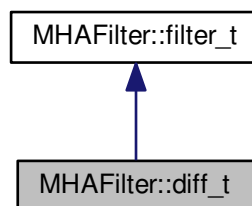

## Public Member Functions

- **diff\_t** (unsigned int *ch*)

## Additional Inherited Members

### 5.189.1 Detailed Description

Differentiator class (non-normalized)

### 5.189.2 Constructor & Destructor Documentation

#### 5.189.2.1 MHAFilter::diff\_t::diff\_t ( unsigned int *ch* )

The documentation for this class was generated from the following files:

- **mha\_filter.hh**
- **mha\_filter.cpp**

## 5.190 MHAFilter::fftfilter\_t Class Reference

FFT based FIR filter implementation.

Inheritance diagram for MHAFilter::fftfilter\_t:

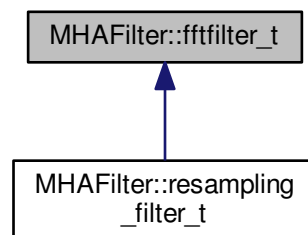

## Public Member Functions

- **fftfilter\_t** (unsigned int **fragsize**, unsigned int **channels**, unsigned int **fftl**)  
*Constructor.*
- **~fftfilter\_t** ()
- void **update\_coeffs** (const **mha\_wave\_t** \*pwIRS)  
*Update the set of coefficients.*
- void **filter** (const **mha\_wave\_t** \*pwIn, **mha\_wave\_t** \*\*ppwOut, const **mha\_wave\_t** \*pwIRS)  
*Apply filter with changing coefficients to a waveform fragment.*
- void **filter** (const **mha\_wave\_t** \*pwIn, **mha\_wave\_t** \*\*ppwOut)  
*Apply filter to waveform fragment, without changing the coefficients.*
- void **filter** (const **mha\_wave\_t** \*pwIn, **mha\_wave\_t** \*\*ppwOut, const **mha\_spec\_t** \*psWeights)  
*Apply filter with changing coefficients to a waveform fragment.*

## Private Attributes

- unsigned int **fragsize**
- unsigned int **channels**
- unsigned int **fftl**
- **MHASignal::waveform\_t** wInput\_fft
- **mha\_wave\_t** wInput
- **MHASignal::waveform\_t** wOutput\_fft
- **mha\_wave\_t** wOutput
- **MHASignal::spectrum\_t** sInput
- **MHASignal::spectrum\_t** sWeights
- **MHASignal::waveform\_t** wIRS\_fft
- **mha\_fft\_t** fft

### 5.190.1 Detailed Description

FFT based FIR filter implementation.

The maximal number of coefficients can be FFT length - fragsize + 1.

### 5.190.2 Constructor & Destructor Documentation

5.190.2.1 **MHAFilter::fftfilter\_t::fftfilter\_t** (  
    unsigned int *fragsize*,  
    unsigned int *channels*,  
    unsigned int *fftl* )

Constructor.

## Parameters

|                 |                                                         |
|-----------------|---------------------------------------------------------|
| <i>fragsize</i> | Number of frames expected in input signal (each cycle). |
| <i>channels</i> | Number of channels expected in input signal.            |
| <i>fftlen</i>   | FFT length of filter.                                   |

## 5.190.2.2 MHAFilter::fftfilter\_t::~fftfilter\_t ( )

## 5.190.3 Member Function Documentation

5.190.3.1 void MHAFilter::fftfilter\_t::update\_coeffs (   
 const mha\_wave\_t \* pwIRS )

Update the set of coefficients.

## Parameters

|              |                        |
|--------------|------------------------|
| <i>pwIRS</i> | Coefficients structure |
|--------------|------------------------|

## Note

The number of channels in h must match the number of channels given in the constructor. The filter length is limited to fftlen-fragsize+1 (longer IRS will be shortened).

5.190.3.2 void MHAFilter::fftfilter\_t::filter (   
 const mha\_wave\_t \* pwIn,   
 mha\_wave\_t \*\* ppwOut,   
 const mha\_wave\_t \* pwIRS )

Apply filter with changing coefficients to a waveform fragment.

## Parameters

|             |                       |
|-------------|-----------------------|
| <i>pwIn</i> | Input signal pointer. |
|-------------|-----------------------|

## Return values

|               |                                                                  |
|---------------|------------------------------------------------------------------|
| <i>ppwOut</i> | Pointer to output signal pointer, will be set to a valid signal. |
|---------------|------------------------------------------------------------------|

## Parameters

|              |                                        |
|--------------|----------------------------------------|
| <i>pwIRS</i> | Pointer to FIR coefficients structure. |
|--------------|----------------------------------------|

```
5.190.3.3 void MHAFilter::fftfilter_t::filter (
            const mha_wave_t * pwIn,
            mha_wave_t ** ppwOut )
```

Apply filter to waveform fragment, without changing the coefficients.

#### Parameters

|             |                       |
|-------------|-----------------------|
| <i>pwIn</i> | Input signal pointer. |
|-------------|-----------------------|

#### Return values

|               |                                                                 |
|---------------|-----------------------------------------------------------------|
| <i>ppwOut</i> | Pointer to output signal pointer, will be set to a valid signal |
|---------------|-----------------------------------------------------------------|

```
5.190.3.4 void MHAFilter::fftfilter_t::filter (
            const mha_wave_t * pwIn,
            mha_wave_t ** ppwOut,
            const mha_spec_t * psWeights )
```

Apply filter with changing coefficients to a waveform fragment.

#### Parameters

|             |                       |
|-------------|-----------------------|
| <i>pwIn</i> | Input signal pointer. |
|-------------|-----------------------|

#### Return values

|               |                                                                  |
|---------------|------------------------------------------------------------------|
| <i>ppwOut</i> | Pointer to output signal pointer, will be set to a valid signal. |
|---------------|------------------------------------------------------------------|

#### Parameters

|                  |                                      |
|------------------|--------------------------------------|
| <i>psWeights</i> | Pointer to filter weights structure. |
|------------------|--------------------------------------|

### 5.190.4 Member Data Documentation

```
5.190.4.1 unsigned int MHAFilter::fftfilter_t::fragsize [private]
```

```
5.190.4.2 unsigned int MHAFilter::fftfilter_t::channels [private]
```

```
5.190.4.3 unsigned int MHAFilter::fftfilter_t::fftlen [private]
```

- 5.190.4.4 MHASignal::waveform\_t MHAFilter::fftfilter\_t::wInput\_fft [private]
- 5.190.4.5 mha\_wave\_t MHAFilter::fftfilter\_t::wInput [private]
- 5.190.4.6 MHASignal::waveform\_t MHAFilter::fftfilter\_t::wOutput\_fft [private]
- 5.190.4.7 mha\_wave\_t MHAFilter::fftfilter\_t::wOutput [private]
- 5.190.4.8 MHASignal::spectrum\_t MHAFilter::fftfilter\_t::sInput [private]
- 5.190.4.9 MHASignal::spectrum\_t MHAFilter::fftfilter\_t::sWeights [private]
- 5.190.4.10 MHASignal::waveform\_t MHAFilter::fftfilter\_t::wIRS\_fft [private]
- 5.190.4.11 mha\_fft\_t MHAFilter::fftfilter\_t::fft [private]

The documentation for this class was generated from the following files:

- **mha\_filter.hh**
- **mha\_filter.cpp**

## 5.191 MHAFilter::fftfilterbank\_t Class Reference

FFT based FIR filterbank implementation.

Inheritance diagram for MHAFilter::fftfilterbank\_t:

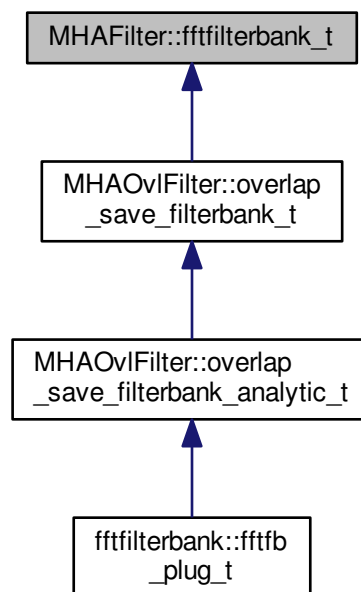

### Public Member Functions

- **fftfilterbank\_t** (unsigned int **fragsize**, unsigned int **inputchannels**, unsigned int **firchannels**, unsigned int **fftlens**)  
*Constructor.*
- **~fftfilterbank\_t** ()
- void **update\_coeffs** (const **mha\_wave\_t** \*h)  
*Update the set of coefficients.*
- void **filter** (const **mha\_wave\_t** \*s\_in, **mha\_wave\_t** \*\*s\_out, const **mha\_wave\_t** \*h)  
*Apply filter with changing coefficients to a waveform fragment.*
- void **filter** (const **mha\_wave\_t** \*s\_in, **mha\_wave\_t** \*\*s\_out)  
*Apply filter to waveform fragment, without changing the coefficients.*
- const **mha\_wave\_t** \* **get\_irs** () const  
*Return the current IRS.*

### Private Attributes

- unsigned int **fragsize**
- unsigned int **inputchannels**
- unsigned int **firchannels**
- unsigned int **outputchannels**
- unsigned int **fftlens**
- **MHASignal::waveform\_t** hw
- **MHASignal::spectrum\_t** Hs
- **MHASignal::waveform\_t** xw
- **MHASignal::spectrum\_t** Xs
- **MHASignal::waveform\_t** yw
- **MHASignal::spectrum\_t** Ys
- **MHASignal::waveform\_t** yw\_temp
- **MHASignal::waveform\_t** tail
- **mha\_fft\_t** fft

#### 5.191.1 Detailed Description

FFT based FIR filterbank implementation.

This class convolves n input channels with m filter coefficient sets and returns n\*m output channels.

The maximal number of coefficients can be FFT length - fragsize + 1.

#### 5.191.2 Constructor & Destructor Documentation

- ##### 5.191.2.1 **MHAFilter::fftfilterbank\_t::fftfilterbank\_t** ( unsigned int *fragsize*, unsigned int *inputchannels*, unsigned int *firchannels*, unsigned int *fftlens* )

Constructor.



## Parameters

|                      |                                                                             |
|----------------------|-----------------------------------------------------------------------------|
| <i>fragsize</i>      | Number of frames expected in input signal (each cycle).                     |
| <i>inputchannels</i> | Number of channels expected in input signal.                                |
| <i>firchannels</i>   | Number of channels expected in FIR filter coefficients (= number of bands). |
| <i>ftflen</i>        | FFT length of filter.                                                       |

The number of output channels is `inputchannels*firchannels`.

## 5.191.2.2 MHAFilter::fftfilterbank\_t::~fftfilterbank\_t ( )

## 5.191.3 Member Function Documentation

5.191.3.1 void MHAFilter::fftfilterbank\_t::update\_coeffs (   
 const mha\_wave\_t \* h )

Update the set of coefficients.

## Parameters

|          |                        |
|----------|------------------------|
| <i>h</i> | Coefficients structure |
|----------|------------------------|

## Note

The number of channels in `h` must match the number of channels given in the constructor, and the number of frames can not be more than `ftflen-fragsize+1`.

5.191.3.2 void MHAFilter::fftfilterbank\_t::filter (   
 const mha\_wave\_t \* s\_in,   
 mha\_wave\_t \*\* s\_out,   
 const mha\_wave\_t \* h )

Apply filter with changing coefficients to a waveform fragment.

## Parameters

|             |                       |
|-------------|-----------------------|
| <i>s_in</i> | Input signal pointer. |
|-------------|-----------------------|

## Return values

|              |                                                                 |
|--------------|-----------------------------------------------------------------|
| <i>s_out</i> | Pointer to output signal pointer, will be set to a valid signal |
|--------------|-----------------------------------------------------------------|

**Parameters**

|          |                  |
|----------|------------------|
| <i>h</i> | FIR coefficients |
|----------|------------------|

5.191.3.3 void MHAFilter::fftfilterbank\_t::filter (  
           const mha\_wave\_t \* *s\_in*,  
           mha\_wave\_t \*\* *s\_out* )

Apply filter to waveform fragment, without changing the coefficients.

**Parameters**

|                          |                       |
|--------------------------|-----------------------|
| <i>s</i> ↔<br><i>_in</i> | Input signal pointer. |
|--------------------------|-----------------------|

**Return values**

|              |                                                                 |
|--------------|-----------------------------------------------------------------|
| <i>s_out</i> | Pointer to output signal pointer, will be set to a valid signal |
|--------------|-----------------------------------------------------------------|

5.191.3.4 const mha\_wave\_t\* MHAFilter::fftfilterbank\_t::get\_irs ( ) const [inline]

Return the current IRS.

**5.191.4 Member Data Documentation**

5.191.4.1 unsigned int MHAFilter::fftfilterbank\_t::fragsize [private]

5.191.4.2 unsigned int MHAFilter::fftfilterbank\_t::inputchannels [private]

5.191.4.3 unsigned int MHAFilter::fftfilterbank\_t::firchannels [private]

5.191.4.4 unsigned int MHAFilter::fftfilterbank\_t::outputchannels [private]

5.191.4.5 unsigned int MHAFilter::fftfilterbank\_t::fftlen [private]

5.191.4.6 MHASignal::waveform\_t MHAFilter::fftfilterbank\_t::hw [private]

5.191.4.7 MHASignal::spectrum\_t MHAFilter::fftfilterbank\_t::Hs [private]

5.191.4.8 MHASignal::waveform\_t MHAFilter::fftfilterbank\_t::xw [private]

5.191.4.9 MHASignal::spectrum\_t MHAFilter::fftfilterbank\_t::Xs [private]

5.191.4.10 MHAFilter::fftfilterbank\_t::yw [private]

5.191.4.11 MHAFilter::fftfilterbank\_t::Ys [private]

5.191.4.12 MHAFilter::fftfilterbank\_t::yw\_temp [private]

5.191.4.13 MHAFilter::fftfilterbank\_t::tail [private]

5.191.4.14 mha\_fft\_t MHAFilter::fftfilterbank\_t::fft [private]

The documentation for this class was generated from the following files:

- **mha\_filter.hh**
- **mha\_filter.cpp**

## 5.192 MHAFilter::filter\_t Class Reference

Generic IIR filter class.

Inheritance diagram for MHAFilter::filter\_t:

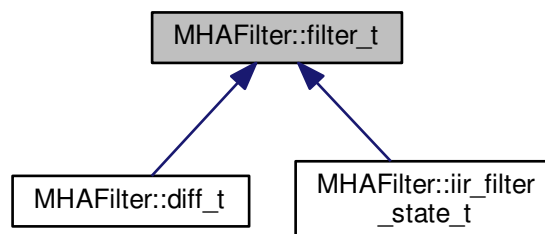

### Public Member Functions

- **filter\_t** (unsigned int ch, unsigned int lena, unsigned int lenb)  
*Constructor.*
- **filter\_t** (unsigned int ch, const std::vector< **mha\_real\_t** > &vA, const std::vector< **mha\_real\_t** > &vB)  
*Constructor with initialization of coefficients.*
- **filter\_t** (const **MHAFilter::filter\_t** &src)
- **~filter\_t** ()
- void **filter** (**mha\_wave\_t** \*out, const **mha\_wave\_t** \*in)

*Filter all channels in a waveform structure.*

- void **filter** (**mha\_real\_t** \*dest, const **mha\_real\_t** \*src, unsigned int dframes, unsigned int frame\_dist, unsigned int channel\_dist, unsigned int channel\_begin, unsigned int channel\_end)

*Filter parts of a waveform structure.*

- **mha\_real\_t filter** (**mha\_real\_t** x, unsigned int ch)

*Filter one sample.*

- unsigned int **get\_len\_A** () const

*Return length of recursive coefficients.*

- unsigned int **get\_len\_B** () const

*Return length of non-recursive coefficients.*

### Public Attributes

- double \* **A**

*Pointer to recursive coefficients.*

- double \* **B**

*Pointer to non-recursive coefficients.*

### Private Attributes

- unsigned int **len\_A**
- unsigned int **len\_B**
- unsigned int **len**
- unsigned int **channels**
- double \* **state**

### 5.192.1 Detailed Description

Generic IIR filter class.

This class implements a generic multichannel IIR filter. It is realized as direct form II. It can work on any float array or on **mha\_wave\_t** (p. 496) structs. The filter coefficients can be directly accessed.

**Todo** Implement a more robust filter form.

### 5.192.2 Constructor & Destructor Documentation

5.192.2.1 **MHAFilter::filter\_t::filter\_t** (  
     unsigned int *ch*,  
     unsigned int *lena*,  
     unsigned int *lenb* )

Constructor.

## Parameters

|             |                                      |
|-------------|--------------------------------------|
| <i>ch</i>   | Number of channels                   |
| <i>lena</i> | Number of recursive coefficients     |
| <i>lenb</i> | Number of non-recursive coefficients |

5.192.2.2 MHAFilter::filter\_t::filter\_t (   
     unsigned int *ch*,  
     const std::vector< mha\_real\_t > & *vA*,  
     const std::vector< mha\_real\_t > & *vB* )

Constructor with initialization of coefficients.

## Parameters

|           |                             |
|-----------|-----------------------------|
| <i>ch</i> | Number of channels.         |
| <i>vA</i> | Recursive coefficients.     |
| <i>vB</i> | Non-recursive coefficients. |

5.192.2.3 MHAFilter::filter\_t::filter\_t (   
     const MHAFilter::filter\_t & *src* )

5.192.2.4 MHAFilter::filter\_t::~~filter\_t ( )

## 5.192.3 Member Function Documentation

5.192.3.1 void MHAFilter::filter\_t::filter (   
     mha\_wave\_t \* *out*,  
     const mha\_wave\_t \* *in* )

Filter all channels in a waveform structure.

## Parameters

|            |               |
|------------|---------------|
| <i>out</i> | Output signal |
| <i>in</i>  | Input signal  |

```

5.192.3.2 void MHAFilter::filter_t::filter (
            mha_real_t * dest,
            const mha_real_t * src,
            unsigned int dframes,
            unsigned int frame_dist,
            unsigned int channel_dist,
            unsigned int channel_begin,
            unsigned int channel_end )

```

Filter parts of a waveform structure.

#### Parameters

|                      |                                              |
|----------------------|----------------------------------------------|
| <i>dest</i>          | Output signal.                               |
| <i>src</i>           | Input signal.                                |
| <i>dframes</i>       | Number of frames to be filtered.             |
| <i>frame_dist</i>    | Index distance between frames of one channel |
| <i>channel_dist</i>  | Index distance between audio channels        |
| <i>channel_begin</i> | Number of first channel to be processed      |
| <i>channel_end</i>   | Number of last channel to be processed       |

```

5.192.3.3 mha_real_t MHAFilter::filter_t::filter (
            mha_real_t x,
            unsigned int ch )

```

Filter one sample.

#### Parameters

|           |                                       |
|-----------|---------------------------------------|
| <i>x</i>  | Input value                           |
| <i>ch</i> | Channel number to use in filter state |

```

5.192.3.4 unsigned int MHAFilter::filter_t::get_len_A ( ) const [inline]

```

Return length of recursive coefficients.

```

5.192.3.5 unsigned int MHAFilter::filter_t::get_len_B ( ) const [inline]

```

Return length of non-recursive coefficients.

## 5.192.4 Member Data Documentation

```

5.192.4.1 double* MHAFilter::filter_t::A

```

Pointer to recursive coefficients.

## 5.192.4.2 double\* MHAFilter::filter\_t::B

Pointer to non-recursive coefficients.

## 5.192.4.3 unsigned int MHAFilter::filter\_t::len\_A [private]

## 5.192.4.4 unsigned int MHAFilter::filter\_t::len\_B [private]

## 5.192.4.5 unsigned int MHAFilter::filter\_t::len [private]

## 5.192.4.6 unsigned int MHAFilter::filter\_t::channels [private]

## 5.192.4.7 double\* MHAFilter::filter\_t::state [private]

The documentation for this class was generated from the following files:

- **mha\_filter.hh**
- **mha\_filter.cpp**

## 5.193 MHAFilter::gammaflt\_t Class Reference

Class for gammatone filter.

## Public Member Functions

- **gammaflt\_t** (std::vector< **mha\_real\_t** > cf, std::vector< **mha\_real\_t** > bw, **mha\_real\_t** state, unsigned int order)  
*Constructor.*
- **~gammaflt\_t** ()
- void **operator()** (**mha\_wave\_t** &X, **mha\_spec\_t** &Y)  
*Filter method.*
- void **operator()** (**mha\_wave\_t** &X, **mha\_wave\_t** &Yre, **mha\_wave\_t** &Yim)  
*Filter method.*
- void **operator()** (**mha\_wave\_t** &Yre, **mha\_wave\_t** &Yim, unsigned int stage)  
*Filter method for specific stage.*
- void **phase\_correction** (unsigned int desired\_delay, unsigned int inchannels)
- void **set\_weights** (std::vector< **mha\_complex\_t** > new\_B)
- void **set\_weights** (unsigned int stage, std::vector< **mha\_complex\_t** > new\_B)
- std::vector< **mha\_complex\_t** > **get\_weights** () const
- std::vector< **mha\_complex\_t** > **get\_weights** (unsigned int stage) const
- std::vector< **mha\_real\_t** > **get\_resynthesis\_gain** () const
- void **reset\_state** ()
- const std::vector< **mha\_complex\_t** > & **get\_A** ()
- std::string **inspect** () const

### Private Attributes

- `std::vector< mha_complex_t > A`
- `std::vector< complex_bandpass_t > GF`
- `MHASignal::delay_t * delay`
- `std::vector< int > envelope_delay`
- `std::vector< mha_real_t > resynthesis_gain`
- `std::vector< mha_real_t > cf_`
- `std::vector< mha_real_t > bw_`
- `mha_real_t srate_`

#### 5.193.1 Detailed Description

Class for gammatone filter.

#### 5.193.2 Constructor & Destructor Documentation

5.193.2.1 `MHAFilter::gammaflt_t::gammaflt_t(`  
     `std::vector< mha_real_t > cf,`  
     `std::vector< mha_real_t > bw,`  
     `mha_real_t srate,`  
     `unsigned int order )`

Constructor.

#### Parameters

|              |                                                    |
|--------------|----------------------------------------------------|
| <i>cf</i>    | Center frequency in Hz.                            |
| <i>bw</i>    | Bandwidth in Hz (same number of entries as in cf). |
| <i>srate</i> | Sampling frequency in Hz.                          |
| <i>order</i> | Filter order.                                      |

5.193.2.2 `MHAFilter::gammaflt_t::~~gammaflt_t( )`

#### 5.193.3 Member Function Documentation

5.193.3.1 `void MHAFilter::gammaflt_t::operator()(`  
     `mha_wave_t & X,`  
     `mha_spec_t & Y ) [inline]`

Filter method.



5.193.3.2 void MHAFilter::gammaflt\_t::operator() (
 mha\_wave\_t & X,
 mha\_wave\_t & Yre,
 mha\_wave\_t & Yim ) [inline]

Filter method.

5.193.3.3 void MHAFilter::gammaflt\_t::operator() (
 mha\_wave\_t & Yre,
 mha\_wave\_t & Yim,
 unsigned int stage ) [inline]

Filter method for specific stage.

5.193.3.4 void MHAFilter::gammaflt\_t::phase\_correction (
 unsigned int desired\_delay,
 unsigned int inchannels )

5.193.3.5 void MHAFilter::gammaflt\_t::set\_weights (
 std::vector< mha\_complex\_t > new\_B )

5.193.3.6 void MHAFilter::gammaflt\_t::set\_weights (
 unsigned int stage,
 std::vector< mha\_complex\_t > new\_B )

5.193.3.7 std::vector<mha\_complex\_t> MHAFilter::gammaflt\_t::get\_weights ( ) const
 [inline]

5.193.3.8 std::vector<mha\_complex\_t> MHAFilter::gammaflt\_t::get\_weights (
 unsigned int stage ) const [inline]

5.193.3.9 std::vector<mha\_real\_t> MHAFilter::gammaflt\_t::get\_resynthesis\_gain ( ) const
 [inline]

5.193.3.10 void MHAFilter::gammaflt\_t::reset\_state ( )

5.193.3.11 const std::vector<mha\_complex\_t>& MHAFilter::gammaflt\_t::get\_A ( ) [inline]

5.193.3.12 std::string MHAFilter::gammaflt\_t::inspect ( ) const [inline]

#### 5.193.4 Member Data Documentation

5.193.4.1 std::vector<mha\_complex\_t> MHAFilter::gammaflt\_t::A [private]

5.193.4.2 std::vector<complex\_bandpass\_t> MHAFilter::gammaflt\_t::GF [private]

- 5.193.4.3 `MHASignal::delay_t*` `MHAFilter::gammaflt_t::delay` [private]
- 5.193.4.4 `std::vector<int>` `MHAFilter::gammaflt_t::envelope_delay` [private]
- 5.193.4.5 `std::vector<mha_real_t>` `MHAFilter::gammaflt_t::resynthesis_gain` [private]
- 5.193.4.6 `std::vector<mha_real_t>` `MHAFilter::gammaflt_t::cf_` [private]
- 5.193.4.7 `std::vector<mha_real_t>` `MHAFilter::gammaflt_t::bw_` [private]
- 5.193.4.8 `mha_real_t` `MHAFilter::gammaflt_t::srate_` [private]

The documentation for this class was generated from the following files:

- `complex_filter.h`
- `complex_filter.cpp`

## 5.194 `MHAFilter::iir_filter_state_t` Class Reference

Inheritance diagram for `MHAFilter::iir_filter_state_t`:

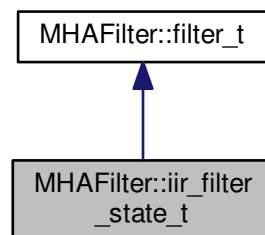

### Public Member Functions

- `iir_filter_state_t` (unsigned int **channels**, `std::vector< float >` `cf_A`, `std::vector< float >` `cf_B`)

## Additional Inherited Members

## 5.194.1 Constructor &amp; Destructor Documentation

5.194.1.1 MHAFilter::iir\_filter\_state\_t::iir\_filter\_state\_t (  
    unsigned int *channels*,  
    std::vector< float > *cf\_A*,  
    std::vector< float > *cf\_B* )

The documentation for this class was generated from the following files:

- **mha\_filter.hh**
- **mha\_filter.cpp**

## 5.195 MHAFilter::iir\_filter\_t Class Reference

IIR filter class wrapper for integration into parser structure.

Inheritance diagram for MHAFilter::iir\_filter\_t:

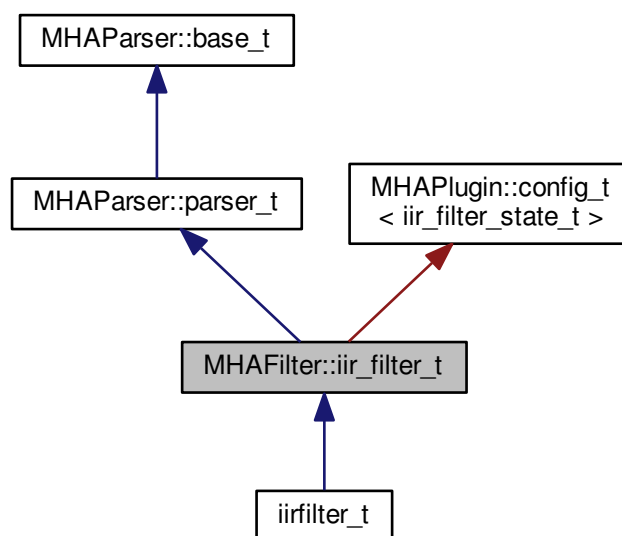

### Public Member Functions

- **iir\_filter\_t** (std::string **help**="IIR filter structure", std::string **def\_A**="[1]", std::string **def\_B**="[1]", unsigned int **channels**=1)  
*Constructor of the IIR filter.*
- void **filter** (**mha\_wave\_t** \*y, const **mha\_wave\_t** \*x)  
*The filter processes the audio signal.*
- **mha\_real\_t filter** (**mha\_real\_t** x, unsigned int ch)  
*Filter a single audio sample.*
- void **resize** (unsigned int **channels**)  
*Change the number of channels after object creation.*

### Private Member Functions

- void **update\_filter** ()

### Private Attributes

- **MHAParser::vfloat\_t A**
- **MHAParser::vfloat\_t B**
- **MHAEvents::patchbay\_t < iir\_filter\_t > connector**
- unsigned int **nchannels**

### Additional Inherited Members

#### 5.195.1 Detailed Description

IIR filter class wrapper for integration into parser structure.

This class implements an infinite impulse response filter. Since it inherits from **MHAParser::parser\_t** (p. 688), it can easily be integrated in the openMHA configuration tree. It provides the configuration language variables "A" (vector of recursive filter coefficients) and "B" (vector of non-recursive filter coefficients).

The filter instance reacts to changes in filter coefficients through the openMHA configuration language, and uses the updated coefficients in the next invocation of the filter method.

Update of the coefficients is thread-safe and non-blocking. Simply add this subparser to your parser items and use the "filter" member function. Filter states are reset to all 0 on update.

#### 5.195.2 Constructor & Destructor Documentation

- ##### 5.195.2.1 MHAFilter::iir\_filter\_t::iir\_filter\_t (
- ```

    std::string help = "IIR filter structure",
    std::string def_A = " [1] ",
    std::string def_B = " [1] ",
    unsigned int channels = 1 )

```

Constructor of the IIR filter.

Initialises the sub-parser structure and the memory for holding the filter's state.

## Parameters

<i>help</i>	The help string for the parser that groups the configuration variables of this filter. Could be used to describe the purpose of this IIR filter.
<i>def_A</i>	The initial value of the vector of the recursive filter coefficients, represented as string.
<i>def_B</i>	The initial value of the vector of the non-recursive filter coefficients, represented as string.
<i>channels</i>	The number of independent audio channels to process with this filter. Needed to allocate a state vector for each audio channel.

## 5.195.3 Member Function Documentation

#### 5.195.3.1 void MHAFilter::iir\_filter\_t::filter (                   mha\_wave\_t \* y,                   const mha\_wave\_t \* x )

The filter processes the audio signal.

All channels in the audio signal are processed using the same filter coefficients. Independent state is stored between calls for each audio channel.

## Parameters

<i>y</i>	Pointer to output signal holder. The output signal is stored here. Has to have the same signal dimensions as the input signal x. In-place processing (y and x pointing to the same signal holder) is possible.
<i>x</i>	Pointer to input signal holder. Number of channels has to be the same as given to the constructor, or to the <b>resize</b> (p. 542) method.

#### 5.195.3.2 mha\_real\_t MHAFilter::iir\_filter\_t::filter (                   mha\_real\_t x,                   unsigned int ch )

Filter a single audio sample.

## Parameters

<i>x</i>	The single audio sample
<i>ch</i>	Zero-based channel index. Use and change the state of channel ch. ch has to be less than the number of channels given to the constructor or the <b>resize</b> (p. 542) method.

**Returns**

the filtered result sample.

**5.195.3.3** void MHAFilter::iir\_filter\_t::resize (   
 unsigned int *channels* )

Change the number of channels after object creation.

**Parameters**

<i>channels</i>	The new number of channels. Old filter states are lost.
-----------------	---

**5.195.3.4** void MHAFilter::iir\_filter\_t::update\_filter ( ) [private]

**5.195.4 Member Data Documentation**

**5.195.4.1** MHAParser::vfloat\_t MHAFilter::iir\_filter\_t::A [private]

**5.195.4.2** MHAParser::vfloat\_t MHAFilter::iir\_filter\_t::B [private]

**5.195.4.3** MHAEvents::patchbay\_t<iir\_filter\_t> MHAFilter::iir\_filter\_t::connector [private]

**5.195.4.4** unsigned int MHAFilter::iir\_filter\_t::nchannels [private]

The documentation for this class was generated from the following files:

- **mha\_filter.hh**
- **mha\_filter.cpp**

**5.196 MHAFilter::iir\_ord1\_real\_t Class Reference**

First order recursive filter.

## Public Member Functions

- **iir\_ord1\_real\_t** (std::vector< **mha\_real\_t** > A, std::vector< **mha\_real\_t** > B)  
*Constructor with filter coefficients (one per channel)*
- **iir\_ord1\_real\_t** (std::vector< **mha\_real\_t** > tau, **mha\_real\_t** srate)  
*Constructor for low pass filter (one time constant per channel)*
- void **set\_state** (**mha\_real\_t** val)
- void **set\_state** (std::vector< **mha\_real\_t** > val)
- void **set\_state** (**mha\_complex\_t** val)
- **mha\_real\_t operator()** (unsigned int ch, **mha\_real\_t** x)  
*Filter method for real value input, one element.*
- **mha\_complex\_t operator()** (unsigned int ch, **mha\_complex\_t** x)  
*Filter method for complex input, one element.*
- void **operator()** (const **mha\_wave\_t** &X, **mha\_wave\_t** &Y)  
*Filter method for real value input.*
- void **operator()** (const **mha\_spec\_t** &X, **mha\_spec\_t** &Y)  
*Filter method for complex value input.*
- void **operator()** (const **mha\_wave\_t** &Xre, const **mha\_wave\_t** &Xim, **mha\_wave\_t** &Yre, **mha\_wave\_t** &Yim)  
*Filter method for complex value input.*

## Private Attributes

- std::vector< **mha\_real\_t** > **A\_**
- std::vector< **mha\_real\_t** > **B\_**
- std::vector< **mha\_complex\_t** > **Yn**

## 5.196.1 Detailed Description

First order recursive filter.

## 5.196.2 Constructor &amp; Destructor Documentation

5.196.2.1 MHAFilter::iir\_ord1\_real\_t::iir\_ord1\_real\_t (  
std::vector< **mha\_real\_t** > A,  
std::vector< **mha\_real\_t** > B )

Constructor with filter coefficients (one per channel)

5.196.2.2 MHAFilter::iir\_ord1\_real\_t::iir\_ord1\_real\_t (  
std::vector< **mha\_real\_t** > tau,  
**mha\_real\_t** srate )

Constructor for low pass filter (one time constant per channel)

### 5.196.3 Member Function Documentation

5.196.3.1 void MHAFilter::iir\_ord1\_real\_t::set\_state (   
 mha\_real\_t val )

5.196.3.2 void MHAFilter::iir\_ord1\_real\_t::set\_state (   
 std::vector< mha\_real\_t > val )

5.196.3.3 void MHAFilter::iir\_ord1\_real\_t::set\_state (   
 mha\_complex\_t val )

5.196.3.4 mha\_real\_t MHAFilter::iir\_ord1\_real\_t::operator() (   
 unsigned int ch,   
 mha\_real\_t x ) [inline]

Filter method for real value input, one element.

5.196.3.5 mha\_complex\_t MHAFilter::iir\_ord1\_real\_t::operator() (   
 unsigned int ch,   
 mha\_complex\_t x ) [inline]

Filter method for complex input, one element.

5.196.3.6 void MHAFilter::iir\_ord1\_real\_t::operator() (   
 const mha\_wave\_t & X,   
 mha\_wave\_t & Y ) [inline]

Filter method for real value input.

5.196.3.7 void MHAFilter::iir\_ord1\_real\_t::operator() (   
 const mha\_spec\_t & X,   
 mha\_spec\_t & Y ) [inline]

Filter method for complex value input.

5.196.3.8 void MHAFilter::iir\_ord1\_real\_t::operator() (   
 const mha\_wave\_t & Xre,   
 const mha\_wave\_t & Xim,   
 mha\_wave\_t & Yre,   
 mha\_wave\_t & Yim ) [inline]

Filter method for complex value input.



## 5.196.4 Member Data Documentation

5.196.4.1 `std::vector<mha_real_t> MHAFilter::iir_ord1_real_t::A_` [private]

5.196.4.2 `std::vector<mha_real_t> MHAFilter::iir_ord1_real_t::B_` [private]

5.196.4.3 `std::vector<mha_complex_t> MHAFilter::iir_ord1_real_t::Yn` [private]

The documentation for this class was generated from the following files:

- `mha_filter.hh`
- `mha_filter.cpp`

## 5.197 MHAFilter::o1\_ar\_filter\_t Class Reference

First order attack-release lowpass filter.

Inheritance diagram for MHAFilter::o1\_ar\_filter\_t:

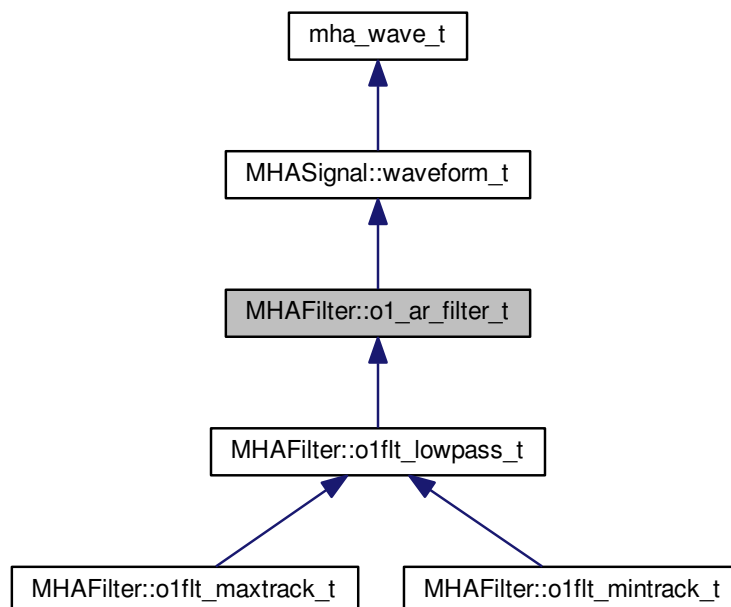

## Public Member Functions

- **o1\_ar\_filter\_t** (unsigned int **channels**, **mha\_real\_t fs**=1.0f, std::vector< mha\_real\_t > **tau\_a**=std::vector< float >(1, 0.0f), std::vector< mha\_real\_t > **tau\_r**=std::vector< float >(1, 0.0f))  
*Constructor, setting all taus to zero.*
- void **set\_tau\_attack** (unsigned int ch, **mha\_real\_t tau**)  
*Set the attack time constant.*
- void **set\_tau\_release** (unsigned int ch, **mha\_real\_t tau**)  
*Set the release time constant.*
- **mha\_real\_t operator()** (unsigned int ch, **mha\_real\_t x**)  
*Apply filter to value x, using state channel ch.*
- void **operator()** (const **mha\_wave\_t** &in, **mha\_wave\_t** &out)  
*Apply filter to a **mha\_wave\_t** (p. 496) data.*

## Protected Attributes

- **MHASignal::waveform\_t c1\_a**
- **MHASignal::waveform\_t c2\_a**
- **MHASignal::waveform\_t c1\_r**
- **MHASignal::waveform\_t c2\_r**
- **mha\_real\_t fs**

## Additional Inherited Members

### 5.197.1 Detailed Description

First order attack-release lowpass filter.

This filter is the base of first order lowpass filter, maximum tracker and minimum tracker.

### 5.197.2 Constructor & Destructor Documentation

5.197.2.1 **MHAFilter::o1\_ar\_filter\_t::o1\_ar\_filter\_t** (  
     unsigned int *channels*,  
     **mha\_real\_t fs** = 1.0f,  
     std::vector< **mha\_real\_t** > *tau\_a* = std::vector<float>(1, 0.0f),  
     std::vector< **mha\_real\_t** > *tau\_r* = std::vector<float>(1, 0.0f) )

Constructor, setting all taus to zero.

The filter state can be accessed through the member functions of **MHASignal::waveform\_t** (p. 812).

## Parameters

<i>channels</i>	Number of independent filters
<i>fs</i>	Sampling rate (optional, default = 1)
<i>tau_a</i>	Attack time constants (optional, default = 0)
<i>tau_r</i>	Release time constants (optional, default = 0)

## 5.197.3 Member Function Documentation

5.197.3.1 void MHAFilter::o1\_ar\_filter\_t::set\_tau\_attack (  
     unsigned int *ch*,  
     mha\_real\_t *tau* )

Set the attack time constant.

## Parameters

<i>ch</i>	Channel number
<i>tau</i>	Time constant

5.197.3.2 void MHAFilter::o1\_ar\_filter\_t::set\_tau\_release (  
     unsigned int *ch*,  
     mha\_real\_t *tau* )

Set the release time constant.

## Parameters

<i>ch</i>	Channel number
<i>tau</i>	Time constant

5.197.3.3 mha\_real\_t MHAFilter::o1\_ar\_filter\_t::operator() (  
     unsigned int *ch*,  
     mha\_real\_t *x* ) [inline]

Apply filter to value *x*, using state channel *ch*.

## Parameters

<i>ch</i>	Channel number
<i>x</i>	Input value

**Returns**

Output value

```
5.197.3.4 void MHAFilter::o1_ar_filter_t::operator() (
           const mha_wave_t & in,
           mha_wave_t & out ) [inline]
```

Apply filter to a **mha\_wave\_t** (p. 496) data.

**Parameters**

<i>in</i>	Input signal
<i>out</i>	Output signal

The number of channels must match the number of filter bands.

**5.197.4 Member Data Documentation**

5.197.4.1 **MHASignal::waveform\_t** MHAFilter::o1\_ar\_filter\_t::c1\_a [protected]

5.197.4.2 **MHASignal::waveform\_t** MHAFilter::o1\_ar\_filter\_t::c2\_a [protected]

5.197.4.3 **MHASignal::waveform\_t** MHAFilter::o1\_ar\_filter\_t::c1\_r [protected]

5.197.4.4 **MHASignal::waveform\_t** MHAFilter::o1\_ar\_filter\_t::c2\_r [protected]

5.197.4.5 **mha\_real\_t** MHAFilter::o1\_ar\_filter\_t::fs [protected]

The documentation for this class was generated from the following files:

- **mha\_filter.hh**
- **mha\_filter.cpp**

**5.198 MHAFilter::o1flt\_lowpass\_t Class Reference**

First order low pass filter.

Inheritance diagram for MHAFilter::o1flt\_lowpass\_t:

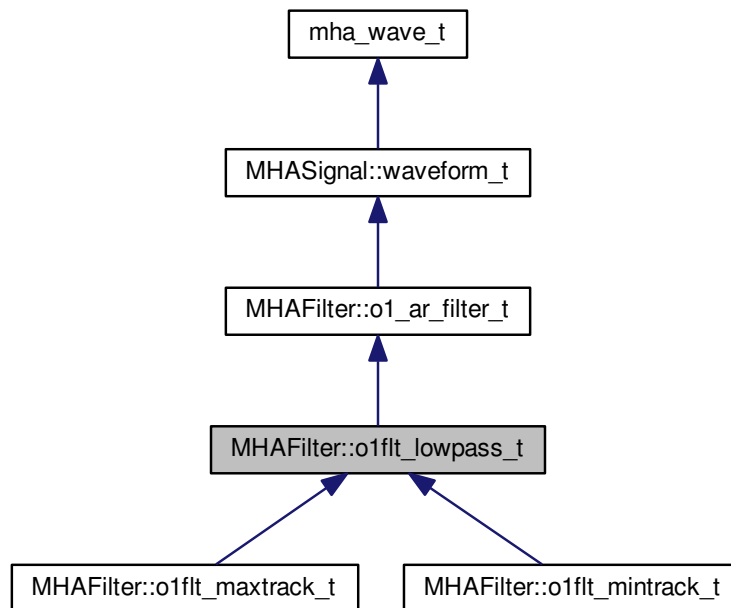

### Public Member Functions

- **o1flt\_lowpass\_t** (const std::vector< **mha\_real\_t** > &, **mha\_real\_t**, **mha\_real\_t**=0)  
*Constructor of low pass filter, sets sampling rate and time constants.*
- void **set\_tau** (unsigned int ch, **mha\_real\_t** tau)  
*change the time constant in one channel*
- void **set\_tau** (**mha\_real\_t** tau)  
*set time constant in all channels to tau*
- **mha\_real\_t** **get\_c1** (unsigned int ch) const
- **mha\_real\_t** **get\_last\_output** (unsigned int ch) const

### Additional Inherited Members

#### 5.198.1 Detailed Description

First order low pass filter.

## 5.198.2 Constructor & Destructor Documentation

5.198.2.1 `MHAFilter::o1flt_lowpass_t::o1flt_lowpass_t (`  
`const std::vector< mha_real_t > & tau,`  
`mha_real_t fs,`  
`mha_real_t startval = 0 )`

Constructor of low pass filter, sets sampling rate and time constants.

### Parameters

<i>tau</i>	Vector of time constants
<i>fs</i>	Sampling rate
<i>startval</i>	Initial internal state value

## 5.198.3 Member Function Documentation

5.198.3.1 `void MHAFilter::o1flt_lowpass_t::set_tau (`  
`unsigned int ch,`  
`mha_real_t tau )`

change the time constant in one channel

5.198.3.2 `void MHAFilter::o1flt_lowpass_t::set_tau (`  
`mha_real_t tau )`

set time constant in all channels to tau

5.198.3.3 `mha_real_t MHAFilter::o1flt_lowpass_t::get_c1 (`  
`unsigned int ch ) const [inline]`

5.198.3.4 `mha_real_t MHAFilter::o1flt_lowpass_t::get_last_output (`  
`unsigned int ch ) const [inline]`

The documentation for this class was generated from the following files:

- `mha_filter.hh`
- `mha_filter.cpp`

## 5.199 MHAFilter::o1flt\_maxtrack\_t Class Reference

First order maximum tracker.

Inheritance diagram for MHAFilter::o1flt\_maxtrack\_t:

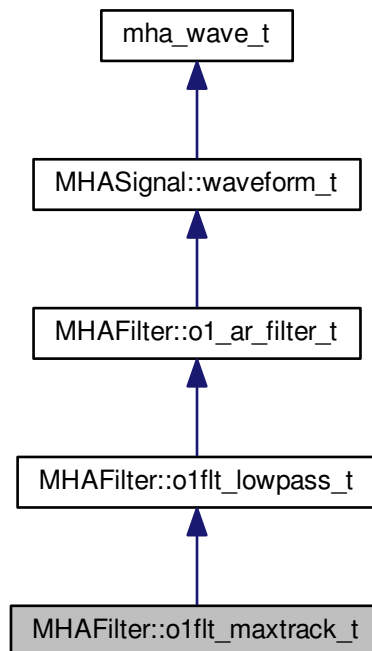

### Public Member Functions

- **o1flt\_maxtrack\_t** (const std::vector< **mha\_real\_t** > &, **mha\_real\_t**, **mha\_real\_t**=0)  
*Constructor of low pass filter, sets sampling rate and time constants.*
- void **set\_tau** (unsigned int ch, **mha\_real\_t** tau)  
*change the time constant in one channel*
- void **set\_tau** (**mha\_real\_t** tau)  
*set time constant in all channels to tau*

### Additional Inherited Members

#### 5.199.1 Detailed Description

First order maximum tracker.

## 5.199.2 Constructor & Destructor Documentation

5.199.2.1 `MHAFilter::o1flt_maxtrack_t::o1flt_maxtrack_t (`  
`const std::vector< mha_real_t > & tau,`  
`mha_real_t fs,`  
`mha_real_t startval = 0 )`

Constructor of low pass filter, sets sampling rate and time constants.

### Parameters

<i>tau</i>	Vector of time constants
<i>fs</i>	Sampling rate
<i>startval</i>	Initial internal state value

## 5.199.3 Member Function Documentation

5.199.3.1 `void MHAFilter::o1flt_maxtrack_t::set_tau (`  
`unsigned int ch,`  
`mha_real_t tau )`

change the time constant in one channel

5.199.3.2 `void MHAFilter::o1flt_maxtrack_t::set_tau (`  
`mha_real_t tau )`

set time constant in all channels to tau

The documentation for this class was generated from the following files:

- `mha_filter.hh`
- `mha_filter.cpp`

## 5.200 MHAFilter::o1flt\_mintrack\_t Class Reference

First order minimum tracker.



Inheritance diagram for MHAFilter::o1flt\_mintrack\_t:

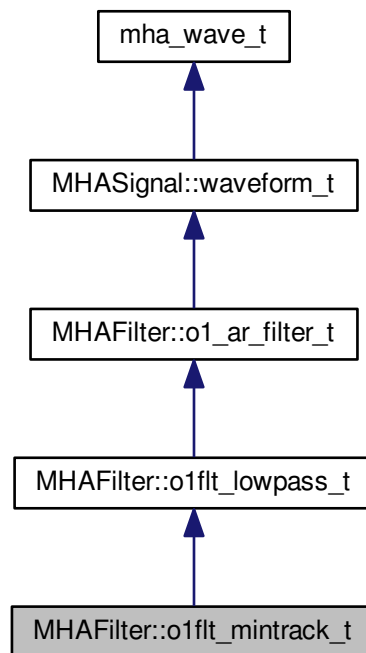

### Public Member Functions

- `o1flt_mintrack_t` (const std::vector< `mha_real_t` > &, `mha_real_t`, `mha_real_t`=0)
- void `set_tau` (unsigned int ch, `mha_real_t` tau)  
*change the time constant in one channel*
- void `set_tau` (`mha_real_t` tau)  
*set time constant in all channels to tau*

### Additional Inherited Members

#### 5.200.1 Detailed Description

First order minimum tracker.

## 5.200.2 Constructor & Destructor Documentation

5.200.2.1 `MHAFilter::o1flt_mintrack_t::o1flt_mintrack_t (`  
     `const std::vector< mha_real_t > & tau,`  
     `mha_real_t fs,`  
     `mha_real_t startval = 0 )`

## 5.200.3 Member Function Documentation

5.200.3.1 `void MHAFilter::o1flt_mintrack_t::set_tau (`  
     `unsigned int ch,`  
     `mha_real_t tau )`

change the time constant in one channel

5.200.3.2 `void MHAFilter::o1flt_mintrack_t::set_tau (`  
     `mha_real_t tau )`

set time constant in all channels to tau

The documentation for this class was generated from the following files:

- `mha_filter.hh`
- `mha_filter.cpp`

## 5.201 MHAFilter::partitioned\_convolution\_t Class Reference

A filter class for partitioned convolution.

### Classes

- struct `index_t`  
     *Bookkeeping class.*

### Public Member Functions

- `partitioned_convolution_t` (unsigned int `fragsize`, unsigned int `nchannels_in`, unsigned int `nchannels_out`, const `transfer_matrix_t` &transfer)  
     *Create a new partitioned convolver.*
- `~partitioned_convolution_t` ()  
     *Free fftw resource allocated in constructor.*
- `mha_wave_t * process` (const `mha_wave_t *s_in`)  
     *processing*

## Public Attributes

- unsigned int **fragsize**  
*Audio fragment size, always equal to partition size.*
- unsigned int **nchannels\_in**  
*Number of audio input channels.*
- unsigned int **nchannels\_out**  
*Number of audio output channels.*
- unsigned int **output\_partitions**  
*The maximum number of partitions in any of the impulse responses.*
- unsigned int **filter\_partitions**  
*The total number of non-zero impulse response partitions.*
- **MHASignal::waveform\_t** **input\_signal\_wave**  
*Buffer for input signal.*
- unsigned int **current\_input\_signal\_buffer\_half\_index**  
*A counter modulo 2.*
- **MHASignal::spectrum\_t** **input\_signal\_spec**  
*Buffer for FFT transformed input signal.*
- **MHASignal::spectrum\_t** **frequency\_response**  
*Buffers for frequency response spectra of impulse response partitions.*
- std::vector< **index\_t** > **bookkeeping**  
*Keeps track of input channels, output channels, impulse response partition, and delay.*
- std::vector< **MHASignal::spectrum\_t** > **output\_signal\_spec**  
*Buffers for FFT transformed output signal.*
- unsigned int **current\_output\_partition\_index**  
*A counter modulo output\_partitions, indexing the "current" output partition.*
- **MHASignal::waveform\_t** **output\_signal\_wave**  
*Buffer for the wave output signal.*
- **mha\_fft\_t** **fft**  
*The FFT transformer.*

## 5.201.1 Detailed Description

A filter class for partitioned convolution.

Impulse responses are partitioned into sections of fragment size. Audio signal is convolved with every partition and delayed as needed. Convolution is done according to overlap-save. FFT length used is 2 times fragment size.

## 5.201.2 Constructor &amp; Destructor Documentation

```
5.201.2.1 MHAFilter::partitioned_convolution_t::partitioned_convolution_t (
    unsigned int fragsize,
    unsigned int nchannels_in,
    unsigned int nchannels_out,
    const transfer_matrix_t & transfer )
```

Create a new partitioned convolver.

**Parameters**

<i>fragsize</i>	Audio fragment size, equal to partition size.
<i>nchannels_in</i>	Number of input audio channels.
<i>nchannels_out</i>	Number of output audio channels.
<i>transfer</i>	A sparse matrix of impulse responses.

**5.201.2.2 MHAFilter::partitioned\_convolution\_t::~~partitioned\_convolution\_t ( )**

Free fftw resource allocated in constructor.

**5.201.3 Member Function Documentation****5.201.3.1 mha\_wave\_t \* MHAFilter::partitioned\_convolution\_t::process ( const mha\_wave\_t \* s\_in )**

processing

**5.201.4 Member Data Documentation****5.201.4.1 unsigned int MHAFilter::partitioned\_convolution\_t::fragsize**

Audio fragment size, always equal to partition size.

**5.201.4.2 unsigned int MHAFilter::partitioned\_convolution\_t::nchannels\_in**

Number of audio input channels.

**5.201.4.3 unsigned int MHAFilter::partitioned\_convolution\_t::nchannels\_out**

Number of audio output channels.

**5.201.4.4 unsigned int MHAFilter::partitioned\_convolution\_t::output\_partitions**

The maximum number of partitions in any of the impulse responses.

Determines the size of the delay line.

**5.201.4.5 unsigned int MHAFilter::partitioned\_convolution\_t::filter\_partitions**

The total number of non-zero impulse response partitions.

5.201.4.6 MHAFilter::partitioned\_convolution\_t::input\_signal\_wave

Buffer for input signal.

Has nchannels\_in channels and fragsize\*2 frames

5.201.4.7 MHAFilter::partitioned\_convolution\_t::current\_input\_signal\_buffer\_half\_index

A counter modulo 2.

Indicates the buffer half in input signal wave into which to copy the current input signal.

5.201.4.8 MHAFilter::partitioned\_convolution\_t::input\_signal\_spec

Buffer for FFT transformed input signal.

Has nchannels\_in channels and fragsize+1 frames (fft bins).

5.201.4.9 MHAFilter::partitioned\_convolution\_t::frequency\_response

Buffers for frequency response spectra of impulse response partitions.

Each "channel" contains another partition of some impulse response. The bookkeeping array is used to keep track what to do with these frequency responses. This container has filter\_partitions channels and fragsize+1 frames (fft bins).

5.201.4.10 MHAFilter::partitioned\_convolution\_t::bookkeeping

Keeps track of input channels, output channels, impulse response partition, and delay.

The index into this array is the same as the "channel" index into the frequency\_response array. Array has filter\_partitions entries.

5.201.4.11 MHAFilter::partitioned\_convolution\_t::output\_signal\_spec

Buffers for FFT transformed output signal.

For each array member, Number of channels is equal to nchannels\_out, number of frames (fft bins) is equal to fragsize+1. Array size is equal to output\_partitions.

5.201.4.12 MHAFilter::partitioned\_convolution\_t::current\_output\_partition\_index

A counter modulo output\_partitions, indexing the "current" output partition.

### 5.201.4.13 MHASignal::waveform\_t MHAFilter::partitioned\_convolution\_t::output\_signal\_wave

Buffer for the wave output signal.

Number of channels is equal to nchannels\_out, number of frames is equal to fragsize

### 5.201.4.14 mha\_fft\_t MHAFilter::partitioned\_convolution\_t::fft

The FFT transformer.

The documentation for this class was generated from the following files:

- **mha\_filter.hh**
- **mha\_filter.cpp**

## 5.202 MHAFilter::partitioned\_convolution\_t::index\_t Struct Reference

Bookkeeping class.

### Public Member Functions

- **index\_t** (unsigned int src, unsigned int tgt, unsigned int dly)  
*Data constructor.*
- **index\_t** ()  
*Default constructor for STL compatibility.*

### Public Attributes

- unsigned int **source\_channel\_index**  
*The input channel index to apply the current partition to.*
- unsigned int **target\_channel\_index**  
*The index of the output channel to which the filter result should go.*
- unsigned int **delay**  
*The delay (in blocks) of this partition.*

### 5.202.1 Detailed Description

Bookkeeping class.

For each impulse response partition, keeps track of which input to filter, which output channel to filter to, and the delay in blocks. Objects of class Index should be kept in an array with the same indices as the corresponding impulse response partitions.

### 5.202.2 Constructor & Destructor Documentation

```
5.202.2.1 MHAFilter::partitioned_convolution_t::index_t::index_t(
    unsigned int src,
    unsigned int tgt,
    unsigned int dly ) [inline]
```

Data constructor.

## Parameters

<i>src</i>	The input channel index to apply the current partition to.
<i>tgt</i>	The index of the output channel to which the filter result should go.
<i>dly</i>	The delay (in blocks) of this partition

## 5.202.2.2 MHAFilter::partitioned\_convolution\_t::index\_t::index\_t( ) [inline]

Default constructor for STL compatibility.

## 5.202.3 Member Data Documentation

## 5.202.3.1 unsigned int MHAFilter::partitioned\_convolution\_t::index\_t::source\_channel\_index

The input channel index to apply the current partition to.

## 5.202.3.2 unsigned int MHAFilter::partitioned\_convolution\_t::index\_t::target\_channel\_index

The index of the output channel to which the filter result should go.

## 5.202.3.3 unsigned int MHAFilter::partitioned\_convolution\_t::index\_t::delay

The delay (in blocks) of this partition.

The documentation for this struct was generated from the following file:

- **mha\_filter.hh**

## 5.203 MHAFilter::polyphase\_resampling\_t Class Reference

A class that performs polyphase resampling.

## Public Member Functions

- **polyphase\_resampling\_t** (unsigned n\_up, unsigned n\_down, **mha\_real\_t** nyquist\_ratio, unsigned n\_irs, unsigned n\_ringbuffer, unsigned n\_channels, unsigned n\_prefill)  
*Construct a polyphase resampler instance.*
- void **write** (**mha\_wave\_t** &signal)  
*Write signal to the ringbuffer.*
- void **read** (**mha\_wave\_t** &signal)  
*Read resampled signal.*
- unsigned **readable\_frames** () const  
*Number of frames at target sampling rate that can be produced.*

### Private Attributes

- unsigned **upsampling\_factor**  
*Integer upsampling factor.*
- unsigned **downsampling\_factor**  
*Integer downsampling factor.*
- unsigned **now\_index**  
*Index of "now" in the interpolated sampling rate.*
- bool **underflow**  
*Set to true when an underflow has occurred.*
- **MHAWindow::hanning\_t impulse\_response**  
*Contains the impulse response of the lowpass filter needed for anti-aliasing.*
- **MHASignal::ringbuffer\_t ringbuffer**  
*Storage of input signal.*

#### 5.203.1 Detailed Description

A class that performs polyphase resampling.

Background information: When resampling from one sampling rate to another, it helps when one sampling rate is a multiple of the other sampling rate: In the case of upsampling, the samples at the original rate are copied to the upsampled signal spread out with a constant number of zero samples between the originally adjacent samples. The signal is then low-pass filtered to avoid frequency aliasing and to fill the zero-samples with interpolated values. In the case of down-sampling, the signal is first low-pass filtered for anti-aliasing, and only every  $n^{\text{th}}$  sample of the filtered output is used for the signal at the new sample rate. Of course, for finite-impulse-response (FIR) filters this means that only every  $n^{\text{th}}$  sample needs to be computed.

When resampling from one sampling rate to another where neither is a multiple of the other, the signal first needs to be upsampled to a sampling rate that is a multiple of both (source and target) sampling rates, and then downsampled again to the target sampling rate. Instead of applying two separate lowpass filters directly after each other (one filter for upsampling and another for downsampling), it is sufficient to apply only one low-pass filter, when producing the output at the final target rate, with a cut-off frequency equal to the lower cut-off-frequency of the replaced two low-pass filters. Not filtering to produce a filtered signal already at the common multiple sampling rate has the side effect that this intermediate signal at the common multiple sampling rate keeps its filler zero samples unaltered. These zero samples can be taken advantage of when filtering to produce the output at the target rate: The zeros do not need to be multiplied with their corresponding filter coefficients, because the result is known to be zero again, and this zero product has no effect on the summation operation to compute a target sample at the target rate. To summarize, the following optimization techniques are available:

- The signal does not need to be stored in memory at the interpolation rate. It is sufficient to have the signal available at the source rate and to know where the zeros would be.
- The signal needs to be low-pass-filtered only once.
- The FIR low-pass filtering can take advantage of



- computing only filter outputs for the required samples at the target rate,
- skipping over zero-samples at the interpolation rate.

The procedure that takes advantage of these optimization possibilities is known as polyphase resampling.

This class implements polyphase resampling in this way for a source sampling rate and a target sampling rate that have common multiple, the interpolation sampling rate. Non-rational and drifting sample rates are outside the scope of this resampler.

### 5.203.2 Constructor & Destructor Documentation

5.203.2.1 MHAFilter::polyphase\_resampling\_t::polyphase\_resampling\_t (   
     unsigned *n\_up*,  
     unsigned *n\_down*,  
     mha\_real\_t *nyquist\_ratio*,  
     unsigned *n\_irs*,  
     unsigned *n\_ringbuffer*,  
     unsigned *n\_channels*,  
     unsigned *n\_prefill* )

Construct a polyphase resampler instance.

Allocates a ringbuffer with the given capacity *n\_ringbuffer*. Client that triggers the constructor must ensure that the capacity *n\_ringbuffer* and the delay *n\_prefill* are sufficient, i.e. enough old and new samples are always available to compute sufficient samples in using an impulse response of length *n\_irs*. Audio block sizes at both sides of the resampler have to be taken into account. Class `MHASignal::blockprocessing_polyphase_resampling_t` takes care of this, and it is recommended to use this class for block-based processing.

Based on *n\_up*, *n\_down*, *n\_irs* and *nyquist\_ratio*, a suitable sinc impulse response is computed and windowed with a hanning window to limit its extent.

The actual source sampling rate, target sampling rate, and interpolation sampling rate are not parameters to this constructors, because only their ratios matter.

#### Parameters

<i>n_up</i>	upsampling factor, ratio between interpolation rate and source rate.
<i>n_down</i>	downsampling factor, ratio between interpolation rate and target rate.
<i>nyquist_ratio</i>	low pass filter cutoff frequency relative to the nyquist frequency of the smaller of the two sampling rates. Example values: E.g. 0.8, 0.9
<i>n_irs</i>	length of impulse response (in samples at interpolation rate)
<i>n_ringbuffer</i>	length of ringbuffer, in samples at source sampling rate
<i>n_channels</i>	audio channels count
<i>n_prefill</i>	Prefill the ringbuffer with this many zero frames in samples at source sampling rate

### 5.203.3 Member Function Documentation

#### 5.203.3.1 void MHAFilter::polyphase\_resampling\_t::write ( mha\_wave\_t & signal )

Write signal to the ringbuffer.

Signal contained in signal is appended to the audio frames already present in the ringbuffer.

##### Parameters

<i>signal</i>	input signal in original sampling rate
---------------	--

##### Exceptions

<b>MHA_Error</b> (p. 445)	Raises exception if there is not enough room or if the number of channels does not match.
---------------------------	---

#### 5.203.3.2 void MHAFilter::polyphase\_resampling\_t::read ( mha\_wave\_t & signal )

Read resampled signal.

Will perform the resampling and remove no longer needed samples from the input buffer.

##### Parameters

<i>signal</i>	buffer to write the resampled signal to.
---------------	--

##### Exceptions

<b>MHA_Error</b> (p. 445)	Raises exception if there is not enough input signal or if the number of channels is too high.
---------------------------	--

#### 5.203.3.3 unsigned MHAFilter::polyphase\_resampling\_t::readable\_frames ( ) const [inline]

Number of frames at target sampling rate that can be produced.

This method only checks for enough future samples present, therefore, this number can be positive and a read operation can still fail if there are not enough past samples present to perform the filtering for the first output sample. This could only happen if the constructor parameters *n\_ringbuffer* or *n\_prefill* have been chosen too small, because otherwise the method **read** (p. 562) ensures that enough past samples are present to compute the next target sample.

## 5.203.4 Member Data Documentation

## 5.203.4.1 unsigned MHAFilter::polyphase\_resampling\_t::upsampling\_factor [private]

Integer upsampling factor.

Interpolation rate divided by source rate.

## 5.203.4.2 unsigned MHAFilter::polyphase\_resampling\_t::downsampling\_factor [private]

Integer downsampling factor.

Interpolation rate divided by target rate.

## 5.203.4.3 unsigned MHAFilter::polyphase\_resampling\_t::now\_index [private]

Index of "now" in the interpolated sampling rate.

**Todo** Index into what? What is the meaning of now?

## 5.203.4.4 bool MHAFilter::polyphase\_resampling\_t::underflow [private]

Set to true when an underflow has occurred.

When this is true, then the object can no longer be used. Underflows have to be avoided by clients, e.g. by checking that enough **readable\_frames** (p. 562) are present before calling **read** (p. 562)

## 5.203.4.5 MHAWindow::hanning\_t MHAFilter::polyphase\_resampling\_t::impulse\_response [private]

Contains the impulse response of the lowpass filter needed for anti-aliasing.

The impulse response is stored at the interpolation sampling rate. We use an instance of **MHAWindow::hanning\_t** (p. 840) here because we are limiting the sinc impulse response with a Hanning window (otherwise the impulse response would extend indefinitely into past and future). And the samples inside an **MHAWindow::hanning\_t** (p. 840) can be altered with `*=`, which our constructor does.

## 5.203.4.6 MHASignal::ringbuffer\_t MHAFilter::polyphase\_resampling\_t::ringbuffer [private]

Storage of input signal.

Part of the polyphase resampling optimization is that apart from the FIR impulse response, nothing is stored at the interpolation rate, saving memory and computation cycles.

The documentation for this class was generated from the following files:

- **mha\_filter.hh**
- **mha\_filter.cpp**

## 5.204 MHAFilter::resampling\_filter\_t Class Reference

Hann shaped low pass filter for resampling.

Inheritance diagram for MHAFilter::resampling\_filter\_t:

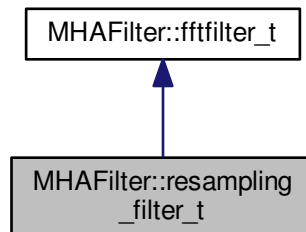

### Public Member Functions

- **resampling\_filter\_t** (unsigned int **fftl**en, unsigned int **irsl**en, unsigned int **chann**els, unsigned int **Nup**, unsigned int **Ndown**, double **fCutOff**)  
*Constructor.*

### Static Public Member Functions

- static unsigned int **fragsize\_validator** (unsigned int **fftl**en, unsigned int **irsl**en)

### Private Attributes

- unsigned int **fragsize**

#### 5.204.1 Detailed Description

Hann shaped low pass filter for resampling.

This class uses FFT filter at upsampled rate.

#### 5.204.2 Constructor & Destructor Documentation

5.204.2.1 MHAFilter::resampling\_filter\_t::resampling\_filter\_t ( unsigned int *fftl*en, unsigned int *irsl*en, unsigned int *chann*els, unsigned int *Nup*, unsigned int *Ndown*, double *fCutOff* )

Constructor.

## Parameters

<i>ffflen</i>	FFT length.
<i>irslen</i>	Length of filter.
<i>channels</i>	Number of channels to be filtered.
<i>Nup</i>	Upsampling ratio.
<i>Ndown</i>	Downsampling ratio.
<i>fCutOff</i>	Cut off frequency (relative to lower Nyquist Frequency)

## 5.204.3 Member Function Documentation

5.204.3.1 unsigned int MHAFilter::resampling\_filter\_t::fragsize\_validator ( unsigned int *ffflen*, unsigned int *irslen* ) [static]

## 5.204.4 Member Data Documentation

5.204.4.1 unsigned int MHAFilter::resampling\_filter\_t::fragsize [private]

The documentation for this class was generated from the following files:

- **mha\_filter.hh**
- **mha\_filter.cpp**

## 5.205 MHAFilter::smoothspec\_t Class Reference

Smooth spectral gains, create a windowed impulse response.

## Public Member Functions

- **smoothspec\_t** (unsigned int *ffflen*, unsigned int *nchannels*, const **MHAWindow**↔  
::**base\_t** &*window*, bool *minphase*, bool *linphase\_asym*=false)  
*Constructor.*
- void **smoothspec** (const **mha\_spec\_t** &*s\_in*, **mha\_spec\_t** &*s\_out*)  
*Create a smoothed spectrum.*
- void **smoothspec** (**mha\_spec\_t** &*spec*)  
*Create a smoothed spectrum (in place)*
- void **spec2fir** (const **mha\_spec\_t** &*spec*, **mha\_wave\_t** &*fir*)  
*Return FIR coefficients.*
- ~**smoothspec\_t** ()

### Private Member Functions

- void **internal\_fir** (const **mha\_spec\_t** &)

### Private Attributes

- unsigned int **fftlen**
- unsigned int **nchannels**
- **MHAWindow::base\_t** **window**
- **MHASignal::waveform\_t** **tmp\_wave**
- **MHASignal::spectrum\_t** **tmp\_spec**
- **MHASignal::minphase\_t** \* **minphase**
- bool **\_linphase\_asym**
- **mha\_fft\_t** **fft**

#### 5.205.1 Detailed Description

Smooth spectral gains, create a windowed impulse response.

Spectral gains are smoothed by multiplying the impulse response with a window function.

If a minimal phase is used, then the original phase is discarded and replaced by the minimal phase function. In this case, the window is applied to the beginning of the inverse Fourier transform of the input spectrum, and the remaining signal set to zero. If the original phase is kept, the window is applied symmetrical around zero, i.e. to the first and last samples of the inverse Fourier transform of the input spectrum. The **spec2fir()** (p. 567) function creates a causal impulse response by circular shifting the impulse response by half of the window length.

The signal dimensions of the arguments of **smoothspec()** (p. 567) must correspond to the FFT length and number of channels provided in the constructor. The function **spec2fir()** (p. 567) can fill signal structures with more than window length frames.

#### 5.205.2 Constructor & Destructor Documentation

5.205.2.1 **MHAFilter::smoothspec\_t::smoothspec\_t** (  
     unsigned int *fftlen*,  
     unsigned int *nchannels*,  
     const **MHAWindow::base\_t** & *window*,  
     bool *minphase*,  
     bool *linphase\_asym* = false )

Constructor.

## Parameters

<i>fftlen</i>	FFT length of input spectrum (fftlen/2+1 bins)
<i>nchannels</i>	Number of channels in input spectrum
<i>window</i>	Window used for smoothing
<i>minphase</i>	Use minimal phase (true) or original phase (false)
<i>linphase_asym</i>	Keep phase, but apply full window at beginning of IRS

## 5.205.2.2 MHAFilter::smoothspec\_t::~smoothspec\_t ( )

## 5.205.3 Member Function Documentation

5.205.3.1 void MHAFilter::smoothspec\_t::smoothspec (   
const mha\_spec\_t & s\_in,   
mha\_spec\_t & s\_out )

Create a smoothed spectrum.

## Parameters

<i>s_in</i>	Input spectrum
-------------	----------------

## Return values

<i>s_out</i>	Output spectrum
--------------	-----------------

5.205.3.2 void MHAFilter::smoothspec\_t::smoothspec (   
mha\_spec\_t & spec ) [inline]

Create a smoothed spectrum (in place)

## Parameters

<i>spec</i>	Spectrum to be smoothed.
-------------	--------------------------

5.205.3.3 void MHAFilter::smoothspec\_t::spec2fir (   
const mha\_spec\_t & spec,   
mha\_wave\_t & fir )

Return FIR coefficients.

## Parameters

<i>spec</i>	Input spectrum
-------------	----------------

## Return values

<i>fir</i>	FIR coefficients, minimum length is window length
------------	---

5.205.3.4 void MHAFilter::smoothspec\_t::internal\_fir (  
const mha\_spec\_t & s\_in ) [private]

## 5.205.4 Member Data Documentation

5.205.4.1 unsigned int MHAFilter::smoothspec\_t::fftlens [private]

5.205.4.2 unsigned int MHAFilter::smoothspec\_t::nchannels [private]

5.205.4.3 MHAWindow::base\_t MHAFilter::smoothspec\_t::window [private]

5.205.4.4 MHASignal::waveform\_t MHAFilter::smoothspec\_t::tmp\_wave [private]

5.205.4.5 MHASignal::spectrum\_t MHAFilter::smoothspec\_t::tmp\_spec [private]

5.205.4.6 MHASignal::minphase\_t\* MHAFilter::smoothspec\_t::minphase [private]

5.205.4.7 bool MHAFilter::smoothspec\_t::\_linphase\_asym [private]

5.205.4.8 mha\_fft\_t MHAFilter::smoothspec\_t::fft [private]

The documentation for this class was generated from the following files:

- **mha\_filter.hh**
- **mha\_filter.cpp**

## 5.206 MHAFilter::thirdoctave\_analyzer\_t Class Reference

## Public Member Functions

- **thirdoctave\_analyzer\_t** (mhaconfig\_t cfg)
- **mha\_wave\_t \* process** (mha\_wave\_t \*)
- unsigned int **nbands** ()
- unsigned int **nchannels** ()
- std::vector< **mha\_real\_t** > **get\_cf\_hz** ()



### Static Public Member Functions

- static `std::vector< mha_real_t > cf_generator (mhaconfig_t cfg)`
- static `std::vector< mha_real_t > bw_generator (mhaconfig_t cfg)`
- static `std::vector< mha_real_t > dup (std::vector< mha_real_t >, mhaconfig_t cfg)`

### Private Attributes

- `mhaconfig_t cfg_`
- `std::vector< mha_real_t > cf`
- `MHAFilter::gammaflt_t fb`
- `MHASignal::waveform_t out_chunk`
- `MHASignal::waveform_t out_chunk_im`

### 5.206.1 Constructor & Destructor Documentation

5.206.1.1 `MHAFilter::thirdoctave_analyzer_t::thirdoctave_analyzer_t ( mhaconfig_t cfg )`

### 5.206.2 Member Function Documentation

5.206.2.1 `mha_wave_t * MHAFilter::thirdoctave_analyzer_t::process ( mha_wave_t * sln )`

5.206.2.2 `unsigned int MHAFilter::thirdoctave_analyzer_t::nbands ( )`

5.206.2.3 `unsigned int MHAFilter::thirdoctave_analyzer_t::nchannels ( )`

5.206.2.4 `std::vector< mha_real_t > MHAFilter::thirdoctave_analyzer_t::get_cf_hz ( )`

5.206.2.5 `std::vector< mha_real_t > MHAFilter::thirdoctave_analyzer_t::cf_generator ( mhaconfig_t cfg )` [static]

5.206.2.6 `std::vector< mha_real_t > MHAFilter::thirdoctave_analyzer_t::bw_generator ( mhaconfig_t cfg )` [static]

5.206.2.7 `std::vector< mha_real_t > MHAFilter::thirdoctave_analyzer_t::dup ( std::vector< mha_real_t > vec, mhaconfig_t cfg )` [static]

### 5.206.3 Member Data Documentation

5.206.3.1 `mhaconfig_t MHAFilter::thirdoctave_analyzer_t::cfg_` [private]

- 5.206.3.2 `std::vector<mha_real_t> MHAFilter::thirdoctave_analyzer_t::cf` [private]
- 5.206.3.3 `MHAFilter::gammaflt_t MHAFilter::thirdoctave_analyzer_t::fb` [private]
- 5.206.3.4 `MHASignal::waveform_t MHAFilter::thirdoctave_analyzer_t::out_chunk` [private]
- 5.206.3.5 `MHASignal::waveform_t MHAFilter::thirdoctave_analyzer_t::out_chunk_im`  
[private]

The documentation for this class was generated from the following files:

- `complex_filter.h`
- `complex_filter.cpp`

## 5.207 MHAFilter::transfer\_function\_t Struct Reference

a structure containing a source channel number, a target channel number, and an impulse response.

### Public Member Functions

- `transfer_function_t ()`  
*Default constructor for STL conformity.*
- `transfer_function_t (unsigned int source_channel_index, unsigned int target_channel_index, const std::vector< float > &impulse_response)`  
*Data constructor.*
- unsigned int **partitions** (unsigned int fragsize) const  
*for the given partition size, return the number of partitions of the impulse response.*
- unsigned int **non\_empty\_partitions** (unsigned int fragsize) const  
*for the given partition size, return the number of non-empty partitions of the impulse response.*
- bool **isempty** (unsigned int fragsize, unsigned int index) const  
*checks if the partition contains only zeros*

### Public Attributes

- unsigned int **source\_channel\_index**  
*Source audio channel index for this transfer function.*
- unsigned int **target\_channel\_index**  
*Target audio channel index for this transfer function.*
- `std::vector< float > impulse_response`  
*Impulse response of transfer from source to target channel.*

## 5.207.1 Detailed Description

a structure containing a source channel number, a target channel number, and an impulse response.

## 5.207.2 Constructor &amp; Destructor Documentation

## 5.207.2.1 MHAFilter::transfer\_function\_t::transfer\_function\_t ( ) [inline]

Default constructor for STL conformity.

Not used.

5.207.2.2 MHAFilter::transfer\_function\_t::transfer\_function\_t (   
           unsigned int *source\_channel\_index*,   
           unsigned int *target\_channel\_index*,   
           const std::vector< float > & *impulse\_response* )

Data constructor.

## Parameters

<i>source_channel_index</i>	Source audio channel index for this transfer function
<i>target_channel_index</i>	Target audio channel index for this transfer function
<i>impulse_response</i>	Impulse response of transfer from source to target channel

## 5.207.3 Member Function Documentation

5.207.3.1 unsigned int MHAFilter::transfer\_function\_t::partitions (   
           unsigned int *fragsize* ) const [inline]

for the given partition size, return the number of partitions of the impulse response.

## Parameters

<i>fragsize</i>	partition size
-----------------	----------------

## Returns

number of partitions occupied by the impulse response

5.207.3.2 `unsigned int MHAFilter::transfer_function_t::non_empty_partitions ( unsigned int fragsize ) const` `[inline]`

for the given partition size, return the number of non-empty partitions of the impulse response.

#### Parameters

<i>fragsize</i>	partition size
-----------------	----------------

#### Returns

the number of non-empty partitions of the impulse response, i.e. partitions containing only zeros are not counted.

5.207.3.3 `bool MHAFilter::transfer_function_t::isempty ( unsigned int fragsize, unsigned int index ) const` `[inline]`

checks if the partition contains only zeros

#### Parameters

<i>fragsize</i>	partition size
<i>index</i>	partition index

#### Returns

true when this partition of the impulse response contains only zeros.

### 5.207.4 Member Data Documentation

5.207.4.1 `unsigned int MHAFilter::transfer_function_t::source_channel_index`

Source audio channel index for this transfer function.

5.207.4.2 `unsigned int MHAFilter::transfer_function_t::target_channel_index`

Target audio channel index for this transfer function.

5.207.4.3 `std::vector<float> MHAFilter::transfer_function_t::impulse_response`

Impulse response of transfer from source to target channel.

The documentation for this struct was generated from the following files:

- `mha_filter.hh`
- `mha_filter.cpp`

## 5.208 MHAFilter::transfer\_matrix\_t Struct Reference

A sparse matrix of transfer function partitions.

Inherits `vector< transfer_function_t >`.

### Public Member Functions

- `std::valarray< unsigned int > partitions (unsigned fragsize) const`  
*Returns an array of the results of calling the **partitions()** (p. 573) method on every matrix member.*
- `std::valarray< unsigned int > non_empty_partitions (unsigned int fragsize) const`  
*Returns an array of the results of calling the **non\_empty\_partitions()** (p. 573) method on every matrix member.*

### 5.208.1 Detailed Description

A sparse matrix of transfer function partitions.

Each matrix element knows its position in the matrix, so they can be stored as a vector.

### 5.208.2 Member Function Documentation

#### 5.208.2.1 `std::valarray<unsigned int> MHAFilter::transfer_matrix_t::partitions ( unsigned fragsize ) const` `[inline]`

Returns an array of the results of calling the **partitions()** (p. 573) method on every matrix member.

#### 5.208.2.2 `std::valarray<unsigned int> MHAFilter::transfer_matrix_t::non_empty_partitions ( unsigned int fragsize ) const` `[inline]`

Returns an array of the results of calling the **non\_empty\_partitions()** (p. 573) method on every matrix member.

The documentation for this struct was generated from the following file:

- **mha\_filter.hh**

## 5.209 MHAIOJack::io\_jack\_t Class Reference

Main class for JACK IO.

Inheritance diagram for MHAIOJack::io\_jack\_t:

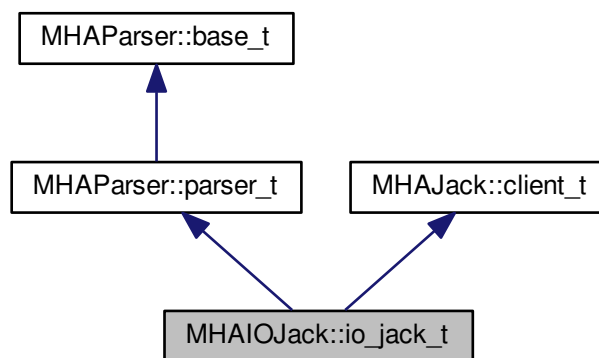

### Public Member Functions

- **io\_jack\_t** (unsigned int **fragsize**, float **samplerate**, **IOProcessEvent\_t proc\_event**, void \***proc\_handle**, **IOStartedEvent\_t start\_event**, void \***start\_handle**, **IOStoppedEvent\_t stop\_event**, void \***stop\_handle**)
- void **prepare** (int, int)  
*Allocate buffers, activate JACK client and install internal ports.*
- void **release** ()

### Private Member Functions

- void **reconnect\_inports** ()  
*Connect the input ports when connection variable is accessed.*
- void **reconnect\_outports** ()  
*Connect the output ports when connection variable is accessed.*
- void **get\_physical\_input\_ports** ()
- void **get\_physical\_output\_ports** ()
- void **get\_all\_input\_ports** ()
- void **get\_all\_output\_ports** ()
- void **get\_delays\_in** ()
- void **get\_delays\_out** ()
- void **read\_get\_cpu\_load** ()
- void **read\_get\_xruns** ()
- void **read\_get\_scheduler** ()

## Private Attributes

- unsigned int **fw\_fragsize**
- float **fw\_samplerate**
- **MHAParser::string\_t** **servername**
- **MHAParser::string\_t** **clientname**
- **MHAParser::vstring\_t** **connections\_in**
- **MHAParser::vint\_mon\_t** **delays\_in**
- **MHAParser::vstring\_t** **connections\_out**
- **MHAParser::vint\_mon\_t** **delays\_out**
- **MHAParser::vstring\_t** **portnames\_in**
- **MHAParser::vstring\_t** **portnames\_out**
- **MHAParser::vstring\_mon\_t** **ports\_in\_physical**
- **MHAParser::vstring\_mon\_t** **ports\_out\_physical**
- **MHAParser::vstring\_mon\_t** **ports\_in\_all**
- **MHAParser::vstring\_mon\_t** **ports\_out\_all**
- **MHAParser::parser\_t** **ports\_parser**
- **MHAParser::float\_mon\_t** **state\_cpuload**
- **MHAParser::int\_mon\_t** **state\_xruns**
- **MHAParser::int\_mon\_t** **state\_priority**
- **MHAParser::string\_mon\_t** **state\_scheduler**
- **MHAParser::parser\_t** **state\_parser**
- **MHAEvents::patchbay\_t** < **io\_jack\_t** > **patchbay**

## Additional Inherited Members

## 5.209.1 Detailed Description

Main class for JACK IO.

This class registers a JACK client. JACK and framework states are managed by this class.

## 5.209.2 Constructor &amp; Destructor Documentation

```
5.209.2.1 io_jack_t::io_jack_t (
    unsigned int fragsize,
    float samplerate,
    IOProcessEvent_t proc_event,
    void * proc_handle,
    IOStartedEvent_t start_event,
    void * start_handle,
    IOStoppedEvent_t stop_event,
    void * stop_handle )
```

## 5.209.3 Member Function Documentation

```
5.209.3.1 void io_jack_t::prepare (
    int nch_in,
    int nch_out )
```

Allocate buffers, activate JACK client and install internal ports.

5.209.3.2 void io\_jack\_t::release ( void )

5.209.3.3 void io\_jack\_t::reconnect\_inports ( ) [private]

Connect the input ports when connection variable is accessed.

5.209.3.4 void io\_jack\_t::reconnect\_outports ( ) [private]

Connect the output ports when connection variable is accessed.

5.209.3.5 void io\_jack\_t::get\_physical\_input\_ports ( ) [private]

5.209.3.6 void io\_jack\_t::get\_physical\_output\_ports ( ) [private]

5.209.3.7 void io\_jack\_t::get\_all\_input\_ports ( ) [private]

5.209.3.8 void io\_jack\_t::get\_all\_output\_ports ( ) [private]

5.209.3.9 void io\_jack\_t::get\_delays\_in ( ) [private]

5.209.3.10 void io\_jack\_t::get\_delays\_out ( ) [private]

5.209.3.11 void io\_jack\_t::read\_get\_cpu\_load ( ) [private]

5.209.3.12 void io\_jack\_t::read\_get\_xruns ( ) [private]

5.209.3.13 void io\_jack\_t::read\_get\_scheduler ( ) [private]

#### 5.209.4 Member Data Documentation

5.209.4.1 unsigned int MHAIOJack::io\_jack\_t::fw\_fragsize [private]

5.209.4.2 float MHAIOJack::io\_jack\_t::fw\_samplerate [private]

5.209.4.3 MHAParser::string\_t MHAIOJack::io\_jack\_t::servername [private]

5.209.4.4 MHAParser::string\_t MHAIOJack::io\_jack\_t::clientname [private]

5.209.4.5 MHAParser::vstring\_t MHAIOJack::io\_jack\_t::connections\_in [private]

5.209.4.6 MHAParser::vint\_mon\_t MHAIOJack::io\_jack\_t::delays\_in [private]



- 5.209.4.7 MHParse::vstring\_t MHAIOJack::io\_jack\_t::connections\_out [private]
- 5.209.4.8 MHParse::vint\_mon\_t MHAIOJack::io\_jack\_t::delays\_out [private]
- 5.209.4.9 MHParse::vstring\_t MHAIOJack::io\_jack\_t::portnames\_in [private]
- 5.209.4.10 MHParse::vstring\_t MHAIOJack::io\_jack\_t::portnames\_out [private]
- 5.209.4.11 MHParse::vstring\_mon\_t MHAIOJack::io\_jack\_t::ports\_in\_physical [private]
- 5.209.4.12 MHParse::vstring\_mon\_t MHAIOJack::io\_jack\_t::ports\_out\_physical [private]
- 5.209.4.13 MHParse::vstring\_mon\_t MHAIOJack::io\_jack\_t::ports\_in\_all [private]
- 5.209.4.14 MHParse::vstring\_mon\_t MHAIOJack::io\_jack\_t::ports\_out\_all [private]
- 5.209.4.15 MHParse::parser\_t MHAIOJack::io\_jack\_t::ports\_parser [private]
- 5.209.4.16 MHParse::float\_mon\_t MHAIOJack::io\_jack\_t::state\_cpuload [private]
- 5.209.4.17 MHParse::int\_mon\_t MHAIOJack::io\_jack\_t::state\_xruns [private]
- 5.209.4.18 MHParse::int\_mon\_t MHAIOJack::io\_jack\_t::state\_priority [private]
- 5.209.4.19 MHParse::string\_mon\_t MHAIOJack::io\_jack\_t::state\_scheduler [private]
- 5.209.4.20 MHParse::parser\_t MHAIOJack::io\_jack\_t::state\_parser [private]
- 5.209.4.21 MHAEvents::patchbay\_t<io\_jack\_t> MHAIOJack::io\_jack\_t::patchbay [private]

The documentation for this class was generated from the following file:

- MHAIOJack.cpp

## 5.210 MHAIOJackdb::io\_jack\_t Class Reference

Main class for JACK IO.

Inheritance diagram for MHAIOJackdb::io\_jack\_t:

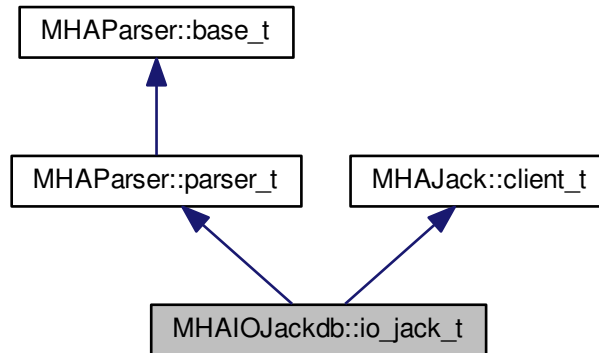

### Public Member Functions

- **io\_jack\_t** (unsigned int **fragsize**, float **samplerate**, **IOProcessEvent\_t** **proc\_event**, void \***proc\_handle**, **IOStartedEvent\_t** **start\_event**, void \***start\_handle**, **IOStoppedEvent\_t** **stop\_event**, void \***stop\_handle**)
- void **prepare** (int, int)  
*Allocate buffers, activate JACK client and install internal ports.*
- void **release** ()
- bool **fail\_on\_async\_jackerror** () const

### Private Member Functions

- int **IOProcessEvent\_inner** (**mha\_wave\_t** \*sIn, **mha\_wave\_t** \*\*sOut)
- void **reconnect\_inports** ()  
*Connect the input ports when connection variable is accessed.*
- void **reconnect\_outports** ()  
*Connect the output ports when connection variable is accessed.*
- void **get\_physical\_input\_ports** ()
- void **get\_physical\_output\_ports** ()
- void **get\_all\_input\_ports** ()
- void **get\_all\_output\_ports** ()
- void **read\_get\_cpu\_load** ()
- void **read\_get\_xruns** ()
- void **read\_get\_scheduler** ()
- void **set\_use\_jack\_transport** ()
- void **set\_locate** ()

### Static Private Member Functions

- static int **IOProcessEvent\_inner** (void \*handle, **mha\_wave\_t** \*sIn, **mha\_wave\_t** \*\*sOut)

### Private Attributes

- **IOProcessEvent\_t** proc\_event
- void \* **proc\_handle**
- unsigned int **mha\_fragsize**
- float **mha\_samplerate**
- unsigned int **fragsize\_ratio**
- **MHAParser::string\_t** servername
- **MHAParser::string\_t** clientname
- **MHAParser::vstring\_t** connections\_in
- **MHAParser::vstring\_t** connections\_out
- **MHAParser::vstring\_t** portnames\_in
- **MHAParser::vstring\_t** portnames\_out
- **MHAParser::bool\_t** fail\_on\_async\_jackerr
- **MHAParser::bool\_t** use\_jack\_transport
- **MHAParser::float\_t** locate
- **MHAParser::float\_mon\_t** server\_srate
- **MHAParser::int\_mon\_t** server\_fragsize
- **MHAParser::vstring\_mon\_t** ports\_in\_physical
- **MHAParser::vstring\_mon\_t** ports\_out\_physical
- **MHAParser::vstring\_mon\_t** ports\_in\_all
- **MHAParser::vstring\_mon\_t** ports\_out\_all
- **MHAParser::parser\_t** ports\_parser
- **MHAParser::float\_mon\_t** state\_cpuload
- **MHAParser::int\_mon\_t** state\_xruns
- **MHAParser::int\_mon\_t** state\_priority
- **MHAParser::string\_mon\_t** state\_scheduler
- **MHAParser::parser\_t** state\_parser
- **MHASignal::waveform\_t** \* pwinner\_out
- **MHAEvents::patchbay\_t** < io\_jack\_t > patchbay

### Additional Inherited Members

#### 5.210.1 Detailed Description

Main class for JACK IO.

This class registers a JACK client. JACK and framework states are managed by this class.

## 5.210.2 Constructor & Destructor Documentation

5.210.2.1 `io_jack_t::io_jack_t (`  
     unsigned int *fragsize*,  
     float *samplerate*,  
     IOProcessEvent\_t *proc\_event*,  
     void \* *proc\_handle*,  
     IOStartedEvent\_t *start\_event*,  
     void \* *start\_handle*,  
     IOStoppedEvent\_t *stop\_event*,  
     void \* *stop\_handle* )

## 5.210.3 Member Function Documentation

5.210.3.1 `void io_jack_t::prepare (`  
     int *nch\_in*,  
     int *nch\_out* )

Allocate buffers, activate JACK client and install internal ports.

5.210.3.2 `void io_jack_t::release (`  
     void )

5.210.3.3 `bool MHAIOJackdb::io_jack_t::fail_on_async_jackerror ( ) const` [inline]

5.210.3.4 `int io_jack_t::IOProcessEvent_inner (`  
     void \* *handle*,  
     mha\_wave\_t \* *sIn*,  
     mha\_wave\_t \*\* *sOut* ) [static],[private]

5.210.3.5 `int io_jack_t::IOProcessEvent_inner (`  
     mha\_wave\_t \* *sIn*,  
     mha\_wave\_t \*\* *sOut* ) [private]

5.210.3.6 `void io_jack_t::reconnect_inports ( )` [private]

Connect the input ports when connection variable is accessed.

5.210.3.7 `void io_jack_t::reconnect_outports ( )` [private]

Connect the output ports when connection variable is accessed.

5.210.3.8 void io\_jack\_t::get\_physical\_input\_ports ( ) [private]

5.210.3.9 void io\_jack\_t::get\_physical\_output\_ports ( ) [private]

5.210.3.10 void io\_jack\_t::get\_all\_input\_ports ( ) [private]

5.210.3.11 void io\_jack\_t::get\_all\_output\_ports ( ) [private]

5.210.3.12 void io\_jack\_t::read\_get\_cpu\_load ( ) [private]

5.210.3.13 void io\_jack\_t::read\_get\_xruns ( ) [private]

5.210.3.14 void io\_jack\_t::read\_get\_scheduler ( ) [private]

5.210.3.15 void io\_jack\_t::set\_use\_jack\_transport ( ) [private]

5.210.3.16 void io\_jack\_t::set\_locate ( ) [private]

#### 5.210.4 Member Data Documentation

5.210.4.1 IOProcessEvent\_t MHAIOJackdb::io\_jack\_t::proc\_event [private]

5.210.4.2 void\* MHAIOJackdb::io\_jack\_t::proc\_handle [private]

5.210.4.3 unsigned int MHAIOJackdb::io\_jack\_t::mha\_fragsize [private]

5.210.4.4 float MHAIOJackdb::io\_jack\_t::mha\_samplerate [private]

5.210.4.5 unsigned int MHAIOJackdb::io\_jack\_t::fragsize\_ratio [private]

5.210.4.6 MHAParser::string\_t MHAIOJackdb::io\_jack\_t::servername [private]

5.210.4.7 MHAParser::string\_t MHAIOJackdb::io\_jack\_t::clientname [private]

5.210.4.8 MHAParser::vstring\_t MHAIOJackdb::io\_jack\_t::connections\_in [private]

5.210.4.9 MHAParser::vstring\_t MHAIOJackdb::io\_jack\_t::connections\_out [private]

5.210.4.10 MHAParser::vstring\_t MHAIOJackdb::io\_jack\_t::portnames\_in [private]

5.210.4.11 MHAParser::vstring\_t MHAIOJackdb::io\_jack\_t::portnames\_out [private]

5.210.4.12 MHAParser::bool\_t MHAIOJackdb::io\_jack\_t::fail\_on\_async\_jackerr [private]

- 5.210.4.13 **MHAParser::bool\_t MHAIOJackdb::io\_jack\_t::use\_jack\_transport** [private]
- 5.210.4.14 **MHAParser::float\_t MHAIOJackdb::io\_jack\_t::locate** [private]
- 5.210.4.15 **MHAParser::float\_mon\_t MHAIOJackdb::io\_jack\_t::server\_srate** [private]
- 5.210.4.16 **MHAParser::int\_mon\_t MHAIOJackdb::io\_jack\_t::server\_fragsize** [private]
- 5.210.4.17 **MHAParser::vstring\_mon\_t MHAIOJackdb::io\_jack\_t::ports\_in\_physical** [private]
- 5.210.4.18 **MHAParser::vstring\_mon\_t MHAIOJackdb::io\_jack\_t::ports\_out\_physical**  
[private]
- 5.210.4.19 **MHAParser::vstring\_mon\_t MHAIOJackdb::io\_jack\_t::ports\_in\_all** [private]
- 5.210.4.20 **MHAParser::vstring\_mon\_t MHAIOJackdb::io\_jack\_t::ports\_out\_all** [private]
- 5.210.4.21 **MHAParser::parser\_t MHAIOJackdb::io\_jack\_t::ports\_parser** [private]
- 5.210.4.22 **MHAParser::float\_mon\_t MHAIOJackdb::io\_jack\_t::state\_cpuload** [private]
- 5.210.4.23 **MHAParser::int\_mon\_t MHAIOJackdb::io\_jack\_t::state\_xruns** [private]
- 5.210.4.24 **MHAParser::int\_mon\_t MHAIOJackdb::io\_jack\_t::state\_priority** [private]
- 5.210.4.25 **MHAParser::string\_mon\_t MHAIOJackdb::io\_jack\_t::state\_scheduler** [private]
- 5.210.4.26 **MHAParser::parser\_t MHAIOJackdb::io\_jack\_t::state\_parser** [private]
- 5.210.4.27 **MHASignal::waveform\_t\* MHAIOJackdb::io\_jack\_t::pwinner\_out** [private]
- 5.210.4.28 **MHAEvents::patchbay\_t<io\_jack\_t> MHAIOJackdb::io\_jack\_t::patchbay**  
[private]

The documentation for this class was generated from the following file:

- **MHAIOJackdb.cpp**

## 5.211 MHAIOPortAudio::device\_info\_t Class Reference

Inheritance diagram for MHAIOPortAudio::device\_info\_t:

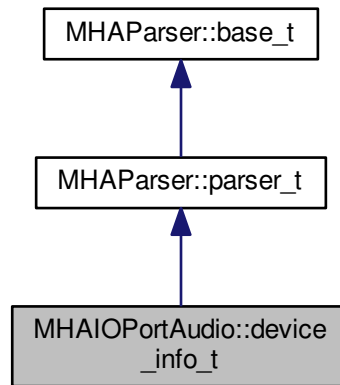

#### Public Member Functions

- `device_info_t ()`
- `void fill_info ()`

#### Public Attributes

- `MHAParser::int_mon_t numDevices`
- `MHAParser::vint_mon_t structVersion`
- `MHAParser::vstring_mon_t name`
- `MHAParser::vint_mon_t hostApi`
- `MHAParser::vint_mon_t maxInputChannels`
- `MHAParser::vint_mon_t maxOutputChannels`
- `MHAParser::vfloat_mon_t defaultLowInputLatency`
- `MHAParser::vfloat_mon_t defaultLowOutputLatency`
- `MHAParser::vfloat_mon_t defaultHighInputLatency`
- `MHAParser::vfloat_mon_t defaultHighOutputLatency`
- `MHAParser::vfloat_mon_t defaultSampleRate`

## Additional Inherited Members

### 5.211.1 Constructor & Destructor Documentation

5.211.1.1 `MHAIOPortAudio::device_info_t::device_info_t( )` [inline]

### 5.211.2 Member Function Documentation

5.211.2.1 `void MHAIOPortAudio::device_info_t::fill_info( )` [inline]

### 5.211.3 Member Data Documentation

5.211.3.1 `MHAParser::int_mon_t MHAIOPortAudio::device_info_t::numDevices`

5.211.3.2 `MHAParser::vint_mon_t MHAIOPortAudio::device_info_t::structVersion`

5.211.3.3 `MHAParser::vstring_mon_t MHAIOPortAudio::device_info_t::name`

5.211.3.4 `MHAParser::vint_mon_t MHAIOPortAudio::device_info_t::hostApi`

5.211.3.5 `MHAParser::vint_mon_t MHAIOPortAudio::device_info_t::maxInputChannels`

5.211.3.6 `MHAParser::vint_mon_t MHAIOPortAudio::device_info_t::maxOutputChannels`

5.211.3.7 `MHAParser::vfloat_mon_t MHAIOPortAudio::device_info_t::defaultLowInputLatency`

5.211.3.8 `MHAParser::vfloat_mon_t MHAIOPortAudio::device_info_t::defaultLowOutputLatency`

5.211.3.9 `MHAParser::vfloat_mon_t MHAIOPortAudio::device_info_t::defaultHighInputLatency`

5.211.3.10 `MHAParser::vfloat_mon_t MHAIOPortAudio::device_info_t::defaultHighOutputLatency`

5.211.3.11 `MHAParser::vfloat_mon_t MHAIOPortAudio::device_info_t::defaultSampleRate`

The documentation for this class was generated from the following file:

- **MHAIOPortAudio.cpp**



## 5.212 MHAIOPortAudio::io\_portaudio\_t Class Reference

Main class for Portaudio sound IO.

Inheritance diagram for MHAIOPortAudio::io\_portaudio\_t:

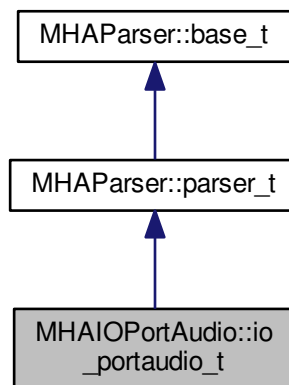

## Public Member Functions

- **io\_portaudio\_t** (unsigned int **fragsize**, float **samplerate**, IOProcessEvent\_t **proc\_event**, void \***proc\_handle**, IOStartedEvent\_t **start\_event**, void \***start\_handle**, IOStoppedEvent\_t **stop\_event**, void \***stop\_handle**)
- void **device\_name\_updated** ()
- void **device\_index\_updated** ()
- ~**io\_portaudio\_t** ()
- void **cmd\_prepare** (int, int)
- void **cmd\_start** ()
- void **cmd\_stop** ()
- void **cmd\_release** ()
- int **portaudio\_callback** (const void \*input, void \*output, unsigned long frame\_count, const PaStreamCallbackTimeInfo \*time\_info, PaStreamCallbackFlags status\_flags)

## Private Attributes

- **device\_info\_t** **device\_info**
- **MHASignal::waveform\_t** \* **s\_in**
- **mha\_wave\_t** \* **s\_out**
- float **samplerate**
- unsigned int **nchannels\_out**
- unsigned int **nchannels\_in**

- unsigned int **fragsize**
- **IOProcessEvent\_t proc\_event**
- void \* **proc\_handle**
- **IOStartedEvent\_t start\_event**
- void \* **start\_handle**
- **IOStoppedEvent\_t stop\_event**
- void \* **stop\_handle**
- PaStream \* **portaudio\_stream**
- **MHAParser::string\_t device\_name**
- **MHAParser::int\_t device\_index**
- **MHAEvents::patchbay\_t< io\_portaudio\_t > patchbay**

#### Additional Inherited Members

##### 5.212.1 Detailed Description

Main class for Portaudio sound IO.

##### 5.212.2 Constructor & Destructor Documentation

5.212.2.1 **MHAIOPortAudio::io\_portaudio\_t::io\_portaudio\_t** (  
     unsigned int *fragsize*,  
     float *samplerate*,  
     **IOProcessEvent\_t proc\_event**,  
     void \* *proc\_handle*,  
     **IOStartedEvent\_t start\_event**,  
     void \* *start\_handle*,  
     **IOStoppedEvent\_t stop\_event**,  
     void \* *stop\_handle* ) [*inline*]

5.212.2.2 **MHAIOPortAudio::io\_portaudio\_t::~io\_portaudio\_t** ( ) [*inline*]

##### 5.212.3 Member Function Documentation

5.212.3.1 void **MHAIOPortAudio::io\_portaudio\_t::device\_name\_updated** ( ) [*inline*]

5.212.3.2 void **MHAIOPortAudio::io\_portaudio\_t::device\_index\_updated** ( ) [*inline*]

5.212.3.3 void **MHAIOPortAudio::io\_portaudio\_t::cmd\_prepare** (  
     int *nchannels\_in*,  
     int *nchannels\_out* )

5.212.3.4 void **MHAIOPortAudio::io\_portaudio\_t::cmd\_start** ( )

- 5.212.3.5 void MHAIOPortAudio::io\_portaudio\_t::cmd\_stop ( )
- 5.212.3.6 void MHAIOPortAudio::io\_portaudio\_t::cmd\_release ( )
- 5.212.3.7 int MHAIOPortAudio::io\_portaudio\_t::portaudio\_callback (   
const void \* *input*,   
void \* *output*,   
unsigned long *frame\_count*,   
const PaStreamCallbackTimeInfo \* *time\_info*,   
PaStreamCallbackFlags *status\_flags* )

#### 5.212.4 Member Data Documentation

- 5.212.4.1 device\_info\_t MHAIOPortAudio::io\_portaudio\_t::device\_info [private]
- 5.212.4.2 MHASignal::waveform\_t\* MHAIOPortAudio::io\_portaudio\_t::s\_in [private]
- 5.212.4.3 mha\_wave\_t\* MHAIOPortAudio::io\_portaudio\_t::s\_out [private]
- 5.212.4.4 float MHAIOPortAudio::io\_portaudio\_t::samplerate [private]
- 5.212.4.5 unsigned int MHAIOPortAudio::io\_portaudio\_t::nchannels\_out [private]
- 5.212.4.6 unsigned int MHAIOPortAudio::io\_portaudio\_t::nchannels\_in [private]
- 5.212.4.7 unsigned int MHAIOPortAudio::io\_portaudio\_t::fragsize [private]
- 5.212.4.8 IOProcessEvent\_t MHAIOPortAudio::io\_portaudio\_t::proc\_event [private]
- 5.212.4.9 void\* MHAIOPortAudio::io\_portaudio\_t::proc\_handle [private]
- 5.212.4.10 IOStartedEvent\_t MHAIOPortAudio::io\_portaudio\_t::start\_event [private]
- 5.212.4.11 void\* MHAIOPortAudio::io\_portaudio\_t::start\_handle [private]
- 5.212.4.12 IOStoppedEvent\_t MHAIOPortAudio::io\_portaudio\_t::stop\_event [private]
- 5.212.4.13 void\* MHAIOPortAudio::io\_portaudio\_t::stop\_handle [private]
- 5.212.4.14 PaStream\* MHAIOPortAudio::io\_portaudio\_t::portaudio\_stream [private]
- 5.212.4.15 MHAParser::string\_t MHAIOPortAudio::io\_portaudio\_t::device\_name [private]
- 5.212.4.16 MHAParser::int\_t MHAIOPortAudio::io\_portaudio\_t::device\_index [private]
- 5.212.4.17 MHAEvents::patchbay\_t<io\_portaudio\_t> MHAIOPortAudio::io\_portaudio\_t↔  
::patchbay [private]

The documentation for this class was generated from the following file:

- **MHAIOPortAudio.cpp**

### 5.213 MHAJack::client\_avg\_t Class Reference

Generic JACK client for averaging a system response across time.

Inheritance diagram for MHAJack::client\_avg\_t:

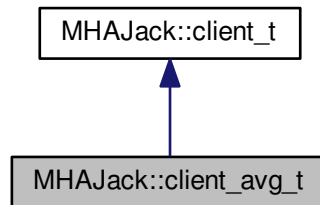

#### Public Member Functions

- **client\_avg\_t** (const std::string &name, const unsigned int &nrep\_)  
*Constructor for averaging client.*
- void **io** (mha\_wave\_t \*s\_out, mha\_wave\_t \*s\_in, const std::vector< std::string > &p\_out, const std::vector< std::string > &p\_in, float \*srate=NULL, unsigned int \*fragsize=NULL)  
*Recording function.*

#### Private Member Functions

- void **proc** (mha\_wave\_t \*sIn, mha\_wave\_t \*\*sOut)
- void **IOStoppedEvent** ()

#### Static Private Member Functions

- static int **proc** (void \*handle, mha\_wave\_t \*sIn, mha\_wave\_t \*\*sOut)
- static void **IOStoppedEvent** (void \*handle, int proc\_err, int io\_err)

#### Private Attributes

- bool **b\_stopped**
- unsigned int **pos**
- mha\_wave\_t \* **sn\_in**
- mha\_wave\_t \* **sn\_out**
- std::string **name**
- MHASignal::waveform\_t \* **frag\_out**
- const unsigned int **nrep**
- unsigned int **n**
- bool **b\_ready**

## Additional Inherited Members

## 5.213.1 Detailed Description

Generic JACK client for averaging a system response across time.

## 5.213.2 Constructor &amp; Destructor Documentation

5.213.2.1 MHAJack::client\_avg\_t::client\_avg\_t (   
                   const std::string & *name\_*,   
                   const unsigned int & *nrep\_* )

Constructor for averaging client.

## Parameters

<i>name_</i>	Name of JACK client
<i>nrep_</i>	Number of repetitions

## 5.213.3 Member Function Documentation

5.213.3.1 void MHAJack::client\_avg\_t::io (   
                   mha\_wave\_t \* *is\_out*,   
                   mha\_wave\_t \* *is\_in*,   
                   const std::vector< std::string > & *p\_out*,   
                   const std::vector< std::string > & *p\_in*,   
                   float \* *srate* = NULL,   
                   unsigned int \* *fragsize* = NULL )

Recording function.

long-description

## Parameters

<i>is_out</i>	Input (test) signal, which will be repeated
<i>is_in</i>	System response (averaged, same length as input required)
<i>p_out</i>	Ports to play back the test signal
<i>p_in</i>	Ports to record from the system response
<i>srate</i>	Pointer to sampling rate variable, will be filled with server sampling rate
<i>fragsize</i>	Pointer to fragment size variable, will be filled with server fragment size

- 5.213.3.2 `int MHAJack::client_avg_t::proc (`  
     `void * handle,`  
     `mha_wave_t * sIn,`  
     `mha_wave_t ** sOut ) [static], [private]`
- 5.213.3.3 `void MHAJack::client_avg_t::IOStoppedEvent (`  
     `void * handle,`  
     `int proc_err,`  
     `int io_err ) [static], [private]`
- 5.213.3.4 `void MHAJack::client_avg_t::proc (`  
     `mha_wave_t * sIn,`  
     `mha_wave_t ** sOut ) [private]`
- 5.213.3.5 `void MHAJack::client_avg_t::IOStoppedEvent ( ) [private]`
- 5.213.4 Member Data Documentation
- 5.213.4.1 `bool MHAJack::client_avg_t::b_stopped [private]`
- 5.213.4.2 `unsigned int MHAJack::client_avg_t::pos [private]`
- 5.213.4.3 `mha_wave_t* MHAJack::client_avg_t::sn_in [private]`
- 5.213.4.4 `mha_wave_t* MHAJack::client_avg_t::sn_out [private]`
- 5.213.4.5 `std::string MHAJack::client_avg_t::name [private]`
- 5.213.4.6 `MHASignal::waveform_t* MHAJack::client_avg_t::frag_out [private]`
- 5.213.4.7 `const unsigned int MHAJack::client_avg_t::nrep [private]`
- 5.213.4.8 `unsigned int MHAJack::client_avg_t::n [private]`
- 5.213.4.9 `bool MHAJack::client_avg_t::b_ready [private]`

The documentation for this class was generated from the following files:

- `mhajack.h`
- `mhajack.cpp`

## 5.214 MHAJack::client\_noncont\_t Class Reference

Generic client for synchronous playback and recording of waveform fragments.

Inheritance diagram for MHAJack::client\_noncont\_t:

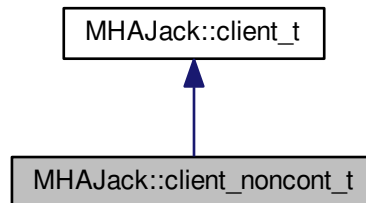

#### Public Member Functions

- **client\_noncont\_t** (const std::string &name, bool use\_jack\_transport=false)
- void **io** (mha\_wave\_t \*s\_out, mha\_wave\_t \*s\_in, const std::vector< std::string > &p\_out, const std::vector< std::string > &p\_in, float \*srate=NULL, unsigned int \*fragsize=NULL)

#### Private Member Functions

- void **proc** (mha\_wave\_t \*sIn, mha\_wave\_t \*\*sOut)
- void **IOStoppedEvent** ()

#### Static Private Member Functions

- static int **proc** (void \*handle, mha\_wave\_t \*sIn, mha\_wave\_t \*\*sOut)
- static void **IOStoppedEvent** (void \*handle, int proc\_err, int io\_err)

#### Private Attributes

- bool **b\_stopped**
- unsigned int **pos**
- mha\_wave\_t \* **sn\_in**
- mha\_wave\_t \* **sn\_out**
- std::string **name**
- MHASignal::waveform\_t \* **frag\_out**

## Additional Inherited Members

### 5.214.1 Detailed Description

Generic client for synchronous playback and recording of waveform fragments.

### 5.214.2 Constructor & Destructor Documentation

5.214.2.1 `MHAJack::client_noncont_t::client_noncont_t (`  
     `const std::string & name,`  
     `bool use_jack_transport = false )`

### 5.214.3 Member Function Documentation

5.214.3.1 `void MHAJack::client_noncont_t::io (`  
     `mha_wave_t * s_out,`  
     `mha_wave_t * s_in,`  
     `const std::vector< std::string > & p_out,`  
     `const std::vector< std::string > & p_in,`  
     `float * srate = NULL,`  
     `unsigned int * fragsize = NULL )`

5.214.3.2 `int MHAJack::client_noncont_t::proc (`  
     `void * handle,`  
     `mha_wave_t * sIn,`  
     `mha_wave_t ** sOut )` [static], [private]

5.214.3.3 `void MHAJack::client_noncont_t::IOStoppedEvent (`  
     `void * handle,`  
     `int proc_err,`  
     `int io_err )` [static], [private]

5.214.3.4 `void MHAJack::client_noncont_t::proc (`  
     `mha_wave_t * sIn,`  
     `mha_wave_t ** sOut )` [private]

5.214.3.5 `void MHAJack::client_noncont_t::IOStoppedEvent ( )` [private]

### 5.214.4 Member Data Documentation

5.214.4.1 `bool MHAJack::client_noncont_t::b_stopped` [private]

5.214.4.2 `unsigned int MHAJack::client_noncont_t::pos` [private]



5.214.4.3 `mha_wave_t* MHAJack::client_noncont_t::sn_in` [private]

5.214.4.4 `mha_wave_t* MHAJack::client_noncont_t::sn_out` [private]

5.214.4.5 `std::string MHAJack::client_noncont_t::name` [private]

5.214.4.6 `MHASignal::waveform_t* MHAJack::client_noncont_t::frag_out` [private]

The documentation for this class was generated from the following files:

- `mhjack.h`
- `mhjack.cpp`

## 5.215 MHAJack::client\_t Class Reference

Generic asynchronous JACK client.

Inheritance diagram for MHAJack::client\_t:

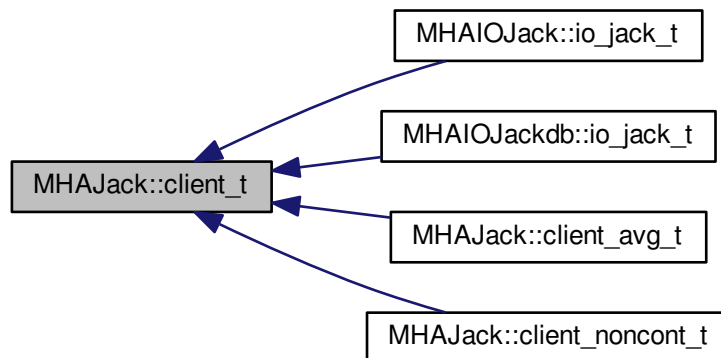

### Public Member Functions

- `client_t` (`IOProcessEvent_t proc_event`, `void *proc_handle=NULL`, `IOStartedEvent_t start_event=NULL`, `void *start_handle=NULL`, `IOStoppedEvent_t stop_event=NULL`, `void *stop_handle=NULL`, `bool use_jack_transport=false`)
- `void prepare` (`const std::string &client_name`, `const unsigned int &nchannels_in`, `const unsigned int &nchannels_out`)

*Allocate buffers, activate JACK client and install internal ports.*

- void **prepare** (const std::string &server\_name, const std::string &client\_name, const unsigned int &nchannels\_in, const unsigned int &nchannels\_out)
  - Allocate buffers, ports, and activates JACK client.*
- void **release** ()
  - Remove JACK client and deallocate internal ports and buffers.*
- void **start** (bool fail\_on\_async\_jack\_error=true)
- void **stop** ()
- void **connect\_input** (const std::vector< std::string > &)
  - Connect the input ports when connection variable is accessed.*
- void **connect\_output** (const std::vector< std::string > &)
  - Connect the output ports when connection variable is accessed.*
- unsigned int **get\_fragsize** () const
- float **get\_srate** () const
- unsigned long **get\_xruns** ()
- unsigned long **get\_xruns\_reset** ()
- std::string **str\_error** (int err)
- void **get\_ports** (std::vector< std::string > &, unsigned long jack\_flags)
  - Get a list of Jack ports.*
- std::vector< std::string > **get\_my\_input\_ports** ()
- std::vector< std::string > **get\_my\_output\_ports** ()
- void **set\_input\_portnames** (const std::vector< std::string > &)
- void **set\_output\_portnames** (const std::vector< std::string > &)
- float **get\_cpu\_load** ()
- void **set\_use\_jack\_transport** (bool ut)

### Protected Attributes

- jack\_client\_t \* **jc**

### Private Member Functions

- void **prepare\_impl** (const char \*server\_name, const char \*client\_name, const unsigned int &nchannels\_in, const unsigned int &nchannels\_out)
  - Allocate buffers, activate JACK client and allocates jack ports Registers the jack client with the given server and activates it.*
- void **internal\_start** ()
- void **internal\_stop** ()
- void **stopped** (int, int)
- int **jack\_proc\_cb** (jack\_nframes\_t)
  - This is the main processing callback.*
- int **jack\_xrun\_cb** ()

### Static Private Member Functions

- static int **jack\_proc\_cb** (jack\_nframes\_t, void \*)
- static int **jack\_xrun\_cb** (void \*)

## Private Attributes

- unsigned long **num\_xruns**
- unsigned int **fragsize**
- float **samplerate**
- unsigned int **nchannels\_in**
- unsigned int **nchannels\_out**
- **IOProcessEvent\_t** **proc\_event**
- void \* **proc\_handle**
- **IOStartedEvent\_t** **start\_event**
- void \* **start\_handle**
- **IOStoppedEvent\_t** **stop\_event**
- void \* **stop\_handle**
- **MHASignal::waveform\_t** \* **s\_in**
- **mha\_wave\_t** \* **s\_out**
- **MHAJack::port\_t** \*\* **inch**
- **MHAJack::port\_t** \*\* **outch**
- unsigned int **flags**
- bool **b\_prepared**
- bool **use\_jack\_transport**
- **jack\_transport\_state\_t** **jstate\_prev**
- **std::vector< std::string >** **input\_portnames**
- **std::vector< std::string >** **output\_portnames**
- bool **fail\_on\_async\_jackerror**

## 5.215.1 Detailed Description

Generic asynchronous JACK client.

## 5.215.2 Constructor &amp; Destructor Documentation

5.215.2.1 **MHAJack::client\_t::client\_t** (  
     **IOProcessEvent\_t** *proc\_event*,  
     void \* *proc\_handle* = NULL,  
     **IOStartedEvent\_t** *start\_event* = NULL,  
     void \* *start\_handle* = NULL,  
     **IOStoppedEvent\_t** *stop\_event* = NULL,  
     void \* *stop\_handle* = NULL,  
     bool *use\_jack\_transport* = false )

## 5.215.3 Member Function Documentation

5.215.3.1 void **MHAJack::client\_t::prepare** (  
     const **std::string** & *client\_name*,  
     const unsigned int & *nch\_in*,  
     const unsigned int & *nch\_out* )

Allocate buffers, activate JACK client and install internal ports.

Registers the jack client with the default jack server and activates it.

## Parameters

<i>client_name</i>	Name of this jack client
<i>nch_in</i>	Input ports to register
<i>nch_out</i>	Output ports to register

```
5.215.3.2 void MHAJack::client_t::prepare (
            const std::string & server_name,
            const std::string & client_name,
            const unsigned int & nch_in,
            const unsigned int & nch_out )
```

Allocate buffers, ports, and activates JACK client.

Registers the jack client with specified jack server and activates it.

## Parameters

<i>server_name</i>	Name of the jack server to register with
<i>client_name</i>	Name of this jack client
<i>nch_in</i>	Input ports to register
<i>nch_out</i>	Output ports to register

```
5.215.3.3 void MHAJack::client_t::release (
            void )
```

Remove JACK client and deallocate internal ports and buffers.

```
5.215.3.4 void MHAJack::client_t::start (
            bool fail_on_async_jack_error = true )
```

```
5.215.3.5 void MHAJack::client_t::stop ( )
```

```
5.215.3.6 void MHAJack::client_t::connect_input (
            const std::vector< std::string > & con )
```

Connect the input ports when connection variable is accessed.

```
5.215.3.7 void MHAJack::client_t::connect_output (
            const std::vector< std::string > & con )
```

Connect the output ports when connection variable is accessed.

5.215.3.8 unsigned int MHAJack::client\_t::get\_fragsize ( ) const [inline]

5.215.3.9 float MHAJack::client\_t::get\_srate ( ) const [inline]

5.215.3.10 unsigned long MHAJack::client\_t::get\_xruns ( ) [inline]

5.215.3.11 unsigned long MHAJack::client\_t::get\_xruns\_reset ( )

5.215.3.12 std::string MHAJack::client\_t::str\_error ( int *err* )

5.215.3.13 void MHAJack::client\_t::get\_ports ( std::vector< std::string > & *res*, unsigned long *jack\_flags* )

Get a list of Jack ports.

#### Parameters

<i>res</i>	Result string vector
<i>jack_flags</i>	Jack port flags (JackPortInput etc.)

5.215.3.14 std::vector< std::string > MHAJack::client\_t::get\_my\_input\_ports ( )

5.215.3.15 std::vector< std::string > MHAJack::client\_t::get\_my\_output\_ports ( )

5.215.3.16 void MHAJack::client\_t::set\_input\_portnames ( const std::vector< std::string > & *names* )

5.215.3.17 void MHAJack::client\_t::set\_output\_portnames ( const std::vector< std::string > & *names* )

5.215.3.18 float MHAJack::client\_t::get\_cpu\_load ( )

5.215.3.19 void MHAJack::client\_t::set\_use\_jack\_transport ( bool *ut* ) [inline]

5.215.3.20 void MHAJack::client\_t::prepare\_impl ( const char \* *server\_name*, const char \* *client\_name*, const unsigned int & *nch\_in*, const unsigned int & *nch\_out* ) [private]

Allocate buffers, activate JACK client and allocates jack ports Registers the jack client with the given server and activates it.

## Parameters

<i>server_name</i>	Name of the jack server to register with
<i>client_name</i>	Name of this jack client
<i>nch_in</i>	Input ports to register
<i>nch_out</i>	Output ports to register

5.215.3.21 void MHAJack::client\_t::internal\_start ( ) [private]

5.215.3.22 void MHAJack::client\_t::internal\_stop ( ) [private]

5.215.3.23 void MHAJack::client\_t::stopped (
  
int *proc\_err*,
  
int *io\_err* ) [private]

5.215.3.24 int MHAJack::client\_t::jack\_proc\_cb (
  
jack\_nframes\_t *n*,
  
void \* *h* ) [static], [private]

5.215.3.25 int MHAJack::client\_t::jack\_proc\_cb (
  
jack\_nframes\_t *n* ) [private]

This is the main processing callback.

Here happens double buffering and downsampling.

5.215.3.26 int MHAJack::client\_t::jack\_xrun\_cb (
  
void \* *h* ) [static], [private]

5.215.3.27 int MHAJack::client\_t::jack\_xrun\_cb ( ) [inline], [private]

#### 5.215.4 Member Data Documentation

5.215.4.1 unsigned long MHAJack::client\_t::num\_xruns [private]

5.215.4.2 unsigned int MHAJack::client\_t::fragsize [private]

5.215.4.3 float MHAJack::client\_t::samplerate [private]

5.215.4.4 unsigned int MHAJack::client\_t::nchannels\_in [private]

5.215.4.5 unsigned int MHAJack::client\_t::nchannels\_out [private]

5.215.4.6 IOProcessEvent\_t MHAJack::client\_t::proc\_event [private]

- 5.215.4.7 void\* MHAJack::client\_t::proc\_handle [private]
- 5.215.4.8 IOStartedEvent\_t MHAJack::client\_t::start\_event [private]
- 5.215.4.9 void\* MHAJack::client\_t::start\_handle [private]
- 5.215.4.10 IOStoppedEvent\_t MHAJack::client\_t::stop\_event [private]
- 5.215.4.11 void\* MHAJack::client\_t::stop\_handle [private]
- 5.215.4.12 MHASignal::waveform\_t\* MHAJack::client\_t::s\_in [private]
- 5.215.4.13 mha\_wave\_t\* MHAJack::client\_t::s\_out [private]
- 5.215.4.14 MHAJack::port\_t\*\* MHAJack::client\_t::inch [private]
- 5.215.4.15 MHAJack::port\_t\*\* MHAJack::client\_t::outch [private]
- 5.215.4.16 jack\_client\_t\* MHAJack::client\_t::jc [protected]
- 5.215.4.17 unsigned int MHAJack::client\_t::flags [private]
- 5.215.4.18 bool MHAJack::client\_t::b\_prepared [private]
- 5.215.4.19 bool MHAJack::client\_t::use\_jack\_transport [private]
- 5.215.4.20 jack\_transport\_state\_t MHAJack::client\_t::jstate\_prev [private]
- 5.215.4.21 std::vector<std::string> MHAJack::client\_t::input\_portnames [private]
- 5.215.4.22 std::vector<std::string> MHAJack::client\_t::output\_portnames [private]
- 5.215.4.23 bool MHAJack::client\_t::fail\_on\_async\_jackerror [private]

The documentation for this class was generated from the following files:

- **mhajack.h**
- **mhajack.cpp**

## 5.216 MHAJack::port\_t Class Reference

Class for one channel/port.

## Public Types

### Public Member Functions

- **port\_t** (jack\_client\_t \***jc**, dir\_t dir, int id)
- **port\_t** (jack\_client\_t \***jc**, dir\_t dir, const std::string &id)  
*Constructor to create port with specific name.*
- ~**port\_t** ()
- void **read** (mha\_wave\_t \*s, unsigned int ch)
- void **write** (mha\_wave\_t \*s, unsigned int ch)
- void **mute** (unsigned int n)
- void **connect\_to** (const char \*pn)
- const char \* **get\_short\_name** ()  
*Return the port name.*

### Private Attributes

- **dir\_t dir\_type**
- jack\_port\_t \* **port**
- jack\_default\_audio\_sample\_t \* **iob**
- jack\_client\_t \* **jc**

#### 5.216.1 Detailed Description

Class for one channel/port.

This class represents one JACK port. Double buffering for asynchronous process callbacks is managed by this class.

#### 5.216.2 Member Enumeration Documentation

##### 5.216.2.1 enum MHAJack::port\_t::dir\_t

Enumerator

*input*  
*output*

#### 5.216.3 Constructor & Destructor Documentation

5.216.3.1 MHAJack::port\_t::port\_t (  
    jack\_client\_t \* *jc*,  
    dir\_t *dir*,  
    int *id* )



## Parameters

<i>jc</i>	JACK client.
<i>dir</i>	Direction (input/output).
<i>id</i>	Number in port name (starting with 1).

5.216.3.2 MHAJack::port\_t::port\_t (  
     jack\_client\_t \* *jc*,  
     dir\_t *dir*,  
     const std::string & *id* )

Constructor to create port with specific name.

## Parameters

<i>jc</i>	JACK client.
<i>dir</i>	Direction (input/output).
<i>id</i>	Port name.

5.216.3.3 MHAJack::port\_t::~~port\_t ( )

## 5.216.4 Member Function Documentation

5.216.4.1 void MHAJack::port\_t::read (  
     mha\_wave\_t \* *s*,  
     unsigned int *ch* )

## Parameters

<i>s</i>	Signal structure to store the audio data.
<i>ch</i>	Channel number in audio data structure to be used.

5.216.4.2 void MHAJack::port\_t::write (  
     mha\_wave\_t \* *s*,  
     unsigned int *ch* )

## Parameters

<i>s</i>	Signal structure from which the audio data is read.
<i>ch</i>	Channel number in audio data structure to be used.

5.216.4.3 void MHAJack::port\_t::mute (  
     unsigned int *n* )

**Parameters**

<i>n</i>	Number of samples to be muted (must be the same as reported by Jack processing callback).
----------	---

5.216.4.4 `void MHAJack::port_t::connect_to (`  
`const char * pn )`

**Parameters**

<i>pn</i>	Port name to connect to
-----------	-------------------------

5.216.4.5 `const char * MHAJack::port_t::get_short_name ( )`

Return the port name.

**5.216.5 Member Data Documentation**

5.216.5.1 `dir_t MHAJack::port_t::dir_type` [private]

5.216.5.2 `jack_port_t* MHAJack::port_t::port` [private]

5.216.5.3 `jack_default_audio_sample_t* MHAJack::port_t::iob` [private]

5.216.5.4 `jack_client_t* MHAJack::port_t::jc` [private]

The documentation for this class was generated from the following files:

- **mhajack.h**
- **mhajack.cpp**

## 5.217 MHAKernel::algo\_comm\_class\_t Class Reference

Inheritance diagram for MHAKernel::algo\_comm\_class\_t:

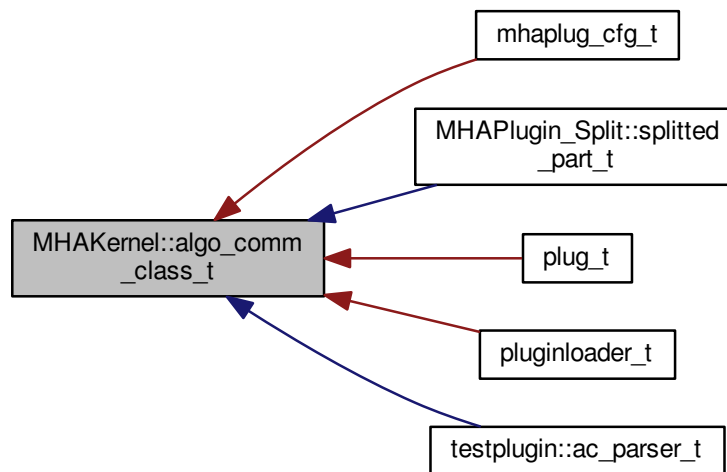

## Public Member Functions

- **algo\_comm\_class\_t** ()
- virtual **~algo\_comm\_class\_t** ()
- **algo\_comm\_t get\_c\_handle** ()
- virtual void **local\_insert\_var** (const char \*, **comm\_var\_t**)
- virtual void **local\_remove\_var** (const char \*)
- virtual void **local\_remove\_ref** (void \*)
- virtual bool **local\_is\_var** (const char \*)
- virtual void **local\_get\_var** (const char \*, **comm\_var\_t** \*)
- virtual std::string **local\_get\_entries** ()
- virtual **comm\_var\_map\_t::size\_type size** () const

## Static Public Member Functions

- static int **insert\_var** (void \*, const char \*, **comm\_var\_t**)
- static int **insert\_var\_int** (void \*, const char \*, int \*)
- static int **insert\_var\_float** (void \*, const char \*, float \*)
- static int **remove\_var** (void \*, const char \*)
- static int **remove\_ref** (void \*, void \*)
- static int **is\_var** (void \*, const char \*)
- static int **get\_var** (void \*, const char \*, **comm\_var\_t** \*)
- static int **get\_var\_int** (void \*, const char \*, int \*)
- static int **get\_var\_float** (void \*, const char \*, float \*)
- static int **get\_entries** (void \*, char \*, unsigned int)
- static const char \* **get\_error** (int)

## Public Attributes

- char \* **algo\_comm\_id\_string**

## Private Attributes

- **algo\_comm\_t ac**
- int **algo\_comm\_id\_string\_len**
- **comm\_var\_map\_t vars**

## 5.217.1 Constructor & Destructor Documentation

5.217.1.1 MHAKernel::algo\_comm\_class\_t::algo\_comm\_class\_t ( )

5.217.1.2 MHAKernel::algo\_comm\_class\_t::~~algo\_comm\_class\_t ( ) [virtual]

## 5.217.2 Member Function Documentation

5.217.2.1 algo\_comm\_t MHAKernel::algo\_comm\_class\_t::get\_c\_handle ( )

5.217.2.2 int MHAKernel::algo\_comm\_class\_t::insert\_var (   
 void \* *handle*,   
 const char \* *name*,   
 comm\_var\_t *var* ) [static]

5.217.2.3 int MHAKernel::algo\_comm\_class\_t::insert\_var\_int (   
 void \* *handle*,   
 const char \* *name*,   
 int \* *ivar* ) [static]

5.217.2.4 int MHAKernel::algo\_comm\_class\_t::insert\_var\_float (   
 void \* *handle*,   
 const char \* *name*,   
 float \* *ivar* ) [static]

5.217.2.5 int MHAKernel::algo\_comm\_class\_t::remove\_var (   
 void \* *handle*,   
 const char \* *name* ) [static]

5.217.2.6 int MHAKernel::algo\_comm\_class\_t::remove\_ref (   
 void \* *handle*,   
 void \* *ref* ) [static]

- 5.217.2.7 int MHAKernel::algo\_comm\_class\_t::is\_var (   
 void \* *handle*,   
 const char \* *name* ) [static]
- 5.217.2.8 int MHAKernel::algo\_comm\_class\_t::get\_var (   
 void \* *handle*,   
 const char \* *name*,   
 comm\_var\_t \* *var* ) [static]
- 5.217.2.9 int MHAKernel::algo\_comm\_class\_t::get\_var\_int (   
 void \* *handle*,   
 const char \* *name*,   
 int \* *ivar* ) [static]
- 5.217.2.10 int MHAKernel::algo\_comm\_class\_t::get\_var\_float (   
 void \* *handle*,   
 const char \* *name*,   
 float \* *ivar* ) [static]
- 5.217.2.11 int MHAKernel::algo\_comm\_class\_t::get\_entries (   
 void \* *handle*,   
 char \* *ret*,   
 unsigned int *len* ) [static]
- 5.217.2.12 const char \* MHAKernel::algo\_comm\_class\_t::get\_error (   
 int *e* ) [static]
- 5.217.2.13 void MHAKernel::algo\_comm\_class\_t::local\_insert\_var (   
 const char \* *name*,   
 comm\_var\_t *var* ) [virtual]
- 5.217.2.14 void MHAKernel::algo\_comm\_class\_t::local\_remove\_var (   
 const char \* *name* ) [virtual]
- 5.217.2.15 void MHAKernel::algo\_comm\_class\_t::local\_remove\_ref (   
 void \* *addr* ) [virtual]
- 5.217.2.16 bool MHAKernel::algo\_comm\_class\_t::local\_is\_var (   
 const char \* *name* ) [virtual]
- 5.217.2.17 void MHAKernel::algo\_comm\_class\_t::local\_get\_var (   
 const char \* *name*,   
 comm\_var\_t \* *var* ) [virtual]
- 5.217.2.18 std::string MHAKernel::algo\_comm\_class\_t::local\_get\_entries ( ) [virtual]

5.217.2.19 `MHAKernel::comm_var_map_t::size_type MHAKernel::algo_comm_class_t::size ( ) const`  
`[virtual]`

### 5.217.3 Member Data Documentation

5.217.3.1 `char* MHAKernel::algo_comm_class_t::algo_comm_id_string`

5.217.3.2 `algo_comm_t MHAKernel::algo_comm_class_t::ac` `[private]`

5.217.3.3 `int MHAKernel::algo_comm_class_t::algo_comm_id_string_len` `[private]`

5.217.3.4 `comm_var_map_t MHAKernel::algo_comm_class_t::vars` `[private]`

The documentation for this class was generated from the following files:

- `mha_algo_comm.hh`
- `mha_algo_comm.cpp`

### 5.218 MHAKernel::comm\_var\_map\_t Class Reference

Inherits `map< std::string, comm_var_t >`.

#### Public Member Functions

- `bool has_key (const std::string &name)`

### 5.218.1 Member Function Documentation

5.218.1.1 `bool MHAKernel::comm_var_map_t::has_key (`  
`const std::string & name )` `[inline]`

The documentation for this class was generated from the following file:

- `mha_algo_comm.hh`

## 5.219 MHAMultiSrc::base\_t Class Reference

Base class for source selection.

Inheritance diagram for MHAMultiSrc::base\_t:

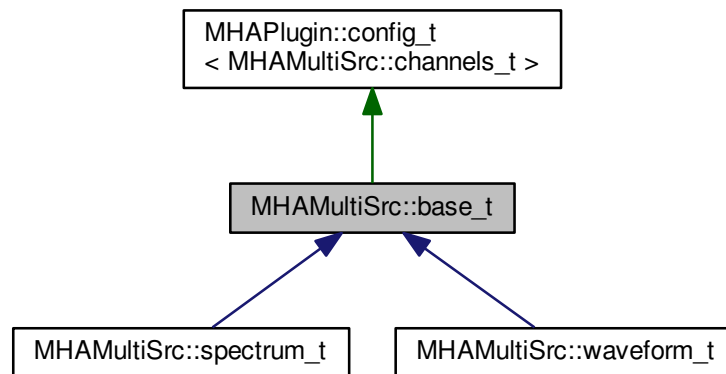

### Public Member Functions

- **base\_t** (**algo\_comm\_t** iac)
- void **select\_source** (const std::vector< std::string > &src, int in\_channels)  
*Change the selection of input sources.*

### Protected Attributes

- **algo\_comm\_t** ac

### Additional Inherited Members

#### 5.219.1 Detailed Description

Base class for source selection.

### See also

- MHAMultiSrc::channel\_t** (p. 608)
- MHAMultiSrc::channels\_t** (p. 609)

## 5.219.2 Constructor & Destructor Documentation

### 5.219.2.1 MHAMultiSrc::base\_t::base\_t ( algo\_comm\_t iac )

## 5.219.3 Member Function Documentation

### 5.219.3.1 void MHAMultiSrc::base\_t::select\_source ( const std::vector< std::string > & src, int in\_channels )

Change the selection of input sources.

This function is real-time and thread safe.

#### Parameters

<i>src</i>	List of input sources
<i>in_channels</i>	Number of input channels in direct input (the processed signal)

## 5.219.4 Member Data Documentation

### 5.219.4.1 algo\_comm\_t MHAMultiSrc::base\_t::ac [protected]

The documentation for this class was generated from the following files:

- **mha\_multisrc.h**
- **mha\_multisrc.cpp**

## 5.220 MHAMultiSrc::channel\_t Class Reference

### Public Attributes

- std::string **name**
- int **channel**

## 5.220.1 Member Data Documentation

### 5.220.1.1 std::string MHAMultiSrc::channel\_t::name

### 5.220.1.2 int MHAMultiSrc::channel\_t::channel

The documentation for this class was generated from the following file:

- **mha\_multisrc.h**



## 5.221 MHAMultiSrc::channels\_t Class Reference

Inherits `vector< MHAMultiSrc::channel_t >`.

### Public Member Functions

- **channels\_t** (const std::vector< std::string > &src, int in\_channels)  
*Separate a list of input sources into a parsable channel list.*

#### 5.221.1 Constructor & Destructor Documentation

5.221.1.1 MHAMultiSrc::channels\_t::channels\_t (  
    const std::vector< std::string > & route,  
    int in\_channels )

Separate a list of input sources into a parsable channel list.

The number of input channels if verified, a list of **MHAMultiSrc::channel\_t** (p. 608) is filled.

#### Parameters

<i>route</i>	vector of source channel ids
<i>in_channels</i>	number of channels in the processed input signal

The documentation for this class was generated from the following files:

- **mha\_multisrc.h**
- **mha\_multisrc.cpp**

## 5.222 MHAMultiSrc::spectrum\_t Class Reference

Inheritance diagram for MHAMultiSrc::spectrum\_t:

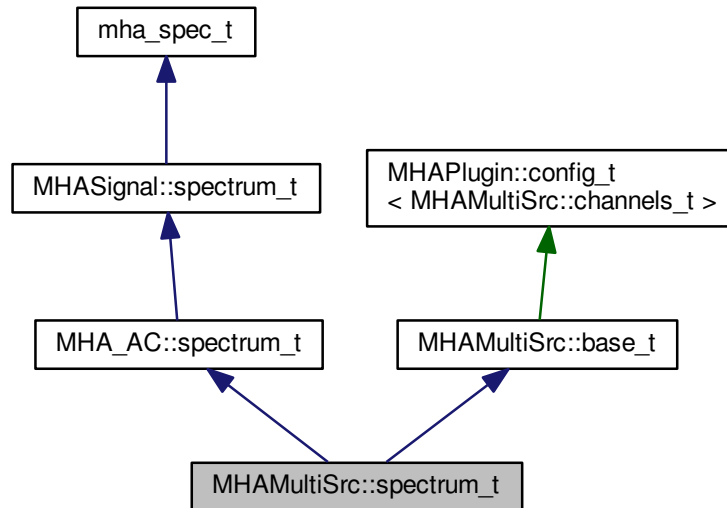

### Public Member Functions

- **spectrum\_t** (**algo\_comm\_t** iac, std::string **name**, unsigned int frames, unsigned int **channels**)
- **mha\_spec\_t \* update** (**mha\_spec\_t \*s**)  
*Update data of spectrum to hold actual input data.*

### Additional Inherited Members

#### 5.222.1 Constructor & Destructor Documentation

5.222.1.1 MHAMultiSrc::spectrum\_t::spectrum\_t (  
**algo\_comm\_t** iac,  
 std::string **name**,  
 unsigned int **frames**,  
 unsigned int **channels** )

#### 5.222.2 Member Function Documentation

5.222.2.1 **mha\_spec\_t \* MHAMultiSrc::spectrum\_t::update** (  
**mha\_spec\_t \* s** )

Update data of spectrum to hold actual input data.

## Parameters

s	Input signal chunk
---	--------------------

## Returns

Return pointer to spectrum structure

The documentation for this class was generated from the following files:

- `mha_multisrc.h`
- `mha_multisrc.cpp`

## 5.223 MHAMultiSrc::waveform\_t Class Reference

Inheritance diagram for MHAMultiSrc::waveform\_t:

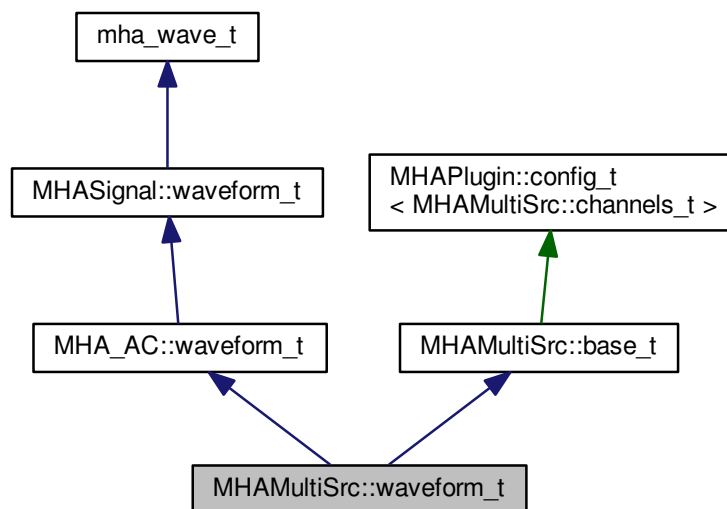

## Public Member Functions

- **waveform\_t** (`algo_comm_t` iac, `std::string` **name**, unsigned int frames, unsigned int channels)
- **mha\_wave\_t \* update** (`mha_wave_t *s`)  
*Update data of waveform to hold actual input data.*

## Additional Inherited Members

### 5.223.1 Constructor & Destructor Documentation

5.223.1.1 `MHAMultiSrc::waveform_t::waveform_t (`  
     `algo_comm_t iac,`  
     `std::string name,`  
     `unsigned int frames,`  
     `unsigned int channels )`

### 5.223.2 Member Function Documentation

5.223.2.1 `mha_wave_t * MHAMultiSrc::waveform_t::update (`  
     `mha_wave_t * s )`

Update data of waveform to hold actual input data.

#### Parameters

<code>s</code>	Input signal chunk
----------------	--------------------

#### Returns

Return pointer to waveform structure

The documentation for this class was generated from the following files:

- `mha_multisrc.h`
- `mha_multisrc.cpp`

## 5.224 MHAOvFilter::band\_descriptor\_t Class Reference

### Public Attributes

- `mha_real_t cf_l`
- `mha_real_t ef_l`
- `mha_real_t cf`
- `mha_real_t ef_h`
- `mha_real_t cf_h`
- `bool low_side_flat`
- `bool high_side_flat`

## 5.224.1 Member Data Documentation

5.224.1.1 mha\_real\_t MHAOvIFilter::band\_descriptor\_t::cf\_l

5.224.1.2 mha\_real\_t MHAOvIFilter::band\_descriptor\_t::ef\_l

5.224.1.3 mha\_real\_t MHAOvIFilter::band\_descriptor\_t::cf

5.224.1.4 mha\_real\_t MHAOvIFilter::band\_descriptor\_t::ef\_h

5.224.1.5 mha\_real\_t MHAOvIFilter::band\_descriptor\_t::cf\_h

5.224.1.6 bool MHAOvIFilter::band\_descriptor\_t::low\_side\_flat

5.224.1.7 bool MHAOvIFilter::band\_descriptor\_t::high\_side\_flat

The documentation for this class was generated from the following file:

- **mha\_fftfb.hh**

## 5.225 MHAOvIFilter::barkscale::bark2hz\_t Class Reference

Inheritance diagram for MHAOvIFilter::barkscale::bark2hz\_t:

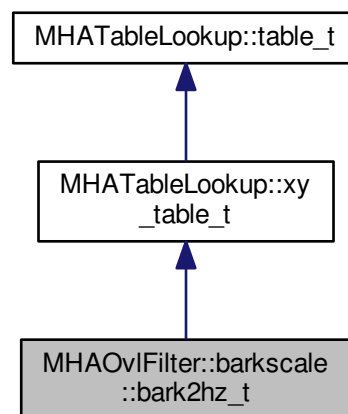

### Public Member Functions

- **bark2hz\_t** ()
- **~bark2hz\_t** ()

### Additional Inherited Members

#### 5.225.1 Constructor & Destructor Documentation

5.225.1.1 MHAOvIFilter::barkscale::bark2hz\_t::bark2hz\_t ( )

5.225.1.2 MHAOvIFilter::barkscale::bark2hz\_t::~bark2hz\_t ( )

The documentation for this class was generated from the following file:

- **mha\_fffb.cpp**

#### 5.226 MHAOvIFilter::barkscale::hz2bark\_t Class Reference

Inheritance diagram for MHAOvIFilter::barkscale::hz2bark\_t:

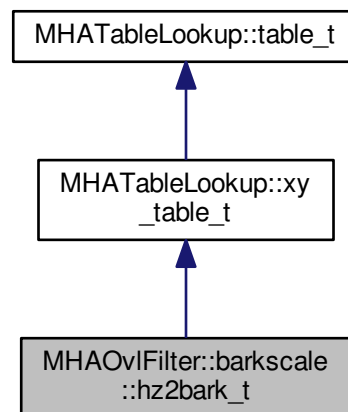

### Public Member Functions

- **hz2bark\_t** ()
- **~hz2bark\_t** ()

## Additional Inherited Members

### 5.226.1 Constructor & Destructor Documentation

5.226.1.1 MHAOvFilter::barkscale::hz2bark\_t::hz2bark\_t ( )

5.226.1.2 MHAOvFilter::barkscale::hz2bark\_t::~~hz2bark\_t ( )

The documentation for this class was generated from the following file:

- **mha\_fftfb.cpp**

## 5.227 MHAOvFilter::fftfb\_ac\_info\_t Class Reference

### Public Member Functions

- **fftfb\_ac\_info\_t** (const **MHAOvFilter::fftfb\_t** &fb, **algo\_comm\_t** ac, const std::string &prefix)
- void **insert** ()

### Private Attributes

- **MHA\_AC::waveform\_t** cfv  
*vector of nominal center frequencies / Hz*
- **MHA\_AC::waveform\_t** efv  
*vector of edge frequencies / Hz*
- **MHA\_AC::waveform\_t** bwv  
*vector of band-weights (sum of squared fft-bin-weights)/num\_frames*
- **MHA\_AC::waveform\_t** cLTASS  
*vector of LTASS correction*

### 5.227.1 Constructor & Destructor Documentation

5.227.1.1 MHAOvFilter::fftfb\_ac\_info\_t::fftfb\_ac\_info\_t (const MHAOvFilter::fftfb\_t & fb, algo\_comm\_t ac, const std::string & prefix )

### 5.227.2 Member Function Documentation

5.227.2.1 void MHAOvFilter::fftfb\_ac\_info\_t::insert ( )

### 5.227.3 Member Data Documentation

5.227.3.1 **MHA\_AC::waveform\_t** MHAOvFilter::fftfb\_ac\_info\_t::cfv [private]

vector of nominal center frequencies / Hz

### 5.227.3.2 MHA\_AC::waveform\_t MHAOvFilter::fftfb\_ac\_info\_t::efv [private]

vector of edge frequencies / Hz

### 5.227.3.3 MHA\_AC::waveform\_t MHAOvFilter::fftfb\_ac\_info\_t::bwv [private]

vector of band-weights (sum of squared fft-bin-weights)/num\_frames

### 5.227.3.4 MHA\_AC::waveform\_t MHAOvFilter::fftfb\_ac\_info\_t::cLTASS [private]

vector of LTASS correction

The documentation for this class was generated from the following files:

- **mha\_fftfb.hh**
- **mha\_fftfb.cpp**

## 5.228 MHAOvFilter::fftfb\_t Class Reference

FFT based overlapping filter bank.

Inheritance diagram for MHAOvFilter::fftfb\_t:

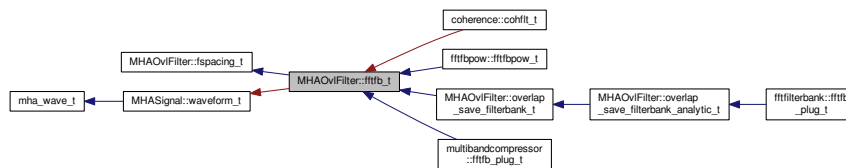

### Public Member Functions

- **fftfb\_t** (MHAOvFilter::fftfb\_vars\_t &par, unsigned int nfft, mha\_real\_t fs)  
*Constructor for a FFT-based overlapping filter bank.*
- **~fftfb\_t** ()
- void **apply\_gains** (mha\_spec\_t \*s\_out, const mha\_spec\_t \*s\_in, const mha\_wave\_t \*gains)
- void **get\_fbpower** (mha\_wave\_t \*fbpow, const mha\_spec\_t \*s\_in)
- void **get\_fbpower\_db** (mha\_wave\_t \*fbpow, const mha\_spec\_t \*s\_in)
- std::vector< mha\_real\_t > **get\_ltass\_gain\_db** () const
- unsigned int **bin1** (unsigned int band) const  
*Return index of first non-zero filter shape window.*
- unsigned int **bin2** (unsigned int band) const  
*Return index of first zero filter shape window above center frequency.*
- unsigned int **get\_fftlen** () const  
*Return fft length.*
- **mha\_real\_t w** (unsigned int k, unsigned int b) const  
*Return filter shape window at index k in band b.*



### Private Attributes

- unsigned int \* **vbin1**
- unsigned int \* **vbin2**
- **mha\_real\_t(\* shape)(mha\_real\_t)**
- unsigned int **fftlens**
- **mha\_real\_t samplingrate**

### Additional Inherited Members

#### 5.228.1 Detailed Description

FFT based overlapping filter bank.

#### 5.228.2 Constructor & Destructor Documentation

5.228.2.1 MHAOvFilter::fftfb\_t::fftfb\_t (  
                   MHAOvFilter::fftfb\_vars\_t & *par*,  
                   unsigned int *nfft*,  
                   mha\_real\_t *fs* )

Constructor for a FFT-based overlapping filter bank.

#### Parameters

<i>par</i>	Parameters for the FFT filterbank that can not be deduced from the signal dimensions are taken from this set of configuration variables.
<i>nfft</i>	FFT length
<i>fs</i>	Sampling rate / Hz

5.228.2.2 MHAOvFilter::fftfb\_t::~~fftfb\_t ( )

#### 5.228.3 Member Function Documentation

5.228.3.1 void MHAOvFilter::fftfb\_t::apply\_gains (  
                   mha\_spec\_t \* *s\_out*,  
                   const mha\_spec\_t \* *s\_in*,  
                   const mha\_wave\_t \* *gains* )

5.228.3.2 void MHAOvFilter::fftfb\_t::get\_fbpower (  
                   mha\_wave\_t \* *fbpow*,  
                   const mha\_spec\_t \* *s\_in* )

5.228.3.3 void MHAOvFilter::fftfb\_t::get\_fbpower\_db (   
           mha\_wave\_t \* *fbpow*,   
           const mha\_spec\_t \* *s\_in* )

5.228.3.4 std::vector< float > MHAOvFilter::fftfb\_t::get\_ltass\_gain\_db ( ) const

5.228.3.5 unsigned int MHAOvFilter::fftfb\_t::bin1 (   
           unsigned int *band* ) const [inline]

Return index of first non-zero filter shape window.

5.228.3.6 unsigned int MHAOvFilter::fftfb\_t::bin2 (   
           unsigned int *band* ) const [inline]

Return index of first zero filter shape window above center frequency.

5.228.3.7 unsigned int MHAOvFilter::fftfb\_t::get\_fftlens ( ) const [inline]

Return fft length.

5.228.3.8 mha\_real\_t MHAOvFilter::fftfb\_t::w (   
           unsigned int *k*,   
           unsigned int *b* ) const [inline]

Return filter shape window at index *k* in band *b*.

#### Parameters

<i>k</i>	Frequency index
<i>b</i>	Band index

#### 5.228.4 Member Data Documentation

5.228.4.1 unsigned int\* MHAOvFilter::fftfb\_t::vbin1 [private]

5.228.4.2 unsigned int\* MHAOvFilter::fftfb\_t::vbin2 [private]

5.228.4.3 mha\_real\_t(\* MHAOvFilter::fftfb\_t::shape) (mha\_real\_t) [private]

5.228.4.4 unsigned int MHAOvFilter::fftfb\_t::fftlens [private]

5.228.4.5 mha\_real\_t MHAOvFilter::fftfb\_t::samplingrate [private]

The documentation for this class was generated from the following files:

- mha\_fftfb.hh
- mha\_fftfb.cpp

## 5.229 MHAOvFilter::fftfb\_vars\_t Class Reference

Set of configuration variables for FFT-based overlapping filters.

Inheritance diagram for MHAOvFilter::fftfb\_vars\_t:

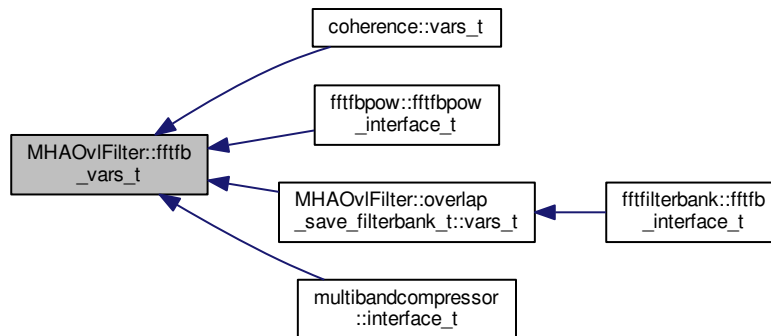

## Public Member Functions

- **fftfb\_vars\_t (MHAParser::parser\_t &p)**

*construct a set of openMHA configuration language variables suitable for configuring the FFT-based overlapping filterbank.*

## Public Attributes

- **scale\_var\_t fscale**  
*Frequency scale type (lin/bark/log/erb).*
- **scale\_var\_t ovltype**  
*Filter shape (rect/lin/hann).*
- **MHAParser::float\_t plateau**  
*relative plateau width.*
- **MHAParser::kw\_t ftype**  
*Flag to decide whether edge or center frequencies are used.*
- **fscale\_t f**  
*Frequency.*
- **MHAParser::bool\_t normalize**  
*Normalize sum of channels.*
- **MHAParser::bool\_t fail\_on\_nonmonotonic**  
*Fail if frequency entries are non-monotonic (otherwise sort)*
- **MHAParser::bool\_t fail\_on\_unique\_bins**  
*Fail if center frequencies share the same FFT bin.*

- **MHAParser::vfloat\_mon\_t cf**  
*Final center frequencies in Hz.*
- **MHAParser::vfloat\_mon\_t ef**  
*Final edge frequencies in Hz.*
- **MHAParser::vfloat\_mon\_t cLTASS**  
*Bandwidth correction for LTASS noise (level of 0 dB RMS LTASS noise)*
- **MHAParser::mfloat\_mon\_t shapes**

### 5.229.1 Detailed Description

Set of configuration variables for FFT-based overlapping filters.

This class enables easy configuration of the FFT-based overlapping filterbank. An instance of **fftfb\_vars\_t** (p. 619) creates openMHA configuration language variables needed for configuring the filterbank, and inserts these variables in the openMHA configuration tree.

This way, the variables are visible to the user and can be configured using the openMHA configuration language.

### 5.229.2 Constructor & Destructor Documentation

#### 5.229.2.1 MHAOvfFilter::fftfb\_vars\_t::fftfb\_vars\_t (MHAParser::parser\_t & p )

construct a set of openMHA configuration language variables suitable for configuring the FFT-based overlapping filterbank.

#### Parameters

<i>p</i>	The node of the configuration tree where the variables created by this instance are inserted.
----------	---

### 5.229.3 Member Data Documentation

#### 5.229.3.1 scale\_var\_t MHAOvfFilter::fftfb\_vars\_t::fscale

Frequency scale type (lin/bark/log/erb).

#### 5.229.3.2 scale\_var\_t MHAOvfFilter::fftfb\_vars\_t::ovltype

Filter shape (rect/lin/hann).

**5.229.3.3 MHAParser::float\_t MHAOvFilter::fftfb\_vars\_t::plateau**

relative plateau width.

**5.229.3.4 MHAParser::kw\_t MHAOvFilter::fftfb\_vars\_t::ftype**

Flag to decide whether edge or center frequencies are used.

**5.229.3.5 fscale\_t MHAOvFilter::fftfb\_vars\_t::f**

Frequency.

**5.229.3.6 MHAParser::bool\_t MHAOvFilter::fftfb\_vars\_t::normalize**

Normalize sum of channels.

**5.229.3.7 MHAParser::bool\_t MHAOvFilter::fftfb\_vars\_t::fail\_on\_nonmonotonic**

Fail if frequency entries are non-monotonic (otherwise sort)

**5.229.3.8 MHAParser::bool\_t MHAOvFilter::fftfb\_vars\_t::fail\_on\_unique\_bins**

Fail if center frequencies share the same FFT bin.

**5.229.3.9 MHAParser::vfloat\_mon\_t MHAOvFilter::fftfb\_vars\_t::cf**

Final center frequencies in Hz.

**5.229.3.10 MHAParser::vfloat\_mon\_t MHAOvFilter::fftfb\_vars\_t::ef**

Final edge frequencies in Hz.

**5.229.3.11 MHAParser::vfloat\_mon\_t MHAOvFilter::fftfb\_vars\_t::cLTASS**

Bandwidth correction for LTASS noise (level of 0 dB RMS LTASS noise)

**5.229.3.12 MHAParser::mfloat\_mon\_t MHAOvFilter::fftfb\_vars\_t::shapes**

The documentation for this class was generated from the following files:

- **mha\_fftfb.hh**
- **mha\_fftfb.cpp**

## 5.230 MHAOvFilter::fscale\_bw\_t Class Reference

Inheritance diagram for MHAOvFilter::fscale\_bw\_t:

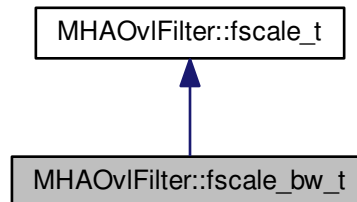

### Public Member Functions

- **fscale\_bw\_t** (MHAParser::parser\_t &parent)
- std::vector< mha\_real\_t > **get\_bw\_hz** () const

### Protected Attributes

- **MHAParser::vfloat\_t** bw
- **MHAParser::vfloat\_mon\_t** bw\_hz

### Private Member Functions

- void **update\_hz** ()

### Private Attributes

- **MHAEvents::connector\_t**< fscale\_bw\_t > **updater**

## Additional Inherited Members

## 5.230.1 Constructor &amp; Destructor Documentation

5.230.1.1 MHAOvFilter::fscale\_bw\_t::fscale\_bw\_t (  
MHAParser::parser\_t & parent )

## 5.230.2 Member Function Documentation

5.230.2.1 std::vector< mha\_real\_t > MHAOvFilter::fscale\_bw\_t::get\_bw\_hz ( ) const

5.230.2.2 void MHAOvFilter::fscale\_bw\_t::update\_hz ( ) [private]

## 5.230.3 Member Data Documentation

5.230.3.1 MHAParser::vfloat\_t MHAOvFilter::fscale\_bw\_t::bw [protected]

5.230.3.2 MHAParser::vfloat\_mon\_t MHAOvFilter::fscale\_bw\_t::bw\_hz [protected]

5.230.3.3 MHAEvents::connector\_t<fscale\_bw\_t> MHAOvFilter::fscale\_bw\_t::updater  
[private]

The documentation for this class was generated from the following files:

- mha\_fftb.hh
- mha\_fftb.cpp

## 5.231 MHAOvFilter::fscale\_t Class Reference

Inheritance diagram for MHAOvFilter::fscale\_t:

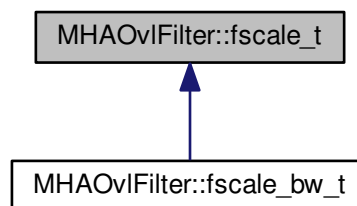

### Public Member Functions

- **fscale\_t** (MHAParser::parser\_t &parent)
- std::vector< mha\_real\_t > **get\_f\_hz** () const

### Public Attributes

- **scale\_var\_t** unit
- **MHAParser::vfloat\_t** f
- **MHAParser::vfloat\_mon\_t** f\_hz

### Private Member Functions

- void **update\_hz** ()

### Private Attributes

- **MHAEvents::connector\_t**< fscale\_t > **updater**

### 5.231.1 Constructor & Destructor Documentation

5.231.1.1 **MHAOvFilter::fscale\_t::fscale\_t** (  
                   **MHAParser::parser\_t** & *parent* )

### 5.231.2 Member Function Documentation

5.231.2.1 std::vector< mha\_real\_t > **MHAOvFilter::fscale\_t::get\_f\_hz** ( ) const

5.231.2.2 void **MHAOvFilter::fscale\_t::update\_hz** ( ) [private]

### 5.231.3 Member Data Documentation

5.231.3.1 **scale\_var\_t** **MHAOvFilter::fscale\_t::unit**

5.231.3.2 **MHAParser::vfloat\_t** **MHAOvFilter::fscale\_t::f**

5.231.3.3 **MHAParser::vfloat\_mon\_t** **MHAOvFilter::fscale\_t::f\_hz**

5.231.3.4 **MHAEvents::connector\_t**<fscale\_t> **MHAOvFilter::fscale\_t::updater** [private]

The documentation for this class was generated from the following files:

- **mha\_fftfb.hh**
- **mha\_fftfb.cpp**



## 5.232 MHAOvFilter::fspacing\_t Class Reference

Class for frequency spacing, used by filterbank shape generator class.

Inheritance diagram for MHAOvFilter::fspacing\_t:

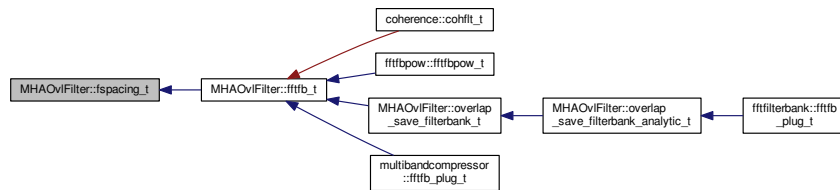

## Public Member Functions

- **fspacing\_t** (const **MHAOvFilter::fftb\_vars\_t** &par, unsigned int nfft, **mha\_real\_t** fs)
- std::vector< unsigned int > **get\_cf\_fftbin** () const
- std::vector< **mha\_real\_t** > **get\_cf\_hz** () const
- std::vector< **mha\_real\_t** > **get\_ef\_hz** () const
- unsigned int **nbands** () const  
*Return number of bands in filter bank.*

## Protected Member Functions

- void **fail\_on\_nonmonotonic\_cf** ()
- void **fail\_on\_unique\_fftbins** ()

## Protected Attributes

- std::vector< **MHAOvFilter::band\_descriptor\_t** > **bands**
- **mha\_real\_t**(\* **symmetry\_scale**)(**mha\_real\_t**)

## Private Member Functions

- void **ef2bands** (std::vector< **mha\_real\_t** > vef)
- void **cf2bands** (std::vector< **mha\_real\_t** > vcf)
- void **equidist2bands** (std::vector< **mha\_real\_t** > vcf)

## Private Attributes

- unsigned int **nfft\_**
- **mha\_real\_t** **fs\_**

### 5.232.1 Detailed Description

Class for frequency spacing, used by filterbank shape generator class.

### 5.232.2 Constructor & Destructor Documentation

5.232.2.1 `MHAOvFilter::fspacing_t::fspacing_t ( const MHAOvFilter::fftfb_vars_t & par, unsigned int nfft, mha_real_t fs )`

### 5.232.3 Member Function Documentation

5.232.3.1 `std::vector< unsigned int > MHAOvFilter::fspacing_t::get_cf_fftbins ( ) const`

5.232.3.2 `std::vector< mha_real_t > MHAOvFilter::fspacing_t::get_cf_hz ( ) const`

5.232.3.3 `std::vector< mha_real_t > MHAOvFilter::fspacing_t::get_ef_hz ( ) const`

5.232.3.4 `unsigned int MHAOvFilter::fspacing_t::nbands ( ) const` `[inline]`

Return number of bands in filter bank.

5.232.3.5 `void MHAOvFilter::fspacing_t::fail_on_nonmonotonic_cf ( )` `[protected]`

5.232.3.6 `void MHAOvFilter::fspacing_t::fail_on_unique_fftbins ( )` `[protected]`

5.232.3.7 `void MHAOvFilter::fspacing_t::ef2bands ( std::vector< mha_real_t > vef )` `[private]`

5.232.3.8 `void MHAOvFilter::fspacing_t::cf2bands ( std::vector< mha_real_t > vcf )` `[private]`

5.232.3.9 `void MHAOvFilter::fspacing_t::equidist2bands ( std::vector< mha_real_t > vcf )` `[private]`

### 5.232.4 Member Data Documentation

5.232.4.1 `std::vector<MHAOvFilter::band_descriptor_t> MHAOvFilter::fspacing_t::bands` `[protected]`

5.232.4.2 `mha_real_t(* MHAOvFilter::fspacing_t::symmetry_scale)(mha_real_t)` `[protected]`

5.232.4.3 `unsigned int MHAOvFilter::fspacing_t::nfft_` `[private]`

5.232.4.4 `mha_real_t MHAOvFilter::fspacing_t::fs_` `[private]`

The documentation for this class was generated from the following files:

- `mha_fftfb.hh`
- `mha_fftfb.cpp`

5.233 MHAOvFilter::overlap\_save\_filterbank\_analytic\_t Class Reference

Inheritance diagram for MHAOvFilter::overlap\_save\_filterbank\_analytic\_t:

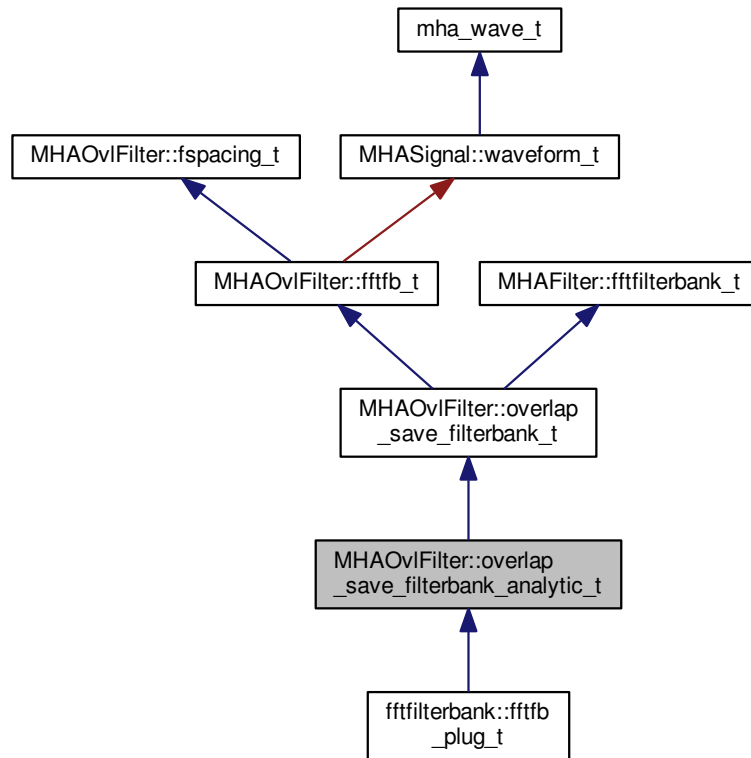

Public Member Functions

- **overlap\_save\_filterbank\_analytic\_t** (MHAOvFilter::overlap\_save\_filterbank\_t↔  
::vars\_t &fbpar, mhaconfig\_t channelconfig\_in)
- void **filter\_analytic** (const mha\_wave\_t \*sIn, mha\_wave\_t \*\*fltRe, mha\_wave\_t \*\*flt↔  
Im)

Private Attributes

- MHAFilter::fftfilterbank\_t imagfb

## Additional Inherited Members

### 5.233.1 Constructor & Destructor Documentation

5.233.1.1 **MHAOvFilter::overlap\_save\_filterbank\_analytic\_t::overlap\_save\_filterbank\_analytic\_t ( MHAOvFilter::overlap\_save\_filterbank\_t::vars\_t & *fbpar*, mhaconfig\_t *channelconfig\_in* )**

### 5.233.2 Member Function Documentation

5.233.2.1 **void MHAOvFilter::overlap\_save\_filterbank\_analytic\_t::filter\_analytic ( const mha\_wave\_t \* *sIn*, mha\_wave\_t \*\* *fltRe*, mha\_wave\_t \*\* *fltIm* )**

### 5.233.3 Member Data Documentation

5.233.3.1 **MHAFilter::fftfilterbank\_t MHAOvFilter::overlap\_save\_filterbank\_analytic\_t::imagfb**  
[private]

The documentation for this class was generated from the following files:

- **mha\_fftfb.hh**
- **mha\_fftfb.cpp**

## 5.234 MHAOvFilter::overlap\_save\_filterbank\_t Class Reference

A time-domain minimal phase filter bank with frequency shapes from **MHAOvFilter::fftfb\_t** (p. 616).

Inheritance diagram for MHAOvFilter::overlap\_save\_filterbank\_t:

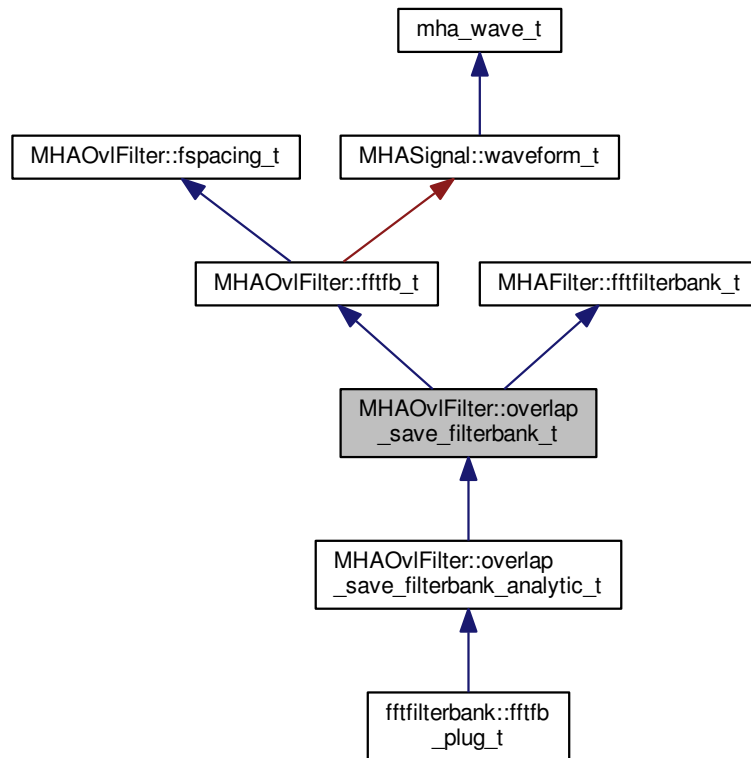

### Classes

- class **vars\_t**

### Public Member Functions

- **overlap\_save\_filterbank\_t** (**MHAOvFilter::overlap\_save\_filterbank\_t::vars\_t** &fbpar, **mhaconfig\_t** channelconfig\_in)
- **mhaconfig\_t** **get\_channelconfig** () const

### Private Attributes

- **mhaconfig\_t** **channelconfig\_out\_**

### Additional Inherited Members

#### 5.234.1 Detailed Description

A time-domain minimal phase filter bank with frequency shapes from **MHAOvFilter::ftfb\_t** (p. 616).

## 5.234.2 Constructor & Destructor Documentation

### 5.234.2.1 MHAOvFilter::overlap\_save\_filterbank\_t::overlap\_save\_filterbank\_t ( MHAOvFilter::overlap\_save\_filterbank\_t::vars\_t & fbpar, mhaconfig\_t channelconfig\_in )

## 5.234.3 Member Function Documentation

### 5.234.3.1 mhaconfig\_t MHAOvFilter::overlap\_save\_filterbank\_t::get\_channelconfig ( ) const [inline]

## 5.234.4 Member Data Documentation

### 5.234.4.1 mhaconfig\_t MHAOvFilter::overlap\_save\_filterbank\_t::channelconfig\_out\_ [private]

The documentation for this class was generated from the following files:

- mha\_fftfb.hh
- mha\_fftfb.cpp

## 5.235 MHAOvFilter::overlap\_save\_filterbank\_t::vars\_t Class Reference

Inheritance diagram for MHAOvFilter::overlap\_save\_filterbank\_t::vars\_t:

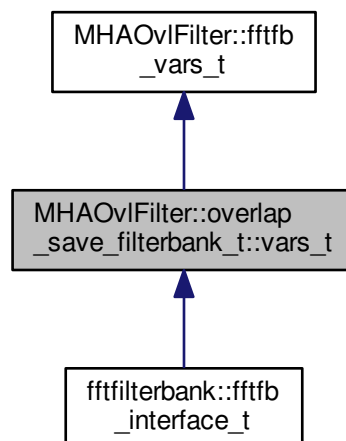

### Public Member Functions

- vars\_t (MHAParser::parser\_t &p)

Public Attributes

- **MHAParser::int\_t** fftlen
- **MHAParser::kw\_t** phasemodel
- **MHAParser::window\_t** irswnd

5.235.1 Constructor & Destructor Documentation

5.235.1.1 MHAOvFilter::overlap\_save\_filterbank\_t::vars\_t::vars\_t ( MHAParser::parser\_t & p )

5.235.2 Member Data Documentation

5.235.2.1 MHAParser::int\_t MHAOvFilter::overlap\_save\_filterbank\_t::vars\_t::fftlen

5.235.2.2 MHAParser::kw\_t MHAOvFilter::overlap\_save\_filterbank\_t::vars\_t::phasemodel

5.235.2.3 MHAParser::window\_t MHAOvFilter::overlap\_save\_filterbank\_t::vars\_t::irswnd

The documentation for this class was generated from the following files:

- **mha\_fftfb.hh**
- **mha\_fftfb.cpp**

## 5.236 MHAOvIFilter::scale\_var\_t Class Reference

Inheritance diagram for MHAOvIFilter::scale\_var\_t:

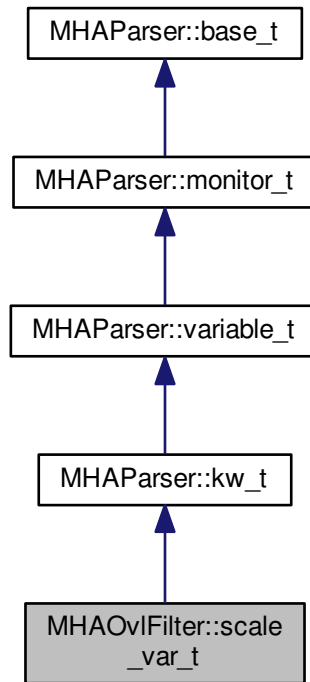

### Public Member Functions

- **scale\_var\_t** (const std::string &help)
- void **add\_fun** (const std::string &name, **scale\_fun\_t** \*fun)
- std::string **get\_name** () const
- **scale\_fun\_t** \* **get\_fun** () const
- **mha\_real\_t** **hz2unit** (**mha\_real\_t** x) const
- **mha\_real\_t** **unit2hz** (**mha\_real\_t** x) const

### Private Attributes

- std::vector< std::string > **names**
- std::vector< **scale\_fun\_t** \* > **funs**



## Additional Inherited Members

### 5.236.1 Constructor & Destructor Documentation

5.236.1.1 MHAOvFilter::scale\_var\_t::scale\_var\_t (   
 const std::string & *help* )

### 5.236.2 Member Function Documentation

5.236.2.1 void MHAOvFilter::scale\_var\_t::add\_fun (   
 const std::string & *name*,   
 scale\_fun\_t \* *fun* )

5.236.2.2 std::string MHAOvFilter::scale\_var\_t::get\_name ( ) const [inline]

5.236.2.3 scale\_fun\_t\* MHAOvFilter::scale\_var\_t::get\_fun ( ) const [inline]

5.236.2.4 mha\_real\_t MHAOvFilter::scale\_var\_t::hz2unit (   
 mha\_real\_t *x* ) const

5.236.2.5 mha\_real\_t MHAOvFilter::scale\_var\_t::unit2hz (   
 mha\_real\_t *x* ) const

### 5.236.3 Member Data Documentation

5.236.3.1 std::vector<std::string> MHAOvFilter::scale\_var\_t::names [private]

5.236.3.2 std::vector<scale\_fun\_t\*> MHAOvFilter::scale\_var\_t::funs [private]

The documentation for this class was generated from the following files:

- **mha\_fftb.hh**
- **mha\_fftb.cpp**

## 5.237 MHParse::base\_t Class Reference

Base class for all parser items.

Inheritance diagram for MHParse::base\_t:

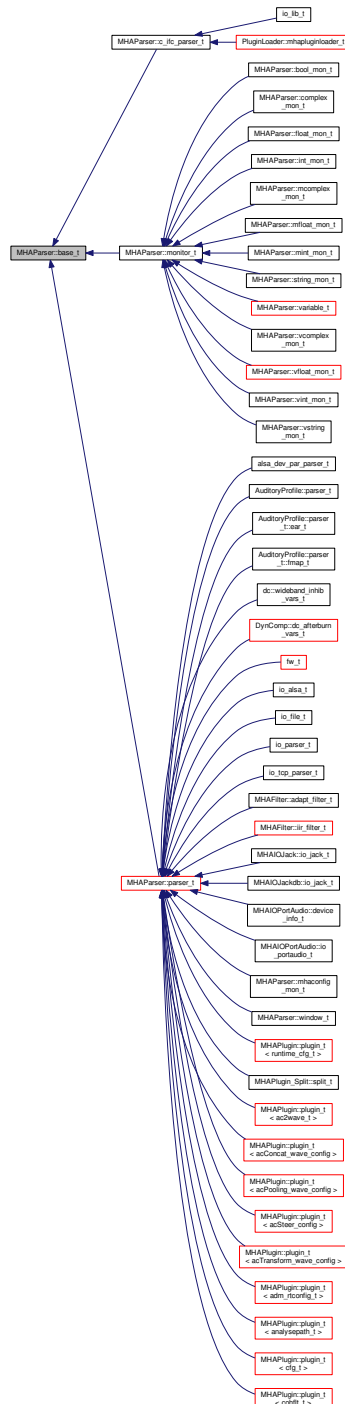

### Classes

- class `replace_t`

## Public Member Functions

- **base\_t** (const std::string &)  
*Constructor for base class of all parser nodes.*
- **base\_t** (const **base\_t** &)
- virtual ~**base\_t** ()
- virtual std::string **parse** (const std::string &)  
*Causes this node to process a command in the openMHA configuration language.*
- virtual void **parse** (const char \*, char \*, unsigned int)  
*This function parses a command and writes the parsing result into a C character array.*
- virtual void **parse** (const std::vector< std::string > &, std::vector< std::string > &)
- virtual std::string **op\_subparse** (**expression\_t** &)
- virtual std::string **op\_setval** (**expression\_t** &)
- virtual std::string **op\_query** (**expression\_t** &)
- virtual std::string **query\_dump** (const std::string &)
- virtual std::string **query\_entries** (const std::string &)
- virtual std::string **query\_perm** (const std::string &)
- virtual std::string **query\_range** (const std::string &)
- virtual std::string **query\_type** (const std::string &)
- virtual std::string **query\_val** (const std::string &)
- virtual std::string **query\_readfile** (const std::string &)
- virtual std::string **query\_savefile** (const std::string &)
- virtual std::string **query\_savefile\_compact** (const std::string &)
- virtual std::string **query\_savemons** (const std::string &)
- virtual std::string **query\_listids** (const std::string &)
- std::string **query\_version** (const std::string &)
- std::string **query\_id** (const std::string &)
- std::string **query\_subst** (const std::string &)
- std::string **query\_addsubst** (const std::string &)
- std::string **query\_help** (const std::string &)
- std::string **query\_cmds** (const std::string &)
- void **set\_node\_id** (const std::string &)  
*Set the identification string of this parser node.*
- void **set\_help** (const std::string &)  
*Set the help comment of a variable or parser.*
- void **add\_parent\_on\_insert** (**parser\_t** \*, std::string)
- void **rm\_parent\_on\_remove** (**parser\_t** \*)
- const std::string & **fullname** () const  
*Return the full dot-separated path name of this parser node in the openMHA configuration tree.*

## Public Attributes

- **MHAEvents::emitter\_t writeaccess**  
*Event emitted on write access.*
- **MHAEvents::emitter\_t valuechanged**  
*Event emitted if the value has changed.*

- **MHAEvents::emitter\_t readaccess**

*Event emitted on read access.*

- **MHAEvents::emitter\_t prereadaccess**

*Event emitted on read access, before the data field is accessed.*

#### Protected Member Functions

- void **activate\_query** (const std::string &, **query\_t**)
- void **notify** ()

#### Protected Attributes

- **query\_map\_t queries**
- bool **data\_is\_initialized**

#### Private Types

- typedef std::vector< **replace\_t** > **repl\_list\_t**

#### Private Member Functions

- void **add\_replace\_pair** (const std::string &, const std::string &)
- std::string **oplist** ()

#### Private Attributes

- std::string **help**
- std::string **id\_str**
- **opact\_map\_t operators**
- **repl\_list\_t repl\_list**
- bool **nested\_lock**
- **parser\_t \* parent**
- std::string **thefullname**

#### 5.237.1 Detailed Description

Base class for all parser items.

The key method of the parser base class is the std::string **parse(const std::string&)** (p. 637) method. Parser proxy derivatives which overwrite any of the other **parse()** (p. 637) methods to be the key method must make sure that the original **parse()** (p. 637) method utilizes the new key method.

## 5.237.2 Member Typedef Documentation

5.237.2.1 `typedef std::vector<replace_t> MHAParser::base_t::repl_list_t` [private]

## 5.237.3 Constructor &amp; Destructor Documentation

5.237.3.1 `MHAParser::base_t::base_t ( const std::string & h )`

Constructor for base class of all parser nodes.

## Parameters

<i>h</i>	Help text describing this parser node. This help text is accessible to the configuration language through the "?help" query command.
----------	--

5.237.3.2 `MHAParser::base_t::base_t ( const base_t & src )`5.237.3.3 `MHAParser::base_t::~~base_t( )` [virtual]

## 5.237.4 Member Function Documentation

5.237.4.1 `std::string MHAParser::base_t::parse ( const std::string & cs )` [virtual]

Causes this node to process a command in the openMHA configuration language.

## Parameters

<i>cs</i>	The command to parse
-----------	----------------------

## Returns

The response to the command, if successful

## Exceptions

<b><i>MHA_Error</i></b> (p. 445)	If the command cannot be executed successfully. The reason for failure is given in the message string of the exception.
----------------------------------	---

Reimplemented in `PluginLoader::mhapluginloader_t` (p. 883), and `altplugs_t` (p. 215).

```
5.237.4.2 void MHParse::base_t::parse (
    const char * cmd,
    char * retv,
    unsigned int len ) [virtual]
```

This function parses a command and writes the parsing result into a C character array.

This base class implementation delegates to **parse(const std::string &)** (p. 637).

#### Parameters

<i>cmd</i>	Command to be parsed
<i>retv</i>	Buffer for the result
<i>len</i>	Length of buffer

Reimplemented in **altplugs\_t** (p. 215).

```
5.237.4.3 void MHParse::base_t::parse (
    const std::vector< std::string > & cs,
    std::vector< std::string > & retv ) [virtual]
```

```
5.237.4.4 std::string MHParse::base_t::op_subparse (
    expression_t & ) [virtual]
```

Reimplemented in **MHParse::c\_ifc\_parser\_t** (p. 649), and **MHParse::parser\_t** (p. 691).

```
5.237.4.5 std::string MHParse::base_t::op_setval (
    expression_t & ) [virtual]
```

Reimplemented in **MHParse::mcomplex\_t** (p. 675), **MHParse::mfloat\_t** (p. 679), **MHParse::vcomplex\_t** (p. 706), **MHParse::vfloat\_t** (p. 710), **MHParse::vint\_t** (p. 714), **MHParse::complex\_t** (p. 655), **MHParse::float\_t** (p. 661), **MHParse::int\_t** (p. 666), **MHParse::bool\_t** (p. 647), **MHParse::vstring\_t** (p. 718), **MHParse::string\_t** (p. 699), **MHParse::kw\_t** (p. 671), **MHParse::variable\_t** (p. 701), **MHParse::c\_ifc\_parser\_t** (p. 649), and **MHParse::parser\_t** (p. 691).

```
5.237.4.6 std::string MHParse::base_t::op_query (
    expression_t & ) [virtual]
```

Reimplemented in **MHParse::monitor\_t** (p. 687), **MHParse::c\_ifc\_parser\_t** (p. 649), and **MHParse::parser\_t** (p. 691).

```
5.237.4.7 std::string MHParse::base_t::query_dump (
    const std::string & s ) [virtual]
```

Reimplemented in **MHParse::monitor\_t** (p. 687), and **MHParse::parser\_t** (p. 691).

5.237.4.8 `std::string MHAParser::base_t::query_entries ( const std::string & s ) [virtual]`

Reimplemented in `MHAParser::parser_t` (p. 691).

5.237.4.9 `std::string MHAParser::base_t::query_perm ( const std::string & s ) [virtual]`

Reimplemented in `MHAParser::variable_t` (p. 701), and `MHAParser::monitor_t` (p. 687).

5.237.4.10 `std::string MHAParser::base_t::query_range ( const std::string & s ) [virtual]`

Reimplemented in `MHAParser::kw_t` (p. 671), and `MHAParser::range_var_t` (p. 694).

5.237.4.11 `std::string MHAParser::base_t::query_type ( const std::string & s ) [virtual]`

Reimplemented in `MHAParser::mcomplex_mon_t` (p. 673), `MHAParser::vcomplex_mon_t` (p. 704), `MHAParser::complex_mon_t` (p. 653), `MHAParser::float_mon_t` (p. 659), `MHAParser::mfloat_mon_t` (p. 677), `MHAParser::vfloat_mon_t` (p. 708), `MHAParser::mint_mon_t` (p. 686), `MHAParser::vint_mon_t` (p. 712), `MHAParser::vstring_mon_t` (p. 716), `MHAParser::string_mon_t` (p. 697), `MHAParser::bool_mon_t` (p. 645), `MHAParser::int_mon_t` (p. 663), `MHAParser::mcomplex_t` (p. 675), `MHAParser::mfloat_t` (p. 679), `MHAParser::vcomplex_t` (p. 706), `MHAParser::vfloat_t` (p. 710), `MHAParser::vint_t` (p. 714), `MHAParser::complex_t` (p. 655), `MHAParser::float_t` (p. 661), `MHAParser::int_t` (p. 666), `MHAParser::bool_t` (p. 647), `MHAParser::vstring_t` (p. 718), `MHAParser::string_t` (p. 699), `MHAParser::kw_t` (p. 671), and `MHAParser::parser_t` (p. 691).

5.237.4.12 `std::string MHAParser::base_t::query_val ( const std::string & s ) [virtual]`

Reimplemented in `MHAParser::mcomplex_mon_t` (p. 673), `MHAParser::vcomplex_mon_t` (p. 704), `MHAParser::complex_mon_t` (p. 653), `MHAParser::float_mon_t` (p. 659), `MHAParser::mfloat_mon_t` (p. 677), `MHAParser::vfloat_mon_t` (p. 708), `MHAParser::mint_mon_t` (p. 686), `MHAParser::vint_mon_t` (p. 712), `MHAParser::vstring_mon_t` (p. 716), `MHAParser::string_mon_t` (p. 697), `MHAParser::bool_mon_t` (p. 645), `MHAParser::int_mon_t` (p. 663), `MHAParser::mcomplex_t` (p. 675), `MHAParser::mfloat_t` (p. 679), `MHAParser::vcomplex_t` (p. 706), `MHAParser::vfloat_t` (p. 710), `MHAParser::vint_t` (p. 714), `MHAParser::complex_t` (p. 655), `MHAParser::float_t` (p. 661), `MHAParser::int_t` (p. 666), `MHAParser::bool_t` (p. 647), `MHAParser::vstring_t` (p. 718), `MHAParser::string_t` (p. 699), `MHAParser::kw_t` (p. 671), and `MHAParser::parser_t` (p. 692).

5.237.4.13 `std::string MHAParser::base_t::query_readfile ( const std::string & s ) [virtual]`

Reimplemented in `MHAParser::parser_t` (p. 691).

5.237.4.14 `std::string MHAParser::base_t::query_savefile (`  
`const std::string & s ) [virtual]`

Reimplemented in **MHAParser::parser\_t** (p. 692).

5.237.4.15 `std::string MHAParser::base_t::query_savefile_compact (`  
`const std::string & s ) [virtual]`

Reimplemented in **MHAParser::parser\_t** (p. 692).

5.237.4.16 `std::string MHAParser::base_t::query_savemons (`  
`const std::string & s ) [virtual]`

Reimplemented in **MHAParser::parser\_t** (p. 692).

5.237.4.17 `std::string MHAParser::base_t::query_listids (`  
`const std::string & s ) [virtual]`

Reimplemented in **MHAParser::parser\_t** (p. 692).

5.237.4.18 `std::string MHAParser::base_t::query_version (`  
`const std::string & )`

5.237.4.19 `std::string MHAParser::base_t::query_id (`  
`const std::string & )`

5.237.4.20 `std::string MHAParser::base_t::query_subst (`  
`const std::string & s )`

5.237.4.21 `std::string MHAParser::base_t::query_addsubst (`  
`const std::string & s )`

5.237.4.22 `std::string MHAParser::base_t::query_help (`  
`const std::string & s )`

5.237.4.23 `std::string MHAParser::base_t::query_cmds (`  
`const std::string & s )`

5.237.4.24 `void MHAParser::base_t::set_node_id (`  
`const std::string & s )`

Set the identification string of this parser node.

The id can be queried from the configuration language using the ?id query command. Nodes can be found by id using the ?listid query command on a containing parser node.



## Parameters

s	The new identification string.
---	--------------------------------

5.237.4.25 void MHAParser::base\_t::set\_help (   
 const std::string & s )

Set the help comment of a variable or parser.

## Parameters

s	New help comment.
---	-------------------

5.237.4.26 void MHAParser::base\_t::add\_parent\_on\_insert (   
 parser\_t \* p,   
 std::string n )

5.237.4.27 void MHAParser::base\_t::rm\_parent\_on\_remove (   
 parser\_t \* )

5.237.4.28 const std::string & MHAParser::base\_t::fullname ( ) const

Return the full dot-separated path name of this parser node in the openMHA configuration tree.

5.237.4.29 void MHAParser::base\_t::activate\_query (   
 const std::string & n,   
 query\_t a ) [protected]

5.237.4.30 void MHAParser::base\_t::notify ( ) [protected]

5.237.4.31 void MHAParser::base\_t::add\_replace\_pair (   
 const std::string & a,   
 const std::string & b ) [private]

5.237.4.32 std::string MHAParser::base\_t::oplist ( ) [private]

## 5.237.5 Member Data Documentation

## 5.237.5.1 MHAEvents::emitter\_t MHAParser::base\_t::writeaccess

Event emitted on write access.

To connect a callback that is invoked on write access to this parser variable, use MHAEvents::patchbay\_t<receiver\_t> method connect(&writeaccess,&receiver\_t::callback) where callback is a method that expects no parameters and returns void.

**5.237.5.2 MHAEvents::emitter\_t MHAParser::base\_t::valuechanged**

Event emitted if the value has changed.

To connect a callback that is invoked when write access to this parser variable actually changes its value, use `MHAEvents::patchbay_t<receiver_t>` method `connect(&valuechanged,&receiver_t::callback)` where `callback` is a method that expects no parameters and returns void.

**5.237.5.3 MHAEvents::emitter\_t MHAParser::base\_t::readaccess**

Event emitted on read access.

To connect a callback that is invoked after the value of this variable has been read through the configuration interface, use `MHAEvents::patchbay_t<receiver_t>` method `connect(&readaccess,&receiver_t::callback)` where `callback` is a method that expects no parameters and returns void.

**5.237.5.4 MHAEvents::emitter\_t MHAParser::base\_t::prereadaccess**

Event emitted on read access, before the data field is accessed.

To connect a callback that is invoked when the value of this variable is about to be read through the configuration interface, so that the callback can influence the value that is reported, use `MHAEvents::patchbay_t<receiver_t>` method `connect(&prereadaccess,&receiver_t::callback)` where `callback` is a method that expects no parameters and returns void.

**5.237.5.5 query\_map\_t MHAParser::base\_t::queries** [protected]**5.237.5.6 bool MHAParser::base\_t::data\_is\_initialized** [protected]**5.237.5.7 std::string MHAParser::base\_t::help** [private]**5.237.5.8 std::string MHAParser::base\_t::id\_str** [private]**5.237.5.9 opact\_map\_t MHAParser::base\_t::operators** [private]**5.237.5.10 repl\_list\_t MHAParser::base\_t::repl\_list** [private]**5.237.5.11 bool MHAParser::base\_t::nested\_lock** [private]**5.237.5.12 parser\_t\* MHAParser::base\_t::parent** [private]**5.237.5.13 std::string MHAParser::base\_t::thefullname** [private]

The documentation for this class was generated from the following files:

- **mha\_parser.hh**
- **mha\_parser.cpp**

## 5.238 MHAParser::base\_t::replace\_t Class Reference

### Public Member Functions

- **replace\_t** (const std::string &, const std::string &)
- void **replace** (std::string &)
- const std::string & **get\_a** () const
- const std::string & **get\_b** () const

### Private Attributes

- std::string **a**
- std::string **b**

#### 5.238.1 Constructor & Destructor Documentation

5.238.1.1 MHAParser::base\_t::replace\_t (   
const std::string & *ia*,   
const std::string & *ib* )

#### 5.238.2 Member Function Documentation

5.238.2.1 void MHAParser::base\_t::replace\_t::replace (   
std::string & *s* )

5.238.2.2 const std::string& MHAParser::base\_t::replace\_t::get\_a ( ) const [inline]

5.238.2.3 const std::string& MHAParser::base\_t::replace\_t::get\_b ( ) const [inline]

#### 5.238.3 Member Data Documentation

5.238.3.1 std::string MHAParser::base\_t::replace\_t::a [private]

5.238.3.2 std::string MHAParser::base\_t::replace\_t::b [private]

The documentation for this class was generated from the following files:

- **mha\_parser.hh**
- **mha\_parser.cpp**

## 5.239 MHAParser::bool\_mon\_t Class Reference

Monitor with string value.

Inheritance diagram for MHAParser::bool\_mon\_t:

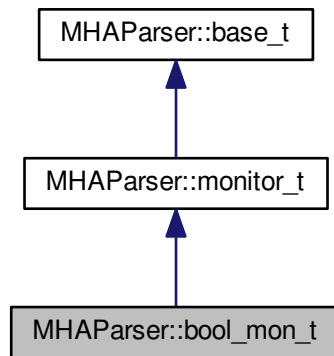

### Public Member Functions

- **bool\_mon\_t** (const std::string &hlp)  
*Create a monitor variable for string values.*

### Public Attributes

- **bool data**  
*Data field.*

### Protected Member Functions

- std::string **query\_val** (const std::string &)
- std::string **query\_type** (const std::string &)

### Additional Inherited Members

#### 5.239.1 Detailed Description

Monitor with string value.

#### 5.239.2 Constructor & Destructor Documentation

##### 5.239.2.1 MHAParser::bool\_mon\_t::bool\_mon\_t (const std::string & hlp )

Create a monitor variable for string values.

## Parameters

<i>help</i>	A help text describing this monitor variable.
-------------	---

## 5.239.3 Member Function Documentation

5.239.3.1 `std::string MHAParser::bool_mon_t::query_val (const std::string & s )` [protected], [virtual]

Reimplemented from **MHAParser::base\_t** (p. 639).

5.239.3.2 `std::string MHAParser::bool_mon_t::query_type (const std::string & s )` [protected], [virtual]

Reimplemented from **MHAParser::base\_t** (p. 639).

## 5.239.4 Member Data Documentation

5.239.4.1 `bool MHAParser::bool_mon_t::data`

Data field.

The documentation for this class was generated from the following files:

- **mha\_parser.hh**
- **mha\_parser.cpp**

## 5.240 MHAParser::bool\_t Class Reference

Variable with a boolean value ("yes"/"no")

Inheritance diagram for MHAParser::bool\_t:

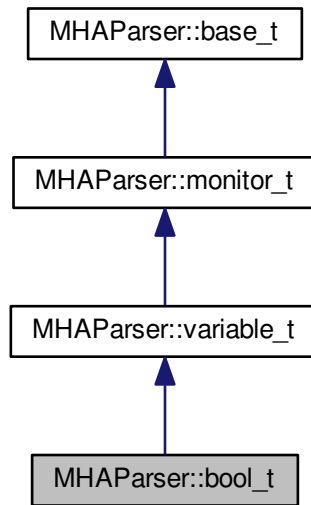

#### Public Member Functions

- **bool\_t** (const std::string &help\_text, const std::string &initial\_value)  
*Constructor for a configuration language variable for boolean values.*

#### Public Attributes

- bool **data**  
*Data field.*

#### Protected Member Functions

- std::string **op\_setval** (expression\_t &)
- std::string **query\_type** (const std::string &)
- std::string **query\_val** (const std::string &)

#### Additional Inherited Members

##### 5.240.1 Detailed Description

Variable with a boolean value ("yes"/"no")

## 5.240.2 Constructor &amp; Destructor Documentation

### 5.240.2.1 MHAParser::bool\_t::bool\_t (

```

    const std::string & help_text,
    const std::string & initial_value )

```

Constructor for a configuration language variable for boolean values.

#### Parameters

<i>help_text</i>	A human-readable text describing the purpose of this configuration variable.
<i>initial_value</i>	The initial value for this variable as a string. The string representation of 'true' is either "yes" or "1". The string representation of 'false' is either "no" or "0".

## 5.240.3 Member Function Documentation

### 5.240.3.1 std::string MHAParser::bool\_t::op\_setval (

```

    expression_t & x ) [protected], [virtual]

```

Reimplemented from **MHAParser::variable\_t** (p. [701](#)).

### 5.240.3.2 std::string MHAParser::bool\_t::query\_type (

```

    const std::string & s ) [protected], [virtual]

```

Reimplemented from **MHAParser::base\_t** (p. [639](#)).

### 5.240.3.3 std::string MHAParser::bool\_t::query\_val (

```

    const std::string & s ) [protected], [virtual]

```

Reimplemented from **MHAParser::base\_t** (p. [639](#)).

## 5.240.4 Member Data Documentation

### 5.240.4.1 bool MHAParser::bool\_t::data

Data field.

The documentation for this class was generated from the following files:

- **mha\_parser.hh**
- **mha\_parser.cpp**

## 5.241 MHAParser::c\_ifc\_parser\_t Class Reference

Inheritance diagram for MHAParser::c\_ifc\_parser\_t:

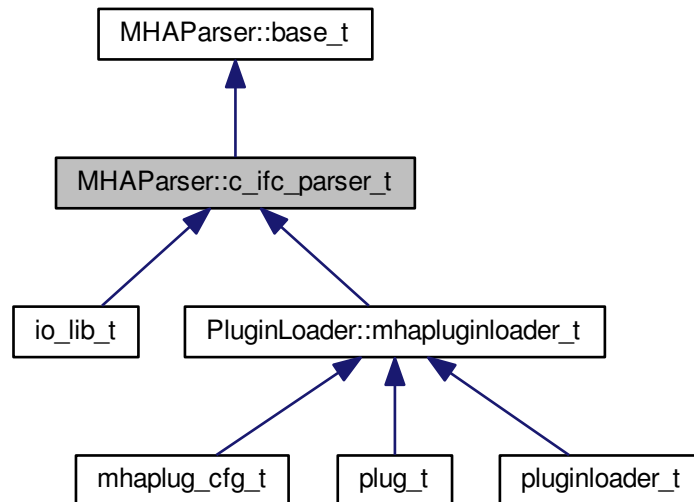

### Public Member Functions

- **c\_ifc\_parser\_t** (const std::string &modulename\_)
- **~c\_ifc\_parser\_t** ()
- void **set\_parse\_cb** (c\_parse\_cmd\_t, c\_parse\_err\_t, void \*)

### Protected Member Functions

- std::string **op\_subparse** (MHAParser::expression\_t &)
- std::string **op\_setval** (MHAParser::expression\_t &)
- std::string **op\_query** (MHAParser::expression\_t &)

### Private Member Functions

- void **test\_error** ()





5.241.2.5 void MHParse::c\_ifc\_parser\_t::test\_error ( ) [private]

### 5.241.3 Member Data Documentation

5.241.3.1 std::string MHParse::c\_ifc\_parser\_t::modulename [private]

5.241.3.2 c\_parse\_cmd\_t MHParse::c\_ifc\_parser\_t::c\_parse\_cmd [private]

5.241.3.3 c\_parse\_err\_t MHParse::c\_ifc\_parser\_t::c\_parse\_err [private]

5.241.3.4 int MHParse::c\_ifc\_parser\_t::liberr [private]

5.241.3.5 void\* MHParse::c\_ifc\_parser\_t::libdata [private]

5.241.3.6 unsigned int MHParse::c\_ifc\_parser\_t::ret\_size [private]

5.241.3.7 char\* MHParse::c\_ifc\_parser\_t::retv [private]

The documentation for this class was generated from the following files:

- mha\_parser.hh
- mha\_parser.cpp

## 5.242 MHParse::commit\_t< receiver\_t > Class Template Reference

Parser variable with event-emission functionality.

Inheritance diagram for MHAParser::commit\_t< receiver\_t >:

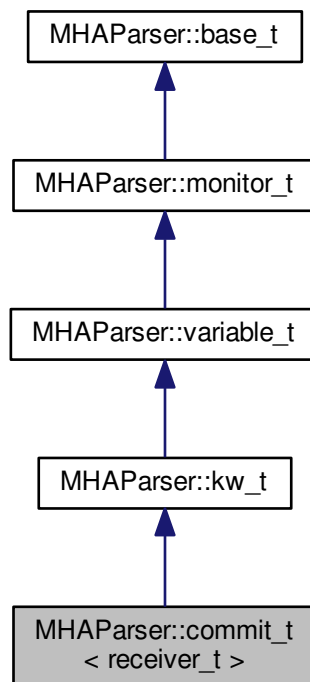

**Public Member Functions**

- **commit\_t** (receiver\_t \*, void(receiver\_t::\*)(), const std::string &help="Variable changes action")

**Private Attributes**

- **MHAEvents::connector\_t**< receiver\_t > **extern\_connector**

**Additional Inherited Members**

5.242.1 Detailed Description

```

template<class receiver_t>
class MHAParser::commit_t< receiver_t >
  
```

Parser variable with event-emission functionality.

The **commit\_t** (p. 650) variable can register an event receiver in its constructor, which is called whenever the variable is set to "commit".

### 5.242.2 Constructor & Destructor Documentation

5.242.2.1 `template<class receiver_t> MHAParser::commit_t< receiver_t >::commit_t ( receiver_t * r, void(receiver_t::*)() rfun, const std::string & help = "Variable changes action" )`

### 5.242.3 Member Data Documentation

5.242.3.1 `template<class receiver_t > MHAEvents::connector_t<receiver_t> MHAParser::commit_t< receiver_t >::extern_connector [private]`

The documentation for this class was generated from the following file:

- `mha_parser.hh`

### 5.243 MHAParser::complex\_mon\_t Class Reference

Monitor with complex value.

Inheritance diagram for MHAParser::complex\_mon\_t:

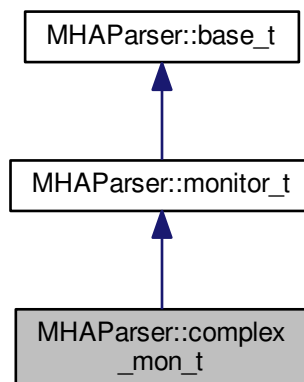

#### Public Member Functions

- **`complex_mon_t`** (const std::string &hlp)  
*Create a complex monitor variable.*

## Public Attributes

- **mha\_complex\_t data**

*Data field.*

## Protected Member Functions

- `std::string query_val` (const `std::string &`)
- `std::string query_type` (const `std::string &`)

## Additional Inherited Members

### 5.243.1 Detailed Description

Monitor with complex value.

### 5.243.2 Constructor & Destructor Documentation

#### 5.243.2.1 MHAParser::complex\_mon\_t::complex\_mon\_t (const `std::string & help` )

Create a complex monitor variable.

#### Parameters

<i>help</i>	A help text describing this monitor variable.
-------------	---

### 5.243.3 Member Function Documentation

#### 5.243.3.1 `std::string MHAParser::complex_mon_t::query_val (const std::string & s )` `[protected]`, `[virtual]`

Reimplemented from **MHAParser::base\_t** (p. 639).

#### 5.243.3.2 `std::string MHAParser::complex_mon_t::query_type (const std::string & s )` `[protected]`, `[virtual]`

Reimplemented from **MHAParser::base\_t** (p. 639).

## 5.243.4 Member Data Documentation

### 5.243.4.1 `mha_complex_t` `MHAParser::complex_mon_t::data`

Data field.

The documentation for this class was generated from the following files:

- `mha_parser.hh`
- `mha_parser.cpp`

## 5.244 `MHAParser::complex_t` Class Reference

Variable with complex value.

Inheritance diagram for `MHAParser::complex_t`:

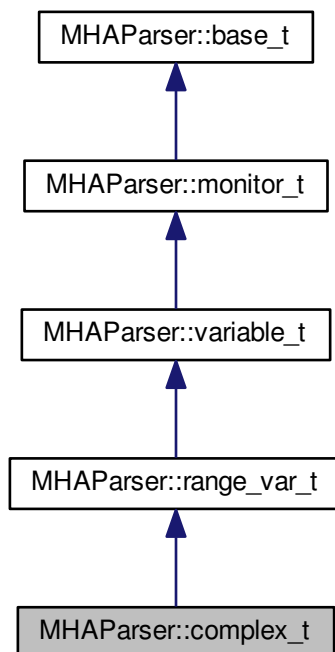

### Public Member Functions

- **`complex_t`** (`const std::string &`, `const std::string &`, `const std::string &=""`)

## Public Attributes

- **mha\_complex\_t data**

*Data field.*

## Protected Member Functions

- `std::string op_setval (expression_t &)`
- `std::string query_type (const std::string &)`
- `std::string query_val (const std::string &)`

## Additional Inherited Members

### 5.244.1 Detailed Description

Variable with complex value.

### 5.244.2 Constructor & Destructor Documentation

5.244.2.1 `MHAParser::complex_t::complex_t (`  
    `const std::string & h,`  
    `const std::string & v,`  
    `const std::string & rg = " " )`

### 5.244.3 Member Function Documentation

5.244.3.1 `std::string MHAParser::complex_t::op_setval (`  
    `expression_t & x )` `[protected]`, `[virtual]`

Reimplemented from `MHAParser::variable_t` (p. 701).

5.244.3.2 `std::string MHAParser::complex_t::query_type (`  
    `const std::string & s )` `[protected]`, `[virtual]`

Reimplemented from `MHAParser::base_t` (p. 639).

5.244.3.3 `std::string MHAParser::complex_t::query_val (`  
    `const std::string & s )` `[protected]`, `[virtual]`

Reimplemented from `MHAParser::base_t` (p. 639).

#### 5.244.4 Member Data Documentation

##### 5.244.4.1 `mha_complex_t` `MHAParser::complex_t::data`

Data field.

The documentation for this class was generated from the following files:

- `mha_parser.hh`
- `mha_parser.cpp`

#### 5.245 `MHAParser::entry_t` Class Reference

##### Public Member Functions

- `entry_t` (`const std::string &`, `base_t *`)

##### Public Attributes

- `std::string name`
- `base_t * entry`

#### 5.245.1 Constructor & Destructor Documentation

##### 5.245.1.1 `MHAParser::entry_t::entry_t` (     `const std::string & n`,     `base_t * e`)

#### 5.245.2 Member Data Documentation

##### 5.245.2.1 `std::string` `MHAParser::entry_t::name`

##### 5.245.2.2 `base_t*` `MHAParser::entry_t::entry`

The documentation for this class was generated from the following files:

- `mha_parser.hh`
- `mha_parser.cpp`



## 5.246 MHAParser::expression\_t Class Reference

## Public Member Functions

- **expression\_t** (const std::string &, const std::string &)  
*Constructor.*
- **expression\_t** ()

## Public Attributes

- std::string **lval**
- std::string **rval**
- std::string **op**

## 5.246.1 Constructor &amp; Destructor Documentation

5.246.1.1 expression\_t::expression\_t (  
const std::string & s,  
const std::string & o )

Constructor.

## Parameters

<i>s</i>	String to be splitted
<i>o</i>	List of valid operators (single character only)

## 5.246.1.2 expression\_t::expression\_t ( )

## 5.246.2 Member Data Documentation

## 5.246.2.1 std::string MHAParser::expression\_t::lval

## 5.246.2.2 std::string MHAParser::expression\_t::rval

## 5.246.2.3 std::string MHAParser::expression\_t::op

The documentation for this class was generated from the following files:

- **mha\_parser.hh**
- **mha\_parser.cpp**

## 5.247 MHAParser::float\_mon\_t Class Reference

Monitor with float value.

Inheritance diagram for MHAParser::float\_mon\_t:

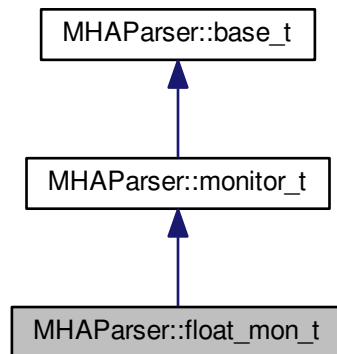

### Public Member Functions

- **float\_mon\_t** (const std::string &hlp)  
*Initialize a floating point (32 bits) monitor variable.*

### Public Attributes

- float **data**  
*Data field.*

### Protected Member Functions

- std::string **query\_val** (const std::string &)
- std::string **query\_type** (const std::string &)

### Additional Inherited Members

#### 5.247.1 Detailed Description

Monitor with float value.

#### 5.247.2 Constructor & Destructor Documentation

##### 5.247.2.1 MHAParser::float\_mon\_t::float\_mon\_t (const std::string & hlp )

Initialize a floating point (32 bits) monitor variable.

## Parameters

<i>help</i>	A help text describing this monitor variable.
-------------	---

## 5.247.3 Member Function Documentation

5.247.3.1 `std::string MHAParser::float_mon_t::query_val (const std::string & s )` [protected], [virtual]

Reimplemented from **MHAParser::base\_t** (p. 639).

5.247.3.2 `std::string MHAParser::float_mon_t::query_type (const std::string & s )` [protected], [virtual]

Reimplemented from **MHAParser::base\_t** (p. 639).

## 5.247.4 Member Data Documentation

5.247.4.1 `float MHAParser::float_mon_t::data`

Data field.

The documentation for this class was generated from the following files:

- **mha\_parser.hh**
- **mha\_parser.cpp**

## 5.248 MHAParser::float\_t Class Reference

Variable with float value.

Inheritance diagram for MHAParser::float\_t:

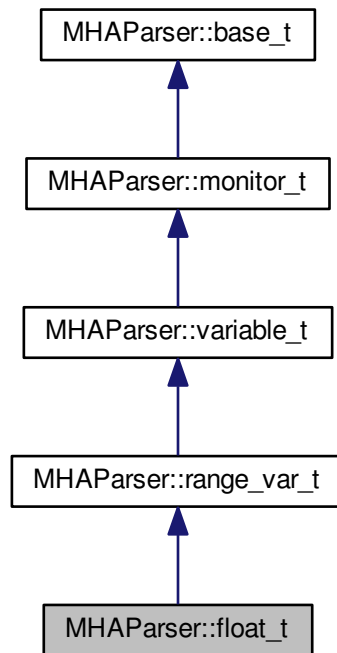

### Public Member Functions

- **float\_t** (const std::string &help\_text, const std::string &initial\_value, const std::string &range="")

*Constructor for a configuration language variable for 32bit ieee floating-point values.*

### Public Attributes

- float **data**  
*Data field.*

### Protected Member Functions

- std::string **op\_setval** (expression\_t &)
- std::string **query\_type** (const std::string &)
- std::string **query\_val** (const std::string &)

## Additional Inherited Members

## 5.248.1 Detailed Description

Variable with float value.

## 5.248.2 Constructor &amp; Destructor Documentation

5.248.2.1 MHAParser::float\_t::float\_t (  
     const std::string & *help\_text*,  
     const std::string & *initial\_value*,  
     const std::string & *range* = " " )

Constructor for a configuration language variable for 32bit ieee floating-point values.

## Parameters

<i>help_text</i>	A human-readable text describing the purpose of this configuration variable.
<i>initial_value</i>	The initial value for this variable as a string (decimal representation of the floating-point variable). If a range is given in the third parameter, then the initial value has to be within the range. A human-readable text describing the purpose of this configuration variable.
<i>range</i>	The range of values that this variable can hold can be restricted. A range is a string of the form "[a,b]", where a and b are decimal representations of the inclusive boundaries of the range. $a \leq b$ . In a range of the form "]a,b[", both boundaries are excluded. Mixed forms are permitted. a or b can also be omitted if there is no lower or upper limit. The range of values is always restricted by the representable range of the underlying C data type.

## 5.248.3 Member Function Documentation

5.248.3.1 std::string MHAParser::float\_t::op\_setval (  
     expression\_t & x ) [protected], [virtual]

Reimplemented from **MHAParser::variable\_t** (p. 701).

5.248.3.2 std::string MHAParser::float\_t::query\_type (  
     const std::string & s ) [protected], [virtual]

Reimplemented from **MHAParser::base\_t** (p. 639).

5.248.3.3 std::string MHAParser::float\_t::query\_val (  
     const std::string & s ) [protected], [virtual]

Reimplemented from **MHAParser::base\_t** (p. 639).

## 5.248.4 Member Data Documentation

### 5.248.4.1 float MHAParser::float\_t::data

Data field.

The documentation for this class was generated from the following files:

- **mha\_parser.hh**
- **mha\_parser.cpp**

## 5.249 MHAParser::int\_mon\_t Class Reference

Monitor variable with int value.

Inheritance diagram for MHAParser::int\_mon\_t:

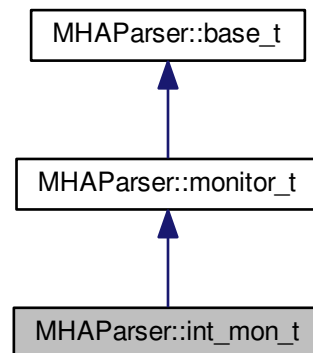

### Public Member Functions

- **int\_mon\_t** (const std::string &hlp)  
*Create a monitor variable for integral values.*

### Public Attributes

- int **data**  
*Data field.*

### Protected Member Functions

- `std::string query_val` (const `std::string &`)
- `std::string query_type` (const `std::string &`)

### Additional Inherited Members

#### 5.249.1 Detailed Description

Monitor variable with int value.

Monitor variables can be of many types. These variables can be queried through the parser. The public data element contains the monitored state. Write access is only possible from the C++ code by direct access to the data field.

#### 5.249.2 Constructor & Destructor Documentation

##### 5.249.2.1 MHAParser::int\_mon\_t::int\_mon\_t ( const `std::string & help` )

Create a monitor variable for integral values.

#### Parameters

<i>help</i>	A help text describing this monitor variable.
-------------	---

#### 5.249.3 Member Function Documentation

##### 5.249.3.1 `std::string MHAParser::int_mon_t::query_val` ( const `std::string & s` ) [`protected`], [`virtual`]

Reimplemented from **MHAParser::base\_t** (p. 639).

##### 5.249.3.2 `std::string MHAParser::int_mon_t::query_type` ( const `std::string & s` ) [`protected`], [`virtual`]

Reimplemented from **MHAParser::base\_t** (p. 639).

## 5.249.4 Member Data Documentation

### 5.249.4.1 int MHParse::int\_mon\_t::data

Data field.

The documentation for this class was generated from the following files:

- `mha_parser.hh`
- `mha_parser.cpp`

## 5.250 MHParse::int\_t Class Reference

Variable with integer value.

Inheritance diagram for MHParse::int\_t:

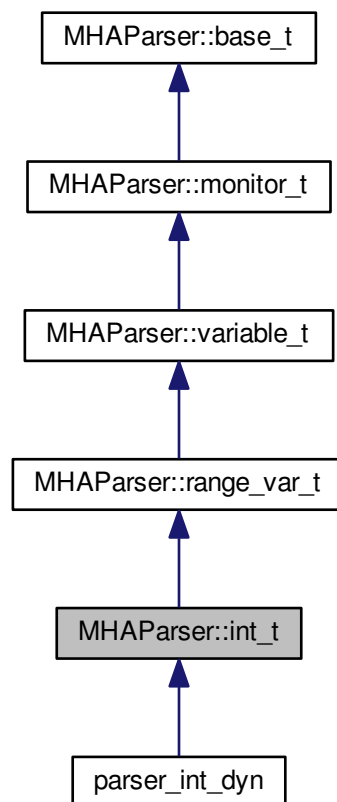



## Public Member Functions

- **int\_t** (const std::string &help\_text, const std::string &initial\_value, const std::string &range="")

*Constructor for a configuration language variable for integral values.*

## Public Attributes

- int **data**

*Data field.*

## Protected Member Functions

- std::string **op\_setval** (expression\_t &)
- std::string **query\_type** (const std::string &)
- std::string **query\_val** (const std::string &)

## Additional Inherited Members

## 5.250.1 Detailed Description

Variable with integer value.

## 5.250.2 Constructor &amp; Destructor Documentation

5.250.2.1 MHAParser::int\_t::int\_t (  
     const std::string & *help\_text*,  
     const std::string & *initial\_value*,  
     const std::string & *range* = " " )

Constructor for a configuration language variable for integral values.

## Parameters

<i>help_text</i>	A human-readable text describing the purpose of this configuration variable.
<i>initial_value</i>	The initial value for this variable as a string (decimal representation of the integer variable). If a range is given in the third parameter, then the initial value has to be within the range.
<i>range</i>	The range of values that this variable can hold can be restricted. A range is a string of the form "[a,b]", where a and b are decimal representations of the integral inclusive boundaries of the range. $a \leq b$ . In a range of the form "]a,b[" , both boundaries are excluded. Mixed forms are permitted. a or b can also be omitted if there is no lower or upper limit. The range of values is always restricted by the representable range of the underlying C data type (usually 32 bits, [-2147483648,2147483647]).

### 5.250.3 Member Function Documentation

5.250.3.1 `std::string MHAParser::int_t::op_setval ( expression_t & x )` [protected], [virtual]

Reimplemented from **MHAParser::variable\_t** (p. 701).

5.250.3.2 `std::string MHAParser::int_t::query_type ( const std::string & s )` [protected], [virtual]

Reimplemented from **MHAParser::base\_t** (p. 639).

5.250.3.3 `std::string MHAParser::int_t::query_val ( const std::string & s )` [protected], [virtual]

Reimplemented from **MHAParser::base\_t** (p. 639).

### 5.250.4 Member Data Documentation

5.250.4.1 `int MHAParser::int_t::data`

Data field.

The documentation for this class was generated from the following files:

- **mha\_parser.hh**
- **mha\_parser.cpp**

### 5.251 MHAParser::keyword\_list\_t Class Reference

Keyword list class.

#### Public Types

- `typedef std::vector< std::string >::size_type` **size\_t**

## Public Member Functions

- void **set\_value** (const std::string &)  
*Select a value from keyword list.*
- void **set\_entries** (const std::string &)  
*Set keyword list entries.*
- const std::string & **get\_value** () const  
*Return selected value.*
- const std::vector< std::string > & **get\_entries** () const  
*Return keyword list.*
- const **size\_t** & **get\_index** () const  
*Return index of selected value.*
- void **set\_index** (unsigned int)
- void **validate** () const  
*Check if index of selected value is valid.*
- void **add\_entry** (const std::string &en)
- **keyword\_list\_t** ()  
*Constructor.*

## Private Attributes

- **size\_t** **index**  
*Index into list.*
- std::vector< std::string > **entries**  
*List of valid entries.*
- std::string **empty\_string**

### 5.251.1 Detailed Description

Keyword list class.

The structure **keyword\_list\_t** (p. 666) defines a keyword list (vector of strings) with an index into the list. Used as **MHAParser::kw\_t** (p. 669), it can be used to access a set of valid keywords through the parser (i.e. one of "pear apple banana").

### 5.251.2 Member Typedef Documentation

5.251.2.1 typedef std::vector<std::string>::size\_type MHAParser::keyword\_list\_t::size\_t

### 5.251.3 Constructor & Destructor Documentation

5.251.3.1 MHAParser::keyword\_list\_t::keyword\_list\_t ( )

Constructor.

#### 5.251.4 Member Function Documentation

##### 5.251.4.1 void MHAParser::keyword\_list\_t::set\_value ( const std::string & s )

Select a value from keyword list.

This function selects a value from the keyword list. The index is set to the last matching entry.

###### Parameters

s	Value to be selected.
---	-----------------------

##### 5.251.4.2 void MHAParser::keyword\_list\_t::set\_entries ( const std::string & s )

Set keyword list entries.

With this function, the keyword list can be set from a space separated string list.

###### Parameters

s	Space separated entry list.
---	-----------------------------

##### 5.251.4.3 const std::string & MHAParser::keyword\_list\_t::get\_value ( ) const

Return selected value.

##### 5.251.4.4 const std::vector< std::string > & MHAParser::keyword\_list\_t::get\_entries ( ) const

Return keyword list.

##### 5.251.4.5 const MHAParser::keyword\_list\_t::size\_t & MHAParser::keyword\_list\_t::get\_index ( ) const

Return index of selected value.

##### 5.251.4.6 void MHAParser::keyword\_list\_t::set\_index ( unsigned int *idx* )

##### 5.251.4.7 void MHAParser::keyword\_list\_t::validate ( ) const

Check if index of selected value is valid.

5.251.4.8 void MHAParser::keyword\_list\_t::add\_entry ( const std::string & en ) [inline]

### 5.251.5 Member Data Documentation

5.251.5.1 size\_t MHAParser::keyword\_list\_t::index [private]

Index into list.

5.251.5.2 std::vector<std::string> MHAParser::keyword\_list\_t::entries [private]

List of valid entries.

5.251.5.3 std::string MHAParser::keyword\_list\_t::empty\_string [private]

The documentation for this class was generated from the following files:

- mha\_parser.hh
- mha\_parser.cpp

## 5.252 MHAParser::kw\_t Class Reference

Variable with keyword list value.

Inheritance diagram for MHAParser::kw\_t:

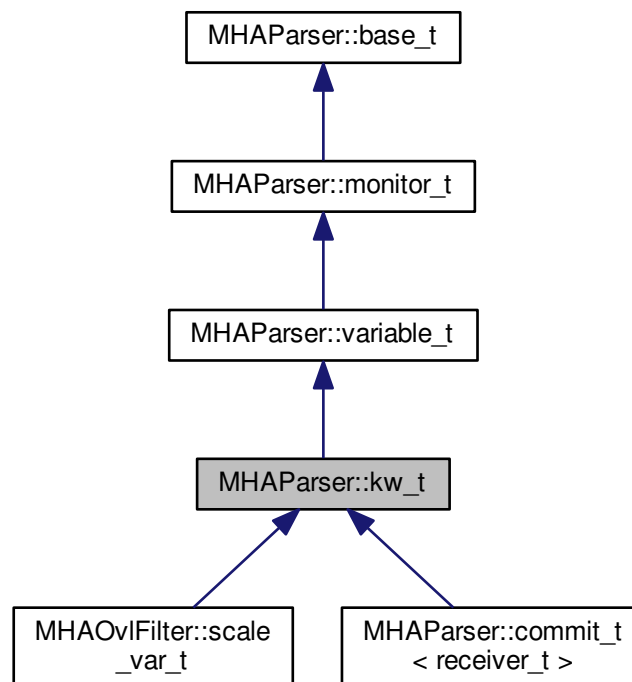

## Public Member Functions

- **kw\_t** (const std::string &, const std::string &, const std::string &)  
*Constructor of a keyword list openMHA configuration variable.*
- **kw\_t** (const **kw\_t** &)  
*Copy constructor.*
- void **set\_range** (const std::string &)  
*Set/change the list of valid entries.*
- bool **isval** (const std::string &) const  
*Test if the given value is selected.*

## Public Attributes

- **keyword\_list\_t data**  
*Variable data in its native type.*

## Protected Member Functions

- void **validate** (const **keyword\_list\_t** &)
- std::string **op\_setval** (**expression\_t** &)
- std::string **query\_range** (const std::string &)
- std::string **query\_val** (const std::string &)
- std::string **query\_type** (const std::string &)

## Additional Inherited Members

### 5.252.1 Detailed Description

Variable with keyword list value.

### 5.252.2 Constructor & Destructor Documentation

5.252.2.1 **MHAParser::kw\_t::kw\_t** (  
     const std::string & *h*,  
     const std::string & *v*,  
     const std::string & *rg* )

Constructor of a keyword list openMHA configuration variable.

#### Parameters

<i>h</i>	A help string describing the purpose of this variable.
<i>v</i>	The initial value, has to be a value from the list of possible values given in the last parameter.
<i>rg</i>	A string containing the list of valid entries. The entries have to be separated by spaces. The list of entries has to be delimited by brackets "[", "]".

5.252.2.2 MHAParser::kw\_t::kw\_t (  
                   const kw\_t & src )

Copy constructor.

### 5.252.3 Member Function Documentation

5.252.3.1 void MHAParser::kw\_t::set\_range (  
                   const std::string & r )

Set/change the list of valid entries.

#### Parameters

<i>r</i>	A string containing the list of valid entries. The entries have to be separated by spaces. The list of entries has to be delimited by brackets "[", "]".
----------	--

5.252.3.2 bool MHAParser::kw\_t::isval (  
                   const std::string & testval ) const

Test if the given value is selected.

5.252.3.3 void MHAParser::kw\_t::validate (  
                   const keyword\_list\_t & s ) [protected]

5.252.3.4 std::string MHAParser::kw\_t::op\_setval (  
                   expression\_t & x ) [protected], [virtual]

Reimplemented from **MHAParser::variable\_t** (p. 701).

5.252.3.5 std::string MHAParser::kw\_t::query\_range (  
                   const std::string & s ) [protected], [virtual]

Reimplemented from **MHAParser::base\_t** (p. 639).

5.252.3.6 std::string MHAParser::kw\_t::query\_val (  
                   const std::string & s ) [protected], [virtual]

Reimplemented from **MHAParser::base\_t** (p. 639).

5.252.3.7 std::string MHAParser::kw\_t::query\_type (  
                   const std::string & s ) [protected], [virtual]

Reimplemented from **MHAParser::base\_t** (p. 639).

### 5.252.4 Member Data Documentation

#### 5.252.4.1 keyword\_list\_t MHAParser::kw\_t::data

Variable data in its native type.

The documentation for this class was generated from the following files:

- **mha\_parser.hh**
- **mha\_parser.cpp**

### 5.253 MHAParser::mcomplex\_mon\_t Class Reference

Matrix of complex numbers monitor.

Inheritance diagram for MHAParser::mcomplex\_mon\_t:

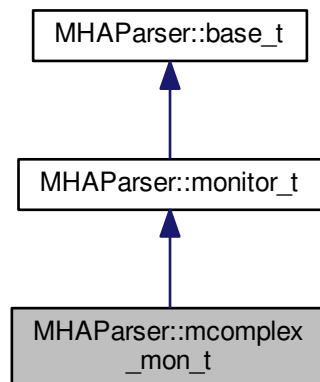

#### Public Member Functions

- **mcomplex\_mon\_t** (const std::string &hlp)  
*Create a matrix of complex floating point monitor values.*

#### Public Attributes

- std::vector< std::vector< **mha\_complex\_t** > > **data**  
*Data field.*



## Protected Member Functions

- `std::string query_val` (const `std::string` &)
- `std::string query_type` (const `std::string` &)

## Additional Inherited Members

### 5.253.1 Detailed Description

Matrix of complex numbers monitor.

### 5.253.2 Constructor & Destructor Documentation

#### 5.253.2.1 MHAParser::mcomplex\_mon\_t::mcomplex\_mon\_t (const `std::string` & *hlp* )

Create a matrix of complex floating point monitor values.

#### Parameters

<i>hlp</i>	A help text describing this monitor variable.
------------	---

### 5.253.3 Member Function Documentation

#### 5.253.3.1 `std::string MHAParser::mcomplex_mon_t::query_val` (const `std::string` & *s* ) [`protected`], [`virtual`]

Reimplemented from **MHAParser::base\_t** (p. 639).

#### 5.253.3.2 `std::string MHAParser::mcomplex_mon_t::query_type` (const `std::string` & *s* ) [`protected`], [`virtual`]

Reimplemented from **MHAParser::base\_t** (p. 639).

### 5.253.4 Member Data Documentation

#### 5.253.4.1 `std::vector< std::vector<mha_complex_t> > MHAParser::mcomplex_mon_t::data`

Data field.

The documentation for this class was generated from the following files:

- `mha_parser.hh`
- `mha_parser.cpp`

## 5.254 MHAParser::mcomplex\_t Class Reference

Matrix variable with complex value.

Inheritance diagram for MHAParser::mcomplex\_t:

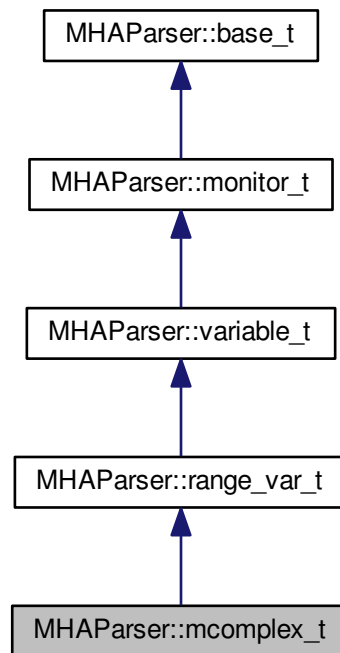

### Public Member Functions

- **mcomplex\_t** (const std::string &, const std::string &, const std::string &= "")

### Public Attributes

- std::vector< std::vector< **mha\_complex\_t** > > **data**  
*Data field.*

### Protected Member Functions

- std::string **op\_setval** (**expression\_t** &)
- std::string **query\_type** (const std::string &)
- std::string **query\_val** (const std::string &)

## Additional Inherited Members

### 5.254.1 Detailed Description

Matrix variable with complex value.

### 5.254.2 Constructor & Destructor Documentation

5.254.2.1 MHAParser::mcomplex\_t::mcomplex\_t (  
    const std::string & *h*,  
    const std::string & *v*,  
    const std::string & *rg* = " " )

### 5.254.3 Member Function Documentation

5.254.3.1 std::string MHAParser::mcomplex\_t::op\_setval (  
    expression\_t & *x* ) [protected], [virtual]

Reimplemented from **MHAParser::variable\_t** (p. 701).

5.254.3.2 std::string MHAParser::mcomplex\_t::query\_type (  
    const std::string & *s* ) [protected], [virtual]

Reimplemented from **MHAParser::base\_t** (p. 639).

5.254.3.3 std::string MHAParser::mcomplex\_t::query\_val (  
    const std::string & *s* ) [protected], [virtual]

Reimplemented from **MHAParser::base\_t** (p. 639).

### 5.254.4 Member Data Documentation

5.254.4.1 std::vector<std::vector<mha\_complex\_t> > MHAParser::mcomplex\_t::data

Data field.

The documentation for this class was generated from the following files:

- **mha\_parser.hh**
- **mha\_parser.cpp**

## 5.255 MHAParser::mfloat\_mon\_t Class Reference

Matrix of floats monitor.

Inheritance diagram for MHAParser::mfloat\_mon\_t:

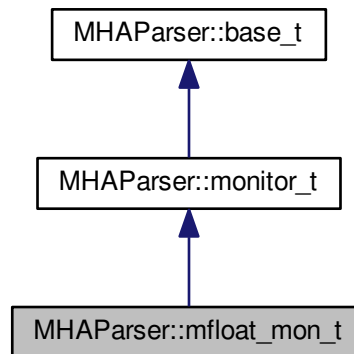

### Public Member Functions

- **mfloat\_mon\_t** (const std::string &hlp)  
*Create a matrix of floating point monitor values.*

### Public Attributes

- std::vector< std::vector< float > > **data**  
*Data field.*

### Protected Member Functions

- std::string **query\_val** (const std::string &)
- std::string **query\_type** (const std::string &)

### Additional Inherited Members

#### 5.255.1 Detailed Description

Matrix of floats monitor.

#### 5.255.2 Constructor & Destructor Documentation

##### 5.255.2.1 MHAParser::mfloat\_mon\_t::mfloat\_mon\_t (const std::string & hlp )

Create a matrix of floating point monitor values.

## Parameters

<i>help</i>	A help text describing this monitor variable.
-------------	---

## 5.255.3 Member Function Documentation

5.255.3.1 `std::string MHAParser::mfloat_mon_t::query_val (const std::string & s )` [protected], [virtual]

Reimplemented from **MHAParser::base\_t** (p. 639).

5.255.3.2 `std::string MHAParser::mfloat_mon_t::query_type (const std::string & s )` [protected], [virtual]

Reimplemented from **MHAParser::base\_t** (p. 639).

## 5.255.4 Member Data Documentation

5.255.4.1 `std::vector< std::vector<float> > MHAParser::mfloat_mon_t::data`

Data field.

The documentation for this class was generated from the following files:

- **mha\_parser.hh**
- **mha\_parser.cpp**

## 5.256 MHAParser::mfloat\_t Class Reference

Matrix variable with float value.

Inheritance diagram for MHAParser::mfloat\_t:

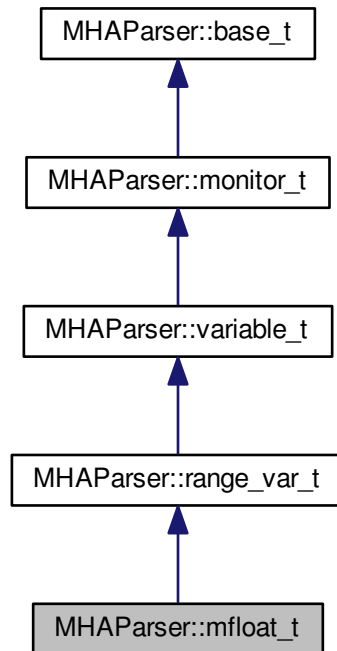

### Public Member Functions

- **mfloat\_t** (const std::string &, const std::string &, const std::string &= "")  
*Create a float matrix parser variable.*

### Public Attributes

- std::vector< std::vector< float > > **data**  
*Data field.*

### Protected Member Functions

- std::string **op\_setval** (**expression\_t** &)
- std::string **query\_type** (const std::string &)
- std::string **query\_val** (const std::string &)

## Additional Inherited Members

## 5.256.1 Detailed Description

Matrix variable with float value.

## 5.256.2 Constructor &amp; Destructor Documentation

5.256.2.1 MHAParser::mfloat\_t::mfloat\_t (  
     const std::string & *h*,  
     const std::string & *v*,  
     const std::string & *rg* = " " )

Create a float matrix parser variable.

## Parameters

<i>h</i>	A human-readable text describing the purpose of this configuration variable.
<i>v</i>	The initial value of the variable, as a string, in openMHA configuration language: (e.g. "[[0 1]; [2 3]]" for a matrix), described in the "Multidimensional Variables" s2.1.3 section of the openMHA User Manual.
<i>rg</i>	The numeric range to enforce on all members of the matrix.

## 5.256.3 Member Function Documentation

5.256.3.1 std::string MHAParser::mfloat\_t::op\_setval (  
     expression\_t & *x* ) [protected], [virtual]

Reimplemented from **MHAParser::variable\_t** (p. 701).

5.256.3.2 std::string MHAParser::mfloat\_t::query\_type (  
     const std::string & *s* ) [protected], [virtual]

Reimplemented from **MHAParser::base\_t** (p. 639).

5.256.3.3 std::string MHAParser::mfloat\_t::query\_val (  
     const std::string & *s* ) [protected], [virtual]

Reimplemented from **MHAParser::base\_t** (p. 639).

## 5.256.4 Member Data Documentation

### 5.256.4.1 `std::vector<std::vector<float>>` `MHAParser::mfloat_t::data`

Data field.

The documentation for this class was generated from the following files:

- `mha_parser.hh`
- `mha_parser.cpp`

## 5.257 `MHAParser::mhaconfig_mon_t` Class Reference

Inheritance diagram for `MHAParser::mhaconfig_mon_t`:

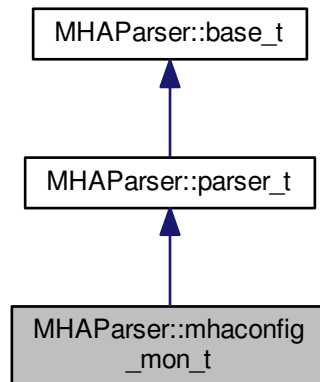

### Public Member Functions

- `mhaconfig_mon_t` (`const std::string &help=""`)
- `void update` (`const mhaconfig_t &cf`)



## Private Attributes

- **MHAParser::int\_mon\_t channels**  
*Number of audio channels.*
- **MHAParser::string\_mon\_t domain**  
*Signal domain (MHA\_WAVEFORM or MHA\_SPECTRUM)*
- **MHAParser::int\_mon\_t fragsize**  
*Fragment size of waveform data.*
- **MHAParser::int\_mon\_t wndlen**  
*Window length of spectral data.*
- **MHAParser::int\_mon\_t fftlen**  
*FFT length of spectral data.*
- **MHAParser::float\_mon\_t srate**  
*Sampling rate in Hz.*

## Additional Inherited Members

## 5.257.1 Constructor &amp; Destructor Documentation

5.257.1.1 **MHAParser::mhaconfig\_mon\_t::mhaconfig\_mon\_t** (  
    const std::string & *help* = " " )

## 5.257.2 Member Function Documentation

5.257.2.1 void **MHAParser::mhaconfig\_mon\_t::update** (  
    const mhaconfig\_t & *cf* )

## 5.257.3 Member Data Documentation

5.257.3.1 **MHAParser::int\_mon\_t MHAParser::mhaconfig\_mon\_t::channels** [private]

Number of audio channels.

5.257.3.2 **MHAParser::string\_mon\_t MHAParser::mhaconfig\_mon\_t::domain** [private]

Signal domain (MHA\_WAVEFORM or MHA\_SPECTRUM)

5.257.3.3 **MHAParser::int\_mon\_t MHAParser::mhaconfig\_mon\_t::fragsize** [private]

Fragment size of waveform data.

5.257.3.4 **MHAParser::int\_mon\_t MHAParser::mhaconfig\_mon\_t::wndlen** [private]

Window length of spectral data.

### 5.257.3.5 `MHAParser::int_mon_t` `MHAParser::mhaconfig_mon_t::ftlen` `[private]`

FFT length of spectral data.

### 5.257.3.6 `MHAParser::float_mon_t` `MHAParser::mhaconfig_mon_t::srate` `[private]`

Sampling rate in Hz.

The documentation for this class was generated from the following files:

- `mha_parser.hh`
- `mha_parser.cpp`

## 5.258 `MHAParser::mhapluginloader_t` Class Reference

Class to create a plugin loader in a parser, including the load logic.

### Public Member Functions

- `mhapluginloader_t` (`MHAParser::parser_t` &parent, `algo_comm_t` ac, const std::string &plugname\_name="plugin\_name", const std::string &prefix="")
- `~mhapluginloader_t` ()
- void `prepare` (`mhaconfig_t` &cf)
- void `release` ()
- void `process` (`mha_wave_t` \*sIn, `mha_wave_t` \*\*sOut)
- void `process` (`mha_spec_t` \*sIn, `mha_spec_t` \*\*sOut)
- void `process` (`mha_wave_t` \*sIn, `mha_spec_t` \*\*sOut)
- void `process` (`mha_spec_t` \*sIn, `mha_wave_t` \*\*sOut)
- `mhaconfig_t` `get_cfin` () const
- `mhaconfig_t` `get_cfout` () const
- const std::string & `get_last_name` () const

### Protected Attributes

- `PluginLoader::mhapluginloader_t` \* `plug`

### Private Member Functions

- void `load_plug` ()

## Private Attributes

- **MHAParser::parser\_t & parent\_**
- **MHAParser::string\_t plugname**
- **std::string prefix\_**
- **MHAEvents::connector\_t< mhapluginloader\_t > connector**
- **algo\_comm\_t ac\_**
- **std::string last\_name**
- **std::string plugname\_name\_**
- **mhaconfig\_t cf\_in\_**
- **mhaconfig\_t cf\_out\_**

## Static Private Attributes

- static double **bookkeeping**

## 5.258.1 Detailed Description

Class to create a plugin loader in a parser, including the load logic.

## 5.258.2 Constructor &amp; Destructor Documentation

5.258.2.1 **MHAParser::mhapluginloader\_t::mhapluginloader\_t (**  
    **MHAParser::parser\_t & parent,**  
    **algo\_comm\_t ac,**  
    **const std::string & plugname\_name = "plugin\_name",**  
    **const std::string & prefix = " " )**

5.258.2.2 **MHAParser::mhapluginloader\_t::~~mhapluginloader\_t ( )**

## 5.258.3 Member Function Documentation

5.258.3.1 **void MHAParser::mhapluginloader\_t::prepare (**  
    **mhaconfig\_t & cf )**

5.258.3.2 **void MHAParser::mhapluginloader\_t::release ( )**

5.258.3.3 **void MHAParser::mhapluginloader\_t::process (**  
    **mha\_wave\_t \* sIn,**  
    **mha\_wave\_t \*\* sOut ) [inline]**

5.258.3.4 **void MHAParser::mhapluginloader\_t::process (**  
    **mha\_spec\_t \* sIn,**  
    **mha\_spec\_t \*\* sOut ) [inline]**

- 5.258.3.5 void MHParse::mhapluginloader\_t::process (
  - mha\_wave\_t\* *sIn*,
  - mha\_spec\_t\*\* *sOut* ) [inline]
- 5.258.3.6 void MHParse::mhapluginloader\_t::process (
  - mha\_spec\_t\* *sIn*,
  - mha\_wave\_t\*\* *sOut* ) [inline]
- 5.258.3.7 mhaconfig\_t MHParse::mhapluginloader\_t::get\_cfin ( ) const [inline]
- 5.258.3.8 mhaconfig\_t MHParse::mhapluginloader\_t::get\_cfout ( ) const [inline]
- 5.258.3.9 const std::string& MHParse::mhapluginloader\_t::get\_last\_name ( ) const [inline]
- 5.258.3.10 void MHParse::mhapluginloader\_t::load\_plug ( ) [private]
- 5.258.4 Member Data Documentation
  - 5.258.4.1 PluginLoader::mhapluginloader\_t\* MHParse::mhapluginloader\_t::plug
    - [protected]
  - 5.258.4.2 MHParse::parser\_t& MHParse::mhapluginloader\_t::parent\_ [private]
  - 5.258.4.3 MHParse::string\_t MHParse::mhapluginloader\_t::plugname [private]
  - 5.258.4.4 std::string MHParse::mhapluginloader\_t::prefix\_ [private]
  - 5.258.4.5 MHAEvents::connector\_t<mhapluginloader\_t> MHParse::mhapluginloader\_t↔
    - ::connector [private]
  - 5.258.4.6 algo\_comm\_t MHParse::mhapluginloader\_t::ac\_ [private]
  - 5.258.4.7 std::string MHParse::mhapluginloader\_t::last\_name [private]
  - 5.258.4.8 std::string MHParse::mhapluginloader\_t::plugname\_name\_ [private]
  - 5.258.4.9 mhaconfig\_t MHParse::mhapluginloader\_t::cf\_in\_ [private]
  - 5.258.4.10 mhaconfig\_t MHParse::mhapluginloader\_t::cf\_out\_ [private]
  - 5.258.4.11 double MHParse::mhapluginloader\_t::bookkeeping [static],[private]

The documentation for this class was generated from the following files:

- **mhapluginloader.h**
- **mhapluginloader.cpp**

## 5.259 MHAParser::mint\_mon\_t Class Reference

Matrix of ints monitor.

Inheritance diagram for MHAParser::mint\_mon\_t:

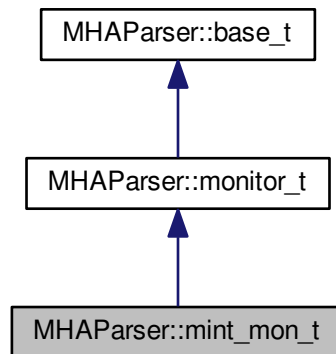
**Public Member Functions**

- **mint\_mon\_t** (const std::string &hlp)  
*Create a matrix of integer monitor values.*

**Public Attributes**

- std::vector< std::vector< int > > **data**  
*Data field.*

**Protected Member Functions**

- std::string **query\_val** (const std::string &)
- std::string **query\_type** (const std::string &)

**Additional Inherited Members**

## 5.259.1 Detailed Description

Matrix of ints monitor.

## 5.259.2 Constructor &amp; Destructor Documentation

5.259.2.1 MHAParser::mint\_mon\_t::mint\_mon\_t (  
const std::string & hlp )

Create a matrix of integer monitor values.

## Parameters

<i>hlp</i>	A help text describing this monitor variable.
------------	---

## 5.259.3 Member Function Documentation

5.259.3.1 `std::string MHAParser::mint_mon_t::query_val ( const std::string & s )` [protected], [virtual]

Reimplemented from **MHAParser::base\_t** (p. 639).

5.259.3.2 `std::string MHAParser::mint_mon_t::query_type ( const std::string & s )` [protected], [virtual]

Reimplemented from **MHAParser::base\_t** (p. 639).

## 5.259.4 Member Data Documentation

5.259.4.1 `std::vector< std::vector<int> > MHAParser::mint_mon_t::data`

Data field.

The documentation for this class was generated from the following files:

- **mha\_parser.hh**
- **mha\_parser.cpp**

## 5.260 MHAParser::monitor\_t Class Reference

Base class for monitors and variable nodes.

Inheritance diagram for MHAParser::monitor\_t:

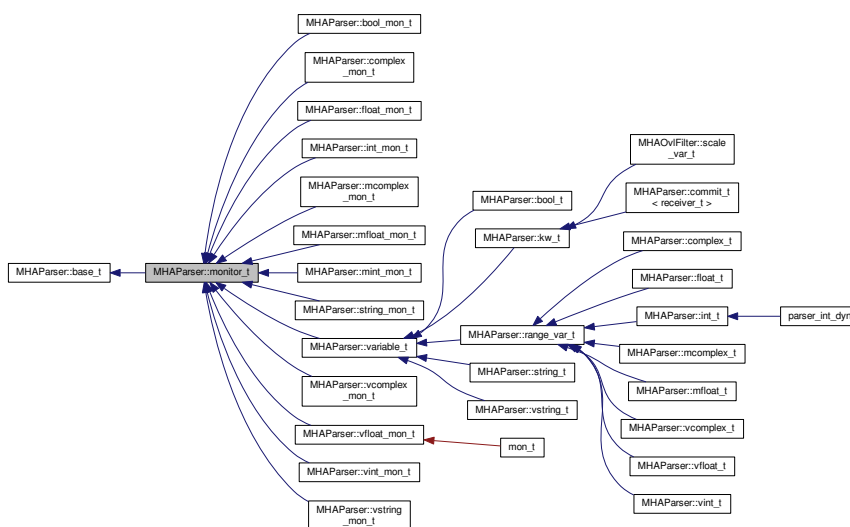

## Public Member Functions

- **monitor\_t** (const std::string &)
- **monitor\_t** (const **monitor\_t** &)
- std::string **op\_query** (**expression\_t** &)
- std::string **query\_dump** (const std::string &)
- std::string **query\_perm** (const std::string &)

## Additional Inherited Members

### 5.260.1 Detailed Description

Base class for monitors and variable nodes.

### 5.260.2 Constructor & Destructor Documentation

5.260.2.1 MHAParser::monitor\_t::monitor\_t (  
const std::string & *h* )

5.260.2.2 MHAParser::monitor\_t::monitor\_t (  
const **monitor\_t** & *src* )

### 5.260.3 Member Function Documentation

5.260.3.1 std::string MHAParser::monitor\_t::op\_query (  
**expression\_t** & *x* ) [virtual]

Reimplemented from **MHAParser::base\_t** (p. 638).

5.260.3.2 std::string MHAParser::monitor\_t::query\_dump (  
const std::string & *s* ) [virtual]

Reimplemented from **MHAParser::base\_t** (p. 638).

5.260.3.3 std::string MHAParser::monitor\_t::query\_perm (  
const std::string & *s* ) [virtual]

Reimplemented from **MHAParser::base\_t** (p. 639).

Reimplemented in **MHAParser::variable\_t** (p. 701).

The documentation for this class was generated from the following files:

- **mha\_parser.hh**
- **mha\_parser.cpp**

## 5.261 MHAParser::parser\_t Class Reference

Parser node class.

Inherits **MHAParser::base\_t**.

Inherited by **alsa\_dev\_par\_parser\_t**, **AuditoryProfile::parser\_t**, **AuditoryProfile::parser\_t::ear\_t**, **AuditoryProfile::parser\_t::fmap\_t**, **dc::wideband\_inhib\_vars\_t**, **DynComp::dc\_afterburn\_vars\_t**, **fw\_t**, **io\_alsa\_t**, **io\_file\_t**, **io\_parser\_t**, **io\_tcp\_parser\_t**, **MHAFilter::adapt\_filter\_t**, **MHAFilter::iir\_filter\_t**, **MHAIOJack::io\_jack\_t**, **MHAIOJackdb::io\_jack\_t**, **MHAIOPortAudio::device\_info\_t**, **MHAIOPortAudio::io\_portaudio\_t**, **MHAParser::mhaconfig\_mon\_t**, **MHAParser::window\_t**, **MHAPlugin::plugin\_t< runtime\_cfg\_t >**, **MHAPlugin\_Split::split\_t**, **MHAPlugin::plugin\_t< ac2wave\_t >**, **MHAPlugin::plugin\_t< acConcat\_wave\_config >**, **MHAPlugin::plugin\_t< acPooling\_wave\_config >**, **MHAPlugin::plugin\_t< acSteer\_config >**, **MHAPlugin::plugin\_t< acTransform\_wave\_config >**, **MHAPlugin::plugin\_t< adm\_rtconfig\_t >**, **MHAPlugin::plugin\_t< analysepath\_t >**, **MHAPlugin::plugin\_t< cfg\_t >**, **MHAPlugin::plugin\_t< cohflt\_t >**, **MHAPlugin::plugin\_t< combc\_t >**, **MHAPlugin::plugin\_t< db\_t >**, **MHAPlugin::plugin\_t< dc\_t >**, **MHAPlugin::plugin\_t< delaysum\_t >**, **MHAPlugin::plugin\_t< doasvm\_classification\_config >**, **MHAPlugin::plugin\_t< doasvm\_feature\_extraction\_config >**, **MHAPlugin::plugin\_t< example5\_t >**, **MHAPlugin::plugin\_t< fftfb\_plug\_t >**, **MHAPlugin::plugin\_t< fftfbpow\_t >**, **MHAPlugin::plugin\_t< float >**, **MHAPlugin::plugin\_t< fshift\_config\_t >**, **MHAPlugin::plugin\_t< gtfb\_analyzer\_cfg\_t >**, **MHAPlugin::plugin\_t< hilbert\_shifter\_t >**, **MHAPlugin::plugin\_t< int >**, **MHAPlugin::plugin\_t< lpc\_bl\_predictor\_config >**, **MHAPlugin::plugin\_t< lpc\_burglattice\_config >**, **MHAPlugin::plugin\_t< lpc\_config >**, **MHAPlugin::plugin\_t< MHA\_AC::spectrum\_t >**, **MHAPlugin::plugin\_t< MHA\_AC::waveform\_t >**, **MHAPlugin::plugin\_t< mhachain::plugs\_t >**, **MHAPlugin::plugin\_t< MHASignal::delay\_t >**, **MHAPlugin::plugin\_t< MHASignal::waveform\_t >**, **MHAPlugin::plugin\_t< MHAWindow::fun\_t >**, **MHAPlugin::plugin\_t< noisePowProposed >**, **MHAPlugin::plugin\_t< overlapadd\_t >**, **MHAPlugin::plugin\_t< plingploing\_t >**, **MHAPlugin::plugin\_t< prediction\_error\_config >**, **MHAPlugin::plugin\_t< resampling\_t >**, **MHAPlugin::plugin\_t< rmslevel\_t >**, **MHAPlugin::plugin\_t< route::process\_t >**, **MHAPlugin::plugin\_t< rt\_nlms\_t >**, **MHAPlugin::plugin\_t< scaler\_t >**, **MHAPlugin::plugin\_t< sine\_cfg\_t >**, **MHAPlugin::plugin\_t< smoothspec\_wrap\_t >**, **MHAPlugin::plugin\_t< spec2wave\_t >**, **MHAPlugin::plugin\_t< spec\_fader\_t >**, **MHAPlugin::plugin\_t< steerbf\_config >**, **MHAPlugin::plugin\_t< timoConfig >**, **MHAPlugin::plugin\_t< wave2spec\_t >**, **MHAPlugin::plugin\_t< wavwriter\_t >**, **softclipper\_variables\_t**, **testplugin::ac\_parser\_t**, **testplugin::config\_parser\_t**, and **testplugin::signal\_parser\_t**.

## Public Member Functions

- **parser\_t** (const std::string &help\_text="")  
*Construct detached node to be used in the configuration tree.*
- **~parser\_t** ()
- void **insert\_item** (const std::string &, **base\_t** \*)  
*Register a parser item into this sub-parser.*
- void **remove\_item** (const std::string &)  
*Remove an item by name.*
- void **force\_remove\_item** (const std::string &)  
*Remove an item by name.*
- void **remove\_item** (const **base\_t** \*)  
*Remove an item by address.*



### Protected Member Functions

- std::string **op\_subparse** (**expression\_t** &)
- std::string **op\_setval** (**expression\_t** &)
- std::string **op\_query** (**expression\_t** &)
- std::string **query\_type** (const std::string &)
- std::string **query\_dump** (const std::string &)
- std::string **query\_entries** (const std::string &)
- std::string **query\_readfile** (const std::string &)
- std::string **query\_savefile** (const std::string &)
- std::string **query\_savefile\_compact** (const std::string &)
- std::string **query\_savemons** (const std::string &)
- std::string **query\_val** (const std::string &)
- std::string **query\_listids** (const std::string &)
- void **set\_id\_string** (const std::string &)

### Private Attributes

- **entry\_map\_t** **entries**
- std::string **id\_string**  
*identification string*
- std::string **srcfile**
- unsigned int **srcline**
- std::string **last\_errormsg**

### Additional Inherited Members

#### 5.261.1 Detailed Description

Parser node class.

A **parser\_t** (p. 688) instance is a node in the configuration tree. A parser node can contain any number of other **parser\_t** (p. 688) instances or configuration language variables. These items are inserted into a parser node using the **parser\_t::insert\_item** (p. 690) method.

#### 5.261.2 Constructor & Destructor Documentation

##### 5.261.2.1 MHAParser::parser\_t::parser\_t ( const std::string & *help\_text* = " " )

Construct detached node to be used in the configuration tree.

**Parameters**

<i>help_text</i>	A text describing this node. E.g. if this node lives at the root of some openMHA plugin, then the help text should describe the functionality of the plugin.
------------------	--

**5.261.2.2 MHAParser::parser\_t::~~parser\_t ( )****5.261.3 Member Function Documentation**
**5.261.3.1 void MHAParser::parser\_t::insert\_item (**  
**const std::string & *n*,**  
**MHAParser::base\_t \* *e* )**

Register a parser item into this sub-parser.

This function registers an item under a given name into this sub-parser and makes it accessible to the parser interface.

**Parameters**

<i>n</i>	Name of the item in the configuration tree
<i>e</i>	C++ pointer to the item instance. <i>e</i> can either point to a variable, to a monitor, or to another sub-parser.

**5.261.3.2 void MHAParser::parser\_t::remove\_item (**  
**const std::string & *n* )**

Remove an item by name.

If the item does not exist, an error is being reported.

**Parameters**

<i>n</i>	Name of parser item to be removed from list.
----------	--

**5.261.3.3 void MHAParser::parser\_t::force\_remove\_item (**  
**const std::string & *n* )**

Remove an item by name.

Non-existing items are ignored.

**Parameters**

<i>n</i>	Name of parser item to be removed from list.
----------	--

5.261.3.4 void MHAParser::parser\_t::remove\_item (  
const base\_t \* addr )

Remove an item by address.

The item belonging to an address is being removed from the list of items.

#### Parameters

<i>addr</i>	Address of parser item to be removed.
-------------	---------------------------------------

5.261.3.5 std::string MHAParser::parser\_t::op\_subparse (  
expression\_t & x ) [protected], [virtual]

Reimplemented from **MHAParser::base\_t** (p. 638).

5.261.3.6 std::string MHAParser::parser\_t::op\_setval (  
expression\_t & x ) [protected], [virtual]

Reimplemented from **MHAParser::base\_t** (p. 638).

5.261.3.7 std::string MHAParser::parser\_t::op\_query (  
expression\_t & x ) [protected], [virtual]

Reimplemented from **MHAParser::base\_t** (p. 638).

5.261.3.8 std::string MHAParser::parser\_t::query\_type (  
const std::string & s ) [protected], [virtual]

Reimplemented from **MHAParser::base\_t** (p. 639).

5.261.3.9 std::string MHAParser::parser\_t::query\_dump (  
const std::string & s ) [protected], [virtual]

Reimplemented from **MHAParser::base\_t** (p. 638).

5.261.3.10 std::string MHAParser::parser\_t::query\_entries (  
const std::string & s ) [protected], [virtual]

Reimplemented from **MHAParser::base\_t** (p. 639).

5.261.3.11 std::string MHAParser::parser\_t::query\_readfile (  
const std::string & fname ) [protected], [virtual]

Reimplemented from **MHAParser::base\_t** (p. 639).

5.261.3.12 `std::string MHAParser::parser_t::query_savefile (`  
`const std::string & fname ) [protected],[virtual]`

Reimplemented from **MHAParser::base\_t** (p. 640).

5.261.3.13 `std::string MHAParser::parser_t::query_savefile_compact (`  
`const std::string & fname ) [protected],[virtual]`

Reimplemented from **MHAParser::base\_t** (p. 640).

5.261.3.14 `std::string MHAParser::parser_t::query_savemons (`  
`const std::string & fname ) [protected],[virtual]`

Reimplemented from **MHAParser::base\_t** (p. 640).

5.261.3.15 `std::string MHAParser::parser_t::query_val (`  
`const std::string & s ) [protected],[virtual]`

Reimplemented from **MHAParser::base\_t** (p. 639).

5.261.3.16 `std::string MHAParser::parser_t::query_listids (`  
`const std::string & s ) [protected],[virtual]`

Reimplemented from **MHAParser::base\_t** (p. 640).

5.261.3.17 `void MHAParser::parser_t::set_id_string (`  
`const std::string & s ) [protected]`

#### 5.261.4 Member Data Documentation

5.261.4.1 `entry_map_t MHAParser::parser_t::entries [private]`

5.261.4.2 `std::string MHAParser::parser_t::id_string [private]`

identification string

5.261.4.3 `std::string MHAParser::parser_t::srcfile [private]`

5.261.4.4 `unsigned int MHAParser::parser_t::srcline [private]`

5.261.4.5 `std::string MHAParser::parser_t::last_errormsg [private]`

The documentation for this class was generated from the following files:

- **mha\_parser.hh**
- **mha\_parser.cpp**

## 5.262 MHAParser::range\_var\_t Class Reference

Base class for all variables with a numeric value range.

Inheritance diagram for MHAParser::range\_var\_t:

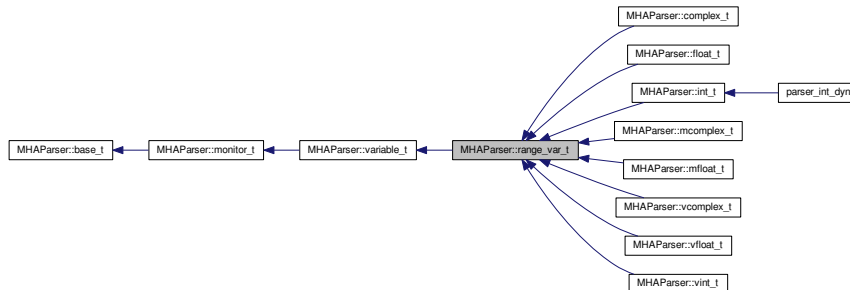

## Public Member Functions

- **range\_var\_t** (const std::string &, const std::string &="")
- **range\_var\_t** (const **range\_var\_t** &)
- std::string **query\_range** (const std::string &)
- void **set\_range** (const std::string &r)  
*Change the valid range of a variable.*
- void **validate** (const int &)
- void **validate** (const float &)
- void **validate** (const **mha\_complex\_t** &)
- void **validate** (const std::vector< int > &)
- void **validate** (const std::vector< float > &)
- void **validate** (const std::vector< **mha\_complex\_t** > &)
- void **validate** (const std::vector< std::vector< float > > &)
- void **validate** (const std::vector< std::vector< **mha\_complex\_t** > > &)

## Protected Attributes

- float **low\_limit**  
*Lower limit of range.*
- float **up\_limit**  
*Upper limit of range.*
- bool **low\_incl**  
*Lower limit is included (or excluded) in range.*
- bool **up\_incl**  
*Upper limit is included (or excluded) in range.*
- bool **check\_low**  
*Check lower limit.*
- bool **check\_up**  
*Check upper limit.*
- bool **check\_range**  
*Range checking is active.*

## Additional Inherited Members

### 5.262.1 Detailed Description

Base class for all variables with a numeric value range.

### 5.262.2 Constructor & Destructor Documentation

5.262.2.1 `MHAParser::range_var_t::range_var_t (`  
                   `const std::string & h,`  
                   `const std::string & r = " " )`

5.262.2.2 `MHAParser::range_var_t::range_var_t (`  
                   `const range_var_t & src )`

### 5.262.3 Member Function Documentation

5.262.3.1 `std::string MHAParser::range_var_t::query_range (`  
                   `const std::string & s ) [virtual]`

Reimplemented from **MHAParser::base\_t** (p. 639).

5.262.3.2 `void MHAParser::range_var_t::set_range (`  
                   `const std::string & r )`

Change the valid range of a variable.

#### Parameters

<i>r</i>	New range of the variable (string representation)
----------	---

5.262.3.3 `void MHAParser::range_var_t::validate (`  
                   `const int & v )`

5.262.3.4 `void MHAParser::range_var_t::validate (`  
                   `const float & v )`

5.262.3.5 `void MHAParser::range_var_t::validate (`  
                   `const mha_complex_t & v )`

5.262.3.6 `void MHAParser::range_var_t::validate (`  
                   `const std::vector< int > & v )`

5.262.3.7 void MHAParser::range\_var\_t::validate (   
 const std::vector< float > & v )

5.262.3.8 void MHAParser::range\_var\_t::validate (   
 const std::vector< mha\_complex\_t > & v )

5.262.3.9 void MHAParser::range\_var\_t::validate (   
 const std::vector< std::vector< float > > & v )

5.262.3.10 void MHAParser::range\_var\_t::validate (   
 const std::vector< std::vector< mha\_complex\_t > > & v )

#### 5.262.4 Member Data Documentation

5.262.4.1 float MHAParser::range\_var\_t::low\_limit [protected]

Lower limit of range.

5.262.4.2 float MHAParser::range\_var\_t::up\_limit [protected]

Upper limit of range.

5.262.4.3 bool MHAParser::range\_var\_t::low\_incl [protected]

Lower limit is included (or excluded) in range.

5.262.4.4 bool MHAParser::range\_var\_t::up\_incl [protected]

Upper limit is included (or excluded) in range.

5.262.4.5 bool MHAParser::range\_var\_t::check\_low [protected]

Check lower limit.

5.262.4.6 bool MHAParser::range\_var\_t::check\_up [protected]

Check upper limit.

5.262.4.7 bool MHAParser::range\_var\_t::check\_range [protected]

Range checking is active.

The documentation for this class was generated from the following files:

- mha\_parser.hh
- mha\_parser.cpp

## 5.263 MHAParser::string\_mon\_t Class Reference

Monitor with string value.

Inheritance diagram for MHAParser::string\_mon\_t:

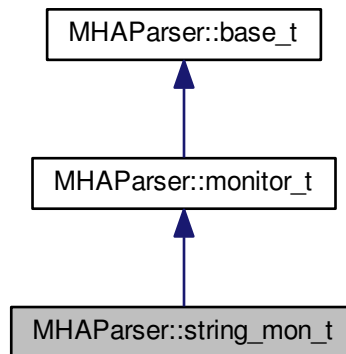

### Public Member Functions

- **string\_mon\_t** (const std::string &hlp)  
*Create a monitor variable for string values.*

### Public Attributes

- std::string **data**  
*Data field.*

### Protected Member Functions

- std::string **query\_val** (const std::string &)
- std::string **query\_type** (const std::string &)

### Additional Inherited Members

#### 5.263.1 Detailed Description

Monitor with string value.

#### 5.263.2 Constructor & Destructor Documentation

##### 5.263.2.1 MHAParser::string\_mon\_t::string\_mon\_t (const std::string & hlp )

Create a monitor variable for string values.



## Parameters

<i>help</i>	A help text describing this monitor variable.
-------------	---

## 5.263.3 Member Function Documentation

5.263.3.1 `std::string MHAParser::string_mon_t::query_val (const std::string & s )` [protected], [virtual]

Reimplemented from **MHAParser::base\_t** (p. 639).

5.263.3.2 `std::string MHAParser::string_mon_t::query_type (const std::string & s )` [protected], [virtual]

Reimplemented from **MHAParser::base\_t** (p. 639).

## 5.263.4 Member Data Documentation

5.263.4.1 `std::string MHAParser::string_mon_t::data`

Data field.

The documentation for this class was generated from the following files:

- **mha\_parser.hh**
- **mha\_parser.cpp**

## 5.264 MHAParser::string\_t Class Reference

Variable with a string value.

Inheritance diagram for MHAParser::string\_t:

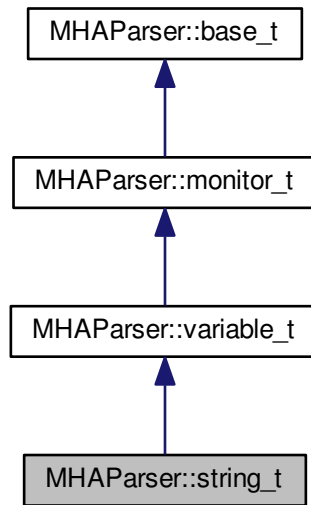

#### Public Member Functions

- **string\_t** (const std::string &, const std::string &)  
*Constructor of a openMHA configuration variable for string values.*

#### Public Attributes

- std::string **data**  
*Data field.*

#### Protected Member Functions

- std::string **op\_setval** (**expression\_t** &)
- std::string **query\_type** (const std::string &)
- std::string **query\_val** (const std::string &)

#### Additional Inherited Members

##### 5.264.1 Detailed Description

Variable with a string value.

## 5.264.2 Constructor & Destructor Documentation

### 5.264.2.1 MHAParser::string\_t::string\_t (     const std::string & *h*,     const std::string & *v* )

Constructor of a openMHA configuration variable for string values.

#### Parameters

<i>h</i>	A help string describing the purpose of this variable.
<i>v</i>	The initial string value

## 5.264.3 Member Function Documentation

### 5.264.3.1 std::string MHAParser::string\_t::op\_setval (     expression\_t & *x* ) [protected], [virtual]

Reimplemented from **MHAParser::variable\_t** (p. 701).

### 5.264.3.2 std::string MHAParser::string\_t::query\_type (     const std::string & *s* ) [protected], [virtual]

Reimplemented from **MHAParser::base\_t** (p. 639).

### 5.264.3.3 std::string MHAParser::string\_t::query\_val (     const std::string & *s* ) [protected], [virtual]

Reimplemented from **MHAParser::base\_t** (p. 639).

## 5.264.4 Member Data Documentation

### 5.264.4.1 std::string MHAParser::string\_t::data

Data field.

The documentation for this class was generated from the following files:

- **mha\_parser.hh**
- **mha\_parser.cpp**



## 5.265.2 Constructor & Destructor Documentation

5.265.2.1 MHParse::variable\_t::variable\_t (   
 const std::string & h )

## 5.265.3 Member Function Documentation

5.265.3.1 std::string MHParse::variable\_t::op\_setval (   
 expression\_t & x ) [virtual]

Reimplemented from **MHParse::base\_t** (p. 638).

Reimplemented in **MHParse::mcomplex\_t** (p. 675), **MHParse::mfloat\_t** (p. 679), **MHParse::vcomplex\_t** (p. 706), **MHParse::vfloat\_t** (p. 710), **MHParse::vint\_t** (p. 714), **MHParse::complex\_t** (p. 655), **MHParse::float\_t** (p. 661), **MHParse::int\_t** (p. 666), **MHParse::bool\_t** (p. 647), **MHParse::vstring\_t** (p. 718), **MHParse::string\_t** (p. 699), and **MHParse::kw\_t** (p. 671).

5.265.3.2 std::string MHParse::variable\_t::query\_perm (   
 const std::string & s ) [virtual]

Reimplemented from **MHParse::monitor\_t** (p. 687).

5.265.3.3 void MHParse::variable\_t::setlock (   
 const bool & b )

Lock a variable against write access.

### Parameters

<i>b</i>	Lock state
----------	------------

## 5.265.4 Member Data Documentation

5.265.4.1 bool MHParse::variable\_t::locked [private]

The documentation for this class was generated from the following files:

- mha\_parser.hh
- mha\_parser.cpp

## 5.266 MHAParser::vcomplex\_mon\_t Class Reference

Monitor with vector of complex values.

Inheritance diagram for MHAParser::vcomplex\_mon\_t:

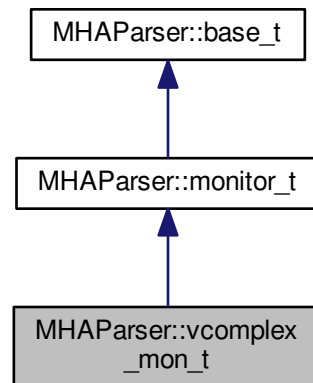

### Public Member Functions

- **vcomplex\_mon\_t** (const std::string &hlp)  
*Create a vector of complex monitor values.*

### Public Attributes

- std::vector< **mha\_complex\_t** > **data**  
*Data field.*

### Protected Member Functions

- std::string **query\_val** (const std::string &)
- std::string **query\_type** (const std::string &)

### Additional Inherited Members

#### 5.266.1 Detailed Description

Monitor with vector of complex values.

## 5.266.2 Constructor &amp; Destructor Documentation

5.266.2.1 MHAParser::vcomplex\_mon\_t::vcomplex\_mon\_t (  
const std::string & *hlp* )

Create a vector of complex monitor values.

## Parameters

<i>help</i>	A help text describing this monitor variable.
-------------	---

### 5.266.3 Member Function Documentation

5.266.3.1 `std::string MHAParser::vcomplex_mon_t::query_val ( const std::string & s )` [protected], [virtual]

Reimplemented from **MHAParser::base\_t** (p. 639).

5.266.3.2 `std::string MHAParser::vcomplex_mon_t::query_type ( const std::string & s )` [protected], [virtual]

Reimplemented from **MHAParser::base\_t** (p. 639).

### 5.266.4 Member Data Documentation

5.266.4.1 `std::vector<mha_complex_t> MHAParser::vcomplex_mon_t::data`

Data field.

The documentation for this class was generated from the following files:

- **mha\_parser.hh**
- **mha\_parser.cpp**

### 5.267 MHAParser::vcomplex\_t Class Reference

Vector variable with complex value.



Inheritance diagram for MHAParser::vcomplex\_t:

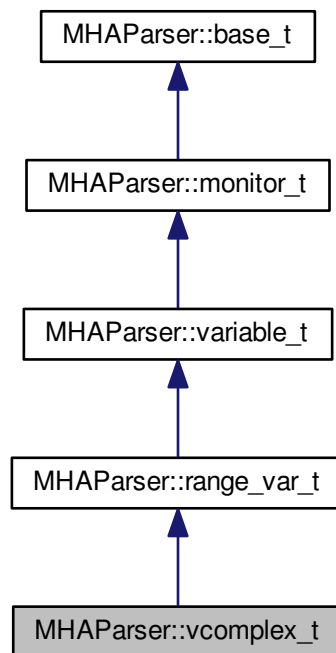

### Public Member Functions

- **vcomplex\_t** (const std::string &, const std::string &, const std::string &= "")

### Public Attributes

- std::vector< **mha\_complex\_t** > **data**  
*Data field.*

### Protected Member Functions

- std::string **op\_setval** (**expression\_t** &)
- std::string **query\_type** (const std::string &)
- std::string **query\_val** (const std::string &)

### Additional Inherited Members

#### 5.267.1 Detailed Description

Vector variable with complex value.

## 5.267.2 Constructor & Destructor Documentation

5.267.2.1 `MHAParser::vcomplex_t::vcomplex_t (`  
    `const std::string & h,`  
    `const std::string & v,`  
    `const std::string & rg = " " )`

## 5.267.3 Member Function Documentation

5.267.3.1 `std::string MHAParser::vcomplex_t::op_setval (`  
    `expression_t & x )` `[protected], [virtual]`

Reimplemented from `MHAParser::variable_t` (p. [701](#)).

5.267.3.2 `std::string MHAParser::vcomplex_t::query_type (`  
    `const std::string & s )` `[protected], [virtual]`

Reimplemented from `MHAParser::base_t` (p. [639](#)).

5.267.3.3 `std::string MHAParser::vcomplex_t::query_val (`  
    `const std::string & s )` `[protected], [virtual]`

Reimplemented from `MHAParser::base_t` (p. [639](#)).

## 5.267.4 Member Data Documentation

5.267.4.1 `std::vector<mha_complex_t> MHAParser::vcomplex_t::data`

Data field.

The documentation for this class was generated from the following files:

- `mha_parser.hh`
- `mha_parser.cpp`

## 5.268 MHAParser::vfloat\_mon\_t Class Reference

Vector of floats monitor.

Inheritance diagram for MHAParser::vfloat\_mon\_t:

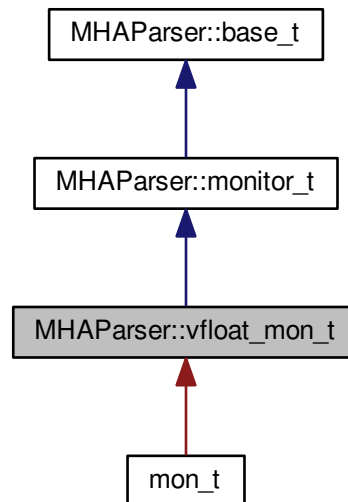

### Public Member Functions

- **vfloat\_mon\_t** (const std::string &hlp)  
*Create a vector of floating point monitor values.*

### Public Attributes

- std::vector< float > **data**  
*Data field.*

### Protected Member Functions

- std::string **query\_val** (const std::string &)
- std::string **query\_type** (const std::string &)

### Additional Inherited Members

#### 5.268.1 Detailed Description

Vector of floats monitor.

## 5.268.2 Constructor & Destructor Documentation

### 5.268.2.1 MHAParser::vfloat\_mon\_t::vfloat\_mon\_t ( const std::string & *hlp* )

Create a vector of floating point monitor values.

#### Parameters

<i>hlp</i>	A help text describing this monitor variable.
------------	---

## 5.268.3 Member Function Documentation

### 5.268.3.1 std::string MHAParser::vfloat\_mon\_t::query\_val ( const std::string & *s* ) [protected], [virtual]

Reimplemented from **MHAParser::base\_t** (p. 639).

### 5.268.3.2 std::string MHAParser::vfloat\_mon\_t::query\_type ( const std::string & *s* ) [protected], [virtual]

Reimplemented from **MHAParser::base\_t** (p. 639).

## 5.268.4 Member Data Documentation

### 5.268.4.1 std::vector<float> MHAParser::vfloat\_mon\_t::data

Data field.

The documentation for this class was generated from the following files:

- **mha\_parser.hh**
- **mha\_parser.cpp**

## 5.269 MHAParser::vfloat\_t Class Reference

Vector variable with float value.

Inheritance diagram for MHAParser::vfloat\_t:

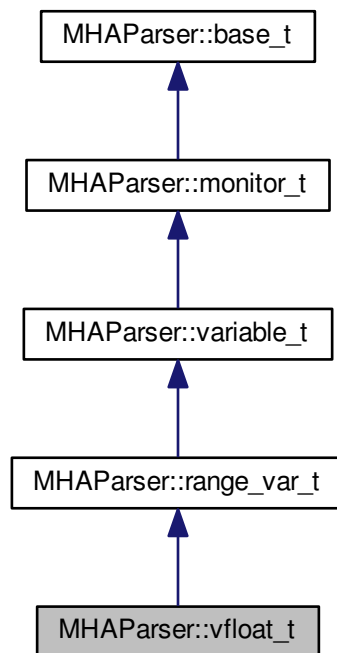

### Public Member Functions

- **vfloat\_t** (const std::string &, const std::string &, const std::string &="")  
*Create a float vector parser variable.*

### Public Attributes

- std::vector< float > **data**  
*Data field.*

### Protected Member Functions

- std::string **op\_setval** (**expression\_t** &)
- std::string **query\_type** (const std::string &)
- std::string **query\_val** (const std::string &)

## Additional Inherited Members

### 5.269.1 Detailed Description

Vector variable with float value.

### 5.269.2 Constructor & Destructor Documentation

5.269.2.1 `MHAParser::vfloat_t::vfloat_t (`  
     `const std::string & h,`  
     `const std::string & v,`  
     `const std::string & rg = " " )`

Create a float vector parser variable.

#### Parameters

<i>h</i>	A human-readable text describing the purpose of this configuration variable.
<i>v</i>	The initial value of the variable, as a string, in openMHA configuration language: (e.g. "[0 1 2.1 3]" for a vector), described in the "Multidimensional Variables" s2.1.3 section of the openMHA User Manual.
<i>rg</i>	The numeric range to enforce on all members of the vector.

•

### 5.269.3 Member Function Documentation

5.269.3.1 `std::string MHAParser::vfloat_t::op_setval (`  
     `expression_t & x )` [protected], [virtual]

Reimplemented from `MHAParser::variable_t` (p. 701).

5.269.3.2 `std::string MHAParser::vfloat_t::query_type (`  
     `const std::string & s )` [protected], [virtual]

Reimplemented from `MHAParser::base_t` (p. 639).

5.269.3.3 `std::string MHAParser::vfloat_t::query_val (`  
     `const std::string & s )` [protected], [virtual]

Reimplemented from `MHAParser::base_t` (p. 639).

## 5.269.4 Member Data Documentation

## 5.269.4.1 std::vector&lt;float&gt; MHAParser::vfloat\_t::data

Data field.

The documentation for this class was generated from the following files:

- `mha_parser.hh`
- `mha_parser.cpp`

## 5.270 MHAParser::vint\_mon\_t Class Reference

Vector of ints monitor.

Inheritance diagram for MHAParser::vint\_mon\_t:

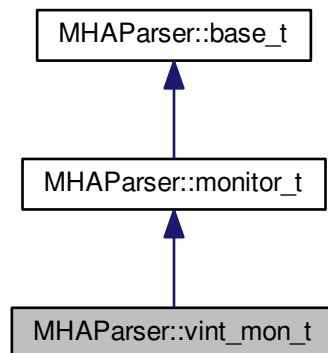

## Public Member Functions

- **vint\_mon\_t** (const std::string &hlp)  
*Create a vector of integer monitor values.*

## Public Attributes

- std::vector< int > **data**  
*Data field.*

## Protected Member Functions

- `std::string query_val` (`const std::string &`)
- `std::string query_type` (`const std::string &`)

## Additional Inherited Members

### 5.270.1 Detailed Description

Vector of ints monitor.

### 5.270.2 Constructor & Destructor Documentation

#### 5.270.2.1 `MHAParser::vint_mon_t::vint_mon_t ( const std::string & hlp )`

Create a vector of integer monitor values.

#### Parameters

<i>hlp</i>	A help text describing this monitor variable.
------------	---

### 5.270.3 Member Function Documentation

#### 5.270.3.1 `std::string MHAParser::vint_mon_t::query_val ( const std::string & s )` `[protected]`, `[virtual]`

Reimplemented from `MHAParser::base_t` (p. 639).

#### 5.270.3.2 `std::string MHAParser::vint_mon_t::query_type ( const std::string & s )` `[protected]`, `[virtual]`

Reimplemented from `MHAParser::base_t` (p. 639).

### 5.270.4 Member Data Documentation

#### 5.270.4.1 `std::vector<int> MHAParser::vint_mon_t::data`

Data field.

The documentation for this class was generated from the following files:

- `mha_parser.hh`
- `mha_parser.cpp`



## 5.271 MHAParser::vint\_t Class Reference

Variable with vector<int> value.

Inheritance diagram for MHAParser::vint\_t:

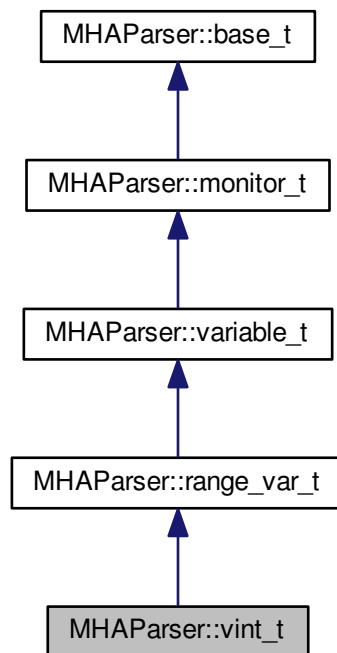

### Public Member Functions

- **vint\_t** (const std::string &, const std::string &, const std::string &="")  
*Constructor.*

### Public Attributes

- std::vector< int > **data**  
*Data field.*

### Protected Member Functions

- std::string **op\_setval** (**expression\_t** &)
- std::string **query\_type** (const std::string &)
- std::string **query\_val** (const std::string &)

## Additional Inherited Members

### 5.271.1 Detailed Description

Variable with vector<int> value.

### 5.271.2 Constructor & Destructor Documentation

5.271.2.1 `MHAParser::vint_t::vint_t (`  
     `const std::string & h,`  
     `const std::string & v,`  
     `const std::string & rg = " " )`

Constructor.

#### Parameters

<i>h</i>	help string
<i>v</i>	initial value
<i>rg</i>	optional: range constraint for all elements

### 5.271.3 Member Function Documentation

5.271.3.1 `std::string MHAParser::vint_t::op_setval (`  
     `expression_t & x )` [protected],[virtual]

Reimplemented from `MHAParser::variable_t` (p. 701).

5.271.3.2 `std::string MHAParser::vint_t::query_type (`  
     `const std::string & s )` [protected],[virtual]

Reimplemented from `MHAParser::base_t` (p. 639).

5.271.3.3 `std::string MHAParser::vint_t::query_val (`  
     `const std::string & s )` [protected],[virtual]

Reimplemented from `MHAParser::base_t` (p. 639).

## 5.271.4 Member Data Documentation

## 5.271.4.1 std::vector&lt;int&gt; MHAParser::vint\_t::data

Data field.

The documentation for this class was generated from the following files:

- `mha_parser.hh`
- `mha_parser.cpp`

## 5.272 MHAParser::vstring\_mon\_t Class Reference

Vector of monitors with string value.

Inheritance diagram for MHAParser::vstring\_mon\_t:

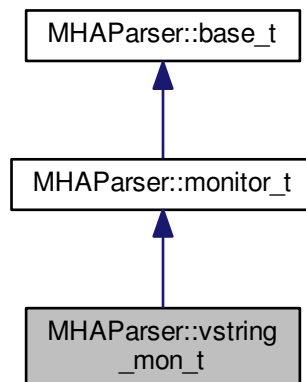

## Public Member Functions

- **vstring\_mon\_t** (const std::string &hp)  
*Create a vector of string monitor values.*

## Public Attributes

- std::vector< std::string > **data**  
*Data field.*

## Protected Member Functions

- `std::string query_val` (`const std::string &`)
- `std::string query_type` (`const std::string &`)

## Additional Inherited Members

### 5.272.1 Detailed Description

Vector of monitors with string value.

### 5.272.2 Constructor & Destructor Documentation

#### 5.272.2.1 `MHAParser::vstring_mon_t::vstring_mon_t ( const std::string & hlp )`

Create a vector of string monitor values.

#### Parameters

<i>hlp</i>	A help text describing this monitor variable.
------------	---

### 5.272.3 Member Function Documentation

#### 5.272.3.1 `std::string MHAParser::vstring_mon_t::query_val ( const std::string & s ) [protected], [virtual]`

Reimplemented from `MHAParser::base_t` (p. 639).

#### 5.272.3.2 `std::string MHAParser::vstring_mon_t::query_type ( const std::string & s ) [protected], [virtual]`

Reimplemented from `MHAParser::base_t` (p. 639).

### 5.272.4 Member Data Documentation

#### 5.272.4.1 `std::vector<std::string> MHAParser::vstring_mon_t::data`

Data field.

The documentation for this class was generated from the following files:

- `mha_parser.hh`
- `mha_parser.cpp`

## 5.273 MHAParser::vstring\_t Class Reference

Vector variable with string values.

Inheritance diagram for MHAParser::vstring\_t:

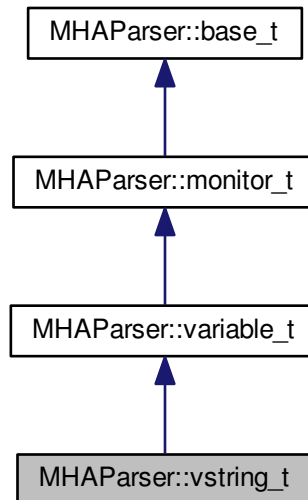

#### Public Member Functions

- **vstring\_t** (const std::string &, const std::string &)

#### Public Attributes

- std::vector< std::string > **data**  
*Data field.*

#### Protected Member Functions

- std::string **op\_setval** (expression\_t &)
- std::string **query\_type** (const std::string &)
- std::string **query\_val** (const std::string &)

#### Additional Inherited Members

##### 5.273.1 Detailed Description

Vector variable with string values.

## 5.273.2 Constructor & Destructor Documentation

5.273.2.1 `MHAParser::vstring_t::vstring_t (`  
    `const std::string & h,`  
    `const std::string & v )`

## 5.273.3 Member Function Documentation

5.273.3.1 `std::string MHAParser::vstring_t::op_setval (`  
    `expression_t & x )` `[protected], [virtual]`

Reimplemented from `MHAParser::variable_t` (p. [701](#)).

5.273.3.2 `std::string MHAParser::vstring_t::query_type (`  
    `const std::string & s )` `[protected], [virtual]`

Reimplemented from `MHAParser::base_t` (p. [639](#)).

5.273.3.3 `std::string MHAParser::vstring_t::query_val (`  
    `const std::string & s )` `[protected], [virtual]`

Reimplemented from `MHAParser::base_t` (p. [639](#)).

## 5.273.4 Member Data Documentation

5.273.4.1 `std::vector<std::string> MHAParser::vstring_t::data`

Data field.

The documentation for this class was generated from the following files:

- `mha_parser.hh`
- `mha_parser.cpp`

## 5.274 MHAParser::window\_t Class Reference

MHA configuration interface for a window function generator.

Inheritance diagram for MHAParser::window\_t:

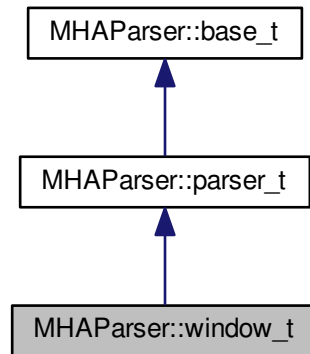

## Public Types

## Public Member Functions

- **window\_t** (const std::string &help="Window type configuration.")  
*Constructor to create parser class.*
- **MHAWindow::base\_t get\_window** (unsigned int len) const  
*Create a window instance, use default parameters.*
- **MHAWindow::base\_t get\_window** (unsigned int len, float xmin) const  
*Create a window instance.*
- **MHAWindow::base\_t get\_window** (unsigned int len, float xmin, float xmax) const  
*Create a window instance.*
- **MHAWindow::base\_t get\_window** (unsigned int len, float xmin, float xmax, bool minin-cluded) const  
*Create a window instance.*
- **MHAWindow::base\_t get\_window** (unsigned int len, float xmin, float xmax, bool minin-cluded, bool maxincluded) const  
*Create a window instance.*
- **MHAParser::window\_t::wtype\_t get\_type** () const  
*Return currently selected window type.*

## Private Attributes

- **MHAParser::kw\_t wtype**
- **MHAParser::vfloat\_t user**

## Additional Inherited Members

### 5.274.1 Detailed Description

MHA configuration interface for a window function generator.

This class implements a configuration interface (sub-parser) for window type selection and user-defined window type. It provides member functions to generate an instance of **MHA↔Window::base\_t** (p. 835) based on the values provided by the configuration interface.

The configuration interface is derived from **MHAParser::parser\_t** (p. 688) and can thus be inserted into the configuration tree using the **insert\_item()** (p. 690) method of the parent parser.

If one of the pre-defined window types is used, then the window is generated using the **MHA↔Window::fun\_t** (p. 838) class constructor; for the user-defined type the values from the "user" variable are copied.

### 5.274.2 Member Enumeration Documentation

#### 5.274.2.1 enum MHAParser::window\_t::wtype\_t

Enumerator

***wnd\_rect***  
***wnd\_hann***  
***wnd\_hamming***  
***wnd\_blackman***  
***wnd\_bartlett***  
***wnd\_user***

### 5.274.3 Constructor & Destructor Documentation

#### 5.274.3.1 MHAParser::window\_t::window\_t ( const std::string & *help* = "Window type configuration." )

Constructor to create parser class.

### 5.274.4 Member Function Documentation

#### 5.274.4.1 MHAWindow::base\_t MHAParser::window\_t::get\_window ( unsigned int *len* ) const

Create a window instance, use default parameters.



5.274.4.2 **MHAWindow::base\_t MHAParser::window\_t::get\_window** (  
    unsigned int *len*,  
    float *xmin* ) const

Create a window instance.

5.274.4.3 **MHAWindow::base\_t MHAParser::window\_t::get\_window** (  
    unsigned int *len*,  
    float *xmin*,  
    float *xmax* ) const

Create a window instance.

5.274.4.4 **MHAWindow::base\_t MHAParser::window\_t::get\_window** (  
    unsigned int *len*,  
    float *xmin*,  
    float *xmax*,  
    bool *minincluded* ) const

Create a window instance.

5.274.4.5 **MHAWindow::base\_t MHAParser::window\_t::get\_window** (  
    unsigned int *len*,  
    float *xmin*,  
    float *xmax*,  
    bool *minincluded*,  
    bool *maxincluded* ) const

Create a window instance.

5.274.4.6 **MHAParser::window\_t::wtype\_t MHAParser::window\_t::get\_type** ( ) const

Return currently selected window type.

## 5.274.5 Member Data Documentation

5.274.5.1 **MHAParser::kw\_t MHAParser::window\_t::wtype** [private]

5.274.5.2 **MHAParser::vfloat\_t MHAParser::window\_t::user** [private]

The documentation for this class was generated from the following files:

- **mha\_windowparser.h**
- **mha\_windowparser.cpp**

## 5.275 mhaplug\_cfg\_t Class Reference

Inheritance diagram for mhaplug\_cfg\_t:

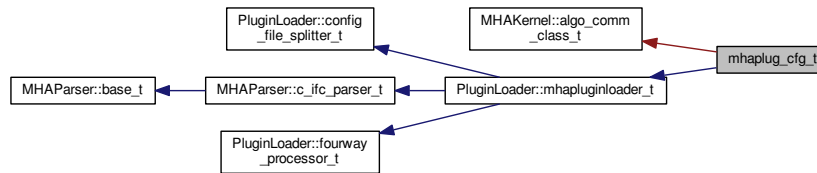

### Public Member Functions

- **mhaplug\_cfg\_t** (**algo\_comm\_t** iac, const std::string &libname, bool use\_own\_ac)
- **~mhaplug\_cfg\_t** () throw ()

### Additional Inherited Members

#### 5.275.1 Constructor & Destructor Documentation

5.275.1.1 mhaplug\_cfg\_t::mhaplug\_cfg\_t (  
**algo\_comm\_t** iac,  
 const std::string & libname,  
 bool use\_own\_ac )

5.275.1.2 mhaplug\_cfg\_t::~mhaplug\_cfg\_t ( ) throw () [inline]

The documentation for this class was generated from the following file:

- **altplugins.cpp**

## 5.276 MHAPlugin::cfg\_chain\_t< runtime\_cfg\_t > Class Template Reference

### Public Member Functions

- **cfg\_chain\_t** (runtime\_cfg\_t \*id)
- **~cfg\_chain\_t** ()

Public Attributes

- **cfg\_chain\_t**< runtime\_cfg\_t > \* **next**
- bool **not\_in\_use**
- runtime\_cfg\_t \* **data**

5.276.1 Constructor & Destructor Documentation

5.276.1.1 `template<class runtime_cfg_t> MHAPlugin::cfg_chain_t< runtime_cfg_t >::cfg_chain_t ( runtime_cfg_t * id )`

5.276.1.2 `template<class runtime_cfg_t > MHAPlugin::cfg_chain_t< runtime_cfg_t >::~~cfg_chain_t( )`

5.276.2 Member Data Documentation

5.276.2.1 `template<class runtime_cfg_t> cfg_chain_t< runtime_cfg_t > * MHAPlugin::cfg_chain_t< runtime_cfg_t >::next`

5.276.2.2 `template<class runtime_cfg_t> bool MHAPlugin::cfg_chain_t< runtime_cfg_t >::not_in_use`

5.276.2.3 `template<class runtime_cfg_t> runtime_cfg_t * MHAPlugin::cfg_chain_t< runtime_cfg_t >::data`

The documentation for this class was generated from the following file:

- **mha\_plugin.hh**

5.277 MHAPlugin::config\_t< runtime\_cfg\_t > Class Template Reference

Template class for thread safe configuration.

Inheritance diagram for MHAPugin::config\_t< runtime\_cfg\_t >:

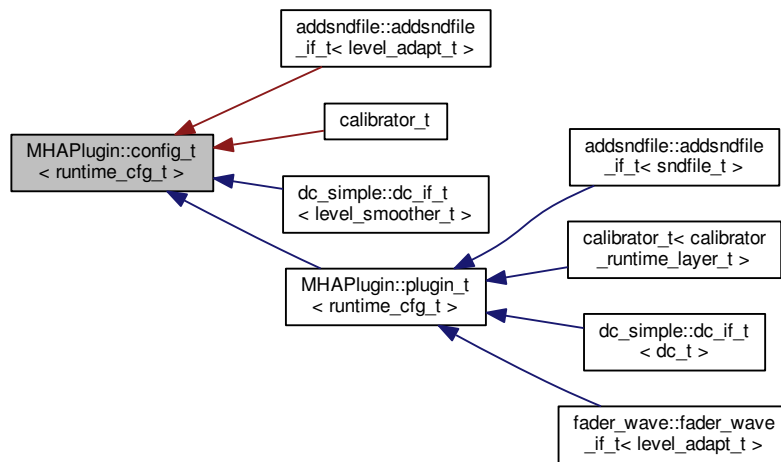

### Public Member Functions

- **config\_t** ()
- **~config\_t** ()

### Protected Member Functions

- runtime\_cfg\_t \* **poll\_config** ()  
*Receive the latest run time configuration.*
- runtime\_cfg\_t \* **last\_config** ()  
*Receive the latest run time configuration.*
- void **push\_config** (runtime\_cfg\_t \*ncfg)  
*Push a new run time configuration into the configuration fifo.*
- void **cleanup\_unused\_cfg** ()

### Protected Attributes

- runtime\_cfg\_t \* **cfg**

### Private Member Functions

- void **remove\_all\_cfg** ()

Private Attributes

- MHAPlugin::cfg\_chain\_t< runtime\_cfg\_t > \* **cfg\_chain**
- MHAPlugin::cfg\_chain\_t< runtime\_cfg\_t > \* **cfg\_chain\_current**

5.277.1 Detailed Description

```
template<class runtime_cfg_t>
class MHAPlugin::config_t< runtime_cfg_t >
```

Template class for thread safe configuration.

This template class provides a mechanism for the handling of thread safe configuration which is required for run time configuration changes of the openMHA plugins.

The template parameter runtime\_cfg\_t is the run time configuration class of the openMHA plugin. The constructor of that class should transform the **MHAParser** (p. 107) variables into derived runtime configuration. The constructor should fail if the configuration is invalid by any reason.

A new runtime configuration is provided by the function **push\_config()** (p. 726). In the processing thread, the actual configuration can be received by a call of **poll\_config()** (p. 726).

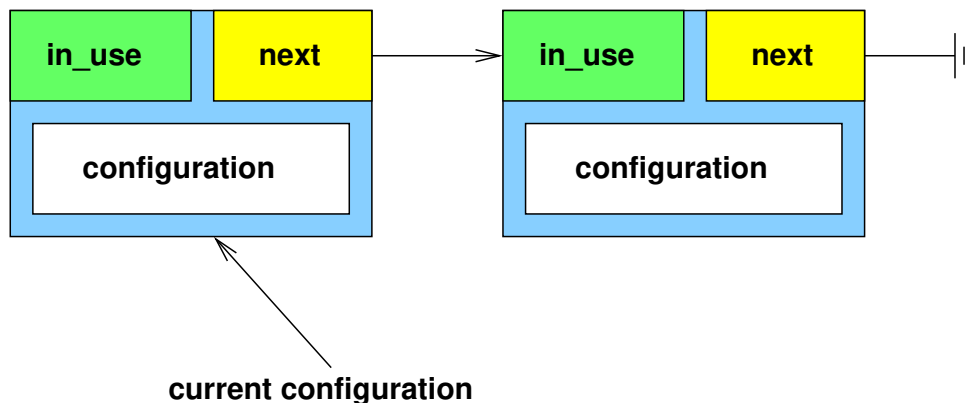

Figure 5 Schematic drawing of runtime configuration update: configuration updated, but not used yet.

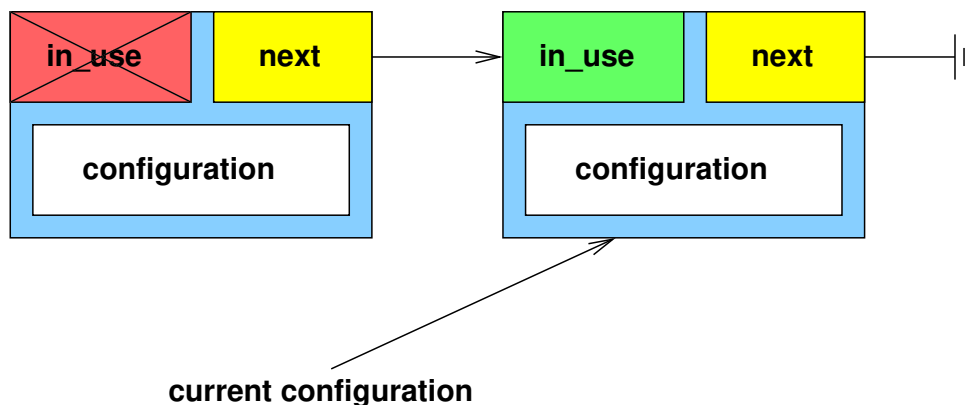

Figure 6 Schematic drawing of runtime configuration update: configuration in use.

## 5.277.2 Constructor & Destructor Documentation

5.277.2.1 `template<class runtime_cfg_t> MHAPLugin::config_t< runtime_cfg_t >::config_t ( )`

5.277.2.2 `template<class runtime_cfg_t> MHAPLugin::config_t< runtime_cfg_t >::~~config_t ( )`

## 5.277.3 Member Function Documentation

5.277.3.1 `template<class runtime_cfg_t> runtime_cfg_t * MHAPLugin::config_t< runtime_cfg_t >::poll_config ( ) [protected]`

Receive the latest run time configuration.

This function stores the latest run time configuration into the protected class member variable 'cfg'. If no configuration exists, then an exception will be thrown. If no changes occurred, then the value of 'cfg' will be untouched. This function should be called before any access to the 'cfg' variable, typically once in each signal processing call.

This function should be only called from the *processing* thread.

### Exceptions

<b><i>MHA_Error</i></b> (p. 445)	if the resulting runtime configuration is NULL. This usually means that no push_config has occurred.
----------------------------------	--

5.277.3.2 `template<class runtime_cfg_t> runtime_cfg_t * MHAPLugin::config_t< runtime_cfg_t >::last_config ( ) [protected]`

Receive the latest run time configuration.

This function stores the latest run time configuration into the protected class member variable 'cfg'. If no configuration exists, then an exception will be thrown. If no changes occurred, then the value of 'cfg' will be untouched. This function may be called instead of poll\_config.

The difference between poll\_config and last\_config is that poll\_config marks previous configurations as ready for deletion, while this function does not. Therefore, memory usage of all runtime configurations will accumulate if only this function is called, but it enables safe access to previous runtime configurations.

Also, last\_config does not raise an Exception when the latest run time configuration is NULL.

5.277.3.3 `template<class runtime_cfg_t> void MHAPLugin::config_t< runtime_cfg_t >::push_config ( runtime_cfg_t * ncfg ) [protected]`

Push a new run time configuration into the configuration fifo.

This function adds a new run time configuration. The next time **poll\_config** (p. 726) is called, this configuration will be available. Configurations which are not in use or are outdated will be removed.

This function should be only called from the *configuration* thread.

## Parameters

<i>ncfg</i>	pointer on a new configuration
-------------	--------------------------------

## Warning

The runtime configuration passed to this function will be removed by the internal garbage collector. Do not free manually.

5.277.3.4 `template<class runtime_cfg_t > void MHAPlugin::config_t< runtime_cfg_t >::cleanup_unused_cfg ( ) [protected]`

5.277.3.5 `template<class runtime_cfg_t > void MHAPlugin::config_t< runtime_cfg_t >::remove_all_cfg ( ) [private]`

## 5.277.4 Member Data Documentation

5.277.4.1 `template<class runtime_cfg_t > runtime_cfg_t* MHAPlugin::config_t< runtime_cfg_t >::cfg [protected]`

5.277.4.2 `template<class runtime_cfg_t > MHAPlugin::cfg_chain_t<runtime_cfg_t>* MHAPlugin::config_t< runtime_cfg_t >::cfg_chain [private]`

5.277.4.3 `template<class runtime_cfg_t > MHAPlugin::cfg_chain_t<runtime_cfg_t>* MHAPlugin::config_t< runtime_cfg_t >::cfg_chain_current [private]`

The documentation for this class was generated from the following file:

- **mha\_plugin.hh**

## 5.278 MHAPlugin::plugin\_t&lt; runtime\_cfg\_t &gt; Class Template Reference

The template class for C++ openMHA plugins.

Inheritance diagram for MHAPlugin::plugin\_t< runtime\_cfg\_t >:

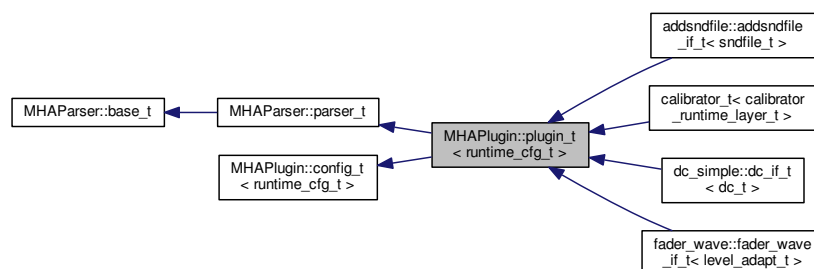



### Public Member Functions

- **plugin\_t** (const std::string &, const **algo\_comm\_t** &)  
*Constructor of plugin template.*
- virtual ~**plugin\_t** ()
- virtual void **prepare** (**mhaconfig\_t** &)=0
- virtual void **release** ()
- void **prepare\_** (**mhaconfig\_t** &)
- void **release\_** ()
- bool **is\_prepared** () const  
*Flag, if the prepare method is successfully called (or currently evaluated)*
- **mhaconfig\_t input\_cfg** () const  
*Current input channel configuration.*
- **mhaconfig\_t output\_cfg** () const  
*Current output channel configuration.*

### Protected Attributes

- **mhaconfig\_t tftype**  
*Member for storage of plugin interface configuration.*
- **algo\_comm\_t ac**  
*AC handle of the chain.*

### Private Attributes

- bool **is\_prepared\_**
- **mhaconfig\_t input\_cfg\_**
- **mhaconfig\_t output\_cfg\_**
- **MHAParser::mhaconfig\_mon\_t mhaconfig\_in**
- **MHAParser::mhaconfig\_mon\_t mhaconfig\_out**

### Additional Inherited Members

#### 5.278.1 Detailed Description

```
template<class runtime_cfg_t>  
class MHAPlugin::plugin_t< runtime_cfg_t >
```

The template class for C++ openMHA plugins.

## Template Parameters

<i>runtime_↔ cfg_t</i>	run-time configuration.
----------------------------	-------------------------

**Todo** Describe all services provided by this class, so that the reason why it is recommended that all plugins use this class as their base is evident. Document all relevant methods and fields.

This template class provides thread safe configuration handling and standard methods to be compatible to the C++ openMHA plugin wrapper macro **MHAPLUGIN\_CALLBACKS** (p. 10).

The template parameter `runtime_cfg_t` should be the runtime configuration of the plugin.

See **MHAPLugin::config\_t** (p. 723) for details on the thread safe communication update mechanism.

### 5.278.2 Constructor & Destructor Documentation

5.278.2.1 `template<class runtime_cfg_t > MHAPLugin::plugin_t< runtime_cfg_t >::plugin_t ( const std::string & help, const algo_comm_t & iac )`

Constructor of plugin template.

#### Parameters

<i>help</i>	Help comment to provide some general information about the plugin.
<i>iac</i>	AC space handle (will be stored into the member variable ac).

5.278.2.2 `template<class runtime_cfg_t > MHAPLugin::plugin_t< runtime_cfg_t >::~~plugin_t ( ) [virtual]`

### 5.278.3 Member Function Documentation

5.278.3.1 `template<class runtime_cfg_t> virtual void MHAPLugin::plugin_t< runtime_cfg_t >::prepare ( mhaconfig_t & ) [pure virtual]`

Implemented in **bbcalib\_interface\_t** (p. 229), **calibrator\_t** (p. 232), **addsndfile↔::addsndfile\_if\_t** (p. 181), **testplugin::if\_t** (p. 935), **analysispath\_if\_t** (p. 220), **adm\_↔if\_t** (p. 196), **ac2lsl::ac2lsl\_t** (p. 132), **overlapadd::overlapadd\_if\_t** (p. 860), **noisePow↔ProposedScale::interface\_t** (p. 856), **dc\_simple::dc\_if\_t** (p. 264), **dc::dc\_if\_t** (p. 254),

**multibandcompressor::interface\_t** (p. 848), **plingploing::if\_t** (p. 866), **combc\_if\_t** (p. 244), **gtfb\_analyzer::gtfb\_analyzer\_t** (p. 357), **coherence::cohflt\_if\_t** (p. 238), **plugin\_interface\_t** (p. 873), **example6\_t** (p. 317), **smoothgains\_bridge::overlapadd\_if\_t** (p. 913), **MHAPlugin\_Resampling::resampling\_if\_t** (p. 734), **shadowfilter\_end::shadowfilter\_end\_t** (p. 909), **ac2wave\_if\_t** (p. 149), **noise\_t** (p. 854), **nlms\_t** (p. 852), **prediction\_error** (p. 888), **fshift\_hilbert::frequency\_translator\_t** (p. 338), **acPooling\_wave** (p. 161), **spec2wave\_if\_t** (p. 921), **mhachain::chain\_base\_t** (p. 499), **acsave::acsave\_t** (p. 166), **fader\_wave::fader\_wave\_if\_t** (p. 321), **doasvm\_feature\_extraction** (p. 284), **fshift::fshift\_t** (p. 335), **rmslevel\_if\_t** (p. 893), **shadowfilter\_begin::shadowfilter\_begin\_t** (p. 906), **example3\_t** (p. 310), **example4\_t** (p. 314), **lpc\_bl\_predictor** (p. 399), **lpc\_burglattice** (p. 404), **steerbf** (p. 927), **delaysum::delaysum\_if\_t** (p. 276), **lpc** (p. 396), **db\_if\_t** (p. 250), **fader\_if\_t** (p. 319), **acConcat\_wave** (p. 153), **acSteer** (p. 173), **acTransform\_wave** (p. 177), **wave2spec\_if\_t** (p. 950), **fftfbpow::fftfbpow\_interface\_t** (p. 325), **gain::gain\_if\_t** (p. 351), **droptect\_t** (p. 288), **example1\_t** (p. 304), **sine\_t** (p. 911), **example2\_t** (p. 307), **doasvm\_classification** (p. 280), **fftfilterbank::fftfb\_interface\_t** (p. 329), **wavrec\_t** (p. 954), **matrixmixer::matmix\_t** (p. 411), **route::interface\_t** (p. 896), **altplugs\_t** (p. 214), **softclip\_t** (p. 917), **ac2osc\_t** (p. 146), **save\_spec\_t** (p. 902), **save\_wave\_t** (p. 903), **acmon::acmon\_t** (p. 158), **timoSmooth** (p. 946), **identity\_t** (p. 360), **cpuload\_t** (p. 248), **delay::interface\_t** (p. 274), **ds\_t** (p. 291), and **us\_t** (p. 948).

5.278.3.2 `template<class runtime_cfg_t > void MHAPlugin::plugin_t< runtime_cfg_t >::release ( )` [virtual]

Reimplemented in **bbcalib\_interface\_t** (p. 229), **calibrator\_t** (p. 232), **addsndfile::addsndfile\_if\_t** (p. 181), **analysispath\_if\_t** (p. 220), **ac2lsl::ac2lsl\_t** (p. 132), **adm\_if\_t** (p. 196), **overlapadd::overlapadd\_if\_t** (p. 861), **dc\_simple::dc\_if\_t** (p. 264), **multibandcompressor::interface\_t** (p. 848), **coherence::cohflt\_if\_t** (p. 238), **smoothgains\_bridge::overlapadd\_if\_t** (p. 913), **MHAPlugin\_Resampling::resampling\_if\_t** (p. 734), **ac2wave\_if\_t** (p. 149), **nlms\_t** (p. 852), **prediction\_error** (p. 888), **fshift\_hilbert::frequency\_translator\_t** (p. 338), **acPooling\_wave** (p. 162), **mhachain::chain\_base\_t** (p. 499), **acsave::acsave\_t** (p. 166), **fader\_wave::fader\_wave\_if\_t** (p. 321), **doasvm\_feature\_extraction** (p. 285), **fshift::fshift\_t** (p. 336), **example3\_t** (p. 311), **example4\_t** (p. 314), **lpc\_bl\_predictor** (p. 400), **lpc\_burglattice** (p. 404), **steerbf** (p. 928), **delaysum::delaysum\_if\_t** (p. 276), **lpc** (p. 397), **db\_if\_t** (p. 250), **acConcat\_wave** (p. 153), **acSteer** (p. 174), **acTransform\_wave** (p. 178), **droptect\_t** (p. 288), **gain::gain\_if\_t** (p. 351), **example2\_t** (p. 307), **doasvm\_classification** (p. 281), **fftfilterbank::fftfb\_interface\_t** (p. 329), **wavrec\_t** (p. 954), **route::interface\_t** (p. 896), **ac2osc\_t** (p. 146), **example1\_t** (p. 304), **altplugs\_t** (p. 215), **acmon::acmon\_t** (p. 159), **timoSmooth** (p. 946), **identity\_t** (p. 360), **ds\_t** (p. 291), and **us\_t** (p. 948).

5.278.3.3 `template<class runtime_cfg_t > void MHAPlugin::plugin_t< runtime_cfg_t >::prepare_ ( mhaconfig_t & cf )`

5.278.3.4 `template<class runtime_cfg_t > void MHAPlugin::plugin_t< runtime_cfg_t >::release_ ( )`

5.278.3.5 `template<class runtime_cfg_t> bool MHAPlugin::plugin_t< runtime_cfg_t >::is_prepared ( ) const` [inline]

Flag, if the prepare method is successfully called (or currently evaluated)

5.278.3.6 `template<class runtime_cfg_t> mhaconfig_t MHAPlugin::plugin_t< runtime_cfg_t >::input_cfg ( ) const [inline]`

Current input channel configuration.

5.278.3.7 `template<class runtime_cfg_t> mhaconfig_t MHAPlugin::plugin_t< runtime_cfg_t >::output_cfg ( ) const [inline]`

Current output channel configuration.

#### 5.278.4 Member Data Documentation

5.278.4.1 `template<class runtime_cfg_t> mhaconfig_t MHAPlugin::plugin_t< runtime_cfg_t >::tftype [protected]`

Member for storage of plugin interface configuration.

This member is defined for convenience of the developer. Typically, the actual contents of **mhaconfig\_t** (p. 504) are stored in this member in the **prepare()** (p. 730) method.

#### Note

This member is likely to be removed in later versions, use **input\_cfg()** (p. 732) and **output\_cfg()** (p. 732) instead.

5.278.4.2 `template<class runtime_cfg_t> algo_comm_t MHAPlugin::plugin_t< runtime_cfg_t >::ac [protected]`

AC handle of the chain.

This variable is initialized in the constructor and can be used by derived plugins to access the AC space. Its contents should not be modified.

5.278.4.3 `template<class runtime_cfg_t> bool MHAPlugin::plugin_t< runtime_cfg_t >::is_prepared_ [private]`

5.278.4.4 `template<class runtime_cfg_t> mhaconfig_t MHAPlugin::plugin_t< runtime_cfg_t >::input_cfg_ [private]`

5.278.4.5 `template<class runtime_cfg_t> mhaconfig_t MHAPlugin::plugin_t< runtime_cfg_t >::output_cfg_ [private]`

5.278.4.6 `template<class runtime_cfg_t> MHAParser::mhaconfig_mon_t MHAPlugin::plugin_t< runtime_cfg_t >::mhaconfig_in [private]`

5.278.4.7 `template<class runtime_cfg_t> MHAParser::mhaconfig_mon_t MHAPlugin::plugin_t< runtime_cfg_t >::mhaconfig_out [private]`

The documentation for this class was generated from the following file:

- **mha\_plugin.hh**

5.279 MHAPLugin\_Resampling::resampling\_if\_t Class Reference

Inheritance diagram for MHAPLugin\_Resampling::resampling\_if\_t:

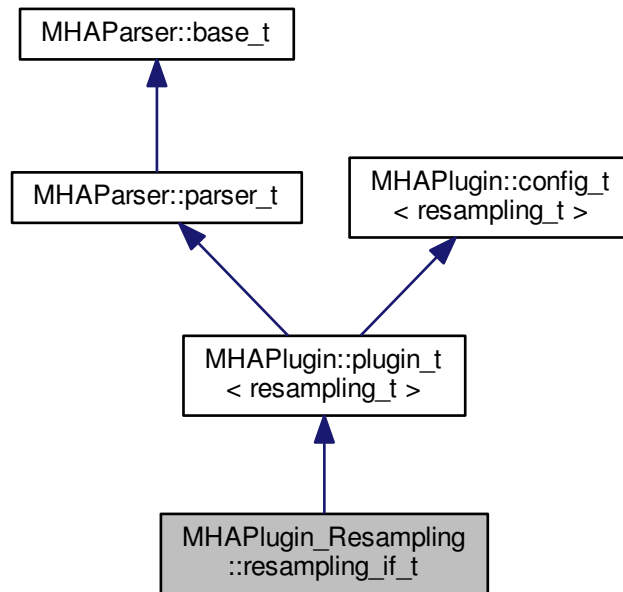

Public Member Functions

- **resampling\_if\_t** (algo\_comm\_t, std::string, std::string)
- **mha\_wave\_t \* process** (mha\_wave\_t \*)
- void **prepare** (mhaconfig\_t &)
- void **release** ()

Private Attributes

- **MHAParser::float\_t srate**
- **MHAParser::int\_t fragsize**
- **MHAParser::float\_t nyquist\_ratio**
- **MHAParser::float\_t irslen\_outer2inner**
- **MHAParser::float\_t irslen\_inner2outer**
- **MHAParser::mhapluginloader\_t plugloader**
- std::string **chain**
- std::string **algo**

## Additional Inherited Members

### 5.279.1 Constructor & Destructor Documentation

5.279.1.1 `MHAPLugin_Resampling::resampling_if_t::resampling_if_t ( algo_comm_t iac, std::string th, std::string al )`

### 5.279.2 Member Function Documentation

5.279.2.1 `mha_wave_t * MHAPLugin_Resampling::resampling_if_t::process ( mha_wave_t * s )`

5.279.2.2 `void MHAPLugin_Resampling::resampling_if_t::prepare ( mhaconfig_t & conf ) [virtual]`

Implements `MHAPLugin::plugin_t< resampling_t >` (p. 730).

5.279.2.3 `void MHAPLugin_Resampling::resampling_if_t::release ( void ) [virtual]`

Reimplemented from `MHAPLugin::plugin_t< resampling_t >` (p. 731).

### 5.279.3 Member Data Documentation

5.279.3.1 `MHAParser::float_t MHAPLugin_Resampling::resampling_if_t::srate [private]`

5.279.3.2 `MHAParser::int_t MHAPLugin_Resampling::resampling_if_t::fragsize [private]`

5.279.3.3 `MHAParser::float_t MHAPLugin_Resampling::resampling_if_t::nyquist_ratio [private]`

5.279.3.4 `MHAParser::float_t MHAPLugin_Resampling::resampling_if_t::irslen_outer2inner [private]`

5.279.3.5 `MHAParser::float_t MHAPLugin_Resampling::resampling_if_t::irslen_inner2outer [private]`

5.279.3.6 `MHAParser::mhapluginloader_t MHAPLugin_Resampling::resampling_if_t::plugloader [private]`

5.279.3.7 `std::string MHAPLugin_Resampling::resampling_if_t::chain [private]`

5.279.3.8 `std::string MHAPLugin_Resampling::resampling_if_t::algo [private]`

The documentation for this class was generated from the following file:

- `resampling.cpp`

## 5.280 MHAPlugin\_Resampling::resampling\_t Class Reference

## Public Member Functions

- **resampling\_t** (unsigned int **outer\_fragsize**, float **outer\_srate**, unsigned int **inner\_fragsize**, float **inner\_srate**, unsigned int **nch\_in**, float **filter\_length\_in**, unsigned int **nch\_out**, float **filter\_length\_out**, float **nyquist\_ratio**, **MHAParser::mhapluginloader\_t** &plug)
- **mha\_wave\_t \* process** (**mha\_wave\_t \***)

## Private Attributes

- unsigned **outer\_fragsize**
- unsigned **inner\_fragsize**
- float **outer\_srate**
- float **inner\_srate**
- unsigned **nchannels\_in**
- unsigned **nchannels\_out**
- **MHAFilter::blockprocessing\_polyphase\_resampling\_t** **outer2inner\_resampling**
- **MHAFilter::blockprocessing\_polyphase\_resampling\_t** **inner2outer\_resampling**
- **MHAParser::mhapluginloader\_t** & **plugloader**
- **MHASignal::waveform\_t** **inner\_signal**
- **MHASignal::waveform\_t** **output\_signal**

## 5.280.1 Constructor &amp; Destructor Documentation

5.280.1.1 MHAPlugin\_Resampling::resampling\_t::resampling\_t ( unsigned int *outer\_fragsize*, float *outer\_srate*, unsigned int *inner\_fragsize*, float *inner\_srate*, unsigned int *nch\_in*, float *filter\_length\_in*, unsigned int *nch\_out*, float *filter\_length\_out*, float *nyquist\_ratio*, **MHAParser::mhapluginloader\_t** & *plug* )

## 5.280.2 Member Function Documentation

5.280.2.1 **mha\_wave\_t \* MHAPlugin\_Resampling::resampling\_t::process** ( **mha\_wave\_t \* s** )

## 5.280.3 Member Data Documentation

- 5.280.3.1 unsigned MHAPlugin\_Resampling::resampling\_t::outer\_fragsize [private]
- 5.280.3.2 unsigned MHAPlugin\_Resampling::resampling\_t::inner\_fragsize [private]
- 5.280.3.3 float MHAPlugin\_Resampling::resampling\_t::outer\_srate [private]
- 5.280.3.4 float MHAPlugin\_Resampling::resampling\_t::inner\_srate [private]
- 5.280.3.5 unsigned MHAPlugin\_Resampling::resampling\_t::nchannels\_in [private]
- 5.280.3.6 unsigned MHAPlugin\_Resampling::resampling\_t::nchannels\_out [private]
- 5.280.3.7 MHAFilter::blockprocessing\_polyphase\_resampling\_t  
MHAPlugin\_Resampling::resampling\_t::outer2inner\_resampling [private]
- 5.280.3.8 MHAFilter::blockprocessing\_polyphase\_resampling\_t  
MHAPlugin\_Resampling::resampling\_t::inner2outer\_resampling [private]
- 5.280.3.9 MHAParser::mhapluginloader\_t& MHAPlugin\_Resampling::resampling\_t::plugloader  
[private]
- 5.280.3.10 MHASignal::waveform\_t MHAPlugin\_Resampling::resampling\_t::inner\_signal  
[private]
- 5.280.3.11 MHASignal::waveform\_t MHAPlugin\_Resampling::resampling\_t::output\_signal  
[private]

The documentation for this class was generated from the following file:

- **resampling.cpp**

## 5.281 MHAPlugin\_Split::domain\_handler\_t Class Reference

Handles domain-specific partial input and output signal.

Inheritance diagram for MHAPlugin\_Split::domain\_handler\_t:

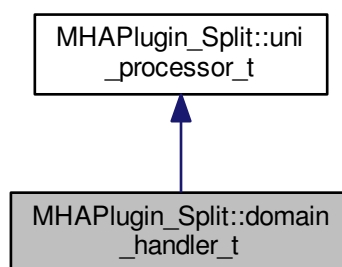



## Public Member Functions

- void **set\_input\_domain** (const **mhaconfig\_t** &settings\_in)  
*Set parameters of input signal.*
- void **set\_output\_domain** (const **mhaconfig\_t** &settings\_out)  
*Set output signal parameters.*
- void **deallocate\_domains** ()  
*Deallocate domain indicators and signal holders.*
- **domain\_handler\_t** (const **mhaconfig\_t** &settings\_in, const **mhaconfig\_t** &settings\_out, **PluginLoader::fourway\_processor\_t** \*processor)  
*Construct a new domain handler once the domains and dimensions of input and output signal of one of the child plugins of split are known.*
- virtual ~**domain\_handler\_t** ()  
*Deallocation of signal holders.*
- unsigned **put\_signal** (**mha\_wave\_t** \*s\_in, unsigned start\_channel)  
*Store the relevant channels from the input signal for processing.*
- unsigned **put\_signal** (**mha\_spec\_t** \*s\_in, unsigned start\_channel)  
*Store the relevant channels from the input signal for processing.*
- unsigned **get\_signal** (**MHASignal::waveform\_t** \*s\_out, unsigned start\_channel)  
*Store all partial signal output channels in the combined waveform signal with the given channel offset.*
- unsigned **get\_signal** (**MHASignal::spectrum\_t** \*s\_out, unsigned start\_channel)  
*Store all partial signal output channels in the combined spectrum signal with the given channel offset.*
- void **process** ()  
*Call the processing method of the processor with configured input/output signal domains.*

## Public Attributes

- **MHASignal::waveform\_t** \* **wave\_in**  
*Partial wave input signal.*
- **mha\_wave\_t** \*\* **wave\_out**  
*Partial wave output signal.*
- **MHASignal::spectrum\_t** \* **spec\_in**  
*Partial spec input signal.*
- **mha\_spec\_t** \*\* **spec\_out**  
*Partial spec input signal.*
- **PluginLoader::fourway\_processor\_t** \* **processor**  
*The domain-specific signal processing methods are implemented here.*

## Private Member Functions

- **domain\_handler\_t** (const **domain\_handler\_t** &)  
*Disallow copy constructor.*
- **domain\_handler\_t** & **operator=** (const **domain\_handler\_t** &)  
*Disallow assignment operator.*

### 5.281.1 Detailed Description

Handles domain-specific partial input and output signal.

### 5.281.2 Constructor & Destructor Documentation

5.281.2.1 `MHAPLugin_Split::domain_handler_t::domain_handler_t ( const domain_handler_t & ) [private]`

Disallow copy constructor.

5.281.2.2 `MHAPLugin_Split::domain_handler_t::domain_handler_t ( const mhaconfig_t & settings_in, const mhaconfig_t & settings_out, PluginLoader::fourway_processor_t * processor ) [inline]`

Construct a new domain handler once the domains and dimensions of input and output signal of one of the child plugins of split are known.

5.281.2.3 `virtual MHAPLugin_Split::domain_handler_t::~~domain_handler_t ( ) [inline], [virtual]`

Deallocation of signal holders.

### 5.281.3 Member Function Documentation

5.281.3.1 `domain_handler_t& MHAPLugin_Split::domain_handler_t::operator= ( const domain_handler_t & ) [private]`

Disallow assignment operator.

5.281.3.2 `void MHAPLugin_Split::domain_handler_t::set_input_domain ( const mhaconfig_t & settings_in ) [inline]`

Set parameters of input signal.

#### Parameters

<code>settings_in</code>	domain and dimensions of partial input signal
--------------------------	---

5.281.3.3 void MHAPlugin\_Split::domain\_handler\_t::set\_output\_domain ( const mhaconfig\_t & settings\_out ) [inline]

Set output signal parameters.

#### Parameters

<i>settings_out</i>	domain and dimensions of partial output signal
---------------------	--

5.281.3.4 void MHAPlugin\_Split::domain\_handler\_t::deallocate\_domains ( ) [inline]

Deallocate domain indicators and signal holders.

5.281.3.5 unsigned MHAPlugin\_Split::domain\_handler\_t::put\_signal ( mha\_wave\_t \* s\_in, unsigned start\_channel ) [inline]

Store the relevant channels from the input signal for processing.

The number of channels to store is taken from the dimensions of the partial input signal holder **wave\_in** (p. 741).

#### Parameters

<i>s_in</i>	The combined waveform input signal.
<i>start_channel</i>	The index (0-based) of the first channel in <i>s_in</i> to be copied to the partial input signal.

#### Returns

The number of channels that were copied from the input signal

5.281.3.6 unsigned MHAPlugin\_Split::domain\_handler\_t::put\_signal ( mha\_spec\_t \* s\_in, unsigned start\_channel ) [inline]

Store the relevant channels from the input signal for processing.

The number of channels to store is taken from the dimensions of the partial input signal holder **spec\_in** (p. 741).

#### Parameters

<i>s_in</i>	The combined spectrum input signal.
<i>start_channel</i>	The index (0-based) of the first channel in <i>s_in</i> to be copied to the partial input signal.

**Returns**

The number of channels that were copied from the input signal

```
5.281.3.7 unsigned MHAPlugin_Split::domain_handler_t::get_signal (
    MHASignal::waveform_t * s_out,
    unsigned start_channel ) [inline]
```

Store all partial signal output channels in the combined waveform signal with the given channel offset.

All channels present in **wave\_out** (p. 741) will be copied. Caller may use (\*wave\_out)->num←\_channels to check the number of channels in advance.

**Parameters**

<i>s_out</i>	The combined waveform output signal.
<i>start_channel</i>	The channel offset (0-based) in s_out.

**Returns**

The number of channels that were copied to the output signal

```
5.281.3.8 unsigned MHAPlugin_Split::domain_handler_t::get_signal (
    MHASignal::spectrum_t * s_out,
    unsigned start_channel ) [inline]
```

Store all partial signal output channels in the combined spectrum signal with the given channel offset.

All channels present in **spec\_out** (p. 741) will be copied. Caller may use (\*spec\_out)->num←\_channels to check the number of channels in advance.

**Parameters**

<i>s_out</i>	The combined spectrum output signal.
<i>start_channel</i>	The channel offset (0-based) in s_out.

**Returns**

The number of channels that were copied to the output signal

```
5.281.3.9 void MHAPlugin_Split::domain_handler_t::process (
    void ) [inline], [virtual]
```

Call the processing method of the processor with configured input/output signal domains.

The input signal has to be stored using **put\_signal** (p. 739) before this method may be called.

Implements **MHAPlugin\_Split::uni\_processor\_t** (p. 760).

#### 5.281.4 Member Data Documentation

##### 5.281.4.1 MHASignal::waveform\_t\* MHAPlugin\_Split::domain\_handler\_t::wave\_in

Partial wave input signal.

##### 5.281.4.2 mha\_wave\_t\*\* MHAPlugin\_Split::domain\_handler\_t::wave\_out

Partial wave output signal.

##### 5.281.4.3 MHASignal::spectrum\_t\* MHAPlugin\_Split::domain\_handler\_t::spec\_in

Partial spec input signal.

##### 5.281.4.4 mha\_spec\_t\*\* MHAPlugin\_Split::domain\_handler\_t::spec\_out

Partial spec input signal.

##### 5.281.4.5 PluginLoader::fourway\_processor\_t\* MHAPlugin\_Split::domain\_handler\_t::processor

The domain-specific signal processing methods are implemented here.

The documentation for this class was generated from the following file:

- **split.cpp**

## 5.282 MHAPlugin\_Split::dummy\_threads\_t Class Reference

Dummy specification of a thread platform: This class implements everything in a single thread.

Inheritance diagram for MHAPlugin\_Split::dummy\_threads\_t:

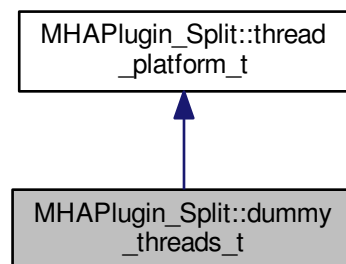

## Public Member Functions

- void **kick\_thread** ()  
*perform signal processing immediately (no multiple threads in this dummy class)*
- void **catch\_thread** ()  
*No implementation needed: Processing has been completed during `ummy_threads_t::kick_thread`.*
- **dummy\_threads\_t** (**uni\_processor\_t** \*proc, const std::string &thread\_scheduler, int thread\_priority)  
*Constructor.*

## Additional Inherited Members

### 5.282.1 Detailed Description

Dummy specification of a thread platform: This class implements everything in a single thread.

### 5.282.2 Constructor & Destructor Documentation

5.282.2.1 **MHAPugin\_Split::dummy\_threads\_t::dummy\_threads\_t** (**uni\_processor\_t** \*proc, const std::string &thread\_scheduler, int thread\_priority ) [inline]

Constructor.

#### Parameters

<i>proc</i>	Pointer to the associated plugin loader
<i>thread_scheduler</i>	Unused in dummy thread platform
<i>thread_priority</i>	Unused in dummy thread platform

### 5.282.3 Member Function Documentation

5.282.3.1 void **MHAPugin\_Split::dummy\_threads\_t::kick\_thread** ( ) [inline],[virtual]

perform signal processing immediately (no multiple threads in this dummy class)

Implements **MHAPugin\_Split::thread\_platform\_t** (p. 758).

5.282.3.2 void MHAPlugin\_Split::dummy\_threads\_t::catch\_thread ( ) [inline],[virtual]

No implementation needed: Processing has been completed during ummy\_threads\_t::kick\_↔ thread.

Implements MHAPlugin\_Split::thread\_platform\_t (p. 758).

The documentation for this class was generated from the following file:

- **split.cpp**

## 5.283 MHAPlugin\_Split::posix\_threads\_t Class Reference

Posix threads specification of thread platform.

Inheritance diagram for MHAPlugin\_Split::posix\_threads\_t:

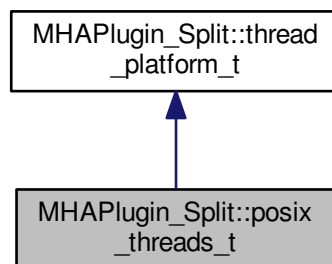

### Public Member Functions

- void **kick\_thread** ()  
*Start signal processing in separate thread.*
- void **catch\_thread** ()  
*Wait for signal processing to finish.*
- **posix\_threads\_t** (**uni\_processor\_t** \*proc, const std::string &thread\_scheduler, int thread\_priority)  
*Constructor.*
- **~posix\_threads\_t** ()  
*Terminate thread.*
- void **main** ()  
*Thread main loop. Wait for process/termination trigger, then act.*

### Static Public Member Functions

- static void \* **thread\_start** (void \*thr)  
*Thread start function.*
- static std::string **current\_thread\_scheduler** ()
- static int **current\_thread\_priority** ()

### Private Attributes

- pthread\_mutex\_t **mutex**  
*The mutex.*
- pthread\_cond\_t **kick\_condition**  
*The condition for signalling the kicking and termination.*
- pthread\_cond\_t **catch\_condition**  
*The condition for signalling the processing is finished.*
- pthread\_attr\_t **attr**  
*Thread attributes.*
- struct sched\_param **priority**  
*Thread scheduling priority.*
- int **scheduler**
- pthread\_t **thread**  
*The thread object.*
- bool **kicked**  
*A flag that is set to true by kick\_thread and to false by the thread after it has woken up from the kicking.*
- bool **processing\_done**  
*A flag that is set to true by the thread when it returns from processing and to false by catch\_↔ thread after it has waited for that return.*
- bool **termination\_request**  
*Set to true by the destructor.*

### Additional Inherited Members

#### 5.283.1 Detailed Description

Posix threads specification of thread platform.

#### 5.283.2 Constructor & Destructor Documentation

5.283.2.1 `MHAPugin_Split::posix_threads_t::posix_threads_t (`  
     `uni_processor_t * proc,`  
     `const std::string & thread_scheduler,`  
     `int thread_priority ) [inline]`

Constructor.



## Parameters

<i>proc</i>	Pointer to the associated signal processor instance
<i>thread_scheduler</i>	A string describing the posix thread scheduler. Possible values: "SCHED_OTHER", "SCHED_RR", "SCHED_FIFO".
<i>thread_priority</i>	The scheduling priority of the new thread.

## 5.283.2.2 MHAPlugin\_Split::posix\_threads\_t::~~posix\_threads\_t ( ) [inline]

Terminate thread.

## 5.283.3 Member Function Documentation

## 5.283.3.1 void MHAPlugin\_Split::posix\_threads\_t::kick\_thread ( ) [inline],[virtual]

Start signal processing in separate thread.

Implements **MHAPlugin\_Split::thread\_platform\_t** (p. 758).

## 5.283.3.2 void MHAPlugin\_Split::posix\_threads\_t::catch\_thread ( ) [inline],[virtual]

Wait for signal processing to finish.

Implements **MHAPlugin\_Split::thread\_platform\_t** (p. 758).

5.283.3.3 static void\* MHAPlugin\_Split::posix\_threads\_t::thread\_start ( void \* *thr* ) [inline],[static]

Thread start function.

## 5.283.3.4 void MHAPlugin\_Split::posix\_threads\_t::main ( ) [inline]

Thread main loop. Wait for process/termination trigger, then act.

## 5.283.3.5 static std::string MHAPlugin\_Split::posix\_threads\_t::current\_thread\_scheduler ( ) [inline],[static]

## 5.283.3.6 static int MHAPlugin\_Split::posix\_threads\_t::current\_thread\_priority ( ) [inline],[static]

## 5.283.4 Member Data Documentation

## 5.283.4.1 pthread\_mutex\_t MHAPlugin\_Split::posix\_threads\_t::mutex [private]

The mutex.

5.283.4.2 `pthread_cond_t MHAPlugin_Split::posix_threads_t::kick_condition` [private]

The condition for signalling the kicking and termination.

5.283.4.3 `pthread_cond_t MHAPlugin_Split::posix_threads_t::catch_condition` [private]

The condition for signalling the processing is finished.

5.283.4.4 `pthread_attr_t MHAPlugin_Split::posix_threads_t::attr` [private]

Thread attributes.

5.283.4.5 `struct sched_param MHAPlugin_Split::posix_threads_t::priority` [private]

Thread scheduling priority.

5.283.4.6 `int MHAPlugin_Split::posix_threads_t::scheduler` [private]

5.283.4.7 `pthread_t MHAPlugin_Split::posix_threads_t::thread` [private]

The thread object.

5.283.4.8 `bool MHAPlugin_Split::posix_threads_t::kicked` [private]

A flag that is set to true by `kick_thread` and to false by the thread after it has woken up from the kicking.

5.283.4.9 `bool MHAPlugin_Split::posix_threads_t::processing_done` [private]

A flag that is set to true by the thread when it returns from processing and to false by `catch_↔` thread after it has waited for that return.

5.283.4.10 `bool MHAPlugin_Split::posix_threads_t::termination_request` [private]

Set to true by the destructor.

The documentation for this class was generated from the following file:

- **split.cpp**

## 5.284 MHAPugin\_Split::split\_t Class Reference

Implements split plugin.

Inheritance diagram for MHAPugin\_Split::split\_t:

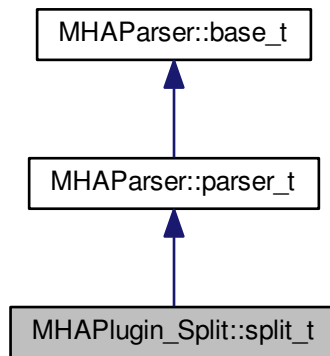

## Public Member Functions

- **split\_t** (**algo\_comm\_t** iac, const std::string &chain\_name, const std::string &algo\_name)  
*Plugin constructor.*
- **~split\_t** ()  
*Plugin destructor. Unloads nested plugins.*
- void **prepare\_** (**mhaconfig\_t** &)  
*Check signal parameters, prepare chains, and allocate output signal holders.*
- void **release\_** ()  
*Delete output signal holder and release chains.*
- template<class SigTypeIn , class SigTypeOut >  
void **process** (SigTypeIn \*, SigTypeOut \*\*)  
*Let the parallel plugins process channel groups of the input signal.*

## Private Member Functions

- void **update** ()  
*Load plugins in response to a value change in the algos variable.*
- void **clear\_chains** ()  
*Unload the plugins.*
- **mha\_wave\_t** \* **copy\_output\_wave** ()
- **mha\_spec\_t** \* **copy\_output\_spec** ()

- `template<class SigType >`  
`void trigger_processing (SigType *s_in)`  
*Split the argument input signal to groups of channels for the plugins and initiate signal processing.*
- `template<class SigType >`  
`void collect_result (SigType *s_out)`  
*Combine the output signal from the plugins.*
- `MHASignal::waveform_t * signal_out (mha_wave_t **)`  
*Waveform domain output signal structure accessor.*
- `MHASignal::spectrum_t * signal_out (mha_spec_t **)`  
*Spectrum domain output signal structure. Parameter is ignored.*

#### Private Attributes

- `MHAEvents::patchbay_t< split_t > patchbay`  
*Reload plugins when the algos variable changes.*
- `MHAParser::vstring_t algos`  
*Vector of plugins to load in parallel.*
- `MHAParser::vint_t channels`  
*Number of channels to route through each plugin.*
- `MHAParser::kw_t thread_platform`  
*Thread platform chooser.*
- `MHAParser::kw_t worker_thread_scheduler`  
*Scheduler used for worker threads.*
- `MHAParser::int_t worker_thread_priority`  
*Priority of worker threads.*
- `MHAParser::string_mon_t framework_thread_scheduler`  
*Scheduler of the signal processing thread.*
- `MHAParser::int_mon_t framework_thread_priority`  
*Priority of signal processing thread.*
- `MHAParser::bool_t delay`  
*Switch to activate parallel processing of plugins at the cost of one block of additional delay.*
- `std::vector< splitted_part_t * > chains`  
*Interfaces to parallel plugins.*
- `MHASignal::waveform_t * wave_out`  
*Combined output waveforms structure.*
- `MHASignal::spectrum_t * spec_out`  
*Combined output spectra structure.*

#### Additional Inherited Members

##### 5.284.1 Detailed Description

Implements split plugin.

An instance of class `split_t` (p. 747) implements the split plugin functionality: The audio channels are splitted and groups of audio channels are processed by different plugins in parallel.

## 5.284.2 Constructor &amp; Destructor Documentation

5.284.2.1 MHAPlugin\_Split::split\_t::split\_t (   
     **algo\_comm\_t** *iac*,  
     const std::string & *chain\_name*,  
     const std::string & *algo\_name* )

Plugin constructor.

5.284.2.2 MHAPlugin\_Split::split\_t::~~split\_t ( )

Plugin destructor. Unloads nested plugins.

## 5.284.3 Member Function Documentation

5.284.3.1 void MHAPlugin\_Split::split\_t::prepare\_ (   
     **mhaconfig\_t** & *signal\_parameters* )

Check signal parameters, prepare chains, and allocate output signal holders.

5.284.3.2 void MHAPlugin\_Split::split\_t::release\_ ( )

Delete output signal holder and release chains.

5.284.3.3 template<class SigTypeIn , class SigTypeOut > void MHAPlugin\_Split::split\_t::process (   
     SigTypeIn \* *s\_in*,  
     SigTypeOut \*\* *s\_out* )

Let the parallel plugins process channel groups of the input signal.

5.284.3.4 void MHAPlugin\_Split::split\_t::update ( ) [private]

Load plugins in response to a value change in the algos variable.

5.284.3.5 void MHAPlugin\_Split::split\_t::clear\_chains ( ) [private]

Unload the plugins.

5.284.3.6 **mha\_wave\_t\*** MHAPlugin\_Split::split\_t::copy\_output\_wave ( ) [private]

5.284.3.7 **mha\_spec\_t\*** MHAPlugin\_Split::split\_t::copy\_output\_spec ( ) [private]

5.284.3.8 template<class SigType > void MHAPlugin\_Split::split\_t::trigger\_processing (   
     SigType \* *s\_in* ) [private]

Split the argument input signal to groups of channels for the plugins and initiate signal processing.

**5.284.3.9** `template<class SigType > void MHAPLugin_Split::split_t::collect_result ( SigType * s_out ) [private]`

Combine the output signal from the plugins.

**5.284.3.10** `MHASignal::waveform_t* MHAPLugin_Split::split_t::signal_out ( mha_wave_t** ) [inline],[private]`

Waveform domain output signal structure accessor.

Parameter is only for domain disambiguation and is ignored.

**5.284.3.11** `MHASignal::spectrum_t* MHAPLugin_Split::split_t::signal_out ( mha_spec_t** ) [inline],[private]`

Spectrum domain output signal structure. Parameter is ignored.

#### **5.284.4 Member Data Documentation**

**5.284.4.1** `MHAEvents::patchbay_t<split_t> MHAPLugin_Split::split_t::patchbay [private]`

Reload plugins when the algos variable changes.

**5.284.4.2** `MHAParser::vstring_t MHAPLugin_Split::split_t::algos [private]`

Vector of plugins to load in parallel.

**5.284.4.3** `MHAParser::vint_t MHAPLugin_Split::split_t::channels [private]`

Number of channels to route through each plugin.

**5.284.4.4** `MHAParser::kw_t MHAPLugin_Split::split_t::thread_platform [private]`

Thread platform chooser.

**5.284.4.5** `MHAParser::kw_t MHAPLugin_Split::split_t::worker_thread_scheduler [private]`

Scheduler used for worker threads.

**5.284.4.6** `MHAParser::int_t MHAPLugin_Split::split_t::worker_thread_priority [private]`

Priority of worker threads.

5.284.4.7 **MHAParser::string\_mon\_t** MHAPlugin\_Split::split\_t::framework\_thread\_scheduler  
[private]

Scheduler of the signal processing thread.

5.284.4.8 **MHAParser::int\_mon\_t** MHAPlugin\_Split::split\_t::framework\_thread\_priority  
[private]

Priority of signal processing thread.

5.284.4.9 **MHAParser::bool\_t** MHAPlugin\_Split::split\_t::delay [private]

Switch to activate parallel processing of plugins at the cost of one block of additional delay.

5.284.4.10 **std::vector<splitted\_part\_t\*>** MHAPlugin\_Split::split\_t::chains [private]

Interfaces to parallel plugins.

5.284.4.11 **MHASignal::waveform\_t\*** MHAPlugin\_Split::split\_t::wave\_out [private]

Combined output waveforms structure.

5.284.4.12 **MHASignal::spectrum\_t\*** MHAPlugin\_Split::split\_t::spec\_out [private]

Combined output spectra structure.

The documentation for this class was generated from the following file:

- **split.cpp**

## 5.285 MHAPlugin\_Split::splitted\_part\_t Class Reference

The **splitted\_part\_t** (p. 751) instance manages the plugin that performs processing on the reduced set of channels.

Inheritance diagram for MHAPlugin\_Split::splitted\_part\_t:

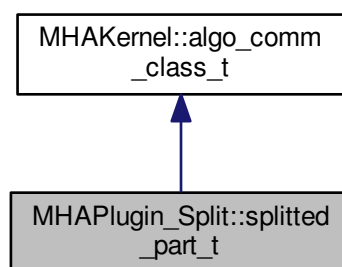

## Public Member Functions

- **splitted\_part\_t** (const std::string &plugname, **MHAParser::parser\_t** \*parent)  
*Load the plugin for this partial signal path.*
- **splitted\_part\_t** (**PluginLoader::fourway\_processor\_t** \*plugin)  
*Create the handler for the partial signal.*
- **~splitted\_part\_t** () throw ()  
*Destructor. Deletes the plugin **plug** (p. 755).*
- void **prepare** (**mhaconfig\_t** &signal\_parameters, const std::string &thread\_platform, const std::string &thread\_scheduler, int thread\_priority)  
*Delegates the prepare method to the plugin and allocates a suitable **MHAPLugin\_Split::domain\_handler\_t** (p. 736) instance.*
- void **release** ()  
*Delegates the release method to the plugin and deletes the **MHAPLugin\_Split::domain\_handler\_t** (p. 736) instance.*
- std::string **parse** (const std::string &str)  
*Delegates parser invocation to plugin.*
- template<class SigType >  
unsigned **trigger\_processing** (SigType \*s\_in, unsigned start\_channel)  
*The domain handler copies the input signal channels.*
- template<class SigType >  
unsigned **collect\_result** (SigType \*s\_out, unsigned start\_channel)  
*Wait until processing is finished, then copy the output data.*

## Private Member Functions

- **splitted\_part\_t** (const **splitted\_part\_t** &)  
*Disallow copy constructor.*
- **splitted\_part\_t** & **operator=** (const **splitted\_part\_t** &)  
*Disallow assignment operator.*

## Private Attributes

- **PluginLoader::fourway\_processor\_t** \* **plug**  
*The plugin that performs the signal processing on the prepared channels.*
- **domain\_handler\_t** \* **domain**  
*The domain specific signal handler, allocated from prepare when input and output domains and signal parameters are known.*
- **thread\_platform\_t** \* **thread**  
*The platform-dependent thread synchronization implementation.*



## Additional Inherited Members

## 5.285.1 Detailed Description

The **splitted\_part\_t** (p. 751) instance manages the plugin that performs processing on the reduced set of channels.

The signal is split by channels by this instance, but the signal is combined again by the calling class.

## 5.285.2 Constructor &amp; Destructor Documentation

#### 5.285.2.1 MHAPlugin\_Split::splitted\_part\_t::splitted\_part\_t ( const splitted\_part\_t & ) [private]

Disallow copy constructor.

#### 5.285.2.2 MHAPlugin\_Split::splitted\_part\_t::splitted\_part\_t ( const std::string & *plugname*, MHAParser::parser\_t \* *parent* )

Load the plugin for this partial signal path.

Loads the MHA plugin for a signal path of these audio channels.

## Parameters

<i>plugname</i>	The name of the MHA plugin, optionally followed by a colon and the algorithm name.
<i>parent</i>	The parser node where the configuration of the new plugin is inserted. The plugin's parser name is the configured name (colon syntax).

#### 5.285.2.3 MHAPlugin\_Split::splitted\_part\_t::splitted\_part\_t ( PluginLoader::fourway\_processor\_t \* *plugin* )

Create the handler for the partial signal.

The plugin is loaded by the caller, but it will be deleted by the destructor of this class. This constructor exists solely for testing purposes.

## Parameters

<i>plugin</i>	The plugin used for processing the signal. The new <b>splitted_part_t</b> (p. 753) instance will take ownership of this instance and release it in the destructor.
---------------	--

### 5.285.2.4 MHAPlugin\_Split::splitted\_part\_t::~splitted\_part\_t ( ) throw )

Destructor. Deletes the plugin **plug** (p. 755).

### 5.285.3 Member Function Documentation

#### 5.285.3.1 splitted\_part\_t & MHAPlugin\_Split::splitted\_part\_t::operator=( const splitted\_part\_t & ) [private]

Disallow assignment operator.

#### 5.285.3.2 void MHAPlugin\_Split::splitted\_part\_t::prepare ( mhaconfig\_t & signal\_parameters, const std::string & thread\_platform, const std::string & thread\_scheduler, int thread\_priority )

Delegates the prepare method to the plugin and allocates a suitable **MHAPlugin\_Split**↔  
**::domain\_handler\_t** (p. 736) instance.

Prepare the loaded plugin.

Plugin preparation.

#### Parameters

<i>signal_parameters</i>	The signal description parameters for this path.
<i>thread_platform</i>	The name of the thread platform to use. Possible values: "posix", "win32", "dummy".
<i>thread_scheduler</i>	The name of the scheduler to use. Posix threads support "SCHED_OTHER", "SCHED_RR", "SCHED_FIFO". The other thread platforms do not support different thread schedulers. This value is not used for platforms other than "posix".
<i>thread_priority</i>	The new thread priority. Interpretation and permitted range depend on the thread platform and possibly on the scheduler.

#### 5.285.3.3 void MHAPlugin\_Split::splitted\_part\_t::release ( void )

Delegates the release method to the plugin and deletes the **MHAPlugin\_Split**↔  
**handler\_t** (p. 736) instance.

Release the loaded plugin.

Plugin release.

5.285.3.4 `std::string MHAPlugin_Split::splitted_part_t::parse ( const std::string & str ) [inline]`

Delegates parser incovation to plugin.

5.285.3.5 `template<class SigType > unsigned MHAPlugin_Split::splitted_part_t::trigger_processing ( SigType * s_in, unsigned start_channel ) [inline]`

The domain handler copies the input signal channels.

Then, processing is initiated.

#### Parameters

<i>s_in</i>	The combined input signal.
<i>start_channel</i>	The index (0-based) of the first channel in <i>s_in</i> to be copied to the partial input signal.

#### Returns

The number of channels that were copied from the input signal

5.285.3.6 `template<class SigType > unsigned MHAPlugin_Split::splitted_part_t::collect_result ( SigType * s_out, unsigned start_channel ) [inline]`

Wait until processing is finished, then copy the output data.

#### Parameters

<i>s_out</i>	The combined waveform output signal.
<i>start_channel</i>	The channel offset (0-based) in <i>s_out</i> .

#### Returns

The number of channels that were copied to the output signal

### 5.285.4 Member Data Documentation

5.285.4.1 `PluginLoader::fourway_processor_t* MHAPlugin_Split::splitted_part_t::plug [private]`

The plugin that performs the signal processing on the prepared channels.

#### 5.285.4.2 `domain_handler_t*` `MHAPugin_Split::splitted_part_t::domain` `[private]`

The domain specific signal handler, allocated from prepare when input and output domains and signal parameters are known.

#### 5.285.4.3 `thread_platform_t*` `MHAPugin_Split::splitted_part_t::thread` `[private]`

The platform-dependent thread synchronization implementation.

The documentation for this class was generated from the following file:

- `split.cpp`

### 5.286 `MHAPugin_Split::thread_platform_t` Class Reference

Basic interface for encapsulating thread creation, thread priority setting, and synchronization on any threading platform (i.e., pthreads or win32threads).

Inheritance diagram for `MHAPugin_Split::thread_platform_t`:

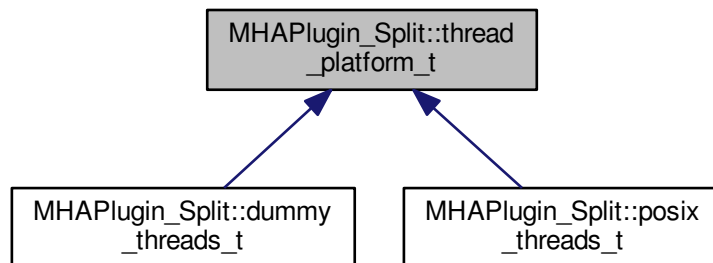

#### Public Member Functions

- `thread_platform_t (uni_processor_t *proc)`  
*Constructor.*
- `virtual ~thread_platform_t ()`  
*Make derived classes destructable via pointer to this base class.*
- `virtual void kick_thread ()=0`  
*Derived classes notify their processing thread that it should call `processor->process()`.*
- `virtual void catch_thread ()=0`  
*Derived classes wait for their signal processing thread to return from the call to `part->process()`.*

## Protected Attributes

- **uni\_processor\_t \* processor**

*A pointer to the plugin loader that processes the sound data in the channels for which this thread was created.*

## Private Member Functions

- **thread\_platform\_t** (const **thread\_platform\_t** &)  
*Disallow copy constructor.*
- **thread\_platform\_t & operator=** (const **thread\_platform\_t** &)  
*Disallow assignment operator.*

## 5.286.1 Detailed Description

Basic interface for encapsulating thread creation, thread priority setting, and synchronization on any threading platform (i.e., pthreads or win32threads).

Derived classes specialize in the actual thread platform.

## 5.286.2 Constructor &amp; Destructor Documentation

## 5.286.2.1 MHAPlugin\_Split::thread\_platform\_t::thread\_platform\_t (const thread\_platform\_t &amp; ) [private]

Disallow copy constructor.

## 5.286.2.2 MHAPlugin\_Split::thread\_platform\_t::thread\_platform\_t (uni\_processor\_t \* proc ) [inline]

Constructor.

Derived classes create the thread in the constructor.

## Parameters

<i>proc</i>	Pointer to the associated plugin loader. This plugin loader has to live at least as long as this instance. This instance does not take possession of the plugin loader. In production code, this thread platform and the plugin loader are both created and destroyed by the <b>MHAPlugin_Split::splitted_part_t</b> (p. 751) instance.
-------------	---

**5.286.2.3** `virtual MHAPlugin_Split::thread_platform_t::~~thread_platform_t ( ) [inline],  
[virtual]`

Make derived classes destructable via pointer to this base class.

Derived classes' destructors notify the thread that it should terminate itself, and wait for the termination to occur.

### 5.286.3 Member Function Documentation

**5.286.3.1** `thread_platform_t& MHAPlugin_Split::thread_platform_t::operator= (   
const thread_platform_t & ) [private]`

Disallow assignment operator.

**5.286.3.2** `virtual void MHAPlugin_Split::thread_platform_t::kick_thread ( ) [pure virtual]`

Derived classes notify their processing thread that it should call `processor->process()`.

Implemented in **MHAPlugin\_Split::posix\_threads\_t** (p. 745), and **MHAPlugin\_Split::dummy\_threads\_t** (p. 742).

**5.286.3.3** `virtual void MHAPlugin_Split::thread_platform_t::catch_thread ( ) [pure virtual]`

Derived classes wait for their signal processing thread to return from the call to `part->process()`.

Implemented in **MHAPlugin\_Split::posix\_threads\_t** (p. 745), and **MHAPlugin\_Split::dummy\_threads\_t** (p. 743).

### 5.286.4 Member Data Documentation

**5.286.4.1** `uni_processor_t* MHAPlugin_Split::thread_platform_t::processor [protected]`

A pointer to the plugin loader that processes the sound data in the channels for which this thread was created.

Using the **MHAPlugin\_Split::uni\_processor\_t** (p. 759) interface instead of the `mhaplugin-loader` class directly for testability (no need to load real plugins for testing the thread platform).

The documentation for this class was generated from the following file:

- **split.cpp**

## 5.287 MHAPugin\_Split::uni\_processor\_t Class Reference

An interface to a class that sports a process method with no parameters and no return value.

Inheritance diagram for MHAPugin\_Split::uni\_processor\_t:

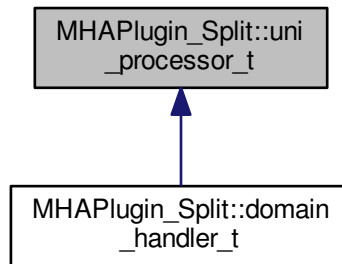

### Public Member Functions

- virtual void **process** ()=0

*This method uses some input signal, performs processing and stores the output signal somewhere.*

- virtual **~uni\_processor\_t** ()

*Classes containing virtual methods need virtual destructors.*

### 5.287.1 Detailed Description

An interface to a class that sports a process method with no parameters and no return value.

No signal transfer occurs through this interface, because the signal transfer is performed in another thread than the processing.

### 5.287.2 Constructor & Destructor Documentation

**5.287.2.1** virtual MHAPugin\_Split::uni\_processor\_t::~~uni\_processor\_t( ) [inline],[virtual]

Classes containing virtual methods need virtual destructors.

### 5.287.3 Member Function Documentation

#### 5.287.3.1 `virtual void MHAPlugin_Split::uni_processor_t::process ( ) [pure virtual]`

This method uses some input signal, performs processing and stores the output signal somewhere.

This method also has to dispatch the process call based on the configured domains.

Signal transfer and domain configuration have to be done in derived class in different methods.

Implemented in `MHAPlugin_Split::domain_handler_t` (p. 740).

The documentation for this class was generated from the following file:

- `split.cpp`

### 5.288 mhaserver\_t Class Reference

MHA Framework listening on TCP port for commands.

Inheritance diagram for `mhaserver_t`:

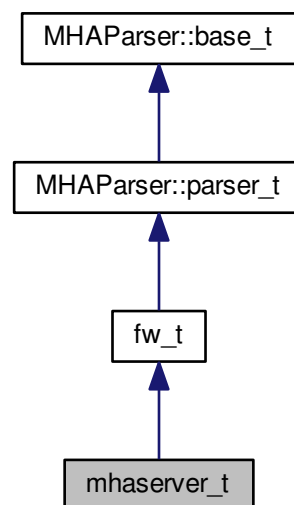



## Public Member Functions

- **mhaserver\_t** (const std::string &ao, const std::string &af, const std::string &lf)
- **~mhaserver\_t** ()
- virtual std::string **received\_group** (const std::string &line)  
*A line of text was received from network client.*
- virtual void **acceptor\_started** (int status)  
*Notification: "TCP port is open".*
- virtual void **set\_announce\_port** (unsigned short **announce\_port**)  
*If set to nonzero, the spawning process has asked to be notified of the TCP port used by this process.*
- void **logstring** (const std::string &)  
*Log a message to log file.*
- int **run** (unsigned short **port**, const std::string &\_interface)  
*Accept network connections and act on commands.*

## Public Attributes

- **MHAParser::int\_t port**

## Private Attributes

- **MHA\_TCP::Server \* tcpserver**
- std::string **ack\_ok**
- std::string **ack\_fail**
- std::string **logfile**
- unsigned short **announce\_port**
- **MHAParser::int\_mon\_t pid\_mon**

## Additional Inherited Members

### 5.288.1 Detailed Description

MHA Framework listening on TCP port for commands.

### 5.288.2 Constructor & Destructor Documentation

- #### 5.288.2.1 mhaserver\_t::mhaserver\_t (
- ```

const std::string & ao,
const std::string & af,
const std::string & lf )

```

**Parameters**

|           |                                                               |
|-----------|---------------------------------------------------------------|
| <i>ao</i> | Acknowledgement string at end of successful command responses |
| <i>af</i> | Acknowledgement string at end of failed command responses     |
| <i>lf</i> | File system path of file to use as log file. MHA appends.     |

5.288.2.2 `mhaserver_t::~mhaserver_t ( )`

**5.288.3 Member Function Documentation**

5.288.3.1 `std::string mhaserver_t::received_group ( const std::string & line ) [virtual]`

A line of text was received from network client.

5.288.3.2 `void mhaserver_t::acceptor_started ( int status ) [virtual]`

Notification: "TCP port is open".

5.288.3.3 `void mhaserver_t::set_announce_port ( unsigned short announce_port ) [virtual]`

If set to nonzero, the spawning process has asked to be notified of the TCP port used by this process.

5.288.3.4 `void mhaserver_t::logstring ( const std::string & s ) [inline]`

Log a message to log file.

5.288.3.5 `int mhaserver_t::run ( unsigned short port, const std::string & _interface )`

Accept network connections and act on commands.

Calls **acceptor\_started()** (p. 762) when the TCP port is opened. Calls `received_group` for every line received.

**Returns**

exit code that can be used as process exit code

## 5.288.4 Member Data Documentation

5.288.4.1 MHA\_TCP::Server\* mhaserver\_t::tcpserver [private]

5.288.4.2 std::string mhaserver\_t::ack\_ok [private]

5.288.4.3 std::string mhaserver\_t::ack\_fail [private]

5.288.4.4 std::string mhaserver\_t::logfile [private]

5.288.4.5 unsigned short mhaserver\_t::announce\_port [private]

5.288.4.6 MHAParser::int\_mon\_t mhaserver\_t::pid\_mon [private]

5.288.4.7 MHAParser::int\_t mhaserver\_t::port

The documentation for this class was generated from the following file:

- **mhamain.cpp**

## 5.289 MHASignal::async\_rmslevel\_t Class Reference

Class for asynchronous level metering.

Inheritance diagram for MHASignal::async\_rmslevel\_t:

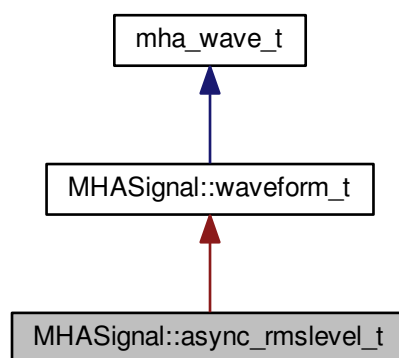

## Public Member Functions

- **async\_rmslevel\_t** (unsigned int frames, unsigned int **channels**)  
*Constructor for level metering class.*
- std::vector< float > **rmslevel** () const  
*Read-only function for querying the current RMS level.*
- std::vector< float > **peaklevel** () const  
*Read-only function for querying the current peak level.*
- void **process** (**mha\_wave\_t** \*s)  
*Function to store a chunk of audio in the level meter.*

## Private Attributes

- unsigned int **pos**
- unsigned int **filled**

## Additional Inherited Members

### 5.289.1 Detailed Description

Class for asynchronous level metering.

### 5.289.2 Constructor & Destructor Documentation

#### 5.289.2.1 MHASignal::async\_rmslevel\_t::async\_rmslevel\_t ( unsigned int *frames*, unsigned int *channels* )

Constructor for level metering class.

Allocate memory for metering. The RMS integration time corresponds to the number of frames in the buffer.

#### Parameters

|                 |                                             |
|-----------------|---------------------------------------------|
| <i>frames</i>   | Number of frames to integrate.              |
| <i>channels</i> | Number of channels used for level-metering. |

### 5.289.3 Member Function Documentation

5.289.3.1 `std::vector< float > MHASignal::async_rmslevel_t::rmslevel ( ) const`

Read-only function for querying the current RMS level.

#### Returns

Vector of floats, one value for each channel, containing the RMS level in dB (SPL if calibrated properly).

5.289.3.2 `std::vector< float > MHASignal::async_rmslevel_t::peaklevel ( ) const`

Read-only function for querying the current peak level.

#### Returns

Vector of floats, one value for each channel, containing the peak level in dB (SPL if calibrated properly).

5.289.3.3 `void MHASignal::async_rmslevel_t::process ( mha_wave_t * s )`

Function to store a chunk of audio in the level meter.

#### Parameters

|                |                                                                             |
|----------------|-----------------------------------------------------------------------------|
| <code>s</code> | Audio chunk (same number of channels required as given in the constructor). |
|----------------|-----------------------------------------------------------------------------|

#### 5.289.4 Member Data Documentation

5.289.4.1 `unsigned int MHASignal::async_rmslevel_t::pos [private]`

5.289.4.2 `unsigned int MHASignal::async_rmslevel_t::filled [private]`

The documentation for this class was generated from the following files:

- `mha_signal.hh`
- `mha_signal.cpp`

## 5.290 MHASignal::delay\_spec\_t Class Reference

### Public Member Functions

- `delay_spec_t` (unsigned int **delay**, unsigned int frames, unsigned int **channels**)
- `~delay_spec_t ()`
- `mha_spec_t * process (mha_spec_t *)`

### Private Attributes

- unsigned int **delay**
- **MHASignal::spectrum\_t** \*\* **buffer**
- unsigned int **pos**

### 5.290.1 Constructor & Destructor Documentation

5.290.1.1 **MHASignal::delay\_spec\_t::delay\_spec\_t** (  
     unsigned int *delay*,  
     unsigned int *frames*,  
     unsigned int *channels* )

5.290.1.2 **MHASignal::delay\_spec\_t::~~delay\_spec\_t** ( )

### 5.290.2 Member Function Documentation

5.290.2.1 **mha\_spec\_t \* MHASignal::delay\_spec\_t::process** (  
     **mha\_spec\_t \* s** )

### 5.290.3 Member Data Documentation

5.290.3.1 unsigned int **MHASignal::delay\_spec\_t::delay** [private]

5.290.3.2 **MHASignal::spectrum\_t\*\* MHASignal::delay\_spec\_t::buffer** [private]

5.290.3.3 unsigned int **MHASignal::delay\_spec\_t::pos** [private]

The documentation for this class was generated from the following files:

- **mha\_signal.hh**
- **mha\_signal.cpp**

### 5.291 MHASignal::delay\_t Class Reference

Class to realize a simple delay of waveform streams.

Inheritance diagram for **MHASignal::delay\_t**:

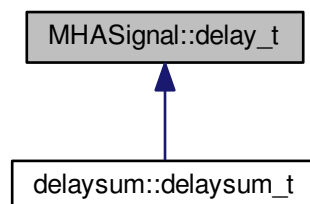

## Public Member Functions

- **delay\_t** (std::vector< int > **delays**, unsigned int **channels**)  
*Constructor.*
- **mha\_wave\_t \* process** (**mha\_wave\_t \*s**)  
*Processing method.*
- **~delay\_t** ()
- std::string **inspect** () const

## Private Attributes

- unsigned int **channels**
- unsigned int \* **delays**
- unsigned int \* **pos**
- **mha\_real\_t \*\* buffer**

## 5.291.1 Detailed Description

Class to realize a simple delay of waveform streams.

## 5.291.2 Constructor &amp; Destructor Documentation

### 5.291.2.1 MHASignal::delay\_t::delay\_t (

std::vector< int > *delays*,  
unsigned int *channels* )

Constructor.

## Parameters

|                 |                                               |
|-----------------|-----------------------------------------------|
| <i>delays</i>   | Vector of delays, one entry for each channel. |
| <i>channels</i> | Number of channels expected.                  |

## 5.291.2.2 MHASignal::delay\_t::~~delay\_t ( )

## 5.291.3 Member Function Documentation

### 5.291.3.1 mha\_wave\_t \* MHASignal::delay\_t::process (

**mha\_wave\_t \* s** )

Processing method.

### Parameters

|   |                                                                           |
|---|---------------------------------------------------------------------------|
| s | Input waveform fragment, with number of channels provided in constructor. |
|---|---------------------------------------------------------------------------|

### Returns

Output waveform fragment.

5.291.3.2 `std::string MHASignal::delay_t::inspect ( ) const` `[inline]`

### 5.291.4 Member Data Documentation

5.291.4.1 `unsigned int MHASignal::delay_t::channels` `[private]`

5.291.4.2 `unsigned int* MHASignal::delay_t::delays` `[private]`

5.291.4.3 `unsigned int* MHASignal::delay_t::pos` `[private]`

5.291.4.4 `mha_real_t** MHASignal::delay_t::buffer` `[private]`

The documentation for this class was generated from the following files:

- `mha_signal.hh`
- `mha_signal.cpp`

### 5.292 MHASignal::delay\_wave\_t Class Reference

Delayline containing wave fragments.

#### Public Member Functions

- `delay_wave_t` (unsigned int **delay**, unsigned int frames, unsigned int **channels**)
- `~delay_wave_t` ()
- `mha_wave_t * process` (`mha_wave_t *`)

#### Private Attributes

- unsigned int **delay**
- `MHASignal::waveform_t ** buffer`
- unsigned int **pos**



### 5.292.1 Detailed Description

Delayline containing wave fragments.

The delayline contains waveform fragments. The delay can be configured in integer fragments (sample delay or sub-sample delay is not possible).

### 5.292.2 Constructor & Destructor Documentation

5.292.2.1 MHASignal::delay\_wave\_t::delay\_wave\_t (   
 unsigned int *delay*,   
 unsigned int *frames*,   
 unsigned int *channels* )

5.292.2.2 MHASignal::delay\_wave\_t::~~delay\_wave\_t ( )

### 5.292.3 Member Function Documentation

5.292.3.1 mha\_wave\_t \* MHASignal::delay\_wave\_t::process (   
 mha\_wave\_t \* s )

### 5.292.4 Member Data Documentation

5.292.4.1 unsigned int MHASignal::delay\_wave\_t::delay [private]

5.292.4.2 MHASignal::waveform\_t\*\* MHASignal::delay\_wave\_t::buffer [private]

5.292.4.3 unsigned int MHASignal::delay\_wave\_t::pos [private]

The documentation for this class was generated from the following files:

- mha\_signal.hh
- mha\_signal.cpp

## 5.293 MHASignal::doublebuffer\_t Class Reference

Double-buffering class.

Inheritance diagram for MHASignal::doublebuffer\_t:

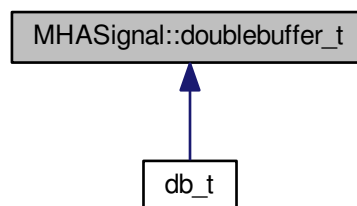

### Public Member Functions

- **doublebuffer\_t** (unsigned int nchannels\_in, unsigned int nchannels\_out, unsigned int outer\_fragsize, unsigned int inner\_fragsize)  
*Constructor of double buffer.*
- virtual **~doublebuffer\_t** ()
- **mha\_wave\_t \* outer\_process** (mha\_wave\_t \*s)  
*Method to pass audio fragments into the inner layer.*

### Protected Member Functions

- virtual **mha\_wave\_t \* inner\_process** (mha\_wave\_t \*s)=0  
*Method to realize inner processing callback.*

### Private Member Functions

- unsigned int **min** (unsigned int a, unsigned int b)

### Private Attributes

- **waveform\_t outer\_out**
- **mha\_wave\_t this\_outer\_out**
- **waveform\_t inner\_in**
- **waveform\_t inner\_out**
- unsigned int **k\_inner**
- unsigned int **k\_outer**
- unsigned int **ch**

#### 5.293.1 Detailed Description

Double-buffering class.

This class has two layers: The outer layer, with an outer fragment size, and an inner layer, with its own fragment size. Data is passed into the inner layer through the `doublebuffer_t::outer_process()` callback. The pure virtual method **`doublebuffer_t::inner_process()`** (p. 771) is called whenever enough data is available.

#### 5.293.2 Constructor & Destructor Documentation

5.293.2.1 **MHASignal::doublebuffer\_t::doublebuffer\_t** (  
    unsigned int *nchannels\_in*,  
    unsigned int *nchannels\_out*,  
    unsigned int *outer\_fragsize*,  
    unsigned int *inner\_fragsize* )

Constructor of double buffer.

## Parameters

|                       |                                                                 |
|-----------------------|-----------------------------------------------------------------|
| <i>nchannels_in</i>   | Number of channels at the input (both layers).                  |
| <i>nchannels_out</i>  | Number of channels at the output (both layers).                 |
| <i>outer_fragsize</i> | Fragment size of the outer layer (e.g., hardware fragment size) |
| <i>inner_fragsize</i> | Fragment size of the inner layer (e.g., software fragment size) |

5.293.2.2 MHASignal::doublebuffer\_t::~~doublebuffer\_t( ) [virtual]

## 5.293.3 Member Function Documentation

5.293.3.1 mha\_wave\_t\* MHASignal::doublebuffer\_t::outer\_process ( mha\_wave\_t\* s )

Method to pass audio fragments into the inner layer.

## Parameters

|   |                                     |
|---|-------------------------------------|
| s | Pointer to input waveform fragment. |
|---|-------------------------------------|

## Returns

Pointer to output waveform fragment.

5.293.3.2 virtual mha\_wave\_t\* MHASignal::doublebuffer\_t::inner\_process ( mha\_wave\_t\* s ) [protected],[pure virtual]

Method to realize inner processing callback.

To be overwritten by derived classes.

## Parameters

|   |                                     |
|---|-------------------------------------|
| s | Pointer to input waveform fragment. |
|---|-------------------------------------|

## Returns

Pointer to output waveform fragment.

Implemented in **db\_t** (p. [252](#)).

5.293.3.3 `unsigned int MHASignal::doublebuffer_t::min ( unsigned int a, unsigned int b )` `[inline], [private]`

#### 5.293.4 Member Data Documentation

5.293.4.1 `waveform_t MHASignal::doublebuffer_t::outer_out` `[private]`

5.293.4.2 `mha_wave_t MHASignal::doublebuffer_t::this_outer_out` `[private]`

5.293.4.3 `waveform_t MHASignal::doublebuffer_t::inner_in` `[private]`

5.293.4.4 `waveform_t MHASignal::doublebuffer_t::inner_out` `[private]`

5.293.4.5 `unsigned int MHASignal::doublebuffer_t::k_inner` `[private]`

5.293.4.6 `unsigned int MHASignal::doublebuffer_t::k_outer` `[private]`

5.293.4.7 `unsigned int MHASignal::doublebuffer_t::ch` `[private]`

The documentation for this class was generated from the following files:

- `mha_signal.hh`
- `mha_signal.cpp`

## 5.294 MHASignal::fft\_t Class Reference

### Public Member Functions

- `fft_t` (const unsigned int &)
- `~fft_t` ()
- void `wave2spec` (const `mha_wave_t` \*, `mha_spec_t` \*, bool swap)  
*fast fourier transform.*
- void `spec2wave` (const `mha_spec_t` \*, `mha_wave_t` \*)
- void `spec2wave` (const `mha_spec_t` \*, `mha_wave_t` \*, unsigned int offset)  
*wave may have fewer number of frames than needed for a complete iFFT.*
- void `forward` (`mha_spec_t` \*sIn, `mha_spec_t` \*sOut)
- void `backward` (`mha_spec_t` \*sIn, `mha_spec_t` \*sOut)
- void `wave2spec_scale` (const `mha_wave_t` \*, `mha_spec_t` \*, bool swap)
- void `spec2wave_scale` (const `mha_spec_t` \*, `mha_wave_t` \*)
- void `forward_scale` (`mha_spec_t` \*sIn, `mha_spec_t` \*sOut)
- void `backward_scale` (`mha_spec_t` \*sIn, `mha_spec_t` \*sOut)

## Private Member Functions

- void **sort\_fftw2spec** (fftw\_real \*s\_fftw, **mha\_spec\_t** \*s\_spec, unsigned int ch)  
*Arrange the order of an fftw spectrum to the internal order.*
- void **sort\_spec2fftw** (fftw\_real \*s\_fftw, const **mha\_spec\_t** \*s\_spec, unsigned int ch)  
*Arrange the order of an internal spectrum to the fftw order.*

## Private Attributes

- unsigned int **nfft**
- unsigned int **n\_re**
- unsigned int **n\_im**
- **mha\_real\_t** **scale**
- **mha\_real\_t** \* **buf\_in**
- **mha\_real\_t** \* **buf\_out**
- rfftw\_plan **fftw\_plan\_wave2spec**
- rfftw\_plan **fftw\_plan\_spec2wave**
- fftw\_plan **fftw\_plan\_fft**
- fftw\_plan **fftw\_plan\_ifft**

## 5.294.1 Constructor &amp; Destructor Documentation

5.294.1.1 MHASignal::fft\_t::fft\_t (  
                  const unsigned int & n )

5.294.1.2 MHASignal::fft\_t::~~fft\_t ( )

## 5.294.2 Member Function Documentation

5.294.2.1 void MHASignal::fft\_t::wave2spec (  
          const **mha\_wave\_t** \* wave,  
          **mha\_spec\_t** \* spec,  
          bool swap )

fast fourier transform.

if swap is set, the buffer halves of the wave signal are exchanged before computing the fft.

5.294.2.2 void MHASignal::fft\_t::spec2wave (  
          const **mha\_spec\_t** \* spec,  
          **mha\_wave\_t** \* wave )

5.294.2.3 void MHASignal::fft\_t::spec2wave (  
          const **mha\_spec\_t** \* spec,  
          **mha\_wave\_t** \* wave,  
          unsigned int offset )

wave may have fewer number of frames than needed for a complete iFFT.

Only as many frames are written into wave as fit, starting with offset offset of the complete iFFT.

- 5.294.2.4 void MHASignal::fft\_t::forward (
  
    mha\_spec\_t \* *sIn*,
  
    mha\_spec\_t \* *sOut* )
- 5.294.2.5 void MHASignal::fft\_t::backward (
  
    mha\_spec\_t \* *sIn*,
  
    mha\_spec\_t \* *sOut* )
- 5.294.2.6 void MHASignal::fft\_t::wave2spec\_scale (
  
    const mha\_wave\_t \* *wave*,
  
    mha\_spec\_t \* *spec*,
  
    bool *swap* )
- 5.294.2.7 void MHASignal::fft\_t::spec2wave\_scale (
  
    const mha\_spec\_t \* *spec*,
  
    mha\_wave\_t \* *wave* )
- 5.294.2.8 void MHASignal::fft\_t::forward\_scale (
  
    mha\_spec\_t \* *sIn*,
  
    mha\_spec\_t \* *sOut* )
- 5.294.2.9 void MHASignal::fft\_t::backward\_scale (
  
    mha\_spec\_t \* *sIn*,
  
    mha\_spec\_t \* *sOut* )
- 5.294.2.10 void MHASignal::fft\_t::sort\_fftw2spec (
  
    fftw\_real \* *s\_fftw*,
  
    mha\_spec\_t \* *s\_spec*,
  
    unsigned int *ch* ) [private]

Arrange the order of an fftw spectrum to the internal order.

The fftw spectrum is arranged [r0 r1 r2 ... rn-1 in in-1 ... i1], while the internal order is [r0 – r1 i1 r2 i2 ... rn-1 in-1 rn –].

- 5.294.2.11 void MHASignal::fft\_t::sort\_spec2fftw (
  
    fftw\_real \* *s\_fftw*,
  
    const mha\_spec\_t \* *s\_spec*,
  
    unsigned int *ch* ) [private]

Arrange the order of an internal spectrum to the fftw order.

### 5.294.3 Member Data Documentation

- 5.294.3.1 unsigned int MHASignal::fft\_t::nfft [private]
- 5.294.3.2 unsigned int MHASignal::fft\_t::n\_re [private]
- 5.294.3.3 unsigned int MHASignal::fft\_t::n\_im [private]
- 5.294.3.4 mha\_real\_t MHASignal::fft\_t::scale [private]
- 5.294.3.5 mha\_real\_t\* MHASignal::fft\_t::buf\_in [private]
- 5.294.3.6 mha\_real\_t\* MHASignal::fft\_t::buf\_out [private]
- 5.294.3.7 rfftw\_plan MHASignal::fft\_t::fftw\_plan\_wave2spec [private]
- 5.294.3.8 rfftw\_plan MHASignal::fft\_t::fftw\_plan\_spec2wave [private]
- 5.294.3.9 fftw\_plan MHASignal::fft\_t::fftw\_plan\_fft [private]
- 5.294.3.10 fftw\_plan MHASignal::fft\_t::fftw\_plan\_ift [private]

The documentation for this class was generated from the following files:

- mha\_signal\_fft.h
- mha\_signal.cpp

## 5.295 MHASignal::hilbert\_fftw\_t Class Reference

### Public Member Functions

- **hilbert\_fftw\_t** (unsigned int len)
- void **hilbert** (const mha\_wave\_t \*, mha\_wave\_t \*)

### Private Attributes

- unsigned int **n**
- rfftw\_plan **p1**
- fftw\_plan **p2**
- fftw\_real \* **buf\_r\_in**
- fftw\_real \* **buf\_r\_out**
- fftw\_complex \* **buf\_c\_in**
- fftw\_complex \* **buf\_c\_out**
- mha\_real\_t **sc**

### 5.295.1 Constructor & Destructor Documentation

5.295.1.1 `MHASignal::hilbert_fftw_t::hilbert_fftw_t ( unsigned int len )`

### 5.295.2 Member Function Documentation

5.295.2.1 `void MHASignal::hilbert_fftw_t::hilbert ( const mha_wave_t* s_in, mha_wave_t* s_out )`

### 5.295.3 Member Data Documentation

5.295.3.1 `unsigned int MHASignal::hilbert_fftw_t::n` [private]

5.295.3.2 `rfftw_plan MHASignal::hilbert_fftw_t::p1` [private]

5.295.3.3 `rfftw_plan MHASignal::hilbert_fftw_t::p2` [private]

5.295.3.4 `fftw_real* MHASignal::hilbert_fftw_t::buf_r_in` [private]

5.295.3.5 `fftw_real* MHASignal::hilbert_fftw_t::buf_r_out` [private]

5.295.3.6 `fftw_complex* MHASignal::hilbert_fftw_t::buf_c_in` [private]

5.295.3.7 `fftw_complex* MHASignal::hilbert_fftw_t::buf_c_out` [private]

5.295.3.8 `mha_real_t MHASignal::hilbert_fftw_t::sc` [private]

The documentation for this class was generated from the following file:

- `mha_signal.cpp`

### 5.296 MHASignal::hilbert\_t Class Reference

Hilbert transformation of a waveform segment.

Inheritance diagram for `MHASignal::hilbert_t`:

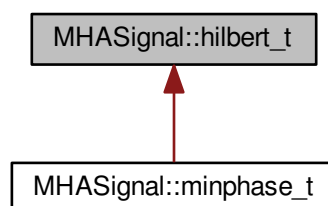



## Public Member Functions

- **hilbert\_t** (unsigned int len)
- **~hilbert\_t** ( )
- void **operator()** (const **mha\_wave\_t** \*, **mha\_wave\_t** \*)  
*Apply Hilbert transformation on a waveform segment.*

## Private Attributes

- void \* **h**

### 5.296.1 Detailed Description

Hilbert transformation of a waveform segment.

Returns the imaginary part of the inverse Fourier transformation of the Fourier transformed input signal with negative frequencies set to zero.

### 5.296.2 Constructor & Destructor Documentation

#### 5.296.2.1 MHASignal::hilbert\_t::hilbert\_t ( unsigned int len )

#### Parameters

|            |                            |
|------------|----------------------------|
| <i>len</i> | Length of waveform segment |
|------------|----------------------------|

#### 5.296.2.2 MHASignal::hilbert\_t::~~hilbert\_t ( )

### 5.296.3 Member Function Documentation

#### 5.296.3.1 void MHASignal::hilbert\_t::operator() ( const **mha\_wave\_t** \* *s\_in*, **mha\_wave\_t** \* *s\_out* )

Apply Hilbert transformation on a waveform segment.

### 5.296.4 Member Data Documentation

#### 5.296.4.1 void\* MHASignal::hilbert\_t::h [private]

The documentation for this class was generated from the following files:

- **mha\_signal.hh**
- **mha\_signal.cpp**

## 5.297 MHA\_Signal::loop\_wavefragment\_t Class Reference

Copy a fixed waveform fragment to a series of waveform fragments of other size.

Inheritance diagram for MHA\_Signal::loop\_wavefragment\_t:

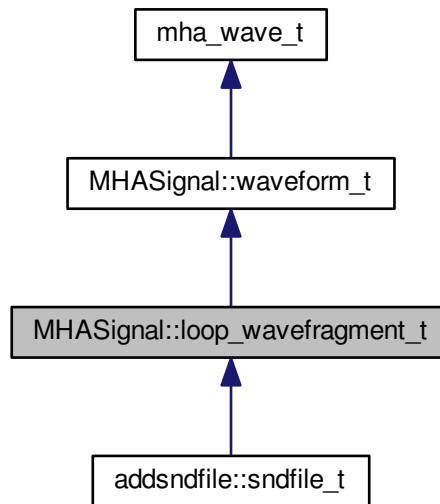

### Public Types

### Public Member Functions

- **loop\_wavefragment\_t** (const **mha\_wave\_t** &src, bool loop, **level\_mode\_t** level\_mode, std::vector< int > **channels**, unsigned int startpos=0)  
*Constructor to create an instance of **loop\_wavefragment\_t** (p. 778) based on an existing waveform block.*
- std::vector< int > **get\_mapping** (unsigned int **channels**)
- void **playback** (**mha\_wave\_t** \*s, **playback\_mode\_t** pmode, **mha\_wave\_t** \*level\_pa, const std::vector< int > &**channels**)  
*Add source waveform block to an output block.*
- void **playback** (**mha\_wave\_t** \*s, **playback\_mode\_t** pmode, **mha\_wave\_t** \*level\_pa)  
*Add source waveform block to an output block.*
- void **playback** (**mha\_wave\_t** \*s, **playback\_mode\_t** pmode)  
*Add source waveform block to an output block.*
- void **set\_level\_lin** (**mha\_real\_t** l)
- void **set\_level\_db** (**mha\_real\_t** l)
- void **rewind** ()
- void **locate\_end** ()
- bool **is\_playback\_active** () const

### Private Attributes

- `std::vector< int >` **playback\_channels**
- `bool` **b\_loop**
- `unsigned int` **pos**
- **MHASignal::waveform\_t** **intern\_level**

### Additional Inherited Members

#### 5.297.1 Detailed Description

Copy a fixed waveform fragment to a series of waveform fragments of other size.

This class is designed to continuously play back a waveform to an output stream, with variable output block size.

#### 5.297.2 Member Enumeration Documentation

##### 5.297.2.1 `enum MHASignal::loop_wavfragment_t::level_mode_t`

Switch for playback level mode.

#### Enumerator

**relative** The nominal level is applied as a gain to the source signal.

**peak** The nominal level is the peak level of source signal in Pascal.

**rms** The nominal level is the RMS level of the source signal in Pascal.

**rms\_limit40**

##### 5.297.2.2 `enum MHASignal::loop_wavfragment_t::playback_mode_t`

Switch for playback mode.

#### Enumerator

**add** Add source signal to output stream.

**replace** Replace output stream by source signal.

**input** Do nothing, keep output stream (source position is unchanged).

**mute** Mute output stream (source position is unchanged).

#### 5.297.3 Constructor & Destructor Documentation

5.297.3.1 `MHASignal::loop_wavfragment_t::loop_wavfragment_t (`  
    `const mha_wave_t & src,`  
    `bool loop,`  
    `level_mode_t level_mode,`  
    `std::vector< int > channels,`  
    `unsigned int startpos = 0 )`

Constructor to create an instance of **loop\_wavfragment\_t** (p. 778) based on an existing waveform block.

## Parameters

|                   |                                                                                                                |
|-------------------|----------------------------------------------------------------------------------------------------------------|
| <i>src</i>        | Waveform block to copy data from.                                                                              |
| <i>loop</i>       | Flag whether the block should be looped or played once.                                                        |
| <i>level_mode</i> | Configuration of playback level (see <b>MHASignal::loop_wavefragment_t::level_mode_t</b> (p. 779) for details) |
| <i>channels</i>   | Mapping of input to output channels.                                                                           |
| <i>startpos</i>   | Starting position                                                                                              |

## 5.297.4 Member Function Documentation

5.297.4.1 `std::vector< int > MHASignal::loop_wavefragment_t::get_mapping ( unsigned int channels )`

5.297.4.2 `void MHASignal::loop_wavefragment_t::playback ( mha_wave_t * s, playback_mode_t pmode, mha_wave_t * level_pa, const std::vector< int > & channels )`

Add source waveform block to an output block.

## Parameters

|                 |                                                                                                                                |
|-----------------|--------------------------------------------------------------------------------------------------------------------------------|
| <i>s</i>        | Output block (streamed signal).                                                                                                |
| <i>pmode</i>    | Playback mode (add, replace, input, mute).                                                                                     |
| <i>level_pa</i> | Linear output level/gain (depending on <i>level_mode</i> parameter in constructor); one value for each sample in output block. |
| <i>channels</i> | Output channels                                                                                                                |

5.297.4.3 `void MHASignal::loop_wavefragment_t::playback ( mha_wave_t * s, playback_mode_t pmode, mha_wave_t * level_pa )`

Add source waveform block to an output block.

## Parameters

|                 |                                                                                                                                |
|-----------------|--------------------------------------------------------------------------------------------------------------------------------|
| <i>s</i>        | Output block (streamed signal).                                                                                                |
| <i>pmode</i>    | Playback mode (add, replace, input, mute).                                                                                     |
| <i>level_pa</i> | Linear output level/gain (depending on <i>level_mode</i> parameter in constructor); one value for each sample in output block. |

5.297.4.4 void MHASignal::loop\_wavefragment\_t::playback (   
                   mha\_wave\_t \* s,   
                   playback\_mode\_t pmode )

Add source waveform block to an output block.

#### Parameters

|              |                                            |
|--------------|--------------------------------------------|
| <i>s</i>     | Output block (streamed signal).            |
| <i>pmode</i> | Playback mode (add, replace, input, mute). |

5.297.4.5 void MHASignal::loop\_wavefragment\_t::set\_level\_lin (   
                   mha\_real\_t l )

5.297.4.6 void MHASignal::loop\_wavefragment\_t::set\_level\_db (   
                   mha\_real\_t l )

5.297.4.7 void MHASignal::loop\_wavefragment\_t::rewind ( ) [inline]

5.297.4.8 void MHASignal::loop\_wavefragment\_t::locate\_end ( ) [inline]

5.297.4.9 bool MHASignal::loop\_wavefragment\_t::is\_playback\_active ( ) const [inline]

#### 5.297.5 Member Data Documentation

5.297.5.1 std::vector<int> MHASignal::loop\_wavefragment\_t::playback\_channels [private]

5.297.5.2 bool MHASignal::loop\_wavefragment\_t::b\_loop [private]

5.297.5.3 unsigned int MHASignal::loop\_wavefragment\_t::pos [private]

5.297.5.4 MHASignal::waveform\_t MHASignal::loop\_wavefragment\_t::intern\_level [private]

The documentation for this class was generated from the following files:

- mha\_signal.hh
- mha\_signal.cpp

## 5.298 MHASignal::matrix\_t Class Reference

n-dimensional matrix with real or complex floating point values.

Inheritance diagram for MHASignal::matrix\_t:

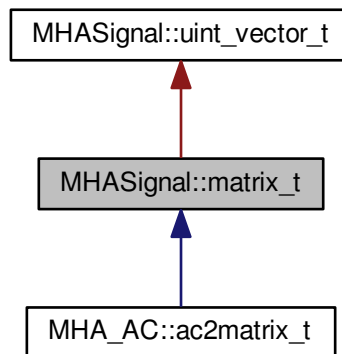

### Public Member Functions

- **matrix\_t** (unsigned int nrows, unsigned int ncols, bool b\_is\_complex=true)  
*Create a two-dimensional matrix.*
- **matrix\_t** (const **mha\_spec\_t** &spec)  
*Create a two-dimensional matrix from a spectrum, copy values.*
- **matrix\_t** (const **MHASignal::uint\_vector\_t** &size, bool b\_is\_complex=true)  
*Create n-dimensional matrix, described by size argument.*
- **matrix\_t** (const **MHASignal::matrix\_t** &)
- **matrix\_t** (const uint8\_t \*buf, unsigned int len)  
*Construct from memory area.*
- **~matrix\_t** ()
- **MHASignal::matrix\_t & operator=** (const **MHASignal::matrix\_t** &)
- **MHASignal::matrix\_t & operator=** (const **comm\_var\_t** &v)  
*Fill matrix with data of an AC variable object.*
- **comm\_var\_t get\_comm\_var** ()  
*Return a AC communication variable pointing to the data of the current matrix.*
- unsigned int **dimension** () const  
*Return the dimension of the matrix.*
- unsigned int **size** (unsigned int k) const  
*Return the size of the matrix.*
- unsigned int **get\_nelements** () const  
*Return total number of elements.*

- **bool is\_same\_size** (const **MHASignal::matrix\_t** &)  
*Test if matrix has same size as other.*
- **bool iscomplex** () const  
*Return information about complexity.*
- **mha\_real\_t & real** (const **MHASignal::uint\_vector\_t** &index)  
*Access real part of an element in a n-dimensional matrix.*
- **mha\_real\_t & imag** (const **MHASignal::uint\_vector\_t** &index)  
*Access imaginary part of an element in a n-dimensional matrix.*
- **mha\_complex\_t & operator()** (const **MHASignal::uint\_vector\_t** &index)  
*Access complex value of an element in a n-dimensional matrix.*
- **const mha\_real\_t & real** (const **MHASignal::uint\_vector\_t** &index) const  
*Access real part of an element in a n-dimensional matrix.*
- **const mha\_real\_t & imag** (const **MHASignal::uint\_vector\_t** &index) const  
*Access imaginary part of an element in a n-dimensional matrix.*
- **const mha\_complex\_t & operator()** (const **MHASignal::uint\_vector\_t** &index) const  
*Access complex value of an element in a n-dimensional matrix.*
- **mha\_real\_t & real** (unsigned int row, unsigned int col)  
*Access real part of an element in a two-dimensional matrix.*
- **mha\_real\_t & imag** (unsigned int row, unsigned int col)  
*Access imaginary part of an element in a two-dimensional matrix.*
- **mha\_complex\_t & operator()** (unsigned int row, unsigned int col)  
*Access complex value of an element in a two-dimensional matrix.*
- **const mha\_real\_t & real** (unsigned int row, unsigned int col) const  
*Access real part of an element in a two-dimensional matrix.*
- **const mha\_real\_t & imag** (unsigned int row, unsigned int col) const  
*Access imaginary part of an element in a two-dimensional matrix.*
- **const mha\_complex\_t & operator()** (unsigned int row, unsigned int col) const  
*Access complex value of an element in a two-dimensional matrix.*
- unsigned int **get\_nreals** () const
- unsigned int **get\_index** (unsigned int row, unsigned int col) const
- unsigned int **get\_index** (const **MHASignal::uint\_vector\_t** &index) const
- unsigned int **numbytes** () const  
*Return number of bytes needed to store into memory.*
- unsigned int **write** (uint8\_t \*buf, unsigned int len) const  
*Copy to memory area.*
- **const mha\_real\_t \* get\_rdata** () const  
*Return pointer of real data.*
- **const mha\_complex\_t \* get\_cdata** () const  
*Return pointer of complex data.*

### Private Attributes

- uint32\_t **complex\_ofs**
  - uint32\_t **nelements**
  - union {
    - mha\_real\_t \* rdata**
    - mha\_complex\_t \* cdata**
- ```
};
```

### Additional Inherited Members

#### 5.298.1 Detailed Description

n-dimensional matrix with real or complex floating point values.

#### Warning

The member functions **imag()** (p. 787) and **operator()** should only be called if the matrix is defined to hold complex values.

#### 5.298.2 Constructor & Destructor Documentation

5.298.2.1 **MHASignal::matrix\_t::matrix\_t** (  
     unsigned int *nrows*,  
     unsigned int *ncols*,  
     bool *b\_is\_complex* = true )

Create a two-dimensional matrix.

#### Parameters

<i>nrows</i>	Number of rows
<i>ncols</i>	Number of columns
<i>b_is_complex</i>	Add space for complex values

5.298.2.2 **MHASignal::matrix\_t::matrix\_t** (  
     const **mha\_spec\_t** & *spec* )

Create a two-dimensional matrix from a spectrum, copy values.

#### Parameters

<i>spec</i>	Source spectrum structure
-------------	---------------------------



5.298.2.3 MHASignal::matrix\_t::matrix\_t (   
                   const MHASignal::uint\_vector\_t & size,   
                   bool *b\_is\_complex* = true )

Create n-dimensional matrix, described by size argument.

#### Parameters

<i>size</i>	Size vector
<i>b_is_complex</i>	Add space for complex values

5.298.2.4 MHASignal::matrix\_t::matrix\_t (   
                   const MHASignal::matrix\_t & src )

5.298.2.5 MHASignal::matrix\_t::matrix\_t (   
                   const uint8\_t \* buf,   
                   unsigned int len )

Construct from memory area.

#### Warning

This constructor is not real time safe

5.298.2.6 MHASignal::matrix\_t::~matrix\_t ( )

### 5.298.3 Member Function Documentation

5.298.3.1 matrix\_t & MHASignal::matrix\_t::operator= (   
                   const MHASignal::matrix\_t & src )

5.298.3.2 MHASignal::matrix\_t & MHASignal::matrix\_t::operator= (   
                   const comm\_var\_t & v )

Fill matrix with data of an AC variable object.

#### Parameters

<i>v</i>	Source AC variable ( <a href="#">comm_var_t</a> (p. 246))
----------	---

#### Note

The type and dimension of the AC variable must match the type and dimension of the matrix.

### 5.298.3.3 `comm_var_t` `MHASignal::matrix_t::get_comm_var ( )`

Return a AC communication variable pointing to the data of the current matrix.

#### Returns

AC variable object (`comm_var_t` (p. 246)), valid for the life time of the matrix.

### 5.298.3.4 `unsigned int` `MHASignal::matrix_t::dimension ( ) const` `[inline]`

Return the dimension of the matrix.

#### Returns

Dimension of the matrix

### 5.298.3.5 `unsigned int` `MHASignal::matrix_t::size ( unsigned int k ) const` `[inline]`

Return the size of the matrix.

#### Parameters

<i>k</i>	Dimension
----------	-----------

#### Returns

Size of the matrix in dimension *k*

### 5.298.3.6 `unsigned int` `MHASignal::matrix_t::get_nelements ( ) const`

Return total number of elements.

### 5.298.3.7 `bool` `MHASignal::matrix_t::is_same_size ( const MHASignal::matrix_t & src )`

Test if matrix has same size as other.

### 5.298.3.8 `bool` `MHASignal::matrix_t::iscomplex ( ) const` `[inline]`

Return information about complexity.

### 5.298.3.9 `mha_real_t&` `MHASignal::matrix_t::real ( const MHASignal::uint_vector_t & index )` `[inline]`

Access real part of an element in a n-dimensional matrix.

## Parameters

<i>index</i>	Index vector
--------------	--------------

5.298.3.10 `mha_real_t& MHASignal::matrix_t::imag (`  
`const MHASignal::uint_vector_t & index )` `[inline]`

Access imaginary part of an element in a n-dimensional matrix.

## Parameters

<i>index</i>	Index vector
--------------	--------------

5.298.3.11 `mha_complex_t& MHASignal::matrix_t::operator() (`  
`const MHASignal::uint_vector_t & index )` `[inline]`

Access complex value of an element in a n-dimensional matrix.

## Parameters

<i>index</i>	Index vector
--------------	--------------

5.298.3.12 `const mha_real_t& MHASignal::matrix_t::real (`  
`const MHASignal::uint_vector_t & index ) const` `[inline]`

Access real part of an element in a n-dimensional matrix.

## Parameters

<i>index</i>	Index vector
--------------	--------------

5.298.3.13 `const mha_real_t& MHASignal::matrix_t::imag (`  
`const MHASignal::uint_vector_t & index ) const` `[inline]`

Access imaginary part of an element in a n-dimensional matrix.

## Parameters

<i>index</i>	Index vector
--------------	--------------

5.298.3.14 `const mha_complex_t& MHASignal::matrix_t::operator() (`  
`const MHASignal::uint_vector_t & index ) const` `[inline]`

Access complex value of an element in a n-dimensional matrix.

**Parameters**

<i>index</i>	Index vector
--------------	--------------

5.298.3.15 `mha_real_t& MHASignal::matrix_t::real (`  
`unsigned int row,`  
`unsigned int col )` `[inline]`

Access real part of an element in a two-dimensional matrix.

**Parameters**

<i>row</i>	Row number of element
<i>col</i>	Column number of element

5.298.3.16 `mha_real_t& MHASignal::matrix_t::imag (`  
`unsigned int row,`  
`unsigned int col )` `[inline]`

Access imaginary part of an element in a two-dimensional matrix.

**Parameters**

<i>row</i>	Row number of element
<i>col</i>	Column number of element

5.298.3.17 `mha_complex_t& MHASignal::matrix_t::operator() (`  
`unsigned int row,`  
`unsigned int col )` `[inline]`

Access complex value of an element in a two-dimensional matrix.

**Parameters**

<i>row</i>	Row number of element
<i>col</i>	Column number of element

5.298.3.18 `const mha_real_t& MHASignal::matrix_t::real ( unsigned int row, unsigned int col ) const` `[inline]`

Access real part of an element in a two-dimensional matrix.

#### Parameters

<i>row</i>	Row number of element
<i>col</i>	Column number of element

5.298.3.19 `const mha_real_t& MHASignal::matrix_t::imag ( unsigned int row, unsigned int col ) const` `[inline]`

Access imaginary part of an element in a two-dimensional matrix.

#### Parameters

<i>row</i>	Row number of element
<i>col</i>	Column number of element

5.298.3.20 `const mha_complex_t& MHASignal::matrix_t::operator() ( unsigned int row, unsigned int col ) const` `[inline]`

Access complex value of an element in a two-dimensional matrix.

#### Parameters

<i>row</i>	Row number of element
<i>col</i>	Column number of element

5.298.3.21 `unsigned int MHASignal::matrix_t::get_nreals ( ) const` `[inline]`

5.298.3.22 `unsigned int MHASignal::matrix_t::get_index ( unsigned int row, unsigned int col ) const`

5.298.3.23 `unsigned int MHASignal::matrix_t::get_index ( const MHASignal::uint_vector_t & index ) const`

5.298.3.24 `unsigned int MHASignal::matrix_t::numbytes ( ) const`

Return number of bytes needed to store into memory.

5.298.3.25 `unsigned int MHASignal::matrix_t::write (`  
`uint8_t * buf,`  
`unsigned int len ) const`

Copy to memory area.

5.298.3.26 `const mha_real_t* MHASignal::matrix_t::get_rdata ( ) const` `[inline]`

Return pointer of real data.

5.298.3.27 `const mha_complex_t* MHASignal::matrix_t::get_cdata ( ) const` `[inline]`

Return pointer of complex data.

#### 5.298.4 Member Data Documentation

5.298.4.1 `uint32_t MHASignal::matrix_t::complex_ofs` `[private]`

5.298.4.2 `uint32_t MHASignal::matrix_t::nelements` `[private]`

5.298.4.3 `mha_real_t* MHASignal::matrix_t::rdata`

5.298.4.4 `mha_complex_t* MHASignal::matrix_t::cdata`

5.298.4.5 `union { ... }` `[private]`

The documentation for this class was generated from the following files:

- `mha_signal.hh`
- `mha_signal.cpp`

#### 5.299 MHASignal::minphase\_t Class Reference

Minimal phase function.

Inheritance diagram for MHASignal::minphase\_t:

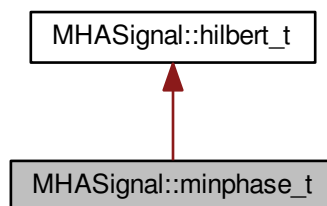

## Public Member Functions

- **minphase\_t** (unsigned int fftlen, unsigned int ch)  
*Constructor.*
- void **operator()** (**mha\_spec\_t** \*s)  
*Transform input spectrum to a minimal-phase spectrum, discarding the original phase.*

## Private Attributes

- **MHASignal::waveform\_t** phase

## Additional Inherited Members

## 5.299.1 Detailed Description

Minimal phase function.

The output spectrum  $Y(f)$  is

$$Y(f) = |X(f)|e^{i\mathcal{H}\{\log|X(f)|\}},$$

with the input spectrum  $X(f)$  and the Hilbert transformation  $\mathcal{H}\{\dots\}$ .

## 5.299.2 Constructor &amp; Destructor Documentation

5.299.2.1 MHASignal::minphase\_t::minphase\_t (  
    unsigned int *fftlen*,  
    unsigned int *ch* )

Constructor.

## Parameters

<i>fftlen</i>	FFT length
<i>ch</i>	Number of channels

## 5.299.3 Member Function Documentation

5.299.3.1 void MHASignal::minphase\_t::operator() (  
    **mha\_spec\_t** \* s )

Transform input spectrum to a minimal-phase spectrum, discarding the original phase.

## Parameters

s	Spectrum to operate on.
---	-------------------------

## 5.299.4 Member Data Documentation

## 5.299.4.1 MHASignal::waveform\_t MHASignal::minphase\_t::phase [private]

The documentation for this class was generated from the following files:

- **mha\_signal.hh**
- **mha\_signal.cpp**

## 5.300 MHASignal::quantizer\_t Class Reference

Simple simulation of fixpoint quantization.

## Public Member Functions

- **quantizer\_t** (unsigned int num\_bits)  
*Constructor.*
- void **operator()** (mha\_wave\_t &s)  
*Quantization of a waveform fragment.*

## Private Attributes

- bool **limit**
- mha\_real\_t **upscale**
- mha\_real\_t **downscale**
- mha\_real\_t **up\_limit**

## 5.300.1 Detailed Description

Simple simulation of fixpoint quantization.

## 5.300.2 Constructor &amp; Destructor Documentation

5.300.2.1 MHASignal::quantizer\_t::quantizer\_t ( unsigned int *num\_bits* )

Constructor.



## Parameters

<i>num_bits</i>	Number of bits to simulate, or zero for limiting to [-1,1] only.
-----------------	--

## 5.300.3 Member Function Documentation

5.300.3.1 void MHASignal::quantizer\_t::operator() (  
mha\_wave\_t & s )

Quantization of a waveform fragment.

## Parameters

<i>s</i>	Waveform fragment to be quantized.
----------	------------------------------------

## 5.300.4 Member Data Documentation

## 5.300.4.1 bool MHASignal::quantizer\_t::limit [private]

## 5.300.4.2 mha\_real\_t MHASignal::quantizer\_t::upscale [private]

## 5.300.4.3 mha\_real\_t MHASignal::quantizer\_t::downscale [private]

## 5.300.4.4 mha\_real\_t MHASignal::quantizer\_t::up\_limit [private]

The documentation for this class was generated from the following files:

- **mha\_signal.hh**
- **mha\_signal.cpp**

## 5.301 MHASignal::ringbuffer\_t Class Reference

A ringbuffer class for time domain audio signal, which makes no assumptions with respect to fragment size.

Inheritance diagram for MHASignal::ringbuffer\_t:

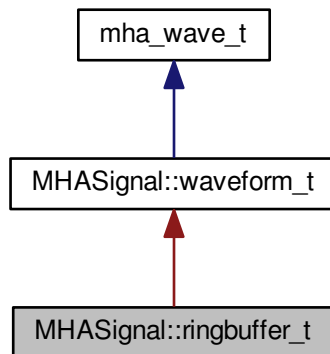

### Public Member Functions

- **ringbuffer\_t** (unsigned frames, unsigned **channels**, unsigned prefilled\_frames)  
*Creates new ringbuffer for time domain signal.*
- unsigned **contained\_frames** () const  
*number of currently contained frames*
- **mha\_real\_t** & **value** (unsigned frame, unsigned channel)  
*Access to value stored in ringbuffer.*
- void **discard** (unsigned frames)  
*Discards the oldest frames.*
- void **write** (**mha\_wave\_t** &signal)  
*Copies the contents of the signal into the ringbuffer if there is enough space.*

### Private Attributes

- unsigned **next\_read\_frame\_index**  
*Index of oldest frame in underlying storage for the ringbuffer.*
- unsigned **next\_write\_frame\_index**  
*Index of first free frame in underlying storage.*

### Additional Inherited Members

#### 5.301.1 Detailed Description

A ringbuffer class for time domain audio signal, which makes no assumptions with respect to fragment size.

Blocks of audio signal can be placed into the ringbuffer using the **write** (p. 796) method. Individual audio samples can be accessed and altered using the **value** (p. 795) method. Blocks of audio data can be deleted from the ringbuffer using the **discard** (p. 796) method.

## 5.301.2 Constructor &amp; Destructor Documentation

5.301.2.1 ringbuffer\_t::ringbuffer\_t (  
    unsigned *frames*,  
    unsigned *channels*,  
    unsigned *prefilled\_frames* )

Creates new ringbuffer for time domain signal.

Constructor allocates enough storage so that *frames* audio samples can be stored in the ringbuffer.

## Parameters

<i>frames</i>	Size of ringbuffer in samples per channel. Maximum number of frames that can be stored in the ringbuffer at one time. This number cannot be changed after instance creation.
<i>channels</i>	Number of audio channels.
<i>prefilled_frames</i>	Number of frames to be prefilled with zero values. Many applications of a ringbuffer require the introduction of a delay. In practice, this delay is achieved by inserting silence audio samples (zeros) into the ringbuffer before the start of the actual signal is inserted for the first time.

## Exceptions

<b><i>MHA_Error</i></b> (p. 445)	if <i>prefilled_frames</i> > <i>frames</i>
----------------------------------	--

## 5.301.3 Member Function Documentation

## 5.301.3.1 unsigned MHASignal::ringbuffer\_t::contained\_frames ( ) const [inline]

number of currently contained frames

5.301.3.2 mha\_real\_t& MHASignal::ringbuffer\_t::value (  
    unsigned *frame*,  
    unsigned *channel* ) [inline]

Access to value stored in ringbuffer.

*frame* index is relative to the oldest frame stored in the ringbuffer, therefore, the meaning of the *frame* changes when the **discard** (p. 796) method is called.

## Parameters

<i>frame</i>	frame index, 0 corresponds to oldest frame stored.
<i>channel</i>	audio channel

**Returns**

reference to contained sample value

**Exceptions**

<b><i>MHA_Error</i></b> (p. 445)	if channel or frame out of bounds.
----------------------------------	------------------------------------

5.301.3.3 void MHA\_Signal::ringbuffer\_t::discard (  
                   unsigned frames ) [inline]

Discards the oldest frames.

Makes room for new **write** (p. 796), alters base frame index for **value** (p. 795)

**Parameters**

<i>frames</i>	how many frames to discard.
---------------	-----------------------------

**Exceptions**

<b><i>MHA_Error</i></b> (p. 445)	if frames > <b>contained_frames</b> (p. 795)
----------------------------------	--

5.301.3.4 void MHA\_Signal::ringbuffer\_t::write (  
                   mha\_wave\_t & signal ) [inline]

Copies the contents of the signal into the ringbuffer if there is enough space.

**Parameters**

<i>signal</i>	New signal to be appended to the signal already present in the ringbuffer
---------------	---

**Exceptions**

<b><i>MHA_Error</i></b> (p. 445)	if there is not enough space or if the channel count mismatches. Nothing is copied if the space is insufficient.
----------------------------------	---

**5.301.4 Member Data Documentation**

5.301.4.1 unsigned MHA\_Signal::ringbuffer\_t::next\_read\_frame\_index [private]

Index of oldest frame in underlying storage for the ringbuffer.

This value is added to the frame parameter of the **value** (p. 795) method, and this value is altered when **discard** (p. 796) is called.

#### 5.301.4.2 unsigned MHASignal::ringbuffer\_t::next\_write\_frame\_index [private]

Index of first free frame in underlying storage.

Next frame to be stored will be placed here.

The documentation for this class was generated from the following files:

- **mha\_signal.hh**
- **mha\_signal.cpp**

## 5.302 MHASignal::schroeder\_t Class Reference

Schroeder tone complex class.

Inheritance diagram for MHASignal::schroeder\_t:

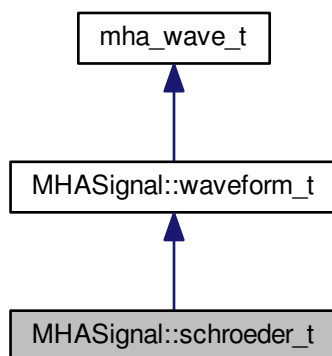

### Public Types

- typedef float(\* **groupdelay\_t**) (float f, float fmin, float fmax)  
*Function type for group delay definition.*

## Public Member Functions

- **schroeder\_t** (unsigned int len, unsigned int **channels**=1, **schroeder\_t::sign\_t** sign=**up**, **mha\_real\_t** speed=1)  
*Constructor.*
- **schroeder\_t** (unsigned int len, unsigned int **channels**=1, **schroeder\_t::groupdelay\_t** freqfun=**MHASignal::schroeder\_t::identity**, float fmin=0, float fmax=1, float eps=1e-10)  
*Construct create Schroeder tone complex from a given frequency function.*

## Static Public Member Functions

- static float **identity** (float x, float, float)
- static float **log\_up** (float x, float fmin, float fmax)
- static float **log\_down** (float x, float fmin, float fmax)

## Additional Inherited Members

### 5.302.1 Detailed Description

Schroeder tone complex class.

The Schroeder tone complex is a sweep defined in the sampled spectrum:

$$\Phi(f) = \sigma 2\pi\tau(2f/f_s)^{2\alpha}, \quad S(f) = e^{i\Phi(f)}$$

$f$  is the sampled frequency in Hz,  $\sigma$  is the sign of the sweep (-1 for up sweep, +1 for down sweep),  $\tau$  is the sweep duration in samples,  $f_s$  is the sampling rate in Hz and  $\alpha$  is the relative sweep speed.

### 5.302.2 Member Typedef Documentation

#### 5.302.2.1 typedef float(\* MHASignal::schroeder\_t::groupdelay\_t) (float f, float fmin, float fmax)

Function type for group delay definition.

#### Parameters

$f$	Frequency relative to Nyquist frequency.
$fmin$	Minimum frequency relative to Nyquist frequency.
$fmax$	Maximum frequency relative to Nyquist frequency.

## 5.302.3 Member Enumeration Documentation

## 5.302.3.1 enum MHASignal::schroeder\_t::sign\_t

Enumerator for sign of Schroeder tone complex sweep direction.

## Enumerator

- up** Sweep from zero to Nyquist frequency ( $\sigma = -1$ )
- down** Sweep from Nyquist frequency to zero ( $\sigma = +1$ )

## 5.302.4 Constructor &amp; Destructor Documentation

5.302.4.1 MHASignal::schroeder\_t::schroeder\_t (  
     unsigned int *len*,  
     unsigned int *channels* = 1,  
     schroeder\_t::sign\_t *sign* = up,  
     mha\_real\_t *speed* = 1 )

Constructor.

Parameters of the Schroeder tone complex are configured in the constructor.

## Parameters

<i>len</i>	Length $\tau$ of the Schroeder tone complex in samples
<i>channels</i>	Number of channels
<i>sign</i>	Sign $\sigma$ of Schroeder sweep
<i>speed</i>	Relative speed $\alpha$ (curvature of phase function)

5.302.4.2 MHASignal::schroeder\_t::schroeder\_t (  
     unsigned int *len*,  
     unsigned int *channels* = 1,  
     schroeder\_t::groupdelay\_t *freqfun* = MHASignal::schroeder\_t↔  
     ::identity,  
     float *fmin* = 0,  
     float *fmax* = 1,  
     float *eps* = 1e-10 )

Construct create Schroeder tone complex from a given frequency function.

The frequency function  $g(f)$  defines the sweep speed and sign (based on the group delay). It must be defined in the interval  $[0,1)$  and should return values in the interval  $[0,1]$ .

$$\Phi(f) = -4\pi\tau \int_0^\tau g(f) \, df, \quad S(f) = e^{i\Phi(f)}$$

## Parameters

<i>len</i>	Length $\tau$ of the Schroeder tone complex in samples.
<i>channels</i>	Number of channels.
<i>freqfun</i>	Frequency function $g(f)$ .
<i>fmin</i>	Start frequency (relative to Nyquist frequency).
<i>fmax</i>	End frequency (relative to Nyquist frequency).
<i>eps</i>	Stability constant for frequency ranges not covered by Schroeder tone complex.

## 5.302.5 Member Function Documentation

5.302.5.1 `static float MHASignal::schroeder_t::identity (`  
`float x,`  
`float ,`  
`float ) [inline],[static]`

5.302.5.2 `static float MHASignal::schroeder_t::log_up (`  
`float x,`  
`float fmin,`  
`float fmax ) [inline],[static]`

5.302.5.3 `static float MHASignal::schroeder_t::log_down (`  
`float x,`  
`float fmin,`  
`float fmax ) [inline],[static]`

The documentation for this class was generated from the following files:

- `mha_signal.hh`
- `mha_signal.cpp`

## 5.303 MHASignal::spectrum\_t Class Reference

a signal processing class for spectral data (based on `mha_spec_t` (p. 465))



Inheritance diagram for MHASignal::spectrum\_t:

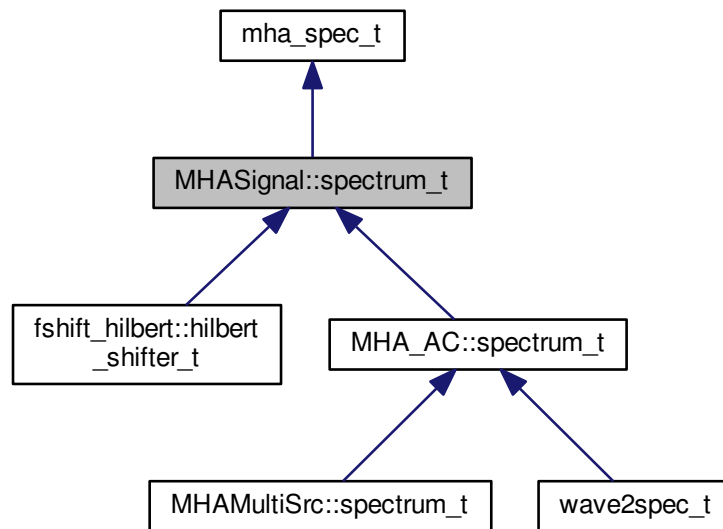

### Public Member Functions

- **spectrum\_t** (const unsigned int &frames, const unsigned int &channels)  
*constructor of spectrum class*
- **spectrum\_t** (const mha\_spec\_t &)  
*Copy constructor.*
- **spectrum\_t** (const MHASignal::spectrum\_t &)  
*Copy constructor.*
- **spectrum\_t** (const std::vector< mha\_complex\_t > &)
- virtual ~**spectrum\_t** (void)
- **mha\_complex\_t** & **operator()** (unsigned int f, unsigned int ch)  
*Access to element.*
- **mha\_complex\_t** & **operator[]** (unsigned int k)  
*Access to a single element, direct index into data buffer.*
- **mha\_complex\_t** & **value** (unsigned int f, unsigned int ch)  
*Access to element.*
- void **copy** (const mha\_spec\_t &)  
*copy all elements from a spectrum*
- void **copy\_channel** (const mha\_spec\_t &s, unsigned sch, unsigned dch)  
*Copy one channel of a given spectrum signal to a target channel.*
- void **export\_to** (mha\_spec\_t &)  
*copy elements to spectrum structure*

- void **scale** (const unsigned int &, const unsigned int &, const unsigned int &, const **mha\_↔\_real\_t** &)  
*scale section [a,b) in channel "ch" by "val"*
- void **scale\_channel** (const unsigned int &, const **mha\_real\_t** &)  
*scale all elements in one channel*

### Additional Inherited Members

#### 5.303.1 Detailed Description

a signal processing class for spectral data (based on **mha\_spec\_t** (p. 465))

#### 5.303.2 Constructor & Destructor Documentation

5.303.2.1 **spectrum\_t::spectrum\_t** (  
    const unsigned int & *frames*,  
    const unsigned int & *channels* )

constructor of spectrum class

Allocates buffers and initializes memory to zeros.

#### Parameters

<i>frames</i>	number of frames (fft bins) in one channel. Number of Frames is usually $\text{fftlen} / 2 + 1$
<i>channels</i>	number of channels

5.303.2.2 **spectrum\_t::spectrum\_t** (  
    const **mha\_spec\_t** & *src* ) [*explicit*]

Copy constructor.

5.303.2.3 **spectrum\_t::spectrum\_t** (  
    const **MHASignal::spectrum\_t** & *src* )

Copy constructor.

5.303.2.4 **spectrum\_t::spectrum\_t** (  
    const std::vector< **mha\_complex\_t** > & *src* )

5.303.2.5 **spectrum\_t::~~spectrum\_t** (  
    void ) [*virtual*]

Reimplemented in **MHA\_AC::spectrum\_t** (p. 423).

## 5.303.3 Member Function Documentation

5.303.3.1 `mha_complex_t& MHASignal::spectrum_t::operator() (`  
    `unsigned int f,`  
    `unsigned int ch ) [inline]`

Access to element.

## Parameters

<i>f</i>	Bin number
<i>ch</i>	Channel number

## Returns

Reference to element

5.303.3.2 `mha_complex_t& MHASignal::spectrum_t::operator[] (`  
    `unsigned int k ) [inline]`

Access to a single element, direct index into data buffer.

## Parameters

<i>k</i>	Buffer index
----------	--------------

## Returns

Reference to element

5.303.3.3 `mha_complex_t& MHASignal::spectrum_t::value (`  
    `unsigned int f,`  
    `unsigned int ch ) [inline]`

Access to element.

## Parameters

<i>f</i>	Bin number
<i>ch</i>	Channel number

## Returns

Reference to element

5.303.3.4 void spectrum\_t::copy (  
           const mha\_spec\_t & src )

copy all elements from a spectrum

**Parameters**

<i>src</i>	input spectrum
------------	----------------

5.303.3.5 void spectrum\_t::copy\_channel (  
           const mha\_spec\_t & s,  
           unsigned sch,  
           unsigned dch )

Copy one channel of a given spectrum signal to a target channel.

**Parameters**

<i>s</i>	Input spectrum signal
<i>sch</i>	Channel index in source signal
<i>dch</i>	Channel index in destination (this) signal

5.303.3.6 void spectrum\_t::export\_to (  
           mha\_spec\_t & dest )

copy elements to spectrum structure

**Parameters**

<i>dest</i>	destination spectrum structure
-------------	--------------------------------

5.303.3.7 void spectrum\_t::scale (  
           const unsigned int & a,  
           const unsigned int & b,  
           const unsigned int & ch,  
           const mha\_real\_t & val )

scale section [a,b) in channel "ch" by "val"

**Parameters**

<i>a</i>	starting frame
<i>b</i>	end frame (excluded)
<i>ch</i>	channel number
<i>val</i>	scale factor

5.303.3.8 void spectrum\_t::scale\_channel (  
           const unsigned int & *ch*,  
           const mha\_real\_t & *src* )

scale all elements in one channel

#### Parameters

<i>ch</i>	channel number
<i>src</i>	scale factor

The documentation for this class was generated from the following files:

- **mha\_signal.hh**
- **mha\_signal.cpp**

## 5.304 MHASignal::stat\_t Class Reference

Inheritance diagram for MHASignal::stat\_t:

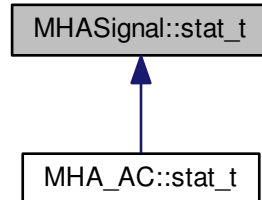

#### Public Member Functions

- **stat\_t** (const unsigned int &frames, const unsigned int &**channels**)
- void **mean** (mha\_wave\_t &m)
- void **mean\_std** (mha\_wave\_t &m, mha\_wave\_t &s)
- void **push** (const mha\_wave\_t &)
- void **push** (const mha\_real\_t &x, const unsigned int &k, const unsigned int &ch)

#### Private Attributes

- **MHASignal::waveform\_t** n
- **MHASignal::waveform\_t** sum
- **MHASignal::waveform\_t** sum2

### 5.304.1 Constructor & Destructor Documentation

5.304.1.1 `MHASignal::stat_t::stat_t (`  
    `const unsigned int & frames,`  
    `const unsigned int & channels )`

### 5.304.2 Member Function Documentation

5.304.2.1 `void MHASignal::stat_t::mean (`  
    `mha_wave_t & m )`

5.304.2.2 `void MHASignal::stat_t::mean_std (`  
    `mha_wave_t & m,`  
    `mha_wave_t & s )`

5.304.2.3 `void MHASignal::stat_t::push (`  
    `const mha_wave_t & x )`

5.304.2.4 `void MHASignal::stat_t::push (`  
    `const mha_real_t & x,`  
    `const unsigned int & k,`  
    `const unsigned int & ch )`

### 5.304.3 Member Data Documentation

5.304.3.1 `MHASignal::waveform_t MHASignal::stat_t::n` `[private]`

5.304.3.2 `MHASignal::waveform_t MHASignal::stat_t::sum` `[private]`

5.304.3.3 `MHASignal::waveform_t MHASignal::stat_t::sum2` `[private]`

The documentation for this class was generated from the following files:

- `mha_signal.hh`
- `mha_signal.cpp`

### 5.305 `MHASignal::subsample_delay_t` Class Reference

implements subsample delay in spectral domain.

## Public Member Functions

- **subsample\_delay\_t** (const std::vector< float > &subsample\_delay, unsigned fftlen)  
*Constructor computes complex phase factors to apply to achieve subsample delay.*
- void **process** (mha\_spec\_t \*s)  
*Apply the phase\_gains to s to achieve the subsample delay.*
- void **process** (mha\_spec\_t \*s, unsigned idx)  
*Apply the phase gains to channel idx in s to achieve the subsample delay in channel idx.*

## Public Attributes

- **spectrum\_t phase\_gains**  
*The complex factors to apply to achieve the necessary phase shift.*

## Private Attributes

- unsigned **last\_complex\_bin**  
*index of the last complex fft bin for the used fft length.*

## 5.305.1 Detailed Description

implements subsample delay in spectral domain.

When transformed back to the time domain, the signal is delayed by the configured fraction of a sample. This operation must not be used in a smoothgains bracket.

## 5.305.2 Constructor &amp; Destructor Documentation

#### 5.305.2.1 MHASignal::subsample\_delay\_t::subsample\_delay\_t (const std::vector< float > &subsample\_delay, unsigned fftlen )

Constructor computes complex phase factors to apply to achieve subsample delay.

## Parameters

<i>subsample_delay</i>	The subsample delay to apply. $-0.5 \leq \text{subsample\_delay} \leq 0.5$
<i>fftlen</i>	FFT length

## Exceptions

<b>MHA_Error</b> (p. 445)	if the parameters are out of range
---------------------------	------------------------------------

### 5.305.3 Member Function Documentation

#### 5.305.3.1 void MHASignal::subsample\_delay\_t::process ( mha\_spec\_t \* s )

Apply the phase\_gains to s to achieve the subsample delay.

#### 5.305.3.2 void MHASignal::subsample\_delay\_t::process ( mha\_spec\_t \* s, unsigned idx )

Apply the phase gains to channel idx in s to achieve the subsample delay in channel idx.

#### Parameters

s	signal
idx	channel index, 0-based

#### Exceptions

<b>MHA_Error</b> (p. 445)	if idx >= s->num_channels
---------------------------	---------------------------

### 5.305.4 Member Data Documentation

#### 5.305.4.1 spectrum\_t MHASignal::subsample\_delay\_t::phase\_gains

The complex factors to apply to achieve the necessary phase shift.

#### 5.305.4.2 unsigned MHASignal::subsample\_delay\_t::last\_complex\_bin [private]

index of the last complex fft bin for the used fft length.

The documentation for this class was generated from the following files:

- mha\_signal.hh
- mha\_signal.cpp



## 5.306 MHASignal::uint\_vector\_t Class Reference

Vector of unsigned values, used for size and index description of n-dimensional matrixes.

Inheritance diagram for MHASignal::uint\_vector\_t:

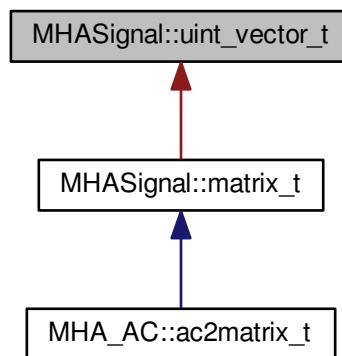

## Public Member Functions

- **uint\_vector\_t** (unsigned int len)  
*Constructor, initializes all elements to zero.*
- **uint\_vector\_t** (const **uint\_vector\_t** &)
- **uint\_vector\_t** (const uint8\_t \*buf, unsigned int len)  
*Construct from memory area.*
- **~uint\_vector\_t** ()
- bool **operator==** (const **uint\_vector\_t** &) const  
*Check for equality.*
- **uint\_vector\_t** & **operator=** (const **uint\_vector\_t** &)  
*Assign from other **uint\_vector\_t** (p. 809).*
- unsigned int **get\_length** () const  
*Return the length of the vector.*
- const uint32\_t & **operator[]** (unsigned int k) const  
*Read-only access to elements.*
- uint32\_t & **operator[]** (unsigned int k)  
*Access to elements.*
- unsigned int **numbytes** () const  
*Return number of bytes needed to store into memory.*
- unsigned int **write** (uint8\_t \*buf, unsigned int len) const  
*Copy to memory area.*
- const uint32\_t \* **getdata** () const  
*Return pointer to the data field.*

## Protected Attributes

- uint32\_t **length**
- uint32\_t \* **data**

### 5.306.1 Detailed Description

Vector of unsigned values, used for size and index description of n-dimensional matrixes.

### 5.306.2 Constructor & Destructor Documentation

#### 5.306.2.1 MHASignal::uint\_vector\_t::uint\_vector\_t ( unsigned int *len* )

Constructor, initializes all elements to zero.

#### Parameters

<i>len</i>	Length of vector.
------------	-------------------

#### 5.306.2.2 MHASignal::uint\_vector\_t::uint\_vector\_t ( const uint\_vector\_t & *src* )

#### 5.306.2.3 MHASignal::uint\_vector\_t::uint\_vector\_t ( const uint8\_t \* *buf*, unsigned int *len* )

Construct from memory area.

#### Warning

This constructor is not real time safe

#### 5.306.2.4 MHASignal::uint\_vector\_t::~~uint\_vector\_t ( )

### 5.306.3 Member Function Documentation

#### 5.306.3.1 bool MHASignal::uint\_vector\_t::operator== ( const uint\_vector\_t & *src* ) const

Check for equality.

5.306.3.2 `uint_vector_t & MHASignal::uint_vector_t::operator=(  
const uint_vector_t & src )`

Assign from other `uint_vector_t` (p. 809).

#### Warning

This assignment will fail if the lengths mismatch.

5.306.3.3 `unsigned int MHASignal::uint_vector_t::get_length ( ) const [inline]`

Return the length of the vector.

5.306.3.4 `const uint32_t& MHASignal::uint_vector_t::operator[](  
unsigned int k ) const [inline]`

Read-only access to elements.

5.306.3.5 `uint32_t& MHASignal::uint_vector_t::operator[](  
unsigned int k ) [inline]`

Access to elements.

5.306.3.6 `unsigned int MHASignal::uint_vector_t::numbytes ( ) const`

Return number of bytes needed to store into memory.

5.306.3.7 `unsigned int MHASignal::uint_vector_t::write (  
uint8_t * buf,  
unsigned int len ) const`

Copy to memory area.

5.306.3.8 `const uint32_t* MHASignal::uint_vector_t::getdata ( ) const [inline]`

Return pointer to the data field.

#### 5.306.4 Member Data Documentation

5.306.4.1 `uint32_t MHASignal::uint_vector_t::length [protected]`

5.306.4.2 `uint32_t* MHASignal::uint_vector_t::data [protected]`

The documentation for this class was generated from the following files:

- `mha_signal.hh`
- `mha_signal.cpp`

### 5.307 MHASignal::waveform\_t Class Reference

signal processing class for waveform data (based on `mha_wave_t` (p. 496))

Inheritance diagram for `MHASignal::waveform_t`:

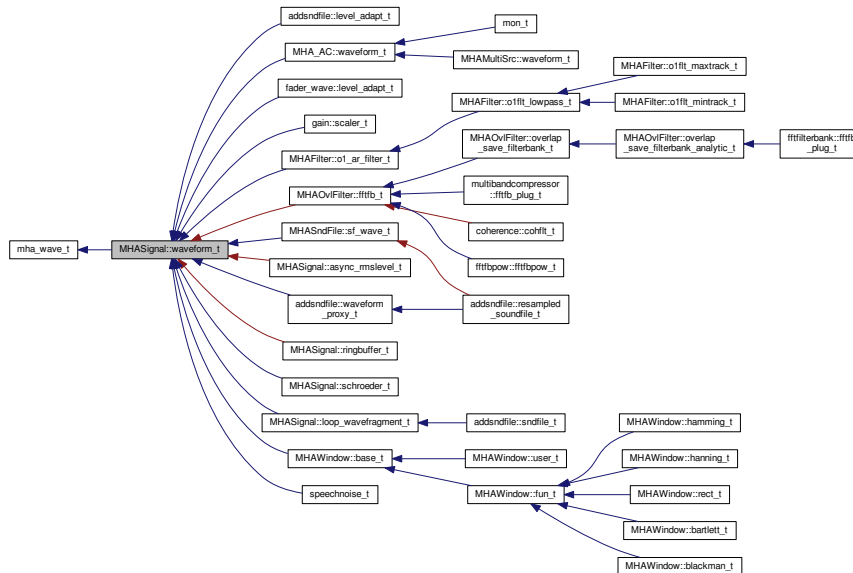

#### Public Member Functions

- **waveform\_t** (const unsigned int &frames, const unsigned int &channels)  
*constructor of waveform\_t* (p. 812)
- **waveform\_t** (const **mhaconfig\_t** &cf)  
*Constructor to create a waveform from plugin configuration.*
- **waveform\_t** (const **mha\_wave\_t** &src)  
*Copy constructor for mha\_wave\_t* (p. 496) source.
- **waveform\_t** (const **MHASignal::waveform\_t** &src)  
*Copy constructor.*
- **waveform\_t** (const std::vector< **mha\_real\_t** > &src)  
*Copy constructor for std::vector<mha\_real\_t> source.*
- virtual **~waveform\_t** (void)
- void **operator=** (const **mha\_real\_t** &v)
- **mha\_real\_t** & **operator[]** (unsigned int k)
- const **mha\_real\_t** & **operator[]** (unsigned int k) const
- **mha\_real\_t** & **value** (unsigned int t, unsigned int ch)  
*Element accessor.*
- **mha\_real\_t** & **operator()** (unsigned int t, unsigned int ch)  
*Element accessor.*
- const **mha\_real\_t** & **value** (unsigned int t, unsigned int ch) const

- Constant element accessor.*

  - const **mha\_real\_t** & **operator()** (unsigned int t, unsigned int ch) const  
*Constant element accessor.*
- **mha\_real\_t** **sum** (const unsigned int &a, const unsigned int &b)  
*sum of all elements between [a,b] in all channels*
- **mha\_real\_t** **sum** (const unsigned int &a, const unsigned int &b, const unsigned int &ch)  
*sum of all elements between [a,b] in channel ch*
- **mha\_real\_t** **sum** ()  
*sum of all elements*
- **mha\_real\_t** **sumsq** ()  
*sum of square of all elements*
- **mha\_real\_t** **sum\_channel** (const unsigned int &)  
*return sum of all elements in one channel*
- void **assign** (const unsigned int &k, const unsigned int &ch, const **mha\_real\_t** &val)  
*set frame "k" in channel "ch" to value "val"*
- void **assign** (const **mha\_real\_t** &)  
*set all elements to value*
- void **assign\_frame** (const unsigned int &k, const **mha\_real\_t** &val)  
*assign value "val" to frame k in all channels*
- void **assign\_channel** (const unsigned int &c, const **mha\_real\_t** &val)  
*assign value "val" to channel ch in all frames*
- void **copy** (const std::vector< **mha\_real\_t** > &v)
- void **copy** (const **mha\_wave\_t** &)  
*copy data from source into current waveform*
- void **copy** (const **mha\_wave\_t** \*)
- void **copy\_channel** (const **mha\_wave\_t** &, unsigned int, unsigned int)  
*Copy one channel of a given waveform signal to a target channel.*
- void **copy\_from\_at** (unsigned int, unsigned int, const **mha\_wave\_t** &, unsigned int)  
*Copy part of the source signal into part of this waveform object.*
- void **export\_to** (**mha\_wave\_t** &)  
*copy data into allocated **mha\_wave\_t** (p. 496) structure*
- void **limit** (const **mha\_real\_t** &min, const **mha\_real\_t** &max)  
*limit target to range [min,max]*
- void **power** (const **waveform\_t** &)  
*transform waveform signal (in Pa) to squared signal (in W/m<sup>2</sup>)*
- void **powspec** (const **mha\_spec\_t** &)  
*get the power spectrum (in W/m<sup>2</sup>) from a complex spectrum*
- void **scale** (const unsigned int &a, const unsigned int &b, const unsigned int &ch, const **mha\_real\_t** &val)  
*scale section [a,b] in channel "ch" by "val"*
- void **scale** (const unsigned int &k, const unsigned int &ch, const **mha\_real\_t** &val)  
*scale one element*
- void **scale\_channel** (const unsigned int &, const **mha\_real\_t** &)  
*scale one channel of target with a scalar*
- void **scale\_frame** (const unsigned int &, const **mha\_real\_t** &)
- unsigned int **get\_size** () const

## Additional Inherited Members

### 5.307.1 Detailed Description

signal processing class for waveform data (based on **mha\_wave\_t** (p. 496))

### 5.307.2 Constructor & Destructor Documentation

5.307.2.1 `waveform_t::waveform_t (`  
                   `const unsigned int & frames,`  
                   `const unsigned int & channels )`

constructor of **waveform\_t** (p. 812)

Allocates buffer memory and initializes values to zero.

#### Parameters

<i>frames</i>	number of frames in each channel
<i>channels</i>	number of channels

5.307.2.2 `waveform_t::waveform_t (`  
                   `const mhaconfig_t & cf ) [explicit]`

Constructor to create a waveform from plugin configuration.

#### Parameters

<i>cf</i>	Plugin configuration
-----------	----------------------

5.307.2.3 `waveform_t::waveform_t (`  
                   `const mha_wave_t & src ) [explicit]`

Copy constructor for **mha\_wave\_t** (p. 496) source.

5.307.2.4 `waveform_t::waveform_t (`  
                   `const MHASignal::waveform_t & src )`

Copy constructor.

5.307.2.5 `waveform_t::waveform_t (`  
                   `const std::vector< mha_real_t > & src )`

Copy constructor for `std::vector<mha_real_t>` source.

A waveform structure with a single channel is created, the length is equal to the number of elements in the source vector.

5.307.2.6 waveform\_t::~~waveform\_t (   
 void ) [virtual]

Reimplemented in **MHA\_AC::waveform\_t** (p. 427).

### 5.307.3 Member Function Documentation

5.307.3.1 void MHASignal::waveform\_t::operator= (   
 const mha\_real\_t & v ) [inline]

5.307.3.2 mha\_real\_t& MHASignal::waveform\_t::operator[] (   
 unsigned int k ) [inline]

5.307.3.3 const mha\_real\_t& MHASignal::waveform\_t::operator[] (   
 unsigned int k ) const [inline]

5.307.3.4 mha\_real\_t& MHASignal::waveform\_t::value (   
 unsigned int t,   
 unsigned int ch ) [inline]

Element accessor.

#### Parameters

<i>t</i>	Frame number
<i>ch</i>	Channel number

#### Returns

Reference to element

5.307.3.5 mha\_real\_t& MHASignal::waveform\_t::operator() (   
 unsigned int t,   
 unsigned int ch ) [inline]

Element accessor.

#### Parameters

<i>t</i>	Frame number
<i>ch</i>	Channel number

**Returns**

Reference to element

```
5.307.3.6  const mha_real_t& MHASignal::waveform_t::value (
            unsigned int t,
            unsigned int ch ) const  [inline]
```

Constant element accessor.

**Parameters**

<i>t</i>	Frame number
<i>ch</i>	Channel number

**Returns**

Reference to element

```
5.307.3.7  const mha_real_t& MHASignal::waveform_t::operator() (
            unsigned int t,
            unsigned int ch ) const  [inline]
```

Constant element accessor.

**Parameters**

<i>t</i>	Frame number
<i>ch</i>	Channel number

**Returns**

Reference to element

```
5.307.3.8  mha_real_t waveform_t::sum (
            const unsigned int & a,
            const unsigned int & b )
```

sum of all elements between [a,b) in all channels

**Parameters**

<i>a</i>	starting frame
<i>b</i>	end frame (excluded)



**Returns**

sum

5.307.3.9 `mha_real_t waveform_t::sum (`  
    `const unsigned int & a,`  
    `const unsigned int & b,`  
    `const unsigned int & ch )`

sum of all elements between [a,b) in channel ch

**Parameters**

<i>a</i>	starting frame
<i>b</i>	end frame (exluded)
<i>ch</i>	channel number

**Returns**

sum

5.307.3.10 `mha_real_t waveform_t::sum ( )`

sum of all elements

**Returns**

sum of all elements

5.307.3.11 `mha_real_t waveform_t::sumsqr ( )`

sum of square of all elements

**Returns**

sum of square of all elements

5.307.3.12 `mha_real_t waveform_t::sum_channel (`  
    `const unsigned int & ch )`

return sum of all elements in one channel

**Parameters**

<i>ch</i>	channel number
-----------	----------------

**Returns**

sum

5.307.3.13 void waveform\_t::assign (  
           const unsigned int & *k*,  
           const unsigned int & *ch*,  
           const mha\_real\_t & *val* )

set frame "k" in channel "ch" to value "val"

**Parameters**

<i>k</i>	frame number
<i>ch</i>	channel number
<i>val</i>	new value

5.307.3.14 void waveform\_t::assign (  
           const mha\_real\_t & *val* )

set all elements to value

**Parameters**

<i>val</i>	new value
------------	-----------

5.307.3.15 void waveform\_t::assign\_frame (  
           const unsigned int & *k*,  
           const mha\_real\_t & *val* )

assign value "val" to frame k in all channels

**Parameters**

<i>k</i>	frame number
<i>val</i>	new value

```
5.307.3.16 void waveform_t::assign_channel (
            const unsigned int & ch,
            const mha_real_t & val )
```

assign value "val" to channel *ch* in all frames

#### Parameters

<i>ch</i>	channel number
<i>val</i>	new value

```
5.307.3.17 void waveform_t::copy (
            const std::vector< mha_real_t > & v )
```

```
5.307.3.18 void waveform_t::copy (
            const mha_wave_t & src )
```

copy data from source into current waveform

#### Parameters

<i>src</i>	input data (need to be same size as target)
------------	---

```
5.307.3.19 void waveform_t::copy (
            const mha_wave_t * src )
```

```
5.307.3.20 void waveform_t::copy_channel (
            const mha_wave_t & src,
            unsigned int src_channel,
            unsigned int dest_channel )
```

Copy one channel of a given waveform signal to a target channel.

#### Parameters

<i>src</i>	Input waveform signal
<i>src_channel</i>	Channel in source signal
<i>dest_channel</i>	Channel number in destination signal

5.307.3.21 void waveform\_t::copy\_from\_at (
   
    unsigned int to\_pos,
   
    unsigned int len,
   
    const mha\_wave\_t & src,
   
    unsigned int from\_pos )

Copy part of the source signal into part of this waveform object.

Source and target have to have the same number of channels.

#### Parameters

<i>to_pos</i>	Offset in target
<i>len</i>	Number of frames copied
<i>src</i>	Source
<i>from_pos</i>	Offset in source

5.307.3.22 void waveform\_t::export\_to (
   
    mha\_wave\_t & dest )

copy data into allocated **mha\_wave\_t** (p. 496) structure

#### Parameters

<i>dest</i>	destination structure
-------------	-----------------------

5.307.3.23 void waveform\_t::limit (
   
    const mha\_real\_t & min,
   
    const mha\_real\_t & max )

limit target to range [min,max]

#### Parameters

<i>min</i>	lower limit
<i>max</i>	upper limit

5.307.3.24 void waveform\_t::power (
   
    const waveform\_t & src )

transform waveform signal (in Pa) to squared signal (in W/m<sup>2</sup>)

#### Parameters

<i>src</i>	linear waveform signal (in Pa)
------------	--------------------------------

5.307.3.25 void waveform\_t::powspec (  
                   const mha\_spec\_t & src )

get the power spectrum (in W/m<sup>2</sup>) from a complex spectrum

#### Parameters

<i>src</i>	complex spectrum (normalized to Pa)
------------	-------------------------------------

5.307.3.26 void waveform\_t::scale (  
                   const unsigned int & a,  
                   const unsigned int & b,  
                   const unsigned int & ch,  
                   const mha\_real\_t & val )

scale section [a,b] in channel "ch" by "val"

#### Parameters

<i>a</i>	starting frame
<i>b</i>	end frame (excluded)
<i>ch</i>	channel number
<i>val</i>	scale factor

5.307.3.27 void waveform\_t::scale (  
                   const unsigned int & k,  
                   const unsigned int & ch,  
                   const mha\_real\_t & val )

scale one element

#### Parameters

<i>k</i>	frame number
<i>ch</i>	channel number
<i>val</i>	scale factor

5.307.3.28 void waveform\_t::scale\_channel (  
                   const unsigned int & ch,  
                   const mha\_real\_t & src )

scale one channel of target with a scalar

## Parameters

<i>ch</i>	channel number
<i>src</i>	factor

5.307.3.29 void waveform\_t::scale\_frame (  
const unsigned int & *frame*,  
const mha\_real\_t & *val* )

5.307.3.30 unsigned int MHASignal::waveform\_t::get\_size ( ) const [inline]

The documentation for this class was generated from the following files:

- mha\_signal.hh
- mha\_signal.cpp

## 5.308 MHASndFile::sf\_t Class Reference

Inheritance diagram for MHASndFile::sf\_t:

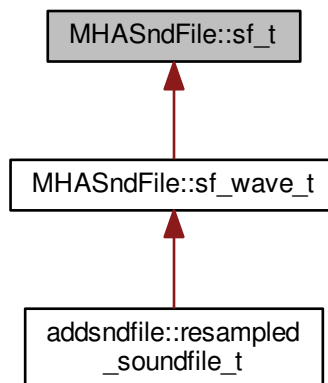

## Public Member Functions

- **sf\_t** (const std::string &fname)
- **~sf\_t** ()

## Public Attributes

- SNDFILE \* **sf**

## 5.308.1 Constructor &amp; Destructor Documentation

5.308.1.1 MHASndFile::sf\_t::sf\_t (   
                  const std::string & *fname* )

5.308.1.2 MHASndFile::sf\_t::~sf\_t ( )

## 5.308.2 Member Data Documentation

5.308.2.1 SNDFILE\* MHASndFile::sf\_t::sf

The documentation for this class was generated from the following files:

- **mhasndfile.h**
- **mhasndfile.cpp**

## 5.309 MHASndFile::sf\_wave\_t Class Reference

Inheritance diagram for MHASndFile::sf\_wave\_t:

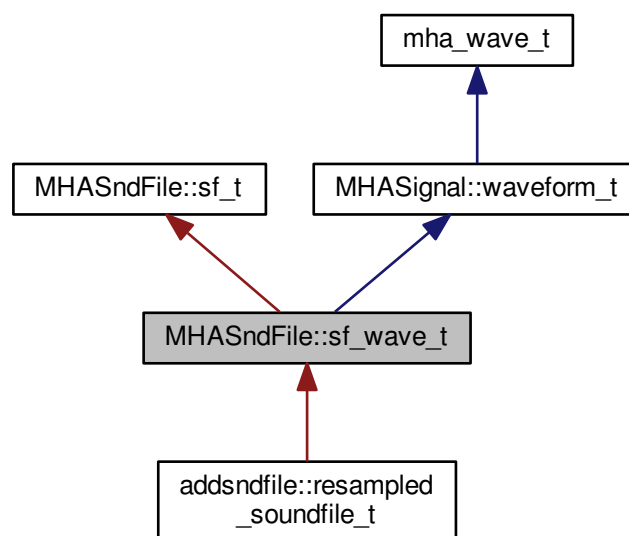

## Public Member Functions

- **sf\_wave\_t** (const std::string &fname, **mha\_real\_t** peaklevel\_db, unsigned int maxlen=std::numeric\_limits< unsigned int >::max(), unsigned int startpos=0, std::vector< int > channel\_map=std::vector< int >())

## Additional Inherited Members

### 5.309.1 Constructor & Destructor Documentation

5.309.1.1 MHASndFile::sf\_wave\_t::sf\_wave\_t (
 const std::string & *fname*,
 **mha\_real\_t** *peaklevel\_db*,
 unsigned int *maxlen* = std::numeric\_limits<unsigned int>::↔
 : **max** (),
 unsigned int *startpos* = 0,
 std::vector< int > *channel\_map* = std::vector<int>() )

The documentation for this class was generated from the following files:

- **mhasndfile.h**
- **mhasndfile.cpp**

### 5.310 MHATableLookup::linear\_table\_t Class Reference

Class for interpolation with equidistant x values.

Inheritance diagram for MHATableLookup::linear\_table\_t:

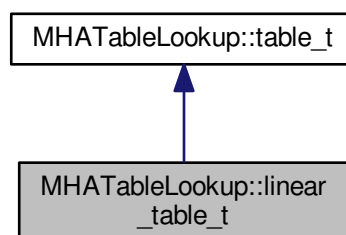



## Public Member Functions

- **linear\_table\_t** (void)  
*constructor creates an empty **linear\_table\_t** (p. 824) object.*
- **mha\_real\_t lookup** (mha\_real\_t x) const  
*look up the y value that is stored for the mesh point where x is lower than or equal to the x value given here.*
- **mha\_real\_t interp** (mha\_real\_t x) const  
*interpolate y value for the given x value.*
- **~linear\_table\_t** (void)  
*destructor*
- void **set\_xmin** (mha\_real\_t xmin)  
*set the x value for the first mesh point.*
- void **add\_entry** (mha\_real\_t y)  
*set the y value for the next mesh point.*
- void **set\_xmax** (mha\_real\_t xmax)  
*this sets the x value for a past-the-end, not added mesh point.*
- void **prepare** (void)  
*prepare computes the x distance of the mesh points based on the values given to set\_xmin, set\_xmax, and the number of times that add\_entry was called.*
- void **clear** (void)  
*clear resets the state of this object to the state directly after construction.*

## Protected Attributes

- **mha\_real\_t \* vy**
- unsigned int **len**

## Private Attributes

- vector< **mha\_real\_t** > **vec\_y**
- **mha\_real\_t xmin**
- **mha\_real\_t xmax**
- **mha\_real\_t scalefac**

## Additional Inherited Members

### 5.310.1 Detailed Description

Class for interpolation with equidistant x values.

This class can be used for linear interpolation tasks where the mesh points are known for equidistant x values.

Before the class can be used for interpolation, it has to be filled with the y values for the mesh points, the x range has to be specified, and when all values are given, the prepare method has to be called so that the object can determine the distance between x values from the range and the number of mesh points given.

Only after prepare has returned, the object may be used for interpolation.

## 5.310.2 Constructor & Destructor Documentation

### 5.310.2.1 `linear_table_t::linear_table_t ( void )`

constructor creates an empty `linear_table_t` (p. 824) object.

`add_entry`, `set_xmin`, `set_xmax` and `prepare` methods have to be called before the object can be used to lookup and interpolate values.

### 5.310.2.2 `linear_table_t::~~linear_table_t ( void )`

destructor

## 5.310.3 Member Function Documentation

### 5.310.3.1 `mha_real_t linear_table_t::lookup ( mha_real_t x ) const [virtual]`

look up the y value that is stored for the mesh point where x is lower than or equal to the x value given here.

This method does not extrapolate, so for  $x < x_{\min}$ , the y value for  $x_{\min}$  is returned. For all x greater than the x of the last mesh point, the y value of the last mesh point is returned.

#### Precondition

`prepare` must have been called before `lookup` may be called.

Implements `MHATableLookup::table_t` (p. 829).

### 5.310.3.2 `mha_real_t linear_table_t::interp ( mha_real_t x ) const [virtual]`

interpolate y value for the given x value.

The y values for the neighbouring mesh points are looked up and linearly interpolated. For x values outside the range of mesh points, the y value is extrapolated from the nearest two mesh points.

#### Precondition

`prepare` must have been called before `interp` may be called.

Implements `MHATableLookup::table_t` (p. 829).

5.310.3.3 void linear\_table\_t::set\_xmin (  
          mha\_real\_t xmin )

set the x value for the first mesh point.

Must be called before prepare can be called.

5.310.3.4 void linear\_table\_t::add\_entry (  
          mha\_real\_t y )

set the y value for the next mesh point.

Must be called at least twice before prepare can be called.

5.310.3.5 void linear\_table\_t::set\_xmax (  
          mha\_real\_t xmax )

this sets the x value for a past-the-end, not added mesh point.

Example:

```
t.set_xmin(100);  
t.add_entry(0); // mesh point {100,0}  
t.add_entry(1); // mesh point {110,1}  
// the next mesh point would be at x=120, but we do not add this  
t.set_xmax(120); // the x where the next mesh point would be  
t.prepare();
```

now, t.interp(100) == 0; t.interp(110) == 1; t.interp(105) == 0.5;

5.310.3.6 void linear\_table\_t::prepare (  
          void )

prepare computes the x distance of the mesh points based on the values given to set\_xmin, set\_xmax, and the number of times that add\_entry was called.

#### Precondition

set\_xmin, set\_xmax, add\_entry functions must have been called before calling prepare, add\_entry must have been called at least twice.

Only after this method has been called, interp or lookup may be called.

5.310.3.7 `void linear_table_t::clear ( void ) [virtual]`

clear resets the state of this object to the state directly after construction.

mesh entries and x range are deleted.

interp and lookup may not be called after this function has been called unless prepare and before that its precondition methods are called again.

Implements **MHATableLookup::table\_t** (p. 829).

#### 5.310.4 Member Data Documentation

5.310.4.1 `mha_real_t* MHATableLookup::linear_table_t::vy [protected]`

5.310.4.2 `unsigned int MHATableLookup::linear_table_t::len [protected]`

5.310.4.3 `vector<mha_real_t> MHATableLookup::linear_table_t::vec_y [private]`

5.310.4.4 `mha_real_t MHATableLookup::linear_table_t::xmin [private]`

5.310.4.5 `mha_real_t MHATableLookup::linear_table_t::xmax [private]`

5.310.4.6 `mha_real_t MHATableLookup::linear_table_t::scalefac [private]`

The documentation for this class was generated from the following files:

- `mha_tablelookup.hh`
- `mha_tablelookup.cpp`

#### 5.311 MHATableLookup::table\_t Class Reference

Inheritance diagram for MHATableLookup::table\_t:

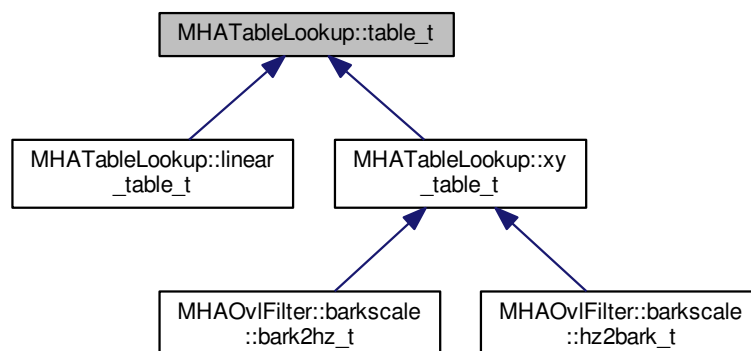

## Public Member Functions

- **table\_t** (void)
- virtual **~table\_t** (void)
- virtual **mha\_real\_t lookup** (mha\_real\_t) const =0
- virtual **mha\_real\_t interp** (mha\_real\_t) const =0

## Protected Member Functions

- virtual void **clear** (void)=0

### 5.311.1 Constructor & Destructor Documentation

5.311.1.1 **table\_t::table\_t** (  
void )

5.311.1.2 **table\_t::~~table\_t** (  
void ) [virtual]

### 5.311.2 Member Function Documentation

5.311.2.1 virtual mha\_real\_t MHATableLookup::table\_t::lookup (  
mha\_real\_t )const [pure virtual]

Implemented in **MHATableLookup::xy\_table\_t** (p. 831), and **MHATableLookup::linear\_↔  
table\_t** (p. 826).

5.311.2.2 virtual mha\_real\_t MHATableLookup::table\_t::interp (  
mha\_real\_t )const [pure virtual]

Implemented in **MHATableLookup::xy\_table\_t** (p. 832), and **MHATableLookup::linear\_↔  
table\_t** (p. 826).

5.311.2.3 virtual void MHATableLookup::table\_t::clear (  
void ) [protected],[pure virtual]

Implemented in **MHATableLookup::xy\_table\_t** (p. 832), and **MHATableLookup::linear\_↔  
table\_t** (p. 828).

The documentation for this class was generated from the following files:

- **mha\_tablelookup.hh**
- **mha\_tablelookup.cpp**

### 5.312 MHATableLookup::xy\_table\_t Class Reference

Class for interpolation with non-equidistant x values.

Inheritance diagram for MHATableLookup::xy\_table\_t:

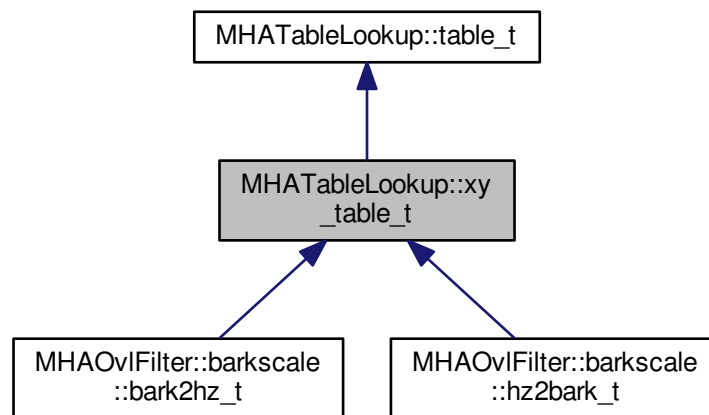

#### Public Member Functions

- **xy\_table\_t** ()
- **mha\_real\_t lookup** (mha\_real\_t x) const  
*Return the y-value at the position of the nearest x value below input.*
- **mha\_real\_t interp** (mha\_real\_t x) const  
*Linear interpolation function.*
- void **add\_entry** (mha\_real\_t x, mha\_real\_t y)  
*Add a single x-y pair entry.*
- void **add\_entry** (mha\_real\_t \*pVX, mha\_real\_t \*pVY, unsigned int len)  
*Add multiple entries at once.*
- void **clear** ()  
*Clear the table and transformation functions.*
- void **set\_xfun** (float(\*pXFun)(float))  
*Set transformation function for x values.*
- void **set\_yfun** (float(\*pYFun)(float))  
*Set transformation function for y values during insertion.*
- void **set\_xyfun** (float(\*pYFun)(float, float))  
*Set transformation function for y values during insertion, based on x and y values.*
- std::pair< mha\_real\_t, mha\_real\_t > **get\_xlimits** () const  
*returns the min and max x of all mesh points that are stored in the lookup table, i.e.*

### Private Attributes

- `std::map< mha_real_t, mha_real_t > mXY`
- `float(* xfun )(float)`
- `float(* yfun )(float)`
- `float(* xyfun )(float, float)`

### Additional Inherited Members

#### 5.312.1 Detailed Description

Class for interpolation with non-equidistant x values.

Linear interpolation of the x-y table is performed. A transformation of x and y-values is possible; if a transformation function is provided for the x-values, the same function is applied to the argument of `xy_table_t::interp()` (p. 832) and `xy_table_t::lookup()` (p. 831). The transformation of y values is applied only during insertion into the table. Two functions for y-transformation can be provided: a simple transformation which depends only on the y values, or a transformation which takes both (non-transformed) x and y value as an argument. The two-argument transformation is applied before the one-argument transformation.

#### 5.312.2 Constructor & Destructor Documentation

##### 5.312.2.1 `xy_table_t::xy_table_t( )`

#### 5.312.3 Member Function Documentation

##### 5.312.3.1 `mha_real_t xy_table_t::lookup ( mha_real_t x ) const` [virtual]

Return the y-value at the position of the nearest x value below input.

#### Parameters

x	Input value
---	-------------

#### Returns

y value at nearest x value below input.

Implements `MHATableLookup::table_t` (p. 829).

5.312.3.2 `mha_real_t xy_table_t::interp (`  
`mha_real_t x ) const` [virtual]

Linear interpolation function.

**Parameters**

<code>x</code>	x value
----------------	---------

**Returns**

interpolated y value

Implements **MHATableLookup::table\_t** (p. 829).

5.312.3.3 `void xy_table_t::add_entry (`  
`mha_real_t x,`  
`mha_real_t y )`

Add a single x-y pair entry.

**Parameters**

<code>x</code>	x value
<code>y</code>	corresponding y value

5.312.3.4 `void xy_table_t::add_entry (`  
`mha_real_t * pVX,`  
`mha_real_t * pVY,`  
`unsigned int uLength )`

Add multiple entries at once.

**Parameters**

<code>pVX</code>	array of x values
<code>pVY</code>	array of y values
<code>uLength</code>	Length of x and y arrays

5.312.3.5 `void xy_table_t::clear (`  
`void )` [virtual]

Clear the table and transformation functions.

Implements **MHATableLookup::table\_t** (p. 829).



5.312.3.6 void xy\_table\_t::set\_xfun (  
float(\*)(float) fun )

Set transformation function for x values.

#### Parameters

<i>fun</i>	Transformation function.
------------	--------------------------

5.312.3.7 void xy\_table\_t::set\_yfun (  
float(\*)(float) fun )

Set transformation function for y values during insertion.

#### Parameters

<i>fun</i>	Transformation function.
------------	--------------------------

5.312.3.8 void xy\_table\_t::set\_xyfun (  
float(\*)(float, float) fun )

Set transformation function for y values during insertion, based on x and y values.

#### Parameters

<i>fun</i>	Transformation function.
------------	--------------------------

5.312.3.9 std::pair<mha\_real\_t,mha\_real\_t> MHATableLookup::xy\_table\_t::get\_xlimits ( ) const  
[inline]

returns the min and max x of all mesh points that are stored in the lookup table, i.e.  
after transformation with xfun, if any. Not real-time safe

#### 5.312.4 Member Data Documentation

5.312.4.1 std::map<mha\_real\_t,mha\_real\_t> MHATableLookup::xy\_table\_t::mXY [private]

5.312.4.2 float(\* MHATableLookup::xy\_table\_t::xfun) (float) [private]

5.312.4.3 float(\* MHATableLookup::xy\_table\_t::yfun) (float) [private]

5.312.4.4 float(\* MHATableLookup::xy\_table\_t::xyfun) (float, float) [private]

The documentation for this class was generated from the following files:

- **mha\_tablelookup.hh**
- **mha\_tablelookup.cpp**

### 5.313 MHAWindow::bartlett\_t Class Reference

Bartlett window.

Inheritance diagram for MHAWindow::bartlett\_t:

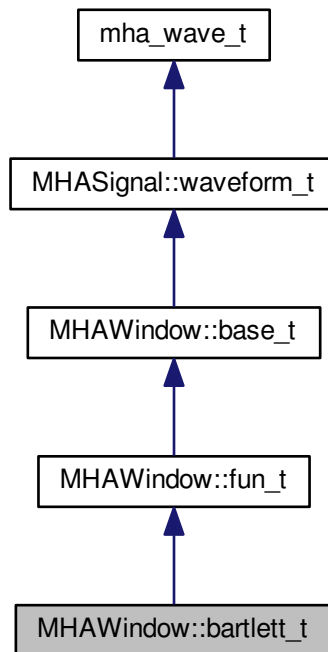

#### Public Member Functions

- **bartlett\_t** (unsigned int n)

#### Additional Inherited Members

##### 5.313.1 Detailed Description

Bartlett window.

##### 5.313.2 Constructor & Destructor Documentation

###### 5.313.2.1 MHAWindow::bartlett\_t::bartlett\_t ( unsigned int n ) [inline]

The documentation for this class was generated from the following file:

- **mha\_windowparser.h**

## 5.314 MHAWindow::base\_t Class Reference

Common base for window types.

Inheritance diagram for MHAWindow::base\_t:

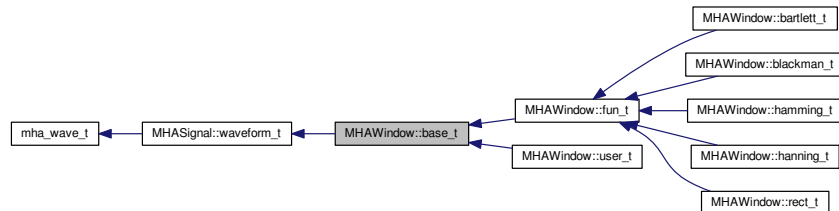

### Public Member Functions

- **base\_t** (unsigned int len)  
*Constructor.*
- **base\_t** (const **MHAWindow::base\_t** &src)  
*Copy constructor.*
- void **operator()** (**mha\_wave\_t** &) const  
*Apply window to waveform segment (reference)*
- void **operator()** (**mha\_wave\_t** \*) const  
*Apply window to waveform segment (pointer)*
- void **ramp\_begin** (**mha\_wave\_t** &) const  
*Apply a ramp at the begining.*
- void **ramp\_end** (**mha\_wave\_t** &) const  
*Apply a ramp at the end.*

### Additional Inherited Members

#### 5.314.1 Detailed Description

Common base for window types.

#### 5.314.2 Constructor & Destructor Documentation

##### 5.314.2.1 MHAWindow::base\_t::base\_t ( unsigned int len )

Constructor.

**Parameters**

<i>len</i>	Window length in samples.
------------	---------------------------

5.314.2.2 **MHAWindow::base\_t::base\_t (**  
**const MHAWindow::base\_t & src )**

Copy constructor.

**Parameters**

<i>src</i>	Source to be copied
------------	---------------------

**5.314.3 Member Function Documentation**

5.314.3.1 **void MHAWindow::base\_t::operator() (**  
**mha\_wave\_t & s ) const**

Apply window to waveform segment (reference)

5.314.3.2 **void MHAWindow::base\_t::operator() (**  
**mha\_wave\_t \* s ) const**

Apply window to waveform segment (pointer)

5.314.3.3 **void MHAWindow::base\_t::ramp\_begin (**  
**mha\_wave\_t & s ) const**

Apply a ramp at the beginning.

5.314.3.4 **void MHAWindow::base\_t::ramp\_end (**  
**mha\_wave\_t & s ) const**

Apply a ramp at the end.

The documentation for this class was generated from the following files:

- **mha\_windowparser.h**
- **mha\_windowparser.cpp**

## 5.315 MHAWindow::blackman\_t Class Reference

Blackman window.

Inheritance diagram for MHAWindow::blackman\_t:

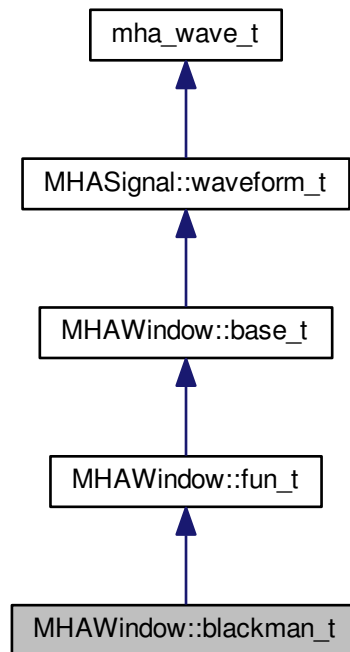

#### Public Member Functions

- **blackman\_t** (unsigned int n)

#### Additional Inherited Members

##### 5.315.1 Detailed Description

Blackman window.

##### 5.315.2 Constructor & Destructor Documentation

###### 5.315.2.1 MHAWindow::blackman\_t::blackman\_t ( unsigned int n ) [inline]

The documentation for this class was generated from the following file:

- **mha\_windowparser.h**

### 5.316 MHAWindow::fun\_t Class Reference

Generic window based on a generator function.

Inheritance diagram for MHAWindow::fun\_t:

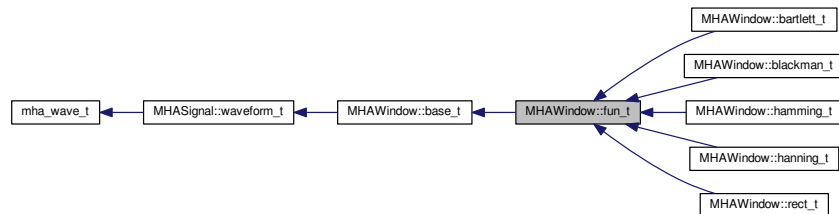

#### Public Member Functions

- **fun\_t** (unsigned int *n*, float(\*fun)(float), float *xmin*=-1, float *xmax*=1, bool *min\_included*=true, bool *max\_included*=false)

*Constructor.*

#### Additional Inherited Members

##### 5.316.1 Detailed Description

Generic window based on a generator function.

The generator function should return a valid window function in the interval  $[-1,1]$ .

##### 5.316.2 Constructor & Destructor Documentation

5.316.2.1 MHAWindow::fun\_t::fun\_t (  
     unsigned int *n*,  
     float(\*) (float) *fun*,  
     float *xmin* = -1,  
     float *xmax* = 1,  
     bool *min\_included* = true,  
     bool *max\_included* = false )

Constructor.

## Parameters

<i>n</i>	Window length
<i>fun</i>	Generator function, i.e. <b>MHAWindow::hanning()</b> (p. 127)
<i>xmin</i>	Start value of window, i.e. -1 for full window or 0 for fade-out ramp.
<i>xmax</i>	Last value of window, i.e. 1 for full window
<i>min_included</i>	Flag if minimum value is included
<i>max_included</i>	Flag if maximum value is included

The documentation for this class was generated from the following files:

- **mha\_windowparser.h**
- **mha\_windowparser.cpp**

## 5.317 MHAWindow::hamming\_t Class Reference

Hamming window.

Inheritance diagram for MHAWindow::hamming\_t:

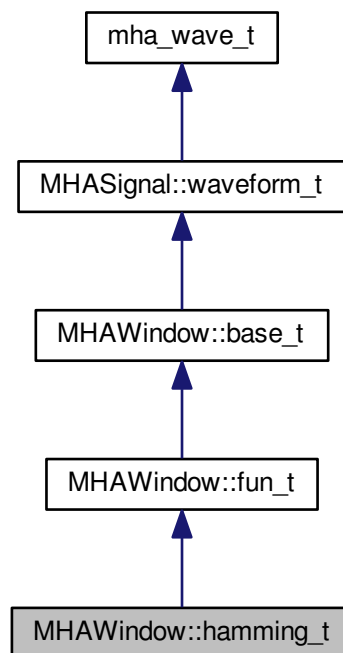

## Public Member Functions

- **hamming\_t** (unsigned int *n*)

## Additional Inherited Members

### 5.317.1 Detailed Description

Hamming window.

### 5.317.2 Constructor & Destructor Documentation

#### 5.317.2.1 MHAWindow::hamming\_t::hamming\_t ( unsigned int *n* ) [inline]

The documentation for this class was generated from the following file:

- **mha\_windowparser.h**

### 5.318 MHAWindow::hanning\_t Class Reference

von-Hann window

Inheritance diagram for MHAWindow::hanning\_t:

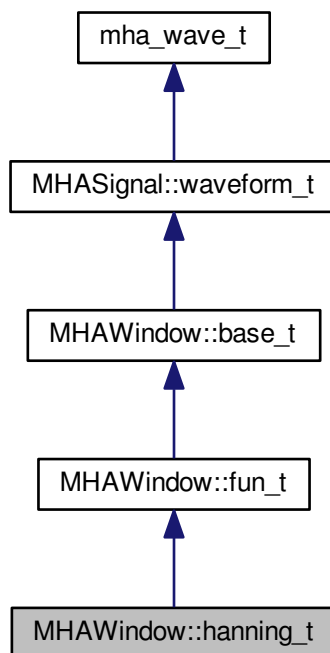



## Public Member Functions

- **hanning\_t** (unsigned int *n*)

## Additional Inherited Members

## 5.318.1 Detailed Description

von-Hann window

## 5.318.2 Constructor &amp; Destructor Documentation

5.318.2.1 MHAWindow::hanning\_t::hanning\_t (  
unsigned int *n* ) [inline]

The documentation for this class was generated from the following file:

- **mha\_windowparser.h**

## 5.319 MHAWindow::rect\_t Class Reference

Rectangular window.

Inheritance diagram for MHAWindow::rect\_t:

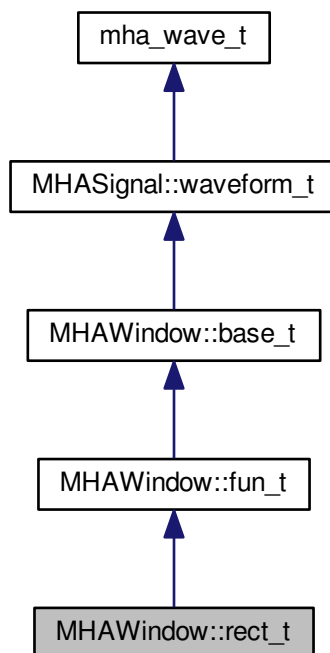

## Public Member Functions

- **rect\_t** (unsigned int n)

## Additional Inherited Members

### 5.319.1 Detailed Description

Rectangular window.

### 5.319.2 Constructor & Destructor Documentation

#### 5.319.2.1 MHAWindow::rect\_t::rect\_t ( unsigned int n ) [inline]

The documentation for this class was generated from the following file:

- **mha\_windowparser.h**

### 5.320 MHAWindow::user\_t Class Reference

User defined window.

Inheritance diagram for MHAWindow::user\_t:

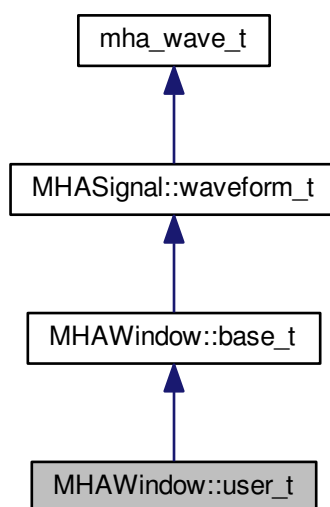

## Public Member Functions

- **user\_t** (const std::vector< **mha\_real\_t** > &wnd)  
*Constructor.*

## Additional Inherited Members

### 5.320.1 Detailed Description

User defined window.

### 5.320.2 Constructor & Destructor Documentation

#### 5.320.2.1 MHAWindow::user\_t::user\_t ( const std::vector< **mha\_real\_t** > & *wnd* )

Constructor.

#### Parameters

<i>wnd</i>	User defined window
------------	---------------------

The documentation for this class was generated from the following files:

- **mha\_windowparser.h**
- **mha\_windowparser.cpp**

### 5.321 mon\_t Class Reference

Inheritance diagram for mon\_t:

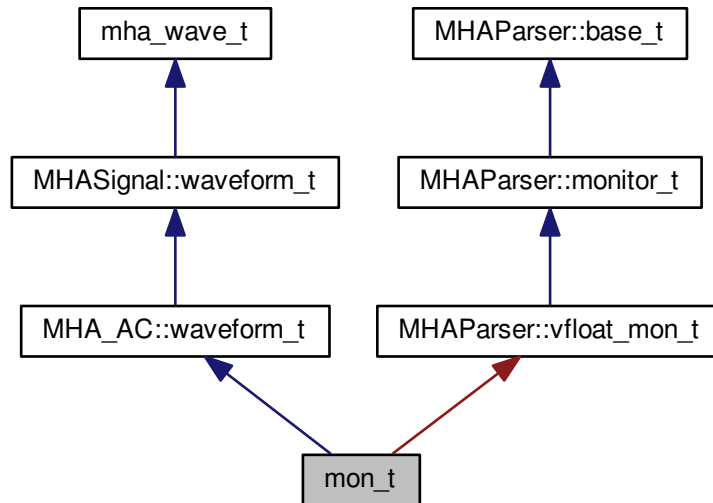

#### Public Member Functions

- **mon\_t** (unsigned int *nch*, std::string *name*, algo\_comm\_t *ac*, std::string *base*, MHA↔Parser::parser\_t &*p*, std::string *help*)
- void **store** ()

#### Additional Inherited Members

##### 5.321.1 Constructor & Destructor Documentation

5.321.1.1 mon\_t::mon\_t (  
     unsigned int *nch*,  
     std::string *name*,  
     algo\_comm\_t *ac*,  
     std::string *base*,  
     MHAParser::parser\_t & *p*,  
     std::string *help* )

##### 5.321.2 Member Function Documentation

5.321.2.1 void mon\_t::store ( )

The documentation for this class was generated from the following file:

- rmslevel.cpp

## 5.322 multibandcompressor::fftfb\_plug\_t Class Reference

Inheritance diagram for multibandcompressor::fftfb\_plug\_t:

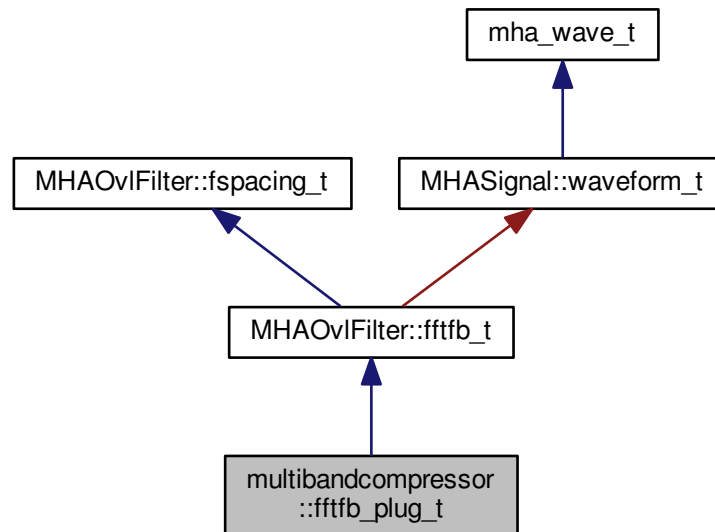

## Public Member Functions

- **fftfb\_plug\_t** (**MHAOvfFilter::fftfb\_vars\_t** &, const **mhaconfig\_t** &cfg, **algo\_comm\_**<sub>↔</sub>**t** ac, std::string alg)
- void **insert** ()

## Private Attributes

- **MHA\_AC::waveform\_t** cfv  
*vector of nominal center frequencies / Hz*
- **MHA\_AC::waveform\_t** efv  
*vector of edge frequencies / Hz*
- **MHA\_AC::waveform\_t** bwv  
*vector of band-weights (sum of squared fft-bin-weights)/num\_frames*

## Additional Inherited Members

### 5.322.1 Constructor & Destructor Documentation

5.322.1.1 `multibandcompressor::fftfb_plug_t::fftfb_plug_t ( MHAOvIFilter::fftfb_vars_t & vars, const mhaconfig_t & cfg, algo_comm_t ac, std::string alg )`

### 5.322.2 Member Function Documentation

5.322.2.1 `void multibandcompressor::fftfb_plug_t::insert ( )`

### 5.322.3 Member Data Documentation

5.322.3.1 `MHA_AC::waveform_t multibandcompressor::fftfb_plug_t::cfv` `[private]`

vector of nominal center frequencies / Hz

5.322.3.2 `MHA_AC::waveform_t multibandcompressor::fftfb_plug_t::efv` `[private]`

vector of edge frequencies / Hz

5.322.3.3 `MHA_AC::waveform_t multibandcompressor::fftfb_plug_t::bwv` `[private]`

vector of band-weights (sum of squared fft-bin-weights)/num\_frames

The documentation for this class was generated from the following file:

- `multibandcompressor.cpp`

## 5.323 multibandcompressor::interface\_t Class Reference

Inheritance diagram for multibandcompressor::interface\_t:

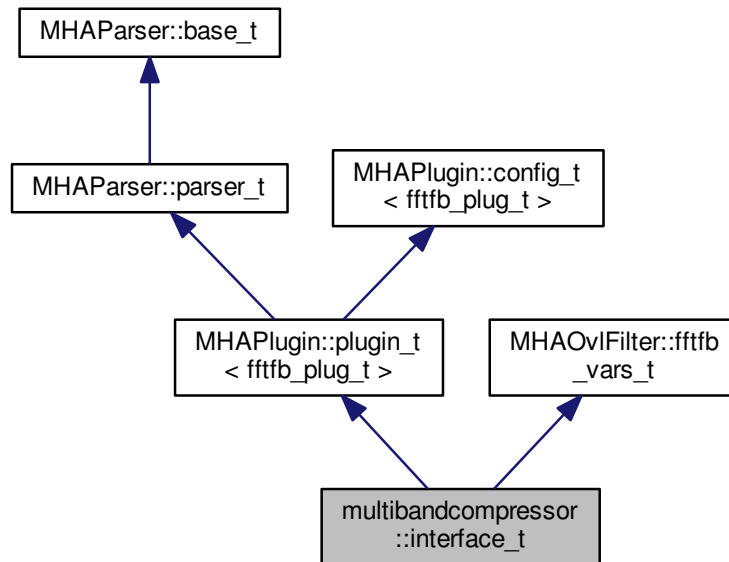

## Public Member Functions

- **interface\_t** (const **algo\_comm\_t** &, const std::string &, const std::string &)
- void **prepare** (**mhaconfig\_t** &)
- void **release** ()
- **mha\_spec\_t** \* **process** (**mha\_spec\_t** \*)

## Private Member Functions

- void **update\_cfg** ()

## Private Attributes

- int **num\_channels**
- **DynComp::dc\_afterburn\_t** **burn**
- **MHAEvents::patchbay\_t** < **interface\_t** > **patchbay**
- std::string **algo**
- **MHAParser::mhapluginloader\_t** **plug**
- **plugin\_signals\_t** \* **plug\_sigs**

## Additional Inherited Members

### 5.323.1 Constructor & Destructor Documentation

5.323.1.1 `multibandcompressor::interface_t::interface_t (`  
`const algo_comm_t & ac,`  
`const std::string & th,`  
`const std::string & al )`

Default values are set and MHA configuration variables registered into the parser.

#### Parameters

<i>ac</i>	algorithm communication handle
<i>th</i>	chain name
<i>al</i>	algorithm name

### 5.323.2 Member Function Documentation

5.323.2.1 `void multibandcompressor::interface_t::prepare (`  
`mhaconfig_t & tf ) [virtual]`

Implements `MHAPlugin::plugin_t< fftfb_plug_t >` (p. 730).

5.323.2.2 `void multibandcompressor::interface_t::release (`  
`void ) [virtual]`

Reimplemented from `MHAPlugin::plugin_t< fftfb_plug_t >` (p. 731).

5.323.2.3 `mha_spec_t * multibandcompressor::interface_t::process (`  
`mha_spec_t * s )`

5.323.2.4 `void multibandcompressor::interface_t::update_cfg (`  
`void ) [private]`

### 5.323.3 Member Data Documentation

5.323.3.1 `int multibandcompressor::interface_t::num_channels [private]`

5.323.3.2 `DynComp::dc_afterburn_t multibandcompressor::interface_t::burn [private]`



## 5.324 multibandcompressor::plugin\_signals\_t Class Reference 849

5.323.3.3 **MHAEvents::patchbay\_t<interface\_t>** multibandcompressor::interface\_t::patchbay [private]

5.323.3.4 **std::string** multibandcompressor::interface\_t::algo [private]

5.323.3.5 **MHAParser::mhapluginloader\_t** multibandcompressor::interface\_t::plug [private]

5.323.3.6 **plugin\_signals\_t\*** multibandcompressor::interface\_t::plug\_sigs [private]

The documentation for this class was generated from the following file:

- **multibandcompressor.cpp**

## 5.324 multibandcompressor::plugin\_signals\_t Class Reference

### Public Member Functions

- **plugin\_signals\_t** (unsigned int **channels**, unsigned int bands)
- void **update\_levels** (MHAOvFilter::fftfb\_t \*, mha\_spec\_t \*s\_in)
- void **apply\_gains** (MHAOvFilter::fftfb\_t \*, DynComp::dc\_afterburn\_t &burn, mha\_spec\_t \*s\_out)

### Public Attributes

- **mha\_wave\_t \* plug\_output**

### Private Attributes

- **MHASignal::waveform\_t plug\_level**
- **MHASignal::waveform\_t gain**

### 5.324.1 Constructor & Destructor Documentation

5.324.1.1 `multibandcompressor::plugin_signals_t::plugin_signals_t ( unsigned int channels, unsigned int bands )`

### 5.324.2 Member Function Documentation

5.324.2.1 `void multibandcompressor::plugin_signals_t::update_levels ( MHAOvIFilter::fftfb_t * pFb, mha_spec_t * s_in )`

5.324.2.2 `void multibandcompressor::plugin_signals_t::apply_gains ( MHAOvIFilter::fftfb_t * pFb, DynComp::dc_afterburn_t & burn, mha_spec_t * s_out )`

### 5.324.3 Member Data Documentation

5.324.3.1 `MHASignal::waveform_t multibandcompressor::plugin_signals_t::plug_level [private]`

5.324.3.2 `MHASignal::waveform_t multibandcompressor::plugin_signals_t::gain [private]`

5.324.3.3 `mha_wave_t* multibandcompressor::plugin_signals_t::plug_output`

The documentation for this class was generated from the following file:

- `multibandcompressor.cpp`

## 5.325 nlms\_t Class Reference

Inheritance diagram for nlms\_t:

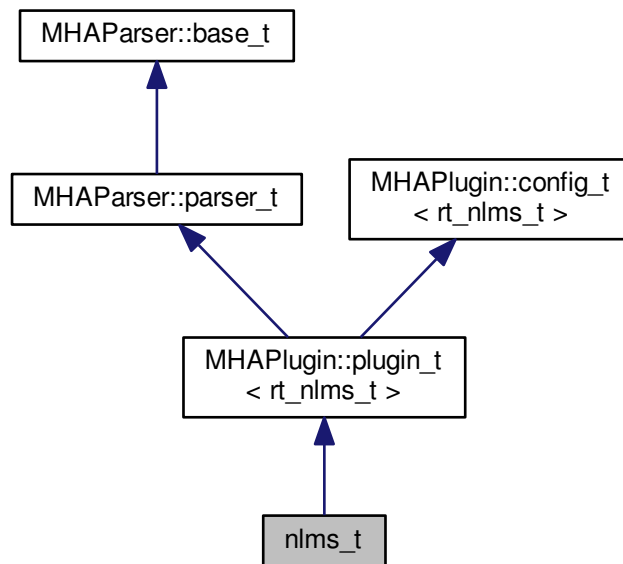

#### Public Member Functions

- **nlms\_t** (**algo\_comm\_t**, const char \*, const char \*)
- void **prepare** (**mhaconfig\_t** &)
- void **release** ()
- **mha\_wave\_t** \* **process** (**mha\_wave\_t** \*)

#### Private Member Functions

- void **update** ()

#### Private Attributes

- **MHAParser::float\_t** rho
- **MHAParser::float\_t** c
- **MHAParser::int\_t** ntaps
- **MHAParser::string\_t** name\_u
- **MHAParser::string\_t** name\_d
- **MHAParser::kw\_t** normtype

- **MHAParser::kw\_t** estimtype
- **MHAParser::float\_t** lambda\_smoothing\_power
- **MHAParser::string\_t** name\_e
- **MHAParser::string\_t** name\_f
- **MHAParser::int\_t** n\_no\_update
- **std::string** algo
- **MHAEvents::patchbay\_t**< nlms\_t > patchbay

#### Additional Inherited Members

#### 5.325.1 Constructor & Destructor Documentation

5.325.1.1 nlms\_t::nlms\_t (  
                   algo\_comm\_t ac,  
                   const char \* ,  
                   const char \* ialg )

#### 5.325.2 Member Function Documentation

5.325.2.1 void nlms\_t::prepare (  
                   mhaconfig\_t & cf ) [virtual]

Implements **MHAPlugin::plugin\_t**< rt\_nlms\_t > (p. 730).

5.325.2.2 void nlms\_t::release (  
                   void ) [virtual]

Reimplemented from **MHAPlugin::plugin\_t**< rt\_nlms\_t > (p. 731).

5.325.2.3 mha\_wave\_t \* nlms\_t::process (  
                   mha\_wave\_t \* s )

5.325.2.4 void nlms\_t::update ( ) [private]

#### 5.325.3 Member Data Documentation

5.325.3.1 **MHAParser::float\_t** nlms\_t::rho [private]

5.325.3.2 **MHAParser::float\_t** nlms\_t::c [private]

5.325.3.3 **MHAParser::int\_t** nlms\_t::ntaps [private]

5.325.3.4 **MHAParser::string\_t** nlms\_t::name\_u [private]

- 5.325.3.5 MHAParser::string\_t nlms\_t::name\_d [private]
- 5.325.3.6 MHAParser::kw\_t nlms\_t::normtype [private]
- 5.325.3.7 MHAParser::kw\_t nlms\_t::estimtype [private]
- 5.325.3.8 MHAParser::float\_t nlms\_t::lambda\_smoothing\_power [private]
- 5.325.3.9 MHAParser::string\_t nlms\_t::name\_e [private]
- 5.325.3.10 MHAParser::string\_t nlms\_t::name\_f [private]
- 5.325.3.11 MHAParser::int\_t nlms\_t::n\_no\_update [private]
- 5.325.3.12 std::string nlms\_t::algo [private]
- 5.325.3.13 MHAEvents::patchbay\_t<nlms\_t> nlms\_t::patchbay [private]

The documentation for this class was generated from the following file:

- nlms\_wave.cpp

## 5.326 noise\_t Class Reference

Inheritance diagram for noise\_t:

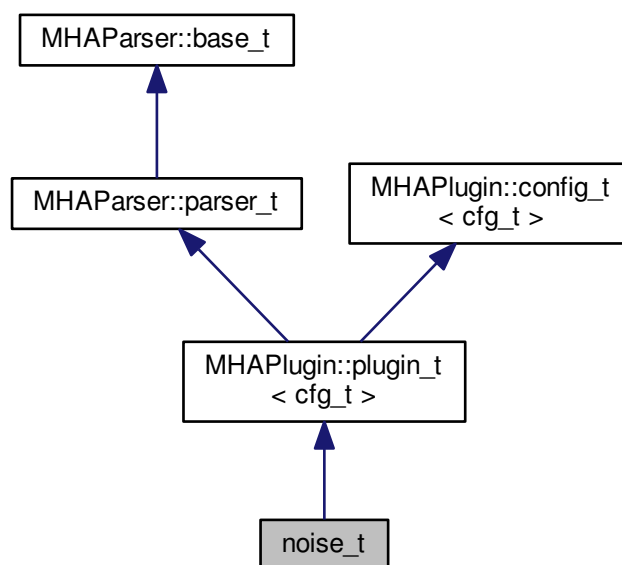

## Public Member Functions

- **noise\_t** (const **algo\_comm\_t** &, const std::string &, const std::string &)
- **mha\_wave\_t \* process** (**mha\_wave\_t** \*)
- **mha\_spec\_t \* process** (**mha\_spec\_t** \*)
- void **prepare** (**mhaconfig\_t** &)
- void **update\_cfg** ()

## Private Attributes

- **MHAParser::float\_t lev**
- **MHAParser::kw\_t mode**
- **MHAParser::float\_t frozennoise\_length**
- **MHAEvents::patchbay\_t< noise\_t > patchbay**

## Additional Inherited Members

### 5.326.1 Constructor & Destructor Documentation

5.326.1.1 **noise\_t::noise\_t** (  
                   const **algo\_comm\_t** & *iac*,  
                   const std::string & ,  
                   const std::string & )

### 5.326.2 Member Function Documentation

5.326.2.1 **mha\_wave\_t \* noise\_t::process** (  
                   **mha\_wave\_t** \* *s* )

5.326.2.2 **mha\_spec\_t \* noise\_t::process** (  
                   **mha\_spec\_t** \* *s* )

5.326.2.3 void **noise\_t::prepare** (  
                   **mhaconfig\_t** & *tf* ) [virtual]

Implements **MHAPLugin::plugin\_t< cfg\_t >** (p. 730).

5.326.2.4 void noise\_t::update\_cfg ( void )

### 5.326.3 Member Data Documentation

5.326.3.1 MHAParser::float\_t noise\_t::lev [private]

5.326.3.2 MHAParser::kw\_t noise\_t::mode [private]

5.326.3.3 MHAParser::float\_t noise\_t::frozennoise\_length [private]

5.326.3.4 MHAEvents::patchbay\_t<noise\_t> noise\_t::patchbay [private]

The documentation for this class was generated from the following file:

- noise.cpp

## 5.327 noisePowProposedScale::interface\_t Class Reference

Inheritance diagram for noisePowProposedScale::interface\_t:

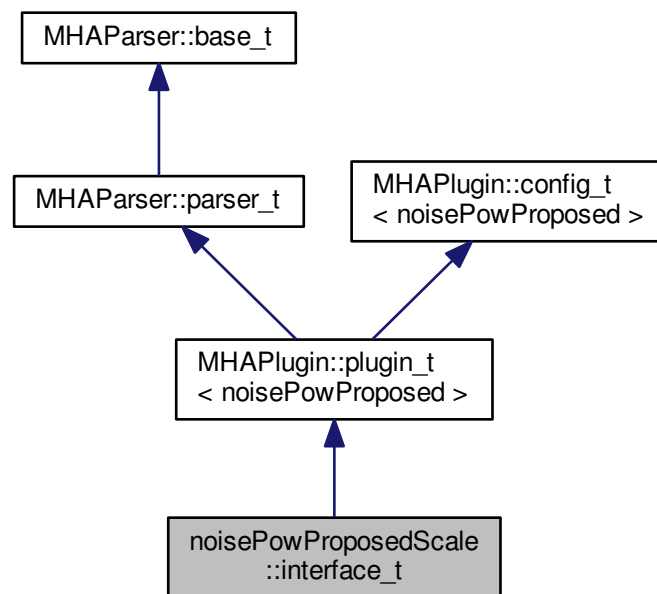

### Public Member Functions

- **interface\_t** (const **algo\_comm\_t** &, const std::string &, const std::string &)
- **mha\_spec\_t \* process** (**mha\_spec\_t** \*)
- void **prepare** (**mhaconfig\_t** &)

### Private Member Functions

- void **update\_cfg** ()

### Private Attributes

- **MHAParser::float\_t alphaPH1mean**
- **MHAParser::float\_t alphaPSD**
- **MHAParser::float\_t q**
- **MHAParser::float\_t xiOptDb**
- std::string **name**
- **MHAEvents::patchbay\_t < interface\_t > patchbay**

### Additional Inherited Members

#### 5.327.1 Constructor & Destructor Documentation

5.327.1.1 **noisePowProposedScale::interface\_t::interface\_t** (  
     const **algo\_comm\_t** & *iac*,  
     const std::string & ,  
     const std::string & *iname* )

#### 5.327.2 Member Function Documentation

5.327.2.1 **mha\_spec\_t \* noisePowProposedScale::interface\_t::process** (  
     **mha\_spec\_t** \* *s* )

5.327.2.2 void **noisePowProposedScale::interface\_t::prepare** (  
     **mhaconfig\_t** & *cf* ) [virtual]

Implements **MHAPlugin::plugin\_t < noisePowProposed >** (p. 730).



5.327.2.3 void noisePowProposedScale::interface\_t::update\_cfg ( void ) [private]

### 5.327.3 Member Data Documentation

5.327.3.1 MHAParser::float\_t noisePowProposedScale::interface\_t::alphaPH1mean [private]

5.327.3.2 MHAParser::float\_t noisePowProposedScale::interface\_t::alphaPSD [private]

5.327.3.3 MHAParser::float\_t noisePowProposedScale::interface\_t::q [private]

5.327.3.4 MHAParser::float\_t noisePowProposedScale::interface\_t::xiOptDb [private]

5.327.3.5 std::string noisePowProposedScale::interface\_t::name [private]

5.327.3.6 MHAEvents::patchbay\_t<interface\_t> noisePowProposedScale::interface\_t::patchbay [private]

The documentation for this class was generated from the following file:

- **noisePowProposedScale.cpp**

## 5.328 noisePowProposedScale::noisePowProposed Class Reference

### Public Member Functions

- **noisePowProposed** (const **mhaconfig\_t** &cf, **algo\_comm\_t** ac, const std::string &name, float alphaPH1mean, float alphaPSD, float q, float xiOptDb)
- void **process** (**mha\_spec\_t** \*noisyDftFrame)
- void **insert** ()

### Private Attributes

- **MHASignal::waveform\_t** noisyPer
- **MHASignal::waveform\_t** PH1mean
- **MHA\_AC::waveform\_t** noisePow
- **MHA\_AC::waveform\_t** inputPow
- **MHA\_AC::waveform\_t** snrPost1Debug
- **MHA\_AC::waveform\_t** GLRDebug
- **MHA\_AC::waveform\_t** PH1Debug
- **MHA\_AC::waveform\_t** estimateDebug
- **MHA\_AC::spectrum\_t** inputSpec
- float **alphaPH1mean\_**
- float **alphaPSD\_**
- float **priorFact**
- float **xiOpt**
- float **logGLRFact**
- float **GLRexp**
- int **frameno**

### 5.328.1 Constructor & Destructor Documentation

5.328.1.1 `noisePowProposedScale::noisePowProposed::noisePowProposed (`  
     `const mhaconfig_t & cf,`  
     `algo_comm_t ac,`  
     `const std::string & name,`  
     `float alphaPH1mean,`  
     `float alphaPSD,`  
     `float q,`  
     `float xiOptDb )`

### 5.328.2 Member Function Documentation

5.328.2.1 `void noisePowProposedScale::noisePowProposed::process (`  
     `mha_spec_t * noisyDftFrame )`

5.328.2.2 `void noisePowProposedScale::noisePowProposed::insert ( ) [inline]`

### 5.328.3 Member Data Documentation

5.328.3.1 `MHASignal::waveform_t noisePowProposedScale::noisePowProposed::noisyPer`  
     `[private]`

5.328.3.2 `MHASignal::waveform_t noisePowProposedScale::noisePowProposed::PH1mean`  
     `[private]`

5.328.3.3 `MHA_AC::waveform_t noisePowProposedScale::noisePowProposed::noisePow`  
     `[private]`

5.328.3.4 `MHA_AC::waveform_t noisePowProposedScale::noisePowProposed::inputPow`  
     `[private]`

5.328.3.5 `MHA_AC::waveform_t noisePowProposedScale::noisePowProposed::snrPost1Debug`  
     `[private]`

5.328.3.6 `MHA_AC::waveform_t noisePowProposedScale::noisePowProposed::GLRDebug`  
     `[private]`

5.328.3.7 `MHA_AC::waveform_t noisePowProposedScale::noisePowProposed::PH1Debug`  
     `[private]`

5.328.3.8 `MHA_AC::waveform_t noisePowProposedScale::noisePowProposed::estimateDebug`  
     `[private]`

5.328.3.9 `MHA_AC::spectrum_t noisePowProposedScale::noisePowProposed::inputSpec`  
     `[private]`

5.328.3.10 float noisePowProposedScale::noisePowProposed::alphaPH1mean\_ [private]

5.328.3.11 float noisePowProposedScale::noisePowProposed::alphaPSD\_ [private]

5.328.3.12 float noisePowProposedScale::noisePowProposed::priorFact [private]

5.328.3.13 float noisePowProposedScale::noisePowProposed::xiOpt [private]

5.328.3.14 float noisePowProposedScale::noisePowProposed::logGLRFact [private]

5.328.3.15 float noisePowProposedScale::noisePowProposed::GLRexp [private]

5.328.3.16 int noisePowProposedScale::noisePowProposed::frameno [private]

The documentation for this class was generated from the following file:

- **noisePowProposedScale.cpp**

## 5.329 overlapadd::overlapadd\_if\_t Class Reference

Inheritance diagram for overlapadd::overlapadd\_if\_t:

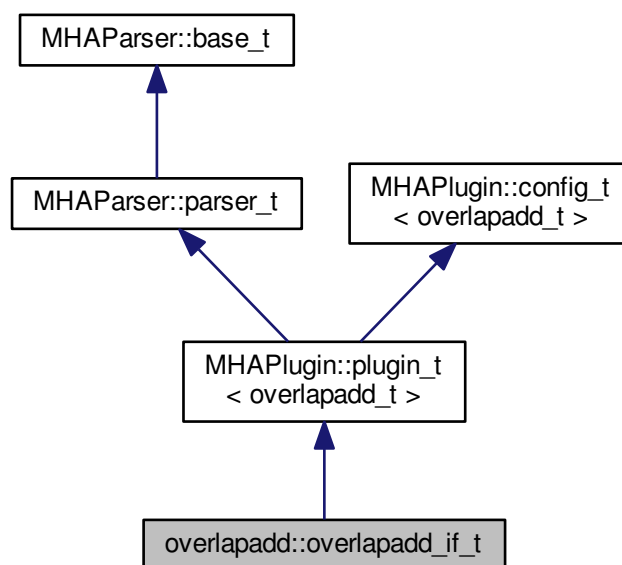

### Public Member Functions

- **overlapadd\_if\_t** (const **algo\_comm\_t** &, const std::string &, const std::string &)
- **~overlapadd\_if\_t** ()
- void **prepare** (**mhaconfig\_t** &)
- void **release** ()
- **mha\_wave\_t \* process** (**mha\_wave\_t \***)

### Private Member Functions

- void **update** ()

### Private Attributes

- **MHAEvents::patchbay\_t< overlapadd\_if\_t > patchbay**
- **MHAParser::int\_t nfft**  
*FFT length to be used, zero-padding is FFT length-wndlength.*
- **MHAParser::int\_t nwnd**  
*Window length to be used (overlap is 1-fragsize/wndlength)*
- **MHAParser::float\_t wndpos**  
*Relative position of zero padding (0 end, 0.5 center, 1 start)*
- **MHAParser::window\_t window**
- **MHAParser::float\_t wndexp**
- **MHAParser::window\_t zerowindow**
- **MHAParser::mhapluginloader\_t plugloader**
- **MHAParser::float\_mon\_t prescale**
- **MHAParser::float\_mon\_t postscale**
- std::string **algo**
- **mhaconfig\_t cf\_in**
- **mhaconfig\_t cf\_out**

### Additional Inherited Members

#### 5.329.1 Constructor & Destructor Documentation

5.329.1.1 **overlapadd::overlapadd\_if\_t::overlapadd\_if\_t** (  
     const **algo\_comm\_t** & *iac*,  
     const std::string & ,  
     const std::string & *ialg* )

5.329.1.2 **overlapadd::overlapadd\_if\_t::~~overlapadd\_if\_t** ( )

#### 5.329.2 Member Function Documentation

5.329.2.1 void **overlapadd::overlapadd\_if\_t::prepare** (  
     **mhaconfig\_t** & *t* ) [virtual]

Implements **MHAPlugin::plugin\_t< overlapadd\_t >** (p. 730).

5.329.2.2 `void overlapadd::overlapadd_if_t::release ( void ) [virtual]`

Reimplemented from `MHAPLugin::plugin_t< overlapadd_t >` (p. 731).

5.329.2.3 `mha_wave_t * overlapadd::overlapadd_if_t::process ( mha_wave_t * wave_in )`

5.329.2.4 `void overlapadd::overlapadd_if_t::update ( ) [private]`

### 5.329.3 Member Data Documentation

5.329.3.1 `MHAEvents::patchbay_t<overlapadd_if_t> overlapadd::overlapadd_if_t::patchbay [private]`

5.329.3.2 `MHAParser::int_t overlapadd::overlapadd_if_t::nfft [private]`

FFT length to be used, zero-padding is FFT length-wndlength.

5.329.3.3 `MHAParser::int_t overlapadd::overlapadd_if_t::nwnd [private]`

Window length to be used (overlap is 1-fragsize/wndlength)

5.329.3.4 `MHAParser::float_t overlapadd::overlapadd_if_t::wndpos [private]`

Relative position of zero padding (0 end, 0.5 center, 1 start)

5.329.3.5 `MHAParser::window_t overlapadd::overlapadd_if_t::window [private]`

5.329.3.6 `MHAParser::float_t overlapadd::overlapadd_if_t::wndexp [private]`

5.329.3.7 `MHAParser::window_t overlapadd::overlapadd_if_t::zerowindow [private]`

5.329.3.8 `MHAParser::mhapluginloader_t overlapadd::overlapadd_if_t::plugloader [private]`

5.329.3.9 `MHAParser::float_mon_t overlapadd::overlapadd_if_t::prescale [private]`

5.329.3.10 `MHAParser::float_mon_t overlapadd::overlapadd_if_t::postscale [private]`

5.329.3.11 `std::string overlapadd::overlapadd_if_t::algo [private]`

5.329.3.12 `mhaconfig_t overlapadd::overlapadd_if_t::cf_in [private]`

5.329.3.13 `mhaconfig_t overlapadd::overlapadd_if_t::cf_out [private]`

The documentation for this class was generated from the following file:

- `overlapadd.cpp`

### 5.330 overlapadd::overlapadd\_t Class Reference

#### Public Member Functions

- **overlapadd\_t** (**mhaconfig\_t** spar\_in, **mhaconfig\_t** spar\_out, float wexp, float wndpos, const **MHAParser::window\_t** &window, const **MHAParser::window\_t** &zerowindow, float &prescale\_fac, float &postscale\_fac)
- **~overlapadd\_t** ()
- **mha\_spec\_t \* ola1** (**mha\_wave\_t \***)
- **mha\_wave\_t \* ola2** (**mha\_spec\_t \***)

#### Private Attributes

- **mha\_fft\_t** fft
- **MHAWindow::base\_t** prewnd
- **MHAWindow::base\_t** postwnd
- **MHASignal::waveform\_t** wave\_in1
- **MHASignal::waveform\_t** wave\_out1
- **MHASignal::spectrum\_t** spec\_in
- **MHASignal::waveform\_t** calc\_out
- **MHASignal::waveform\_t** out\_buf
- **MHASignal::waveform\_t** write\_buf
- unsigned int **n\_zero**
- unsigned int **n\_pad1**
- unsigned int **n\_pad2**

#### 5.330.1 Constructor & Destructor Documentation

5.330.1.1 **overlapadd::overlapadd\_t::overlapadd\_t** (  
**mhaconfig\_t** *spar\_in*,  
**mhaconfig\_t** *spar\_out*,  
float *wexp*,  
float *wndpos*,  
const **MHAParser::window\_t** & *window*,  
const **MHAParser::window\_t** & *zerowindow*,  
float & *prescale\_fac*,  
float & *postscale\_fac* )

5.330.1.2 **overlapadd::overlapadd\_t::~overlapadd\_t** ( )

#### 5.330.2 Member Function Documentation

5.330.2.1 **mha\_spec\_t \* overlapadd::overlapadd\_t::ola1** (  
**mha\_wave\_t \* s** )

5.330.2.2 mha\_wave\_t \* overlapadd::overlapadd\_t::ola2 ( mha\_spec\_t \* s )

### 5.330.3 Member Data Documentation

5.330.3.1 mha\_fft\_t overlapadd::overlapadd\_t::fft [private]

5.330.3.2 MHASignal::base\_t overlapadd::overlapadd\_t::prewnd [private]

5.330.3.3 MHASignal::base\_t overlapadd::overlapadd\_t::postwnd [private]

5.330.3.4 MHASignal::waveform\_t overlapadd::overlapadd\_t::wave\_in1 [private]

5.330.3.5 MHASignal::waveform\_t overlapadd::overlapadd\_t::wave\_out1 [private]

5.330.3.6 MHASignal::spectrum\_t overlapadd::overlapadd\_t::spec\_in [private]

5.330.3.7 MHASignal::waveform\_t overlapadd::overlapadd\_t::calc\_out [private]

5.330.3.8 MHASignal::waveform\_t overlapadd::overlapadd\_t::out\_buf [private]

5.330.3.9 MHASignal::waveform\_t overlapadd::overlapadd\_t::write\_buf [private]

5.330.3.10 unsigned int overlapadd::overlapadd\_t::n\_zero [private]

5.330.3.11 unsigned int overlapadd::overlapadd\_t::n\_pad1 [private]

5.330.3.12 unsigned int overlapadd::overlapadd\_t::n\_pad2 [private]

The documentation for this class was generated from the following file:

- **overlapadd.cpp**

### 5.331 parser\_int\_dyn Class Reference

Inheritance diagram for parser\_int\_dyn:

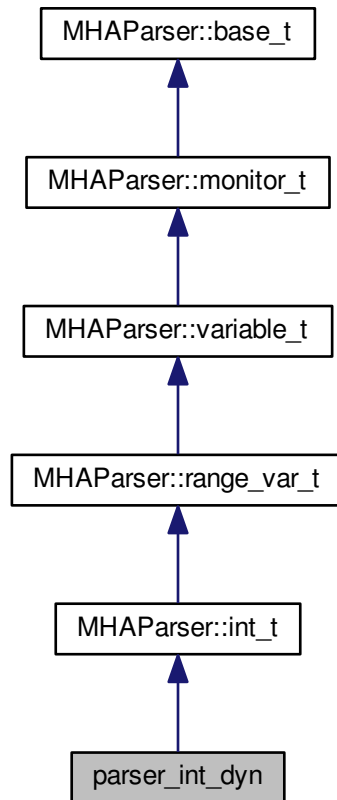

#### Public Member Functions

- **parser\_int\_dyn** (const std::string &help\_text, const std::string &initial\_value, const std::string &range)
- void **set\_max\_angle\_ind** (unsigned int max\_ind)

#### Additional Inherited Members

##### 5.331.1 Constructor & Destructor Documentation

5.331.1.1 `parser_int_dyn::parser_int_dyn (`  
     const std::string & *help\_text*,  
     const std::string & *initial\_value*,  
     const std::string & *range* ) [inline]



## 5.331.2 Member Function Documentation

5.331.2.1 void parser\_int\_dyn::set\_max\_angle\_ind ( unsigned int *max\_ind* ) [inline]

The documentation for this class was generated from the following file:

- **steerbf.h**

## 5.332 plingploing::if\_t Class Reference

Plugin class of the plingploing music generator.

Inheritance diagram for plingploing::if\_t:

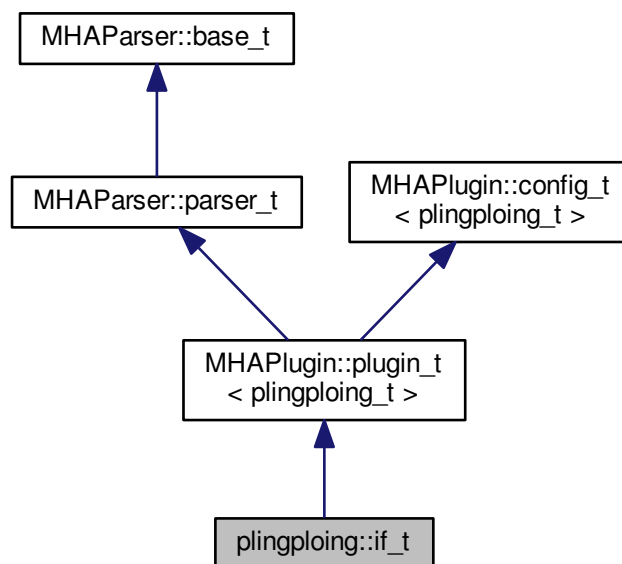

## Public Member Functions

- **if\_t** (algo\_comm\_t, const char \*, const char \*)
- **mha\_wave\_t \* process** (mha\_wave\_t \*)
- void **prepare** (mhaconfig\_t &cf)

## Private Member Functions

- void **update** ()

### Private Attributes

- **MHAEvents::patchbay\_t< if\_t > patchbay**
- **MHAParser::float\_t level**  
*Output level in dB SPL.*
- **MHAParser::float\_t pitch**  
*Bass pitch in Hz.*
- **MHAParser::float\_t fun1\_key**  
*Key1.*
- **MHAParser::float\_t fun1\_range**  
*Range1.*
- **MHAParser::float\_t fun2\_key**  
*Key 2.*
- **MHAParser::float\_t fun2\_range**  
*Range 2.*
- **MHAParser::float\_t bpm**  
*Speed in beats per minute (bpm)*
- **MHAParser::float\_t minlen**  
*Minimum note length in beats.*
- **MHAParser::float\_t maxlen**  
*Maximum note length in beats.*
- **MHAParser::float\_t bassmod**  
*Bass key modulation depth.*
- **MHAParser::float\_t bassperiod**  
*Bass key modulation period.*

### Additional Inherited Members

#### 5.332.1 Detailed Description

Plugin class of the plingploing music generator.

#### 5.332.2 Constructor & Destructor Documentation

5.332.2.1 `plingploing::if_t::if_t (`  
     `algo_comm_t iac,`  
     `const char *,`  
     `const char * )`

#### 5.332.3 Member Function Documentation

5.332.3.1 `mha_wave_t * plingploing::if_t::process (`  
     `mha_wave_t * s )`

5.332.3.2 `void plingploing::if_t::prepare (`  
     `mhaconfig_t & cf ) [virtual]`

Implements **MHAPLugin::plugin\_t< plingploing\_t >** (p. 730).

5.332.3.3 void plingploing::if\_t::update ( ) [private]

#### 5.332.4 Member Data Documentation

5.332.4.1 MHAEvents::patchbay\_t<if\_t> plingploing::if\_t::patchbay [private]

5.332.4.2 MHAParser::float\_t plingploing::if\_t::level [private]

Output level in dB SPL.

5.332.4.3 MHAParser::float\_t plingploing::if\_t::pitch [private]

Bass pitch in Hz.

5.332.4.4 MHAParser::float\_t plingploing::if\_t::fun1\_key [private]

Key1.

5.332.4.5 MHAParser::float\_t plingploing::if\_t::fun1\_range [private]

Range1.

5.332.4.6 MHAParser::float\_t plingploing::if\_t::fun2\_key [private]

Key 2.

5.332.4.7 MHAParser::float\_t plingploing::if\_t::fun2\_range [private]

Range 2.

5.332.4.8 MHAParser::float\_t plingploing::if\_t::bpm [private]

Speed in beats per minute (bpm)

5.332.4.9 MHAParser::float\_t plingploing::if\_t::minlen [private]

Minimum note length in beats.

5.332.4.10 MHAParser::float\_t plingploing::if\_t::maxlen [private]

Maximum note length in beats.

#### 5.332.4.11 `MHAParser::float_t plingploing::if_t::bassmod` [private]

Bass key modulation depth.

#### 5.332.4.12 `MHAParser::float_t plingploing::if_t::bassperiod` [private]

Bass key modulation period.

The documentation for this class was generated from the following file:

- `plingploing.cpp`

### 5.333 `plingploing::plingploing_t` Class Reference

Run-time configuration of the plingploing music generator.

#### Public Member Functions

- `plingploing_t` (`mhaconfig_t`, `mha_real_t level`, `mha_real_t pitch`, `mha_real_t k1`, `mha_real_t k2`, `mha_real_t i1`, `mha_real_t i2`, `mha_real_t bpm`, `mha_real_t minlen`, `mha_real_t maxlen`, `mha_real_t bassmod`, `mha_real_t bassperiod`)
- void `process` (`mha_wave_t *`)

#### Private Attributes

- `mhaconfig_t cf`
- `mha_real_t pitch_`
- unsigned int `bt`
- unsigned int `t`
- unsigned int `len`
- `mha_real_t dur_`
- `mha_real_t minlen_`
- `mha_real_t maxlen_`
- `mha_real_t bass`
- `mha_real_t freq`
- `mha_real_t fun1_key`
- `mha_real_t fun1_range`
- `mha_real_t fun1`
- `mha_real_t fun2`
- `mha_real_t fun2_key`
- `mha_real_t fun2_range`
- `mha_real_t dist`
- `mha_real_t dist1`
- `mha_real_t alph`
- `mha_real_t rms`
- `mha_real_t bassmod_`
- `mha_real_t bassperiod_`
- `MHAWindow::hanning_t hann1`
- `MHAWindow::hanning_t hann2`
- `mha_real_t level`

### 5.333.1 Detailed Description

Run-time configuration of the plingploing music generator.

### 5.333.2 Constructor & Destructor Documentation

5.333.2.1 `plingploing::plingploing_t::plingploing_t ( mhaconfig_t c, mha_real_t level, mha_real_t pitch, mha_real_t k1, mha_real_t k2, mha_real_t i1, mha_real_t i2, mha_real_t bpm, mha_real_t minlen, mha_real_t maxlen, mha_real_t bassmod, mha_real_t bassperiod )`

### 5.333.3 Member Function Documentation

5.333.3.1 `void plingploing::plingploing_t::process ( mha_wave_t* s )`

### 5.333.4 Member Data Documentation

5.333.4.1 `mhaconfig_t plingploing::plingploing_t::cf [private]`

5.333.4.2 `mha_real_t plingploing::plingploing_t::pitch_ [private]`

5.333.4.3 `unsigned int plingploing::plingploing_t::bt [private]`

5.333.4.4 `unsigned int plingploing::plingploing_t::t [private]`

5.333.4.5 `unsigned int plingploing::plingploing_t::len [private]`

5.333.4.6 `mha_real_t plingploing::plingploing_t::dur_ [private]`

5.333.4.7 `mha_real_t plingploing::plingploing_t::minlen_ [private]`

5.333.4.8 `mha_real_t plingploing::plingploing_t::maxlen_ [private]`

5.333.4.9 `mha_real_t plingploing::plingploing_t::bass [private]`

- 5.333.4.10 `mha_real_t plingploing::plingploing_t::freq` [private]
- 5.333.4.11 `mha_real_t plingploing::plingploing_t::fun1_key` [private]
- 5.333.4.12 `mha_real_t plingploing::plingploing_t::fun1_range` [private]
- 5.333.4.13 `mha_real_t plingploing::plingploing_t::fun1` [private]
- 5.333.4.14 `mha_real_t plingploing::plingploing_t::fun2` [private]
- 5.333.4.15 `mha_real_t plingploing::plingploing_t::fun2_key` [private]
- 5.333.4.16 `mha_real_t plingploing::plingploing_t::fun2_range` [private]
- 5.333.4.17 `mha_real_t plingploing::plingploing_t::dist` [private]
- 5.333.4.18 `mha_real_t plingploing::plingploing_t::dist1` [private]
- 5.333.4.19 `mha_real_t plingploing::plingploing_t::alph` [private]
- 5.333.4.20 `mha_real_t plingploing::plingploing_t::rms` [private]
- 5.333.4.21 `mha_real_t plingploing::plingploing_t::bassmod_` [private]
- 5.333.4.22 `mha_real_t plingploing::plingploing_t::bassperiod_` [private]
- 5.333.4.23 `MHAWindow::hanning_t plingploing::plingploing_t::hann1` [private]
- 5.333.4.24 `MHAWindow::hanning_t plingploing::plingploing_t::hann2` [private]
- 5.333.4.25 `mha_real_t plingploing::plingploing_t::level` [private]

The documentation for this class was generated from the following file:

- `plingploing.cpp`

### 5.334 `plug_t` Class Reference

Inheritance diagram for `plug_t`:

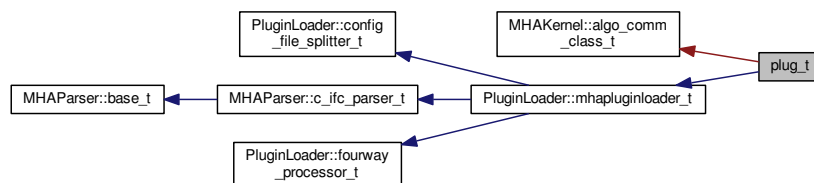

## Public Member Functions

- **plug\_t** (const std::string &libname, const std::string &chain, const std::string &algo)
- **~plug\_t** () throw ()
- **MHAProc\_wave2wave\_t** get\_process\_wave ()
- **MHAProc\_wave2spec\_t** get\_process\_spec ()
- void \* **get\_handle** ()
- **algo\_comm\_t** get\_ac ()

## Additional Inherited Members

### 5.334.1 Constructor & Destructor Documentation

5.334.1.1 **plug\_t::plug\_t** (  
    const std::string & *libname*,  
    const std::string & *chain*,  
    const std::string & *algo* )

5.334.1.2 **plug\_t::~~plug\_t** ( ) throw () [inline]

### 5.334.2 Member Function Documentation

5.334.2.1 **MHAProc\_wave2wave\_t** plug\_t::get\_process\_wave ( )

5.334.2.2 **MHAProc\_wave2spec\_t** plug\_t::get\_process\_spec ( )

5.334.2.3 void \* **plug\_t::get\_handle** ( )

5.334.2.4 **algo\_comm\_t** plug\_t::get\_ac ( ) [inline]

The documentation for this class was generated from the following file:

- **analysispath.cpp**

### 5.335 plugin\_interface\_t Class Reference

Inheritance diagram for plugin\_interface\_t:

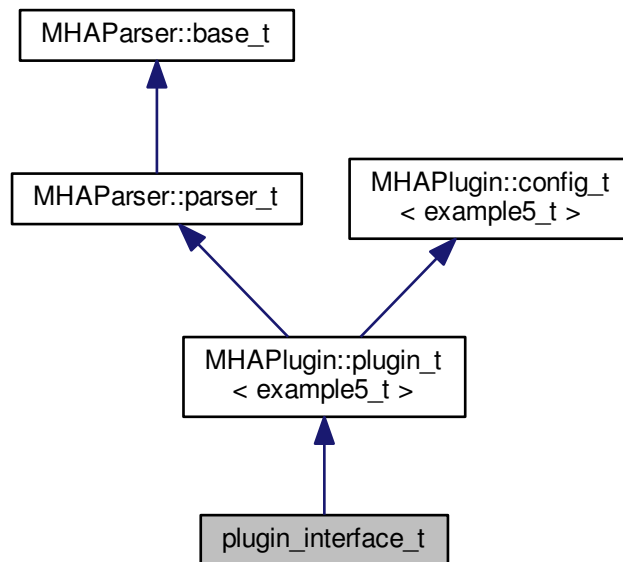

#### Public Member Functions

- **plugin\_interface\_t** (const **algo\_comm\_t** &, const std::string &, const std::string &)
- **mha\_spec\_t \* process** (mha\_spec\_t \*)
- void **prepare** (mhaconfig\_t &)

#### Private Member Functions

- void **update\_cfg** ()

#### Private Attributes

- **MHAParser::int\_t scale\_ch**
- **MHAParser::float\_t factor**
- **MHAEvents::patchbay\_t < plugin\_interface\_t > patchbay**



## Additional Inherited Members

## 5.335.1 Constructor &amp; Destructor Documentation

5.335.1.1 `plugin_interface_t::plugin_interface_t ( const algo_comm_t & iac, const std::string & , const std::string & )`

## 5.335.2 Member Function Documentation

5.335.2.1 `mha_spec_t * plugin_interface_t::process ( mha_spec_t * spec )`

5.335.2.2 `void plugin_interface_t::prepare ( mhaconfig_t & tcfg ) [virtual]`

Implements `MHAParser::plugin_t< example5_t >` (p. 730).

5.335.2.3 `void plugin_interface_t::update_cfg ( ) [private]`

## 5.335.3 Member Data Documentation

5.335.3.1 `MHAParser::int_t plugin_interface_t::scale_ch [private]`

5.335.3.2 `MHAParser::float_t plugin_interface_t::factor [private]`

5.335.3.3 `MHAEvents::patchbay_t<plugin_interface_t> plugin_interface_t::patchbay [private]`

The documentation for this class was generated from the following file:

- `example5.cpp`

## 5.336 pluginbrowser\_t Class Reference

## Public Member Functions

- `pluginbrowser_t ()`
- `void get_paths ()`
- `plugindescription_t scan_plugin (const std::string &name)`
- `void add_plugins ()`
- `void clear_plugins ()`
- `void scan_plugins ()`
- `void add_plugin (const std::string &name)`
- `std::list< plugindescription_t > get_plugins () const`

## Private Attributes

- `std::string` **plugin\_extension**
- `std::list< std::string >` **library\_paths**
- `std::list< pluginindescription_t >` **plugins**
- `std::map< std::string, pluginloader_t * >` **p**

### 5.336.1 Constructor & Destructor Documentation

5.336.1.1 `pluginbrowser_t::pluginbrowser_t( )`

### 5.336.2 Member Function Documentation

5.336.2.1 `void pluginbrowser_t::get_paths( )`

5.336.2.2 `pluginindescription_t pluginbrowser_t::scan_plugin( const std::string & name )`

5.336.2.3 `void pluginbrowser_t::add_plugins( )`

5.336.2.4 `void pluginbrowser_t::clear_plugins( )`

5.336.2.5 `void pluginbrowser_t::scan_plugins( )`

5.336.2.6 `void pluginbrowser_t::add_plugin( const std::string & name )`

5.336.2.7 `std::list<pluginindescription_t> pluginbrowser_t::get_plugins( ) const` `[inline]`

### 5.336.3 Member Data Documentation

5.336.3.1 `std::string pluginbrowser_t::plugin_extension` `[private]`

5.336.3.2 `std::list<std::string> pluginbrowser_t::library_paths` `[private]`

5.336.3.3 `std::list<pluginindescription_t> pluginbrowser_t::plugins` `[private]`

5.336.3.4 `std::map<std::string,pluginloader_t*> pluginbrowser_t::p` `[private]`

The documentation for this class was generated from the following files:

- **pluginbrowser.h**
- **pluginbrowser.cpp**

5.337 `plugindescription_t` Class Reference

## Public Attributes

- `std::string` **name**
- `std::string` **fullname**
- `std::string` **documentation**
- `std::vector< std::string >` **categories**
- `bool` **wave2wave**
- `bool` **wave2spec**
- `bool` **spec2wave**
- `bool` **spec2spec**
- `std::vector< std::string >` **query\_cmds**
- `std::map< std::string, std::string >` **queries**

## 5.337.1 Member Data Documentation

5.337.1.1 `std::string` `plugindescription_t::name`

5.337.1.2 `std::string` `plugindescription_t::fullname`

5.337.1.3 `std::string` `plugindescription_t::documentation`

5.337.1.4 `std::vector<std::string>` `plugindescription_t::categories`

5.337.1.5 `bool` `plugindescription_t::wave2wave`

5.337.1.6 `bool` `plugindescription_t::wave2spec`

5.337.1.7 `bool` `plugindescription_t::spec2wave`

5.337.1.8 `bool` `plugindescription_t::spec2spec`

5.337.1.9 `std::vector<std::string>` `plugindescription_t::query_cmds`

5.337.1.10 `std::map<std::string,std::string>` `plugindescription_t::queries`

The documentation for this class was generated from the following file:

- **pluginbrowser.h**

### 5.338 PluginLoader::config\_file\_splitter\_t Class Reference

Inheritance diagram for PluginLoader::config\_file\_splitter\_t:

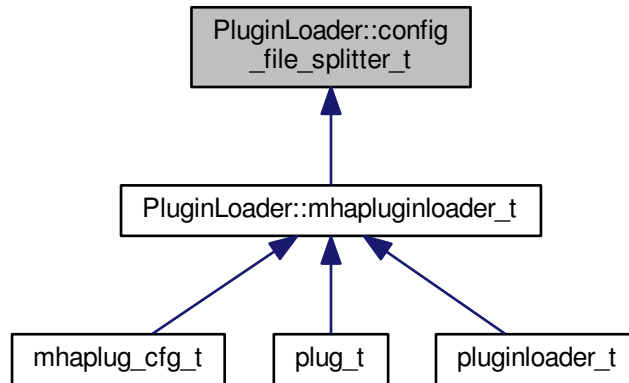

#### Public Member Functions

- **config\_file\_splitter\_t** (const std::string &name)
- const std::string & **get\_configname** () const
- const std::string & **get\_libname** () const
- const std::string & **get\_origname** () const
- const std::string & **get\_configfile** () const

#### Private Attributes

- std::string **libname**
- std::string **configname**
- std::string **origname**
- std::string **configfile**

#### 5.338.1 Constructor & Destructor Documentation

5.338.1.1 PluginLoader::config\_file\_splitter\_t::config\_file\_splitter\_t (const std::string & *name* )

#### 5.338.2 Member Function Documentation

5.338.2.1 `const std::string& PluginLoader::config_file_splitter_t::get_configname ( ) const` `[inline]`

5.338.2.2 `const std::string& PluginLoader::config_file_splitter_t::get_libname ( ) const` `[inline]`

5.338.2.3 `const std::string& PluginLoader::config_file_splitter_t::get_oriname ( ) const` `[inline]`

5.338.2.4 `const std::string& PluginLoader::config_file_splitter_t::get_configfile ( ) const` `[inline]`

### 5.338.3 Member Data Documentation

5.338.3.1 `std::string PluginLoader::config_file_splitter_t::libname` `[private]`

5.338.3.2 `std::string PluginLoader::config_file_splitter_t::configname` `[private]`

5.338.3.3 `std::string PluginLoader::config_file_splitter_t::oriname` `[private]`

5.338.3.4 `std::string PluginLoader::config_file_splitter_t::configfile` `[private]`

The documentation for this class was generated from the following files:

- `mhappluginloader.h`
- `mhappluginloader.cpp`

## 5.339 PluginLoader::fourway\_processor\_t Class Reference

This abstract class defines the interface for classes that implement all types of signal domain processing supported by the MHA: `wave2wave`, `spec2spec`, `wave2spec`, and `spec2wave`.

Inheritance diagram for `PluginLoader::fourway_processor_t`:

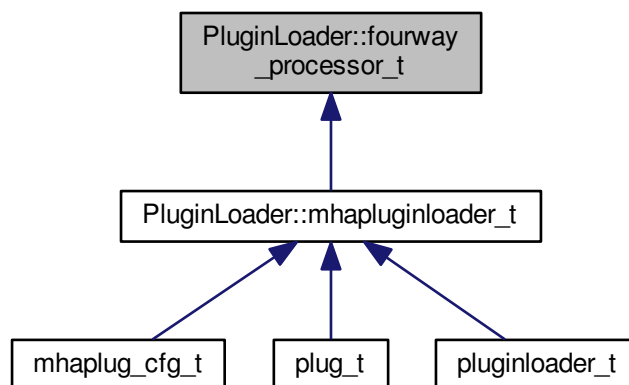

## Public Member Functions

- virtual void **process** (**mha\_wave\_t** \*s\_in, **mha\_wave\_t** \*\*s\_out)=0  
*Pure waveform processing.*
- virtual void **process** (**mha\_spec\_t** \*s\_in, **mha\_spec\_t** \*\*s\_out)=0  
*Pure spectrum processing.*
- virtual void **process** (**mha\_wave\_t** \*s\_in, **mha\_spec\_t** \*\*s\_out)=0  
*Signal processing with domain transformation from waveform to spectrum.*
- virtual void **process** (**mha\_spec\_t** \*s\_in, **mha\_wave\_t** \*\*s\_out)=0  
*Signal processing with domain transformation from spectrum to waveform.*
- virtual void **prepare** (**mhaconfig\_t** &settings)=0  
*Prepares the processor for signal processing.*
- virtual void **release** ()=0  
*Resources allocated for signal processing in **fourway\_processor\_t::prepare** (p. 880) are released here in **fourway\_processor\_t::release** (p. 880).*
- virtual std::string **parse** (const std::string &query)=0  
*Parser interface.*
- virtual ~**fourway\_processor\_t** ()  
*Classes with virtual methods need virtual destructor.*

### 5.339.1 Detailed Description

This abstract class defines the interface for classes that implement all types of signal domain processing supported by the MHA: wave2wave, spec2spec, wave2spec, and spec2wave.

For supporting different output domains for the same input domain, the processing methods are overloaded with respect to input domain and output domain.

### 5.339.2 Constructor & Destructor Documentation

**5.339.2.1** virtual PluginLoader::fourway\_processor\_t::~fourway\_processor\_t ( ) [inline],  
[virtual]

Classes with virtual methods need virtual destructor.

This destructor is empty.

### 5.339.3 Member Function Documentation

**5.339.3.1** virtual void PluginLoader::fourway\_processor\_t::process (  
    **mha\_wave\_t** \* s\_in,  
    **mha\_wave\_t** \*\* s\_out ) [pure virtual]

Pure waveform processing.

## Parameters

<i>s_in</i>	input waveform signal
<i>s_out</i>	output waveform signal

Implemented in **PluginLoader::mhapluginloader\_t** (p. 883).

5.339.3.2 `virtual void PluginLoader::fourway_processor_t::process ( mha_spec_t * s_in, mha_spec_t ** s_out )` [pure virtual]

Pure spectrum processing.

## Parameters

<i>s_in</i>	input spectrum signal
<i>s_out</i>	output spectrum signal

Implemented in **PluginLoader::mhapluginloader\_t** (p. 883).

5.339.3.3 `virtual void PluginLoader::fourway_processor_t::process ( mha_wave_t * s_in, mha_spec_t ** s_out )` [pure virtual]

Signal processing with domain transformation from waveform to spectrum.

## Parameters

<i>s_in</i>	input waveform signal
<i>s_out</i>	output spectrum signal

Implemented in **PluginLoader::mhapluginloader\_t** (p. 883).

5.339.3.4 `virtual void PluginLoader::fourway_processor_t::process ( mha_spec_t * s_in, mha_wave_t ** s_out )` [pure virtual]

Signal processing with domain transformation from spectrum to waveform.

## Parameters

<i>s_in</i>	input spectrum signal
<i>s_out</i>	output waveform signal

Implemented in **PluginLoader::mhapluginloader\_t** (p. 883).

**5.339.3.5** `virtual void PluginLoader::fourway_processor_t::prepare ( mhaconfig_t & settings ) [pure virtual]`

Prepares the processor for signal processing.

#### Parameters

<i>settings</i>	domain and dimensions of the signal. The contents of settings may be modified by the prepare implementation. Upon calling <b>fourway_processor_t::prepare</b> (p. 880), settings reflects domain and dimensions of the input signal. When <b>fourway_processor_t::prepare</b> (p. 880) returns, settings reflects domain and dimensions of the output signal.
-----------------	---

Implemented in **PluginLoader::mhapluginloader\_t** (p. 883).

**5.339.3.6** `virtual void PluginLoader::fourway_processor_t::release ( ) [pure virtual]`

Resources allocated for signal processing in **fourway\_processor\_t::prepare** (p. 880) are released here in **fourway\_processor\_t::release** (p. 880).

Implemented in **PluginLoader::mhapluginloader\_t** (p. 883).

**5.339.3.7** `virtual std::string PluginLoader::fourway_processor_t::parse ( const std::string & query ) [pure virtual]`

Parser interface.

Implemented in **PluginLoader::mhapluginloader\_t** (p. 883).

The documentation for this class was generated from the following file:

- **mhapluginloader.h**

## 5.340 PluginLoader::mhapluginloader\_t Class Reference

Inheritance diagram for PluginLoader::mhapluginloader\_t:

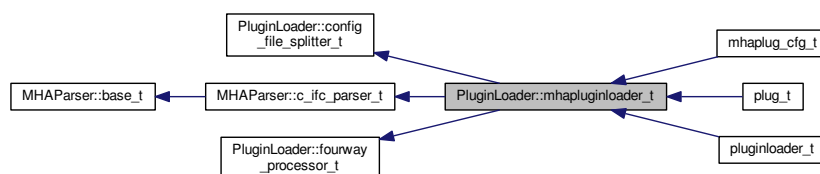



## Public Member Functions

- `std::string parse` (const `std::string` &str)
- `mhapluginloader_t` (`algo_comm_t` iac, const `std::string` &libname, bool check\_↔ version=true)
  - Loads and initializes mha plugin and establishes interface.*
- `~mhapluginloader_t` () throw ()
- bool `has_process` (`mha_domain_t` in, `mha_domain_t` out) const
- bool `has_parser` () const
- `mha_domain_t input_domain` () const
- `mha_domain_t output_domain` () const
- void `prepare` (`mhaconfig_t` &)
- void `release` ()
- void `process` (`mha_wave_t` \*, `mha_wave_t` \*\*)
- void `process` (`mha_spec_t` \*, `mha_spec_t` \*\*)
- void `process` (`mha_wave_t` \*, `mha_spec_t` \*\*)
- void `process` (`mha_spec_t` \*, `mha_wave_t` \*\*)
- `std::string getfullname` () const
- `std::string get_documentation` () const
- `std::vector< std::string > get_categories` () const
- bool `is_prepared` () const

## Protected Member Functions

- void `test_error` ()
- void `test_version` ()
- void `mha_test_struct_size` (unsigned int s)
- void `resolve_and_init` ()

## Protected Attributes

- int `lib_err`
- `algo_comm_t` ac
- `dynamiclib_t` lib\_handle
- void \* `lib_data`
- `MHAGetVersion_t` `MHAGetVersion_cb`
- `MHAInit_t` `MHAInit_cb`
- `MHADestroy_t` `MHADestroy_cb`
- `MHAPrepare_t` `MHAPrepare_cb`
- `MHARelease_t` `MHARelease_cb`
- `MHAProc_wave2wave_t` `MHAProc_wave2wave_cb`
- `MHAProc_spec2spec_t` `MHAProc_spec2spec_cb`
- `MHAProc_wave2spec_t` `MHAProc_wave2spec_cb`
- `MHAProc_spec2wave_t` `MHAProc_spec2wave_cb`
- `MHASet_t` `MHASet_cb`
- `MHAStrError_t` `MHAStrError_cb`

- **mhaconfig\_t cf\_input**
- **mhaconfig\_t cf\_output**
- `std::string` **plugin\_documentation**
- `std::vector< std::string >` **plugin\_categories**
- `bool` **b\_check\_version**
- `bool` **b\_is\_prepared**

#### Additional Inherited Members

#### 5.340.1 Constructor & Destructor Documentation

5.340.1.1 `PluginLoader::mhapluginloader_t::mhapluginloader_t (`  
     `algo_comm_t iac,`  
     `const std::string & libname,`  
     `bool check_version = true )`

Loads and initializes mha plugin and establishes interface.

#### Parameters

<i>iac</i>	AC space (algorithm communication variables)
<i>libname</i>	Either file name of MHA plugin without platform-specific extension (i.e. "identity" for "identity.so" or "identity.dll") to be found on the MHA_LIBRARY_PATH (which is an environment variable). Or the same file name without extension followed by a colon ":" followed by the "configuration name" of the MHA plugin, which may be used to differentiate between multiple identical MHA plugins or to give the plugin a self-documenting name that fits its purpose. The library name - configuration name expression can be followed by a "<" followed by a configuration file name, which will be read after initialization of the plugin.

Example: "overlapadd:agc<compression.cfg" will load the plugin "overlapadd.so" or "overlapadd.dll", insert it as the configuration node "agc", and reads the configuration file "compression.cfg" into that node.

#### Parameters

<i>check_version</i>	Pluginloader will not check that the plugin was built using a known compatible MHA version if this flag is set to false. Disabling version check is discouraged.
----------------------	--

5.340.1.2 `PluginLoader::mhapluginloader_t::~~mhapluginloader_t( ) throw )`

#### 5.340.2 Member Function Documentation

5.340.2.1 `std::string PluginLoader::mhapluginloader_t::parse ( const std::string & str ) [inline],[virtual]`

Implements **PluginLoader::fourway\_processor\_t** (p. 880).

5.340.2.2 `bool PluginLoader::mhapluginloader_t::has_process ( mha_domain_t in, mha_domain_t out ) const`

5.340.2.3 `bool PluginLoader::mhapluginloader_t::has_parser ( ) const`

5.340.2.4 `mha_domain_t PluginLoader::mhapluginloader_t::input_domain ( ) const`

5.340.2.5 `mha_domain_t PluginLoader::mhapluginloader_t::output_domain ( ) const`

5.340.2.6 `void PluginLoader::mhapluginloader_t::prepare ( mhaconfig_t & tf ) [virtual]`

Implements **PluginLoader::fourway\_processor\_t** (p. 880).

5.340.2.7 `void PluginLoader::mhapluginloader_t::release ( ) [virtual]`

Implements **PluginLoader::fourway\_processor\_t** (p. 880).

5.340.2.8 `void PluginLoader::mhapluginloader_t::process ( mha_wave_t * s_in, mha_wave_t ** s_out ) [virtual]`

Implements **PluginLoader::fourway\_processor\_t** (p. 878).

5.340.2.9 `void PluginLoader::mhapluginloader_t::process ( mha_spec_t * s_in, mha_spec_t ** s_out ) [virtual]`

Implements **PluginLoader::fourway\_processor\_t** (p. 879).

5.340.2.10 `void PluginLoader::mhapluginloader_t::process ( mha_wave_t * s_in, mha_spec_t ** s_out ) [virtual]`

Implements **PluginLoader::fourway\_processor\_t** (p. 879).

5.340.2.11 `void PluginLoader::mhapluginloader_t::process ( mha_spec_t * s_in, mha_wave_t ** s_out ) [virtual]`

Implements **PluginLoader::fourway\_processor\_t** (p. 879).

- 5.340.2.12 `std::string PluginLoader::mhapluginloader_t::getfullname ( ) const` [inline]
- 5.340.2.13 `std::string PluginLoader::mhapluginloader_t::get_documentation ( ) const` [inline]
- 5.340.2.14 `std::vector<std::string> PluginLoader::mhapluginloader_t::get_categories ( ) const`  
[inline]
- 5.340.2.15 `bool PluginLoader::mhapluginloader_t::is_prepared ( ) const` [inline]
- 5.340.2.16 `void PluginLoader::mhapluginloader_t::test_error ( )` [protected]
- 5.340.2.17 `void PluginLoader::mhapluginloader_t::test_version ( )` [protected]
- 5.340.2.18 `void PluginLoader::mhapluginloader_t::mha_test_struct_size (`  
`unsigned int s )` [protected]
- 5.340.2.19 `void PluginLoader::mhapluginloader_t::resolve_and_init ( )` [protected]
- 5.340.3 Member Data Documentation
  - 5.340.3.1 `int PluginLoader::mhapluginloader_t::lib_err` [protected]
  - 5.340.3.2 `algo_comm_t PluginLoader::mhapluginloader_t::ac` [protected]
  - 5.340.3.3 `dynamiclib_t PluginLoader::mhapluginloader_t::lib_handle` [protected]
  - 5.340.3.4 `void* PluginLoader::mhapluginloader_t::lib_data` [protected]
  - 5.340.3.5 `MHAGetVersion_t PluginLoader::mhapluginloader_t::MHAGetVersion_cb`  
[protected]
  - 5.340.3.6 `MHAINit_t PluginLoader::mhapluginloader_t::MHAINit_cb` [protected]
  - 5.340.3.7 `MHADestroy_t PluginLoader::mhapluginloader_t::MHADestroy_cb` [protected]
  - 5.340.3.8 `MHAPrepare_t PluginLoader::mhapluginloader_t::MHAPrepare_cb` [protected]
  - 5.340.3.9 `MHARelease_t PluginLoader::mhapluginloader_t::MHARelease_cb` [protected]
  - 5.340.3.10 `MHAProc_wave2wave_t PluginLoader::mhapluginloader_t::MHAProc_wave2wave_cb`  
[protected]
  - 5.340.3.11 `MHAProc_spec2spec_t PluginLoader::mhapluginloader_t::MHAProc_spec2spec_cb`  
[protected]

- 5.340.3.12 **MHAProc\_wave2spec\_t** PluginLoader::mhapluginloader\_t::MHAProc\_wave2spec\_cb [protected]
- 5.340.3.13 **MHAProc\_spec2wave\_t** PluginLoader::mhapluginloader\_t::MHAProc\_spec2wave\_cb [protected]
- 5.340.3.14 **MHASET\_t** PluginLoader::mhapluginloader\_t::MHASET\_cb [protected]
- 5.340.3.15 **MHASTrError\_t** PluginLoader::mhapluginloader\_t::MHASTrError\_cb [protected]
- 5.340.3.16 **mhaconfig\_t** PluginLoader::mhapluginloader\_t::cf\_input [protected]
- 5.340.3.17 **mhaconfig\_t** PluginLoader::mhapluginloader\_t::cf\_output [protected]
- 5.340.3.18 **std::string** PluginLoader::mhapluginloader\_t::plugin\_documentation [protected]
- 5.340.3.19 **std::vector<std::string>** PluginLoader::mhapluginloader\_t::plugin\_categories [protected]
- 5.340.3.20 **bool** PluginLoader::mhapluginloader\_t::b\_check\_version [protected]
- 5.340.3.21 **bool** PluginLoader::mhapluginloader\_t::b\_is\_prepared [protected]

The documentation for this class was generated from the following files:

- **mhapluginloader.h**
- **mhapluginloader.cpp**

## 5.341 pluginloader\_t Class Reference

Inheritance diagram for pluginloader\_t:

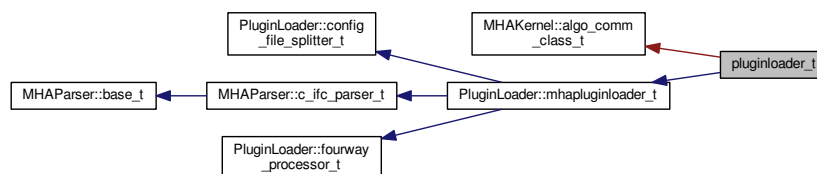

### Public Member Functions

- **pluginloader\_t** (const std::string &name)
- **~pluginloader\_t** () throw ()

## Additional Inherited Members

### 5.341.1 Constructor & Destructor Documentation

5.341.1.1 pluginloader\_t::pluginloader\_t (   
 const std::string & name )

5.341.1.2 pluginloader\_t::~~pluginloader\_t ( ) throw )

The documentation for this class was generated from the following files:

- pluginbrowser.h
- pluginbrowser.cpp

### 5.342 prediction\_error Class Reference

Inheritance diagram for prediction\_error:

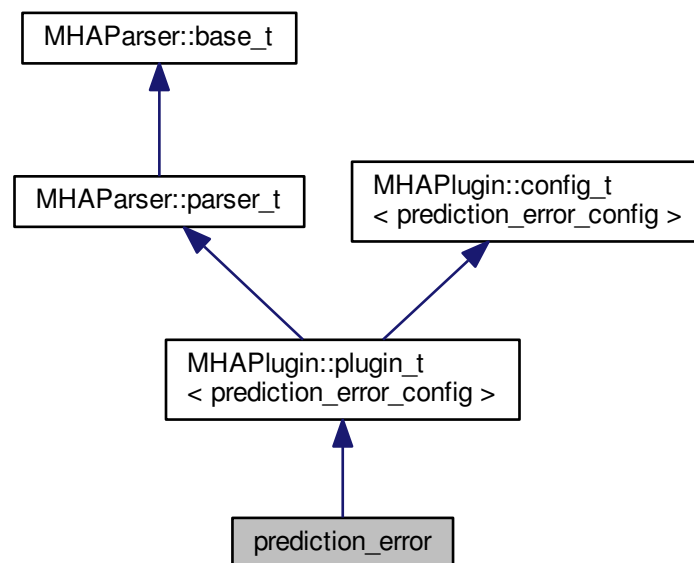

## Public Member Functions

- **prediction\_error** (**algo\_comm\_t** &**ac**, const std::string &chain\_name, const std::string &algo\_name)  
*Constructs our plugin.*
- **~prediction\_error** ()
- **mha\_wave\_t \* process** (**mha\_wave\_t \***)  
*Checks for the most recent configuration and defers processing to it.*
- void **prepare** (**mhaconfig\_t** &)  
*Plugin preparation.*
- void **release** (void)

## Public Attributes

- **MHAParser::float\_t rho**
- **MHAParser::float\_t c**
- **MHAParser::int\_t ntaps**
- **MHAParser::vfloat\_t gains**
- **MHAParser::string\_t name\_e**
- **MHAParser::string\_t name\_f**
- **MHAParser::string\_t name\_lpc**
- **MHAParser::int\_t lpc\_order**
- **MHAParser::vint\_t pred\_err\_delay**
- **MHAParser::vint\_t delay\_w**
- **MHAParser::vint\_t delay\_d**
- **MHAParser::int\_t n\_no\_update**

## Private Member Functions

- void **update\_cfg** ()

## Private Attributes

- **MHAEvents::patchbay\_t< prediction\_error > patchbay**

## Additional Inherited Members

## 5.342.1 Constructor &amp; Destructor Documentation

- 5.342.1.1 prediction\_error::prediction\_error (  
     **algo\_comm\_t** & *ac*,  
     const std::string & *chain\_name*,  
     const std::string & *algo\_name* )

Constructs our plugin.

5.342.1.2 `prediction_error::~~prediction_error ( )`

5.342.2 Member Function Documentation

5.342.2.1 `mha_wave_t * prediction_error::process ( mha_wave_t * signal )`

Checks for the most recent configuration and defers processing to it.

5.342.2.2 `void prediction_error::prepare ( mhaconfig_t & signal_info ) [virtual]`

Plugin preparation.

An opportunity to validate configuration parameters before instantiating a configuration.

Parameters

<i>signal_info</i>	Structure containing a description of the form of the signal (domain, number of channels, frames per block, sampling rate).
--------------------	---

Implements **MHAPLugin::plugin\_t< prediction\_error\_config >** (p. 730).

5.342.2.3 `void prediction_error::release ( void ) [inline], [virtual]`

Reimplemented from **MHAPLugin::plugin\_t< prediction\_error\_config >** (p. 731).

5.342.2.4 `void prediction_error::update_cfg ( void ) [private]`

5.342.3 Member Data Documentation

5.342.3.1 **MHAParser::float\_t prediction\_error::rho**

5.342.3.2 **MHAParser::float\_t prediction\_error::c**

5.342.3.3 **MHAParser::int\_t prediction\_error::ntaps**

5.342.3.4 **MHAParser::vfloat\_t prediction\_error::gains**

5.342.3.5 **MHAParser::string\_t prediction\_error::name\_e**

5.342.3.6 **MHAParser::string\_t prediction\_error::name\_f**



5.342.3.7 MHAParser::string\_t prediction\_error::name\_lpc

5.342.3.8 MHAParser::int\_t prediction\_error::lpc\_order

5.342.3.9 MHAParser::vint\_t prediction\_error::pred\_err\_delay

5.342.3.10 MHAParser::vint\_t prediction\_error::delay\_w

5.342.3.11 MHAParser::vint\_t prediction\_error::delay\_d

5.342.3.12 MHAParser::int\_t prediction\_error::n\_no\_update

5.342.3.13 MHAEvents::patchbay\_t<prediction\_error> prediction\_error::patchbay  
[private]

The documentation for this class was generated from the following files:

- prediction\_error.h
- prediction\_error.cpp

## 5.343 prediction\_error\_config Class Reference

### Public Member Functions

- prediction\_error\_config (algo\_comm\_t &ac, const mhaconfig\_t in\_cfg, prediction\_error \*pred\_err)
- ~prediction\_error\_config ()
- mha\_wave\_t \* process (mha\_wave\_t \*s\_Y, mha\_real\_t rho, mha\_real\_t c)
- void insert ()

### Private Attributes

- algo\_comm\_t ac
- unsigned int ntaps
- unsigned int frames
- unsigned int channels
- MHA\_AC::waveform\_t s\_E
- MHA\_AC::waveform\_t F
- MHASignal::waveform\_t Pu  
*Power of input signal delayline.*
- std::string name\_d\_
- std::string name\_lpc\_
- int n\_no\_update\_
- int no\_iter

- `int iter`
- `MHASignal::waveform_t v_G`
- `MHASignal::waveform_t s_U`
- `MHASignal::delay_t s_E_pred_err_delay`
- `MHASignal::delay_t s_W`
- `MHASignal::ringbuffer_t s_Wflt`
- `MHASignal::delay_t s_U_delay`
- `MHASignal::ringbuffer_t s_U_delayflt`
- `MHASignal::waveform_t F_Uflt`
- `MHASignal::delay_t s_Y_delay`
- `MHASignal::ringbuffer_t s_Y_delayflt`
- `MHASignal::ringbuffer_t UbufferPrew`
- `mha_wave_t s_LPC`
- `mha_wave_t UPrew`
- `mha_wave_t YPrew`
- `mha_wave_t EPrew`
- `mha_wave_t UPrewW`
- `mha_wave_t smpl`
- `mha_wave_t * s_Usmpl`

#### 5.343.1 Constructor & Destructor Documentation

5.343.1.1 `prediction_error_config::prediction_error_config (`  
`algo_comm_t & ac,`  
`const mhaconfig_t in_cfg,`  
`prediction_error * pred_err )`

5.343.1.2 `prediction_error_config::~~prediction_error_config ( )`

#### 5.343.2 Member Function Documentation

5.343.2.1 `mha_wave_t * prediction_error_config::process (`  
`mha_wave_t * s_Y,`  
`mha_real_t rho,`  
`mha_real_t c )`

5.343.2.2 `void prediction_error_config::insert ( )`

#### 5.343.3 Member Data Documentation

5.343.3.1 `algo_comm_t prediction_error_config::ac` [private]

5.343.3.2 `unsigned int prediction_error_config::ntaps` [private]

5.343.3.3 unsigned int prediction\_error\_config::frames [private]

5.343.3.4 unsigned int prediction\_error\_config::channels [private]

5.343.3.5 MHA\_AC::waveform\_t prediction\_error\_config::s\_E [private]

5.343.3.6 MHA\_AC::waveform\_t prediction\_error\_config::F [private]

5.343.3.7 MHASignal::waveform\_t prediction\_error\_config::Pu [private]

Power of input signal delayline.

5.343.3.8 std::string prediction\_error\_config::name\_d\_ [private]

5.343.3.9 std::string prediction\_error\_config::name\_lpc\_ [private]

5.343.3.10 int prediction\_error\_config::n\_no\_update\_ [private]

5.343.3.11 int prediction\_error\_config::no\_iter [private]

5.343.3.12 int prediction\_error\_config::iter [private]

5.343.3.13 MHASignal::waveform\_t prediction\_error\_config::v\_G [private]

5.343.3.14 MHASignal::waveform\_t prediction\_error\_config::s\_U [private]

5.343.3.15 MHASignal::delay\_t prediction\_error\_config::s\_E\_pred\_err\_delay [private]

5.343.3.16 MHASignal::delay\_t prediction\_error\_config::s\_W [private]

5.343.3.17 MHASignal::ringbuffer\_t prediction\_error\_config::s\_Wflt [private]

5.343.3.18 MHASignal::delay\_t prediction\_error\_config::s\_U\_delay [private]

5.343.3.19 MHASignal::ringbuffer\_t prediction\_error\_config::s\_U\_delayflt [private]

5.343.3.20 MHASignal::waveform\_t prediction\_error\_config::F\_Uflt [private]

5.343.3.21 MHASignal::delay\_t prediction\_error\_config::s\_Y\_delay [private]

5.343.3.22 MHASignal::ringbuffer\_t prediction\_error\_config::s\_Y\_delayflt [private]

5.343.3.23 MHASignal::ringbuffer\_t prediction\_error\_config::UbufferPrew [private]

- 5.343.3.24 `mha_wave_t prediction_error_config::s_LPC` [private]
- 5.343.3.25 `mha_wave_t prediction_error_config::UPrew` [private]
- 5.343.3.26 `mha_wave_t prediction_error_config::YPrew` [private]
- 5.343.3.27 `mha_wave_t prediction_error_config::EPrew` [private]
- 5.343.3.28 `mha_wave_t prediction_error_config::UPrewW` [private]
- 5.343.3.29 `mha_wave_t prediction_error_config::smpl` [private]
- 5.343.3.30 `mha_wave_t* prediction_error_config::s_Usmpl` [private]

The documentation for this class was generated from the following files:

- `prediction_error.h`
- `prediction_error.cpp`

#### 5.344 `rmslevel_if_t` Class Reference

Inheritance diagram for `rmslevel_if_t`:

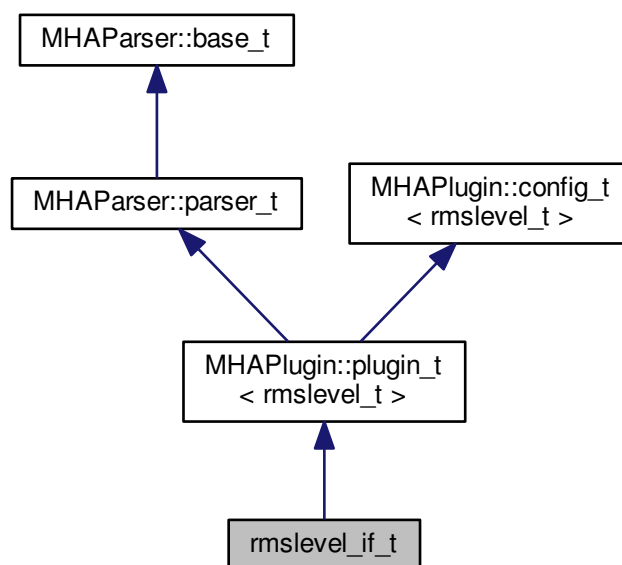

## Public Member Functions

- **rmslevel\_if\_t** (const **algo\_comm\_t** &, const std::string &, const std::string &)
- **mha\_spec\_t \* process** (**mha\_spec\_t** \*)
- **mha\_wave\_t \* process** (**mha\_wave\_t** \*)
- void **prepare** (**mhaconfig\_t** &)

## Private Attributes

- std::string **name**

## Additional Inherited Members

### 5.344.1 Constructor & Destructor Documentation

5.344.1.1 **rmslevel\_if\_t::rmslevel\_if\_t** (  
    const **algo\_comm\_t** & *iac*,  
    const std::string & *ith*,  
    const std::string & *ial* )

### 5.344.2 Member Function Documentation

5.344.2.1 **mha\_spec\_t \* rmslevel\_if\_t::process** (  
    **mha\_spec\_t** \* *s* )

5.344.2.2 **mha\_wave\_t \* rmslevel\_if\_t::process** (  
    **mha\_wave\_t** \* *s* )

5.344.2.3 void **rmslevel\_if\_t::prepare** (  
    **mhaconfig\_t** & *tf* ) [virtual]

Implements **MHAPlugin::plugin\_t**< **rmslevel\_t** > (p. 730).

### 5.344.3 Member Data Documentation

5.344.3.1 std::string **rmslevel\_if\_t::name** [private]

The documentation for this class was generated from the following file:

- **rmslevel.cpp**

## 5.345 rmslevel\_t Class Reference

### Public Member Functions

- **rmslevel\_t** (unsigned int *nch*, **algo\_comm\_t** *ac*, std::string *name*, **MHAParser::parser**↔  
\_t &*p*, unsigned int *fftlen\_*)
- **mha\_spec\_t \* process** (**mha\_spec\_t \***)
- **mha\_wave\_t \* process** (**mha\_wave\_t \***)
- void **insert** ()

### Private Attributes

- **mon\_t level\_db**
- **mon\_t peak\_db**
- **mon\_t level**
- **mon\_t peak**
- unsigned int **fftlen**

### 5.345.1 Constructor & Destructor Documentation

5.345.1.1 **rmslevel\_t::rmslevel\_t** (  
    unsigned int *nch*,  
    **algo\_comm\_t** *ac*,  
    std::string *name*,  
    **MHAParser::parser\_t** & *p*,  
    unsigned int *fftlen\_* )

### 5.345.2 Member Function Documentation

5.345.2.1 **mha\_spec\_t \* rmslevel\_t::process** (  
    **mha\_spec\_t \* s** )

5.345.2.2 **mha\_wave\_t \* rmslevel\_t::process** (  
    **mha\_wave\_t \* s** )

5.345.2.3 void **rmslevel\_t::insert** ( )

### 5.345.3 Member Data Documentation

5.345.3.1 **mon\_t rmslevel\_t::level\_db** [private]

5.345.3.2 **mon\_t rmslevel\_t::peak\_db** [private]

5.345.3.3 **mon\_t rmslevel\_t::level** [private]

5.345.3.4 **mon\_t rmslevel\_t::peak** [private]

5.345.3.5 unsigned int **rmslevel\_t::fftlen** [private]

The documentation for this class was generated from the following file:

- **rmslevel.cpp**

## 5.346 route::interface\_t Class Reference

Inheritance diagram for route::interface\_t:

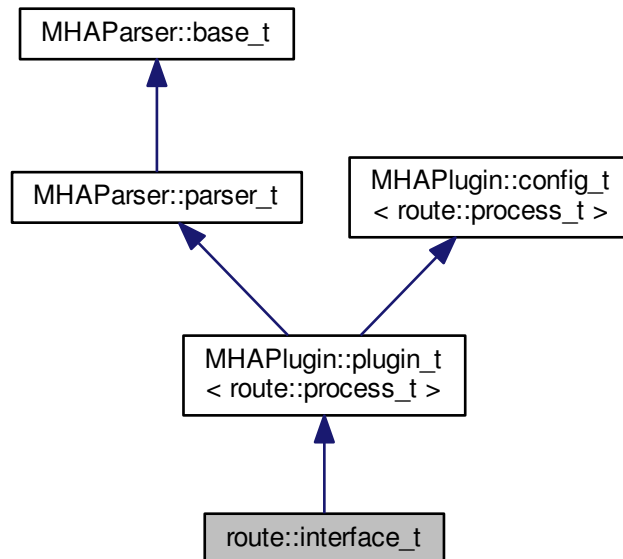

## Public Member Functions

- **interface\_t** (algo\_comm\_t iac, const std::string &, const std::string &)
- void **prepare** (mhaconfig\_t &)
- void **release** ()
- mha\_wave\_t \* **process** (mha\_wave\_t \*)
- mha\_spec\_t \* **process** (mha\_spec\_t \*)

## Private Member Functions

- void **update** ()

## Private Attributes

- MHAEvents::patchbay\_t < route::interface\_t > **patchbay**
- MHAParser::vstring\_t **route\_out**
- MHAParser::vstring\_t **route\_ac**
- mhaconfig\_t **cfin**
- mhaconfig\_t **cfout**
- mhaconfig\_t **cfac**
- bool **prepared**
- bool **stopped**
- std::string **algo**

## Additional Inherited Members

### 5.346.1 Constructor & Destructor Documentation

5.346.1.1 `route::interface_t::interface_t (`  
     `algo_comm_t iac,`  
     `const std::string &`  
     `const std::string & ialg )`

### 5.346.2 Member Function Documentation

5.346.2.1 `void route::interface_t::prepare (`  
     `mhaconfig_t & cf ) [virtual]`

Implements **MHAPLugin::plugin\_t< route::process\_t >** (p. 730).

5.346.2.2 `void route::interface_t::release (`  
     `void ) [virtual]`

Reimplemented from **MHAPLugin::plugin\_t< route::process\_t >** (p. 731).

5.346.2.3 `mha_wave_t * route::interface_t::process (`  
     `mha_wave_t * s )`

5.346.2.4 `mha_spec_t * route::interface_t::process (`  
     `mha_spec_t * s )`

5.346.2.5 `void route::interface_t::update ( ) [private]`

### 5.346.3 Member Data Documentation

5.346.3.1 `MHAEvents::patchbay_t<route::interface_t> route::interface_t::patchbay`  
     `[private]`

5.346.3.2 `MHAParser::vstring_t route::interface_t::route_out [private]`

5.346.3.3 `MHAParser::vstring_t route::interface_t::route_ac [private]`

5.346.3.4 `mhaconfig_t route::interface_t::cfin [private]`

5.346.3.5 `mhaconfig_t route::interface_t::cfout [private]`

5.346.3.6 `mhaconfig_t route::interface_t::cfac [private]`

5.346.3.7 `bool route::interface_t::prepared [private]`

5.346.3.8 `bool route::interface_t::stopped [private]`

5.346.3.9 `std::string route::interface_t::algo [private]`

The documentation for this class was generated from the following file:

- **route.cpp**



## 5.347 route::process\_t Class Reference

## Public Member Functions

- **process\_t** (**algo\_comm\_t** iac, const std::string acname, const std::vector< std::string > &r\_out, const std::vector< std::string > &r\_ac, const **mhaconfig\_t** &cf\_in, const **mhaconfig\_t** &cf\_out, const **mhaconfig\_t** &cf\_ac, bool sync)
- **mha\_wave\_t** \* **process** (**mha\_wave\_t** \*)
- **mha\_spec\_t** \* **process** (**mha\_spec\_t** \*)

## Private Attributes

- **MHAMultiSrc::waveform\_t** wout
- **MHAMultiSrc::spectrum\_t** sout
- **MHAMultiSrc::waveform\_t** wout\_ac
- **MHAMultiSrc::spectrum\_t** sout\_ac

## 5.347.1 Constructor &amp; Destructor Documentation

5.347.1.1 route::process\_t::process\_t (  
     **algo\_comm\_t** iac,  
     const std::string acname,  
     const std::vector< std::string > &r\_out,  
     const std::vector< std::string > &r\_ac,  
     const **mhaconfig\_t** &cf\_in,  
     const **mhaconfig\_t** &cf\_out,  
     const **mhaconfig\_t** &cf\_ac,  
     bool sync )

## 5.347.2 Member Function Documentation

5.347.2.1 **mha\_wave\_t** \* route::process\_t::process (  
     **mha\_wave\_t** \* s )

5.347.2.2 **mha\_spec\_t** \* route::process\_t::process (  
     **mha\_spec\_t** \* s )

## 5.347.3 Member Data Documentation

5.347.3.1 **MHAMultiSrc::waveform\_t** route::process\_t::wout [private]

5.347.3.2 **MHAMultiSrc::spectrum\_t** route::process\_t::sout [private]

5.347.3.3 **MHAMultiSrc::waveform\_t** route::process\_t::wout\_ac [private]

5.347.3.4 **MHAMultiSrc::spectrum\_t** route::process\_t::sout\_ac [private]

The documentation for this class was generated from the following file:

- **route.cpp**

## 5.348 `rt_nlms_t` Class Reference

### Public Member Functions

- `rt_nlms_t` (`algo_comm_t` iac, const std::string &name, const `mhaconfig_t` &cfg, unsigned int ntaps\_, const std::string &name\_u, const std::string &name\_d, const std::string &name\_e, const std::string &name\_f, const int n\_no\_update)
- `~rt_nlms_t` ()
- `mha_wave_t * process` (`mha_wave_t *sUD`, `mha_real_t` rho, `mha_real_t` c, unsigned int norm\_type, unsigned int estim\_type, `mha_real_t` lambda\_smooth)
- void `insert` ()

### Private Attributes

- `algo_comm_t` ac
- unsigned int `ntaps`
- unsigned int `frames`
- unsigned int `channels`
- `MHA_AC::waveform_t` F
- `MHASignal::waveform_t` U  
*Input signal cache.*
- `MHASignal::waveform_t` Uflt  
*Input signal cache (second filter)*
- `MHASignal::waveform_t` Pu  
*Power of input signal delayline.*
- `MHASignal::waveform_t` fu  
*Filtered input signal.*
- `MHASignal::waveform_t` fuflt  
*Filtered input signal.*
- `MHASignal::waveform_t` fu\_previous
- `MHASignal::waveform_t` y\_previous
- `MHASignal::waveform_t` P\_Sum
- std::string `name_u_`
- std::string `name_d_`
- std::string `name_e_`
- int `n_no_update_`
- int `no_iter`
- `mha_wave_t` s\_E

## 5.348.1 Constructor &amp; Destructor Documentation

5.348.1.1 `rt_nlms_t::rt_nlms_t (`  
     `algo_comm_t iac,`  
     `const std::string & name,`  
     `const mhaconfig_t & cfg,`  
     `unsigned int ntaps_,`  
     `const std::string & name_u,`  
     `const std::string & name_d,`  
     `const std::string & name_e,`  
     `const std::string & name_f,`  
     `const int n_no_update )`

5.348.1.2 `rt_nlms_t::~rt_nlms_t( )` [`inline`]

## 5.348.2 Member Function Documentation

5.348.2.1 `mha_wave_t * rt_nlms_t::process (`  
     `mha_wave_t * sUD,`  
     `mha_real_t rho,`  
     `mha_real_t c,`  
     `unsigned int norm_type,`  
     `unsigned int estim_type,`  
     `mha_real_t lambda_smooth )`

5.348.2.2 `void rt_nlms_t::insert ( )`

## 5.348.3 Member Data Documentation

5.348.3.1 `algo_comm_t rt_nlms_t::ac` [`private`]

5.348.3.2 `unsigned int rt_nlms_t::ntaps` [`private`]

5.348.3.3 `unsigned int rt_nlms_t::frames` [`private`]

5.348.3.4 `unsigned int rt_nlms_t::channels` [`private`]

5.348.3.5 `MHA_AC::waveform_t rt_nlms_t::F` [`private`]

5.348.3.6 `MHASignal::waveform_t rt_nlms_t::U` [`private`]

Input signal cache.

5.348.3.7 `MHASignal::waveform_t rt_nlms_t::Uflt` [`private`]

Input signal cache (second filter)

5.348.3.8 `MHASignal::waveform_t rt_nlms_t::Pu` [private]

Power of input signal delayline.

5.348.3.9 `MHASignal::waveform_t rt_nlms_t::fu` [private]

Filtered input signal.

5.348.3.10 `MHASignal::waveform_t rt_nlms_t::fufilt` [private]

Filtered input signal.

5.348.3.11 `MHASignal::waveform_t rt_nlms_t::fu_previous` [private]

5.348.3.12 `MHASignal::waveform_t rt_nlms_t::y_previous` [private]

5.348.3.13 `MHASignal::waveform_t rt_nlms_t::P_Sum` [private]

5.348.3.14 `std::string rt_nlms_t::name_u_` [private]

5.348.3.15 `std::string rt_nlms_t::name_d_` [private]

5.348.3.16 `std::string rt_nlms_t::name_e_` [private]

5.348.3.17 `int rt_nlms_t::n_no_update_` [private]

5.348.3.18 `int rt_nlms_t::no_iter` [private]

5.348.3.19 `mha_wave_t rt_nlms_t::s_E` [private]

The documentation for this class was generated from the following file:

- `nlms_wave.cpp`

## 5.349 save\_spec\_t Class Reference

Inheritance diagram for save\_spec\_t:

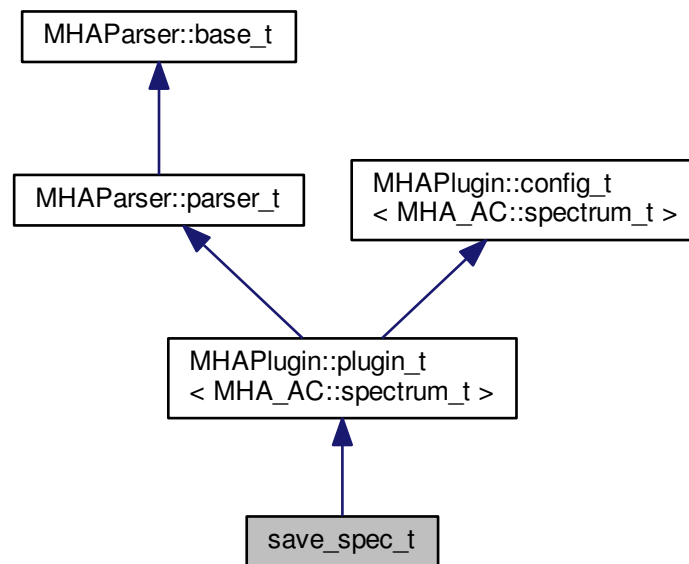

## Public Member Functions

- **save\_spec\_t** (const **algo\_comm\_t** &iac, const std::string &ith, const std::string &ial)
- **mha\_spec\_t \* process** (mha\_spec\_t \*s)
- void **prepare** (mhaconfig\_t &tf)

## Private Attributes

- std::string **basename**

## Additional Inherited Members

## 5.349.1 Constructor &amp; Destructor Documentation

5.349.1.1 save\_spec\_t::save\_spec\_t (  
 const **algo\_comm\_t** & iac,  
 const std::string & ith,  
 const std::string & ial ) [inline]

### 5.349.2 Member Function Documentation

5.349.2.1 `mha_spec_t* save_spec_t::process ( mha_spec_t* s )` [inline]

5.349.2.2 `void save_spec_t::prepare ( mhaconfig_t & tf )` [inline],[virtual]

Implements `MHAPLugin::plugin_t< MHA_AC::spectrum_t >` (p. 730).

### 5.349.3 Member Data Documentation

5.349.3.1 `std::string save_spec_t::basename` [private]

The documentation for this class was generated from the following file:

- `save_spec.cpp`

### 5.350 save\_wave\_t Class Reference

Inheritance diagram for `save_wave_t`:

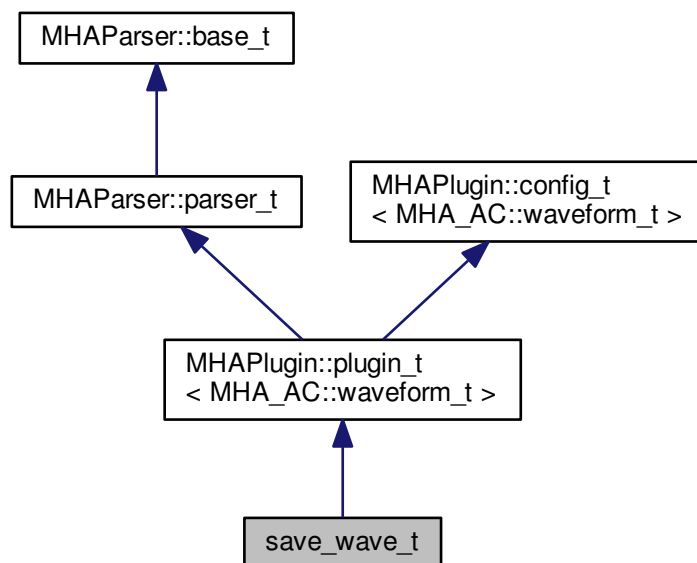

## Public Member Functions

- **save\_wave\_t** (const **algo\_comm\_t** &iac, const std::string &ith, const std::string &ial)
- **mha\_wave\_t \* process** (**mha\_wave\_t** \*s)
- void **prepare** (**mhaconfig\_t** &tf)

## Private Attributes

- std::string **basename**

## Additional Inherited Members

### 5.350.1 Constructor & Destructor Documentation

5.350.1.1 **save\_wave\_t::save\_wave\_t** (  
    const **algo\_comm\_t** & iac,  
    const std::string & ith,  
    const std::string & ial ) [inline]

### 5.350.2 Member Function Documentation

5.350.2.1 **mha\_wave\_t\* save\_wave\_t::process** (  
    **mha\_wave\_t** \* s ) [inline]

5.350.2.2 void **save\_wave\_t::prepare** (  
    **mhaconfig\_t** & tf ) [inline], [virtual]

Implements **MHAPlugin::plugin\_t**< **MHA\_AC::waveform\_t** > (p. 730).

### 5.350.3 Member Data Documentation

5.350.3.1 std::string **save\_wave\_t::basename** [private]

The documentation for this class was generated from the following file:

- **save\_wave.cpp**

## 5.351 shadowfilter\_begin::cfg\_t Class Reference

### Public Member Functions

- **cfg\_t** (int nfft, int inch, int outch, **algo\_comm\_t** ac, std::string name)
- **mha\_spec\_t \* process** (**mha\_spec\_t** \*)

## Private Attributes

- **MHA\_AC::spectrum\_t in\_spec\_copy**
- **MHASignal::spectrum\_t out\_spec**
- **MHA\_AC::int\_t nch**
- **MHA\_AC::int\_t ntracks**

### 5.351.1 Constructor & Destructor Documentation

5.351.1.1 `cfg_t::cfg_t (`  
    *int nfft,*  
    *int inch,*  
    *int outch,*  
    *algo\_comm\_t ac,*  
    *std::string name )*

### 5.351.2 Member Function Documentation

5.351.2.1 `mha_spec_t * cfg_t::process (`  
    *mha\_spec\_t \* s )*

### 5.351.3 Member Data Documentation

5.351.3.1 `MHA_AC::spectrum_t shadowfilter_begin::cfg_t::in_spec_copy` [private]

5.351.3.2 `MHASignal::spectrum_t shadowfilter_begin::cfg_t::out_spec` [private]

5.351.3.3 `MHA_AC::int_t shadowfilter_begin::cfg_t::nch` [private]

5.351.3.4 `MHA_AC::int_t shadowfilter_begin::cfg_t::ntracks` [private]

The documentation for this class was generated from the following file:

- **shadowfilter\_begin.cpp**



## 5.352 shadowfilter\_begin::shadowfilter\_begin\_t Class Reference

Inheritance diagram for shadowfilter\_begin::shadowfilter\_begin\_t:

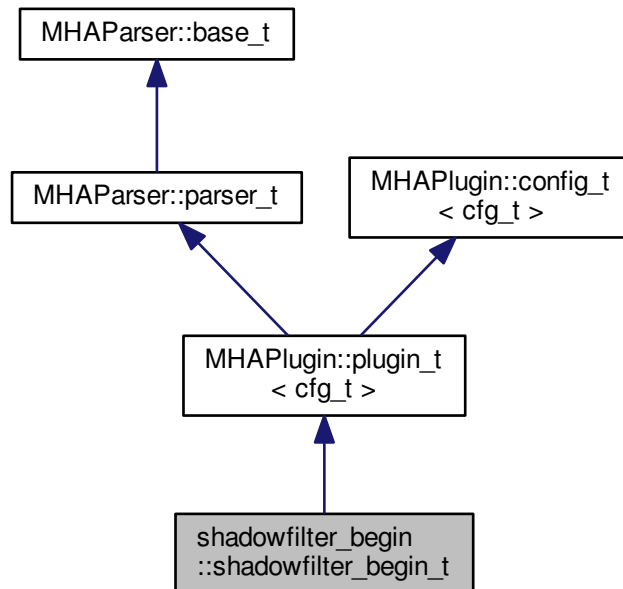

## Public Member Functions

- **shadowfilter\_begin\_t** (const **algo\_comm\_t** &, const std::string &, const std::string &)
- **mha\_spec\_t \* process** (mha\_spec\_t \*)
- void **prepare** (mhaconfig\_t &)

## Private Attributes

- std::string **basename**
- **MHAParser::int\_t nch**
- **MHAParser::int\_t ntracks**

## Additional Inherited Members

## 5.352.1 Constructor &amp; Destructor Documentation

5.352.1.1 `shadowfilter_begin::shadowfilter_begin_t::shadowfilter_begin_t (`  
     `const algo_comm_t & iac,`  
     `const std::string & ith,`  
     `const std::string & ial )`

### 5.352.2 Member Function Documentation

5.352.2.1 `mha_spec_t * shadowfilter_begin::shadowfilter_begin_t::process (`  
     `mha_spec_t * s )`

5.352.2.2 `void shadowfilter_begin::shadowfilter_begin_t::prepare (`  
     `mhaconfig_t & tf ) [virtual]`

Implements `MHAPLugin::plugin_t< cfg_t >` (p. 730).

### 5.352.3 Member Data Documentation

5.352.3.1 `std::string shadowfilter_begin::shadowfilter_begin_t::basename [private]`

5.352.3.2 `MHAParser::int_t shadowfilter_begin::shadowfilter_begin_t::nch [private]`

5.352.3.3 `MHAParser::int_t shadowfilter_begin::shadowfilter_begin_t::ntracks [private]`

The documentation for this class was generated from the following file:

- `shadowfilter_begin.cpp`

## 5.353 shadowfilter\_end::cfg\_t Class Reference

### Public Member Functions

- `cfg_t (int nfft_, algo_comm_t ac_, std::string name_)`
- `mha_spec_t * process (mha_spec_t *)`

### Private Attributes

- `algo_comm_t ac`
- `std::string name`
- `int nfft`
- `int ntracks`
- `int nch_out`
- `mha_spec_t in_spec`
- `MHASignal::spectrum_t out_spec`
- `MHA_AC::spectrum_t gains`

### 5.353.1 Constructor & Destructor Documentation

5.353.1.1 `cfg_t::cfg_t (`  
    `int nfft,`  
    `algo_comm_t ac,`  
    `std::string name_ )`

### 5.353.2 Member Function Documentation

5.353.2.1 `mha_spec_t * cfg_t::process (`  
    `mha_spec_t * s )`

### 5.353.3 Member Data Documentation

5.353.3.1 `algo_comm_t shadowfilter_end::cfg_t::ac` [private]

5.353.3.2 `std::string shadowfilter_end::cfg_t::name` [private]

5.353.3.3 `int shadowfilter_end::cfg_t::nfft` [private]

5.353.3.4 `int shadowfilter_end::cfg_t::ntracks` [private]

5.353.3.5 `int shadowfilter_end::cfg_t::nch_out` [private]

5.353.3.6 `mha_spec_t shadowfilter_end::cfg_t::in_spec` [private]

5.353.3.7 `MHASignal::spectrum_t shadowfilter_end::cfg_t::out_spec` [private]

5.353.3.8 `MHA_AC::spectrum_t shadowfilter_end::cfg_t::gains` [private]

The documentation for this class was generated from the following file:

- `shadowfilter_end.cpp`

### 5.354 shadowfilter\_end::shadowfilter\_end\_t Class Reference

Inheritance diagram for shadowfilter\_end::shadowfilter\_end\_t:

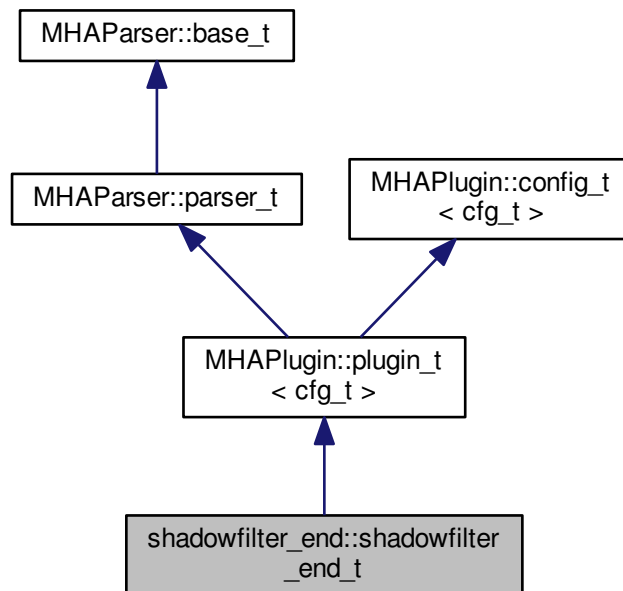

#### Public Member Functions

- **shadowfilter\_end\_t** (const **algo\_comm\_t** &, const std::string &, const std::string &)
- **mha\_spec\_t \* process** (mha\_spec\_t \*)
- void **prepare** (mhaconfig\_t &)

#### Private Attributes

- **MHAParser::string\_t** **basename**

#### Additional Inherited Members

#### 5.354.1 Constructor & Destructor Documentation

5.354.1.1 shadowfilter\_end::shadowfilter\_end\_t::shadowfilter\_end\_t (const **algo\_comm\_t** & *iac*, const std::string & *ith*, const std::string & *ial* )

### 5.354.2 Member Function Documentation

5.354.2.1 `mha_spec_t * shadowfilter_end::shadowfilter_end_t::process ( mha_spec_t * s )`

5.354.2.2 `void shadowfilter_end::shadowfilter_end_t::prepare ( mhaconfig_t & tf ) [virtual]`

Implements `MHAPlugin::plugin_t< cfg_t >` (p. 730).

### 5.354.3 Member Data Documentation

5.354.3.1 `MHAParser::string_t shadowfilter_end::shadowfilter_end_t::basename [private]`

The documentation for this class was generated from the following file:

- `shadowfilter_end.cpp`

## 5.355 sine\_cfg\_t Struct Reference

### Public Member Functions

- `sine_cfg_t` (double `sampling_rate`, `mha_real_t` `frequency`, `mha_real_t` `newlev`, int `_mix`, const std::vector< int > &`_channels`)

### Public Attributes

- double `phase_increment_div_2pi`
- double `amplitude`
- int `mix`
- const std::vector< int > `channels`

### 5.355.1 Constructor & Destructor Documentation

5.355.1.1 `sine_cfg_t::sine_cfg_t(`  
     *double sampling\_rate,*  
     *mha\_real\_t frequency,*  
     *mha\_real\_t newlev,*  
     *int mix,*  
     *const std::vector< int > &\_channels )* [inline]

### 5.355.2 Member Data Documentation

5.355.2.1 `double sine_cfg_t::phase_increment_div_2pi`

5.355.2.2 `double sine_cfg_t::amplitude`

5.355.2.3 `int sine_cfg_t::mix`

5.355.2.4 `const std::vector<int> sine_cfg_t::channels`

The documentation for this struct was generated from the following file:

- **sine.cpp**

### 5.356 sine\_t Class Reference

Inheritance diagram for `sine_t`:

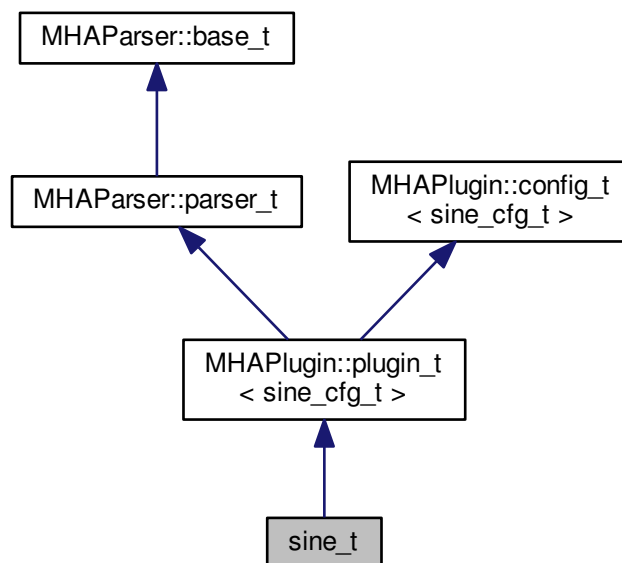

## Public Member Functions

- **sine\_t** (const **algo\_comm\_t** &, const std::string &chain\_name, const std::string &algo\_name)
- **~sine\_t** ()
- **mha\_wave\_t \* process** (**mha\_wave\_t \***)
- void **prepare** (**mhaconfig\_t** &)

## Private Member Functions

- void **update\_cfg** ()

## Private Attributes

- **MHAParser::float\_t** lev
- **MHAParser::float\_t** frequency
- **MHAParser::kw\_t** mode
- **MHAParser::vint\_t** channels
- double **phase\_div\_2pi**
- **MHAEvents::patchbay\_t**< **sine\_t** > patchbay

## Additional Inherited Members

## 5.356.1 Constructor &amp; Destructor Documentation

5.356.1.1 **sine\_t::sine\_t** (  
                   const **algo\_comm\_t** & *iac*,  
                   const std::string & *chain\_name*,  
                   const std::string & *algo\_name* )

5.356.1.2 **sine\_t::~sine\_t** ( )

## 5.356.2 Member Function Documentation

5.356.2.1 **mha\_wave\_t \* sine\_t::process** (  
                   **mha\_wave\_t \* s** )

5.356.2.2 void **sine\_t::prepare** (  
                   **mhaconfig\_t** & *tf* ) [virtual]

Implements **MHAPlugin::plugin\_t**< **sine\_cfg\_t** > (p. 730).

5.356.2.3 void sine\_t::update\_cfg ( void ) [private]

### 5.356.3 Member Data Documentation

5.356.3.1 MHAParser::float\_t sine\_t::lev [private]

5.356.3.2 MHAParser::float\_t sine\_t::frequency [private]

5.356.3.3 MHAParser::kw\_t sine\_t::mode [private]

5.356.3.4 MHAParser::vint\_t sine\_t::channels [private]

5.356.3.5 double sine\_t::phase\_div\_2pi [private]

5.356.3.6 MHAEvents::patchbay\_t<sine\_t> sine\_t::patchbay [private]

The documentation for this class was generated from the following file:

- sine.cpp

### 5.357 smoothgains\_bridge::overlapadd\_if\_t Class Reference

Inheritance diagram for smoothgains\_bridge::overlapadd\_if\_t:

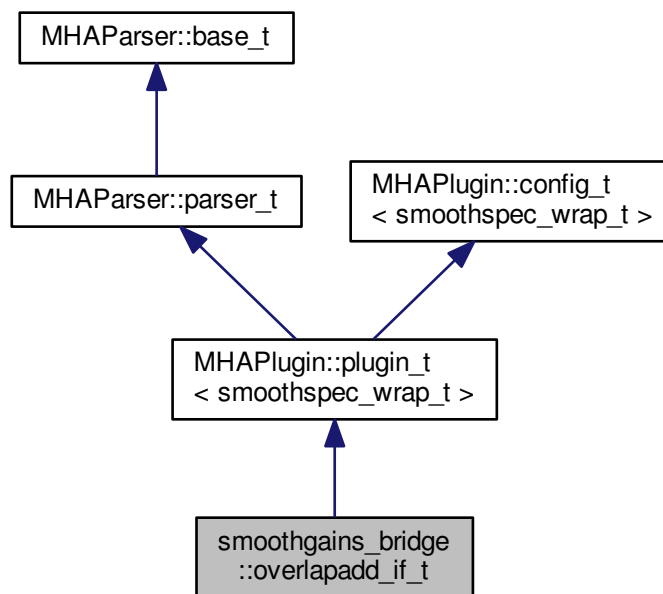



## Public Member Functions

- **overlapadd\_if\_t** (const **algo\_comm\_t** &, const std::string &, const std::string &)
- **~overlapadd\_if\_t** ()
- void **prepare** (**mhaconfig\_t** &)
- void **release** ()
- **mha\_spec\_t** \* **process** (**mha\_spec\_t** \*)

## Private Member Functions

- void **update** ()

## Private Attributes

- **MHAEvents::patchbay\_t**< **overlapadd\_if\_t** > **patchbay**
- **MHAParser::kw\_t** **mode**
- **MHAParser::window\_t** **irswnd**
- **MHAParser::float\_t** **epsilon**
- **MHAParser::mhapluginloader\_t** **plugloader**
- std::string **algo**
- **mhaconfig\_t** **cf\_in**
- **mhaconfig\_t** **cf\_out**

## Additional Inherited Members

## 5.357.1 Constructor &amp; Destructor Documentation

5.357.1.1 **smoothgains\_bridge::overlapadd\_if\_t::overlapadd\_if\_t** (  
     const **algo\_comm\_t** & *iac*,  
     const std::string & ,  
     const std::string & *ialg* )

5.357.1.2 **smoothgains\_bridge::overlapadd\_if\_t::~~overlapadd\_if\_t** ( )

## 5.357.2 Member Function Documentation

5.357.2.1 void **smoothgains\_bridge::overlapadd\_if\_t::prepare** (  
     **mhaconfig\_t** & *t* ) [virtual]

Implements **MHAPlugin::plugin\_t**< **smoothspec\_wrap\_t** > (p. 730).

5.357.2.2 void **smoothgains\_bridge::overlapadd\_if\_t::release** (  
     void ) [virtual]

Reimplemented from **MHAPlugin::plugin\_t**< **smoothspec\_wrap\_t** > (p. 731).

- 5.357.2.3 `mha_spec_t * smoothgains_bridge::overlapadd_if_t::process ( mha_spec_t * spec )`
- 5.357.2.4 `void smoothgains_bridge::overlapadd_if_t::update ( ) [private]`
- 5.357.3 Member Data Documentation
- 5.357.3.1 `MHAEvents::patchbay_t<overlapadd_if_t> smoothgains_bridge::overlapadd_if_t::patchbay [private]`
- 5.357.3.2 `MHAParser::kw_t smoothgains_bridge::overlapadd_if_t::mode [private]`
- 5.357.3.3 `MHAParser::window_t smoothgains_bridge::overlapadd_if_t::irswnd [private]`
- 5.357.3.4 `MHAParser::float_t smoothgains_bridge::overlapadd_if_t::epsilon [private]`
- 5.357.3.5 `MHAParser::mhapluginloader_t smoothgains_bridge::overlapadd_if_t::plugloader [private]`
- 5.357.3.6 `std::string smoothgains_bridge::overlapadd_if_t::algo [private]`
- 5.357.3.7 `mhaconfig_t smoothgains_bridge::overlapadd_if_t::cf_in [private]`
- 5.357.3.8 `mhaconfig_t smoothgains_bridge::overlapadd_if_t::cf_out [private]`

The documentation for this class was generated from the following file:

- `smoothgains_bridge.cpp`

## 5.358 `smoothgains_bridge::smoothspec_wrap_t` Class Reference

### Public Member Functions

- `smoothspec_wrap_t (mhaconfig_t spar_in, mhaconfig_t spar_out, const MHAParser::kw_t &mode, const MHAParser::window_t &irswnd, const MHAParser::float_t &epsilon)`
- `mha_spec_t * proc_1 (mha_spec_t *)`
- `mha_spec_t * proc_2 (mha_spec_t *)`

### Private Attributes

- `MHASignal::spectrum_t spec_in_copy`  
*Copy of input spectrum for smoothspec.*
- `MHAFilter::smoothspec_t smoothspec`  
*Smoothspec calculator.*
- `bool use_smoothspec`
- `float smoothspec_epsilon`

## 5.358 smoothgains\_bridge::smoothspec\_wrap\_t Class Reference 15

### 5.358.1 Constructor & Destructor Documentation

5.358.1.1 `smoothgains_bridge::smoothspec_wrap_t::smoothspec_wrap_t ( mhaconfig_t spar_in, mhaconfig_t spar_out, const MHAParser::kw_t & mode, const MHAParser::window_t & irswnd, const MHAParser::float_t & epsilon )`

### 5.358.2 Member Function Documentation

5.358.2.1 `mha_spec_t * smoothgains_bridge::smoothspec_wrap_t::proc_1 ( mha_spec_t * s )`

5.358.2.2 `mha_spec_t * smoothgains_bridge::smoothspec_wrap_t::proc_2 ( mha_spec_t * s )`

### 5.358.3 Member Data Documentation

5.358.3.1 `MHASignal::spectrum_t smoothgains_bridge::smoothspec_wrap_t::spec_in_copy` [private]

Copy of input spectrum for smoothspec.

5.358.3.2 `MHAFilter::smoothspec_t smoothgains_bridge::smoothspec_wrap_t::smoothspec` [private]

Smoothspec calculator.

5.358.3.3 `bool smoothgains_bridge::smoothspec_wrap_t::use_smoothspec` [private]

5.358.3.4 `float smoothgains_bridge::smoothspec_wrap_t::smoothspec_epsilon` [private]

The documentation for this class was generated from the following file:

- `smoothgains_bridge.cpp`

### 5.359 softclip\_t Class Reference

Inheritance diagram for softclip\_t:

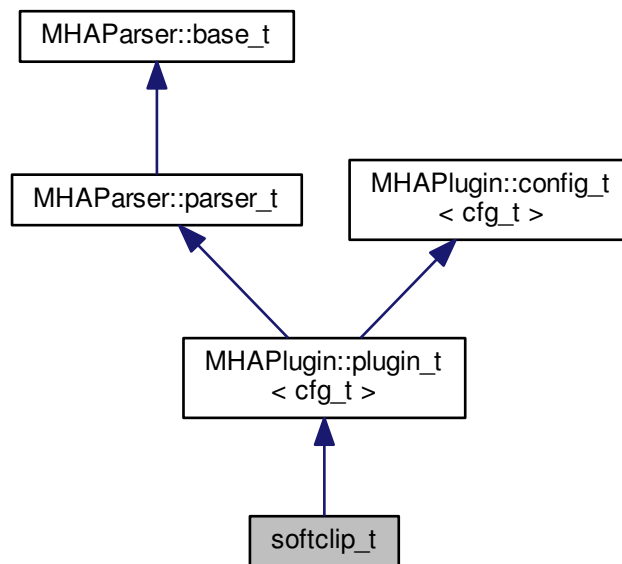

#### Public Member Functions

- **softclip\_t** (const **algo\_comm\_t** &, const std::string &, const std::string &)
- **mha\_wave\_t \* process** (**mha\_wave\_t \***)
- void **prepare** (**mhaconfig\_t** &)
- void **update** ()

#### Private Attributes

- **mhaconfig\_t** tftype
- **MHAParser::float\_t** attack
- **MHAParser::float\_t** decay
- **MHAParser::float\_t** start\_limit
- **MHAParser::float\_t** slope\_db
- **MHAEvents::patchbay\_t** < **softclip\_t** > patchbay

## Additional Inherited Members

## 5.359.1 Constructor &amp; Destructor Documentation

5.359.1.1 `softclip_t::softclip_t (`  
     `const algo_comm_t & iac,`  
     `const std::string & chain,`  
     `const std::string & name )`

## 5.359.2 Member Function Documentation

5.359.2.1 `mha_wave_t * softclip_t::process (`  
     `mha_wave_t * s )`

5.359.2.2 `void softclip_t::prepare (`  
     `mhaconfig_t & tf )` [virtual]

Implements `MHAPugin::plugin_t< cfg_t >` (p. 730).

5.359.2.3 `void softclip_t::update ( )`

## 5.359.3 Member Data Documentation

5.359.3.1 `mhaconfig_t softclip_t::tftype` [private]

5.359.3.2 `MHAParser::float_t softclip_t::attack` [private]

5.359.3.3 `MHAParser::float_t softclip_t::decay` [private]

5.359.3.4 `MHAParser::float_t softclip_t::start_limit` [private]

5.359.3.5 `MHAParser::float_t softclip_t::slope_db` [private]

5.359.3.6 `MHAEvents::patchbay_t<softclip_t> softclip_t::patchbay` [private]

The documentation for this class was generated from the following file:

- `softclip.cpp`

5.360 `softclipper_t` Class Reference

## Public Member Functions

- `softclipper_t (const softclipper_variables_t &v, const mhaconfig_t &)`
- `mha_real_t process (mha_wave_t *)`

## Private Attributes

- **MHAFilter::o1flt\_lowpass\_t** attack
- **MHAFilter::o1flt\_maxtrack\_t** decay
- **MHAFilter::o1flt\_lowpass\_t** clipmeter
- **mha\_real\_t** threshold
- **mha\_real\_t** hardlimit
- **mha\_real\_t** slope
- **bool** linear

### 5.360.1 Constructor & Destructor Documentation

5.360.1.1 `softclipper_t::softclipper_t (`  
                   `const softclipper_variables_t & v,`  
                   `const mhaconfig_t & tf )`

### 5.360.2 Member Function Documentation

5.360.2.1 `mha_real_t softclipper_t::process (`  
                   `mha_wave_t * s )`

### 5.360.3 Member Data Documentation

5.360.3.1 `MHAFilter::o1flt_lowpass_t softclipper_t::attack` [private]

5.360.3.2 `MHAFilter::o1flt_maxtrack_t softclipper_t::decay` [private]

5.360.3.3 `MHAFilter::o1flt_lowpass_t softclipper_t::clipmeter` [private]

5.360.3.4 `mha_real_t softclipper_t::threshold` [private]

5.360.3.5 `mha_real_t softclipper_t::hardlimit` [private]

5.360.3.6 `mha_real_t softclipper_t::slope` [private]

5.360.3.7 `bool softclipper_t::linear` [private]

The documentation for this class was generated from the following file:

- **transducers.cpp**

## 5.361 softclipper\_variables\_t Class Reference

Inheritance diagram for softclipper\_variables\_t:

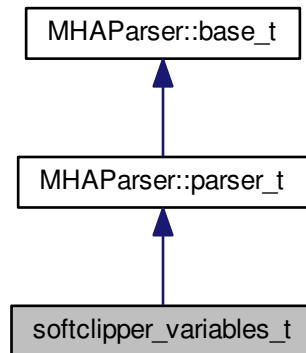

#### Public Member Functions

- **softclipper\_variables\_t ( )**

#### Public Attributes

- **MHAParser::float\_t tau\_attack**
- **MHAParser::float\_t tau\_decay**
- **MHAParser::float\_t tau\_clip**
- **MHAParser::float\_t threshold**
- **MHAParser::float\_t hardlimit**
- **MHAParser::float\_t slope**
- **MHAParser::bool\_t linear**
- **MHAParser::float\_mon\_t clipped**
- **MHAParser::float\_t max\_clipped**

#### Additional Inherited Members

##### 5.361.1 Constructor & Destructor Documentation

###### 5.361.1.1 softclipper\_variables\_t::softclipper\_variables\_t ( )

##### 5.361.2 Member Data Documentation

- 5.361.2.1 MHAParser::float\_t softclipper\_variables\_t::tau\_attack
- 5.361.2.2 MHAParser::float\_t softclipper\_variables\_t::tau\_decay
- 5.361.2.3 MHAParser::float\_t softclipper\_variables\_t::tau\_clip
- 5.361.2.4 MHAParser::float\_t softclipper\_variables\_t::threshold
- 5.361.2.5 MHAParser::float\_t softclipper\_variables\_t::hardlimit
- 5.361.2.6 MHAParser::float\_t softclipper\_variables\_t::slope
- 5.361.2.7 MHAParser::bool\_t softclipper\_variables\_t::linear
- 5.361.2.8 MHAParser::float\_mon\_t softclipper\_variables\_t::clipped
- 5.361.2.9 MHAParser::float\_t softclipper\_variables\_t::max\_clipped

The documentation for this class was generated from the following file:

- **transducers.cpp**

## 5.362 spec2wave\_if\_t Class Reference

Inheritance diagram for spec2wave\_if\_t:

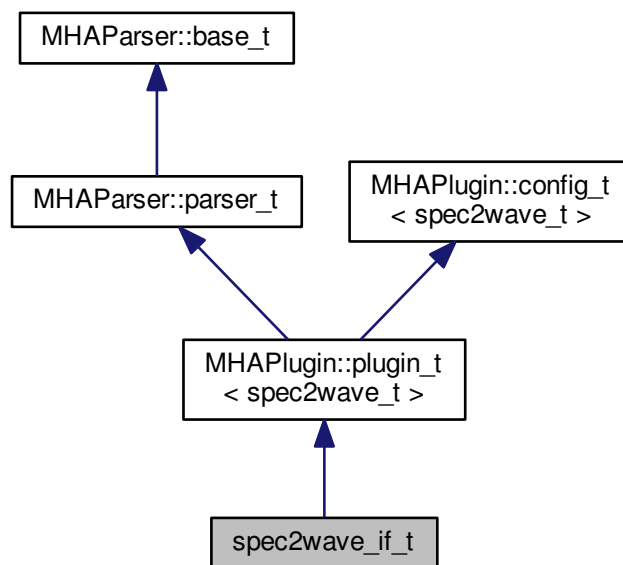



### Public Member Functions

- **spec2wave\_if\_t** (const **algo\_comm\_t** &, const std::string &, const std::string &)
- void **prepare** (**mhaconfig\_t** &)
- **mha\_wave\_t \* process** (**mha\_spec\_t \***)

### Private Member Functions

- void **update** ()

### Private Attributes

- **MHAEvents::patchbay\_t**< **spec2wave\_if\_t** > **patchbay**
- **MHAParser::float\_t** **ramplen**
- **windowselector\_t** **window\_config**

### Additional Inherited Members

#### 5.362.1 Constructor & Destructor Documentation

5.362.1.1 **spec2wave\_if\_t::spec2wave\_if\_t** (  
    const **algo\_comm\_t** & *iac*,  
    const std::string & ,  
    const std::string & )

#### 5.362.2 Member Function Documentation

5.362.2.1 void **spec2wave\_if\_t::prepare** (  
    **mhaconfig\_t** & *t* ) [virtual]

Implements **MHAPlugin::plugin\_t**< **spec2wave\_t** > (p. 730).

5.362.2.2 **mha\_wave\_t \* spec2wave\_if\_t::process** (  
    **mha\_spec\_t \* spec\_in** )

5.362.2.3 void **spec2wave\_if\_t::update** ( ) [private]

#### 5.362.3 Member Data Documentation

5.362.3.1 **MHAEvents::patchbay\_t**<**spec2wave\_if\_t**> **spec2wave\_if\_t::patchbay** [private]

5.362.3.2 **MHAParser::float\_t** **spec2wave\_if\_t::ramplen** [private]

5.362.3.3 **windowselector\_t** **spec2wave\_if\_t::window\_config** [private]

The documentation for this class was generated from the following file:

- **spec2wave.cpp**

### 5.363 spec2wave\_t Class Reference

#### Public Member Functions

- **spec2wave\_t** (unsigned int *nfft\_*, unsigned int *nwnd\_*, unsigned int *nwndshift\_*, unsigned int *nch*, **mha\_real\_t** *ramplen*, const **MHAWindow::base\_t** &*postwin*)
- **~spec2wave\_t** ()
- **mha\_wave\_t \* process** (**mha\_spec\_t** \*)

#### Private Attributes

- **mha\_fft\_t ft**  
*FFT class.*
- unsigned int **npad1**  
*length of zero padding before window*
- unsigned int **npad2**  
*length of zero padding after window*
- **hanning\_ramps\_t ramps**
- **MHASignal::waveform\_t calc\_out**
- **MHASignal::waveform\_t out\_buf**
- **MHASignal::waveform\_t write\_buf**
- **mha\_real\_t sc**
- unsigned int **nfft**
- unsigned int **nwndshift**
- **MHAWindow::base\_t postwindow**

#### 5.363.1 Constructor & Destructor Documentation

5.363.1.1 **spec2wave\_t::spec2wave\_t** (  
     unsigned int *nfft\_*,  
     unsigned int *nwnd\_*,  
     unsigned int *nwndshift\_*,  
     unsigned int *nch*,  
     **mha\_real\_t** *ramplen*,  
     const **MHAWindow::base\_t** & *postwin* )

5.363.1.2 **spec2wave\_t::~~spec2wave\_t** ( )

#### 5.363.2 Member Function Documentation

5.363.2.1 **mha\_wave\_t \* spec2wave\_t::process** (  
     **mha\_spec\_t** \* *spec\_in* )

#### 5.363.3 Member Data Documentation

5.363.3.1 **mha\_fft\_t spec2wave\_t::ft** [*private*]

FFT class.

5.363.3.2 unsigned int spec2wave\_t::npad1 [private]

length of zero padding before window

5.363.3.3 unsigned int spec2wave\_t::npad2 [private]

length of zero padding after window

5.363.3.4 hanning\_ramps\_t spec2wave\_t::ramps [private]

5.363.3.5 MHASignal::waveform\_t spec2wave\_t::calc\_out [private]

5.363.3.6 MHASignal::waveform\_t spec2wave\_t::out\_buf [private]

5.363.3.7 MHASignal::waveform\_t spec2wave\_t::write\_buf [private]

5.363.3.8 mha\_real\_t spec2wave\_t::sc [private]

5.363.3.9 unsigned int spec2wave\_t::nfft [private]

5.363.3.10 unsigned int spec2wave\_t::nwndshift [private]

5.363.3.11 MHAWindow::base\_t spec2wave\_t::postwindow [private]

The documentation for this class was generated from the following file:

- **spec2wave.cpp**

## 5.364 spec\_fader\_t Class Reference

### Public Member Functions

- **spec\_fader\_t** (unsigned int ch, **mha\_real\_t** fr, **MHAParser::vfloat\_t** &ng, **MHAParser**↔  
::float\_t &t)
- **~spec\_fader\_t** ()

### Public Attributes

- unsigned int **nch**
- **mha\_real\_t** \* **gains**
- unsigned int **fr**

### 5.364.1 Constructor & Destructor Documentation

5.364.1.1 `spec_fader_t::spec_fader_t ( unsigned int ch, mha_real_t fr, MHAParser::vfloat_t & ng, MHAParser::float_t & t )`

5.364.1.2 `spec_fader_t::~spec_fader_t ( )` [inline]

### 5.364.2 Member Data Documentation

5.364.2.1 `unsigned int spec_fader_t::nch`

5.364.2.2 `mha_real_t* spec_fader_t::gains`

5.364.2.3 `unsigned int spec_fader_t::fr`

The documentation for this class was generated from the following file:

- `fader_spec.cpp`

### 5.365 speechnoise\_t Class Reference

Inheritance diagram for `speechnoise_t`:

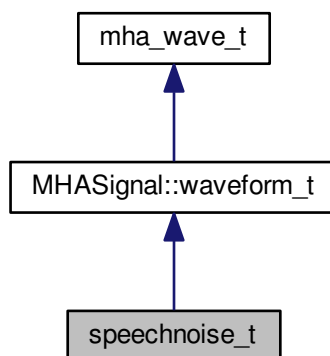

## Public Types

## Public Member Functions

- `speechnoise_t` (float duration, float srate, unsigned int **channels**, `speechnoise_t::noise_type_t` noise\_type=`speechnoise_t::mha`)
- `speechnoise_t` (unsigned int length\_samples, float srate, unsigned int **channels**, `speechnoise_t::noise_type_t` noise\_type=`speechnoise_t::mha`)

## Private Member Functions

- void **creator** (`speechnoise_t::noise_type_t` noise\_type, float srate)

## Additional Inherited Members

### 5.365.1 Member Enumeration Documentation

#### 5.365.1.1 enum `speechnoise_t::noise_type_t`

##### Enumerator

***mha***

***olnoise***

***LTASS\_combined***

***LTASS\_female***

***LTASS\_male***

***white***

***pink***

***brown***

***TEN\_SPL***

***TEN\_SPL\_250\_8k***

***TEN\_SPL\_50\_16k***

***sin125***

***sin250***

***sin500***

***sin1k***

***sin2k***

***sin4k***

***sin8k***

### 5.365.2 Constructor & Destructor Documentation

5.365.2.1 `speechnoise_t::speechnoise_t (`  
     `float duration,`  
     `float srate,`  
     `unsigned int channels,`  
     `speechnoise_t::noise_type_t noise_type = speechnoise_t::mha )`

5.365.2.2 `speechnoise_t::speechnoise_t (`  
     `unsigned int length_samples,`  
     `float srate,`  
     `unsigned int channels,`  
     `speechnoise_t::noise_type_t noise_type = speechnoise_t::mha )`

### 5.365.3 Member Function Documentation

5.365.3.1 `void speechnoise_t::creator (`  
     `speechnoise_t::noise_type_t noise_type,`  
     `float srate ) [private]`

The documentation for this class was generated from the following files:

- **speechnoise.h**
- **speechnoise.cpp**

## 5.366 steerbf Class Reference

Inheritance diagram for `steerbf`:

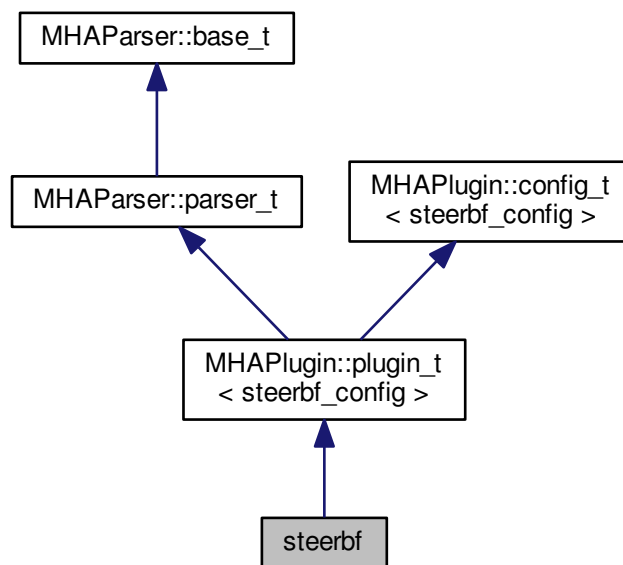

## Public Member Functions

- **steerbf** (**algo\_comm\_t** &**ac**, const std::string &chain\_name, const std::string &algo\_name)
  - Constructs our plugin.*
- **~steerbf** ()
- **mha\_spec\_t** \* **process** (**mha\_spec\_t** \*)
  - Defers to configuration class.*
- void **prepare** (**mhaconfig\_t** &)
  - Plugin preparation.*
- void **release** (void)

## Public Attributes

- **MHAParser::string\_t** **bf\_src**
- **parser\_int\_dyn** **angle\_ind**
- **MHAParser::string\_t** **angle\_src**

## Private Member Functions

- void **update\_cfg** ()

## Private Attributes

- **MHAEvents::patchbay\_t** < **steerbf** > **patchbay**

## Additional Inherited Members

## 5.366.1 Constructor &amp; Destructor Documentation

5.366.1.1 **steerbf::steerbf** (  
                   **algo\_comm\_t** & *ac*,  
                   const std::string & *chain\_name*,  
                   const std::string & *algo\_name* )

Constructs our plugin.

5.366.1.2 **steerbf::~steerbf** ( )

## 5.366.2 Member Function Documentation

5.366.2.1 **mha\_spec\_t** \* **steerbf::process** (  
                   **mha\_spec\_t** \* *signal* )

Defers to configuration class.

5.366.2.2 void **steerbf::prepare** (  
                   **mhaconfig\_t** & *signal\_info* ) [virtual]

Plugin preparation.

An opportunity to validate configuration parameters before instantiating a configuration.

## Parameters

<i>signal_info</i>	Structure containing a description of the form of the signal (domain, number of channels, frames per block, sampling rate).
--------------------	---

Implements **MHAPLugin::plugin\_t< steerbf\_config >** (p. 730).

5.366.2.3 `void steerbf::release ( void ) [inline], [virtual]`

Reimplemented from **MHAPLugin::plugin\_t< steerbf\_config >** (p. 731).

5.366.2.4 `void steerbf::update_cfg ( void ) [private]`

### 5.366.3 Member Data Documentation

5.366.3.1 `MHAParser::string_t steerbf::bf_src`

5.366.3.2 `parser_int_dyn steerbf::angle_ind`

5.366.3.3 `MHAParser::string_t steerbf::angle_src`

5.366.3.4 `MHAEvents::patchbay_t<steerbf> steerbf::patchbay [private]`

The documentation for this class was generated from the following files:

- **steerbf.h**
- **steerbf.cpp**

## 5.367 steerbf\_config Class Reference

### Public Member Functions

- **steerbf\_config (algo\_comm\_t &ac, const mhaconfig\_t in\_cfg, steerbf \*steerbf)**
- **~steerbf\_config ()**
- **mha\_spec\_t \* process (mha\_spec\_t \*)**



### Private Attributes

- unsigned int **nchan**
- unsigned int **nfreq**
- **MHASignal::spectrum\_t** **outSpec**
- **mha\_spec\_t** **bf\_vec**
- unsigned int **nangle**
- **steerbf** \* **\_steerbf**
- **algo\_comm\_t** & **ac**
- std::string **bf\_src\_copy**

### 5.367.1 Constructor & Destructor Documentation

5.367.1.1 `steerbf_config::steerbf_config (`  
    `algo_comm_t & ac,`  
    `const mhaconfig_t in_cfg,`  
    `steerbf * steerbf )`

5.367.1.2 `steerbf_config::~~steerbf_config ( )`

### 5.367.2 Member Function Documentation

5.367.2.1 `mha_spec_t * steerbf_config::process (`  
    `mha_spec_t * inSpec )`

### 5.367.3 Member Data Documentation

5.367.3.1 `unsigned int steerbf_config::nchan` [private]

5.367.3.2 `unsigned int steerbf_config::nfreq` [private]

5.367.3.3 `MHASignal::spectrum_t steerbf_config::outSpec` [private]

5.367.3.4 `mha_spec_t steerbf_config::bf_vec` [private]

5.367.3.5 `unsigned int steerbf_config::nangle` [private]

5.367.3.6 `steerbf* steerbf_config::_steerbf` [private]

5.367.3.7 `algo_comm_t& steerbf_config::ac` [private]

5.367.3.8 `std::string steerbf_config::bf_src_copy` [private]

The documentation for this class was generated from the following files:

- **steerbf.h**
- **steerbf.cpp**

### 5.368 testplugin::ac\_parser\_t Class Reference

Inheritance diagram for testplugin::ac\_parser\_t:

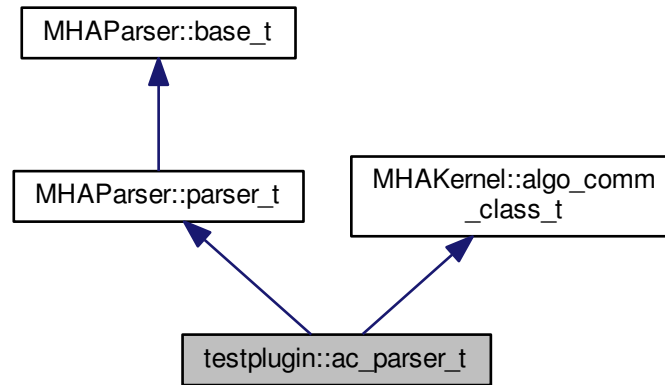

#### Public Types

#### Public Member Functions

- **ac\_parser\_t** ()
- void **do\_insert\_var** ()  
*Insert variable into AC space.*
- void **do\_get\_var** ()

#### Public Attributes

- **MHAParser::string\_t** insert\_var
- **MHAParser::string\_t** get\_var
- **MHAParser::kw\_t** data\_type
- **MHAParser::int\_t** num\_entries
- **MHAParser::int\_t** stride
- **MHAParser::string\_t** char\_data
- **MHAParser::vint\_t** int\_data
- **MHAParser::vfloat\_t** float\_data
- **MHAParser::vcomplex\_t** complex\_data
- **MHAEvents::patchbay\_t**< ac\_parser\_t > patchbay

## Additional Inherited Members

### 5.368.1 Member Enumeration Documentation

#### 5.368.1.1 enum testplugin::ac\_parser\_t::data\_type\_t

##### Enumerator

***\_MHA\_AC\_CHAR***  
***\_MHA\_AC\_INT***  
***\_MHA\_AC\_MHAREAL***  
***\_MHA\_AC\_FLOAT***  
***\_MHA\_AC\_DOUBLE***  
***\_MHA\_AC\_MHACOMPLEX***  
***\_unknown***

### 5.368.2 Constructor & Destructor Documentation

#### 5.368.2.1 testplugin::ac\_parser\_t::ac\_parser\_t( ) [inline]

### 5.368.3 Member Function Documentation

#### 5.368.3.1 void testplugin::ac\_parser\_t::do\_insert\_var( ) [inline]

Insert variable into AC space.

This leaks memory by design, as the plugin is for testing only

#### 5.368.3.2 void testplugin::ac\_parser\_t::do\_get\_var( ) [inline]

### 5.368.4 Member Data Documentation

#### 5.368.4.1 MHAParser::string\_t testplugin::ac\_parser\_t::insert\_var

#### 5.368.4.2 MHAParser::string\_t testplugin::ac\_parser\_t::get\_var

#### 5.368.4.3 MHAParser::kw\_t testplugin::ac\_parser\_t::data\_type

#### 5.368.4.4 MHAParser::int\_t testplugin::ac\_parser\_t::num\_entries

#### 5.368.4.5 MHAParser::int\_t testplugin::ac\_parser\_t::stride

#### 5.368.4.6 MHAParser::string\_t testplugin::ac\_parser\_t::char\_data

#### 5.368.4.7 MHAParser::vint\_t testplugin::ac\_parser\_t::int\_data

#### 5.368.4.8 MHAParser::vfloat\_t testplugin::ac\_parser\_t::float\_data

#### 5.368.4.9 MHAParser::vcomplex\_t testplugin::ac\_parser\_t::complex\_data

#### 5.368.4.10 MHAEvents::patchbay\_t<ac\_parser\_t> testplugin::ac\_parser\_t::patchbay

The documentation for this class was generated from the following file:

- **testplugin.cpp**

### 5.369 testplugin::config\_parser\_t Class Reference

Inheritance diagram for testplugin::config\_parser\_t:

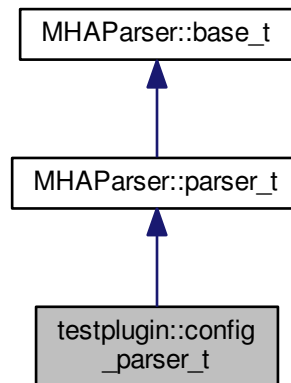

#### Public Member Functions

- void **setlock** (const bool &b)
- **config\_parser\_t** ()
- **mhaconfig\_t get** () const
- void **set** (**mhaconfig\_t** c)

#### Public Attributes

- **MHAParser::int\_t channels**
- **MHAParser::kw\_t domain**
- **MHAParser::int\_t fragsize**
- **MHAParser::int\_t wndlen**
- **MHAParser::int\_t fftlen**
- **MHAParser::float\_t srate**

#### Additional Inherited Members

#### 5.369.1 Constructor & Destructor Documentation

5.369.1.1 testplugin::config\_parser\_t::config\_parser\_t ( ) [inline]

## 5.369.2 Member Function Documentation

5.369.2.1 void testplugin::config\_parser\_t::setlock (   
const bool & b ) [inline]

5.369.2.2 mhaconfig\_t testplugin::config\_parser\_t::get ( ) const [inline]

5.369.2.3 void testplugin::config\_parser\_t::set (   
mhaconfig\_t c ) [inline]

## 5.369.3 Member Data Documentation

5.369.3.1 MHAParser::int\_t testplugin::config\_parser\_t::channels

5.369.3.2 MHAParser::kw\_t testplugin::config\_parser\_t::domain

5.369.3.3 MHAParser::int\_t testplugin::config\_parser\_t::fragsize

5.369.3.4 MHAParser::int\_t testplugin::config\_parser\_t::wndlen

5.369.3.5 MHAParser::int\_t testplugin::config\_parser\_t::ffflen

5.369.3.6 MHAParser::float\_t testplugin::config\_parser\_t::srate

The documentation for this class was generated from the following file:

- testplugin.cpp

### 5.370 testplugin::if\_t Class Reference

Inheritance diagram for testplugin::if\_t:

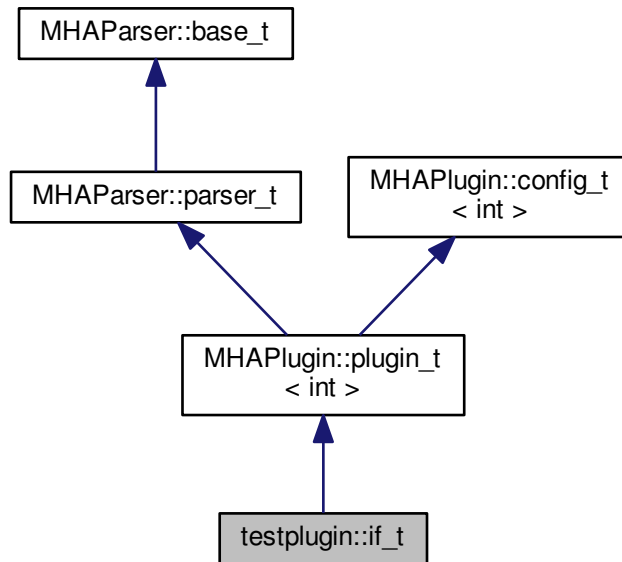

#### Public Member Functions

- **if\_t** (const **algo\_comm\_t** &iac, const std::string &ith, const std::string &ial)
- **mha\_spec\_t \* process** (**mha\_spec\_t** \*s\_in)
- **mha\_wave\_t \* process** (**mha\_wave\_t** \*s\_in)
- void **prepare** (**mhaconfig\_t** &)

#### Private Member Functions

- void **test\_prepare** ()
- void **test\_process** ()

#### Private Attributes

- **config\_parser\_t** config\_in
- **config\_parser\_t** config\_out
- **ac\_parser\_t** ac
- **signal\_parser\_t** signal
- **MHAParser::bool\_t** \_prepare
- **MHAEvents::patchbay\_t** < if\_t > patchbay
- **MHAParser::mhapluginloader\_t** plug

## Additional Inherited Members

### 5.370.1 Constructor & Destructor Documentation

5.370.1.1 testplugin::if\_t (   
    const algo\_comm\_t & iac,   
    const std::string & ith,   
    const std::string & ial )

### 5.370.2 Member Function Documentation

5.370.2.1 mha\_spec\_t\* testplugin::if\_t::process (   
    mha\_spec\_t \* s\_in ) [inline]

5.370.2.2 mha\_wave\_t\* testplugin::if\_t::process (   
    mha\_wave\_t \* s\_in ) [inline]

5.370.2.3 void testplugin::if\_t::prepare (   
    mhaconfig\_t & ) [inline],[virtual]

Implements **MHAPLugin::plugin\_t**< int > (p. 730).

5.370.2.4 void testplugin::if\_t::test\_prepare ( ) [private]

5.370.2.5 void testplugin::if\_t::test\_process ( ) [private]

### 5.370.3 Member Data Documentation

5.370.3.1 config\_parser\_t testplugin::if\_t::config\_in [private]

5.370.3.2 config\_parser\_t testplugin::if\_t::config\_out [private]

5.370.3.3 ac\_parser\_t testplugin::if\_t::ac [private]

5.370.3.4 signal\_parser\_t testplugin::if\_t::signal [private]

5.370.3.5 MHAParser::bool\_t testplugin::if\_t::\_prepare [private]

5.370.3.6 MHAEvents::patchbay\_t<if\_t> testplugin::if\_t::patchbay [private]

5.370.3.7 MHAParser::mhapluginloader\_t testplugin::if\_t::plug [private]

The documentation for this class was generated from the following file:

- testplugin.cpp

### 5.371 testplugin::signal\_parser\_t Class Reference

Inheritance diagram for testplugin::signal\_parser\_t:

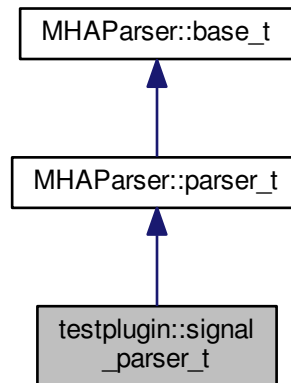

#### Public Member Functions

- **signal\_parser\_t ()**

#### Public Attributes

- **MHAParser::mfloat\_t input\_wave**
- **MHAParser::mcomplex\_t input\_spec**
- **MHAParser::mfloat\_mon\_t output\_wave**
- **MHAParser::mcomplex\_mon\_t output\_spec**

#### Additional Inherited Members

##### 5.371.1 Constructor & Destructor Documentation

5.371.1.1 testplugin::signal\_parser\_t::signal\_parser\_t ( ) [inline]

##### 5.371.2 Member Data Documentation

5.371.2.1 MHAParser::mfloat\_t testplugin::signal\_parser\_t::input\_wave

5.371.2.2 MHAParser::mcomplex\_t testplugin::signal\_parser\_t::input\_spec

5.371.2.3 MHAParser::mfloat\_mon\_t testplugin::signal\_parser\_t::output\_wave

5.371.2.4 MHAParser::mcomplex\_mon\_t testplugin::signal\_parser\_t::output\_spec

The documentation for this class was generated from the following file:

- **testplugin.cpp**



## 5.372 timo\_AC Class Reference

## Public Member Functions

- **timo\_AC** (**algo\_comm\_t** &ac, unsigned int fftlen, unsigned int nfreq, unsigned int nchan)
- void **copy** ()
- void **insert** ()

## Public Attributes

- **MHA\_AC::waveform\_t** gamma\_post\_AC
- **MHA\_AC::waveform\_t** xi\_ml\_AC
- **MHA\_AC::spectrum\_t** lambda\_ml\_AC
- **MHA\_AC::spectrum\_t** lambda\_ml\_ceps\_AC
- **MHA\_AC::waveform\_t** lambda\_ml\_smooth\_AC
- **MHA\_AC::waveform\_t** max\_q\_AC
- **MHA\_AC::waveform\_t** max\_val\_AC
- **MHA\_AC::waveform\_t** pitch\_set\_first\_AC
- **MHA\_AC::waveform\_t** pitch\_set\_last\_AC
- **MHA\_AC::waveform\_t** alpha\_hat\_AC
- **MHA\_AC::waveform\_t** alpha\_frame\_AC
- **MHA\_AC::spectrum\_t** lambda\_ceps\_AC
- **MHA\_AC::spectrum\_t** log\_lambda\_spec\_AC
- **MHA\_AC::waveform\_t** lambda\_spec\_AC
- **MHA\_AC::waveform\_t** xi\_est\_AC
- **MHA\_AC::waveform\_t** gain\_wiener\_AC
- **MHA\_AC::waveform\_t** winF0\_AC
- **MHA\_AC::waveform\_t** SPP

## 5.372.1 Constructor &amp; Destructor Documentation

5.372.1.1 **timo\_AC::timo\_AC** (  
                   **algo\_comm\_t** &ac,  
                   unsigned int *fftlen*,  
                   unsigned int *nfreq*,  
                   unsigned int *nchan* ) [inline]

## 5.372.2 Member Function Documentation

5.372.2.1 void **timo\_AC::copy** ( )

5.372.2.2 void **timo\_AC::insert** ( )

## 5.372.3 Member Data Documentation

- 5.372.3.1 MHA\_AC::waveform\_t timo\_AC::gamma\_post\_AC
- 5.372.3.2 MHA\_AC::waveform\_t timo\_AC::xi\_ml\_AC
- 5.372.3.3 MHA\_AC::spectrum\_t timo\_AC::lambda\_ml\_AC
- 5.372.3.4 MHA\_AC::spectrum\_t timo\_AC::lambda\_ml\_ceps\_AC
- 5.372.3.5 MHA\_AC::waveform\_t timo\_AC::lambda\_ml\_smooth\_AC
- 5.372.3.6 MHA\_AC::waveform\_t timo\_AC::max\_q\_AC
- 5.372.3.7 MHA\_AC::waveform\_t timo\_AC::max\_val\_AC
- 5.372.3.8 MHA\_AC::waveform\_t timo\_AC::pitch\_set\_first\_AC
- 5.372.3.9 MHA\_AC::waveform\_t timo\_AC::pitch\_set\_last\_AC
- 5.372.3.10 MHA\_AC::waveform\_t timo\_AC::alpha\_hat\_AC
- 5.372.3.11 MHA\_AC::waveform\_t timo\_AC::alpha\_frame\_AC
- 5.372.3.12 MHA\_AC::spectrum\_t timo\_AC::lambda\_ceps\_AC
- 5.372.3.13 MHA\_AC::spectrum\_t timo\_AC::log\_lambda\_spec\_AC
- 5.372.3.14 MHA\_AC::waveform\_t timo\_AC::lambda\_spec\_AC
- 5.372.3.15 MHA\_AC::waveform\_t timo\_AC::xi\_est\_AC
- 5.372.3.16 MHA\_AC::waveform\_t timo\_AC::gain\_wiener\_AC
- 5.372.3.17 MHA\_AC::waveform\_t timo\_AC::winF0\_AC
- 5.372.3.18 MHA\_AC::waveform\_t timo\_AC::SPP

The documentation for this class was generated from the following files:

- **timoconfig.h**
- **timoconfig.cpp**

## 5.373 timo\_params Class Reference

## Public Member Functions

- **timo\_params** (const **mhaconfig\_t** & *in\_cfg*, float *\_xi\_min\_db*, float *\_f0\_low*, float *\_f0\_high*, float *\_delta\_pitch*, float *\_lambda\_thresh*, float *\_alpha\_pitch*, float *\_beta\_const*, float *\_kappa\_const*, float *\_prior\_q*, float *\_xi\_opt\_db*, float *\_gain\_min\_db*, std::vector< float > & *\_winF0*, std::vector< float > & *\_alpha\_const\_vals*, std::vector< float > & *\_alpha\_const\_limits\_hz*, std::string & *\_noisePow\_name*)

## Public Attributes

- const **mhaconfig\_t** *in\_cfg*
- float **xi\_min\_db**
- float **f0\_low**
- float **f0\_high**
- float **delta\_pitch**
- float **lambda\_thresh**
- float **alpha\_pitch**
- float **beta\_const**
- float **kappa\_const**
- float **prior\_q**
- float **xi\_opt\_db**
- float **gain\_min\_db**
- std::vector< float > **winF0**
- std::vector< float > **alpha\_const\_vals**
- std::vector< float > **alpha\_const\_limits\_hz**
- std::string **noisePow\_name**

## 5.373.1 Constructor &amp; Destructor Documentation

```
5.373.1.1 timo_params::timo_params (
    const mhaconfig_t & in_cfg,
    float _xi_min_db,
    float _f0_low,
    float _f0_high,
    float _delta_pitch,
    float _lambda_thresh,
    float _alpha_pitch,
    float _beta_const,
    float _kappa_const,
    float _prior_q,
    float _xi_opt_db,
    float _gain_min_db,
    std::vector< float > & _winF0,
    std::vector< float > & _alpha_const_vals,
    std::vector< float > & _alpha_const_limits_hz,
    std::string & _noisePow_name ) [inline]
```

## 5.373.2 Member Data Documentation

- 5.373.2.1 `const mhaconfig_t timo_params::in_cfg`
- 5.373.2.2 `float timo_params::xi_min_db`
- 5.373.2.3 `float timo_params::f0_low`
- 5.373.2.4 `float timo_params::f0_high`
- 5.373.2.5 `float timo_params::delta_pitch`
- 5.373.2.6 `float timo_params::lambda_thresh`
- 5.373.2.7 `float timo_params::alpha_pitch`
- 5.373.2.8 `float timo_params::beta_const`
- 5.373.2.9 `float timo_params::kappa_const`
- 5.373.2.10 `float timo_params::prior_q`
- 5.373.2.11 `float timo_params::xi_opt_db`
- 5.373.2.12 `float timo_params::gain_min_db`
- 5.373.2.13 `std::vector<float> timo_params::winF0`
- 5.373.2.14 `std::vector<float> timo_params::alpha_const_vals`
- 5.373.2.15 `std::vector<float> timo_params::alpha_const_limits_hz`
- 5.373.2.16 `std::string timo_params::noisePow_name`

The documentation for this class was generated from the following file:

- **timoconfig.h**

## 5.374 timoConfig Class Reference

### Public Member Functions

- **timoConfig** (`algo_comm_t &ac, timo_params &params`)
- **~timoConfig** (`()`)
- **mha\_spec\_t \* process** (`mha_spec_t *`)

### Private Member Functions

- void **copy\_AC** (timo\_AC &tAC)

### Private Attributes

- **algo\_comm\_t** ac
- **timo\_params** params
- unsigned int **fftl**
- **mha\_fft\_t** mha\_fft
- unsigned int **nfreq**
- unsigned int **nchan**
- **timo\_AC** tAC
- float **ola\_powspec\_scale**
- float **q\_low**
- float **q\_high**
- **MHASignal::waveform\_t** winF0
- float **xi\_min**
- float **gain\_min**
- **MHASignal::waveform\_t** alpha\_const
- **MHASignal::waveform\_t** alpha\_prev
- **MHASignal::waveform\_t** noisePow
- **MHASignal::waveform\_t** powSpec
- **MHASignal::waveform\_t** gamma\_post
- **MHASignal::waveform\_t** xi\_ml
- **MHASignal::spectrum\_t** lambda\_ml\_full
- **MHASignal::spectrum\_t** lambda\_ml\_ceps
- **MHASignal::waveform\_t** lambda\_ml\_smooth
- **MHASignal::waveform\_t** alpha\_hat
- **MHASignal::waveform\_t** alpha\_frame
- **MHASignal::spectrum\_t** lambda\_ceps
- **MHASignal::waveform\_t** lambda\_ceps\_prev
- **MHASignal::spectrum\_t** log\_lambda\_spec
- **MHASignal::waveform\_t** lambda\_spec
- **MHASignal::waveform\_t** xi\_est
- **MHASignal::waveform\_t** gain\_wiener
- **MHASignal::spectrum\_t** spec\_out
- double \* **max\_val**
- int \* **max\_q**
- int \* **pitch\_set\_first**
- int \* **pitch\_set\_last**
- float **priorFact**
- float **xiOpt**
- float **logGLRFact**
- float **GLRexp**
- **MHASignal::waveform\_t** GLR

### 5.374.1 Constructor & Destructor Documentation

5.374.1.1 `timoConfig::timoConfig (`  
    `algo_comm_t & ac,`  
    `timo_params & params )`

5.374.1.2 `timoConfig::~~timoConfig ( )`

### 5.374.2 Member Function Documentation

5.374.2.1 `mha_spec_t * timoConfig::process (`  
    `mha_spec_t * noisyFrame )`

5.374.2.2 `void timoConfig::copy_AC (`  
    `timo_AC & tAC ) [private]`

### 5.374.3 Member Data Documentation

5.374.3.1 `algo_comm_t timoConfig::ac [private]`

5.374.3.2 `timo_params timoConfig::params [private]`

5.374.3.3 `unsigned int timoConfig::fftlens [private]`

5.374.3.4 `mha_fft_t timoConfig::mha_fft [private]`

5.374.3.5 `unsigned int timoConfig::nfreq [private]`

5.374.3.6 `unsigned int timoConfig::nchan [private]`

5.374.3.7 `timo_AC timoConfig::tAC [private]`

5.374.3.8 `float timoConfig::ola_powspec_scale [private]`

5.374.3.9 `float timoConfig::q_low [private]`

5.374.3.10 `float timoConfig::q_high [private]`

5.374.3.11 `MHASignal::waveform_t timoConfig::winF0 [private]`

5.374.3.12 `float timoConfig::xi_min [private]`

5.374.3.13 `float timoConfig::gain_min [private]`

- 5.374.3.14 `MHASignal::waveform_t timoConfig::alpha_const` [private]
- 5.374.3.15 `MHASignal::waveform_t timoConfig::alpha_prev` [private]
- 5.374.3.16 `MHASignal::waveform_t timoConfig::noisePow` [private]
- 5.374.3.17 `MHASignal::waveform_t timoConfig::powSpec` [private]
- 5.374.3.18 `MHASignal::waveform_t timoConfig::gamma_post` [private]
- 5.374.3.19 `MHASignal::waveform_t timoConfig::xi_ml` [private]
- 5.374.3.20 `MHASignal::spectrum_t timoConfig::lambda_ml_full` [private]
- 5.374.3.21 `MHASignal::spectrum_t timoConfig::lambda_ml_ceps` [private]
- 5.374.3.22 `MHASignal::waveform_t timoConfig::lambda_ml_smooth` [private]
- 5.374.3.23 `MHASignal::waveform_t timoConfig::alpha_hat` [private]
- 5.374.3.24 `MHASignal::waveform_t timoConfig::alpha_frame` [private]
- 5.374.3.25 `MHASignal::spectrum_t timoConfig::lambda_ceps` [private]
- 5.374.3.26 `MHASignal::waveform_t timoConfig::lambda_ceps_prev` [private]
- 5.374.3.27 `MHASignal::spectrum_t timoConfig::log_lambda_spec` [private]
- 5.374.3.28 `MHASignal::waveform_t timoConfig::lambda_spec` [private]
- 5.374.3.29 `MHASignal::waveform_t timoConfig::xi_est` [private]
- 5.374.3.30 `MHASignal::waveform_t timoConfig::gain_wiener` [private]
- 5.374.3.31 `MHASignal::spectrum_t timoConfig::spec_out` [private]
- 5.374.3.32 `double* timoConfig::max_val` [private]
- 5.374.3.33 `int* timoConfig::max_q` [private]
- 5.374.3.34 `int* timoConfig::pitch_set_first` [private]
- 5.374.3.35 `int* timoConfig::pitch_set_last` [private]
- 5.374.3.36 `float timoConfig::priorFact` [private]
- 5.374.3.37 `float timoConfig::xiOpt` [private]
- 5.374.3.38 `float timoConfig::logGLRFact` [private]
- 5.374.3.39 `float timoConfig::GLRexp` [private]
- 5.374.3.40 `MHASignal::waveform_t timoConfig::GLR` [private]

The documentation for this class was generated from the following files:

- `timoconfig.h`
- `timoconfig.cpp`

### 5.375 timoSmooth Class Reference

Inheritance diagram for timoSmooth:

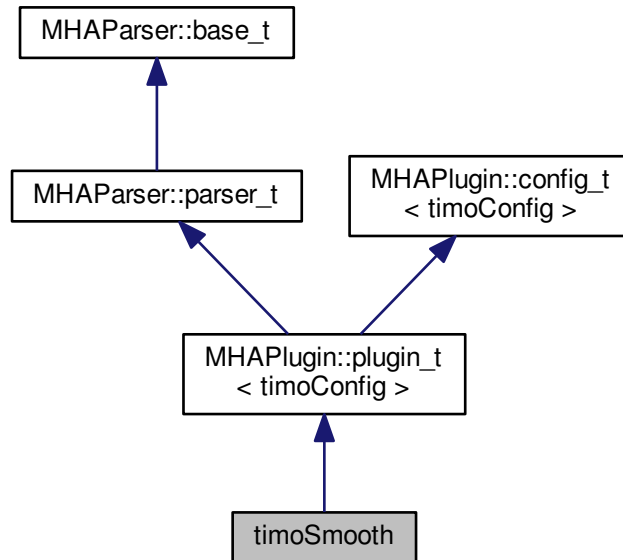

#### Public Member Functions

- **timoSmooth** (**algo\_comm\_t** &ac, const std::string &chain\_name, const std::string &algo\_name)  
*Constructs the beamforming plugin.*
- **~timoSmooth** ()
- **mha\_spec\_t \* process** (**mha\_spec\_t \***)  
*This plugin implements noise reduction using spectral subtraction: by nonnegative subtraction from the output magnitude of the estimated noise magnitude spectrum.*
- void **prepare** (**mhaconfig\_t** &)  
*Plugin preparation.*
- void **release** (void)

#### Private Member Functions

- void **update\_cfg** ()
- void **on\_model\_param\_valuechanged** ()



## Private Attributes

- MHAParser::float\_t xi\_min\_db
- MHAParser::float\_t f0\_low
- MHAParser::float\_t f0\_high
- MHAParser::float\_t delta\_pitch
- MHAParser::float\_t lambda\_thresh
- MHAParser::float\_t alpha\_pitch
- MHAParser::float\_t beta\_const
- MHAParser::float\_t kappa\_const
- MHAParser::float\_t gain\_min\_db
- MHAParser::vfloat\_t win\_f0
- MHAParser::vfloat\_t alpha\_const\_vals
- MHAParser::vfloat\_t alpha\_const\_limits\_hz
- MHAParser::string\_t noisePow\_name
- MHAParser::parser\_t spp
- MHAParser::float\_t prior\_q
- MHAParser::float\_t xi\_opt\_db
- MHAEvents::patchbay\_t< timoSmooth > patchbay
- bool prepared

## Additional Inherited Members

## 5.375.1 Constructor &amp; Destructor Documentation

5.375.1.1 timoSmooth::timoSmooth (   
                   algo\_comm\_t & ac,   
                   const std::string & chain\_name,   
                   const std::string & algo\_name )

Constructs the beamforming plugin.

5.375.1.2 timoSmooth::~~timoSmooth ( )

## 5.375.2 Member Function Documentation

5.375.2.1 mha\_spec\_t \* timoSmooth::process (   
                   mha\_spec\_t \* signal )

This plugin implements noise reduction using spectral subtraction: by nonnegative subtraction from the output magnitude of the estimated noise magnitude spectrum.

## Parameters

<i>signal</i>	Pointer to the input signal structure.
---------------	--

**Returns**

Returns a pointer to the input signal structure, with a the signal modified by this plugin.

5.375.2.2 `void timoSmooth::prepare ( mhaconfig_t & signal_info ) [virtual]`

Plugin preparation.

This plugin checks that the input signal has the spectral domain and contains at least one channel

**Parameters**

<i>signal_info</i>	Structure containing a description of the form of the signal (domain, number of channels, frames per block, sampling rate).
--------------------	---

Implements **MHAPLugin::plugin\_t< timoConfig >** (p. 730).

5.375.2.3 `void timoSmooth::release ( void ) [inline],[virtual]`

Reimplemented from **MHAPLugin::plugin\_t< timoConfig >** (p. 731).

5.375.2.4 `void timoSmooth::update_cfg ( void ) [private]`

5.375.2.5 `void timoSmooth::on_model_param_valuechanged ( ) [private]`

**5.375.3 Member Data Documentation**

5.375.3.1 **MHAParser::float\_t timoSmooth::xi\_min\_db** [private]

5.375.3.2 **MHAParser::float\_t timoSmooth::f0\_low** [private]

5.375.3.3 **MHAParser::float\_t timoSmooth::f0\_high** [private]

5.375.3.4 **MHAParser::float\_t timoSmooth::delta\_pitch** [private]

5.375.3.5 **MHAParser::float\_t timoSmooth::lambda\_thresh** [private]

5.375.3.6 **MHAParser::float\_t timoSmooth::alpha\_pitch** [private]

5.375.3.7 **MHAParser::float\_t timoSmooth::beta\_const** [private]

- 5.375.3.8 MHParse::float\_t timoSmooth::kappa\_const [private]
- 5.375.3.9 MHParse::float\_t timoSmooth::gain\_min\_db [private]
- 5.375.3.10 MHParse::vfloat\_t timoSmooth::win\_f0 [private]
- 5.375.3.11 MHParse::vfloat\_t timoSmooth::alpha\_const\_vals [private]
- 5.375.3.12 MHParse::vfloat\_t timoSmooth::alpha\_const\_limits\_hz [private]
- 5.375.3.13 MHParse::string\_t timoSmooth::noisePow\_name [private]
- 5.375.3.14 MHParse::parser\_t timoSmooth::spp [private]
- 5.375.3.15 MHParse::float\_t timoSmooth::prior\_q [private]
- 5.375.3.16 MHParse::float\_t timoSmooth::xi\_opt\_db [private]
- 5.375.3.17 MHAEvents::patchbay\_t<timoSmooth> timoSmooth::patchbay [private]
- 5.375.3.18 bool timoSmooth::prepared [private]

The documentation for this class was generated from the following files:

- timosmooth.h
- timoSmooth.cpp

## 5.376 us\_t Class Reference

Inheritance diagram for us\_t:

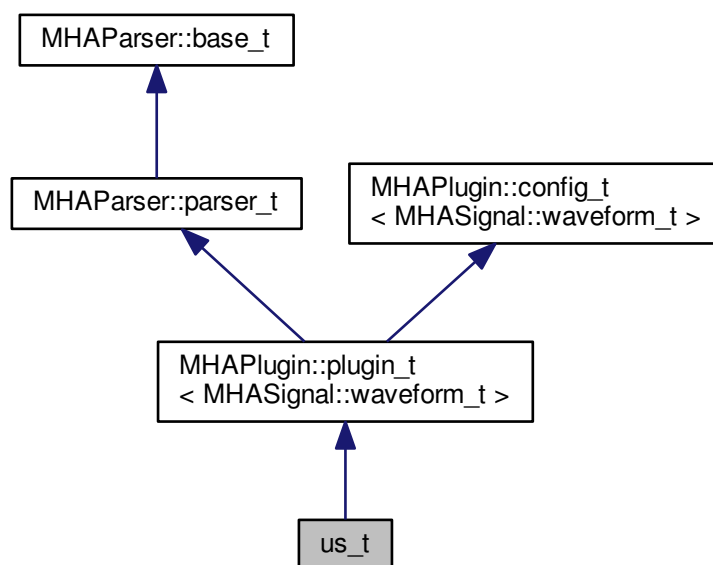

## Public Member Functions

- **us\_t** (**algo\_comm\_t**, std::string, std::string)
- **mha\_wave\_t \* process** (**mha\_wave\_t \***)
- void **prepare** (**mhaconfig\_t &**)
- void **release** (**)**

## Private Attributes

- **MHAParser::int\_t ratio**
- **MHAFilter::iir\_filter\_t antialias**

## Additional Inherited Members

### 5.376.1 Constructor & Destructor Documentation

5.376.1.1 **us\_t::us\_t** (  
                   **algo\_comm\_t iac**,  
                   std::string ,  
                   std::string )

### 5.376.2 Member Function Documentation

5.376.2.1 **mha\_wave\_t \* us\_t::process** (  
                   **mha\_wave\_t \* s** )

5.376.2.2 void **us\_t::prepare** (  
                   **mhaconfig\_t & cf** ) [virtual]

Implements **MHAPLugin::plugin\_t< MHASignal::waveform\_t >** (p. 730).

5.376.2.3 void **us\_t::release** (  
                   void ) [virtual]

Reimplemented from **MHAPLugin::plugin\_t< MHASignal::waveform\_t >** (p. 731).

### 5.376.3 Member Data Documentation

5.376.3.1 **MHAParser::int\_t us\_t::ratio** [private]

5.376.3.2 **MHAFilter::iir\_filter\_t us\_t::antialias** [private]

The documentation for this class was generated from the following file:

- **upsample.cpp**

## 5.377 wave2spec\_if\_t Class Reference

Inheritance diagram for wave2spec\_if\_t:

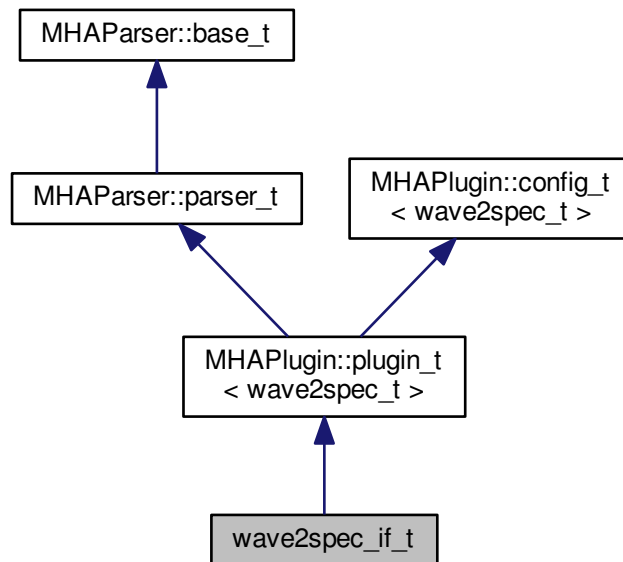

## Public Member Functions

- **wave2spec\_if\_t** (const **algo\_comm\_t** &, const std::string &, const std::string &)
- void **prepare** (**mhaconfig\_t** &)
- void **process** (**mha\_wave\_t** \*, **mha\_spec\_t** \*\*)
- void **process** (**mha\_wave\_t** \*, **mha\_wave\_t** \*\*)

## Private Member Functions

- void **update** ()

## Private Attributes

- **MHAEvents::patchbay\_t** < **wave2spec\_if\_t** > **patchbay**
- **MHAParser::int\_t** **nfft**
- **MHAParser::int\_t** **nwnd**
- **MHAParser::float\_t** **wndpos**
- **windowselector\_t** **window\_config**
- **MHAParser::bool\_t** **return\_wave**
- std::string **algo**

## Additional Inherited Members

### 5.377.1 Constructor & Destructor Documentation

5.377.1.1 `wave2spec_if_t::wave2spec_if_t (`  
     `const algo_comm_t & iac,`  
     `const std::string &`  
     `const std::string & ialg )`

### 5.377.2 Member Function Documentation

5.377.2.1 `void wave2spec_if_t::prepare (`  
     `mhaconfig_t & t ) [virtual]`

Implements `MHAPugin::plugin_t< wave2spec_t >` (p. 730).

5.377.2.2 `void wave2spec_if_t::process (`  
     `mha_wave_t * wave_in,`  
     `mha_spec_t ** sout )`

5.377.2.3 `void wave2spec_if_t::process (`  
     `mha_wave_t * wave_in,`  
     `mha_wave_t ** sout )`

5.377.2.4 `void wave2spec_if_t::update ( ) [private]`

### 5.377.3 Member Data Documentation

5.377.3.1 `MHAEvents::patchbay_t<wave2spec_if_t> wave2spec_if_t::patchbay [private]`

5.377.3.2 `MHAParser::int_t wave2spec_if_t::nfft [private]`

5.377.3.3 `MHAParser::int_t wave2spec_if_t::nwnd [private]`

5.377.3.4 `MHAParser::float_t wave2spec_if_t::wndpos [private]`

5.377.3.5 `windowselector_t wave2spec_if_t::window_config [private]`

5.377.3.6 `MHAParser::bool_t wave2spec_if_t::return_wave [private]`

5.377.3.7 `std::string wave2spec_if_t::algo [private]`

The documentation for this class was generated from the following file:

- `wave2spec.cpp`

## 5.378 wave2spec\_t Class Reference

Inheritance diagram for wave2spec\_t:

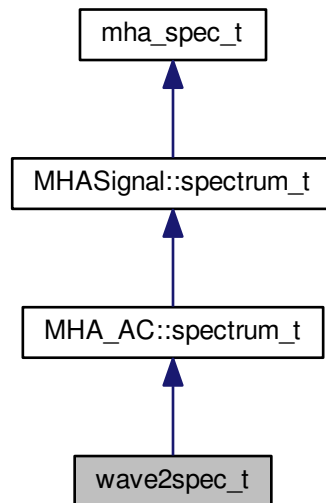

## Public Member Functions

- **wave2spec\_t** (unsigned int nfft, unsigned int nwnd\_, unsigned int nwndshift\_, unsigned int nch, **mha\_real\_t** wndpos, const **MHAWindow::base\_t** &window, **algo\_comm\_t** ac, std::string algo)
- **mha\_spec\_t** \* **process** (**mha\_wave\_t** \*)
- ~**wave2spec\_t** ()

## Private Member Functions

- void **calc\_pre\_wnd** (**MHASignal::waveform\_t** &, const **MHASignal::waveform\_t** &)

## Private Attributes

- unsigned int **nwnd**
- unsigned int **nwndshift**
- **mha\_fft\_t** ft  
*FFT class.*
- unsigned int **npad1**  
*length of zero padding before window*
- unsigned int **npad2**

*length of zero padding after window*

- **MHAWindow::base\_t window**
- **MHASignal::waveform\_t calc\_in**
- **MHASignal::waveform\_t in\_buf**
- **MHASignal::spectrum\_t spec\_in**

*non-interleaved, complex, fftlen*

### Additional Inherited Members

#### 5.378.1 Constructor & Destructor Documentation

5.378.1.1 **wave2spec\_t::wave2spec\_t (**  
     **unsigned int *nfft*,**  
     **unsigned int *nwnd*,**  
     **unsigned int *nwndshift*,**  
     **unsigned int *nch*,**  
     ***mha\_real\_t* *wndpos*,**  
     **const MHAWindow::base\_t & *window*,**  
     ***algo\_comm\_t* *ac*,**  
     **std::string *algo* )**

5.378.1.2 **wave2spec\_t::~~wave2spec\_t ( )**

#### 5.378.2 Member Function Documentation

5.378.2.1 ***mha\_spec\_t* \* wave2spec\_t::process (**  
     ***mha\_wave\_t* \* *wave\_in* )**

5.378.2.2 **void wave2spec\_t::calc\_pre\_wnd (**  
     **MHASignal::waveform\_t & *dest*,**  
     **const MHASignal::waveform\_t & *src* )** [private]

#### 5.378.3 Member Data Documentation

5.378.3.1 **unsigned int wave2spec\_t::nwnd** [private]

5.378.3.2 **unsigned int wave2spec\_t::nwndshift** [private]

5.378.3.3 ***mha\_fft\_t* wave2spec\_t::ft** [private]

FFT class.

5.378.3.4 **unsigned int wave2spec\_t::npad1** [private]

length of zero padding before window



5.378.3.5 unsigned int wave2spec\_t::npad2 [private]

length of zero padding after window

5.378.3.6 MHASignal::base\_t wave2spec\_t::window [private]

5.378.3.7 MHASignal::waveform\_t wave2spec\_t::calc\_in [private]

5.378.3.8 MHASignal::waveform\_t wave2spec\_t::in\_buf [private]

5.378.3.9 MHASignal::spectrum\_t wave2spec\_t::spec\_in [private]

non-interleaved, complex, fftlen

The documentation for this class was generated from the following file:

- **wave2spec.cpp**

## 5.379 wavrec\_t Class Reference

Inheritance diagram for wavrec\_t:

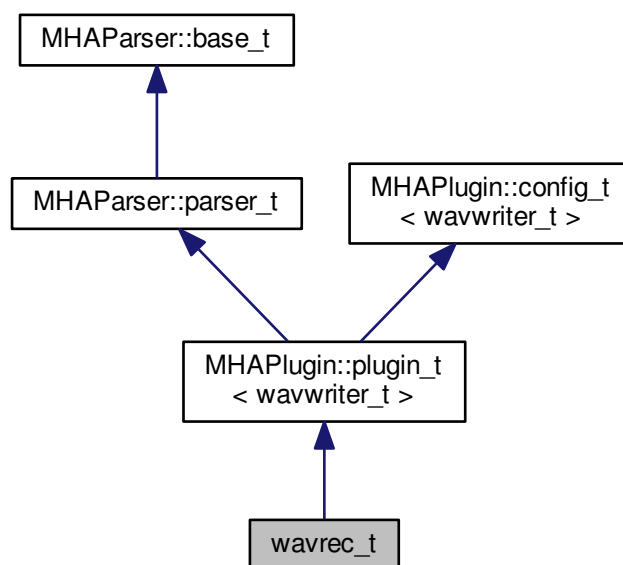

### Public Member Functions

- **mha\_wave\_t \* process** (mha\_wave\_t \*)
- void **prepare** (mhaconfig\_t &cf)
- void **release** ()
- **wavrec\_t** (const algo\_comm\_t &iac, const std::string &, const std::string &)

### Private Member Functions

- void **start\_new\_session** ()

### Private Attributes

- **MHAParser::bool\_t** record
- **MHAParser::int\_t** fifolen
- **MHAParser::int\_t** minwrite
- **MHAParser::string\_t** prefix
- **MHAParser::bool\_t** use\_date
- **MHAEvents::patchbay\_t**< wavrec\_t > patchbay

### Additional Inherited Members

#### 5.379.1 Constructor & Destructor Documentation

5.379.1.1 wavrec\_t::wavrec\_t (  
                   const algo\_comm\_t & iac,  
                   const std::string & ,  
                   const std::string & algo\_name )

#### 5.379.2 Member Function Documentation

5.379.2.1 mha\_wave\_t \* wavrec\_t::process (  
                   mha\_wave\_t \* s )

5.379.2.2 void wavrec\_t::prepare (  
                   mhaconfig\_t & cf ) [virtual]

Implements **MHAPlugin::plugin\_t**< wavwriter\_t > (p. 730).

5.379.2.3 void wavrec\_t::release (  
                   void ) [virtual]

Reimplemented from **MHAPlugin::plugin\_t**< wavwriter\_t > (p. 731).

5.379.2.4 void wavrec\_t::start\_new\_session ( ) [private]

### 5.379.3 Member Data Documentation

5.379.3.1 MHAParser::bool\_t wavrec\_t::record [private]

5.379.3.2 MHAParser::int\_t wavrec\_t::fifolen [private]

5.379.3.3 MHAParser::int\_t wavrec\_t::minwrite [private]

5.379.3.4 MHAParser::string\_t wavrec\_t::prefix [private]

5.379.3.5 MHAParser::bool\_t wavrec\_t::use\_date [private]

5.379.3.6 MHAEvents::patchbay\_t<wavrec\_t> wavrec\_t::patchbay [private]

The documentation for this class was generated from the following file:

- **wavrec.cpp**

## 5.380 wavwriter\_t Class Reference

### Public Member Functions

- **wavwriter\_t** (bool active, const **mhaconfig\_t** &cf, unsigned int fifosize, unsigned int minwrite, const std::string &prefix, bool use\_date)
- **~wavwriter\_t** ()
- void **process** (**mha\_wave\_t** \*)

### Private Member Functions

- void **write\_thread** ()

### Static Private Member Functions

- static void \* **write\_thread** (void \*this\_)

### Private Attributes

- bool **close\_session**
- bool **act\_**
- **mhaconfig\_t cf\_**
- SNDFILE \* **sf**
- **mha\_fifo\_t< mha\_real\_t > fifo**
- unsigned int **minw\_**
- pthread\_t **writethread**
- float \* **data**

### 5.380.1 Constructor & Destructor Documentation

5.380.1.1 `wavwriter_t::wavwriter_t (`  
     *bool active,*  
     *const mhaconfig\_t & cf,*  
     *unsigned int fifiesize,*  
     *unsigned int minwrite,*  
     *const std::string & prefix,*  
     *bool use\_date )*

5.380.1.2 `wavwriter_t::~~wavwriter_t ( )`

### 5.380.2 Member Function Documentation

5.380.2.1 `void wavwriter_t::process (`  
     *mha\_wave\_t \* s )*

5.380.2.2 `static void* wavwriter_t::write_thread (`  
     *void \* this\_ ) [inline],[static],[private]*

5.380.2.3 `void wavwriter_t::write_thread ( ) [private]`

### 5.380.3 Member Data Documentation

5.380.3.1 `bool wavwriter_t::close_session [private]`

5.380.3.2 `bool wavwriter_t::act_ [private]`

5.380.3.3 `mhaconfig_t wavwriter_t::cf_ [private]`

5.380.3.4 `SNDFILE* wavwriter_t::sf [private]`

5.380.3.5 `mha_fifo_t<mha_real_t> wavwriter_t::fifo [private]`

5.380.3.6 `unsigned int wavwriter_t::minw_ [private]`

5.380.3.7 `pthread_t wavwriter_t::writethread [private]`

5.380.3.8 `float* wavwriter_t::data [private]`

The documentation for this class was generated from the following file:

- **wavrec.cpp**

## 5.381 windowselector\_t Class Reference

A combination of mha parser variables to describe an overlapadd analysis window.

## Public Member Functions

- **windowselector\_t** (const std::string &default\_type)  
*constructor creates the mha parser variables that describe an overlapadd analysis window.*
- **~windowselector\_t** ()  
*destructor frees window data that were allocated*
- const **MHAWindow::base\_t** & **get\_window\_data** (unsigned length)  
*re-computes the window if required.*
- void **insert\_items** (**MHAParser::parser\_t** \*p)  
*insert the window parameters "wndtype", "wndexp", and "userwnd" as mha configuration parameters into the given mha configuration parser.*

## Public Attributes

- **MHAEvents::emitter\_t** updated  
*A collector event that fires when any of the window parameters managed here is written to.*

## Private Member Functions

- void **invalidate\_window\_data** ()  
*invalidates any allocated window samples.*
- void **update\_parser** ()  
*invoked when a parser parameter changes.*

## Private Attributes

- **MHAWindow::base\_t** \* wnd  
*Storage for the window data returned by **get\_window\_data()** (p. 958)*
- **MHAParser::kw\_t** wndtype  
*parser variable for window type*
- **MHAParser::float\_t** wndexp  
*parser variable for window exponent*
- **MHAParser::vfloat\_t** userwnd  
*parser variable for user window samples to use*
- **MHAEvents::patchbay\_t** < **windowselector\_t** > patchbay  
*patchbay to watch for changes for the parser variables*

### 5.381.1 Detailed Description

A combination of mha parser variables to describe an overlapadd analysis window.

Provides a method to get the window samples as an instance of **MHAWindow::base\_t** (p. 835) when needed.

### 5.381.2 Constructor & Destructor Documentation

#### 5.381.2.1 windowselector\_t::windowselector\_t ( const std::string & default\_type )

constructor creates the mha parser variables that describe an overlapadd analysis window.

#### Parameters

<i>default_type</i>	name of the default analysis window type. Must be one of: "rect", "bartlett", "hanning", "hamming", "blackman"
---------------------	--

#### 5.381.2.2 windowselector\_t::~~windowselector\_t ( )

destructor frees window data that were allocated

### 5.381.3 Member Function Documentation

#### 5.381.3.1 const MHAWindow::base\_t & windowselector\_t::get\_window\_data ( unsigned length )

re-computes the window if required.

#### Parameters

<i>length</i>	the desired window length in samples return the window's samples as a constref to <b>MHAWindow::base_t</b> (p. 835) instance. The referenced instance lives until the window parameters are changed, or this <b>windowselector_t</b> (p. 957) instance is destroyed.
---------------	--

#### 5.381.3.2 void windowselector\_t::insert\_items ( MHAParser::parser\_t \* p )

insert the window parameters "wndtype", "wndexp", and "userwnd" as mha configuration parameters into the given mha configuration parser.

## Parameters

<i>p</i>	The configuration parser where to insert the window parameters. E.g. the plugin wave2spec's interface class.
----------	--

**5.381.3.3** void windowselector\_t::invalidate\_window\_data ( ) [private]

invalidates any allocated window samples.

**5.381.3.4** void windowselector\_t::update\_parser ( ) [private]

invoked when a parser parameter changes.

Calls **invalidate\_window\_data()** (p. 959) and emits the updated event.

#### 5.381.4 Member Data Documentation

**5.381.4.1** MHAEvents::emitter\_t windowselector\_t::updated

A collector event that fires when any of the window parameters managed here is written to.

**5.381.4.2** MHAWindow::base\_t\* windowselector\_t::wnd [private]

Storage for the window data returned by **get\_window\_data()** (p. 958)

**5.381.4.3** MHAParser::kw\_t windowselector\_t::wndtype [private]

parser variable for window type

**5.381.4.4** MHAParser::float\_t windowselector\_t::wndexp [private]

parser variable for window exponent

**5.381.4.5** MHAParser::vfloat\_t windowselector\_t::userwnd [private]

parser variable for user window samples to use

**5.381.4.6** MHAEvents::patchbay\_t<windowselector\_t> windowselector\_t::patchbay  
[private]

patchbay to watch for changes for the parser variables

The documentation for this class was generated from the following files:

- **windowselector.h**
- **windowselector.cpp**

## 6 File Documentation

### 6.1 ac2lsl.cpp File Reference

#### Classes

- struct **ac2lsl::type\_info**
- class **ac2lsl::save\_var\_base\_t**  
*Interface for ac to lsl bridge variable.*
- class **ac2lsl::save\_var\_t< T >**  
*Implementation for all ac to lsl bridges except complex types.*
- class **ac2lsl::save\_var\_t< mha\_complex\_t >**  
*Template specialization of the **ac2lsl** (p. 78) bridge to take care of complex numbers.*
- class **ac2lsl::cfg\_t**  
*Runtime configuration class of the **ac2lsl** (p. 78) plugin.*
- class **ac2lsl::ac2lsl\_t**  
*Plugin class of **ac2lsl** (p. 78).*

#### Namespaces

- **ac2lsl**  
*All types for the **ac2lsl** (p. 78) plugins live in this namespace.*

#### Variables

- const std::map< int, type\_info > **ac2lsl::types**

### 6.2 ac2osc.cpp File Reference

#### Classes

- class **ac2osc\_t**  
*Plugin class of the ac2osc plugin.*

### 6.3 ac2wave.cpp File Reference

#### Classes

- class **ac2wave\_t**
- class **ac2wave\_if\_t**



## 6.4 ac\_monitor\_type.cpp File Reference

## 6.5 ac\_monitor\_type.hh File Reference

### Classes

- class **acmon::ac\_monitor\_t**  
*A class for converting AC variables to Parser monitors of correct type.*

### Namespaces

- **acmon**  
*Namespace for displaying ac variables as parser monitors.*

## 6.6 acConcat\_wave.cpp File Reference

### Macros

- #define **PATCH\_VAR**(var) patchbay.connect(&var.valuechanged, this, &acConcat\_↔  
**wave::update\_cfg**)
- #define **INSERT\_PATCH**(var) insert\_member(var); **PATCH\_VAR**(var)

### 6.6.1 Macro Definition Documentation

6.6.1.1 #define **PATCH\_VAR**(  
*var* ) patchbay.connect(&var.valuechanged, this, &acConcat\_wave::update\_↔  
\_cfg)

6.6.1.2 #define **INSERT\_PATCH**(  
*var* ) insert\_member(var); **PATCH\_VAR**(var)

## 6.7 acConcat\_wave.h File Reference

### Classes

- class **acConcat\_wave\_config**
- class **acConcat\_wave**

## 6.8 acmon.cpp File Reference

### Classes

- class **acmon::acmon\_t**

## Namespaces

- **acmon**

*Namespace for displaying ac variables as parser monitors.*

## 6.9 acPooling\_wave.cpp File Reference

### Macros

- #define **PATCH\_VAR**(var) patchbay.connect(&var.valuechanged, this, &acPooling\_↔  
**wave::update\_cfg**)
- #define **INSERT\_PATCH**(var) insert\_member(var); **PATCH\_VAR**(var)

### 6.9.1 Macro Definition Documentation

6.9.1.1 #define **PATCH\_VAR**(  
var ) patchbay.connect(&var.valuechanged, this, &acPooling\_wave::update↔  
\_cfg)

6.9.1.2 #define **INSERT\_PATCH**(  
var ) insert\_member(var); **PATCH\_VAR**(var)

## 6.10 acPooling\_wave.h File Reference

### Classes

- class **acPooling\_wave\_config**
- class **acPooling\_wave**

## 6.11 acsave.cpp File Reference

### Classes

- class **acsave::save\_var\_t**
- class **acsave::cfg\_t**
- class **acsave::acsave\_t**
- struct **acsave::mat4head\_t**

## Namespaces

- **acsave**

## Macros

- `#define ACSAVE_FMT_TXT 0`
- `#define ACSAVE_SFMT_TXT "txt"`
- `#define ACSAVE_FMT_MAT4 1`
- `#define ACSAVE_SFMT_MAT4 "mat4"`
- `#define ACSAVE_FMT_M 2`
- `#define ACSAVE_SFMT_M "m"`

### 6.11.1 Macro Definition Documentation

6.11.1.1 `#define ACSAVE_FMT_TXT 0`

6.11.1.2 `#define ACSAVE_SFMT_TXT "txt"`

6.11.1.3 `#define ACSAVE_FMT_MAT4 1`

6.11.1.4 `#define ACSAVE_SFMT_MAT4 "mat4"`

6.11.1.5 `#define ACSAVE_FMT_M 2`

6.11.1.6 `#define ACSAVE_SFMT_M "m"`

## 6.12 acSteer.cpp File Reference

### Macros

- `#define PATCH_VAR(var) patchbay.connect(&var.valuechanged, this, &acSteer↔  
::update_cfg)`
- `#define INSERT_PATCH(var) insert_member(var); PATCH_VAR(var)`

### 6.12.1 Macro Definition Documentation

6.12.1.1 `#define PATCH_VAR(  
var ) patchbay.connect(&var.valuechanged, this, &acSteer::update_cfg)`

6.12.1.2 `#define INSERT_PATCH(  
var ) insert_member(var); PATCH_VAR(var)`

## 6.13 acSteer.h File Reference

### Classes

- class `acSteer_config`
- class `acSteer`

## 6.14 acTransform\_wave.cpp File Reference

### Macros

- #define **PATCH\_VAR**(var) patchbay.connect(&var.valuechanged, this, &acTransform\_wave::update\_cfg)
- #define **INSERT\_PATCH**(var) insert\_member(var); **PATCH\_VAR**(var)

### 6.14.1 Macro Definition Documentation

6.14.1.1 #define **PATCH\_VAR**(  
                   var ) patchbay.connect(&var.valuechanged, this, &acTransform\_wave  
                   ::update\_cfg)

6.14.1.2 #define **INSERT\_PATCH**(  
                   var ) insert\_member(var); **PATCH\_VAR**(var)

## 6.15 acTransform\_wave.h File Reference

### Classes

- class **acTransform\_wave\_config**
- class **acTransform\_wave**

## 6.16 addsndfile.cpp File Reference

### Classes

- class **addsndfile::waveform\_proxy\_t**  
     *Class helps to specify which instance of MHASignal\_waveform\_t parent instance is meant in resampled\_soundfile\_t (p. 184).*
- class **addsndfile::resampled\_soundfile\_t**  
     *Reads sound from file and resamples it if necessary and wanted.*
- class **addsndfile::sndfile\_t**
- class **addsndfile::level\_adapt\_t**
- class **addsndfile::addsndfile\_if\_t**

### Namespaces

- **addsndfile**

## Macros

- `#define DEBUG(x) std::cerr << __FILE__ << ":" << __LINE__ << " " #x "=" << x << std::endl`

## Typedefs

- typedef **MHAPLugin::config\_t**< level\_adapt\_t > **addsndfile::level\_adaptor**
- typedef **MHAPLugin::plugin\_t**< sndfile\_t > **addsndfile::wave\_reader**

## Enumerations

## Functions

- static unsigned **addsndfile::resampled\_num\_frames** (unsigned num\_source\_frames, float source\_rate, float target\_rate, addsndfile\_resampling\_mode\_t resampling\_mode)

### 6.16.1 Macro Definition Documentation

6.16.1.1 `#define DEBUG(  
x ) std::cerr << __FILE__ << ":" << __LINE__ << " " #x "=" << x <<  
std::endl`

## 6.17 adm.cpp File Reference

### Classes

- class **adm\_rtconfig\_t**
- class **adm\_if\_t**

### Functions

- **MHASignal::waveform\_t \* adm\_fir\_lp** (unsigned int fs, unsigned f\_pass, unsigned int f\_stop, unsigned int order)
- **MHASignal::waveform\_t \* adm\_fir\_decomb** (unsigned int fs, float dist\_m, unsigned int order)

## 6.17.1 Function Documentation

6.17.1.1 **MHASignal::waveform\_t\*** adm\_fir\_lp (   
     unsigned int *fs*,   
     unsigned *f\_pass*,   
     unsigned int *f\_stop*,   
     unsigned int *order* )

6.17.1.2 **MHASignal::waveform\_t\*** adm\_fir\_decomb (   
     unsigned int *fs*,   
     float *dist\_m*,   
     unsigned int *order* )

## 6.18 adm.hh File Reference

### Classes

- class **ADM::Linearphase\_FIR**< **F** >   
     *An efficient linear-phase fir filter implementation.*
- class **ADM::Delay**< **F** >   
     *A delay-line class which can also do subsample-delays for a limited frequency range below fs/4.*
- class **ADM::ADM**< **F** >   
     *Adaptive differential microphone, working for speech frequency range.*

### Namespaces

- **ADM**

### Functions

- static double **ADM::subsampledelay\_coeff** (double samples, double f\_design, double fs=1.0)   
     *compute IIR coefficient for subsample delay*

### Variables

- const double **ADM::PI** = 3.14159265358979312
- const double **ADM::C** = 340
- const double **ADM::DELAY\_FREQ** = 2000
- const double **ADM::START\_BETA** = 0.5

## 6.19 altplugins.cpp File Reference

### Classes

- class **mhaplug\_cfg\_t**
- class **altplugins\_t**

### Macros

- #define **MHAPLUGIN\_OVERLOAD\_OUTDOMAIN**

#### 6.19.1 Macro Definition Documentation

##### 6.19.1.1 #define MHAPLUGIN\_OVERLOAD\_OUTDOMAIN

## 6.20 analysemhaplugin.cpp File Reference

### Functions

- std::string **strdom** (**mha\_domain\_t** d)
- void **print\_ac** (**MHAKernel::algo\_comm\_class\_t** &ac, std::string txt)
- int **main** (int argc, char \*\*argv)

#### 6.20.1 Function Documentation

##### 6.20.1.1 std::string strdom (                           **mha\_domain\_t** d )

##### 6.20.1.2 void print\_ac (                           **MHAKernel::algo\_comm\_class\_t** &ac,                           std::string txt )

##### 6.20.1.3 int main (                           int argc,                           char \*\* argv )

## 6.21 analysispath.cpp File Reference

### Classes

- class **analysepath\_t**
- class **plug\_t**
- class **analysispath\_if\_t**

## Functions

- static void \* **thread\_start** (void \*instance)

### 6.21.1 Function Documentation

6.21.1.1 static void\* thread\_start (  
void \* *instance* ) [static]

### 6.22 auditory\_profile.cpp File Reference

### 6.23 auditory\_profile.h File Reference

## Classes

- class **AuditoryProfile::fmap\_t**  
*A class to store frequency dependent data (e.g., HTL and UCL).*
- class **AuditoryProfile::profile\_t**  
*The Auditory Profile class.*
- class **AuditoryProfile::profile\_t::ear\_t**  
*Class for ear-dependent parameters, e.g., audiograms or unilateral loudness scaling.*
- class **AuditoryProfile::parser\_t**  
*Class to make the auditory profile accessible through the parser interface.*
- class **AuditoryProfile::parser\_t::fmap\_t**
- class **AuditoryProfile::parser\_t::ear\_t**

## Namespaces

- **AuditoryProfile**  
*Namespace for classes and functions around the auditory profile (e.g., audiogram handling)*

### 6.24 browsehmaplugins.cpp File Reference

## Macros

- **#define DEBUG(x)** std::cerr << \_\_FILE\_\_ << ":" << \_\_LINE\_\_ << " " << #x<<"="<<x  
<< std::endl

## Functions

- int **main** (int argc, char \*\*argv)



### 6.24.1 Macro Definition Documentation

6.24.1.1 `#define DEBUG(x) std::cerr << __FILE__ << ":" << __LINE__ << " " << #x << "=" << x << std::endl`

### 6.24.2 Function Documentation

6.24.2.1 `int main (int argc, char ** argv )`

## 6.25 coherence.cpp File Reference

### Classes

- class `coherence::vars_t`
- class `coherence::cohflt_t`
- class `coherence::cohflt_if_t`

### Namespaces

- `coherence`

### Functions

- void `coherence::getcipd (mha_complex_t &c, mha_real_t &a, const mha_complex_t &xl, const mha_complex_t &xr)`

## 6.26 combinechannels.cpp File Reference

### Classes

- class `combc_t`
- class `combc_if_t`

## 6.27 compiler\_id.cpp File Reference

## 6.28 compiler\_id.hh File Reference

### Macros

- #define **COMPILER\_ID\_VENDOR** "gcc"
- #define **COMPILER\_ID\_MAJOR** \_\_GNUC\_\_
- #define **COMPILER\_ID\_MINOR** \_\_GNUC\_MINOR\_\_
- #define **COMPILER\_ID\_PATCH** \_\_GNUC\_PATCHLEVEL\_\_
- #define **COMPILER\_ID\_VERSION\_HELPER2**(x, y, z) #x "." #y "." #z
- #define **COMPILER\_ID\_VERSION\_HELPER1**(x, y, z) **COMPILER\_ID\_VERSION\_HELPER2**(x,y,z)
- #define **COMPILER\_ID\_VERSION**
- #define **COMPILER\_ID** **COMPILER\_ID\_VENDOR** "-" **COMPILER\_ID\_VERSION** "-" **COMPILER\_ID\_STANDARD**

### 6.28.1 Macro Definition Documentation

6.28.1.1 #define **COMPILER\_ID\_VENDOR** "gcc"

6.28.1.2 #define **COMPILER\_ID\_MAJOR** \_\_GNUC\_\_

6.28.1.3 #define **COMPILER\_ID\_MINOR** \_\_GNUC\_MINOR\_\_

6.28.1.4 #define **COMPILER\_ID\_PATCH** \_\_GNUC\_PATCHLEVEL\_\_

6.28.1.5 #define **COMPILER\_ID\_VERSION\_HELPER2**(  
     x,  
     y,  
     z ) #x "." #y "." #z

6.28.1.6 #define **COMPILER\_ID\_VERSION\_HELPER1**(  
     x,  
     y,  
     z ) **COMPILER\_ID\_VERSION\_HELPER2**(x,y,z)

6.28.1.7 #define **COMPILER\_ID\_VERSION**

6.28.1.8 #define **COMPILER\_ID** **COMPILER\_ID\_VENDOR** "-" **COMPILER\_ID\_VERSION** "-" **COMPILER\_ID\_STANDARD**

## 6.29 complex\_filter.cpp File Reference

## 6.30 complex\_filter.h File Reference

### Classes

- class **MHAFilter::complex\_bandpass\_t**  
     *Complex bandpass filter.*
- class **MHAFilter::gammaflt\_t**  
     *Class for gammatone filter.*
- class **MHAFilter::thirdoctave\_analyzer\_t**

## Namespaces

- **MHAFilter**

*Namespace for IIR and FIR filter classes.*

## 6.31 cpuload.cpp File Reference

### Classes

- class **cpuload\_t**

## 6.32 db.cpp File Reference

### Classes

- class **db\_t**
- class **db\_if\_t**

## 6.33 dc.cpp File Reference

### Classes

- class **dc::wb\_inhib\_cfg\_t**
- class **dc::wideband\_inhib\_vars\_t**
- class **dc::dc\_vars\_t**
- class **dc::dc\_vars\_validator\_t**
- class **dc::dc\_t**
- class **dc::dc\_if\_t**

## Namespaces

- **dc**

## Macros

- `#define DUPVEC(x) v.x.data = MHASignal::dupvec_chk(v.x.data,s)`

## Functions

- unsigned int **dc::get\_audiochannels** (unsigned int totalchannels, std::string acname, **algo\_comm\_t** ac)

### 6.33.1 Macro Definition Documentation

6.33.1.1 #define DUPVEC(  
x ) v.x.data = MHASignal::dupvec\_chk(v.x.data,s)

### 6.34 dc\_afterburn.cpp File Reference

#### Namespaces

- **DynComp**  
*dynamic compression related classes and functions*

#### Functions

- float **mylogf** (float x)

### 6.34.1 Function Documentation

6.34.1.1 float mylogf (  
float x )

### 6.35 dc\_afterburn.h File Reference

#### Classes

- class **DynComp::dc\_afterburn\_vars\_t**  
*Variables for **dc\_afterburn\_t** (p. 294) class.*
- class **DynComp::dc\_afterburn\_rt\_t**  
*Real-time class for after burn effect.*
- class **DynComp::dc\_afterburn\_t**  
*Afterburn class, to be defined as a member of compressors.*

#### Namespaces

- **DynComp**  
*dynamic compression related classes and functions*

## 6.36 dc\_simple.cpp File Reference

### Classes

- class **dc\_simple::dc\_vars\_t**
- class **dc\_simple::dc\_vars\_validator\_t**
- class **dc\_simple::level\_smoother\_t**
- class **dc\_simple::dc\_t**
- class **dc\_simple::dc\_t::line\_t**
- class **dc\_simple::dc\_if\_t**

### Namespaces

- **dc\_simple**

### Typedefs

- typedef **MHAPlugin::plugin\_t**< dc\_t > **dc\_simple::DC**
- typedef **MHAPlugin::config\_t**< level\_smoother\_t > **dc\_simple::LEVEL**

### Functions

- void **dc\_simple::test\_fail** (const std::vector< float > &v, unsigned int s, const std::string &name)
- std::vector< float > **dc\_simple::force\_resize** (const std::vector< float > &v, unsigned int s, const std::string &name)
- **mha\_real\_t dc\_simple::not\_zero** (**mha\_real\_t** x, const std::string &comment="")

## 6.37 delay.cpp File Reference

### Classes

- class **delay::interface\_t**

### Namespaces

- **delay**

## 6.38 delaysum.cpp File Reference

### Classes

- class **delaysum::delaysum\_t**  
*Runtime configuration of the delaysum plugin.*
- class **delaysum::delaysum\_if\_t**  
*Interface class for the delaysum plugin.*

### Namespaces

- **delaysum**  
*This namespace contains the delaysum plugin.*

## 6.39 doasvm\_classification.cpp File Reference

### Macros

- **#define PATCH\_VAR**(var) patchbay.connect(&var.valuechanged, this, &doasvm\_↔  
**classification::update\_cfg**)
- **#define INSERT\_PATCH**(var) **insert\_member**(var); **PATCH\_VAR**(var)

### 6.39.1 Macro Definition Documentation

6.39.1.1 **#define PATCH\_VAR**(  
var ) patchbay.connect(&var.valuechanged, this, &doasvm\_↔  
**classification::update\_cfg**)

6.39.1.2 **#define INSERT\_PATCH**(  
var ) **insert\_member**(var); **PATCH\_VAR**(var)

## 6.40 doasvm\_classification.h File Reference

### Classes

- class **doasvm\_classification\_config**
- class **doasvm\_classification**

## 6.41 doasvm\_feature\_extraction.cpp File Reference

### Macros

- **#define PATCH\_VAR**(var) patchbay.connect(&var.valuechanged, this, &doasvm\_↔  
**feature\_extraction::update\_cfg**)
- **#define INSERT\_PATCH**(var) **insert\_member**(var); **PATCH\_VAR**(var)

## 6.41.1 Macro Definition Documentation

6.41.1.1 #define PATCH\_VAR(  
    *var* ) patchbay.connect(&var.valuechanged, this, &doasvm\_feature\_↔  
    extraction::update\_cfg)

6.41.1.2 #define INSERT\_PATCH(  
    *var* ) insert\_member(*var*); PATCH\_VAR(*var*)

## 6.42 doasvm\_feature\_extraction.h File Reference

## Classes

- class **doasvm\_feature\_extraction\_config**
- class **doasvm\_feature\_extraction**

## 6.43 doc\_appendix.h File Reference

## 6.44 doc\_examples.h File Reference

## 6.45 doc\_frameworks.h File Reference

## 6.46 doc\_general.h File Reference

## 6.47 doc\_kernel.h File Reference

## 6.48 doc\_matlab.h File Reference

## 6.49 doc\_mhamain.h File Reference

## 6.50 doc\_parser.h File Reference

## 6.51 doc\_pluginif.cpp File Reference

## 6.52 doc\_plugins.h File Reference

## 6.53 doc\_system.h File Reference

## 6.54 doc\_toolbox.h File Reference

## 6.55 downsample.cpp File Reference

## Classes

- class **ds\_t**

## 6.56 droptect.cpp File Reference

### Classes

- class **droptect\_t**  
*Detect dropouts in a signal with a constant spectrum.*

## 6.57 example1.cpp File Reference

### Classes

- class **example1\_t**  
*This C++ class implements the simplest example plugin for the step-by-step tutorial.*

## 6.58 example2.cpp File Reference

### Classes

- class **example2\_t**  
*This C++ class implements the second example plugin for the step-by-step tutorial.*

## 6.59 example3.cpp File Reference

### Classes

- class **example3\_t**  
*A Plugin class using the openMHA Event mechanism.*

## 6.60 example4.cpp File Reference

### Classes

- class **example4\_t**  
*A Plugin class using the spectral signal.*

## 6.61 example5.cpp File Reference

### Classes

- class **example5\_t**
- class **plugin\_interface\_t**



## Macros

- #define **\_\_declspec**(*p*)

### 6.61.1 Macro Definition Documentation

#### 6.61.1.1 #define **\_\_declspec**( *p*)

## 6.62 example6.cpp File Reference

## Classes

- class **cfg\_t**
- class **example6\_t**

## Macros

- #define **\_\_declspec**(*p*)

### 6.62.1 Macro Definition Documentation

#### 6.62.1.1 #define **\_\_declspec**( *p*)

## 6.63 fader\_spec.cpp File Reference

## Classes

- class **spec\_fader\_t**
- class **fader\_if\_t**

## 6.64 fader\_wave.cpp File Reference

## Classes

- class **fader\_wave::level\_adapt\_t**
- class **fader\_wave::fader\_wave\_if\_t**

## Namespaces

- **fader\_wave**

## Macros

- `#define DEBUG(x) std::cerr << __FILE__ << ":" << __LINE__ << " " #x "=" << x << std::endl`

## Typedefs

- `typedef MHAPlugin::plugin_t < level_adapt_t > fader_wave::level_adaptor`

### 6.64.1 Macro Definition Documentation

- 6.64.1.1 `#define DEBUG(  
                   x ) std::cerr << __FILE__ << ":" << __LINE__ << " " #x "=" << x << std::endl`

### 6.65 `fffbpow.cpp` File Reference

#### Classes

- class `fffbpow::fffbpow_t`  
*Run time configuration for the ffbpow plugin.*
- class `fffbpow::fffbpow_interface_t`  
*Interface class for ffbpow plugin.*

#### Namespaces

- `fffbpow`  
*Namespace for the ffbpow plugin.*

### 6.66 `fftfilterbank.cpp` File Reference

#### Classes

- class `fftfilterbank::fftfb_plug_t`
- class `fftfilterbank::fftfb_interface_t`

#### Namespaces

- `fftfilterbank`

## 6.67 fshift.cpp File Reference

## 6.68 fshift.hh File Reference

### Classes

- class **fshift::fshift\_config\_t**  
*fshift runtime config class*
- class **fshift::fshift\_t**  
*fshift plugin interface class*

### Namespaces

- **fshift**  
*All types for the fshift plugin live in this namespace.*

### Functions

- int **fshift::fft\_find\_bin** (**mha\_real\_t** frequency, unsigned fftlen, **mha\_real\_t** srate)  
*Finds bin number of FFT bin nearest to the given frequency.*

## 6.69 fshift\_hilbert.cpp File Reference

### Classes

- class **fshift\_hilbert::hilbert\_shifter\_t**
- class **fshift\_hilbert::frequency\_translator\_t**

### Namespaces

- **fshift\_hilbert**  
*All types for the hilbert frequency shifter live in this namespace.*

## 6.70 gain.cpp File Reference

### Classes

- class **gain::scaler\_t**
- class **gain::gain\_if\_t**

## Namespaces

- **gain**

## 6.71 gaintable.cpp File Reference

### Functions

- `std::vector< mha_real_t > convert_f2logf` (const `std::vector< mha_real_t >` &vF)
- `bool isempty` (const `std::vector< std::vector< mha_real_t > >` &arg)

### 6.71.1 Function Documentation

6.71.1.1 `std::vector<mha_real_t> convert_f2logf (`  
`const std::vector< mha_real_t > & vF )`

6.71.1.2 `bool isempty (`  
`const std::vector< std::vector< mha_real_t > > & arg )`

## 6.72 gaintable.h File Reference

### Classes

- class **DynComp::gaintable\_t**  
*Gain table class.*

## Namespaces

- **DynComp**  
*dynamic compression related classes and functions*

### Functions

- `mha_real_t DynComp::interp1` (const `std::vector< mha_real_t >` &vX, const `std::vector< mha_real_t >` &vY, `mha_real_t X`)  
*One-dimensional linear interpolation.*
- `mha_real_t DynComp::interp2` (const `std::vector< mha_real_t >` &vX, const `std::vector< mha_real_t >` &vY, const `std::vector< std::vector< mha_real_t > >` &mZ, `mha_real_t X`, `mha_real_t Y`)  
*Linear interpolation in a two-dimensional field.*

## 6.73 generatemhaplugindoc.cpp File Reference

## Classes

- class **latex\_doc\_t**

*Class to access the information stored in the plugin source code's MHAPLUGIN\_DOCUMENTATION macro.*

## Functions

- `std::string conv2latex` (`std::string s`, `bool iscolored=false`)

*Escapes various character sequences in texts not intended to be processed by LaTeX for processing by LaTeX.*

- static void **print\_plugin\_references** (`const std::set< std::string > &all_categories`, `std::map< std::string, std::vector< std::string > > main_category_plugins`, `std::map< std::string, std::vector< std::string > > additional_category_plugins`, `std::ofstream &ofile`, `const std::string &category_macro`)

*Function prints an overview of all categories and their associated plugins into the document.*

- `std::vector< std::string > create_latex_doc` (`std::map< std::string, std::string > &doc`, `const std::string &pluginname`, `const std::string &plugin_macro`)

*Loads the plugin, creates the latex documentation for the plugin, and adds the latex documentation for this plugin to the plugin's main category entry in doc.*

- int **main** (`int argc`, `char **argv`)

## 6.73.1 Function Documentation

### 6.73.1.1 `std::string conv2latex (` `std::string s,` `bool iscolored = false )`

Escapes various character sequences in texts not intended to be processed by LaTeX for processing by LaTeX.

Focus is on correct display of symbols contained in these texts. E.g. the help texts of MHA configuration variables can be processed by this function. The contents of the MHAPLUGIN\_DOCUMENTATION is already in LaTeX format and should not be processed by this function.

## Returns

A copy of `s` with various symbols escaped for LaTeX processing

## Parameters

<code>s</code>	Text not ready for LaTeX
<code>iscolored</code>	if true, the complete returned text is surrounded with <code>"\color{monitorcolor}{"</code> and <code>"}"</code>

```

6.73.1.2 static void print_plugin_references (
    const std::set< std::string > & all_categories,
    std::map< std::string, std::vector< std::string > > main_category_plugins,
    std::map< std::string, std::vector< std::string > > additional_category_plugins,
    std::ofstream & ofile,
    const std::string & category_macro ) [static]

```

Function prints an overview of all categories and their associated plugins into the document.

#### Parameters

<i>all_categories</i>	A sorted container with all category names
<i>main_category_plugins</i>	map of main categories to plugin names
<i>additional_category_plugins</i>	map of tags to plugin names
<i>ofile</i>	Latex document is produced by writing output to this stream

```

6.73.1.3 std::vector<std::string> create_latex_doc (
    std::map< std::string, std::string > & doc,
    const std::string & plugname,
    const std::string & plugin_macro )

```

Loads the plugin, creates the latex documentation for the plugin, and adds the latex documentation for this plugin to the plugin's main category entry in doc.

#### Returns

the vector of all categories.

#### Parameters

<i>doc</i>	map of main categories to a string containint the documentation of all plugins in that categories. The documentation of the current plugin will be appended to the existing documentation of its main category. Will be created if non-existant.
<i>plugname</i>	Name of the MHA plugin to process
<i>plugin_macro</i>	name of the LaTeX section macro that documents a single plugin (e.g. "section", "subsection", "subsubsection", ...)

```

6.73.1.4 int main (
    int argc,
    char ** argv )

```

## 6.74 gtfb\_analyzer.cpp File Reference

Gammatone Filterbank Analyzer Plugin.

## Classes

- struct **gtfb\_analyzer::gtfb\_analyzer\_cfg\_t**  
*Configuration for Gammatone Filterbank Analyzer.*
- class **gtfb\_analyzer::gtfb\_analyzer\_t**  
*Gammatone Filterbank Analyzer Plugin.*

## Namespaces

- **gtfb\_analyzer**

## Functions

- static const **mha\_complex\_t** & **filter\_complex** (const **mha\_complex\_t** &input, const **mha\_complex\_t** &coeff, **mha\_complex\_t** \*states, unsigned orders)  
*Filters a complex input sample with the given filter coefficient.*
- static const **mha\_complex\_t** & **filter\_real** (**mha\_real\_t** input, **mha\_complex\_t** &tmp←\_complex, const **mha\_complex\_t** &coeff, **mha\_complex\_t** \*states, unsigned orders, const **mha\_complex\_t** &normphase)  
*Filters a real input sample with the given filter coefficient and applies the given normalization with phase correction.*

## 6.74.1 Detailed Description

Gammatone Filterbank Analyzer Plugin.

## 6.74.2 Function Documentation

6.74.2.1 static const **mha\_complex\_t** & **filter\_complex** (  
    const **mha\_complex\_t** & *input*,  
    const **mha\_complex\_t** & *coeff*,  
    **mha\_complex\_t** \* *states*,  
    unsigned *orders* ) [inline],[static]

Filters a complex input sample with the given filter coefficient.

No normalization takes place. The implementation is tail-recursive and to exploit compiler optimization.

## Parameters

<i>input</i>	The complex input sample
<i>coeff</i>	The complex filter coefficient
<i>states</i>	Pointer to the array of complex filter states.
<i>orders</i>	The filter order

**Returns**

A const ref to the filtered sample

```
6.74.2.2 static const mha_complex_t& filter_real (
    mha_real_t input,
    mha_complex_t & tmp_complex,
    const mha_complex_t & coeff,
    mha_complex_t * states,
    unsigned orders,
    const mha_complex_t & normphase ) [inline], [static]
```

Filters a real input sample with the given filter coefficient and applies the given normalization with phase correction.

**Parameters**

<i>input</i>	The real input sample
<i>tmp_complex</i>	A reference to a <b>mha_complex_t</b> (p. 431) used for intermediate results. No assumptions should be made about the state of <i>tmp_complex</i> after the return of <i>filter_real</i> . This is an optimization to reduce the number of dtor/ctor calls of <b>mha_complex_t</b> (p. 431)
<i>coeff</i>	The complex filter coefficient
<i>states</i>	Pointer to the array of complex filter states.
<i>orders</i>	The filter order
<i>normphase</i>	Normalization coefficient including the phase correction

**Returns**

A const ref to the filtered sample

**6.75 hann.cpp File Reference****Macros**

- #define **PI** 3.14159265358979323846

**Functions**

- float \* **hannf** (const unsigned int N)
- double \* **hann** (const unsigned int N)



### 6.75.1 Macro Definition Documentation

6.75.1.1 #define PI 3.14159265358979323846

### 6.75.2 Function Documentation

6.75.2.1 float\* hannf (  
                  const unsigned int *N* )

6.75.2.2 double\* hann (  
                  const unsigned int *N* )

## 6.76 hann.h File Reference

### Functions

- float \* **hannf** (const unsigned int *N*)
- double \* **hann** (const unsigned int *N*)

### 6.76.1 Function Documentation

6.76.1.1 float\* hannf (  
                  const unsigned int *N* )

6.76.1.2 double\* hann (  
                  const unsigned int *N* )

## 6.77 identity.cpp File Reference

### Classes

- class **identity\_t**

## 6.78 ifftshift.cpp File Reference

### Functions

- void **ifftshift** (**mha\_wave\_t** \*spec)

## 6.78.1 Function Documentation

6.78.1.1 void `ifftshift` (  
                   `mha_wave_t * spec` )

## 6.79 `ifftshift.h` File Reference

### Functions

- void **`ifftshift`** (`mha_wave_t *spec`)

## 6.79.1 Function Documentation

6.79.1.1 void `ifftshift` (  
                   `mha_wave_t * spec` )

## 6.80 `iirfilter.cpp` File Reference

### Classes

- class **`iirfilter_t`**

## 6.81 `ipc.cpp` File Reference

### Macros

- `#define PATCH_VAR(var) patchbay.connect(&var.valuechanged, this, &ipc::update_↔  
                   cfg)`
- `#define INSERT_PATCH(var) insert_member(var); PATCH_VAR(var)`

### Functions

- void **`Levinson2`** (unsigned int P, const std::vector< `mha_real_t` > &R, std::vector< `mha_↔  
                   _real_t` > &A)

## 6.81.1 Macro Definition Documentation

6.81.1.1 #define PATCH\_VAR(  
     *var* ) patchbay.connect(&var.valuechanged, this, &lpc::update\_cfg)

6.81.1.2 #define INSERT\_PATCH(  
     *var* ) insert\_member(var); PATCH\_VAR(var)

## 6.81.2 Function Documentation

6.81.2.1 void Levinson2 (  
     unsigned int *P*,  
     const std::vector< mha\_real\_t > & *R*,  
     std::vector< mha\_real\_t > & *A* )

## 6.82 Ipc.h File Reference

## Classes

- class **lpc\_config**
- class **lpc**

## 6.83 ipc\_bl\_predictor.cpp File Reference

## Macros

- #define **PATCH\_VAR**(var) patchbay.connect(&var.valuechanged, this, &lpc\_bl\_predictor::update\_cfg)
- #define **INSERT\_PATCH**(var) insert\_member(var); **PATCH\_VAR**(var)

## 6.83.1 Macro Definition Documentation

6.83.1.1 #define PATCH\_VAR(  
     *var* ) patchbay.connect(&var.valuechanged, this, &lpc\_bl\_predictor::update\_cfg)

6.83.1.2 #define INSERT\_PATCH(  
     *var* ) insert\_member(var); PATCH\_VAR(var)

## 6.84 ipc\_bl\_predictor.h File Reference

## Classes

- class **lpc\_bl\_predictor\_config**
- class **lpc\_bl\_predictor**

## Macros

- #define **EPSILON** 1e-10

### 6.84.1 Macro Definition Documentation

#### 6.84.1.1 #define EPSILON 1e-10

## 6.85 ipc\_burg-lattice.cpp File Reference

## Macros

- #define **PATCH\_VAR**(var) patchbay.connect(&var.valuechanged, this, &ipc\_burglattice↔  
::update\_cfg)
- #define **INSERT\_PATCH**(var) insert\_member(var); **PATCH\_VAR**(var)

### 6.85.1 Macro Definition Documentation

#### 6.85.1.1 #define PATCH\_VAR( var ) patchbay.connect(&var.valuechanged, this, &ipc\_burglattice↔ \_cfg)

#### 6.85.1.2 #define INSERT\_PATCH( var ) insert\_member(var); PATCH\_VAR(var)

## 6.86 ipc\_burg-lattice.h File Reference

## Classes

- class **ipc\_burglattice\_config**
- class **ipc\_burglattice**

## Macros

- #define **EPSILON** 1e-10

### 6.86.1 Macro Definition Documentation

#### 6.86.1.1 #define EPSILON 1e-10

## 6.87 matrixmixer.cpp File Reference

## Classes

- class **matrixmixer::cfg\_t**
- class **matrixmixer::matmix\_t**

## Namespaces

- **matrixmixer**

## 6.88 mha.cpp File Reference

### Functions

- int **mhamain** (int argc, char \*argv[])
- int **main** (int argc, char \*argv[])

### 6.88.1 Function Documentation

6.88.1.1 int mhamain (  
                  int *argc*,  
                  char \* *argv*[ ] )

6.88.1.2 int main (  
                  int *argc*,  
                  char \* *argv*[ ] )

## 6.89 mha.hh File Reference

common types for MHA kernel, MHA framework applications and external plugins

### Classes

- struct **mha\_complex\_t**  
*Type for complex floating point values.*
- struct **mha\_complex\_test\_array\_t**  
*Several places in MHA rely on the fact that you can cast an array of **mha\_complex\_t** (p. 431) *c*[] to an array of **mha\_real\_t** *r*[] with *r*[0] == *c*[0].re *r*[1] == *c*[0].im *r*[2] == *c*[1].re ...*
- struct **mha\_real\_test\_array\_t**
- struct **mha\_direction\_t**  
*Channel source direction structure.*
- struct **mha\_channel\_info\_t**  
*Channel information structure.*
- struct **mha\_wave\_t**  
*Waveform signal structure.*
- struct **mha\_spec\_t**  
*Spectrum signal structure.*
- struct **mha\_audio\_descriptor\_t**  
*Description of an audio fragment (planned as a replacement of **mhaconfig\_t** (p. 504)).*

- struct **mha\_audio\_t**  
*An audio fragment in the openMHA (planned as a replacement of **mha\_wave\_t** (p. 496) and **mha\_spec\_t** (p. 465)).*
- struct **mhaconfig\_t**  
*MHA prepare configuration structure.*
- struct **comm\_var\_t**  
*Algorithm communication variable structure.*
- struct **algo\_comm\_t**  
*A reference handle for algorithm communication variables.*

## Macros

- #define **MHA\_CALLBACK\_TEST(x)**  
*Test macro to compare function type definition and declaration.*
- #define **MHA\_CALLBACK\_TEST\_PREFIX(prefix, x)**
- #define **MHA\_XSTRF(x) MHA\_STRF(x)**
- #define **MHA\_STRF(x) #x**
- #define **MHA\_VERSION\_MAJOR 4**  
*Major version number of MHA.*
- #define **MHA\_VERSION\_MINOR 8**  
*Minor version number of MHA.*
- #define **MHA\_VERSION\_RELEASE 0**  
*Release number of MHA.*
- #define **MHA\_VERSION\_BUILD 0**  
*Build number of MHA (currently unused)*
- #define **MHA\_STRUCT\_SIZEMATCH** (unsigned int)((sizeof(**mha\_real\_t**)==4)+2\*(sizeof(**mha\_complex\_t**)==8)+4\*(sizeof(**mha\_wave\_t**)==8+2\*sizeof(void\*)))+8\*(sizeof(**mha\_spec\_t**)==8+2\*sizeof(void\*)))+16\*(sizeof(**mhaconfig\_t**)==24))  
*Test number for structure sizes.*
- #define **MHA\_VERSION** (unsigned int)((**MHA\_STRUCT\_SIZEMATCH** | (**MHA\_VERSION\_RELEASE** << 8) | (**MHA\_VERSION\_MINOR** << 16) | (**MHA\_VERSION\_MAJOR** << 24)))  
*Full version number of MHA kernel.*
- #define **MHA\_VERSION\_STRING** MHA\_XSTRF(MHA\_VERSION\_MAJOR) "." MHA\_XSTRF(MHA\_VERSION\_MINOR)  
*Version string of MHA kernel (major.minor)*
- #define **MHA\_RELEASE\_VERSION\_STRING** MHA\_XSTRF(MHA\_VERSION\_MAJOR) "." MHA\_XSTRF(MHA\_VERSION\_MINOR) "." MHA\_XSTRF(MHA\_VERSION\_RELEASE)  
*Version string of MHA kernel (major.minor.release)*
- #define **MHA\_WAVEFORM 0**
- #define **MHA\_SPECTRUM 1**
- #define **MHA\_DOMAIN\_MAX 2**
- #define **MHA\_DOMAIN\_UNKNOWN** MHA\_DOMAIN\_MAX
- #define **MHA\_AC\_UNKNOWN 0**
- #define **MHA\_AC\_CHAR 1**

- #define **MHA\_AC\_INT** 2
- #define **MHA\_AC\_MHAREAL** 3
- #define **MHA\_AC\_FLOAT** 4
- #define **MHA\_AC\_DOUBLE** 5
- #define **MHA\_AC\_MHACOMPLEX** 6
- #define **MHA\_AC\_VEC\_FLOAT** 51
- #define **MHA\_AC\_USER** 1000

## Typedefs

- typedef unsigned int **mha\_domain\_t**
- typedef float **mha\_real\_t**  
*openMHA type for real numbers*
- typedef void \* **mha\_fft\_t**  
*Handle for an FFT object.*
- typedef struct **algo\_comm\_t** **algo\_comm\_t**
- typedef unsigned int(\* **MHAGetVersion\_t**) (void)
- typedef int(\* **MHAInit\_t**) (**algo\_comm\_t** algo\_comm, const char \*chain, const char \*algo, void \*\*h)
- typedef int(\* **MHAPrepare\_t**) (void \*h, **mhaconfig\_t** \*cfg)
- typedef int(\* **MHARelease\_t**) (void \*h)
- typedef void(\* **MHADestroy\_t**) (void \*h)
- typedef int(\* **MHASET\_t**) (void \*h, const char \*cmd, char \*retval, unsigned int len)
- typedef const char \*(**MHAStrError\_t**) (void \*h, int err)
- typedef int(\* **MHAProc\_wave2wave\_t**) (void \*h, **mha\_wave\_t** \*sIn, **mha\_wave\_t** \*\*sOut)
- typedef int(\* **MHAProc\_wave2spec\_t**) (void \*h, **mha\_wave\_t** \*sIn, **mha\_spec\_t** \*\*sOut)
- typedef int(\* **MHAProc\_spec2wave\_t**) (void \*h, **mha\_spec\_t** \*sIn, **mha\_wave\_t** \*\*sOut)
- typedef int(\* **MHAProc\_spec2spec\_t**) (void \*h, **mha\_spec\_t** \*sIn, **mha\_spec\_t** \*\*sOut)
- typedef const char \*(**MHAPluginDocumentation\_t**) (void)
- typedef const char \*(**MHAPluginCategory\_t**) (void)

### 6.89.1 Detailed Description

common types for MHA kernel, MHA framework applications and external plugins

### 6.89.2 Macro Definition Documentation

#### 6.89.2.1 #define MHA\_CALLBACK\_TEST( x )

Test macro to compare function type definition and declaration.

6.89.2.2 `#define MHA_CALLBACK_TEST_PREFIX(  
    prefix,  
    x )`

6.89.2.3 `#define MHA_XSTRF(  
    x ) MHA_STRF( x )`

6.89.2.4 `#define MHA_STRF(  
    x ) #x`

6.89.2.5 `#define MHA_VERSION_MAJOR 4`

Major version number of MHA.

6.89.2.6 `#define MHA_VERSION_MINOR 8`

Minor version number of MHA.

6.89.2.7 `#define MHA_VERSION_RELEASE 0`

Release number of MHA.

6.89.2.8 `#define MHA_VERSION_BUILD 0`

Build number of MHA (currently unused)

6.89.2.9 `#define MHA_STRUCT_SIZEMATCH (unsigned int)((sizeof(mha_real_t)==4)+2*(sizeof(mha_↔  
_complex_t)==8)+4*(sizeof(mha_wave_t)==8+2*sizeof(void*)))+8*(sizeof(mha_spec_↔  
t)==8+2*sizeof(void*)))+16*(sizeof(mhaconfig_t)==24))`

Test number for structure sizes.

6.89.2.10 `#define MHA_VERSION (unsigned int)((MHA_STRUCT_SIZEMATCH |  
    (MHA_VERSION_RELEASE << 8) | (MHA_VERSION_MINOR << 16) |  
    (MHA_VERSION_MAJOR << 24)))`

Full version number of MHA kernel.

6.89.2.11 `#define MHA_VERSION_STRING MHA_XSTRF(MHA_VERSION_MAJOR) "."  
    MHA_XSTRF(MHA_VERSION_MINOR)`

Version string of MHA kernel (major.minor)



```
6.89.2.12 #define MHA_RELEASE_VERSION_STRING MHA_XSTRF(MHA_VERSION_MAJOR) "." MHA_XSTRF(MHA_VERSION_MINOR) "." MHA_XSTRF(MHA_VERSION_RELEASE)
```

Version string of MHA kernel (major.minor.release)

```
6.89.2.13 #define MHA_WAVEFORM 0
```

```
6.89.2.14 #define MHA_SPECTRUM 1
```

```
6.89.2.15 #define MHA_DOMAIN_MAX 2
```

```
6.89.2.16 #define MHA_DOMAIN_UNKNOWN MHA_DOMAIN_MAX
```

```
6.89.2.17 #define MHA_AC_UNKNOWN 0
```

```
6.89.2.18 #define MHA_AC_CHAR 1
```

```
6.89.2.19 #define MHA_AC_INT 2
```

```
6.89.2.20 #define MHA_AC_MHAREAL 3
```

```
6.89.2.21 #define MHA_AC_FLOAT 4
```

```
6.89.2.22 #define MHA_AC_DOUBLE 5
```

```
6.89.2.23 #define MHA_AC_MHACOMPLEX 6
```

```
6.89.2.24 #define MHA_AC_VEC_FLOAT 51
```

```
6.89.2.25 #define MHA_AC_USER 1000
```

### 6.89.3 Typedef Documentation

```
6.89.3.1 typedef unsigned int mha_domain_t
```

```
6.89.3.2 typedef struct algo_comm_t algo_comm_t
```

```
6.89.3.3 typedef unsigned int(* MHAGetVersion_t)(void)
```

```
6.89.3.4 typedef int(* MHAInit_t)(algo_comm_t algo_comm, const char *chain, const char *algo, void **h)
```

```
6.89.3.5 typedef int(* MHAPrepare_t)(void *h, mhaconfig_t *cfg)
```

- 6.89.3.6 `typedef int(* MHARelease_t) (void *h)`
- 6.89.3.7 `typedef void(* MHA_Destroy_t) (void *h)`
- 6.89.3.8 `typedef int(* MHASet_t) (void *h, const char *cmd, char *retval, unsigned int len)`
- 6.89.3.9 `typedef const char*(* MHAStrError_t) (void *h, int err)`
- 6.89.3.10 `typedef int(* MHAProc_wave2wave_t) (void *h, mha_wave_t *sIn, mha_wave_t **sOut)`
- 6.89.3.11 `typedef int(* MHAProc_wave2spec_t) (void *h, mha_wave_t *sIn, mha_spec_t **sOut)`
- 6.89.3.12 `typedef int(* MHAProc_spec2wave_t) (void *h, mha_spec_t *sIn, mha_wave_t **sOut)`
- 6.89.3.13 `typedef int(* MHAProc_spec2spec_t) (void *h, mha_spec_t *sIn, mha_spec_t **sOut)`
- 6.89.3.14 `typedef const char*(* MHAPluginDocumentation_t) (void)`
- 6.89.3.15 `typedef const char*(* MHAPluginCategory_t) (void)`

## 6.90 mha\_algo\_comm.cpp File Reference

### Macros

- `#define AC_SUCCESS 0`
- `#define AC_INVALID_HANDLE -1`
- `#define AC_INVALID_NAME -2`
- `#define AC_STRING_TRUNCATED -3`
- `#define AC_INVALID_OUTPTR -4`
- `#define AC_TYPE_MISMATCH -5`
- `#define AC_DIM_MISMATCH -6`

### Variables

- `algo_comm_t algo_comm_default`

## 6.90.1 Macro Definition Documentation

6.90.1.1 #define AC\_SUCCESS 0

6.90.1.2 #define AC\_INVALID\_HANDLE -1

6.90.1.3 #define AC\_INVALID\_NAME -2

6.90.1.4 #define AC\_STRING\_TRUNCATED -3

6.90.1.5 #define AC\_INVALID\_OUTPTR -4

6.90.1.6 #define AC\_TYPE\_MISMATCH -5

6.90.1.7 #define AC\_DIM\_MISMATCH -6

## 6.90.2 Variable Documentation

6.90.2.1 algo\_comm\_t algo\_comm\_default

## 6.91 mha\_algo\_comm.h File Reference

Header file for Algorithm Communication.

### Classes

- class **MHA\_AC::spectrum\_t**  
*Insert a **MHASignal::spectrum\_t** (p. 800) class into the AC space.*
- class **MHA\_AC::waveform\_t**  
*Insert a **MHASignal::waveform\_t** (p. 812) class into the AC space.*
- class **MHA\_AC::int\_t**  
*Insert a integer variable into the AC space.*
- class **MHA\_AC::float\_t**  
*Insert a float point variable into the AC space.*
- class **MHA\_AC::double\_t**  
*Insert a double precision floating point variable into the AC space.*
- class **MHA\_AC::stat\_t**
- class **MHA\_AC::ac2matrix\_helper\_t**
- class **MHA\_AC::ac2matrix\_t**  
*Copy AC variable to a matrix.*
- class **MHA\_AC::acspace2matrix\_t**  
*Copy all or a subset of all numeric AC variables into an array of matrixes.*

## Namespaces

- **MHA\_AC**

*Functions and classes for Algorithm Communication (AC) support.*

## Functions

- **mha\_spec\_t MHA\_AC::get\_var\_spectrum (algo\_comm\_t ac, const std::string &name)**  
*Convert an AC variable into a spectrum.*
- **mha\_wave\_t MHA\_AC::get\_var\_waveform (algo\_comm\_t ac, const std::string &name)**  
*Convert an AC variable into a waveform.*
- **int MHA\_AC::get\_var\_int (algo\_comm\_t ac, const std::string &name)**  
*Return value of an integer scalar AC variable.*
- **float MHA\_AC::get\_var\_float (algo\_comm\_t ac, const std::string &name)**  
*Return value of an floating point scalar AC variable.*
- **std::vector< float > MHA\_AC::get\_var\_vfloat (algo\_comm\_t ac, const std::string &name)**  
*Return value of an floating point vector AC variable as standard vector of floats.*

### 6.91.1 Detailed Description

Header file for Algorithm Communication.

### 6.92 mha\_algo\_comm.hh File Reference

## Classes

- class **MHAKernel::comm\_var\_map\_t**
- class **MHAKernel::algo\_comm\_class\_t**

## Namespaces

- **MHAKernel**

## Macros

- **#define ALGO\_COMM\_ID\_STR "MFVK3jL5rmeus1XtggEI971aXCR/GU7RRhKz4k↔Qtrg="**

## Functions

- algo\_comm\_class\_t \* **MHAKernel::algo\_comm\_safe\_cast** (void \*)

## Variables

- **algo\_comm\_t algo\_comm\_default**

### 6.92.1 Macro Definition Documentation

6.92.1.1 #define **ALGO\_COMM\_ID\_STR** "MFVK3jL5rmeus1XtggEI971aXCR/GU7RRhKz4kQtrg="

### 6.92.2 Variable Documentation

6.92.2.1 **algo\_comm\_t algo\_comm\_default**

## 6.93 mha\_defs.h File Reference

Preprocessor definitions common to all MHA components.

### Macros

- #define **\_\_MHA\_FUN\_\_** **\_\_FUNC\_\_**
- #define **CHECK\_EXPR(x)** {if(!(x)){throw **MHA\_Error**(\_\_FILE\_\_, \_\_LINE\_\_, "The expression \"\" #x \"\" is invalid.");}}
- #define **CHECK\_VAR(x)** {if(!(x)){throw **MHA\_Error**(\_\_FILE\_\_, \_\_LINE\_\_, "The variable \"\" #x \"\" is not defined.");}}
- #define **\_\_declspec(p)**
- #define **M\_PI** 3.14159265358979323846  
*Define pi if it is not defined yet.*
- #define **MIN(a, b)** (((a)<(b))?(a):(b))  
*Macro for minimum function.*
- #define **MAX(a, b)** (((a)>(b))?(a):(b))  
*Macro for maximum function.*
- #define **MHA\_EAR\_LEFT** 0
- #define **MHA\_EAR\_RIGHT** 1
- #define **MHA\_EAR\_MAX** 2

### 6.93.1 Detailed Description

Preprocessor definitions common to all MHA components.

This file contains all preprocessor and type definitions which are common to all Master Hearing Aid components.

## 6.93.2 Macro Definition Documentation

6.93.2.1 `#define __MHA_FUN__ __FUNC__`

6.93.2.2 `#define CHECK_EXPR(  
                   x ) {if(!(x)){throw MHA_Error(__FILE__, __LINE__, "The expression \"\" #x \"\" is  
 invalid.);}}`

6.93.2.3 `#define CHECK_VAR(  
                   x ) {if(!(x)){throw MHA_Error(__FILE__, __LINE__, "The variable \"\" #x \"\" is not  
 defined.);}}`

6.93.2.4 `#define __declspec(  
                   p )`

6.93.2.5 `#define M_PI 3.14159265358979323846`

Define pi if it is not defined yet.

6.93.2.6 `#define MIN(  
                   a,  
                   b ) (((a)<(b))?a):(b))`

Macro for minimum function.

6.93.2.7 `#define MAX(  
                   a,  
                   b ) (((a)>(b))?a):(b))`

Macro for maximum function.

6.93.2.8 `#define MHA_EAR_LEFT 0`

6.93.2.9 `#define MHA_EAR_RIGHT 1`

6.93.2.10 `#define MHA_EAR_MAX 2`

## 6.94 mha\_errno.c File Reference

### Macros

- `#define STRLEN 0x1000`

## Functions

- const char \* **mha\_strerror** (int mhaerrno)
- void **mha\_set\_user\_error** (const char \*str)

## Variables

- char **next\_except\_str** [STRLEN] = ""
- const char \* **cstr\_strerror** [MHA\_ERR\_USER]

### 6.94.1 Macro Definition Documentation

6.94.1.1 #define STRLEN 0x1000

### 6.94.2 Function Documentation

6.94.2.1 const char\* mha\_strerror (  
int *mhaerrno* )

6.94.2.2 void mha\_set\_user\_error (  
const char \* *str* )

### 6.94.3 Variable Documentation

6.94.3.1 char next\_except\_str[STRLEN] = ""

6.94.3.2 const char\* cstr\_strerror[MHA\_ERR\_USER]

## 6.95 mha\_errno.h File Reference

### Macros

- #define **MHA\_ERR\_SUCCESS** 0
- #define **MHA\_ERR\_UNKNOWN** 1
- #define **MHA\_ERR\_INVALID\_HANDLE** 2
- #define **MHA\_ERR\_NULL** 3
- #define **MHA\_ERR\_VARRANGE** 4
- #define **MHA\_ERR\_VARFMT** 5
- #define **MHA\_ERR\_USER** 10000

### Functions

- const char \* **mha\_strerror** (int mhaerrno)
- void **mha\_set\_user\_error** (const char \*str)

## 6.95.1 Macro Definition Documentation

6.95.1.1 `#define MHA_ERR_SUCCESS 0`

6.95.1.2 `#define MHA_ERR_UNKNOWN 1`

6.95.1.3 `#define MHA_ERR_INVALID_HANDLE 2`

6.95.1.4 `#define MHA_ERR_NULL 3`

6.95.1.5 `#define MHA_ERR_VARRANGE 4`

6.95.1.6 `#define MHA_ERR_VARFMT 5`

6.95.1.7 `#define MHA_ERR_USER 10000`

## 6.95.2 Function Documentation

6.95.2.1 `const char* mha_strerror (`  
`int mhaerrno )`

6.95.2.2 `void mha_set_user_error (`  
`const char * str )`

## 6.96 mha\_error.cpp File Reference

Implementation of openMHA error handling.

### Namespaces

- **mha\_error\_helpers**

### Functions

- unsigned **mha\_error\_helpers::digits** (unsigned n)  
*Compute number of decimal digits required to represent an unsigned integer.*
- unsigned **mha\_error\_helpers::snprintf\_required\_length** (const char \*formatstring,...)  
*snprintf\_required\_length Compute the number of bytes (excluding the terminating nul) required to store the result of an snprintf.*
- void **mha\_debug** (const char \*fmt,...)  
*Print an info message (stderr on Linux, OutputDebugString in Windows).*



### 6.96.1 Detailed Description

Implementation of openMHA error handling.

This file forms a separate library.

## 6.97 mha\_error.hh File Reference

### Classes

- class **MHA\_Error**  
*Error reporting exception class.*

### Namespaces

- **mha\_error\_helpers**

### Macros

- #define **Getmsg**(e) ((e).get\_msg())
- #define **MHA\_ErrorMsg**(x) **MHA\_Error**(\_\_FILE\_\_, \_\_LINE\_\_, "%s", x)  
*Throw an openMHA error with a text message.*
- #define **MHA\_assert**(x) if(!(x)) throw **MHA\_Error**(\_\_FILE\_\_, \_\_LINE\_\_, "\"%s\" is false.", #x)  
*Assertion macro, which throws an **MHA\_Error** (p. 445).*
- #define **MHA\_assert\_equal**(a, b) if( a != b ) throw **MHA\_Error**(\_\_FILE\_\_, \_\_LINE\_\_, "\"%s == %s\" is false (%s = %g, %s = %g).", #a, #b, #a, (double)(a), #b, (double)(b))  
*Equality assertion macro, which throws an **MHA\_Error** (p. 445) with the values.*

### Functions

- void **mha\_debug** (const char \*fmt,...)  
*Print an info message (stderr on Linux, OutputDebugString in Windows).*
- unsigned **mha\_error\_helpers::digits** (unsigned n)  
*Compute number of decimal digits required to represent an unsigned integer.*
- unsigned **mha\_error\_helpers::snprintf\_required\_length** (const char \*formatstring,...)  
*snprintf\_required\_length Compute the number of bytes (excluding the terminating nul) required to store the result of an snprintf.*

## 6.97.1 Macro Definition Documentation

6.97.1.1 #define Getmsg(  
e ) ((e).get\_msg())

## 6.98 mha\_event\_emitter.h File Reference

### Classes

- class **MHAEvents::connector\_base\_t**
- class **MHAEvents::emitter\_t**  
*Class for emitting openMHA events.*

### Namespaces

- **MHAEvents**  
*Collection of event handling classes.*

## 6.99 mha\_events.cpp File Reference

## 6.100 mha\_events.h File Reference

### Classes

- class **MHAEvents::connector\_t< receiver\_t >**
- class **MHAEvents::patchbay\_t< receiver\_t >**  
*Patchbay which connects any event emitter with any member function of the parameter class.*

### Namespaces

- **MHAEvents**  
*Collection of event handling classes.*

## 6.101 mha\_fftfb.cpp File Reference

### Classes

- class **MHAOvIFilter::barkscale::hz2bark\_t**
- class **MHAOvIFilter::barkscale::bark2hz\_t**

## Namespaces

- **MHAOvIFilter**  
*Namespace for overlapping FFT based filter bank classes and functions.*
- **MHAOvIFilter::barkscale**
- **MHAOvIFilter::FreqScaleFun**  
*Transform functions from linear scale in Hz to new frequency scales.*
- **MHAOvIFilter::ShapeFun**  
*Shape functions for overlapping filters.*

## Macros

- #define **BARKSCALE\_ENTRIES** 50

## Functions

- **mha\_real\_t MHAOvIFilter::FreqScaleFun::hz2hz** (mha\_real\_t x)  
*Dummy scale transformation Hz to Hz.*
- **mha\_real\_t MHAOvIFilter::FreqScaleFun::hz2khz** (mha\_real\_t x)
- **mha\_real\_t MHAOvIFilter::FreqScaleFun::hz2octave** (mha\_real\_t x)
- **mha\_real\_t MHAOvIFilter::FreqScaleFun::hz2third\_octave** (mha\_real\_t x)
- **mha\_real\_t MHAOvIFilter::FreqScaleFun::hz2bark** (mha\_real\_t x)  
*Transformation to bark scale.*
- **mha\_real\_t MHAOvIFilter::FreqScaleFun::hz2bark\_analytic** (mha\_real\_t)
- **mha\_real\_t MHAOvIFilter::FreqScaleFun::hz2erb** (mha\_real\_t)
- **mha\_real\_t MHAOvIFilter::FreqScaleFun::hz2erb\_glasberg1990** (mha\_real\_t)
- **mha\_real\_t MHAOvIFilter::FreqScaleFun::hz2log** (mha\_real\_t)  
*Third octave frequency scale.*
- **mha\_real\_t MHAOvIFilter::FreqScaleFun::inv\_scale** (mha\_real\_t, mha\_real\_t(\*) (mha\_real\_t))
- **mha\_real\_t MHAOvIFilter::ShapeFun::rect** (mha\_real\_t x)  
*Filter shape function for rectangular filters.*
- **mha\_real\_t MHAOvIFilter::ShapeFun::linear** (mha\_real\_t x)  
*Filter shape function for sawtooth filters.*
- **mha\_real\_t MHAOvIFilter::ShapeFun::hann** (mha\_real\_t x)  
*Filter shape function for hanning shaped filters.*
- **mha\_real\_t MHAOvIFilter::ShapeFun::expflt** (mha\_real\_t)
- **mha\_real\_t MHAOvIFilter::ShapeFun::gauss** (mha\_real\_t)
- **mha\_real\_t filtershapefun** (mha\_real\_t f, MHAOvIFilter::band\_descriptor\_t b, mha\_real\_t plateau)

## Variables

- **mha\_real\_t MHAOvIFilter::barkscale::vfreq** [BARKSCALE\_ENTRIES]
- **mha\_real\_t MHAOvIFilter::barkscale::vbark** [BARKSCALE\_ENTRIES]

## 6.101.1 Macro Definition Documentation

### 6.101.1.1 #define BARKSCALE\_ENTRIES 50

## 6.101.2 Function Documentation

### 6.101.2.1 `mha_real_t filtershapefun (` `mha_real_t f,` `MHAOvIFilter::band_descriptor_t b,` `mha_real_t plateau )`

## 6.102 mha\_fftfb.hh File Reference

### Classes

- class **MHAOvIFilter::band\_descriptor\_t**
- class **MHAOvIFilter::scale\_var\_t**
- class **MHAOvIFilter::fscale\_t**
- class **MHAOvIFilter::fscale\_bw\_t**
- class **MHAOvIFilter::fftfb\_vars\_t**  
*Set of configuration variables for FFT-based overlapping filters.*
- class **MHAOvIFilter::fspacing\_t**  
*Class for frequency spacing, used by filterbank shape generator class.*
- class **MHAOvIFilter::fftfb\_t**  
*FFT based overlapping filter bank.*
- class **MHAOvIFilter::overlap\_save\_filterbank\_t**  
*A time-domain minimal phase filter bank with frequency shapes from **MHAOvIFilter::fftfb\_t** (p. 616).*
- class **MHAOvIFilter::overlap\_save\_filterbank\_t::vars\_t**
- class **MHAOvIFilter::overlap\_save\_filterbank\_analytic\_t**
- class **MHAOvIFilter::fftfb\_ac\_info\_t**

### Namespaces

- **MHAOvIFilter**  
*Namespace for overlapping FFT based filter bank classes and functions.*

### Typedefs

- typedef **mha\_real\_t (MHAOvIFilter::scale\_fun\_t) (mha\_real\_t)**

## 6.103 mha\_fifo.cpp File Reference

## 6.104 mha\_fifo.h File Reference

## Classes

- class **mha\_fifo\_t**< T >  
*A FIFO class for blocksize adaptation Synchronization: None.*
- class **mha\_drifter\_fifo\_t**< T >  
*A FIFO class for blocksize adaptation without Synchronization.*
- class **mha\_fifo\_thread\_platform\_t**  
*Abstract base class for synchronizing multithreaded (producer/consumer) fifo operations.*
- class **mha\_fifo\_posix\_threads\_t**
- class **mha\_fifo\_thread\_guard\_t**  
*Simple Mutex Guard Class.*
- class **mha\_fifo\_lw\_t**< T >  
*This FIFO uses locks to synchronize access.*
- class **mha\_dblbuf\_t**< FIFO >  
*The doublebuffer adapts blocksizes between an outer process, which provides input data and takes output data, and an inner process, which processes the input signal and generates output data using a different block size than the outer process.*
- class **mha\_rt\_fifo\_element\_t**< T >  
*Object wrapper for **mha\_rt\_fifo\_t** (p. 462).*
- class **mha\_rt\_fifo\_t**< T >  
*Template class for thread safe, half real time safe fifo without explicit locks.*

## Macros

- **#define mha\_fifo\_thread\_platform\_implementation\_t mha\_fifo\_posix\_threads\_t**

## 6.104.1 Macro Definition Documentation

## 6.104.1.1 #define mha\_fifo\_thread\_platform\_implementation\_t mha\_fifo\_posix\_threads\_t

## 6.105 mha\_filter.cpp File Reference

## Functions

- **std::vector< mha\_real\_t > diff\_coeffs ()**

### 6.105.1 Function Documentation

#### 6.105.1.1 `std::vector<mha_real_t> diff_coeffs ( )`

### 6.106 `mha_filter.hh` File Reference

Header file for IIR filter classes.

#### Classes

- class **MHAFilter::filter\_t**  
*Generic IIR filter class.*
- class **MHAFilter::diff\_t**  
*Differentiator class (non-normalized)*
- class **MHAFilter::o1\_ar\_filter\_t**  
*First order attack-release lowpass filter.*
- class **MHAFilter::o1flt\_lowpass\_t**  
*First order low pass filter.*
- class **MHAFilter::o1flt\_maxtrack\_t**  
*First order maximum tracker.*
- class **MHAFilter::o1flt\_mintrack\_t**  
*First order minimum tracker.*
- class **MHAFilter::iir\_filter\_state\_t**
- class **MHAFilter::iir\_filter\_t**  
*IIR filter class wrapper for integration into parser structure.*
- class **MHAFilter::adapt\_filter\_state\_t**
- class **MHAFilter::adapt\_filter\_param\_t**
- class **MHAFilter::adapt\_filter\_t**  
*Adaptive filter.*
- class **MHAFilter::fftfilter\_t**  
*FFT based FIR filter implementation.*
- class **MHAFilter::fftfilterbank\_t**  
*FFT based FIR filterbank implementation.*
- struct **MHAFilter::transfer\_function\_t**  
*a structure containing a source channel number, a target channel number, and an impulse response.*
- struct **MHAFilter::transfer\_matrix\_t**  
*A sparse matrix of transfer function partitions.*
- class **MHAFilter::partitioned\_convolution\_t**  
*A filter class for partitioned convolution.*
- struct **MHAFilter::partitioned\_convolution\_t::index\_t**  
*Bookkeeping class.*
- class **MHAFilter::smoothspec\_t**  
*Smooth spectral gains, create a windowed impulse response.*

- class **MHAFilter::resampling\_filter\_t**  
*Hann shaped low pass filter for resampling.*
- class **MHAFilter::polyphase\_resampling\_t**  
*A class that performs polyphase resampling.*
- class **MHAFilter::blockprocessing\_polyphase\_resampling\_t**  
*A class that does polyphase resampling and takes into account block processing.*
- class **MHAFilter::iir\_ord1\_real\_t**  
*First order recursive filter.*

## Namespaces

- **MHAFilter**  
*Namespace for IIR and FIR filter classes.*

## Functions

- void **MHAFilter::make\_friendly\_number** (mha\_real\_t &x)
- void **MHAFilter::make\_friendly\_number** (mha\_complex\_t &x)
- void **MHAFilter::make\_friendly\_number** (double &x)
- void **MHAFilter::o1\_lp\_coeffs** (const mha\_real\_t tau, const mha\_real\_t fs, mha\_real\_t &c1, mha\_real\_t &c2)  
*Set first order filter coefficients from time constant and sampling rate.*
- void **MHAFilter::butter\_stop\_ord1** (double \*A, double \*B, double f1, double f2, double fs)  
*Setup a first order butterworth band stop filter.*
- **MHASignal::waveform\_t** \* **MHAFilter::spec2fir** (const mha\_spec\_t \*spec, const unsigned int fftlen, const **MHAWindow::base\_t** &>window, const bool minphase)  
*Create a windowed impulse response/FIR filter coefficients from a spectrum.*
- unsigned **MHAFilter::gcd** (unsigned a, unsigned b)  
*greatest common divisor*
- double **MHAFilter::sinc** (double x)  
*sin(x)/x function, coping with x=0.*
- std::pair< unsigned, unsigned > **MHAFilter::resampling\_factors** (float source\_sampling\_rate, float target\_sampling\_rate, float factor=1.0f)  
*Computes rational resampling factor from two sampling rates.*

### 6.106.1 Detailed Description

Header file for IIR filter classes.

## 6.107 mha\_generic\_chain.cpp File Reference

### Functions

- void **mhaconfig\_compare** (mhaconfig\_t req, mhaconfig\_t avail, const char \*cpref)

### 6.107.1 Function Documentation

6.107.1.1 void mhaconfig\_compare (  
           mhaconfig\_t req,  
           mhaconfig\_t avail,  
           const char \* cpref )

### 6.108 mha\_generic\_chain.h File Reference

#### Classes

- class **mhachain::plugs\_t**
- class **mhachain::chain\_base\_t**

#### Namespaces

- **mhachain**

#### Macros

- #define **MHAPLUGIN\_OVERLOAD\_OUTDOMAIN**

### 6.108.1 Macro Definition Documentation

6.108.1.1 #define MHAPLUGIN\_OVERLOAD\_OUTDOMAIN

### 6.109 mha\_io\_ifc.h File Reference

#### Typedefs

- typedef int(\* **IOProcessEvent\_t**) (void \*handle, **mha\_wave\_t** \*sln, **mha\_wave\_t** \*\*S↔  
 Out)  
     *Event handler for signal stream.*
- typedef void(\* **IOStoppedEvent\_t**) (void \*handle, int proc\_err, int io\_err)  
     *Event handler for stop event.*
- typedef void(\* **IOStartedEvent\_t**) (void \*handle)  
     *Event handler for start event.*
- typedef int(\* **IOInit\_t**) (int fragsize, float samplerate, **IOProcessEvent\_t** proc\_event, void  
   \*proc\_handle, **IOStartedEvent\_t** start\_event, void \*start\_handle, **IOStoppedEvent\_t** ↔  
   t stop\_event, void \*stop\_handle, void \*\*handle)
- typedef int(\* **IOPrepare\_t**) (void \*handle, int num\_inchannels, int num\_outchannels)
- typedef int(\* **IOStart\_t**) (void \*handle)
- typedef int(\* **IOStop\_t**) (void \*handle)
- typedef int(\* **IORelease\_t**) (void \*handle)
- typedef int(\* **IOSetVar\_t**) (void \*handle, const char \*cmd, char \*retval, unsigned int len)
- typedef const char \*(**IOStrError\_t**) (void \*handle, int err)
- typedef void(\* **IODestroy\_t**) (void \*handle)



### 6.109.1 Typedef Documentation

6.109.1.1 `typedef int(* IOProcessEvent_t) (void *handle, mha_wave_t *sln, mha_wave_t **sOut)`

Event handler for signal stream.

This event handler needs to be realtime compatible. All signal path processing will be performed in this callback.

6.109.1.2 `typedef void(* IOStoppedEvent_t) (void *handle, int proc_err, int io_err)`

Event handler for stop event.

This event handler needs to be realtime compatible. The function must return immediatly.

6.109.1.3 `typedef void(* IOStartedEvent_t) (void *handle)`

Event handler for start event.

This event handler needs to be realtime compatible. The function must return immediatly.

6.109.1.4 `typedef int(* IOInit_t) (int fragsize, float samplerate, IOProcessEvent_t proc_event, void *proc_handle, IOStartedEvent_t start_event, void *start_handle, IOStoppedEvent_t stop_event, void *stop_handle, void **handle)`

6.109.1.5 `typedef int(* IOPrepare_t) (void *handle, int num_inchannels, int num_outchannels)`

6.109.1.6 `typedef int(* IOStart_t) (void *handle)`

6.109.1.7 `typedef int(* IOStop_t) (void *handle)`

6.109.1.8 `typedef int(* IORelease_t) (void *handle)`

6.109.1.9 `typedef int(* IOSetVar_t) (void *handle, const char *cmd, char *retval, unsigned int len)`

6.109.1.10 `typedef const char*(* IOStrError_t) (void *handle, int err)`

6.109.1.11 `typedef void(* IODestroy_t) (void *handle)`

## 6.110 mha\_multisrc.cpp File Reference

### Namespaces

- **MHAMultiSrc**

*Collection of classes for selecting audio chunks from multiple sources.*

## 6.111 mha\_multisrc.h File Reference

### Classes

- class **MHAMultiSrc::channel\_t**
- class **MHAMultiSrc::channels\_t**
- class **MHAMultiSrc::base\_t**  
*Base class for source selection.*
- class **MHAMultiSrc::waveform\_t**
- class **MHAMultiSrc::spectrum\_t**

### Namespaces

- **MHAMultiSrc**  
*Collection of classes for selecting audio chunks from multiple sources.*

## 6.112 mha\_os.cpp File Reference

### Functions

- bool **mha\_hasenv** (const std::string &envvar)  
*Checks if environment variable exists.*
- std::string **mha\_getenv** (const std::string &envvar)  
*Get value of environment variable.*
- void **mha\_delenv** (const std::string &envvar)  
*Deletes environment variable from process environment if it exists.*
- int **mha\_setenv** (const std::string &envvar, const std::string &value)  
*Set value of environment variable.*
- std::list< std::string > **mha\_library\_paths** ()
- std::list< std::string > **list\_dir** (const std::string &path, const std::string &pattern)

### 6.112.1 Function Documentation

#### 6.112.1.1 bool mha\_hasenv (const std::string & envvar )

Checks if environment variable exists.

#### Parameters

<i>envvar</i>	Name of environment variable to check
---------------	---------------------------------------

**Returns**

true if the environment has a variable of this name

**6.112.1.2** `std::string mha_getenv (`  
`const std::string & envvar )`

Get value of environment variable.

**Parameters**

<i>envvar</i>	Name of environment variable to retrieve
---------------	--

**Returns**

content of environment variable if it exists, empty string if the environment variable does not exist

**6.112.1.3** `void mha_delenv (`  
`const std::string & envvar )`

Deletes environment variable from process environment if it exists.

**Parameters**

<i>envvar</i>	Name of environment variable to delete
---------------	--

**6.112.1.4** `int mha_setenv (`  
`const std::string & envvar,`  
`const std::string & value )`

Set value of environment variable.

**Parameters**

<i>envvar</i>	Name of environment variable to set
<i>value</i>	New content for environment variable

**Returns**

error code: 0 on success, OS dependent error code on failure

**6.112.1.5** `std::list<std::string> mha_library_paths ( )`

6.112.1.6 `std::list<std::string> list_dir (`  
     `const std::string & path,`  
     `const std::string & pattern )`

## 6.113 mha\_os.h File Reference

### Classes

- class **mha\_stash\_environment\_variable\_t**  
     *This class changes the value of an environment variable when constructed and restores the original state of the environment variable when destroyed.*
- class **dynamiclib\_t**

### Macros

- #define **mha\_loadlib**(x) `dlopen(x,RTLD_NOW)`
- #define **mha\_freelib**(x) `dlclose(x)`
- #define **mha\_freelib\_success**(x) `(x == 0)`
- #define **mha\_getlibfun**(h, x) `x ## _cb = (x ## _t)dlsym(h,#x)`
- #define **mha\_getlibfun\_checked**(h, x) `x ## _cb = (x ## _t)dlsym(h,#x);if(! x ## _cb) throw MHA_Error(__FILE__,__LINE__,"Function " #x " is undefined.")`
- #define **mha\_loadlib\_error**(x) `dlerror()`
- #define **mha\_lib\_extension** ".so"
- #define **mha\_msleep**(milliseconds) `usleep((milliseconds)*1000)`
- #define **FMTsz** "%zu"  
     *printf modifier to print integers of type size\_t*
- #define **MHA\_RESOLVE**(h, t) `t ## _cb = (t ## _t)(h->resolve(#t))`
- #define **MHA\_RESOLVE\_CHECKED**(h, t) `t ## _cb = (t ## _t)(h->resolve_checked(#t))`

### Typedefs

- typedef void \* **mha\_libhandle\_t**

### Functions

- `std::string mha_getenv` (const `std::string` &envvar)  
     *Get value of environment variable.*
- `bool mha_hasenv` (const `std::string` &envvar)  
     *Checks if environment variable exists.*
- `int mha_setenv` (const `std::string` &envvar, const `std::string` &value)  
     *Set value of environment variable.*
- `void mha_delenv` (const `std::string` &envvar)  
     *Deletes environment variable from process environment if it exists.*
- `std::list< std::string > mha_library_paths` ()
- `std::list< std::string > list_dir` (const `std::string` &path, const `std::string` &pattern)
- `void mha_hton` (float \*data, unsigned int len)
- `void mha_ntoh` (float \*data, unsigned int len)
- `void mha_hton` (uint32\_t \*data, unsigned int len)
- `void mha_ntoh` (uint32\_t \*data, unsigned int len)
- `void mha_hton` (int32\_t \*data, unsigned int len)
- `void mha_ntoh` (int32\_t \*data, unsigned int len)

## 6.113.1 Macro Definition Documentation

6.113.1.1 `#define mha_loadlib(  
x ) dlopen(x,RTLD_NOW)`

6.113.1.2 `#define mha_freelib(  
x ) dlclose(x)`

6.113.1.3 `#define mha_freelib_success(  
x )(x == 0)`

6.113.1.4 `#define mha_getlibfun(  
h,  
x ) x ## _cb = (x ## _t)dlsym(h,#x)`

6.113.1.5 `#define mha_getlibfun_checked(  
h,  
x ) x ## _cb = (x ## _t)dlsym(h,#x);if(! x ## _cb) throw  
MHA_Error(__FILE__,__LINE__,"Function " #x " is undefined.")`

6.113.1.6 `#define mha_loadlib_error(  
x ) dlerror()`

6.113.1.7 `#define mha_lib_extension ".so"`

6.113.1.8 `#define mha_msleep(  
milliseconds ) usleep((milliseconds)*1000)`

6.113.1.9 `#define FMTsz "%zu"`

printf modifier to print integers of type `size_t`

6.113.1.10 `#define MHA_RESOLVE(  
h,  
t ) t ## _cb = (t ## _t)(h->resolve(#t))`

6.113.1.11 `#define MHA_RESOLVE_CHECKED(  
h,  
t ) t ## _cb = (t ## _t)(h->resolve_checked(#t))`

## 6.113.2 Typedef Documentation

6.113.2.1 `typedef void* mha_libhandle_t`

## 6.113.3 Function Documentation

6.113.3.1 `std::string mha_getenv (  
const std::string & envvar )`

Get value of environment variable.

**Parameters**

<i>envvar</i>	Name of environment variable to retrieve
---------------	--

**Returns**

content of environment variable if it exists, empty string if the environment variable does not exist

6.113.3.2 `bool mha_hasenv (`  
`const std::string & envvar )`

Checks if environment variable exists.

**Parameters**

<i>envvar</i>	Name of environment variable to check
---------------	---------------------------------------

**Returns**

true if the environment has a variable of this name

6.113.3.3 `int mha_setenv (`  
`const std::string & envvar,`  
`const std::string & value )`

Set value of environment variable.

**Parameters**

<i>envvar</i>	Name of environment variable to set
<i>value</i>	New content for environment variable

**Returns**

error code: 0 on success, OS dependent error code on failure

6.113.3.4 `void mha_delenv (`  
`const std::string & envvar )`

Deletes environment variable from process environment if it exists.

## Parameters

<i>envvar</i>	Name of environment variable to delete
---------------	--

6.113.3.5 `std::list<std::string> mha_library_paths ( )`

6.113.3.6 `std::list<std::string> list_dir (`  
`const std::string & path,`  
`const std::string & pattern )`

6.113.3.7 `void mha_hton (`  
`float * data,`  
`unsigned int len ) [inline]`

6.113.3.8 `void mha_ntoh (`  
`float * data,`  
`unsigned int len ) [inline]`

6.113.3.9 `void mha_hton (`  
`uint32_t * data,`  
`unsigned int len ) [inline]`

6.113.3.10 `void mha_ntoh (`  
`uint32_t * data,`  
`unsigned int len ) [inline]`

6.113.3.11 `void mha_hton (`  
`int32_t * data,`  
`unsigned int len ) [inline]`

6.113.3.12 `void mha_ntoh (`  
`int32_t * data,`  
`unsigned int len ) [inline]`

## 6.114 mha\_parser.cpp File Reference

## Namespaces

- **MHAParser**  
*Name space for the openMHA-Parser configuration language.*
- **MHAParser::StrCnv**  
*String converter namespace.*

## Macros

- `#define MHAPLATFORM "undefined-linux"`

## Functions

- int **MHAParser::get\_precision** ()
- int **MHAParser::StrCnv::num\_brackets** (const std::string &s)  
*Return number of brackets at beginning and end of string.*
- int **MHAParser::StrCnv::bracket\_balance** (const std::string &s)
- static std::ostream & **write\_float** (std::ostream &o, const float &f)
- static std::string **parse\_1\_float** (const std::string &s, **mha\_real\_t** &v)  
*This internal function parses a floating point number from the beginning of a string.*
- static std::string **parse\_1\_complex** (const std::string &s, **mha\_complex\_t** &v)  
*This internal function parses a complex number from the beginning of a string.*

### 6.114.1 Macro Definition Documentation

6.114.1.1 **#define MHAPLATFORM "undefined-linux"**

### 6.114.2 Function Documentation

6.114.2.1 **static std::ostream& write\_float** (  
    std::ostream & *o*,  
    const float & *f* ) [*inline*],[*static*]

6.114.2.2 **static std::string parse\_1\_float** (  
    const std::string & *s*,  
    **mha\_real\_t** & *v* ) [*static*]

This internal function parses a floating point number from the beginning of a string.

#### Parameters

<i>s</i>	The string to parse
<i>v</i>	The float variable to fill with a value

#### Returns

The rest of the string.

6.114.2.3 **static std::string parse\_1\_complex** (  
    const std::string & *s*,  
    **mha\_complex\_t** & *v* ) [*static*]

This internal function parses a complex number from the beginning of a string.



**Parameters**

<b>s</b>	The string to parse
<b>v</b>	The complex variable to fill with a value

**Returns**

The rest of the string.

**6.115 mha\_parser.hh File Reference**

Header file for the MHA-Parser script language.

**Classes**

- class **MHAParser::keyword\_list\_t**  
*Keyword list class.*
- class **MHAParser::expression\_t**
- class **MHAParser::entry\_t**
- class **MHAParser::base\_t**  
*Base class for all parser items.*
- class **MHAParser::base\_t::replace\_t**
- class **MHAParser::parser\_t**  
*Parser node class.*
- class **MHAParser::c\_ifc\_parser\_t**
- class **MHAParser::monitor\_t**  
*Base class for monitors and variable nodes.*
- class **MHAParser::variable\_t**  
*Base class for variable nodes.*
- class **MHAParser::range\_var\_t**  
*Base class for all variables with a numeric value range.*
- class **MHAParser::kw\_t**  
*Variable with keyword list value.*
- class **MHAParser::string\_t**  
*Variable with a string value.*
- class **MHAParser::vstring\_t**  
*Vector variable with string values.*
- class **MHAParser::bool\_t**  
*Variable with a boolean value ("yes"/"no")*
- class **MHAParser::int\_t**  
*Variable with integer value.*
- class **MHAParser::float\_t**  
*Variable with float value.*

- class **MHAParser::complex\_t**  
*Variable with complex value.*
- class **MHAParser::vint\_t**  
*Variable with vector<int> value.*
- class **MHAParser::vfloat\_t**  
*Vector variable with float value.*
- class **MHAParser::vcomplex\_t**  
*Vector variable with complex value.*
- class **MHAParser::mfloat\_t**  
*Matrix variable with float value.*
- class **MHAParser::mcomplex\_t**  
*Matrix variable with complex value.*
- class **MHAParser::int\_mon\_t**  
*Monitor variable with int value.*
- class **MHAParser::bool\_mon\_t**  
*Monitor with string value.*
- class **MHAParser::string\_mon\_t**  
*Monitor with string value.*
- class **MHAParser::vstring\_mon\_t**  
*Vector of monitors with string value.*
- class **MHAParser::vint\_mon\_t**  
*Vector of ints monitor.*
- class **MHAParser::mint\_mon\_t**  
*Matrix of ints monitor.*
- class **MHAParser::vfloat\_mon\_t**  
*Vector of floats monitor.*
- class **MHAParser::mfloat\_mon\_t**  
*Matrix of floats monitor.*
- class **MHAParser::float\_mon\_t**  
*Monitor with float value.*
- class **MHAParser::complex\_mon\_t**  
*Monitor with complex value.*
- class **MHAParser::vcomplex\_mon\_t**  
*Monitor with vector of complex values.*
- class **MHAParser::mcomplex\_mon\_t**  
*Matrix of complex numbers monitor.*
- class **MHAParser::commit\_t< receiver\_t >**  
*Parser variable with event-emission functionality.*
- class **MHAParser::mhaconfig\_mon\_t**

## Namespaces

- **MHAParser**  
*Name space for the openMHA-Parser configuration language.*
- **MHAParser::StrCnv**  
*String converter namespace.*

## Macros

- #define **DEFAULT\_RETSIZE** 0x100000
- #define **insert\_member**(x) insert\_item(#x,&x)  
*Macro to insert a member variable into a parser.*

## Typedefs

- typedef std::string(base\_t::\* **MHAParser::opact\_t**) (**expression\_t** &)
- typedef std::string(base\_t::\* **MHAParser::query\_t**) (const std::string &)
- typedef std::map< std::string, opact\_t > **MHAParser::opact\_map\_t**
- typedef std::map< std::string, query\_t > **MHAParser::query\_map\_t**
- typedef std::list< entry\_t > **MHAParser::entry\_map\_t**
- typedef int(\* **MHAParser::c\_parse\_cmd\_t**) (void \*, const char \*, char \*, unsigned int)
- typedef const char \*(\* **MHAParser::c\_parse\_err\_t**) (void \*, int)

## Functions

- std::string **MHAParser::commentate** (const std::string &s)
- void **MHAParser::trim** (std::string &s)
- std::string **MHAParser::cfg\_dump** (base\_t \*, const std::string &)
- std::string **MHAParser::cfg\_dump\_short** (base\_t \*, const std::string &)
- std::string **MHAParser::all\_dump** (base\_t \*, const std::string &)
- std::string **MHAParser::mon\_dump** (base\_t \*, const std::string &)
- std::string **MHAParser::all\_ids** (base\_t \*, const std::string &, const std::string &="")
- void **MHAParser::strreplace** (std::string &, const std::string &, const std::string &)  
*string replace function*
- void **MHAParser::envreplace** (std::string &s)
- void **MHAParser::StrCnv::str2val** (const std::string &, bool &)  
*Convert from string.*
- void **MHAParser::StrCnv::str2val** (const std::string &, float &)  
*Convert from string.*
- void **MHAParser::StrCnv::str2val** (const std::string &, **mha\_complex\_t** &)  
*Convert from string.*
- void **MHAParser::StrCnv::str2val** (const std::string &, int &)  
*Convert from string.*
- void **MHAParser::StrCnv::str2val** (const std::string &, keyword\_list\_t &)  
*Convert from string.*
- void **MHAParser::StrCnv::str2val** (const std::string &, std::string &)  
*Convert from string.*
- template<class arg\_t >  
void **MHAParser::StrCnv::str2val** (const std::string &s, std::vector< arg\_t > &val)  
*Converter for vector types.*

- `template<>`  
`void MHAParser::StrCnv::str2val< mha_real_t > (const std::string &s, std::vector<  
mha_real_t > &v)`  
*Converter for vector<mha\_real\_t> with Matlab-style expansion.*
- `template<class arg_t >`  
`void MHAParser::StrCnv::str2val (const std::string &s, std::vector< std::vector< arg_t  
> > &val)`  
*Converter for matrix types.*
- `std::string MHAParser::StrCnv::val2str (const bool &)`  
*Convert to string.*
- `std::string MHAParser::StrCnv::val2str (const float &)`  
*Convert to string.*
- `std::string MHAParser::StrCnv::val2str (const mha_complex_t &)`  
*Convert to string.*
- `std::string MHAParser::StrCnv::val2str (const int &)`  
*Convert to string.*
- `std::string MHAParser::StrCnv::val2str (const keyword_list_t &)`  
*Convert to string.*
- `std::string MHAParser::StrCnv::val2str (const std::string &)`  
*Convert to string.*
- `std::string MHAParser::StrCnv::val2str (const std::vector< float > &)`  
*Convert to string.*
- `std::string MHAParser::StrCnv::val2str (const std::vector< mha_complex_t > &)`  
*Convert to string.*
- `std::string MHAParser::StrCnv::val2str (const std::vector< int > &)`  
*Convert to string.*
- `std::string MHAParser::StrCnv::val2str (const std::vector< std::vector< int > > &)`  
*Convert to string.*
- `std::string MHAParser::StrCnv::val2str (const std::vector< std::string > &)`  
*Convert to string.*
- `std::string MHAParser::StrCnv::val2str (const std::vector< std::vector< float > > &)`  
*Convert to string.*
- `std::string MHAParser::StrCnv::val2str (const std::vector< std::vector< mha_↔  
complex_t > > &)`  
*Convert to string.*

### 6.115.1 Detailed Description

Header file for the MHA-Parser script language.

## 6.115.2 Macro Definition Documentation

6.115.2.1 `#define DEFAULT_RETSIZE 0x100000`

6.115.2.2 `#define insert_member(  
          x ) insert_item(#x,&x)`

Macro to insert a member variable into a parser.

## Parameters

x	Member variable to be inserted. Name of member variable will be used as configuration name.
---	---

See also `MHAParser::parser_t::insert_item()` (p. 690).

## 6.116 mha\_plugin.hh File Reference

Header file for MHA C++ plugin class templates.

## Classes

- class `MHAPLugin::cfg_chain_t< runtime_cfg_t >`
- class `MHAPLugin::config_t< runtime_cfg_t >`  
*Template class for thread safe configuration.*
- class `MHAPLugin::plugin_t< runtime_cfg_t >`  
*The template class for C++ openMHA plugins.*

## Namespaces

- **MHAPLugin**  
*Namespace for openMHA plugin class templates and thread-safe runtime configurations.*

## Macros

- `#define __declspec(p)`
- `#define WINAPI`
- `#define HINSTANCE int`
- `#define GITCOMMITHASH "independent-plugin-build"`
- `#define MHAPLUGIN_PROC_CALLBACK_PREFIX(prefix, classname, indom, outdom)`
- `#define MHAPLUGIN_INIT_CALLBACKS_PREFIX(prefix, classname)`
- `#define MHAPLUGIN_CALLBACKS_PREFIX(prefix, classname, indom, outdom)`  
*C++ wrapper macro for the plugin interface.*
- `#define MHAPLUGIN_DOCUMENTATION_PREFIX(prefix, cat, doc)`
- `#define MHAPLUGIN_PROC_CALLBACK(plugname, classname, indom, outdom) M↔  
HAPLUGIN_PROC_CALLBACK_PREFIX(MHA_STATIC_ ## plugname ## _↔  
,classname,indom,outdom)`
- `#define MHAPLUGIN_INIT_CALLBACKS(plugname, classname) MHAPLUGIN_INIT↔  
_CALLBACKS_PREFIX(MHA_STATIC_ ## plugname ## _,classname)`
- `#define MHAPLUGIN_CALLBACKS(plugname, classname, indom, outdom) MHAPLU↔  
GIN_CALLBACKS_PREFIX(MHA_STATIC_ ## plugname ## _,classname,indom,outdom)`  
*C++ wrapper macro for the plugin interface.*
- `#define MHAPLUGIN_DOCUMENTATION(plugname, cat, doc) MHAPLUGIN_DOCU↔  
MENTATION_PREFIX(MHA_STATIC_ ## plugname ## _,cat,doc)`  
*Wrapper macro for the plugin documentation interface.*

## Functions

- **\_\_attribute\_\_** ((unused)) static const char \*mha\_git\_commit\_hash  
*store git commit hash in every binary plgin to support reproducible research*

### 6.116.1 Detailed Description

Header file for MHA C++ plugin class templates.

This file defines useful macros and template classes for the development of MHA plugins. A set of macros wraps a C++ interface around the ANSI-C plugin interface. The plugin\_t template class defines a corresponding C++ class with all required members. This class can make use of thread safe configurations (config\_t).

### 6.116.2 Macro Definition Documentation

6.116.2.1 #define \_\_declspec(  
    *p* )

6.116.2.2 #define WINAPI

6.116.2.3 #define HINSTANCE int

6.116.2.4 #define GITCOMMITHASH "independent-plugin-build"

6.116.2.5 #define MHAPLUGIN\_PROC\_CALLBACK\_PREFIX(  
    *prefix,*  
    *classname,*  
    *indom,*  
    *outdom* )

6.116.2.6 #define MHAPLUGIN\_INIT\_CALLBACKS\_PREFIX(  
    *prefix,*  
    *classname* )

6.116.2.7 #define MHAPLUGIN\_DOCUMENTATION\_PREFIX(  
    *prefix,*  
    *cat,*  
    *doc* )

6.116.2.8 #define MHAPLUGIN\_PROC\_CALLBACK(  
    *plugname,*  
    *classname,*  
    *indom,*  
    *outdom* ) MHAPLUGIN\_PROC\_CALLBACK\_PREFIX(MHA\_STATIC\_ ##  
    plugname ## \_,classname,indom,outdom)

```
6.116.2.9 #define MHAPLUGIN_INIT_CALLBACKS(
           plugname,
           classname ) MHAPLUGIN_INIT_CALLBACKS_PREFIX(MHA_STATIC_
           ## plugname ## _,classname)
```

### 6.116.3 Function Documentation

```
6.116.3.1 __attribute__ (
           (unused) ) const
```

store git commit hash in every binary plgin to support reproducible research

## 6.117 mha\_profiling.c File Reference

### Functions

- void **mha\_tic** (*mha\_tictoc\_t* \**t*)
- void **mha\_platform\_tic** (*mha\_platform\_tictoc\_t* \**t*)
- float **mha\_toc** (*mha\_tictoc\_t* \**t*)
- float **mha\_platform\_toc** (*mha\_platform\_tictoc\_t* \**t*)

### 6.117.1 Function Documentation

```
6.117.1.1 void mha_tic (
           mha_tictoc_t * t )
```

```
6.117.1.2 void mha_platform_tic (
           mha_platform_tictoc_t * t )
```

```
6.117.1.3 float mha_toc (
           mha_tictoc_t * t )
```

```
6.117.1.4 float mha_platform_toc (
           mha_platform_tictoc_t * t )
```

## 6.118 mha\_profiling.h File Reference

### Classes

- struct **mha\_tictoc\_t**

### Typedefs

- typedef **mha\_tictoc\_t** **mha\_platform\_tictoc\_t**



## Functions

- void **mha\_platform\_tic** (mha\_platform\_tictoc\_t \*)
- float **mha\_platform\_toc** (mha\_platform\_tictoc\_t \*)

### 6.118.1 Typedef Documentation

#### 6.118.1.1 typedef mha\_tictoc\_t mha\_platform\_tictoc\_t

### 6.118.2 Function Documentation

#### 6.118.2.1 void mha\_platform\_tic ( mha\_platform\_tictoc\_t \* t )

#### 6.118.2.2 float mha\_platform\_toc ( mha\_platform\_tictoc\_t \* t )

## 6.119 mha\_ruby.cpp File Reference

### Typedefs

- typedef VALUE(\* **rb\_f\_t**) (...)

### Functions

- static void **mha\_free** (void \*mha)
- static VALUE **mha\_alloc** (VALUE klass)
- static VALUE **mha\_exit\_request** (VALUE self)
- static VALUE **mha\_parse** (VALUE self, VALUE request)
- void **Init\_mha\_ruby** ()

### 6.119.1 Typedef Documentation

#### 6.119.1.1 typedef VALUE(\* rb\_f\_t) (...)

### 6.119.2 Function Documentation

#### 6.119.2.1 static void mha\_free ( void \* *mha* ) [static]

#### 6.119.2.2 static VALUE mha\_alloc ( VALUE *klass* ) [static]

6.119.2.3 static VALUE mha\_exit\_request (  
VALUE self ) [static]

6.119.2.4 static VALUE mha\_parse (  
VALUE self,  
VALUE request ) [static]

6.119.2.5 void Init\_mha\_ruby ( )

## 6.120 mha\_signal.cpp File Reference

### Classes

- class **MHASignal::hilbert\_fftw\_t**

### Namespaces

- **MHASignal**

*Namespace for audio signal handling and processing classes.*

### Macros

- #define **MHA\_ID\_UINT\_VECTOR** "MHASignal::uint\_vector\_t"
- #define **MHA\_ID\_MATRIX** "MHASignal::matrix\_t"
- #define **ASSERT\_EQUAL\_DIM**(a, b)
- #define **ASSERT\_EQUAL\_DIM\_PTR**(a, b)

### Functions

- void **set\_minabs** (mha\_spec\_t &self, const mha\_real\_t &m)
- mha\_wave\_t & **operator+=** (mha\_wave\_t &self, const mha\_real\_t &v)  
*Addition operator.*
- mha\_wave\_t & **operator\*=** (mha\_wave\_t &self, const mha\_real\_t &v)  
*Element-wise multiplication operator.*
- mha\_spec\_t & **operator\*=** (mha\_spec\_t &self, const mha\_real\_t &v)  
*Element-wise multiplication operator.*
- mha\_wave\_t & **operator\*=** (mha\_wave\_t &self, const mha\_wave\_t &v)  
*Element-wise multiplication operator.*
- mha\_spec\_t & **operator\*=** (mha\_spec\_t &self, const mha\_wave\_t &v)  
*Element-wise multiplication operator.*
- mha\_spec\_t & **operator\*=** (mha\_spec\_t &self, const mha\_spec\_t &v)  
*Element-wise multiplication operator.*
- mha\_spec\_t & **safe\_div** (mha\_spec\_t &self, const mha\_spec\_t &v, mha\_real\_t eps)  
*In-Place division with lower limit on divisor.*

- **mha\_spec\_t & operator/= (mha\_spec\_t &self, const mha\_spec\_t &v)**  
*Element-wise division operator.*
- **mha\_wave\_t & operator/= (mha\_wave\_t &self, const mha\_wave\_t &v)**  
*Element-wise division operator.*
- **mha\_spec\_t & operator+= (mha\_spec\_t &self, const mha\_spec\_t &v)**  
*Addition operator.*
- **mha\_spec\_t & operator+= (mha\_spec\_t &self, const mha\_real\_t &v)**  
*Addition operator.*
- **mha\_wave\_t & operator+= (mha\_wave\_t &self, const mha\_wave\_t &v)**  
*Addition operator.*
- **mha\_wave\_t & operator-= (mha\_wave\_t &self, const mha\_wave\_t &v)**  
*Subtraction operator.*
- **mha\_spec\_t & operator-= (mha\_spec\_t &self, const mha\_spec\_t &v)**  
*Subtraction operator.*
- **mha\_fft\_t mha\_fft\_new** (unsigned int n)  
*Create a new instance of an FFT object.*
- void **mha\_fft\_free** (mha\_fft\_t h)  
*Remove an FFT object.*
- void **mha\_fft\_wave2spec** (mha\_fft\_t h, const mha\_wave\_t \*in, mha\_spec\_t \*out)  
*Perform an FFT on each channel of input waveform signal.*
- void **mha\_fft\_wave2spec** (mha\_fft\_t h, const mha\_wave\_t \*in, mha\_spec\_t \*out, bool swap)  
*Transform waveform segment into spectrum.*
- void **mha\_fft\_spec2wave** (mha\_fft\_t h, const mha\_spec\_t \*in, mha\_wave\_t \*out)  
*Perform an inverse FFT on each channel of input spectrum.*
- void **mha\_fft\_spec2wave** (mha\_fft\_t h, const mha\_spec\_t \*in, mha\_wave\_t \*out, unsigned int offset)  
*Perform an inverse FFT on each channel of input spectrum.*
- void **mha\_fft\_forward** (mha\_fft\_t h, mha\_spec\_t \*sIn, mha\_spec\_t \*sOut)  
*Complex to complex FFT (forward).*
- void **mha\_fft\_backward** (mha\_fft\_t h, mha\_spec\_t \*sIn, mha\_spec\_t \*sOut)  
*Complex to complex FFT (backward).*
- void **mha\_fft\_forward\_scale** (mha\_fft\_t h, mha\_spec\_t \*sIn, mha\_spec\_t \*sOut)  
*Complex to complex FFT (forward).*
- void **mha\_fft\_backward\_scale** (mha\_fft\_t h, mha\_spec\_t \*sIn, mha\_spec\_t \*sOut)  
*Complex to complex FFT (backward).*
- void **mha\_fft\_wave2spec\_scale** (mha\_fft\_t h, const mha\_wave\_t \*in, mha\_spec\_t \*out)  
*Transform waveform segment into spectrum.*
- void **mha\_fft\_spec2wave\_scale** (mha\_fft\_t h, const mha\_spec\_t \*in, mha\_wave\_t \*out)  
*Transform spectrum into waveform segment.*
- std::vector< float > **std\_vector\_float** (const mha\_wave\_t &w)  
*Converts a **mha\_wave\_t** (p. 496) structure into a std::vector<float> (interleaved order).*
- std::vector< std::vector< float > > **std\_vector\_vector\_float** (const mha\_wave\_t &w)

- Converts a **mha\_wave\_t** (p. 496) structure into a `std::vector< std::vector<float> >` (outer vector represents channels).*
- `std::vector< std::vector< mha_complex_t > > std_vector_vector_complex (const mha_spec_t &w)`  
*Converts a **mha\_spec\_t** (p. 465) structure into a `std::vector< std::vector<mha_complex_t> >` (outer vector represents channels).*
- static `mha_real_t intensity (const mha_spec_t &s, unsigned int channel, unsigned int fftlen, mha_real_t *sqfreq_response=0)`
- void `integrate (mha_wave_t &s)`  
*Numeric integration of a signal vector (real values)*
- void `integrate (mha_spec_t &s)`  
*Numeric integration of a signal vector (complex values)*
- `mha_wave_t & operator^= (mha_wave_t &self, const mha_real_t &arg)`  
*Exponent operator.*
- `mha_wave_t range (mha_wave_t s, unsigned int k0, unsigned int len)`  
*Return a time interval from a waveform chunk.*
- `mha_spec_t channels (mha_spec_t s, unsigned int ch_start, unsigned int nch)`  
*Return a channel interval from a spectrum.*
- void `assign (mha_wave_t self, const mha_wave_t &val)`  
*Set all values of waveform 'self' to 'val'.*
- void `assign (mha_spec_t self, const mha_spec_t &val)`  
*Set all values of spectrum 'self' to 'val'.*
- void `timeshift (mha_wave_t &self, int shift)`  
*Time shift of waveform chunk.*

### 6.120.1 Macro Definition Documentation

6.120.1.1 `#define MHA_ID_UINT_VECTOR "MHASignal::uint_vector_t"`

6.120.1.2 `#define MHA_ID_MATRIX "MHASignal::matrix_t"`

6.120.1.3 `#define ASSERT_EQUAL_DIM(  
                   a,  
                   b )`

6.120.1.4 `#define ASSERT_EQUAL_DIM_PTR(  
                   a,  
                   b )`

### 6.120.2 Function Documentation

6.120.2.1 `void set_minabs (  
                   mha_spec_t & self,  
                   const mha_real_t & m )`

6.120.2.2 `mha_spec_t & safe_div (  
                   mha_spec_t & self,  
                   const mha_spec_t & v,  
                   mha_real_t eps )`

In-Place division with lower limit on divisor.

```
6.120.2.3 static mha_real_t intensity (
    const mha_spec_t & s,
    unsigned int channel,
    unsigned int fftlen,
    mha_real_t * sqfreq_response = 0 ) [static]
```

## 6.121 mha\_signal.hh File Reference

Header file for audio signal handling and processing classes.

### Classes

- class **MHASignal::spectrum\_t**  
*a signal processing class for spectral data (based on [mha\\_spec\\_t](#) (p. 465))*
- class **MHASignal::waveform\_t**  
*signal processing class for waveform data (based on [mha\\_wave\\_t](#) (p. 496))*
- class **MHASignal::doublebuffer\_t**  
*Double-buffering class.*
- class **MHASignal::ringbuffer\_t**  
*A ringbuffer class for time domain audio signal, which makes no assumptions with respect to fragment size.*
- class **MHASignal::hilbert\_t**  
*Hilbert transformation of a waveform segment.*
- class **MHASignal::minphase\_t**  
*Minimal phase function.*
- class **MHASignal::stat\_t**
- class **MHASignal::delay\_wave\_t**  
*Delayline containing wave fragments.*
- class **MHASignal::delay\_spec\_t**
- class **MHASignal::async\_rmslevel\_t**  
*Class for asynchronous level metering.*
- class **MHASignal::uint\_vector\_t**  
*Vector of unsigned values, used for size and index description of n-dimensional matrixes.*
- class **MHASignal::matrix\_t**  
*n-dimensional matrix with real or complex floating point values.*
- class **MHASignal::schroeder\_t**  
*Schroeder tone complex class.*
- class **MHASignal::quantizer\_t**  
*Simple simulation of fixpoint quantization.*
- class **MHASignal::loop\_wavefragment\_t**  
*Copy a fixed waveform fragment to a series of waveform fragments of other size.*
- class **MHASignal::delay\_t**  
*Class to realize a simple delay of waveform streams.*
- class **MHASignal::subsample\_delay\_t**  
*implements subsample delay in spectral domain.*

## Namespaces

- **MHASignal**

*Namespace for audio signal handling and processing classes.*

## Macros

- #define **M\_PI** 3.14159265358979323846
- #define **mha\_round**(x) (int)((float)x+0.5)

## Functions

- void **MHASignal::for\_each** (mha\_wave\_t \*s, mha\_real\_t(\*fun)(mha\_real\_t))  
*Apply a function to each element of a **mha\_wave\_t** (p. 496).*
- mha\_real\_t **MHASignal::lin2db** (mha\_real\_t x)  
*Conversion from linear scale to dB (no SPL reference)*
- mha\_real\_t **MHASignal::db2lin** (mha\_real\_t x)  
*Conversion from dB scale to linear (no SPL reference)*
- mha\_real\_t **MHASignal::pa2dbspl** (mha\_real\_t x)  
*Conversion from linear Pascal scale to dB SPL.*
- mha\_real\_t **MHASignal::pa2dbspl** (mha\_real\_t x, mha\_real\_t eps=1e-20f)  
*Conversion from squared Pascal scale to dB SPL.*
- mha\_real\_t **MHASignal::dbspl2pa** (mha\_real\_t x)  
*Conversion from dB SPL to linear Pascal scale.*
- mha\_real\_t **MHASignal::smp2sec** (mha\_real\_t n, mha\_real\_t srate)  
*conversion from samples to seconds*
- mha\_real\_t **MHASignal::sec2smp** (mha\_real\_t sec, mha\_real\_t srate)  
*conversion from seconds to samples*
- mha\_real\_t **MHASignal::bin2freq** (mha\_real\_t bin, unsigned fftlen, mha\_real\_t srate)  
*conversion from fft bin index to frequency*
- mha\_real\_t **MHASignal::freq2bin** (mha\_real\_t freq, unsigned fftlen, mha\_real\_t srate)  
*conversion from frequency to fft bin index*
- mha\_real\_t **MHASignal::smp2rad** (mha\_real\_t samples, unsigned bin, unsigned fftlen)  
*conversion from delay in samples to phase shift*
- mha\_real\_t **MHASignal::rad2smp** (mha\_real\_t phase\_shift, unsigned bin, unsigned fftlen)  
*conversion from phase shift to delay in samples*
- template<class elem\_type >  
std::vector< elem\_type > **MHASignal::dupvec** (std::vector< elem\_type > vec, unsigned n)  
*Duplicate last vector element to match desired size.*
- template<class elem\_type >  
std::vector< elem\_type > **MHASignal::dupvec\_chk** (std::vector< elem\_type > vec, unsigned n)  
*Duplicate last vector element to match desired size, check for dimension.*

- bool **equal\_dim** (const **mha\_wave\_t** &a, const **mha\_wave\_t** &b)  
*Test for equal dimension of waveform structures.*
- bool **equal\_dim** (const **mha\_wave\_t** &a, const **mhaconfig\_t** &b)  
*Test for match of waveform dimension with mhaconfig structure.*
- bool **equal\_dim** (const **mha\_spec\_t** &a, const **mha\_spec\_t** &b)  
*Test for equal dimension of spectrum structures.*
- bool **equal\_dim** (const **mha\_spec\_t** &a, const **mhaconfig\_t** &b)  
*Test for match of spectrum dimension with mhaconfig structure.*
- bool **equal\_dim** (const **mha\_wave\_t** &a, const **mha\_spec\_t** &b)  
*Test for equal dimension of waveform/spectrum structures.*
- bool **equal\_dim** (const **mha\_spec\_t** &a, const **mha\_wave\_t** &b)  
*Test for equal dimension of waveform/spectrum structures.*
- void **integrate** (**mha\_wave\_t** &s)  
*Numeric integration of a signal vector (real values)*
- void **integrate** (**mha\_spec\_t** &s)  
*Numeric integration of a signal vector (complex values)*
- unsigned int **mha\_min\_1** (unsigned int a)
- unsigned int **size** (const **mha\_wave\_t** &s)  
*Return size of a waveform structure.*
- unsigned int **size** (const **mha\_spec\_t** &s)  
*Return size of a spectrum structure.*
- unsigned int **size** (const **mha\_wave\_t** \*s)  
*Return size of a waveform structure.*
- unsigned int **size** (const **mha\_spec\_t** \*s)  
*Return size of a spectrum structure.*
- void **clear** (**mha\_wave\_t** &s)  
*Set all values of waveform to zero.*
- void **clear** (**mha\_wave\_t** \*s)  
*Set all values of waveform to zero.*
- void **clear** (**mha\_spec\_t** &s)  
*Set all values of spectrum to zero.*
- void **clear** (**mha\_spec\_t** \*s)  
*Set all values of spectrum to zero.*
- void **assign** (**mha\_wave\_t** self, **mha\_real\_t** val)  
*Set all values of waveform 'self' to 'val'.*
- void **assign** (**mha\_wave\_t** self, const **mha\_wave\_t** &val)  
*Set all values of waveform 'self' to 'val'.*
- void **assign** (**mha\_spec\_t** self, const **mha\_spec\_t** &val)  
*Set all values of spectrum 'self' to 'val'.*
- void **timeshift** (**mha\_wave\_t** &self, int shift)  
*Time shift of waveform chunk.*
- **mha\_wave\_t** **range** (**mha\_wave\_t** s, unsigned int k0, unsigned int len)  
*Return a time interval from a waveform chunk.*
- **mha\_spec\_t** **channels** (**mha\_spec\_t** s, unsigned int ch\_start, unsigned int nch)  
*Return a channel interval from a spectrum.*

- **mha\_real\_t & value (mha\_wave\_t \*s, unsigned int fr, unsigned int ch)**  
*Access an element of a waveform structure.*
- **const mha\_real\_t & value (const mha\_wave\_t \*s, unsigned int fr, unsigned int ch)**  
*Constant access to an element of a waveform structure.*
- **mha\_real\_t & value (mha\_wave\_t \*s, unsigned int k)**
- **mha\_complex\_t & value (mha\_spec\_t \*s, unsigned int k)**
- **mha\_complex\_t & value (mha\_spec\_t \*s, unsigned int fr, unsigned int ch)**  
*Access to an element of a spectrum.*
- **const mha\_complex\_t & value (const mha\_spec\_t \*s, unsigned int fr, unsigned int ch)**  
*Constant access to an element of a spectrum.*
- **mha\_real\_t & value (mha\_wave\_t &s, unsigned int fr, unsigned int ch)**  
*Access to an element of a waveform structure.*
- **const mha\_real\_t & value (const mha\_wave\_t &s, unsigned int fr, unsigned int ch)**  
*Constant access to an element of a waveform structure.*
- **mha\_complex\_t & value (mha\_spec\_t &s, unsigned int fr, unsigned int ch)**  
*Access to an element of a spectrum.*
- **const mha\_complex\_t & value (const mha\_spec\_t &s, unsigned int fr, unsigned int ch)**  
*Constant access to an element of a spectrum.*
- **std::vector< float > std\_vector\_float (const mha\_wave\_t &)**  
*Converts a **mha\_wave\_t** (p. 496) structure into a **std::vector<float>** (interleaved order).*
- **std::vector< std::vector< float > > std\_vector\_vector\_float (const mha\_wave\_t &)**  
*Converts a **mha\_wave\_t** (p. 496) structure into a **std::vector< std::vector<float> >** (outer vector represents channels).*
- **std::vector< std::vector< mha\_complex\_t > > std\_vector\_vector\_complex (const mha\_spec\_t &)**  
*Converts a **mha\_spec\_t** (p. 465) structure into a **std::vector< std::vector<mha\_complex\_t> >** (outer vector represents channels).*
- **mha\_wave\_t & operator+= (mha\_wave\_t &, const mha\_real\_t &)**  
*Addition operator.*
- **mha\_wave\_t & operator+= (mha\_wave\_t &, const mha\_wave\_t &)**  
*Addition operator.*
- **mha\_wave\_t & operator-= (mha\_wave\_t &, const mha\_wave\_t &)**  
*Subtraction operator.*
- **mha\_spec\_t & operator-= (mha\_spec\_t &, const mha\_spec\_t &)**  
*Subtraction operator.*
- **mha\_wave\_t & operator\*= (mha\_wave\_t &, const mha\_real\_t &)**  
*Element-wise multiplication operator.*
- **mha\_wave\_t & operator\*= (mha\_wave\_t &, const mha\_wave\_t &)**  
*Element-wise multiplication operator.*
- **mha\_spec\_t & operator\*= (mha\_spec\_t &, const mha\_real\_t &)**  
*Element-wise multiplication operator.*
- **mha\_spec\_t & operator\*= (mha\_spec\_t &, const mha\_wave\_t &)**  
*Element-wise multiplication operator.*
- **mha\_spec\_t & operator\*= (mha\_spec\_t &, const mha\_spec\_t &)**  
*Element-wise multiplication operator.*



- **mha\_spec\_t & operator/= (mha\_spec\_t &, const mha\_spec\_t &)**  
*Element-wise division operator.*
- **mha\_wave\_t & operator/= (mha\_wave\_t &, const mha\_wave\_t &)**  
*Element-wise division operator.*
- **mha\_spec\_t & operator+= (mha\_spec\_t &, const mha\_spec\_t &)**  
*Addition operator.*
- **mha\_spec\_t & operator+= (mha\_spec\_t &, const mha\_real\_t &)**  
*Addition operator.*
- void **set\_minabs (mha\_spec\_t &, const mha\_real\_t &)**
- **mha\_spec\_t & safe\_div (mha\_spec\_t &self, const mha\_spec\_t &v, mha\_real\_t eps)**  
*In-Place division with lower limit on divisor.*
- **mha\_wave\_t & operator^= (mha\_wave\_t &self, const mha\_real\_t &arg)**  
*Exponent operator.*
- void **MHASignal::copy\_channel (mha\_spec\_t &self, const mha\_spec\_t &src, unsigned sch, unsigned dch)**  
*Copy one channel of a source signal.*
- void **MHASignal::copy\_channel (mha\_wave\_t &self, const mha\_wave\_t &src, unsigned src\_channel, unsigned dest\_channel)**  
*Copy one channel of a source signal.*
- **mha\_real\_t MHASignal::rmslevel (const mha\_spec\_t &s, unsigned int channel, unsigned int fftlen)**  
*Return RMS level of a spectrum channel.*
- **mha\_real\_t MHASignal::colored\_intensity (const mha\_spec\_t &s, unsigned int channel, unsigned int fftlen, mha\_real\_t sqfreq\_response[])**  
*Colored spectrum intensity.*
- **mha\_real\_t MHASignal::maxabs (const mha\_spec\_t &s, unsigned int channel)**  
*Find maximal absolute value.*
- **mha\_real\_t MHASignal::rmslevel (const mha\_wave\_t &s, unsigned int channel)**  
*Return RMS level of a waveform channel.*
- **mha\_real\_t MHASignal::maxabs (const mha\_wave\_t &s, unsigned int channel)**  
*Find maximal absolute value.*
- **mha\_real\_t MHASignal::maxabs (const mha\_wave\_t &s)**  
*Find maximal absolute value.*
- **mha\_real\_t MHASignal::max (const mha\_wave\_t &s)**  
*Find maximal value.*
- **mha\_real\_t MHASignal::min (const mha\_wave\_t &s)**  
*Find minimal value.*
- **mha\_real\_t MHASignal::sumsq\_channel (const mha\_wave\_t &s, unsigned int channel)**  
*Calculate sum of squared values in one channel.*
- **mha\_real\_t MHASignal::sumsq\_frame (const mha\_wave\_t &s, unsigned int frame)**  
*Calculate sum over all channels of squared values.*
- void **MHASignal::scale (mha\_spec\_t \*dest, const mha\_wave\_t \*src)**
- void **MHASignal::limit (mha\_wave\_t &s, const mha\_real\_t &min, const mha\_real\_t &max)**  
*Limit the signal in the waveform buffer to the range [min, max].*

- **mha\_complex\_t & set (mha\_complex\_t &self, mha\_real\_t real, mha\_real\_t imag=0)**  
*Assign real and imaginary parts to a **mha\_complex\_t** (p. 431) variable.*
- **mha\_complex\_t mha\_complex (mha\_real\_t real, mha\_real\_t imag=0)**  
*Create a new **mha\_complex\_t** (p. 431) with specified real and imaginary parts.*
- **mha\_complex\_t & set (mha\_complex\_t &self, const std::complex< mha\_real\_t > &stdcomplex)**  
*Assign a **mha\_complex\_t** (p. 431) variable from a **std::complex**.*
- **std::complex< mha\_real\_t > stdcomplex (const mha\_complex\_t &self)**  
*Create a **std::complex** from **mha\_complex\_t** (p. 431).*
- **mha\_complex\_t & expi (mha\_complex\_t &self, mha\_real\_t angle)**  
*replaces the value of the given **mha\_complex\_t** (p. 431) with  $\exp(i*b)$ .*
- **double angle (const mha\_complex\_t &self)**  
*Computes the angle of a complex number in the complex plane.*
- **mha\_complex\_t & operator+= (mha\_complex\_t &self, const mha\_complex\_t &other)**  
*Addition of two complex numbers, overwriting the first.*
- **mha\_complex\_t operator+ (const mha\_complex\_t &self, const mha\_complex\_t &other)**  
*Addition of two complex numbers, result is a temporary object.*
- **mha\_complex\_t & operator+= (mha\_complex\_t &self, mha\_real\_t other\_real)**  
*Addition of a complex and a real number, overwriting the complex.*
- **mha\_complex\_t operator+ (const mha\_complex\_t &self, mha\_real\_t other\_real)**  
*Addition of a complex and a real number, result is a temporary object.*
- **mha\_complex\_t & operator-= (mha\_complex\_t &self, const mha\_complex\_t &other)**  
*Subtraction of two complex numbers, overwriting the first.*
- **mha\_complex\_t operator- (const mha\_complex\_t &self, const mha\_complex\_t &other)**  
*Subtraction of two complex numbers, result is a temporary object.*
- **mha\_complex\_t & operator-= (mha\_complex\_t &self, mha\_real\_t other\_real)**  
*Subtraction of a complex and a real number, overwriting the complex.*
- **mha\_complex\_t operator- (const mha\_complex\_t &self, mha\_real\_t other\_real)**  
*Subtraction of a complex and a real number, result is a temporary object.*
- **mha\_complex\_t & operator\*= (mha\_complex\_t &self, const mha\_complex\_t &other)**  
*Multiplication of two complex numbers, overwriting the first.*
- **mha\_complex\_t operator\* (const mha\_complex\_t &self, const mha\_complex\_t &other)**  
*Multiplication of two complex numbers, result is a temporary object.*
- **mha\_complex\_t & operator\*= (mha\_complex\_t &self, mha\_real\_t other\_real)**  
*Multiplication of a complex and a real number, overwriting the complex.*
- **mha\_complex\_t & expi (mha\_complex\_t &self, mha\_real\_t angle, mha\_real\_t factor)**  
*replaces (!) the value of the given **mha\_complex\_t** (p. 431) with  $a * \exp(i*b)$*
- **mha\_complex\_t operator\* (const mha\_complex\_t &self, mha\_real\_t other\_real)**  
*Multiplication of a complex and a real number, result is a temporary object.*
- **mha\_real\_t abs2 (const mha\_complex\_t &self)**  
*Compute the square of the absolute value of a complex value.*
- **mha\_real\_t abs (const mha\_complex\_t &self)**

*Compute the absolute value of a complex value.*

- **mha\_complex\_t & operator/=** (mha\_complex\_t &self, mha\_real\_t other\_real)  
*Division of a complex and a real number, overwriting the complex.*
- **mha\_complex\_t operator/** (const mha\_complex\_t &self, mha\_real\_t other\_real)  
*Division of a complex and a real number, result is a temporary object.*
- **mha\_complex\_t & safe\_div** (mha\_complex\_t &self, const mha\_complex\_t &other, mha\_real\_t eps, mha\_real\_t eps2)  
*Safe division of two complex numbers, overwriting the first.*
- **mha\_complex\_t & operator/=** (mha\_complex\_t &self, const mha\_complex\_t &other)  
*Division of two complex numbers, overwriting the first.*
- **mha\_complex\_t operator/** (const mha\_complex\_t &self, const mha\_complex\_t &other)  
*Division of two complex numbers, result is a temporary object.*
- **mha\_complex\_t operator-** (const mha\_complex\_t &self)  
*Unary minus on a complex results in a negative temporary object.*
- **bool operator==** (const mha\_complex\_t &x, const mha\_complex\_t &y)  
*Compare two complex numbers for equality.*
- **bool operator!=** (const mha\_complex\_t &x, const mha\_complex\_t &y)  
*Compare two complex numbers for inequality.*
- **void conjugate** (mha\_complex\_t &self)  
*Replace (!) the value of this **mha\_complex\_t** (p. 431) with its conjugate.*
- **void conjugate** (mha\_spec\_t &self)  
*Replace (!) the value of this **mha\_spec\_t** (p. 465) with its conjugate.*
- **mha\_complex\_t \_conjugate** (const mha\_complex\_t &self)  
*Compute the conjugate of this complex value.*
- **void reciprocal** (mha\_complex\_t &self)  
*Replace the value of this complex with its reciprocal.*
- **mha\_complex\_t \_reciprocal** (const mha\_complex\_t &self)  
*compute the reciprocal of this complex value.*
- **void normalize** (mha\_complex\_t &self)  
*Divide a complex by its absolute value, thereby normalizing it (projecting onto the unit circle).*
- **void normalize** (mha\_complex\_t &self, mha\_real\_t margin)  
*Divide a complex by its absolute value, thereby normalizing it (projecting onto the unit circle), with a safety margin.*
- **bool almost** (const mha\_complex\_t &self, const mha\_complex\_t &other, mha\_real\_t times\_epsilon=1e2)  
*Compare two complex numbers for equality except for a small relative error.*
- **bool operator<** (const mha\_complex\_t &x, const mha\_complex\_t &y)  
*Compares the absolute values of two complex numbers.*
- **std::ostream & operator<<** (std::ostream &o, const mha\_complex\_t &c)  
*ostream operator for **mha\_complex\_t** (p. 431)*
- **std::istream & operator>>** (std::istream &i, mha\_complex\_t &c)  
*preliminary istream operator for **mha\_complex\_t** (p. 431) without error checking*
- **mha\_fft\_t mha\_fft\_new** (unsigned int n)  
*Create a new FFT handle.*

- void **mha\_fft\_free** (mha\_fft\_t h)  
*Destroy an FFT handle.*
- void **mha\_fft\_wave2spec** (mha\_fft\_t h, const mha\_wave\_t \*in, mha\_spec\_t \*out)  
*Transform waveform segment into spectrum.*
- void **mha\_fft\_wave2spec** (mha\_fft\_t h, const mha\_wave\_t \*in, mha\_spec\_t \*out, bool swaps)  
*Transform waveform segment into spectrum.*
- void **mha\_fft\_spec2wave** (mha\_fft\_t h, const mha\_spec\_t \*in, mha\_wave\_t \*out)  
*Transform spectrum into waveform segment.*
- void **mha\_fft\_spec2wave** (mha\_fft\_t h, const mha\_spec\_t \*in, mha\_wave\_t \*out, unsigned int offset)  
*Transform spectrum into waveform segment.*
- void **mha\_fft\_forward** (mha\_fft\_t h, mha\_spec\_t \*sIn, mha\_spec\_t \*sOut)  
*Complex to complex FFT (forward).*
- void **mha\_fft\_backward** (mha\_fft\_t h, mha\_spec\_t \*sIn, mha\_spec\_t \*sOut)  
*Complex to complex FFT (backward).*
- void **mha\_fft\_forward\_scale** (mha\_fft\_t h, mha\_spec\_t \*sIn, mha\_spec\_t \*sOut)  
*Complex to complex FFT (forward).*
- void **mha\_fft\_backward\_scale** (mha\_fft\_t h, mha\_spec\_t \*sIn, mha\_spec\_t \*sOut)  
*Complex to complex FFT (backward).*
- void **mha\_fft\_wave2spec\_scale** (mha\_fft\_t h, const mha\_wave\_t \*in, mha\_spec\_t \*out)  
*Transform waveform segment into spectrum.*
- void **mha\_fft\_spec2wave\_scale** (mha\_fft\_t h, const mha\_spec\_t \*in, mha\_wave\_t \*out)  
*Transform spectrum into waveform segment.*
- template<class elem\_type >  
elem\_type **MHASignal::kth\_smallest** (elem\_type array[], unsigned n, unsigned k)  
*Fast search for the kth smallest element of an array.*
- template<class elem\_type >  
elem\_type **MHASignal::median** (elem\_type array[], unsigned n)  
*Fast median search.*
- template<class elem\_type >  
elem\_type **MHASignal::mean** (const std::vector< elem\_type > &data, elem\_type start\_val)  
*Calculate average of elements in a vector.*
- template<class elem\_type >  
std::vector< elem\_type > **MHASignal::quantile** (std::vector< elem\_type > data, const std::vector< elem\_type > &p)  
*Calculate quantile of elements in a vector.*
- void **MHASignal::saveas\_mat4** (const mha\_spec\_t &data, const std::string &varname, FILE \*fh)  
*Save a openMHA spectrum as a variable in a Matlab4 file.*
- void **MHASignal::saveas\_mat4** (const mha\_wave\_t &data, const std::string &varname, FILE \*fh)  
*Save a openMHA waveform as a variable in a Matlab4 file.*

- void **MHASignal::saveas\_mat4** (const std::vector< **mha\_real\_t** > &data, const std::string &varname, FILE \*fh)  
*Save a float vector as a variable in a Matlab4 file.*
- void **MHASignal::copy\_permuted** (**mha\_wave\_t** \*dest, const **mha\_wave\_t** \*src)  
*Copy contents of a waveform to a permuted waveform.*

### Variables

- unsigned long int **MHASignal::signal\_counter** = 0  
*Signal counter to produce signal ID strings.*

#### 6.121.1 Detailed Description

Header file for audio signal handling and processing classes.

The classes for waveform, spectrum and filterbank signals defined in this file are "intelligent" versions of the basic waveform, spectrum and filterbank structures used in the C function calls.

#### 6.121.2 Macro Definition Documentation

6.121.2.1 `#define M_PI 3.14159265358979323846`

6.121.2.2 `#define mha_round(x) (int)((float)x+0.5)`

#### 6.121.3 Function Documentation

6.121.3.1 `unsigned int mha_min_1 ( unsigned int a ) [inline]`

6.121.3.2 `mha_real_t& value ( mha_wave_t * s, unsigned int k ) [inline]`

6.121.3.3 `mha_complex_t& value ( mha_spec_t * s, unsigned int k ) [inline]`

6.121.3.4 `void set_minabs ( mha_spec_t &, const mha_real_t & )`

6.121.3.5 `mha_spec_t& safe_div ( mha_spec_t & self, const mha_spec_t & v, mha_real_t eps )`

In-Place division with lower limit on divisor.

6.121.3.6 `std::ostream& operator<< (`  
`std::ostream & o,`  
`const mha_complex_t & c ) [inline]`

ostream operator for `mha_complex_t` (p. 431)

6.121.3.7 `std::istream& operator>> (`  
`std::istream & i,`  
`mha_complex_t & c ) [inline]`

preliminary istream operator for `mha_complex_t` (p. 431) without error checking

## 6.122 mha\_signal\_fft.h File Reference

### Classes

- class `MHASignal::fft_t`

### Namespaces

- **MHASignal**  
*Namespace for audio signal handling and processing classes.*

## 6.123 mha\_tablelookup.cpp File Reference

## 6.124 mha\_tablelookup.hh File Reference

Header file for table lookup classes.

### Classes

- class `MHATableLookup::table_t`
- class `MHATableLookup::linear_table_t`  
*Class for interpolation with equidistant x values.*
- class `MHATableLookup::xy_table_t`  
*Class for interpolation with non-equidistant x values.*

### Namespaces

- **MHATableLookup**  
*Namespace for table lookup classes.*

### 6.124.1 Detailed Description

Header file for table lookup classes.

## 6.125 mha\_tcp.cpp File Reference

### Classes

- class **MHA\_TCP::sock\_init\_t**

### Namespaces

- **MHA\_TCP**  
*A Namespace for TCP helper classes.*

### Macros

- #define **INVALID\_SOCKET** (-1)
- #define **SOCKET\_ERROR** (-1)
- #define **closesocket**(fd) (close((fd)))
- #define **ASYNC\_CONNECT\_STARTED** EINPROGRESS

### Typedefs

- typedef int **SOCKET**

### Functions

- std::string **MHA\_TCP::STRERROR** (int err)  
*Portable conversion from error number to error string.*
- std::string **MHA\_TCP::HSTRERROR** (int err)  
*Portable conversion from hostname error number to error string.*
- int **MHA\_TCP::N\_ERRNO** ()  
*Portable access to last network error number.*
- int **MHA\_TCP::H\_ERRNO** ()  
*Portable access to last hostname error number.*
- int **MHA\_TCP::G\_ERRNO** ()  
*Portable access to last non-network error number.*
- static sockaddr\_in **host\_port\_to\_sock\_addr** (const std::string &host, unsigned short port)
- static **SOCKET tcp\_connect\_to** (const std::string &host, unsigned short port)
- static **SOCKET tcp\_connect\_to\_with\_timeout** (const std::string &host, unsigned short port, **Timeout\_Watcher** &timeout\_watcher)
- static void \* **thread\_start\_func** (void \*thread)

## Variables

- class **MHA\_TCP::sock\_init\_t** **MHA\_TCP::sock\_initializer**

### 6.125.1 Macro Definition Documentation

6.125.1.1 #define **INVALID\_SOCKET** (-1)

6.125.1.2 #define **SOCKET\_ERROR** (-1)

6.125.1.3 #define **closesocket**(  
    *fd* ) (close((fd)))

6.125.1.4 #define **ASYNC\_CONNECT\_STARTED** EINPROGRESS

### 6.125.2 Typedef Documentation

6.125.2.1 typedef int **SOCKET**

### 6.125.3 Function Documentation

6.125.3.1 static **sockaddr\_in** **host\_port\_to\_sock\_addr** (  
    const std::string & *host*,  
    unsigned short *port* ) [static]

6.125.3.2 static **SOCKET** **tcp\_connect\_to** (  
    const std::string & *host*,  
    unsigned short *port* ) [static]

6.125.3.3 static **SOCKET** **tcp\_connect\_to\_with\_timeout** (  
    const std::string & *host*,  
    unsigned short *port*,  
    Timeout\_Watcher & *timeout\_watcher* ) [static]

6.125.3.4 static void\* **thread\_start\_func** (  
    void \* *thread* ) [static]

### 6.126 mha\_tcp.hh File Reference

## Classes

- struct **MHA\_TCP::OS\_EVENT\_TYPE**
- class **MHA\_TCP::Wakeup\_Event**  
    *A base class for asynchronous wakeup events.*
- class **MHA\_TCP::Async\_Notify**



*Portable Multiplexable cross-thread notification.*

- class **MHA\_TCP::Event\_Watcher**  
*OS-independent event watcher, uses select on Unix and WaitForMultipleObjects on Windows.*
- class **MHA\_TCP::Timeout\_Event**
- class **MHA\_TCP::Timeout\_Watcher**  
*OS-independent event watcher with internal fixed-end-time timeout.*
- class **MHA\_TCP::Sockread\_Event**  
*Watch socket for incoming data.*
- class **MHA\_TCP::Sockwrite\_Event**
- class **MHA\_TCP::Sockaccept\_Event**
- class **MHA\_TCP::Connection**  
***Connection** (p. 471) handles Communication between client and server, is used on both sides.*
- class **MHA\_TCP::Server**
- class **MHA\_TCP::Client**  
*A portable class for a tcp client connections.*
- class **MHA\_TCP::Thread**  
*A very simple class for portable threads.*

#### Namespaces

- **MHA\_TCP**  
*A Namespace for TCP helper classes.*

#### Macros

- `#define Sleep(x) usleep((x)*1000);`

#### Typedefs

- typedef int **MHA\_TCP::SOCKET**

#### Functions

- std::string **MHA\_TCP::STRERROR** (int err)  
*Portable conversion from error number to error string.*
- std::string **MHA\_TCP::HSTRERROR** (int err)  
*Portable conversion from hostname error number to error string.*
- int **MHA\_TCP::N\_ERRNO** ()  
*Portable access to last network error number.*
- int **MHA\_TCP::H\_ERRNO** ()  
*Portable access to last hostname error number.*
- int **MHA\_TCP::G\_ERRNO** ()  
*Portable access to last non-network error number.*
- double **MHA\_TCP::dtime** ()  
*Time access function for system's high resolution time, retrieve current time as double.*
- double **MHA\_TCP::dtime** (const struct timeval &tv)  
*Time access function for unix' high resolution time, converts struct timeval to double.*
- struct timeval **MHA\_TCP::stime** (double d)  
*Time access function for unix' high resolution time, converts time from double to struct timeval.*

## 6.126.1 Macro Definition Documentation

6.126.1.1 `#define Sleep(  
x ) usleep((x)*1000);`

## 6.127 mha\_toolbox.h File Reference

## 6.128 mha\_windowparser.cpp File Reference

### Variables

- `float(* wnd_funs [ ])(float)`

## 6.128.1 Variable Documentation

6.128.1.1 `float(* wnd_funs[ ])(float)`

## 6.129 mha\_windowparser.h File Reference

### Classes

- class **MHAWindow::base\_t**  
*Common base for window types.*
- class **MHAWindow::fun\_t**  
*Generic window based on a generator function.*
- class **MHAWindow::rect\_t**  
*Rectangular window.*
- class **MHAWindow::bartlett\_t**  
*Bartlett window.*
- class **MHAWindow::hanning\_t**  
*von-Hann window*
- class **MHAWindow::hamming\_t**  
*Hamming window.*
- class **MHAWindow::blackman\_t**  
*Blackman window.*
- class **MHAWindow::user\_t**  
*User defined window.*
- class **MHAParser::window\_t**  
*MHA configuration interface for a window function generator.*

## Namespaces

- **MHAWindow**  
*Collection of Window types.*
- **MHAParser**  
*Name space for the openMHA-Parser configuration language.*

## Functions

- float **MHAWindow::rect** (float)  
*Rectangular window function.*
- float **MHAWindow::bartlett** (float)  
*Bartlett window function.*
- float **MHAWindow::hanning** (float)  
*Hanning window function.*
- float **MHAWindow::hamming** (float)  
*Hamming window function.*
- float **MHAWindow::blackman** (float)  
*Blackman window function.*

## 6.130 mhachain.cpp File Reference

### Classes

- class **mhachain::mhachain\_t**

### Namespaces

- **mhachain**

## 6.131 mhafw\_lib.cpp File Reference

## 6.132 mhafw\_lib.h File Reference

### Classes

- class **io\_lib\_t**  
*Class for loading MHA sound IO module.*
- class **fw\_vars\_t**
- class **fw\_t**

## 6.133 MHAIOalsa.cpp File Reference

### Classes

- class **alsa\_base\_t**
- class **alsa\_dev\_par\_parser\_t**  
*Parser variables corresponding to one alsa device.*
- class **alsa\_t< T >**  
*Our representation of one alsa device.*
- class **io\_alsa\_t**  
*MHA IO interface class for ALSA IO.*

### Macros

- #define **DBG(x)** `fprintf(stderr,"%s:%d\n",__FILE__,__LINE__)`
- #define **ERR\_SUCCESS** 0
- #define **ERR\_IHANDLE** -1
- #define **ERR\_USER** -1000
- #define **MAX\_USER\_ERR** 0x500
- #define **IOInit** `MHA_STATIC_MHAIOalsa_IOInit`
- #define **IOPrepare** `MHA_STATIC_MHAIOalsa_IOPrepare`
- #define **IOStart** `MHA_STATIC_MHAIOalsa_IOStart`
- #define **IOStop** `MHA_STATIC_MHAIOalsa_IOStop`
- #define **IORelease** `MHA_STATIC_MHAIOalsa_IORelease`
- #define **IOSetVar** `MHA_STATIC_MHAIOalsa_IOSetVar`
- #define **IOStrError** `MHA_STATIC_MHAIOalsa_IOStrError`
- #define **IODestroy** `MHA_STATIC_MHAIOalsa_IODestroy`
- #define **dummy\_interface\_test** `MHA_STATIC_MHAIOalsa_dummy_interface_test`

### Functions

- int **IOInit** (int fragsize, float samplerate, **IOProcessEvent\_t** proc\_event, void \*proc\_↔ handle, **IOStartedEvent\_t** start\_event, void \*start\_handle, **IOStoppedEvent\_t** stop\_↔ event, void \*stop\_handle, void \*\*handle)  
*IO library initialization function, called by framework after loading this IO library into the MHA process.*
- int **IOPrepare** (void \*handle, int nch\_in, int nch\_out)  
*IO library prepare function, called after the MHA prepared the processing plugins.*
- int **IOStart** (void \*handle)
- int **IOStop** (void \*handle)
- int **IORelease** (void \*handle)
- int **IOSetVar** (void \*handle, const char \*command, char \*retval, unsigned int maxretlen)
- const char \* **IOStrError** (void \*handle, int err)
- void **IODestroy** (void \*handle)
- void **dummy\_interface\_test** (void)

## Variables

- static char **user\_err\_msg** [MAX\_USER\_ERR]

## 6.133.1 Macro Definition Documentation

6.133.1.1 #define DBG(  
                   x ) fprintf(stderr,"%s:%d\n",\_\_FILE\_\_,\_\_LINE\_\_)

6.133.1.2 #define ERR\_SUCCESS 0

6.133.1.3 #define ERR\_IHANDLE -1

6.133.1.4 #define ERR\_USER -1000

6.133.1.5 #define MAX\_USER\_ERR 0x500

6.133.1.6 #define IOInit MHA\_STATIC\_MHAIOalsa\_IOInit

6.133.1.7 #define IOPrepare MHA\_STATIC\_MHAIOalsa\_IOPrepare

6.133.1.8 #define IOStart MHA\_STATIC\_MHAIOalsa\_IOStart

6.133.1.9 #define IOStop MHA\_STATIC\_MHAIOalsa\_IOStop

6.133.1.10 #define IORelease MHA\_STATIC\_MHAIOalsa\_IORelease

6.133.1.11 #define IOSetVar MHA\_STATIC\_MHAIOalsa\_IOSetVar

6.133.1.12 #define IOStrError MHA\_STATIC\_MHAIOalsa\_IOStrError

6.133.1.13 #define IODestroy MHA\_STATIC\_MHAIOalsa\_IODestroy

6.133.1.14 #define dummy\_interface\_test MHA\_STATIC\_MHAIOalsa\_dummy\_interface\_test

## 6.133.2 Function Documentation

6.133.2.1 int IOInit (  
                   int *fragsize*,  
                   float *samplerate*,  
                   IOProcessEvent\_t *proc\_event*,  
                   void \* *proc\_handle*,  
                   IOStartedEvent\_t *start\_event*,  
                   void \* *start\_handle*,  
                   IOStoppedEvent\_t *stop\_event*,  
                   void \* *stop\_handle*,  
                   void \*\* *handle* )

IO library initialization function, called by framework after loading this IO library into the MHA process.

Gives plugin callback functions and callback handles to interact with the MHA framework.

## Parameters

<i>handle</i>	output parameter. IO library returns pointer to void to the caller via this parameter. All other function calls from the MHA framework will use this handle.
---------------	--

6.133.2.2 int IOPrepare (  
                   void \* *handle*,  
                   int *nch\_in*,  
                   int *nch\_out* )

IO library prepare function, called after the MHA prepared the processing plugins.

6.133.2.3 int IOStart (  
                   void \* *handle* )

6.133.2.4 int IOStop (  
                   void \* *handle* )

6.133.2.5 int IORelease (  
                   void \* *handle* )

6.133.2.6 int IOSetVar (  
                   void \* *handle*,  
                   const char \* *command*,  
                   char \* *retval*,  
                   unsigned int *maxretlen* )

6.133.2.7 const char\* IOStrError (  
                   void \* *handle*,  
                   int *err* )

6.133.2.8 void IODestroy (  
                   void \* *handle* )

6.133.2.9 void dummy\_interface\_test (  
                   void )

## 6.133.3 Variable Documentation

6.133.3.1 char user\_err\_msg[MAX\_USER\_ERR] [static]

## 6.134 MHAIOFile.cpp File Reference

## Classes

- class **io\_file\_t**  
     *File IO.*

## Macros

- #define **DEBUG**(x) std::cerr << \_\_FILE\_\_ << ":" << \_\_LINE\_\_ << " " << #x " = " << x << std::endl
- #define **ERR\_SUCCESS** 0
- #define **ERR\_IHANDLE** -1
- #define **ERR\_USER** -1000
- #define **MAX\_USER\_ERR** 0x500
- #define **IOInit** MHA\_STATIC\_MHAIOFile\_IOInit
- #define **IOPrepare** MHA\_STATIC\_MHAIOFile\_IOPrepare
- #define **IOStart** MHA\_STATIC\_MHAIOFile\_IOStart
- #define **IOStop** MHA\_STATIC\_MHAIOFile\_IOStop
- #define **IORelease** MHA\_STATIC\_MHAIOFile\_IORelease
- #define **IOSetVar** MHA\_STATIC\_MHAIOFile\_IOSetVar
- #define **IOStrError** MHA\_STATIC\_MHAIOFile\_IOStrError
- #define **IODestroy** MHA\_STATIC\_MHAIOFile\_IODestroy
- #define **dummy\_interface\_test** MHA\_STATIC\_MHAIOFile\_dummy\_interface\_test

## Functions

- int **IOInit** (int fragsize, float samplerate, **IOProcessEvent\_t** proc\_event, void \*proc\_↔ handle, **IOStartedEvent\_t** start\_event, void \*start\_handle, **IOStoppedEvent\_t** stop\_↔ event, void \*stop\_handle, void \*\*handle)
- int **IOPrepare** (void \*handle, int nch\_in, int nch\_out)
- int **IOStart** (void \*handle)
- int **IOStop** (void \*handle)
- int **IORelease** (void \*handle)
- int **IOSetVar** (void \*handle, const char \*command, char \*retval, unsigned int maxretlen)
- const char \* **IOStrError** (void \*handle, int err)
- void **IODestroy** (void \*handle)
- void **dummy\_interface\_test** (void)

## Variables

- static char **user\_err\_msg** [**MAX\_USER\_ERR**]

### 6.134.1 Macro Definition Documentation

6.134.1.1 #define **DEBUG**(  
                   x ) std::cerr << \_\_FILE\_\_ << ":" << \_\_LINE\_\_ << " " << #x " = " << x << std::endl

6.134.1.2 #define **ERR\_SUCCESS** 0

- 6.134.1.3 #define ERR\_IHANDLE -1
- 6.134.1.4 #define ERR\_USER -1000
- 6.134.1.5 #define MAX\_USER\_ERR 0x500
- 6.134.1.6 #define IOInit MHA\_STATIC\_MHAIOFile\_IOInit
- 6.134.1.7 #define IOPrepare MHA\_STATIC\_MHAIOFile\_IOPrepare
- 6.134.1.8 #define IOStart MHA\_STATIC\_MHAIOFile\_IOStart
- 6.134.1.9 #define IOStop MHA\_STATIC\_MHAIOFile\_IOStop
- 6.134.1.10 #define IORelease MHA\_STATIC\_MHAIOFile\_IORelease
- 6.134.1.11 #define IOSetVar MHA\_STATIC\_MHAIOFile\_IOSetVar
- 6.134.1.12 #define IOStrError MHA\_STATIC\_MHAIOFile\_IOStrError
- 6.134.1.13 #define IODestroy MHA\_STATIC\_MHAIOFile\_IODestroy
- 6.134.1.14 #define dummy\_interface\_test MHA\_STATIC\_MHAIOFile\_dummy\_interface\_test
- 6.134.2 Function Documentation
  - 6.134.2.1 int IOInit (
    - int *fragsize*,
    - float *samplerate*,
    - IOProcessEvent\_t *proc\_event*,
    - void \* *proc\_handle*,
    - IOStartedEvent\_t *start\_event*,
    - void \* *start\_handle*,
    - IOStoppedEvent\_t *stop\_event*,
    - void \* *stop\_handle*,
    - void \*\* *handle* )
  - 6.134.2.2 int IOPrepare (
    - void \* *handle*,
    - int *nch\_in*,
    - int *nch\_out* )
  - 6.134.2.3 int IOStart (
    - void \* *handle* )



6.134.2.4 int IOStop (  
    void \* *handle* )

6.134.2.5 int IORelease (  
    void \* *handle* )

6.134.2.6 int IOSetVar (  
    void \* *handle*,  
    const char \* *command*,  
    char \* *retval*,  
    unsigned int *maxretlen* )

6.134.2.7 const char\* IOStrError (  
    void \* *handle*,  
    int *err* )

6.134.2.8 void IODestroy (  
    void \* *handle* )

6.134.2.9 void dummy\_interface\_test (  
    void )

### 6.134.3 Variable Documentation

6.134.3.1 char user\_err\_msg[MAX\_USER\_ERR] [static]

## 6.135 MHAIOJack.cpp File Reference

### Classes

- class **MHAIOJack::io\_jack\_t**  
*Main class for JACK IO.*

### Namespaces

- **MHAIOJack**  
*JACK IO.*

## Macros

- `#define ERR_SUCCESS 0`
- `#define ERR_IHANDLE -1`
- `#define ERR_USER -1000`
- `#define MAX_USER_ERR 0x500`
- `#define IOInit MHA_STATIC_MHAIOJack_IOInit`
- `#define IOPrepare MHA_STATIC_MHAIOJack_IOPrepare`
- `#define IOStart MHA_STATIC_MHAIOJack_IOStart`
- `#define IOStop MHA_STATIC_MHAIOJack_IOStop`
- `#define IORelease MHA_STATIC_MHAIOJack_IORelease`
- `#define IOSetVar MHA_STATIC_MHAIOJack_IOSetVar`
- `#define IOStrError MHA_STATIC_MHAIOJack_IOStrError`
- `#define IODestroy MHA_STATIC_MHAIOJack_IODestroy`
- `#define dummy_interface_test MHA_STATIC_MHAIOJack_dummy_interface_test`

## Functions

- int **IOInit** (int fragsize, float samplerate, **IOProcessEvent\_t** proc\_event, void \*proc\_↔ handle, **IOStartedEvent\_t** start\_event, void \*start\_handle, **IOStoppedEvent\_t** stop\_↔ event, void \*stop\_handle, void \*\*handle)
- int **IOPrepare** (void \*handle, int nch\_in, int nch\_out)
- int **IOStart** (void \*handle)
- int **IOStop** (void \*handle)
- int **IORelease** (void \*handle)
- int **IOSetVar** (void \*handle, const char \*command, char \*retval, unsigned int maxretlen)
- const char \* **IOStrError** (void \*handle, int err)
- void **IODestroy** (void \*handle)
- void **dummy\_interface\_test** (void)

## Variables

- static char **user\_err\_msg** [**MAX\_USER\_ERR**] = ""

### 6.135.1 Macro Definition Documentation

6.135.1.1 `#define ERR_SUCCESS 0`

6.135.1.2 `#define ERR_IHANDLE -1`

6.135.1.3 `#define ERR_USER -1000`

6.135.1.4 `#define MAX_USER_ERR 0x500`

- 6.135.1.5 #define IOInit MHA\_STATIC\_MHAIOJack\_IOInit
- 6.135.1.6 #define IOPrepare MHA\_STATIC\_MHAIOJack\_IOPrepare
- 6.135.1.7 #define IOStart MHA\_STATIC\_MHAIOJack\_IOStart
- 6.135.1.8 #define IOStop MHA\_STATIC\_MHAIOJack\_IOStop
- 6.135.1.9 #define IORelease MHA\_STATIC\_MHAIOJack\_IORelease
- 6.135.1.10 #define IOSetVar MHA\_STATIC\_MHAIOJack\_IOSetVar
- 6.135.1.11 #define IOStrError MHA\_STATIC\_MHAIOJack\_IOStrError
- 6.135.1.12 #define IODestroy MHA\_STATIC\_MHAIOJack\_IODestroy
- 6.135.1.13 #define dummy\_interface\_test MHA\_STATIC\_MHAIOJack\_dummy\_interface\_test

## 6.135.2 Function Documentation

6.135.2.1 int IOInit (  
    int *fragsize*,  
    float *samplerate*,  
    IOProcessEvent\_t *proc\_event*,  
    void \* *proc\_handle*,  
    IOStartedEvent\_t *start\_event*,  
    void \* *start\_handle*,  
    IOStoppedEvent\_t *stop\_event*,  
    void \* *stop\_handle*,  
    void \*\* *handle* )

6.135.2.2 int IOPrepare (  
    void \* *handle*,  
    int *nch\_in*,  
    int *nch\_out* )

6.135.2.3 int IOStart (  
    void \* *handle* )

6.135.2.4 int IOStop (  
    void \* *handle* )

6.135.2.5 int IORelease (  
    void \* *handle* )

6.135.2.6 int IOSetVar (  
     void \* *handle*,  
     const char \* *command*,  
     char \* *retval*,  
     unsigned int *maxretlen* )

6.135.2.7 const char\* IOStrError (  
     void \* *handle*,  
     int *err* )

6.135.2.8 void IODestroy (  
     void \* *handle* )

6.135.2.9 void dummy\_interface\_test (  
     void )

### 6.135.3 Variable Documentation

6.135.3.1 char user\_err\_msg[MAX\_USER\_ERR] = "" [static]

## 6.136 MHAIOJackdb.cpp File Reference

### Classes

- class **MHAIOJackdb::io\_jack\_t**  
     *Main class for JACK IO.*

### Namespaces

- **MHAIOJackdb**

### Macros

- #define **ERR\_SUCCESS** 0
- #define **ERR\_IHANDLE** -1
- #define **ERR\_USER** -1000
- #define **MAX\_USER\_ERR** 0x500
- #define **IOInit** MHA\_STATIC\_MHAIOJackdb\_IOInit
- #define **IOPrepare** MHA\_STATIC\_MHAIOJackdb\_IOPrepare
- #define **IOStart** MHA\_STATIC\_MHAIOJackdb\_IOStart
- #define **IOStop** MHA\_STATIC\_MHAIOJackdb\_IOStop
- #define **IORelease** MHA\_STATIC\_MHAIOJackdb\_IORelease
- #define **IOSetVar** MHA\_STATIC\_MHAIOJackdb\_IOSetVar
- #define **IOStrError** MHA\_STATIC\_MHAIOJackdb\_IOStrError
- #define **IODestroy** MHA\_STATIC\_MHAIOJackdb\_IODestroy
- #define **dummy\_interface\_test** MHA\_STATIC\_MHAIOJackdb\_dummy\_interface\_test

## Functions

- int **IOInit** (int fragsize, float samplerate, **IOProcessEvent\_t** proc\_event, void \*proc\_↔ handle, **IOStartedEvent\_t** start\_event, void \*start\_handle, **IOStoppedEvent\_t** stop\_↔ event, void \*stop\_handle, void \*\*handle)
- int **IOPrepare** (void \*handle, int nch\_in, int nch\_out)
- int **IOStart** (void \*handle)
- int **IOStop** (void \*handle)
- int **IORelease** (void \*handle)
- int **IOSetVar** (void \*handle, const char \*command, char \*retval, unsigned int maxretlen)
- const char \* **IOStrError** (void \*handle, int err)
- void **IODestroy** (void \*handle)
- void **dummy\_interface\_test** (void)

## Variables

- static char **user\_err\_msg** [**MAX\_USER\_ERR**] = ""

### 6.136.1 Macro Definition Documentation

6.136.1.1 #define ERR\_SUCCESS 0

6.136.1.2 #define ERR\_IHANDLE -1

6.136.1.3 #define ERR\_USER -1000

6.136.1.4 #define MAX\_USER\_ERR 0x500

6.136.1.5 #define IOInit MHA\_STATIC\_MHAIOJackdb\_IOInit

6.136.1.6 #define IOPrepare MHA\_STATIC\_MHAIOJackdb\_IOPrepare

6.136.1.7 #define IOStart MHA\_STATIC\_MHAIOJackdb\_IOStart

6.136.1.8 #define IOStop MHA\_STATIC\_MHAIOJackdb\_IOStop

6.136.1.9 #define IORelease MHA\_STATIC\_MHAIOJackdb\_IORelease

6.136.1.10 #define IOSetVar MHA\_STATIC\_MHAIOJackdb\_IOSetVar

6.136.1.11 #define IOStrError MHA\_STATIC\_MHAIOJackdb\_IOStrError

6.136.1.12 #define IODestroy MHA\_STATIC\_MHAIOJackdb\_IODestroy

6.136.1.13 #define dummy\_interface\_test MHA\_STATIC\_MHAIOJackdb\_dummy\_interface\_test

## 6.136.2 Function Documentation

6.136.2.1 int IOInit (  
    int *fragsize*,  
    float *samplerate*,  
    IOProcessEvent\_t *proc\_event*,  
    void \* *proc\_handle*,  
    IOStartedEvent\_t *start\_event*,  
    void \* *start\_handle*,  
    IOStoppedEvent\_t *stop\_event*,  
    void \* *stop\_handle*,  
    void \*\* *handle* )

6.136.2.2 int IOPrepare (  
    void \* *handle*,  
    int *nch\_in*,  
    int *nch\_out* )

6.136.2.3 int IOStart (  
    void \* *handle* )

6.136.2.4 int IOStop (  
    void \* *handle* )

6.136.2.5 int IORelease (  
    void \* *handle* )

6.136.2.6 int IOSetVar (  
    void \* *handle*,  
    const char \* *command*,  
    char \* *retval*,  
    unsigned int *maxretlen* )

6.136.2.7 const char\* IOStrError (  
    void \* *handle*,  
    int *err* )

6.136.2.8 void IODestroy (  
    void \* *handle* )

6.136.2.9 void dummy\_interface\_test (  
    void )

## 6.136.3 Variable Documentation

6.136.3.1 `char user_err_msg[MAX_USER_ERR] = ""` [static]

## 6.137 MHAIOParser.cpp File Reference

### Classes

- class **io\_parser\_t**  
*Main class for Parser IO.*

### Macros

- #define **ERR\_SUCCESS** 0
- #define **ERR\_IHANDLE** -1
- #define **ERR\_USER** -1000
- #define **MAX\_USER\_ERR** 0x500
- #define **IOInit** MHA\_STATIC\_MHAIOParser\_IOInit
- #define **IOPrepare** MHA\_STATIC\_MHAIOParser\_IOPrepare
- #define **IOStart** MHA\_STATIC\_MHAIOParser\_IOStart
- #define **IOStop** MHA\_STATIC\_MHAIOParser\_IOStop
- #define **IORelease** MHA\_STATIC\_MHAIOParser\_IORelease
- #define **IOSetVar** MHA\_STATIC\_MHAIOParser\_IOSetVar
- #define **IOStrError** MHA\_STATIC\_MHAIOParser\_IOStrError
- #define **IODestroy** MHA\_STATIC\_MHAIOParser\_IODestroy
- #define **dummy\_interface\_test** MHA\_STATIC\_MHAIOParser\_dummy\_interface\_test

### Functions

- int **IOInit** (int fragsize, float, **IOProcessEvent\_t** proc\_event, void \*proc\_handle, **IOStartedEvent\_t** start\_event, void \*start\_handle, **IOStoppedEvent\_t** stop\_event, void \*stop\_handle, void \*\*handle)
- int **IOPrepare** (void \*handle, int nch\_in, int nch\_out)
- int **IOStart** (void \*handle)
- int **IOStop** (void \*handle)
- int **IORelease** (void \*handle)
- int **IOSetVar** (void \*handle, const char \*command, char \*retval, unsigned int maxretlen)
- const char \* **IOStrError** (void \*handle, int err)
- void **IODestroy** (void \*handle)
- void **dummy\_interface\_test** (void)

### Variables

- static char **user\_err\_msg** [MAX\_USER\_ERR]

### 6.137.1 Macro Definition Documentation

6.137.1.1 #define ERR\_SUCCESS 0

6.137.1.2 #define ERR\_IHANDLE -1

6.137.1.3 #define ERR\_USER -1000

6.137.1.4 #define MAX\_USER\_ERR 0x500

6.137.1.5 #define IOInit MHA\_STATIC\_MHAIOParser\_IOInit

6.137.1.6 #define IOPrepare MHA\_STATIC\_MHAIOParser\_IOPrepare

6.137.1.7 #define IOStart MHA\_STATIC\_MHAIOParser\_IOStart

6.137.1.8 #define IOStop MHA\_STATIC\_MHAIOParser\_IOStop

6.137.1.9 #define IORelease MHA\_STATIC\_MHAIOParser\_IORelease

6.137.1.10 #define IOSetVar MHA\_STATIC\_MHAIOParser\_IOSetVar

6.137.1.11 #define IOStrError MHA\_STATIC\_MHAIOParser\_IOStrError

6.137.1.12 #define IODestroy MHA\_STATIC\_MHAIOParser\_IODestroy

6.137.1.13 #define dummy\_interface\_test MHA\_STATIC\_MHAIOParser\_dummy\_interface\_test

### 6.137.2 Function Documentation

6.137.2.1 int IOInit (  
    int *fragsize*,  
    float ,  
    IOProcessEvent\_t *proc\_event*,  
    void \* *proc\_handle*,  
    IOStartedEvent\_t *start\_event*,  
    void \* *start\_handle*,  
    IOStoppedEvent\_t *stop\_event*,  
    void \* *stop\_handle*,  
    void \*\* *handle* )

6.137.2.2 int IOPrepare (  
    void \* *handle*,  
    int *nch\_in*,  
    int *nch\_out* )



6.137.2.3 int IOStart (  
    void \* *handle* )

6.137.2.4 int IOStop (  
    void \* *handle* )

6.137.2.5 int IORelease (  
    void \* *handle* )

6.137.2.6 int IOSetVar (  
    void \* *handle*,  
    const char \* *command*,  
    char \* *retval*,  
    unsigned int *maxretlen* )

6.137.2.7 const char\* IOStrError (  
    void \* *handle*,  
    int *err* )

6.137.2.8 void IODestroy (  
    void \* *handle* )

6.137.2.9 void dummy\_interface\_test (  
    void )

### 6.137.3 Variable Documentation

6.137.3.1 char user\_err\_msg[MAX\_USER\_ERR] [static]

## 6.138 MHAIOPortAudio.cpp File Reference

### Classes

- class **MHAIOPortAudio::device\_info\_t**
- class **MHAIOPortAudio::io\_portaudio\_t**  
*Main class for Portaudio sound IO.*

### Namespaces

- **MHAIOPortAudio**

## Macros

- #define **ERR\_SUCCESS** 0
- #define **ERR\_IHANDLE** -1
- #define **ERR\_USER** -1000
- #define **MAX\_USER\_ERR** 0x500
- #define **IOInit** MHA\_STATIC\_MHAIOPortAudio\_IOInit
- #define **IOPrepare** MHA\_STATIC\_MHAIOPortAudio\_IOPrepare
- #define **IOStart** MHA\_STATIC\_MHAIOPortAudio\_IOStart
- #define **IOStop** MHA\_STATIC\_MHAIOPortAudio\_IOStop
- #define **IORelease** MHA\_STATIC\_MHAIOPortAudio\_IORelease
- #define **IOSetVar** MHA\_STATIC\_MHAIOPortAudio\_IOSetVar
- #define **IOStrError** MHA\_STATIC\_MHAIOPortAudio\_IOStrError
- #define **IODestroy** MHA\_STATIC\_MHAIOPortAudio\_IODestroy
- #define **dummy\_interface\_test** MHA\_STATIC\_MHAIOPortAudio\_dummy\_interface\_↔  
test

## Functions

- static std::string **MHAIOPortAudio::parserFriendlyName** (const std::string &in)
- int **portaudio\_callback** (const void \*input, void \*output, unsigned long frameCount, const PaStreamCallbackTimeInfo \*timeInfo, PaStreamCallbackFlags statusFlags, void \*user↔  
Data)
- int **IOInit** (int fragsize, float samplerate, **IOProcessEvent\_t** proc\_event, void \*proc\_↔  
handle, **IOStartedEvent\_t** start\_event, void \*start\_handle, **IOStoppedEvent\_t** stop\_↔  
event, void \*stop\_handle, void \*\*handle)
- int **IOPrepare** (void \*handle, int nch\_in, int nch\_out)
- int **IOStart** (void \*handle)
- int **IOStop** (void \*handle)
- int **IORelease** (void \*handle)
- int **IOSetVar** (void \*handle, const char \*command, char \*retval, unsigned int maxretlen)
- const char \* **IOStrError** (void \*handle, int err)
- void **IODestroy** (void \*handle)
- void **dummy\_interface\_test** (void)

## Variables

- static char **user\_err\_msg [MAX\_USER\_ERR]** = ""
- PaStreamCallback **portaudio\_callback**

### 6.138.1 Macro Definition Documentation

6.138.1.1 #define ERR\_SUCCESS 0

6.138.1.2 #define ERR\_IHANDLE -1

6.138.1.3 #define ERR\_USER -1000

6.138.1.4 #define MAX\_USER\_ERR 0x500

6.138.1.5 #define IOInit MHA\_STATIC\_MHAIOPortAudio\_IOInit

6.138.1.6 #define IOPrepare MHA\_STATIC\_MHAIOPortAudio\_IOPrepare

6.138.1.7 #define IOStart MHA\_STATIC\_MHAIOPortAudio\_IOStart

6.138.1.8 #define IOStop MHA\_STATIC\_MHAIOPortAudio\_IOStop

6.138.1.9 #define IORelease MHA\_STATIC\_MHAIOPortAudio\_IORelease

6.138.1.10 #define IOSetVar MHA\_STATIC\_MHAIOPortAudio\_IOSetVar

6.138.1.11 #define IOStrError MHA\_STATIC\_MHAIOPortAudio\_IOStrError

6.138.1.12 #define IODestroy MHA\_STATIC\_MHAIOPortAudio\_IODestroy

6.138.1.13 #define dummy\_interface\_test MHA\_STATIC\_MHAIOPortAudio\_dummy\_interface\_test

### 6.138.2 Function Documentation

6.138.2.1 int portaudio\_callback (  
    const void \* *input*,  
    void \* *output*,  
    unsigned long *frameCount*,  
    const PaStreamCallbackTimeInfo \* *timeInfo*,  
    PaStreamCallbackFlags *statusFlags*,  
    void \* *userData* )

6.138.2.2 int IOInit (  
    int *fragsize*,  
    float *samplerate*,  
    IOProcessEvent\_t *proc\_event*,  
    void \* *proc\_handle*,  
    IOStartedEvent\_t *start\_event*,  
    void \* *start\_handle*,  
    IOStoppedEvent\_t *stop\_event*,  
    void \* *stop\_handle*,  
    void \*\* *handle* )

- 6.138.2.3 int IOPrepare (  
     void \* *handle*,  
     int *nch\_in*,  
     int *nch\_out* )
- 6.138.2.4 int IOStart (  
     void \* *handle* )
- 6.138.2.5 int IOStop (  
     void \* *handle* )
- 6.138.2.6 int IORelease (  
     void \* *handle* )
- 6.138.2.7 int IOSetVar (  
     void \* *handle*,  
     const char \* *command*,  
     char \* *retval*,  
     unsigned int *maxretlen* )
- 6.138.2.8 const char\* IOStrError (  
     void \* *handle*,  
     int *err* )
- 6.138.2.9 void IODestroy (  
     void \* *handle* )
- 6.138.2.10 void dummy\_interface\_test (  
     void )

### 6.138.3 Variable Documentation

- 6.138.3.1 char user\_err\_msg[MAX\_USER\_ERR] = "" [static]
- 6.138.3.2 PaStreamCallback portaudio\_callback

## 6.139 MHAOTCP.cpp File Reference

### Classes

- class **io\_tcp\_parser\_t**  
     *The parser interface of the IOTCP library.*
- class **io\_tcp\_sound\_t**  
     *Sound data handling of io tcp library.*
- union **io\_tcp\_sound\_t::float\_union**  
     *This union helps in conversion of floats from host byte order to network byte order and back again.*
- class **io\_tcp\_fwcb\_t**  
     *TCP sound-io library's interface to the framework callbacks.*
- class **io\_tcp\_t**  
     *The tcp sound io library.*

## Macros

- #define **ERR\_SUCCESS** 0
- #define **ERR\_IHANDLE** -1
- #define **ERR\_USER** -1000
- #define **MAX\_USER\_ERR** 0x2000
- #define **MHA\_ErrorMsg2**(x, y) **MHA\_Error**(\_\_FILE\_\_, \_\_LINE\_\_, (x), (y))
- #define **MHA\_ErrorMsg3**(x, y, z) **MHA\_Error**(\_\_FILE\_\_, \_\_LINE\_\_, (x), (y), (z))
- #define **MIN\_TCP\_PORT** 0
- #define **MIN\_TCP\_PORT\_STR** "0"
- #define **MAX\_TCP\_PORT** 65535
- #define **MAX\_TCP\_PORT\_STR** "65535"
- #define **IOInit** MHA\_STATIC\_MHAIOTCP\_IOInit
- #define **IOPrepare** MHA\_STATIC\_MHAIOTCP\_IOPrepare
- #define **IOStart** MHA\_STATIC\_MHAIOTCP\_IOStart
- #define **IOStop** MHA\_STATIC\_MHAIOTCP\_IOStop
- #define **IORelease** MHA\_STATIC\_MHAIOTCP\_IORelease
- #define **IOSetVar** MHA\_STATIC\_MHAIOTCP\_IOSetVar
- #define **IOStrError** MHA\_STATIC\_MHAIOTCP\_IOStrError
- #define **IODestroy** MHA\_STATIC\_MHAIOTCP\_IODestroy
- #define **dummy\_interface\_test** MHA\_STATIC\_MHAIOTCP\_dummy\_interface\_test

## Functions

- static int **copy\_error** (**MHA\_Error** &e)
- static void \* **thread\_startup\_function** (void \*parameter)
- int **IOInit** (int fragsize, float samplerate, **IOProcessEvent\_t** proc\_event, void \*proc\_↔ handle, **IOStartedEvent\_t** start\_event, void \*start\_handle, **IOStoppedEvent\_t** stop\_↔ event, void \*stop\_handle, void \*\*handle)
- int **IOPrepare** (void \*handle, int num\_inchannels, int num\_outchannels)
- int **IOStart** (void \*handle)
- int **IOStop** (void \*handle)
- int **IORelease** (void \*handle)
- int **IOSetVar** (void \*handle, const char \*cmd, char \*retval, unsigned int len)
- const char \* **IOStrError** (void \*handle, int err)
- void **IODestroy** (void \*handle)
- void **dummy\_interface\_test** (void)

## Variables

- static char **user\_err\_msg** [**MAX\_USER\_ERR**]

**6.139.1 Macro Definition Documentation****6.139.1.1 #define ERR\_SUCCESS 0****6.139.1.2 #define ERR\_IHANDLE -1****6.139.1.3 #define ERR\_USER -1000****6.139.1.4 #define MAX\_USER\_ERR 0x2000****6.139.1.5 #define MHA\_ErrorMsg2(  
    x,  
    y ) MHA\_Error(\_\_FILE\_\_, \_\_LINE\_\_, (x), (y))****6.139.1.6 #define MHA\_ErrorMsg3(  
    x,  
    y,  
    z ) MHA\_Error(\_\_FILE\_\_, \_\_LINE\_\_, (x), (y), (z))****6.139.1.7 #define MIN\_TCP\_PORT 0****6.139.1.8 #define MIN\_TCP\_PORT\_STR "0"****6.139.1.9 #define MAX\_TCP\_PORT 65535****6.139.1.10 #define MAX\_TCP\_PORT\_STR "65535"****6.139.1.11 #define IOInit MHA\_STATIC\_MHAIOTCP\_IOInit****6.139.1.12 #define IOPrepare MHA\_STATIC\_MHAIOTCP\_IOPrepare****6.139.1.13 #define IOStart MHA\_STATIC\_MHAIOTCP\_IOStart****6.139.1.14 #define IOStop MHA\_STATIC\_MHAIOTCP\_IOStop****6.139.1.15 #define IORelease MHA\_STATIC\_MHAIOTCP\_IORelease****6.139.1.16 #define IOSetVar MHA\_STATIC\_MHAIOTCP\_IOSetVar****6.139.1.17 #define IOStrError MHA\_STATIC\_MHAIOTCP\_IOStrError****6.139.1.18 #define IODestroy MHA\_STATIC\_MHAIOTCP\_IODestroy****6.139.1.19 #define dummy\_interface\_test MHA\_STATIC\_MHAIOTCP\_dummy\_interface\_test**

## 6.139.2 Function Documentation

6.139.2.1 static int copy\_error (  
MHA\_Error & e ) [static]

6.139.2.2 static void\* thread\_startup\_function (  
void \* parameter ) [static]

6.139.2.3 int IOInit (  
int fragsize,  
float samplerate,  
IOProcessEvent\_t proc\_event,  
void \* proc\_handle,  
IOStartedEvent\_t start\_event,  
void \* start\_handle,  
IOStoppedEvent\_t stop\_event,  
void \* stop\_handle,  
void \*\* handle )

6.139.2.4 int IOPrepare (  
void \* handle,  
int num\_inchannels,  
int num\_outchannels )

6.139.2.5 int IOStart (  
void \* handle )

6.139.2.6 int IOStop (  
void \* handle )

6.139.2.7 int IORelease (  
void \* handle )

6.139.2.8 int IOSetVar (  
void \* handle,  
const char \* cmd,  
char \* retval,  
unsigned int len )

6.139.2.9 const char\* IOStrError (  
void \* handle,  
int err )

6.139.2.10 void IODestroy (  
void \* handle )

6.139.2.11 void `dummy_interface_test` (  
void )

### 6.139.3 Variable Documentation

6.139.3.1 char `user_err_msg`[MAX\_USER\_ERR] [static]

## 6.140 mhajack.cpp File Reference

### Functions

- static void `jack_error_handler` (const char \*msg)
- static int `dummy_jack_proc_cb` (jack\_nframes\_t, void \*)
- void `make_friendly_number` (jack\_default\_audio\_sample\_t &x)

### Variables

- char `last_jack_err_msg` [MAX\_USER\_ERR] = ""
- int `last_jack_err` = 0

### 6.140.1 Function Documentation

6.140.1.1 static void `jack_error_handler` (  
const char \* *msg* ) [static]

6.140.1.2 static int `dummy_jack_proc_cb` (  
jack\_nframes\_t,  
void \* ) [static]

6.140.1.3 void `make_friendly_number` (  
jack\_default\_audio\_sample\_t & *x* ) [inline]

### 6.140.2 Variable Documentation

6.140.2.1 char `last_jack_err_msg`[MAX\_USER\_ERR] = ""

6.140.2.2 int `last_jack_err` = 0

## 6.141 mhajack.h File Reference

### Classes

- class `MHAJack::port_t`  
*Class for one channel/port.*
- class `MHAJack::client_t`  
*Generic asynchronous JACK client.*
- class `MHAJack::client_noncont_t`  
*Generic client for synchronous playback and recording of waveform fragments.*
- class `MHAJack::client_avg_t`  
*Generic JACK client for averaging a system response across time.*



## Namespaces

- **MHAJack**

*Classes and functions for openMHA and JACK interaction.*

## Macros

- #define **MHAJACK\_FW\_STARTED** 1
- #define **MHAJACK\_STOPPED** 2
- #define **MHAJACK\_STARTING** 8
- #define **IO\_ERROR\_JACK** 11
- #define **IO\_ERROR\_MHAJACKLIB** 12
- #define **MAX\_USER\_ERR** 0x500

## Functions

- void **MHAJack::io** (**mha\_wave\_t** \*s\_out, **mha\_wave\_t** \*s\_in, const std::string &name, const std::vector< std::string > &p\_out, const std::vector< std::string > &p\_in, float \*srate=NULL, unsigned int \*fragsize=NULL, bool use\_jack\_transport=false)  
*Functional form of generic client for synchronous playback and recording of waveform fragments.*
- std::vector< unsigned int > **MHAJack::get\_port\_capture\_latency** (const std::vector< std::string > &ports)  
*Return the JACK port latency of ports.*
- std::vector< int > **MHAJack::get\_port\_capture\_latency\_int** (const std::vector< std::string > &ports)  
*Return the JACK port latency of ports.*
- std::vector< unsigned int > **MHAJack::get\_port\_playback\_latency** (const std::vector< std::string > &ports)  
*Return the JACK port latency of ports.*
- std::vector< int > **MHAJack::get\_port\_playback\_latency\_int** (const std::vector< std::string > &ports)

## Variables

- char **last\_jack\_err\_msg** [**MAX\_USER\_ERR**]

### 6.141.1 Macro Definition Documentation

6.141.1.1 `#define MHAJACK_FW_STARTED 1`

6.141.1.2 `#define MHAJACK_STOPPED 2`

6.141.1.3 `#define MHAJACK_STARTING 8`

6.141.1.4 `#define IO_ERROR_JACK 11`

6.141.1.5 `#define IO_ERROR_MHAJACKLIB 12`

6.141.1.6 `#define MAX_USER_ERR 0x500`

### 6.141.2 Variable Documentation

6.141.2.1 `char last_jack_err_msg[MAX_USER_ERR]`

## 6.142 mhamain.cpp File Reference

### Classes

- class **mhaserver\_t**  
*MHA Framework listening on TCP port for commands.*

### Macros

- `#define MAX_LINE_LENGTH 0x100000`
- `#define HELP_TEXT`
- `#define GREETING_TEXT`

### Functions

- void **create\_lock** (unsigned int p, std::string s)
- void **remove\_lock** (unsigned int p)
- int **mhamain** (int argc, char \*argv[])

## 6.142.1 Macro Definition Documentation

6.142.1.1 #define MAX\_LINE\_LENGTH 0x100000

6.142.1.2 #define HELP\_TEXT

6.142.1.3 #define GREETING\_TEXT

## 6.142.2 Function Documentation

6.142.2.1 void create\_lock (  
                          unsigned int *p*,  
                          std::string *s* )6.142.2.2 void remove\_lock (  
                          unsigned int *p* )6.142.2.3 int mhamain (  
                  int *argc*,  
                  char \* *argv*[ ] )

## 6.143 mhapluginloader.cpp File Reference

## 6.144 mhapluginloader.h File Reference

## Classes

- class **PluginLoader::config\_file\_splitter\_t**
- class **PluginLoader::fourway\_processor\_t**  
*This abstract class defines the interface for classes that implement all types of signal domain processing supported by the MHA: wave2wave, spec2spec, wave2spec, and spec2wave.*
- class **PluginLoader::mhapluginloader\_t**
- class **MHAParser::mhapluginloader\_t**  
*Class to create a plugin loader in a parser, including the load logic.*

## Namespaces

- **PluginLoader**
- **MHAParser**  
*Name space for the openMHA-Parser configuration language.*

## Functions

- const char \* **PluginLoader::mhastrdomain** (**mha\_domain\_t**)
- void **PluginLoader::mhaconfig\_compare** (const **mhaconfig\_t** &req, const **mhaconfig\_t** &avail, const std::string &pref="")  
*Compare two **mhaconfig\_t** (p. 504) structures, and report differences as an error.*

## 6.145 mhasndfile.cpp File Reference

### Functions

- void **write\_wave** (const **mha\_wave\_t** &sig, const char \*fname, const float &srate, const int &format)
- unsigned int **validator\_channels** (std::vector< int > channel\_map, unsigned int **channels**)
- unsigned int **validator\_length** (unsigned int maxlen, unsigned int frames, unsigned int startpos)

### 6.145.1 Function Documentation

6.145.1.1 void write\_wave (  
                           const **mha\_wave\_t** & sig,  
                           const char \* *fname*,  
                           const float & *srate*,  
                           const int & *format* )

6.145.1.2 unsigned int validator\_channels (  
                           std::vector< int > *channel\_map*,  
                           unsigned int *channels* )

6.145.1.3 unsigned int validator\_length (  
                           unsigned int *maxlen*,  
                           unsigned int *frames*,  
                           unsigned int *startpos* )

## 6.146 mhasndfile.h File Reference

### Classes

- class **MHASndFile::sf\_t**
- class **MHASndFile::sf\_wave\_t**

### Namespaces

- **MHASndFile**

## Functions

- void **write\_wave** (const **mha\_wave\_t** &sig, const char \*fname, const float &srate=44100, const int &format=SF\_FORMAT\_WAV|SF\_FORMAT\_FLOAT|SF\_ENDIAN\_FILE)

### 6.146.1 Function Documentation

6.146.1.1 void write\_wave (  
     const **mha\_wave\_t** & sig,  
     const char \* fname,  
     const float & *srate* = 44100,  
     const int & *format* = SF\_FORMAT\_WAV|SF\_FORMAT\_FLOAT|SF\_ENDIAN↔  
     \_FILE )

## 6.147 multibandcompressor.cpp File Reference

### Classes

- class **multibandcompressor::plugin\_signals\_t**
- class **multibandcompressor::fftfb\_plug\_t**
- class **multibandcompressor::interface\_t**

### Namespaces

- **multibandcompressor**

## 6.148 nlms\_wave.cpp File Reference

### Classes

- class **rt\_nlms\_t**
- class **nlms\_t**

### Macros

- #define **NORMALIZATION\_TYPES** "[none default sum]"
- #define **NORM\_NONE** 0
- #define **NORM\_DEFAULT** 1
- #define **NORM\_SUM** 2
- #define **ESTIMATION\_TYPES** "[previous current]"
- #define **ESTIM\_PREV** 0
- #define **ESTIM\_CUR** 1

## Functions

- void **make\_friendly\_number\_by\_limiting** (**mha\_real\_t** &x)

### 6.148.1 Macro Definition Documentation

6.148.1.1 **#define** NORMALIZATION\_TYPES "[none default sum]"

6.148.1.2 **#define** NORM\_NONE 0

6.148.1.3 **#define** NORM\_DEFAULT 1

6.148.1.4 **#define** NORM\_SUM 2

6.148.1.5 **#define** ESTIMATION\_TYPES "[previous current]"

6.148.1.6 **#define** ESTIM\_PREV 0

6.148.1.7 **#define** ESTIM\_CUR 1

### 6.148.2 Function Documentation

6.148.2.1 void **make\_friendly\_number\_by\_limiting** (  
                  **mha\_real\_t** & x ) [*inline*]

## 6.149 noise.cpp File Reference

### Classes

- class **cfg\_t**
- class **noise\_t**

## 6.150 noisePowProposedScale.cpp File Reference

### Classes

- class **noisePowProposedScale::noisePowProposed**
- class **noisePowProposedScale::interface\_t**

### Namespaces

- **noisePowProposedScale**

## Macros

- `#define POWSPEC_FACTOR 0.0025`

### 6.150.1 Macro Definition Documentation

#### 6.150.1.1 #define POWSPEC\_FACTOR 0.0025

## 6.151 overlapadd.cpp File Reference

### Classes

- class `overlapadd::overlapadd_t`
- class `overlapadd::overlapadd_if_t`

### Namespaces

- `overlapadd`

## 6.152 plingploing.cpp File Reference

### Classes

- class `plingploing::plingploing_t`  
*Run-time configuration of the plingploing music generator.*
- class `plingploing::if_t`  
*Plugin class of the plingploing music generator.*

### Namespaces

- `plingploing`  
*All classes for the plingploing music generator live in this namespace.*

### Functions

- double `plingploing::drand` (double a, double b)

### 6.153 pluginbrowser.cpp File Reference

### 6.154 pluginbrowser.h File Reference

#### Classes

- class **plugindescription\_t**
- class **pluginloader\_t**
- class **pluginbrowser\_t**

### 6.155 prediction\_error.cpp File Reference

#### Macros

- **#define PATCH\_VAR**(var) patchbay.connect(&var.valuechanged, this, &prediction\_error::update\_cfg)
- **#define INSERT\_PATCH**(var) insert\_member(var); PATCH\_VAR(var)

#### Functions

- void **make\_friendly\_number\_by\_limiting** (mha\_real\_t &x)

#### 6.155.1 Macro Definition Documentation

6.155.1.1 **#define PATCH\_VAR**(  
                   var ) patchbay.connect(&var.valuechanged, this,  
                   &prediction\_error::update\_cfg)

6.155.1.2 **#define INSERT\_PATCH**(  
                   var ) insert\_member(var); PATCH\_VAR(var)

#### 6.155.2 Function Documentation

6.155.2.1 void **make\_friendly\_number\_by\_limiting** (  
                   mha\_real\_t &x ) [inline]

### 6.156 prediction\_error.h File Reference

#### Classes

- class **prediction\_error\_config**
- class **prediction\_error**



## 6.157 resampling.cpp File Reference

## Classes

- class **MHAPugin\_Resampling::resampling\_t**
- class **MHAPugin\_Resampling::resampling\_if\_t**

## Namespaces

- **MHAPugin\_Resampling**

## 6.158 rmslevel.cpp File Reference

## Classes

- class **mon\_t**
- class **rmslevel\_t**
- class **rmslevel\_if\_t**

## 6.159 route.cpp File Reference

## Classes

- class **route::process\_t**
- class **route::interface\_t**

## Namespaces

- **route**

## 6.160 save\_spec.cpp File Reference

## Classes

- class **save\_spec\_t**

## 6.161 save\_wave.cpp File Reference

## Classes

- class **save\_wave\_t**

## 6.162 shadowfilter\_begin.cpp File Reference

### Classes

- class **shadowfilter\_begin::cfg\_t**
- class **shadowfilter\_begin::shadowfilter\_begin\_t**

### Namespaces

- **shadowfilter\_begin**

## 6.163 shadowfilter\_end.cpp File Reference

### Classes

- class **shadowfilter\_end::cfg\_t**
- class **shadowfilter\_end::shadowfilter\_end\_t**

### Namespaces

- **shadowfilter\_end**

## 6.164 sine.cpp File Reference

### Classes

- struct **sine\_cfg\_t**
- class **sine\_t**

## 6.165 smoothgains\_bridge.cpp File Reference

### Classes

- class **smoothgains\_bridge::smoothspec\_wrap\_t**
- class **smoothgains\_bridge::overlapadd\_if\_t**

### Namespaces

- **smoothgains\_bridge**

## 6.166 softclip.cpp File Reference

## Classes

- class **cfg\_t**
- class **softclip\_t**

## 6.167 spec2wave.cpp File Reference

## Classes

- class **hanning\_ramps\_t**
- class **spec2wave\_t**
- class **spec2wave\_if\_t**

## Functions

- unsigned int **max** (unsigned int a, unsigned int b)
- unsigned int **min** (unsigned int a, unsigned int b)

## 6.167.1 Function Documentation

6.167.1.1 unsigned int max (  
                  unsigned int a,  
                  unsigned int b ) [inline]

6.167.1.2 unsigned int min (  
                  unsigned int a,  
                  unsigned int b ) [inline]

## 6.168 spechnoise.cpp File Reference

## Macros

- #define **NUM\_ENTR\_MHAORIG** 76
- #define **NUM\_ENTR\_LTASS** 25
- #define **NUM\_ENTR\_OLNOISE** 49

## Functions

- float **fhz2bandno** (float x)
- float **erb\_hz\_f\_hz** (float f\_hz)
- float **hz2hz** (float x)  
*Dummy scale transformation Hz to Hz.*
- float **bandw\_correction** (float f, float ldb)

## Variables

- float **vMHAOrigSpec** [NUM\_ENTR\_MHAORIG] = {-1.473, 0, -4.939, -10.14, -13.94, -14.83, -14.27, -15.66, -16.16, -18.22, -20.5, -21.23, -22.13, -22.58, -23.98, -26.58, -26.4, -25.15, -23.89, -25.54, -27, -30.15, -31.68, -30.14, -27.55, -25.79, -25.89, -26.11, -27.↵  
48, -30.37, -33.13, -36.23, -36.64, -36.35, -35.03, -35.48, -36.35, -37.95, -40.53, -42.37,  
-41.29, -38.49, -36.32, -34.85, -34.05, -33.81, -33.48, -34.1, -35.19, -36.29, -36.94, -37.↵  
53, -38.71, -38.7, -38.92, -40.36, -41.26, -42.19, -43.65, -44.37, -43.95, -43.15, -42.57,  
-41.57, -41.86, -42.34, -42.87, -42.35, -42.71, -42.85, -43.47, -47.43, -67.54, -76.3, -77.↵  
43, -77.43}
- float **vMHAOrigFreq** [NUM\_ENTR\_MHAORIG] = {172.266,344.532,516.797,689.↵  
063,861.329,1033.59,1205.86,1378.13,1550.39,1722.66,1894.92,2067.19,2239.↵  
46,2411.72,2583.99,2756.25,2928.52,3100.78,3273.05,3445.32,3617.58,3789.85,3962.↵  
11,4134.38,4306.64,4478.91,4651.18,4823.44,4995.71,5167.97,5340.24,5512.51,5684.↵  
77,5857.04,6029.3,6201.57,6373.83,6546.1,6718.37,6890.63,7062.9,7235.16,7407.↵  
43,7579.69,7751.96,7924.23,8096.49,8268.76,8441.02,8613.29,8785.56,8957.82,9130.↵  
09,9302.35,9474.62,9646.88,9819.15,9991.42,10163.7,10335.9,10508.2,10680.↵  
5,10852.7,11025,11197.3,11369.5,11541.8,11714.1,11886.3,12058.6,12230.9,12403.↵  
1,12575.4,12747.7,12919.9,13092.2}
- float **vLTASS\_freq** [NUM\_ENTR\_LTASS] = {63, 80, 100, 125, 160, 200, 250, 315, 400,  
500, 630, 800, 1000, 1250, 1600, 2000, 2500, 3150, 4000, 5000, 6300, 8000, 10000,  
12500, 16000}
- float **vLTASS\_combined\_lev** [NUM\_ENTR\_LTASS] = {38.6, 43.5, 54.4, 57.7, 56.8,  
60.2, 60.3, 59.0, 62.1, 62.1, 60.5, 56.8, 53.7, 53.0, 52.0, 48.7, 48.1, 46.8, 45.6, 44.5,  
44.3, 43.7, 43.4, 41.3, 40.7}
- float **vLTASS\_female\_lev** [NUM\_ENTR\_LTASS] = {37.0,36.0,37.5,40.1,53.4,62.2,60.↵  
9,58.1,61.7,61.7,60.4,58,54.3,52.3,51.7,48.8,47.3,46.7,45.3,44.6,45.2,44.9,45.0,42.↵  
8,41.1}
- float **vLTASS\_male\_lev** [NUM\_ENTR\_LTASS] = {38.6,43.5,54.4,57.7,56.8,58.2,59.↵  
7,60.0,62.4,62.6,60.6,55.7,53.1,53.7,52.3,48.7,48.9,47.0,46.0,44.4,43.3,42.4,41.9,39.↵  
8,40.4}
- float **vOlnoiseFreq** [NUM\_ENTR\_OLNOISE] = {62.5,70.1539,78.7451,88.3884,99.↵  
2126,111.362,125,140.308,157.49,176.777,198.425,222.725,250,280.616,314.98,353.↵  
553,396.85,445.449,500,561.231,629.961,707.107,793.701,890.899,1000,1122.↵  
46,1259.92,1414.21,1587.4,1781.8,2000,2244.92,2519.84,2828.43,3174.8,3563.↵  
59,4000,4489.85,5039.68,5656.85,6349.6,7127.19,8000,8979.7,10079.4,11313.↵  
7,12699.2,14254.4,16000}
- float **vOlnoiseLev** [NUM\_ENTR\_OLNOISE] = {45.9042,38.044,48.9444,61.3697,67.↵  
6953,69.7451,71.6201,71.2431,65.2754,63.2547,70.2264,72.1434,73.4433,73.2659,69.↵  
8424,71.0132,70.9577,70.3492,68.691,64.8436,64.0435,64.2879,60.5889,60.6596,60.↵  
3727,61.2003,61.8477,61.1478,61.2312,58.6584,57.2892,56.8299,56.0191,53.3018,56.↵  
0525,54.3592,50.8823,55.992,54.6768,47.2616,46.9914,45.209,50.413,47.5848,43.↵  
3215,43.754,38.5773,-0.39427,5.74224}

## 6.168.1 Macro Definition Documentation

6.168.1.1 #define NUM\_ENTR\_MHAORIG 76

6.168.1.2 #define NUM\_ENTR\_LTASS 25

6.168.1.3 `#define NUM_ENTR_OLNOISE 49`

## 6.168.2 Function Documentation

6.168.2.1 `float fhz2bandno ( float x )`

6.168.2.2 `float erb_hz_f_hz ( float f_hz )`

6.168.2.3 `float hz2hz ( float x )`

Dummy scale transformation Hz to Hz.

This function implements a dummy scale transformation (linear frequency scale).

### Parameters

<code>x</code>	Input frequency in Hz
----------------	-----------------------

### Returns

Frequency in Hz

6.168.2.4 `float bandw_correction ( float f, float ldb )`

## 6.168.3 Variable Documentation

6.168.3.1 `float vMHAOrigSpec[NUM_ENTR_MHAORIG] = {-1.473, 0, -4.939, -10.14, -13.94, -14.83, -14.27, -15.66, -16.16, -18.22, -20.5, -21.23, -22.13, -22.58, -23.98, -26.58, -26.4, -25.15, -23.89, -25.54, -27, -30.15, -31.68, -30.14, -27.55, -25.79, -25.89, -26.11, -27.48, -30.37, -33.13, -36.23, -36.64, -36.35, -35.03, -35.48, -36.35, -37.95, -40.53, -42.37, -41.29, -38.49, -36.32, -34.85, -34.05, -33.81, -33.48, -34.1, -35.19, -36.29, -36.94, -37.53, -38.71, -38.7, -38.92, -40.36, -41.26, -42.19, -43.65, -44.37, -43.95, -43.15, -42.57, -41.57, -41.86, -42.34, -42.87, -42.35, -42.71, -42.85, -43.47, -47.43, -67.54, -76.3, -77.43, -77.43}`

6.168.3.2 `float vMHAOrigFreq[NUM_ENTR_MHAORIG] = {172.266,344.532,516.797,689.063,861.↵  
329,1033.59,1205.86,1378.13,1550.39,1722.66,1894.92,2067.19,2239.46,2411.72,2583.99,2756.↵  
25,2928.52,3100.78,3273.05,3445.32,3617.58,3789.85,3962.11,4134.38,4306.64,4478.91,4651.↵  
18,4823.44,4995.71,5167.97,5340.24,5512.51,5684.77,5857.04,6029.3,6201.57,6373.83,6546.↵  
1,6718.37,6890.63,7062.9,7235.16,7407.43,7579.69,7751.96,7924.23,8096.49,8268.76,8441.↵  
02,8613.29,8785.56,8957.82,9130.09,9302.35,9474.62,9646.88,9819.15,9991.42,10163.7,10335.↵  
9,10508.2,10680.5,10852.7,11025,11197.3,11369.5,11541.8,11714.1,11886.3,12058.6,12230.↵  
9,12403.1,12575.4,12747.7,12919.9,13092.2}`

- 6.168.3.3 float vLTASS\_freq[NUM\_ENTR\_LTASS] = {63, 80, 100, 125, 160, 200, 250, 315, 400, 500, 630, 800, 1000, 1250, 1600, 2000, 2500, 3150, 4000, 5000, 6300, 8000, 10000, 12500, 16000}
- 6.168.3.4 float vLTASS\_combined\_lev[NUM\_ENTR\_LTASS] = {38.6, 43.5, 54.4, 57.7, 56.8, 60.2, 60.3, 59.0, 62.1, 62.1, 60.5, 56.8, 53.7, 53.0, 52.0, 48.7, 48.1, 46.8, 45.6, 44.5, 44.3, 43.7, 43.4, 41.3, 40.7}
- 6.168.3.5 float vLTASS\_female\_lev[NUM\_ENTR\_LTASS] = {37.0,36.0,37.5,40.1,53.4,62.2,60.9,58.↵  
1,61.7,61.7,60.4,58,54.3,52.3,51.7,48.8,47.3,46.7,45.3,44.6,45.2,44.9,45.0,42.8,41.1}
- 6.168.3.6 float vLTASS\_male\_lev[NUM\_ENTR\_LTASS] = {38.6,43.5,54.4,57.7,56.8,58.2,59.7,60.0,62.↵  
4,62.6,60.6,55.7,53.1,53.7,52.3,48.7,48.9,47.0,46.0,44.4,43.3,42.4,41.9,39.8,40.4}
- 6.168.3.7 float vOlnoiseFreq[NUM\_ENTR\_OLNOISE] = {62.5,70.1539,78.7451,88.3884,99.2126,111.↵  
362,125,140.308,157.49,176.777,198.425,222.725,250,280.616,314.98,353.553,396.85,445.↵  
449,500,561.231,629.961,707.107,793.701,890.899,1000,1122.46,1259.92,1414.21,1587.4,1781.↵  
8,2000,2244.92,2519.84,2828.43,3174.8,3563.59,4000,4489.85,5039.68,5656.85,6349.6,7127.↵  
19,8000,8979.7,10079.4,11313.7,12699.2,14254.4,16000}
- 6.168.3.8 float vOlnoiseLev[NUM\_ENTR\_OLNOISE] = {45.9042,38.044,48.9444,61.3697,67.6953,69.↵  
7451,71.6201,71.2431,65.2754,63.2547,70.2264,72.1434,73.4433,73.2659,69.8424,71.0132,70.↵  
9577,70.3492,68.691,64.8436,64.0435,64.2879,60.5889,60.6596,60.3727,61.2003,61.8477,61.↵  
1478,61.2312,58.6584,57.2892,56.8299,56.0191,53.3018,56.0525,54.3592,50.8823,55.992,54.↵  
6768,47.2616,46.9914,45.209,50.413,47.5848,43.3215,43.754,38.5773,-0.39427,5.74224}

## 6.169 speechnoise.h File Reference

### Classes

- class **speechnoise\_t**

## 6.170 split.cpp File Reference

### Classes

- class **MHAPLugin\_Split::uni\_processor\_t**  
*An interface to a class that sports a process method with no parameters and no return value.*
- class **MHAPLugin\_Split::thread\_platform\_t**  
*Basic interface for encapsulating thread creation, thread priority setting, and synchronization on any threading platform (i.e., pthreads or win32threads).*
- class **MHAPLugin\_Split::dummy\_threads\_t**  
*Dummy specification of a thread platform: This class implements everything in a single thread.*
- class **MHAPLugin\_Split::posix\_threads\_t**  
*Posix threads specification of thread platform.*
- class **MHAPLugin\_Split::domain\_handler\_t**  
*Handles domain-specific partial input and output signal.*
- class **MHAPLugin\_Split::splitted\_part\_t**  
*The **splitted\_part\_t** (p. 751) instance manages the plugin that performs processing on the reduced set of channels.*
- class **MHAPLugin\_Split::split\_t**  
*Implements split plugin.*

## Namespaces

- **MHAPLugin\_Split**

## Macros

- **#define MHAPLUGIN\_OVERLOAD\_OUTDOMAIN**  
*This define modifies the definition of MHAPLUGIN\_CALLBACKS and friends.*
- **#define posixthreads 1**
- **#define default\_thread\_platform\_string "posix"**
- **#define default\_thread\_platform\_type posix\_threads\_t**

## Enumerations

### 6.170.1 Detailed Description

Source code for the split plugin. The split plugin splits the audio signal by channel. The splitted paths execute in parallel.

### 6.170.2 Macro Definition Documentation

#### 6.170.2.1 **#define MHAPLUGIN\_OVERLOAD\_OUTDOMAIN**

This define modifies the definition of MHAPLUGIN\_CALLBACKS and friends.

The output signal is transferred through a second parameter to the process method, enabling all four domain transformations in a single plugin.

#### 6.170.2.2 **#define posixthreads 1**

#### 6.170.2.3 **#define default\_thread\_platform\_string "posix"**

#### 6.170.2.4 **#define default\_thread\_platform\_type posix\_threads\_t**

## 6.171 `steerbf.cpp` File Reference

### Macros

- **#define PATCH\_VAR(var)** `patchbay.connect(&var.valuechanged, this, &steerbf↔  
::update_cfg)`
- **#define INSERT\_PATCH(var)** `insert_member(var); PATCH_VAR(var)`

### 6.171.1 Macro Definition Documentation

6.171.1.1 `#define PATCH_VAR(  
var ) patchbay.connect(&var.valuechanged, this, &steerbf::update_cfg)`

6.171.1.2 `#define INSERT_PATCH(  
var ) insert_member(var); PATCH_VAR(var)`

### 6.172 steerbf.h File Reference

#### Classes

- class `parser_int_dyn`
- class `steerbf_config`
- class `steerbf`

### 6.173 testalsadevice.c File Reference

#### Functions

- int `main` (int argc, char \*\*argv)

### 6.173.1 Function Documentation

6.173.1.1 `int main (  
int argc,  
char ** argv )`

### 6.174 testplugin.cpp File Reference

#### Classes

- class `testplugin::config_parser_t`
- class `testplugin::ac_parser_t`
- class `testplugin::signal_parser_t`
- class `testplugin::if_t`

#### Namespaces

- `testplugin`



## 6.175 timoconfig.cpp File Reference

### Macros

- #define **LPSCALE** (5.2429e+007)
- #define **POWSPEC\_FACTOR** 0.0025
- #define **OVERLAP\_FACTOR** 2
- #define **EPSILON** (1e-10)
- #define **CHANLOOP** for ( unsigned int c=0; c<nchan; ++c )

### 6.175.1 Macro Definition Documentation

#### 6.175.1.1 #define LPSCALE (5.2429e+007)

#### 6.175.1.2 #define POWSPEC\_FACTOR 0.0025

#### 6.175.1.3 #define OVERLAP\_FACTOR 2

#### 6.175.1.4 #define EPSILON (1e-10)

#### 6.175.1.5 #define CHANLOOP for ( unsigned int c=0; c<nchan; ++c )

## 6.176 timoconfig.h File Reference

### Classes

- class **timo\_AC**
- class **timo\_params**
- class **timoConfig**

## 6.177 timoSmooth.cpp File Reference

### Macros

- #define **INSERT\_VAR**(var) insert\_item(#var, &var)
- #define **PATCH\_VAR**(var) patchbay.connect(&var.valuechanged, this, &timoSmooth->::on\_model\_param\_valuechanged)
- #define **INSERT\_PATCH**(var) **INSERT\_VAR**(var); **PATCH\_VAR**(var)

### 6.177.1 Macro Definition Documentation

6.177.1.1 `#define INSERT_VAR(  
var ) insert_item(#var, &var)`

6.177.1.2 `#define PATCH_VAR(  
var ) patchbay.connect(&var.valuechanged, this,  
&timoSmooth::on_model_param_valuechanged)`

6.177.1.3 `#define INSERT_PATCH(  
var ) INSERT_VAR(var); PATCH_VAR(var)`

### 6.178 timosmooth.h File Reference

#### Classes

- class **timoSmooth**

### 6.179 transducers.cpp File Reference

#### Classes

- class **softclipper\_variables\_t**
- class **softclipper\_t**
- class **calibrator\_variables\_t**
- class **calibrator\_runtime\_layer\_t**
- class **calibrator\_t**
- class **bbcalib\_interface\_t**

#### Typedefs

- typedef **MHAPugin::config\_t** < **MHASignal::async\_rmslevel\_t** > **rmslevelmeter**
- typedef **MHAPugin::plugin\_t** < **calibrator\_runtime\_layer\_t** > **rtcalibrator**

#### Functions

- **speechnoise\_t::noise\_type\_t kw\_index2type** (unsigned int idx)
- **std::vector< int > vint\_0123n1** (unsigned int n)

## 6.179.1 Typedef Documentation

6.179.1.1 typedef MHAPlugin::config\_t&lt;MHASignal::async\_rmslevel\_t&gt; rmslevelmeter

6.179.1.2 typedef MHAPlugin::plugin\_t&lt;calibrator\_runtime\_layer\_t&gt; rtcalibrator

## 6.179.2 Function Documentation

6.179.2.1 speechnoise\_t::noise\_type\_t kw\_index2type ( unsigned int *idx* )6.179.2.2 std::vector<int> vint\_0123n1 ( unsigned int *n* )

## 6.180 upsample.cpp File Reference

## Classes

- class **us\_t**

## 6.181 wave2spec.cpp File Reference

## Classes

- class **wave2spec\_t**
- class **wave2spec\_if\_t**

## Macros

- #define **MHAPLUGIN\_OVERLOAD\_OUTDOMAIN**

## 6.181.1 Macro Definition Documentation

6.181.1.1 #define MHAPLUGIN\_OVERLOAD\_OUTDOMAIN

## 6.182 wavrec.cpp File Reference

## Classes

- class **wavwriter\_t**
- class **wavrec\_t**

## Macros

- `#define DEBUG(x) std::cerr << __FILE__ << ":" << __LINE__ << " " << #x << "=" << x << std::endl`

### 6.182.1 Macro Definition Documentation

- 6.182.1.1 `#define DEBUG(  
x ) std::cerr << __FILE__ << ":" << __LINE__ << " " << #x << "=" << x << std::endl`

### 6.183 windowselector.cpp File Reference

### 6.184 windowselector.h File Reference

## Classes

- class **windowselector\_t**  
*A combination of mha parser variables to describe an overalapadd analysis window.*

## Index

- `_MHA_AC_CHAR`
  - `testplugin::ac_parser_t`, 931
- `_MHA_AC_DOUBLE`
  - `testplugin::ac_parser_t`, 931
- `_MHA_AC_FLOAT`
  - `testplugin::ac_parser_t`, 931
- `_MHA_AC_INT`
  - `testplugin::ac_parser_t`, 931
- `_MHA_AC_MHACOMPLEX`
  - `testplugin::ac_parser_t`, 931
- `_MHA_AC_MHAREAL`
  - `testplugin::ac_parser_t`, 931
- `__MHA_FUN__`
  - `mha_defs.h`, 998
- `__attribute__`
  - `mha_plugin.hh`, 1024
- `__declspec`
  - `example5.cpp`, 977
  - `example6.cpp`, 977
  - `mha_defs.h`, 998
  - `mha_plugin.hh`, 1023
- `_cf`
  - `DynComp::dc_afterburn_t`, 296
- `_channels`
  - `DynComp::dc_afterburn_t`, 296
- `_conjugate`
  - Complex arithmetics in the openMHA, 68
- `_linphase_asym`
  - `MHAFilter::smoothspec_t`, 568
- `_prepare`
  - `testplugin::if_t`, 935
- `_reciprocal`
  - Complex arithmetics in the openMHA, 69
- `_srate`
  - `DynComp::dc_afterburn_t`, 296
- `_steerbf`
  - `steerbf_config`, 929
- `_unknown`
  - `testplugin::ac_parser_t`, 931
- `~Async_Notify`
  - `MHA_TCP::Async_Notify`, 469
- `~Connection`
  - `MHA_TCP::Connection`, 473
- `~Delay`
  - `ADM::Delay`, 192
- `~Event_Watcher`
  - `MHA_TCP::Event_Watcher`, 479
- `~Linearphase_FIR`
  - `ADM::Linearphase_FIR`, 194
- `~MHA_Error`
  - `MHA_Error`, 446
- `~Server`
  - `MHA_TCP::Server`, 482
- `~Thread`
  - `MHA_TCP::Thread`, 489
- `~Timeout_Watcher`
  - `MHA_TCP::Timeout_Watcher`, 492
- `~Wakeup_Event`
  - `MHA_TCP::Wakeup_Event`, 494
- `~acConcat_wave`
  - `acConcat_wave`, 152
- `~acConcat_wave_config`
  - `acConcat_wave_config`, 154
- `~acPooling_wave`
  - `acPooling_wave`, 161
- `~acPooling_wave_config`
  - `acPooling_wave_config`, 163
- `~acSteer`
  - `acSteer`, 173
- `~acSteer_config`
  - `acSteer_config`, 175
- `~acTransform_wave`
  - `acTransform_wave`, 177
- `~acTransform_wave_config`
  - `acTransform_wave_config`, 179
- `~acmon_t`
  - `acmon::acmon_t`, 158
- `~acspace2matrix_t`
  - `MHA_AC::acspace2matrix_t`, 417
- `~adm_rtconfig_t`
  - `adm_rtconfig_t`, 199
- `~algo_comm_class_t`
  - `MHAKernel::algo_comm_class_t`, 604
- `~alsa_base_t`
  - `alsa_base_t`, 207
- `~alsa_t`
  - `alsa_t`, 211
- `~analysepath_t`
  - `analysepath_t`, 217
- `~analysispath_if_t`
  - `analysispath_if_t`, 220
- `~bark2hz_t`
  - `MHAOvfFilter::barkscale::bark2hz_t`, 614
- `~base_t`
  - `MHAParser::base_t`, 637
- `~bbcalib_interface_t`

- bbcalib\_interface\_t, 229
- ~blockprocessing\_polyphase\_resampling\_t
  - MHAFilter::blockprocessing\_polyphase\_resampling\_t, 518
- ~c\_ifc\_parser\_t
  - MHAParser::c\_ifc\_parser\_t, 649
- ~cfg\_chain\_t
  - MHAPLugin::cfg\_chain\_t, 723
- ~cfg\_t
  - acsave::cfg\_t, 168
- ~config\_t
  - MHAPLugin::config\_t, 726
- ~connector\_base\_t
  - MHAEvents::connector\_base\_t, 506
- ~connector\_t
  - MHAEvents::connector\_t, 509
- ~db\_if\_t
  - db\_if\_t, 250
- ~delay\_spec\_t
  - MHASignal::delay\_spec\_t, 766
- ~delay\_t
  - MHASignal::delay\_t, 767
- ~delay\_wave\_t
  - MHASignal::delay\_wave\_t, 769
- ~doasvm\_classification
  - doasvm\_classification, 280
- ~doasvm\_classification\_config
  - doasvm\_classification\_config, 282
- ~doasvm\_feature\_extraction
  - doasvm\_feature\_extraction, 284
- ~doasvm\_feature\_extraction\_config
  - doasvm\_feature\_extraction\_config, 286
- ~domain\_handler\_t
  - MHAPLugin\_Split::domain\_handler\_t, 738
- ~double\_t
  - MHA\_AC::double\_t, 419
- ~doublebuffer\_t
  - MHASignal::doublebuffer\_t, 771
- ~dynamiclib\_t
  - dynamiclib\_t, 292
- ~emitter\_t
  - MHAEvents::emitter\_t, 511
- ~fft\_t
  - MHASignal::fft\_t, 773
- ~fftfb\_t
  - MHAOvFilter::fftfb\_t, 617
- ~fftfilter\_t
  - MHAFilter::fftfilter\_t, 525
- ~fftfilterbank\_t
  - MHAFilter::fftfilterbank\_t, 529
- ~filter\_t
  - MHAFilter::filter\_t, 533
- ~float\_t
  - MHA\_AC::float\_t, 420
- ~fourway\_processor\_t
  - PluginLoader::fourway\_processor\_t, 878
- ~fshift\_config\_t
  - fshift::fshift\_config\_t, 332
- ~fshift\_t
  - fshift::fshift\_t, 335
- ~fw\_t
  - fw\_t, 345
- ~gaintable\_t
  - DynComp::gaintable\_t, 301
- ~gammaflt\_t
  - MHAFilter::gammaflt\_t, 536
- ~gtfb\_analyzer\_cfg\_t
  - gtfb\_analyzer::gtfb\_analyzer\_cfg\_t, 354
- ~hanning\_ramps\_t
  - hanning\_ramps\_t, 358
- ~hilbert\_shifter\_t
  - fshift\_hilbert::hilbert\_shifter\_t, 341
- ~hilbert\_t
  - MHASignal::hilbert\_t, 777
- ~hz2bark\_t
  - MHAOvFilter::barkscale::hz2bark\_t, 615
- ~int\_t
  - MHA\_AC::int\_t, 421
- ~io\_file\_t
  - io\_file\_t, 366
- ~io\_lib\_t
  - io\_lib\_t, 370
- ~io\_parser\_t
  - io\_parser\_t, 373
- ~io\_portaudio\_t
  - MHAIOPortAudio::io\_portaudio\_t, 586
- ~io\_tcp\_fwcb\_t
  - io\_tcp\_fwcb\_t, 376
- ~io\_tcp\_parser\_t
  - io\_tcp\_parser\_t, 380
- ~io\_tcp\_sound\_t
  - io\_tcp\_sound\_t, 385
- ~io\_tcp\_t
  - io\_tcp\_t, 390
- ~linear\_table\_t
  - MHATableLookup::linear\_table\_t, 826
- ~lpc
  - lpc, 396
- ~lpc\_bl\_predictor
  - lpc\_bl\_predictor, 399
- ~lpc\_bl\_predictor\_config
  - lpc\_bl\_predictor\_config, 401

- ~lpc\_burglattice
  - lpc\_burglattice, 403
- ~lpc\_burglattice\_config
  - lpc\_burglattice\_config, 405
- ~lpc\_config
  - lpc\_config, 407
- ~matrix\_t
  - MHASignal::matrix\_t, 785
- ~mha\_dblbuf\_t
  - mha\_dblbuf\_t, 434
- ~mha\_fifo\_lw\_t
  - mha\_fifo\_lw\_t, 448
- ~mha\_fifo\_posix\_threads\_t
  - mha\_fifo\_posix\_threads\_t, 451
- ~mha\_fifo\_t
  - mha\_fifo\_t, 454
- ~mha\_fifo\_thread\_guard\_t
  - mha\_fifo\_thread\_guard\_t, 457
- ~mha\_fifo\_thread\_platform\_t
  - mha\_fifo\_thread\_platform\_t, 458
- ~mha\_rt\_fifo\_element\_t
  - mha\_rt\_fifo\_element\_t, 461
- ~mha\_rt\_fifo\_t
  - mha\_rt\_fifo\_t, 463
- ~mha\_stash\_environment\_variable\_t
  - mha\_stash\_environment\_variable\_t, 467
- ~mhaplugin\_cfg\_t
  - mhaplugin\_cfg\_t, 722
- ~mhapluginloader\_t
  - MHAParser::mhapluginloader\_t, 683
  - PluginLoader::mhapluginloader\_t, 882
- ~mhaserver\_t
  - mhaserver\_t, 762
- ~overlapadd\_if\_t
  - overlapadd::overlapadd\_if\_t, 860
  - smoothgains\_bridge::overlapadd\_if\_t, 913
- ~overlapadd\_t
  - overlapadd::overlapadd\_t, 862
- ~parser\_t
  - MHAParser::parser\_t, 690
- ~partitioned\_convolution\_t
  - MHAFilter::partitioned\_convolution\_t, 556
- ~patchbay\_t
  - MHAEvents::patchbay\_t, 512
- ~plug\_t
  - plug\_t, 871
- ~plugin\_t
  - MHAPLugin::plugin\_t, 730
- ~pluginloader\_t
  - pluginloader\_t, 886
- ~plugs\_t
  - mhachain::plugs\_t, 502
- ~port\_t
  - MHAJack::port\_t, 601
- ~posix\_threads\_t
  - MHAPLugin\_Split::posix\_threads\_t, 745
- ~prediction\_error
  - prediction\_error, 887
- ~prediction\_error\_config
  - prediction\_error\_config, 890
- ~rt\_nlms\_t
  - rt\_nlms\_t, 899
- ~save\_var\_base\_t
  - ac2lsl::save\_var\_base\_t, 136
- ~save\_var\_t
  - ac2lsl::save\_var\_t, 139
  - ac2lsl::save\_var\_t< mha\_complex\_t >, 141
  - acsave::save\_var\_t, 170
- ~sf\_t
  - MHASndFile::sf\_t, 823
- ~sine\_t
  - sine\_t, 911
- ~smoothspec\_t
  - MHAFilter::smoothspec\_t, 567
- ~spec2wave\_t
  - spec2wave\_t, 922
- ~spec\_fader\_t
  - spec\_fader\_t, 924
- ~spectrum\_t
  - MHA\_AC::spectrum\_t, 423
  - MHASignal::spectrum\_t, 802
- ~split\_t
  - MHAPLugin\_Split::split\_t, 749
- ~splitted\_part\_t
  - MHAPLugin\_Split::splitted\_part\_t, 753
- ~steerbf
  - steerbf, 927
- ~steerbf\_config
  - steerbf\_config, 929
- ~table\_t
  - MHATableLookup::table\_t, 829
- ~thread\_platform\_t
  - MHAPLugin\_Split::thread\_platform\_t, 757
- ~timoConfig
  - timoConfig, 942
- ~timoSmooth
  - timoSmooth, 945
- ~uint\_vector\_t
  - MHASignal::uint\_vector\_t, 810
- ~uni\_processor\_t

- MHAPugin\_Split::uni\_processor\_t, 759
- ~wave2spec\_t
  - wave2spec\_t, 952
- ~waveform\_t
  - MHA\_AC::waveform\_t, 426
  - MHASignal::waveform\_t, 814
- ~wavwriter\_t
  - wavwriter\_t, 956
- ~windowselector\_t
  - windowselector\_t, 958
- A
  - lpc\_config, 408
  - MHAFilter::filter\_t, 534
  - MHAFilter::gammaflt\_t, 537
  - MHAFilter::iir\_filter\_t, 542
- a
  - MHAParser::base\_t::replace\_t, 643
- A\_
  - MHAFilter::complex\_bandpass\_t, 522
  - MHAFilter::iir\_ord1\_real\_t, 545
- AC\_DIM\_MISMATCH
  - mha\_algo\_comm.cpp, 995
- AC\_INVALID\_HANDLE
  - mha\_algo\_comm.cpp, 995
- AC\_INVALID\_NAME
  - mha\_algo\_comm.cpp, 995
- AC\_INVALID\_OUTPTR
  - mha\_algo\_comm.cpp, 995
- AC\_STRING\_TRUNCATED
  - mha\_algo\_comm.cpp, 995
- AC\_SUCCESS
  - mha\_algo\_comm.cpp, 995
- AC\_TYPE\_MISMATCH
  - mha\_algo\_comm.cpp, 995
- ACSAVE\_FMT\_MAT4
  - acsave.cpp, 963
- ACSAVE\_FMT\_TXT
  - acsave.cpp, 963
- ACSAVE\_FMT\_M
  - acsave.cpp, 963
- ACSAVE\_SFMT\_MAT4
  - acsave.cpp, 963
- ACSAVE\_SFMT\_TXT
  - acsave.cpp, 963
- ACSAVE\_SFMT\_M
  - acsave.cpp, 963
- ADM::ADM< F >, 188
- ADM::ADM
  - ADM, 189
  - beta, 190
  - m\_beta, 190
  - m\_decomb, 190
  - m\_delay\_back, 190
  - m\_delay\_front, 190
  - m\_lp\_bf, 190
  - m\_lp\_result, 190
  - m\_mu\_beta, 190
  - m\_powerfilter\_coeff, 190
  - m\_powerfilter\_norm, 190
  - m\_powerfilter\_state, 190
  - process, 189
- ADM::Delay
  - ~Delay, 192
  - Delay, 191
  - m\_coeff, 192
  - m\_fullsamples, 192
  - m\_norm, 192
  - m\_now\_in, 192
  - m\_state, 192
  - process, 192
- ADM::Delay< F >, 191
- ADM::Linearphase\_FIR< F >, 193
- ADM::Linearphase\_FIR
  - ~Linearphase\_FIR, 194
  - Linearphase\_FIR, 193
  - m\_alphas, 194
  - m\_now, 194
  - m\_order, 194
  - m\_output, 194
  - process, 194
- ADM, 80
  - ADM::ADM, 189
  - C, 81
  - DELAY\_FREQ, 81
  - PI, 81
  - START\_BETA, 81
  - subsampledelay\_coeff, 81
- ALGO\_COMM\_ID\_STR
  - mha\_algo\_comm.hh, 997
- ASSERT\_EQUAL\_DIM\_PTR
  - mha\_signal.cpp, 1028
- ASSERT\_EQUAL\_DIM
  - mha\_signal.cpp, 1028
- ASYNC\_CONNECT\_STARTED
  - mha\_tcp.cpp, 1040
- abandonned
  - mha\_rt\_fifo\_element\_t, 461
- abs
  - Complex arithmetics in the openMHA, 67
- abs2
  - Complex arithmetics in the openMHA, 67
- ac



- ac2lsl::cfg\_t, 135
- ac2wave\_t, 150
- acConcat\_wave\_config, 154
- acPooling\_wave\_config, 164
- acTransform\_wave\_config, 179
- acmon::acmon\_t, 159
- acsave::cfg\_t, 169
- acsave::save\_var\_t, 171
- doasvm\_classification\_config, 282
- fw\_t, 347
- latex\_doc\_t, 394
- lpc\_bl\_predictor\_config, 401
- lpc\_burglattice\_config, 405
- MHA\_AC::ac2matrix\_helper\_t, 413
- MHA\_AC::double\_t, 419
- MHA\_AC::float\_t, 420
- MHA\_AC::int\_t, 421
- MHA\_AC::spectrum\_t, 424
- MHA\_AC::waveform\_t, 427
- MHAKernel::algo\_comm\_class\_t, 606
- MHAMultiSrc::base\_t, 608
- MHAPlugin::plugin\_t, 732
- mhachain::plugs\_t, 502
- PluginLoader::mhapluginloader\_t, 884
- prediction\_error\_config, 890
- rt\_nlms\_t, 899
- shadowfilter\_end::cfg\_t, 907
- steerbf\_config, 929
- testplugin::if\_t, 935
- timoConfig, 942
- AC variable, 4
- ac2lsl, 78
  - types, 78
- ac2lsl.cpp, 960
- ac2lsl::ac2lsl\_t, 130
  - ac2lsl\_t, 132
  - activate, 133
  - get\_all\_names\_from\_ac\_space, 132
  - is\_first\_run, 133
  - patchbay, 133
  - prepare, 132
  - process, 132
  - release, 132
  - rt\_strict, 133
  - skip, 133
  - source\_id, 133
  - update, 133
  - vars, 133
- ac2lsl::cfg\_t, 133
  - ac, 135
  - cfg\_t, 134
  - check\_vars, 135
  - create\_or\_replace\_var, 135
  - process, 135
  - skip, 135
  - skipcnt, 135
  - source\_id, 135
  - srate, 135
  - update\_varlist, 135
  - varlist, 135
- ac2lsl::save\_var\_base\_t, 136
  - ~save\_var\_base\_t, 136
  - data\_type, 137
  - get\_buf\_address, 136
  - info, 137
  - num\_entries, 137
  - send\_frame, 136
  - set\_buf\_address, 137
- ac2lsl::save\_var\_t
  - ~save\_var\_t, 139
  - buf, 140
  - data\_type, 139
  - data\_type\_, 140
  - get\_buf\_address, 139
  - info, 139
  - num\_entries, 139
  - save\_var\_t, 138
  - send\_frame, 140
  - set\_buf\_address, 139
  - stream, 140
- ac2lsl::save\_var\_t< mha\_complex\_t >, 140
  - ~save\_var\_t, 141
  - buf, 143
  - data\_type, 142
  - get\_buf\_address, 142
  - info, 142
  - num\_entries, 142
  - save\_var\_t, 141
  - send\_frame, 142
  - set\_buf\_address, 142
  - stream, 143
- ac2lsl::save\_var\_t< T >, 137
- ac2lsl::type\_info, 143
  - format, 143
  - name, 143
- ac2lsl\_t
  - ac2lsl::ac2lsl\_t, 132
- ac2matrix\_helper\_t
  - MHA\_AC::ac2matrix\_helper\_t, 412
- ac2matrix\_t
  - MHA\_AC::ac2matrix\_t, 414
- ac2osc.cpp, 960

- ac2osc\_t, 144
  - ac2osc\_t, 145
  - acspace, 147
  - b\_record, 147
  - framerate, 147
  - host, 146
  - is\_first\_run, 147
  - lo\_addr, 147
  - mode, 147
  - patchbay, 147
  - port, 146
  - prepare, 146
  - process, 146
  - release, 146
  - rt\_strict, 147
  - rtmem, 147
  - send\_osc\_float, 146
  - skip, 147
  - skipcnt, 147
  - ttl, 147
  - update\_mode, 146
  - vars, 147
- ac2wave.cpp, 960
- ac2wave\_if\_t, 148
  - ac2wave\_if\_t, 149
  - delay\_ac, 149
  - delay\_in, 149
  - gain\_ac, 149
  - gain\_in, 149
  - name, 149
  - patchbay, 149
  - prepare, 149
  - prepared, 149
  - process, 149
  - release, 149
  - update, 149
  - zeros, 149
- ac2wave\_t, 150
  - ac, 150
  - ac2wave\_t, 150
  - channels, 150
  - delay\_ac, 151
  - delay\_in, 151
  - frames, 150
  - gain\_ac, 151
  - gain\_in, 151
  - name, 151
  - process, 150
  - w, 150
- ac\_
  - combc\_t, 245
  - MHAParser::mhapluginloader\_t, 684
  - ac\_fifo
    - analysepath\_t, 218
  - ac\_monitor\_t
    - acmon::ac\_monitor\_t, 155
  - ac\_monitor\_type.cpp, 961
  - ac\_monitor\_type.hh, 961
  - ac\_parser\_t
    - testplugin::ac\_parser\_t, 931
  - acConcat\_wave, 151
    - ~acConcat\_wave, 152
    - acConcat\_wave, 152
    - name\_con\_AC, 153
    - num\_AC, 153
    - numchannels, 153
    - patchbay, 153
    - prefix\_names\_AC, 153
    - prepare, 153
    - process, 153
    - release, 153
    - samples\_AC, 153
    - update\_cfg, 153
  - acConcat\_wave.cpp, 961
    - INSERT\_PATCH, 961
    - PATCH\_VAR, 961
  - acConcat\_wave.h, 961
  - acConcat\_wave\_config, 154
    - ~acConcat\_wave\_config, 154
    - ac, 154
    - acConcat\_wave\_config, 154
    - numSamples\_AC, 154
    - process, 154
    - strNames\_AC, 154
    - vGCC\_con, 154
    - vGCC, 154
  - acPooling\_wave, 160
    - ~acPooling\_wave, 161
    - acPooling\_wave, 161
    - alpha, 162
    - like\_ratio\_name, 162
    - lower\_threshold, 162
    - max\_pool\_ind\_name, 162
    - neighbourhood, 162
    - numsamples, 162
    - p\_biased\_name, 162
    - p\_name, 162
    - patchbay, 162
    - pool\_name, 162
    - pooling\_type, 162
    - pooling\_wndlen, 162
    - prepare, 161

- prob\_bias, 162
- process, 161
- release, 162
- update\_cfg, 162
- upper\_threshold, 162
- acPooling\_wave.cpp, 962
  - INSERT\_PATCH, 962
  - PATCH\_VAR, 962
- acPooling\_wave.h, 962
- acPooling\_wave\_config, 163
  - ~acPooling\_wave\_config, 163
  - ac, 164
  - acPooling\_wave\_config, 163
  - alpha, 164
  - c, 164
  - insert, 163
  - like\_ratio, 164
  - low\_thresh, 164
  - neigh, 164
  - p, 164
  - p\_biased, 164
  - p\_max, 164
  - pool, 164
  - pooling\_ind, 164
  - pooling\_option, 164
  - pooling\_size, 164
  - prob\_bias\_func, 164
  - process, 163
  - raw\_p\_name, 164
  - up\_thresh, 164
- acSteer, 172
  - ~acSteer, 173
  - acSteer, 173
  - acSteerName1, 174
  - acSteerName2, 174
  - nrefmic, 174
  - nsteerchan, 174
  - patchbay, 174
  - prepare, 173
  - process, 173
  - release, 173
  - steerFile, 174
  - update\_cfg, 174
- acSteer.cpp, 963
  - INSERT\_PATCH, 963
  - PATCH\_VAR, 963
- acSteer.h, 963
- acSteer\_config, 174
  - ~acSteer\_config, 175
  - acSteer\_config, 175
  - insert, 175
  - nangle, 175
  - nchan, 175
  - nfreq, 175
  - nrefmic, 175
  - nsteerchan, 175
  - specSteer1, 175
  - specSteer2, 175
- acSteerName1
  - acSteer, 174
- acSteerName2
  - acSteer, 174
- acTransform\_wave, 176
  - ~acTransform\_wave, 177
  - acTransform\_wave, 177
  - ang\_name, 178
  - numsamples, 178
  - patchbay, 178
  - prepare, 177
  - process, 177
  - raw\_p\_max\_name, 178
  - raw\_p\_name, 178
  - release, 177
  - rotated\_p\_max\_name, 178
  - rotated\_p\_name, 178
  - to\_from, 178
  - update\_cfg, 178
- acTransform\_wave.cpp, 964
  - INSERT\_PATCH, 964
  - PATCH\_VAR, 964
- acTransform\_wave.h, 964
- acTransform\_wave\_config, 178
  - ~acTransform\_wave\_config, 179
  - ac, 179
  - acTransform\_wave\_config, 179
  - ang\_name, 179
  - offset, 179
  - process, 179
  - raw\_p\_max\_name, 179
  - raw\_p\_name, 179
  - resolution, 179
  - rotated\_i, 179
  - rotated\_p, 179
  - to\_from, 179
- accept
  - MHA\_TCP::Server, 482
- accept\_event
  - MHA\_TCP::Server, 483
- accept\_loop
  - io\_tcp\_t, 390
- acceptor\_started
  - mhaserver\_t, 762

- ack\_fail
  - mhaserver\_t, 763
- ack\_ok
  - mhaserver\_t, 763
- acmon, 78
- acmon.cpp, 961
- acmon::ac\_monitor\_t, 155
  - ac\_monitor\_t, 155
  - dimstr, 156
  - getvar, 156
  - mon, 156
  - mon\_complex, 156
  - mon\_mat, 156
  - mon\_mat\_complex, 156
  - name, 156
  - p\_parser, 157
  - use\_mat, 157
- acmon::acmon\_t, 157
  - ~acmon\_t, 158
  - ac, 159
  - acmon\_t, 158
  - algo, 159
  - b\_cont, 159
  - b\_snapshot, 159
  - chain, 159
  - dimensions, 159
  - dispmode, 159
  - patchbay, 159
  - prepare, 158
  - process, 159
  - recmode, 159
  - release, 158
  - save\_vars, 159
  - update\_recmode, 159
  - varlist, 159
  - vars, 159
- acmon\_t
  - acmon::acmon\_t, 158
- acsave, 79
- acsave.cpp, 962
  - ACSAVE\_FMT\_MAT4, 963
  - ACSAVE\_FMT\_TXT, 963
  - ACSAVE\_FMT\_M, 963
  - ACSAVE\_SFMT\_MAT4, 963
  - ACSAVE\_SFMT\_TXT, 963
  - ACSAVE\_SFMT\_M, 963
- acsave::acsave\_t, 165
  - acsave\_t, 166
  - algo, 167
  - b\_flushed, 167
  - b\_prepared, 167
  - bflush, 167
  - chain, 167
  - event\_start\_recording, 167
  - event\_stop\_and\_flush, 167
  - fileformat, 167
  - fname, 167
  - patchbay, 167
  - prepare, 166
  - process, 166, 167
  - reclen, 167
  - release, 166
  - variables, 167
  - varlist, 167
  - varlist\_t, 166
- acsave::cfg\_t, 168
  - ~cfg\_t, 168
  - ac, 169
  - cfg\_t, 168
  - flush\_data, 168
  - max\_frames, 169
  - nvars, 169
  - rec\_frames, 169
  - store\_frame, 168
  - varlist, 169
- acsave::mat4head\_t, 169
  - cols, 169
  - imag, 169
  - namelen, 169
  - rows, 169
  - t, 169
- acsave::save\_var\_t, 170
  - ~save\_var\_t, 170
  - ac, 171
  - b\_complex, 171
  - data, 171
  - framecnt, 171
  - maxframe, 171
  - name, 171
  - ndim, 171
  - nframes, 171
  - save\_m, 171
  - save\_mat4, 170
  - save\_txt, 170
  - save\_var\_t, 170
  - store\_frame, 170
- acsave\_t
  - acsave::acsave\_t, 166
- acspace
  - ac2osc\_t, 147
- acspace2matrix\_t
  - MHA\_AC::acspace2matrix\_t, 416

- acspace\_template
  - analysispath\_if\_t, 220
- act\_
  - wavwriter\_t, 956
- actgains
  - fader\_if\_t, 319
- activate
  - ac2lsl::ac2lsl\_t, 133
- activate\_query
  - MHAParser::base\_t, 641
- active
  - addsndfile::addsndfile\_if\_t, 182
- acvar
  - MHA\_AC::ac2matrix\_helper\_t, 413
- adapt\_filter\_param\_t
  - MHAFilter::adapt\_filter\_param\_t, 514
- adapt\_filter\_state\_t
  - MHAFilter::adapt\_filter\_state\_t, 515
- adapt\_filter\_t
  - MHAFilter::adapt\_filter\_t, 516
- add
  - MHASignal::loop\_wavefragment\_t, 779
- add\_entry
  - MHAParser::keyword\_list\_t, 668
  - MHATableLookup::linear\_table\_t, 827
  - MHATableLookup::xy\_table\_t, 832
- add\_fun
  - MHAOvIFilter::scale\_var\_t, 633
- add\_parent\_on\_insert
  - MHAParser::base\_t, 641
- add\_plug
  - altplugs\_t, 216
- add\_plugin
  - pluginbrowser\_t, 874
- add\_plugins
  - pluginbrowser\_t, 874
- add\_replace\_pair
  - MHAParser::base\_t, 641
- added\_via\_plugs
  - altplugs\_t, 216
- addsndfile, 79
  - addsndfile\_resampling\_mode\_t, 80
  - DO\_RESAMPLE, 80
  - DONT\_RESAMPLE\_PERMISSIVE, 80
  - DONT\_RESAMPLE\_STRICT, 80
  - level\_adaptor, 80
  - resampled\_num\_frames, 80
  - wave\_reader, 80
- addsndfile.cpp, 964
  - DEBUG, 965
- addsndfile::addsndfile\_if\_t, 180
  - active, 182
  - addsndfile\_if\_t, 181
  - change\_mode, 182
  - channels, 182
  - filename, 182
  - level, 182
  - levelmode, 182
  - loop, 182
  - mapping, 182
  - mhachannels, 182
  - mode, 182
  - numchannels, 182
  - patchbay, 182
  - path, 182
  - prepare, 181
  - process, 181
  - ramplen, 182
  - release, 181
  - resamplingmode, 182
  - scan\_dir, 182
  - search\_pattern, 182
  - search\_result, 182
  - set\_level, 182
  - startpos, 182
  - uint\_mode, 182
  - update, 181
- addsndfile::level\_adapt\_t, 183
  - can\_update, 184
  - get\_level, 184
  - ilen, 184
  - l\_new, 184
  - l\_old, 184
  - level\_adapt\_t, 183
  - pos, 184
  - update\_frame, 184
  - wnd, 184
- addsndfile::resampled\_soundfile\_t, 184
  - resampled\_soundfile\_t, 185
- addsndfile::sndfile\_t, 186
  - sndfile\_t, 186
- addsndfile::waveform\_proxy\_t, 187
  - waveform\_proxy\_t, 188
- addsndfile\_if\_t
  - addsndfile::addsndfile\_if\_t, 181
- addsndfile\_resampling\_mode\_t
  - addsndfile, 80
- adm
  - adm\_rtconfig\_t, 200
- adm.cpp, 965
  - adm\_fir\_decomb, 966
  - adm\_fir\_lp, 966

- adm.hh, 966
- adm\_fir\_decomb
  - adm.cpp, 966
- adm\_fir\_lp
  - adm.cpp, 966
- adm\_if\_t, 195
  - adm\_if\_t, 196
  - beta, 197
  - bypass, 197
  - coeff\_decomb, 197
  - coeff\_lp, 197
  - decomb\_order, 197
  - distances, 197
  - front\_channels, 197
  - input\_channels, 197
  - is\_prepared, 197
  - lp\_order, 197
  - mu\_beta, 197
  - out, 197
  - patchbay, 197
  - prepare, 196
  - process, 196
  - rear\_channels, 197
  - release, 196
  - srate, 197
  - tau\_beta, 197
  - update, 196
- adm\_rtconfig\_t, 197
  - ~adm\_rtconfig\_t, 199
  - adm, 200
  - adm\_rtconfig\_t, 198
  - adm\_t, 198
  - adms, 200
  - check\_index, 199
  - decomb\_coefs, 200
  - front\_channel, 200
  - front\_channels, 200
  - lp\_coefs, 200
  - num\_adms, 199
  - rear\_channel, 200
  - rear\_channels, 200
- adm\_t
  - adm\_rtconfig\_t, 198
- adms
  - adm\_rtconfig\_t, 200
- algo
  - acmon::acmon\_t, 159
  - acsave::acsave\_t, 167
  - analysispath\_if\_t, 220
  - coherence::cohflt\_if\_t, 238
  - db\_if\_t, 251
  - dc::dc\_if\_t, 254
  - fftfilterbank::fftfb\_interface\_t, 330
  - MHAPugin\_Resampling::resampling\_if\_↔\_t, 734
  - multibandcompressor::interface\_t, 849
  - nlms\_t, 853
  - overlapadd::overlapadd\_if\_t, 861
  - route::interface\_t, 896
  - smoothgains\_bridge::overlapadd\_if\_↔\_t, 914
  - wave2spec\_if\_t, 950
- algo\_comm\_class\_t
  - MHAKernel::algo\_comm\_class\_t, 604
- algo\_comm\_default
  - mha\_algo\_comm.cpp, 995
  - mha\_algo\_comm.hh, 997
- algo\_comm\_id\_string
  - MHAKernel::algo\_comm\_class\_t, 606
- algo\_comm\_id\_string\_len
  - MHAKernel::algo\_comm\_class\_t, 606
- algo\_comm\_safe\_cast
  - MHAKernel, 101
- algo\_comm\_t, 201
  - get\_entries, 205
  - get\_error, 205
  - get\_var, 204
  - get\_var\_float, 204
  - get\_var\_int, 204
  - handle, 201
  - insert\_var, 201
  - insert\_var\_float, 202
  - insert\_var\_int, 202
  - is\_var, 203
  - mha.hh, 993
  - remove\_ref, 203
  - remove\_var, 202
- algo\_name
  - lpc, 397
- algos
  - MHAPugin\_Split::split\_t, 750
  - mhachain::chain\_base\_t, 499
  - mhachain::plugs\_t, 502
- all\_dump
  - MHAParser, 111
- all\_ids
  - MHAParser, 111
- alloc\_plugs
  - mhachain::plugs\_t, 502
- almost
  - Complex arithmetics in the openMHA, 69
- alph

- plingploing::plingploing\_t, 870
- alpha
  - acPooling\_wave, 162
  - acPooling\_wave\_config, 164
  - cfg\_t, 236
  - coherence::cohflt\_t, 240
  - coherence::vars\_t, 242
- alpha\_const
  - timoConfig, 942
- alpha\_const\_limits\_hz
  - timo\_params, 940
  - timoSmooth, 947
- alpha\_const\_vals
  - timo\_params, 940
  - timoSmooth, 947
- alpha\_frame
  - timoConfig, 943
- alpha\_frame\_AC
  - timo\_AC, 938
- alpha\_hat
  - timoConfig, 943
- alpha\_hat\_AC
  - timo\_AC, 938
- alpha\_pitch
  - timo\_params, 940
  - timoSmooth, 946
- alpha\_prev
  - timoConfig, 943
- alphaPH1mean
  - noisePowProposedScale::interface\_t, 857
- alphaPH1mean\_
  - noisePowProposedScale::noisePow↔  
Proposed, 858
- alphaPSD\_
  - noisePowProposedScale::noisePow↔  
Proposed, 859
- alphaPSD
  - noisePowProposedScale::interface\_t, 857
- alsa\_base\_t, 206
  - ~alsa\_base\_t, 207
  - alsa\_base\_t, 207
  - pcm, 208
  - read, 207
  - start, 207
  - stop, 207
  - write, 207
- alsa\_dev\_par\_parser\_t, 208
  - alsa\_dev\_par\_parser\_t, 209
  - device, 209
  - nperiods, 209
  - stream\_dir, 209
- alsa\_start\_counter
  - io\_alsa\_t, 364
- alsa\_t
  - ~alsa\_t, 211
  - alsa\_t, 211
  - buffer, 212
  - channels, 212
  - fragsize, 212
  - frame\_data, 212
  - gain, 212
  - invgain, 213
  - pcm\_format, 213
  - read, 212
  - start, 211
  - stop, 211
  - val\_max, 213
  - val\_min, 213
  - wave, 212
  - write, 212
- alsa\_t< T >, 210
- altplugs.cpp, 967
  - MHAPLUGIN\_OVERLOAD\_OUTDOM↔  
AIN, 967
- altplugs\_t, 213
  - add\_plug, 216
  - added\_via\_plugs, 216
  - altplugs\_t, 214
  - cfin, 216
  - cfout, 216
  - current, 216
  - delete\_plug, 216
  - event\_add\_plug, 215
  - event\_delete\_plug, 215
  - event\_select\_plug, 215
  - event\_set\_plugs, 215
  - fallback\_spec, 216
  - fallback\_wave, 216
  - nondefault\_labels, 216
  - parse, 215
  - parser\_plugs, 216
  - patchbay, 216
  - plugs, 216
  - prepare, 214
  - prepared, 216
  - proc\_ramp, 215
  - process, 215
  - ramp\_counter, 216
  - ramp\_len, 216
  - ramplen, 216
  - release, 214
  - select\_plug, 216

- selected\_plug, 216
- update\_ramplen, 215
- update\_selector\_list, 215
- use\_own\_ac, 216
- amplitude
  - sine\_cfg\_t, 910
- analysemhaplugin.cpp, 967
  - main, 967
  - print\_ac, 967
  - strdom, 967
- analysepath\_t, 217
  - ~analysepath\_t, 217
  - ac\_fifo, 218
  - analysepath\_t, 217
  - attr, 218
  - cond\_to\_process, 218
  - flag\_terminate\_inner\_thread, 218
  - has\_inner\_error, 218
  - inner\_ac\_copy, 218
  - inner\_error, 218
  - inner\_input, 218
  - inner\_out\_domain, 218
  - inner\_process\_wave2spec, 218
  - inner\_process\_wave2wave, 218
  - input\_to\_process, 218
  - libdata, 218
  - outer\_ac, 218
  - outer\_ac\_copy, 218
  - priority, 218
  - ProcessMutex, 218
  - rt\_process, 218
  - scheduler, 218
  - svc, 218
  - thread, 218
  - wave\_fifo, 218
- analysispath.cpp, 967
  - thread\_start, 968
- analysispath\_if\_t, 219
  - ~analysispath\_if\_t, 220
  - acspace\_template, 220
  - algo, 220
  - analysispath\_if\_t, 220
  - chain, 220
  - fifolen, 220
  - fragsize, 220
  - libname, 220
  - loadlib, 220
  - patchbay, 220
  - plug, 220
  - prepare, 220
  - priority, 220
  - process, 220
  - release, 220
  - vars, 220
- analytic
  - fshift\_hilbert::hilbert\_shifter\_t, 341
- ang\_name
  - acTransform\_wave, 178
  - acTransform\_wave\_config, 179
- angle
  - Complex arithmetics in the openMHA, 64
- angle\_ind
  - steerbf, 928
- angle\_src
  - steerbf, 928
- angles
  - doasvm\_classification, 281
- announce\_port
  - mhaserver\_t, 763
- antialias
  - ds\_t, 291
  - us\_t, 948
- apply\_gains
  - MHAOviFilter::fftb\_t, 617
  - multibandcompressor::plugin\_signals\_t, 850
- acquire\_mutex
  - mha\_fifo\_posix\_threads\_t, 451
  - mha\_fifo\_thread\_platform\_t, 459
- arg
  - MHA\_TCP::Thread, 489
- assign
  - MHASignal::waveform\_t, 818
  - Vector and matrix processing toolbox, 49, 50
- assign\_channel
  - MHASignal::waveform\_t, 818
- assign\_frame
  - MHASignal::waveform\_t, 818
- Async\_Notify
  - MHA\_TCP::Async\_Notify, 469
- async\_poll\_msg
  - fw\_t, 347
- async\_read
  - fw\_t, 347
- async\_rmslevel\_t
  - MHASignal::async\_rmslevel\_t, 764
- attack
  - cfg\_t, 236
  - dc::dc\_t, 256
  - dc\_simple::level\_smoother\_t, 272
  - softclip\_t, 917



- softclipper\_t, 918
- attr
  - analysepath\_t, 218
  - MHAPugin\_Split::posix\_threads\_t, 746
- auditory\_profile.cpp, 968
- auditory\_profile.h, 968
- AuditoryProfile, 81
- AuditoryProfile::fmap\_t, 221
  - get\_frequencies, 221
  - get\_values, 221
  - isempty, 221
- AuditoryProfile::parser\_t, 222
  - get\_current\_profile, 223
  - L, 223
  - parser\_t, 223
  - R, 223
- AuditoryProfile::parser\_t::ear\_t, 223
  - ear\_t, 224
  - get\_ear, 224
  - HTL, 224
  - UCL, 224
- AuditoryProfile::parser\_t::fmap\_t, 224
  - f, 225
  - fmap\_t, 225
  - get\_fmap, 225
  - name\_, 225
  - patchbay, 225
  - validate, 225
  - value, 225
- AuditoryProfile::profile\_t, 226
  - get\_ear, 226
  - L, 227
  - R, 227
- AuditoryProfile::profile\_t::ear\_t, 227
  - convert\_empty2normal, 227
  - HTL, 227
  - UCL, 227
- average
  - coherence::vars\_t, 242
- avg\_ipd
  - coherence::cohflt\_t, 240
- azimuth
  - mha\_direction\_t, 438
- B
  - MHAFilter::filter\_t, 534
  - MHAFilter::iir\_filter\_t, 542
- b
  - doasvm\_classification, 281
  - MHAParser::base\_t::replace\_t, 643
- B\_
  - MHAFilter::complex\_bandpass\_t, 522
- MHAFilter::iir\_ord1\_real\_t, 545
- b\_check\_version
  - PluginLoader::mhapluginloader\_t, 885
- b\_complex
  - acsave::save\_var\_t, 171
- b\_cont
  - acmon::acmon\_t, 159
- b\_est
  - lpc\_bl\_predictor\_config, 401
- b\_exit\_request
  - fw\_t, 348
- b\_flushed
  - acsave::acsave\_t, 167
- b\_fw\_started
  - io\_parser\_t, 374
- b\_is\_input
  - calibrator\_runtime\_layer\_t, 231
  - calibrator\_t, 233
- b\_is\_prepared
  - PluginLoader::mhapluginloader\_t, 885
- b\_loop
  - MHASignal::loop\_wavefragment\_t, 781
- b\_ltg
  - coherence::cohflt\_t, 241
- b\_prepared
  - acsave::acsave\_t, 167
  - io\_file\_t, 368
  - io\_parser\_t, 374
  - MHAJack::client\_t, 599
  - mhachain::chain\_base\_t, 499
  - mhachain::plugs\_t, 502
- b\_process
  - io\_alsa\_t, 364
- b\_ready
  - MHAJack::client\_avg\_t, 590
- b\_record
  - ac2osc\_t, 147
- b\_snapshot
  - acmon::acmon\_t, 159
- b\_starting
  - io\_parser\_t, 374
- b\_stopped
  - io\_parser\_t, 374
  - MHAJack::client\_avg\_t, 590
  - MHAJack::client\_noncont\_t, 592
- b\_use\_clipping
  - calibrator\_runtime\_layer\_t, 231
- b\_use\_fir
  - calibrator\_runtime\_layer\_t, 231
- b\_use\_profiling
  - mhachain::plugs\_t, 503

- BARKSCALE\_ENTRIES
  - mha\_fftfb.cpp, 1004
- blinvert
  - coherence::cohflt\_t, 241
- backward
  - lpc\_bl\_predictor\_config, 401
  - lpc\_burglattice\_config, 406
  - MHASignal::fft\_t, 774
- backward\_scale
  - MHASignal::fft\_t, 774
- band\_weights
  - dc::dc\_vars\_t, 259
- bands
  - dc::wideband\_inhib\_vars\_t, 263
  - gtfb\_analyzer::gtfb\_analyzer\_cfg\_t, 354
  - MHAOvFilter::fspacing\_t, 626
- bandw\_correction
  - speechnoise.cpp, 1077
- bark2hz\_t
  - MHAOvFilter::barkscale::bark2hz\_t, 614
- bartlett
  - MHAWindow, 126
- bartlett\_t
  - MHAWindow::bartlett\_t, 834
- base\_t
  - MHAMultiSrc::base\_t, 608
  - MHAParser::base\_t, 637
  - MHAWindow::base\_t, 835, 836
- basename
  - save\_spec\_t, 902
  - save\_wave\_t, 903
  - shadowfilter\_begin::shadowfilter\_begin\_↔  
\_t, 906
  - shadowfilter\_end::shadowfilter\_end\_↔  
t, 909
- bass
  - plingploing::plingploing\_t, 869
- bassmod
  - plingploing::if\_t, 867
- bassmod\_
  - plingploing::plingploing\_t, 870
- bassperiod
  - plingploing::if\_t, 868
- bassperiod\_
  - plingploing::plingploing\_t, 870
- bbcalib\_interface\_t, 228
  - ~bbcalib\_interface\_t, 229
  - bbcalib\_interface\_t, 229
  - calib\_in, 229
  - calib\_out, 229
  - plugloader, 229
  - prepare, 229
  - process, 229
  - release, 229
- bbgain
  - gain::gain\_if\_t, 351
- beta
  - ADM::ADM, 190
  - adm\_if\_t, 197
- beta\_const
  - timo\_params, 940
  - timoSmooth, 946
- bf\_src
  - steerbf, 928
- bf\_src\_copy
  - steerbf\_config, 929
- bf\_vec
  - steerbf\_config, 929
- bflush
  - acsave::acsave\_t, 167
- bin1
  - MHAOvFilter::fftfb\_t, 618
- bin2
  - MHAOvFilter::fftfb\_t, 618
- bin2freq
  - Vector and matrix processing toolbox, 45
- blackman
  - MHAWindow, 127
- blackman\_t
  - MHAWindow::blackman\_t, 837
- blockprocessing\_polyphase\_resampling\_t
  - MHAFilter::blockprocessing\_polyphase\_↔  
\_resampling\_t, 518
- blocks
  - droptect\_t, 289
- bookkeeping
  - MHAFilter::partitioned\_convolution\_t, 557
  - MHAParser::mhapluginloader\_t, 684
- bool\_mon\_t
  - MHAParser::bool\_mon\_t, 644
- bool\_t
  - MHAParser::bool\_t, 647
- bpm
  - plingploing::if\_t, 867
- bprofiling
  - mhachain::chain\_base\_t, 499
- bracket\_balance
  - MHAParser::StrCnv, 114
- brown
  - speechnoise\_t, 925
- browsemhaplugins.cpp, 968
  - DEBUG, 969

- main, [969](#)
- bt
  - plingploing::plingploing\_t, [869](#)
- buf
  - ac2lsl::save\_var\_t, [140](#)
  - ac2lsl::save\_var\_t< mha\_complex\_t >, [143](#)
  - mha\_fifo\_t, [456](#)
  - mha\_spec\_t, [466](#)
  - mha\_wave\_t, [497](#)
- buf\_c\_in
  - MHASignal::hilbert\_fftw\_t, [776](#)
- buf\_c\_out
  - MHASignal::hilbert\_fftw\_t, [776](#)
- buf\_in
  - MHASignal::fft\_t, [775](#)
- buf\_out
  - MHASignal::fft\_t, [775](#)
- buf\_r\_in
  - MHASignal::hilbert\_fftw\_t, [776](#)
- buf\_r\_out
  - MHASignal::hilbert\_fftw\_t, [776](#)
- buf\_uses\_placement\_new
  - mha\_fifo\_t, [456](#)
- buffer
  - alsa\_t, [212](#)
  - MHASignal::delay\_spec\_t, [766](#)
  - MHASignal::delay\_t, [768](#)
  - MHASignal::delay\_wave\_t, [769](#)
- buffered\_incoming\_bytes
  - MHA\_TCP::Connection, [477](#)
- buffered\_outgoing\_bytes
  - MHA\_TCP::Connection, [477](#)
- burn
  - DynComp::dc\_afterburn\_rt\_t, [293](#)
  - DynComp::dc\_afterburn\_t, [295](#)
  - multibandcompressor::interface\_t, [848](#)
- butter\_stop\_ord1
  - MHAFilter, [96](#)
- bw
  - MHAOvFilter::fscale\_bw\_t, [623](#)
- bw\_
  - MHAFilter::gammaflt\_t, [538](#)
- bw\_generator
  - MHAFilter::thirdoctave\_analyzer\_t, [569](#)
- bw\_hz
  - MHAOvFilter::fscale\_bw\_t, [623](#)
- bw\_name
  - dc::dc\_vars\_t, [259](#)
- bwv
  - MHAOvFilter::fftfb\_ac\_info\_t, [616](#)
- multibandcompressor::fftfb\_plug\_t, [846](#)
- bypass
  - adm\_if\_t, [197](#)
  - db\_if\_t, [251](#)
  - dc::dc\_t, [256](#)
  - dc::dc\_vars\_t, [259](#)
  - dc\_simple::dc\_vars\_t, [270](#)
  - DynComp::dc\_afterburn\_vars\_t, [298](#)
- C
  - ADM, [81](#)
- c
  - acPooling\_wave\_config, [164](#)
  - doasvm\_classification\_config, [282](#)
  - io\_tcp\_sound\_t::float\_union, [388](#)
  - mha\_complex\_test\_array\_t, [432](#)
  - nlms\_t, [852](#)
  - prediction\_error, [888](#)
- c1\_a
  - MHAFilter::o1\_ar\_filter\_t, [548](#)
- c1\_r
  - MHAFilter::o1\_ar\_filter\_t, [548](#)
- c2\_a
  - MHAFilter::o1\_ar\_filter\_t, [548](#)
- c2\_r
  - MHAFilter::o1\_ar\_filter\_t, [548](#)
- c\_ifc\_parser\_t
  - MHAParser::c\_ifc\_parser\_t, [649](#)
- c\_min
  - coherence::cohflt\_t, [240](#)
- c\_parse\_cmd
  - MHAParser::c\_ifc\_parser\_t, [650](#)
- c\_parse\_cmd\_t
  - MHAParser, [111](#)
- c\_parse\_err
  - MHAParser::c\_ifc\_parser\_t, [650](#)
- c\_parse\_err\_t
  - MHAParser, [111](#)
- c\_scale
  - coherence::cohflt\_t, [240](#)
- CHANLOOP
  - timoconfig.cpp, [1081](#)
- CHECK\_EXPR
  - mha\_defs.h, [998](#)
- CHECK\_VAR
  - mha\_defs.h, [998](#)
- cLTASS
  - MHAOvFilter::fftfb\_ac\_info\_t, [616](#)
  - MHAOvFilter::fftfb\_vars\_t, [621](#)
- COMPILER\_ID\_MAJOR
  - compiler\_id.hh, [970](#)
- COMPILER\_ID\_MINOR

- compiler\_id.hh, 970
- COMPILER\_ID\_PATCH
  - compiler\_id.hh, 970
- COMPILER\_ID\_VENDOR
  - compiler\_id.hh, 970
- COMPILER\_ID\_VERSION\_HELPER1
  - compiler\_id.hh, 970
- COMPILER\_ID\_VERSION\_HELPER2
  - compiler\_id.hh, 970
- COMPILER\_ID\_VERSION
  - compiler\_id.hh, 970
- COMPILER\_ID
  - compiler\_id.hh, 970
- calc\_in
  - wave2spec\_t, 953
- calc\_out
  - overlapadd::overlapadd\_t, 863
  - spec2wave\_t, 923
- calc\_pre\_wnd
  - wave2spec\_t, 952
- calib\_in
  - bbcalib\_interface\_t, 229
- calib\_out
  - bbcalib\_interface\_t, 229
- calibrator\_runtime\_layer\_t, 229
  - b\_is\_input, 231
  - b\_use\_clipping, 231
  - b\_use\_fir, 231
  - calibrator\_runtime\_layer\_t, 230
  - fir, 230
  - firfir2fftl, 230
  - firfirlen, 230
  - gain, 230
  - pmode, 231
  - process, 230
  - quant, 230
  - softclip, 230
  - speechnoise, 231
- calibrator\_t, 231
  - b\_is\_input, 233
  - calibrator\_t, 232
  - patchbay, 233
  - prepare, 232
  - prepared, 233
  - process, 232
  - read\_levels, 233
  - release, 232
  - update, 233
  - update\_tau\_level, 233
  - vars, 233
- calibrator\_variables\_t, 233
  - calibrator\_variables\_t, 234
  - config\_parser, 234
  - do\_clipping, 234
  - fir, 234
  - fragsize, 234
  - nbits, 234
  - num\_channels, 234
  - peaklevel, 234
  - rmslevel, 234
  - softclip, 234
  - spnoise\_channels, 234
  - spnoise\_level, 234
  - spnoise\_mode, 234
  - spnoise\_parser, 234
  - srate, 234
  - tau\_level, 234
- can\_read
  - MHAFilter::blockprocessing\_polyphase←  
\_resampling\_t, 519
- can\_read\_bytes
  - MHA\_TCP::Connection, 475
- can\_read\_line
  - MHA\_TCP::Connection, 475
- can\_sysread
  - MHA\_TCP::Connection, 473
- can\_syswrite
  - MHA\_TCP::Connection, 473
- can\_update
  - addsndfile::level\_adapt\_t, 184
  - fader\_wave::level\_adapt\_t, 323
- catch\_condition
  - MHAPlugin\_Split::posix\_threads\_t, 746
- catch\_thread
  - MHAPlugin\_Split::dummy\_threads\_t, 742
  - MHAPlugin\_Split::posix\_threads\_t, 745
  - MHAPlugin\_Split::thread\_platform\_t, 758
- categories
  - plugindescription\_t, 875
- cdata
  - MHASignal::matrix\_t, 790
  - mha\_audio\_t, 429
- center\_frequencies
  - dc::dc\_vars\_t, 259
  - dc\_simple::dc\_if\_t, 265
- cf
  - MHAFilter::thirdoctave\_analyzer\_t, 569
  - MHAOvFilter::band\_descriptor\_t, 613
  - MHAOvFilter::fftb\_vars\_t, 621
  - mha\_audio\_descriptor\_t, 428
  - plingploing::plingploing\_t, 869
- cf2bands

- MHAOvFilter::fspacing\_t, 626
- cf\_
  - MHAFilter::gammaflt\_t, 538
  - wavwriter\_t, 956
- cf\_generator
  - MHAFilter::thirdoctave\_analyzer\_t, 569
- cf\_h
  - MHAOvFilter::band\_descriptor\_t, 613
- cf\_in
  - overlapadd::overlapadd\_if\_t, 861
  - smoothgains\_bridge::overlapadd\_if\_↔  
t, 914
- cf\_in\_
  - MHAParser::mhapluginloader\_t, 684
- cf\_input
  - PluginLoader::mhapluginloader\_t, 885
- cf\_l
  - MHAOvFilter::band\_descriptor\_t, 613
- cf\_name
  - dc::dc\_vars\_t, 259
- cf\_out
  - overlapadd::overlapadd\_if\_t, 861
  - smoothgains\_bridge::overlapadd\_if\_↔  
t, 914
- cf\_out\_
  - MHAParser::mhapluginloader\_t, 684
- cf\_output
  - PluginLoader::mhapluginloader\_t, 885
- cfac
  - route::interface\_t, 896
- cfg
  - MHAPLugin::config\_t, 728
- cfg\_
  - MHAFilter::thirdoctave\_analyzer\_t, 569
- cfg\_chain
  - MHAPLugin::config\_t, 728
- cfg\_chain\_current
  - MHAPLugin::config\_t, 728
- cfg\_chain\_t
  - MHAPLugin::cfg\_chain\_t, 723
- cfg\_dump
  - MHAParser, 111
- cfg\_dump\_short
  - MHAParser, 111
- cfg\_t, 235
  - ac2lsl::cfg\_t, 134
  - acsave::cfg\_t, 168
  - alpha, 236
  - attack, 236
  - cfg\_t, 235
  - channel, 236
  - decay, 236
  - frozen\_noise\_, 236
  - gain\_spec\_, 236
  - gain\_wave\_, 236
  - matrixmixer::cfg\_t, 409
  - pos, 236
  - process, 236
  - replace\_, 236
  - shadowfilter\_begin::cfg\_t, 904
  - shadowfilter\_end::cfg\_t, 907
  - start\_lin, 236
  - use\_frozen\_, 236
- cfin
  - altplugs\_t, 216
  - fw\_t, 348
  - mhachain::chain\_base\_t, 499
  - route::interface\_t, 896
- cfout
  - altplugs\_t, 216
  - fw\_t, 348
  - mhachain::chain\_base\_t, 499
  - route::interface\_t, 896
- cfv
  - MHAOvFilter::fftb\_ac\_info\_t, 615
  - multibandcompressor::fftb\_plug\_t, 846
- cg
  - coherence::cohfft\_t, 240
- ch
  - MHASignal::doublebuffer\_t, 772
- chain
  - acmon::acmon\_t, 159
  - acsave::acsave\_t, 167
  - analysispath\_if\_t, 220
  - db\_if\_t, 251
  - MHAPLugin\_Resampling::resampling\_if\_↔  
t, 734
  - mhachain::chain\_base\_t, 499
  - mhachain::plugs\_t, 503
- chain\_base\_t
  - mhachain::chain\_base\_t, 498
- chains
  - MHAPLugin\_Split::split\_t, 751
- change\_mode
  - addsndfile::addsndfile\_if\_t, 182
- channel
  - cfg\_t, 236
  - example5\_t, 316
  - MHAMultiSrc::channel\_t, 608
- channel\_gain\_name
  - combc\_if\_t, 244
- channel\_gains\_

- combc\_t, 245
- channel\_info
  - mha\_spec\_t, 466
  - mha\_wave\_t, 497
- channel\_no
  - example6\_t, 317
- channelconfig\_out\_
  - MHAOvIFilter::overlap\_save\_filterbank\_t, 630
- channels
  - ac2wave\_t, 150
  - addsndfile::addsndfile\_if\_t, 182
  - alsa\_t, 212
  - dc::wideband\_inhib\_vars\_t, 263
  - gtfb\_analyzer::gtfb\_analyzer\_cfg\_t, 354
  - MHAFilter::fftfilter\_t, 526
  - MHAFilter::filter\_t, 535
  - MHAParser::mhaconfig\_mon\_t, 681
  - MHAPlugin\_Split::split\_t, 750
  - MHASignal::delay\_t, 768
  - mhaconfig\_t, 505
  - prediction\_error\_config, 891
  - rt\_nlms\_t, 899
  - sine\_cfg\_t, 910
  - sine\_t, 912
  - testplugin::config\_parser\_t, 933
  - Vector and matrix processing toolbox, 42
- channels\_t
  - MHAMultiSrc::channels\_t, 609
- char\_data
  - testplugin::ac\_parser\_t, 931
- chdir
  - mha\_audio\_descriptor\_t, 428
- check\_index
  - adm\_rtconfig\_t, 199
- check\_low
  - MHAParser::range\_var\_t, 695
- check\_range
  - MHAParser::range\_var\_t, 695
- check\_sound\_data\_type
  - io\_tcp\_sound\_t, 386
- check\_up
  - MHAParser::range\_var\_t, 695
- check\_vars
  - ac2lsl::cfg\_t, 135
- chname
  - dc::dc\_vars\_t, 259
- chunkbytes\_in
  - io\_tcp\_sound\_t, 386
- ci
  - matrixmixer::matmix\_t, 411
- cleanup\_plugs
  - mhachain::plugs\_t, 502
- cleanup\_unused\_cfg
  - MHAPlugin::config\_t, 728
- clear
  - MHATableLookup::linear\_table\_t, 827
  - MHATableLookup::table\_t, 829
  - MHATableLookup::xy\_table\_t, 832
  - mha\_fifo\_t, 456
  - Vector and matrix processing toolbox, 49
- clear\_chains
  - MHAPlugin\_Split::split\_t, 749
- clear\_plugins
  - pluginbrowser\_t, 874
- Client
  - MHA\_TCP::Client, 470
- client\_avg\_t
  - MHAJack::client\_avg\_t, 589
- client\_noncont\_t
  - MHAJack::client\_noncont\_t, 592
- client\_t
  - MHAJack::client\_t, 595
- clientid
  - dc::dc\_vars\_t, 259
  - dc\_simple::dc\_if\_t, 265
- clientname
  - MHAIOJack::io\_jack\_t, 576
  - MHAIOJackdb::io\_jack\_t, 581
- clipmeter
  - softclipper\_t, 918
- clipped
  - softclipper\_variables\_t, 920
- close\_session
  - wavwriter\_t, 956
- closed
  - MHA\_TCP::Connection, 477
- closesocket
  - mha\_tcp.cpp, 1040
- cmd\_prepare
  - MHAIOPortAudio::io\_portaudio\_t, 586
- cmd\_release
  - MHAIOPortAudio::io\_portaudio\_t, 587
- cmd\_start
  - MHAIOPortAudio::io\_portaudio\_t, 586
- cmd\_stop
  - MHAIOPortAudio::io\_portaudio\_t, 586
- co
  - matrixmixer::matmix\_t, 411
- coeff
  - gtfb\_analyzer::gtfb\_analyzer\_cfg\_t, 354
  - gtfb\_analyzer::gtfb\_analyzer\_t, 357

- coeff\_decomb
  - adm\_if\_t, 197
- coeff\_lp
  - adm\_if\_t, 197
- coh\_c
  - coherence::cohflt\_t, 241
- coh\_rlp
  - coherence::cohflt\_t, 241
- coherence, 82
  - getcipd, 82
- coherence.cpp, 969
- coherence::cohflt\_if\_t, 237
  - algo, 238
  - cohflt\_if\_t, 238
  - patchbay, 238
  - prepare, 238
  - process, 238
  - release, 238
  - update, 238
  - vars, 238
- coherence::cohflt\_t, 239
  - alpha, 240
  - avg\_ipd, 240
  - b\_ltg, 241
  - blinvert, 241
  - c\_min, 240
  - c\_scale, 240
  - cg, 240
  - coh\_c, 241
  - coh\_rlp, 241
  - cohflt\_t, 240
  - g, 240
  - gain, 241
  - gain\_delay, 241
  - insert, 240
  - limit, 240
  - lp1i, 240
  - lp1ltg, 241
  - lp1r, 240
  - nbands, 240
  - process, 240
  - s\_out, 241
  - staticgain, 241
- coherence::vars\_t, 241
  - alpha, 242
  - average, 242
  - delay, 242
  - invert, 242
  - limit, 242
  - ltgcomp, 242
  - ltgtau, 242
  - mapping, 242
  - staticgain, 242
  - tau, 242
  - tau\_unit, 242
  - vars\_t, 242
- cohflt\_if\_t
  - coherence::cohflt\_if\_t, 238
- cohflt\_t
  - coherence::cohflt\_t, 240
- collect\_result
  - MHAPugin\_Split::split\_t, 749
  - MHAPugin\_Split::splitted\_part\_t, 755
- colored\_intensity
  - Vector and matrix processing toolbox, 57
- cols
  - acsave::mat4head\_t, 169
- combc\_if\_t, 243
  - channel\_gain\_name, 244
  - combc\_if\_t, 244
  - element\_gain\_name, 244
  - interleaved, 244
  - outchannels, 244
  - prepare, 244
  - process, 244
- combc\_t, 244
  - ac\_, 245
  - channel\_gains\_, 245
  - combc\_t, 245
  - element\_gain\_name\_, 245
  - interleaved\_, 245
  - nbands, 245
  - process, 245
  - s\_out, 245
  - w\_out, 245
- combinechannels.cpp, 969
- comm\_var\_t, 246
  - data, 247
  - data\_type, 246
  - num\_entries, 246
  - stride, 247
- commentate
  - MHAParser, 111
- commit
  - DynComp::dc\_afterburn\_vars\_t, 298
- commit\_pending
  - DynComp::dc\_afterburn\_t, 296
- commit\_t
  - MHAParser::commit\_t, 652
- Communication between algorithms, 28
  - get\_var\_float, 30
  - get\_var\_int, 30

- get\_var\_spectrum, 29
- get\_var\_vfloat, 31
- get\_var\_waveform, 30
- comp\_each\_iter
  - lpc, 397
  - lpc\_config, 407
- comp\_iter
  - lpc\_config, 408
- compiler\_id.cpp, 970
- compiler\_id.hh, 970
  - COMPILER\_ID\_MAJOR, 970
  - COMPILER\_ID\_MINOR, 970
  - COMPILER\_ID\_PATCH, 970
  - COMPILER\_ID\_VENDOR, 970
  - COMPILER\_ID\_VERSION\_HELPER1, 970
  - COMPILER\_ID\_VERSION\_HELPER2, 970
  - COMPILER\_ID\_VERSION, 970
  - COMPILER\_ID, 970
- Complex arithmetics in the openMHA, 61
  - \_conjugate, 68
  - \_reciprocal, 69
  - abs, 67
  - abs2, 67
  - almost, 69
  - angle, 64
  - conjugate, 68
  - expi, 64, 66
  - mha\_complex, 63
  - normalize, 69
  - operator!=, 68
  - operator<, 69
  - operator\*, 66, 67
  - operator\*=: 66
  - operator+, 65
  - operator+=: 65
  - operator-, 65, 66, 68
  - operator-=, 65
  - operator/, 67, 68
  - operator/=, 67
  - operator==, 68
  - reciprocal, 68
  - safe\_div, 67
  - set, 63, 64
  - stdcomplex, 64
- complex\_bandpass\_t
  - MHAFilter::complex\_bandpass\_t, 521
- complex\_data
  - testplugin::ac\_parser\_t, 931
- complex\_filter.cpp, 970
- complex\_filter.h, 970
- complex\_mon\_t
  - MHAParser::complex\_mon\_t, 653
- complex\_ofs
  - MHASignal::matrix\_t, 790
- complex\_t
  - MHAParser::complex\_t, 655
- compression
  - dc\_simple::dc\_t, 267
- compute\_something
  - cpuload\_t, 248
- compute\_something\_else
  - cpuload\_t, 249
- Concept of Variables and Data Exchange in the openMHA, 4
- cond\_to\_process
  - analysepath\_t, 218
- config\_file\_splitter\_t
  - PluginLoader::config\_file\_splitter\_t, 876
- config\_in
  - testplugin::if\_t, 935
- config\_out
  - testplugin::if\_t, 935
- config\_parser
  - calibrator\_variables\_t, 234
- config\_parser\_t
  - testplugin::config\_parser\_t, 932
- config\_t
  - MHAPLugin::config\_t, 726
- configfile
  - PluginLoader::config\_file\_splitter\_t, 877
- configname
  - PluginLoader::config\_file\_splitter\_t, 877
- configuration, 4
- configuration variable, 4
- conflux
  - DynComp::dc\_afterburn\_rt\_t, 294
  - DynComp::dc\_afterburn\_vars\_t, 298
- conjugate
  - Complex arithmetics in the openMHA, 68
  - Vector and matrix processing toolbox, 60
- connect
  - MHAEvents::emitter\_t, 511
  - MHAEvents::patchbay\_t, 512, 513
- connect\_input
  - MHAJack::client\_t, 596
- connect\_output
  - MHAJack::client\_t, 596
- connect\_to
  - MHAJack::port\_t, 602
- connected



- io\_tcp\_parser\_t, 383
- Connection
  - MHA\_TCP::Connection, 473
- connection\_loop
  - io\_tcp\_t, 390
- connections
  - MHAEvents::emitter\_t, 511
- connections\_in
  - MHAIOJack::io\_jack\_t, 576
  - MHAIOJackdb::io\_jack\_t, 581
- connections\_out
  - MHAIOJack::io\_jack\_t, 576
  - MHAIOJackdb::io\_jack\_t, 581
- connector
  - MHAFilter::adapt\_filter\_t, 517
  - MHAFilter::iir\_filter\_t, 542
  - MHAParser::mhapluginloader\_t, 684
- connector\_base\_t
  - MHAEvents::connector\_base\_t, 506
- connector\_t
  - MHAEvents::connector\_t, 509
- cons
  - MHAEvents::patchbay\_t, 513
- consecutive\_dropouts
  - droptect\_t, 289
- contained\_frames
  - MHASignal::ringbuffer\_t, 795
- conv2latex
  - generatemhaplugindoc.cpp, 981
- convert\_empty2normal
  - AuditoryProfile::profile\_t::ear\_t, 227
- convert\_f2logf
  - gaintable.cpp, 980
- copy
  - MHASignal::spectrum\_t, 803
  - MHASignal::waveform\_t, 819
  - timo\_AC, 937
- copy\_AC
  - timoConfig, 942
- copy\_channel
  - MHASignal::spectrum\_t, 804
  - MHASignal::waveform\_t, 819
  - Vector and matrix processing toolbox, 56
- copy\_error
  - MHAIOTCP.cpp, 1063
- copy\_from\_at
  - MHASignal::waveform\_t, 819
- copy\_output\_spec
  - MHAPLugin\_Split::split\_t, 749
- copy\_output\_wave
  - MHAPLugin\_Split::split\_t, 749
- copy\_permuted
  - MHASignal, 124
- corr\_out
  - lpc\_config, 408
- cpuload.cpp, 971
- cpuload\_t, 247
  - compute\_something, 248
  - compute\_something\_else, 249
  - cpuload\_t, 248
  - factor, 249
  - phase, 249
  - prepare, 248
  - process, 248
  - result, 249
  - table, 249
  - use\_sine, 249
- create\_latex\_doc
  - generatemhaplugindoc.cpp, 982
- create\_lock
  - mhamain.cpp, 1067
- create\_or\_replace\_var
  - ac2lsl::cfg\_t, 135
- creator
  - speechnoise\_t, 926
- creator\_A
  - MHAFilter::complex\_bandpass\_t, 521
- creator\_B
  - MHAFilter::complex\_bandpass\_t, 521
- cstr\_strerror
  - mha\_errno.c, 999
- current
  - altplugs\_t, 216
  - dc::wideband\_inhib\_vars\_t, 262
  - mha\_rt\_fifo\_t, 464
- current\_input\_signal\_buffer\_half\_index
  - MHAFilter::partitioned\_convolution\_t, 557
- current\_output\_partition\_index
  - MHAFilter::partitioned\_convolution\_t, 557
- current\_powspec
  - droptect\_t, 289
- current\_thread\_priority
  - MHAPLugin\_Split::posix\_threads\_t, 745
- current\_thread\_scheduler
  - MHAPLugin\_Split::posix\_threads\_t, 745
- cvalue
  - gftb\_analyzer::gftb\_analyzer\_cfg\_t, 354
- DBG
  - MHAIOalsa.cpp, 1045
- DEBUG
  - addsndfile.cpp, 965
  - browsemhaplugins.cpp, 969

- fader\_wave.cpp, 978
- MHAIOFile.cpp, 1047
- wavrec.cpp, 1084
- DEFAULT\_RETSIZE
  - mha\_parser.hh, 1021
- DELAY\_FREQ
  - ADM, 81
- DO\_RESAMPLE
  - addsndfile, 80
- DONT\_RESAMPLE\_PERMISSIVE
  - addsndfile, 80
- DONT\_RESAMPLE\_STRICT
  - addsndfile, 80
- DUPVEC
  - dc.cpp, 972
- data
  - acsave::save\_var\_t, 171
  - comm\_var\_t, 247
  - DynComp::gaintable\_t, 303
  - MHA\_AC::acspace2matrix\_t, 418
  - MHA\_AC::double\_t, 419
  - MHA\_AC::float\_t, 420
  - MHA\_AC::int\_t, 421
  - MHAParser::bool\_mon\_t, 645
  - MHAParser::bool\_t, 647
  - MHAParser::complex\_mon\_t, 654
  - MHAParser::complex\_t, 656
  - MHAParser::float\_mon\_t, 659
  - MHAParser::float\_t, 662
  - MHAParser::int\_mon\_t, 664
  - MHAParser::int\_t, 666
  - MHAParser::kw\_t, 672
  - MHAParser::mcomplex\_mon\_t, 673
  - MHAParser::mcomplex\_t, 675
  - MHAParser::mfloat\_mon\_t, 677
  - MHAParser::mfloat\_t, 680
  - MHAParser::mint\_mon\_t, 686
  - MHAParser::string\_mon\_t, 697
  - MHAParser::string\_t, 699
  - MHAParser::vcomplex\_mon\_t, 704
  - MHAParser::vcomplex\_t, 706
  - MHAParser::vfloat\_mon\_t, 708
  - MHAParser::vfloat\_t, 711
  - MHAParser::vint\_mon\_t, 712
  - MHAParser::vint\_t, 715
  - MHAParser::vstring\_mon\_t, 716
  - MHAParser::vstring\_t, 718
  - MHAPugin::cfg\_chain\_t, 723
  - MHASignal::uint\_vector\_t, 811
  - mha\_rt\_fifo\_element\_t, 461
  - wavwriter\_t, 956
- data\_is\_initialized
  - MHAParser::base\_t, 642
- data\_type
  - ac2Isl::save\_var\_base\_t, 137
  - ac2Isl::save\_var\_t, 139
  - ac2Isl::save\_var\_t< mha\_complex\_t >, 142
  - comm\_var\_t, 246
  - testplugin::ac\_parser\_t, 931
- data\_type\_
  - ac2Isl::save\_var\_t, 140
- data\_type\_t
  - testplugin::ac\_parser\_t, 931
- db.cpp, 971
- db2lin
  - Vector and matrix processing toolbox, 43
- db\_if\_t, 249
  - ~db\_if\_t, 250
  - algo, 251
  - bypass, 251
  - chain, 251
  - db\_if\_t, 250
  - fragsize, 251
  - patchbay, 251
  - plugloader, 251
  - prepare, 250
  - process, 250
  - release, 250
- db\_t, 251
  - db\_t, 252
  - inner\_process, 252
  - plugloader, 252
- dbspl2pa
  - Vector and matrix processing toolbox, 44
- DC
  - dc\_simple, 84
- dc, 82
  - get\_audiochannels, 83
- dc.cpp, 971
  - DUPVEC, 972
- dc::dc\_if\_t, 253
  - algo, 254
  - dc\_if\_t, 254
  - patchbay, 254
  - prepare, 254
  - process, 254
  - update, 254
  - update\_monitors, 254
  - wbinhib, 254
- dc::dc\_t, 255
  - attack, 256

- bypass, [256](#)
- dc\_t, [256](#)
- decay, [256](#)
- explicit\_insert, [256](#)
- get\_level\_in\_db, [256](#)
- get\_level\_in\_db\_adjusted, [256](#)
- get\_nbands, [256](#)
- gt, [256](#)
- inhib\_gain, [257](#)
- k\_nyquist, [257](#)
- level\_in\_db, [257](#)
- level\_in\_db\_adjusted, [257](#)
- max\_level\_difference, [257](#)
- naudiochannels, [257](#)
- nbands, [257](#)
- powersum, [256](#)
- process, [256](#)
- rmslevel, [256](#)
- dc::dc\_vars\_t, [257](#)
  - band\_weights, [259](#)
  - bw\_name, [259](#)
  - bypass, [259](#)
  - center\_frequencies, [259](#)
  - cf\_name, [259](#)
  - chname, [259](#)
  - clientid, [259](#)
  - dc\_vars\_t, [258](#)
  - edge\_frequencies, [259](#)
  - ef\_name, [259](#)
  - filterbank, [259](#)
  - filtered\_level, [259](#)
  - gainrule, [259](#)
  - gtdata, [258](#)
  - gtmin, [258](#)
  - gtstep, [258](#)
  - input\_level, [259](#)
  - max\_level\_difference, [259](#)
  - modified, [259](#)
  - powersum, [258](#)
  - preset, [259](#)
  - tauattack, [258](#)
  - taudecay, [259](#)
  - taurmslevel, [258](#)
  - use\_wbinhib, [259](#)
- dc::dc\_vars\_validator\_t, [260](#)
  - dc\_vars\_validator\_t, [260](#)
- dc::wb\_inhib\_cfg\_t, [260](#)
  - dl\_diff, [261](#)
  - dl\_map\_max, [261](#)
  - dl\_map\_min, [261](#)
  - g\_scale, [261](#)
  - l\_min, [261](#)
  - wb\_inhib\_cfg\_t, [261](#)
  - weights, [261](#)
- dc::wideband\_inhib\_vars\_t, [261](#)
  - bands, [263](#)
  - channels, [263](#)
  - current, [262](#)
  - dl\_map\_max, [262](#)
  - dl\_map\_min, [262](#)
  - g\_scale, [262](#)
  - l\_min, [262](#)
  - patchbay, [263](#)
  - setchannels, [262](#)
  - update, [262](#)
  - weights, [262](#)
  - wideband\_inhib\_vars\_t, [262](#)
- dc\_afterburn.cpp, [972](#)
  - mylogf, [972](#)
- dc\_afterburn.h, [972](#)
- dc\_afterburn\_rt\_t
  - DynComp::dc\_afterburn\_rt\_t, [293](#)
- dc\_afterburn\_t
  - DynComp::dc\_afterburn\_t, [295](#)
- dc\_afterburn\_vars\_t
  - DynComp::dc\_afterburn\_vars\_t, [298](#)
- dc\_if\_t
  - dc::dc\_if\_t, [254](#)
  - dc\_simple::dc\_if\_t, [264](#)
- dc\_simple, [83](#)
  - DC, [84](#)
  - force\_resize, [84](#)
  - LEVEL, [84](#)
  - not\_zero, [84](#)
  - test\_fail, [84](#)
- dc\_simple.cpp, [973](#)
- dc\_simple::dc\_if\_t, [263](#)
  - center\_frequencies, [265](#)
  - clientid, [265](#)
  - dc\_if\_t, [264](#)
  - edge\_frequencies, [265](#)
  - filterbank, [265](#)
  - gainrule, [265](#)
  - has\_been\_modified, [265](#)
  - modified, [265](#)
  - mon\_g, [265](#)
  - mon\_l, [265](#)
  - patchbay, [265](#)
  - prepare, [264](#)
  - prepared, [265](#)
  - preset, [265](#)
  - process, [264](#), [265](#)

- read\_modified, 265
- release, 264
- update\_dc, 265
- update\_gain\_mon, 265
- update\_level, 265
- update\_level\_mon, 265
- dc\_simple::dc\_t, 266
  - compression, 267
  - dc\_t, 267
  - expansion, 267
  - expansion\_threshold, 267
  - limiter, 267
  - limiter\_threshold, 267
  - maxgain, 267
  - mon\_g, 267
  - mon\_l, 267
  - nbands, 267
  - process, 267
- dc\_simple::dc\_t::line\_t, 268
  - line\_t, 268
  - m, 268
  - operator(), 268
  - y0, 268
- dc\_simple::dc\_vars\_t, 269
  - bypass, 270
  - dc\_vars\_t, 269
  - expansion\_slope, 270
  - expansion\_threshold, 270
  - g50, 269
  - g80, 269
  - limiter\_threshold, 270
  - maxgain, 269
  - tauattack, 270
  - taudecay, 270
- dc\_simple::dc\_vars\_validator\_t, 270
  - dc\_vars\_validator\_t, 271
- dc\_simple::level\_smoother\_t, 271
  - attack, 272
  - decay, 272
  - ffflen, 272
  - level\_smoother\_t, 272
  - level\_spec, 272
  - level\_wave, 272
  - nbands, 272
  - process, 272
- dc\_t
  - dc::dc\_t, 256
  - dc\_simple::dc\_t, 267
- dc\_vars\_t
  - dc::dc\_vars\_t, 258
  - dc\_simple::dc\_vars\_t, 269
- dc\_vars\_validator\_t
  - dc::dc\_vars\_validator\_t, 260
  - dc\_simple::dc\_vars\_validator\_t, 271
- deallocate\_domains
  - MHAPLugin\_Split::domain\_handler\_t, 739
- debug
  - io\_tcp\_parser\_t, 383
- debug\_file
  - io\_tcp\_parser\_t, 384
- debug\_filename
  - io\_tcp\_parser\_t, 384
- decay
  - cfg\_t, 236
  - dc::dc\_t, 256
  - dc\_simple::level\_smoother\_t, 272
  - softclip\_t, 917
  - softclipper\_t, 918
- decomb\_coeffs
  - adm\_rtconfig\_t, 200
- decomb\_order
  - adm\_if\_t, 197
- decrease\_condition
  - mha\_fifo\_posix\_threads\_t, 452
- decrement
  - mha\_fifo\_posix\_threads\_t, 451
  - mha\_fifo\_thread\_platform\_t, 459
- default\_thread\_platform\_string
  - split.cpp, 1079
- default\_thread\_platform\_type
  - split.cpp, 1079
- defaultHighInputLatency
  - MHAIOPortAudio::device\_info\_t, 584
- defaultHighOutputLatency
  - MHAIOPortAudio::device\_info\_t, 584
- defaultLowInputLatency
  - MHAIOPortAudio::device\_info\_t, 584
- defaultLowOutputLatency
  - MHAIOPortAudio::device\_info\_t, 584
- defaultSampleRate
  - MHAIOPortAudio::device\_info\_t, 584
- Delay
  - ADM::Delay, 191
- delay, 84
  - coherence::vars\_t, 242
  - delaysum::delaysum\_if\_t, 276
  - MHAFilter::gammaflt\_t, 537
  - MHAFilter::partitioned\_convolution\_t↔
    - ::index\_t, 559
  - MHAPLugin\_Split::split\_t, 751
  - MHASignal::delay\_spec\_t, 766
  - MHASignal::delay\_wave\_t, 769

- mha\_dblbuf\_t, 437
- delay.cpp, 973
- delay::interface\_t, 273
  - delays, 274
  - interface\_t, 274
  - patchbay, 274
  - prepare, 274
  - process, 274
  - update, 274
- delay\_ac
  - ac2wave\_if\_t, 149
  - ac2wave\_t, 151
- delay\_d
  - prediction\_error, 889
- delay\_in
  - ac2wave\_if\_t, 149
  - ac2wave\_t, 151
- delay\_spec\_t
  - MHASignal::delay\_spec\_t, 766
- delay\_t
  - MHASignal::delay\_t, 767
- delay\_w
  - prediction\_error, 889
- delay\_wave\_t
  - MHASignal::delay\_wave\_t, 769
- delays
  - delay::interface\_t, 274
  - MHASignal::delay\_t, 768
- delays\_in
  - MHAIOJack::io\_jack\_t, 576
- delays\_out
  - MHAIOJack::io\_jack\_t, 577
- delaysum, 84
- delaysum.cpp, 974
- delaysum::delaysum\_if\_t, 274
  - delay, 276
  - delaysum\_if\_t, 276
  - patchbay, 276
  - prepare, 276
  - process, 276
  - release, 276
  - update\_cfg, 276
  - weights, 276
- delaysum::delaysum\_t, 277
  - delaysum\_t, 278
  - out, 278
  - process, 278
  - weights, 278
- delaysum\_if\_t
  - delaysum::delaysum\_if\_t, 276
- delaysum\_t
  - delaysum::delaysum\_t, 278
- delete\_plug
  - altplugs\_t, 216
- delta\_phi
  - fshift::fshift\_config\_t, 333
  - fshift\_hilbert::hilbert\_shifter\_t, 342
- delta\_phi\_total
  - fshift::fshift\_config\_t, 333
  - fshift\_hilbert::hilbert\_shifter\_t, 342
- delta\_pitch
  - timo\_params, 940
  - timoSmooth, 946
- descriptor
  - mha\_audio\_t, 429
- desired\_fill\_count
  - mha\_drifter\_fifo\_t, 443
- dev\_in
  - io\_alsa\_t, 364
- dev\_out
  - io\_alsa\_t, 364
- device
  - alsa\_dev\_par\_parser\_t, 209
- device\_index
  - MHAIOPortAudio::io\_portaudio\_t, 587
- device\_index\_updated
  - MHAIOPortAudio::io\_portaudio\_t, 586
- device\_info
  - MHAIOPortAudio::io\_portaudio\_t, 587
- device\_info\_t
  - MHAIOPortAudio::device\_info\_t, 584
- device\_name
  - MHAIOPortAudio::io\_portaudio\_t, 587
- device\_name\_updated
  - MHAIOPortAudio::io\_portaudio\_t, 586
- df
  - fshift::fshift\_config\_t, 333
  - fshift::fshift\_t, 336
  - fshift\_hilbert::frequency\_translator\_t, 338
  - fshift\_hilbert::hilbert\_shifter\_t, 342
- diff\_coefs
  - mha\_filter.cpp, 1006
- diff\_t
  - MHAFilter::diff\_t, 523
- digits
  - mha\_error\_helpers, 90
- dimension
  - MHASignal::matrix\_t, 786
- dimensions
  - acmon::acmon\_t, 159
- dimstr
  - acmon::ac\_monitor\_t, 156

- dir
  - mha\_channel\_info\_t, [430](#)
- dir\_t
  - MHAJack::port\_t, [600](#)
- dir\_type
  - MHAJack::port\_t, [602](#)
- discard
  - MHASignal::ringbuffer\_t, [796](#)
- disconnect
  - MHAEvents::emitter\_t, [511](#)
- dispmode
  - acmon::acmon\_t, [159](#)
- dist
  - plingploing::plingploing\_t, [870](#)
- dist1
  - plingploing::plingploing\_t, [870](#)
- distance
  - mha\_direction\_t, [438](#)
- distances
  - adm\_if\_t, [197](#)
- dl\_diff
  - dc::wb\_inhib\_cfg\_t, [261](#)
- dl\_map\_max
  - dc::wb\_inhib\_cfg\_t, [261](#)
  - dc::wideband\_inhib\_vars\_t, [262](#)
- dl\_map\_min
  - dc::wb\_inhib\_cfg\_t, [261](#)
  - dc::wideband\_inhib\_vars\_t, [262](#)
- dm
  - lpc\_burglattice\_config, [406](#)
- do\_clipping
  - calibrator\_variables\_t, [234](#)
- do\_get\_var
  - testplugin::ac\_parser\_t, [931](#)
- do\_insert\_var
  - testplugin::ac\_parser\_t, [931](#)
- doagcc
  - doasvm\_feature\_extraction\_config, [286](#)
- doasvm
  - doasvm\_classification\_config, [282](#)
- doasvm\_classification, [279](#)
  - ~doasvm\_classification, [280](#)
  - angles, [281](#)
  - b, [281](#)
  - doasvm\_classification, [280](#)
  - max\_p\_ind\_name, [281](#)
  - p\_name, [281](#)
  - patchbay, [281](#)
  - prepare, [280](#)
  - process, [280](#)
  - release, [280](#)
  - update\_cfg, [281](#)
  - vGCC\_name, [281](#)
  - w, [281](#)
  - x, [281](#)
  - y, [281](#)
- doasvm\_classification.cpp, [974](#)
  - INSERT\_PATCH, [974](#)
  - PATCH\_VAR, [974](#)
- doasvm\_classification.h, [974](#)
- doasvm\_classification\_config, [281](#)
  - ~doasvm\_classification\_config, [282](#)
  - ac, [282](#)
  - c, [282](#)
  - doasvm, [282](#)
  - doasvm\_classification\_config, [282](#)
  - p, [282](#)
  - p\_max, [282](#)
  - process, [282](#)
- doasvm\_feature\_extraction, [283](#)
  - ~doasvm\_feature\_extraction, [284](#)
  - doasvm\_feature\_extraction, [284](#)
  - fftlens, [285](#)
  - max\_lag, [285](#)
  - nupsample, [285](#)
  - patchbay, [285](#)
  - prepare, [284](#)
  - process, [284](#)
  - release, [284](#)
  - update\_cfg, [285](#)
  - vGCC\_name, [285](#)
- doasvm\_feature\_extraction.cpp, [974](#)
  - INSERT\_PATCH, [975](#)
  - PATCH\_VAR, [975](#)
- doasvm\_feature\_extraction.h, [975](#)
- doasvm\_feature\_extraction\_config, [285](#)
  - ~doasvm\_feature\_extraction\_config, [286](#)
  - doagcc, [286](#)
  - doasvm\_feature\_extraction\_config, [286](#)
  - fft, [286](#)
  - fftlens, [286](#)
  - G, [286](#)
  - G\_length, [286](#)
  - GCC\_end, [286](#)
  - GCC\_start, [286](#)
  - hifftwin, [286](#)
  - hifftwin\_sum, [286](#)
  - hwin, [286](#)
  - ifft, [286](#)
  - in\_spec, [286](#)
  - proc\_wave, [286](#)
  - process, [286](#)

- vGCC\_ac, [286](#)
- vGCC, [286](#)
- wndlen, [286](#)
- doc\_appendix.h, [975](#)
- doc\_examples.h, [975](#)
- doc\_frameworks.h, [975](#)
- doc\_general.h, [975](#)
- doc\_kernel.h, [975](#)
- doc\_matlab.h, [975](#)
- doc\_mhamain.h, [975](#)
- doc\_parser.h, [975](#)
- doc\_pluginif.cpp, [975](#)
- doc\_plugins.h, [975](#)
- doc\_system.h, [975](#)
- doc\_toolbox.h, [975](#)
- documentation
  - plugindescription\_t, [875](#)
- domain
  - MHAParser::mhaconfig\_mon\_t, [681](#)
  - MHAPugin\_Split::splitted\_part\_t, [755](#)
  - mhaconfig\_t, [505](#)
  - testplugin::config\_parser\_t, [933](#)
- domain\_handler\_t
  - MHAPugin\_Split::domain\_handler\_t, [738](#)
- double\_t
  - MHA\_AC::double\_t, [419](#)
- doublebuffer\_t
  - MHASignal::doublebuffer\_t, [770](#)
- down
  - MHASignal::schroeder\_t, [799](#)
- downsample.cpp, [975](#)
- downsampling\_factor
  - MHAFilter::polyphase\_resampling\_t, [563](#)
- downscale
  - MHASignal::quantizer\_t, [793](#)
- drain
  - DynComp::dc\_afterburn\_vars\_t, [298](#)
- drain\_inv
  - DynComp::dc\_afterburn\_rt\_t, [294](#)
- drand
  - plingploing, [128](#)
- dropouts
  - droptect\_t, [289](#)
- droptect.cpp, [976](#)
- droptect\_t, [287](#)
  - blocks, [289](#)
  - consecutive\_dropouts, [289](#)
  - current\_powspec, [289](#)
  - dropouts, [289](#)
  - droptect\_t, [288](#)
  - filter\_activated, [289](#)
  - filtered\_powspec, [289](#)
  - filtered\_powspec\_mon, [289](#)
  - level\_mon, [289](#)
  - period, [289](#)
  - prepare, [288](#)
  - process, [288](#)
  - release, [288](#)
  - reset, [289](#)
  - tau, [289](#)
  - threshold, [289](#)
- ds\_t, [290](#)
  - antialias, [291](#)
  - ds\_t, [290](#)
  - prepare, [291](#)
  - process, [291](#)
  - ratio, [291](#)
  - release, [291](#)
- dt
  - mha\_audio\_descriptor\_t, [428](#)
- dtime
  - MHA\_TCP, [93](#)
- dummy\_interface\_test
  - MHAIOFile.cpp, [1048](#), [1049](#)
  - MHAIOJack.cpp, [1051](#), [1052](#)
  - MHAIOJackdb.cpp, [1053](#), [1054](#)
  - MHAIOParser.cpp, [1056](#), [1057](#)
  - MHAIOPortAudio.cpp, [1059](#), [1060](#)
  - MHAIOTCP.cpp, [1062](#), [1063](#)
  - MHAIOalsa.cpp, [1045](#), [1046](#)
- dummy\_jack\_proc\_cb
  - mhajack.cpp, [1064](#)
- dummy\_threads\_t
  - MHAPugin\_Split::dummy\_threads\_t, [742](#)
- dump\_mha
  - fw\_t, [347](#)
- dup
  - MHAFilter::thirdoctave\_analyzer\_t, [569](#)
- dupvec
  - Vector and matrix processing toolbox, [46](#)
- dupvec\_chk
  - Vector and matrix processing toolbox, [47](#)
- dur\_
  - plingploing::plingploing\_t, [869](#)
- DynComp, [85](#)
  - interp1, [85](#)
  - interp2, [86](#)
- DynComp::dc\_afterburn\_rt\_t, [292](#)
  - burn, [293](#)
  - conflux, [294](#)
  - dc\_afterburn\_rt\_t, [293](#)
  - drain\_inv, [294](#)

- lp, 294
- maxgain, 294
- mpo\_inv, 294
- DynComp::dc\_afterburn\_t, 294
  - \_cf, 296
  - \_channels, 296
  - \_srate, 296
  - burn, 295
  - commit\_pending, 296
  - dc\_afterburn\_t, 295
  - fb\_pars\_configured, 296
  - patchbay, 296
  - set\_fb\_pars, 295
  - unset\_fb\_pars, 295
  - update, 296
  - update\_burner, 295
- DynComp::dc\_afterburn\_vars\_t, 296
  - bypass, 298
  - commit, 298
  - conflux, 298
  - dc\_afterburn\_vars\_t, 298
  - drain, 298
  - f, 298
  - maxgain, 298
  - mpo, 298
  - taugain, 298
- DynComp::gaintable\_t, 298
  - ~gaintable\_t, 301
  - data, 303
  - gaintable\_t, 300
  - get\_gain, 301, 302
  - get\_iofun, 302
  - get\_vF, 302
  - get\_vL, 302
  - nbands, 302
  - nchannels, 302
  - num\_channels, 302
  - num\_F, 302
  - num\_L, 302
  - update, 301
  - vFlog, 303
  - vF, 303
  - vL, 302
- dynamiclib\_t, 291
  - ~dynamiclib\_t, 292
  - dynamiclib\_t, 292
  - fullname, 292
  - getmodulename, 292
  - getname, 292
  - h, 292
  - modulename, 292
  - resolve, 292
  - resolve\_checked, 292
- EPSILON
  - lpc\_bl\_predictor.h, 988
  - lpc\_burg-lattice.h, 988
  - timoconfig.cpp, 1081
- EPrew
  - prediction\_error\_config, 892
- ERR\_IHANDLE
  - MHAIOFile.cpp, 1047
  - MHAIOJack.cpp, 1050
  - MHAIOJackdb.cpp, 1053
  - MHAIOParser.cpp, 1056
  - MHAIOPortAudio.cpp, 1059
  - MHAIOTCP.cpp, 1062
  - MHAIOalsa.cpp, 1045
- ERR\_SUCCESS
  - MHAIOFile.cpp, 1047
  - MHAIOJack.cpp, 1050
  - MHAIOJackdb.cpp, 1053
  - MHAIOParser.cpp, 1056
  - MHAIOPortAudio.cpp, 1059
  - MHAIOTCP.cpp, 1062
  - MHAIOalsa.cpp, 1045
- ERR\_USER
  - MHAIOFile.cpp, 1048
  - MHAIOJack.cpp, 1050
  - MHAIOJackdb.cpp, 1053
  - MHAIOParser.cpp, 1056
  - MHAIOPortAudio.cpp, 1059
  - MHAIOTCP.cpp, 1062
  - MHAIOalsa.cpp, 1045
- ESTIM\_CUR
  - nlms\_wave.cpp, 1070
- ESTIM\_PREV
  - nlms\_wave.cpp, 1070
- ESTIMATION\_TYPES
  - nlms\_wave.cpp, 1070
- ear\_t
  - AuditoryProfile::parser\_t::ear\_t, 224
- edge\_frequencies
  - dc::dc\_vars\_t, 259
  - dc\_simple::dc\_if\_t, 265
- ef
  - MHAOVFilter::fftfb\_vars\_t, 621
- ef2bands
  - MHAOVFilter::fspacing\_t, 626
- ef\_h
  - MHAOVFilter::band\_descriptor\_t, 613
- ef\_l
  - MHAOVFilter::band\_descriptor\_t, 613



- ef\_name
  - dc::dc\_vars\_t, 259
- efv
  - MHAOvFilter::fftfb\_ac\_info\_t, 615
  - multibandcompressor::fftfb\_plug\_t, 846
- element\_gain\_name
  - combc\_if\_t, 244
- element\_gain\_name\_
  - combc\_t, 245
- elevation
  - mha\_direction\_t, 438
- emit\_event
  - MHAEvents::connector\_base\_t, 507
  - MHAEvents::connector\_t, 509
- emitter
  - MHAEvents::connector\_t, 510
- emitter\_die
  - MHAEvents::connector\_base\_t, 507
- emitter\_is\_alive
  - MHAEvents::connector\_base\_t, 507
- empty\_string
  - MHAParser::keyword\_list\_t, 669
- end\_time
  - MHA\_TCP::Timeout\_Event, 491
- entries
  - MHAParser::keyword\_list\_t, 669
  - MHAParser::parser\_t, 692
- entry
  - MHAParser::entry\_t, 656
- entry\_map\_t
  - MHAParser, 111
- entry\_t
  - MHAParser::entry\_t, 656
- envelope\_delay
  - MHAFilter::gammaflt\_t, 538
- envreplace
  - MHAParser, 112
- eof
  - MHA\_TCP::Connection, 474
- epsilon
  - smoothgains\_bridge::overlapadd\_if\_↔  
t, 914
- equal\_dim
  - Vector and matrix processing toolbox, 47,  
48
- equidist2bands
  - MHAOvFilter::fspacing\_t, 626
- erb\_hz\_f\_hz
  - speechnoise.cpp, 1077
- err\_in
  - MHAFilter::adapt\_filter\_param\_t, 514
- MHAFilter::adapt\_filter\_t, 517
- error
  - MHA\_TCP::Thread, 490
  - mha\_fifo\_lw\_t, 450
- Error handling in the openMHA, 32
  - MHA\_ErrorMsg, 32
  - MHA\_assert, 33
  - MHA\_assert\_equal, 33
  - mha\_debug, 33
- errorlog
  - fw\_t, 347
- estimateDebug
  - noisePowProposedScale::noisePow↔  
Proposed, 858
- estimtype
  - nlms\_t, 853
- event\_add\_plug
  - altplugs\_t, 215
- event\_delete\_plug
  - altplugs\_t, 215
- event\_select\_plug
  - altplugs\_t, 215
- event\_set\_plugs
  - altplugs\_t, 215
- event\_start\_recording
  - acsave::acsave\_t, 167
- event\_stop\_and\_flush
  - acsave::acsave\_t, 167
- eventhandler
  - MHAEvents::connector\_t, 510
- eventhandler\_s
  - MHAEvents::connector\_t, 510
- eventhandler\_suu
  - MHAEvents::connector\_t, 510
- Events
  - MHA\_TCP::Event\_Watcher, 479
- events
  - MHA\_TCP::Event\_Watcher, 479
- example1.cpp, 976
- example1\_t, 303
  - example1\_t, 304
  - prepare, 304
  - process, 305
  - release, 304
- example2.cpp, 976
- example2\_t, 305
  - example2\_t, 307
  - factor, 308
  - prepare, 307
  - process, 307
  - release, 307

- scale\_ch, 308
- example3.cpp, 976
- example3\_t, 308
  - example3\_t, 310
  - factor, 311
  - on\_prereadaccess, 310
  - on\_scale\_ch\_readaccess, 310
  - on\_scale\_ch\_valuechanged, 310
  - on\_scale\_ch\_writeaccess, 310
  - patchbay, 311
  - prepare, 310
  - prepared, 311
  - process, 311
  - release, 311
  - scale\_ch, 311
- example4.cpp, 976
- example4\_t, 312
  - example4\_t, 313
  - factor, 315
  - on\_prereadaccess, 314
  - on\_scale\_ch\_readaccess, 314
  - on\_scale\_ch\_valuechanged, 314
  - on\_scale\_ch\_writeaccess, 314
  - patchbay, 315
  - prepare, 314
  - prepared, 315
  - process, 314
  - release, 314
  - scale\_ch, 315
- example5.cpp, 976
  - \_\_declspec, 977
- example5\_t, 315
  - channel, 316
  - example5\_t, 316
  - process, 316
  - scale, 316
- example6.cpp, 977
  - \_\_declspec, 977
- example6\_t, 316
  - channel\_no, 317
  - example6\_t, 317
  - patchbay, 317
  - prepare, 317
  - process, 317
  - rmsdb, 317
  - update\_cfg, 317
- exec\_fw\_command
  - fw\_t, 346
- existed\_before
  - mha\_stash\_environment\_variable\_t, 467
- exit\_on\_stop
  - fw\_t, 347
- exit\_request
  - fw\_t, 345
- expansion
  - dc\_simple::dc\_t, 267
- expansion\_slope
  - dc\_simple::dc\_vars\_t, 270
- expansion\_threshold
  - dc\_simple::dc\_t, 267
  - dc\_simple::dc\_vars\_t, 270
- expflt
  - MHAOvFilter::ShapeFun, 107
- expi
  - Complex arithmetics in the openMHA, 64, 66
- explicit\_insert
  - dc::dc\_t, 256
- export\_to
  - MHASignal::spectrum\_t, 804
  - MHASignal::waveform\_t, 820
- expression\_t, 318
  - MHAParser::expression\_t, 657
- extern\_connector
  - MHAParser::commit\_t, 652
- F
  - prediction\_error\_config, 891
  - rt\_nlms\_t, 899
- f
  - AuditoryProfile::parser\_t::fmap\_t, 225
  - DynComp::dc\_afterburn\_vars\_t, 298
  - io\_tcp\_sound\_t::float\_union, 388
  - MHAOvFilter::fftfb\_vars\_t, 621
  - MHAOvFilter::fscale\_t, 624
- f0\_high
  - timo\_params, 940
  - timoSmooth, 946
- f0\_low
  - timo\_params, 940
  - timoSmooth, 946
- F\_Uflt
  - prediction\_error\_config, 891
- f\_est
  - lpc\_bl\_predictor\_config, 401
- f\_hz
  - MHAOvFilter::fscale\_t, 624
- FINISHED
  - MHA\_TCP::Thread, 488
- FMTsz
  - mha\_os.h, 1013
- factor
  - cpuload\_t, 249

- example2\_t, 308
- example3\_t, 311
- example4\_t, 315
- plugin\_interface\_t, 873
- fader\_if\_t, 318
  - actgains, 319
  - fader\_if\_t, 319
  - newgains, 319
  - patchbay, 319
  - prepare, 319
  - process, 319
  - tau, 319
  - update\_cfg, 319
- fader\_spec.cpp, 977
- fader\_wave, 86
  - level\_adaptor, 86
- fader\_wave.cpp, 977
  - DEBUG, 978
- fader\_wave::fader\_wave\_if\_t, 320
  - fader\_wave\_if\_t, 321
  - gain, 321
  - patchbay, 321
  - prepare, 321
  - prepared, 321
  - process, 321
  - ramplen, 321
  - release, 321
  - set\_level, 321
- fader\_wave::level\_adapt\_t, 322
  - can\_update, 323
  - get\_level, 323
  - ilen, 323
  - l\_new, 323
  - l\_old, 323
  - level\_adapt\_t, 322
  - pos, 323
  - update\_frame, 323
  - wnd, 323
- fader\_wave\_if\_t
  - fader\_wave::fader\_wave\_if\_t, 321
- fail\_on\_async\_jackerr
  - MHAIOJackdb::io\_jack\_t, 581
- fail\_on\_async\_jackerror
  - MHAIOJackdb::io\_jack\_t, 580
  - MHAJack::client\_t, 599
- fail\_on\_nonmonotonic
  - MHAOvFilter::fftfb\_vars\_t, 621
- fail\_on\_nonmonotonic\_cf
  - MHAOvFilter::fspacing\_t, 626
- fail\_on\_unique\_bins
  - MHAOvFilter::fftfb\_vars\_t, 621
- fail\_on\_unique\_fftbins
  - MHAOvFilter::fspacing\_t, 626
- fallback\_spec
  - altplugs\_t, 216
- fallback\_wave
  - altplugs\_t, 216
- Fast Fourier Transform functions, 71
  - mha\_fft\_backward, 75
  - mha\_fft\_backward\_scale, 76
  - mha\_fft\_forward, 75
  - mha\_fft\_forward\_scale, 76
  - mha\_fft\_free, 72
  - mha\_fft\_new, 72
  - mha\_fft\_spec2wave, 74
  - mha\_fft\_spec2wave\_scale, 77
  - mha\_fft\_t, 72
  - mha\_fft\_wave2spec, 73
  - mha\_fft\_wave2spec\_scale, 76
- fatallog
  - fw\_t, 347
- fb
  - MHAFilter::thirdoctave\_analyzer\_t, 570
- fb\_acinfo
  - fftfilterbank::fftfb\_plug\_t, 331
- fb\_pars\_configured
  - DynComp::dc\_afterburn\_t, 296
- fbpow
  - fftfbpow::fftfbpow\_t, 327
- fd
  - MHA\_TCP::Connection, 477
  - MHA\_TCP::OS\_EVENT\_TYPE, 480
- fft
  - doasvm\_feature\_extraction\_config, 286
  - MHAFilter::fftfilter\_t, 527
  - MHAFilter::fftfilterbank\_t, 531
  - MHAFilter::partitioned\_convolution\_t, 558
  - MHAFilter::smoothspec\_t, 568
  - overlapadd::overlapadd\_t, 863
- fft\_find\_bin
  - fshift, 87
- fft\_t
  - MHASignal::fft\_t, 773
- fftfb\_ac\_info\_t
  - MHAOvFilter::fftfb\_ac\_info\_t, 615
- fftfb\_interface\_t
  - fftfilterbank::fftfb\_interface\_t, 328
- fftfb\_plug\_t
  - fftfilterbank::fftfb\_plug\_t, 331
  - multibandcompressor::fftfb\_plug\_t, 846
- fftfb\_t
  - MHAOvFilter::fftfb\_t, 617

- fftfb\_vars\_t
  - MHAOvFilter::fftfb\_vars\_t, 620
- fftfbpow, 86
- fftfbpow.cpp, 978
- fftfbpow::fftfbpow\_interface\_t, 323
  - fftfbpow\_interface\_t, 324
  - name, 325
  - patchbay, 325
  - prepare, 325
  - process, 325
  - update\_cfg, 325
- fftfbpow::fftfbpow\_t, 326
  - fbpow, 327
  - fftfbpow\_t, 327
- fftfbpow\_interface\_t
  - fftfbpow::fftfbpow\_interface\_t, 324
- fftfbpow\_t
  - fftfbpow::fftfbpow\_t, 327
- fftfilter\_t
  - MHAFilter::fftfilter\_t, 524
- fftfilterbank, 87
- fftfilterbank.cpp, 978
- fftfilterbank::fftfb\_interface\_t, 328
  - algo, 330
  - fftfb\_interface\_t, 328
  - nbands, 330
  - nchannels, 330
  - patchbay, 330
  - prepare, 329
  - prepared, 330
  - process, 329
  - release, 329
  - return\_imag, 330
  - update\_cfg, 329
- fftfilterbank::fftfb\_plug\_t, 330
  - fb\_acinfo, 331
  - fftfb\_plug\_t, 331
  - imag, 331
  - insert, 331
  - process, 331
  - return\_imag\_, 331
  - s\_out, 331
- fftfilterbank\_t
  - MHAFilter::fftfilterbank\_t, 528
- fftlens
  - dc\_simple::level\_smoother\_t, 272
  - doasvm\_feature\_extraction, 285
  - doasvm\_feature\_extraction\_config, 286
  - MHAFilter::fftfilter\_t, 526
  - MHAFilter::fftfilterbank\_t, 530
  - MHAFilter::smoothspec\_t, 568
- MHAOvFilter::fftfb\_t, 618
- MHAOvFilter::overlap\_save\_filterbank\_↔
  - t::vars\_t, 631
- MHAParser::mhaconfig\_mon\_t, 681
- mhaconfig\_t, 505
- rmslevel\_t, 894
- testplugin::config\_parser\_t, 933
- timoConfig, 942
- fftw\_plan\_fft
  - MHASignal::fft\_t, 775
- fftw\_plan\_ifft
  - MHASignal::fft\_t, 775
- fftw\_plan\_spec2wave
  - MHASignal::fft\_t, 775
- fftw\_plan\_wave2spec
  - MHASignal::fft\_t, 775
- fhz2bandno
  - speechnoise.cpp, 1077
- fifo
  - wavwriter\_t, 956
- fifo\_size
  - mha\_dblbuf\_t, 437
- fifolen
  - analysispath\_if\_t, 220
  - wavrec\_t, 955
- fileformat
  - acsave::acsave\_t, 167
- filename
  - addsndfile::addsndfile\_if\_t, 182
- filename\_input
  - io\_file\_t, 368
- filename\_output
  - io\_file\_t, 368
- fill\_info
  - MHAIOPortAudio::device\_info\_t, 584
- filled
  - MHASignal::async\_rmslevel\_t, 765
- filter
  - MHAFilter::adapt\_filter\_state\_t, 515
  - MHAFilter::adapt\_filter\_t, 516
  - MHAFilter::complex\_bandpass\_t, 521, 522
  - MHAFilter::fftfilter\_t, 525, 526
  - MHAFilter::fftfilterbank\_t, 529, 530
  - MHAFilter::filter\_t, 533, 534
  - MHAFilter::iir\_filter\_t, 541
- filter\_activated
  - droptect\_t, 289
- filter\_analytic
  - MHAOvFilter::overlap\_save\_filterbank\_↔
    - analytic\_t, 628

- filter\_complex
  - gtfb\_analyzer.cpp, 983
- filter\_partitions
  - MHAFilter::partitioned\_convolution\_t, 556
- filter\_real
  - gtfb\_analyzer.cpp, 984
- filter\_t
  - MHAFilter::filter\_t, 532, 533
- filterbank
  - dc::dc\_vars\_t, 259
  - dc\_simple::dc\_if\_t, 265
- filtered\_level
  - dc::dc\_vars\_t, 259
- filtered\_powspec
  - droptect\_t, 289
- filtered\_powspec\_mon
  - droptect\_t, 289
- filtershapefun
  - mha\_fftfb.cpp, 1004
- fir
  - calibrator\_runtime\_layer\_t, 230
  - calibrator\_variables\_t, 234
- firchannels
  - MHAFilter::fftfilterbank\_t, 530
- firfir2fftltn
  - calibrator\_runtime\_layer\_t, 230
- firfirltn
  - calibrator\_runtime\_layer\_t, 230
- flag\_terminate\_inner\_thread
  - analysepath\_t, 218
- flags
  - MHAJack::client\_t, 599
- float\_data
  - testplugin::ac\_parser\_t, 931
- float\_mon\_t
  - MHAParser::float\_mon\_t, 658
- float\_t
  - MHA\_AC::float\_t, 420
  - MHAParser::float\_t, 661
- flush\_data
  - acsave::cfg\_t, 168
- fmap\_t
  - AuditoryProfile::parser\_t::fmap\_t, 225
- fmax
  - fshift::fshift\_t, 336
  - fshift\_hilbert::frequency\_translator\_t, 339
- fmin
  - fshift::fshift\_t, 336
  - fshift\_hilbert::frequency\_translator\_t, 338
- fname
  - acsave::acsave\_t, 167
- for\_each
  - Vector and matrix processing toolbox, 43
- force\_remove\_item
  - MHAParser::parser\_t, 690
- force\_resize
  - dc\_simple, 84
- format
  - ac2lsl::type\_info, 143
  - io\_alsa\_t, 364
- forward
  - lpc\_bl\_predictor\_config, 401
  - lpc\_burglattice\_config, 405
  - MHASignal::fft\_t, 773
- forward\_scale
  - MHASignal::fft\_t, 774
- fr
  - spec\_fader\_t, 924
- frag\_out
  - MHAJack::client\_avg\_t, 590
  - MHAJack::client\_noncont\_t, 593
- fragsize
  - alsa\_t, 212
  - analysispath\_if\_t, 220
  - calibrator\_variables\_t, 234
  - db\_if\_t, 251
  - io\_file\_t, 367
  - io\_parser\_t, 374
  - io\_tcp\_sound\_t, 387
  - MHAFilter::fftfilter\_t, 526
  - MHAFilter::fftfilterbank\_t, 530
  - MHAFilter::partitioned\_convolution\_t, 556
  - MHAFilter::resampling\_filter\_t, 565
  - MHAIOPortAudio::io\_portaudio\_t, 587
  - MHAJack::client\_t, 598
  - MHAParser::mhaconfig\_mon\_t, 681
  - MHAPlugin\_Resampling::resampling\_if↔\_t, 734
  - mhaconfig\_t, 505
  - testplugin::config\_parser\_t, 933
- fragsize\_in
  - MHAFilter::blockprocessing\_polyphase↔\_resampling\_t, 519
- fragsize\_out
  - MHAFilter::blockprocessing\_polyphase↔\_resampling\_t, 519
- fragsize\_ratio
  - MHAIOJackdb::io\_jack\_t, 581
- fragsize\_validator
  - MHAFilter::resampling\_filter\_t, 565
- frame
  - MHA\_AC::acspace2matrix\_t, 418

- frame\_data
  - alsa\_t, 212
- framecnt
  - acsave::save\_var\_t, 171
- frameno
  - MHA\_AC::acspace2matrix\_t, 418
  - noisePowProposedScale::noisePow↔  
Proposed, 859
- framerate
  - ac2osc\_t, 147
- frames
  - ac2wave\_t, 150
  - gtfb\_analyzer::gtfb\_analyzer\_cfg\_t, 354
  - prediction\_error\_config, 890
  - rt\_nlms\_t, 899
- frameshift
  - fshift\_hilbert::hilbert\_shifter\_t, 342
- framework\_thread\_priority
  - MHAPlugin\_Split::split\_t, 751
- framework\_thread\_scheduler
  - MHAPlugin\_Split::split\_t, 750
- freq
  - plingploing::plingploing\_t, 869
- freq2bin
  - Vector and matrix processing toolbox, 45
- frequency
  - sine\_t, 912
- frequency\_response
  - MHAFilter::partitioned\_convolution\_t, 557
- frequency\_translator\_t
  - fshift\_hilbert::frequency\_translator\_t, 338
- front\_channel
  - adm\_rtconfig\_t, 200
- front\_channels
  - adm\_if\_t, 197
  - adm\_rtconfig\_t, 200
- frozen\_noise
  - cfg\_t, 236
- frozennoise\_length
  - noise\_t, 855
- fs
  - MHAFilter::o1\_ar\_filter\_t, 548
- fs\_
  - MHAOvFilter::fspacing\_t, 626
- fscale
  - MHAOvFilter::fftb\_vars\_t, 620
- fscale\_bw\_t
  - MHAOvFilter::fscale\_bw\_t, 623
- fscale\_t
  - MHAOvFilter::fscale\_t, 624
- fshift, 87
  - fft\_find\_bin, 87
  - fshift.cpp, 979
  - fshift.hh, 979
  - fshift::fshift\_config\_t, 332
    - ~fshift\_config\_t, 332
  - delta\_phi, 333
  - delta\_phi\_total, 333
  - df, 333
  - fshift\_config\_t, 332
  - kmax, 333
  - kmin, 333
  - process, 333
  - fshift::fshift\_t, 334
    - ~fshift\_t, 335
  - df, 336
  - fmax, 336
  - fmin, 336
  - fshift\_t, 335
  - m\_df, 336
  - m\_fmax, 336
  - m\_fmin, 336
  - patchbay, 336
  - prepare, 335
  - process, 335
  - release, 336
  - update\_cfg, 336
  - fshift\_config\_t
    - fshift::fshift\_config\_t, 332
  - fshift\_hilbert, 88
  - fshift\_hilbert.cpp, 979
  - fshift\_hilbert::frequency\_translator\_t, 337
    - df, 338
    - fmax, 339
    - fmin, 338
    - frequency\_translator\_t, 338
    - irslen, 339
    - patchbay, 338
    - phasemode, 339
    - prepare, 338
    - process, 338
    - release, 338
    - update, 338
  - fshift\_hilbert::hilbert\_shifter\_t, 339
    - ~hilbert\_shifter\_t, 341
  - analytic, 341
  - delta\_phi, 342
  - delta\_phi\_total, 342
  - df, 342
  - frameshift, 342
  - fullspec, 341
  - hilbert\_shifter\_t, 340

- kmax, [342](#)
- kmin, [342](#)
- mhafft, [342](#)
- mixw\_ref, [341](#)
- mixw\_shift, [341](#)
- plan\_spec2analytic, [341](#)
- process, [341](#)
- shifted, [341](#)
- fshift\_t
  - fshift::fshift\_t, [335](#)
- fspacing\_t
  - MHAOvFilter::fspacing\_t, [626](#)
- ft
  - spec2wave\_t, [922](#)
  - wave2spec\_t, [952](#)
- ftype
  - MHAOvFilter::fftb\_vars\_t, [621](#)
- fu
  - rt\_nlms\_t, [900](#)
- fu\_previous
  - rt\_nlms\_t, [900](#)
- fufit
  - rt\_nlms\_t, [900](#)
- fullname
  - dynamiclib\_t, [292](#)
  - MHAParser::base\_t, [641](#)
  - plugindescription\_t, [875](#)
- fullspec
  - fshift\_hilbert::hilbert\_shifter\_t, [341](#)
- fun1
  - plingploing::plingploing\_t, [870](#)
- fun1\_key
  - plingploing::if\_t, [867](#)
  - plingploing::plingploing\_t, [870](#)
- fun1\_range
  - plingploing::if\_t, [867](#)
  - plingploing::plingploing\_t, [870](#)
- fun2
  - plingploing::plingploing\_t, [870](#)
- fun2\_key
  - plingploing::if\_t, [867](#)
  - plingploing::plingploing\_t, [870](#)
- fun2\_range
  - plingploing::if\_t, [867](#)
  - plingploing::plingploing\_t, [870](#)
- fun\_t
  - MHAWindow::fun\_t, [838](#)
- funs
  - MHAOvFilter::scale\_var\_t, [633](#)
- fw\_cmd
  - fw\_t, [347](#)
- fw\_exiting
  - fw\_t, [345](#)
- fw\_fragsize
  - io\_alsa\_t, [364](#)
  - MHAIOJack::io\_jack\_t, [576](#)
- fw\_running
  - fw\_t, [345](#)
- fw\_samplerate
  - io\_alsa\_t, [364](#)
  - MHAIOJack::io\_jack\_t, [576](#)
- fw\_sleep
  - fw\_t, [347](#)
- fw\_sleep\_cmd
  - fw\_t, [346](#)
- fw\_starting
  - fw\_t, [345](#)
- fw\_stopped
  - fw\_t, [345](#)
- fw\_stopping
  - fw\_t, [345](#)
- fw\_t, [343](#)
  - ~fw\_t, [345](#)
  - ac, [347](#)
  - async\_poll\_msg, [347](#)
  - async\_read, [347](#)
  - b\_exit\_request, [348](#)
  - cfin, [348](#)
  - cfout, [348](#)
  - dump\_mha, [347](#)
  - errorlog, [347](#)
  - exec\_fw\_command, [346](#)
  - exit\_on\_stop, [347](#)
  - exit\_request, [345](#)
  - fatallog, [347](#)
  - fw\_cmd, [347](#)
  - fw\_exiting, [345](#)
  - fw\_running, [345](#)
  - fw\_sleep, [347](#)
  - fw\_sleep\_cmd, [346](#)
  - fw\_starting, [345](#)
  - fw\_stopped, [345](#)
  - fw\_stopping, [345](#)
  - fw\_t, [345](#)
  - fw\_unprepared, [345](#)
  - fw\_until, [347](#)
  - fw\_until\_cmd, [346](#)
  - get\_input\_signal\_dimension, [346](#)
  - get\_parserstate, [347](#)
  - inst\_name, [347](#)
  - io\_error, [348](#)
  - io\_lib, [348](#)

- io\_name, [347](#)
- load\_io\_lib, [346](#)
- load\_proc\_lib, [346](#)
- nchannels\_out, [347](#)
- parserstate, [347](#)
- patchbay, [348](#)
- plugin\_paths, [347](#)
- plugins, [347](#)
- prepare, [345](#)
- prepare\_vars, [347](#)
- proc\_error, [348](#)
- proc\_error\_string, [348](#)
- proc\_lib, [348](#)
- proc\_name, [347](#)
- process, [346](#)
- quit, [346](#)
- release, [346](#)
- start, [345](#)
- started, [346](#)
- state, [348](#)
- state\_t, [345](#)
- stop, [345](#)
- stopped, [346](#)
- fw\_unprepared
  - fw\_t, [345](#)
- fw\_until
  - fw\_t, [347](#)
- fw\_until\_cmd
  - fw\_t, [346](#)
- fw\_vars\_t, [348](#)
  - fw\_vars\_t, [349](#)
  - lock\_channels, [349](#)
  - lock\_srate\_fragsize, [349](#)
  - pfragmentsize, [349](#)
  - pinchannels, [349](#)
  - psrate, [349](#)
  - unlock\_channels, [349](#)
  - unlock\_srate\_fragsize, [349](#)
- fwcb
  - io\_tcp\_t, [391](#)
- G
  - doasvm\_feature\_extraction\_config, [286](#)
- g
  - coherence::cohflt\_t, [240](#)
- g50
  - dc\_simple::dc\_vars\_t, [269](#)
- g80
  - dc\_simple::dc\_vars\_t, [269](#)
- G\_ERRNO
  - MHA\_TCP, [92](#)
- G\_length
  - doasvm\_feature\_extraction\_config, [286](#)
- g\_scale
  - dc::wb\_inhib\_cfg\_t, [261](#)
  - dc::wideband\_inhib\_vars\_t, [262](#)
- GCC\_end
  - doasvm\_feature\_extraction\_config, [286](#)
- GCC\_start
  - doasvm\_feature\_extraction\_config, [286](#)
- GITCOMMITHASH
  - mha\_plugin.hh, [1023](#)
- GLRDebug
  - noisePowProposedScale::noisePow↔Proposed, [858](#)
- GLRexp
  - noisePowProposedScale::noisePow↔Proposed, [859](#)
  - timoConfig, [943](#)
- GLR
  - timoConfig, [943](#)
- GREETING\_TEXT
  - mhamain.cpp, [1067](#)
- gain, [88](#)
  - alsa\_t, [212](#)
  - calibrator\_runtime\_layer\_t, [230](#)
  - coherence::cohflt\_t, [241](#)
  - fader\_wave::fader\_wave\_if\_t, [321](#)
  - multibandcompressor::plugin\_signals\_t, [850](#)
- gain.cpp, [979](#)
- gain::gain\_if\_t, [350](#)
  - bbgain, [351](#)
  - gain\_if\_t, [351](#)
  - gains, [351](#)
  - patchbay, [351](#)
  - prepare, [351](#)
  - process, [351](#)
  - release, [351](#)
  - update\_bbgain, [351](#)
  - update\_gain, [351](#)
  - update\_minmax, [351](#)
  - vmax, [351](#)
  - vmin, [351](#)
- gain::scaler\_t, [352](#)
  - scaler\_t, [352](#)
- gain\_ac
  - ac2wave\_if\_t, [149](#)
  - ac2wave\_t, [151](#)
- gain\_delay
  - coherence::cohflt\_t, [241](#)
- gain\_if\_t
  - gain::gain\_if\_t, [351](#)



- gain\_in
  - ac2wave\_if\_t, 149
  - ac2wave\_t, 151
- gain\_min
  - timoConfig, 942
- gain\_min\_db
  - timo\_params, 940
  - timoSmooth, 947
- gain\_spec\_
  - cfg\_t, 236
- gain\_wave\_
  - cfg\_t, 236
- gain\_wiener
  - timoConfig, 943
- gain\_wiener\_AC
  - timo\_AC, 938
- gainrule
  - dc::dc\_vars\_t, 259
  - dc\_simple::dc\_if\_t, 265
- gains
  - gain::gain\_if\_t, 351
  - prediction\_error, 888
  - shadowfilter\_end::cfg\_t, 907
  - spec\_fader\_t, 924
- gaintable.cpp, 980
  - convert\_f2logf, 980
  - isempty, 980
- gaintable.h, 980
- gaintable\_t
  - DynComp::gaintable\_t, 300
- gammaflt\_t
  - MHAFilter::gammaflt\_t, 536
- gamma\_post
  - timoConfig, 943
- gamma\_post\_AC
  - timo\_AC, 937
- gauss
  - MHAOvFilter::ShapeFun, 107
- gcd
  - MHAFilter, 97
- generatemhaplugin.doc.cpp, 981
  - conv2latex, 981
  - create\_latex\_doc, 982
  - main, 982
  - print\_plugin\_references, 982
- get
  - testplugin::config\_parser\_t, 933
- get\_A
  - MHAFilter::gammaflt\_t, 537
- get\_a
  - MHAParser::base\_t::replace\_t, 643
- get\_ac
  - latex\_doc\_t, 394
  - plug\_t, 871
- get\_accept\_event
  - MHA\_TCP::Server, 482
- get\_all\_input\_ports
  - MHAIOJack::io\_jack\_t, 576
  - MHAIOJackdb::io\_jack\_t, 581
- get\_all\_names\_from\_ac\_space
  - ac2lsl::ac2lsl\_t, 132
- get\_all\_output\_ports
  - MHAIOJack::io\_jack\_t, 576
  - MHAIOJackdb::io\_jack\_t, 581
- get\_audiochannels
  - dc, 83
- get\_available\_space
  - mha\_drifter\_fifo\_t, 442
  - mha\_fifo\_t, 455
- get\_b
  - MHAParser::base\_t::replace\_t, 643
- get\_buf\_address
  - ac2lsl::save\_var\_base\_t, 136
  - ac2lsl::save\_var\_t, 139
  - ac2lsl::save\_var\_t< mha\_complex\_t >, 142
- get\_bw\_hz
  - MHAOvFilter::fscale\_bw\_t, 623
- get\_c1
  - MHAFilter::o1flt\_lowpass\_t, 550
- get\_c\_handle
  - MHAKernel::algo\_comm\_class\_t, 604
- get\_categories
  - latex\_doc\_t, 393
  - PluginLoader::mhapluginloader\_t, 884
- get\_cdata
  - MHASignal::matrix\_t, 790
- get\_cf\_fftbin
  - MHAOvFilter::fspacing\_t, 626
- get\_cf\_hz
  - MHAFilter::thirdoctave\_analyzer\_t, 569
  - MHAOvFilter::fspacing\_t, 626
- get\_cfin
  - MHAParser::mhapluginloader\_t, 684
- get\_cfout
  - MHAParser::mhapluginloader\_t, 684
- get\_channelconfig
  - MHAOvFilter::overlap\_save\_filterbank\_t, 630
- get\_comm\_var
  - MHASignal::matrix\_t, 785
- get\_configfile

- PluginLoader::config\_file\_splitter\_t, 877
- get\_configname
  - PluginLoader::config\_file\_splitter\_t, 876
- get\_connected
  - io\_tcp\_parser\_t, 381
- get\_cpu\_load
  - MHAJack::client\_t, 597
- get\_current\_profile
  - AuditoryProfile::parser\_t, 223
- get\_delay
  - mha\_dbdbuf\_t, 435
- get\_delays\_in
  - MHAIOJack::io\_jack\_t, 576
- get\_delays\_out
  - MHAIOJack::io\_jack\_t, 576
- get\_des\_fill\_count
  - mha\_drifter\_fifo\_t, 442
- get\_documentation
  - PluginLoader::mhapluginloader\_t, 884
- get\_ear
  - AuditoryProfile::parser\_t::ear\_t, 224
  - AuditoryProfile::profile\_t, 226
- get\_ef\_hz
  - MHAOvFilter::fspacing\_t, 626
- get\_entries
  - algo\_comm\_t, 205
  - MHAKernel::algo\_comm\_class\_t, 605
  - MHAParser::keyword\_list\_t, 668
- get\_error
  - algo\_comm\_t, 205
  - MHAKernel::algo\_comm\_class\_t, 605
- get\_f\_hz
  - MHAOvFilter::fscale\_t, 624
- get\_fbpower
  - MHAOvFilter::fftfb\_t, 617
- get\_fbpower\_db
  - MHAOvFilter::fftfb\_t, 617
- get\_fd
  - MHA\_TCP::Connection, 474
- get\_ffflen
  - MHAOvFilter::fftfb\_t, 618
- get\_fifo\_size
  - mha\_dbdbuf\_t, 435
- get\_fill\_count
  - mha\_drifter\_fifo\_t, 442
  - mha\_fifo\_t, 455
- get\_fmap
  - AuditoryProfile::parser\_t::fmap\_t, 225
- get\_fragsize
  - MHAJack::client\_t, 596
- get\_frequencies
  - AuditoryProfile::fmap\_t, 221
- get\_fun
  - MHAOvFilter::scale\_var\_t, 633
- get\_gain
  - DynComp::gaintable\_t, 301, 302
- get\_handle
  - plug\_t, 871
- get\_index
  - MHAParser::keyword\_list\_t, 668
  - MHASignal::matrix\_t, 789
- get\_inner\_error
  - mha\_dbdbuf\_t, 435
- get\_inner\_size
  - mha\_dbdbuf\_t, 434
- get\_input\_channels
  - mha\_dbdbuf\_t, 435
- get\_input\_fifo\_fill\_count
  - mha\_dbdbuf\_t, 435
- get\_input\_fifo\_space
  - mha\_dbdbuf\_t, 435
- get\_input\_signal\_dimension
  - fw\_t, 346
- get\_interface
  - MHA\_TCP::Server, 482
- get\_iofun
  - DynComp::gaintable\_t, 302
- get\_irs
  - MHAFilter::fftfilterbank\_t, 530
- get\_last\_name
  - MHAParser::mhapluginloader\_t, 684
- get\_last\_output
  - MHAFilter::o1flt\_lowpass\_t, 550
- get\_latex\_doc
  - latex\_doc\_t, 393
- get\_len\_A
  - MHAFilter::filter\_t, 534
- get\_len\_B
  - MHAFilter::filter\_t, 534
- get\_length
  - MHASignal::uint\_vector\_t, 811
- get\_level
  - addsndfile::level\_adapt\_t, 184
  - fader\_wave::level\_adapt\_t, 323
- get\_level\_in\_db
  - dc::dc\_t, 256
- get\_level\_in\_db\_adjusted
  - dc::dc\_t, 256
- get\_libname
  - PluginLoader::config\_file\_splitter\_t, 877
- get\_local\_address
  - io\_tcp\_parser\_t, 380

- get\_local\_port
  - io\_tcp\_parser\_t, 380
- get\_longmsg
  - MHA\_Error, 446
- get\_ltass\_gain\_db
  - MHAOvFilter::fffb\_t, 618
- get\_main\_category
  - latex\_doc\_t, 393
- get\_mapping
  - MHASignal::loop\_wavefragment\_t, 780
- get\_max\_fill\_count
  - mha\_fifo\_t, 455
- get\_min\_fill\_count
  - mha\_drifter\_fifo\_t, 442
- get\_msg
  - MHA\_Error, 446
- get\_my\_input\_ports
  - MHAJack::client\_t, 597
- get\_my\_output\_ports
  - MHAJack::client\_t, 597
- get\_name
  - MHAOvFilter::scale\_var\_t, 633
- get\_nbands
  - dc::dc\_t, 256
- get\_nelements
  - MHASignal::matrix\_t, 786
- get\_nreals
  - MHASignal::matrix\_t, 789
- get\_origname
  - PluginLoader::config\_file\_splitter\_t, 877
- get\_os\_event
  - MHA\_TCP::Timeout\_Event, 491
  - MHA\_TCP::Wakeup\_Event, 494
- get\_outer\_size
  - mha\_dbdbuf\_t, 434
- get\_output\_channels
  - mha\_dbdbuf\_t, 435
- get\_output\_fifo\_fill\_count
  - mha\_dbdbuf\_t, 435
- get\_output\_fifo\_space
  - mha\_dbdbuf\_t, 435
- get\_parser\_tab
  - latex\_doc\_t, 394
- get\_parser\_var
  - latex\_doc\_t, 394
- get\_parserstate
  - fw\_t, 347
- get\_paths
  - pluginbrowser\_t, 874
- get\_peer\_address
  - MHA\_TCP::Connection, 474
- get\_peer\_port
  - MHA\_TCP::Connection, 474
- get\_physical\_input\_ports
  - MHAIOJack::io\_jack\_t, 576
  - MHAIOJackdb::io\_jack\_t, 580
- get\_physical\_output\_ports
  - MHAIOJack::io\_jack\_t, 576
  - MHAIOJackdb::io\_jack\_t, 581
- get\_plugins
  - pluginbrowser\_t, 874
- get\_port
  - MHA\_TCP::Server, 482
- get\_port\_capture\_latency
  - MHAJack, 100
- get\_port\_capture\_latency\_int
  - MHAJack, 100
- get\_port\_playback\_latency
  - MHAJack, 101
- get\_port\_playback\_latency\_int
  - MHAJack, 101
- get\_ports
  - MHAJack::client\_t, 597
- get\_precision
  - MHAParser, 111
- get\_process\_spec
  - plug\_t, 871
- get\_process\_wave
  - plug\_t, 871
- get\_rdata
  - MHASignal::matrix\_t, 790
- get\_read\_event
  - MHA\_TCP::Connection, 474
- get\_resynthesis\_gain
  - MHAFilter::gammaflt\_t, 537
- get\_server\_port\_open
  - io\_tcp\_parser\_t, 381
- get\_short\_name
  - MHAJack::port\_t, 602
- get\_signal
  - MHAPugin\_Split::domain\_handler\_t, 740
- get\_size
  - MHASignal::waveform\_t, 822
- get\_srate
  - MHAJack::client\_t, 597
- get\_type
  - MHAParser::window\_t, 721
- get\_value
  - MHAParser::keyword\_list\_t, 668
- get\_values
  - AuditoryProfile::fmap\_t, 221
- get\_var

- algo\_comm\_t, 204
- MHAKernel::algo\_comm\_class\_t, 605
- testplugin::ac\_parser\_t, 931
- get\_var\_float
  - algo\_comm\_t, 204
  - Communication between algorithms, 30
  - MHAKernel::algo\_comm\_class\_t, 605
- get\_var\_int
  - algo\_comm\_t, 204
  - Communication between algorithms, 30
  - MHAKernel::algo\_comm\_class\_t, 605
- get\_var\_spectrum
  - Communication between algorithms, 29
- get\_var\_vfloat
  - Communication between algorithms, 31
- get\_var\_waveform
  - Communication between algorithms, 30
- get\_vF
  - DynComp::gaintable\_t, 302
- get\_vL
  - DynComp::gaintable\_t, 302
- get\_weights
  - MHAFilter::complex\_bandpass\_t, 521
  - MHAFilter::gammaflt\_t, 537
- get\_window
  - MHAParser::window\_t, 720, 721
- get\_window\_data
  - windowselector\_t, 958
- get\_write\_event
  - MHA\_TCP::Connection, 474
- get\_xlimits
  - MHATableLookup::xy\_table\_t, 833
- get\_xruns
  - MHAJack::client\_t, 597
- get\_xruns\_reset
  - MHAJack::client\_t, 597
- getcpid
  - coherence, 82
- getdata
  - MHASignal::uint\_vector\_t, 811
- getfullname
  - PluginLoader::mhapluginloader\_t, 883
- getmodulename
  - dynamiclib\_t, 292
- Getmsg
  - mha\_error.hh, 1002
- getname
  - dynamiclib\_t, 292
  - MHA\_AC::ac2matrix\_t, 414
- getusername
  - MHA\_AC::ac2matrix\_t, 415
- getvar
  - acmon::ac\_monitor\_t, 156
  - MHA\_AC::ac2matrix\_helper\_t, 412
- GF
  - MHAFilter::gammaflt\_t, 537
- groupdelay\_t
  - MHASignal::schroeder\_t, 798
- gt
  - dc::dc\_t, 256
- gtdata
  - dc::dc\_vars\_t, 258
- gtfb\_analyzer, 88
- gtfb\_analyzer.cpp, 982
- filter\_complex, 983
- filter\_real, 984
- gtfb\_analyzer::gtfb\_analyzer\_cfg\_t, 352
  - ~gtfb\_analyzer\_cfg\_t, 354
  - bands, 354
  - channels, 354
  - coeff, 354
  - cvalue, 354
  - frames, 354
  - gtfb\_analyzer\_cfg\_t, 353
  - norm\_phase, 354
  - order, 354
  - s\_out, 355
  - state, 355
  - states, 354
- gtfb\_analyzer::gtfb\_analyzer\_t, 355
  - coeff, 357
  - gtfb\_analyzer\_t, 357
  - norm\_phase, 357
  - order, 357
  - patchbay, 357
  - prepare, 357
  - prepared, 357
  - process, 357
  - update\_cfg, 357
- gtfb\_analyzer\_cfg\_t
  - gtfb\_analyzer::gtfb\_analyzer\_cfg\_t, 353
- gtfb\_analyzer\_t
  - gtfb\_analyzer::gtfb\_analyzer\_t, 357
- gtmin
  - dc::dc\_vars\_t, 258
- gtstep
  - dc::dc\_vars\_t, 258
- h
  - dynamiclib\_t, 292
  - MHASignal::hilbert\_t, 777
- H\_ERRNO
  - MHA\_TCP, 92

- HELP\_TEXT
  - mhamain.cpp, [1067](#)
- HINSTANCE
  - mha\_plugin.hh, [1023](#)
- HSTRERROR
  - MHA\_TCP, [92](#)
- HTL
  - AuditoryProfile::parser\_t::ear\_t, [224](#)
  - AuditoryProfile::profile\_t::ear\_t, [227](#)
- hamming
  - MHAWindow, [127](#)
- hamming\_t
  - MHAWindow::hamming\_t, [840](#)
- handle
  - algo\_comm\_t, [201](#)
- hann
  - hann.cpp, [985](#)
  - hann.h, [985](#)
  - MHAOvFilter::ShapeFun, [107](#)
- hann.cpp, [984](#)
- hann, [985](#)
- hannf, [985](#)
- PI, [985](#)
- hann.h, [985](#)
- hann, [985](#)
- hannf, [985](#)
- hann1
  - plingploing::plingploing\_t, [870](#)
- hann2
  - plingploing::plingploing\_t, [870](#)
- hannf
  - hann.cpp, [985](#)
  - hann.h, [985](#)
- hanning
  - MHAWindow, [127](#)
- hanning\_ramps\_t, [358](#)
- ~hanning\_ramps\_t, [358](#)
- hanning\_ramps\_t, [358](#)
- len\_a, [358](#)
- len\_b, [358](#)
- operator(), [358](#)
- ramp\_a, [358](#)
- ramp\_b, [358](#)
- hanning\_t
  - MHAWindow::hanning\_t, [841](#)
- hardlimit
  - softclipper\_t, [918](#)
  - softclipper\_variables\_t, [920](#)
- has\_been\_modified
  - dc\_simple::dc\_if\_t, [265](#)
- has\_inner\_error
  - analysepath\_t, [218](#)
- has\_key
  - MHAKernel::comm\_var\_map\_t, [606](#)
- has\_parser
  - PluginLoader::mhapluginloader\_t, [883](#)
- has\_process
  - PluginLoader::mhapluginloader\_t, [883](#)
- header
  - io\_tcp\_sound\_t, [386](#)
- help
  - MHAParser::base\_t, [642](#)
- hifftwin
  - doasvm\_feature\_extraction\_config, [286](#)
- hifftwin\_sum
  - doasvm\_feature\_extraction\_config, [286](#)
- high\_side\_flat
  - MHAOvFilter::band\_descriptor\_t, [613](#)
- hilbert
  - MHASignal::hilbert\_fftw\_t, [776](#)
- hilbert\_fftw\_t
  - MHASignal::hilbert\_fftw\_t, [776](#)
- hilbert\_shifter\_t
  - fshift\_hilbert::hilbert\_shifter\_t, [340](#)
- hilbert\_t
  - MHASignal::hilbert\_t, [777](#)
- host
  - ac2osc\_t, [146](#)
- host\_port\_to\_sock\_addr
  - mha\_tcp.cpp, [1040](#)
- hostApi
  - MHAIOPortAudio::device\_info\_t, [584](#)
- Hs
  - MHAFilter::fftfilterbank\_t, [530](#)
- hton
  - io\_tcp\_sound\_t, [387](#)
- hw
  - MHAFilter::fftfilterbank\_t, [530](#)
- hwin
  - doasvm\_feature\_extraction\_config, [286](#)
- hz2bark
  - MHAOvFilter::FreqScaleFun, [105](#)
- hz2bark\_analytic
  - MHAOvFilter::FreqScaleFun, [105](#)
- hz2bark\_t
  - MHAOvFilter::barkscale::hz2bark\_t, [615](#)
- hz2erb
  - MHAOvFilter::FreqScaleFun, [105](#)
- hz2erb\_glasberg1990
  - MHAOvFilter::FreqScaleFun, [105](#)
- hz2hz
  - MHAOvFilter::FreqScaleFun, [104](#)

- speechnoise.cpp, [1077](#)
- hz2khz
  - MHAOvFilter::FreqScaleFun, [104](#)
- hz2log
  - MHAOvFilter::FreqScaleFun, [105](#)
- hz2octave
  - MHAOvFilter::FreqScaleFun, [104](#)
- hz2third\_octave
  - MHAOvFilter::FreqScaleFun, [104](#)
- hz2unit
  - MHAOvFilter::scale\_var\_t, [633](#)
- i
  - io\_tcp\_sound\_t::float\_union, [388](#)
- INSERT\_PATCH
  - acConcat\_wave.cpp, [961](#)
  - acPooling\_wave.cpp, [962](#)
  - acSteer.cpp, [963](#)
  - acTransform\_wave.cpp, [964](#)
  - doasvm\_classification.cpp, [974](#)
  - doasvm\_feature\_extraction.cpp, [975](#)
  - lpc.cpp, [987](#)
  - lpc\_bl\_predictor.cpp, [987](#)
  - lpc\_burg-lattice.cpp, [988](#)
  - prediction\_error.cpp, [1072](#)
  - steerbf.cpp, [1080](#)
  - timoSmooth.cpp, [1082](#)
- INSERT\_VAR
  - timoSmooth.cpp, [1082](#)
- INVALID\_SOCKET
  - mha\_tcp.cpp, [1040](#)
- INVALID\_THREAD\_PRIORITY
  - MHAPugin\_Split, [118](#)
- IO\_ERROR\_JACK
  - mhajack.h, [1066](#)
- IO\_ERROR\_MHAJACKLIB
  - mhajack.h, [1066](#)
- IODestroy
  - MHAIOFile.cpp, [1048](#), [1049](#)
  - MHAIOJack.cpp, [1051](#), [1052](#)
  - MHAIOJackdb.cpp, [1053](#), [1054](#)
  - MHAIOParser.cpp, [1056](#), [1057](#)
  - MHAIOPortAudio.cpp, [1059](#), [1060](#)
  - MHAIOTCP.cpp, [1062](#), [1063](#)
  - MHAIOalsa.cpp, [1045](#), [1046](#)
- IODestroy\_cb
  - io\_lib\_t, [371](#)
- IODestroy\_t
  - mha\_io\_ifc.h, [1009](#)
- IOInit
  - MHAIOFile.cpp, [1048](#)
  - MHAIOJack.cpp, [1050](#), [1051](#)
  - MHAIOJackdb.cpp, [1053](#), [1054](#)
  - MHAIOParser.cpp, [1056](#)
  - MHAIOPortAudio.cpp, [1059](#)
  - MHAIOTCP.cpp, [1062](#), [1063](#)
  - MHAIOalsa.cpp, [1045](#)
- IOInit\_cb
  - io\_lib\_t, [371](#)
- IOInit\_t
  - mha\_io\_ifc.h, [1009](#)
- IOPrepare
  - MHAIOFile.cpp, [1048](#)
  - MHAIOJack.cpp, [1051](#)
  - MHAIOJackdb.cpp, [1053](#), [1054](#)
  - MHAIOParser.cpp, [1056](#)
  - MHAIOPortAudio.cpp, [1059](#)
  - MHAIOTCP.cpp, [1062](#), [1063](#)
  - MHAIOalsa.cpp, [1045](#), [1046](#)
- IOPrepare\_cb
  - io\_lib\_t, [371](#)
- IOPrepare\_t
  - mha\_io\_ifc.h, [1009](#)
- IOProcessEvent\_inner
  - MHAIOJackdb::io\_jack\_t, [580](#)
- IOProcessEvent\_t
  - mha\_io\_ifc.h, [1009](#)
- IORelease
  - MHAIOFile.cpp, [1048](#), [1049](#)
  - MHAIOJack.cpp, [1051](#)
  - MHAIOJackdb.cpp, [1053](#), [1054](#)
  - MHAIOParser.cpp, [1056](#), [1057](#)
  - MHAIOPortAudio.cpp, [1059](#), [1060](#)
  - MHAIOTCP.cpp, [1062](#), [1063](#)
  - MHAIOalsa.cpp, [1045](#), [1046](#)
- IORelease\_cb
  - io\_lib\_t, [371](#)
- IORelease\_t
  - mha\_io\_ifc.h, [1009](#)
- IOSetVar
  - MHAIOFile.cpp, [1048](#), [1049](#)
  - MHAIOJack.cpp, [1051](#)
  - MHAIOJackdb.cpp, [1053](#), [1054](#)
  - MHAIOParser.cpp, [1056](#), [1057](#)
  - MHAIOPortAudio.cpp, [1059](#), [1060](#)
  - MHAIOTCP.cpp, [1062](#), [1063](#)
  - MHAIOalsa.cpp, [1045](#), [1046](#)
- IOSetVar\_cb
  - io\_lib\_t, [371](#)
- IOSetVar\_t
  - mha\_io\_ifc.h, [1009](#)
- IOStart
  - MHAIOFile.cpp, [1048](#)

- MHAIOJack.cpp, 1051
- MHAIOJackdb.cpp, 1053, 1054
- MHAIOParser.cpp, 1056
- MHAIOPortAudio.cpp, 1059, 1060
- MHAIOTCP.cpp, 1062, 1063
- MHAIOalsa.cpp, 1045, 1046
- IOStart\_cb
  - io\_lib\_t, 371
- IOStart\_t
  - mha\_io\_ifc.h, 1009
- IOStartedEvent\_t
  - mha\_io\_ifc.h, 1009
- IOStop
  - MHAIOFile.cpp, 1048
  - MHAIOJack.cpp, 1051
  - MHAIOJackdb.cpp, 1053, 1054
  - MHAIOParser.cpp, 1056, 1057
  - MHAIOPortAudio.cpp, 1059, 1060
  - MHAIOTCP.cpp, 1062, 1063
  - MHAIOalsa.cpp, 1045, 1046
- IOStop\_cb
  - io\_lib\_t, 371
- IOStop\_t
  - mha\_io\_ifc.h, 1009
- IOStoppedEvent
  - MHAJack::client\_avg\_t, 590
  - MHAJack::client\_noncont\_t, 592
- IOStoppedEvent\_t
  - mha\_io\_ifc.h, 1009
- IOStrError
  - MHAIOFile.cpp, 1048, 1049
  - MHAIOJack.cpp, 1051, 1052
  - MHAIOJackdb.cpp, 1053, 1054
  - MHAIOParser.cpp, 1056, 1057
  - MHAIOPortAudio.cpp, 1059, 1060
  - MHAIOTCP.cpp, 1062, 1063
  - MHAIOalsa.cpp, 1045, 1046
- IOStrError\_cb
  - io\_lib\_t, 371
- IOStrError\_t
  - mha\_io\_ifc.h, 1009
- id
  - mha\_channel\_info\_t, 430
- id\_str
  - MHAParser::base\_t, 642
- id\_string
  - MHAParser::parser\_t, 692
- identity
  - MHASignal::schroeder\_t, 800
- identity.cpp, 985
- identity\_t, 359
- identity\_t, 359
  - prepare, 360
  - process, 359, 360
  - release, 360
- idstr
  - mha\_channel\_info\_t, 430
- if\_t
  - plingploing::if\_t, 866
  - testplugin::if\_t, 935
- iface
  - MHA\_TCP::Server, 483
- ifft
  - doasvm\_feature\_extraction\_config, 286
- ifftshift
  - ifftshift.cpp, 986
  - ifftshift.h, 986
- ifftshift.cpp, 985
  - ifftshift, 986
- ifftshift.h, 986
  - ifftshift, 986
- ignore
  - MHA\_TCP::Event\_Watcher, 479
- ignored\_by
  - MHA\_TCP::Wakeup\_Event, 494
- iir\_filter\_state\_t
  - MHAFilter::iir\_filter\_state\_t, 539
- iir\_filter\_t
  - MHAFilter::iir\_filter\_t, 540
- iir\_ord1\_real\_t
  - MHAFilter::iir\_ord1\_real\_t, 543
- iirfilter.cpp, 986
- iirfilter\_t, 360
  - iirfilter\_t, 361
  - prepare\_, 361
  - process, 361
  - release\_, 361
- ilen
  - addsndfile::level\_adapt\_t, 184
  - fader\_wave::level\_adapt\_t, 323
- im
  - mha\_complex\_t, 431
- imag
  - acsave::mat4head\_t, 169
  - fftfilterbank::fftfb\_plug\_t, 331
  - MHASignal::matrix\_t, 787–789
- imagfb
  - MHAOvFilter::overlap\_save\_filterbank\_↔
    - analytic\_t, 628
- impulse\_response
  - MHAFilter::polyphase\_resampling\_t, 563
  - MHAFilter::transfer\_function\_t, 572

- in\_buf
  - wave2spec\_t, 953
- in\_cfg
  - timo\_params, 940
- in\_spec
  - doasvm\_feature\_extraction\_config, 286
  - shadowfilter\_end::cfg\_t, 907
- in\_spec\_copy
  - shadowfilter\_begin::cfg\_t, 904
- inbuf
  - MHA\_TCP::Connection, 477
- inch
  - MHAJack::client\_t, 599
- increase\_condition
  - mha\_fifo\_posix\_threads\_t, 452
- increment
  - mha\_fifo\_posix\_threads\_t, 451
  - mha\_fifo\_thread\_platform\_t, 459
- index
  - MHAParser::keyword\_list\_t, 669
- index\_t
  - MHAFilter::partitioned\_convolution\_t↔  
::index\_t, 558, 559
- info
  - ac2lsl::save\_var\_base\_t, 137
  - ac2lsl::save\_var\_t, 139
  - ac2lsl::save\_var\_t< mha\_complex\_t >, 142
- inhib\_gain
  - dc::dc\_t, 257
- Init\_mha\_ruby
  - mha\_ruby.cpp, 1026
- init\_peer\_data
  - MHA\_TCP::Connection, 473
- initialize
  - MHA\_TCP::Server, 482
- inner2outer\_resampling
  - MHAPlugin\_Resampling::resampling\_t, 736
- inner\_ac\_copy
  - analysepath\_t, 218
- inner\_error
  - analysepath\_t, 218
  - mha\_dbdbuf\_t, 437
- inner\_fragsize
  - MHAPlugin\_Resampling::resampling\_t, 736
- inner\_in
  - MHASignal::doublebuffer\_t, 772
- inner\_input
  - analysepath\_t, 218
- inner\_out
  - MHASignal::doublebuffer\_t, 772
- inner\_out\_domain
  - analysepath\_t, 218
- inner\_process
  - db\_t, 252
  - MHASignal::doublebuffer\_t, 771
- inner\_process\_wave2spec
  - analysepath\_t, 218
- inner\_process\_wave2wave
  - analysepath\_t, 218
- inner\_signal
  - MHAPlugin\_Resampling::resampling\_t, 736
- inner\_size
  - mha\_dbdbuf\_t, 437
- inner\_srate
  - MHAPlugin\_Resampling::resampling\_t, 736
- input
  - io\_parser\_t, 374
  - MHAJack::port\_t, 600
  - MHASignal::loop\_wavefragment\_t, 779
  - mha\_dbdbuf\_t, 436
- input\_cfg
  - MHAPlugin::plugin\_t, 731
- input\_cfg\_
  - MHAPlugin::plugin\_t, 732
- input\_channels
  - adm\_if\_t, 197
  - mha\_dbdbuf\_t, 437
- input\_domain
  - PluginLoader::mhapluginloader\_t, 883
- input\_fifo
  - mha\_dbdbuf\_t, 437
- input\_level
  - dc::dc\_vars\_t, 259
- input\_portnames
  - MHAJack::client\_t, 599
- input\_signal\_spec
  - MHAFilter::partitioned\_convolution\_t, 557
- input\_signal\_wave
  - MHAFilter::partitioned\_convolution\_t, 556
- input\_spec
  - testplugin::signal\_parser\_t, 936
- input\_to\_process
  - analysepath\_t, 218
- input\_wave
  - testplugin::signal\_parser\_t, 936
- inputPow
  - noisePowProposedScale::noisePow↔



- Proposed, 858
- inputSpec
  - noisePowProposedScale::noisePow↔
  - Proposed, 858
- inputchannels
  - MHAFilter::fftfilterbank\_t, 530
- insert
  - acPooling\_wave\_config, 163
  - acSteer\_config, 175
  - coherence::cohflt\_t, 240
  - fftfilterbank::fftfb\_plug\_t, 331
  - lpc\_config, 407
  - MHA\_AC::ac2matrix\_t, 415
  - MHA\_AC::acspace2matrix\_t, 418
  - MHA\_AC::spectrum\_t, 423
  - MHA\_AC::stat\_t, 425
  - MHA\_AC::waveform\_t, 427
  - MHAOvFilter::fftfb\_ac\_info\_t, 615
  - multibandcompressor::fftfb\_plug\_t, 846
  - noisePowProposedScale::noisePow↔
  - Proposed, 858
  - prediction\_error\_config, 890
  - rmslevel\_t, 894
  - rt\_nlms\_t, 899
  - timo\_AC, 937
- insert\_item
  - MHAParser::parser\_t, 690
- insert\_items
  - windowselector\_t, 958
- insert\_member
  - mha\_parser.hh, 1021
- insert\_var
  - algo\_comm\_t, 201
  - MHAKernel::algo\_comm\_class\_t, 604
  - testplugin::ac\_parser\_t, 931
- insert\_var\_float
  - algo\_comm\_t, 202
  - MHAKernel::algo\_comm\_class\_t, 604
- insert\_var\_int
  - algo\_comm\_t, 202
  - MHAKernel::algo\_comm\_class\_t, 604
- inspect
  - MHAFilter::complex\_bandpass\_t, 522
  - MHAFilter::gammaflt\_t, 537
  - MHASignal::delay\_t, 768
- inst\_name
  - fw\_t, 347
- int\_data
  - testplugin::ac\_parser\_t, 931
- int\_mon\_t
  - MHAParser::int\_mon\_t, 663
- int\_t
  - MHA\_AC::int\_t, 421
  - MHAParser::int\_t, 665
- integrate
  - Vector and matrix processing toolbox, 48
- intensity
  - mha\_signal.cpp, 1028
- interface\_t
  - delay::interface\_t, 274
  - multibandcompressor::interface\_t, 848
  - noisePowProposedScale::interface\_t, 856
  - route::interface\_t, 896
- interleaved
  - combc\_if\_t, 244
- interleaved\_
  - combc\_t, 245
- intern\_level
  - MHASignal::loop\_wavefragment\_t, 781
- internal\_fir
  - MHAFilter::smoothspec\_t, 568
- internal\_start
  - MHAJack::client\_t, 598
- internal\_stop
  - MHAJack::client\_t, 598
- interp
  - MHATableLookup::linear\_table\_t, 826
  - MHATableLookup::table\_t, 829
  - MHATableLookup::xy\_table\_t, 831
- interp1
  - DynComp, 85
- interp2
  - DynComp, 86
- inv\_scale
  - MHAOvFilter::FreqScaleFun, 105
- invalidate\_window\_data
  - windowselector\_t, 959
- invert
  - coherence::vars\_t, 242
- invgain
  - alsa\_t, 213
- inwave
  - lpc\_config, 408
- io
  - MHAJack, 100
  - MHAJack::client\_avg\_t, 589
  - MHAJack::client\_noncont\_t, 592
- io\_alsa\_t, 361
  - alsa\_start\_counter, 364
  - b\_process, 364
  - dev\_in, 364
  - dev\_out, 364

- format, 364
- fw\_fragsize, 364
- fw\_samplerate, 364
- io\_alsa\_t, 363
- p\_in, 364
- p\_out, 364
- patchbay, 364
- pcmlink, 364
- prepare, 363, 364
- priority, 364
- proc\_event, 364
- proc\_handle, 364
- proc\_thread, 364
- process, 364
- release, 363
- start, 363
- start\_event, 364
- start\_handle, 364
- stop, 363
- stop\_event, 364
- stop\_handle, 364
- thread\_start, 363
- io\_err
  - io\_tcp\_fwcb\_t, 378
- io\_error
  - fw\_t, 348
- io\_file\_t, 365
  - ~io\_file\_t, 366
  - b\_prepared, 368
  - filename\_input, 368
  - filename\_output, 368
  - fragsize, 367
  - io\_file\_t, 366
  - length, 368
  - nchannels\_file\_in, 367
  - nchannels\_in, 367
  - nchannels\_out, 367
  - output\_sample\_format, 368
  - prepare, 367
  - proc\_event, 368
  - proc\_handle, 368
  - release, 367
  - s\_file\_in, 368
  - s\_in, 368
  - s\_out, 368
  - samplerate, 367
  - setlock, 367
  - sf\_in, 368
  - sf\_out, 368
  - sfinf\_in, 368
  - sfinf\_out, 368
  - start, 367
  - start\_event, 368
  - start\_handle, 368
  - startsample, 368
  - stop, 367
  - stop\_event, 368
  - stop\_handle, 368
  - stopped, 367
  - strict\_channel\_match, 368
  - strict\_srate\_match, 368
  - total\_read, 368
- io\_lib
  - MHAIOJack::io\_lib\_t, 575
  - MHAIOJackdb::io\_lib\_t, 580
- io\_lib
  - fw\_t, 348
- io\_lib\_t, 369
  - ~io\_lib\_t, 370
  - IODestroy\_cb, 371
  - IOInit\_cb, 371
  - IOPrepare\_cb, 371
  - IORelease\_cb, 371
  - IOSetVar\_cb, 371
  - IOStart\_cb, 371
  - IOStop\_cb, 371
  - IOStrError\_cb, 371
  - io\_lib\_t, 370
  - lib\_data, 371
  - lib\_err, 371
  - lib\_handle, 371
  - lib\_str\_error, 371
  - prepare, 370
  - release, 371
  - start, 371
  - stop, 371
  - test\_error, 371
- io\_name
  - fw\_t, 347
- io\_parser\_t, 372
  - ~io\_parser\_t, 373
  - b\_fw\_started, 374
  - b\_prepared, 374
  - b\_starting, 374
  - b\_stopped, 374
  - fragsize, 374
  - input, 374
  - io\_parser\_t, 373
  - nchannels\_in, 374
  - nchannels\_out, 374
  - output, 374
  - patchbay, 374

- prepare, 373
- proc\_event, 374
- proc\_handle, 374
- process\_frame, 374
- release, 374
- s\_in, 374
- s\_out, 374
- start, 373
- start\_event, 374
- start\_handle, 374
- started, 374
- stop, 374
- stop\_event, 374
- stop\_handle, 374
- stopped, 374
- io\_portaudio\_t
  - MHAIOPortAudio::io\_portaudio\_t, 586
- io\_tcp\_fwcb\_t, 375
  - ~io\_tcp\_fwcb\_t, 376
  - io\_err, 378
  - io\_tcp\_fwcb\_t, 376
  - proc\_err, 378
  - proc\_event, 377
  - proc\_handle, 377
  - process, 376
  - set\_errnos, 376
  - start, 376
  - start\_event, 377
  - start\_handle, 378
  - stop, 377
  - stop\_event, 377
  - stop\_handle, 378
- io\_tcp\_parser\_t, 378
  - ~io\_tcp\_parser\_t, 380
  - connected, 383
  - debug, 383
  - debug\_file, 384
  - debug\_filename, 384
  - get\_connected, 381
  - get\_local\_address, 380
  - get\_local\_port, 380
  - get\_server\_port\_open, 381
  - io\_tcp\_parser\_t, 380
  - local\_address, 383
  - local\_port, 383
  - peer\_address, 383
  - peer\_port, 384
  - server\_port\_open, 383
  - set\_connected, 382
  - set\_local\_port, 380
  - set\_new\_peer, 382
  - set\_server\_port\_open, 381
  - io\_tcp\_sound\_t, 384
    - ~io\_tcp\_sound\_t, 385
    - check\_sound\_data\_type, 386
    - chunkbytes\_in, 386
    - fragsize, 387
    - header, 386
    - hton, 387
    - io\_tcp\_sound\_t, 385
    - ntoh, 386
    - num\_inchannels, 387
    - num\_outchannels, 388
    - prepare, 386
    - release, 386
    - s\_in, 388
    - samplerate, 387
  - io\_tcp\_sound\_t::float\_union, 388
    - c, 388
    - f, 388
    - i, 388
- io\_tcp\_t, 389
  - ~io\_tcp\_t, 390
  - accept\_loop, 390
  - connection\_loop, 390
  - fwcb, 391
  - io\_tcp\_t, 390
  - notify\_release, 391
  - notify\_start, 391
  - notify\_stop, 391
  - parse, 391
  - parser, 391
  - prepare, 390
  - release, 390
  - server, 391
  - sound, 391
  - start, 390
  - stop, 390
  - thread, 391
- iob
  - MHAJack::port\_t, 602
- irslen
  - fshift\_hilbert::frequency\_translator\_t, 339
- irslen\_inner2outer
  - MHAPlugin\_Resampling::resampling\_if↔\_t, 734
- irslen\_outer2inner
  - MHAPlugin\_Resampling::resampling\_if↔\_t, 734
- irswnd
  - MHAOvFilter::overlap\_save\_filterbank↔::vars\_t, 631

- smoothgains\_bridge::overlapadd\_if\_↔  
t, 914
- is\_complex
  - MHA\_AC::ac2matrix\_helper\_t, 413
  - mha\_audio\_descriptor\_t, 428
- is\_first\_run
  - ac2lsl::ac2lsl\_t, 133
  - ac2osc\_t, 147
- is\_playback\_active
  - MHASignal::loop\_wavefragment\_t, 781
- is\_prepared
  - adm\_if\_t, 197
  - MHAPlugin::plugin\_t, 731
  - PluginLoader::mhapluginloader\_t, 884
- is\_prepared\_
  - MHAPlugin::plugin\_t, 732
- is\_same\_size
  - MHASignal::matrix\_t, 786
- is\_var
  - algo\_comm\_t, 203
  - MHAKernel::algo\_comm\_class\_t, 604
- iscomplex
  - MHASignal::matrix\_t, 786
- isempty
  - AuditoryProfile::fmap\_t, 221
  - gaintable.cpp, 980
  - MHAFilter::transfer\_function\_t, 572
- isval
  - MHAParser::kw\_t, 671
- iter
  - prediction\_error\_config, 891
- iterator
  - MHA\_TCP::Event\_Watcher, 479
- jack\_error\_handler
  - mhjack.cpp, 1064
- jack\_proc\_cb
  - MHAJack::client\_t, 598
- jack\_xrun\_cb
  - MHAJack::client\_t, 598
- jc
  - MHAJack::client\_t, 599
  - MHAJack::port\_t, 602
- jstate\_prev
  - MHAJack::client\_t, 599
- k\_inner
  - MHASignal::doublebuffer\_t, 772
- k\_nyquist
  - dc::dc\_t, 257
- k\_outer
  - MHASignal::doublebuffer\_t, 772
- kappa
  - lpc\_burglattice\_config, 406
- kappa\_block
  - lpc\_burglattice\_config, 406
- kappa\_const
  - timo\_params, 940
  - timoSmooth, 946
- keyword\_list\_t
  - MHAParser::keyword\_list\_t, 667
- kick\_condition
  - MHAPlugin\_Split::posix\_threads\_t, 745
- kick\_thread
  - MHAPlugin\_Split::dummy\_threads\_t, 742
  - MHAPlugin\_Split::posix\_threads\_t, 745
  - MHAPlugin\_Split::thread\_platform\_t, 758
- kicked
  - MHAPlugin\_Split::posix\_threads\_t, 746
- km
  - lpc\_bl\_predictor\_config, 402
- kmax
  - fshift::fshift\_config\_t, 333
  - fshift\_hilbert::hilbert\_shifter\_t, 342
- kmin
  - fshift::fshift\_config\_t, 333
  - fshift\_hilbert::hilbert\_shifter\_t, 342
- kth\_smallest
  - MHASignal, 121
- kw\_index2type
  - transducers.cpp, 1083
- kw\_t
  - MHAParser::kw\_t, 670, 671
- L
  - AuditoryProfile::parser\_t, 223
  - AuditoryProfile::profile\_t, 227
- l\_min
  - dc::wb\_inhib\_cfg\_t, 261
  - dc::wideband\_inhib\_vars\_t, 262
- l\_new
  - addsndfile::level\_adapt\_t, 184
  - fader\_wave::level\_adapt\_t, 323
- l\_old
  - addsndfile::level\_adapt\_t, 184
  - fader\_wave::level\_adapt\_t, 323
- LEVEL
  - dc\_simple, 84
- LPSCALE
  - timoconfig.cpp, 1081
- LTASS\_combined
  - speechnoise\_t, 925
- LTASS\_female
  - speechnoise\_t, 925

- LTASS\_male
  - speechnoise\_t, 925
- lambda
  - lpc\_burglattice, 404
  - lpc\_burglattice\_config, 406
- lambda\_ceps
  - timoConfig, 943
- lambda\_ceps\_AC
  - timo\_AC, 938
- lambda\_ceps\_prev
  - timoConfig, 943
- lambda\_ml\_AC
  - timo\_AC, 938
- lambda\_ml\_ceps
  - timoConfig, 943
- lambda\_ml\_ceps\_AC
  - timo\_AC, 938
- lambda\_ml\_full
  - timoConfig, 943
- lambda\_ml\_smooth
  - timoConfig, 943
- lambda\_ml\_smooth\_AC
  - timo\_AC, 938
- lambda\_smoothing\_power
  - nlms\_t, 853
- lambda\_spec
  - timoConfig, 943
- lambda\_spec\_AC
  - timo\_AC, 938
- lambda\_thresh
  - timo\_params, 940
  - timoSmooth, 946
- last\_complex\_bin
  - MHASignal::subsample\_delay\_t, 808
- last\_config
  - MHAPLugin::config\_t, 726
- last\_errormsg
  - MHAParser::parser\_t, 692
- last\_jack\_err
  - mhajack.cpp, 1064
- last\_jack\_err\_msg
  - mhajack.cpp, 1064
  - mhajack.h, 1066
- last\_name
  - MHAParser::mhapluginloader\_t, 684
- latex\_doc\_t, 391
  - ac, 394
  - get\_ac, 394
  - get\_categories, 393
  - get\_latex\_doc, 393
  - get\_main\_category, 393
  - get\_parser\_tab, 394
  - get\_parser\_var, 394
  - latex\_doc\_t, 392
  - latex\_plugname, 394
  - loader, 394
  - parseiname, 394
  - plugin\_macro, 394
  - plugname, 394
  - strdom, 393
- latex\_plugname
  - latex\_doc\_t, 394
- len
  - MHA\_AC::acspace2matrix\_t, 418
  - MHAFilter::filter\_t, 535
  - MHATableLookup::linear\_table\_t, 828
  - plingploing::plingploing\_t, 869
- len\_A
  - MHAFilter::filter\_t, 535
- len\_a
  - hanning\_ramps\_t, 358
- len\_B
  - MHAFilter::filter\_t, 535
- len\_b
  - hanning\_ramps\_t, 358
- length
  - io\_file\_t, 368
  - MHASignal::uint\_vector\_t, 811
- lev
  - noise\_t, 855
  - sine\_t, 912
- level
  - addsndfile::addsndfile\_if\_t, 182
  - plingploing::if\_t, 867
  - plingploing::plingploing\_t, 870
  - rmslevel\_t, 894
- level\_adapt\_t
  - addsndfile::level\_adapt\_t, 183
  - fader\_wave::level\_adapt\_t, 322
- level\_adaptor
  - addsndfile, 80
  - fader\_wave, 86
- level\_db
  - rmslevel\_t, 894
- level\_in\_db
  - dc::dc\_t, 257
- level\_in\_db\_adjusted
  - dc::dc\_t, 257
- level\_mode\_t
  - MHASignal::loop\_wavefragment\_t, 779
- level\_mon
  - droptect\_t, 289

- level\_smoother\_t
  - dc\_simple::level\_smoother\_t, 272
- level\_spec
  - dc\_simple::level\_smoother\_t, 272
- level\_wave
  - dc\_simple::level\_smoother\_t, 272
- levelmode
  - addsndfile::addsndfile\_if\_t, 182
- Levinson2
  - lpc.cpp, 987
- lib\_data
  - io\_lib\_t, 371
  - PluginLoader::mhapluginloader\_t, 884
- lib\_err
  - io\_lib\_t, 371
  - PluginLoader::mhapluginloader\_t, 884
- lib\_handle
  - io\_lib\_t, 371
  - PluginLoader::mhapluginloader\_t, 884
- lib\_str\_error
  - io\_lib\_t, 371
- libdata
  - analysepath\_t, 218
  - MHAParser::c\_ifc\_parser\_t, 650
- liberr
  - MHAParser::c\_ifc\_parser\_t, 650
- libname
  - analysepath\_if\_t, 220
  - PluginLoader::config\_file\_splitter\_t, 877
- library\_paths
  - pluginbrowser\_t, 874
- like\_ratio
  - acPooling\_wave\_config, 164
- like\_ratio\_name
  - acPooling\_wave, 162
- limit
  - coherence::cohflt\_t, 240
  - coherence::vars\_t, 242
  - MHASignal, 121
  - MHASignal::quantizer\_t, 793
  - MHASignal::waveform\_t, 820
- limiter
  - dc\_simple::dc\_t, 267
- limiter\_threshold
  - dc\_simple::dc\_t, 267
  - dc\_simple::dc\_vars\_t, 270
- lin2db
  - Vector and matrix processing toolbox, 43
- line\_t
  - dc\_simple::dc\_t::line\_t, 268
- linear
  - MHAOvFilter::ShapeFun, 106
  - softclipper\_t, 918
  - softclipper\_variables\_t, 920
- linear\_table\_t
  - MHATableLookup::linear\_table\_t, 826
- Linearphase\_FIR
  - ADM::Linearphase\_FIR, 193
- list\_dir
  - mha\_os.cpp, 1011
  - mha\_os.h, 1015
- io\_addr
  - ac2osc\_t, 147
- load\_io\_lib
  - fw\_t, 346
- load\_plug
  - MHAParser::mhapluginloader\_t, 684
- load\_proc\_lib
  - fw\_t, 346
- loader
  - latex\_doc\_t, 394
- loadlib
  - analysispath\_if\_t, 220
- local\_address
  - io\_tcp\_parser\_t, 383
- local\_get\_entries
  - MHAKernel::algo\_comm\_class\_t, 605
- local\_get\_var
  - MHAKernel::algo\_comm\_class\_t, 605
- local\_insert\_var
  - MHAKernel::algo\_comm\_class\_t, 605
- local\_is\_var
  - MHAKernel::algo\_comm\_class\_t, 605
- local\_port
  - io\_tcp\_parser\_t, 383
- local\_remove\_ref
  - MHAKernel::algo\_comm\_class\_t, 605
- local\_remove\_var
  - MHAKernel::algo\_comm\_class\_t, 605
- locate
  - MHAIOJackdb::io\_jack\_t, 582
- locate\_end
  - MHASignal::loop\_wavefragment\_t, 781
- lock\_channels
  - fw\_vars\_t, 349
- lock\_srate\_fragmentsize
  - fw\_vars\_t, 349
- locked
  - MHAParser::variable\_t, 701
- log\_down
  - MHASignal::schroeder\_t, 800
- log\_lambda\_spec

- timoConfig, 943
- log\_lambda\_spec\_AC
  - timo\_AC, 938
- log\_up
  - MHASignal::schroeder\_t, 800
- logGLRFact
  - noisePowProposedScale::noisePow↔  
Proposed, 859
  - timoConfig, 943
- logfile
  - mhaserver\_t, 763
- logstring
  - mhaserver\_t, 762
- longmsg
  - MHA\_Error, 447
- lookup
  - MHATableLookup::linear\_table\_t, 826
  - MHATableLookup::table\_t, 829
  - MHATableLookup::xy\_table\_t, 831
- loop
  - addsndfile::addsndfile\_if\_t, 182
- loop\_wavefragment\_t
  - MHASignal::loop\_wavefragment\_t, 779
- low\_incl
  - MHAParser::range\_var\_t, 695
- low\_limit
  - MHAParser::range\_var\_t, 695
- low\_side\_flat
  - MHAOvfFilter::band\_descriptor\_t, 613
- low\_thresh
  - acPooling\_wave\_config, 164
- lower\_threshold
  - acPooling\_wave, 162
- lp
  - DynComp::dc\_afterburn\_rt\_t, 294
- lp1i
  - coherence::cohflt\_t, 240
- lp1ltg
  - coherence::cohflt\_t, 241
- lp1r
  - coherence::cohflt\_t, 240
- lp\_coeffs
  - adm\_rtconfig\_t, 200
- lp\_order
  - adm\_if\_t, 197
- lpc, 395
  - ~lpc, 396
  - algo\_name, 397
  - comp\_each\_iter, 397
  - lpc, 396
  - lpc\_buffer\_size, 397
  - lpc\_order, 397
  - norm, 397
  - patchbay, 397
  - prepare, 396
  - process, 396
  - release, 396
  - shift, 397
  - update\_cfg, 397
- lpc.cpp, 986
  - INSERT\_PATCH, 987
  - Levinson2, 987
  - PATCH\_VAR, 987
- lpc.h, 987
- lpc\_bl\_predictor, 398
  - ~lpc\_bl\_predictor, 399
  - lpc\_bl\_predictor, 399
  - lpc\_order, 400
  - name\_b, 400
  - name\_f, 400
  - name\_kappa, 400
  - name\_lpc\_b, 400
  - name\_lpc\_f, 400
  - patchbay, 400
  - prepare, 399
  - process, 399
  - release, 399
  - update\_cfg, 400
- lpc\_bl\_predictor.cpp, 987
  - INSERT\_PATCH, 987
  - PATCH\_VAR, 987
- lpc\_bl\_predictor.h, 987
  - EPSILON, 988
- lpc\_bl\_predictor\_config, 400
  - ~lpc\_bl\_predictor\_config, 401
  - ac, 401
  - b\_est, 401
  - backward, 401
  - f\_est, 401
  - forward, 401
  - km, 402
  - lpc\_bl\_predictor\_config, 401
  - lpc\_order, 401
  - name\_b, 402
  - name\_f, 401
  - name\_km, 401
  - process, 401
  - s\_b, 402
  - s\_f, 402
- lpc\_buffer\_size
  - lpc, 397
  - lpc\_config, 408

- lpc\_burg-lattice.cpp, 988
  - INSERT\_PATCH, 988
  - PATCH\_VAR, 988
- lpc\_burg-lattice.h, 988
  - EPSILON, 988
- lpc\_burglattice, 402
  - ~lpc\_burglattice, 403
  - lambda, 404
  - lpc\_burglattice, 403
  - lpc\_order, 404
  - name\_b, 404
  - name\_f, 404
  - name\_kappa, 404
  - patchbay, 404
  - prepare, 404
  - process, 404
  - release, 404
  - update\_cfg, 404
- lpc\_burglattice\_config, 405
  - ~lpc\_burglattice\_config, 405
  - ac, 405
  - backward, 406
  - dm, 406
  - forward, 405
  - kappa, 406
  - kappa\_block, 406
  - lambda, 406
  - lpc\_burglattice\_config, 405
  - lpc\_order, 406
  - name\_b, 406
  - name\_f, 406
  - nm, 406
  - process, 405
  - s\_b, 406
  - s\_f, 406
- lpc\_config, 406
  - ~lpc\_config, 407
  - A, 408
  - comp\_each\_iter, 407
  - comp\_iter, 408
  - corr\_out, 408
  - insert, 407
  - inwave, 408
  - lpc\_buffer\_size, 408
  - lpc\_config, 407
  - lpc\_out, 408
  - N, 408
  - norm, 407
  - order, 407
  - process, 407
  - R, 408
  - sample, 408
  - shift, 407
- lpc\_order
  - lpc, 397
  - lpc\_bl\_predictor, 400
  - lpc\_bl\_predictor\_config, 401
  - lpc\_burglattice, 404
  - lpc\_burglattice\_config, 406
  - prediction\_error, 889
- lpc\_out
  - lpc\_config, 408
- ltgcomp
  - coherence::vars\_t, 242
- ltgtau
  - coherence::vars\_t, 242
- lval
  - MHAParser::expression\_t, 657
- m
  - dc\_simple::dc\_t::line\_t, 268
  - matrixmixer::cfg\_t, 409
- M\_PI
  - mha\_defs.h, 998
  - mha\_signal.hh, 1037
- m\_alphas
  - ADM::Linearphase\_FIR, 194
- m\_beta
  - ADM::ADM, 190
- m\_coeff
  - ADM::Delay, 192
- m\_decomb
  - ADM::ADM, 190
- m\_delay\_back
  - ADM::ADM, 190
- m\_delay\_front
  - ADM::ADM, 190
- m\_df
  - fshift::fshift\_t, 336
- m\_fmax
  - fshift::fshift\_t, 336
- m\_fmin
  - fshift::fshift\_t, 336
- m\_fullsamples
  - ADM::Delay, 192
- m\_lp\_bf
  - ADM::ADM, 190
- m\_lp\_result
  - ADM::ADM, 190
- m\_mu\_beta
  - ADM::ADM, 190
- m\_norm
  - ADM::Delay, 192



- m\_now
  - ADM::Linearphase\_FIR, 194
- m\_now\_in
  - ADM::Delay, 192
- m\_order
  - ADM::Linearphase\_FIR, 194
- m\_output
  - ADM::Linearphase\_FIR, 194
- m\_powerfilter\_coeff
  - ADM::ADM, 190
- m\_powerfilter\_norm
  - ADM::ADM, 190
- m\_powerfilter\_state
  - ADM::ADM, 190
- m\_state
  - ADM::Delay, 192
- MAX\_LINE\_LENGTH
  - mhamain.cpp, 1067
- MAX\_TCP\_PORT\_STR
  - MHAIOTCP.cpp, 1062
- MAX\_TCP\_PORT
  - MHAIOTCP.cpp, 1062
- MAX\_USER\_ERR
  - MHAIIOFile.cpp, 1048
  - MHAIIOJack.cpp, 1050
  - MHAIIOJackdb.cpp, 1053
  - MHAIOParser.cpp, 1056
  - MHAIOPortAudio.cpp, 1059
  - MHAIOTCP.cpp, 1062
  - MHAIOalsa.cpp, 1045
  - mhajack.h, 1066
- MAX
  - mha\_defs.h, 998
- MHA\_AC::ac2matrix\_helper\_t, 412
  - ac, 413
  - ac2matrix\_helper\_t, 412
  - acvar, 413
  - getvar, 412
  - is\_complex, 413
  - name, 413
  - size, 413
  - username, 413
- MHA\_AC::ac2matrix\_t, 413
  - ac2matrix\_t, 414
  - getname, 414
  - getusername, 415
  - insert, 415
  - update, 414
- MHA\_AC::acspace2matrix\_t, 415
  - ~acspace2matrix\_t, 417
  - acspace2matrix\_t, 416
  - data, 418
  - frame, 418
  - frameno, 418
  - insert, 418
  - len, 418
  - operator=, 417
  - operator[], 417
  - size, 418
  - update, 418
- MHA\_AC::double\_t, 418
  - ~double\_t, 419
  - ac, 419
  - data, 419
  - double\_t, 419
- MHA\_AC::float\_t, 420
  - ~float\_t, 420
  - ac, 420
  - data, 420
  - float\_t, 420
- MHA\_AC::int\_t, 421
  - ~int\_t, 421
  - ac, 421
  - data, 421
  - int\_t, 421
- MHA\_AC::spectrum\_t, 422
  - ~spectrum\_t, 423
  - ac, 424
  - insert, 423
  - name, 424
  - spectrum\_t, 423
- MHA\_AC::stat\_t, 424
  - insert, 425
  - mean, 425
  - stat\_t, 425
  - std, 425
  - update, 425
- MHA\_AC::waveform\_t, 425
  - ~waveform\_t, 426
  - ac, 427
  - insert, 427
  - name, 427
  - waveform\_t, 426
- MHA\_AC\_CHAR
  - mha.hh, 993
- MHA\_AC\_DOUBLE
  - mha.hh, 993
- MHA\_AC\_FLOAT
  - mha.hh, 993
- MHA\_AC\_INT
  - mha.hh, 993
- MHA\_AC\_MHACOMPLEX

- mha.hh, [993](#)
- MHA\_AC\_MHAREAL
  - mha.hh, [993](#)
- MHA\_AC\_UNKNOWN
  - mha.hh, [993](#)
- MHA\_AC\_USER
  - mha.hh, [993](#)
- MHA\_AC\_VEC\_FLOAT
  - mha.hh, [993](#)
- MHA\_AC, [89](#)
- MHA\_CALLBACK\_TEST\_PREFIX
  - mha.hh, [991](#)
- MHA\_CALLBACK\_TEST
  - mha.hh, [991](#)
- MHA\_DOMAIN\_MAX
  - mha.hh, [993](#)
- MHA\_DOMAIN\_UNKNOWN
  - mha.hh, [993](#)
- MHA\_EAR\_LEFT
  - mha\_defs.h, [998](#)
- MHA\_EAR\_MAX
  - mha\_defs.h, [998](#)
- MHA\_EAR\_RIGHT
  - mha\_defs.h, [998](#)
- MHA\_ERR\_INVALID\_HANDLE
  - mha\_errno.h, [1000](#)
- MHA\_ERR\_NULL
  - mha\_errno.h, [1000](#)
- MHA\_ERR\_SUCCESS
  - mha\_errno.h, [1000](#)
- MHA\_ERR\_UNKNOWN
  - mha\_errno.h, [1000](#)
- MHA\_ERR\_USER
  - mha\_errno.h, [1000](#)
- MHA\_ERR\_VARFMT
  - mha\_errno.h, [1000](#)
- MHA\_ERR\_VARRANGE
  - mha\_errno.h, [1000](#)
- MHA\_Error, [445](#)
  - ~MHA\_Error, [446](#)
  - get\_longmsg, [446](#)
  - get\_msg, [446](#)
  - longmsg, [447](#)
  - MHA\_Error, [446](#)
  - msg, [447](#)
  - operator=, [446](#)
  - what, [446](#)
- MHA\_ErrorMsg
  - Error handling in the openMHA, [32](#)
- MHA\_ErrorMsg2
  - MHAIOTCP.cpp, [1062](#)
- MHA\_ErrorMsg3
  - MHAIOTCP.cpp, [1062](#)
- MHA\_ID\_MATRIX
  - mha\_signal.cpp, [1028](#)
- MHA\_ID\_UINT\_VECTOR
  - mha\_signal.cpp, [1028](#)
- MHA\_RELEASE\_VERSION\_STRING
  - mha.hh, [992](#)
- MHA\_RESOLVE\_CHECKED
  - mha\_os.h, [1013](#)
- MHA\_RESOLVE
  - mha\_os.h, [1013](#)
- MHA\_SPECTRUM
  - mha.hh, [993](#)
- MHA\_STRUCT\_SIZEMATCH
  - mha.hh, [992](#)
- MHA\_STRF
  - mha.hh, [992](#)
- MHA\_TCP::Async\_Notify, [468](#)
  - ~Async\_Notify, [469](#)
  - Async\_Notify, [469](#)
  - pipe, [469](#)
  - reset, [469](#)
  - set, [469](#)
- MHA\_TCP::Client, [469](#)
  - Client, [470](#)
- MHA\_TCP::Connection, [471](#)
  - ~Connection, [473](#)
  - buffered\_incoming\_bytes, [477](#)
  - buffered\_outgoing\_bytes, [477](#)
  - can\_read\_bytes, [475](#)
  - can\_read\_line, [475](#)
  - can\_sysread, [473](#)
  - can\_syswrite, [473](#)
  - closed, [477](#)
  - Connection, [473](#)
  - eof, [474](#)
  - fd, [477](#)
  - get\_fd, [474](#)
  - get\_peer\_address, [474](#)
  - get\_peer\_port, [474](#)
  - get\_read\_event, [474](#)
  - get\_write\_event, [474](#)
  - inbuf, [477](#)
  - init\_peer\_data, [473](#)
  - needs\_write, [476](#)
  - outbuf, [477](#)
  - peer\_addr, [477](#)
  - read\_bytes, [476](#)
  - read\_event, [477](#)
  - read\_line, [475](#)

- sysread, 473
- syswrite, 474
- try\_write, 476
- write, 476
- write\_event, 477
- MHA\_TCP::Event\_Watcher, 478
  - ~Event\_Watcher, 479
  - Events, 479
  - events, 479
  - ignore, 479
  - iterator, 479
  - observe, 479
  - wait, 479
- MHA\_TCP::OS\_EVENT\_TYPE, 480
  - fd, 480
  - mode, 480
  - R, 480
  - T, 480
  - timeout, 480
  - W, 480
  - X, 480
- MHA\_TCP::Server, 481
  - ~Server, 482
  - accept, 482
  - accept\_event, 483
  - get\_accept\_event, 482
  - get\_interface, 482
  - get\_port, 482
  - iface, 483
  - initialize, 482
  - port, 483
  - Server, 481, 482
  - serversocket, 483
  - sock\_addr, 483
  - try\_accept, 483
- MHA\_TCP::Sockaccept\_Event, 484
  - Sockaccept\_Event, 484
- MHA\_TCP::Sockread\_Event, 485
  - Sockread\_Event, 485
- MHA\_TCP::Sockwrite\_Event, 486
  - Sockwrite\_Event, 486
- MHA\_TCP::Thread, 486
  - ~Thread, 489
  - arg, 489
  - error, 490
  - FINISHED, 488
  - PREPARED, 488
  - RUNNING, 488
  - return\_value, 489
  - run, 489
  - state, 489
  - thr\_f, 488
  - Thread, 488
  - thread\_arg, 490
  - thread\_attr, 489
  - thread\_finish\_event, 489
  - thread\_func, 490
  - thread\_handle, 489
- MHA\_TCP::Timeout\_Event, 490
  - end\_time, 491
  - get\_os\_event, 491
  - Timeout\_Event, 491
- MHA\_TCP::Timeout\_Watcher, 491
  - ~Timeout\_Watcher, 492
  - timeout, 492
  - Timeout\_Watcher, 492
- MHA\_TCP::Wakeup\_Event, 493
  - ~Wakeup\_Event, 494
  - get\_os\_event, 494
  - ignored\_by, 494
  - observed\_by, 494
  - observers, 495
  - os\_event, 495
  - os\_event\_valid, 495
  - reset, 494
  - status, 495
  - Wakeup\_Event, 494
- MHA\_TCP::sock\_init\_t, 483
  - sock\_init\_t, 484
- MHA\_TCP, 91
  - dtime, 93
  - G\_ERRNO, 92
  - H\_ERRNO, 92
  - HSTRERROR, 92
  - N\_ERRNO, 92
  - SOCKET, 92
  - STRERROR, 92
  - sock\_initializer, 93
  - stime, 93
- MHA\_VERSION\_BUILD
  - mha.hh, 992
- MHA\_VERSION\_MAJOR
  - mha.hh, 992
- MHA\_VERSION\_MINOR
  - mha.hh, 992
- MHA\_VERSION\_RELEASE
  - mha.hh, 992
- MHA\_VERSION\_STRING
  - mha.hh, 992
- MHA\_VERSION
  - mha.hh, 992
- MHA\_WAVEFORM

- mha.hh, 993
  - MHA\_XSTRF
    - mha.hh, 992
  - MHA\_assert
    - Error handling in the openMHA, 33
  - MHA\_assert\_equal
    - Error handling in the openMHA, 33
  - MHADestroy\_cb
    - PluginLoader::mhapluginloader\_t, 884
  - MHADestroy\_t
    - mha.hh, 994
  - MHAEvents, 93
  - MHAEvents::connector\_base\_t, 506
    - ~connector\_base\_t, 506
    - connector\_base\_t, 506
    - emit\_event, 507
    - emitter\_die, 507
    - emitter\_is\_alive, 507
  - MHAEvents::connector\_t
    - ~connector\_t, 509
    - connector\_t, 509
    - emit\_event, 509
    - emitter, 510
    - eventhandler, 510
    - eventhandler\_s, 510
    - eventhandler\_suu, 510
    - receiver, 510
  - MHAEvents::connector\_t< receiver\_t >, 508
  - MHAEvents::emitter\_t, 510
    - ~emitter\_t, 511
    - connect, 511
    - connections, 511
    - disconnect, 511
    - operator(), 511
  - MHAEvents::patchbay\_t
    - ~patchbay\_t, 512
    - connect, 512, 513
    - cons, 513
  - MHAEvents::patchbay\_t< receiver\_t >, 512
  - MHAFilter, 94
    - butter\_stop\_ord1, 96
    - gcd, 97
    - make\_friendly\_number, 96
    - o1\_lp\_coeffs, 96
    - resampling\_factors, 97
    - sinc, 97
    - spec2fir, 97
  - MHAFilter::adapt\_filter\_param\_t, 513
    - adapt\_filter\_param\_t, 514
    - err\_in, 514
    - mu, 514
  - MHAFilter::adapt\_filter\_state\_t, 514
    - adapt\_filter\_state\_t, 515
    - filter, 515
    - nchannels, 515
    - ntaps, 515
    - od, 515
    - oy, 515
    - W, 515
    - X, 515
  - MHAFilter::adapt\_filter\_t, 515
    - adapt\_filter\_t, 516
    - connector, 517
    - err\_in, 517
    - filter, 516
    - mu, 517
    - nchannels, 517
    - ntaps, 517
    - set\_channelcnt, 516
    - update\_mu, 516
    - update\_ntaps, 516
  - MHAFilter::blockprocessing\_polyphase\_↔
    - resampling\_t, 517
  - ~blockprocessing\_polyphase\_resampling\_↔
    - \_t, 518
  - blockprocessing\_polyphase\_resampling\_↔
    - \_t, 518
  - can\_read, 519
  - fragsize\_in, 519
  - fragsize\_out, 519
  - num\_channels, 519
  - read, 519
  - resampling, 519
  - write, 518
- MHAFilter::complex\_bandpass\_t, 520
    - A\_, 522
    - B\_, 522
    - complex\_bandpass\_t, 521
    - creator\_A, 521
    - creator\_B, 521
    - filter, 521, 522
    - get\_weights, 521
    - inspect, 522
    - set\_state, 521
    - set\_weights, 521
    - Yn, 522
  - MHAFilter::diff\_t, 522
    - diff\_t, 523
  - MHAFilter::fftfir\_t, 523
    - ~fftfir\_t, 525
    - channels, 526
    - fft, 527

- fftfilter\_t, 524
- fftlens, 526
- filter, 525, 526
- fragsize, 526
- sInput, 527
- sWeights, 527
- update\_coefs, 525
- wIRS\_fft, 527
- wInput, 527
- wInput\_fft, 526
- wOutput, 527
- wOutput\_fft, 527
- MHAFilter::fftfilterbank\_t, 527
  - ~fftfilterbank\_t, 529
  - fft, 531
  - fftfilterbank\_t, 528
  - fftlens, 530
  - filter, 529, 530
  - firchannels, 530
  - fragsize, 530
  - get\_irs, 530
  - Hs, 530
  - hw, 530
  - inputchannels, 530
  - outputchannels, 530
  - tail, 531
  - update\_coefs, 529
  - Xs, 530
  - xw, 530
  - Ys, 531
  - yw, 530
  - yw\_temp, 531
- MHAFilter::filter\_t, 531
  - ~filter\_t, 533
  - A, 534
  - B, 534
  - channels, 535
  - filter, 533, 534
  - filter\_t, 532, 533
  - get\_len\_A, 534
  - get\_len\_B, 534
  - len, 535
  - len\_A, 535
  - len\_B, 535
  - state, 535
- MHAFilter::gammaflt\_t, 535
  - ~gammaflt\_t, 536
  - A, 537
  - bw\_, 538
  - cf\_, 538
  - delay, 537
  - envelope\_delay, 538
  - gammaflt\_t, 536
  - get\_A, 537
  - get\_resynthesis\_gain, 537
  - get\_weights, 537
  - GF, 537
  - inspect, 537
  - operator(), 536, 537
  - phase\_correction, 537
  - reset\_state, 537
  - resynthesis\_gain, 538
  - set\_weights, 537
  - srate\_, 538
- MHAFilter::iir\_filter\_state\_t, 538
  - iir\_filter\_state\_t, 539
- MHAFilter::iir\_filter\_t, 539
  - A, 542
  - B, 542
  - connector, 542
  - filter, 541
  - iir\_filter\_t, 540
  - nchannels, 542
  - resize, 542
  - update\_filter, 542
- MHAFilter::iir\_ord1\_real\_t, 542
  - A\_, 545
  - B\_, 545
  - iir\_ord1\_real\_t, 543
  - operator(), 544
  - set\_state, 544
  - Yn, 545
- MHAFilter::o1\_ar\_filter\_t, 545
  - c1\_a, 548
  - c1\_r, 548
  - c2\_a, 548
  - c2\_r, 548
  - fs, 548
  - o1\_ar\_filter\_t, 546
  - operator(), 547, 548
  - set\_tau\_attack, 547
  - set\_tau\_release, 547
- MHAFilter::o1flt\_lowpass\_t, 548
  - get\_c1, 550
  - get\_last\_output, 550
  - o1flt\_lowpass\_t, 550
  - set\_tau, 550
- MHAFilter::o1flt\_maxtrack\_t, 551
  - o1flt\_maxtrack\_t, 552
  - set\_tau, 552
- MHAFilter::o1flt\_mintrack\_t, 552
  - o1flt\_mintrack\_t, 554

- set\_tau, 554
- MHAFilter::partitioned\_convolution\_t, 554
  - ~partitioned\_convolution\_t, 556
  - bookkeeping, 557
  - current\_input\_signal\_buffer\_half\_index, 557
  - current\_output\_partition\_index, 557
  - fft, 558
  - filter\_partitions, 556
  - fragsize, 556
  - frequency\_response, 557
  - input\_signal\_spec, 557
  - input\_signal\_wave, 556
  - nchannels\_in, 556
  - nchannels\_out, 556
  - output\_partitions, 556
  - output\_signal\_spec, 557
  - output\_signal\_wave, 557
  - partitioned\_convolution\_t, 555
  - process, 556
- MHAFilter::partitioned\_convolution\_t::index←\_t, 558
  - delay, 559
  - index\_t, 558, 559
  - source\_channel\_index, 559
  - target\_channel\_index, 559
- MHAFilter::polyphase\_resampling\_t, 559
  - downsampling\_factor, 563
  - impulse\_response, 563
  - now\_index, 563
  - polyphase\_resampling\_t, 561
  - read, 562
  - readable\_frames, 562
  - ringbuffer, 563
  - underflow, 563
  - upsampling\_factor, 563
  - write, 562
- MHAFilter::resampling\_filter\_t, 564
  - fragsize, 565
  - fragsize\_validator, 565
  - resampling\_filter\_t, 564
- MHAFilter::smoothspec\_t, 565
  - \_linphase\_asym, 568
  - ~smoothspec\_t, 567
  - fft, 568
  - fftlens, 568
  - internal\_fir, 568
  - minphase, 568
  - nchannels, 568
  - smoothspec, 567
  - smoothspec\_t, 566
  - spec2fir, 567
  - tmp\_spec, 568
  - tmp\_wave, 568
  - window, 568
- MHAFilter::thirdoctave\_analyzer\_t, 568
  - bw\_generator, 569
  - cf, 569
  - cf\_generator, 569
  - cfg\_, 569
  - dup, 569
  - fb, 570
  - get\_cf\_hz, 569
  - nbands, 569
  - nchannels, 569
  - out\_chunk, 570
  - out\_chunk\_im, 570
  - process, 569
  - thirdoctave\_analyzer\_t, 569
- MHAFilter::transfer\_function\_t, 570
  - impulse\_response, 572
  - isempty, 572
  - non\_empty\_partitions, 571
  - partitions, 571
  - source\_channel\_index, 572
  - target\_channel\_index, 572
  - transfer\_function\_t, 571
- MHAFilter::transfer\_matrix\_t, 573
  - non\_empty\_partitions, 573
  - partitions, 573
- MHAGetVersion\_cb
  - PluginLoader::mhapluginloader\_t, 884
- MHAGetVersion\_t
  - mha.hh, 993
- MHAIOfFile.cpp, 1046
  - DEBUG, 1047
  - dummy\_interface\_test, 1048, 1049
  - ERR\_IHANDLE, 1047
  - ERR\_SUCCESS, 1047
  - ERR\_USER, 1048
  - IODestroy, 1048, 1049
  - IOInit, 1048
  - IOPrepare, 1048
  - IORelease, 1048, 1049
  - IOSetVar, 1048, 1049
  - IOStart, 1048
  - IOStop, 1048
  - IOStrError, 1048, 1049
  - MAX\_USER\_ERR, 1048
  - user\_err\_msg, 1049
- MHAIOWJack, 98
- MHAIOWJack.cpp, 1049

- dummy\_interface\_test, 1051, 1052
- ERR\_IHANDLE, 1050
- ERR\_SUCCESS, 1050
- ERR\_USER, 1050
- IODestroy, 1051, 1052
- IOInit, 1050, 1051
- IOPrepare, 1051
- IORelease, 1051
- IOSetVar, 1051
- IOStart, 1051
- IOStop, 1051
- IOStrError, 1051, 1052
- MAX\_USER\_ERR, 1050
- user\_err\_msg, 1052
- MHAIOJack::io\_jack\_t, 574
  - clientname, 576
  - connections\_in, 576
  - connections\_out, 576
  - delays\_in, 576
  - delays\_out, 577
  - fw\_fragsize, 576
  - fw\_samplerate, 576
  - get\_all\_input\_ports, 576
  - get\_all\_output\_ports, 576
  - get\_delays\_in, 576
  - get\_delays\_out, 576
  - get\_physical\_input\_ports, 576
  - get\_physical\_output\_ports, 576
  - io\_jack\_t, 575
  - patchbay, 577
  - portnames\_in, 577
  - portnames\_out, 577
  - ports\_in\_all, 577
  - ports\_in\_physical, 577
  - ports\_out\_all, 577
  - ports\_out\_physical, 577
  - ports\_parser, 577
  - prepare, 575
  - read\_get\_cpu\_load, 576
  - read\_get\_scheduler, 576
  - read\_get\_xruns, 576
  - reconnect\_inports, 576
  - reconnect\_outports, 576
  - release, 575
  - servername, 576
  - state\_cpuload, 577
  - state\_parser, 577
  - state\_priority, 577
  - state\_scheduler, 577
  - state\_xruns, 577
- MHAIOJackdb, 98
  - MHAIOJackdb.cpp, 1052
    - dummy\_interface\_test, 1053, 1054
    - ERR\_IHANDLE, 1053
    - ERR\_SUCCESS, 1053
    - ERR\_USER, 1053
    - IODestroy, 1053, 1054
    - IOInit, 1053, 1054
    - IOPrepare, 1053, 1054
    - IORelease, 1053, 1054
    - IOSetVar, 1053, 1054
    - IOStart, 1053, 1054
    - IOStop, 1053, 1054
    - IOStrError, 1053, 1054
    - MAX\_USER\_ERR, 1053
    - user\_err\_msg, 1054
  - MHAIOJackdb::io\_jack\_t, 578
    - clientname, 581
    - connections\_in, 581
    - connections\_out, 581
    - fail\_on\_async\_jackerr, 581
    - fail\_on\_async\_jackerror, 580
    - fragsize\_ratio, 581
    - get\_all\_input\_ports, 581
    - get\_all\_output\_ports, 581
    - get\_physical\_input\_ports, 580
    - get\_physical\_output\_ports, 581
    - IOProcessEvent\_inner, 580
    - io\_jack\_t, 580
    - locate, 582
    - mha\_fragsize, 581
    - mha\_samplerate, 581
    - patchbay, 582
    - portnames\_in, 581
    - portnames\_out, 581
    - ports\_in\_all, 582
    - ports\_in\_physical, 582
    - ports\_out\_all, 582
    - ports\_out\_physical, 582
    - ports\_parser, 582
    - prepare, 580
    - proc\_event, 581
    - proc\_handle, 581
    - pwinner\_out, 582
    - read\_get\_cpu\_load, 581
    - read\_get\_scheduler, 581
    - read\_get\_xruns, 581
    - reconnect\_inports, 580
    - reconnect\_outports, 580
    - release, 580
    - server\_fragsize, 582
    - server\_srate, 582

- servername, 581
- set\_locate, 581
- set\_use\_jack\_transport, 581
- state\_cpuload, 582
- state\_parser, 582
- state\_priority, 582
- state\_scheduler, 582
- state\_xruns, 582
- use\_jack\_transport, 581
- MHAIOParser.cpp, 1055
  - dummy\_interface\_test, 1056, 1057
  - ERR\_IHANDLE, 1056
  - ERR\_SUCCESS, 1056
  - ERR\_USER, 1056
  - IODestroy, 1056, 1057
  - IOInit, 1056
  - IOPrepare, 1056
  - IORelease, 1056, 1057
  - IOSetVar, 1056, 1057
  - IOStart, 1056
  - IOStop, 1056, 1057
  - IOStrError, 1056, 1057
  - MAX\_USER\_ERR, 1056
  - user\_err\_msg, 1057
- MHAIOPortAudio, 98
  - parserFriendlyName, 99
- MHAIOPortAudio.cpp, 1057
  - dummy\_interface\_test, 1059, 1060
  - ERR\_IHANDLE, 1059
  - ERR\_SUCCESS, 1059
  - ERR\_USER, 1059
  - IODestroy, 1059, 1060
  - IOInit, 1059
  - IOPrepare, 1059
  - IORelease, 1059, 1060
  - IOSetVar, 1059, 1060
  - IOStart, 1059, 1060
  - IOStop, 1059, 1060
  - IOStrError, 1059, 1060
  - MAX\_USER\_ERR, 1059
  - portaudio\_callback, 1059, 1060
  - user\_err\_msg, 1060
- MHAIOPortAudio::device\_info\_t, 583
  - defaultHighInputLatency, 584
  - defaultHighOutputLatency, 584
  - defaultLowInputLatency, 584
  - defaultLowOutputLatency, 584
  - defaultSampleRate, 584
  - device\_info\_t, 584
  - fill\_info, 584
  - hostApi, 584
  - maxInputChannels, 584
  - maxOutputChannels, 584
  - name, 584
  - numDevices, 584
  - structVersion, 584
- MHAIOPortAudio::io\_portaudio\_t, 585
  - ~io\_portaudio\_t, 586
  - cmd\_prepare, 586
  - cmd\_release, 587
  - cmd\_start, 586
  - cmd\_stop, 586
  - device\_index, 587
  - device\_index\_updated, 586
  - device\_info, 587
  - device\_name, 587
  - device\_name\_updated, 586
  - fragsize, 587
  - io\_portaudio\_t, 586
  - nchannels\_in, 587
  - nchannels\_out, 587
  - patchbay, 587
  - portaudio\_callback, 587
  - portaudio\_stream, 587
  - proc\_event, 587
  - proc\_handle, 587
  - s\_in, 587
  - s\_out, 587
  - samplerate, 587
  - start\_event, 587
  - start\_handle, 587
  - stop\_event, 587
  - stop\_handle, 587
- MHAIOTCP.cpp, 1060
  - copy\_error, 1063
  - dummy\_interface\_test, 1062, 1063
  - ERR\_IHANDLE, 1062
  - ERR\_SUCCESS, 1062
  - ERR\_USER, 1062
  - IODestroy, 1062, 1063
  - IOInit, 1062, 1063
  - IOPrepare, 1062, 1063
  - IORelease, 1062, 1063
  - IOSetVar, 1062, 1063
  - IOStart, 1062, 1063
  - IOStop, 1062, 1063
  - IOStrError, 1062, 1063
  - MAX\_TCP\_PORT\_STR, 1062
  - MAX\_TCP\_PORT, 1062
  - MAX\_USER\_ERR, 1062
  - MHA\_ErrorMsg2, 1062
  - MHA\_ErrorMsg3, 1062



- MIN\_TCP\_PORT\_STR, 1062
- MIN\_TCP\_PORT, 1062
- thread\_startup\_function, 1063
- user\_err\_msg, 1064
- MHAIOalsa.cpp, 1044
  - DBG, 1045
  - dummy\_interface\_test, 1045, 1046
  - ERR\_IHANDLE, 1045
  - ERR\_SUCCESS, 1045
  - ERR\_USER, 1045
  - IODestroy, 1045, 1046
  - IOInit, 1045
  - IOPrepare, 1045, 1046
  - IORelease, 1045, 1046
  - IOSetVar, 1045, 1046
  - IOStart, 1045, 1046
  - IOStop, 1045, 1046
  - IOStrError, 1045, 1046
  - MAX\_USER\_ERR, 1045
  - user\_err\_msg, 1046
- MHAInit\_cb
  - PluginLoader::mhapluginloader\_t, 884
- MHAInit\_t
  - mha.hh, 993
- MHAJACK\_FW\_STARTED
  - mhajack.h, 1066
- MHAJACK\_STARTING
  - mhajack.h, 1066
- MHAJACK\_STOPPED
  - mhajack.h, 1066
- MHAJack, 99
  - get\_port\_capture\_latency, 100
  - get\_port\_capture\_latency\_int, 100
  - get\_port\_playback\_latency, 101
  - get\_port\_playback\_latency\_int, 101
  - io, 100
- MHAJack::client\_avg\_t, 588
  - b\_ready, 590
  - b\_stopped, 590
  - client\_avg\_t, 589
  - frag\_out, 590
  - IOStoppedEvent, 590
  - io, 589
  - n, 590
  - name, 590
  - nrep, 590
  - pos, 590
  - proc, 590
  - sn\_in, 590
  - sn\_out, 590
- MHAJack::client\_noncont\_t, 591
  - b\_stopped, 592
  - client\_noncont\_t, 592
  - frag\_out, 593
  - IOStoppedEvent, 592
  - io, 592
  - name, 593
  - pos, 592
  - proc, 592
  - sn\_in, 592
  - sn\_out, 593
- MHAJack::client\_t, 593
  - b\_prepared, 599
  - client\_t, 595
  - connect\_input, 596
  - connect\_output, 596
  - fail\_on\_async\_jackerror, 599
  - flags, 599
  - fragsize, 598
  - get\_cpu\_load, 597
  - get\_fragsize, 596
  - get\_my\_input\_ports, 597
  - get\_my\_output\_ports, 597
  - get\_ports, 597
  - get\_srate, 597
  - get\_xruns, 597
  - get\_xruns\_reset, 597
  - inch, 599
  - input\_portnames, 599
  - internal\_start, 598
  - internal\_stop, 598
  - jack\_proc\_cb, 598
  - jack\_xrun\_cb, 598
  - jc, 599
  - jstate\_prev, 599
  - nchannels\_in, 598
  - nchannels\_out, 598
  - num\_xruns, 598
  - outch, 599
  - output\_portnames, 599
  - prepare, 595, 596
  - prepare\_impl, 597
  - proc\_event, 598
  - proc\_handle, 598
  - release, 596
  - s\_in, 599
  - s\_out, 599
  - samplerate, 598
  - set\_input\_portnames, 597
  - set\_output\_portnames, 597
  - set\_use\_jack\_transport, 597
  - start, 596

- start\_event, 599
- start\_handle, 599
- stop, 596
- stop\_event, 599
- stop\_handle, 599
- stopped, 598
- str\_error, 597
- use\_jack\_transport, 599
- MHAJack::port\_t, 599
  - ~port\_t, 601
  - connect\_to, 602
  - dir\_t, 600
  - dir\_type, 602
  - get\_short\_name, 602
  - input, 600
  - iob, 602
  - jc, 602
  - mute, 601
  - output, 600
  - port, 602
  - port\_t, 600, 601
  - read, 601
  - write, 601
- MHAKernel, 101
  - algo\_comm\_safe\_cast, 101
- MHAKernel::algo\_comm\_class\_t, 603
  - ~algo\_comm\_class\_t, 604
  - ac, 606
  - algo\_comm\_class\_t, 604
  - algo\_comm\_id\_string, 606
  - algo\_comm\_id\_string\_len, 606
  - get\_c\_handle, 604
  - get\_entries, 605
  - get\_error, 605
  - get\_var, 605
  - get\_var\_float, 605
  - get\_var\_int, 605
  - insert\_var, 604
  - insert\_var\_float, 604
  - insert\_var\_int, 604
  - is\_var, 604
  - local\_get\_entries, 605
  - local\_get\_var, 605
  - local\_insert\_var, 605
  - local\_is\_var, 605
  - local\_remove\_ref, 605
  - local\_remove\_var, 605
  - remove\_ref, 604
  - remove\_var, 604
  - size, 605
  - vars, 606
- MHAKernel::comm\_var\_map\_t, 606
  - has\_key, 606
- MHAMultiSrc, 101
  - MHAMultiSrc::base\_t, 607
    - ac, 608
    - base\_t, 608
    - select\_source, 608
  - MHAMultiSrc::channel\_t, 608
    - channel, 608
    - name, 608
  - MHAMultiSrc::channels\_t, 609
    - channels\_t, 609
  - MHAMultiSrc::spectrum\_t, 610
    - spectrum\_t, 610
    - update, 610
  - MHAMultiSrc::waveform\_t, 611
    - update, 612
    - waveform\_t, 612
- MHAOvIFilter, 102
  - scale\_fun\_t, 103
- MHAOvIFilter::FreqScaleFun, 103
  - hz2bark, 105
  - hz2bark\_analytic, 105
  - hz2erb, 105
  - hz2erb\_glasberg1990, 105
  - hz2hz, 104
  - hz2khz, 104
  - hz2log, 105
  - hz2octave, 104
  - hz2third\_octave, 104
  - inv\_scale, 105
- MHAOvIFilter::ShapeFun, 106
  - expflt, 107
  - gauss, 107
  - hann, 107
  - linear, 106
  - rect, 106
- MHAOvIFilter::band\_descriptor\_t, 612
  - cf, 613
  - cf\_h, 613
  - cf\_l, 613
  - ef\_h, 613
  - ef\_l, 613
  - high\_side\_flat, 613
  - low\_side\_flat, 613
- MHAOvIFilter::barkscale, 103
  - vbark, 103
  - vfreq, 103
- MHAOvIFilter::barkscale::bark2hz\_t, 613
  - ~bark2hz\_t, 614
  - bark2hz\_t, 614

- MHAOvFilter::barkscale::hz2bark\_t, 614
  - ~hz2bark\_t, 615
  - hz2bark\_t, 615
- MHAOvFilter::fftfb\_ac\_info\_t, 615
  - bwv, 616
  - cLTASS, 616
  - cfv, 615
  - efv, 615
  - fftfb\_ac\_info\_t, 615
  - insert, 615
- MHAOvFilter::fftfb\_t, 616
  - ~fftfb\_t, 617
  - apply\_gains, 617
  - bin1, 618
  - bin2, 618
  - fftfb\_t, 617
  - fftlens, 618
  - get\_fbpower, 617
  - get\_fbpower\_db, 617
  - get\_fftlens, 618
  - get\_ltass\_gain\_db, 618
  - samplingrate, 618
  - shape, 618
  - vbin1, 618
  - vbin2, 618
  - w, 618
- MHAOvFilter::fftfb\_vars\_t, 619
  - cLTASS, 621
  - cf, 621
  - ef, 621
  - f, 621
  - fail\_on\_nonmonotonic, 621
  - fail\_on\_unique\_bins, 621
  - fftfb\_vars\_t, 620
  - fscale, 620
  - ftype, 621
  - normalize, 621
  - ovltype, 620
  - plateau, 620
  - shapes, 621
- MHAOvFilter::fscale\_bw\_t, 622
  - bw, 623
  - bw\_hz, 623
  - fscale\_bw\_t, 623
  - get\_bw\_hz, 623
  - update\_hz, 623
  - updater, 623
- MHAOvFilter::fscale\_t, 623
  - f, 624
  - f\_hz, 624
  - fscale\_t, 624
  - get\_f\_hz, 624
  - unit, 624
  - update\_hz, 624
  - updater, 624
- MHAOvFilter::fspacing\_t, 625
  - bands, 626
  - cf2bands, 626
  - ef2bands, 626
  - equidist2bands, 626
  - fail\_on\_nonmonotonic\_cf, 626
  - fail\_on\_unique\_fftbins, 626
  - fs\_, 626
  - fspacing\_t, 626
  - get\_cf\_fftbin, 626
  - get\_cf\_hz, 626
  - get\_ef\_hz, 626
  - nbands, 626
  - nfft\_, 626
  - symmetry\_scale, 626
- MHAOvFilter::overlap\_save\_filterbank\_↔
  - analytic\_t, 627
  - filter\_analytic, 628
  - imagfb, 628
  - overlap\_save\_filterbank\_analytic\_t, 628
- MHAOvFilter::overlap\_save\_filterbank\_t, 628
  - channelconfig\_out\_, 630
  - get\_channelconfig, 630
  - overlap\_save\_filterbank\_t, 630
- MHAOvFilter::overlap\_save\_filterbank\_t↔
  - ::vars\_t, 630
  - fftlens, 631
  - irswnd, 631
  - phasemodel, 631
  - vars\_t, 631
- MHAOvFilter::scale\_var\_t, 632
  - add\_fun, 633
  - funs, 633
  - get\_fun, 633
  - get\_name, 633
  - hz2unit, 633
  - names, 633
  - scale\_var\_t, 633
  - unit2hz, 633
- MHAPLATFORM
  - mha\_parser.cpp, 1016
- MHAPLUGIN\_CALLBACKS\_PREFIX
  - The openMHA Plugins (programming interface), 9
- MHAPLUGIN\_CALLBACKS
  - The openMHA Plugins (programming interface), 9

- MHAPLUGIN\_DOCUMENTATION\_PREFIX
  - mha\_plugin.hh, [1023](#)
- MHAPLUGIN\_DOCUMENTATION
  - The openMHA Plugins (programming interface), [10](#)
- MHAPLUGIN\_INIT\_CALLBACKS\_PREFIX
  - mha\_plugin.hh, [1023](#)
- MHAPLUGIN\_INIT\_CALLBACKS
  - mha\_plugin.hh, [1023](#)
- MHAPLUGIN\_OVERLOAD\_OUTDOMAIN
  - altplugs.cpp, [967](#)
  - mha\_generic\_chain.h, [1008](#)
  - split.cpp, [1079](#)
  - wave2spec.cpp, [1083](#)
- MHAPLUGIN\_PROC\_CALLBACK\_PREFIX
  - mha\_plugin.hh, [1023](#)
- MHAPLUGIN\_PROC\_CALLBACK
  - mha\_plugin.hh, [1023](#)
- MHAParser, [107](#)
  - all\_dump, [111](#)
  - all\_ids, [111](#)
  - c\_parse\_cmd\_t, [111](#)
  - c\_parse\_err\_t, [111](#)
  - cfg\_dump, [111](#)
  - cfg\_dump\_short, [111](#)
  - commentate, [111](#)
  - entry\_map\_t, [111](#)
  - envreplace, [112](#)
  - get\_precision, [111](#)
  - mon\_dump, [111](#)
  - opact\_map\_t, [111](#)
  - opact\_t, [111](#)
  - query\_map\_t, [111](#)
  - query\_t, [111](#)
  - strreplace, [111](#)
  - trim, [111](#)
- MHAParser::StrCnv, [112](#)
  - bracket\_balance, [114](#)
  - num\_brackets, [113](#)
  - str2val, [114](#), [115](#)
  - str2val< mha\_real\_t >, [114](#)
  - val2str, [115](#), [116](#)
- MHAParser::base\_t, [634](#)
  - ~base\_t, [637](#)
  - activate\_query, [641](#)
  - add\_parent\_on\_insert, [641](#)
  - add\_replace\_pair, [641](#)
  - base\_t, [637](#)
  - data\_is\_initialized, [642](#)
  - fullname, [641](#)
  - help, [642](#)
  - id\_str, [642](#)
  - nested\_lock, [642](#)
  - notify, [641](#)
  - op\_query, [638](#)
  - op\_setval, [638](#)
  - op\_subparse, [638](#)
  - operators, [642](#)
  - oplist, [641](#)
  - parent, [642](#)
  - parse, [637](#), [638](#)
  - prereadaccess, [642](#)
  - queries, [642](#)
  - query\_addsubst, [640](#)
  - query\_cmds, [640](#)
  - query\_dump, [638](#)
  - query\_entries, [638](#)
  - query\_help, [640](#)
  - query\_id, [640](#)
  - query\_listids, [640](#)
  - query\_perm, [639](#)
  - query\_range, [639](#)
  - query\_readfile, [639](#)
  - query\_savefile, [639](#)
  - query\_savefile\_compact, [640](#)
  - query\_savemons, [640](#)
  - query\_subst, [640](#)
  - query\_type, [639](#)
  - query\_val, [639](#)
  - query\_version, [640](#)
  - readaccess, [642](#)
  - repl\_list, [642](#)
  - repl\_list\_t, [637](#)
  - rm\_parent\_on\_remove, [641](#)
  - set\_help, [641](#)
  - set\_node\_id, [640](#)
  - thefullname, [642](#)
  - valuechanged, [641](#)
  - writeaccess, [641](#)
- MHAParser::base\_t::replace\_t, [643](#)
  - a, [643](#)
  - b, [643](#)
  - get\_a, [643](#)
  - get\_b, [643](#)
  - replace, [643](#)
  - replace\_t, [643](#)
- MHAParser::bool\_mon\_t, [644](#)
  - bool\_mon\_t, [644](#)
  - data, [645](#)
  - query\_type, [645](#)
  - query\_val, [645](#)
- MHAParser::bool\_t, [645](#)

- bool\_t, 647
- data, 647
- op\_setval, 647
- query\_type, 647
- query\_val, 647
- MHAParser::c\_ifc\_parser\_t, 648
  - ~c\_ifc\_parser\_t, 649
  - c\_ifc\_parser\_t, 649
  - c\_parse\_cmd, 650
  - c\_parse\_err, 650
  - libdata, 650
  - liberr, 650
  - modulename, 650
  - op\_query, 649
  - op\_setval, 649
  - op\_subparse, 649
  - ret\_size, 650
  - retv, 650
  - set\_parse\_cb, 649
  - test\_error, 649
- MHAParser::commit\_t
  - commit\_t, 652
  - extern\_connector, 652
- MHAParser::commit\_t< receiver\_t >, 650
- MHAParser::complex\_mon\_t, 652
  - complex\_mon\_t, 653
  - data, 654
  - query\_type, 653
  - query\_val, 653
- MHAParser::complex\_t, 654
  - complex\_t, 655
  - data, 656
  - op\_setval, 655
  - query\_type, 655
  - query\_val, 655
- MHAParser::entry\_t, 656
  - entry, 656
  - entry\_t, 656
  - name, 656
- MHAParser::expression\_t, 657
  - expression\_t, 657
  - lval, 657
  - op, 657
  - rval, 657
- MHAParser::float\_mon\_t, 658
  - data, 659
  - float\_mon\_t, 658
  - query\_type, 659
  - query\_val, 659
- MHAParser::float\_t, 659
  - data, 662
  - float\_t, 661
  - op\_setval, 661
  - query\_type, 661
  - query\_val, 661
- MHAParser::int\_mon\_t, 662
  - data, 664
  - int\_mon\_t, 663
  - query\_type, 663
  - query\_val, 663
- MHAParser::int\_t, 664
  - data, 666
  - int\_t, 665
  - op\_setval, 666
  - query\_type, 666
  - query\_val, 666
- MHAParser::keyword\_list\_t, 666
  - add\_entry, 668
  - empty\_string, 669
  - entries, 669
  - get\_entries, 668
  - get\_index, 668
  - get\_value, 668
  - index, 669
  - keyword\_list\_t, 667
  - set\_entries, 668
  - set\_index, 668
  - set\_value, 668
  - size\_t, 667
  - validate, 668
- MHAParser::kw\_t, 669
  - data, 672
  - isval, 671
  - kw\_t, 670, 671
  - op\_setval, 671
  - query\_range, 671
  - query\_type, 671
  - query\_val, 671
  - set\_range, 671
  - validate, 671
- MHAParser::mcomplex\_mon\_t, 672
  - data, 673
  - mcomplex\_mon\_t, 673
  - query\_type, 673
  - query\_val, 673
- MHAParser::mcomplex\_t, 674
  - data, 675
  - mcomplex\_t, 675
  - op\_setval, 675
  - query\_type, 675
  - query\_val, 675
- MHAParser::mfloat\_mon\_t, 676

- data, [677](#)
- mfloat\_mon\_t, [676](#)
- query\_type, [677](#)
- query\_val, [677](#)
- MHAParser::mfloat\_t, [677](#)
  - data, [680](#)
  - mfloat\_t, [679](#)
  - op\_setval, [679](#)
  - query\_type, [679](#)
  - query\_val, [679](#)
- MHAParser::mhaconfig\_mon\_t, [680](#)
  - channels, [681](#)
  - domain, [681](#)
  - ffflen, [681](#)
  - fragsize, [681](#)
  - mhaconfig\_mon\_t, [681](#)
  - srate, [682](#)
  - update, [681](#)
  - wndlen, [681](#)
- MHAParser::mhapluginloader\_t, [682](#)
  - ~mhapluginloader\_t, [683](#)
  - ac\_, [684](#)
  - bookkeeping, [684](#)
  - cf\_in\_, [684](#)
  - cf\_out\_, [684](#)
  - connector, [684](#)
  - get\_cfin, [684](#)
  - get\_cfout, [684](#)
  - get\_last\_name, [684](#)
  - last\_name, [684](#)
  - load\_plug, [684](#)
  - mhapluginloader\_t, [683](#)
  - parent\_, [684](#)
  - plug, [684](#)
  - plugname, [684](#)
  - plugname\_name\_, [684](#)
  - prefix\_, [684](#)
  - prepare, [683](#)
  - process, [683](#), [684](#)
  - release, [683](#)
- MHAParser::mint\_mon\_t, [685](#)
  - data, [686](#)
  - mint\_mon\_t, [685](#)
  - query\_type, [686](#)
  - query\_val, [686](#)
- MHAParser::monitor\_t, [686](#)
  - monitor\_t, [687](#)
  - op\_query, [687](#)
  - query\_dump, [687](#)
  - query\_perm, [687](#)
- MHAParser::parser\_t, [688](#)
  - ~parser\_t, [690](#)
  - entries, [692](#)
  - force\_remove\_item, [690](#)
  - id\_string, [692](#)
  - insert\_item, [690](#)
  - last\_errormsg, [692](#)
  - op\_query, [691](#)
  - op\_setval, [691](#)
  - op\_subparse, [691](#)
  - parser\_t, [689](#)
  - query\_dump, [691](#)
  - query\_entries, [691](#)
  - query\_listids, [692](#)
  - query\_readfile, [691](#)
  - query\_savefile, [691](#)
  - query\_savefile\_compact, [692](#)
  - query\_savemons, [692](#)
  - query\_type, [691](#)
  - query\_val, [692](#)
  - remove\_item, [690](#), [691](#)
  - set\_id\_string, [692](#)
  - srcfile, [692](#)
  - srcline, [692](#)
- MHAParser::range\_var\_t, [693](#)
  - check\_low, [695](#)
  - check\_range, [695](#)
  - check\_up, [695](#)
  - low\_incl, [695](#)
  - low\_limit, [695](#)
  - query\_range, [694](#)
  - range\_var\_t, [694](#)
  - set\_range, [694](#)
  - up\_incl, [695](#)
  - up\_limit, [695](#)
  - validate, [694](#), [695](#)
- MHAParser::string\_mon\_t, [696](#)
  - data, [697](#)
  - query\_type, [697](#)
  - query\_val, [697](#)
  - string\_mon\_t, [696](#)
- MHAParser::string\_t, [697](#)
  - data, [699](#)
  - op\_setval, [699](#)
  - query\_type, [699](#)
  - query\_val, [699](#)
  - string\_t, [699](#)
- MHAParser::variable\_t, [700](#)
  - locked, [701](#)
  - op\_setval, [701](#)
  - query\_perm, [701](#)
  - setlock, [701](#)

- variable\_t, 701
- MHAParser::vcomplex\_mon\_t, 702
  - data, 704
  - query\_type, 704
  - query\_val, 704
  - vcomplex\_mon\_t, 703
- MHAParser::vcomplex\_t, 704
  - data, 706
  - op\_setval, 706
  - query\_type, 706
  - query\_val, 706
  - vcomplex\_t, 706
- MHAParser::vfloat\_mon\_t, 707
  - data, 708
  - query\_type, 708
  - query\_val, 708
  - vfloat\_mon\_t, 708
- MHAParser::vfloat\_t, 709
  - data, 711
  - op\_setval, 710
  - query\_type, 710
  - query\_val, 710
  - vfloat\_t, 710
- MHAParser::vint\_mon\_t, 711
  - data, 712
  - query\_type, 712
  - query\_val, 712
  - vint\_mon\_t, 712
- MHAParser::vint\_t, 713
  - data, 715
  - op\_setval, 714
  - query\_type, 714
  - query\_val, 714
  - vint\_t, 714
- MHAParser::vstring\_mon\_t, 715
  - data, 716
  - query\_type, 716
  - query\_val, 716
  - vstring\_mon\_t, 716
- MHAParser::vstring\_t, 717
  - data, 718
  - op\_setval, 718
  - query\_type, 718
  - query\_val, 718
  - vstring\_t, 718
- MHAParser::window\_t, 719
  - get\_type, 721
  - get\_window, 720, 721
  - user, 721
  - window\_t, 720
  - wnd\_bartlett, 720
  - wnd\_blackman, 720
  - wnd\_hamming, 720
  - wnd\_hann, 720
  - wnd\_rect, 720
  - wnd\_user, 720
  - wtype, 721
  - wtype\_t, 720
- MHAPugin, 116
- MHAPugin::cfg\_chain\_t
  - ~cfg\_chain\_t, 723
  - cfg\_chain\_t, 723
  - data, 723
  - next, 723
  - not\_in\_use, 723
- MHAPugin::cfg\_chain\_t< runtime\_cfg\_t >, 722
- MHAPugin::config\_t
  - ~config\_t, 726
  - cfg, 728
  - cfg\_chain, 728
  - cfg\_chain\_current, 728
  - cleanup\_unused\_cfg, 728
  - config\_t, 726
  - last\_config, 726
  - poll\_config, 726
  - push\_config, 726
  - remove\_all\_cfg, 728
- MHAPugin::config\_t< runtime\_cfg\_t >, 723
- MHAPugin::plugin\_t
  - ~plugin\_t, 730
  - ac, 732
  - input\_cfg, 731
  - input\_cfg\_, 732
  - is\_prepared, 731
  - is\_prepared\_, 732
  - mhaconfig\_in, 732
  - mhaconfig\_out, 732
  - output\_cfg, 732
  - output\_cfg\_, 732
  - plugin\_t, 730
  - prepare, 730
  - prepare\_, 731
  - release, 731
  - release\_, 731
  - tftype, 732
- MHAPugin::plugin\_t< runtime\_cfg\_t >, 728
- MHAPugin\_Resampling, 117
- MHAPugin\_Resampling::resampling\_if\_←t, 733
  - algo, 734
  - chain, 734

- fragsize, 734
- irslen\_inner2outer, 734
- irslen\_outer2inner, 734
- nyquist\_ratio, 734
- plugloader, 734
- prepare, 734
- process, 734
- release, 734
- resampling\_if\_t, 734
- srate, 734
- MHAPugin\_Resampling::resampling\_t, 735
  - inner2outer\_resampling, 736
  - inner\_fragsize, 736
  - inner\_signal, 736
  - inner\_srate, 736
  - nchannels\_in, 736
  - nchannels\_out, 736
  - outer2inner\_resampling, 736
  - outer\_fragsize, 735
  - outer\_srate, 736
  - output\_signal, 736
  - plugloader, 736
  - process, 735
  - resampling\_t, 735
- MHAPugin\_Split, 117
  - INVALID\_THREAD\_PRIORITY, 118
- MHAPugin\_Split::domain\_handler\_t, 736
  - ~domain\_handler\_t, 738
  - deallocate\_domains, 739
  - domain\_handler\_t, 738
  - get\_signal, 740
  - operator=, 738
  - process, 740
  - processor, 741
  - put\_signal, 739
  - set\_input\_domain, 738
  - set\_output\_domain, 738
  - spec\_in, 741
  - spec\_out, 741
  - wave\_in, 741
  - wave\_out, 741
- MHAPugin\_Split::dummy\_threads\_t, 741
  - catch\_thread, 742
  - dummy\_threads\_t, 742
  - kick\_thread, 742
- MHAPugin\_Split::posix\_threads\_t, 743
  - ~posix\_threads\_t, 745
  - attr, 746
  - catch\_condition, 746
  - catch\_thread, 745
  - current\_thread\_priority, 745
  - current\_thread\_scheduler, 745
  - kick\_condition, 745
  - kick\_thread, 745
  - kicked, 746
  - main, 745
  - mutex, 745
  - posix\_threads\_t, 744
  - priority, 746
  - processing\_done, 746
  - scheduler, 746
  - termination\_request, 746
  - thread, 746
  - thread\_start, 745
- MHAPugin\_Split::split\_t, 747
  - ~split\_t, 749
  - algos, 750
  - chains, 751
  - channels, 750
  - clear\_chains, 749
  - collect\_result, 749
  - copy\_output\_spec, 749
  - copy\_output\_wave, 749
  - delay, 751
  - framework\_thread\_priority, 751
  - framework\_thread\_scheduler, 750
  - patchbay, 750
  - prepare\_, 749
  - process, 749
  - release\_, 749
  - signal\_out, 750
  - spec\_out, 751
  - split\_t, 749
  - thread\_platform, 750
  - trigger\_processing, 749
  - update, 749
  - wave\_out, 751
  - worker\_thread\_priority, 750
  - worker\_thread\_scheduler, 750
- MHAPugin\_Split::splitted\_part\_t, 751
  - ~splitted\_part\_t, 753
  - collect\_result, 755
  - domain, 755
  - operator=, 754
  - parse, 754
  - plug, 755
  - prepare, 754
  - release, 754
  - splitted\_part\_t, 753
  - thread, 756
  - trigger\_processing, 755
- MHAPugin\_Split::thread\_platform\_t, 756



- ~thread\_platform\_t, 757
- catch\_thread, 758
- kick\_thread, 758
- operator=, 758
- processor, 758
- thread\_platform\_t, 757
- MHAPPlugin\_Split::uni\_processor\_t, 759
  - ~uni\_processor\_t, 759
  - process, 760
- MHAPPluginCategory\_t
  - mha.hh, 994
- MHAPPluginDocumentation\_t
  - mha.hh, 994
- MHAPPrepare\_cb
  - PluginLoader::mhappluginloader\_t, 884
- MHAPPrepare\_t
  - mha.hh, 993
- MHAProc\_spec2spec\_cb
  - PluginLoader::mhappluginloader\_t, 884
- MHAProc\_spec2spec\_t
  - mha.hh, 994
- MHAProc\_spec2wave\_cb
  - PluginLoader::mhappluginloader\_t, 885
- MHAProc\_spec2wave\_t
  - mha.hh, 994
- MHAProc\_wave2spec\_cb
  - PluginLoader::mhappluginloader\_t, 884
- MHAProc\_wave2spec\_t
  - mha.hh, 994
- MHAProc\_wave2wave\_cb
  - PluginLoader::mhappluginloader\_t, 884
- MHAProc\_wave2wave\_t
  - mha.hh, 994
- MHARelease\_cb
  - PluginLoader::mhappluginloader\_t, 884
- MHARelease\_t
  - mha.hh, 993
- MHASet\_cb
  - PluginLoader::mhappluginloader\_t, 885
- MHASet\_t
  - mha.hh, 994
- MHASignal, 118
  - copy\_permuted, 124
  - kth\_smallest, 121
  - limit, 121
  - mean, 123
  - median, 122
  - quantile, 123
  - saveas\_mat4, 123, 124
  - scale, 121
  - signal\_counter, 125
- MHASignal::async\_rmslevel\_t, 763
  - async\_rmslevel\_t, 764
  - filled, 765
  - peaklevel, 765
  - pos, 765
  - process, 765
  - rmslevel, 764
- MHASignal::delay\_spec\_t, 765
  - ~delay\_spec\_t, 766
  - buffer, 766
  - delay, 766
  - delay\_spec\_t, 766
  - pos, 766
  - process, 766
- MHASignal::delay\_t, 766
  - ~delay\_t, 767
  - buffer, 768
  - channels, 768
  - delay\_t, 767
  - delays, 768
  - inspect, 768
  - pos, 768
  - process, 767
- MHASignal::delay\_wave\_t, 768
  - ~delay\_wave\_t, 769
  - buffer, 769
  - delay, 769
  - delay\_wave\_t, 769
  - pos, 769
  - process, 769
- MHASignal::doublebuffer\_t, 769
  - ~doublebuffer\_t, 771
  - ch, 772
  - doublebuffer\_t, 770
  - inner\_in, 772
  - inner\_out, 772
  - inner\_process, 771
  - k\_inner, 772
  - k\_outer, 772
  - min, 771
  - outer\_out, 772
  - outer\_process, 771
  - this\_outer\_out, 772
- MHASignal::fft\_t, 772
  - ~fft\_t, 773
  - backward, 774
  - backward\_scale, 774
  - buf\_in, 775
  - buf\_out, 775
  - fft\_t, 773
  - fftw\_plan\_fft, 775

- fftw\_plan\_ifft, [775](#)
- fftw\_plan\_spec2wave, [775](#)
- fftw\_plan\_wave2spec, [775](#)
- forward, [773](#)
- forward\_scale, [774](#)
- n\_im, [775](#)
- n\_re, [775](#)
- nfft, [775](#)
- scale, [775](#)
- sort\_fftw2spec, [774](#)
- sort\_spec2fftw, [774](#)
- spec2wave, [773](#)
- spec2wave\_scale, [774](#)
- wave2spec, [773](#)
- wave2spec\_scale, [774](#)
- MHASignal::hilbert\_fftw\_t, [775](#)
  - buf\_c\_in, [776](#)
  - buf\_c\_out, [776](#)
  - buf\_r\_in, [776](#)
  - buf\_r\_out, [776](#)
  - hilbert, [776](#)
  - hilbert\_fftw\_t, [776](#)
  - n, [776](#)
  - p1, [776](#)
  - p2, [776](#)
  - sc, [776](#)
- MHASignal::hilbert\_t, [776](#)
  - ~hilbert\_t, [777](#)
  - h, [777](#)
  - hilbert\_t, [777](#)
  - operator(), [777](#)
- MHASignal::loop\_wavefragment\_t, [778](#)
  - add, [779](#)
  - b\_loop, [781](#)
  - get\_mapping, [780](#)
  - input, [779](#)
  - intern\_level, [781](#)
  - is\_playback\_active, [781](#)
  - level\_mode\_t, [779](#)
  - locate\_end, [781](#)
  - loop\_wavefragment\_t, [779](#)
  - mute, [779](#)
  - peak, [779](#)
  - playback, [780](#), [781](#)
  - playback\_channels, [781](#)
  - playback\_mode\_t, [779](#)
  - pos, [781](#)
  - relative, [779](#)
  - replace, [779](#)
  - rewind, [781](#)
  - rms, [779](#)
  - rms\_limit40, [779](#)
  - set\_level\_db, [781](#)
  - set\_level\_lin, [781](#)
- MHASignal::matrix\_t, [782](#)
  - ~matrix\_t, [785](#)
  - cdata, [790](#)
  - complex\_ofs, [790](#)
  - dimension, [786](#)
  - get\_cdata, [790](#)
  - get\_comm\_var, [785](#)
  - get\_index, [789](#)
  - get\_nelements, [786](#)
  - get\_nreals, [789](#)
  - get\_rdata, [790](#)
  - imag, [787–789](#)
  - is\_same\_size, [786](#)
  - iscomplex, [786](#)
  - matrix\_t, [784](#), [785](#)
  - nelements, [790](#)
  - numbytes, [789](#)
  - operator(), [787–789](#)
  - operator=, [785](#)
  - rdata, [790](#)
  - real, [786–788](#)
  - size, [786](#)
  - write, [789](#)
- MHASignal::minphase\_t, [790](#)
  - minphase\_t, [791](#)
  - operator(), [791](#)
  - phase, [792](#)
- MHASignal::quantizer\_t, [792](#)
  - downscale, [793](#)
  - limit, [793](#)
  - operator(), [793](#)
  - quantizer\_t, [792](#)
  - up\_limit, [793](#)
  - upscale, [793](#)
- MHASignal::ringbuffer\_t, [793](#)
  - contained\_frames, [795](#)
  - discard, [796](#)
  - next\_read\_frame\_index, [796](#)
  - next\_write\_frame\_index, [797](#)
  - ringbuffer\_t, [795](#)
  - value, [795](#)
  - write, [796](#)
- MHASignal::schroeder\_t, [797](#)
  - down, [799](#)
  - groupdelay\_t, [798](#)
  - identity, [800](#)
  - log\_down, [800](#)
  - log\_up, [800](#)

- schroeder\_t, 799
- sign\_t, 799
- up, 799
- MHASignal::spectrum\_t, 800
  - ~spectrum\_t, 802
  - copy, 803
  - copy\_channel, 804
  - export\_to, 804
  - operator(), 803
  - operator[], 803
  - scale, 804
  - scale\_channel, 805
  - spectrum\_t, 802
  - value, 803
- MHASignal::stat\_t, 805
  - mean, 806
  - mean\_std, 806
  - n, 806
  - push, 806
  - stat\_t, 806
  - sum, 806
  - sum2, 806
- MHASignal::subsample\_delay\_t, 806
  - last\_complex\_bin, 808
  - phase\_gains, 808
  - process, 808
  - subsample\_delay\_t, 807
- MHASignal::uint\_vector\_t, 809
  - ~uint\_vector\_t, 810
  - data, 811
  - get\_length, 811
  - getdata, 811
  - length, 811
  - numbytes, 811
  - operator=, 810
  - operator==, 810
  - operator[], 811
  - uint\_vector\_t, 810
  - write, 811
- MHASignal::waveform\_t, 812
  - ~waveform\_t, 814
  - assign, 818
  - assign\_channel, 818
  - assign\_frame, 818
  - copy, 819
  - copy\_channel, 819
  - copy\_from\_at, 819
  - export\_to, 820
  - get\_size, 822
  - limit, 820
  - operator(), 815, 816
  - operator=, 815
  - operator[], 815
  - power, 820
  - powspec, 821
  - scale, 821
  - scale\_channel, 821
  - scale\_frame, 822
  - sum, 816, 817
  - sum\_channel, 817
  - sumsqr, 817
  - value, 815, 816
  - waveform\_t, 814
- MHASndFile, 125
- MHASndFile::sf\_t, 822
  - ~sf\_t, 823
  - sf, 823
  - sf\_t, 823
- MHASndFile::sf\_wave\_t, 823
  - sf\_wave\_t, 824
- MHAStrError\_cb
  - PluginLoader::mhapluginloader\_t, 885
- MHAStrError\_t
  - mha.hh, 994
- MHATableLookup, 125
- MHATableLookup::linear\_table\_t, 824
  - ~linear\_table\_t, 826
  - add\_entry, 827
  - clear, 827
  - interp, 826
  - len, 828
  - linear\_table\_t, 826
  - lookup, 826
  - prepare, 827
  - scalefac, 828
  - set\_xmax, 827
  - set\_xmin, 826
  - vec\_y, 828
  - vy, 828
  - xmax, 828
  - xmin, 828
- MHATableLookup::table\_t, 828
  - ~table\_t, 829
  - clear, 829
  - interp, 829
  - lookup, 829
  - table\_t, 829
- MHATableLookup::xy\_table\_t, 830
  - add\_entry, 832
  - clear, 832
  - get\_xlimits, 833
  - interp, 831

- lookup, [831](#)
- mXY, [833](#)
- set\_xfun, [832](#)
- set\_xyfun, [833](#)
- set\_yfun, [833](#)
- xfun, [833](#)
- xy\_table\_t, [831](#)
- xyfun, [833](#)
- yfun, [833](#)
- MHAWindow, [125](#)
  - bartlett, [126](#)
  - blackman, [127](#)
  - hamming, [127](#)
  - hanning, [127](#)
  - rect, [126](#)
- MHAWindow::bartlett\_t, [834](#)
  - bartlett\_t, [834](#)
- MHAWindow::base\_t, [835](#)
  - base\_t, [835](#), [836](#)
  - operator(), [836](#)
  - ramp\_begin, [836](#)
  - ramp\_end, [836](#)
- MHAWindow::blackman\_t, [837](#)
  - blackman\_t, [837](#)
- MHAWindow::fun\_t, [838](#)
  - fun\_t, [838](#)
- MHAWindow::hamming\_t, [839](#)
  - hamming\_t, [840](#)
- MHAWindow::hanning\_t, [840](#)
  - hanning\_t, [841](#)
- MHAWindow::rect\_t, [841](#)
  - rect\_t, [842](#)
- MHAWindow::user\_t, [842](#)
  - user\_t, [843](#)
- MIN\_TCP\_PORT\_STR
  - MHAIOTCP.cpp, [1062](#)
- MIN\_TCP\_PORT
  - MHAIOTCP.cpp, [1062](#)
- MIN
  - mha\_defs.h, [998](#)
- mXY
  - MHATableLookup::xy\_table\_t, [833](#)
- main
  - analysemhaplugin.cpp, [967](#)
  - browsemhaplugins.cpp, [969](#)
  - generatemhaplugindoc.cpp, [982](#)
  - MHAPLugin\_Split::posix\_threads\_t, [745](#)
  - mha.cpp, [989](#)
  - testalsadevice.c, [1080](#)
- make\_friendly\_number
  - MHAFilter, [96](#)
  - mhajack.cpp, [1064](#)
- make\_friendly\_number\_by\_limiting
  - nlms\_wave.cpp, [1070](#)
  - prediction\_error.cpp, [1072](#)
- mapping
  - addsndfile::addsndfile\_if\_t, [182](#)
  - coherence::vars\_t, [242](#)
- matmix\_t
  - matrixmixer::matmix\_t, [411](#)
- matrix\_t
  - MHASignal::matrix\_t, [784](#), [785](#)
- matrixmixer, [89](#)
- matrixmixer.cpp, [988](#)
- matrixmixer::cfg\_t, [408](#)
  - cfg\_t, [409](#)
  - m, [409](#)
  - process, [409](#)
  - sout, [409](#)
  - wout, [409](#)
- matrixmixer::matmix\_t, [410](#)
  - ci, [411](#)
  - co, [411](#)
  - matmix\_t, [411](#)
  - mixer, [411](#)
  - patchbay, [411](#)
  - prepare, [411](#)
  - process, [411](#)
  - update\_m, [411](#)
- max
  - spec2wave.cpp, [1075](#)
  - Vector and matrix processing toolbox, [59](#)
- max\_clipped
  - softclipper\_variables\_t, [920](#)
- max\_fill\_count
  - mha\_fifo\_t, [456](#)
- max\_frames
  - acsave::cfg\_t, [169](#)
- max\_lag
  - doasvm\_feature\_extraction, [285](#)
- max\_level\_difference
  - dc::dc\_t, [257](#)
  - dc::dc\_vars\_t, [259](#)
- max\_p\_ind\_name
  - doasvm\_classification, [281](#)
- max\_pool\_ind\_name
  - acPooling\_wave, [162](#)
- max\_q
  - timoConfig, [943](#)
- max\_q\_AC
  - timo\_AC, [938](#)
- max\_val

- timoConfig, 943
- max\_val\_AC
  - timo\_AC, 938
- maxInputChannels
  - MHAIOPortAudio::device\_info\_t, 584
- maxOutputChannels
  - MHAIOPortAudio::device\_info\_t, 584
- maxabs
  - Vector and matrix processing toolbox, 57, 58
- maxframe
  - acsave::save\_var\_t, 171
- maxgain
  - dc\_simple::dc\_t, 267
  - dc\_simple::dc\_vars\_t, 269
  - DynComp::dc\_afterburn\_rt\_t, 294
  - DynComp::dc\_afterburn\_vars\_t, 298
- maximum\_reader\_xruns\_in\_succession\_↔
  - before\_stop
  - mha\_drifter\_fifo\_t, 444
- maximum\_writer\_xruns\_in\_succession\_↔
  - before\_stop
  - mha\_drifter\_fifo\_t, 444
- maxlen
  - plingploing::if\_t, 867
- maxlen\_
  - plingploing::plingploing\_t, 869
- mcomplex\_mon\_t
  - MHAParser::mcomplex\_mon\_t, 673
- mcomplex\_t
  - MHAParser::mcomplex\_t, 675
- mean
  - MHA\_AC::stat\_t, 425
  - MHASignal, 123
  - MHASignal::stat\_t, 806
- mean\_std
  - MHASignal::stat\_t, 806
- median
  - MHASignal, 122
- mfloat\_mon\_t
  - MHAParser::mfloat\_mon\_t, 676
- mfloat\_t
  - MHAParser::mfloat\_t, 679
- mha
  - speechnoise\_t, 925
- mha.cpp, 989
  - main, 989
  - mhamain, 989
- mha.hh, 989
  - algo\_comm\_t, 993
  - MHA\_AC\_CHAR, 993
  - MHA\_AC\_DOUBLE, 993
  - MHA\_AC\_FLOAT, 993
  - MHA\_AC\_INT, 993
  - MHA\_AC\_MHACOMPLEX, 993
  - MHA\_AC\_MHAREAL, 993
  - MHA\_AC\_UNKNOWN, 993
  - MHA\_AC\_USER, 993
  - MHA\_AC\_VEC\_FLOAT, 993
  - MHA\_CALLBACK\_TEST\_PREFIX, 991
  - MHA\_CALLBACK\_TEST, 991
  - MHA\_DOMAIN\_MAX, 993
  - MHA\_DOMAIN\_UNKNOWN, 993
  - MHA\_RELEASE\_VERSION\_STRING, 992
  - MHA\_SPECTRUM, 993
  - MHA\_STRUCT\_SIZEMATCH, 992
  - MHA\_STRF, 992
  - MHA\_VERSION\_BUILD, 992
  - MHA\_VERSION\_MAJOR, 992
  - MHA\_VERSION\_MINOR, 992
  - MHA\_VERSION\_RELEASE, 992
  - MHA\_VERSION\_STRING, 992
  - MHA\_VERSION, 992
  - MHA\_WAVEFORM, 993
  - MHA\_XSTRF, 992
  - MHADestroy\_t, 994
  - MHAGetVersion\_t, 993
  - MHAInit\_t, 993
  - MHAPluginCategory\_t, 994
  - MHAPluginDocumentation\_t, 994
  - MHAPrepare\_t, 993
  - MHAProc\_spec2spec\_t, 994
  - MHAProc\_spec2wave\_t, 994
  - MHAProc\_wave2spec\_t, 994
  - MHAProc\_wave2wave\_t, 994
  - MHARelease\_t, 993
  - MHASet\_t, 994
  - MHAStrError\_t, 994
  - mha\_domain\_t, 993
- mha\_algo\_comm.cpp, 994
  - AC\_DIM\_MISMATCH, 995
  - AC\_INVALID\_HANDLE, 995
  - AC\_INVALID\_NAME, 995
  - AC\_INVALID\_OUTPTR, 995
  - AC\_STRING\_TRUNCATED, 995
  - AC\_SUCCESS, 995
  - AC\_TYPE\_MISMATCH, 995
  - algo\_comm\_default, 995
- mha\_algo\_comm.h, 995
- mha\_algo\_comm.hh, 996
  - ALGO\_COMM\_ID\_STR, 997

- algo\_comm\_default, 997
- mha\_alloc
  - mha\_ruby.cpp, 1025
- mha\_audio\_descriptor\_t, 427
  - cf, 428
  - chdir, 428
  - dt, 428
  - is\_complex, 428
  - n\_channels, 428
  - n\_freqs, 428
  - n\_samples, 428
- mha\_audio\_t, 428
  - cdata, 429
  - descriptor, 429
  - rdata, 429
- mha\_channel\_info\_t, 429
  - dir, 430
  - id, 430
  - idstr, 430
  - peaklevel, 430
  - side, 430
- mha\_complex
  - Complex arithmetics in the openMHA, 63
- mha\_complex\_t, 431
  - im, 431
  - re, 431
- mha\_complex\_test\_array\_t, 431
  - c, 432
- mha\_dblbuf\_t
  - ~mha\_dblbuf\_t, 434
  - delay, 437
  - fifo\_size, 437
  - get\_delay, 435
  - get\_fifo\_size, 435
  - get\_inner\_error, 435
  - get\_inner\_size, 434
  - get\_input\_channels, 435
  - get\_input\_fifo\_fill\_count, 435
  - get\_input\_fifo\_space, 435
  - get\_outer\_size, 434
  - get\_output\_channels, 435
  - get\_output\_fifo\_fill\_count, 435
  - get\_output\_fifo\_space, 435
  - inner\_error, 437
  - inner\_size, 437
  - input, 436
  - input\_channels, 437
  - input\_fifo, 437
  - mha\_dblbuf\_t, 434
  - outer\_error, 437
  - outer\_size, 436
  - output, 436
  - output\_channels, 437
  - output\_fifo, 437
  - process, 435
  - provoke\_inner\_error, 435
  - provoke\_outer\_error, 435
  - value\_type, 434
- mha\_dblbuf\_t< FIFO >, 432
- mha\_debug
  - Error handling in the openMHA, 33
- mha\_defs.h, 997
  - \_\_MHA\_FUN\_\_, 998
  - \_\_declspec, 998
  - CHECK\_EXPR, 998
  - CHECK\_VAR, 998
  - M\_PI, 998
  - MAX, 998
  - MHA\_EAR\_LEFT, 998
  - MHA\_EAR\_MAX, 998
  - MHA\_EAR\_RIGHT, 998
  - MIN, 998
- mha\_delenv
  - mha\_os.cpp, 1011
  - mha\_os.h, 1014
- mha\_direction\_t, 438
  - azimuth, 438
  - distance, 438
  - elevation, 438
- mha\_domain\_t
  - mha.hh, 993
- mha\_drifter\_fifo\_t
  - desired\_fill\_count, 443
  - get\_available\_space, 442
  - get\_des\_fill\_count, 442
  - get\_fill\_count, 442
  - get\_min\_fill\_count, 442
  - maximum\_reader\_xruns\_in\_succession↔  
\_before\_stop, 444
  - maximum\_writer\_xruns\_in\_succession↔  
\_before\_stop, 444
  - mha\_drifter\_fifo\_t, 441
  - minimum\_fill\_count, 443
  - null\_data, 444
  - read, 441
  - reader\_started, 443
  - reader\_xruns\_in\_succession, 444
  - reader\_xruns\_since\_start, 444
  - reader\_xruns\_total, 443
  - starting, 443
  - startup\_zeros, 444
  - stop, 442

- write, [441](#)
- writer\_started, [443](#)
- writer\_xruns\_in\_succession, [444](#)
- writer\_xruns\_since\_start, [444](#)
- writer\_xruns\_total, [443](#)
- mha\_drifter\_fifo\_t< T >, [439](#)
- mha\_errno.c, [998](#)
  - cstr\_strerror, [999](#)
  - mha\_set\_user\_error, [999](#)
  - mha\_strerror, [999](#)
  - next\_except\_str, [999](#)
  - STRLEN, [999](#)
- mha\_errno.h, [999](#)
  - MHA\_ERR\_INVALID\_HANDLE, [1000](#)
  - MHA\_ERR\_NULL, [1000](#)
  - MHA\_ERR\_SUCCESS, [1000](#)
  - MHA\_ERR\_UNKNOWN, [1000](#)
  - MHA\_ERR\_USER, [1000](#)
  - MHA\_ERR\_VARFMT, [1000](#)
  - MHA\_ERR\_VARRANGE, [1000](#)
  - mha\_set\_user\_error, [1000](#)
  - mha\_strerror, [1000](#)
- mha\_error.cpp, [1000](#)
- mha\_error.hh, [1001](#)
  - Getmsg, [1002](#)
- mha\_error\_helpers, [90](#)
  - digits, [90](#)
  - snprintf\_required\_length, [90](#)
- mha\_event\_emitter.h, [1002](#)
- mha\_events.cpp, [1002](#)
- mha\_events.h, [1002](#)
- mha\_exit\_request
  - mha\_ruby.cpp, [1025](#)
- mha\_fft
  - timoConfig, [942](#)
- mha\_fft\_backward
  - Fast Fourier Transform functions, [75](#)
- mha\_fft\_backward\_scale
  - Fast Fourier Transform functions, [76](#)
- mha\_fft\_forward
  - Fast Fourier Transform functions, [75](#)
- mha\_fft\_forward\_scale
  - Fast Fourier Transform functions, [76](#)
- mha\_fft\_free
  - Fast Fourier Transform functions, [72](#)
- mha\_fft\_new
  - Fast Fourier Transform functions, [72](#)
- mha\_fft\_spec2wave
  - Fast Fourier Transform functions, [74](#)
- mha\_fft\_spec2wave\_scale
  - Fast Fourier Transform functions, [77](#)
- mha\_fft\_t
  - Fast Fourier Transform functions, [72](#)
- mha\_fft\_wave2spec
  - Fast Fourier Transform functions, [73](#)
- mha\_fft\_wave2spec\_scale
  - Fast Fourier Transform functions, [76](#)
- mha\_fftfb.cpp, [1002](#)
  - BARKSCALE\_ENTRIES, [1004](#)
  - filtershapefun, [1004](#)
- mha\_fftfb.hh, [1004](#)
- mha\_fifo.cpp, [1005](#)
- mha\_fifo.h, [1005](#)
  - mha\_fifo\_thread\_platform\_implementation←\_t, [1005](#)
- mha\_fifo\_lw\_t
  - ~mha\_fifo\_lw\_t, [448](#)
  - error, [450](#)
  - mha\_fifo\_lw\_t, [448](#)
  - read, [449](#)
  - set\_error, [449](#)
  - sync, [449](#)
  - write, [448](#)
- mha\_fifo\_lw\_t< T >, [447](#)
- mha\_fifo\_posix\_threads\_t, [450](#)
  - ~mha\_fifo\_posix\_threads\_t, [451](#)
  - acquire\_mutex, [451](#)
  - decrease\_condition, [452](#)
  - decrement, [451](#)
  - increase\_condition, [452](#)
  - increment, [451](#)
  - mha\_fifo\_posix\_threads\_t, [451](#)
  - mutex, [452](#)
  - release\_mutex, [451](#)
  - wait\_for\_decrease, [451](#)
  - wait\_for\_increase, [451](#)
- mha\_fifo\_t
  - ~mha\_fifo\_t, [454](#)
  - buf, [456](#)
  - buf\_uses\_placement\_new, [456](#)
  - clear, [456](#)
  - get\_available\_space, [455](#)
  - get\_fill\_count, [455](#)
  - get\_max\_fill\_count, [455](#)
  - max\_fill\_count, [456](#)
  - mha\_fifo\_t, [454](#)
  - operator=, [455](#)
  - read, [455](#)
  - read\_ptr, [456](#)
  - value\_type, [454](#)
  - write, [454](#)
  - write\_ptr, [456](#)

- mha\_fifo\_t< T >, 452
- mha\_fifo\_thread\_guard\_t, 456
  - ~mha\_fifo\_thread\_guard\_t, 457
  - mha\_fifo\_thread\_guard\_t, 457
  - sync, 457
- mha\_fifo\_thread\_platform\_implementation\_t
  - mha\_fifo.h, 1005
- mha\_fifo\_thread\_platform\_t, 457
  - ~mha\_fifo\_thread\_platform\_t, 458
  - acquire\_mutex, 459
  - decrement, 459
  - increment, 459
  - mha\_fifo\_thread\_platform\_t, 458
  - operator=, 460
  - release\_mutex, 459
  - wait\_for\_decrease, 459
  - wait\_for\_increase, 459
- mha\_filter.cpp, 1005
  - diff\_coefs, 1006
- mha\_filter.hh, 1006
- mha\_fragsize
  - MHAIOJackdb::io\_jack\_t, 581
- mha\_free
  - mha\_ruby.cpp, 1025
- mha\_freelib
  - mha\_os.h, 1013
- mha\_freelib\_success
  - mha\_os.h, 1013
- mha\_generic\_chain.cpp, 1007
  - mhaconfig\_compare, 1008
- mha\_generic\_chain.h, 1008
  - MHAPLUGIN\_OVERLOAD\_OUTDOM←AIN, 1008
- mha\_getenv
  - mha\_os.cpp, 1011
  - mha\_os.h, 1013
- mha\_getlibfun
  - mha\_os.h, 1013
- mha\_getlibfun\_checked
  - mha\_os.h, 1013
- mha\_hasenv
  - mha\_os.cpp, 1010
  - mha\_os.h, 1014
- mha\_hton
  - mha\_os.h, 1015
- mha\_io\_ifc.h, 1008
  - IODestroy\_t, 1009
  - IOInit\_t, 1009
  - IOPrepare\_t, 1009
  - IOProcessEvent\_t, 1009
  - IORelease\_t, 1009
  - IOSetVar\_t, 1009
  - IOStart\_t, 1009
  - IOStartedEvent\_t, 1009
  - IOStop\_t, 1009
  - IOStoppedEvent\_t, 1009
  - IOStrError\_t, 1009
- mha\_lib\_extension
  - mha\_os.h, 1013
- mha\_libhandle\_t
  - mha\_os.h, 1013
- mha\_library\_paths
  - mha\_os.cpp, 1011
  - mha\_os.h, 1015
- mha\_loadlib
  - mha\_os.h, 1013
- mha\_loadlib\_error
  - mha\_os.h, 1013
- mha\_min\_1
  - mha\_signal.hh, 1037
- mha\_msleep
  - mha\_os.h, 1013
- mha\_multisrc.cpp, 1009
- mha\_multisrc.h, 1010
- mha\_ntoh
  - mha\_os.h, 1015
- mha\_os.cpp, 1010
  - list\_dir, 1011
  - mha\_delenv, 1011
  - mha\_getenv, 1011
  - mha\_hasenv, 1010
  - mha\_library\_paths, 1011
  - mha\_setenv, 1011
- mha\_os.h, 1012
  - FMTsz, 1013
  - list\_dir, 1015
  - MHA\_RESOLVE\_CHECKED, 1013
  - MHA\_RESOLVE, 1013
  - mha\_delenv, 1014
  - mha\_freelib, 1013
  - mha\_freelib\_success, 1013
  - mha\_getenv, 1013
  - mha\_getlibfun, 1013
  - mha\_getlibfun\_checked, 1013
  - mha\_hasenv, 1014
  - mha\_hton, 1015
  - mha\_lib\_extension, 1013
  - mha\_libhandle\_t, 1013
  - mha\_library\_paths, 1015
  - mha\_loadlib, 1013
  - mha\_loadlib\_error, 1013
  - mha\_msleep, 1013



- mha\_ntoh, 1015
- mha\_setenv, 1014
- mha\_parse
  - mha\_ruby.cpp, 1026
- mha\_parser.cpp, 1015
  - MHAPLATFORM, 1016
  - parse\_1\_complex, 1016
  - parse\_1\_float, 1016
  - write\_float, 1016
- mha\_parser.hh, 1017
  - DEFAULT\_RETSIZE, 1021
  - insert\_member, 1021
- mha\_platform\_tic
  - mha\_profiling.c, 1024
  - mha\_profiling.h, 1025
- mha\_platform\_tictoc\_t
  - mha\_profiling.h, 1025
- mha\_platform\_toc
  - mha\_profiling.c, 1024
  - mha\_profiling.h, 1025
- mha\_plugin.hh, 1022
  - \_\_attribute\_\_, 1024
  - \_\_declspec, 1023
  - GITCOMMITHASH, 1023
  - HINSTANCE, 1023
  - MHAPLUGIN\_DOCUMENTATION\_PTR↔EFIX, 1023
  - MHAPLUGIN\_INIT\_CALLBACKS\_PTR↔FIX, 1023
  - MHAPLUGIN\_INIT\_CALLBACKS, 1023
  - MHAPLUGIN\_PROC\_CALLBACK\_PTR↔EFIX, 1023
  - MHAPLUGIN\_PROC\_CALLBACK, 1023
  - WINAPI, 1023
- mha\_profiling.c, 1024
  - mha\_platform\_tic, 1024
  - mha\_platform\_toc, 1024
  - mha\_tic, 1024
  - mha\_toc, 1024
- mha\_profiling.h, 1024
  - mha\_platform\_tic, 1025
  - mha\_platform\_tictoc\_t, 1025
  - mha\_platform\_toc, 1025
- mha\_real\_t
  - Vector and matrix processing toolbox, 42
- mha\_real\_test\_array\_t, 460
  - r, 460
- mha\_round
  - mha\_signal.hh, 1037
- mha\_rt\_fifo\_element\_t
  - ~mha\_rt\_fifo\_element\_t, 461
- abandoned, 461
- data, 461
- mha\_rt\_fifo\_element\_t, 461
  - next, 461
- mha\_rt\_fifo\_element\_t< T >, 460
- mha\_rt\_fifo\_t
  - ~mha\_rt\_fifo\_t, 463
  - current, 464
  - mha\_rt\_fifo\_t, 463
  - poll, 463
  - poll\_1, 463
  - push, 464
  - remove\_abandoned, 464
  - remove\_all, 464
  - root, 464
- mha\_rt\_fifo\_t< T >, 462
- mha\_ruby.cpp, 1025
  - Init\_mha\_ruby, 1026
  - mha\_alloc, 1025
  - mha\_exit\_request, 1025
  - mha\_free, 1025
  - mha\_parse, 1026
  - rb\_f\_t, 1025
- mha\_samplerate
  - MHAIOJackdb::io\_jack\_t, 581
- mha\_set\_user\_error
  - mha\_errno.c, 999
  - mha\_errno.h, 1000
- mha\_setenv
  - mha\_os.cpp, 1011
  - mha\_os.h, 1014
- mha\_signal.cpp, 1026
  - ASSERT\_EQUAL\_DIM\_PTR, 1028
  - ASSERT\_EQUAL\_DIM, 1028
  - intensity, 1028
  - MHA\_ID\_MATRIX, 1028
  - MHA\_ID\_UINT\_VECTOR, 1028
  - safe\_div, 1028
  - set\_minabs, 1028
- mha\_signal.hh, 1029
  - M\_PI, 1037
  - mha\_min\_1, 1037
  - mha\_round, 1037
  - operator<<, 1037
  - operator>>, 1038
  - safe\_div, 1037
  - set\_minabs, 1037
  - value, 1037
- mha\_signal\_fft.h, 1038
- mha\_spec\_t, 465
  - buf, 466

- channel\_info, 466
- num\_channels, 466
- num\_frames, 466
- mha\_stash\_environment\_variable\_t, 466
  - ~mha\_stash\_environment\_variable\_↔  
t, 467
  - existed\_before, 467
  - mha\_stash\_environment\_variable\_t, 467
  - original\_content, 467
  - variable\_name, 467
- mha\_strerror
  - mha\_errno.c, 999
  - mha\_errno.h, 1000
- mha\_tablelookup.cpp, 1038
- mha\_tablelookup.hh, 1038
- mha\_tcp.cpp, 1039
  - ASYNC\_CONNECT\_STARTED, 1040
  - closesocket, 1040
  - host\_port\_to\_sock\_addr, 1040
  - INVALID\_SOCKET, 1040
  - SOCKET\_ERROR, 1040
  - SOCKET, 1040
  - tcp\_connect\_to, 1040
  - tcp\_connect\_to\_with\_timeout, 1040
  - thread\_start\_func, 1040
- mha\_tcp.hh, 1040
  - Sleep, 1042
- mha\_test\_struct\_size
  - PluginLoader::mhapluginloader\_t, 884
- mha\_tic
  - mha\_profiling.c, 1024
- mha\_tictoc\_t, 495
  - t, 495
  - tv1, 495
  - tv2, 495
  - tz, 495
- mha\_toc
  - mha\_profiling.c, 1024
- mha\_toolbox.h, 1042
- mha\_wave\_t, 496
  - buf, 497
  - channel\_info, 497
  - num\_channels, 497
  - num\_frames, 497
- mha\_windowparser.cpp, 1042
  - wnd\_funs, 1042
- mha\_windowparser.h, 1042
- mhachain, 93
- mhachain.cpp, 1043
- mhachain::chain\_base\_t, 497
  - algos, 499
  - b\_prepared, 499
  - bprofiling, 499
  - cfin, 499
  - cfout, 499
  - chain, 499
  - chain\_base\_t, 498
  - old\_algos, 499
  - patchbay, 499
  - prepare, 499
  - process, 498, 499
  - release, 499
  - update, 499
- mhachain::mhachain\_t, 500
  - mhachain\_t, 500
- mhachain::plugs\_t, 501
  - ~plugs\_t, 502
  - ac, 502
  - algos, 502
  - alloc\_plugs, 502
  - b\_prepared, 502
  - b\_use\_profiling, 503
  - chain, 503
  - cleanup\_plugs, 502
  - parser, 502
  - plugs\_t, 502
  - prepare, 502
  - prepared, 502
  - proc\_cnt, 503
  - process, 502
  - prof\_algos, 503
  - prof\_cfg, 503
  - prof\_init, 503
  - prof\_load\_con, 503
  - prof\_prepare, 503
  - prof\_process, 503
  - prof\_process\_load, 503
  - prof\_process\_tt, 503
  - prof\_release, 503
  - prof\_tt\_con, 503
  - profiling, 503
  - release, 502
  - tictoc, 503
  - update\_proc\_load, 502
- mhachain\_t
  - mhachain::mhachain\_t, 500
- mhachannels
  - addsndfile::addsndfile\_if\_t, 182
- mhaconfig\_compare
  - mha\_generic\_chain.cpp, 1008
  - PluginLoader, 129
- mhaconfig\_in

- MHAPugin::plugin\_t, 732
- mhaconfig\_mon\_t
  - MHAParser::mhaconfig\_mon\_t, 681
- mhaconfig\_out
  - MHAPugin::plugin\_t, 732
- mhaconfig\_t, 504
  - channels, 505
  - domain, 505
  - fttlen, 505
  - fragsize, 505
  - srate, 505
  - wndlen, 505
- mhafft
  - fshift\_hilbert::hilbert\_shifter\_t, 342
- mhafw\_lib.cpp, 1043
- mhafw\_lib.h, 1043
- mhajack.cpp, 1064
  - dummy\_jack\_proc\_cb, 1064
  - jack\_error\_handler, 1064
  - last\_jack\_err, 1064
  - last\_jack\_err\_msg, 1064
  - make\_friendly\_number, 1064
- mhajack.h, 1064
  - IO\_ERROR\_JACK, 1066
  - IO\_ERROR\_MHAJACKLIB, 1066
  - last\_jack\_err\_msg, 1066
  - MAX\_USER\_ERR, 1066
  - MHAJACK\_FW\_STARTED, 1066
  - MHAJACK\_STARTING, 1066
  - MHAJACK\_STOPPED, 1066
- mhamain
  - mha.cpp, 989
  - mhamain.cpp, 1067
- mhamain.cpp, 1066
  - create\_lock, 1067
  - GREETING\_TEXT, 1067
  - HELP\_TEXT, 1067
  - MAX\_LINE\_LENGTH, 1067
  - mhamain, 1067
  - remove\_lock, 1067
- mhaplugin\_cfg\_t, 722
  - ~mhaplugin\_cfg\_t, 722
  - mhaplugin\_cfg\_t, 722
- mhapluginloader.cpp, 1067
- mhapluginloader.h, 1067
- mhapluginloader\_t
  - MHAParser::mhapluginloader\_t, 683
  - PluginLoader::mhapluginloader\_t, 882
- mhaserver\_t, 760
  - ~mhaserver\_t, 762
  - acceptor\_started, 762
  - ack\_fail, 763
  - ack\_ok, 763
  - announce\_port, 763
  - logfile, 763
  - logstring, 762
  - mhaserver\_t, 761
  - pid\_mon, 763
  - port, 763
  - received\_group, 762
  - run, 762
  - set\_announce\_port, 762
  - tcpserver, 763
- mhasndfile.cpp, 1068
  - validator\_channels, 1068
  - validator\_length, 1068
  - write\_wave, 1068
- mhasndfile.h, 1068
  - write\_wave, 1069
- mhastrdomain
  - PluginLoader, 129
- min
  - MHASignal::doublebuffer\_t, 771
  - spec2wave.cpp, 1075
  - Vector and matrix processing toolbox, 59
- minimum\_fill\_count
  - mha\_drifter\_fifo\_t, 443
- minlen
  - plingploing::if\_t, 867
- minlen\_
  - plingploing::plingploing\_t, 869
- minphase
  - MHAFilter::smoothspec\_t, 568
- minphase\_t
  - MHASignal::minphase\_t, 791
- mint\_mon\_t
  - MHAParser::mint\_mon\_t, 685
- minw\_
  - wavwriter\_t, 956
- minwrite
  - wavrec\_t, 955
- mix
  - sine\_cfg\_t, 910
- mixer
  - matrixmixer::matmix\_t, 411
- mixw\_ref
  - fshift\_hilbert::hilbert\_shifter\_t, 341
- mixw\_shift
  - fshift\_hilbert::hilbert\_shifter\_t, 341
- mode
  - ac2osc\_t, 147
  - addsndfile::addsndfile\_if\_t, 182

- MHA\_TCP::OS\_EVENT\_TYPE, 480
- noise\_t, 855
- sine\_t, 912
- smoothgains\_bridge::overlapadd\_if\_↔  
t, 914
- modified
  - dc::dc\_vars\_t, 259
  - dc\_simple::dc\_if\_t, 265
- modulename
  - dynamiclib\_t, 292
  - MHAParser::c\_ifc\_parser\_t, 650
- mon
  - acmon::ac\_monitor\_t, 156
- mon\_complex
  - acmon::ac\_monitor\_t, 156
- mon\_dump
  - MHAParser, 111
- mon\_g
  - dc\_simple::dc\_if\_t, 265
  - dc\_simple::dc\_t, 267
- mon\_l
  - dc\_simple::dc\_if\_t, 265
  - dc\_simple::dc\_t, 267
- mon\_mat
  - acmon::ac\_monitor\_t, 156
- mon\_mat\_complex
  - acmon::ac\_monitor\_t, 156
- mon\_t, 844
  - mon\_t, 844
  - store, 844
- monitor variable, 4
- monitor\_t
  - MHAParser::monitor\_t, 687
- mpo
  - DynComp::dc\_afterburn\_vars\_t, 298
- mpo\_inv
  - DynComp::dc\_afterburn\_rt\_t, 294
- msg
  - MHA\_Error, 447
- mu
  - MHAFilter::adapt\_filter\_param\_t, 514
  - MHAFilter::adapt\_filter\_t, 517
- mu\_beta
  - adm\_if\_t, 197
- multibandcompressor, 127
- multibandcompressor.cpp, 1069
- multibandcompressor::fftfb\_plug\_t, 845
  - bwv, 846
  - cfv, 846
  - efv, 846
  - fftfb\_plug\_t, 846
  - insert, 846
- multibandcompressor::interface\_t, 847
  - algo, 849
  - burn, 848
  - interface\_t, 848
  - num\_channels, 848
  - patchbay, 848
  - plug, 849
  - plug\_sigs, 849
  - prepare, 848
  - process, 848
  - release, 848
  - update\_cfg, 848
- multibandcompressor::plugin\_signals\_t, 849
  - apply\_gains, 850
  - gain, 850
  - plug\_level, 850
  - plug\_output, 850
  - plugin\_signals\_t, 850
  - update\_levels, 850
- mute
  - MHAJack::port\_t, 601
  - MHASignal::loop\_wavefragment\_t, 779
- mutex
  - MHAPlugin\_Split::posix\_threads\_t, 745
  - mha\_fifo\_posix\_threads\_t, 452
- mylogf
  - dc\_afterburn.cpp, 972
- N
  - lpc\_config, 408
- n
  - MHAJack::client\_avg\_t, 590
  - MHASignal::hilbert\_fftw\_t, 776
  - MHASignal::stat\_t, 806
- N\_ERRNO
  - MHA\_TCP, 92
- n\_channels
  - mha\_audio\_descriptor\_t, 428
- n\_freqs
  - mha\_audio\_descriptor\_t, 428
- n\_im
  - MHASignal::fft\_t, 775
- n\_no\_update
  - nlms\_t, 853
  - prediction\_error, 889
- n\_no\_update\_
  - prediction\_error\_config, 891
  - rt\_nlms\_t, 900
- n\_pad1
  - overlapadd::overlapadd\_t, 863
- n\_pad2

- overlapadd::overlapadd\_t, 863
- n\_re
  - MHASignal::fft\_t, 775
- n\_samples
  - mha\_audio\_descriptor\_t, 428
- n\_zero
  - overlapadd::overlapadd\_t, 863
- NORM\_DEFAULT
  - nlms\_wave.cpp, 1070
- NORM\_NONE
  - nlms\_wave.cpp, 1070
- NORM\_SUM
  - nlms\_wave.cpp, 1070
- NORMALIZATION\_TYPES
  - nlms\_wave.cpp, 1070
- NUM\_ENTR\_LTASS
  - speechnoise.cpp, 1076
- NUM\_ENTR\_MHAORIG
  - speechnoise.cpp, 1076
- NUM\_ENTR\_OLNOISE
  - speechnoise.cpp, 1076
- name
  - ac2lsl::type\_info, 143
  - ac2wave\_if\_t, 149
  - ac2wave\_t, 151
  - acmon::ac\_monitor\_t, 156
  - acsave::save\_var\_t, 171
  - fftfbpow::fftfbpow\_interface\_t, 325
  - MHA\_AC::ac2matrix\_helper\_t, 413
  - MHA\_AC::spectrum\_t, 424
  - MHA\_AC::waveform\_t, 427
  - MHAIOPortAudio::device\_info\_t, 584
  - MHAJack::client\_avg\_t, 590
  - MHAJack::client\_noncont\_t, 593
  - MHAMultiSrc::channel\_t, 608
  - MHAParser::entry\_t, 656
  - noisePowProposedScale::interface\_t, 857
  - plugindescription\_t, 875
  - rmslevel\_if\_t, 893
  - shadowfilter\_end::cfg\_t, 907
- name\_
  - AuditoryProfile::parser\_t::fmap\_t, 225
- name\_b
  - lpc\_bl\_predictor, 400
  - lpc\_bl\_predictor\_config, 402
  - lpc\_burglattice, 404
  - lpc\_burglattice\_config, 406
- name\_con\_AC
  - acConcat\_wave, 153
- name\_d
  - nlms\_t, 852
- name\_d\_
  - prediction\_error\_config, 891
  - rt\_nlms\_t, 900
- name\_e
  - nlms\_t, 853
  - prediction\_error, 888
- name\_e\_
  - rt\_nlms\_t, 900
- name\_f
  - lpc\_bl\_predictor, 400
  - lpc\_bl\_predictor\_config, 401
  - lpc\_burglattice, 404
  - lpc\_burglattice\_config, 406
  - nlms\_t, 853
  - prediction\_error, 888
- name\_kappa
  - lpc\_bl\_predictor, 400
  - lpc\_burglattice, 404
- name\_km
  - lpc\_bl\_predictor\_config, 401
- name\_lpc
  - prediction\_error, 888
- name\_lpc\_
  - prediction\_error\_config, 891
- name\_lpc\_b
  - lpc\_bl\_predictor, 400
- name\_lpc\_f
  - lpc\_bl\_predictor, 400
- name\_u
  - nlms\_t, 852
- name\_u\_
  - rt\_nlms\_t, 900
- namelen
  - acsave::mat4head\_t, 169
- names
  - MHAOvFilter::scale\_var\_t, 633
- nangle
  - acSteer\_config, 175
  - steerbf\_config, 929
- naudiochannels
  - dc::dc\_t, 257
- nbands
  - coherence::cohflt\_t, 240
  - combc\_t, 245
  - dc::dc\_t, 257
  - dc\_simple::dc\_t, 267
  - dc\_simple::level\_smoother\_t, 272
  - DynComp::gaintable\_t, 302
  - fftfilterbank::fftfb\_interface\_t, 330
  - MHAFilter::thirdoctave\_analyzer\_t, 569
  - MHAOvFilter::fspacing\_t, 626

- nbits
  - calibrator\_variables\_t, 234
- nch
  - shadowfilter\_begin::cfg\_t, 904
  - shadowfilter\_begin::shadowfilter\_begin\_t, 906
  - spec\_fader\_t, 924
- nch\_out
  - shadowfilter\_end::cfg\_t, 907
- nchan
  - acSteer\_config, 175
  - steerbf\_config, 929
  - timoConfig, 942
- nchannels
  - DynComp::gaintable\_t, 302
  - fftfilterbank::fftfb\_interface\_t, 330
  - MHAFilter::adapt\_filter\_state\_t, 515
  - MHAFilter::adapt\_filter\_t, 517
  - MHAFilter::iir\_filter\_t, 542
  - MHAFilter::smoothspec\_t, 568
  - MHAFilter::thirdoctave\_analyzer\_t, 569
- nchannels\_file\_in
  - io\_file\_t, 367
- nchannels\_in
  - io\_file\_t, 367
  - io\_parser\_t, 374
  - MHAFilter::partitioned\_convolution\_t, 556
  - MHAIOPortAudio::io\_portaudio\_t, 587
  - MHAJack::client\_t, 598
  - MHAPLugin\_Resampling::resampling\_t, 736
- nchannels\_out
  - fw\_t, 347
  - io\_file\_t, 367
  - io\_parser\_t, 374
  - MHAFilter::partitioned\_convolution\_t, 556
  - MHAIOPortAudio::io\_portaudio\_t, 587
  - MHAJack::client\_t, 598
  - MHAPLugin\_Resampling::resampling\_t, 736
- ndim
  - acsave::save\_var\_t, 171
- needs\_write
  - MHA\_TCP::Connection, 476
- neigh
  - acPooling\_wave\_config, 164
- neighbourhood
  - acPooling\_wave, 162
- nelements
  - MHASignal::matrix\_t, 790
- nested\_lock
  - MHAParser::base\_t, 642
- newgains
  - fader\_if\_t, 319
- next
  - MHAPLugin::cfg\_chain\_t, 723
  - mha\_rt\_fifo\_element\_t, 461
- next\_except\_str
  - mha\_errno.c, 999
- next\_read\_frame\_index
  - MHASignal::ringbuffer\_t, 796
- next\_write\_frame\_index
  - MHASignal::ringbuffer\_t, 797
- nfft
  - MHASignal::fft\_t, 775
  - overlapadd::overlapadd\_if\_t, 861
  - shadowfilter\_end::cfg\_t, 907
  - spec2wave\_t, 923
  - wave2spec\_if\_t, 950
- nfft\_
  - MHAOvIFilter::fspacing\_t, 626
- nframes
  - acsave::save\_var\_t, 171
- nfreq
  - acSteer\_config, 175
  - steerbf\_config, 929
  - timoConfig, 942
- nlms\_t, 851
  - algo, 853
  - c, 852
  - estimtype, 853
  - lambda\_smoothing\_power, 853
  - n\_no\_update, 853
  - name\_d, 852
  - name\_e, 853
  - name\_f, 853
  - name\_u, 852
  - nlms\_t, 852
  - normtype, 853
  - ntaps, 852
  - patchbay, 853
  - prepare, 852
  - process, 852
  - release, 852
  - rho, 852
  - update, 852
- nlms\_wave.cpp, 1069
  - ESTIM\_CUR, 1070
  - ESTIM\_PREV, 1070
  - ESTIMATION\_TYPES, 1070
  - make\_friendly\_number\_by\_limiting, 1070
  - NORM\_DEFAULT, 1070

- NORM\_NONE, 1070
- NORM\_SUM, 1070
- NORMALIZATION\_TYPES, 1070
- nm
  - lpc\_burglattice\_config, 406
- no\_iter
  - prediction\_error\_config, 891
  - rt\_nlms\_t, 900
- noise.cpp, 1070
- noise\_t, 853
  - frozennoise\_length, 855
  - lev, 855
  - mode, 855
  - noise\_t, 854
  - patchbay, 855
  - prepare, 854
  - process, 854
  - update\_cfg, 854
- noise\_type\_t
  - speechnoise\_t, 925
- noisePow
  - noisePowProposedScale::noisePow↔  
Proposed, 858
  - timoConfig, 943
- noisePow\_name
  - timo\_params, 940
  - timoSmooth, 947
- noisePowProposed
  - noisePowProposedScale::noisePow↔  
Proposed, 858
- noisePowProposedScale, 127
- noisePowProposedScale.cpp, 1070
  - POWSPEC\_FACTOR, 1071
- noisePowProposedScale::interface\_t, 855
  - alphaPH1mean, 857
  - alphaPSD, 857
  - interface\_t, 856
  - name, 857
  - patchbay, 857
  - prepare, 856
  - process, 856
  - q, 857
  - update\_cfg, 856
  - xiOptDb, 857
- noisePowProposedScale::noisePowProposed, 857
  - alphaPH1mean\_, 858
  - alphaPSD\_, 859
  - estimateDebug, 858
  - frameno, 859
  - GLRDebug, 858
  - GLRexp, 859
  - inputPow, 858
  - inputSpec, 858
  - insert, 858
  - logGLRFact, 859
  - noisePow, 858
  - noisePowProposed, 858
  - noisyPer, 858
  - PH1Debug, 858
  - PH1mean, 858
  - priorFact, 859
  - process, 858
  - snrPost1Debug, 858
  - xiOpt, 859
- noisyPer
  - noisePowProposedScale::noisePow↔  
Proposed, 858
- non\_empty\_partitions
  - MHAFilter::transfer\_function\_t, 571
  - MHAFilter::transfer\_matrix\_t, 573
- nondefault\_labels
  - altplugs\_t, 216
- norm
  - lpc, 397
  - lpc\_config, 407
- norm\_phase
  - gtfb\_analyzer::gtfb\_analyzer\_cfg\_t, 354
  - gtfb\_analyzer::gtfb\_analyzer\_t, 357
- normalize
  - Complex arithmetics in the openMHA, 69
  - MHAOvIFilter::fftb\_vars\_t, 621
- normtype
  - nlms\_t, 853
- not\_in\_use
  - MHAPugin::cfg\_chain\_t, 723
- not\_zero
  - dc\_simple, 84
- notify
  - MHAParser::base\_t, 641
- notify\_release
  - io\_tcp\_t, 391
- notify\_start
  - io\_tcp\_t, 391
- notify\_stop
  - io\_tcp\_t, 391
- now\_index
  - MHAFilter::polyphase\_resampling\_t, 563
- npad1
  - spec2wave\_t, 922
  - wave2spec\_t, 952
- npad2

- spec2wave\_t, 923
- wave2spec\_t, 952
- nperiods
  - alsa\_dev\_par\_parser\_t, 209
- nrefmic
  - acSteer, 174
  - acSteer\_config, 175
- nrep
  - MHAJack::client\_avg\_t, 590
- nsteerchan
  - acSteer, 174
  - acSteer\_config, 175
- ntaps
  - MHAFilter::adapt\_filter\_state\_t, 515
  - MHAFilter::adapt\_filter\_t, 517
  - nlms\_t, 852
  - prediction\_error, 888
  - prediction\_error\_config, 890
  - rt\_nlms\_t, 899
- ntoh
  - io\_tcp\_sound\_t, 386
- ntracks
  - shadowfilter\_begin::cfg\_t, 904
  - shadowfilter\_begin::shadowfilter\_begin←  
\_t, 906
  - shadowfilter\_end::cfg\_t, 907
- null\_data
  - mha\_drifter\_fifo\_t, 444
- num\_AC
  - acConcat\_wave, 153
- num\_adms
  - adm\_rtconfig\_t, 199
- num\_brackets
  - MHAParser::StrCnv, 113
- num\_channels
  - calibrator\_variables\_t, 234
  - DynComp::gaintable\_t, 302
  - MHAFilter::blockprocessing\_polyphase←  
\_resampling\_t, 519
  - mha\_spec\_t, 466
  - mha\_wave\_t, 497
  - multibandcompressor::interface\_t, 848
- num\_entries
  - ac2lsl::save\_var\_base\_t, 137
  - ac2lsl::save\_var\_t, 139
  - ac2lsl::save\_var\_t< mha\_complex\_t >, 142
  - comm\_var\_t, 246
  - testplugin::ac\_parser\_t, 931
- num\_F
  - DynComp::gaintable\_t, 302
- num\_frames
  - mha\_spec\_t, 466
  - mha\_wave\_t, 497
- num\_inchannels
  - io\_tcp\_sound\_t, 387
- num\_L
  - DynComp::gaintable\_t, 302
- num\_outchannels
  - io\_tcp\_sound\_t, 388
- num\_xruns
  - MHAJack::client\_t, 598
- numDevices
  - MHAIOPortAudio::device\_info\_t, 584
- numSamples\_AC
  - acConcat\_wave\_config, 154
- numbytes
  - MHASignal::matrix\_t, 789
  - MHASignal::uint\_vector\_t, 811
- numchannels
  - acConcat\_wave, 153
  - addsndfile::addsndfile\_if\_t, 182
- numsamples
  - acPooling\_wave, 162
  - acTransform\_wave, 178
- nupsample
  - doasvm\_feature\_extraction, 285
- nvars
  - acsave::cfg\_t, 169
- nwnd
  - overlapadd::overlapadd\_if\_t, 861
  - wave2spec\_if\_t, 950
  - wave2spec\_t, 952
- nwndshift
  - spec2wave\_t, 923
  - wave2spec\_t, 952
- nyquist\_ratio
  - MHAPlugin\_Resampling::resampling\_if←  
\_t, 734
- o1\_ar\_filter\_t
  - MHAFilter::o1\_ar\_filter\_t, 546
- o1\_lp\_coeffs
  - MHAFilter, 96
- o1flt\_lowpass\_t
  - MHAFilter::o1flt\_lowpass\_t, 550
- o1flt\_maxtrack\_t
  - MHAFilter::o1flt\_maxtrack\_t, 552
- o1flt\_mintrack\_t
  - MHAFilter::o1flt\_mintrack\_t, 554
- OVERLAP\_FACTOR
  - timoconfig.cpp, 1081
- observe



- MHA\_TCP::Event\_Watcher, 479
- observed\_by
  - MHA\_TCP::Wakeup\_Event, 494
- observers
  - MHA\_TCP::Wakeup\_Event, 495
- od
  - MHAFilter::adapt\_filter\_state\_t, 515
- offset
  - acTransform\_wave\_config, 179
- ola1
  - overlapadd::overlapadd\_t, 862
- ola2
  - overlapadd::overlapadd\_t, 862
- ola\_powspec\_scale
  - timoConfig, 942
- old\_algos
  - mhachain::chain\_base\_t, 499
- olnoise
  - speechnoise\_t, 925
- on\_model\_param\_valuechanged
  - timoSmooth, 946
- on\_prereadaccess
  - example3\_t, 310
  - example4\_t, 314
- on\_scale\_ch\_readaccess
  - example3\_t, 310
  - example4\_t, 314
- on\_scale\_ch\_valuechanged
  - example3\_t, 310
  - example4\_t, 314
- on\_scale\_ch\_writeaccess
  - example3\_t, 310
  - example4\_t, 314
- op
  - MHAParser::expression\_t, 657
- op\_query
  - MHAParser::base\_t, 638
  - MHAParser::c\_ifc\_parser\_t, 649
  - MHAParser::monitor\_t, 687
  - MHAParser::parser\_t, 691
- op\_setval
  - MHAParser::base\_t, 638
  - MHAParser::bool\_t, 647
  - MHAParser::c\_ifc\_parser\_t, 649
  - MHAParser::complex\_t, 655
  - MHAParser::float\_t, 661
  - MHAParser::int\_t, 666
  - MHAParser::kw\_t, 671
  - MHAParser::mcomplex\_t, 675
  - MHAParser::mfloat\_t, 679
  - MHAParser::parser\_t, 691
  - MHAParser::string\_t, 699
  - MHAParser::variable\_t, 701
  - MHAParser::vcomplex\_t, 706
  - MHAParser::vfloat\_t, 710
  - MHAParser::vint\_t, 714
  - MHAParser::vstring\_t, 718
- op\_subparse
  - MHAParser::base\_t, 638
  - MHAParser::c\_ifc\_parser\_t, 649
  - MHAParser::parser\_t, 691
- opact\_map\_t
  - MHAParser, 111
- opact\_t
  - MHAParser, 111
- operator!=
  - Complex arithmetics in the openMHA, 68
- operator<
  - Complex arithmetics in the openMHA, 69
- operator<<
  - mha\_signal.hh, 1037
- operator>>
  - mha\_signal.hh, 1038
- operator\*
  - Complex arithmetics in the openMHA, 66, 67
- operator\*=
  - Complex arithmetics in the openMHA, 66
  - Vector and matrix processing toolbox, 54, 55
- operator^=
  - Vector and matrix processing toolbox, 56
- operator()
  - dc\_simple::dc\_t::line\_t, 268
  - hanning\_ramps\_t, 358
  - MHAEvents::emitter\_t, 511
  - MHAFilter::gammaflt\_t, 536, 537
  - MHAFilter::iir\_ord1\_real\_t, 544
  - MHAFilter::o1\_ar\_filter\_t, 547, 548
  - MHASignal::hilbert\_t, 777
  - MHASignal::matrix\_t, 787–789
  - MHASignal::minphase\_t, 791
  - MHASignal::quantizer\_t, 793
  - MHASignal::spectrum\_t, 803
  - MHASignal::waveform\_t, 815, 816
  - MHAWindow::base\_t, 836
- operator+
  - Complex arithmetics in the openMHA, 65
- operator+=
  - Complex arithmetics in the openMHA, 65
  - Vector and matrix processing toolbox, 54, 55

- operator-
  - Complex arithmetics in the openMHA, [65](#), [66](#), [68](#)
- operator==
  - Complex arithmetics in the openMHA, [65](#)
  - Vector and matrix processing toolbox, [54](#)
- operator/
  - Complex arithmetics in the openMHA, [67](#), [68](#)
- operator/=
  - Complex arithmetics in the openMHA, [67](#)
  - Vector and matrix processing toolbox, [55](#)
- operator=
  - MHA\_AC::acspace2matrix\_t, [417](#)
  - MHA\_Error, [446](#)
  - MHAPugin\_Split::domain\_handler\_t, [738](#)
  - MHAPugin\_Split::splitted\_part\_t, [754](#)
  - MHAPugin\_Split::thread\_platform\_t, [758](#)
  - MHASignal::matrix\_t, [785](#)
  - MHASignal::uint\_vector\_t, [810](#)
  - MHASignal::waveform\_t, [815](#)
  - mha\_fifo\_t, [455](#)
  - mha\_fifo\_thread\_platform\_t, [460](#)
- operator==
  - Complex arithmetics in the openMHA, [68](#)
  - MHASignal::uint\_vector\_t, [810](#)
- operator[]
  - MHA\_AC::acspace2matrix\_t, [417](#)
  - MHASignal::spectrum\_t, [803](#)
  - MHASignal::uint\_vector\_t, [811](#)
  - MHASignal::waveform\_t, [815](#)
- operators
  - MHAParser::base\_t, [642](#)
- oplist
  - MHAParser::base\_t, [641](#)
- order
  - gtfb\_analyzer::gtfb\_analyzer\_cfg\_t, [354](#)
  - gtfb\_analyzer::gtfb\_analyzer\_t, [357](#)
  - lpc\_config, [407](#)
- original\_content
  - mha\_stash\_environment\_variable\_t, [467](#)
- origname
  - PluginLoader::config\_file\_splitter\_t, [877](#)
- os\_event
  - MHA\_TCP::Wakeup\_Event, [495](#)
- os\_event\_valid
  - MHA\_TCP::Wakeup\_Event, [495](#)
- out
  - adm\_if\_t, [197](#)
  - delaysum::delaysum\_t, [278](#)
- out\_buf
  - overlapadd::overlapadd\_t, [863](#)
  - spec2wave\_t, [923](#)
- out\_chunk
  - MHAFilter::thirddoctave\_analyzer\_t, [570](#)
- out\_chunk\_im
  - MHAFilter::thirddoctave\_analyzer\_t, [570](#)
- out\_spec
  - shadowfilter\_begin::cfg\_t, [904](#)
  - shadowfilter\_end::cfg\_t, [907](#)
- outSpec
  - steerbf\_config, [929](#)
- outbuf
  - MHA\_TCP::Connection, [477](#)
- outch
  - MHAJack::client\_t, [599](#)
- outchannels
  - combc\_if\_t, [244](#)
- outer2inner\_resampling
  - MHAPugin\_Resampling::resampling\_t, [736](#)
- outer\_ac
  - analysepath\_t, [218](#)
- outer\_ac\_copy
  - analysepath\_t, [218](#)
- outer\_error
  - mha\_dblbuf\_t, [437](#)
- outer\_fragsize
  - MHAPugin\_Resampling::resampling\_t, [735](#)
- outer\_out
  - MHASignal::doublebuffer\_t, [772](#)
- outer\_process
  - MHASignal::doublebuffer\_t, [771](#)
- outer\_size
  - mha\_dblbuf\_t, [436](#)
- outer\_srate
  - MHAPugin\_Resampling::resampling\_t, [736](#)
- output
  - io\_parser\_t, [374](#)
  - MHAJack::port\_t, [600](#)
  - mha\_dblbuf\_t, [436](#)
- output\_cfg
  - MHAPugin::plugin\_t, [732](#)
- output\_cfg\_
  - MHAPugin::plugin\_t, [732](#)
- output\_channels
  - mha\_dblbuf\_t, [437](#)
- output\_domain
  - PluginLoader::mhapuginloader\_t, [883](#)
- output\_fifo

- mha\_dblbuf\_t, [437](#)
- output\_partitions
  - MHAFilter::partitioned\_convolution\_t, [556](#)
- output\_portnames
  - MHAJack::client\_t, [599](#)
- output\_sample\_format
  - io\_file\_t, [368](#)
- output\_signal
  - MHAPlugin\_Resampling::resampling\_t, [736](#)
- output\_signal\_spec
  - MHAFilter::partitioned\_convolution\_t, [557](#)
- output\_signal\_wave
  - MHAFilter::partitioned\_convolution\_t, [557](#)
- output\_spec
  - testplugin::signal\_parser\_t, [936](#)
- output\_wave
  - testplugin::signal\_parser\_t, [936](#)
- outputchannels
  - MHAFilter::fftfilterbank\_t, [530](#)
- overlap\_save\_filterbank\_analytic\_t
  - MHAOvfFilter::overlap\_save\_filterbank\_↔analytic\_t, [628](#)
- overlap\_save\_filterbank\_t
  - MHAOvfFilter::overlap\_save\_filterbank\_t, [630](#)
- overlapadd, [127](#)
- overlapadd.cpp, [1071](#)
- overlapadd::overlapadd\_if\_t, [859](#)
  - ~overlapadd\_if\_t, [860](#)
  - algo, [861](#)
  - cf\_in, [861](#)
  - cf\_out, [861](#)
  - nfft, [861](#)
  - nwnd, [861](#)
  - overlapadd\_if\_t, [860](#)
  - patchbay, [861](#)
  - plugloader, [861](#)
  - postscale, [861](#)
  - prepare, [860](#)
  - prescale, [861](#)
  - process, [861](#)
  - release, [860](#)
  - update, [861](#)
  - window, [861](#)
  - wndexp, [861](#)
  - wndpos, [861](#)
  - zerowindow, [861](#)
- overlapadd::overlapadd\_t, [862](#)
  - ~overlapadd\_t, [862](#)
  - calc\_out, [863](#)
  - fft, [863](#)
  - n\_pad1, [863](#)
  - n\_pad2, [863](#)
  - n\_zero, [863](#)
  - ola1, [862](#)
  - ola2, [862](#)
  - out\_buf, [863](#)
  - overlapadd\_t, [862](#)
  - postwnd, [863](#)
  - prewnd, [863](#)
  - spec\_in, [863](#)
  - wave\_in1, [863](#)
  - wave\_out1, [863](#)
  - write\_buf, [863](#)
- overlapadd\_if\_t
  - overlapadd::overlapadd\_if\_t, [860](#)
  - smoothgains\_bridge::overlapadd\_if\_↔t, [913](#)
- overlapadd\_t
  - overlapadd::overlapadd\_t, [862](#)
- ovtype
  - MHAOvfFilter::fftfb\_vars\_t, [620](#)
- oy
  - MHAFilter::adapt\_filter\_state\_t, [515](#)
- p
  - acPooling\_wave\_config, [164](#)
  - doasvm\_classification\_config, [282](#)
  - pluginbrowser\_t, [874](#)
- p1
  - MHASignal::hilbert\_fftw\_t, [776](#)
- p2
  - MHASignal::hilbert\_fftw\_t, [776](#)
- P\_Sum
  - rt\_nlms\_t, [900](#)
- p\_biased
  - acPooling\_wave\_config, [164](#)
- p\_biased\_name
  - acPooling\_wave, [162](#)
- p\_in
  - io\_alsa\_t, [364](#)
- p\_max
  - acPooling\_wave\_config, [164](#)
  - doasvm\_classification\_config, [282](#)
- p\_name
  - acPooling\_wave, [162](#)
  - doasvm\_classification, [281](#)
- p\_out
  - io\_alsa\_t, [364](#)
- p\_parser
  - acmon::ac\_monitor\_t, [157](#)
- PATCH\_VAR

- acConcat\_wave.cpp, 961
- acPooling\_wave.cpp, 962
- acSteer.cpp, 963
- acTransform\_wave.cpp, 964
- doasvm\_classification.cpp, 974
- doasvm\_feature\_extraction.cpp, 975
- lpc.cpp, 987
- lpc\_bl\_predictor.cpp, 987
- lpc\_burg-lattice.cpp, 988
- prediction\_error.cpp, 1072
- steerbf.cpp, 1080
- timoSmooth.cpp, 1082
- PH1Debug
  - noisePowProposedScale::noisePow↔  
Proposed, 858
- PH1mean
  - noisePowProposedScale::noisePow↔  
Proposed, 858
- POWSPEC\_FACTOR
  - noisePowProposedScale.cpp, 1071
  - timoconfig.cpp, 1081
- PREPARED
  - MHA\_TCP::Thread, 488
- pa22dbspl
  - Vector and matrix processing toolbox, 44
- pa2dbspl
  - Vector and matrix processing toolbox, 43
- params
  - timoConfig, 942
- parent
  - MHAParser::base\_t, 642
- parent\_
  - MHAParser::mhapluginloader\_t, 684
- parse
  - altplugs\_t, 215
  - io\_tcp\_t, 391
  - MHAParser::base\_t, 637, 638
  - MHAPugin\_Split::splitted\_part\_t, 754
  - PluginLoader::fourway\_processor\_t, 880
  - PluginLoader::mhapluginloader\_t, 882
- parse\_1\_complex
  - mha\_parser.cpp, 1016
- parse\_1\_float
  - mha\_parser.cpp, 1016
- parser
  - io\_tcp\_t, 391
  - mhachain::plugs\_t, 502
- parser\_int\_dyn, 864
  - parser\_int\_dyn, 864
  - set\_max\_angle\_ind, 865
- parser\_plugs
  - altplugs\_t, 216
- parser\_t
  - AuditoryProfile::parser\_t, 223
  - MHAParser::parser\_t, 689
- parserFriendlyName
  - MHAIOPortAudio, 99
- parsername
  - latex\_doc\_t, 394
- parserstate
  - fw\_t, 347
- partitioned\_convolution\_t
  - MHAFilter::partitioned\_convolution\_t, 555
- partitions
  - MHAFilter::transfer\_function\_t, 571
  - MHAFilter::transfer\_matrix\_t, 573
- patchbay
  - ac2lsl::ac2lsl\_t, 133
  - ac2osc\_t, 147
  - ac2wave\_if\_t, 149
  - acConcat\_wave, 153
  - acPooling\_wave, 162
  - acSteer, 174
  - acTransform\_wave, 178
  - acmon::acmon\_t, 159
  - acsave::acsave\_t, 167
  - addsndfile::addsndfile\_if\_t, 182
  - adm\_if\_t, 197
  - altplugs\_t, 216
  - analysispath\_if\_t, 220
  - AuditoryProfile::parser\_t::fmap\_t, 225
  - calibrator\_t, 233
  - coherence::cohflt\_if\_t, 238
  - db\_if\_t, 251
  - dc::dc\_if\_t, 254
  - dc::wideband\_inhib\_vars\_t, 263
  - dc\_simple::dc\_if\_t, 265
  - delay::interface\_t, 274
  - delaysum::delaysum\_if\_t, 276
  - doasvm\_classification, 281
  - doasvm\_feature\_extraction, 285
  - DynComp::dc\_afterburn\_t, 296
  - example3\_t, 311
  - example4\_t, 315
  - example6\_t, 317
  - fader\_if\_t, 319
  - fader\_wave::fader\_wave\_if\_t, 321
  - fftfbpow::fftfbpow\_interface\_t, 325
  - fftfilterbank::fftfb\_interface\_t, 330
  - fshift::fshift\_t, 336
  - fshift\_hilbert::frequency\_translator\_t, 338
  - fw\_t, 348

- gain::gain\_if\_t, 351
- gtfb\_analyzer::gtfb\_analyzer\_t, 357
- io\_alsa\_t, 364
- io\_parser\_t, 374
- lpc, 397
- lpc\_bl\_predictor, 400
- lpc\_burglattice, 404
- MHAIOJack::io\_jack\_t, 577
- MHAIOJackdb::io\_jack\_t, 582
- MHAIOPortAudio::io\_portaudio\_t, 587
- MHAPlugin\_Split::split\_t, 750
- matrixmixer::matmix\_t, 411
- mhachain::chain\_base\_t, 499
- multibandcompressor::interface\_t, 848
- nlms\_t, 853
- noise\_t, 855
- noisePowProposedScale::interface\_t, 857
- overlapadd::overlapadd\_if\_t, 861
- plingploing::if\_t, 867
- plugin\_interface\_t, 873
- prediction\_error, 889
- route::interface\_t, 896
- sine\_t, 912
- smoothgains\_bridge::overlapadd\_if\_↔  
t, 914
- softclip\_t, 917
- spec2wave\_if\_t, 921
- steerbf, 928
- testplugin::ac\_parser\_t, 931
- testplugin::if\_t, 935
- timoSmooth, 947
- wave2spec\_if\_t, 950
- wavrec\_t, 955
- windowselector\_t, 959
- path
  - addsndfile::addsndfile\_if\_t, 182
- pcm
  - alsa\_base\_t, 208
- pcm\_format
  - alsa\_t, 213
- pcmlink
  - io\_alsa\_t, 364
- peak
  - MHASignal::loop\_wavefragment\_t, 779
  - rmslevel\_t, 894
- peak\_db
  - rmslevel\_t, 894
- peaklevel
  - calibrator\_variables\_t, 234
  - MHASignal::async\_rmslevel\_t, 765
  - mha\_channel\_info\_t, 430
- peer\_addr
  - MHA\_TCP::Connection, 477
- peer\_address
  - io\_tcp\_parser\_t, 383
- peer\_port
  - io\_tcp\_parser\_t, 384
- period
  - droptect\_t, 289
- pfragmentsize
  - fw\_vars\_t, 349
- phase
  - cpuload\_t, 249
  - MHASignal::minphase\_t, 792
- phase\_correction
  - MHAFilter::gammaflt\_t, 537
- phase\_div\_2pi
  - sine\_t, 912
- phase\_gains
  - MHASignal::subsample\_delay\_t, 808
- phase\_increment\_div\_2pi
  - sine\_cfg\_t, 910
- phasemode
  - fshift\_hilbert::frequency\_translator\_t, 339
- phasemodel
  - MHAOvFilter::overlap\_save\_filterbank\_↔  
::vars\_t, 631
- PI
  - ADM, 81
  - hann.cpp, 985
- pid\_mon
  - mhaserver\_t, 763
- pinchannels
  - fw\_vars\_t, 349
- pink
  - speechnoise\_t, 925
- pipe
  - MHA\_TCP::Async\_Notify, 469
- pitch
  - plingploing::if\_t, 867
- pitch\_
  - plingploing::plingploing\_t, 869
- pitch\_set\_first
  - timoConfig, 943
- pitch\_set\_first\_AC
  - timo\_AC, 938
- pitch\_set\_last
  - timoConfig, 943
- pitch\_set\_last\_AC
  - timo\_AC, 938
- plan\_spec2analytic
  - fshift\_hilbert::hilbert\_shifter\_t, 341

- plateau
  - MHAOvIFilter::fftb\_vars\_t, 620
- playback
  - MHASignal::loop\_wavefragment\_t, 780, 781
- playback\_channels
  - MHASignal::loop\_wavefragment\_t, 781
- playback\_mode\_t
  - MHASignal::loop\_wavefragment\_t, 779
- plingploing, 128
  - drand, 128
- plingploing.cpp, 1071
- plingploing::if\_t, 865
  - bassmod, 867
  - bassperiod, 868
  - bpm, 867
  - fun1\_key, 867
  - fun1\_range, 867
  - fun2\_key, 867
  - fun2\_range, 867
  - if\_t, 866
  - level, 867
  - maxlen, 867
  - minlen, 867
  - patchbay, 867
  - pitch, 867
  - prepare, 866
  - process, 866
  - update, 866
- plingploing::plingploing\_t, 868
  - alph, 870
  - bass, 869
  - bassmod\_, 870
  - bassperiod\_, 870
  - bt, 869
  - cf, 869
  - dist, 870
  - dist1, 870
  - dur\_, 869
  - freq, 869
  - fun1, 870
  - fun1\_key, 870
  - fun1\_range, 870
  - fun2, 870
  - fun2\_key, 870
  - fun2\_range, 870
  - hann1, 870
  - hann2, 870
  - len, 869
  - level, 870
  - maxlen\_, 869
  - minlen\_, 869
  - pitch\_, 869
  - plingploing\_t, 869
  - process, 869
  - rms, 870
  - t, 869
- plingploing\_t
  - plingploing::plingploing\_t, 869
- plug
  - analysispath\_if\_t, 220
  - MHAParser::mhapluginloader\_t, 684
  - MHAPLugin\_Split::splitted\_part\_t, 755
  - multibandcompressor::interface\_t, 849
  - testplugin::if\_t, 935
- plug\_level
  - multibandcompressor::plugin\_signals\_t, 850
- plug\_output
  - multibandcompressor::plugin\_signals\_t, 850
- plug\_sigs
  - multibandcompressor::interface\_t, 849
- plug\_t, 870
  - ~plug\_t, 871
  - get\_ac, 871
  - get\_handle, 871
  - get\_process\_spec, 871
  - get\_process\_wave, 871
  - plug\_t, 871
- plugin\_categories
  - PluginLoader::mhapluginloader\_t, 885
- plugin\_documentation
  - PluginLoader::mhapluginloader\_t, 885
- plugin\_extension
  - pluginbrowser\_t, 874
- plugin\_interface\_t, 872
  - factor, 873
  - patchbay, 873
  - plugin\_interface\_t, 873
  - prepare, 873
  - process, 873
  - scale\_ch, 873
  - update\_cfg, 873
- plugin\_macro
  - latex\_doc\_t, 394
- plugin\_paths
  - fw\_t, 347
- plugin\_signals\_t
  - multibandcompressor::plugin\_signals\_t, 850
- plugin\_t

- MHAPugin::plugin\_t, 730
- PluginLoader, 128
  - mhaconfig\_compare, 129
  - mhastrdomain, 129
- PluginLoader::config\_file\_splitter\_t, 876
  - config\_file\_splitter\_t, 876
  - configfile, 877
  - configname, 877
  - get\_configfile, 877
  - get\_configname, 876
  - get\_libname, 877
  - get\_oriname, 877
  - libname, 877
  - oriname, 877
- PluginLoader::fourway\_processor\_t, 877
  - ~fourway\_processor\_t, 878
  - parse, 880
  - prepare, 880
  - process, 878, 879
  - release, 880
- PluginLoader::mhapuginloader\_t, 880
  - ~mhapuginloader\_t, 882
  - ac, 884
  - b\_check\_version, 885
  - b\_is\_prepared, 885
  - cf\_input, 885
  - cf\_output, 885
  - get\_categories, 884
  - get\_documentation, 884
  - getfullname, 883
  - has\_parser, 883
  - has\_process, 883
  - input\_domain, 883
  - is\_prepared, 884
  - lib\_data, 884
  - lib\_err, 884
  - lib\_handle, 884
  - MHADestroy\_cb, 884
  - MHAGetVersion\_cb, 884
  - MHAINit\_cb, 884
  - MHAPrepare\_cb, 884
  - MHAProc\_spec2spec\_cb, 884
  - MHAProc\_spec2wave\_cb, 885
  - MHAProc\_wave2spec\_cb, 884
  - MHAProc\_wave2wave\_cb, 884
  - MHARelease\_cb, 884
  - MHASet\_cb, 885
  - MHASTrError\_cb, 885
  - mha\_test\_struct\_size, 884
  - mhapuginloader\_t, 882
  - output\_domain, 883
  - parse, 882
  - plugin\_categories, 885
  - plugin\_documentation, 885
  - prepare, 883
  - process, 883
  - release, 883
  - resolve\_and\_init, 884
  - test\_error, 884
  - test\_version, 884
- pluginbrowser.cpp, 1072
- pluginbrowser.h, 1072
- pluginbrowser\_t, 873
  - add\_plugin, 874
  - add\_plugins, 874
  - clear\_plugins, 874
  - get\_paths, 874
  - get\_plugins, 874
  - library\_paths, 874
  - p, 874
  - plugin\_extension, 874
  - pluginbrowser\_t, 874
  - plugins, 874
  - scan\_plugin, 874
  - scan\_plugins, 874
- plugindescription\_t, 875
  - categories, 875
  - documentation, 875
  - fullname, 875
  - name, 875
  - queries, 875
  - query\_cmds, 875
  - spec2spec, 875
  - spec2wave, 875
  - wave2spec, 875
  - wave2wave, 875
- pluginloader\_t, 885
  - ~pluginloader\_t, 886
  - pluginloader\_t, 886
- plugins
  - fw\_t, 347
  - pluginbrowser\_t, 874
- plugloader
  - bbcalib\_interface\_t, 229
  - db\_if\_t, 251
  - db\_t, 252
  - MHAPugin\_Resampling::resampling\_if\_↔  
\_t, 734
  - MHAPugin\_Resampling::resampling\_t,  
736
  - overlapadd::overlapadd\_if\_t, 861
  - smoothgains\_bridge::overlapadd\_if\_↔

- t, [914](#)
- plugname
  - latex\_doc\_t, [394](#)
  - MHAParser::mhapluginloader\_t, [684](#)
- plugname\_name\_
  - MHAParser::mhapluginloader\_t, [684](#)
- plugs
  - altplugs\_t, [216](#)
- plugs\_t
  - mhachain::plugs\_t, [502](#)
- pmode
  - calibrator\_runtime\_layer\_t, [231](#)
- poll
  - mha\_rt\_fifo\_t, [463](#)
- poll\_1
  - mha\_rt\_fifo\_t, [463](#)
- poll\_config
  - MHAPugin::config\_t, [726](#)
- polyphase\_resampling\_t
  - MHAFilter::polyphase\_resampling\_t, [561](#)
- pool
  - acPooling\_wave\_config, [164](#)
- pool\_name
  - acPooling\_wave, [162](#)
- pooling\_ind
  - acPooling\_wave\_config, [164](#)
- pooling\_option
  - acPooling\_wave\_config, [164](#)
- pooling\_size
  - acPooling\_wave\_config, [164](#)
- pooling\_type
  - acPooling\_wave, [162](#)
- pooling\_wndlen
  - acPooling\_wave, [162](#)
- port
  - ac2osc\_t, [146](#)
  - MHA\_TCP::Server, [483](#)
  - MHAJack::port\_t, [602](#)
  - mhaserver\_t, [763](#)
- port\_t
  - MHAJack::port\_t, [600](#), [601](#)
- portaudio\_callback
  - MHAIOPortAudio.cpp, [1059](#), [1060](#)
  - MHAIOPortAudio::io\_portaudio\_t, [587](#)
- portaudio\_stream
  - MHAIOPortAudio::io\_portaudio\_t, [587](#)
- portnames\_in
  - MHAIOJack::io\_jack\_t, [577](#)
  - MHAIOJackdb::io\_jack\_t, [581](#)
- portnames\_out
  - MHAIOJack::io\_jack\_t, [577](#)
- MHAIOJackdb::io\_jack\_t, [581](#)
- ports\_in\_all
  - MHAIOJack::io\_jack\_t, [577](#)
  - MHAIOJackdb::io\_jack\_t, [582](#)
- ports\_in\_physical
  - MHAIOJack::io\_jack\_t, [577](#)
  - MHAIOJackdb::io\_jack\_t, [582](#)
- ports\_out\_all
  - MHAIOJack::io\_jack\_t, [577](#)
  - MHAIOJackdb::io\_jack\_t, [582](#)
- ports\_out\_physical
  - MHAIOJack::io\_jack\_t, [577](#)
  - MHAIOJackdb::io\_jack\_t, [582](#)
- ports\_parser
  - MHAIOJack::io\_jack\_t, [577](#)
  - MHAIOJackdb::io\_jack\_t, [582](#)
- pos
  - addsndfile::level\_adapt\_t, [184](#)
  - cfg\_t, [236](#)
  - fader\_wave::level\_adapt\_t, [323](#)
  - MHAJack::client\_avg\_t, [590](#)
  - MHAJack::client\_noncont\_t, [592](#)
  - MHASignal::async\_rmslevel\_t, [765](#)
  - MHASignal::delay\_spec\_t, [766](#)
  - MHASignal::delay\_t, [768](#)
  - MHASignal::delay\_wave\_t, [769](#)
  - MHASignal::loop\_wavefragment\_t, [781](#)
- posix\_threads\_t
  - MHAPugin\_Split::posix\_threads\_t, [744](#)
- posixthreads
  - split.cpp, [1079](#)
- postscale
  - overlapadd::overlapadd\_if\_t, [861](#)
- postwindow
  - spec2wave\_t, [923](#)
- postwnd
  - overlapadd::overlapadd\_t, [863](#)
- powSpec
  - timoConfig, [943](#)
- power
  - MHASignal::waveform\_t, [820](#)
- powersum
  - dc::dc\_t, [256](#)
  - dc::dc\_vars\_t, [258](#)
- powspec
  - MHASignal::waveform\_t, [821](#)
- pred\_err\_delay
  - prediction\_error, [889](#)
- prediction\_error, [886](#)
  - ~prediction\_error, [887](#)
- c, [888](#)



- delay\_d, 889
- delay\_w, 889
- gains, 888
- lpc\_order, 889
- n\_no\_update, 889
- name\_e, 888
- name\_f, 888
- name\_lpc, 888
- ntaps, 888
- patchbay, 889
- pred\_err\_delay, 889
- prediction\_error, 887
- prepare, 888
- process, 888
- release, 888
- rho, 888
- update\_cfg, 888
- prediction\_error.cpp, 1072
  - INSERT\_PATCH, 1072
  - make\_friendly\_number\_by\_limiting, 1072
  - PATCH\_VAR, 1072
- prediction\_error.h, 1072
- prediction\_error\_config, 889
  - ~prediction\_error\_config, 890
  - ac, 890
  - channels, 891
  - EPrew, 892
  - F, 891
  - F\_Uflt, 891
  - frames, 890
  - insert, 890
  - iter, 891
  - n\_no\_update\_, 891
  - name\_d\_, 891
  - name\_lpc\_, 891
  - no\_iter, 891
  - ntaps, 890
  - prediction\_error\_config, 890
  - process, 890
  - Pu, 891
  - s\_E\_pred\_err\_delay, 891
  - s\_LPC, 891
  - s\_U\_delay, 891
  - s\_U\_delayflt, 891
  - s\_Usmpl, 892
  - s\_Wflt, 891
  - s\_Y\_delay, 891
  - s\_Y\_delayflt, 891
  - s\_E, 891
  - s\_U, 891
  - s\_W, 891
  - smpl, 892
  - UPrew, 892
  - UPrewW, 892
  - UbufferPrew, 891
  - v\_G, 891
  - YPrew, 892
- prefix
  - wavrec\_t, 955
- prefix\_
  - MHAParser::mhapluginloader\_t, 684
- prefix\_names\_AC
  - acConcat\_wave, 153
- prepare
  - ac2Isl::ac2Isl\_t, 132
  - ac2osc\_t, 146
  - ac2wave\_if\_t, 149
  - acConcat\_wave, 153
  - acPooling\_wave, 161
  - acSteer, 173
  - acTransform\_wave, 177
  - acmon::acmon\_t, 158
  - acsave::acsave\_t, 166
  - addsndfile::addsndfile\_if\_t, 181
  - adm\_if\_t, 196
  - altplugs\_t, 214
  - analysispath\_if\_t, 220
  - bbcalib\_interface\_t, 229
  - calibrator\_t, 232
  - coherence::cohflt\_if\_t, 238
  - combc\_if\_t, 244
  - cpuload\_t, 248
  - db\_if\_t, 250
  - dc::dc\_if\_t, 254
  - dc\_simple::dc\_if\_t, 264
  - delay::interface\_t, 274
  - delaysum::delaysum\_if\_t, 276
  - doasvm\_classification, 280
  - doasvm\_feature\_extraction, 284
  - droptect\_t, 288
  - ds\_t, 291
  - example1\_t, 304
  - example2\_t, 307
  - example3\_t, 310
  - example4\_t, 314
  - example6\_t, 317
  - fader\_if\_t, 319
  - fader\_wave::fader\_wave\_if\_t, 321
  - fftfbpow::fftfbpow\_interface\_t, 325
  - fftfilterbank::fftfb\_interface\_t, 329
  - fshift::fshift\_t, 335
  - fshift\_hilbert::frequency\_translator\_t, 338

- fw\_t, 345
- gain::gain\_if\_t, 351
- gtfb\_analyzer::gtfb\_analyzer\_t, 357
- identity\_t, 360
- io\_alsa\_t, 363, 364
- io\_file\_t, 367
- io\_lib\_t, 370
- io\_parser\_t, 373
- io\_tcp\_sound\_t, 386
- io\_tcp\_t, 390
- lpc, 396
- lpc\_bl\_predictor, 399
- lpc\_burglattice, 404
- MHAIOJack::io\_jack\_t, 575
- MHAIOJackdb::io\_jack\_t, 580
- MHAJack::client\_t, 595, 596
- MHAParser::mhapluginloader\_t, 683
- MHAPLugin::plugin\_t, 730
- MHAPLugin\_Resampling::resampling\_if↔  
\_t, 734
- MHAPLugin\_Split::splitted\_part\_t, 754
- MHATableLookup::linear\_table\_t, 827
- matrixmixer::matmix\_t, 411
- mhachain::chain\_base\_t, 499
- mhachain::plugs\_t, 502
- multibandcompressor::interface\_t, 848
- nlms\_t, 852
- noise\_t, 854
- noisePowProposedScale::interface\_t, 856
- overlapadd::overlapadd\_if\_t, 860
- plingploing::if\_t, 866
- plugin\_interface\_t, 873
- PluginLoader::fourway\_processor\_t, 880
- PluginLoader::mhapluginloader\_t, 883
- prediction\_error, 888
- rmslevel\_if\_t, 893
- route::interface\_t, 896
- save\_spec\_t, 902
- save\_wave\_t, 903
- shadowfilter\_begin::shadowfilter\_begin↔  
\_t, 906
- shadowfilter\_end::shadowfilter\_end↔  
\_t, 909
- sine\_t, 911
- smoothgains\_bridge::overlapadd\_if↔  
\_t, 913
- softclip\_t, 917
- spec2wave\_if\_t, 921
- steerbf, 927
- testplugin::if\_t, 935
- timoSmooth, 946
- us\_t, 948
- wave2spec\_if\_t, 950
- wavrec\_t, 954
- prepare\_
  - iirfilter\_t, 361
  - MHAPLugin::plugin\_t, 731
  - MHAPLugin\_Split::split\_t, 749
- prepare\_impl
  - MHAJack::client\_t, 597
- prepare\_vars
  - fw\_t, 347
- prepared
  - ac2wave\_if\_t, 149
  - altplugs\_t, 216
  - calibrator\_t, 233
  - dc\_simple::dc\_if\_t, 265
  - example3\_t, 311
  - example4\_t, 315
  - fader\_wave::fader\_wave\_if\_t, 321
  - fftfilterbank::fftb\_interface\_t, 330
  - gtfb\_analyzer::gtfb\_analyzer\_t, 357
  - mhachain::plugs\_t, 502
  - route::interface\_t, 896
  - timoSmooth, 947
- preadaccess
  - MHAParser::base\_t, 642
- prescale
  - overlapadd::overlapadd\_if\_t, 861
- preset
  - dc::dc\_vars\_t, 259
  - dc\_simple::dc\_if\_t, 265
- prewnd
  - overlapadd::overlapadd\_t, 863
- print\_ac
  - analysemhaplugin.cpp, 967
- print\_plugin\_references
  - generatemhaplugin.doc.cpp, 982
- prior\_q
  - timo\_params, 940
  - timoSmooth, 947
- priorFact
  - noisePowProposedScale::noisePow↔  
Proposed, 859
  - timoConfig, 943
- priority
  - analysepath\_t, 218
  - analysispath\_if\_t, 220
  - io\_alsa\_t, 364
  - MHAPLugin\_Split::posix\_threads\_t, 746
- prob\_bias
  - acPooling\_wave, 162

- prob\_bias\_func
  - acPooling\_wave\_config, 164
- proc
  - MHAJack::client\_avg\_t, 590
  - MHAJack::client\_noncont\_t, 592
- proc\_1
  - smoothgains\_bridge::smoothspec\_↔  
wrap\_t, 915
- proc\_2
  - smoothgains\_bridge::smoothspec\_↔  
wrap\_t, 915
- proc\_cnt
  - mhachain::plugs\_t, 503
- proc\_err
  - io\_tcp\_fwcb\_t, 378
- proc\_error
  - fw\_t, 348
- proc\_error\_string
  - fw\_t, 348
- proc\_event
  - io\_alsa\_t, 364
  - io\_file\_t, 368
  - io\_parser\_t, 374
  - io\_tcp\_fwcb\_t, 377
  - MHAIOJackdb::io\_jack\_t, 581
  - MHAIOPortAudio::io\_portaudio\_t, 587
  - MHAJack::client\_t, 598
- proc\_handle
  - io\_alsa\_t, 364
  - io\_file\_t, 368
  - io\_parser\_t, 374
  - io\_tcp\_fwcb\_t, 377
  - MHAIOJackdb::io\_jack\_t, 581
  - MHAIOPortAudio::io\_portaudio\_t, 587
  - MHAJack::client\_t, 598
- proc\_lib
  - fw\_t, 348
- proc\_name
  - fw\_t, 347
- proc\_ramp
  - altplugs\_t, 215
- proc\_thread
  - io\_alsa\_t, 364
- proc\_wave
  - doasvm\_feature\_extraction\_config, 286
- process
  - ADM::ADM, 189
  - ADM::Delay, 192
  - ADM::Linearphase\_FIR, 194
  - ac2lsl::ac2lsl\_t, 132
  - ac2lsl::cfg\_t, 135
  - ac2osc\_t, 146
  - ac2wave\_if\_t, 149
  - ac2wave\_t, 150
  - acConcat\_wave, 153
  - acConcat\_wave\_config, 154
  - acPooling\_wave, 161
  - acPooling\_wave\_config, 163
  - acSteer, 173
  - acTransform\_wave, 177
  - acTransform\_wave\_config, 179
  - acmon::acmon\_t, 159
  - acsave::acsave\_t, 166, 167
  - addsndfile::addsndfile\_if\_t, 181
  - adm\_if\_t, 196
  - altplugs\_t, 215
  - analysispath\_if\_t, 220
  - bbcalib\_interface\_t, 229
  - calibrator\_runtime\_layer\_t, 230
  - calibrator\_t, 232
  - cfg\_t, 236
  - coherence::cohflt\_if\_t, 238
  - coherence::cohflt\_t, 240
  - combc\_if\_t, 244
  - combc\_t, 245
  - cpuload\_t, 248
  - db\_if\_t, 250
  - dc::dc\_if\_t, 254
  - dc::dc\_t, 256
  - dc\_simple::dc\_if\_t, 264, 265
  - dc\_simple::dc\_t, 267
  - dc\_simple::level\_smoother\_t, 272
  - delay::interface\_t, 274
  - delaysum::delaysum\_if\_t, 276
  - delaysum::delaysum\_t, 278
  - doasvm\_classification, 280
  - doasvm\_classification\_config, 282
  - doasvm\_feature\_extraction, 284
  - doasvm\_feature\_extraction\_config, 286
  - droptect\_t, 288
  - ds\_t, 291
  - example1\_t, 305
  - example2\_t, 307
  - example3\_t, 311
  - example4\_t, 314
  - example5\_t, 316
  - example6\_t, 317
  - fader\_if\_t, 319
  - fader\_wave::fader\_wave\_if\_t, 321
  - fftfbpow::fftfbpow\_interface\_t, 325
  - fftfilterbank::fftfb\_interface\_t, 329
  - fftfilterbank::fftfb\_plug\_t, 331

- fshift::fshift\_config\_t, 333
- fshift::fshift\_t, 335
- fshift\_hilbert::frequency\_translator\_t, 338
- fshift\_hilbert::hilbert\_shifter\_t, 341
- fw\_t, 346
- gain::gain\_if\_t, 351
- gtfb\_analyzer::gtfb\_analyzer\_t, 357
- identity\_t, 359, 360
- iirfilter\_t, 361
- io\_alsa\_t, 364
- io\_tcp\_fwcb\_t, 376
- lpc, 396
- lpc\_bl\_predictor, 399
- lpc\_bl\_predictor\_config, 401
- lpc\_burglattice, 404
- lpc\_burglattice\_config, 405
- lpc\_config, 407
- MHAFilter::partitioned\_convolution\_t, 556
- MHAFilter::thirdoctave\_analyzer\_t, 569
- MHAParser::mhapluginloader\_t, 683, 684
- MHAPLugin\_Resampling::resampling\_if↔  
\_t, 734
- MHAPLugin\_Resampling::resampling\_t,  
735
- MHAPLugin\_Split::domain\_handler\_t, 740
- MHAPLugin\_Split::split\_t, 749
- MHAPLugin\_Split::uni\_processor\_t, 760
- MHASignal::async\_rmslevel\_t, 765
- MHASignal::delay\_spec\_t, 766
- MHASignal::delay\_t, 767
- MHASignal::delay\_wave\_t, 769
- MHASignal::subsample\_delay\_t, 808
- matrixmixer::cfg\_t, 409
- matrixmixer::matmix\_t, 411
- mha\_dblbuf\_t, 435
- mhachain::chain\_base\_t, 498, 499
- mhachain::plugs\_t, 502
- multibandcompressor::interface\_t, 848
- nlms\_t, 852
- noise\_t, 854
- noisePowProposedScale::interface\_t, 856
- noisePowProposedScale::noisePow↔  
Proposed, 858
- overlapadd::overlapadd\_if\_t, 861
- plingploing::if\_t, 866
- plingploing::plingploing\_t, 869
- plugin\_interface\_t, 873
- PluginLoader::fourway\_processor\_t, 878,  
879
- PluginLoader::mhapluginloader\_t, 883
- prediction\_error, 888
- prediction\_error\_config, 890
- rmslevel\_if\_t, 893
- rmslevel\_t, 894
- route::interface\_t, 896
- route::process\_t, 897
- rt\_nlms\_t, 899
- save\_spec\_t, 902
- save\_wave\_t, 903
- shadowfilter\_begin::cfg\_t, 904
- shadowfilter\_begin::shadowfilter\_begin↔  
\_t, 906
- shadowfilter\_end::cfg\_t, 907
- shadowfilter\_end::shadowfilter\_end↔  
\_t, 909
- sine\_t, 911
- smoothgains\_bridge::overlapadd\_if↔  
\_t, 913
- softclip\_t, 917
- softclipper\_t, 918
- spec2wave\_if\_t, 921
- spec2wave\_t, 922
- steerbf, 927
- steerbf\_config, 929
- testplugin::if\_t, 935
- timoConfig, 942
- timoSmooth, 945
- us\_t, 948
- wave2spec\_if\_t, 950
- wave2spec\_t, 952
- wavrec\_t, 954
- wavwriter\_t, 956
- process\_frame
  - io\_parser\_t, 374
- process\_t
  - route::process\_t, 897
- ProcessMutex
  - analysepath\_t, 218
- processing\_done
  - MHAPLugin\_Split::posix\_threads\_t, 746
- processor
  - MHAPLugin\_Split::domain\_handler\_t, 741
  - MHAPLugin\_Split::thread\_platform\_t, 758
- prof\_algos
  - mhachain::plugs\_t, 503
- prof\_cfg
  - mhachain::plugs\_t, 503
- prof\_init
  - mhachain::plugs\_t, 503
- prof\_load\_con
  - mhachain::plugs\_t, 503
- prof\_prepare

- mhachain::plugs\_t, 503
- prof\_process
  - mhachain::plugs\_t, 503
- prof\_process\_load
  - mhachain::plugs\_t, 503
- prof\_process\_tt
  - mhachain::plugs\_t, 503
- prof\_release
  - mhachain::plugs\_t, 503
- prof\_tt\_con
  - mhachain::plugs\_t, 503
- profiling
  - mhachain::plugs\_t, 503
- provoke\_inner\_error
  - mha\_dbdbuf\_t, 435
- provoke\_outer\_error
  - mha\_dbdbuf\_t, 435
- psrate
  - fw\_vars\_t, 349
- Pu
  - prediction\_error\_config, 891
  - rt\_nlms\_t, 899
- push
  - MHASignal::stat\_t, 806
  - mha\_rt\_fifo\_t, 464
- push\_config
  - MHAPLugin::config\_t, 726
- put\_signal
  - MHAPLugin\_Split::domain\_handler\_t, 739
- pwinner\_out
  - MHAIOJackdb::io\_jack\_t, 582
- q
  - noisePowProposedScale::interface\_t, 857
- q\_high
  - timoConfig, 942
- q\_low
  - timoConfig, 942
- quant
  - calibrator\_runtime\_layer\_t, 230
- quantile
  - MHASignal, 123
- quantizer\_t
  - MHASignal::quantizer\_t, 792
- queries
  - MHAParser::base\_t, 642
  - plugindescription\_t, 875
- query\_addsubst
  - MHAParser::base\_t, 640
- query\_cmds
  - MHAParser::base\_t, 640
  - plugindescription\_t, 875
- query\_dump
  - MHAParser::base\_t, 638
  - MHAParser::monitor\_t, 687
  - MHAParser::parser\_t, 691
- query\_entries
  - MHAParser::base\_t, 638
  - MHAParser::parser\_t, 691
- query\_help
  - MHAParser::base\_t, 640
- query\_id
  - MHAParser::base\_t, 640
- query\_listids
  - MHAParser::base\_t, 640
  - MHAParser::parser\_t, 692
- query\_map\_t
  - MHAParser, 111
- query\_perm
  - MHAParser::base\_t, 639
  - MHAParser::monitor\_t, 687
  - MHAParser::variable\_t, 701
- query\_range
  - MHAParser::base\_t, 639
  - MHAParser::kw\_t, 671
  - MHAParser::range\_var\_t, 694
- query\_readfile
  - MHAParser::base\_t, 639
  - MHAParser::parser\_t, 691
- query\_savefile
  - MHAParser::base\_t, 639
  - MHAParser::parser\_t, 691
- query\_savefile\_compact
  - MHAParser::base\_t, 640
  - MHAParser::parser\_t, 692
- query\_savemons
  - MHAParser::base\_t, 640
  - MHAParser::parser\_t, 692
- query\_subst
  - MHAParser::base\_t, 640
- query\_t
  - MHAParser, 111
- query\_type
  - MHAParser::base\_t, 639
  - MHAParser::bool\_mon\_t, 645
  - MHAParser::bool\_t, 647
  - MHAParser::complex\_mon\_t, 653
  - MHAParser::complex\_t, 655
  - MHAParser::float\_mon\_t, 659
  - MHAParser::float\_t, 661
  - MHAParser::int\_mon\_t, 663
  - MHAParser::int\_t, 666
  - MHAParser::kw\_t, 671

- MHAParser::mcomplex\_mon\_t, 673
- MHAParser::mcomplex\_t, 675
- MHAParser::mfloat\_mon\_t, 677
- MHAParser::mfloat\_t, 679
- MHAParser::mint\_mon\_t, 686
- MHAParser::parser\_t, 691
- MHAParser::string\_mon\_t, 697
- MHAParser::string\_t, 699
- MHAParser::vcomplex\_mon\_t, 704
- MHAParser::vcomplex\_t, 706
- MHAParser::vfloat\_mon\_t, 708
- MHAParser::vfloat\_t, 710
- MHAParser::vint\_mon\_t, 712
- MHAParser::vint\_t, 714
- MHAParser::vstring\_mon\_t, 716
- MHAParser::vstring\_t, 718
- query\_val
  - MHAParser::base\_t, 639
  - MHAParser::bool\_mon\_t, 645
  - MHAParser::bool\_t, 647
  - MHAParser::complex\_mon\_t, 653
  - MHAParser::complex\_t, 655
  - MHAParser::float\_mon\_t, 659
  - MHAParser::float\_t, 661
  - MHAParser::int\_mon\_t, 663
  - MHAParser::int\_t, 666
  - MHAParser::kw\_t, 671
  - MHAParser::mcomplex\_mon\_t, 673
  - MHAParser::mcomplex\_t, 675
  - MHAParser::mfloat\_mon\_t, 677
  - MHAParser::mfloat\_t, 679
  - MHAParser::mint\_mon\_t, 686
  - MHAParser::parser\_t, 692
  - MHAParser::string\_mon\_t, 697
  - MHAParser::string\_t, 699
  - MHAParser::vcomplex\_mon\_t, 704
  - MHAParser::vcomplex\_t, 706
  - MHAParser::vfloat\_mon\_t, 708
  - MHAParser::vfloat\_t, 710
  - MHAParser::vint\_mon\_t, 712
  - MHAParser::vint\_t, 714
  - MHAParser::vstring\_mon\_t, 716
  - MHAParser::vstring\_t, 718
- query\_version
  - MHAParser::base\_t, 640
- quit
  - fw\_t, 346
- R
  - AuditoryProfile::parser\_t, 223
  - AuditoryProfile::profile\_t, 227
  - lpc\_config, 408
  - MHA\_TCP::OS\_EVENT\_TYPE, 480
  - r
    - mha\_real\_test\_array\_t, 460
  - RUNNING
    - MHA\_TCP::Thread, 488
  - rad2smpl
    - Vector and matrix processing toolbox, 46
  - ramp\_a
    - hanning\_ramps\_t, 358
  - ramp\_b
    - hanning\_ramps\_t, 358
  - ramp\_begin
    - MHAWindow::base\_t, 836
  - ramp\_counter
    - altplugs\_t, 216
  - ramp\_end
    - MHAWindow::base\_t, 836
  - ramp\_len
    - altplugs\_t, 216
  - ramplen
    - addsndfile::addsndfile\_if\_t, 182
    - altplugs\_t, 216
    - fader\_wave::fader\_wave\_if\_t, 321
    - spec2wave\_if\_t, 921
  - ramps
    - spec2wave\_t, 923
  - range
    - Vector and matrix processing toolbox, 42
  - range\_var\_t
    - MHAParser::range\_var\_t, 694
  - ratio
    - ds\_t, 291
    - us\_t, 948
  - raw\_p\_max\_name
    - acTransform\_wave, 178
    - acTransform\_wave\_config, 179
  - raw\_p\_name
    - acPooling\_wave\_config, 164
    - acTransform\_wave, 178
    - acTransform\_wave\_config, 179
  - rb\_f\_t
    - mha\_ruby.cpp, 1025
  - rdata
    - MHASignal::matrix\_t, 790
    - mha\_audio\_t, 429
  - re
    - mha\_complex\_t, 431
  - read
    - alsa\_base\_t, 207
    - alsa\_t, 212
    - MHAFilter::blockprocessing\_polyphase↔

- [\\_resampling\\_t](#), 519
- [MHAFilter::polyphase\\_resampling\\_t](#), 562
- [MHAJack::port\\_t](#), 601
- [mha\\_drifter\\_fifo\\_t](#), 441
- [mha\\_fifo\\_lw\\_t](#), 449
- [mha\\_fifo\\_t](#), 455
- [read\\_bytes](#)
  - [MHA\\_TCP::Connection](#), 476
- [read\\_event](#)
  - [MHA\\_TCP::Connection](#), 477
- [read\\_get\\_cpu\\_load](#)
  - [MHAIOJack::io\\_jack\\_t](#), 576
  - [MHAIOJackdb::io\\_jack\\_t](#), 581
- [read\\_get\\_scheduler](#)
  - [MHAIOJack::io\\_jack\\_t](#), 576
  - [MHAIOJackdb::io\\_jack\\_t](#), 581
- [read\\_get\\_xruns](#)
  - [MHAIOJack::io\\_jack\\_t](#), 576
  - [MHAIOJackdb::io\\_jack\\_t](#), 581
- [read\\_levels](#)
  - [calibrator\\_t](#), 233
- [read\\_line](#)
  - [MHA\\_TCP::Connection](#), 475
- [read\\_modified](#)
  - [dc\\_simple::dc\\_if\\_t](#), 265
- [read\\_ptr](#)
  - [mha\\_fifo\\_t](#), 456
- [readable\\_frames](#)
  - [MHAFilter::polyphase\\_resampling\\_t](#), 562
- [readaccess](#)
  - [MHAParser::base\\_t](#), 642
- [reader\\_started](#)
  - [mha\\_drifter\\_fifo\\_t](#), 443
- [reader\\_xruns\\_in\\_succession](#)
  - [mha\\_drifter\\_fifo\\_t](#), 444
- [reader\\_xruns\\_since\\_start](#)
  - [mha\\_drifter\\_fifo\\_t](#), 444
- [reader\\_xruns\\_total](#)
  - [mha\\_drifter\\_fifo\\_t](#), 443
- [real](#)
  - [MHASignal::matrix\\_t](#), 786–788
- [rear\\_channel](#)
  - [adm\\_rtconfig\\_t](#), 200
- [rear\\_channels](#)
  - [adm\\_if\\_t](#), 197
  - [adm\\_rtconfig\\_t](#), 200
- [rec\\_frames](#)
  - [acsave::cfg\\_t](#), 169
- [received\\_group](#)
  - [mhaserver\\_t](#), 762
- [receiver](#)
  - [MHAEvents::connector\\_t](#), 510
- [reciprocal](#)
  - [Complex arithmetics in the openMHA](#), 68
- [reclen](#)
  - [acsave::acsave\\_t](#), 167
- [recmode](#)
  - [acmon::acmon\\_t](#), 159
- [reconnect\\_inports](#)
  - [MHAIOJack::io\\_jack\\_t](#), 576
  - [MHAIOJackdb::io\\_jack\\_t](#), 580
- [reconnect\\_outports](#)
  - [MHAIOJack::io\\_jack\\_t](#), 576
  - [MHAIOJackdb::io\\_jack\\_t](#), 580
- [record](#)
  - [wavrec\\_t](#), 955
- [rect](#)
  - [MHAOvFilter::ShapeFun](#), 106
  - [MHAWindow](#), 126
- [rect\\_t](#)
  - [MHAWindow::rect\\_t](#), 842
- [relative](#)
  - [MHASignal::loop\\_wavefragment\\_t](#), 779
- [release](#)
  - [ac2lsl::ac2lsl\\_t](#), 132
  - [ac2osc\\_t](#), 146
  - [ac2wave\\_if\\_t](#), 149
  - [acConcat\\_wave](#), 153
  - [acPooling\\_wave](#), 162
  - [acSteer](#), 173
  - [acTransform\\_wave](#), 177
  - [acmon::acmon\\_t](#), 158
  - [acsave::acsave\\_t](#), 166
  - [addsndfile::addsndfile\\_if\\_t](#), 181
  - [adm\\_if\\_t](#), 196
  - [altplugs\\_t](#), 214
  - [analysispath\\_if\\_t](#), 220
  - [bbcalib\\_interface\\_t](#), 229
  - [calibrator\\_t](#), 232
  - [coherence::cohflt\\_if\\_t](#), 238
  - [db\\_if\\_t](#), 250
  - [dc\\_simple::dc\\_if\\_t](#), 264
  - [delaysum::delaysum\\_if\\_t](#), 276
  - [doasvm\\_classification](#), 280
  - [doasvm\\_feature\\_extraction](#), 284
  - [droptect\\_t](#), 288
  - [ds\\_t](#), 291
  - [example1\\_t](#), 304
  - [example2\\_t](#), 307
  - [example3\\_t](#), 311
  - [example4\\_t](#), 314
  - [fader\\_wave::fader\\_wave\\_if\\_t](#), 321

- fftfilterbank::fftfb\_interface\_t, 329
- fshift::fshift\_t, 336
- fshift\_hilbert::frequency\_translator\_t, 338
- fw\_t, 346
- gain::gain\_if\_t, 351
- identity\_t, 360
- io\_alsa\_t, 363
- io\_file\_t, 367
- io\_lib\_t, 371
- io\_parser\_t, 374
- io\_tcp\_sound\_t, 386
- io\_tcp\_t, 390
- lpc, 396
- lpc\_bl\_predictor, 399
- lpc\_burglattice, 404
- MHAIOJack::io\_jack\_t, 575
- MHAIOJackdb::io\_jack\_t, 580
- MHAJack::client\_t, 596
- MHAParser::mhapluginloader\_t, 683
- MHAPugin::plugin\_t, 731
- MHAPugin\_Resampling::resampling\_if\_↵  
\_t, 734
- MHAPugin\_Split::splitted\_part\_t, 754
- mhachain::chain\_base\_t, 499
- mhachain::plugs\_t, 502
- multibandcompressor::interface\_t, 848
- nlms\_t, 852
- overlapadd::overlapadd\_if\_t, 860
- PluginLoader::fourway\_processor\_t, 880
- PluginLoader::mhapluginloader\_t, 883
- prediction\_error, 888
- route::interface\_t, 896
- smoothgains\_bridge::overlapadd\_if\_↵  
t, 913
- steerbf, 928
- timoSmooth, 946
- us\_t, 948
- wavrec\_t, 954
- release\_
  - iirfilter\_t, 361
  - MHAPugin::plugin\_t, 731
  - MHAPugin\_Split::split\_t, 749
- release\_mutex
  - mha\_fifo\_posix\_threads\_t, 451
  - mha\_fifo\_thread\_platform\_t, 459
- remove\_abandonned
  - mha\_rt\_fifo\_t, 464
- remove\_all
  - mha\_rt\_fifo\_t, 464
- remove\_all\_cfg
  - MHAPugin::config\_t, 728
- remove\_item
  - MHAParser::parser\_t, 690, 691
- remove\_lock
  - mhamain.cpp, 1067
- remove\_ref
  - algo\_comm\_t, 203
  - MHAKernel::algo\_comm\_class\_t, 604
- remove\_var
  - algo\_comm\_t, 202
  - MHAKernel::algo\_comm\_class\_t, 604
- repl\_list
  - MHAParser::base\_t, 642
- repl\_list\_t
  - MHAParser::base\_t, 637
- replace
  - MHAParser::base\_t::replace\_t, 643
  - MHASignal::loop\_wavefragment\_t, 779
- replace\_
  - cfg\_t, 236
- replace\_t
  - MHAParser::base\_t::replace\_t, 643
- resampled\_num\_frames
  - addsndfile, 80
- resampled\_soundfile\_t
  - addsndfile::resampled\_soundfile\_t, 185
- resampling
  - MHAFilter::blockprocessing\_polyphase\_↵  
\_resampling\_t, 519
- resampling.cpp, 1073
- resampling\_factors
  - MHAFilter, 97
- resampling\_filter\_t
  - MHAFilter::resampling\_filter\_t, 564
- resampling\_if\_t
  - MHAPugin\_Resampling::resampling\_if\_↵  
\_t, 734
- resampling\_t
  - MHAPugin\_Resampling::resampling\_t,  
735
- resamplingmode
  - addsndfile::addsndfile\_if\_t, 182
- reset
  - droptect\_t, 289
  - MHA\_TCP::Async\_Notify, 469
  - MHA\_TCP::Wakeup\_Event, 494
- reset\_state
  - MHAFilter::gammaflt\_t, 537
- resize
  - MHAFilter::iir\_filter\_t, 542
- resolution
  - acTransform\_wave\_config, 179



- resolve
  - dynamiclib\_t, 292
- resolve\_and\_init
  - PluginLoader::mhapluginloader\_t, 884
- resolve\_checked
  - dynamiclib\_t, 292
- result
  - cpuload\_t, 249
- resynthesis\_gain
  - MHAFilter::gammaflt\_t, 538
- ret\_size
  - MHAParser::c\_ifc\_parser\_t, 650
- return\_imag
  - fftfilterbank::fftfb\_interface\_t, 330
- return\_imag\_
  - fftfilterbank::fftfb\_plug\_t, 331
- return\_value
  - MHA\_TCP::Thread, 489
- return\_wave
  - wave2spec\_if\_t, 950
- retv
  - MHAParser::c\_ifc\_parser\_t, 650
- rewind
  - MHASignal::loop\_wavefragment\_t, 781
- rho
  - nlms\_t, 852
  - prediction\_error, 888
- ringbuffer
  - MHAFilter::polyphase\_resampling\_t, 563
- ringbuffer\_t
  - MHASignal::ringbuffer\_t, 795
- rm\_parent\_on\_remove
  - MHAParser::base\_t, 641
- rms
  - MHASignal::loop\_wavefragment\_t, 779
  - plingploing::plingploing\_t, 870
- rms\_limit40
  - MHASignal::loop\_wavefragment\_t, 779
- rmsdb
  - example6\_t, 317
- rmslevel
  - calibrator\_variables\_t, 234
  - dc::dc\_t, 256
  - MHASignal::async\_rmslevel\_t, 764
  - Vector and matrix processing toolbox, 57, 58
- rmslevel.cpp, 1073
- rmslevel\_if\_t, 892
  - name, 893
  - prepare, 893
  - process, 893
- rmslevel\_if\_t, 893
- rmslevel\_t, 894
  - ffflen, 894
  - insert, 894
  - level, 894
  - level\_db, 894
  - peak, 894
  - peak\_db, 894
  - process, 894
  - rmslevel\_t, 894
- rmslevelmeter
  - transducers.cpp, 1083
- root
  - mha\_rt\_fifo\_t, 464
- rotated\_i
  - acTransform\_wave\_config, 179
- rotated\_p
  - acTransform\_wave\_config, 179
- rotated\_p\_max\_name
  - acTransform\_wave, 178
- rotated\_p\_name
  - acTransform\_wave, 178
- route, 129
- route.cpp, 1073
- route::interface\_t, 895
  - algo, 896
  - cfac, 896
  - cfin, 896
  - cfout, 896
  - interface\_t, 896
  - patchbay, 896
  - prepare, 896
  - prepared, 896
  - process, 896
  - release, 896
  - route\_ac, 896
  - route\_out, 896
  - stopped, 896
  - update, 896
- route::process\_t, 897
  - process, 897
  - process\_t, 897
  - sout, 897
  - sout\_ac, 897
  - wout, 897
  - wout\_ac, 897
- route\_ac
  - route::interface\_t, 896
- route\_out
  - route::interface\_t, 896
- rows

- acsave::mat4head\_t, 169
- rt\_nlms\_t, 898
  - ~rt\_nlms\_t, 899
  - ac, 899
  - channels, 899
  - F, 899
  - frames, 899
  - fu, 900
  - fu\_previous, 900
  - fufit, 900
  - insert, 899
  - n\_no\_update\_, 900
  - name\_d\_, 900
  - name\_e\_, 900
  - name\_u\_, 900
  - no\_iter, 900
  - ntaps, 899
  - P\_Sum, 900
  - process, 899
  - Pu, 899
  - rt\_nlms\_t, 899
  - s\_E, 900
  - U, 899
  - Uflt, 899
  - y\_previous, 900
- rt\_process
  - analysepath\_t, 218
- rt\_strict
  - ac2lsl::ac2lsl\_t, 133
  - ac2osc\_t, 147
- rtcalibrator
  - transducers.cpp, 1083
- rtmem
  - ac2osc\_t, 147
- run
  - MHA\_TCP::Thread, 489
  - mhaserver\_t, 762
- runtime configuration, 5
- rval
  - MHAParser::expression\_t, 657
- s\_E\_pred\_err\_delay
  - prediction\_error\_config, 891
- s\_LPC
  - prediction\_error\_config, 891
- s\_U\_delay
  - prediction\_error\_config, 891
- s\_U\_delayflt
  - prediction\_error\_config, 891
- s\_Usmpl
  - prediction\_error\_config, 892
- s\_Wflt
  - prediction\_error\_config, 891
- s\_Y\_delay
  - prediction\_error\_config, 891
- s\_Y\_delayflt
  - prediction\_error\_config, 891
- s\_b
  - lpc\_bl\_predictor\_config, 402
  - lpc\_burglattice\_config, 406
- s\_E
  - prediction\_error\_config, 891
  - rt\_nlms\_t, 900
- s\_f
  - lpc\_bl\_predictor\_config, 402
  - lpc\_burglattice\_config, 406
- s\_file\_in
  - io\_file\_t, 368
- s\_in
  - io\_file\_t, 368
  - io\_parser\_t, 374
  - io\_tcp\_sound\_t, 388
  - MHAIOPortAudio::io\_portaudio\_t, 587
  - MHAJack::client\_t, 599
- s\_out
  - coherence::cohflt\_t, 241
  - combc\_t, 245
  - fftfilterbank::fftfb\_plug\_t, 331
  - gtfb\_analyzer::gtfb\_analyzer\_cfg\_t, 355
  - io\_file\_t, 368
  - io\_parser\_t, 374
  - MHAIOPortAudio::io\_portaudio\_t, 587
  - MHAJack::client\_t, 599
- s\_U
  - prediction\_error\_config, 891
- s\_W
  - prediction\_error\_config, 891
- sInput
  - MHAFilter::fftfilter\_t, 527
- SOCKET\_ERROR
  - mha\_tcp.cpp, 1040
- SOCKET
  - MHA\_TCP, 92
  - mha\_tcp.cpp, 1040
- SPP
  - timo\_AC, 938
- START\_BETA
  - ADM, 81
- STRERROR
  - MHA\_TCP, 92
- STRLEN
  - mha\_errno.c, 999
- sWeights

- MHAFilter::fftfiler\_t, 527
- safe\_div
  - Complex arithmetics in the openMHA, 67
  - mha\_signal.cpp, 1028
  - mha\_signal.hh, 1037
- sample
  - lpc\_config, 408
- samplerate
  - io\_file\_t, 367
  - io\_tcp\_sound\_t, 387
  - MHAIOPortAudio::io\_portaudio\_t, 587
  - MHAJack::client\_t, 598
- samples\_AC
  - acConcat\_wave, 153
- samplingrate
  - MHAOvFilter::fftfb\_t, 618
- save\_m
  - acsave::save\_var\_t, 171
- save\_mat4
  - acsave::save\_var\_t, 170
- save\_spec.cpp, 1073
- save\_spec\_t, 901
  - basename, 902
  - prepare, 902
  - process, 902
  - save\_spec\_t, 901
- save\_txt
  - acsave::save\_var\_t, 170
- save\_var\_t
  - ac2lsl::save\_var\_t, 138
  - ac2lsl::save\_var\_t< mha\_complex\_t >, 141
  - acsave::save\_var\_t, 170
- save\_vars
  - acmon::acmon\_t, 159
- save\_wave.cpp, 1073
- save\_wave\_t, 902
  - basename, 903
  - prepare, 903
  - process, 903
  - save\_wave\_t, 903
- saveas\_mat4
  - MHASignal, 123, 124
- sc
  - MHASignal::hilbert\_fftw\_t, 776
  - spec2wave\_t, 923
- scale
  - example5\_t, 316
  - MHASignal, 121
  - MHASignal::fft\_t, 775
  - MHASignal::spectrum\_t, 804
  - MHASignal::waveform\_t, 821
- scale\_ch
  - example2\_t, 308
  - example3\_t, 311
  - example4\_t, 315
  - plugin\_interface\_t, 873
- scale\_channel
  - MHASignal::spectrum\_t, 805
  - MHASignal::waveform\_t, 821
- scale\_frame
  - MHASignal::waveform\_t, 822
- scale\_fun\_t
  - MHAOvFilter, 103
- scale\_var\_t
  - MHAOvFilter::scale\_var\_t, 633
- scafac
  - MHATableLookup::linear\_table\_t, 828
- scaler\_t
  - gain::scaler\_t, 352
- scan\_dir
  - addsndfile::addsndfile\_if\_t, 182
- scan\_plugin
  - pluginbrowser\_t, 874
- scan\_plugins
  - pluginbrowser\_t, 874
- scheduler
  - analysepath\_t, 218
  - MHAPlugin\_Split::posix\_threads\_t, 746
- schroeder\_t
  - MHASignal::schroeder\_t, 799
- search\_pattern
  - addsndfile::addsndfile\_if\_t, 182
- search\_result
  - addsndfile::addsndfile\_if\_t, 182
- sec2smp
  - Vector and matrix processing toolbox, 44
- select\_plug
  - altplugs\_t, 216
- select\_source
  - MHAMultiSrc::base\_t, 608
- selected\_plug
  - altplugs\_t, 216
- send\_frame
  - ac2lsl::save\_var\_base\_t, 136
  - ac2lsl::save\_var\_t, 140
  - ac2lsl::save\_var\_t< mha\_complex\_t >, 142
- send\_osc\_float
  - ac2osc\_t, 146
- Server
  - MHA\_TCP::Server, 481, 482

- server
  - io\_tcp\_t, 391
- server\_fragsize
  - MHAIOJackdb::io\_jack\_t, 582
- server\_port\_open
  - io\_tcp\_parser\_t, 383
- server\_srate
  - MHAIOJackdb::io\_jack\_t, 582
- servername
  - MHAIOJack::io\_jack\_t, 576
  - MHAIOJackdb::io\_jack\_t, 581
- serversocket
  - MHA\_TCP::Server, 483
- set
  - Complex arithmetics in the openMHA, 63, 64
  - MHA\_TCP::Async\_Notify, 469
  - testplugin::config\_parser\_t, 933
- set\_announce\_port
  - mhaserver\_t, 762
- set\_buf\_address
  - ac2lsl::save\_var\_base\_t, 137
  - ac2lsl::save\_var\_t, 139
  - ac2lsl::save\_var\_t< mha\_complex\_t >, 142
- set\_channelcnt
  - MHAFilter::adapt\_filter\_t, 516
- set\_connected
  - io\_tcp\_parser\_t, 382
- set\_entries
  - MHAParser::keyword\_list\_t, 668
- set\_errnos
  - io\_tcp\_fwcb\_t, 376
- set\_error
  - mha\_fifo\_lw\_t, 449
- set\_fb\_pars
  - DynComp::dc\_afterburn\_t, 295
- set\_help
  - MHAParser::base\_t, 641
- set\_id\_string
  - MHAParser::parser\_t, 692
- set\_index
  - MHAParser::keyword\_list\_t, 668
- set\_input\_domain
  - MHAPlugin\_Split::domain\_handler\_t, 738
- set\_input\_portnames
  - MHAJack::client\_t, 597
- set\_level
  - addsndfile::addsndfile\_if\_t, 182
  - fader\_wave::fader\_wave\_if\_t, 321
- set\_level\_db
  - MHASignal::loop\_wavefragment\_t, 781
- set\_level\_lin
  - MHASignal::loop\_wavefragment\_t, 781
- set\_local\_port
  - io\_tcp\_parser\_t, 380
- set\_locate
  - MHAIOJackdb::io\_jack\_t, 581
- set\_max\_angle\_ind
  - parser\_int\_dyn, 865
- set\_minabs
  - mha\_signal.cpp, 1028
  - mha\_signal.hh, 1037
- set\_new\_peer
  - io\_tcp\_parser\_t, 382
- set\_node\_id
  - MHAParser::base\_t, 640
- set\_output\_domain
  - MHAPlugin\_Split::domain\_handler\_t, 738
- set\_output\_portnames
  - MHAJack::client\_t, 597
- set\_parse\_cb
  - MHAParser::c\_ifc\_parser\_t, 649
- set\_range
  - MHAParser::kw\_t, 671
  - MHAParser::range\_var\_t, 694
- set\_server\_port\_open
  - io\_tcp\_parser\_t, 381
- set\_state
  - MHAFilter::complex\_bandpass\_t, 521
  - MHAFilter::iir\_ord1\_real\_t, 544
- set\_tau
  - MHAFilter::o1flt\_lowpass\_t, 550
  - MHAFilter::o1flt\_maxtrack\_t, 552
  - MHAFilter::o1flt\_mintrack\_t, 554
- set\_tau\_attack
  - MHAFilter::o1\_ar\_filter\_t, 547
- set\_tau\_release
  - MHAFilter::o1\_ar\_filter\_t, 547
- set\_use\_jack\_transport
  - MHAIOJackdb::io\_jack\_t, 581
  - MHAJack::client\_t, 597
- set\_value
  - MHAParser::keyword\_list\_t, 668
- set\_weights
  - MHAFilter::complex\_bandpass\_t, 521
  - MHAFilter::gamma\_filt\_t, 537
- set\_xfun
  - MHATableLookup::xy\_table\_t, 832
- set\_xmax
  - MHATableLookup::linear\_table\_t, 827
- set\_xmin

- MHATableLookup::linear\_table\_t, 826
- set\_xyfun
  - MHATableLookup::xy\_table\_t, 833
- set\_yfun
  - MHATableLookup::xy\_table\_t, 833
- setchannels
  - dc::wideband\_inhib\_vars\_t, 262
- setlock
  - io\_file\_t, 367
  - MHAParser::variable\_t, 701
  - testplugin::config\_parser\_t, 933
- sf
  - MHASndFile::sf\_t, 823
  - wavwriter\_t, 956
- sf\_in
  - io\_file\_t, 368
- sf\_out
  - io\_file\_t, 368
- sf\_t
  - MHASndFile::sf\_t, 823
- sf\_wave\_t
  - MHASndFile::sf\_wave\_t, 824
- sfinf\_in
  - io\_file\_t, 368
- sfinf\_out
  - io\_file\_t, 368
- shadowfilter\_begin, 129
- shadowfilter\_begin.cpp, 1074
- shadowfilter\_begin::cfg\_t, 903
  - cfg\_t, 904
  - in\_spec\_copy, 904
  - nch, 904
  - ntracks, 904
  - out\_spec, 904
  - process, 904
- shadowfilter\_begin::shadowfilter\_begin\_t, 905
  - basename, 906
  - nch, 906
  - ntracks, 906
  - prepare, 906
  - process, 906
  - shadowfilter\_begin\_t, 905
- shadowfilter\_begin\_t
  - shadowfilter\_begin::shadowfilter\_begin↔\_t, 905
- shadowfilter\_end, 129
- shadowfilter\_end.cpp, 1074
- shadowfilter\_end::cfg\_t, 906
  - ac, 907
  - cfg\_t, 907
  - gains, 907
  - in\_spec, 907
  - name, 907
  - nch\_out, 907
  - nfft, 907
  - ntracks, 907
  - out\_spec, 907
  - process, 907
- shadowfilter\_end::shadowfilter\_end\_t, 908
  - basename, 909
  - prepare, 909
  - process, 909
  - shadowfilter\_end\_t, 908
- shadowfilter\_end\_t
  - shadowfilter\_end::shadowfilter\_end↔\_t, 908
- shape
  - MHAOvFilter::fftb\_t, 618
- shapes
  - MHAOvFilter::fftb\_vars\_t, 621
- shift
  - lpc, 397
  - lpc\_config, 407
- shifted
  - fshift\_hilbert::hilbert\_shifter\_t, 341
- side
  - mha\_channel\_info\_t, 430
- sign\_t
  - MHASignal::schroeder\_t, 799
- signal
  - testplugin::if\_t, 935
- signal\_counter
  - MHASignal, 125
- signal\_out
  - MHAPlugin\_Split::split\_t, 750
- signal\_parser\_t
  - testplugin::signal\_parser\_t, 936
- sin125
  - speechnoise\_t, 925
- sin1k
  - speechnoise\_t, 925
- sin250
  - speechnoise\_t, 925
- sin2k
  - speechnoise\_t, 925
- sin4k
  - speechnoise\_t, 925
- sin500
  - speechnoise\_t, 925
- sin8k
  - speechnoise\_t, 925
- sinc

- MHAFilter, 97
- sine.cpp, 1074
- sine\_cfg\_t, 909
  - amplitude, 910
  - channels, 910
  - mix, 910
  - phase\_increment\_div\_2pi, 910
  - sine\_cfg\_t, 910
- sine\_t, 910
  - ~sine\_t, 911
  - channels, 912
  - frequency, 912
  - lev, 912
  - mode, 912
  - patchbay, 912
  - phase\_div\_2pi, 912
  - prepare, 911
  - process, 911
  - sine\_t, 911
  - update\_cfg, 911
- size
  - MHA\_AC::ac2matrix\_helper\_t, 413
  - MHA\_AC::acspace2matrix\_t, 418
  - MHAKernel::algo\_comm\_class\_t, 605
  - MHASignal::matrix\_t, 786
  - Vector and matrix processing toolbox, 48, 49
- size\_t
  - MHAParser::keyword\_list\_t, 667
- skip
  - ac2lsl::ac2lsl\_t, 133
  - ac2lsl::cfg\_t, 135
  - ac2osc\_t, 147
- skipcnt
  - ac2lsl::cfg\_t, 135
  - ac2osc\_t, 147
- Sleep
  - mha\_tcp.hh, 1042
- slope
  - softclipper\_t, 918
  - softclipper\_variables\_t, 920
- slope\_db
  - softclip\_t, 917
- smoothgains\_bridge, 130
- smoothgains\_bridge.cpp, 1074
- smoothgains\_bridge::overlapadd\_if\_t, 912
  - ~overlapadd\_if\_t, 913
  - algo, 914
  - cf\_in, 914
  - cf\_out, 914
  - epsilon, 914
  - irswnd, 914
  - mode, 914
  - overlapadd\_if\_t, 913
  - patchbay, 914
  - plugloader, 914
  - prepare, 913
  - process, 913
  - release, 913
  - update, 914
- smoothgains\_bridge::smoothspec\_wrap\_↔
  - t, 914
  - proc\_1, 915
  - proc\_2, 915
  - smoothspec, 915
  - smoothspec\_epsilon, 915
  - smoothspec\_wrap\_t, 915
  - spec\_in\_copy, 915
  - use\_smoothspec, 915
- smoothspec
  - MHAFilter::smoothspec\_t, 567
  - smoothgains\_bridge::smoothspec\_↔
    - wrap\_t, 915
- smoothspec\_epsilon
  - smoothgains\_bridge::smoothspec\_↔
    - wrap\_t, 915
- smoothspec\_t
  - MHAFilter::smoothspec\_t, 566
- smoothspec\_wrap\_t
  - smoothgains\_bridge::smoothspec\_↔
    - wrap\_t, 915
- smp2rad
  - Vector and matrix processing toolbox, 45
- smp2sec
  - Vector and matrix processing toolbox, 44
- smp1
  - prediction\_error\_config, 892
- sn\_in
  - MHAJack::client\_avg\_t, 590
  - MHAJack::client\_noncont\_t, 592
- sn\_out
  - MHAJack::client\_avg\_t, 590
  - MHAJack::client\_noncont\_t, 593
- sndfile\_t
  - addsndfile::sndfile\_t, 186
- snprintf\_required\_length
  - mha\_error\_helpers, 90
- snrPost1Debug
  - noisePowProposedScale::noisePow↔
    - Proposed, 858
- sock\_addr
  - MHA\_TCP::Server, 483

- sock\_init\_t
  - MHA\_TCP::sock\_init\_t, 484
- sock\_initializer
  - MHA\_TCP, 93
- Socketaccept\_Event
  - MHA\_TCP::Socketaccept\_Event, 484
- Socketread\_Event
  - MHA\_TCP::Socketread\_Event, 485
- Socketwrite\_Event
  - MHA\_TCP::Socketwrite\_Event, 486
- softclip
  - calibrator\_runtime\_layer\_t, 230
  - calibrator\_variables\_t, 234
- softclip.cpp, 1075
- softclip\_t, 916
  - attack, 917
  - decay, 917
  - patchbay, 917
  - prepare, 917
  - process, 917
  - slope\_db, 917
  - softclip\_t, 917
  - start\_limit, 917
  - tftype, 917
  - update, 917
- softclipper\_t, 917
  - attack, 918
  - clipmeter, 918
  - decay, 918
  - hardlimit, 918
  - linear, 918
  - process, 918
  - slope, 918
  - softclipper\_t, 918
  - threshold, 918
- softclipper\_variables\_t, 919
  - clipped, 920
  - hardlimit, 920
  - linear, 920
  - max\_clipped, 920
  - slope, 920
  - softclipper\_variables\_t, 919
  - tau\_attack, 919
  - tau\_clip, 920
  - tau\_decay, 920
  - threshold, 920
- sort\_fftw2spec
  - MHASignal::fft\_t, 774
- sort\_spec2fftw
  - MHASignal::fft\_t, 774
- sound
  - io\_tcp\_t, 391
- source\_channel\_index
  - MHAFilter::partitioned\_convolution\_t↔  
::index\_t, 559
  - MHAFilter::transfer\_function\_t, 572
- source\_id
  - ac2lsl::ac2lsl\_t, 133
  - ac2lsl::cfg\_t, 135
- sout
  - matrixmixer::cfg\_t, 409
  - route::process\_t, 897
- sout\_ac
  - route::process\_t, 897
- spec2fir
  - MHAFilter, 97
  - MHAFilter::smoothspec\_t, 567
- spec2spec
  - plugindescription\_t, 875
- spec2wave
  - MHASignal::fft\_t, 773
  - plugindescription\_t, 875
- spec2wave.cpp, 1075
  - max, 1075
  - min, 1075
- spec2wave\_if\_t, 920
  - patchbay, 921
  - prepare, 921
  - process, 921
  - ramplen, 921
  - spec2wave\_if\_t, 921
  - update, 921
  - window\_config, 921
- spec2wave\_scale
  - MHASignal::fft\_t, 774
- spec2wave\_t, 922
  - ~spec2wave\_t, 922
  - calc\_out, 923
  - ft, 922
  - nfft, 923
  - npad1, 922
  - npad2, 923
  - nwndshift, 923
  - out\_buf, 923
  - postwindow, 923
  - process, 922
  - ramps, 923
  - sc, 923
  - spec2wave\_t, 922
  - write\_buf, 923
- spec\_fader\_t, 923
  - ~spec\_fader\_t, 924

- fr, [924](#)
- gains, [924](#)
- nch, [924](#)
- spec\_fader\_t, [924](#)
- spec\_in
  - MHAPLugin\_Split::domain\_handler\_t, [741](#)
  - overlapadd::overlapadd\_t, [863](#)
  - wave2spec\_t, [953](#)
- spec\_in\_copy
  - smoothgains\_bridge::smoothspec\_↔  
wrap\_t, [915](#)
- spec\_out
  - MHAPLugin\_Split::domain\_handler\_t, [741](#)
  - MHAPLugin\_Split::split\_t, [751](#)
  - timoConfig, [943](#)
- specSteer1
  - acSteer\_config, [175](#)
- specSteer2
  - acSteer\_config, [175](#)
- spectrum\_t
  - MHA\_AC::spectrum\_t, [423](#)
  - MHAMultiSrc::spectrum\_t, [610](#)
  - MHASignal::spectrum\_t, [802](#)
- speechnoise
  - calibrator\_runtime\_layer\_t, [231](#)
- speechnoise.cpp, [1075](#)
  - bandw\_correction, [1077](#)
  - erb\_hz\_f\_hz, [1077](#)
  - fhz2bandno, [1077](#)
  - hz2hz, [1077](#)
  - NUM\_ENTR\_LTASS, [1076](#)
  - NUM\_ENTR\_MHAORIG, [1076](#)
  - NUM\_ENTR\_OLNOISE, [1076](#)
  - vLTASS\_combined\_lev, [1078](#)
  - vLTASS\_female\_lev, [1078](#)
  - vLTASS\_freq, [1077](#)
  - vLTASS\_male\_lev, [1078](#)
  - vMHAOrigFreq, [1077](#)
  - vMHAOrigSpec, [1077](#)
  - vOlnoiseFreq, [1078](#)
  - vOlnoiseLev, [1078](#)
- speechnoise.h, [1078](#)
- speechnoise\_t, [924](#)
  - brown, [925](#)
  - creator, [926](#)
  - LTASS\_combined, [925](#)
  - LTASS\_female, [925](#)
  - LTASS\_male, [925](#)
  - mha, [925](#)
  - noise\_type\_t, [925](#)
  - olnoise, [925](#)
  - pink, [925](#)
  - sin125, [925](#)
  - sin1k, [925](#)
  - sin250, [925](#)
  - sin2k, [925](#)
  - sin4k, [925](#)
  - sin500, [925](#)
  - sin8k, [925](#)
  - speechnoise\_t, [926](#)
  - TEN\_SPL\_250\_8k, [925](#)
  - TEN\_SPL\_50\_16k, [925](#)
  - TEN\_SPL, [925](#)
  - white, [925](#)
- split.cpp, [1078](#)
  - default\_thread\_platform\_string, [1079](#)
  - default\_thread\_platform\_type, [1079](#)
  - MHAPLUGIN\_OVERLOAD\_OUTDOM↔  
AIN, [1079](#)
  - posixthreads, [1079](#)
- split\_t
  - MHAPLugin\_Split::split\_t, [749](#)
- splitted\_part\_t
  - MHAPLugin\_Split::splitted\_part\_t, [753](#)
- spnoise\_channels
  - calibrator\_variables\_t, [234](#)
- spnoise\_level
  - calibrator\_variables\_t, [234](#)
- spnoise\_mode
  - calibrator\_variables\_t, [234](#)
- spnoise\_parser
  - calibrator\_variables\_t, [234](#)
- spp
  - timoSmooth, [947](#)
- srate
  - ac2lsl::cfg\_t, [135](#)
  - adm\_if\_t, [197](#)
  - calibrator\_variables\_t, [234](#)
  - MHAParser::mhaconfig\_mon\_t, [682](#)
  - MHAPLugin\_Resampling::resampling\_if↔  
\_t, [734](#)
  - mhaconfig\_t, [505](#)
  - testplugin::config\_parser\_t, [933](#)
- srate\_
  - MHAFilter::gammaflt\_t, [538](#)
- srcfile
  - MHAParser::parser\_t, [692](#)
- srcline
  - MHAParser::parser\_t, [692](#)
- start
  - alsa\_base\_t, [207](#)
  - alsa\_t, [211](#)



- fw\_t, [345](#)
- io\_alsa\_t, [363](#)
- io\_file\_t, [367](#)
- io\_lib\_t, [371](#)
- io\_parser\_t, [373](#)
- io\_tcp\_fwcb\_t, [376](#)
- io\_tcp\_t, [390](#)
- MHAJack::client\_t, [596](#)
- start\_event
  - io\_alsa\_t, [364](#)
  - io\_file\_t, [368](#)
  - io\_parser\_t, [374](#)
  - io\_tcp\_fwcb\_t, [377](#)
  - MHAIOPortAudio::io\_portaudio\_t, [587](#)
  - MHAJack::client\_t, [599](#)
- start\_handle
  - io\_alsa\_t, [364](#)
  - io\_file\_t, [368](#)
  - io\_parser\_t, [374](#)
  - io\_tcp\_fwcb\_t, [378](#)
  - MHAIOPortAudio::io\_portaudio\_t, [587](#)
  - MHAJack::client\_t, [599](#)
- start\_limit
  - softclip\_t, [917](#)
- start\_lin
  - cfg\_t, [236](#)
- start\_new\_session
  - wavrec\_t, [954](#)
- started
  - fw\_t, [346](#)
  - io\_parser\_t, [374](#)
- starting
  - mha\_drifter\_fifo\_t, [443](#)
- startpos
  - addsndfile::addsndfile\_if\_t, [182](#)
- startsample
  - io\_file\_t, [368](#)
- startup\_zeros
  - mha\_drifter\_fifo\_t, [444](#)
- stat\_t
  - MHA\_AC::stat\_t, [425](#)
  - MHASignal::stat\_t, [806](#)
- state
  - fw\_t, [348](#)
  - gtfb\_analyzer::gtfb\_analyzer\_cfg\_t, [355](#)
  - MHA\_TCP::Thread, [489](#)
  - MHAFilter::filter\_t, [535](#)
- state\_cpuload
  - MHAIOJack::io\_jack\_t, [577](#)
  - MHAIOJackdb::io\_jack\_t, [582](#)
- state\_parser
  - MHAIOJack::io\_jack\_t, [577](#)
  - MHAIOJackdb::io\_jack\_t, [582](#)
- state\_priority
  - MHAIOJack::io\_jack\_t, [577](#)
  - MHAIOJackdb::io\_jack\_t, [582](#)
- state\_scheduler
  - MHAIOJack::io\_jack\_t, [577](#)
  - MHAIOJackdb::io\_jack\_t, [582](#)
- state\_t
  - fw\_t, [345](#)
- state\_xruns
  - MHAIOJack::io\_jack\_t, [577](#)
  - MHAIOJackdb::io\_jack\_t, [582](#)
- states
  - gtfb\_analyzer::gtfb\_analyzer\_cfg\_t, [354](#)
- staticgain
  - coherence::cohflt\_t, [241](#)
  - coherence::vars\_t, [242](#)
- status
  - MHA\_TCP::Wakeup\_Event, [495](#)
- std
  - MHA\_AC::stat\_t, [425](#)
- std\_vector\_float
  - Vector and matrix processing toolbox, [53](#)
- std\_vector\_vector\_complex
  - Vector and matrix processing toolbox, [54](#)
- std\_vector\_vector\_float
  - Vector and matrix processing toolbox, [53](#)
- stdcomplex
  - Complex arithmetics in the openMHA, [64](#)
- steerFile
  - acSteer, [174](#)
- steerbf, [926](#)
  - ~steerbf, [927](#)
  - angle\_ind, [928](#)
  - angle\_src, [928](#)
  - bf\_src, [928](#)
  - patchbay, [928](#)
  - prepare, [927](#)
  - process, [927](#)
  - release, [928](#)
  - steerbf, [927](#)
  - update\_cfg, [928](#)
- steerbf.cpp, [1079](#)
- INSERT\_PATCH, [1080](#)
- PATCH\_VAR, [1080](#)
- steerbf.h, [1080](#)
- steerbf\_config, [928](#)
  - \_steerbf, [929](#)
  - ~steerbf\_config, [929](#)
  - ac, [929](#)

- bf\_src\_copy, 929
- bf\_vec, 929
- nangle, 929
- nchan, 929
- nfreq, 929
- outSpec, 929
- process, 929
- steerbf\_config, 929
- stime
  - MHA\_TCP, 93
- stop
  - alsa\_base\_t, 207
  - alsa\_t, 211
  - fw\_t, 345
  - io\_alsa\_t, 363
  - io\_file\_t, 367
  - io\_lib\_t, 371
  - io\_parser\_t, 374
  - io\_tcp\_fwcb\_t, 377
  - io\_tcp\_t, 390
  - MHAJack::client\_t, 596
  - mha\_drifter\_fifo\_t, 442
- stop\_event
  - io\_alsa\_t, 364
  - io\_file\_t, 368
  - io\_parser\_t, 374
  - io\_tcp\_fwcb\_t, 377
  - MHAIOPortAudio::io\_portaudio\_t, 587
  - MHAJack::client\_t, 599
- stop\_handle
  - io\_alsa\_t, 364
  - io\_file\_t, 368
  - io\_parser\_t, 374
  - io\_tcp\_fwcb\_t, 378
  - MHAIOPortAudio::io\_portaudio\_t, 587
  - MHAJack::client\_t, 599
- stopped
  - fw\_t, 346
  - io\_file\_t, 367
  - io\_parser\_t, 374
  - MHAJack::client\_t, 598
  - route::interface\_t, 896
- store
  - mon\_t, 844
- store\_frame
  - acsave::cfg\_t, 168
  - acsave::save\_var\_t, 170
- str2val
  - MHAParser::StrCnv, 114, 115
- str2val< mha\_real\_t >
  - MHAParser::StrCnv, 114
- str\_error
  - MHAJack::client\_t, 597
- strNames\_AC
  - acConcat\_wave\_config, 154
- strdom
  - analysemhaplugin.cpp, 967
  - latex\_doc\_t, 393
- stream
  - ac2lsl::save\_var\_t, 140
  - ac2lsl::save\_var\_t< mha\_complex\_t >, 143
- stream\_dir
  - alsa\_dev\_par\_parser\_t, 209
- strict\_channel\_match
  - io\_file\_t, 368
- strict\_srate\_match
  - io\_file\_t, 368
- stride
  - comm\_var\_t, 247
  - testplugin::ac\_parser\_t, 931
- string\_mon\_t
  - MHAParser::string\_mon\_t, 696
- string\_t
  - MHAParser::string\_t, 699
- strreplace
  - MHAParser, 111
- structVersion
  - MHAIOPortAudio::device\_info\_t, 584
- subsample\_delay\_t
  - MHASignal::subsample\_delay\_t, 807
- subsampledelay\_coeff
  - ADM, 81
- sum
  - MHASignal::stat\_t, 806
  - MHASignal::waveform\_t, 816, 817
- sum2
  - MHASignal::stat\_t, 806
- sum\_channel
  - MHASignal::waveform\_t, 817
- sumsqr
  - MHASignal::waveform\_t, 817
- sumsqr\_channel
  - Vector and matrix processing toolbox, 59
- sumsqr\_frame
  - Vector and matrix processing toolbox, 60
- svc
  - analysepath\_t, 218
- symmetry\_scale
  - MHAOvIFilter::fspacing\_t, 626
- sync
  - mha\_fifo\_lw\_t, 449

- mha\_fifo\_thread\_guard\_t, 457
- sysread
  - MHA\_TCP::Connection, 473
- syswrite
  - MHA\_TCP::Connection, 474
- T
- T
  - MHA\_TCP::OS\_EVENT\_TYPE, 480
- t
- acsave::mat4head\_t, 169
  - mha\_tictoc\_t, 495
  - plingploing::plingploing\_t, 869
- tAC
  - timoConfig, 942
- TEN\_SPL\_250\_8k
  - speechnoise\_t, 925
- TEN\_SPL\_50\_16k
  - speechnoise\_t, 925
- TEN\_SPL
  - speechnoise\_t, 925
- table
  - cpuload\_t, 249
- table\_t
  - MHATableLookup::table\_t, 829
- tail
  - MHAFilter::fftfilterbank\_t, 531
- target\_channel\_index
  - MHAFilter::partitioned\_convolution\_t↔  
::index\_t, 559
  - MHAFilter::transfer\_function\_t, 572
- tau
  - coherence::vars\_t, 242
  - droptect\_t, 289
  - fader\_if\_t, 319
- tau\_attack
  - softclipper\_variables\_t, 919
- tau\_beta
  - adm\_if\_t, 197
- tau\_clip
  - softclipper\_variables\_t, 920
- tau\_decay
  - softclipper\_variables\_t, 920
- tau\_level
  - calibrator\_variables\_t, 234
- tau\_unit
  - coherence::vars\_t, 242
- tauattack
  - dc::dc\_vars\_t, 258
  - dc\_simple::dc\_vars\_t, 270
- taudecay
  - dc::dc\_vars\_t, 259
  - dc\_simple::dc\_vars\_t, 270
- taugain
  - DynComp::dc\_afterburn\_vars\_t, 298
- taurmslevel
  - dc::dc\_vars\_t, 258
- tcp\_connect\_to
  - mha\_tcp.cpp, 1040
- tcp\_connect\_to\_with\_timeout
  - mha\_tcp.cpp, 1040
- tcpserver
  - mhaserver\_t, 763
- termination\_request
  - MHAPLugin\_Split::posix\_threads\_t, 746
- test\_error
  - io\_lib\_t, 371
  - MHAParser::c\_ifc\_parser\_t, 649
  - PluginLoader::mhapluginloader\_t, 884
- test\_fail
  - dc\_simple, 84
- test\_prepare
  - testplugin::if\_t, 935
- test\_process
  - testplugin::if\_t, 935
- test\_version
  - PluginLoader::mhapluginloader\_t, 884
- testalsadevice.c, 1080
  - main, 1080
- testplugin, 130
- testplugin.cpp, 1080
- testplugin::ac\_parser\_t, 930
  - \_MHA\_AC\_CHAR, 931
  - \_MHA\_AC\_DOUBLE, 931
  - \_MHA\_AC\_FLOAT, 931
  - \_MHA\_AC\_INT, 931
  - \_MHA\_AC\_MHACOMPLEX, 931
  - \_MHA\_AC\_MHAREAL, 931
  - \_unknown, 931
- ac\_parser\_t, 931
- char\_data, 931
- complex\_data, 931
- data\_type, 931
- data\_type\_t, 931
- do\_get\_var, 931
- do\_insert\_var, 931
- float\_data, 931
- get\_var, 931
- insert\_var, 931
- int\_data, 931
- num\_entries, 931
- patchbay, 931
- stride, 931
- testplugin::config\_parser\_t, 932

- channels, 933
- config\_parser\_t, 932
- domain, 933
- fftlens, 933
- fragsize, 933
- get, 933
- set, 933
- setlock, 933
- srates, 933
- wndlen, 933
- testplugin::if\_t, 934
  - \_prepare, 935
  - ac, 935
  - config\_in, 935
  - config\_out, 935
  - if\_t, 935
  - patchbay, 935
  - plug, 935
  - prepare, 935
  - process, 935
  - signal, 935
  - test\_prepare, 935
  - test\_process, 935
- testplugin::signal\_parser\_t, 936
  - input\_spec, 936
  - input\_wave, 936
  - output\_spec, 936
  - output\_wave, 936
  - signal\_parser\_t, 936
- tftype
  - MHAPlugin::plugin\_t, 732
  - softclip\_t, 917
- The MHA Framework interface, 27
- The openMHA configuration language, 34
- The openMHA Plugins (programming interface), 7
  - MHAPLUGIN\_CALLBACKS\_PREFIX, 9
  - MHAPLUGIN\_CALLBACKS, 9
  - MHAPLUGIN\_DOCUMENTATION, 10
- The openMHA Toolbox library, 35
- thefullname
  - MHAParser::base\_t, 642
- thirddoctave\_analyzer\_t
  - MHAFilter::thirddoctave\_analyzer\_t, 569
- this\_outer\_out
  - MHASignal::doublebuffer\_t, 772
- thr\_f
  - MHA\_TCP::Thread, 488
- Thread
  - MHA\_TCP::Thread, 488
- thread
  - analysepath\_t, 218
  - io\_tcp\_t, 391
  - MHAPlugin\_Split::posix\_threads\_t, 746
  - MHAPlugin\_Split::splitted\_part\_t, 756
  - thread\_arg
    - MHA\_TCP::Thread, 490
  - thread\_attr
    - MHA\_TCP::Thread, 489
  - thread\_finish\_event
    - MHA\_TCP::Thread, 489
  - thread\_func
    - MHA\_TCP::Thread, 490
  - thread\_handle
    - MHA\_TCP::Thread, 489
  - thread\_platform
    - MHAPlugin\_Split::split\_t, 750
  - thread\_platform\_t
    - MHAPlugin\_Split::thread\_platform\_t, 757
  - thread\_start
    - analysispath.cpp, 968
    - io\_alsa\_t, 363
    - MHAPlugin\_Split::posix\_threads\_t, 745
  - thread\_start\_func
    - mha\_tcp.cpp, 1040
  - thread\_startup\_function
    - MHA\_IOTCP.cpp, 1063
  - threshold
    - droptect\_t, 289
    - softclipper\_t, 918
    - softclipper\_variables\_t, 920
  - tictoc
    - mhachain::plugs\_t, 503
  - timeout
    - MHA\_TCP::OS\_EVENT\_TYPE, 480
    - MHA\_TCP::Timeout\_Watcher, 492
  - Timeout\_Event
    - MHA\_TCP::Timeout\_Event, 491
  - Timeout\_Watcher
    - MHA\_TCP::Timeout\_Watcher, 492
  - timeshift
    - Vector and matrix processing toolbox, 50
  - timo\_AC, 937
    - alpha\_frame\_AC, 938
    - alpha\_hat\_AC, 938
    - copy, 937
    - gain\_wiener\_AC, 938
    - gamma\_post\_AC, 937
    - insert, 937
    - lambda\_ceps\_AC, 938
    - lambda\_ml\_AC, 938
    - lambda\_ml\_ceps\_AC, 938

- lambda\_ml\_smooth\_AC, 938
- lambda\_spec\_AC, 938
- log\_lambda\_spec\_AC, 938
- max\_q\_AC, 938
- max\_val\_AC, 938
- pitch\_set\_first\_AC, 938
- pitch\_set\_last\_AC, 938
- SPP, 938
- timo\_AC, 937
- winF0\_AC, 938
- xi\_est\_AC, 938
- xi\_ml\_AC, 938
- timo\_params, 939
  - alpha\_const\_limits\_hz, 940
  - alpha\_const\_vals, 940
  - alpha\_pitch, 940
  - beta\_const, 940
  - delta\_pitch, 940
  - f0\_high, 940
  - f0\_low, 940
  - gain\_min\_db, 940
  - in\_cfg, 940
  - kappa\_const, 940
  - lambda\_thresh, 940
  - noisePow\_name, 940
  - prior\_q, 940
  - timo\_params, 939
  - winF0, 940
  - xi\_min\_db, 940
  - xi\_opt\_db, 940
- timoConfig, 940
  - ~timoConfig, 942
  - ac, 942
  - alpha\_const, 942
  - alpha\_frame, 943
  - alpha\_hat, 943
  - alpha\_prev, 943
  - copy\_AC, 942
  - fftlens, 942
  - GLRexp, 943
  - GLR, 943
  - gain\_min, 942
  - gain\_wiener, 943
  - gamma\_post, 943
  - lambda\_ceps, 943
  - lambda\_ceps\_prev, 943
  - lambda\_ml\_ceps, 943
  - lambda\_ml\_full, 943
  - lambda\_ml\_smooth, 943
  - lambda\_spec, 943
  - log\_lambda\_spec, 943
  - logGLRFact, 943
  - max\_q, 943
  - max\_val, 943
  - mha\_fft, 942
  - nchan, 942
  - nfreq, 942
  - noisePow, 943
  - ola\_powspec\_scale, 942
  - params, 942
  - pitch\_set\_first, 943
  - pitch\_set\_last, 943
  - powSpec, 943
  - priorFact, 943
  - process, 942
  - q\_high, 942
  - q\_low, 942
  - spec\_out, 943
  - tAC, 942
  - timoConfig, 942
  - winF0, 942
  - xi\_est, 943
  - xi\_min, 942
  - xi\_ml, 943
  - xiOpt, 943
- timoSmooth, 944
  - ~timoSmooth, 945
  - alpha\_const\_limits\_hz, 947
  - alpha\_const\_vals, 947
  - alpha\_pitch, 946
  - beta\_const, 946
  - delta\_pitch, 946
  - f0\_high, 946
  - f0\_low, 946
  - gain\_min\_db, 947
  - kappa\_const, 946
  - lambda\_thresh, 946
  - noisePow\_name, 947
  - on\_model\_param\_valuechanged, 946
  - patchbay, 947
  - prepare, 946
  - prepared, 947
  - prior\_q, 947
  - process, 945
  - release, 946
  - spp, 947
  - timoSmooth, 945
  - update\_cfg, 946
  - win\_f0, 947
  - xi\_min\_db, 946
  - xi\_opt\_db, 947
- timoSmooth.cpp, 1081

- INSERT\_PATCH, [1082](#)
- INSERT\_VAR, [1082](#)
- PATCH\_VAR, [1082](#)
- timoconfig.cpp, [1081](#)
- CHANLOOP, [1081](#)
- EPSILON, [1081](#)
- LPSCALE, [1081](#)
- OVERLAP\_FACTOR, [1081](#)
- POWSPEC\_FACTOR, [1081](#)
- timoconfig.h, [1081](#)
- timosmooth.h, [1082](#)
- tmp\_spec
  - MHAFilter::smoothspec\_t, [568](#)
- tmp\_wave
  - MHAFilter::smoothspec\_t, [568](#)
- to\_from
  - acTransform\_wave, [178](#)
  - acTransform\_wave\_config, [179](#)
- total\_read
  - io\_file\_t, [368](#)
- transducers.cpp, [1082](#)
- kw\_index2type, [1083](#)
- rmslevelmeter, [1083](#)
- rtcalibrator, [1083](#)
- vint\_0123n1, [1083](#)
- transfer\_function\_t
  - MHAFilter::transfer\_function\_t, [571](#)
- trigger\_processing
  - MHAPugin\_Split::split\_t, [749](#)
  - MHAPugin\_Split::splitted\_part\_t, [755](#)
- trim
  - MHAParser, [111](#)
- try\_accept
  - MHA\_TCP::Server, [483](#)
- try\_write
  - MHA\_TCP::Connection, [476](#)
- ttl
  - ac2osc\_t, [147](#)
- tv1
  - mha\_tictoc\_t, [495](#)
- tv2
  - mha\_tictoc\_t, [495](#)
- types
  - ac2lsl, [78](#)
- tz
  - mha\_tictoc\_t, [495](#)
- U
  - rt\_nlms\_t, [899](#)
- UCL
  - AuditoryProfile::parser\_t::ear\_t, [224](#)
  - AuditoryProfile::profile\_t::ear\_t, [227](#)
- UPrew
  - prediction\_error\_config, [892](#)
- UPrewW
  - prediction\_error\_config, [892](#)
- UbufferPrew
  - prediction\_error\_config, [891](#)
- Ufft
  - rt\_nlms\_t, [899](#)
- uint\_mode
  - addsndfile::addsndfile\_if\_t, [182](#)
- uint\_vector\_t
  - MHASignal::uint\_vector\_t, [810](#)
- underflow
  - MHAFilter::polyphase\_resampling\_t, [563](#)
- unit
  - MHAOvIFilter::fscale\_t, [624](#)
- unit2hz
  - MHAOvIFilter::scale\_var\_t, [633](#)
- unlock\_channels
  - fw\_vars\_t, [349](#)
- unlock\_srate\_fragmentsize
  - fw\_vars\_t, [349](#)
- unset\_fb\_pars
  - DynComp::dc\_afterburn\_t, [295](#)
- up
  - MHASignal::schroeder\_t, [799](#)
- up\_incl
  - MHAParser::range\_var\_t, [695](#)
- up\_limit
  - MHAParser::range\_var\_t, [695](#)
  - MHASignal::quantizer\_t, [793](#)
- up\_thresh
  - acPooling\_wave\_config, [164](#)
- update
  - ac2lsl::ac2lsl\_t, [133](#)
  - ac2wave\_if\_t, [149](#)
  - addsndfile::addsndfile\_if\_t, [181](#)
  - adm\_if\_t, [196](#)
  - calibrator\_t, [233](#)
  - coherence::cohflt\_if\_t, [238](#)
  - dc::dc\_if\_t, [254](#)
  - dc::wideband\_inhib\_vars\_t, [262](#)
  - delay::interface\_t, [274](#)
  - DynComp::dc\_afterburn\_t, [296](#)
  - DynComp::gaintable\_t, [301](#)
  - fshift\_hilbert::frequency\_translator\_t, [338](#)
  - MHA\_AC::ac2matrix\_t, [414](#)
  - MHA\_AC::acspace2matrix\_t, [418](#)
  - MHA\_AC::stat\_t, [425](#)
  - MHAMultiSrc::spectrum\_t, [610](#)
  - MHAMultiSrc::waveform\_t, [612](#)

- MHAParser::mhaconfig\_mon\_t, 681
- MHAPugin\_Split::split\_t, 749
- mhachain::chain\_base\_t, 499
- nlms\_t, 852
- overlapadd::overlapadd\_if\_t, 861
- plingploing::if\_t, 866
- route::interface\_t, 896
- smoothgains\_bridge::overlapadd\_if\_↔  
t, 914
- softclip\_t, 917
- spec2wave\_if\_t, 921
- wave2spec\_if\_t, 950
- update\_bbgain
  - gain::gain\_if\_t, 351
- update\_burner
  - DynComp::dc\_afterburn\_t, 295
- update\_cfg
  - acConcat\_wave, 153
  - acPooling\_wave, 162
  - acSteer, 174
  - acTransform\_wave, 178
  - delaysum::delaysum\_if\_t, 276
  - doasvm\_classification, 281
  - doasvm\_feature\_extraction, 285
  - example6\_t, 317
  - fader\_if\_t, 319
  - fftfbpow::fftfbpow\_interface\_t, 325
  - fftfilterbank::fftfb\_interface\_t, 329
  - fshift::fshift\_t, 336
  - gtfb\_analyzer::gtfb\_analyzer\_t, 357
  - lpc, 397
  - lpc\_bl\_predictor, 400
  - lpc\_burglattice, 404
  - multibandcompressor::interface\_t, 848
  - noise\_t, 854
  - noisePowProposedScale::interface\_t, 856
  - plugin\_interface\_t, 873
  - prediction\_error, 888
  - sine\_t, 911
  - steerbf, 928
  - timoSmooth, 946
- update\_coeffs
  - MHAFilter::fftfiler\_t, 525
  - MHAFilter::fftfilerbank\_t, 529
- update\_dc
  - dc\_simple::dc\_if\_t, 265
- update\_filter
  - MHAFilter::iir\_filter\_t, 542
- update\_frame
  - addsndfile::level\_adapt\_t, 184
  - fader\_wave::level\_adapt\_t, 323
- update\_gain
  - gain::gain\_if\_t, 351
- update\_gain\_mon
  - dc\_simple::dc\_if\_t, 265
- update\_hz
  - MHAOvIFilter::fscale\_bw\_t, 623
  - MHAOvIFilter::fscale\_t, 624
- update\_level
  - dc\_simple::dc\_if\_t, 265
- update\_level\_mon
  - dc\_simple::dc\_if\_t, 265
- update\_levels
  - multibandcompressor::plugin\_signals\_t,  
850
- update\_m
  - matrixmixer::matmix\_t, 411
- update\_minmax
  - gain::gain\_if\_t, 351
- update\_mode
  - ac2osc\_t, 146
- update\_monitors
  - dc::dc\_if\_t, 254
- update\_mu
  - MHAFilter::adapt\_filter\_t, 516
- update\_ntaps
  - MHAFilter::adapt\_filter\_t, 516
- update\_parser
  - windowselector\_t, 959
- update\_proc\_load
  - mhachain::plugs\_t, 502
- update\_ramplen
  - altplugs\_t, 215
- update\_recmode
  - acmon::acmon\_t, 159
- update\_selector\_list
  - altplugs\_t, 215
- update\_tau\_level
  - calibrator\_t, 233
- update\_varlist
  - ac2lsl::cfg\_t, 135
- updated
  - windowselector\_t, 959
- updater
  - MHAOvIFilter::fscale\_bw\_t, 623
  - MHAOvIFilter::fscale\_t, 624
- upper\_threshold
  - acPooling\_wave, 162
- upsample.cpp, 1083
- upsampling\_factor
  - MHAFilter::polyphase\_resampling\_t, 563
- upscale

- MHASignal::quantizer\_t, 793
- us\_t, 947
  - antialias, 948
  - prepare, 948
  - process, 948
  - ratio, 948
  - release, 948
  - us\_t, 948
- use\_date
  - wavrec\_t, 955
- use\_frozen\_
  - cfg\_t, 236
- use\_jack\_transport
  - MHAIOJackdb::io\_jack\_t, 581
  - MHAJack::client\_t, 599
- use\_mat
  - acmon::ac\_monitor\_t, 157
- use\_own\_ac
  - altplugs\_t, 216
- use\_sine
  - cpuload\_t, 249
- use\_smoothspec
  - smoothgains\_bridge::smoothspec\_↔
    - wrap\_t, 915
- use\_wbinhib
  - dc::dc\_vars\_t, 259
- user
  - MHAParser::window\_t, 721
- user\_err\_msg
  - MHAIOFile.cpp, 1049
  - MHAIOJack.cpp, 1052
  - MHAIOJackdb.cpp, 1054
  - MHAIOParser.cpp, 1057
  - MHAIOPortAudio.cpp, 1060
  - MHAIOTCP.cpp, 1064
  - MHAIOalsa.cpp, 1046
- user\_t
  - MHAWindow::user\_t, 843
- username
  - MHA\_AC::ac2matrix\_helper\_t, 413
- userwnd
  - windowselector\_t, 959
- v\_G
  - prediction\_error\_config, 891
- vFlog
  - DynComp::gaintable\_t, 303
- vGCC\_ac
  - doasvm\_feature\_extraction\_config, 286
- vGCC\_con
  - acConcat\_wave\_config, 154
- vGCC\_name
  - doasvm\_classification, 281
  - doasvm\_feature\_extraction, 285
- vGCC
  - acConcat\_wave\_config, 154
  - doasvm\_feature\_extraction\_config, 286
- vLTASS\_combined\_lev
  - speechnoise.cpp, 1078
- vLTASS\_female\_lev
  - speechnoise.cpp, 1078
- vLTASS\_freq
  - speechnoise.cpp, 1077
- vLTASS\_male\_lev
  - speechnoise.cpp, 1078
- vMHAOrigFreq
  - speechnoise.cpp, 1077
- vMHAOrigSpec
  - speechnoise.cpp, 1077
- vOlnoiseFreq
  - speechnoise.cpp, 1078
- vOlnoiseLev
  - speechnoise.cpp, 1078
- val2str
  - MHAParser::StrCnv, 115, 116
- val\_max
  - alsa\_t, 213
- val\_min
  - alsa\_t, 213
- validate
  - AuditoryProfile::parser\_t::fmap\_t, 225
  - MHAParser::keyword\_list\_t, 668
  - MHAParser::kw\_t, 671
  - MHAParser::range\_var\_t, 694, 695
- validator\_channels
  - mhasndfile.cpp, 1068
- validator\_length
  - mhasndfile.cpp, 1068
- value
  - AuditoryProfile::parser\_t::fmap\_t, 225
  - MHASignal::ringbuffer\_t, 795
  - MHASignal::spectrum\_t, 803
  - MHASignal::waveform\_t, 815, 816
  - mha\_signal.hh, 1037
  - Vector and matrix processing toolbox, 50–53
- value\_type
  - mha\_dblbuf\_t, 434
  - mha\_fifo\_t, 454
- valuechanged
  - MHAParser::base\_t, 641
- variable, 4
- variable\_name



- mha\_stash\_environment\_variable\_t, 467
- variable\_t
  - MHAParser::variable\_t, 701
- variables, 4
  - acsave::acsave\_t, 167
- varlist
  - ac2lsl::cfg\_t, 135
  - acmon::acmon\_t, 159
  - acsave::acsave\_t, 167
  - acsave::cfg\_t, 169
- varlist\_t
  - acsave::acsave\_t, 166
- vars
  - ac2lsl::ac2lsl\_t, 133
  - ac2osc\_t, 147
  - acmon::acmon\_t, 159
  - analysispath\_if\_t, 220
  - calibrator\_t, 233
  - coherence::cohflt\_if\_t, 238
  - MHAKernel::algo\_comm\_class\_t, 606
- vars\_t
  - coherence::vars\_t, 242
  - MHAOvFilter::overlap\_save\_filterbank\_↔  
t::vars\_t, 631
- vbark
  - MHAOvFilter::barkscale, 103
- vbin1
  - MHAOvFilter::fftfb\_t, 618
- vbin2
  - MHAOvFilter::fftfb\_t, 618
- vcomplex\_mon\_t
  - MHAParser::vcomplex\_mon\_t, 703
- vcomplex\_t
  - MHAParser::vcomplex\_t, 706
- vec\_y
  - MHATableLookup::linear\_table\_t, 828
- Vector and matrix processing toolbox, 37
  - assign, 49, 50
  - bin2freq, 45
  - channels, 42
  - clear, 49
  - colored\_intensity, 57
  - conjugate, 60
  - copy\_channel, 56
  - db2lin, 43
  - dbspl2pa, 44
  - dupvec, 46
  - dupvec\_chk, 47
  - equal\_dim, 47, 48
  - for\_each, 43
  - freq2bin, 45
  - integrate, 48
  - lin2db, 43
  - max, 59
  - maxabs, 57, 58
  - mha\_real\_t, 42
  - min, 59
  - operator\*=: 54, 55
  - operator^=: 56
  - operator+=, 54, 55
  - operator-=, 54
  - operator/=, 55
  - pa22dbspl, 44
  - pa2dbspl, 43
  - rad2smp, 46
  - range, 42
  - rmslevel, 57, 58
  - sec2smp, 44
  - size, 48, 49
  - smp2rad, 45
  - smp2sec, 44
  - std\_vector\_float, 53
  - std\_vector\_vector\_complex, 54
  - std\_vector\_vector\_float, 53
  - sumsqr\_channel, 59
  - sumsqr\_frame, 60
  - timeshift, 50
  - value, 50–53
- vF
  - DynComp::gaintable\_t, 303
- vfloat\_mon\_t
  - MHAParser::vfloat\_mon\_t, 708
- vfloat\_t
  - MHAParser::vfloat\_t, 710
- vfreq
  - MHAOvFilter::barkscale, 103
- vint\_0123n1
  - transducers.cpp, 1083
- vint\_mon\_t
  - MHAParser::vint\_mon\_t, 712
- vint\_t
  - MHAParser::vint\_t, 714
- vL
  - DynComp::gaintable\_t, 302
- vmax
  - gain::gain\_if\_t, 351
- vmin
  - gain::gain\_if\_t, 351
- vstring\_mon\_t
  - MHAParser::vstring\_mon\_t, 716
- vstring\_t
  - MHAParser::vstring\_t, 718

- vy
  - MHATableLookup::linear\_table\_t, 828
- W
  - MHA\_TCP::OS\_EVENT\_TYPE, 480
  - MHAFilter::adapt\_filter\_state\_t, 515
- w
  - ac2wave\_t, 150
  - doasvm\_classification, 281
  - MHAOvFilter::fftfb\_t, 618
- w\_out
  - combc\_t, 245
- WINAPI
  - mha\_plugin.hh, 1023
- wIRS\_fft
  - MHAFilter::fftfiler\_t, 527
- wInput
  - MHAFilter::fftfiler\_t, 527
- wInput\_fft
  - MHAFilter::fftfiler\_t, 526
- wOutput
  - MHAFilter::fftfiler\_t, 527
- wOutput\_fft
  - MHAFilter::fftfiler\_t, 527
- wait
  - MHA\_TCP::Event\_Watcher, 479
- wait\_for\_decrease
  - mha\_fifo\_posix\_threads\_t, 451
  - mha\_fifo\_thread\_platform\_t, 459
- wait\_for\_increase
  - mha\_fifo\_posix\_threads\_t, 451
  - mha\_fifo\_thread\_platform\_t, 459
- Wakeup\_Event
  - MHA\_TCP::Wakeup\_Event, 494
- wave
  - alsa\_t, 212
- wave2spec
  - MHASignal::fft\_t, 773
  - plugindescription\_t, 875
- wave2spec.cpp, 1083
  - MHAPLUGIN\_OVERLOAD\_OUTDOM↔AIN, 1083
- wave2spec\_if\_t, 949
  - algo, 950
  - nfft, 950
  - nwnd, 950
  - patchbay, 950
  - prepare, 950
  - process, 950
  - return\_wave, 950
  - update, 950
  - wave2spec\_if\_t, 950
  - window\_config, 950
  - wndpos, 950
- wave2spec\_scale
  - MHASignal::fft\_t, 774
- wave2spec\_t, 951
  - ~wave2spec\_t, 952
  - calc\_in, 953
  - calc\_pre\_wnd, 952
  - ft, 952
  - in\_buf, 953
  - npad1, 952
  - npad2, 952
  - nwnd, 952
  - nwndshift, 952
  - process, 952
  - spec\_in, 953
  - wave2spec\_t, 952
  - window, 953
- wave2wave
  - plugindescription\_t, 875
- wave\_fifo
  - analysepath\_t, 218
- wave\_in
  - MHAPLugin\_Split::domain\_handler\_t, 741
- wave\_in1
  - overlapadd::overlapadd\_t, 863
- wave\_out
  - MHAPLugin\_Split::domain\_handler\_t, 741
  - MHAPLugin\_Split::split\_t, 751
- wave\_out1
  - overlapadd::overlapadd\_t, 863
- wave\_reader
  - addsndfile, 80
- waveform\_proxy\_t
  - addsndfile::waveform\_proxy\_t, 188
- waveform\_t
  - MHA\_AC::waveform\_t, 426
  - MHAMultiSrc::waveform\_t, 612
  - MHASignal::waveform\_t, 814
- wavrec.cpp, 1083
  - DEBUG, 1084
- wavrec\_t, 953
  - fifolen, 955
  - minwrite, 955
  - patchbay, 955
  - prefix, 955
  - prepare, 954
  - process, 954
  - record, 955
  - release, 954
  - start\_new\_session, 954

- use\_date, 955
- wavrec\_t, 954
- wavwriter\_t, 955
  - ~wavwriter\_t, 956
  - act\_, 956
  - cf\_, 956
  - close\_session, 956
  - data, 956
  - fifo, 956
  - minw\_, 956
  - process, 956
  - sf, 956
  - wavwriter\_t, 956
  - write\_thread, 956
  - writethread, 956
- wb\_inhib\_cfg\_t
  - dc::wb\_inhib\_cfg\_t, 261
- wbinhib
  - dc::dc\_if\_t, 254
- weights
  - dc::wb\_inhib\_cfg\_t, 261
  - dc::wideband\_inhib\_vars\_t, 262
  - delaysum::delaysum\_if\_t, 276
  - delaysum::delaysum\_t, 278
- what
  - MHA\_Error, 446
- white
  - speechnoise\_t, 925
- wideband\_inhib\_vars\_t
  - dc::wideband\_inhib\_vars\_t, 262
- win\_f0
  - timoSmooth, 947
- winF0
  - timo\_params, 940
  - timoConfig, 942
- winF0\_AC
  - timo\_AC, 938
- window
  - MHAFilter::smoothspec\_t, 568
  - overlapadd::overlapadd\_if\_t, 861
  - wave2spec\_t, 953
- window\_config
  - spec2wave\_if\_t, 921
  - wave2spec\_if\_t, 950
- window\_t
  - MHAParser::window\_t, 720
- windowselector.cpp, 1084
- windowselector.h, 1084
- windowselector\_t, 957
  - ~windowselector\_t, 958
  - get\_window\_data, 958
- insert\_items, 958
- invalidate\_window\_data, 959
- patchbay, 959
- update\_parser, 959
- updated, 959
- userwnd, 959
- windowselector\_t, 958
- wnd, 959
- wndexp, 959
- wndtype, 959
- wnd
  - addsndfile::level\_adapt\_t, 184
  - fader\_wave::level\_adapt\_t, 323
  - windowselector\_t, 959
- wnd\_bartlett
  - MHAParser::window\_t, 720
- wnd\_blackman
  - MHAParser::window\_t, 720
- wnd\_funs
  - mha\_windowparser.cpp, 1042
- wnd\_hamming
  - MHAParser::window\_t, 720
- wnd\_hann
  - MHAParser::window\_t, 720
- wnd\_rect
  - MHAParser::window\_t, 720
- wnd\_user
  - MHAParser::window\_t, 720
- wndexp
  - overlapadd::overlapadd\_if\_t, 861
  - windowselector\_t, 959
- wndlen
  - doasvm\_feature\_extraction\_config, 286
  - MHAParser::mhaconfig\_mon\_t, 681
  - mhaconfig\_t, 505
  - testplugin::config\_parser\_t, 933
- wndpos
  - overlapadd::overlapadd\_if\_t, 861
  - wave2spec\_if\_t, 950
- wndtype
  - windowselector\_t, 959
- worker\_thread\_priority
  - MHAPLugin\_Split::split\_t, 750
- worker\_thread\_scheduler
  - MHAPLugin\_Split::split\_t, 750
- wout
  - matrixmixer::cfg\_t, 409
  - route::process\_t, 897
- wout\_ac
  - route::process\_t, 897
- write

- alsa\_base\_t, 207
- alsa\_t, 212
- MHA\_TCP::Connection, 476
- MHAFilter::blockprocessing\_polyphase↔  
\_resampling\_t, 518
- MHAFilter::polyphase\_resampling\_t, 562
- MHAJack::port\_t, 601
- MHASignal::matrix\_t, 789
- MHASignal::ringbuffer\_t, 796
- MHASignal::uint\_vector\_t, 811
- mha\_drifter\_fifo\_t, 441
- mha\_fifo\_lw\_t, 448
- mha\_fifo\_t, 454
- write\_buf
  - overlapadd::overlapadd\_t, 863
  - spec2wave\_t, 923
- write\_event
  - MHA\_TCP::Connection, 477
- write\_float
  - mha\_parser.cpp, 1016
- write\_ptr
  - mha\_fifo\_t, 456
- write\_thread
  - wavwriter\_t, 956
- write\_wave
  - mhasndfile.cpp, 1068
  - mhasndfile.h, 1069
- writeaccess
  - MHAParser::base\_t, 641
- writer\_started
  - mha\_drifter\_fifo\_t, 443
- writer\_xruns\_in\_succession
  - mha\_drifter\_fifo\_t, 444
- writer\_xruns\_since\_start
  - mha\_drifter\_fifo\_t, 444
- writer\_xruns\_total
  - mha\_drifter\_fifo\_t, 443
- writethread
  - wavwriter\_t, 956
- Writing openMHA Plugins. A step-by-step tutorial, 11
- wtype
  - MHAParser::window\_t, 721
- wtype\_t
  - MHAParser::window\_t, 720
- X
  - MHA\_TCP::OS\_EVENT\_TYPE, 480
  - MHAFilter::adapt\_filter\_state\_t, 515
- x
  - doasvm\_classification, 281
- xfun
  - MHATableLookup::xy\_table\_t, 833
- xi\_est
  - timoConfig, 943
- xi\_est\_AC
  - timo\_AC, 938
- xi\_min
  - timoConfig, 942
- xi\_min\_db
  - timo\_params, 940
  - timoSmooth, 946
- xi\_ml
  - timoConfig, 943
- xi\_ml\_AC
  - timo\_AC, 938
- xi\_opt\_db
  - timo\_params, 940
  - timoSmooth, 947
- xiOpt
  - noisePowProposedScale::noisePow↔  
Proposed, 859
  - timoConfig, 943
- xiOptDb
  - noisePowProposedScale::interface\_t, 857
- xmax
  - MHATableLookup::linear\_table\_t, 828
- xmin
  - MHATableLookup::linear\_table\_t, 828
- Xs
  - MHAFilter::fftfilterbank\_t, 530
- xw
  - MHAFilter::fftfilterbank\_t, 530
- xy\_table\_t
  - MHATableLookup::xy\_table\_t, 831
- xyfun
  - MHATableLookup::xy\_table\_t, 833
- y
  - doasvm\_classification, 281
- y0
  - dc\_simple::dc\_t::line\_t, 268
- y\_previous
  - rt\_nlms\_t, 900
- YPrew
  - prediction\_error\_config, 892
- yfun
  - MHATableLookup::xy\_table\_t, 833
- Yn
  - MHAFilter::complex\_bandpass\_t, 522
  - MHAFilter::iir\_ord1\_real\_t, 545
- Ys
  - MHAFilter::fftfilterbank\_t, 531
- yw

---

MHAFilter::fftfilterbank\_t, [530](#)  
yw\_temp  
    MHAFilter::fftfilterbank\_t, [531](#)  
zeros  
    ac2wave\_if\_t, [149](#)  
zerowindow  
    overlapadd::overlapadd\_if\_t, [861](#)