

NEC

Portable Projector

VT670/VT570/VT470/VT47

User's Manual



Important Information

Safety Cautions

Precautions

Please read this manual carefully before using your NEC VT670/VT570/VT470/VT47 Projector and keep the manual handy for future reference. Your serial number is located on the bottom of your projector. Record it here:

CAUTION



To turn off main power, be sure to remove the plug from power outlet.
The power outlet socket should be installed as near to the equipment as possible, and should be easily accessible.

CAUTION



TO PREVENT SHOCK, DO NOT OPEN THE CABINET.
NO USER-SERVICEABLE PARTS INSIDE.
REFER SERVICING TO QUALIFIED NEC SERVICE PERSONNEL.



This symbol warns the user that uninsulated voltage within the unit may be sufficient to cause electrical shock. Therefore, it is dangerous to make any kind of contact with any part inside of the unit.



This symbol alerts the user that important information concerning the operation and maintenance of this unit has been provided.
The information should be read carefully to avoid problems.

WARNING: TO PREVENT FIRE OR SHOCK, DO NOT EXPOSE THIS UNIT TO RAIN OR MOISTURE.
DO NOT USE THIS UNIT'S PLUG WITH AN EXTENSION CORD OR IN AN OUTLET UNLESS ALL THE PRONGS CAN BE FULLY INSERTED.
DO NOT OPEN THE CABINET. THERE ARE HIGH-VOLTAGE COMPONENTS INSIDE. ALL SERVICING MUST BE DONE BY QUALIFIED NEC SERVICE PERSONNEL.

DOC Compliance Notice (for Canada only)

This Class B digital apparatus meets all requirements of the Canadian Interference-Causing Equipment Regulations.

Acoustic Noise Information Ordinance-3. GSGV (for Germany only):

The sound pressure level is less than 70 dB (A) according to ISO 3744 or ISO 7779.

CAUTION

- Avoid displaying stationary images for a prolonged period of time.
Doing so can result in these images being temporarily sustained on the surface of the LCD panel.
If this should happen, continue to use your projector. The static background from previous images will disappear.

WARNING TO CALIFORNIA RESIDENTS:

Handling the cables supplied with this product, will expose you to lead, a chemical known to the State of California to cause birth defects or other reproductive harm. Wash hands after handling.

RF Interference (for USA only)

WARNING

The Federal Communications Commission does not allow any modifications or changes to the unit EXCEPT those specified by NEC Solutions (America), Inc. in this manual. Failure to comply with this government regulation could void your right to operate this equipment. This equipment has been tested and found to comply with the limits for a Class B digital device, pursuant to Part 15 of the FCC Rules. These limits are designed to provide reasonable protection against harmful interference in a residential installation. This equipment generates, uses, and can radiate radio frequency energy and, if not installed and used in accordance with the instructions, may cause harmful interference to radio communications. However, there is no guarantee that interference will not occur in a particular installation.

If this equipment does cause harmful interference to radio or television reception, which can be determined by turning the equipment off and on, the user is encouraged to try to correct the interference by one or more of the following measures:

- Reorient or relocate the receiving antenna.
- Increase the separation between the equipment and receiver.
- Connect the equipment into an outlet on a circuit different from that to which the receiver is connected.
- Consult the dealer or an experienced radio / TV technician for help.

For UK only: In UK, a BS approved power cable with moulded plug has a Black (five Amps) fuse installed for use with this equipment. If a power cable is not supplied with this equipment please contact your supplier.

Important Safeguards

These safety instructions are to ensure the long life of your projector and to prevent fire and shock. Please read them carefully and heed all warnings.

Installation

1. For best results, use your projector in a darkened room.
2. Place the projector on a flat, level surface in a dry area away from dust and moisture.
3. Do not place your projector in direct sunlight, near heaters or heat radiating appliances.
4. Exposure to direct sunlight, smoke or steam can harm internal components.
5. Handle your projector carefully. Dropping or jarring can damage internal components.
6. Do not place heavy objects on top of the projector.
7. If you wish to have the projector installed on the ceiling:
 - a. Do not attempt to install the projector yourself.
 - b. The projector must be installed by qualified technicians in order to ensure proper operation and reduce the risk of bodily injury.
 - c. In addition, the ceiling must be strong enough to support the projector and the installation must be in accordance with any local building codes.
 - d. Please consult your dealer for more information.

Fire and Shock Precautions

1. Ensure that there is sufficient ventilation and that vents are unobstructed to prevent the build-up of heat inside your projector. Allow at least 3 inches (10 cm) of space between your projector and a wall.
2. Prevent foreign objects such as paper clips and bits of paper from falling into your projector.
Do not attempt to retrieve any objects that might fall into your projector. Do not insert any metal objects such as a wire or screwdriver into your projector. If something should fall into your projector, disconnect it immediately and have the object removed by a qualified NEC service personnel.
3. Do not place any liquids on top of your projector.
4. Do not look into the lens while the projector is on. Serious damage to your eyes could result.
5. Keep any items such as magnifying glass out of the light path of the projector. The light being projected from the lens is extensive, therefore any kind of abnormal objects that can redirect light coming out of the lens, can cause unpredictable outcome such as fire or injury to the eyes.
6. Do not cover the lens with the supplied lens cap or equivalent while the projector is on. Doing so can lead to melting of the cap and possibly burning your hands due to the heat emitted from the light output.
7. The projector is designed to operate on a power supply of 100-240V AC 50/60 Hz. Ensure that your power supply fits this requirement before attempting to use your projector.
8. Handle the power cable carefully and avoid excessive bending.
A damaged cord can cause electric shock or fire.
9. If the projector is not to be used for an extended period of time, disconnect the plug from the power outlet.
10. Do not touch the power plug during a thunderstorm. Doing so can cause electrical shock or fire.
11. Do not handle the power plug with wet hands.

CAUTION

- Do not try to touch the ventilation outlet on the left side (when seen from the front) as it can become heated while the projector is turned on.
- Do not use the tilt-foot for purposes other than originally intended. Misuses such as gripping the tilt-foot or hanging on the wall can cause damage to the projector.
- When carrying the projector by the carrying handle, make sure the two screws that attach the carrying handle to the projector cabinet are tight. (VT670/VT470 only)
Insufficient tightening of the two screws could result in the projector falling and causing injury.
- Do not send the projector in the soft carrying case by parcel delivery service or cargo shipment. The projector inside the soft carrying case could be damaged.
- Select [High] in Fan mode if you continue to use the projector for consecutive days. (From the menu, select [Advanced] → [Fan Mode] → [High].)
- Do not unplug the power cable from the wall outlet under any one of the following circumstances.
Doing so can cause damage to the projector:
 - * While the Hour Glass icon appears.
 - * While the cooling fans are running. (The cooling fans continue to work for 30 seconds after the projector is turned off).

Lamp Replacement

- To replace the lamp, follow all instructions provided on page 53.
- Be sure to replace the lamp when the message “**The lamp has reached the end of its usable life. Please replace the lamp.**” appears. If you continue to use the lamp after the lamp has reached the end of its usable life, the lamp bulb may shatter, and pieces of glass may be scattered in the lamp case. Do not touch them as the pieces of glass may cause injury.

If this happens, contact your NEC dealer for lamp replacement.

- Allow a minimum of 30 seconds to elapse after turning off the projector. Then turn off the main power switch, disconnect the power cable and allow 60 minutes to cool the projector before replacing the lamp.

Table of Contents

Important Information	i
1. Introduction	1
1 What's in the Box?	1
2 Introduction to the Projector	2
3 Part Names of the Projector	4
Attaching the Supplied Carrying Handle (VT670/VT470 only)	5
Top Features	6
Terminal Panel Features	7
4 Part Names of the Remote Control	8
VT670/VT470	8
Battery Installation	10
Remote Control Precautions	10
Operating Range for Wireless Remote Control	10
VT570/VT47	11
Battery Installation	12
Remote Control Precautions	12
Operating Range for Wireless Remote Control	12
2. Installation and Connections	13
1 Setting Up the Screen and the Projector	13
Selecting a Location	13
VT670/VT570/VT470	13
VT47	14
Throw Distance and Screen Size	15
2 Making Connections	17
Enabling the computer's external display	17
Connecting Your PC or Macintosh Computer	17
To connect SCART output (RGB)	18
Connecting an External Monitor	19
Connecting Your DVD Player with Component Output	20
Connecting Your VCR or Laser Disc Player	21
Connecting the Supplied Power Cable	22
3. Projecting an Image (Basic Operation)	23
1 Turning on the Projector	23
Note on Startup Screen (Menu Language Select screen)	24
2 Selecting a Source	25
3 Adjusting the Picture Size and Position	27
4 Correcting Keystone Distortion	29
5 Optimizing RGB Picture Automatically	31
6 Turning Up or Down Volume	31
7 Turning off the Projector	32
8 After Use	32

4. Convenient Features	33
1 Turning Off the Image and Sound	33
2 Freezing a Picture (VT670/VT470 only)	33
3 Enlarging and Moving a Picture (VT670/VT470 only)	33
4 Using the Remote Mouse Function (VT670/VT470 only)	34
5. Using On-Screen Menu	35
1 Using the Menus	35
2 Menu Elements	37
3 List of Menu Items	38
4 Menu Descriptions & Functions [Picture]	40
5 Menu Descriptions & Functions [Image]	42
6 Menu Descriptions & Functions [Setup]	43
7 Menu Descriptions & Functions [Advanced]	45
8 Menu Descriptions & Functions [Information]	49
9 Menu Descriptions & Functions [Default]	50
6. Maintenance	51
1 Cleaning or Replacing the Filter	51
2 Cleaning the Cabinet and the Lens	52
3 Replacing the Lamp	53
7. Appendix	56
1 Troubleshooting	56
2 Specifications	59
3 Cabinet Dimensions	61
VT670/VT570/VT470	61
VT47	62
4 Pin Assignments of D-Sub COMPUTER Input Connector	63
5 Compatible Input Signal List	64
6 PC Control Codes and Cable Connection	65
7 Optional Presentation Remote Control Kit (PR52KIT)	67
8 Troubleshooting Check List	71
9 TravelCare	73

1. Introduction

① What's in the Box?

Make sure your box contains everything listed. If any pieces are missing, contact your dealer. Please save the original box and packing materials if you ever need to ship your projector.

Projector

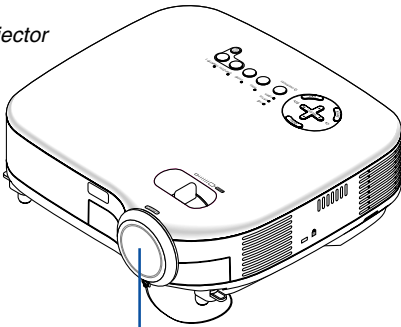

Lens cap
(24F40111)

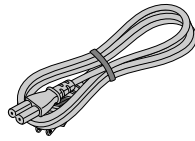

Power cable
(US: VT670/VT470: 7N080213)
(US: VT570/VT47: 7N080212)
(EU: VT670G/VT470G: 7N080007)
(EU: VT570G/VT47G: 7N080005)

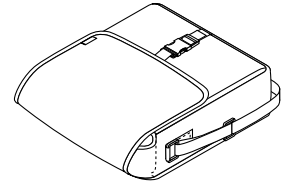

Soft carrying case
(24BS7421)

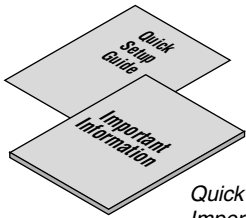

Quick Setup Guide
Important Information

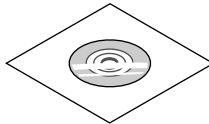

CD-ROM
User's manual

For North America only
Registration card
Limited warranty
For Europe only
Guarantee policy

For VT670 and VT470 only

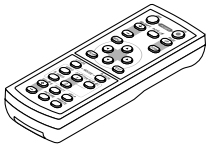

Remote control
(7N900521)

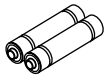

Batteries (AAA×2)

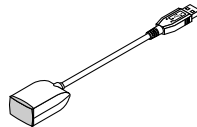

Remote mouse receiver
(7N900561)

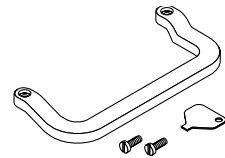

Carrying handle (24F39671)
Screw (M4×2: 24N07501)
Flathead screwdriver (24H51611)

For VT570 and VT47 only



Remote control
(7N900551)

Lithium battery (CR2032)

② Introduction to the Projector

This section introduces you to your new VT670/VT570/VT470/VT47 Projector and describes the features and controls.

Congratulations on Your Purchase of The VT670/VT570/VT470/VT47 Projector

The VT670/VT570/VT470/VT47 is one of the very best projectors available today. The VT670/VT570/VT470/VT47 enables you to project precise images up to 300 inches across (measured diagonally) from your PC or Macintosh computer (desktop or notebook), VCR, DVD player, document camera, or a laser disc player.

You can use the projector on a tabletop or cart, you can use the projector to project images from behind the screen, and the projector can be permanently mounted on a ceiling*¹. The remote control can be used wirelessly.

*¹ Do not attempt to mount the projector on a ceiling yourself.

The projector must be installed by qualified technicians in order to ensure proper operation and reduce the risk of bodily injury.

In addition, the ceiling must be strong enough to support the projector and the installation must be in accordance with any local building codes. Please consult your dealer for more information.

Features you'll enjoy:

- Auto vertical keystone correction up to +/- 30 degrees
- Built-in Wall Color Correction presets provide for adaptive color correction when projecting onto non-white screen material.
- Quick Start & Quick Shutoff
The quick start & quick shutoff function means you can set up or put away the projector without delay. Nine seconds after turning on the power, the projector is ready to display PC or video images. When you're finished, the fans stop in 30 seconds after turning off the power, so you can put away the projector quickly after the conference or class.
- Low level operation noise
- Short focal length lens
- 130W lamp (110W Eco mode) : VT570/VT47
180W lamp (150W Eco mode) : VT670/VT470
- Direct keys for source selection
- New Color Management system
- New menu design improves operation
- Safety protect by Security function
Security feature prevents the projector from being used by unauthorized individuals. Keyword prevents unauthorized individuals from changing projector settings or adjustments.
- NEC's exclusive Advanced AccuBlend intelligent pixel blending technology - an extremely accurate image compression technology - offers a crisp image with UXGA (1600 × 1200) resolution*².
- Supports most IBM VGA, SVGA, XGA, SXGA/UXGA(with Advanced AccuBlend)*², Macintosh, component signal (YCbCr/YPbPr) or any other RGB signals within a horizontal frequency range of 24 to 100 kHz and a vertical frequency range of 50 to 120 Hz. This includes NTSC, PAL, PAL-N, PAL-M, PAL60, SECAM and NTSC4.43 standard video signals.

*² A UXGA (1600 × 1200) and SXGA image (1280 × 1024) are displayed with NEC's Advanced AccuBlend on VT670 and VT570.

A UXGA (1600 × 1200), SXGA (1280 × 1024) and XGA (1024 × 768) image are displayed with NEC's Advanced AccuBlend on VT470.

An SXGA (1280 × 1024) and XGA (1024 × 768) images are displayed with NEC's Advanced AccuBlend on VT47.

NOTE: Composite video standards are as follows:

NTSC: U.S. TV standard for video in U.S. and Canada.

PAL: TV standard used in Western Europe.

PAL-N: TV standard used in Argentine, Paraguay and Uruguay.

PAL-M: TV standard used in Brazil.

PAL60: TV standard used for NTSC playback on PAL TVs.

SECAM: TV standard used in France and Eastern Europe.

NTSC4.43: TV standard used in Middle East countries.

- You can use the supplied wireless remote control and remote mouse receiver to operate your PC mouse wireless from across the room. The remote mouse receiver supports almost any PC using a USB connection (VT670 and VT470).
- You can control the projector with a PC or control system using the PC Control port.
- The contemporary cabinet design is light, compact, easy to carry, and complements any office, boardroom or auditorium.

About this user's manual

The fastest way to get started is to take your time and do everything right the first time. Take a few minutes now to review the user's manual. This may save you time later on. At the beginning of each section of the manual you'll find an overview. If the section doesn't apply, you can skip it.

- IBM is a trademark or registered trademark of International Business Machines Corporation.
- Mac and PowerBook are trademarks of Apple Computer, Inc., registered in the U.S. and other countries.
- Windows, Windows 98, Windows Me, Windows XP or Windows 2000 are trademarks or registered trademarks of Microsoft Corporation.
- Other product and company names mentioned in this user's manual may be the trademarks or registered trademarks of their respective holders.

3 Part Names of the Projector

Front/Top

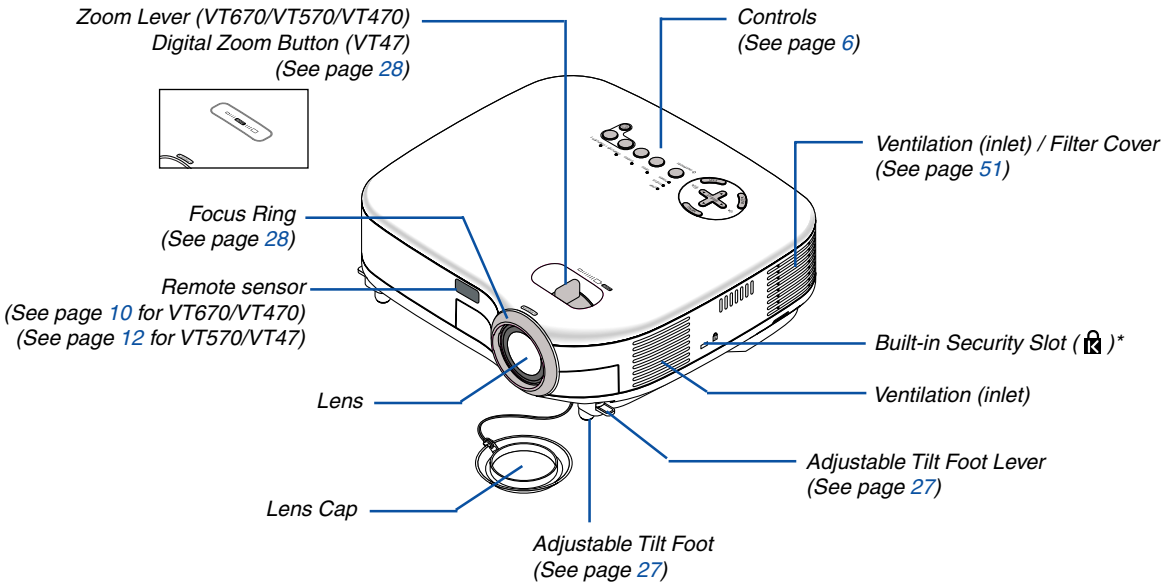

* This security slot supports the MicroSaver® Security System. MicroSaver® is a registered trademark of Kensington Microware Inc. The logo is trademarked and owned by Kensington Microware Inc.

Rear

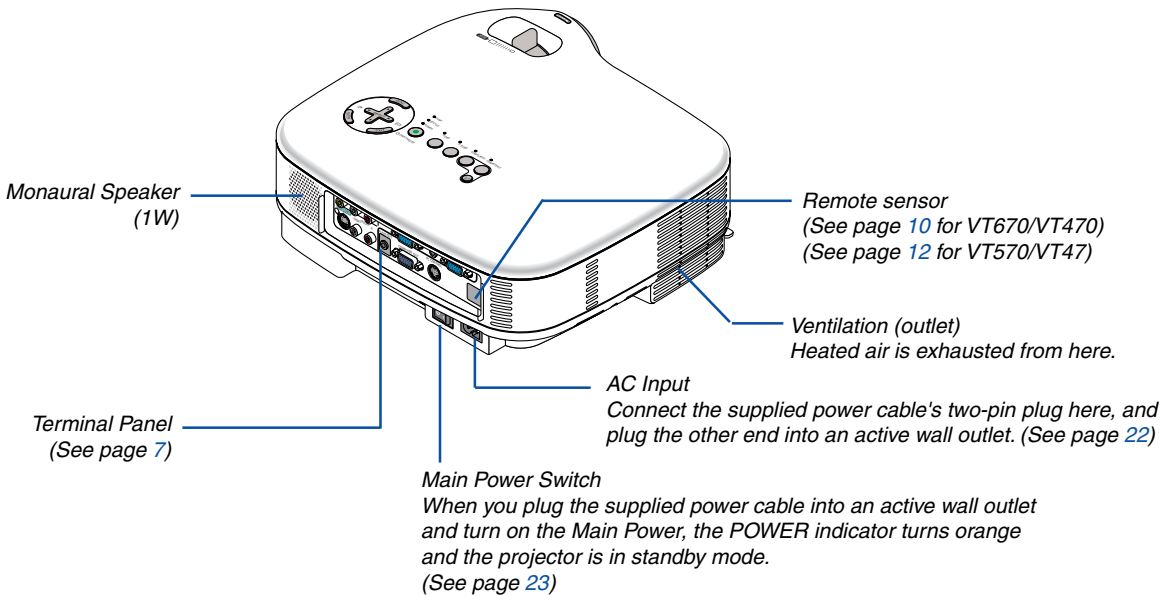

Bottom

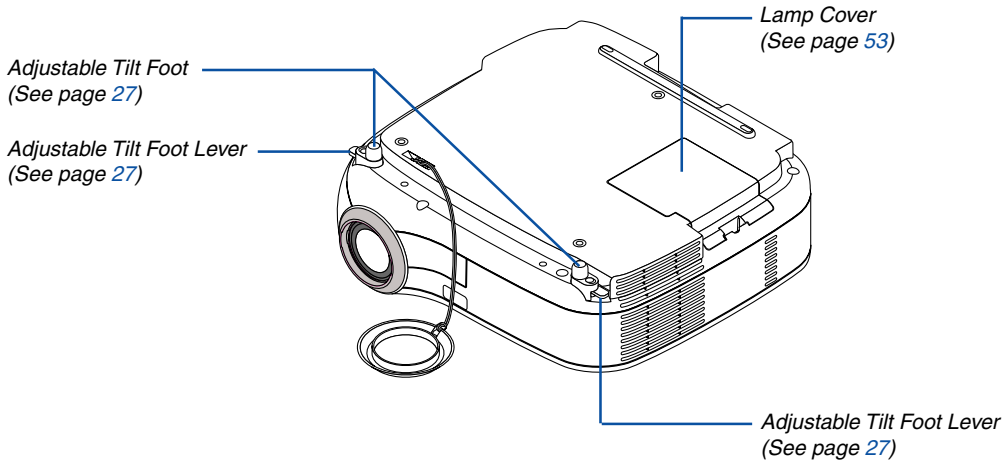

For VT670 and VT470 only

Attaching the supplied carrying handle

You can carry the projector by attaching the supplied carrying handle securely to the projector. To attach the supplied carrying handle, use the supplied flathead screwdriver and two screws. Place a soft cloth on the working surface before turning the projector over to prevent scratching the top cover. Make sure that the carrying handle is attached with correct orientation as shown below.

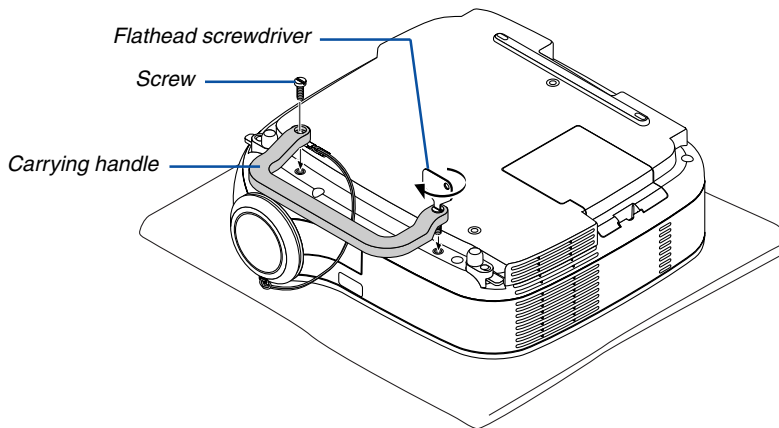

CAUTION

When carrying the projector by the carrying handle, make sure the two screws that attach the carrying handle to the projector cabinet are tight.

Top Features

VT670/VT570/VT470

VT47

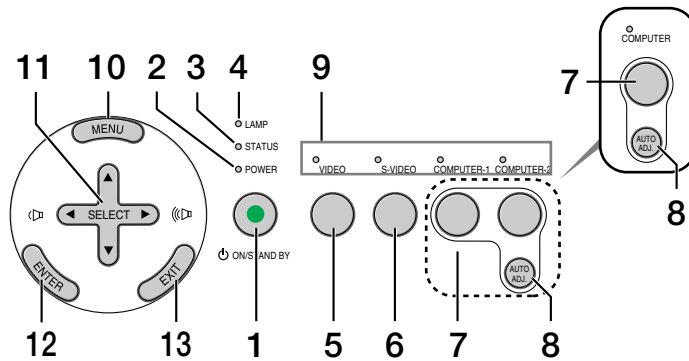

- 1. POWER Button (ON / STAND BY) (⏻)**
 Use this button to turn the power on and off when the main power is supplied and the projector is in standby mode.
 To turn on the projector, press and hold this button for a minimum of two seconds. To turn off the projector, press this button twice.
- 2. POWER Indicator**
 When this indicator is green, the projector is on; when this indicator is orange, it is in standby mode. See the Power Indicator section on page 56 for more details.
- 3. STATUS Indicator**
 If this light blinks red rapidly, it indicates that an error has occurred, the lamp cover is not attached properly or the projector has overheated. If this light remains orange, it indicates that you have pressed a cabinet key while the Cabinet Button Lock is enabled. See the Status Indicator section on page 56 for more details.
- 4. LAMP Indicator**
 If this light blinks red rapidly, it's warning you that the lamp has reached the end of its usable life. After this light appears, replace the lamp as soon as possible (See page 53). If this is lit green continually, it indicates that the lamp mode is set to Eco. See the Lamp Indicator section on page 56 for more details.
- 5. VIDEO Button**
 Press this button to select a video source from a VCR, DVD player, laser disc player or document camera.
- 6. S-VIDEO Button**
 Press this button to select an S-Video source from a VCR, DVD player, laser disc player or document camera.
- 7. COMPUTER1 and 2 Buttons (one COMPUTER port on VT47) Button**
 Press this button to select an RGB source from computer or component equipment connected to your COMPUTER 1 or 2 port.
- 8. AUTO ADJ. Button**
 Use this button to adjust an RGB source for an optimal picture (See page 31).
- 9. Source Indicators**
 When one of the COMPUTER, VIDEO or S-VIDEO input is selected, the corresponding source indicator lights.
- 10. MENU Button**
 Displays the menu.
- 11. SELECT ▲▼◀▶ / Volume Buttons**
 ▲▼ : Use these buttons to select the menu of the item you wish to adjust.
 ▶ : Use these buttons to change the level of a selected menu item. A press of the ▶ button executes the selection. When no menus appear, these buttons work as a volume control.
 When an image is magnified, the SELECT ▲▼▶ button moves the image.
- 12. ENTER Button**
 Executes your menu selection and activates items selected from the menu.
- 13. EXIT Button**
 Pressing this button will return to the previous menu. While you are in the main menu, pressing this button will close the menu.

Terminal Panel Features

VT670/VT570/VT470

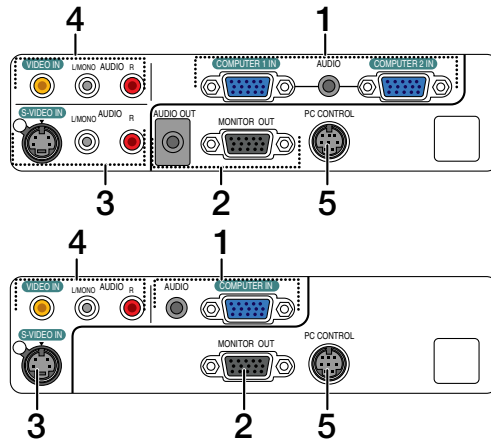

VT47

1. COMPUTER 1 and 2 IN / Component Input Connector (Mini D-Sub 15 Pin) (One COMPUTER port on VT47)

Connect your computer or other analog RGB equipment such as IBM compatible or Macintosh computers. Use the supplied RGB cable to connect to your computer. This also serves as a component input connector that allows you to connect a component video output of component equipment such as a DVD player. This connector also supports SCART output signal. See page 18 for more details.

COMPUTER AUDIO Input Mini Jack (Stereo Mini)

This is where you connect the audio output from your computer or DVD player when connected to the COMPUTER input. A commercially available audio cable is required.

2. MONITOR OUT Connector (Mini D-Sub 15 Pin)

You can use this connector to loop your computer image to an external monitor from the RGB input source.

This connector outputs RGB signal in standby mode.

AUDIO OUT Mini Jack (Stereo Mini) (Not available on VT47)

You can use this jack to output sound from the currently selected source (COMPUTER, VIDEO or S-VIDEO). Output sound level can be adjusted in accordance with the sound level of the internal speaker.

Note that this cannot be used as a headphone jack.

(When audio equipment is connected, the projector speaker is disabled.)

When a cable mini-plug is inserted into this jack, both the right and left audio signals are not mixed, but separate.

For example, when a cable mini-plug is inserted into the left AUDIO IN jack only, only left sound is output.

3. S-VIDEO IN Connector (Mini DIN 4 Pin)

Here is where you connect the S-Video input from an external source like a VCR.

NOTE: S-Video provides more vivid color and higher resolution than the traditional composite video format.

S-VIDEO AUDIO Input Jacks L/R (RCA)

These are your left and right channel audio inputs for stereo sound from an S-Video source.

4. VIDEO IN Connector (RCA)

Connect a VCR, DVD player, laser disc player, or document camera here to project video.

VIDEO AUDIO Input Jacks L/R (RCA)

These are your left and right channel audio inputs for stereo sound from a Video source.

NOTE: The VIDEO AUDIO inputs can also be used as S-VIDEO AUDIO inputs on VT47.

5. PC CONTROL Port (DIN 8 Pin)

Use this port to connect a PC or control system. This enables you to control the projector using serial communication protocol. If you are writing your own program, typical PC control codes are on page 65.

4 Part Names of the Remote Control

For VT670/VT470

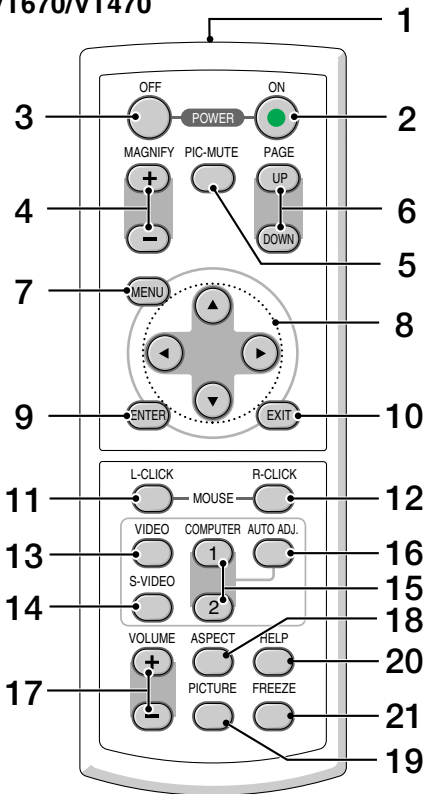

5. **PIC-MUTE Button**
This button turns off the image and sound for a short period of time. Press again to restore the image and sound.
6. **PAGE UP/DOWN Button**
Use these buttons to operate your computer with the supplied remote mouse receiver. See page 34. You can use these buttons to scroll the viewing area of the window or to move to the previous or next slide in PowerPoint on your computer.
7. **MENU Button**
Displays the menu for various settings and adjustments.
8. **SELECT ▲▼◀▶ (Mouse) Button**
▲▼ : Use these buttons to select the menu of the item you wish to adjust.
◀▶ : Use these buttons to change the level of a selected menu item. A press of the ▶ button executes the selection.
When an image is magnified, the SELECT ▲▼◀▶ button moves the image. See page 33.
9. **ENTER Button**
Use this button to enter your menu selection. It works the same way as the ENTER button on the cabinet. See page 6.
10. **EXIT Button**
It works the same way as the EXIT button on the cabinet. See page 6.
11. **MOUSE L-CLICK Button**
This button works as the mouse left button when the supplied remote mouse receiver is connected with your computer. See page 34.
12. **MOUSE R-CLICK Button**
This button works as the mouse right button when the supplied remote mouse receiver is connected with your computer. See page 34.
13. **VIDEO Button**
Press this button to select a video source from a VCR, DVD player, laser disc player or document camera.
14. **S-VIDEO Button**
Press this button to select an S-Video source from a VCR.
15. **COMPUTER 1/2 Button**
Press this button to select COMPUTER 1 or 2 (or Component) input.

NOTE: If you are using a Macintosh computer, you can click either the MOUSE R-CLICK or MOUSE L-CLICK button to activate the mouse.

1. **Infrared Transmitter**
Direct the remote control toward the remote sensor on the projector cabinet.
2. **POWER ON Button**
When the main power is on, you can use this button to turn your projector on.

NOTE: To turn on the projector, press and hold the POWER ON button for a minimum of two seconds.
3. **POWER OFF Button**
You can use this button to turn your projector off.

NOTE: To turn off the projector, press the POWER OFF button twice.
4. **MAGNIFY (+)(-) Button**
Use this button to adjust the image size up to 400%. The image is magnified about the center of the screen. See page 33.

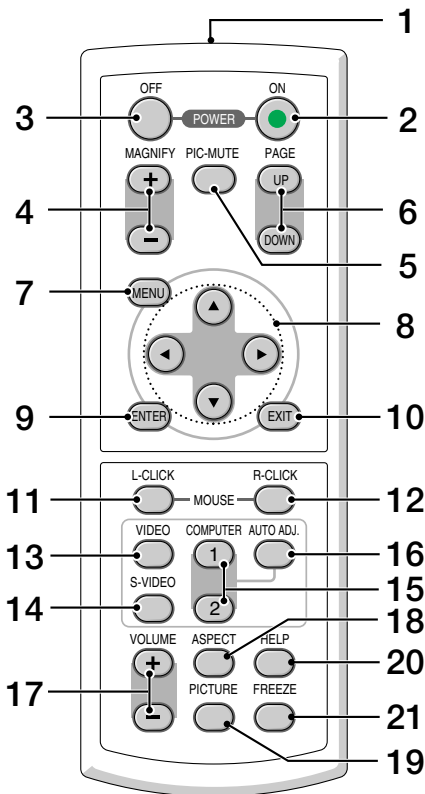

16. AUTO ADJ. Button

Use this button to adjust an RGB source for an optimal picture.
See page [31](#).

17. VOLUME (+)(-) Button

Press (+) to increase the volume and (-) to decrease it.

18. ASPECT Button

Press this button once to display the Aspect Ratio select menu. Keep pressing will change aspect ratios.
See page [42](#).

19. PICTURE Button

Press this button to display the Picture adjustment menu to adjust Wall Color, Picture Management, Brightness, Contrast, Sharpness, Color and Hue. See pages [40](#) to [41](#).

20. HELP Button

Provides the information on the current signal and projector settings. See page [49](#).

21. FREEZE Button

This button will freeze a picture. Press again to resume motion. See page [33](#).

Battery Installation

1 Press firmly and slide the battery cover off.

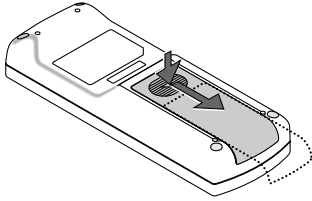

2 Remove both old batteries and install new ones (AAA). Ensure that you have the batteries' polarity (+/-) aligned correctly.

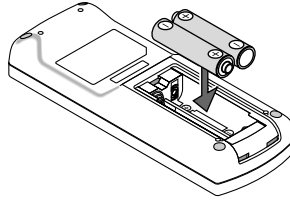

3 Slip the cover back over the batteries until it snaps into place. Do not mix different types of batteries or new and old batteries.

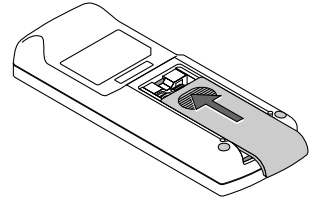

Remote Control Precautions

- Handle the remote control carefully.
- If the remote control gets wet, wipe it dry immediately.
- Avoid excessive heat and humidity.
- If you will not be using the remote control for a long time, remove the batteries.
- Do not place the batteries upside down.
- Do not use new and old batteries together, or use different types of batteries together.

Operating Range for Wireless Remote Control

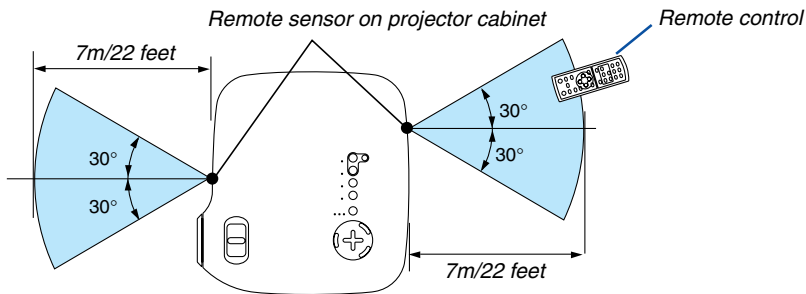

- The infrared signal operates by line-of-sight up to a distance of about 22 feet/7 m and within a 60-degree angle of the remote sensor on the projector cabinet.
- The projector will not respond if there are objects between the remote control and the sensor, or if strong light falls on the sensor. Weak batteries will also prevent the remote control from properly operating the projector.

For VT570/VT47

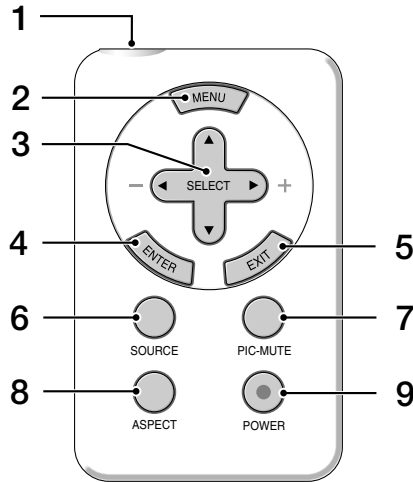

1. Infrared Transmitter
Direct the remote control toward the remote sensor on the projector cabinet.
2. MENU Button
Displays the menu for various settings and adjustments.
3. SELECT ▲▼◀▶ / Volume Buttons
▲▼ : Use these buttons to select the menu of the item you wish to adjust.
◀▶ : Use these buttons to change the level of a selected menu item. A press of the ▶ button executes the selection. When no menus appear, these buttons work as a volume control.
4. ENTER Button
Executes your menu selection and activates items selected from the menu.
5. EXIT Button
Pressing this button will return to the previous menu. While you are in the main menu, pressing this button will close the menu.
6. SOURCE Button
Press this button to select a video source such as a PC, VCR or DVD player. Each time this button is pressed, the input source will change as follows:
VT570
Computer1 → Computer2 → Video → S-Video → Computer1 → ...
VT47
Computer → Video → S-Video → Computer → ...
7. PIC-MUTE Button
This button turns off the image and sound for a short period of time. Press again to restore the image and sound.
8. ASPECT Button
Press this button once to display the Aspect Ratio select menu. Keep pressing will change aspect ratios. See page 42.
9. POWER Button
Use this button to turn the power on and off when the main power is supplied and the projector is in standby mode.
To turn on the projector, press and hold this button for a minimum of two seconds. To turn off the projector, press this button once to display the confirmation message and then press the POWER button or ENTER button.

Battery Installation

1 Push the catch to the right and remove the battery holder.

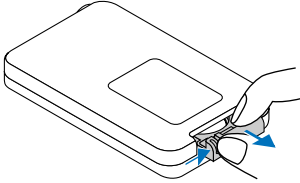

2 Remove the old Lithium coin cell and install new one (CR2032). Ensure that the side with the mark “+” is up.

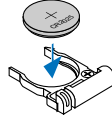

3 Push the battery holder back into the remote control until you feel a click.

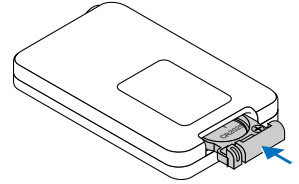

Remote Control Precautions

- Handle the remote control carefully.
- If the remote control gets wet, wipe it dry immediately.
- Avoid excessive heat and humidity.
- If you will not be using the remote control for a long time, remove the battery.
- Do not place the battery upside down.
- Keep the coin cell battery out of reach of children so as not to allow them to swallow the cell battery.

CAUTION

Danger of explosion if battery is incorrectly replaced.
Replace only with the same or equivalent type recommended by the manufacturer.
Dispose of used batteries according to your local regulations.

Operating Range for Wireless Remote Control

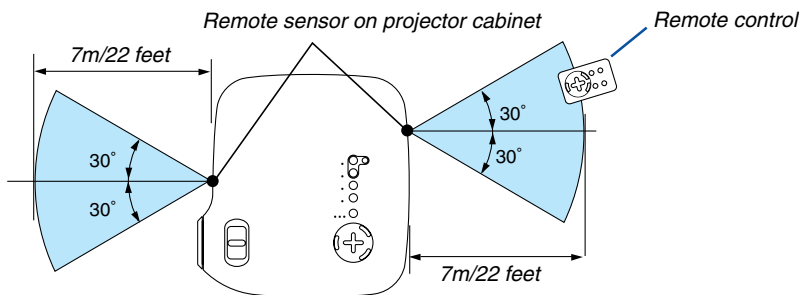

- The infrared signal operates by line-of-sight up to a distance of about 22 feet/7 m and within a 60-degree angle of the remote sensor on the projector cabinet.
- The projector will not respond if there are objects between the remote control and the sensor, or if strong light falls on the sensor.
Weak battery will also prevent the remote control from properly operating the projector.

2. Installation and Connections

This section describes how to set up your projector and how to connect video and audio sources.

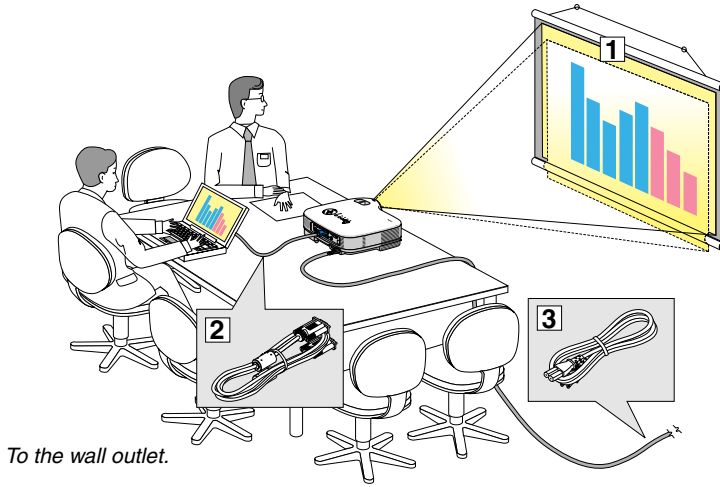

Your projector is simple to set up and use. But before you get started, you must first:

- 1 Set up a screen and the projector.
- 2 Connect your computer or video equipment to the projector. See pages 17 to 21.
- 3 Connect the supplied power cable. See page 22.

NOTE: Ensure that the power cable and any other cables are disconnected before moving the projector. When moving the projector or when it is not in use, cover the lens with the lens cap.

1 Setting Up the Screen and the Projector

Selecting a Location (VT670/VT570/VT470)

The further your projector is from the screen or wall, the larger the image. The minimum size the image can be is approximately 21" (0.53 m) measured diagonally when the projector is roughly 29 inches (0.73 m) from the wall or screen. The largest the image can be is 300" (7.6 m) when the projector is about 393 inches (10 m) from the wall or screen. Use the drawing below as a guide.

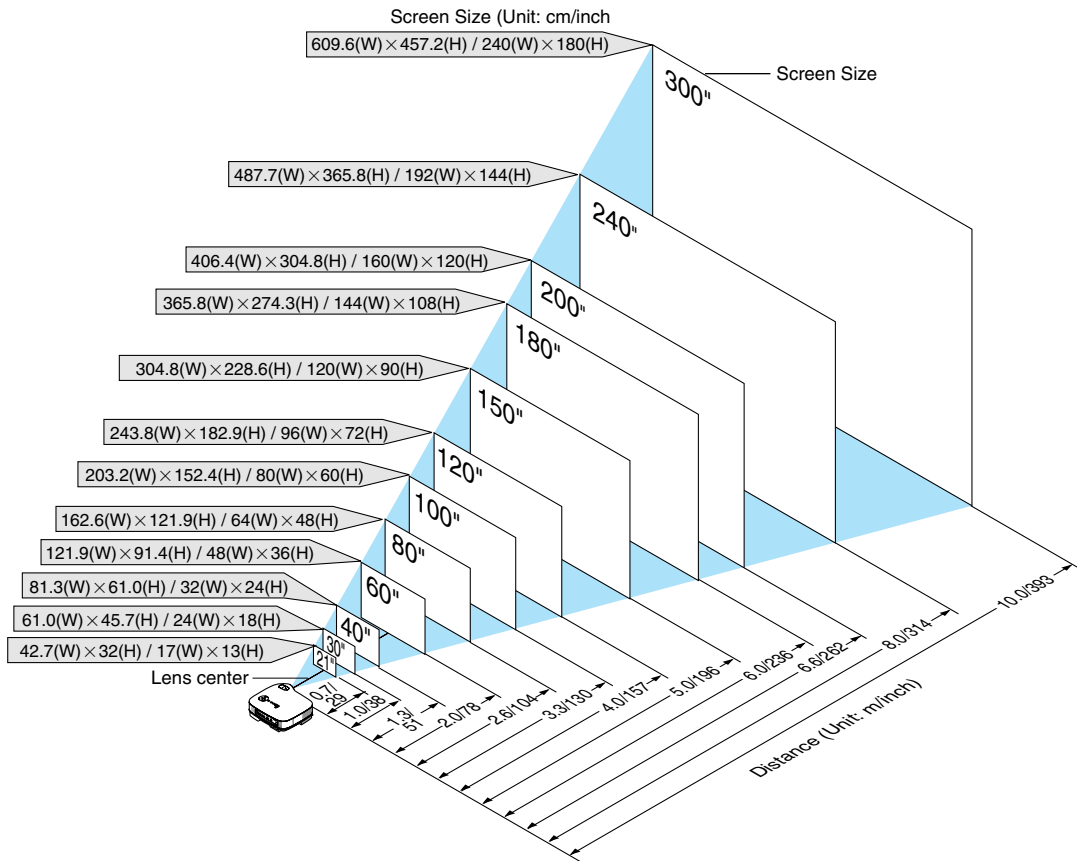

Selecting a Location (VT47)

The further your projector is from the screen or wall, the larger the image. The minimum size the image can be is approximately 25" (0.64 m) measured diagonally when the projector is roughly 23 inches (0.6 m) from the wall or screen. The largest the image can be is 300" (7.6 m) when the projector is about 287 inches (7.3 m) from the wall or screen. Use the drawing below as a guide.

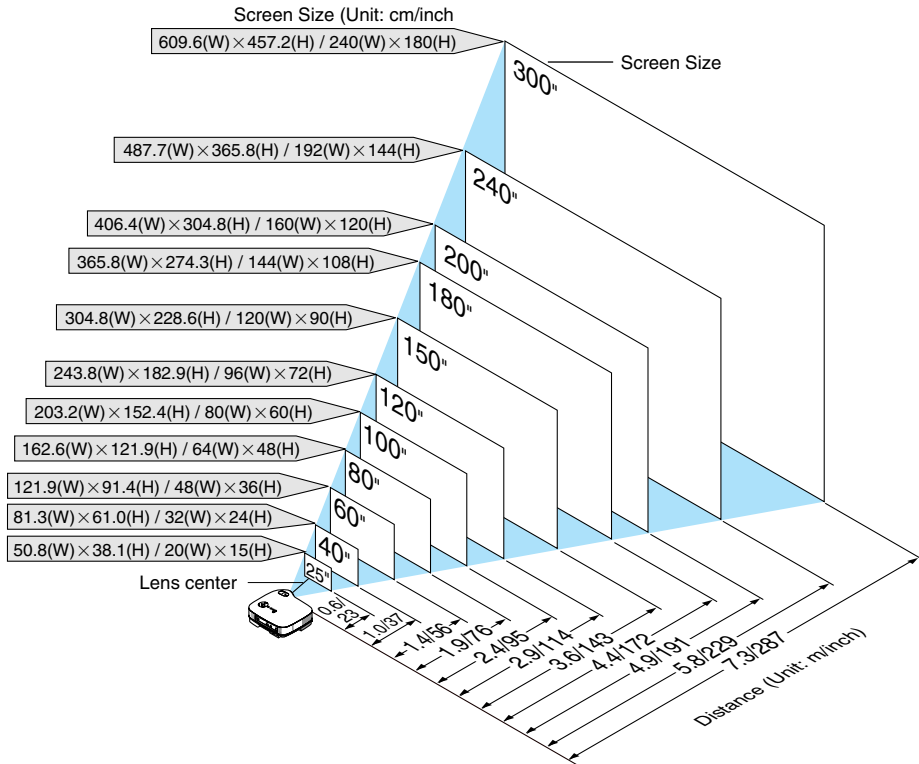

NOTE: Digital Zoom can cause result in a blurry image because zooming is made electronically.

2. Installation and Connections

Throw Distance and Screen Size

The following shows the proper relative positions of the projector and screen. Refer to the table to determine the position of installation.

Distance Chart

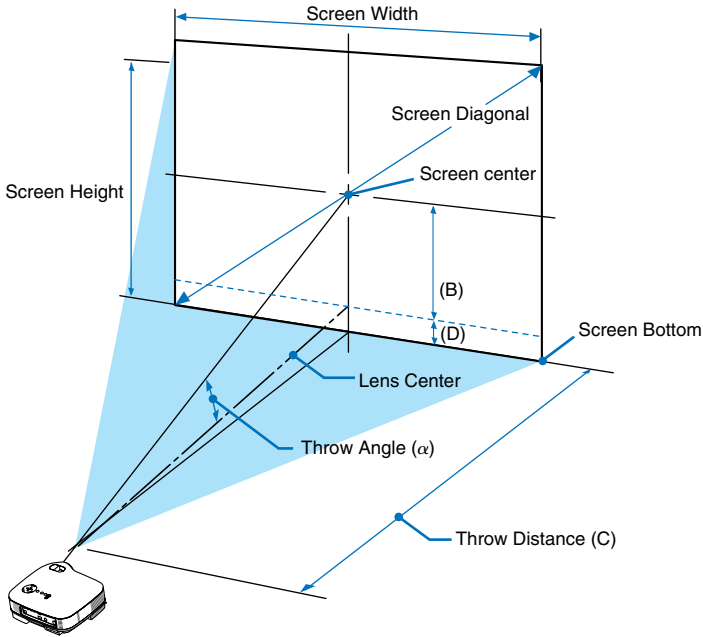

- B = Vertical distance between lens center and screen center
- C = Throw distance
- D = Vertical distance between lens center and bottom of screen (top of screen for ceiling application)
- α = Throw angle

NOTE: Distances may vary +/-5%.

VT670/VT570/VT470

Screen Size			B inch	C		D inch	α Wide - Tele degree
Diagonal inch	Width inch	Height inch		Wide - Tele inch	inch		
21	17	13	5	—	29	-1	— - 9.9
25	20	15	6	28	34	-2	12.0 - 9.8
30	24	18	7	34	42	-2	11.9 - 9.8
40	32	24	10	46	56	-2	11.7 - 9.7
60	48	36	14	70	85	-4	11.6 - 9.6
72	58	43	17	84	102	-4	11.6 - 9.6
80	64	48	19	93	113	-5	11.6 - 9.6
84	67	50	20	98	119	-5	11.6 - 9.6
90	72	54	22	105	128	-6	11.5 - 9.6
100	80	60	24	117	142	-6	11.5 - 9.6
120	96	72	29	141	171	-7	11.5 - 9.5
150	120	90	36	176	214	-9	11.5 - 9.5
180	144	108	43	212	257	-11	11.5 - 9.5
200	160	120	48	236	285	-12	11.5 - 9.5
210	168	126	50	247	300	-13	11.5 - 9.5
240	192	144	57	283	343	-15	11.5 - 9.5
270	216	162	65	319	386	-17	11.4 - 9.5
300	240	180	72	354	429	-18	11.4 - 9.5

Screen Size			B mm	C		D mm	α Wide - Tele degree
Diagonal mm	Width mm	Height mm		Wide - Tele mm	mm		
533	427	320	130	—	730	-30	— - 9.9
635	508	381	150	720	870	-40	12.0 - 9.8
762	610	457	180	870	1060	-50	11.9 - 9.8
1016	813	610	240	1170	1420	-60	11.7 - 9.7
1524	1219	914	360	1770	2150	-90	11.6 - 9.6
1829	1463	1097	440	2130	2590	-110	11.6 - 9.6
2032	1626	1219	490	2370	2880	-120	11.6 - 9.6
2134	1707	1280	510	2490	3020	-130	11.6 - 9.6
2286	1829	1372	550	2670	3240	-140	11.5 - 9.6
2540	2032	1524	610	2970	3600	-160	11.5 - 9.6
3048	2438	1829	730	3580	4330	-190	11.5 - 9.5
3810	3048	2286	910	4480	5420	-230	11.5 - 9.5
4572	3658	2743	1090	5380	6520	-280	11.5 - 9.5
5080	4064	3048	1210	5980	7240	-310	11.5 - 9.5
5334	4267	3200	1270	6280	7610	-330	11.5 - 9.5
6096	4877	3658	1460	7190	8700	-370	11.5 - 9.5
6858	5486	4115	1640	8090	9790	-420	11.4 - 9.5
7620	6096	4572	1820	8990	10880	-470	11.4 - 9.5

VT47

Screen Size			B inch	C inch	D inch	α degree
Diagonal inch	Width inch	Height inch				
25	20	15	6	23	-2	14.6
30	24	18	7	28	-2	14.5
40	32	24	10	37	-2	14.4
60	48	36	14	56	-4	14.2
72	58	43	17	68	-4	14.2
80	64	48	19	76	-5	14.2
84	67	50	20	80	-5	14.2
90	72	54	22	85	-6	14.1
100	80	60	24	95	-6	14.1
120	96	72	29	114	-7	14.1
150	120	90	36	143	-9	14.1
180	144	108	43	172	-11	14.1
200	160	120	48	191	-12	14.0
210	168	126	50	201	-13	14.0
240	192	144	57	229	-15	14.0
270	216	162	65	258	-17	14.0
300	240	180	72	287	-18	14.0

Screen Size			B mm	C mm	D mm	α degree
Diagonal mm	Width mm	Height mm				
635	508	381	150	580	-40	14.6
762	610	457	180	700	-50	14.5
1016	813	610	240	950	-60	14.4
1524	1219	914	360	1440	-90	14.2
1829	1463	1097	440	1730	-110	14.2
2032	1626	1219	490	1920	-120	14.2
2134	1707	1280	510	2020	-130	14.2
2286	1829	1372	550	2170	-140	14.1
2540	2032	1524	610	2410	-160	14.1
3048	2438	1829	730	2900	-190	14.1
3810	3048	2286	910	3630	-230	14.1
4572	3658	2743	1090	4360	-280	14.1
5080	4064	3048	1210	4850	-310	14.0
5334	4267	3200	1270	5100	-330	14.0
6096	4877	3658	1460	5830	-370	14.0
6858	5486	4115	1640	6560	-420	14.0
7620	6096	4572	1820	7290	-470	14.0

WARNING

- * Installing your projector on the ceiling must be done by a qualified technician. Contact your NEC dealer for more information.
- * Do not attempt to install the projector yourself.
- Only use your projector on a solid, level surface. If the projector falls to the ground, you can be injured and the projector severely damaged.
- Do not use the projector where temperatures vary greatly. The projector must be used at temperatures between 41°F (5°C) and 95°F (35°C).
- Do not expose the projector to moisture, dust, or smoke. This will harm the screen image.

- Ensure that you have adequate ventilation around your projector so heat can dissipate. Do not cover the vents on the side or the front of the projector.

Reflecting the Image

Using a mirror to reflect your projector's image enables you to enjoy a much larger image. Contact your NEC dealer if you need a mirror system. If you're using a mirror system and your image is inverted, use the MENU and SELECT buttons on your projector cabinet or your remote control to correct the orientation. See page 44.

2 Making Connections

NOTE: When using with a notebook PC, be sure to connect between the projector and the notebook PC before turning on the power to the notebook PC. In most cases signal cannot be output from RGB output unless the notebook PC is turned on after connecting with the projector.

** If the screen goes blank while using your remote control, it may be the result of the computer's screen-saver or power management software.*

Enabling the computer's external display

Displaying an image on the notebook PC's screen does not necessarily mean it outputs a signal to the projector. When using a PC compatible laptop, a combination of function keys will enable/disable the external display. Usually, the combination of the 'Fn' key along with one of the 12 function keys gets the external display to come on or off. For example, NEC laptops use Fn + F3, while Dell laptops use Fn + F8 key combinations to toggle through external display selections.

Connecting Your PC or Macintosh Computer

NOTE:

- VT670/570/470: The COMPUTER 1 connector supports Plug & Play (DDC2).
- VT47: The COMPUTER connector supports Plug & Play (DDC2).

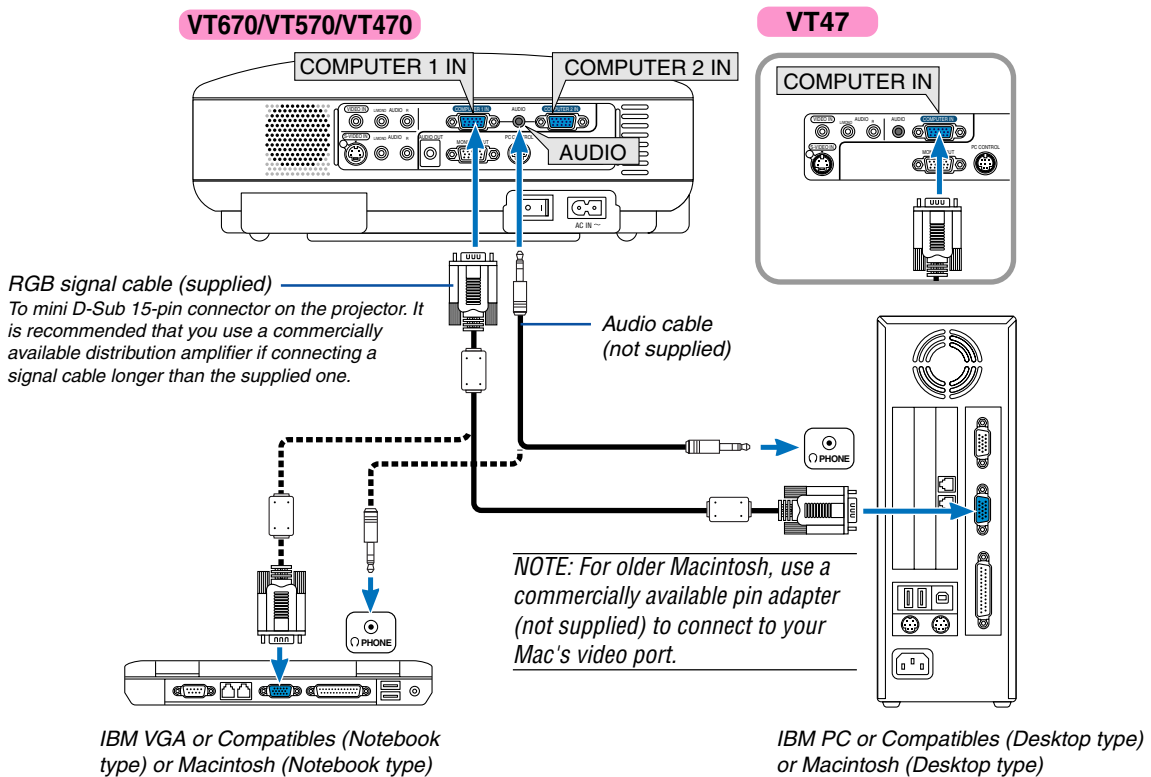

Connecting your PC or Macintosh computer to your projector will enable you to project your computer's screen image for an impressive presentation.

To connect to a PC or Macintosh, simply:

1. Turn off the power to your projector and computer.
2. Use the supplied signal cable to connect your PC or Macintosh to the projector.
3. Connect the supplied power cable. See page 22.
4. Turn on the projector and the computer.
5. If the projector goes blank after a period of inactivity, it may be caused by a screen saver installed on the computer you've connected to the projector.

2. Installation and Connections

NOTE: The projector is not compatible with video decoded outputs of either the NEC ISS-6020 and ISS-6010 switchers.

NOTE: An image may not be displayed correctly when a Video or S-Video source is played back via a commercially available scan converter.

This is because the projector will process a video signal as a computer signal at the default setting. In that case, do the following.

- * *When an image is displayed with the lower and upper black portion of the screen or a dark image is not displayed correctly:
Project an image to fill the screen and then press the AUTO ADJ button on the remote control or the AUTO ADJUST button on the projector cabinet.*

To connect SCART output (RGB)

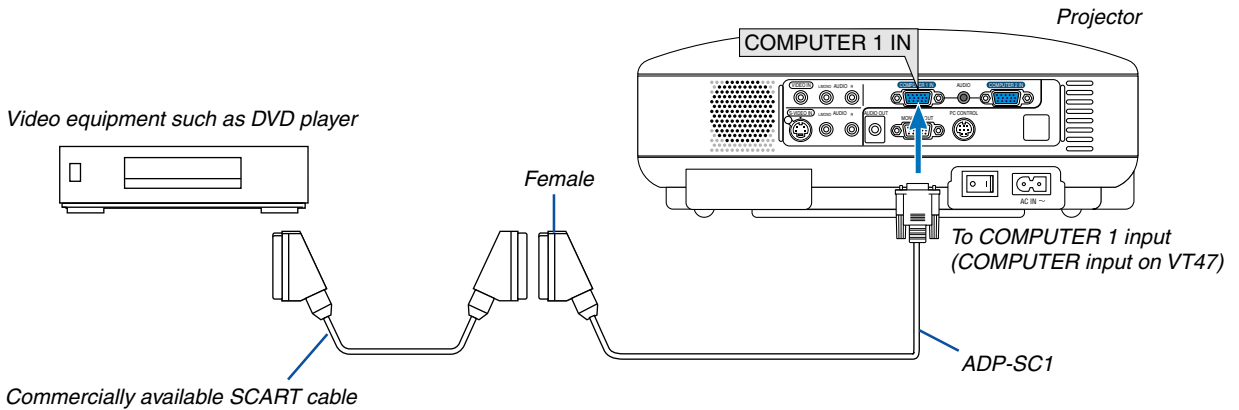

Before connections: An exclusive SCART adapter (ADP-SC1) and a commercially available SCART cable are required for this connection.

NOTE: Audio signal is not available for this connection.

1. Turn off the power to the projector and your video equipment.
2. Use the NEC ADP-SC1 SCART adapter and a commercially available SCART cable to connect the RGB input of your projector and a SCART output (RGB) of your video equipment.
3. Connect the supplied power cable. See page 22.
4. Turn on the power to the projector and your video equipment.
5. Use the COMPUTER 1 button on the remote control to select the COMPUTER 1 input.
Use the COMPUTER button on the remote control to select the COMPUTER input on VT47.
6. Press the MENU button on the remote control to display the menu.
7. From the menu, select [Advanced] → [Signal Select] → [Computer 1 ([Computer] on VT47)] → [Scart].
SCART is a standard European audio-visual connector for TVs, VCRs and DVD players. It is also referred to as Euro-connector.

NOTE: The ADP-SC1 SCART adapter is obtainable from your NEC dealer in Europe. Contact your NEC dealer in Europe for more information.

Connecting an External Monitor

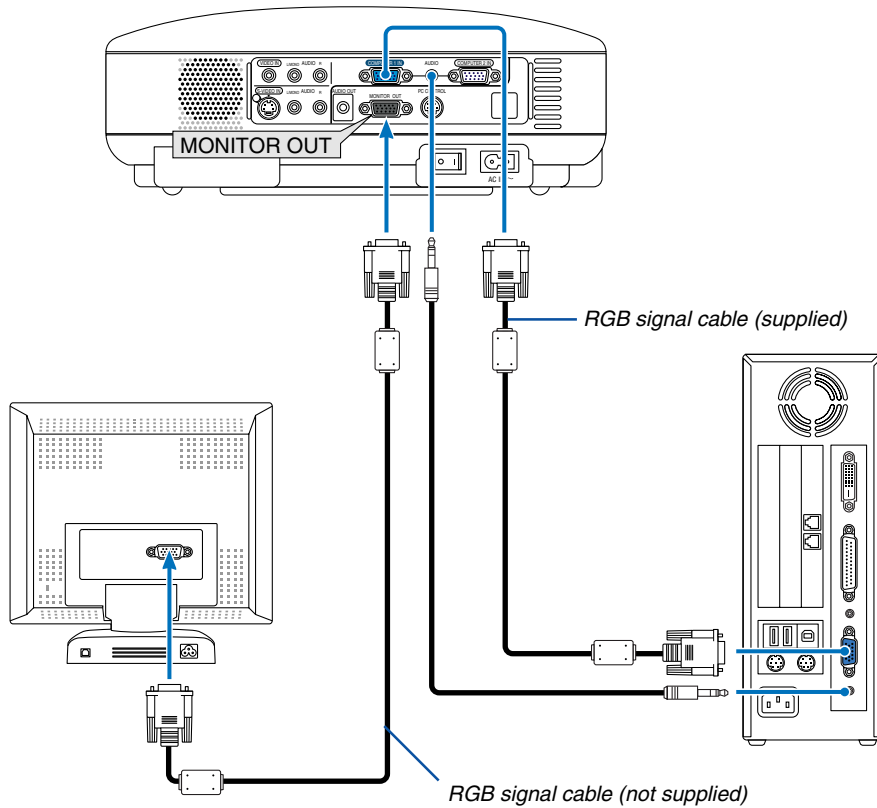

You can connect a separate, external monitor to your projector to simultaneously view on a monitor the RGB analog image you're projecting.

To do so:

1. Turn off the power to your projector, monitor and computer.
2. Use a 15-pin cable to connect your monitor to the MONITOR OUT (Mini D-Sub 15 pin) connector on your projector.
3. Connect the supplied power cable. See page [22](#).
4. Turn on the projector, monitor and the computer.

NOTE: Daisy chain connection is not possible.

Connecting Your DVD Player with Component Output

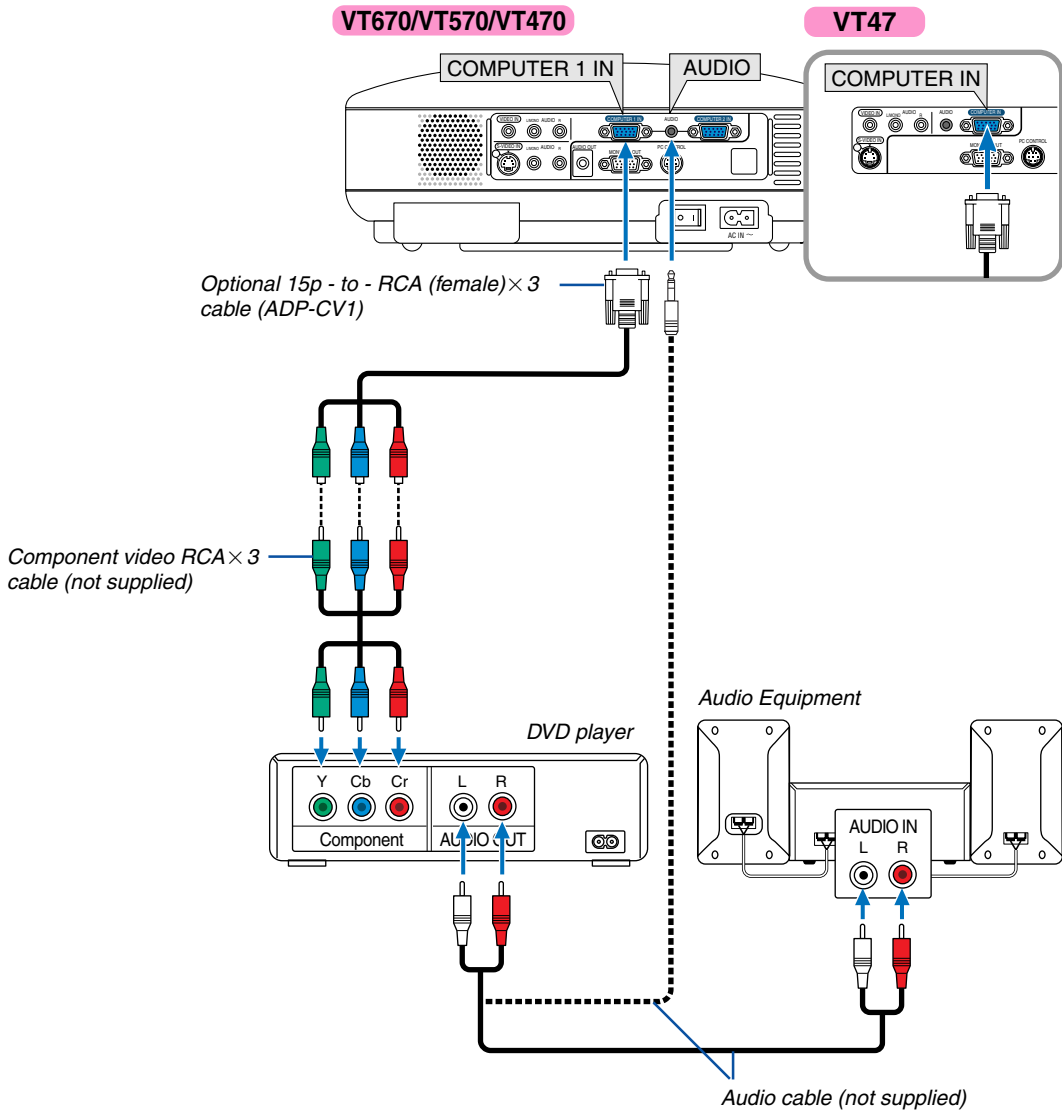

You can connect your projector to a DVD player with component output or Video output. To do so, simply:

1. Turn off the power to your projector and DVD player.
2. If your DVD player has the component video (Y,Cb,Cr) output, use a commercially available component video cable (RCA×3) and the optional 15-pin-to-RCA (female)×3 cable to connect your DVD player to the COMPUTER IN connector on the projector.

For a DVD player without component video (Y,Cb,Cr) output, use common RCA cables (not provided) to connect a composite VIDEO output of the DVD player to the Video Input of the projector.

3. Connect the supplied power cable. See page 22.
4. Turn on the projector and DVD player.

A component signal will be automatically displayed. If not, from the menu, select [Advanced] → [Signal Select] → [Computer], and then place a check mark in the Component radio button.

NOTE: Refer to your DVD player's owner's manual for more information about your DVD player's video output requirements.

Connecting Your VCR or Laser Disc Player

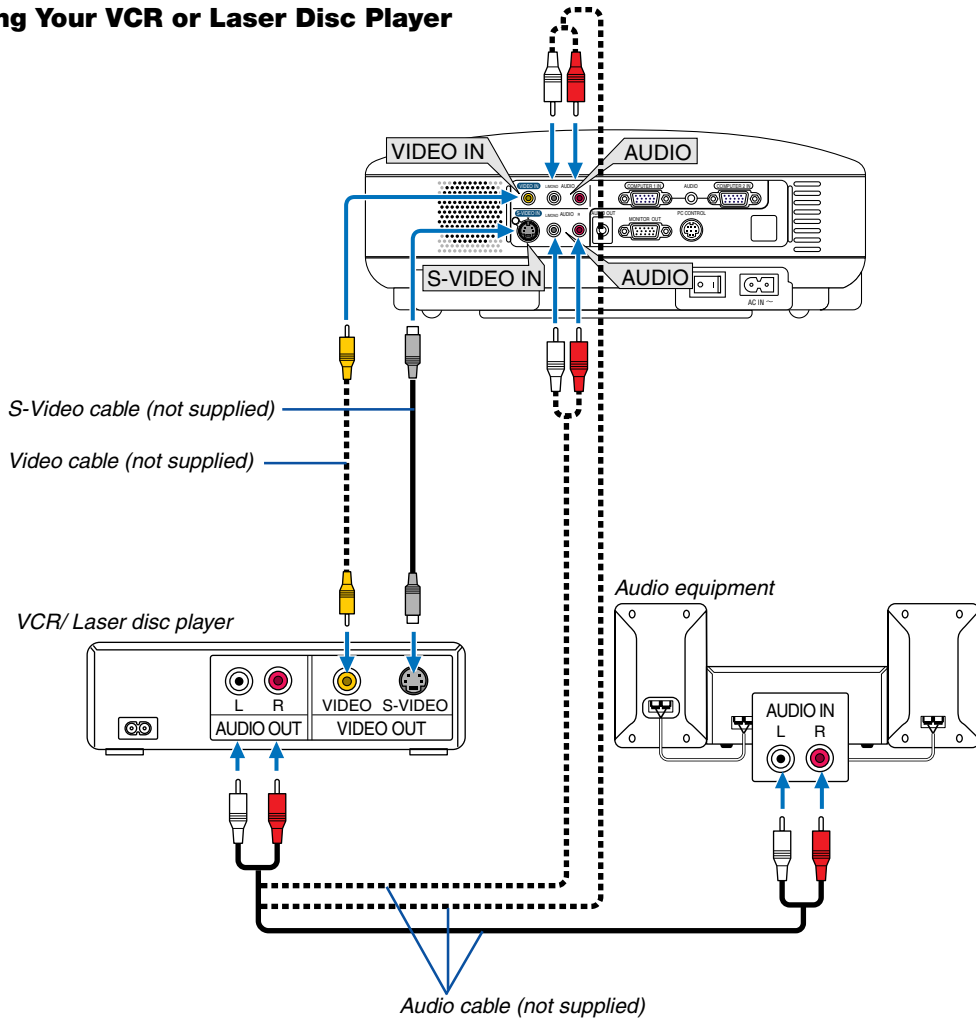

Use an RCA or S-Video cable (not provided) to connect the video and use RCA cables (not provided) to connect the audio from your VCR, laser disc player or document camera to your projector.

To make these connections, simply:

1. Turn off the power to the projector and VCR, laser disc player or document camera.
2. Connect one end of an RCA cable to the video output (or one end of an S-Video cable to the S-Video output connector) on the back of your VCR or laser disc player, connect the other end to the appropriate video input on your projector. Connect one end of a pair RCA cables (not supplied) to the audio output on the back of your VCR or laser disc player, connect the other end to your audio equipment or to the appropriate audio input on the projector.
Be careful to keep the right and left channel connections correct for stereo sound.

NOTE: The AUDIO IN L/MONO and R jacks (RCA) are shared between the Video and S-Video inputs on VT47.

3. Connect the supplied power cable. See page 22.
4. Turn on the projector and the VCR or laser disc player.

NOTE: Refer to your VCR or laser disc player owner's manual for more information about your equipment's video output requirements.

NOTE: An image may not be displayed correctly when a Video or S-Video source is played back in fast-forward or fast-rewind via a scan converter.

Connecting the Supplied Power Cable

Connect the supplied power cable to the projector.

First connect the supplied power cable's two-pin plug to the AC IN of the projector, and then connect the other plug of the supplied power cable in the wall outlet.

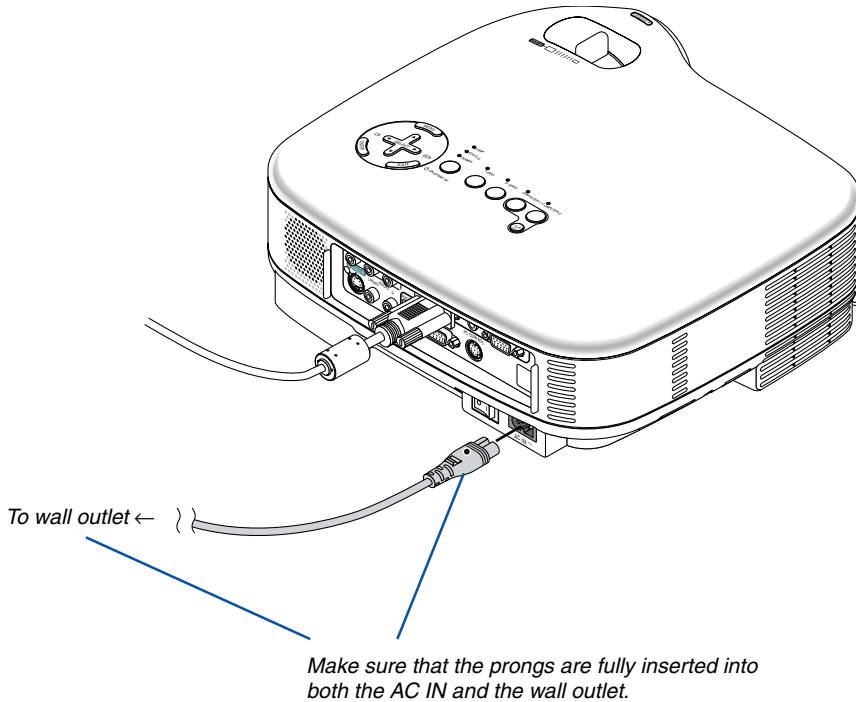

CAUTION:

Do not unplug the power cable from the wall outlet under any one of the following circumstances.

Doing so can cause damage to the projector:

- While the Hour Glass icon appears.
- While the cooling fans are running. The cooling fans continue to work for 30 seconds after the projector is turned off.

3. Projecting an Image (Basic Operation)

This section describes how to turn on the projector and to project a picture onto the screen.

1 Turning on the Projector

NOTE:

- The projector has two power switches: a main power switch and a POWER (ON/STAND BY) button (POWER ON and OFF on the remote control of VT670/VT470 and POWER on the remote control of VT570/VT47).
- When plugging in or unplugging the supplied power cable, make sure that the main power switch is pushed to the off (O) position. Failure to do so may cause damage to the projector.

1. To turn on the main power to the projector, press the Main Power switch to the on position (I).

- The POWER indicator will light orange.
See the Power Indicator section on page 56 for more details.

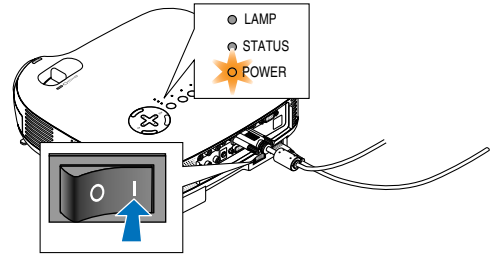

2. Press the POWER (ON/STAND BY) button on the projector cabinet or the POWER ON button (the POWER button on VT570/VT47) on the remote control for a minimum of 2 seconds. The POWER indicator will turn to green and the projector will become ready to use.

After you turn on your projector, ensure that the computer or video source is turned on and that your lens cap is removed.

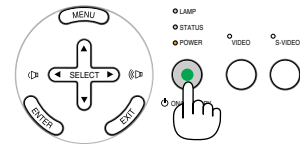

VT670/VT470

VT570/VT47

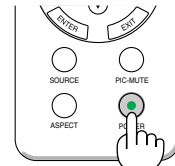
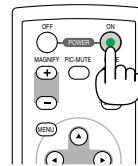

NOTE: When no signal is available, a blue, black or logo screen is displayed.

When the projector displays a blue or a black screen (not logo), the Eco mode will be automatically selected in "Lamp Mode."

NOTE: If you turn on the projector immediately after the lamp is turned off or when the temperature is high, the fans runs without displaying an image for some time and then the projector will display the image.

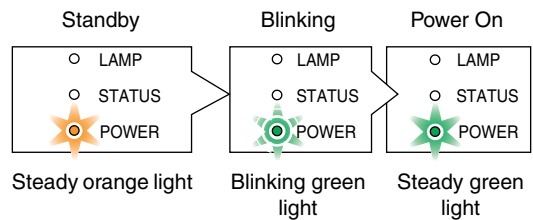

See page 56 for more details.

3. Projecting an Image (Basic Operation)

Note on Startup screen (Menu Language Select screen)

When you first turn on the projector, you will get the Startup menu. This menu gives you the opportunity to select one of the 8 menu languages.

To select a menu language, follow these steps:

1. Use the **SELECT** ▲ or ▼ button to select one of the 8 languages for the menu.

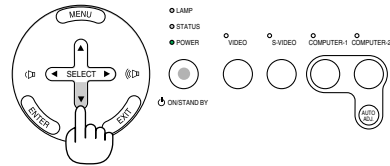
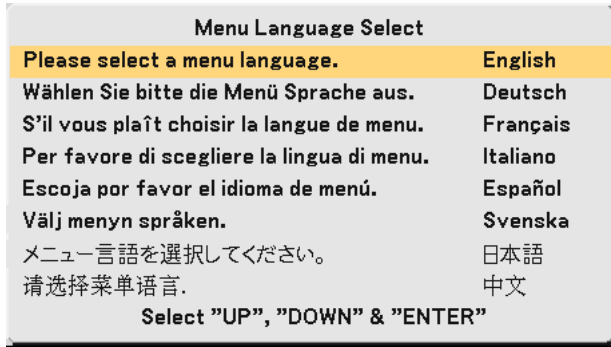

VT670/VT470

VT570/VT47

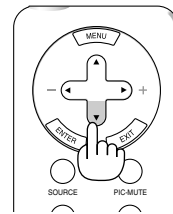
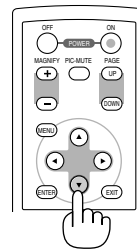

2. Press the **ENTER** button to execute the selection.

After this has been done, you can proceed to the menu operation.

If you want, you can select the menu language later. See "Language" on pages 38 and 44.

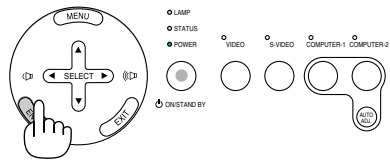

VT670/VT470

VT570/VT47

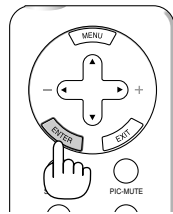
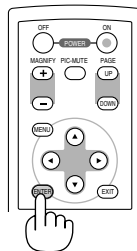

NOTE: Immediately after turning on the projector, screen flicker may occur. This is not a fault. Wait 3 to 5 minutes until the lamp lighting is stabilized.

When the Lamp mode is set to Eco, the LAMP indicator will light green.

If one of the following things happens, the projector will not turn on.

- If the internal temperature of the projector is too high, the projector detects abnormal high temperature. In this condition the projector will not turn on to protect the internal system. If this happens, wait for the projector's internal components to cool down.
- When the lamp reaches its end of usable life, the projector will not turn on. If this happens, replace the lamp.
- If the lamp fails to light, and if the STATUS indicator flashes on and off in a cycle of six times, wait a full minute and then turn on the power.

2 Selecting a Source

Selecting the computer or video source

NOTE: Turn on the computer or VCR connected to the projector.

Using the cabinet buttons

Press any one of the COMPUTER 1/2 (COMPUTER button on VT47), VIDEO and S-VIDEO buttons.

The corresponding indicator will light green.

Using the Remote Control (VT670/VT470)

Press any one of the COMPUTER 1/2, COMPONENT, VIDEO or S-VIDEO buttons.

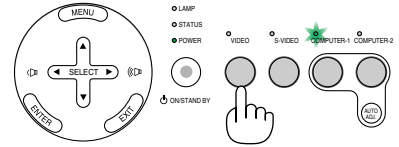

VT670/VT470

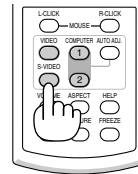

VT570/VT47



Selecting from the Source List (VT570/VT47)

1. Press and quickly release the SOURCE button on the remote control.

The Source list will be displayed.

2. Press and quickly release the SOURCE button to select the source in the Source list.

Each time the SOURCE button is pressed, the selection in the Source list will change as follows:

VT570

Computer 1 → Computer 2 → Video → S-Video → Computer 1 → ...

VT47

Computer → Video → S-Video → Computer → ...

VT570

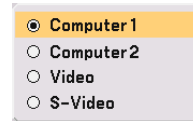

VT47

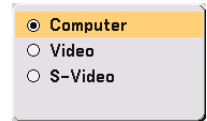

3. Press the ENTER button to display the selected source.

NOTE: Highlighting the source for 2 seconds without pressing the ENTER button will also display the selected source.

VT570/VT47

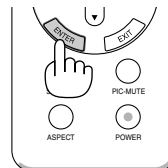

3. Projecting an Image (Basic Operation)

Detecting the Signal Automatically

Press and hold the SOURCE button for a minimum of 1 second, the projector will search for the next available input source. Each time you press and hold the SOURCE button for a minimum of 1 second, the source will change as follows:

VT570

Computer 1 → Computer 2 → Video → S-Video → Computer 1 → ...

VT47

Computer → Video → S-Video → Computer → ...

If no input signal is present, the input will be skipped.

VT570/VT47

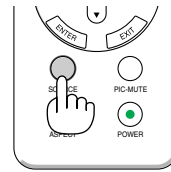

③ Adjusting the Picture Size and Position

Place your projector on a flat level surface and ensure that the projector is square to the screen.

Lift the front edge of the projector to center the image vertically.

* If the projected image does not appear square to the screen then use the Keystone feature for proper adjustment. See page 29.

Move the projector left to center the image horizontally on the screen.

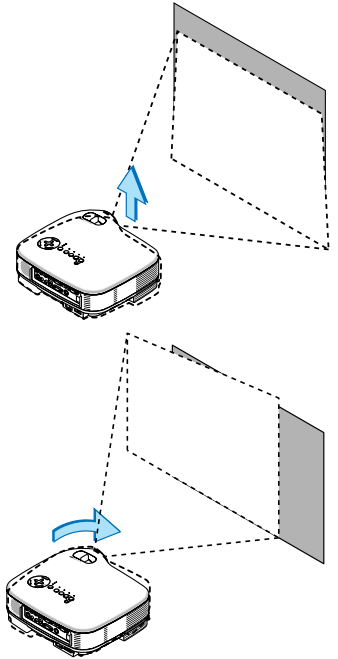

Adjust the Tilt Foot

1. Lift the front edge of the projector.
2. Push up the Adjustable Tilt Foot Levers on the right and left sides of the projector to extend the adjustable tilt feet (maximum height).
3. Push down the Adjustable Tilt Foot Levers.
4. Lower the front of the projector to the desired height and release the Adjustable Tilt Foot Lever to lock the Adjustable tilt foot. There is approximately 10 degrees of up and down adjustment for the front of the projector.

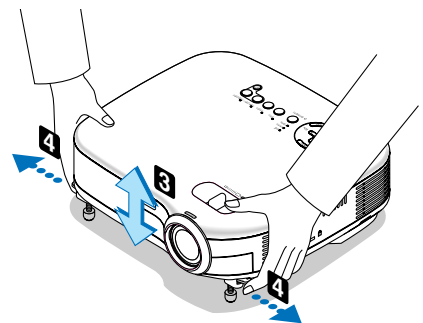
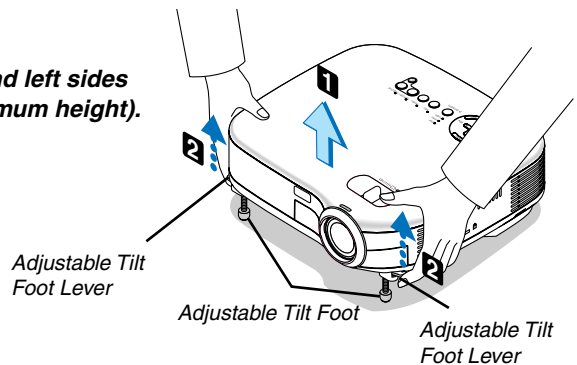

CAUTION

Do not use the tilt-foot for purposes other than originally intended. Misuses such as gripping the tilt-foot or hanging on the wall can cause damage to the projector.

3. Projecting an Image (Basic Operation)

Zoom

VT670/VT570/VT470

Use the ZOOM lever to finely adjust the image size on the screen.

VT47

Use the Digital ZOOM button on the projector cabinet to electronically enlarge or reduce the image size.

NOTE: Digital Zoom can cause result in a blurry image because zooming is made electronically.

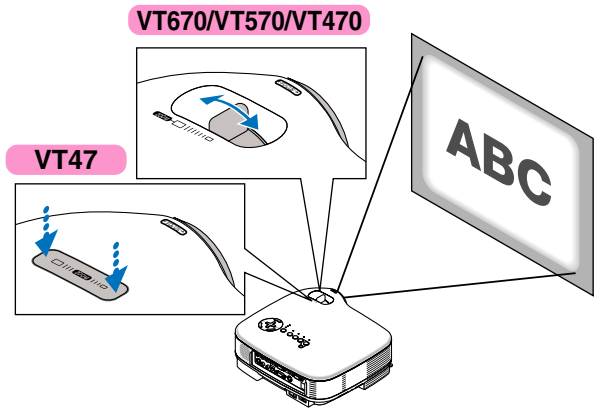

Focus

Use the FOCUS ring to obtain the best focus.

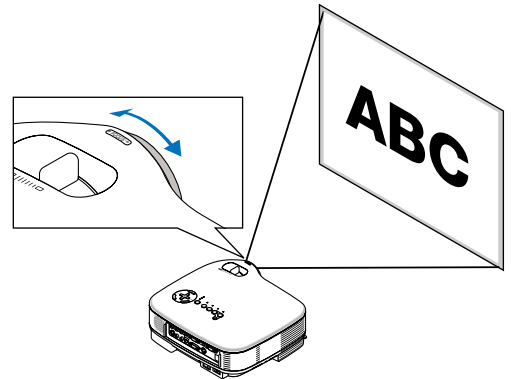

4 Correcting Keystone Distortion

Auto Keystone Correction

The Auto Keystone correction feature will correct the vertical distortion of a projected image on the screen. No special operation required. Just put the projector on a flat surface.

Note that the vertical keystone angle can be corrected between 30 degrees upward and 30 degrees downward of projector tilt from level.



NOTE: Auto and Manual Keystone correction angle could be less than 30 degrees depending on some kinds of signal and aspect ratios.

NOTE: The Auto Keystone Correction feature can cause an image to be slightly blurred because the correction is made electronically.

Manual Keystone Correction

You can also correct the vertical keystone distortion manually.

To do so:

1. Press the MENU button.

The menu will be displayed.

2. Turn off the Auto Keystone function.

Use the SELECT ▼ button to select “Image” and then press the SELECT ► button. The “Auto Keystone” will be displayed. Press the SELECT ► to select “Off”.

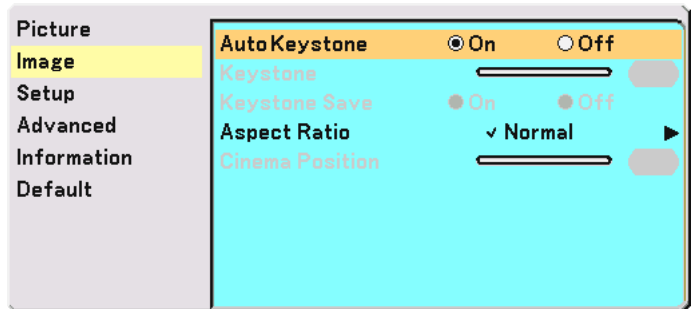

3. Select the Keystone function.

Use the SELECT ▼ button to select “Keystone”.

4. Correct the vertical distortion.

Use the SELECT ◀ or ▶ button to correct the vertical keystone distortion.

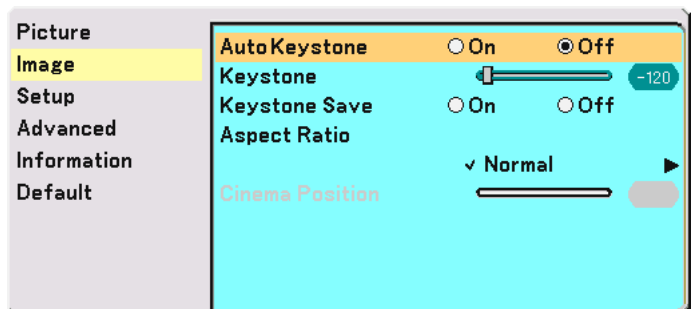

NOTE: The Keystone Correction feature can cause an image to be slightly blurred because the correction is made electronically.

3. Projecting an Image (Basic Operation)

5. Press the MENU button to close the menu.

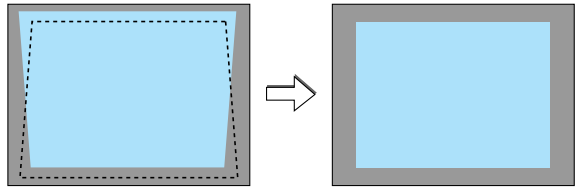

NOTE: You can save the changes using the Keystone Save feature when you turn off the projector. See page 42.

5 Optimizing RGB Picture Automatically

Adjusting the Image Using Auto Adjust

Optimizing an RGB image automatically.

Press the Auto Adjust button to optimize an RGB image automatically.

[Poor picture]

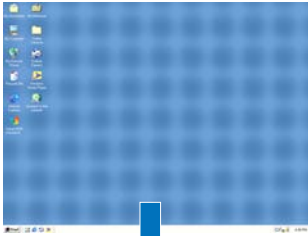

[Normal picture]

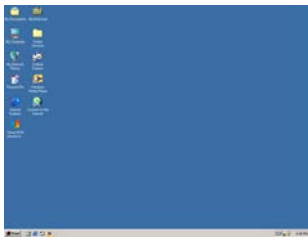

VT670/VT570/VT470

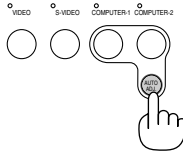

VT47

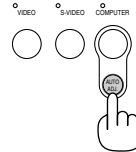

VT670/VT470

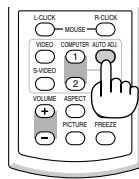

VT570/VT47

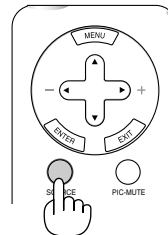

Press the Auto Adjust button to fine-tune the computer image or to remove any vertical banding that might appear and to reduce video noise, dot interference or cross talk (this is evident when part of your image appears to be shimmering). This function adjusts the clock frequencies that eliminate the horizontal banding in the image. This function also adjusts the clock phase to reduce video noise, dot interference or cross talk. (This is evident when part of your image appears to be shimmering.)

This adjustment may be necessary when you connect your computer for the first time.

NOTE:

Some signals may not be displayed correctly or take time.

- The Auto Adjust function does not work for component and video signal.
- If the Auto Adjust operation cannot optimize the RGB signal, try to adjust Horizontal/Vertical Position Clock and Phase manually. See page 48.

6 Turning Up or Down Volume

VT670/VT470

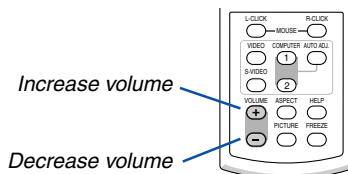

Sound level from the speaker and the AUDIO OUT jack (Stereo mini) on the projector can be adjusted.

VT570/VT47

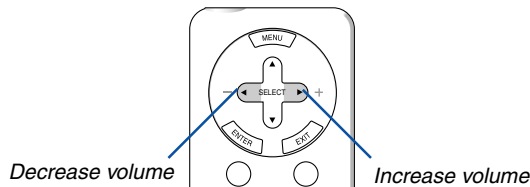

7 Turning off the Projector

To turn off the projector:

First, press the **POWER (ON/STAND BY)** button on the projector cabinet or the **POWER OFF** button on the remote control. The “Power Off / Are you sure?” message will appear.

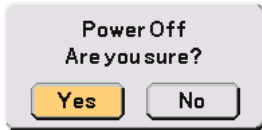

Secondly, press the **ENTER** button or press the **POWER (ON/STAND BY)**, the **POWER OFF** or the **POWER** button again.

The power indicator will glow orange. After the projector turns off, the cooling fans keep operating for 30 seconds (Cooling-off time).

Immediately after turning on the projector and displaying an image, you cannot turn off the projector for 60 seconds.

Finally, turn off the Main Power switch. The power indicator will go out.

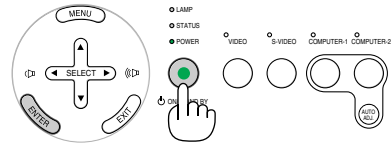

VT670/VT470

VT570/VT47

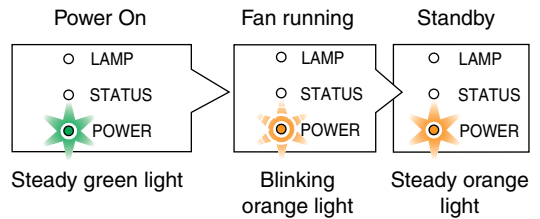
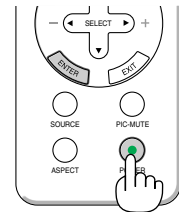
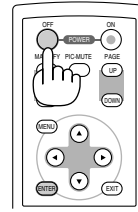

CAUTION

Do not unplug the power cable from the wall outlet or do not turn off the main power under any one of the following circumstances. Doing so can cause damage to the projector:

- While the Hour Glass icon appears.
- While the cooling fans are running. (The cooling fans continue to work for 30 seconds after the projector is turned off).

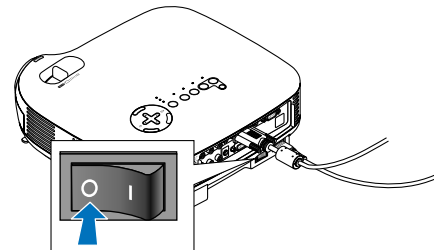

8 After Use

Preparation: Make sure that the projector is turned off.

1. Unplug the power cable.
2. Disconnect any other cables.
3. Retract adjustable tilt feet if extended.
4. Cover the lens with the lens cap.
5. Put the projector and its accessories in the supplied soft carrying case.

4. Convenient Features

❶ Turning off the Image and Sound

Press the PIC-MUTE button to turn off the image and sound for a short period of time. Press again to restore the image and sound.

VT670/VT470

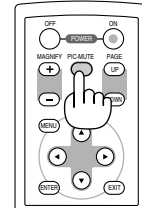

VT570/VT47

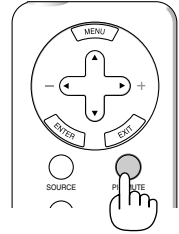

❷ Freezing a Picture (VT670/VT470 only)

Press the FREEZE button to freeze a picture. Press again to resume motion.

NOTE: The optional remote control PR52 (RD-408E) allows you to use this feature on VT570 and VT47.

VT670/VT470

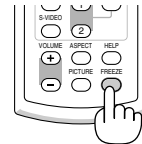

❸ Enlarging and Moving a Picture (VT670/VT470 only)

You can enlarge the picture up to 400 percent.

To do so:

1. Press the MAGNIFY (+) button to magnify the picture.
To move the magnified image, use the SELECT button.

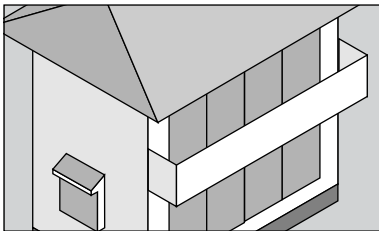
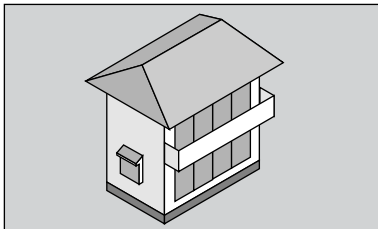

VT670/VT470

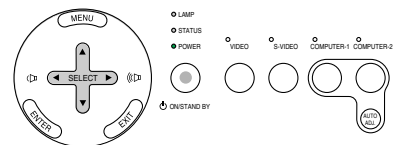
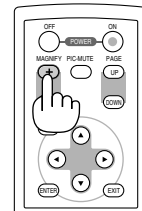

2. Return the image to the original size.

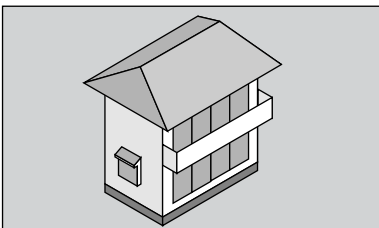

VT670/VT470

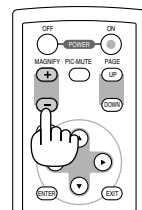

NOTE: The optional remote control PR52 (RD-408E) allows you to use this feature on VT570 and VT47.

4 Using Remote Mouse Receiver (VT670/VT470 only)

The remote mouse receiver enables you to operate your computer's mouse functions from the remote control. It is a great convenience for clicking through your computer-generated presentations.

Connecting the remote mouse receiver to your computer

If you wish to use the remote mouse function, connect the mouse receiver and computer. The mouse receiver can be connected directly to the computer's USB port (type A).

NOTE: Depending on the type of connection or OS installed on your computer, you may have to restart your computer or change your computer settings.

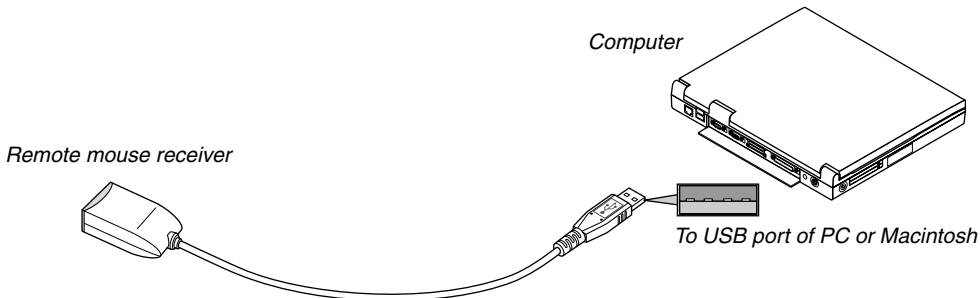

When operating a computer via the remote mouse receiver

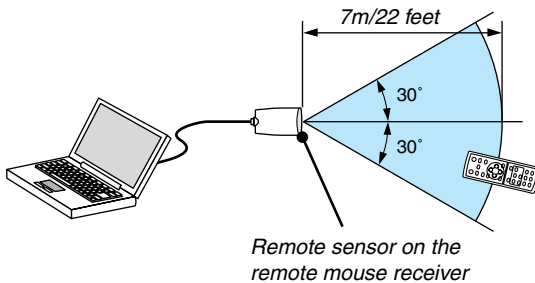

When connecting using the USB terminal

For PC, the mouse receiver can only be used with a Windows 98/Me/XP* or Windows 2000 operating system.

** NOTE: In Windows XP, if the mouse cursor will not move correctly, do the following:*

Clear the Enhance pointer precision check box underneath the mouse speed slider in the Mouse Properties dialog box [Pointer Options tab].

NOTE: Wait at least 5 seconds after disconnecting the mouse receiver before reconnecting it and vice versa. The computer may not identify the mouse receiver if it is repeatedly connected and disconnected in rapid intervals.

Operating your computer's mouse from the remote control

You can operate your computer's mouse from the remote control.

PAGE UP/DOWN Button: scrolls the viewing area of the window or to move to the previous or next slide in PowerPoint on your computer.

▲▼◀▶ / Mouse Buttons: moves the mouse cursor on your computer.

MOUSE L-CLICK Button: works as the mouse left button.

MOUSE R-CLICK Button: works as the mouse right button.

5. Using On-Screen Menu

① Using the Menus

NOTE: The on-screen menu may not be displayed correctly while interlaced motion video image is projected.

1. Press the **MENU** button on the remote control or projector cabinet to display the Menu.

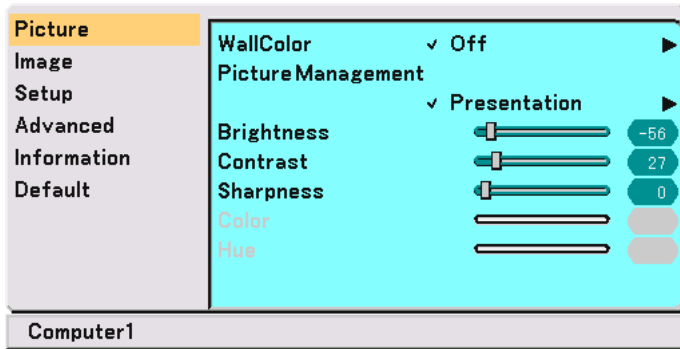

VT670/VT470

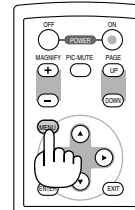

VT570/VT47

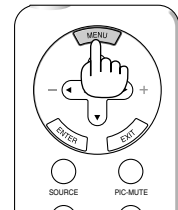

2. Press the **SELECT** ▲▼ buttons on the remote control or the projector cabinet to highlight the menu for the item you want to adjust or set.

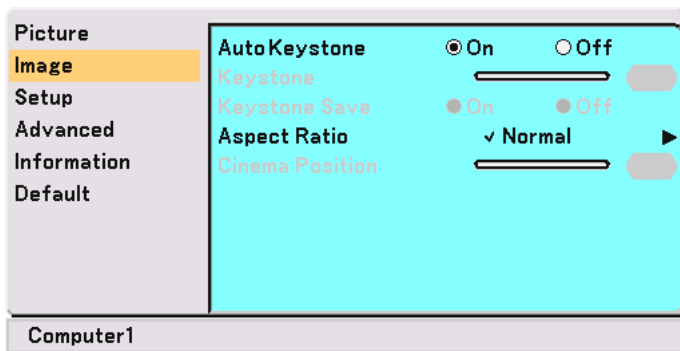

VT670/VT470

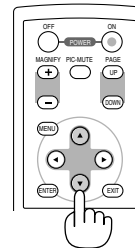

VT570/VT47

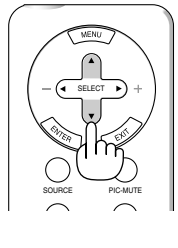

3. Press the **SELECT** ► button or the **ENTER** button on the remote control or the projector cabinet to select a submenu or item.

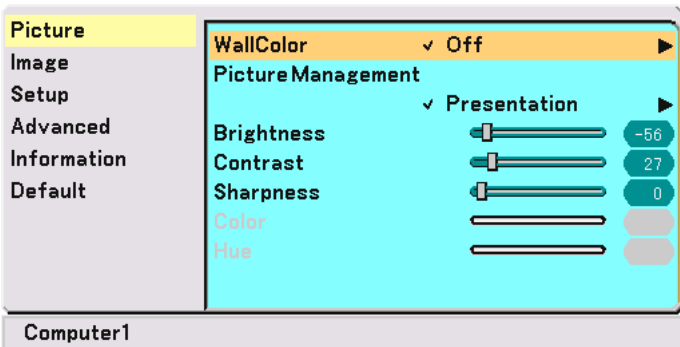

VT670/VT470

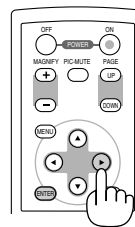

VT570/VT47

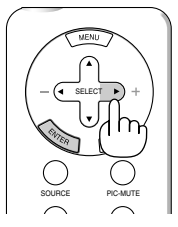

5. Using On-Screen Menu

4. Use the **SELECT** ▲▼ buttons on the remote control or the projector cabinet to select the item you want to adjust or set.

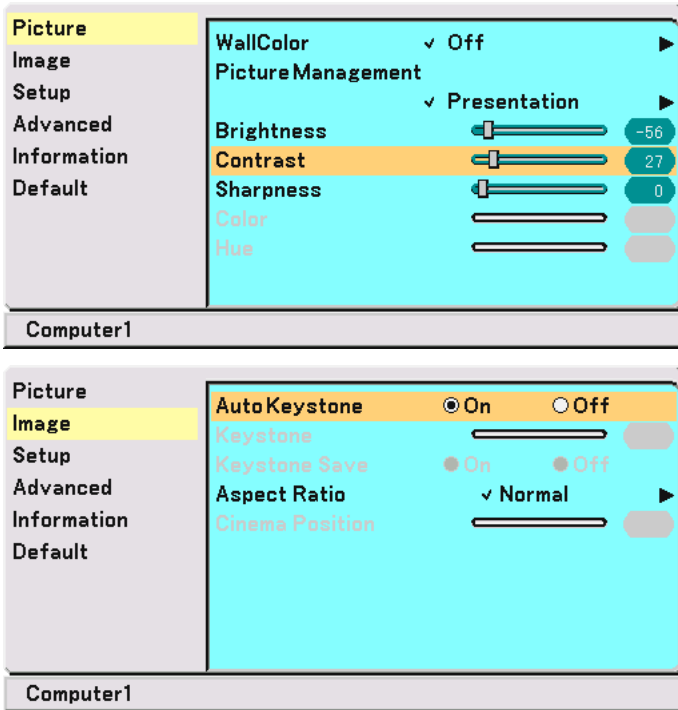

VT670/VT470

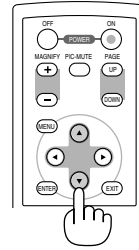

VT570/VT47

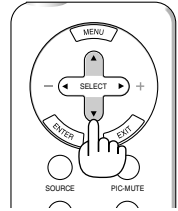

5. Adjust the level or turn the selected item on or off by using **SELECT** ◀ or ▶ buttons on the remote control or the projector cabinet.

The on-screen slide bar will show you the amount of increase or decrease.

Changes are stored until you adjust it again.

EXIT Return to the previous menu.

VT670/VT470

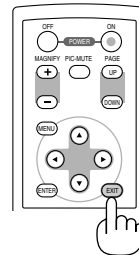

VT570/VT47

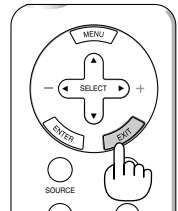

6. Repeat steps 2-5 to adjust an additional item, or press the **MENU** button to close the menu.

VT670/VT470

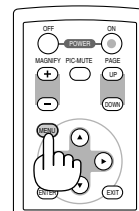

VT570/VT47

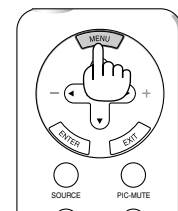

2 Menu Elements

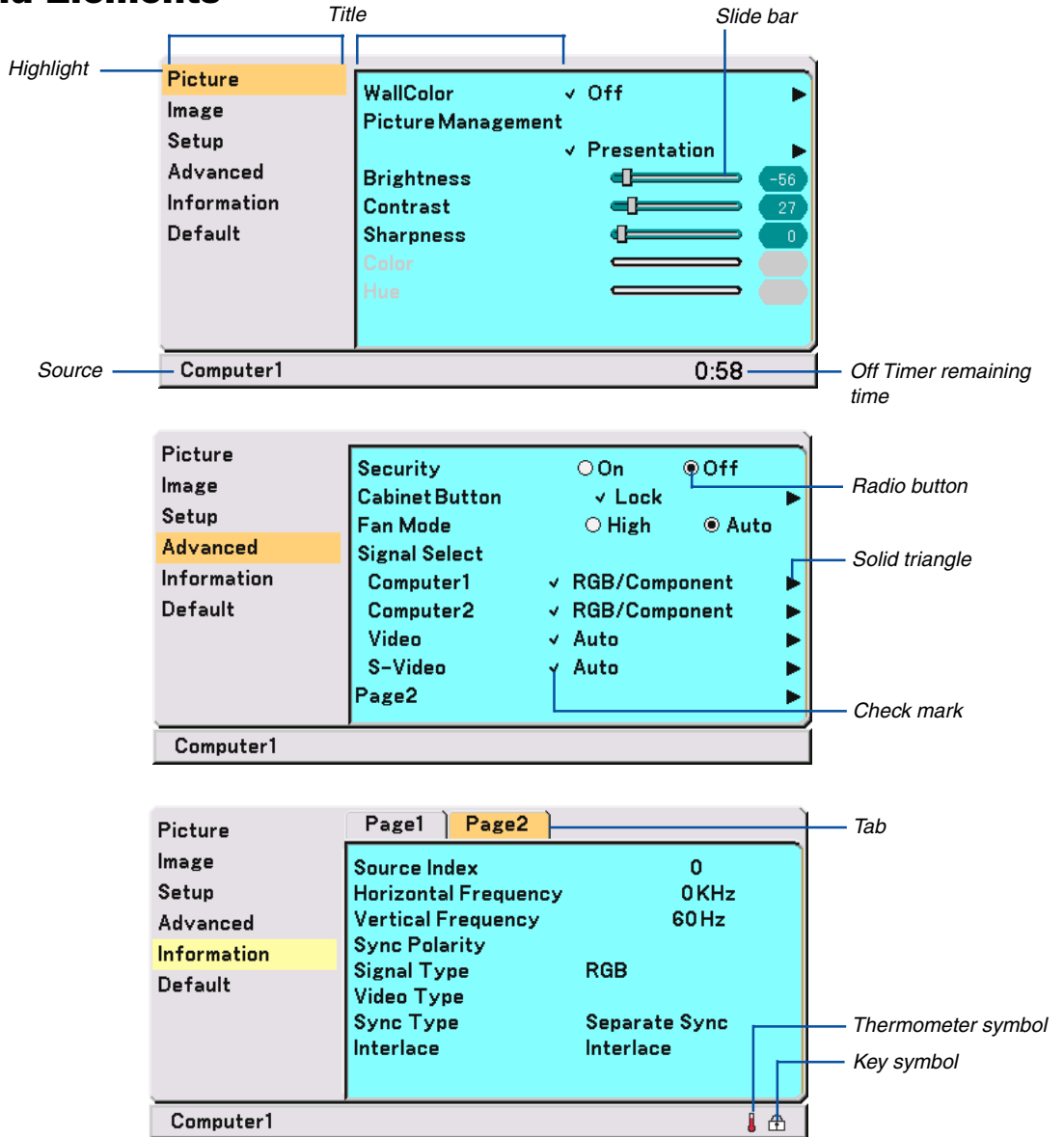

Menu windows or dialog boxes typically have the following elements:

- Title Indicates the menu title.
- Highlight..... Indicates the selected menu or item.
- Source Indicates the currently selected source.
- Remaining countdown time Indicates the remaining countdown time when the Off Timer is preset.
- Solid triangle Indicates further choices are available. A highlighted triangle indicates the item is active.
- Tab Indicates a group of features in a dialog box. Selecting on any tab brings its page to the front.
- Radio button Use this round button to select an option in a dialog box.
- Check mark Indicates the item is selected.
- Slide bar Indicates settings or the direction of adjustment.
- Key symbol Indicates the Cabinet Button Lock is enabled.
- Thermometer symbol Indicates the lamp mode is forcibly set to Eco mode because the internal temperature is too high.

③ List of Menu Items

Picture	
Wall Color	Off, Blackboard, Light yellow, Light green, Light blue, Sky blue, Light rose, Pink
Picture Management	Presentation, Video, Movie, Graphic, sRGB
	User
	Base Setting Presentation, Video, Movie, Graphic, sRGB
	Gamma Correction Dynamic, Black Detail, Natural
	Brightness R,G,B
	Contrast R,G,B
Brightness	
Contrast	
Sharpness	
Color	
Hue	
Image	
Auto Keystone	On, Off
Keystone	
Keystone Save	On, Off
Aspect Ratio	Normal, Wide Zoom, Cinema, Native
Cinema Position	
Setup	
Off Timer	Off, 0:30, 1:00, 2:00, 3:00, 4:00, 6:00, 8:00
Lamp Mode	Normal, Eco
Language	Language-1 English, Deutsch, Français, Italiano, Español, Português, Nederlands Language-2 Svenska, Norsk, Suomi, Český, Magyar, Polski, Türkçe Language-3 Русский, Ελληνικά, 日本語, 中文, 한국어, العربية, Dansk
Menu Color Select	Color, Monochrome
Menu Display Time	Manual, Auto 5 sec, Auto 15sec, Auto 45 sec
Background	Blue, Black, Logo
Orientation	Desktop Front, Ceiling Rear, Desktop Rear, Ceiling Front
Beep	On, Off
Advanced	
Security	On, Off
Cabinet Button	Lock, Unlock
Fan Mode	High, Auto
Signal Select COMPUTER1*	RGB/Component, RGB, Component, Scart
COMPUTER2	RGB/Component, RGB, Component
Video	Auto, NTSC3.58, NTSC4.43, PAL, PAL-M, PAL-N, PAL60, SECAM
S-Video	Auto, NTSC3.58, NTSC4.43, PAL, PAL-M, PAL-N, PAL60, SECAM
Page2	Power Management On, Off
	Noise Reduction On, Off
	Flicker Reduction On, Off
	Auto Adjust Off, Normal, Fine
	Horizontal
	Vertical
	Clock
	Phase
	Communication Speed 4800, 9600, 19200

* Only COMPUTER on VT47.

5. Using On-Screen Menu

Information	
Page1	Remaining Lamp Time, Lamp Hour Meter, Filter Usage, Projector Usage, BIOS Version, Firmware Version, Data Version
Page2	Source Index, Horizontal Frequency, Vertical Frequency, Sync Polarity Signal Type, Video Type, Sync Type, Interlace

Default	
Factory Default	Current Signal All Data
Clear Filter Usage	
Clear Lamp Hour Meter	

NOTE: Some menu items are not available depending on the input source.

4 Menu Descriptions & Functions [Picture]

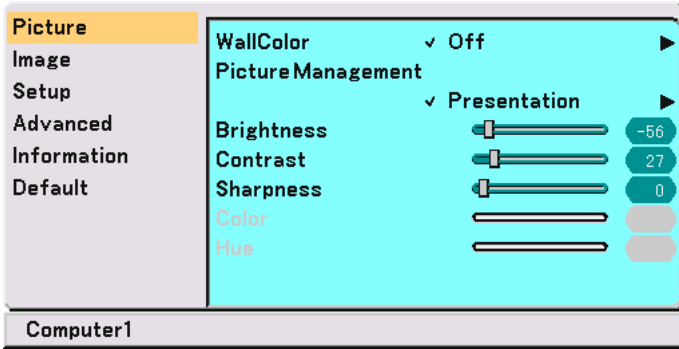

Using the Wall Color Correction [Wall Color]

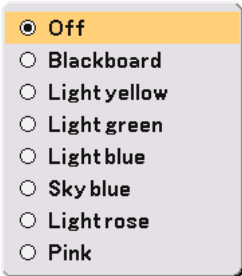

This function allows for quick adaptive color correction in applications where the screen material is not white. The following eight options are available.

- OFF
- Blackboard
- Light yellow
- Light green
- Light blue
- Sky blue
- Light rose
- Pink

Using Picture Management [Picture Management]

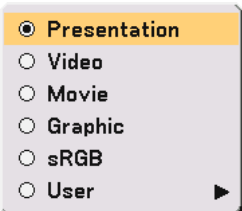

This option allows you to adjust neutral tint for yellow, cyan or magenta. There are 5 factory presets optimized for various types of images, or you can set user adjustable settings.

- Presentation Recommended for making a presentation using a PowerPoint file
- Video Recommended for regular picture such as TV program
- Movie Recommended for movies
- Graphic Recommended for graphics
- sRGB Standard color values
- User User adjustable

NOTE: When "sRGB", "Graphic", "Video" or "Movie" is selected, the brightness decreases slightly when compared to "Presentation". This is not a malfunction.

User Adjust (when using User)

When selecting user adjustable presetting (User), the submenu will be displayed.

You can customize each gamma or color. To do so, first select "User" and press the ENTER button, and then proceed the following steps.

Selecting Base Setting [Base Setting]

This feature allows you to use white balance or gamma values as reference data to optimize for various types of images. You can select one of the following five settings.

- Presentation
- Movie
- sRGB
- Video
- Graphic

Selecting Gamma Correction Mode [Gamma Correction]

Each mode is recommended for :

- Dynamic Creates a high-contrast picture
- Black Detail Emphasizes detail in dark areas of the picture
- Natural Natural reproduction of the picture

Adjusting White Balance [Brightness RGB/Contrast RGB]

This allows you to adjust the white balance. Brightness for each color (RGB) is used to adjust the black level of the screen; Contrast for each color (RGB) to adjust the white level of the screen.

Adjusting Brightness, Contrast, Sharpness, Color and Hue

- Brightness Adjusts the brightness level or the back raster intensity.
- Contrast Adjusts the intensity of the image according to the incoming signal.
- Sharpness Controls the detail of the image for Video.
- Color Increases or decreases the color saturation level (not valid for RGB).
- Hue Varies the color level from +/- green to +/- blue. The red level is used as reference. This adjustment is only valid for Video and Component inputs (not valid for RGB).

5 Menu Descriptions & Functions [Image]

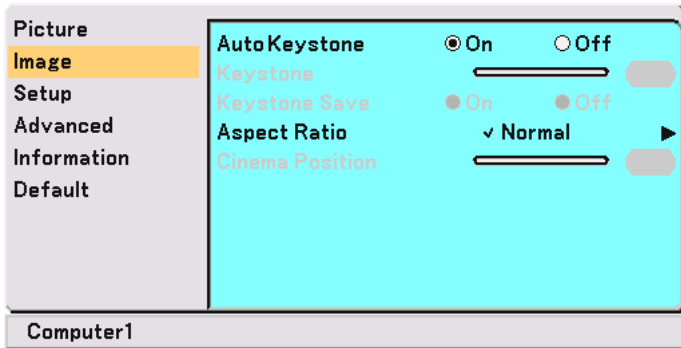

Enabling Auto Keystone [Auto Keystone]

This feature allows the projector to detect its tilt and correct vertical distortion automatically. To turn on the Auto Keystone feature, select “On”.

Correcting Vertical Keystone Distortion Manually [Keystone]

You can correct vertical distortion manually from the menu when “Auto Keystone” is turned off. You can save the changes using the Keystone Save feature when you turn off the projector.

Saving Vertical Keystone Correction [Keystone Save]

This option enables you to save your current keystone settings. Saving your change once affects all sources. The changes are saved when the projector is off.

Selecting Aspect Ratio [Aspect Ratio]

Aspect Ratio allows you to select the best Aspect mode to display your source image. You can also display the Aspect Ratio menu by pressing the “ASPECT” button on the remote control.

When 4:3 is selected from the source (i.e. DVD player), the following selections will display:

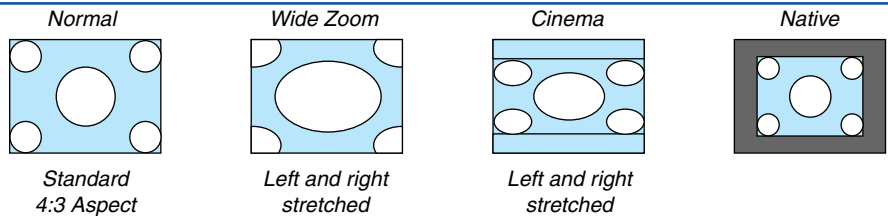

When 16:9 is selected from the source (i.e. DVD player), the following selections will display:

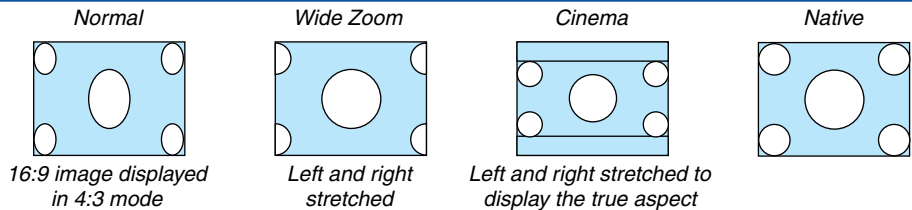

Native (RGB only): Turns off the Advanced AccuBlend feature. The projector displays the current image in its true resolution.

NOTE:

- While you are displaying an image at the projector's native resolution or higher, “Native” is not available.
- You can adjust the image position for Cinema aspect. See “Cinema Position” for setting the image position.

Copyright

Please note that using this projector for the purpose of commercial gain or the attraction of public attention in a venue such as a coffee shop or hotel and employing compression or expansion of the screen image with a “Aspect Ratio” setting may raise concern about the infringement of copyrights which are protected by copyright law.

Adjusting the Vertical Position of Image [Cinema Position] (for Cinema only)

This feature adjusts the vertical position of the image when viewing video with Cinema aspect ratio selected. When “Cinema” is selected in “Aspect Ratio”, the image is displayed with black borders on the top and bottom. You can adjust the vertical position between top and bottom.

NOTE: This option is available only when “Cinema” is selected in Aspect Ratio.

6 Menu Descriptions & Functions [Setup]

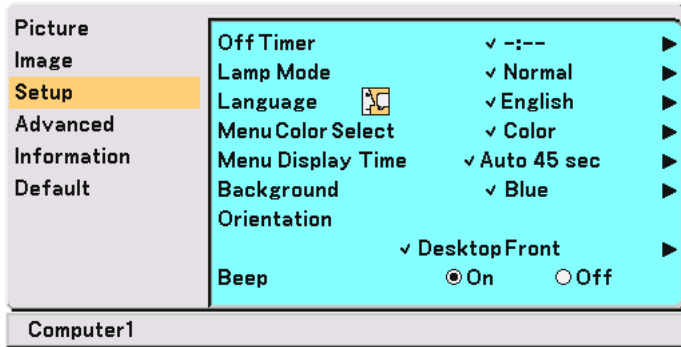

Using Off Timer [Off Timer]

You can set the timer so that the projector turns itself off at the preset time.

1. Use the SELECT ▲▼ to select your desired time between 30 minutes and 8 hours: Off, 0:30, 1:00, 2:00, 3:00, 4:00, 6:00 and 8:00.
2. Press the ENTER button.
3. The Off Timer starts counting down remaining time.
4. The projector turns off after the countdown is complete.

NOTE:

- To cancel the preset time, select “Off” for the preset time or turn off the power.
- When the remaining time reaches 3 minutes before the projector is turned off, the “Projector will turn off in 3 minutes” message will be displayed on the bottom of the screen.

Selecting Lamp Mode [Lamp Mode]

This feature enables you to select two brightness modes of the lamp: Normal and Eco modes. The lamp life can be extended by using the Eco mode.

- Normal Mode This is the default setting (100% Brightness).
- Eco Mode Select this mode to increase the lamp life (80% Brightness).

NOTE: If the projector is overheated in Normal mode, there may be a case where the Lamp mode automatically changes to Eco mode to protect the projector. When the projector is in Eco mode, the picture brightness decreases. When the projector comes back to normal temperature, the Lamp mode returns to Normal mode.

NOTE: Thermometer symbol  indicates the lamp mode is automatically set to Eco mode because the internal temperature is too high.

Selecting Menu Language [Language]

You can choose one of 21 languages for on-screen instructions.

Selecting Menu Color [Menu Color Select]

You can choose between two color modes for menu color: color and monochrome.

Selecting Menu Display Time [Menu Display Time]

This option allows you to select how long the projector waits after the last touch of a button to turn off the menu. The preset choices are "Manual", "Auto 5 sec", "Auto 15 sec", and "Auto 45 sec". The "Auto 45 sec" is the factory preset.

Selecting a Color or Logo for Background [Background]

Use this feature to display a black/ blue screen or logo when no signal is available.

Selecting Projector Orientation [Orientation]

This sets your image for your type of projection. The options are: desktop front projection, ceiling rear projection, desktop rear projection, and ceiling front projection.

Enabling Key Sound and Error Sound [Beep]

This feature turns on or off the keypad sound or alarm when a button on the cabinet and the remote control is pressed or an error occurs.

7 Menu Descriptions & Functions [Advanced]

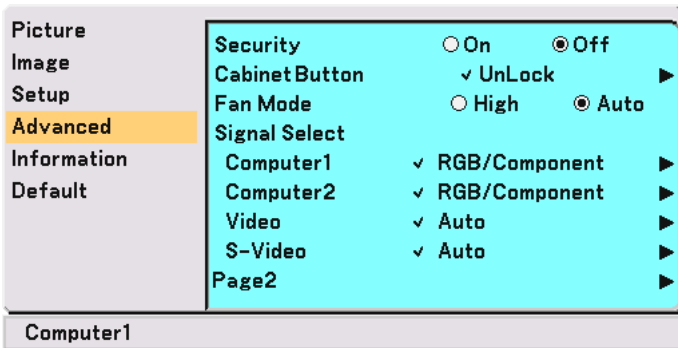

Security

A keyword can be set for your projector to avoid operation by an unauthorized user using the Menu. When a keyword is set, turning on the projector will display the Keyword input screen. Unless the correct keyword is entered, the projector cannot project an image.

To enable the Security function:

1. Select [Advanced] → [Security] and press the ◀ button to select "On".

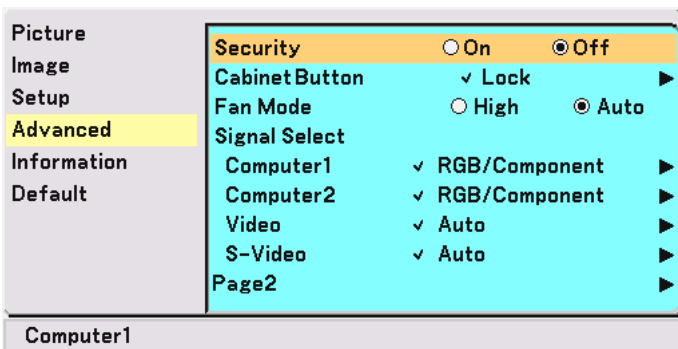

The [Keyword] screen will be displayed.

2. Type in a combination of the four SELECT buttons ▲▼◀▶ and press the ENTER button.

NOTE: A keyword must be four to 10 digits in length.

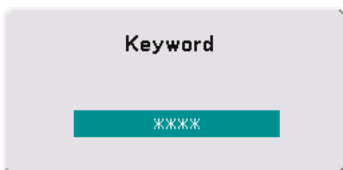

The [Confirm Keyword] screen will be displayed.



3. Type in the same combination of SELECT buttons ▲▼◀▶ and press the ENTER button.
The confirmation screen will be displayed.

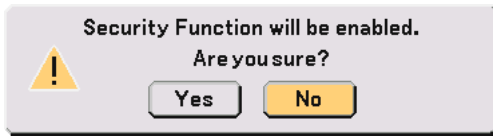

4. Select "Yes" and press the ENTER button.
The Security function has been enabled.

To disable the Security function:

1. Select [Advanced] → [Security] and press the ► button to select "Off".

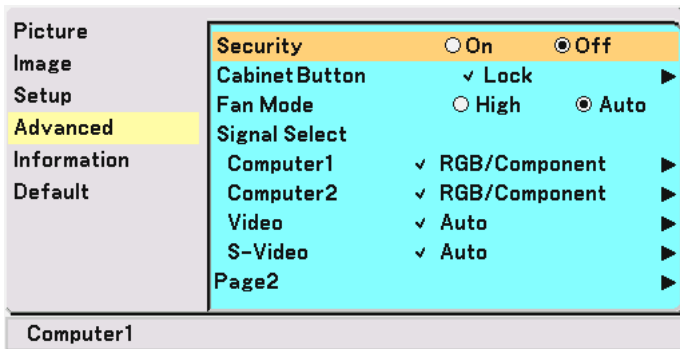

The Keyword confirmation screen will be displayed.

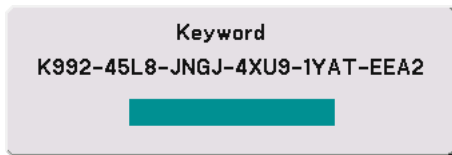

2. Type in your keyword and press the ENTER button.
When the correct keyword is entered, the Security function will be disabled.

When the Security function is enabled and the projector is turned on, the projector will display a blue background.

To display an image at this time, press the MENU button to display the Keyword input screen.

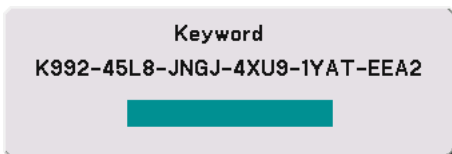

Type in the correct keyword and press the ENTER button. The projector will display an image.

NOTE:

- The security disable mode is maintained until the main power is turned off (by setting the main power switch to "0" or unplugging the power cable).
- If you forget your keyword, contact your dealer. Your dealer will provide you with your keyword in exchange for your request code. Your request code is displayed in the Keyword Confirmation screen. In this example "K992-45L8-JNGJ-4XU9-1YAT-EEA2" is a request code.

Disabling the Cabinet Buttons [Cabinet Button Lock]

This option turns on or off the Cabinet Button Lock function.

NOTE:

- This Cabinet Button Lock does not affect the remote control and the PC Control functions.
 - When the cabinet buttons are unlocked, pressing and holding the EXIT button for about 10 seconds will change the setting to enable.
 - Key symbol  indicates the Cabinet Button Lock is enabled.
-

Enabling High Speed Fan Mode [Fan Mode]

This option allows you to select two modes for fan speed: High speed mode and Auto mode.

High The built-in fans run at a fixed high speed.

Auto The built-in fans automatically run at a variable speed according to the internal temperature.

When you wish to cool down the temperature inside the projector quickly, select “High”.

NOTE: Select “High” if you continue to use the projector for consecutive days.

Selecting Signal Format [Signal Select]

[Computer]

Allows you to choose “Computer” for an RGB source such as a computer, or “Component” for a component video source such as a DVD player. Normally select “RGB/Component” and the projector automatically detects a component signal. However there may be some component signals that the projector is unable to detect. If this is the case, select “Component”. Select “Scart” in Computer 1 (Computer on VT47) for the European Scart signal.

[Video & S-Video System Select]

This feature enables you to select composite video standards manually. Normally select “Auto”.

When you select the video standard for Video and S-Video, select the video standard from the pull-down menu.

This must be done for Video and S-Video respectively.

(Advanced Page 2)

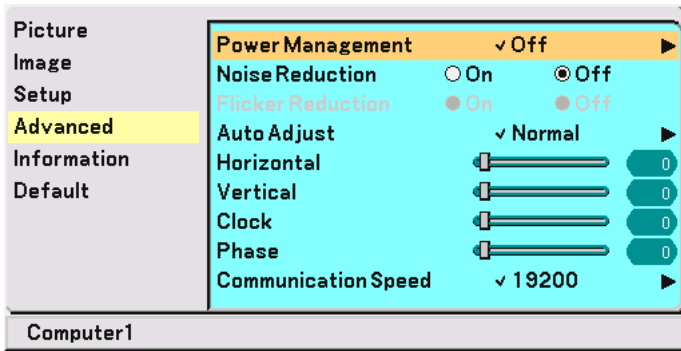

Enabling Power Management [Power Management]

When this option is on and there is no input for five minutes or more, the projector will automatically turn itself off.

Turning On Noise Reduction [Noise Reduction] (not available for Video and S-Video signals)

Reduces video noise. Select “On” to enable the Noise Reduction feature.

Turning On Flicker Reduction [Flicker Reduction]

Reduces flicker which can occur in an interlaced signal. This feature is not available for RGB and HDTV signals.

NOTE: When the Flicker Reduction is ON, jagged lines can be visible depending on the signal. In that case, select OFF.

NOTE: This feature may not be available depending on your video equipment connected to the projector.

Setting Auto Adjust [Auto Adjust]

This feature sets the Auto Adjust mode so that the RGB image can be automatically or manually adjusted for noise and stability. You can automatically make adjustment in two ways: Normal and Fine

- Off The RGB image will not be automatically adjusted.
You can manually optimize the RGB image.
- Normal Default setting. The RGB image will be automatically adjusted. Normally select this option.
- Fine Select this option if fine adjustment is needed. It takes more time to switch to the source than when “Normal” is selected.

Adjusting Position/Clock (when Auto Adjust is off)

This allows you to manually adjust the image horizontally and vertically, and adjust Clock and Phase.

[Horizontal/Vertical]

Adjusts the image location horizontally and vertically.
This adjustment is made automatically when the Auto Adjust is turned on.

[Clock] (available for RGB and HDTV signals only)

Use this item with the “Auto Adjust off” to fine tune the computer image or to remove any vertical banding that might appear. This function adjusts the clock frequencies that eliminate the horizontal banding in the image. This adjustment may be necessary when you connect your computer for the first time. This adjustment is made automatically when the Auto Adjust is turned on.

[Phase] (available for RGB and HDTV signals only)

Use this item to adjust the clock phase or to reduce video noise, dot interference or cross talk. (This is evident when part of your image appears to be shimmering.)

Use "Phase" only after the "Clock" is complete.

This adjustment is made automatically when the Auto Adjust is turned on.

Selecting Communication Speed [Communication Speed]

This feature sets the baud rate of the PC Control port (DIN 8 Pin). It supports data rates from 4800 to 19200 bps.

The default is 19200 bps.

Select the appropriate baud rate for your equipment to be connected (depending on the equipment, a lower baud rate may be recommended for long cable runs).

8 Menu Descriptions & Functions [Information]

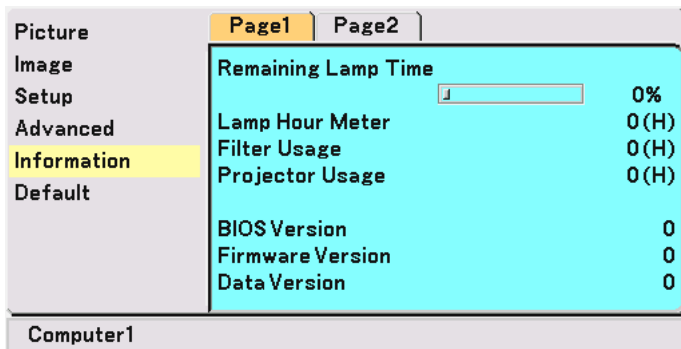

Displays the status of the current signal, remaining lamp (%), lamp/filter/projector usage time (hours) and version information. The Information has two pages. The Information included is as follows:

[Page 1]

Remaining Lamp Time (%)*

Lamp Hour Meter (H)

Filter Usage

Projector Usage

- * The progress indicator shows the percentage of remaining bulb life. The value informs you of the amount of lamp usage. When the remaining lamp time reaches 0, the Remaining Lamp Time bar indicator changes from 0% to 100 Hours and starts counting down.

If the remaining lamp time reaches 0 hours, the projector will not turn on regardless of whether the lamp mode is set to Normal or Eco.

BIOS Version

Firmware Version

Data Version

[Page 2]

Source Index

Horizontal Frequency

Vertical Frequency

Sync Polarity

Signal Type

Video Type

Sync Type

Interlace

9 Menu Descriptions & Functions [Default]

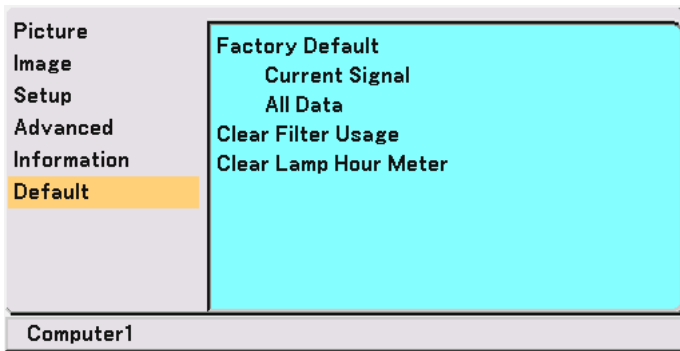

Returning to Factory Default [Factory Default]

The Factory Default feature allows you to change adjustments and setting to the factory preset.

[Current Signal]

Resets the adjustments for the current signal to the factory preset levels.

The items that can be reset are: Brightness, Contrast, Color, Hue, Sharpness, Noise Reduction, Aspect Ratio, Horizontal Position, Vertical Position, Clock, Phase and Picture Management.

[All Data]

Reset all the adjustments and settings for all the signals to the factory preset for source except the following: Language, Security, Communication Speed, Remaining Lamp Time, Lamp Hour Meter, Filter Usage and Projector Usage. To reset the lamp usage time, see "Clear Lamp Hour Meter" and "Clear Filter Usage".

Resetting the Filter Usage Hours [Clear Filter Usage]

Resets the filter usage back to zero. Selecting this option displays submenu for a confirmation. Select "Yes" and press the ENTER button.

Clearing Lamp Hour Meter [Clear Lamp Hour Meter]

Resets the lamp clock back to zero. Selecting this option displays submenu for a confirmation. Select "Yes" and press the ENTER button.

NOTE: The projector will turn off and go into standby mode after 2100 hours (up to 3100 hours in Eco mode) of service. If this happens, do the following while in standby condition to clear values for the Lamp Hour Meter:

For VT670/VT470 press the HELP button on the remote control for a minimum of 10 seconds.

For VT570/VT47 press and hold the POWER and the EXIT buttons on the remote control simultaneously for a minimum of 10 seconds.

When the lamp time clock is reset to zero, the LAMP indicator goes out.

Do this only after replacing the lamp.

6. Maintenance

This section describes the simple maintenance procedures you should follow to clean the filter and replace the lamp.

① Cleaning or Replacing the Filter

The air-filter sponge keeps dust and dirt from getting inside the projector and should be cleaned after every 100 hours of operation (more often in dusty conditions). If the filter is dirty or clogged, your projector may overheat.

CAUTION

- Turn off the projector, turn off the main power switch and unplug the projector before replacing the filter.
- Only clean the outside of the filter cover with a vacuum cleaner.
- Do not attempt to operate the projector without the filter cover.

To clean the air-filter:

Vacuum the filter-through the filter cover.

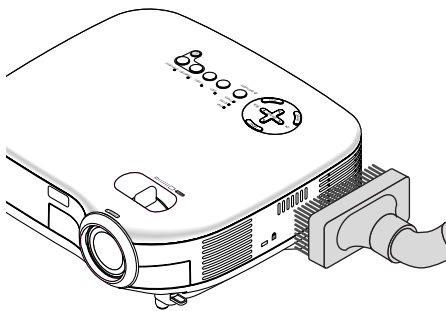

To reset the filter usage time, from the menu, select [Default] → [Clear Filter Usage]. See also page 50 for resetting the filter usage time.

To replace the filter (sponge):

1. *Remove the filter cover by pushing down on the catch of the cover until you feel it detach.*

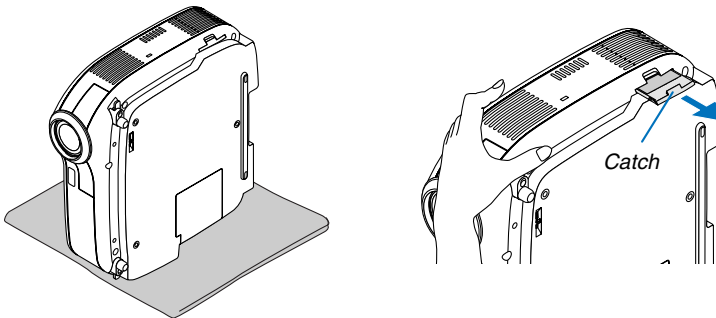

2. *Gently peel off the filter (sponge) and replace it with the new one.*

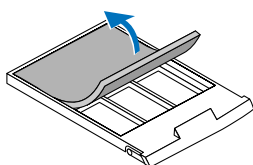

3. Reinstall the new filter cover.

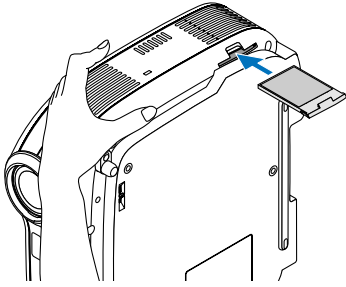

NOTE: Do not wash the filter with soap and water. Soap and water will damage the filter membrane. Before replacing the filter, remove dust and dirt from the projector cabinet. Keep out dust and dirt during filter replacement.

NOTE: When you replace the lamp, it is also wise to replace the filter. The filter comes in the same package with your replacement lamp.

② Cleaning the Cabinet and the Lens

1. Turn off the projector before cleaning.
2. Clean the cabinet periodically with a damp cloth. If heavily soiled, use a mild detergent. Never use strong detergents or solvents such as alcohol or thinner.
3. Use a blower or lens paper to clean the lens, and be careful not to scratch or mar the lens.

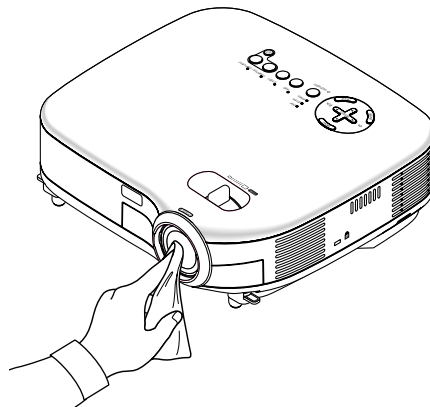
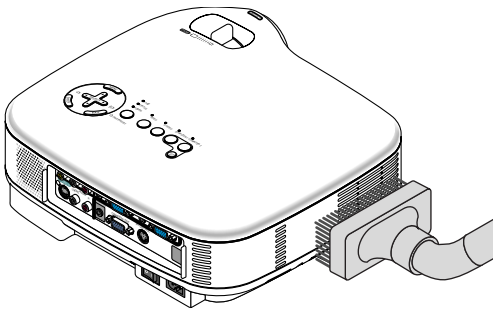

③ Replacing the Lamp

After your lamp has been operating for 2000 hours (up to 3000 hours in Eco mode) or longer, the LAMP indicator in the cabinet will blink red and the message will appear. Even though the lamp may still be working, replace it at 2000 (up to 3000 hours in Eco mode) hours to maintain optimal projector performance. After replacing the lamp, be sure to clear the lamp hour meter. See page 50.

CAUTION

- DO NOT TOUCH THE LAMP immediately after it has been used. It will be extremely hot. Turn the projector off, wait 30 seconds, turn off the main power switch and then disconnect the power cable. Allow at least one hour for the lamp to cool before handling.
- DO NOT REMOVE ANY SCREWS except two lamp case screws. You could receive an electric shock.
- Do not break the glass on the lamp housing.
Keep finger prints off the glass surface on the lamp housing. Leaving finger prints in the glass surface might cause an unwanted shadow and poor picture quality.
- The projector will turn off and go into stand by mode after 2100 (up to 3100 hours in Eco mode) hours of service. If this happens, be sure to replace the lamp. If you continue to use the lamp after 2000 hours (up to 3000 hours in Eco mode) of use, the lamp bulb may shatter, and pieces of glass may be scattered in the lamp case. Do not touch them as the pieces of glass may cause injury. If this happens, contact your NEC dealer for lamp replacement.

To replace the lamp:

Optional lamp and tools needed for replacement:

- Replacement lamp VT75LP (VT670/VT470) or VT70LP (VT570/VT47).
- Phillips screwdriver or equivalent

*NOTE: The two lamp houses are slightly different in appearance.
The following explanation uses drawings for the lamp VT75LP.*

1. Place the projector on a soft cloth and turn it over to access the lamp cover on the bottom.

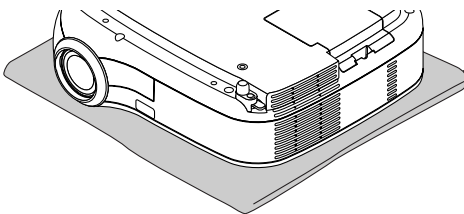

2. Use a Phillips screwdriver to push and release the tab.
Push up and remove the lamp cover.

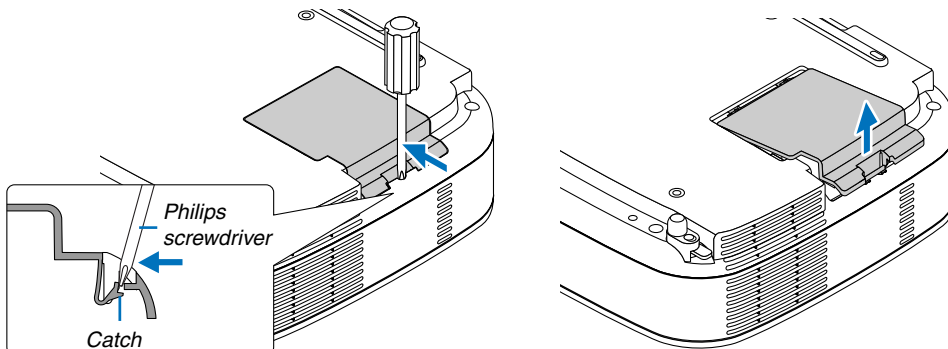

3. Loosen the two screws securing the lamp housing until the phillips screwdriver goes into a freewheeling condition. The two screws are not removable. Remove the lamp housing by holding it.

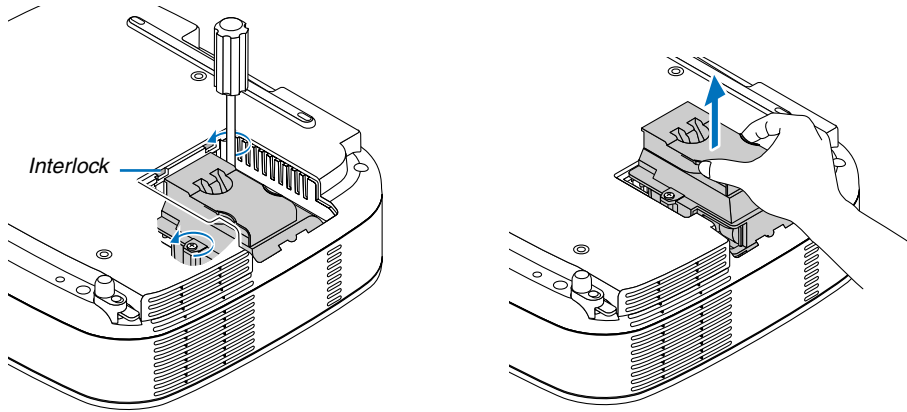

NOTE: There is an interlock on this case to prevent the risk of electrical shock. Do not attempt to circumvent this interlock.

4. Insert a new lamp housing until the lamp housing is plugged into the socket.

CAUTION

Do not use a lamp other than the NEC replacement lamp VT75LP (VT670/VT470) or VT70LP (VT570/VT47). Order this from your NEC dealer.

- Secure it in place with the two screws.
Be sure to tighten the screws.

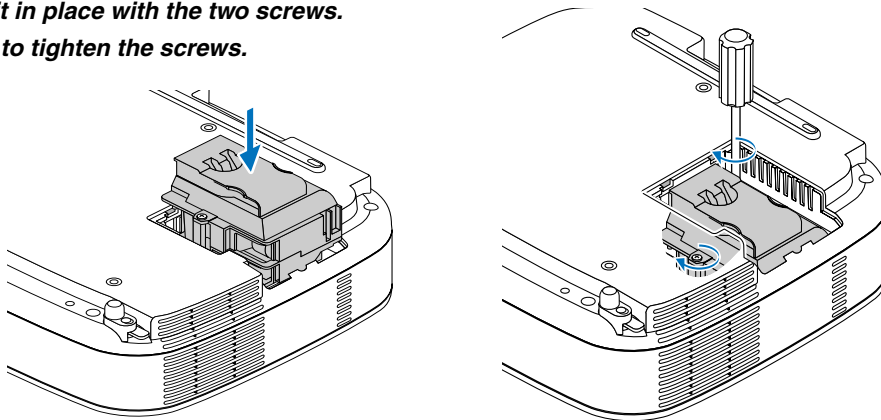

5. Reattach the lamp cover.
Slip the lamp cover back until it snaps into place.

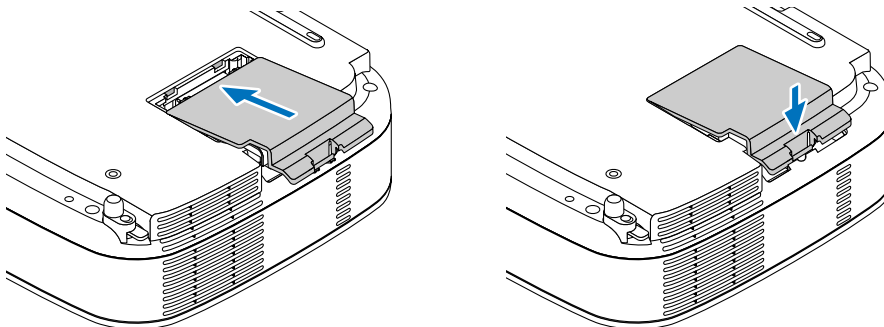

6. Finally, select the menu → [Default] → [Clear Lamp Hour Meter] to reset the lamp usage hours.

NOTE: When the lamp exceeds 2100 hours (up to 3100 hours in Eco mode) of service, the projector cannot turn on and the menu is not displayed. If this happens, do the following while in standby condition to clear values for the Remaining Lamp Time and the Lamp Hour Meter:

For VT670/VT470 press the HELP button on the remote control for a minimum of 10 seconds.

For VT570/VT47 press and hold the POWER and the EXIT buttons on the remote control simultaneously for a minimum of 10 seconds.

When the lamp time clock is reset to zero, the LAMP indicator goes out.

7. Appendix

1 Troubleshooting

This section helps you resolve problems you may encounter while setting up or using the projector.

Indicator Messages

Power Indicator

Indicator Condition			Projector Condition	Note
Off			The main power is off	–
Blinking light	Green	0.5 sec On, 0.5 sec Off	The projector is getting ready to turn on.	Wait for a moment.
		2.5 sec On, 0.5 sec Off	Off Timer is enabled.	–
	Orange	0.5 sec On, 0.5 sec Off	The projector is cooling down.	Wait for a moment.
Steady light	Green		The projector is turned on.	–
	Orange		The projector is in Standby.	–

Status Indicator

Indicator Condition			Projector Condition	Note
Off			Normal	–
Blinking light	Red	1 cycle (0.5 sec On, 2.5 sec Off)	Lamp cover error or lamp housing error	Replace the lamp cover or lamp housing correctly.
		2 cycle (0.5 sec On, 0.5 sec Off)	Temperature error	The projector is overheated. Move the projector to a cooler location.
		4 cycle (0.5 sec On, 0.5 sec Off)	Fan error	Fans will not work correctly.
		6 cycle (0.5 sec On, 0.5 sec Off)	Lamp error	Lamp fails to light. Wait a full minute and then turn on again.
	Green		Re-firing the lamp (The projector is cooling down.)	The projector is re-firing. Wait for a moment.
Steady light	Orange		Cabinet button is locked	You have pressed cabinet button when Cabinet Button is locked.

Lamp Indicator

Indicator Condition			Projector Condition	Note
Off			Normal	–
Blinking light	Red		Lamp has reached its end of life. Lamp replacement message will be displayed.	Replace the lamp.
Steady light	Red		Lamp has been used beyond its limit. The projector will not turn on until the lamp is replaced.	Replace the lamp.
	Green		Lamp mode is set to Eco mode	–

Common Problems & Solutions (See also "Power/Status/Lamp Indicator" on page 56.)

Problem	Check These Items
Does not turn on	<ul style="list-style-type: none"> • Check that the power cable is plugged in and that the power button on the projector cabinet or the remote control is on. See pages 22 and 23. • Ensure that the lamp cover is installed correctly. See page 54. • Check to see if the projector has overheated or the lamp usage exceeds 2100 hours (up to 3100 hours : Eco mode). If there is insufficient ventilation around the projector or if the room where you're presenting is particularly warm, move the projector to a cooler location. • The lamp may fail to light. Wait a full minute and then turn on the power again. • The lamp has reached the end of its usable life. Replace the lamp.
Will turn off	<ul style="list-style-type: none"> • Ensure that the Power Management is off. See page 48.
No picture	<ul style="list-style-type: none"> • Use the VIDEO, the S-VIDEO or the COMPUTER button (the SOURCE button on VT570/VT47) on the remote control to select your source (Computer, Video or S-Video). See page 25. If there is still no picture, press the button again. • Ensure your cables are connected properly. • Use menus to adjust the brightness and contrast. See page 41. • Remove the lens cap. • Reset the settings or adjustments to factory preset levels using the "Default" in the Menu. See page 50. • Enter your registered keyword if the Security function is enabled. See page 45. • When using with a notebook PC, be sure to connect between the projector and the notebook PC before turning on the power to the notebook PC. In most cases signal cannot be output from RGB output unless the notebook PC is turned on after connecting with the projector. <ul style="list-style-type: none"> * If the screen goes blank while using your remote control, it may be the result of the computer's screen-saver or power management software. • See also the next page.
Picture suddenly becomes dark	<ul style="list-style-type: none"> • When one of the following happens, the Lamp mode automatically changes from Normal to Eco. <ul style="list-style-type: none"> * When there are no signals (blue or black screen) → To return to the Normal mode, select another available source. * When the image is muted using the PIC-MUTE button on the remote control → Press the PIC-MUTE button again to return to the Normal mode. * When the room where you're presenting is particularly warm → Move the projector to a cooler location.
Color tone or hue is unusual	<ul style="list-style-type: none"> • Check if an appropriate color is selected in "Wall Color". If so, select an appropriate option. See page 40. • Adjust "Hue" in "Picture". See page 41.
Image isn't square to the screen	<ul style="list-style-type: none"> • Reposition the projector to improve its angle to the screen. See page 27. • Use the Keystone correction function to correct the trapezoid distortion. See page 29.
Picture is blurred	<ul style="list-style-type: none"> • Adjust the focus. See page 28. • Reposition the projector to improve its angle to the screen. See page 27. • Ensure that the distance between the projector and screen is within the adjustment range of the lens. See pages 13 for VT670/VT570/VT470 and 14 for VT47. • Condensation may form on the lens if the projector is cold, brought into a warm place and is then turned on. Should this happen, let the projector stand until there is no condensation on the lens.
Image is scrolling vertically, horizontally or both	<ul style="list-style-type: none"> • Use the SOURCE button on the projector cabinet or the VIDEO, the S-VIDEO or the COMPUTER button (the SOURCE button on VT570/VT47) on the remote control to select your source (Video, S-Video or Computer). See page 25. • Adjust the computer image manually with the Horizontal/Vertical in the "Advanced → Page 2". See page 48.
Remote control does not work	<ul style="list-style-type: none"> • Install new batteries. <ul style="list-style-type: none"> VT670/VT470: AAA × 2. See page 10. VT570/VT47: Lithium coin cell (CR2032). See page 12. • Make sure there are no obstacles between you and the projector. • Stand within 22 feet (7 m) of the projector. pages 10 for VT670/VT470 and 12 for VT570/VT47.
Indicator is lit or blinking	<ul style="list-style-type: none"> • See the POWER/STATUS/LAMP Indicator on page 56.
Cross color in RGB mode	<ul style="list-style-type: none"> • Press the AUTO ADJUST button on the projector cabinet or the AUTO ADJ. button on the remote control. See page 31. • When "Off" is selected in Auto Adjust, adjust the computer image manually with Clock/Phase in "Advanced → Page 2" in the menu. See page 48.

For more information contact your dealer.

If there is no picture, or the picture is not displayed correctly.

- Power on process for the projector and the PC.

Be sure to connect the RGB cable between the projector and the computer before turning on the computer. There are some notebook PCs, which do not output signal unless there is a projector or monitor connected first.

NOTE: You can check the horizontal frequency of the current signal in the projector's menu under Information. If it reads "0kHz", this means there is no signal being output from the computer. See page 49 or go to next step.

- Enabling the computer's external display.

Displaying an image on the notebook PC's screen does not necessarily mean it outputs a signal to the projector. When using a PC compatible laptop, a combination of function keys will enable/disable the external display. Usually, the combination of the 'Fn' key along with one of the 12 function keys gets the external display to come on or off. For example, NEC laptops use Fn + F3, while Dell laptops use Fn + F8 key combinations to toggle through external display selections.

- Non-standard signal output from the computer

If the output signal from a notebook PC is not an industry standard, the projected image may not be displayed correctly. Should this happen, deactivate the notebook PC's LCD screen when the projector display is in use. Each notebook PC has a different way of deactivate/reactivate the local LCD screens as described in the previous step. Refer to your computer's documentation for detailed information.

- Image displayed is incorrect when using a Macintosh

When using a Macintosh with the projector, set the DIPswitch of the Mac adapter (not supplied with the projector) according to your resolution. After setting, restart your Macintosh for the changes to take affect.

For setting display modes other than those supported by your Macintosh and the projector, changing the DIP switch on a Mac adapter may bounce an image slightly or may display nothing. Should this happen, set the DIP switch to the 13" fixed mode and then restart your Macintosh. After that, restore the DIP switches to a displayable mode and then restart the Macintosh again.

NOTE: A Video Adapter cable manufactured by Apple Computer is needed for a PowerBook which does not have a mini D-Sub 15-pin connector.

- Mirroring on a PowerBook

- * When using the projector with a Macintosh PowerBook, output may not be set to 1024 x 768 unless "mirroring" is off on your PowerBook. Refer to owner's manual supplied with your Macintosh computer for mirroring.

- Folders or icons are hidden on the Macintosh screen

Folders or icons may not be seen on the screen. Should this happen, select [View] → [Arrange] from the Apple menu and arrange icons.

② Specifications

This section provides technical information about the VT670/VT570/VT470/VT47 Projector's performance.

Model Number	VT670/VT570/VT470/VT47
Optical	
LCD Panel	0.7" p-Si TFT active-matrix (with Micro Lens Array on VT670 only)
Resolution	VT670/VT570: 1024 × 768 pixels* native, up to UXGA with Advanced AccuBlend VT470: 800 × 600 pixels* native, up to UXGA with Advanced AccuBlend VT47: 800 × 600 pixels* native, up to SXGA with Advanced AccuBlend
Lens	VT670/VT570/VT470: Manual zoom and manual focus F1.7 - 2.0 f=21.6 - 25.9 mm VT47: Digital zoom and manual focus F2.0 f=17.5 mm
Lamp	VT670/VT470: 180W DC lamp (150W Eco mode) VT570/VT47: 130W DC lamp (110W Eco mode)
Image Size (Diagonal)	VT670/VT570/VT470: 21 - 300 inches / 0.5 - 7.6 m VT47: 25 - 300 inches / 0.6 - 7.6 m
Projection Distance	VT670/VT570/VT470: 2.4 - 35.89 ft / 0.73 - 10.9 m VT47: 1.9 - 23.92 ft / 0.58 - 7.3 m
Projection Angle	VT670/VT570/VT470: Tele: 9.5° - 9.9°/ Wide: 11.5° - 12.0° VT47: 14.0° - 14.6°
Keystone Correction	+/- 30° Vertical (auto)
Electrical	
Inputs	VT670/VT570/VT470: 2 RGB/Component (D-Sub 15 Pin), 1 S-Video (DIN 4 Pin), 1 Video (RCA), 2 (L/R) RCA Audio, 1 Stereo Mini Audio, 1 PC Control (DIN 8 Pin) VT47: 1 RGB/Component (D-Sub 15 Pin), 1 S-Video (DIN 4 Pin), 1 Video (RCA), 1 (L/R) RCA Audio, 1 Stereo Mini Audio, 1 PC Control (DIN 8 Pin)
Outputs	1 RGB (D-Sub 15 Pin), 1 Stereo Mini Audio (not available on VT47)
Video Compatibility	NTSC, NTSC4.43, PAL, PAL-60, PAL-N, PAL-M, SECAM, HDTV: 1080i, 1080i/50Hz, 720p, 576p, 480p, 480i/60Hz
Scan Rate	Horizontal: 15 kHz to 100 kHz (RGB: 24 kHz or over) Vertical: 50 Hz to 120 Hz
Video Bandwidth	RGB: 80 MHz (-3dB)
Color Reproduction	16.7 million colors simultaneously, Full color
Horizontal Resolution	NTSC / NTSC4.43/PAL/PAL-M/PAL-N/PAL60: 540 TV lines SECAM: 300 TV lines YCbCr: 800 TV lines RGB: VT670/VT570: 1024 dots (H) × 768 dots (V), VT470/VT47: 800 dots (H) × 600 dots (V)
External Control	RS232, IR
Sync Compatibility	Separate Sync / Composite Sync / Sync on G
Built-in Speaker	1W (monaural)

* Effective pixels are more than 99.99%.

Power Requirement	100 - 240V AC, 50 / 60 Hz
Input Current	VT670/VT470: 2.7 - 1.4A (100 - 240V AC) VT570/VT47: 2.1 - 1.2A (100 - 240V AC)
Power Consumption	VT670/VT470: 8W in Standby mode / 250W in Lamp Normal mode / 200W in Lamp Eco mode VT570/VT47: 8W in Standby mode / 190W in Lamp Normal mode / 155W in Lamp Eco mode

Mechanical

Installation Orientation	Desktop/Front, Desktop/Rear, Ceiling/Front, Ceiling/Rear
Dimensions	11.6" (W) × 3.7" (H) × 10.2" (D) 294mm (W) × 93mm (H) × 260mm (D) (not including protrusions)
Net Weight	6.5 lbs / 2.9 kg
Environmental Considerations	Operational Temperatures : 41° to 95°F (5° to 35°C), 20% to 80% humidity (non-condensing) Storage Temperatures : 14° to 122°F (-10° to 50°C), 20% to 80% humidity (non-condensing)
Regulations	<i>For United States:</i> UL Approved (UL 60950) Meets FCC Class B requirements <i>For Canada:</i> UL Approved (CSA 60950) Meets DOC Canada Class B requirements <i>For Australia/New Zealand:</i> Meets AS/NZS CISPR.22 Class B <i>For Europe:</i> Meets EMC Directive (EN55022, EN55024, EN61000-3-2, EN61000-3-3) Meets Low Voltage Directive (EN60950, TUV GS Approved)



For additional information visit:

US : <http://www.necvisualsystems.com>

Europe : <http://www.neceurope.com/>

Global : <http://www.nec-pj.com/>

The specifications are subject to change without notice.

3 Cabinet Dimensions

VT670/VT570/VT470

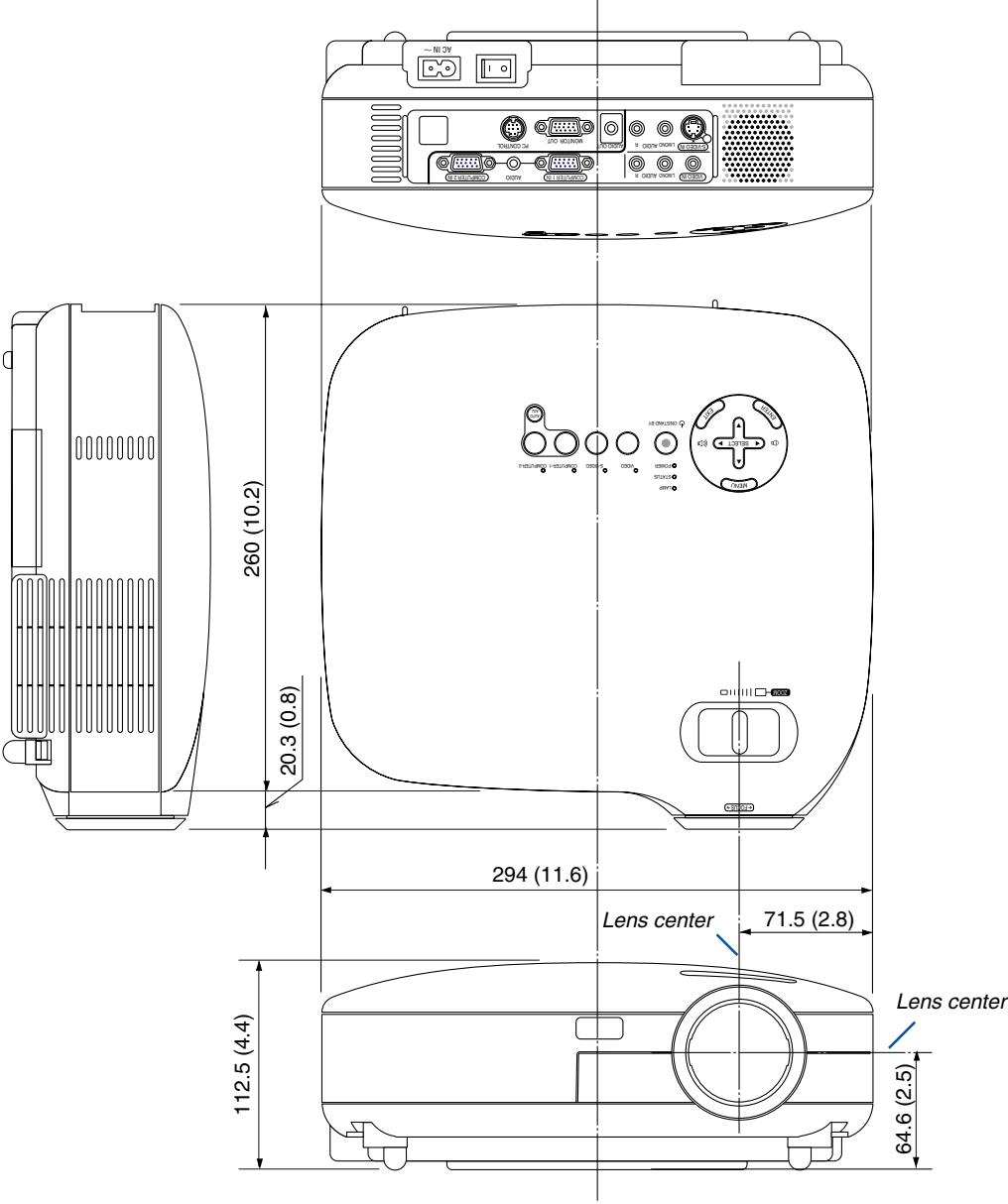

Unit: mm (inch)

VT47

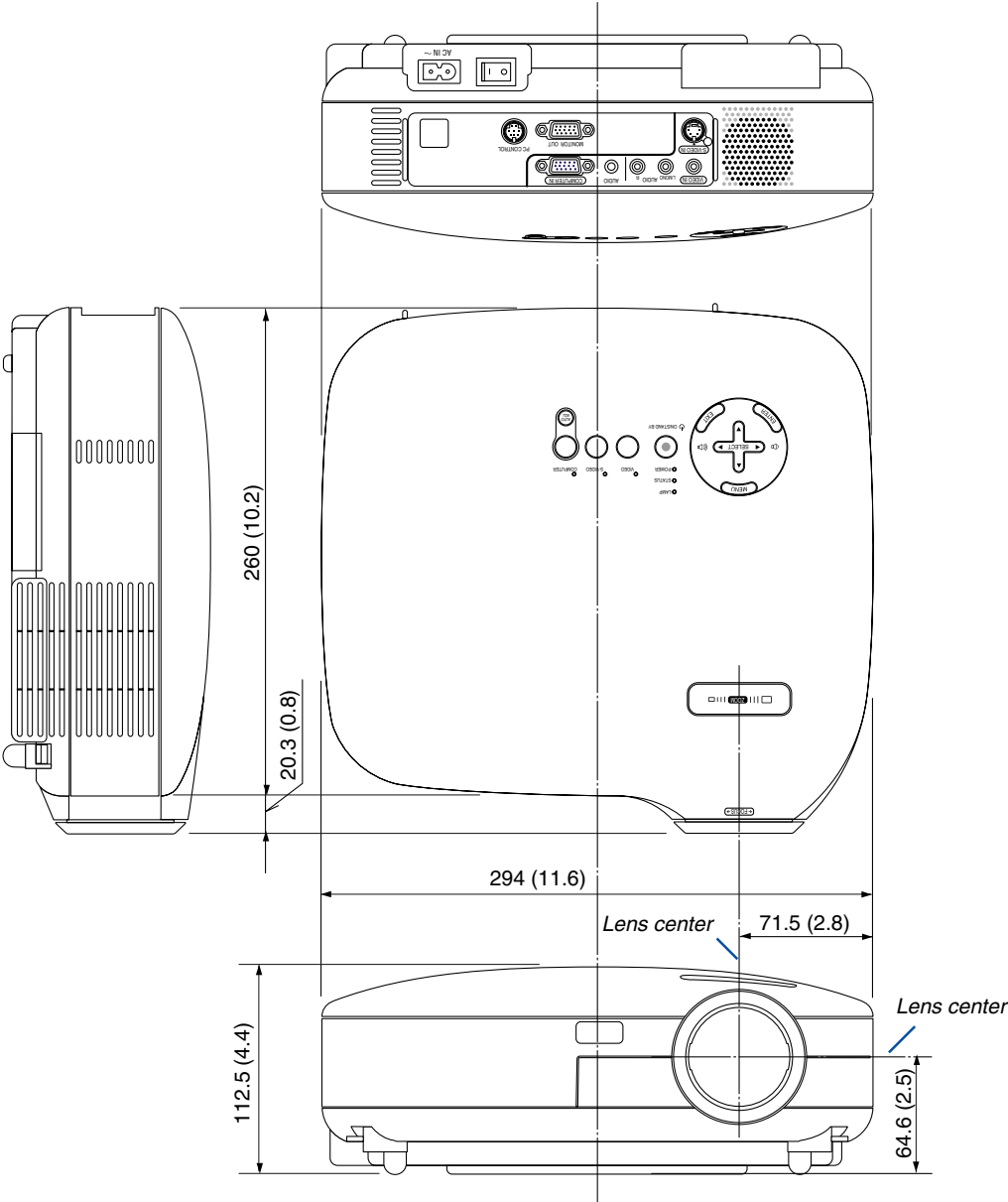

Unit: mm (inch)

④ Pin Assignments of D-Sub COMPUTER Input Connector

Mini D-Sub 15 Pin Connector

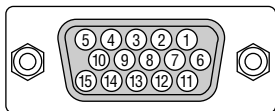

Signal Level
 Video signal : 0.7Vp-p (Analog)
 Sync signal : TTL level

Pin No.	RGB Signal (Analog)	YCbCr Signal
1	Red	Cr
2	Green or Sync on Green	Y
3	Blue	Cb
4	Ground	
5	Ground	
6	Red Ground	Cr Ground
7	Green Ground	Y Ground
8	Blue Ground	Cb Ground
9	No Connection	
10	Sync Signal Ground	
11	SCART Sync	
12	Bi-directional DATA (SDA)*	
13	Horizontal Sync or Composite Sync	
14	Vertical Sync	
15	Data Clock*	

* Only COMPUTER 1 input connector supported on VT670/VT570/VT470.

5 Compatible Input Signal List

Signal	Resolution (Dots)	Frequency H. (kHz)	Refresh Rate (Hz)
NTSC	–	15.734	60
PAL	–	15.625	50
PAL60	–	15.734	60
SECAM	–	15.625	50
VESA	640 × 480	31.47	59.94
IBM	640 × 480	31.47	60
MAC	640 × 480	31.47	60
MAC	640 × 480	34.97	66.67
MAC	640 × 480	35	66.67
VESA	640 × 480	37.86	72.81
VESA	640 × 480	37.5	75
IBM	640 × 480	39.375	75
VESA	640 × 480	43.269	85.01
IBM	720 × 350	31.469	70.09
VESA	720 × 400	37.927	85.04
IBM	720 × 350	39.44	87.85
IBM	720 × 400	39.44	87.85
VESA	800 × 600	35.16	56.25
VESA	800 × 600	37.879	60.32
VESA	800 × 600	48.077	72.19
VESA	800 × 600	46.88	75
VESA	800 × 600	53.674	85.06
MAC	832 × 624	49.725	74.55
@ VESA	1024 × 768	35.5	43 Interlaced
@ VESA	1024 × 768	48.363	60
@ VESA	1024 × 768	56.476	70.07
@ MAC	1024 × 768	60.241	74.93
@ VESA	1024 × 768	60.023	75.03
@ VESA	1024 × 768	68.677	85
@ # VESA	1152 × 864	67.5	75
@ # MAC	1152 × 870	68.681	75.06
@ # SUN	1152 × 900	61.796	65.95
@ # SGI	1152 × 900	71.736	76.05
@ # VESA	1280 × 960	60	60
@ # VESA	1280 × 1024	63.981	60.02
@ # MAC	1280 × 1024	69.89	65.18
@ # HP	1280 × 1024	78.125	72.01
@ # SUN	1280 × 1024	81.13	76.11
@ # VESA	1280 × 1024	79.976	75.03
@ # VESA	1280 × 1024	91.146	85.02
@ # SXGA+	1400 × 1050	–	–
@ # HDTV (1080p)	1920 × 1080	67.5	60 Progressive
@ # SDTV(576i)(625i)	–	15.6	50
@ # SDTV(576p)(625p)	–	31.5	50
@ # HDTV (1080i)(1125i)	1920 × 1080	33.75	60 Interlace
@ # HDTV (1080i)(1125i)	1920 × 1080	28.125	50 Interlace
@ # HDTV (720p)(750p)	1280 × 720	45	60 Progressive
@ # SDTV (480p)(525p)	–	31.47	59.94 Progressive
@ # * VESA	1600 × 1200	75.0	60
@ # * VESA	1600 × 1200	81.25	65
@ # * VESA	1600 × 1200	87.5	70
@ # * VESA	1600 × 1200	93.75	75
DVD YCbCr	–	15.734	59.94 Interlaced
DVD YCbCr	–	15.625	50 Interlaced

: Images in above flagged with # are compressed with Advanced AccuBlend on VT670/VT570.

@ : Images in above flagged with @ are compressed with Advanced AccuBlend on VT470/VT47.

* : Images in above flagged with * are not supported on VT47.

NOTE: Some composite sync signals may not be displayed correctly.

Signals other than those specified in the table above may not be displayed correctly. If this should happen, change the refresh rate or resolution on your PC. Refer to Display Properties help section of your PC for procedures.

UXGA (1600 × 1200) is supported for separate sync signal only.

6 PC Control Codes and Cable Connection

PC Control Codes (VT670/VT570/VT470)

Function	Code Data								
POWER ON	02H	00H	00H	00H	00H	02H			
POWER OFF	02H	01H	00H	00H	00H	03H			
INPUT SELECT COMPUTER 1	02H	03H	00H	00H	02H	01H	01H	09H	
INPUT SELECT COMPUTER 2	02H	03H	00H	00H	02H	01H	02H	0AH	
INPUT SELECT VIDEO	02H	03H	00H	00H	02H	01H	06H	0EH	
INPUT SELECT S-VIDEO	02H	03H	00H	00H	02H	01H	0BH	13H	
PICTURE MUTE ON	02H	10H	00H	00H	00H	12H			
PICTURE MUTE OFF	02H	11H	00H	00H	00H	13H			
SOUND MUTE ON	02H	12H	00H	00H	00H	14H			
SOUND MUTE OFF	02H	13H	00H	00H	00H	15H			

PC Control Codes (VT47)

Function	Code Data								
POWER ON	02H	00H	00H	00H	00H	02H			
POWER OFF	02H	01H	00H	00H	00H	03H			
INPUT SELECT COMPUTER	02H	03H	00H	00H	02H	01H	01H	09H	
INPUT SELECT VIDEO	02H	03H	00H	00H	02H	01H	06H	0EH	
INPUT SELECT S-VIDEO	02H	03H	00H	00H	02H	01H	0BH	13H	
PICTURE MUTE ON	02H	10H	00H	00H	00H	12H			
PICTURE MUTE OFF	02H	11H	00H	00H	00H	13H			
SOUND MUTE ON	02H	12H	00H	00H	00H	14H			
SOUND MUTE OFF	02H	13H	00H	00H	00H	15H			

NOTE: Contact your local dealer for a full list of the PC Control Codes if needed.

Cable Connection

Communication Protocol

Baud rate 19200 bps
 Data length 8 bits
 Parity No parity
 Stop bit One bit
 X on/off None
 Communications procedure Full duplex

NOTE: Depending on the equipment, a lower baud rate may be recommended for long cable runs.

PC Control Connector (DIN-8P)

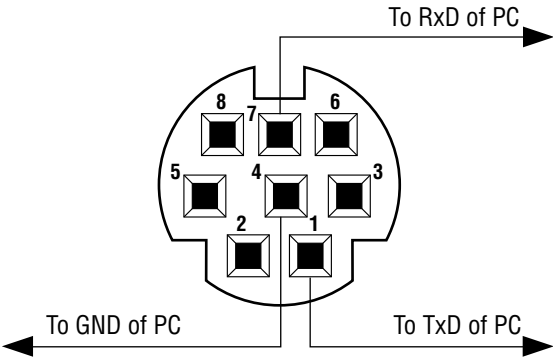

NOTE: Pins 2, 3, 5, 6 and 8 are used inside the projector.

⑦ Optional Presentation Remote Control Kit (PR52KIT)



The PR52KIT is an optional remote control kit for operating your NEC projector and performing your computer mouse operations.

Package List

- RD-408E remote control unit..... 1
- AAA batteries 2
- Mouse receiver 1
- User's manual 1

Part Names and Functions of the Remote Control

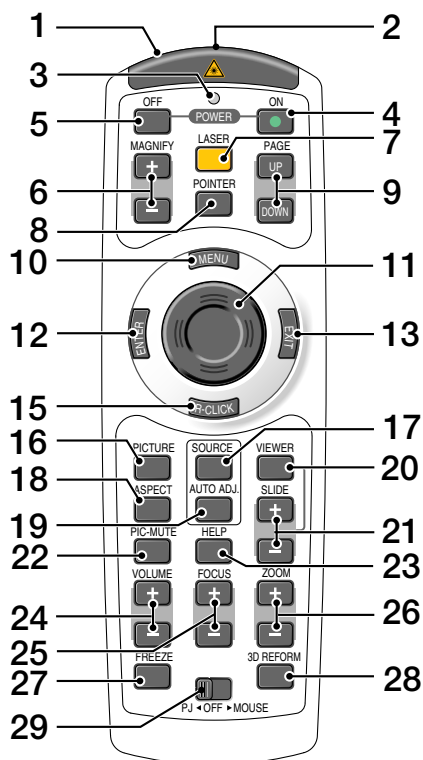

1. Infrared Transmitter/Laser Pointer

Transmits an infrared signal when any button other than LASER is pressed.

Direct the remote control toward the remote sensor on the projector cabinet.

Beams a laser light when the Laser button is pressed.

CAUTION:

- * Do not look into the laser pointer while it is on.
- * Do not point the laser beam at a person.

2. Remote Jack

Not available on this model.

3. LED

Flashes when any button is pressed.

4. POWER ON Button

When the main power is on, you can use this button to turn your projector on.

NOTE: To turn on the projector, press and hold the POWER ON button for a minimum of two seconds.

5. POWER OFF Button

You can use this button to turn your projector off.

NOTE: To turn off the projector, press the POWER OFF button twice.

6. MAGNIFY (+)(-) Buttons

Use these buttons to adjust the image size.

The image can be magnified about the center of the screen up to 400%.

7. LASER Button

Press and hold this button to activate the laser pointer. When lit, you can use the laser to draw your audience's attention to a red dot that you can place on any object.

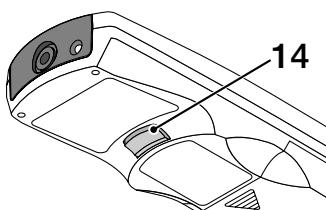

8. POINTER Button

Not available on this model.

9. PAGE UP/DOWN Buttons*

Use these buttons to operate your computer with the supplied remote mouse receiver. You can use these buttons to scroll the viewing area of the window or to move to the previous or next slide in PowerPoint on your computer.

10. MENU Button

Displays the menu for various settings and adjustments.

11. Mouse Button

In Mouse mode*, this button works as your computer mouse.

In Projector mode, this button is used for projector's menu operation and moving the magnified image.

12. ENTER Button

Executes your menu selection and activates items selected from the menu.

13. EXIT Button

Returns to the previous menu.

While you are in the main menu, pressing this button will close the menu.

14. L-CLICK Button*

Works as the mouse left button when the supplied remote mouse receiver is connected with your computer.

15. R-CLICK Button*

Works as the mouse right button when the supplied remote mouse receiver is connected with your computer.

16. PICTURE Button

Press this button to display the Picture window. Each time this button is pressed, the option will be changed: Wall Color → Picture Management → Brightness → Contrast → Sharpness → Color → Hue

17. SOURCE Button

Use this button to select a video source such as a PC, VCR or DVD player.

Press and release this button quickly to display the Source List.

Each time this button is pressed for a minimum of ONE second, the input source will change.

If no input signal is present, the input will be skipped.

18. ASPECT Button

Press this button to display the Aspect Ratio select screen.

19. AUTO ADJ. Button

Use this button to adjust an RGB source for an optimal picture.

20. VIEWER Button

Not available on this model.

21. SLIDE +/- Buttons

Not available on this model.

22. PIC-MUTE Button

This button turns off the image and sound for a short period of time. Press again to restore the image and sound.

23. HELP Button

Provides the Information screen.

24. VOLUME +/- Buttons

Press (+) to increase the volume and (-) to decrease it.

25. FOCUS +/- Buttons

Not available on this model.

26. ZOOM +/- Buttons

Use to finely adjust the image on the screen. (VT47 only)

27. FREEZE Button

This button will freeze a picture. Press again to resume motion.

28. 3D REFORM Button

Not available on this model.

29. PJ ◀ OFF ▶ MOUSE Slide Switch

Use to switch mouse button operation modes between Mouse and Projector. Setting to OFF will disable all the buttons on the remote control.

**NOTE: The PAGE UP/DOWN, L-CLICK, R-CLICK and MOUSE (as computer mouse) buttons are available only when the PJ ◀ OFF ▶ MOUSE Slide Switch is set to MOUSE.*

Battery Installation

- 1** Remove the battery cover.
NOTE: Do not pull the battery cover by force. Doing so can result in it coming off.

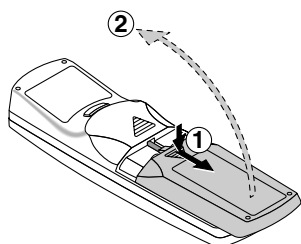

- 2** Remove both old batteries and install new ones (AAA). Ensure that you have the batteries' polarity (+/-) aligned correctly.

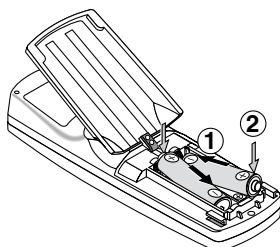

- 3** Slip the cover back over the batteries until it snaps into place.
NOTE: Do not mix different types of batteries or new and old batteries.

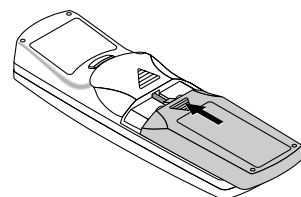

Operating Range for Wireless Remote Control

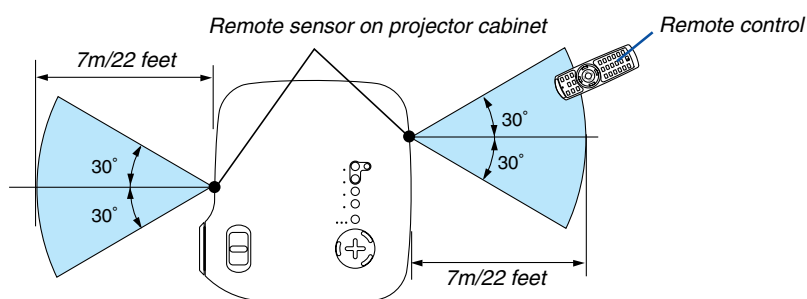

- The infrared signal operates by line-of-sight up to a distance of about 22 feet/7 m and within a 60-degree angle of the remote sensor on the projector cabinet.
 - The projector will not respond if there are objects between the remote control and the sensor, or if strong light falls on the sensor.
- Weak batteries will also prevent the remote control from properly operating the projector.

Remote Control Precautions

- Handle the remote control carefully.
- If the remote control gets wet, wipe it dry immediately.
- Avoid excessive heat and humidity.
- If you will not be using the remote control for a long time, remove the batteries.
- Do not place the batteries upside down.
- Do not use new and old batteries together, or use different types of batteries together.

Using the Laser Pointer

You can use the laser to draw your audience's attention to a red dot that you can place on any object.



CAUTION:

- Do not look into the laser pointer while it is on.
- Do not point the laser beam at a person.
- Do not allow children to use the laser pointer.

Press and hold the LASER button to activate the laser pointer.

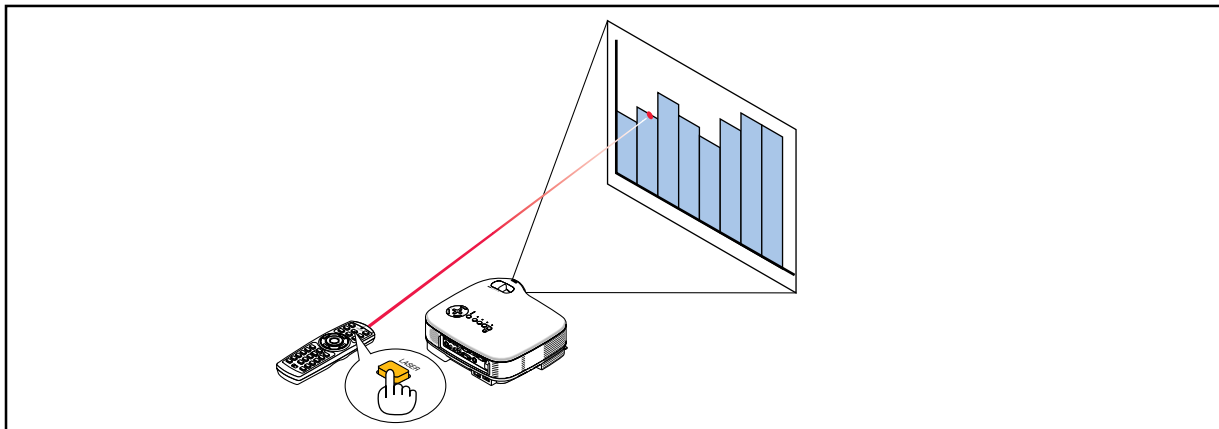

To disable the laser pointer, set the function switch to "Off".

Decide whether to enable or disable laser, then set the switch as necessary using the tip of a thin ball-point pen. On this model, the other selector switch is not used.

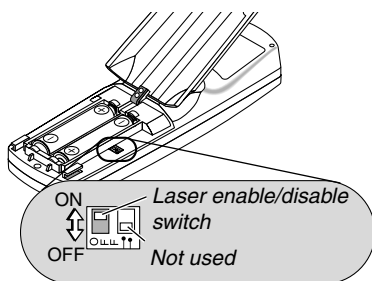

On: Enabled (the laser lights when the LASER button is pressed) [Factory default]

Off: Disabled (the laser does not light even when the LASER button is pressed)

Disable the laser when using in an environment in which the unit is accessible to children.

Using Remote Mouse Receiver (VT670/VT470 only)

See page [34](#).

8 Troubleshooting Check List

Before contacting your dealer or service personnel, check the following list to be sure repairs are needed also by referring to the "Troubleshooting" section in your user's manual. This checklist below will help us solve your problem more efficiently.

* Print the following pages.

Frequency of occurrence always sometimes (How often? _____) other (_____)

Power

- No power (POWER indicator does not light green) See also "Status Indicator (STATUS)".
 - Power cable's plug is fully inserted into the wall outlet.
 - Main power switch is pressed to the ON position.
 - Lamp cover is installed correctly .
 - Lamp Hour Meter (lamp operation hours) was cleared after lamp replacement.
 - No power even though you press and hold the POWER button for a minimum of 2 seconds.
- Shut down during operation.
 - Power cable's plug is fully inserted into the wall outlet.
 - Lamp cover is installed correctly .
 - Power Management is turned off (only models with the Power Management function).
 - Sleep Timer is turned off (only models with the Sleep Timer function).

Video and Audio

- No image is displayed from your PC or video equipment to the projector.
 - Still no image even though you connect the projector to the PC first, then start the PC.
 - Enabling your notebook PC's signal output to the projector.
 - *A combination of function keys will enable/disable the external display. Usually, the combination of the "Fn" key along with one of the 12 function keys turns the external display on or off.*
 - No image (blue background, logo, no display).
 - Still no image even though you press the AUTO ADJUST button.
 - Still no image even though you carry out "Reset" in the projector's menu.
 - Signal cable's plug is fully inserted into the input connector
 - A message appears on the screen. (_____)
 - The source connected to the projector is active and available.
 - Still no image even though you adjust the brightness and/or the contrast.
 - Input source's resolution and frequency are supported by the projector.
- Image is too dark.
 - Remains unchanged even though you adjust the brightness and/or the contrast.
- Image is distorted.
 - Image appears to be trapezoidal (unchanged even though you carry out the "Keystone" or "3D Reform" adjustment).
- Parts of the image are lost.
 - Still unchanged even though you press the AUTO ADJUST button.
 - Still unchanged even though you carry out "Reset" in the projector's menu.
- Image is shifted in the vertical or horizontal direction.
 - Horizontal and vertical positions are correctly adjusted on a computer signal.
 - Input source's resolution and frequency are supported by the projector.
 - Some pixels are lost.
- Image is flickering.
 - Still unchanged even though you press the AUTO ADJUST button.
 - Still unchanged even though you carry out "Reset" in the projector's menu.
 - Image shows flickering or color drift on a computer signal.
- Image appears blurry or out of focus.
 - Still unchanged even though you checked the signal's resolution on PC and changed it to projector's native resolution.
 - Still unchanged even though you adjusted the focus.
- No sound.
 - Audio cable is correctly connected to the audio input of the projector.
 - Still unchanged even though you adjusted the volume level.
 - AUDIO OUT is connected to your audio equipment (only models with the AUDIO OUT connector).

Other

- Remote control does not work.
 - No obstacles between the sensor of the projector and the remote control.
 - Projector is placed near a fluorescent light that can disturb the infrared remote controls.
 - One or more remote sensors are enabled (only models with the Remote Sensor Selection function).
 - Batteries are new and are not reversed in installation.
 - If present on the remote control, projector selector switch is not used.
- Buttons on the projector cabinet do not work (only models with the Key Lock function).
 - Cabinet Button Lock is not turned on or is disabled in the menu.
 - Still unchanged even though you press and hold the EXIT button for a minimum of 10 seconds.

In the space below please describe your problem in detail.

Information on application and environment where your projector is used

Projector

Model number:
 Serial No.:
 Date of purchase:
 Lamp operating time (hours):
 Lamp Mode: Normal Eco
 Information on input signal:
 Horizontal synch frequency [] kHz
 Vertical synch frequency [] Hz
 Synch polarity H (+) (-)
 V (+) (-)
 Synch type Separate Composite
 Sync on Green
 STATUS Indicator:
 Steady light Orange Green
 Flashing light [] cycles
 Remote control model number:

Installation environment

Screen size: inch
 Screen type: White matte Beads Polarization
 Wide angle High contrast
 Throw distance: feet/inch/m
 Orientation: Ceiling mount Desktop
 Power outlet connection:
 Connected directly to wall outlet
 Connected to power cord extender or other (the number of connected equipment _____)
 Connected to a power cord reel or other (the number of connected equipment _____)

Computer

Manufacturer:
 Model number:
 Notebook PC / Desktop
 Native resolution:
 Refresh rate:
 Video adapter:
 Other:

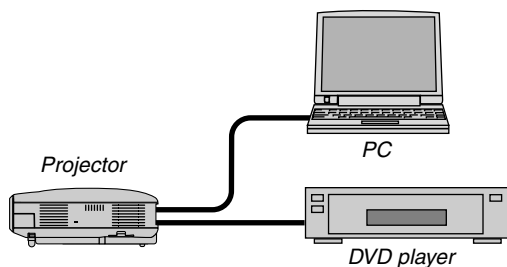

Signal cable

NEC standard or other manufacturer's cable?
 Model number: Length: inch/m
 Distribution amplifier
 Model number:
 Switcher
 Model number:
 Adapter
 Model number:

Video equipment

VCR, DVD player, Video camera, Video game or other
 Manufacturer:
 Model number:

9 TravelCare Guide

TravelCare - a service for international travelers

This product is eligible for "TravelCare", NEC's unique international warranty.

Please note that TravelCare coverage differs in part from coverage under the warranty included with the product.

Services offered with TravelCare

This warranty allows customers to receive service on their product at the NEC and NEC-designated service stations in the countries listed herein when temporarily traveling internationally for business or pleasure.

For details on services offered by the different service stations, please refer to the "List of TravelCare Outlets" below.

1 Repair services

The product will be repaired and delivered within 10 business days, not including shipping time.

During the term of warranty, the cost of maintenance parts, labor costs for repairs and shipping costs within the service station's coverage area are covered by the warranty.

2 Replacement product rental service

If the customer desires, he or she can rent a replacement product while the original product is being repaired.

Fee: US\$200 for 12 days

This fee must be paid at the local service station in cash or credit card.

The \$200 rental fee is non-refundable even if the customer rents it less than 12 days before returning.

The replacement product will be delivered within 3 business days.

If the customer did not return the replacement product within 12 days, the customer will be charged the price of the unit.

If the customer returned the replacement product in a faulty or damaged condition, the repair cost will be charged to the customer.

Note that this service is not offered in all countries and regions. Please refer to the "List of TravelCare Outlets".

In addition, this replacement product rental service is not offered after the product's warranty has expired.

Term of warranty

1

- a. Upon presentation of the warranty or receipt received upon purchase:

Valid for the term indicated on the warranty or the normal term of warranty for the country of purchase.

- b. When only the product is brought in:

Valid for a period of within 14 months of the date of manufacture indicated by the serial number attached to the product.

- 2 When a product whose term of warranty is expired is brought in:

Repairs will be offered for a fee. In this case the customer is not eligible for the replacement product rental service.

- 3 In the following cases, repairs may be charged, even if the product's warranty is still in effect:

- 1) If the term of warranty, model name, serial number and name of the store of purchase are not indicated on the warranty or have been altered.
- 2) Problems or damage caused by dropping or shocks during shipment or movement by the customer or by improper handling by the customers.
- 3) Problems or damage caused by improper usage or unwarrantable alterations or repairs by the customer.
- 4) Problems or damage caused by fire, salt damage, gas damage, earthquakes, lightning damage, storm or flood damage or other natural disasters or such external factors as dust, cigarette smoke, abnormal voltage, etc.

- 5) Problems or damage caused by use in hot or humid places, in vehicles, boats or ships, etc.
- 6) Problems or damage caused by expendable supplies or devices connected to the product other than those designated by NEC.
- 7) Problems caused by natural consumption, wear or deterioration of parts under normal usage conditions.
- 8) Problems or damage to lamps and other expendable supplies, included parts or optional parts.
- 9) Other conditions stipulated in the warranty included with the product also apply.

NOTE: The product can be used overseas with voltages of 100 to 120V and 200 to 240V by using a power cable suited for the standards and power source voltage of the country in which the product is being used.

List of TravelCare Outlets

This list applies as of April 1, 2004.

For the most up-to-date information, please refer to the websites of the service stations in the various countries on the List of TravelCare Outlets or to the NEC website at <http://www.nec-pj.com>.

In Europe

NEC Europe, Ltd. / European Technical Centre

Address: Unit G, Stafford Park 12, Telford TF3 3BJ, U.K.
 Telephone: +44 1952 237000
 Fax Line: +44 1952 237006
 Email Address: AFR@uk.necEUR.com
 WEB Address: <http://www.necEUR.com>

(Regions Covered)

EU: Austria*, Belgium*, Denmark*, Finland*, France*, Germany*, Greece*, Ireland*, Italy*, Luxembourg*, The Netherlands*, Portugal*, Spain*, Sweden* and the United Kingdom*

EEA: Norway*, Iceland and Liechtenstein

In North America

NEC Solutions (America), Inc.

Address: 1250 N. Arlington Heights Road, Suite 400
 Itasca, Illinois 60143, U.S.A.
 Telephone: +1 800 836 0655
 Fax Line: +1 800 356 2415
 Email Address: vsd.tech-support@necsam.com
 WEB Address: <http://www.necvisualsystems.com>

(Regions Covered)

U.S.A. *, Canada*

In Oceania

NEC Australia Pty., Ltd.

Address: New South Wales;
 184 Milperra Road, Reversby 2212
 Victoria;
 480 Princess Hwy Noble Park 3174
 South Australia;
 84A Richmond Road, Keswick 5035
 Queensland;
 116 Ipswich Road, Woollongabba 4102
 Western Australia;
 45 Sarich Court Osborne Park 6017
 Telephone: 131 632 (from domestic)
 +61 8 8375 5706 (from overseas)
 Fax Line: +61 8 8375 5757
 Email Address: lee.gramola@nec.com.au
 WEB Address: <http://www.nec.com.au>

(Regions Covered)

Australia*, New Zealand

In Asia and Middle East

NEC Viewtechnology, Ltd.

Address: 686-1, Nishioi, Oi-Machi, Ashigarakami-Gun,
Kanagawa 258-0017, Japan
Telephone: +81 465 85 2369
Fax Line: +81 465 85 2393
Email Address: support_pjweb@nevt.nec.co.jp
WEB Address: <http://www.nec-pj.com>

(Regions Covered)
Japan*

NEC Hong Kong Ltd.

Address: 11th Floor, Tower B, New Mandarin Plaza, 14
Science Museum Road,
Tsim Sha Tsui East, Kowloon, Hong Kong
Telephone: +852 2369 0335
Fax Line: +852 2795 6618
Email Address: esmond_au@nechk.nec.com.hk
WEB Address: <http://www.nec.com.hk>

(Regions Covered)
Hong Kong

NEC Taiwan Ltd.

Address: 7F, No.167, SEC.2, Nan King East Road, Taipei,
Taiwan, R.O.C.
Telephone: +886 2 8500 1734
Fax Line: +886 2 8500 1420
Email Address: nickliao@nec.com.tw
WEB Address: <http://www.nec.com.tw>

(Regions Covered)
Taiwan

NEC Solutions Asia Pacific Pte. Ltd

Address: 401 Commonwealth Drive, #07-02, Haw Par
Technocentre, Singapore 149598
Telephone: +65 6 273 8333
Fax Line: +65 6 274 2226
Email Address: tehgh@rsc.ap.nec.com.sg
WEB Address: <http://www.nec.com.sg/ap>

(Regions Covered)
Singapore

NEC Systems Integration Malaysia Sdn Bhd

Address: Ground Floor, Menara TA One, 22, Jalan P. Ramlee,
50250 Kuala Lumpur, Malaysia
Telephone: +6 03 2164 1199
Fax Line: +6 03 2160 3900
Email Address: necare@nsm.nec.co.jp
WEB Address: <http://www.necmalaysia.com.my>

(Regions Covered)
Malaysia

Nautilus Hyosung Inc.

Address: 7th Floor, Cheongdam Building, 52,
Cheongdam-Dong,
Kangnam-Ku, Seoul, Korea 135-100
Telephone: +82 2 510 0234
Fax Line: +82 2 540 3584
Email Address: hds-ykc@hyosung.com

(Regions Covered)
South Korea

Lenso Communication Co., Ltd.

Address: 292 Lenso House 4, 1st Floor, Srinakarin Road,
Huamark, Bangkok, Bangkok 10240, Thailand
Telephone: +66 2 375 2425
Fax Line: +66 2 375 2434
Email Address: pattara@lenso.com
WEB Address: <http://www.lenso.com>

(Regions Covered)
Thailand

ABBA Electronics L.L.C.

Address: Tariq Bin Ziyad Road, P.O.Box 327, Dubai,
United Arab Emirates
Telephone: +971 4 371800
Fax Line: +971 4 364283
Email Address: ABBA@emirates.net.ae

(Regions Covered)
United Arab Emirates

Samir Photographic Supplies

Address: P.O.Box 599, Jeddah 21421, Saudi Arabia
Telephone: +966 2 6828219
Fax Line: +966 2 6830820
Email Address: vartkes@samir-photo.com

(Regions Covered)
Saudi Arabia

NOTE: In countries designated with an asterisk(*), replacement product rental service are offered.

Date: / / ,

P-1/ ,

TO: NEC or NEC's Authorized Service Station:

FM:

(Company & Name with signature)

Dear Sir (s),

I would like to apply your TravelCare Service Program based on attached registration and qualification sheet and agree with your following conditions, and also the Service fee will be charged to my credit card account, if I don't return the Loan units within the specified period. I also confirm following information is correct. Regards.

Application Sheet for TravelCare Service Program

Country, product purchased :	
User's Company Name :	
User's Company Address : Phone No., Fax No. :	
User's Name :	
User's Address :	
Phone No., Fax No. :	
Local Contact office :	
Local Contact office Address :	
Phone No., Fax No. :	
User's Model Name :	
Date of Purchase :	
Serial No. on cabinet :	
Problem of units per User :	
Required Service :	(1) Repair and Return (2) Loan unit
Requested period of Loan unit :	
Payment method :	(1) Credit Card (2) Travelers Cheque (3) Cash
In Case of Credit Card : Card No. w/Valid Date :	

Condition of your TravelCare Service Program

Enduser is requested to understand following condition of TravelCare Service Program and complete the necessary information on the application sheet.

1. Service Options:

There are 3 types of "Service" available. Enduser has to understand following condition and is required to fill in the Application Sheet.

1) Repair and Return:

The 'Faulty unit' is sent or collected from the customer. It is repaired and returned within 10 days to the customer, excluding transport time.

There may have a case, repair and return can't be done by NEC Authorized Service Station, because of shortage of spare parts due to same model is not sold in the territory.

2) Repair and Return with Loan: (This service is limited to some Service Stations)

This service is offered to the Enduser, who cannot wait until their unit is repaired.

The customer can borrow a unit for \$200 up to 12 days. Customer then sends in inoperable unit to nearest NEC Authorized Service Station for service. In order to prevent collection problem, Enduser is required to fill in Application Sheet.

Enduser needs to confirm the availability of the Service to NEC Authorized Service Stations.

3) Loan Only:

For this service, NEC Authorized Service Station supplies the customer with a loan unit for US\$200 up to 12 days. Customer keeps the inoperable unit and when customer returns home, customer arranges to have the projector serviced in the home country.

2. Warranty Exclusions:

This program does not apply if the Projector's serial number has been defaced, modified or removed.

If, in the judgement of NEC Authorized Service Station or its agent the defects or failures result from any cause other than fair wear and tear or NEC neglect, or fault including the following without limitation:

- 1) Accidents, transportation, neglect, misuse, abuse, water, dust, smoke or default of or by the Customer its employees or agents or any third party;
- 2) Failure or fluctuation of electrical power, electrical circuitry, air conditioning, humidity control or other environmental conditions such as use it in smoking area;
- 3) Any fault in the attachments or associated products or components (whether or not supplied by NEC or its agents which do not form part of the Product covered by this warranty);
- 4) Any act of God, fire, flood, war, act of violence or any similar occurrence;
- 5) Any attempt by any person other than any person authorized by NEC to adjust, modify, repair, install or service the product.
- 6) Any Cross-border charges such as, duty, insurance, tax etc.

3. Charges for Warranty Exclusions and Out of Warranty Case:

In case faulty unit is under warranty exclusions case or under Out of Warranty period, NEC Authorized Service Station will Inform estimation of actual service cost to the Enduser with reason.

4. Dead on Arrival (DOA):

Enduser must take this issue up with their original supplier in the country of purchase.

NEC Authorized Service Station will repair the DOA unit as a Warranty repair, but will not exchange DOA unit with new units.

5. Loan Service Charges and Conditions:

Upon acceptance of this NEC Projector, Customer agrees to assume liability for this loan unit.

The current cost of use of this loan unit is \$200.00 USD for 12 calendar days.

If Customer does not return the unit within the 12 calendar days, Customer will be charged the next highest cost up to and including the full list price to Credit Cards, which price will be informed by NEC Authorized Service Stations. Please see the attached listing of contacts for each country to arrange for pickup of the loan unit.

If you return to their country of origin with the loan unit, you will be charged additional freight to return the unit to the loaning country.

Thank you for your understanding of this program.

LIMITED WARRANTY (USA and Canada only)

NEC SOLUTIONS' PROJECTOR PRODUCTS

NEC Solutions (America), Inc. (hereafter NEC Solutions) warrants this product to be free from defects in material and workmanship under the following terms.

HOW LONG IS THE WARRANTY

NEC Solutions' VT670, VT570, VT470 and VT47 projectors are covered by a two (2) year limited parts and labor warranty from the date of the first customer purchase. The lamp when used under normal operating conditions is warranted for 500 hours or 90 days, whichever comes first.

WHO IS PROTECTED

This warranty may be enforced only by the first purchaser, and is not transferable.

WHAT IS COVERED AND WHAT IS NOT COVERED

Except as specified below, this warranty covers all defects in material or workmanship in this product.

NEC SOLUTIONS' LIABILITY FOR ANY DEFECTIVE PRODUCT IS LIMITED TO THE REPAIR OR REPLACEMENT OF THE PRODUCT AT NEC SOLUTIONS' OPTION. REPLACEMENT PRODUCTS MAY BE NEW OR RECONDITIONED PRODUCTS, AND REPLACEMENT PARTS MAY BE NEW OR SERVICEABLE USED PARTS. The following are not covered by the limited warranty and NEC Solutions shall not be liable for:

1. Any product which is not distributed in the U.S.A. or Canada by NEC Solutions or which is not purchased, installed, and operated in the U.S.A or Canada.
2. Any product on which the serial number has been defaced, modified or removed.
3. Normal decrease in lamp light output over time.
4. Damage, deterioration or malfunction resulting from:
 - a. Accident, misuse, abuse, neglect, improper ventilation, fire, dust, smoke, water, lightning or other acts of nature, unauthorized product modification, or failure to follow instructions supplied with the product.
 - b. Repair or attempted repair by anyone other than a NEC Solutions authorized service center.
 - c. Any shipment of the product (claims must be presented to the carrier).
 - d. Removal or installation of the product.
 - e. Any other cause which does not relate to a product defect.
 - f. Use of the product beyond normal operating conditions. Normal operating conditions are defined as product use not in excess of 8 hours per day and 260 days per year.
5. Cartons, carrying cases, shipping cases, batteries, external cabinets, magnetic tapes, or any accessories used in connection with the product.
6. Service required as a result of third party components.

WHAT NEC SOLUTIONS WILL PAY FOR

NEC Solutions will pay labor and material expenses for covered items, but NEC Solutions will not pay for the following:

1. Removal or installation charges.
2. Costs of technical adjustments, set-up, maintenance, or adjustment of user controls.
3. Payment of shipping and related charges incurred in returning the product for warranty repair.

HOW YOU CAN GET WARRANTY SERVICE

1. To obtain service on your product, consult the dealer from whom you purchased the product.
2. Whenever warranty service is required, the original dated invoice (or a copy) must be presented as proof of warranty coverage. In order to obtain warranty service, you may be required to describe and demonstrate the problem to your dealer or to NEC Solutions.
3. All products returned to NEC Solutions for service MUST have prior approval. To receive approval or for the name of the nearest NEC Solutions authorized service center, call NEC Solutions at 800-836-0655.
4. It shall be your obligation and expense to ship the product, freight prepaid, or to deliver it to a NEC Solutions authorized service center, in either the original package or a similar package affording an equal degree of protection.
5. In the event a product is returned to NEC Solutions for warranty service, and it is determined that there is no product defect or that the product condition is not covered by this limited warranty, a diagnostic service fee may be charged to the customer.

LIMITATION OF IMPLIED WARRANTIES

EXCEPT AS EXPRESSLY SET FORTH IN THIS LIMITED WARRANTY, NEC SOLUTIONS MAKES NO OTHER WARRANTIES, EXPRESS OR IMPLIED, INCLUDING BUT NOT LIMITED TO ANY IMPLIED WARRANTIES OR CONDITIONS OF MERCHANTABILITY AND FITNESS FOR A PARTICULAR PURPOSE. ANY IMPLIED WARRANTIES THAT MAY BE IMPOSED BY LAW ARE LIMITED TO THE TERMS AND DURATION OF THIS LIMITED WARRANTY.

EXCLUSION OF DAMAGES

NEC SOLUTIONS' LIABILITY FOR ANY DEFECTIVE PRODUCT IS LIMITED TO THE REPAIR OR REPLACEMENT OF THE PRODUCT AT NEC SOLUTIONS' OPTION. NEC SOLUTIONS SHALL NOT BE LIABLE FOR:

1. DAMAGE TO OTHER PROPERTY CAUSED BY ANY DEFECTS IN THIS PRODUCT, DAMAGES BASED UPON INCONVENIENCE, LOSS OF USE OF THE PRODUCT, LOSS OF TIME, COMMERCIAL LOSS; OR
2. ANY OTHER DAMAGES, WHETHER INCIDENTAL, CONSEQUENTIAL OR OTHERWISE.

HOW STATE LAW RELATES TO THE WARRANTY

SOME STATES DO NOT ALLOW LIMITATIONS ON HOW LONG AN IMPLIED WARRANTY LASTS AND/OR DO NOT ALLOW THE EXCLUSION OR LIMITATION OF INCIDENTAL OR CONSEQUENTIAL DAMAGES, SO THE ABOVE LIMITATIONS AND EXCLUSIONS MAY NOT APPLY TO YOU. THIS LIMITED WARRANTY GIVES YOU SPECIFIC LEGAL RIGHTS, AND YOU MAY HAVE OTHER RIGHTS WHICH VARY FROM STATE TO STATE.

FOR MORE INFORMATION, CONTACT:

NEC SOLUTIONS (AMERICA), INC.
1250 N. Arlington Heights Road, Suite 400
Itasca, Illinois 60143-1248
TELEPHONE 800-836-0655
www.necvisualsystems.com

Customers are cautioned that product performance is affected by system configuration, software, the application, customer data, and operator control, among other factors. While NEC Solutions' products are considered to be compatible with many systems, the specific functional implementation by the customers of the product may vary. Therefore, the suitability of a product for a specific purpose or application must be determined by the customer and is not warranted by NEC Solutions.

DECLARATION OF CONFORMITY

This device complies with Part 15 of FCC Rules. Operation is subject to the following two conditions. (1) This device may not cause harmful interference, and (2) this device must accept any interference received, including interference that may cause undesired operation.

U.S. Responsible Party:	NEC Solutions (America), Inc.
Address:	1250 N. Arlington Heights Road Itasca, Illinois 60143
Tel. No.:	(630) 467-5000

Type of Product:	Projector
Equipment Classification:	Class B Peripheral
Models:	VT670/VT570/VT470/VT47

*We hereby declare that the equipment specified above
conforms to the technical standards as specified in the FCC Rules.*

