

# PULSE

Ultrasonic chemical injection metering valves



Insert-retrievable, self-regulating subsea chemical injection metering valves for greater accuracy and reliability in low-dose inhibitor injection and hydrate mitigation

Cameron PULSE\* ultrasonic chemical injection metering valves (CIMVs) are remotely operated, ROV-retrievable, self-regulating subsea chemical injection metering systems. Self regulation is an integral part of all our CIMV technology and only requires one user-defined input—flow rate—for the system to monitor and control using onboard closed-loop control.

At the core of each PULSE CIMV is a nonintrusive line-of-sight ultrasonic flowmeter that reinvents achievable accuracy levels in CIMVs. Use of an ultrasonic flowmeter is replacing intrusive flow measurement techniques in other designs, introducing a step change in CIMV technology. The ultrasonic flowmeter fires an ultrasonic pulse with and against the chemical flow, then measures the difference in time of flight in both directions.

The ultrasonic flowmeter is combined in closed-loop control with an electrically actuated throttling valve. Real-time feedback from the ultrasonic flowmeter is used to autonomously control the throttling valve, indefinitely maintaining an injection rate set point despite up- and downstream system disturbances. This technology is particulate tolerant, provides consistent best-in-class accuracy, and reliably measures chemical inhibitor flow rate without the need for filtration. It also features a high turndown ratio for adjustment from minimum to maximum flow combined with a low native pressure drop.

### Low-, medium- and high-flow CIMVs

The Cameron PULSE LF low-flow ultrasonic CIMV is designed for long-step-out, deepwater projects with complex system architectures, requiring subsea distributed injection of chemical inhibitors to address flow assurance challenges. It provides greater control and accuracy over the levels of low-dose inhibitors (LDIs) that are added to the flow at lower capex and opex compared with point-to-point injection.

The technology uses a precision needle valve to regulate the flow through the system. The needle has an equal-percentage flow curve, providing exceptional control over a large flow range. It is operated by an electric actuator, which provides fine system adjustment and is controlled by the feedback from the microbore nonintrusive line-of-sight ultrasonic flowmeter via an onboard closed-loop control algorithm.

The PULSE MF medium-flow and HF high-flow ultrasonic CIMVs are designed for hydrate mitigation and handle the contaminated regenerated monoethylene glycol (MEG) stream without requiring subsea filtration. They were developed to further optimize the MEG or methanol distribution system, reducing the distribution system pressure rating and achieving significant cost savings.

These CIMVs incorporate a large-bore flowmeter that meters contaminated MEG and methanol streams up to 7,000 galUS/h [26,500 L/h] while still consistently achieving a high turndown ratio in excess of 130:1. They use a field-proven multiple orifice valve (MOV) choke trim technology to provide an erosion-resistant throttling element. The MOV trim consists of two sintered and hot-isostatic-pressed (HIP) tungsten carbide discs—one fixed, and the other rotated by a stepper motor via a gear train. Both discs have specially shaped, extended-range orifices that, when rotated relative to each other, achieve precise control with a high turndown ratio and fine system adjustment.

The PULSE CIMV retrievable technology uses onboard diagnostics to stream back accurate performance data, giving operators a clear picture of what is happening at the injection point and allowing full inhibition without overdosing.



### Onboard closed-loop control

In automatic mode, the PULSE CIMVs use real-time flow rate feedback in closed-loop control to adjust the throttling valve and maintain the injection flow rate irrespective of any disturbance in the upstream and downstream pressures. For example, in a situation where several CIMVs are tied to a common chemical supply header, the header pressure may fall as the other chemical injection valves in the system adjust. If it does, the flow rate across the throttling valve will also drop. This will, in turn, be registered by the flowmeter. If the measured flow rate falls outside the adjustable dead bands, the onboard algorithm will proportionally adjust the throttling valve to correct the flow rate.

These CIMVs also have manual modes of operation in which the closed-loop control is suspended and the valve is operated in open-loop control while an adjustable throttling valve and a flowmeter in series provides flow rate feedback. Operation of our CIMVs is user friendly with a single user-defined input—flow rate—and a straightforward user interface combined with onboard diagnostics for improved monitoring of the system.



# PULSE LF Low-Flow Ultrasonic CIMV

Designed for injection of LDIs for wax, scale, and corrosion, the PULSE LF CIMV uses a nonintrusive ultrasonic flowmeter and a microneedle and seat throttling valve in closed-loop control. It has been engineered to handle flow rates from 0.07 to 159 galUS/h [0.25 to 600 L/h] and is retrievable by ROV, whether mounted in a horizontal or vertical orientation.

## Flow measurement

At the core of the PULSE LF CIMV is our patented microbore nonintrusive line-of-sight ultrasonic flowmeter. The ultrasonic flowmeter has no moving parts and, unlike the Venturi-type flowmeter, is pressure independent with a low native pressure drop. Flow rate is determined by time-of-flight measurement of an ultrasonic pulse traveling with and against the chemical flow. This technology features a high turndown ratio, is particulate tolerant, provides consistent high accuracy of reading, and reliably measures chemical inhibitor flow rate without the need for subsea filtration.

For redundancy, a secondary method of flow determination is supplied that consists of two pressure sensors across the throttling valve and a linear variable differential transformer to provide valve position. This information can be used with trended field data to determine the flow rate.

## Throttling valve

The PULSE LF CIMV includes a precision needle valve to regulate the flow through the system. The needle has an equal-percentage flow curve, providing exceptional control over a large flow range. It is operated by a precision electric actuator that enables fine system adjustment and is controlled by the feedback from the ultrasonic flowmeter via the onboard closed-loop control algorithm.

## PULSE LF CIMV System Architecture

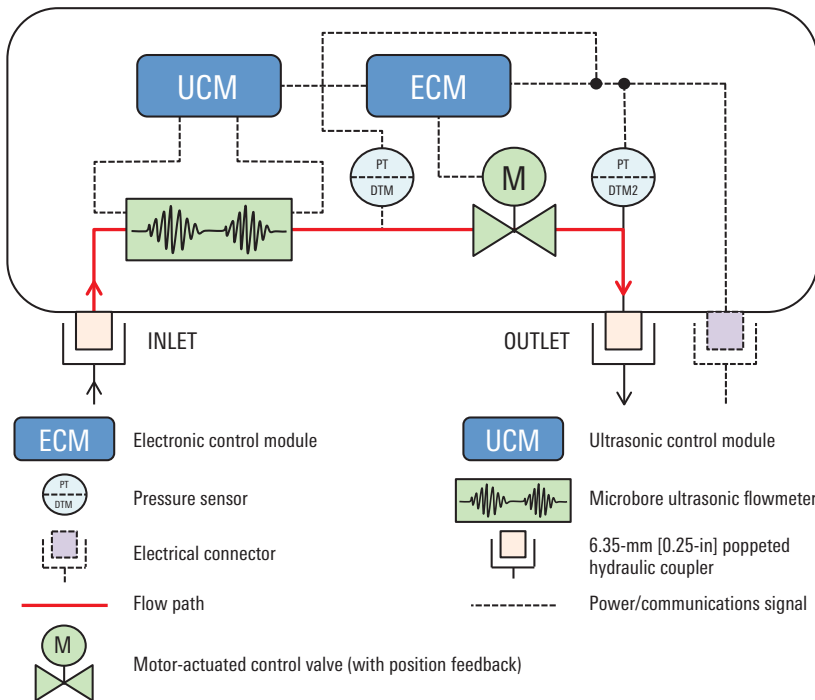

- ROV-retrievable, self-regulating metering valve
- Application: corrosion, scale, wax inhibitors, and LDIs
- Flow range of 0.07–159 galUS/h [0.25–600 L/h]
- Microbore nonintrusive line-of-sight ultrasonic flowmeter
- Accuracy better than  $\pm 2\%$  of reading
- 10,000-psi [68.9-MPa] and 15,000-psi [103.4-MPa] maximum working pressure
- 13,123-ft [4,000-m] water depth
- 154-lbm [70-kg] insert weight in water
- Vertical or horizontal tree or manifold mounting
- CANbus, CiA 443, or Modbus communication
- Redundant flow measurement system
- Onboard control and diagnostics

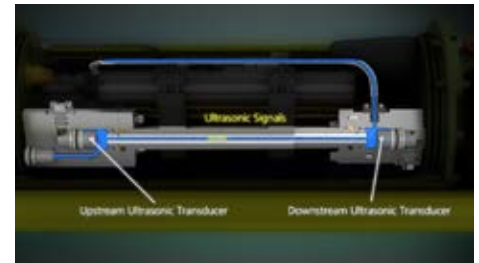

Nonintrusive line-of-sight ultrasonic flowmeter.



Microneedle and seat.



PULSE LF CIMV insert and receptacle.

**PULSE LF CIMV 0.07–159 galUS/h [0.25–600 L/h]****Technical Details**

Model	Remotely operated, ROV-retrievable PULSE LF CIMV
Application	LDIs (corrosion, scale, wax, asphaltene, demulsifiers, etc.)
Installation orientation	Horizontal or vertical
Design standard	API 17D/ISO 13628-4; API 17F/ISO 13628-6
Design life	25 years
Failure mode	Fail as is; will continue to inject on loss of power or communication
Pressure rating	10,000 psi [68.9 MPa] or 15,000 psi [103.4 MPa]
Max. differential pressure <sup>†</sup>	3,500 psi [24.1 MPa] for flow rates < 0.26 galUS/h [1 L/h]
Min. differential pressure <sup>†</sup>	< 50 psi [0.34 MPa] for flow rates up to 26 galUS/h [100 L/h] < 500 psi [3.45 MPa] for flow rates up to 159 galUS/h [600 L/h]
Hydraulic connection	Hunting® RS-4 hydraulic couplers (two off) poppetted with weld tails (size and material per project)
Electrical connection	Seven-way electrical connector (OneSubsea Diamould* electric connectors, Siemens Tronic®, Teledyne ODI®, stab and ROV mate options)
Envelope dimensions	
Total length	Approx. 41.7 in [1,059 mm]
Insert diameter	Approx. 10 in [254 mm]
Insert weight	Approx. 154 lbm [70 kg] in water, suitable for ROV deployment
ROV lockdown interface	API 17H/ISO 13628-8 Class 4
Temperature rating electronics	
Storage	0 to 122 degF [–18 to 50 degC]
Operational	23 to 104 degF [–5 to 40 degC]
Working depth	13,123 ft [4,000 m]
Flow range	
Standard	0.07–159 galUS/h [0.25–600 L/h]
Turndown	2,400:1
Cleanliness	Particulate-tolerant system; recommended SAE AS4059 Class 12 B-F (supplied flushed to SAE AS4059 Class 6 B-F)
Accuracy	Better than ±2% of reading above 0.53 galUS/h [2 L/h]
Pressure sensors	Two off (used to determine secondary flow)
Additional features	Secondary flow system and onboard status indicators (e.g., zero flow, max flow, reverse flow, totalizer, and diagnostics)

**Pressure-Containing and Pressure-Controlling Component Materials**

Valve trim	Nickel alloy 718 and Stellite® 6 stainless steel
Valve body	Duplex stainless steel
Valve seals (stem)	Polytetrafluoroethylene (PTFE) based stack
Flowmeter	22% chromium duplex body with nickel alloy 718 transducers
Pressure seals	Metal-to-metal nickel alloy with elastomeric backups

**Electrical Controlling Components**

Motor	Stepper
Power consumption	
Min.	2.2 W (no flow metering); <6W (during flow rate monitoring)
Norm	<8.6 W (motor operating)
Max.	<14.5 W (at 39.2-degF environment based on full pressure)
Electronics system	Housed in 1-atm housing
Interface protocol	CANOpen, CiA 443 Version 3, SIIS Level 2 fault-tolerant CANbus, or Modbus
Inrush current	< 600 mA for < 500 ms (SIIS Level 2 compliant)
Default bit rate	50 kbps

<sup>†</sup> Max. and min. differential pressures are based on a 40-cP fluid at minimum and maximum flow rates, respectively, to maintain controllability. Higher or lower differential pressures are possible dependent on flowing conditions.

# PULSE LF CIMV Typical Configurations

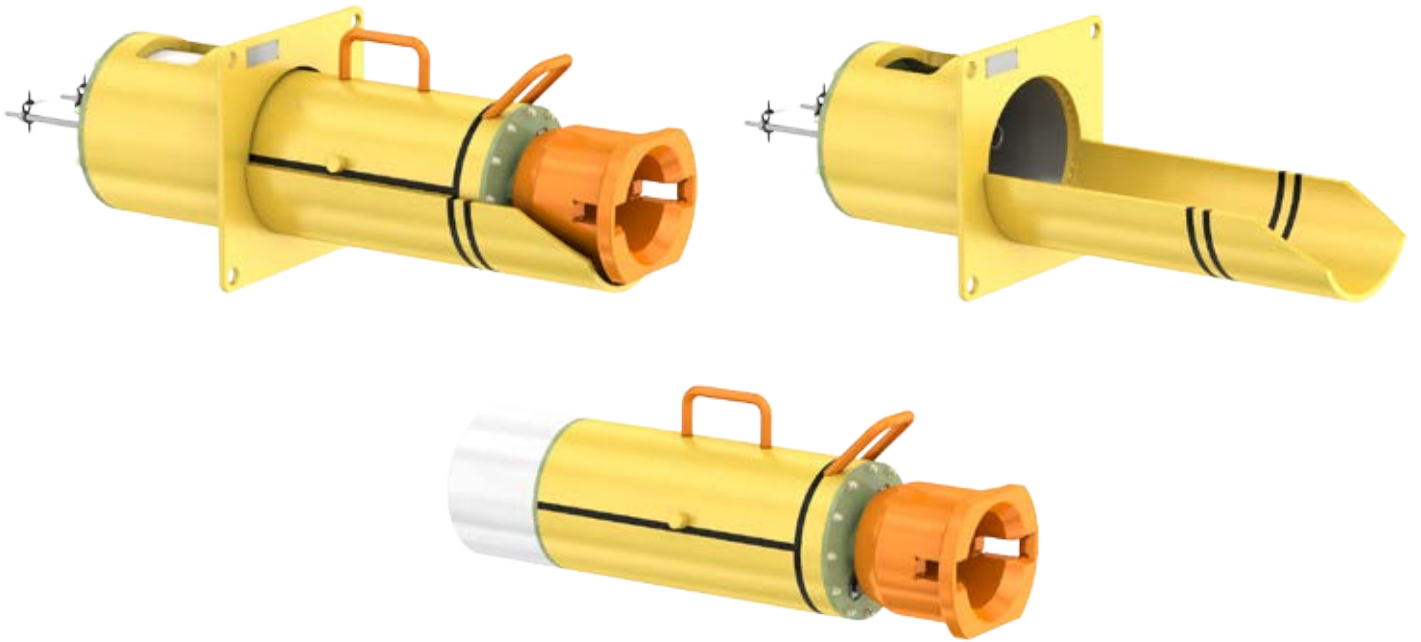

*Horizontal installation—insert with stab mate electrical connector and receptacle.*

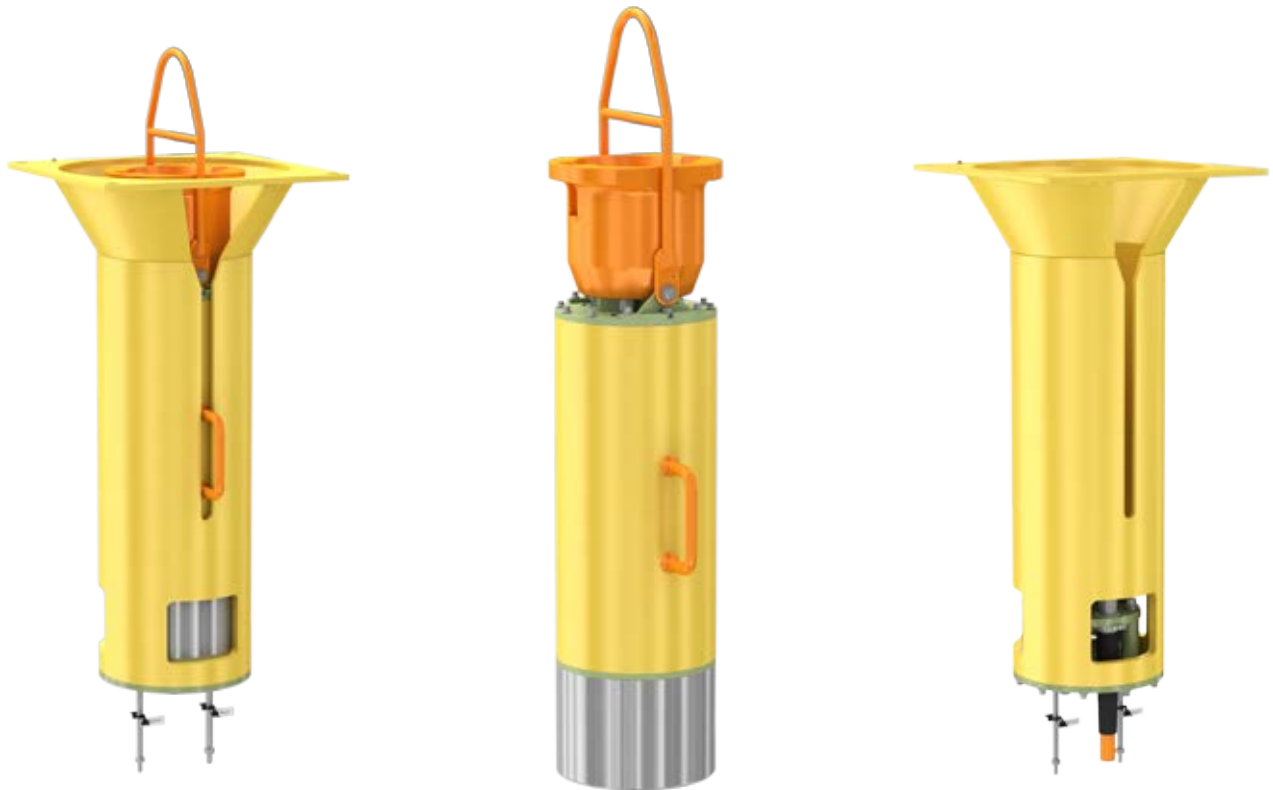

*Vertical installation—insert with stab mate electrical connector and receptacle.*

# PULSE LF CIMV Insert and Receptacle Features

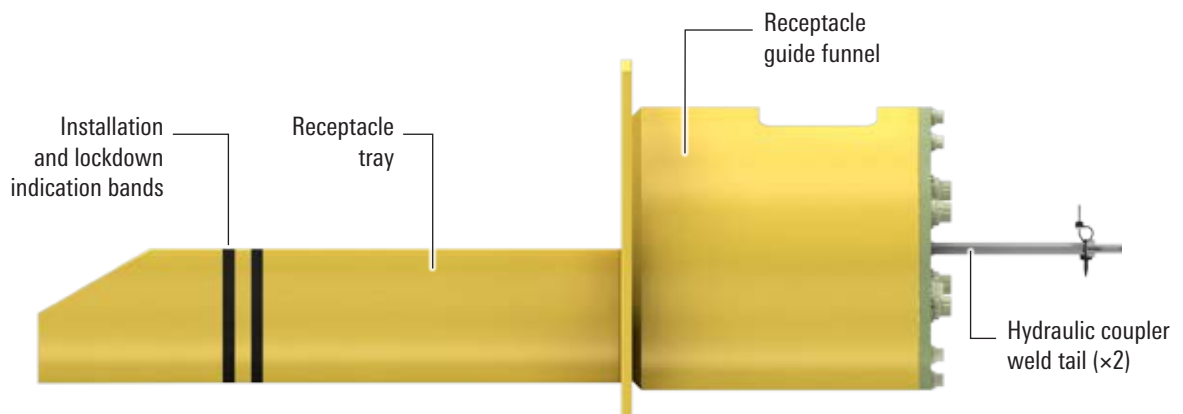
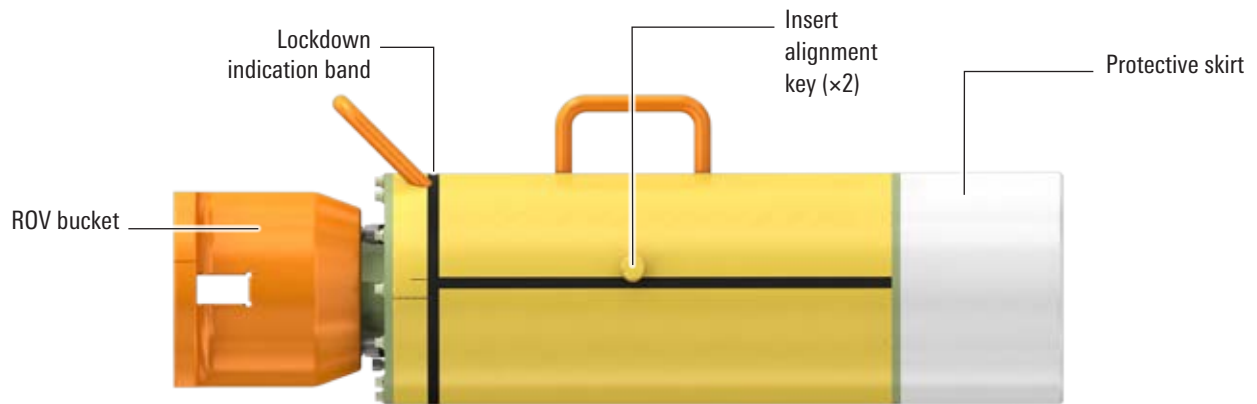
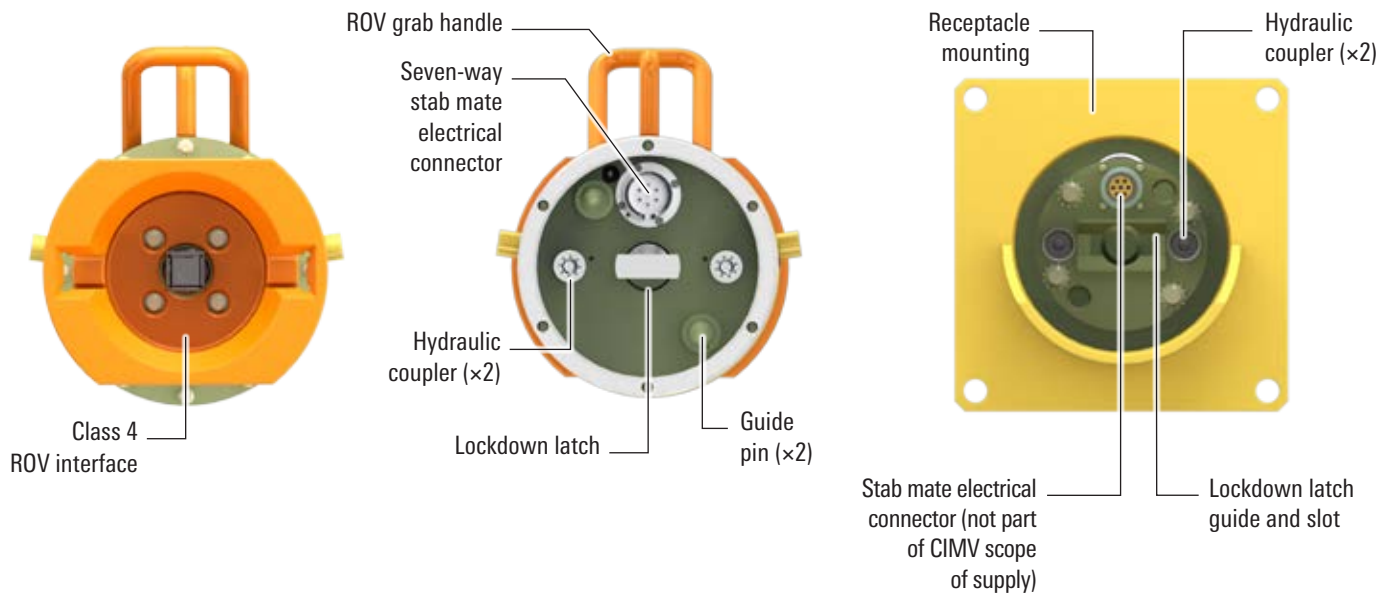

# PULSE MF Medium-Flow Ultrasonic CIMV

The PULSE MF CIMV is designed for injection of MEG and methanol as part of a subsea hydrate mitigation strategy. It handles the contaminated regenerated MEG stream. At the heart of the PULSE MF and HF CIMVs is our patented nonintrusive line-of-sight ultrasonic flowmeter, developed with our advanced ultrasonic time-of-flight technology. The robust nonintrusive particulate-tolerant nature of the medium- and high-flow CIMVs means that no subsea filtration of the MEG or methanol is required.

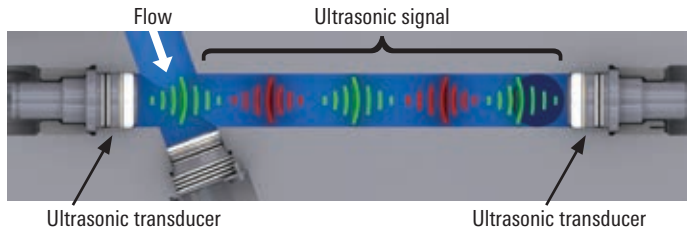

## Flow measurement

The large-diameter, nonintrusive line-of-sight ultrasonic flowmeter at the heart of the PULSE MF CIMV fires an ultrasonic pulse with and against the flow, measuring the difference in time of flight in both directions. The  $\Delta T$  measured is the speed of the fluid, allowing the flow rate to be accurately calculated.

As with the PULSE LF CIMV, a secondary flow determination system is supplied that consists of two pressure sensors across the throttling valve and a rotary position sensor to provide valve position. Processing at the system level can then be used to convert this data to flow rates via a table of trended field data.

## Throttling valve

The PULSE MF and HF CIMVs use a field-proven MOV choke trim technology to provide an erosion-resistant throttling element. The MOV trim consists of two sintered and HIP tungsten carbide discs—one fixed and the other rotated by a stepper motor via a gear train. Both discs have specially shaped, extended-range orifices that, when rotated relative to each other, easily achieve a turndown ratio in excess of 137:1 with fine system adjustment.

## PULSE MF CIMV System Architecture

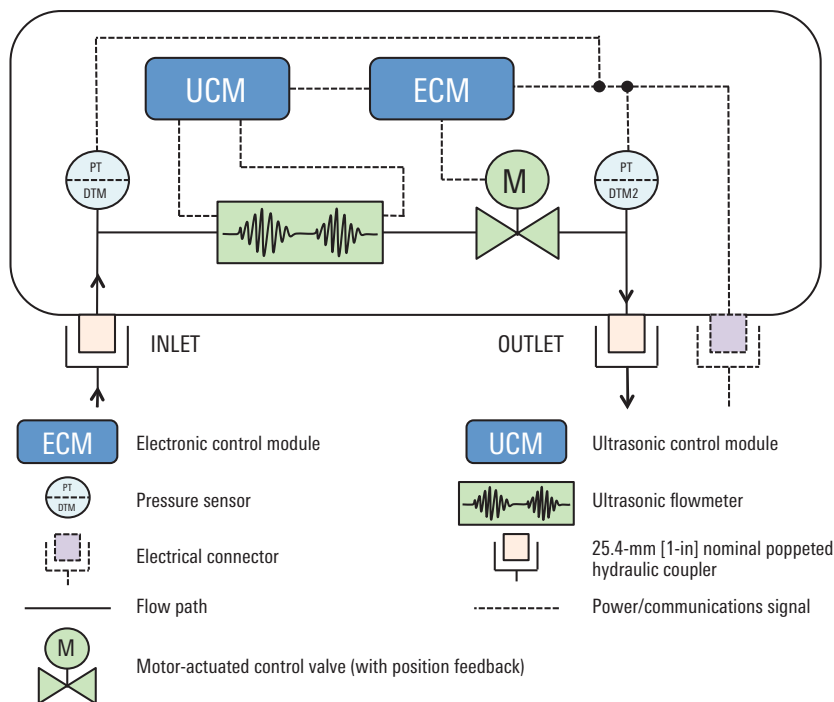

*PULSE MF CIMV insert and receptacle.*

- Insert-retrievable, self-regulating metering valve
- Application: hydrate mitigation (regenerated MEG and methanol)
- Flow range from 21 to 2,906+ galUS/h [80 to 11,000+ L/h]
- 1-in [25.4-mm] poppeted or poppetless couplers
- Patented large-bore, nonintrusive line-of-sight flowmeter
- Accuracy better than  $\pm 3\%$  of reading
- 10,000-psi [68.9-MPa] maximum working pressure
- 10,000-ft [3,048-m] water depth
- Insert weight approx. 551 lbm [250 kg] in water
- Vertical mounting on tree or manifold
- CANbus, CiA 443, or Modbus communication
- Redundant flow measurement system
- Onboard control and diagnostics



**PULSE MF CIMV 21–2,906+ galUS/h [80–11,000+ L/h]****Technical Details**

Model	Cameron remotely operated, insert-retrievable PULSE MF CIMV
Application	MEG, regenerated MEG, and methanol dosing
Installation orientation	Vertical
Design standard	API 17D/ISO 13628-4; API 17F/ISO 13628-6
Design life	25 years
Failure mode	Fail as is; will continue to inject on loss of power or communication
Pressure rating	10,000 psi [68.9 MPa] Optional 15,000 psi [103.4 MPa]
Max. differential pressure <sup>†</sup>	3,500 psi [24.1 MPa]
Min. differential pressure <sup>†</sup>	< 150 psi [1.03 MPa]
Hydraulic connection	1-in [25.4-mm] Hunting RS-16 hydraulic couplers (two off) popped or nonpopped with weld tails (size and material as per project)
Electrical connection	Seven-way electrical connector (OneSubsea Diamould, Siemens Tronic, Teledyne ODI, stab and ROV mate options)
Envelope dimensions	
Total length	Approx. 44.9 in [1,141 mm]
Insert diameter	Approx. 10 in [254 mm]
Insert weight	Approx. 551 lbm [250 kg] in water, suitable for ROV deployment with buoyancy or wireline
ROV lockdown interface	API 17H/ISO 13628-8 Class 4
Electronics temperature rating	
Storage	0 to 122 degF [–18 to 50 degC]
Operational	23 to 104 degF [–5 to 40 degC]
Working depth	10,000 ft [3,048 m]
Filter	None required
Flow range	21–2,906+ galUS/h [80–11,000+ L/h] Turndown: 137:1
Cleanliness	No filtration necessary; particulate-tolerant design with large throughbores, nonintrusive flowmeter, and erosion-resistant choke trim technology
Accuracy	Better than ±3% of reading over entire flow range
Pressure sensors	Two off (used for secondary flow measurement)
Additional features	Secondary flow determination system and onboard status indicators (e.g., zero flow, max flow, reverse flow, flow totalizer, and diagnostics)

**Pressure-Containing and Pressure-Controlling Component Materials**

Valve trim	Nickel alloy 718 and tungsten carbide with tungsten carbide wear sleeve
Valve body	Duplex stainless steel
Valve seals (stem)	Spring-energized PTFE seal
Flowmeter	Nickel alloy 625
Pressure seals	Metal-to-metal nickel alloy with inert elastomeric backups

**Electrical Controlling Components**

Motor	High-efficiency stepper
Power consumption	
Minimum	< 4 watts (quiescent)
Normal	9.6 watts (motor operating)
Maximum	< 12 watts (at 39 degF [4 degC] and full 10,000-psi [68.9-MPa] pressure)
Electronics system	Housed in 1-atm housing
Interface protocol	CANOpen, CiA 443 Ver 3, SIIIS Level 2 fault-tolerant CANbus, or Modbus
Inrush current	< 600 mA for < 500 ms (SIIIS Level 2 compliant)
Default bit rate	50 kbps

<sup>†</sup> Max. and min. differential pressures are based on a 25-cP fluid at minimum and maximum flow rates, respectively, to maintain controllability. Higher or lower differential pressures are possible dependent on flowing conditions.

# PULSE MF CIMV Insert and Receptacle Features



*CIMV insert and receptacle assembly.*



*CIMV receptacle.*

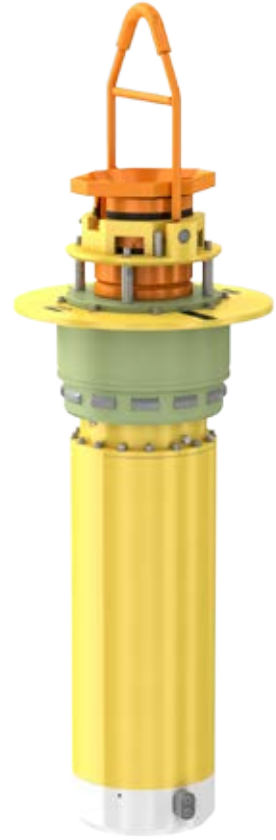

*CIMV insert.*

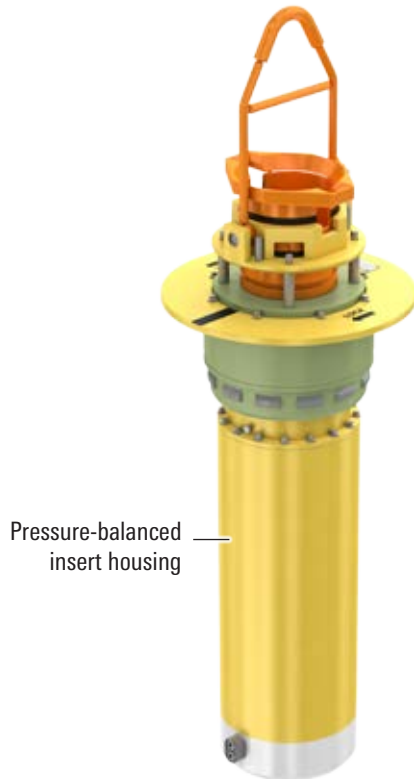

Pressure-balanced insert housing

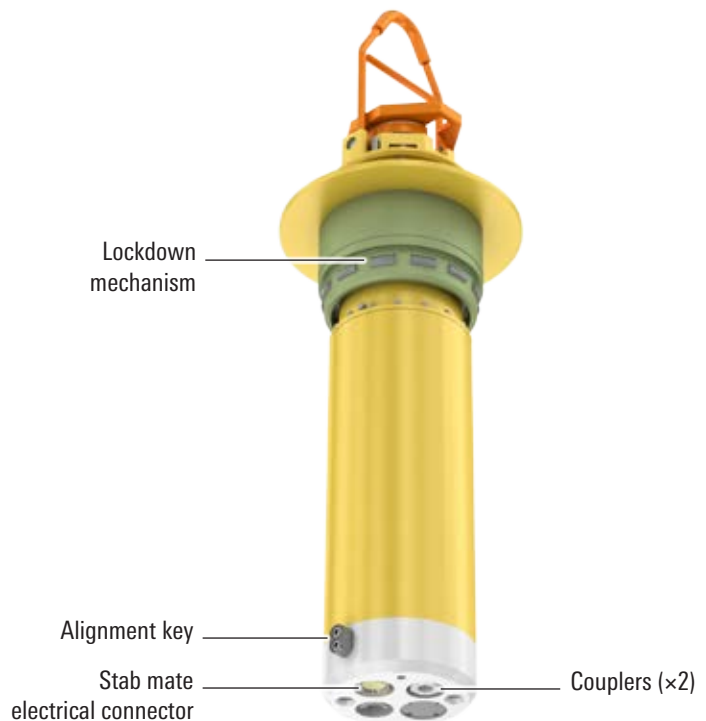

Lockdown mechanism

Alignment key

Stab mate electrical connector

Couplers (x2)

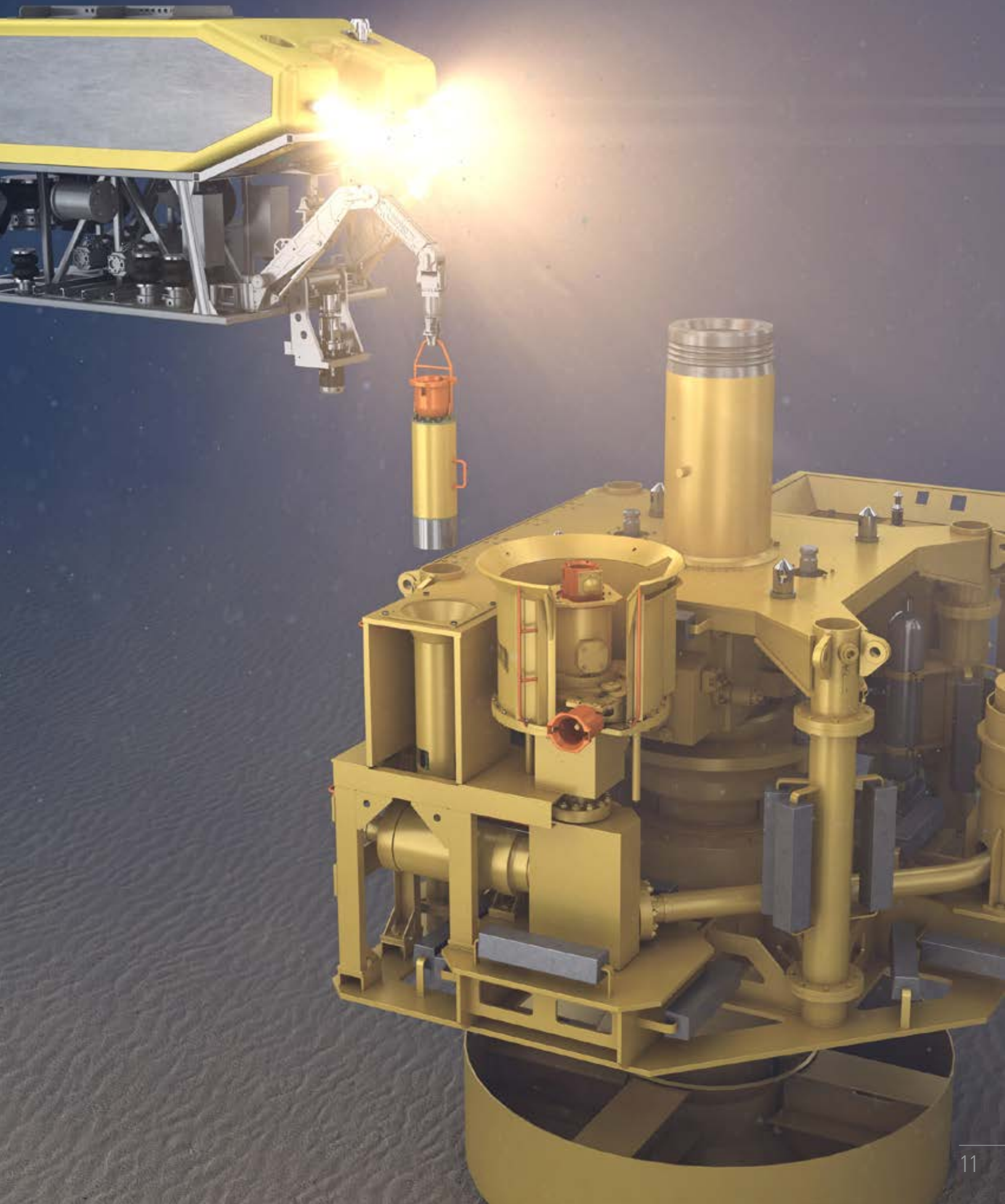

# PULSE HF High-Flow Ultrasonic CIMV

Developed for the ultrahigh-flow MEG and methanol requirements of large gas projects, and effective during startup and continuous hydrate inhibition, the Cameron PULSE HF CIMV is designed for a flow range of from 42 to 7,000 galUS/h [160 to 26,500 L/h] and tested in excess of 7,925 galUS/h [30,000 L/h]. Even at these ultrahigh design flow rates, the large-diameter nominal throughbore in the PULSE HF CIMV results in average erosion velocities below the API recommendation and, with a tungsten carbide throttling element based on the field-proven MOV choke trim technology, risk of trim erosion is greatly reduced.

The large-throughbore, nonintrusive line-of-sight ultrasonic flowmeter also results in an inherently low-pressure-drop device, with minimal pressure head above the injection pressure required. For example, with the valve set at 80% open, a pressure drop of only 100 psi [0.69 MPa] is required to inject fluid at 6,604 galUS/h [25,000 L/h].



PULSE HF CIMV insert and receptacle.

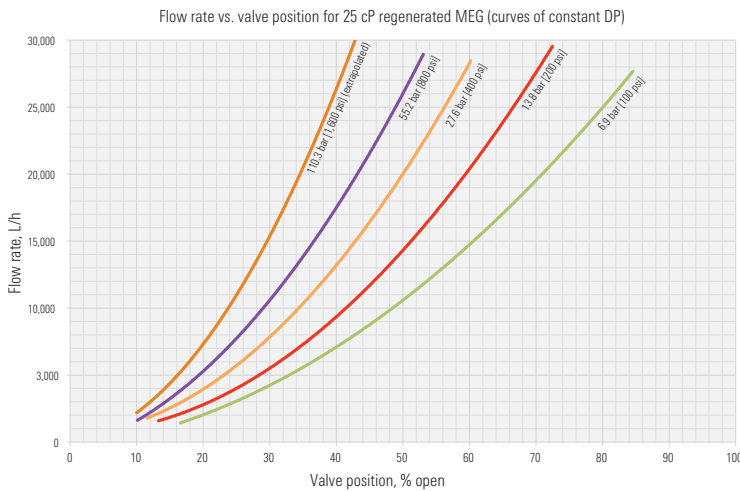

## PULSE HF CIMV System Architecture

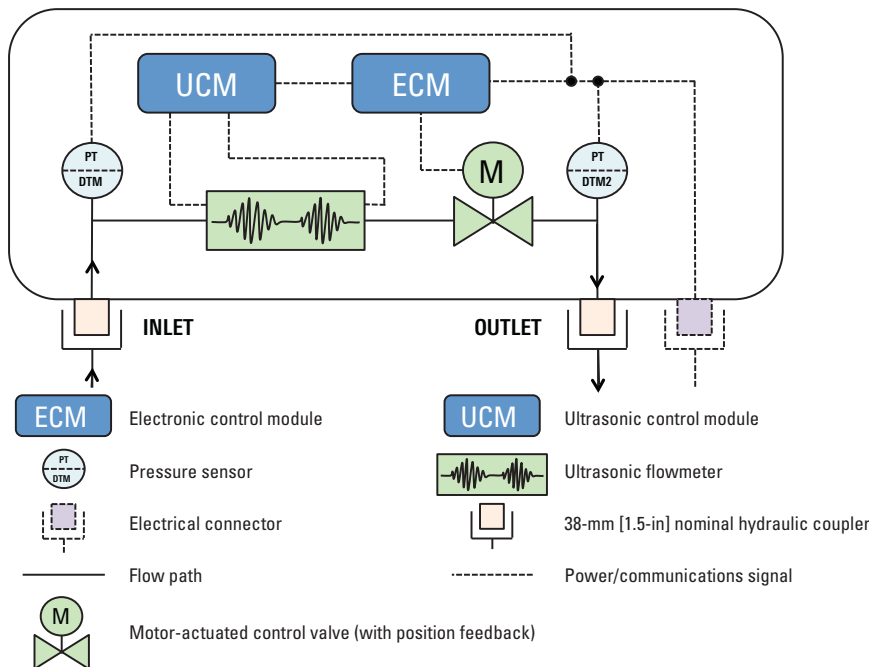

- Insert-retrievable, self-regulating metering valve
- Application: hydrate mitigation (regenerated MEG and methanol)
- Flow range of 42 to 7,000+ galUS/h [160 to 26,500+ L/h]
- 1.5-in [38.1-mm] nominal throughbore coupler
- Ultralow pressure drop
- Patented large-bore, nonintrusive line-of-sight ultrasonic flowmeter
- Accuracy better than  $\pm 3\%$  of reading
- 10,000-psi [68.9-MPa] MWP
- 10,000-ft [3,048-m] water depth
- Insert weight approx. 551 lbm [250 kg] in water
- Vertical mounting on tree or manifold
- CANbus, CiA 443, or Modbus communication
- Redundant flow measurement system
- Onboard control and diagnostics



**PULSE HF CIMV 42–7,000+ galUS/h [160–26,500+ L/h]****Technical Details**

Model	Cameron remotely operated, insert-retrievable, PULSE HF CIMV
Application	MEG, regenerated MEG, and methanol dosing
Installation orientation	Vertical
Design standard	API 17D/ISO 13628-4, API 17F/ISO 13628-6
Design life	25 years
Failure mode	Fail as is; will continue to inject on loss of power or communication
Pressure rating	10,000 psi [68.9 MPa] Optional 15,000 psi [103.4 MPa]
Max. differential pressure <sup>†</sup>	3,500 psi [24.1 MPa]
Min. differential pressure <sup>†</sup>	<100 psi [0.69 MPa]
Hydraulic connection	1.45-in [37-mm] nominal throughbore; nonpoppeted couplers with metal-to-metal sealing
Electrical connection	Seven-way electrical connector (OneSubsea Diamould, Siemens Tronic, Teledyne ODI, stab and ROV mate options)
Envelope dimensions	
Total length	Approx. 69 in [1,753 mm]
Insert diameter	Approx. 10 in [254 mm]
Insert weight	Approx. 551 lbm [250 kg] in water, suitable for ROV deployment with buoyancy or wireline
ROV lockdown interface	API 17H/ISO 13628-8 Class 4
Temperature rating electronics	
Storage	0 to 122 degF [–18 to 50 degC]
Operational	23 to 104 degF [–5 to 40 degC]
Working depth	10,000 ft [3,048 m]
Filter	None required
Flow range	42–7,000+ galUS/h [160–26,500+ L/h] Turndown: 165:1
Cleanliness	No filtration necessary; particulate-tolerant design with large throughbores, nonintrusive flowmeter, and erosion-resistant choke trim technology
Accuracy	Better than $\pm 3\%$ of reading over entire flow range
Pressure sensors	Two off (used for secondary flow measurement)
Additional features	Secondary flow determination system and onboard status indicators (e.g., zero flow, max flow, reverse flow, flow totalizer, and diagnostics)

**Pressure-Containing and Pressure-Controlling Component Materials**

Valve trim	Nickel alloy 718 and tungsten carbide with tungsten carbide wear sleeve
Valve body	Duplex stainless steel
Valve seals (stem)	Spring-energized PTFE seal
Flowmeter	Nickel alloy 625
Pressure seals	Metal-to-metal nickel alloy with inert elastomeric backups

**Electrical Controlling Components**

Motor	High-efficiency stepper
Power consumption	
Minimum	< 4 watts (quiescent)
Normal	9.6 watts (motor operating)
Maximum	< 12 watts (at 39 degF [4 degC] and full 10,000-psi [68.9-MPa] pressure)
Electronics system	Housed in 1-atm housing
Interface protocol	CANOpen, CiA 443 Ver. 3, SIIS Level 2 fault-tolerant CANbus, or Modbus
Inrush current	< 600 mA for < 500 ms (SIIS Level 2 compliant)
Default bit rate	50 kbps

<sup>†</sup> Max. and min. differential pressures are based on a 25-cP fluid at minimum and maximum flow rates, respectively, to maintain controllability. Higher or lower differential pressures are possible dependent on flowing conditions.

# PULSE HF CIMV Insert and Receptacle Features

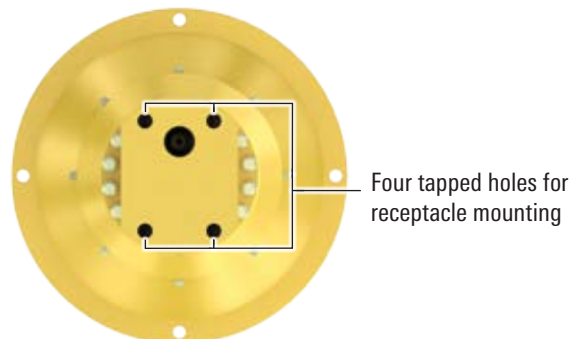
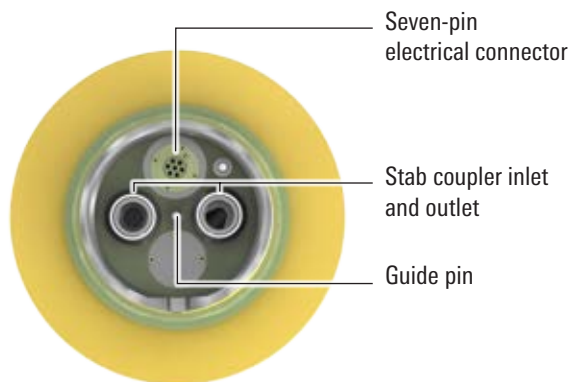
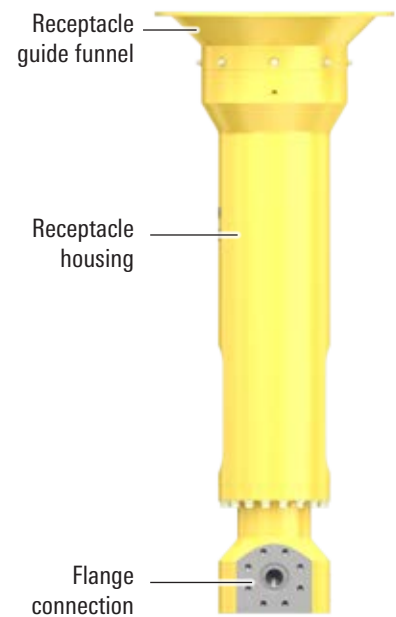
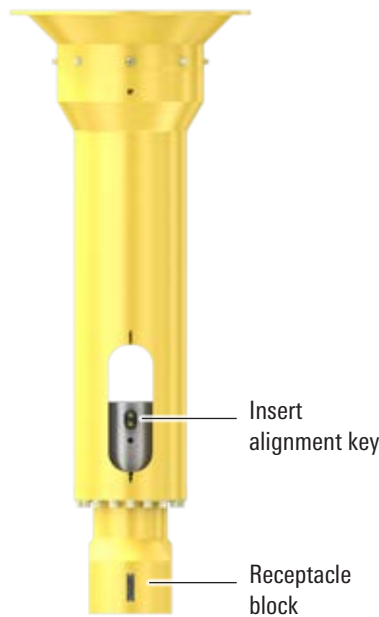
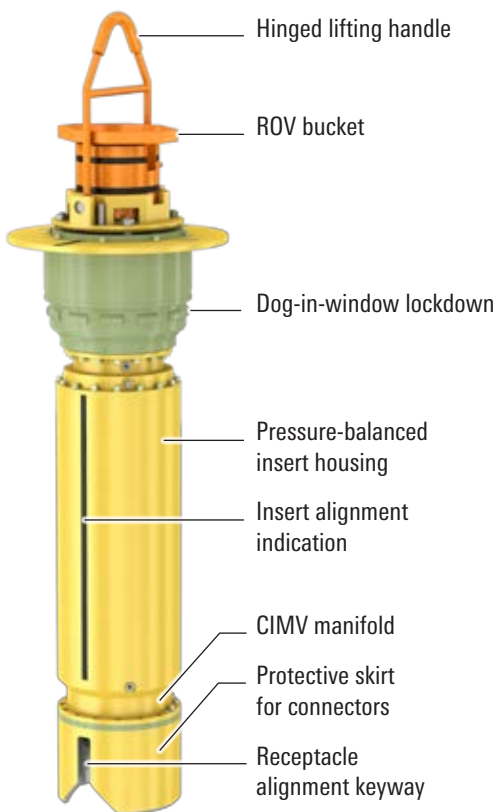
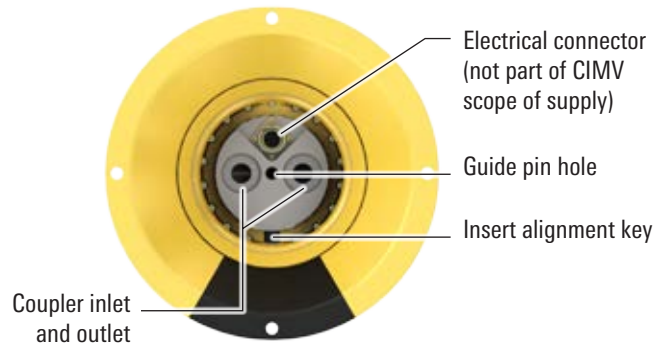
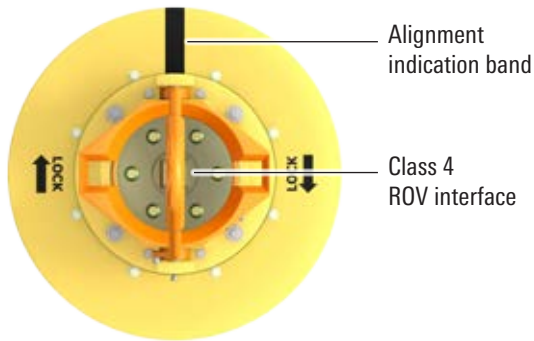

# Nonretrievable PULSE HF and MF CIMVs

Our PULSE HF and MF CIMV technologies are also available in a nonretrievable unit, providing a smaller, lighter unit that is suited to applications in flow control modules or other subsea retrievable packages. Manufactured from a single duplex manifold, the nonretrievable technologies use the same internals as the retrievable versions and can be mounted either vertically or horizontally.

## Specification

Process connections (studded)	1 <sup>3</sup> / <sub>16</sub> -in [46-mm] API 10K or 2-in [50.8-mm] SPO® Compact flange
Weight (in water)	Approx. 440 lbm [200 kg]
Size (height × diameter)	32.5 in × 10 in [825.5 mm × 254 mm]
Pressure rating	10,000 psi [68.9 MPa]
Depth rating	10,000 ft [3,048 m]
Electrical interface	Four-pin OneSubsea Diamould, Siemens Tronic, Teledyne ODI, diver connector with 4.9-ft- [1.5-m-] long jumper
Mounting	Vertical or horizontal; fixing points provided in top and base

- Fixed-mounted, self-regulating metering valve
- Application: hydrate mitigation (regenerated MEG and methanol)
- Flow range from 21 to 2,906 galUS/h or 42 to 7,000+ galUS/h [80 to 11,000 L/h or 160 to 26,500+ L/h]
- Ultralow pressure drop
- Studded inlet and outlet
- Patented nonintrusive ultrasonic flowmeter
- Accuracy better than ±3% of reading
- 10,000-psi [68.9-MPa] MWP
- 10,000-ft [3,048-m] water depth
- Vertical or horizontal mounting on tree or manifold
- CANbus, CiA 443, or Modbus communication
- Redundant flow determination system
- Onboard control and diagnostics



# Ancillary Equipment

Cameron has developed a complete suite of ancillary equipment to support the operator and subsea production system equipment supplier with every aspect of the supply, installation, commissioning, and aftermarket support for this equipment.

## Simulators

The PULSE CIMV simulator facilitates testing of the subsea control module and the electrical and software interfaces. The simulator has the same electrical behavior as the actual PULSE CIMV. The software and interface modules of the simulator are identical to the ones that run on the PULSE CIMV. The simulator has the capability to adjust the pressure values and flow rates as well as simulate multiple fault modes and operating conditions, as implemented in the metering valve.



*Simulator.*

## Flushing insert and long-term protective cap

This item is an ROV- or wireline-deployed insert module, consisting of the lock-down mechanisms and hydraulic couplers that allow flow between the inlet and outlet coupler, i.e., the operator can inject chemicals subsea, but only unmetred. This same item can be used as a long-term protective cap while the tree is installed subsea without the PULSE CIMV insert installed; for flushing of the chemical lines between the stab plates and the tree valve block during factory acceptance tests, site integrating tests, and later in the field where the CIMV insert is not installed; or as a short-term protective cap during changeout operation subsea.



*PULSE HF CIMV flushing insert (left) and PULSE MF CIMV receptacle (right).*

## Additional CIMV receptacle

Additional receptacles can be affixed to the subsea tree or manifold during fabrication and connected directly to the chemical lines for future chemicals. The receptacles are offered in horizontal and vertical mounting arrangements and contain lock-down interface and hydraulic couplers for connection to the chemical lines. For a stab-mate electrical connector configuration, the mating half of the electrical connector is supplied by the control system supplier and mounted to the receptacle during tree build.

## Ship and test skids

Cameron provides a full range of CIMV insert ship and test skids for low-, medium- and high-flow units. The skid can be supplied with hydraulic and electrical interfaces to test the CIMV inserts before deployment. Portable electronic test units with power supplies and test interface software can also be supplied.



*PULSE MF CIMV insert ship and test skid.*



# Microbore Nonintrusive Line-of-Sight Ultrasonic Flowmeter

## Flowmeter applications extend to low flow

Nonintrusive line-of-sight ultrasonic flowmeters were introduced in 2010 in our medium- and high-flow CIMVs for hydrate mitigation using regenerated MEG and methanol injection. Ultrasonic flowmeter technology was selected for this application based on its particulate tolerance, its ability to handle contaminated flow streams, a high turndown ratio, accuracy, and low native pressure drop. Other types of CIMV flow measurement technologies are particulate sensitive and experience blockages and measurement inaccuracy in these applications. What emerged from operator participation in our R&D program is a field-proven technology for medium- and high-flow chemical injection for hydrate management, operating on deepwater large-bore gas wells across the globe.

Cameron launched a microbore nonintrusive line-of-sight ultrasonic flowmeter development program for LDIs based on a growing operator need for reliable and accurate subsea distributed chemical injection. In development for several years, the microbore ultrasonic flowmeter was subjected to extensive qualification testing in terms of pressure, temperature, vibration, electronic reliability, and characterization of the flow across its full pressure and flow rate range with varying fluid properties to confirm its industry-leading accuracy and repeatability across the entire range. The microbore ultrasonic flowmeter accuracy is better than  $\pm 2\%$  of reading, whereas the conventional Venturi-type flowmeter accuracy can range from 5% to 10% full scale.

The outcome of this development is the introduction of the PULSE LF CIMV. The patented ultrasonic flowmeters, now across our complete CIMV product family, offer the following advantages:

- Nonintrusive flow measurement with no moving parts maximizes long-term reliability of the subsea chemical injection system
- Debris tolerance with no risk of flowmeter blockage combined with a self-flushing throttling valve
- Very high turndown ratio from maximum to minimum flow rate measurement, allowing one CIMV model to cover a wide range of applications
- Pressure-independent flow measurement with low native pressure drop for optimized chemical distribution systems and high-pressure applications
- Insensitivity to chemical properties enables operators to make chemical decisions independent of installed hardware.

## How it works

The microbore ultrasonic flowmeter used in the PULSE LF CIMV and the large-bore ultrasonic flowmeter used in the PULSE MF and HF CIMVs are line-of-sight meters with an ultrasonic transducer at either end of the metering path. An ultrasonic pulse is transmitted through the fluid from either transducer with and against the flow direction. The difference in time of flight of the sound pulses in either direction ( $\Delta T$ ) is accurately measured by the onboard ultrasonic control module (UCM). From that  $\Delta T$  measurement, flow rate of the chemical passing through the flowmeter is calculated. The flowmeter is combined with an electrically actuated throttling valve in closed-loop control. Flow rate monitoring and valve actuation via the onboard closed-loop control algorithm, along with external communications, are managed by the electronic control module (ECM) that streams back operational performance data to the operator via the master control station. Real-time feedback from the flowmeter is used to autonomously control the throttling valve, maintaining a user-defined injection rate set point indefinitely regardless of up- or downstream system disturbances.

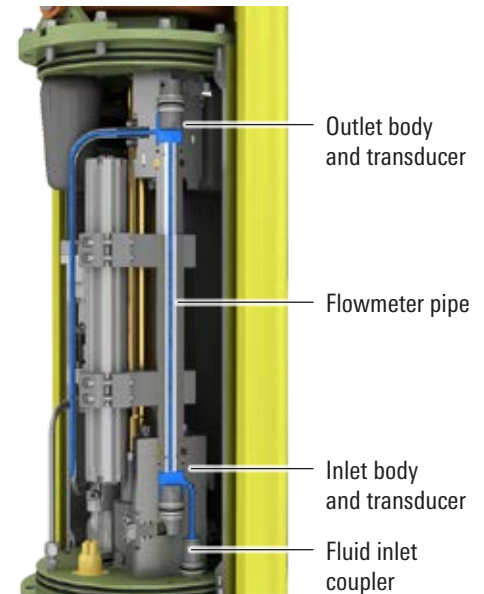

*Chemical flow path through ultrasonic flowmeter.*

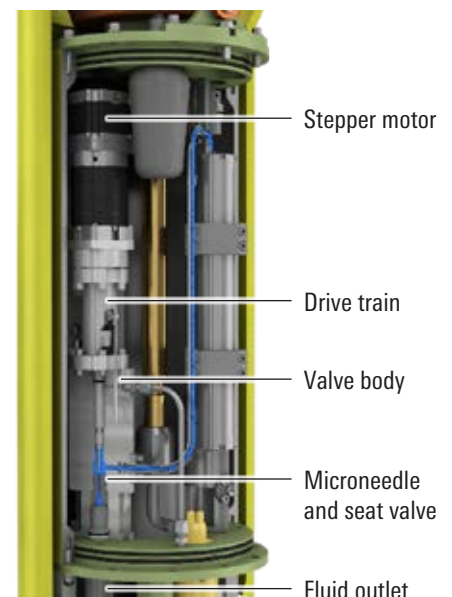

*Chemical flow path through throttling valve.*

# Premier Manufacturing

The Cameron PULSE CIMV and subsea choke facility in Longford, Ireland, has global responsibility for the design and manufacture of all subsea chokes and intervention tooling, as well as subsea CIMV technologies.

This plant is equipped with sophisticated machine tools and flow control technology, including computer numeric control machining centers; fabrication and weld-cladding stations; hydrotest bays; TV-monitored hydrostatic and gas test facilities rated to 30,000 psi [206.8 MPa]; hyperbaric and environmental test chambers; advanced nondestructive examination capabilities, including X-ray, ultrasonic testing, and positive material identification; and a semiautomated blast-and-paint facility.

The Cameron in-house R&D group works hand-in-hand with sales and marketing teams worldwide, with further support provided by Cameron Services locations. Wherever you need us, we're already there.

Cameron has developed a complete suite of ancillary equipment to support the operator and SPS equipment supplier with every aspect of the supply, installation commissioning, and aftermarket support for this equipment.



*Cameron PULSE CIMV and subsea choke facility in Longford, Ireland.*



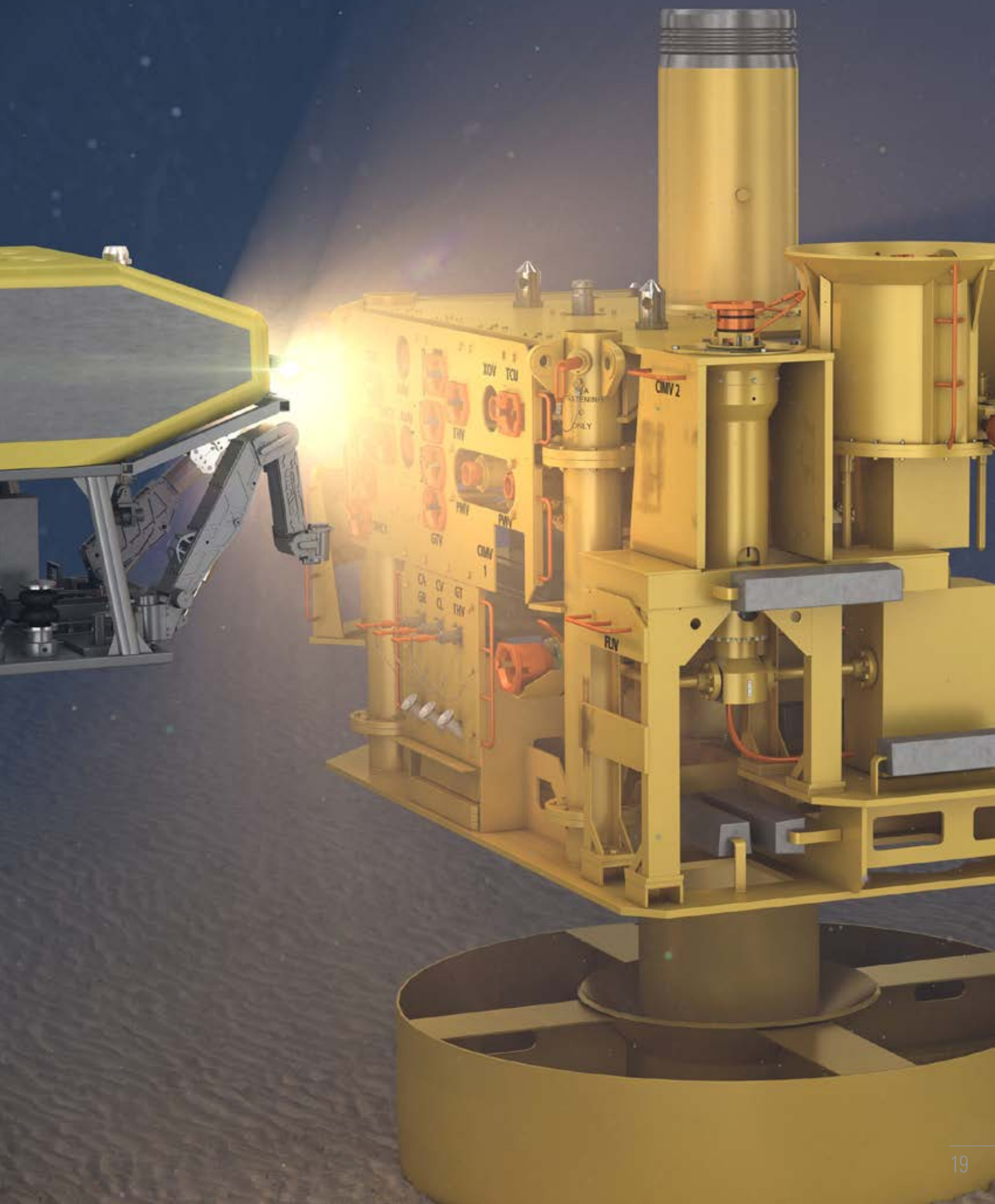

# PULSE



[cameron.slb.com/PULSE](http://cameron.slb.com/PULSE)

\*Mark of Schlumberger  
Other company, product, and service names  
are the properties of their respective owners.  
Copyright © 2016 Schlumberger. All rights reserved. SUR-1151

 **CAMERON**  
A Schlumberger Company