

Technical Manual for a Coupled Sea-Ice/Ocean Circulation Model (Version 5)

Katherine S. Hedström
College of Fisheries and Ocean Sciences
University of Alaska Fairbanks

U.S. Department of the Interior
Bureau of Ocean Energy Management
Alaska OCS Region
Anchorage, Alaska

Cooperative Agreement No. M15AC00011

Technical Manual for a Coupled Sea-Ice/Ocean Circulation Model (Version 5)

Katherine S. Hedström
College of Fisheries and Ocean Sciences
University of Alaska Fairbanks

March 2018

This study was funded by the Alaska Outer Continental Shelf Region of the Bureau of Ocean Energy Management, U.S. Department of the Interior, Anchorage, Alaska, through Cooperative Agreement **M15AC00011** with the University of Alaska Fairbanks (UAF).

DISCLAIMER

This report was prepared under agreement between the Bureau of Ocean Energy Management (BOEM) and UAF. This report has been technically reviewed by BOEM, and it has been approved for publication. Approval does not signify that the contents necessarily reflect the views and policies of BOEM, nor does mention of trade names or commercial products constitute endorsement or recommendation for use. It is, however, exempt from review and compliance with BOEM editorial standards.

REPORT AVAILABILITY

The report may be downloaded from the boem.gov website at: <http://www.boem.gov/ESPIS/> or <http://www.boem.gov/akpubs/>.

CITATION

K. Hedstrom. 2018. Technical Manual for a Coupled Sea-Ice/Ocean Circulation Model (Version 5). U.S. Dept. of the Interior, Bureau of Ocean Energy Management, Alaska OCS Region. OCS Study BOEM 2016-037. 169 pp.

This document was prepared with L^AT_EX, xfig, and inkscape.

Acknowledgments

The ROMS model is descended from the SPEM and SCRUM models, but has been entirely rewritten by Sasha Shchepetkin, Hernan Arango and John Warner, with many, many other contributors. I am indebted to every one of them for their hard work.

Bill Hibler first came up with the viscous-plastic rheology we are using. Paul Budgell has rewritten the dynamic sea-ice model, improving the solution procedure and making the water-stress term implicit in time, then changing it again to use the elastic-viscous-plastic rheology of Hunke and Dukowicz. I am very grateful that he is allowing us to use his version of the code. The sea-ice thermodynamics is derived from Sirpa Häkkinen's implementation of the Mellor-Kantha scheme. She was kind enough to allow Paul and I to start with her code.

Thanks to the internet community for providing great tools like Perl, Python, cpp, svn, git, and gmake to aid in software development (and to make it more fun).

This work was supported in part by a grant of HPC resources from the Arctic Region Supercomputing Center.

Development and testing of the ROMS model has been funded by many, including the USGS Coastal and Marine Program, the Office of Naval Research, and the National Ocean Partnership Program.

Abstract

The Regional Ocean Modeling System (ROMS), authored by many, most notably Sasha Shchepetkin, is one approach to regional and basin-scale ocean modeling. This user's manual for ROMS describes the model equations and algorithms, as well as additional user configurations necessary for specific applications. ROMS itself has now branched out as well—the version described here is that available through the myroms.org svn site with modifications to include sea ice and other changes. This sea ice branch is available at github.com.

Contents

1	Introduction	1
2	Getting started	3
2.1	myroms.org	3
2.2	Prerequisites	3
2.3	Acquiring the ROMS code	3
2.4	Compiling ROMS	4
2.4.1	Environment Variables for make	4
2.4.2	Providing the Environment	5
2.4.3	Build scripts	7
2.5	Running ROMS	7
2.6	Warnings and bugs	8
3	Ocean Model Formulation	9
3.1	Equations of motion	9
3.2	Vertical boundary conditions	10
3.3	Horizontal boundary conditions	11
3.4	Terrain-following coordinate system	11
3.5	Horizontal curvilinear coordinates	12
4	Numerical Solution Technique	14
4.1	Vertical and horizontal discretization	14
4.1.1	Horizontal grid	14
4.1.2	Vertical grid	14
4.2	Masking of land areas	14
4.2.1	Velocity	14
4.2.2	Temperature, salinity and surface elevation	15
4.2.3	Wetting and drying	15
4.3	Time-stepping overview	16
4.4	Conservation properties	17
4.5	Depth-integrated equations	20
4.6	Density in the mode coupling	23
4.7	Time stepping: internal velocity modes and tracers	24
4.8	Advection schemes	24
4.8.1	Second-order Centered	24
4.8.2	Fourth-order Centered	25
4.8.3	Fourth-order Akima	25
4.8.4	Third-order Upwind	25
4.9	Determination of the vertical velocity and density fields	26
4.10	Horizontal mixing	27
4.10.1	Deviatory stress tensor (viscosity)	27
4.10.2	Transverse stress tensor	28
4.10.3	Rotated Transverse Stress Tensor	29
4.10.4	Horizontal diffusion	29
4.10.5	Laplacian	30
4.10.6	Biharmonic	30
4.10.7	Rotated mixing tensors	30
4.11	Vertical mixing schemes	31
4.11.1	The Large, McWilliams and Doney parameterization	31

4.11.2	Mellor-Yamada	35
4.11.3	Generic length scale	36
4.12	Timestepping vertical viscosity and diffusion	37
4.13	Lateral Boundary Conditions	38
4.13.1	Gradient boundary condition	39
4.13.2	Wall boundary condition	39
4.13.3	Clamped boundary condition	39
4.13.4	Flather boundary condition	39
4.13.5	Shchepetkin boundary condition	39
4.13.6	Chapman boundary condition	39
4.13.7	Radiation boundary condition	39
4.13.8	Mixed radiation-nudging boundary condition	40
5	Ice Model Formulation	41
5.1	Dynamics	41
5.1.1	Landfast ice	42
5.2	Thermodynamics	42
5.2.1	Ocean surface boundary conditions	48
5.2.2	Frazil ice formation	49
5.2.3	Differences from Mellor and Kantha	50
6	Details of the Code	51
6.1	Directory structure	51
6.2	Main subroutines	53
6.2.1	master.F	53
6.2.2	ocean_control.F	54
6.2.3	ROMS_initialize	54
6.2.4	ROMS_run	54
6.2.5	ROMS_finalize	54
6.3	Initialization	55
6.3.1	main3d	56
6.4	Modules	58
6.5	Functionals	61
6.6	Other subroutines and functions	62
6.7	C preprocessor variables	63
6.8	Important parameters	73
6.9	Domain decomposition	74
6.9.1	ROMS internal numbers	74
6.9.2	MPI exchange	76
6.9.3	Code syntax	77
6.9.4	Input/output	81
7	Configuring ROMS for a Specific Application	83
7.1	Configuring ROMS	83
7.1.1	Case Name	83
7.1.2	Case-specific Include File	84
7.1.3	Functionals	84
7.1.4	checkdefs.F	84
7.1.5	Model domain	85
7.1.6	x, y grid	85
7.1.7	ξ, η grid	85

7.1.8	Initial conditions	86
7.1.9	Equation of state	86
7.1.10	Boundary conditions	86
7.1.11	Model forcing	86
7.1.12	ocean.in	87
7.1.13	User variables and subroutines	94
7.2	Upwelling/Downwelling Example	95
7.2.1	cppdefs.h	95
7.2.2	Model domain	96
7.2.3	ana_grid	97
7.2.4	Initial conditions and the equation of state	97
7.2.5	Boundary conditions	97
7.2.6	Model forcing	97
7.2.7	ocean.in	98
7.2.8	Output	98
7.3	Arctic example	112
7.3.1	arctic.h	112
7.3.2	Arctic code chunks	118
7.3.3	Model domain	119
7.3.4	Initial and boundary conditions	119
7.3.5	Forcing	120
7.3.6	ocean.in	120
7.3.7	Output	121
7.4	Northwest Gulf of Alaska example	121
7.4.1	nwgoa.h	121
7.4.2	NWGOA code chunks	121
7.4.3	Model domain	121
7.4.4	Initial and boundary conditions	124
7.4.5	Forcing	124
7.4.6	ocean.in	124
7.4.7	Output	125
7.5	Beaufort Sea example	125
7.5.1	beaufort.h	128
7.5.2	BEAUFORT code chunks	128
7.5.3	Model domains	128
7.5.4	Initial and boundary conditions	129
7.5.5	Forcing	129
7.5.6	ocean.in	129
7.5.7	Output	129
A	Model Time-stepping Schemes	132
A.1	Euler	132
A.2	Leapfrog	132
A.3	Third-order Adams-Bashforth (AB3)	132
A.4	Forward-Backward	133
A.5	Forward-Backward Feedback (RK2-FB)	133
A.6	LF-TR and LF-AM3 with FB Feedback	134
A.7	Generalized FB with an AB3-AM4 Step	134

B	The vertical σ-coordinate	135
B.1	Transform	135
B.2	Stretching	136
C	Horizontal curvilinear coordinates	137
D	Viscosity and Diffusion	138
D.1	Horizontal viscosity	138
D.2	Horizontal Diffusion	138
D.3	Vertical Viscosity and Diffusion	138
E	Radiant heat fluxes	139
E.1	Shortwave radiation	139
E.2	Longwave radiation	139
E.3	Sensible heat	139
E.4	Latent heat	139
F	The C preprocessor	141
F.1	File inclusion	141
F.2	Macro substitution	141
F.3	Conditional inclusion	142
F.4	C comments	143
F.5	A note on style	143
F.6	Potential problems	143
F.7	Modern Fortran	144
G	Makefiles	145
G.1	Introduction to Portable make	145
G.1.1	Macros	146
G.1.2	Implicit Rules	146
G.1.3	Dependencies	147
G.2	gnu make	147
G.2.1	Make rules	148
G.2.2	Assignments	148
G.2.3	Include and a Few Functions	149
G.2.4	Conditionals	150
G.3	Multiple Source Directories the ROMS Way	151
G.3.1	Directory Structure	151
G.3.2	Conditionally Including Components	151
G.3.3	User-defined make Functions	152
G.3.4	Library Module.mk	154
G.3.5	Main Program	154
G.3.6	Top Level Makefile	155
G.4	Final warnings	158
H	sfmakedepend	159
I	Subversion	161
I.1	Overview	161
I.2	Checking out the code	161
I.3	Updates	162
I.4	Code changes	162

I.5	Conflicts	162
I.5.1	Merging conflicts by hand	163
I.5.2	Copying a file onto your working file	164
I.5.3	Punting: Using svn revert	164

List of Figures

1	Placement of variables on an Arakawa C grid	14
2	Placement of variables on staggered vertical grid	15
3	Masked region within the domain	16
4	Diagrams of the time stepping and mode coupling used in various ROMS versions. (a) Rutgers University ROMS (from myroms.org), (b) older ROMS AGRIF, (c) UCLA ROMS, described in Shchepetkin and McWilliams [2005], (d) non-hydrostatic ROMS (Kanarska et al. [2007]). In all, the curved arrows update the 3-D fields; those with “pillars” are leapfrog in nature with the pillar representing the r.h.s. terms. Straight arrows indicate exchange between the barotropic and baroclinic modes. The shape functions for the fast time steps show just one option out of many possibilities. The grey function has weights to produce an estimate at time $n + 1$, while the light red function has weights to produce an estimate at time $n + \frac{1}{2}$	18
5	The split time stepping used in the model.	21
6	Weights for the barotropic time stepping. The upper panel shows the primary weights, centered at time $n + 1$, while the lower panel shows the secondary weights, centered at time $n + \frac{1}{2}$	22
7	Cartoon of an ice floe with a deep keel.	44
8	Diagram of the different locations where ice melting and freezing can occur.	46
9	Diagram of internal ice temperatures and fluxes. The hashed layer is the snow.	46
10	ROMS directory structure.	52
11	ROMS main structure.	54
12	Flow chart of the model main program in forward mode. Calls to nesting for nested grid applications have been left out.	56
13	The whole grid. Note that there are Lm by Mm interior computational points. The points on the thick outer line and those outside it are provided by the boundary conditions.	75
14	A tiled grid with some ROMS tile variables.	76
15	A choice of numbering schemes: (a) each tile is numbered the same, and (b) each tile retains the numbering of the parent domain.	77
16	Some ROMS variables for tiles, for both a periodic and non-periodic case. Shown are the variables in the i -direction, the j -direction is similar.	78
17	A tiled grid with out-of-date halo regions shown in grey and the interior points color-coded by tile: (a) before an exchange and (b) after an exchange.	79
18	The upwelling/downwelling bathymetry.	108
19	Surface velocities after one day, showing the flow to the left of the wind (southern hemisphere).	109
20	Constant ξ slices of the u, v, T and w fields at day 1.	110
21	Constant ξ slices of the u, v, T , and w fields at day 5.	111
22	Bathymetry of the Arctic domain.	113
23	Grid spacing of the Arctic domain.	114
24	Ice concentration averaged over the month of September, 1982.	122
25	Ice thickness averaged over the month of September, 1982.	123
26	Bathymetry of the NWGOA domain.	124
27	Surface salinity for 10 August, 2008. Graticules shown are 60°N and 150°W	125
28	Surface temperature and velocities for 10 August, 2008. Graticules shown are 60°N and 150°W	126
29	Bathymetry of the larger Beaufort2 domain (m).	127
30	Bathymetry of the smaller Beaufort3 domain (m).	127

31	Ice speed contour at 0.0005 m/s for the April climatology in the Beaufort3 domain. This contour was chosen as an estimate of the land-fast ice extent.	130
32	Sea-ice concentration for the June climatology in the Beaufort3 domain. Note the location of a few warm rivers between 148° and 151° W longitude.	130
33	Vertical slices for the August climatology in the Beaufort3 domain, (a) salinity, (b) temperature ($^\circ\text{C}$), (c) longshore velocity (m/s) and (d) cross-shore velocity (m/s). Note the warm, fresh water right up on the shelf, trapped by a barrier island.	131

List of Tables

1	The variables used in the description of the ocean model	10
2	The variables used in the vertical boundary conditions for the ocean model	10
3	The time stepping schemes used in the various ROMS versions. $\alpha \equiv \omega\delta t$ is the Courant number and $\omega = ck$ is the frequency for a wave component with wavenumber k	19
4	Generic length scale parameters. Note that Mellor-Yamada 2.5 is an example of a $k - kl$ scheme.	37
5	Variables used in the ice momentum equations.	43
6	Variables used in the landfast ice parameterization.	43
7	Variables used in the ice thermodynamics	45
8	Ocean surface variables	48
9	Frazil ice variables	50
10	Variables used in computing the incoming radiation and latent and sensible heat	140

1 Introduction

This user's manual for the Regional Ocean Modeling System (ROMS) describes the model equations and algorithms, as well as additional user configurations necessary for specific applications. This manual also describes the sea-ice model that we are using [Budgell, 2005].

The principle attributes of the model are as follows:

General

- Primitive equations with potential temperature, salinity, and an equation of state.
- Hydrostatic and Boussinesq approximations.
- Optional third-order upwind advection scheme.
- Optional Smolarkiewicz advection scheme for tracers (potential temperature, salinity, etc.).
- Optional Lagrangian floats.
- Option for point sources and sinks.

Horizontal

- Orthogonal-curvilinear coordinates.
- Arakawa C grid.
- Closed basin, periodic, prescribed, radiation, and gradient open boundary conditions.
- Masking of land areas.
- Early version of nesting.

Vertical

- σ (terrain-following) coordinate.
- Free surface.
- Tridiagonal solve with implicit treatment of vertical viscosity and diffusivity.

Ice

- Hunke and Dukowicz elastic-viscous-plastic dynamics.
- Mellor-Kantha thermodynamics.
- Orthogonal-curvilinear coordinates.
- Arakawa C grid.
- Smolarkiewicz advection of tracers.
- Lemieux landfast ice parameterization.

Mixing options

- Horizontal Laplacian and biharmonic diffusion along constant s , z or density surfaces.
- Horizontal Laplacian and biharmonic viscosity along constant s or z surfaces.
- Optional Smagorinsky horizontal viscosity and diffusion (but not recommended for diffusion).
- Horizontal free-slip or no-slip boundaries.
- Vertical harmonic viscosity and diffusion with a spatially variable coefficient, with options to compute the coefficients via Large et al. [1994], Mellor and Yamada [1974], or generic length scale (GLS) Umlauf and Burchard [2003] mixing schemes.

Implementation

- Dimensional in meter, kilogram, second (MKS) units.
- Fortran 90.
- Runs under UNIX, requires the C preprocessor, gnu make, and Perl.
- All input and output is done in NetCDF Rew et al. [1996] (Network Common Data Format), requires the NetCDF and NetCDF-fortran libraries.
- Options include serial, parallel with MPI, and parallel with OpenMP.

The above list hasn't changed so very much in the past ten to fifteen years, but many of the numerical details have changed a great deal. Examples include consistent temporal averaging of the barotropic mode to guarantee both exact conservation and constancy preservation properties for tracers; redefined barotropic pressure-gradient terms to account for local variations in the density field; vertical interpolation performed using conservative parabolic splines; and higher-order, quasi-monotone advection algorithms.

New with this version of the manual is the introduction of nesting capabilities which requires Matlab for preprocessing.

ROMS also comes with a full suite of advanced data assimilation routines; these options are beyond the scope of this document.

In addition to the sea ice model described here, there are ongoing efforts to couple ROMS with the Community sea ice model (CICE) [Hunke et al., 2013]. Please ask for the latest status of these efforts, which include direct coupling, using the model coupling toolkit (MCT) and using the new National Unified Operational Prediction Capability (NUOPC) layer to the Earth System Modeling Framework (ESMF). As of this writing, the first two of these are available on github while the third is in private alpha testing/debugging and will ultimately include atmospheric and wave models as well.

Chapter 2 has some information on getting started with ROMS. Chapters 3 and 4 describe the model physics and numerical techniques and contain information from Shchepetkin and McWilliams [2009b], Haidvogel et al. [2007]. Chapter 5 describes the ice equations and Chapter 6 lists the model subroutines and functions. As distributed, ROMS is ready to run with a number of example problems. The process of configuring ROMS for a particular application and running it is described in Chapter 7, including a discussion of a few example applications.

2 Getting started

2.1 myroms.org

Starting off with ROMS is not the easiest thing to do, and it just seems to be getting more complex as time goes by. There are some resources, however, beginning with the electronic home for ROMS users at www.myroms.org. Go to register, which gives you access to the subversion server for the code and to the discussion forum for all things ROMS. There is also a wiki, a bug tracking system, and even a developer blog.

The wiki contains parts of this manual, but the nature of wikis is that they can be more fluid, with more authors, than a document such as this. Dave Robertson (robertson@marine.rutgers.edu) is the one to talk to if you would like to contribute to the wiki. On the other hand, this manual is now at github, with all that implies (not that I've gotten pull requests there yet).

2.2 Prerequisites

As mentioned in Chapter 1, ROMS has some external requirements. These are:

- UNIX or UNIX-like environment, such as Cygwin.
- A Fortran 90 compiler.
- The NetCDF library and the netcdf-fortran library compiled with the above compiler (and a C compiler).
- svn, the subversion revision control software. See Appendix I and the ROMS wiki.
- git is optional, but can be used instead of svn, especially for downloading the ice branch of roms from github.
- Gnu make version 3.81 or higher. Appendix G contains more than you ever wanted to know about this software.
- A C preprocessor—the one from gnu with the **-traditional** flag works well. See Appendix F.
- The Perl scripting language.
- Matlab is optional, but it is a common tool for pre- and post-processing of ROMS files.
- Python is also optional, but might be a good thing to learn if you want an alternative to Matlab.

Make sure you've got the right environment before attempting to download or compile ROMS. In particular, it's best to download ROMS using the same environment as will be used when compiling and running it.

2.3 Acquiring the ROMS code

The main ROMS code is available for download via **svn** at <https://www.myroms.org/svn/src/>. The version of the model described in this document is a merger between ROMS 3.7 and the integrated Budgell sea-ice model and is available at github. I am no longer maintaining the svn branch on the myroms.org site.

ROMS comes with several cases all ready to go at the flip of a switch. Try these out first and learn how they are set up.

- §2.4 describes how to pick the cases and set up the build environment.

- §6.7 lists all the ROMS options that can be added to your case.
- §6.5 lists the fields which can be provided to ROMS via analytic expressions.
- §7.1.12 lists the input parameters ROMS reads from a text file at run time.
- Chapters 6 and 7 are meant to be informative for the simple and not-so-simple cases. If that isn't the case, please let me know.

In addition to this manual, there are some other ROMS resources:

- You may be best served by going to the ROMS wiki which includes sections called Getting Started and Tutorials, as well as a Frequently Asked Questions (FAQ) section.
- Don't be afraid to use the forum. It has everything from employment opportunities to debugging help. Posting there can get you help from one of several people, improving your odds of success over private emails. Registered users get an email once a day about new postings, so you might have to wait a day (or more) for a reply.
- There have been ROMS meetings and classes in which a tutorial session is included as part of the program.

2.4 Compiling ROMS

2.4.1 Environment Variables for make

ROMS has a growing list of choices the user must make before starting the compile process. These are user-defined variables, some about the model, some about your computer. This section is on the computer/compiler pairing that is your build system. Since we now use **gnu make**, it is possible to set the value of these variables in the Unix environment in a build script, rather than necessarily inside the **Makefile** (see §G). The user-definable variables understood by the ROMS **makefile** are:

ROMS_APPLICATION Set the **cpp** option defining the particular application. This is used for setting up options inside the code specific to this application and also determines the name of the **.h** header file for it. This can be either a predefined case, such as **BENCHMARK**, or one of your own, such as **NEP5** (a Northeast Pacific application). It should be in all upper case by convention.

MY_HEADER_DIR Sets the path to the user's header file, if any. It can be left empty for the standard cases, since **benchmark.h** and the like are found in **ROMS/Include**, which is already in the search path. In the case of **NEP5**, this is set to **Apps/NEP** where **nep5.h** resides.

MY_ANALYTICAL_DIR Sets the path to the user's analytic files described in §6.5, if any. This can be **User/Functionals** or some other location. I tend to place both the header file and the functionals in the same directory, one directory per application.

MY_CPP_FLAGS Set tunable **cpp** options. Sometimes it is desirable to activate one or more **cpp** options to run different variants of the same application without modifying its header file. If this is the case, specify each option here using the **-D** syntax. Notice that you need to use the shell's quoting syntax (either single or double quotes) to enclose the definition if you are using one of the build scripts below.

Compiler-specific Options These flags are used by the files inside the **Compilers** directory.

USE_DEBUG Set this to **on** to turn off optimization and turn on the **-g** flag for debugging.

USE_MPI Set this if running an MPI parallel job.

USE_OpenMP Set this if running an OpenMP parallel job.

USE_MPIF90 This flag changes the name of the Fortran compiler to **mpif90**, while **USE_MPI** changes the **cpp** flags for changing the source code (you might need both). **OpenMPI** and others provide a shell script called **mpif90** for finding the required MPI files.

USE_LARGE Some systems support both 32-bit and 64-bit options. Select this to get 64-bit addressing, usually used for programs needing more than 2 GB of memory on 32-bit systems. I run on machines which are 64-bit by default, making this option obsolete.

USE_NETCDF4 Set this if linking against the NetCDF4 library, which is highly recommended. If you set this, you can skip the next two.

NETCDF_INCDIR The location of the **netcdf.mod** and **typesizes.mod** files.

NETCDF_LIBDIR The location of the NetCDF and netcdf-fortran libraries.

FORT A shorthand name for the compiler to be used when selecting which system-compiler file is to be included from the **Compilers** directory. See section §G.2.3 and §2.4.2.

Local File Options:

BINDIR Directory in which to place the binary executable. The default is “.”, the current directory.

SCRATCH_DIR Put the **.f90** and the temporary binary files in a build directory to avoid clutter. The default is **Build** under the current directory. Set it to something else if you want to keep these files for multiple projects at the same time, each in their own directory or if they need to be outside your source tree to comply with system quotas.

2.4.2 Providing the Environment

Before compiling, you will need to find out some background information:

- What is the name of your compiler?
- What is returned by **uname -s** on your system?
- Is there a working NetCDF-fortran library?
- Where is it?
- Was it built with the above compiler?
- Did it come with a working **nc-config**? How about **nf-config**?
- Do you have access to MPI or OpenMP?

As described more fully in §G.2.3, the **makefile** will be looking for a file in the **Compilers** directory with the combination of your operating system and your compiler. For instance, using Linux and the Gnu compiler, the file would be called **Linux-gfortran.mk**. Is the corresponding file for your system and compiler in the **Compilers** directory? If not, you will have to create it following the existing examples there.

Next, there are several ways to provide the location for the NetCDF files (and optional HDF5 library). The recommended way is to take advantage of the **nc-config** program that comes with NetCDF 4.0.1 and newer. The files in the **Compilers** directory will attempt to do this if **USE_NETCDF4** is defined. Specifically, it will invoke “nc-config –flibs” and “nc-config –prefix” which you can run on the command line yourself for testing purposes:

```
pacman3 201% nc-config --flibs
-L/usr/local/pkg/netcdf/netcdf-4.3.0.gnu-4.7.3/lib -lnetcdff
-L/usr/local/pkg/hdf5/hdf5-1.8.10-p1.gnu-4.7.3/lib
-L/usr/local/pkg/zip/zip-2.1.gnu/lib
-L/usr/local/pkg/udunits/udunits-2.1.24.gnu-4.7.3/lib
-L/usr/local/pkg/netcdf/netcdf-4.3.0.gnu-4.7.3/lib -lnetcdf -lnetcdf
pacman3 202% nc-config --prefix
/usr/local/pkg/netcdf/netcdf-4.3.0.gnu-4.7.3
```

As you can see, if it needs to link to the hdf5 library, it does this automatically. Another example:

```
kate@ThinkPad-W520$ nc-config --flibs

kate@ThinkPad-W520$ nf-config --flibs
-L/usr/local/lib -lnetcdff -lnetcdf -lnetcdf
kate@ThinkPad-W520$ nf-config --prefix
/usr/local
```

This is an example of a system where **nc-config** is broken but **nf-config** works. Edit this line of the corresponding file in the **Compilers** directory:

```
NC_CONFIG ?= nf-config
```

If you insist on using the old method, it requires setting the location of the NetCDF files in one of three ways:

1. Hardcoding lines in the **Compilers/xxx-yyy.mk** file:

```
NETCDF_INCDIR ?= /usr/local/include
NETCDF_LIBDIR ?= /usr/local/lib
```

2. Setting them in the **build.bash** (if you can figure out where in all those if cases).
3. Edit your **.profile** or **.login** files to globally set them. Here is an example for **tcsh**:

```
setenv NETCDF_INCDIR /usr/local/netcdf4/include
setenv NETCDF_LIBDIR /usr/local/netcdf4/lib
setenv HDF5_LIBDIR /usr/local/hdf5/lib
```

The **bash** equivalent is:

```
export NETCDF_INCDIR=/usr/local/netcdf4/include
export NETCDF_LIBDIR=/usr/local/netcdf4/lib
export HDF5_LIBDIR=/usr/local/hdf5/lib
```

Perhaps you can see why we recommend using **nc-config**!

2.4.3 Build scripts

If you have more than one application (or more than one compiler), you will get tired of editing the **makefile**. One option is to have a **makefile** for each configuration, then type:

```
make -f makefile.circle_pgi
```

for instance. Another option for keeping track of the user-defined choices is in a **build script**. The advantage is that updates to the **build scripts** are less frequent than updates to the **makefile**. There are now two of these scripts in the **ROMS/Bin** directory: **build.sh** (which is surprisingly a **csh** script) and **build.bash**. The **build scripts** use environment variables to provide values for the list above, overwriting those found in the **ROMS makefile**. Just as in the multiple **makefile** option, you will need as many copies of the build script as you have applications. The scope of these variables is local to the build script, allowing you to compile different applications at the same time from the same sources as long as each **\$(SCRATCH_DIR)** is unique.

Both scripts have the same options:

-j [N] Compile in parallel using **N** cpus, omit argument for all available CPUs.

-noclean Do not clean already compiled objects.

Note that the default is to compile serially and to issue a “**make clean**” before compiling. It is left as an exercise for the user if you prefer a different default behavior.

There are also a few variables which are not recognized by the **ROMS makefile**, but are used locally inside the build script. These are:

MY_PROJECT_DIR This is used in setting **\$(SCRATCH_DIR)** and **\$(BINDIR)**.

MY_ROMS_SRC Set the path to the user’s local current **ROMS** source code. This is used so that the script can be run from any directory, not necessarily only from the top **ROMS** directory.

2.5 Running ROMS

ROMS expects to read a number of variables from an ASCII file (details of the file are in §7.1.12). For serial or OpenMP execution, the syntax is:

```
oceanS (or ocean0) < ocean.in > roms.out &
```

while **MPI** execution requires:

```
oceanM ocean.in > roms.out &
```

so that each process can read the **ocean.in** file.

Realistically, you would only want to run relatively small applications such as **UPWELLING** interactively on the command line as shown here. Also, for either of the parallel options, you will have to provide some information to **ROMS** and to the operating system about how many threads or processes to use. Parallel computers may also have some sort of batch queuing system in place in which you would submit a job script. I have had easy access to a number of systems over the years, each with its own style of job script. Some **MPI** environments require that you run **ROMS** with:

```
cd $PBS_0_WORKDIR
mpirun -np 32 ./oceanM ocean_benchmark3.in
```

while others need:

```
aprun -np 32 ./oceanM ocean_benchmark3.in
```

You just have to find out from the locals, for this as well as the syntax of the batch queue scripts.

If all goes according to plan, ROMS will create both a collection of NetCDF files and a verbose text file on standard out. There is a large and ever-changing list of ways to view NetCDF files, but I like **ncview** for a first view of what's going on. Other tools include Matlab, Python, NCL, Fortran and ferret.

If things don't go according to plan, the text output file is your friend. Examine it carefully. If it fails on the **UPWELLING** problem, you can compare your output to that in §7.2.8. If it fails on your application, make sure simple domains like **UPWELLING** work on your system.

2.6 Warnings and bugs

ROMS is not a large program by some standards, but it is still complex enough to require some effort to use effectively. Some specific things to be wary of include:

- It is recommended that you use 64 bits of precision rather than 32 bits.
- The code must be run through the C preprocessor before it is compiled. This can occasionally be dangerous, especially with the newer ANSI C versions of **cpp**. Potential problems are listed in Appendix F. The gnu **cpp** with the **-traditional** flag is known to work well. On the other hand, the output of **cpp** is saved in the **\$(SCRATCH_DIR)**, where it can be examined.
- The vertical σ -coordinate was chosen as being a sensible way to handle variations in the water depth as seen in the coastal oceans. Changes to the code have allowed us to expand the well-behaved range of depths and the range of values for **THETA_S**, plus there are some new vertical coordinate options.
- σ -coordinates have long had a bad reputation because errors in the pressure gradient terms can lead to spurious currents. These errors are much less troublesome than in the past due to code improvements and there are more improvements possible through an alternate equation of state [Shchepetkin and McWilliams, 2011], though they are not yet in the myroms.org code. The pressure gradient errors can also be controlled with some smoothing of the bathymetry. This in turn changes the shape of the basin and leads to its own set of problems, such as altered sill depths. Also, the currents will react to the change in shelf slope—you are now solving a different problem.
- I occasionally get the model to run for multiple days/months, then suddenly blow up mid-depth. Just restart with a smaller timestep and keep on going.
- There remain bugs in ROMS. If you find any, please report them on the forum and/or the bug tracking system at myroms.org.

3 Ocean Model Formulation

3.1 Equations of motion

ROMS is a member of a general class of three-dimensional, free-surface, terrain-following numerical models that solve the Reynolds-averaged Navier-Stokes equations using the hydrostatic and Boussinesq assumptions. The governing equations in Cartesian coordinates can be written:

$$\frac{\partial u}{\partial t} + \vec{v} \cdot \nabla u - fv = -\frac{\partial \phi}{\partial x} - \frac{\partial}{\partial z} \left(\overline{u'w'} - \nu \frac{\partial u}{\partial z} \right) + \mathcal{F}_u + \mathcal{D}_u \quad (1)$$

$$\frac{\partial v}{\partial t} + \vec{v} \cdot \nabla v + fu = -\frac{\partial \phi}{\partial y} - \frac{\partial}{\partial z} \left(\overline{v'w'} - \nu \frac{\partial v}{\partial z} \right) + \mathcal{F}_v + \mathcal{D}_v \quad (2)$$

$$\frac{\partial \phi}{\partial z} = \frac{-\rho g}{\rho_o} \quad (3)$$

with the continuity equation:

$$\frac{\partial u}{\partial x} + \frac{\partial v}{\partial y} + \frac{\partial w}{\partial z} = 0. \quad (4)$$

and scalar transport given by:

$$\frac{\partial C}{\partial t} + \vec{v} \cdot \nabla C = -\frac{\partial}{\partial z} \left(\overline{C'w'} - \nu_\theta \frac{\partial C}{\partial z} \right) + \mathcal{F}_C + \mathcal{D}_C. \quad (5)$$

An equation of state is also required:

$$\rho = \rho(T, S, P) \quad (6)$$

The variables are shown in Table 3.1. An overbar represents a time average and a prime represents a fluctuation about the mean. These equations are closed by parameterizing the Reynolds stresses and turbulent tracer fluxes as:

$$\overline{u'w'} = -K_M \frac{\partial u}{\partial z}; \quad \overline{v'w'} = -K_M \frac{\partial v}{\partial z}; \quad \overline{C'w'} = -K_C \frac{\partial C}{\partial z}. \quad (7)$$

Equations (1) and (2) express the momentum balance in the x - and y -directions, respectively. The time evolution of all scalar concentration fields, including those for $T(x, y, z, t)$ and $S(x, y, z, t)$, are governed by the advective-diffusive equation (5). The equation of state is given by equation (6). In the Boussinesq approximation, density variations are neglected in the momentum equations except for their contribution to the buoyancy force in the vertical momentum equation (3). Under the hydrostatic approximation, it is further assumed that the vertical pressure gradient balances the buoyancy force. Lastly, equation (4) expresses the continuity equation for an incompressible fluid. For the moment, the effects of forcing and horizontal dissipation will be represented by the schematic terms \mathcal{F} and \mathcal{D} , respectively. The horizontal and vertical mixing will be described more fully in §4.10.

Variable	Description
$C(x, y, z, t)$	scalar quantity, i.e. temperature, salinity, nutrient concentration
$\mathcal{D}_u, \mathcal{D}_v, \mathcal{D}_C$	optional horizontal diffusive terms
$\mathcal{F}_u, \mathcal{F}_v, \mathcal{F}_C$	forcing/source terms
$f(x, y)$	Coriolis parameter
g	acceleration of gravity
$h(x, y)$	depth of sea floor below mean sea level
$H_z(x, y, z)$	vertical grid spacing
ν, ν_θ	molecular viscosity and diffusivity
K_M, K_C	vertical eddy viscosity and diffusivity
P	total pressure $P \approx -\rho_o g z$
$\phi(x, y, z, t)$	dynamic pressure $\phi = (P/\rho_o)$
$\rho_o + \rho(x, y, z, t)$	total <i>in situ</i> density
$S(x, y, z, t)$	salinity
t	time
$T(x, y, z, t)$	potential temperature
u, v, w	the (x, y, z) components of vector velocity \vec{v}
x, y	horizontal coordinates
z	vertical coordinate
$\zeta(x, y, t)$	the surface elevation

Table 1: The variables used in the description of the ocean model

3.2 Vertical boundary conditions

The vertical boundary conditions can be prescribed as follows:

$$\begin{aligned}
 \text{top } (z = \zeta(x, y, t)) \quad & K_m \frac{\partial u}{\partial z} = \tau_s^x(x, y, t) \\
 & K_m \frac{\partial v}{\partial z} = \tau_s^y(x, y, t) \\
 & K_C \frac{\partial C}{\partial z} = \frac{Q_C}{\rho_o c_P} \\
 & w = \frac{\partial \zeta}{\partial t} \\
 \text{and bottom } (z = -h(x, y)) \quad & K_m \frac{\partial u}{\partial z} = \tau_b^x(x, y, t) \\
 & K_m \frac{\partial v}{\partial z} = \tau_b^y(x, y, t) \\
 & K_C \frac{\partial C}{\partial z} = 0 \\
 & -w + \vec{v} \cdot \nabla h = 0.
 \end{aligned}$$

Variable	Description
Q_C	surface concentration flux
τ_s^x, τ_s^y	surface wind stress
τ_b^x, τ_b^y	bottom stress

Table 2: The variables used in the vertical boundary conditions for the ocean model

The surface boundary condition variables are defined in Table 3.2. Since Q_T is a strong function of the surface temperature, we usually choose to compute Q_T using the surface temperature and the atmospheric fields in an atmospheric bulk flux parameterization. This bulk flux routine also computes the wind stress from the winds.

On the variable bottom, $z = -h(x, y)$, the horizontal velocity has a prescribed bottom stress which is a choice between linear, quadratic, or logarithmic terms. The vertical concentration flux

may also be prescribed at the bottom, although it is usually set to zero.

3.3 Horizontal boundary conditions

As distributed, the model can easily be configured for a periodic channel, a doubly periodic domain, or a closed basin. Code is also included for open boundaries which may or may not work for your particular application. Horizontal boundary conditions are described more fully in §4.13 and are provided for u, v, T, S , and ζ .

The model domain is logically rectangular, but it is possible to mask out land areas on the boundary and in the interior. Boundary conditions on these masked regions are straightforward, with a choice of no-slip or free-slip walls.

If biharmonic friction is used, a higher order boundary condition must also be provided. The model currently has this built into the code where the biharmonic terms are calculated. The high order boundary conditions used for u are $\frac{\partial}{\partial x} \left(\nu \frac{\partial^2 u}{\partial x^2} \right) = 0$ on the eastern and western boundaries and $\frac{\partial}{\partial y} \left(\nu \frac{\partial^2 u}{\partial y^2} \right) = 0$ on the northern and southern boundaries. The boundary conditions for v and C are similar. These boundary conditions were chosen because they preserve the property of no gain or loss of volume-integrated momentum or scalar concentration.

3.4 Terrain-following coordinate system

From the point of view of the computational model, it is highly convenient to introduce a stretched vertical coordinate system which essentially “flattens out” the variable bottom at $z = -h(x, y)$. Such “ σ ” coordinate systems have long been used, with slight appropriate modification, in both meteorology and oceanography [e.g., Phillips, 1957, Freeman et al., 1972]. To proceed, we make the coordinate transformation:

$$\begin{aligned}\hat{x} &= x \\ \hat{y} &= y \\ \sigma &= \sigma(x, y, z) \\ z &= z(x, y, \sigma)\end{aligned}$$

and

$$\hat{t} = t.$$

See Appendix B for the form of σ used here. Also, see Shchepetkin and McWilliams [2005] for a discussion about the nature of this form of σ and how it differs from that used in SCRUM.

In the stretched system, the vertical coordinate σ spans the range $-1 \leq \sigma \leq 0$; we are therefore left with level upper ($\sigma = 0$) and lower ($\sigma = -1$) bounding surfaces. The chain rules for this transformation are:

$$\begin{aligned}\left(\frac{\partial}{\partial x}\right)_z &= \left(\frac{\partial}{\partial x}\right)_\sigma - \left(\frac{1}{H_z}\right) \left(\frac{\partial z}{\partial x}\right)_\sigma \frac{\partial}{\partial \sigma} \\ \left(\frac{\partial}{\partial y}\right)_z &= \left(\frac{\partial}{\partial y}\right)_\sigma - \left(\frac{1}{H_z}\right) \left(\frac{\partial z}{\partial y}\right)_\sigma \frac{\partial}{\partial \sigma} \\ \frac{\partial}{\partial z} &= \left(\frac{\partial \sigma}{\partial z}\right) \frac{\partial}{\partial \sigma} = \frac{1}{H_z} \frac{\partial}{\partial \sigma}\end{aligned}$$

where

$$H_z \equiv \frac{\partial z}{\partial \sigma}$$

As a trade-off for this geometric simplification, the dynamic equations become somewhat more complicated. The resulting dynamic equations are, after dropping the carats:

$$\frac{\partial u}{\partial t} - fv + \vec{v} \cdot \nabla u = -\frac{\partial \phi}{\partial x} - \left(\frac{g\rho}{\rho_0}\right) \frac{\partial z}{\partial x} - g \frac{\partial \zeta}{\partial x} + \frac{1}{H_z} \frac{\partial}{\partial \sigma} \left[\frac{K_m}{H_z} \frac{\partial u}{\partial \sigma} \right] + \mathcal{F}_u + \mathcal{D}_u \quad (8)$$

$$\frac{\partial v}{\partial t} + fu + \vec{v} \cdot \nabla v = -\frac{\partial \phi}{\partial y} - \left(\frac{g\rho}{\rho_o}\right) \frac{\partial z}{\partial y} - g \frac{\partial \zeta}{\partial y} + \frac{1}{H_z} \frac{\partial}{\partial \sigma} \left[\frac{K_m}{H_z} \frac{\partial v}{\partial \sigma} \right] + \mathcal{F}_v + \mathcal{D}_v \quad (9)$$

$$\frac{\partial C}{\partial t} + \vec{v} \cdot \nabla C = \frac{1}{H_z} \frac{\partial}{\partial \sigma} \left[\frac{K_C}{H_z} \frac{\partial C}{\partial \sigma} \right] + \mathcal{F}_T + \mathcal{D}_T \quad (10)$$

$$\rho = \rho(T, S, P) \quad (11)$$

$$\frac{\partial \phi}{\partial \sigma} = \left(\frac{-gH_z \rho}{\rho_o} \right) \quad (12)$$

$$\frac{\partial H_z}{\partial t} + \frac{\partial(H_z u)}{\partial x} + \frac{\partial(H_z v)}{\partial y} + \frac{\partial(H_z \Omega)}{\partial \sigma} = 0 \quad (13)$$

where

$$\vec{v} = (u, v, \Omega)$$

$$\vec{v} \cdot \nabla = u \frac{\partial}{\partial x} + v \frac{\partial}{\partial y} + \Omega \frac{\partial}{\partial \sigma}.$$

The vertical velocity in σ coordinates is

$$\Omega(x, y, \sigma, t) = \frac{1}{H_z} \left[w - \left(\frac{z+h}{\zeta+h} \right) \frac{\partial \zeta}{\partial t} - u \frac{\partial z}{\partial x} - v \frac{\partial z}{\partial y} \right]$$

and

$$w = \frac{\partial z}{\partial t} + u \frac{\partial z}{\partial x} + v \frac{\partial z}{\partial y} + \Omega H_z.$$

In the stretched coordinate system, the vertical boundary conditions become:

$$\begin{aligned} \text{top } (\sigma = 0) \quad & \left(\frac{K_m}{H_z} \right) \frac{\partial u}{\partial \sigma} = \tau_s^x(x, y, t) \\ & \left(\frac{K_m}{H_z} \right) \frac{\partial v}{\partial \sigma} = \tau_s^y(x, y, t) \\ & \left(\frac{K_C}{H_z} \right) \frac{\partial C}{\partial \sigma} = \frac{Q_C}{\rho_o c_P} \\ & \Omega = 0 \end{aligned}$$

$$\begin{aligned} \text{and bottom } (\sigma = -1) \quad & \left(\frac{K_m}{H_z} \right) \frac{\partial u}{\partial \sigma} = \tau_b^x(x, y, t) \\ & \left(\frac{K_m}{H_z} \right) \frac{\partial v}{\partial \sigma} = \tau_b^y(x, y, t) \\ & \left(\frac{K_C}{H_z} \right) \frac{\partial C}{\partial \sigma} = 0 \\ & \Omega = 0. \end{aligned}$$

Note the simplification of the boundary conditions on vertical velocity that arises from the σ coordinate transformation.

3.5 Horizontal curvilinear coordinates

In many applications of interest (e.g., flow adjacent to a coastal boundary), the fluid may be confined horizontally within an irregular region. In such problems, a horizontal coordinate system which conforms to the irregular lateral boundaries is advantageous. It is often also true in many geophysical problems that the simulated flow fields have regions of enhanced structure (e.g., boundary currents or fronts) which occupy a relatively small fraction of the physical/computational domain. In these problems, added efficiency can be gained by placing more computational resolution in such regions.

The requirement for a boundary-following coordinate system and for a laterally variable grid resolution can both be met, for suitably smooth domains, by introducing an appropriate orthogonal

coordinate transformation in the horizontal. Let the new coordinates be $\xi(x, y)$ and $\eta(x, y)$, where the relationship of horizontal arc length to the differential distance is given by:

$$(ds)_\xi = \left(\frac{1}{m}\right) d\xi \quad (14)$$

$$(ds)_\eta = \left(\frac{1}{n}\right) d\eta \quad (15)$$

Here, $m(\xi, \eta)$ and $n(\xi, \eta)$ are the scale factors which relate the differential distances $(\Delta\xi, \Delta\eta)$ to the actual (physical) arc lengths. Appendix C contains the curvilinear version of several common vector quantities.

Denoting the velocity components in the new coordinate system by

$$\vec{v} \cdot \hat{\xi} = u \quad (16)$$

and

$$\vec{v} \cdot \hat{\eta} = v \quad (17)$$

the equations of motion (8)-(13) can be re-written [see, e.g., Arakawa and Lamb, 1977] as:

$$\begin{aligned} \frac{\partial}{\partial t} \left(\frac{H_z u}{mn} \right) + \frac{\partial}{\partial \xi} \left(\frac{H_z u^2}{n} \right) + \frac{\partial}{\partial \eta} \left(\frac{H_z uv}{m} \right) + \frac{\partial}{\partial \sigma} \left(\frac{H_z u \Omega}{mn} \right) \\ - \left\{ \left(\frac{f}{mn} \right) + v \frac{\partial}{\partial \xi} \left(\frac{1}{n} \right) - u \frac{\partial}{\partial \eta} \left(\frac{1}{m} \right) \right\} H_z v = \\ - \left(\frac{H_z}{n} \right) \left(\frac{\partial \phi}{\partial \xi} + \frac{g\rho}{\rho_o} \frac{\partial z}{\partial \xi} + g \frac{\partial \zeta}{\partial \xi} \right) + \frac{1}{mn} \frac{\partial}{\partial \sigma} \left[\frac{K_m}{H_z} \frac{\partial u}{\partial \sigma} \right] + \frac{H_z}{mn} (\mathcal{F}_u + \mathcal{D}_u) \end{aligned} \quad (18)$$

$$\begin{aligned} \frac{\partial}{\partial t} \left(\frac{H_z v}{mn} \right) + \frac{\partial}{\partial \xi} \left(\frac{H_z uv}{n} \right) + \frac{\partial}{\partial \eta} \left(\frac{H_z v^2}{m} \right) + \frac{\partial}{\partial \sigma} \left(\frac{H_z v \Omega}{mn} \right) \\ + \left\{ \left(\frac{f}{mn} \right) + v \frac{\partial}{\partial \xi} \left(\frac{1}{n} \right) - u \frac{\partial}{\partial \eta} \left(\frac{1}{m} \right) \right\} H_z u = \\ - \left(\frac{H_z}{m} \right) \left(\frac{\partial \phi}{\partial \eta} + \frac{g\rho}{\rho_o} \frac{\partial z}{\partial \eta} + g \frac{\partial \zeta}{\partial \eta} \right) + \frac{1}{mn} \frac{\partial}{\partial \sigma} \left[\frac{K_m}{H_z} \frac{\partial v}{\partial \sigma} \right] + \frac{H_z}{mn} (\mathcal{F}_v + \mathcal{D}_v) \end{aligned} \quad (19)$$

$$\begin{aligned} \frac{\partial}{\partial t} \left(\frac{H_z C}{mn} \right) + \frac{\partial}{\partial \xi} \left(\frac{H_z u C}{n} \right) + \frac{\partial}{\partial \eta} \left(\frac{H_z v C}{m} \right) + \frac{\partial}{\partial \sigma} \left(\frac{H_z \Omega C}{mn} \right) = \\ \frac{1}{mn} \frac{\partial}{\partial \sigma} \left[\frac{K_C}{H_z} \frac{\partial C}{\partial \sigma} \right] + \frac{H_z}{mn} (\mathcal{F}_C + \mathcal{D}_C) \end{aligned} \quad (20)$$

$$\rho = \rho(T, S, P) \quad (21)$$

$$\frac{\partial \phi}{\partial \sigma} = - \left(\frac{g H_z \rho}{\rho_o} \right) \quad (22)$$

$$\frac{\partial}{\partial t} \left(\frac{H_z}{mn} \right) + \frac{\partial}{\partial \xi} \left(\frac{H_z u}{n} \right) + \frac{\partial}{\partial \eta} \left(\frac{H_z v}{m} \right) + \frac{\partial}{\partial \sigma} \left(\frac{H_z \Omega}{mn} \right) = 0. \quad (23)$$

All boundary conditions remain unchanged.

4 Numerical Solution Technique

4.1 Vertical and horizontal discretization

4.1.1 Horizontal grid

In the horizontal (ξ, η) , a traditional, centered, second-order finite-difference approximation is adopted. In particular, the horizontal arrangement of variables is as shown in Fig. 1. This is equivalent to the well known Arakawa “C” grid, which is well suited for problems with horizontal resolution that is fine compared to the first radius of deformation [Arakawa and Lamb, 1977].

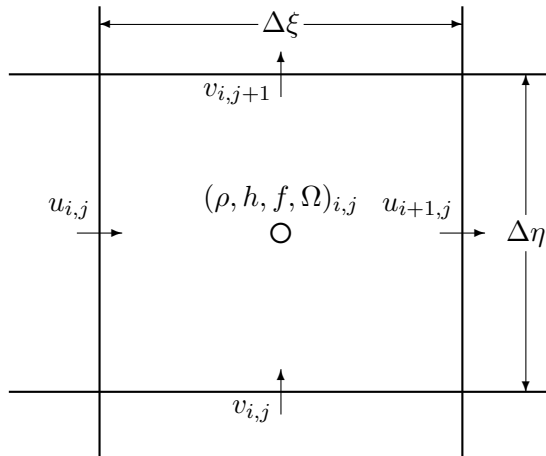

Figure 1: Placement of variables on an Arakawa C grid

Note that the relative placement of the velocity points which match the indices of the central tracer point is known as the Southwest convention while some other well-known models use a Northeast convention.

4.1.2 Vertical grid

The vertical discretization also uses a second-order finite-difference approximation. Just as we use a staggered horizontal grid, the model was found to be more well-behaved with a staggered vertical grid. The vertical grid is shown in Fig. 2.

4.2 Masking of land areas

ROMS has the ability to work with interior land areas, although the computations occur over the entire model domain. One grid cell is shown in Fig. 1 while several cells are shown in Fig. 3, including two land cells. The process of defining which areas are to be masked is external to ROMS and is usually accomplished in **Matlab** or **Python**; this section describes how the masking affects the computation of the various terms in the equations of motion.

4.2.1 Velocity

At the end of every time step, the values of many variables within the masked region are set to zero by multiplying by the mask for either the u , v or ρ points. This is appropriate for the v points **E** and **L** in Fig. 3, since the flow in and out of the land should be zero. It is likewise appropriate for the u point at **I**, but is not necessarily correct for point **G**. The only term in the u equation that

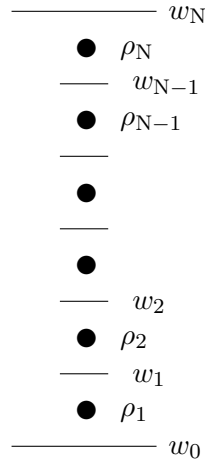

Figure 2: Placement of variables on staggered vertical grid

requires the u value at point **G** is the horizontal viscosity, which has a term of the form $\frac{\partial}{\partial \eta} \nu \frac{\partial u}{\partial \eta}$. Since point **G** is used in this term by both points **A** and **M**, it is not sufficient to replace its value with that of the image point for **A**. Instead, the term $\frac{\partial u}{\partial \eta}$ is computed and the values at points **D** and **K** are replaced with the values appropriate for either free-slip or no-slip boundary conditions. Likewise, the term $\frac{\partial}{\partial \xi} \nu \frac{\partial v}{\partial \xi}$ in the v equation must be corrected at the mask boundaries.

This is accomplished by having a fourth mask array defined at the ψ points, in which the values are set to be no-slip in **metrics**. For no-slip boundaries, we count on the values inside the land (point **G**) having been zeroed out. For point **D**, the image point at **G** should contain minus the value of u at point **A**. The desired value of $\frac{\partial u}{\partial \eta}$ is therefore $2u_{\mathbf{A}}$ while instead we have simply $u_{\mathbf{A}}$. In order to achieve the correct result, we multiply by a mask which contains the value 2 at point **D**. It also contains a 2 at point **K** so that $\frac{\partial u}{\partial \eta}$ there will acquire the desired value of $-2u_{\mathbf{M}}$. The corner point **F** is set to have a value of 1.

4.2.2 Temperature, salinity and surface elevation

The handling of masks by the temperature, salinity and surface elevation equations is similar to that in the momentum equations, and is in fact simpler. Values of T , S and ζ inside the land masks, such as point **H** in Fig. 3, are set to zero after every time step. This point would be used by the horizontal diffusion term for points **B**, **J**, and **N**. This is corrected by setting the first derivative terms at points **E**, **I**, and **L** to zero, to be consistent with a no-flux boundary condition. Note that the equation of state must be able to handle $T = S = 0$ since these are the values inside masked regions.

4.2.3 Wetting and drying

There is now an option to have wetting and drying in the model, in which a cell can switch between being wet or being dry as the tides come in and go out, for instance. However, cells which are masked out as in Fig. 3 are never allowed to be wet.

- In the case of wetting and drying, a critical depth, D_{crit} , is supplied by the user.
- The total water depth ($D = h + \zeta$) is compared to D_{crit} . If the water level is less than this depth, no flux is allowed out of that cell. Water can always flow in and resubmerge the cell.
- The wetting and drying only happens during the 2-D computations; the 3-D computations see a depth of D_{crit} in the “dry” areas, though surface fluxes are turned off in the dry cells, as are some other processes.

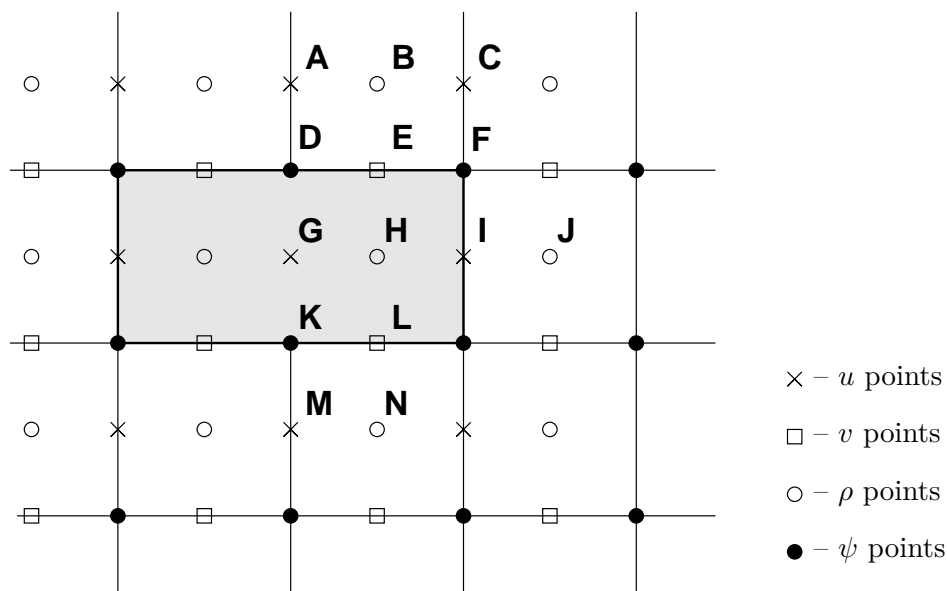

Figure 3: Masked region within the domain

- The ice component now checks for dry cells when computing the ice rheology and ice thermodynamics.

4.3 Time-stepping overview

While time stepping the model, we have a stored history of the model fields at time $n - 1$, an estimate of the fields at the current time n , and we need to come up with an estimate for time $n + 1$. For reasons of efficiency, we choose to use a split-explicit time step, integrating the depth-integrated equations with a shorter time step than the full 3-D equations. There is an integer ratio M between the time steps. The exact details of how the time stepping is done vary from one version of ROMS to the next, with the Rutgers ROMS described here being older than other branches. Still, all versions have these steps:

1. Take a predictor step for at least the 3-D tracers to time $n + \frac{1}{2}$.
2. Compute $\bar{\rho}$ and ρ^* for use in the depth-integrated time steps, from the density either at time n or time $n + \frac{1}{2}$.
3. Depth integrate the 3-D momentum right-hand side terms at time $n + \frac{1}{2}$ for use in the depth-integrated time steps (or extrapolate to obtain an estimate of those terms).
4. Take all the depth-integrated steps. Store weighted time-means of the \bar{u} , \bar{v} fields centered at both time $n + \frac{1}{2}$ and time $n + 1$ (plus ζ at time $n + 1$). The latter requires this time stepping to extend past time $n + 1$, using M^* steps rather than just M .
5. Use the weighted time-means from depth-integrated fields to complete the corrector step for the 3-D fields to time $n + 1$.

Great care is taken to avoid the introduction of a mode-splitting instability due to the use of shorter time steps for the depth-integrated computations.

The mode coupling has evolved through the various ROMS versions, as shown in Fig. 4 [from Shchepetkin and McWilliams, 2009a]. The time stepping schemes are also listed in Table 4.3 and

described in detail in Shchepetkin and McWilliams [2005] and Shchepetkin and McWilliams [2009b]; the relevant ones are described in Appendix A.

4.4 Conservation properties

From Shchepetkin and McWilliams [2005], we have a tracer concentration equation in advective form:

$$\frac{\partial C}{\partial t} + (u \cdot \nabla)C = 0 \quad (24)$$

and also a tracer concentration equation in conservation form:

$$\frac{\partial C}{\partial t} + \nabla \cdot (uC) = 0. \quad (25)$$

The continuity equation:

$$(\nabla \cdot u) = 0 \quad (26)$$

can be used to get from one tracer equation to the other. As a consequence of eq. (24), if the tracer is spatially uniform, it will remain so regardless of the velocity field (constancy preservation). On the other hand, as a consequence of (25), the volume integral of the tracer concentration is conserved in the absence of internal sources and fluxes through the boundary. Both properties are valuable and should be retained when constructing numerical ocean models.

The semi-discrete form of the tracer equation (20) is:

$$\frac{\partial}{\partial t} \left(\frac{H_z C}{mn} \right) + \delta_\xi \left(\frac{u \overline{H_z^\xi} \overline{C^\xi}}{\overline{n^\xi}} \right) + \delta_\eta \left(\frac{v \overline{H_z^\eta} \overline{C^\eta}}{\overline{m^\eta}} \right) + \delta_\sigma \left(\overline{C^\sigma} \frac{H_z \Omega}{mn} \right) = \frac{1}{mn} \frac{\partial}{\partial \sigma} \left(\frac{K_m}{\Delta z} \frac{\partial C}{\partial \sigma} \right) + \mathcal{D}_C + \mathcal{F}_C \quad (27)$$

Here δ_ξ , δ_η and δ_σ denote simple centered finite-difference approximations to $\partial/\partial\xi$, $\partial/\partial\eta$ and $\partial/\partial\sigma$ with the differences taken over the distances $\Delta\xi$, $\Delta\eta$ and $\Delta\sigma$, respectively. Δz is the vertical distance from one ρ point to another. $\overline{(\)^\xi}$, $\overline{(\)^\eta}$ and $\overline{(\)^\sigma}$ represent averages taken over the distances $\Delta\xi$, $\Delta\eta$ and $\Delta\sigma$.

The finite volume version of the same equation is no different, except that a quantity C is defined as the volume-averaged concentration over the grid box ΔV :

$$C = \frac{mn}{H_z} \int_{\Delta V} \frac{H_z C}{mn} \delta\xi \delta\eta \delta\sigma \quad (28)$$

The quantity $\left(\frac{u \overline{H_z^\xi} \overline{C^\xi}}{\overline{n^\xi}} \right)$ is the flux through an interface between adjacent grid boxes.

This method of averaging was chosen because it internally conserves first moments in the model domain, although it is still possible to exchange mass and energy through the open boundaries. The method is similar to that used in Arakawa and Lamb [1977], though their scheme also conserves enstrophy. Instead, we will focus on (nearly) retaining constancy preservation while coupling the barotropic (depth-integrated) equations and the baroclinic equations.

The time step in eq. (27) is assumed to be from time n to time $n+1$, with the other terms being evaluated at time $n + \frac{1}{2}$ for second-order accuracy. Setting C to 1 everywhere reduces eq. (27) to:

$$\frac{\partial}{\partial t} \left(\frac{H_z}{mn} \right) + \delta_\xi \left(\frac{u \overline{H_z^\xi}}{\overline{n^\xi}} \right) + \delta_\eta \left(\frac{v \overline{H_z^\eta}}{\overline{m^\eta}} \right) + \delta_\sigma \left(\frac{H_z \Omega}{mn} \right) = 0 \quad (29)$$

If this equation holds true for the step from time n to time $n+1$, then our constancy preservation will hold.

In a hydrostatic model such as ROMS, the discrete continuity equation is needed to compute vertical velocity rather than grid-box volume $\frac{H_z}{mn}$ (the latter is controlled by changes in ζ in the

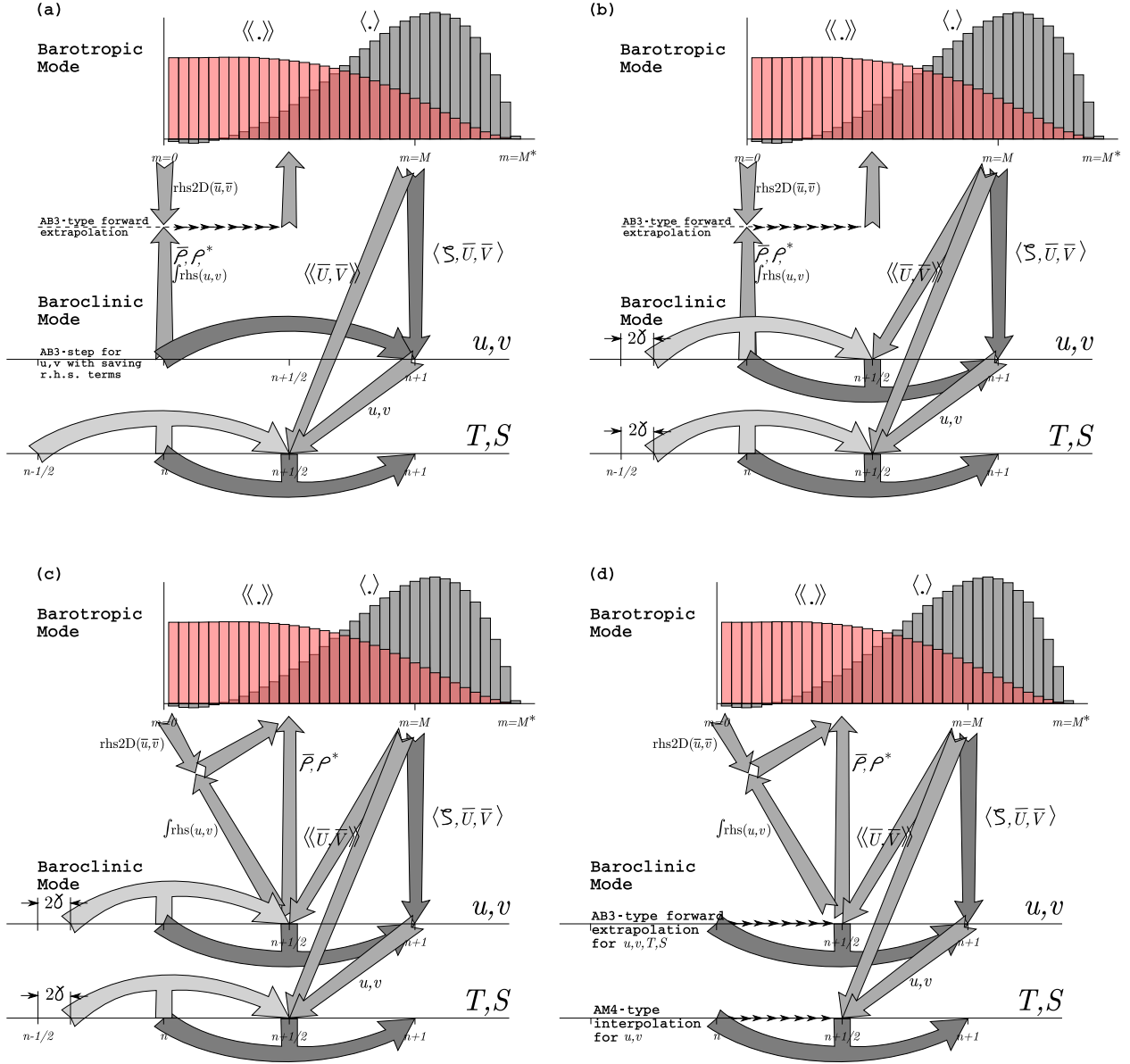

Figure 4: Diagrams of the time stepping and mode coupling used in various ROMS versions. (a) Rutgers University ROMS (from myroms.org), (b) older ROMS AGRIF, (c) UCLA ROMS, described in Shchepetkin and McWilliams [2005], (d) non-hydrostatic ROMS (Kanarska et al. [2007]). In all, the curved arrows update the 3-D fields; those with “pillars” are leapfrog in nature with the pillar representing the r.h.s. terms. Straight arrows indicate exchange between the barotropic and baroclinic modes. The shape functions for the fast time steps show just one option out of many possibilities. The grey function has weights to produce an estimate at time $n + 1$, while the light red function has weights to produce an estimate at time $n + \frac{1}{2}$.

	SCRUM 3.0	Rutgers	AGRIF	UCLA	Non-hydrostatic
Reference	Hedstrom [2000]	Haidvogel et al. [2000]	Penven et al. [2006]	Shchepetkin and McWilliams [2005]	Kanarska et al. [2007]
Barotropic mode	LF-TR	LF-AM3 with FB feedback	LF-AM3 with FB feedback ^a	Gen. FB (AB3-AM4)	Gen. FB (AB3-AM4)
2-D α_{\max} , iter.	$\sqrt{2}$, (2) ^b	1.85, (2)	1.85, (2)	1.78, (1)	1.78, (1)
3-D momenta	AB3	AB3	LF-AM3	LF-AM3	AB3 (mod)
Tracers	AB3	LF-TR	LF-AM3	LF-AM3	AB3 (mod)
Internal waves	AB3	Gen. FB (AB3-TR)	LF-AM3, FB feedback	LF-AM3, FB feedback	Gen. FB (AB3-AM4)
α_{\max} , advect.	0.72	0.72	1.587	1.587	0.78
α_{\max} , Cor.	0.72	0.72	1.587	1.587	0.78
α_{\max} , int. w.	0.72, (1)	1.14, (1,2)	1.85, (2)	1.85, (2)	1.78, (1)

Table 3: The time stepping schemes used in the various ROMS versions. $\alpha \equiv \omega \delta t$ is the Courant number and $\omega = ck$ is the frequency for a wave component with wavenumber k .

^aThe generalized FB barotropic mode was ported into the newest AGRIF code at the end of 2007.

^bThe number in parentheses (e.g., 2) indicates the number of r.h.s. computations per time step. If there are two parenthesized numbers, the first one is for momenta, the second for tracers.

barotropic mode computations). Here, $\frac{H_z \Omega}{mn}$ is the finite-volume flux across the *moving* grid-box interface, vertically on the w grid.

The vertical integral of the continuity eq. (23), using the vertical boundary conditions on Ω , is:

$$\frac{\partial}{\partial t} \left(\frac{\zeta}{mn} \right) + \delta_\xi \left(\frac{\bar{u} \bar{D}^\xi}{\bar{n}^\xi} \right) + \delta_\eta \left(\frac{\bar{v} \bar{D}^\eta}{\bar{m}^\eta} \right) = 0 \quad (30)$$

where ζ is the surface elevation, $D = h + \zeta$ is the total depth, and \bar{u}, \bar{v} are the depth-integrated horizontal velocities. This equation and the corresponding 2-D momentum equations are time stepped on a shorter time step than eq. (27) and the other 3-D equations. Due to the details in the mode coupling, it is only possible to maintain constancy preservation to the accuracy of the barotropic time steps.

4.5 Depth-integrated equations

The depth average of a quantity A is given by:

$$\bar{A} = \frac{1}{D} \int_{-1}^0 H_z A d\sigma \quad (31)$$

where the overbar indicates a vertically averaged quantity and

$$D \equiv \zeta(\xi, \eta, t) + h(\xi, \eta) \quad (32)$$

is the total depth of the water column. The vertical integral of equation (18) is:

$$\begin{aligned} \frac{\partial}{\partial t} \left(\frac{D\bar{u}}{mn} \right) + \frac{\partial}{\partial \xi} \left(\frac{D\bar{u}\bar{u}}{n} \right) + \frac{\partial}{\partial \eta} \left(\frac{D\bar{u}\bar{v}}{m} \right) - \frac{Df\bar{v}}{mn} \\ - \left[\bar{v}\bar{v} \frac{\partial}{\partial \xi} \left(\frac{1}{n} \right) - \bar{u}\bar{v} \frac{\partial}{\partial \eta} \left(\frac{1}{m} \right) \right] D = -\frac{D}{n} \left(\frac{\partial \bar{\phi}_2}{\partial \xi} + g \frac{\partial \zeta}{\partial \xi} \right) \\ + \frac{D}{mn} \left(\bar{\mathcal{F}}_u + \bar{\mathcal{D}}_{h_u} \right) + \frac{1}{mn} \left(\tau_s^\xi - \tau_b^\xi \right) \end{aligned} \quad (33)$$

where ϕ_2 includes the $\frac{\partial z}{\partial \xi}$ term, $\bar{\mathcal{D}}_{h_u}$ is the horizontal viscosity, and the vertical viscosity only contributes through the upper and lower boundary conditions. The corresponding vertical integral of equation (19) is:

$$\begin{aligned} \frac{\partial}{\partial t} \left(\frac{D\bar{v}}{mn} \right) + \frac{\partial}{\partial \xi} \left(\frac{D\bar{u}\bar{v}}{n} \right) + \frac{\partial}{\partial \eta} \left(\frac{D\bar{v}\bar{v}}{m} \right) + \frac{Df\bar{u}}{mn} \\ + \left[\bar{u}\bar{v} \frac{\partial}{\partial \xi} \left(\frac{1}{n} \right) - \bar{u}\bar{u} \frac{\partial}{\partial \eta} \left(\frac{1}{m} \right) \right] D = -\frac{D}{m} \left(\frac{\partial \bar{\phi}_2}{\partial \eta} + g \frac{\partial \zeta}{\partial \eta} \right) \\ + \frac{D}{mn} \left(\bar{\mathcal{F}}_v + \bar{\mathcal{D}}_{h_v} \right) + \frac{1}{mn} \left(\tau_s^\eta - \tau_b^\eta \right). \end{aligned} \quad (34)$$

We also need the vertical integral of equation (23), shown above as eq. (30).

The presence of a free surface introduces waves which propagate at a speed of $\sqrt{g\bar{h}}$. These waves usually impose a more severe time-step limit than any of the internal processes. We have therefore chosen to solve the full equations by means of a split time step. In other words, the depth integrated equations (33), (34), and (30) are integrated using a short time step and the values of \bar{u} and \bar{v} are used to replace those found by integrating the full equations on a longer time step. A diagram of the barotropic time stepping is shown in Fig. 5.

Barotropic steps

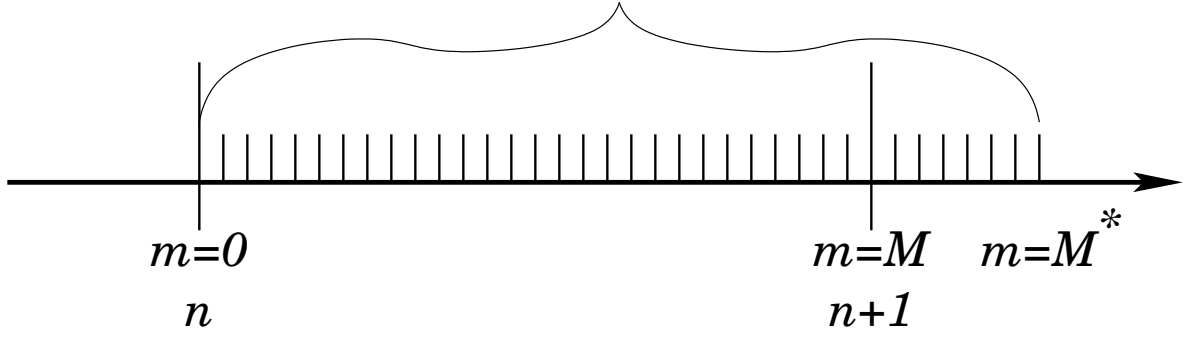

Figure 5: The split time stepping used in the model.

Some of the terms in equations (33) and (34) are updated on the short time step while others are not. The contributions from the slow terms are computed once per long time step and stored. If we call these terms $R_{u_{\text{slow}}}$ and $R_{v_{\text{slow}}}$, equations (33) and (34) become:

$$\begin{aligned} \frac{\partial}{\partial t} \left(\frac{D\bar{u}}{mn} \right) + \frac{\partial}{\partial \xi} \left(\frac{D\bar{u}\bar{u}}{n} \right) + \frac{\partial}{\partial \eta} \left(\frac{D\bar{u}\bar{v}}{m} \right) - \frac{Df\bar{v}}{mn} \\ - \left[\bar{v}\bar{v} \frac{\partial}{\partial \xi} \left(\frac{1}{n} \right) - \bar{u}\bar{v} \frac{\partial}{\partial \eta} \left(\frac{1}{m} \right) \right] D = R_{u_{\text{slow}}} - \frac{gD}{n} \frac{\partial \zeta}{\partial \xi} + \frac{D}{mn} \mathcal{D}_{\bar{u}} - \frac{1}{mn} \tau_b^\xi \end{aligned} \quad (35)$$

$$\begin{aligned} \frac{\partial}{\partial t} \left(\frac{D\bar{v}}{mn} \right) + \frac{\partial}{\partial \xi} \left(\frac{D\bar{u}\bar{v}}{n} \right) + \frac{\partial}{\partial \eta} \left(\frac{D\bar{v}\bar{v}}{m} \right) + \frac{Df\bar{u}}{mn} \\ + \left[\bar{u}\bar{v} \frac{\partial}{\partial \xi} \left(\frac{1}{n} \right) - \bar{u}\bar{u} \frac{\partial}{\partial \eta} \left(\frac{1}{m} \right) \right] D = R_{v_{\text{slow}}} - \frac{gD}{m} \frac{\partial \zeta}{\partial \eta} + \frac{D}{mn} \mathcal{D}_{\bar{v}} - \frac{1}{mn} \tau_b^\eta. \end{aligned} \quad (36)$$

When time stepping the model, we compute the right-hand-sides for equations (18) and (19) as well as the right-hand-sides for equations (35) and (36). The vertical integral of the 3-D right-hand-sides are obtained and then the 2-D right-hand-sides are subtracted. The resulting fields are the slow forcings $R_{u_{\text{slow}}}$ and $R_{v_{\text{slow}}}$. This was found to be the easiest way to retain the baroclinic contributions of the non-linear terms such as $\bar{u}\bar{u} - \bar{u}\bar{u}$.

The model is time stepped from time n to time $n+1$ by using short time steps on equations (35), (36) and (30). Equation (30) is time stepped first, so that an estimate of the new D is available for the time rate of change terms in equations (35) and (36). A third-order predictor-corrector time stepping is used. In practice, we actually time step all the way to time $(n + \mathbf{dftfast} \times M^*)$, while maintaining weighted averages of the values of \bar{u} , \bar{v} and ζ . The averages are used to replace the values at time $n+1$ in both the baroclinic and barotropic modes, and for recomputing the vertical grid spacing H_z . Fig. 6 shows one option for how these weights might look.

The primary weights, a_m , are used to compute $\langle \zeta \rangle^{n+1} \equiv \sum_{m=1}^{M^*} a_m \zeta^m$. There is a related set of secondary weights b_m , used as $\langle \bar{u} \rangle^{n+\frac{1}{2}} \equiv \sum_{m=1}^{M^*} b_m \bar{u}^m$. In order to maintain constancy preservation, this relation must hold:

$$\langle \zeta \rangle_{i,j}^{n+1} = \langle \zeta \rangle_{i,j}^n - (mn)_{i,j} \Delta t \left[\left\langle \left\langle \frac{D\bar{u}}{n} \right\rangle \right\rangle_{i+\frac{1}{2},j}^{n+\frac{1}{2}} - \left\langle \left\langle \frac{D\bar{u}}{n} \right\rangle \right\rangle_{i-\frac{1}{2},j}^{n+\frac{1}{2}} + \left\langle \left\langle \frac{D\bar{v}}{m} \right\rangle \right\rangle_{i,j+\frac{1}{2}}^{n+\frac{1}{2}} - \left\langle \left\langle \frac{D\bar{v}}{m} \right\rangle \right\rangle_{i,j-\frac{1}{2}}^{n+\frac{1}{2}} \right] \quad (37)$$

Shchepetkin and McWilliams [2005] introduce a range of possible weights, but the ones used here have a shape function:

$$A(\tau) = A_0 \left\{ \left(\frac{\tau}{\tau_0} \right)^p \left[1 - \left(\frac{\tau}{\tau_0} \right)^q \right] - r \frac{\tau}{\tau_0} \right\} \quad (38)$$

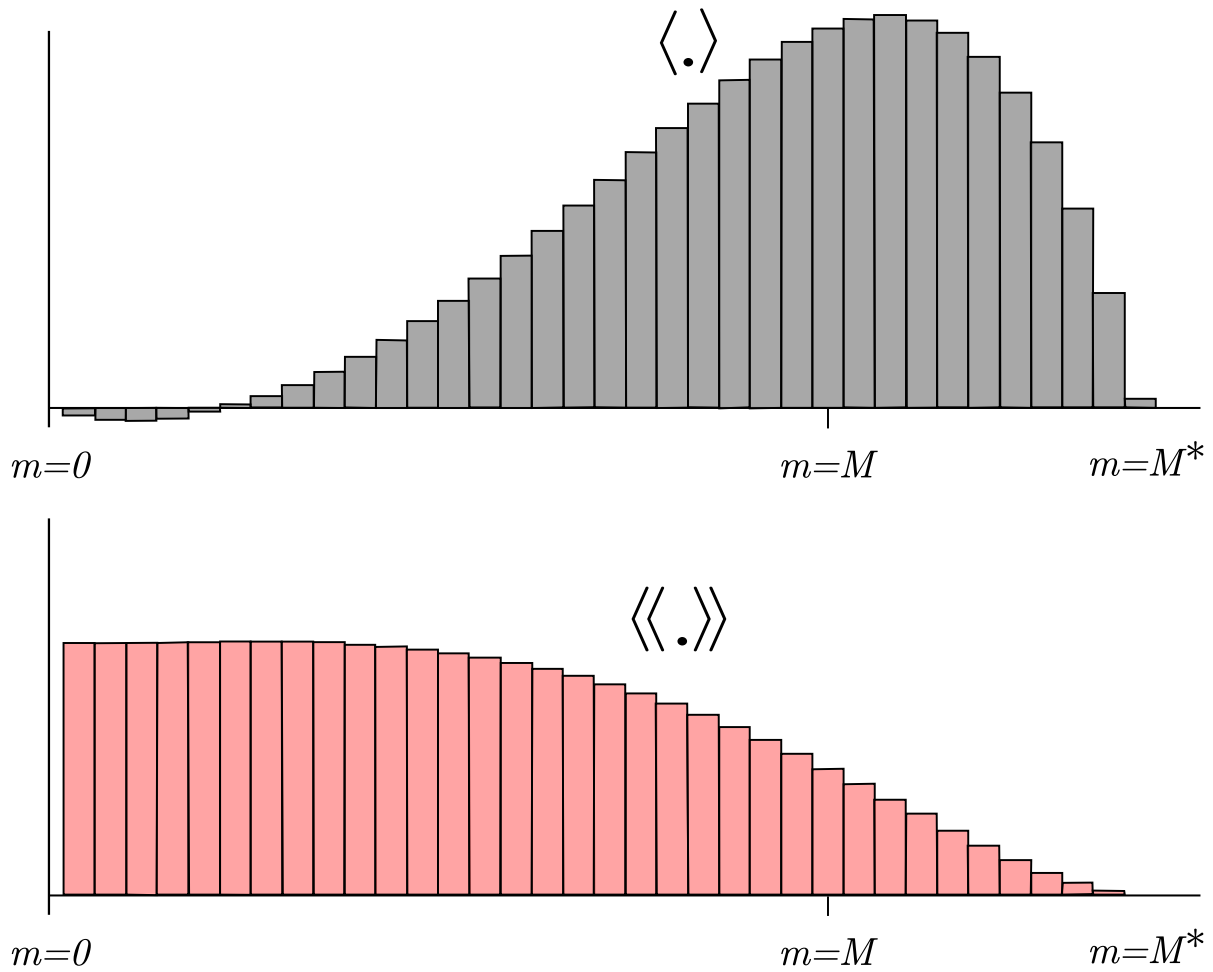

Figure 6: Weights for the barotropic time stepping. The upper panel shows the primary weights, centered at time $n + 1$, while the lower panel shows the secondary weights, centered at time $n + \frac{1}{2}$.

where p, q are parameters and A_0, τ_0 , and r are chosen to satisfy normalization, consistency, and second-order accuracy conditions,

$$I_n = \int_0^{\tau^*} \tau^n A(\tau) d\tau = 1, \quad n = 0, 1, 2 \quad (39)$$

using Newton iterations. τ^* is the upper limit of τ with $A(\tau) \geq 0$. In practice we initially set

$$A_0 = 1, r = 0 \quad \text{and} \quad \tau = \frac{(p+2)(p+q+2)}{(p+1)(p+q+1)},$$

compute $A(\tau)$ using eq. (38), normalize using:

$$\sum_{m=1}^{M^*} a_m \equiv 1, \quad \sum_{m=1}^{M^*} a_m \frac{m}{M} \equiv 1, \quad (40)$$

and adjust r iteratively to satisfy the $n = 2$ condition of (39). We are using values of $p = 2$, $q = 4$, and $r = 0.284$. This form allows some negative weights for small m , allowing M^* to be less than $1.5M$.

ROMS also supports an older cosine weighting option, which isn't recommended since it is only first-order accurate.

4.6 Density in the mode coupling

Equation (35) contains the term $R_{u_{\text{slow}}}$, computed as the difference between the 3-D right-hand-side and the 2-D right-hand-side. The pressure gradient therefore has the form:

$$-\frac{gD}{n} \frac{\partial \zeta}{\partial \xi} + \left[\frac{gD}{n} \frac{\partial \zeta}{\partial \xi} + \mathcal{F} \right] \quad (41)$$

where the term in square brackets is the mode coupling term and is held fixed over all the barotropic steps and

$$\mathcal{F} = -\frac{1}{\rho_0 n} \int_{-h}^{\zeta} \frac{\partial P}{\partial \xi} dz \quad (42)$$

is the vertically integrated pressure gradient. The latter is a function of the bathymetry, free surface gradient, and the free surface itself, as well as the vertical distribution of density.

The disadvantage of this approach is that after the barotropic time stepping is complete and the new free surface is substituted into the full baroclinic pressure gradient, its vertical integral will no longer be equal to the sum of the new surface slope term and the original coupling term based on the old free surface. This is one form of mode-splitting error which can lead to trouble because the vertically integrated pressure gradient is not in balance with the barotropic mass flux.

Instead, let us define the following:

$$\bar{\rho} = \frac{1}{D} \int_{-h}^{\zeta} \rho dz, \quad \rho^* = \frac{1}{\frac{1}{2}D^2} \int_{-h}^{\zeta} \left\{ \int_z^{\zeta} \rho dz' \right\} dz \quad (43)$$

Changing the vertical coordinate to σ yields:

$$\bar{\rho} = \int_{-1}^0 \rho d\sigma, \quad \rho^* = 2 \int_{-1}^0 \left\{ \int_{\sigma}^0 \rho d\sigma' \right\} d\sigma \quad (44)$$

which implies that $\bar{\rho}$ and ρ^* are actually independent of ζ as long as the density profile $\rho = \rho(\sigma)$ does not change. The vertically integrated pressure gradient becomes:

$$-\frac{1}{\rho_0 n} \frac{g}{\partial \xi} \left\{ \frac{\partial}{\partial \xi} \left(\frac{\rho^* D^2}{2} \right) - \bar{\rho} D \frac{\partial h}{\partial \xi} \right\} = -\frac{1}{\rho_0 n} \frac{g}{D} \left\{ \rho^* \frac{\partial \zeta}{\partial \xi} + \frac{D}{2} \frac{\partial \rho^*}{\partial \xi} + (\rho^* - \bar{\rho}) \frac{\partial h}{\partial \xi} \right\} \quad (45)$$

In the case of uniform density ρ_0 , we obtain $\rho^* \equiv \bar{\rho} \equiv \rho_0$, but we otherwise have two new terms. The accuracy of these terms depends on an accurate vertical integration of the density, as described in Shchepetkin and McWilliams [2005].

4.7 Time stepping: internal velocity modes and tracers

The momentum equations (18) and (19) are advanced before the tracer equation, by computing all the terms except the vertical viscosity and then using the implicit scheme described in §4.12 to find the new values for u and v . The depth-averaged component is then removed and replaced by the $\langle \bar{u} \rangle$ and $\langle \bar{v} \rangle$ computed as in §4.5. A third-order Adams-Bashforth (AB3) time stepping is used, requiring multiple right-hand-side time levels (see Appendix A). These stored up r.h.s. values can be used to extrapolate to a value at time $n + \frac{1}{2}$ for use in the barotropic steps as shown in Fig. 4.

The tracer concentration equation (27) is advanced in a predictor-corrector leapfrog-trapezoidal step, with great care taken to optimize both the conservation and constancy-preserving properties of the continuous equations. The corrector step can maintain both, as long as it uses velocities and column depths which satisfy eq. (37). This also requires tracer values centered at time $n + \frac{1}{2}$, obtained from the predictor step. The vertical diffusion is computed as in §4.12.

The predictor step cannot be both constancy-preserving and conservative; it was therefore decided to make it constancy-preserving. Also, since it is only being used to compute the advection for the corrector step, the expensive diffusion operations are not carried out during the predictor step.

The preceding notes on tracer advection refer to all but the MPDATA option. The MPDATA algorithm has its own predictor-corrector with emphasis on not allowing values to exceed their original range; it therefore gives up the constancy-preservation. This is most noticeable in shallow areas with large tides.

4.8 Advection schemes

The advection of a tracer C has an equation of the form

$$\frac{\partial H_z C}{\partial t mn} = -\frac{\partial}{\partial \xi} F^\xi - \frac{\partial}{\partial \eta} F^\eta - \frac{\partial}{\partial \sigma} F^\sigma, \quad (46)$$

where we have introduced the advective fluxes:

$$F^\xi = \frac{H_z u C}{n} \quad (47)$$

$$F^\eta = \frac{H_z v C}{m} \quad (48)$$

$$F^\sigma = \frac{H_z \Omega C}{mn}. \quad (49)$$

4.8.1 Second-order Centered

The simplest form of the advective fluxes is the centered second-order:

$$F^\xi = \frac{\overline{H_z^\xi} u \overline{C^\xi}}{\overline{n^\xi}} \quad (50)$$

$$F^\eta = \frac{\overline{H_z^\eta} v \overline{C^\eta}}{\overline{m^\eta}} \quad (51)$$

$$F^\sigma = \frac{\overline{H_z^\sigma} \Omega \overline{C^\sigma}}{mn}. \quad (52)$$

This scheme is known to have some unfortunate properties in the presence of strong gradients, such as large over- and under-shoots of tracers, leading to the need for large amounts of horizontal smoothing. ROMS provides alternative advection schemes with better behavior in many situations, but retains this one for comparison purposes.

4.8.2 Fourth-order Centered

The barotropic advection is centered fourth-order unless you specifically pick centered second-order as your horizontal advection scheme. To get fourth-order, create gradient terms:

$$G^\xi = \overline{\left(\frac{\partial C}{\partial \xi}\right)}^\xi \quad (53)$$

$$G^\eta = \overline{\left(\frac{\partial C}{\partial \eta}\right)}^\eta \quad (54)$$

$$G^\sigma = \overline{\left(\frac{\partial C}{\partial \sigma}\right)}^\sigma. \quad (55)$$

The fluxes now become:

$$F^\xi = \frac{\overline{H}_z^\xi}{\overline{n}^\xi} u \left(\overline{C}^\xi - \frac{1}{3} \frac{\partial G^\xi}{\partial \xi} \right) \quad (56)$$

$$F^\eta = \frac{\overline{H}_z^\eta}{\overline{m}^\eta} v \left(\overline{C}^\eta - \frac{1}{3} \frac{\partial G^\eta}{\partial \eta} \right) \quad (57)$$

$$F^\sigma = \frac{\overline{H}_z^\sigma}{\overline{mn}^\sigma} \Omega \left(\overline{C}^\sigma - \frac{1}{3} \frac{\partial G^\sigma}{\partial \sigma} \right). \quad (58)$$

4.8.3 Fourth-order Akima

An alternate fourth-order algorithm is that by Akima:

$$G^\xi = 2 \frac{\partial C}{\partial \xi_i} \frac{\partial C}{\partial \xi_{i+1}} / \left(\frac{\partial C}{\partial \xi_i} + \frac{\partial C}{\partial \xi_{i+1}} \right) \quad (59)$$

$$G^\eta = 2 \frac{\partial C}{\partial \eta_j} \frac{\partial C}{\partial \eta_{j+1}} / \left(\frac{\partial C}{\partial \eta_j} + \frac{\partial C}{\partial \eta_{j+1}} \right) \quad (60)$$

$$G^\sigma = 2 \frac{\partial C}{\partial \sigma_k} \frac{\partial C}{\partial \sigma_{k-1}} / \left(\frac{\partial C}{\partial \sigma_k} + \frac{\partial C}{\partial \sigma_{k-1}} \right) \quad (61)$$

$$(62)$$

With the fluxes as in 56–58.

4.8.4 Third-order Upwind

There is a class of third-order upwind advection schemes, both one-dimensional [Leonard, 1979] and two-dimensional [Rasch, 1994, Shchepetkin and McWilliams, 1998]. This scheme is known as UTOPIA (Uniformly Third-Order Polynomial Interpolation Algorithm). Applying flux limiters to UTOPIA is explored in Thuburn [1996], although it is not implemented in ROMS. The two-dimensional formulation in Rasch contains terms of order u^2C and u^3C , including cross terms (uvC). The terms which are nonlinear in velocity have been dropped in ROMS, leaving one extra upwind term in the computation of the advective fluxes:

$$F^\xi = \frac{H_z u}{n} \left(C - \gamma \frac{\partial^2 C}{\partial \xi^2} \right) \quad (63)$$

$$F^\eta = \frac{H_z v}{m} \left(C - \gamma \frac{\partial^2 C}{\partial \eta^2} \right) \quad (64)$$

The second derivative terms are centered on a ρ point in the grid, but are needed at a u or v point in the flux. The upstream value is used:

$$F_{i,j,k}^\xi = \frac{\overline{H_z}^\xi}{\overline{n}^\xi} [\max(0, u_{i,j,k})C_{i-1,j,k} + \min(0, u_{i,j,k})C_{i,j,k}]. \quad (65)$$

The value of γ in the model is $\frac{1}{8}$ while that in Rasch [1994] is $\frac{1}{6}$.

Because the third-order upwind scheme is designed to be two-dimensional, it is not used in the vertical (though one might argue that we are simply performing one-dimensional operations here). Instead, we use a centered fourth-order scheme in the vertical when the third-order upwind option is turned on:

$$F^s = \frac{H_z w}{mn} \left[-\frac{1}{16}C_{i,j,k-1} + \frac{9}{16}C_{i,j,k} + \frac{9}{16}C_{i,j,k+1} - \frac{1}{16}C_{i,j,k+2} \right] \quad (66)$$

One advantage of UTOPIA over MPDATA is that it can be used on variables having both negative and positive values. Therefore, it can be used on velocity as well as scalars. For the u -velocity, we have:

$$F^\xi = \left(u - \gamma \frac{\partial^2 u}{\partial \xi^2} \right) \left[\frac{H_z u}{n} - \gamma \frac{\partial^2}{\partial \xi^2} \left(\frac{H_z u}{n} \right) \right] \quad (67)$$

$$F^\eta = \left(u - \gamma \frac{\partial^2 u}{\partial \eta^2} \right) \left[\frac{H_z v}{m} - \gamma \frac{\partial^2}{\partial \eta^2} \left(\frac{H_z v}{m} \right) \right] \quad (68)$$

$$F^\sigma = \frac{H_z w}{mn} \left[-\frac{1}{16}u_{i,j,k-1} + \frac{9}{16}u_{i,j,k} + \frac{9}{16}u_{i,j,k+1} - \frac{1}{16}u_{i,j,k+2} \right] \quad (69)$$

while for the v -velocity we have:

$$F^\xi = \left(v - \gamma \frac{\partial^2 v}{\partial \xi^2} \right) \left[\frac{H_z u}{n} - \gamma \frac{\partial^2}{\partial \eta^2} \left(\frac{H_z u}{n} \right) \right] \quad (70)$$

$$F^\eta = \left(v - \gamma \frac{\partial^2 v}{\partial \eta^2} \right) \left[\frac{H_z v}{m} - \gamma \frac{\partial^2}{\partial \eta^2} \left(\frac{H_z v}{m} \right) \right] \quad (71)$$

$$F^\sigma = \frac{H_z w}{mn} \left[-\frac{1}{16}v_{i,j,k-1} + \frac{9}{16}v_{i,j,k} + \frac{9}{16}v_{i,j,k+1} - \frac{1}{16}v_{i,j,k+2} \right] \quad (72)$$

In all these terms, the second derivatives are evaluated at an upstream location.

4.9 Determination of the vertical velocity and density fields

Having obtained a complete specification of the u, v, T , and S fields at the next time level by the methods outlined above, the vertical velocity and density fields can be calculated. The vertical velocity is obtained by combining equations (23) and (30) to obtain:

$$\frac{\partial}{\partial \xi} \left(\frac{H_z u}{n} \right) + \frac{\partial}{\partial \eta} \left(\frac{H_z v}{m} \right) + \frac{\partial}{\partial \sigma} \left(\frac{H_z \Omega}{mn} \right) - \frac{\partial}{\partial \xi} \left(\frac{D\bar{u}}{n} \right) - \frac{\partial}{\partial \eta} \left(\frac{D\bar{v}}{m} \right) = 0. \quad (73)$$

Solving for $H_z \Omega / mn$ and using the semi-discrete notation of §4.4 we obtain:

$$\frac{H_z \Omega}{mn} = \int \left[\delta_\xi \left(\frac{\bar{u} D^\xi}{\bar{n}^\xi} \right) + \delta_\eta \left(\frac{\bar{v} D^\eta}{\bar{m}^\eta} \right) - \delta_\xi \left(\frac{u \overline{H_z}^\xi}{\bar{n}^\xi} \right) - \delta_\eta \left(\frac{v \overline{H_z}^\eta}{\bar{m}^\eta} \right) \right] d\sigma. \quad (74)$$

The integral is actually computed as a sum from the bottom upwards and also as a sum from the top downwards. The value used is a linear combination of the two, weighted so that the surface down value is used near the surface while the other is used near the bottom.

The density is obtained from temperature and salinity via an equation of state. ROMS provides a choice of a nonlinear equation of state $\rho = \rho(T, S, z)$ or a linear equation of state $\rho = \rho(T)$. The nonlinear equation of state has been modified and now corresponds to the UNESCO equation of state as derived by Jackett and McDougall [1995]. It computes *in situ* density as a function of potential temperature, salinity and pressure.

Warning: although we have used it quite extensively, McDougall (personal communication) claims that the single-variable ($\rho = \rho(T)$) equation of state is not dynamically appropriate as is. He has worked out the extra source and sink terms required, arising from vertical motions and the compressibility of water. They are quite complicated and we have not implemented them to see if they alter the flow.

4.10 Horizontal mixing

In Chapter 3, the diffusive terms were written simply as $\mathcal{D}_u, \mathcal{D}_v, \mathcal{D}_T$, and \mathcal{D}_S . The vertical component of these terms is described in §4.12. Here we describe the ROMS options for representing the horizontal component of these terms, first the viscosity then the diffusion.

4.10.1 Deviatoric stress tensor (viscosity)

Note: this material was copied from the wiki, where it was contributed by Hernan Arango. He uses “s” where we have been using “ σ ” while here σ is the stress tensor.

The horizontal components of the divergence of the stress tensor [Wajsowicz, 1993] in nondimensional, orthogonal curvilinear coordinates (ξ, η, s) with dimensional, spatially-varying metric factors $(\frac{1}{m}, \frac{1}{n}, H_z)$ and velocity components $(u, v, \omega H_z)$ are given by:

$$F^u \equiv \hat{\xi} \cdot (\nabla \cdot \vec{\sigma}) = \frac{mn}{H_z} \left[\frac{\partial}{\partial \xi} \left(\frac{H_z \sigma_{\xi\xi}}{n} \right) + \frac{\partial}{\partial \eta} \left(\frac{H_z \sigma_{\xi\eta}}{m} \right) + \frac{\partial}{\partial s} \left(\frac{\sigma_{\xi s}}{mn} \right) + \right. \quad (75)$$

$$\left. H_z \sigma_{\xi\eta} \frac{\partial}{\partial \eta} \left(\frac{1}{m} \right) - H_z \sigma_{\eta\eta} \frac{\partial}{\partial \xi} \left(\frac{1}{n} \right) - \frac{1}{n} \sigma_{ss} \frac{\partial H_z}{\partial \xi} \right] \quad (76)$$

$$F^v \equiv \hat{\eta} \cdot (\nabla \cdot \vec{\sigma}) = \frac{mn}{H_z} \left[\frac{\partial}{\partial \xi} \left(\frac{H_z \sigma_{\eta\xi}}{n} \right) + \frac{\partial}{\partial \eta} \left(\frac{H_z \sigma_{\eta\eta}}{m} \right) + \frac{\partial}{\partial s} \left(\frac{\sigma_{\eta s}}{mn} \right) + \right. \quad (77)$$

$$\left. H_z \sigma_{\eta\xi} \frac{\partial}{\partial \xi} \left(\frac{1}{n} \right) - H_z \sigma_{\xi\xi} \frac{\partial}{\partial \eta} \left(\frac{1}{m} \right) - \frac{1}{m} \sigma_{ss} \frac{\partial H_z}{\partial \eta} \right] \quad (78)$$

where

$$\sigma_{\xi\xi} = (A_M + \nu) e_{\xi\xi} + (\nu - A_M) e_{\eta\eta}, \quad (79)$$

$$\sigma_{\eta\eta} = (\nu - A_M) e_{\xi\xi} + (A_M + \nu) e_{\eta\eta}, \quad (80)$$

$$\sigma_{ss} = 2\nu e_{ss}, \quad (81)$$

$$\sigma_{\xi\eta} = \sigma_{\eta\xi} = 2A_M e_{\xi\eta}, \quad (82)$$

$$\sigma_{\xi s} = 2K_M e_{\xi s}, \quad (83)$$

$$\sigma_{\eta s} = 2K_M e_{\eta s}, \quad (84)$$

and the strain field is:

$$e_{\xi\xi} = m \frac{\partial u}{\partial \xi} + mnv \frac{\partial}{\partial \eta} \left(\frac{1}{m} \right), \quad (85)$$

$$e_{\eta\eta} = n \frac{\partial v}{\partial \eta} + mnu \frac{\partial}{\partial \xi} \left(\frac{1}{n} \right), \quad (86)$$

$$e_{ss} = \frac{1}{H_z} \frac{\partial (\omega H_z)}{\partial s} + \frac{m}{H_z} u \frac{\partial H_z}{\partial \xi} + \frac{n}{H_z} v \frac{\partial H_z}{\partial \eta}, \quad (87)$$

$$2e_{\xi\eta} = \frac{m}{n} \frac{\partial (nv)}{\partial \xi} + \frac{n}{m} \frac{\partial (mu)}{\partial \eta}, \quad (88)$$

$$2e_{\xi s} = \frac{1}{mH_z} \frac{\partial (mu)}{\partial s} + mH_z \frac{\partial \omega}{\partial \xi}, \quad (89)$$

$$2e_{\eta s} = \frac{1}{nH_z} \frac{\partial (nv)}{\partial s} + nH_z \frac{\partial \omega}{\partial \eta}. \quad (90)$$

Here, $A_M(\xi, \eta)$ and $K_M(\xi, \eta, s)$ are the spatially varying horizontal and vertical viscosity coefficients, respectively, and ν is another (very small, often neglected) horizontal viscosity coefficient. Notice that because of the generalized terrain-following vertical coordinates of ROMS, we need to transform the horizontal partial derivatives from constant "z"-surfaces to constant "s"-surfaces. And the vertical metric or level thickness is the Jacobian of the transformation, $H_z = \frac{\partial z}{\partial s}$. Also in these models, the "vertical" velocity is computed as $\frac{\omega H_z}{mn}$ and has units of m^3/s .

4.10.2 Transverse stress tensor

Assuming transverse isotropy, as in Sadourny and Maynard [1997] and Griffies and Hallberg [2000], the deviatoric stress tensor can be split into vertical and horizontal sub-tensors. The horizontal (or transverse) sub-tensor is symmetric, it has a null trace, and it possesses axial symmetry in the local vertical direction. Then, the transverse stress tensor can be derived from eq. (76) and (78), yielding

$$H_z F^u = n^2 m \frac{\partial}{\partial \xi} \left(\frac{H_z F^{u\xi}}{n} \right) + m^2 n \frac{\partial}{\partial \eta} \left(\frac{H_z F^{u\eta}}{m} \right) \quad (91)$$

$$H_z F^v = n^2 m \frac{\partial}{\partial \xi} \left(\frac{H_z F^{v\xi}}{n} \right) + m^2 n \frac{\partial}{\partial \eta} \left(\frac{H_z F^{v\eta}}{m} \right) \quad (92)$$

where

$$F^{u\xi} = \frac{1}{n} A_M \left[\frac{m}{n} \frac{\partial (nu)}{\partial \xi} - \frac{n}{m} \frac{\partial (mv)}{\partial \eta} \right], \quad (93)$$

$$F^{u\eta} = \frac{1}{m} A_M \left[\frac{n}{m} \frac{\partial (mu)}{\partial \eta} + \frac{m}{n} \frac{\partial (nv)}{\partial \xi} \right], \quad (94)$$

$$F^{v\xi} = \frac{1}{n} A_M \left[\frac{m}{n} \frac{\partial (nv)}{\partial \xi} + \frac{n}{m} \frac{\partial (mu)}{\partial \eta} \right], \quad (95)$$

$$F^{v\eta} = \frac{1}{m} A_M \left[\frac{n}{m} \frac{\partial (mv)}{\partial \eta} - \frac{m}{n} \frac{\partial (nu)}{\partial \xi} \right]. \quad (96)$$

Notice the flux form of eq. (91) and (92) and the symmetry between the $F^{u\xi}$ and $F^{v\eta}$ terms which are defined at density points on a C-grid. Similarly, the $F^{u\eta}$ and $F^{v\xi}$ terms are symmetric

and defined at vorticity points. These staggering positions are optimal for the discretization of the tensor; it has no computational modes and satisfies first-moment conservation.

The biharmonic friction operator can be computed by applying the tensor operator eq. (91) and (92) twice, but with the squared root of the biharmonic viscosity coefficient [Griffies and Hallberg, 2000]. For simplicity and momentum balance, the thickness H_z appears only when computing the second harmonic operator as in Griffies and Hallberg [2000].

4.10.3 Rotated Transverse Stress Tensor

In some applications with tall and steep topography, it will be advantageous to substantially reduce the contribution of the stress tensor eq. (91) and (92) to the vertical mixing when operating along constant s -surfaces. The transverse stress tensor rotated along geopotentials (constant depth) is then given by

$$H_z R^u = n^2 m \frac{\partial}{\partial \xi} \left(\frac{H_z R^{u\xi}}{n} \right) + m^2 n \frac{\partial}{\partial \eta} \left(\frac{H_z R^{u\eta}}{m} \right) + \frac{\partial}{\partial s} \left(R^{us} \right) \quad (97)$$

$$H_z R^v = n^2 m \frac{\partial}{\partial \xi} \left(\frac{H_z R^{v\xi}}{n} \right) + m^2 n \frac{\partial}{\partial \eta} \left(\frac{H_z R^{v\eta}}{m} \right) + \frac{\partial}{\partial s} \left(R^{vs} \right) \quad (98)$$

where

$$R^{u\xi} = \frac{1}{n} A_M \left[\frac{1}{n} \left(m \frac{\partial (nu)}{\partial \xi} - m \frac{\partial z}{\partial \xi} \frac{1}{H_z} \frac{\partial (nu)}{\partial s} \right) - \frac{1}{m} \left(n \frac{\partial (mv)}{\partial \eta} - n \frac{\partial z}{\partial \eta} \frac{1}{H_z} \frac{\partial (mv)}{\partial s} \right) \right], \quad (99)$$

$$R^{u\eta} = \frac{1}{m} A_M \left[\frac{1}{m} \left(n \frac{\partial (mu)}{\partial \eta} - n \frac{\partial z}{\partial \eta} \frac{1}{H_z} \frac{\partial (mu)}{\partial s} \right) + \frac{1}{n} \left(m \frac{\partial (nv)}{\partial \xi} - m \frac{\partial z}{\partial \xi} \frac{1}{H_z} \frac{\partial (nv)}{\partial s} \right) \right], \quad (100)$$

$$R^{us} = m \frac{\partial z}{\partial \xi} A_M \left[\frac{1}{n} \left(m \frac{\partial z}{\partial \xi} \frac{1}{H_z} \frac{\partial (nu)}{\partial s} - m \frac{\partial (nu)}{\partial \xi} \right) - \frac{1}{m} \left(n \frac{\partial z}{\partial \eta} \frac{1}{H_z} \frac{\partial (mv)}{\partial s} - n \frac{\partial (mv)}{\partial \eta} \right) \right] + \quad (101)$$

$$n \frac{\partial z}{\partial \eta} A_M \left[\frac{1}{m} \left(n \frac{\partial z}{\partial \eta} \frac{1}{H_z} \frac{\partial (mu)}{\partial s} - n \frac{\partial (mu)}{\partial \eta} \right) + \frac{1}{n} \left(m \frac{\partial z}{\partial \xi} \frac{1}{H_z} \frac{\partial (nv)}{\partial s} - m \frac{\partial (nv)}{\partial \xi} \right) \right], \quad (102)$$

$$R^{v\xi} = \frac{1}{n} A_M \left[\frac{1}{n} \left(m \frac{\partial (nv)}{\partial \xi} - m \frac{\partial z}{\partial \xi} \frac{1}{H_z} \frac{\partial (nv)}{\partial s} \right) + \frac{1}{m} \left(n \frac{\partial (mu)}{\partial \eta} - n \frac{\partial z}{\partial \eta} \frac{1}{H_z} \frac{\partial (mu)}{\partial s} \right) \right], \quad (103)$$

$$R^{v\eta} = \frac{1}{m} A_M \left[\frac{1}{m} \left(n \frac{\partial (mv)}{\partial \eta} - n \frac{\partial z}{\partial \eta} \frac{1}{H_z} \frac{\partial (mv)}{\partial s} \right) - \frac{1}{n} \left(m \frac{\partial (nu)}{\partial \xi} - m \frac{\partial z}{\partial \xi} \frac{1}{H_z} \frac{\partial (nu)}{\partial s} \right) \right], \quad (104)$$

$$R^{vs} = m \frac{\partial z}{\partial \xi} A_M \left[\frac{1}{n} \left(m \frac{\partial z}{\partial \xi} \frac{1}{H_z} \frac{\partial (nv)}{\partial s} - m \frac{\partial (nv)}{\partial \xi} \right) + \frac{1}{m} \left(n \frac{\partial z}{\partial \eta} \frac{1}{H_z} \frac{\partial (mu)}{\partial s} - n \frac{\partial (mu)}{\partial \eta} \right) \right] + \quad (105)$$

$$n \frac{\partial z}{\partial \eta} A_M \left[\frac{1}{m} \left(n \frac{\partial z}{\partial \eta} \frac{1}{H_z} \frac{\partial (mv)}{\partial s} - n \frac{\partial (mv)}{\partial \eta} \right) - \frac{1}{n} \left(m \frac{\partial z}{\partial \xi} \frac{1}{H_z} \frac{\partial (nu)}{\partial s} - m \frac{\partial (nu)}{\partial \xi} \right) \right]. \quad (106)$$

Notice that the transverse stress tensor remains invariant under coordinate transformation. The rotated tensor (97) and (98) retains the same properties as the unrotated tensor (91) and (92). The additional terms that arise from the slopes of s -surfaces along geopotentials are discretized using a modified version of the triad approach of Griffies et al. [1998].

4.10.4 Horizontal diffusion

In Chapter 3, the diffusive terms were written simply as \mathcal{D}_T and \mathcal{D}_S . The vertical component of these terms is described in §4.12. Here we describe the various options for representing the horizontal component of these terms.

4.10.5 Laplacian

The Laplacian of a scalar C in curvilinear coordinates is (see Appendix C):

$$\nabla^2 C = \nabla \cdot \nabla C = mn \left[\frac{\partial}{\partial \xi} \left(\frac{m}{n} \frac{\partial C}{\partial \xi} \right) + \frac{\partial}{\partial \eta} \left(\frac{n}{m} \frac{\partial C}{\partial \eta} \right) \right] \quad (107)$$

In ROMS, this term is multiplied by $\frac{\nu_2 H_z}{mn}$ and becomes

$$\left[\frac{\partial}{\partial \xi} \left(\frac{\nu_2 H_z m}{n} \frac{\partial C}{\partial \xi} \right) + \frac{\partial}{\partial \eta} \left(\frac{\nu_2 H_z n}{m} \frac{\partial C}{\partial \eta} \right) \right] \quad (108)$$

where C is any tracer. This form guarantees that the term does not contribute to the volume-integrated equations.

4.10.6 Biharmonic

The biharmonic operator is $\nabla^4 = \nabla^2 \nabla^2$; the corresponding term is computed using a temporary variable Y :

$$Y = \frac{mn}{H_z} \left[\frac{\partial}{\partial \xi} \left(\frac{\nu_4 H_z m}{n} \frac{\partial C}{\partial \xi} \right) + \frac{\partial}{\partial \eta} \left(\frac{\nu_4 H_z n}{m} \frac{\partial C}{\partial \eta} \right) \right] \quad (109)$$

and is

$$- \left[\frac{\partial}{\partial \xi} \left(\frac{\nu_4 H_z m}{n} \frac{\partial Y}{\partial \xi} \right) + \frac{\partial}{\partial \eta} \left(\frac{\nu_4 H_z n}{m} \frac{\partial Y}{\partial \eta} \right) \right] \quad (110)$$

where C is once again any tracer and ν_4 is the square root of the input value so that it can be applied twice.

4.10.7 Rotated mixing tensors

Both the Laplacian and biharmonic terms above operate on surfaces of constant s and can contribute substantially to the vertical mixing. However, the oceans are thought to mix along constant density surfaces so this is not entirely satisfactory. Therefore, the option of using rotated mixing tensors for the Laplacian and biharmonic operators has been added. Options exist to diffuse on constant z surfaces (**MIX_GEO_TS**) and constant potential density surfaces (**MIX_ISO_TS**).

The horizontal Laplacian diffusion operator is computed by finding the three components of the flux of the quantity C . The ξ and η components are locally horizontal, rather than along the s surface. The diffusive fluxes are:

$$F^\xi = \nu_2 \left[m \frac{\partial C}{\partial \xi} - \underbrace{\left(m \frac{\partial z}{\partial \xi} \underbrace{+ S_x}_{\text{MIX_ISO}} \right)}_{\text{MIX_GEO}} \frac{\partial C}{\partial z} \right] \quad (111)$$

$$F^\eta = \nu_2 \left[n \frac{\partial C}{\partial \eta} - \underbrace{\left[n \frac{\partial z}{\partial \eta} \underbrace{+ S_y}_{\text{MIX_ISO}} \right]}_{\text{MIX_GEO}} \frac{\partial C}{\partial z} \right] \quad (112)$$

$$F^s = - \underbrace{\frac{1}{H_z} \left(m \frac{\partial z}{\partial \xi} \underbrace{+ S_x}_{\text{MIX_ISO}} \right)}_{\text{MIX_GEO}} F^\xi - \underbrace{\frac{1}{H_z} \left(n \frac{\partial z}{\partial \eta} \underbrace{+ S_y}_{\text{MIX_ISO}} \right)}_{\text{MIX_GEO}} F^\eta \quad (113)$$

where

$$S_x = \frac{\frac{\partial \rho}{\partial x}}{\frac{\partial \rho}{\partial z}} = \frac{\left[m \frac{\partial \rho}{\partial \xi} - \frac{m}{H_z} \frac{\partial z}{\partial \xi} \frac{\partial \rho}{\partial s} \right]}{\frac{1}{H_z} \frac{\partial \rho}{\partial s}}$$

$$S_y = \frac{\frac{\partial \rho}{\partial y}}{\frac{\partial \rho}{\partial z}} = \frac{\left[n \frac{\partial \rho}{\partial \eta} - \frac{n}{H_z} \frac{\partial z}{\partial \eta} \frac{\partial \rho}{\partial s} \right]}{\frac{1}{H_z} \frac{\partial \rho}{\partial s}}$$

and there is some trickery whereby the computational details depend on the sign of $\frac{\partial z}{\partial \xi}$ and of $\frac{\partial z}{\partial \eta}$. No flux boundary conditions are easily imposed by setting

$$\begin{aligned} F^\xi &= 0 & \text{at } \xi \text{ walls} \\ F^\eta &= 0 & \text{at } \eta \text{ walls} \\ F^s &= 0 & \text{at } s = -1, 0 \end{aligned}$$

Finally, the flux divergence is calculated and is added to the right-hand-side term for the field being computed:

$$\frac{\partial}{\partial \xi} \left(\frac{H_z F^\xi}{n} \right) + \frac{\partial}{\partial \eta} \left(\frac{H_z F^\eta}{m} \right) + \frac{\partial}{\partial s} \left(\frac{H_z F^s}{mn} \right) \quad (114)$$

The biharmonic rotated mixing tensors are computed much as the non-rotated biharmonic mixing. We define a temporary variable Y based on equation (114):

$$Y = \frac{mn}{H_z} \left[\frac{\partial}{\partial \xi} \left(\frac{\nu_4 H_z F^\xi}{n} \right) + \frac{\partial}{\partial \eta} \left(\frac{\nu_4 H_z F^\eta}{m} \right) + \frac{\partial}{\partial s} \left(\frac{\nu_4 H_z F^s}{mn} \right) \right]. \quad (115)$$

We then build up fluxes of Y as in equations (111)–(113). We then apply equation (114) to these Y fluxes to obtain the biharmonic mixing tensors. Again, the value of ν_4 is the square root of that read in so that it can be applied twice.

4.11 Vertical mixing schemes

ROMS contains a variety of methods for setting the vertical viscous and diffusive coefficients. The choices range from simply choosing fixed values to the K-profile Parameterization (KPP) of Large et al. [1994], generic lengthscale (GLS) and Mellor-Yamada turbulence closure schemes. See Large [1998] for a review of surface ocean mixing schemes. Many schemes have a background molecular value which is used when the turbulent processes are assumed to be small (such as in the interior). All assume that there is some $K_m(\zeta, \eta, s)$ such that the vertical turbulent mixing can be applied as:

$$\overline{u'w'} = -K_m \frac{\partial u}{\partial z} \quad \text{and} \quad \overline{v'w'} = -K_m \frac{\partial v}{\partial z} \quad (116)$$

with a similar K_s for temperature, salinity and other tracers. The primed quantities represent perturbations of smaller scale than those resolved by the model while the unprimed u and v are those in the model.

4.11.1 The Large, McWilliams and Doney parameterization

The vertical mixing parameterization introduced by Large et al. [1994] is a versatile first order scheme which has been shown to perform well in open ocean settings. Its design facilitates experimentation with additional or modified representations of specific turbulent processes.

Surface boundary layer The Large, McWilliams and Doney scheme (LMD, also known as KPP) matches separate parameterizations for vertical mixing of the surface boundary layer and the ocean interior. A formulation based on boundary layer similarity theory is applied in the water column above a calculated boundary layer depth h_{sbl} . This parameterization is then matched at the interior with schemes to account for local shear, internal wave and double diffusive mixing effects.

Viscosity and diffusivities at model levels above a calculated surface boundary layer depth (h_{sbl}) are expressed as the product of the length scale h_{sbl} , a turbulent velocity scale w_x and a non-dimensional shape function.

$$\nu_x = h_{sbl} w_x(\sigma) G_x(\sigma) \quad (117)$$

where σ is a non-dimensional coordinate ranging from 0 to 1 indicating depth within the surface boundary layer. The x subscript stands for one of momentum, temperature and salinity.

Surface Boundary layer depth The boundary layer depth h_{sbl} is calculated as the minimum of the Ekman depth, estimated as,

$$h_e = 0.7 u_* / f \quad (118)$$

(where u_* is the friction velocity $u_* = \sqrt{\tau_x^2 + \tau_y^2 / \rho}$), the Monin-Obukhov depth:

$$L = u_*^3 / (\kappa B_f) \quad (119)$$

(where $\kappa = 0.4$ is von Karman's constant and B_f is the surface buoyancy flux), and the shallowest depth at which a critical bulk Richardson number is reached. The critical bulk Richardson number (Ri_c) is typically in the range 0.25–0.5. The bulk Richardson number (Ri_b) is calculated as:

$$Ri_b(z) = \frac{(B_r - B(d))d}{|\vec{V}_r - \vec{V}(d)|^2 + V_t^2(d)} \quad (120)$$

where d is distance down from the surface, B is the buoyancy, B_r is the buoyancy at a near surface reference depth, \vec{V} is the mean horizontal velocity, \vec{V}_r the velocity at the near surface reference depth and V_t is an estimate of the turbulent velocity contribution to velocity shear.

The turbulent velocity shear term in this equation is given by LMD as,

$$V_t^2(d) = \frac{C_v (-\beta_T)^{1/2}}{Ri_c \kappa} (c_s \epsilon)^{-1/2} d N w_s \quad (121)$$

where C_v is the ratio of interior N to N at the entrainment depth, β_T is ratio of entrainment flux to surface buoyancy flux, c_s and ϵ are constants, and w_s is the turbulent velocity scale for scalars. LMD derive (121) based on the expected behavior in the pure convective limit. The empirical rule of convection states that the ratio of the surface buoyancy flux to that at the entrainment depth be a constant. Thus the entrainment flux at the bottom of the boundary layer under such conditions should be independent of the stratification at that depth. Without a turbulent shear term in the denominator of the bulk Richardson number calculation, the estimated boundary layer depth is too shallow and the diffusivity at the entrainment depth is too low to obtain the necessary entrainment flux. Thus by adding a turbulent shear term proportional to the stratification in the denominator, the calculated boundary layer depth will be deeper and will lead to a high enough diffusivity to satisfy the empirical rule of convection.

Turbulent velocity scale To estimate w_x (where x is m - momentum *or* s - any scalar) throughout the boundary layer, surface layer similarity theory is utilized. Following an argument by Troen and Mahrt [1986], Large et al. [1994] estimate the velocity scale as

$$w_x = \frac{\kappa u_*}{\phi_x(\zeta)} \quad (122)$$

where ζ is the surface layer stability parameter defined as z/L . ϕ_x is a non-dimensional flux profile which varies based on the stability of the boundary layer forcing. The stability parameter used in this equation is assumed to vary over the entire depth of the boundary layer in stable and neutral conditions. In unstable conditions it is assumed only to vary through the surface layer which is defined as ϵh_{sbl} (where ϵ is set at 0.10). Beyond this depth ζ is set equal to its value at ϵh_{sbl} .

The flux profiles are expressed as analytical fits to atmospheric surface boundary layer data. In stable conditions they vary linearly with the stability parameter ζ as

$$\phi_x = 1 + 5\zeta \quad (123)$$

In near-neutral unstable conditions common Businger-Dyer forms are used which match with the formulation for stable conditions at $\zeta = 0$. Near neutral conditions are defined as

$$-0.2 \leq \zeta < 0 \quad (124)$$

for momentum and,

$$-1.0 \leq \zeta < 0 \quad (125)$$

for scalars. The non dimensional flux profiles in this regime are,

$$\phi_m = (1 - 16\zeta)^{1/4} \quad (126)$$

$$\phi_s = (1 - 16\zeta)^{1/2} \quad (127)$$

In more unstable conditions ϕ_x is chosen to match the Businger-Dyer forms and with the free convective limit. Here the flux profiles are

$$\phi_m = (1.26 - 8.38\zeta)^{1/3} \quad (128)$$

$$\phi_s = (-28.86 - 98.96\zeta)^{1/3} \quad (129)$$

The shape function The non-dimensional shape function $G(\sigma)$ is a third order polynomial with coefficients chosen to match the interior viscosity at the bottom of the boundary layer and Monin-Obukhov similarity theory approaching the surface. This function is defined as a 3rd order polynomial.

$$G(\sigma) = a_o + a_1\sigma + a_2\sigma^2 + a_3\sigma^3 \quad (130)$$

with the coefficients specified to match surface boundary conditions and to smoothly blend with the interior,

$$a_o = 0 \quad (131)$$

$$a_1 = 1 \quad (132)$$

$$a_2 = -2 + 3\frac{\nu_x(h_{sbl})}{hw_x(1)} + \frac{\partial_x \nu_x(h)}{w_x(1)} + \frac{\nu_x(h)\partial_\sigma w_x(1)}{hw_x^2(1)} \quad (133)$$

$$a_3 = 1 - 2\frac{\nu_x(h_{sbl})}{hw_x(1)} - \frac{\partial_x \nu_x(h)}{w_x(1)} - \frac{\nu_x(h)\partial_\sigma w_x(1)}{hw_x^2(1)} \quad (134)$$

where $\nu_x(h)$ is the viscosity calculated by the interior parameterization at the boundary layer depth.

Countergradient flux term The second term of the LMD scheme's surface boundary layer formulation is the non-local transport term γ which can play a significant role in mixing during surface cooling events. This is a redistribution term included in the tracer equation separate from the diffusion term and is written as

$$-\frac{\partial}{\partial z} K\gamma. \quad (135)$$

LMD base their formulation for non-local scalar transport on a parameterization for pure free convection from Mailhôt and Benoit [1982]. They extend this parameterization to cover any unstable surface forcing conditions to give

$$\gamma_T = C_s \frac{\overline{wT_0} + \overline{wT_R}}{w_T(\sigma)h} \quad (136)$$

for temperature and

$$\gamma_S = C_s \frac{\overline{wS_0}}{w_S(\sigma)h} \quad (137)$$

for salinity (other scalar quantities with surface fluxes can be treated similarly). LMD argue that although there is evidence of non-local transport of momentum as well, the form the term would take is unclear so they simply specify $\gamma_m = 0$.

The interior scheme The interior scheme of Large, McWilliams and Doney estimates the viscosity coefficient by adding the effects of several generating mechanisms: shear mixing, double-diffusive mixing and internal wave generated mixing.

$$\nu_x(d) = \nu_x^s + \nu_x^d + \nu_x^w \quad (138)$$

Shear generated mixing The shear mixing term is calculated using a gradient Richardson number formulation, with viscosity estimated as:

$$\nu_x^s = \begin{cases} \nu_0 & Ri_g < 0, \\ \nu_0 [1 - (Ri_g/Ri_0)^2]^3 & 0 < Ri_g < Ri_0, \\ 0 & Ri_g > Ri_0. \end{cases} \quad (139)$$

where ν_0 is $5.0 \times 10^{-3} m^2/s$, $Ri_0 = 0.7$.

Double diffusive processes The second component of the interior mixing parameterization represents double diffusive mixing. From limited sources of laboratory and field data LMD parameterize the salt fingering case ($R_\rho > 1.0$)

$$\nu_s^d(R_\rho) = \begin{cases} 1 \times 10^{-4} [1 - (\frac{R_\rho - 1}{R_\rho^0 - 1})^2]^3 & \text{for } 1.0 < R_\rho < R_\rho^0 = 1.9, \\ 0 & \text{otherwise.} \end{cases} \quad (140)$$

$$\nu_\theta^d(R_\rho) = 0.7 \nu_s^d \quad (141)$$

For diffusive convection ($0 < R_\rho < 1.0$) LMD suggest several formulations from the literature and choose the one with the most significant impact on mixing [Fedorov, 1988].

$$\nu_\theta^d = (1.5^{-6})(0.909 \exp(4.6 \exp[-0.54(R_\rho^{-1} - 1)]) \quad (142)$$

for temperature. For other scalars,

$$\nu_s^d = \begin{cases} \nu_\theta^d (1.85 - 0.85 R_\rho^{-1}) R_\rho & \text{for } 0.5 \leq R_\rho < 1.0, \\ \nu_\theta^d 0.15 R_\rho & \text{otherwise.} \end{cases} \quad (143)$$

Internal wave generated mixing Internal wave generated mixing serves as the background mixing in the LMD scheme. It is specified as a constant for both scalars and momentum. Eddy diffusivity is estimated based on the data of Ledwell et al. [1993]. While Peters et al. [1988] suggest eddy viscosity should be 7 to 10 times larger than diffusivity for gradient Richardson numbers below approximately 0.7. Therefore LMD use

$$\nu_m^w = 1.0 \times 10^{-4} m^2 s^{-1} \quad (144)$$

$$\nu_s^w = 1.0 \times 10^{-5} m^2 s^{-1} \quad (145)$$

4.11.2 Mellor-Yamada

One of the more popular closure schemes is that of Mellor and Yamada [1974, 1982]. They actually present a hierarchy of closures of increasing complexity. ROMS provides only the ‘‘Level 2.5’’ closure with the Galperin et al. [1988] modifications as described in Allen et al. [1995]. This closure scheme adds two prognostic equations, one for the turbulent kinetic energy ($\frac{1}{2}q^2$) and one for the turbulent kinetic energy times a length scale (q^2l).

The turbulent kinetic energy equation is:

$$\frac{D}{Dt} \left(\frac{q^2}{2} \right) - \frac{\partial}{\partial z} \left[K_q \frac{\partial}{\partial z} \left(\frac{q^2}{2} \right) \right] = P_s + P_b - \xi_d \quad (146)$$

where P_s is the shear production, P_b is the buoyant production and ξ_d is the dissipation of turbulent kinetic energy. These terms are given by

$$P_s = K_m \left[\left(\frac{\partial u}{\partial z} \right)^2 + \left(\frac{\partial v}{\partial z} \right)^2 \right], \quad (147)$$

$$P_b = -K_s N^2, \quad (148)$$

$$\xi_d = \frac{q^3}{B_1 l} \quad (149)$$

where B_1 is a constant. One can also add a traditional horizontal Laplacian or biharmonic diffusion (\mathcal{D}_q) to the turbulent kinetic energy equation. The form of this equation in the model coordinates becomes

$$\begin{aligned} \frac{\partial}{\partial t} \left(\frac{H_z q^2}{mn} \right) + \frac{\partial}{\partial \xi} \left(\frac{H_z u q^2}{n} \right) + \frac{\partial}{\partial \eta} \left(\frac{H_z v q^2}{m} \right) + \frac{\partial}{\partial s} \left(\frac{H_z \Omega q^2}{mn} \right) - \frac{\partial}{\partial s} \left(\frac{K_q}{mn H_z} \frac{\partial q^2}{\partial s} \right) = \\ \frac{2H_z K_m}{mn} \left[\left(\frac{\partial u}{\partial z} \right)^2 + \left(\frac{\partial v}{\partial z} \right)^2 \right] + \frac{2H_z K_s}{mn} N^2 - \frac{2H_z q^3}{mn B_1 l} + \frac{H_z}{mn} \mathcal{D}_q. \end{aligned} \quad (150)$$

The vertical boundary conditions are:

$$\begin{aligned} \text{top } (z = \zeta(x, y, t)) \quad & \frac{H_z \Omega}{mn} = 0 \\ & \frac{K_q}{mn H_z} \frac{\partial q^2}{\partial s} = \frac{B_1^{2/3}}{\rho_o} \left[(\tau_s^\xi)^2 + (\tau_s^\eta)^2 \right] \\ & H_z K_m \left(\frac{\partial u}{\partial z}, \frac{\partial v}{\partial z} \right) = \frac{1}{\rho_o} (\tau_s^\xi, \tau_s^\eta) \\ & H_z K_s N^2 = \frac{Q}{\rho_o c_P} \end{aligned}$$

$$\begin{aligned} \text{and bottom } (z = -h(x, y)) \quad & \frac{H_z \Omega}{mn} = 0 \\ & \frac{K_q}{mn H_z} \frac{\partial q^2}{\partial s} = \frac{B_1^{2/3}}{\rho_o} \left[(\tau_b^\xi)^2 + (\tau_b^\eta)^2 \right] \\ & H_z K_m \left(\frac{\partial u}{\partial z}, \frac{\partial v}{\partial z} \right) = \frac{1}{\rho_o} (\tau_b^\xi, \tau_b^\eta) \\ & H_z K_s N^2 = 0 \end{aligned}$$

There is also an equation for the turbulent length scale l :

$$\frac{D}{Dt} (lq^2) - \frac{\partial}{\partial z} \left[K_l \frac{\partial lq^2}{\partial z} \right] = lE_1(P_s + P_b) - \frac{q^3}{B_1} \tilde{W} \quad (151)$$

where \tilde{W} is the wall proximity function:

$$\tilde{W} = 1 + E_2 \left(\frac{l}{kL} \right)^2 \quad (152)$$

$$L^{-1} = \frac{1}{\zeta - z} + \frac{1}{H + z} \quad (153)$$

The form of this equation in the model coordinates becomes

$$\begin{aligned} \frac{\partial}{\partial t} \left(\frac{H_z q^2 l}{mn} \right) + \frac{\partial}{\partial \xi} \left(\frac{H_z u q^2 l}{n} \right) + \frac{\partial}{\partial \eta} \left(\frac{H_z v q^2 l}{m} \right) + \frac{\partial}{\partial s} \left(\frac{H_z \Omega q^2 l}{mn} \right) - \frac{\partial}{\partial s} \left(\frac{K_q}{mn H_z} \frac{\partial q^2 l}{\partial s} \right) = \\ \frac{H_z}{mn} l E_1 (P_s + P_b) - \frac{H_z q^3}{mn B_1} \tilde{W} + \frac{H_z}{mn} \mathcal{D}_{ql}. \end{aligned} \quad (154)$$

where \mathcal{D}_{ql} is the horizontal diffusion of the quantity $q^2 l$. Both equations (150) and (154) are timestepped much like the model tracer equations, including an implicit solve for the vertical operations and options for centered second and fourth-order advection. They are timestepped with a predictor-corrector scheme in which the predictor step is only computing the advection.

Given these solutions for q and l , the vertical viscosity and diffusivity coefficients are:

$$K_m = qlS_m + K_{m\text{background}} \quad (155)$$

$$K_s = qlS_h + K_{s\text{background}} \quad (156)$$

$$K_q = qlS_q + K_{q\text{background}} \quad (157)$$

and the stability coefficients S_m , S_h and S_q are found by solving

$$S_s [1 - (3A_2 B_2 + 18A_1 A_2) G_h] = A_2 [1 - 6A_1 B_1^{-1}] \quad (158)$$

$$S_m [1 - 9A_1 A_2 G_h] - S_s [G_h (18A_1^2 + 9A_1 A_2) G_h] = A_1 [1 - 3C_1 - 6A_1 B_1^{-1}] \quad (159)$$

$$G_h = \min\left(-\frac{l^2 N^2}{q^2}, 0.028\right). \quad (160)$$

$$S_q = 0.41 S_m \quad (161)$$

The constants are set to $(A_1, A_2, B_1, B_2, C_1, E_1, E_2) = (0.92, 0.74, 16.6, 10.1, 0.08, 1.8, 1.33)$. The quantities q^2 and $q^2 l$ are both constrained to be no smaller than 10^{-8} while l is set to be no larger than $0.53q/N$.

4.11.3 Generic length scale

[Umlauf and Burchard, 2003] have come up with a generic two-equation turbulence closure scheme which can be tuned to behave like several of the traditional schemes, including that of Mellor and Yamada §(4.11.2). This is known as the Generic Length Scale, or GLS vertical mixing scheme and was introduced to ROMS in [Warner et al., 2005]. Its parameters are set in the ROMS input file.

The first of Warner et al.'s equations is the same as (146) with $k = 1/2q^2$. Their dissipation is given by:

$$\epsilon = (c_\mu^0)^{3+p/n} k^{3/2+m/n} \psi^{-1/n} \quad (162)$$

where ψ is a generic parameter that is used to establish the turbulence length scale. The equation for ψ is:

$$\frac{D\psi}{Dt} = \frac{\partial}{\partial z} \left(K_\psi \frac{\partial \psi}{\partial z} \right) + \frac{\psi}{k} (c_1 P_s + c_3 P_b - c_2 \epsilon F_{\text{wall}}) \quad (163)$$

Coefficients c_1 and c_2 are chosen to be consistent with observations of decaying homogeneous, isotropic turbulence. The parameter c_3 has differing values for stable (c_3^+) and unstable (c_3^-) stratification. Also,

$$\psi = (c_\mu^0)^p k^m l^n \quad (164)$$

$$l = (c_\mu^0)^3 k^{3/2} \epsilon^{-1} \quad (165)$$

Depending on the choice of the various parameters, these two equations can be made to solve a variety of traditional two-equation turbulence closure models. The list of parameters is shown in table 4.11.3 and is also given inside the comments section of the ROMS input file.

	$k - kl$ $\psi = k^1 l^1$	$k - \epsilon$ $\psi = (c_\mu^0)^3 k^{3/2} l^{-1}$	$k - \omega$ $\psi = (c_\mu^0)^{-1} k^{1/2} l^{-1}$	gen $\psi = (c_\mu^0)^2 k^1 l^{-2/3}$
p	0.0	3.0	-1.0	2.0
m	1.0	1.5	0.5	1.0
n	1.0	-1.0	-1.0	-0.67
$\sigma_k = \frac{K_M}{K_k}$	1.96	1.0	2.0	0.8
$\sigma_\psi = \frac{K_M}{K_\psi}$	1.96	1.3	2.0	1.07
c_1	0.9	1.44	0.555	1.0
c_2	0.52	1.92	0.833	1.22
c_3^-	2.5	-0.4	-0.6	0.1
c_3^+	1.0	1.0	1.0	1.0
k_{min}	5.0e-6	7.6e-6	7.6e-6	1.0e-8
ψ_{min}	5.0e-6	1.0e-12	1.0e-12	1.0e-8
c_μ^0	0.5544	0.5477	0.5477	0.5544

Table 4: Generic length scale parameters. Note that Mellor-Yamada 2.5 is an example of a $k - kl$ scheme.

4.12 Timestepping vertical viscosity and diffusion

The \mathcal{D}_u , \mathcal{D}_v , and \mathcal{D}_C terms in equations (18)–(20) represent both horizontal and vertical mixing processes. The horizontal options were covered in §4.10. The model has several options for computing the vertical coefficients; these are described in §4.11. The vertical viscosity and diffusion terms have the form:

$$\frac{\partial}{\partial \sigma} \left(\frac{K}{H_z mn} \frac{\partial \phi}{\partial \sigma} \right) \quad (166)$$

where ϕ represents one of u , v , or C , and K is the corresponding vertical viscous or diffusive coefficient. This is timestepped using a semi-implicit Crank-Nicholson scheme with a weighting of 0.5 on the old timestep and 0.5 on the new timestep. Specifically, the equation of motion for ϕ can be written as:

$$\frac{\partial(H_z \phi)}{\partial t} = mn R_\phi + \frac{\partial}{\partial \sigma} \left(\frac{K}{H_z} \frac{\partial \phi}{\partial \sigma} \right) \quad (167)$$

where R_ϕ represents all of the forcing terms other than the vertical viscosity or diffusion. Since we want the diffusion term to be evaluated partly at the current timestep n and partly at the next

timestep $n + 1$, we introduce the parameter λ and rewrite equation (167) as:

$$\frac{\partial(H_z\phi)}{\partial t} = mnR_\phi + (1 - \lambda)\frac{\partial}{\partial\sigma}\left(\frac{K}{H_z}\frac{\partial\phi^n}{\partial\sigma}\right) + \lambda\frac{\partial}{\partial\sigma}\left(\frac{K}{H_z}\frac{\partial\phi^{n+1}}{\partial\sigma}\right). \quad (168)$$

The discrete form of equation (168) is:

$$\begin{aligned} \frac{H_{z_k}^{n+1}\phi_k^{n+1} - H_{z_k}^n\phi_k^n}{\Delta t} = mnR_\phi + \frac{(1 - \lambda)}{\Delta\sigma^2} \left[\frac{K_k}{H_{z_k}}(\phi_{k+1}^n - \phi_k^n) - \frac{K_{k-1}}{H_{z_{k-1}}}(\phi_k^n - \phi_{k-1}^n) \right] \\ + \frac{\lambda}{\Delta\sigma^2} \left[\frac{K_k}{H_{z_k}}(\phi_{k+1}^{n+1} - \phi_k^{n+1}) - \frac{K_{k-1}}{H_{z_{k-1}}}(\phi_k^{n+1} - \phi_{k-1}^{n+1}) \right] \end{aligned} \quad (169)$$

where k is used as the vertical level index. This can be reorganized so that all the terms involving ϕ^{n+1} are on the left and all the other terms are on the right. The equation for ϕ_k^{n+1} will contain terms involving the neighbors above and below (ϕ_{k+1}^{n+1} and ϕ_{k-1}^{n+1}) which leads to a set of coupled equations with boundary conditions for the top and bottom. The general form of these equations is:

$$A_k\phi_{k+1}^{n+1} + B_k\phi_k^{n+1} + C_k\phi_{k-1}^{n+1} = D_k \quad (170)$$

where the boundary conditions are written into the coefficients for the end points. In this case the coefficients become:

$$A(1) = 0 \quad (171)$$

$$A(2 : \mathbf{N}) = -\frac{\lambda\Delta t K_{k-1}}{\Delta\sigma^2 H_{z_{k-1}}^{n+1}} \quad (172)$$

$$B(1) = H_{z_1}^{n+1} + \frac{\lambda\Delta t K_1}{\Delta\sigma^2 H_{z_1}^{n+1}} \quad (173)$$

$$B(2 : \mathbf{Nm}) = H_{z_k}^{n+1} + \frac{\lambda\Delta t K_k}{\Delta\sigma^2 H_{z_k}^{n+1}} + \frac{\lambda\Delta t K_{k-1}}{\Delta\sigma^2 H_{z_{k-1}}^{n+1}} \quad (174)$$

$$B(\mathbf{N}) = H_{z_{\mathbf{N}}}^{n+1} + \frac{\lambda\Delta t K_{\mathbf{Nm}}}{\Delta\sigma^2 H_{z_{\mathbf{Nm}}}^{n+1}} \quad (175)$$

$$C(1 : \mathbf{Nm}) = -\frac{\lambda\Delta t K_k}{\Delta\sigma^2 H_{z_k}^{n+1}} \quad (176)$$

$$C(\mathbf{N}) = 0 \quad (177)$$

$$D(1) = H_{z_1}^n\phi_1^n + \Delta t mnR_{\phi_1} + \frac{\Delta t(1 - \lambda) K_1}{\Delta\sigma^2} \frac{1}{H_{z_1}^n}(\phi_2^n - \phi_1^n) - \frac{\Delta t}{\Delta\sigma}\tau_b \quad (178)$$

$$D(2 : \mathbf{Nm}) = H_{z_k}^n\phi_k^n + \Delta t mnR_{\phi_k} + \quad (179)$$

$$\frac{\Delta t(1 - \lambda)}{\Delta\sigma^2} \left[\frac{K_k}{H_{z_k}^n}(\phi_{k+1}^n - \phi_k^n) - \frac{K_{k-1}}{H_{z_{k-1}}^n}(\phi_k^n - \phi_{k-1}^n) \right] \quad (180)$$

$$D(\mathbf{N}) = H_{z_{\mathbf{N}}}^n\phi_{\mathbf{N}}^n + \Delta t mnR_{\phi_{\mathbf{N}}} - \frac{\Delta t(1 - \lambda) K_{\mathbf{Nm}}}{\Delta\sigma^2} \frac{1}{H_{z_{\mathbf{Nm}}}^n}(\phi_{\mathbf{N}}^n - \phi_{\mathbf{Nm}}^n) + \frac{\Delta t}{\Delta\sigma}\tau_s \quad (181)$$

This is a standard tridiagonal system for which the solution procedure can be found in any standard reference, such as Press et al. [1986].

4.13 Lateral Boundary Conditions

ROMS comes with a variety of boundary conditions, including open, closed, and periodic. See Marchesiello et al. [2001] for a more thorough exploration of the options. Some options require a value for the boundary points from either an included analytic expression (§6.5) or from an external NetCDF file. Here, ϕ^{ext} represents the exterior value of a quantity ϕ .

4.13.1 Gradient boundary condition

This boundary condition is extremely simple and consists of setting the gradient of a field to zero at the edge. The outside value is set equal to the closest interior value.

4.13.2 Wall boundary condition

ROMS now assumes a wall condition if no other boundary condition is chosen. This is a zero gradient condition for tracers and the surface elevation and zero flow for the normal velocity. For tangential velocities, the wall is treated as either no-slip or free-slip, depending on the value of `gamma2` chosen by the user.

4.13.3 Clamped boundary condition

Almost as simple is setting the boundary value to a known exterior value.

$$\phi = \phi^{\text{ext}} \quad (182)$$

4.13.4 Flather boundary condition

For the normal component of the barotropic velocity, one option is to radiate out deviations from exterior values at the speed of the external gravity waves [Flather, 1976]:

$$\bar{u} = \bar{u}^{\text{ext}} - \sqrt{\frac{g}{D}} (\zeta - \zeta^{\text{ext}}) \quad (183)$$

The exterior values are often used to provide tidal boundary conditions to the barotropic mode. However, there are times when only the tidal elevation is known. A reduced physics option is available for estimating \bar{u}^{ext} in that case.

4.13.5 Shchepetkin boundary condition

Similar to Flather in purpose is the Shchepetkin boundary condition [Mason et al., 2010]. As in the Flather condition, it will use a reduced physics option if \bar{u}^{ext} is not available.

4.13.6 Chapman boundary condition

The condition for surface elevation to be used with either the Flather or Shchepetkin momentum boundary is that of [Chapman, 1985], assuming all outgoing signals leave at the shallow-water wave speed of \sqrt{gD} .

$$\frac{\partial \zeta}{\partial t} = \pm \sqrt{gD} \frac{\partial \zeta}{\partial \xi} \quad (184)$$

The time derivative here can be handled either explicitly or implicitly in ROMS, depending on how the term $\frac{\partial \zeta}{\partial \xi}$ is evaluated.

4.13.7 Radiation boundary condition

In realistic domains, open boundary conditions can be extremely difficult to get right. There are situations in which incoming flow and outgoing flow happen along the same boundary or even at different depths at the same horizontal location. Orlanski [1976] proposed a radiation scheme in which a local normal phase velocity is computed and used to radiate things out (if it is indeed going out). This works well for a wave propagating normal to the boundary, but has problems when waves approach the boundary at an angle. Raymond and Kuo [1984] have modified the scheme to account

for propagation in all three directions. In ROMS, only the two horizontal directions are accounted for (with the recommended `RADIATION_2D` option):

$$\frac{\partial \phi}{\partial t} = - \left(\phi_\xi \frac{\partial \phi}{\partial \xi} + \phi_\eta \frac{\partial \phi}{\partial \eta} \right) \quad (185)$$

where

$$\phi_\xi = \frac{F \frac{\partial \phi}{\partial \xi}}{\left(\frac{\partial \phi}{\partial \xi} \right)^2 + \left(\frac{\partial \phi}{\partial \eta} \right)^2} \quad (186)$$

$$\phi_\eta = \frac{F \frac{\partial \phi}{\partial \eta}}{\left(\frac{\partial \phi}{\partial \xi} \right)^2 + \left(\frac{\partial \phi}{\partial \eta} \right)^2} \quad (187)$$

$$F = - \frac{\partial \phi}{\partial t} \quad (188)$$

These terms are evaluated at the closest interior point in a manner consistent with the time stepping scheme used. The phase velocities are limited so that the local Courant-Friedrichs-Lewy (CFL) condition is satisfied. They are then applied to the boundary point using equation (185), again using a consistent time stepping scheme. Raymond and Kuo give the form used for centered differencing and a leapfrog time step while ROMS uses one-sided differences.

The radiation approach is appropriate for waves leaving the domain. A check is made to see which way the phase velocity is headed. If it is entering the domain, a zero gradient condition is applied unless an additional nudging option is also specified as described below.

4.13.8 Mixed radiation-nudging boundary condition

As described in [Marchesiello et al., 2001], ROMS has an option for providing radiation conditions on outflow and nudging to a known exterior value on inflow. This is implemented as a variation on the radiation condition, requiring two timescales: the inflow nudging timescale and the outflow nudging timescale. These timescales are provided in the input to ROMS (§7.1.12).

5 Ice Model Formulation

The sea-ice component of ROMS is a combination of the elastic-viscous-plastic (EVP) rheology [Hunke and Dukowicz, 1997, Hunke, 2001] and simple one-layer ice and snow thermodynamics with a molecular sublayer under the ice [Mellor and Kantha, 1989]. It is tightly coupled, having the same grid (Arakawa-C) and timestep as the ocean and sharing the same parallel coding structure for use with MPI or OpenMP [Budgell, 2005].

5.1 Dynamics

The momentum equations describe the change in ice/snow velocity due to the combined effects of the Coriolis force, surface ocean tilt, air and water stress, and internal ice stress: (189) and (190):

$$\frac{d}{dt}(A\rho_i h_i u) = A\rho_i h_i f v - A\rho_i h_i g \frac{\partial \zeta_w}{\partial x} + A(\tau_a^x + \tau_w^x) + \mathcal{F}_x \quad (189)$$

$$\frac{d}{dt}(A\rho_i h_i v) = -A\rho_i h_i f u - A\rho_i h_i g \frac{\partial \zeta_w}{\partial y} + A(\tau_a^y + \tau_w^y) + \mathcal{F}_y. \quad (190)$$

In this model, we neglect the nonlinear advection terms as well as the curvilinear terms in the internal ice stress. Nonlinear formulae are used for both the ocean-ice and air-ice surface stress:

$$\vec{\tau}_a = \rho_a C_a |\vec{V}_{10}| \vec{V}_{10} \quad (191)$$

$$C_a = \frac{1}{2} C_d [1 - \cos(2\pi \min(h_i + .1, .5))] \quad (192)$$

$$\vec{\tau}_w = \rho_w C_w |\vec{v}_w - \vec{v}| (\vec{v}_w - \vec{v}). \quad (193)$$

The force due to the internal ice stress is given by the divergence of the stress tensor σ . The rheology is given by the stress-strain relation of the medium. We would like to emulate the viscous-plastic rheology of Hibler [1979]:

$$\sigma_{ij} = 2\eta \dot{\epsilon}_{ij} + (\zeta - \eta) \dot{\epsilon}_{kk} \delta_{ij} - \frac{P}{2} \delta_{ij} \quad (194)$$

$$\dot{\epsilon}_{ij} \equiv \frac{1}{2} \left(\frac{\partial u_i}{\partial x_j} + \frac{\partial u_j}{\partial x_i} \right) \quad (195)$$

where the nonlinear viscosities are given by:

$$\zeta = \frac{P}{2 [(\epsilon_{11}^2 + \epsilon_{22}^2)(1 + 1/e^2) + 4e^{-2}\epsilon_{12}^2 + 2\epsilon_{11}\epsilon_{22}(1 - 1/e^2)]^{1/2}} \quad (196)$$

$$\eta = \frac{\zeta}{e^2}. \quad (197)$$

Hibler's ice strength is given by:

$$P = P^* A h_i e^{-C(1-A)} \quad (198)$$

while Overland and Pease [1988] advocate a nonlinear strength:

$$P = P^* A h_i^2 e^{-C(1-A)} \quad (199)$$

in which P^* now depends on the grid spacing. Both options are available in ROMS.

We would also like to have an explicit model that can be solved efficiently on parallel computers. The EVP rheology has a tunable coefficient E (the Young's modulus) which can be chosen to make the elastic term small compared to the other terms. We rearrange the VP rheology:

$$\frac{1}{2\eta} \sigma_{ij} + \frac{\eta - \zeta}{4\eta\zeta} \sigma_{kk} \delta_{ij} + \frac{P}{4\zeta} \delta_{ij} = \dot{\epsilon}_{ij} \quad (200)$$

then add the elastic term:

$$\frac{1}{E} \frac{\partial \sigma_{ij}}{\partial t} + \frac{1}{2\eta} \sigma_{ij} + \frac{\eta - \zeta}{4\eta\zeta} \sigma_{kk} \delta_{ij} + \frac{P}{4\zeta} \delta_{ij} = \dot{\epsilon}_{ij} \quad (201)$$

Much like the ocean model, the ice model has a split timestep. The internal ice stress term is updated on a shorter timestep so as to allow the elastic wave velocity to be resolved.

Once the new ice velocities are computed, the ice tracers can be advected using the MPDATA scheme [Smolarkiewicz and Grabowski, 1990]. The tracers in this case are the ice thickness, ice concentration, snow thickness, internal ice temperature, and surface melt ponds. The continuity equations describing the evolution of these parameters (equations (202)–(204)) also include thermodynamic terms (S_h , S_s and S_A), which will be described in §5.2:

$$\frac{\partial Ah_i}{\partial t} = -\frac{\partial(uAh_i)}{\partial x} - \frac{\partial(vAh_i)}{\partial y} + S_h + \mathcal{D}_h \quad (202)$$

$$\frac{\partial Ah_s}{\partial t} = -\frac{\partial(uAh_s)}{\partial x} - \frac{\partial(vAh_s)}{\partial y} + S_s + \mathcal{D}_s \quad (203)$$

$$\frac{\partial A}{\partial t} = -\frac{\partial(uA)}{\partial x} - \frac{\partial(vA)}{\partial y} + S_A + \mathcal{D}_A \quad 0 \leq A \leq 1. \quad (204)$$

The first two equations represent the conservation of ice and snow. Equation (204) is discussed in some detail in Mellor and Kantha [1989], but represents the advection of ice blocks in which no ridging occurs as long as there is any open water. The symbols used in these equations along with the values for the constants are listed in Table 5.

Note that Hibler’s h_I variable is equivalent to our Ah_i combination - his h_I is the average thickness over the whole gridbox while our h_i is the average thickness over the ice-covered fraction of the gridbox.

5.1.1 Landfast ice

The Arctic ocean has many shallow shelves, on which landfast ice can form every winter. The model as described thus far has no way to reproduce the landfast ice, but Lemieux et al. [2015] describes a landfast ice parameterization. Basal stress terms τ_b are added to equations (189) and (190) representing a bottom drag applied to the deepest ice keels. Included is a parameterization of the ice thickness distribution so that even a single ice-category model can use the landfast ice option. Figure 7 shows a cartoon of an ice floe with a keel.

Introducing the tunable parameters k_1 and k_2 , plus the expression $h_c = Ah_w/k_1$, the u -component of the basal stress due to the dragging of ice keels is computed as:

$$\tau_{bu} = \begin{cases} 0 & \text{if } h_w \geq h_c, \\ k_2 \left(\frac{u}{|\bar{v}| + u_0} \right) (h_w - h_c) \exp^{-C_b(1-A)} & \text{if } h_w < h_c. \end{cases} \quad (205)$$

where h_w is the water depth. The expression for the v -component is similar.

5.2 Thermodynamics

The thermodynamics is based on calculating how much ice grows and melts on each of the surface, bottom, and sides of the ice floes, as well as frazil ice formation [Mellor and Kantha, 1989]. Once the ice tracers are advected, the ice concentration and thickness are timestepped according to the terms on the right.

Variable	Value	Description
$A(x, y, t)$		ice concentration
C_a		nonlinear air drag coefficient
C_d	2.2×10^{-3}	air drag coefficient
C_w	10×10^{-3}	water drag coefficient
$(\mathcal{D}_h, \mathcal{D}_s, \mathcal{D}_A)$		diffusion terms
δ_{ij}		Kronecker delta function
E		Young's modulus
e	2	eccentricity of the elliptical yield curve
$\epsilon_{ij}(x, y, t)$		strain rate tensor
$\eta(x, y, t)$		nonlinear shear viscosity
$f(x, y)$		Coriolis parameter
$(\mathcal{F}_x, \mathcal{F}_y)$		internal ice stress
g	9.8 m s^{-2}	acceleration of gravity
H		Heaviside function
$h_i(x, y, t)$		ice thickness of ice-covered fraction
h_o	1 m	ice cutoff thickness
$h_s(x, y, t)$		snow thickness on ice-covered fraction
$M(x, y, t)$		ice mass (density times thickness)
$P(x, y, t)$		ice pressure or strength
(P^*, C)	$(2.75 \times 10^4, 20)$	ice strength parameters
(S_h, S_s, S_A)		thermodynamic terms
$\sigma_{ij}(x, y, t)$		stress tensor
$\vec{\tau}_a$		air stress
$\vec{\tau}_w$		water stress
(u, v)		the (x, y) components of ice velocity \vec{v}
$(\vec{V}_{10}, \vec{v}_w)$		10 meter air and surface water velocities
(ρ_a, ρ_w)	$(1.3 \text{ kg m}^{-3}, 1025 \text{ kg m}^{-3})$	air and water densities
$\zeta(x, y, t)$		nonlinear bulk viscosity
$\zeta_w(x, y, t)$		height of the ocean surface

Table 5: Variables used in the ice momentum equations.

Variable	Value	Description
h_w		water depth
h_{rt}		ridge height above level ice
h_{rb}		draft of keels below level ice bottom
h_d		draft of ice below sea surface
l_i		length of ice floe within grid cell
Δx		x -dimension of grid cell
β	$O(0.01)$	ridged fraction of floe
k_1	8.0	tunable parameter
k_2	15.0	tunable parameter
u_0	5.0×10^{-5}	small velocity
C_b	20	ice strength parameter

Table 6: Variables used in the landfast ice parameterization.

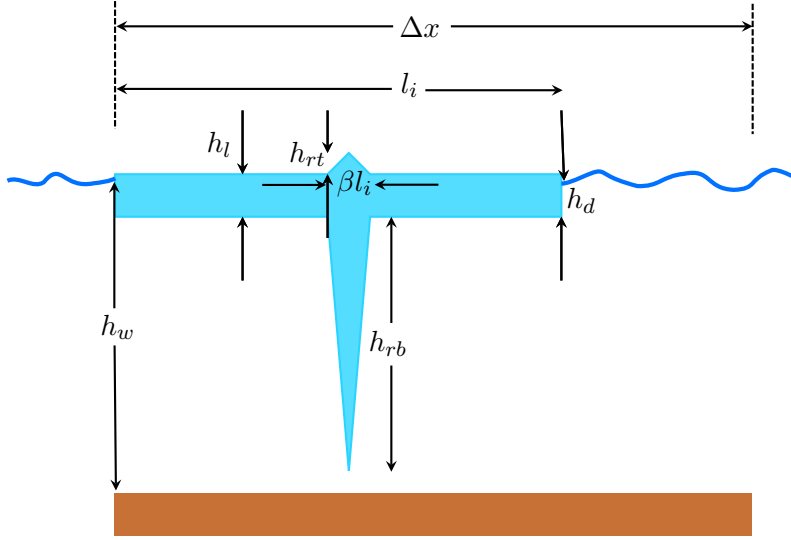

Figure 7: Cartoon of an ice floe with a deep keel.

Equations (202) and (204) become:

$$\frac{DAh_i}{Dt} = \frac{\rho_o}{\rho_i} [A(W_{io} - W_{ai}) + (1 - A)W_{ao} + W_{fr}] \quad (206)$$

$$\frac{DA}{Dt} = \frac{\rho_o}{\rho_i h_i} [\Phi(1 - A)W_{ao} + (1 - A)W_{fr}] \quad 0 \leq A \leq 1. \quad (207)$$

The term Ah_i is the “effective thickness”, a measure of the ice volume. Its evolution equation is simply quantifying the change in the amount of ice. The ice concentration equation is more interesting in that it provides the partitioning between ice melt/growth on the sides vs. on the top and bottom. The parameter Φ controls this and has differing values for ice melt and retreat. In principle, most of the ice growth is assumed to happen at the base of the ice while rather more of the melt happens on the sides of the ice due to warming of the water in the leads.

The heat fluxes through the ice are based on a simple one layer Semtner [1976] type model with snow on top. The temperature is assumed to be linear within the snow and within the ice. The ice contains brine pockets for a total ice salinity of 3.2 or the surface salinity, whichever is less. The surface ocean temperature and salinity is half a dz below the surface. The water right below the surface is assumed to be at the freezing temperature; a logarithmic boundary layer is computed having the temperature and salinity matched at freezing.

Here, the W variables are the freeze or melt rates as shown in Fig. 8 and Table 7. The frazil ice growth W_{fr} will be discussed further in §5.2.2—note that it contributes to changes in A as well as to changes in h_i . The other term that contributes to A is W_{ao} . This term includes a factor Φ which Mellor and Kantha set to different values depending on whether ice is melting or freezing:

$$\Phi = 4.0 \quad W_{ao} \geq 0 \quad (208)$$

$$\Phi = 0.5 \quad W_{ao} < 0 \quad (209)$$

Similar to Eq. (206) is the snow equation:

$$\frac{DAh_s}{Dt} = [A(W_s - W_{sm})] \quad (210)$$

where W_s and W_{sm} are the snowfall and snow melt rates, respectively, in units of equivalent water. Currently all snow and ice melt ends up in W_{ro} , though melt ponds could be added with some effort.

Variable	Value	Description
α_w	0.10	shortwave albedo of water
α_i	0.60, 0.65	shortwave albedo of wet, dry ice
α_s	0.72, 0.85	shortwave albedo of wet snow
C_k		snow correction factor
C_{pi}	2093 J kg ⁻¹ K ⁻¹	specific heat of ice
C_{po}	3990 J kg ⁻¹ K ⁻¹	specific heat of water
ϵ_w	0.97	longwave emissivity of water
ϵ_i	0.97	longwave emissivity of ice
ϵ_s	0.99	longwave emissivity of snow
$E(T, r)$		enthalpy of the ice/brine system
$F_T \uparrow$		heat flux from the ocean into the ice
h^*		test for thick snow pushing ice surface under water
$H \downarrow$		sensible heat
I_o	part of $(1 - \alpha_i)SW \downarrow$	shortwave radiation entering ice
i_w		fraction of the solar heating transmitted through a lead into the water below
k_i	2.04 W m ⁻¹ K ⁻¹	thermal conductivity of ice
k_s	0.31 W m ⁻¹ K ⁻¹	thermal conductivity of snow
L_i	302 MJ m ⁻³	latent heat of fusion of ice
L_s	110 MJ m ⁻³	latent heat of fusion of snow
$LE \downarrow$		latent heat
$LW \downarrow$		incoming longwave radiation
m	-0.054°C	coefficient in linear $T_f(S) = mS$ equation
Φ		contribution to A equation from freezing water
Q_{ai}		heat flux out of the snow/ice surface
Q_{ao}		heat flux out of the ocean surface
Q_{i2}		heat flux up out of the ice
Q_{io}		heat flux up into the ice
Q_s		heat flux up through the snow
r	$0 \leq r \leq 0.2$	brine fraction in ice
ρ_i	910 m ³ /kg	density of ice
S_i	3.2	salinity of the ice
$SW \downarrow$		incoming shortwave radiation
σ	5.67×10^{-8} W m ⁻² K ⁻⁴	Stefan-Boltzmann constant
T_0		temperature of the bottom of the ice
T_1		temperature of the interior of the ice
T_2		temperature at the upper surface of the ice
T_3		temperature at the upper surface of the snow
T_f		freezing temperature
T_{melt_i}	mS_i	melting temperature of ice
T_{melt_s}	0° C	melting temperature of snow
W_{ai}		melt rate on the upper ice/snow surface
W_{ao}		freeze rate at the air/water interface
W_{fr}		rate of frazil ice growth
W_{io}		freeze rate at the ice/water interface
W_{ro}		rate of run-off of surface melt water
W_s		snowfall rate
W_{sm}		snow melt rate

Table 7: Variables used in the ice thermodynamics

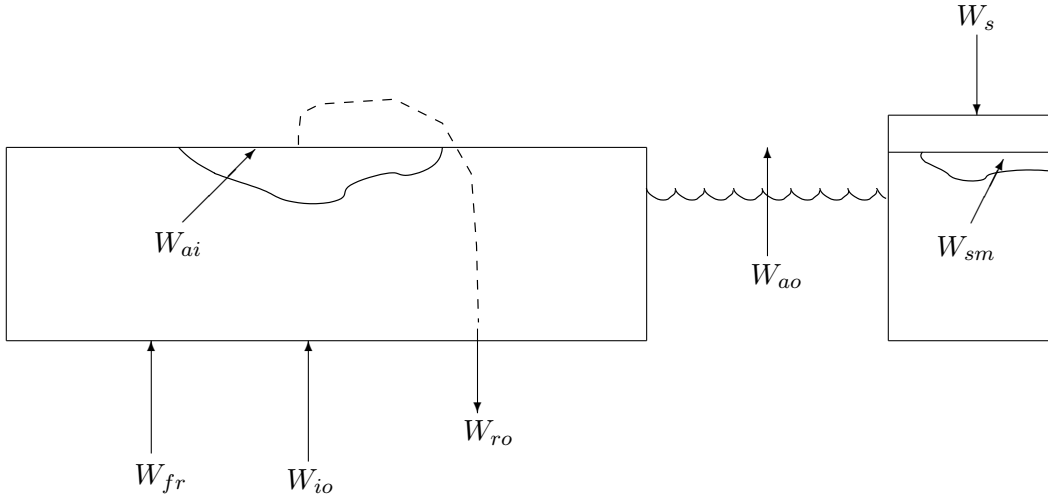

Figure 8: Diagram of the different locations where ice melting and freezing can occur.

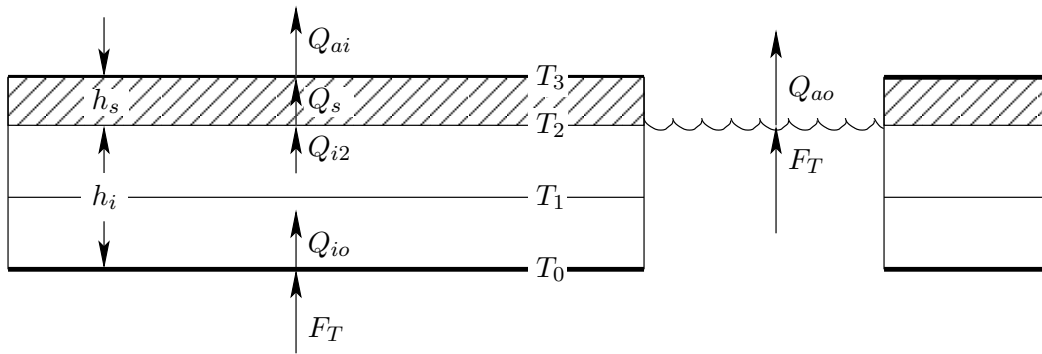

Figure 9: Diagram of internal ice temperatures and fluxes. The hashed layer is the snow.

Figure 9 shows the locations of the ice and snow temperatures and the heat fluxes. The temperature profile is assumed to be linear between adjacent temperature points. The interior of the ice contains “brine pockets”, leading to a prognostic equation for the temperature T_1 .

The surface flux to the air is:

$$Q_{ai} = -H\downarrow - LE\downarrow - \epsilon_s LW\downarrow - (1 - \alpha_s)SW\downarrow + \epsilon_s \sigma (T_3 + 273)^4 \quad (211)$$

The incoming shortwave and longwave radiations are assumed to come from an atmospheric model. The formulae for sensible heat, latent heat, and outgoing longwave radiation are the same as in Parkinson and Washington [1979] and are shown in Appendix E. The sensible heat is a function of T_3 , as is the heat flux through the snow Q_s . Setting $Q_{ai} = Q_s$, we can solve for T_3 by setting $T_3^{n+1} = T_3^n + \Delta T_3$ and linearizing in ΔT_3 . As in Parkinson and Washington, if T_3 is found to be above the melting temperature, it is set to T_{melt} and the extra energy goes into melting the snow or ice:

$$W_{ai} = \frac{Q_{ai} - Q_{i2}}{\rho_o L_3} \quad (212)$$

$$L_3 \equiv [E(T_3, 1) - E(T_1, r)] \quad (213)$$

Note that $L_3 = (1 - r)L_i$ plus a small sensible heat correction.

If there is no snow, there is an option to allow some of the incoming shortwave radiation ($I_o = 0.17(1 - \alpha_i)SW\downarrow$) to enter the ice and contribute to heating up the ice rather than to melting the surface ice [Maykut and Untersteiner, 1971]. It essentially reduces Q_{i2} by the amount I_o in both equations (212) and (221).

Inside the ice there are brine pockets in which there is salt water at the *in situ* freezing temperature. It is assumed that the ice has a uniform overall salinity of S_i and that the freezing temperature is a linear function of salinity. The brine fraction r is given by

$$r = \frac{S_i m}{T_1}$$

The enthalpy of the combined ice/brine system is given by

$$E(T, r) = r(L_i + C_{po}T) + (1 - r)C_{pi}T \quad (214)$$

Substituting in for r and differentiating gives:

$$\frac{\partial E}{\partial T_1} = -\frac{S_i m L_i}{T_1^2} + C_{pi} \quad (215)$$

Inside the snow, we have

$$Q_s = \frac{k_s}{h_s}(T_2 - T_3) \quad (216)$$

The heat conduction in the upper part of the ice layer is

$$Q_{I2} = \frac{2k_i}{h_i}(T_1 - T_2) \quad (217)$$

These can be set equal to each other to solve for T_2

$$T_2 = \frac{T_3 + C_k T_1}{1 + C_k} \quad (218)$$

where

$$C_k \equiv \frac{2k_i h_s}{h_i k_s}.$$

Substituting into (217), we get:

$$Q_s = Q_{I2} = \frac{2k_i}{h_i} \frac{(T_1 - T_3)}{(1 + C_k)} \quad (219)$$

Note that in the absence of snow, C_k becomes zero and we recover the formula for the no-snow case in which $T_3 = T_2$.

At the bottom of the ice, we have

$$Q_{I0} = \frac{2k_i}{h_i}(T_0 - T_1) \quad (220)$$

The difference between Q_{I0} and Q_{I2} goes into the enthalpy of the ice:

$$\rho_i h_i \left[\frac{\partial E}{\partial t} + \vec{v} \cdot \nabla E \right] = Q_{I0} - Q_{I2} \quad (221)$$

We can use the chain rule to obtain an equation for timestepping T_1 :

$$\rho_i h_i \frac{\partial E}{\partial T_1} \left[\frac{\partial T_1}{\partial t} + \vec{v} \cdot \nabla T_1 \right] = Q_{I0} - Q_{I2} \quad (222)$$

Variable	Value	Definition
b	3.14	factor
\dot{E}		evaporation
k	0.4	von Karman's constant
K_m		vertical viscosity of seawater
ν	$1.8 \times 10^{-6} m^2 s^{-1}$	kinematic viscosity of seawater
\dot{P}		precipitation
Pr	13.0	molecular Prandtl number
Pr_t	0.85	turbulent Prandtl number
S		internal ocean salinity
S_0		surface salinity
Sc	2432.0	molecular Schmidt number
τ_{io}		stress on the ocean from the ice
τ_{ao}		stress on the ocean from the wind
T		internal ocean temperature
T_0		surface temperature
u_τ		friction velocity $ \tau_{io} ^{1/2} \rho_o^{-1/2}$
z_0		roughness parameter

Table 8: Ocean surface variables

where

$$\begin{aligned}
Q_{I0} - Q_{I2} &= \frac{2k_i}{h_i} \left[(T_0 - T_1) - \frac{(T_1 - T_3)}{1 + C_k} \right] \\
&= \frac{2k_i}{h_i} \left[(T_0 + \frac{T_3 - (2 + C_k)T_1}{1 + C_k}) \right]
\end{aligned}$$

When the snow gets thick enough, it pushes the ice down to the point where seawater floods onto the ice where it can possibly refreeze. The condition for such thick snow is $h^* > 0$, where

$$h^* = h_s - \frac{(\rho_w - \rho_i)}{\rho_s} h_i \quad (223)$$

An optional model process is to convert the thick snow into ice directly:

$$h_s = h_s - \frac{\rho_i h^*}{\rho_w} \quad (224)$$

$$h_i = h_i + \frac{\rho_s h^*}{\rho_w} \quad (225)$$

5.2.1 Ocean surface boundary conditions

The ocean receives surface stresses from both the atmosphere and the ice, according to the ice concentration:

$$K_m \frac{\partial u_w}{\partial z} = \frac{A}{\rho_o} \tau_{io}^x + \frac{1 - A}{\rho_o} \tau_{ao}^x \quad (226)$$

$$K_m \frac{\partial v_w}{\partial z} = \frac{A}{\rho_o} \tau_{io}^y + \frac{1 - A}{\rho_o} \tau_{ao}^y \quad (227)$$

where the relevant variables are in Table 8.

The surface ocean is assumed to be at the freezing temperature for the surface salinity ($T_0 = mS_0$) in the presense of ice. We also have T and S at the uppermost computed ocean point

$\frac{1}{2}dz$ below the surface. In order to solve for T_0 and S_0 , we assume a [Yaglom and Kader, 1974] logarithmic boundary layer. The upper ocean heat flux is:

$$\frac{F_T}{\rho_o C_{po}} = -C_{Tz}(T_0 - T) \quad z \rightarrow 0 \quad (228)$$

where

$$C_{Tz} = \frac{u_\tau}{P_{rt}k^{-1} \ln(-z/z_0) + B_T} \quad (229)$$

$$B_T = b \left(\frac{z_0 u_\tau}{\nu} \right)^{1/2} P_r^{2/3} \quad (230)$$

Likewise, we have the following equation for the surface salt flux:

$$F_S = -C_{S_z}(S_0 - S) \quad z \rightarrow 0 \quad (231)$$

where

$$C_{S_z} = \frac{u_\tau}{P_{rt}k^{-1} \ln(-z/z_0) + B_S} \quad (232)$$

$$B_S = b \left(\frac{z_0 u_\tau}{\nu} \right)^{1/2} S_c^{2/3} \quad (233)$$

The ocean model receives the following heat and salt fluxes:

$$F_T = A Q_{io} + (1 - A) Q_{ao} - W_o L_o \quad (234)$$

$$F_S = (W_o - A W_{ro})(S_i - S_0) + (1 - A) S_o (\dot{P} - \dot{E}) \quad (235)$$

$$W_o \equiv A W_{io} + (1 - A) W_{ao} \quad (236)$$

[Mellor and Kantha, 1989] describe solving simultaneously for the five unknowns W_o , T_0 , S_0 , F_T and F_S . Instead, we use the old value of T_0 to find W_{io} and therefore W_o . Using the new value of W_{io} , solve for a new value of S_0 and then find the new T_0 as the freezing temperature for that salinity:

$$W_{io} = \frac{1}{L_o} \left[\frac{Q_{io}}{\rho_o} + C_{po} C_{Tz} (T_o - T) \right] \quad (237)$$

$$S_0 = \frac{C_{S_z} S + (W_{ro} - W_{io}) S_i}{C_{S_z} + W_{ro} - W_{io}} \quad (238)$$

5.2.2 Frazil ice formation

Following Steele et al. [1989], we check to see if any of the ocean temperatures are below freezing at the end of each timestep. If so, frazil ice is formed, changing the local temperature and salinity. The ice that forms is assumed to instantly float up to the surface and add to the ice layer there. We balance the mass, heat, and salt before and after the ice is formed:

$$m_{w_1} = m_{w_2} + m_i \quad (239)$$

$$m_{w_1} (C_{pw} T_1 + L) = m_{w_2} (C_{pw} T_2 + L) + m_i C_{pi} T_2 \quad (240)$$

$$m_{w_1} S_1 = m_{w_2} S_2. \quad (241)$$

The variables are defined in Table 9. Defining $\gamma = m_i/m_{w_2}$ and dropping terms of order γ^2 leads

Variable	Value	Definition
C_{pi}	1994 J kg ⁻¹ K ⁻¹	specific heat of ice
C_{pw}	3987 J kg ⁻¹ K ⁻¹	specific heat of water
γ	m_i/m_{w2}	fraction of water that froze
L	3.16e5 J kg ⁻¹	latent heat of fusion
m_i		mass of ice formed
m_{w1}		mass of water before freezing
m_{w2}		mass of water after freezing
m	-0.0543	constant in freezing equation
S_1		salinity before freezing
S_2		salinity after freezing
T_1		temperature before freezing
T_2		temperature after freezing

Table 9: Frazil ice variables

to:

$$T_2 = T_1 + \gamma \left[\frac{L}{C_{pw}} + T_1 \left(1 - \frac{C_{pi}}{C_{pw}} \right) \right] \quad (242)$$

$$S_2 = S_1(1 + \gamma). \quad (243)$$

We also want the final temperature and salinity to be on the freezing line, which we approximate as:

$$T_f = mS. \quad (244)$$

We can then solve for γ :

$$\gamma = \frac{-T_1 + mS_1}{LC_{pw} + T_1 \left(1 - \frac{C_{pi}}{C_{pw}} \right) - mS_1}. \quad (245)$$

The ocean is checked at each depth k and at each timestep for supercooling. If the water is below freezing, the temperature and salinity are adjusted as in equations (242) and (243) and the ice above is thickened by the amount:

$$\Delta h = \gamma_k \Delta z_k \frac{\rho_w}{\rho_i}. \quad (246)$$

Note that Steele et al. [1989] include a compressibility term in equations (244) and (245), but we use potential temperature instead of *in situ* temperature.

5.2.3 Differences from Mellor and Kantha

We have tried to modify the **hakkis** model to more closely follow Mellor and Kantha [1989]. However, there are also ways in which we have deviated from it.

- Add advection of snow.
- Add lateral melting of snow when ice is melting laterally.
- Add various limiters:
 - Ice concentration: $A_{\min} \leq A \leq 1.0$, $A_{\min} = 1.e - 30$.
 - Ice thickness: $h_i \geq 0.0$.
 - Snow thickness: $h_s \geq 0.0$.
 - Brine fraction: $r \leq r_{\max}$, $r_{\max} = 0.2$

6 Details of the Code

6.1 Directory structure

The directory structure is as shown in Fig. 10, with the ability to run the ocean alone or coupled to atmospheric and/or wave models. If running just the ocean, the model can be run forward in time (the nonlinear model) or as an adjoint, tangent linear, or representer model for data assimilation purposes. This document describes the uncoupled forward model only, specifically the version used for our domains containing sea ice and other changes from the main trunk code. Details are subject to change without notice—check your own source code for specific details as they apply to you.

The directories shown here are:

Apps This directory contains a subdirectory for each of my personal applications and is not in the trunk code. In fact, it is now a git submodule, i.e., a separate repository. Its subdirectories contain files used by each application: the ROMS header file for setting cpp definitions, the analytic formulations for fields computed in the model rather than read from files (bottom heat flux of zero, for instance), and ASCII input files read by ROMS on startup to set things such as forcing file names and model time-step. Some of these applications are:

Arctic This is the curvilinear grid covering the whole Arctic ocean, with 5–6 km resolution off Alaska, coarser to the far side.

Beaufort This is shared code for two different Beaufort Sea domains, one curvilinear at 3 km, the other rectangular at 0.5 km.

Bering This is a 10 km grid of the Bering Sea, generated for coupling to WRF in the COAWST branch, but also tested with CICE.

Circle This is a circular domain wave propagation problem with an analytic solution used as a test problem [Lamb, 1932].

NEP This is the Northeast Pacific domain covering the waters off the west coast of the US, from California to the Bering Sea. It is a rectangular domain at about 11 km resolution when viewed in a conformal conic projection with standard latitudes of 40 and 60 N.

NWGOA This is a 1.5 km grid of the Northwest Gulf of Alaska. It gets boundary conditions from the Northeast Pacific grid, but is not aligned with it.

Other unsupported applications are also here. The application-specific files included in the main trunk ROMS are elsewhere.

Atmosphere This directory is under development, not currently distributed. If you want to run with a coupled atmosphere or wave model, contact John Warner for access to the COAWST branch or wait for the NUOPC coupling code to become public.

Compilers This contains **makefile** fragments as described in §G.3.

Data Directories under here contain example forcing, grid, and initial condition NetCDF files. There is also a directory containing the headers of these files in the format produced by **ncdump** (CDL).

Lib The ARPACK and MCT libraries are needed by the data assimilation codes and by the coupled models, respectively.

makefile This is the standard ROMS makefile as described in §G.

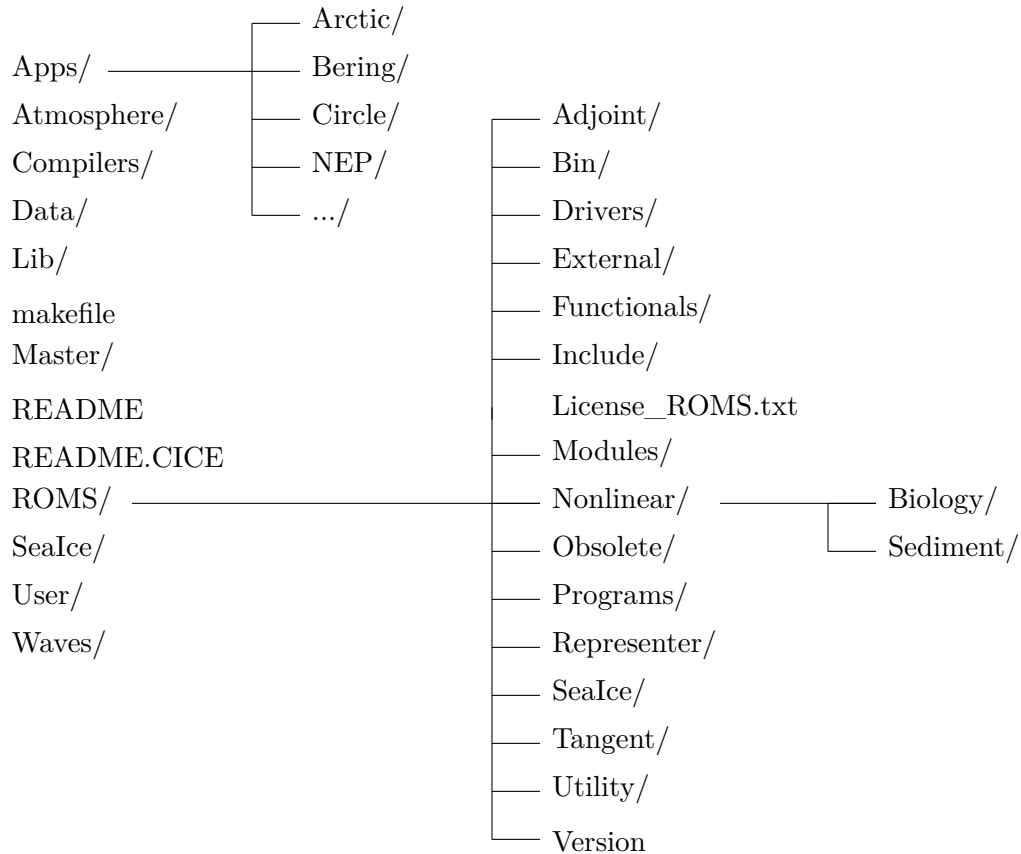

Figure 10: ROMS directory structure.

Master The ROMS main program is here, in various forms for the forward model, coupled models and others. See §6.2.

README A few words about the code, recommended for all github projects.

README.CICE A few words about the “fake” (direct) coupling to the Los Alamos CICE model.

ROMS These files are for the ocean model, as opposed to other components of the coupled system.

Adjoint This is the adjoint of the forward model, for data assimilation.

Bin Various shell and Perl scripts for use with the model. Note that the **.sh** files are actually **cs**h scripts, not **sh** scripts.

Drivers The main program includes one of these files, depending on how you are running the model. The forward model is in **nl_ocean.h**.

External ROMS reads an ASCII file on startup. Here are examples for various applications, also examples of the optional files for extra components such as a sediment model or a stations file.

Functionals The file **analytical.F** can include one or more code bits for the analytic specification of for instance the initial conditions. Here are examples for the supported model test problems.

Include Each application has a header file with C preprocessor options for that application. For instance, the **UPWELLING** case has the include file **upwelling.h** containing C preprocessor options for its periodic channel domain. The full

list of available options is in **cppdefs.h**. Another important include file is **globaldefs.h**, which can define some helper C preprocessor tags.

License_ROMS.txt The open source license under which ROMS is copyrighted.

Modules The ROMS data structures are now in Fortran 90 module files, located here.

Nonlinear The routines used by the nonlinear forward model are here, implementing the physics described in §4.

Biology The files for the ecosystem parts of the forward model are here.

Sediment The files for the sediment parts of the forward model are here.

Obsolete Long unused versions of the boundary conditions are stored here.

Programs Not all computer architectures or compilers are the same. The **types.F** program checks your compiler for the sizes of the Fortran floating point types.

Representer This is the representer of the forward model, for data assimilation.

SeaIce The sea ice model described in §5 is here.

Tangent This is the tangent linear of the forward model, for data assimilation.

Utility Here are utility functions used by the various ROMS routines, many dealing with I/O.

Version A file containing the time and date of this **svn** revision, also the **svn** URL—if and only if you check out with **svn**. At least the date in the file is kept current by Hernan. “git log” can show you the **svn** history, in commits such as:

```
commit b4e77b3a45208ee8059ca7b83e038371a60bc0d0
Author: arango <arango@f091316a-d328-0410-a40a-876eff57d070>
Date:   Fri Jun 23 23:22:54 2017 +0000
```

```
src:ticket:733
```

```
git-svn-id: https://www.myroms.org/svn/src/trunk@851
f091316a-d328-0410-a40a-876eff57d070
```

where the commit is associated with trac ticket 733 and **svn** revision 851.

SeaIce This is code for coupling to the Los Alamos CICE model with some tips in **README.CICE**. It works, although the coupling is inefficient. The Norwegians have also been working on this problem and they have released the **metroms** coupling using MCT on github.

User Some might choose to use this directory rather than the **Apps** directory. It serves the same purpose but is arranged by file type rather than by application.

Waves The SWAN wave model is here.

6.2 Main subroutines

6.2.1 master.F

The main program is in **master.F**. It is simply a shell, including one of **mct_coupler.h**, **esmf_coupler.h** or **ocean.h**. In our case, **ocean.h** contains the actual main program, which initializes MPI (if needed), calls **ROMS_initialize**, calls **ROMS_run** with an argument for how long to run for, then **ROMS_finalize**, and finally wraps up the MPI. See Fig. 11.

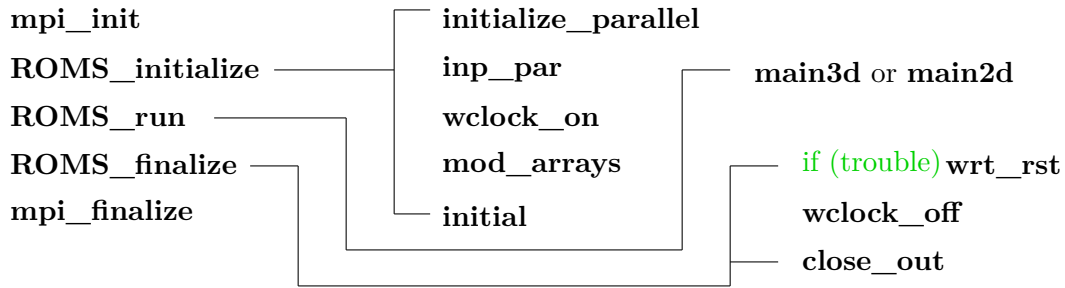

Figure 11: ROMS main structure.

6.2.2 ocean_control.F

This is again a shell which includes one of many other files to do the actual work. In this case, the worker files all contain **ROMS_initialize**, **ROMS_run** and **ROMS_finalize** and live in the **ROMS/Drivers** directory. The driver file we will be looking at is **nl_ocean.h**.

6.2.3 ROMS_initialize

This is called at the beginning of the run and therefore starts off by finding out how many parallel processes are running and which one this is, then calls the following ROMS routines:

initialize_parallel In the **mod_parallel** module, set up a few variables, including some for the built-in profiling.

inp_par Call **read_phypar** to read in the ASCII input file(s) used by ROMS, set up the parallel tiles, then call routines to read in the rest of the ASCII input for biology, ice, etc.

wclock_on In **timers.F**, initialize a timer for the built-in profiling.

mod_arrays Allocate and initialize the dynamically sized arrays in ROMS based on the grid sizes read in by **inp_par**.

initial Read in the initial conditions from one or more NetCDF files (one per grid) or compute them analytically. Likewise for the grid, plus set up the vertical grid spacing to be used and many other details.

6.2.4 ROMS_run

Call one of these two routines with the RunInterval argument:

main3d or **main2d** Solve the full equations described in §4 (**main3d**) or the depth-integrated version only (**main2d**).

6.2.5 ROMS_finalize

This is called at the end of the run, whether it was otherwise successful or not. The routines called are:

wrt_rst If the run had an error code set, write out a restart record of the current model fields in case they are useful in diagnosing the trouble.

wclock_off End the built-in timers and cause them to print out a report.

close_io Close all open files so as to flush the buffers and put NetCDF files into a finished state.

6.3 Initialization

- checkdefs** Report on which C preprocessor variables have been **#defined** and check their consistency (called from **inp_par**).
- ana_grid** Compute the grid(s) internally.
- ana_mask** Compute the land mask internally.
- get_grid** Read in the curvilinear coordinate arrays as well as f and h from one NetCDF file per grid.
- set_scoord** Set and initialize relevant variables associated with the vertical transformation to nondimensional σ -coordinate described in Appendix B.
- set_weights** Set the barotropic time-step average weighting function.
- metrics** Compute the metric term combinations which do not depend on the surface elevation and therefore remain constant in time.
- ini_strengthcoef** Compute a field for the nonlinear ice strength option [Overland and Pease, 1988].
- ana_wtype** Compute the Jerlov water type field internally.
- ana_nudgcoef** Compute the nudging time scales.
- get_nudgcoef** Read the nudging time scales from a file.
- ini_hmixcoef** Initialize the horizontal mixing coefficients.
- ana_sponge** Compute the horizontal mixing coefficients internally.
- ana_initial** Analytic initial conditions for momentum and active tracers.
- ana_passive** Analytic initial conditions for passive tracers.
- ana_biology** Analytic initial conditions for ecosystem tracers.
- ana_sediment** Analytic initial conditions for sediment tracers.
- ana_ice** Analytic initial conditions for ice variables.
- get_state** Read initial fields from disk—either restart or from some other source which has been converted to the appropriate NetCDF format.
- get_wetdry** or **wetdry** Initialize wet/dry masks.
- set_depth** Compute time-evolving depths.
- set_massflux** Compute initial horizontal mass fluxes.
- omega** Compute initial vertical velocities.
- rho_eos** Compute initial density fields.
- ana_psource** Set up analytic point sources.
- check_multifile** Read input files in which one or more file is specified to find out time-ranges, etc.

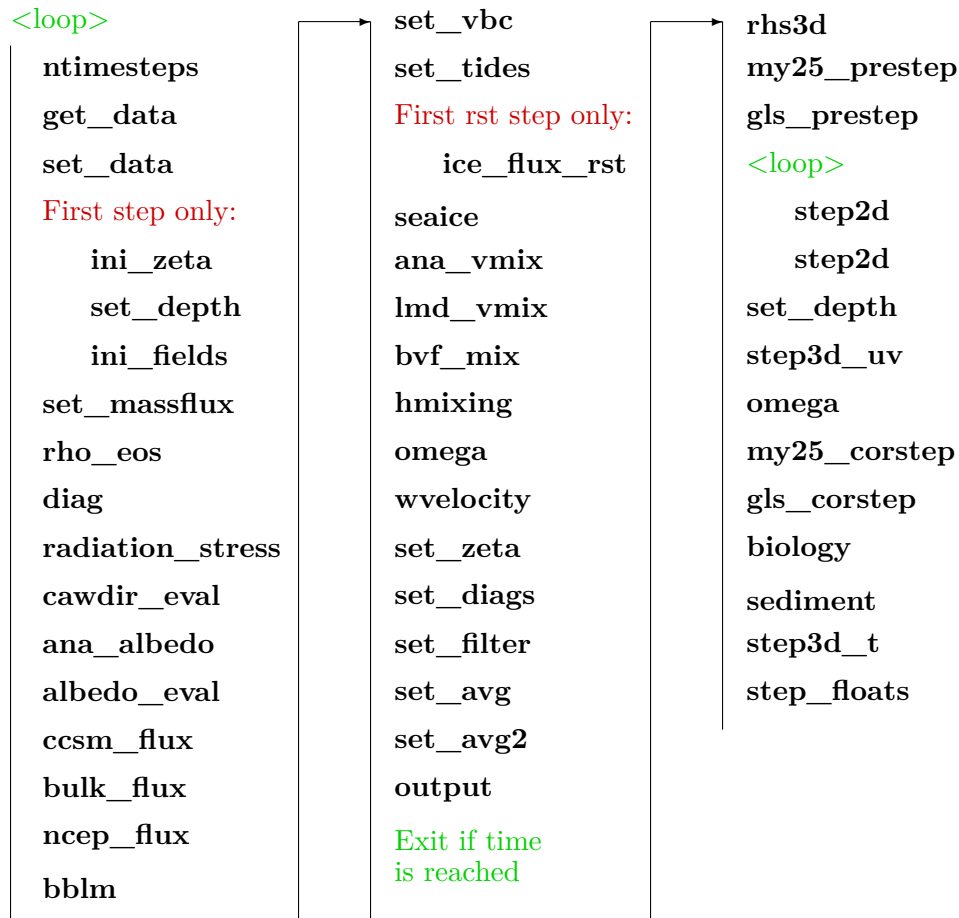

Figure 12: Flow chart of the model main program in forward mode. Calls to **nesting** for nested grid applications have been left out.

get_idata Read in time-invariant forcing data.

get_data Read in the first record of time-varying forcing fields, boundary conditions, etc.

set_masks Compute I/O masks.

ana_drag Compute bottom drag coefficients internally.

stiffness Compute grid stiffness.

grid_coords Convert initial float and station locations to fractional grid coordinates.

nesting Perform inter-grid communications.

6.3.1 main3d

This solves the full three-dimensional equations described in §4. It has siblings **main2d** for solving the depth-integrated equations and **main3d_offline** for reading files from a prior simulation and using them to advect the biological tracers or the Lagrangian floats. The full version is shown in Fig. 12, where the outer loop is over both timesteps and grids. Note that many subroutines are optional and only get called if the appropriate C preprocessor switches have been set. The subroutines are described as follows:

ntimesteps Find out how many timesteps to take on each grid.

get_data Read in the second and subsequent records of time-varying forcing fields, boundary conditions, etc.

set_data Time interpolate between the records read in by **get_data**.

ini_zeta Check for wet/dry cells if needed and initialize all the time levels of zeta.

ini_fields Initialize the 2-D velocities to match the vertical integral of the 3-D velocities, making all the time levels match.

set_massflux Compute horizontal mass fluxes, $\frac{H_z u}{n}$ and $\frac{H_z v}{m}$.

rho_eos Compute the nonlinear equation of state.

diag Compute some global sums, print them, and check them to see if they are sensible. If not, stop the model run.

radiation_stress Compute the radiation stresses due to wave-current interactions [Mellor, 2003, 2005].

cawdir_eval , **ana_albedo** or **albedo_eval** Compute the albedo at the ice and ocean surface.

ccsm_flux Compute the surface fluxes from the atmosphere based on a marine boundary layer. This version comes from CCSM [Large and Yeager, 2009] and is reputed to do better outside of the tropics than the default bulk flux computation.

bulk_flux Compute the surface fluxes from the atmosphere based on a marine boundary layer. This version comes from COARE version 3.0 [Fairall et al., 2003, Taylor and Yelland, 2001, Oost et al., 2002].

ncep_flux Compute the surface fluxes from the NCEP atmospheric model.

bblm Compute the bottom stresses from one of three bottom boundary layer models.

set_vbc Compute the surface and bottom fluxes and stresses that aren't computed elsewhere—set vertical boundary conditions.

set_tides Compute the tidal boundary conditions from the tidal constituents.

seaice Run the sea ice model described in §5. It changes the surface boundary conditions for the ocean and therefore gets called before the call to **output** or anything else that would be needing the surface boundary conditions. In the case of a perfect restart, **ice_flux_rst** is called instead on the first timestep—this restores surface fluxes from the restart file.

ana_vmix Called if there's an analytic profile for the vertical mixing coefficient.

lmd_vmix Called when using the K-profile parameterization of vertical mixing [Large et al., 1994, Large, 1998].

bvf_mix Compute the vertical mixing as a function of the Brunt-Väisälä frequency.

hmixing Compute time-dependent horizontal mixing coefficients [Smagorinsky, 1963, Holland et al., 1998, Webb et al., 1998, Griffies and Hallberg, 2000].

omega Compute the Ω vertical velocity from the horizontal divergences.

wvelocity Compute the physical vertical velocity for the model output.

set_zeta Set the surface elevation to the time-mean over the last baroclinic time-step.

set_diags Accumulate the time-average of the diagnostics fields.

set_filter Accumulate a weighted sum using a Lanczos filter for detiding the most important of the output fields. Not in the trunk code.

set_avg Accumulate time-averaged fields for the averages output.

set_avg2 Accumulate the time-averaged surface fields for the second averages output. Not in the trunk code.

output Write to various output NetCDF files.

rhs3d Call **pre_step3d** to compute a predictor step on the three-dimensional variables, then compute right-hand-sides of the three-dimensional velocity fields for the corrector step, including pressure gradients.

my25_prestep Compute the predictor step for turbulent kinetic energy prognostic variables, **tke** and **gls**.

gls_prestep Compute the predictor step for turbulent kinetic energy prognostic variables, **tke** and **gls**.

step2d Compute the depth-integrated time-step. It is called in a loop over all the short time-steps, first as a predictor step, then as a corrector step.

step3d_uv Complete the time-step for the three-dimensional velocities.

omega Compute the Ω vertical velocity.

my25_corstep Perform the corrector step for turbulent kinetic energy and length scale prognostic variables, **tke** and **gls** [Mellor and Yamada, 1982, Galperin et al., 1988].

gls_corstep Perform the corrector step for turbulent kinetic energy and length scale prognostic variables, **tke** and **gls** [Umlauf and Burchard, 2003, Warner et al., 2005].

biology Compute the changes to the biological tracers due to biological activity using one of several options for the ecosystem model.

sediment Compute changes to the sediment tracers [Warner et al., 2008].

step3d_t Complete the tracer time-step.

ice_frazil Compute the frazil ice growth, if any. Now called from inside **step3d_t**.

step_floats Time-step the Lagrangian floats.

6.4 Modules

Now that we are using Fortran 90, the method of choice for managing data structures is modules. The **ROMS/Modules** directory contains all of the ROMS modules that contain globally used variables. The complete list is:

mod_arrays.F This actually has no data structures, but has the routine that calls the allocate and initialize routines for all the others.

mod_average.F If **AVERAGES** is defined, this will provide the storage for the running means of the fields you are averaging.

mod_average2.F If **AVERAGES2** is defined, this will provide the storage for the surface running means of the fields you are averaging.

mod_bbl.F If **BBL_MODEL** is defined, this will provide the storage for the bottom boundary fields.

mod_behavior.F If **FLOAT_BIOLOGY** is defined, this will include a file for adding behavior to floats, such as oysters sinking to the bottom.

mod_biology.F If **BIOLOGY** is defined, this will provide the storage for the biology interaction parameters.

mod_boundary.F This contains the storage for the open boundary conditions. If they aren't provided analytically, this will also provide the storage for fields read from a file that need to be time-interpolated.

mod_clima.F If one of **LsshCLM** or several other options is set to **.true.**, this will provide the storage for the climatology fields.

mod_coupler.F If either **MODEL_COUPLING** or **ESMF_LIB** is defined, this will set up the requisite fields and data structures for the coupling.

mod_coupling.F If **SOLVE3D** is defined, this will provide the storage for the fields used in coupling the 2-D and 3-D components of the simulation.

mod_diags.F If **DIAGNOSTICS** is defined, this will provide the storage for the various tendency terms.

mod_eclight.F If both **BIOLOGY** and **ECOSIM** are defined, this will set up the spectral irradiance variables.

mod_eoscoef.F If **NONLIN_EOS** is defined, this will provide the polynomial expansion coefficients for the nonlinear equation of state for sea water.

mod_filter.F If **FILTERED** is defined, this will provide the storage for the weighted means used in detiding the averages. Not in the trunk code.

mod_floats.F If **FLOATS** is defined, this will provide the storage for the float tracking variables.

mod_forces.F This provides the storage for the surface and bottom forcing fields.

mod_fourdvar.F If either **FOUR_DVAR** or **VERIFICATION** is defined, this will set up the variational data assimilation variables.

mod_grid.F This provides the storage for the model grid fields.

mod_ice.F If **ICE_MODEL** or **CICE_MODEL** is defined, this will provide storage for the ice fields.

mod_iounits.F This contains a number of variables used by the I/O, including file names and file IDs.

mod_kinds.F This contains the integers associated with the various integer and real Fortran types. If you find more systems supporting 128-bit reals, let us know.

mod_mixing.F This contains the arrays for the various optional horizontal and vertical mixing parameterizations.

mod_ncparam.F This contains all sorts of parameters relating to the NetCDF I/O files, including those read from the **varinfo.dat** file. The parameters **MV** and **NV** are set here, giving the maximum number of variables that can be read [this is a change from the trunk code].

mod_nesting.F If **NESTING** is defined, this module defines generic structures used for nesting, composed, and mosaic grids. Still in development, but some cases do now work.

mod_netcdf.F This brings in **netcdf.mod** and defines wrapper functions for many of the netcdf functions.

mod_ocean.F This contains the 2-D and 3-D fields of the primitive ocean variables and optionally the sediment variables.

mod_parallel.F This sets up some global variables such as **Master**, which is true for the master thread or process. It also initializes the internal ROMS profiling arrays.

mod_param.F This contains the sizes of each grid used, plus things like how many tidal constituents are being used. Many of these are read from the input files during initialization, not known at compile time.

mod_scalars.F This contains a large number of scalars, i.e. values which don't have spatial dependence. Some are fixed constants such as **itemp** referring to the temperature tracer. Others could have a different value on each grid.

mod_sedbed.F If either **SEDIMENT** or **BBL_MODEL** is defined, this contains parameters for the sediment bed layers.

mod_sediment.F If either **SEDIMENT** or **BBL_MODEL** is defined, this contains parameters for the respective model.

mod_sources.F This contains the variables used for point sources, only allocated if one of **LuvSrc**, **LwSrc** or **LtracerSrc** is set to **.true**.

mod_stepping.F This contains the time-stepping variables used to point to the relevant time level.

mod_storage.F If **PROPAGATOR** is defined, this module defines the work space for the Generalized Stability Theory (GST) Analysis package (ARPACK).

mod_strings.F This contains strings such as a title for the run, the list of **cpp** options defined, and the names of the sections of code being profiled.

mod_tides.F If **SSH_TIDES** and/or **UV_TIDES** is defined, this will provide the storage for the tidal constituents.

mod_trc_sources.F If **TRC_PSOURCE** is defined, this contains the variables used for tracer point sources. Not in the trunk code.

6.5 Functionals

The Functionals directory contains **analytical.F** which conditionally includes code bits for computing analytic values for a wide variety of fields. Many are alternates for reading from NetCDF files, especially for idealized problems.

ana_aiobc Provide analytic open boundary conditions for the ice concentration.

ana_albedo Compute analytic surface albedo.

ana_biology Provide analytic initial conditions for the biology tracers.

ana_btflux Compute analytic kinematic bottom flux of tracer type variables (default of zero).

ana_cloud Provide analytic cloud fraction.

ana_diag Compute customized diagnostics.

ana_dqdsst Provide analytic variation of surface heat flux as a function of SST.

ana_drag Compute customized bottom drag coefficients.

ana_fsobc Provide analytic open boundary conditions for the free surface.

ana_grid Set up an analytic grid.

ana_hiobc Provide analytic open boundary conditions for the ice thickness.

ana_hsnobc Provide analytic open boundary conditions for the snow thickness.

ana_hsnobc Provide analytic open boundary conditions for the snow thickness.

ana_humid Provide analytic atmospheric humidity.

ana_ice Provide analytic initial conditions for the sea ice.

ana_initial Set up analytic initial conditions for the ocean.

ana_lrflux Provide analytic kinematic surface downward longwave radiation.

ana_m2clima Set up an analytic climatology for the two-dimensional momentum.

ana_m2obc Provide analytic open boundary conditions for the two-dimensional momentum.

ana_m3clima Set up an analytic climatology for the three-dimensional momentum.

ana_m3obc Provide open boundary conditions for the three-dimensional momentum.

ana_mask Set up an analytic mask.

ana_ncep Set up analytic fields as if they came from NCEP.

ana_nudgcoef Set up spatially dependent nudging coefficients for nudging to a climatology.

ana_pair Provide analytic sea-level air pressure.

ana_passive Provide analytic initial conditions for passive tracers.

ana_perturb Provide analytic perturbations to the initial conditions.

ana_psource Provide analytic point source fluxes.

ana_rain Provide analytic rainfall.

ana_scope Set adjoint sensitivity spatial scope masking arrays.

ana_sediment Provide analytic initial conditions for the sediment tracers.

ana_smflux Provide analytic kinematic surface momentum flux (wind stress).

ana_snow Provide analytic snowfall.

ana_specir Set surface solar downwelling spectral irradiance at just beneath the sea surface.

ana_spinning Set time-variable rotation force as the sum of Coriolis and Centripetal accelerations. This is used in polar coordinate applications (annulus grid).

ana_sponge Provide spatially variable horizontal mixing coefficients.

ana_srflux Provide analytic kinematic surface shortwave radiation.

ana_ssh Provide analytic sea surface height.

ana_sss Provide analytic sea surface salinity.

ana_sst Provide analytic sea surface temperature.

ana_stflux Provide analytic kinematic surface flux of tracer type variables.

ana_tair Provide analytic air temperature.

ana_tclima Provide analytic tracer climatology fields.

ana_tobc Provide analytic open boundary conditions for all tracers (active, passive, biology, and sediment).

ana_vmix Provide analytic vertical mixing coefficients.

ana_winds Provide analytic winds.

ana_wwave Provide analytic wind-induced wave amplitude, direction and period.

6.6 Other subroutines and functions

The ROMS/Utility directory contains an assortment of useful routines, many of which deal with I/O:

NetCDF I/O The I/O has been cleaned up so that *all* processes check for the return code on reads and writes and exit on failure. In many cases, the master process is the only one actually doing the I/O, but it then broadcasts its status to the rest.

def_* Create the ROMS NetCDF file of the appropriate type, including dimensions, attributes, and variables.

def_info Add some standard scalar variables to any NetCDF file.

get_*fld Read a field from a netcdf file, perhaps using one of **nf_fread2d** and its kin. **nf_fread2d** is special in that it can read uniformly gridded forcing files and call **regrid** to regrid them onto the ROMS grid.

wrt_* Write to the ROMS NetCDF file of the appropriate type.

Text input ROMS can parse text files in a specific format. These files replace what many other models use namelists for.

read_* The ocean_xx.in file is read by **read_phypar** while others read the stations, floats, and other text files.

6.7 C preprocessor variables

Before it can be compiled, the model must be run through the C preprocessor **cpp**, as described in Appendix F. The C preprocessor has its own variables, which may be defined either with an explicit **#define** command or with a command line option to **cpp**. We have chosen to define these variables in an application-specific include file, except for some machine-dependent ones, which are defined in the **makefile**. These variables allow you to conditionally compile sections of the code. For instance, if **MASKING** is not defined, the masking code will not be seen by the compiler, and the masking variables will not be declared.

The top of each Fortran file contains **#include "cppdefs.h"**. This file will include the user-provided file of **cpp** options and then include **globaldefs.h**. This latter will set some internal ROMS **cpp** variables for you, depending on choices you have made. For instance, if you don't provide analytic surface forcing fields by one means or another, **globaldefs.h** will set **FRC_FILE** and ROMS will attempt to read a forcing file. Some combinations of options don't make sense, so **checkdefs** will complain and cause the run to end if it finds any incompatibilities in your setup.

The exact list of user-selectable **cpp** variables will depend on which ROMS branch you have. Those listed below are in the sea-ice branch on github. They can be grouped into several categories:

Momentum terms The default horizontal advection is 3rd-order upstream bias for 3D momentum and 4th-order centered for 2D momentum. The default vertical advection is 4th-order centered for 3D momentum. If this is what you want, no flags for momentum advection need to be activated except for **UV_ADV**.

The 3rd-order upstream split advection (**UV_U3ADV_SPLIT**) can be used to correct for the spurious mixing of the advection operator in terrain-following coordinates. If this is chosen, the advection operator is split into advective and viscosity components and several internal flags are activated in **globaldefs.h**. Notice that horizontal and vertical advection of momentum is 4th-order centered plus biharmonic viscosity to correct for spurious mixing.

UV_ADV Define to compute the momentum advection terms.

CURVGRID Define to compute the extra non-linear advection terms which arise when using curvilinear coordinates.

UV_COR Define to compute the Coriolis term.

UV_U3ADV_SPLIT Define for 3rd-order upstream split momentum advection.

UV_C2ADVECTION Define for 2nd-order centered advection.

UV_C4ADVECTION Define for 4rd-order centered advection.

UV_SADVECTION Define for splines vertical advection (for shallow, vertically well-resolved domains).

UV_VIS2 Define to compute the horizontal Laplacian viscosity.

UV_VIS4 Define to compute the horizontal biharmonic viscosity.

UV_SMAGORINSKY Define for Smagorinsky-like viscosity.

UV_LOGDRAG Define for logarithmic bottom friction.

UV_LDRAG Define for linear bottom friction.

UV_QDRAG Define for quadratic bottom friction.
UV_WAVEDRAG Define for extra linear bottom wave drag.
UV_DRAG_GRID Define for spatially variable bottom drag.
SPLINES_VVISC Define for splines reconstruction of vertical viscosity.
LIMIT_BSTRESS Define for bottom drag limiter.

Tracers The default horizontal and vertical advection is 4th-order centered.

The 3rd-order upstream split advection (**TS_U3ADV_SPLIT**) can be used to correct for the spurious diapycnal diffusion of the advection operator in terrain-following coordinates. If this is chosen, the advection operator is split in advective and diffusive components and several internal flags are activated in **globaldefs.h**. Notice that horizontal and vertical advection of tracer is 4th-order centered plus biharmonic diffusion to correct for spurious diapycnal mixing. The total time-dependent horizontal mixing coefficient are computed in **hmixing.F**. It is also recommended to use the rotated mixing tensor along geopotentials (**MIX_GEO_TS**) for the biharmonic operator.

TS_U3ADV_SPLIT Define for 3rd-order upstream split tracer advection.
TS_A4HADVECTION Define for 4nd-order Akima horizontal advection.
TS_C2HADVECTION Define for 2nd-order centered horizontal advection.
TS_C4HADVECTION Define for 4rd-order centered horizontal advection.
TS_MPDATA Define for recursive MPDATA 3D advection [Margolin and Smolarkievicz, 1998].
TS_MPDATA_LIMIT Define to limit upwind corrector fluxes for stability.
TS_U3HADVECTION Define for 3nd-order upstream horizontal advection.
TS_A4VADVECTION Define for 4nd-order Akima vertical advection.
TS_C2VADVECTION Define for 2nd-order centered vertical advection.
TS_C4VADVECTION Define for 4rd-order centered vertical advection.
TS_SADVECTION Define for splines vertical advection (for shallow, vertically well-resolved domains).
TS_DIF2 Define to compute horizontal Laplacian diffusion.
TS_DIF4 Define to compute horizontal biharmonic diffusion.
TS_SMAGORINSKY Define for Smagorinsky-like diffusion.
TS_FIXED Define for a diagnostic calculation in which the tracer fields do not change in time.
T_PASSIVE Define for passive tracers.
AGE_MEAN Define for computing mean age of passive tracers (requires two passive tracers per age tracer).
SALINITY Define if salinity is used as one of the active tracers.
NONLIN_EOS Define to use the nonlinear equation of state.
QCORRECTION Define to use the net heat flux correction.
SCORRECTION Define to use freshwater flux correction.
SSSC_THRESHOLD Define to limit the freshwater flux correction.
LIMIT_STFLX_COOLING Define to limit the surface cooling to prevent water from freezing.

SOLAR_SOURCE Define to use solar radiation source term.

SPLINES_VDIFF Define to use splines reconstruction of vertical diffusion.

SRELAXATION Define to use salinity relaxation as a freshwater flux.

TRC_PSOURCE Define for passive tracer point sources/sinks.

ONE_TRACER_SOURCE Define for one value per tracer for all sources.

TWO_D_TRACER_SOURCE Define for one value per tracer per source.

Pressure gradient options If no option is selected, the pressure gradient term is computed using standard density Jacobian algorithm. Notice that there are two quartic pressure Jacobian options. They differ on how the WENO reconciliation step is done and in the monotonicity constraining algorithms.

DJ_GRADPS Define for splines density Jacobian [Shchepetkin and McWilliams, 2003].

PJ_GRADP Define for finite volume Pressure Jacobian [Lin, 1997].

PJ_GRADPSQ2 Define for quartic 2 Pressure Jacobian [Shchepetkin and McWilliams, 2003].

PJ_GRADPSQ4 Define for quartic 4 Pressure Jacobian [Shchepetkin and McWilliams, 2003].

WJ_GRADPS Define for weighted density Jacobian [Song, 1998].

ATM_PRESS Define to impose atmospheric sea-level pressure onto the sea surface.

Atmospheric boundary layer There are now four ways to provide longwave radiation in the atmospheric boundary layer: (1) Compute the net longwave radiation internally using the Berliand (1952) equation (**LONGWAVE**) as function of air temperature, sea surface temperature, relative humidity, and cloud fraction; (2) provide (read) longwave downwelling radiation only and then add outgoing longwave radiation (**LONGWAVE_OUT**) as a function of the model sea surface temperature; (3) provide net longwave radiation (default); (4) provide analytic longwave radiation (net or downwelling) via **ana_lrflux.h**.

BULK_FLUXES Define for bulk flux computation (required for either Fairall et al. [2003] or Large and Yeager [2009]).

CCSM_FLUXES Define for CCSM version of bulk flux computation [Large and Yeager, 2009].

NCEP_FLUXES Define if NCEP forcing files are used.

GLOBAL_PERIODIC Define if letting ROMS interpolate onto a grid which spans the full longitude range of the globe.

NL_BULK_FLUXES Define to use bulk fluxes computed by nonlinear (forward) model.

COOL_SKIN Define for cool skin correction.

LONGWAVE Define to compute net longwave radiation.

LONGWAVE_OUT Define to compute outgoing longwave radiation. Sea-ice models compute the outgoing longwave over the ice-covered part of the domain, requiring this option over the ocean.

EMINUSP Define to compute evaporation minus precipitation.

EMINUSP_SSH Define to compute changes in SSH due to evaporation minus precipitation.

RUNOFF Define to read freshwater runoff as a second rain-like field.

RUNOFF_SSH Define to compute changes in SSH due to **RUNOFF**.

The shortwave radiation can be provided as net without an albedo correction for ocean-only simulations. For sea-ice, it is best to provide downwelling shortwave radiation and perform an albedo correction. In addition, input shortwave radiation data computed from averaged data (with snapshots greater or equal to 24 hours) can be modulated by the local diurnal cycle which is a function longitude, latitude and day-of-year.

ALBEDO_CLOUD Define to use albedo equation for shortwave radiation (for water).

ALBEDO_CSIM Define to use albedo function of ice type from CSIM model (for ice).

ICE_ALB_EC92 Define to use albedo function of ice type from Ebert and Curry [1993] (for ice).

ALBEDO_CURVE Define to use albedo function of latitude from Large and Yeager [2009] (for water).

ALBEDO_FILE Define to use albedo from a file (for both ice and water).

DIURNAL_SRFLUX Define to impose the local diurnal cycle onto the shortwave radiation.

Wave roughness in bulk fluxes

COARE_TAYLOR_YELLAND Define to use Taylor and Yelland wave roughness [Taylor and Yelland, 2001].

COARE_OOST Define to use Oost et al. wave roughness [Oost et al., 2002].

DEEPWATER_WAVES Define to use deep water waves approximation.

Model output

PROFILE Define for time profiling.

AVERAGES Define to write out time-averaged model fields.

AVERAGES2 Define to write out secondary time-averaged model fields.

QUICK Define to write out secondary history fields.

NO_HIS Define to turn off writing of primary history fields.

AVERAGES_DETIDE Define to write out time-averaged detided fields, one method.

FILTERED Define to write out time-averaged detided fields, using a Lanczos filter.

DIAGNOSTICS_BIO Define to write out ecosystem diagnostics.

DIAGNOSTICS_UV Define to write out momentum diagnostics.

DIAGNOSTICS_TS Define to write out tracer diagnostics.

STATIONS Define to write out time-series information at specific points in the model.

STATIONS_CGRID Define if stations are on native C-grid.

Lagrangian floats

FLOATS Define for simulated Lagrangian drifters.

FLOAT_STICKY Define for floats to stick/reflect when hitting the bottom or surface.

FLOAT_VWALK Define if floats do vertical random walk.

VWALK_FORWARD Define for forward time stepping of vertical random walk.

FLOATS_OYSTER Define to activate oyster behavior on floats.

DIAPAUSE Define to simulate diapause on floats.

General model configuration

SOLVE3D Define to solve the 3-D primitive equations.

MASKING Define if there is land in the domain to be masked out.

BODYFORCE Define to apply the surface stress as a body force.

ICESHELF Define for ice shelf cavities.

ICESHELF_3EQ Define for floating three equation ice shelves.

SPHERICAL Define if lat/lon coordinates rather than x/y.

DEBUGGING Define to suppress timestamps for easier comparisons between files.

Analytic fields

ANA__ALBEDO Define for analytic albedo fields.

ANA__BIOLOGY Define for analytic biology initial conditions.

ANA__BPFLUX Define for an analytic bottom passive tracer flux.

ANA__BSFLUX Define for an analytic bottom salt flux.

ANA__BTFLUX Define for an analytic bottom heat flux.

ANA__CLOUD Define for an analytic cloud fraction.

ANA__DIAG Define for customized diagnostics.

ANA__DQDSST Define for an analytic surface heat flux sensitivity to SST.

ANA__DRAG Define for an analytic spatially variable bottom drag.

ANA__FSOBC Define for analytic free-surface boundary conditions.

ANA__GRID Define for an analytic model grid set-up.

ANA__HUMIDITY Define for analytic surface air humidity.

ANA__ICE Define for analytic ice initial conditions.

ANA__INITIAL Define for analytic initial conditions.

ANA__LRFLUX Define for analytic longwave radiation.

ANA__M2CLIMA Define for an analytic 2D momentum climatology.

ANA__M2OBC Define for analytic 2D momentum boundary conditions.

ANA__M3CLIMA Define for an analytic 3D momentum climatology.

ANA__M3OBC Define for analytic 3D momentum boundary conditions.

ANA__MASK Define for an analytic mask.

ANA__NUDGCoeff Define for an analytic nudging coefficients.

ANA__PAIR Define for an analytic surface air pressure.

ANA__PASSIVE Define for analytic initial conditions for inert tracers.

ANA__PERTURB Define for analytic perturbation of initial conditions.

ANA__PSOURCE Define for analytic point sources.

ANA__PTOBC Define for analytic passive tracer boundary conditions.

ANA__RAIN Define for analytic rain fall rate.

ANA_SEDIMENT Define for analytic sediment initial fields.
ANA_SMFLUX Define for an analytic kinematic surface momentum stress.
ANA_SNOW Define for analytic snow fall rate.
ANA_SPFLUX Define for analytic surface passive tracers fluxes.
ANA_SPINNING Define for an analytic time-varying rotation force.
ANA_SPONGE Define for analytic sponge (higher viscosity).
ANA_SRFLUX Define for an analytic kinematic surface shortwave radiation.
ANA_SSFLUX Define for an analytic kinematic surface freshwater flux.
ANA_SSH Define for an analytic sea surface height.
ANA_SSS Define for an analytic sea surface salinity.
ANA_SST Define for an analytic SST and $\partial Q/\partial \text{SST}$.
ANA_STFLUX Define for an analytic kinematic surface heat flux.
ANA_TAIR Define for analytic surface air temperature.
ANA_TCLIMA Define for an analytic tracer climatology.
ANA_TOBC Define for analytic tracer open boundary conditions.
ANA_TRC_PSOURCE Define for analytic passive tracer point sources.
ANA_VMIX Define for analytic vertical mixing coefficients.
ANA_WINDS Define for analytic surface winds.
ANA_WWAVE Define for an analytic wind induced wave field.

Horizontal mixing of momentum

MIX_GEO_UV Define for viscosity along constant z (geopotential) surfaces.
MIX_S_UV Define for viscosity along constant s surfaces.
VISC_GRID Define for horizontally variable viscosity coefficient.

Horizontal mixing of tracers

DIFF_GRID Define for horizontally variable diffusion coefficient.
MIX_GEO_TS Define for diffusion along constant z (geopotential) surfaces.
MIX_ISO_TS Define for diffusion along constant potential density (epineutral) surfaces.
MIX_S_TS Define for diffusion along constant s surfaces.
TS_MIX_CLIMA Define for diffusion of tracer perturbation $T - T_{clm}$.
TS_MIX_MAX_SLOPE Define for maximum slope in epineutral diffusion.
TS_MIX_MIN_STRAT Define for minimum stratification in epineutral diffusion.
TS_MIX_STABILITY Define for weighting diffusion between two time levels.

Vertical mixing

BVF_MIXING Define to activate Brunt-Väisälä frequency mixing.
GLS_MIXING Define for Generic Length-Scale mixing.
CANUTO_A Define for Canuto A-stability function formulation.
CANUTO_B Define for Canuto B-stability function formulation.

CHARNOK Define for Charnok surface roughness from wind stress.

CRAIG_BANNER Define for Craig and Banner wave breaking surface flux.

KANTHA_CLAYSON Define for Kantha and Clayson stability function.

K_C2ADVECTION Define for 2th-order centered advection.

K_C4ADVECTION Define for 4th-order centered advection.

N2S2_HORAVG Define for horizontal smoothing of buoyancy/shear.

RI_SPLINES Define for splines reconstruction of vertical shear.

ZOS_HSIG Define for surface roughness from wave amplitude.

TKE_WAVEDISS Define for wave breaking surface flux from wave amplitude.

LMD_MIXING Define to activate Large/McWilliams/Doney interior closure.

LMD_BKPP Define to add a bottom boundary layer from a local K-Profile Parameterization (KPP).

LMD_CONVEC Define to add convective mixing due to shear instabilities.

LMD_DDMIX Define to add double-diffusive mixing.

LMD_NONLOCAL Define to add convective nonlocal transport.

LMD_RIMIX Define to add diffusivity due to shear instabilities.

LMD_SHAPIRO Define to Shapiro filtering boundary layer depths.

LMD_SKPP Define to add a surface boundary layer from a local K-Profile Parameterization (KPP).

WTYPE_GRID Define for spatially dependent Jerlov water type.

RI_SPLINES Define for splines reconstruction of vertical shear.

MY25_MIXING Define to activate Mellor/Yamada Level-2.5 closure.

KANTHA_CLAYSON Define for Kantha and Clayson stability function.

K_C2ADVECTION Define for 2th-order centered advection.

K_C4ADVECTION Define for 4th-order centered advection.

N2S2_HORAVG Define for horizontal smoothing of buoyancy/shear.

RI_SPLINES Define for splines reconstruction of vertical shear.

These two can be used if **RI_SPLINES** is not defined.

RI_HORAVG Define for horizontal Richardson number smoothing.

RI_VERAVG Define for vertical Richardson number smoothing.

Bottom boundary layer The Options **MB_ZOBL** and **MB_ZORIP** should be activated concurrently.

MB_BBL Define to activate Meinte Blaas BBL closure.

MB_CALC_ZNOT Define to compute bottom roughness internally.

MB_CALC_UB Define to compute bottom orbital velocity internally.

MB_ZOBIO Define for biogenic bedform roughness for ripples.

MB_ZOBL Define for bedload roughness for ripples.

MB_ZORIP Define for bedform roughness for ripples.

SG_BBL Define to activate Styles/Glenn bottom boundary layer formulation.

SG_CALC_ZNOT Define to compute bottom roughness internally.

SG_CALC_UB Define to compute bottom orbital velocity internally.

SG_LOGINT Define for logarithmic interpolation of (Ur,Vr).

SSW_BBL Define to activate Sherwood/Signell/Warner bottom boundary layer closure.
SSW_CALC_ZNOT Define to compute bottom roughness internally.
SSW_CALC_UB Define to compute bottom orbital velocity internally.
SSW_LOGINT Define for logarithmic interpolation of (U_r, V_r).
SSW_FORM_DRAG_COR Define to activate form drag coefficient.
SSW_ZOBIO Define for biogenic bedform roughness for ripples.
SSW_ZOBL Define for bedload roughness for ripples.
SSW_ZORIP Define for bedform roughness for ripples.

Sea ice

ICE_MODEL Define to use ice component of the model (see §5).
ICE_THERMO Define for ice thermodynamics.
ICE_MK Define for Mellor and Kantha [1989] ice thermodynamics—this is the only choice.
ICE_MOMENTUM Define for momentum component of the ice.
ICE_MOM_BULK Define for alternate ice-water stress computation.
ICE_EVP Define for elastic-viscous-plastic rheology [Hunke and Dukowicz, 1997, Hunke, 2001].
ICE_QUAD_STRENGTH Define for quadratic ice strength from Overland and Pease [1988].
ICE_ADVECT Define for advection of ice tracers.
ICE_SMOLAR Define to use MPDATA for ice tracers (no other option).
ICE_UPWIND Define for upwind advection.
ICE_SHOREFAST Define for simple shorefast-ice algorithm [Budgell, 2005].
ICE_LANDFAST Define for alternate shorefast-ice algorithm [Lemieux et al., 2015].
FASTICE_CLIMATOLOGY Define for clamping to a climatology of landfast ice.
ICE_BULK_FLUXES Define for ice part of bulk flux computation.
ICE_I_O Define to allow light into the ice as heat.
ICE_CONVSNOW Define for conversion of flooded snow to ice.
OUTFLOW_MASK Define for Hibler style outflow cells.
INI_GLOYS_ICE Define to read initial conditions for **aice**, **hice**, and surface temperature from a GLOYS file.
NO_SCORRECTION_ICE Define to turn off surface salinity nudging under the ice.

Boundary conditions

RADIATION_2D Define for tangential phase speed in radiation conditions.

Tides The tidal data is processed in terms of tidal constituents, classified by period. The tidal forcing is computed for the full horizontal grid. If requested, the tidal forcing is added to the processed open boundary data.

Both tidal elevation and tidal currents are required to force the model properly. However, if only the tidal elevation is available, the tidal currents at the open boundary can be estimated by reduced physics. Only the pressure gradient, Coriolis, and surface and bottom

stresses terms are considered at the open boundary. See **u2dbc_im.F** or **v2dbc_im.F** for details. Notice that there is an additional option (**FSOBC_REDUCED**) for the computation of the pressure gradient term in both Flather or reduced physics boundary conditions.

SSH_TIDES Define if imposing tidal elevation.

UV_TIDES Define if imposing tidal currents.

POT_TIDES Define if imposing potential tides.

RAMP_TIDES Define if ramping (over one day) tidal forcing from zero.

ADD_FSOBC Define to add tidal elevation to processed OBC data.

ADD_M2OBC Define to add tidal currents to processed OBC data.

FSOBC_REDUCED Define for reduced physics when providing SSH boundary conditions but not the 2D momentum fields.

TIDES_ASTRO Define to add contributions from the long-period tides as done by Foreman.

Climatology These are for **OFFLINE** options only.

OCLIMATOLOGY Define for reading (rather than computing) the vertical momentum climatology arrays.

AKTCLIMATOLOGY Define for reading the tracer vertical diffusion climatology arrays.

Ecosystem models

BIO_FENNEL Define for Fennel et al. [2006] nitrogen-based model.

BIO_SEDIMENT Define to restore fallen material to the nutrient pool.

CARBON Define to add carbon constituents.

DENITRIFICATION Define to add denitrification processes.

OXYGEN Define to add oxygen dynamics.

OCMIP_OXYGEN_SC Define if Schmidt number from Keeling et al. [1998].

TALK_NONCONSERV Define for nonconservative computation of alkalinity.

BEST_NPZ Define for Gibson et al. (personal communication) Bering Sea model.

STATIONARY Define for extra output.

BENTHIC Define for benthic components.

ICE_BIO Define for ice algae.

JELLY Define for jellyfish.

CLIM_ICE_1D Define if 1-D with ice.

BIO_UMAINE Define for Xiu and Chai [2014], Xiu and Chai [2012] model with iron limitation.

OXYGEN

CARBON

SINK_OP1

SINK_OP2

TALK_NONCONSERV

DIURNAL_LIGHT

OPTIC_UMaine

- BIO_GOANPZ** Define for Hinckley et al. [2009] Gulf of Alaska model.
- NPZD_FRANKS** Define for NPZD model of Franks et al. [1986].
- NPZD_IRON** Define for NPZD model with iron limitation.
- NPZD_POWELL** Define for NPZD model of Powell et al. [2006].
- IRON_LIMIT** Define for iron limitation on phytoplankton growth (for a few of the biology models).
- IRON_RELAX** Define for nudging to iron over the shelf.
- ECOSIM** Define for bio-optical EcoSim model.
- NEMURO** Define for Nemuro ecosystem model [Kishi et al., 2007]. Need to choose a zooplankton grazing option (**HOLLING_GRAZING** or **IVLEV_EXPLICIT**). The default implicit **IVLEV** algorithm does not work yet.
- BIO_SEDIMENT** Define to restore fallen material to the nutrient pool.
- NEMURO_SED1** Define for sediment remineralization.
- PRIMARY_PROD** Define for primary productivity output.
- HOLLING_GRAZING** Define for Holling-type s-shaped curve grazing (implicit).
- IVLEV_EXPLICIT** Define for Ivlev explicit grazing algorithm.
- RED_TIDE** Define for red tide biological model.

Sediment transport model

- SEDIMENT** Define to activate sediment transport model [Warner et al., 2008].
- BEDLOAD_MPM** Define to activate Meyer-Peter-Mueller bed load.
- BEDLOAD_SOULSBY** Define to activate Soulsby wave/current bed load.
- SED_DENS** Define to allow sediment to affect equation of state.
- SED_MORPH** Define to allow bottom model elevation to evolve.
- SUSPLOAD** Define to activate suspended load transport.

Nearshore options

- WET_DRY** Define to allow wetting and drying of cells.
- NEARSHORE_MELLOR05** Define for radiation stress terms from waves [Mellor, 2005].
- NEARSHORE_MELLOR08** Define for radiation stress terms from waves [Mellor, 2008].

Nesting

- NESTING** Define to activate composite/refinement nesting.
- NO_CORRECT_TRACER** Define to avoid two-way correction of boundary tracer.
- ONE_WAY** Define for one-way nesting in refinement grids.
- TIME_INTERP_FLUX** Time-interpolate coarse mass flux instead of persist.

NetCDF input/output

- DEFLATE** Define to set compression of NetCDF-4/HDF5 format files.

HDF5 Define to create NetCDF-4/HDF5 format files.

NO_LBC_ATT Define to not check **NLM_LBC** global attribute on restart.

NO_READ_GHOST Define to not include ghost points during read/scatter.

NO_WRITE_GRID Define to omit writing of grid arrays.

PARALLEL_IN Define for parallel input via HDF5 or pnetcdf libraries.

PARALLEL_OUT Define for parallel output via HDF5 or pnetcdf libraries.

PERFECT_RESTART Define to include reading and writing enough variables and time levels for a perfect restart.

PNETCDF Define for parallel I/O via pnetcdf library (classic format).

POSITIVE_ZERO Define for positive zero on output.

READ_WATER Define to only read water points.

WRITE_WATER Define to only write water points.

RST_SINGLE Define to write single precision restart fields.

OUT_DOUBLE Define to write double precision output fields.

INLINE_2DIO Define to read/write 3D fields level by level.

6.8 Important parameters

The following is a list of some of the important parameters in the model. These are in **mod_param.F** and are read from the standard input file as described in §7.1.12.

Ngrids Number of grids.

NestLayers Number of levels of refinement grids.

GridsInLayer Number of grids in each refinement level (needs **NestLayers** values).

Lm Number of interior grid points in the ξ -direction for each grid.

Mm Number of interior grid points in the η -direction for each grid.

N Number of grid points in the vertical for each grid.

NAT Number of active tracers (usually 2 for temperature and salinity).

NBT Number of biological tracers. This will depend on the ecosystem model used.

NST Number of sediment tracers.

NPT Number of passive tracers.

NT Total number of tracer fields. $NT = NAT + NBT + NST + NPT$

NtileI Number of tiles in the ξ -direction for each grid.

NtileJ Number of tiles in the η -direction for each grid.

LBC In the old days, the choice of boundary condition was made via **cpp** options. After a significant rewrite to support nesting, the boundary condition choices are now loaded into this array.

6.9 Domain decomposition

ROMS supports serial, OpenMP, and MPI computations, with the user choosing between them at compile time. The serial code can also take advantage of multiple small tiles which can be sized to fit in cache. All are accomplished through domain decomposition in the horizontal. All of the horizontal operations are explicit with a relatively small footprint, so the tiling is a logical choice. Some goals in the parallel design of ROMS were:

- Minimize code changes.
- Don't hard-code the number of processes.
- MPI and OpenMP share the same basic structure.
- Don't break the serial optimizations.
- Same result as serial code for any number of processes (not always the case for large numbers of processes).
- Portability—able to run on any (Unix) system.

First, some `cpp` options. If we're compiling for `MPI`, the option `-DMPI` gets added to the argument list for `cpp`. Then, in `globaldefs.h`, we have:

```
#if defined MPI
# define DISTRIBUTE
#endif
```

The rest of the code uses `DISTRIBUTE` to identify distributed memory jobs. The OpenMP case is more straightforward, with `-D__OPENMP` getting passed to `cpp` and `__OPENMP` being the tag to check within ROMS.

The whole horizontal ROMS grid is shown in Fig. 13. The computations are done over the cells inside the darker line; the cells are numbered 1 to `Lm` in the ξ -direction and 1 to `Mm` in the η -direction. Those looking ahead to running in parallel would be wise to include factors of two in their choice of `Lm` and `Mm`. ROMS will run in parallel with any values of `Lm` and `Mm`, but the computations might not be load-balanced.

6.9.1 ROMS internal numbers

A domain with tiles is shown in Fig. 14. The overlap areas are known as ghost points or halo points. Each tile is an MPI process, an OpenMP thread, or a discrete unit of computation in a serial run. The tile contains enough information to time-step all the interior points, so the number of ghost points is dictated by the footprint of the algorithm using the largest number of neighbor points. In ROMS, the halo area would be two grids points wide unless the `MPDATA` advection or biharmonic viscosity scheme is used, in which case it needs three. The variable `NghostPoints` is set accordingly in `inp_par`:

```
#if defined TS_MPDATA || defined UV_VIS4
    NghostPoints=3
#else
    NghostPoints=2
#endif
IF (ANY(ComposedGrid).or.ANY(RefinedGrid)) THEN
    NghostPoints=MAX(3,NghostPoints)
END IF
```

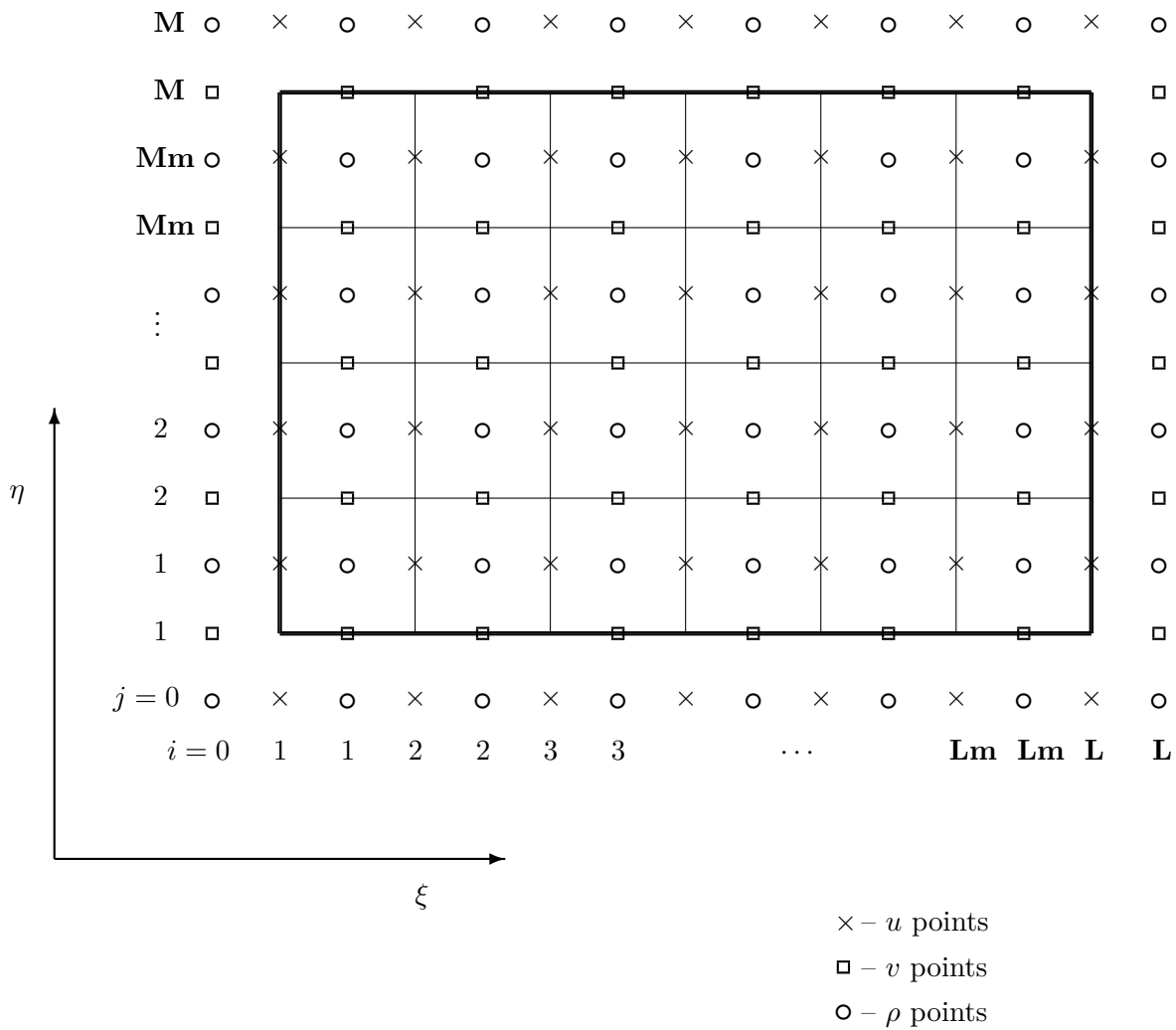

Figure 13: The whole grid. Note that there are \mathbf{Lm} by \mathbf{Mm} interior computational points. The points on the thick outer line and those outside it are provided by the boundary conditions.

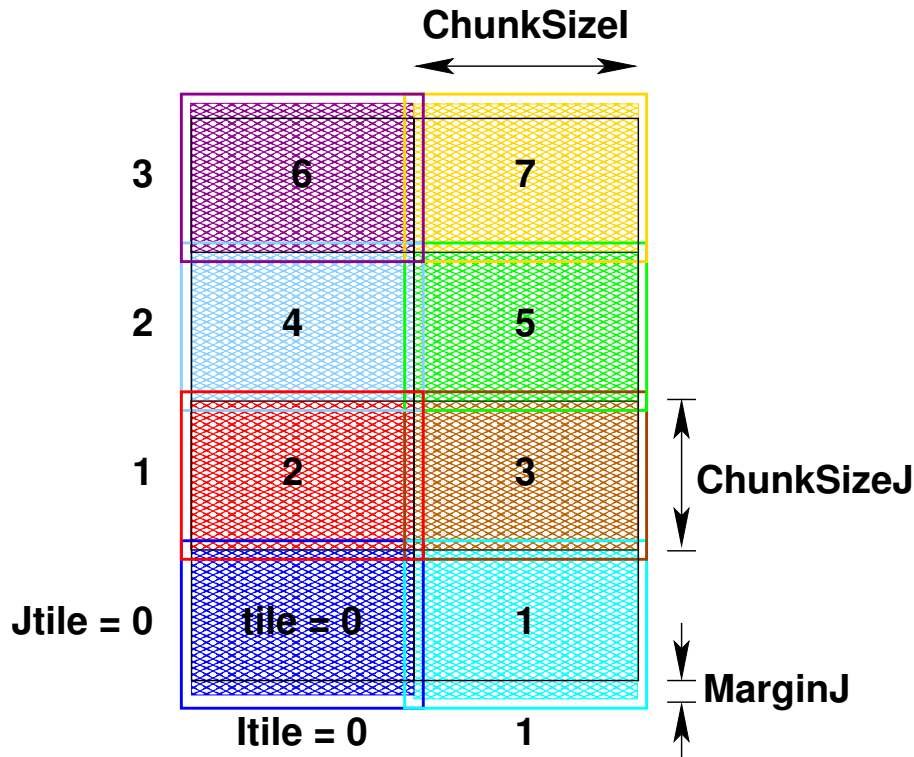

Figure 14: A tiled grid with some ROMS tile variables.

The grid nesting requires `NghostPoints=3`, hence the last bit there.

The number of tiles is set in the input file as `NtileI` and `NtileJ`. For an MPI job, the product of the two must equal the number of MPI processes. For an OpenMP job, the number of tiles must be a multiple of the number of threads. For instance, for `NtileI= 4` and `NtileJ= 6`, you must have 24 MPI processes while 2, 3, 4, 6, 8, 12 and 24 are all valid numbers of OpenMP threads. Also, a serial run could have 24 tiles and would just compute them sequentially.

Once the input file has been read, we can compute the tile sizes in `get_bounds`:

```

ChunkSizeI = (Lm+NtileI-1)/NtileI
ChunkSizeJ = (Mm+NtileJ-1)/NtileJ
MarginI = (NtileI*ChunkSizeI-Lm)/2
MarginJ = (NtileJ*ChunkSizeJ-Mm)/2

```

Some internal ROMS numbers are shown in Fig. 14 and are in the `BOUNDS` structure in `mod_param.F`. `MarginI` and `MarginJ` are zero if the numbers work out perfectly, i.e. `Lm/NtileI` and `Mm/NtileJ` are integers. The tile numbers match the MPI process numbers.

In picking a numbering scheme for indices within a tile, there are two common choices, as shown in Fig. 15. Each tile can be numbered from 1 to `ChunksizeI` or it can retain the numbering it would have in the whole grid. We have chosen this second option for ease when debugging features such as river inputs which apply to specific locations on the grid. It is simple to do using Fortran 90 dynamic memory allocation.

With the tile sizes known, we can assign beginning and ending indices for each tile. Some of the details depend on whether or not the domain is periodic in that direction, as shown in Fig. 16.

6.9.2 MPI exchange

For MPI jobs, the ghost points need to be updated between interior point computations. The routines `mp_exchange2d`, `mp_exchange3d` and `mp_exchange4d` can be used to update the

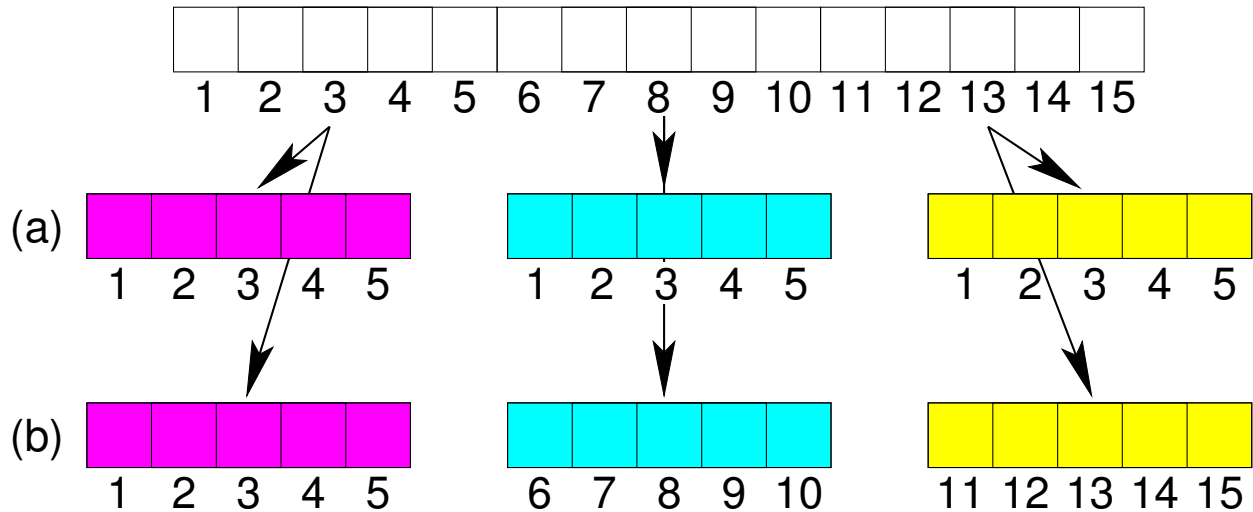

Figure 15: A choice of numbering schemes: (a) each tile is numbered the same, and (b) each tile retains the numbering of the parent domain.

halo points of up to four arrays at a time. Each of these routines calls `tile_neighbors` to figure out which tiles are neighboring and whether or not there really is a neighboring tile on each side. The `mp_exchangexd` routines then call:

```

mpi_irecv
mpi_send
mpi_wait

```

The exchanges happen first in the east-west direction, then in the north-south direction, saving the need for diagonal exchanges. A figure with interior points colored by tile and grey halo points needing an update is shown in Fig. 17(a). The updated halo points are shown in Fig. 17(b).

6.9.3 Code syntax

In `main3d`, many function calls are surrounded by nesting code such as:

```

DO ig=1,GridsInLayer(nl)
  ng=GridNumber(ig,nl)
  DO tile=first_tile(ng),last_tile(ng),+1
    CALL set_data (ng, tile)
  END DO
!$OMP BARRIER
END DO
IF (exit_flag.ne.NoError) RETURN

```

where `first_tile` and `last_tile` are set in `nl_ocean.h`:

```

#if defined _OPENMP
  MyThread=my_threadnum()
#elif defined DISTRIBUTE
  MyThread=MyRank
#else
  MyThread=0
#endif

```

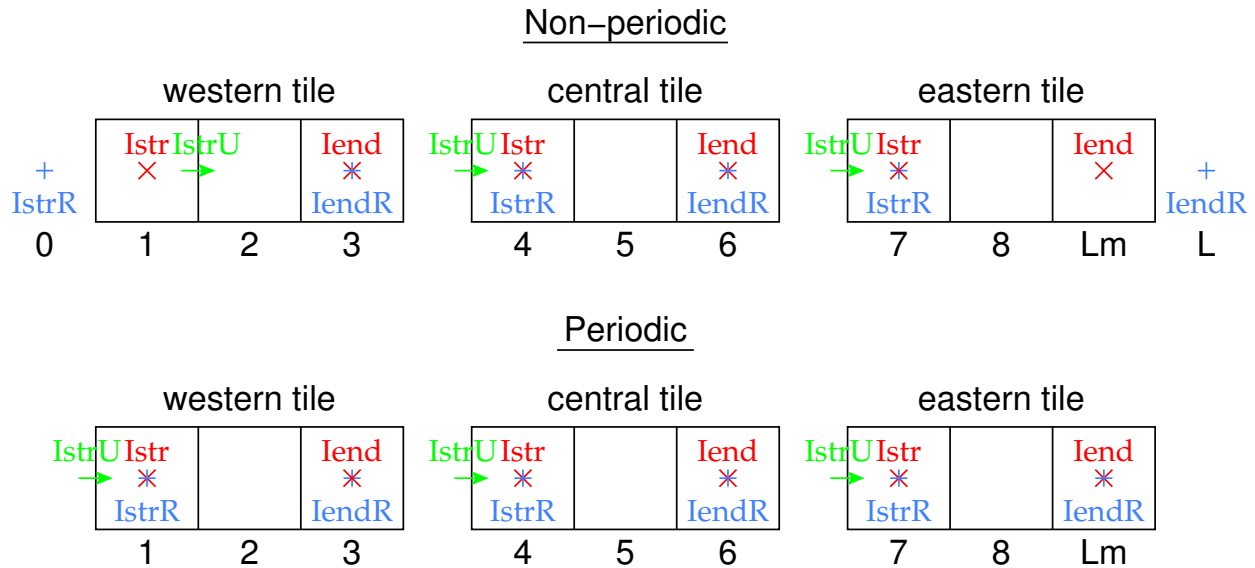

Figure 16: Some ROMS variables for tiles, for both a periodic and non-periodic case. Shown are the variables in the *i*-direction, the *j*-direction is similar.

```

DO ng=1,Ngrids
  chunk_size=(NtileX(ng)*NtileE(ng)+numthreads-1)/numthreads
  first_tile(ng)=MyThread*chunk_size
  last_tile(ng)=first_tile(ng)+chunk_size-1
END DO

```

NtileX and **NtileE** no longer depend on whether we're using MPI:

```

NtileX(1:Ngrids)=NtileI(1:Ngrids)
NtileE(1:Ngrids)=NtileJ(1:Ngrids)

```

Instead, **numthreads** varies, being set to 1 for serial jobs, to the number of MPI processes for MPI and to **omp_get_max_threads()** for OpenMP jobs. For MPI jobs, integer division gives **chunk_size** the value of 1 and **first_tile** and **last_tile** are both set to the process number.

In looking at a typical routine that's called from **main3d**, the routine is usually quite short, calling a **__tile** version of itself in which the actual work happens:

```

SUBROUTINE set_data (ng, tile)
# include "tile.h"
  CALL set_data_tile (ng, tile,                                &
&                    LBi, UBi, LBj, UBj,                      &
&                    IminS, ImaxS, JminS, JmaxS)
  RETURN
END SUBROUTINE set_data

```

Here, there are two sets of array lower and upper bounds, those in the **LBi** family and those in the **IminS** family. Both depend on the **Istr** family shown in Fig. 16. The **IminS** family is for work arrays that are local to an MPI process or to an OpenMP thread, also local to a **__tile** routine. They are initialized:

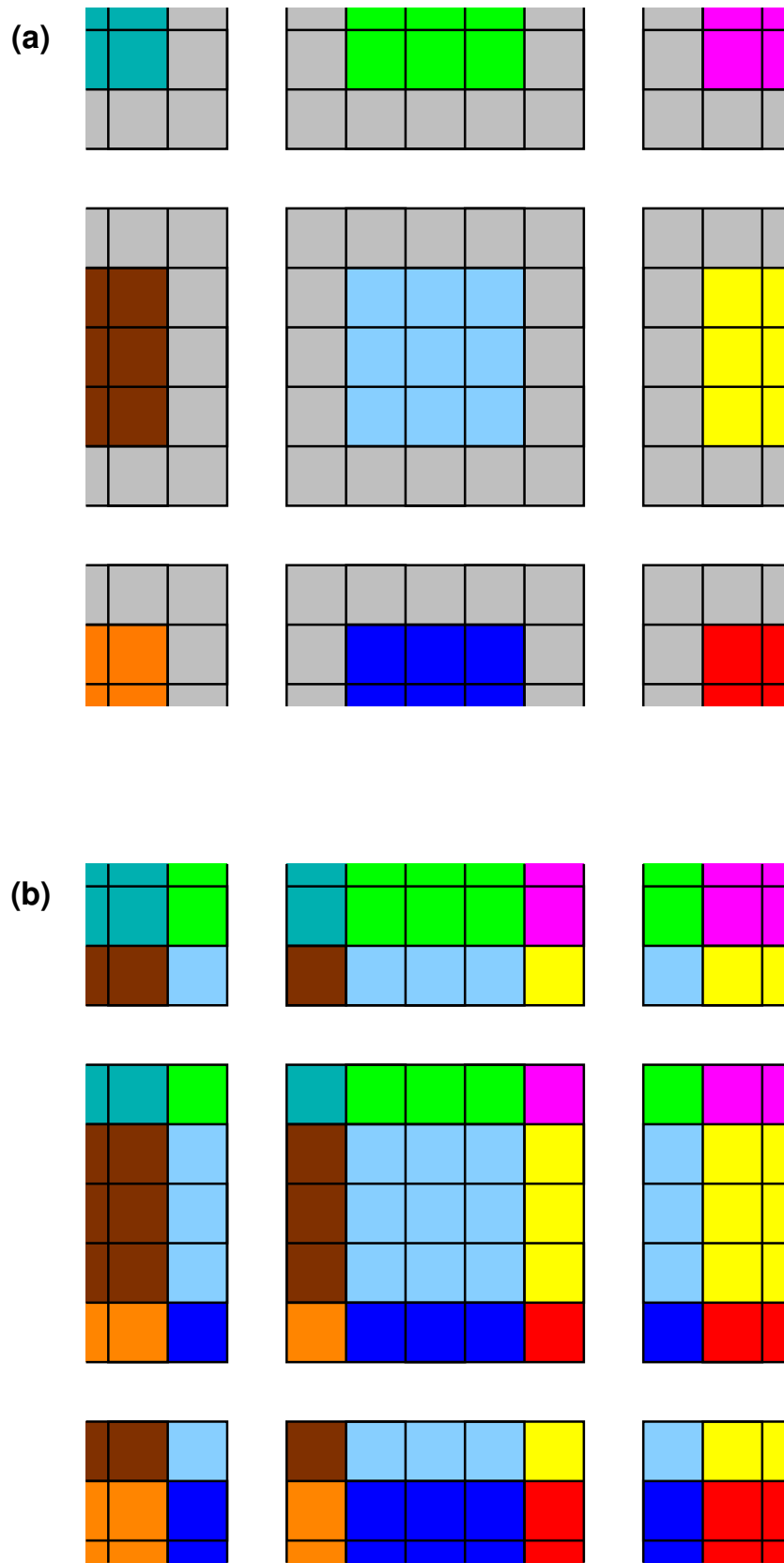

Figure 17: A tiled grid with out-of-date halo regions shown in grey and the interior points color-coded by tile: (a) before an exchange and (b) after an exchange.

```

IminS=BOUNDS(ng)%Istr(tile)-3
ImaxS=BOUNDS(ng)%Iend(tile)+3
JminS=BOUNDS(ng)%Jstr(tile)-3
JmaxS=BOUNDS(ng)%Jend(tile)+3

```

and used:

```

real(r8), dimension(IminS:ImaxS,JminS:JmaxS) :: work1
real(r8), dimension(IminS:ImaxS,JminS:JmaxS) :: work2

```

The **Istr** and **LBi** families are dimensioned by the number of tiles once it is known by **inp_par**:

```

DO ng=1,Ngrids
  Ntiles=NtileI(ng)*NtileJ(ng)-1
  allocate ( BOUNDS(ng) % LBi (-1:Ntiles) )
  :
  allocate ( BOUNDS(ng) % Jend (-1:Ntiles) )
END DO

```

They are then initialized in calls to the routines in **get_bounds.F**. **Imin** is set to **-NghostPoints** or zero, for periodic and non-periodic domains, respectively. The **UBi** family is set once the **Istr** family is known:

```

IF ((Itile.eq.-1).or.(Itile.eq.0)) THEN
  LBi=Imin
ELSE
  LBi=Istr-Nghost
END IF

```

In the case of **set_data**, we are simply passing array indices for the tiled arrays. To access the tiled arrays from within **set_data_tile**, we need to **use** the relevant modules and then refer to the array with its full name:

```

USE mod_forces
:
CALL set_2dfld_tile (ng, tile, iNLM, idCfra,           &
&                   LBi, UBi, LBj, UBj,             &
&                   FORCES(ng)%cloudG,             &
&                   FORCES(ng)%cloud,              &
&                   update)

```

In other cases, the parent routine would have the **use**, then would pass the relevant array to the **__tile** routine:

```

USE mod_grid
:
CALL prsgrd_tile (ng, tile,                           &
:
&                 GRID(ng) % Hz,                      &
:
SUBROUTINE prsgrd_tile (ng, tile,                      &
:
&                 Hz, z_r, z_w,                       &
:
real(r8), intent(in) :: Hz(LBi:,LBj:,:)

```

This allows the **__tile** routine to use **H_z** with the same syntax as the pre-parallel, pre-module code once had.

6.9.4 Input/output

In ROMS, the distributed memory I/O is all happening on the master process (0) unless you specifically ask it to use MPI-I/O, which requires either or both of **PARALLEL_IN**, **PARALLEL_OUT** and either of the **HDF5** or **PNETCDF** **cpp** flags to be defined. If you choose **HDF5**, you will be reading and/or writing **HDF5** files and will need to update your pre- and post-processing tools accordingly. I have tentatively tried the parallel I/O and found it to be exceedingly slow—I've been told since that this is the fault of the **NetCDF-4** layer sitting on top of **HDF5**—**HDF5** alone should be fast.

In the case of having all the I/O pass through the master process, we can still read and write classic NetCDF-3 files. Care must be taken though, in the event of an error. ROMS has been cleaned up so that the master process will broadcast its return state to the other processes and they can all die gracefully together when there is a problem.

An example of a routine which reads from disk is **get_grid**, called from **initial**. Each MPI process calls **get_grid**:

```
        CALL get_grid (ng, iNLM)
# ifdef DISTRIBUTE
        CALL mp_bcasti (ng, iNLM, exit_flag)
# endif
        if (exit_flag.ne.NoError) RETURN
```

If any one of the processes has trouble, it will enter into the **exit_flag** which is then shared by all.

To read in an array variable, all processes in **get_grid** use **nf_fread2d** and friends:

```
        status=nf_fread2d(ng, model, ncname, ncGRDId(ng),      &
&                        var_name(it), var_id(it),           &
&                        0, gtype, Vsize,                   &
&                        LBi, UBi, LBj, UBj,                 &
&                        Fscl, Fmin, Fmax,                  &
&                        GRID(ng) % rmask,                  &
&                        GRID(ng) % rmask)
        IF (status.ne.nf90_noerr) THEN
            exit_flag=2
            ioerror=status
            EXIT
        END IF
```

Within **nf_fread2d**, we get to a call to the NetCDF library from just the master process:

```
        IF (InpThread) THEN
            status=nf90_get_var(ncid, ncvarid, wrk, start, total)
            :
        END IF
# ifdef DISTRIBUTE
        CALL mp_bcasti (ng, model, status)
# endif
        IF (status.ne.nf90_noerr) THEN
            exit_flag=2
            ioerror=status
            nf_fread2d=status
            RETURN
        END IF
```

At this point, the master process has the entire 2-D array stored in **wrk**. This then needs to be divvied out to the various tiles to their copy of the array in question (stored in the **A** argument to **nf_fread2d**):

```
# ifdef DISTRIBUTE
    CALL mp_scatter2d (ng, model, LBi, UBi, LBj, UBj,      &
        &
        Nghost, MyType, Amin, Amax,                    &
#   if defined READ_WATER && defined MASKING
        &
        NWpts, SCALARS(ng)%IJwater(:,wtype),          &
#   endif
        &
        Npts, wrk, A)
```

Something similar happens when writing to output files.

PIO I have a branch in which I linked to the Parallel-IO or PIO library from NCAR. It's unstable for fewer writers than processes, but let me know if you'd like to try it.

7 Configuring ROMS for a Specific Application

This chapter describes the parts of ROMS for which the user is responsible when configuring it for a given application. Section 7.1 describes the process in a generic fashion while §7.2, §7.3, §7.4 and §7.5 step through the application of ROMS to idealized upwelling/downwelling and several realistic wind-driven domains respectively. As distributed, ROMS is ready to run quite a few examples, where the C preprocessor flags determine which is to be executed. Some of these examples are described in Haidvogel and Beckmann [1999], some are listed here:

BASIN This is a rectangular, flat-bottomed basin with double-gyre wind forcing. When run, it produces a western boundary current flowing into a central “Gulf Stream” which goes unstable and generates eddies. The goal is to run adiabatically to study the homogenization of potential vorticity. It earned its nickname of Big Bad Basin by taking a long time to run and by causing difficulties for the spectral versions of SPEM.

GRAV_ADJ The gravitational adjustment problem takes place in a long narrow domain which is initialized with dense water at one end and light water at the other. At time zero, the water is released and it generates two propagating fronts as the light water rushes to fill the top and the dense water rushes to fill the bottom. This configuration can be used to test various advection schemes.

OVERFLOW This configuration is similar to the GRAV_ADJ problem, but is initialized with dense water in the shallow part of a domain with a sloping bottom.

SEAMOUNT The seamount test has been used to test the pressure gradient errors. It has an idealized seamount in a periodic channel. See Beckmann and Haidvogel [1993] and McCalpin [1994] for more information.

UPWELLING The upwelling/downwelling example was contributed by Macks and Middleton [1993] and consists of a periodic channel with shelves on each side. There is along-channel wind forcing and the Coriolis term leads to upwelling on one side and downwelling on the other side. If you run it for several days without vertical mixing, you end up with dense water over light water.

Some NetCDF input files for the ROMS examples can be found under **Data/ROMS** in the ROMS distribution while many others can be downloaded as part of the ROMS test package. The ASCII input files are under **ROMS/External**.

7.1 Configuring ROMS

The four main sections you need to change in ROMS are the **makefile** or **build.bash**, an include file with **cpp** options, any analytic functions, and the ASCII input file. If more realistic fields are desired, you will have to provide other NetCDF input files as well, for instance for the grid and the wind forcing.

7.1.1 Case Name

First, you need to decide on a name for your particular application or configuration. This name is provided via the **ROMS_APPLICATION** in either the makefile or the build script. This name should be reasonably short, all uppercase, with spaces converted to underscores. For example, let’s say we pick the name **WIKI_TEST**. This name gets defined during the build, so you can add code protected by **#ifdef WIKI_TEST** as needed. This would be a good time to either copy the makefile or the build Script to create one specific to this case prior to editing it.

7.1.2 Case-specific Include File

Each application has its own include file, included by **cppdefs.h**. The name of this file is the name of your application (**WIKI_TEST** here) turned into lower case, with '.h' appended (**wiki_test.h**). The location of this file is set by **MY_HEADER_DIR**, pointing to **User/Include** or some other location of your choosing.

The complete list of options to be set prior to compilation are listed in §6.7. Place those you need in the **wiki_test.h** file. These include algorithm choices (e.g. advection and turbulence closure schemes), output options (averages, diagnostics, stations, floats), and application modules (biology, sediments). Each line should be of the form:

```
#define SOME_VAR
```

Note that any undefined variable need not be mentioned.

Also note that if you copy a predefined application from **ROMS/Include** as a template for your application, you must rename it. If you don't change the name, ROMS will use the one in **ROMS/Include** and your file will be ignored during the build procedure.

7.1.3 Functionals

Some of the cpp options have names beginning with **ANA_**. For each one of these, you will be expected to provide an analytic expression for the field in question in the corresponding include file. These files are listed in §6.5 and their location is determined by **MY_ANALYTICAL_DIR**. You may chose to copy those from **User/Functionals** to some new directory and place your version of the assignments within

```
#ifdef WIKI_TEST
! Set weird and wonderful winds
:
#endif
```

This makes it easy to search for later, if nothing else.

7.1.4 checkdefs.F

If you add new **cpp** variables to the code (other than your application name), it is recommended that you also add the appropriate code to **checkdefs.F**, such as:

```
#ifdef SLEET
    IF (Master) WRITE(stdout,20) 'SLEET',           &
    & 'Sleet falling on the ice option.'
    is=lenstr(Coptions)+1
    Coptions(is:is+7)=' SLEET,'
#endif /* SLEET */
```

Note that the number "7" on the **Coptions** line must be set according to the length of the string you are adding. In this case 7 is for " SLEET,", including the comma and the space. You do not need to do this for your application name (**WIKI_TEST** here), since **checkdefs** will print whatever is in **MyAppCPP**.

7.1.5 Model domain

It is assumed in this manual that **Ngrids** will be set to 1. Having multiple grids talk to each other is brand new in ROMS 3.7, with documentation appearing on the ROMS wiki.

One of the first things the user must decide is how many grid points to use, and can be afforded. There are three parameters in **ocean.in** which specify the grid size and one parameter for the number of active tracers:

- Lm** Number of finite-difference points in ξ .
- Mm** Number of finite-difference points in η .
- N** Number of finite-difference points in the vertical.
- NAT** Number of active tracers.

The number of biological tracers is set in the **biology.in** file. There are no constraints on these except **Lm** ≥ 2 , **Mm** ≥ 2 , **N** ≥ 1 and **NAT** ≥ 1 . **Lm** and **Mm** should be at least 3 if the domain is periodic in that direction. If **N** == 1, don't define SOLVE_3D.

7.1.6 x, y grid

The subroutine **get_grid** or **ana_grid** is called by **initial** to set the grid arrays, the bathymetry, and the Coriolis parameter. Most of the simple test problems have their grid information specified in **ana_grid.h** in the directory **ROMS/Functionals**. More realistic problems require a NetCDF grid file, produced by the grid generation programs described in Wilkin and Hedstrom [1991], by the Matlab **SeaGrid**, or by some other method. The variables which are read by **get_grid** are:

xl, el, spherical, f, h, pm, pn, x_rho, y_rho, lon_rho, lat_rho, angle.

If the grid is curved, **get_grid** will also read:

dndx, dmde.

Likewise, if **MASKING** is defined, it will read:

mask_rho, mask_u, mask_v, mask_psi.

7.1.7 ξ, η grid

Before providing initial conditions and boundary conditions, the user must understand the model grid. The fields are laid out on an Arakawa C grid as in Fig. 1. The overall grid is shown in Fig. 13. The thick outer line shows the position of the model boundary. The points inside this boundary are those which are advanced in time using the model physics. The points on the boundary and those on the outside must be supplied by the boundary conditions.

The three-dimensional model fields are carried in four-dimensional arrays, where the fourth array index refers to one of two or three time levels. The tracers have a fifth array index telling which tracer is being referred to. For instance, **itemp** = 1 refers to potential temperature while **isalt** = 2 refers to salinity. The integers i , j , and k are used throughout the model to index the three spatial dimensions:

- i Index variable for the ξ -direction.
- j Index variable for the η -direction.
- k Index variable for the σ -direction. $k = 1$ refers to the bottom while $k = \mathbf{N}$ refers to the surface.

In terms of grid extent, the model is expecting values for rho-point indices from $i = 0$ through $i = \mathbf{Lm} + 1$, even though the computational domain extends from $i = 1$ through $i = \mathbf{Lm}$.

7.1.8 Initial conditions

The initial values for the model fields are provided by either `ana_initial` or `get_state`. `get_state` is also used to read a restart file if the model is being restarted from a previous run.

Also in `initial`, `rho_eos` is called to initialize the density field. `rho_eos` also computes `rhoA`, the vertically averaged density, and `rhoS`, the density perturbation. Both `rhoA` and `rhoS` are used in the barotropic pressure gradient.

7.1.9 Equation of state

The equation of state is defined in the subroutine `rho_eos`. Two versions are provided in ROMS: a nonlinear $\rho = \rho(T, S, z)$ from Jackett and McDougall [1995] and a linear $\rho(T, S)$. The linear form is

$$\rho = \mathbf{R0} - \mathbf{Tcoef} \cdot (T - T0) + \mathbf{Scoef} \cdot (S - S0)$$

or

$$\rho = \mathbf{R0} + \mathbf{Tcoef} \cdot (T - T0),$$

depending on whether or not `SALINITY` is defined. Specify which equation of state you would like to use with the `NONLIN_EOS` C preprocessor flag in your application include file. The linear coefficients `R0`, `T0`, `Tcoef`, `S0`, and `Scoef` are set in `ocean.in`. Note that we are computing *in situ* density from potential temperature and salinity. Some of the vertical mixing schemes require potential density and some other fields, which are computed by `rho_eos` as well.

7.1.10 Boundary conditions

The horizontal boundary conditions are provided by the subroutines in `u3dbc_im`, `v3dbc_im`, `u2dbc_im`, `v2dbc_im`, `t3dbc_im`, and `zetabc`. They are called every time-step and provide the boundary values for the fields u, v, \bar{u}, \bar{v} , all tracers, and ζ , respectively. They are currently configured for a closed basin, a periodic channel, a doubly periodic domain or a domain with various open boundary conditions. Each side is controlled independently with “West” being the `i=1` boundary, “East” being the `i=L` boundary, “South” being the `j=1` boundary, and “North” being the `j=M` boundary. These choices are set in `ocean.in` via the `LBC` array.

Many of the choices for open boundaries require that the model have some boundary values for the field in question. These can be specified in the appropriate `ana_XXX.h` file for say `ANA_TOBC` or they can be read from a boundary NetCDF file. There is logic in `globaldefs.h` by which ROMS decides whether or not it needs to read a boundary file.

7.1.11 Model forcing

(a) Winds and thermal fluxes

There are two different ways to apply a wind forcing: as a surface momentum flux in the vertical viscosity term, or as a body force over the upper water column. Usually, we set the vertical σ -coordinate parameters to retain some resolution near the surface and apply the fluxes as boundary conditions to the vertical viscosity/diffusivity. In either case, the surface and bottom fluxes are either defined analytically, read from a forcing file, or computed inside ROMS using a bulk flux formula from the appropriate atmospheric fields (air temperature and winds, for instance). You must either edit the appropriate `ana_XXX.h` or create a NetCDF forcing file in the format expected by ROMS. Note that it is quite common to put the surface variables in the forcing file while having an analytic bottom heat flux. ROMS now has the capability of reading in a list of forcing fields—it can be convenient to have one file per field rather than stuffing tides, winds, river inputs all into one file.

In the past, our vertical resolution was relatively coarse and the vertical viscosity would have to have been unreasonably large for us to resolve the surface Ekman layer. If that is your situation, define **BODYFORCE** in **cppdefs.h** and provide a value for **levsfrc** in **ocean.in**. The forcing is applied over the levels from **levsfrc** to **N**. The above caution about vertical resolution also applies to the surface fluxes of T and S , although **BODYFORCE** only refers to wind stress, not the surface tracer fluxes.

(b) Climatology

One way to force the model is via a nudging to the tracer and/or momentum climatologies. Nudging to values from a global model near the boundaries can be useful when the boundary conditions alone are not entirely well-behaved. Set the climatologies in **ana_tclima.h** or in a file read by **get_data**, set **LtracerCLM** in **ocean_wiki_test.in** and also set the array **Tnudgcoef** in either **ana_nudgcoef.h** or in a file (with name in **NUDNAME** variable in the **ocean.in**).

(c) Tides

There is also more than one way to force with tides. One way is to provide boundary conditions with enough temporal resolution to resolve the tides. Another is to provide ROMS with the tidal constituents at all grid points and to have ROMS reconstruct the tidal currents (**UV_TIDES**) and/or elevations (**SSH_TIDES**) for any given time. An example of such a tidal forcing file is in **Data/ROMS/Forcing/test_head_frc.nc**.

The non-trunk code with ice, etc. includes the **TIDES_ASTRO** option to add on the long-period tides from Foreman [1996a] and Foreman [1996b]. There is also an option to include the tidal potential forcing term (**POT_TIDES**), requiring the tidal potential to be included in the tides forcing file.

(d) Rivers

Point sources can be used to provide river inflow to the model. These have their own input file (**SSFNAME**) if not provided via **ana_psource**.

7.1.12 ocean.in

ROMS expects to read a number of variables from an ASCII file as described in §2.5. Example input files are in **ROMS/External** with names like **ocean_grav_adj.in**, where “grav_adj” refers to the name of the application. Lines beginning with “!” are comments and will be ignored by ROMS on reading them.

The input is organized as key/value pairs, separated by one or two equals signs. It is possible for ROMS to run on more than one grid simultaneously, with the number of grids being read from the input file. If there is one equals sign (=), ROMS will use the corresponding value for all grids. If there are two (==), ROMS will read a value for each grid. Thus far, most domains have used just one grid, though I did run a two-grid Palau domain—check in **Apps/Palau** for a two-grid **ocean.in** file (which I generated using a Python script).

ROMS will ignore the parameters not needed by the current simulation, e.g., the GLS parameters will not be read if you are not using that mixing scheme. Most of the example files contain all possible parameters, with **User/External/ocean.in** being for sure updated with each addition. The parameters are described in comments at the bottom of the **ocean.in** files. Skipping those having to do with data assimilation, the input parameters are as follows:

Header

TITLE A text string to put in the output files.

MyAppCPP The shorthand name for this application.

VARNAME The location of the **varinfo.dat** file containing information about fields to read/write from/to NetCDF files.

Ngrids The number of grids to compute on.
NestLayers The number of levels of nested grids.
GridsInLayer The number of grids in each nesting level.

Grid-dimension parameters

Lm Number of i -direction INTERIOR RHO-points.
Mm Number of j -direction INTERIOR RHO-points.
N Number of vertical levels.
Nbed Number of sediment bed layers.
NAT Number of active tracers (usually 2).
NPT Number of passive tracers.
NCS Number of cohesive (mud) sediment tracers.
NNS Number of non-cohesive (sand) sediment tracers.

Domain-decomposition parameters

NtileI Number of i -direction partitions.
NtileJ Number of j -direction partitions.

Boundary conditions

LBC A line is given for each field, each line containing four values, one for each side in the order “West”, “South”, “East”, “North”. Each value is a string, with the possible values being:

- Cha** Chapman implicit.
- Che** Chapman explicit.
- Cl** Clamped.
- Clo** Closed.
- Fl** Flather.
- Gra** Gradient.
- Mix** Ice only—mixed clamped and radiation.
- Nes** Nested.
- Per** Periodic—should match the opposing boundary.
- Rad** Radiation.
- RadNud** Radiation and nudging.
- Red** Reduced Physics—note that this also requires the **FSOBC_REDUCED** cpp flag.
- Shc** Schepetkin.

VolCons Four values for the volume conservation, one for each edge.

Time-stepping parameters

NTIMES Number of time-steps to evolve the 3-D equations in the current run. This is actually the total number, including any previous segments of the same run. For instance, if you already did a three-month run and wish to continue for another three months, set **NTIMES** to the number of steps needed for six months.

DT Time-step in seconds for the 3-D equations.

NDTFAST Number of time-steps for the 2-D equations to be executed each **dt**. This is the number shown as M in Figure 5—the model will compute M^* at run time.

Input/Output parameters

ROMS has several possible output files. The output files can include a restart file, a history file, an averages file, and a station file, for instance. The restart file often contains only two records with the older record being overwritten during the next write. The history file can contain a subset of the restart fields, for instance just the surface elevation and the surface temperature. The averages file contains time-averages of the model fields, for instance daily or monthly means, depending on **NAVG**. The station file contains timeseries for specified points, possibly quite frequently since each record is small. For some, machinery is in place to write multiple files, numbering them `_0001`, `_0002`, etc.

NRREC Record number of the restart file to read as the initial conditions. Set to 0 at the beginning of the run, -1 to read the latest record.

LcycleRST Logical, true to cycle between two records of the restart file.

NRST Number of time-steps between writing of restart fields.

NSTA Number of time-steps between writing fields into the stations file.

NFLT Number of time-steps between writing fields into the floats file.

NINFO Number of time-steps between calling **diag** to write some global information and to check for NaN values.

History, average, diagnostic output parameters

LDEFOUT True for creating new output files for stations, history, floats, etc. If false, output is appended to these files.

NHIS Number of time-steps between writing history records.

NDEFHIS Number of time-steps between starting new history files.

NQCK Number of time-steps between writing secondary history records.

NDEFQCK Number of time-steps between starting new secondary history files.

NTSAVG Starting time-step for the accumulation of output time-averaged data. For instance, you might want to average over the last day of a thirty-day run.

NAVG Number of time-steps between writing time-averaged data into the averages file.

NDEFAVG Number of time-steps between starting new averages files.

NTSAVG2 Starting time-step for the accumulation of output secondary time-averaged data. For instance, you might want to average over the last day of a thirty-day run.

NAVG2 Number of time-steps between writing time-averaged data into the secondary averages file.

NDEFAVG2 Number of time-steps between starting new secondary averages files.

NTSDIA Starting time-step for the accumulation of output diagnostics data. For instance, you might want to write diagnostics for the last day of a thirty-day run.

NDIA Number of time-steps between writing diagnostics data into the diagnostics file.

NDEFDIA Number of time-steps between starting new diagnostics files.

Horizontal mixing of tracers

- TNU2** Constant mixing coefficient for the horizontal Laplacian diffusion of each tracer. A value is expected for each of the **NAT+NPT** tracers.
- TNU4** Constant mixing coefficient for the horizontal biharmonic diffusion of each tracer. A value is expected for each of the **NAT+NPT** tracers.

Horizontal viscosity coefficients

- VISC2** Constant mixing coefficient for the horizontal Laplacian viscosity.
- VISC4** Constant mixing coefficient for the horizontal biharmonic viscosity.

Horizontal sponge

- LuvSponge** Logical for applying a sponge (increased horizontal viscosity) to momentum fields.
- LtracerSponge** Logical for applying a sponge (increased horizontal diffusivity) to tracer fields.

Vertical mixing coefficients for tracers

- AKT_BAK** Background vertical mixing coefficient for the tracers (**NAT+NPT** values).

Vertical mixing coefficient for momentum

- AKV_BAK** Background vertical mixing coefficient for momentum.

Turbulent closure parameters

- AKK_BAK** Background vertical mixing coefficient for turbulent kinetic energy.
- AKP_BAK** Background vertical mixing coefficient for turbulent generic statistical field.
- TKENU2** Constant mixing coefficient for the horizontal Laplacian diffusion of turbulent kinetic energy.
- TKENU4** Constant mixing coefficient for the horizontal biharmonic diffusion of turbulent kinetic energy.

Generic length-scale turbulence closure parameters

- GLS_P** Stability exponent.
- GLS_M** Turbulent kinetic energy exponent.
- GLS_N** Turbulent length scale exponent.
- GLS_Kmin** Minimum value of specific turbulent kinetic energy.
- GLS_Pmin** Minimum value of dissipation.
- GLS_CMU0** Stability coefficient.
- GLS_C1** Shear production coefficient.
- GLS_C2** Dissipation coefficient.
- GLS_C3M** Buoyancy production coefficient (minus).
- GLS_C3P** Buoyancy production coefficient (plus).
- GLS_SIGK** Constant Schmidt number (non-dimensional) for turbulent kinetic energy diffusivity.

GLS_SIGP Constant Schmidt number (non-dimensional) for turbulent generic statistical field, “psi”.

Constants used in surface TKE flux computation

CHARNOK_ALPHA Charnok surface roughness.

ZOS_HSIG_ALPHA Roughness from wave amplitude.

SZ_ALPHA Roughness from wave dissipation.

CRGBAN_CW Craig and Banner wave breaking.

Bottom drag coefficients

RDRG Linear bottom drag coefficient.

RDRG2 Quadratic bottom drag coefficient.

Zob Bottom roughness.

Zos Surface roughness (under ice shelves).

Height of atmospheric measurements for bulk flux parameterizations

BLK_ZQ Height of air humidity values.

BLK_ZT Height of air temperature values.

BLK_ZW Height of wind values.

Wetting and drying parameter

DCRIT Minimum depth for dry cells.

Various parameters

WTYPE Jerlov water type.

LEVSFRC Deepest level to apply surface momentum stresses as a body force. Used when the C-preprocessor option BODYFORCE is defined.

LEVBFRC Shallowest level to apply bottom momentum stresses as a body force. Used when the C-preprocessor option BODYFORCE is defined.

Vertical coordinate parameters

Vtransform Transformation equation, 1 for old style, 2 now recommended.

Vstretching Stretching function, 1 for old style, 4 now recommended.

Vertical σ -coordinates parameters

THETA_S σ -coordinate surface control parameter, [$0 < \mathbf{theta_s} < 20$ for old style].

THETA_B σ -coordinate bottom control parameter, [$0 < \mathbf{theta_b} < 1$ for old style].

TCLINE Width of the surface or bottom boundary layer in which higher vertical resolution is required during stretching.

Mean Density and Brunt-Väisälä frequency

RHO0 Mean density used in the Boussinesq approximation.

BVF_BAK Background Brunt-Väisälä frequency squared.

Time parameters

DSTART Time stamp assigned to model initialization (days).
TIDE_START Time of tidal origin relative to model origin.
TIME_REF Reference time in the format `yyymmdd.dd` or else a special value for specific calendars as documented in the `ocean.in` files.

Nudging time scales

TNUDG Time scale (days) of nudging towards tracer climatology at the interior and at the boundaries. A value is expected for each active tracer.
ZNUDG Time scale (days) of nudging towards free surface climatology at the interior and at the boundaries.
M2NUDG Time scale (days) of nudging towards 2-D momentum climatology at the interior and at the boundaries.
M3NUDG Time scale (days) of nudging towards 3-D momentum climatology at the interior and at the boundaries.
TNUDG_SSS Time scale (days) of nudging towards surface salinity climatology.
SSS_MISMATCH_THRESHOLD Parameter when both **SCORRECTION** and **SSSC_THRESHOLD** are used.

Open boundary factor

OBCFAC Ratio of inflow and outflow nudging time scales.

Linear equation of state parameters

R0 Background density value used in the linear equation of state.
T0 Background potential temperature constant.
S0 Background salinity constant.
TCOEF Thermal expansion coefficient in the linear equation of state.
SCOEF Saline contraction coefficient in the linear equation of state.

Slipperiness parameter

GAMMA2 Slipperiness variable, either 1.0 (free slip) or -1.0 (no slip).

Point sources

LuvSrc Logical for lateral flux point sources.
LwSrc Logical for vertical flux point sources.
LtracerSrc Logical, one value per tracer, whether or not point sources have tracer values.

Climatology nudging

LsshCLM Logical for SSH climatology.
Lm2CLM Logical for 2D momentum climatologies.
Lm3CLM Logical for 3D momentum climatologies.
LtracerCLM Logical, one value per tracer, whether or not to have tracer climatologies.
LnudgeM2CLM Logical for nudging to 2D momentum climatologies.
LnudgeM3CLM Logical for nudging to 3D momentum climatologies.

LnudgeTCLM Logical, one value per tracer, whether or not to nudge to tracer climatologies.

Logical switches to activate the writing of history/averages fields Values for all of these for the ice model are now set in **ice.in**.

Hout History output switches, one line per variable. Check the **ocean.in** file for the names of the fields involved.

Qout Secondary history output switches, one line per variable. Check the **ocean.in** file for the names of the fields involved.

Aout Averages output switches, one line per variable. Check the **ocean.in** file for the names of the fields involved.

Aout2 Averages2 output switches, one line per variable. Check the **ocean.in** file for the names of the fields involved.

Dout Diagnostics output switches, one line per term. Check the **ocean.in** file for the names of the fields involved.

User parameters

NUSER Number of user parameters

USER Values of user parameters (NUSER values).

NetCDF-4/HDF5 parameters

NC_SHUFFLE If non-zero, turn on shuffle filter.

NC_DEFLATE If non-zero, turn on deflate filter.

NC_DLEVEL Deflate level (0–9).

Input NetCDF file names

GRDNAME Grid file.

ININAME Initial conditions file.

ITLNAME Initial tangent linear file.

IRPNAME Initial representer file.

IADNAME Initial adjoint file.

FWDNAME Forward model file.

ADSNAME Adjoint sensitivity functional file.

NGCNAME Nesting connectivity file.

NUDNAME Nudging coefficients file.

SSFNAME Sources/sinks forcing file.

Boundary, Climatology and Forcing NetCDF files These can each have an array of files, with one set of files per variable, each file in a set for a different range of times. See **ocean.in** for syntax. Note that the trunk code only does this for forcing files, while if you use the code described here, you *must* specify the number of files of the appropriate type before providing the filenames. For instance, not setting **NBCFILES** before setting **BRYNAME** will lead to a segmentation fault.

NCLMFILES Number of climatology files.

CLMNAME Climatology file.
NBCFILES Number of boundary files.
BRYNAME Boundary condition file.
NFFILES Number of forcing files.
FRCNAME Forcing files.

Output NetCDF file names

DAINAME Data assimilation next cycle initial conditions file.
GSTNAME GST analysis restart file.
RSTNAME Restart file.
HISNAME History file.
QCKNAME Secondary history file.
TLMNAME Tangent linear file.
TLFNAME Impulse forcing file (for tangent linear model).
ADJNAME Adjoint file.
AVGNAME Averages file.
AVG2NAME Secondary averages file.
DIANAME Diagnostics file.
STANAME Stations file.
FLTNAME Lagrangian floats file.

ASCII input file names

APARNAM Assimilation parameters.
SPOSNAM Stations positions.
FPOSNAM Initial drifter positions.
IPARNAM Ice parameters.
BPARNAM Biology parameters.
SPARNAM Sediment parameters.
USRNAME User's generic input.

The bottom of the sample files contain comments describing some of these in greater detail, including the data assimilation parameters.

7.1.13 User variables and subroutines

It is possible for the user to add new variables and functionality, though it is discouraged. The design goal is to isolate the most common features a user would change to the **cpp** switches (§6.7), the **ana_xx.h** files (§6.5) and the ASCII input file (§7.1.12). A query on the ROMS forum might be in order if you have something specific in mind.

If you do choose to add bits, know that the **makefile** fragments called **Module.mk** will attempt to compile and link into a library anything with a **.F** extension in the directories already generating a library from such files.

7.2 Upwelling/Downwelling Example

The application which ROMS is configured to run as distributed is a wind-driven upwelling and downwelling example, described in Macks and Middleton [1993]. There is a shelf on each wall of a periodic channel and an along-channel wind forcing, which drives upwelling at one wall and downwelling at the other. This problem depends on the Ekman layer, therefore a surface stress is used with vertical viscosity. The Ekman depth is estimated to be 9 m if $A_v = 0.01m^2/s$, so the vertical grid spacing must resolve this. The maximum depth is 150 m and our choice of the vertical grid parameters leads to a surface Δz of 1.6 m. A possible update to this example would be to increase **N** and decrease **Lm**, the latter because the solution does not vary in the along-channel direction.

7.2.1 cppdefs.h

The C preprocessor variable **UPWELLING** is used for the upwelling configuration of the model. The **makefile** will direct **cppdefs.h** to include the file **upwelling.h**:

```
#define UV_ADV
#define UV_COR
#define UV_LDRAG
#define UV_VIS2
#undef MIX_GEO_UV
#define MIX_S_UV
#define SPLINES_VDIFF
#define SPLINES_VVISC
#define TS_U3HADVECTION
#define TS_C4VADVECTION
#undef TS_MPDATA
#define DJ_GRADPS
#define TS_DIF2
#undef TS_DIF4
#undef MIX_GEO_TS
#define MIX_S_TS

#define SALINITY
#define SOLVE3D
#define AVERAGES
#define DIAGNOSTICS_TS
#define DIAGNOSTICS_UV

#define ANA_GRID
#define ANA_INITIAL
#define ANA_SMFLUX
#define ANA_STFLUX
#define ANA_SSFLUX
#define ANA_BTFLUX
#define ANA_BSFLUX

#if defined GLS_MIXING || defined MY25_MIXING
# define KANTHA_CLAYSON
# define N2S2_HORAVG
# define RI_SPLINES
```

```

#else
# define ANA_VMIX
#endif

#if defined BIO_FENNEL || defined ECOSIM || \
    defined NPZD_POWELL || defined NEMURO || \
    defined BIO_UMAINE
# define ANA_BIOLOGY
# define ANA_SPFLUX
# define ANA_BPFLUX
# define ANA_SRFLUX
#endif

#if defined NEMURO
# define HOLLING_GRAZING
# undef IVLEV_EXPLICIT
#endif

#ifdef BIO_FENNEL
# define CARBON
# define DENITRIFICATION
# define BIO_SEDIMENT
# define DIAGNOSTICS_BIO
#endif

#ifdef BIO_UMAINE
# define OXYGEN
# undef CARBON
#endif

#ifdef PERFECT_RESTART
# undef AVERAGES
# undef DIAGNOSTICS_BIO
# undef DIAGNOSTICS_TS
# undef DIAGNOSTICS_UV
# define OUT_DOUBLE
#endif

```

Here we have declared that we want a three-dimensional solution, but no masking. There is salinity but we're using a linear equation of state. The momentum equations have advection, Coriolis force and pressure gradients. There is both horizontal viscosity and diffusion, but they are along constant σ -surfaces and if you check the input file, you find that the horizontal diffusion is set to zero.

There are ifdefs for various biology cases, none of which have been defined. Likewise, we are using the default of **ANA_VMIX** as distributed. We are asking for many other analytic functions too, including the grid. We are asking for diagnostic output with the **DIAGNOSTICS_TS** and **DIAGNOSTICS_UV**.

7.2.2 Model domain

The flow does not vary in x , so **Lm** can be almost anything. Set the values for **Lm**, **Mm**, **N** and **NAT** in the input file:

```

Lm == 41          ! Number of I-direction INTERIOR RHO-points
Mm == 80          ! Number of J-direction INTERIOR RHO-points
N == 16           ! Number of vertical levels

NAT = 2           ! Number of active tracers (usually, 2)

```

A historical note: **Lm** here really is 41 for 41 boxes in the x -direction. It was originally set to 41 for 40 boxes, but the periodic boundary conditions are now more efficient and no longer need an extra box. One could just as well set it to 40 (or even 5).

7.2.3 ana_grid

For this geometry one has a choice of using one of the external grid-generation programs or of using **ana_grid** to create the grid analytically. The code in **ana_grid.h** was modified to produce a bathymetry with a shelf on both walls of the channel when **UPWELLING** is defined. The fluid depth ranges from 27 m on the shelves to 150 m in the center of the channel. The horizontal grid spacing is uniform at 1 km and the Coriolis parameter f is set to a constant value suitable for Sydney, Australia.

7.2.4 Initial conditions and the equation of state

We would like the initial conditions to be a motionless fluid with an exponential stratification. The **UPWELLING** section of **ana_initial.h** is configured accordingly.

The stratification can be provided by either T or S , or by both T and S . For simplicity we will only have an active temperature field and we will use the linear equation of state by setting **NONLIN_EOS** to **#undef**. We want the density to be 26.35 at the bottom and 24.22 at the top with an e-folding scale of 50 meters. The initial temperature is set to **T0**+ $8e^{z/50}$ in **ana_initial**. The linear equation of state parameters are set in **ocean_upwelling.in**:

```

R0 == 1027.0d0      ! kg/m3
T0 == 14.0d0        ! Celsius
S0 == 35.0d0        ! PSU
TCOEF == 1.7d-4     ! 1/Celsius
SCOEF == 0.0d0      ! 1/PSU

```

Since density does not depend on salinity, we have a choice of how to handle the second tracer. The salinity is set to a uniform value of **S0**, though it could be left out entirely if we undefine **SALINITY** and set **NAT** to 1.

7.2.5 Boundary conditions

In **ocean_upwelling.in**, the variable **LBC** is set to be periodic in the East-West direction, with closed walls to the North and South. No boundary values are required.

7.2.6 Model forcing

In this problem we want to resolve the surface Ekman layer and to use a surface wind stress rather than a body force. We want the amplitude of the wind to ramp up with time so we modify **ana_smflux.h** accordingly. The wind stress will build to an amplitude of 0.1 Pascals / ρ_o , or $10^{-4}m^2s^{-2}$.

We need to edit **ana_vmix.h** to make sure that the vertical viscosity **Akv** is set to the value we want. This must be large at the surface ($10^{-2}m^2s^{-1}$) to create a thick Ekman layer, but has been chosen to decrease with depth. We also need to check that **ana_btflux**, **ana_stflux**, etc.

are set correctly, in this case taking the default of zero rather than explicitly setting anything for **UPWELLING**. However, we do set **ana_srflux** to be non-zero in case we opt to turn on one of the biology models.

7.2.7 ocean.in

The model has been set up to run for five days with an internal time-step of 300 *s* and an external time-step of 10 *s*.

```

NTIMES == 1440
  DT == 300.0d0
NDTFAST == 30

```

We will write history, averages, and diagnostics records every 1/4 day, restart records once a day.

```

NRREC == 0
LcycleRST == T
  NRST == 288
LDEFOUT == T
  NHIS == 72
NDEFHIS == 0
  NQCK == 0
NDEFQCK == 0
  NTSAVG == 1
  NAVG == 72
NDEFAVG == 0
  NTSDIA == 1
  NDIA == 72
NDEFDIA == 0

```

As stated before, there is no horizontal diffusivity, but a small horizontal viscosity has been set. The value of the linear bottom friction coefficient **rdrng** is set to 3.0×10^{-4} and the channel walls are set to be free-slip:

```

TNU2 == 0.0d0 0.0d0           ! m2/s
VISC2 == 5.0d0                ! m2/s
RDRG == 3.0d-04              ! m/s
GAMMA2 == 1.0d0

```

The vertical stretching is set to a modest value of **theta_s**= 3:

```

Vtransform == 2                ! transformation equation
Vstretching == 4               ! stretching function
  THETA_S == 3.0d0             ! surface stretching parameter
  THETA_B == 0.0d0            ! bottom stretching parameter
  TCLINE == 25.0d0            ! critical depth (m)

```

7.2.8 Output

The model writes much information to standard out. While I like having **ninfo** set to 1 in general, I set it to 72 here to save space. Also note that this was run before the secondary history output option was added to the trunk code.

Wind-Driven Upwelling/Downwelling over a Periodic Channel

Operating system : Darwin
CPU/hardware : x86_64
Compiler system : gfortran
Compiler command : /usr/local/bin/gfortran
Compiler flags : -fpack-arrays -O3 -ffree-form -ffree-form

SVN Root URL : <https://myroms.org/svn/src>
SVN Revision : Unversioned directory

Local Root : /Users/kate/roms/feedme
Header Dir : /Users/kate/roms/feedme/ROMS/Include
Header file : upwelling.h
Analytical Dir: /Users/kate/roms/feedme/ROMS/Functionals

Resolution, Grid 01: 0041x0080x016, Parallel Threads: 1, Tiling: 001x001

Physical Parameters, Grid: 01

=====

1440	ntimes	Number of timesteps for 3-D equations.
300.000	dt	Timestep size (s) for 3-D equations.
30	ndtfast	Number of timesteps for 2-D equations between each 3D timestep.
1	ERstr	Starting ensemble/perturbation run number.
1	ERend	Ending ensemble/perturbation run number.
0	nrrec	Number of restart records to read from disk.
T	LcycleRST	Switch to recycle time-records in restart file.
288	nRST	Number of timesteps between the writing of data into restart fields.
72	ninfo	Number of timesteps between print of information to standard output.
T	ldefout	Switch to create a new output NetCDF file(s).
72	nHIS	Number of timesteps between the writing fields into history file.
1	ntsAVG	Starting timestep for the accumulation of output time-averaged data.
72	nAVG	Number of timesteps between the writing of time-averaged data into averages file.
1	ntsDIA	Starting timestep for the accumulation of output time-averaged diagnostics data.
72	nDIA	Number of timesteps between the writing of time-averaged data into diagnostics file.

0.0000E+00	nl_tnu2(01)	NLM Horizontal, harmonic mixing coefficient (m2/s) for tracer 01: temp
0.0000E+00	nl_tnu2(02)	NLM Horizontal, harmonic mixing coefficient (m2/s) for tracer 02: salt
5.0000E+00	nl_visc2	NLM Horizontal, harmonic mixing coefficient (m2/s) for momentum.
	F LuvSponge	Turning OFF sponge on horizontal momentum.
	F LtracerSponge(01)	Turning OFF sponge on tracer 01: temp
	F LtracerSponge(02)	Turning OFF sponge on tracer 02: salt
1.0000E-06	Akt_bak(01)	Background vertical mixing coefficient (m2/s) for tracer 01: temp
1.0000E-06	Akt_bak(02)	Background vertical mixing coefficient (m2/s) for tracer 02: salt
1.0000E-05	Akv_bak	Background vertical mixing coefficient (m2/s) for momentum.
3.0000E-04	rdrg	Linear bottom drag coefficient (m/s).
3.0000E-03	rdrg2	Quadratic bottom drag coefficient.
2.0000E-02	Zob	Bottom roughness (m).
	2 Vtransform	S-coordinate transformation equation.
	4 Vstretching	S-coordinate stretching function.
3.0000E+00	theta_s	S-coordinate surface control parameter.
0.0000E+00	theta_b	S-coordinate bottom control parameter.
25.000	Tcline	S-coordinate surface/bottom layer width (m) used in vertical coordinate stretching.
1025.000	rho0	Mean density (kg/m3) for Boussinesq approximation.
0.000	dstart	Time-stamp assigned to model initialization (days).
0.00	time_ref	Reference time for units attribute (yyyymmdd.dd)
0.0000E+00	Tnudg(01)	Nudging/relaxation time scale (days) for tracer 01: temp
0.0000E+00	Tnudg(02)	Nudging/relaxation time scale (days) for tracer 02: salt
9.0000E+01	Tnudg_SSS	Nudging/relaxation time scale (days) for sea surface salinity.
0.0000E+00	Znudg	Nudging/relaxation time scale (days) for free-surface.
0.0000E+00	M2nudg	Nudging/relaxation time scale (days) for 2D momentum.
0.0000E+00	M3nudg	Nudging/relaxation time scale (days) for 3D momentum.
0.0000E+00	obcfac	Factor between passive and active open boundary conditions.
	F VolCons(1)	NLM western edge boundary volume conservation.
	F VolCons(2)	NLM southern edge boundary volume conservation.
	F VolCons(3)	NLM eastern edge boundary volume conservation.
	F VolCons(4)	NLM northern edge boundary volume conservation.
14.000	T0	Background potential temperature (C) constant.
35.000	S0	Background salinity (PSU) constant.
1027.000	R0	Background density (kg/m3) used in linear Equation of State.
1.7000E-04	Tcoef	Thermal expansion coefficient (1/Celsius).

0.0000E+00	Scoef	Saline contraction coefficient (1/PSU).
1.000	gamma2	Slipperiness variable: free-slip (1.0) or no-slip (-1.0).
F	LuvSrc	Turning OFF momentum point Sources/Sinks.
F	LwSrc	Turning OFF volume influx point Sources/Sinks.
F	LtracerSrc(01)	Turning OFF point Sources/Sinks on tracer 01: temp
F	LtracerSrc(02)	Turning OFF point Sources/Sinks on tracer 02: salt
F	LsshCLM	Turning OFF processing of SSH climatology.
F	Lm2CLM	Turning OFF processing of 2D momentum climatology.
F	Lm3CLM	Turning OFF processing of 3D momentum climatology.
F	LtracerCLM(01)	Turning OFF processing of climatology tracer 01: temp
F	LtracerCLM(02)	Turning OFF processing of climatology tracer 02: salt
F	LnudgeM2CLM	Turning OFF nudging of 2D momentum climatology.
F	LnudgeM3CLM	Turning OFF nudging of 3D momentum climatology.
F	LnudgeTCLM(01)	Turning OFF nudging of climatology tracer 01: temp
F	LnudgeTCLM(02)	Turning OFF nudging of climatology tracer 02: salt
T	Hout(idFsur)	Write out free-surface.
T	Hout(idUbar)	Write out 2D U-momentum component.
T	Hout(idVbar)	Write out 2D V-momentum component.
T	Hout(idUvel)	Write out 3D U-momentum component.
T	Hout(idVvel)	Write out 3D V-momentum component.
T	Hout(idWvel)	Write out W-momentum component.
T	Hout(idOvel)	Write out omega vertical velocity.
T	Hout(idTvar)	Write out tracer 01: temp
T	Hout(idTvar)	Write out tracer 02: salt
T	Aout(idFsur)	Write out averaged free-surface.
T	Aout(idUbar)	Write out averaged 2D U-momentum component.
T	Aout(idVbar)	Write out averaged 2D V-momentum component.
T	Aout(idUvel)	Write out averaged 3D U-momentum component.
T	Aout(idVvel)	Write out averaged 3D V-momentum component.
T	Aout(idWvel)	Write out averaged W-momentum component.
T	Aout(idOvel)	Write out averaged omega vertical velocity.
T	Aout(idTvar)	Write out averaged tracer 01: temp
T	Aout(idTvar)	Write out averaged tracer 02: salt
T	Dout(M2rate)	Write out 2D momentum acceleration.
T	Dout(M2pgrd)	Write out 2D momentum pressure gradient.
T	Dout(M2fcor)	Write out 2D momentum Coriolis force.
T	Dout(M2hadv)	Write out 2D momentum horizontal advection.
T	Dout(M2xadv)	Write out 2D momentum horizontal X-advection.
T	Dout(M2yadv)	Write out 2D momentum horizontal Y-advection.
T	Dout(M2hvis)	Write out 2D momentum horizontal viscosity.
T	Dout(M2xvis)	Write out 2D momentum horizontal X-viscosity.
T	Dout(M2yvis)	Write out 2D momentum horizontal Y-viscosity.
T	Dout(M2sstr)	Write out 2D momentum surface stress.
T	Dout(M2bstr)	Write out 2D momentum bottom stress.
T	Dout(M3rate)	Write out 3D momentum acceleration.
T	Dout(M3pgrd)	Write out 3D momentum pressure gradient.

```

T  Dout(M3fcor)      Write out 3D momentum Coriolis force.
T  Dout(M3hadv)      Write out 3D momentum horizontal advection.
T  Dout(M3xadv)      Write out 3D momentum horizontal X-advection.
T  Dout(M3yadv)      Write out 3D momentum horizontal Y-advection.
T  Dout(M3vadv)      Write out 3D momentum vertical advection.
T  Dout(M3hvis)      Write out 3D momentum horizontal viscosity.
T  Dout(M3xvis)      Write out 3D momentum horizontal X-viscosity.
T  Dout(M3yvis)      Write out 3D momentum horizontal Y-viscosity.
T  Dout(M3vvis)      Write out 3D momentum vertical viscosity.

T  Dout(iTrate)      Write out rate of change of tracer 01: temp
T  Dout(iTrate)      Write out rate of change of tracer 02: salt
T  Dout(iThadv)      Write out horizontal advection, tracer 01: temp
T  Dout(iThadv)      Write out horizontal advection, tracer 02: salt
T  Dout(iTxadv)      Write out horizontal X-advection, tracer 01: temp
T  Dout(iTxadv)      Write out horizontal X-advection, tracer 02: salt
T  Dout(iTyadv)      Write out horizontal Y-advection, tracer 01: temp
T  Dout(iTyadv)      Write out horizontal Y-advection, tracer 02: salt
T  Dout(iTvadv)      Write out vertical advection, tracer 01: temp
T  Dout(iTvadv)      Write out vertical advection, tracer 02: salt
T  Dout(iThdif)      Write out horizontal diffusion, tracer 01: temp
T  Dout(iThdif)      Write out horizontal diffusion, tracer 02: salt
T  Dout(iTxdif)      Write out horizontal X-diffusion, tracer 01: temp
T  Dout(iTxdif)      Write out horizontal X-diffusion, tracer 02: salt
T  Dout(iTydif)      Write out horizontal Y-diffusion , tracer 01: temp
T  Dout(iTydif)      Write out horizontal Y-diffusion , tracer 02: salt
T  Dout(iTvdif)      Write out vertical diffusion, tracer 01: temp
T  Dout(iTvdif)      Write out vertical diffusion, tracer 02: salt

```

Output/Input Files:

```

      Output Restart File:  ocean_rst.nc
      Output History File:  ocean_his.nc
      Output Averages File:  ocean_avg.nc
      Output Diagnostics File:  ocean_dia.nc

```

Tile partition information for Grid 01: 0041x0080x0016 tiling: 001x001

tile	Istr	Iend	Jstr	Jend	Npts
Number of tracers:			2		
0	1	41	1	80	52480

Tile minimum and maximum fractional coordinates for Grid 01:
(interior points only)

tile	Xmin	Xmax	Ymin	Ymax	grid
0	-1.50	42.50	0.50	81.50	RHO-points

0 -2.00 42.00 0.50 81.50 U-points

0 -1.50 42.50 0.00 81.00 V-points

Lateral Boundary Conditions: NLM

=====

Variable	Grid	West Edge	South Edge	East Edge	North Edge
zeta	1	Periodic	Closed	Periodic	Closed
ubar	1	Periodic	Closed	Periodic	Closed
vbar	1	Periodic	Closed	Periodic	Closed
u	1	Periodic	Closed	Periodic	Closed
v	1	Periodic	Closed	Periodic	Closed
temp	1	Periodic	Closed	Periodic	Closed
salt	1	Periodic	Closed	Periodic	Closed

Activated C-preprocessing Options:

UPWELLING Wind-Driven Upwelling/Downwelling over a Periodic Channel
ANA_BSFLUX Analytical kinematic bottom salinity flux.
ANA_BTFLUX Analytical kinematic bottom temperature flux.
ANA_GRID Analytical grid set-up.
ANA_INITIAL Analytical initial conditions.
ANA_SMFLUX Analytical kinematic surface momentum flux.
ANA_SSFLUX Analytical kinematic surface salinity flux.
ANA_STFLUX Analytical kinematic surface temperature flux.
ANA_VMIX Analytical vertical mixing coefficients.
ASSUMED_SHAPE Using assumed-shape arrays.
AVERAGES Writing out time-averaged nonlinear model fields.
DIAGNOSTICS_TS Computing and writing tracer diagnostic terms.
DIAGNOSTICS_UV Computing and writing momentum diagnostic terms.
DJ_GRADPS Parabolic Splines density Jacobian (Shchepetkin, 2002).
DOUBLE_PRECISION Double precision arithmetic.
MIX_S_TS Mixing of tracers along constant S-surfaces.
MIX_S_UV Mixing of momentum along constant S-surfaces.
NONLINEAR Nonlinear Model.
!NONLIN_EOS Linear Equation of State for seawater.
POWER_LAW Power-law shape time-averaging barotropic filter.
PROFILE Time profiling activated .
!RST_SINGLE Double precision fields in restart NetCDF file.
SALINITY Using salinity.
SOLVE3D Solving 3D Primitive Equations.

SPLINES_VDIFF Parabolic Spline Reconstruction for Vertical Diffusion.
 SPLINES_VVISC Parabolic Spline Reconstruction for Vertical Viscosity.
 TS_U3HADVECTION Third-order upstream horizontal advection of tracers.
 TS_C4VADVECTION Fourth-order centered vertical advection of tracers.
 TS_DIF2 Harmonic mixing of tracers.
 UV_ADV Advection of momentum.
 UV_COR Coriolis term.
 UV_U3HADVECTION Third-order upstream horizontal advection of 3D momentum.
 UV_C4VADVECTION Fourth-order centered vertical advection of momentum.
 UV_LDRAG Linear bottom stress.
 UV_VIS2 Harmonic mixing of momentum.
 VAR_RHO_2D Variable density barotropic mode.

Process Information:

Thread # 0 (pid= 7266) is active.

INITIAL: Configuring and initializing forward nonlinear model ...

Vertical S-coordinate System, Grid 01:

level	S-coord	Cs-curve	Z	at hmin	at hc	half way	at hmax
16	0.0000000	0.0000000		0.000	0.000	0.000	0.000
15	-0.0625000	-0.0019442		-0.809	-0.806	-1.348	-1.589
14	-0.1250000	-0.0078455		-1.668	-1.661	-2.966	-3.687
13	-0.1875000	-0.0179119		-2.580	-2.568	-4.867	-6.321
12	-0.2500000	-0.0324983		-3.549	-3.531	-7.077	-9.535
11	-0.3125000	-0.0521190		-4.581	-4.558	-9.630	-13.397
10	-0.3750000	-0.0774659		-5.686	-5.656	-12.573	-17.996
9	-0.4375000	-0.1094327		-6.875	-6.837	-15.967	-23.445
8	-0.5000000	-0.1491465		-8.162	-8.114	-19.889	-29.890
7	-0.5625000	-0.1980075		-9.564	-9.506	-24.435	-37.512
6	-0.6250000	-0.2577387		-11.104	-11.034	-29.721	-46.531
5	-0.6875000	-0.3304460		-12.808	-12.724	-35.892	-57.218
4	-0.7500000	-0.4186931		-14.709	-14.609	-43.121	-69.903
3	-0.8125000	-0.5255915		-16.846	-16.726	-51.622	-84.987
2	-0.8750000	-0.6549105		-19.266	-19.124	-61.651	-102.953
1	-0.9375000	-0.8112096		-22.028	-21.859	-73.518	-124.388
0	-1.0000000	-1.0000000		-25.200	-25.000	-87.600	-150.000

Time Splitting Weights for Grid 01: ndtfast = 30 nfast = 42

=====

Primary	Secondary	Accumulated to Current Step
1-0.0008094437383769	0.0333333333333333	-0.0008094437383769 0.0333333333333333
2-0.0014053566728197	0.0333603147912792	-0.0022148004111966 0.0666936481246126
3-0.0017877524645903	0.0334071600137066	-0.0040025528757869 0.1001008081383191

```

4-0.0019566842408176 0.0334667517625262-0.0059592371166046 0.1335675599008454
5-0.0019122901320372 0.0335319745705535-0.0078715272486418 0.1670995344713989
6-0.0016548570247459 0.0335957175749547-0.0095263842733877 0.2006952520463537
7-0.0011849025289723 0.0336508794757796-0.0107112868023601 0.2343461315221333
8-0.0005032751608632 0.0336903762267453-0.0112145619632232 0.2680365077488786
9 0.0003887272597151 0.0337071520654408-0.0108258347035082 0.3017436598143194
10 0.0014892209965583 0.0336941944901170-0.0093366137069498 0.3354378543044363
11 0.0027955815694920 0.0336445537902317-0.0065410321374578 0.3690824080946680
12 0.0043042707117221 0.0335513677379153-0.0022367614257357 0.4026337758325833
13 0.0060106451121704 0.0334078920475245 0.0037738836864347 0.4360416678801078
14 0.0079087469427945 0.0332075372104522 0.0116826306292293 0.4692492050905600
15 0.0099910761708920 0.0329439123123590 0.0216737068001212 0.5021931174029191
16 0.0122483446563884 0.0326108764399960 0.0339220514565097 0.5348039938429150
17 0.0146692120341107 0.0322025982847830 0.0485912634906204 0.5670065921276980
18 0.0172400033810439 0.0317136245503127 0.0658312668716643 0.5987202166780107
19 0.0199444086685725 0.0311389577709445 0.0857756755402368 0.6298591744489552
20 0.0227631639997064 0.0304741441486588 0.1085388395399432 0.6603333185976140
21 0.0256737146312911 0.0297153720153352 0.1342125541712343 0.6900486906129493
22 0.0286498597812017 0.0288595815276255 0.1628624139524359 0.7189082721405748
23 0.0316613792205220 0.0279045862015855 0.1945237931729579 0.7468128583421604
24 0.0346736416507075 0.0268492068942347 0.2291974348236654 0.7736620652363951
25 0.0376471948657328 0.0256934188392112 0.2668446296893983 0.7993554840756063
26 0.0405373376992233 0.0244385123436867 0.3073819673886216 0.8237939964192931
27 0.0432936737565711 0.0230872677537126 0.3506756411451927 0.8468812641730057
28 0.0458596469320356 0.0216441452951603 0.3965352880772283 0.8685254094681659
29 0.0481720587108285 0.0201154903974257 0.4447073467880568 0.8886408998655917
30 0.0501605672561820 0.0185097551070648 0.4948679140442388 0.9071506549726565
31 0.0517471682814031 0.0168377361985254 0.5466150823256418 0.9239883911711818
32 0.0528456577069106 0.0151128305891453 0.5994607400325525 0.9391012217603271
33 0.0533610761022577 0.0133513086655816 0.6528218161348102 0.9524525304259086
34 0.0531891349131380 0.0115726061288397 0.7060109510479481 0.9640251365547483
35 0.0522156244733761 0.0097996349650684 0.7582265755213241 0.9738247715198167
36 0.0503158038019030 0.0080591141492892 0.8085423793232271 0.9818838856691059
37 0.0473537721847153 0.0063819206892258 0.8558961515079425 0.9882658063583316
38 0.0431818225418188 0.0048034616164019 0.8990779740497613 0.9930692679747335
39 0.0376397765791563 0.0033640675316746 0.9367177506289176 0.9964333355064081
40 0.0305543017255205 0.0021094083123694 0.9672720523544381 0.9985427438187775
41 0.0217382098544503 0.0010909315881854 0.9890102622088884 0.9996336754069629
42 0.0109897377911117 0.0003663245930371 1.0000000000000000 1.0000000000000000

```

```
ndtfast, nfast = 30 42 nfast/ndtfast = 1.40000
```

```
Centers of gravity and integrals (values must be 1, 1, approx 1/2, 1, 1):
```

```
1.000000000000 1.047601458608 0.523800729304 1.000000000000 1.000000000000
```

```
Power filter parameters, Fgamma, gamma = 0.28400 0.18933
```

```
Metrics information for Grid 01:
```

```
=====
```

Minimum X-grid spacing, DXmin = 1.00000000E+00 km
 Maximum X-grid spacing, DXmax = 1.00000000E+00 km
 Minimum Y-grid spacing, DYmin = 1.00000000E+00 km
 Maximum Y-grid spacing, DYmax = 1.00000000E+00 km
 Minimum Z-grid spacing, DZmin = 8.08965824E-01 m
 Maximum Z-grid spacing, DZmax = 2.56123321E+01 m

Minimum barotropic Courant Number = 2.22358627E-01
 Maximum barotropic Courant Number = 5.42494240E-01
 Maximum Coriolis Courant Number = 2.47800000E-02

Basin information for Grid 01:

Maximum grid stiffness ratios: rx0 = 6.931666E-02 (Beckmann and Haidvogel)
 rx1 = 8.661243E-01 (Haney)

Initial basin volumes: TotVolume = 3.8843755884E+11 m3
 MinVolume = 8.4521383562E+05 m3
 MaxVolume = 2.5612332106E+07 m3
 Max/Min = 3.0302783777E+01

NL ROMS/TOMS: started time-stepping: (Grid: 01 TimeSteps: 00000001 - 00001440)

STEP	Day HH:MM:SS	KINETIC_ENRG	POTEN_ENRG	TOTAL_ENRG	NET_VOLUME
	C => (i,j,k)	Cu	Cv	Cw	Max Speed
0	0 00:00:00	0.000000E+00	6.585677E+02	6.585677E+02	3.884376E+11
	(00,00,00)	0.000000E+00	0.000000E+00	0.000000E+00	0.000000E+00
	DEF_HIS - creating history file, Grid 01: ocean_his.nc				
	WRT_HIS - wrote history fields (Index=1,1) into time record = 0000001				
	DEF_AVG - creating average file, Grid 01: ocean_avg.nc				
	DEF_DIAGS - creating diagnostics file, Grid 01: ocean_dia.nc				
72	0 06:00:00	8.578634E-06	6.585677E+02	6.585677E+02	3.884376E+11
	(01,01,13)	4.614888E-03	3.202922E-04	2.134530E-03	1.975948E-02
	:				
1440	5 00:00:00	2.448524E-02	6.585713E+02	6.585958E+02	3.884376E+11
	(01,02,10)	1.604228E-01	8.313453E-03	4.693175E-02	6.425970E-01
	WRT_HIS - wrote history fields (Index=1,1) into time record = 0000021				
	WRT_AVG - wrote averaged fields into time record = 0000020				
	WRT_DIAGS - wrote diagnostics fields into time record = 0000020				
	WRT_RST - wrote re-start fields (Index=1,1) into time record = 0000001				

Elapsed CPU time (seconds):

Thread # 0 CPU: 219.878
 Total: 219.878

Nonlinear ocean model elapsed time profile, Grid: 01

Allocation and array initialization	0.083	(0.0377 %)
Ocean state initialization	0.009	(0.0043 %)
Reading of input data	0.006	(0.0028 %)
Processing of input data	0.099	(0.0452 %)
Processing of output time averaged data	22.404	(10.1894 %)
Computation of vertical boundary conditions	0.082	(0.0373 %)
Computation of global information integrals	0.047	(0.0213 %)
Writing of output data	1.255	(0.5708 %)
Model 2D kernel	111.940	(50.9101 %)
2D/3D coupling, vertical metrics	2.108	(0.9589 %)
Omega vertical velocity	1.248	(0.5676 %)
Equation of state for seawater	0.872	(0.3965 %)
3D equations right-side terms	9.147	(4.1603 %)
3D equations predictor step	20.887	(9.4995 %)
Pressure gradient	5.047	(2.2954 %)
Harmonic mixing of tracers, S-surfaces	3.353	(1.5250 %)
Harmonic stress tensor, S-surfaces	3.882	(1.7657 %)
Corrector time-step for 3D momentum	18.233	(8.2926 %)
Corrector time-step for tracers	15.304	(6.9604 %)
Total:	216.009	98.2406

All percentages are with respect to total time = 219.878

ROMS/TOMS - Output NetCDF summary for Grid 01:

number of time records written in HISTORY file = 00000021
number of time records written in RESTART file = 00000002
number of time records written in AVERAGE file = 00000020

Analytical header files used:

ROMS/Functionals/ana_btflux.h
ROMS/Functionals/ana_grid.h
ROMS/Functionals/ana_initial.h
ROMS/Functionals/ana_smflux.h
ROMS/Functionals/ana_stflux.h
ROMS/Functionals/ana_vmix.h

ROMS/TOMS: DONE... Thursday - December 3, 2015 - 9:56:54 AM

Note that it ends by printing out a profile of where the time was used—the ratios will vary depending on the application.

NetCDF history and restart files are also created, containing the model fields at the requested times. We have asked it to save restart records every day. In this case, the restart file has been told to “cycle”, or to write over the second last record. The restart file at the end of the run contains the fields at day 4 and day 5. The history file contains records for 0, 1/4, 1/2, 3/4, and 1 day, etc., while the averages and diagnostics files are at 1/8, 3/8, 5/8, and 7/8 day, etc.. Plots can be made from any one of these files, using the plotting software described in ROMS plotting package. Selected frames from such plots for an older run are shown in Fig. 18 to 21.

ROMS 3.2
Upwelling

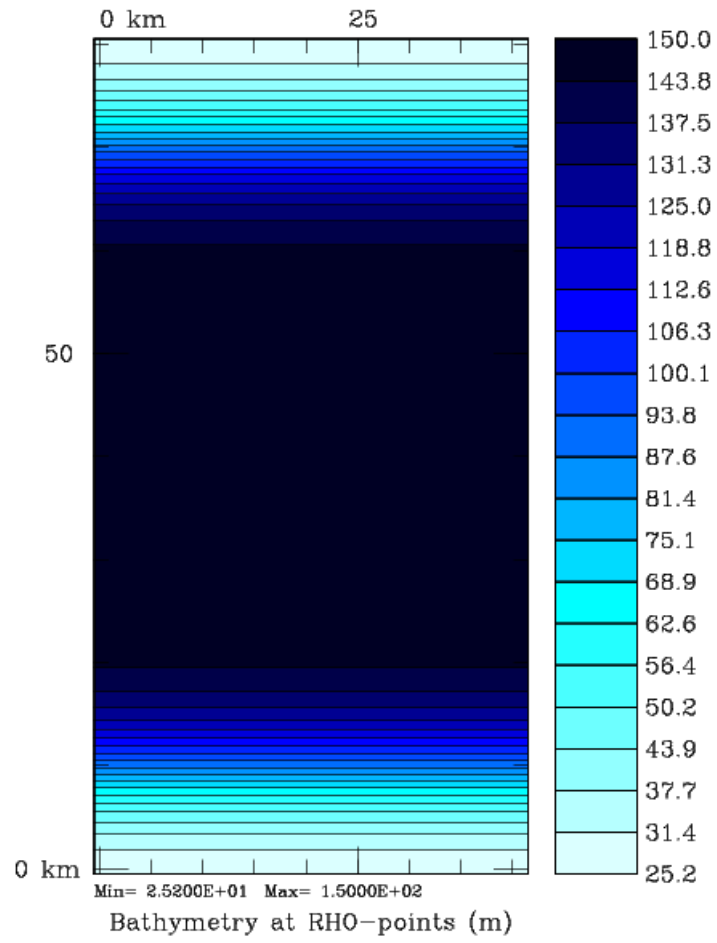

Figure 18: The upwelling/downwelling bathymetry.

ROMS 3.2
Upwelling

1.00 Day

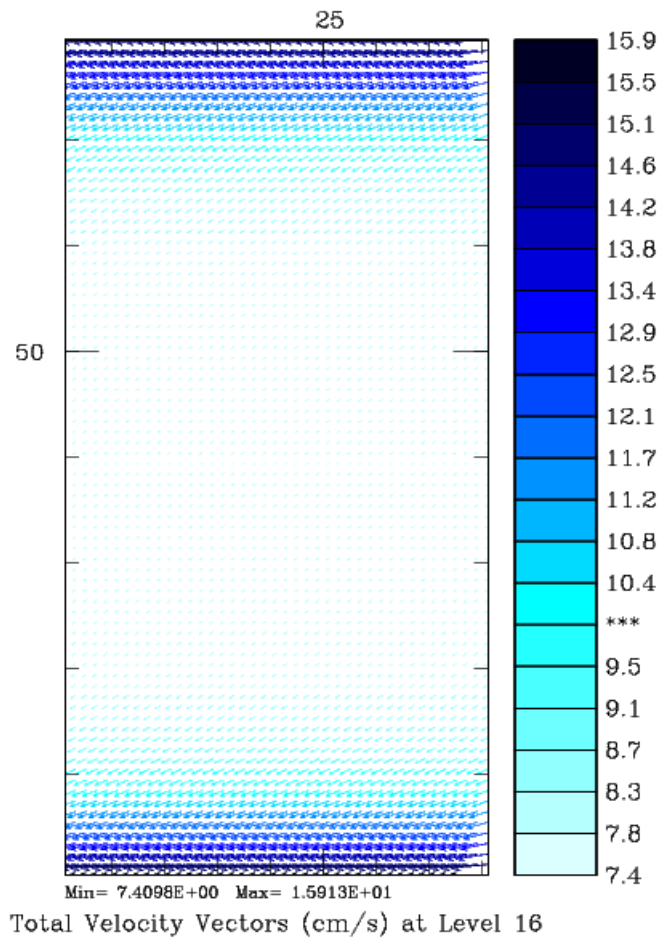

Figure 19: Surface velocities after one day, showing the flow to the left of the wind (southern hemisphere).

ROMS 3.2

Upwelling

1.00 Day

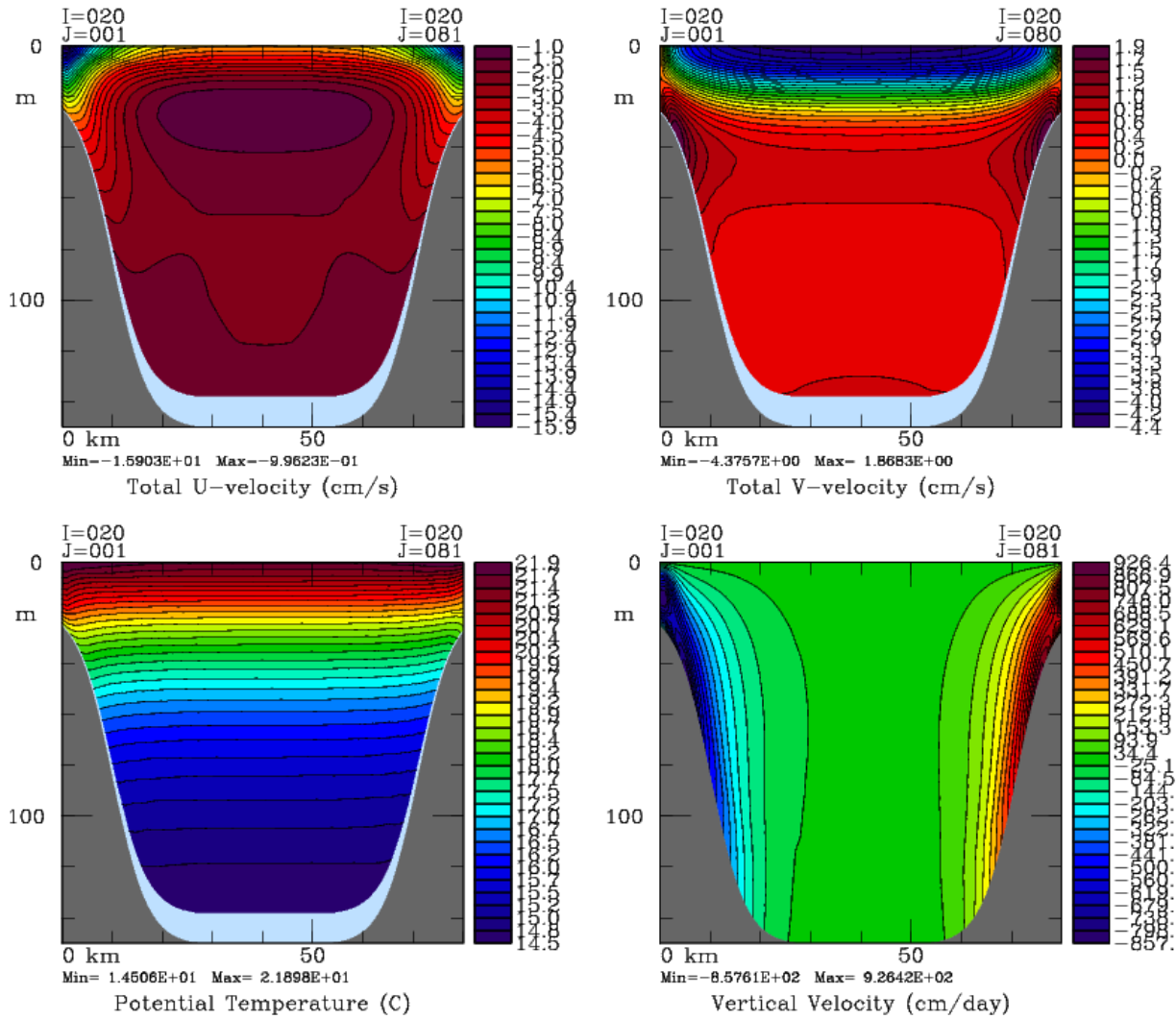

Figure 20: Constant ξ slices of the u, v, T and w fields at day 1.

ROMS 3.2
Upwelling

5.00 Day

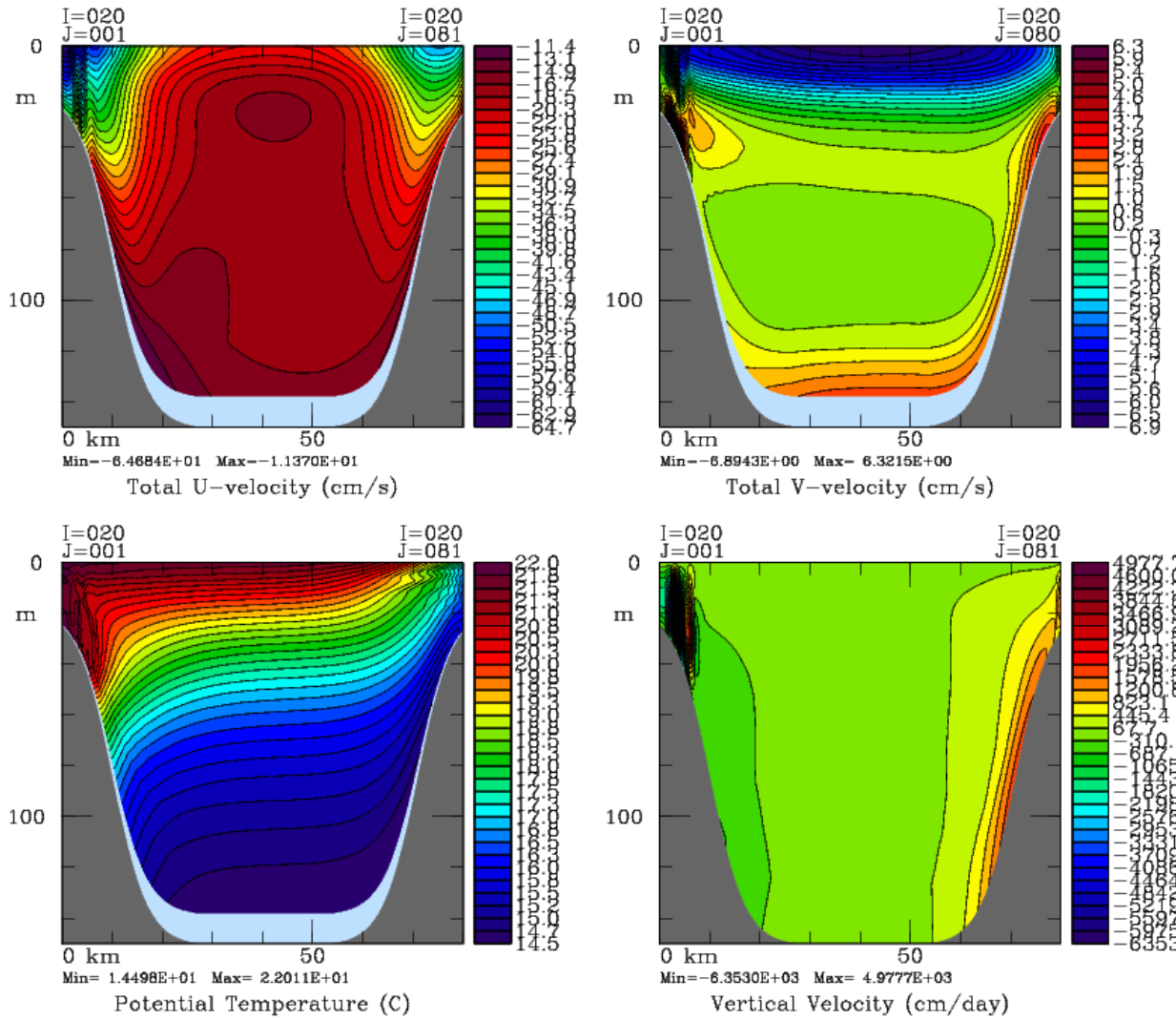

Figure 21: Constant ξ slices of the u, v, T , and w fields at day 5.

7.3 Arctic example

The upwelling/downwelling examples is one in which all the start-up fields are defined analytically. The other extreme is one in which everything is read from files, as in our Arctic simulations. Figure 22 shows the bathymetry and the extent of this domain. The grid is non-uniform, having more resolution close to Alaska—a measure of grid spacing is shown in Figure 23.

7.3.1 arctic.h

The C preprocessor variable **ARCTIC** has been chosen to label our Arctic domain—the header include file then becomes **arctic.h**:

```
/*
** svn $Id$
*****
** Copyright (c) 2002-2015 The ROMS/TOMS Group
**
** Licensed under a MIT/X style license
**
** See License_ROMS.txt
**
*****
** Options for ARCTIC simulation
*/

#define NO_HIS
#define GLOBAL_PERIODIC
#define HDF5
#define DEFLATE
#undef PARALLEL_IN
#undef PARALLEL_OUT
#define PERFECT_RESTART

/* general */

#define CURVGRID
#define MASKING
#define NONLIN_EOS
#define SOLVE3D
#define SALINITY
#ifdef SOLVE3D
# define SPLINES_VDIFF
# define SPLINES_VVISC
# define RI_SPLINES
#endif
#define FLOATS
#define STATIONS
#undef WET_DRY

#define T_PASSIVE
#ifdef T_PASSIVE
```

Bottom Topography

MIN DEPTH = 9.924

MAX DEPTH = 7900.9

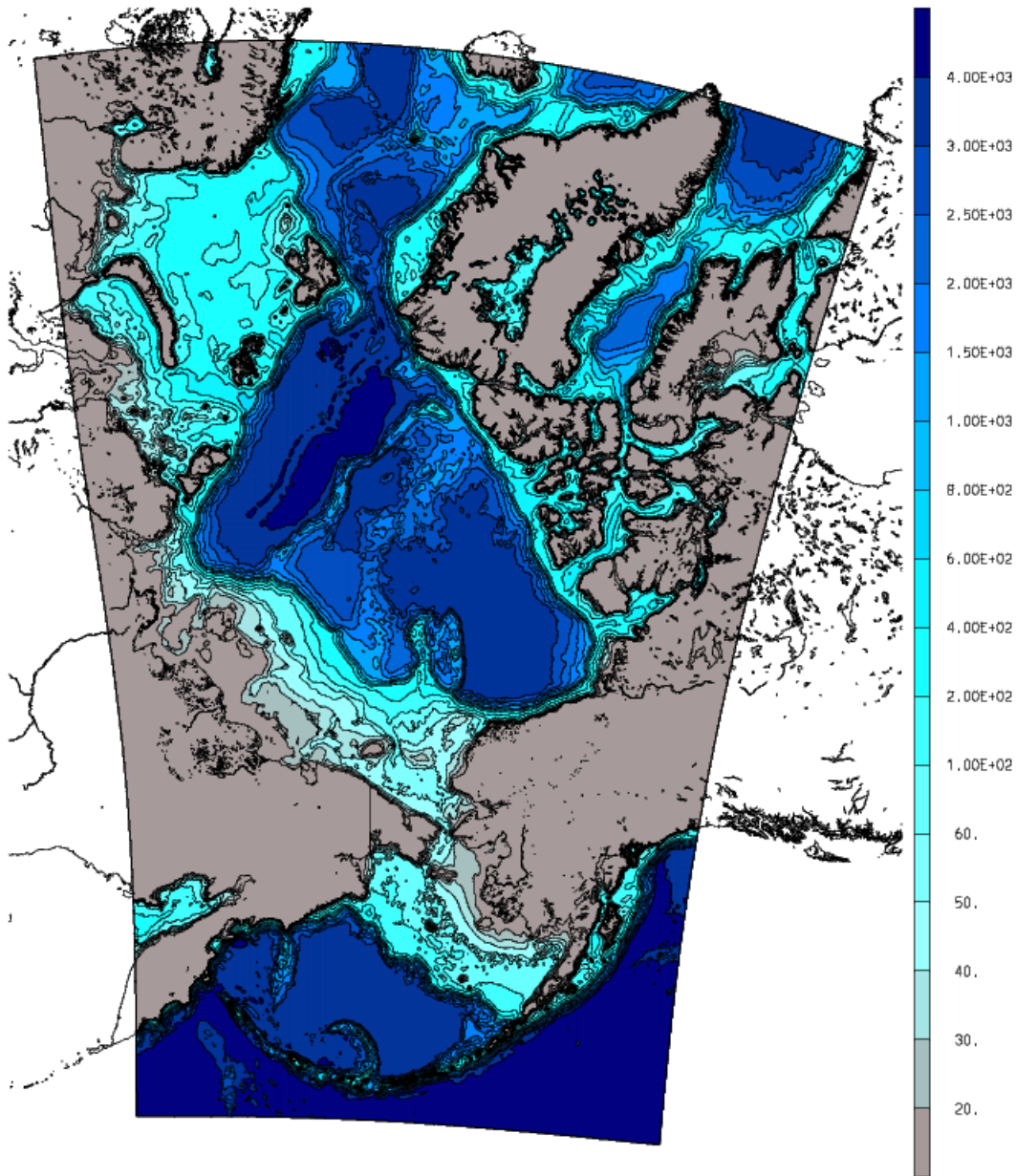

Figure 22: Bathymetry of the Arctic domain.

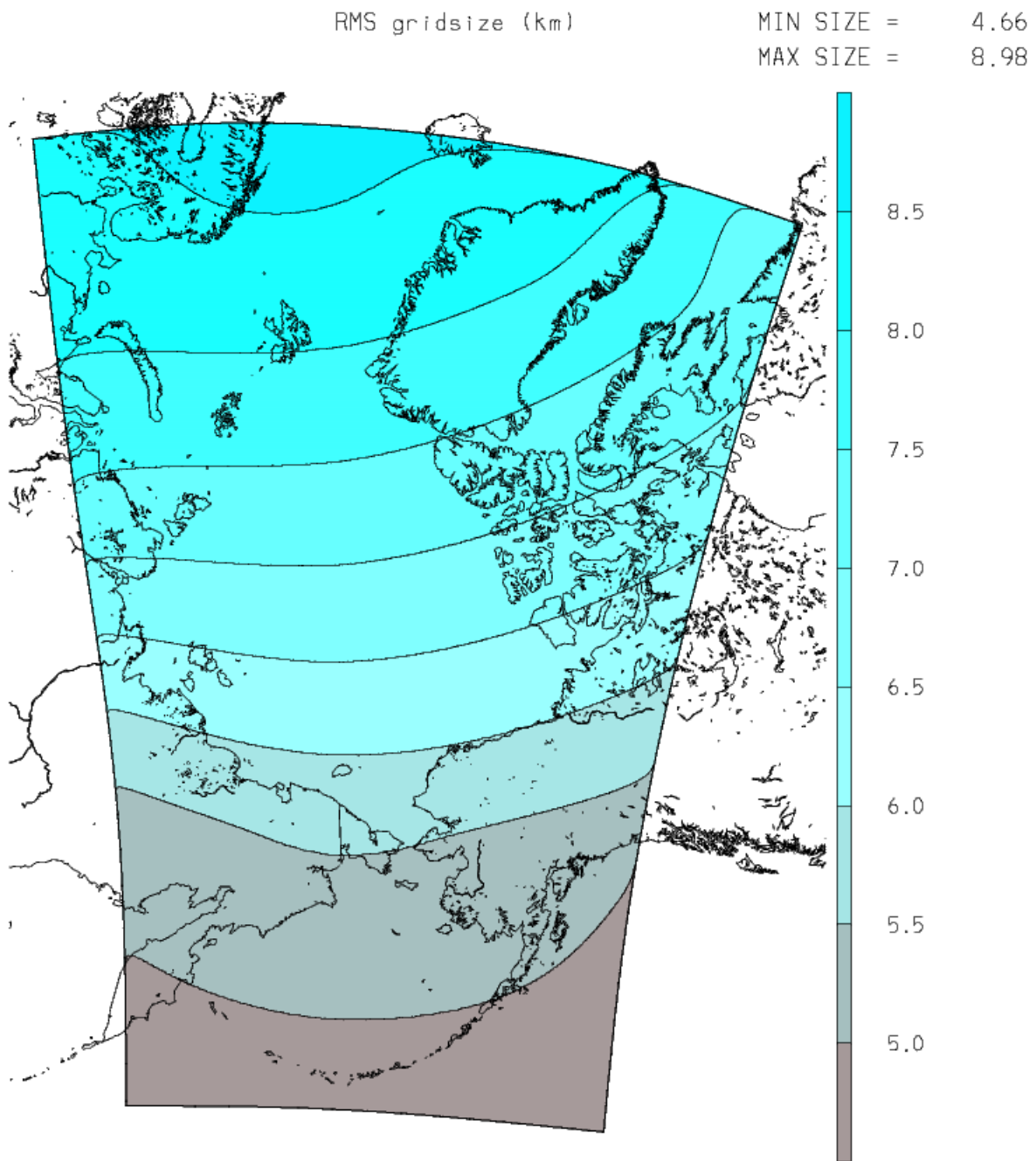

Figure 23: Grid spacing of the Arctic domain.

```

# define ANA_BPFLUX          /* analytical bottom passive tracers fluxes */
# define ANA_SPFLUX
# define ANA_PASSIVE
# define TRC_PSOURCE
# define ANA_TRC_PSOURCE
# define AGE_MEAN
# define PTOBC
#endif

/* ice */

#ifdef SOLVE3D
# undef CICE_MODEL
# ifdef CICE_MODEL
# define SNOWFALL
# define SNOW_FROM_RAIN
# define INI_GLORYS_ICE
# endif

# define ICE_MODEL
# ifdef ICE_MODEL
# define ANA_ICE
# define INI_GLORYS_ICE
# define OUTFLOW_MASK
# undef FASTICE_CLIMATOLOGY
# define ICE_LANDFAST
# define ICE_THERMO
# define ICE_MK
# define ICE_MOMENTUM
# define ICE_MOM_BULK
# define ICE_EVP
# define ICE_STRENGTH_QUAD
# define ICE_ADVECT
# define ICE_SMOLAR
# define ICE_UPWIND
# define ICE_BULK_FLUXES
# define ICE_CONVSNOW
# define ICE_I_0
# endif
#endif

/* output stuff */

#define NO_WRITE_GRID
#undef OUT_DOUBLE
#ifdef PERFECT_RESTART
# define RST_SINGLE
#endif
#define AVERAGES
#define AVERAGES2

```

```

#ifdef SOLVE3D
# undef AVERAGES_DETIDE
# undef DIAGNOSTICS_TS
#endif
#undef DIAGNOSTICS_UV

/* advection, dissipation, pressure grad, etc. */

#ifdef SOLVE3D
# define DJ_GRADPS
#endif

#define UV_ADV
#define UV_COR

#ifdef SOLVE3D
# define TS_U3HADVECTION
# define TS_C4VADVECTION
# undef TS_MPDATA
#endif

#define UV_VIS2
#undef UV_SMAGORINSKY
#undef VISC_3DCOEF
#define MIX_S_UV
#define VISC_GRID

#ifdef SOLVE3D
# define TS_DIF2
# define MIX_GEO_TS
# define DIFF_GRID
#endif

/* vertical mixing */

#ifdef SOLVE3D
# define WTYPE_GRID

# define LMD_MIXING
# ifdef LMD_MIXING
# define LMD_RIMIX
# define LMD_CONVEC
# define LMD_SKPP
# undef LMD_BKPP
# define LMD_NONLOCAL
# define LMD_SHAPIRO
# undef LMD_DDMIX
# endif

# undef GLS_MIXING

```



```

# undef MY25_MIXING

# if defined GLS_MIXING || defined MY25_MIXING
# define KANTHA_CLAYSON
# define N2S2_HORAVG
# endif
#endif

/* surface forcing */

#ifdef SOLVE3D
# define CORE_FORCING
# define BULK_FLUXES
# define CCSM_FLUXES
# undef ARCTIC_MERRA_HACK
# if defined BULK_FLUXES
# define LONGWAVE_OUT
# undef DIURNAL_SRFLUX
# define SOLAR_SOURCE
# define EMINUSP
# undef ALBEDO_CLOUD
# define ALBEDO_CURVE /* for water */
# undef ICE_ALB_EC92 /* for ice */
# define ALBEDO_CSIM /* for ice */
# undef ALBEDO_FILE /* for both */
# undef LONGWAVE
# endif
#endif

/* surface and side corrections */

#ifdef SOLVE3D
# define SCORRECTION
# define NO_SCORRECTION_ICE
#endif

#ifdef SOLVE3D
# define ANA_NUDGCOEF
#endif

/* point sources (rivers, line sources) */

/* Using both for different regions */
#ifdef SOLVE3D
# define RUNOFF
# define TWO_D_TRACER_SOURCE
#endif

/* tides */

```

```

#define LTIDES
#ifdef LTIDES
# if defined AVERAGES && !defined USE_DEBUG
#  undef FILTERED
# endif
# define SSH_TIDES
# define UV_TIDES
# define ADD_FSOBC
# define ADD_M2OBC
# undef RAMP_TIDES
# define TIDES_ASTRO
# define POT_TIDES

# define UV_DRAG_GRID
# define ANA_DRAG
# define LIMIT_BSTRESS
# undef UV_LDRAG
# define UV_QDRAG
#else
# define UV_QDRAG
#endif

/* Boundary conditions...careful with grid orientation */

#define RADIATION_2D

/* roms quirks */

#ifdef SOLVE3D
# define ANA_BSFLUX
# define ANA_BTFLUX
#else
# define ANA_SMFLUX
#endif

```

We've got masking, salinity, sea ice and the non-linear equation of state. We want Laplacian viscosity on σ -surfaces, diffusion along constant z -surfaces and the full non-linear, curvilinear momentum equations.

Notice that comments are allowed in this file as long as they are in the C syntax. Also, conditionals are fine—some parts are only wanted when **SOLVE3D** is on. Sources are now turned on in the **ocean_arctic2.in** file, while **RUNOFF** is still a **cpp** option. We have both in this domain, using different fresh water inputs for different parts of the domain.

7.3.2 Arctic code chunks

The **Apps/Arctic** directory contains the **ana_** family of include files for setting the bottom drag, the horizontal nudging coefficients and the passive tracers. The bottom drag is a function of the bottom depth with a tunable parameter which was adjusted to give a reasonable Bering Strait throughflow.

Doing a search for **ARCTIC** shows up a few other bits of code. One is in **output.F**, forcing a new station file after every restart:

```

#ifdef ARCTIC
    CALL def_station (ng, .true.)
#else
    CALL def_station (ng, ldefout(ng))
#endif

```

A better fix (someday) would be to allow the station files to be numbered just like the averages files. Why not set `ldefout` to be true? It is shared by many outputs, including the floats, and you can only restart floats with `ldefout` set to false.

There is a hack in `grid_coords.F` so that floats and stations are placed at the correct i, j position. Otherwise, the code to find i, j from longitude, latitude finds two boxes with the correct range, one where I want it, the other at the same latitude, but where the longitude jumps from 360 back to 0.

There is code in `set_masks.F` to position the mask for the ice outflow cells off the coast of Greenland.

Finally, there is a kludge in `step_floats.F` for a float reuse strategy, restarting them each year. Having a handy tag like `ARCTIC` allows me to search for these little hacks later.

7.3.3 Model domain

A number of horizontal grid points was chosen to resolve the domain at roughly 6 km near Alaska, less well across the basin. Values for `Lm`, `Mm`, and `N` are:

```

Lm == 688          ! Number of I-direction INTERIOR RHO-points
Mm == 1088        ! Number of J-direction INTERIOR RHO-points
N == 50           ! Number of vertical levels

```

The vertical structure is set to our new favorite, using the new stretching function:

```

Vtransform == 2          ! transformation equation
Vstretching == 4        ! stretching function

THETA_S == 7.0d0        ! surface stretching parameter
THETA_B == 2.0d0        ! bottom stretching parameter
TCLINE == 250.0d0       ! critical depth (m)

```

7.3.4 Initial and boundary conditions

The best ocean fields we knew of when setting this up are known as SODA, a reanalysis from 1958 through 2008 by Carton et al. [2005]. There are global HYCOM (<https://hycom.org/>) fields for later years. There are **Python** scripts to create initial, climatology and boundary conditions from the SODA and HYCOM files. Ice initial thickness and concentration are extracted from a GLORYS simulation while the other initial ice conditions are set to uniform values where the SST is cold, zero otherwise. Ice boundary conditions are assumed to be not needed with the boundaries so far from the pack ice.

The side known as “South” is across the North Pacific and the “East” and “West” sides are only open for a short bit in the North Pacific. The “North” boundary is on the Atlantic side; these all have our usual combination of radiation and nudging for the ocean. The ice boundary conditions are closed here, but “outflow cells” have been created along the “North” side.

```

LBC(isFsur) == Che      Che      Che      Che      ! free-surface
LBC(isUbar) == Shc      Shc      Shc      Shc      ! 2D U-momentum
LBC(isVbar) == Shc      Shc      Shc      Shc      ! 2D V-momentum

```

```

LBC(isUvel) == RadNud RadNud RadNud RadNud      ! 3D U-momentum
LBC(isVvel) == RadNud RadNud RadNud RadNud      ! 3D V-momentum
LBC(isMtke) == Clo      Clo      Clo      Clo      ! mixing TKE

LBC(isTvar) == RadNud RadNud RadNud RadNud \    ! temperature
                RadNud RadNud RadNud RadNud \    ! salinity
                Clo      Clo      Clo      Clo  \    ! inert(1)
                Clo      Clo      Clo      Clo  \    ! inert(2)
                Clo      Clo      Clo      Clo  \    ! inert(3)
                Clo      Clo      Clo      Clo  \    ! inert(4)
                Clo      Clo      Clo      Clo  \    ! inert(5)
                Clo      Clo      Clo      Clo  \    ! inert(6)

```

! Ice boundary conditions

```

LBC(isAice) == Clo      Clo      Clo      Clo      ! ice concentration
LBC(isHice) == Clo      Clo      Clo      Clo      ! ice thickness
LBC(isHsno) == Clo      Clo      Clo      Clo      ! snow thickness
LBC(isTice) == Clo      Clo      Clo      Clo      ! ice temperature
LBC(isApond) == Clo      Clo      Clo      Clo      ! surface water
LBC(isHpond) == Clo      Clo      Clo      Clo      ! surface water
LBC(isSig11) == Clo      Clo      Clo      Clo      ! sigma-11
LBC(isSig12) == Clo      Clo      Clo      Clo      ! sigma-12
LBC(isSig22) == Clo      Clo      Clo      Clo      ! sigma-22
LBC(isUice) == Gra      Gra      Gra      Gra      ! ice U-momentum
LBC(isVice) == Gra      Gra      Gra      Gra      ! ice V-momentum

```

7.3.5 Forcing

We are using the MERRA forcing files [Rienecker et al., 2011] and computing the momentum, heat and salt fluxes from the atmospheric conditions and the model’s surface temperature. There are two options, one provided by **bulk_flux.F** and the other provided by **ccsm_flux.F**. We are using the second. We have **Python** scripts for downloading MERRA so that the MERRA files can be used as is, on their native grid, then interpolated by ROMS internally to the domain at hand. We have added a processing step to the MERRA files so that only values from over the ocean are used—these are extrapolated into the land points in the MERRA fields (R. Dussin, personal communication).

For fresh water input from land, we have the ARDAT fields for the Arctic ocean [Whitefield et al., 2015], which includes monthly river temperature. These are applied as point sources to include the effects of bringing in warm water. For the rest of the domain, we are applying Dai et al. [2009] as the **RUNOFF** field. Other forcings include a nudging to sea surface salinity, tides from Egbert and Erofeeva [2002] (TPXO) and a nudging to a monthly climatology around the edges from the same sources as the boundary conditions. We were using a landfast ice climatology for the Beaufort Sea from Andy Mahoney, but have since switched to a landfast ice parameterization from Lemieux et al. [2015].

7.3.6 ocean.in

We use an internal time-step of 60 to 100 s and an external time-step of 10 s. The horizontal viscosity and diffusion is:

```

TNU2 == 5.0d0  5.0d0          ! m2/s
VISC2 == 25.0d0                ! m2/s

```

7.3.7 Output

The model writes voluminous information to standard out, as shown for the **UPWELLING** case. It also writes out NetCDF files for restart, daily averages, three-hourly averages, stations and floats. Plots can be made from any of these files; some examples are shown in Fig. 24–25 .

7.4 Northwest Gulf of Alaska example

The Northwest Gulf of Alaska (NWGOA) domain is set up much like the Arctic, described in §7.3. This is a rectangular domain with uniform 1.5 km resolution over Cook Inlet and beyond, as shown in Fig. 26.

The bathymetry was clipped to 20 m elevation above sea level for the wetting and drying algorithm. Smoothing and editing was done to give a stable simulation, but the usual bottom steepness metric depends on water depth being everywhere positive. The assumption is that extremely shallow waters would be vertically well-mixed, so that pressure gradient errors would vanish. It was discovered that the rotated mixing tensors for horizontal diffusion were unstable in the near-shore, with high-and-dry points next to relatively deep wet points; thus the explicit horizontal diffusion was turned off. The model ran stably with the third-order upwind advection scheme providing some implicit diffusion.

The bathymetry is a combination of ARDEM [Danielson et al., 2015] and a Cook Inlet product from Lyon Lanerolle (personal communication). This melding was found to give better tides at Anchorage than either product alone.

7.4.1 nwgoa.h

The C preprocessor variable **NWGOA** has been chosen to label this domain—the header include file then becomes **nwgoa.h**. It shares many of the options with the Arctic domain, differing in that has neither outflow cells nor any attempt at landfast ice. One notable change is the inclusion of the **WET_DRY** option, which was challenging to get to run stably. Another change is that fresh water is now all coming from the output of a hydrology model—**RUNOFF** is not used here.

7.4.2 NWGOA code chunks

The **Apps/NWGOA** directory contains the **ana_** family of include files for setting the bottom drag, the horizontal nudging coefficients and the passive tracers. Doing a search for **NWGOA** shows up a few other bits of code. The only such bit not shared by **ARCTIC** is in **mod_scalars.F**:

```

#ifdef NWGOA
    real(r8) :: max_speed = 80.0_r8          ! m/s
#else
    real(r8) :: max_speed = 20.0_r8          ! m/s
#endif

```

This is because the summer river flows can be large enough to exceed the default “speed limit” put into the code to check for growing instabilities.

7.4.3 Model domain

A number of horizontal grid points was chosen to resolve the domain at 1.5 km everywhere. Values for **Lm**, **Mm**, and **N** are:

ROMS Arctic Simulation

15 September 1982

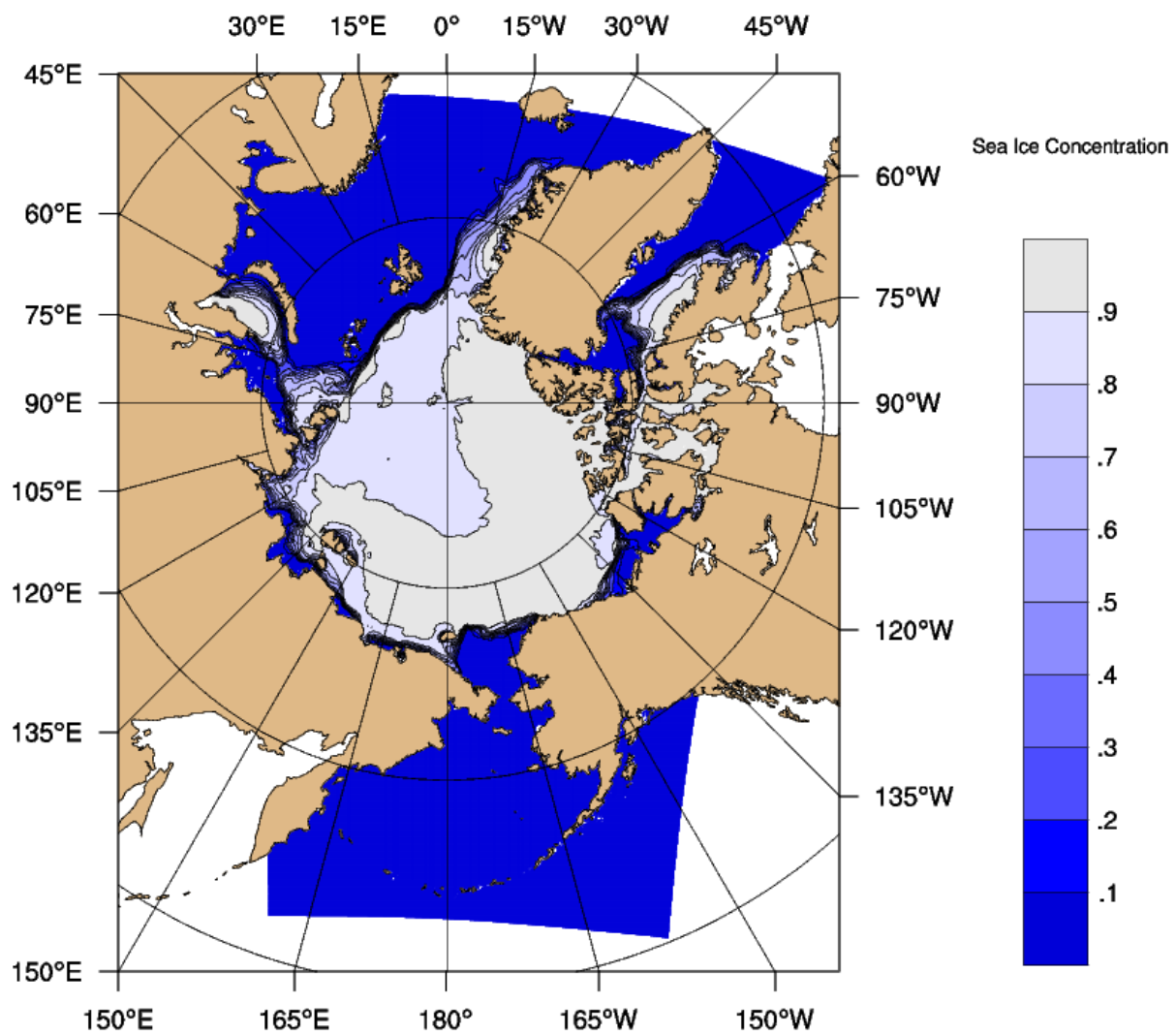

Figure 24: Ice concentration averaged over the month of September, 1982.

ROMS Arctic Simulation

15 September 1982

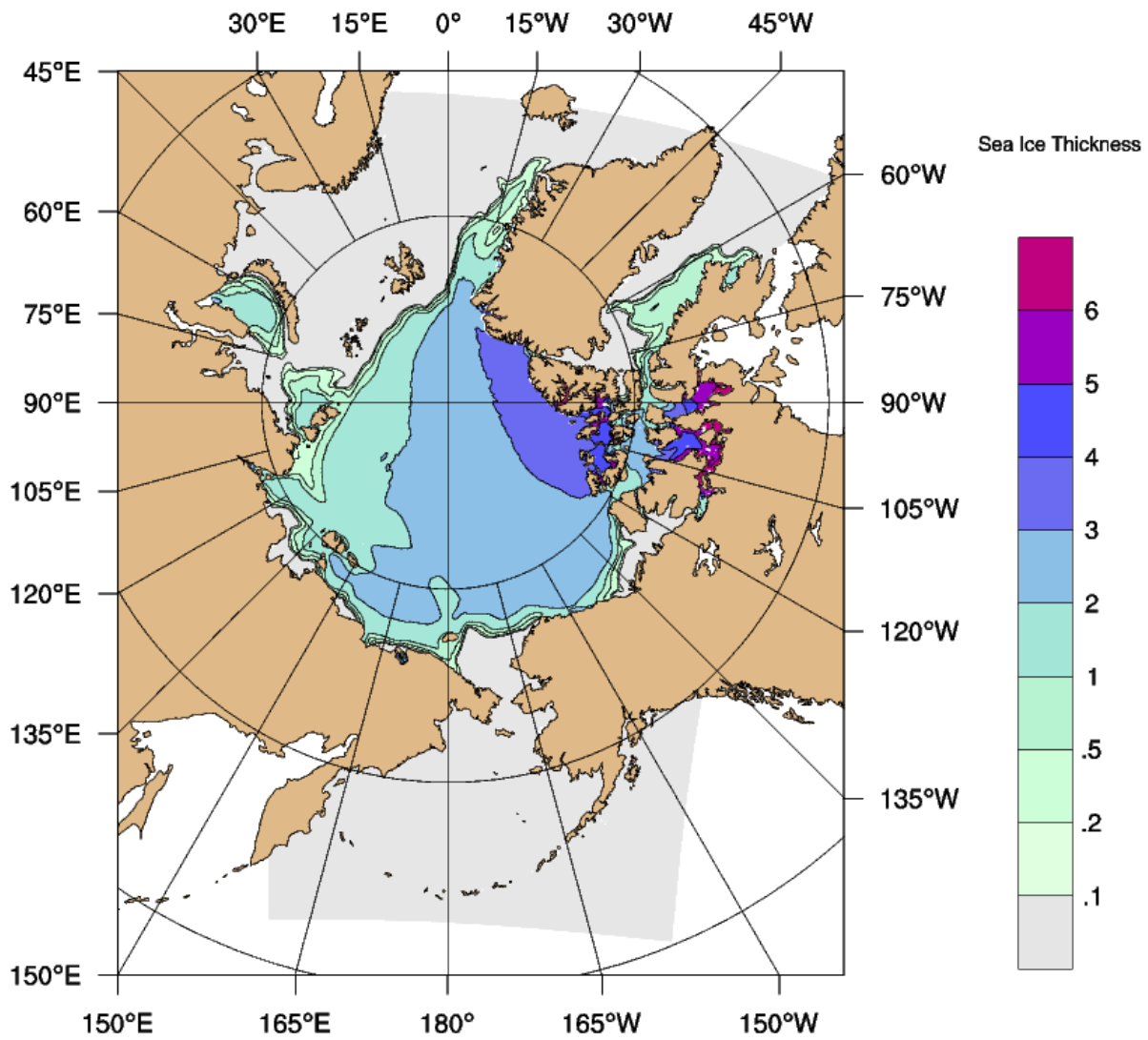

Figure 25: Ice thickness averaged over the month of September, 1982.

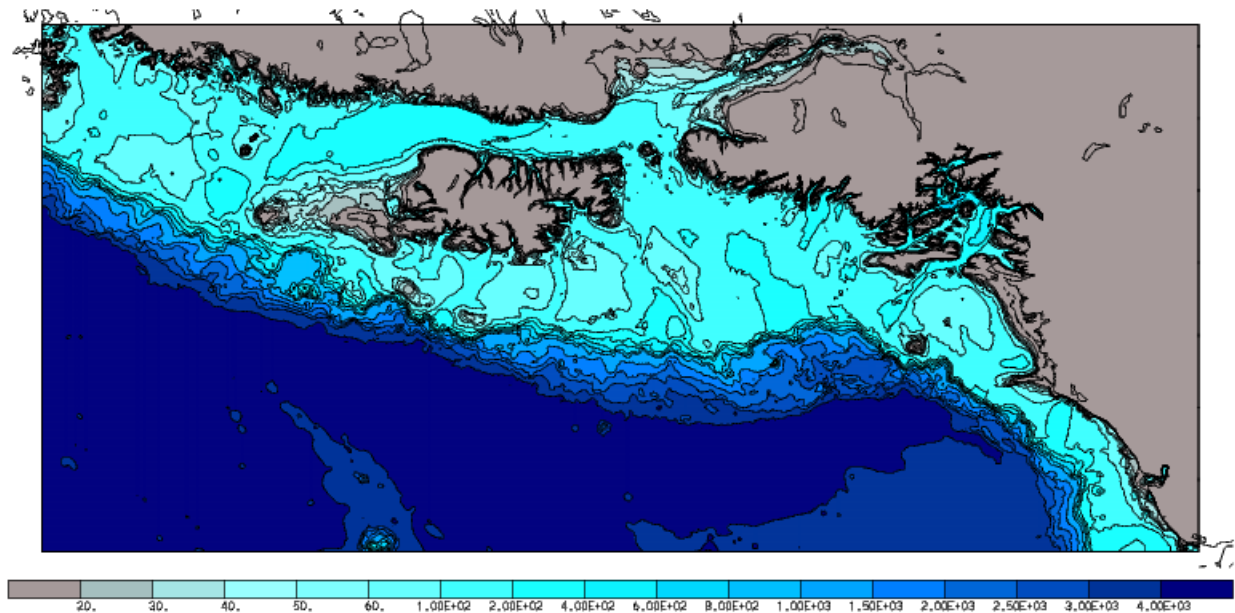

Figure 26: Bathymetry of the NWGOA domain.

```

Lm == 792          ! Number of I-direction INTERIOR RHO-points
Mm == 360          ! Number of J-direction INTERIOR RHO-points
N == 50           ! Number of vertical levels

```

The vertical structure is again our current favorite:

```

Vtransform == 2      ! transformation equation
Vstretching == 4     ! stretching function

THETA_S == 7.0d0    ! surface stretching parameter
THETA_B == 2.0d0    ! bottom stretching parameter
TCLINE == 250.0d0   ! critical depth (m)

```

7.4.4 Initial and boundary conditions

All initial and boundary conditions were extracted from prior runs in the **NEP6** domain covering the Northeast Pacific. The **LBC** options are the same as in the **Arctic** for all open boundaries. There is no need for any nudging to climatology in this case.

7.4.5 Forcing

We are using the same MERRA forcing with extrapolation into land as described above, as well as a tidal file from TPXO. The fresh water forcing is daily output from a hydrology model [Beamer et al., 2016], interpolated to the ROMS grid and then converted to lateral “sources” along the coastline.

7.4.6 ocean.in

We use an internal time-step of 30 s and an external time-step of 3 s. The horizontal viscosity is:

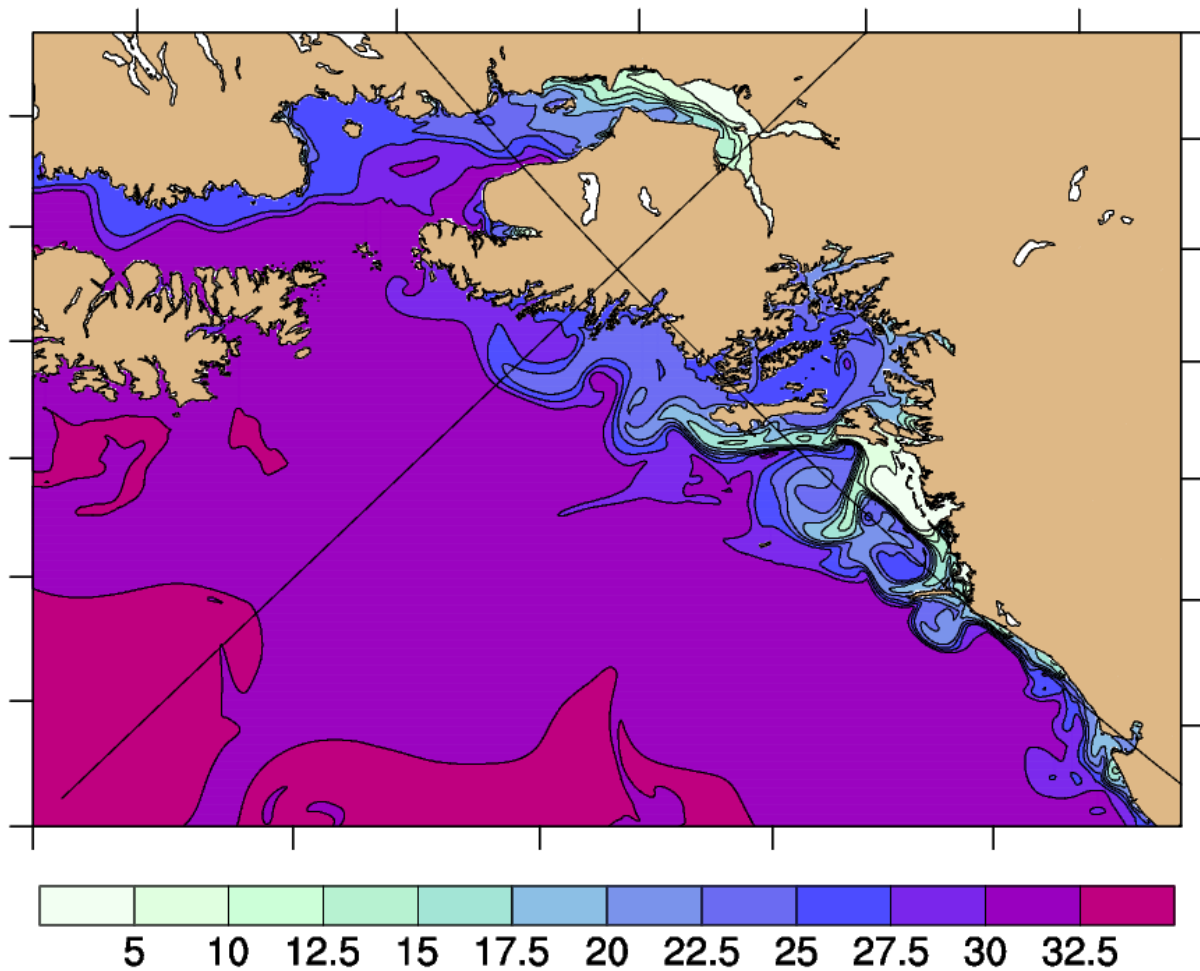

Figure 27: Surface salinity for 10 August, 2008. Graticules shown are 60°N and 150°W.

```
VISC2 == 25.0d0          ! m2/s
```

while the explicit horizontal diffusivity was turned off.

7.4.7 Output

The model writes voluminous information to standard out, as shown for the **UPWELLING** case. It also writes out NetCDF files for restart, daily averages, stations and floats. We also saved hourly history output. Plots can be made from any of these files; some examples are shown in Fig. 27–28 .

7.5 Beaufort Sea example

The Beaufort Sea (BEAUFORT) domains are set up much like the Arctic, described in §7.3. This is actually two domains, a roughly 3 km curvilinear domain (Beaufort2), and a rectangular domain with uniform 0.5 km resolution over the coastal Beaufort (Beaufort3), as shown in Fig. 29–30.

The bathymetry was clipped to 3 *m* and 2 *m* depth for the two domains, respectively. The wetting and drying algorithm was turned on later for the small domain after an enclosed bay became unstable several years into the run. The bathymetry is from ARDEM [Danielson et al., 2015].

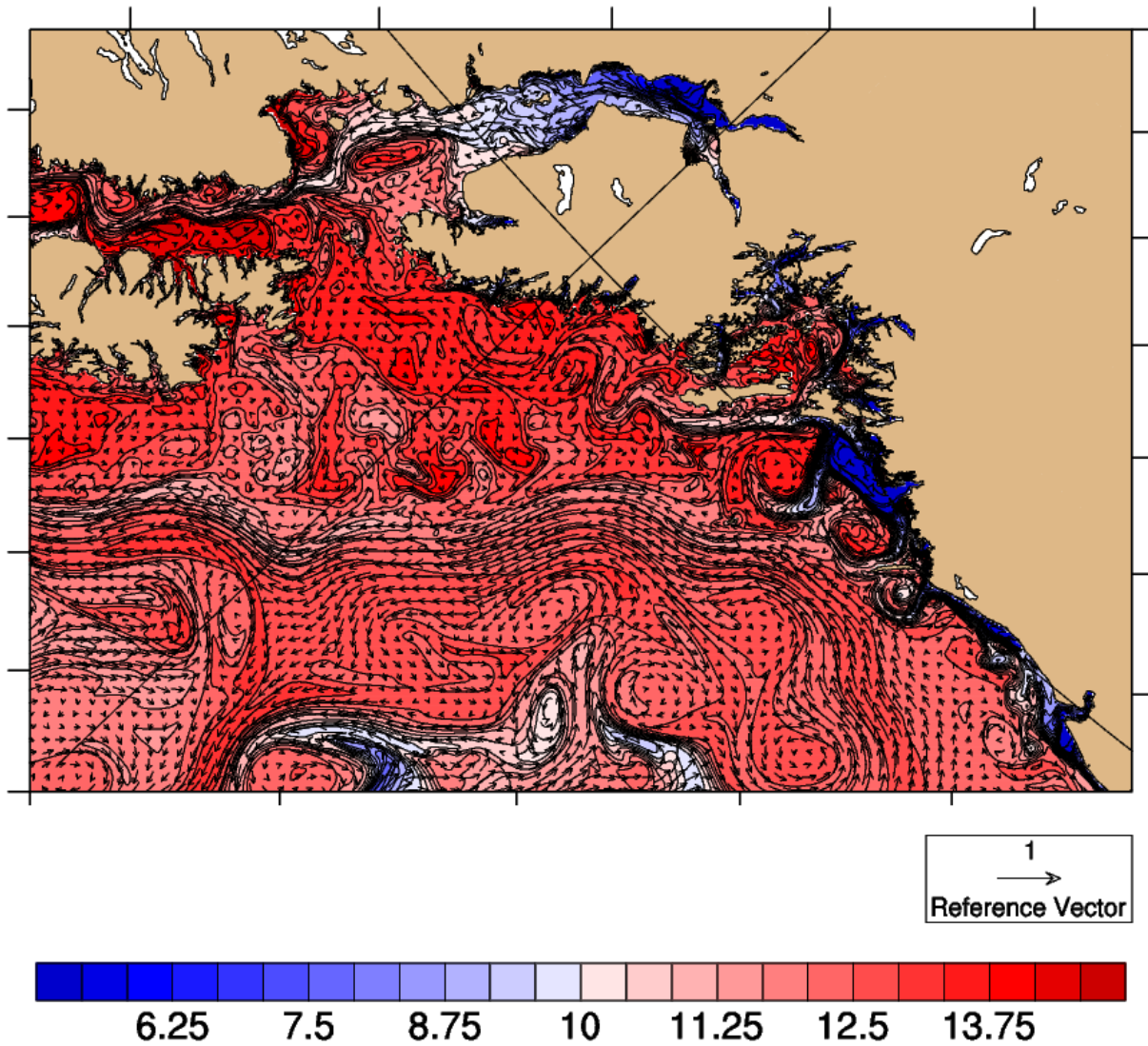
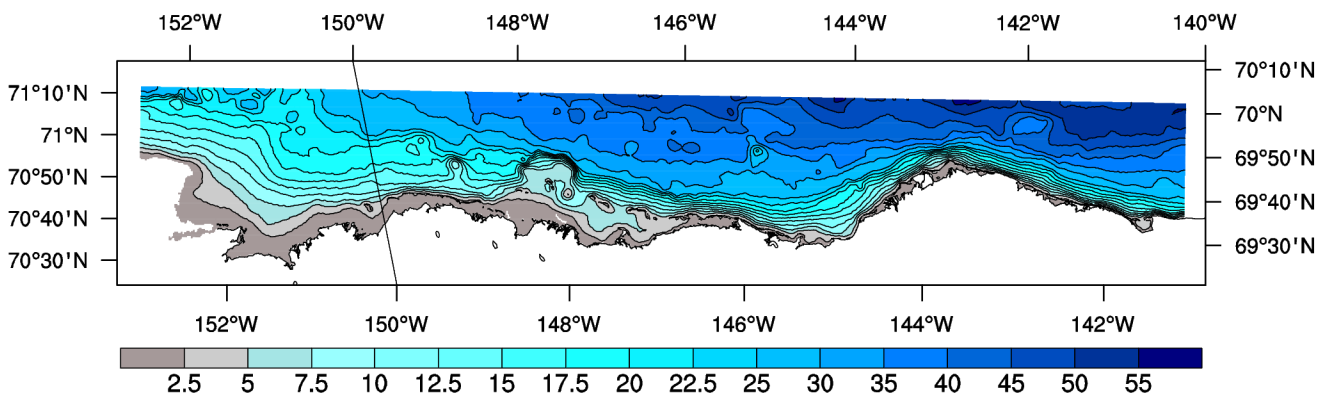
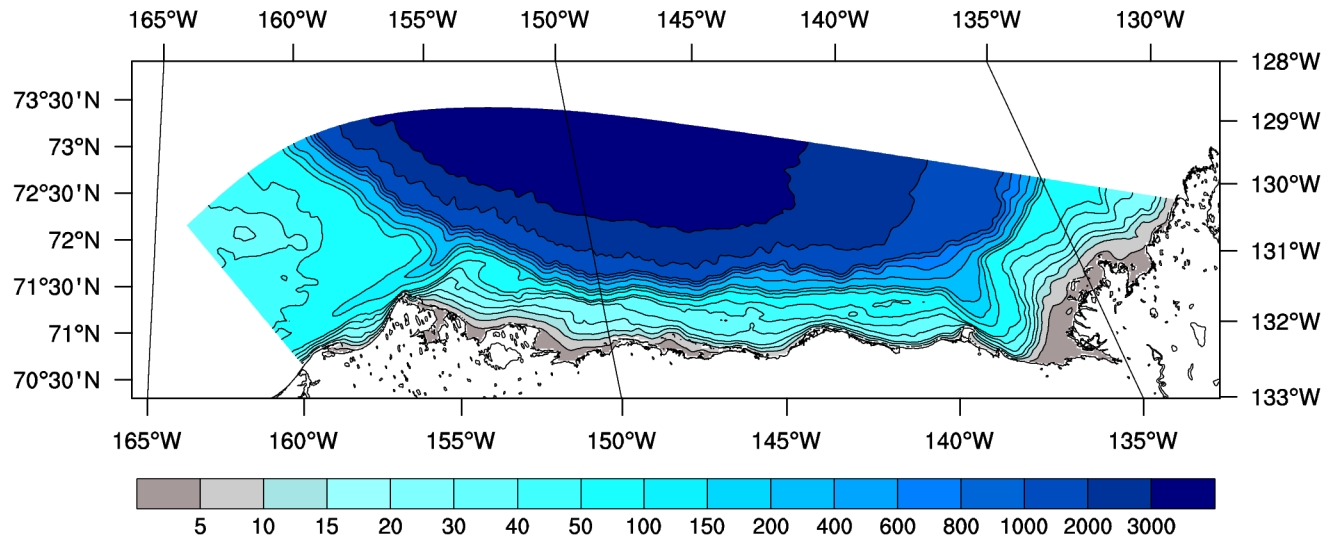

Figure 28: Surface temperature and velocities for 10 August, 2008. Graticules shown are 60°N and 150°W.



7.5.1 beaufort.h

The C preprocessor variable **BEAUFORT** has been chosen to label both of these domains—the header include file then becomes **beaufort.h**. It shares many of the options with the Arctic domain, differing in that there are no outflow cells and in that we've enabled the KPP bottom boundary layer code. Like the Arctic, this domain uses the ARDAT hydrology for fresh water inputs, but unlike the Arctic, does not also include RUNOFF.

7.5.2 BEAUFORT code chunks

The **Apps/Beaufort** directory contains the **ana__** family of include files for setting the bottom drag and the horizontal nudging coefficients. The only novelty here is that the two grids have differing nudging coefficients along the eastern boundary:

```
! cff3-point wide linearly tapered nudging zone
  IF (Lm(ng) == 936) THEN ! Beaufort3 grid only
    DO i=MAX(IstrT,Lm(ng)+1-INT(cff3)),IendT      ! EAST boundary
      DO j=JstrT,JendT
        wrk(i,j)=MAX(wrk(i,j),                    &
&          cff1+REAL(Lm(ng)+1-i,r8)*(cff2-cff1)/cff3)
      END DO
    END DO
  END IF
```

since it is only an open boundary in the smaller domain.

7.5.3 Model domains

A number of horizontal grid points was chosen to resolve the outer domain at roughly 3.0 km everywhere (Beaufort2), while the inner domain has a uniform 0.5 km resolution (Beaufort3). Values for **Lm**, **Mm**, and **N** are:

```
Lm == 400      ! Number of I-direction INTERIOR RHO-points
Mm == 96       ! Number of J-direction INTERIOR RHO-points
N == 50        ! Number of vertical levels

Lm == 936      ! Number of I-direction INTERIOR RHO-points
Mm == 160      ! Number of J-direction INTERIOR RHO-points
N == 30        ! Number of vertical levels
```

The Beaufort3 domain is entirely on the shelf and was deemed too shallow to require our usual 50 levels. The vertical structure is again our current favorite:

```
Vtransform == 2      ! transformation equation
Vstretching == 4     ! stretching function

THETA_S == 7.0d0     ! surface stretching parameter
THETA_B == 2.0d0     ! bottom stretching parameter
TCLINE == 250.0d0    ! critical depth (m)
```

7.5.4 Initial and boundary conditions

All initial and boundary conditions for the Beaufort2 domain were extracted from prior runs of the **ARCTIC** domain while those for the Beaufort3 domain were extracted from Beaufort2. In both cases, we use higher frequencies of one to three hours for the ice fields and daily averages for the ocean fields. The **LBC** options are the same as in the **ARCTIC** for all open boundaries, except we now use “RadNud” for the ice velocities and “Mix” for all the other ice variables. There is no need for any nudging to climatology in the ocean, but we use a nudging band to monthly climatologies for some sea ice variables with a relatively short (three-day) timescale close to the boundary.

7.5.5 Forcing

We use the same MERRA forcing with extrapolation into land as described above, as well as a tidal file from TPXO. I’ve omitted the tidal potential contribution in these domains. The fresh water forcing is from the monthly ARDAT climatology [Whitefield et al., 2015], interpolated to the ROMS grid and then converted to lateral “sources” along the coastline.

7.5.6 ocean.in

We use an internal time-step of 60 *s* for Beaufort2 and an internal time-step of 45 *s* for Beaufort3. Both have an external-internal time-step ratio of 20. The horizontal diffusivity and viscosity for Beaufort2 are:

```
TNU2 == 2*1.0d0           ! m2/s
VISC2 == 5.0d0            ! m2/s
```

while Beaufort3 has:

```
TNU2 == 2*0.2d0          ! m2/s
VISC2 == 1.0d0           ! m2/s
```

7.5.7 Output

The model writes voluminous information to standard out, as shown for the **UPWELLING** case. It also writes out NetCDF files for restart, daily averages, three-hourly averaged surface fields, stations and floats. Plots can be made from any of these files; some examples are shown in Fig. 31–33. Fig. 31 shows the land-fast ice extent, in which it is clear that I’ve turned off the land-fast ice parameterization within the boundary nudging band.

Sea Ice Speed

April

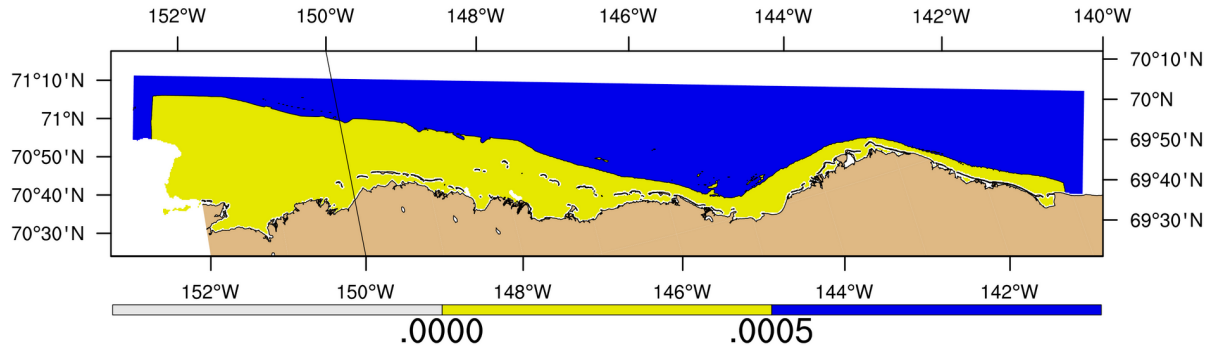

Figure 31: Ice speed contour at 0.0005 m/s for the April climatology in the Beaufort3 domain. This contour was chosen as an estimate of the land-fast ice extent.

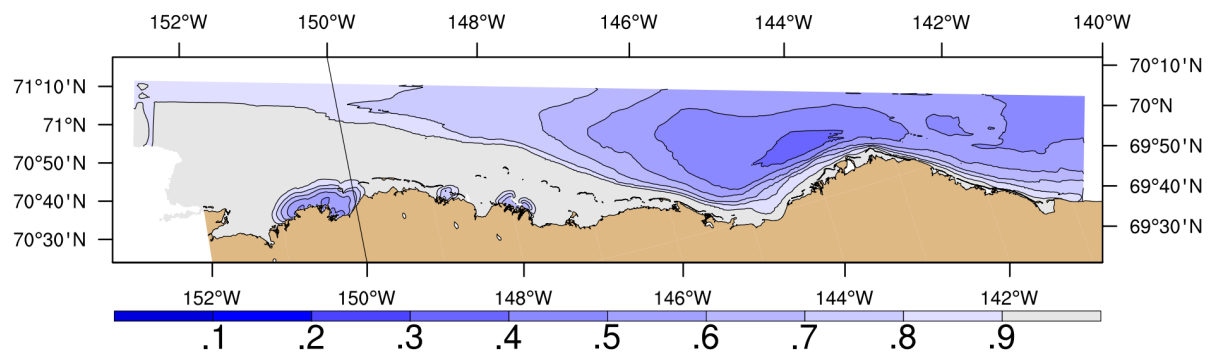

Figure 32: Sea-ice concentration for the June climatology in the Beaufort3 domain. Note the location of a few warm rivers between 148° and 151° W longitude.

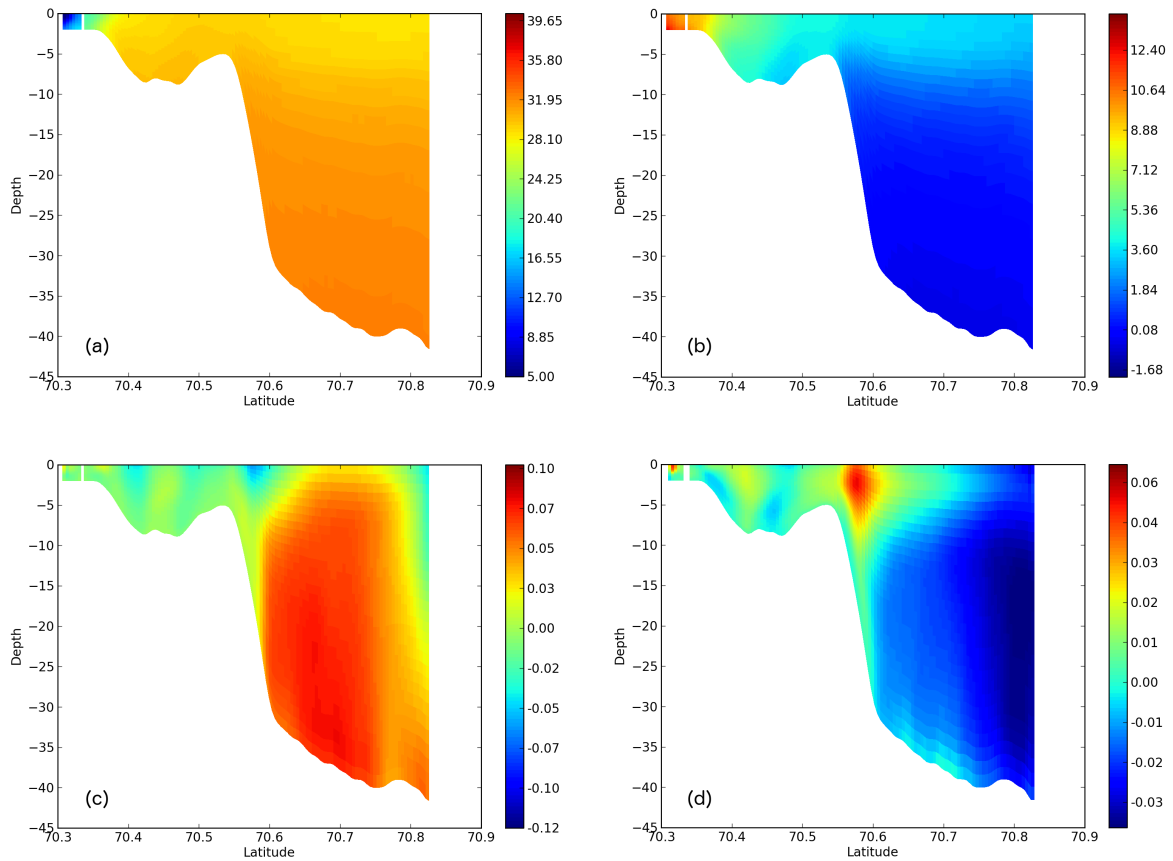

Figure 33: Vertical slices for the August climatology in the Beaufort3 domain, (a) salinity, (b) temperature ($^{\circ}\text{C}$), (c) longshore velocity (m/s) and (d) cross-shore velocity (m/s). Note the warm, fresh water right up on the shelf, trapped by a barrier island.

A Model Time-stepping Schemes

Numerical time stepping uses a discrete approximation to:

$$\frac{\partial\phi(t)}{\partial t} = \mathcal{F}(t) \quad (247)$$

where ϕ represents one of u , v , C , or ζ , and $\mathcal{F}(t)$ represents all the right-hand-side terms. In ROMS, the goal is to find time-stepping schemes which are accurate where they are valid and damping on unresolved signals [Shchepetkin and McWilliams, 2009b]. Also, the preference is for time-stepping schemes requiring only one set of the right-hand-side terms so that different time-stepping schemes can be used for different terms in the equations. Finally, as mentioned in Table 4.3, not all versions of ROMS use the same time-stepping algorithm. We list some time-stepping schemes here which are used or have been used by the ROMS/SCRUM family of models, plus a few to help explain some of the more esoteric ones.

A.1 Euler

The simplest approximation is the Euler time step:

$$\frac{\phi(t + \Delta t) - \phi(t)}{\Delta t} = \mathcal{F}(t) \quad (248)$$

where you predict the next ϕ value based only on the current fields. This method is accurate to first order in Δt ; however, it is unconditionally unstable with respect to advection.

A.2 Leapfrog

The leapfrog time step is accurate to $O(\Delta t^2)$:

$$\frac{\phi(t + \Delta t) - \phi(t - \Delta t)}{2\Delta t} = \mathcal{F}(t). \quad (249)$$

This time step is more accurate, but it is unconditionally unstable with respect to diffusion. Also, the even and odd time steps tend to diverge in a computational mode. This computational mode can be damped by taking correction steps. SCRUM's time step on the depth-integrated equations was a leapfrog step with a trapezoidal correction (LF-TR) on every step, which uses a leapfrog step to obtain an initial guess of $\phi(t + \Delta t)$. We will call the right-hand-side terms calculated from this initial guess $\mathcal{F}^*(t + \Delta t)$:

$$\frac{\phi(t + \Delta t) - \phi(t)}{\Delta t} = \frac{1}{2} [\mathcal{F}(t) + \mathcal{F}^*(t + \Delta t)]. \quad (250)$$

This leapfrog-trapezoidal time step is stable with respect to diffusion and it strongly damps the computational mode. However, the right-hand-side terms are computed twice per time step.

A.3 Third-order Adams-Bashforth (AB3)

The time step on SCRUM's full 3-D fields is done with a third-order Adams-Bashforth step. It uses three time-levels of the right-hand-side terms:

$$\frac{\phi(t + \Delta t) - \phi(t)}{\Delta t} = \alpha\mathcal{F}(t) + \beta\mathcal{F}(t - \Delta t) + \gamma\mathcal{F}(t - 2\Delta t) \quad (251)$$

where the coefficients α , β and γ are chosen to obtain a third-order estimate of $\phi(t + \Delta t)$. We use a Taylor series expansion:

$$\frac{\phi(t + \Delta t) - \phi(t)}{\Delta t} = \phi' + \frac{\Delta t}{2}\phi'' + \frac{\Delta t^2}{6}\phi''' + \dots \quad (252)$$

where

$$\begin{aligned}\mathcal{F}(t) &= \phi' \\ \mathcal{F}(t - \Delta t) &= \phi' - \Delta t \phi'' + \frac{\Delta t^2}{2} \phi''' + \dots \\ \mathcal{F}(t - 2\Delta t) &= \phi' - 2\Delta t \phi'' + 2\Delta t^2 \phi''' + \dots\end{aligned}$$

We find that the coefficients are:

$$\alpha = \frac{23}{12}, \quad \beta = -\frac{4}{3}, \quad \gamma = \frac{5}{12}$$

This requires one time level for the physical fields and three time levels of the right-hand-side information and requires special treatment on startup.

A.4 Forward-Backward

In equation 247 above, we assume that multiple equations for any number of variables are time stepped synchronously. For coupled equations, we can actually do better by time stepping asynchronously. Consider these equations:

$$\begin{aligned}\frac{\partial \zeta}{\partial t} &= \mathcal{F}(u) \\ \frac{\partial u}{\partial t} &= \mathcal{G}(\zeta)\end{aligned}\tag{253}$$

If we time step them alternately, we can always be using the newest information:

$$\begin{aligned}\zeta^{n+1} &= \zeta^n + \mathcal{F}(u^n) \Delta t \\ u^{n+1} &= u^n + \mathcal{G}(\zeta^{n+1}) \Delta t\end{aligned}\tag{254}$$

This scheme is second-order accurate and is stable for longer time steps than many other schemes. It is however unstable for advection terms.

A.5 Forward-Backward Feedback (RK2-FB)

One option for solving equation 253 is a predictor-corrector with predictor step:

$$\begin{aligned}\zeta^{n+1,*} &= \zeta^n + \mathcal{F}(u^n) \Delta t \\ u^{n+1,*} &= u^n + \left[\beta \mathcal{G}(\zeta^{n+1,*}) + (1 - \beta) \mathcal{G}(\zeta^n) \right] \Delta t\end{aligned}\tag{255}$$

and corrector step:

$$\begin{aligned}\zeta^{n+1} &= \zeta^n + \frac{1}{2} \left[\mathcal{F}(u^{n+1,*}) + \mathcal{F}(u^n) \right] \Delta t \\ u^{n+1} &= u^n + \frac{1}{2} \left[\epsilon \mathcal{G}(\zeta^{n+1}) + (1 - \epsilon) \mathcal{G}(\zeta^{n+1,*}) + \mathcal{G}(\zeta^n) \right] \Delta t\end{aligned}\tag{256}$$

Setting $\beta = \epsilon = 0$ in the above, it becomes a standard second order Runge-Kutta scheme, which is unstable for a non-dissipative system. Adding the β and ϵ terms adds Forward-Backward feedback to this algorithm, and allows us to improve both its accuracy and stability. The choice of $\beta = 1/3$ and $\epsilon = 2/3$ leads to a stable third-order scheme with $\alpha_{\max} = 2.14093$ [Shchepetkin and McWilliams, 2009b].

A.6 LF-TR and LF-AM3 with FB Feedback

Another possibility is a leapfrog predictor:

$$\begin{aligned}\zeta^{n+1,*} &= \zeta^{n-1} + 2\mathcal{F}(u^n)\Delta t \\ u^{n+1,*} &= u^{n-1} + 2\left\{(1-2\beta)\mathcal{G}(\zeta^n) + \beta\left[\mathcal{G}(\zeta^{n+1,*}) + \mathcal{G}(\zeta^{n-1})\right]\right\}\Delta t\end{aligned}\tag{257}$$

and either a two-time trapezoidal or a three-time Adams-Moulton corrector:

$$\begin{aligned}\zeta^{n+1} &= \zeta^n + \left[\left(\frac{1}{2} - \gamma\right)\mathcal{F}(u^{n+1,*}) + \left(\frac{1}{2} + 2\gamma\right)\mathcal{F}(u^n) - \gamma\mathcal{F}(u^{n-1})\right]\Delta t \\ u^{n+1} &= u^n + \left\{\left(\frac{1}{2} - \gamma\right)\left[\epsilon\mathcal{G}(\zeta^{n+1}) + (1-\epsilon)\mathcal{G}(\zeta^{n+1,*})\right] + \left(\frac{1}{2} + 2\gamma\right)\mathcal{G}(\zeta^n) - \gamma\mathcal{G}(\zeta^{n-1})\right\}\Delta t\end{aligned}\tag{258}$$

where the parameters β and ϵ introduce FB-feedback during both stages, while γ controls the type of corrector scheme. Without FB-feedback, we have:

$$\beta = \epsilon = 0 \Rightarrow \begin{cases} \gamma = 0 & \Rightarrow \text{LF-TR} & \alpha_{\max} = \sqrt{2} \\ \gamma = 1/12 & \Rightarrow \text{LF-AM3} & \alpha_{\max} = 1.5874 \\ \gamma = 0.0804 & \Rightarrow \text{max stability} & \alpha_{\max} = 1.5876 \end{cases}$$

Keeping $\gamma = 1/12$ maintains third-order accuracy. The most accurate choices for β and ϵ are $\beta = 17/120$ and $\epsilon = 11/20$, which yields a fourth-order scheme with low numerical dispersion and diffusion and $\alpha_{\max} = 1.851640$ [Shchepetkin and McWilliams, 2009b].

A.7 Generalized FB with an AB3-AM4 Step

One drawback of the previous two schemes is the need to evaluate the right-hand-side (r.h.s.) terms twice per time step. The original forward-backward scheme manages to achieve $\alpha_{\max} = 2$ while only evaluating each r.h.s. term once. It is possible to construct a robust scheme using a combination of a three-time AB3-like step for ζ with a four-time AM4-like step for u :

$$\begin{aligned}\zeta^{n+1} &= \zeta^n + \left[\left(\frac{3}{2} + \beta\right)\mathcal{F}(u^n) - \left(\frac{1}{2} + 2\beta\right)\mathcal{F}(u^{n-1}) + \beta\mathcal{F}(u^{n-2})\right]\Delta t \\ u^{n+1} &= u^n + \left[\left(\frac{1}{2} + \gamma + 2\epsilon\right)\mathcal{G}(\zeta^{n+1}) + \left(\frac{1}{2} - 2\gamma - 3\epsilon\right)\mathcal{G}(\zeta^n) + \gamma\mathcal{G}(\zeta^{n-1}) + \epsilon\mathcal{G}(\zeta^{n-2})\right]\Delta t\end{aligned}\tag{259}$$

This is second-order accurate for any set of values for β , γ , and ϵ . It is third-order accurate if $\beta = 5/12$. However, it has a wider stability range for $\beta = 0.281105$. [Shchepetkin and McWilliams, 2009b] choose to use this scheme for the barotropic mode in their model with $\beta = 0.281105$, $\gamma = 0.0880$, and $\epsilon = 0.013$, to obtain $\alpha_{\max} = 1.7802$, close to the value of 2 for pure FB, but with better stability properties for the combination of waves, advection, and Coriolis terms.

B The vertical σ -coordinate

ROMS now supports several vertical coordinate systems as fully described on the ROMS wiki. See also Shchepetkin and McWilliams [2005]. The currently recommended values correspond to **Vtransform**= 2 and **Vstretching**= 4, therefore that is what is described here.

B.1 Transform

The vertical coordinate corresponding to **Vtransform**= 2 is:

$$z(x, y, \sigma, t) = \zeta(x, y, t) + [\zeta(x, y, t) + h(x, y)] S(x, y, \sigma), \quad (260)$$

$$S(x, y, \sigma) = \frac{h_c \sigma + h(x, y) C(\sigma)}{h_c + h(x, y)} \quad (261)$$

where h_c is a (positive) thickness above which we wish to have more resolution and $C(\sigma)$ is a nondimensional, monotonic, vertical stretching function ranging from $-1 \leq C(\sigma) \leq 0$.

In an undisturbed ocean state, corresponding to zero free-surface, $z = S(x, y, \sigma)$ so that in our coordinate system, the depths are not affected by the displacements of the free-surface. This ensures that the vertical mass fluxes generated by a purely barotropic motion will vanish at every interface.

We find it convenient to define:

$$H_z \equiv \frac{\partial z}{\partial \sigma} \quad (262)$$

We compute H_z discretely as $\Delta z / \Delta \sigma$ since this leads to the vertical sum of H_z being exactly the total water depth D .

Notice that, unlike our previous stretching function,

$$S(x, y, \sigma) = \begin{cases} 0, & \text{if } \sigma = 0, C(\sigma) = 0, \text{ at the free-surface;} \\ -1, & \text{if } \sigma = -1, C(\sigma) = -1, \text{ at the ocean bottom;} \end{cases} \quad (263)$$

The new stretching is superior in that:

- Regardless of the design of $C(\sigma)$, it behaves like equally-spaced sigma-coordinates in shallow regions, where $h(x, y) \ll h_c$. This is advantageous because it avoids excessive resolution and associated CFL limitation in such areas.
- Near-surface refinement behaves more or less like geopotential coordinates in deep regions (level thicknesses, H_z , do not depend or weakly depend on bathymetry), while near-bottom like sigma coordinates (H_z is roughly proportional to depth). This reduces the extreme r-factors near the bottom and reduces pressure gradient errors.
- The “true” sigma-coordinate system is recovered as $h_c \rightarrow \infty$. This is useful when configuring applications with “flat” bathymetry and “uniform” level thickness. Practically, you can achieve this by setting **Tcline** to 1.0d+16 in **ocean.in**. This will set $h_c = 1.0 \times 10^{16}$. Although not necessary, we also recommend that you set $\theta_S = 0$ and $\theta_B = 0$.
- In an undisturbed ocean state, $\zeta \equiv 0$, transformation (2) yields the following unperturbed depths, \hat{z} ,

$$\hat{z}(x, y, \sigma) \equiv h(x, y) S(x, y, \sigma) = h(x, y) \left[\frac{h_c \sigma + h(x, y) C(\sigma)}{h_c + h(x, y)} \right] \quad (264)$$

and

$$d\hat{z} = d\sigma h(x, y) \left[\frac{h_c}{h_c + h(x, y)} \right] \quad (265)$$

As a consequence, the uppermost grid box retains very little dependency from bathymetry in deep areas, where $h_c \ll h(x, y)$. For example, if $h_c = 250 \text{ m}$ and $h(x, y)$ changes from 2000 to 6000 m, the uppermost grid box changes only by a factor of 1.08 (less than 10%).

B.2 Stretching

In ROMS, we recommend **Vstretching**= 4. $C(\sigma)$ is defined as a continuous, double stretching function:

- Surface refinement function:

$$C(\sigma) = \frac{1 - \cosh(\theta_S \sigma)}{\cosh(\theta_S) - 1}, \quad \text{for } \theta_S > 0, \quad C(\sigma) = -\sigma^2, \quad \text{for } \theta_S \leq 0 \quad (266)$$

- Bottom refinement function:

$$C(\sigma) = \frac{\exp(\theta_B C(\sigma)) - 1}{1 - \exp(-\theta_B)}, \quad \text{for } \theta_B > 0 \quad (267)$$

Notice that the bottom function (267) is the second stretching of an already stretched transform (266). The resulting stretching function is continuous with respect to θ_S and θ_B as their values approach zero. The range of meaningful values for θ_S and θ_B are:

$$0 \leq \theta_S \leq 10 \quad \text{and} \quad 0 \leq \theta_B \leq 4$$

However, users need to pay attention to extreme r-factor **rx1** values near the bottom.

C Horizontal curvilinear coordinates

The requirement for a boundary-following coordinate system and for a laterally variable grid resolution can both be met (for suitably smooth domains) by introducing an appropriate orthogonal coordinate transformation in the horizontal. Let the new coordinates be $\xi(x, y)$ and $\eta(x, y)$ where the relationship of horizontal arc length to the differential distance is given by:

$$(ds)_\xi = \left(\frac{1}{m}\right) d\xi \quad (268)$$

$$(ds)_\eta = \left(\frac{1}{n}\right) d\eta \quad (269)$$

Here, $m(\xi, \eta)$ and $n(\xi, \eta)$ are the scale factors which relate the differential distances $(\Delta\xi, \Delta\eta)$ to the actual (physical) arc lengths.

It is helpful to write the equations in vector notation and to use the formulas for div, grad, and curl in curvilinear coordinates [see Batchelor, 1967, Appendix 2]:

$$\nabla\phi = \hat{\xi}m\frac{\partial\phi}{\partial\xi} + \hat{\eta}n\frac{\partial\phi}{\partial\eta} \quad (270)$$

$$\nabla \cdot \vec{a} = mn \left[\frac{\partial}{\partial\xi} \left(\frac{a}{n} \right) + \frac{\partial}{\partial\eta} \left(\frac{b}{m} \right) \right] \quad (271)$$

$$\nabla \times \vec{a} = mn \begin{vmatrix} \hat{\xi}_1 & \hat{\xi}_2 & \hat{k} \\ \frac{\partial}{\partial\xi} & \frac{\partial}{\partial\eta} & \frac{\partial}{\partial z} \\ \frac{a}{m} & \frac{b}{n} & c \end{vmatrix} \quad (272)$$

$$\nabla^2\phi = \nabla \cdot \nabla\phi = mn \left[\frac{\partial}{\partial\xi} \left(\frac{m}{n} \frac{\partial\phi}{\partial\xi} \right) + \frac{\partial}{\partial\eta} \left(\frac{n}{m} \frac{\partial\phi}{\partial\eta} \right) \right] \quad (273)$$

where ϕ is a scalar and \vec{a} is a vector with components a , b , and c .

D Viscosity and Diffusion

D.1 Horizontal viscosity

The horizontal viscosity and diffusion coefficients are scalars which are read in from **ocean.in**. Several factors to consider when choosing these values are:

spindown time The spindown time on wavenumber k is $\frac{1}{k^2\nu_2}$ for the Laplacian operator and $\frac{1}{k^4\nu_4}$ for the biharmonic operator. The smallest wavenumber corresponds to the length $2\Delta x$ and is $k = \frac{\pi}{\Delta x}$, leading to

$$\Delta t < t_{damp} = \frac{\Delta x^2}{\pi^2\nu_2} \quad \text{or} \quad \frac{\Delta x^4}{\pi^4\nu_4} \quad (274)$$

This time should be short enough to damp out the numerical noise which is being generated but long enough on the larger scales to retain the features you are interested in. This time should also be resolved by the model timestep.

boundary layer thickness The western boundary layer has a thickness proportional to

$$\Delta x < L_{BL} = \left(\frac{\nu_2}{\beta}\right)^{\frac{1}{3}} \quad \text{and} \quad \left(\frac{\nu_4}{\beta}\right)^{\frac{1}{5}} \quad (275)$$

for the Laplacian and biharmonic viscosity, respectively. We have found that the model typically requires the boundary layer to be resolved with at least one grid cell. This leads to coarse grids requiring large values of ν .

D.2 Horizontal Diffusion

We have chosen anything from zero to the value of the horizontal viscosity for the horizontal diffusion coefficient. One common choice is an order of magnitude smaller than the viscosity.

D.3 Vertical Viscosity and Diffusion

ROMS stores the vertical mixing coefficients in arrays with three spatial dimensions called **Akv** and **Akt**. **Akt** also has a fourth dimension specifying which tracer, so that temperature and salt can have differing values. Both **Akt** and **Akv** are stored at w -points in the model; horizontal averaging is done to obtain **Akv** at the horizontal u and v -points. The values for these coefficients can be set in a number of ways, as described in §4.11.

E Radiant heat fluxes

As was seen in §5.2, the model thermodynamics requires fluxes of latent and sensible heat and longwave and shortwave radiation. We follow the lead of Parkinson and Washington [1979] in computing these terms.

E.1 Shortwave radiation

The Zillman equation for radiation under cloudless skies is:

$$Q_o = \frac{S \cos^2 Z}{(\cos Z + 2.7)e \times 10^{-5} + 1.085 \cos Z + 0.10} \quad (276)$$

where the variables are as in Table 10. The cosine of the zenith angle is computed using the formula:

$$\cos Z = \sin \phi \sin \delta + \cos \phi \cos \delta \cos HA. \quad (277)$$

The declination is

$$\delta = 23.44^\circ \times \cos [(172 - \text{day of year}) \times 2\pi/365] \quad (278)$$

and the hour angle is

$$HA = (12 \text{ hours} - \text{solar time}) \times \pi/12. \quad (279)$$

The correction for cloudiness is given by

$$SW\downarrow = Q_o(1 - 0.6c^3). \quad (280)$$

E.2 Longwave radiation

The clear sky formula for incoming longwave radiation is given by:

$$F\downarrow = \sigma T_a^4 \left\{ 1 - 0.261 \exp \left[-7.77 \times 10^{-4} (273 - T_a)^2 \right] \right\} \quad (281)$$

while the cloud correction is given by:

$$LW\downarrow = (1 + 0.275c) F\downarrow. \quad (282)$$

E.3 Sensible heat

The sensible heat is given by the standard aerodynamic formula:

$$H\downarrow = \rho_a c_p C_H V_{wg} (T_a - T_{sfc}). \quad (283)$$

E.4 Latent heat

The latent heat depends on the vapor pressure and the saturation vapor pressure given by:

$$e = 611 \times 10^{a(T_d - 273.16)/(T_d - b)} \quad (284)$$

$$e_s = 611 \times 10^{a(T_{sfc} - 273.16)/(T_{sfc} - b)} \quad (285)$$

The vapor pressures are used to compute specific humidities according to:

$$q_{10m} = \frac{\epsilon e}{p - (1 - \epsilon)e} \quad (286)$$

$$q_s = \frac{\epsilon e_s}{p - (1 - \epsilon)e_s} \quad (287)$$

The latent heat is also given by a standard aerodynamic formula:

$$LE\downarrow = \rho_a L C_E V_{wg} (q_{10m} - q_s). \quad (288)$$

Note that these need to be computed independently for the ice-covered and ice-free portions of each gridbox since the empirical factors a and b and the factor L differ depending on the surface type.

Variable	Value	Description
(a, b)	(9.5, 7.66)	vapor pressure constants over ice
(a, b)	(7.5, 35.86)	vapor pressure constants over water
c		cloud cover fraction
C_E	1.75×10^{-3}	transfer coefficient for latent heat
C_H	1.75×10^{-3}	transfer coefficient for sensible heat
c_p	$1004 \text{ J kg}^{-1} \text{ K}^{-1}$	specific heat of dry air
δ		declination
e		vapor pressure in pascals
e_s		saturation vapor pressure
ϵ	0.622	ratio of molecular weight of water to dry air
HA		hour angle
L	$2.5 \times 10^6 \text{ J kg}^{-1}$	latent heat of vaporization
L	$2.834 \times 10^6 \text{ J kg}^{-1}$	latent heat of sublimation
ϕ		latitude
Q_o		incoming radiation for cloudless skies
q_s		surface specific humidity
q_{10m}		10 meter specific humidity
ρ_a		air density
S	1353 W m^{-2}	solar constant
σ	$5.67 \times 10^{-8} \text{ W m}^{-2} \text{ K}^{-4}$	Stefan-Boltzmann constant
T_a		air temperature
T_d		dew point temperature
T_{sfc}		surface temperature of the water/ice/snow
V_{wg}		geostrophic wind speed
Z		solar zenith angle

Table 10: Variables used in computing the incoming radiation and latent and sensible heat

F The C preprocessor

The C preprocessor, **cpp**, is a standalone program which comes with most C compilers. On older UNIX systems it was not in the default path, but in `/lib` or in `/usr/lib`. Most modern systems have some version of **gcc** which comes with a quite capable **cpp**. Just be sure to give it the **-traditional** flag.

This Appendix describes the C preprocessor as used in ROMS with the Fortran language. A more complete description is given by Kernighan and Ritchie [1988]. More practical advice on using **cpp** is given by Hazard [1991].

F.1 File inclusion

Placing common blocks in smaller files, which are then included in each subroutine, is the easiest way to make sure that the common blocks are declared consistently. Many Fortran compilers support an include statement where the compiler replaces the line

```
include 'file.h'
```

with the contents of **file.h**; **file.h** is assumed to be in the current directory. The C preprocessor has an equivalent include statement:

```
#include "file.h"
```

We are using the C preprocessor style of include because many of the ROMS include files are not pure Fortran and must be processed by **cpp**.

F.2 Macro substitution

A macro definition has the form

```
#define name replacement text
```

where “name” would be replaced with “replacement text” throughout the rest of the file. This was used in SCRUM as a reasonably portable way to get 64-bit precision:

```
#define BIGREAL real*8
```

It is customary to use uppercase for **cpp** macros—the C preprocessor is case sensitive.

It is also possible to define macros with arguments, as in

```
#define av2(a1,a2) (.5 * ((a1) + (a2)))
```

although this is riskier than the equivalent statement function

```
av2(a1,a2) = .5 * (a1 + a2)
```

The statement function is preferable because it allows the compiler to do type checking and because you don't have to be as careful about using enough parentheses.

The third form of macro has no replacement text at all:

```
#define MASKING
```

In this case, **MASKING** will evaluate to **true** in the conditional tests described below.

F.3 Conditional inclusion

It is possible to control which parts of the code are seen by the Fortran compiler by the use of **cpp**'s conditional inclusion. For example, the statements

```
#ifndef MASKING
# include "mask.h"
#endif /* MASKING */
:
# ifdef MASKING
c
c Apply Land/Sea mask: slipperiness.
c
      do j=1,M
        do i=2,Lm
          Uflux(i,j)=Uflux(i,j)*pmask(i,j)
        enddo
      enddo
# endif /* MASKING */
```

will not be in the Fortran source code if **MASKING** has not been defined. Likewise, **#ifndef** tests for a macro being undefined:

```
#ifndef RMDOCINC
c rmask      Mask at RHO-points (0=Land, 1=Sea).
c pmask      Slipperiness mask at PSI-points (0=Land, 1=Sea,
c                                     1-gamma2=boundary).
c umask      Mask at U-points (0=Land, 1=Sea).
c vmask      Mask at V-points (0=Land, 1=Sea).
c
c=====
#endif
```

There are also **#else** and **#elif** (else if) statements. An example using **#else** and **#elif** is shown:

```
#ifdef SOLITON
      real(r8) :: g = 1.0_r8                ! non-dimensional
# elif defined WBC_1 || defined WBC_2 || defined WBC_3
      real(r8) :: g = 9.8_r8                ! m/s2
# elif defined CIRCLE
      real(r8) :: g = 3.92e-2_r8            ! m/s2
# else
      real(r8) :: g = 9.81_r8                ! m/s2
# endif
```

Actually, **#ifdef** is a restricted version of the more general test

```
#if      expression
```

where “expression” is a constant integer value. Zero evaluates to **false** and everything else is considered **true**. Compound expressions may be built using the C logical operators:

```
&&      logical and
||      logical or
!       logical not
```

These symbols would be used as in the following example:

```
#if defined CANYON_A || defined CANYON_B
  do j=0,M
    do i=0,L
      yc=c32000-c16000*(sin(pi*xr(i,j)/xl)**24
      h(i,j)=c20+p5*(hmax-c20)*(c1+tanh((yr(i,j)-yc)/c10000))
    enddo
  enddo
#endif
```

F.4 C comments

The C preprocessor will also delete C language comments starting with `/*` and ending with `*/` as in:

```
#endif /* MASKING */
```

When mixed with Fortran code, it is safer to use a Fortran comment.

F.5 A note on style

In ROMS, the style adopted is as shown above and here:

```
#define NEP5
#if defined NEP5 || defined BERING
  :
# ifdef MASKING
  :
# endif
#endif
```

The **gnu** community has instead adopted this style:

```
#define NEP5 1
#if NEP5 || BERING
  :
# if MASKING
  :
# endif
#endif
```

Both styles work and you should be aware that there's more than one way to do it.

F.6 Potential problems

The use of the C preprocessor is not entirely free of problems, but many can be worked around or avoided by using the **gnu** version of **cpp** with the **-traditional** flag.

1. Apostrophes in Fortran comments. **cpp** does not know that it is in a comment and some versions will complain about unmatched apostrophes in the following:

```
! Some useful comment about Green's functions.
```

2. C++ comments. Some of the newer versions of **cpp** will remove C++ comments which go from `'//'` to the end of the line. Some perfectly reasonable Fortran lines contain two consecutive slashes, such as:

```
        common // var1, var2
44  format(//)
```

and Fortran 90 string concatenation:

```
mystring = 'Hello, ' // 'World!'
```

3. Macro replacement. One feature of **cpp** is that you can define macros and have it perform replacements. The code:

```
#define REAL double precision
      REAL really_long_variable, second_long_variable
```

becomes

```
double precision really_long_variable, second_long_variable
```

and you run the risk of creating lines which are longer than 72 characters in length.

Also, make sure that your macros will not be found anywhere else in the code. I used to use `#define DOUBLE` for double precision until it was pointed out to me that **DOUBLE PRECISION** is perfectly valid Fortran. Since a string that is simply “defined” becomes 1, the macro processor would turn this into **1 PRECISION**.

F.7 Modern Fortran

I started working on these ocean models before 1990, much less before Fortran 90 compilers were generally available. Fortran 90’s **kind** feature as used in ROMS is a better way to handle the **BIGREAL** type declarations. On the other hand, Fortran 90 does not include conditional compilation. However, it is deemed useful enough that the Fortran 2003 standard has the *coco* means of conditional compilation. We *might* start using this in about ten years.

G Makefiles

One of the software development tools which comes with the UNIX operating system is called **make**. **Make** has many uses, but is most commonly used to keep track of how a large program should be compiled. ROMS now requires the **gnu** version of **make**, sometimes known as **gmake** [Mechlenburg, 2005]. This appendix describes generic **make**, the **gnu** enhancements to **make**, as well as describing the **makefile** structure used in ROMS. This material first appeared in the ARSC HPC Newsletter in several segments and has been updated and restructured here.

G.1 Introduction to Portable make

Make gets its instructions from a description file, by default named **makefile** or **Makefile**. This file is called the **Makefile**, but other files can be used by invoking **make** with the **-f** option:

```
make -f Makefile.yukon
```

The ancestor to ROMS originally had a **Makefile** that looked something like:

```
model: main.o init.o plot.o
<TAB>  f77 -o model main.o init.o plot.o

main.o: main.f
<TAB>  f77 -c -O main.f

init.o: init.f
<TAB>  f77 -c -O init.f

plot.o: plot.f
<TAB>  f77 -c -O0 plot.f

clean:
<TAB>  rm *.o core
```

The default thing to build is **model**, the first target. The syntax is:

```
target: dependencies
<TAB>  command
<TAB>  command
```

The target **model** depends on the object files, **main.o** and friends. They have to exist and be up to date before **model**'s link command can be run. If the target is out of date according to the timestamp on the file, then the commands will be run. Note that the tab is required on the command lines.

The other targets tell **make** how to create the object files and that they in turn have dependencies. To compile **model**, simply type "**make**". **Make** will look for the file **makefile**, read it, and do whatever is necessary to make **model** up to date. If you edit **init.f**, that file will be newer than **init.o**. **Make** would see that **init.o** is out of date and run the "**f77 -c -O init.f**" command. Now **init.o** is newer than **model**, so the link command "**f77 -o model main.o init.o plot.o**" must be executed.

To clean up, type "**make clean**" and the **clean** target will be brought up to date. The **clean** target has no dependencies. What happens in that case is that the command ("**rm *.o core**") will always be executed.

The original version of this **Makefile** turned off optimization on **plot.f** due to a compiler bug, but hopefully you won't ever have to worry about that.

G.1.1 Macros

Make supports a simple string substitution macro. Set it with:

```
MY_MACRO = nothing today
```

and refer to it with:

```
$(MY_MACRO)
```

The convention is to put the macros near the top of your **Makefile** and to use upper case. Also, use separate macros for the name of your compiler and the flags it needs:

```
F90 = f90
F90FLAGS = -O3
LIBDIR = /usr/local/lib
LIBS = -L$(LIBDIR) -lmylib
```

Let's rewrite our **Makefile** using macros:

```
#
# IBM version
#
F90 = xlf90_r
F90FLAGS = -O3 -qstrict
LDLFLAGS = -bmaxdata:0x40000000

model: main.o init.o plot.o
    $(F90) $(LDLFLAGS) -o model main.o init.o plot.o

main.o: main.f
    $(F90) -c $(F90FLAGS) main.f

init.o: init.f
    $(F90) -c $(F90FLAGS) init.f

plot.o: plot.f
    $(F90) -c $(F90FLAGS) plot.f

clean:
    rm *.o core
```

Now when we change computers, we only have to change the compiler name in one place. Likewise, if we want to try a different optimization level, we only specify that in one place.

Notice that you can use comments by starting the line with a **#**.

G.1.2 Implicit Rules

Make has some rules already built in. For fortran, you might be able to get away with:

```
OBJS = main.o init.o plot.o

model: $(OBJS)
    $(FC) $(LDLFLAGS) -o model $(OBJS)
```

as your whole **Makefile**. **Make** will automatically invoke its default Fortran compiler, possibly **f77** or **g77**, with whatever default compile options it happens to have (**FFLAGS**). One built-in rule often looks like:

```
.c.o:
    $(CC) $(CFLAGS) -c $<
```

which says to compile **.c** files to **.o** files using the compiler **CC** and options **CFLAGS**. We can write our own suffix rules in this same style. The only thing to watch for is that **make** by default has a limited set of file extensions that it knows about. Let's write our **Makefile** using a suffix rule:

```
#
# Cray version
#
F90 = f90
F90FLAGS = -O3
LDFLAGS =

.f.o:
    $(F90) $(F90FLAGS) -c $<

model: main.o init.o plot.o
    $(F90) $(LDFLAGS) -o model main.o init.o plot.o

clean:
    rm *.o core
```

G.1.3 Dependencies

There may be additional dependencies beyond the **source->object** ones. In our little example, all our source files include a file called **commons.h**. If **commons.h** gets modified to add a new variable, everything must be recompiled. **Make** won't know that unless you tell it:

```
# include dependencies
main.o: commons.h
init.o: commons.h
plot.o: commons.h
```

Fortran 90 introduces module dependencies as well. See §H for how we automatically generate this dependency information.

The most common newbie mistake is to forget that the commands after a target *have* to start with a tab.

G.2 gnu make

Over the years, the community has moved from the stance of writing portable **Makefiles** to a stance of just using a powerful, portable **make**. The previous section described a portable subset of **make** features. We now delve into some of the more powerful tools available in **gnu make**.

G.2.1 Make rules

The core of **make** hasn't changed in decades, but concentrating on **gmake** allows one to make use of its nifty little extras designed by real programmers to help with real projects. The first change that matters to my **Makefiles** is the change from suffix rules to pattern rules. I've always found the **.SUFFIXES** list to be odd, especially since **.f90** is not in the default list. Good riddance to all of that! For a concrete example, the old way to provide a rule for going from **file.f90** to **file.o** is:

```
.SUFFIXES: .o .f90 .F .F90
.f90.o:
<TAB> $(FC) -c $(FFLAGS) $<
```

while the new way is:

```
%.o: %.f90
<TAB> $(FC) -c $(FFLAGS) $<
```

In fact, going to a uniform **make** means that we can figure out what symbols are defined and use their standard values—in this case, **\$(FC)** and **\$(FFLAGS)** are the built-in default names for the compiler and its options. If you have any questions about this, you can always run **make** with the **-p** (or **--print-data-base**) option. This prints out all the rules **make** knows about, such as:

```
# default
COMPILE.f = $(FC) $(FFLAGS) $(TARGET_ARCH) -c
```

Printing the rules database will show variables that **make** is picking up from the environment, from the **Makefile**, and from its built-in rules—and which of these sources is providing each value.

G.2.2 Assignments

In the old days, I only used one kind of assignment: **=** (equals sign). **Gmake** has several kinds of assignment (other **makes** might as well, but I no longer have to know or care). An example of the power of **gnu make** is shown by an example from my Cray X1 **Makefile**. There is a routine which runs much more quickly if a short function in another file is inlined. The way to accomplish this is through the **-O inlinefrom=file** directive to the compiler. I can't add this option to **FFLAGS**, since the inlined routine won't compile with this directive—there is only the one file that needs it. I had:

```
FFLAGS = -O 3,aggress -e I -e m
FFLAGS2 = -O 3,aggress -O inlinefrom=lmd_wscale.f90 -e I -e m

lmd_skpp.o:
<TAB> $(FC) -c $(FFLAGS2) $*.f90
```

The first change I can make to this using other assignments is:

```
FFLAGS := -O 3,aggress -e I -e m
FFLAGS2 := $(FFLAGS) -O inlinefrom=lmd_wscale.f90
```

The **:=** assignment means to evaluate the right hand side immediately. In this case, there is no reason not to, as long as the second assignment follows the first one (since it's using the value of **\$(FFLAGS)**). For the plain equals, **make** doesn't evaluate the right-hand side until its second pass through the **Makefile**. However, **gnu make** supports an assignment which avoids the need for **FFLAGS2** entirely:

```
lmd_skpp.o: FFLAGS += -O inlinefrom=lmd_wscale.f90
```

What this means is that for the target **lmd_skpp.o** only, append the inlining directive to **FFLAGS**. I think this is pretty cool!

One last kind of assignment is to set the value only if there is no value from somewhere else (the environment, for instance):

```
FC ?= mpx1f90_r
```

If we used `:=` or `=`, we would override the value from the environment.

G.2.3 Include and a Few Functions

One reasonably portable **make** feature is the include directive. It can be used to clean up the **Makefile** by putting bits in an include file. The syntax is simply:

```
include file
```

and we use it liberally to keep the project information neat. We can also include a file with the system/compiler information in it, assuming we have some way of deciding *which* file to include. We can use **uname -s** to find out which operating system we're using. We also need to know which compiler we're using.

One user-defined variable is called **FORT**, the name of the Fortran compiler. This value is combined with the result of "**uname -s**" to provide a machine and compiler combination. For instance, **ftn** on Linux is the Cray cross-compiler. This would link to a different copy of the NetCDF library and use different compiler flags than the Intel compiler which might be on the same system.

```
# The user sets FORT:
FORT ?= ftn
OS := $(shell uname -s | sed 's/[\/ ]/-/g')

include $(COMPILERS)/$(OS)-$(strip $(FORT)).mk
```

We pick one include file at compile time, here picking **Linux-ftn.mk**, containing the Cray cross-compiler information. The value **Linux** comes from the **uname** command, the **ftn** comes from the user, and the two are concatenated. The sed command will turn the slash in **UNICOS/mp** into a dash; the native Cray include file is **UNICOS-mp-ftn.mk**. Strip is a built-in function to strip away any extra white space.

Another tricky system is **CYGWIN**, which puts a version number in the **uname** output, such as **CYGWIN_NT-5.1**. **Gnu make** has quite a few built-in functions, one of which allows us to do string substitution:

```
OS := $(patsubst CYGWIN_%,CYGWIN,$(OS))
```

In **make**, the **%** symbol is a sort of wild card, much like ***** in the shell. Here, we match **CYGWIN** followed by an underscore and anything else, replacing the whole with simply **CYGWIN**. Another example of a built-in function is the substitution we do in:

```
objects = $(subst .F,.o,$(sources))
```

where we build our list of objects from the list of sources. There are quite a few other functions, plus the user can define their own. From Mechlenburg [2005]:

GNU make supports both built-in and user-defined functions. A function invocation looks much like a variable reference, but includes one or more parameters separated by commas. Most built-in functions expand to some value that is then assigned to a variable or passed to a subshell. A user-defined function is stored in a variable or macro and expects one or more parameters to be passed by the caller.

We will show some user-defined functions in §G.3.3.

G.2.4 Conditionals

We used to have way too many **Makefiles**, a separate one for each of the serial/MPI/OpenMP versions on each system (if supported). For instance, the name of the IBM compiler changes when using MPI; the options change for OpenMP. The compiler options also change when using 64-bit addressing or for debugging. A better way to organize this is to have the user select 64-bit or not, MPI or not, etc., then use conditionals. The complete list of user definable **make** variables is given in §2.4.1.

Gnu make supports two kinds of **if** test, **ifdef** and **ifeq** (plus the negative versions **ifndef**, **ifneq**). The example from the book is:

```
ifdef COMSPEC
    # We are running Windows
else
    # We are not on Windows
endif
```

An example from the IBM include file is:

```
ifdef USE_DEBUG
    FFLAGS += -g -qfullpath
else
    FFLAGS += -O3 -qstrict
endif
```

To test for equality, an example is:

```
ifeq ($(USE_MPI),on)
    # Do MPI things
endif
```

or

```
ifeq "$(USE_MPI)" "on"
    # Do MPI things
endif
```

The user has to set values for the **USE_MPI**, **USE_DEBUG**, and **USE_LARGE** switches in the **Makefile** or the build script *before* the compiler-dependent piece is included:

```
USE_MPI ?= on
USE_DEBUG ?=
USE_LARGE ?=
```

The **Makefile** uses the conditional assign “**?**=” in case a build script is used to set them in the environment. Be sure to leave the switches meant to be off set to an empty string—the string “**off**” will test true on an **ifdef** test.

G.3 Multiple Source Directories the ROMS Way

There's more than one way to divide your sources into separate directories. The choices we have made include nonrecursive **make** and putting the temporary files in their own **\$(SCRATCH_DIR)** directory. These include the **.f90** files which have been through the C preprocessor, object files, module files, and libraries.

G.3.1 Directory Structure

The directory structure of the source code has the top directory, a **Master** directory, a **ROMS** directory with a number of subdirectories, and several other directories. **Master** contains the main program while the rest contain sources for libraries and other files. Note that the bulk of the source code gets compiled into files that become libraries with the **ar** command, one library per directory. There is also a **Compilers** directory for the system- and compiler-specific **Makefile** components.

G.3.2 Conditionally Including Components

The **makefile** will build the lists of libraries to create and source files to compile. They start out empty at the top of the **makefile**:

```
sources    :=
libraries  :=
```

That's simple enough, but the list of directories to search for these sources will depend on the options chosen by the user, not just in the **make** options (§2.4.1), but inside the **ROMS_HEADER** file as well. How does this happen? Once **make** knows how to find the **ROMS_HEADER**, it is used by **cpp** to generate an include file telling **make** about these other options.

```
MAKE_MACROS := Compilers/make_macros.mk
MACROS := $(shell cpp -P $(ROMS_CPPFLAGS) Compilers/make_macros.h > \
           $(MAKE_MACROS); $(CLEAN) $(MAKE_MACROS))
```

The **make__macros.h** file contains blocks such as:

```
#ifdef SWAN_COUPLING
  USE_SWAN := on
#else
  USE_SWAN :=
#endif
```

The resulting **make__macros.mk** file will simply end up with either

```
USE_SWAN := on
```

or

```
USE_SWAN :=
```

This file can then be included by the **makefile** and the variable **USE_SWAN** will have the correct state for this particular compilation. We can now use it and all the similar flags to build a list of directories.

We initialize two lists:

```
modules    :=
includes   :=    ROMS/Include
```

Add the adjoint bits:

```
ifndef USE_ADJOINT
  modules +=    ROMS/Adjoint
endif
ifndef USE_ADJOINT
  includes +=   ROMS/Adjoint
endif
```

Add the bits we'll always need:

```
modules +=    ROMS/Nonlinear \
              ROMS/Functionals \
              ROMS/Utility \
              ROMS/Modules
includes +=   ROMS/Nonlinear \
              ROMS/Utility \
              ROMS/Drivers
```

Then we add in some more:

```
ifndef USE_SWAN
  modules +=   Waves/SWAN/Src
  includes +=  Waves/SWAN/Src
endif

modules +=    Master
includes +=   Master Compilers
```

Now that our lists are complete, let's put them to use:

```
vpath %.F $(modules)
vpath %.h $(includes)
vpath %.f90 $(SCRATCH_DIR)
vpath %.o $(SCRATCH_DIR)

include $(addsuffix /Module.mk,$(modules))

CPPFLAGS += $(patsubst %,-I%,$(includes))
```

1. **vpath** is a standard **make** feature for providing a list of directories for **make** to search for files of different types. Here we are saying that ***.F** files can be found in the directories provided in the **\$(modules)** list, and so on for the others.
2. For each directory in the **\$(modules)** list, **make** will include the file **Module.mk** that is found there. More on these later.
3. For each directory in the **\$(includes)** list, add that directory to the list searched by **cpp** with the **-I** flag.

G.3.3 User-defined make Functions

The **Module.mk** fragments mentioned before call some user-defined functions. It's time to show these functions and talk about how they work. They get defined in the top Makefile:

```

#-----
# Make functions for putting the temporary files in $(SCRATCH_DIR)
#-----

# $(call source-dir-to-binary-dir, directory-list)
source-dir-to-binary-dir = $(addprefix $(SCRATCH_DIR)/, $(notdir $1))

# $(call source-to-object, source-file-list)
source-to-object = $(call source-dir-to-binary-dir, \
    $(subst .F,.o,$(filter %.F,$1)))

# $(call f90-source, source-file-list)
f90-source = $(call source-dir-to-binary-dir, \
    $(subst .F,.f90,$1))

# $(call make-library, library-name, source-file-list)
define make-library
    libraries += $(SCRATCH_DIR)/$1
    sources    += $2

    $(SCRATCH_DIR)/$1: $(call source-dir-to-binary-dir, \
        $(subst .F,.o,$2))
        $(AR) $(ARFLAGS) $$@ $$^
        $(RANLIB) $$@
endef

# $(call one-compile-rule, binary-file, f90-file, source-files)
define one-compile-rule
    $1: $2 $3
        cd $$$(SCRATCH_DIR); $$$(FC) -c $$$(FFLAGS) $(notdir $2)

    $2: $3
        $$$(CPP) $$$(CPPFLAGS) $$$(MY_CPP_FLAGS) $$< > $$@
        $$$(CLEAN) $$@
endef

# $(compile-rules)
define compile-rules
    $(foreach f, $(local_src), \
        $(call one-compile-rule,$(call source-to-object,$f), \
            $(call f90-source,$f),$f))
endef

```

1. We define a function to convert the path from the source directory to the **Build** directory, called **source-dir-to-binary-dir**. Note that the **Build** directory is called **\$(SCRATCH_DIR)** here. All it does is strip off the leading directory with the the built-in function **notdir**, then paste on the **Build** directory.
2. Next comes **source-to-object**, which calls the function above to return the object filename when given the source filename. It assumes that all sources have a **.F** extension.

3. A similar function is **f90-source**, which returns the name of the intermediate source which is created by **cpp** from our **.F** file.
4. The **Module.mk** fragment in each library source directory invokes **make-library**, which takes the library name and the list of sources as its arguments. The function adds its **library** to the global list of **libraries** and provides rules for building itself. The double dollar signs are to delay the variable substitution. Note that we call **source-dir-to-binary-dir** instead of **source-to-object**—this is a work-around for a make bug.
5. The next, **one-compile-rule**, takes three arguments: the **.o** filename, the **.f90** filename, and the **.F** filename. From these, it produces the **make** rules for running **cpp** and the compiler.

A note on directories: **make** uses **vpath** to find the source file where it resides. It would be possible to compile from the top directory and put the **.o** file in **Build** with the appropriate arguments, but I don't know how to get the **.mod** file into **Build** short of a **mv** command. Likewise, if we compile in the top directory, we need to know the compiler option to tell it to look in **Build** for the **.mod** files it uses. Doing a **cd** to **Build** before compiling is just simpler.
6. The last, **compile-rules**, is given a list of sources, then calls **one-compile-rule** once per source file.

Again, you can invoke **make -p** to see how **make** internally transforms all this into actual targets and rules.

G.3.4 Library Module.mk

In each library directory, there is a file called **Module.mk** which gets included by the top level **makefile**. These **Module.mk** bits build onto the list of sources and libraries to be compiled and built, respectively. These **Module.mk** files look something like:

```
local_sub := ROMS/Nonlinear
local_lib := libNLM.a

local_src := $(wildcard $(local_sub)/*.F)

$(eval $(call make-library,$(local_lib),$(local_src)))

$(eval $(compile-rules))
```

First, we provide the name of the current directory and the library to be built from the resident sources. Next, we use the **wildcard** function to search the subdirectory for these sources. Note that every **.F** file found will be compiled. If you have half-baked files that you don't want used, make sure they have a different extension.

Each subdirectory is resetting the **local_src** variable. That's OK because we're saving the values in the global **sources** variable inside the **make-library** function, which also adds the local library to the **libraries** list. The **compile-rules** function uses this **local_src** variable to generate the rules for compiling each file, placing the resulting files in the **Build** directory.

G.3.5 Main Program

The main program is in a directory called **Master** and its **Module.mk** is similar to the library one:

```

local_sub := Master
local_src := $(wildcard $(local_sub)/*.F)

local_objs := $(subst .F,.o,$(local_src))
local_objs := $(addprefix $(SCRATCH_DIR)/, $(notdir $(local_objs)))

sources += $(local_src)

ifdef LD_WINDOWS
$(BIN): $(libraries) $(local_objs)
    $(LD) $(FFLAGS) $(local_objs) -o $@ $(libraries) $(LIBS_WIN32) $(LDFLAGS)
else
$(BIN): $(libraries) $(local_objs)
    $(LD) $(FFLAGS) $(LDFLAGS) $(local_objs) -o $@ $(libraries) $(LIBS)
endif

$(eval $(compile-rules))

```

Instead of a rule for building a library, we have a rule for building a binary **\$(BIN)**. In this case, the name of the ROMS binary is defined elsewhere. The binary depends on the **libraries** getting compiled first, as well as the local sources. During the link, the **\$(libraries)** are compiled from the sources in the other directories, while **\$(LIBS)** are external libraries such as NetCDF.

G.3.6 Top Level Makefile

Now we get to the glue that holds it all together. We've covered many things so far, but there's still a few bits which might be confusing:

1. There can be rare cases where you might have special code for some systems. You can check which system you are on in the **.F** file with:

```

#ifdef X86_64
!    special stuff
#endif

```

To be sure this is defined on each **X86_64** system, it has to be passed to **cpp**:

```

CPPFLAGS += -D$(shell echo ${OS} | tr "-" "_" | tr [a-z] [A-Z])
CPPFLAGS += -D$(shell echo ${CPU} | tr "-" "_" | tr [a-z] [A-Z])
CPPFLAGS += -D$(shell echo ${FORT} | tr "-" "_" | tr [a-z] [A-Z])

CPPFLAGS += -D'ROOT_DIR="$(ROOTDIR)''
ifdef ROMS_APPLICATION
    CPPFLAGS += $(ROMS_CPPFLAGS)
    CPPFLAGS += -DNestedGrids=$(NestedGrids)
    MDEPFLAGS += -DROMS_HEADER="$(HEADER)''
endif

```

This guarantees that **CPPFLAGS** will have terms in it such as:

```

-DLINUX -DX86_64 -DPGI
-D'ROOT_DIR="/export/staffdata/kate/roms/trunk"' -DSHOREFACE
-D'HEADER="shoreface.h"' -D'ROMS_HEADER="shoreface.h"'
-DNestedGrids=1

```

2. For `mod_strings.F`, there is a special case:

```
$(SCRATCH_DIR)/mod_strings.f90: CPPFLAGS += -DMY_OS='$(OS)' \
    -DMY_CPU='$(CPU)' -DMY_FORT='$(FORT)' \
    -DMY_FC='$(FC)' -DMY_FFLAGS='$(FFLAGS)'
```

allowing ROMS to report in its output:

```
Operating system : Linux
CPU/hardware     : x86_64
Compiler system  : pgi
Compiler command : pgf90
Compiler flags   : -O3 -tp k8-64 -Mfree

Local Root      : /export/staffdata/kate/roms/trunk
Header Dir      : ./ROMS/Include
Header file     : shoreface.h
```

Though this doesn't seem to work on the Mac.

3. The very first `makefile` I showed had a set list of files to remove on `make clean`. We now build a list, called `clean_list`:

```
clean_list := core *.ipo $(SCRATCH_DIR)

ifeq "$(strip $(SCRATCH_DIR))" "."
    clean_list := core *.o *.oo *.mod *.f90 lib*.a *.bak
    clean_list += $(CURDIR)/*.ipo
endif
```

In other words, we want to clean up the **Build** directory unless it happens to be the top level directory, in which case we only want to remove specific files there.

4. “**all**” is the first target that gets seen by `make`, making it the default **target**. In this case, we know there is only the one binary, whose name we know—Mechlenburg [2005] shows what to do with more than one binary. Both “**all**” and “**clean**” are phony targets in that no files of those names get generated—make has the **.PHONY** designation for such targets. Also, the **clean** target doesn't require any compiler information, so the compiler include doesn't happen if the target is “clean”:

```
ifneq "$(MAKECMDGOALS)" "clean"
    include $(COMPILERS)/$(OS)-$(strip $(FORT)).mk
endif
```

`$(MAKECMDGOALS)` is a special variable containing the current `make` target.

5. We'll be creating different executable names, depending on which options we've picked:

```
BIN := $(BINDIR)/oceanS
ifdef USE_DEBUG
    BIN := $(BINDIR)/oceanG
else
```



```

ifdef USE_MPI
  BIN := $(BINDIR)/oceanM
endif
ifdef USE_OpenMP
  BIN := $(BINDIR)/ocean0
endif
endif

```

6. The NetCDF library gets included during the final link stage. However, we are now using the Fortran 90 version of it which requires its module information as well. We just copy the **.mod** files into the **Build** directory:

```

NETCDF_MODFILE := netcdf.mod
TYPESIZES_MODFILE := typesizes.mod

$(SCRATCH_DIR)/$(NETCDF_MODFILE): | $(SCRATCH_DIR)
  cp -f $(NETCDF_INCDIR)/$(NETCDF_MODFILE) $(SCRATCH_DIR)

$(SCRATCH_DIR)/$(TYPESIZES_MODFILE): | $(SCRATCH_DIR)
  cp -f $(NETCDF_INCDIR)/$(TYPESIZES_MODFILE) $(SCRATCH_DIR)

```

Old versions of NetCDF do not have the **typesizes.mod** file, in which case it has to be removed from the following dependency list:

```

$(SCRATCH_DIR)/MakeDepend: makefile \
    $(SCRATCH_DIR)/$(NETCDF_MODFILE) \
    $(SCRATCH_DIR)/$(TYPESIZES_MODFILE) \
    | $(SCRATCH_DIR)

```

7. Then there is **MakeDepend** itself. This file is created by the **Perl** script **sfmakedepend**. **MakeDepend** gets created by “**make depend**” and included on **make**’s second pass through the **makefile**:

```

depend: $(SCRATCH_DIR)
    $(SFMAKEDEPEND) $(MDEPFLAGS) $(sources) > $(SCRATCH_DIR)/MakeDepend

ifneq "$(MAKECMDGOALS)" "clean"
  -include $(SCRATCH_DIR)/MakeDepend
endif

```

The dash before the **include** tells **make** to ignore errors so that **make depend** will succeed before the file exists. The **MakeDepend** file will contain the include and module dependencies for each source file, such as:

```

Build/mod_diags.o: tile.h cppdefs.h globaldefs.h shoreface.h
Build/mod_diags.f90: tile.h cppdefs.h globaldefs.h shoreface.h
Build/mod_diags.o: Build/mod_kinds.o Build/mod_param.o Build/mod_diags.f90

```

Note that the **.h** files are included by **cpp**, so that both the **.f90** and **.o** files become out of date when an include file is modified. Without the module dependencies, **make** would try to build the sources in the wrong order and the compiler would fail with a complaint about not finding **mod_param.mod**, for instance.

G.4 Final warnings

The cost of this nifty **make** stuff is:

1. We're a little closer to the **gnu make** bugs here, and we need a newer version of **gnu make** than before (version 3.81, 3.80 if you're lucky). Hence this stuff at the top of the **makefile**:

```
NEED_VERSION := 3.80 3.81 3.82
$(if $(filter $(MAKE_VERSION),$(NEED_VERSION)),, \
$(error This makefile requires one of GNU make version $(NEED_VERSION).))
```

2. The **Makefile** dependencies get just a little trickier every change we make. Note that **F90** has potentially both **include** and **module** use dependencies. The book example uses the C compiler to produce its own dependencies for each source file into a corresponding **.d** file to be included by **make**. Our Fortran compilers are not so smart. For these hairy compiles, it's critical to have accurate dependency information unless we're willing to **make clean** between compiles.

H `sfmakedepend`

One **Perl** script I use with Fortran creates the dependency information, much like the X11 program **makedepend**. I originally wrote **fmakedepend** which was used with traditional Fortran include statements. I later wrote a variant of it for use with the C preprocessor, called **sfmakedepend**. The latest version of **sfmakedepend** does the job of both programs and also searches for the dependencies introduced by Fortran 90 modules. It is used by the **Makefiles** described in §G.

It recursively searches for Fortran style includes, for instance if **file.f** has the statement:

```
include 'commons.h'
```

the line

```
file.o: commons.h
```

will be added to the bottom of the **Makefile**. This tells **make** that **file.o** depends on **commons.h** as well as **file.f**, and to recompile **file.f** whenever **commons.h** is modified. It likewise searches source files for C style includes such as

```
#include "commons.h"
```

and adds the corresponding dependencies to the **Makefile**. It has several options, including **-s**, required for Fortran compilers which will not invoke the C preprocessor for you. In this case the above dependency line would become

```
file.o: commons.h  
file.f: commons.h
```

letting **make** know that the C preprocessor must be rerun on **file.F** whenever **commons.h** is updated.

When using the C preprocessor, you can ask it to search directories other than the current directory. Likewise, **sfmakedepend** can be instructed to search other directories with **-I dir** options. Note that it is legal to have more than one **-I dir** option as in:

```
sfmakedepend -I /usr/local/include -I /home/me/include *.F
```

Fortran 90 introduces some interesting dependencies. Two compilers I have access to (NAG **f90** and IBM **xlf**) produce a private **my_module.mod** file if you define **module My_Module** in file **mod.f90**. This file is used by the compiler when you use the module as a consistency check (type-safe programming). If **foo.f90** uses that module, you will need the following dependency information:

```
foo.o: my_module.mod  
my_module.mod: mod.o
```

This says that before compiling **foo.f90** we need to have the file **my_module.mod**. This file in turn depends on **mod.o**, so that **mod.f90** must be compiled before **foo.f90**. The sgi is similar except that it uses the file **MY_MODULE.kmo** to store the private module information. Use **sfmakedepend -g** on the SGI.

Rather than creating extra module files, the Cray and Parasoft compilers store the module information in the object file and then files which use the modules need to be compiled with extra flags pointing to the module object files. For instance, if **foo.f90** uses **My_Module** which was defined in **mod.f90**, then you will need to compile **mod.f90** first and provide the Cray compiler with the extra option **-p mod.o** when compiling **foo.f90**. When using the Cray, use **sfmakedepend -c** to get the dependency information:

```
foo.o: mod.o
    $(FC) $(FFLAGS) -c -p mod.o foo.f90
```

\$(FC) and **\$(FFLAGS)** are assumed to be previously defined as the name of the compiler and the compiler options, respectively.

Note: Gnu **make** is robust enough to handle these chained dependencies. Some hasn't always been true of other old (very old now) versions of **make**.

sfmakedepend assumes that all the files using and defining modules are in the same directory and are all in the list of files to be searched. It seems that the industry has not settled on a practical way to deal with a separate modules directory, anyway.

I sometimes include non-existent files as a compile time consistency check:

```
#ifndef PLOTS
#include "must_define_PLOTS"      /* bogus include */
#endif
```

This program warns about include files it can't find, but not if there is a "bogus" on the same line.

See the comments at the top of **sfmakedepend** for up-to-date information on the options. Compiler vendors have managed to more nearly standardize the Fortran module business and just about all work with these options to **sfmakedepend**:

```
--cpp --fext=f90 --file=- --objdir=$(SCRATCH_DIR)
```

I Subversion

The ROMS source code is distributed using Subversion (*svn*). There are *svn* clients available for nearly every operating system and many resources available, including an O’Reilly book [Collins-Sussman et al., 2008]. I’ll just cover a few basics here, taken in part from the ROMS wiki.

If you wish to maintain your own copy of ROMS in a source code repository, you may want to investigate *git*, which has the ability to download from an *svn* server. There is an excellent book about *git* which is online and free—really, do yourself a favor and read it [Chacon and Straub, 2014]. I have rambled at length about *git* on the ROMS wiki because I truly believe that *svn* is not the best tool for most ROMS users (those who can’t check back in). My ramblings about the shortcomings of *svn* have driven one ROMS user to adopt Mercurial instead, another valid option.

I.1 Overview

Subversion is a tool for managing software development that keeps track of who modified what and allows the return to a previous version if changes don’t work as expected. All the ROMS/TOMS files are stored in a *svn* repository on www.myroms.org with access controlled by requiring authentication with the same ROMS Username/Password combination assigned to registered users of the ROMS Forum.

This *svn* repository is the official version of the code which only the developers are allowed to change. Users should download the ROMS code to their local machines using an *svn* client. Don’t attempt to use a regular web browser to browse or download files from the *svn* repository - there are much better tools for interacting with the code repository.

We strongly recommend that users always check out the current *trunk* version since this has the most recent updates and bug fixes. The tags version is kept largely as an historical record of stable releases at the conclusion of major code upgrades.

Below is a general description of how subversion works. Please look at the *svn* book [Collins-Sussman et al., 2008] for more detailed information and the wiki for more on some available GUI clients.

I.2 Checking out the code

WARNING: It is strongly suggested that you checkout the ROMS source code using the same operating system you wish to compile and run ROMS on. If you download the code on a Windows machine and wish to run it on a non-Windows machine you will need convert the line endings with a utility like *dos2unix* or *recode*. Even with these utilities you may still have problems compiling ROMS.

In order download source code from a Subversion repository, the *svn* client software must be installed on your local machine. If you are compiling subversion on your own be sure to build it with SSL support or you will not be able to download the ROMS source code. Most Linux distributions come with subversion (the command name is *svn*), so shell commands may be used without installing additional software. If your username on your local computer is not the same as your ROMS username you will need to pass the `-username <username>` option to *svn*; an example is given below. The general form of subversion commands is:

```
svn action from to {optional_qualifiers}
```

To check-out the files from the ROMS repository trunk:

```
svn checkout https://www.myroms.org/svn/src/trunk MyDir
```

where *MyDir* is the destination directory on your local computer. Note the *https* rather than *http*. If your username on your local computer is not the same as your ROMS username you will need to pass the `-username` option to *svn*:

```
svn checkout --username joe_roms https://www.myroms.org/svn/src/trunk MyDir
```

You only check out once, after that, a hidden directory called `.svn` exists to keep track of the source, destination and a bunch of other information. Your username and password will also be saved.

I.3 Updates

Now and again, you might feel the urge to get up to speed with the latest changes that have been made to the ROMS repository. When that happens, simply go to the directory that was “MyDir” above and type:

```
svn update
```

Subversion will remember where you checked out from before and see if a newer revision exists. If so, it will download and apply all the relevant changes.

I.4 Code changes

As you use ROMS, you may find yourself adding new files and new chunks of code to existing files. Unless you are a developer with write access to the repository at `www.myroms.org`, you have no easy way to save your changes within the `svn` framework, since any one directory can only point to one repository. To keep getting updates from the trunk, you must keep using the `svn` server at `myroms.org`. At the very least, saving a tarball before fetching major updates is a prudent step.

I.5 Conflicts

Sometimes when you make changes to your copy of the ROMS code, those changes will conflict with changes made to the repository. This means that the changes from the server overlapped with your own, and now you have to manually choose between them.

Whenever a conflict occurs, three things typically occur to assist you in resolving that conflict:

- Subversion halts during the update, offering you several choices, and remembers that the file is in a state of conflict if you don't clear it right then.
- If Subversion considers the file to be mergeable, it places conflict markers (special strings of text which delimit the “sides” of the conflict, usually “<” and “>” characters) into the file to visibly demonstrate the overlapping areas.
- For every conflicted file, Subversion places three extra unversioned (not under Subversion control) files in your working copy:

filename.mine : This is your file as it existed in your working copy (local copy) before you updated your working copy. This file has only your latest changes in it. (If Subversion considers the file to be unmergeable, then the `.mine` file isn't created, since it would be identical to the working file.)

filename.rOLDREV : This is the file that was the BASE revision before you updated your working copy. That is, the file that you checked out before you made your latest edits.

filename.rNEWREV : This is the file that your Subversion client just received from the server when you updated your working copy. This file corresponds to the HEAD (latest) revision of the repository.

For example, let's say you checked out revision 280 and made some changes to a file, for instance **User/Functionals/ana_hmixcoef.h**. Now you want to update your ROMS source code to take advantage of a new algorithm but when you run `svn update` your **ana_hmixcoef.h** is now in conflict with the new version in the repository:

```
> svn update
U Version
U ROMS/Modules/mod_mixing.F
U ROMS/Functionals/ana_hmixcoef.h
C User/Functionals/ana_hmixcoef.h
Updated to revision 291.

>
```

The above is with an older version of `svn`. The latest, greatest does this:

```
Conflict discovered in 'ROMS/Utility/inp_par.F'.
Select: (p) postpone, (df) diff-full, (e) edit,
(mc) mine-conflict, (tc) theirs-conflict,
(s) show all options:
```

Selecting (p) will behave as the old version.

If you get a conflict, you need to do one of three things:

- Merge the conflicted text “by hand” by examining and editing the conflict markers within the file.
- Copy one of the temporary files on top of your working file.
- Run `svn revert <filename>` to throw away all of your local changes.

Once you've resolved the conflict, you need to let Subversion know by running “`svn resolved`”. This removes the three temporary files and Subversion no longer considers the file to be in a state of conflict. More on this below.

I.5.1 Merging conflicts by hand

To merge your changes with those from the latest revision in the repository, open **ana_hmixcoef.h** in your favorite editor and look for a string of “<” characters. You should see something like this:

```
<<<<<<< .mine
#ifdef DISTRIBUTE
IF (Lanafile.and.(tile.eq.0)) THEN
#else
IF (Lanafile) THEN
#endif
=====
#ifdef DISTRIBUTE
IF (Lanafile) THEN
#else
IF (Lanafile.and.(tile.eq.0)) THEN
#endif
>>>>>>> .r291
```

After comparing the two code blocks (separated by the “=” symbols), you decide that you prefer the logic from the repository so you remove the conflict markers and your code so the section now looks like this:

```
#ifdef DISTRIBUTE
IF (Lanafile) THEN
#else
IF (Lanafile.and.(tile.eq.0)) THEN
#endif
```

Now you can save the file and let Subversion know that you have resolved the conflict:

```
> svn resolved User/Functionals/ana_hmixcoef.h
Resolved conflicted state of 'User/Functionals/ana_hmixcoef.h'
```

I.5.2 Copying a file onto your working file

If you get a conflict and decide that you want to throw out your changes, you can merely copy one of the temporary files created by Subversion over the file in your working copy. Let's say you want to use the new revision from the repository:

```
> cd User/Functionals
> ls ana_hmixcoef.h*
ana_hmixcoef.h ana_hmixcoef.h.mine ana_hmixcoef.h.r280
ana_hmixcoef.h.r291

> cp ana_hmixcoef.h.r291 ana_hmixcoef.h
> svn resolved ana_hmixcoef.h
Resolved conflicted state of 'ana_hmixcoef.h'
```

I.5.3 Punting: Using `svn revert`

If you get a conflict, and upon examination decide that you want to throw out your changes and start your edits again, just revert your changes:

```
> cd User/Functionals
> svn revert ana_hmixcoef.h
Reverted 'ana_hmixcoef.h'
```

Note that when you revert a conflicted file, you don't have to run “svn resolved”.

References

- J. S. Allen, P. A. Newberger, and J. Federiuk. Upwelling circulation on the oregon continental shelf. part i: Response to idealized forcing. *J. Phys. Oceanogr.*, 25:1843–1866, 1995.
- A. Arakawa and V. R. Lamb. *Methods of computational physics*, volume 17, pages 174–265. Academic Press, 1977.
- G. K. Batchelor. *An introduction to fluid dynamics*. Cambridge University Press, 1967.
- J. P. Beamer, D. F. Hill, A. Arendt, and G. E. Liston. High-resolution modeling of coastal freshwater discharge and glacier mass balance in the gulf of alaska watershed. *Water Resour. Res.*, 52:3888–3909, 2016. doi:10.1002/2015WR018457.
- A. Beckmann and D. B. Haidvogel. Numerical simulation of flow around a tall, isolated seamount. part i: Problem formulation and model accuracy. *J. Phys. Oceanogr.*, 23:1736–1753, 1993.
- W.P. Budgell. Numerical simulation of ice-ocean variability in the barents sea region: Towards dynamical downscaling. *Ocean Dynamics*, 2005. doi:10.1007/s10236-005-0008-3.
- J. A. Carton, B. S. Giese, and S. A. Grodsky. Sea level rise and the warming of the oceans in the soda ocean reanalysis. *J. Geophys. Res.*, 110, 2005. doi:10.1029/2004JC002817.
- S. Chacon and B. Straub. *Pro Git*. Apress, second edition, 2014. ISBN 978-1484200773. <https://progit.org/>.
- D. C. Chapman. Numerical treatment of cross-shelf open boundaries in a barotropic coastal ocean model. *J. Phys. Oceanogr.*, 15:1060–1075, 1985.
- Ben Collins-Sussman, Brian W. Fitzpatrick, and C. Michael Pilato. *Version Control with Subversion*. O’Reilly & Associates, Inc., Sebastopol, CA, second edition, 2008. <http://svnbook.red-bean.com/>.
- A. Dai, T. Qian, K. E. Trenberth, and J. D. Milliman. Changes in continental freshwater discharge from 1948–2004. *J. CLimate*, 22:2773–2791, 2009. doi:10.1175/2008JCLI2592.1.
- S. L. Danielson, E. L. Dobbins, M. Jakobsson, M. A. Johnson, T. J. Weingartner, W. J. Williams, and Y. Zarayskaya. Sounding the northern seas. *Eos*, 96, 2015. doi:10.1029/2015EO040975. Published on 29 December 2015.
- E. E. Ebert and J. A. Curry. An intermediate one-dimensional thermodynamic sea ice model for investigating ice-atmosphere interactions. *J. Geophys. Res.*, 98:10085–10109, 1993.
- G. D. Egbert and S. Y. Erofeeva. Efficient inverse modeling of barotropic ocean tides. *J. Atmos. Ocean. Tech.*, 19:183–204, 2002. doi:10.1175/1520-0426(2002)019<0183:EIMOBO>2.0.CO;2.
- C. W. Fairall, E. F. Bradley, J. E. Hare, A. A. Grachev, and J. B. Edson. Bulk parameterization of air-sea fluxes: Updates and verification for the coare algorithm. *J. Climate*, 16:571–591, 2003.
- K. N. Fedorov. Layer thicknesses and effective diffusivities in the diffusive thermocline convection in the ocean. In J. C. J. Nihoul and B. M. Jamart, editors, *Small-scale turbulence and mixing in the ocean*, pages 471–479. Elsevier, New York, 1988.
- K. Fennel, J. Wilkin, J. Levin, J. Moisan, J. O’Reilly, and D. Haidvogel. Nitrogen cycling in the mid atlantic bight and implications for the north atlantic nitrogen budget: Results from a three-dimensional model. *Global Biogeochem. Cycles*, 20, 2006. doi:10.1029/2005GB002456.

- R. A. Flather. A tidal model of the northwest european continental shelf. *Memoires de la Société Royale de Sciences de Liège*, 6:141–164, 1976.
- M. G. G. Foreman. Manual for tidal heights analysis and prediction. Technical Report 77-10, Institute of Ocean Sciences, Patricia Bay, 1996a. Pacific Marine Science Report.
- M. G. G. Foreman. Manual for tidal currents analysis and prediction. Technical Report 77-10, Institute of Ocean Sciences, Patricia Bay, 1996b. Pacific Marine Science Report.
- P. J. S. Franks, J. S. Wroblewski, and G. R. Flierl. Behavior of a simple plankton model with food-level acclimation by herbivores. *Mar. Biol.*, 91:121–129, 1986.
- N. G. Freeman, A. M. Hale, and M. B. Danard. A modified sigma equations' approach to the numerical modeling of great lake hydrodynamics. *J. Geophys. Res.*, 77(6):1050–1060, 1972.
- B. Galperin, L. H. Kantha, S. Hassid, and A. Rosati. A quasi-equilibrium turbulent energy model for geophysical flows. *J. Atmos. Sci.*, 45:55–62, 1988.
- S.M. Griffies and R.W. Hallberg. Biharmonic friction with a smagorinsky-like viscosity for use in large-scale eddy-permitting ocean models. *Mon. Wea. Rev.*, 128:2935–2946, 2000.
- S.M. Griffies, A. Gnanadesikan, R.C. Pacanowski, V. Larichev, J.K. Dukowicz, and R.D. Smith. Isonutral diffusion in a z-coordinate ocean model. *J. Phys. Oceanogr.*, 28:805–830, 1998.
- D. B. Haidvogel and A. Beckmann. *Numerical Ocean Circulation Modeling*. Imperial College Press, 1999.
- D. B. Haidvogel, H. G. Arango, K. Hedstrom, A. Beckmann, P. Malanotte-Rizzoli, and A. F. Shchepetkin. Model evaluation experiments in the north atlantic basin: Simulations in nonlinear terrain-following coordinates. *Dyn. Atmos. Ocean.*, 32:239–281, 2000.
- D. B. Haidvogel, H. G. Arango, W. P. Budgell, B. D. Cornuelle, E. Curchitser, E. Di Lorenzo, K. Fennel, W. R. Geyer, A. J. Hermann, L. Lanerolle, J. Levin, J. C. McWilliams, A. J. Miller, A. M. Moore, T. M. Powell, A. F. Shchepetkin, C. R. Sherwood, R. P. Signell, J. C. Warner, and J. Wilkin. Ocean forecasting in terrain-following coordinates: formulation and skill assessment of the regional ocean modeling system. *J. Comp. Phys.*, 227:3429–3430, 2007. doi:10.1016/j.jcp.2007.01.016.
- W. P. Hazard. Using cpp to aid portability. *Computer Language*, 8(11):49–54, 1991.
- K. S. Hedstrom. Technical manual for a coupled sea-ice/ocean circulation model (version 2). Technical report, Institute of Marine and Coastal Sciences, New Brunswick, NJ, June 2000. OCS Study MMS 2000-047.
- W. D. Hibler, III. A dynamic thermodynamic sea ice model. *J. Phys. Oceanogr.*, 9:815–846, 1979.
- S. Hinckley, K. O. Coyle, G. Gibson, A. J. Hermann, and E. L. Dobbins. A biophysical npz model with iron for the gulf of alaska: Reproducing the differences between an oceanic hnlc ecosystem and a classical northern temperate shelf ecosystem. *Deep Sea Res. II*, 2009. in press.
- W. R. Holland, J. C. Chow, and F. O. Bryan. Application of a third-order upwind scheme in the near ocean model. *J. Climate*, 11:1487–1493, 1998.
- E. C. Hunke. Viscous-plastic sea ice dynamics with the evp model: linearization issues. *J. Comp. Phys.*, 170:18–38, 2001.

- E. C. Hunke and J. K. Dukowicz. An elastic-viscous-plastic model for sea ice dynamics. *J. Phys. Oceanogr.*, 27:1849–1868, 1997.
- E. C. Hunke, W. H. Lipscomb, A. K. Turner, N. Jeffery, and S. Elliott. Cice: the los alamos sea ice model documentation and software user’s manual, version 5.0. Technical report, LANL, Los Alamos, NM, 2013. LA-CC-06-012.
- D. R. Jackett and T. J. McDougall. Stabilization of hydrographic data. *J. Atmos. Ocean. Tech.*, 12:381–389, 1995.
- Y. Kanarska, A. F. Shchepetkin, and J. C. McWilliams. Algorithm for non-hydrostatic dynamics in roms. *Ocean Modeling*, 18:143–174, 2007.
- R. F. Keeling, B. B. Stephens, R. G. Najjar, S. C. Doney, D. Archer, and M. Heimann. Seasonal variations in the atmospheric O_2/N_2 ratio in relation to kinetics of air-sea gas exchange. *Global Biogeochem. Cycles*, 12:141–163, 1998.
- B. W. Kernighan and D. M. Ritchie. *The C Programming Language*. Prentice Hall, Englewood Cliffs, New Jersey 07632, second edition, 1988.
- M. J. Kishi, M. Kashiwai, D. M. Ware, B. A. Megrey, D. L. Eslinger, F. E. Werner, M. Noguchi-Aita, T. Azumaya, M. Fujii, S. Hashimoto, D. Huang, H. Iizumi, Y. Ishida, S. Kang, G. A. Kantakov, H.-C. Kim, K. Komatsu, V. V. Navrotsky, S. Lan Smith, K. Tadokoro, A. Tsuda, O. Yamamura, Y. Yamanaka, K. Yokouchi, N. Yoshie, J. Zhang, Y. I. Zuenko, and V. I. Zvalinsky. Nemuro—a lower trophic level model for the north pacific marine ecosystem. *Ecological Modelling*, 2002: 12–25, 2007.
- H. Lamb. *Hydrodynamics*. Cambridge University Press, 6 edition, 1932. (1945 Dover Publications reproduction).
- W. G. Large. Modeling and parameterization ocean planetary boundary layers. In E. P. Chassignet and J. Verron, editors, *Ocean Modeling and Parameterization*, pages 81–120. Kluwer Academic Publishers, 1998.
- W. G. Large and S. G. Yeager. The global climatology of an interannually varying air-sea flux data set. *Clim. Dyn.*, 33:341–364, 2009. DOI 10.1007/s00382-008-0441-3.
- W. G. Large, J. C. McWilliams, and S. C. Doney. Oceanic vertical mixing: a review and a model with a nonlocal boundary layer parameterization. *Rev. Geophys.*, 32:363–403, 1994.
- J. R. Ledwell, A. J. Wilson, and C. S. Low. Evidence for slow mixing across the pycnocline from an open-ocean tracer-release experiment. *Nature*, 364:701–703, 1993.
- J.-F. Lemieux, B. Tremblay, F. Dupont, M. Plante, G. C. Smith, and D. Dumont. A basal stress parameterization for modeling landfast ice. *J. Geophys. Res.*, 120:3157–3173, 2015. doi:10.1002/2014JC010678.
- B. P. Leonard. A stable and accurate convective modelling procedure based on quadratic upstream interpolation. *Comput. Method Appl. Mech. Eng.*, 19:59–98, 1979.
- S.-J. Lin. A finite volume integration method for computing pressure gradient force in general vertical coordinates. *Quart. J. R. Met. Soc.*, 123:1749–1762, 1997.
- A. Macks and J. Middleton. Numerical modelling of wind-driven upwelling and downwelling. University of New South Wales, 1993.

- J. Maillôt and R. Benoit. A finite-element model of the atmospheric boundary layer suitable for use with numerical weather prediction models. *J. Atmos. Sci.*, 39:2249–2266, 1982.
- P. Marchesiello, J. C. McWilliams, and A. Shchepetkin. Open boundary conditions for long-term integration of regional oceanic models. *Ocean Modelling*, 3:1–20, 2001.
- L. Margolin and P. K. Smolarkiewicz. Antidiffusive velocities for multipass donor cell advection. *SIAM J. Sci. Comput.*, pages 907–929, 1998.
- E. Mason, J. Molemaker, A. F. Shchepetkin, F. Colas, J. C. McWilliams, and P. Sangrà. Procedures for offline grid nesting in regional ocean models. *Ocean Modelling*, 35:1–15, 2010.
- G. A. Maykut and N. Untersteiner. Some results from a time-dependent thermodynamic model of sea ice. *J. Geophys. Res.*, 76:1550–1575, 1971.
- John D. McCalpin. A comparison of second-order and fourth-order pressure gradient algorithms in a σ -coordinate ocean model. *Int. J. Num. Meth. Fluids*, 18:361–383, 1994.
- R. Mechlenburg. *Managing Projects with GNU Make*. O’Reilly & Associates, Inc., Sebastopol, CA, 2005.
- G. L. Mellor. The three-dimensional current and surface wave equations. *J. Phys. Oceanogr.*, 33:1978–1989, 2003.
- G. L. Mellor. Some consequences of the three-dimensional currents and surface wave equation. *J. Phys. Oceanogr.*, 35:2291–2298, 2005.
- G. L. Mellor. The depth-dependent current and wave interaction equations: a revision. *J. Phys. Oceanogr.*, 38:2586–2596, 2008.
- G. L. Mellor and L. Kantha. An ice-ocean coupled model. *J. Geophys. Res.*, 94:10,937–10,954, 1989.
- G. L. Mellor and T. Yamada. A hierarchy of turbulence closure models for planetary boundary layers. *J. Atmos. Sci.*, 31:1791–1806, 1974.
- G. L. Mellor and T. Yamada. Development of a turbulence closure model for geophysical fluid problems. *Rev. Geophys. Space Phys.*, 20:851–875, 1982.
- W. A. Oost, G. J. Komen, C. M. J. Jacobs, and C. van Oort. New evidence for a relation between wind stress and wave age from measurements during asgamage. *Bound.-Layer Meteor.*, 103:409–438, 2002.
- I. Orlanski. A simple boundary condition for unbounded hyperbolic flows. *J. Comp. Phys.*, 21(3):251–269, July 1976.
- J. E. Overland and C. H. Pease. Modeling ice dynamics of coastal seas. *J. Geophys. Res.*, 93:15,619–15,637, 1988.
- C. L. Parkinson and W. M. Washington. A large-scale numerical model of sea ice. *J. Geophys. Res.*, 84:6565–6575, 1979.
- P. Penven, L. Debreu, P. Marchesiello, and J. C. McWilliams. Evaluation and application of the roms 1-way embedding procedure to the central california upwelling system. *Ocean Modeling*, 12:157–187, 2006.

- H. Peters, M. C. Gregg, and J. M. Toole. On the parameterization of equatorial turbulence. *J. Geophys. Res.*, 93:1199–1218, 1988.
- N. A. Phillips. A coordinate system having some special advantages for numerical forecasting. *J. Meteorology*, 14(2):184–185, 1957.
- T. M. Powell, C. V. W. Lewis, E. N. Curchitser, D. B. Haidvogel, A. J. Hermann, and E. L. Dobbins. Results from a three-dimensional, nested biological-physical model of the california current system and comparisons with statistics from satellite imagery. *J. Geophys. Res.*, 111(C07018), 2006. doi:10.1029/2004JC002506.
- W. H. Press, B. P. Flannery, S. A. Teukolsky, and W. T. Vetterling. *Numerical Recipes, The Art of Scientific Computing*. Cambridge University Press, 1986.
- P. J. Rasch. Conservative shape-preserving two-dimensional transport on a spherical reduced grid. *Mon. Wea. Rev.*, 122:1337–1350, 1994.
- W. H. Raymond and H. L. Kuo. A radiation boundary condition for multi-dimensional flows. *Quart. J. R. Met. Soc.*, 110:535–551, 1984.
- R. Rew, G. Davis, S. Emmerson, and H. Davies. *NetCDF User’s Guide*. Unidata, University Corporation for Atmospheric Research, Boulder, Colorado, 1996. Version 2.4.
- M. M. Rienecker, M. J. Suarez, R. Gelaro, R. Todling, J. Bacmeister, E. Liu, M. G. Bosilovich, S. D. Schubert, L. Takacs, G.-K. Kim, S. Bloom, J. Chen, D. Collins, A. Conaty, and A. da Silva. Merra: Nasa’s modern-era retrospective analysis for research and applications. *J. Climate*, 24:3624–3648, 2011. doi:10.1175/JCLI-D-11-00015.1.
- R. Sadourny and K. Maynard. Formulations of lateral diffusion in geophysical fluid dynamics models. In C.A. Lin, R. Laprise, and H. Ritchie, editors, *Numerical Methods of Atmospheric and Oceanic Modelling*, pages 547–556. NRC Research Press, 1997.
- A. J. Semtner, Jr. A model for the thermodynamic growth of sea ice in numerical investigations of climate. *J. Phys. Oceanogr.*, 6:379–389, 1976.
- A. F. Shchepetkin and J. C. McWilliams. Quasi-monotone advection schemes based on explicit locally adaptive dissipation. *Mon. Wea. Rev.*, 126:1541–1580, 1998.
- A. F. Shchepetkin and J. C. McWilliams. A method for computing horizontal pressure-gradient force in an oceanic model with a nonaligned vertical coordinate. *J. Geophys. Res.*, 108:1–34, 2003. doi:10.1029/2001JC001047.
- A. F. Shchepetkin and J. C. McWilliams. The regional ocean modeling system (roms): A split-explicit, free-surface, topography-following coordinates oceanic model. *Ocean Modeling*, 9:347–404, 2005.
- A. F. Shchepetkin and J. C. McWilliams. A correction note for “ocean forecasting in terrain-following coordinates: formulation and skill assessment of the regional ocean modeling system”. *J. Comp. Phys.*, 228:8985–9000, 2009a.
- A. F. Shchepetkin and J. C. McWilliams. Computational kernel algorithms for fine-scale, multi-process, long-time oceanic simulations. In R. Temam and J. Tribbia, editors, *Handbook of Numerical Analysis: Computational Methods for the Ocean and the Atmosphere*, volume 14, pages 121–183. Elsevier Science, 2009b.

- A. F. Shchepetkin and J. C. McWilliams. An accurate boussinesq oceanic model with a practical, “stiffened” equation of state. *Ocean Modeling*, 38:41–70, 2011.
- J. Smagorinsky. General circulation experiments with the primitive equations. i. the basic experiment. *Mon. Wea. Rev.*, 91:99–164, 1963.
- P. K. Smolarkiewicz and W. W. Grabowski. The multidimensional positive definite advection transport algorithm: non-oscillatory option. *J. Comp. Phys.*, 86:355–375, 1990.
- Y. Song. A general pressure gradient formulation for ocean models. part i: Scheme design and diagnostic analysis. *Mon. Wea. Rev.*, 126:3213–3230, 1998.
- M. Steele, G. L. Mellor, and M. G. McPhee. Role of the molecular sublayer in the melting or freezing of sea ice. *J. Phys. Oceanogr.*, 19:139–147, 1989.
- P. K. Taylor and M. A. Yelland. The dependence of sea surface roughness on the height and steepness of the waves. *J. Phys. Oceanogr.*, 31:572–590, 2001.
- J. Thuburn. Multidimensional flux-limited advection schemes. *J. Comp. Phys.*, 123:74–83, 1996.
- I. B. Troen and L. Mahrt. A simple model of the atmospheric boundary layer; sensitivity to surface evaporation. *Boundary-Layer Meteor.*, 37:129–148, 1986.
- L. Umlauf and H. Burchard. A generic length-scale equation for geophysical turbulence models. *J. Marine Res.*, 61:235–265, 2003.
- R. C. Wajswicz. A consistent formulation of the anisotropic stress tensor for use in models of the large-scale ocean circulation. *J. Comp. Phys.*, 105:333–338, 1993.
- J. C. Warner, C. R. Sherwood, H. G. Arango, and R. P. Signell. Performance of four turbulence closure models implemented using a generic length scale method. *Ocean Modelling*, 8:81–113, 2005.
- J. C. Warner, C. R. Sherwood, R. P. Signell, C. K. Harris, and H. G. Arango. Development of a three-dimensional, regional, coupled wave, current, and sediment-transport model. *Computers & Geosciences*, 34:1284–1306, 2008.
- D. J. Webb, B. A. De Cuevas, and C. S. Richmond. Improved advection schemes for ocean models. *J. Atmos. Ocean. Tech.*, 15:1171–1187, 1998.
- J. Whitefield, P. Winsor, J. W. McClelland, and D. Menemenlis. A new river discharge and river temperature climatology data set for the pan-arctic region. *Ocean Modelling*, 2015. doi:10.1016/j.ocemod.2014.12.012.
- J. Wilkin and K. Hedstrom. User’s manual for an orthogonal curvilinear grid-generation package. Institute for Naval Oceanography, 1991.
- P. Xiu and F. Chai. Spatial and temporal variability in phytoplankton carbon, chlorophyll, and nitrogen in the north pacific. *J. Geophys. Res.*, 117, 2012. doi:10.1029/2012JC008067.
- P. Xiu and F. Chai. Connections between physical, optical and biogeochemical processes in the pacific ocean. *Prog. in Oceanogr.*, 122:30–53, 2014. doi:10.1016/j.pocean.2013.11.008.
- A. M. Yaglom and B. A. Kader. Heat and mass transfer between a rough wall and turbulent fluid at high reynolds and pecelet numbers. *J. Fluid. Mech.*, 62:601–623, 1974.



The Department of the Interior Mission

As the Nation's principal conservation agency, the Department of the Interior has responsibility for most of our nationally owned public lands and natural resources. This includes fostering the sound use of our land and water resources, protecting our fish, wildlife and biological diversity; preserving the environmental and cultural values of our national parks and historical places; and providing for the enjoyment of life through outdoor recreation. The Department assesses our energy and mineral resources and works to ensure that their development is in the best interests of all our people by encouraging stewardship and citizen participation in their care. The Department also has a major responsibility for Americal Indian reservation communities and for people who live in island communities.

The Bureau of Ocean Energy Management



The Bureau of Ocean Energy Management (BOEM) works to manage the exploration and development of the nation's offshore resources in a way that appropriately balances economic development, energy independence, and environmental protection through oil and gas leases, renewable energy development and environmental reviews and studies.

www.boem.gov