

CUTTING PARTS

Section 2



A-Frame Bracket Set.....	21
Alligator Rivet Belt Lacing	18
Baler, Rake & Tedder Teeth	10-12
Baler Shear Bolt Kits	17
Bale Spear.....	17
Blade Bolts	16
Replacement Blade Bolt Kit for	
Servis Model 1310 Shredder.....	21
Box Blade Cutting Edges	20
Box Blade Shanks	20
Bulk Belting for Round Baler.....	14
Cast Wheel Hub	40
Clipper Belt Lacing	13-14
Disc Mower Blades.....	2,4,6
Disc Mower Parts.....	8
Drum Mower Nuts & Bolts.....	8
Fabricated Tail Wheel Hub	40
Finishing Mower Blades	15-16
Flail Blades.....	16
Grain Gate.....	17
Mower Deck Height Stabilizer Kits.....	21
Nuts & Bolts for Disc Mower Blades.....	3,5,7
Pin Punch	
Replacement Part	14

Rotary Cutter Blades

BMB.....	22
Bushog.....	22-24
Ford.....	25
Howse/Hico	25
IMCO	26
Land Pride.....	26
Modern	27
Mohawk	28
Schulte	28-29
Servis/Rhino	29-32
Sidewinder	32-35
Terrain King	35-36
Tiger	37
US Mower.....	37
Woods	38-39
Rotary Cutter Blade Bolts	21
Rotary Cutter Blade Carriers.....	19
Rotary Cutter Tailwheel Parts.....	40-41
Sickle Section Riverter and Punch	14
Skid Shoe	8
Specialty V-Belts for Ag Machines	17
Stump Jumper Pans.....	20
Tail Wheel Assembly	41
Universal Hay Bale Counter	17
Wheel Rakes	9

FINISHING MOWER BLADES

We guarantee that every blade is hand straightened, produced from high-carbon boron-alloy steel, heat treated and austempered and is electrostatic power painted.

BEFCO



Replaces OEM#: 0006845, Length: 24-1/2"
Center Hole: .755", Width: 2-1/2"

128-91040

Replaces OEM#: 0006641, Length: 20.215"
Center Hole: .755", Width: 2-1/2"

128-91041

BIG BEE

Left Hand Cut



Length: 19" Center Hole: 17/32", Width: 2-1/2"

128-91045

Length: 20" Center Hole: 17/32", Width: 2-1/2"

128-91046

Length: 25" Center Hole: 17/32", Width: 2-1/2"

128-91047

BUSH HOG

(3) for 60" cut



Replaces OEM#: 82324, Length: 21"
Center Hole: .5", Width: 2-1/2"

128-91071

CARONI



Replaces OEM#: 48007700, Length: 16-7/8"
Center Hole: 3/4", Width: 2"

128-91140

Replaces OEM#: 59006200, Length: 20-1/4"
Center Hole: 3/4", Width: 2"

128-91141

Replaces OEM#: 71001000, Length: 24-1/8"
Center Hole: 3/4", Width: 2-1/2"

128-91142

KING KUTTER

Left hand Cut



Length: 20-1/16", Center Hole: 17/32", Width:

128-91452

Length: 24", Center Hole: 17/32", Width: 2"

128-91453

KUBOTA



Replaces OEM#: 76529-34330, Length: 18-5/8"
Center Hole: 1-1/8", Model: (3) for 54" belly mower,
Width: 2-1/2"

128-91436

Replaces OEM#: 76539-34330, Length: 20-9/16"
Center Hole: 1-1/8", Model: (3) for 60" front mount
mower, Width: 2-1/2"

128-91438

LANDPRIDE



Replaces OEM#: 890-172C, Length: 24-29/32"
Center Hole: 1", Width: 2-1/2"

128-91456

Replaces OEM#: 890-171C, Length: 20-15/16"
Center Hole: 1", Width: 2-1/2"

128-91457

SOUTHEAST-BIG OX



Length: 16-1/4", Center Hole: 3/8", Width: 2-3/4"

900-7284

Length: 20-1/4", Center Hole: 3/8", Width: 2-3/4"

900-7285



CUTTING PARTS

Finishing Mower Blades, Flail Blades,
Blade Bolts

WOODS

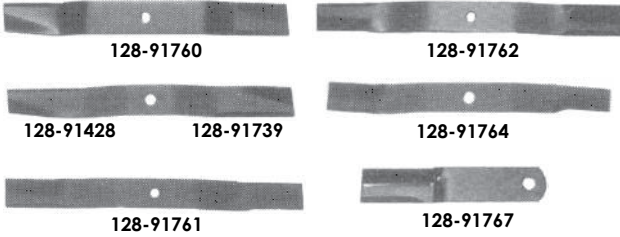

Replaces OEM#: 5081, Model: LH Cut, Length: 16-3/4",
Center Hole: 5/8", Width: 1-3/4"

128-91760

Replaces OEM#: 12170, Model: RM48K, 304K, U304H,
U304M15, 348's. Length: 16-3/4", Center Hole: 5/8"
Width: 1-3/4"

128-91428

Replaces OEM#: 23825 & 31359, Model: Left Hand Cut,
(3) For 60" Cut; RM500, F35, RM59. Length: 20-3/16"
Center Hole: 5/8", Width: 2"

128-91761

Replaces OEM#: 6950, Model: Medium lift, (3) for 60" cut,
Model 59C2. Length: 20-3/16", Center Hole: 5/8", Width: 2"

128-91762

Replaces OEM#: 13404 & 31306, Model: Left hand cut,
(3) for 72" cut; L306, RM306 & RM600. Length: 24-7/16"
Center Hole: 1", Width: 2-1/2"

128-91764

Replaces OEM#: 24590, Model: Blade tip, Length: 11-1/2",
Center Hole: 7/8"

128-91767



15127 WOODS

(3) for 72" Cut

Replaces OEM#: 15127, Length: 24-5/8", Center Hole: 5/8",
Width: 250-250

128-91766

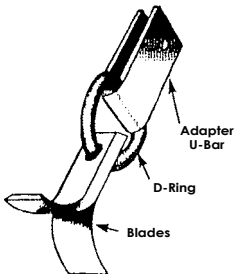

ALLOWAY Flail Blades

Flail parts are made of high quality steel to
insure durability and proper operation. All
knives are heat treated to give them the
greatest wear-resistance.

PART NO.	DESCRIPTION	OEM NO.
125-2001	Alloway Flail Blade	505-3-0001
125-2201	Alloway D-Ring	505-3-0008
125-2301	Alloway U-Bar	505-3-0114

BLADE BOLTS

BUSH HOG

Regular duty Models
Marvel 4, 5, 6, & 7 FT. Models
HICO STD 4, 5, & 6 FT. Models
Terrain King 735900,
TK60 Series, CP180, X3
Southeast all models,
Mono Cutters

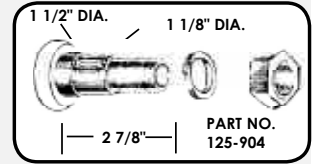

412-8043-01 • OEM NO. 7919 / 125-907

FORD

Complete kit for 901
Series 22-47 & 70 5 ft. cutters

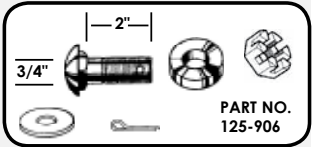

125-906 • OEM NO. 309719

HARDEE

Part No.	Description
125-949	Blade Bolt Kit For Hardee
C-46	37322 Nut 1-1/4"
C-47	33640 Lockwasher 1-1/4"
C-48	Blade Bolt BB18 Hardee
126-5265	Blade Nut 86515265 (50)
126-5925	Blade Bolt 86515925 (25)
126-5926	Blade Bolt 86515926 (25)

MODERN

Bolt only 1" left hand thread

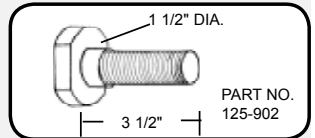

**125-902
OEM NO. 412-0057-02**

MOHAWK

125-907 (12-180)	Bolt 1-1/8"
12-181	Nut 1-1/8"
7-220-01	7/8" Blade Bolt Kit for 1-1/2" hole
7-220-02	7/8" Blade Bolt Kit for 1-1/4" hole



SERVIS (RHINO)

Bolt only 1" left hand thread.
Cyclone 60, 72, 84, 128, Flex 15,
Gyro 60, 72, 84, 128, 160

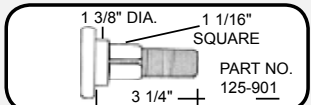

125-901 • OEM NO. 57104-4
Bolt only 3/4" left hand thread.
Saturn 5,6,7 & 8; Gyro 66 & 140

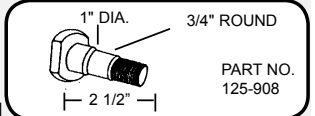

125-908 • OEM NO. 36-107-2ALH

SIDEWINDER

GB602, 607, 722, 725, 842,
RS160, RS213;
Flexwing 16 & 216

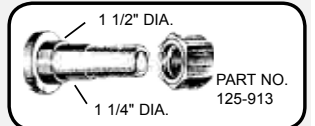

125-913HW • OEM NO. 27724

125-92 Blade Bolt, 1-1/8" X 3-18" Length

TIGER

Part No.	Description
125-06538000	Blade Bolt
125-34497	Blade Bolt
125-963	Blade Bolt, 1-1/8 - 12

ROTARY CUTTER BLADE CARRIERS

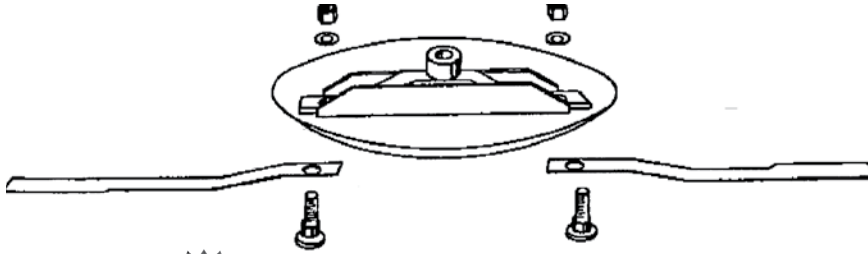

PART NO. 300-26176

Fits Sidewinder

15 Spline Hub • 28" Ctr - Ctr Blade Bolt Holes.
Half Moon Holes • Includes Stump Jumper Pan

Note: Blades, Bolts, and Hardware not included.

PART NO. 401-5450	PART NO. 16-158-01
--------------------------	---------------------------

*Fits Modern 4' - 5' - 6' Competitor and Sunshine Series Cutters
12 Spline Hub
15 1/2" Ctr - Ctr Blade Bolt Holes
1 1/8" Keyed Blade Bolt Holes
Includes Stump Jumper Pan*

*Fits Howse, King, International and Mohawk Cutters
15 Spline Hub
14" Ctr - Ctr Blade Bolt Holes
1 1/8" Keyed Blade Bolt Holes
Includes Stump Jumper Pan*

PART NO. 401-5455	PART NO. 300-26369
--------------------------	---------------------------

*Fits Modern 5' and 6' Highway Special Cutters
15 Spline Hub
15 1/2" Ctr - Ctr Blade Bolt Holes
1 1/8" Keyed Blade Bolt Holes
Includes Stump Jumper Pan*

*Fits Sidewinder GB722, FW15, 215, 216, GB5, GB6, FW315, 325, 415 and 425 15 Spline Hub
17 3/4" Ctr - Ctr Blade Bolt Holes
"D" Style Bolt Holes
Includes Stump Jumper Pan*

PART NO. 401-5460	PART NO. 300-22983
--------------------------	---------------------------

*Fits Modern 7' Highway Special and Predator Cutters
15 Spline Hub
27 1/2" Ctr - Ctr Blade Bolt Holes
1 1/8" Keyed Blade Bolt Holes
Includes Stump Jumper Pan*

*Fits Sidewinder PG210
15 Spline Hub
17 3/4" Ctr - Ctr Blade Bolt Holes
Threaded Bolt Holes 1" NF
Includes Stump Jumper Pan*

PART NO. 16-158	PART NO. 300-22962
------------------------	---------------------------

*Fits Howse, King, International and Mohawk Cutters
12 Spline Hub
14" Ctr - Ctr Blade Bolt Holes
1 1/8" Keyed Blade Bolt Holes
Includes Stump Jumper Pan*

*Fits Sidewinder 6 x 6, GB90, GB96, GB 108
12 Spline Hub
17 3/4" Ctr - Ctr Blade Bolt Holes
Threaded Bolt Holes 1" NF
Includes Stump Jumper Pan*

STUMP JUMPER PANS FOR ROTARY CUTTERS

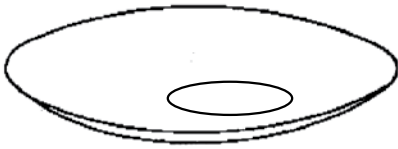

<u>PART NO.</u>	<u>FITS</u>	<u>CENTER-TO-CENTER HOLE</u>
401-0054-01 . . .	MODERN 4', 5', 6' CUTTERS	15-1/2"
401-0182	MODERN 7' CUTTERS	28"
300-17165	ALL SIDEWINDER CUTTERS	17-3/4"

NUT ONLY FOR BOLTS

Nylon insert locknut only for Servis and Modern,
Size: 1" LH
125-922 • OEM NO. 5GL16140

Nylon insert locknut only for Servis,
Size: 3/4" LH
125-923 • OEM NO. 5GL12160

Nut only for Sidewinder, Size: 1-1/8" RH
125-924 • OEM NO. 15061

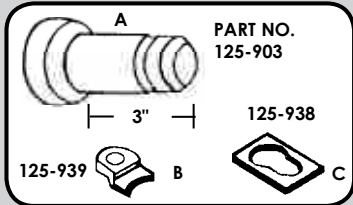

WOODS

PART NO.	O.E.M. NO.	DESCRIPTION
125-903	4622	1 1/2" DIA. PIN
125-920		CLAMP KIT (B & C)
125-921	32606	BLADE PIN KIT (A, B & C)

Applications: M4, M5, 60, 72, 84, C80, MC80, 120Q, R105, 5106, 5120, 210, D210R, B214, B315, D315, D320, SM2090

Replacement Blade Bolt Kit For Servis Model 1310 Shredder

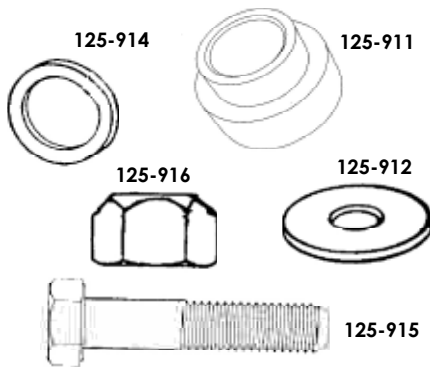

PART NO.	DESCRIPTION	MFG NO.
125-911	.. Bushing (1310)	.. 681062
125-912	.. Heavy Washer (1310)	.. 681064
125-914	.. Small Washer (1310)	.. 5312316
125-915	.. Bolt (SAE 3/4" x 3 1/2")	.. 7AHB121628
125-916	.. Locknut 3/4"	.. 5JRC12160

125-910KIT Complete Bolt Kit Assy
Contains: (2) 125-911, (2) 125-912, (2) 125-914,
(1) 125-915 & (1) 125-916

ROTARY CUTTER BLADE BOLTS

Howse Blade Bolt Kit

125-909
MFG NO. BB-75

Replacement for: Howse HL418N

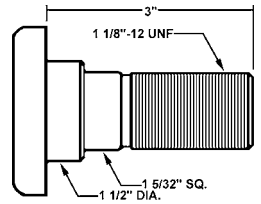

Blade Bolt Kit

125-917 KIT
MFG. NO. BB-55
125-905
125-925
636-18

DESCRIPTION
Includes bolt, nut & lockwasher
Bolt
Nut
Lockwasher

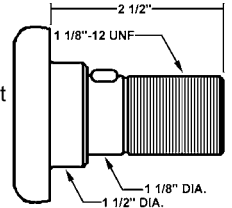

Replacement for: Big Bee, Burroughs, Dale Phillips, Fred Cain (BH-250), Fresno Mfg., Grizzley, International, J-Bar, King Kutter, Kodiak (124-SMHD), L & S (BB55), Lowery, M.K. Martin, Rollins, Samson, Southern (123-RMH), Taylor Pittsburgh, Tebben, Wallace & Worksaver.

Kit Contains 2 Brackets: & 2 Chains with Smaller Brackets:

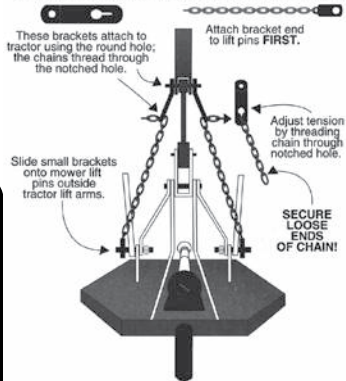

159-335

Chain is 1/4" proof coil, 1175 lbs. working load limit, 1/4" thick steel plates. Kit contains one bracket & one chain w/smaller bracket for kit (159-335).



Blade Bolt Spacer Bushing

Spacer bushing for sidewinder & mono. Use with 1" x 3" grade 5 UNF bolt.

PART NO.	OEM NO	DESCRIPTION
125-918	16197SW	FOR 3/8" BLADES
125-919	22132SW	FOR 1/2" BLADES

A-Frame Bracket Set

162-1000

Category 1, 1 1/2" X 2-1/2" Brackets, Universal fit, for Rotary Cutters & Small Discs.

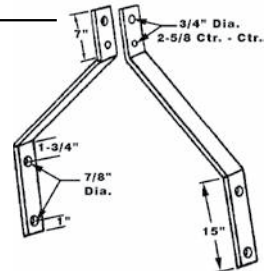



ROTARY CUTTER BLADES



Catalog No. 700-8079

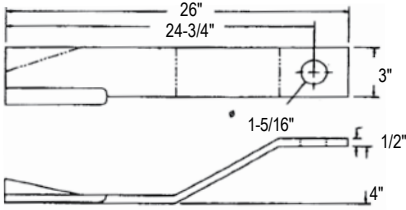

BMB

MODELS- XL-6, BR-6, FR-7, TBR-144 LH, MM CENTER
UPDRAFT **CCW ROTATION**

O.E.M. No.	Overall Length	Width at Edge	Thickness	Hole Size	Weight Ea.
BMB-8079	26"	3-1/2"	1/2"	1-5/16"	10.6 LBS

Catalog No. 700-8082

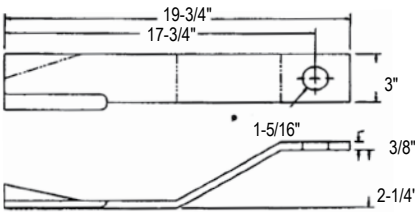

MODELS- B-4, B-5, UL, XL-5
UPDRAFT **CCW ROTATION**

O.E.M. No.	Overall Length	Width at Edge	Thickness	Hole Size	Weight Ea.
BMB-8082	19-3/4"	3-3/8"	3/8"	1-5/16"	6.5 LBS

Catalog No. 125-1201

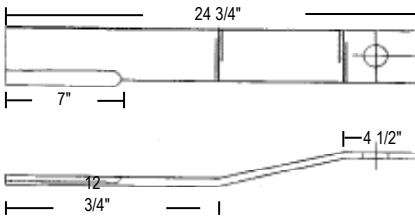

MODELS- 6, 12, 105, 205,
266, 305, 504, 600, 5-FT. **CCW ROTATION**

O.E.M. No.	Overall Length	Width at Edge	Thickness	Hole Size	Weight Ea.
462	24-3/4"	4"	1/2"	1-1/2"	11.8 LBS

Catalog No. 125-1202

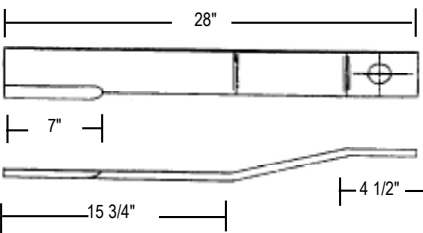

MODELS- 206, 306, 307, 6 - FT.
CCW ROTATION

O.E.M. No.	Overall Length	Width at Edge	Thickness	Hole Size	Weight Ea.
463	28"	4"	1/2"	1-1/2"	12 LBS

Catalog No. 125-1203

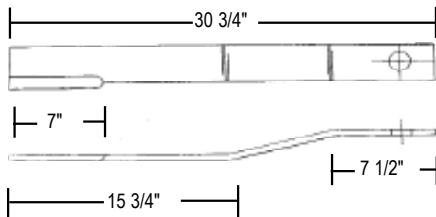

MODEL- 307, 7- FT.
CCW ROTATION

O.E.M. No.	Overall Length	Width at Edge	Thickness	Hole Size	Weight Ea.
464	30-3/4"	4"	1/2"	1-1/2"	13 LBS



ROTARY CUTTER BLADES



BUSH HOG (Continued)

MODELS- 109 LEFT SIDE 2 USED, 109 OFFSET 4 USED, 160 RIGHT SIDE 2 USED, 160 CENTER 2 USED, 166 RIGHT SIDE 2 USED, 166 CENTER 2 USED, 1109 LEFT SIDE 2 USED, 1109 OFFSET 4 USED, 1166 RIGHT SIDE 2 USED, 1166 CENTER 2 USED, 1209 LEFT AISW 2 USED, 1600 RIGHT SIDE 2 USED, 1600 CENTER 2 USED.

CCW ROTATION

Catalog No. 125-1204

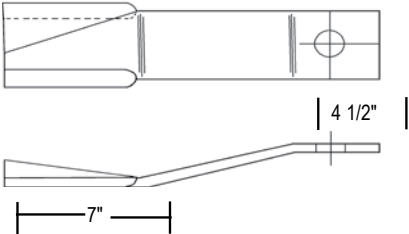
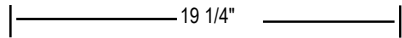

O.E.M. No.	Overall Length	Width at Edge	Thickness	Hole Size	Weight Ea.
7828 (Updraft)	19-1/4"	4"	1/2"	1-1/2"	11.5 LBS

Catalog No. 125-1205

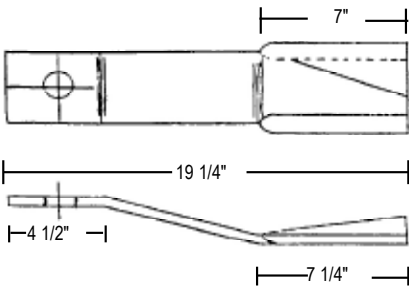

MODELS- 109 RIGHT SIDE 2 USED, 160 LEFT SIDE 2 USED, 166 LEFT SIDE 2 USED, 1109 RIGHT SIDE 2 USED, 1166 LEFT SIDE 2 USED, 1209 RIGHT SIDE 2 USED, 1600 LEFT SIDE 2 USED.

CW ROTATION

O.E.M. No.	Overall Length	Width at Edge	Thickness	Hole Size	Weight Ea.
7829 (Updraft)	19-3/4"	4-1/2"	1/2"	1-1/2"	11.5 LBS

Catalog No. 800-7555

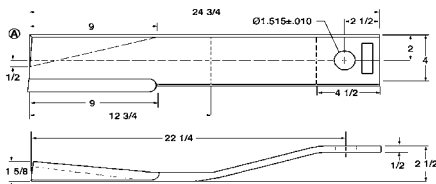

MODELS- 126 LEFT SIDE 2 USED, 126 OFFSET 4 USED, 310 RIGHT SIDE 2 USED, 315 RIGHT SIDE 2 USED, 1126 LEFT SIDE 2 USED, 1126 OFFSET 4 USED, 1226 LEFT SIDE 2 USED, 1310 RIGHT SIDE 2 USED, 1315 RIGHT SIDE 2 USED, 6 UPLIFT 2 USED, 12 UPLIFT 2 USED, 105 UPLIFT 2 USED, 205 UPLIFT 2 USED, 266 UPLIFT 2 USED, 305 UPLIFT 2 USED, 502 UPLIFT 2 USED, 600 UPLIFT 2 USED, 2615 RIGHT SIDE 2 USED. **CCW ROTATION**

O.E.M. No.	Overall Length	Width at Edge	Thickness	Hole Size	Weight Ea.
7555 (Updraft)	24-3/4"	4-1/2"	1/2"	1-1/2"	13.9 LBS

Catalog No. 800-7556

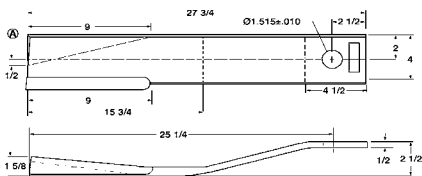

MODELS- 310 CENTER 2 USED, 315 CENTER 2 USED, 1310 CENTER 2 USED, 1315 CENTER 2 USED, 206 UPLIFT 2 USED, 306 UPLIFT 2 USED, 2615 CENTER 2 USED. **CCW ROTATION**

O.E.M. No.	Overall Length	Width at Edge	Thickness	Hole Size	Weight Ea.
7556 (Updraft)	27-3/4"	4-1/2"	1/2"	1-1/2"	15.7 LBS



ROTARY CUTTER BLADES



BUSH HOG (Continued)

Catalog No. 800-11150

MODELS- 126 RIGHT SIDE 2 USED, 315 LEFT SIDE 2 USED, 1126 RIGHT SIDE 2 USED, 1226 RIGHT SIDE 2 USED, 1315 LEFT SIDE 2 USED, 2615 LEFT SIDE 2 USED.

CW ROTATION

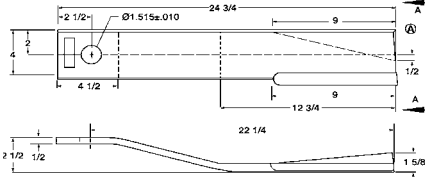

O.E.M. No.	Overall Length	Width at Edge	Thickness	Hole Size	Weight Ea.
11150 (Updraft)	24-3/4"	4-1/2"	1/2"	1-1/2"	13.9 LBS

Catalog No. 125-1209

MODELS- 6, 12, 105, 205, 255, 266, 305, 502, 600, RB-60, SQUEELER 60.

CCW ROTATION

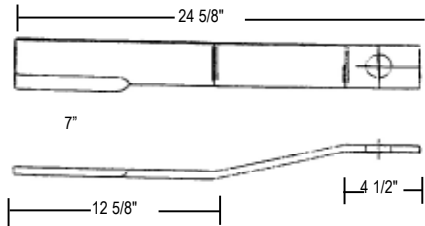

O.E.M. No.	Overall Length	Width at Edge	Thickness	Hole Size	Weight Ea.
36	24-5/8"	3-1/2"	1/2"	1-1/2"	10 LBS

Catalog No. 125-1210

MODEL- 220 4 USED (2 RIGHT, 2 CENTER) UPDRAFT

CCW ROTATION

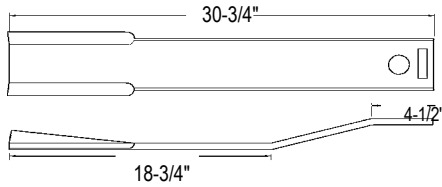

O.E.M. No.	Overall Length	Width at Edge	Thickness	Hole Size	Weight Ea.
7557	31"	4"	1/2"	1-1/2"	17.3 LBS

Catalog No. 125-1212

MODELS- 316S, 1312R, 3126 (2 USED), 3126R, 3210, 13126S.

CW ROTATION, UPDRAFT

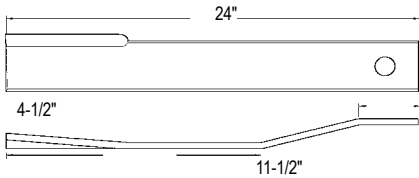

O.E.M. No.	Overall Length	Width at Edge	Thickness	Hole Size	Weight Ea.
90014 78494	24"	4-1/2"	1/2"	1-1/2"	13.6 LBS

Catalog No. 125-78496

FITS:13168,3168. **CW ROTATION LIFT.** (2 USED)

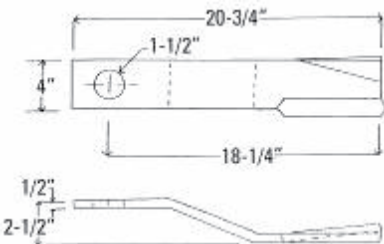

O.E.M. No.	Overall Length	Width at Edge	Thickness	Hole Size	Weight Ea.
78496	20-3/4"	4"	1/2"	1-1/2"	13.6 LBS



ROTARY CUTTER BLADES



FORD (Continued)

Catalog No. 125-1102

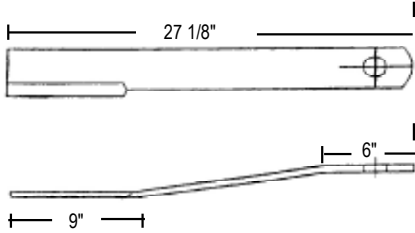

MODELS-910
CCW ROTATION

O.E.M. No.	Overall Length	Width at Edge	Thickness	Hole Size	Weight Ea.
7502411	27-1/8"	3-1/2"	1/2"	1-1/2"	12 LBS

Catalog No. 125-1103

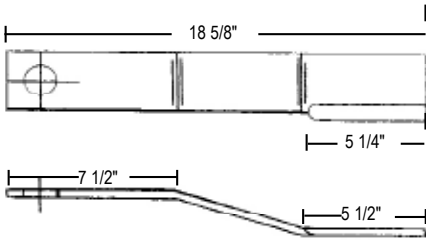

MODELS-902 - 100"
CCW ROTATION

O.E.M. No.	Overall Length	Width at Edge	Thickness	Hole Size	Weight Ea.
107281	18-5/8"	3-1/2"	3/8"	1-1/2"	6.1 LBS

Catalog No. 125-1415

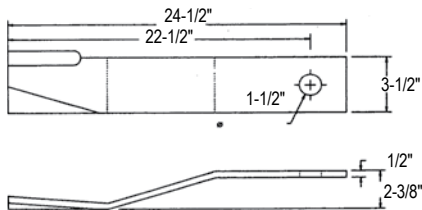

MODELS- 10 FT. UPDRAFT
CW ROTATION

O.E.M. No.	Overall Length	Width at Edge	Thickness	Hole Size	Weight Ea.
HL421-LN	24-1/2	N/A	1/2"	1-1/2	11.5 LBS

Catalog No. 125-1416

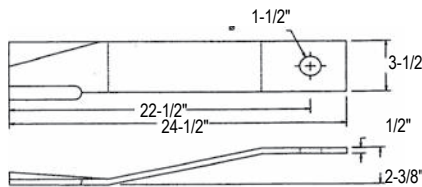

MODELS- 10 FT.
UPDRAFT CCW ROTATION

O.E.M. No.	Overall Length	Width at Edge	Thickness	Hole Size	Weight Ea.
HL421LN	24-1/2	N/A	1/2"	1-1/2	11.5 LBS

Catalog No. 125-1417

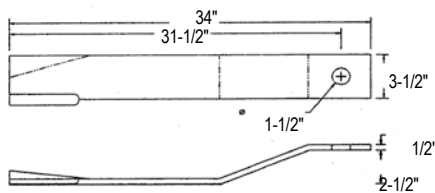

MODEL - 7 FT.
UPDRAFT CCW ROTATION

O.E.M. No.	Overall Length	Width at Edge	Thickness	Hole Size	Weight Ea.
HL423N	34"	4"	1/2"	1-1/2"	16.2 LBS



ROTARY CUTTER BLADES



IMCO SOUTHEAST, BIG OX

Catalog No. 125-1151

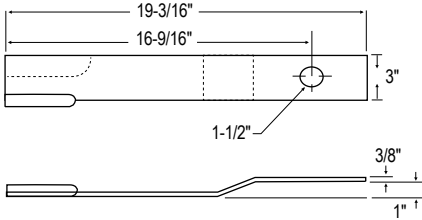

MODELS- 5 FT. UPDRAFT **CCW** ROTATION

O.E.M. No.	Overall Length	Width at Edge	Thickness	Hole Size	Weight Ea.
1500	19-3/16"	N/A	3/8"	1-1/2"	5.8 LBS

Catalog No. 125-1152

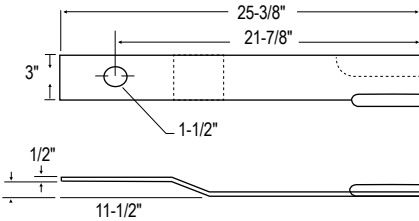

MODELS- 5 FT. UPDRAFT **CW** ROTATION

O.E.M. No.	Overall Length	Width at Edge	Thickness	Hole Size	Weight Ea.
1501	25-3/8"	N/A	1/2"	1-1/2"	10.2 LBS

Catalog No. 820-168C

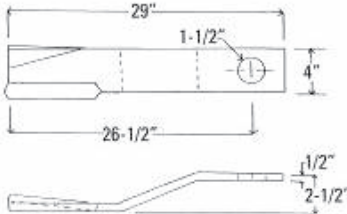

LAND PRIDE

MODELS- RCR5015, RCR6015 CENTER BLADE.. **CCW** ROTATION 2-1/2" OFFSET. 26-1/2" CENTER HOLE TO END OF BLADE.

O.E.M. No.	Overall Length	Width at Edge	Thickness	Hole Size	Weight Ea.
820-168C	29"	4"	1/2"	1-1/2"	N/A

Catalog No. 820-169C

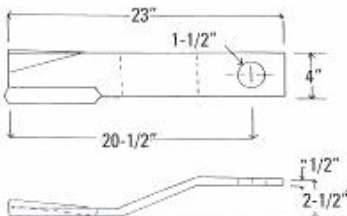

MODELS- RCR5015, RCR6015 LEFT HAND BLADE. **CCW** ROTATION LIFT. 20-1/2 CENTER HOLE TO END OF BLADE.

O.E.M. No.	Overall Length	Width at Edge	Thickness	Hole Size	Weight Ea.
820-169C	23"	4"	1/2"	1-1/2"	14 LBS

Catalog No. 820-170C

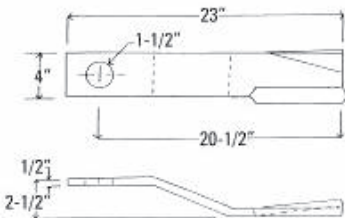

MODELS- RCR5015, RCR6015 LEFT HAND BLADE. **CW** ROTATION LIFT. 20-1/2 CENTER HOLE TO END OF BLADE.

O.E.M. No.	Overall Length	Width at Edge	Thickness	Hole Size	Weight Ea.
820-170C	23"	4	1/2"	1-1/2"	14 LBS



ROTARY CUTTER BLADES



MODERN

Catalog No. 125-1251

MODELS- ALL 5 FT., HIGHWAY SPECIAL
CCW ROTATION

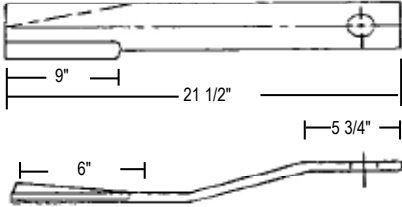

O.E.M. No.	Overall Length	Width at Edge	Thickness	Hole Size	Weight Ea.
MC36867A 8-401-0179)	21-1/2"	4-1/2"	1/2"	1-1/2"	9.9 LBS

Catalog No. 401-0175S

MODEL - 6' COMMANDO, 6' & 7' HWY SPECIAL, 6' & 7'
SUPER COMMANDO UPDRAFT CCW ROTATION

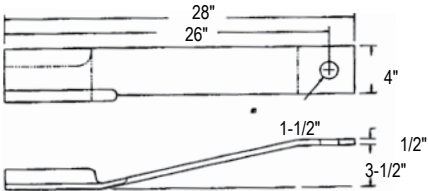

O.E.M. No.	Overall Length	Width at Edge	Thickness	Hole Size	Weight Ea.
401-0175S	28"	4-1/2"	1/2"	1-1/2"	15.3 LBS

Catalog No. 401-0153

MODEL - 42" SUNSHINE, 42" COMPETITOR
FLAT CW/CCW ROTATION

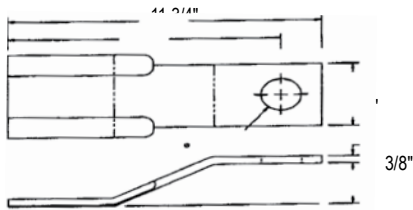

O.E.M. No.	Overall Length	Width at Edge	Thickness	Hole Size	Weight Ea.
401-0153	11-3/4"	3-1/2"	3/8"	1-1/2"	3.5 LBS

Catalog No. 401-0174S

MODEL - 4' SUNSHINE, 4' COMMANDO, 4'
COMPETITOR
UPDRAFT CCW ROTATION

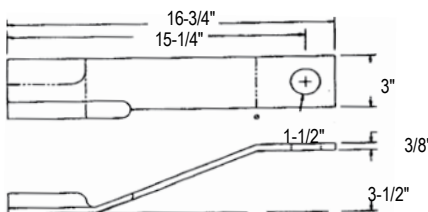

O.E.M. No.	Overall Length	Width at Edge	Thickness	Hole Size	Weight Ea.
401-0174S	16-3/4"	3-1/4"	3/8"	1-1/2"	5 LBS



ROTARY CUTTER BLADES

**Forged from 5160
high quality steel.**

MOHAWK

Catalog No. 125-1301

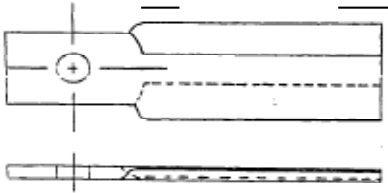

MODEL- 507
CW/CCW ROTATION

O.E.M. No.	Overall Length	Width at Edge	Thickness	Hole Size	Weight Ea.
1-210	15"	4"	1/2"	1-1/4"	5.5 LBS

Catalog No. 125-1302

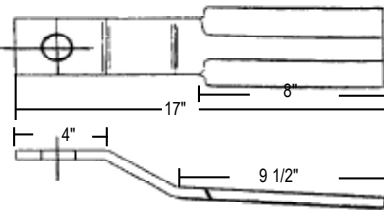

MODEL- 840, 1360
CW/CCW ROTATION

O.E.M. No.	Overall Length	Width at Edge	Thickness	Hole Size	Weight Ea.
1-214	17"	4"	1/2"	1-1/2"	7.3 LBS

Catalog No. 18-181AL

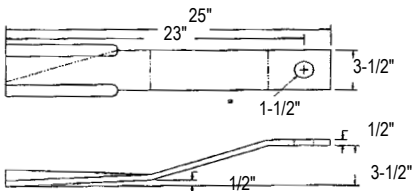

MODEL - 15' FLEX EAGLE (6 USED)
UPDRAFT CCW ROTATION

O.E.M. No.	Overall Length	Width at Edge	Thickness	Hole Size	Weight Ea.
18-181AL 7-724	25"	4-5/8"	1/2"	1-1/2"	11.9 LBS

SCHULTE

Catalog No. 401-026

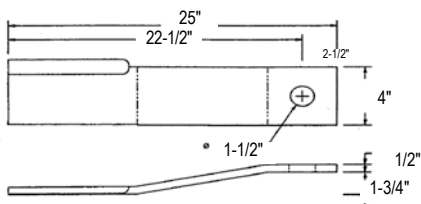

MODELS- XH1500
FLAT CW ROTATION

O.E.M. No.	Overall Length	Width at Edge	Thickness	Hole Size	Weight Ea.
401-026	25"	4-1/2"	1/2"	1-1/2"	13.3 LBS

Catalog No. 401-027

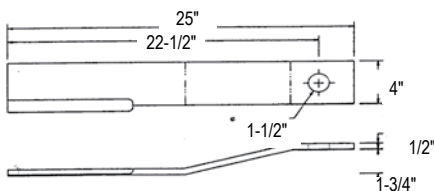

MODELS- XH1500, XH1000
FLAT CCW ROTATION

O.E.M. No.	Overall Length	Width at Edge	Thickness	Hole Size	Weight Ea.
401-027	25"	4-1/2"	1/2"	1-1/2"	13.3 LBS



ROTARY CUTTER BLADES

**Forged from 5160
high quality steel.**

SCHULTE

Catalog No. 401-028

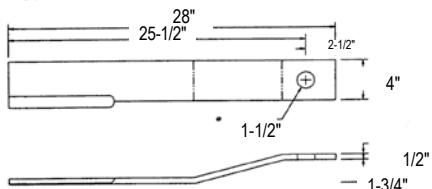

MODELS- XH1500
FLAT **CCW** ROTATION

O.E.M. No.	Overall Length	Width at Edge	Thickness	Hole Size	Weight Ea.
401-028	28"	4-1/2"	1/2"	1-1/2"	15.3 LBS

Catalog No. 401-032

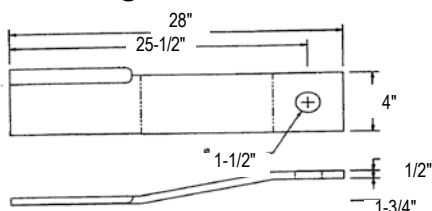

MODELS- XH1000
FLAT **CW** ROTATION

O.E.M. No.	Overall Length	Width at Edge	Thickness	Hole Size	Weight Ea.
401-032	28"	4-1/2"	1/2"	1-1/2"	15.3 LBS

SERVIS/RHINO

Catalog No. 00753841

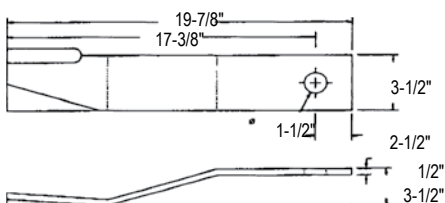

MODEL - SAT8, (2 USED), AFTER S/N 10340, SR120, SR166, TW96
UPDRAFT **CW** ROTATION

O.E.M. No.	Overall Length	Width at Edge	Thickness	Hole Size	Weight Ea.
00753841	19-7/8"	4"	1/2"	1-1/2"	9.1 LBS

Catalog No. 00753842

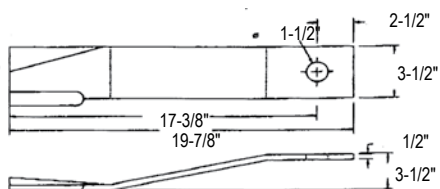

MODEL - SAT8 (2 USED) AFTER S/N 10340,
SR120, SR166, TW96
UPDRAFT **CCW** ROTATION

O.E.M. No.	Overall Length	Width at Edge	Thickness	Hole Size	Weight Ea.
00753842	19-7/8"	4"	1/2"	1-1/2"	9.1 LBS

Catalog No. 00759495

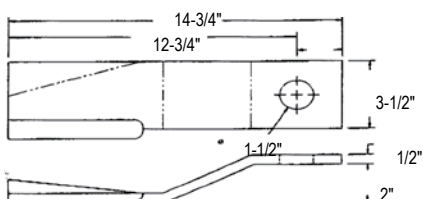

MODEL - SR80
UPDRAFT **CCW** ROTATION

O.E.M. No.	Overall Length	Width at Edge	Thickness	Hole Size	Weight Ea.
00759495	14-3/4"	3-1/4"	1/2"	1-1/2"	6.8 LBS



ROTARY CUTTER BLADES



SERVIS/RHINO

Catalog No. 125-1354

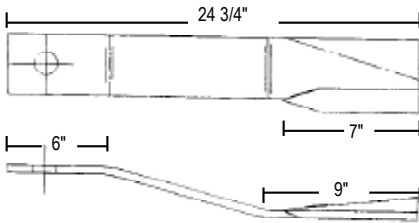

MODEL - CY128, FL15, FS15, S128, SR15

CW ROTATION

O.E.M. No.	Overall Length	Width at Edge	Thickness	Hole Size	Weight Ea.
65201-RF (Updraft)	24 3/4"	5"	1/2"	1-3/8"	10.5 LBS

Catalog No. 125-1355

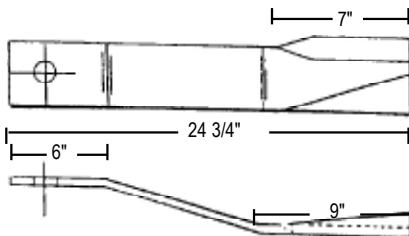

MODEL - CY128, CY60, FL15, FS15, S128, SM66, SR15

CCW ROTATION

O.E.M. No.	Overall Length	Width at Edge	Thickness	Hole Size	Weight Ea.
62201-3F (Updraft)	24 3/4"	5"	1/2"	1-3/8"	10.5 LBS

Catalog No. 125-1356

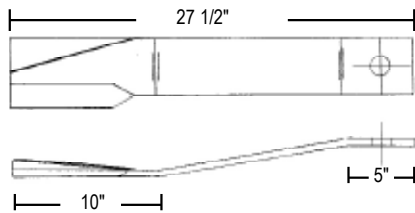

MODEL - CY72, FL15, FL20-BAR, SR15, SR15M, SR18

CCW ROTATION

O.E.M. No.	Overall Length	Width at Edge	Thickness	Hole Size	Weight Ea.
58201-3F (Updraft)	27-1/2"	5"	1/2"	1-3/8"	15 LBS

Catalog No. 125-1357

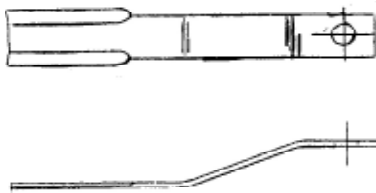

MODELS- 1310, SR166

CW/CCW ROTATION

O.E.M. No.	Overall Length	Width at Edge	Thickness	Hole Size	Weight Ea.
68-106-3	19"	5"	1/2"	1-3/8"	10.5 LBS

Catalog No. 125-1359

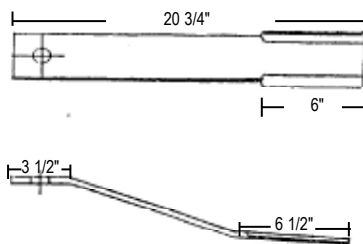

MODELS SATURN 8

CW/CCW ROTATION

O.E.M. No.	Overall Length	Width at Edge	Thickness	Hole Size	Weight Ea.
73-1300-010	20-1/4"	3-1/2"	3/8"	1"	4.5 LBS



ROTARY CUTTER BLADES

Forged from 5160
high quality steel.

SERVIS/RHINO

Catalog No. 125-1360

MODEL E60, SC80 - CCW ROTATION

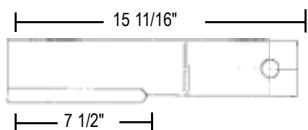

O.E.M. No.	Overall Length	Width at Edge	Thickness	Hole Size	Weight Ea.
47-106-5B	15-11/16"	3-1/2"	.401"	1"	7 LBS

Catalog No. 125-1361

MODELS - FLEX 15 RIGHT - 2 USED LEFT - 2 USED,
CY60, CY128, SM66, SR-15 CW/CCW ROTATION

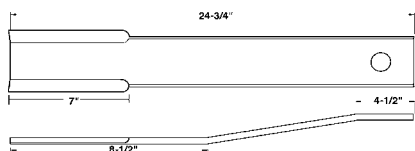

O.E.M. No.	Overall Length	Width at Edge	Thickness	Hole Size	Weight Ea.
65-201-30	24-1/2"	5"	1/2"	1-3/8"	14 LBS

Catalog No. 125-1362

MODELS - SATURN 5 AND SE 6, FLEX S-15 -
CCW ROTATION

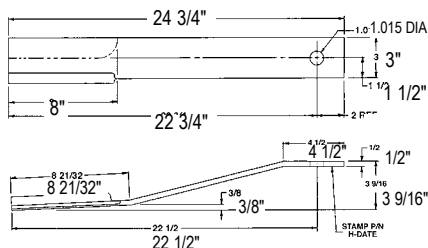

O.E.M. No.	Overall Length	Width at Edge	Thickness	Hole Size	Weight Ea.
71-103	24-3/4"	3"	3/8"	1"	8.3 LBS

Catalog No. 125-1365

MODELS- CY60, FLEX 15 CENTER
2 USED, FLEX 20 WITHOUT STUMP JUMPER
CW/CCW ROTATION

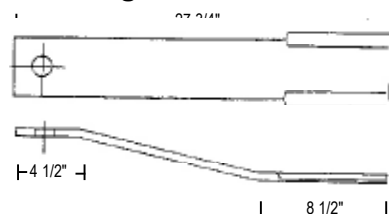

O.E.M. No.	Overall Length	Width at Edge	Thickness	Hole Size	Weight Ea.
58-201-030	27-3/4"	5"	1/2"	1-3/8"	16 LBS

Catalog No. 125-1366

MODEL - SR 15 M - CW ROTATION
RIGHT UPDRAFT

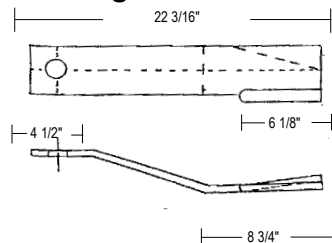

O.E.M. No.	Overall Length	Width at Edge	Thickness	Hole Size	Weight Ea.
00759338	22-3/16"	4-1/2"	1/2"	1-3/8"	12.4 LBS



ROTARY CUTTER BLADES



SERVIS/RHINO

Catalog No. 125-1367

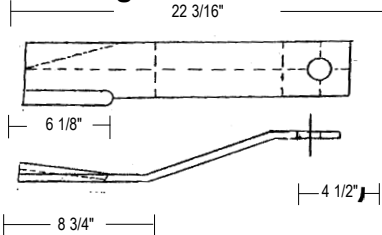

MODEL - SR 15 M -CCW ROTATION
LEFT UPDRAFT

O.E.M. No.	Overall Length	Width at Edge	Thickness	Hole Size	Weight Ea.
00759339	22-3/16"	4-1/2"	1/2"	1-3/8"	12.4 LBS

Catalog No. 125-1370

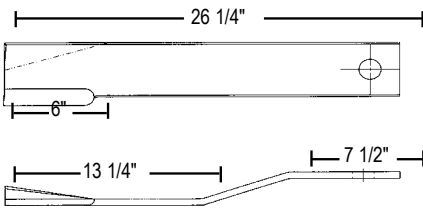

MODELS SE15, TW72, SR72 (SER. NO. 10205 & UP), A72, AG72B, A415, SUPERFLEX 15 III, SUPERFLEX 15 HD, SUPERFLEX 15
CCW ROTATION

O.E.M. No.	Overall Length	Width at Edge	Thickness	Hole Size	Weight Ea.
8588 (Updraft)	26 1/4"	4 1/2"	1/2"	1-1/2"	14 LBS

Catalog No. 125-1371

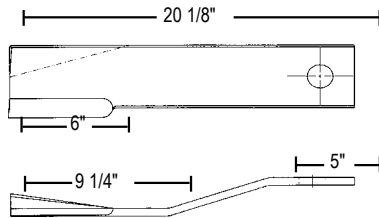

MODELS SE15, TW60, TW120, A60, AG60B, A415, SUPERFLEX 15 III, SUPERFLEX 15HD, SUPERFLEX 15, SR60 (SET NO. 10145 & UP) LEFT UPDRAFT - **CCW ROTATION**

O.E.M. No.	Overall Length	Width at Edge	Thickness	Hole Size	Weight Ea.
8589 (Updraft)	20 1/8"	4 1/2"	1/2"	1-1/2"	10.6 LBS

Catalog No. 125-1372

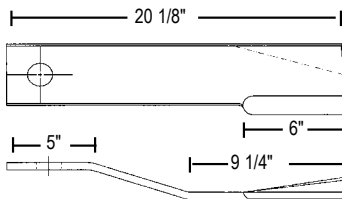

MODEL SE15, TW120, SUPERFLEX 15 III, SUPERFLEX 15HD, SUPERFLEX 15. RIGHT UPDRAFT **CW ROTATION**

O.E.M. No.	Overall Length	Width at Edge	Thickness	Hole Size	Weight Ea.
8590 (Updraft)	20 1/8"	4 1/2"	1/2"	1-1/2"	10.6 LBS

Catalog No. 125-1401

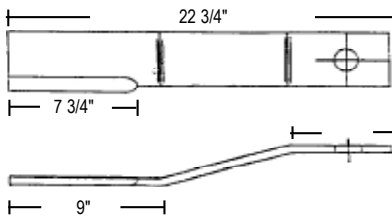

MODELS-GB602, GB605,GB60, GB660, SW 72 (TIRE DRIVE) **CCW ROTATION**

O.E.M. No.	Overall Length	Width at Edge	Thickness	Hole Size	Weight Ea.
15096	22-3/4"	4"	1/2"	1-1/2"	13 LBS

SIDEWINDER



ROTARY CUTTER BLADES

Forged from 5160
high quality steel.

SIDEWINDER

Catalog No. 125-1402

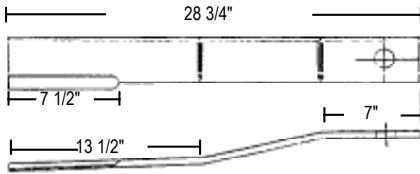

MODELS - 6X6, 7X7, GW842,
GB722, GB842, SW842, GB72, GB725,
S84, GB84 **CCW ROTATION**

O.E.M. No.	Overall Length	Width at Edge	Thickness	Hole Size	Weight Ea.
15120	28-3/4"	4"	1/2"	1-1/2"	14 LBS

Catalog No. 125-1403

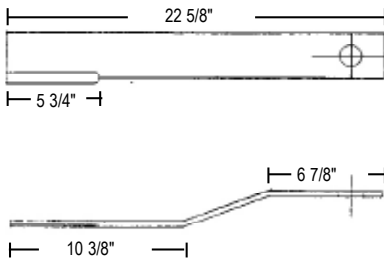

MODELS- SX60, 5X5
CCW ROTATION

O.E.M. No.	Overall Length	Width at Edge	Thickness	Hole Size	Weight Ea.
17065	22-5/8"	3-3/8"	3/8"	1-1/2"	6.5 LBS

Catalog No. 125-1404

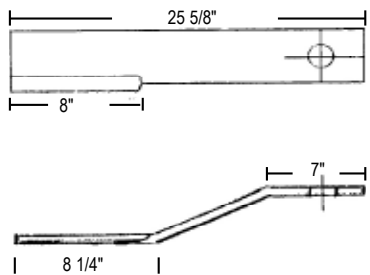

MODEL - FW325, FW425, FW215, FW315
CCW ROTATION

O.E.M. No.	Overall Length	Width at Edge	Thickness	Hole Size	Weight Ea.
22934LH (Updraft)	25-5/8"	4"	1/2"	1-1/2"	12.5 LBS

Catalog No. 125-1405

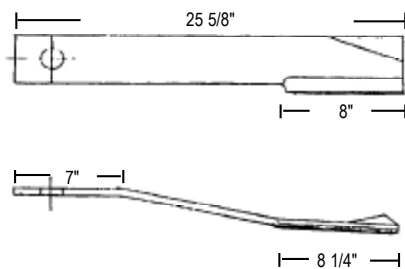

MODEL- FW325, FW425 FW215, FW315
CW ROTATION

O.E.M. No.	Overall Length	Width at Edge	Thickness	Hole Size	Weight Ea.
22935RH (Updraft)	22-5/8"	4"	1/2"	1-1/2"	12.5 LBS

Catalog No. 125-1406

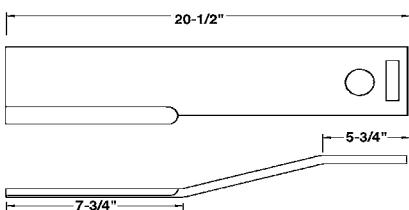

MODEL- GM66, SW66, GB48,
GB144, RS213 (TIRE DRIVE)
CCW ROTATION

O.E.M. No.	Overall Length	Width at Edge	Thickness	Hole Size	Weight Ea.
15074	20-1/2"	4"	1/2"	1-1/2"	10.5 LBS



ROTARY CUTTER BLADES

SIDEWINDER

**Forged from 5160
high quality steel.**

Catalog No. 300-21301

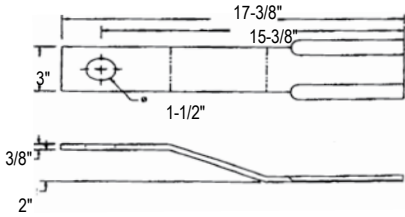

MODEL - LX60, SX42, SX50, GB90
FLAT CW/CCW ROTATION

O.E.M. No.	Overall Length	Width at Edge	Thickness	Hole Size	Weight Ea.
21301	17-3/8"	3-3/4"	3/8"	1-1/2"	5.2 LBS

Catalog No. 300-25899

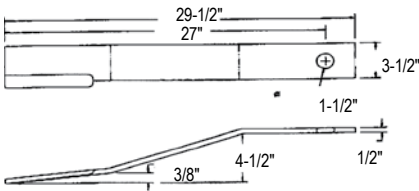

MODEL - GB6, GB7, SW7
FLAT CCW ROTATION

O.E.M. No.	Overall Length	Width at Edge	Thickness	Hole Size	Weight Ea.
25899	29-1/2"	4"	1/2"	1-1/2"	14.3 LBS

Catalog No. 300-25990

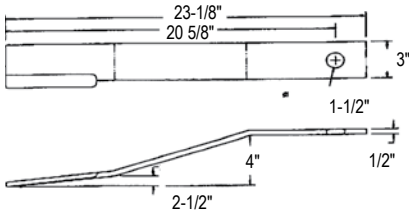

MODEL - GM60, 5X5 CW, MG5
FLAT CCW ROTATION

O.E.M. No.	Overall Length	Width at Edge	Thickness	Hole Size	Weight Ea.
25990	23-1/8"	N/A	1/2"	1-1/2"	9.4 LBS

Catalog No. 300-25992

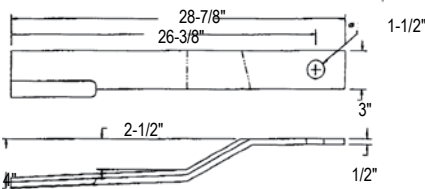

MODEL - GM72, 6X6CW, MG6
TWIST CCW ROTATION

O.E.M. No.	Overall Length	Width at Edge	Thickness	Hole Size	Weight Ea.
25992	28-7/8"	N/A	1/2"	1-1/2"	12.8 LBS

Catalog No. 300-26225

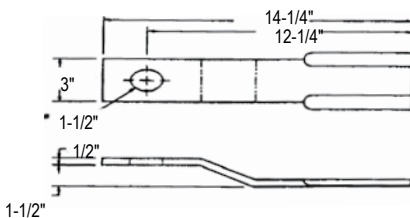

MODEL - GM42, GB10
FLAT CW/CCW ROTATION

O.E.M. No.	Overall Length	Width at Edge	Thickness	Hole Size	Weight Ea.
26225	14-1/4"	4"	1/2"	1-1/2"	5.5 LBS



ROTARY CUTTER BLADES



SIDEWINDER

Catalog No.125-1302

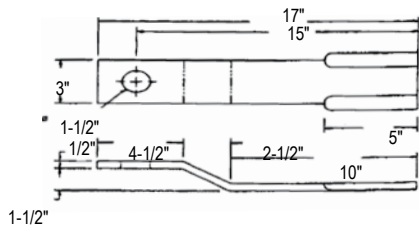

MODEL -GM48
FLAT CW/CCW ROTATION

O.E.M. No.	Overall Length	Width at Edge	Thickness	Hole Size	Weight Ea.
26226	17"	4"	1/2"	1-1/2"	6.8 LBS

Catalog No. 300-27485

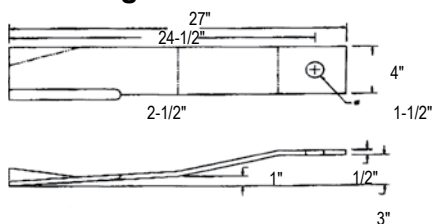

MODEL - FW425
UPDRAFT CCW ROTATION

O.E.M. No.	Overall Length	Width at Edge	Thickness	Hole Size	Weight Ea.
27485	27"	4-1/2"	1/2"	1-1/2"	14.6 LBS

TERRAIN KING

Catalog No. 00752974

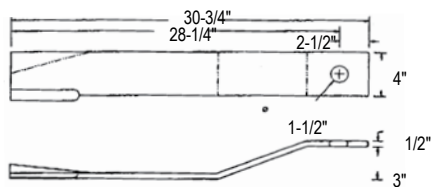

MODEL - TK84, MD84
UPDRAFT CCW ROTATION

O.E.M. No.	Overall Length	Width at Edge	Thickness	Hole Size	Weight Ea.
00752974	30-3/4"	4-1/2"	1/2"	1-1/2"	16.8 LBS

Catalog No. 02962635

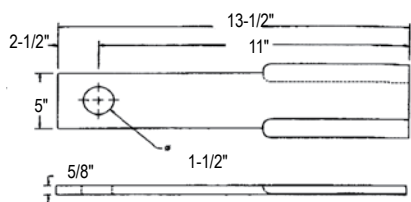

MODEL - BOOM AX MODELS
FLAT CW/CCW ROTATION

O.E.M. No.	Overall Length	Width at Edge	Thickness	Hole Size	Weight Ea.
02962635	13-1/2"	6-1/2"	5/8"	1-1/2"	11.2 LBS

Catalog No. 02964824

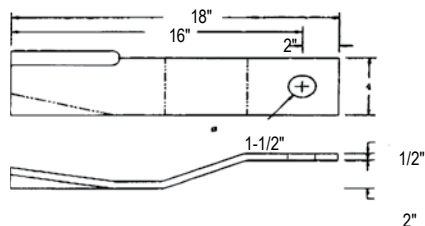

MODEL - A BOOM
UPDRAFT CW ROTATION

O.E.M. No.	Overall Length	Width at Edge	Thickness	Hole Size	Weight Ea.
02964824	18"	4-1/2"	1/2"	1-1/2"	10.8 LBS



ROTARY CUTTER BLADES



TERRAIN KING

Catalog No. 125-1451

MODEL- SMC, MOWAL 15', TK-530 A-BOOM
CW/CCW ROTATION

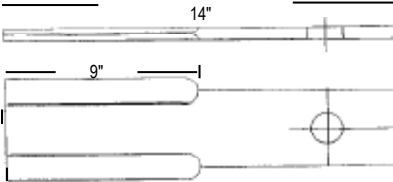

O.E.M. No.	Overall Length	Width at Edge	Thickness	Hole Size	Weight Ea.
1270-28	14"	4-1/4"	1/2"	1-1/4"	6 LBS

Catalog No. 125-1452

CCW ROTATION

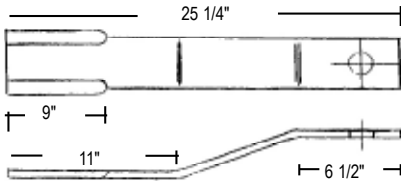

O.E.M. No.	Overall Length	Width at Edge	Thickness	Hole Size	Weight Ea.
750121	25-1/4"	4"	1/2"	1-1/2"	11.5 LBS

Catalog No. 125-1453

MODEL- TK15, TK15HD, A15IV, MD60, MD72, SR60 (up to 10145),
SR72 (up to 10205) HYDRO 15 RIGHT WING (UPDRAFT)
CCW ROTATION

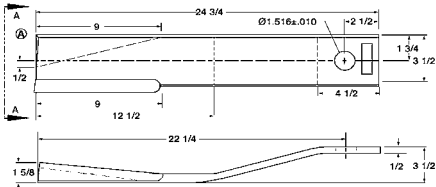

O.E.M. No.	Overall Length	Width at Edge	Thickness	Hole Size	Weight Ea.
750788	24-7/8"	4-1/2"	1/2"	1-1/2"	12 LBS

Catalog No. 125-1454

MODELS TK15, TK15HD, A15IV, DB60
CW ROTATION

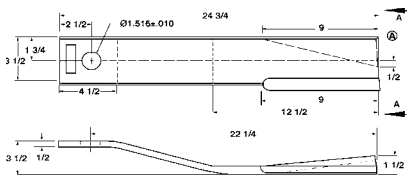

O.E.M. No.	Overall Length	Width at Edge	Thickness	Hole Size	Weight Ea.
750787	24-3/4"	4"	1/2"	1-1/2"	12 LBS

Catalog No. 125-1455

MODEL - BOOM AX MODELS
FLAT CW/CCW ROTATION

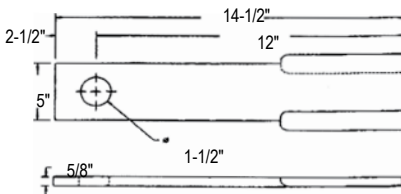

O.E.M. No.	Overall Length	Width at Edge	Thickness	Hole Size	Weight Ea.
02726900	14-1/2"	6-1/8"	5/8"	1-1/2"	12 LBS



ROTARY CUTTER BLADES

TIGER



Catalog No. 125-06521000

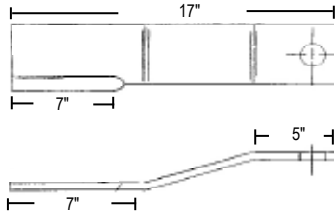

MODEL - SIDE MOUNT

O.E.M. No.	Overall Length	Width at Edge	Thickness	Hole Size	Weight Ea.
06521000	17"	5"	1/2"	1-1/2"	14 LBS

Catalog No. 125-1551

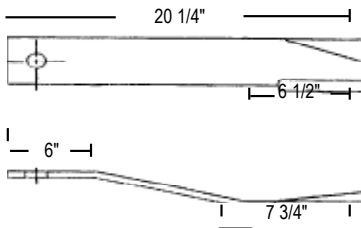

MODEL - SIDE MOUNT

O.E.M. No.	Overall Length	Width at Edge	Thickness	Hole Size	Weight Ea.
6T1021R	20-1/4"	4-1/2"	1/2"	1-1/2"	11.3 LBS

Catalog No. 125-1553

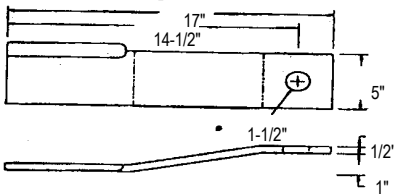

MODEL - BOOM FLAT CW ROTATION

O.E.M. No.	Overall Length	Width at Edge	Thickness	Hole Size	Weight Ea.
06521000	17"	5"	1/2"	1-1/2"	14 LBS

Catalog No. 125-34682

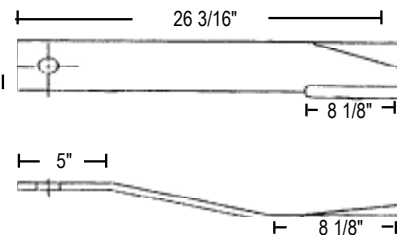

MODEL - SIDE MOUNT CCW ROTATION

O.E.M. No.	Overall Length	Width at Edge	Thickness	Hole Size	Weight Ea.
34682	26-3/16"	5"	1/2"	1-1/2"	14.1 LBS

US MOWER

Catalog No. 125-2558363

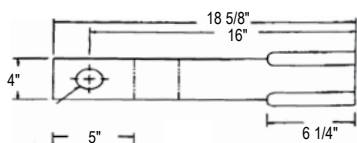

MODEL - SIDE MOUNT
CW/CCW ROTATION

O.E.M. No.	Overall Length	Width at Edge	Thickness	Hole Size	Weight Ea.
2558363	26-3/16"	5"	1/2"	1-1/2"	10 LBS



ROTARY CUTTER BLADES



WOODS

Catalog No. 125-1502

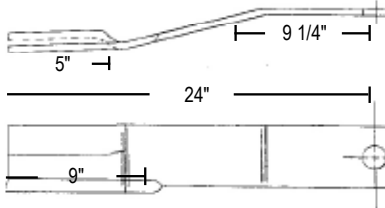

MODELS- R105, MR105, S105-1, S105-2 (4 USED)
P315-2, D315-3, HD315 - **CCW ROTATION**

O.E.M. No.	Overall Length	Width at Edge	Thickness	Hole Size	Weight Ea.
12892L	24-1/8"	4-1/2"	.401	1-1/2"	11.9 LBS

Catalog No. 125-1504

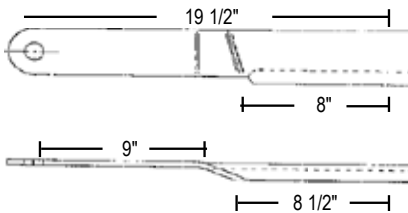

MODEL- 42C- **CW ROTATION**

O.E.M. No.	Overall Length	Width at Edge	Thickness	Hole Size	Weight Ea.
3975	19-1/2"	3"	9/32"	7/8"	3.9 LBS

Catalog No. 125-1505

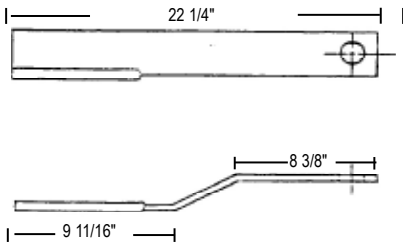

MODELS - M5-3, M54, 60-2,
60-3, 60-4, E60 - **CCW ROTATION**

O.E.M. No.	Overall Length	Width at Edge	Thickness	Hole Size	Weight Ea.
6866	22-1/4"	3-1/2"	3/8"	1-1/2"	6.4 LBS

Catalog No. 125-1509

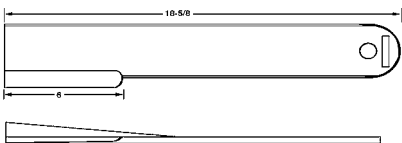

MODEL - 114 4 USED - **CCW ROTATION**

O.E.M. No.	Overall Length	Width at Edge	Thickness	Hole Size	Weight Ea.
3915	18-5/8"	3-1/2"	3/8"	7/8"	6.4 LBS

Catalog No. 125-1510

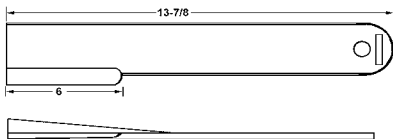

MODEL - 114 2 USED - **CCW ROTATION**

O.E.M. No.	Overall Length	Width at Edge	Thickness	Hole Size	Weight Ea.
3917	13-7/8"	3-1/2"	3/8"	7/8"	5.75 LBS



ROTARY CUTTER BLADES

**Forged from 5160
high quality steel.**

WOODS

Catalog No. 125-19160

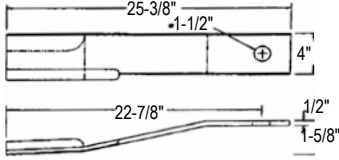

MODELS- 3180 (4 USED) L.H. & CTR
UPDRAFT **CCW** ROTATION

O.E.M. No.	Overall Length	Width at Edge	Thickness	Hole Size	Weight Ea.
19160	25-3/8	4-1/4"	1/2"	1-1/2"	13.7 LBS

Catalog No. 125-19161

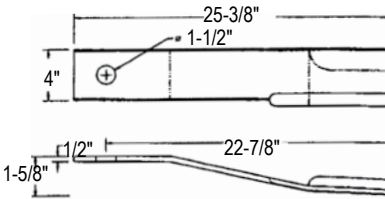

MODEL- 3180 (2 USED) R.H.
UPDRAFT **CW** ROTATION

O.E.M. No.	Overall Length	Width at Edge	Thickness	Hole Size	Weight Ea.
19161	25-3/8"	4-3/8"	1/2"	1-1/2"	13.7 LBS

Catalog No. 750-12916

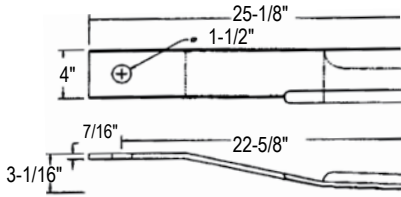

MODELS- HD210R-5, HD315-5
UPDRAFT **CW** ROTATION

O.E.M. No.	Overall Length	Width at Edge	Thickness	Hole Size	Weight Ea.
12916	25-1/8"	4-3/8"	7/16"	1-1/2"	11.9 LBS

Catalog No. 750-12917

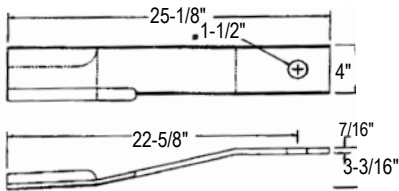

MODELS- HD210R-5, HD315-5
UPDRAFT **CCW** ROTATION

O.E.M. No.	Overall Length	Width at Edge	Thickness	Hole Size	Weight Ea.
12917	25-1/8"	4-3/8"	7/16"	1-1/2"	11.9 LBS

Tail Wheel Assembly & Tires

Wheel Hubs

A) Fabricated Tail Wheel Hub

Fits the most common model tail wheel assemblies. Comes with studs, nuts, and lockwashers.

- 325-2601 Tail wheel hub with studs, less bushings
..... (2 bushings used per hub - not included) ;
- 325-2621 5/8" bushing
- 325-2622 3/4" bushing .
- 325-2624 1" bushing . . .

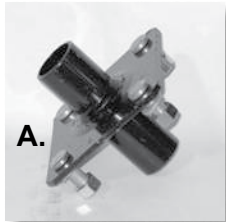

A.

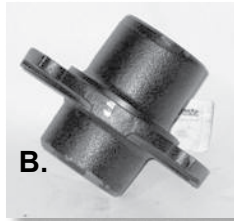

B.

B) Cast Wheel Hub 325-2501

Hub and bearing kit for 4 bolt wheel above includes hub, stud bolts, bearing, cups, and seals - axle not included.

- 325-2510 Hubs only w/cups from 325-2501.
- 325-2705 Bearings, cups, and seals kit for 4-bolt hub .
- 324-3226 Bearing cup only L44610 for cast hub . .
- 324-3227 Bearing cone only L44643 for cast hub .
- 322-2703 Seal only 7781-S for cast hub
- 325-2191 Bushing for 4 x 8 Tail Wheel
1" ID x 1/4" OD x 3/4" long.
- 325-2195 Reducer bushing 1" to 3/4" axle .
- 610-597 Wheelbolt stud only for tail wheel hub .
- 401-3581-01 . . T/W Hub Complete , 1" Axle.
- 401-3581A . . . T/W Hub Complete , 3/4" Axle .

Tail Wheel Assembly Heavy Duty

1 1/2" dia. stem on yoke.
Heavy Duty Cast Iron Hub with Bearing Races, seals, and axle bolt **325-2602**



1 1/4" dia. stem on yoke.
Heavy Duty Cast Iron Hub with Bearing Races, seals, and axle bolt **325-2605**



6 x 9 Laminated Tire

Outside diameter 20", 5 bolt holes on 5-1/2" circle, 4" pilot hole. Fits most 15' batwing cutters. **103-211**

4 x 8 Laminated Tire

Outside diameter 15", 4 bolt holes on 5" circle, 3-5/8" pilot hole. Fits most light, medium & heavy duty single deck cutters. **103-209**



6 x 9 Laminated Tire 4 Hole (not shown)

Outside diameter 20", 4 bolt holes on 5" circle. Fits Woods Cutters. **401-8810**

Aircraft Tailwheel

401-8812
Size: 6x9" • Type: 5 Bolt
Comes with valve stem

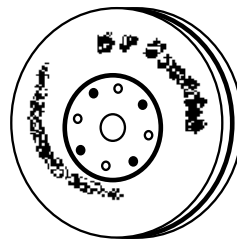

401-8812-04
FOAM FILLED

TAIL WHEEL FORK



325-2192
325-2603

- 325-2192 Fork Only, 1-1/2" Shaft for 325-2602
- 325-2602 Complete Assembly 1 1/2" Diameter Stem
- 325-2603 Fork Only 1-1/4" Shaft for 3/4" Axle;
- Also replaces: Bush Hog - 95541
Taylorway - 505044 & Woods.
- 325-2605KIT . . Tail Wheel assembly, heavy duty , 1-1/4" Yoke

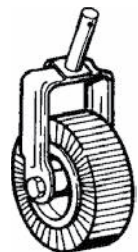

325-2602
325-2605KIT

Tail Wheel Assembly

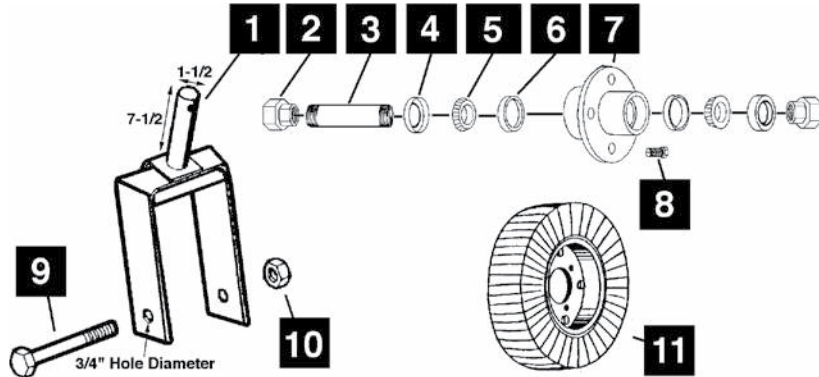

ITEM#	PART #	DESCRIPTION
1	325-2192	Fork Assembly
2	325-2626	Spindle Tube Nut
3	325-2625	Treaded Spindle Tube
4	322-1135	7781-S Grease Seal
5	324-5143	Inner Bearing Cone 15123
6	324-5144	Inner Bearing Cup 15245

ITEM #	PART #	DESCRIPTION
7	325-2506 325-2507KIT	Hub Only Hub Kit Fits Landpride & Taylor Pittsburg ; Includes Items: 2, 3, 4, 5, 6, 7.
8	512-0650	Wheel Bolt 1/2 x 1 UNF
9	412-0036	Bolt 3/4 X 8
10	412-0060	Nylon Lock Nut 3/4
11	103-209	Wheel Flange & Tire Assy.

BUSH HOG TAIL WHEEL PARTS

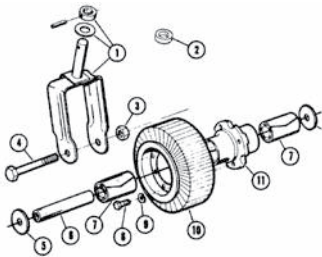

ITEM#	REPLACES#	PART NO.	DESCRIPTION
1	12528	325-2194	FORK ASSEMBLY
5	12261	320-5186	WEAR WASHER
6	12263	320-5187	SPACER TUBE
7	12250	320-5185	ROLLER BEARING
11	12268	325-2512	HUB ONLY

Bushhog Tail Wheel Replacement Parts

- 325-2149..... SPINDLE BOLT FOR BUSH HOG (1317BH)
- 325-2197..... BUSHING FOR BH TAILWHEEL KIT

TAILWHEEL FORK BUSHINGS

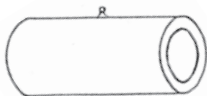

THESE BUSHINGS ARE WELD-ON REPLACEMENT FOR MOWER DECK BUSHINGS TO HOLD TAILWHEEL FORK. COMES WITH ZERK FITTINGS. 2-3/8" O.D. 6" LENGTH.

PART NO.	SIZE
325-2198	1 1/2" I.D.
325-2199	1 5/8" I.D.

ERN