

SIEMENS

SINAMICS

SINAMICS S120

With STARTER

Commissioning manual

Edition

07/2016

SIEMENS

SINAMICS

S120 STARTER Commissioning Manual

Commissioning Manual

Preface

Fundamental safety
instructions

1

Preparation for
commissioning

2

Commissioning

3

Diagnostics

4

Appendix



A

Applies to:
Firmware Version 4.8

Legal information

Warning notice system

This manual contains notices you have to observe in order to ensure your personal safety, as well as to prevent damage to property. The notices referring to your personal safety are highlighted in the manual by a safety alert symbol, notices referring only to property damage have no safety alert symbol. These notices shown below are graded according to the degree of danger.

 DANGER
indicates that death or severe personal injury will result if proper precautions are not taken.
 WARNING
indicates that death or severe personal injury may result if proper precautions are not taken.
 CAUTION
indicates that minor personal injury can result if proper precautions are not taken.
NOTICE
indicates that property damage can result if proper precautions are not taken.

If more than one degree of danger is present, the warning notice representing the highest degree of danger will be used. A notice warning of injury to persons with a safety alert symbol may also include a warning relating to property damage.

Qualified Personnel

The product/system described in this documentation may be operated only by **personnel qualified** for the specific task in accordance with the relevant documentation, in particular its warning notices and safety instructions. Qualified personnel are those who, based on their training and experience, are capable of identifying risks and avoiding potential hazards when working with these products/systems.

Proper use of Siemens products

Note the following:

 WARNING
Siemens products may only be used for the applications described in the catalog and in the relevant technical documentation. If products and components from other manufacturers are used, these must be recommended or approved by Siemens. Proper transport, storage, installation, assembly, commissioning, operation and maintenance are required to ensure that the products operate safely and without any problems. The permissible ambient conditions must be complied with. The information in the relevant documentation must be observed.

Trademarks

All names identified by ® are registered trademarks of Siemens AG. The remaining trademarks in this publication may be trademarks whose use by third parties for their own purposes could violate the rights of the owner.

Disclaimer of Liability

We have reviewed the contents of this publication to ensure consistency with the hardware and software described. Since variance cannot be precluded entirely, we cannot guarantee full consistency. However, the information in this publication is reviewed regularly and any necessary corrections are included in subsequent editions.

Preface

SINAMICS documentation

The SINAMICS documentation is organized in the following categories:

- General documentation/catalogs
- User documentation
- Manufacturer/service documentation

Additional information

You can find information on the following topics at the following address (<https://support.industry.siemens.com/cs/de/en/view/108993276>):

- Ordering documentation/overview of documentation
- Additional links to download documents
- Using documentation online (find and search in manuals/information)

Please send any questions about the technical documentation (e.g. suggestions for improvement, corrections) to the following e-mail address (<mailto:docu.motioncontrol@siemens.com>).

Siemens MySupport/Documentation

At the following address (<https://support.industry.siemens.com/My/ww/en/documentation>), you can find information on how to create your own individual documentation based on Siemens' content, and adapt it for your own machine documentation.

Training

At the following address (<http://www.siemens.com/sitrain>), you can find information about SITRAIN (Siemens training on products, systems and solutions for automation and drives).

FAQs

You can find Frequently Asked Questions in the Service&Support pages under Product Support (<https://support.industry.siemens.com/cs/de/en/ps/faq>).

SINAMICS

You can find information about SINAMICS at the following address (<http://www.siemens.com/sinamics>).

Usage phases and their documents/tools (as an example)

Table 1 Usage phases and the available documents/tools

Usage phase	Document/tool
Orientation	SINAMICS S Sales Documentation
Planning/configuration	<ul style="list-style-type: none"> • SIZER Engineering Tool • Configuration Manuals, Motors
Deciding/ordering	SINAMICS S120 catalogs <ul style="list-style-type: none"> • SIMOTION, SINAMICS S120 and Motors for Production Machines (Catalog PM 21) • SINAMICS and Motors for Single-axis Drives (Catalog D 31) • SINUMERIK & SINAMICS Equipment for Machine Tools (Catalog NC 61) • SINUMERIK 840D sl Type 1B Equipment for Machine Tools (Catalog NC 62)
Installation/assembly	<ul style="list-style-type: none"> • SINAMICS S120 Manual for Control Units and Additional System Components • SINAMICS S120 Manual for Booksize Power Units • SINAMICS S120 Manual for Booksize Power Units C/D Type • SINAMICS S120 Manual for Chassis Power Units, Air-cooled • SINAMICS S120 Manual for Chassis Power Units, Liquid-cooled • SINAMICS S120 Manual for AC Drives • SINAMICS S120 Manual Combi • SINAMICS S120M Manual Distributed Drive Technology • SINAMICS HLA System Manual Hydraulic Drive
Commissioning	<ul style="list-style-type: none"> • STARTER Commissioning Tool • SINAMICS S120 Getting Started with STARTER • SINAMICS S120 Commissioning Manual with STARTER • SINAMICS S120 CANopen Commissioning Manual • SINAMICS S120 Function Manual Drive Functions • SINAMICS S120 Safety Integrated Function Manual • SINAMICS S120/S150 List Manual • SINAMICS HLA System Manual Hydraulic Drive • Startdrive commissioning tool¹⁾ • SINAMICS S120 Getting Started with Startdrive¹⁾ • SINAMICS S120 Commissioning Manual with Startdrive¹⁾
Usage/operation	<ul style="list-style-type: none"> • SINAMICS S120 Commissioning Manual with STARTER • SINAMICS S120/S150 List Manual • SINAMICS HLA System Manual Hydraulic Drive • SINAMICS S120 Commissioning Manual with Startdrive¹⁾

Usage phase	Document/tool
Maintenance/servicing	<ul style="list-style-type: none"> • SINAMICS S120 Commissioning Manual with STARTER • SINAMICS S120/S150 List Manual • SINAMICS S120 Commissioning Manual with Startdrive¹⁾
References	<ul style="list-style-type: none"> • SINAMICS S120/S150 List Manual

¹⁾ available as of Startdrive V14 release

Target group

This documentation is intended for machine manufacturers, commissioning engineers, and service personnel who use the SINAMICS drive system.

Benefits

This manual provides all of the information, procedures and operator actions required for the particular usage phase.

Standard scope

The scope of the functionality described in this document can differ from that of the drive system that is actually supplied.

- Other functions not described in this documentation might be able to be executed in the drive system. However, no claim can be made regarding the availability of these functions when the equipment is first supplied or in the event of service.
- The documentation can also contain descriptions of functions that are not available in a particular product version of the drive system. The functionality of the supplied drive system should only be taken from the ordering documentation.
- Extensions or changes made by the machine manufacturer must be documented by the machine manufacturer.

For reasons of clarity, this documentation does not contain all of the detailed information on all of the product types, and cannot take into consideration every conceivable type of installation, operation and service/maintenance.

Technical Support

Country-specific telephone numbers for technical support are provided in the Internet at the following address (<https://support.industry.siemens.com/sc/ww/en/sc/2090>) in the "Contact" area.

Relevant directives and standards

You can obtain an up-to-date list of currently certified components on request from your local Siemens office. If you have any questions relating to certifications that have not yet been completed, please ask your Siemens contact person.

Certificates for download

The certificates can be downloaded from the Internet:

Certificates (<https://support.industry.siemens.com/cs/ww/de/ps/13206/cert>)



EC Declaration of Conformity

You can find the EC Declaration of Conformity for the relevant directives as well as the relevant certificates, prototype test certificates, manufacturers declarations and test certificates for functions relating to functional safety ("Safety Integrated") on the Internet at the following address (<https://support.industry.siemens.com/cs/ww/en/ps/13231/cert>).

The following directives and standards are relevant for SINAMICS S devices:

European low-voltage directive

SINAMICS S devices fulfil the requirements stipulated in the Low-Voltage Directive 2014/35/EU, insofar as they are covered by the application area of this directive.

European machinery directive

SINAMICS S devices fulfil the requirements stipulated in the Low-Voltage Directive 2006/42/EU, insofar as they are covered by the application area of this directive.

However, the use of the SINAMICS S devices in a typical machine application has been fully assessed for compliance with the main regulations in this directive concerning health and safety.

European EMC Directive

SINAMICS S devices comply with the EMC Directive 2014/30/EU.



EMC requirements for South Korea

SINAMICS S devices with the KC marking on the rating plate satisfy the EMC requirements for South Korea.

Specification for semiconductor process equipment voltage drop immunity

SINAMICS S devices meet the requirements of standard SEMI F47-0706.



Eurasian conformity

SINAMICS S comply with the requirements of the Russia/Belarus/Kazakhstan customs union (EAC).



North American market

SINAMICS S devices provided with one of the test symbols displayed fulfil the requirements stipulated for the North American market as a component of drive applications.

You can find the relevant certificates on the Internet pages of the certifiers:

- For products with UL certificate (<http://database.ul.com/cgi-bin/XYV/template/LISEXT/1FRAME/index.html>)
- For products with TÜV SÜD certificate (https://www.tuev-sued.de/industry_and_consumer_products/certificates)

Possible test symbols



Australia and New Zealand (RCM formerly C-Tick)

SINAMICS S devices showing the test symbols fulfil the EMC requirements for Australia and New Zealand.

Quality systems

Siemens AG employs a quality management system that meets the requirements of ISO 9001 and ISO 14001.

Not relevant standards



China Compulsory Certification

SINAMICS S devices do not fall in the area of validity of the China Compulsory Certification (CCC).

EMC limit values in South Korea

이 기기는 업무용(A급) 전자파적합기기로서 판매자 또는 사용자는 이 점을 주의하시기 바라며, 가정외의 지역에서 사용하는 것을 목적으로 합니다.
For sellers or other users, please bear in mind that this device is an A-grade electromagnetic wave device. This device is intended to be used in areas other than at home.

The EMC limit values to be observed for Korea correspond to the limit values of the EMC product standard for variable-speed electric drives EN 61800-3 of category C2 or the limit value class A, Group 1 to KN11. By implementing appropriate additional measures, the limit values according to category C2 or limit value class A, Group 1, are observed. Further, additional measures may be required, such as using an additional radio interference suppression filter (EMC filter).

The measures for EMC-compliant design of the system are described in detail in this manual respectively in the EMC Installation Guideline Configuration Manual.

The final statement regarding compliance with the standard is given by the respective label attached to the individual unit.

Ensuring reliable operation

The manual describes a desired state which, if maintained, ensures the required level of operational reliability and compliance with EMC limit values.

Should there be any deviation from the requirements in the manual, appropriate actions (e.g. measurements) must be taken to check/prove that the required level of operational reliability and compliance with EMC limit values are ensured.

Spare parts

Spare parts are available on the Internet at the following address

(<https://www.automation.siemens.com/sow?sap-language=EN>).

Product maintenance

The components are subject to continuous further development within the scope of product maintenance (improvements to robustness, discontinuations of components, etc).

These further developments are "spare parts-compatible" and do not change the article number.

In the scope of such spare parts-compatible further developments, connector positions are sometimes changed slightly. This does not cause any problems with proper use of the components. Please take this fact into consideration in special installation situations (e.g. allow sufficient clearance for the cable length).

Use of third-party products



This document contains recommendations relating to third-party products. Siemens accepts the fundamental suitability of these third-party products.

You can use equivalent products from other manufacturers.

Siemens does not accept any warranty for the properties of third-party products.

Ground symbols

Table 2 Symbols

Symbol	Meaning
	Connection for protective conductor (PE)
	Ground (e.g. M 24 V)
	Connection for function potential bonding

Notation

The following notation and abbreviations are used in this documentation:

Notation for faults and alarms (examples):

- F12345 Fault 12345
- A67890 Alarm 67890
- C23456 Safety message

Notation for parameters (examples):

- p0918 Adjustable parameter 918
- r1024 Display parameter 1024
- p1070[1] Adjustable parameter 1070, index 1
- p2098[1].3 Adjustable parameter 2098, index 1 bit 3
- p0099[0...3] Adjustable parameter 99, indices 0 to 3
- r0945[2](3) Display parameter 945, index 2 of drive object 3
- p0795.4 Adjustable parameter 795, bit 4

Contents

	Preface	5
1	Fundamental safety instructions	19
1.1	General safety instructions	19
1.2	Safety instructions for electromagnetic fields (EMF)	24
1.3	Handling electrostatic sensitive devices (ESD)	25
1.4	Industrial security	26
1.5	Residual risks of power drive systems.....	27
2	Preparation for commissioning	29
2.1	Requirements for commissioning	30
2.2	Check lists to commission SINAMICS S.....	32
2.3	PROFIBUS components	35
2.4	PROFINET components	36
2.5	System rules, sampling times and DRIVE-CLiQ wiring	37
2.5.1	Overview of system limits and system utilization	37
2.5.2	System rules	38
2.5.3	Rules on the sampling times.....	40
2.5.3.1	Rules when setting the sampling times	40
2.5.3.2	Rules for isochronous mode	42
2.5.3.3	Default settings for the sampling times	44
2.5.3.4	Setting the pulse frequency	45
2.5.3.5	Setting sampling times	46
2.5.3.6	Overview of important parameters.....	47
2.5.4	Rules for wiring with DRIVE-CLiQ	48
2.5.4.1	Binding DRIVE-CLiQ interconnection rules	48
2.5.4.2	Recommended interconnection rules	50
2.5.4.3	Rules for automatic configuration	53
2.5.4.4	Changing the offline topology in the STARTER commissioning tool.....	54
2.5.4.5	Modular machine concept: Offline correction of the reference topology	55
2.5.5	Notes on the number of controllable drives	58
2.5.5.1	Number of drives depending on the control mode and cycle times.....	58
2.5.5.2	Cycle mix for servo control and vector control.....	64
2.6	Supported sample topologies	67
2.6.1	Topology example: Drives in vector control.....	67
2.6.2	Topology example: Parallel Motor Modules in vector control	69
2.6.3	Topology example: Power Modules.....	70
2.6.4	Example topologies: Drives in servo control	72
2.6.4.1	Example: Sampling time 125 μ s	72
2.6.4.2	Examples: Sampling time 62.5 μ s and 31.25 μ s	73
2.6.5	Topology example: Drives in U/f control (vector control).....	74

2.7	DRIVE-CLiQ diagnostics.....	75
2.8	Powering-up/powering-down the drive system	76
3	Commissioning	81
3.1	Safety instructions for commissioning	81
3.2	Procedure when commissioning	82
3.3	STARTER commissioning tool.....	84
3.3.1	General information on STARTER.....	84
3.3.1.1	Calling STARTER	84
3.3.1.2	Description of the user interface	85
3.3.1.3	BICO interconnection procedure in STARTER.....	86
3.3.2	Important functions in the STARTER commissioning tool.....	95
3.3.2.1	Restoring the factory settings	95
3.3.2.2	Load project to target device.....	96
3.3.2.3	Create data records (offline) and copy	96
3.3.2.4	Retentively saving data	96
3.3.2.5	Load the project to the PG/PC.....	97
3.3.2.6	Create and correct safety functions	97
3.3.2.7	Activate write protection.....	97
3.3.2.8	Activate know-how protection	98
3.3.3	Activating online operation: STARTER via PROFIBUS.....	100
3.3.4	Activating online operation: STARTER via Ethernet.....	102
3.3.5	Activating online operation: STARTER via PROFINET IO	108
3.4	Creating a project in the STARTER commissioning tool	115
3.4.1	Creating a project offline	115
3.4.2	Creating a project online	119
3.5	Commissioning the servo control booksize format for the first time	123
3.5.1	Task	123
3.5.2	Component wiring (example).....	125
3.5.3	Signal flow of the commissioning example	126
3.5.4	Commissioning with STARTER (example)	127
3.6	Commissioning U/f vector control booksize format for the first time.....	133
3.6.1	Task	133
3.6.2	Component wiring (example).....	134
3.6.3	Signal flow of the commissioning example	135
3.6.4	Commissioning with STARTER (example)	136
3.7	Commissioning the vector control chassis format for the first time	143
3.7.1	Task	144
3.7.2	Component wiring (example).....	145
3.7.3	Signal flow of the commissioning example	146
3.7.4	Commissioning with STARTER (example)	147
3.8	First commissioning vector control AC drive blocksize format	155
3.8.1	Task	155
3.8.2	Component wiring (example).....	156
3.8.3	Quick commissioning using the BOP (example).....	156

3.9	First commissioning servo control AC drive blocksize format	160
3.9.1	Task	160
3.9.2	Component wiring (example).....	161
3.9.3	Quick commissioning using the BOP (example)	162
3.10	Commissioning of power units connected in parallel.....	165
3.11	Learn devices.....	171
3.12	Selection and configuration of encoders.....	173
3.12.1	Encoder selection	173
3.12.2	Configuring an encoder.....	174
3.12.3	Example: Commissioning and replacement of a DRIVE-CLiQ encoder.....	180
3.13	Commissioning of SIMOTICS L-1FN3 linear motors	182
3.13.1	Safety instructions for commissioning linear motors	182
3.13.2	Checklists for commissioning	183
3.13.3	General information for setting the commutation.....	185
3.13.4	Parameterizing a motor and encoder	186
3.13.5	Parameterizing and testing the temperature sensors.....	200
3.13.6	Determining the angular commutation offset / maintaining the tolerance	204
3.13.6.1	Checking the commutation angle offset with STARTER	205
3.13.6.2	Checking the commutation angle offset with an oscilloscope	206
3.13.7	Special case of a parallel connection	218
3.13.8	Optimization of the closed-loop control.....	219
3.14	Commissioning induction motors (ASM).....	220
3.15	Commissioning of synchronous reluctance motors 1FP1 without a damper cage.....	223
3.16	Commissioning permanent-magnet synchronous motors	225
3.16.1	Encoder adjustment in operation	230
3.16.2	Automatic encoder adjustment	232
3.16.3	Pole position identification	232
3.16.4	Overview of the important parameters.....	234
3.17	Commissioning separately-excited synchronous motors	235
3.18	Commissioning SIMOTICS T-1FW6 built-in torque motors.....	236
3.18.1	Safety instructions for commissioning of built-in torque motors	236
3.18.2	Checklists for commissioning	237
3.18.3	General information for setting the commutation.....	239
3.18.4	Parameterizing a motor and encoder	240
3.18.5	Parameterizing and testing the temperature sensors.....	254
3.18.6	Determining the angular commutation offset / maintaining the tolerance	258
3.18.6.1	Checking the commutation angle offset with STARTER	260
3.18.6.2	Checking the commutation angle offset with an oscilloscope	260
3.18.7	Special case of a parallel connection	272
3.18.8	Optimization of the closed-loop control.....	273
3.19	Commissioning of SSI encoders.....	274
3.19.1	Notes on commissioning SSI encoders	274
3.19.2	Encoder identification for SSI encoders without incremental tracks.....	278
3.19.3	Overview of important parameters.....	280
3.20	Commissioning of a 2-pole resolver as absolute encoder.....	281

3.21	Temperature sensors for SINAMICS components	282
3.22	Basic Operator Panel 20 (BOP20)	292
3.22.1	Operation with BOP20 (Basic Operator Panel 20)	292
3.22.1.1	General information about the BOP20	292
3.22.1.2	Displays and using the BOP20	296
3.22.1.3	Fault and alarm displays	301
3.22.1.4	Controlling the drive using the BOP20	302
3.22.2	Important functions via BOP20	302
4	Diagnostics	305
4.1	Diagnostics via LEDs	306
4.1.1	Control Units	306
4.1.1.1	Description of the LED states of a CU320-2	306
4.1.1.2	Description of the LED states of a CU310-2	311
4.1.2	Power units	316
4.1.2.1	Safety instructions for diagnostic LEDs of the power units	316
4.1.2.2	Active Line Module booksize	316
4.1.2.3	Basic Line Module booksize	317
4.1.2.4	Smart Line Modules booksize 5 kW and 10 kW	318
4.1.2.5	Smart Line Modules booksize 16 kW to 55 kW	318
4.1.2.6	Single Motor Module / Double Motor Module / Power Module	319
4.1.2.7	Braking Module in booksize format	320
4.1.2.8	Smart Line Module booksize compact format	320
4.1.2.9	Motor Module booksize compact format	321
4.1.2.10	Control Interface Module in the Active Line Module chassis format	322
4.1.2.11	Control Interface Module in the Basic Line Module chassis format	323
4.1.2.12	Control Interface Module in the Smart Line Module chassis format	324
4.1.2.13	Control Interface Module in the Motor Module chassis format	325
4.1.2.14	Control Interface Module in the Power Module chassis format	326
4.1.3	Additional modules	327
4.1.3.1	Control Supply Module	327
4.1.3.2	Sensor Module Cabinet SMC10 / SMC20	327
4.1.3.3	Sensor Module Cabinet SMC30	328
4.1.3.4	Sensor Module Cabinet SMC40	328
4.1.3.5	Communication Board CBC10 for CANopen	329
4.1.3.6	Communication Board Ethernet CBE20	330
4.1.3.7	Communication Board Ethernet CBE25	332
4.1.3.8	Voltage Sensing Module VSM10	334
4.1.3.9	DRIVE-CLiQ Hub Module DMC20	334
4.1.4	Terminal Module	335
4.1.4.1	Terminal Module TM15	335
4.1.4.2	Terminal Module TM31	336
4.1.4.3	Terminal Module TM120	336
4.1.4.4	Terminal Module TM150	337
4.1.4.5	Terminal Module TM41	338
4.1.4.6	Terminal Module TM54F	339

4.2	Diagnostics via STARTER	341
4.2.1	Function generator	341
4.2.2	Trace function	345
4.2.2.1	Single trace	345
4.2.2.2	Multiple trace	348
4.2.2.3	Startup trace	350
4.2.2.4	Overview of important alarms and faults	352
4.2.3	Measuring function	353
4.2.4	Measuring sockets	355
4.3	Diagnostic buffer	360
4.4	Diagnostics of uncommissioned axes	363
4.5	Fault and alarm messages	366
4.5.1	General information about faults and alarms	366
4.5.2	Buffer for faults and alarms	367
4.5.3	Configuring messages	371
4.5.4	Overview of important function diagrams and parameters	374
4.5.5	Propagation of faults	375
4.5.6	Alarm classes	376
4.6	Troubleshooting for encoders	378
A	Appendix.....	381
A.1	List of abbreviations	381
A.2	Documentation overview	391
A.3	Availability of hardware components	392
A.4	Availability of SW functions	397
	Index.....	403

Fundamental safety instructions

1.1 General safety instructions



	<p>! DANGER</p> <p>Danger to life due to live parts and other energy sources</p> <p>Death or serious injury can result when live parts are touched.</p> <ul style="list-style-type: none"> • Only work on electrical devices when you are qualified for this job. • Always observe the country-specific safety rules. <p>Generally, six steps apply when establishing safety:</p> <ol style="list-style-type: none"> 1. Prepare for shutdown and notify all those who will be affected by the procedure. 2. Disconnect the machine from the supply. <ul style="list-style-type: none"> – Switch off the machine. – Wait until the discharge time specified on the warning labels has elapsed. – Check that it really is in a no-voltage condition, from phase conductor to phase conductor and phase conductor to protective conductor. – Check whether the existing auxiliary supply circuits are de-energized. – Ensure that the motors cannot move. 3. Identify all other dangerous energy sources, e.g. compressed air, hydraulic systems, or water. 4. Isolate or neutralize all hazardous energy sources by closing switches, grounding or short-circuiting or closing valves, for example. 5. Secure the energy sources against switching on again. 6. Ensure that the correct machine is completely interlocked. <p>After you have completed the work, restore the operational readiness in the inverse sequence.</p>
--	---



	<p>! WARNING</p> <p>Danger to life through a hazardous voltage when connecting an unsuitable power supply</p> <p>Touching live components can result in death or severe injury.</p> <ul style="list-style-type: none"> • Only use power supplies that provide SELV (Safety Extra Low Voltage) or PELV- (Protective Extra Low Voltage) output voltages for all connections and terminals of the electronics modules.
--	--



! WARNING

Danger to life when live parts are touched on damaged devices

Improper handling of devices can cause damage.

For damaged devices, hazardous voltages can be present at the enclosure or at exposed components; if touched, this can result in death or severe injury.

- Ensure compliance with the limit values specified in the technical data during transport, storage and operation.
- Do not use any damaged devices.



! WARNING

Danger to life through electric shock due to unconnected cable shields

Hazardous touch voltages can occur through capacitive cross-coupling due to unconnected cable shields.

- As a minimum, connect cable shields and the conductors of power cables that are not used (e.g. brake cores) at one end at the grounded housing potential.



! WARNING

Danger to life due to electric shock when not grounded

For missing or incorrectly implemented protective conductor connection for devices with protection class I, high voltages can be present at open, exposed parts, which when touched, can result in death or severe injury.

- Ground the device in compliance with the applicable regulations.



! WARNING

Danger to life due to electric shock when opening plug connections in operation

When opening plug connections in operation, arcs can result in severe injury or death.

- Only open plug connections when the equipment is in a no-voltage state, unless it has been explicitly stated that they can be opened in operation.

NOTICE**Material damage due to loose power connections**

Insufficient tightening torques or vibrations can result in loose electrical connections. This can result in damage due to fire, device defects or malfunctions.

- Tighten all power connections with the specified tightening torques, e.g. line supply connection, motor connection, DC link connections.
- Check all power connections at regular intervals. This applies in particular after transport.

 **WARNING****Danger to life due to fire spreading if housing is inadequate**

Fire and smoke development can cause severe personal injury or material damage.

- Install devices without a protective housing in a metal control cabinet (or protect the device by another equivalent measure) in such a way that contact with fire is prevented.
- Ensure that smoke can only escape via controlled and monitored paths.

 **WARNING****Danger to life through unexpected movement of machines when using mobile wireless devices or mobile phones**

Using mobile wireless devices or mobile phones with a transmit power > 1 W closer than approx. 2 m to the components may cause the devices to malfunction, influence the functional safety of machines therefore putting people at risk or causing material damage.

- Switch the wireless devices or mobile phones off in the immediate vicinity of the components.

 **WARNING****Danger to life due to the motor catching fire in the event of insulation overload**

There is higher stress on the motor insulation through a ground fault in an IT system. If the insulation fails, it is possible that death or severe injury can occur as a result of smoke and fire.

- Use a monitoring device that signals an insulation fault.
- Correct the fault as quickly as possible so the motor insulation is not overloaded.

 **WARNING**

Danger to life due to fire if overheating occurs because of insufficient ventilation clearances

Inadequate ventilation clearances can cause overheating of components with subsequent fire and smoke. This can cause severe injury or even death. This can also result in increased downtime and reduced service lives for devices/systems.

- Ensure compliance with the specified minimum clearance as ventilation clearance for the respective component.

 **WARNING**

Danger of an accident occurring due to missing or illegible warning labels

Missing or illegible warning labels can result in accidents involving death or serious injury.

- Check that the warning labels are complete based on the documentation.
- Attach any missing warning labels to the components, in the national language if necessary.
- Replace illegible warning labels.

NOTICE

Device damage caused by incorrect voltage/insulation tests

Incorrect voltage/insulation tests can damage the device.

- Before carrying out a voltage/insulation check of the system/machine, disconnect the devices as all converters and motors have been subject to a high voltage test by the manufacturer, and therefore it is not necessary to perform an additional test within the system/machine.

 **WARNING**

Danger to life when safety functions are inactive

Safety functions that are inactive or that have not been adjusted accordingly can cause operational faults on machines that could lead to serious injury or death.

- Observe the information in the appropriate product documentation before commissioning.
- Carry out a safety inspection for functions relevant to safety on the entire system, including all safety-related components.
- Ensure that the safety functions used in your drives and automation tasks are adjusted and activated through appropriate parameterizing.
- Perform a function test.
- Only put your plant into live operation once you have guaranteed that the functions relevant to safety are running correctly.

Note

Important safety notices for Safety Integrated functions

If you want to use Safety Integrated functions, you must observe the safety notices in the Safety Integrated manuals.

 **WARNING**

Danger to life or malfunctions of the machine as a result of incorrect or changed parameterization

As a result of incorrect or changed parameterization, machines can malfunction, which in turn can lead to injuries or death.

- Protect the parameterization (parameter assignments) against unauthorized access.
- Respond to possible malfunctions by applying suitable measures (e.g. EMERGENCY STOP or EMERGENCY OFF).

1.2 Safety instructions for electromagnetic fields (EMF)



 **WARNING**

Danger to life from electromagnetic fields

Electromagnetic fields (EMF) are generated by the operation of electrical power equipment such as transformers, converters or motors.

People with pacemakers or implants are at a special risk in the immediate vicinity of these devices/systems.

- Ensure that the persons involved are the necessary distance away (minimum 2 m).

1.3 Handling electrostatic sensitive devices (ESD)

Electrostatic sensitive devices (ESD) are individual components, integrated circuits, modules or devices that may be damaged by either electric fields or electrostatic discharge.



NOTICE

Damage through electric fields or electrostatic discharge

Electric fields or electrostatic discharge can cause malfunctions through damaged individual components, integrated circuits, modules or devices.

- Only pack, store, transport and send electronic components, modules or devices in their original packaging or in other suitable materials, e.g. conductive foam rubber or aluminum foil.
- Only touch components, modules and devices when you are grounded by one of the following methods:
 - Wearing an ESD wrist strap
 - Wearing ESD shoes or ESD grounding straps in ESD areas with conductive flooring
- Only place electronic components, modules or devices on conductive surfaces (table with ESD surface, conductive ESD foam, ESD packaging, ESD transport container).

1.4 Industrial security

Note

Industrial security

Siemens provides products and solutions with industrial security functions that support the secure operation of plants, solutions, machines, equipment and/or networks. They are important components in a holistic industrial security concept. With this in mind, Siemens' products and solutions undergo continuous development. Siemens recommends strongly that you regularly check for product updates.

For the secure operation of Siemens products and solutions, it is necessary to take suitable preventive action (e.g. cell protection concept) and integrate each component into a holistic, state-of-the-art industrial security concept. Third-party products that may be in use should also be considered. For more information about industrial security, visit this address (<http://www.siemens.com/industrialsecurity>).

To stay informed about product updates as they occur, sign up for a product-specific newsletter. For more information, visit this address (<http://support.automation.siemens.com>).

WARNING

Danger as a result of unsafe operating states resulting from software manipulation

Software manipulation (e.g. by viruses, Trojan horses, malware, worms) can cause unsafe operating states to develop in your installation which can result in death, severe injuries and/or material damage.

- Keep the software up to date.
You will find relevant information and newsletters at this address (<http://support.automation.siemens.com>).
- Incorporate the automation and drive components into a holistic, state-of-the-art industrial security concept for the installation or machine.
You will find further information at this address (<http://www.siemens.com/industrialsecurity>).
- Make sure that you include all installed products into the holistic industrial security concept.

WARNING

Danger to life due to software manipulation when using exchangeable storage media

Storing files onto exchangeable storage media amounts to an increased risk of infection, e.g. with viruses and malware. As a result of incorrect parameterization, machines can malfunction, which in turn can lead to injuries or death.

- Protect files stored on exchangeable storage media from malicious software by taking suitable protection measures, e.g. virus scanners.

1.5 Residual risks of power drive systems

When assessing the machine- or system-related risk in accordance with the respective local regulations (e.g., EC Machinery Directive), the machine manufacturer or system installer must take into account the following residual risks emanating from the control and drive components of a drive system:

1. Unintentional movements of driven machine or system components during commissioning, operation, maintenance, and repairs caused by, for example,
 - Hardware and/or software errors in the sensors, control system, actuators, and cables and connections
 - Response times of the control system and of the drive
 - Operation and/or environmental conditions outside the specification
 - Condensation/conductive contamination
 - Parameterization, programming, cabling, and installation errors
 - Use of wireless devices/mobile phones in the immediate vicinity of electronic components
 - External influences/damage
 - X-ray, ionizing radiation and cosmic radiation
2. Unusually high temperatures, including open flames, as well as emissions of light, noise, particles, gases, etc., can occur inside and outside the components under fault conditions caused by, for example:
 - Component failure
 - Software errors
 - Operation and/or environmental conditions outside the specification
 - External influences/damage
3. Hazardous shock voltages caused by, for example:
 - Component failure
 - Influence during electrostatic charging
 - Induction of voltages in moving motors
 - Operation and/or environmental conditions outside the specification
 - Condensation/conductive contamination
 - External influences/damage
4. Electrical, magnetic and electromagnetic fields generated in operation that can pose a risk to people with a pacemaker, implants or metal replacement joints, etc., if they are too close
5. Release of environmental pollutants or emissions as a result of improper operation of the system and/or failure to dispose of components safely and correctly

For more information about the residual risks of the drive system components, see the relevant sections in the technical user documentation.

Preparation for commissioning

Before commissioning observe the conditions described in this chapter.

- The preconditions for commissioning must be fulfilled (in the next chapter).
- The relevant checklist must have been worked through.
- The bus components required for communication must be wired up.
- DRIVE-CLiQ wiring rules must be complied with.
- The ON-OFF responses of the drive.

2.1 Requirements for commissioning

The following are necessary for commissioning a SINAMICS S drive system:

- A programming device (PG/PC)
- STARTER commissioning tool
- A communication interface, e.g. PROFIBUS, PROFINET, Ethernet
- Completely wired-up drive line-up (see the SINAMICS S120 Manual)

The following diagram shows a configuration example with booksize and chassis components, as well as with PROFIBUS and PROFINET communication:

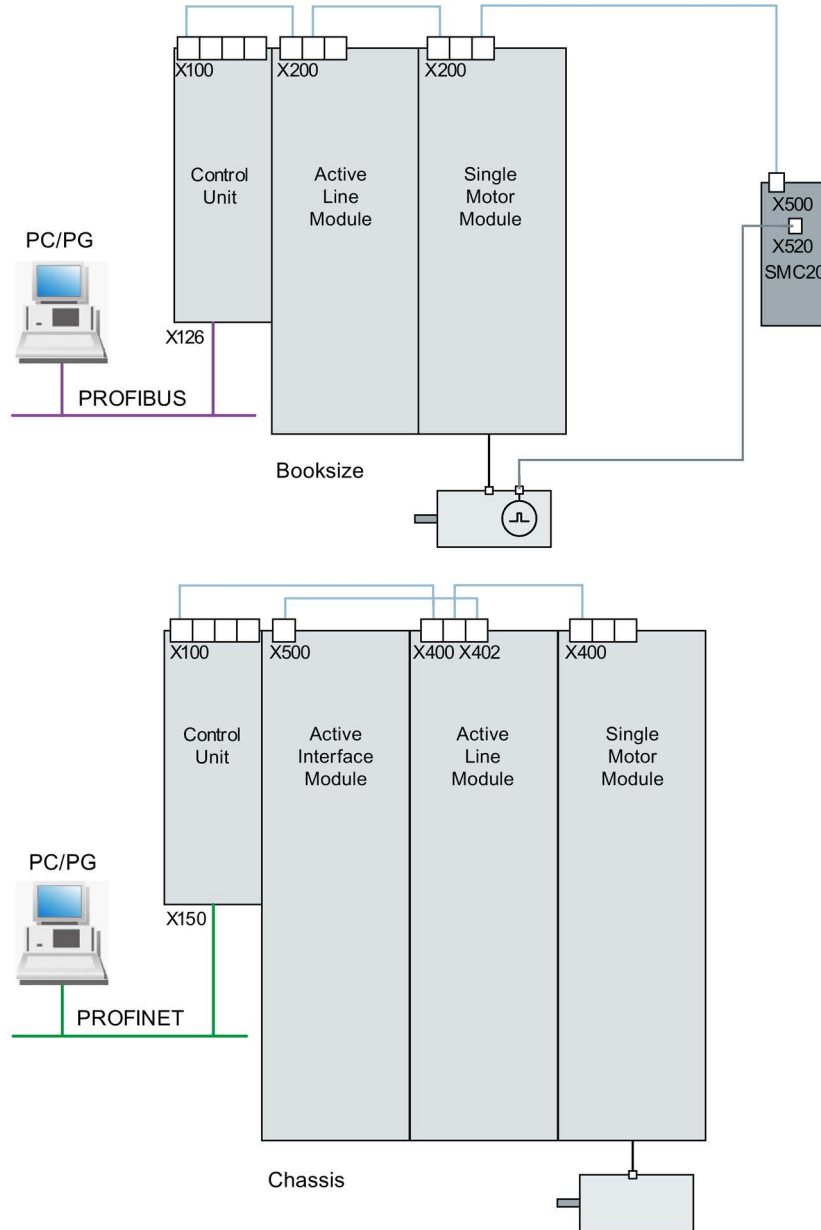

Image 2-1 Component configuration (example)

2.2 Check lists to commission SINAMICS S

Checklist (1) for commissioning booksize power units

The following checklist must be carefully observed. Read the safety instructions in the manuals before starting any work.

Table 2- 1 Checklist for commissioning (booksize)

Check	OK
Are the environmental conditions in the permissible range?	
Is the component firmly attached to the fixing points provided?	
Is the specified air flow for cooling the devices ensured?	
Have the ventilation clearances for the components been observed?	
Is the memory card correctly inserted in the Control Unit?	
Are all necessary components of the configured drive line-up available, installed and connected?	
Do the temperature monitoring circuits fulfill the specifications of protective separation?	
Have the DRIVE-CLiQ topology rules been observed?	
Have the line-side and motor-side power cables been dimensioned and routed in accordance with the environmental and routing conditions?	
Have the maximum permitted cable lengths between the frequency converter and the motor (depending on the type of cables used) been observed?	
Have the power cables been properly connected to the component terminals with the specified torque?	
Have all of the remaining screws been tightened to the specified torque?	
Has all wiring work been successfully completed?	
Are all connectors correctly plugged in and screwed in place?	
Have all the covers for the DC link been closed and latched into place?	
Have the shield supports been correctly connected through a large surface area?	

Checklist (2) for commissioning chassis power units

The following checklist must be carefully observed. Read the safety instructions in the manuals before starting any work.

Table 2- 2 Checklist for commissioning (chassis)

Activity	OK
Are the environmental conditions in the permissible range?	
Are the components correctly installed in the cabinets?	
Is the specified air flow for cooling the devices ensured?	
Is an air short-circuit between the air inlet and outlet for the chassis components prevented by the installation arrangements?	
Have the ventilation clearances for the components been observed?	

Activity	OK
Is the memory card correctly inserted in the Control Unit?	
Are all necessary components of the configured drive line-up available, installed and connected?	
Do the temperature monitoring circuits fulfill the specifications of protective separation?	
Have the DRIVE-CLiQ topology rules been observed?	
Have the line-side and motor-side power cables been dimensioned and routed in accordance with the environmental and routing conditions?	
Have the maximum permitted cable lengths between the frequency converter and the motor (depending on the type of cables used) been observed?	
Is the ground for the motors directly connected to the ground for the Motor Modules (shortest distance)?	
Are the motors connected with shielded power cables?	
Are the power cable shields connected as closely as possible to the terminal box across a wide area?	
Have the power cables been properly connected to the component terminals with the specified torque?	
Have all of the remaining screws been tightened to the specified torque?	
Has the total power of the DC busbar been dimensioned sufficiently?	
Has the busbar/wiring for the DC connection between the infeed and the Motor Modules been dimensioned sufficiently with regard to the load and installation conditions?	
Are the cables between the low-voltage switchgear and the power unit protected with line fuses? Line protection ⁽¹⁾ must be taken into account.	
Have measures been taken to relieve strain on the cables?	
For external auxiliary infeed: Have the cables for the auxiliary infeed been connected according to the Equipment Manual?	
Have the control cables been connected in accordance with the required interface configuration and the shield applied?	
Have the digital and analog signals been routed with separate cables?	
Has the distance from power cables been observed?	
Has the cabinet been properly grounded at the points provided?	
Has the connection voltage for the fans in the chassis components been adapted accordingly to the supply voltages?	
For operation on non-grounded supply systems: Has the connection bracket for the interference suppression at the Infeed Module or the Power Module been removed?	
Is the period from the date of manufacture to the initial commissioning or the downtime of the power components less than two years ⁽²⁾ ?	
Is the drive operated from a higher-level controller/control room?	

⁽¹⁾ Combined fuses are recommended for conductor and semi-conductor protection (VDE 636, Part 10 and Part 40 / EN 60269-4). For information about the relevant fuses, see the catalog.

⁽²⁾ If the downtime period is longer than two years, the DC-link capacitors must be formed (see the "Maintenance and Servicing" chapter in the Equipment Manual). The cabinet type plate can be used to ascertain the date of manufacture.

Checklist (3) for commissioning blocksize Power Modules

The following checklist must be carefully observed. Read the safety instructions in the manuals before starting any work.

Table 2- 3 Check list for commissioning blocksize

Check	OK
Are the environmental conditions in the permissible range?	
Is the component firmly attached to the fixing points provided?	
Is the specified air flow for cooling the devices ensured?	
Have the ventilation clearances for the components been observed?	
Is the memory card correctly inserted in the Control Unit?	
Are all necessary components of the configured drive line-up available, installed and connected?	
Do the temperature monitoring circuits fulfill the specifications of protective separation?	
Have the line-side and motor-side power cables been dimensioned and routed in accordance with the environmental and routing conditions?	
Have the maximum permitted cable lengths between the frequency converter and the motor (depending on the type of cables used) been observed?	
Have the power cables been properly connected to the component terminals with the specified torque?	
Have all of the remaining screws been tightened to the specified torque?	
Has all wiring work been successfully completed?	
Are all connectors correctly plugged in and screwed in place?	
Have the shield supports been correctly connected through a large surface area?	

2.3 PROFIBUS components

For communication via PROFIBUS, the following components are necessary.

- A communication module for PG/PC connection via the PROFIBUS interface.
 - PROFIBUS connection to a PG/PC via USB port (USB V2.0).
Structure: USB port (USB V2.0) + adapter with 9-pin SUB-D socket connector to connect to PROFIBUS.
Used with driver SIMATIC NET PC Software Edition 2008 + SP2
Article number: 6GK1571-1AA00
- Connecting cable
Connecting cable between PROFIBUS adapter and PG/PC, such as
 - CP 5xxx cable, article number: 6ES7901-4BD00-0XA0
 - MPI cable (SIMATIC S7), article number: 6ES7901-0BF00-0AA0

Cable lengths

Table 2- 4 Permissible PROFIBUS cable lengths

Baud rate [bit/s]	Max. cable length [m]
9.6 k to 187.5 k	1000
500 k	400
1500 k	200
3000 to 12000 k	100

2.4 PROFINET components

For communication via PROFINET, the following components are necessary:

- A communication module for PG/PC connection via the PROFINET interface.

Note

Cables that can be used for commissioning

For commissioning using the STARTER commissioning tool, the onboard Ethernet interface of the Control Unit can be used with a crossover cable from CAT5 and higher.

The PROFINET module CBE20 supports all standard Ethernet cables and crossover cables from CAT5/5e and higher. The crossover cable is essential for an Ethernet X127 interface.

- Connecting cable
Connecting cable between PROFINET interface and PG/PC, such as
 - Industrial Ethernet FC TP Standard Cable GP 2 x 2 (up to max. 100 m)
Standard bus cable with rigid conductors and a special design for fast installation
 - Industrial Ethernet FC TP Flexible Cable GP 2 x 2 (up to max. 85 m)
 - Industrial Ethernet FC Trailing Cable GP 2 x 2 (up to max. 85 m)
 - Industrial Ethernet FC Trailing Cable 2 x 2 (up to max. 85 m)
 - Industrial Ethernet FC Marine Cable 2 x 2 (up to max. 85 m)
- Connector
Connector between the PROFINET interface and the PG/PC, for example
 - Industrial Ethernet FC RJ45 Plug 145 for Control Unit

2.5 System rules, sampling times and DRIVE-CLiQ wiring

2.5.1 Overview of system limits and system utilization

The number and type of controlled axes, infeeds and Terminal Modules as well as the additionally activated functions can be scaled by configuring the firmware.

Note

The subsequently described rules are applicable for both the STARTER and Startdrive commissioning tools. This is the reason that only the "Commissioning tool" term is used.

The software and control functions available in the system are executed cyclically with different sampling times (p0115, p0799, p4099). These sampling times are automatically pre-assigned when configuring the drive (see Section Default setting (Page 44)). They can be subsequently adapted by the user.

The number of controllable drives, infeeds and Terminal Modules that can be operated with the selected Control Unit depends on some system rules, the set sampling times, the control mode and the activated additional functions.

There are also still dependencies and rules for the components used and the selected DRIVE-CLiQ wiring.

The existing rules are described in greater detail in the following sub-sections. After this there are notes on the number of controllable drives and some example topologies.

The following standard quantity structures are operable with standard clock cycles:

- 12 V/f control axes with 500 μ s
- 6 vector axes with 500 μ s
- 6 servo axes with 125 μ s
- 3 vector axes with 250 μ s
- 3 servo axes with 62.5 μ s
- 1 servo axis with 31.25 μ s (single-axis module)

Consequently, the conversion of an axis from 125 μ s to 62.5 μ s normally leads to the loss of an axis. This rule can also be used for the clock-cycle mixing to achieve a general estimate of the quantity structure.

Especially for demanding configurations, drives with high dynamic response or a large number of axes with additional utilization of special functions for example, a check using the SIZER engineering tool is recommended. The SIZER engineering tool calculates the feasibility of the project.

Finally, the utilization flag in r9976 indicates whether a topology is operable. If the utilization exceeds 100%, this is indicated with fault F01054. In this case, one or more axes must be dispensed with or the function scope reduced.

2.5.2 System rules

A maximum of 24 drive objects (DOs) can be connected to one Control Unit.

Control Units

- The CU310-2 Control Unit is a single-axis control module for operating the AC/AC Power Modules in the Blocksize (PM240-2 or PM340) and Chassis formats. Terminal Modules, Sensor Modules and HUB Modules can also be connected in addition to these.
- The CU320-2 Control Unit is a multi-axis control module for operating Infeed Modules and Motor Modules in Booksize, Chassis and Blocksize formats. Terminal Modules, Sensor Modules and HUB Modules can also be connected in addition to these.

Motor Modules/control modes

For the CU310-2 Control Unit the following applies:

- The CU310-2 Control Unit is a single-axis control module (servo control, vector control or vector control V/f control) plugged into a PM240-2 or PM340 Power Module, or for operation with a maximum of one AC/AC Power Module in the Chassis format (via the X100 DRIVE-CLiQ connection).

For the CU320-2 Control Unit the following applies:

- The CU320-2 Control Unit is a multi-axis control module for operating Motor Modules in the Booksize, Chassis and Blocksize formats (PM240-2 and PM340 via CUA).
- For multi-axis modules, each axis counts individually (one Double Motor Module = two Motor Modules).
- A maximum of 6 drive objects may be operated concurrently in servo control and HLA control.
- There can be a maximum of 12 drive objects of the VECTOR type present concurrently.
 - A maximum of 6 drive objects can be operated concurrently in vector control.
 - A maximum of 12 drive objects can be operated concurrently with U/f control.
- Mixed operation of control types:

The following are permitted:

- Mixed operation of servo control and V/f control.
- Mixed operation of vector control and V/f control.
- Mixed operation of HLA and servo control.
- Mixed operation of HLA and vector control and V/f control.

The following are not permitted:

- Mixed operation of servo control and vector control.
- Mixed operation of HLA and servo control and V/f control.

The following applies when connecting Motor Modules in parallel:

- A parallel connection is only permitted in the chassis format and only in the vector control or V/f control mode.
- A maximum of four Motor Modules are permitted in a parallel connection. All Motor Modules connected in parallel must have the same output.
- A drive object is created for a parallel connection.
- Only one parallel connection exactly is permitted per Control Unit.

Line Modules

For the CU310-2 Control Unit the following applies:

- Operating Line Modules is not permitted

For the CU320-2 Control Unit the following applies:

- Only one drive object of the Smart Line Module (SLM), Basic Line Module (BLM) and Active Line Module (ALM) types is permitted in each case.
- Mixed operation of an Active Line Module with a Smart Line Module (SLM) or with a Basic Line Module (BLM) is not permitted.
- Mixed operation of a drive object of the Smart Line Module (SLM) type with a drive object of the Basic Line Module (BLM) type is permitted.
- An active Voltage Sensing Module (VSM) must be assigned to each active Active Line Module (ALM) or Smart Line Module (SLM) of the chassis format. A violation of this rule causes fault F05061 to be issued.
- Two further Voltage Sensing Modules can be operated with the "network transformer" function module for Active Line Modules (ALM).

The following applies to parallel connection of Line Modules:

- Parallel connection is permitted for Infeed Modules in the chassis format and for Active Line Modules (ALM) from the 120 kW performance class for the booksize format.
- A maximum of four Infeed Modules are permitted within a parallel connection.
- In booksize format, a maximum of two Active Line Modules (ALM) from the 120 kW performance class are permitted within a parallel connection.
- The operation of Infeed Modules with different performance values is not permitted within a parallel connection.
- An active Voltage Sensing Module (VSM) must be assigned to each Active Line Module (ALM) in the parallel connection. A violation of this rule causes alarm F05061 to be issued.
- When using Smart Line Modules (SLM) an active Voltage Sensing Module (VSM) must be assigned to at least one Smart Line Module (SLM) in the parallel connection. A violation of this rule causes fault F05061 to be issued.

Terminal Modules

Control Unit CU320-2:

- In total a maximum of 16 drive objects of the types TM15 Base, TM31, TM15, TM17, TM41, TM120 or TM150 can be operated concurrently.
- A maximum of one F Terminal Module (TM54F) can be connected (in addition).

Control Unit CU310-2:

- In total a maximum of eight drive objects of the types TM15 Base, TM31, TM15, TM17, TM41, TM120 or TM150 can be operated concurrently.
- A maximum of three drive objects of the types TM15, TM17 and TM41 may be operated concurrently in each case.
- A maximum of one F Terminal Module (TM54F) can be connected (in addition).

DRIVE-CLiQ Module (HUB)

- A maximum of eight drive objects can be operated concurrently for a DRIVE-CLiQ Module (DMC20 or DME20). DMC20/DME20 do not count twice here.

2.5.3 Rules on the sampling times

2.5.3.1 Rules when setting the sampling times

The following rules apply when setting the sampling times:

General rules

- There are a maximum 2 possible cycle levels on the Control Unit, where the lowest sampling times are not integer multiples with respect to one another. All sampling times set must be an integer multiple of the smallest sampling time from one of these two cycle levels.

Example 1:

- Smallest sampling time cycle level 1: Active Line Module with 250 μ s
- Smallest sampling time cycle level 2: One VECTOR drive object with 455 μ s (p0113 = 1.098 kHz)

This setting is permitted.

Additional sampling times must be integer multiples of 250 μ s or 455 μ s.

Terminal Modules, Terminal Board, Control Unit:

- For the digital and analog inputs/outputs of these components the minimum sampling time (p0799, p4099, p0115) set must be 125 μ s.

Pulse frequencies and current controller sampling times:

- The current controller sampling times of the drives and infeeds must be synchronous to the set pulse frequency of the power unit (see also p1800 in the SINAMICS S120/S150 Lists Manual). Any increase in the pulse frequency requires a reduction in the sampling times and increases the derating in the power unit.

Line Modules

- For Active Line Modules (ALM) and Smart Line Modules (SLM) in booksize format the only current controller sampling time which can be set is 125 μ s or 250 μ s.
- For Active Line Modules (ALM) and Smart Line Modules (SLM) in chassis format the permitted current controller sampling time depends on the relevant module. The current controller sampling time can either only be set to 250 μ s or the current controller sampling time selected can be 400 μ s or 375 μ s (375 μ s for p0092 = 1).
- For Basic Line Modules (BLM) the only current controller sampling time which can be set is 2000 μ s (chassis format) or 250 μ s (booksize format).

Motor Modules

- For Single Motor Modules in booksize format, a current controller sampling time of minimum 31.25 μ s can be set ($31.25 \mu\text{s} \leq p0115[0] \leq 500 \mu\text{s}$).
- For Double Motor Modules in booksize format, a current controller sampling time of minimum 62.5 μ s can be set ($62.5 \mu\text{s} \leq p0115[0] \leq 500 \mu\text{s}$).
- For Motor Modules in chassis format, a current controller sampling time of minimum 125 μ s can be set ($125 \mu\text{s} \leq p0115[0] \leq 500 \mu\text{s}$).
- For Motor Modules in blocksize format, a current controller sampling time of 62.5 μ s, 125 μ s, 250 μ s or 500 μ s can be set (only pulse frequencies in multiples of 2 kHz are permissible).

For PM240-2 FS D-F the minimum current controller sampling time is 125 μ s.

- For the HLA module, a current controller sampling time of minimum 62.5 μ s can be set ($62.5 \mu\text{s} \leq p0115[0] \leq 250 \mu\text{s}$).

Servo control / HLA control

- A current controller sampling time between 31.25 μ s and 250 μ s can be set for servo drives ($31.25 \mu\text{s} \leq p0115[0] \leq 250 \mu\text{s}$).
- For HLA drives, a current controller sampling time between 62.5 μ s and 250 μ s can be set ($62.5 \mu\text{s} \leq p0115[0] \leq 250 \mu\text{s}$).
- The fastest sampling time for a drive object in servo control or HLA is as follows:
 - $T_i = 31.25 \mu\text{s}$: Exactly one drive object in servo control
 - $T_i = 62.5 \mu\text{s}$: Max. three drive objects in servo control or HLA
 - $T_i = 125 \mu\text{s}$: Max. six drive objects in servo control or HLA

Vector control / V/f control

- A current controller sampling time between 125 μs and 500 μs can be set for vector drives ($125 \mu\text{s} \leq p0115[0] \leq 500 \mu\text{s}$). This also applies to operation with V/f control.
- For vector control and vector control, V/f control modes, and when using a sine-wave filter ($p0230 > 0$), it is only permissible to change the current controller sampling time of the DO involved in multiple integer steps of the default value on account of the design of the sine-wave filter.
- The fastest sampling time of a drive object in vector control mode is obtained as follows:
 - $T_i = 250 \mu\text{s}$: Max. three drive objects in vector control
 - $T_i = 375 \mu\text{s}$: Max. four drive objects in vector control
 - $T_i = 400 \mu\text{s}$: Max. five drive objects in vector control
 - $T_i = 500 \mu\text{s}$: Max. six drive objects in vector control

Note

Restriction of the number of axes for chassis in vector control

For active edge modulation / optimized pulse patterns and active wobbling, only half the number of axes is permitted.

- The fastest sampling time of a drive object in V/f control mode is obtained as follows:
 - $T_i = 500 \mu\text{s}$: Max. 12 drive objects in V/f control mode
- When vector control is operated together with vector control, V/f control, a maximum of 11 axes is possible (ALM, TB and TM additionally possible).

Safety functions

- Only Single Motor Modules are permitted for servo axes with a current controller cycle $T_{iReg} \leq 62.5 \mu\text{s}$ with the "Safety sensorless" functionality.

2.5.3.2 Rules for isochronous mode

Note

PROFIBUS legend

T_{dp} = PROFIBUS cycle (also DP cycle)

T_{mapc} = master application cycle time

T_i = Input Time (German time of incorporation of actual value)

T_o = Output Time (German time for setpoint value specification)

The following supplementary conditions must be observed for isochronous operation:

- The PROFIBUS cycle T_{dp} must be an integer multiple of 250 μs .
- The PROFIBUS cycle T_{dp} must be an integer multiple of the current controller cycle.
- The times T_i (time of incorporation of actual value) and T_o (time for setpoint value specification) must be integer multiples of 125 μs .
- The times T_i and T_o must be an integer multiple of the current controller cycle.
- T_{mapc} is an integer multiple of the speed controller cycle.
- Because T_i and T_o are always predefined for a PROFIBUS line, all drives of a Control Unit are affected and run with the same setting.
- $p0092 = 1$ (isochronous operation preassignment/validation) sets default values for the controller cycles for isochronous PROFIdrive operation during the initial commissioning.
 - The current controller cycles from "Table 2-9 Pulse frequencies and current controller cycles for servo control (Page 59)" can be set for servo control.
 - The current controller cycles from "Table 2-11 Pulse frequencies and current controller cycles for vector control (Page 60)" can be set for vector control.
- The setting rules for the safety actual value acquisition cycle and the safety monitoring cycle must be observed (for details, see SINAMICS S120 Safety Integrated Function Manual):
 - The monitoring cycle (p9500) must be an integer multiple of the actual value acquisition cycle (p9511). For $p9511 = 0$, the isochronous PROFIBUS cycle T_{dp} is used as the actual value acquisition cycle.
 - Actual value acquisition cycle $\geq 4 \times$ current controller cycle.
 - The DP cycle should be at least one current controller cycle longer than the sum of T_i and T_o .

The above conditions mean that the smallest common multiple of the current controller cycles of all axes operated on the isochronous PROFIBUS and 125 μs is used to set T_i , T_o and T_{dp} .

If isochronous operation is not possible due to incorrect sampling time settings, an appropriate message will be output (A01223, A01224).

Cycle settings for SINAMICS Link

SINAMICS Link permits only three cycle settings:

Table 2- 5 Settings for activated isochronous operation

T_i [μs]	T_o [μs]	T_{dp} [μs]
500	500	500
500	1000	1000
1500	1500	1500

2.5.3.3 Default settings for the sampling times

The sampling times of the functions are pre-assigned automatically when the drive is configured.

These default settings are based on the selected mode (vector/servo control) and the activated functions.

If isochronous mode is to be possible with a controller, before the automatic configuration, parameter p0092 must be set to "1" in order that the sampling times are appropriately preset. If isochronous operation is not possible due to incorrect sampling time settings, an appropriate message will be output (A01223, A01224).

If the application requires a change of the preset sampling times, they can be set using parameters p0112 and p0113 or directly using p0115, p0799 and p4099.

Note

Recommendation

Only appropriately qualified experts should change the sampling times set as default values.

When commissioning for the first time, the current controller sampling times (p0115[0]) are automatically preset with factory setting values:

Table 2- 6 Factory settings

Construction type	Number	p0112	p0115[0]	p1800
Active Infeed				
Booksize	1	2 (Low)	250 µs	-
Chassis				
400 V / ≤ 300 kW	1	2 (Low)	250 µs	-
690 V / ≤ 330 kW	1	2 (Low)	250 µs	-
Chassis				
400 V / > 300 kW	1	0 (Expert)	375 µs (p0092 = 1)	-
690 V / > 330 kW	1	1 (xLow)	400 µs (p0092 = 0)	-
Smart Infeed				
Booksize	1	2 (Low)	250 µs	-
Chassis				
400 V / ≤ 355 kW	1	2 (Low)	250 µs	-
690 V / ≤ 450 kW	1	2 (Low)	250 µs	-
Chassis				
400 V / > 355 kW	1	0 (Expert)	375 µs (p0092 = 1)	-
690 V / > 450 kW	1	1 (xLow)	400 µs (p0092 = 0)	-
Basic Infeed				
Booksize	1	4 (High)	250 µs	-
Chassis	1	2 (Low)	2000 µs	-

Construction type	Number	p0112	p0115[0]	p1800
SERVO				
Booksize	1 ... 6	3 (Standard)	125 µs	4 kHz
Chassis	1 ... 6	1 (xLow)	250 µs	2 kHz
Blocksize	1 ... 5	3 (Standard)	125 µs	4 kHz
VECTOR				
Booksize	1 ... 3 only n_ctrl	3 (Standard)	250 µs	4 kHz
Chassis 400 V / ≤ 250 kW	1 ... 6 only U/f			2 kHz
Booksize	4 ... 6 only n_ctrl	0 (Expert)	500 µs	4 kHz
Chassis 400 V / ≤ 250 kW	7 ... 12 only f_ctrl			2 kHz
Chassis 400 V / > 250 kW 690 V	1 ... 4 only n_ctrl 1 ... 5 only U/f 5 ... 6 only n_ctrl	0 (Expert) 1 (xLow) 0 (Expert)	375 µs (p0092 = 1) 400 µs (p0092 = 0) 500 µs (p0092 = 1)	1.333 kHz 1.25 kHz 1.0 kHz

Note

If a Power Module Blocksize is connected to a Control Unit, the sampling times of all vector drives are set according to the rules for Power Modules Blocksize (only 250 µs or 500 µs possible).

2.5.3.4 Setting the pulse frequency

The sampling times for the following functions are set by selecting the appropriate values in p0112 for the closed-loop control configuration in µs and are copied to p0115[0...6] depending on the performance levels required:

- Current controller (p0115[0])
- Speed controller (p0115[1])
- Flux controller (p0115[2])
- Setpoint channel (p0115[3])
- Position controller (p0115[4])
- Positioner (p0115[5])
- Technology controller (p0115[6])

The performance levels range from xLow to xHigh. Details of how to set the sampling times are given in the SINAMICS S120/S150 List Manual.

Setting the pulse frequency using the commissioning tool in online operation

Enter the minimum pulse frequency in p0113. For isochronous operation (p0092 = 1), you can only set the parameter so that a resulting current controller cycle with an integer multiple of 125 µs is obtained. The required pulse frequency can be set after commissioning (p0009 = p0010 = 0) in p1800.

Table 2- 7 Pulse frequency for isochronous operation

Control type	p0115[0] Current controller cycle / µs	p0113 Pulse frequency / kHz
Servo control	250	2
	125	4
Vector control	500	1
	250	2

When commissioning is exited (p0009 = p0010 = 0), the effective pulse frequency (p1800) is appropriately pre-assigned, depending on p0113, and can be subsequently modified.

2.5.3.5 Setting sampling times

If sampling times are required which cannot be set using p0112 > 1, you can directly set the sampling times in expert mode using p0115.

If p0115 is changed online, then the values of higher indices are automatically adapted.

Note

Do not change the sampling times when the commissioning tool is in the offline mode, because in this case if there is an incorrect parameterization, the project download is canceled.

Making and checking settings

1. Activate in the expert list of the Control Unit the drive base configuration with p0009 = 3.
2. In the expert list of the drive object, activate the expert mode with p0112 = 0.
3. Specify the current controller cycle for the drive object as follows: p0115[0] = current controller cycle.
For the current controller clock cycle, only use the values from "Table 2-9 Pulse frequencies and current controller cycles for servo control (Page 59)" and "Table 2-11 Pulse frequencies and current controller cycles for vector control (Page 60)".
4. Close in the expert list of the Control Unit the cycle setting with p0009 = 0.
A startup is then performed. The speed controller cycle and flux controller cycle are adapted automatically so that they remain an integer multiple of the current controller cycle.
5. Then check the maximum speed p1082, the set pulse frequency p1800 and start an automatic calculation of the controller data (p0340 = 4).

2.5.3.6 Overview of important parameters

Overview of important parameters (see SINAMICS S120/S150 List Manual)

- p0009 Device commissioning parameter filter
- p0092 Isochronous mode, pre-assignment/check
- p0097 Select drive object type
- r0110[0...2] Basic sampling times
- p0112 Sampling times pre-setting p0115
- p0113 Pulse frequency minimum selection
- r0114[0...9] Pulse frequency minimum recommended
- p0115[0...6] Sampling times for internal control loops
- r0116[0...1] Drive object cycle recommended
- p0118 Current controller computing dead time
- p0340[0...n] Automatic calculation of motor/control parameters
- p0799[0...2] CU inputs/outputs, sampling time
- p1082[0...n] Maximum velocity
- p1800[0...n] Pulse frequency setpoint
- p4099 Inputs/outputs sampling time
- r9780 SI monitoring cycle (Control Unit)
- r9880 SI monitoring cycle (Motor Module)
- r9976[0...7] System utilization

2.5.4 Rules for wiring with DRIVE-CLiQ

Rules apply for wiring components with DRIVE-CLiQ. A distinction is made between binding DRIVE-CLiQ rules, which must be unconditionally observed and recommended rules, which should then be maintained so that the topology, generated offline in the commissioning tool, no longer has to be changed.

The maximum number of DRIVE-CLiQ components and the possible wiring type depend on the following factors:

- The binding DRIVE-CLiQ wiring rules
- The number and type of activated drives and functions on the Control Unit in question
- The computing power of the Control Unit in question
- The set processing and communication cycles

Below you will find the binding wiring rules and some other recommendations as well as a few sample topologies for DRIVE-CLiQ wiring.

The components used in these examples can be removed, replaced with others or supplemented. If components are replaced by another type or additional components are added, then the SIZER configuring tool should be used to check this topology.

If the actual topology does not match the topology created offline using the commissioning tool, the offline topology must be changed accordingly before it is downloaded.

2.5.4.1 Binding DRIVE-CLiQ interconnection rules

The following generally binding DRIVE-CLiQ rules must be observed to ensure safe operation of the drive.

- Only one Control Unit is permitted in the role of DRIVE-CLiQ master in a DRIVE-CLiQ topology.
- A maximum of 14 DRIVE-CLiQ nodes can be connected to a Control Unit port on a DRIVE-CLiQ line.

Note

One Double Motor Module, one DMC20, one DME20, one TM54F and one CUA32 each correspond to two DRIVE-CLiQ nodes. This also applies to Double Motor Modules, at which just one drive is configured.

- Ring wiring or double wiring of components is not permitted.
- Drive topologies with DRIVE-CLiQ components that are not supported (by the type and the firmware version of the Control Unit) are not permitted.

- The sampling times (p0115[0] and p4099) of all components that are connected to a DRIVE-CLiQ line must be divisible by one another with an integer result, or all the sampling times set for the components must be an integer multiple of a common "base cycle".
 - Example 1: A Line Module with 250 μs and Motor Modules with 125 μs can be operated together on a DRIVE-CLiQ line ("base cycle": 125 μs)
 - Example 2: A Line Module with 250 μs and a Motor Module with 375 μs can be operated together on a DRIVE-CLiQ line ("base cycle": 125 μs)

If the current controller sampling time T_i at one drive object has to be changed in a sampling time that does not match the other drive objects in the DRIVE-CLiQ line, the following solutions are available:

- Insert the modified drive object into a separate DRIVE-CLiQ line. Note here that a total of 2 cycle levels are permissible on a Control Unit.
 - Modify the current controller sampling times and/or the sampling times of the inputs/outputs of the other drive objects similarly so they match the modified sampling time again.
- With the CU310-2 Control Unit the connection to the AC/AC Power Modules in chassis format is made via the DRIVE-CLiQ connection X100.

Rules and instructions for avoiding overloads

In general any overload must be avoided of a DRIVE-CLiQ line and the components connected to it through too many components with small sampling times. The following rules and instruction apply for this:

- A DRIVE-CLiQ line with components with a sampling time of $T_i = 31.25 \mu\text{s}$ may only be connected with components that are permitted for this sampling time. The following components are permitted:
 - Single Motor Modules in booksize format
 - Sensor Modules SMC20, SMI20, SMI24, SME20, SME25, SME120 and SME125
 - High-frequency damping modules (HF damping modules)
 - Additional DRIVE-CLiQ lines must be used for additional components.
- With current controller sampling times 31.25 μs and 62.5 μs the axes to the DRIVE-CLiQ connections must be distributed as follows:
 - DRIVE-CLiQ socket X100: Infeed, axes 2, 4, 6, ...
 - DRIVE-CLiQ socket X101: Axes 1, 3, 5, ...
- For a current controller cycle of 31.25 μs , a filter module should be directly connected to a DRIVE-CLiQ socket of the Control Unit.
- A maximum of 4 Motor Modules with Safety Extended Functions may be operated on one DRIVE-CLiQ line (for current controller cycle $T_{i\text{Reg}} = 125 \mu\text{s}$ on all axes). No further DRIVE-CLiQ components other than a Line Module and Sensor Modules may be connected to this DRIVE-CLiQ line.

Exception: For SINAMICS S120M, a maximum of 6 S120M with Safety Extended Functions can be operated on one DRIVE-CLiQ line.

The following applies for the CU Link and the CX32 and NX10/NX15 Control Units:

- In a topology with CU Link, the SINUMERIK NCU is DRIVE-CLiQ master for the NX and the SIMOTION D4xx is master for the CX32.
- The CX32 or NX10/NX15 Control Units are master for the subordinate components.
- The connection to the Control Unit is obtained from the PROFIBUS address of the CX/NX (10 → X100, 11 → X101, 12 → X102, 13 → X103, 14 → X104, 15 → X105).
- It is not permitted to combine SIMOTION Master Control Units and SINUMERIK Slave Control Units.
- It is not permitted to combine SINUMERIK Master Control Units and SIMOTION Slave Control Units.

2.5.4.2 Recommended interconnection rules

The following recommended rules should be observed for the DRIVE-CLiQ wiring:

General

- The following applies to all DRIVE-CLiQ components with the exception of the Control Unit: The DRIVE-CLiQ sockets Xx00 are DRIVE-CLiQ inputs (Uplink), the other DRIVE-CLiQ sockets are outputs (Downlink).
 - The DRIVE-CLiQ cable from the Control Unit should be connected to DRIVE-CLiQ socket X200 on the first booksize power unit or X400 on the first chassis power unit.
 - The DRIVE-CLiQ connections between the power units should each be connected from the DRIVE-CLiQ sockets X201 to X200 and/or X401 to X400 on the follow-on component.

Line Modules

- An individual Line Module should be connected directly to the Control Unit (recommended DRIVE-CLiQ socket: X100).
 - Several Line Modules should be connected in series.

Motor Modules

- No more than 6 Motor Modules should be connected to a DRIVE-CLiQ line on the Control Unit (including with vector, V/f control).
- Motor Modules should be connected directly to the Control Unit in vector control.
 - If the DRIVE-CLiQ socket X100 is already assigned to a Line Module, the DRIVE-CLiQ socket X101 should be used.
 - Several Motor Modules should be connected in a line.
 - If there is already a Line Module present at X100, the Motor Module should be connected in line to socket X201 of the Line Module.
 - Several Motor Modules should be connected in a line.

- In servo control Motor Modules should be connected to a DRIVE-CLiQ line together with the Line Module.
 - Several Motor Modules should be connected in a line.
 - If there is already a Line Module present, the first Motor Module should be connected in line to socket X201 of the Line Module.
 - If there is no Line Module present, the first Motor Module should be connected directly to the Control Unit (recommended DRIVE-CLiQ socket: X100).
- If the Motor Modules need to be distributed across two DRIVE-CLiQ lines (e.g. on account of the predetermined current controller sampling times), the next higher DRIVE-CLiQ socket on the Control Unit should be used.
Example, vector control in the chassis format:
 - Active Line Module current controller cycle 400 μ s: X100
 - Motor Module current controller cycle 250 μ s: X101
 - Motor Module current controller cycle 400 μ s: X102
- Only one end node should be connected to free DRIVE-CLiQ sockets within a DRIVE-CLiQ line (e.g. Motor Modules wired in a line), for example, one Sensor Module or one Terminal Module, without routing to additional components.
- For mixed operation of the servo control and vector V/f control operating modes, separate DRIVE-CLiQ lines should be used for the Motor Modules.
- A Power Module with the CUA31/CUA32 should be connected to the middle or end of the DRIVE-CLiQ line.

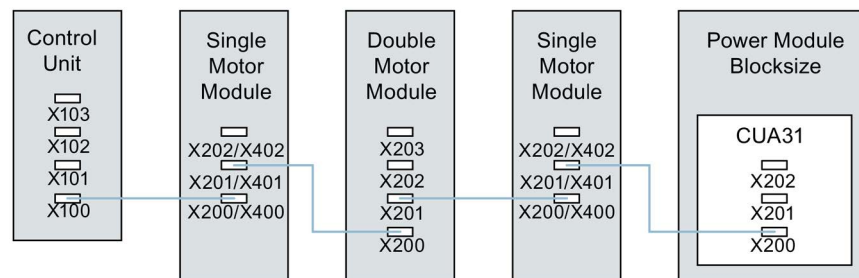

Image 2-2 DRIVE-CLiQ line example

Encoder, Sensor Modules

- The motor encoder or Sensor Module should be connected to the associated Motor Module.
Connecting the motor encoder via DRIVE-CLiQ:
 - Single Motor Module Booksize to terminal X202
 - Double Motor Module Booksize motor X1 to terminal X202 and motor X2 to terminal X203
 - Single Motor Module chassis to terminal X402
 - Power Module blocksize with CUA31: Encoder to terminal X202
 - Power Module blocksize with CU310-2: Encoder to terminal X100 or to terminal X501 of a Terminal Module
 - Power Module chassis to terminal X402
- If possible, Sensor Modules of direct measuring systems should not be connected to the DRIVE-CLiQ line of Motor Modules, but rather to free DRIVE-CLiQ sockets of the Control Unit.

Note

This restriction does not apply to star-type connections for the Motor Modules.

Voltage Sensing Modules

- The Voltage Sensing Module (VSM) should be connected to the DRIVE-CLiQ socket X202 (booksize format) or X402 (chassis format) of the associated Line Module/Motor Module.
 - If the DRIVE-CLiQ socket X202/X402 is not available, a free DRIVE-CLiQ socket on the Line Module/Motor Module should be selected.

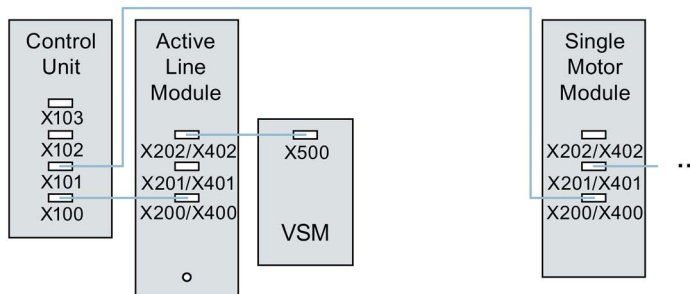

Image 2-3 Example of a topology with VSM for booksize and chassis components

Terminal Modules

- Terminal Modules should be connected to DRIVE-CLiQ socket X103 of the Control Unit in series.
- The TM54F should not be operated together on the same DRIVE-CLiQ line as Line Modules or Motor Modules.
- If possible, Terminal Modules should not be connected to the DRIVE-CLiQ line of Motor Modules, but rather to free DRIVE-CLiQ sockets of the Control Unit.

Note

This restriction does not apply to star-type connections for the Motor Modules.

2.5.4.3 Rules for automatic configuration

With "Automatic Configuration" (Auto commissioning) the Control Unit software creates drive objects for the connected Line Modules, Motor Modules and Terminal Modules. For the Motor Modules the control mode is set via parameter p0097.

In addition to this the following DRIVE-CLiQ wiring topologies support automatic assignment of components to the drive objects.

- An encoder that is connected directly to a Motor Module or via a Sensor Module, is assigned to this drive object as motor encoder (encoder 1).
- If a second encoder is connected to a Motor Module in addition to the motor encoder, it is assigned to the drive as encoder 2. The encoder connected to terminal X202 or X402 is then the motor encoder (encoder 1).
- If a TM120 or TM150 is connected to the Motor Module, the temperature channels of the TM are connected with the motor temperature monitoring of the drive. In this case, the motor encoder may be connected to the TM120 or TM150.
- If a Voltage Sensing Module (VSM) is connected to a Line Module then it is assigned to the infeed drive object.

Recommended connection:

- Booksize to terminal X202
- Chassis to terminal X402
- If a Voltage Sensing Module (VSM) is connected to a Motor Module then it is assigned to the drive object.

Note

If two VSMs are connected to the Motor Module, the first (p0151[0]) is assigned to the line voltage measurement (see p3801) and the second is assigned to the motor voltage measurement (see p1200).

2.5.4.4 Changing the offline topology in the STARTER commissioning tool

The device topology can be changed in the STARTER commissioning tool by shifting the components in the topology tree.

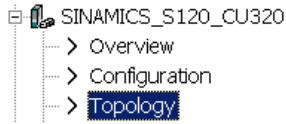

Example: Changing the DRIVE-CLiQ topology

1. Select the DRIVE-CLiQ component.

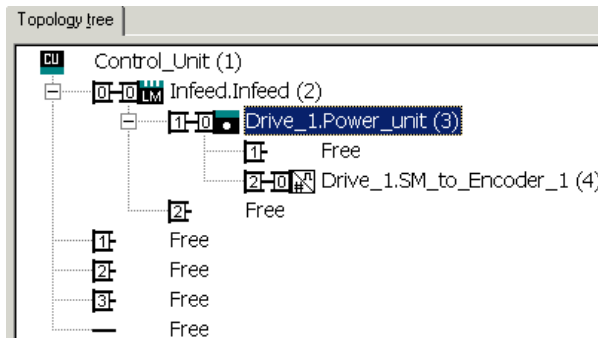

2. While holding down the mouse button, drag the component to the required DRIVE-CLiQ interface and release the mouse button.

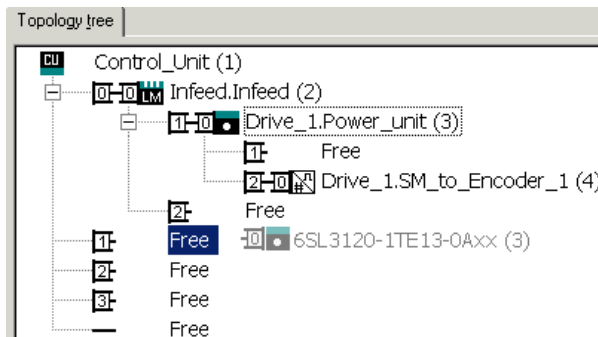

You have changed the topology in the STARTER commissioning tool.

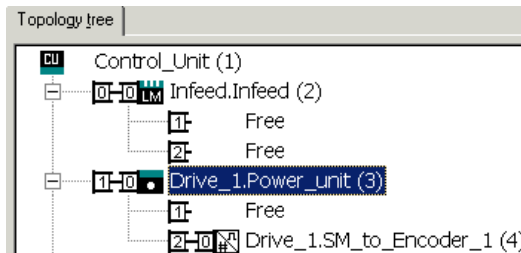

2.5.4.5 Modular machine concept: Offline correction of the reference topology

The topology is based on a modular machine concept. The machine concept is created offline in the STARTER commissioning tool in the maximum version as reference topology.

The maximum version is the maximum expansion of a particular machine type. In the maximum version, all the machine components that can be used are pre-configured in the reference topology.

Deactivating components / handling non-existent components

In a lower expansion stage of the machine, you must mark drive objects and encoders that are not used in the STARTER topology. To do this, for the corresponding drive objects and encoder, set parameter p0105 or p0145 = 2 (deactivate component and does not exist). Components set to the value "2" in a project generated offline must never be inserted in the actual topology at all.

If a component fails, the sub-topology can also be used to allow a machine to continue to operate until the spare part is available. In this case, however, no BICO source must be interconnected from this drive object to other drive objects.

Example of a sub-topology

The starting point is a machine created offline in the STARTER commissioning tool. "Drive 1" was not implemented for this machine.

1. You can remove drive object "Drive 1" "offline" from the reference topology using p0105 = 2.
2. Change over the DRIVE-CLiQ cable from the Control Unit directly to "Drive 2".
3. Transfer the project with "Download to drive unit".

4. Then execute a "Copy RAM to ROM".

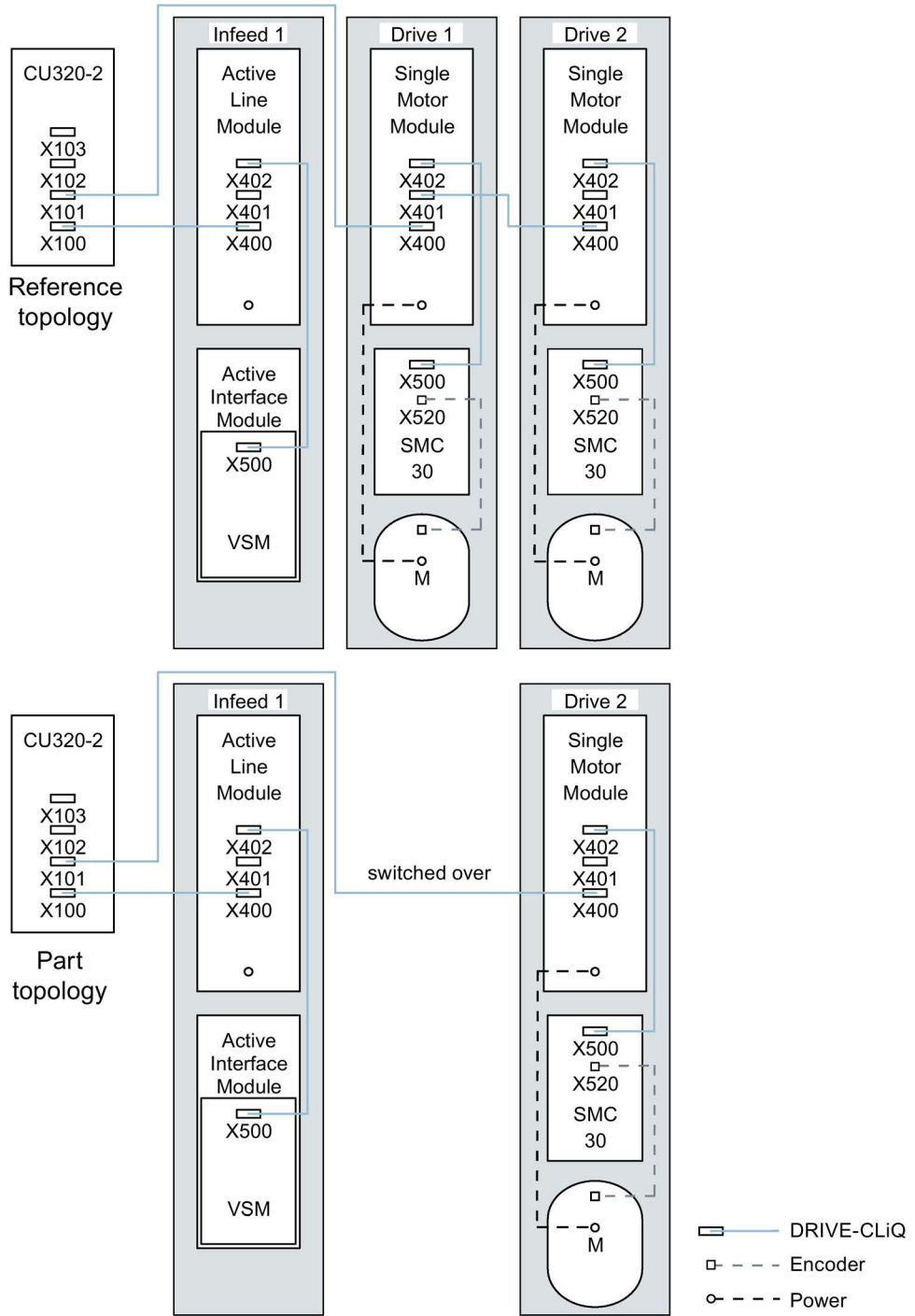

Image 2-4 Example of a sub-topology

Note

Incorrect SI status display

If a drive in a Safety Integrated drive line-up is deactivated using p0105, then r9774 is not correctly output. The signals of a deactivated drive are no longer updated.

Activating/deactivating components

Drive objects can be activated/deactivated using parameter p0105 and encoders with p0145[0...n] in the Expert list in the same way. If a component is not required at certain times, then for the component, change parameter p0105 or p0145 from "1" to "0". The deactivated components remain inserted, however, they are deactivated. Errors are not displayed from deactivated components.

Overview of important parameters (see SINAMICS S120/S150 List Manual)

- p0105 Activating/deactivating drive object
- r0106 Drive object active/inactive
- p0125[0...n] Activate/deactivate power unit component
- r0126[0...n] Power unit components active/inactive
- p0145[0...n] Enable/disable sensor interface
- r0146[0...n] Sensor interface active/inactive
- p9495 BICO behavior for deactivated drive objects
- p9496 BICO behavior when activating drive objects
- p9498[0...29] BICO BI/CI parameters to de-activated drive objects
- p9499[0...29] BICO BO/CO parameters to de-activated drive objects
- r9774.0...31 CO/BO: SI Status (group STO)

2.5.5 Notes on the number of controllable drives

2.5.5.1 Number of drives depending on the control mode and cycle times

The number of axes that can be operated with a Control Unit depends on the cycle times and the control mode. The number of usable axes and the associated clock cycle times for each control type are listed below. The other available remaining computation times are available for options (e.g. DCC).

Cycle times for servo control and HLA

The following table lists the number of axes that can be operated with a Control Unit in servo control and HLA. The number of axes is also dependent on the cycle times of the controller:

Table 2- 8 Sampling time setting for servo control

Cycle times [µs]		Number		Motor/dir. measuring systems	TM ¹⁾ /TB
Current controller	Speed controller	Axes	Infeed		
125	125	6	1 [250 µs]	6 / 6	3 [2000 µs]
62.5	62.5	3	1 [250 µs]	3 / 3	3 [2000 µs]
31.25 ²⁾	31.25 ²⁾	1	1 [250 µs]	1 / 1	3 [2000 µs]

- 1) Valid for TM31 or TM15IO; restrictions are possible for TM54F, TM41, TM15, TM17, TM120, TM150 depending on the set sampling time.
- 2) In the cycle level 31.25 µs, you can also create the following objects:
 Sensor Module External (SME) and SMC20 that support the current firmware and hardware. These can be recognized from the Article end number ... 3.
 No additional axis can be operated in this cycle level.

Adjustable pulse frequencies and current controller cycles for servo control

The pulse frequencies that can be set depending on the selected current controller cycle are shown in r0114. Because of the integrating current measurement, pulse frequencies that are a multiple of half the current controller sampling frequency should be preferred. Otherwise, the current is not measured synchronous to the pulse frequency and a fluctuating actual current value results. This causes disturbance in the control circuits and higher losses in the motor (such as pulse frequency 5.333 kHz and current controller cycle 62.5 µs).

The recommended settings are marked with **XX** in the Table; all other possible settings are marked with X.

Table 2- 9 Pulse frequencies and current controller cycles for servo control

Pulse frequency [kHz]	Current controller cycle [μ s]										
	250.0	187.5	150.0	125.0	100.0	93.75	75.0	62.5	50.0	37.5	31.25
16.0	X	-	-	X	-	-	-	X	-	-	XX
13.333	-	-	X	-	-	-	X	-	-	XX	-
12.0	X	-	-	-	-	-	-	-	-	-	-
10.666	-	X	-	-	-	X	-	-	-	-	X
10.0	-	-	-	-	X	-	-	-	XX	-	-
8.888	-	-	-	-	-	-	-	-	-	X	-
8.0	X	-	-	X	-	-	-	XX	-	-	X
6.666	-	-	X	-	-	-	XX	-	X	X	-
6.4	-	-	-	-	-	-	-	-	-	-	X
5.333	-	X	-	-	-	XX	-	X	-	X	-
5.0	-	-	-	-	XX	-	-	-	X	-	-
4.444	-	-	-	-	-	-	X	-	-	-	-
4.0	X	-	-	XX	-	-	-	X	-	-	-
3.555	-	-	-	-	-	X	-	-	-	-	-
3.333	-	-	XX	-	X	-	X	-	-	-	-
3.2	-	-	-	-	-	-	-	X	-	-	-
2.666	-	XX	-	X	-	-	-	-	-	-	-
2.5	-	-	-	-	X	-	-	-	-	-	-
2.222	-	-	X	-	-	-	-	-	-	-	-
2.133	-	-	-	-	-	X	-	-	-	-	-
2.0	XX	-	-	X	X	-	-	-	-	-	-
1.777	-	X	-	-	-	-	-	-	-	-	-
1.666	-	-	X	-	-	-	-	-	-	-	-
1.6	-	-	-	X	-	-	-	-	-	-	-
1.333	-	X	X	-	-	-	-	-	-	-	-

Note**Clock cycle mix**

Detailed information about the clock cycle mix for servo control is provided in Section Cycle mix for servo control and vector control (Page 64).

Cycle times for vector control

This following table lists the number of axes that can be operated with a Control Unit in the vector control mode. The number of axes is also dependent on the cycle times of the controller:

Table 2- 10 Sampling time setting for vector control

Cycle times [µs]		Number		Motor/dir. measuring systems	TM ¹ /TB
Current controller	Speed controller	Axes	Infeed ²⁾		
500 µs	2000 µs	6	1 [250 µs]	6 / 6	3 [2000 µs]
400 ³⁾ µs	1600 µs	5	1 [250 µs]	5/5	3 [2000 µs]
250 µs	1000 µs	3	1 [250 µs]	3 / 3	3 [2000 µs]

- 1) Valid for TM31 or TM15IO; restrictions are possible for TM54F, TM41, TM15, TM17, TM120, TM150 depending on the set sampling time.
- 2) For power units in chassis format, the infeed cycle depends on the power rating of the module and can be 400 µs, 375 µs or 250 µs.
- 3) This setting results in lower remaining computation times.

Adjustable pulse frequencies and current controller cycles for vector control

The pulse frequencies that can be set depending on the selected current controller cycle are shown in r0114.

This means that maximum 2 cycle levels can be mixed.

Note

Clock cycle mix

Detailed information about the clock cycle mix for servo control is provided in Section Cycle mix for servo control and vector control (Page 64).

Table 2- 11 Pulse frequencies and current controller cycles for vector control

Pulse frequency [kHz]	Current controller cycle [µs]											
	500.0	375.0	312.5	250.0	218.75	200.0	187.5	175.0	156.25	150.0	137.5	125.0
16.0	X	X	X	X	-	-	X	-	-	-	-	X
15.0	-	-	-	-	-	X	-	-	-	-	-	-
14.545	-	-	-	-	-	-	-	-	-	-	X	-
14.0	X	-	-	-	-	-	-	-	-	-	-	-
13.714	-	-	-	-	X	-	-	-	-	-	-	-
13.333	-	X	-	-	-	-	-	-	-	X	-	-
12.8	-	-	X	-	-	-	-	-	X	-	-	-
12.0	X	-	-	X	-	-	-	-	-	-	-	-
11.428	-	-	-	-	-	-	-	X	-	-	-	-

Pulse frequency [kHz]	Current controller cycle [μ s]											
	500.0	375.0	312.5	250.0	218.75	200.0	187.5	175.0	156.25	150.0	137.5	125.0
10.666	-	X	-	-	-	-	X	-	-	-	-	-
10.0	X	-	-	-	-	X	-	-	-	-	-	-
9.6	-	-	X	-	-	-	-	-	-	-	-	-
9.142	-	-	-	-	X	-	-	-	-	-	-	-
8.0	X	X	-	X	-	-	-	-	-	-	-	X
7.272	-	-	-	-	-	-	-	-	-	-	X	-
6.666	-	-	-	-	-	-	-	-	-	X	-	-
6.4	-	-	X	-	-	-	-	-	X	-	-	-
6.0	X	-	-	-	-	-	-	-	-	-	-	-
5.714	-	-	-	-	-	-	-	X	-	-	-	-
5.333	-	X	-	-	-	-	X	-	-	-	-	-
5.0	-	-	-	-	-	X	-	-	-	-	-	-
4.571	-	-	-	-	X	-	-	-	-	-	-	-
4.0	X	-	-	X	-	-	-	-	-	-	-	X
3.636	-	-	-	-	-	-	-	-	-	-	X	-
3.333	-	-	-	-	-	-	-	-	-	X	-	-
3.2	-	-	X	-	-	-	-	-	X	-	-	-
2.857	-	-	-	-	-	-	-	X	-	-	-	-
2.666	-	X	-	-	-	-	X	-	-	-	-	-
2.5	-	-	-	-	-	X	-	-	-	-	-	-
2.285	-	-	-	-	X	-	-	-	-	-	-	-
2.0	X	-	-	X	-	-	-	-	-	-	-	-
1.6	-	-	X	-	-	-	-	-	-	-	-	-
1.333	-	X	-	-	-	-	-	-	-	-	-	-
1.0	X	-	-	-	-	-	-	-	-	-	-	-

Note**Restriction for the chassis format**

If edge modulation and wobbling are activated simultaneously with $p1802 \geq 7$ and $p1810.2 = 1$ respectively, the quantity structure for vector control is halved. Then a maximum of 3 axes at a current control cycle of 500 μ s, 2 axes at 400 μ s or 1 axis at 250 μ s are permitted.

Cycle times for V/f control

The following table lists the number of axes that can be operated with a Control Unit in the V/f control mode. The number of axes is dependent on the current controller clock cycle:

Table 2- 12 Sampling time setting for V/f control

Cycle times [µs]		Number		Motor/dir. measuring systems	TM/TB
Current controller	Speed controller	Drives	Infeed		
500	2000	12	1 [250 µs]	- / -	3 [2000 µs]

Mixed operation of servo control and V/f open-loop control

In mixed operation with servo control and U/f control, one axis in servo control at 125 µs uses exactly as much computing power as 2 axes in U/f control at 500 µs. In conjunction with servo control, a maximum of 11 axes are permitted (1 servo control plus 10 vector control V/f).

Table 2- 13 Number of axes for mixed servo control operation

Number of axes in servo control				Number of axes in V/f control	
6	125 µs	3	62.5 µs	0	-
5	125 µs	-	-	2	500 µs
4	125 µs	2	62.5 µs	4	500 µs
3	125 µs	-	-	6	500 µs
2	125 µs	1	62.5 µs	8	500 µs
1	125 µs	-	-	10	500 µs
0	-	0	-	12	500 µs

Mixed operation of vector control and V/f open-loop control

In mixed operation with vector control and V/f control, one axis in vector control at 250 µs uses exactly as much computing power as two axes in V/f control at 500 µs. In conjunction with vector control, a maximum of 11 axes are permitted (1 vector control plus 10 V/f control).

Table 2- 14 Number of axes for mixed vector control operation

Number of axes in vector control				Number of axes in V/f control	
6	500 µs	3	250 µs	0	-
5	500 µs	-	-	2	500 µs
4	500 µs	2	250 µs	4	500 µs
3	500 µs	-	-	6	500 µs
2	500 µs	1	250 µs	8	500 µs
1	500 µs	-	-	10	500 µs
0	-	0	-	12	500 µs

Cycle times of the CU310-2 in the servo control mode

Table 2- 15 Sampling time setting for servo control

Cycle times [μ s]		Number		Via DQ ²⁾	Snapped-on	TM ¹⁾ /TB
Current controller	Speed controller	Axes	Infeed	Motor Module	Power Module	
125	125	1	-	-	1	3 [2000 μ s]
62.5	62.5	1	-	-	1	3 [2000 μ s]

1) Valid for TM15, TM17 or TM41; for TM54F, TM31, TM120, TM150 - restrictions are possible dependent on the set sampling time.

2) DQ = DRIVE-CLiQ

If the 310-2 Control Unit is snapped on to a PM340 or a PM240-2 FS A-C, a minimum current controller clock cycle of 62.5 μ s is possible. For PM240-2 FS D-F the minimum current controller clock cycle is 125 μ s.

Using DCC

The available remaining computation time can be used for DCC. In this case, the following supplementary conditions apply:

- For a 2 ms time slice, a max. of 75 DCC blocks can be configured for each servo control axis with 125 μ s that can be omitted/eliminated (\pm 2 V/f axes with 500 μ s).
- 50 DCC blocks for 2 ms time slice correspond to 1.5 V/f axes with 500 μ s.

Detailed information about handling and using DCC standard blocks is provided in the "SINAMICS/SIMOTION Editor Description DCC" manual.

Using EPOS

The following table lists the number of axes that can be operated with a SINAMICS S120 when using a "basic positioner" (EPOS) function module. The number of axes is dependent on the current controller clock cycle.

Table 2- 16 Sampling times when using EPOS

Cycle times [μ s]		Cycle times [ms]		Number	
Current controller	Speed controller	Position controller	Positioner	Axes	Infeed
250	250	2	8	6	1 [250 μ s]
250	250	1	4	5	1 [250 μ s]
125	125	1	4	4	1 [250 μ s]

The CPU processing time required for the function module EPOS (with 1 ms position controller/4 ms positioner) corresponds to the same CPU processing time of 0.5 V/f axes with 500 μ s.

Use of SINAMICS web server

The available computation time can be used for SINAMICS web server. The following boundary condition applies here:

- The utilization of the system (r9976) must be less than 90%!
- A maximum of 5 users can access data on the same drive via the SINAMICS web server.

Using CUA31/CUA32

Information on using the Control Unit Adapter CUA31 or CUA32:

- CUA31/32 is the first component in the CUA31/32 topology: 5 axes
- CUA31/32 is **not** the first component in the CUA31/32 topology: 6 axes
- For a current controller cycle of 62.5 μ s, only one axis is possible with one CUA31/32.

2.5.5.2 Cycle mix for servo control and vector control

Supplementary conditions

The rules for setting the sampling time (see Chapter Rules when setting the sampling times (Page 40)) and the rules on isochronous mode (see Chapter Rules for isochronous mode (Page 42)) apply.

These rules mean that the smallest common multiple of the current controller cycles of all axes operated on the isochronous PROFIBUS and 125 μ s is used to set T_i , T_o and T_{dp} .

Current controller cycles for cycle mix

Consequently the smallest common multiple of the current and speed controller cycles of all axes operated on the isochronous PROFIBUS is used to set the base cycle for T_i , T_o and T_{dp} . For a cycle mix, a compromise must be sought between the base cycle to set T_i , T_o and T_{dp} , and the required pulse frequency.

Table 2- 17 Examples of cycle mixes for servo control

Cycle mix: Current controller cycles [μs]		Base cycle for T _i , T _o [μs]	Base cycle for T _{dp} , T _{mapc} [μs]
250.00	+125.00	250	250
187.50	+125.00	375	750
150.00	+125.00	750	750
125.00	+125.00	125	250
100.00	+125.00	500	500
93.75	+125.00	375	750
75.00	+125.00	375	750
62.50	+125.00	125	250
50.00	+125.00	250	250
37.50	+125.00	750	750
31.25	+125.00	125	250

Base cycles for the isochronous PROFIBUS for a cycle mix with 125 μs

Table 2- 18 Examples for cycle mixes for vector control

Cycle mix: Current controller cycles [μs]		Base cycle for T _i , T _o [μs]	Base cycle for T _{dp} [μs]	Base cycle for T _{mapc} [μs]
500.00	+250.00	500	500	2000
375.00	+250.00	750	750	3000
312.50	+250.00	1250	1250	5000
250.00	+250.00	250	250	1000
218.75	+250.00	1750	1750	7000
200.00	+250.00	1000	1000	4000
187.50	+250.00	750	750	3000
175.00	+250.00	1750	1750	7000
156.25	+250.00	1250	1250	5000
150.00	+250.00	750	750	3000
137.50	+250.00	2750	2750	11000
125.00	+250.00	250	250	1000

Base cycles for the isochronous PROFIBUS for a cycle mix with 250 μs

Note

The speed controller cycle is assigned automatically when the current controller cycle is set:

- Servo control: Speed controller cycle = current controller cycle
- Vector control: Speed controller cycle = current controller cycle x 4

The preassignment of the speed controller cycle can be changed to influence T_{mapc} . For example, the current controller cycle can be increased from 800 μs to 1000 μs so that T_{mapc} can be set to be a multiple of 1000 μs .

Asynchronous node on the isochronous PROFIBUS

For cycle mix, lengthened base cycles with the following effects often result on the isochronous PROFIBUS:

- Because the isochronous PROFIBUS can no longer be operated with the default setting, adaptations must be made to the hardware configuration.
- The increased setting values for T_i , T_o and T_{dp} have disadvantageous effects on the dynamics of the position control loop.

Despite a cycle mix, the parameter p2049 can be used to operate the axis with the different current controller cycle asynchronously on the isochronous PROFIBUS. This allows the default setting of the hardware configuration to be retained.

This, however, causes the advantages of the isochronous operation for the asynchronous axis to be lost:

- The setpoints act at times that differ from T_o , i.e. an interpolating position-controlled operation with other axes is not possible.
- The actual values are read at times that differ from T_i , i.e. the actual values must not be used to control other axes.

A critical application would be, for example, a spindle that cuts a thread with the programmed thread pitch together with a position-controlled Z-axis by the controller adjusting the plunging depth of the Z-axis depending on the spindle position.

2.6 Supported sample topologies

2.6.1 Topology example: Drives in vector control

Example 1

A drive line-up with three Motor Modules in chassis format with identical pulse frequencies or three Motor Modules in booksize format in vector control mode.

The Motor Modules chassis format with identical pulse frequencies or the Motor Modules booksize format in vector control mode can be connected to 1 DRIVE-CLiQ interface on the Control Unit.

In the following diagram, three Motor Modules are connected to the DRIVE-CLiQ socket X101.

Note

The offline topology automatically generated in the STARTER commissioning tool must be manually modified, if this topology was wired.

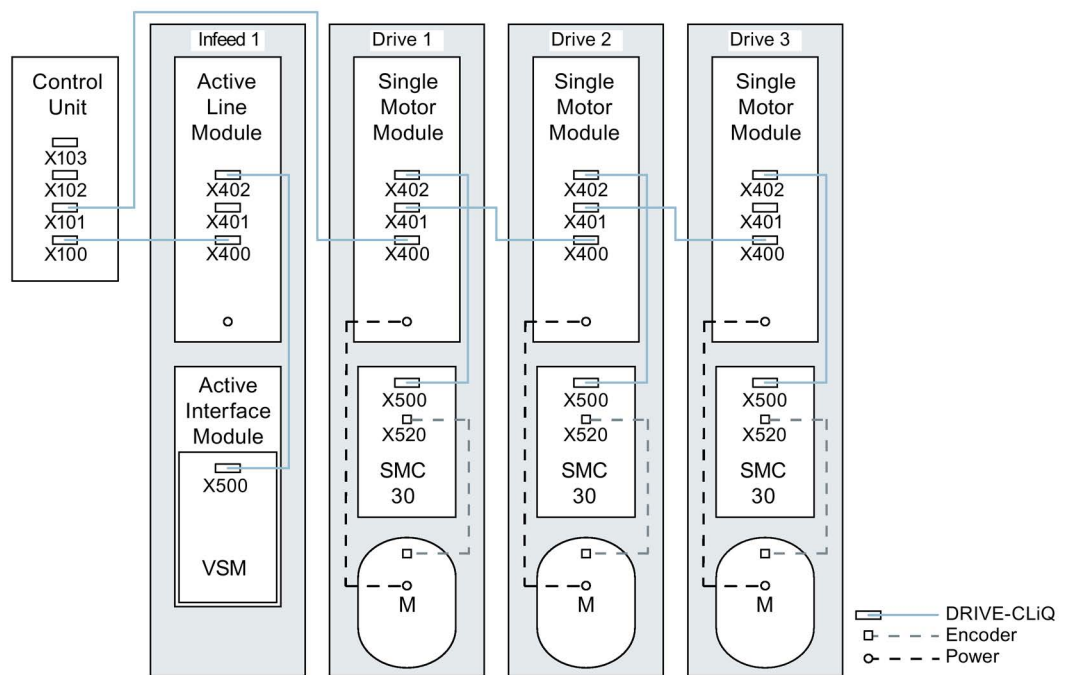

Image 2-5 Drive line-up (chassis) with identical pulse frequencies

Drive line-up comprising four Motor Modules in the chassis format with different pulse frequencies

It is advantageous to connect Motor Modules with different pulse frequencies to different DRIVE-CLiQ sockets of the Control Unit. They may also be connected at the same DRIVE-CLiQ line.

In the following diagram, two Motor Modules (400 V, output ≤ 250 kW, pulse frequency 2 kHz) are connected to interface X101 and two Motor Modules (400 V, output > 250 kW, pulse frequency 1.25 kHz) are connected to interface X102.

Note

The offline topology automatically generated in the STARTER commissioning tool must be manually modified, if this topology was wired.

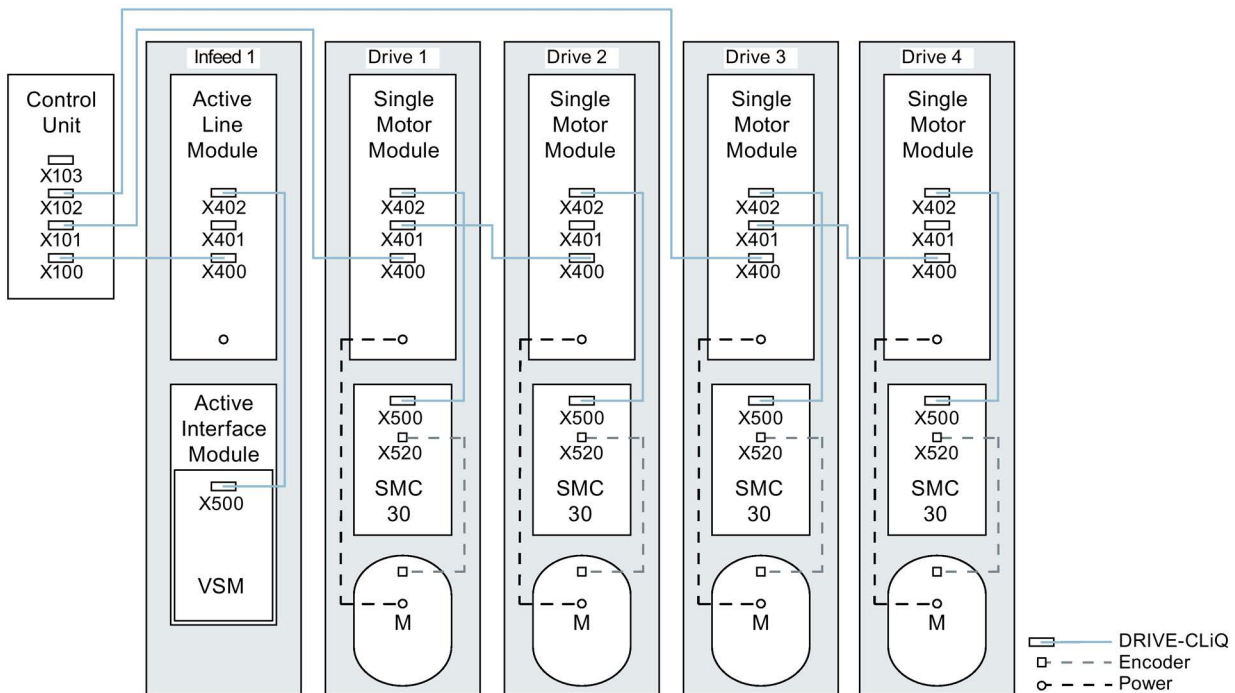

Image 2-6 Drive line-up in chassis format with different pulse frequencies

2.6.2 Topology example: Parallel Motor Modules in vector control

Drive line-up with two parallel-connected Line Modules and Motor Modules in the chassis format of the same type

Parallel-connected Line Modules in the chassis format and Motor Modules in the chassis format of the same type can be connected to a DRIVE-CLiQ socket of the Control Unit.

In the following diagram, two Active Line Modules and two Motor Modules are connected to the X100 or X101 socket.

You can find additional notes in Chapter "Parallel connection of power units" in the SINAMICS S120 Function Manual.

Note

The offline topology automatically generated in the STARTER commissioning tool must be manually modified, if this topology was wired.

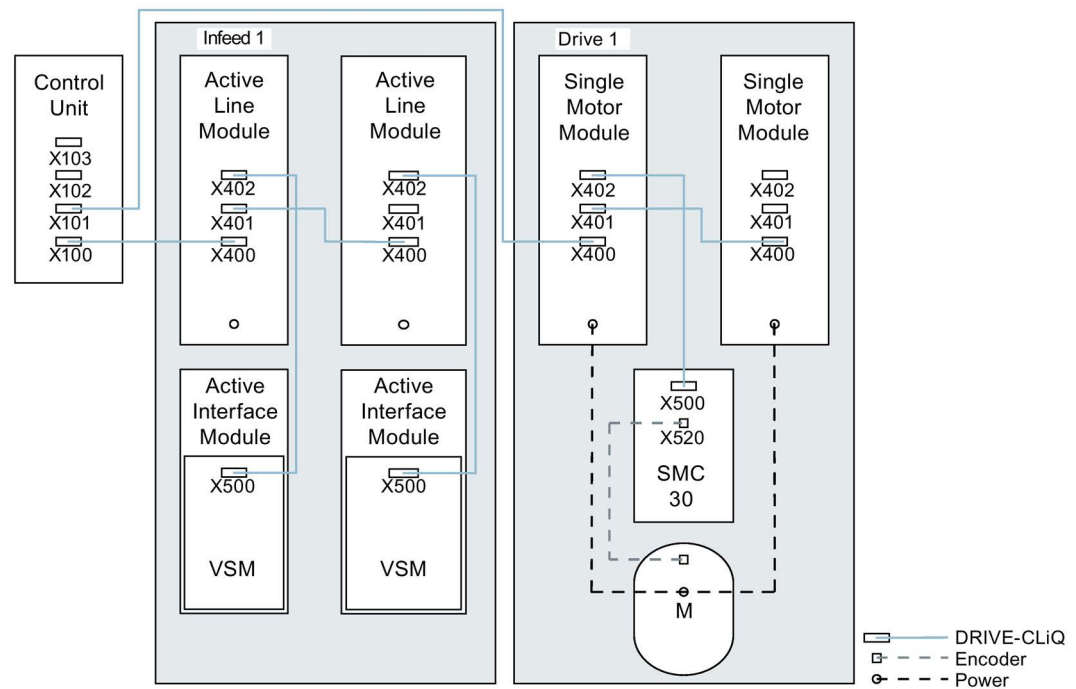

Image 2-7 Drive line-up with parallel-connected power units in the chassis format

2.6.3 Topology example: Power Modules

Blocksize

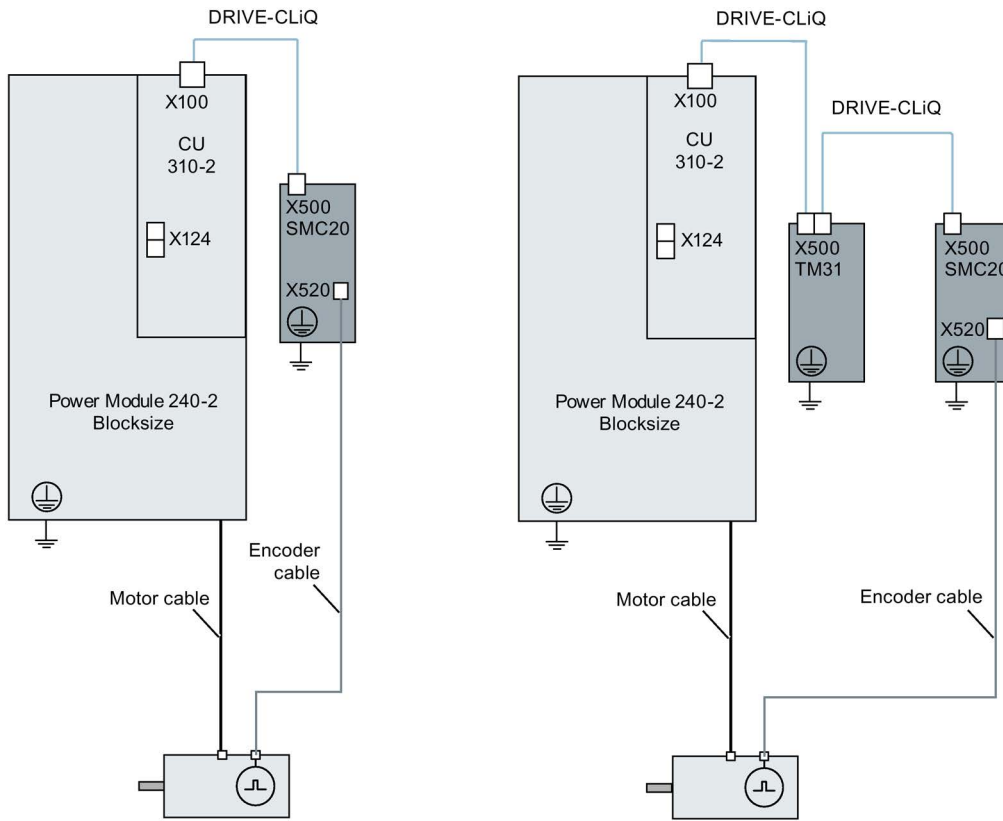

Image 2-8 Drive line-ups with Power Modules blocksize

Chassis

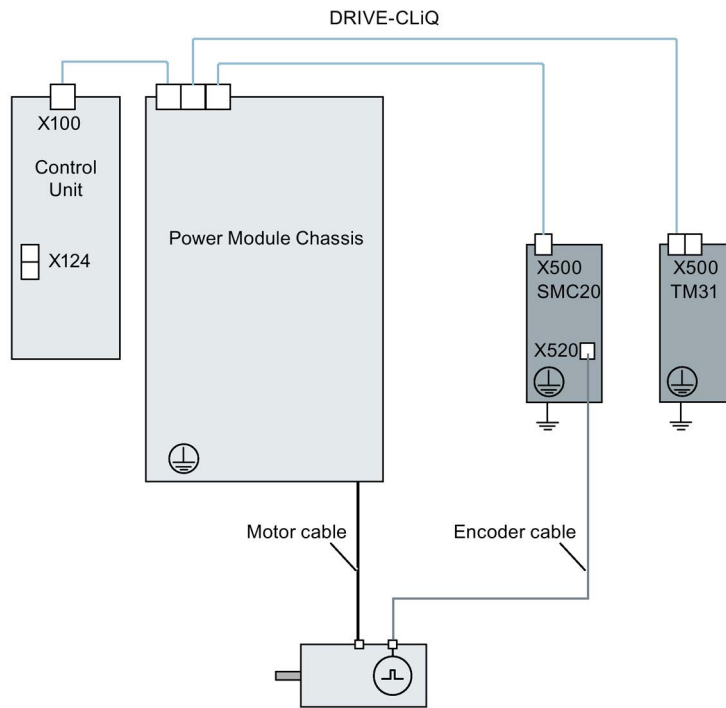

Image 2-9 Drive line-up of a Power Module chassis

2.6.4 Example topologies: Drives in servo control.

2.6.4.1 Example: Sampling time 125 µs

The following diagram shows the maximum number of controllable servo drives and extra components. The sampling times of individual system components are:

- Active Line Module: p0115[0] = 250 µs
- Motor Modules: p0115[0] = 125 µs
- Terminal Module/Terminal Board p4099 = 1 ms

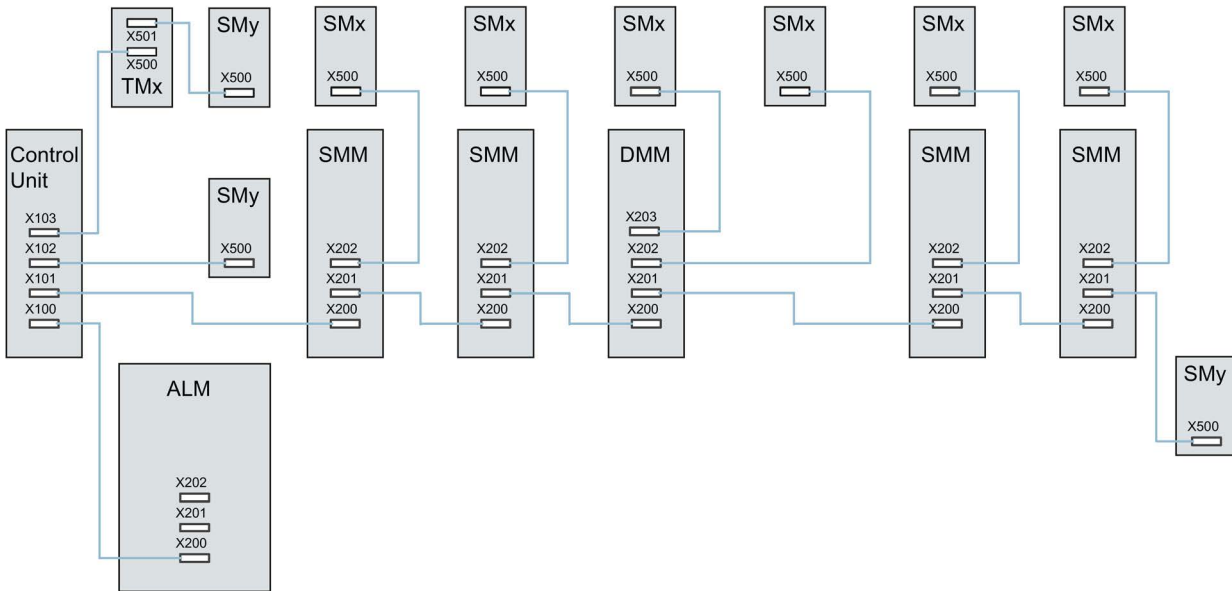

Image 2-10 Topology example of a SERVO drive line-up

Legend for the topology example:
 ALM = Active Line Module
 SMM = Single Motor Module
 DMM = Double Motor Module
 SMx = Motor encoder
 SMY = Direct measuring system
 TMx = TM31, TM15DI/DO, TB30

2.6.4.2 Examples: Sampling time 62.5 μ s and 31.25 μ s

Examples, CU320-2 with 62.5 μ s sampling time:

- Topology 1: 1 x ALM (250 μ s) + 2 x servo (62.5 μ s) + 2 x servo (125 μ s) + 3 x TM15 Base (p4099[0] = 2000 μ s) + TM54F + 4 x Safety Integrated Extended Functions with encoder SI Motion monitoring clock cycle (p9500) = 12 ms + SI Motion actual value sensing clock cycle (p9511) = 4 ms + 4 x direct measuring systems.
- Topology 2: 1 x ALM (250 μ s) + 2 x servo (62.5 μ s) + 2 x V/f (500 μ s) + 3 x TM15 Base (p4099[0] = 2000 μ s) + 2 x Safety Integrated Extended Functions with encoder SI Motion monitoring clock cycle (p9500) = 12 ms + SI Motion actual value sensing clock cycle (p9511) = 4 ms + 2 x Safety Integrated Extended Functions sensorless + 2 x direct measuring systems.
- Topology 3: 1 x servo (62.5 μ s) + 4 x V/f is not possible in connection with Safety Integrated.

Example, CU320-2 with 31.25 μ s sampling time:

- Topology 1: 1 ALM (250 μ s) on a line, 1 x servo (31.25 μ s) on a line, 3 x TM15 Base (p4099[0] = 2000 μ s) on a line and in series.
- Topology 2: 1 ALM (250 μ s) on a line, 1 x servo (31.25 μ s) on a line, 1 direct measuring system on a line.

2.6.5 Topology example: Drives in U/f control (vector control)

The following diagram shows the maximum number of controllable vector V/f drives with additional components. The sampling times of individual system components are:

- Active Line Module: p0115[0] = 250 μ s
- Motor Modules: p0115[0] = 500 μ s
- Terminal Module/Terminal Board p4099 = 2 ms

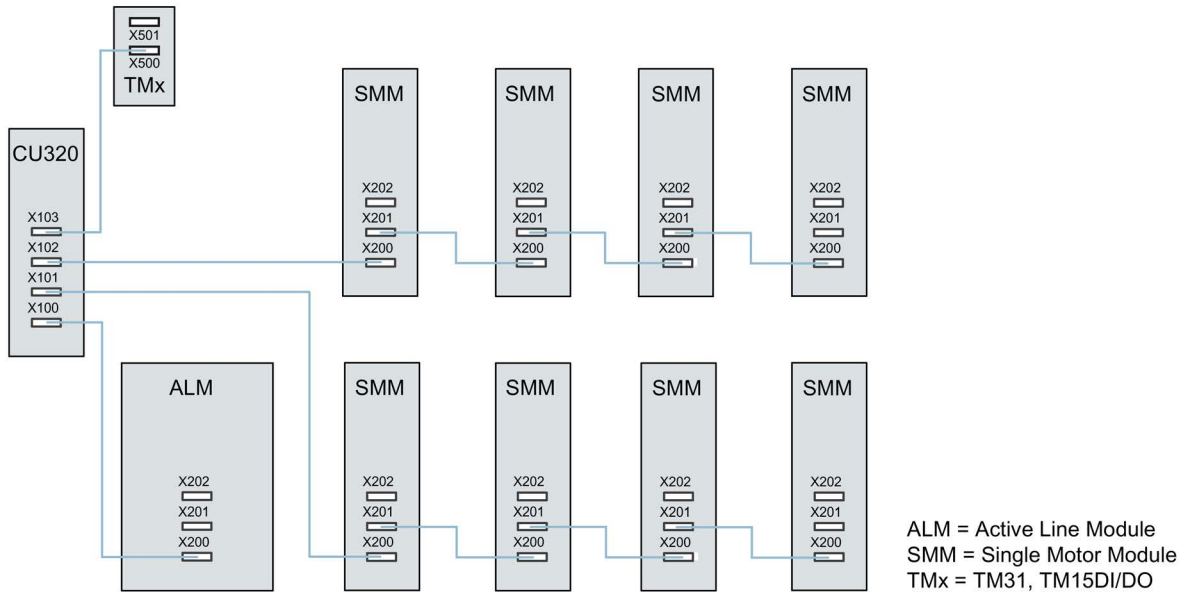

Image 2-11 Topology example of a vector drive line-up in U/f control

2.7 DRIVE-CLiQ diagnostics

Using the DRIVE-CLiQ diagnostics, you can check the connections and cables of DRIVE-CLiQ connections. For data transfer errors, to localize the faulted connection, the error counter in the involved blocks can be evaluated.

In addition to the error counter showing all errors, detailed diagnostics can be carried out for the individual connections. For selected connections, the number of errors is determined for a time interval that can be specified and made traceable using a parameter. As a result of the interconnectability, you can record when data transfer errors occur and correlate them with other events in the drive.

Overview of important parameters (see SINAMICS S120/S150 List Manual)

- r9936[0...199] DRIVE-CLiQ diagnostics, error counter connection
- p9937 DRIVE-CLiQ diagnostics configuration
- p9938 DRIVE-CLiQ detailed diagnostics configuration
- p9939 DRIVE-CLiQ detailed diagnostics time interval
- p9942 DRIVE-CLiQ detailed diagnostics individual connection selection
- r9943 DRIVE-CLiQ detailed diagnostics individual connection error counter

2.8 Powering-up/powering-down the drive system

Powering up the infeed

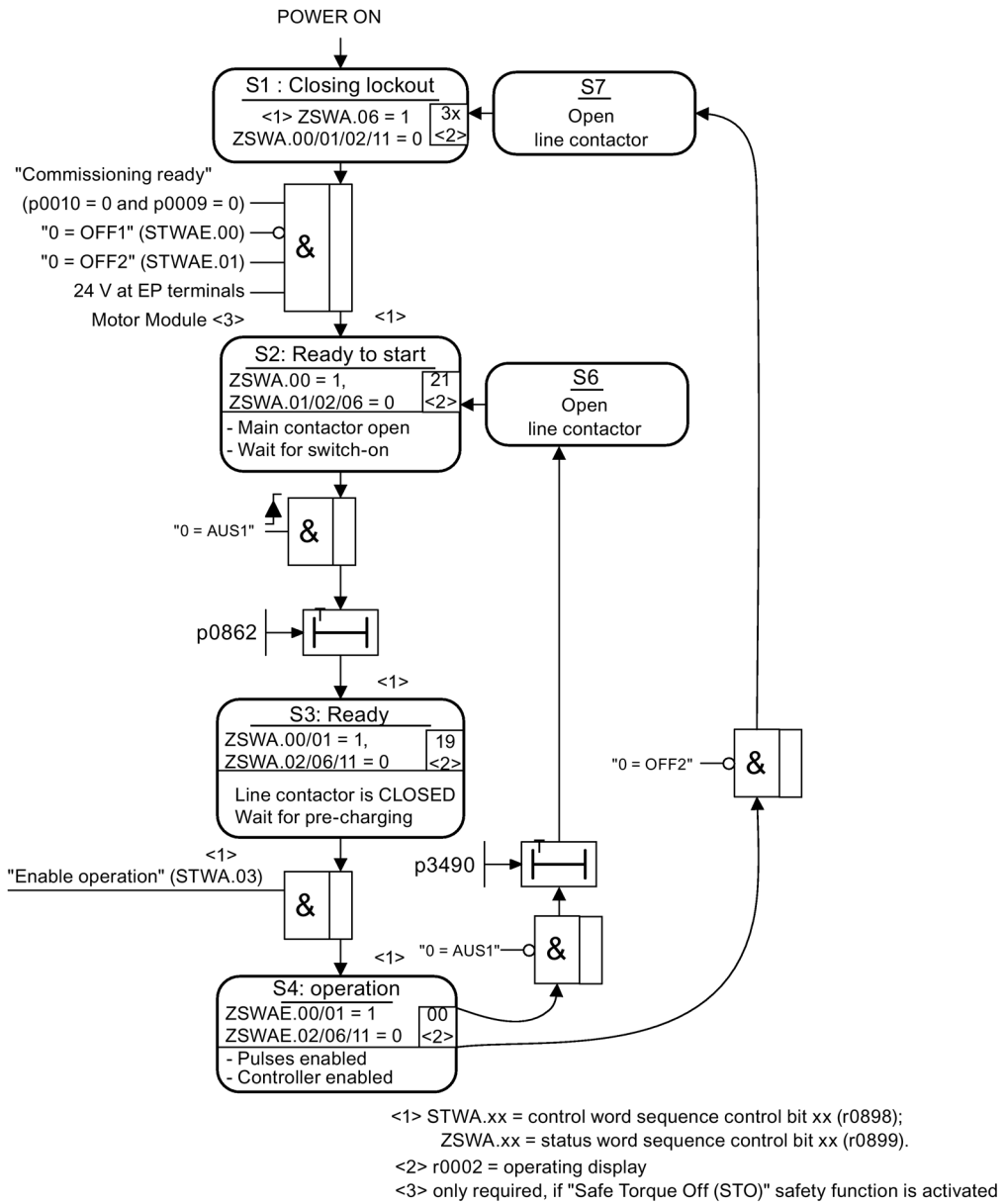

Image 2-12 Powering up the infeed

Powering up the drive

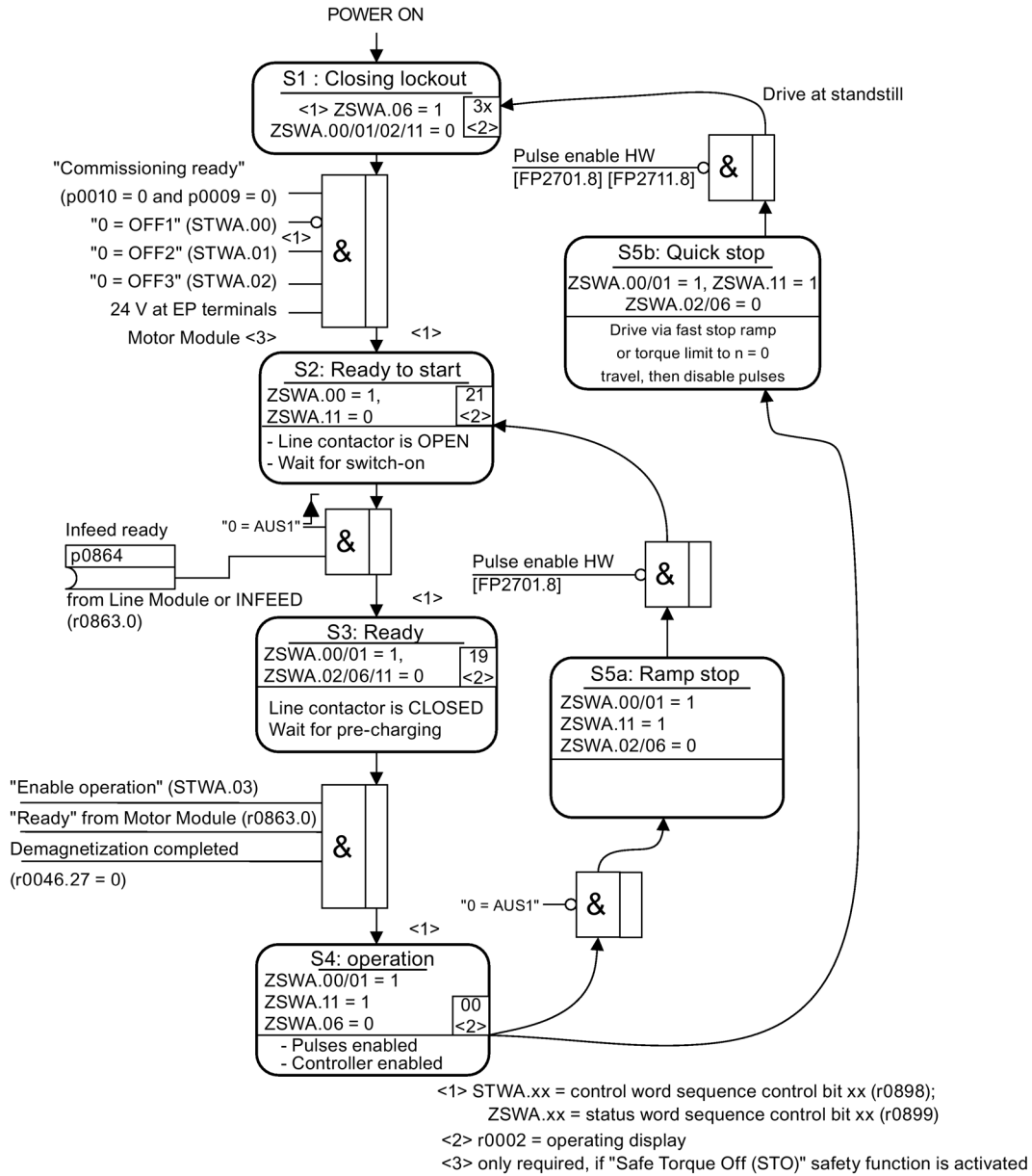

Image 2-13 Powering up the drive

Off responses

- OFF1
 - n_set = 0 is input immediately to brake the drive along the deceleration ramp (p1121).
 - When zero speed is detected, the motor holding brake (if parameterized) is closed (p1215). The pulses are suppressed when the brake application time (p1217) expires. Zero speed is detected if the actual speed drops below the threshold (p1226) or if the monitoring time (p1227) started when the speed setpoint ≤ speed threshold (p1226) has expired.
- OFF2
 - Instantaneous pulse suppression, the drive "coasts" to a standstill.
 - The motor holding brake (if parameterized) is closed immediately.
 - Switching on inhibited is activated.
- OFF3
 - n_set=0 is input immediately to brake the drive along the OFF3 deceleration ramp (p1135).
 - When zero speed is detected, the motor holding brake (if parameterized) is closed. The pulses are suppressed when the brake application time (p1217) expires. Zero speed is detected if the actual speed drops below the threshold (p1226) or if the monitoring time (p1227) started when the speed setpoint ≤ speed threshold (p1226) has expired.
 - Switching on inhibited is activated.

Control and status messages

Table 2- 19 Power-on/power-off control

Signal name	Internal control word	Binector input	PROFIdrive/Siemens telegram 1 ... 352
0 = OFF1	STWA.00 STWAE.00	p0840 ON/OFF1	STW1.0
0 = OFF2	STWA.01 STWAE.01	p0844 1. OFF2 p0845 2. OFF2	STW1.1
0 = OFF3	STWA.02	p0848 1. OFF3 p0849 2. OFF3	STW1.2
Enable operation	STWA.03 STWAE.03	p0852 Enable operation	STW1.3

Table 2- 20 Switch-in/switch-out status signal

Signal name	Internal status word	Parameter	PROFIdrive/Siemens telegram 1 ... 352
Ready for switching on	ZSWA.00 ZSWAE.00	r0899.0	ZSW1.0
Ready for operation	ZSWA.01 ZSWAE.01	r0899.1	ZSW1.1
Operation enabled	ZSWA.02 ZSWAE.02	r0899.2	ZSW1.2
Closing lockout active	ZSWA.06 ZSWAE.06	r0899.6	ZSW1.6
Pulses enabled	ZSWA.11	r0899.11	ZSW2.10 ¹⁾

¹⁾ only available in Interface Mode p2038 = 0

Function diagrams (see SINAMICS S120/S150 List Manual)

- 2610 Sequence control - control unit
- 2634 Sequence control - missing enable signals, line contactor control, logic operation
- 8732 Basic Infeed - control unit
- 8832 Smart Infeed - control unit
- 8932 Active Infeed - control unit

Commissioning

3.1 Safety instructions for commissioning

 WARNING
Danger to life if the fundamental safety instructions and residual risks are not carefully observed
The non-observance of the fundamental safety instructions and residual risks stated in Chapter 1 can result in accidents with severe injuries or death.
<ul style="list-style-type: none">• Adhere to the fundamental safety instructions.• When assessing the risk, take into account residual risks.

 WARNING
Danger to life as a result of motor movement during motor data identification
Motor data identification causes movements of the drive, which can result in death, serious injury, or damage to property.
<ul style="list-style-type: none">• Ensure that nobody is in the danger zone and that the mechanical parts can move freely.• Respond to possible malfunctions by applying suitable measures (e.g. EMERGENCY STOP or EMERGENCY OFF).

3.2 Procedure when commissioning

The following steps are required when commissioning a drive:

1. Create project with STARTER.
2. Configure the drive unit in STARTER.
3. Save the project in STARTER.
4. Establish online operation with the target device in STARTER.
5. Load project to target device.
6. The result: the motor turns.

 WARNING
--

Risk of death if safety instructions and residual risks are not carefully observed

If the safety instructions and residual risks are not observed in the associated hardware documentation, accidents involving severe injuries or death can occur.
--

- | |
|--|
| <ul style="list-style-type: none">• Observe the safety instructions provided in the hardware documentation.• When assessing the risk, take into account residual risks. |
|--|

Note

Acceptance test required

A project with Safety Integrated can be created offline. However, for commissioning, an acceptance test must be performed which is only possible online.

Note

Updating units only after the project upload

In the commissioning tool (STARTER or Startdrive), after the changeover of the axis type via p9302/p9502 and subsequent POWER ON, the units that depend on the axis type are only updated after a project upload.

Note

Please observe the installation guidelines and safety instructions in the SINAMICS S120 Equipment Manuals.

If several Motor Modules are supplied from a non-regenerative infeed unit (e.g. a Basic Line Module), or for power failure or overload (for SLM/ALM), the Vdc_max control may only be activated for a Motor Module whose drive should have a high moment of inertia. For the other Motor Modules this function must be disabled or monitoring must be set. If the Vdc_max control is active for several Motor Modules, then for an unfavorable parameterization, the controllers can mutually influence one another negatively. The drives can become unstable, individual drives can unintentionally accelerate.

Remedial measures:

- Activating the Vdc_max control:
 - Vector control: p1240 = 1 (factory setting)
 - Servo control: p1240 = 1
 - U/f control: p1280 = 1 (factory setting)
- Inhibiting the Vdc_max control:
 - Vector control: p1240 = 0
 - Servo control: p1240 = 0 (factory setting)
 - U/f control: p1280 = 0
- Activating the Vdc_max monitoring function
 - Vector control: p1240 = 4 or 6
 - Servo control: p1240 = 4 or 6
 - U/f control: p1280 = 4 or 6

 **WARNING****Danger to life as a result of unplanned motion of individual drives**

If several Motor Modules are supplied from one infeed unit, then if the Vdc_max control is incorrectly parameterized, individual drives can accelerate in an uncontrolled fashion - which can lead to death or severe injury.

- Only activate the Vdc_max control for the Motor Module whose drive has the highest moment of inertia.
- Inhibit this function for all other Motor Modules, or set this function to monitoring only.

3.3 STARTER commissioning tool

The STARTER commissioning tool is used to parameterize and commission drive units from the SINAMICS product family.

The STARTER commissioning tool can be used for the following:

- Commissioning
- Testing (via the control panel)
- Drive optimization
- Diagnostics
- Setting up and activating the safety functions

System prerequisites

You can find the system requirements for the STARTER commissioning tool in the "readme" file in the STARTER installation directory.

3.3.1 General information on STARTER

3.3.1.1 Calling STARTER

Note

The following procedure refers to the Windows 7 operating system. Operation can differ slightly for other operating systems (e.g. Windows XP).

Calling the STARTER application

1. Click the STARTER symbol  of your user interface.

Or

2. In the Windows starting menu, call the menu command "Start > STARTER > STARTER".

3.3.1.2 Description of the user interface

You can use the STARTER commissioning tool to create the project. The different areas of the user interface are used for different configuration tasks (refer to diagram below):

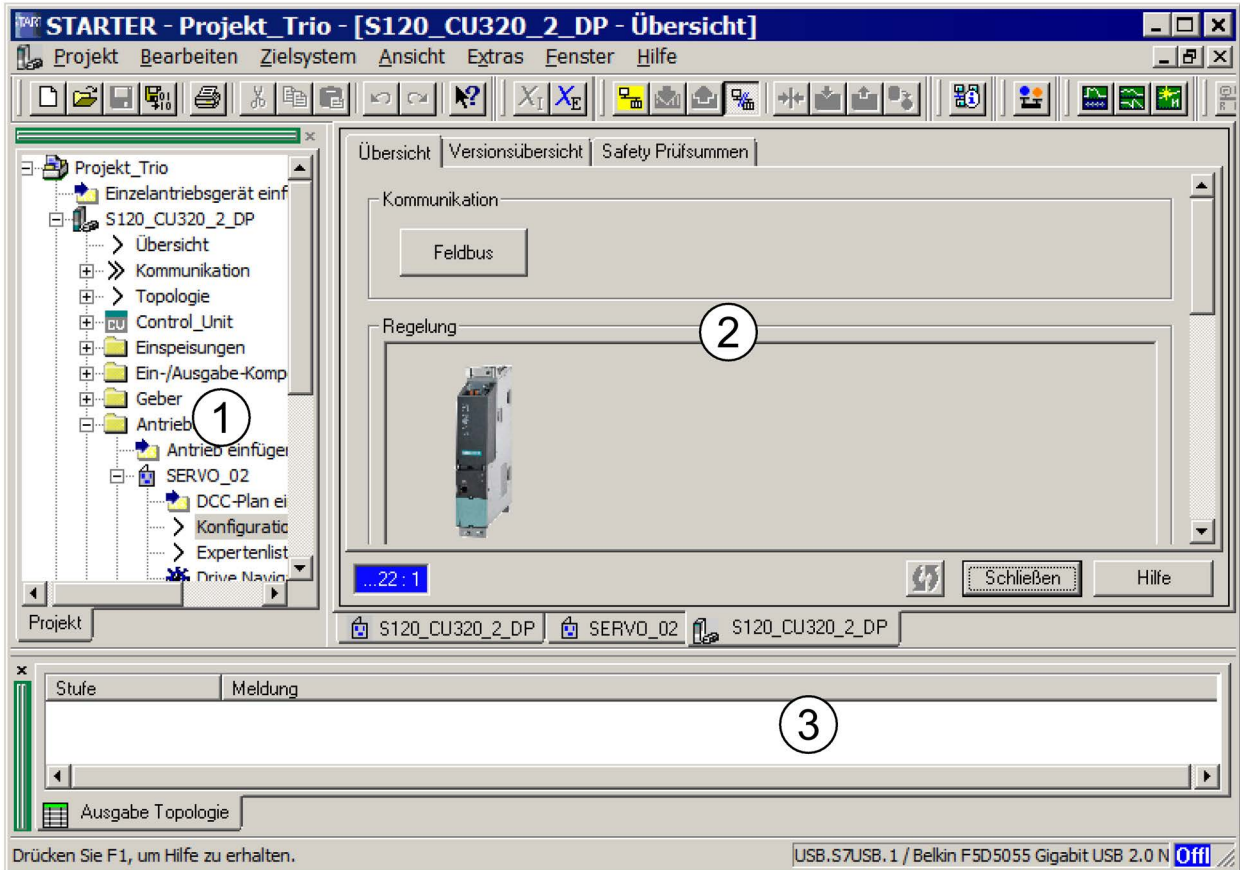

Image 3-1 The different areas of the STARTER user interface

No.	Operating area	Description
①	Project navigator	This area displays the elements and objects that can be added to your project.
②	Work area	In this area you perform the tasks to create the project: <ul style="list-style-type: none"> • When you are configuring the drive, this area contains the Wizards that help you configure the drive objects. • When you configure the parameters for the speed setpoint filter, for example. • When you call up the expert list, the system displays a list of all the parameters that you can view or change.
③	Detail view	This area provides detailed information on faults and alarms, for example.

3.3.1.3 BICO interconnection procedure in STARTER

You can parameterize the drive settings in the OFFLINE mode via STARTER by means of BICO interconnection. Parameterization can be carried out via the following means:

- Expert list
- Graphical screen interface

The steps described below explain the general BICO interconnection procedure in the STARTER commissioning tool.

BICO interconnection in the expert list

When carrying out BICO interconnection via the expert list, proceed as follows:

You want to interconnect parameter p0840 of the control word with parameter r8890[0], for example.

1. In the project navigator, select for example "Drive_1", and call the expert list via the shortcut menu "Expert list".
2. Search for parameter p0840.

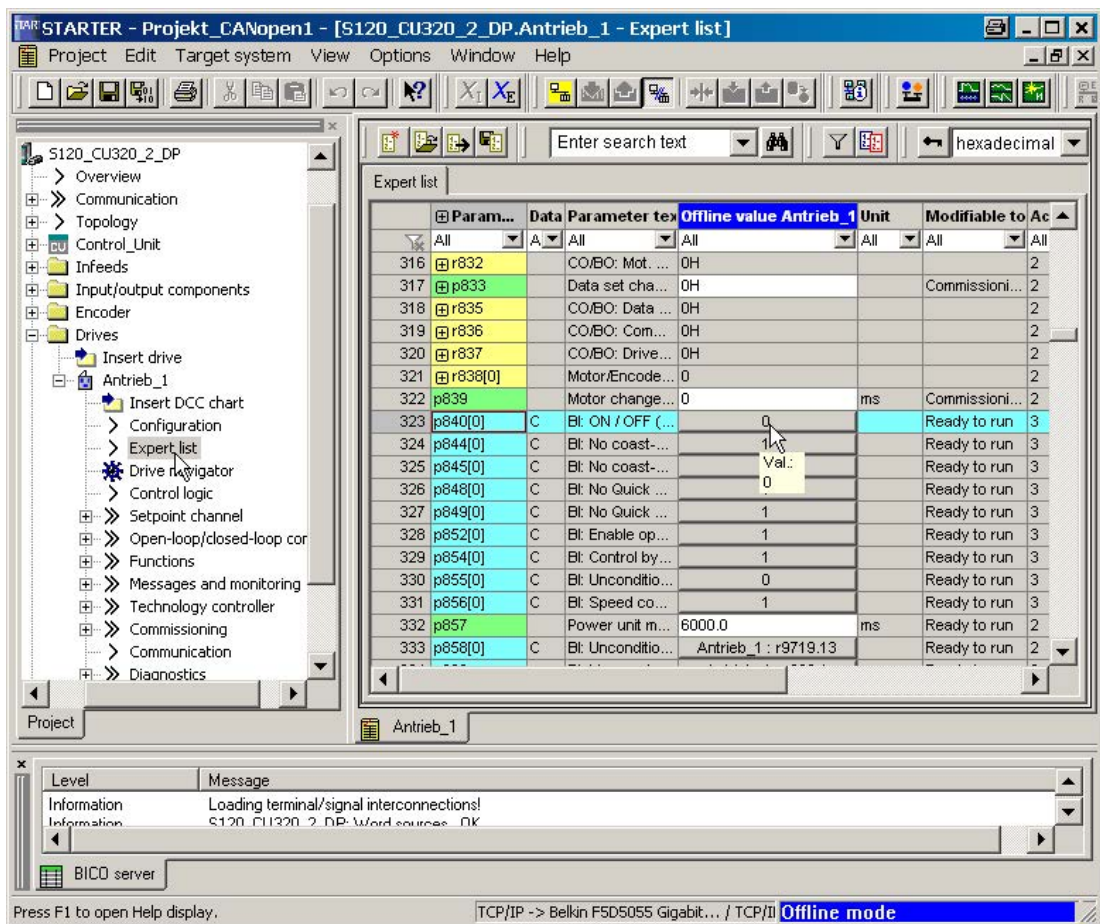

Image 3-2 Parameters in the expert list

3. Click the button to interconnect with a parameter.

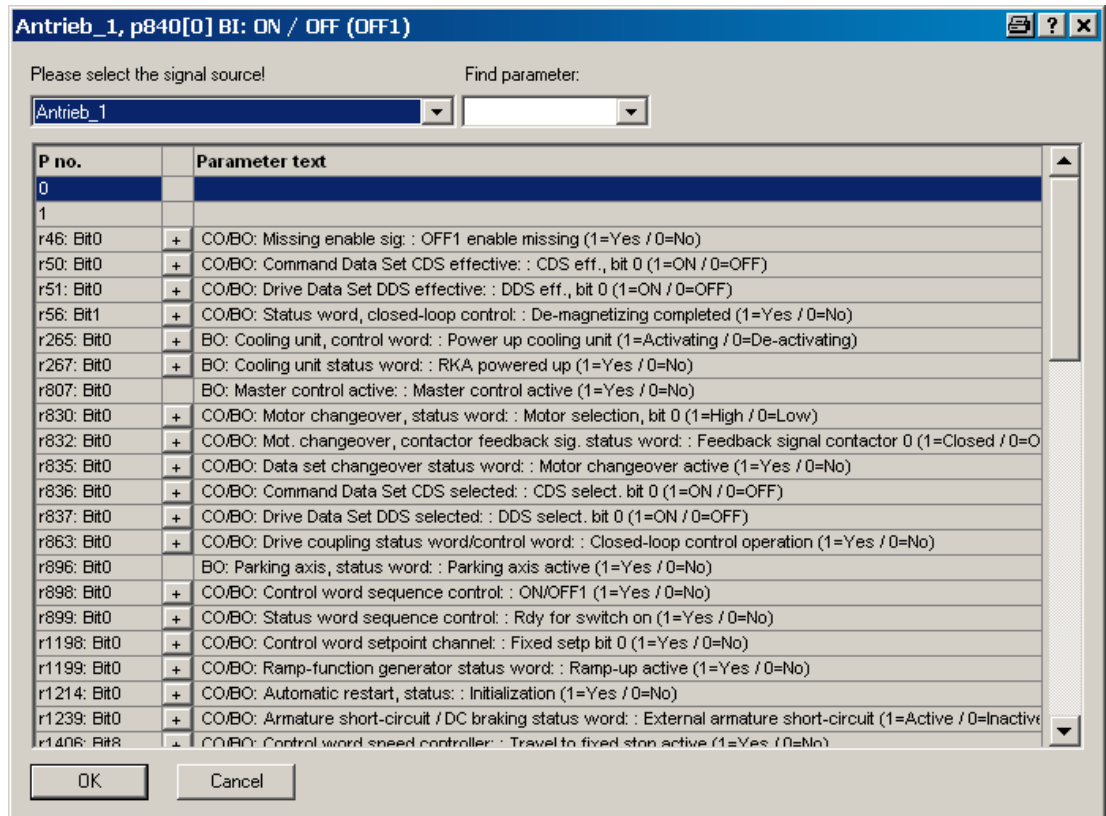

Image 3-3 Interconnectable parameters

A list from which you can select the available r parameters is now displayed.

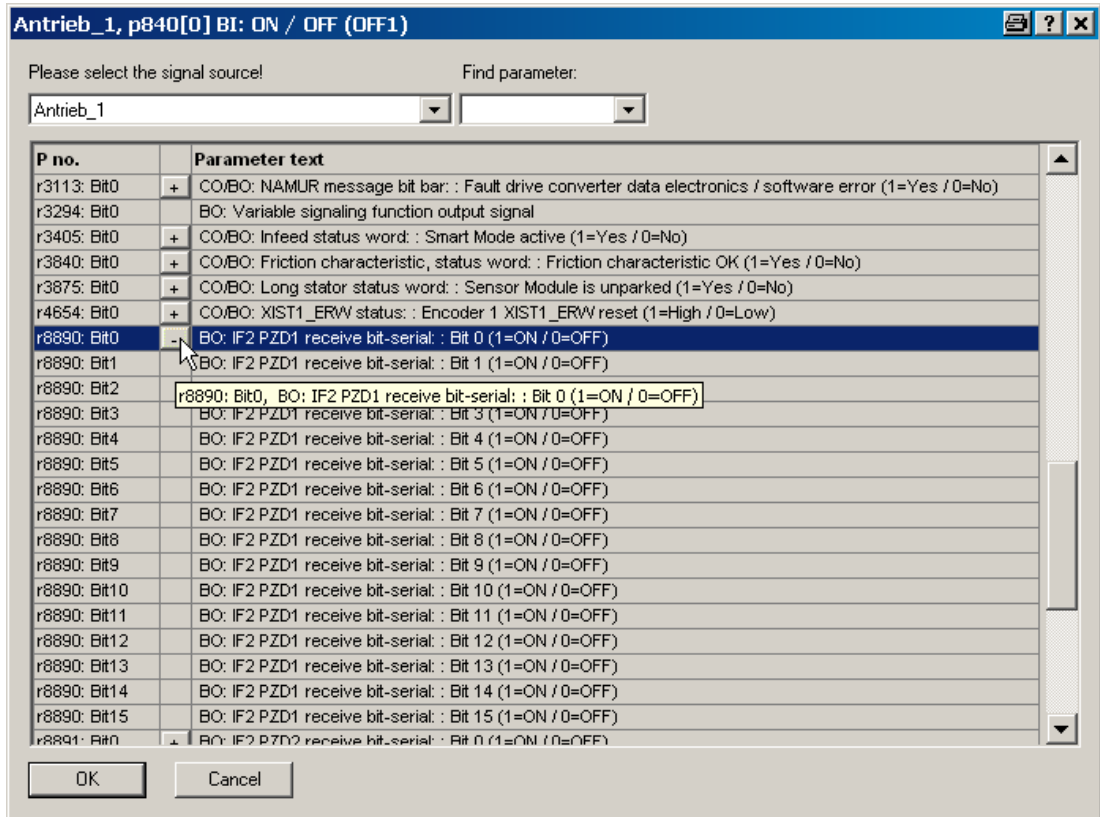

Image 3-4 Selection list

4. Click the plus symbol of parameter r8890:bit0.

5. Double-click r8890: Bit0.

In the expert list, you can now see that p0840 has been interconnected with parameter r8890[0].

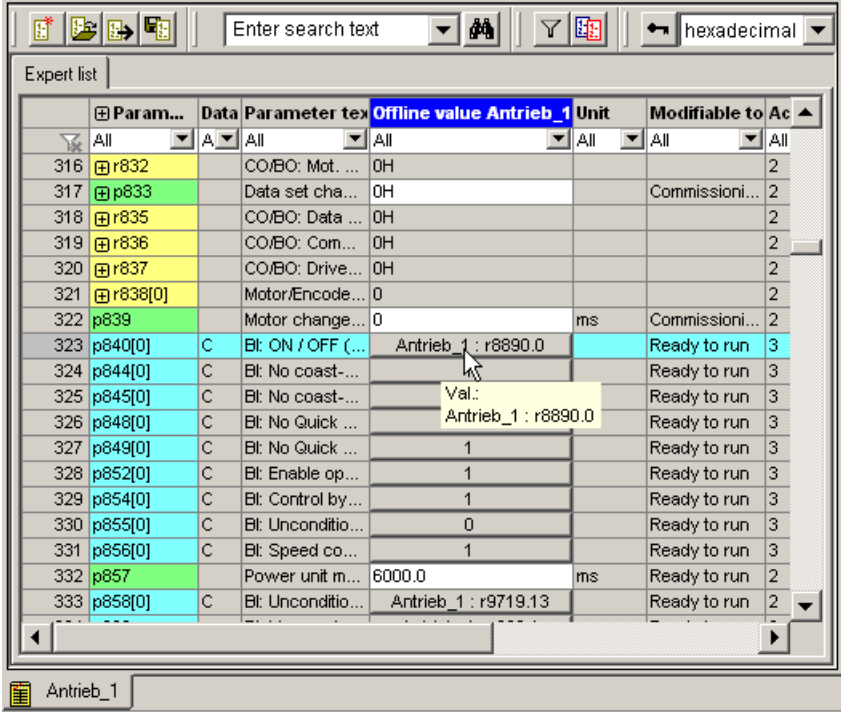

Image 3-5 Interconnection closed

Graphical screen interface

When carrying out BICO interconnection via the graphical screen interface, proceed as follows:

For the setpoint velocity, which is a 32-bit data type, you want to interconnect parameter p1155[0] for "Speed setpoint 1" with parameter r8860[1], for example.

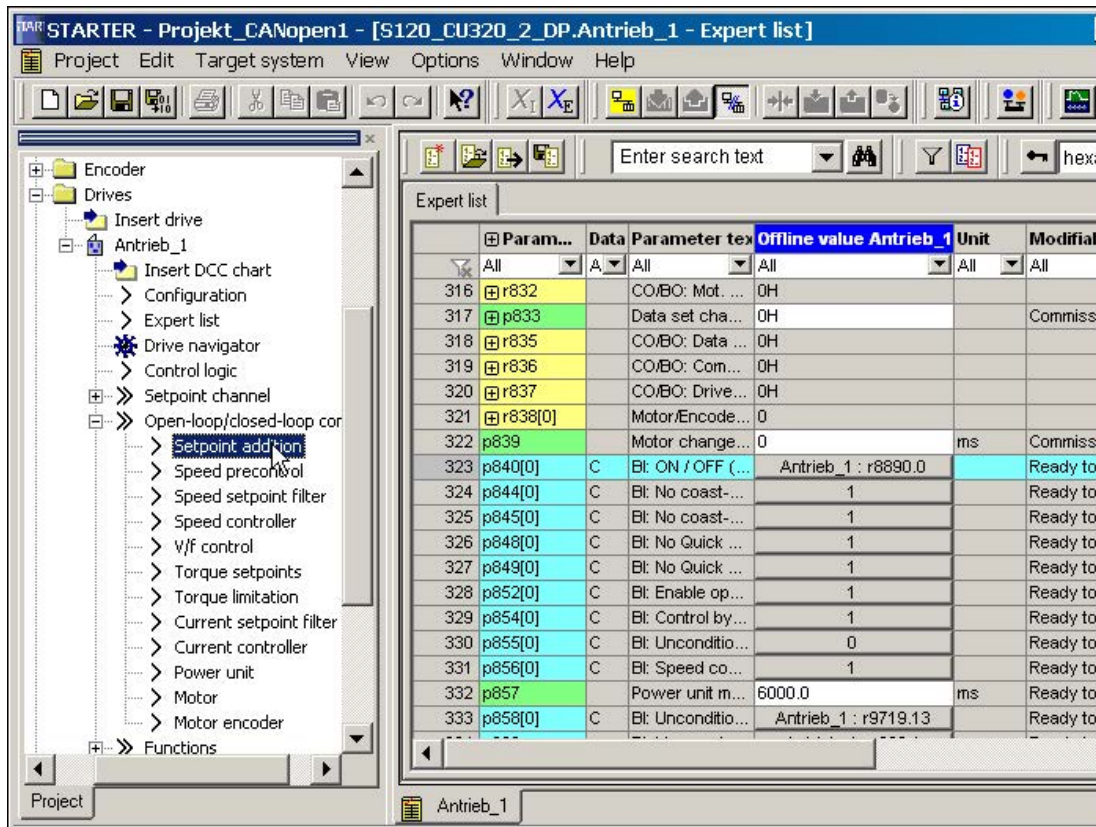

Image 3-6 Parameters in the expert list

1. In the project navigator, double-click the "Setpoint addition" selection under "Drive_1 > Open-loop/closed-loop control".

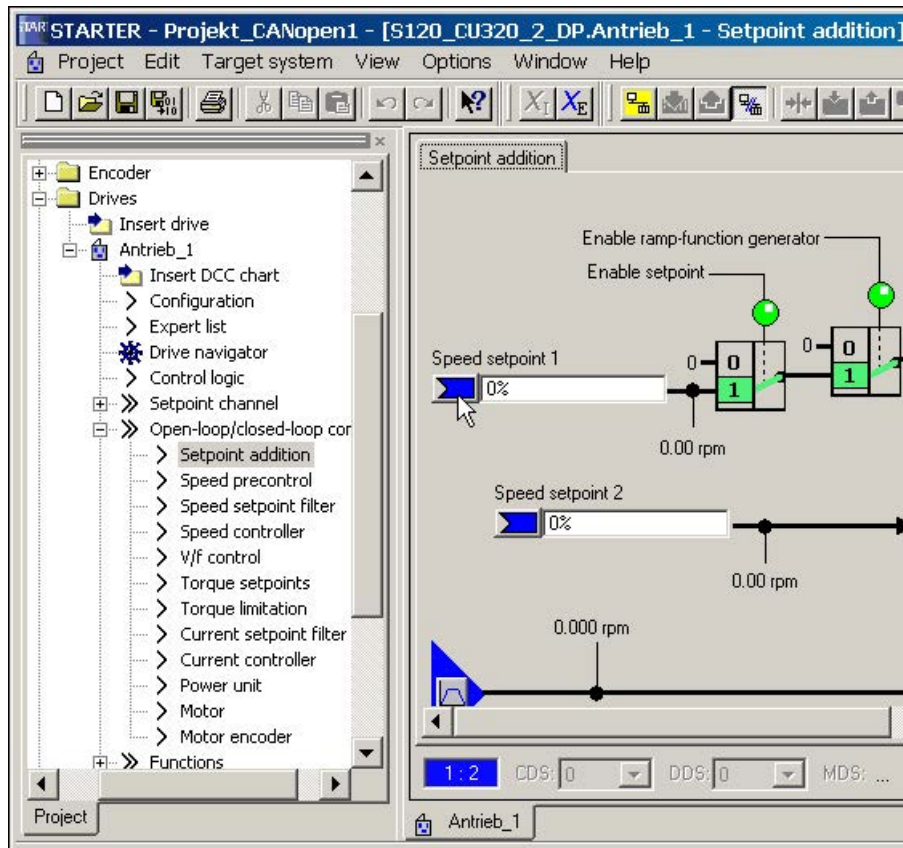

Image 3-7 Setpoint addition

2. Click the blue field to the left of the field for "Speed setpoint 1" and then click the selection "Further interconnections", which is now displayed.

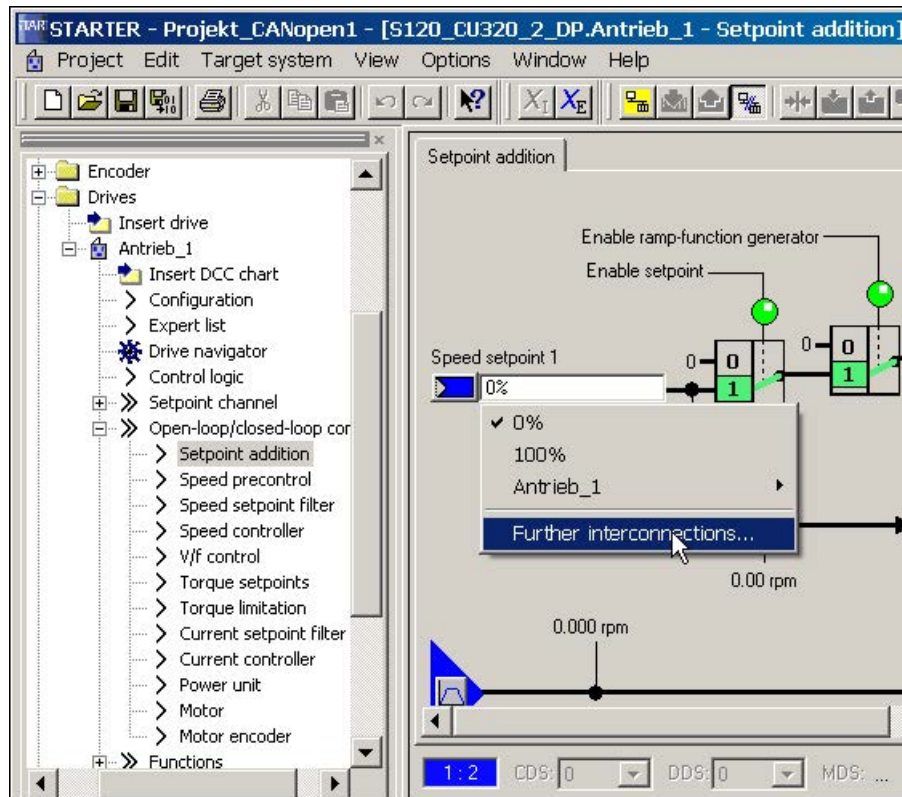

Image 3-8 Display additional interconnections

A list from which you can select the available r parameters is now displayed.

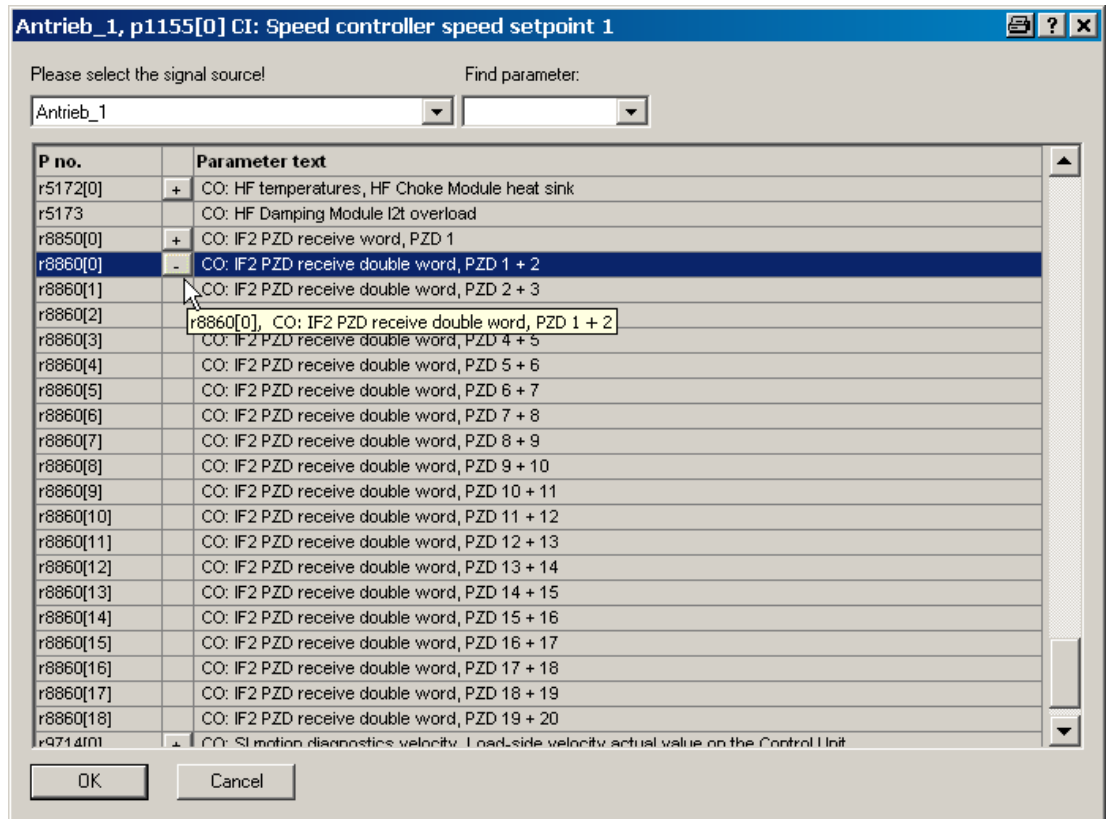

Image 3-9 Selection list

- 3. Double-click r8860[1].

In the graphic screen interface, you can now see that p1155 has been interconnected with parameter r8860[1].

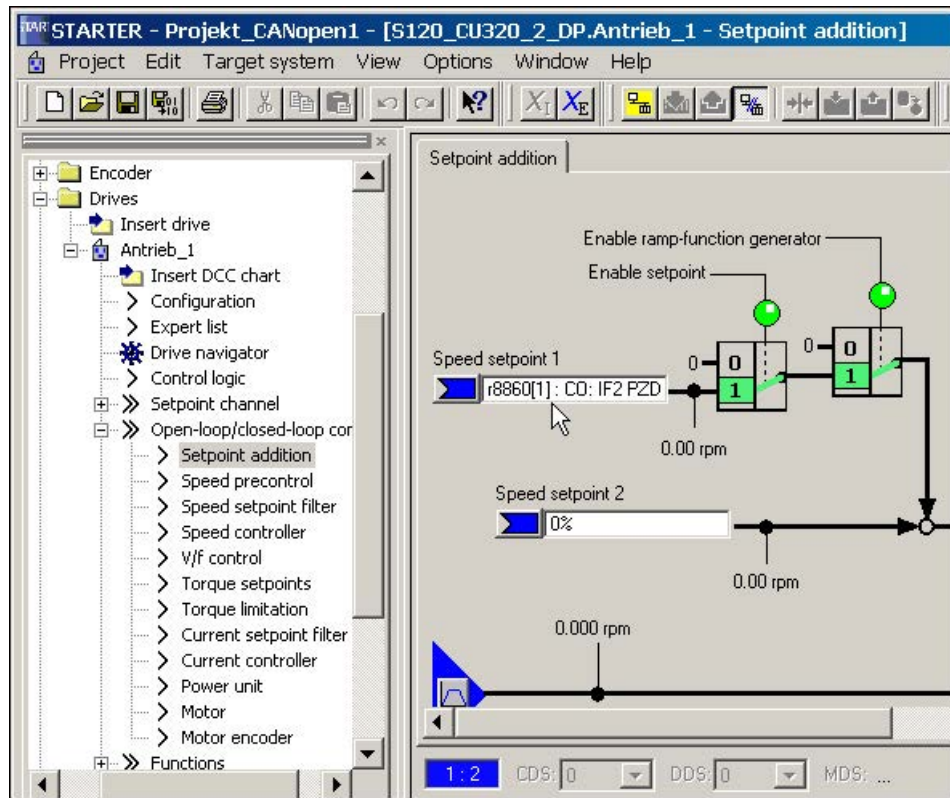

Image 3-10 Interconnection closed

3.3.2 Important functions in the STARTER commissioning tool

The STARTER commissioning tool offers the following functions to support the project handling:

- Restoring the factory settings
- Various operating wizards
- Configuring and parameterizing drives
- A virtual control panel to rotate the motors
- Run trace functions for controller optimization of the drives
- Create and copy data records
- Load the project from the programming device to the target device
- Copy volatile data from RAM to ROM
- Load the project from the target device to the programming device
- Create and activate safety functions
- Activate write protection
- Activate know-how protection

The programming device is called "PG/PC" in the subsequent text. The Control Unit of the SINAMICS drive system is called the "Target device".

Operating support using wizards

Wizards are integrated in STARTER for various functions to support operation.

3.3.2.1 Restoring the factory settings

You can use this function to set all the parameters in the working memory of the Control Unit to the factory settings. To ensure that the data on the memory card is also reset to the factory settings, choose the "Copy from RAM to ROM" function. This function can only be activated in the online mode. To activate the function:

1. Call the shortcut menu "Drive unit > Target device > Restore factory settings".

In the following prompt window you can select as to whether you also wish to save the factory setting in the ROM.

2. Click "OK" to acknowledge.

3.3.2.2 Load project to target device.

You can use this function to load the actual project from the PG/PC into the Control Unit. A consistency check is first made for the project. If inconsistencies are detected, corresponding messages are output. You must resolve the inconsistencies before loading. If the data is consistent, then it will be transferred into the work memory of the Control Unit. In order to execute this function in the online mode, the following operator actions are alternatively available:

1. Select the drive unit and call the menu "Project > Load to target system".
or
2. Select the drive unit and call the shortcut menu "Target device > Load to target device".
Or
3. Select the drive unit and call the menu "Target system > Load > Load CPU/drive unit to target device...".
Or
4. If the drive unit has a gray background, click the symbol  "Load CPU/drive unit to target device...".

3.3.2.3 Create data records (offline) and copy

Drive and command data sets (DDS and CDS) can be added in the drive's configuration screen. Click the appropriate buttons to do this. Before data sets are copied, all the wiring needed for both data sets should be completed.

For more information about data sets, refer to Chapter "Basics of the drive system" in the SINAMICS S120 Function Manual Drive Functions.

3.3.2.4 Retentively saving data

You can use this function to save volatile Control Unit data to the non-volatile memory (memory card). After backing up, the data is also retained if the 24 V Control Unit supply has been switched off. In order to execute this function in the online mode, the following operator actions are alternatively available:

1. Select the drive unit and call the menu "Target system > Copy RAM to ROM".
Or
2. Select the drive unit and call the shortcut menu "Target device > Copy RAM to ROM".
Or
3. If the drive unit has a gray background, click the symbol  "Copy RAM to ROM".
Or
4. If, after every download into the target device, data is also to be automatically transferred into the non-volatile memory, call the menu "Tools > Settings...".
5. Click the "Download" tab and activate the option "After loading, copy RAM to ROM". Click "OK" to confirm this setting.

3.3.2.5 Load the project to the PG/PC

You can use this function to load the current Control Unit project to STARTER. This function can only be activated in the online mode. In order to execute this function in the online mode, the following operator actions are alternatively available:

1. Select the drive unit and call the shortcut menu "Target device > Load CPU/drive unit into PG/PC...".
Or
2. Select the drive unit and call the menu "Target system > Load > Load CPU/drive unit to PG...".
Or
3. If the drive unit has a gray background, click the symbol  "Load CPU/drive unit to PG/PC...".

3.3.2.6 Create and correct safety functions

To set up, activate and operate the Safety Integrated functions, various screen forms are available in the STARTER commissioning tool wizards. You can access the Safety Integrated functions online and offline in the project tree.

1. In the project tree, open the following structure: "Drive unit xy > Drives > Drive xy > Functions > Safety Integrated".
2. Double-click the function entry "Safety Integrated".

Note

Additional information about how to use Safety Integrated functions is provided in the SINAMICS S120 Function Manual Safety Integrated.

3.3.2.7 Activate write protection

Write protection prevents settings from being inadvertently changed. No password is required for write protection. This function can only be activated in the online mode.

1. Select the required drive unit in the project navigator of your STARTER project.
2. Call the shortcut menu "Write protection drive unit > Activate".

Write protection is now activated. In the expert list you can recognize that write protection is active by the fact that the entry fields of all adjustable parameters are shown with gray shading.

In order to permanently transfer your setting, after changing write protection, you must carry out the "RAM to ROM" data save operation.

3.3.2.8 Activate know-how protection

Activate know-how protection

The "Know-how protection function" prevents, for example, strictly confidential company know-how for configuration and parameter assignment from being read. The know-how protection requires a password. The password must comprise at least 1 and a maximum of 30 characters.

1. Select the required drive unit in the project navigator of your STARTER project.
2. Call the shortcut menu "Know-how protection drive unit > Activate".

The "Activate Know-how Protection for Drive Unit" dialog box opens.



Image 3-11 Activate know-how protection

3. The "Without copy protection" option is active by default. When an appropriate memory card is inserted in the Control Unit, you can choose from two copy-protection options:
 - With basic copy protection (permanently linked to the memory card)
 - With extended copy protection (permanently linked to the memory card and control unit)

 WARNING
<p>Danger to life through software manipulation when using removable storage media</p> <p>The storage of files on removable storage media involves a high risk of infection, e.g. via viruses or malware. As a result of incorrect parameterization, machines can malfunction, which in turn can lead to injuries or death.</p> <ul style="list-style-type: none"> • Protect the files on removable storage media against harmful software through appropriate protective measures, e.g. virus scanners.

4. Click "Specify".

The "Know-how Protection for Drive Unit - Specify Password" dialog box opens.

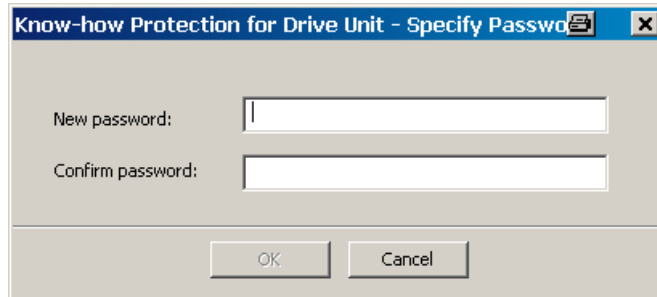

Image 3-12 Set a password for the know-how protection.

5. In the "New password" field, enter the password (1 to 30 characters). Pay attention to upper- and lower-case.
6. Enter it again in the "Confirm password" field and click "OK" to confirm the entry.
7. If, despite active know-how protection, you permit diagnostic functions, activate the "Allow diagnostic functions (trace and measuring functions)" option with a mouse click.
8. The "Copy RAM to ROM" option is active by default and ensures that the know-how protection is permanently stored in the Control Unit. If you want to use the know-how protection temporarily, deactivate this option.
9. Click "OK" to confirm the settings you made.

The dialog box is closed and the password is shown in encrypted form in the "Activate Know-how Protection for Drive Unit" dialog box.

This allows the trace function, the measuring function and the function generator to be used despite know-how protection.

Know-how protection is now activated. If larger data volumes are being encrypted, a progress display informs that the encryption or the activation of the know-how protection is still running.

The text "Know-how protected" then appears instead of the content in all protected parameters of the expert list.

Note

A detailed description of the know-how protection functions is provided in Chapter "Basics of the drive system" in the SINAMICS S120 Function Manual Drive Functions.

3.3.3 Activating online operation: STARTER via PROFIBUS

The programming device (PG/PC), on which the STARTER commissioning tool is activated, is connected to PROFIBUS using a PROFIBUS adapter.

STARTER via PROFIBUS (example with 2 CU320-2 DP)

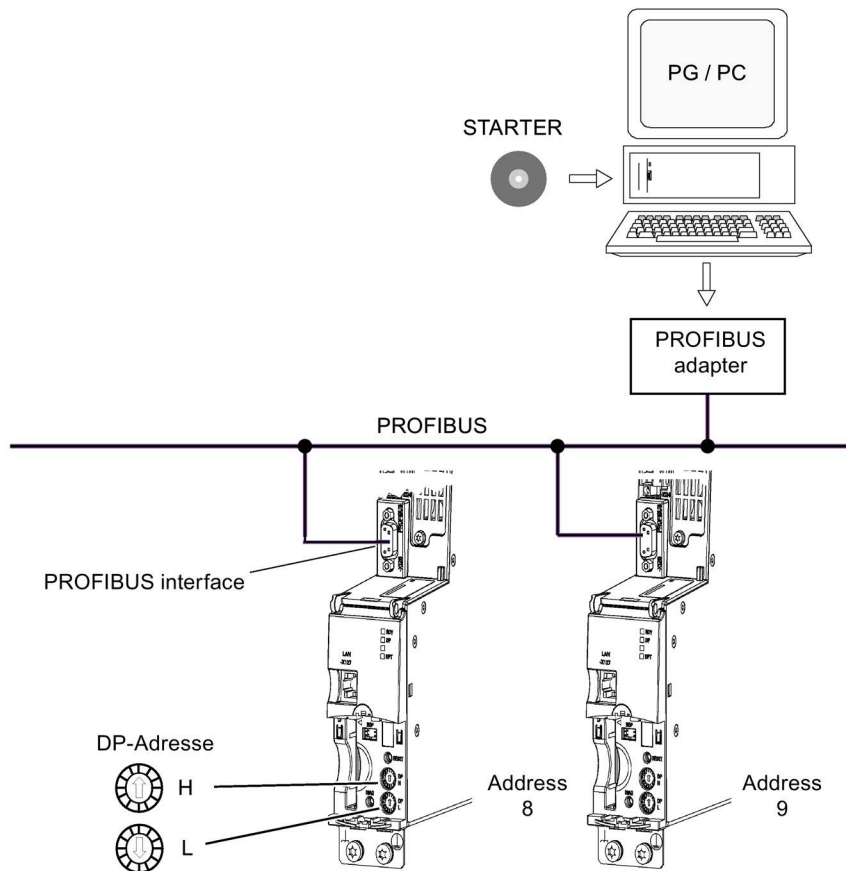

Image 3-13 Connecting the programming device to the target device via PROFIBUS

Making the STARTER settings for PROFIBUS

The following settings are required in the STARTER commissioning tool for communication via PROFIBUS:

1. Call the menu "Tools > Set PG/PC interface ...".
2. If the interface has still not been installed, click on the "Select" button.
3. In the selection list on the left-hand side, select the module that you want to use as the interface.
4. Click the "Install" button.

The selected module is then listed in the "Installed" list.

5. Click on "Close".
6. Call the menu "Tools > Set PG/PC interface ..." and click on the "Properties" button.
7. Activate or deactivate the option "PG/PC is the only master on the bus".

Note

PROFIBUS setting

- Baud rate
 - Connect STARTER to an operational PROFIBUS:
The STARTER commissioning tool automatically detects the baud rate used by SINAMICS for PROFIBUS, and this is then used.
 - Connect STARTER for commissioning:
The Control Unit automatically detects the baud rate set in the STARTER commissioning tool, and this is then used.
 - PROFIBUS addresses:
The PROFIBUS addresses for the individual drive units must be specified in the project and must match the address settings on the devices.
-

3.3.4 Activating online operation: STARTER via Ethernet

The Control Unit can be commissioned with the PG/PC via the integrated Ethernet interface. This interface is provided for commissioning purposes only and cannot be used to control the drive in operation. Routing with a possibly inserted CBE20 expansion card is not possible.

Precondition

- STARTER as of version 4.1.5
- Control Unit CU320-2 DP as of version "C" or CU320-2 PN

STARTER via Ethernet (example)

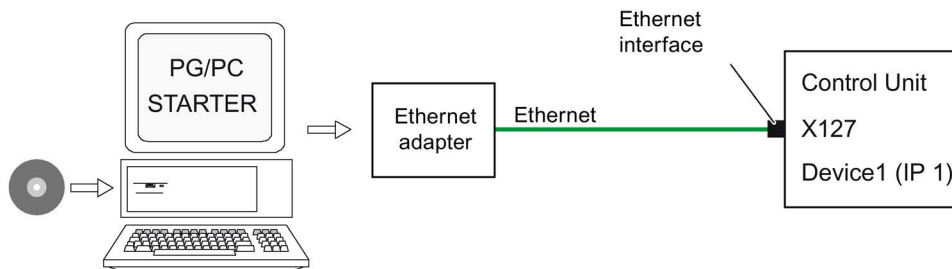

Image 3-14 Connecting the PG/PC to the target device via Ethernet (example)

Install online operation via Ethernet

1. Install the Ethernet interface in the PG/PC according to the manufacturer's instructions.
2. Set the IP address of the Ethernet interface in Windows:
 - Assign the PG/PC a free IP address (e.g. 169.254.11.1).
 - In the delivery condition, the IP address of the internal Ethernet interface X127 of the Control Unit is 169.254.11.22.

Note

Ethernet interface X127 is intended for commissioning and diagnostics.

Do not use this interface for other purposes and ensure that X127 is always accessible (e.g. for service).

3. Set the access point of the STARTER commissioning tool.
4. Use the STARTER commissioning tool to specify a name for the Control Unit interface.

Setting the IP address in Windows 7

Note

The following procedure is based on the Windows 7 operating system. Under other operating systems (such as Windows XP), operation may differ slightly.

1. In the PG/PC call the control panel using the "Start > Control Panel" menu item.
2. In the control panel of your PG/PC, under "Network and Internet", select the "Network and Sharing Center" function.
3. For your network card that is displayed, click the connection link.
4. Click in the status dialog of the connection on "Properties" and acknowledge the subsequent confirmation prompt with "Yes".
5. In the properties dialog of the connection, select the "Internet protocol 4 (TCP/IPv4)" element and then click "Properties".
6. In the properties dialog, activate the "Use the following IP address" option.
7. Set the IP address of the PG/PC access interface to the Control Unit to 169.254.11.1 and the subnet mask to 255.255.0.0.

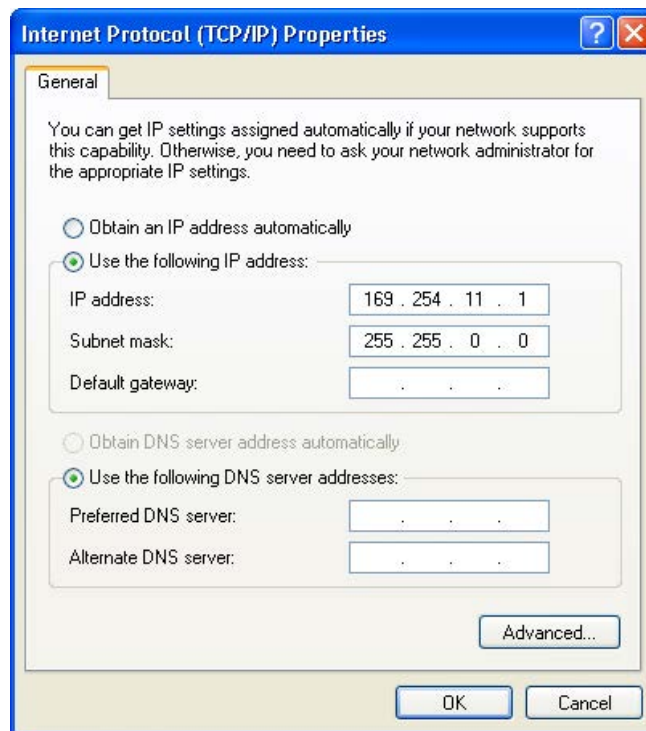

Image 3-15 Example: IPv4 address of the PG/PC

8. Click "OK" and close the Windows-specific window of the network connections.

Making settings in the STARTER commissioning tool

In the STARTER commissioning tool, set the communication via Ethernet as follows (in our example, we are using the Ethernet interface "Belkin F5D 5055"):

1. Call the menu "Tools > Set PG/PC interface ...".
2. Select the "Access point of the application", and therefore the interface parameter assignment (in the example we use the access point "S7ONLINE (STEP 7)" and the interface parameterization "TCP/IP(Auto)->Belkin F5D 5055").

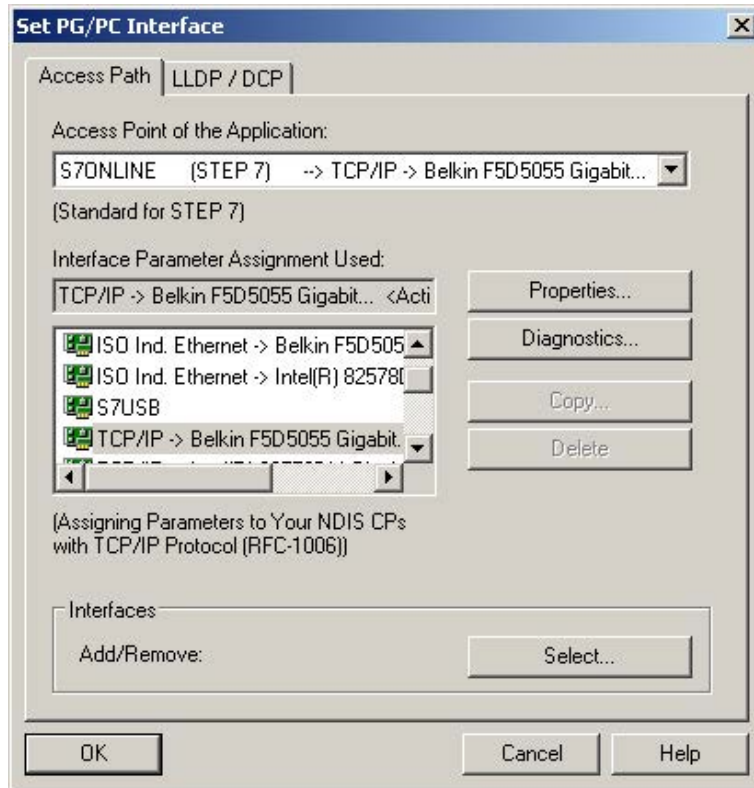

Image 3-16 Selecting the Ethernet interface at the PG/PC

If the desired interface does not yet exist in the selection list, you can create it.

3. Click the "Select" button.

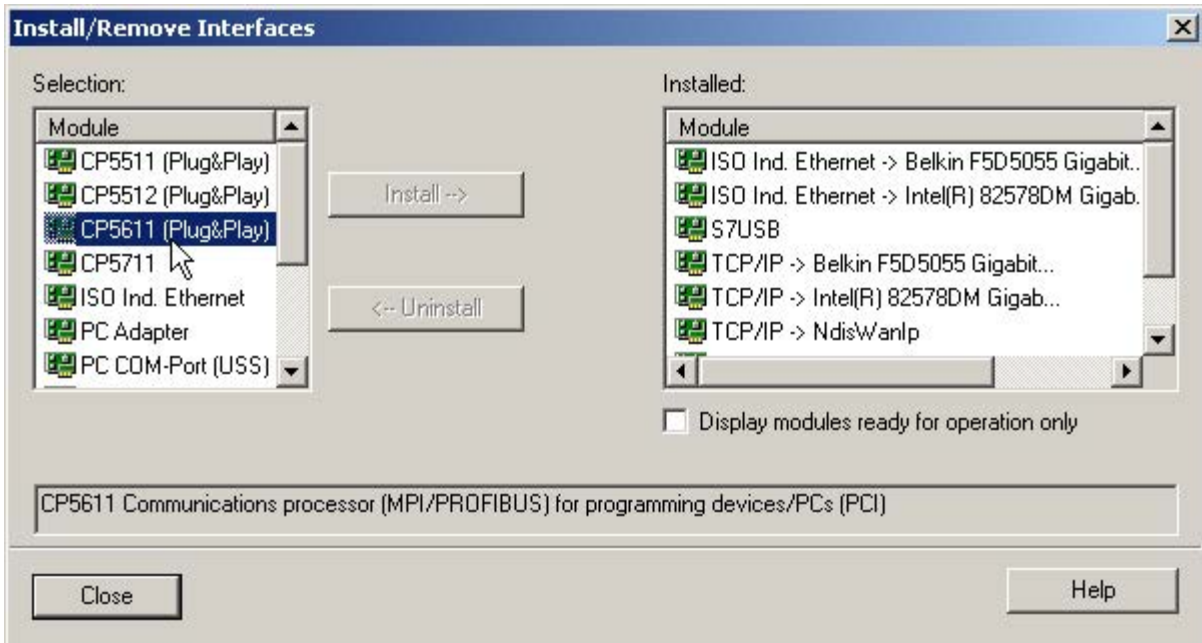

Image 3-17 Setting the interface

4. In the selection list on the left-hand side, select the module that you want to use as the interface.
5. Click the "Install" button.
The selected module is then listed in the "Installed" list.
6. Click the "Close" button.

You can then check the IP address of the integrated Ethernet interface as follows:

7. Select the drive unit and call the shortcut menu "Target device > Online access ...".
8. Click the "Module addresses" tab.

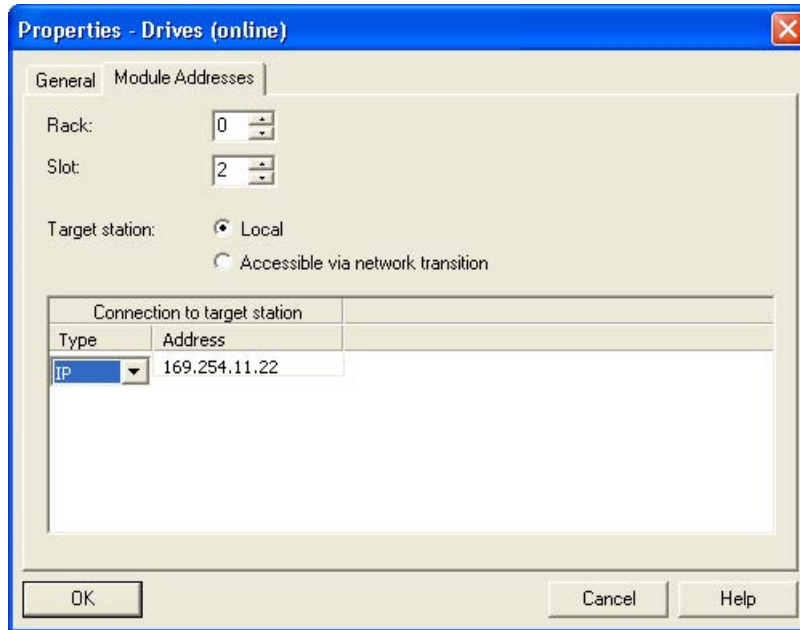

Image 3-18 Setting the online access

Assigning the IP address and name

Note

When assigning names to IO devices (e.g. a Control Unit) in Ethernet (SINAMICS components), then ST conventions (Structured Text) must be complied with. The names must be unique within Ethernet. Other than "-" and ".", no special characters are permitted in the name of an IO device.

Note

The IP address and device name are stored non-volatile on the memory card of the Control Unit.

Assigning the IP address using the "Accessible nodes" function

Use the STARTER commissioning tool to assign an IP address and a name for the Ethernet interface.

1. Connect the Control Unit to the PG/PC.
2. Switch on the Control Unit.
3. Open STARTER.
4. Load your project or create a new project.

5. Call the menu "Project > Accessible nodes" or click the symbol  "Accessible nodes" to search for available nodes in the Ethernet.

The SINAMICS drive unit is identified and displayed as bus participant Drive unit_1 with IP address 169.254.11.22.

6. Select the bus node entry and select the shortcut menu "Edit Ethernet node...".
7. In the dialog "Edit Ethernet nodes", enter the device name for the Ethernet interface.
 - Click "Assign name".
 - If no entry is in the subnet mask, enter 255.255.0.0 in the subnet mask for the IP configuration.
 - Click the "Assign IP configuration" button.
 - Close the Information window "The parameters were transferred successfully".
 - Click the "Close" button.
8. Click the "View/Refresh (F5)" button to display the IP address and the value "NameOfStation" = "The assigned name" in the entry for the bus node.

Note

If these two pieces of information are not be displayed in the entry for the bus node, close the "Accessible nodes" dialog and search for nodes that can be accessed again.

9. If the Ethernet interface is displayed as bus node, select the entry and click the "Accept" button.

The SINAMICS drive is displayed as new drive object in the project tree. You can now configure the new drive unit.

10. Click the "Connect to selected target devices" button and call the menu "Target system > Load to target device", to load the project to the Control Unit memory card.

The IP address and device name are stored non-volatile on the memory card of the Control Unit.

Parameterizing the interface in the expert list

1. Assign the "Name of Station" in parameter p8900
2. Assign the "IP Address of Station" in parameter p8901 (factory setting 169.254.11.22).
3. Assign the "Default Gateway of Station" in parameter p8902 (factory setting 0.0.0.0).
4. Assign the "Subnet Mask of Station" in parameter p8903 (factory setting 255.255.0.0).
5. Activate the configuration with p8905 = 1.
6. Activate and save the configuration with p8905 = 2.

3.3.5 Activating online operation: STARTER via PROFINET IO

Online operation with PROFINET IO is implemented using TCP/IP.

Preconditions

- STARTER as of version 4.1.5
- PROFINET-conform CU3xx PN
- CU32x with CBE20

STARTER via PROFINET IO (example)

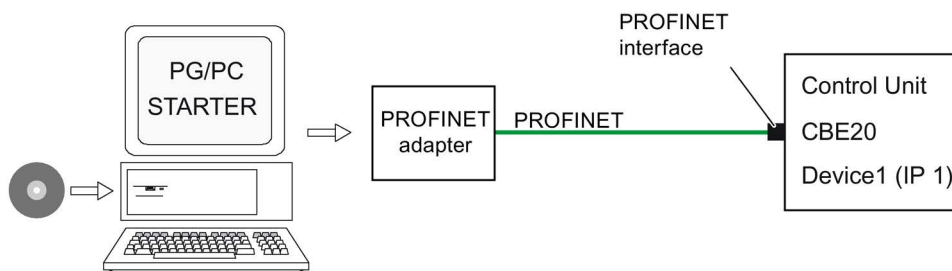

Image 3-19 Connecting the PG/PC to the target device via PROFINET (example)

Establishing online operation with PROFINET

1. Assign the PG/PC a fixed, free IP address. In our example, we selected 169.254.11.1, based on the factory setting of the integrated Ethernet interface X127 (169.254.11.22). Set the subnet mask to 255.255.0.0.

Note

Ethernet interface X127 is intended for commissioning and diagnostics.

Do not use this interface for other purposes and ensure that X127 is always accessible (e.g. for service).

2. Make the settings in the STARTER commissioning tool.
3. Select online operation in the STARTER commissioning tool.

Setting the IP address in Windows 7

Note

The following procedure is based on the Windows 7 operating system. Under other operating systems (such as Windows XP), operation may differ slightly.

1. In the PG/PC call the control panel using the "Start > Control Panel" menu item.
2. In the control panel of your PG/PC, under "Network and Internet", select the "Network and Sharing Center" function.
3. For your network card that is displayed, click the connection link.
4. Click in the status dialog of the connection on "Properties" and acknowledge the subsequent confirmation prompt with "Yes".
5. In the properties dialog of the connection, select the "Internet protocol 4 (TCP/IPv4)" element and then click "Properties".
6. In the properties dialog, activate the "Use the following IP address" option.
7. Set the IP address of the PG/PC access interface to the Control Unit to 169.254.11.1 and the subnet mask to 255.255.0.0.

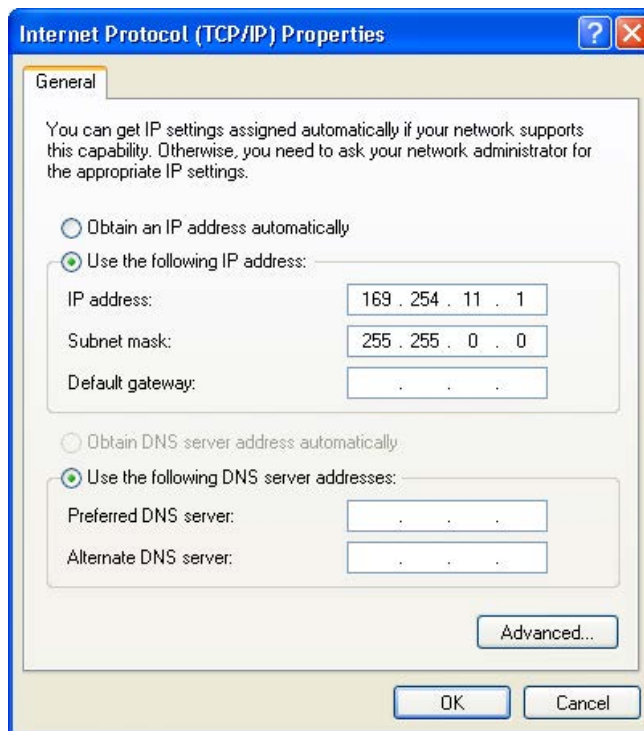

Image 3-20 Example: IPv4 address of the PG/PC

8. Click "OK" and close the Windows-specific window of the network connections.

Setting the interface in the STARTER commissioning tool

In the STARTER commissioning tool, you set communication via PROFINET as follows:

1. Call the menu "Tools > Set PG/PC interface ...".
2. Select the "Access point of the application", and therefore the interface parameter assignment (in the example we use the access point "S7ONLINE (STEP 7)" and the interface parameterization "TCP/IP(Auto)->Belkin F5D 5055").

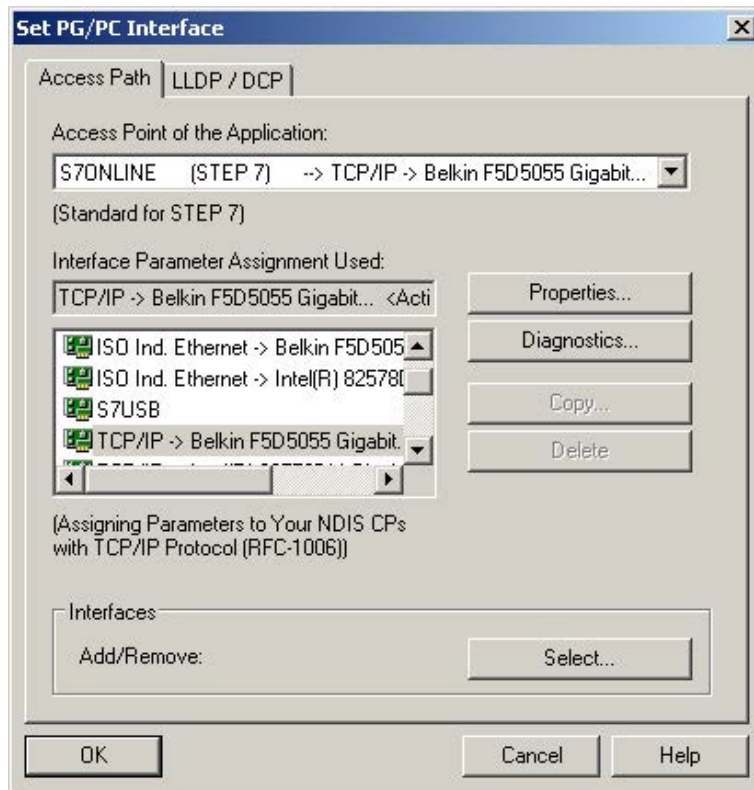

Image 3-21 Setting the PG/PC interface

If the desired interface does not yet exist in the selection list, you can create it.

3. Click the "Select" button.

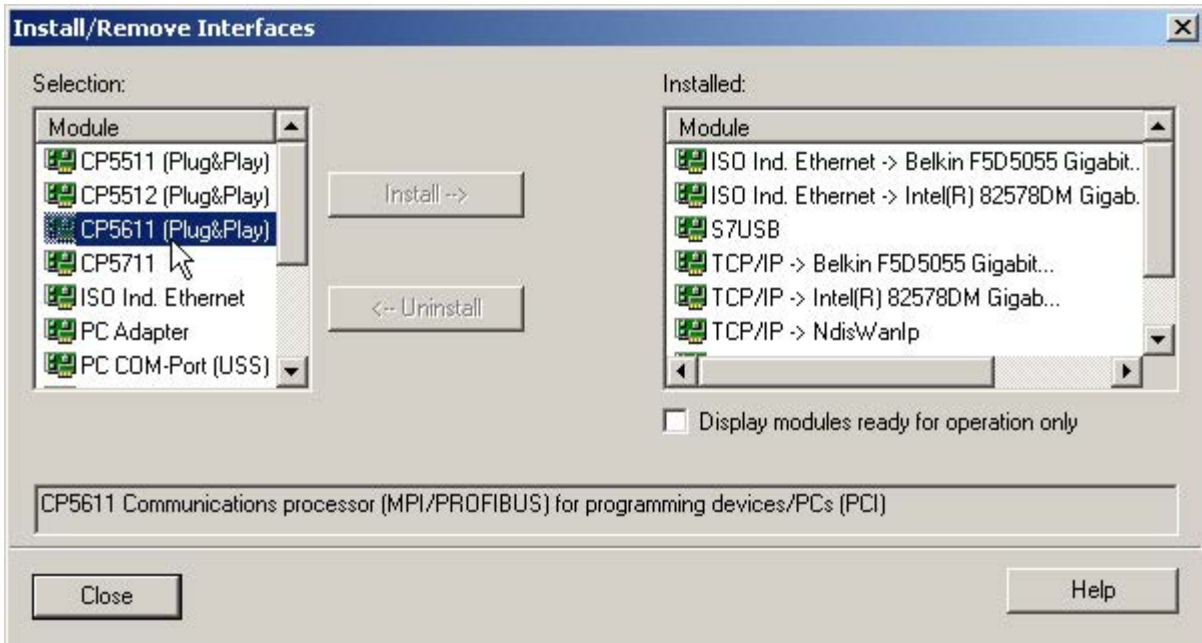

Image 3-22 Setting the interface

4. In the selection list on the left-hand side, select the module that you want to use as the interface.
5. Click the "Install" button.
The selected module is then listed in the "Installed" list.
6. Click the "Close" button.

You can then check the IP address of the integrated Ethernet interface as follows:

7. Select the drive unit and call the shortcut menu "Target device > Online access ...".
8. Click the "Module addresses" tab.

The IP address that you set must be located under "Connect to target station".

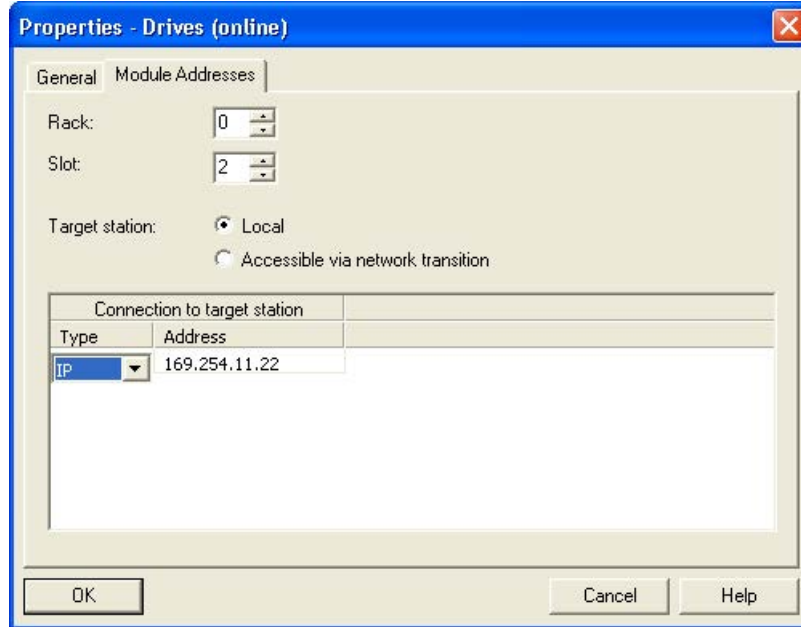

Image 3-23 Setting online access

Assigning an IP address and a name to the drive unit

With the STARTER commissioning tool, you can assign an IP address and a name to the PROFINET interface (e.g. CBE20) of the drive unit. The following steps are required:

1. Connect the PG/PC via a Crosslink-Ethernet cable with the CBE20, inserted in the CU320-2.
2. Switch on the Control Unit.
3. Open the STARTER commissioning tool.
4. Call the menu "Project > Accessible nodes" or click the symbol "Accessible nodes".
 - The search is performed for available nodes connected to PROFINET.
 - The Control Unit is identified and displayed under "Accessible nodes" as the bus node with the IP address 0.0.0.0, without any type information.

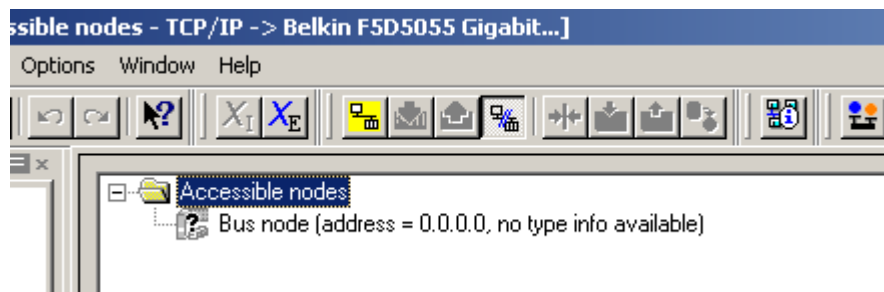

Image 3-24 Bus nodes found

5. Right-click the bus node entry to open the shortcut menu "Edit Ethernet node ...".
 - In the selection window that opens "Edit Ethernet node" you will also see the MAC address.
6. Under "Set IP configuration", enter the IP address that you selected (e.g. 169.254.11.33) and the subnet mask (e.g. 255.255.0.0).
7. Click the "Set IP configuration" button.
 - The data transfer is confirmed.
8. Click the "Update" button.
 - The bus node is identified as drive unit.
 - The address and the type are specified.

In the "Edit Ethernet node" selection window you can also assign a device name to the drive unit that has been detected.
9. In the "Device name" field, enter the name that you have selected.

Note

ST (Structured Text) conventions must be satisfied for the name assignment of IO devices in PROFINET (SINAMICS components). The names must be unique within PROFINET. Rules for assigning names:

- Other than "-" and ".", no special characters (such as accented characters, spaces, brackets) are permitted in the name of an IO device.
 - The device name must not begin or end with the "-" character.
 - The device name must not begin with a number.
 - Maximum total length of 240 characters (lowercase characters, numbers, hyphen, or period)
 - A name component within the device name, e.g. a string between two periods, must not exceed 63 characters.
 - The device name must not take the form n.n.n.n (n = 0..999).
 - The device name must not begin with the character sequence "port-xyz" or "port-xyz-abcde" (a, b, c, d, e, x, y, z = 0..9).
-

10. Click the "Assign name" button.
 - The data transfer is confirmed.
11. Click the "Update" button.
 - The bus node is detected as drive unit and is consecutively numbered.
 - The address, device name and the type are specified.

12. Close the "Edit Ethernet node" window.

13. Activate the option button in front of the detected drive unit and click the "Accept" button.

The SINAMICS drive with CBE20 is transferred as a drive object into the project tree. You can now continue to configure the drive object.

14. Click the "Connect to target system" button and then call the menu "Target system > Load > To target device", to load the project to the Control Unit memory card.

The IP address and device name are stored non-volatile on the memory card of the Control Unit.

3.4 Creating a project in the STARTER commissioning tool

3.4.1 Creating a project offline

PROFIBUS

To create a project offline, you need the PROFIBUS address, the device type and the device version, e.g. firmware version 4.5 or higher. Example of a sequence of the grouping:

Create a new project

1. Call the "Project > New ..." menu.

The following default settings are displayed:

- User projects: Projects already in the target directory
- Name: Project_1 (can be freely selected)
- Type: Project
- Storage location (path): Default (can be set as required)

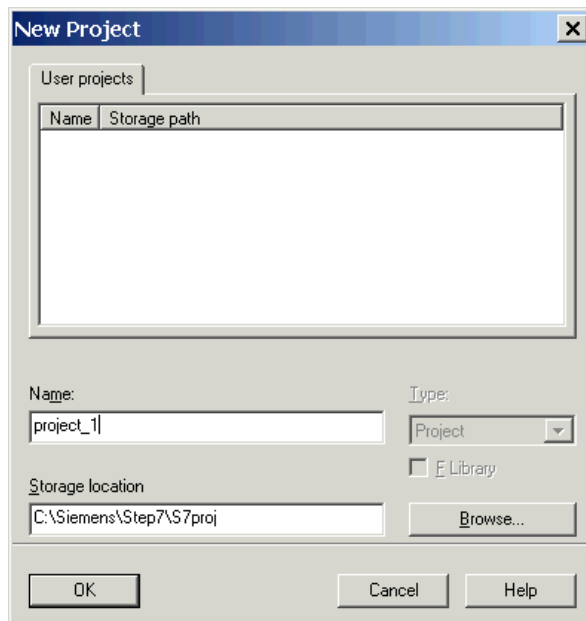

2. If necessary, correct "Name" and "Storage location", and confirm with "OK".

The project is created offline and loaded to the target system when the configuring is complete.

Add a single drive

1. Double-click in the project tree on "Insert single drive unit".

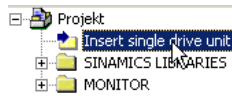

The following settings are pre-assigned:

- Device type: CU320-2 DP
- Device version: 4.5 or higher
- Address type: PROFIBUS/USS/PPI
- Bus address: 7

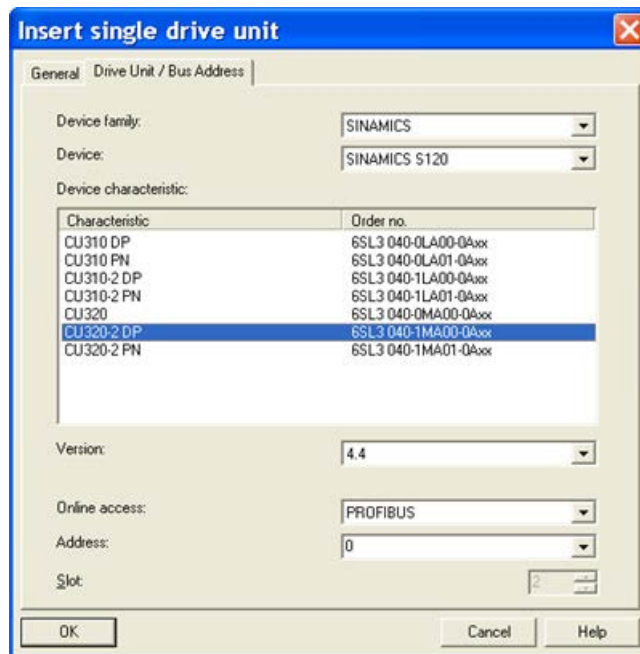

2. If necessary, correct the settings, and confirm with "OK".

Note

Bus address

The PROFIBUS address of the Control Unit must be set for initial commissioning.

Using the rotary coding switches on the Control Unit, the address can be set to a value between 1 and 126 and read via p0918. If the coding switches are at "0" (factory setting), the value can be alternatively set between 1 and 126 using p0918.

Configure the drive unit

Once you have created the project, you have to configure the drive unit. Some examples are provided in the following Chapters.

PROFINET

To create a project offline, you need the PROFINET address, the device type and the device version, e.g. firmware version 4.5 or higher.

Create a new project

1. Call the "Project > New ..." menu.

The following default settings are displayed:

- User projects: Projects already in the target directory
- Name: Project_1 (can be freely selected)
- Type: Project
- Storage location (path): Default (can be set as required)

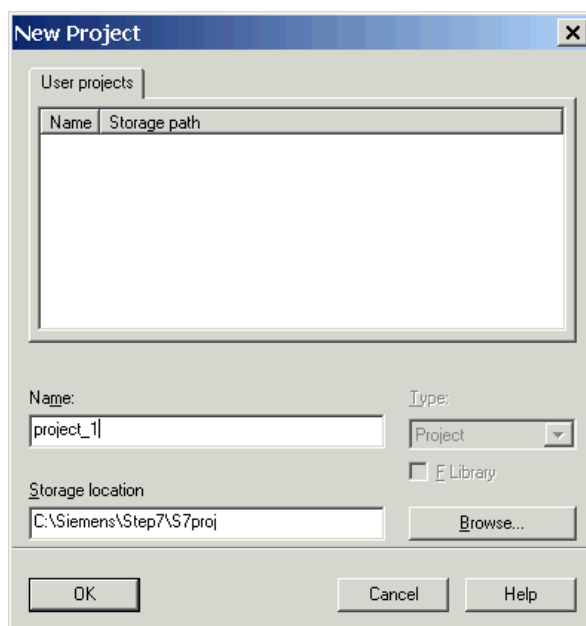

2. If necessary, correct "Name" and "Storage location", and confirm with "OK".

The project is created offline and loaded to the target system when the configuring is complete.

Add a single drive

1. Double-click in the project tree on "Insert single drive unit".

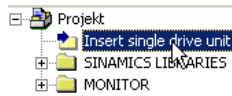

The following settings are pre-assigned:

- Device type: CU320-2 PN
- Version: 4.5 or higher
- Online access: IP
- Address: 169.254.11.22

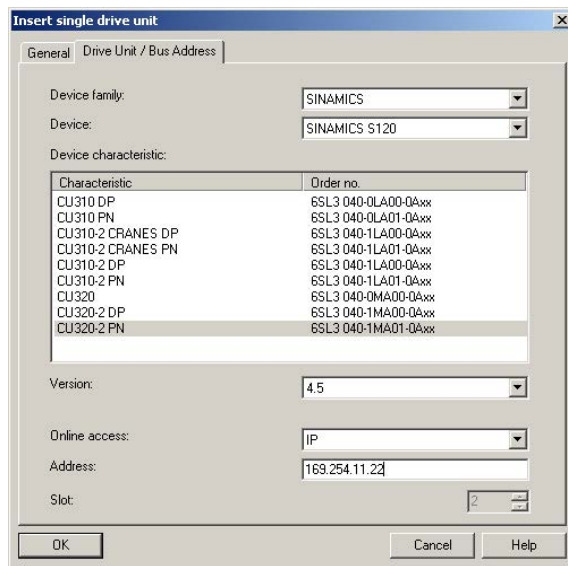

2. If necessary, correct the settings, and confirm with "OK".

Note

Bus address

The PROFINET address of the Control Unit must not be set for initial commissioning.

When delivered, the TCP/IP address of the Control Unit is set to 169.254.11.22. The address can be correspondingly changed to meet individual requirements.

Configure the drive unit

Once you have created the project, you have to configure the drive unit. Some examples are provided in the following Chapters.

3.4.2 Creating a project online

In order to search online for bus nodes via PROFIBUS or PROFINET, the drive unit must be connected with the PG/PC via PROFIBUS or PROFINET. Example of a commissioning sequence with STARTER

Create a new project

1. Call the menu "Project > New with wizard".
2. Click "Find drive units online".

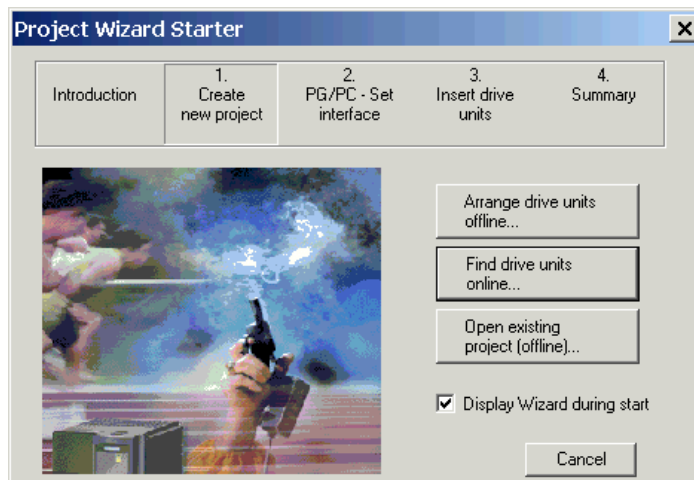

Enter the project data.

1. Enter the following project data:
 - Project name: Project_1, can be freely selected
 - Author: Any
 - Storage location: Any
 - Comment: Any

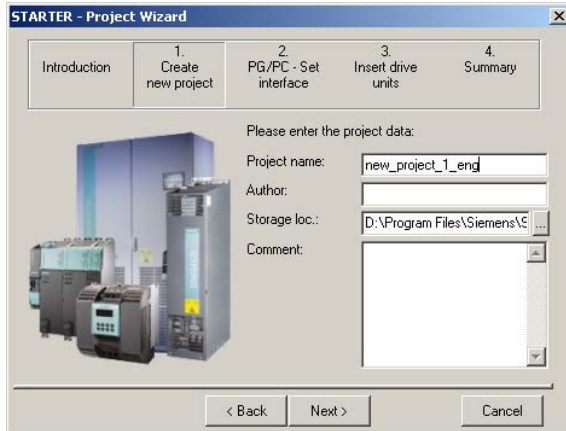

2. If necessary, correct the corresponding project data.
3. Click "Continue >".

Set up the PG/PC interface

The PG/PC interface can be setup in this window.

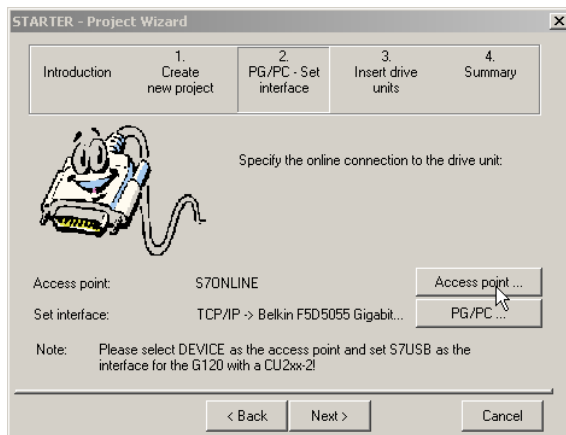

Selecting the access point

The target device can be accessed using STARTER or via STEP 7.

1. For step 2, click "Access point".

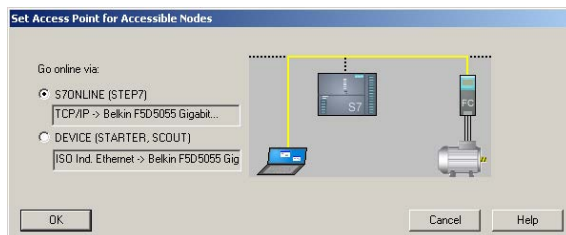

2. Select the access point for the accessible nodes, and confirm with "OK".

Selecting the PG/PC interface

In this window, the interface can be selected, set and tested.

1. For step 2, click "PG/PC".
2. Select the "Access point of the application" and therefore also the interface parameter assignment.

If the desired interface does not yet exist in the selection list, you can create additional interfaces clicking the "Select" button.

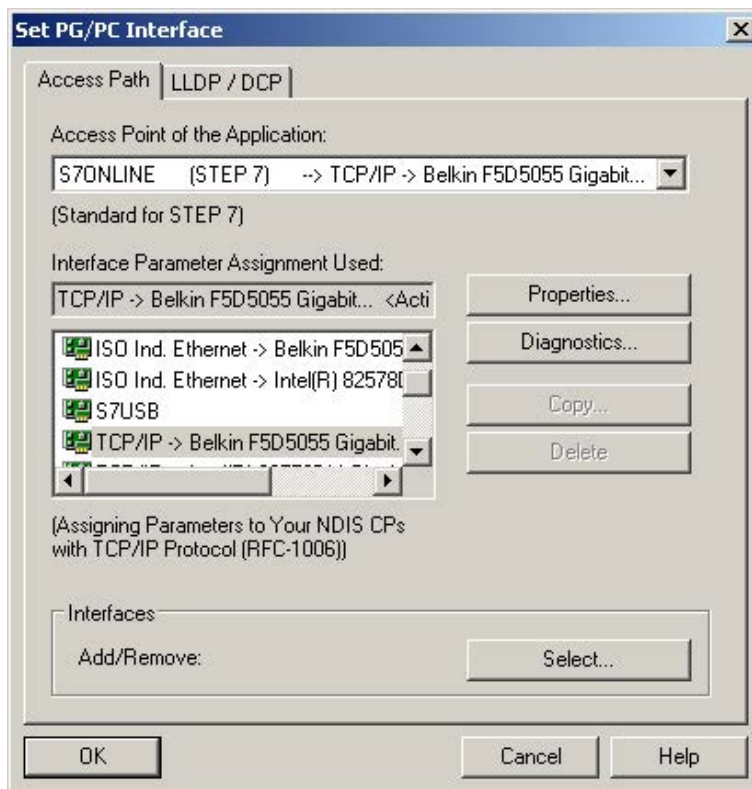

3. Click "OK" to confirm your settings.

Insert drives

The nodes are shown here in the preview.

Use the button "Refresh view" to update the preview.

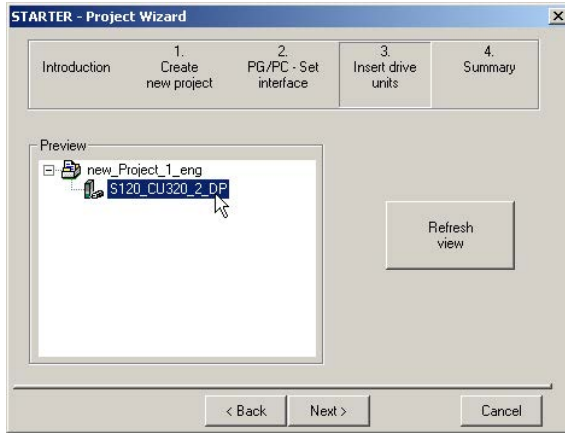

1. Click "Continue >".

Summary

You have now created the project. The project wizard shows the current settings.

1. Click "Finish".

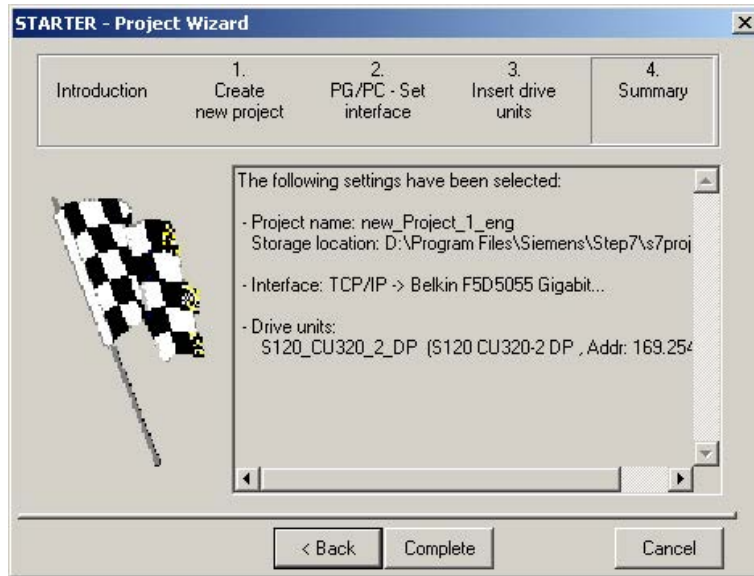

Configure the drive unit

Once you have created the project, you have to configure the drive unit. Some examples are provided in the following Chapters.

3.5 Commissioning the servo control booksize format for the first time

An example provided in this chapter explains all the configuration and parameter settings, as well as tests that are required for initial commissioning. Commissioning is carried out using the STARTER commissioning tool.

Preconditions for commissioning

- The commissioning preconditions (Page 30) have been met.
- The commissioning checklists (Page 32) (Tables 2-1 and 2-2) have been completed and the points fulfilled.
- The STARTER commissioning tool is installed and activated.
 - System prerequisites, refer to the Readme file in the STARTER installation directory.
- The drive system has been wired according to the specifications.
- The communication between the PG/PC and drive system has been prepared.
- The power supply of the Control Unit (24 V DC) has been switched on.

3.5.1 Task

Commissioning a drive unit with the following components:

Table 3- 1 Component overview

Designation	Component	Article number
Closed-loop control and infeed		
Control Unit 1	Control Unit 320-2 DP	6SL3040-1MA00-0AA0
Active Line Module	Active Line Module 16 kW	6SL3130-7TE21-6AA.
Line filter	Active Interface Module	6SL3100-0BE21-6AB0
Drive 1		
Single Motor Module 1	Single Motor Module 9 A	6SL3120-1TE21-0AA.
Sensor Module 1.0	SMC20	6SL3055-0AA00-5BA.
Motor 1	Synchronous motor	1FK7061-7AF7.-....
Motor encoder 1	Incremental encoder sin/cos C/D 1 Vpp 2048 p/r	1FK7...-.....-A..
Sensor Module 1.1	SMC20	6SL3055-0AA00-5BA.
External encoder	Incremental encoder sin/cos 1 Vpp 4096 p/r	-
Drive 2		
Single Motor Module 2	Single Motor Module 18 A	6SL3120-1TE21-8AA.
Motor 2	Induction motor	1PH7103-.NG..-L..
Sensor Module 2	SMC20	6SL3055-0AA00-5BA.
Motor encoder 2	Incremental encoder sin/cos 1 Vpp 2048 p/r	1PH7...-M...-....

3.5 Commissioning the servo control booksize format for the first time

The enable signals for the infeed and the two drives must be transmitted via PROFIBUS.

- Telegram for the Active Line Module
Telegram 370: Infeed, 1 word
- Telegram for drive 1
Standard telegram 4: Speed control, 2 position encoders
- Enable signals for drive 2
Standard telegram 3: Speed control, 1 position encoder

Note

For more information about telegram types, see SINAMICS S120 Function Manual Drive Functions or SINAMICS S120/S150 List Manual.

3.5.2 Component wiring (example)

The following diagram shows the structure of the components and the appropriate wiring. The DRIVE-CLiQ wiring is highlighted in bold.

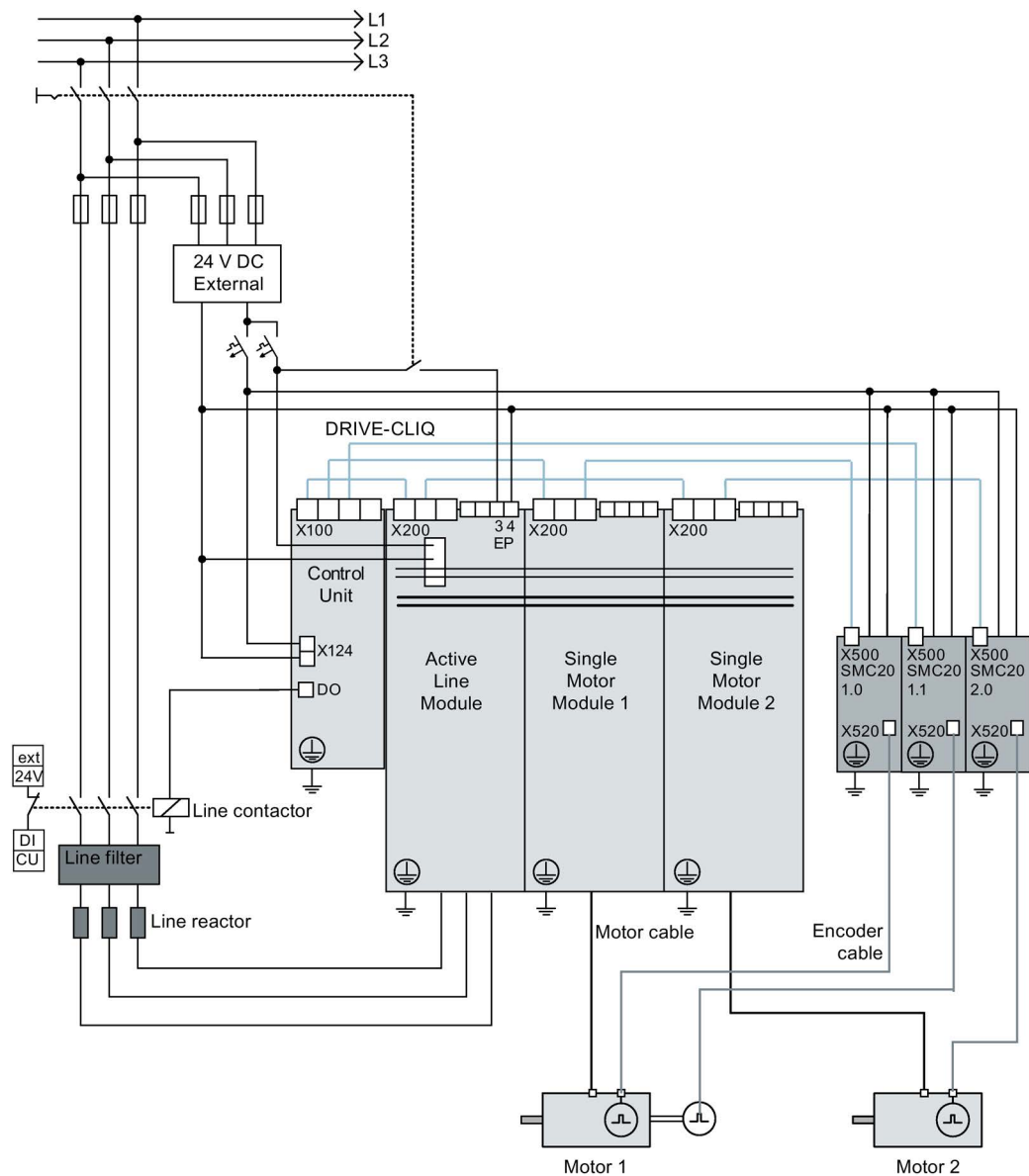

Image 3-25 Component wiring (example)

Additional information on wiring and connecting the encoder system is provided in the Manual.

3.5.3 Signal flow of the commissioning example

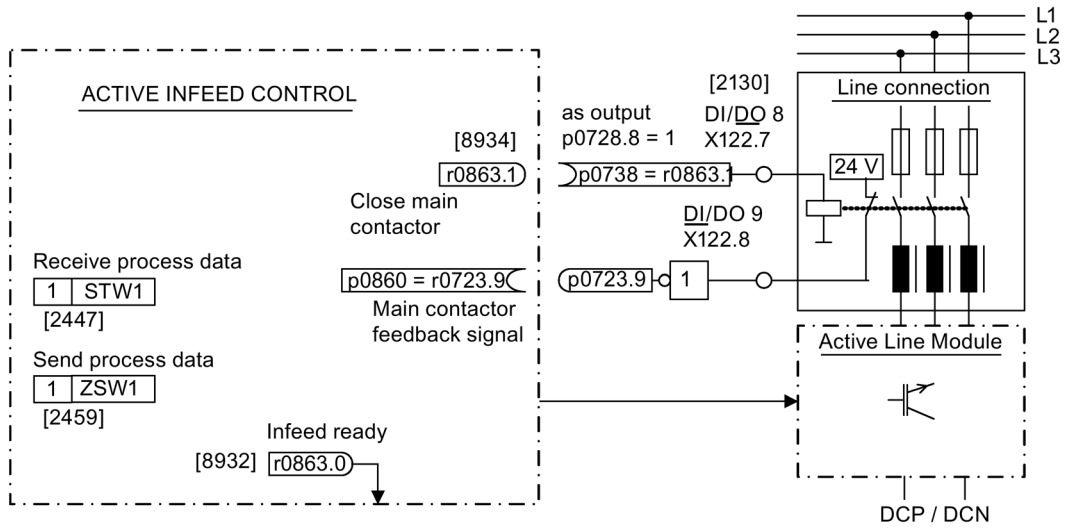

Image 3-26 Signal flow of the commissioning example - servo control, Part 1

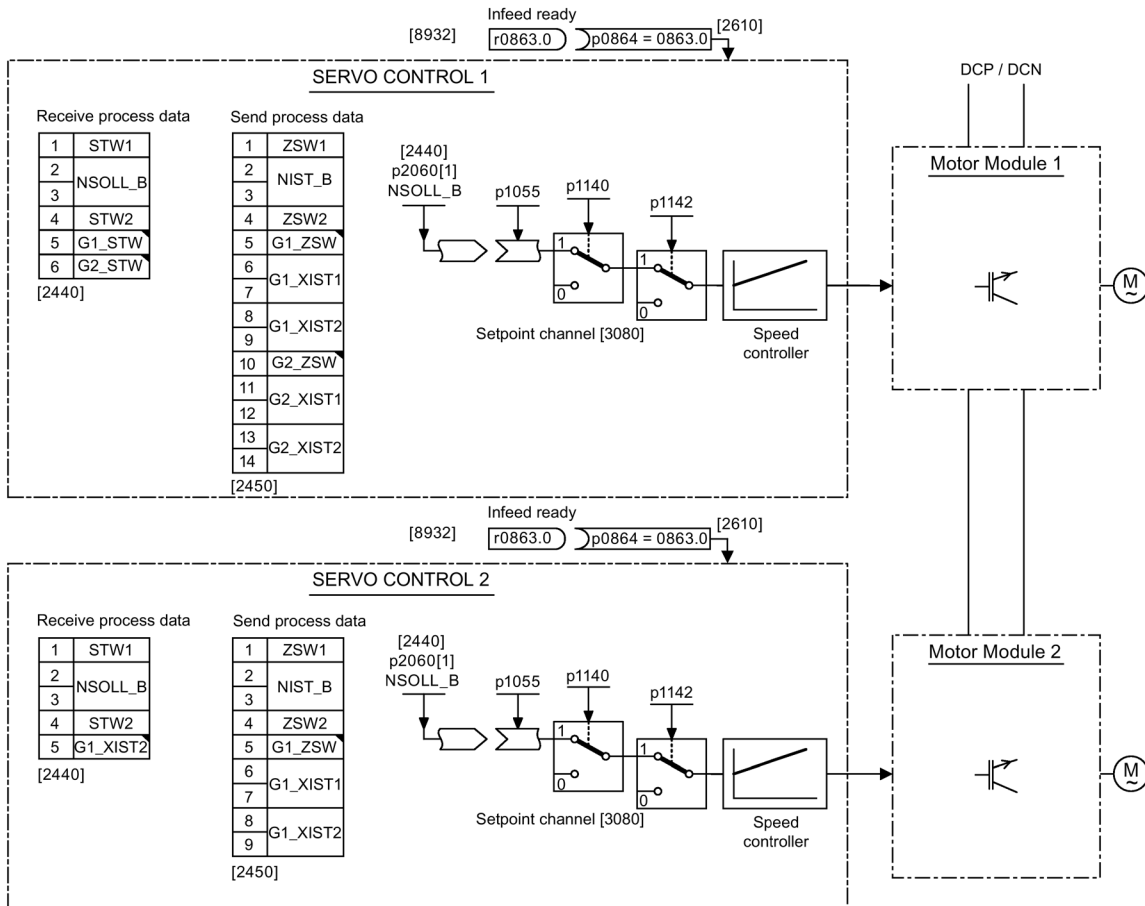

Image 3-27 Signal flow of the commissioning example - servo control, Part 2

3.5.4 Commissioning with STARTER (example)

The table below describes the steps for commissioning a drive using the STARTER commissioning tool.

Table 3- 2 Sequence for commissioning with the STARTER commissioning tool (example)

	What?	How?	Comment
1.	Creating a new project	<ol style="list-style-type: none"> 1. Call the "Project > New..." menu. 2. Enter a project name in the "New project" dialog. 3. Click "OK". 	-
2.	Automatic configuration	<ol style="list-style-type: none"> 1. Call the "Project > Connect to selected target devices" menu. As there is still no device available in the project, the STARTER commissioning tool offers the option of searching for accessible nodes. 2. Click "Yes". 3. Activate the drive unit accessed by clicking the checkbox. 4. Click "Apply". The drive project is transferred into the project view. 5. Call the "Project" > "Connect to selected target devices" menu again. You are now connected online to the drive unit. 6. Double-click "Automatic configuration". Click "Configure". 7. During automatic commissioning, the wizard will offer you the option of selecting the drive object type. As default assignment, select all of the "SERVO" components. 8. Click "Create". 9. After the automatic configuration has been completed, you have the option of going OFFLINE or remaining ONLINE. Select "Go OFFLINE". 	-
3.	Configuring the infeed	<ol style="list-style-type: none"> 1. Double-click in the project tree on "Infeeds". 2. Double-click the infeed that has been created. 3. Click the yellow "Wizard..." button. 4. To check the automatic settings and to enter additional data, such as equipment codes, etc. continue with step 3.2. 	-
<p>Note:</p> <p>When the factory setting is p7826 = 1, the firmware is automatically updated to the status on the memory card when a configured DRIVE-CLiQ component is first booted. This may take several minutes and is indicated by the READY-LED on the corresponding components flashing green/red and the Control Unit flashing orange (0.5 Hz). Once all updates have been completed, the READY-LED on the Control Unit flashes orange at 2 Hz and the corresponding READY-LED on the components flashes green/red at 2 Hz. For the firmware to be activated, a POWER ON must be carried out for the components.</p> <p>For infeed units connected to the drive unit, which during the automatic configuration do not communicate with the Control Unit via DRIVE-CLiQ, you must manually configure and transfer them into the drive topology. These devices can only be inserted in the offline mode.</p>			

3.5 Commissioning the servo control booksize format for the first time

	What?	How?	Comment
3.1	Inserting an infeed unit	<p>If there is no DRIVE-CLiQ connection to the Control Unit, then you must manually enter the data of the infeed unit using the wizard.</p> <ol style="list-style-type: none"> 1. Double-click in the project tree on "Infeeds". 2. Double-click "Insert infeeds". 3. Enter a name for the infeed. 4. Select the type. 5. Click "OK". 	If the line environment or DC-link components are changed, line/DC-link identification should be repeated.
3.2	Infeed	<ol style="list-style-type: none"> 1. Enter a component name. 2. Select the line voltage range. 3. Select the cooling type. 4. Select the baud rate. 5. The available components are now in the selection list. 6. Select the required infeed from the list. 7. Click "Continue >". 	-
3.3	Infeed - additional data	<ol style="list-style-type: none"> 1. Activate the line/DC-link identification when switching-on for the first time. 2. Accept the device supply voltage from the previous window. The rated line frequency is determined automatically. 3. Make sure that the option "Line filter available" is activated. 4. For an infeed in the "booksize" format, select a line filter. You can select one from several versions. 5. If applicable, enter the number of parallel infeeds. 6. Where relevant, select a Voltage Sensing Module. 7. Where relevant, select an external Braking Module. 8. Where relevant, select master/slave operation for several infeeds. 9. Click "Continue >". 	-
3.4	Process data exchange (infeed)	<p>One of three telegrams can be selected for communication: 370, 371 and 999.</p> <ol style="list-style-type: none"> 1. Select the required telegram (e.g. 370). 2. Click "Continue >". 	-
3.6	Configuration, summary	<p>Configuration of the infeed unit has been completed. A summary is displayed.</p> <ol style="list-style-type: none"> 1. Click "Complete". 	The infeed unit data can be copied to the clipboard for plant documentation purposes and then added to a text program, for example.

<p>NOTICE</p> <p>Damage to the infeed for control using another Control Unit</p> <p>If the infeed is controlled by a Control Unit other than that used for the Motor Module, the "Ready" signal for the infeed r0863.0 must be interconnected with drive parameter p0864 "Infeed ready" via a digital input/output. If this is not taken into account, the infeed may be damaged.</p>

3.5 Commissioning the servo control booksize format for the first time

	What?	How?	Comment
4.	Configuring the drives	You must individually configure the drives in the offline mode. The wizard displays the data determined automatically from the electronic type plate.	-
<p>For drives connected to the drive unit, which during the automatic configuration do not communicate with the Control Unit via DRIVE-CLiQ, you must manually configure and transfer them into the drive topology. These devices can only be inserted in the offline mode. In this case, perform the commissioning with step 4.1.</p> <p>If the drives have already been created by the automatic configuration, click "Configuration" > "Configure DDS..." under the drive. Then continue from step 4.2. Settings of the power unit data and for motors with DRIVE-CLiQ interface, the motor data is also already pre-assigned based on the electronic type plate.</p>			
4.1	Inserting drives	<ol style="list-style-type: none"> 1. Double-click in the project tree on "Drives". 2. Double-click the "Insert drives" entry. 3. Enter a name for the drive. 4. For the drive object, select "SERVO". 5. Click "OK". 	-
4.2	Control structure	<ol style="list-style-type: none"> 1. Select function modules. 2. Select the required control mode. 3. Click "Continue >". 	-
4.3	Power unit	<ol style="list-style-type: none"> 1. Enter a name for the component. 2. Select the DC supply voltage. 3. Select the cooling type. 4. Select the type. The available components are now in the selection list. 5. Select the required power unit from the list. 6. Click "Continue >". 	-
4.4	Configuration, power unit BICO interconnection	<p>If an infeed without DRIVE-CLiQ connection is used, a message is displayed stating that the operating signal must be connected.</p> <ol style="list-style-type: none"> 1. In the following dialog "Infeed in operation", set parameter p0864 to the binector output of the digital input to which the operating feedback signal of the infeed is interconnected. 2. Click "Continue >". 	-
5	Configuring the motor	<ol style="list-style-type: none"> 1. Enter a name for the motor (e.g. an equipment code). 2. If your motor has its own DRIVE-CLiQ interface, select the "Motor with DRIVE-CLiQ interface" item. 3. Click "Continue >" and proceed with step 5.2. <p>When commissioning, the motor data is automatically transferred to the Control Unit.</p> <hr/> <ol style="list-style-type: none"> 1. If you use a standard motor select the item, "Select standard motor from list". 2. Select the standard motor type from the "Motor type" list. 3. Select your motor. 4. Click "Continue >". <p>Depending on the particular motor type, motor properties are additionally queried; then continue with step 5.2.</p>	You can select a standard motor from the list of motors or manually enter the motor data. You can then select the motor type.

3.5 Commissioning the servo control booksize format for the first time

	What?	How?	Comment
		<ol style="list-style-type: none"> 1. If your motor is not in the default list, select "Enter motor data". 2. Click your motor type in the "Motor type" list. 3. Click "Continue >". 	
5.1	Configuring the motor data	<p>Enter your motor data according to the data sheet.</p> <p>Alternatively, after entering the motor data, perform a motor data identification when commissioning for the first time.</p> <p>Alternatively, for some motor types you can use motor data from the motor list.</p> <ol style="list-style-type: none"> 1. To do so, click the template. 2. Follow the instructions of the wizard and click "Continue >". 3. If known, enter the mechanical/electrical data of the motor and the drive train or the data of a PE spindle. 4. For this drive, select whether you require a calculation of the motor/controller data. 	If you have no mechanical data, then the data is estimated based on the type plate data. The equivalent circuit diagram data is also estimated on the basis of the data on the type plate or determined by means of automatic motor data identification.
5.2	Configuring a motor holding brake	<ol style="list-style-type: none"> 1. If you are not using a motor holding brake, click "Continue >" Or 2. If you are using a motor holding brake, select it in the dialog box and then subsequently configure it. 3. Click "Continue >". 	Additional information: see SINAMICS S120 Function Manual Drive Functions.
5.3	Configuring an encoder	<p>You can connect up to three encoders.</p> <ol style="list-style-type: none"> 1. If you are using DRIVE-CLiQ encoders, select the appropriate item. 2. Click "Continue >". <p>The encoder is automatically identified and configured.</p> <p>Alternatively, you can use a standard encoder.</p> <ol style="list-style-type: none"> 1. Select this encoder from the list. 2. Click "Continue >". <p>Alternatively, you can use your own encoder.</p> <ol style="list-style-type: none"> 1. Select "Enter data". 2. Click "Encoder data". 3. Select the measuring system. 4. Enter the required data and click "OK". 5. Click "Continue >". 	<p>If you are using an encoder that is not in the list, you can also manually enter the data.</p> <p>By clicking Details, you can view the data of the encoder selected from the encoder list.</p>
5.4	Entering encoder data	<ol style="list-style-type: none"> 1. Enter the encoder data into the input screen form and click "OK". 2. If a standard motor was selected in step 5, continue with step 5.6. 	Enter additional encoders in the same way as described above.
5.5	Drive functions	<ol style="list-style-type: none"> 1. If a standard motor was not selected, select the technological application here. 2. When required, activate the motor identification function. 	Your choice of application influences the calculation for the open-loop/closed-loop control parameters.
5.6	Configuring process data exchange	<ol style="list-style-type: none"> 1. For communication, select the PROFIdrive telegram from several telegrams. 	-

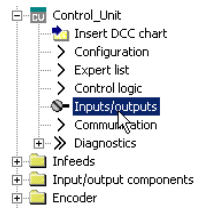
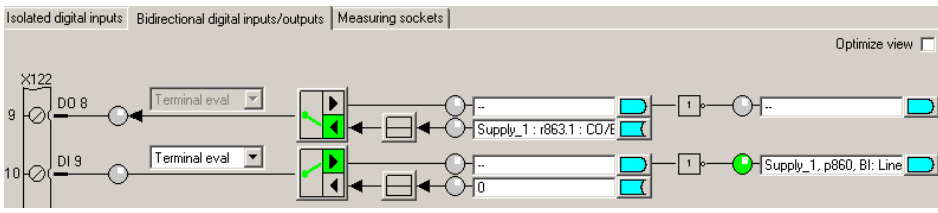
	What?	How?	Comment
5.7	Configuration, summary	The configuration of the drive train has been completed. A summary is displayed. 1. Click "Complete".	The drive data can be copied to the clipboard for plant documentation purposes and then added to a text program, for example.
5.8	Configuring drive functions	1. In the project tree click Drives\Drive xy\Configuration. 2. Click the "Function modules/technology packages" button. Under the "Function modules" tab, you can activate single or multiple function modules. 3. Click "OK".	-
5.9	Summary	The drive data can be copied to the clipboard for system documentation purposes and then pasted into a text processing program, for example.	-
Note			
The reference parameters and limit values can be protected from being automatically overwritten in the STARTER commissioning tool by p0340 = 1: Drive -> Configuration-> "Reference parameters / blocked list" tab.			
6	Enable signals and BICO interconnections	The enable signals for the infeed and the two drives must be implemented via the digital inputs on the Control Unit.	-
6.1	Line contactor	1. Make the following settings for the line contactor: - p0728.8 = 1, sets DI/DO as output - p0738 = 0863.1 line contactor on - p0860 = 0723.9 line contactor, feedback signal	The line contactor should be controlled from the drive object (DO) Infeed_1. See function diagram [8838] In the "Function > Line contactor control" screen form, you can check that the interconnection is correct.
			
7.	Save the parameters on the device	<p>1. Call the "Project" > "Connect to selected target devices" menu (online mode).</p> <p>2. Call the "Target system > Load > Load CPU/drive unit to target device..." menu.</p>	Left-click the drive unit (SINAMICS S120).
	<p>1. Select the drive unit in the project tree.</p> <p>2. Call the "Target system > Copy RAM to ROM" menu (save the data on the memory card).</p>		

3.5 Commissioning the servo control booksize format for the first time

	What?	How?	Comment
8.	The motor starts to run	<p>The drives can be started via the control panel in the STARTER commissioning tool.</p> <p>The control panel can be found in the project navigator under "Drive unit > Drives > Commissioning > Control panel".</p>	<p>For more information about the control panel, see Getting Started.</p> <p>The control panel supplies the control word 1 (STW1) and speed setpoint 1 (NSOLL).</p> <p>For more information about line/DC-link identification, see the SINAMICS S120 Function Manual Drive Functions.</p>

Diagnostic functions in the STARTER commissioning tool

Under Component > Diagnostics > Control/status words

- Control/status words
- Status parameters
- Missing enable signals

3.6 Commissioning U/f vector control booksize format for the first time

An example provided in this chapter explains all the configuration and parameter settings, as well as tests that are required for initial commissioning. Commissioning is carried out using the STARTER commissioning tool.

Preconditions for commissioning

- The commissioning preconditions (Page 30) have been met.
- The commissioning checklists (Page 32) (Tables 2-1 and 2-2) have been completed and the points fulfilled.
- The STARTER commissioning tool is installed and activated.
 - System prerequisites, refer to the Readme file in the STARTER installation directory.
- The drive system has been wired according to the specifications.
- The communication between the PG/PC and drive system has been prepared.
- The power supply of the Control Unit (24 V DC) has been switched on.

3.6.1 Task

A drive in the "booksize" format with "V/f vector control" control mode with the following components is to be commissioned for the first time:

Table 3- 3 Component overview

Designation	Component	Article number
Closed-loop control and infeed		
Control Unit	Control Unit 320-2 DP	6SL3040-1MA00-0AA0
Smart Line Module	Smart Line Module 16 kW	6SL3130-6TE21-6A..
Line filter package 16 kW	Line filter and line reactor	6SL3100-0BE21-6AB0
Drive 1		
Single Motor Module 1	Single Motor Module 9 A	6SL3120-1TE21-0A..
Motor 1	Induction motor	1PH8083-1.F2.-....
Drive 2		
Single Motor Module 2	Single Motor Module 9 A	6SL3120-1TE21-0A..
Motor 2	Induction motor	1PH8083-1.F2.-....

The enable signals for the infeed and the drive should be implemented via terminals.

3.6.2 Component wiring (example)

The following diagram shows the structure of the components and the appropriate wiring. The DRIVE-CLiQ wiring is highlighted in bold.

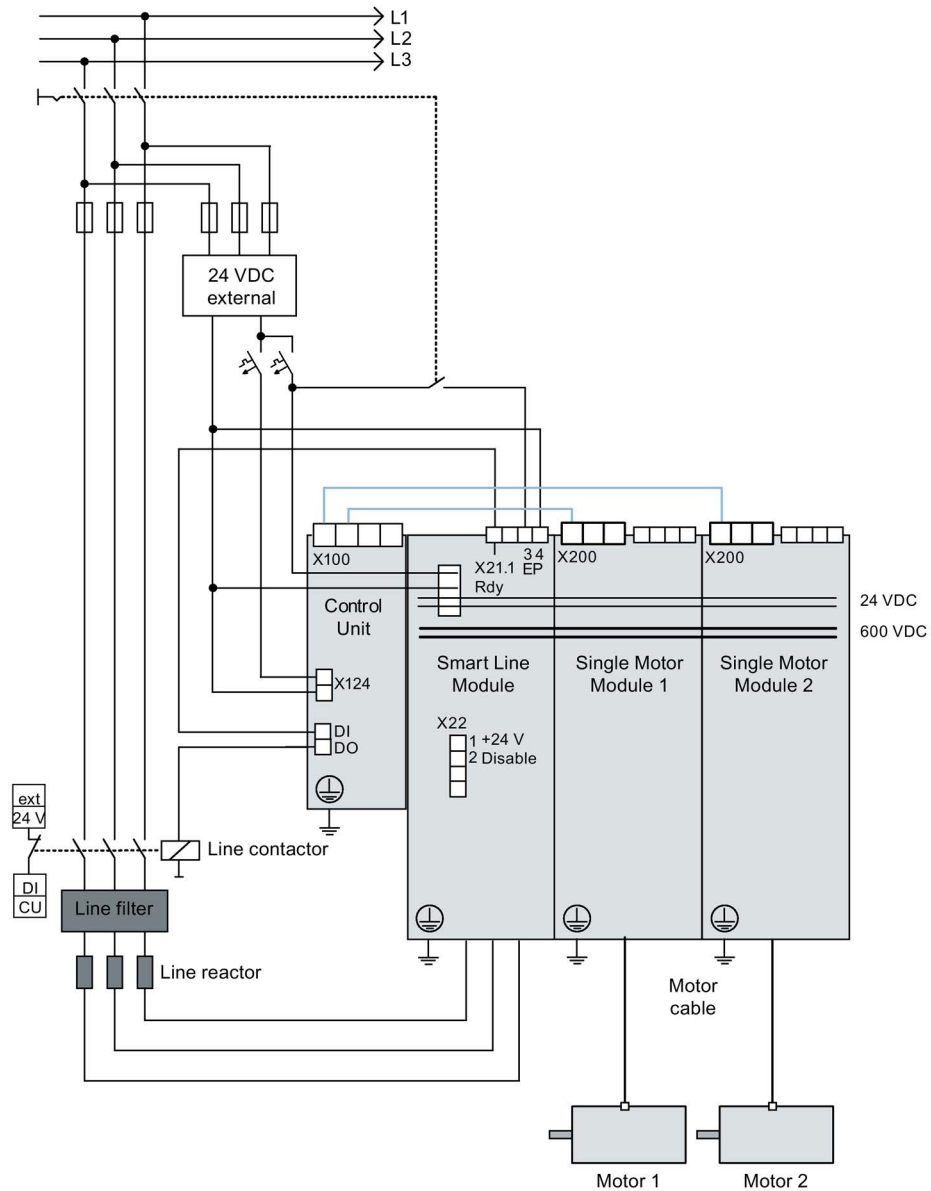

Image 3-28 Component wiring (example)

For more information on wiring and connecting the encoder system, see the Equipment Manual.

3.6.3 Signal flow of the commissioning example

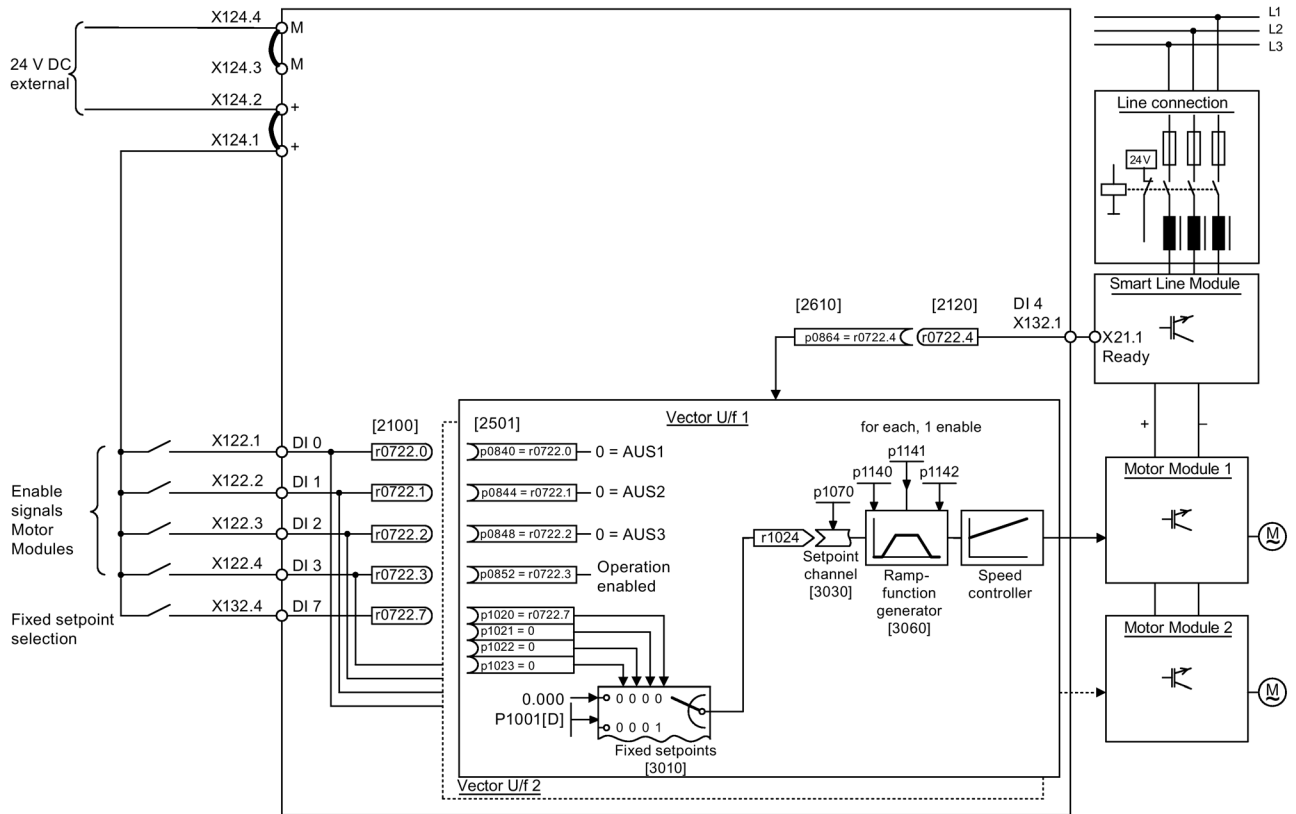

Image 3-29 Signal flow diagram of the example vector U/f control mode in the booksize format

3.6.4 Commissioning with STARTER (example)

The table below describes the steps for commissioning the example using the STARTER commissioning tool.

Table 3- 4 Commissioning sequence (example)

	What?	How?	Comment
1.	Creating a new project	<ol style="list-style-type: none"> 1. Call the "Project > New..." menu. 2. Enter a project name in the "New project" dialog. 3. Click "OK". 	-
2.	Automatic configuration	<ol style="list-style-type: none"> 1. Call the "Project > Connect to selected target devices" menu. As there is still no device available in the project, STARTER offers the option of searching for accessible nodes. 2. Click "Yes". 3. Activate the drive unit accessed by clicking the checkbox. 4. Click "Apply". The drive unit is transferred into the project window. 5. Call the "Project" > "Connect to selected target devices" menu again. You are now connected online with the drive unit. 6. Double-click "Automatic configuration". Click "Configure". 7. During automatic commissioning, the wizard will offer you the option of selecting the drive object type. As default assignment, select all of the "Vector" components. 8. Click "Create". 9. After the automatic configuration has been completed, you have the option of going OFFLINE or remaining ONLINE. Select "Go OFFLINE". 	-
3.	Configuring the infeed	<ol style="list-style-type: none"> 1. Double-click in the project tree on "Infeeds". 2. Double-click the infeed that has been created. 3. Click the yellow "Wizard..." button. 4. To check the automatic settings and to enter additional data, such as equipment codes, etc. continue with step 3.2. 	-

Note:

When the factory setting is p7826 = 1, the firmware is automatically updated to the status on the memory card when a configured DRIVE-CLiQ component is first booted. This may take several minutes and is indicated by the READY-LED on the corresponding components flashing green/red and the Control Unit flashing orange (0.5 Hz). Once all updates have been completed, the READY-LED on the Control Unit flashes orange at 2 Hz and the corresponding READY-LED on the components flashes green/red at 2 Hz. For the firmware to be activated, a POWER ON must be carried out for the components.

For infeed units connected to the drive unit, which during the automatic configuration do not communicate with the Control Unit via DRIVE-CLiQ, you must manually configure and transfer them into the drive topology. These devices can only be inserted in the offline mode.

	What?	How?	Comment
3.1	Inserting an infeed unit	If there is no DRIVE-CLiQ connection to the Control Unit, then you must manually enter the data of the infeed unit using the wizard. <ol style="list-style-type: none"> 1. Double-click in the project tree on "Infeeds". 2. Double-click "Insert infeed". 3. Enter a name for the infeed. 4. Select the type. 5. Click "OK". 	If the line environment or DC-link components are changed, line/DC-link identification should be repeated.
3.2	Infeed	<ol style="list-style-type: none"> 1. Enter a component name. 2. Select the line voltage range. 3. Select the cooling type. 4. Select the type. The available components are now in the selection list. 5. Select the required infeed from the list. 6. Click "Continue >". 	-
3.3	Infeed - additional data	<ol style="list-style-type: none"> 1. Activate the line/DC-link identification when switching-on for the first time. 2. Accept the device supply voltage from the previous window. The rated line frequency is determined automatically. 3. If applicable, enter the number of parallel infeeds. 4. Where relevant, select a Voltage Sensing Module. 5. Where relevant, select an external Braking Module. 6. Click "Continue >". 	-
3.4	Process data exchange (infeed)	One of three telegrams can be selected for communication: 370, 371 and 999. <ol style="list-style-type: none"> 1. Select the required telegram. 2. Click "Continue >". 	-
3.5	Configuration, summary	Configuration of the infeed unit completed. A summary is displayed. <ol style="list-style-type: none"> 1. Click "Complete". 	The infeed unit data can be copied to the clipboard for plant documentation purposes and then added to a text program, for example.

NOTICE**Damage to the infeed for control using another Control Unit**

If the infeed is controlled from another Control Unit, then the ready signal of the infeed must be connected to parameter p0864 "infeed ready" of the drive through a digital input/output. If this is not taken into account, the infeed may be damaged.

3.6 Commissioning U/f vector control booksize format for the first time

	What?	How?	Comment
4.	Configuring the drives	You must individually configure the drives in the offline mode. The wizard displays the data determined automatically from the electronic type plate.	-
<p>For drives connected to the drive unit, which during the automatic configuration do not communicate with the Control Unit via DRIVE-CLiQ, you must manually configure and transfer them into the drive topology. These devices can only be inserted in the offline mode. In this case, perform the commissioning with step 4.1.</p> <p>If the drives have already been created by the automatic configuration, click "Configuration" > "Configure DDS..." under the drive. Then continue from step 4.2. Settings of the power unit data and for motors with DRIVE-CLiQ interface, the motor data is also already pre-assigned based on the electronic type plate.</p>			
4.1	Inserting drives	<ol style="list-style-type: none"> 1. Double-click in the project tree on "Drives". 2. Double-click the "Insert drives" entry. 3. Enter a name for the drive. 4. For the drive object, select "VECTOR". 5. Click "OK". 	-
4.2	Control structure	<ol style="list-style-type: none"> 1. Select function modules. 2. Switch the closed-loop control to "V/f control". 3. Select the required control mode. 4. Click "Continue >". 	-
4.3	Power unit	<ol style="list-style-type: none"> 1. Enter a name for the component. 2. Select the DC supply voltage. 3. Select the cooling type. 4. Select the type. The available components are now in the selection list. 5. Select the required power unit. 6. Click "Continue >". 	-
4.4	Configuration, power unit BICO interconnection	<p>If an infeed without DRIVE-CLiQ connection is used, a message is displayed stating that the operating signal must be connected.</p> <ol style="list-style-type: none"> 1. In the following dialog "Infeed in operation", set parameter p0864 to the binector output of the digital input to which the operating feedback signal of the infeed is interconnected. 2. Click "Continue >". 	-
4.5	Configuring additional data	<p>In this window, you can additionally select the following</p> <ul style="list-style-type: none"> • Various output filters • A Voltage Sensing Module • A parallel connection 	With this dialog window, the configuration of the Motor Module has been completed.

NOTICE

Damage to a sine-wave filter if it is not activated during commissioning

The sine-wave filter may be damaged if it is not activated during commissioning.

- Activate use of a sine-wave filter during commissioning via parameter p0230 = 3.

	What?	How?	Comment
5	Drive setting	You can select the motor standard (IEC/NEMA) and power unit application (duty cycles).	-
5.1	Configuring the motor	<ol style="list-style-type: none"> 1. Enter a name for the motor (e.g. an equipment code). 2. If your motor has its own DRIVE-CLiQ interface, select the item. 3. Click "Continue >". <p>When commissioning, the motor data is automatically transferred to the Control Unit.</p> <ol style="list-style-type: none"> 1. If you use a standard motor select the item, "Select standard motor from list". 2. Select the standard motor type from the "Motor type" list. 3. Select your motor. 4. Click "Continue >". <ol style="list-style-type: none"> 1. If your motor is not in the default list, select "Enter motor data". 2. Click your motor type in the "Motor type" list. 3. Click "Continue >". 	You can select a standard motor from the list of motors or manually enter the motor data. You can then select the motor type.
5.2	Configuring the motor data	<p>Enter your motor data according to the data sheet.</p> <p>Alternatively, after entering the motor data, perform a motor data identification when commissioning for the first time.</p> <p>Alternatively, for some motor types you can use motor data from the motor list.</p> <ol style="list-style-type: none"> 1. To do so, click the template. 2. Follow the wizard by clicking "Next >". 3. If known, you can enter the mechanical/electrical data of the motor and the drive train or the data of a PE spindle. 4. If necessary, select a complete calculation of the motor/controller data without equivalent circuit diagram data. 5. For this example, select the simple drive. 	If you have no mechanical data, then the data is estimated based on the type plate data. The equivalent circuit diagram data is also estimated on the basis of the data on the type plate or determined by means of automatic motor data identification.
5.3	Configuring a motor holding brake	<ol style="list-style-type: none"> 1. If you are not using a motor holding brake, click "Continue >". Or 2. If you are using a motor holding brake, you can select and configure the brake in this window. 3. Click "Continue >". 	For additional information, see SINAMICS S120 Function Manual Drive Functions.
5.4	Configuring an encoder	<p>You can connect up to three encoders.</p> <ol style="list-style-type: none"> 1. If you are using a DRIVE-CLiQ encoder, then select the appropriate item. 2. Click "Next >". The encoder is automatically identified and configured. <p>Alternatively, you can use a standard encoder.</p> <ol style="list-style-type: none"> 1. Select the encoder from the list. 2. Click "Continue >". 	<p>When using an encoder that is not in the list, after step 4.8, you can also enter the data manually.</p> <p>By clicking Details, you can view the data of the encoder selected from the the encoder list.</p>

3.6 Commissioning U/f vector control booksize format for the first time

	What?	How?	Comment
		Alternatively, you can use your own encoder. 1. Select Enter data. 2. Click the encoder data. 3. Select the measuring system. 4. Enter the required data and click "OK". 5. Click "Continue >".	
5.5	Entering encoder data	Enter the encoder data into the input screen form and click "OK".	Enter additional encoders in the same way as described above.
5.6	Configuring drive functions	You can select certain technological applications and the type of motor data identification.	Your choice of application influences the calculation for the open-loop/closed-loop control parameters.
5.7	Configuring process data exchange	For communication, select the PROFIdrive telegram from several telegrams.	-
5.8	Important parameters	You can specify important parameters as limit values in this window. These include, the mechanical supplementary conditions of the drive train.	-
5.9	Configuration, summary	The configuration of the drive train has been completed. A summary is displayed. 1. Click "Complete".	The drive data can be copied to the clipboard for plant documentation purposes and then added to a text program, for example.
Note			
The reference parameters and limit values can be protected from being automatically overwritten in the STARTER commissioning tool by setting p0340 = 1. In the STARTER commissioning tool, you will find this under Drive > Configuration > Blocked list tab.			
6.	Enable signals and BICO interconnections	The enable signals for the infeed and the two drives must be implemented via the digital inputs on the Control Unit. 1. In the project tree, click "Drive unit \ Control Unit \ Inputs/outputs". 2. Select "Bidirectional digital inputs/outputs".	-
6.1	Line contactor	1. Make the following settings for the line contactor: - p0728.8 = 1, sets DI/DO as output - p0738 = 0863.1 control (energize) line contactor - p0860 = 0723.9 line contactor, feedback signal	The line contactor must be controlled by the infeed_1 drive object (DO). See function diagram [8834] In the "Function > Line contactor control" screen form, you can check that the interconnection is correct.

3.6 Commissioning U/f vector control booksize format for the first time

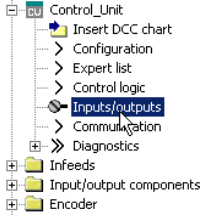
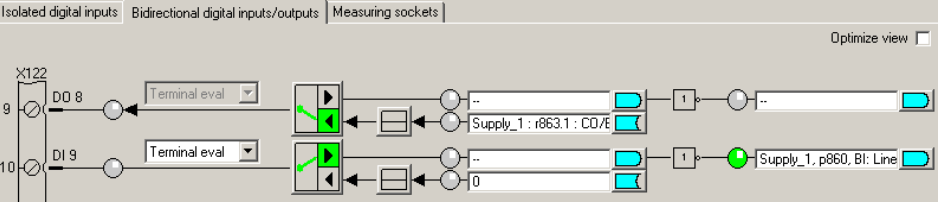
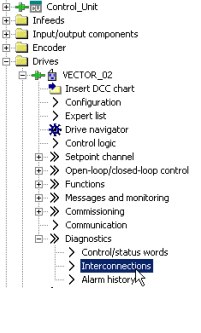
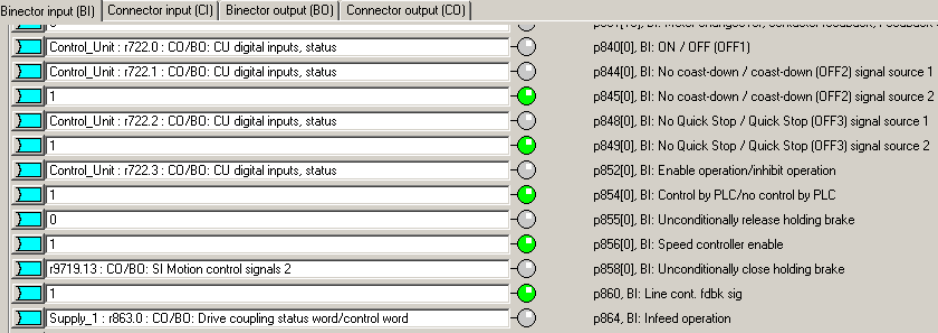
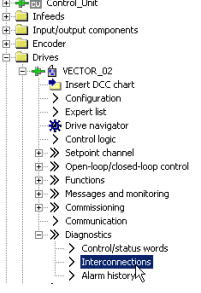
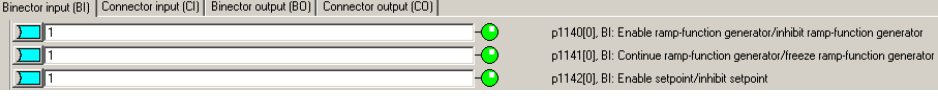
	What?	How?	Comment
			
6.2	<p>Enable Motor Module</p>	<ul style="list-style-type: none"> Enable signals for the Motor Module (drive_1) <ul style="list-style-type: none"> p0840 = 722.0 ON/OFF1 p0844 = 722.1 1. OFF2 p0845 = 1 2. OFF2 p0848 = 722.2 1. OFF3 p0849 = 1 2. OFF3 p0852 = 722.3 Enable operation 	<p>See function diagram [2501]</p>
			
6.3	<p>Ramp-function generator</p>	<ul style="list-style-type: none"> Ramp-function generator <ul style="list-style-type: none"> p1140 = 1 Ramp-function generator enable p1141 = 1 Ramp-function generator start p1142 = 1 Enable setpoint 	<p>See function diagram [3060]</p>
			
6.4	<p>Setpoint</p>	<ul style="list-style-type: none"> Specify setpoint <ul style="list-style-type: none"> p1001 = 40 Fixed setpoint 1 	<p>See function diagram [3010]</p>

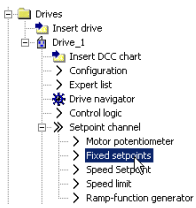
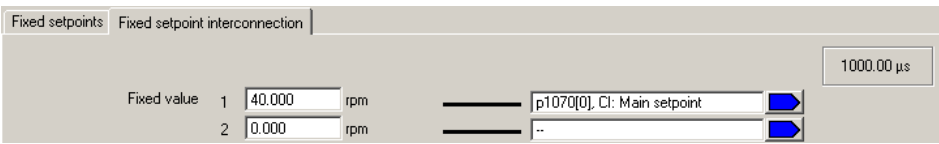
	What?	How?	Comment
			
7	Save the parameters on the device	<ol style="list-style-type: none"> 1. Select the drive unit in the project tree. 2. Call the "Connect target device" shortcut menu. 3. Call the "Target device > Load into the target device" context menu. The "After loading, copy the RAM to ROM" option is active. Click "Yes" to confirm the backup. Or 4. Call the "Target device > Copy RAM to ROM" shortcut menu. 	Position the cursor on the drive unit (SINAMICS S120) and right-click.
8	The motor starts to run	<p>The drives can be started via the control panel in the STARTER commissioning tool.</p> <ul style="list-style-type: none"> • Line/DC-link identification will be carried out once the pulses for the infeed have been enabled and line/DC-link identification has been activated. The infeed then switches into the "Operation" state. • Once the pulses are enabled, a one-off motor data identification run (if activated) is carried out. • When the pulses are enabled again, optimization with a rotating motor is carried out, if this is activated. 	<p>For more information about the control panel, see Getting Started.</p> <p>During motor data identification, a current flows through the motor, which means that it can align itself by up to a quarter of a revolution.</p> <p>For more information about line / DC link / motor data identification, see the SINAMICS S120 Function Manual Drive Functions.</p>

Diagnostic functions in the STARTER commissioning tool

Under Component > Diagnostics > Control/status words

- Control/status words
- Status parameters
- Missing enable signals

3.7 Commissioning the vector control chassis format for the first time

An example provided in this chapter explains all the configuration and parameter settings, as well as tests that are required for initial commissioning. Commissioning is carried out using the STARTER commissioning tool.

Preconditions for commissioning

- The commissioning preconditions (Page 30) have been met.
- The commissioning checklists (Page 32) (Tables 2-1 and 2-2) have been completed and the points fulfilled.
- The STARTER commissioning tool is installed and activated.
 - System prerequisites, refer to the Readme file in the STARTER installation directory.
- The drive system has been wired according to the specifications.
- The communication between the PG/PC and drive system has been prepared.
- The power supply of the Control Unit (24 V DC) has been switched on.

3.7.1 Task

A drive in the "chassis" format in vector control with the following components is to be commissioned for the first time:

Table 3- 5 Component overview

Designation	Component	Article number
Closed-loop control and infeed		
Control Unit	Control Unit 320-2 PN	6SL3040-1MA01-0AA0
Active Line Module	Active Line Module 380 kW / 400 V	6SL3330-7TE36-1AA.
Active Interface Module	Active Interface Module	6SL3300-7TE38-4A.0
Drive 1		
Motor Module 1	Motor Module 380 A	6SL3320-1TE33-8AA.
Motor 1	Induction motor <ul style="list-style-type: none"> • Without brake • With encoder 	Type: 1PL6226-...F...-.... Rated voltage = 400 V Rated current = 350 A Rated power = 200 kW Rated frequency = 59.10 Hz Rated speed = 1750 rpm Cooling type = non-ventilated HTL encoder, 1024 p/r, A/B, R
Drive 2		
Motor Module 1	Motor Module 380 A	6SL3320-1TE33-8AA.
Motor 1	Induction motor <ul style="list-style-type: none"> • Without brake • With encoder 	Type: 1PL6226-...F...-.... Rated voltage = 400 V Rated current = 350 A Rated power = 200 kW Rated frequency = 59.10 Hz Rated speed = 1750 rpm Cooling type = non-ventilated HTL encoder, 1024 p/r, A/B, R

The enable signals for the infeed and the drive should be implemented via terminals.

3.7.2 Component wiring (example)

The following diagram shows the structure of the components and the appropriate wiring. The DRIVE-CLiQ wiring is highlighted in bold.

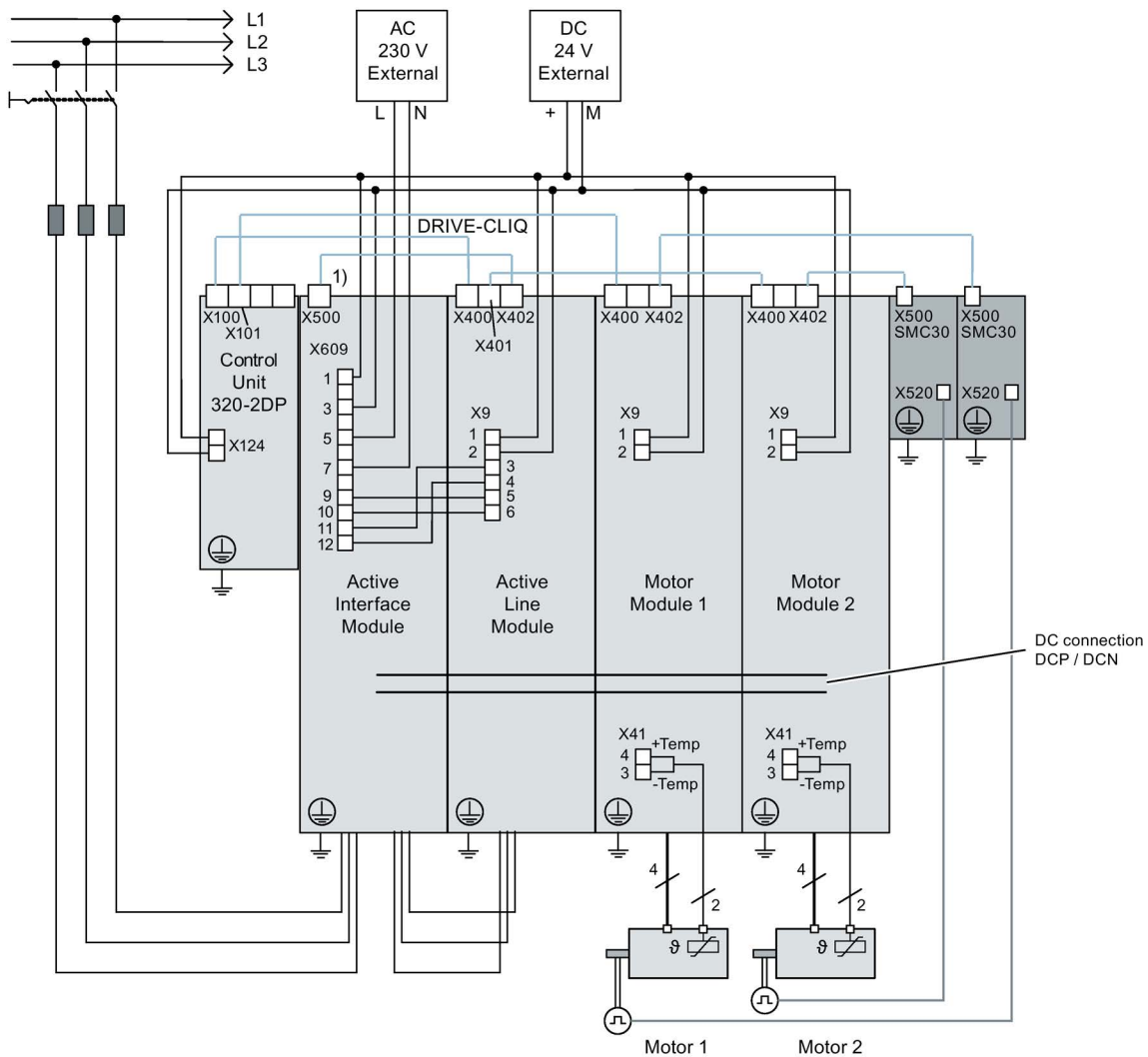

1) X500 at the Voltage Sensing Module

Image 3-30 Component wiring (example)

For more information on wiring and connecting the encoder system, see the Equipment Manual.

3.7.3 Signal flow of the commissioning example

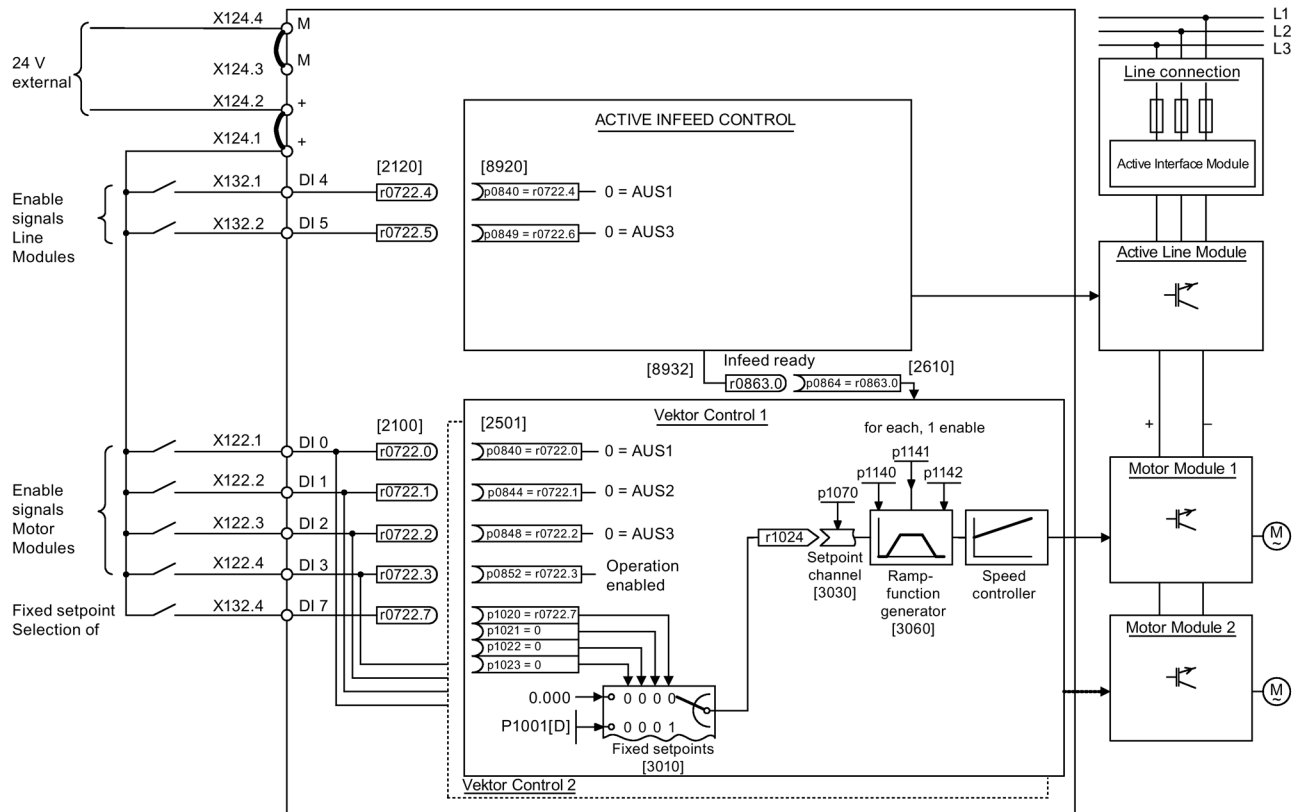

Image 3-31 Signal flow of the commissioning example chassis

3.7.4 Commissioning with STARTER (example)

The table below describes the steps for commissioning a drive using the STARTER commissioning tool.

	What?	How?	Comment
1.	Creating a new project	<ol style="list-style-type: none"> 1. Call the "Project > New..." menu. 2. Enter a project name in the "New project" dialog. 3. Click "OK". 	-
2.	Automatic configuration	<ol style="list-style-type: none"> 1. Call the "Project > Connect to selected target devices" menu. As there is still no device available in the project, STARTER offers the option of searching for accessible nodes. 2. Click "Yes". 3. Activate the drive unit accessed by clicking the checkbox. 4. Click "Accept". The drive unit is transferred into the project window. 5. Call the "Project" > "Connect to selected target devices" menu again. You are now connected online with the drive unit. 6. Double-click "Automatic configuration". Click "Configure". 7. During automatic commissioning, the wizard will offer you the option of selecting the drive object type. As default assignment, select all of the "Vector" components. 8. Click "Create". 9. After the automatic configuration has been completed, you have the option of going OFFLINE or remaining ONLINE. Select "Go OFFLINE". 	-
3.	Configuring the infeed	<ol style="list-style-type: none"> 1. Double-click "Infeeds" in the project navigator. 2. Double-click the infeed that has been created. 3. Click the yellow "Wizard..." button. 4. To check the automatic settings and to enter additional data, such as equipment codes, etc. continue with step 3.2. 	-
<p>Note:</p> <p>When the factory setting is p7826 = 1, the firmware is automatically updated to the status on the memory card when a configured DRIVE-CLiQ component is first booted. This may take a few minutes and is indicated by the READY-LED on the corresponding components flashing green/red and the LED on the Control Unit flashing orange (0.5 Hz). Once all updates have been completed, the READY-LED on the Control Unit flashes orange at 2 Hz and the corresponding READY-LED on the components flashes green/red at 2 Hz. For the firmware to be activated, a POWER ON must be carried out for the components.</p> <p>For infeed units connected to the drive unit, which during the automatic configuration do not communicate with the Control Unit via DRIVE-CLiQ, you must manually configure and transfer them into the drive topology. These devices can only be inserted in the offline mode.</p>			

3.7 Commissioning the vector control chassis format for the first time

	What?	How?	Comment
3.1	Inserting an infeed unit	If there is no DRIVE-CLiQ connection to the Control Unit, then you must manually enter the data of the infeed unit using the wizard. <ol style="list-style-type: none"> 1. Double-click "Infeeds" in the project navigator. 2. Double-click "Insert infeed". 3. Enter a name for the infeed. 4. Select the type. 5. Click "OK". 	If the line environment or DC-link components are changed, line/DC-link identification should be repeated.
3.2	Infeed	<ol style="list-style-type: none"> 1. Assign a component name. 2. Select the line voltage range. 3. Select the cooling type. 4. Select the type. The available components are now in the selection list. 5. Select the required infeed from the list. 6. Click "Continue >". 	-
3.3	Infeed - additional data	<ol style="list-style-type: none"> 1. Activate the line/DC-link identification when switching-on for the first time. 2. Accept the device supply voltage from the previous window. The rated line frequency is determined automatically. 3. Make sure that the "Line filter available" option is activated. 4. If applicable, enter the number of parallel infeeds. 5. Where relevant, select an external Braking Module. 6. Where relevant, select master/slave operation for several infeeds. 7. Click "Continue >". 	-
3.4	Process data exchange (infeed)	One of three telegrams can be selected for communication: 370, 371 and 999. <ol style="list-style-type: none"> 1. Select the required telegram. 2. Click "Continue >". 	-
3.5	Configuration, summary	Configuration of the infeed unit completed. A summary is displayed. <ol style="list-style-type: none"> 1. Click "Complete". 	The infeed unit data can be copied to the clipboard for plant documentation purposes and then added to a text program, for example.

<p>NOTICE</p>
<p>Damage of the infeed</p> <p>If the infeed is controlled by a different Control Unit than the Motor Modules, this can result in damage to the infeed.</p> <ul style="list-style-type: none"> • In this case, wire the ready signal of the infeed r0863.0 to parameter p0864 "Infeed ready" of the drive through a digital input/output.

3.7 Commissioning the vector control chassis format for the first time

	What?	How?	Comment
4.	Configuring the drives	You must individually configure the drives in the offline mode. The wizard displays the data determined automatically from the electronic type plate.	-
<p>For drives connected to the drive unit, which during the automatic configuration do not communicate with the Control Unit via DRIVE-CLiQ, you must manually configure and transfer them into the drive topology. These devices can only be inserted in the offline mode. In this case, continue commissioning with step 4.1.</p> <p>If the drives have already been created by the automatic configuration, under the drive, click "Configuration" > "Configure DDS... ". Then continue from step 4.2. Settings of the power unit data and for motors with DRIVE-CLiQ interface, the motor data is also already pre-assigned based on the electronic type plate.</p>			
4.1	Inserting drives	<ol style="list-style-type: none"> 1. Double-click "Drives" in the project navigator. 2. Double-click the "Insert drives" entry. 3. Enter a name for the drive. 4. Select "Vector" as drive object type. 5. Click "OK". 	-
4.2	Control structure	<ol style="list-style-type: none"> 1. Where relevant, select function modules. 2. Select the control "n-/M control + V/f control, I/f control". 3. Select the control mode "[21] speed control (with encoder)". 4. Click "Continue >". 	-
4.3	Power unit	<ol style="list-style-type: none"> 1. Enter a name for the component. 2. Select the DC supply voltage. 3. Select the cooling type. 4. Select the baud rate. 5. Select the required power unit from the list. 6. Click "Continue >". 	-
4.4	Configuration, power unit BICO interconnection	<p>If an infeed without DRIVE-CLiQ connection is used, a message is displayed stating that the operating signal must be connected.</p> <ol style="list-style-type: none"> 1. In the following dialog "Infeed in operation", set parameter p0864 to the binector output of the digital input to which the operating feedback signal of the infeed is interconnected. 2. Click "Continue >". 	-
4.5	Additional power unit data	<p>In this window, you can additionally select the following</p> <ul style="list-style-type: none"> • Various output filters • A Voltage Sensing Module • A parallel connection 	With this dialog window, the configuration of the Motor Module has been completed.

NOTICE**Damage to a sine-wave filter if it is not activated during commissioning**

The sine-wave filter may be damaged if it is not activated during commissioning.

- Activate use of a sine-wave filter during commissioning via parameter p0230 = 3.

3.7 Commissioning the vector control chassis format for the first time

	What?	How?	Comment
5	Configuration, drive setting	You can select the motor standard (IEC/NEMA) and power unit application (duty cycles).	The motor data is selected and entered.
5.1	Configuring the motor	<ol style="list-style-type: none"> 1. Enter a name for the motor (e.g. an equipment code). 2. If your motor has its own DRIVE-CLiQ interface, select the item. 3. Click "Continue >". When commissioning, the motor data is automatically transferred to the Control Unit. 	You can select a standard motor from the list of motors or manually enter the motor data. You can then select the motor type.
	<ol style="list-style-type: none"> 1. If you use a standard motor select the item, "Select standard motor from list". 2. Select the standard motor type from the "Motor type" list. 3. Select your motor. 4. Click "Continue >". 		
	<ol style="list-style-type: none"> 1. If your motor is not in the default list, select "Enter motor data". 2. Click your motor type in the "Motor type" list. 3. Click "Continue >". 		
5.2	Configuring the motor data	<p>Enter your motor data according to the data sheet.</p> <p>Alternatively, after entering the motor data, perform a motor data identification when commissioning for the first time.</p> <p>Alternatively, for some motor types you can use motor data from the motor list.</p> <ol style="list-style-type: none"> 1. To do so, click the template. 2. Follow the wizard by clicking "Next >". 3. If known, you can enter the mechanical data of the motor and the drive train or the data of a PE spindle. 4. If necessary, select a complete calculation of the motor/controller data without equivalent circuit diagram data. 5. For this example, select the simple drive. 	If you have no mechanical data, then the data is estimated based on the type plate data. The equivalent circuit diagram data is also estimated on the basis of the data on the type plate or determined by means of automatic motor data identification.
5.3	Configuring a motor brake	<ol style="list-style-type: none"> 1. If you are not using a motor holding brake, click "Continue >". 2. If you are using a motor holding brake, you can select and configure the brake in this window. 3. Click "Continue >". 	For more information, see SINAMICS S120 Function Manual Drive Functions.
5.4	Configuring an encoder	<p>You can connect up to three encoders.</p> <ol style="list-style-type: none"> 1. If you are using a DRIVE-CLiQ encoder, then select the appropriate item. 2. Click "Next >". The encoder is automatically identified and configured. <p>Alternatively, you can use a standard encoder.</p> <ol style="list-style-type: none"> 1. Select the encoder from the list. 2. Click "Continue >". 	<p>If you are using an encoder that is not in the list, you can also manually enter the data.</p> <p>By clicking Details, you can view the data of the encoder selected from the the encoder list.</p>

3.7 Commissioning the vector control chassis format for the first time

	What?	How?	Comment
		Alternatively, you can use your own encoder. 1. Select Enter data. 2. Click the encoder data. 3. Select the measuring system. 4. Enter the required data and click "OK". 5. Click "Continue >".	
5.5	Entering encoder data	1. Enter the encoder data into the input screen form. 2. Click "OK".	Enter additional encoders in the same way as described above.
5.6	Configuring drive functions	You can select certain technological applications and the type of motor data identification.	Your choice of application influences the calculation for the open-loop/closed-loop control parameters.
5.7	Configuring process data exchange	For communication, you can select the PROFIdrive telegram from various telegrams. 1. For the example, select "[999] Free telegram configuration with BICO". 2. Click "Continue >".	-
5.8	Important parameters	In this window, you can specify important parameters as limit values. When doing this, observe the general mechanical conditions for the drive train.	-
5.9	Summary	The configuration of the drive train has been completed. A summary is displayed. 1. Click "Complete".	The drive data can be copied to the clipboard for plant documentation purposes and then added to a text program, for example.
Note			
The reference parameters and limit values can be protected from being automatically overwritten in the STARTER commissioning tool by setting p0340 = 1. You can find this function in the STARTER commissioning tool under Drive > Configuration > Blocked list tab.			
6.	Enable signals and BICO interconnections	The enable signals for the infeed and the two drives must be implemented via the digital inputs on the Control Unit.	Note: If an Active Line Module is used, to enable the infeed unit, a signal source other than that used for the Motor Module must be used.
6.1	Active Line Module	<ul style="list-style-type: none"> Enable signals for the Active Line Module: p0840 = 722.4 ON/OFF1 p0844 = 722.5 OFF2 p0852 = 722.6 Enable operation 	See function diagram [8920]

3.7 Commissioning the vector control chassis format for the first time

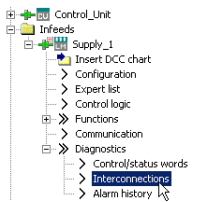
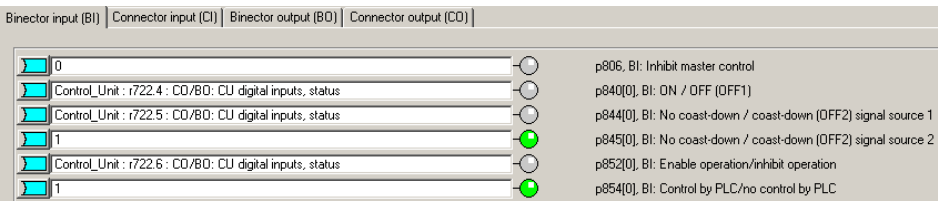
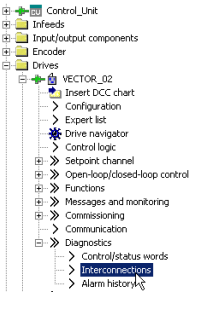
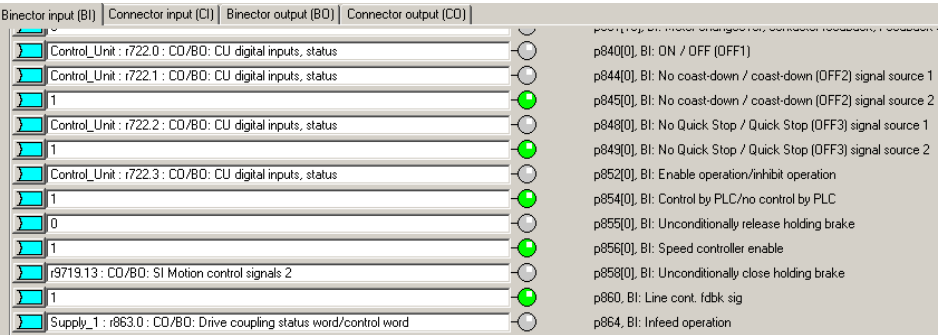
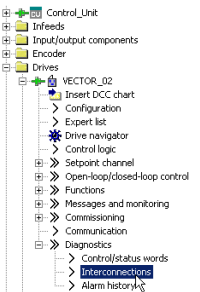
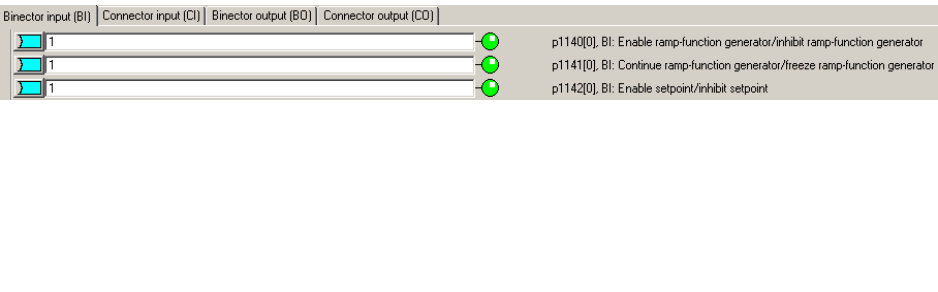
	What?	How?	Comment
			
6.2	<p>Enable the Motor Module</p>	<ul style="list-style-type: none"> Enable signals for the Motor Module (drive_1): <ul style="list-style-type: none"> p0840 = 722.0 ON/OFF1 p0844 = 722.1 1. OFF2 p0845 = 1 2. OFF2 p0848 = 722.2 1. OFF3 p0849 = 1 2. OFF3 p0852 = 722.3 Enable operation p0864 = 863.0 Infeed operation 	<p>See function diagram [2501]</p>
			
6.3	<p>Ramp-function generator configuration</p>	<ul style="list-style-type: none"> Ramp-function generator <ul style="list-style-type: none"> p1140 = 1 Ramp-function generator enable p1141 = 1 Ramp-function generator start p1142 = 1 Enable setpoint 	<p>See function diagram [3060]</p>
			

3.7 Commissioning the vector control chassis format for the first time

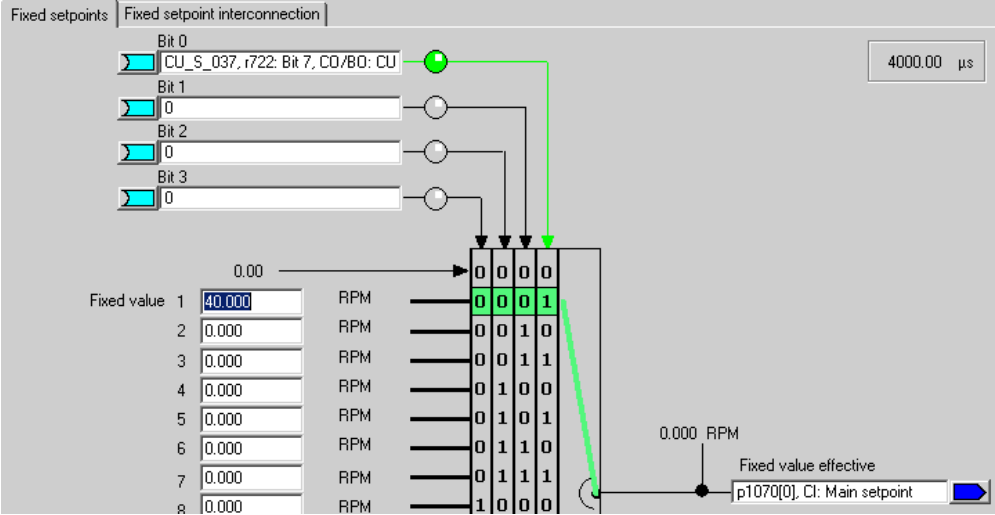
	What?	How?	Comment
6.4	Setpoint configuration	<ul style="list-style-type: none"> • Specify setpoint: <ul style="list-style-type: none"> p1001 = 0 Fixed setpoint 1 p1002 = 40 Fixed setpoint 2 p1020 = r0722 Fixed speed setpoint selection r1024 = p1070 Fixed setpoint active 	<p>A setpoint of 0 (0 signal) or 40 (1 signal) is defaulted via digital input 7. This setpoint is then applied to the main setpoint p1070.</p> <p>See function diagram [3010]</p>
			
7.	Load parameters to device	<ol style="list-style-type: none"> 1. Select the drive unit in the project navigator. 2. Call the "Connect target device" shortcut menu. 3. Call the "Target device" > "Load to target device" shortcut menu. 	Position the cursor on the drive unit and right-click.
8.	Configuration, motor temperature	<p>To select a temperature sensor, you must set p0340 = 0.</p> <ol style="list-style-type: none"> 1. Make the following settings: <ul style="list-style-type: none"> – The way in which the motor temperature is received – The temperature sensor type – For overtemperature, the response to alarm and fault (no reduction of I_{max}) – The alarm message when a sensor fails – The delay time to 0.100 s – The warning threshold to 120.0° C – The fault threshold to 155.0° C 	

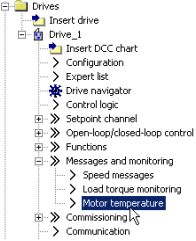
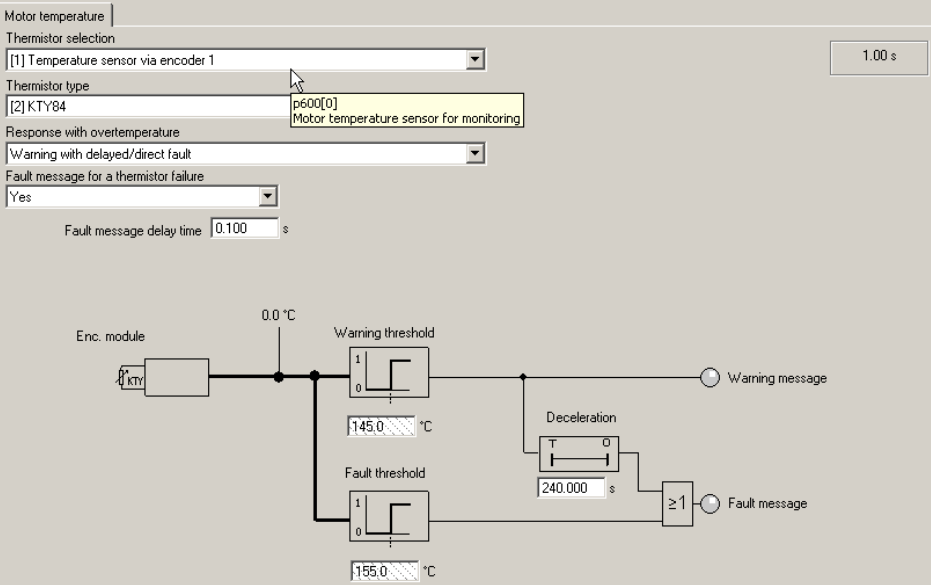
	What?	How?	Comment
			
9.	Save the parameters on the device	<ol style="list-style-type: none"> 1. Select the drive unit in the project navigator. 2. Call the "Connect target device" shortcut menu. 3. Call the "Target device > Load into the target device" context menu. The "After loading, copy the RAM to ROM" option is active. Click "Yes" to confirm the backup. Or 4. Call the "Target device > Copy RAM to ROM" shortcut menu. 	Position the cursor on the drive unit (SINAMICS S120) and right-click.
10	The motor starts to run	<p>The drives can be started via the control panel in the STARTER commissioning tool.</p> <ul style="list-style-type: none"> • Line/DC-link identification will be carried out once the pulses for the infeed have been enabled and line/DC-link identification has been activated. The infeed then switches into the "Operation" state. • When the pulses are enabled, a one-off motor data identification run (if activated) is carried out. • When the pulses are enabled again, optimization with a rotating motor (if activated) is carried out. 	<p>For more information about the control panel, see Getting Started.</p> <p>During motor data identification, a current flows through the motor, which means that it can align itself by up to a quarter of a revolution.</p> <p>For more information about line / DC-link / motor data identification, see the SINAMICS S120 Function Manual Drive Functions.</p>

Important diagnostic parameters (see the SINAMICS S120/S150 List Manual)

- r0002 Drive operating display
 - r0046.0...31 CO/BO:Missing enables
- For further information, see Chapter "Diagnostics"

3.8 First commissioning vector control AC drive blocksize format

An example provided in this chapter explains all the configuration and parameter settings, as well as tests that are required for initial commissioning. Commissioning is carried out using the STARTER commissioning tool.

Preconditions for commissioning

- The commissioning preconditions (Page 30) have been met.
- The commissioning checklists (Page 32) (Tables 2-1 and 2-2) have been completed and the points fulfilled.
- The STARTER commissioning tool is installed and activated.
 - System prerequisites, refer to the Readme file in the STARTER installation directory.
- The drive system has been wired according to the specifications.
- The communication between the PG/PC and drive system has been prepared.
- The power supply of the Control Unit (24 V DC) has been switched on.

3.8.1 Task

A drive unit is to be commissioned (vector control, closed-loop speed control), without DRIVE-CLiQ and without speed encoder with the following components:

Designation	Component	Article number
Closed-loop control		
Control Unit	Control Unit 310-2 DP	6SL3040-1LA00-0AA0
Operator Panel	Basic Operator Panel BOP20	6SL3055-0AA00-4BA.
Infeed and drive		
Power Module	240-2 Power Module	6SL3210-1P...-....
Motor	Induction motor (without DRIVE-CLiQ interface)	1LA7

Commissioning is performed using the BOP20.

The function keys on the BOP20 must be parameterized so that the ON/OFF signal and speed settings can be defined via these keys.

3.8.2 Component wiring (example)

The following diagram shows the structure of the components and the appropriate wiring.

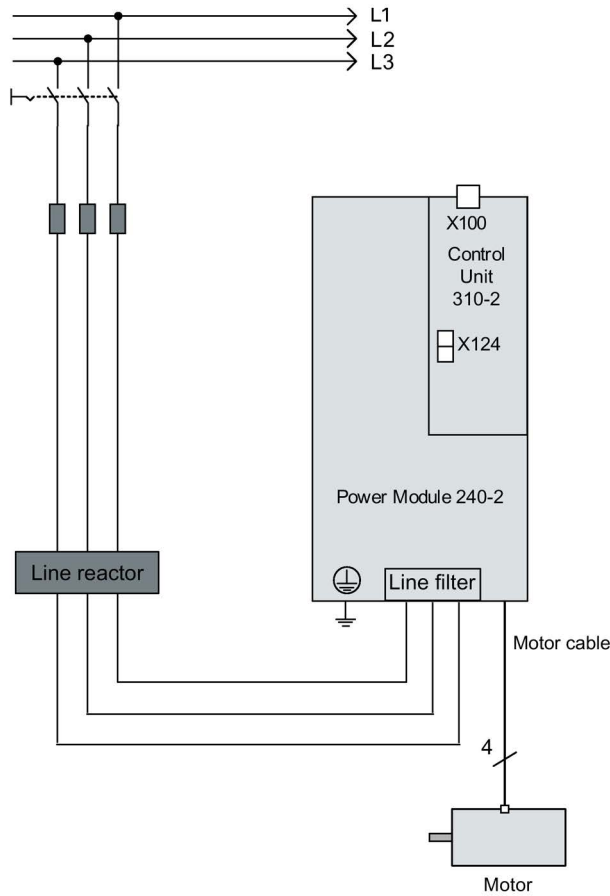

Image 3-32 Component wiring (example)

For more information on wiring, see the Equipment Manual.

3.8.3 Quick commissioning using the BOP (example)

⚠ WARNING
Danger to life from hazardous axis movements
During the motor data identification, the drive can move the motor uncontrolled.
<ul style="list-style-type: none">Respond to possible malfunctions by applying suitable measures (e.g. EMERGENCY STOP or EMERGENCY OFF).

Table 3- 6 Quick commissioning for a VECTOR drive without a DRIVE-CLiQ interface

	Procedure	Description	Factory setting
Restore the drive to the factory setting:			
1.	p0009 = 30	Device commissioning parameter filter¹⁾ 0 Ready 1 Device configuration 30 Parameter reset	1
2.	p0976 = 1	Reset and load all parameters 0 Not active 1 Start restoring all parameters to their factory settings	0
After approx. 15 sec. wait time, the BOP display = 35 and the RDY-LED is green. p0009 is automatically set to 1, p0976 to 0. Note: As soon as the RDY-LED is green again, the factory setting has been completed and commissioning can start.			
3.	p0009 = 1	Device commissioning parameter filter¹⁾ 0 Ready 1 Device configuration 30 Parameter reset	1
4.	p0097 = 2	Select drive object type¹⁾ 0 No selection 1 Drive object type SERVO 2 Drive object type VECTOR	0
5.	p0009 = 0	Device commissioning parameter filter¹⁾ 0 Ready 1 Device configuration	1
Note: Wait approx. 10 sec. The basic configuration is saved once the RDY lights green. In order to transfer this state into the ROM, press the "p" button until the display flashes. When the flashing stops, the RDY changes from orange to green and the transfer has been completed. Alarm A07991 indicates that the motor data identification function has been activated at drive "DO 2". To enter the drive parameters:			
6.	DO = 2	Select drive object (DO) = 2 (= VECTOR) 1 Expert list of the CU 2 Expert list of the drive To select a drive object (DO), simultaneously press the "Fn" key and the arrow ↑ key. The selected drive object is displayed at the top left.	1
7.	p0010 = 1	Drive commissioning parameter filter¹⁾ 0 Ready 1 Quick commissioning	1

3.8 First commissioning vector control AC drive blocksize format

	Procedure	Description	Factory setting
8.	p0100 = 0	IEC/NEMA motor standard	0
		0 IEC motor (SI units, e.g. kW) Preset: Rated motor frequency (p0310): 50 Hz Specification of the power factor cos φ (p0308)	
		1 NEMA motor (US units, e.g. hp) Preset: Rated motor frequency (p0310): 60 Hz Specification of the efficiency (p0309)	
		Note: When p0100 is changed, all the rated motor parameters are reset.	
9.	p03XX[0] = ...	Rated motor data [MDS] Only when p0300 < 100 (third-party motor) Enter the rated motor data in accordance with the type plate, e.g.	-
		p0304[0] Rated motor voltage [MDS]	
		p0305[0] Rated motor current [MDS]	
		p0307[0] Rated motor output [MDS]	
		p0308[0] Rated motor power factor [MDS] (only when p0100 = 0)	
		p0309[0] Rated motor efficiency [MDS] (only when p0100 = 1)	
		p0310[0] Rated motor frequency [MDS]	
		p0311[0] Rated motor speed [MDS]	
		p0335[0] Motor cooling type [MDS] * 0: Natural cooling 1: Forced cooling 2: Water cooling	
10.	p1900 = 2	Motor data identification and rotating measurement¹⁾	2
		0 Inhibited	
		1 Motor data identification for rotating motor	
		2 Motor data identification for a stationary motor	
		Message A07991 is displayed, motor data identification has been activated.	
11.	p0010 = 0	Drive commissioning parameter filter¹⁾	1
		0 Ready	
		1 Quick commissioning	
RDY is lit red, fault F07085 signals that a control parameter has been changed.			
Parameter p0840[0] can only be changed with access level p0003 = 3.			
12.	p0840[0] = r0019.0(DO 1)	BI: ON/OFF1 [CDS] Sets the signal source for STW1.0 (ON/OFF1) Interconnection with r0019.000 of the drive object Control Unit (DO 1) Effect: Signal ON/OFF1 from the BOP	0
13.	p1035[0] = r0019.13 (DO 1)	BI: Motor potentiometer setpoint higher [CDS] Sets the signal source to increase the setpoint for the motorized potentiometer Interconnection with r0019.13 of the drive object Control Unit (DO 1) Effect: Signal, motorized potentiometer setpoint higher from BOP	0

	Procedure	Description	Factory setting
14.	p1036[0] = r0019.14 (DO 1)	BI: Motor potentiometer setpoint lower [CDS] Sets the signal source to reduce the setpoint for the motorized potentiometer Interconnection with r0019.14 of the drive object Control Unit (DO 1) Effect: Signal, motorized potentiometer lower setpoint from BOP	0
15.	p1070[0] = r1050 (DO 63)	CI: Main setpoint [CDS] Sets the signal source for speed setpoint 1 of the speed controller. Interconnection with r1050.00 to the separate drive object (DO 63) Effect: Motorized potentiometer supplies the speed setpoint	0
16.	Press "FN" and "P". The display indicates 41, press "O", the display jumps to 31.		
17.	Start the motor data identification with "I". The drive switches off again after approx. 5 sec., the display goes back to 41.		
18.	After pressing "O", 31 is displayed again. The drive is now ready. The drive is switched on by pressing "I", the motor accelerates by pressing the "↑" key.		
19.	Save all parameters	Press the P key for approx. 5 sec until the display flashes.	

1) These parameters offer more setting options than specified here. For further setting options see the SINAMICS S120/S150 List Manual.

[CDS] Parameter depends on command data sets (CDS). Data set 0 is preset.

[DDS] Parameter depends on drive data sets (DDS). Data set 0 is preset.

[MDS] Parameter depends on motor data sets (MDS). Data set 0 is preset.

BI binector input

BO binector output

CI connector input

CO connector output

3.9 First commissioning servo control AC drive blocksize format

An example provided in this chapter explains all the configuration and parameter settings, as well as tests that are required for initial commissioning. Commissioning is carried out using the STARTER commissioning tool.

Preconditions for commissioning

- The commissioning preconditions (Page 30) have been met.
- The commissioning checklists (Page 32) (Tables 2-1 and 2-2) have been completed and the points fulfilled.
- The STARTER commissioning tool is installed and activated.
 - System prerequisites, refer to the Readme file in the STARTER installation directory.
- The drive system has been wired according to the specifications.
- The communication between the PG/PC and drive system has been prepared.
- The power supply of the Control Unit (24 V DC) has been switched on.

3.9.1 Task

A drive unit is to be commissioned (servo control, closed-loop speed control) with the following components:

Designation	Component	Article number
Closed-loop control		
Control Unit	Control Unit 310-2 DP	6SL3040-1LA00-0AA0
Operator Panel	Basic Operator Panel 20 (BOP20)	6SL3055-0AA00-4BA.
Infeed and drive		
Power Module	240-2 Power Module	6SL3210-1P...-....
Motor	Synchronous motor with DRIVE-CLiQ interface	1FK7061-7AF7.-.A..
Motor encoder via DRIVE-CLiQ	Incremental encoder sin/cos C/D 1 Vpp 2048 p/r	1FK7...-.....-A..

Commissioning is performed using the BOP20.

The Basic Operator Panel (BOP) should be parameterized so that the ON/OFF signal and the speed setpoints are entered using the function keys.

3.9.2 Component wiring (example)

The following diagram shows the structure of the components and the appropriate wiring.

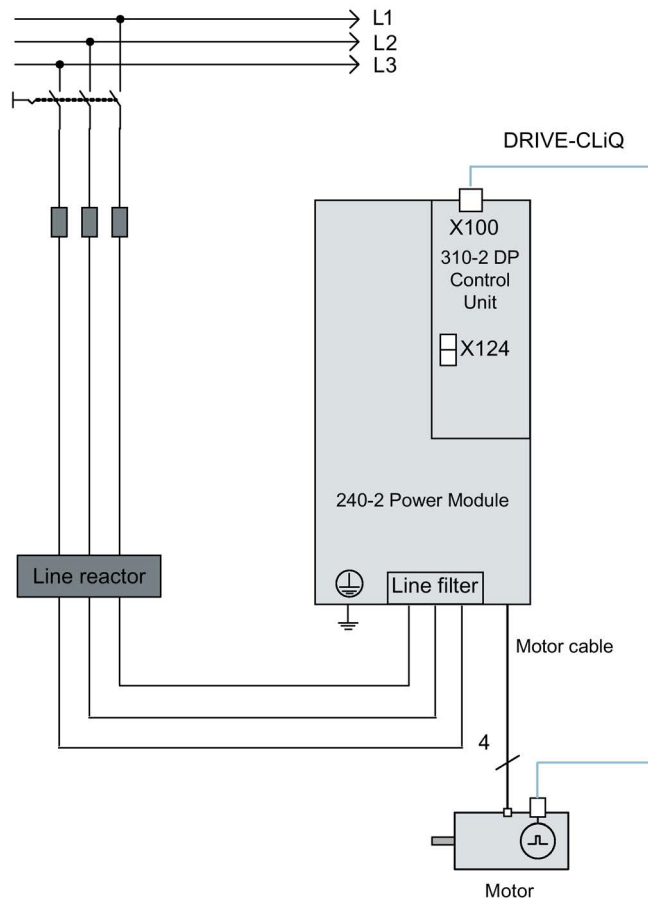

Image 3-33 Component wiring with integrated Sensor Module (example)

For more information on wiring and connecting the encoder system, see the Equipment Manual.

3.9.3 Quick commissioning using the BOP (example)

Table 3- 7 Quick commissioning for a servo drive with a DRIVE-CLiQ interface

	Procedure	Description	Factory setting
Note: Before commissioning for the first time, in the drive mode DO = 1, the drive is restored to the factory setting.			
1.	p0009 = 30	Device commissioning parameter filter	1
		0 Ready	
		1 Device configuration	
		30 Parameter reset	
2.	p0976 = 1	Reset and load all parameters	0
		0 Not active	
		1 Start restoring all parameters to their factory settings	
Note: As soon as the RDY-LED is green again, the factory setting has been established and commissioning can start.			
3.	p0003 = 3	Access levels	1
		1 Standard	
		2 Extended	
		3 Expert	
4.	p0009 = 1	Device commissioning parameter filter¹⁾	1
		0 Ready	
		1 Device configuration	
		30 Parameter reset	
5.	p0097 = 1	Select drive object type¹⁾	0
		0 No selection	
		1 Drive object type SERVO	
		2 Drive object type VECTOR	
6.	p0009 = 0	Device commissioning parameter filter¹⁾	1
		0 Ready	
		1 Device configuration	
		30 Parameter reset	
Note: For the firmware to be activated, a POWER ON must be carried out for the components. The extended setpoint channel must be opened for motorized potentiometer simulation with p0108[1] = H0104			
7.	p0009 = 2	Device commissioning parameter filter¹⁾	1
		0 Ready	
		1 Device configuration	
		2 Defining the drive type / drive options	
		30 Parameter reset	
8.	p0108[1] = 0104 hex	Drive object function module¹⁾	0000 hex
		Bit 2 Closed-loop speed/torque control	
		Bit 8 Extended setpoint channel	

	Procedure	Description	Factory setting
9.	p0009 = 0	Device commissioning parameter filter¹⁾	1
		0 Ready	
		1 Device configuration	
		30 Parameter reset	
Note:			
Wait until the RDY-LED changes from orange to green. To save the setting in the ROM, press the "P" key for approx. 5 seconds until the BOP display flashes, then wait until flashing has stopped. The drive is now ready.			
10.	DO = 2	Select drive object (DO) 2 (= SERVO)	1
		1 Expert list of the CU	
		2 Expert list of the servo drive	
		To select a drive object (DO), simultaneously press the "FN" key and the "Arrow up" key. The selected drive object is displayed at the top left.	
11.	p0840[0] = r0019.0(DO 1)	BI: ON/OFF1 [CDS] Sets the signal source for STW1.0 (ON/OFF1) Interconnection with r0019.0 of the drive object Control Unit (DO 1) Effect: Signal ON/OFF1 from the BOP	0
12.	p1035[0] = r0019.13 (DO 1)	BI: Motor potentiometer setpoint higher [CDS] Sets the signal source to increase the setpoint for the motorized potentiometer Interconnection with r0019.13 of the drive object Control Unit (DO 1) Effect: Signal, motorized potentiometer setpoint higher from BOP	0
13.	p1036[0] = r0019.14 (DO 1)	BI: Motor potentiometer setpoint lower [CDS] Sets the signal source to reduce the setpoint for the motorized potentiometer Interconnection with r0019.14 of the drive object Control Unit (DO 1) Effect: Signal, motorized potentiometer lower setpoint from BOP	0
14.	p1037 = 6.000	Max. speed, setpoint potentiometer	0.000
15.	p1070[0] = r1050 (DO 63)	CI: Main setpoint [CDS] Sets the signal source for speed setpoint 1 of the speed controller Interconnection with r1050 on its own drive object (DO 63) Effect: Motorized potentiometer supplies the speed setpoint	1024

3.9 First commissioning servo control AC drive blocksize format

	Procedure	Description	Factory setting
16.	p0006 = 0	BOP status display mode¹⁾	4
		0 Operation -> r0021, otherwise r0020 <-> r0021	
		1 Operation -> r0021, otherwise r0020	
		2 Operation -> p0005, otherwise p0005 <-> r0020	
		3 Operation -> r0002, otherwise r0002 <-> r0020	
		4 p0005	
Press "FN" and "P" the display in DO = 2 displays 31.			
17.	Save all parameters	Press the "P" key for approx. 5 sec, 41 is displayed. After pressing the "O" key, the display jumps to 31 - and the drive is now ready. 10 is displayed in DO = 1.	

¹⁾ These parameters offer more setting options than specified here. For further setting options see the SINAMICS S120/S150 List Manual.
 [CDS] Parameter depends on command data sets (CDS). Data set 0 is preset.
 [DDS] Parameter depends on drive data sets (DDS). Data set 0 is preset.
 BI binector input
 BO binector output
 CI connector input
 CO connector output

3.10 Commissioning of power units connected in parallel

During commissioning, power units connected in parallel are treated like a power unit on the line or motor side. With parallel connection, the parameter display for the actual values changes only slightly. Suitable "total values" are derived from the individual values of the power units.

Only power units in the "chassis" format are released for a parallel connection:

- Infeeds
- Motor Modules for vector control

When commissioning the power units for the first time, activate the parallel connection via the wizards in the STARTER commissioning tool. Select the parallel connection when selecting the power unit (infeed and/or Motor Module) according to the following diagrams as option:

Parallel connection of infeeds in the STARTER commissioning tool

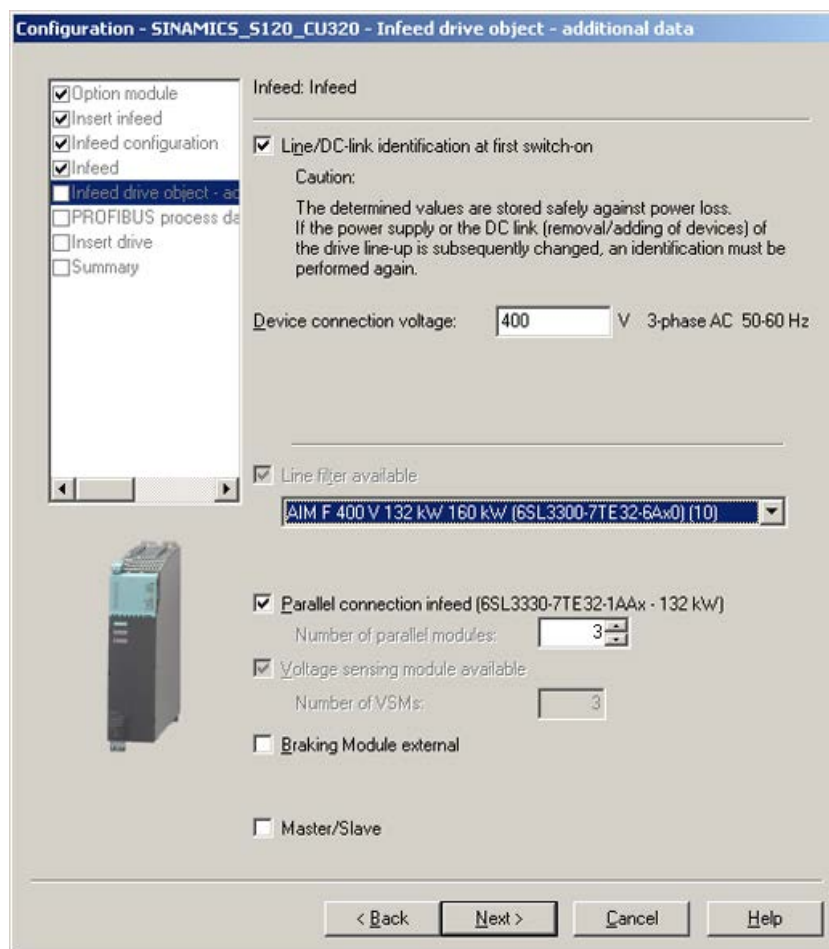

Image 3-34 Example of parallel connection of 3 Active Line Modules (chassis type)

3.10 Commissioning of power units connected in parallel

You need to specify the number of infeeds to be connected in parallel in the appropriate field (maximum 4 infeeds are permitted).

Active Line Modules can also be used in the master/slave mode. The master/slave function can be selected as an option in this window (for further information, refer to the Chapter "Master/slave function for infeeds" in the SINAMICS S120 Function Manual Drive Functions).

The line filter is offered as an option, depending on the infeed. An Active Interface Module (AIM) with integrated line filter is required to operate an "Active Line Module" (ALM). We recommend external line filters to operate the "Basic Line Module" (BLM) and "Smart Line Module" (SLM) Line Modules.

Parallel connection of Motor Modules in the STARTER commissioning tool

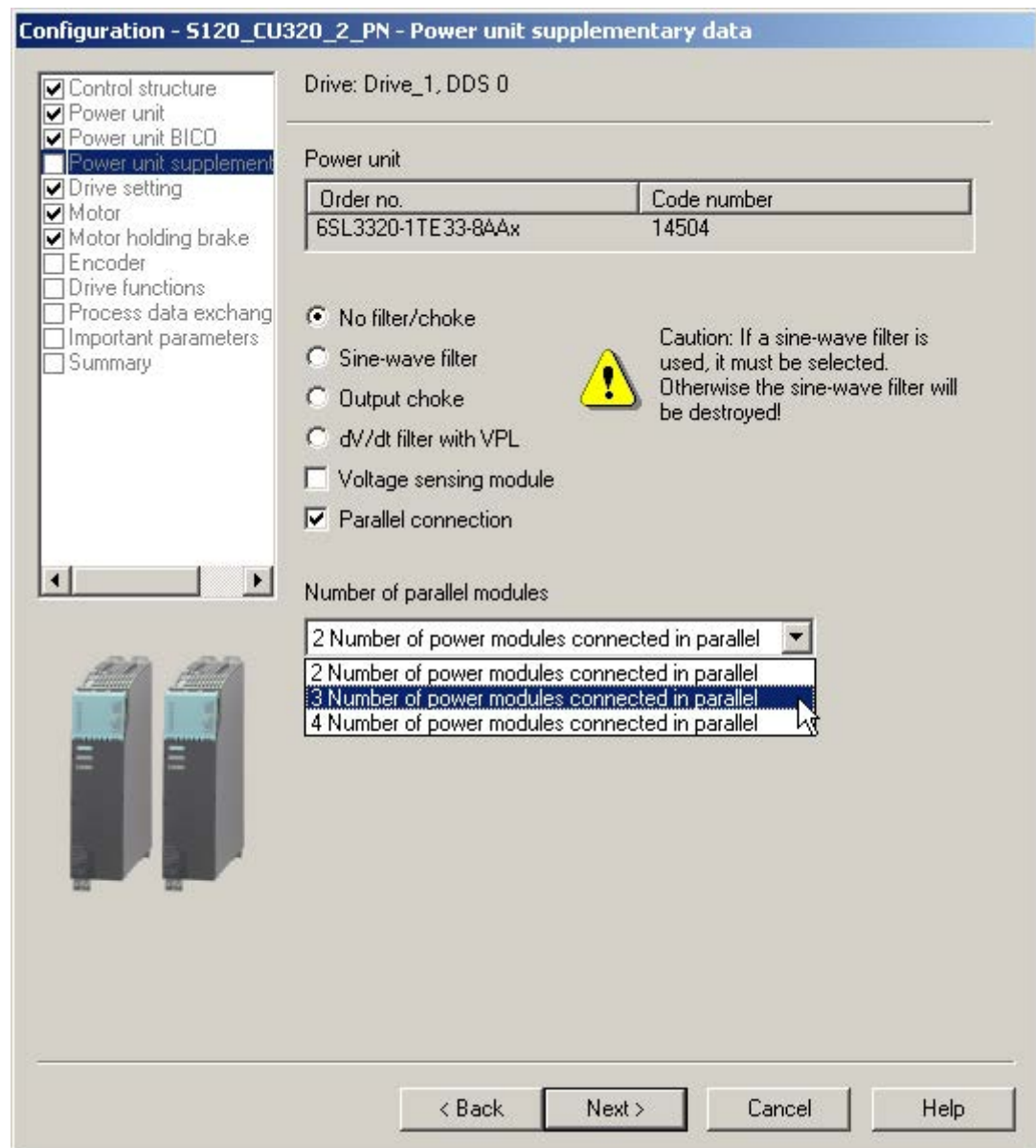

Image 3-35 Example of a parallel connection of 3 Motor Modules (chassis format, in vector control)

Select the number of Motor Modules connected in parallel in the drop-down list, "Number of parallel modules" (max. 4 Motor Modules).

Note

For the parallel connection, operation is released for a maximum of 8 power units (max. 4 Motor Modules and max. 4 Line Modules).

Configuration of parallel connections using parameters

From the perspective of the higher-level controller, the parallel connection of infeeds behaves exactly the same as when controlling a single infeed, whose power is the same as the total power of the individual infeeds connected in parallel.

PROFIdrive telegrams allow the power units to be individually activated and their status queried using parameter services from a higher-level controller. Infeeds may also be activated using the appropriate control and status words. They are documented in chapter "Communication according to PROFIdrive" in the SINAMICS S120 Drive Functions Function Manual.

Power units should only be activated and deactivated in the event of a fault, for example, after replacing a failed power unit. This approach is unsuitable for variable power control, because the Control Unit recalculates the drive line-up control parameters after every change. Optimal, highly dynamic control behavior of the drive line-up can only be ensured by recalculation.

The power units can be monitored and parameterized individually:

- Using p0125, you activate or deactivate a power unit from the topology (select using the topology number).
- With p0895, you specifically activate or deactivate power units via an interconnected digital input (BI).
- The number of currently active power units in a parallel connection is displayed in r7000.
- After a fault or replacement, parameter p7001 allows you to specifically deactivate or activate connected power units.

Alarm messages (e.g. as a result of overtemperature) can still be sent in this state. Individual power units cannot be disabled for motors with separate winding systems (p7003 = 1). p7001 is reset automatically if a power unit is deactivated with p0125 or p0895.

- You can use parameter r7002 to query whether the pulses in a power unit are inhibited or enabled.
- The circulating currents of U, V, W at the power units are displayed in parameters r7050, r7051 and r7052.
- Overload states and various temperature states in the power units can be displayed in parameters from r7200 up to r7219.

Parallel connection is indicated with a "P" in front of the value shown on the parameter value display.

Other parameters relevant for the operation and parameterization of power units can be taken from the SINAMICS S120/S150 List Manual from parameter r7002 or from p0125 onwards.

Parallel connection with one or two Control Units

If an infeed is deactivated, the pre-charging must be able to charge the remaining infeeds in the DC link. For example, the charging time is doubled, if only one of the two infeeds connected in parallel is activated. Configure the infeeds in such a way that one of the parallel infeeds or, for redundant interconnection (2 Control Units), one subsystem is able to pre-charge the whole DC link.

The connected capacitance should not be too large. However, pre-charging double an infeed's rated capacitance (one of two infeeds previously out of operation) will work with no problems.

Pre-charging contactor monitoring

To monitor the pre-charging contactors (for infeed failure), you must insert the auxiliary terminal blocks on the pre-charging contactors.

The following diagram shows the basic concept of interconnection:

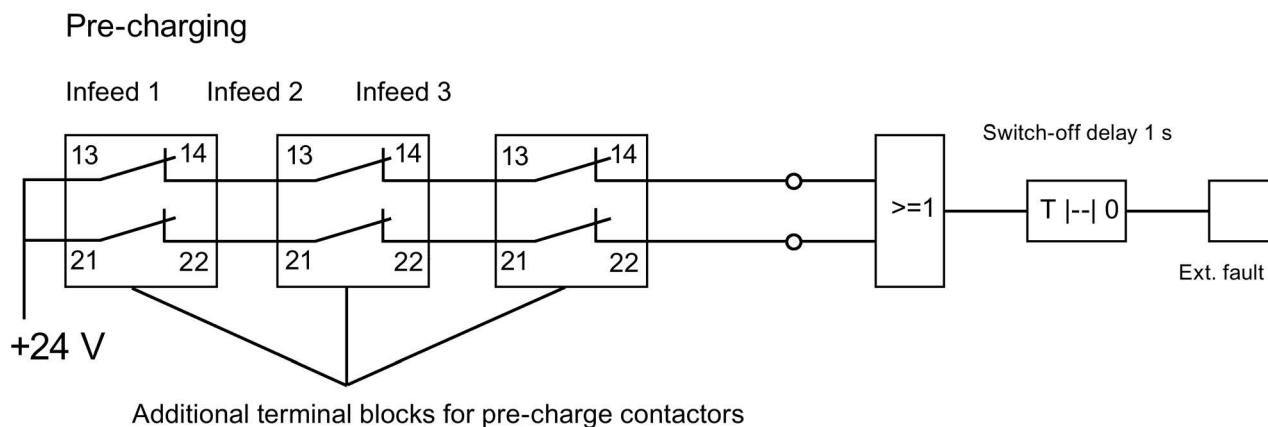

Image 3-36 Pre-charging contactor monitoring

The contactor states can be monitored using the logic blocks "free blocks" in the SINAMICS drive. If one of the contactors does not pick up, an external fault message is generated.

Operating state of power units connected in parallel

Fault messages and alarms from A05000 or F05000 onwards indicate faults in a power unit.

Power unit faults are stored in the fault buffer in the appropriate Control Unit and can be read as a fault value using parameter r0949 (interpreted decimally). This fault value corresponds to the drive object number in the drive line-up topology. The number of the fault occurring is stored in parameter r0945.

The power unit's operating state (Infeed or Motor Module) is displayed at both front LEDs on the corresponding Control Interface Module (CIM).

The power unit for a specific drive can be identified using parameter p0124. During p0124[0...n] = 1, the LED READY on the power unit concerned flashes green/orange or red/orange at 2 Hz. For parallel connections the parameter index is assigned to one power unit in each case.

Configuration of power units connected in parallel

Information on the hardware configuration and wiring the power units is provided in the SINAMICS S120 Manual Chassis Power Units.

You can find information on configuration in "SINAMICS Configuration Manual G130, G150, S120 Chassis, S120 Cabinet Modules, S150". The installation of power units within a control cabinet with Line Connection Modules is also described in this manual.

3.11 Learn devices

Description

Using a software update, the "learning devices" function amends an existing STARTER (as of version V4.2) with information about later drive firmware versions.

The update is implemented with a SINAMICS Support Package (SSP) from STARTER version 4.2. Here, equipment descriptions have been added to the STARTER commissioning tool, without having to reinstall the tool or change the code and without the drive being physically available.

A SINAMICS Support Package must be installed if SINAMICS versions are to be supported by the STARTER commissioning tool that are not included in STARTER version 4.2. You can download SINAMICS Support Packages on the Internet from the PridaNet pages (<https://pridanet.automation.siemens.com/PridaWeb/>) (Product information and data Net). The existence of new SSPs in Product Support will be announced when a new SINAMICS version is released for delivery.

SSP (SINAMICS Support Package)

An SSP contains only description files of the devices and drive objects. By installing an SSP, new drive objects and devices can be added to an existing STARTER installation, without changing its program code.

After installation, all the functions of the new SINAMICS version can be configured with the expert list. All screens and wizards are also available for all the functions compatible with the previous version.

SSP content:

- New drive objects
- New device versions
- New and changed parameters in the expert list
- New and changed faults, alarms and messages
- New and changed sequence parameterizations
- Expansions of the component catalog (new motors, encoders, DRIVE-CLiQ components)
- Expansion of the configuration catalog (SD)
- Changed online help files (parameter help, function diagrams)

Installation

All SSPs released for a STARTER version may be installed in any order.

The installed SINAMICS Support Packages are displayed in the Info dialog box of STARTER.

If a new STARTER version has been created and delivered, this STARTER contains all SSPs released up until the present time, or is compatible with them.

Compatible SSPs can also be installed a multiple number of times if repairs are necessary, without functional changes.

The STARTER commissioning tool should not be running during SSP installation. The installation program should be started and run through. Only after the installation has been finished and STARTER has been called up again, can you now configure the newly installed SINAMICS versions offline and operate them online (via "Accessible nodes" for example).

3.12 Selection and configuration of encoders

3.12.1 Encoder selection

For a SINAMICS drive system, there are three possibilities of selecting the encoder using the STARTER commissioning tool:

- Evaluating the motor and encoder data via a DRIVE-CLiQ interface.
The encoder is identified automatically by setting the parameter p0400 = 10000 or 10100. This means all motor and encoder data required for the configuration is read from the encoder. For p0400 = 10100, the identification time is not limited.
- Selecting a standard encoder from a list (also possible via the motor article number for encoder 1/motor encoder). Every encoder type on the list has a code number that can also be assigned using parameter p0400 (encoder type selection).
- Manually entering user-defined encoder data. In this case, the encoder can be configured using the encoder-specific input screens in the STARTER commissioning tool.

The encoders can also be configured using the expert list (parameters p0400 to p0499).

Table 3- 8 Assigning encoder type, encoder code and evaluation modules for standard encoders

Encoder type		Encoder code	Encoder evaluation procedure	Evaluation module
DRIVE-CLiQ encoder	Absolute rotary	202 242 204 244	Abs., singleturn 20-bit abs., singleturn 24-bit abs., multiturn 12-bit, singleturn 20-bit) abs., multiturn 12-bit, singleturn 24-bit)	-
Resolver	Incremental rotary	1001 1002 1003 1004	Resolver 1-speed Resolver 2-speed Resolver 3-speed Resolver 4-speed	SMC10, SMI10
Encoder with sin/cos 1Vpp	Incremental rotary	2001 2002 2003 2005 2010	2048, 1 Vpp, A/B C/D R 2048, 1 Vpp, A/B R 256, 1 Vpp, A/B R 512, 1 Vpp, A/B R 18000, 1 Vpp, A/B R distance-coded	SMC20, SMI20, SME20, SME120
EnDat encoder	Absolute rotary	2051 2052 2053 2054 2055	2048, 1 Vpp, A/B, EnDat, multiturn 4096 32, 1 Vpp, A/B, EnDat, multiturn 4096 512, 1 Vpp, A/B, EnDat, multiturn 4096 16, 1 Vpp, A/B, EnDat, multiturn 4096 2048, 1 Vpp, A/B, EnDat, singleturn	SMC20, SMC40 ¹⁾ , SMI20, SME25
SSI encoder with sin/cos 1Vpp	Absolute rotary	2081 2082 2083 2084	2048, 1 Vpp, A/B, SSI, singleturn 2048, 1 Vpp, A/B, SSI, multiturn 4096 2048, 1 Vpp, A/B, SSI, singleturn, error bit 2048, 1 Vpp, A/B, SSI, multiturn 4096, error bit	SMC20, SMI20, SME25, SME125
Linear encoder	Incremental linear	2110 2111 2112 2151	4000 nm, 1 Vpp, A/B R distance-coded 20000 nm, 1 Vpp, A/B R distance-coded 40000 nm, 1 Vpp, A/B R distance-coded 16000 nm, 1 Vpp, A/B, EnDat, resolution 100 nm	SMC20, SMI20, SME20

3.12 Selection and configuration of encoders

Encoder type		Encoder code	Encoder evaluation procedure	Evaluation module
	Absolute linear	2151	16000 nm, 1 Vpp, A/B, EnDat, resolution 100 nm	SMC20, SMI20, SME25
HTL/TTL encoders	Incremental square wave rotary	3001 3002 3003 3005 3006 3007 3008 3009 3011 3020	1024 HTL A/B R 1024 TTL A/B R 2048 HTL A/B R 1024 HTL A/B 1024 TTL A/B 2048 HTL A/B 2048 TTL A/B 1024 HTL A/B unipolar 2048 HTL A/B unipolar 2048 TTL A/B R, with Sense	SMC30
SSI encoder absolute	Absolute rotary	3081 3082	SSI, singleturn, 24 V SSI, multiturn 4096, 24 V Not for motor control, only as a direct measurement system	SMC30
SSI encoder absolute HTL	Absolute rotary	3090	4096, HTL, A/B, SSI, singleturn	SMC30
Linear encoder	Incremental linear	3109	2000 nm, TTL, A/B R distance-coded	SMC20, SMI20, SME20
SIMAG H2	Incremental rotary	2002 2003 2004 2005 2006 2007 2008	2048, 1 Vpp, A/B R 256, 1 Vpp, A/B R 400, 1 Vpp, A/B R 512, 1 Vpp, A/B R 192, 1 Vpp, A/B R 480, 1 Vpp, A/B R 800, 1 Vpp, A/B R	SMC20, SMI20, SME20

1) The SMC40 can only be completely configured if an associated EnDat 2.2 encoder is connected. Without a connected encoder, it is not possible to integrate the SMC40 into the topology.

3.12.2 Configuring an encoder

You can configure the encoders using an input screen in the STARTER commissioning tool. You have three configuration options:

Configuration for encoders with DRIVE-CLiQ interface

1. Activate the "Encoder with DRIVE-CLiQ interface" option button with a mouse click.

The encoder with DRIVE-CLiQ interface is then automatically identified in the encoder configuration screen.

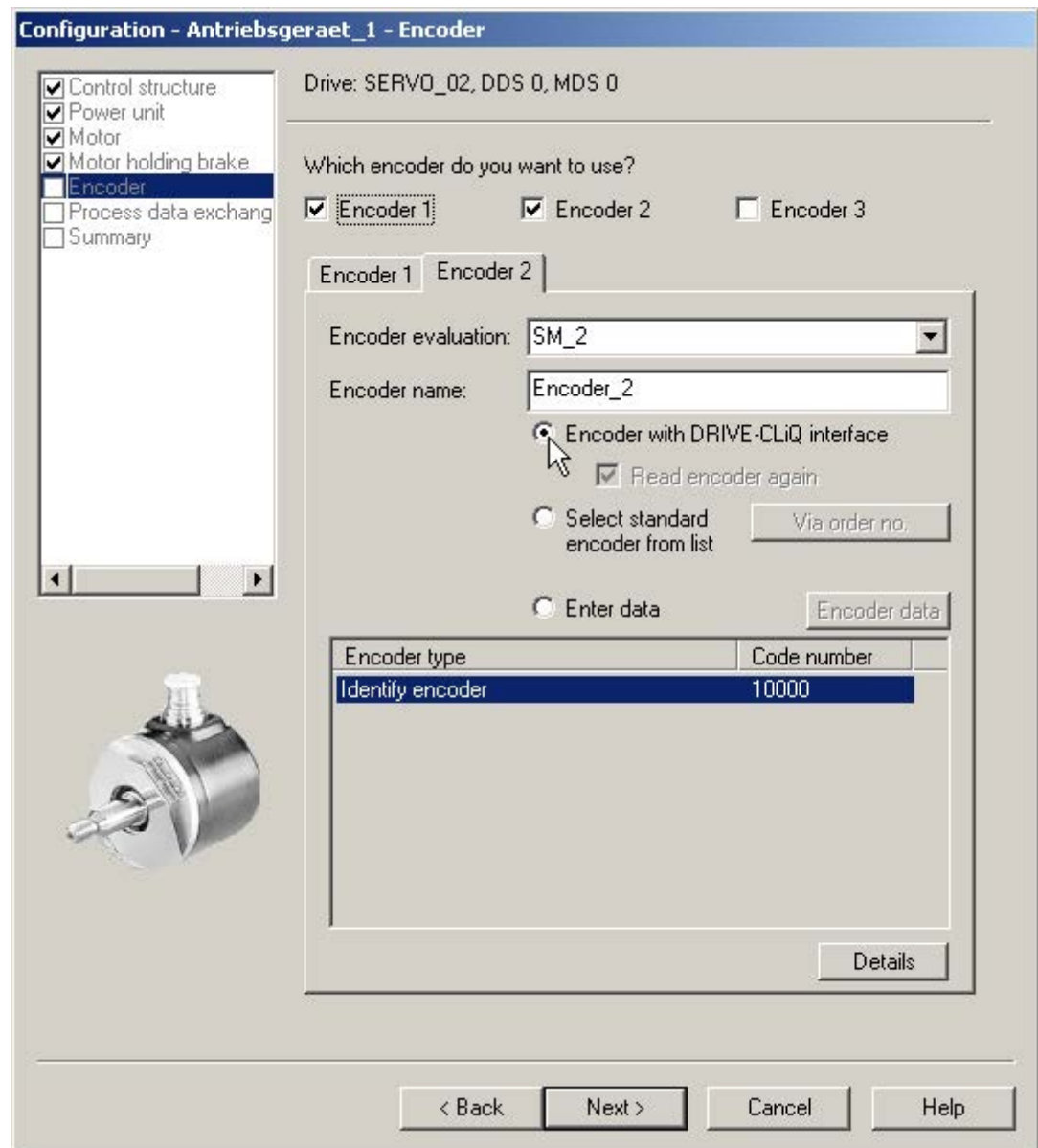

Image 3-37 Identifying DRIVE-CLiQ encoders

Configuration of standard encoders

1. Select the "Select standard encoder from list" option field.

The encoder 1/motor encoder can also be selected and configured at the same time using the motor article number.

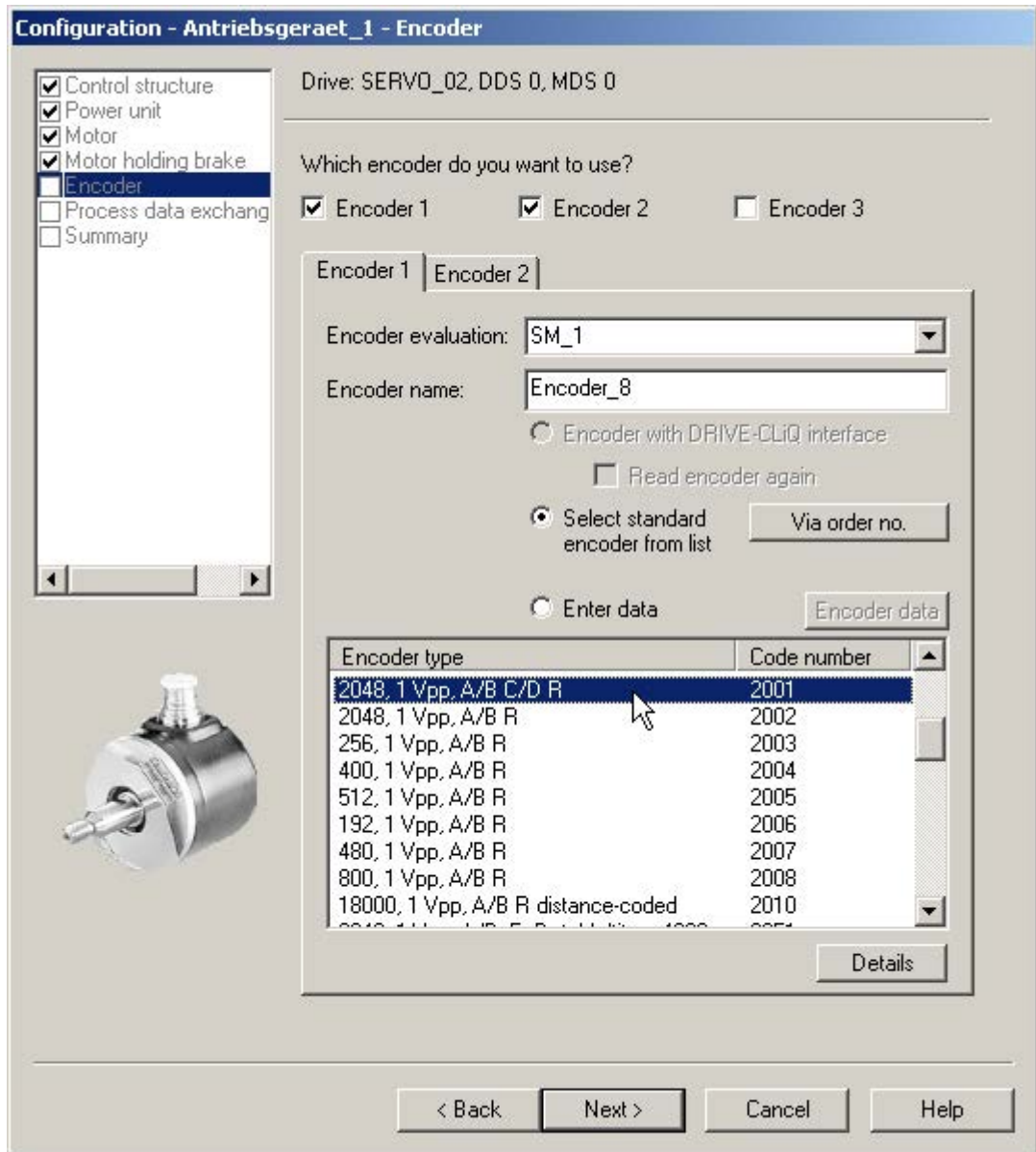

Image 3-38 Standard encoder option

When configuring the drive you can select the standard encoders offered by Siemens from a list under "encoders". When the encoder type is chosen, all necessary parameterizations are simultaneously and automatically transferred into the encoder configuration. The standard encoder type and the corresponding evaluation modules are shown in the above table.

Configuration using manually determined user data

1. To manually enter user-defined encoder data, use the mouse to activate the "Enter data" option field.

In this case, the encoder can be configured using the encoder-specific input screens in the STARTER commissioning tool.

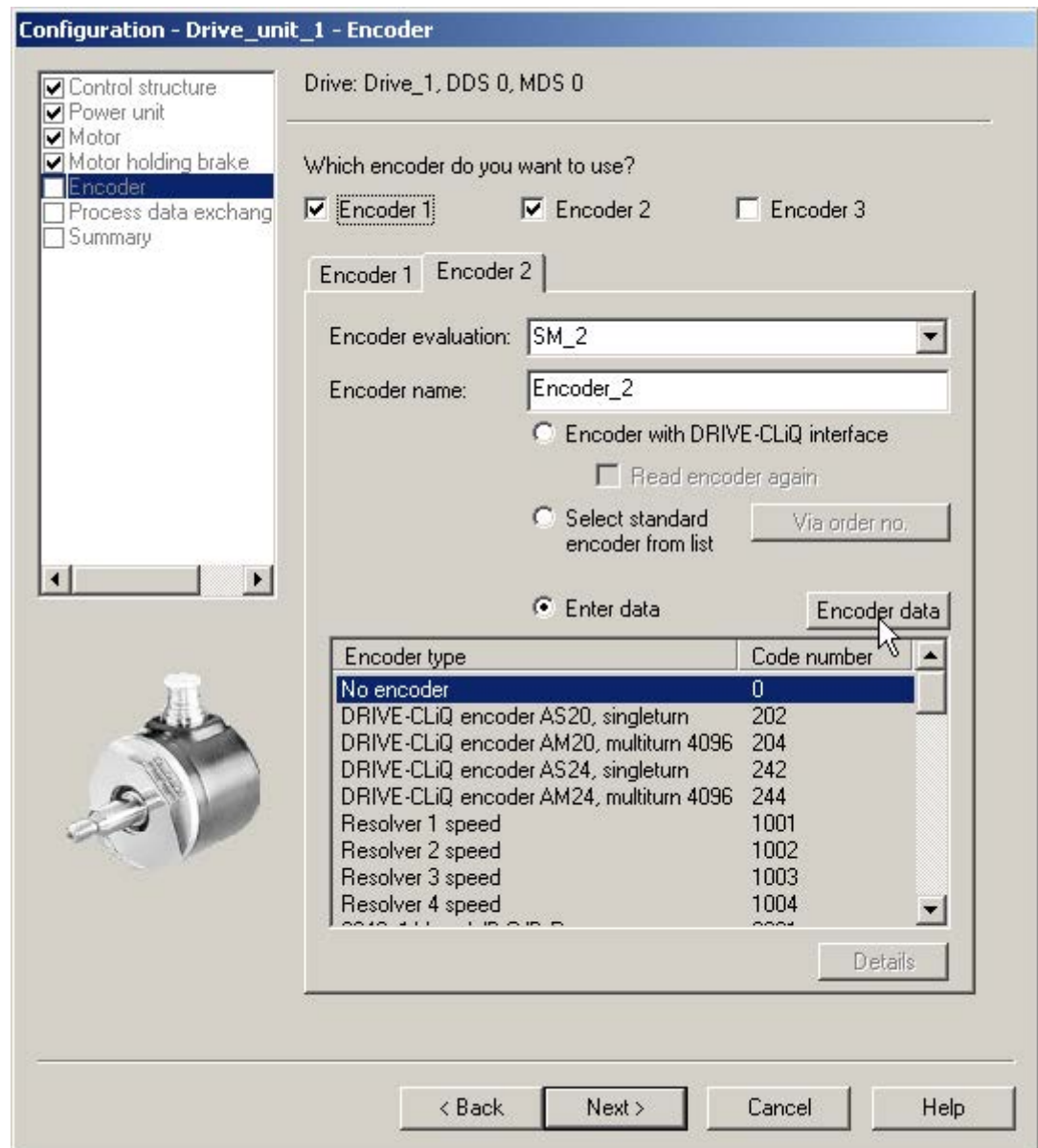

Image 3-39 User-defined encoder option

2. Click the "Encoder data" button.

The following window opens for encoder data:

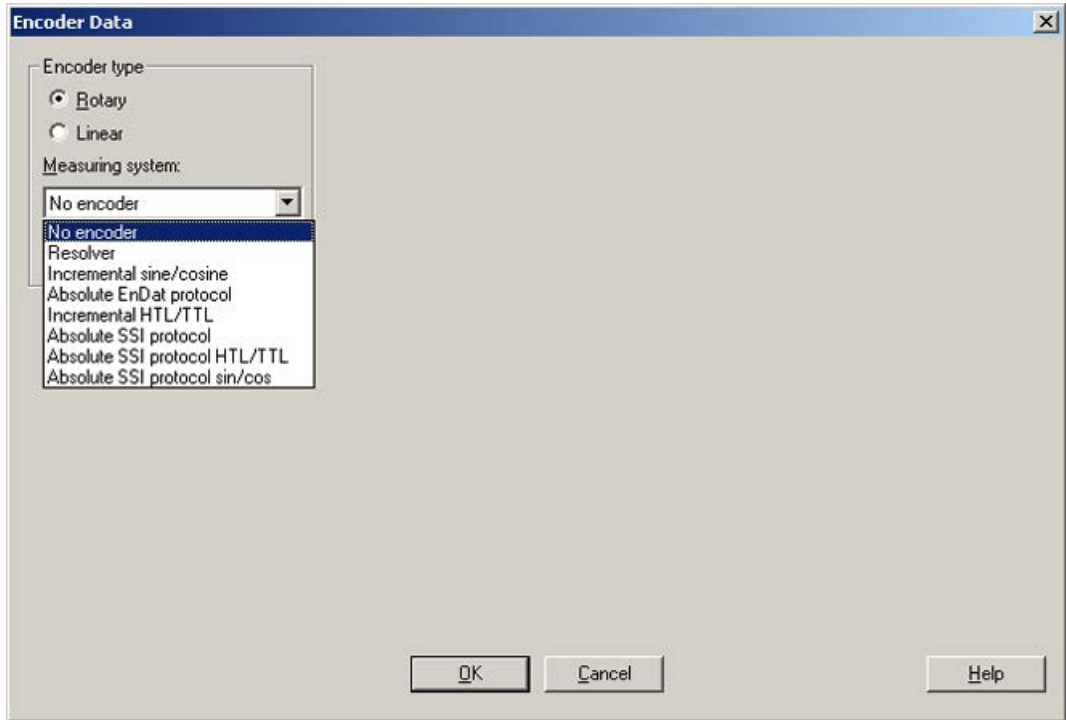

Image 3-40 Rotary encoder types

In this window, you can select between "rotary" and "linear" encoders.

3. Select the encoder type by clicking the appropriate option field.

The drop-down list for the "linear" encoder type lists, for example, the following encoders:

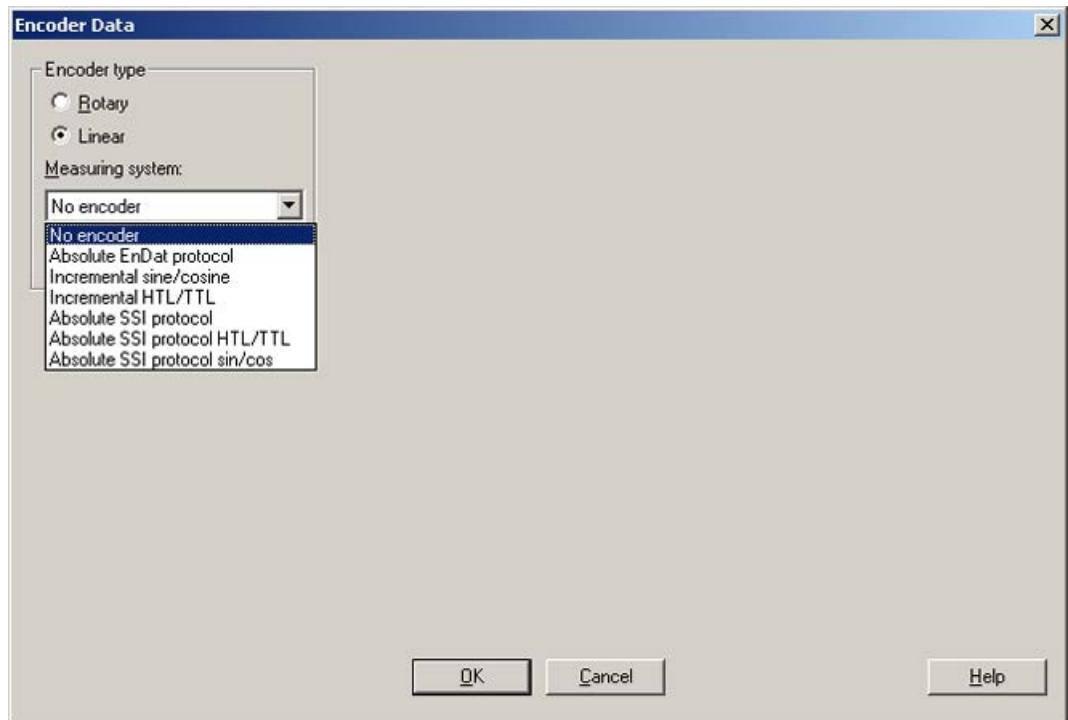

Image 3-41 Linear encoder types

4. Select the required encoder from the drop-down list.

The encoder-specific input screens for rotary and linear encoders are self-explanatory and therefore not explicitly explained here.

3.12.3 Example: Commissioning and replacement of a DRIVE-CLiQ encoder

The following describes commissioning and replacing an encoder using the DRIVE-CLiQ encoder as an example.

Support by STARTER

The STARTER commissioning tool supports encoders with DRIVE-CLiQ interface. Additional article numbers for the corresponding DRIVE-CLiQ motors are provided in the encoder overview.

The motor article number is used for an SMI or DQI motor.

When configuring a motor with DRIVE-CLiQ interface, a distinction is not made between SMI motors and DQI motors.

If you replace a motor with encoder and external DRIVE-CLiQ interface by an SMI motor or DQI motor, then you must appropriately reparameterize the SMI/DQI motor.

The functional behavior differs for the following encoder changes:

- If the encoders differ due to the measurement principle and the resolution.
- If the encoders are used in applications where the evaluation requires a zero mark (for example for referencing purposes). The encoder with integrated DRIVE-CLiQ interface does not supply a separate zero mark, as it involves an absolute encoder. So in these applications (and/or in the higher-level controllers) the changed behavior must be selected.
- If an encoder is to be used on an axis with SINAMICS Safety Integrated Extended functions or SINUMERIK Safety Integrated, because a lower position accuracy (SOS Safe Operating Stop) and a lower maximum velocity (SLS Safely Limited Speed) is obtained as a result of the lower resolution of the redundant position value (POS2).

A new commissioning test and, if necessary, new configuration must be carried out for activated SINAMICS Safety Integrated Extended functions or SINUMERIK Safety Integrated.

Commissioning encoders with DRIVE-CLiQ interface

For DRIVE-CLiQ encoders, the properties of a rotary absolute encoder are identified with the following parameters of the Control Unit:

p0404[0..n]	Encoder configuration active
p0408[0..n]	Rotary encoder pulse No.
p0421[0..n]	Absolute encoder rotary multiturn resolution
p0423[0..n]	Absolute encoder rotary singleturn resolution

This data is pre-assigned according to the preset codes in p0400 (encoder type selection) from the encoder lists. Parameters p0404, p0408, p0421 and p0423 are checked by the Control Unit when booting.

Alternatively, this data can be read out of the encoder with the setting p0400 = 10000 or p0400 = 10100. If the encoder data read out matches a known encoder type, this code is entered in p0400 using the Control Unit. In the other case, general codes are entered, e.g. P0400 = 10050 (encoder with EnDat interface 2.1 identified), p0400 = 10058 (digital encoder (absolute) identified) or p0400 = 10059 (digital encoder (incremental) identified).

A DRIVE-CLiQ encoder is identified by the parameter p0404.10 = 1.

For DRIVE-CLiQ encoders, encoder codes are defined respectively for parameter p0400 (see SINAMICS S120/S150 List Manual and above table).

If the Control Unit identifies a DRIVE-CLiQ encoder type for which no code is stored, during identification it enters the code p0400 = 10051 (DRIVE-CLiQ encoder identified).

The data is also automatically identified if a DRIVE-CLiQ encoder is found during automatic commissioning. During identification, the Control Unit reads out the values for p0404, p0421 and p0423 from the DRIVE-CLiQ encoder. The Control Unit uses this data to determine the contents of p0400. The newly defined codes are not stored in the DRIVE-CLiQ encoder.

Replacing a SINAMICS Sensor Module Integrated

If a defect occurs in a SINAMICS Sensor Module Integrated (SMI) or in a DRIVE-CLiQ Sensor Integrated (DQI), contact your local Siemens office for a repair.

3.13 Commissioning of SIMOTICS L-1FN3 linear motors

3.13.1 Safety instructions for commissioning linear motors

 WARNING
Danger to life as a result of unintended motor movement
Unexpected movements of the motor may cause death, serious injury (crushing) and/or property damage.
<ul style="list-style-type: none">• Do not work in the danger area while a machine is switched on.• Keep persons away from moving parts and areas where there is a danger of crushing.• Ensure the free axis travel path.• Observe the instructions on commutation.• Limit the motor currents.• Set the speed limitation to small values.• Monitor the end positions of the motor.

 WARNING
Risk of burn injuries on hot surfaces
Touching the surfaces of the motor can cause serious injury.
<ul style="list-style-type: none">• Do not touch the motor during or immediately after operation.• Attach the "Hot Surface Do Not Touch" (DW-026) warning sign close to the source of danger where it can be easily seen.

 WARNING
Danger to life due to electric shock
Every movement of the primary part compared with the secondary part and vice versa produces an induced voltage. If you touch cable connections, you could suffer an electric shock, which can result in death or serious injury.
<ul style="list-style-type: none">• Secure the primary section so that it cannot move before you touch the cable connections.• Connect the cable connections of the motor correctly and insulate them correctly.

3.13.2 Checklists for commissioning

Checklists for commissioning 1FN3 linear motors

Please thoroughly familiarize yourself with the safety instructions and observe the checklists below before starting any work.

Table 3-9 Checklist (1) - general checks

Check	OK
Are all of the necessary components of the configured drive line-up available, correctly dimensioned, correctly installed and connected?	
Are the manufacturer's documentation for the system components (e.g. drive system, encoder, cooling system, brake) and the "SIMOTICS L-1FN3 linear motors" Configuration Manual available?	
Are the following up-to-date SINAMICS documents available? <ul style="list-style-type: none"> • SINAMICS S120 Commissioning Manual • SINAMICS S120 Getting Started • SINAMICS S120 Function Manual Drive Functions • SINAMICS S120/S150 List Manual 	
Was the Chapter "Checklists for commissioning SINAMICS S" taken into account?	
Is the motor type to be commissioned known? (e.g. 1FN3 ____-____-____)	
As a minimum, is the following data for the motor known, if it involves a "third-party motor"? (A "third-party motor" is every motor that is not saved as standard in the Siemens commissioning software.) <ul style="list-style-type: none"> • Rated motor current • Motor rated velocity • Motor polar distance • Motor force constant • Motor maximum speed • Maximum motor current • Motor limit current • Motor weight • Phase resistance of the cold motor winding • Phase inductance of the winding 	
Are the environmental conditions in accordance with "SIMOTICS L-1FN3 linear motors" Operating Instructions in the permitted range?	
Is it guaranteed that the maximum permitted temperature of the secondary part does not exceed 70° C?	
Is it guaranteed that at least two people work together?	

3.13 Commissioning of SIMOTICS L-1FN3 linear motors

Table 3- 10 Checklist (2) - checking the mechanical system

Check	OK
Has the motor been correctly installed according to the motor manufacturer's specifications and is it ready to be switched on?	
Can the axis move freely over the complete travel range?	
Have all the screws been tightened to the specified torque?	
Does the air gap between the secondary section track and the primary and section correspond to the motor manufacturer's data?	
If there is a motor holding brake, does it function correctly?	
Has the position measuring system been correctly mounted and adjusted according to the manufacturer's specifications? Important associated information is also contained in the "SIMOTICS L-1FN3 linear motors" Configuration Manual.	
Has a cooling system, required for liquid-cooled motors, been connected according to the manufacturer's specifications and is it functioning correctly?	
Does the cooling medium comply with the requirements listed in the "Cooling media" chapter of the "SIMOTICS L-1FN3 linear motors" Configuration Manual?	
Were the cooling circuits flushed before been filled with the cooling medium?	
Is it ensured that the permitted pressure in the cooling circuit is not exceeded (here, refer to "Technical features" in the "SIMOTICS L-1FN3 Linear Motors" Configuration Manual)?	
Are moving cables correctly routed in a tow chain?	
Have the power cables been connected properly to the terminals with the specified torque?	
Have measures been taken to relieve strain on the cables?	

Table 3- 11 Checklist (3) - checking the electrical system

Check	OK
Has all wiring work been successfully completed?	
Is the protective conductor correctly connected?	
Is the motor ground directly connected to the Power Module ground (short distance in order to avoid high leakage currents)?	
Are all connectors correctly plugged in and screwed in place?	
Are the motors connected with shielded power cables?	
Are the power cable shields connected as closely as possible to the terminal box across a wide area?	
Are all cable shields connected to the respective housing through a large surface area?	
Have the control cables been connected in accordance with the required interface configuration and the shield applied?	
Have the motor power cables been correctly connected to the Power Module with the phase sequence UVW (clockwise rotating field)?	
Do the temperature monitoring circuits fulfill the specifications of protective separation? Additional important information on the Temp-S and Temp-F temperature monitoring circuits can be found in the "SIMOTICS L-1FN3 Linear Motors" Configuration Manual.	
Before commissioning and before switching on the DC-link voltage for the first time, have you checked the temperature monitoring circuits to ensure that they correctly trip / shut down?	
Is the position measuring system correctly connected?	

Check	OK
Are the digital and analog signals routed using separate cables?	
Has the distance between the power cables and the signal lines been observed?	
Is it guaranteed that temperature-sensitive parts (electric cables, electronic components) are not placed on hot surfaces?	
Have the line-side and motor-side power cables been dimensioned and routed in accordance with the environmental and routing conditions?	
Have the maximum permitted cable lengths between the frequency converter and the motor (depending on the type of cables used) been observed?	

3.13.3 General information for setting the commutation

You can use the following two pole position identification techniques for all frame sizes of SIMOTICS L-1FN3 linear motors:

- The motion-based technique
- The saturation-based technique (1st harmonic)

Irrespective of which of these two techniques is deployed, you can also use a Hall sensor box to determine the pole position.

Note

Fine synchronization is recommended for precise commutation

Use either a measuring system with a zero mark that can be evaluated or an absolute measuring system.

Motion-based technique

This technique can also be used during commissioning when the commutation angle offset is initially determined or when it is checked in conjunction with an absolute measuring system.

The technique can be applied for horizontal and inclined axes whose load cannot be lowered in an uncontrolled manner when the machine is disconnected from the power supply. In this case, the axes must be able to be freely moved and not be braked. (static friction < 10% of the rated motor force).

In the worst-case scenario, the axes can move in the range of ± 5 degrees when this technique is used.

 WARNING
Danger to life from vertical or inclined axes
With vertical or inclined axes, the load can fall down and cause death or severe injury when a motion-based technique is used.
<ul style="list-style-type: none"> • Ensure that nobody is in the danger zone. • Use the saturation-based technique for vertical axes.

Saturation-based technique

This technique does not require any axis movement and so it can also be used for axes that are locked (e.g. using a brake). Axes movements, however, can occur for axes that are not locked. Depending on the actual design, this technique can result in a higher noise level when the axes are powered up during the identification routine.

3.13.4 Parameterizing a motor and encoder

Configuring data for a standard motor

You must individually configure the drives.

1. Double-click in the project navigator on "Drives" > "Drive name" > "Configuration" > "Configure DDS" one after the other.
2. Select the standard motor provided for the commissioning from the list.
The associated motor data is stored and does not need to be entered manually.

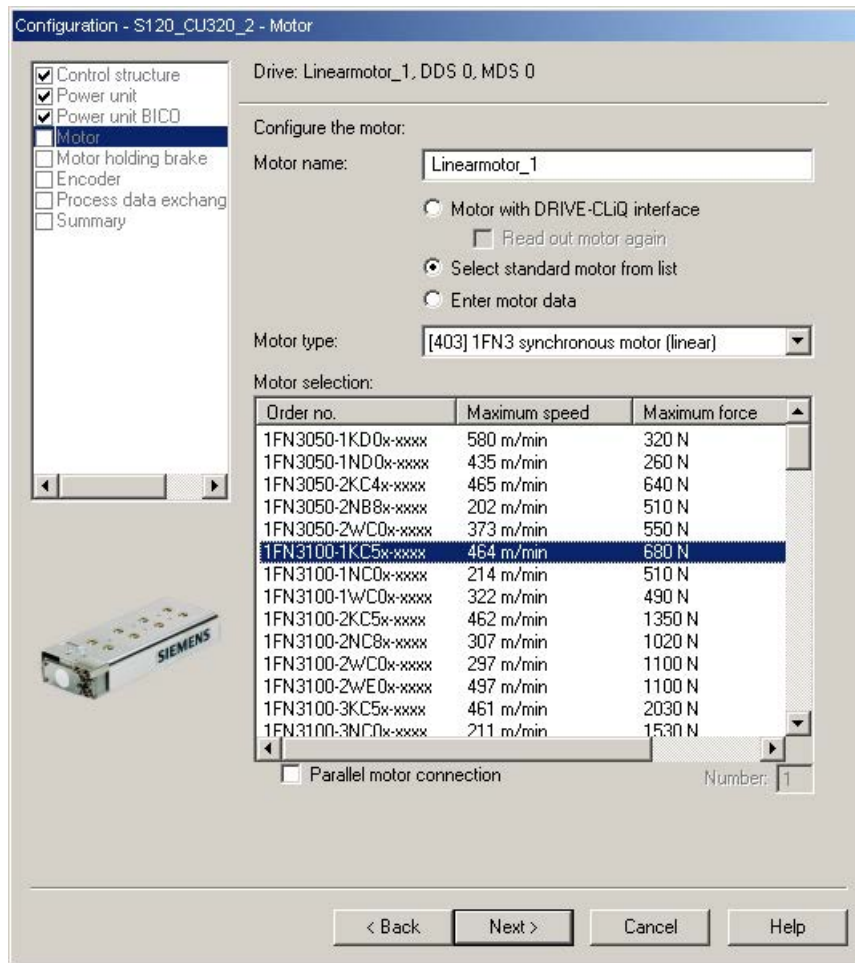

Image 3-42 Screen to configure a motor - selecting a standard motor

Configuring data for a third-party motor

1FN3 linear motors are not included in the list if they are customer-specific special motors or new developments.

1. Please take the motor data from the attached motor data sheet and make the following settings:

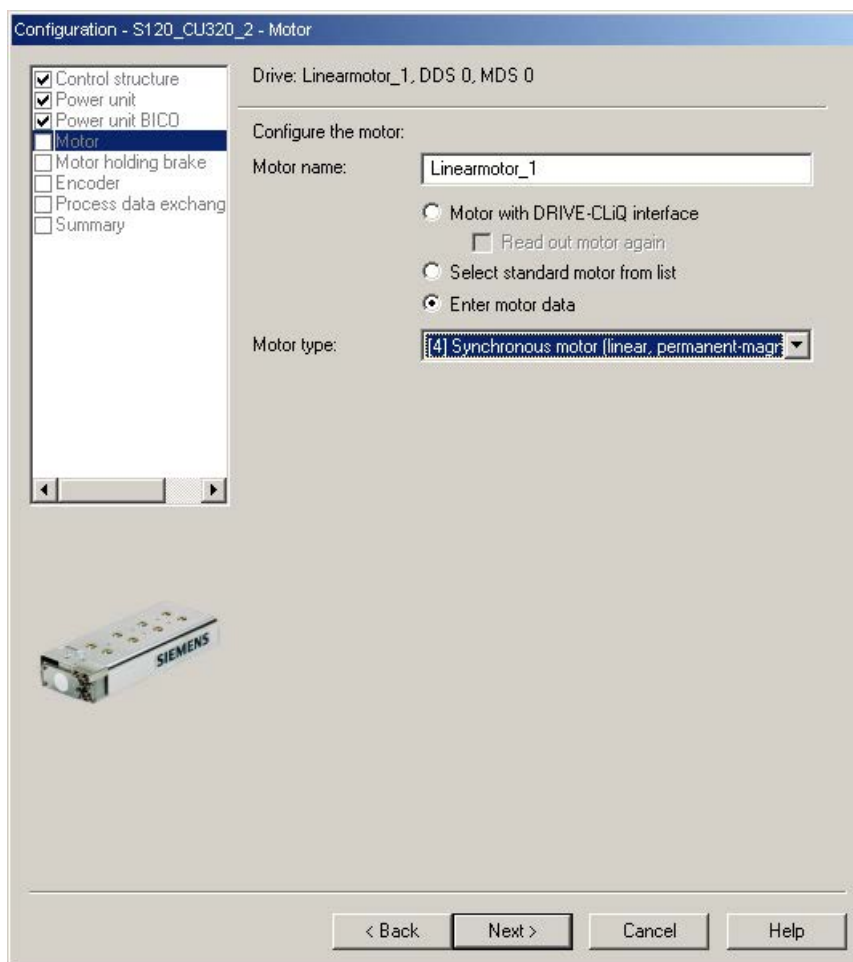

Image 3-43 Screen to configure the motor – setting for a third-party motor

2. Enter the following data for a linear permanent-magnet synchronous motor:

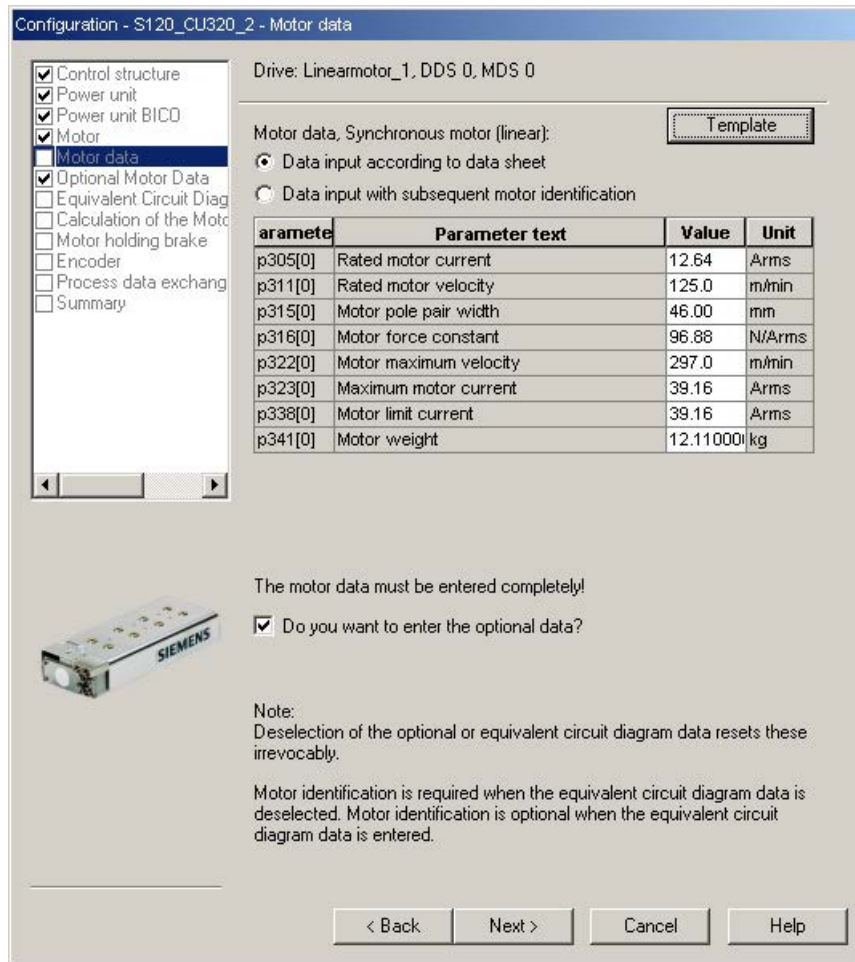

Image 3-44 Example of motor data that has been entered

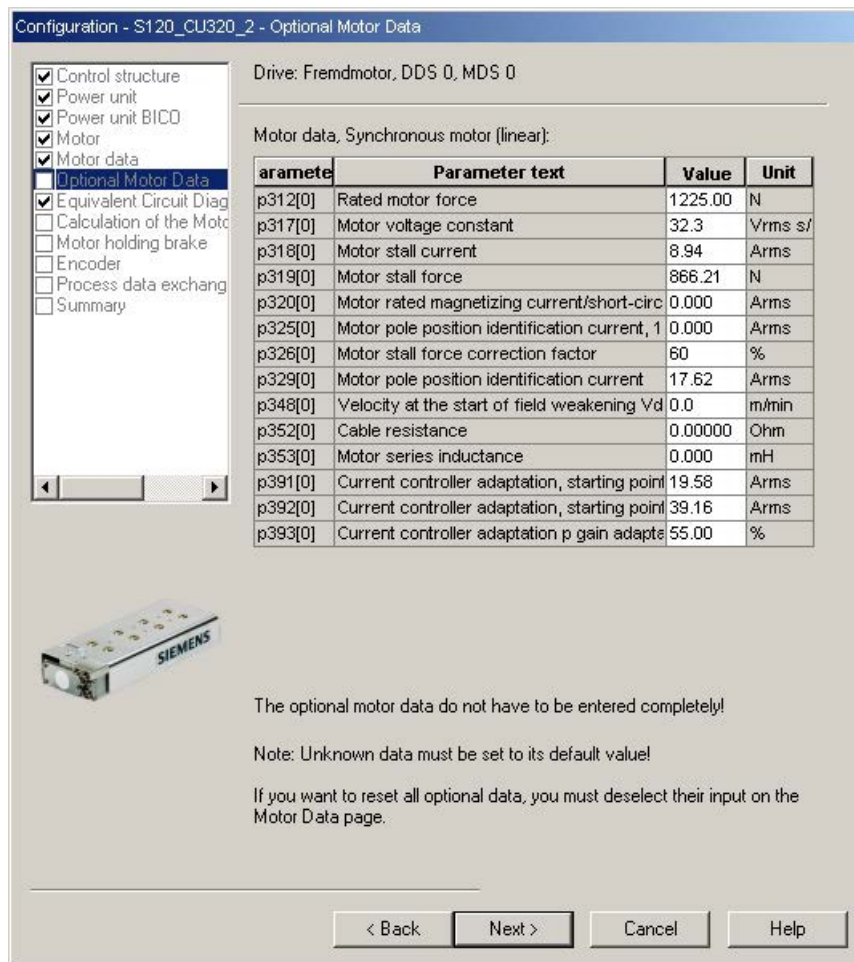

Image 3-45 Example of optional motor data that has been entered

Entering equivalent circuit diagram data

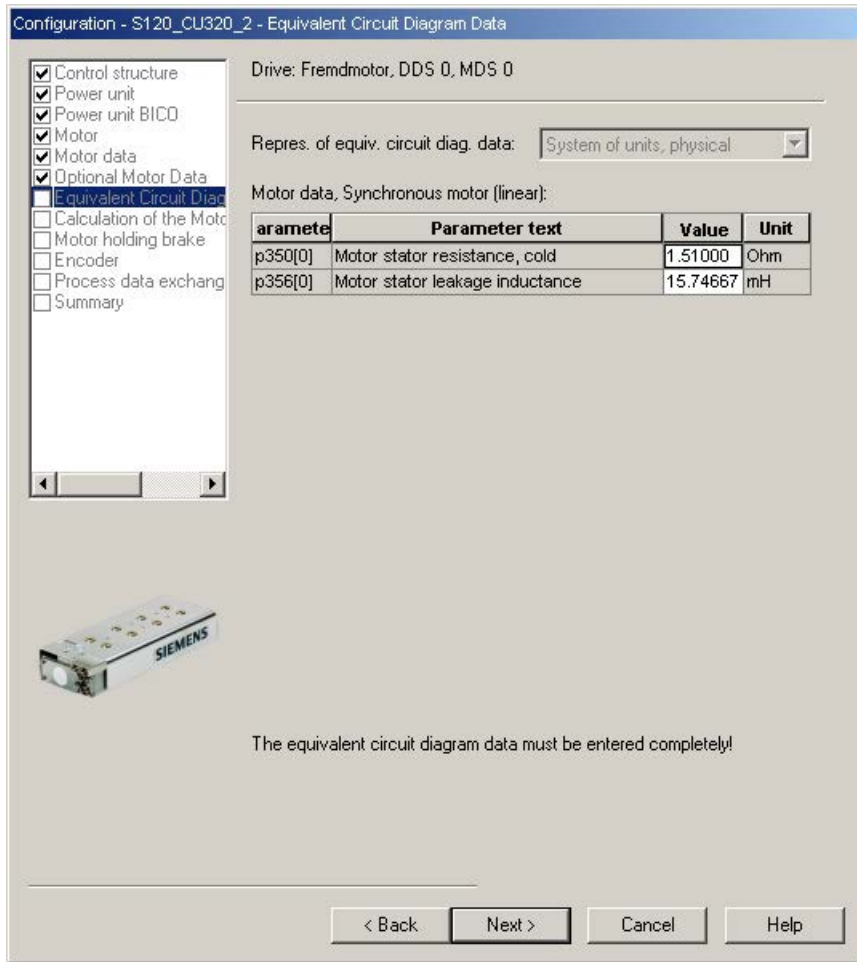

Image 3-46 Example of equivalent circuit diagram data that has been entered

Calculating controller data

After selecting the motor and entering the motor data, completely calculate the controller data.

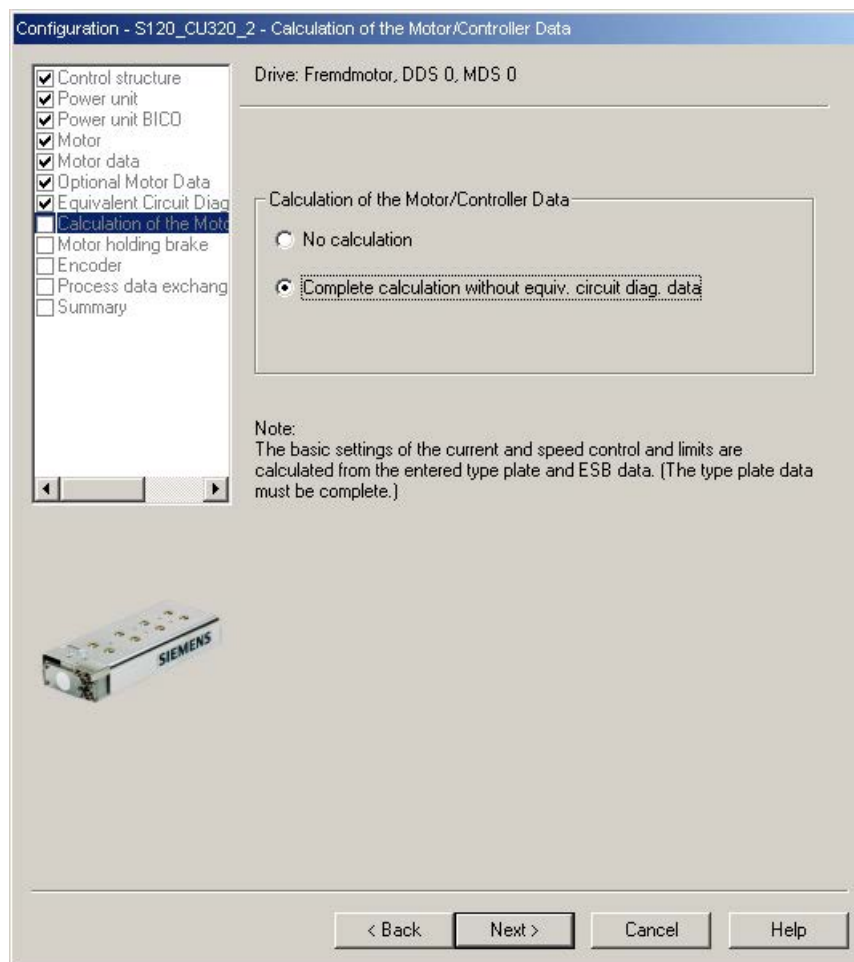

Image 3-47 Screen form for calculating the motor/controller data

Configuring the motor holding brake

If a motor holding brake is being used, configure it in the following window.

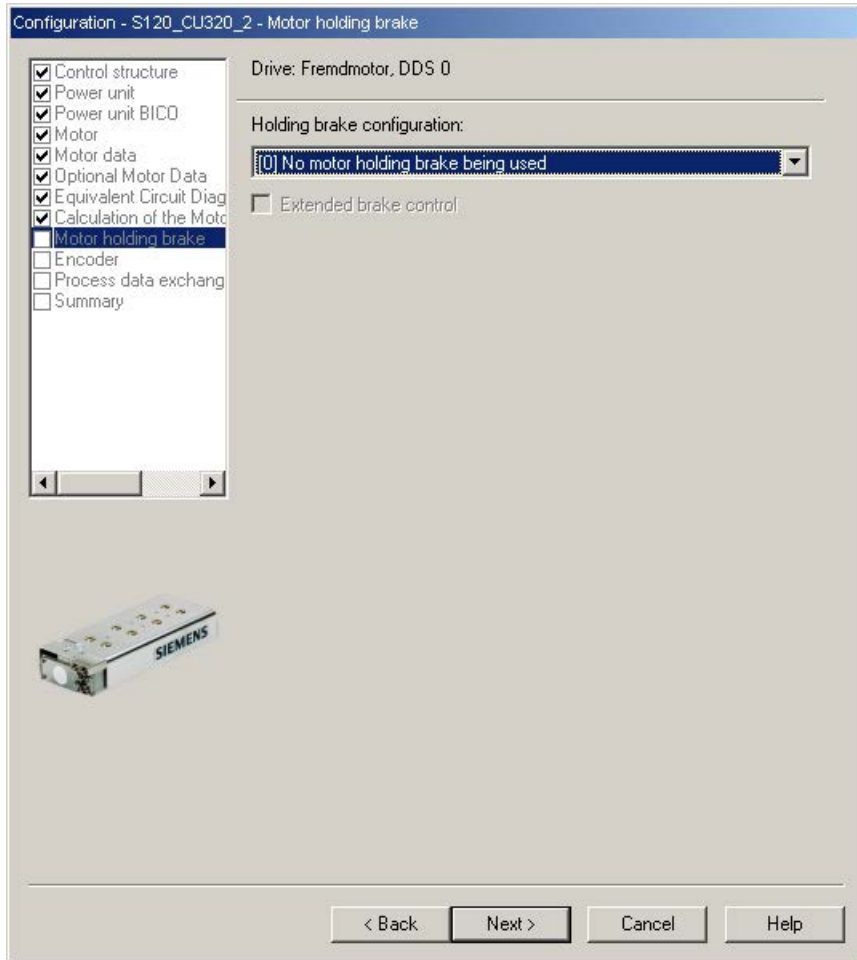

Image 3-48 Screen form for configuring a motor holding brake

Configuring encoder data

1. Note the data of the encoder manufacturer and the information in Chapter "Selecting and configuring encoders (Page 173)" in this manual.
2. Configure the encoder data for the linear motor using the "Encoder data" screen form. To do this, click the "Encoder data" button in the dialog.

Configuration - S120_CU320_2 - Encoder

Drive: Fremdmotor, DDS 0, MDS 0

Which encoder do you want to use?

Encoder 1 Encoder 2 Encoder 3

Encoder 1

Encoder evaluation: SM_x

Encoder name: Geber_1

Encoder with DRIVE-CLiQ interface
 Read encoder again

Select standard encoder from list Via order no.

Enter data Encoder data

Encoder type	Code number
No encoder	0
DRIVE-CLiQ encoder AS20, singleturn	202
DRIVE-CLiQ encoder AM20, multiturn	204
DRIVE-CLiQ encoder AS24, singleturn	242
DRIVE-CLiQ encoder AM24, multiturn	244
Resolver 1 speed	1001
Resolver 2 speed	1002
Resolver 3 speed	1003
Resolver 4 speed	1004

Details

< Back Next > Cancel Help

Image 3-49 Screen form to configure an encoder

Incremental measuring system

Example of an incremental sine/cosine encoder with a lattice pitch of 16000 nm and a zero mark:

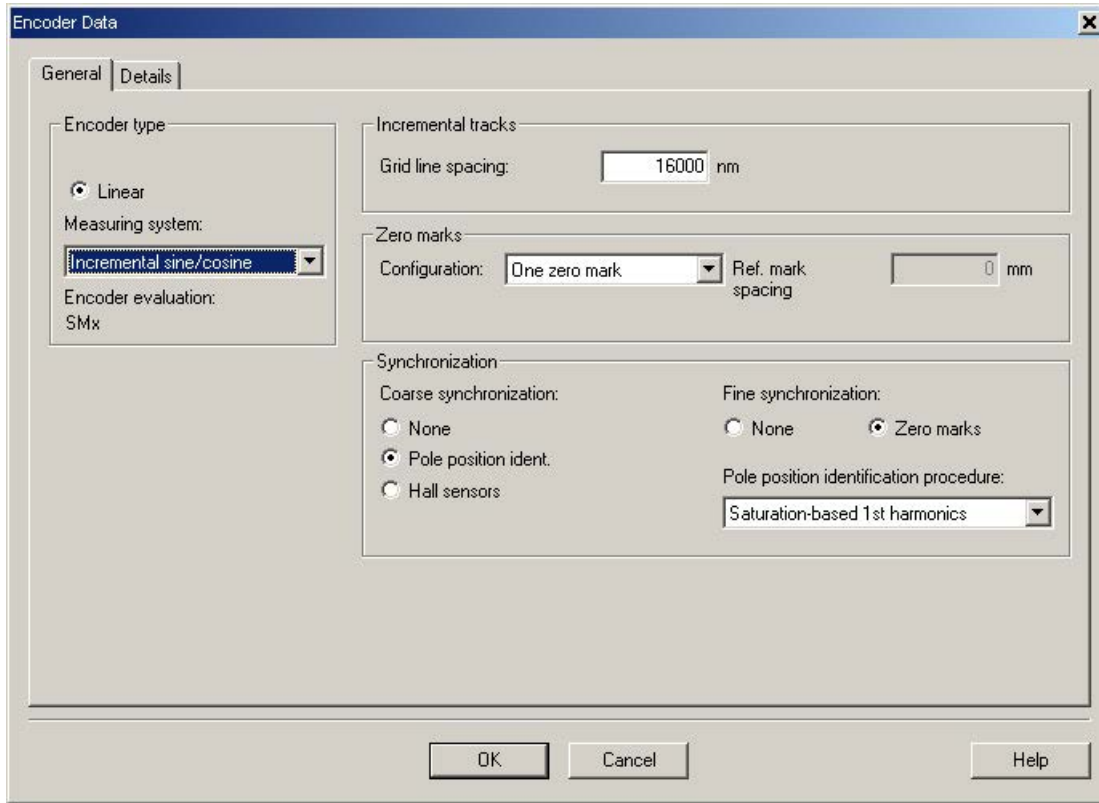

Image 3-50 Screen form for entering the encoder data

Note

A pole position identification is required for SIMOTICS L-1FN3 linear motors with incremental measuring systems

The following techniques are possible to do this:

- The motion-based technique
- The saturation-based technique (1st harmonic)

For incremental measuring systems, generally, fine synchronization is performed at the zero mark. When commissioning the system for the first time, the angular commutation offset (p0431) must be pre-assigned, see Chapter "Determining the angular commutation offset / maintaining the tolerance (Page 204)".

For third-party motors, a pole position identification routine to determine the angular commutation offset cannot be entered.

Absolute measuring system

The encoder is detected by the Control Unit as long as it is a DRIVE-CLiQ encoder. For all other encoder types, you must use the SINAMICS Sensor Module in accordance with the encoder interface in order to transfer the encoder signals to the Control Unit.

Note

SINAMICS Sensor Modules in conjunction with EnDat encoders of Heidenhain Corp.

SMC20, SME25 and SME125: EnDat encoders with incremental signals, article designation EnDat02 or EnDat01.

SMC40: EnDat encoder with EnDat protocol 2.2 without incremental signals, article designation Endat22.

The following inputs must be made in the configuration screen form after clicking the "Encoder data" button.

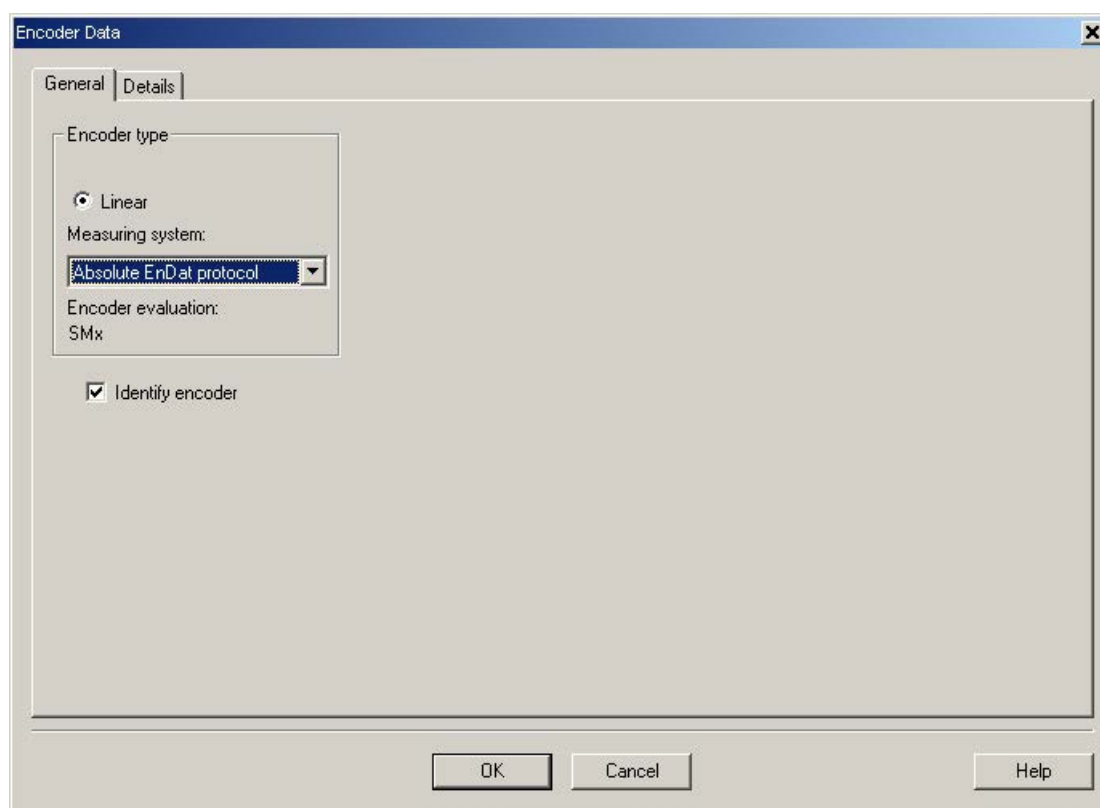

Image 3-51 Screen form to configure an absolute encoder with EnDat protocol

Definition of the control sense

The control sense of an axis is correct if the positive direction of the drive (= clockwise rotating field U, V, W) coincides with the positive counting direction of the measuring system.

If the positive direction of the drive and positive counting direction of the measuring system do not match, then you must invert the actual speed value in the "Encoder configuration - details" screen form when the drive is being commissioned (p0410.0 or p0410.1). See the "Screen form for entering additional encoder data (Page 196)" figure.

Setting additional encoder data

1. If necessary, use "Encoder data" and "Details" to invert the actual speed and position value.
This allows the control sense to be changed.
2. To do this, first click the "Encoder data" button in the screen form used for the encoder configuration.

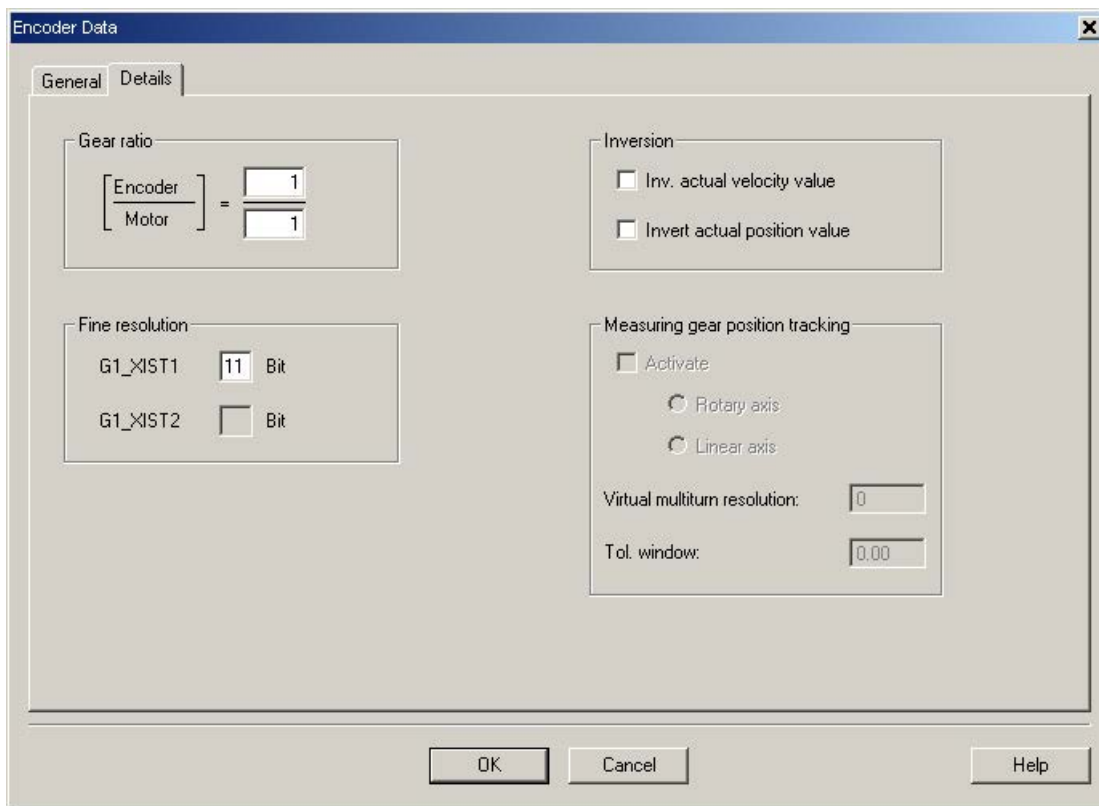

Image 3-52 Screen form for entering additional encoder data

Determining the drive direction

The direction of the drive rotation is positive if the primary section moves relative to the secondary section in the opposite direction to the cable outlet direction.

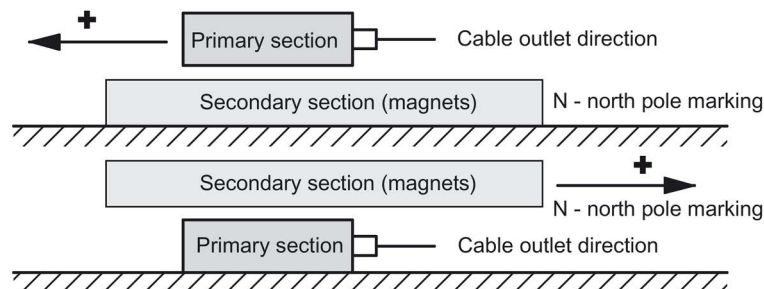

Image 3-53 Determining the positive direction of the drive

Determining the counting direction of the measuring system

The counting direction depends on the measuring system and the mounting position. The counting direction of the measuring system must match the travel direction of the motor. If necessary, you must adapt the counting direction by making the appropriate parameter assignment. Please refer to the manufacturer's documentation for the measuring system. If necessary, you must invert the counting direction, as described in the "Screen form to enter additional encoder data" (Page 196) figure.

Note

Checking the counting direction of the measuring system

The measuring system counting direction can also be checked, by first parameterizing the drive, and then manually moving it with the enable signals inhibited.

If the axis is moved in the positive direction, the actual speed value must also count in the positive direction.

Completing parameterization

1. The selection of the PROFIdrive telegram and the summary closes the parameterization of the drive.

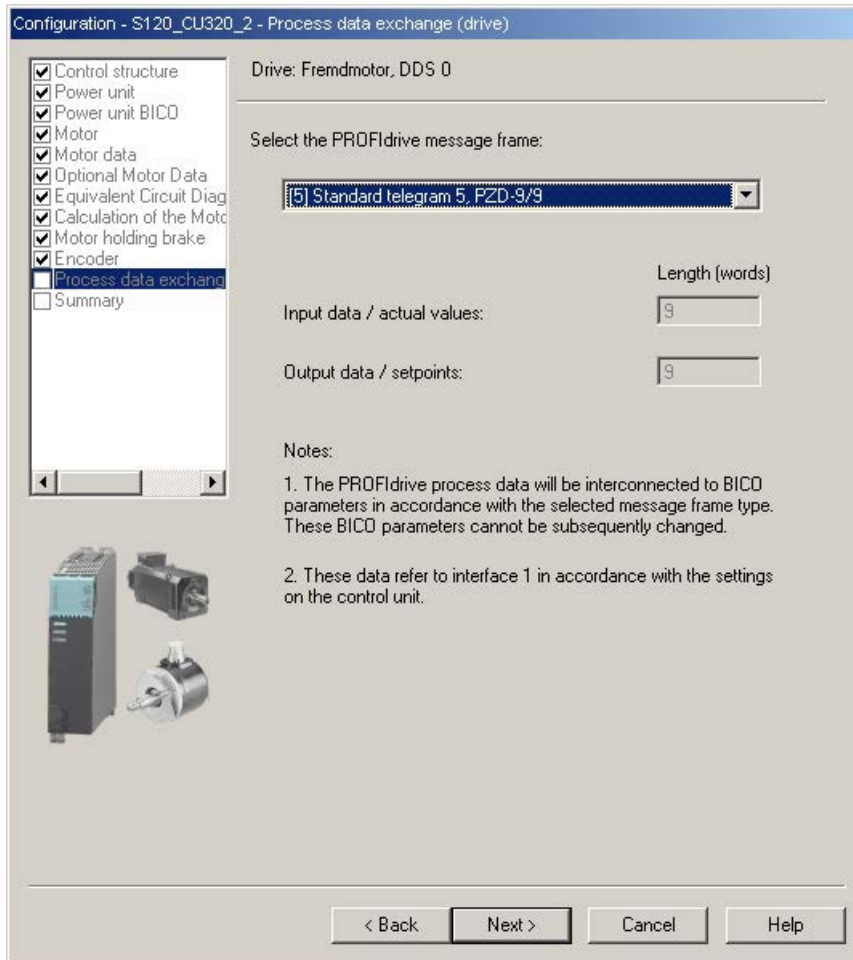

Image 3-54 Screen form for selecting the telegram for the process data exchange

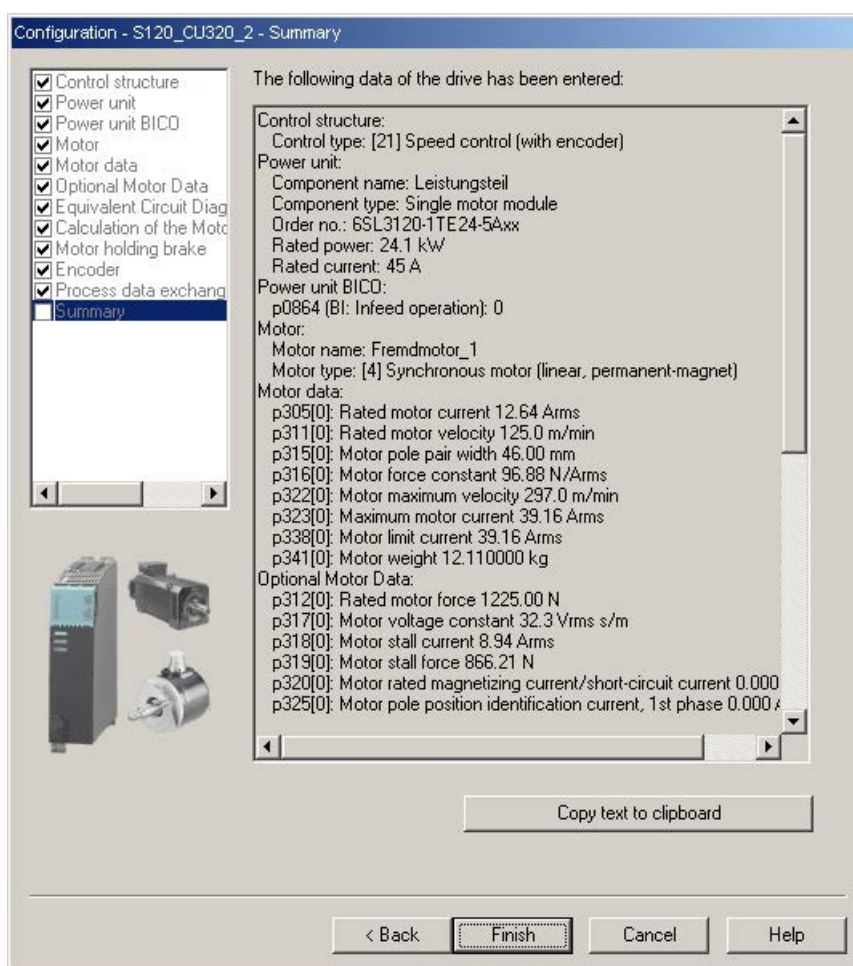

Image 3-55 Summary of the configuration

- The created offline project must now be loaded into the drive. In STARTER, go online with the target device.

If an absolute measuring system with EnDat protocol was selected, then after establishing an online connection, the encoder serial number is loaded and the corresponding encoder parameters are set.

3.13.5 Parameterizing and testing the temperature sensors

SME12x Sensor Module External

The connection of the SME modules is described in the "System integration" chapter in the "SIMOTICS L-1FN3 Linear Motors" Configuration Manual. Information on the SME12x Sensor Module External can be found in the "SINAMICS S120 Equipment Manual for Control Units and Additional System Components" in Chapter "Sensor Module External 120 (SME120)" and in Chapter "Sensor Module External 125 (SME125)".

The parameterization of the temperature sensors is explained in detail in Chapter "Temperature sensors for SINAMICS components (Page 282)".

A parameterizing example of a linear motor with a PT1000 (or alternatively: KTY 84) and a PTC sensor, connected to a SME12x Sensor Module External is provided below.

Use the expert list to parameterize the drive.

Table 3- 12 Parameterization in the drive:

Parameter	Input
p0600	Motor temperature sensor for monitoring 1: Temperature sensor via encoder 1
p0601	Motor temperature sensor, sensor type 10: Evaluation via several temperature channels SME12x
p0604	Motor temperature alarm threshold Sets the alarm threshold for monitoring the motor temperature. For motors from the motor list (p0301), this parameter is automatically pre-assigned (120° C).
p0605	Motor temperature fault threshold Sets the fault threshold for monitoring the motor temperature. For motors from the motor list (p0301), this parameter is automatically pre-assigned (155° C).
p0606	Motor temperature timer 0...2 s Setting the timer for the alarm threshold for the motor temperature monitoring, if alarm with timer was selected in the parameters p4600...4603. This timer is started if the temperature alarm threshold (p0604) is exceeded. If the timer has expired, and in the meantime the temperature alarm threshold has not been undershot, then fault F07011 is output.

Parameter	Input
p0607	Temperature sensor fault timer Setting the timer for timing the period between output of the alarm and fault when a temperature sensor fault is detected. If a sensor fault has been detected, this timer is started. If the sensor fault persists when the timer has expired, the relevant fault is output.
p4600...4603	Motor temperature sensor 1...4 sensor type Sets the temperature sensor type for the motor temperature monitoring. Channels 2 ... 4 are used for the Sensor Module External SME12x. Channel 1 remains free. The following values are possible for linear motors: 0: No sensor 10: PTC fault 12: PTC alarm & timer 20: KTY 84 60: PT1000 If you make a selection with timer, you must pre-assign parameter p0606 with the corresponding timer for a maximum of 2 s.

Example: SIMOTICS L-1FN3 standard linear motors

p4600	0: No sensor
p4601	60: PT1000 (or alternatively 20: KTY 84)
p4602	10: PTC fault
p4603	0: No sensor

If you are not using a standard motor, then you must parameterize parameters p0600...p0606 (see above). Select parameters p4600...p4603 to match the sensor types or temperature channels of the Sensor Module External SME12x.

Checking the temperature sensors for the Sensor Module External SME12x

In the online mode, you can read out the temperatures of the sensors at the channels of the Sensor Module External SME12x in parameter r4620[0...3] using the STARTER commissioning tool.

The maximum motor temperature can also be read in r0035. This parameter indicates the highest value from parameters r4620[0...3].

For a parameterized PTC sensor type, irrespective of the actual temperature in r4620, -200° C is always displayed.

The temperature values shown in parameters r0035 or r4620[1] provide information about whether a parameterized temperature sensor does not match the temperature sensor actually connected (connection to the wrong temperature sensor):

Parameterized temperature sensor	Connected temperature sensor	Displayed value in °C at room temperature 25°C
KTY 84	PTC	-40 ... -80 °C
PT1000	PTC	-100 ... -200 °C
KTY 84	PT1000	+115°C
PT1000	KTY 84	-100°C

Checking the PTC sensor type

You can simulate a sensor responding to an overtemperature condition (high ohmic state) by disconnecting the connections. You can disconnect the connections for the temperature sensors by removing the Sensor Module External SME12x (connector, interface X200).

If the sensor type is parameterized as PTC fault, then fault "F07011 drive: Motor overtemperature" is immediately displayed independent of the setting of p0604...p0606. If the sensor type is parameterized as PTC alarm with timer, after the time parameterized in p0606, fault F07011 is generated.

Test for sensor type PT1000 or KTY

If you withdraw the connector of interface X200 and have therefore disconnected the PT1000 connection (or KTY connection), after the time parameterized in p0607 has expired, fault "F07016 drive: Motor temperature sensor fault" is displayed in the alarm window of the STARTER commissioning tool.

Check the wiring of the temperature sensors by checking the resistance values at connector interface X200. The wiring is OK for the following resistance values:

PT1000 at 20 °C approx. 1080 Ω

KTY 84 at 20 °C approx. 580 Ω

PTC for 20 °C 120 Ω...300 Ω

The assignment of connector interface X200 can be found in the "SINAMICS S120 Manual Control Units and Additional System Components".

Terminal Module TM120

Terminal Module TM120 is a DRIVE-CLiQ component for temperature evaluation with safe isolation, see also "SINAMICS S120 Manual for Control Units and Additional System Components" in Chapter "System components".

TM120 is an autonomous input/output component. You can freely assign the temperature channels to any Motor Module.

You can assign every channel to the following sensor types:

- PTC
- KTY 84
- PT1000
- Bimetallic NC contact

Parameterization

For a standard configuration with correct pre-assignment of the temperature channels, the Terminal Module TM120 must be located between the Sensor Module and the Motor Module (DRIVE-CLiQ).

If this is not the case, you must parameterize all of the required temperature channels in both the Motor Module and Terminal Module TM120.

You must always carefully check the temperature shutdown circuits (e.g. by disconnecting the sensors) before commissioning the motor for the first time.

Use the expert list to parameterize the drive.

Table 3- 13 Parameterization in the drive:

Parameter	Input
p0600	Motor temperature sensor for monitoring 20: Temperature sensor via BICO interconnection p0608
p0601	Motor temperature sensor, sensor type 11: Evaluation via several temperature channels BICO
p0606	Motor temperature timer 0...2 s Sets the timer for the alarm threshold for the motor temperature monitoring, if alarm with timer was selected in p4610...4613. This timer is started when the temperature alarm threshold (p0604) is exceeded. If the timer expires before the temperature falls below the alarm threshold, then fault F07011 is output.
p0608	[0...3] CI: Motor temperature, signal source 2 Sets the signal source 2 for the evaluation of the motor temperature via a BICO interconnection, e.g. [0]: Motor temperature channel 1 TM120 . r4105[0] [1]: Motor temperature channel 2 TM120 . r4105[1] [2]: Motor temperature channel 3 TM120 . r4105[2] [3]: Motor temperature channel 4 TM120 . r4105[3]
p4610...p4613	Motor temperature sensor 1...4 sensor type Sets the temperature sensor type for the motor temperature monitoring. The following values are possible for linear motors: 0: No sensor 10: PTC fault 12: PTC alarm & timer 20: KTY84, PT100, PT1000 30: Bimetallic NC contact fault 32: Bimetallic NC contact alarm & timer If you make a selection with timer, you must pre-assign parameter p0606 with the corresponding timer for a maximum of 2 s.

Table 3- 14 Parameterization in the expert list of the Terminal Module TM120

Parameter	Input
p4100[0...3]	TM120 temperature evaluation, sensor type Sets the temperature evaluation of Terminal Module TM120. This means that the temperature sensor type is selected and the evaluation is activated. The following values are possible: 0: Evaluation deactivated 1: PTC thermistor 2: KTY84 4: Bimetal NC contact 6: PT1000

Check the temperature sensors in the same way as described for the SME12x Sensor Module External (see section "Checking the temperature sensors for the Sensor Module External SME12x"). Test each individual temperature channel by separating the connection.

3.13.6 Determining the angular commutation offset / maintaining the tolerance

<p>NOTICE</p> <p>Material damage as a result of an incorrectly commutated drive</p> <p>When the system is commissioned for the first time or after an encoder/motor has been replaced, it is possible that the drive could be incorrectly commutated if the angular commutation offset has not yet been adjusted. Current is fed into the motor at the incorrect time for an incorrectly commutated motor. This means it can perform inadvertent movements. For example, it can turn with high speed in the wrong direction and so damage a workpiece.</p> <ul style="list-style-type: none"> • Set the current limit using the p0640 parameter to 20% of p0323 (motor maximum current). • Therefore, to complete commissioning, it is imperative that you check the angular commutation offset according to the following description.

You can determine the pole position, required for synchronous motors, for the SIMOTICS L-1FN3 linear motors using a software-based automatic pole position identification technique.

The following two techniques are suitable for all frame sizes of the SIMOTICS L-1FN3 linear motors:

- The motion-based technique p1980 = 10
- The saturation-based technique (1st harmonic) p1980 = 1

Also refer to the information in Chapter "General information for the commutation setting" (Page 185).

Making parameter entries / commutation setting

Incremental measuring system

1. Activate automatic determination of the commutation angle offset with $p1990 = 1$.

Alarm A07971 is output while the commutation angle offset is being determined.

2. Set the drive enable signals (OFF3, OFF2, OFF1).

This results in coarse synchronization. A successful coarse synchronization is indicated by the parameter $r1992.9$.

3. Move the drive over the zero mark.

When the drive moves over the zero mark, the angular commutation offset is entered into $p0431$. $p1990$ is automatically set to 0 after the angular commutation offset has been determined. Alarm A07965 is displayed as a prompt to save the change in a non-volatile fashion.

Absolute measuring system

Set $p1990 = 1$ before activating the enable signals.

By activating the enable signals, the angular commutation offset entered into $p0431$ and $p1990$ is automatically set to 0. Alarm A07965 (N) is displayed as a prompt to save the change in non-volatile storage.

3.13.6.1 Checking the commutation angle offset with STARTER

Note

Coarse synchronization means that the pole position identification has been carried out, but the drive has not yet been moved over the zero mark. After the drive has been moved over the zero mark, the drive is finely synchronized. Fine synchronization is omitted when an absolute measuring system is being used, because the drive is always fine synchronized after being switched on. A coarse synchronization is required only for the initial commissioning for the commutation angle offset determination ($p0431$).

Checking the pole position identification

You can check the pole position identification with p1983 in the finely-synchronized state.

1. Position the drive at different points in an electrical period (pole pitch) and set parameter p1983 = 1. For example, start at 0° and perform a measurement every 30°.

This means that a pole position identification is performed again and the deviation determined is displayed in parameter p1984.

After completion of the pole position identification, parameter p1983 is set to 0 again. The angular difference read out of parameter p1984 must lie in the interval [-10°...+10°].

The average of the measured angle differences must be added to the commutation angle offset entered in p0431. (Note the sign of the commutation angle offset.)

For a change to parameter p0431, p0010 must be set to 4 (see the "Representation of the tolerance field for the pole position angle (Page 216)" figure).

2. Perform a coarse and fine synchronization again. The fine synchronization is not applicable for an absolute measuring system.

3.13.6.2 Checking the commutation angle offset with an oscilloscope

Checking the EMF voltages

If you have commissioned the motor according to the appropriate instructions, and in spite of this, unexpected messages are output, you must first check the individual EMF voltages of the motor. To do this, the following techniques are described:

- "Record the phase voltage and the pole position angle using an oscilloscope"
- "Record the phase voltage and the pole position angle using the STARTER trace function"

Recording the phase voltage and the pole position angle using an oscilloscope

1. Switch the drive line-up into a no-current condition.
2. After the DC link has completely discharged, disconnect the motor cables from the converter.
If motors are connected in parallel, then disconnect them.
3. Form an artificial neutral point using 1 k Ω resistors (for a parallel connection, for each motor).

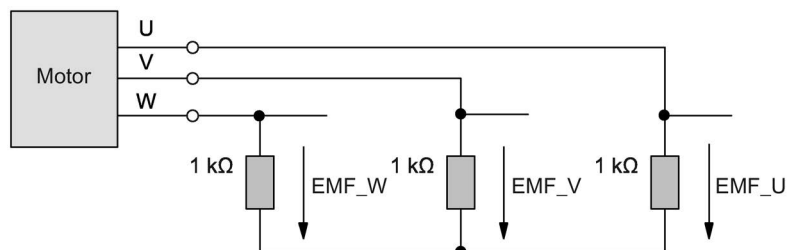

Image 3-56 Arrangement for measuring

4. Move the drive with a constant speed in the positive direction. The direction of the drive rotation is positive if the primary section moves relative to the secondary section in the opposite direction to the cable outlet direction (see also the "Determining the positive direction of the drive (Page 197)" figure).

Checking the phase sequence

For the positive direction of the drive, the phase sequence must be as follows:

EMF phase U - EMF phase V - EMF phase W

Checking phase relation

The phase displacement of the individual voltages EMC phase U – EMC phase V – EMC phase W to each other is 120° in the following figure.

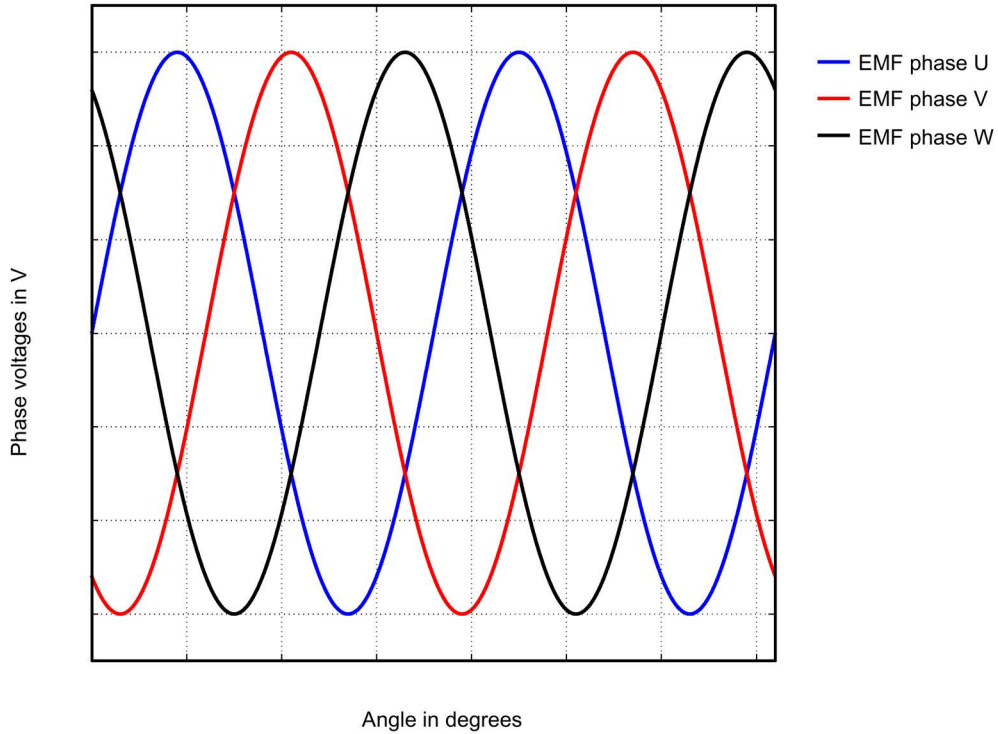

Image 3-57 Phase sequence, EMF phase U - EMF phase V - EMF phase W

Checking the phase relation for parallel-connected motors

The phase relations EMC phase U – EMC phase V – EMC phase W of the individual motors to each other must match.

- EMF phase U motor 1 with EMF phase U motor 2
- EMF phase V motor 1 with EMF phase V motor 2
- EMF phase W motor 1 with EMF phase W motor 2

The deviation within a particular phase position may be a maximum of 10°.

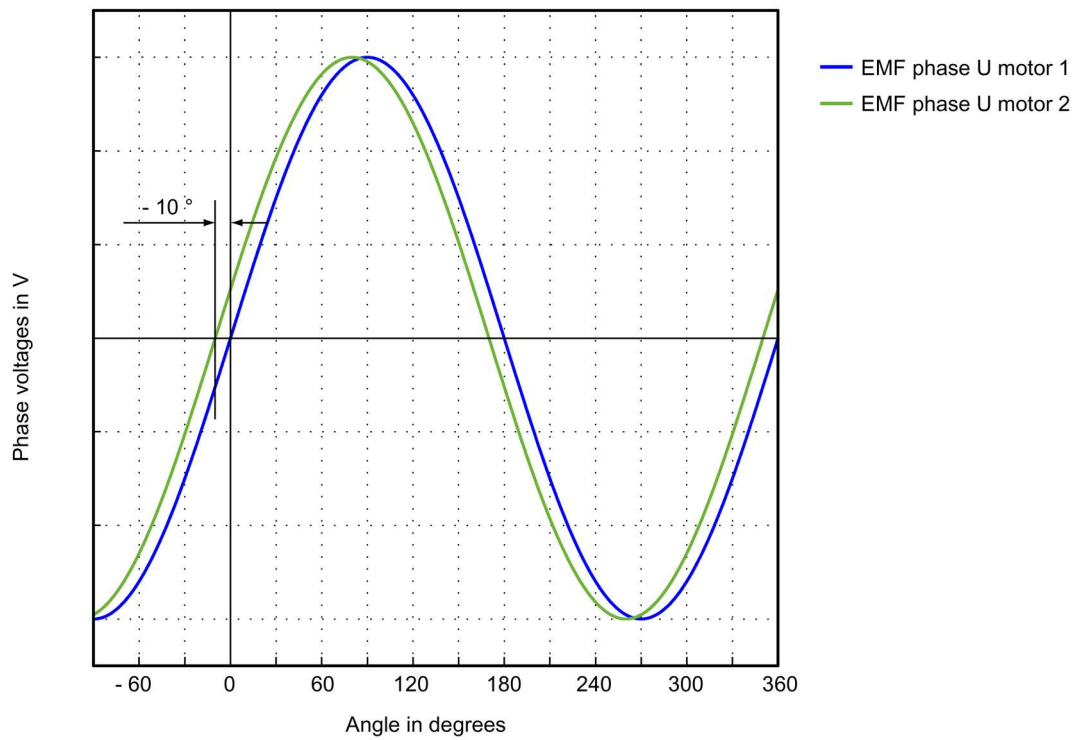

Image 3-58 Phase U motor 1 may not lag behind EMF phase U motor 2 by more than 10°

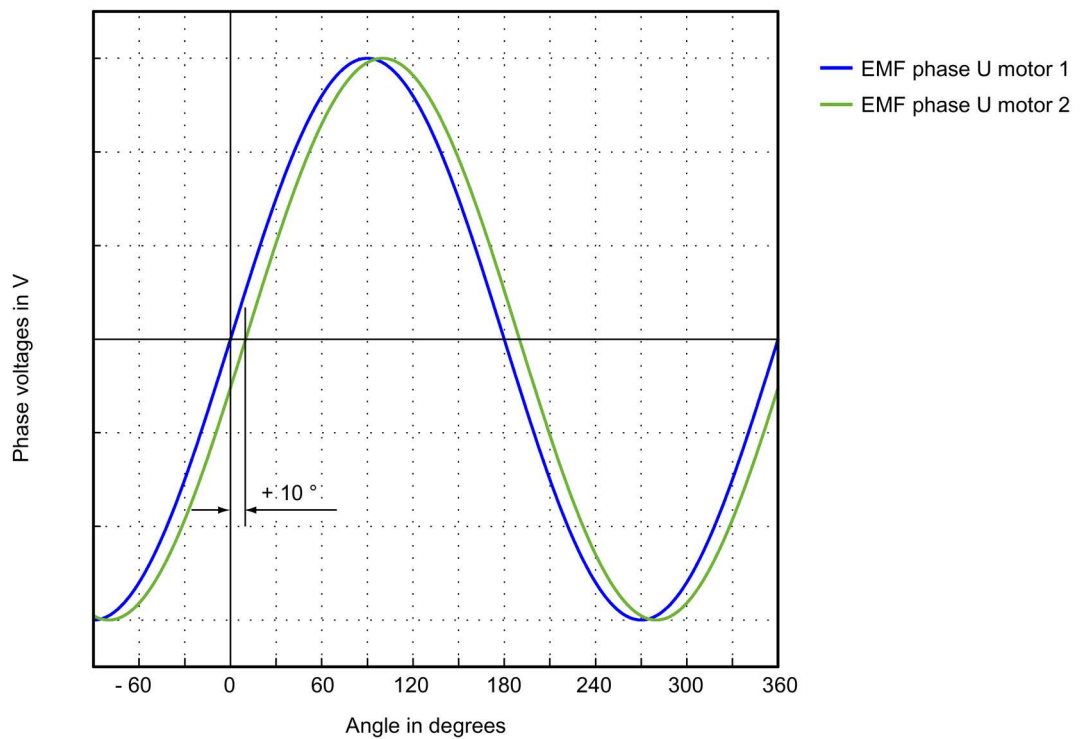

Image 3-59 EMF phase U motor 1 may not lead EMF phase U motor 2 by more than 10°

Determining the angular commutation offset by making a measurement

In the event of a fault and for a parallel connection, you must check the angular commutation offset as follows.

1. The drive with an incremental measuring system must be fine synchronized. To do this, connect the motor and enable the controller for coarse synchronization.
2. Then move the drive over the zero mark.
3. Remove power from the drive as described for the "Checking the phase voltage and the pole position angle using an oscilloscope" technique.

Please note that for this technique, it is not permissible that the control voltage for the Control Unit is shut down; however the infeed must be disconnected from the line supply.

You can determine the angular commutation offset by measuring the EMF and the normalized electrical pole position angle via the analog output. The normalized electrical pole position angle allows you to parameterize the test socket connections T0 to T2 and retrieve the signals (see Chapter "Measuring sockets (Page 355)").

Definition of channels (Ch1 ... Ch4):

- Ch1: EMF phase U with respect to the neutral point
- Ch2: EMF phase V with respect to the neutral point
- Ch3: EMF phase W with respect to the neutral point
- Ch4: Normalized electrical angular pole position via analog output

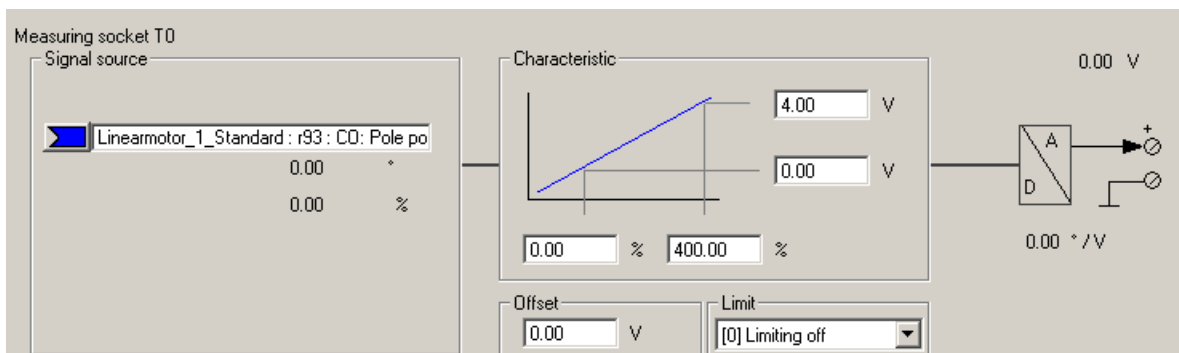

Image 3-60 Setting measuring socket T0 on CU320

The status of the coarse and fine synchronization can be read out online via parameter r1992: r1992.8 (fine synchronization carried out) and r1992.9 (coarse synchronization carried out).

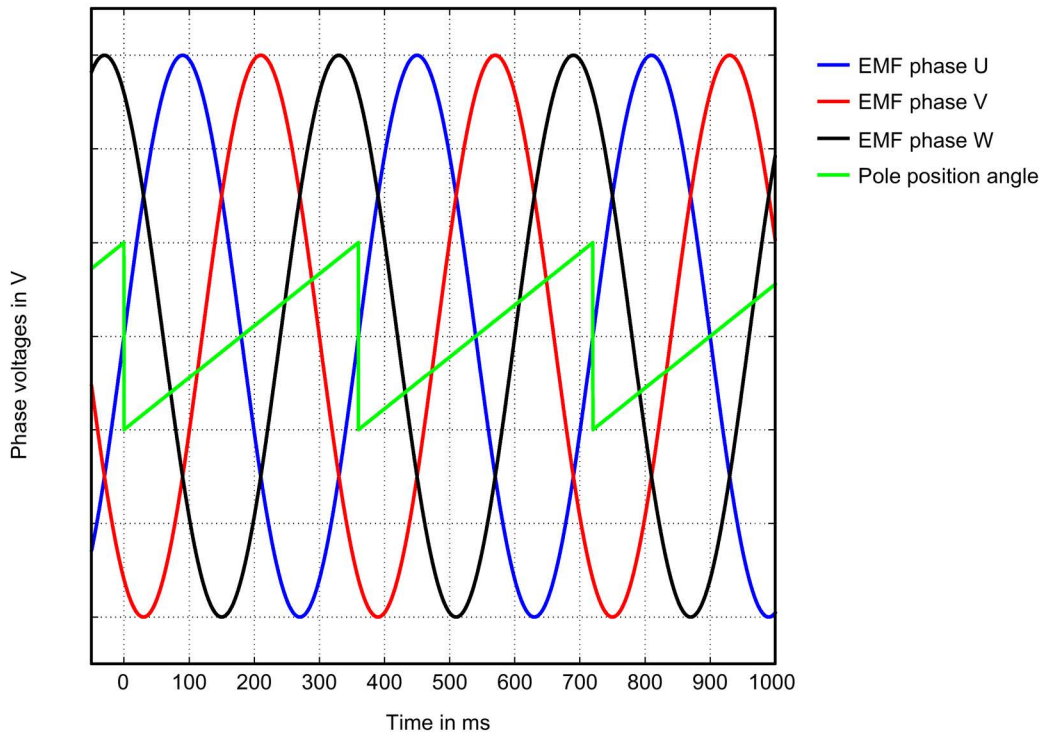

Image 3-61 Ideal characteristic of EMF voltages and the pole position angle of an optimally commutated drive

Recording the phase voltage and the pole position angle using the STARTER trace function

An oscilloscope is not used for this technique. You do not need to disconnect the motor. However, this technique is less accurate, as the motor voltages are not directly measured, but calculated from the transistor turn-on duration. This technique is not permitted for parallel-connected motors, see Chapter "Special case parallel connection (Page 218)".

1. Set the following parameters:

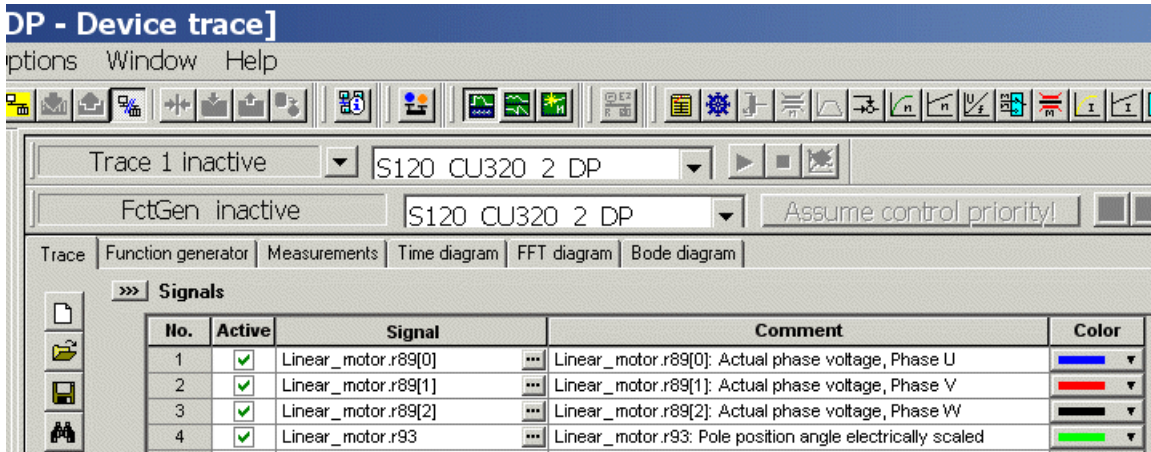

Image 3-62 Assignment of trace channels to check the angular commutation offset

The drive is operated force-controlled. The following parameterization is required:

2. Set p0640 = 0, to limit the motor current to 0.
3. Set p1545 = 1, to activate the travel to fixed stop.

4. The motor must be in closed-loop control and traveled externally.

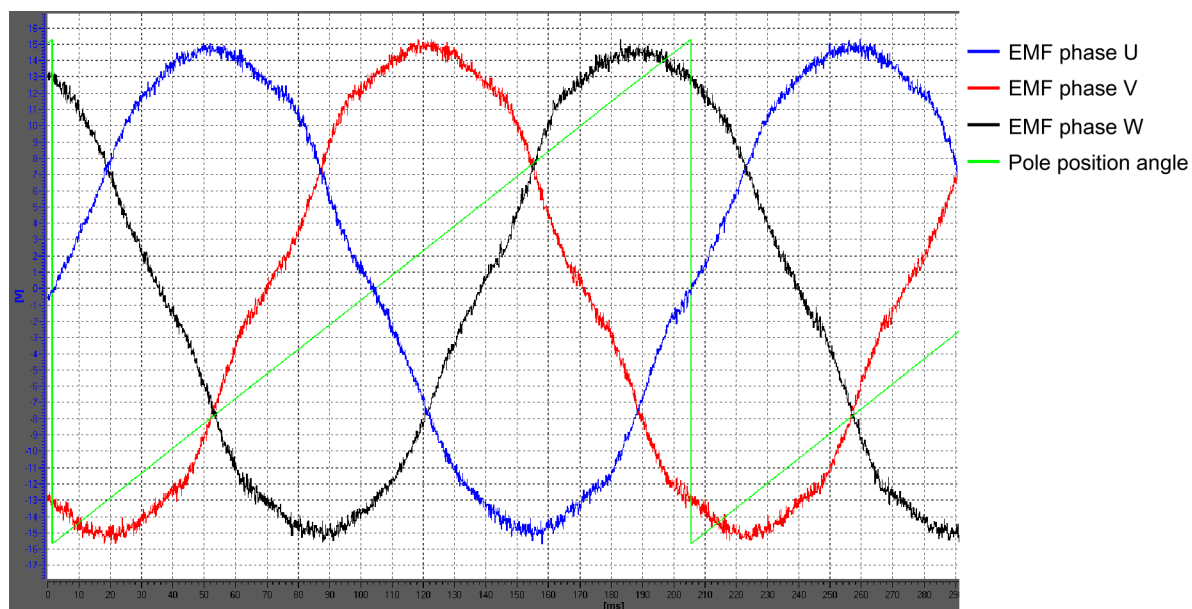

Image 3-63 Example of an optimally commutated drive (recorded using the trace function of the STARTER commissioning tool)

Evaluation of the results (applies to both measuring techniques)

For a positive drive direction (definition, refer to the diagram "Determining the positive direction of the drive (Page 197)", the sawtooth must increase monotonously between 0° and 360°, refer to the diagram "Ideal characteristic of the EMF voltages and the pole position angle for an optimally commutated drive (Page 211)."

If the curve is falling monotonously, and the phase sequence is EMF phase U - EMF phase V - EMF phase W, then you must change the control sense of the drive if necessary via p0410 bit 0 "Invert speed actual value". If the position controller is being used, then you must also check p0410 bit 1 "Invert actual position value". See the "Screen form for entering additional encoder data (Page 196)" figure in Chapter "Parameterizing a motor and encoder".

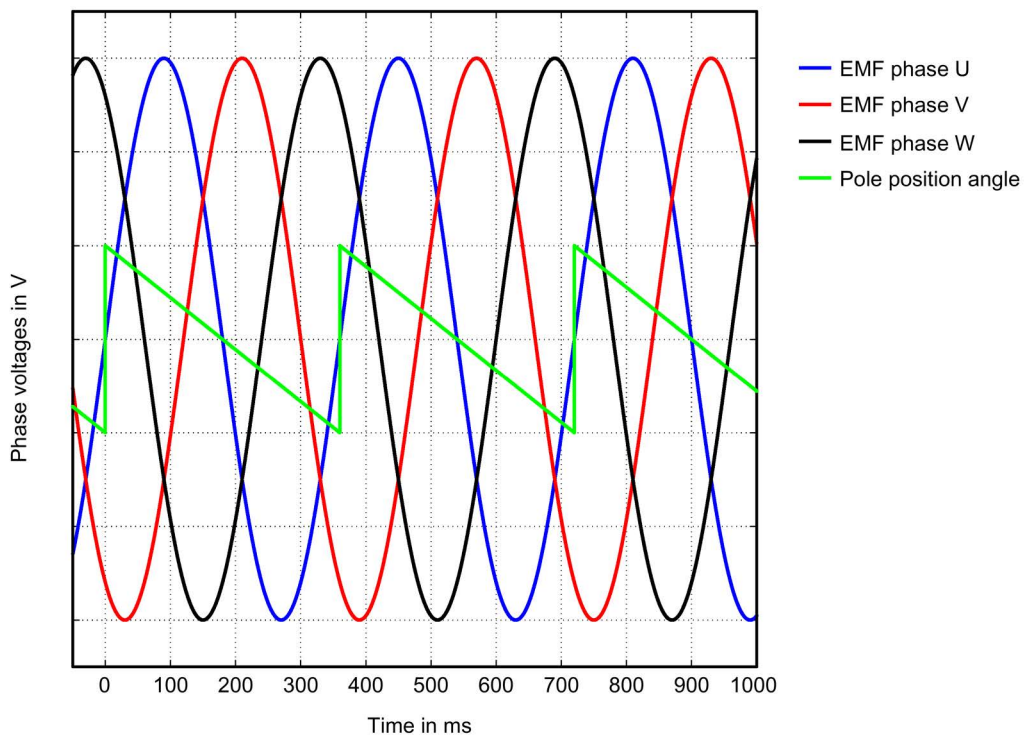

Image 3-64 EMF for incorrect speed actual value inversion

If the curve is monotonously decreasing, and the phase sequence is EMF phase U – EMF phase W – EMF phase V (i.e. if the phase sequence of V and W is interchanged), then according to the diagram "Determining the positive direction of the drive" (Page 197) in Chapter "Parameterizing a motor and encoder", the drive direction is negative (i.e. the primary section moves relative to the secondary section in the cable outlet direction).

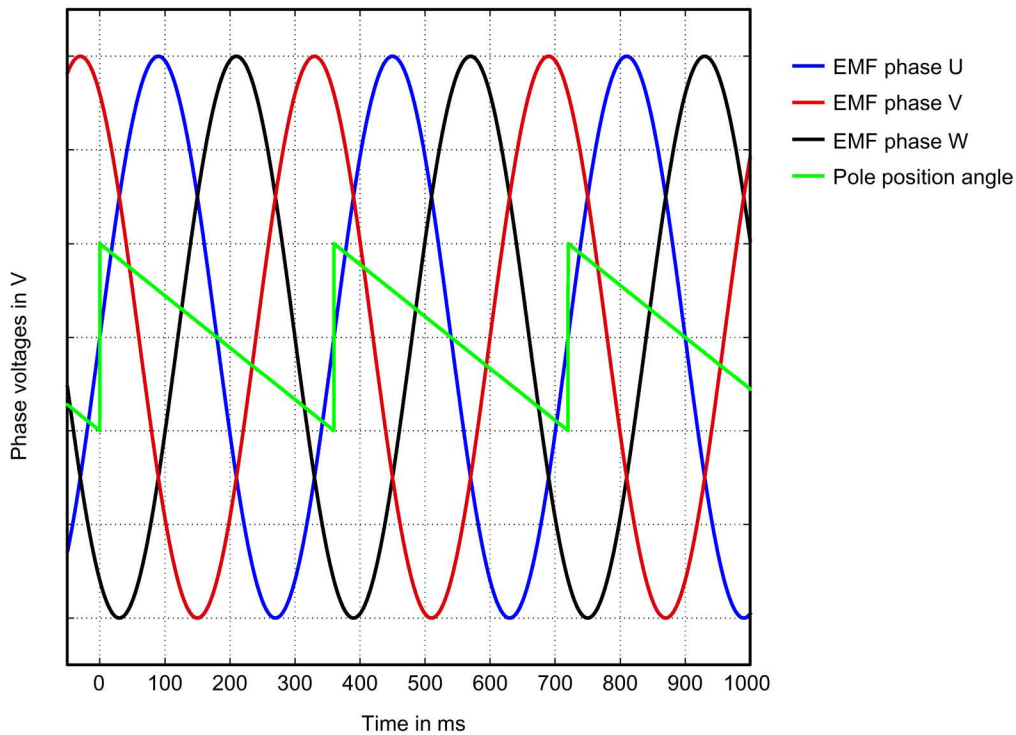

Image 3-65 EMC for the negative travel direction

Displaying the commutation angle tolerance

For a finely synchronized drive, the difference between EMF phase U and the normalized, electrical pole position angle may be a maximum of 10°. This means that the zero points of the falling edge of the sawtooth and EMF phase U may differ by a maximum of 10° electrical. For motors connected in parallel, this maximum permitted deviation for the EMF, phase U is valid for each motor connected in parallel.

If the difference is greater, then you must adapt the angular commutation offset. If, when moving over the zero mark, fault message "F31130 (N, A) encoder 1: Zero mark and position error from the coarse synchronization" is output, then the deviation of the commutation is greater than 60° electrical. You must check the commutation angle again using the techniques described.

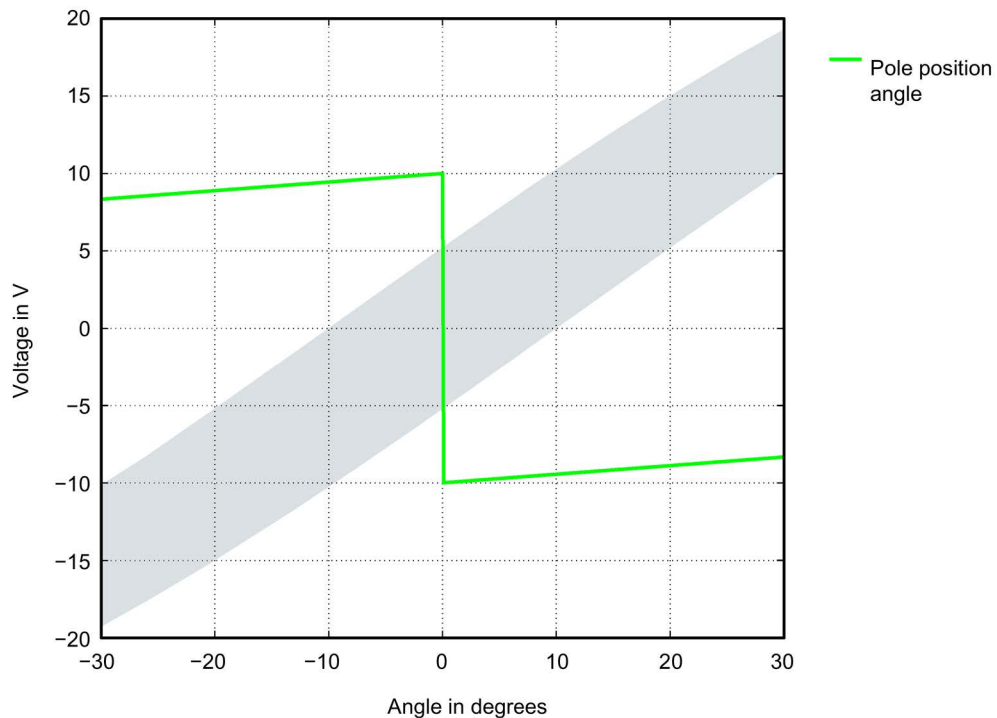

Image 3-66 Tolerance envelope for the pole position angle

Commutation angle outside the tolerance

Example: The falling edge of the sawtooth voltage (pole position angle) leads the zero crossing of EMF phase U by approx. 18° electrical.

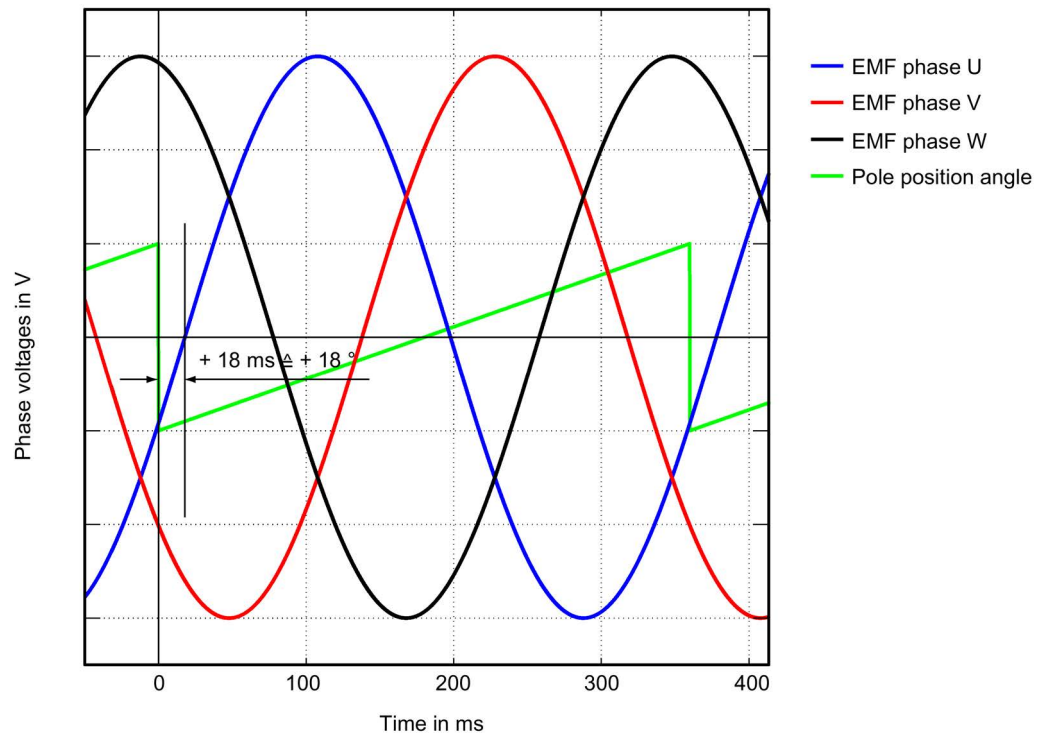

Image 3-67 Example of an incorrectly commutated drive

Adapt the incorrect commutation shown in the figure above according to Chapter "Checking the commutation angle offset with STARTER (Page 205)".

p0431 = p0431 - 18

3.13.7 Special case of a parallel connection

Note**Parallel connection**

Only linear motors with the same "primary section format", the same "winding type" and the same "air gap" may be switched in parallel.

The article numbers of the primary sections 1FN3...-....0-0□A1 may differ only by the placeholder shown as "□".

For more information and connection diagrams, refer to the "SIMOTICS L-1FN3 linear motors" Configuration Manual in Chapter "Parallel connection of motors".

The following requirements must be met in order to operate several linear motors in parallel on a SINAMICS Motor Module:

- The motors must be arranged according to the data in the "SIMOTICS L-1FN3 linear motors" Configuration Manual.
- The travel direction of the parallel-connected motors must match the details in the "SIMOTICS L-1FN3 linear motors" Configuration Manual. For a Janus arrangement, when connecting the stoker, phases V and W must be interchanged so that the stoker has the same travel direction as the master, also refer to the "SIMOTICS L-1FN3 linear motors" Configuration Manual, Chapter "Parallel connection of motors".
- Ensure the position of the EMF voltages of the parallel-connected motors as described in Chapter "Checking the angular commutation with an oscilloscope (Page 206)"; it is imperative that you check these carefully. Maintain the maximum deviation of the phase angle between the EMF voltages of the motors according to Chapter "Checking the angular commutation offset with an oscilloscope". You may only connect the motors to the converter after the deviation of the commutation angle for all of the motors to be connected in parallel lies within the limit value.
- Before commissioning and switching-on the DC voltage for the first time, note that the temperature monitoring circuits must be carefully checked to ensure that they correctly trip.

Then commission the system using the STARTER commissioning tool according to Chapter "Parameterizing a motor and encoder (Page 186)". The parallel connection for the SIMOTICS L-1FN3 linear motors selected from the motors list can be activated using the "Motor parallel connection" checkbox below it. Enter the desired number of motors to be connected in parallel in the "Number" field. Alternatively, you can also parameterize the parallel connection in the expert list of the drive.

After changing p0306, you must adapt the control parameters for a motor from the list by the automatic calculation with p0340 = 1. For a third-party motor not contained in the list, this setting, however, would cause the data of the electrical equivalent circuit diagram to be lost. Consequently, select the setting p0340 = 3 for a third-party motor.

Detailed information about parameter p0306 is contained in the STARTER commissioning tool help and in the SINAMICS S120/S150 List Manual.

If p0306 is changed during quick commissioning (p0010 = 1), then the maximum current p0640 is appropriately pre-assigned. This is not the case in the motor commissioning (p0010 = 3)!

The motor data displayed in the STARTER commissioning tool is only valid for one motor and is only internally interpolated up to N motors connected in parallel.

3.13.8 Optimization of the closed-loop control

When running through the drive configuration, in the step "Calculating the motor/controller data", drive-specific controller parameters are calculated, see the "Screen form to calculate motor/controller data (Page 191)" figure. However, to be able to use the optimal performance of the machine, a subsequent optimization of the controller parameters is required. You can achieve higher positioning/machining accuracy and reduce cycle times by means of optimized settings.

Controller optimization may only be performed by experienced specialists.

In the control, for optimizing the controller, there is the possibility of measuring frequency responses or recording setpoint steps. Especially the frequency response measurement allows machine-specific natural frequencies that restrict the bandwidth of the closed-loop control to be taken into account.

You can ask your local Siemens office regarding optimization of the closed-loop control as a service.

3.14 Commissioning induction motors (ASM)

Note

Induction motors are commissioned in vector control.

Equivalent circuit diagram for induction motor and cable

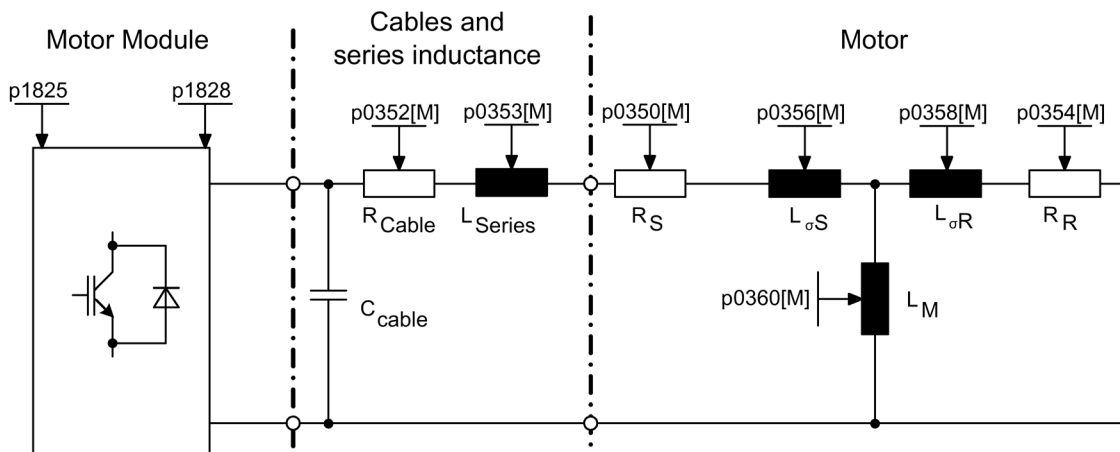

Image 3-68 Equivalent circuit diagram for induction motor and cable

Induction motors, rotating

The following parameters must be entered in the commissioning wizard of STARTER:

Table 3- 15 Motor data type plate

Parameter	Description	Comment
p0304	Rated motor voltage	If this value is not known, a "0" can also be entered. Using this value, the stator leakage inductance can be more precisely calculated (p0356, p0357).
p0305	Rated motor current	-
p0307	Rated motor power	-
p0308	Rated motor power factor	-
p0310	Rated motor frequency	-
p0311	Motor rated speed	-
p0335	Motor cooling type	-

The following parameters can be optionally entered:

Table 3- 16 Optional motor data

Parameter	Description	Comment
p0320	Motor rated magnetizing current / short-circuit current	-
p0322	Maximum motor speed	-
p0341	Motor moment of inertia	-
p0342	Moment of inertia ratio between the total and motor	-
p0344	Motor weight (for thermal motor type)	-
p0352	Cable resistance (component of the stator resistance)	<ul style="list-style-type: none"> Especially for vector control without encoder (SLVC) this parameter has a significant influence on the quality of the closed-loop control at low speeds. This parameter is required for the correct function of flying restart operating mode.
p0353	Motor series inductance	-

Table 3- 17 Equivalent circuit diagram for motor data

Parameter	Description	Comment
p0350	Motor stator resistance, cold	-
p0354	Motor rotor resistance, cold	-
p0356	Motor stator leakage inductance	-
p0358	Motor rotor leakage inductance	-
p0360	Motor magnetizing inductance	-

Features

- Field weakening up to approx. 1.2 * rated speed (this depends on the drive converter supply voltage and the motor data, also refer to supplementary conditions)
- Flying restart
- Vector closed-loop speed and torque control
- Vector V/f control
- Motor data identification
- Speed controller optimization (rotating measurement)
- Thermal protection via temperature sensor (PTC/KTY/PT1000)
- All encoders that can be connected to an SMC10, SMC20 or SMC30 are supported.
- Operation with or without encoder is possible

Depending on the terminal voltage and load cycle, the maximum torque can be taken from the motor data sheets / configuration instructions.

Commissioning

To commission induction motors, motor identification and rotating measurement are recommended. Make the following setting for this:

1. Configure p1900 = 1.

For induction motors, motor data identification (p1910 = 1) and rotating measurement (p1960) are activated automatically.

- OR -

2. Activate both functions individually:
 - Configure the zero speed measurement: p1910 = 1.
 - Configure the rotating measurement p1960 = 0,1,2 (depending on p1300).

The optional motor data can be entered if it is known. Otherwise, it is estimated using the type plate data or is determined using a motor data identification routine or speed controller optimization.

3.15 Commissioning of synchronous reluctance motors 1FP1 without a damper cage

Unlike induction motors, reluctance motors cannot be operated by entering rating plate data on any drive. For reluctance motors, the characteristic saturation properties must be known and stored in the drive. SIEMENS reluctance motors of the series 1FP1 can be operated in vector control with or without an encoder.

Configuring the reluctance motor as a standard motor

You must individually configure the drives.

1. Double-click in the project navigator on "Drives" > "Drive name" > "Configuration" > "Configure DDS" one after the other.

2. Select the standard motor to be commissioned from the list.

The associated motor data is stored and does not to be entered manually.

3. Select a "[600] 1FP1 standard reluctance motor" for the "Motor type" as the standard motor.

Commissioning sequence

1. Motor identification is preset for commissioning synchronous reluctance motors. The first time the motor is switched on after commissioning, a zero speed measurement (p1900) is therefore performed automatically. The non-linearities of the converter and the stator resistance of the machine are measured.
2. If the drive has an encoder, automatic encoder adjustment is performed and the commutation angle offset (p0431) is also determined the 2nd time the motor is switched on. The following encoders are supported:

Incremental encoder	<ul style="list-style-type: none"> • HTL/TTL with zero mark • sin/cos with zero mark and/or CD track
Absolute encoder	<ul style="list-style-type: none"> • EnDat

3. Moreover, a rotating measurement is recommended to optimize the speed loop setting. Configure the rotating measurement p1960 = 0,1,2 (depending on p1300).

Overview of important parameters (see SINAMICS S120/S150 List Manual)

- p0300[0...n] Motor type selection
- p0301[0...n] Motor code number selection
- p0325[0...n] Motor pole position identification current 1st phase
- p0329[0...n] Motor pole position identification current
- p0431[0...n] Commutation angle offset
- p1900 Motor data identification and rotating measurement
- p1910 Motor data identification selection
- p1960 Rotating measurement selection

3.16 Commissioning permanent-magnet synchronous motors

Note

Permanent-magnet synchronous motors are commissioned in vector control.

Equivalent circuit diagram for synchronous motor and cable

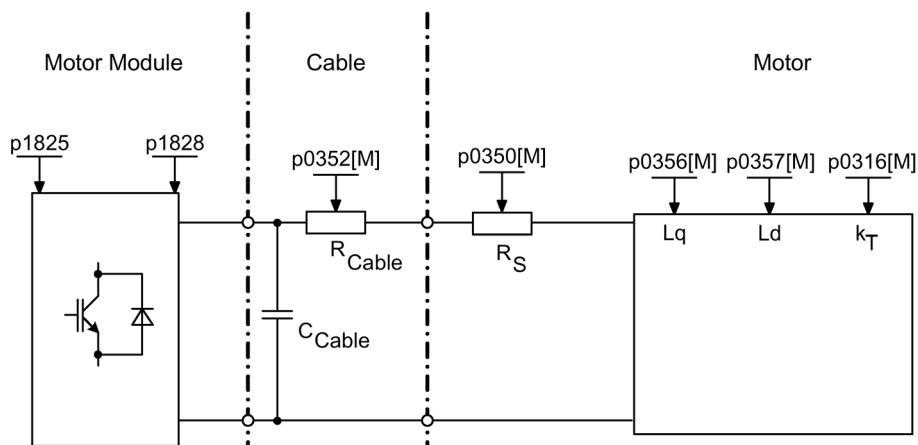

Image 3-69 Equivalent circuit diagram for synchronous motor and cable

Permanent-magnet synchronous motors, rotating

Permanent-magnet synchronous motors with or without encoder are supported.

The following encoder types are supported:

- Encoder with absolute position information (e.g. without CD track or reference signal)
- Encoder without absolute position information

For operation without encoders or with encoders without absolute position information, pole position identification must be carried out (see Section "Pole position identification (Page 232)" for further details).

Typical applications include direct drives with torque motors, which are characterized by high torque at low speeds. When these drives are used, gear units and mechanical parts subject to wear can be dispensed with if the application allows this.

3.16 Commissioning permanent-magnet synchronous motors

Temperature protection can be implemented using a temperature sensor (KTY/PT1000/PTC). In order to achieve a high torque accuracy, we recommend that a KTY or PT1000 temperature sensor is used.

Table 3- 18 Motor data

Parameter	Description	Comment
p0304	Rated motor voltage	If this value is not known, a "0" can also be entered. Using this value, the stator leakage inductance can be more precisely calculated (p0356, p0357).
p0305	Rated motor current	-
p0307	Rated motor power	-
p0310	Rated motor frequency	-
p0311	Rated motor speed	-

If the torque constant k_T is not stamped on the type plate or specified in the data sheet, you can calculate this value from the rated motor data (index n) or from the stall current I_o and stall torque M_o as follows:

$$k_T = \frac{M_N}{I_N} = \frac{P_N}{2\pi \cdot \frac{\min}{60} n_N \cdot I_N} \quad \text{or} \quad k_T = \frac{M_o}{I_o}$$

Table 3- 19 Optional data

Parameter	Description	Comment
p0314	Motor pole pair number	-
p0316	Motor torque constant	-
p0320	Motor rated magnetizing current / short-circuit current	This is used for the field weakening characteristic
p0322	Maximum motor speed	Maximum mechanical speed
p0323	Maximum motor current	Demagnetization protection
p0325	Motor pole position information	-
p0327	Optimum motor load angle	-
p0328	PE spindle, reluctance torque constant	-
p0329	Motor pole position identification current	-
p0341	Motor moment of inertia	For speed controller precontrol
p0342	Moment of inertia ratio total to motor	-

Table 3- 20 Equivalent circuit diagram for motor data

Parameter	Description	Comment
p0350	Motor stator resistance, cold	-
p0356	Motor stator leakage inductance	-
p0357	Motor stator inductance, d axis	-

Features

- Field weakening up to approx. 1.2 * rated speed (this depends on the drive converter supply voltage and the motor data, also refer to supplementary conditions)
- Flying restart (for operation without encoder, only possible with additional VSM)
- Vector closed-loop speed and torque control
- Vector V/f control for diagnostics
- Motor data identification
- Automatic rotating encoder adjustment (the zero encoder position is calibrated)
- Speed controller optimization (rotating measurement)
- Thermal protection via temperature sensor (PTC/KTY/PT1000)
- All encoders that can be connected to an SMC10, SMC20 or SMC30 are supported.
- Operation with or without encoder is possible.

Supplementary conditions

- Maximum speed or maximum torque depend on the converter output voltage available and the back EMF of the motor (calculation specifications: EMF must not exceed U_{rated} converter).
- Calculating the maximum speed:

$$n_{max} = n_N \cdot \sqrt{\frac{3}{2} \cdot \frac{V_{DC,lim} \cdot I_N}{P_N}}$$

or

$$n_{max} = \frac{60s}{min} \cdot \sqrt{\frac{3}{2} \cdot \frac{V_{DC,lim}}{2\pi \cdot k_T}}$$

$V_{DC,lim}$:

690 V devices: 1220 V

500 V devices: 1022 V

400 V devices: 820 V

Image 3-70 Formula vector maximum speed

Calculating k_T see "Commissioning".

Note

If pulse inhibition of the converter occurs (fault or OFF2), synchronous motors can generate high terminal voltages in the field-weakening range, which could lead to overvoltage in the DC link. The following possibilities exist to protect the drive system from being destroyed due to overvoltage:

1. Restrict (p0643 = 0) maximum speed (p1082)
2. External voltage limiter or chopper or other measures appropriate to the application.

 **WARNING**

Dangerous overvoltage

With p0643 = 1, it must be ensured that there is sufficiently high and suitable overvoltage protection. If necessary, system-side precautions should be taken.

Do not enter the working area of the motor.

- Depending on the terminal voltage and load cycle, the maximum torque can be taken from the motor data sheets / configuration instructions.

Commissioning

 WARNING**Danger to life as a result of motor movement during motor data identification**

Motor data identification causes movements of the drive that can result in death, serious injury, or damage to property.

- Ensure that nobody is in the danger zone and that the mechanical parts can move freely.
- Respond to possible malfunctions by applying suitable measures (e.g. EMERGENCY STOP or EMERGENCY OFF).

To commission permanent-magnet synchronous motors, motor identification, rotating measurement, and encoder adjustment are recommended. Make the following setting for this:

1. Configure p1900 = 1.

For permanent-magnet synchronous motors, motor data identification (p1910 = 1), rotating measurement (p1960), and encoder adjustment (p1990 = 1) are activated automatically.

- OR -

2. Activate the functions individually:
 - Configure the zero speed measurement: p1910 = 1.
 - Configure the rotating measurement: p1960 = 0,1,2 (depending on p1300).
 - Start encoder adjustment: p1990 = 1.

Note

During initial commissioning and every time the encoder is replaced, the encoder must be adjusted (p1990).

The optional motor data can be entered if it is known. Otherwise, it is estimated using the type plate data or is determined using a motor data identification routine or speed controller optimization.

3.16.1 Encoder adjustment in operation

This function can only be used for permanent-magnet synchronous motors operating in the "vector control" mode. You can use this function to readjust encoders that have been replaced in operation. The encoders can be adjusted within a motor line-up. The adjustment is also possible when coupled to the load.

Adjusting a new encoder

1. After mounting the encoder, set p1990 = 3 to select a new adjustment.
 - The encoder adjustment is automatically selected when switching on the next time.
2. Enable the pulses.
 - The pole position identification determines the offset.
 - If the zero mark position of the encoder is not known you are prompted to specify a setpoint to start the drive.
3. In this case, specify a setpoint.
 - The drive then starts with the specified setpoint.
 - The zero mark position of the encoder is determined.
 - The pulse inhibit is set.
 - The commutation angle offset is determined from the offset and position of the zero mark.
 - The commutation angle offset is written automatically to parameter p0431.
 - p1990 = 0 is set automatically at the end of the adjustment and the result saved to the RAM.

The encoder module checks the consistency of the encoder pulses and zero mark. With this technique, you can achieve an accuracy of approx. $\pm 15^\circ$ electrical. This accuracy is sufficient for starting with maximum 95% rated torque. A fine calibration/adjustment is required for higher starting torques.

If, after two motor revolutions, a zero mark has not been detected, the drive switches off with fault F07970.

Fine adjustment

1. The fine adjustment is started when the motor rotates with $p1905 = 90$.

The measurement takes approx. 1 minute. The actual steps of the fine encoder adjustment are displayed using alarm A07976. During the measurement, the difference between the encoder and the EMF model is determined. The fine adjustment can also be carried out in no-load operation (idle operation).

Note

Maintain the minimum motor speed

During the rotating measurement, the motor speed must exceed 40% of the rated speed. The torque must remain below half of the rated torque.

The parameter setting $p1905 = 0$ is made automatically at the end of the measurement, which completes the fine adjustment. An additional alarm informs you that the result from $p0431$ will be written to the RAM at the next pulse inhibit.

2. To back up the new values, perform a "RAM to ROM" after the adjustment.

The adjustment result is also valid if, when the plant starts, the motor is driven by other motors in the group of motors through the material web coupling. By correctly evaluating the encoder, the Control Unit identifies the pole position and speed of the motor.

Note

1FW4 permanent-magnet synchronous motors

1FW4 motors are optimized for operation with this function. When commissioning with the STARTER commissioning tool, all of the required data are automatically transferred to the Control Unit.

3.16.2 Automatic encoder adjustment

The pole wheel-oriented closed-loop control of the synchronous motor requires information about the pole wheel position angle. Automatic encoder adjustment must be used in the following cases:

- The pole wheel position encoders are not mechanically adjusted
- After a motor encoder has been replaced

Automatic encoder adjustment only makes sense for encoders with absolute position information and/or zero mark. The following encoder types are supported:

- Sin/Cos encoder with A/B-, R-track as well as with A/B-, C/D-, R-track
- Resolver
- Absolute encoder (e.g. EnDat, DRIVE-CLiQ encoder, SSI)
- Incremental encoder with zero mark

Encoder adjustment using a zero mark

If an incremental encoder with zero mark is being used, after the zero mark has been passed, the position of the zero mark can be calibrated. Commutation with the zero mark is activated via p0404.15.

Commissioning the encoder

Automatic encoder adjustment is activated with p1990 = 1. When the pulses are enabled the next time, the measurement is carried out and the angular difference determined (p1984) is entered into p0431. For p1990 = 2 the determined angular difference (p1984) is not entered into p0431 and has not effect on the closed-loop motor control. Using this function, the angular difference - entered into p0431 - can be checked. For extremely high moments of inertia, the run time can be scaled higher using p1999.

 WARNING
Danger to life as a result of motor movement during measurement
The measurement can trigger rotation or movement of the motor. This can cause death or serious injury.
<ul style="list-style-type: none">• Ensure that nobody is in the danger zone of the motor.

3.16.3 Pole position identification

The pole position identification routine is used to determine the rotor position at start up. This is required when no pole position information is available. If, for example, incremental encoders are used or operation without encoder is employed, then pole position identification is started automatically. For operation with encoder, pole position identification can be started via p1982 = 1, or via p1780.6 = 1, for operation without encoder .

If possible, pole position identification should be carried out in decoupled state. If there is no large moment of inertia and there is only negligible friction, then the identification can also be carried out in coupled state.

If there is negligible friction and high moment of inertia, then the dynamic response for the speed encoder can be adjusted to the moment of inertia by increasing p1999.

If there is high friction torque or an active load, then an adjustment is only possible in decoupled state.

Traversing

Four pole position identification techniques can be selected:

- p1980 = 1, voltage pulsing, first harmonic

This technique functions for magnetically isotropic motors if adequate iron saturation can be achieved.

- p1980 = 4, voltage pulsing, 2-stage

This technique functions with motors that are magnetically anisotropic. During the measurement, the motor must be at a standstill. The measurement is carried out the next time that the pulses are enabled.

Note

Using this type of identification, the motor can emit a significant amount of noise.

- p1980 = 6, voltage pulsing, 2-stage inverse

- p1980 = 10, DC current impression

This technique functions for all motors; however, it takes more time than the measurement selected via p1980 = 4. During the measurement, the motor must be able to rotate. The measurement is carried out the next time that the pulses are enabled. For extremely high moments of inertia, the run time can be scaled higher via p1999.

 WARNING
<p>Danger to life as a result of motor movement during measurement</p> <p>The measurement can trigger rotation or movement of the motor. This can cause death or serious injury.</p> <ul style="list-style-type: none"> • Ensure that nobody is in the danger zone of the motor.

3.16.4 Overview of the important parameters

Overview of important parameters (see SINAMICS S120/S150 List Manual)

- p0300[0...n] Motor type selection
- p0301[0...n] Motor code number selection
- p0304[0...n] Rated motor voltage
- p0305[0...n] Rated motor current
- p0307[0...n] Rated motor power
- p0311[0...n] Rated motor speed
- p0312[0...n] Rated motor torque
- p0314[0...n] Motor pole pair number
- p0322[0...n] Maximum motor speed
- p0323[0...n] Maximum motor current
- p0324[0...n] Winding maximum speed
- p0431[0...n] Commutation angle offset
- p1905 Parameter tuning selection
- p1990 Encoder adjustment, determine commutation angle offset

Pole position identification

- p0325[0..n] Motor pole position identification current 1st phase
- p0329[0..n] Motor pole position identification current
- p1780[0..n].6 Motor model adaptation configuration; selects pole position identification PMSM without an encoder
- p1980[0..n] PolID procedure
- p1982[0..n] PolID selection
- r1984 PolID angular difference
- r1985 PolID saturation curve
- r1987 PolID trigger curve
- p1999[0..n] Commutation angle offset calibration and PolID scaling

Automatic encoder adjustment

- p0404[0..n].15 Encoder configuration; commutation with zero mark (not induction motor)
- p0431[0...n] Commutation angle offset
- p1990 Encoder adjustment, determine commutation angle offset
- p1999[0...n] Commutation angle offset calibration and PolID scaling

3.17 Commissioning separately-excited synchronous motors

Note

Separately excited synchronous motor

Please consult Siemens technical support if you wish to commission a separately-excited synchronous motor.

3.18 Commissioning SIMOTICS T-1FW6 built-in torque motors

3.18.1 Safety instructions for commissioning of built-in torque motors

 **WARNING**

Danger to life as a result of unintended motor movement

Unexpected movements of the motor may cause death, serious injury (crushing) and/or property damage.

- Do not work in the danger area while a machine is switched on.
- Keep persons away from rotating parts and areas where there is a danger of crushing.
- Ensure the free axis travel path.
- Observe the instructions on commutation.
- Limit the motor currents.
- Set the speed limitation to small values.
- Monitor the end positions of the motor.

 **WARNING**

Risk of burn injuries on hot surfaces

Touching the surfaces of the motor can cause serious injury.

- Do not touch the motor during or immediately after operation.
- Attach the "Hot Surface Do Not Touch" (DW-026) warning sign close to the source of danger where it can be easily seen.

 **WARNING**

Danger to life due to electric shock

Every movement of the rotor compared with the stator and vice versa produces an induced voltage. If you touch cable connections, you could suffer an electric shock, which can result in death or serious injury.

- Secure the rotor so that it cannot move before you touch the cable connections.
- Connect the cable connections of the motor correctly and insulate them correctly.

3.18.2 Checklists for commissioning

Checklists for commissioning 1FW6 built-in torque motors

Please thoroughly familiarize yourself with the safety instructions and observe the checklists below before starting any work.

Table 3- 21 Checklist (1) - general checks

Check	OK
Are all of the necessary components of the configured drive line-up available, correctly dimensioned, correctly installed and connected?	
Are the manufacturer's documentation for the system components (e.g. drive system, encoder, cooling system, brake) and the "SIMOTICS T-1FW6 built-in torque motors" Configuration Manual available?	
Are the following up-to-date SINAMICS documents available? <ul style="list-style-type: none"> • SINAMICS S120 Commissioning Manual • SINAMICS S120 Getting Started • SINAMICS S120 Function Manual Drive Functions • SINAMICS S120/S150 List Manual 	
Was the Chapter "Checklists for commissioning SINAMICS S" taken into account?	
Is the motor type to be commissioned known? (e.g. 1FW6 ___ - ___ - ___)	
As a minimum, is the following data for the motor known, if it involves a "third-party motor"? (A "third-party motor" is every motor that is not saved as standard in the Siemens commissioning software.) <ul style="list-style-type: none"> • Rated motor current • Rated motor speed • Motor pole pair number • Motor torque constant • Maximum motor speed • Maximum motor current • Motor limit current • Motor moment of inertia • Motor stator resistance, cold • Motor stator leakage inductance 	
Are the environmental conditions in accordance with "SIMOTICS T-1FW6 built-in torque motors" Operating Instructions in the permitted range?	
Is it guaranteed that the maximum permitted temperature of the rotors does not exceed 120° C?	
Is it guaranteed that at least two people work together?	

3.18 Commissioning SIMOTICS T-1FW6 built-in torque motors

Table 3- 22 Checklist (2) - checking the mechanical system

Check	OK
Has the motor been correctly installed according to the motor manufacturer's specifications and is it ready to be switched on?	
Were the transport locks removed according to the installation chapter of the "SIMOTICS T-1FW6 built-in torque motors" Configuration Manual?	
Can the axis freely rotate over the complete rotational range?	
Have all the screws been tightened to the specified torque?	
Are the stator and rotor centered with respect to one another corresponding to the motor manufacturer's specifications?	
If there is a motor holding brake, does it function correctly?	
Has the encoder been correctly mounted and adjusted according to the manufacturer's specifications? Important information on the encoders can also be found in the "SIMOTICS T-1FW6 built-in torque motors" Configuration Manual.	
Has a cooling system, required for liquid-cooled motors, been connected according to the manufacturer's specifications and is it functioning correctly?	
Does the cooling medium comply with the requirements listed in Chapter "Cooling media" in the "SIMOTICS T-1FW6 built-in torque motors" Configuration Manual?	
Were the cooling circuits flushed before been filled with the cooling medium?	
Is it ensured that the permitted pressure in the cooling circuit is not exceeded (here, refer to "Technical features" in the "SIMOTICS T-1FW6 built-in torque motors") Configuration Manual?	
Are moving cables correctly routed in a tow chain?	
Have the power cables been properly connected to the component terminals with the specified torque?	
Have measures been taken to relieve strain on the cables?	

Table 3- 23 Checklist (3) - checking the electrical system

Check	OK
Has all wiring work been successfully completed?	
Is the protective conductor correctly connected?	
Is the motor ground directly connected to the Power Module ground (short distance in order to avoid high leakage currents)?	
Are all connectors correctly plugged in and screwed in place?	
Are the motors connected with shielded power cables?	
Are the power cable shields connected as closely as possible to the terminal box across a wide area?	
Are all cable shields connected to the respective housing through a large surface area?	
Have the control cables been connected in accordance with the required interface configuration and the shield applied?	
Have the motor power cables been correctly connected to the Power Module with the phase sequence UVW (clockwise rotating field)?	
Do the temperature monitoring circuits fulfill the specifications of protective separation? Additional information on temperature monitoring circuits Temp-S and Temp-F can be found in the "SIMOTICS T-1FW6 built-in torque motors" Configuration Manual.	
Before commissioning and before switching on the DC-link voltage for the first time, have you checked the temperature monitoring circuits to ensure that they correctly trip / shut down?	

Check	OK
Is the encoder correctly connected?	
Are the digital and analog signals routed using separate cables?	
Has the distance between the power cables and the signal lines been observed?	
Is it guaranteed that temperature-sensitive parts (electric cables, electronic components) are not placed on hot surfaces?	
Have the line-side and motor-side power cables been dimensioned and routed in accordance with the environmental and routing conditions?	
Have the maximum permitted cable lengths between the frequency converter and the motor (depending on the type of cables used) been observed?	

3.18.3 General information for setting the commutation

You can use the following two pole position identification techniques for all frame sizes of SIMOTICS T-1FW6 built-in torque motors:

- The motion-based technique
- The saturation-based technique (1st harmonic)

Note

Fine synchronization is recommended for precise commutation

Use either a measuring system with a zero mark that can be evaluated or an absolute measuring system.

Motion-based technique

This technique can also be used during commissioning when the commutation angle offset is initially determined or when it is checked in conjunction with an absolute measuring system (e.g. RCN 85xx from Heidenhain).

The technique can be applied for vertical and horizontal axes whose load cannot be reduced in an uncontrolled manner when the machine is disconnected from the power supply. In this case, the axes must be able to be freely moved and not be braked. (static friction < 10% of the rated motor torque).

In the worst-case scenario, the rotor can move in the range of ± 5 degrees when this technique is used.

 WARNING
Danger to life from vertical or inclined axes
With vertical or inclined axes, the load can fall down and cause death or severe injury when a motion-based technique is used.
<ul style="list-style-type: none"> • Ensure that nobody is in the danger zone. • Use the saturation-based technique for vertical axes.

Saturation-based technique

This technique does not require the rotor to move, which means that it can also be used for axes that are locked (e.g. using a brake). Axes that are not locked can rotate, however. Depending on the actual design, this technique can result in a higher noise level when the axes are powered up during the identification routine.

3.18.4 Parameterizing a motor and encoder

Configuring data for a standard motor

You must individually configure the drives.

1. Double-click in the project navigator on "Drives" > "Drive name" > "Configuration" > "Configure DDS" one after the other.
2. Select the standard motor to be commissioned from the list.

The associated motor data is stored and does not to be entered manually.

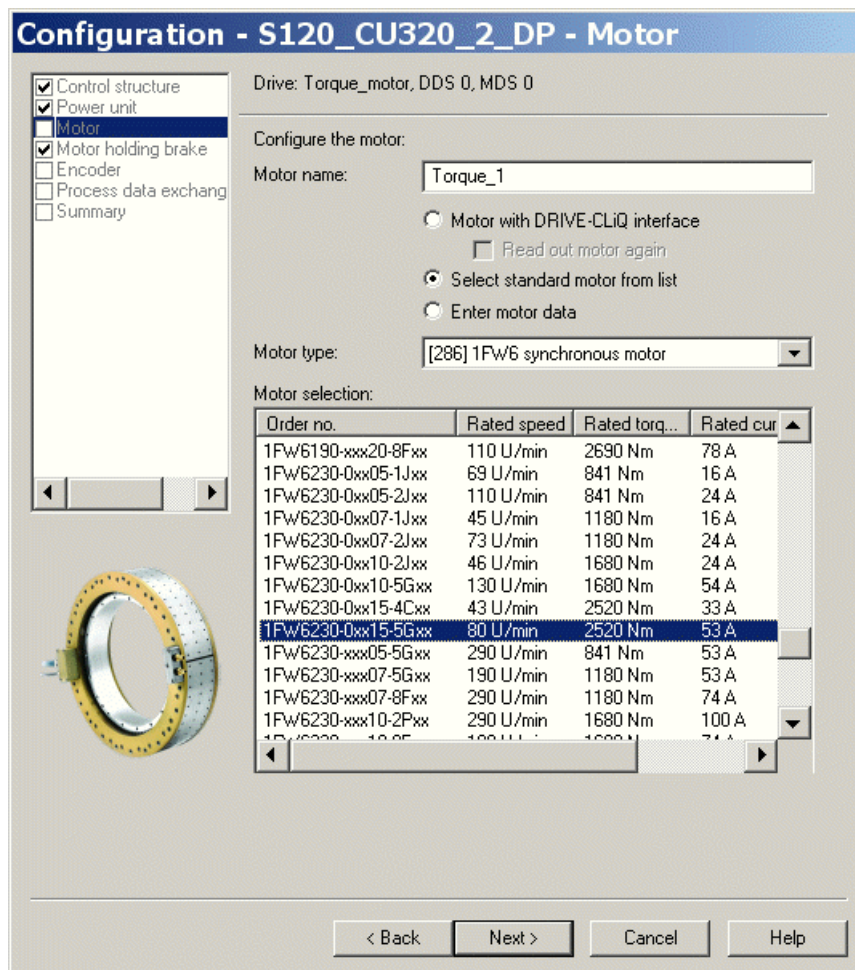

Image 3-71 Screen to configure a motor - selecting a standard motor

Configuring data for a third-party motor

1FW6 built-in torque motors are not included in the list if they are customer-specific special motors or new developments.

1. Please take the motor data from the attached motor data sheet and make the following settings:

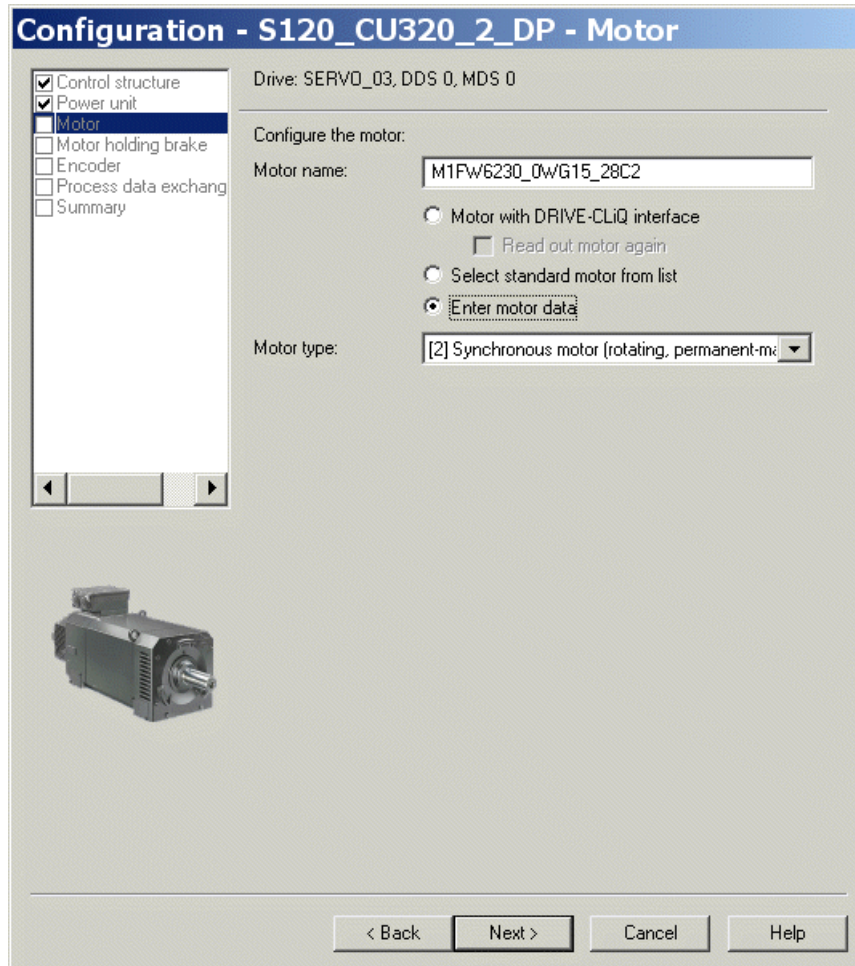

Image 3-72 Screen to configure the motor – setting for a third-party motor

2. Enter the following data for a rotating permanent-magnet synchronous motor:

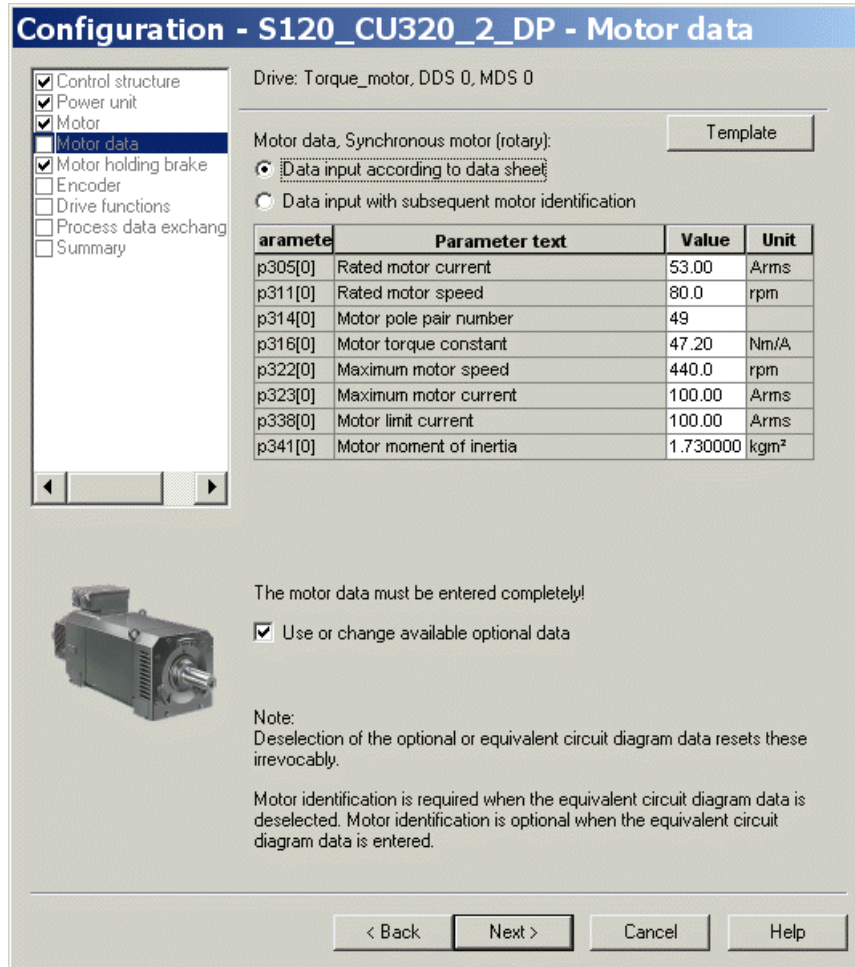

Image 3-73 Example of motor data that has been entered

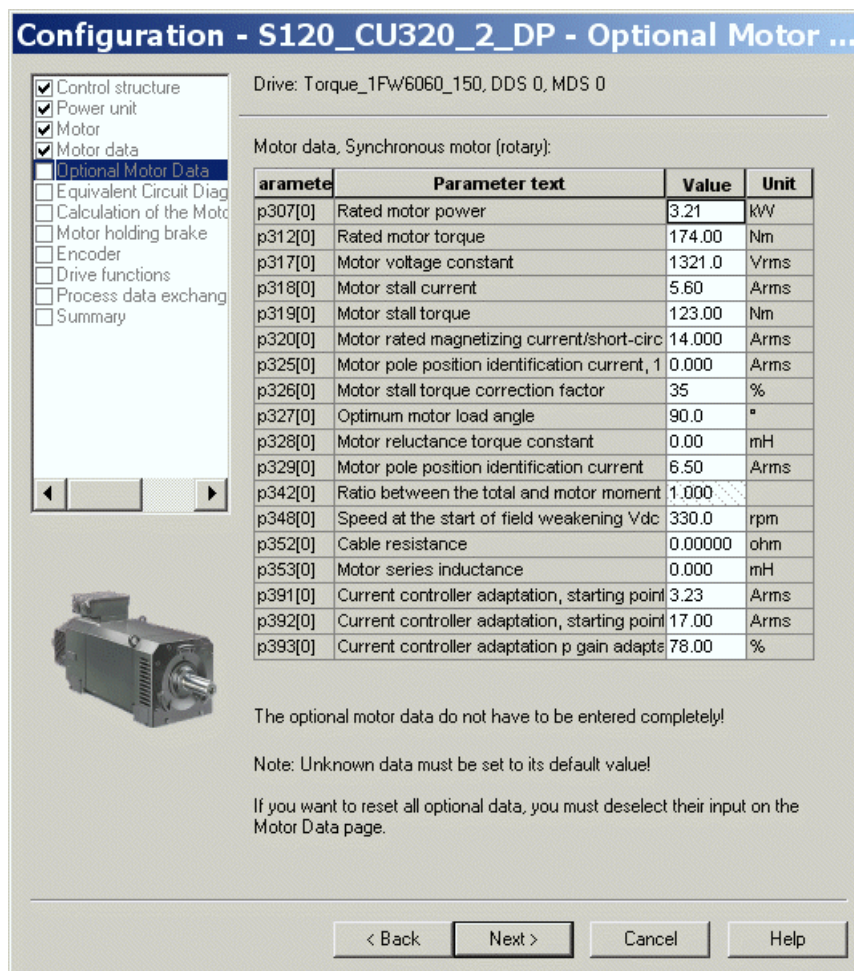

Image 3-74 Example of optional motor data that has been entered

Entering equivalent circuit diagram data

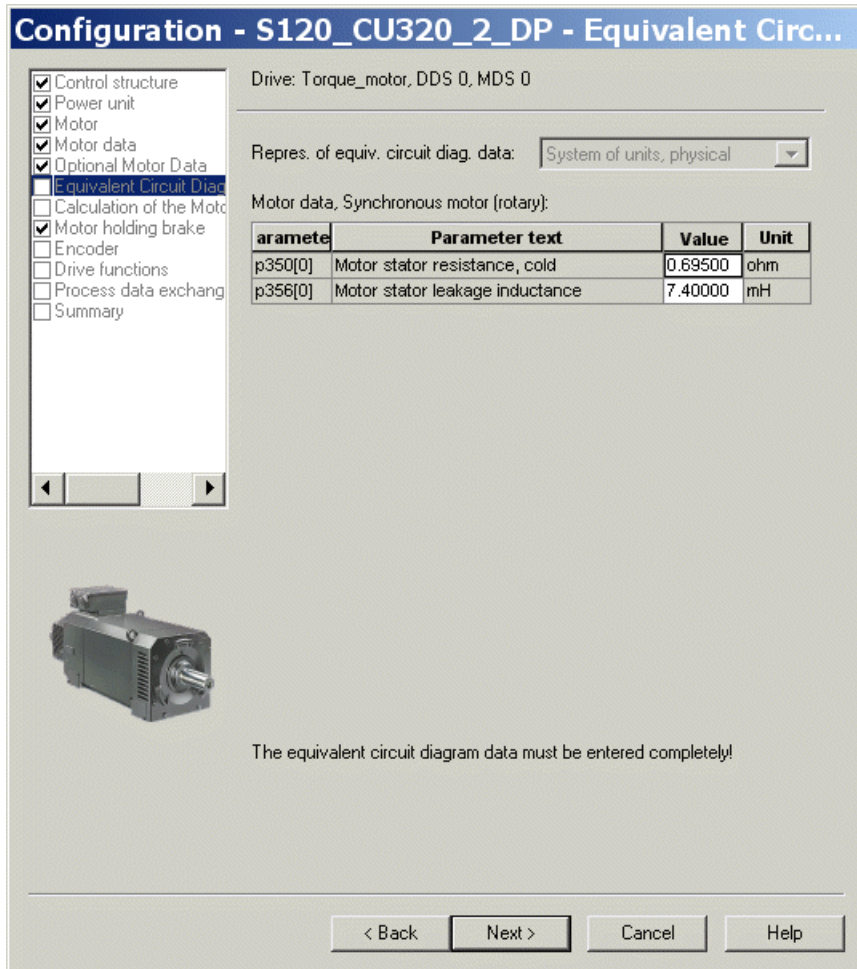

Image 3-75 Example of equivalent circuit diagram data that have been entered

Calculating controller data

After selecting the motor and entering the motor data, completely calculate the controller data.



Image 3-76 Screen form for calculating the motor/controller data

Configuring the motor holding brake

If a motor holding brake is being used, configure it in the following window.

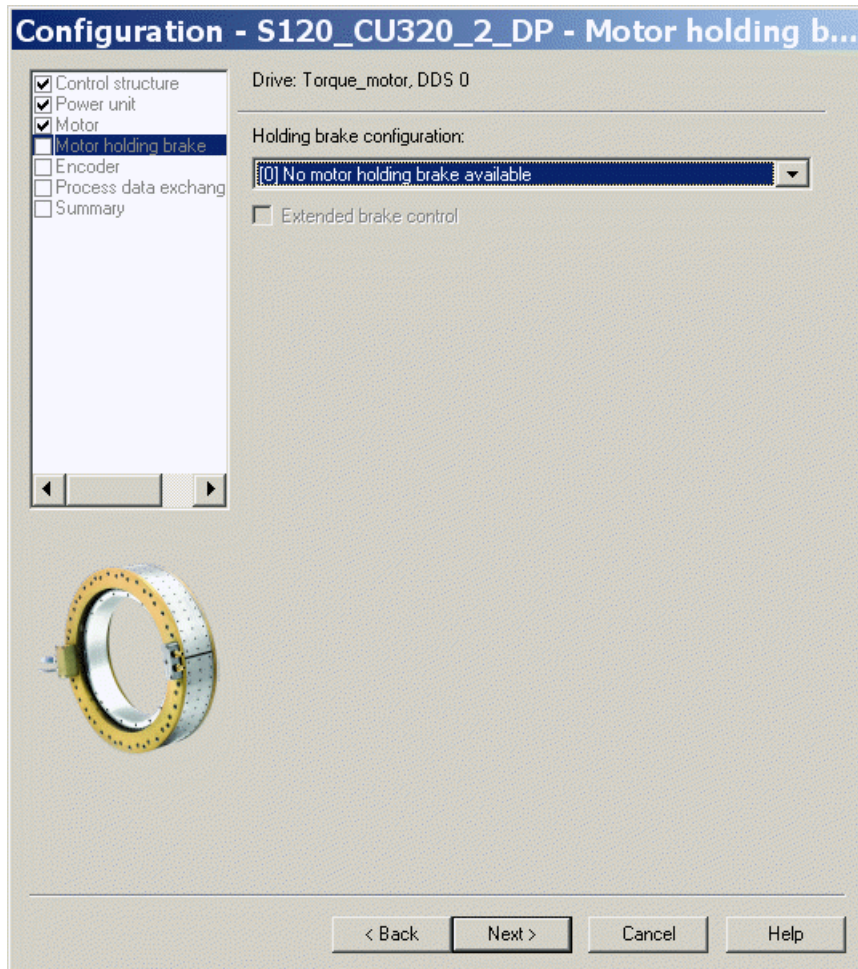

Image 3-77 Screen form for configuring a motor holding brake

Configuring encoder data

1. Note the data of the encoder manufacturer and the information in Chapter "Selecting and configuring encoders (Page 173)" in this manual.
2. Configure the encoder data for the torque motor using the "Encoder data" screen form. To do this, click the "Encoder data" button in the dialog.

Configuration - S120_CU320_2_DP - Encoder

Drive: Torque_motor, DDS 0, MDS 0

Which encoder do you want to use?

Encoder 1 Encoder 2 Encoder 3

Encoder 1

Encoder evaluation: SM_x

Encoder name: Encoder_1

Encoder with DRIVE-CLiQ interface
 Read encoder again

Select standard encoder from list Via order no.

Enter data Encoder data

Encoder type	Code number
No encoder	0
DRIVE-CLiQ encoder AS20, singleturn	202
DRIVE-CLiQ encoder AM20, multiturn 40...	204
DRIVE-CLiQ encoder AS24, singleturn	242
DRIVE-CLiQ encoder AM24, multiturn 40...	244
Resolver 1 speed	1001
Resolver 2 speed	1002
Resolver 3 speed	1003
Resolver 4 speed	1004

Details

< Back Next > Cancel Help

Image 3-78 Screen form to configure an encoder

Incremental measuring system

Example of an incremental sine/cosine encoder with 18,000 pulses per revolution with one zero mark per revolution:

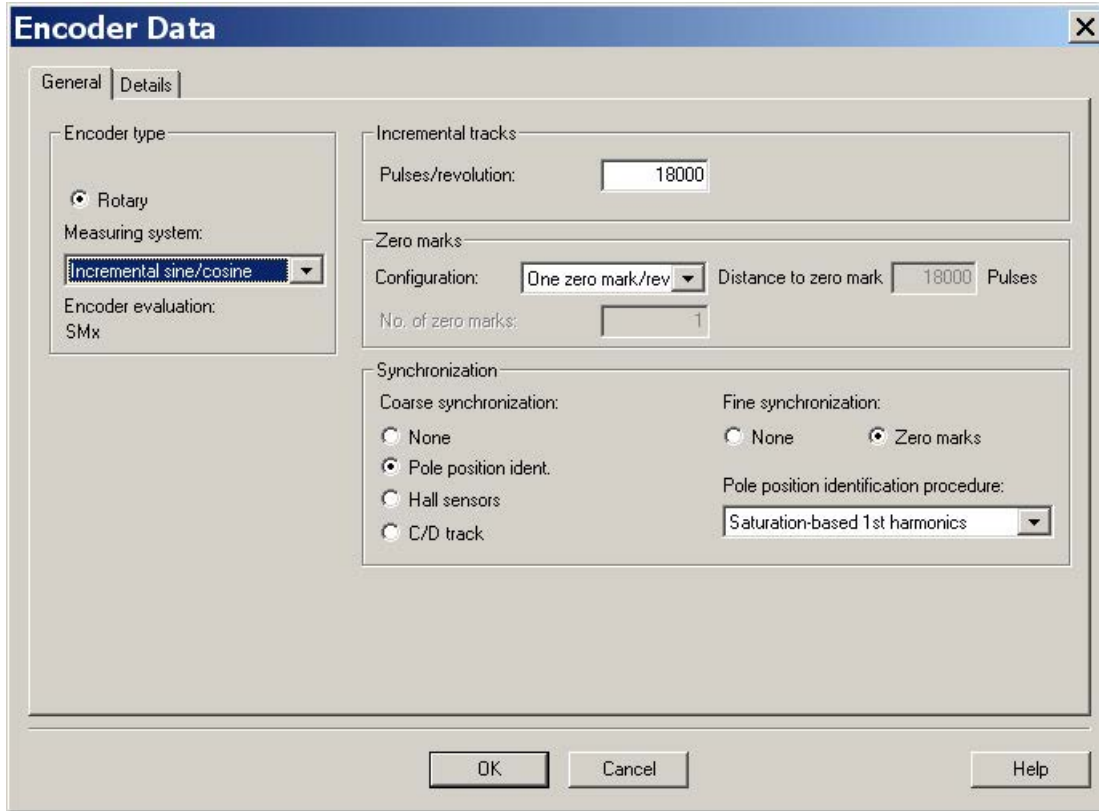

Image 3-79 Screen form for entering the encoder data

Note

Pole position identification is required for SIMOTICS T-1FW6 built-in torque motors with incremental measuring systems.

The following techniques are possible to do this:

- The motion-based technique
- The saturation-based technique (1st harmonic)

For incremental measuring systems, generally, fine synchronization is performed at the zero mark. When commissioning the system for the first time, the angular commutation offset (p0431) must be pre-assigned, see Chapter "Determining the angular commutation offset / maintaining the tolerance (Page 258)".

For third-party motors, a pole position identification routine to determine the angular commutation offset cannot be entered.

Absolute measuring system

The encoder is detected by the Control Unit as long as it is a DRIVE-CLiQ encoder. For all other encoder types, you must use the SINAMICS Sensor Module in accordance with the encoder interface in order to transfer the encoder signals to the Control Unit.

Note

SINAMICS Sensor Modules in conjunction with EnDat encoders of Heidenhain Corp.

SMC20, SME25 and SME125: EnDat encoders with incremental signals, article designation EnDat02 or EnDat01.

SMC40: EnDat encoder with EnDat protocol 2.2 without incremental signals, article designation Endat22.

The following inputs must be made in the configuration screen form after clicking the "Encoder data" button.

The screenshot shows a software dialog box titled "Encoder Data". It has a "General" tab selected. Inside the dialog, there is a section for "Encoder type" with a radio button selected for "Rotary". Below this is a "Measuring system:" dropdown menu currently showing "Absolute EnDat protocol". Underneath is "Encoder evaluation:" with the text "SMx". At the bottom of the configuration area is a checked checkbox labeled "Identify encoder". At the very bottom of the dialog are three buttons: "OK", "Cancel", and "Help".

Image 3-80 Screen form to configure an absolute encoder with EnDat protocol

Definition of the control sense

The control sense of an axis is correct if the positive direction of the drive (= clockwise rotating field U, V, W) coincides with the positive counting direction of the measuring system.

If the positive direction of the drive and positive counting direction of the measuring system do not match, then you must invert the actual speed value in the "Encoder configuration - details" screen form when the drive is being commissioned (p0410.0 or p0410.1). See the "Screen form for entering additional encoder data (Page 250)" figure.

Setting additional encoder data

1. If necessary, use "Encoder data" and "Details" to invert the actual speed and position value.
This allows the control sense to be changed.
2. To do this, first click the "Encoder data" button in the screen form used for the encoder configuration.

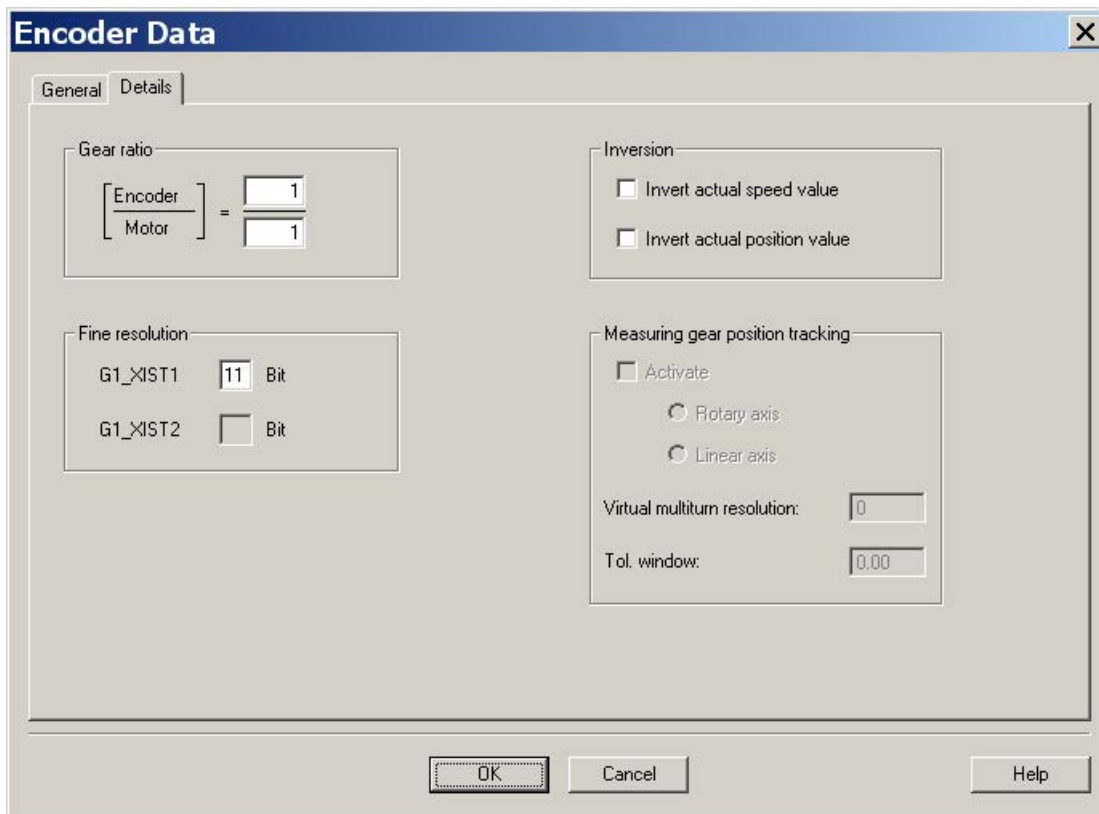

Image 3-81 Screen form for entering additional encoder data

Determining the drive direction

The direction of the drive is positive, if when viewing the DE flange, the rotor is rotating clockwise.

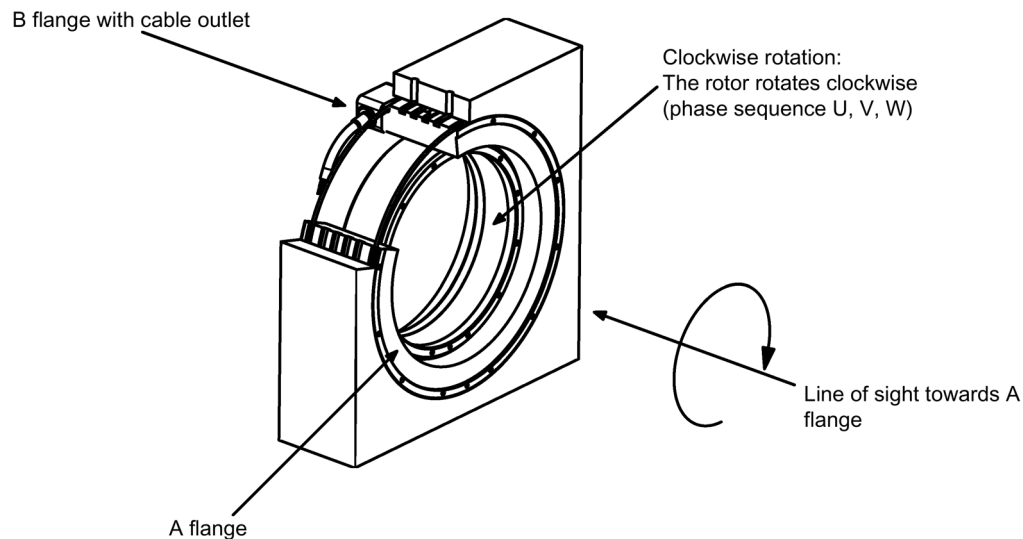

Image 3-82 Determining the positive direction of the drive

Determining the counting direction of the measuring system

The counting direction depends on the measuring system and the mounting position. The counting direction of the measuring system must match the direction of rotation of the motor. If necessary, you must adapt the counting direction by making the appropriate parameter assignment. Please refer to the manufacturer's documentation for the measuring system. If necessary, you must invert the counting direction as described in Image 3-81 Screen form for entering additional encoder data (Page 250).

Note

Checking the counting direction of the measuring system

The measuring system counting direction can also be checked, by first parameterizing the drive, and then manually moving it with the enable signals inhibited.

If the axis is rotated in the positive direction, the actual speed value must also count in the positive direction.

Completing parameterization

SIMOTICS T-1FW6 built-in torque motors are feed drives (maximum current limiting).



Image 3-83 Screen form to select the application

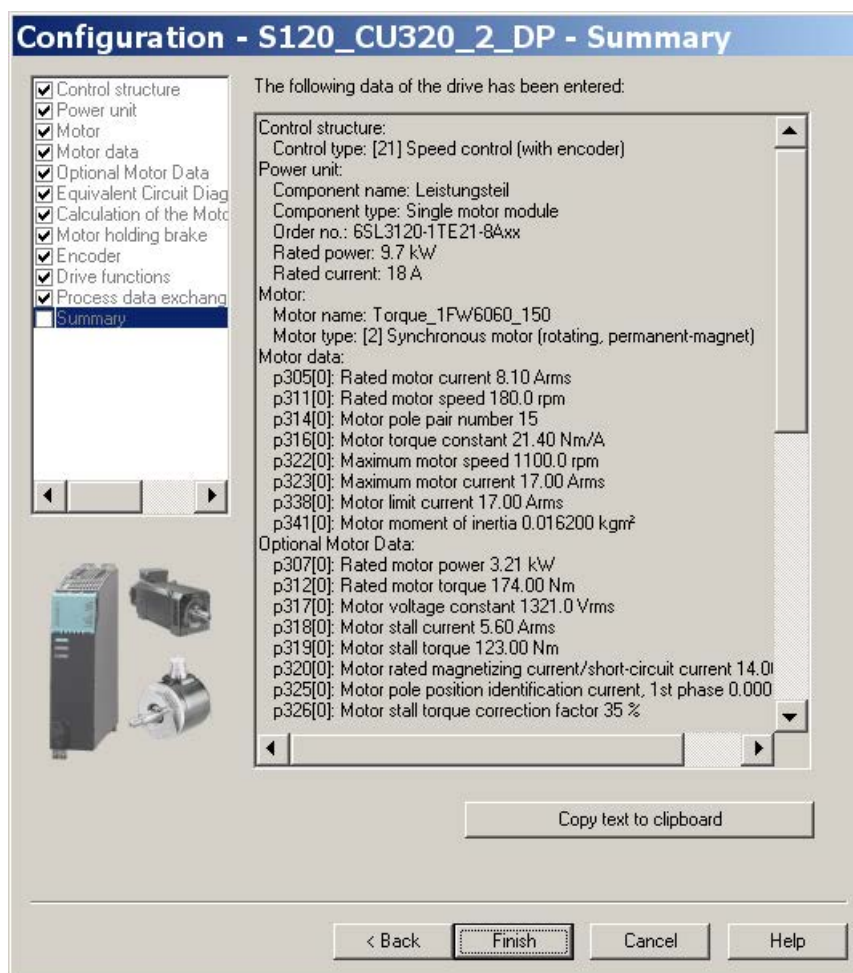

Image 3-84 Summary of the configuration

The created offline project must now be loaded into the drive. In STARTER, go online with the target device.

If an absolute measuring system with EnDat protocol was selected, then after establishing an online connection, the encoder serial number is loaded and the corresponding encoder parameters are set.

3.18.5 Parameterizing and testing the temperature sensors

SME12x Sensor Module External

The connection of the SME modules is described in Chapter "System integration" in the "SIMOTICS T-1FW6 built-in torque motors" Configuration Manual. Information on the SME12x Sensor Module External can be found in the "SINAMICS S120 Equipment Manual for Control Units and Additional System Components" in Chapter "Sensor Module External 120 (SME120)" and in Chapter "Sensor Module External 125 (SME125)".

The parameterization of the temperature sensors is explained in detail in Chapter "Temperature sensors for SINAMICS components (Page 282)".

A parameterizing example of a torque motor with a PT1000 (or alternatively: KTY 84) and two PTC sensors, connected to a SME12x Sensor Module External is provided below.

Use the expert list to parameterize the drive.

Table 3- 24 Parameterization in the drive:

Parameter	Input
p0600	Motor temperature sensor for monitoring 1: Temperature sensor via encoder 1
p0601	Motor temperature sensor, sensor type 10: Evaluation via several temperature channels SME12x
p0604	Motor temperature alarm threshold Sets the alarm threshold for monitoring the motor temperature. For motors from the motor list (p0301), this parameter is automatically pre-assigned (120° C).
p0605	Motor temperature fault threshold Sets the fault threshold for monitoring the motor temperature. For motors from the motor list (p0301), this parameter is automatically pre-assigned (155° C).
p0606	Motor temperature timer 0...2 s Setting the timer for the alarm threshold for the motor temperature monitoring, if alarm with timer was selected in the parameters p4600...4603. This timer is started if the temperature alarm threshold (p0604) is exceeded. If the timer has expired, and in the meantime the temperature alarm threshold has not been undershot, then fault F07011 is output.

Parameter	Input
p0607	Temperature sensor fault timer Setting the timer for timing the period between output of the alarm and fault when a temperature sensor fault is detected. If a sensor fault has been detected, this timer is started. If the sensor fault persists when the timer has expired, the relevant fault is output.
p4600...p4603	Motor temperature sensor 1...4 sensor type Sets the temperature sensor type for the motor temperature monitoring. Channels 2 ... 4 are used for the Sensor Module External SME12x. Channel 1 remains free. The following values are possible for torque motors: 0: No sensor 10: PTC fault 12: PTC alarm & timer 20: KTY 84 60: PT1000 If you make a selection with timer, you must pre-assign parameter p0606 with the corresponding timer for a maximum of 2 s.

Example: Standard SIMOTICS T-1FW6 built-in torque motors

p4600 0: No sensor
p4601 60: PT1000 (or alternatively 20: KTY 84)
p4602 10: PTC fault (PTC 130 °C)
p4603 10: PTC fault (PTC 150 °C)

If you are not using a standard motor, then you must parameterize parameters p0600...p0606 (see above). Select parameters p4600...p4603 to match the sensor types or temperature channels of the Sensor Module External SME12x.

Checking the temperature sensors for the Sensor Module External SME12x

In the online mode, you can read out the temperatures of the sensors at the channels of the Sensor Module External SME12x in parameter r4620[0...3] using the STARTER commissioning tool.

The maximum motor temperature can also be read in r0035. This parameter indicates the highest value from parameters r4620[0...3].

For a parameterized PTC sensor type, irrespective of the actual temperature in r4620, -200° C is always displayed.

The temperature values shown in parameters r0035 or r4620[1] provide information about whether a parameterized temperature sensor does not match the temperature sensor actually connected (connection to the wrong temperature sensor):

Parameterized temperature sensor	Connected temperature sensor	Displayed value in °C at room temperature 25°C
KTY 84	PTC	-40 ... -80 °C
PT1000	PTC	-100 ... -200 °C
KTY 84	PT1000	+115°C
PT1000	KTY 84	-100°C

Checking the PTC sensor type

You can simulate a sensor responding to an overtemperature condition (high ohmic state) by disconnecting the connections. You can disconnect the connections for the temperature sensors by removing the Sensor Module External SME12x (connector, interface X200).

If the sensor type is parameterized as PTC fault, then fault "F07011 drive: Motor overtemperature" is immediately displayed independent of the setting of p0604...p0606. If the sensor type is parameterized as PTC alarm with timer, after the time parameterized in p0606, fault F07011 is generated.

Test for sensor type PT1000 or KTY

If you withdraw the connector of interface X200 and have therefore disconnected the PT1000 connection (or KTY connection), after the time parameterized in p0607 has expired, fault "F07016 drive: Motor temperature sensor fault" is displayed in the alarm window of the STARTER commissioning tool.

Check the wiring of the temperature sensors by checking the resistance values at connector interface X200. The wiring is OK for the following resistance values:

PT1000 at 20 °C approx. 1080 Ω

KTY 84 at 20 °C approx. 580 Ω

PTC for 20 °C 120 Ω...300 Ω

The assignment of connector interface X200 can be found in the "SINAMICS S120 Manual Control Units and Additional System Components".

Terminal Module TM120

Terminal Module TM120 is a DRIVE-CLiQ component for temperature evaluation with safe isolation, see also "SINAMICS S120 Manual for Control Units and Additional System Components" in Chapter "System components".

TM120 is an autonomous input/output component. You can freely assign the temperature channels to any Motor Module.

You can assign every channel to the following sensor types:

- PTC
- KTY 84
- PT1000
- Bimetallic NC contact

Parameterization

For a standard configuration with correct pre-assignment of the temperature channels, the Terminal Module TM120 must be located between the Sensor Module and the Motor Module (DRIVE-CLiQ).

If this is not the case, you must parameterize all of the required temperature channels in both the Motor Module and Terminal Module TM120.

You must always carefully check the temperature shutdown circuits (e.g. by disconnecting the sensors) before commissioning the motor for the first time.

Use the expert list to parameterize the drive.

Table 3- 25 Parameterization in the drive:

Parameter	Input
p0600	Motor temperature sensor for monitoring 20: Temperature sensor via BICO interconnection p0608
p0601	Motor temperature sensor, sensor type 11: Evaluation via several temperature channels BICO
p0606	Motor temperature timer 0...2 s Sets the timer for the alarm threshold for the motor temperature monitoring, if alarm with timer was selected in p4610...4613. This timer is started when the temperature alarm threshold (p0604) is exceeded. If the timer expires before the temperature falls below the alarm threshold, then fault F07011 is output.
p0608	[0...3] CI: Motor temperature, signal source 2 Sets the signal source 2 for the evaluation of the motor temperature via a BICO interconnection, e.g. [0]: Motor temperature channel 1 TM120 . r4105[0] [1]: Motor temperature channel 2 TM120 . r4105[1] [2]: Motor temperature channel 3 TM120 . r4105[2] [3]: Motor temperature channel 4 TM120 . r4105[3]
p4610...p4613	Motor temperature sensor 1...4 sensor type Sets the temperature sensor type for the motor temperature monitoring. The following values are possible for torque motors: 0: No sensor 10: PTC fault 12: PTC alarm & timer 20: KTY84, PT100, PT1000 30: Bimetallic NC contact fault 32: Bimetallic NC contact alarm & timer If you make a selection with timer, you must pre-assign parameter p0606 with the corresponding timer for a maximum of 2 s.

Table 3- 26 Parameterization in the expert list of the Terminal Module TM120

Parameter	Input
p4100[0...3]	TM120 temperature evaluation, sensor type Sets the temperature evaluation of Terminal Module TM120. This means that the temperature sensor type is selected and the evaluation is activated. The following values are possible: 0: Evaluation deactivated 1: PTC thermistor 2: KTY84 4: Bimetal NC contact 6: PT1000

Check the temperature sensors in the same way as described for the SME12x Sensor Module External (see section "Checking the temperature sensors for the Sensor Module External SME12x"). Test each individual temperature channel by separating the connection.

3.18.6 Determining the angular commutation offset / maintaining the tolerance

NOTICE

Material damage as a result of an incorrectly commutated drive

When the system is commissioned for the first time or after an encoder/motor has been replaced, it is possible that the drive could be incorrectly commutated if the angular commutation offset has not yet been adjusted. Current is fed into the motor at the incorrect time for an incorrectly commutated motor. This means it can perform inadvertent movements. For example, it can turn with high speed in the wrong direction and so damage a workpiece.

- Set the current limit using the p0640 parameter to 20% of p0323 (motor maximum current).
- Therefore, to complete commissioning, it is imperative that you check the angular commutation offset according to the following description.

You can determine the pole position, required for synchronous motors, for the SIMOTICS T-1FW6 built-in torque motors using a software-based automatic pole position identification technique.

The following two techniques are suitable for all frame sizes of SIMOTICS T-1FW6 built-in torque motors:

- The motion-based technique p1980 = 10
- The saturation-based technique (1st harmonic) p1980 = 1

Also refer to the information in Chapter "General information for setting the commutation (Page 239)."

Making parameter entries / commutation setting

Incremental measuring system

1. Activate automatic determination of the commutation angle offset with p1990 = 1.

Alarm A07971 is output while the commutation angle offset is being determined.

2. Set the drive enable signals (OFF3, OFF2, OFF1).

This results in coarse synchronization. A successful coarse synchronization is indicated by the parameter r1992.9.

3. Move the drive over the zero mark.

When the drive moves over the zero mark, the angular commutation offset is entered into p0431. p1990 is automatically set to 0 after the angular commutation offset has been determined. Alarm A07965 is displayed as a prompt to save the change in a non-volatile fashion.

Absolute measuring system

Set p1990 = 1 before activating the enable signals.

By activating the enable signals, the angular commutation offset entered into p0431 and p1990 is automatically set to 0. Alarm A07965 is displayed as a prompt to save the change in a non-volatile fashion.

3.18.6.1 Checking the commutation angle offset with STARTER

Note

Coarse synchronization means that the pole position identification has been carried out, but the drive has not yet been moved over the zero mark. After the drive has been moved over the zero mark, the drive is finely synchronized. When an absolute measuring system is used, the drive is always fine synchronized after being switched on. A coarse synchronization is required only for the initial commissioning for the commutation angle offset determination (p0431).

Checking the pole position identification

You can check the pole position identification with p1983 in the finely-synchronized state.

1. Position the drive at different points in an electrical period (pole pitch) and set parameter p1983 = 1. For example, start at 0° and perform a measurement every 30°.

This means that a pole position identification is performed again and the deviation determined is displayed in parameter p1984.

After completion of the pole position identification, parameter p1983 is set to 0 again. The angular difference read out of parameter p1984 must lie in the interval [-10°...+10°].

The average of the measured angle differences must be added to the commutation angle offset entered in p0431. (Note the sign of the commutation angle offset.)

To change parameter p0431, p0010 must be set to 4 (see "Image 3-95 Tolerance envelope for the pole position angle (Page 270)").

2. Perform a coarse and fine synchronization again. The fine synchronization is not applicable for an absolute measuring system.

3.18.6.2 Checking the commutation angle offset with an oscilloscope

Checking the EMF voltages

If you have commissioned the motor according to the appropriate instructions, and in spite of this, unexpected messages are output, you must first check the individual EMF voltages of the motor. To do this, the following techniques are described:

- "Record the phase voltage and the pole position angle using an oscilloscope"
- "Record the phase voltage and the pole position angle using the STARTER trace function"

Recording the phase voltage and the pole position angle using an oscilloscope

1. Switch the drive line-up into a no-current condition.
2. After the DC link has completely discharged, disconnect the motor cables from the converter.
If motors are connected in parallel, then disconnect them.
3. Form an artificial neutral point using 1 k Ω resistors (for a parallel connection, for each motor).

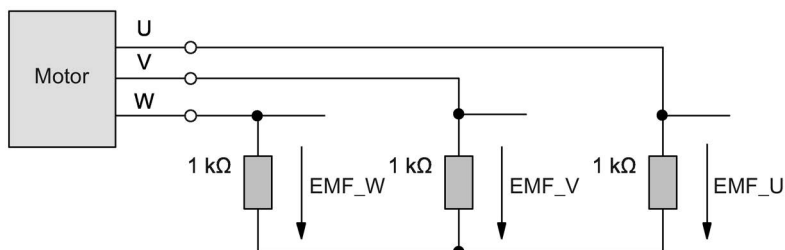

Image 3-85 Arrangement for measuring

4. Turn the rotor with the most constant speed possible in the clockwise direction. The rotor is turning in a clockwise direction if, when viewing the DE flange, it rotates clockwise (see also the "Determining the positive direction of the drive (Page 251)" figure).

Checking the phase sequence

For the positive direction of the drive, the phase sequence must be as follows:

EMF phase U - EMF phase V - EMF phase W

Checking phase relation

The phase displacement of the individual voltages EMC phase U – EMC phase V – EMC phase W to each other is 120° in the following figure.

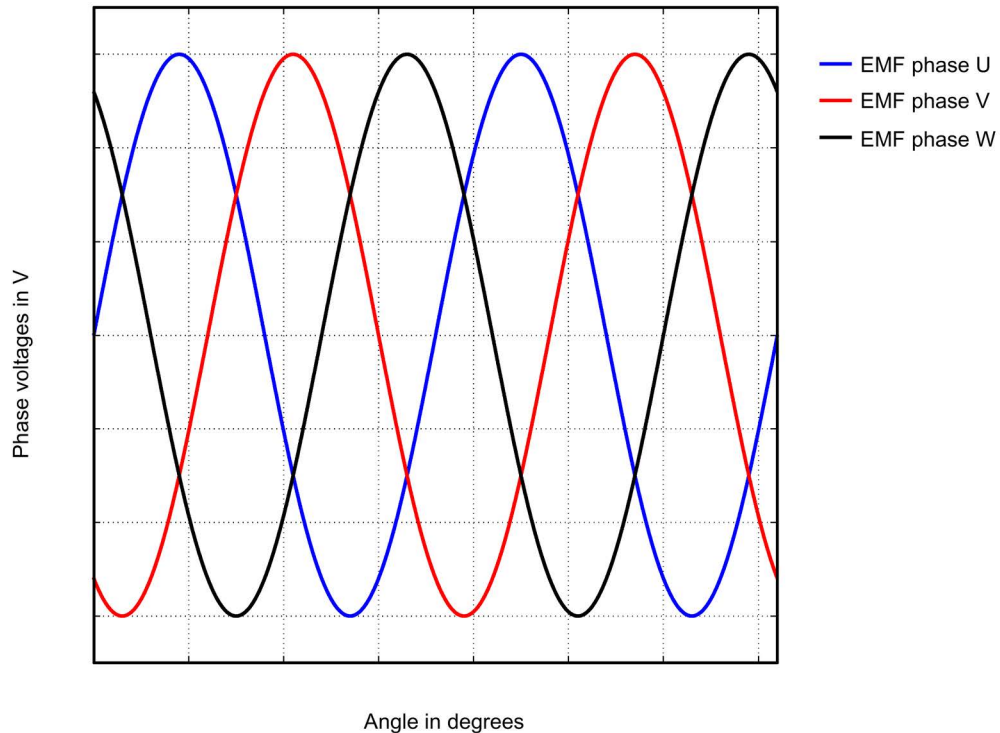

Image 3-86 Phase sequence, EMF phase U - EMF phase V - EMF phase W

Checking the phase relation for parallel-connected motors

The phase relations EMC phase U – EMC phase V – EMC phase W of the individual motors to each other must match.

- EMF phase U motor 1 with EMF phase U motor 2
- EMF phase V motor 1 with EMF phase V motor 2
- EMF phase W motor 1 with EMF phase W motor 2

The deviation within a particular phase position may be a maximum of 10°.

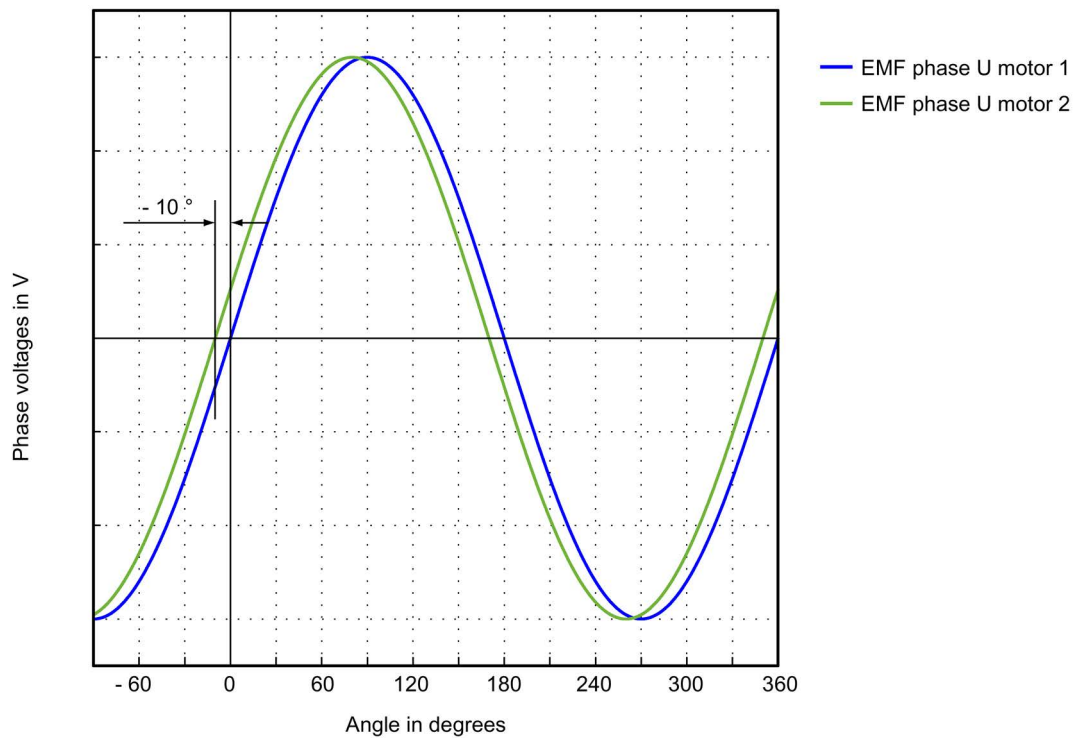

Image 3-87 Phase U motor 1 may not lag behind EMF phase U motor 2 by more than 10°

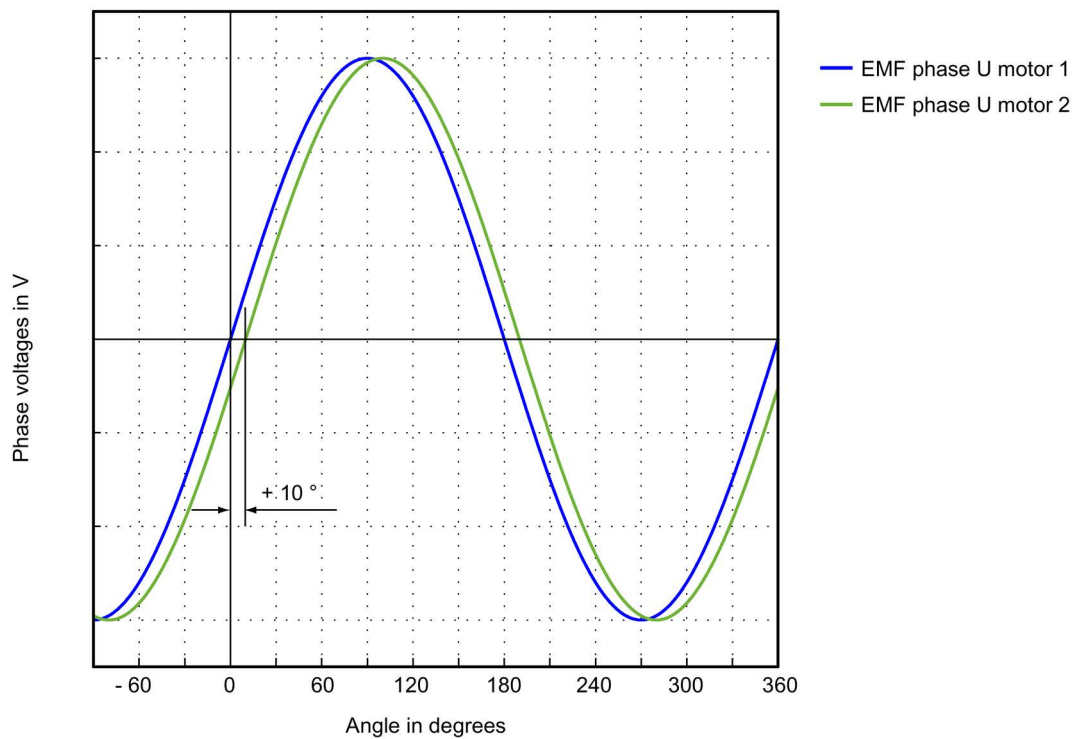

Image 3-88 EMF phase U motor 1 may not lead EMF phase U motor 2 by more than 10°

Determining the angular commutation offset by making a measurement

In the event of a fault and for a parallel connection, you must check the angular commutation offset as follows.

1. The drive with an incremental measuring system must be fine synchronized. To do this, connect the motor and enable the controller for coarse synchronization.
2. Then move the drive over the zero mark.
3. Remove power from the drive as described for the "Checking the phase voltage and the pole position angle using an oscilloscope" technique.

Please note that for this technique, it is not permissible that the control voltage for the Control Unit is shut down; however the infeed must be disconnected from the line supply.

You can determine the angular commutation offset by measuring the EMF and the normalized electrical pole position angle via the analog output. The normalized electrical pole position angle allows you to parameterize the test socket connections T0 to T2 and retrieve the signals (see Chapter "Measuring sockets (Page 355)").

Definition of channels (Ch1 ... Ch4):

- Ch1: EMF phase U with respect to the neutral point
- Ch2: EMF phase V with respect to the neutral point
- Ch3: EMF phase W with respect to the neutral point
- Ch4: Normalized electrical angular pole position via analog output

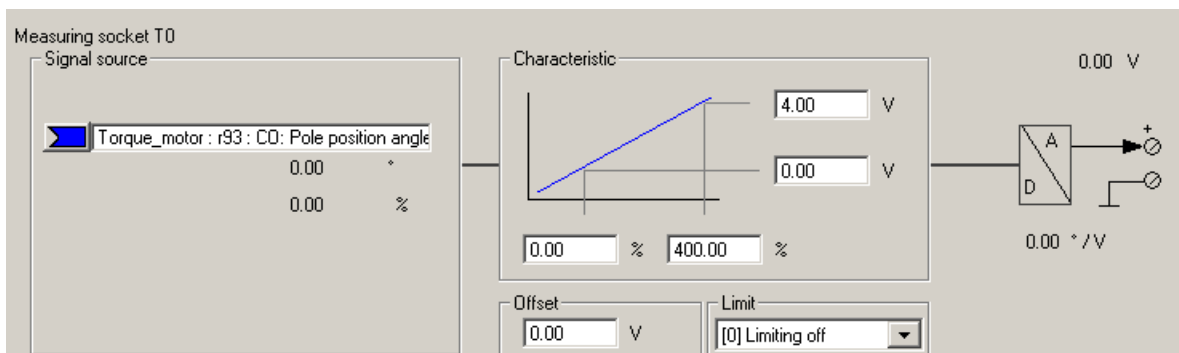

Image 3-89 Setting measuring socket T0 on CU320

The status of the coarse and fine synchronization can be read out online via parameter r1992: r1992.8 (fine synchronization carried out) and r1992.9 (coarse synchronization carried out).

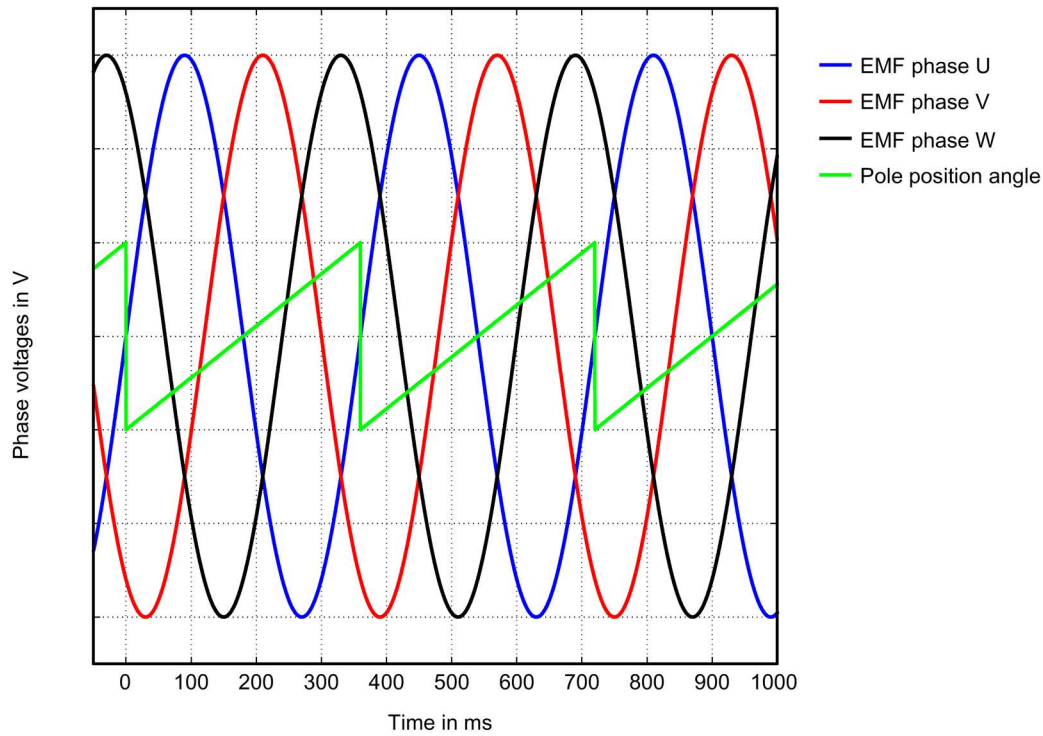

Image 3-90 Ideal characteristic of EMF voltages and the pole position angle of an optimally commutated drive

Recording the phase voltage and the pole position angle using the STARTER trace function

An oscilloscope is not used for this technique. You do not need to disconnect the motor. However, this technique is less accurate, as the motor voltages are not directly measured, but calculated from the transistor turn-on duration. This technique is not permitted for parallel-connected motors, see Chapter "Special case parallel connection (Page 272)".

1. Set the following parameters:

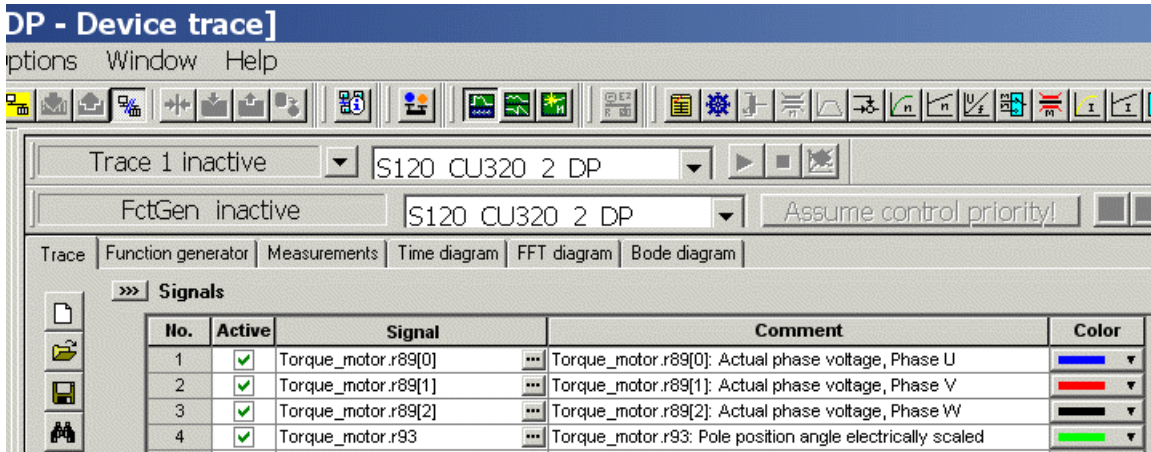

Image 3-91 Assignment of trace channels to check the angular commutation offset

The drive is operated in the open-loop torque controlled mode. The following parameterization is required:

2. Set p0640 = 0, to limit the motor current to 0.

3. Set p1545 = 1, to activate the travel to fixed stop.
4. The motor must be in closed-loop control and rotated externally.

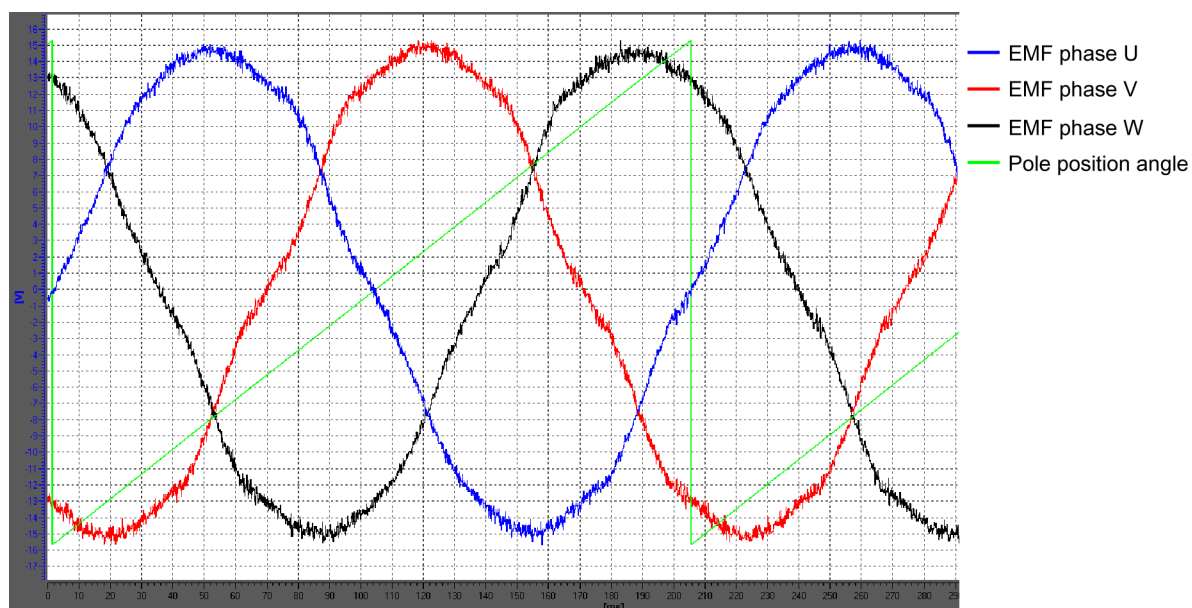

Image 3-92 Example of an optimally commutated drive (recorded using the trace function of the STARTER commissioning tool)

Evaluation of the results (applies to both measuring techniques)

For a positive drive direction (definition, refer to the "Determining the positive direction of the drive (Page 251)" figure, the sawtooth must increase monotonously between 0° and 360°, refer to the "Ideal characteristic of the EMF voltages and the pole position angle for an optimally commutated drive (Page 265)" figure.

If the curve is decreasing monotonously, and the phase sequence is EMF phase U - EMF phase V - EMF phase W, then you must change the control sense of the drive if necessary via p0410 bit 0 "Invert actual speed value". If the position controller is being used, then you must also check p0410 bit 1 "Invert actual position value". See the "Screen form for entering additional encoder data (Page 250)" figure in Chapter "Parameterizing a motor and encoder".

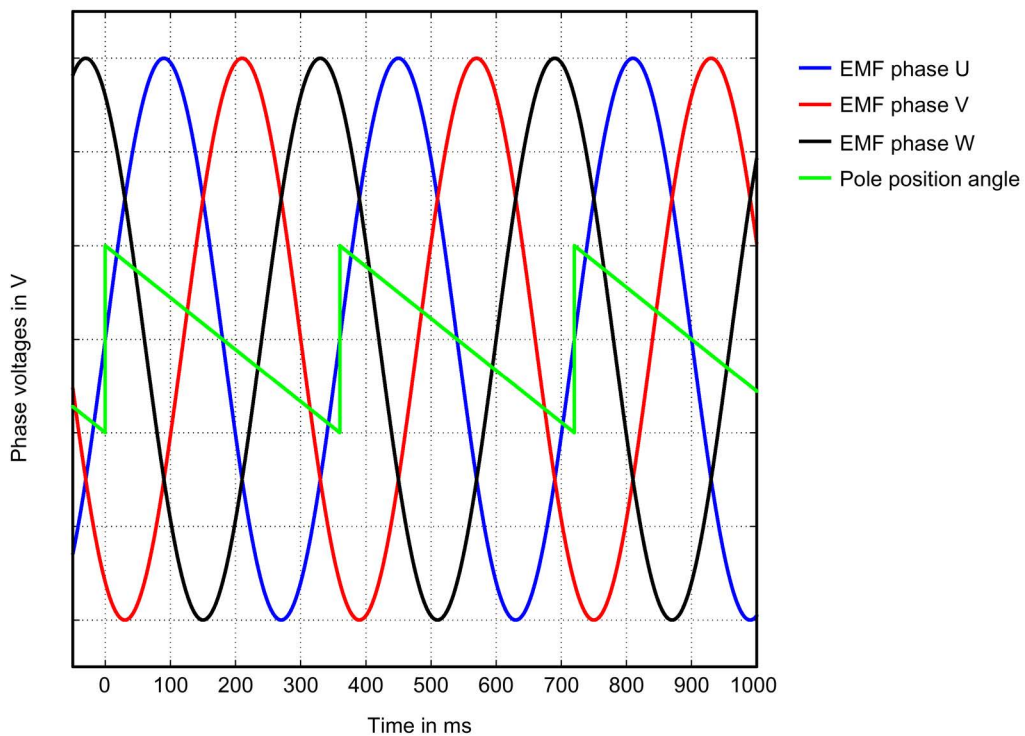

Image 3-93 EMF for incorrect actual speed value inversion

If the curve is monotonously decreasing, and the phase sequence is EMF phase U – EMF phase W – EMF phase V (i.e. if the phase sequence of V and W is interchanged), then according to the "Determining the positive direction of the drive (Page 251)" figure in Chapter "Parameterizing a motor and encoder", the drive direction is negative (i.e. when viewing the DE flange the axis is rotating counterclockwise).

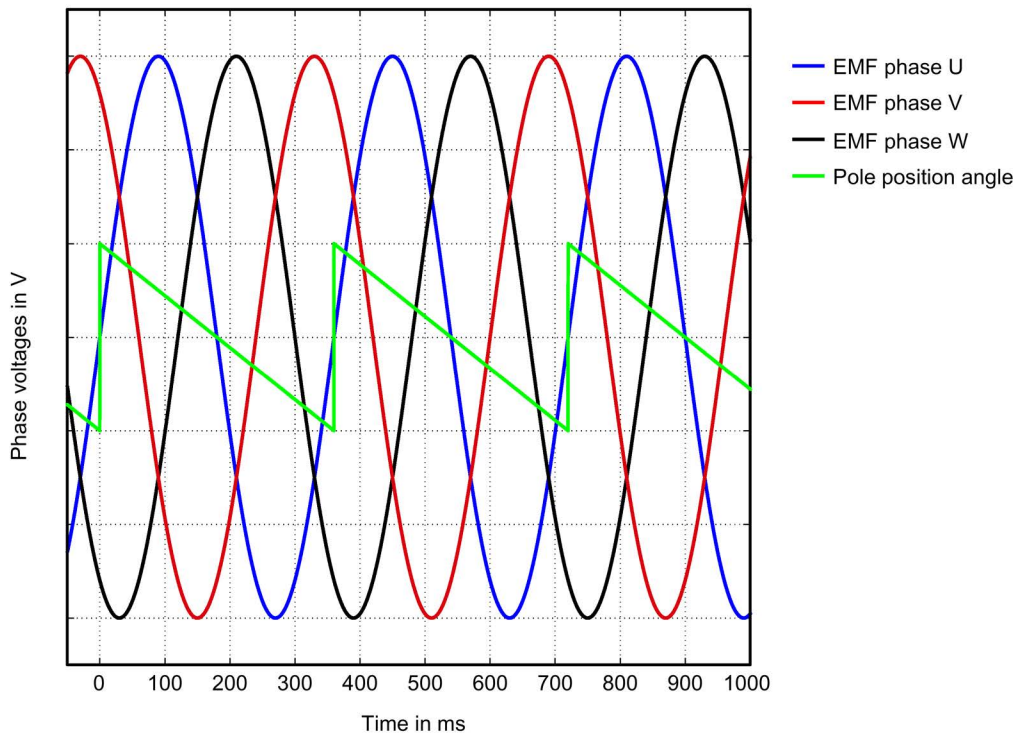

Image 3-94 EMC for the negative direction of rotation

Displaying the commutation angle tolerance

For a finely synchronized drive, the difference between EMF phase U and the normalized, electrical pole position angle may be a maximum of 10°. This means that the zero points of the falling edge of the sawtooth and EMF phase U may differ by a maximum of 10° electrical. For motors connected in parallel, this maximum permitted deviation for the EMF, phase U is valid for each motor connected in parallel.

If the difference is greater, then you must adapt the angular commutation offset. If, when moving over the zero mark, fault message "F31130 (N, A) encoder 1: Zero mark and position error from the coarse synchronization" is output, then the deviation of the commutation is greater than 60° electrical. You must check the commutation angle again using the techniques described.

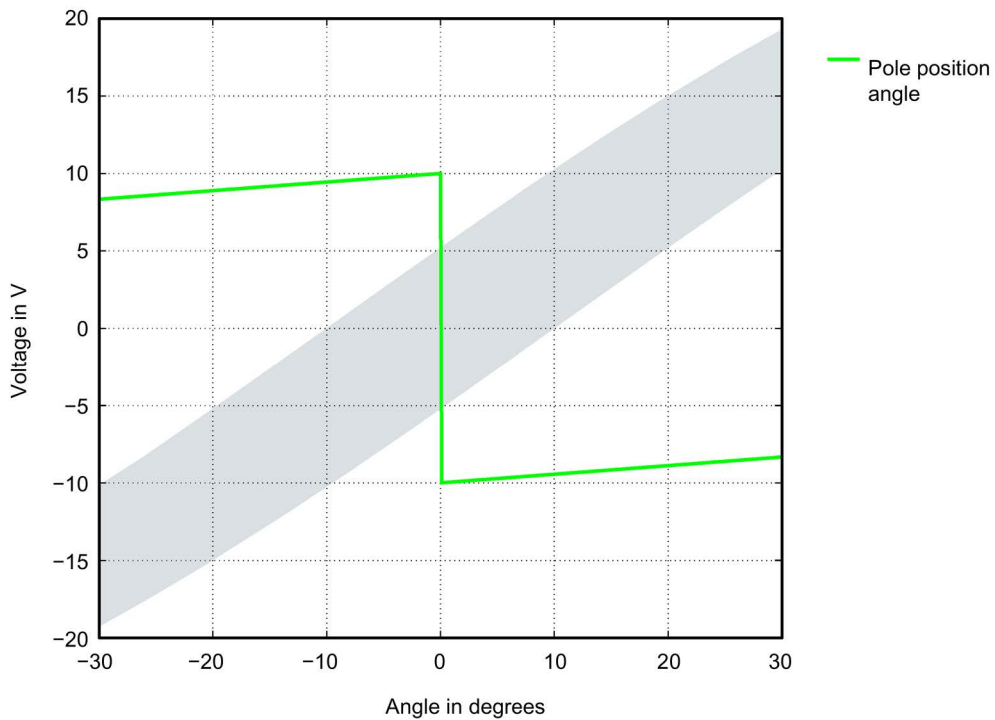

Image 3-95 Tolerance envelope for the pole position angle

Commutation angle outside the tolerance

Example: The falling edge of the sawtooth voltage (pole position angle) leads the zero crossing of EMF phase U by approx. 18° electrical.

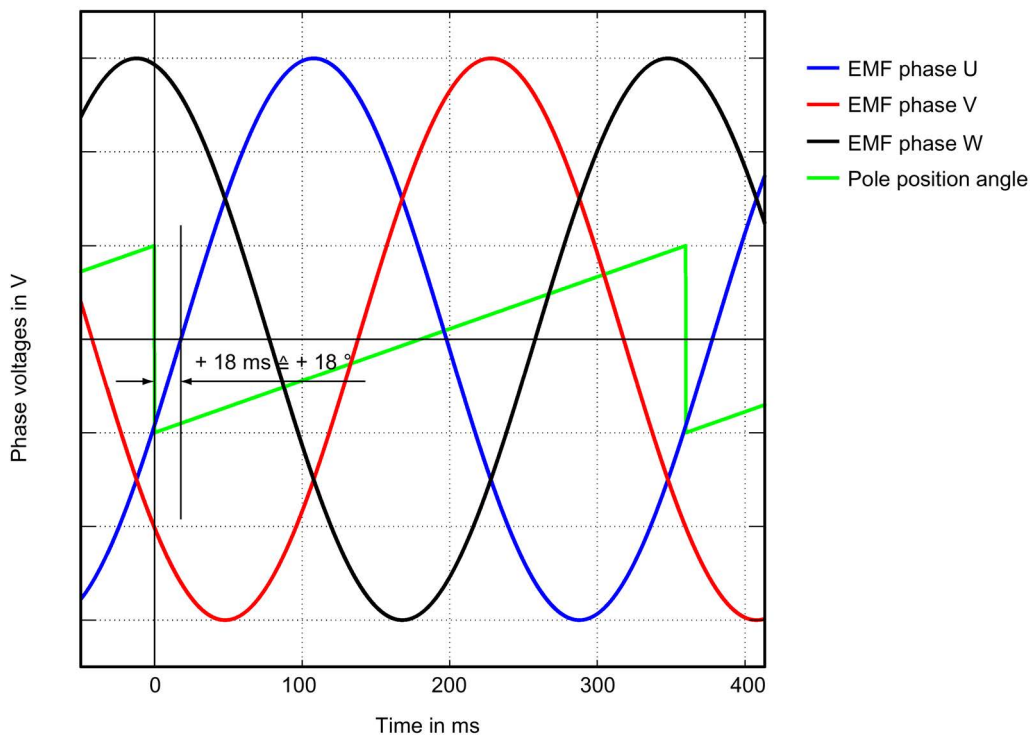

Image 3-96 Example of an incorrectly commutated drive

Adapt the incorrect commutation shown in the figure above according to Chapter "Checking the commutation angle offset with STARTER (Page 260)".

p0431 = p0431 - 18

3.18.7 Special case of a parallel connection

Note

Parallel connection

Only torque motors that are the same size and have the same current requirements (same winding design) can be connected in parallel. The article numbers of the motors must only differ with regard to the position "component (position of the interfaces)".

For more information and connection diagrams, refer to the "SIMOTICS T-1FW6 built-in Torque Motors" Configuration Manual in Chapter "Coupled motors".

The following requirements must be met in order to operate several torque motors in parallel on a SINAMICS Motor Module:

- The motors must be arranged according to the data in the "SIMOTICS T-1FW6 built-in torque motors" Configuration Manual.
- The direction of rotation of parallel-connected motors must match the data in the "SIMOTICS T-1FW6 built-in torque motors" Configuration Manual. For a Janus arrangement, when connecting the stoker, phases V and W must be interchanged so that the stoker has the same direction of rotation as the master, also refer to the "SIMOTICS T-1FW6 built-in torque motors" Configuration Manual in Chapter "Power and signal connection for parallel operation".
- Ensure the position of the EMF voltages of the parallel-connected motors as described in Chapter "Checking the angular commutation with an oscilloscope (Page 260)"; it is imperative that you check these carefully. Maintain the maximum deviation of the phase angle between the EMF voltages of the motors according to Chapter "Check angular commutation offset by taking measurements". You may only connect the motors to the converter after the deviation of the commutation angle for all of the motors to be connected in parallel lies within the limit value.
- Before commissioning and switching-on the DC voltage for the first time, note that the temperature monitoring circuits must be carefully checked to ensure that they correctly trip.

Then commission the system using the STARTER commissioning tool according to Chapter "Parameterizing a motor and encoder (Page 240)". The parallel connection for the SIMOTICS T-1FW6 built-in torque motors selected from the motor list can only be parameterized in the expert list of the drive.

After completing the configuration, in the STARTER commissioning tool, open the expert list of the drive and assign parameter p0306 = N, where N is the number of motors to be operated in parallel. The number of motors set must correspond to the number of motors that are actually connected in parallel.

After changing p0306, you must adapt the control parameters for a motor from the list by the automatic calculation with p0340 = 1. For a third-party motor not contained in the list, this setting, however, would cause the data of the electrical equivalent circuit diagram to be lost. Consequently, select the setting p0340 = 3 for a third-party motor.

Detailed information about parameter p0306 is contained in the STARTER commissioning tool help and in the SINAMICS S120/S150 List Manual.

If p0306 is changed during quick commissioning (p0010 = 1), then the maximum current p0640 is appropriately pre-assigned. This is not the case in the motor commissioning (p0010 = 3)!

The motor data displayed in the STARTER commissioning tool is only valid for one motor and is only internally interpolated up to N motors connected in parallel.

3.18.8 Optimization of the closed-loop control

When running through the drive configuration, in the step "Calculating the motor/controller data", drive-specific controller parameters are calculated, see the "Screen form to calculate motor/controller data (Page 245)" figure. However, to be able to use the optimal performance of the machine, a subsequent optimization of the controller parameters is required. Higher positioning/machining accuracy can be achieved and cycle times can be reduced by means of optimized settings.

Controller optimization may only be performed by experienced specialists.

In the control, for optimizing the controller, there is the possibility of measuring frequency responses or recording setpoint steps. Especially the frequency response measurement allows machine-specific natural frequencies that restrict the bandwidth of the closed-loop control to be taken into account.

You can ask your local Siemens office regarding optimization of the closed-loop control as a service.

3.19 Commissioning of SSI encoders

3.19.1 Notes on commissioning SSI encoders

Using error bits

The number and position of error bits can vary for SSI (Synchronous Serial Interface) encoders. In the event of faults, error codes may even sometimes be transferred within the position information.

It is therefore essential that you assess all the error bits present (see "Parameterization" and "Limitations" in this chapter) as otherwise an error code may be interpreted as position information if faults are present.

Hardware requirements

- SMC20 Sensor Module Cabinet Mounted
- SME25 Sensor Module External
- SMC30 Sensor Module Cabinet Mounted
- SME125 Sensor Module External
- Control Unit (CU320-2, CU310-2 or CUA32): Either the Sensor Module must be connected using DRIVE-CLiQ or an SSI encoder evaluation integrated in the Control Unit.

Types of encoder that can be connected

Encoder evaluation using the module	Incremental tracks	Absolute position	Voltage supply for encoder	SSI baud rate	Remarks
SMC20	sin/cos, 1 Vpp	SSI not cyclic ¹⁾	5 V	100 kBaud	-
SME25	sin/cos, 1 Vpp	SSI not cyclic ¹⁾	5 V	100 kBaud	SME25 is only suited to direct measuring systems
SMC30	Square or no incremental tracks	SSI not cyclic ^{1), 3)} SSI, cyclic ²⁾	5 V or 24 V	100-250 kBaud	-
SME125	sin/cos, 1 Vpp	SSI not cyclic ¹⁾	5 V	100 kBaud	SME125 is only suited to direct measuring systems

- 1) "not cyclic" means that the absolute position is only read when initializing the Sensor Module, after which the position is only calculated by the incremental tracks.
- 2) "cyclic" means that the absolute position is read permanently (usually in the PROFIBUS or position controller cycle) and the position (X_IST1) formed from this.
- 3) The SSI protocol is cyclically read-out for the plausibility checks.

Note

Only encoders that support a transfer rate of 100 kHz and that have a high level in idle state may be used.

The monoflop time should be parameterized such that it is greater than or equal to the specified monoflop time of the encoder. This must lie in the range between 15 – 30 μ s.

The level during the monoflop time must be low.

Ramp-up time of the encoder

In order to ensure that the correct sensor data is received, the encoder evaluation module checks whether the connected encoder is activated and ready for operation:

- After the power supply is switched on at the encoder, no signals are evaluated for a waiting period of 800 ms.
- After the waiting period has expired, test signals are applied to the clock cable and the response of the data line observed. As long as the encoder is not ready, the encoder holds the data line permanently in the idle state (as a rule, "high"). It is expected that the encoder has reached its ready state by this time.
- If the encoder has not signaled that it is in the ready state after approx. 10 seconds, the encoder evaluation module signals a timeout error.

The waiting period starts again when:

- The 5 V power supply is applied to the encoder.
- Switchover to 24 V power supply after completed ramp-up of the encoder evaluation in accordance with the parameterized voltage level.

Note

The activation routine is started each time that the encoder is inserted. The activation routine has been completed with the ready message to the evaluation module.

Note

An external 24 V encoder supply is permitted.

Parameterization

- **Predefined encoders**

Various predefined SSI encoders are available for commissioning. These can be selected in the commissioning windows of the STARTER commissioning tool.

- **User-defined encoders**

If there are no predefined entries for the encoder used, user-defined encoder data can be entered via windows using the commissioning wizard.

Special settings

- Error bits (special case, several error bits)

If an SSI encoder has several error bits, the evaluation is activated in the list of experts as follows using parameter p0434[x]:

Value = dcba

ba: Position of error bit in protocol (0 ... 63)

c: Level (0: Low level 1: High level)

d: Status of evaluation (0: Off, 1: On with 1 error bit, 2: On with 2 error bits ... 9: On with 9 error bits)

For several error bits, the following applies:

- The position specified under ba and the additional bits are assigned in ascending order.
- The level set under c is applicable for all error bits.

Example:

p0434 = 1013

--> the evaluation is activated, and the error bit is at position 13 with low level.

p0434 = 1113

--> the evaluation is activated, and the error bit is at position 13 with high level.

p0434 = 2124

--> the evaluation is activated, and the 2 error bits are at a high level from position 24.

- Fine resolution p0418 and p0419

In order to make full use of the entire traversing range of the absolute encoder, the position information, including fine resolution, must not exceed 32 bits.

Example:

An SSI encoder without incremental tracks is used. The encoder has a singleturn resolution of 16 bits and a multiturn resolution of 14 bits. The absolute position resolution is therefore 30 bits.

Consequently, only a fine resolution of 2 bits can be set. Parameters p0418[x] and p0419[x] in the list of experts should therefore be set to the value 2.

Diagnostics

Example 1

An SSI encoder without incremental tracks is used. The encoder has a singleturn resolution of 16 bits and a multiturn resolution of 14 bits. The fine resolution p0418[x] and p0419[x] is set to the value 2. In parameter r0482[x] (X_IST1), the product is formed from "pulses per revolution" and fine resolution p0418[x]. If using SSI encoders without incremental tracks, the number of pulses and singleturn resolution are identical. In our example, the actual position value X_IST1 (r0482[x]) must therefore have changed by the following value after one encoder revolution:

$$\text{Single turn resolution} * \text{fine resolution} = 2^{16} * 2^2 = 262144$$

Example 2

An SSI encoder with incremental tracks is used. In this case, incorrect SSI protocol settings can be seen, e.g. by the fact that once the system has been switched on a different absolute position is indicated from that before it was last deactivated.

The absolute position X_IST2 (r0483[x]) must be considered by way of a check. Following PROFIdrive, however, just one value is displayed in this parameter if bit 13 (request absolute value in cycles) is set to the value 1 in the encoder control word p0480[x].

This bit can be set, e.g. with the aid of the binector-connector converter.

Once switched on, the SSI encoder is now turned a few revolutions. Once switched off and on again, the absolute position of X_IST2 (r0483[x]) must indicate an unchanged value. Only minor deviations may occur in the fine resolution area.

3.19.2 Encoder identification for SSI encoders without incremental tracks

The SSI (Synchronous Serial Interface) is used to transfer the absolute value for absolute value encoders. Because the data transfer format is not standardized for SSI, the manufacturers of encoder systems can define the format themselves. Consequently, a universal parameterization of SSI encoders was introduced for the SINAMICS drive system so that the largest possible number of different encoders and manufacturers are supported. The encoder identification for SSI encoders simplifies the encoder configuring. Two different techniques are available for the encoder identification.

Moving the axis manually

The manual technique is particularly suitable for easily accessible axes as well as rotary axes without a holding brake.

For this technique, the axis must be turned or moved using a defined movement. For a rotary encoder, this movement corresponds to one encoder revolution. For a linear encoder, it is 25 mm.

Precondition

The encoder/motor must be easily accessible and it must be possible to rotate the axis (released brake).

Moving the axis by the converter

The technique is particularly suitable for large and poorly accessible axes as well as rotary axes with a holding brake.

For this technique, the axis must be moved with a defined speed or velocity. The speed for the rotary encoder is 60 rpm or the velocity for the linear encoder is 1.5 m * rpm.

Precondition

The drive has been completely commissioned and can be traveled. If the SSI encoder is used as motor encoder, the control type must have been set previously to "encoderless" (p1300).

Once the encoder has been identified, the pulses are locked again automatically.

Procedure

Note

The "x" serves as placeholder for the encoder number in the following description. Encoder numbers 1, 2 or 3 are possible.

1. Proceed as follows:
 - p0010:= 4 (start encoder commissioning)
 - p0400[x] = 9999 (user-defined encoder)
2. Set the not identified properties (linear/rotary, 5 V / 24 V) and the "SSI encoder" property:
 - p0404[x].0 = 0: Rotary
 - p0404[x].0 = 1: Linear
 - p0404[x].9 = 1: SSI encoder
 - p0404[x].20 = 1: Voltage level 5 V
 - p0404[x].21 = 1: Voltage level 24 V
3. Start the encoder identification using p0400[x] = 10100 (identify encoder (waiting)).
4. Depending on the technique, perform a defined movement (see "Moving the axis manually" or "Moving the axis by the converter" technique).
5. After the identification, check the encoder configuration.

The associated parameters are listed in the Section "Overview of the important parameters" (Page 280).

- In particular, compare the parameters of the encoder lines or spacing with the documentation of the encoder, and correct these parameters if necessary. For rotary encoder, these are p0408, p0421 and p0423. For linear encoders, these are p0407 and p0422.
- If special bits are identified in the SSI telegram (p0448), the first special bit is configured as a fault bit (p0434) and the second special bit as an alarm bit (p0435). Compare this setting with the documentation of the encoder, and correct the above parameters if necessary.

Note

The alarm A07569 "Encoder identification active" remains pending while the identification task has not yet completed.

Note

If the connected SSI encoder cannot be identified, alarm F3x153 "Encoder x: Identification failed" is issued and the value 0, "No encoder", is entered in parameter p0400. This encoder must then be configured manually.

3.19.3 Overview of important parameters

Overview of important parameters (see SINAMICS S120/S150 List Manual)

- p0400[0...n]¹⁾ Encoder type selection
- p0404[0...n]¹⁾ Encoder configuration active
- p0407[0...n]¹⁾ Linear encoder scale
- p0408[0...n]¹⁾ Rotary encoder pulse No.
- p0421[0...n]¹⁾ Absolute encoder rotary multiturn resolution
- p0422[0...n]¹⁾ Absolute encoder linear measuring increments resolution
- p0423[0...n]¹⁾ Absolute encoder rotary singleturn resolution
- p0427[0...n] SSI encoder baud rate
- p0428[0...n] SSI encoder monoflop time
- p0429[0...n]¹⁾ SSI encoder configuration
- p0434[0...n]¹⁾ SSI encoder error bit
- p0435[0...n]¹⁾ SSI encoder alarm bit
- p0436[0...n]¹⁾ SSI encoder parity bit
- p0446[0...n] SSI encoder bit count before the absolute value
- p0447[0...n]¹⁾ SSI encoder bit count absolute value
- p0448[0...n]¹⁾ SSI encoder bit count after the absolute value
- p0449[0...n]¹⁾ SSI encoder bit count filler bits

¹⁾ Changed for SSI encoder identification

3.20 Commissioning of a 2-pole resolver as absolute encoder

Description

You can use 2-pole (1 pole pair) resolvers as singleturn absolute encoders. The absolute encoder position actual value is provided in Gn_XIST2 (r0483[x]).

Actual position value format

The factory setting for the fine resolution of Gn_XIST1 differs from the fine resolution in Gn_XIST2 (p0418 = 11, p0419 = 9). This may cause a slight displacement of the encoder position after switching the drive unit off/on.

Therefore, when using a 2-pole resolver as an absolute encoder, we recommend that the fine resolution for Gn_XIST1 (p0418) is set the same as the fine resolution for Gn_XIST2 (p0419), e.g. p0418 = p0419 = 11.

2-pole resolvers are automatically entered in the PROFIdrive profile (r0979) as singleturn absolute encoders.

Position tracking

You can also activate position tracking for a 2-pole resolver. Please note, however, that the resolver may not be moved more than half an encoder revolution (pole width) when switched off. The activation and configuration of the position tracking is described in the chapter "Position tracking".

EPOS - absolute encoder adjustment

If the 2-pole resolver is used as an absolute encoder for basic positioning (EPOS), the absolute encoder adjustment must be performed in the expert list.

To do this, set reference point coordinate p2599 to the value corresponding to the mechanical system and request the adjustment with p2507 = 2.

You will then need to back up the data from RAM to ROM.

3.21 Temperature sensors for SINAMICS components

 WARNING
<p>Danger to life due to electric shock in the event of voltage flashovers on the temperature sensor cable</p> <p>Voltage flashovers to the signal electronics can occur in motors without safe electrical separation of the temperature sensors.</p> <ul style="list-style-type: none"> • Use temperature sensors that satisfy the specifications of the protective separation in accordance with IEC 61800-5-1. • If protective separation cannot be guaranteed (with linear motors or third-party motors, for example), use a Sensor Module External (SME120 or SME125) or the TM120 Terminal Module.

The following table provides an overview of the SINAMICS drive system components available with temperature sensor connections.

Table 3- 27 Temperature sensor connections for SINAMICS components

Module	Interface	Pin	Signal name	Technical specifications
SMC10/SMC20	X520 (sub D)	13 25	+Temp -Temp	Temperature sensor KTY84-1C130/PTC/PT1000
SMC30	X520 (sub D) Temperature channel 2	1 8	+Temp -Temp	Temperature sensor KTY84-1C130/PTC/PT1000/bimetallic switch with NC contact
	X531 (terminal) Temperature channel 1	3 4	-Temp +Temp	Temperature sensor KTY84-1C130/PTC/PT1000/bimetallic switch with NC contact
CU310-2 DP CU310-2 PN	X23 (sub D)	1 8	+Temp -Temp	Temperature sensor KTY84-1C130 /PTC/PT1000
	X120 (terminal)	1 2	+Temp -Temp	Temperature sensor KTY84-1C130/PTC/PT1000
CUA31	X210 (terminal)	1 2	+Temp -Temp	Temperature sensor KTY84-1C130/PTC/PT1000
CUA32	X210 (terminal) Temperature channel 2	1 2	+Temp -Temp	Temperature sensor KTY84-1C130/PTC/PT1000/bimetallic switch with NC contact
	X220 (sub D) Temperature channel 1	1 8	+Temp -Temp	Temperature sensor KTY84-1C130/PTC/PT1000/bimetallic switch with NC contact
TM31	X522 (terminal)	7 8	+Temp -Temp	Temperature sensor KTY84-1C130/PTC/PT1000

Module	Interface	Pin	Signal name	Technical specifications
TM120	X524 (terminal)	1	-Temp	Temperature sensor connection KTY84-1C130/PTC/PT1000/ bi- metallic switch with NC contact For linear motor applications, here the motor temperature sensor Connect KTY84-1C130/PT1000
		2	+Temp	
		3	-Temp	
		4	+Temp	
		5	-Temp	
TM150	X531	6	+Temp	KTY84-1C130/PTC/bimetallic NC contact/PT100/PT1000 Information on interconnecting the temperature channels can be found below
		7	-Temp	
		3	+Temp	
		4	-Temp	
	X532	1	+Temp	
		2	-Temp	
		3	+Temp	
		4	-Temp	
	X533	1	+Temp	
		2	-Temp	
		3	+Temp	
		4	-Temp	
	X534	1	+Temp	
		2	-Temp	
		3	+Temp	
		4	-Temp	
	X535	1	+Temp	
		2	-Temp	
		3	+Temp	
		4	-Temp	
	X536	1	+Temp	
2		-Temp		
3		+Temp		
4		-Temp		
SME20	Measuring system interface	7 9	-Temp +Temp	Temperature sensor KTY84-1C130 / PTC connection cable with article num- ber 6FX8002-2CA88-.... neces- sary ¹⁾
SME120/SME125	X200 (connector) Temperature chan- nel 2	1	-Temp	Temperature sensor KTY84- 1C130/PTC/PT1000/bimetallic switch with NC contact
		2	+Temp	
	X200 (connector) Temperature chan- nel 3	3	+Temp	Temperature sensor KTY84- 1C130/PTC/PT1000/bimetallic switch with NC contact
		4	-Temp	
	X200 (connector) Temperature chan- nel 4	5	+Temp	Temperature sensor KTY84- 1C130/PTC/PT1000/bimetallic switch with NC contact
		6	-Temp	

Module	Interface	Pin	Signal name	Technical specifications
Active Line Module	Booksize X21 (terminal)	1 2	+Temp -Temp	Active Line Module temperature sensor Temperature switch type: bimetallic switch with NC contact
	Chassis X41 (terminal)	4 3	+Temp -Temp	
Smart Line Module	Booksize X21 (terminal)	1 2	+Temp -Temp	Active Line Module temperature sensor Temperature switch type: bimetallic switch with NC contact
	Chassis X41 (terminal)	4 3	+Temp -Temp	
Basic Line Module	Booksize X21 (terminal)	1 2	+Temp -Temp	Basic Line Module temperature sensor Temperature switch type: bimetallic switch with NC contact
	Chassis X41 (terminal)	4 3	+Temp -Temp	
Motor Module	Booksize X21/X22 (terminal)	1 2	+Temp -Temp	Temperature sensor KTY84-1C130/PTC/PT1000 Bimetallic switch with NC contact: Alarm and timer (only for temperature evaluation via MM) PT100 temperature sensor
	The following applies to chassis: X41 (terminal)	4 3	+Temp -Temp	

1) Cable for connection to direct measurement systems: Article number 6FX.002-2CB54-....

Commissioning information

The index [0...n] used in the following identifies either the motor data set or the encoder data set.

SMC10/SMC20

You can use the STARTER screen (\messages and monitoring \ motor temperature) to parameterize the motor temperature evaluation via SUB-D socket X520.

SMC30 (as of article number 6SL3055-0AA00-5CA2)

In addition to temperature evaluation via terminal X531 (temperature channel 1), this module also has temperature evaluation at SUB-D socket X520 (temperature channel 2).

In the default setting (p0600 = 1 "Temperature via encoder 1" and p0601 = 2 "KTY" or p0601 = 6 "PT1000"), the temperature is evaluated via the first temperature channel. The temperature sensor is connected to terminal X531 on the SMC30. The temperature is shown via r0035.

The parameterization of the motor temperature evaluation via the sub D socket X520 must be performed in the expert list as follows:

- p0600[0...n]: Selection of the encoder (1, 2 or 3) to which the SMC30 that is used for the temperature evaluation, is assigned (n = motor data set).
- p0601[0...n] = 10 (evaluation via several temperature channels), n = motor data set.
- p4601[0...n]: Select the temperature sensor type for temperature channel 2 (depends on encoder data set n, not the motor data set).

Note

With several encoders, the index [n] of the relevant encoder / encoder data set, via which the temperature evaluation is performed, must be used.

The temperature is displayed in parameter r4620[1] (temperature channel 2). For multiple temperature channels (use of temperature channels 1 and 2 on SMC30), parameter r0035 shows the maximum temperature.

Example:

A KTY temperature sensor is connected at the sub D socket X520 on the SMC30 of Encoder 1.

This is parameterized via:

- p0600[0...n] = 1 / p0601[0...n] = 10 / p4601[0...n] = 20

Both temperature channels (X520 and X531) can be used at the same time. In addition to the above parameterization, the temperature sensor type connected at terminal X531 must be entered in p4600[0...n]. The maximum value is then generated for the motor temperature and displayed in r0035.

Note

With several encoders, the index [n] of the relevant encoder / encoder data set, via which the temperature evaluation is performed, must be used.

CU310-2 DP/CU310-2 PN

The Control Unit 310-2 has an integrated SMC30 encoder interface. This encoder interface is accessed via the 15-pin Sub-D-contact X23 and is evaluated as temperature channel 1.

There are three options available to evaluate the temperature:

Option	The following parameter settings must be made:
Temperature channel 1 via the SMC30 encoder interface X23.	<ul style="list-style-type: none"> • p0600[0...n] = 1: Selection of the encoder (1, 2 or 3), which is assigned to encoder interface X23 and via which the temperature is evaluated, n = motor data set • p0601[0...n] = 1 or 2: Selection of the temperature sensor type, n = motor data set • r0035: Display of the temperature value
Temperature channel 1 via terminal X120, for example, if an encoder is being used.	<ul style="list-style-type: none"> • p0600[0...n] = 11: Activation from temperature channel 1 via terminal X120 • p0601[0...n] = 1 or 2: Selection of the temperature sensor type, n = motor data set • r0035: Display of the temperature value
Two temperature channels via X23 and X120. Encoder interface X23 is assigned to temperature channel 1 and terminal X120 is assigned to temperature channel 2.	<ul style="list-style-type: none"> • p0600[0...n] = 1: Selection of the encoder (1, 2 or 3), which is assigned to encoder interface X23 and via which the temperature is evaluated, n = motor data set • p0601[0...n] = 10: Evaluation via several temperature channels • p4600[0...n]: Selection of the temperature sensor type from temperature channel 1, n = encoder data set • p4601[0...n]: Selection of the temperature sensor type from temperature channel 2, n = encoder data set • r4620[0...3]: Reading the temperature values <ul style="list-style-type: none"> – Index n = 0 temperature channel 1 – Index n = 1 temperature channel 2 • r0035: Display of the higher temperature value of temperature channels 1 and 2

CUA31

The parameterization of the temperature evaluation via terminal X210 can be performed using the STARTER screen (messages and monitoring > motor temperature). "Temperature sensor via Motor Module (11)" should be selected in the "Temperature sensor selection" field. The temperature of the sensor is displayed in r0035.

CUA32

The parameterization of the temperature evaluation via terminal X210 or sub D socket X220 is performed using two temperature channels.

p0600 = 11: Temperature sensor via Motor Module

For the SINAMICS S120 AC Drive (AC/AC) and if Control Unit Adapter CUA31/CUA32 is used, the temperature sensor connection is on the adapter (X210).

TM31

A Terminal Module 31 (TM31) is used when additional digital and analog inputs/outputs are required. The sensor type used is set via p4100 and the temperature signal interconnected via r4105.

TM120

If the temperature sensors in the installed motors do not have protective separation, then you require a Terminal Module 120 (TM120). Up to 4 different temperature sensors can be connected to the TM120. The TM120 senses the temperature values, evaluates them, and sends them via DRIVE-CLiQ to the Control Unit. The actual temperature values measured using KTY84 or PT1000 are evaluated in the range from -140°C to $+188.6^{\circ}\text{C}$. Actual temperature values outside this range are not taken into account. The fault and alarm thresholds (p4102) of the temperature values can be set from -48°C to 251°C .

Settings for the measurement:

- With p0600 = 20 or 21, the motor temperature sensing is activated using an external sensor.
- With p0601 = 11, the evaluation is set over several temperature channels.
- In p0604, the motor temperature alarm threshold is set.
- In p0605, the motor temperature fault threshold is set.
- With p0608 and p0609, the temperature channels are assigned to the signal sources for the motor temperatures.
 - With p4100[0...3] = 1, temperature sensor type PTC is set to the corresponding channel 1 to 4 and the evaluation activated.
 - With p4100[0...3] = 2, temperature sensor type KTY84 is set to the corresponding channel 1 to 4 and the evaluation activated.
 - With p4100[0...3] = 4, the temperature sensor type bimetal NC contact is set and the evaluation activated.
 - With p4100[0...3] = 6, temperature sensor type PT1000 is set to the corresponding channel 1 to 4 and the evaluation activated.
- The actual resistance value of the particular temperature sensor is displayed in parameter r4101[0...3].
- For p4102[0...7] = 251°C , the evaluation of the associated threshold is deactivated.
For sensor type "PTC thermistor" (p4100[0...3] = 1), the following applies:
To activate the associated alarm or fault, p4102[0...7] $\leq 250^{\circ}\text{C}$ must be set.
- The actual temperature value of the temperature evaluation is displayed in parameter r4105[0...3]. If no sensor has been selected, or if the actual temperature value is invalid, then the value -300°C is in parameter r4105[0...3].
- With p4610[0...n] to p4613[0...n], the temperature sensors are assigned to the motor and the response defined.

TM150

The Terminal Module 150 (TM150) has 6x 4-pole terminals for temperature sensors. Temperature sensors can be connected in a 2, 3 or 4-wire system. Up to 12 input channels can be evaluated if two 2-wire sensors are connected to the 4 poles at the input terminal strips. Twelve (12) input channels can be evaluated in the factory setting. The temperature channels of a TM150 can be subdivided into 3 groups and evaluated together.

When using 2-wire sensors, to increase the measuring accuracy, the cable resistance can be measured and saved. To do this, short-circuit the sensor cable as close as possible to the sensor. The technique is described in the SINAMICS S120/150 List Manual in p4109[0...11]. The measured cable resistance is then taken into account when evaluating the temperature. The cable resistance value is saved in p4110[0...11].

The TM150 can acquire the signals from KTY84, PTC, bimetallic NC contact, PT100 and PT1000 temperature sensors and evaluate them. The fault and alarm thresholds of the temperature values can be set from -99° C to 251° C. The temperature sensors are connected at terminal strip X531 to X536 according to the table above. For further information on the configuration and the connections, refer to the function diagrams 9625, 9626 and 9627 in the SINAMICS S120/S150 List Manual.

- p4100[0...11] sets the sensor type for the respective temperature channel.

Value of p4100[0...11]	Temperature sensor	Temperature display range r4105[0...11]
0	Evaluation disabled	-
1	PTC thermistor	-50° C or +250° C
2	KTY84	-99° C to +250° C
4	Bimetallic NC contact	-50° C or +250° C
5	PT100	-99° C to +250° C
6	PT1000	-99° C to +250° C

- r4105[0...11] indicates the actual value of the temperature channel.

For switching temperature sensors, such as PTC and bimetallic NC contact, two limit values are displayed symbolically:

- r4105[0...11] = -50°C: The actual temperature value is below the rated response temperature.
- r4105[0...11] = +250°C: The actual temperature value is above the rated response temperature.

Note

For PTC and bimetal NC contact the following applies:

What is shown in r4105[0...11] does not correspond to the actual temperature value.

- With p4108[0...5] = 0, you evaluate a sensor in a 2-wire system at a 4-wire connection at terminals 1 and 2. Terminals 3 and 4 remain open.
- With p4108[0...5] = 2, you evaluate a sensor in a 3-wire system at a 4-wire connection at terminals 3 and 4. The measuring cable is connected at terminal 1. You must short-circuit terminals 2 and 4.
- With p4108[0...5] = 3, you evaluate a sensor in a 4-wire system at a 4-wire connection at terminals 3 and 4. The measuring cable is connected at terminals 1 and 2.

You can find additional information in function diagram 9626 in the SINAMICS S120/S150 List Manual and in the SINAMICS S120 Function Manual Drive Functions in Chapter "Thermal motor protection".

SME20

The evaluation of KTY, PT1000, or PTC temperature sensors can be parameterized using the STARTER screen (Messages and monitoring > Motor temperature):

- Temperature sensor selection ($\hat{=}$ p0600[0...n]): Selection of the source to which the SME module is assigned (temperature sensor via encoder (1, 2 or 3), temperature sensor via BICO interconnections or temperature sensor via Motor Module).
- Temperature sensor type ($\hat{=}$ p0601[0...n]): Sets the sensor type for motor temperature monitoring.

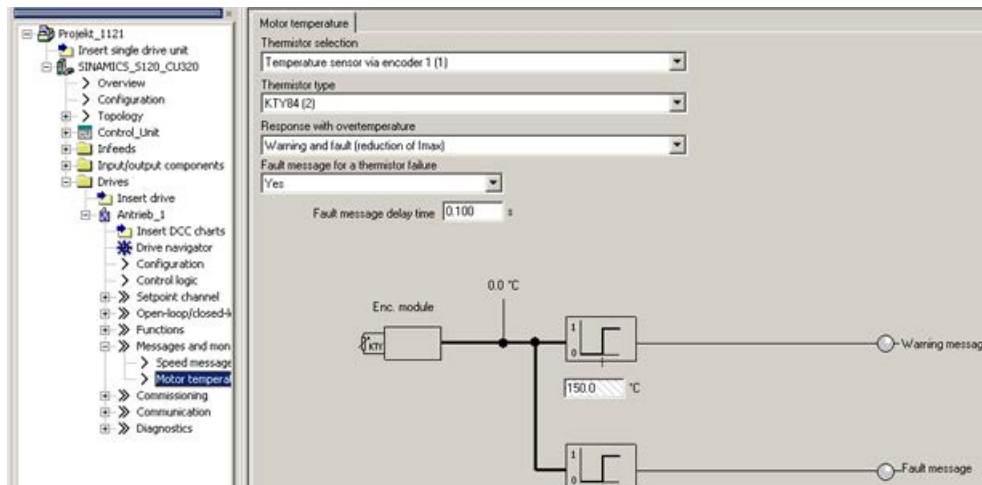

Image 3-97 Selection of temperature sensor for SME20 modules

SME120/SME125

For modules with several temperature sensor connections (SME modules), the temperature sensor is selected depending on encoder data set n via parameters p4601[0...n]..p4603[0...n]. A maximum of three motor temperature sensors can be evaluated simultaneously via terminal X200.

The parameterization of the motor temperature evaluation via terminal X200 must be performed in the expert list as follows:

- p0600[0...n]: Selection of the encoder (1, 2 or 3) to which the SMC used for the temperature evaluation is assigned, n = motor data set.
- p0601[0...n] = 10 (evaluation via several temperature channels), n = motor data set.
- p4601[0...n]-p4603[0...n]: Selection of the temperature sensor type of temperature channels 2-4, depending on encoder data set n.
Only temperature channels 2-4 are available at terminal X200.
- Parameter r4620[0...3] Motor temperatures SME
Displays the current temperatures in the motor, measured via an SME120 or SME125.
The indices mean:
[1] = SME temperature channel 2 / motor temperature sensor 2
[2] = SME temperature channel 3 / motor temperature sensor 3
[3] = SME temperature channel 4 / motor temperature sensor 4

Diagnostic parameters r0458[0...2] Sensor Module properties

Index [0...2]: Encoder 1...encoder 3

Parameter r0458 allows the following properties to be queried at the temperature sensor modules:

Bit	Feature
02	Temperature sensor connection present
03	Connection for PTC for motors with DRIVE-CLiQ also present
04	Module temperature available
08	Evaluation set up across several temperature channels

Selection of several temperature channels p4601 ... p4603 is only possible, for example, when parameter p0601 = 10 is set. This can be checked using the entry r0458.8 = 1.

You can find further information on parameter r0458 in: SINAMICS S 120/S150 List Manual.

Active Line Module, Basic Line Module, Smart Line Module, Motor Module (chassis)

Parameter p0601 "Motor temperature sensor type" enables the setting for the sensor type for the temperature measurement at input X21 (booksize) or X41 (chassis). The measured value is displayed in r0035.

Faults and alarms

F07011 drive: Motor overtemperature

KTY or PT1000 sensor:

The motor temperature has exceeded the fault threshold (p0605) or the timer stage (p0606) after the alarm threshold was exceeded (p0604) has expired. This results in the response parameterized in p0610.

PTC sensor + bimetallic switch:

The response threshold of 1650 Ohm was exceeded and the timer stage (p0606) has expired.

This results in the response parameterized in p0610.

If an SME is used (p0601 = 10), parameter r0949 displays the number of the sensor channel that has triggered the message.

A07015 drive: Motor temperature sensor alarm

A fault was detected when evaluating the temperature sensor set in p0600 and p0601.

When the fault occurs, the time in p0607 is started. If the fault still exists after this time has expired, fault F07016 is output – however, not until at least 50 ms after alarm A07015.

If an SME is used (p0601 = 10), parameter r2124 displays the number of the sensor channel that has triggered the message.

F07016 drive: Motor temperature sensor fault

A fault was detected when evaluating the temperature sensor set in p0600 and p0601.

If alarm A07015 is present, the time in p0607 is started. If the fault still exists after this time has expired, fault F07016 is output – however, not until at least 50 ms after alarm A07015.

If an SME is used (p0601 = 10), parameter r0949 displays the number of the sensor channel that has triggered the message.

Function diagrams (see SINAMICS S120/S150 List Manual)

- 8016 Signals and monitoring functions - thermal monitoring motor, Mot_temp ZSW F/A

Overview of important parameters (see SINAMICS S120/S150 List Manual)

- r0035 CO: Motor temperature
- r0458[0...2] Sensor Module properties
- p0600[0...n] Motor temperature sensor for monitoring
- p0601[0...n] Motor temperature sensor type
- p0603 CI: Motor temperature signal source
- p0604[0...n] Mot_temp_mod 2: Sensor alarm threshold
- p0605[0...n] Mot_temp_mod 1/2 sensor threshold and temperature value
- p0606[0...n] Mot_temp_mod 2: Sensor timer
- p0607[0...n] Temperature sensor fault timer
- p0610[0...n] Motor overtemperature response
- p4100[0...3] TM120 temperature evaluation, sensor type
- p4100 TM31 sensor type
- p4102[0...7] TM120 fault threshold / alarm threshold
- r4105[0...3] CO:TM120 actual temperature value
- r4105 CO:TM31 actual temperature value
- p4600[0...n] Motor temperature sensor 1 sensor type
- p4601[0...n] Motor temperature sensor 2 sensor type
- p4602[0...n] Motor temperature sensor 3 sensor type
- p4603[0...n] Motor temperature sensor 4 sensor type
- r4620[0...3] Motor temperature measured

3.22 Basic Operator Panel 20 (BOP20)

Brief description

The Basic Operator Panel 20 (BOP20) has six keys and a two-line display unit with background lighting. The BOP20 can be plugged onto the SINAMICS Control Unit and operated.

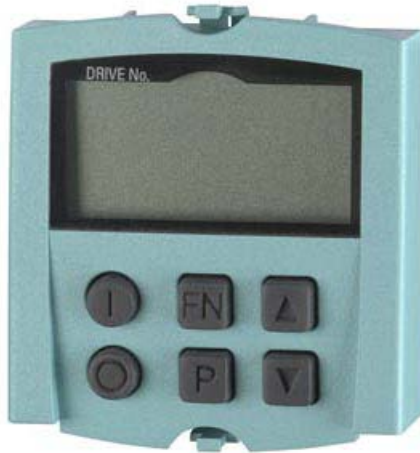

Image 3-98 BOP20

The BOP20 supports the following functions:

- Input and changing parameters
- Display of operating modes, parameters and alarms
- Display and acknowledgment of faults
- Powering-up/powering-down while commissioning
- Simulation of a motorized potentiometer

3.22.1 Operation with BOP20 (Basic Operator Panel 20)

3.22.1.1 General information about the BOP20

The BOP20 can be used to switch on and switch off drives during the commissioning phase as well as to display and modify parameters. Faults can be diagnosed as well as acknowledged.

The BOP20 is snapped onto the Control Unit. To do this, the blanking cover must be removed (for additional information on mounting, please refer to the SINAMICS S120 Manual Control Units and Supplementary System Components).

Displays and keys

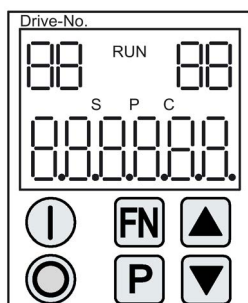

Image 3-99 Overview of displays and keys

Information on the displays

Table 3- 28 LED

Display	Meaning
top left 2 positions	The active drive object of the BOP is displayed here. The displays and key operations always refer to this drive object.
RUN	Lit if at least one drive in the drive line-up is in the RUN state (in operation). RUN is also displayed via bit r0899.2 of the drive.
top right 2 positions	The following is displayed in this field: <ul style="list-style-type: none"> • More than 6 digits: Characters that are still present but are invisible (e.g. "r2" → 2 characters to the right are invisible, "L1" → 1 character to the left is invisible) • Faults: Selects/displays other drives with faults • Designation of BICO inputs (bi, ci) • Designation of BICO outputs (bo, co) • Source object of a BICO interconnection to a drive object different than the active one.
S	Is (bright) if at least one parameter was changed and the value was not transferred into the non-volatile memory.
P	Is lit (bright) if, for a parameter, the value only becomes effective after pressing the P key.
C	Is light (bright) if at least one parameter was changed and the calculation for consistent data management has still not been initiated.
Below, 6 digit	Displays, e.g. parameters, indices, faults and alarms.

Information on the keys

Table 3- 29 Keys

Key	Name	Meaning
	ON	Powering up the drives for which the command "ON/OFF1" should come from the BOP. Binector output r0019.0 is set using this key.
	OFF	Powering down the drives for which the commands "ON/OFF1", "OFF2" or "OFF3" should come from the BOP. The binector outputs r0019.0, .1 and .2 are simultaneously reset when this key is pressed. After the key has been released, binector outputs r0019.1 and .2 are again set to a "1" signal. Note: The effectiveness of these keys can be defined by appropriately parameterizing the BICO (e.g. using these keys it is possible to simultaneously control all of the existing drives).
	Functions	The significance of this key depends on the actual display. Note: The effectiveness of this key to acknowledge faults can be defined using the appropriate BiCo parameterization.
	Parameter	The significance of this key depends on the actual display. If this key is pressed for 3 s, the "Copy RAM to ROM" function is executed. The "S" displayed on the BOP disappears.
	Raise	The significance of these keys is dependent on the actual display and is used to increase or decrease values.
	Lower	

BOP20 functions

Table 3- 30 Functions

Name	Description
Backlighting	The backlighting can be set using p0007 in such a way that it switches itself off automatically after the set time if no actions are carried out.
Changeover active drive	From the BOP perspective the active drive is defined using p0008 or using the keys "FN" and "Arrow up".
Units	The units are not displayed on the BOP.
Access level	The access level for the BOP is defined using p0003. The higher the access level, the more parameters can be selected using the BOP.
Parameter filter	Using the parameter filter in p0004, the available parameters can be filtered corresponding to their particular function.
Selecting the operating display	Actual values and setpoints are displayed on the operating display. The operating display can be set using p0006.
User parameter list	Using the user parameter list in p0013, parameters can be selected for access.

Name	Description
Unplug while voltage is present	<p>The BOP can be withdrawn and inserted under voltage.</p> <ul style="list-style-type: none"> • The ON key and OFF key have a function. <p>When withdrawing, the drives are stopped.</p> <p>After inserting, the drives must be switched on again.</p> <ul style="list-style-type: none"> • The ON key and OFF key have no function. <p>Withdrawing and inserting has no effect on the drives.</p>
Actuating keys	<p>The following applies to the "P" and "FN" keys:</p> <ul style="list-style-type: none"> • When used in a combination with another key, "P" or "FN" must be pressed first and then the other key.

Overview of important parameters (see SINAMICS S120/S150 List Manual)

All drive objects

- p0005[0...1] BOP status display selection
- p0006 BOP status display mode
- p0013[0...49] BOP user-defined list
- p0971 Save drive object parameters

Drive object, Control Unit

- r0002 Control Unit status display
- p0003 BOP access level
- p0004 BOP display filter
- p0007 BOP backlighting
- p0008 BOP drive object after powering up
- p0009 Device commissioning parameter filter
- p0011 BOP password input (p0013)
- p0012 BOP password confirmation (p0013)
- r0019.0...14 CO/BO: Control word, BOP
- p0977 Save all parameters

Other drive objects (e.g. SERVO, VECTOR, X_INF, TM41 etc.)

- p0010 Drive, commissioning parameter filter

3.22.1.2 Displays and using the BOP20

Features

- Status indicator
- Changing the active drive object
- Displaying/changing parameters
- Displaying/acknowledging faults and alarms
- Controlling the drive using the BOP20

Status indicator

The operating display for each drive object can be set using p0005 and p0006. Using the operating display, you can change into the parameter display or to another drive object. The following functions are possible:

- Changing the active drive object
 - Press key "FN" and "Arrow up" -> the drive object number at the top left flashes
 - Select the required drive object using the arrow keys
 - Acknowledge using the "P" key
- Parameter display
 - Press the "P" key.
 - The required parameters can be selected using the arrow keys.
 - Press the "FN" key -> "r00000" is displayed
 - Press the "P" key -> changes back to the operating display

Parameter display

The parameters are selected in the BOP20 using the number. The parameter display is reached from the operating display by pressing the "P" key. Parameters can be searched for using the arrow keys. The parameter value is displayed by pressing the "P" key again. You can toggle between the drive objects by simultaneously pressing the "FN" key and an arrow key. You can toggle between "r00000" and the parameter that was last displayed by pressing the "FN" key in the parameter display.

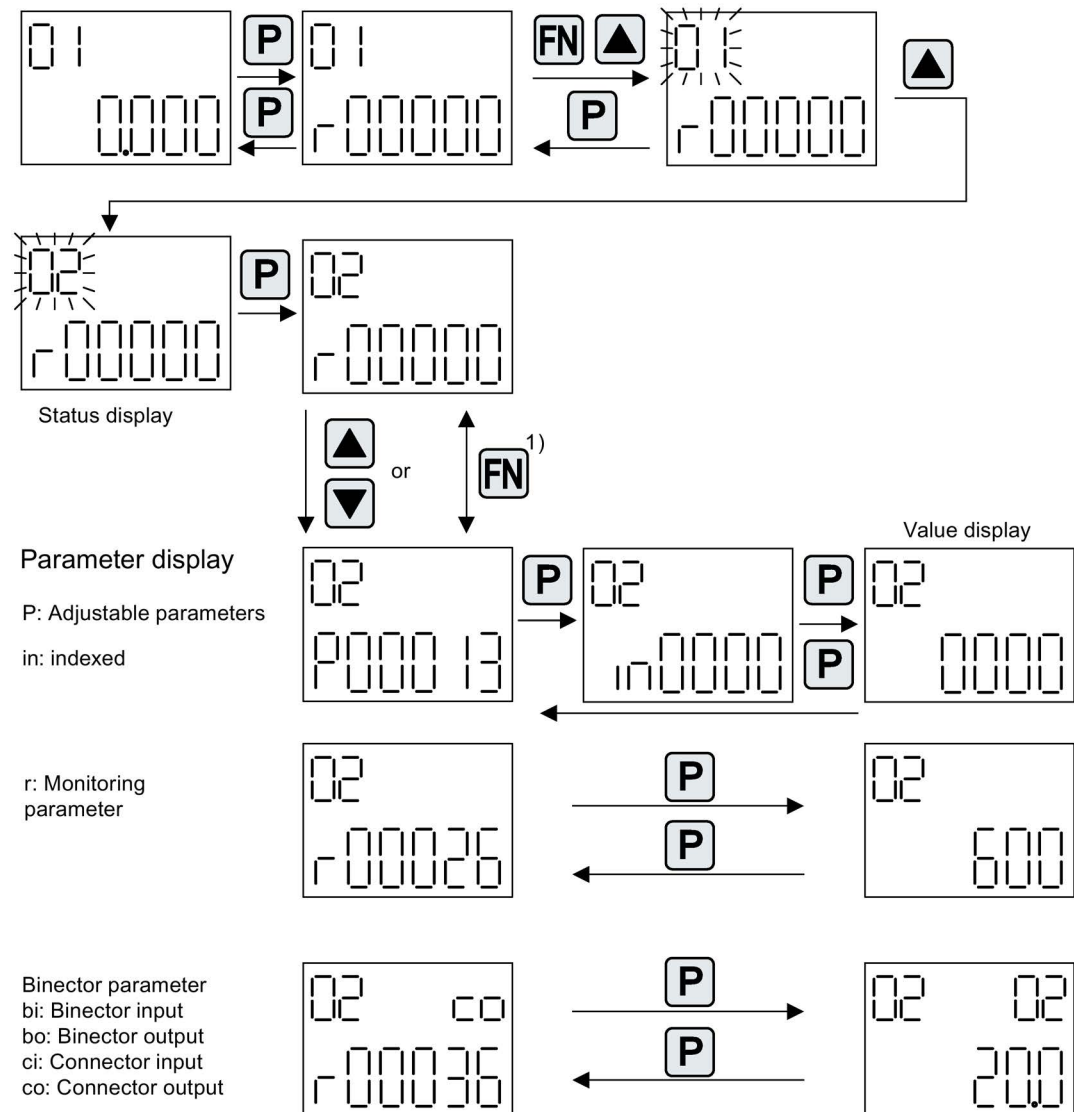

1) You can switch between "r00000" and the parameter that was last displayed by pressing the FN key in the parameter display.

Image 3-100 Parameter display

Value display

To switch from the parameter display to the value display, press the "P" key. In the value display, the values of the adjustable parameters can be increased and decreased using the arrow. The cursor can be selected using the "FN" key.

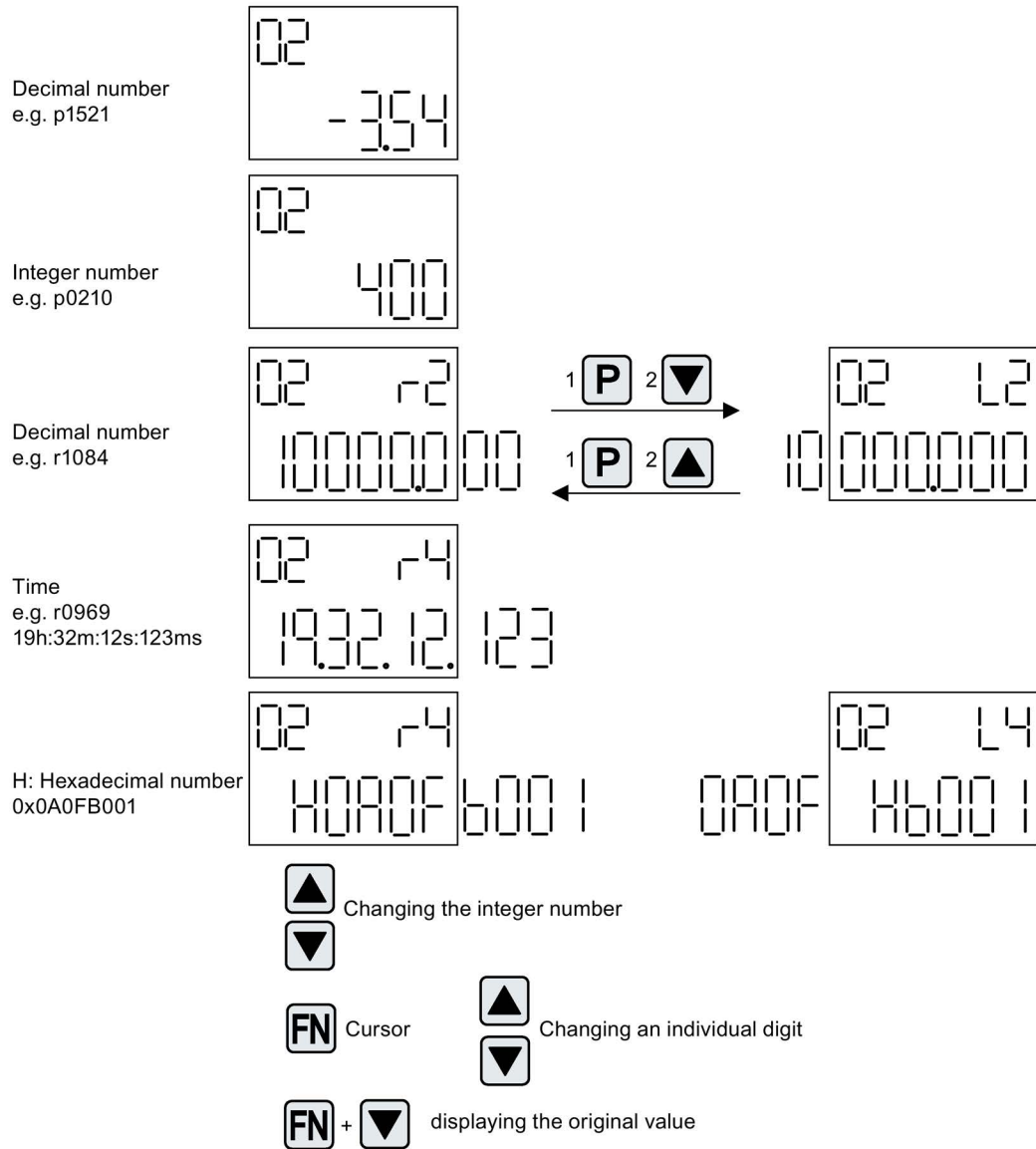

Image 3-101 Value display

Example: Changing a parameter

Precondition: The appropriate access level is set
(for this particular example, p0003 = 3).

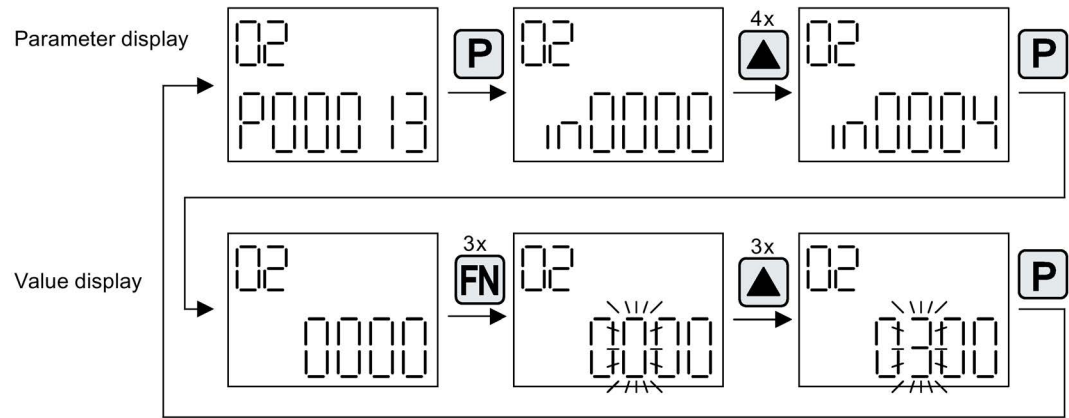

Image 3-102 Example: Changing p0013[4] from 0 to 300

Example: Changing binector and connector input parameters

For the binector input p0840[0] (OFF1) of drive object 2 binector output r0019.0 of the Control Unit (drive object 1) is interconnected.

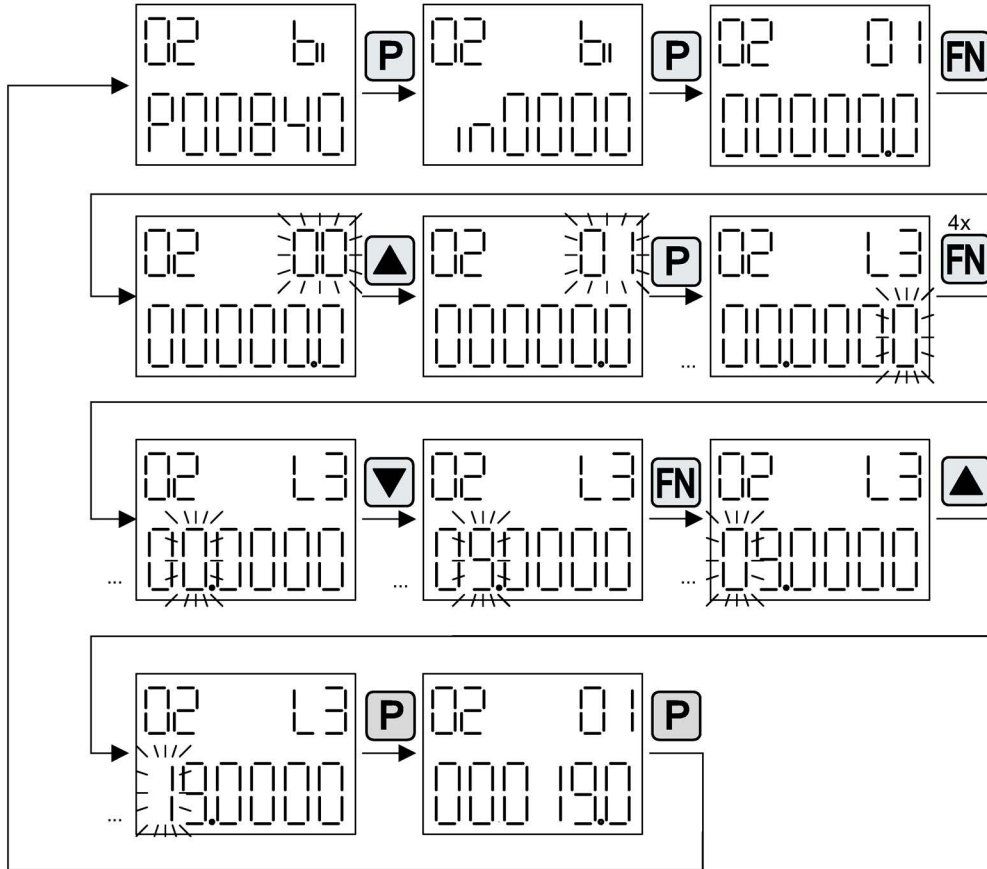

Image 3-103 Example: Changing indexed binector parameters

3.22.1.3 Fault and alarm displays

Displaying faults

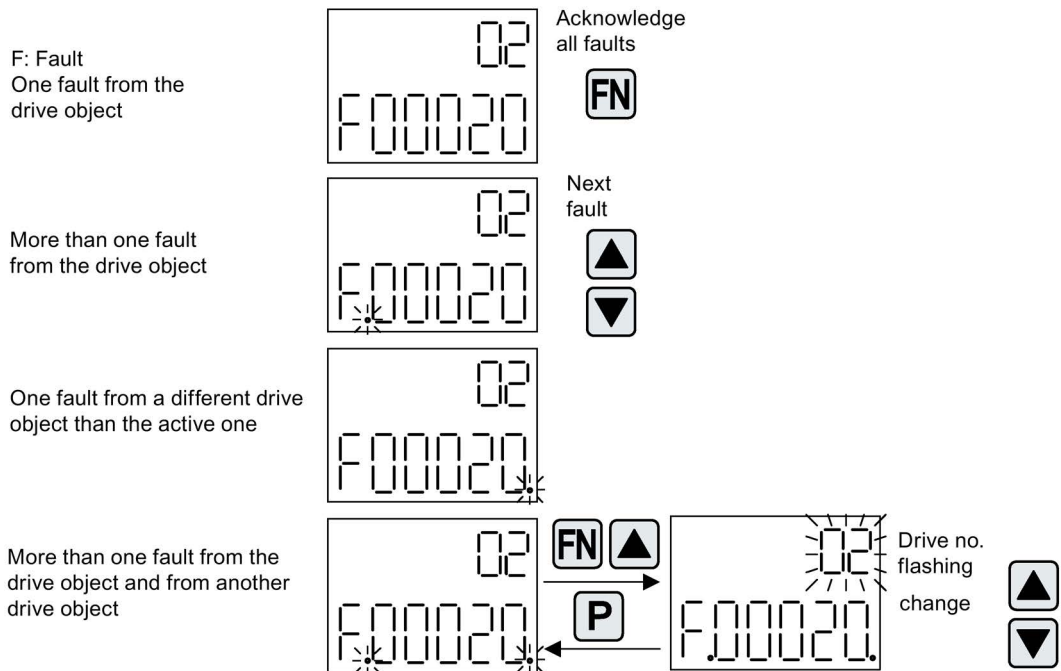

Image 3-104 Faults

Displaying alarms

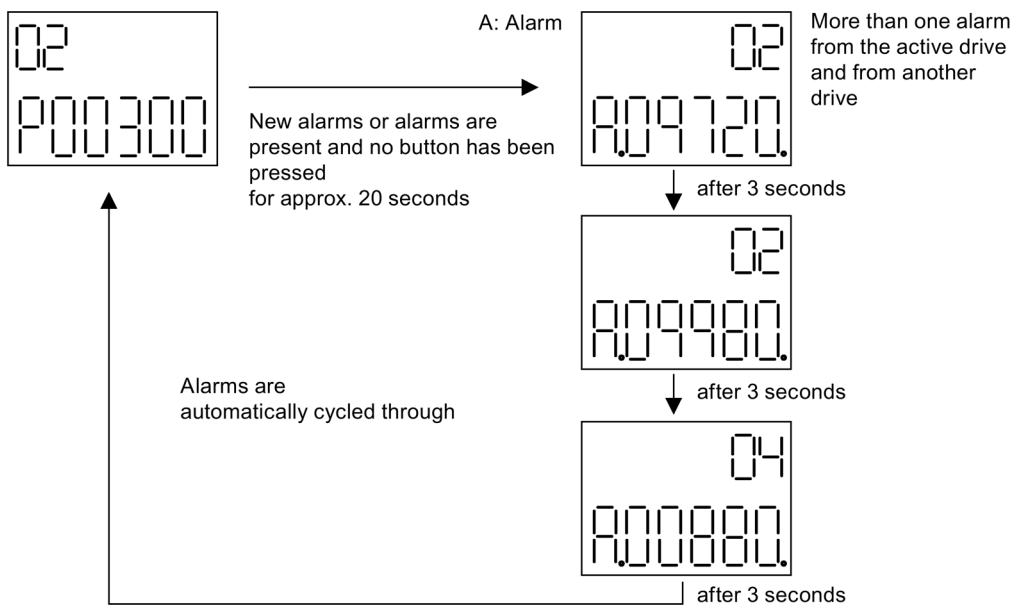

Image 3-105 Alarms

3.22.1.4 Controlling the drive using the BOP20

When commissioning the drive, it can be controlled via the BOP20. A control word is available on the Control Unit drive object (r0019) for this purpose, which can be interconnected with the appropriate binector inputs of e.g. the drive.

The interconnections do not function if a standard PROFIdrive telegram was selected as its interconnection cannot be disconnected.

Table 3- 31 BOP20 control word

Bit (r0019)	Name	Example, interconnection parameters
0	ON / OFF (OFF1)	p0840
1	No coast down/coast down (OFF2)	p0844
2	No fast stop/fast stop (OFF3)	p0848
7	Acknowledge fault (0 -> 1)	p2102
13	Motorized potentiometer, raise	p1035
14	Motorized potentiometer, lower	p1036

Note

For simple commissioning, only bit 0 should be interconnected. When interconnecting bits 0 ... 2, then the system is powered-down according to the following priority: OFF2, OFF3, OFF1.

3.22.2 Important functions via BOP20

Description

The BOP20 can be used to execute the following functions (via parameters) that help you handle your project:

- Restoring the factory settings
- Copy RAM to ROM
- Identification via LED
- Acknowledging faults

Restoring the factory settings

The factory setting of the complete device can be established in the drive object CU.

- p0009 = 30
- p0976 = 1

Copy RAM to ROM

You can initiate the saving of all parameters to the non-volatile memory (memory card) in the drive object CU:

- Press the P key for 3 seconds,
or
- p0009 = 0
- p0977 = 1

Note

This parameter is not accepted if an identification run (e.g. motor data identification) has been selected on a drive.

Identification via LED

The main component of a drive object (e.g. Motor Module) can be identified using the index of p0124. The "Ready" LED on the component starts to flash. The index matches the index in p0107. The drive object type can be identified via this parameter.

On the drive objects, the components can also be identified via the following parameters:

- p0124 Power unit detection via LED
- p0144 Voltage Sensing Module detection via LED
- p0144 Sensor Module detection via LED

Acknowledging faults

To acknowledge all the faults that have been rectified, press the Fn key.

Diagnostics

This chapter describes the following diagnostic features of the SINAMICS S drive system:

- Diagnostics via LEDs
- Diagnostics via STARTER
- Diagnostic buffer
- Diagnostics of uncommissioned axes
- Fault and alarm messages
- Encoder troubleshooting

4.1 Diagnostics via LEDs

4.1.1 Control Units

4.1.1.1 Description of the LED states of a CU320-2

The various states of the Control Units CU320-2 DP and CU320-2 PN during power-up and during operation are displayed using LEDs on the Control Unit. The duration of the individual statuses varies.

Table 4- 1 LEDs

LED	Function
RDY	Ready
DP/PN	PROFIdrive cyclic operation via PROFIBUS (DP) or PROFINET (PN)
OPT	OPTION

- If an error occurs, the booting procedure is terminated and the cause is indicated accordingly via the LEDs.
- Once the unit has successfully booted up, all the LEDs are switched off briefly.
- Once the unit has booted up, the LEDs are controlled via the loaded software.

Control Unit 320-2 DP while powering up

Table 4- 2 Load software

LED			State	Comment
RDY	DP	OPT		
Red	Orange	Orange	Reset	Hardware reset RDY LED lights up red, all other LEDs light up orange
Red	Red	Off	BIOS loaded	–
Red flashing light 2 Hz	Red	Off	BIOS error	<ul style="list-style-type: none"> • Error occurred while loading the BIOS
Red flashing light 2 Hz	Red Flashing light 2 Hz	Off	File error	<ul style="list-style-type: none"> • Memory card not inserted or faulty • Software on memory card not present or corrupted
Red	Orange flashing light	Off	FW loading	RDY LED lights up red, PN LED flashes orange without fixed frequency
Red	Off	Off	FW loaded	–

LED			State	Comment
RDY	DP	OPT		
Off	Red	Off	FW checked (no CRC error)	–
Red flashing light 0.5 Hz	Red flashing light 0.5 Hz	Off	FW checked (CRC error)	• CRC invalid

Table 4- 3 Firmware

LED			State	Comment
RDY	DP	OPT		
Orange	Off	Off	Initializing	–
Alternating			Running	See the table below

Control Unit 320-2 DP in operation

Table 4- 4 Control Unit CU320-2 DP – Description of the LEDs after booting

LED	Color	State	Description, cause	Remedy
RDY (READY)	–	OFF	Electronic power supply is missing or outside permissible tolerance range.	Check power supply
	Green	Continuous light	The component is ready for operation and cyclic DRIVE-CLiQ communication is taking place.	–
		Flashing light 0.5 Hz	Commissioning/reset	–
		Flashing light 2 Hz	Writing to the memory card	–
	Red	Flashing light 2 Hz	General errors	Check parameterization / configuration data
	Red/ green	Flashing light 0.5 Hz	Control Unit is ready for operation. However, there are no software licenses.	Obtain licenses
	Orange	Flashing light 0.5 Hz	Updating the firmware of the DRIVE-CLiQ components	–
		Flashing light 2 Hz	DRIVE-CLiQ component firmware update complete. Wait for POWER ON for the components in question.	Turn POWER ON for the components in question

4.1 Diagnostics via LEDs

LED	Color	State	Description, cause	Remedy
	Green/ orange or red/ orange	Flashing light 2 Hz	Component detection via LED is activated (p0124[0]). Note: Both options depend on the LED status when component recognition is activated via p0124[0] = 1.	–
DP PROFIdrive cyclic operation	–	Off	Cyclic communication has not (yet) taken place. Note: PROFIdrive is ready for communication when the Control Unit is ready (see LED RDY).	–
	Green	Continuous light	Cyclic communication is taking place.	–
		Flashing light 0.5 Hz	Full cyclic communication has not yet taken place. Possible causes: <ul style="list-style-type: none"> • The controller is not transferring any setpoints. • During isochronous operation, no global control (GC) or a faulty global control (GC) is transferred by the controller. 	–
	Red	Flashing light 0.5 Hz	PROFIBUS master is sending wrong parameterization/configuration data	Adapt configuration between master/controller and CU
		Flashing light 2 Hz	Cyclic bus communication has been interrupted or could not be established	Remedy fault
OPT (OPTION)	–	Off	Electronic power supply is missing or outside permissible tolerance range. Component is not ready. Option board not installed or no associated drive object has been created.	Check power supply and/or component
	Green	Continuous light	Option board is ready.	–
		Flashing light 0.5 Hz	Depends on the option board used.	–
	Red	Flashing light 2 Hz	This component has at least one fault. The Option Board is not ready (e.g. after switching on).	Remedy and acknowledge fault
RDY and DP	Red	Flashing light 2 Hz	Bus error - communication has been interrupted	Remedy fault
RDY and OPT	Orange	Flashing light 0.5 Hz	Firmware update in progress for connected Option Board CBE20	–

Control Unit 320-2 PN while powering up

Table 4- 5 Load software

LED			Status	Comment
RDY	PN	OPT		
Red	Orange	Orange	Reset	Hardware reset RDY LED lights up red, all other LEDs light up orange
Red	Red	Off	BIOS loaded	–
Red flashing light 2 Hz	Red	Off	BIOS error	<ul style="list-style-type: none"> Error occurred while loading the BIOS
Red flashing light 2 Hz	Red flashing light 2 Hz	Off	File error	<ul style="list-style-type: none"> Memory card not inserted or faulty Software on memory card not present or corrupted
Red	Orange flashing light	Off	FW loading	RDY LED lights up red, PN LED flashes orange without fixed frequency
Red	Off	Off	FW loaded	–
Off	Red	Off	FW checked (no CRC error)	–
Red flashing light 0.5 Hz	Red flashing light 0.5 Hz	Off	FW checked (CRC error)	<ul style="list-style-type: none"> CRC invalid

Table 4- 6 Firmware

LED			Status	Comment
RDY	PN	OPT		
Orange	Off	Off	Initializing	–
Alternating			Running	See the table below

Control Unit 320-2 PN in operation

Table 4- 7 Control Unit CU320-2 PN – Description of the LEDs after booting

LED	Color	State	Description, cause	Remedy
RDY (READY)	–	OFF	The electronics power supply is missing or outside the permissible tolerance range.	Check power supply
	Green	Continuous light	The component is ready for operation and cyclic DRIVE-CLiQ communication is taking place.	–
		Flashing light 0.5 Hz	Commissioning/reset	–
		Flashing light 2 Hz	Writing to the memory card	–
	Red	Flashing light 2 Hz	General fault	Check parameterization / configuration
	Red/ green	Flashing light 0.5 Hz	Control Unit is ready for operation. However, there are no software licenses.	Obtain licenses
	Orange	Flashing light 0.5 Hz	Updating the firmware of the DRIVE-CLiQ components.	–
		Flashing light 2 Hz	DRIVE-CLiQ component firmware update complete. Wait for POWER ON for the components in question.	Turn POWER ON for the components in question
	Green/ orange or red/ orange	Flashing light 2 Hz	Component detection via LED is activated (p0124[0]). Note: Both options depend on the LED status when component recognition is activated via p0124[0] = 1.	–
	PN PROFIdrive cyclic operation	–	Off	Cyclic communication has not (yet) taken place. Note: PROFIdrive is ready for communication when the Control Unit is ready (see LED RDY).
Green		Continuous light	Cyclic communication is taking place.	–
		Flashing light 0.5 Hz	Full cyclic communication has not yet taken place. Possible causes: <ul style="list-style-type: none">• The controller is not transferring any setpoints.• During isochronous operation, no global control (GC) or a faulty global control (GC) is transferred by the controller.• "Shared Device" is selected (p8929=2) and only one controller connected.	–

LED	Color	State	Description, cause	Remedy
	Red	Flashing light 0.5 Hz	Bus fault, incorrect parameter assignment/configuration.	Adapt configuration between controller and devices
		Flashing light 2 Hz	Cyclic bus communication has been interrupted or could not be established.	Remove the fault
OPT (OPTION)	–	Off	The electronics power supply is missing or outside the permissible tolerance range. Component is not ready. Option board not installed or no associated drive object has been created.	Check power supply and/or component
	Green	Continu- ous light	Option board is ready.	–
		Flashing light 0.5 Hz	Depends on the option board used.	–
	Red	Flashing light 2 Hz	This component has at least one fault. The Option Board is not ready (e.g. after switching on).	Remove the fault and acknowledge
RDY and DP	Red	Flashing light 2 Hz	Bus fault - communication has been interrupted.	Remove the fault
RDY and OPT	Orange	Flashing light 0.5 Hz	Firmware update in progress for connected Option Board CBE20.	–

4.1.1.2 Description of the LED states of a CU310-2

There are four LEDs on the front panel of the CU310-2 DP housing.

Table 4- 8 LEDs

RDY	Ready
COM	Option Board
OUT > 5V	Encoder current supply > 5 V (TTL/HTL)
MOD	Operating mode (reserved)

The various LEDs are switched either on or off as the Control Unit powers up (depending on the phase that the system is currently in). When switched on, the color of the LEDs shows the status of the corresponding power-up phase.

In the event of a fault, power up will be ended in the corresponding phase. The LEDs that are switched on retain their colors so that the fault can be determined on the basis of the combination of the color LEDs that are lit and unlit.

All the LEDs go out briefly if the CU310-2 DP has powered up without fault. The system is ready for operation when the LED "RDY" is permanently green.

All the LEDs are controlled by the loaded software during operation.

Control Unit 310-2 DP while powering up

Table 4- 9 Load software

LED				State	Comment
RDY	COM	OUT > 5V	MOD		
Orange	Orange	Orange	Orange	POWER ON	All LEDs light up for approx. 1 s
Red	Red	Off	Off	Hardware reset	After pressing the RESET button the LEDs light up for approx. 1 s
Red	Red	Off	Off	BIOS loaded	-
Red Flashing light 2 Hz	Red	Off	Off	BIOS error	Fault occurred while loading the BIOS
Red Flashing light 2 Hz	Red Flashing light 2 Hz	Off	Off	File error	Memory card not inserted or faulty
					Software on memory card not present or corrupted

Table 4- 10 Firmware

LED				State	Comment
RDY	COM	OUT > 5V	MOD		
Red	Orange	Off	Off	Firmware loading	COM-LED flashing without specific flashing frequency
Red	Off	Off	Off	Firmware loaded	-
Off	Red	Off	Off	Firmware check (no CRC error)	-
Red Flashing light 0.5 Hz	Red Flashing light 0.5 Hz	Off	Off	Firmware check (CRC error)	CRC is incorrect
Orange	Off	Off	Off	Firmware initialization	-

Control Unit 310-2 DP in operation

Table 4- 11 Description of the LEDs during operation of the CU310-2 DP

LED	Color	State	Description / cause	Remedy
RDY (READY)	-	Off	Electronic power supply is missing or outside permissible tolerance range.	Check the power supply
	Green	Continuous light	The unit is ready for operation. Cyclic DRIVE-CLiQ communication is in progress.	-
		Flashing light 0.5 Hz	Commissioning/reset	-

LED	Color	State	Description / cause	Remedy
		Flashing light 2 Hz	Writing to the memory card.	-
	Red	Flashing light 2 Hz	General errors	Check parameter assignment/configuration
	Red/green	Flashing light 0.5 Hz	The control unit is ready for operation, but there are no software licenses.	Install the missing licenses.
	Orange	Flashing light 0.5 Hz	Updating the firmware of the DRIVE-CLiQ components.	-
		Flashing light 2 Hz	DRIVE-CLiQ component firmware update completed. Waiting for POWER ON of the corresponding components.	Switch on the component.
	Green / orange or red / orange	Flashing light 2 Hz	Detection of the component via LED is activated (p0124[0]). Note: Both options depend on the LED status when module recognition is activated via p0124[0] = 1.	-
COM	-	Off	Cyclic communication is not (yet) running. Note: The PROFIdrive is ready for communication when the Control Unit is ready for operation (see LED: RDY).	-
	Green	Continuous light	Cyclic communication is taking place.	-
		Flashing light 0.5 Hz	Cyclic communication is not yet fully up and running. Possible causes: - The controller is not transmitting any setpoints. - In isochronous mode, the controller is not sending a GC (Global Control) or it is sending a defective GC	-
	Red	Flashing light 0.5 Hz	The PROFIBUS master is sending a faulty parameter assignment or the configuration file is corrupted.	Modify the configuration between the master/controller and the Control unit.
Flashing light 2 Hz		Cyclic bus communication has been interrupted or could not be established.	Rectify the fault in bus communication.	
MOD	-	Off	-	-
OUT > 5 V	-	Off	-	-
	Orange	Continuous light	The voltage of the electronics power supply for the measuring system is 24 V.	

Control Unit 310-2 PN while powering up

Table 4- 12 Load software

LED				State	Comment
RDY	COM	OUT>5V	MOD		
Orange	Orange	Orange	Orange	POWER ON	All LEDs light up for approx. 1 s
Red	Red	Off	Off	Hardware reset	After pressing the RESET button the LEDs light up for approx. 1 s
Red	Red	Off	Off	BIOS loaded	-
Red Flashing light 2 Hz	Red	Off	Off	BIOS error	Error occurred while loading the BIOS
Red Flashing light 2 Hz	Red Flashing light 2 Hz	Off	Off	File error	Memory card not inserted or faulty Software on memory card not present or corrupted

Table 4- 13 Firmware

LED				State	Comment
RDY	COM	OUT>5V	MOD		
Red	Orange	Off	Off	Firmware loading	COM-LED flashing without specific flashing frequency
Red	Off	Off	Off	Firmware loaded	-
Off	Red	Off	Off	Firmware check (no CRC error)	-
Red Flashing light 0.5 Hz	Red Flashing light 0.5 Hz	Off	Off	Firmware check (CRC error)	CRC is incorrect
Orange	Off	Off	Off	Firmware initialization	-

Control Unit 310-2 PN in operation

Table 4- 14 Description of the LEDs during operation of the CU310-2 PN

LED	Color	State	Description / cause	Remedy
RDY (READY)	-	Off	Electronic power supply is missing or outside permissible tolerance range.	Check the power supply
	Green	Continuous light	The unit is ready for operation. Cyclic DRIVE-CLiQ communication is in progress.	-
		Flashing light 0.5 Hz	Commissioning/reset	-
		Flashing light 2 Hz	Writing to the memory card.	-

LED	Color	State	Description / cause	Remedy
	Red	Flashing light 2 Hz	General errors	Check parameter assignment/ configuration
	Red/green	Flashing light 0.5 Hz	The control unit is ready for operation, but there are no software licenses.	Install the missing licenses.
	Orange	Flashing light 0.5 Hz	Updating the firmware of the DRIVE-CLiQ components.	-
		Flashing light 2 Hz	DRIVE-CLiQ component firmware update completed. Waiting for POWER ON of the corresponding components.	Switch on the component.
	Green / orange or red / orange	Flashing light 2 Hz	Component detection via LED is activated (p0124[0]). Note: Both options depend on the LED status when component recognition is activated via p0124[0] = 1.	-
COM	-	Off	Cyclic communication has not (yet) taken place. Note: PROFIdrive is ready for communication when the Control Unit is ready (see LED: RDY).	-
	Green	Continuous light	Cyclic communication is taking place.	-
		Flashing light 0.5 Hz	Full cyclic communication is not yet taking place. Possible causes: <ul style="list-style-type: none"> The controller is not transferring any set-points. During isochronous operation, the controller is transmitting no GC (Global Control) or a faulty GC. 	-
	Red	Flashing light 0.5 Hz	The PROFIBUS master is sending a faulty parameter assignment or the configuration file is corrupted.	Modify the configuration between the master/controller and the Control unit.
Flashing light 2 Hz		Cyclic bus communication has been interrupted or could not be established.	Rectify the fault in bus communication.	
MOD	-	Off	-	-
OUT > 5 V	-	Off	-	-
	Orange	Continuous light	The voltage of the electronics power supply for the measuring system is 24 V.	

4.1.2 Power units

4.1.2.1 Safety instructions for diagnostic LEDs of the power units

 WARNING
<p>Danger to life if the fundamental safety instructions and residual risks are not carefully observed</p> <p>The non-observance of the fundamental safety instructions and residual risks stated in Chapter 1 can result in accidents with severe injuries or death.</p> <ul style="list-style-type: none"> • Adhere to the fundamental safety instructions. • When assessing the risk, take into account residual risks.

 WARNING
<p>Danger to life when live parts of the DC link are touched</p> <p>Irrespective of the status of the "DC LINK" LED, hazardous DC link voltages can be present. This means that the touching of live parts can result in death or serious injury.</p> <ul style="list-style-type: none"> • Observe the warning information on the component.

4.1.2.2 Active Line Module booksize

Table 4- 15 Meaning of the LEDs on the Active Line Module

State		Description, cause	Remedy
Ready	DC link		
Off	Off	Electronic power supply is missing or outside permissible tolerance range.	–
Green	Off	The component is ready for operation and cyclic DRIVE-CLiQ communication is taking place.	–
	Orange	The component is ready for operation and cyclic DRIVE-CLiQ communication is taking place. The DC link voltage is present.	–
	Red	The component is ready for operation and cyclic DRIVE-CLiQ communication is taking place. The DC link voltage is too high.	Check the line voltage
Orange	Orange	DRIVE-CLiQ communication is being established.	–
Red	–	At least one fault is present in this component. Note: LED is controlled irrespective of the corresponding messages being reconfigured.	Remedy and acknowledge fault

State		Description, cause	Remedy
Ready	DC link		
Green / red flashing light 0.5 Hz	–	Firmware is being downloaded.	–
Green / red flashing light 2 Hz	–	Firmware download is complete. Wait for POWER ON.	Carry out a POWER ON
Green / orange or Red / orange	–	Component detection via LED is activated (p0124). Note: Both options depend on the LED status when module recognition is activated via p0124 = 1.	–

4.1.2.3 Basic Line Module booksize

Table 4- 16 Meaning of the LEDs on the Basic Line Module

State		Description, cause	Remedy
Ready	DC link		
Off	Off	Electronic power supply is missing or outside permissible tolerance range.	–
Green	Off	The component is ready for operation and cyclic DRIVE-CLiQ communication is taking place.	–
	Orange	The component is ready for operation and cyclic DRIVE-CLiQ communication is taking place. The DC link voltage is present.	–
	Red	The component is ready for operation and cyclic DRIVE-CLiQ communication is taking place. The DC link voltage is too high.	Check the line voltage.
Orange	Orange	DRIVE-CLiQ communication is being established.	–
Red	–	At least one fault is present in this component. Note: LED is controlled irrespective of the corresponding messages being reconfigured.	Remedy and acknowledge fault.
Green / red flashing light 0.5 Hz	–	Firmware is being downloaded.	–
Green / red flashing light 2 Hz	–	Firmware download is complete. Wait for POWER ON.	Carry out a POWER ON
Green / orange or Red / orange flashing light	–	Component detection via LED is activated (p0124). Note: Both options depend on the LED status when module recognition is activated via p0124 = 1.	–

4.1.2.4 Smart Line Modules booksize 5 kW and 10 kW

Table 4- 17 Meaning of the LEDs at the Smart Line Modules 5 kW and 10 kW

LED	Color	State	Description, cause	Remedy
READY	–	Off	Electronic power supply is missing or outside permissible tolerance range.	–
	Green	Continuous light	Component is ready to operate.	–
	Yellow	Continuous light	Pre-charging not completed. Bypass relay dropped out EP terminals not supplied with 24 VDC.	–
	Red	Continuous light	Overtemperature Overcurrent	Diagnose fault (via output terminals) and acknowledge it (via input terminal)
DC LINK	–	Off	Electronic power supply is missing or outside permissible tolerance range.	–
	Yellow	Continuous light	DC link voltage within permissible tolerance range.	–
	Red	Continuous light	DC link voltage outside permissible tolerance range. Line supply fault.	Check the line voltage.

4.1.2.5 Smart Line Modules booksize 16 kW to 55 kW

Table 4- 18 Meaning of the LEDs at the Smart Line Modules ≥ 16 kW

State		Description, cause	Remedy
Ready	DC link		
Off	Off	Electronic power supply is missing or outside permissible tolerance range.	–
Green	Off	The component is ready for operation and cyclic DRIVE-CLiQ communication is taking place.	–
	Orange	The component is ready for operation and cyclic DRIVE-CLiQ communication is taking place. The DC link voltage is present.	–
	Red	The component is ready for operation and cyclic DRIVE-CLiQ communication is taking place. The DC link voltage is too high.	Check the line voltage
Orange	Orange	DRIVE-CLiQ communication is being established.	–
Red	–	At least one fault is present in this component. Note: LED is controlled irrespective of the corresponding messages being reconfigured.	Remedy and acknowledge fault
Green / red flashing light 0.5 Hz	–	Firmware is being downloaded.	–

State		Description, cause	Remedy
Ready	DC link		
Green / red flashing light 2 Hz	–	Firmware download is complete. Wait for POWER ON.	Carry out a POWER ON
Green / orange or Red / orange flashing light	–	Component detection via LED is activated (p0124). Note: Both options depend on the LED status when module recognition is activated via p0124 = 1.	–

4.1.2.6 Single Motor Module / Double Motor Module / Power Module

Table 4- 19 Meaning of the LEDs on the Motor Module

State		Description, cause	Remedy
Ready	DC link		
Off	Off	Electronic power supply is missing or outside permissible tolerance range.	–
Green	Off	The component is ready for operation and cyclic DRIVE-CLiQ communication is taking place.	–
	Orange	The component is ready for operation and cyclic DRIVE-CLiQ communication is taking place. The DC link voltage is present.	–
	Red	The component is ready for operation and cyclic DRIVE-CLiQ communication is taking place. The DC link voltage is too high.	Check the line voltage
Orange	Orange	DRIVE-CLiQ communication is being established.	–
Red	–	At least one fault is present in this component. Note: LED is controlled irrespective of the corresponding messages being reconfigured.	Remedy and acknowledge fault
Green / red flashing light 0.5 Hz	–	Firmware is being downloaded.	–
Green / red flashing light 2 Hz	–	Firmware download is complete. Wait for POWER ON.	Carry out a POWER ON
Green / orange or Red / orange	–	Component detection via LED is activated (p0124). Note: Both options depend on the LED status when module recognition is activated via p0124 = 1.	–

4.1.2.7 Braking Module in booksize format

Table 4- 20 Meaning of the LEDs on the Braking Module booksize

LED	Color	State	Description, cause	Remedy
READY	–	Off	Electronic power supply is missing or outside permissible tolerance range. Component deactivated via terminal.	–
	Green	Continuous light	Component is ready to operate.	–
	Red	Continuous light	Enable signal missing (input terminal) Overtemperature Overcurrent trip I ² t monitoring responded Ground fault/short circuit Note: In the event of an overtemperature, the error cannot be acknowledged until after a cooling down time.	Diagnose fault (via output terminals) and acknowledge it (via input terminal)
DC LINK	–	Off	There is no DC link voltage or the electronic power supply is missing or outside permissible tolerance range. Component not active.	–
	Green	Flashing light	Component active (DC link discharge via braking resistor in progress).	–

4.1.2.8 Smart Line Module booksize compact format

Table 4- 21 Meaning of the LEDs on the Smart Line Module booksize compact

State		Description, cause	Remedy
RDY	DC LINK		
Off	Off	Electronic power supply is missing or outside permissible tolerance range.	–
Green	–	The component is ready for operation and cyclic DRIVE-CLiQ communication is taking place.	–
	Orange	The component is ready for operation and cyclic DRIVE-CLiQ communication is taking place. The DC link voltage is present.	–
	Red	The component is ready for operation and cyclic DRIVE-CLiQ communication is taking place. The DC link voltage is too high.	Check the line voltage
Orange	Orange	DRIVE-CLiQ communication is being established.	–
Red	–	At least one fault is present in this component. Note: LED is controlled irrespective of the corresponding messages being reconfigured.	Remedy and acknowledge fault
Green/red (0.5 Hz)	–	Firmware is being downloaded.	–

State		Description, cause	Remedy
RDY	DC LINK		
Green/red (2 Hz)	–	Firmware download is complete. Wait for POWER ON.	Carry out a POWER ON
Green/ orange or red/ orange	–	Identifying whether the component is activated using the LED (p0124) Note: Both options depend on the LED status when module recognition is activated via p0124 = 1.	–

4.1.2.9 Motor Module booksize compact format

Table 4- 22 Meaning of the LEDs on the Motor Module booksize compact

Status		Description, cause	Remedy
RDY	DC LINK		
Off	Off	The electronics power supply is missing or outside the permissible tolerance range.	–
Green	–	The component is ready for operation. Cyclic DRIVE-CLiQ communication is taking place.	–
	Orange	The component is ready for operation. Cyclic DRIVE-CLiQ communication is taking place. The DC link voltage is present.	–
	Red	The component is ready for operation. Cyclic DRIVE-CLiQ communication is taking place. The DC link voltage is outside the permissible tolerance range.	Check the line supply voltage.
Orange	Orange	DRIVE-CLiQ communication is being established.	–
Red	–	This component has at least one fault. Note: The LED is activated regardless of whether the corresponding messages have been reconfigured.	Resolve and acknowledge the fault.
Green/red (0.5 Hz)	–	Firmware is being downloaded.	–
Green/red (2 Hz)	–	Firmware download has been completed. The system waits for POWER ON.	Carry out a POWER ON.
Green/ orange or red/orange	–	Component recognition via LED is activated ¹⁾ . Note: Both options depend on the LED status when component recognition is activated using the parameter.	–

¹⁾ See SINAMICS S120/S150 List Manual for the parameters to activate the recognition of components via LED

4.1.2.10 Control Interface Module in the Active Line Module chassis format

Table 4- 23 Meaning of the LEDs "READY" and "DC LINK" on the Control Interface Module in the Active Line Module

LED, state		Description
Ready	DC link	
Off	Off	The electronic power supply is missing or lies outside the permissible tolerance range.
Green	Off	The component is ready for operation and cyclic DRIVE-CLiQ communication is taking place.
	Orange	The component is ready for operation and cyclic DRIVE-CLiQ communication is taking place. The DC link voltage is present.
	Red	The component is ready for operation and cyclic DRIVE-CLiQ communication is taking place. The DC link voltage is too high.
Orange	Orange	DRIVE-CLiQ communication is being established.
Red	---	At least one fault is present in this component. Note: LED is activated irrespective of any reconfiguring of the corresponding messages.
Green / red flashing light 0.5 Hz	---	Firmware is being downloaded.
Green / red flashing light 2 Hz	---	Firmware download is complete. Wait for POWER ON.
Green / orange or red / orange flashing light 2 Hz	---	Component detection using LED is activated (p0124). Note: Both options depend on the LED state when module recognition is activated via p0124 = 1.

Table 4- 24 Meaning of the LED "POWER OK" on the Control Interface Module in the Active Line Module

LED	Color	State	Description
POWER OK	Green	Off	DC link voltage < 100 V and voltage at -X9:1/2 less than 12 V.
		On	The component is ready for operation.
		Flashing light	There is a fault. If the LED continues to flash after you have performed a POWER ON, please contact your Siemens service center.

4.1.2.11 Control Interface Module in the Basic Line Module chassis format

Table 4- 25 Meaning of the LEDs "Ready" and "DC Link" on the Control Interface Module in the Basic Line Module

LED, state		Description
Ready	DC link	
Off	Off	The electronic power supply is missing or lies outside the permissible tolerance range.
Green	Off	The component is ready for operation and cyclic DRIVE-CLiQ communication is taking place.
	Orange	The component is ready for operation and cyclic DRIVE-CLiQ communication is taking place. The DC link voltage is present.
	Red	The component is ready for operation and cyclic DRIVE-CLiQ communication is taking place. The DC link voltage is too high.
Orange	Orange	DRIVE-CLiQ communication is being established.
Red	---	At least one fault is present in this component. Note: LED is activated irrespective of any reconfiguring of the corresponding messages.
Green / red flashing light 0.5 Hz	---	Firmware is being downloaded.
Green / red flashing light 2 Hz	---	Firmware download is complete. Wait for POWER ON.
Green / orange or red / orange flashing light 2 Hz	---	Component detection using LED is activated (p0124). Note: Both options depend on the LED state when module recognition is activated via p0124 = 1.

Table 4- 26 Meaning of the LED "POWER OK" on the Control Interface Module in the Basic Line Module

LED	Color	State	Description
POWER OK	Green	Off	DC link voltage < 100 V and voltage at -X9:1/2 less than 12 V.
		On	The component is ready for operation.
		Flashing light	There is a fault. If the LED continues to flash after you have performed a POWER ON, please contact your Siemens service center.

4.1.2.12 Control Interface Module in the Smart Line Module chassis format

Table 4- 27 Meaning of the LEDs "READY" and "DC LINK" on the Control Interface Module in the Smart Line Module

LED, state		Description
READY	DC LINK	
Off	Off	The electronic power supply is missing or lies outside the permissible tolerance range.
Green	Off	The component is ready for operation and cyclic DRIVE-CLiQ communication is taking place.
	Orange	The component is ready for operation and cyclic DRIVE-CLiQ communication is taking place. The DC link voltage is present.
	Red	The component is ready for operation and cyclic DRIVE-CLiQ communication is taking place. The DC link voltage is too high.
Orange	Orange	DRIVE-CLiQ communication is being established.
Red	---	At least one fault is present in this component. Note: LED is activated irrespective of any reconfiguring of the corresponding messages.
Flashing light 0.5 Hz: Green / red	---	Firmware is being downloaded.
Flashing light 2 Hz: Green / red	---	Firmware download is complete. Wait for POWER ON.
Flashing light 2 Hz: Green / orange or red / orange	---	Component detection using LED is activated (p0124). Note: Both options depend on the LED state when module recognition is activated via p0124 = 1.

Table 4- 28 Meaning of the LED "POWER OK" on the Control Interface Module in the Smart Line Module

LED	Color	State	Description
POWER OK	Green	Off	DC link voltage < 100 V and voltage at -X9:1/2 less than 12 V.
		On	The component is ready for operation.
		Flashing light	There is a fault. If the LED continues to flash after you have performed a POWER ON, please contact your Siemens service center.

4.1.2.13 Control Interface Module in the Motor Module chassis format

Table 4- 29 Meaning of the LEDs "Ready" and "DC Link" on the Control Interface Module in the Motor Module

LED, state		Description
Ready	DC link	
Off	Off	The electronic power supply is missing or lies outside the permissible tolerance range.
Green	Off	The component is ready for operation and cyclic DRIVE-CLiQ communication is taking place.
	Orange	The component is ready for operation and cyclic DRIVE-CLiQ communication is taking place. The DC link voltage is present.
	Red	The component is ready for operation and cyclic DRIVE-CLiQ communication is taking place. The DC link voltage is too high.
Orange	Orange	DRIVE-CLiQ communication is being established.
Red	---	At least one fault is present in this component. Note: LED is activated irrespective of any reconfiguring of the corresponding messages.
Green / red flashing light 0.5 Hz	---	Firmware is being downloaded.
Green / red flashing light 2 Hz	---	Firmware download is complete. Wait for POWER ON.
Green / orange or red / orange flashing light 2 Hz	---	Component detection using LED is activated (p0124). Note: Both options depend on the LED status when module recognition is activated via p0124 = 1.

Table 4- 30 Meaning of the LED "POWER OK" on the Control Interface Module in the Motor Module

LED	Color	State	Description
POWER OK	Green	Off	DC link voltage < 100 V and voltage at -X9:1/2 less than 12 V.
		On	The component is ready for operation.
		Flashing light	There is a fault. If the LED continues to flash after you have performed a POWER ON, please contact your Siemens service center.

4.1.2.14 Control Interface Module in the Power Module chassis format

Table 4- 31 Meaning of the LEDs "READY" and "DC LINK" on the Control Interface Module in the Power Module

LED, state		Description
READY	DC LINK	
Off	Off	The electronic power supply is missing or lies outside the permissible tolerance range.
Green	Off	The component is ready for operation and cyclic DRIVE-CLiQ communication is taking place.
	Orange	The component is ready for operation and cyclic DRIVE-CLiQ communication is taking place. The DC link voltage is present.
	Red	The component is ready for operation and cyclic DRIVE-CLiQ communication is taking place. The DC link voltage is too high.
Orange	Orange	DRIVE-CLiQ communication is being established.
Red	---	At least one fault is present in this component. Note: LED is controlled irrespective of the corresponding messages being reconfigured.
Flashing light 0.5 Hz: Green / red	---	Firmware is being downloaded.
Flashing light 2 Hz: Green / red	---	Firmware download is complete. Wait for POWER ON.
Flashing light 2 Hz: Green / orange or red / orange	---	Component detection using LED is activated (p0124). Note: Both options depend on the LED status when module recognition is activated via p0124 = 1.

Table 4- 32 Meaning of the LED "POWER OK" on the Control Interface Module in the Power Module

LED	Color	State	Description
POWER OK	Green	Off	DC link voltage < 100 V and voltage at -X9:1/2 less than 12 V.
		On	The component is ready for operation.
		Flashing light	There is a fault. If the LED continues to flash after you have performed a POWER ON, please contact your Siemens service center.

4.1.3 Additional modules

4.1.3.1 Control Supply Module

Table 4- 33 Control Supply Module – description of the LEDs

LED	Color	State	Description, cause	Remedy
READY	–	off	Electronic power supply is missing or outside permissible tolerance range.	–
	Green	Continuous light	Component is ready to operate.	–
DC LINK	–	off	Electronic power supply is missing or outside permissible tolerance range.	–
	Orange	Continuous light	DC link voltage within permissible tolerance range.	–
	Red	Continuous light	DC link voltage outside permissible tolerance range.	–

4.1.3.2 Sensor Module Cabinet SMC10 / SMC20

Table 4- 34 Sensor Module Cabinet 10/20 (SMC10/SMC20) – description of the LEDs

LED	Color	State	Description, cause	Remedy	
RDY READY	–	off	Electronic power supply is missing or outside permissible tolerance range.	–	
	Green	Continuous light	The component is ready for operation and cyclic DRIVE-CLiQ communication is taking place.	–	
	Orange	Continuous light	DRIVE-CLiQ communication is being established.	–	
	Red	Continuous light	At least one fault is present in this component. Note: LED is controlled irrespective of the corresponding messages being reconfigured.	Remedy and acknowledge fault	
	Green/red	Flashing light 0.5 Hz	Flashing light 0.5 Hz	Firmware is being downloaded.	–
			Flashing light 2 Hz	Firmware download is complete. Wait for POWER ON	Carry out a POWER ON
	Green/orange or Red/orange	Flashing light	Component recognition via LED is activated (p0144). Note: Both options depend on the LED status when module recognition is activated via p0144 = 1.	–	

4.1.3.3 Sensor Module Cabinet SMC30

Table 4- 35 Meaning of LEDs on the Sensor Module Cabinet SMC30

LED	Color	Status	Description, cause	Remedy
RDY READY	–	Off	The electronics power supply is missing or outside the permissible tolerance range.	–
	Green	Continuous light	The component is ready for operation. Cyclic DRIVE-CLiQ communication is taking place.	–
	Orange	Continuous light	DRIVE-CLiQ communication is being established.	–
	Red	Continuous light	This component has at least one fault. Note: LED is controlled irrespective of the corresponding messages being reconfigured.	Remedy and acknowledge fault
	Green/red	Flashing light 0.5 Hz	Firmware is being downloaded.	–
	Green/red	Flashing light 2 Hz	Firmware download is complete. The system waits for POWER ON.	Carry out a POWER ON
	Green/orange or Red/orange	Flashing light	Component recognition via LED is activated ¹⁾ . Note: Both options depend on the LED status when component recognition is activated.	–
OUT > 5 V	–	Off	The electronic power supply is missing or outside permissible tolerance range. Power supply ≤ 5 V.	–
	Orange	Continuous light	The electronics power supply for the encoder system is available. Power supply > 5 V	–

1) The parameters for activating component recognition using LEDs can be taken from the following reference:
Reference: /LH1/ SINAMICS S120/S150 List Manual

4.1.3.4 Sensor Module Cabinet SMC40

Table 4- 36 Meaning of the LEDs on the Sensor Module Cabinet-Mounted SMC40

LED	Color	Status	Description, cause	Remedy
RDY READY	–	Off	The electronics power supply is missing or outside the permissible tolerance range.	–
	Green	Continuous light	The component is ready for operation. Cyclic DRIVE-CLiQ communication is taking place.	–
	Orange	Continuous light	DRIVE-CLiQ communication is being established.	–
	Red	Continuous light	This component has at least one fault. Note: LED is controlled irrespective of the corresponding messages being reconfigured.	Remove and acknowledge the fault.

LED	Color	Status	Description, cause	Remedy
	Green/red	Flashing light 2 Hz	Firmware download is complete. The system waits for POWER ON.	Carry out a POWER ON.
	Green/ orange or Red/ orange	Flashing light	Component recognition via LED is activated ¹⁾ . Note: Both options depend on the LED status when component recognition is activated.	–

1) The parameter for activating component recognition can be taken from the following reference:
Reference: /LH1/ SINAMICS S120/S150 List Manual

Each channel has a multifunction LED.

4.1.3.5 Communication Board CBC10 for CANopen

Table 4- 37 Meaning of the LEDs on the Communication Board CAN CBC10

LED	Color	State	Description, cause	Remedy
OPT on the Control Unit	–	Off	Electronic power supply is missing or outside permissible tolerance range. Communication Board either defective or not inserted.	–
	Green	LED ON	OPERATIONAL	–
		LED Blinking	PREOPERATIONAL No PDO communication possible	–
		LED Single flash	STOPPED Only NMT communication possible	–
	Red	LED ON	BUS OFF	Check baud rate Check cabling
		LED Single flash	ERROR PASSIVE MODE The error counter for "error passive" has reached the value 127. After the SINAMICS drive system was booted no further active CAN component was on the bus.	Check baud rate Check cabling
		LED Double flash	Error Control Event, a Guard Event has occurred	Check connection to CANopen master

4.1.3.6 Communication Board Ethernet CBE20

Meaning of the LEDs on the CBE20 Communication Board Ethernet

Table 4- 38 Meaning of the LEDs at ports 1 to 4 of the X1400 interface

LED	Color	Status	Description
Link port	–	Off	The electronics power supply is missing or outside the permissible tolerance range (link missing or defective).
	Green	Continuous light	A different device is connected to port x and a physical connection exists.
Activity port	–	Off	The electronics power supply is missing or outside the permissible tolerance range (no activity).
	Yellow	Flashing light	Data is being received or sent at port x.

Table 4- 39 Meaning of the Sync and Fault LEDs on the CBE20

LED	Color	Status	Description
Fault	–	Off	If the link port LED is green: The CBE20 is operating normally, data is being exchanged with the configured IO Controller.
	Red	Flashing light	<ul style="list-style-type: none"> The response monitoring interval has elapsed. Communications is interrupted. The IP address is incorrect. Incorrect or no configuration. Incorrect parameter settings. Incorrect or missing device name. IO Controller not connected/switched off, although an Ethernet connection has been established. Other CBE20 faults
		Continuous light	CBE20 fault error <ul style="list-style-type: none"> No physical connection to a subnet/switch. Incorrect transmission rate Full duplex transmission is not activated.
Sync	–	Off	If the link port LED is green: The Control Unit task system is not synchronized with the IRT clock. An internal substitute clock is generated.
	Green	Flashing light	The Control Unit task system has synchronized with the IRT clock and data is being exchanged.
		Continuous light	The Task system and the MC-PLL have synchronized with the IRT clock.

Table 4- 40 Meaning of the OPT LED on the Control Unit

LED	Color	Status	Description, cause	Remedy
OPT	–	OFF	The electronics power supply is missing or outside the permissible tolerance range. CBE20 either defective or not inserted.	–
	Green	Continuous light	CBE20 is ready and cyclic communication is taking place.	–
		Flashing light 0.5 Hz	CBE20 is ready but cyclic communication is not running. Possible causes: <ul style="list-style-type: none"> • Communication is being established. • At least one fault is present. 	–
	Red	Continuous light	Cyclic communication via PROFINET has not yet been established. However, non-cyclic communications are possible. SINAMICS is waiting for a parameterization/configuration telegram.	–
		Flashing light 0.5 Hz	The firmware update into the CBE20 has been completed with an error. Possible causes: <ul style="list-style-type: none"> • The memory card for the control unit is defective. • The CBE20 is defective. In this state CBE20 cannot be used.	–
		Flashing light 2 Hz	There is a communications error between the Control Unit and the CBE20. Possible causes: <ul style="list-style-type: none"> • The CBE20 was withdrawn after booting. • The CBE20 is defective. 	Correctly insert the board, if required, replace.
	Orange	Flashing light 0.5 Hz	Firmware of the CBE20 currently being updated.	–

4.1.3.7 Communication Board Ethernet CBE25

Meaning of the LEDs on the Communication Board Ethernet CBE25

Table 4- 41 Meaning of the LEDs on Ethernet ports 1-2

LED	Color	State	Description
Link port	–	Off	Electronics power supply is missing or outside the permissible tolerance range (link missing or defective).
	Green	Continuous light	A different device is connected to port x and a physical connection exists.
Activity port	–	Off	Electronics power supply is missing or outside the permissible tolerance range (no activity).
	Yellow	Flashing light	Data is being received or sent at port x.

Table 4- 42 Meaning of the Bus Sync/PN Sync and Bus Fault on the CBE25

LED	Color	State	Description
Bus Fault	–	Off	If the link port LED is green: The CBE25 is operating normally, data is being exchanged with the configured IO Controller.
	Red	Flashing light	<ul style="list-style-type: none"> The response monitoring interval has elapsed. Communications is interrupted. The IP address is incorrect. Incorrect or no configuration. Incorrect parameter settings. Incorrect or missing device name. IO Controller not connected/switched off, although an Ethernet connection has been established. Other CBE25 errors
		Continuous light	CBE25 bus fault <ul style="list-style-type: none"> No physical connection to a subnet/switch. Incorrect transmission rate Full duplex transmission is not activated.
Bus Sync/PN Sync	–	Off	If the link port LED is green: The Control Unit task system is not synchronized with the IRT clock. An internal substitute clock is generated.
	Green	Flashing light	The Control Unit task system has synchronized with the IRT clock and data is being exchanged.
		Continuous light	The Task system and the MC-PLL have synchronized with the IRT clock.

Table 4- 43 Meaning of the OPT LED on the Control Unit

LED	Color	State	Description, cause	Remedy
OPT	–	OFF	The electronics power supply is missing or outside the permissible tolerance range. Communication Board either defective or not inserted.	–
	Green	Continuous light	Communication Board is ready and cyclic communication is taking place.	–
		Flashing light 0.5 Hz	The Communication Board is ready, but cyclic communications is not running. Possible causes: <ul style="list-style-type: none"> • Communication is being established. • At least one fault is present. 	–
	Red	Continuous light	Cyclic communication via PROFINET has not yet been established. However, non-cyclic communications are possible. SINAMICS waits for a parameterizing/configuring telegram	–
		Flashing light 0.5 Hz	The firmware update into the CBE25 has been completed with an error. Possible causes: <ul style="list-style-type: none"> • The CBE25 is defective. • The memory card for the Control Unit is defective. In this state the CBE25 cannot be used.	–
		Flashing light 2 Hz	There is a communications error between the Control Unit and the CBE25. Possible causes: <ul style="list-style-type: none"> • The CBE25 is defective. • The CBE25 was withdrawn after booting. 	Correctly insert the board, if required, replace.
	Orange	Flashing light 0.5 Hz	Firmware is being updated.	–

4.1.3.8 Voltage Sensing Module VSM10

Table 4- 44 Meanings of the LEDs on the Voltage Sensing Module VSM10

LED	Color	Status	Description, cause	Remedy	
READY	–	Off	The electronics power supply is missing or outside the permissible tolerance range.	–	
	Green	Continuous light	The component is ready for operation. Cyclic DRIVE-CLiQ communication is taking place.	–	
	Orange	Continuous light	DRIVE-CLiQ communication is being established.	–	
	Red	Continuous light	This component has at least one fault. Note: LED is controlled irrespective of the corresponding messages being reconfigured.	Remove and acknowledge the fault.	
	Green/red	Flashing light 0.5 Hz	Flashing light 0.5 Hz	Firmware is being downloaded.	–
			Flashing light 2 Hz	Firmware download is complete. The system waits for POWER ON.	Carry out a POWER ON.
	Green/orange or Red/orange	Flashing light	Detection of the component via LED is activated (p0144 = 1). Note: Both options depend on the LED status when component recognition is activated.	–	

4.1.3.9 DRIVE-CLiQ Hub Module DMC20

Table 4- 45 Description of the LEDs on the DRIVE-CLiQ Hub Module DMC20

LED	Color	Status	Description, cause	Remedy	
READY	–	Off	The electronics power supply is missing or outside the permissible tolerance range.	–	
	Green	Continuous light	The component is ready for operation. Cyclic DRIVE-CLiQ communication is taking place.	–	
	Orange	Continuous light	DRIVE-CLiQ communication is being established.	–	
	Red	Continuous light	This component has at least one fault. Note: LED is controlled irrespective of the corresponding messages being reconfigured.	Remove and acknowledge the fault.	
	Green/red	Flashing light 0.5 Hz	Flashing light 0.5 Hz	Firmware is being downloaded.	–
			Flashing light 2 Hz	Firmware download is complete. The system waits for POWER ON.	Carry out a POWER ON.

LED	Color	Status	Description, cause	Remedy
	Green/ orange or Red/ orange	Flashing light	Component recognition via LED is activated (p0154 = 1). Note: Both options depend on the LED status when component recognition is activated.	–

4.1.4 Terminal Module

4.1.4.1 Terminal Module TM15

Table 4- 46 Meanings of the LEDs on the Terminal Module TM15

LED	Color	Status	Description, cause	Remedy	
READY	-	Off	The electronics power supply is missing or outside the permissible tolerance range.	–	
	Green	Continuous light	The component is ready for operation. Cyclic DRIVE-CLiQ communication is taking place.	–	
	Orange	Continuous light	DRIVE-CLiQ communication is being established.	–	
	Red	Continuous light	This component has at least one fault. Note: The LED is activated irrespective of whether the corresponding messages have been reconfigured.	Remove and acknowledge the fault.	
	Green/red		Flashing light 0.5 Hz	Firmware is being downloaded.	–
			Flashing light 2 Hz	Firmware download is complete. The system waits for POWER ON.	Carry out a POWER ON.
	Green/ orange or Red/orange	Flashing light	Component recognition via LED is activated ¹⁾ . Note: Both options depend on the LED status when component recognition is activated.	–	

¹⁾ The parameters for activating component recognition using LEDs can be taken from the following reference:
Reference: /LH1/ SINAMICS S120/S150 List Manual

4.1 Diagnostics via LEDs

4.1.4.2 Terminal Module TM31

Table 4- 47 Meanings of the LEDs on the Terminal Module TM31

LED	Color	Status	Description, cause	Remedy	
READY	-	Off	The electronics power supply is missing or outside the permissible tolerance range.	-	
	Green	Continuous light	The component is ready for operation. Cyclic DRIVE-CLiQ communication is taking place.	-	
	Orange	Continuous light	DRIVE-CLiQ communication is being established.	-	
	Red	Continuous light	This component has at least one fault. Note: The LED is activated irrespective of whether the corresponding messages have been reconfigured.	Remove and acknowledge the fault.	
	Green/red	Flashing light 0.5 Hz	Flashing light 0.5 Hz	Firmware is being downloaded.	-
			Flashing light 2 Hz	Firmware download is complete. The system waits for POWER ON.	Carry out a POWER ON.
	Green/orange or Red/orange	Flashing light	Component recognition via LED is activated ¹⁾ . Note: Both options depend on the LED status when component recognition is activated.	-	

1) The parameters for activating component recognition using LEDs can be taken from the following reference:
Reference: /LH1/ SINAMICS S120/S150 List Manual

4.1.4.3 Terminal Module TM120

Table 4- 48 Meaning of the LEDs on the Terminal Module TM120

LED	Color	Status	Description, cause	Remedy	
READY	-	Off	The electronics power supply is missing or outside the permissible tolerance range.	Check the power supply.	
	Green	Continuous light	The component is ready for operation. Cyclic DRIVE-CLiQ communication is taking place.	-	
	Orange	Continuous light	DRIVE-CLiQ communication is being established.	-	
	Red	Continuous light	This component has at least one fault. Note: The LED is activated irrespective of whether the corresponding messages have been reconfigured.	Remove and acknowledge the fault.	
	Green/red	Flashing light 0.5 Hz	Flashing light 0.5 Hz	Firmware is being downloaded.	-
			Flashing light 2 Hz	Firmware download is complete. The system waits for POWER ON.	Carry out a POWER ON.

LED	Color	Status	Description, cause	Remedy
	Green/ orange or red/ orange	Flashing light 2 Hz	Component recognition via LED is activated ¹⁾ . Note: Both options depend on the LED status when component recognition is activated.	-

1) The parameters for activating component recognition using LEDs can be taken from the following reference:
Reference: /LH1/ SINAMICS S120/S150 List Manual

4.1.4.4 Terminal Module TM150

Table 4- 49 Meaning of the LEDs at the Terminal Module TM150

LED	Color	State	Description, cause	Remedy
READY	-	Off	Electronic power supply is missing or outside permissible tolerance range.	Check power supply
	Green	Continuous light	The component is ready for operation and cyclic DRIVE-CLiQ communication is taking place.	-
	Orange	Continuous light	DRIVE-CLiQ communication is being established.	-
	Red	Continuous light	This component has at least one fault. Note: LED is controlled irrespective of the corresponding messages being reconfigured.	Remedy and acknowledge fault
	Green/ Red	Flashing light 0.5 Hz	Firmware is being downloaded.	-
		Flashing light 2 Hz	Firmware has been downloaded. Wait for POWER ON.	Carry out a POWER ON
	Green/ orange or red/ orange	Flashing light 2 Hz	Component recognition via LED is activated (p0154). Note: Both options depend on the LED status when module recognition is activated via p0154 = 1.	-

4.1.4.5 Terminal Module TM41

Table 4- 50 Meaning of the LEDs on the Terminal Module TM41

LED	Color	Status	Description, cause	Remedy	
READY	-	Off	The electronics power supply is missing or outside the permissible tolerance range.	-	
	Green	Continuous light	The component is ready for operation. Cyclic DRIVE-CLiQ communication is taking place.	-	
	Orange	Continuous light	DRIVE-CLiQ communication is being established.	-	
	Red	Continuous light	This component has at least one fault. Note: The LED is activated irrespective of whether the corresponding messages have been reconfigured.	Remove and acknowledge the fault.	
	Green/red	Flashing light 0.5 Hz	Flashing light 0.5 Hz	Firmware is being downloaded.	-
			Flashing light 2 Hz	Firmware download is complete. The system waits for POWER ON.	Carry out a POWER ON.
	Green/orange or Red/orange	Flashing light	Component recognition via LED is activated ¹⁾ . Note: Both options depend on the LED status when component recognition is activated.	-	
Z pulses	-	Off	The zero mark was found and the system waits for the zero mark output. OR The component is switched off.	-	
	Red	Continuous light	The zero mark has not been released, or the zero mark search is running.	-	
	Green	Continuous light	The system stops at the zero mark.	-	
		Flashing light	The zero mark is output at each virtual revolution.	-	

¹⁾ The parameters for activating component recognition using LEDs can be taken from the following reference:
Reference: /LH1/ SINAMICS S120/S150 List Manual

4.1.4.6 Terminal Module TM54F

Table 4- 51 Meaning of the LEDs on the Terminal Module TM54F

LED	Color	Status	Description, cause	Remedy	
READY	-	Off	The electronics power supply is missing or outside the permissible tolerance range.	-	
	Green	Continuous light	The component is ready for operation, cyclic DRIVE-CLiQ communication is taking place.	-	
	Orange	Continuous light	DRIVE-CLiQ communication is being established.	-	
	Red	Continuous light	This component has at least one fault. Remark: The LED is activated irrespective of whether the corresponding messages have been reconfigured.	Remedy and acknowledge fault or safely acknowledge the fault	
	Green/red		Flashing light 0.5 Hz	Firmware is being downloaded.	-
			Flashing light 2 Hz	Firmware download is complete. Wait for POWER ON.	Carry out a POWER ON
	Green / orange or Red / orange	Flashing light 1 Hz	Component recognition via LED is activated (p0154 = 1). Remark: Both options depend on the LED status when component recognition is activated. Green / orange: Component is operating without any faults Red/orange: Component signals a fault	-	
L1+, L2+	-	Off	The controllable sensor power supply is functioning fault-free.	-	
	Red	Continuous light	There is a fault in the controllable sensor power supply.	-	
L3+	-	Off	The sensor power supply is operating fault-free.		
	Red	Continuous light	The sensor power supply has a fault.		

4.1 Diagnostics via LEDs

LED	Color		Status	Description, cause	Remedy
Fail-safe inputs / double inputs					
F_DI z (input x, (x+1)+, (x+1)-)	LED	LED			–
	x	x+1		NC contact/NC contact¹⁾: (z = 0 ... 9, x = 0, 2, ... 18)	
	–	Red	Continuous light	Different signal states at input x and x+1	
	–	–	Off	No signal at input x and no signal at input x+1	
	NC contact/NO contact¹⁾: (z = 0 ... 9, x = 0, 2, ... 18)				
	–	Red	Continuous light	Same signal states at input x and x+1	
	–	–	Off	No signal at input x and no signal at input x+1	
	LED	LED			
	x	x+1		NC contact/NC contact¹⁾: (z = 0 ... 9, x = 0, 2, ... 18)	
	Green	Green	Continuous light	One signal at input x and one signal at input x+1	
NC contact/NO contact¹⁾: (z = 0 ... 9, x = 0, 2, ... 18)					
Green	Green	Continuous light	One signal at input x and no signal at input x+1	–	
Single digital inputs, not fail-safe					
DI x	–		Off	No signal at digital input x (x = 20 ... 23)	–
	Green		Continuous light	Signal at digital input x	–
Fail-safe digital outputs with associated readback channel					
F_DO y (0+...3+, 0-...3-)	Green		Continuous light	Output y (y = 0 ... 3) has an active signal	–
Readback input DI 2y for output F_DO y (y = 0 ... 3) for test stop. The status of the LEDs also depends on the type of external circuit.					
DI 2y	–		Off	One of the two output lines y+ or y- or both lines of output y carry a signal	–
	Green		Continuous light	Both output lines y+ and y- carry no signal	–

1) Inputs x+1 (DI 1+, 3+, .. 19+) can be individually set using a parameter
 Additional information can be taken from the following reference:
 Reference: /LH1/ SINAMICS S120/S150 List Manual

4.2 Diagnostics via STARTER

The diagnostic functions support commissioning and service personnel during commissioning, troubleshooting, diagnostics and service activities.

Precondition

- Online operation of the STARTER commissioning tool.

Diagnostic functions

The following diagnostic functions are available in the STARTER commissioning tool:

- Specifying signals with the ramp-function generator
- Signal recording with the trace function
- Analyzing the control response with the measuring function
- Outputting voltage signals for external measuring devices via test sockets

4.2.1 Function generator

The function generator is part of the STARTER commissioning tool.

The ramp-function generator can be used, for example, for the following tasks:

- To measure and optimize control loops.
- To compare the dynamic response of coupled drives.
- To specify a simple traversing profile without a traversing program.

The ramp-function generator can be used to generate different signal shapes.

In the "Connector output" operating mode (r4818), the output signal can be injected into the control loop via the BICO interconnection.

For vector control, corresponding to the selected operating mode, this setpoint can also be fed into the control structure as, for example, a current setpoint, disturbing torque, or current setpoint. The impact of superimposed control loops is automatically suppressed.

Properties

- Operating modes of the ramp-function generator for SERVO and VECTOR drive types:
 - Connector output
- Operating modes of the function generator for a SERVO drive:
 - Speed setpoint downstream of filter (speed setpoint filter)
 - Speed setpoint upstream of filter (speed setpoint filter)
 - Disturbing torque (downstream of current setpoint filter)
 - Current setpoint downstream of filter (current setpoint filter)
 - Current setpoint upstream of filter (current setpoint filter)
- Connecting to each drive of the topology is possible.
- The following parameterizable signal shapes can be set:
 - Square-wave
 - Staircase
 - Triangular
 - Sinusoidal
 - PRBS (pseudo random binary signal, white noise)
- An offset is possible for each signal. The ramp-up to the offset is parameterizable. Signal generation begins after the ramp-up to the offset.
- Restriction of the output signal to the minimum and maximum value settable.

Injection points of the function generator

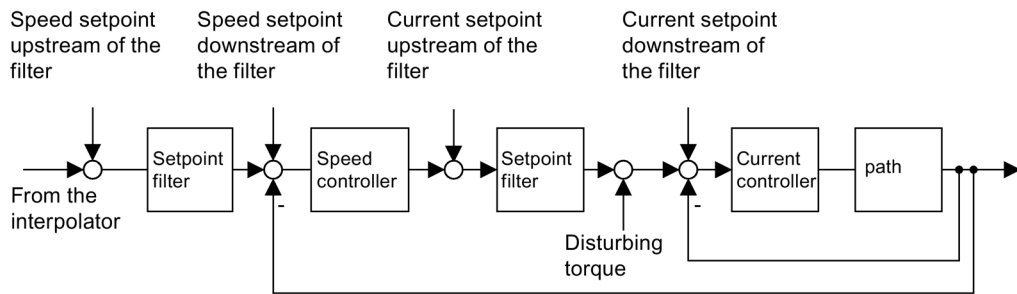

Image 4-1 Injection points of the ramp-function generator

Further signal shapes

Additional signal waveforms can be generated.

Example:

The "triangular" signal form can be parameterized with "upper limitation" to produce a triangle with no peak.

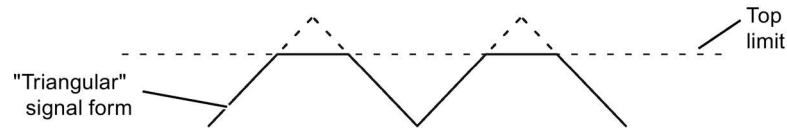

Image 4-2 "Triangular" signal without peak

Parameterizing and operating the ramp-function generator

You operate and parameterize the function generator using the STARTER commissioning tool.

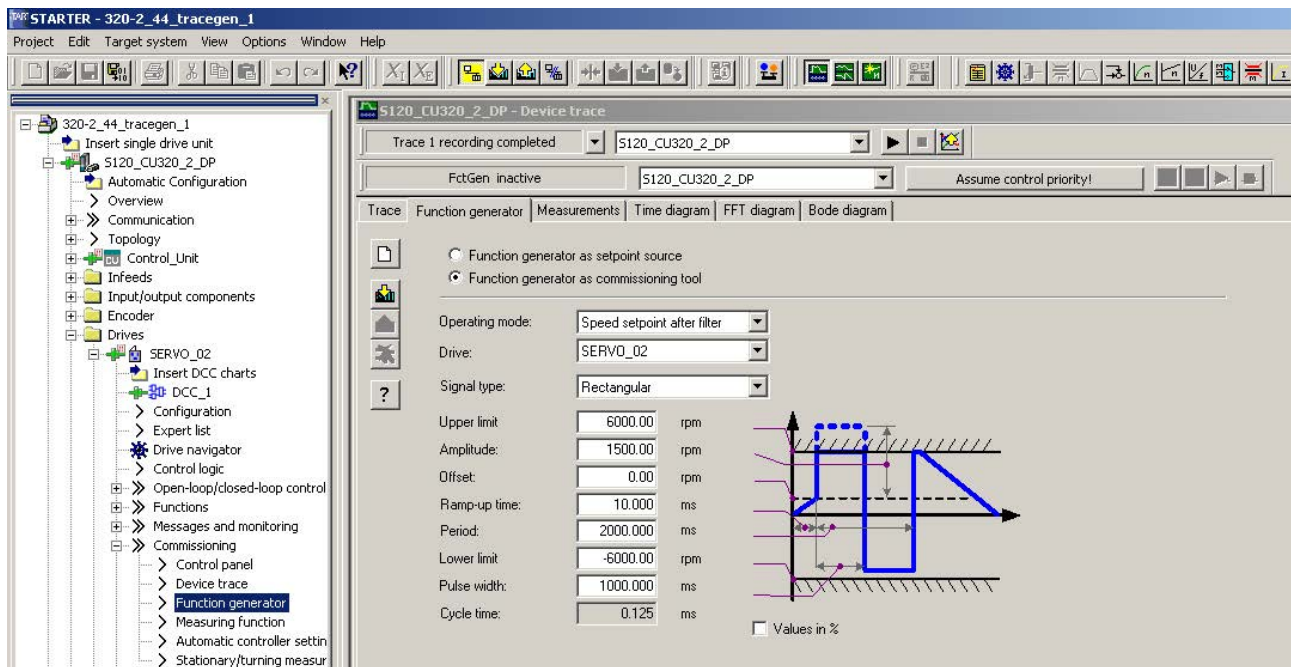

Image 4-3 Function generator

Note

Please refer to the online help for more information about parameterizing and operation.

Starting/stopping the ramp-function generator



NOTICE

Damage to property due to unexpected movements while the function generator is active

Some monitoring functions are deactivated when the function generator is activated. Incorrect parameterization of the function generator can result in unexpected movements of the motor, which damage the machine.

- Do not leave the machine unattended while the function generator is active.
- Ensure that the parameter assignments are correct.

Start function generator:

1. Load the function generator.
 - Click on the symbol .
 - or
 - In the project navigator, double-click on "Drives" > "Drive_xy" > "Commissioning" > "Function generator".
2. Select "Function generator as a commissioning tool".
3. Select an operating mode e.g. "Speed setpoint after filter".
4. Select a drive, for instance "SERVO_02".
5. Set a signal shape, for example, "Squarewave".
6. Click the "Assume control priority!" button.
7. For "Sign of life monitoring" click on the "Accept" button. (the control priority button then changes to yellow).
8. Click on the symbol  "Drive on".
9. Start the function generator by clicking on the triangle next to the red zero ("Start FctGen" button).
10. Carefully read the "Caution" note and confirm with "Yes".
 - The drive starts and executes the selected trace function.
 - Trace recordings are now possible.

Stopping the function generator:

1. Click on the "Stop FctGen" button.
 - Or
2. Click on the symbol  "Drive off" in order to stop the drive.

Parameterization

The "Function generator" parameter screen is selected with the  symbol in the toolbar of the STARTER commissioning tool.

4.2.2 Trace function

4.2.2.1 Single trace

You can use the trace function to record measured values over a defined period, depending on trigger conditions. Alternatively, the measured values can also be recorded using immediate recording.

In the STARTER commissioning tool you can parameterize the trace function by using the "Trace" parameterizing screen form.

Calling the "Trace" parameterizing screen form

1. In the STARTER commissioning tool, click the symbol  (device trace-function generator).

The "Trace" parameterizing screen form is then displayed. Example:

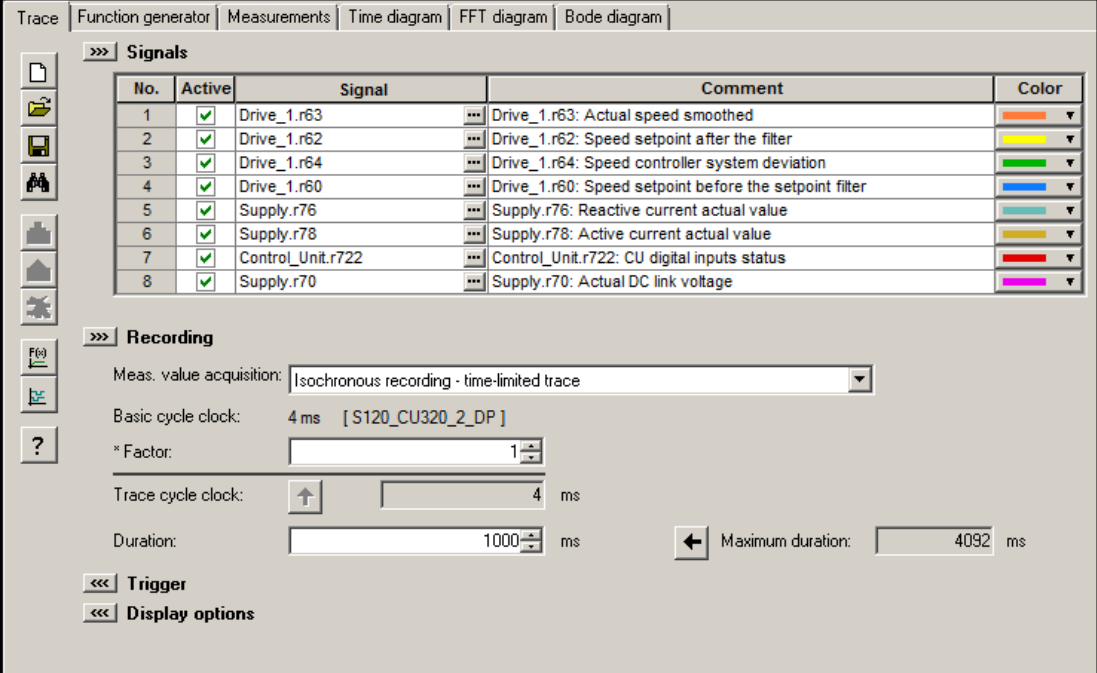

The screenshot displays the 'Trace' parameterizing screen form. It features a tabbed interface with 'Trace' selected. The main area is divided into sections: 'Signals', 'Recording', 'Trigger', and 'Display options'.

Signals Table:

No.	Active	Signal	Comment	Color
1	<input checked="" type="checkbox"/>	Drive_1.r63	Drive_1.r63: Actual speed smoothed	
2	<input checked="" type="checkbox"/>	Drive_1.r62	Drive_1.r62: Speed setpoint after the filter	
3	<input checked="" type="checkbox"/>	Drive_1.r64	Drive_1.r64: Speed controller system deviation	
4	<input checked="" type="checkbox"/>	Drive_1.r60	Drive_1.r60: Speed setpoint before the setpoint filter	
5	<input checked="" type="checkbox"/>	Supply.r76	Supply.r76: Reactive current actual value	
6	<input checked="" type="checkbox"/>	Supply.r78	Supply.r78: Active current actual value	
7	<input checked="" type="checkbox"/>	Control_Unit.r722	Control_Unit.r722: CU digital inputs status	
8	<input checked="" type="checkbox"/>	Supply.r70	Supply.r70: Actual DC link voltage	

Recording Section:

- Meas. value acquisition: Isochronous recording - time-limited trace
- Basic cycle clock: 4 ms [S120_CU320_2_DP]
- * Factor: 1
- Trace cycle clock: 4 ms
- Duration: 1000 ms
- Maximum duration: 4092 ms

Buttons: <<< Trigger, <<< Display options

Image 4-4 Trace function

Parameterizing and using the trace function

Note

Detailed information on how to parameterize and operate the trace function is available in the STARTER online help in Chapter "Trace, measuring functions and automatic controller setting".

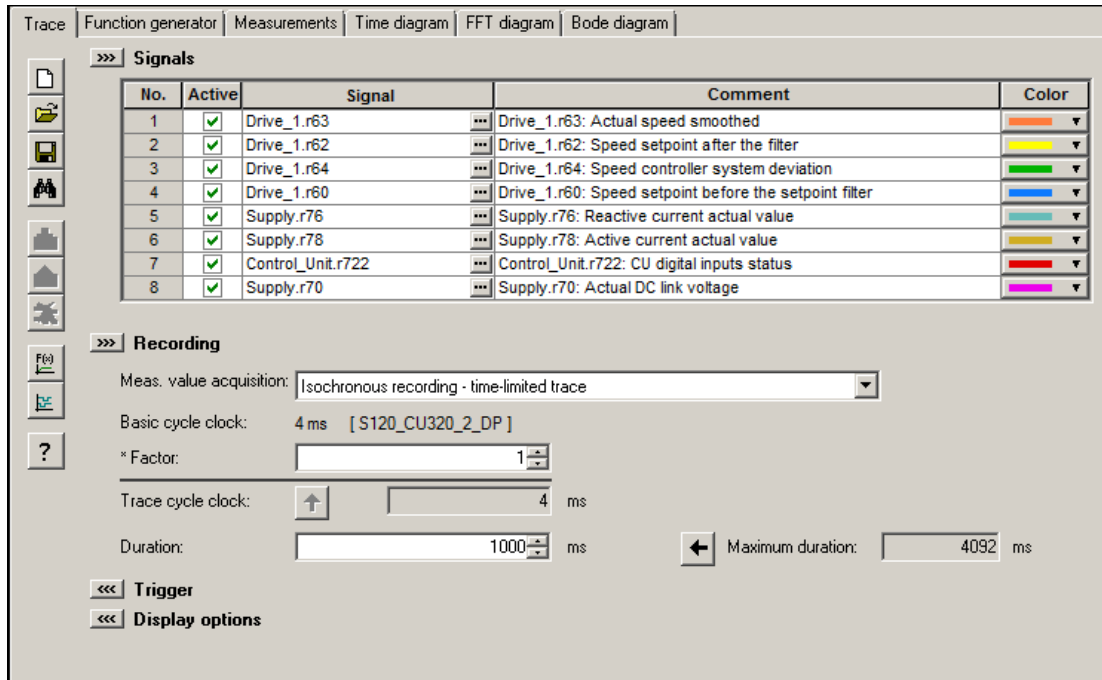

Image 4-5 Trace function

The unit cycle time display flashes 3 times at around 1 Hz when the time slice is changed from < 4 ms to ≥ 4 ms (see description under "Properties"). The display also flashes in the inverse direction from ≥ 4 ms to < 4 ms.

Properties

- Two independent traces per Control Unit
- Up to 8 recording channels for each trace
When more than 4 channels per single trace are used, the trace's device clock cycle is switched automatically from 0.125 ms (0.250 ms for vector control) to 4 ms. As a consequence, the performance of the SINAMICS S120 is not influenced too strongly by the trace function.
- Single trace:
Device clock cycles of the SINAMICS S120 trace
Up to 4 channels: 0.125 ms (servo control)/0.250 ms (vector control)
≥ 5 channels: 4 ms (servo control/vector control)
The specified trace cycles can be increased.
- Endless trace:
The parameter data is written to the memory until it is full. Additional parameter data is then lost.
A ring buffer can be selected in order to avoid this. When the ring buffer is activated, then the STARTER commissioning tool automatically starts again from the beginning to write to the trace memory after the last trace parameter was saved.
Device cycle of the SINAMICS S120 trace for an endless trace:
 - Up to 4 channels: 2 ms (servo control/vector control)
 - ≥ 5 channels: 4 ms (servo control/vector control)
The specified trace cycles can be increased.
If the 4 ms time slice is not available, then the next higher time slice is selected.
- Triggering
 - Without triggering (recording immediately after start)
 - Triggering on signal with edge or on level
- STARTER commissioning tool
 - Automatic or adjustable scaling of display axes
 - Signal measurement via cursor
- Adjustable trace cycle: Integer multiples of the basic sampling time

4.2.2.2 Multiple trace

A multiple trace consists of individual, completed consecutive traces. Using multiple tracing on a card, it is possible to cyclically record (a specific number) traces with the same trace configuration (number of channels, sample depth, recording cycle,...), and to save these traces persistently on the drive memory card.

The functions "endless trace", "individual trace" and "multiple-trace" cannot be used at the same time. With a correspondingly incorrect configuration, alarm "A02097" is output. However, a multiple trace with a cycle of 1 is nothing more than a single trace with saved measurement results.

Note

Shorter service life of memory cards as a result of multiple traces

The service life of the cards can be shortened by the multiple traces because the memory media is subject to wear as a result of the write access operations from a technical point of view.

Note

The performance of the complete system can be negatively influenced by a continuous multiple trace.

Precondition

A multiple trace is only possible if the memory card is plugged in and not blocked. In this case, alarm "A02098 MTrace: cannot be saved" is output with alarm value "1".

Activating a multiple trace

Note

The multiple trace can be activated or set separately for each trace recorder.

- In STARTER, click the symbol  (device trace-function generator).
The "Trace" parameterizing screen form is then displayed.

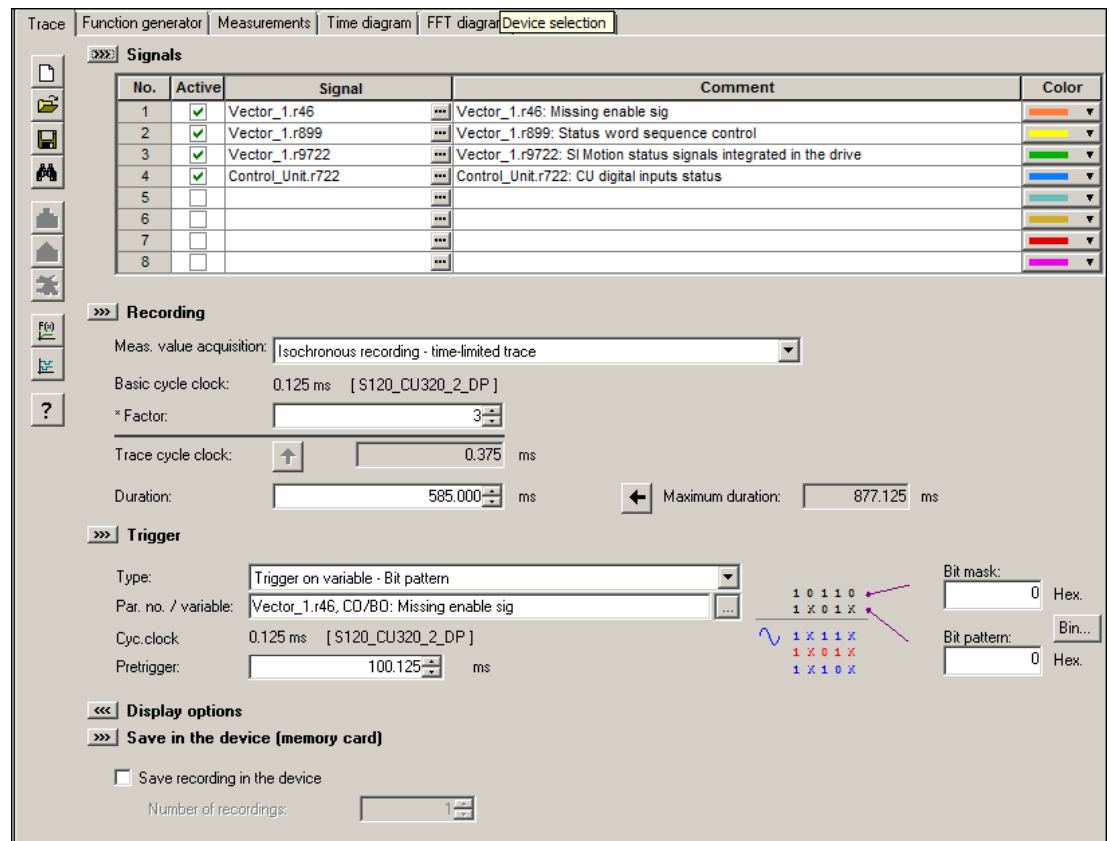

Image 4-6 Multiple trace in STARTER

- Activate the "Save the recording in the device" option.
- Enter the number of cycles in the "Number of recordings" field.

Note

Detailed information on how to parameterize and operate the trace function is available in the STARTER online help in Chapter "Trace, measuring functions and automatic controller setting".

- Make the required trace settings and save the settings.

Sequence of multiple trace

1. A multiple trace is started just like a conventional single trace using the STARTER "Trace" screen form.
2. The multiple trace component saves the measurement result after the trigger condition has occurred and the trace data has been completely recorded.
3. The single trace that has actually been completed is now automatically restarted from the multiple trace component. In this case, the same trace configuration (trigger condition, recording cycle, etc.) is used as before. The trace buffer of the previous single trace is emptied in the process.

Trace status

The status of the multiple trace is displayed in the screen form (red frame):

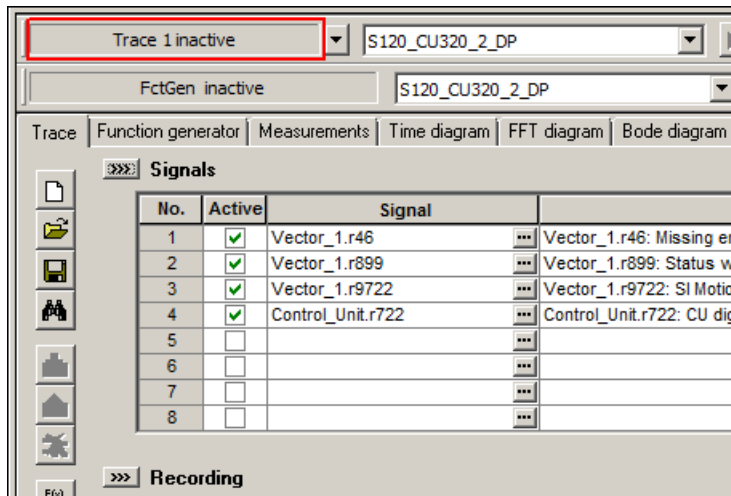

Image 4-7 Trace status in STARTER

4.2.2.3 Startup trace

A startup trace basically consists of a conventional single trace with all of its configuration options (number of channels, sampling depth, recording cycle, etc.). With the appropriate configuration, a startup trace is automatically active after a drive restarts.

Configure startup trace

1. In STARTER, click the symbol  (device trace-function generator).

The "Trace" parameterizing screen form is then displayed.

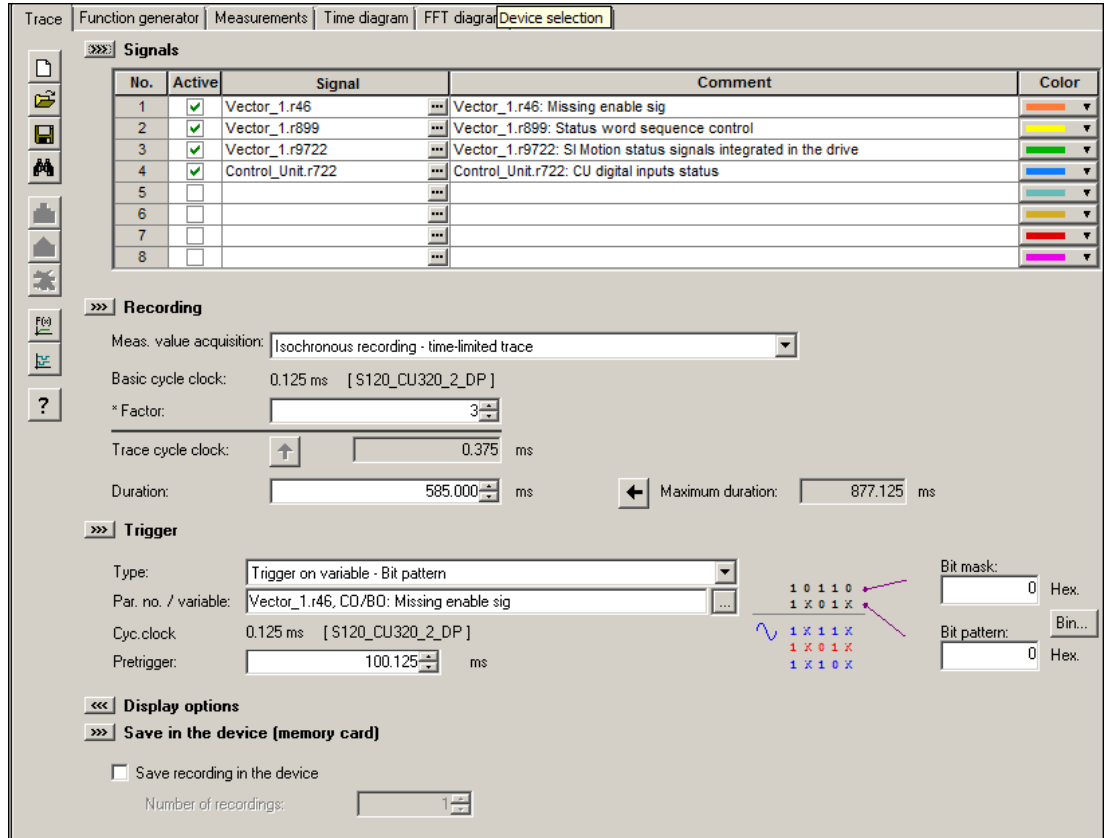

The screenshot shows the 'Trace' parameterizing screen in STARTER. The 'Device selection' tab is active. The 'Signals' section contains the following table:

No.	Active	Signal	Comment	Color
1	<input checked="" type="checkbox"/>	Vector_1.r46	Vector_1.r46: Missing enable sig	Orange
2	<input checked="" type="checkbox"/>	Vector_1.r899	Vector_1.r899: Status word sequence control	Yellow
3	<input checked="" type="checkbox"/>	Vector_1.r9722	Vector_1.r9722: SI Motion status signals integrated in the drive	Green
4	<input checked="" type="checkbox"/>	Control_Unit.r722	Control_Unit.r722: CU digital inputs status	Blue
5	<input type="checkbox"/>			
6	<input type="checkbox"/>			
7	<input type="checkbox"/>			
8	<input type="checkbox"/>			

The 'Recording' section shows:

- Meas. value acquisition: Isochronous recording - time-limited trace
- Basic cycle clock: 0.125 ms [S120_CU320_2_DP]
- * Factor: 3
- Trace cycle clock: 0.375 ms
- Duration: 585.000 ms
- Maximum duration: 877.125 ms

The 'Trigger' section shows:

- Type: Trigger on variable - Bit pattern
- Par. no. / variable: Vector_1.r46, CO/BO: Missing enable sig
- Cyc. clock: 0.125 ms [S120_CU320_2_DP]
- Pretrigger: 100.125 ms
- Bit mask: 0 Hex
- Bit pattern: 0 Hex

The 'Display options' section shows:

- Save recording in the device
- Number of recordings: 1

Image 4-8 Startup trace in STARTER

2. Activate the "Save the recording in the device" option.
3. Enter a number ≥ 1 in the "Number of recordings" field.

Note

Detailed information on how to parameterize and operate the trace function is available in the STARTER online help in Chapter "Trace, measuring functions and automatic controller setting".

4. Make the required trace settings and save the settings.

5. Start the trace.

This is followed by the prompt whether the parameterization in the device should be saved.

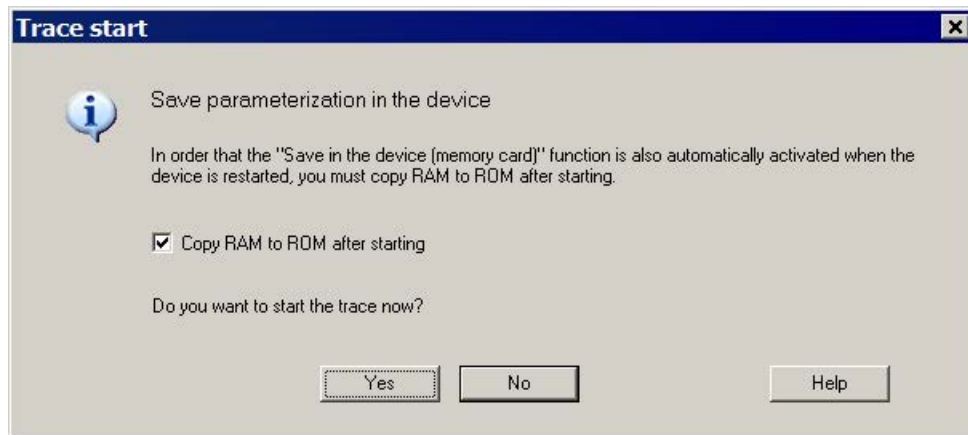

Image 4-9 Trace save prompt in STARTER

6. Activate the "Copy RAM to ROM after starting" option.

7. Click "Yes" to start the trace.

After the drive restarts, a new trace is immediately started (without any additional user action).

4.2.2.4 Overview of important alarms and faults

Overview of important alarms and faults (see SINAMICS S120/S150 List Manual)

- A02097 MTrace 1: multiple trace cannot be activated
- A02098 MTrace 1: cannot be saved

4.2.3 Measuring function

The measuring function is used for optimizing the drive controller. By parameterizing the measuring function, the impact of superimposed control loops can be suppressed selectively and the dynamic response of the individual drives analyzed. The ramp-function generator and trace function are linked for this purpose. The control loop is supplied with the ramp-function generator signal at a given point (e.g. speed setpoint) and recorded by the trace function at another (e.g. actual speed value). The trace function is parameterized automatically when the measuring function is parameterized. Specific predefined operating modes for the trace function are used for this purpose.

Parameterizing and using the measuring function

The measuring function is parameterized and operated via the STARTER commissioning tool.

No.	Active	Signal	Comment	Color
1	<input checked="" type="checkbox"/>	Drive_1.r77	Drive_1.r77: Current setpoint torque-generating	Orange
2	<input checked="" type="checkbox"/>	Drive_1.r78[0]	Drive_1.r78[0]: Current actual value torque-generating, Unsmoothed	Yellow
3	<input type="checkbox"/>	...		Green
4	<input type="checkbox"/>	...		Blue

Image 4-10 "Measuring function" initial screen

Note

Please refer to the online help for more information about parameterizing and operation.

Measuring functions

- Speed controller reference frequency response (downstream of the speed setpoint filter)
- Speed controller path (excitation downstream of current setpoint filter)
- Speed controller interference frequency response (fault downstream of the current setpoint filter)
- Speed controller reference frequency response (upstream of the speed setpoint filter)
- Speed controller setpoint change (downstream of the speed setpoint filter)
- Speed controller disturbance step change (fault downstream of the current setpoint filter)
- Current controller reference frequency response (downstream of the current setpoint filter)
- Current controller setpoint change (downstream of the current setpoint filter)

Starting/stopping the measuring function

NOTICE
Damage to property due to unexpected movements while the measurement function is active
Some monitoring functions are deactivated when the measurement function is activated. Incorrect parameterization of the measurement function can result in unexpected movements of the motor that damage the machine.
<ul style="list-style-type: none">• Do not leave the machine unattended while the measurement function is active.• Ensure that the parameter assignments are correct.

To start the measuring function:

1. Set the preconditions for starting the measuring function.
2. Select the drive in the project navigator.
3. In the project navigator, double-click "Drive" > "Commissioning" > "Measuring function".
4. Set the required measuring function.
5. Download the settings to the target device by clicking the symbol  "Download parameterization".
6. Start the function generator ("Start measuring function" button).

To stop the measuring function:

The measuring function runs for a limited time and then automatically stops.

1. If you wish to stop immediately, click the "Stop measuring function" button.

Parameterization

The "Measurement function" parameterizing screen form is selected via the following symbol  in the toolbar of the STARTER commissioning tool.

4.2.4 Measuring sockets

The 3 measuring sockets are used to output analog signals. Any interconnectable analog signal can be output at each measuring socket on the Control Unit.

Note

Use of the measuring sockets

The measuring sockets are intended for commissioning and diagnostic functions. Connection for operational purposes can violate the EMC limits.

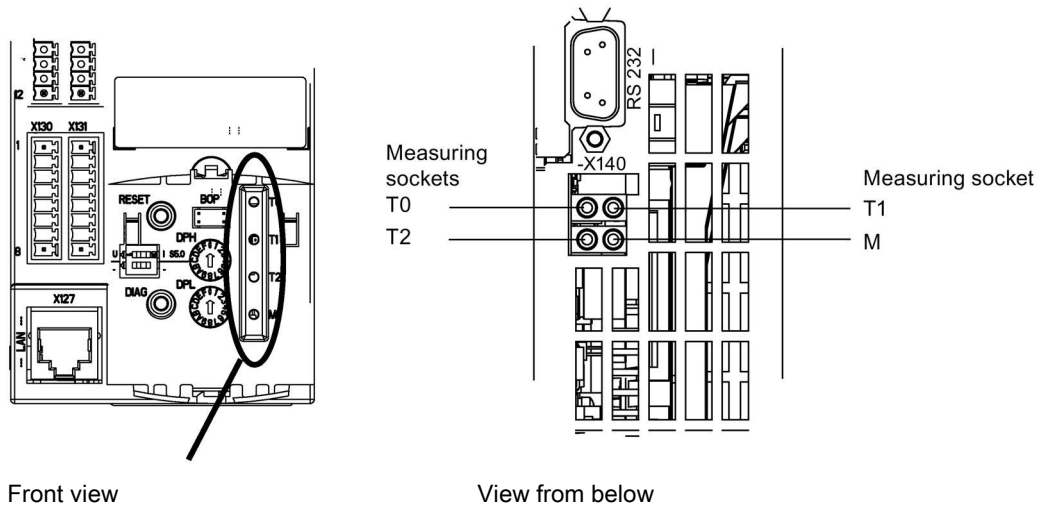

Image 4-11 CU310-2 DP/PN measuring sockets, CU320-2 DP/PN measuring sockets

Parameterizing and using the measuring sockets

The measuring sockets are parameterized and operated via the STARTER commissioning tool. You can access the operating window for the measuring sockets in the project window under "Control Unit" > "Inputs/outputs". In the inputs/outputs window, click the "Test sockets" tab.

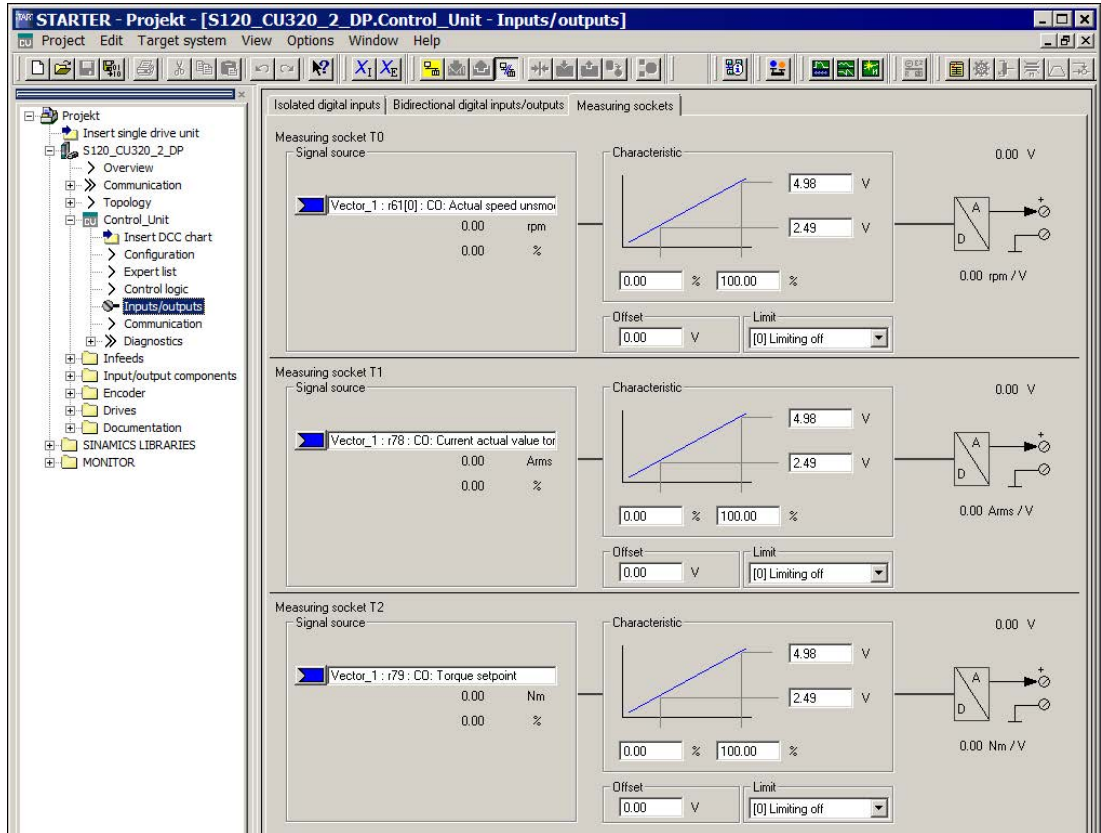

Image 4-12 "Measuring sockets" initial screen

Note

You can find additional information on parameterizing and operating in the online help.

Properties

- Resolution: 8-bit
- Voltage range: 0 V to +4.98 V
- Measuring cycle: Depends on the measuring signal (e.g. actual speed value in speed controller cycle 125 µs)
- Short-circuit-proof
- Parameterizable scaling
- Adjustable offset
- Adjustable limitation

Signal chart for measuring sockets

The signal characteristic for measuring sockets is shown in function diagram 8134 (see SINAMICS S120/S150 List Manual).

Which signal can be output via measuring sockets?

The signal to be output via a measuring socket is specified by parameterizing the connector input p0771[0...2].

Important measuring signals (examples):

r0060	CO: Speed setpoint before speed setpoint filter
r0063	CO: Actual speed value
r0069[0...2]	CO: Actual phase currents value
r0075	CO: Field-generating current setpoint
r0076	CO: Actual field-generating current value
r0077	CO: Torque-generating current setpoint
r0078	CO: Actual torque-generating current value

Scaling

Scaling specifies how the measuring signal is processed. A straight line with 2 points must be defined for this purpose.

Example:

$$x1 / y1 = 0.0\% / 2.49 \text{ V} \quad x2 / y2 = 100.0\% / 4.98 \text{ V (default setting)}$$

0.0 % is mapped to 2.49 V

100.0 % is mapped to 4.98 V

– 100.0 % is mapped to 0.00 V

Offset

The offset is applied additively to the signal to be output. The signal to be output can thus be displayed within the measuring range.

Limitation

- Limitation On
If signals are output outside the permissible measuring range, the signal is limited to 4.98 V or to 0V.
- Limitation Off
The output of signals outside the permissible measuring range causes a signal overflow. In the event of an overflow, the signal jumps from 0 V to 4.98 V or from 4.98 to 0 V.

Example of measured value output via a measuring socket

The actual speed (r0063) is to be output for a drive via measuring socket T1.

The following settings should be made:

1. Connect and set the measuring device.
2. Interconnect the signal (e.g. STARTER).

Interconnect the connector input (CI) belonging to the measuring socket with the desired connector output (CO):

CI: p0771[1] = CO: r0063

3. Parameterize the signal characteristic (scaling, offset, limitation).

Function diagrams (see SINAMICS S120/S150 List Manual)

- 8134 Diagnosics - measuring sockets (T0, T1, T2)

Overview of important parameters (see SINAMICS S120/S150 List Manual)**Adjustable parameters**

- p0771[0...2] CI: Measuring sockets signal source
- p0777[0...2] Measuring sockets characteristic value x1
- p0778[0...2] Measuring sockets characteristic value y1
- p0779[0...2] Measuring sockets characteristic value x2
- p0780[0...2] Measuring sockets characteristic value y2
- p0783[0...2] Measuring sockets offset
- p0784[0...2] Measuring sockets limit on/off

Display parameters

- r0772[0...2] Measuring sockets signal to be output
- r0774[0...2] Measuring sockets output voltage
- r0786[0...2] Measuring sockets normalization per volt

4.3 Diagnostic buffer

The diagnostic buffer can be used to log important operating events as a logbook. (Restriction: The availability of the diagnostics buffer mechanism is also dependent on the hardware release of the Control Unit).

The diagnostic buffer is in the non-volatile memory, so data written to it can be read out for subsequent analysis of a malfunction (including pre-history).

The essential events recorded in the buffer are:

- Faults
- Important changes to the boot status (end status) and partial booting of DOs
- Commissioning procedures
- State change of PROFIBUS/PROFINET communication
- Exceptions

The entries in the diagnostic buffer can be called up via the drive unit properties (symbol in project navigator --> right-click) under the menu option "Target device" > "Device diagnostics".

Note

STEP 7 full version

Device diagnostics in the STARTER commissioning tool is only displayed when you have installed the full version of STEP 7.

Events recorded by the diagnostic buffer

The following list shows the entries defined for SINAMICS drive units. Additional information is marked with <>.

Faults

An entry is defined for each possible DO number. The fault code and fault value are entered in the additional information.

Example:

Fault DO 5: Fault code 1005 fault value 0x30012

Alarms are not saved in the diagnostic buffer. Propagated faults (faults which are signaled to all DOs) are only stored in the diagnostic buffer once.

Bootling procedures and bootling status changes

In principle, only start and completion are recorded for bootling procedures. Bootling status (see r3988) are only recorded when an end status arises that can only be exited by user action (r3988 = 1, 10, 200, 250, 325, 370, 800). Bootling statuses and bootling status changes are:

- POWER ON
- Error in bootling (r3988 = 1)
- Fatal error in bootling (r3988 = 10)
- Waiting for first commissioning (r3988 = 200)
- Topology error in bootling (r3988 = 250)
- Waiting for entry of drive type (r3988 = 325)
- Waiting until p0009 = 0 is set (r3988 = 370)
- Boot status r3988 = <state at which 670 or 680> reached
- Bootling finished, cyclic operation
- Reason for new boot < 0 = Internal reason; 1 = Warm start; 2 = Bootling from saved data; 3 = Bootling after download>
- Drive reset via p0972 = <Mode>
- Partial bootling DO started <DO number>
- Partial bootling DO <DO number> finished

Commissioning procedures

- Device commissioning: New status p0009 = <new value p0009>
- Commissioning DO <DO number>: New status p0010 = <new value p0010>
- Ram2Rom DO <0 for all DOs> started
- Ram2Rom DO <0 for all DOs> completed
- Project download started
- DO <DO_Number> deactivated
- DO <DO_Number> reactivated
- Component <Component number> deactivated
- Component <Component number> reactivated
- Power Off / Power On required after firmware update (DO <DO number> Component < Component number >)
- DO <DO-No> deactivated and not available
- Component <component number> deactivated and not available

Communication (PROFIBUS, PROFINET, ...)

- PZD <IF1 or IF2> cyclic data exchange started
- PZD <IF1 or IF2> cyclic data exchange completed
- Changeover to UTC time for operating hours count status <Days> <Milliseconds>
- Time correction (correct) by <correction value> seconds

Exceptions

Exceptions can be taken from the crash diagnostics already available in the new boot run. The exceptions are always entered into the diagnostic buffer first, even before the entry "POWER ON".

- Data Abort Exception Address: <Content Program Counter>
- Floating Point Exception Address: <Content Program Counter>
- Prefetch Abort Exception Address: <Content Program Counter>
- Exception type <Type coding> Info: <Info depends on type>

Treatment of the time stamp

After successful time synchronization (in cyclic operation), the UTC time is used as a time stamp. Up until this time (POWER ON and switching to UTC time) the operating hours counter is used for all entries. The UTC time is entered for following entries.

4.4 Diagnostics of uncommissioned axes

To be able to identify uncommissioned drive objects of the classes "Infeeds", "Motor Module", "SERVO" and "VECTOR", there is an operating display in parameter r0002.

- r0002 "Infeed operating display" = 35: Carry out the first startup
- r0002 "Drive operating display" = 35: Carry out the first startup

The parameter r0002 "drive operating display" = 35 is then displayed if p3998[D]=0 is in any data set. Parameter p3998 specifies whether the first commissioning of the drive is still to be carried out (0 = yes, 2 = no).

Parameter p3998 is set to the value 2 when the calculation of the motor and control parameters for all data sets has been completed without errors (see r3925 bit0 = 1) and the encoder selection p0400 is not at 10100 (encoder identification).

The limitation that all drive data sets (DDS) must be commissioned in order to exit commissioning is ensured by checking the parameters involved (see also F07080 in the SINAMICS S120/S150 List Manual).

Infeed Module

An infeed (Active Line Modules, Basic Line Modules or Smart Line Modules with DRIVE-CLiQ) is considered commissioned when the line voltage and line frequency have been parameterized with appropriate values. A basic setting of 50 Hz or 60 Hz is expected for the line frequency.

The line voltage p0210 may need to be adjusted to the existing power supply.

To exit the state r0002 "Infeed operating display" = 35, set parameter p3900 "completion of quick commissioning" to the value 3, after any necessary adjustment to the line voltage.

For a 400 V unit, for example, the voltage p0210 is always initialized with 400 V. Although it is possible to switch on when connected to all line supplies from 380 V to 480 V, operation is not always optimal and/or alarm messages are displayed (see SINAMICS S120/S150 List Manual).

If the unit is not connected to a 400 V line supply, then the rated voltage p0210 should be adjusted. This can also be done after the first time the unit is switched on, by setting p0010 = 1.

Motor Module

A drive is considered to have been commissioned when in every drive data set (DDS) the motor and encoder data sets have been assigned valid data:

- Motor data sets (MDS):
p0131, p0300, p0301 etc. (see SINAMICS S120/S150 List Manual)
- Encoder data sets (EDS):
p0141, p0142, p0400 etc. (see SINAMICS S120/S150 List Manual)

After parameterizing the motor and encoder data via quick commissioning (p0010 = 1 ->0) use p3900 "completion of quick commissioning" > 0 to exit.

If commissioning should not be run using quick commissioning, the motor data should be entered via p0010 = 3 (p0340[0...n] "Automatic calculation of motor/control parameters" =1) after entering the type plate data, and the encoder data entered via p0010 = 4.

If the above conditions are not met, in r0002 of the drive concerned, the value r0002 = 35: "Carry out first commissioning" will be displayed.

It is not taken into account whether at switch on (pulse enable) required BICO sources are already parameterized, or are still at the value 0. Example:

- p0840 "BI: ON/OFF1" or
- p0864 "BI: Infeed operation"

If, after commissioning all DDSs, parameter p0010 is set once more to a value greater than 0, in r0002 the value r0002 = 46: "Switching on inhibited - exit the commissioning mode (p0009, p0010)" will be displayed.

The drive has been commissioned, however the pulses cannot be enabled.

Note on p0010 = 1 (quick commissioning):

Quick commissioning with p3900 > 0 (when p0010 = 1) works for all DDSs, where motor and encoder data has been entered.

This means that if quick commissioning is carried out a second or third time (or more), previously calculated and possibly user-adjusted data will be overwritten or recalculated.

For this reason we recommend carrying out any subsequent commissioning of a certain DDS (e.g. changing the motor), specifically using p0010 = 3 and p0010 = 4 instead of p0010 = 1.

Example

The image below shows a diagram of the diagnostic performance of uncommissioned infeeds and drives. A configuration with one power unit (DO2) and respectively two DDSs, MDSs and EDSs has been assumed. DO1 represents the CU.

The unit has already been commissioned.

The number of data sets and the components assigned to the DO2 have already been entered and the data set allocated.

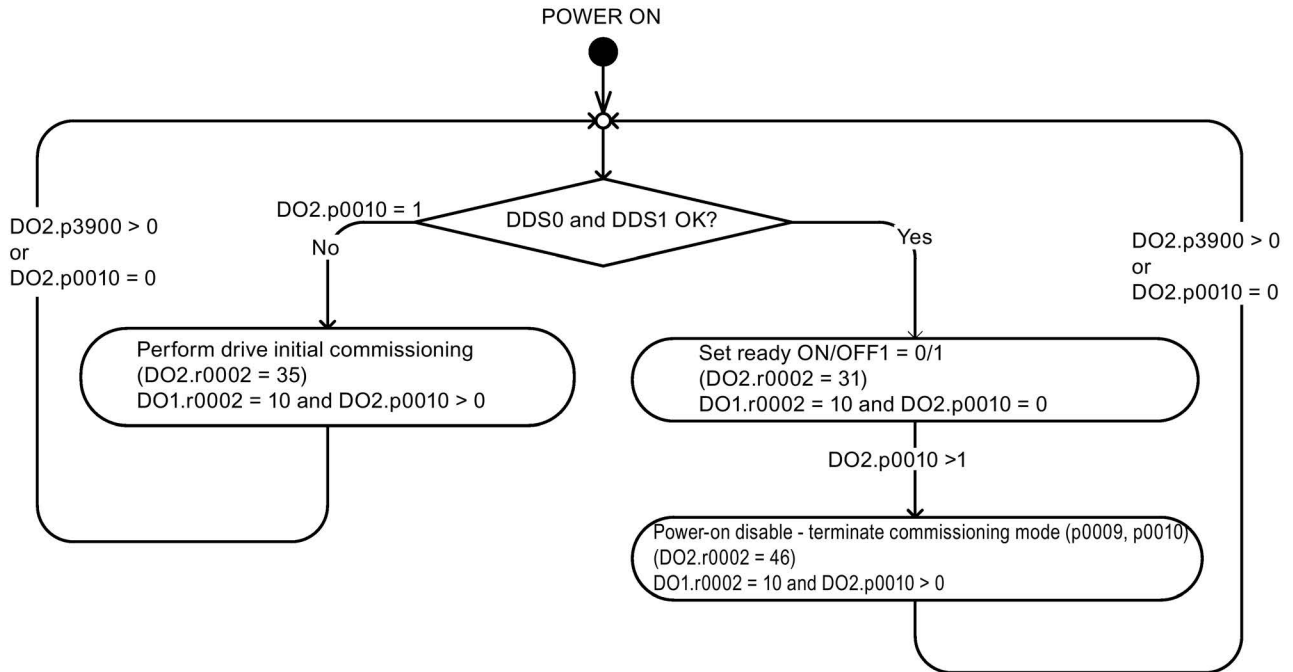

Image 4-13 Diagnostics of uncommissioned axes

4.5 Fault and alarm messages

4.5.1 General information about faults and alarms

The errors and states detected by the individual components of the drive system are indicated by messages.

The messages are categorized into faults and alarms.

Note

The individual faults and alarms are described in Chapter "Faults and alarms" in the SINAMICS S120/S150 List Manual. Function diagrams for the fault buffer, alarm buffer, fault trigger and fault configuration are also contained in the Section "Function diagrams" - "Faults and alarms".

Properties of faults and alarms

- Faults (code F01234)
 - Are identified by Fxxxx.
 - Can lead to a fault reaction.
 - Must be acknowledged once the cause has been remedied.
 - Status via Control Unit and LED RDY.
 - Status via PROFIBUS status signal ZSW1.3 (fault active).
 - Entry in the fault buffer.
- Alarms (code A56789)
 - Are identified by Axxxx.
 - Have no further effect on the drive.
 - The alarms are automatically reset once the cause has been remedied. No acknowledgement is required.
 - Status via PROFIBUS status signal ZSW1.7 (alarm active).
 - Entry in the alarm buffer.
- General properties of faults and alarms
 - Can be configured (e.g. change fault to alarm, fault reaction).
 - Triggering on selected messages possible.
 - Initiation of messages possible via an external signal.
 - Contains the component number for identifying the SINAMICS component involved
 - Contains diagnostic information on the message involved

Acknowledging faults

The list of faults and alarms specifies how each fault is acknowledged after the cause has been remedied.

- Acknowledgement of faults by "POWER ON"
 - Switch the drive on/off (POWER ON)
 - Press the RESET button on the Control Unit
- Acknowledgement of faults by "IMMEDIATE"
 - Via a PROFIdrive control signal:
STW1.7 (reset fault memory): 0/1 edge
Set STW1.0 (ON/OFF1) = "0" and "1"
 - Via external input signal
Binector input and interconnection with digital input
p2103 = "Requested signal source"
p2104 = "Requested signal source"
p2105 = "Requested signal source"
Across all of the drive objects (DO) of a Control Unit
p2102 = "Requested signal source"
- Acknowledge faults with "PULSE INHIBIT"
 - The fault can only be acknowledged with a pulse inhibit (r0899.11 = 0).
 - The same possibilities are available for acknowledging as described under acknowledge IMMEDIATELY.

Note

The drive can only resume operation after all active faults have been acknowledged.

4.5.2 Buffer for faults and alarms

Note

A fault and alarm buffer is provided for each drive. The drive and device-specific messages are entered in these buffers.

The contents of the fault buffer are saved to non-volatile memory when the Control Unit is powered down, i.e. the fault buffer history is still available when the unit is powered up again.

Note

The entry in the fault/alarm buffer is made after a delay. For this reason, the fault/alarm buffer should not be read until a change in the buffer is also recognized (r0944, r2121) after "Fault active"/"Alarm active" is output.

Fault buffer

Faults which occur are entered in the fault buffer as follows:

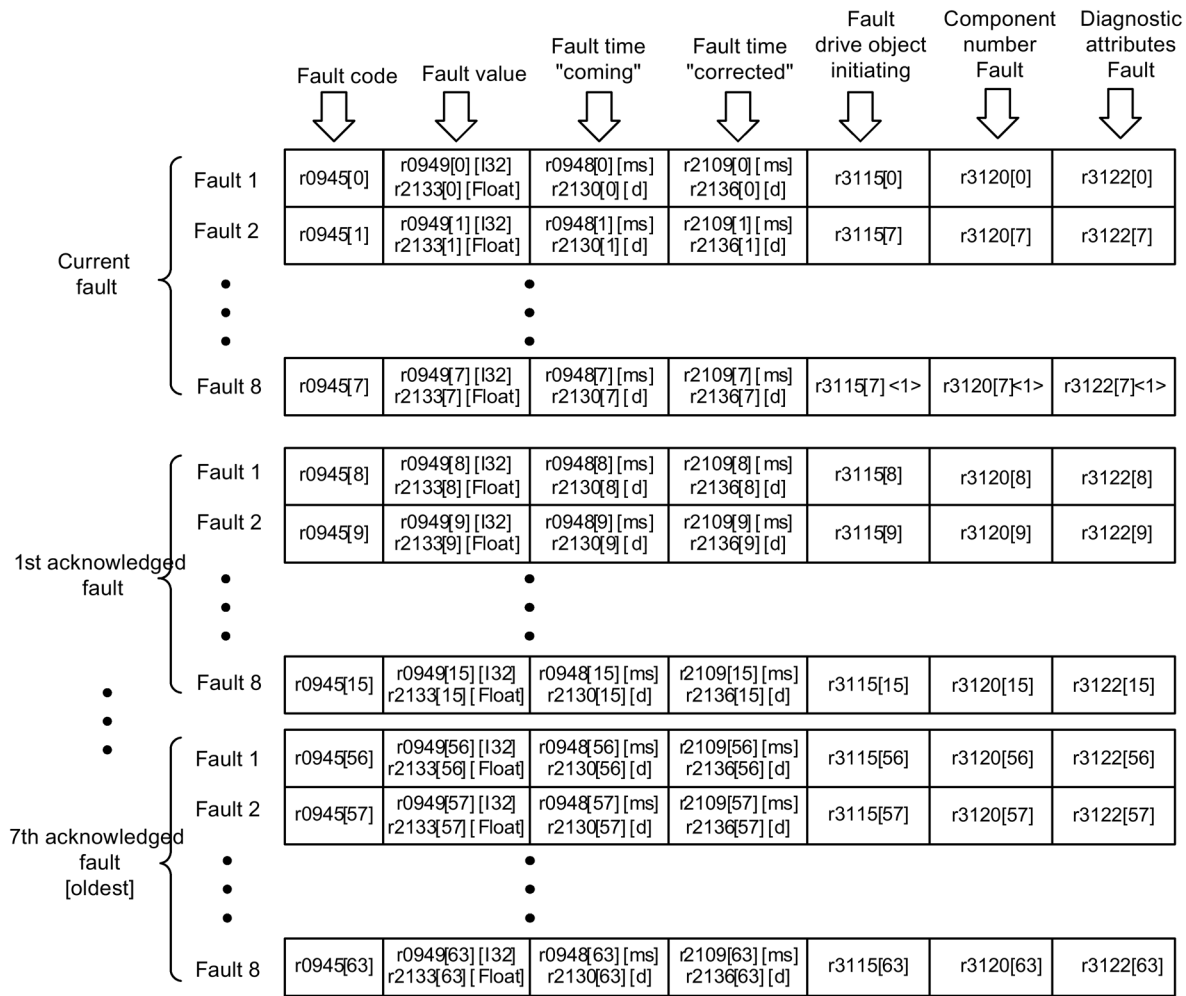

<1> This fault is overwritten by "more recent" faults (except "safety faults").

Image 4-14 Structure of the fault buffer

Properties of the fault buffer:

- A new fault incident encompasses one or more faults and is entered in "Current fault incident".
- The entries are arranged in the buffer according to the time at which they occurred.
- If a new fault incident occurs, the fault buffer is reorganized. The history is recorded in "Acknowledged fault incident" 1 to 7.
- If the cause of at least one fault in "Current fault incident" is remedied and acknowledged, the fault buffer is reorganized. Faults that have not been remedied remain in "Current fault incident".
- If "Current fault incident" contains eight faults and a new fault occurs, the fault in the parameters in index 7 is overwritten by the new fault.
- r0944 is incremented each time the fault buffer changes.
- A fault value (r0949) can be output for a fault. The fault value is used to diagnose the fault more accurately; please refer to the fault description for details of the meaning.

Clear fault buffer

- Delete fault buffer for all drive objects:
p2147 = 1 --> p2147 = 0 is automatically set after execution.
- Delete fault buffer for a specific drive object:
p0952 = 0 --> The parameter belongs to the specified drive object.

The fault buffer contents are automatically deleted for the following events:

- Restore factory setting (p0009 = 30 and p0976 = 1).
- Change drive object type
- Upgrade firmware to later version.

Alarm buffer, alarm history

An alarm in the alarm buffer comprises the alarm code, the alarm value and the alarm time (received, resolved). The alarm history occupies the last indices ([8...63]) of the parameter.

	Alarm code	Alarm value	Alarm time "raised"	Alarm time "cleared"	Component number alarm	Diagnostic attribute alarm
	↓	↓	↓	↓	↓	↓
Warning 1 (oldest)	r2122[0]	r2124 [0] [I32] r2134[0] [Float]	r2123[0] [ms] r2145[0] [d]	r2125[0] [ms] r2146[0] [d]	r3121[0]	r3123[0]
Alarm 2	r2122[1]	r2124 [1] [I32] r2134[1] [Float]	r2123[1] [ms] r2145[1] [d]	r2125[1] [ms] r2146[1] [d]	r3121[1]	r3123[1]
•			•			
•			•			
•			•			
Alarm 8 (newest)	r2122[7]	r2124 [7] [I32] r2134[7] [Float]	r2123[7] [ms] r2145[7] [d]	r2125[7] [ms] r2146[7] [d]	r3121[7]	r3123[7]

Alarm history

Warning 1 (newest)	r2122[8]	r2124 [8] [I32] r2134[8] [Float]	r2123[8] [ms] r2145[8] [d]	r2125[8] [ms] r2146[8] [d]	r3121[8]	r3123[8]
Alarm 2	r2122[9]	r2124 [9] [I32] r2134[9] [Float]	r2123[9] [ms] r2145[9] [d]	r2125[9] [ms] r2146[9] [d]	r3121[9]	r3123[9]
•			•			
•			•			
•			•			
Alarm 56 (oldest)	r2122[63]	r2124 [63] [I32] r2134[63] [Float]	r2123[63] [ms] r2145[63] [d]	r2125[63] [ms] r2146[63] [d]	r3121[10]	r3123[10]

Image 4-15 Structure of alarm buffer

Alarms that occur are entered in the alarm buffer as follows:

A maximum of 64 alarms are displayed in the alarm buffer:

- Index 0 ... 6: The first 7 alarms are displayed.
- Index 7: The most recent alarm is displayed.

A maximum of 56 alarms are displayed in the alarm history:

- Index 8: The most recent alarm is displayed.
- Index 9 .. 63: The first 55 alarms are displayed.

Properties of the alarm buffer/alarm history:

- The alarms in the alarm buffer are arranged from 7 to 0 according to the time that they occurred. In the alarm history, this is from 8 to 63.
- If 8 alarms have been entered into the alarm buffer, and a new alarm is received, then the alarms that have been resolved are transferred into the alarm history.
- r2121 is incremented each time the alarm buffer changes.
- An alarm value (r2124) can be output for an alarm. The alarm value is used to diagnose the alarm more accurately; please refer to the alarm description for details of the meaning.

Deleting the alarm buffer, index [0...7]:

- The alarm buffer index [0...7] is reset as follows: p2111 = 0

4.5.3 Configuring messages

The properties of the faults and alarms in the drive system are permanently defined.

For several messages, in a specific scope defined by the drive system, the properties can be changed as follows:

Change message type (example)

Select message	Set message type
p2118[5] = 1001	p2119[5] = 1: Fault (F)
	= 2: Alarm (A)
	= 3: No message (N)

Change fault reaction (example)

Select message	Set fault response
p2100[3] = 1002	p2101[3] = 0: None
	= 1: OFF1
	= 2: OFF2
	= 3: OFF3
	= 4: STOP1 (available soon)
	= 5: STOP2
	= 6: IASC/DC brake
	Internal armature short-circuit braking or DC brake
	= 7: ENCODER (p0491)

Change acknowledgement (example)

Select message	Set acknowledgement
p2126[4] = 1003	p2127[4] = 1: POWER ON
	= 2: IMMEDIATELY
	= 3: PULSE INHIBIT

19 message types per drive object can be changed.

Note

If BICO interconnections exist between drive objects, all interconnected objects must be configured.

Example:

The TM31 has BICO interconnections with drive 1 and 2 and F35207 is to be reconfigured as an alarm.

- p2118[n] = 35207 and p2119[n] = 2
 - These settings are required for for TM31, drive 1 and drive 2.
-

Note

Only those messages which are listed in the indexed parameters can be changed as desired. All other message settings retain their factory settings or are reset to the factory settings.

Examples:

- In the case of messages listed via p2128[0...19], the message type can be changed. The factory setting is set for all other messages.
 - The fault response of fault F12345 has been changed via p2100[n]. The factory settings should be restored (p2100[n] = 0).
-

Triggering on messages (example)

Select message	Trigger signal
p2128[0] = 1001	BO: r2129.0
or	
p2128[1] = 1002	BO: r2129.1

Note

The value from CO: r2129 can be used as group trigger.

CO: r2129 = 0 No selected message has been output.

CO: r2129 > 0 Group trigger.

At least one selected message has been output.

The individual binector outputs BO: r2129 should be investigated.

External triggering messages

If the appropriate binector input is interconnected with an input signal, fault 1, 2 or 3 or alarm 1, 2 or 3 can be triggered via an external input signal.

Once an external fault (1 to 3) has been triggered on the Control Unit drive object, this fault is also present on all associated drive objects. If one of these external faults is triggered on a different drive object, it is only present on that particular drive object.

Bl: p2106	—> External fault 1	—> F07860(A)
Bl: p2107	—> External fault 2	—> F07861(A)
Bl: p2108	—> External fault 3	—> F07862(A)
Bl: p2112	—> External alarm 1	—> A07850(F)
Bl: p2116	—> External alarm 2	—> A07851(F)
Bl: p2117	—> External alarm 3	—> A07852(F)

Note

An external fault or alarm is triggered by a 1/0 signal.

An external fault and alarm do not usually mean that an internal drive message has been generated. The cause of an external fault and warning should, therefore, be remedied outside the drive.

4.5.4 Overview of important function diagrams and parameters

Overview of important function diagrams (see SINAMICS S120/S150 List Manual)

- 8050 Diagnosis - Overview
- 8060 Diagnostics - fault buffer
- 8065 Diagnostics - alarm buffer
- 8070 Diagnostics - faults/alarms trigger word (r2129)
- 8075 Diagnostics - faults/alarms configuration
- 8134 Diagnostics - measuring sockets (T0, T1, T2)

Overview of important parameters (see SINAMICS S120/S150 List Manual)

- r0944 CO: Counter for fault buffer changes
- p0952 Fault cases, counter
- p2100[0...19] Changing the fault reaction, fault number
- r2139.0...15 CO/BO: Status word, faults/alarms 1
- r3120[0...63] Component fault
- r3121[0...63] Component alarm
- r3122[0...63] Diagnostic attribute fault
- r3123[0...63] Diagnostic attribute alarm

4.5.5 Propagation of faults

In the case of faults that are, for example, triggered by the Control Unit or a Terminal Module, central functions of the drive are also often affected. As a result of propagation, faults that are triggered by one drive object are therefore forwarded to other drive objects.

This behavior also applies to the faults that are set in a DCC on the Control Unit with the aid of the DCC block.

There are the following types of propagation:

- BICO

The fault is propagated to all active drive objects with closed-loop control functions (infeed, drive) to which there is a BICO interconnection.

- DRIVE

The fault is propagated to all active drive objects with closed-loop control functions.

- GLOBAL

The fault is propagated to all active drive objects.

- LOCAL

The behavior of this propagation type is dependent on parameter p3116.

- With binector input p3116 = 0 (factory setting) the following applies:
The fault is propagated to the first active drive object with closed-loop control functions.
- With binector input p3116 = 1 signal, the following applies:
The fault is not propagated.

4.5.6 Alarm classes

Fault and alarm classes

There are differentiated alarm messages in the cyclic telegrams between the former alarm classes "Alarm" and "Fault".

The alarm classes have been extended to give three additional levels of alarm between the pure alarm and the fault.

The function permits higher-level control (SIMATIC, SIMOTION, SINUMERIK, etc.) to have different control reactions to alarm messages from the drive.

The new statuses act as alarms for the drive, therefore there is NO immediate reaction from the drive (like for the former level "alarm").

Information on alarm classes are described in status word ZSW2 at bit positions bit 5/6 (for SINAMICS) or bit 11/12 (SIMODRIVE 611) (see also "ZSW2" in Chapter "Cyclic communication" for PROFIdrive communication in the SINAMICS S120 Function Manual Drive Functions).

ZSW2: Valid for SINAMICS Interface Mode p2038 = 0 (function diagram 2454)

Bit 5 - 6 Alarm classes alarms

= 0: Alarm (former alarm level)

= 1: Alarm class A alarms

= 2: Alarm class B alarms

= 3: Alarm class C alarms

ZSW2: Valid for SIMODRIVE 611 Interface Mode p2038 = 1 (function diagram 2453)

Bit 11 - 12 Alarm classes alarms

= 0: Alarm (former alarm level)

= 1: Alarm class A alarms

= 2: Alarm class B alarms

= 3: Alarm class C alarms

These attributes for differentiating the alarms are implicitly assigned to the appropriate alarm numbers. The reaction to the existing alarm classes in the alarm is defined by the user program in the higher-level control.

Explanations of the alarm classes

- Alarm class A: Drive operation currently not limited
 - E.g. alarm when measurement systems inactive
 - No limitation on current movement
 - Prevent possible switching to the defective measuring system
- Alarm class B: Time-limited operation
 - E.g. prewarning temperature: Without further action the drive may need to be switched off
 - After a timer stage -> additional fault
 - After exceeding a switch-off threshold -> additional fault
- Alarm class C: Functionally limited operation
 - E.g. reduced voltage/current/torque/speed limits (i2t)
 - E.g. continue with reduced accuracy / resolution
 - E.g. continue without encoder

4.6 Troubleshooting for encoders

If an encoder fault is present, it can be acknowledged separately according to encoder channels in a PROFIdrive telegram via the encoder interface (Gn_STW.15) or the drive interface of the appropriate drive object.

Configuration example: 2-encoder system

- Encoder G1 motor measurement system
- Encoder G2 direct measurement system

Case considered: All encoders signal encoder faults.

- The faults are entered in the encoder interface - and from there in encoder channel n of the PROFIDRIVE telegram. Bit15 of the encoder status word (Gn_ZSW.15 = 1) is set.
- The faults are transferred to the drive object.
- Motor measuring system faults set the drive object to fault (ZSW1 bit3), the faults are additionally signaled via the drive interface. An entry is made in fault buffer p0945. The parameterized fault response is initiated internally.
- Direct measuring system faults are converted by the assigned drive object into the "Alarm" message type and signaled via the drive interface (ZSW1 bit7). An entry is made in alarm buffer r2122.
No drive responses are initiated.

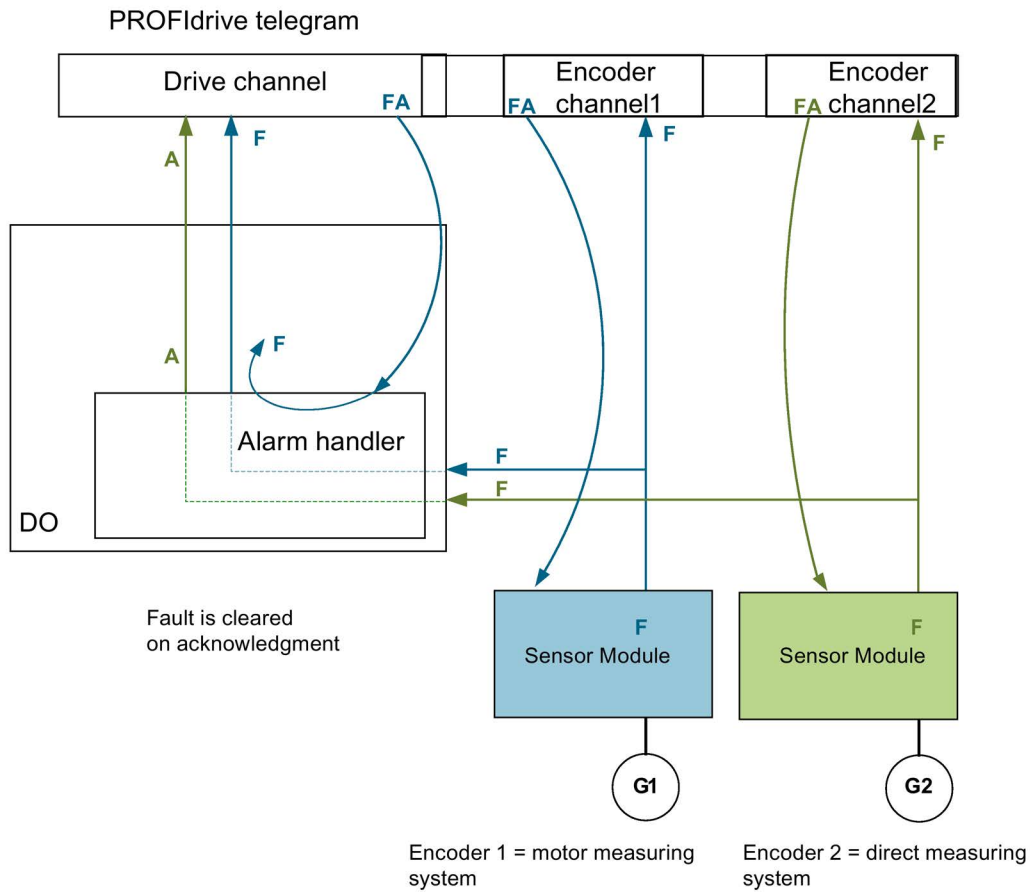

Image 4-16 Encoder fault handling

Alarm A:
The alarm is cancelled immediately, if the encoder fault was able to be acknowledged.

Fault F:
The fault remains active at the drive object until it is acknowledged via the cyclic interface.

Cyclic acknowledgement

Acknowledgement using the encoder interface (Gn_STW.15)

The following responses are possible:

- The encoder is set to fault-free if a fault is no longer active. The fault bit in the encoder interface is acknowledged. The evaluation modules indicate RDY LED = green after acknowledgement.
This behavior is valid for all encoders connected to the encoder interface, irrespective of the measurement system type (motor or direct).
- If the fault still exists, or if other faults exist, the acknowledgement is not successful – and the highest priority fault (can be the same or another fault entry) is transferred via the encoder interface.
The RDY LED on the evaluation modules is continuously red.
This behavior is valid for all encoders connected via the encoder interface, irrespective of the measuring system type (motor or direct).
- The drive object is not detected via the encoder interface. Faults set in the drive object remain, the drive does not even start with the encoder which in the meantime is fault-free. The drive object must also be acknowledged via the drive interface (fault memory RESET).

Acknowledgement using the drive interface (STW1.7 (cyclic) or p3981(acyclic))

The following responses are possible:

- If no more faults exist, the encoder is set to fault-free and the fault bit in the drive interface is acknowledged. The evaluation modules indicate RDY LED = green.
Acknowledgement takes place on all encoders that are logically assigned to the drive.
- If the fault still exists, or other faults exist, then the acknowledgement is not successful; the next, highest priority fault is transferred via the drive interface and also via the encoder interface involved.
- The RDY LED on the evaluation modules is continuously red.
- The encoder interfaces of the assigned encoders are NOT reset by acknowledgement at the drive interface; the set faults remain.
- The encoder interfaces must also be acknowledged via the corresponding encoder control word Gn_STW.15.

Appendix

A.1 List of abbreviations

Note

The following list of abbreviations includes all abbreviations and their meanings used in the entire SINAMICS family of drives.

Abbreviation	Source of abbreviation	Significance
A		
A...	Alarm	Warning
AC	Alternating Current	Alternating current
ADC	Analog Digital Converter	Analog-Digital converter
AI	Analog Input	Analog input
AIM	Active Interface Module	Active Interface Module
ALM	Active Line Module	Active Line Module
AO	Analog Output	Analog output
AOP	Advanced Operator Panel	Advanced Operator Panel
APC	Advanced Positioning Control	Advanced Positioning Control
AR	Automatic Restart	Automatic restart
ASC	Armature Short Circuit	Armature short-circuit
ASCII	American Standard Code for Information Interchange	American coding standard for the exchange of information
AS-i	AS-Interface (Actuator Sensor Interface)	AS-interface (open bus system in automation technology)
ASM	Asynchronmotor	Induction motor
B		
BB	Betriebsbedingung	Operation condition
BERO	-	Contactless proximity switch
BI	Binector Input	Binector input
BIA	Berufsgenossenschaftliches Institut für Arbeitssicherheit	BG-Institute for Occupational Safety and Health
BICO	Binector Connector Technology	Binector connector technology
BLM	Basic Line Module	Basic Line Module

Abbreviation	Source of abbreviation	Significance
BO	Binector Output	Binector output
BOP	Basic Operator Panel	Basic operator panel
C		
C	Capacitance	Capacitance
C...	-	Safety message
CAN	Controller Area Network	Serial bus system
CBC	Communication Board CAN	Communication Board CAN
CBE	Communication Board Ethernet	PROFINET communication module (Ethernet)
CD	Compact Disc	Compact disk
CDS	Command Data Set	Command data set
CF Card	CompactFlash Card	CompactFlash card
CI	Connector Input	Connector input
CLC	Clearance Control	Clearance control
CNC	Computerized Numerical Control	Computer-supported numerical control
CO	Connector Output	Connector output
CO/BO	Connector Output / Binector Output	Connector Output / Binector Output
COB ID	CAN Object-Identification	CAN Object-Identification
CoL	Certificate of License	Certificate of License
COM	Common contact of a changeover relay	Center contact of a changeover contact
COMM	Commissioning	Startup
CP	Communication Processor	Communications processor
CPU	Central Processing Unit	Central processing unit
CRC	Cyclic Redundancy Check	Cyclic redundancy check
CSM	Control Supply Module	Control Supply Module
CU	Control Unit	Control Unit
CUA	Control Unit Adapter	Control Unit Adapter
CUD	Control Unit DC	Control Unit DC
D		
DAC	Digital Analog Converter	Digital analog converter
DC	Direct Current	DC current
DCB	Drive Control Block	Drive Control Block
DCBRK	DC Brake	DC braking
DCC	Drive Control Chart	Drive Control Chart
DCN	Direct Current Negative	Direct current negative
DCP	Direct Current Positive	Direct current positive
DDC	Dynamic Drive Control	Dynamic Drive Control
DDS	Drive Data Set	Drive Data Set
DI	Digital Input	Digital input
DI/DO	Digital Input / Digital Output	Digital input/output, bidirectional
DMC	DRIVE-CLiQ Hub Module Cabinet	DRIVE-CLiQ Hub Module Cabinet

Abbreviation	Source of abbreviation	Significance
DME	DRIVE-CLiQ Hub Module External	DRIVE-CLiQ Hub Module External
DMM	Double Motor Module	Double Motor Module
DO	Digital Output	Digital output
DO	Drive Object	Drive object
DP	Decentralized Peripherals	Distributed I/O
DPRAM	Dual-Port Random Access Memory	Dual-Port Random Access Memory
DQ	DRIVE-CLiQ	DRIVE-CLiQ
DRAM	Dynamic Random Access Memory	Dynamic Random Access Memory
DRIVE-CLiQ	Drive Component Link with IQ	Drive Component Link with IQ
DSC	Dynamic Servo Control	Dynamic Servo Control
DTC	Digital Time Clock	Timer
E		
EASC	External Armature Short-Circuit	External armature short-circuit
EDS	Encoder Data Set	Encoder data set
EEPROM	Electrically Erasable Programmable Read-Only Memory	Electrically Erasable Programmable Read-Only-Memory
EGB	Elektrostatisch gefährdete Baugruppen	Electrostatic sensitive devices
ELCB	Earth Leakage Circuit-Breaker	Residual current operated circuit breaker
ELP	Earth Leakage Protection	Ground-fault monitoring
EMC	Electromagnetic Compatibility	Electromagnetic compatibility
EMF	Electromotive Force	Electromotive force
EMK	Elektromotorische Kraft	Electromotive force
EMV	Elektromagnetische Verträglichkeit	Electromagnetic compatibility
EN	Europäische Norm	European Standard
EnDat	Encoder-Data-Interface	Encoder interface
EP	Enable Pulses	Pulse enable
EPOS	Einfachpositionierer	Basic positioner
ES	Engineering System	Engineering system
ESB	Ersatzschaltbild	Equivalent circuit diagram
ESD	Electrostatically Sensitive Devices	Electrostatic sensitive devices
ESM	Essential Service Mode	Essential service mode
ESR	Extended Stop and Retract	Extended stop and retract
F		
F...	Fault	Fault
FAQ	Frequently Asked Questions	Frequently Asked Questions
FBLOCKS	Free Blocks	Free function blocks
FCC	Function control chart	Function control chart
FCC	Flux Current Control	Flux current control
FD	Function Diagram	Function diagram
F-DI	Fail-safe Digital Input	Failsafe digital input

Abbreviation	Source of abbreviation	Significance
F-DO	Fail-safe Digital Output	Fail-safe digital output
FEPRM	Flash-EPROM	Non-volatile write and read memory
FG	Function Generator	Function Generator
FI	-	Fault current
FOC	Fiber-Optic Cable	Fiber-optic cable
FP	Funktionsplan	Function diagram
FPGA	Field Programmable Gate Array	Field Programmable Gate Array
FW	Firmware	Firmware
G		
GB	Gigabyte	Gigabyte
GC	Global Control	Global control telegram (broadcast telegram)
GND	Ground	Reference potential for all signal and operating voltages, usually defined as 0 V (also referred to as M)
GSD	Gerätstammdatei	Generic Station Description: Describes the features of a PROFIBUS slave
GSV	Gate Supply Voltage	Gate supply voltage
GUID	Globally Unique Identifier	Globally Unique Identifier
H		
HF	High Frequency	High frequency
HFD	Hochfrequenzdrossel	Radio frequency reactor
HLA	Hydraulic Linear Actuator	Hydraulic linear actuator
HLG	Hochlaufgeber	Ramp-function Generator
HM	Hydraulic Module	Hydraulic Module
HMI	Human Machine Interface	Human Machine Interface
HTL	High-Threshold Logic	Logic with high interference threshold
HW	Hardware	Hardware
I		
i. V.	In Vorbereitung	Under development: This property is currently not available
I/O	Input/Output	Input/output
I2C	Inter-Integrated Circuit	Internal serial data bus
IASC	Internal Armature Short-Circuit	Internal armature short-circuit
IBN	Inbetriebnahme	Startup
ID	Identifier	Identification
IE	Industrial Ethernet	Industrial Ethernet
IEC	International Electrotechnical Commission	International Electrotechnical Commission
IF	Interface	Interface
IGBT	Insulated Gate Bipolar Transistor	Insulated gate bipolar transistor
IGCT	Integrated Gate-Controlled Thyristor	Semiconductor power switch with integrated control electrode

Abbreviation	Source of abbreviation	Significance
IL	Impulslöschung	Pulse suppression
IP	Internet Protocol	Internet protocol
IPO	Interpolator	Interpolator
IT	Isolé Terre	Non-grounded three-phase line supply
IVP	Internal Voltage Protection	Internal voltage protection
J		
JOG	Jogging	Jogging
K		
KDV	Kreuzweiser Datenvergleich	Data cross-check
KHP	Know-How Protection	Know-how protection
KIP	Kinetische Pufferung	Kinetic buffering
Kp	-	Proportional gain
KTY84	-	Temperature sensor
L		
L	-	Symbol for inductance
LED	Light Emitting Diode	Light emitting diode
LIN	Linearmotor	Linear motor
LR	Lageregler	Position controller
LSB	Least Significant Bit	Least Significant Bit
LSC	Line-side converter	Line-side converter
LSS	Line-Side Switch	Line-side switch
LU	Length Unit	Length unit
LWL	Lichtwellenleiter	Fiber-optic cable
M		
M	-	Symbol for torque
M	Masse	Reference potential for all signal and operating voltages, usually defined as 0 V (also referred to as GND)
MB	Megabyte	Megabyte
MCC	Motion Control Chart	Motion Control Chart
MDI	Manual Data Input	Manual data input
MDS	Motor Data Set	Motor data set
MLFB	Maschinenlesbare Fabrikatebezeichnung	Machine-readable product code
MM	Motor Module	Motor Module
MMC	Man-Machine Communication	Man-machine communication
MMC	Micro Memory Card	Micro memory card
MSB	Most Significant Bit	Most significant bit
MSC	Motor Side Converter	Motor-side converter
MSCY_C1	Master Slave Cycle Class 1	Cyclic communication between master (class 1) and slave

A.1 List of abbreviations

Abbreviation	Source of abbreviation	Significance
MSC	Motorstromrichter	Motor-side converter
MT	Messtaster	Probe
N		
N. C.	Not Connected	Not connected
N...	No Report	No report or internal message
NAMUR	Normenarbeitsgemeinschaft für Mess- und Regeltechnik in der chemischen Industrie	Standardization association for measurement and control in chemical industries
NC	Normally Closed (contact)	NC contacts
NC	Numerical Control	Numerical control
NEMA	National Electrical Manufacturers Association	Standardization association in USA (United States of America)
NM	Nullmarke	Zero mark
NO	Normally Open (contact)	NO contacts
NSR	Netzstromrichter	Line-side converter
NVRAM	Non-Volatile Random Access Memory	Non-volatile read/write memory
O		
OA	Open Architecture	Software component which provides additional functions for the SINAMICS drive system
OAIF	Open Architecture Interface	Version of the SINAMICS firmware as of which the OA-application can be used
OASP	Open Architecture Support Package	Expands the STARTER commissioning tool by the corresponding OA-application
OC	Operating Condition	Operation condition
OEM	Original Equipment Manufacturer	Original equipment manufacturer
OLP	Optical Link Plug	Bus connector for fiber-optic cable
OMI	Option Module Interface	Option Module Interface
P		
p...	-	Adjustable parameters
P1	Processor 1	CPU 1
P2	Processor 2	CPU 2
PB	PROFIBUS	PROFIBUS
PcCtrl	PC Control	Master control
PD	PROFIdrive	PROFIdrive
PDC	Precision Drive Control	Precision Drive Control
PDS	Power Unit Data Set	Power unit data set
PE	Protective Earth	Protective ground
PELV	Protective Extra-Low Voltage	Safety extra-low voltage
PFH	Probability of dangerous failure per hour	Probability of dangerous failure per hour
PG	Programmiergerät	Programming device
PI	Proportional integral	Proportional integral
PID	Proportional integral differential	Proportional integral differential

Abbreviation	Source of abbreviation	Significance
PLC	Programmable Logic Controller	Programmable logic controller
PLL	Phase-locked loop	Phase-locked loop
PM	Power Module	Power Module
PMSM	Permanent-Magnet Synchronous Motor	Permanent-magnet synchronous motor
PN	PROFINET	PROFINET
PNO	PROFIBUS Nutzerorganisation	PROFIBUS user organization
PPI	Point-to-Point Interface	Point-to-point interface
PRBS	Pseudo Random Binary Signal	White noise
PROFIBUS	Process Field Bus	Serial data bus
PS	Power Supply	Power supply
PSA	Power Stack Adapter	Power Stack Adapter
PT1000	-	Temperature sensor
PTC	Positive Temperature Coefficient	Positive temperature coefficient
PTP	Point-To-Point	Point-to-point
PWM	Pulse Width Modulation	Pulse width modulation
PZD	Prozessdaten	Process data
Q		
R		
r...	-	Display parameters (read only)
RAM	Random Access Memory	Speicher zum Lesen und Schreiben
RCCB	Residual Current Circuit Breaker	Residual current operated circuit breaker
RCD	Residual Current Device	Residual current operated circuit breaker
RCM	Residual Current Monitor	Residual current monitor
REL	Reluctance motor textile	Reluctance motor textile
RESM	Reluctance Synchronous Motor	Synchronous reluctance motor
RFG	Ramp-Function Generator	Ramp-function Generator
RJ45	Registered Jack 45	Term for an 8-pin socket system for data transmission with shielded or non-shielded multi-wire copper cables
RKA	Rückkühlanlage	Cooling unit
RLM	Renewable Line Module	Renewable Line Module
RO	Read Only	Read only
ROM	Read-Only Memory	Read-only memory
RPDO	Receive Process Data Object	Receive Process Data Object
RS232	Recommended Standard 232	Interface standard for a cable-connected serial data transmission between a sender and receiver (also known as EIA232)
RS485	Recommended Standard 485	Interface standard for a cable-connected differential, parallel, and/or serial bus system (data transmission between a number of senders and receivers, also known as EIA485)

Abbreviation	Source of abbreviation	Significance
RTC	Real-Time Clock	Real-time clock
RZA	Raumzeigerapproximation	Space-vector approximation
S		
S1	-	Continuous operation
S3	-	Intermittent duty
SAM	Safe Acceleration Monitor	Safe acceleration monitoring
SBC	Safe Brake Control	Safe brake control
SBH	Sicherer Betriebshalt	Safe operating stop
SBR	Safe Brake Ramp	Safe brake ramp monitoring
SBT	Safe Brake Test	Safe brake test
SCA	Safe Cam	Safe cam
SCC	Safety Control Channel	Safety Control Channel
SD Card	SecureDigital Card	Secure digital memory card
SDC	Standard Drive Control	Standard Drive Control
SDI	Safe Direction	Safe motion direction
SE	Sicherer Software-Endschalter	Safe software limit switch
SESM	Separately Excited Synchronous Motor	Separately excited synchronous motor
SG	Sicher reduzierte Geschwindigkeit	Safely-limited speed
SGA	Sicherheitsgerichteter Ausgang	Safety-related output
SGE	Sicherheitsgerichteter Eingang	Safety-related input
SH	Sicherer Halt	Safe stop
SI	Safety Integrated	Safety Integrated
SIC	Safety Info Channel	Safety Info Channel
SIL	Safety Integrity Level	Safety Integrity Level
SITOP	-	Siemens power supply system
SLM	Smart Line Module	Smart Line Module
SLP	Safely Limited Position	Safely Limited Position
SLS	Safely-Limited Speed	Safely-limited speed
SLVC	Sensorless Vector Control	Sensorless vector control
SM	Sensor Module	Sensor Module
SMC	Sensor Module Cabinet	Sensor Module Cabinet
SME	Sensor Module External	Sensor Module External
SMI	SINAMICS Sensor Module Integrated	SINAMICS Sensor Module Integrated
SMM	Single Motor Module	Single Motor Module
SN	Sicherer Software-Nocken	Safe software cam
SOS	Safe Operating Stop	Safe operating stop
SP	Service Pack	Service pack
SP	Safe Position	Safe position
SPC	Setpoint Channel	Setpoint channel
SPI	Serial Peripheral Interface	Serial peripheral interface

Abbreviation	Source of abbreviation	Significance
SPS	Speicherprogrammierbare Steuerung	Programmable logic controller
SS1	Safe Stop 1	Safe Stop 1 (monitored for time and ramp)
SS1E	Safe Stop 1 External	Safe Stop 1 with external stop
SS2	Safe Stop 2	Safe Stop 2
SS2E	Safe Stop 2 External	Safe Stop 2 with external stop
SSI	Synchronous Serial Interface	Synchronous serial interface
SSM	Safe Speed Monitor	Safe feedback from speed monitor
SSP	SINAMICS support package	SINAMICS support package
STO	Safe Torque Off	Safe torque off
STW	Steuerwort	Control word
T		
TB	Terminal Board	Terminal Board
TEC	Technology Extension	Software component which is installed as an additional technology package and which expands the functionality of SINAMICS (previously OA-application)
TIA	Totally Integrated Automation	Totally Integrated Automation
TM	Terminal Module	Terminal Module
TN	Terre Neutre	Grounded three-phase line supply
Tn	-	Integral time
TPDO	Transmit Process Data Object	Transmit Process Data Object
TT	Terre Terre	Grounded three-phase line supply
TTL	Transistor-Transistor Logic	Transistor-Transistor-Logik
Tv	-	Rate time
U		
UL	Underwriters Laboratories Inc.	Underwriters Laboratories Inc.
UPS	Uninterruptible Power Supply	Uninterruptible power supply
USV	Unterbrechungsfreie Stromversorgung	Uninterruptible power supply
UTC	Universal Time Coordinated	Universal time coordinated
V		
VC	Vector Control	Vector control
Vdc	-	DC-link voltage
VdcN	-	Partial DC-link voltage negative
VdcP	-	Partial DC-link voltage positive
VDE	Verband Deutscher Elektrotechniker	Verband Deutscher Elektrotechniker [Association of German Electrical Engineers]
VDI	Verein Deutscher Ingenieure	Verein Deutscher Ingenieure [Association of German Engineers]
VPM	Voltage Protection Module	Voltage Protection Module
Vpp	Volt peak to peak	Volt peak to peak
VSM	Voltage Sensing Module	Voltage Sensing Module

Abbreviation	Source of abbreviation	Significance
W		
WEA	Wiedereinschaltautomatik	Automatic restart
WZM	Werkzeugmaschine	Machine tool
X		
XML	Extensible Markup Language	Extensible markup language (standard language for Web publishing and document management)
Y		
Z		
ZK	Zwischenkreis	DC link
ZM	Zero Mark	Zero mark
ZSW	Zustandswort	Status Word

A.2 Documentation overview

General documentation/catalogs			
SINAMICS	G110	D11.1	- Inverter built-in units 0.12 kW up to 3 kW
	G120	D31	- SINAMICS Inverters for Single-Axis Drives and SIMOTICS Motors
	G130, G150	D11.1	- Inverter built-in units - Inverter cabinet units
	S120, S150	D21.3	- SINAMICS S120 Built-in units in the Chassis format and Cabinet Modules - SINAMICS S150 Drive Converter Cabinet Units
SIMOTION, SINAMICS	S120	PM21	- SIMOTION, SINAMICS S120 and Motors for Production Machines
Manufacturer/service documentation			
SINAMICS	G110		- Getting Started - Operating instructions - List Manuals
	G120		- Getting Started - Operating instructions - Hardware Installation Manuals - Function Manual Safety Integrated - List Manuals
	G130		- Operating instructions - List Manual
	G150		- Operating instructions - List Manual
	GM150, SM120/SM150, GL150, SL150		- Operating instructions - List Manuals
	S110		- Manual - Getting Started - Function Manual - List Manual
	S120		- Getting Started with STARTER - Commissioning Manual with STARTER - Getting Started with Startdrive (available as of Startdrive V14 release) - Commissioning Manual with Startdrive (available as of Startdrive V14 release) - Commissioning Manual CANopen - Function Manual Drive Functions - Function Manual Safety Integrated - Function Manual DCC - List Manual - Manual Control Unit and supplementary system components - Manual LT Booksize - Manual LT Booksize C/D Type - Manual LT Chassis air-cooled - Manual LT Chassis liquid-cooled - Manual Combi - Manual Cabinet Modules - Manual AC Drive - SINAMICS S120M Manual Distributed Drive Technology - SINAMICS HLA System Manual Hydraulic Drive
	S150		- Operating instructions - List Manual
Motors			- Configuration Manuals, Motors
General			- Configuration Manual, EMC Guidelines

A.3 Availability of hardware components

Table A- 1 Hardware components available as of 03.2006

No.	Hardware component	Article number	Version	Revisions
1	AC Drive (CU320, PM340)	refer to the Catalog		New
2	SMC30	6SL3055-0AA00-5CA1		With SSI support
3	DMC20	6SL3055-0AA00-6AA.		New
4	TM41	6SL3055-0AA00-3PA.		New
5	SME120 SME125	6SL3055-0AA00-5JA. 6SL3055-0AA00-5KA.		New
6	BOP20	6SL3055-0AA00-4BA.		New
7	CUA31	6SL3040-0PA00-0AA.		New

Table A- 2 Hardware components available as of 08.2007

No.	Hardware component	Article number	Version	Revisions
1	TM54F	6SL3055-0AA00-3BA.		New
2	Active Interface Module (booksize)	6SL3100-0BE...-AB.		New
3	Basic Line Module (booksize)	6SL3130-1TE...-0AA.		New
4	DRIVE-CLiQ encoder	6FX2001-5.D...-0AA.		New
5	CUA31 Suitable for Safety Extended functions via PROFIsafe and TM54	6SL3040-0PA00-0AA1		New
6	CUA32	6SL3040-0PA01-0AA.		New
7	SMC30 (30 mm wide)	6SL3055-0AA00-5CA2		New

Table A- 3 Hardware components available as of 10.2008

No.	Hardware component	Article number	Version	Revisions
1	TM31	6SL3055-0AA00-3AA1		New
2	TM41	6SL3055-0AA00-3PA1		New
3	DME20	6SL3055-0AA00-6AB.		New
4	SMC20 (30 mm wide)	6SL3055-0AA00-5BA2		New
5	Active Interface Module booksize 16 kW	6SL3100-0BE21-6AB.		New
6	Active Interface Module booksize 36 kW	6SL3100-0BE23-6AB.		New
7	Smart Line Modules booksize compact	6SL3430-6TE21-6AA.		New

No.	Hardware component	Article number	Version	Revisions
8	Motor Modules booksize compact	6SL3420-1TE13-0AA. 6SL3420-1TE15-0AA. 6SL3420-1TE21-0AA. 6SL3420-1TE21-8AA. 6SL3420-2TE11-0AA. 6SL3420-2TE13-0AA. 6SL3420-2TE15-0AA.		New
9	Power Modules blocksize liquid cooled	6SL3215-1SE23-0AA. 6SL3215-1SE26-0AA. 6SL3215-1SE27-5UA. 6SL3215-1SE31-0UA. 6SL3215-1SE31-1UA. 6SL3215-1SE31-8UA.		New
10	Reinforced DC-link busbars for 50 mm components	6SL3162-2DB00-0AA.		New
11	Reinforced DC-link busbars for 100 mm components	6SL3162-2DD00-0AA.		New

Table A- 4 Hardware components available as of 11.2009

No.	Hardware component	Article number	Version	Revisions
1	Control Unit 320-2DP	6SL3040-1MA00-0AA1 Actual 2014: 6SL3040-1MA00-0AA0	4.3	New
2	TM120	6SL3055-0AA00-3KA0	4.3	New
3	SMC10 (30 mm wide)	6SL3055-0AA00-5AA3	4.3	New

Table A- 5 Hardware components available as of 01.2011

No.	Hardware component	Article number	Version	Revisions
1	Control Unit 320-2PN	6SL3040-1MA01-0AA1 Actual 2014: 6SL3040-1MA01-0AA0	4.4	New
2	Braking Module booksize compact	6SL3100-1AE23-5AA0	4.4	New
3	SLM 55kW booksize	6SL3130-6TE25-5AA.	4.4	New
4	TM120 evaluation of up to four motor temperature sensors	6SL3055-0AA00-3KA.	4.4	New

A.3 Availability of hardware components

Table A- 6 Hardware components available as of 04.2011

No.	Hardware component	Article number	Version	Revisions
1	S120 Combi three axes Power Module	6SL3111-3VE21-6FA0 6SL3111-3VE21-6EA0 6SL3111-3VE22-0HA0	4.4	New
2	S120 Combi four axes Power Module	6SL3111-4VE21-6FA0 6SL3111-4VE21-6EA0 6SL3111-4VE22-0HA0	4.4	New
3	S120 Booksize Compact power units Single Motor Module	6SL3420-1TE13-0AA0 6SL3420-1TE15-0AA0 6SL3420-1TE21-0AA0 6SL3420-1TE21-8AA0	4.4	New
4	S120 Booksize Compact power units Double Motor Module	6SL3420-2TE11-7AA0 6SL3420-2TE13-0AA0 6SL3420-2TE15-0AA0	4.4	New
5	Braking Module booksize	6SL3100-1AE31-0AB0	4.4	New

Table A- 7 Hardware components available as of 01.2012

No.	Hardware component	Article number	Version	Revisions
1	TM150 evaluation of up to 12 temperature sensors	6SL3055- 0AA0-3LA0	4.5	New
2	CU310-2 PN	6SL3040-1LA01-0AA0	4.5	New
3	CU310-2 DP	6SL3040-1LA00-0AA0	4.5	New

Table A- 8 Hardware components available as of Q4 2012

No.	Hardware component	Article number	Version	Revisions
1	Adapter Module 600	6SL3555-2BC10-0AA0	4.5	New

Table A- 9 Hardware components available as of 01.2013

No.	Hardware component	Article number	Version	Revisions
1	300% overload, booksize up to 18 A	6SL312.-.....-...4 for Motor Modules with 50 mm and: 3 A, 5 A, 9 A, 18 A, 2x3 A, 2x5 A, 2x9 A	4.6	New
2	SINAMICS S120M	6SL3532-6DF71-0R.. 6SL3540-6DF71-0R.. 6SL3542-6DF71-0R.. 6SL3562-6DF71-0R.. 6SL3563-6DF71-0R..	4.6	New

Table A- 10 Hardware components available as of 04.2014

No.	Hardware component	Article number	Version	Revisions
1	S120 Combi: New power unit	6SL3111-4VE21-0EA Four axis Power Modules with high amperage: 24 A, 12 A, 12 A, 12 A	4.7	New
2	Power Module PM240-2	6SL321.-.P.-..... FSA, FSB and FSC for 200 V and 400 V	4.7	New

Table A- 11 Hardware components available as of 04.2015

Nr	Hardware component	Article number	Version	Changes
1	TM31 Terminal Module	6SL3055-0AA00-3AA1	4.7 SP2	Revised
2	TM41 Terminal Module	6SL3055-0AA00-3PA1	4.7 SP2	Revised
3	DRIVE-CLiQ Hub Module DMC20	6SL3055-0AA00-6AA1	4.7 SP2	Revised

Table A- 12 Hardware components available as of 10.2015

Nr	Hardware component	Article number	Version	Changes
1	Motor Module with up to 2x over- load (Booksize redesign)	6SL3120-1TE21-8AC. (18 A) 6SL3120-1TE23-0AC. (30 A) 6SL3120-2TE21-8AC. (2 x 18 A)	-	New
2	Motor Module with up to 3x over- load (Booksize redesign)	6SL3120-1TE13-0AD. (3 A) 6SL3120-1TE15-0AD. (5 A) 6SL3120-1TE21-0AD. (9 A) 6SL3120-1TE21-8AD. (18 A) 6SL3120-1TE23-0AD. (30 A) 6SL3120-2TE13-0AD. (2 x 3 A) 6SL3120-2TE15-0AD. (2 x 5 A) 6SL3120-2TE21-0AD. (2 x 9 A) 6SL3120-2TE21-8AD. (2 x 18 A)	-	New
3	Motor plug connector with push- in connection	6SL3162-2MB00-0AC0	-	New
4	Motor plug connector with screw- type connection	6SL3162-2MA00-0AC0	-	New

Table A- 13 Hardware components available as of 07.2016

No.	Hardware component	Article number	Version	Changes
1	PM240-2 Power Module	6SL321.-.P.-..... FSD, FSE and FSF for 200 V, 400 V and 690 V	4.8	New
2	TM31 Terminal Module	6SL3055-0AA00-3AA1	4.8	Revised
3	TM41 Terminal Module	6SL3055-0AA00-3PA1	4.8	Revised
4	TM54F Terminal Module	6SL3055-0AA00-3BA.	4.8	Revised
5	DMC20 DRIVE-CLiQ Hub Mod- ule	6SL3055-0AA00-6AA1	4.8	Revised
6	VSM10 Voltage Sensing Module	6SL3053-0AA00-3AA1	4.8	Revised

A.4 Availability of SW functions

Table A- 14 New functions, firmware 4.3

No.	SW function	SERVO	VECTOR	HW component
1	The 1FN6 motor series is supported	x	-	-
-2	DRIVE-CLiQ motors with star-delta changeover are supported	x	-	-
3	Referencing with several zero marks per revolution via the encoder interface	x	-	-
4	Permanent-magnet synchronous motors can be controlled down to zero speed without having to use an encoder	-	x	-
5	"SINAMICS Link": Direct communication between several SINAMICS S120	x	x	-
6	Safety Integrated: <ul style="list-style-type: none"> Control of the Basic Functions via PROFIsafe SLS without encoder for induction motors SBR without encoder for induction motors Own threshold value parameters for SBR: Up until now, SSM used parameter p9546 	x	x	-
7	Drive object encoder: An encoder can now be directly read-in via the encoder drive object and can then be evaluated by SIMOTION using the TO external encoder.	-	x	-
8	Support of new components <ul style="list-style-type: none"> CU320-2 TM120 	x	x	-
9	GSDML file expanded for Profisafe	x	x	-
10	USS protocol at interface X140	x	x	-
11	V/f diagnostics (p1317) permitted as regular operating mode	x	-	-
12	Setpoint-based utilization display, instead of the previous actual value-based utilization display	x	x	-
13	A performance license is required from the 4th axis (for servo/vector) or from the 7th U/f axis, instead of from a utilization of 50% and higher – which was the case up until now.	x	x	-
14	Tolerant encoder monitoring, 2nd part: <ul style="list-style-type: none"> Monitoring, tolerance band, pulse number Switchable edge evaluation for square-wave encoders Setting the zero speed measuring time for pulse encoder signal evaluation Changeover measuring procedure, actual value acquisition for square-wave encoder "LED check" encoder monitoring 	x	x	-

Table A- 15 New functions, firmware 4.4

No.	SW function	SERVO	VECTOR	HW component
1	Safety Integrated functions <ul style="list-style-type: none"> SDI (Safe Direction) for induction motors (with and without encoder), for synchronous motors with encoder. Supplementary condition for Safety without encoder (for induction motors): Only possible with devices in booksize and blocksize format. Not for devices in chassis format. 	x	x	-
2	Communication <ul style="list-style-type: none"> PROFINET address can be written via parameter (e.g. when completely generating the project offline) Shared device for SINAMICS S PROFINET modules: CU320-2 PN, CU310-2 PN 	x	x	-
3	Emergency retraction (ESR = Extended Stop and Retract)	x	x	-
4	TM41: Rounding for pulse encoder emulation (gear ratio; also resolver as encoder)	x	x	-
5	Further pulse frequencies for servo control and isochronous operation (3.2 / 5.33 / 6.4 kHz)	x	-	-
6	Chassis format: Current controller in 125 μ s for servo control for higher speeds (up to approx. 700 Hz output frequency)	x	-	-
7	Propagation of faults	x	x	-

Table A- 16 New functions, firmware 4.5

No.	SW function	SERVO	VECTOR	HW component
1	Support for new components, CU310-2	x	x	Refer to Appendix A1
2	Support for new components, TM150	x	x	-
3	Support for high-frequency spindles with pulse frequencies up to 32 kHz (a current controller cycle of 31.25 μ s)	x	-	-
4	PROFINET: Support for the PROFenergy profile	x	x	-
5	PROFINET: Improved usability for Shared Device	x	x	-
6	PROFINET: Smallest selectable send cycle 250 μ s	x	x	-
7	PROFINET: Bumpless media redundancy with CU310-2 PN, CU320-2 PN and CU320-2 with CBE20	x	x	-
8	Ethernet/IP communication extension via CBE20	x	x	-
9	SINAMICS Link: Smallest adjustable send clock 0.5 ms	x	x	-
10	Parameterization of SINAMICS Link connections without POWER ON	x	x	-
11	Write protection	x	x	-
12	Know-how protection	x	x	-
13	PMSM (old: PEM) encoderless up to n = 0 rpm	x	x	-
14	Decoupling of the pulse frequency from the current controller cycle, valid only for power units in the chassis format	-	x	-

No.	SW function	SERVO	VECTOR	HW component
15	Expansion of the number of process data words for infeeds up to 10 words for the send and receive directions	x	x	-
Safety Integrated functions				
16	CU310-2 safety functionality via terminals and PROFIsafe	x	x	-
17	Permanent activation of the speed limit and the safe direction of rotation without PROFIsafe or TM54F	x	x	-
18	Safely Limited Position (SLP)	x	x	-
19	Transfer of the Safely Limited Position via PROFIsafe	x	x	-
20	Variably adjustable SLS limit	x	x	-
21	New PROFIsafe telegrams 31, 901, 902	x	x	-

Table A- 17 New functions, firmware 4.6

No.	Software function	SERVO	VECTOR	Hardware component
1	Integrated Web server for SINAMICS Project and firmware download via Ethernet on the memory card Protection against power failure while updating via the Web server	x	x	-
2	Replacing a part with know-how protection: Encrypted loading into the file system	x	x	-
3	Parameterizable bandstop filters for Active Infeed control, chassis format	x	x	-
4	Current setpoint filter	x	-	-
5	Shortened rotating measurement	-	x	-
6	Redundant data backup on the memory card	x	x	-
7	Multiple trace	x	x	-
8	Brake control adaptation	x	x	-
9	Fast flying restart	-	x	-
10	Diagnostic alarms for PROFIBUS	x	x	-
11	DCC SINAMICS: Support of DCB libraries generated from the SINAMICS DCB Studio	x	x	-
12	SMC40 (EnDat 2.2)	x	x	-
13	CANopen expansions	x	x	-
14	Support of new components S120M	x	-	-
Safety Integrated functions				
15	Safety Integrated Extended functions with two TTL/HTL encoders	x	x	-
16	Safety: Safe Brake Test	x	x	-
17	Safety Info Channel	x	x	-

Table A- 18 New functions, firmware 4.7

No.	Software function	SERVO	VECTOR	Hardware component
1	Separately excited synchronous machine: New operating mode, only with HTL encoder and VSM	-	x	-
2	S120 Combi support	x	-	New power unit: 6SL3111-4VE21-0EA
3	Identification & Maintenance data sets (I&M 0...4) support	x	x	-
4	Isochronous support for IRT devices	-	x	-
5	Dynamic IP address assignment (DHCP) and temporary device names for PROFINET	x	x	-
6	Fast flying restart with voltage measurement	x	x	-
7	One button tuning	x	-	-
8	Online tuning	x	-	-
9	Adaptive current setpoint filter for online tuning	x	-	-
10	Independent setting of the pulse frequency and the PROFIBUS and PROFINET cycles	x	x	-
11	PROFenergy for SINAMICS S120	x	x	-
12	Activation of network functionality for booksize modules for renewable energies	x	x	-
13	New mode for ramp-function generator tracking with torque, power or current limit	-	x	-
Safety Integrated functions				
14	Parameterizable line contactor activation for STO	x	x	-
15	Extension of the safe gearbox switchover	x	x	-
16	Execute test stop automatically during ramp-up	x	x	-
17	Safety Integrated Extended Functions with two TTL/HTL encoders for booksize and blocksize	x	x	-
18	Uniform behavior for component replacement	x	x	-
19	SINAMICS S120 hydraulic drive with Safety Integrated	x	-	-

Table A- 19 New functions, firmware 4.8

No.	Software function	SERVO	VECTOR	Hardware component
1	Synchronous reluctance motors	-	x	-
2	Moment of inertia precontrol of the moment of inertia estimator	-	x	-
3	Expansion of the thermal motor models	x	x	-
4	Communication via MODBUS TCP	x	x	-
5	PROFINET system redundancy	x	x	
6	Expansion of SINAMICS Link functionality	x	x	-
7	Optimization of the web server functionality	x	x	-
8	Cogging torque compensation (under license)	x	-	-
9	Advanced Positioning Control (APC) (under license)	x	-	-
Safety Integrated functions				
10	SBR can now also be selected for SS1/SS2 with encoder	x	x	-
11	Basic Functions controllable via TM54F	x	x	-
12	Safe Stop 2 with external stop (SS2E)	x	x	-

Index

A

- Acknowledgment, 367
- Actual position value format
 - 2-pole resolver, 281
- Alarm buffer, 370
- Alarm classes
 - Faults and alarms, 376
- Alarm history, 370
- Alarm value, 370
- Alarms, 366
 - Alarm buffer, 370
 - Alarm history, 370
 - Configuring, 371
- Automatic encoder adjustment
 - Vector, 232

B

- Basic Line Module
 - Vdc_max controller, 82
- BICO interconnection, 86
- Blocksize
 - PM, 34
- Booksize
 - Booksize power unit, 32
- BOP20
 - Control word, drive, 302
 - Important functions, 292, 302

C

- Chassis, 32
- Closed-loop control
 - Optimization, 219, 273
- Commissioning
 - Checklist blocksize, 34
 - Checklist booksize, 32
 - Checklist chassis, 32
 - First commissioning, 123, 133, 143, 155, 160
 - Linear motors, 183
 - Linear motors checklist, 183
 - Parallel connection of Infeed Modules, 165
 - Parallel connection of Motor Modules, 165
 - Parallel connection of power units, 165
 - Reluctance motors, 223

- Torque motors, 237
 - Torque motors checklist, 237
 - With STARTER, 84
- Commutation angle offset
 - Check, 205, 206, 207, 212, 260, 260, 261, 266
 - Incorrect commutation, 204, 258
 - Measurement results, 214, 268
 - Parameterization, 204, 258
- Commutation setting, 185, 239
- Control Unit CU320-2 DP
 - LEDs after booting, 307
 - LEDs during booting, 306
- Control Unit CU320-2 PN
 - LEDs after booting, 310
 - LEDs during booting, 309
- Controller data
 - Linear motor, 191
 - Torque motor, 245
- Counting direction of the measuring system
 - Linear motor, 197
 - Torque motor, 251
- Creating a project
 - Offline with PROFIBUS, 115
 - Offline with PROFINET, 117

D

- DDS
 - Drive data set, 364
- Detail view, 85
- Diagnostic buffer, 360
- Diagnostic function, 341
 - Function generator, 341
 - Measuring sockets, 355
- Diagnostics
 - via Starter, 355
 - Via Starter, 341, 341, 345, 353
- Diagnostics via LEDs
 - Active Line Modules, 316
 - Basic Line Modules, 317
 - Braking Module Booksize, 320
 - CBE20 Ethernet Communication Board, 330
 - Communication Board CBC10, 329
 - Communication Board Ethernet CBE25, 332
 - Control Supply Module, 327
 - Control Unit CU310-2 DP, 311
 - Control Unit CU320-2 DP, 307
 - Control Unit CU320-2 PN, 310

- DRIVE-CLiQ Hub Module DMC20, 334
- Motor Module booksize compact, 321
- Motor Modules, 319
- Sensor Module Cabinet 10, 327
- Sensor Module Cabinet 20, 327
- Sensor Module Cabinet SMC30, 328
- Sensor Module Cabinet SMC40, 328
- Smart Line Module Booksize Compact, 320
- Smart Line Modules 16 kW and higher, 318
- Smart Line Modules 5 kW and 10 kW, 318
- Terminal Module TM120, 336
- Terminal Module TM15, 335
- Terminal Module TM150, 337
- Terminal Module TM31, 336
- Terminal Module TM41, 338
- Terminal Module TM54F, 339
- Voltage Sensing Module VSM10, 334
- Diagnostics via Starter
 - Function generator, 341
 - Measuring function, 353
 - Measuring sockets, 355
 - Trace function, 345, 350
- Drive direction
 - Linear motor, 197
 - Torque motor, 251
- Drive interface, 378
- DRIVE-CLiQ
 - Check connections, 75
 - Diagnostics, 75
 - Wiring rules, 48
- DRIVE-CLiQ encoder, 180

E

- EDS
 - Encoder data set, 364
- Encoder
 - Configuration, 174
 - Linear, 179
 - Rotary, 178
 - Troubleshooting, 378
 - User-defined, 177
- Encoder adjustment, 230
 - Fine adjustment, 231
- Encoder data
 - Linear motor, 193
 - Torque motor, 247
- Encoder interface, 378
- Encoder selection, 173
- Encoder types, 275
- EPOS
 - Absolute encoder adjustment, 281

F

- Fault buffer, 368
- Fault value, 368
- Faults, 366
 - Acknowledge, 367
 - Configuring, 371
 - Fault buffer, 368
- Faults and alarms
 - Alarm classes, 376
 - Forwarding, 375
 - Propagation, 375
- First commissioning, 123, 133, 143, 155, 160
- Function generator, 343
 - Properties, 342

G

- Generator for signals, 341

I

- Initialization
 - Initializing the interface, 106

L

- Learning devices, 171
- LEDs
 - Active Line Modules, 316, 322, 322
 - Basic Line Modules, 317, 323, 323
 - Braking Module Booksize, 320
 - CBE20 Ethernet Communication Board, 330
 - Communication Board CBC10, 329
 - Communication Board Ethernet CBE25, 332
 - Control Unit CU310-2 DP, 311
 - Control Unit CU320-2 DP, 307
 - Control Unit CU320-2 PN, 310
 - DRIVE-CLiQ Hub Module DMC20, 334
 - Motor Module booksize compact, 321
 - Motor Modules, 319, 325, 325
 - On the Control Supply Module, 327
 - On the Sensor Module Cabinet 10, 327
 - On the Sensor Module Cabinet 20, 327
 - Power Modules, 326, 326
 - Sensor Module Cabinet SMC30, 328
 - Sensor Module Cabinet SMC40, 328
 - Smart Line Module Booksize Compact, 320
 - Smart Line Modules, 324, 324
 - Smart Line Modules 16 kW and higher, 318
 - Smart Line Modules 5 kW and 10 kW, 318

- Terminal Module TM120, 336
- Terminal Module TM15, 335
- Terminal Module TM150, 337
- Terminal Module TM31, 336
- Terminal Module TM41, 338
- Terminal Module TM54F, 339
- Voltage Sensing Module VSM10, 334
- Line protection, 33
 - Power unit, 33
- Linear motors
 - Connecting in parallel, 218

M

- MDS
 - Motor data set, 364
- Measuring sockets, 355
- Messages, 366
 - Configuring, 371
 - External triggering, 373
 - Trigger on, 372
- Motor data
 - Parameterizing linear motors, 186, 187
 - Parameterizing torque motors, 240, 241
- Motor holding brake
 - Linear motor, 192
 - Torque motor, 246
- Motor Modules
 - Parallel connection, commissioning, 167
- Motor temperature monitoring
 - CU310-2, 285
 - CUA31/32, 286
 - Faults/alarms, 290
 - Motor temperature, 33
 - SMC10/20, 284
 - SMC30, 284
 - SME120/125, 289
 - SME20, 289
 - TM120, 287
 - TM150, 287
 - TM31, 286

N

- Number of controllable drives
 - Notes, 58

O

- Online operation with STARTER, 108

P

- Parallel connection
 - Linear motors, 218
 - Torque motors, 272
- Parameterizing
 - Calculating controller data, 191, 245
 - Commutation angle offset, 204, 258
 - Complete, 198, 252
 - Configuring encoder data, 193, 247
 - Configuring the motor holding brake, 192, 246
 - Determining the counting direction of the measuring system, 197, 251
 - Determining the drive direction, 197, 251
 - Internal LAN interface, 107
 - Motor data for standard linear motors, 186
 - Motor data for standard torque motors, 240
 - Motor data for third-party linear motors, 187
 - Motor data for third-party torque motors, 241
 - Terminal Module, 202, 256
 - With STARTER, 84
- Parameterizing the internal LAN interface
 - Internal LAN interface, 107
- Parameterizing with BOP, 292
- Pole position identification
 - Vector, 233
- Pole position identification technique, 185, 239
- Position tracking
 - 2-pole resolver, 281
- Power units
 - Parallel connection, commissioning, 168
- PROFIBUS
 - Components, 35
- Project navigator, 85
- Propagation type, 375
- Pulse frequency
 - Setting, 45

R

- Ramp-up with partial topology, 55
- Reluctance motor, 223
- RESM, 223
- Resolver
 - 2-pole, 281

S

- Sampling times, 37
 - Setting, 46
- Setting the IP address, 103
- Signal recording with the trace function, 341

- SINAMICS Support Package, 171
- Singleturn absolute encoder, 281
- SME12x Sensor Module External, 200, 254
- Sockets for measurement, 355
- SSI encoder, 274
 - Encoder identification, 278
 - Moving the axis by the converter, 279
 - Moving the axis manually, 278
- SSP, 171
- STARTER, 84
 - Important functions, 95
 - Online operation via PROFINET, 108
- Status display
 - Uncommissioned drive objects, 363
- Switching off, 76
- Switching on, 76
- Synchronous motors
 - Permanent-magnet, 225
- System sampling times, 37
 - CU31/CU32, 64
 - DCC, 63
 - EPOS, 63
 - Mixed operation, 62
 - Servo control, 58
 - V/f control, 62
 - Vector control, 60

T

- T0, T1, T2, 355
- Temperature monitoring
 - Temperature monitoring circuit, 33
- Temperature sensors
 - SINAMICS components, 282
 - Testing, 200, 201, 254, 255
- Terminal Module
 - Testing, 202, 256
- Terminal Module TM120, 202, 256
- Time stamp, 362
- Tools
 - STARTER, 84
- Torque motors
 - Connecting in parallel, 272
- Trace function
 - Call trace function, 345, 349, 350
 - Multiple trace, 349
 - Operation of the trace function, 346
 - Parameter, 352
 - Properties of the trace function, 347
 - Signal recording, 341
 - Single trace, 345
 - Startup trace, 350

U

- User interface, 85

V

- Vector
 - Permanent-magnet synchronous motors, 225

W

- Wiring rules
 - DRIVE-CLiQ, 48
- Work area, 85

Siemens AG
Digital Factory
Motion Control
Postfach 3180
91050 ERLANGEN
GERMANY

Subject to change

www.siemens.com/motioncontrol