

R330  
R317

Q300

C345  
R318

C335  
C334  
C333  
C332  
C331  
C330  
C329  
C328  
C327  
C326  
C325  
C324  
C322

CN300

C306  
C310  
C311  
C312  
C313  
C314  
U404  
C315  
C316  
C317  
C318  
C319  
C320  
C323

C219C218R221  
L200  
U202

VR205  
VR201  
VR200

VR203  
VR206

1

R207  
LED204

2

R203  
LED200

3

4

R208  
LED205

5

R204  
LED201

6

R211  
LED208

7

R209  
LED206

8

R205  
LED202

9

VR202  
R213  
LED210

\*

R210  
LED207

0

R206  
LED203

SHAPE

SGH-C300 REV 0.1

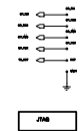
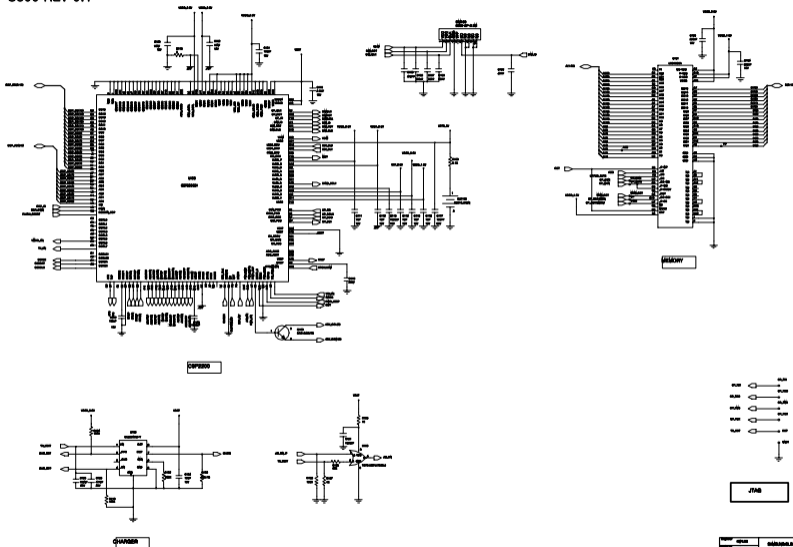

REV	0.1	DATE	1998-08-01
DESIGNER	...	CHECKED	...
<b>SGH-C300 REV 0.1</b>			
SCALE	...	UNIT	...

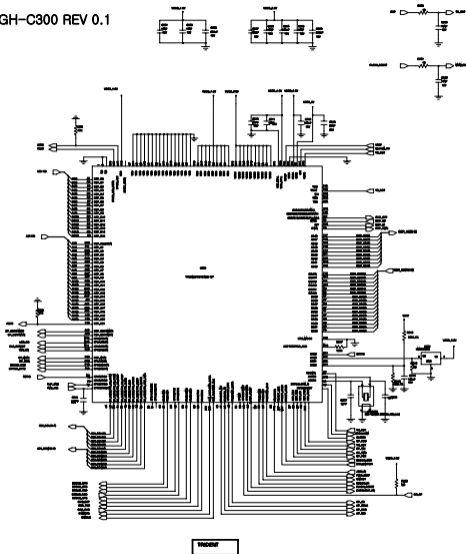

TRIDENT

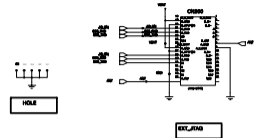

HALL IC

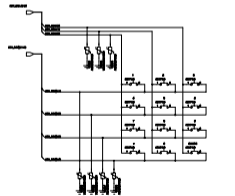

KEY

MANUFACTURING	
DATE	
TIME	
OPERATOR	
INSPECTOR	
REVISION	
SGH-C300 REV 0.1	

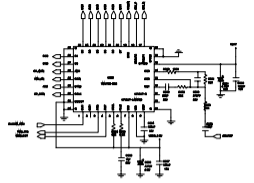
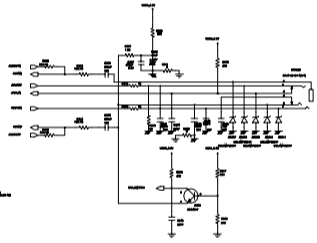
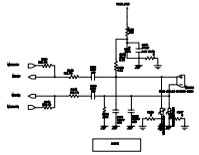
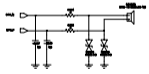
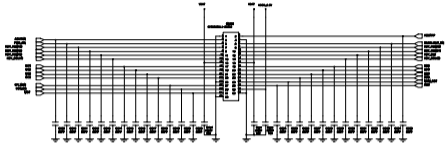
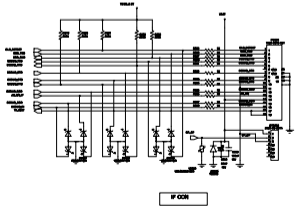

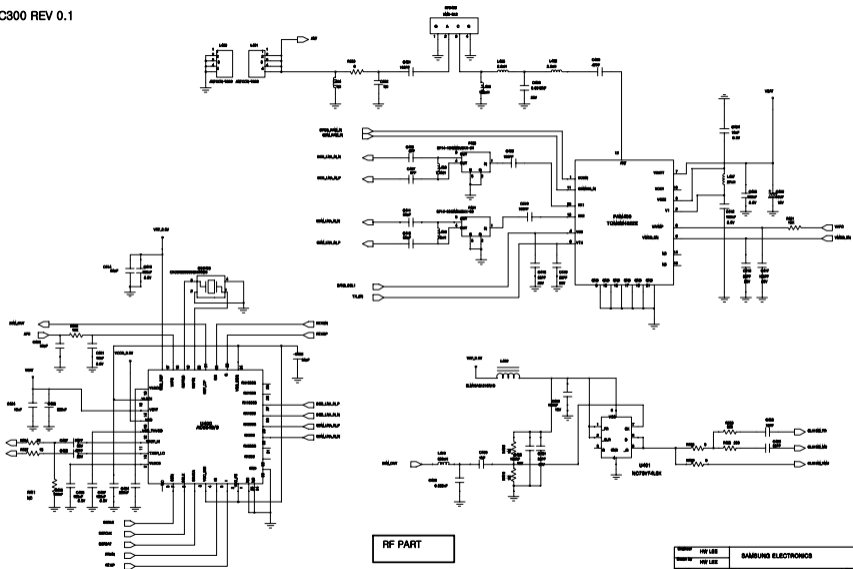

RF PART

DESIGNER	HYU LEE	SAMSUNG ELECTRONICS
REVIEWER	HYU LEE	
DATE		
SGH-NUVO REV0.1		

[www.s-manuals.com](http://www.s-manuals.com)