

|              |              |
|--------------|--------------|
| Engineer     | COMPANY NAME |
| Drawn by     | Address      |
| Check by     | CITY         |
| DATE         | STATE        |
| PROJECT NAME | SGH-E900     |
| DESIGNER     |              |
| DATE         |              |

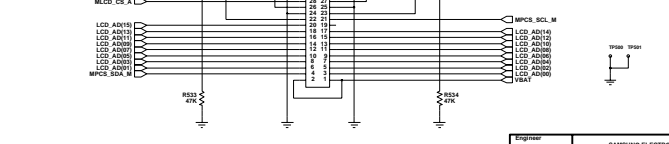

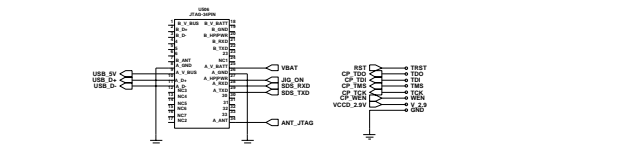

|              |                     |     |
|--------------|---------------------|-----|
| Engineer     | SAMSUNG ELECTRONICS |     |
| Drawn by     | TITLE               | REV |
| MODIFIED CHK | DATE                | BY  |
| WFTNDR CHK   | SGH-E900            |     |

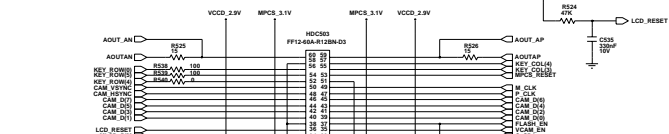
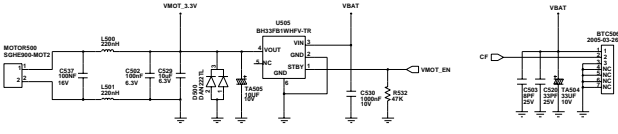
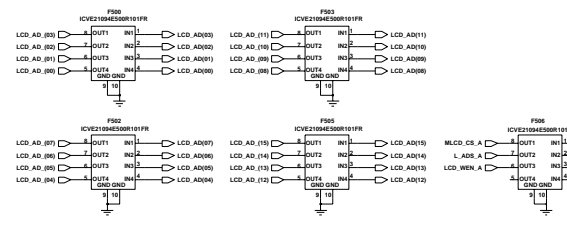
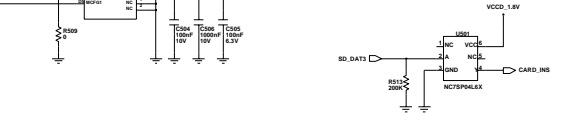
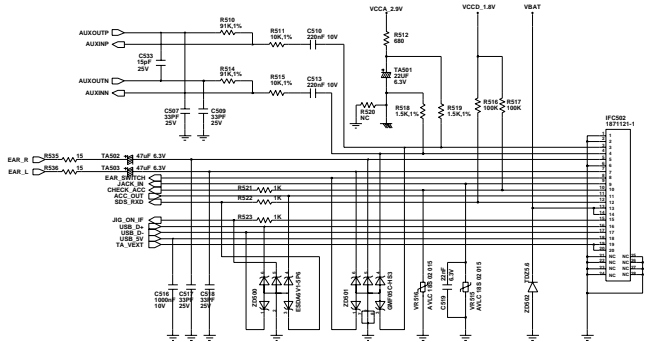
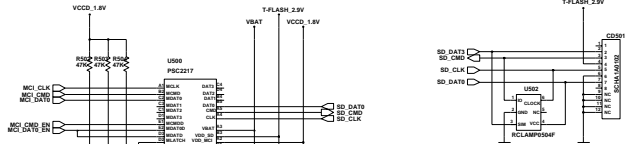
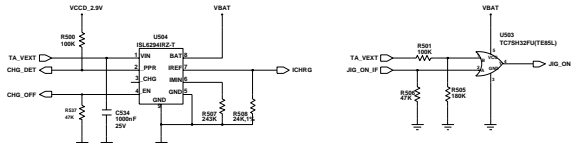