

SAMSUNG

GSM TELEPHONE

SGH-X530

SERVICE *Manual*

GSM TELEPHONE

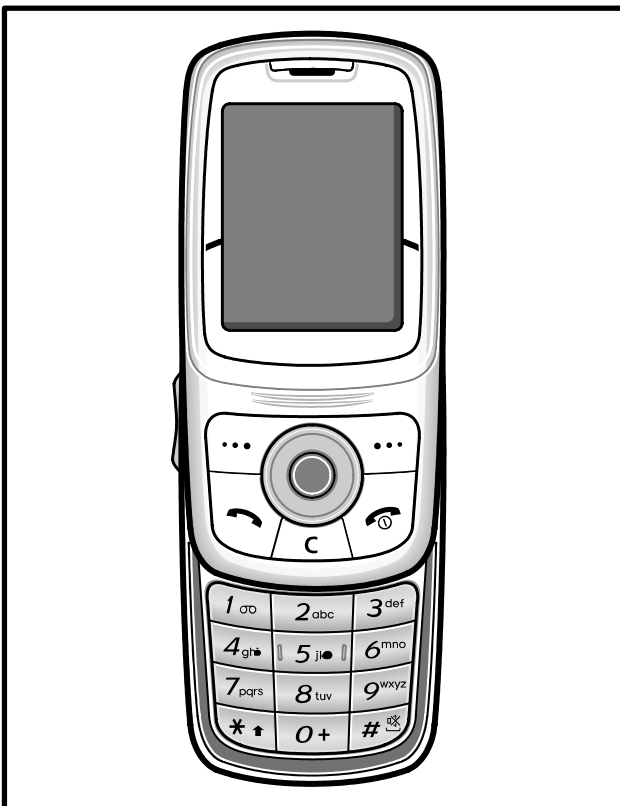

CONTENTS

1. Safety Precautions
2. Specification
3. Product Function
4. Array course control
5. Exploded View and Parts list
6. MAIN Electrical Parts List
7. Block Diagrams
8. PCB Diagrams
9. Flow Chart of Troubleshooting
10. Reference data

Contents

1. Safety Precautions

- 1-1. Repair Precaution1-1
- 1-2. ESD(Electrostatically Sensitive Devices) Precaution1-2

2. Specification

- 2-1. GSM General Specification2-1
- 2-2. GSM TX power Level2-2

3. Product Function

4. Array course control

- 4-1. Downloading Binary Files4-2
- 4-2. Pre-requisite for Downloading4-2
- 4-3. S/W Downloader Program4-3

5. Exploded View and Parts list

- 5-1. Cellular phone Exploded View5-1
- 5-2. Cellular phone Parts list5-2
- 5-3. Disassembly5-4
- 5-4. Assembly5-6

6. MAIN Electrical Parts List

7. Block Diagrams

8. PCB Diagrams

Contents

9. Flow Chart of Troubleshooting

9-1. Baseband	9-1
9-1-1. Power ON	9-1
9-1-2. Initial	9-4
9-1-3. SIM Part	9-6
9-1-4. Microphone Part	9-7
9-1-5. Speaker Part_1(MP3, SPEAKER PHONE)	9-8
9-1-6. Speaker Part_2(RECEIVER)	9-10
9-1-7. Charging Part	9-11
9-2. RF	9-13
9-2-1. EGSM RX	9-13
9-2-2. DCS RX	9-15
9-2-3. PCS RX	9-16
9-2-4. EGSM TX	9-17
9-2-5. DCS TX	9-18
9-2-6. PCS TX	9-19

10. Reference data

1. Safety Precautions

1-1. Repair Precaution

- Repair in Shield Box, during detailed tuning.
Take specially care of tuning or test,
because specipicty of cellular phone is sensitive for surrounding interference(RF noise).
- Be careful to use a kind of magnetic object or tool,
because performance of parts is damaged by the influence of manetic force.
- Surely use a standard screwdriver when you disassemble this product,
otherwise screw will be worn away.
- Use a thicken twisted wire when you measure level.
A thicken twisted wire has low resistance, therefore error of measurement is few.
- Repair after separate Test Pack and Set because for short danger (for example an
overcurrent and furious flames of parts etc) when you repair board in condition of
connecting Test Pack and tuning on.
- Take specially care of soldering, because Land of PCB is small and weak in heat.
- Surely tune on/off while using AC power plug, because a repair of battery charger is
dangerous when tuning ON/OFF PBA and Connector after disassembling charger.
- Don't use as you pleases after change other material than replacement registered on SEC
System.
Otherwise engineer in charge isn't charged with problem that you don't keep this rules.

1-2. ESD(Electrostatically Sensitive Devices) Precaution

Several semiconductor may be damaged easily by static electricity. Such parts are called by ESD(Electrostatically Sensitive Devices), for example IC,BGA chip etc. Read Precaution below. You can prevent from ESD damage by static electricity.

- Remove static electricity remained your body before you touch semiconductor or parts with semiconductor. There are ways that you touch an earthed place or wear static electricity prevention string on wrist.
- Use earthed soldering steel when you connect or disconnect ESD.
- Use soldering removing tool to break static electricity. , otherwise ESD will be damaged by static electricity.
- Don't unpack until you set up ESD on product. Because most of ESD are packed by box and aluminum plate to have conductive power,they are prevented from static electricity.
- You must maintain electric contact between ESD and place due to be set up until ESD is connected completely to the proper place or a circuit board.

2. Specification

2-1. GSM General Specification

	GSM900 Phase 1	EGSM 900 Phase 2	DCS1800 Phase 1	PCS1900
Freq. Band[MHz] Uplink/Downlink	890~915 935~960	880~915 925~960	1710~1785 1805~1880	1850~1910 1930~1990
ARFCN range	1~124	0~124 & 975~1023	512~885	512~810
Tx/Rx spacing	45 MHz	45 MHz	95 MHz	80 MHz
Mod. Bit rate/ Bit Period	270.833 kbps 3.692 us	270.833 kbps 3.692 us	270.833 kbps 3.692 us	270.833 kbps 3.692 us
Time Slot Period/Frame Period	576.9 us 4.615 ms	576.9 us 4.615 ms	576.9 us 4.615 ms	576.9 us 4.615 ms
Modulation	0.3GMSK	0.3 GMSK	0.3 GMSK	0.3 GMSK
MS Power	33 dBm~13 dBm	33 dBm~5 dBm	30 dBm~0 dBm	30 dBm~0 dBm
Power Class	5 pcl ~ 15 pcl	5 pcl ~ 19 pcl	0 pcl ~ 15 pcl	0 pcl ~ 15 pcl
Sensitivity	-102 dBm	-102 dBm	-100 dBm	-100 dBm
TDMA Mux	8	8	8	8
Cell Radius	35 Km	35 Km	2 Km	-

2-2. GSM Tx Power Class

TX Power control level	GSM900	TX Power control level	DCS1800	TX Power control level	PCS1900
5	33±2 dBm	0	30±3 dBm	0	30±3 dBm
6	31±2 dBm	1	28±3 dBm	1	28±3 dBm
7	29±2 dBm	2	26±3 dBm	2	26±3 dBm
8	27±2 dBm	3	24±3 dBm	3	24±3 dBm
9	25±2 dBm	4	22±3 dBm	4	22±3 dBm
10	23±2 dBm	5	20±3 dBm	5	20±3 dBm
11	21±2 dBm	6	18±3 dBm	6	18±3 dBm
12	19±2 dBm	7	16±3 dBm	7	16±3 dBm
13	17±2 dBm	8	14±3 dBm	8	14±3 dBm
14	15±2 dBm	9	12±4 dBm	9	12±4 dBm
15	13±2 dBm	10	10±4 dBm	10	10±4 dBm
16	11±3 dBm	11	8±4 dBm	11	8±4 dBm
17	9±3 dBm	12	6±4 dBm	12	6±4 dBm
18	7±3 dBm	13	4±4 dBm	13	4±4 dBm
19	5±3 dBm	14	2±5 dBm	14	2±5 dBm
		15	0±5 dBm	15	0±5 dBm

3. Product Function

Main Function

- Speed dial
- SDN(Service Dialling Numbers)
- Network services
- Read SMS or MMS message
- Voicemail
- SOS messages

4. Array course control

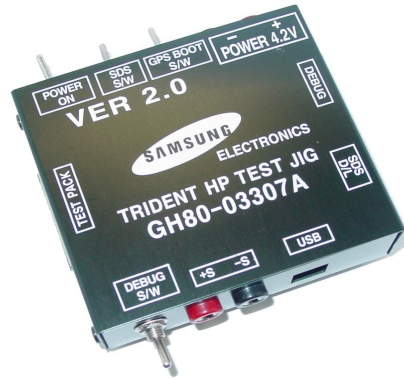

Test Jig (GH80-03307A)



Test Cable (GH39-00127A)



RF Test Cable (GH39-00283A)

4-1. Downloading Binary Files (1)

- Swift Model firmware is composed of 2 files
- *.s3 : Main source code binary.

4-2. Prerequisite

- Downloader program(Optiflash.exe)
- X530 Mobile Phone
- Data Cable
- Binary Files

4-3. S/W Downloader Program

1. Load the binary download program by execution the "OptiFlash.exe"



2. Select the "Options" -> "Settings" -> "Generic" -> "Specify hardware platform".
Choose hardware platform for the downloader file setting.
Set the everything else as the default values which are shown below

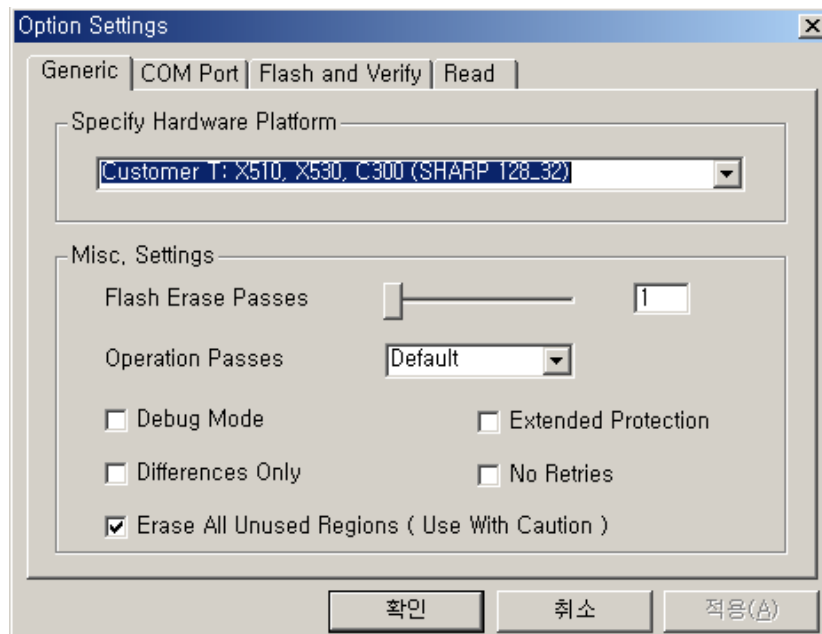

3. Select the **COM port** where the download cable is connected

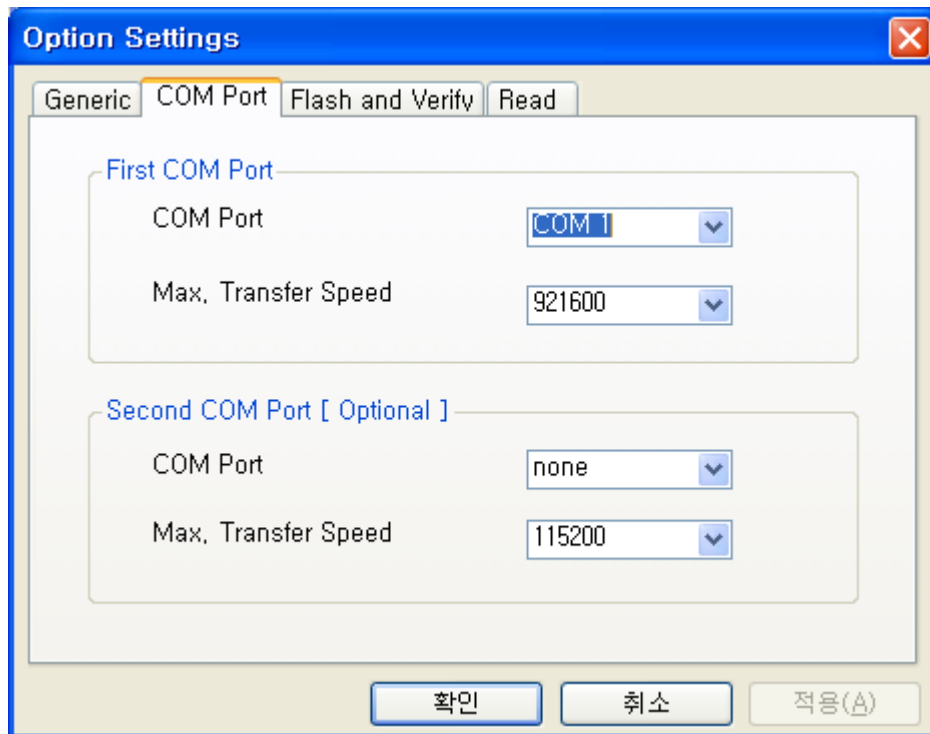

Only COM1 is supported. Additionally you can select the maximum transfer speed OptiFlash will use to communicate with the phone. However, Optiflash will use a slower speed if either the PC's or the phone's serial hardware is incapable of handling the selected speed.

4. Select the "Flash&Verify" -> "Browse"

Set the directory path and choose the latest S/W binary, for example "gsmstack.s3", for the downloader binary setting.

And Check "Reserved Memory Regions" - **0x00008000 - 0x0001ffff**

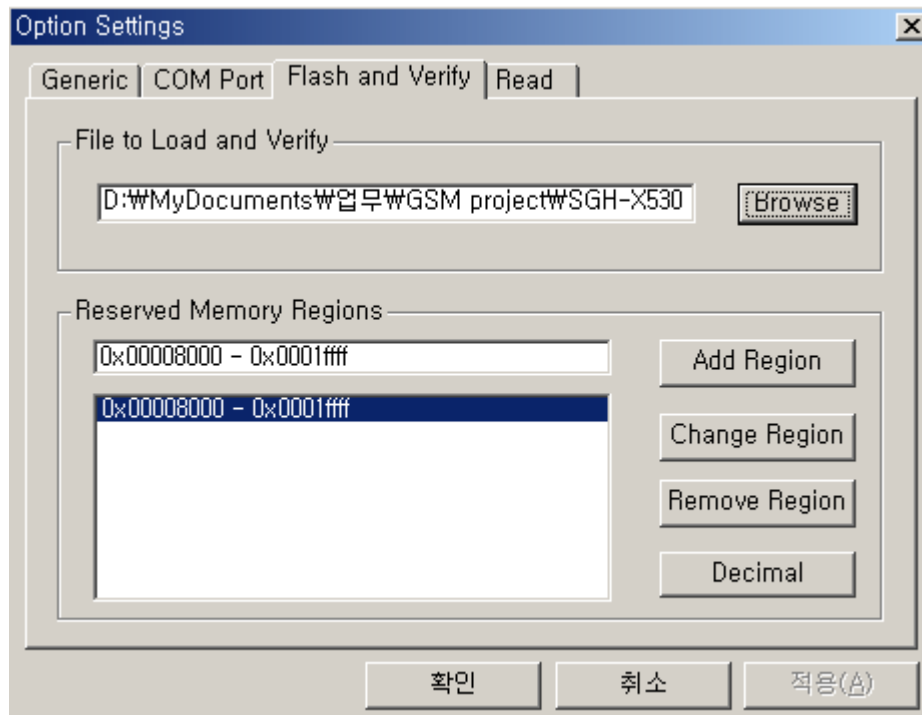

5. 1st. Press "Flash".

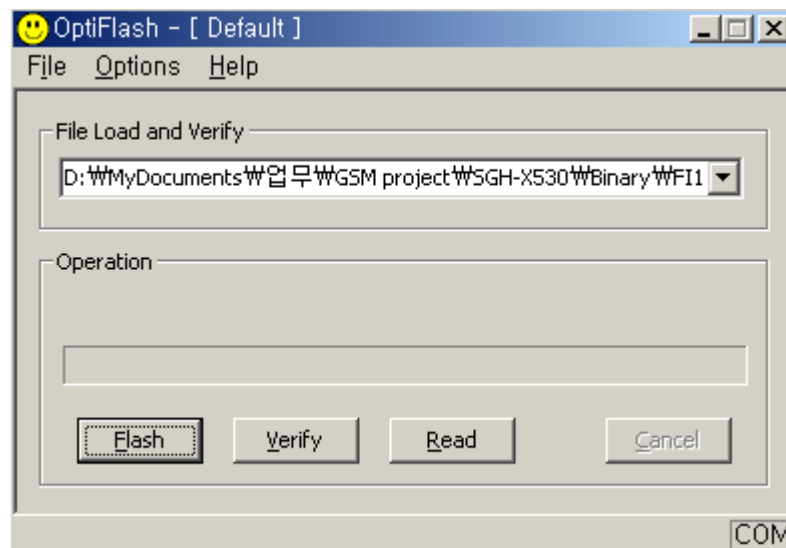

2nd. Turn on Power of mobile

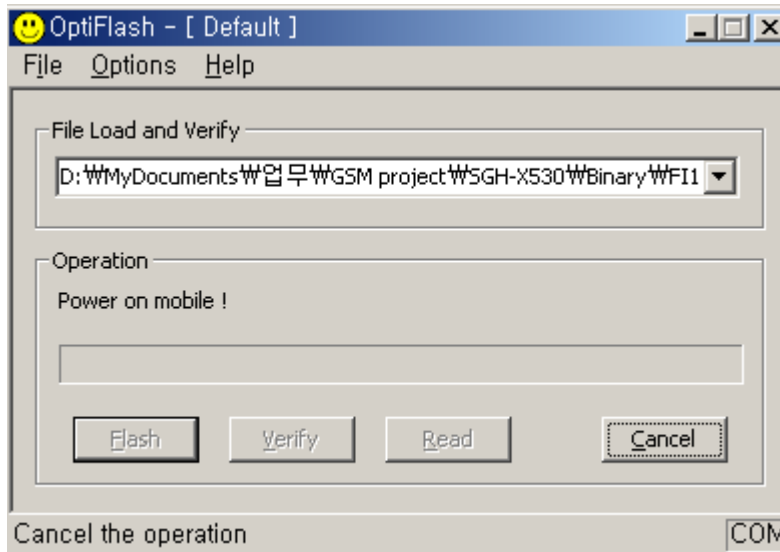

6. When downloading is finished successfully, there is a “All is well” message.

7. After finishing downloading, Certain memory resets should be done to guarantee the normal performance.

8. Confirm the downloaded version name by key-string(***#1234#**)
Memory reset will be done by pressing the following key-strings.
Full Reset : “***2767*3855#**” will reboot the phone automatically.

5. Exploded View and Parts List

5-1. Cellular phone Exploded View

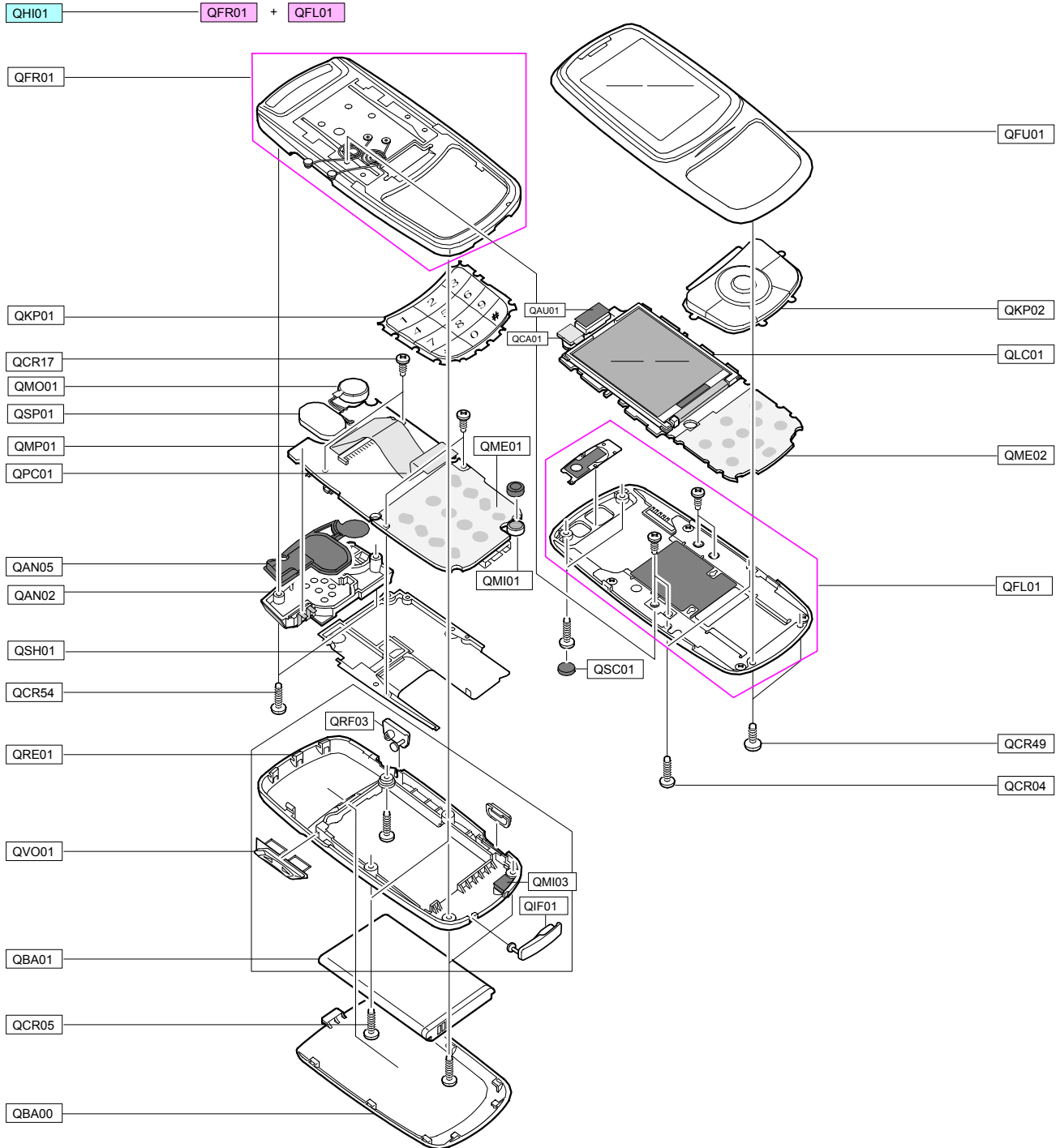

5-2. Cellular phone Parts list

Design LOC		Discription	SEC CODE
QAN02		INTENNA-SGHX530	GH42-00995A
QAN05		ASSY RUBBER-INTENNA	GH98-02741A
QAU01		AUDIO-RECEIVER	3009-001243
QBA00		PMO-COVER BATT	GH72-34196A
QBA01		INNER BATTERY PACK-800MAH,MAIN	GH43-02589A
QCA01		UNIT-CAMERA	GH59-03701A
QCR04		SCREW-MACHINE	6001-001479
QCR05		SCREW-MACHINE	6001-001478
QCR17		SCREW-MACHINE	6001-001460
QCR49		SCREW-MACHINE	6001-001823
QCR54		SCREW-MACHINE	6001-001645
QFU01		ASSY COVER-SLIDE UPPER	GH98-02234A
QKP01		ASSY KEYPAD-MAIN(OPEN/BRN)	GH98-02239A
QKP02		ASSY KEYPAD-SUB(OPEN/BRN)	GH98-02238A
QLC01		ELA UNIT-SGHX530 LCD MODULE	GH96-02314A
QME01		UNIT-DOME SHEET (MAIN KEY)	GH59-03675A
QME02		UNIT-DOME SHEET (NAVI KEY)	GH59-03682A
QMI01		MICROPHONE-ASSY-SGHX530	GH30-00320A
QMO01		MOTOR DC-SPHV8400	GH31-00187A
QMP01		PBA MAIN-SGHX530S (PBA MAIN)	GH92-03125A
QPC01		MEA-SLIDE FPCB KIT	GH97-06774A
QSC01		RMO-RUBBER SCREW	GH73-08015A
QSH03		ASSY BRACKET-SHIELD REAR	GH98-02241A
QSP01		SPEAKER	3001-002075
QVO01		PMO-KEY VOLUME	GH72-34195A
QHI01		ASSY HINGE	GH98-02235A
	QFL01	ASSY COVER-SLIDE LOWER	GH98-02236A
	QFR01	ASSY COVER-FRONT	GH98-02237A
QRE01		ASSY COVER-REAR	GH98-02240A
	QIF01	PMO-COVER IF	GH72-34193A
	QMI03	RMO-RUBBER MIC	GH73-08289A
	QRF03	PMO-COVER EAR JACK	GH72-34192A

Discription	SEC CODE
BAG PE	6902-000297
ADAPTOR-SCHN391 HUTCHSON	GH44-00745A
UNIT-EARPHONE	GH59-01694A
LABEL(P)-IMEI	GH68-01335D
LABEL(P)-WATER SOAK	GH68-02026A
LABEL(P)-WATER SOAK	GH68-02026A
MANUAL USERS-EU ENGLISH	GH68-12661A
LABEL(R)-MAIN((XSA)	GH68-13025D
BOX(P)-UNIT MAIN(SEA_2)	GH69-04689K
RMO-RUBBER MIC HOLDER	GH73-08016A
RMO-RUBBER BGA A	GH73-08526A
RMO-RUBBER BGA B	GH73-08527A
RMO-RUBBER BGA C	GH73-08528A
RMO-RUBBER BGA D	GH73-08529A
MPR-REMOVE TAPE LCD	GH74-13804A
MPR-TAPE LCD SHORT	GH74-19768A
MPR-GASKET LCD SIDE	GH74-24930A
MPR-VINYL BOHO CAMERA LENS	GH74-25648A
MPR-TAPE	GH74-26727A
MPR-TAPE	GH74-26727A
MPR-SPONGE CAM	GH74-28219A
MPR-INSU TAPE	GH74-28241A
MPR-INSU TAPE LCD PCB	GH74-28645A
MPR-INSU TAPE MAIN PCB	GH74-28646A
MPR-TAPE ELEC ESD	GH74-28649A
MPR-VINYL BOHO WINDOW	GH74-28851A
MPR-TAPE BGA B	GH74-28856A
MPR-TAPE MAIN FPCB HOLD	GH74-28942A
MPR-SPONGE PCB	GH74-28944A
MPR-ELEC TAPE PCB A	GH74-28946A
MPR-VINYL BOHO FRONT	GH74-29101A

5-3. Disassembly

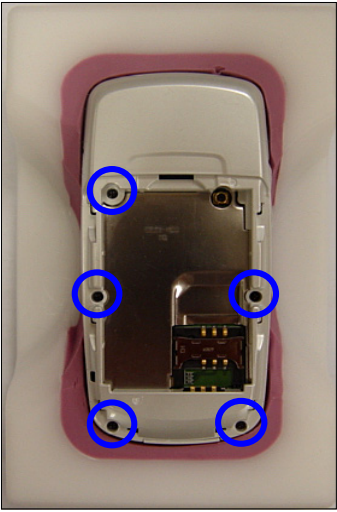
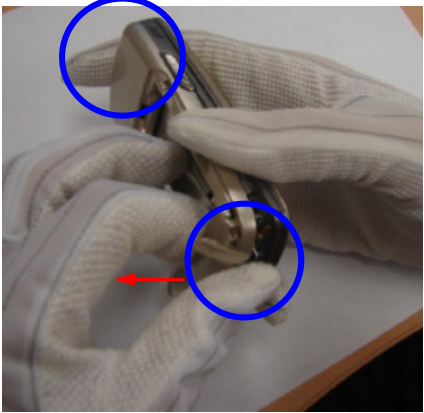
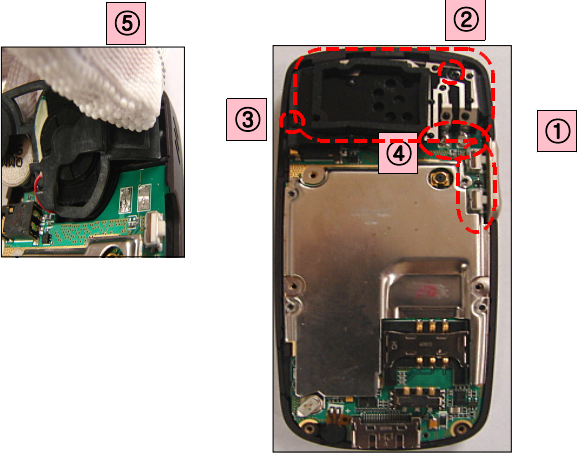
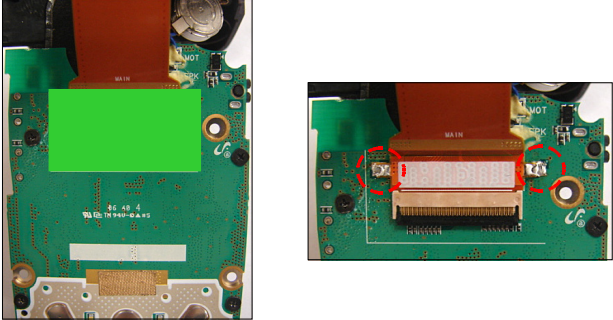
<p>1</p> 	<p>2</p> 
<p>1) Disjoint the REAR Screw of 5 Points.</p> <p>* caution</p> <p>1) Be careful for scratch</p>	<p>1) Disjoint REAR's lower locker and remove REAR case just like a picture below.</p> <p>* caution</p> <p>1) Be careful for scratch</p>
<p>3</p> 	<p>4</p> 
<p>1) Disjoint VOL KEY with tweezers.</p> <p>2) Disjoint an INTENNA SCREW.</p> <p>3) Disjoint an INTENNA SCREW.</p> <p>4) Remove an INTENA.</p> <p>5) Disjoint SPEAKER RUBBER, MOTOR and SPEAKER with tweezers</p> <p>* caution</p> <p>1) Be careful for the damage on the WIRE or RUBBER.</p>	<p>1) Remove the green tape on the FPCB</p> <p>2) Disjoint the FPCB by DESOLDERING.</p> <p>* caution</p> <p>1) Be careful for the FPCB's crack</p>



1) Disjoin 6 screws.

*** caution**

- 1) Be careful for scratch
- 2) Using the '+' screw driver.

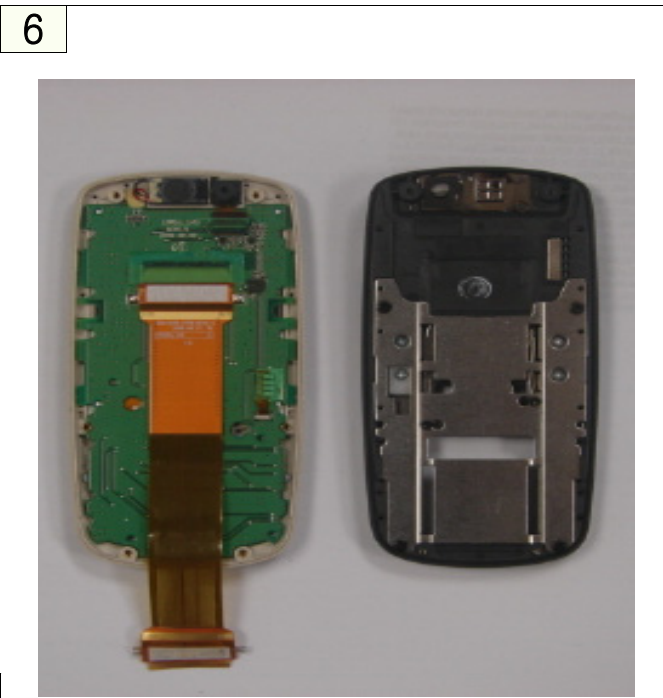

1) Disjoint HINGE ASSY like the picture below.

*** caution**

- 1) Be careful FPCB's crumpling.

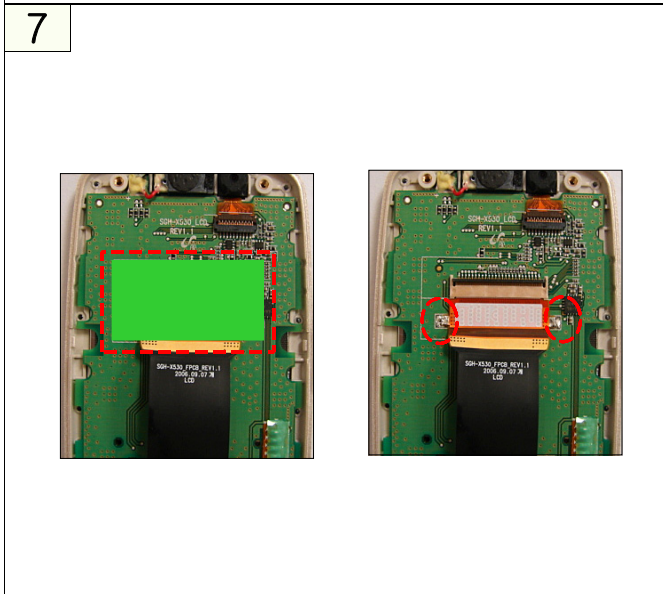

- 1) Remove the green tape from the FPCB
- 2) Disjoint the FPCB with DESOLDERING.

*** caution**

- 1) Be careful for the FPCB's crack

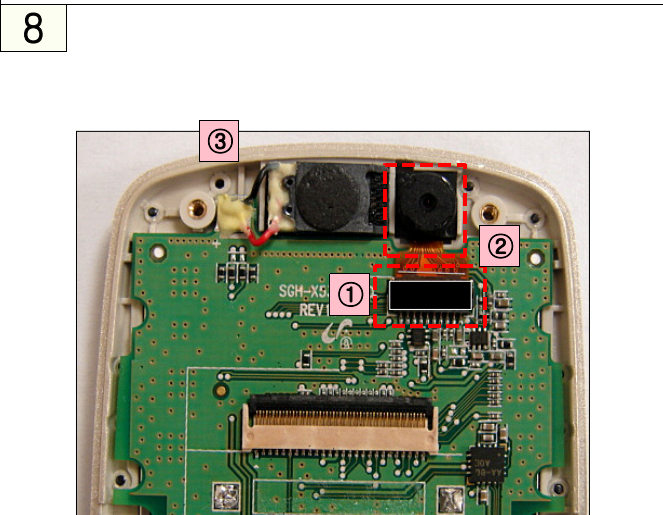



1),2) First, Remove the Black tape, and then disjoint the CAM from connector.

3) Take off the receiver from the Upper plastic.

*** caution**

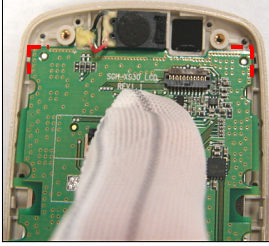
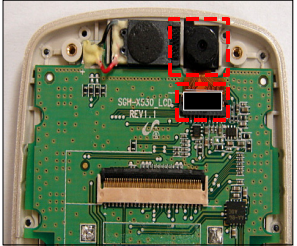
- 1) Be careful for the Cammera's crack.

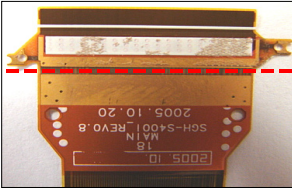
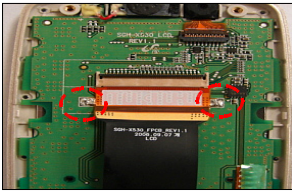
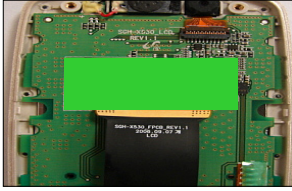
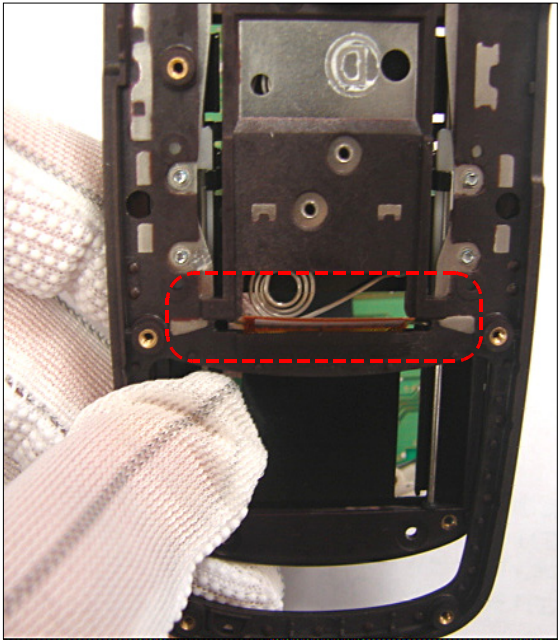
<p>5</p> <p>1</p>  <p>1) Put the NAVI key like the picture below.</p> <p>* caution</p> <p>1) Put the hole of NAVY key to UPPER</p>	<p>6</p> <p>2</p> <div style="display: flex; justify-content: space-around;"> <div style="text-align: center;"> <p>①</p>  </div> <div style="text-align: center;"> <p>②</p>  </div> </div> <p>1) Put the receiver and the SUB PBA.</p> <p>2) Insert the CAMERA, and then put up the SPONGE along the edge of connector</p> <p>* caution</p> <p>1) Check the fabrication status of RCV & CAM</p> <p>2) Be careful for the CAM FPCB's crack.</p>
<p>3</p> <div style="display: flex; justify-content: space-around;"> <div style="text-align: center;"> <p>①</p>  </div> <div style="text-align: center;">  </div> </div> <div style="display: flex; justify-content: space-around; margin-top: 10px;"> <div style="text-align: center;"> <p>②</p>  </div> <div style="text-align: center;">  </div> </div> <p>1) Fold the FPCB like the picture below.</p> <p>2) Insert the LCD FPCB to the CONNECTOR, SOLDERING 2 points and then put the green TAPE.</p> <p>* caution</p> <p>1) Be careful for scratch</p> <p>2) Be careful for the FPCB's crack</p>	<p>4</p>  <p>1) Insert the MAIN FPCB like the picture below.</p> <p>* caution</p> <p>1) Be careful for the FPCB's crack</p>

5

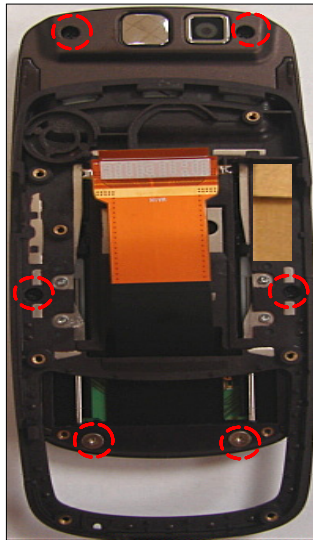

1) Joint the 6 screws with the slide stopping JIG.

*** caution**

1) Fix the slide tightly.

7

①



②

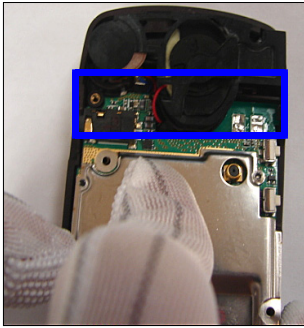

1) Put the NAVY key like the picture below.

2) Put the PBA first, and then MOT, SPK.

*** caution**

1) Be careful the wire.

6

①

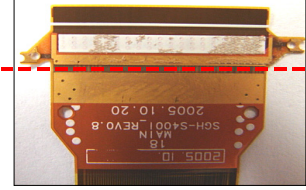
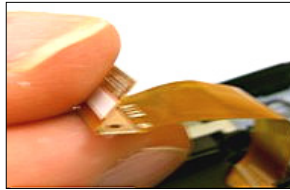

②

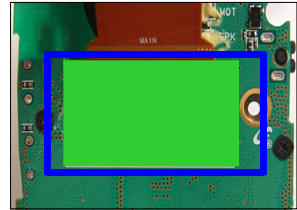
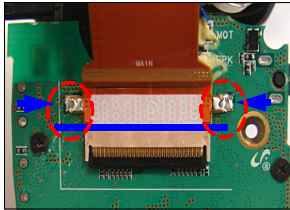

1) Fold the FPCB like the picture below.

2) Insert the LCD FPCB to the CONNECTOR

along the SILK LINE, SOLDERING 2 points and then put the green TAPE.

*** caution**

1) Be careful for the FPCB's crack

8

①

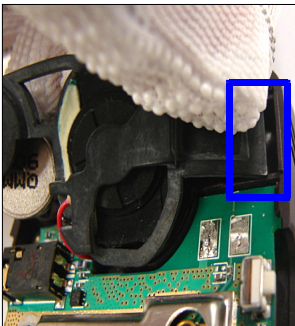

②

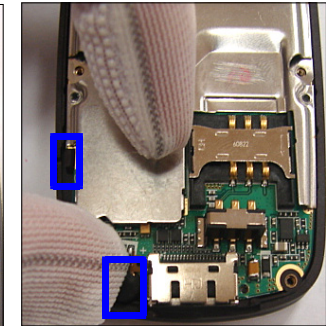



1) Insert the SPK RUBBER like the picture below.

2) Lock the PBA on the left side HOOK and then put the MIC.

*** caution**

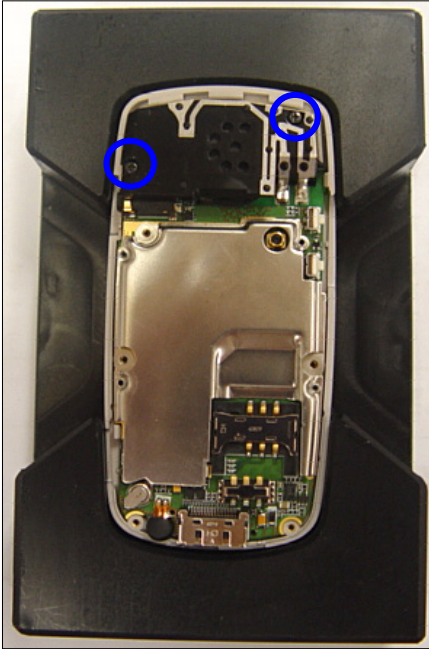
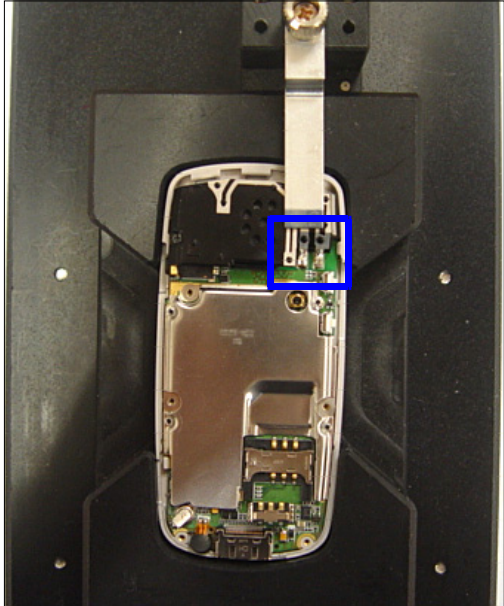
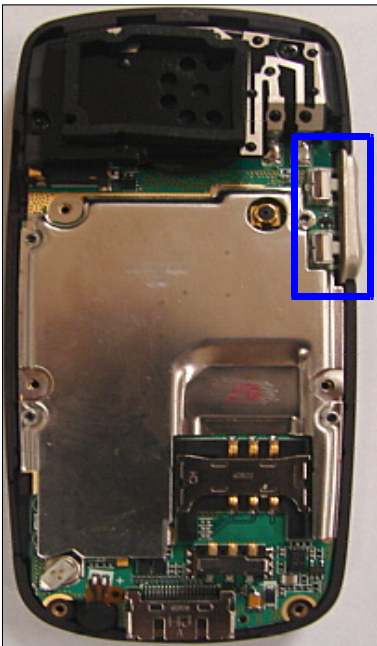
1) Be careful the rubber's folding.

<p>9</p> 	<p>10</p> 
<p>1) Joint the 2 screws with the screw JIG. * caution 1) Be careful for the damage to INTENNA pattern.</p>	<p>1) Soldering the Intenna pads. * caution 1) Be careful for the damage of plastic.</p>
<p>11</p> 	<p>12</p> 
<p>1) Insert the VOL KEY. * caution 1) Be careful for the damage of plastic.</p>	<p>1) Joint the lower REAR plastic first. 2) Push the upper REAR plastic like the picture below until hearing the locking sound. * caution 1) Be careful for the damage of plastic.</p>

13

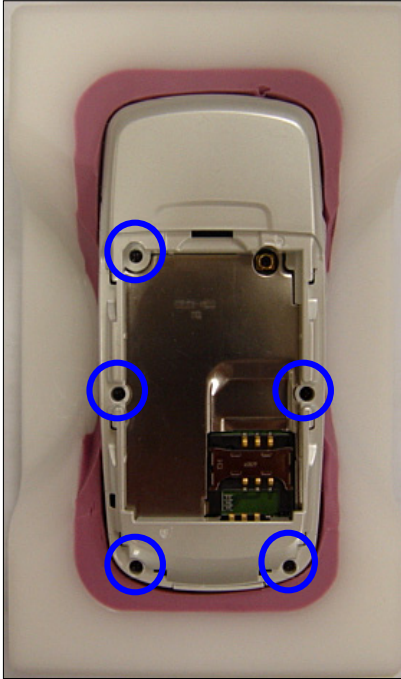

1) Joint 5 screws with the prop.

* **caution**

1) Be careful for the damage of plastic.

6. MAIN Electrical Parts List

SEC CODE	Design LOC	Discription	SEC CODE
0401-001141	D300	DIODE-SWITCHING	SA
0403-001547	D101	DIODE-ZENER	SA
0406-001197	ZD100	DIODE-TVS	SA
0406-001197	ZD101	DIODE-TVS	SA
0406-001197	ZD301	DIODE-TVS	SA
0406-001201	ZD302	DIODE-TVS	SA
0406-001260	D200	DIODE-TVS	SA
0501-000225	TR302	TR-SMALL SIGNAL	SA
0504-000168	TR300	TR-DIGITAL	SA
0601-001819	LED200	LED	SA
0601-001819	LED201	LED	SA
0601-001819	LED202	LED	SA
0601-001819	LED203	LED	SA
0601-001819	LED204	LED	SA
0601-001819	LED205	LED	SA
0601-001819	LED206	LED	SA
0601-001819	LED207	LED	SA
0601-001819	LED208	LED	SA
0601-001819	LED209	LED	SA
0601-001819	LED210	LED	SA
0601-001819	LED211	LED	SA
0604-001306	IRDA	PHOTO-IRDA	SA
0801-002529	U104	IC-CMOS LOGIC	SA
1009-001027	U200	IC-HALL EFFECT S/W	SA
1108-000010	UME200	IC-MCP	SA
1201-002278	U100	IC-POWER AMP	SA
1203-003304	UCP300	IC-POWER SUPERVISOR	SA
1203-003663	U103	IC-BATTERY	SA
1204-001811	U300	IC-MELODY	SA
1205-003116	U101	IC-TRANSCIEVER	SA
1209-001712	U201	IC-SENSOR	SA
1405-001082	V100	VARISTOR	SA
1405-001082	V102	VARISTOR	SA
1405-001082	V103	VARISTOR	SA
1405-001082	V205	VARISTOR	SA
1405-001082	V206	VARISTOR	SA
1405-001082	V306	VARISTOR	SA

Main Electrical Parts List

SEC CODE	Design LOC	Discription	SEC CODE
1405-001082	V307	VARISTOR	SA
1405-001082	V308	VARISTOR	SA
1405-001082	V309	VARISTOR	SA
1405-001082	V310	VARISTOR	SA
1405-001177	V101	VARISTOR	SA
1405-001177	V200	VARISTOR	SA
1405-001177	V201	VARISTOR	SA
1405-001177	V202	VARISTOR	SA
1405-001177	V203	VARISTOR	SA
1405-001177	V204	VARISTOR	SA
1405-001177	V207	VARISTOR	SA
1405-001177	V208	VARISTOR	SA
1405-001177	V209	VARISTOR	SA
1405-001177	V210	VARISTOR	SA
2007-000070	R335	R-CHIP	SA
2007-000140	R120	R-CHIP	SA
2007-000140	R316	R-CHIP	SA
2007-000144	R301	R-CHIP	SA
2007-000148	R307	R-CHIP	SA
2007-000148	R312	R-CHIP	SA
2007-000148	R330	R-CHIP	SA
2007-000148	R331	R-CHIP	SA
2007-000157	R205	R-CHIP	SA
2007-000157	R209	R-CHIP	SA
2007-000160	R320	R-CHIP	SA
2007-000161	R306	R-CHIP	SA
2007-000161	R315	R-CHIP	SA
2007-000162	R112	R-CHIP	SA
2007-000162	R119	R-CHIP	SA
2007-000162	R211	R-CHIP	SA
2007-000164	R206	R-CHIP	SA
2007-000164	R318	R-CHIP	SA
2007-000168	R325	R-CHIP	SA
2007-000170	R212	R-CHIP	SA
2007-000170	R303	R-CHIP	SA
2007-000171	R313	R-CHIP	SA
2007-000171	R314	R-CHIP	SA

SEC CODE	Design LOC	Discription	SEC CODE
2007-000172	R111	R-CHIP	SA
2007-000172	R200	R-CHIP	SA
2007-000172	R201	R-CHIP	SA
2007-000566	R114	R-CHIP	SA
2007-000566	R116	R-CHIP	SA
2007-000566	R117	R-CHIP	SA
2007-000566	R118	R-CHIP	SA
2007-000775	R319	R-CHIP	SA
2007-000775	R321	R-CHIP	SA
2007-000775	R322	R-CHIP	SA
2007-000831	R113	R-CHIP	SA
2007-000831	R324	R-CHIP	SA
2007-001119	R304	R-CHIP	SA
2007-001119	R326	R-CHIP	SA
2007-001284	R215	R-CHIP	SA
2007-001290	R302	R-CHIP	SA
2007-001320	R305	R-CHIP	SA
2007-001320	R327	R-CHIP	SA
2007-001323	R317	R-CHIP	SA
2007-001325	R323	R-CHIP	SA
2007-001335	R234	R-CHIP	SA
2007-002965	R308	R-CHIP	SA
2007-002965	R310	R-CHIP	SA
2007-003023	R235	R-CHIP	SA
2007-007014	R329	R-CHIP	SA
2007-007468	R328	R-CHIP	SA
2007-007468	R332	R-CHIP	SA
2007-007573	R210	R-CHIP	SA
2007-007573	R213	R-CHIP	SA
2007-008045	R103	R-CHIP	SA
2007-008137	R121	R-CHIP	SA
2007-008419	R122	R-CHIP	SA
2007-008419	R124	R-CHIP	SA
2007-008419	R125	R-CHIP	SA
2007-008419	R126	R-CHIP	SA
2007-008419	R127	R-CHIP	SA
2007-008419	R128	R-CHIP	SA

Main Electrical Parts List

SEC CODE	Design LOC	Discription	SEC CODE
2007-008419	R129	R-CHIP	SA
2007-008419	R130	R-CHIP	SA
2007-008419	R131	R-CHIP	SA
2007-008419	R132	R-CHIP	SA
2007-008419	R133	R-CHIP	SA
2007-008419	R134	R-CHIP	SA
2007-008483	R136	R-CHIP	SA
2007-008486	R115	R-CHIP	SA
2007-008516	R106	R-CHIP	SA
2007-008516	R107	R-CHIP	SA
2007-008531	R104	R-CHIP	SA
2007-008548	R100	R-CHIP	SA
2007-008587	R101	R-CHIP	SA
2007-008590	R333	R-CHIP	SNA
2007-009111	R219	R-CHIP	SA
2007-009111	R220	R-CHIP	SA
2007-009111	R223	R-CHIP	SA
2007-009111	R224	R-CHIP	SA
2007-009111	R225	R-CHIP	SA
2007-009111	R227	R-CHIP	SA
2007-009111	R228	R-CHIP	SA
2007-009111	R229	R-CHIP	SA
2007-009111	R230	R-CHIP	SA
2007-009111	R231	R-CHIP	SA
2007-009111	R232	R-CHIP	SA
2007-009111	R233	R-CHIP	SA
2007-009160	R123	R-CHIP	SA
2007-009315	R204	R-CHIP	SA
2007-009315	R300	R-CHIP	SA
2203-000233	C222	C-CER,CHIP	SA
2203-000233	C316	C-CER,CHIP	SA
2203-000254	C204	C-CER,CHIP	SA
2203-000254	C205	C-CER,CHIP	SA
2203-000254	C206	C-CER,CHIP	SA
2203-000254	C207	C-CER,CHIP	SA
2203-000254	C209	C-CER,CHIP	SA
2203-000254	C210	C-CER,CHIP	SA

SEC CODE	Design LOC	Discription	SEC CODE
2203-000254	C211	C-CER,CHIP	SA
2203-000254	C218	C-CER,CHIP	SA
2203-000254	C301	C-CER,CHIP	SA
2203-000254	C302	C-CER,CHIP	SA
2203-000254	C334	C-CER,CHIP	SA
2203-000254	C340	C-CER,CHIP	SA
2203-000254	C359	C-CER,CHIP	SA
2203-000278	C353	C-CER,CHIP	SA
2203-000311	C341	C-CER,CHIP	SA
2203-000330	C223	C-CER,CHIP	SA
2203-000330	C224	C-CER,CHIP	SA
2203-000359	C356	C-CER,CHIP	SA
2203-000359	C357	C-CER,CHIP	SA
2203-000425	C321	C-CER,CHIP	SA
2203-000425	C322	C-CER,CHIP	SA
2203-000438	C343	C-CER,CHIP	SA
2203-000679	C217	C-CER,CHIP	SA
2203-000812	C305	C-CER,CHIP	SA
2203-000812	C306	C-CER,CHIP	SA
2203-000812	C332	C-CER,CHIP	SA
2203-000940	C303	C-CER,CHIP	SA
2203-000940	C325	C-CER,CHIP	SA
2203-000940	C333	C-CER,CHIP	SA
2203-000940	C346	C-CER,CHIP	SA
2203-000940	C358	C-CER,CHIP	SA
2203-000995	C307	C-CER,CHIP	SA
2203-000995	C336	C-CER,CHIP	SA
2203-000995	C339	C-CER,CHIP	SA
2203-001072	C352	C-CER,CHIP	SA
2203-002668	C164	C-CER,CHIP	SA
2203-005344	C216	C-CER,CHIP	SA
2203-005344	C323	C-CER,CHIP	SA
2203-005344	C337	C-CER,CHIP	SA
2203-005395	C163	C-CER,CHIP	SA
2203-005482	C335	C-CER,CHIP	SA
2203-005482	C338	C-CER,CHIP	SA
2203-005682	C102	C-CER,CHIP	SA

Main Electrical Parts List

SEC CODE	Design LOC	Discription	SEC CODE
2203-005682	C104	C-CER,CHIP	SA
2203-005682	C125	C-CER,CHIP	SA
2203-005682	C127	C-CER,CHIP	SA
2203-005682	C128	C-CER,CHIP	SA
2203-005682	C129	C-CER,CHIP	SA
2203-005731	C103	C-CER,CHIP	SA
2203-005736	C105	C-CER,CHIP	SA
2203-005736	C112	C-CER,CHIP	SA
2203-005736	C115	C-CER,CHIP	SA
2203-005736	C126	C-CER,CHIP	SA
2203-005777	C101	C-CER,CHIP	SA
2203-005777	C106	C-CER,CHIP	SA
2203-005777	C111	C-CER,CHIP	SA
2203-005777	C113	C-CER,CHIP	SA
2203-005819	C311	C-CER,CHIP	SA
2203-005819	C312	C-CER,CHIP	SA
2203-005819	C313	C-CER,CHIP	SA
2203-005819	C314	C-CER,CHIP	SA
2203-005819	C315	C-CER,CHIP	SA
2203-006048	C148	C-CER,CHIP	SA
2203-006048	C200	C-CER,CHIP	SA
2203-006048	C201	C-CER,CHIP	SA
2203-006048	C202	C-CER,CHIP	SA
2203-006048	C203	C-CER,CHIP	SA
2203-006048	C208	C-CER,CHIP	SA
2203-006048	C214	C-CER,CHIP	SA
2203-006048	C215	C-CER,CHIP	SA
2203-006048	C221	C-CER,CHIP	SA
2203-006048	C300	C-CER,CHIP	SA
2203-006048	C317	C-CER,CHIP	SA
2203-006048	C319	C-CER,CHIP	SA
2203-006048	C324	C-CER,CHIP	SA
2203-006048	C326	C-CER,CHIP	SA
2203-006048	C330	C-CER,CHIP	SA
2203-006048	C342	C-CER,CHIP	SA
2203-006048	C345	C-CER,CHIP	SA
2203-006048	C349	C-CER,CHIP	SA

SEC CODE	Design LOC	Discription	SEC CODE
2203-006048	C351	C-CER,CHIP	SA
2203-006048	C355	C-CER,CHIP	SA
2203-006194	C107	C-CER,CHIP	SA
2203-006194	C108	C-CER,CHIP	SA
2203-006194	C116	C-CER,CHIP	SA
2203-006194	C121	C-CER,CHIP	SA
2203-006257	C304	C-CER,CHIP	SA
2203-006257	C310	C-CER,CHIP	SA
2203-006257	C348	C-CER,CHIP	SA
2203-006260	C212	C-CER,CHIP	SA
2203-006260	C213	C-CER,CHIP	SA
2203-006305	C137	C-CER,CHIP	SA
2203-006318	C114	C-CER,CHIP	SA
2203-006318	C117	C-CER,CHIP	SA
2203-006324	C308	C-CER,CHIP	SA
2203-006324	C350	C-CER,CHIP	SA
2203-006377	C130	C-CER,CHIP	SA
2203-006410	C110	C-CER,CHIP	SA
2203-006423	C118	C-CER,CHIP	SA
2203-006423	C120	C-CER,CHIP	SA
2203-006423	C122	C-CER,CHIP	SA
2203-006423	C123	C-CER,CHIP	SA
2203-006423	C219	C-CER,CHIP	SA
2203-006423	C220	C-CER,CHIP	SA
2203-006556	C100	C-CER,CHIP	SA
2203-006556	C109	C-CER,CHIP	SA
2203-006556	C133	C-CER,CHIP	SA
2203-006556	C134	C-CER,CHIP	SA
2203-006556	C135	C-CER,CHIP	SA
2203-006556	C136	C-CER,CHIP	SA
2203-006556	C157	C-CER,CHIP	SA
2203-006556	C158	C-CER,CHIP	SA
2203-006556	C159	C-CER,CHIP	SA
2203-006556	C160	C-CER,CHIP	SA
2203-006556	C161	C-CER,CHIP	SA
2203-006556	C162	C-CER,CHIP	SA
2203-006562	C143	C-CER,CHIP	SA

Main Electrical Parts List

SEC CODE	Design LOC	Discription	SEC CODE
2203-006562	C144	C-CER,CHIP	SA
2203-006562	C309	C-CER,CHIP	SA
2203-006562	C318	C-CER,CHIP	SA
2203-006562	C320	C-CER,CHIP	SA
2203-006562	C327	C-CER,CHIP	SA
2203-006626	C328	C-CER,CHIP	SA
2203-006626	C329	C-CER,CHIP	SA
2203-006648	C119	C-CER,CHIP	SA
2203-006681	C146	C-CER,CHIP	SA
2203-006824	C225	C-CER,CHIP	SA
2203-006824	C226	C-CER,CHIP	SA
2203-006824	C354	C-CER,CHIP	SA
2203-006824	C360	C-CER,CHIP	SA
2203-006824	C361	C-CER,CHIP	SA
2404-001225	TA303	C-TA,CHIP	SA
2404-001225	TA304	C-TA,CHIP	SA
2404-001374	TA102	C-TA,CHIP	SA
2404-001406	TA103	C-TA,CHIP	SA
2404-001414	TA300	C-TA,CHIP	SA
2404-001414	TA302	C-TA,CHIP	SA
2703-001513	L301	INDUCTOR-SMD	SA
2703-001513	L302	INDUCTOR-SMD	SA
2703-001513	L303	INDUCTOR-SMD	SA
2703-001513	L304	INDUCTOR-SMD	SA
2703-002313	L106	INDUCTOR-SMD	SA
2703-002485	L101	INDUCTOR-SMD	SA
2703-002544	L109	INDUCTOR-SMD	SA
2703-002558	L110	INDUCTOR-SMD	SA
2703-002597	L108	INDUCTOR-SMD	SA
2703-002858	L103	INDUCTOR-SMD	SA
2703-002858	L104	INDUCTOR-SMD	SA
2801-003856	OSC200	CRYSTAL-SMD	SA
2801-004455	OSC100	CRYSTAL-SMD	SA
2801-004573	OSC300	CRYSTAL-SMD	SA
2904-001592	F100	FILTER-SAW	SA
2904-001599	F101	FILTER-SAW	SA
2904-001600	F102	FILTER-SAW	SA

SEC CODE	Design LOC	Discription	SEC CODE
3301-001208	L300	BEAD-SMD	SA
3301-001729	L200	BEAD-SMD	SA
3404-001152	TAC1	SWITCH-TACT	SA
3404-001152	TAC2	SWITCH-TACT	SA
3705-001358	RFS601	CONNECTOR-COAXIAL	SA
3708-002278	CN103	CONNECTOR-FPC/FFC/PIC	SA
3709-001384	SIM300	CONNECTOR-CARD EDGE	SA
3710-001611	IFC101	CONNECTOR-INTERFACE	SA
3711-006228	BTC104	HEADER-BATTERY	SA
3722-002067	EAR300	JACK-EAR PHONE	SA
4302-001130	BAT300	BATTERY-LI(2ND)	SA
GH09-00036A	UCP201	IC MICOM-SGHX480	SA
GH13-00036A	U301	IC ASIC-SGHX670	SA

7. Block Diagrams

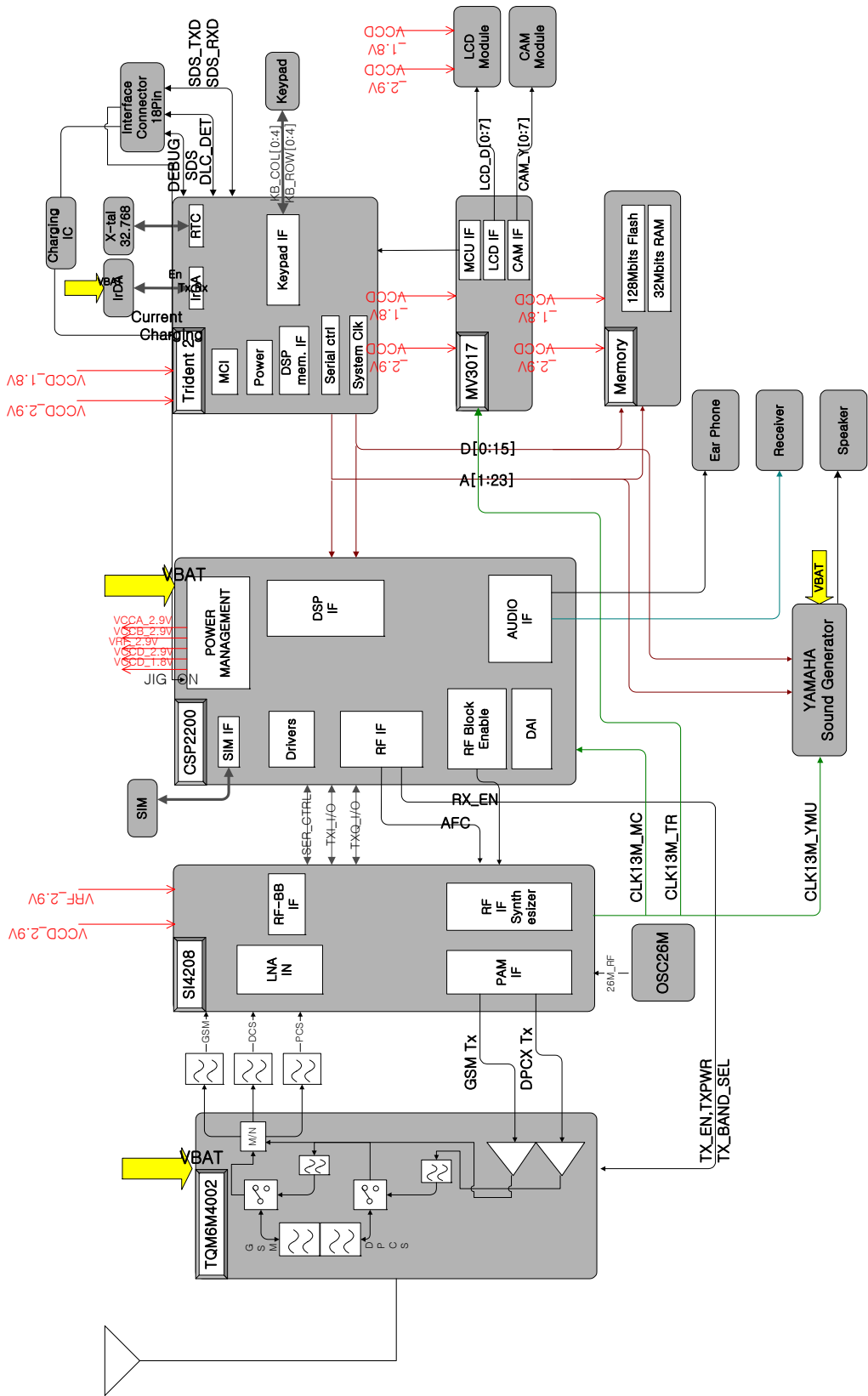

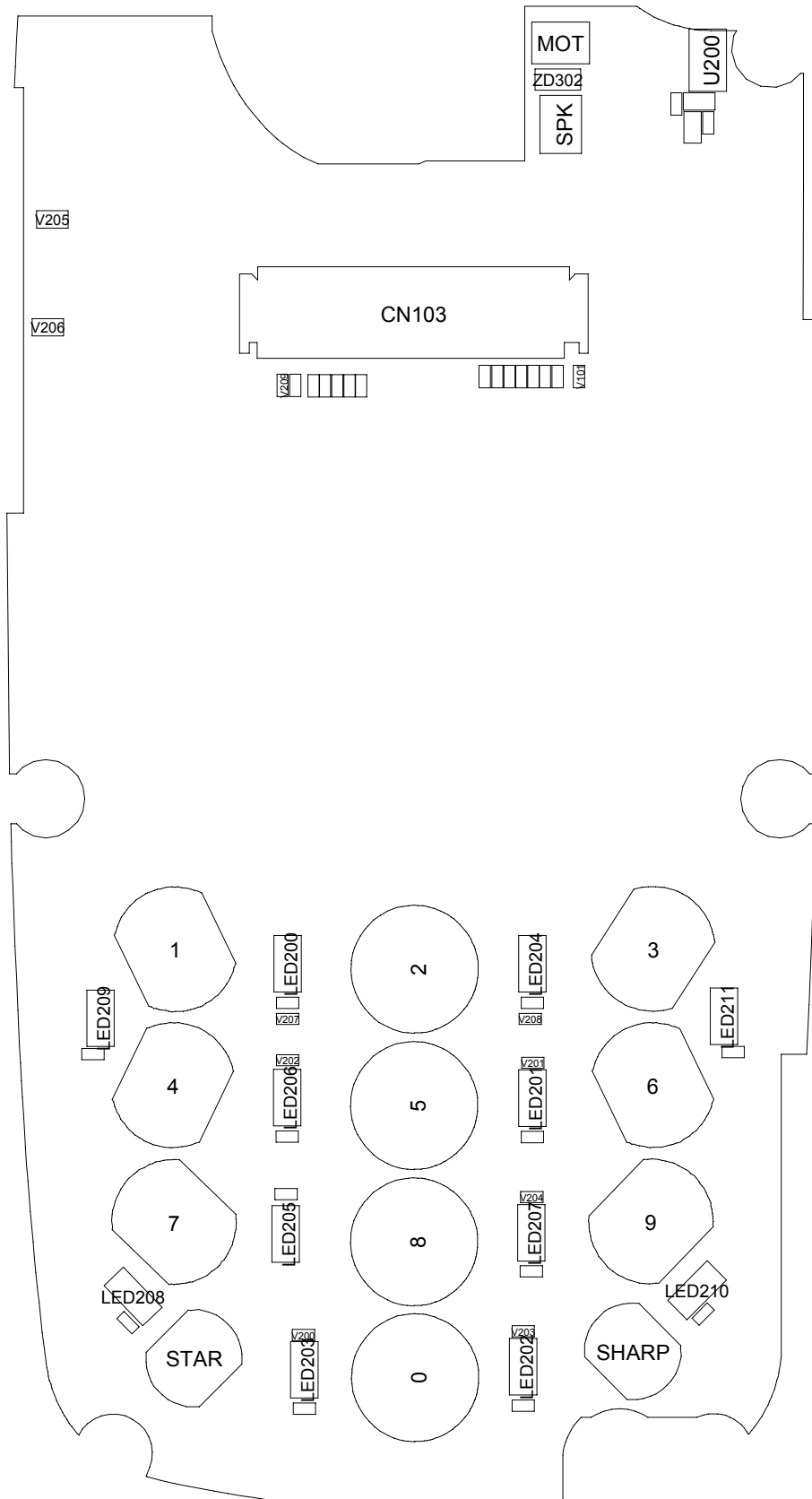

9. Flow Chart of Troubleshooting

9-1. Baseband

9-1-1. Power ON

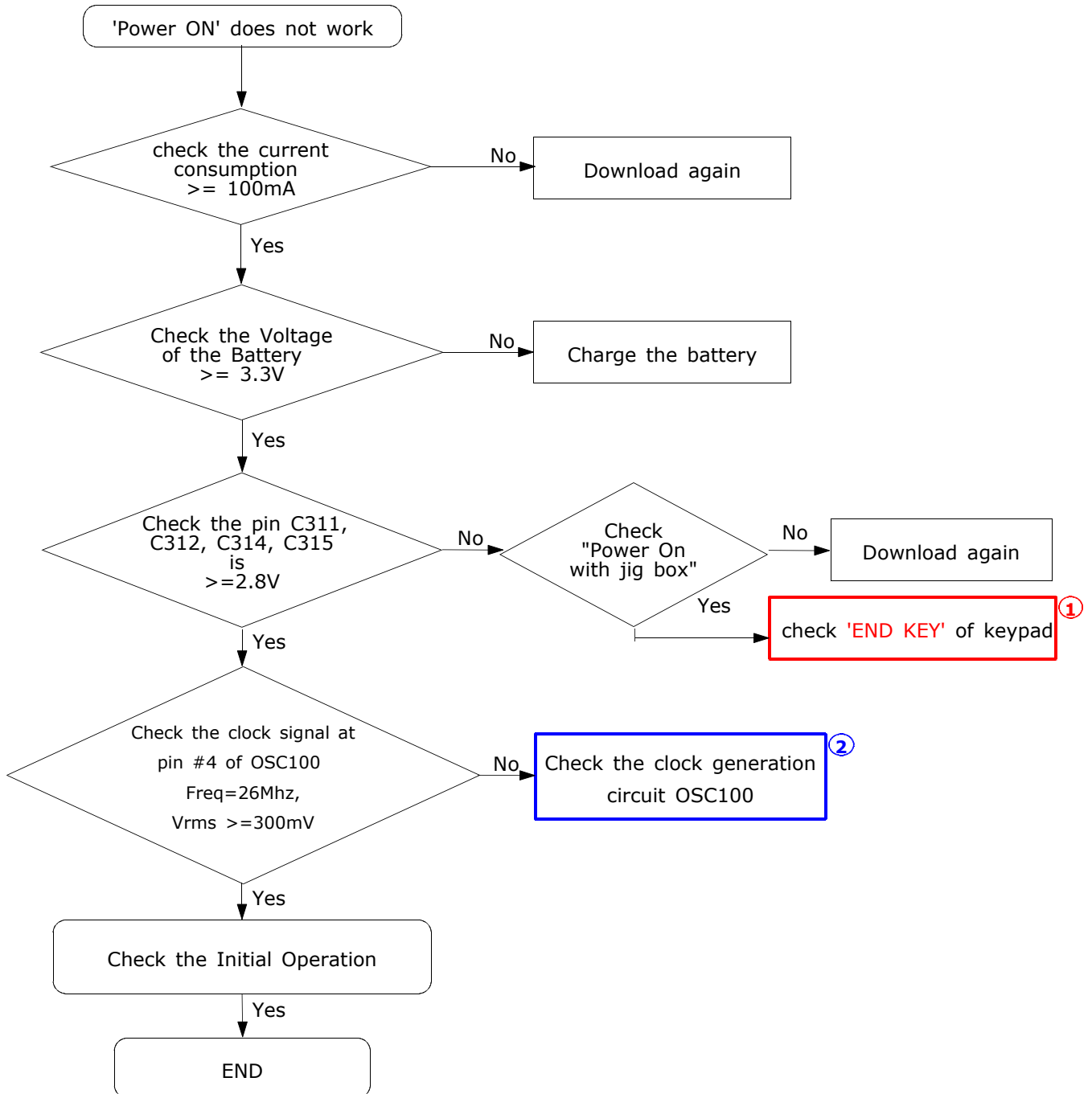

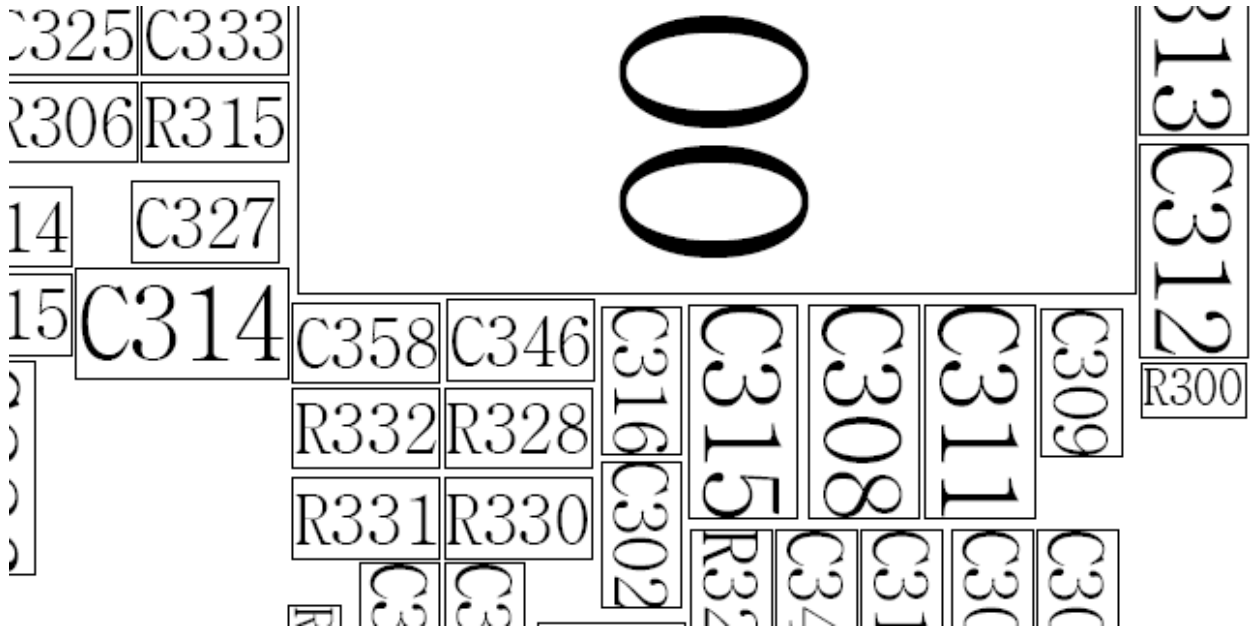
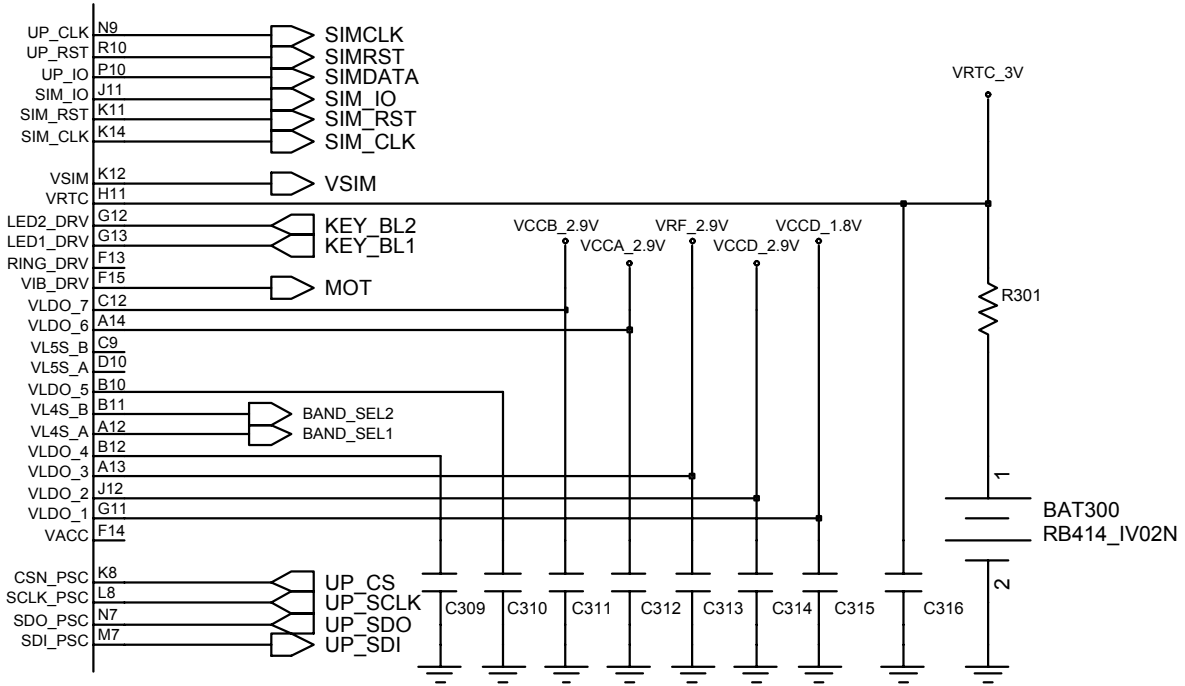

9-1-2. Initial

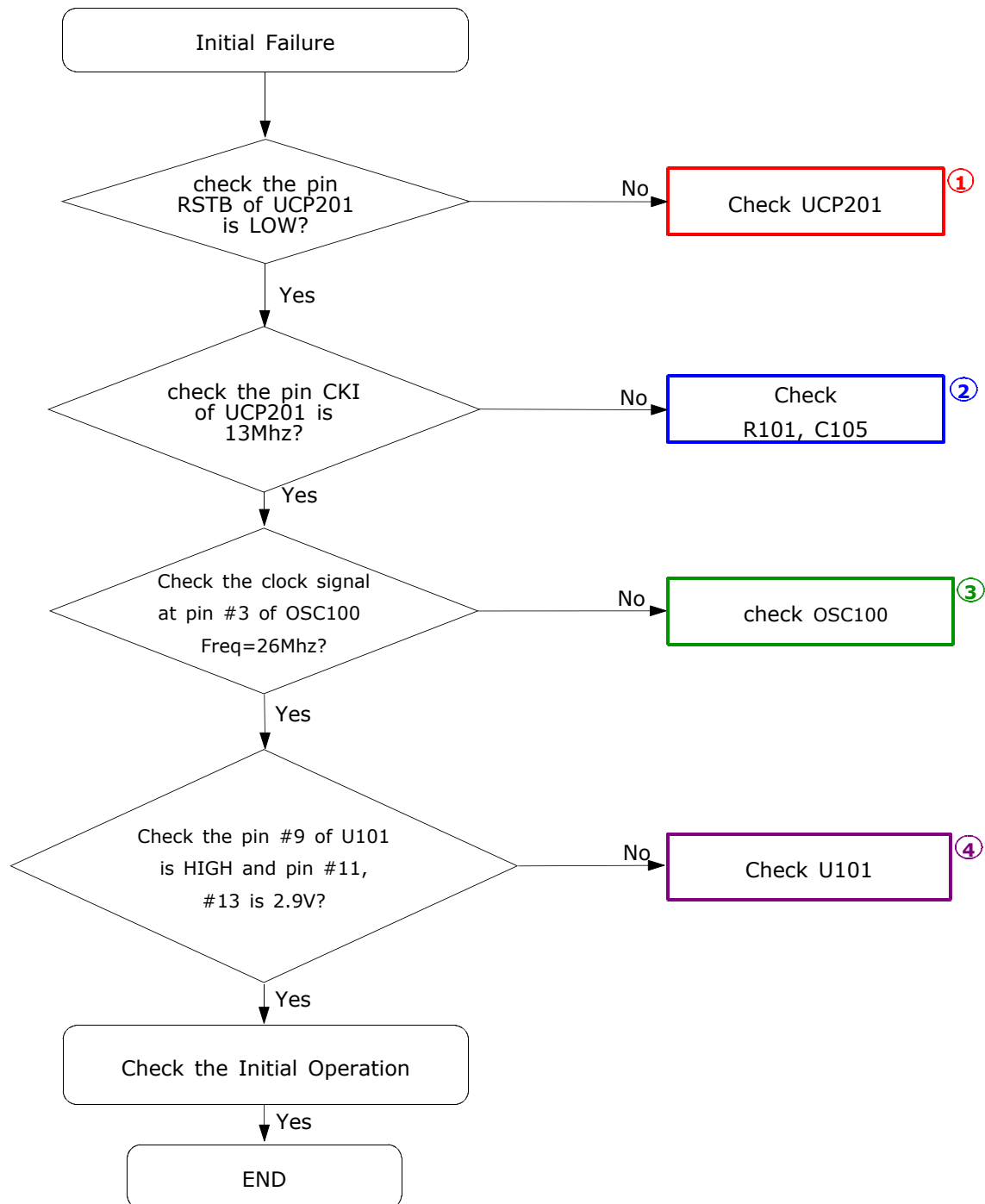

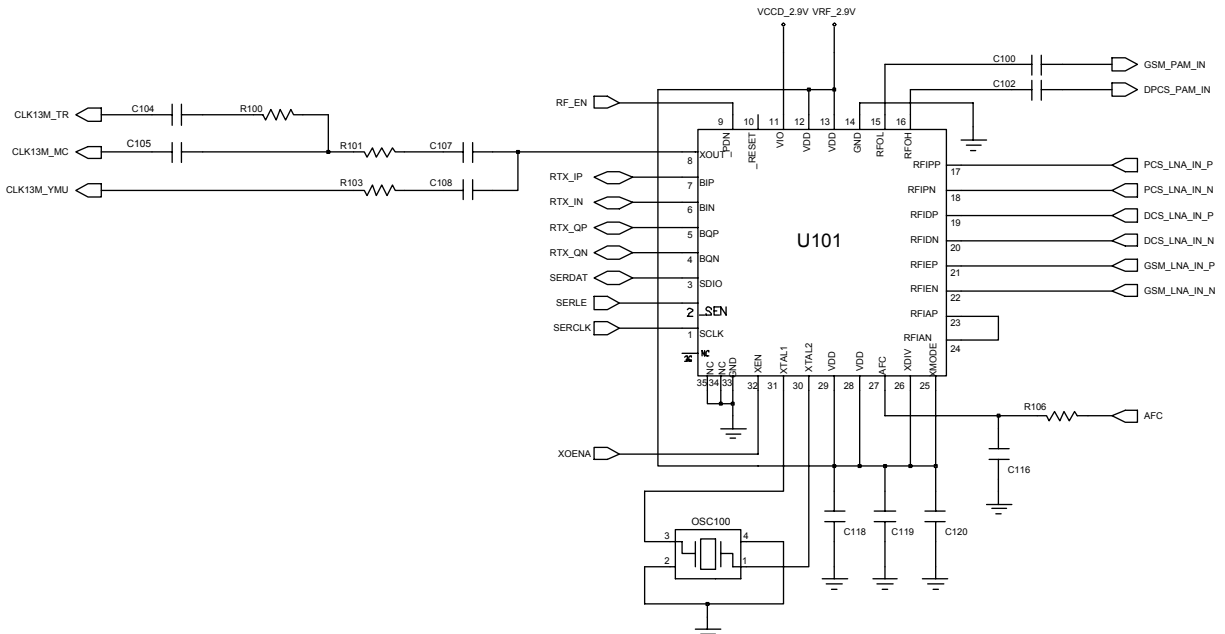
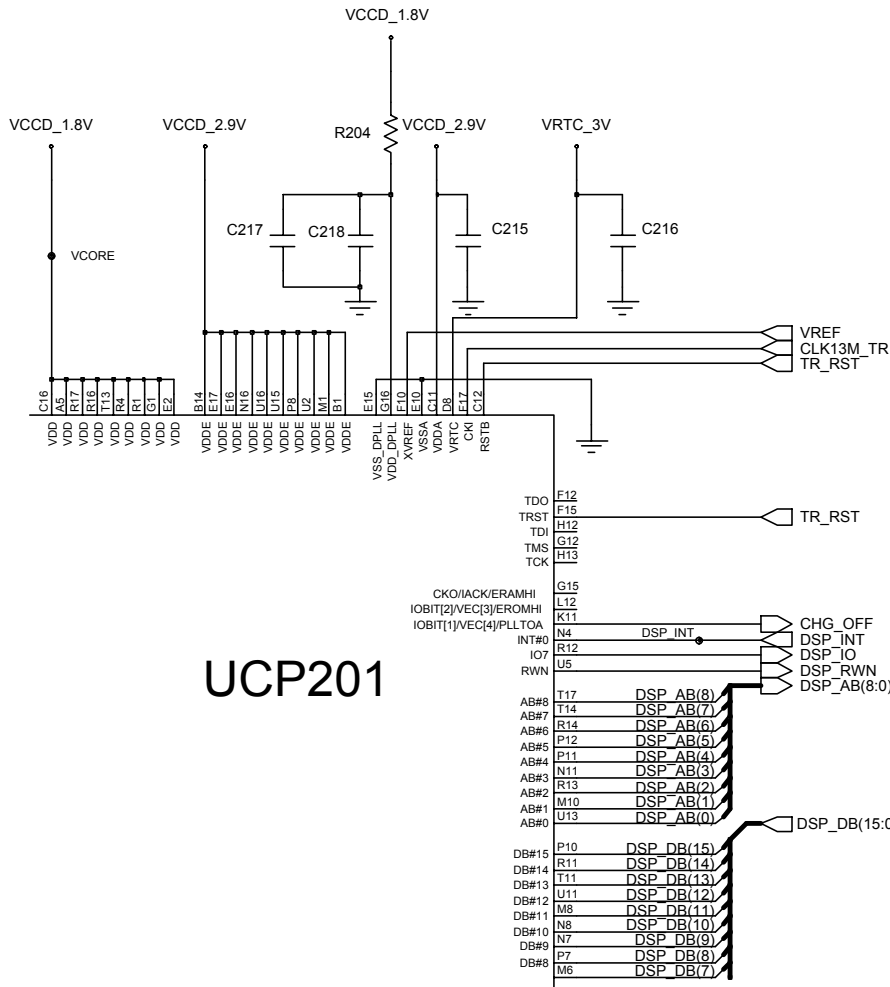

9-1-3. Sim Part

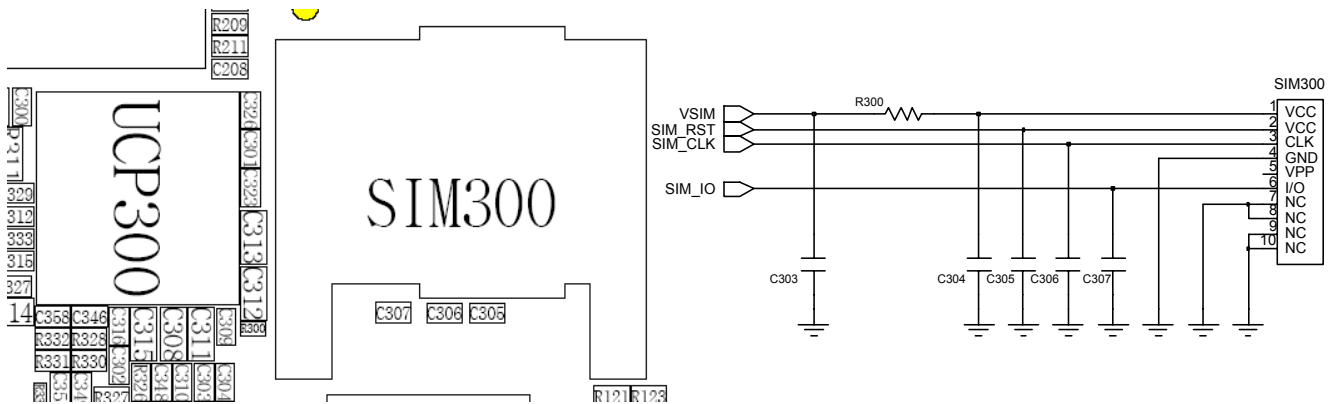
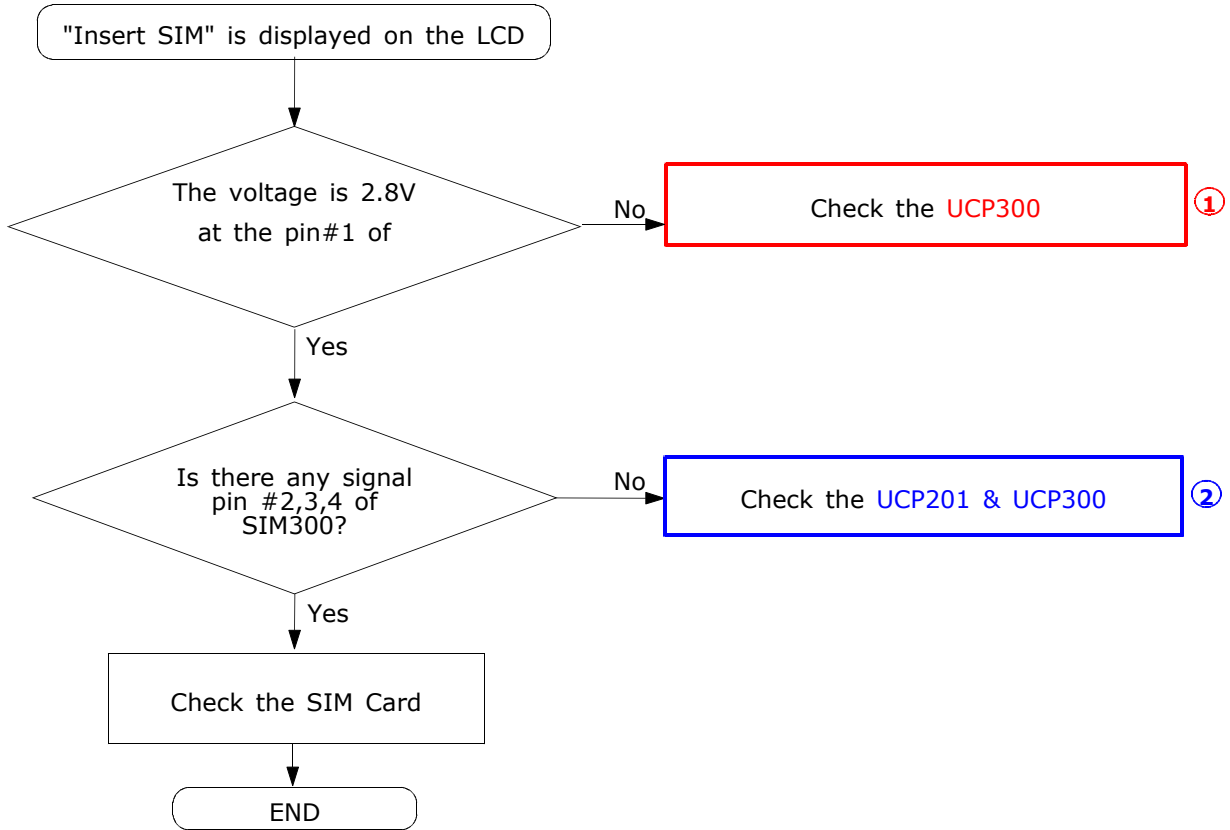

9-1-4. Microphone Part

* Call with Sim before testing.

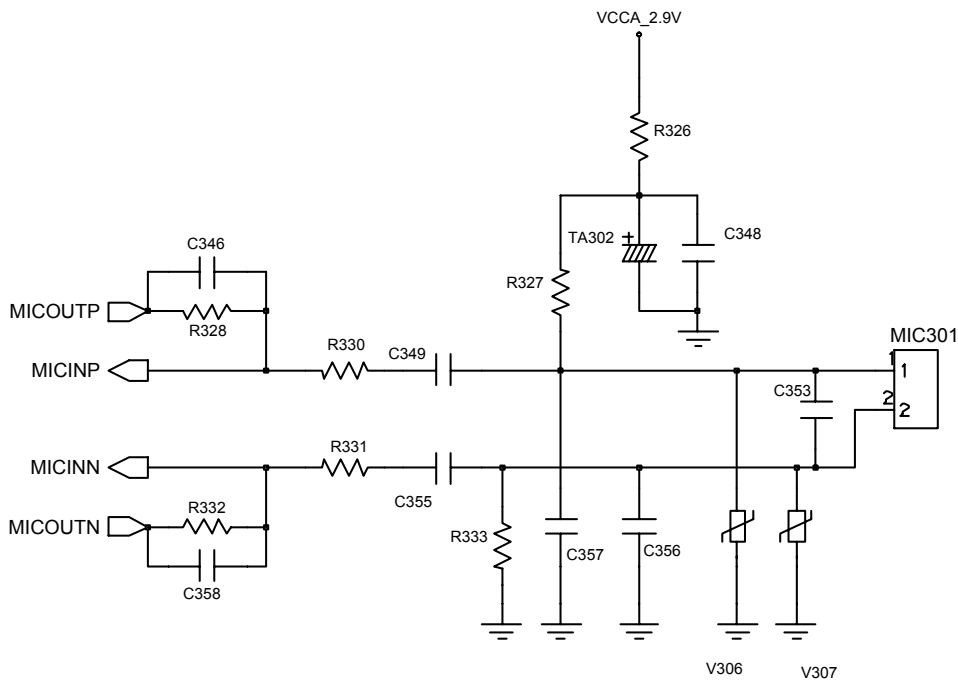
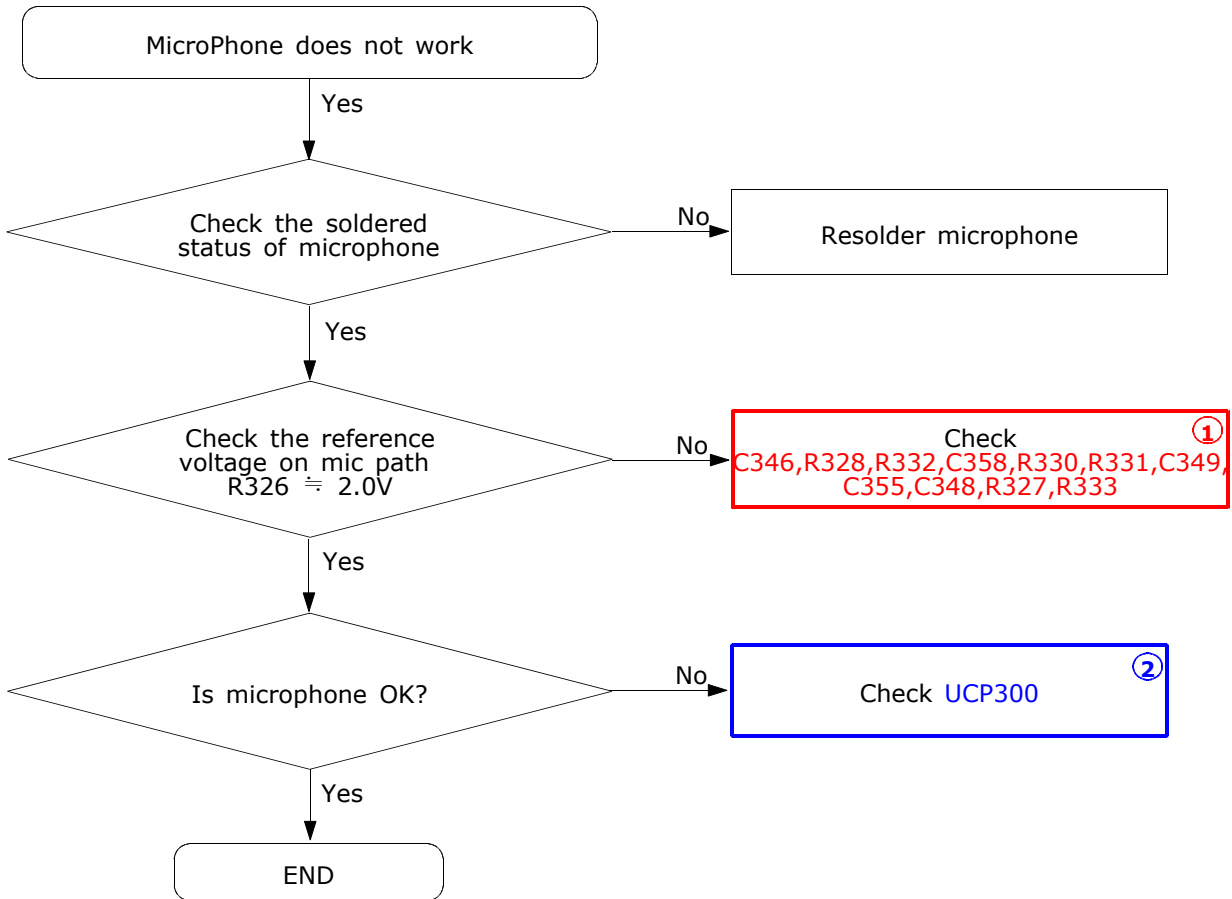

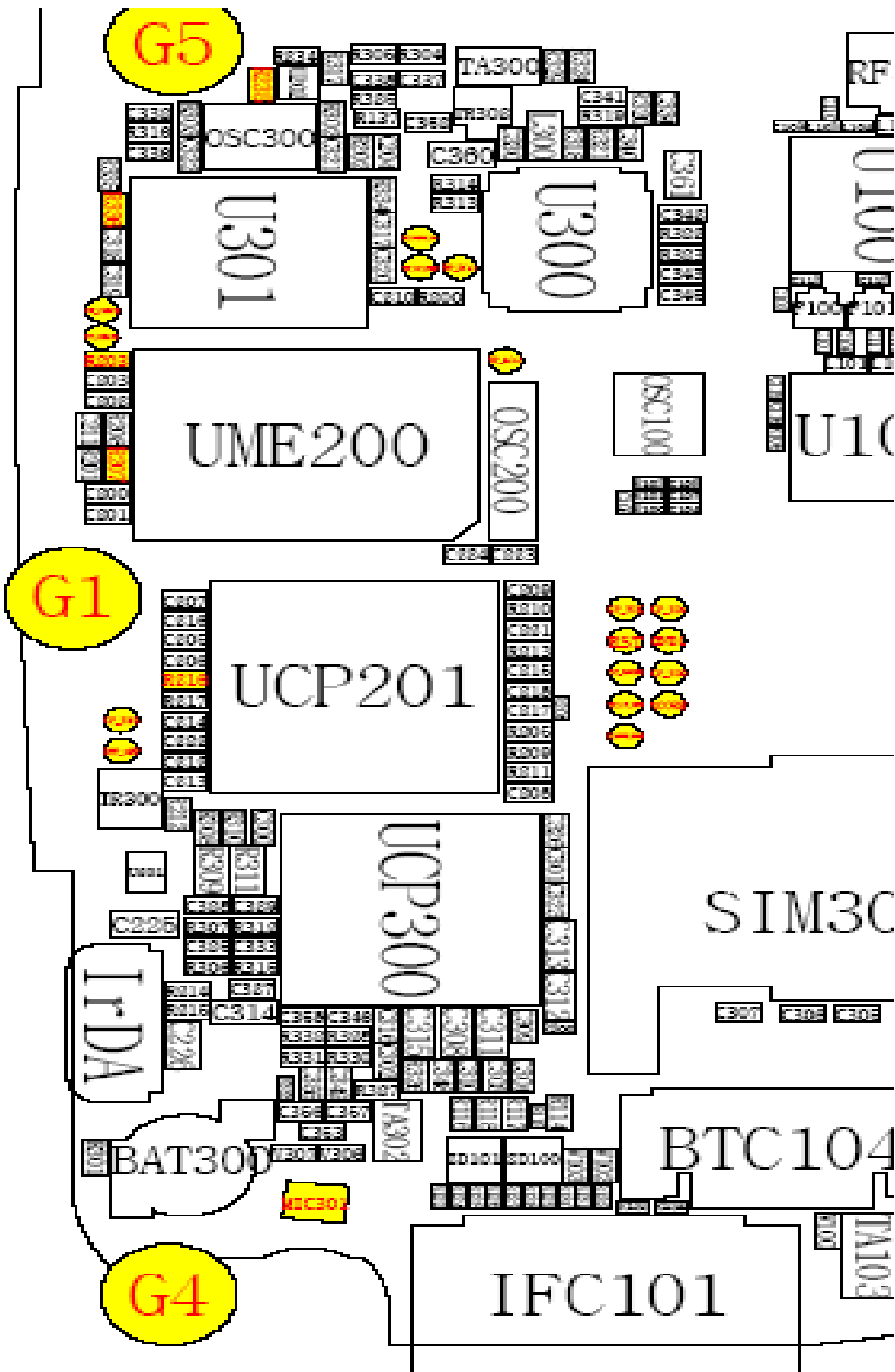

9-1-5. Speaker Part

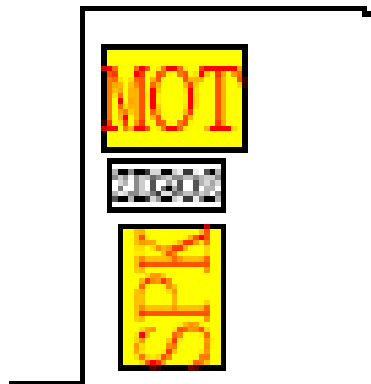
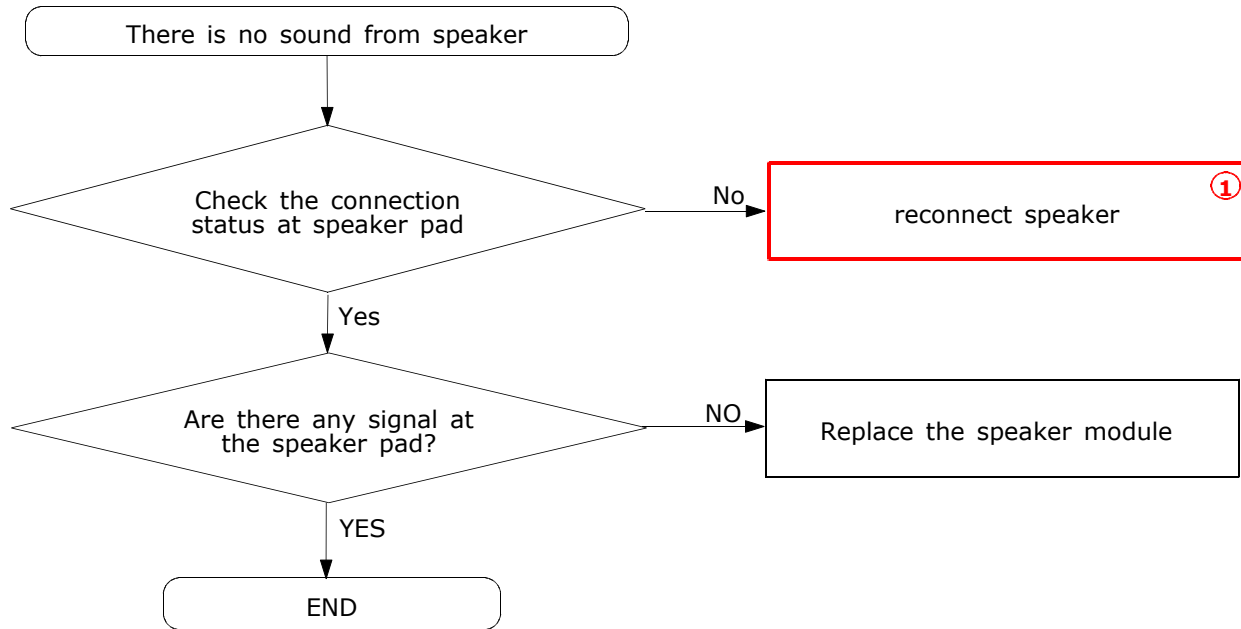

9-1-6. LCD backlight

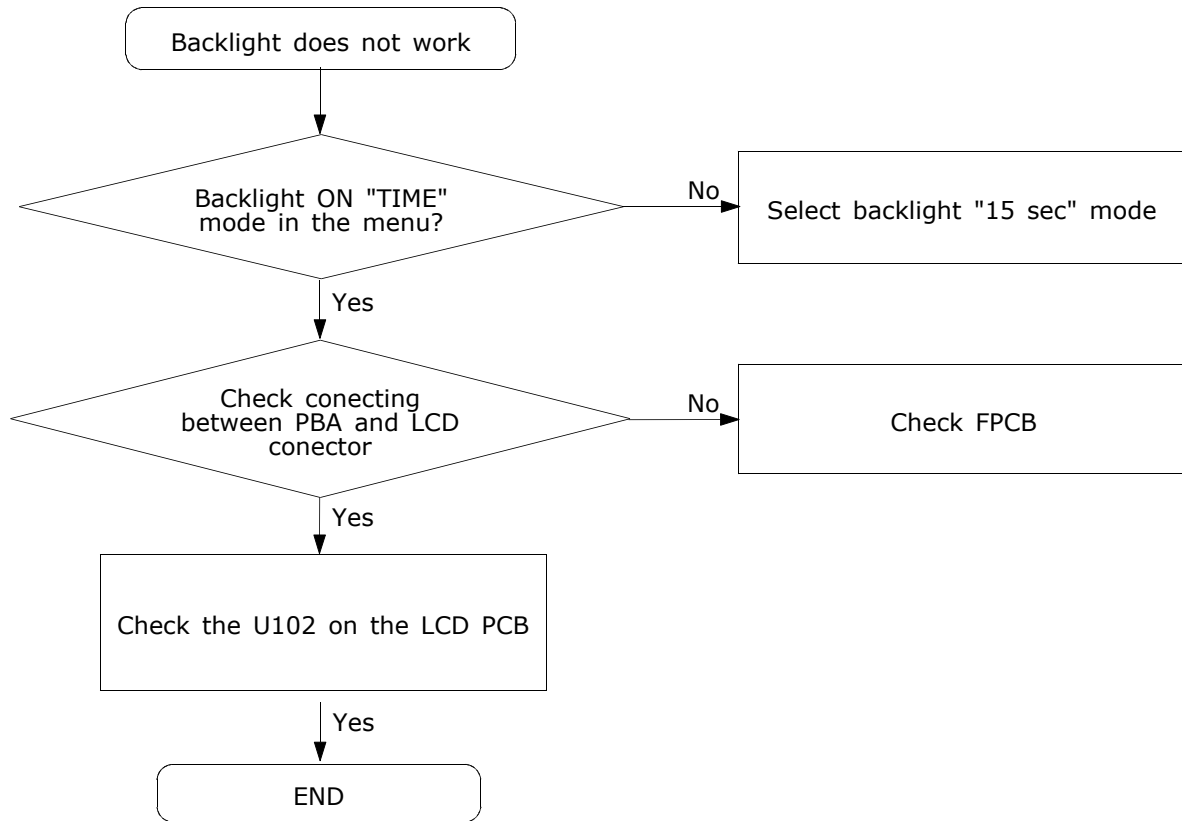

9-2. RF

9-2-1. GSM Rx

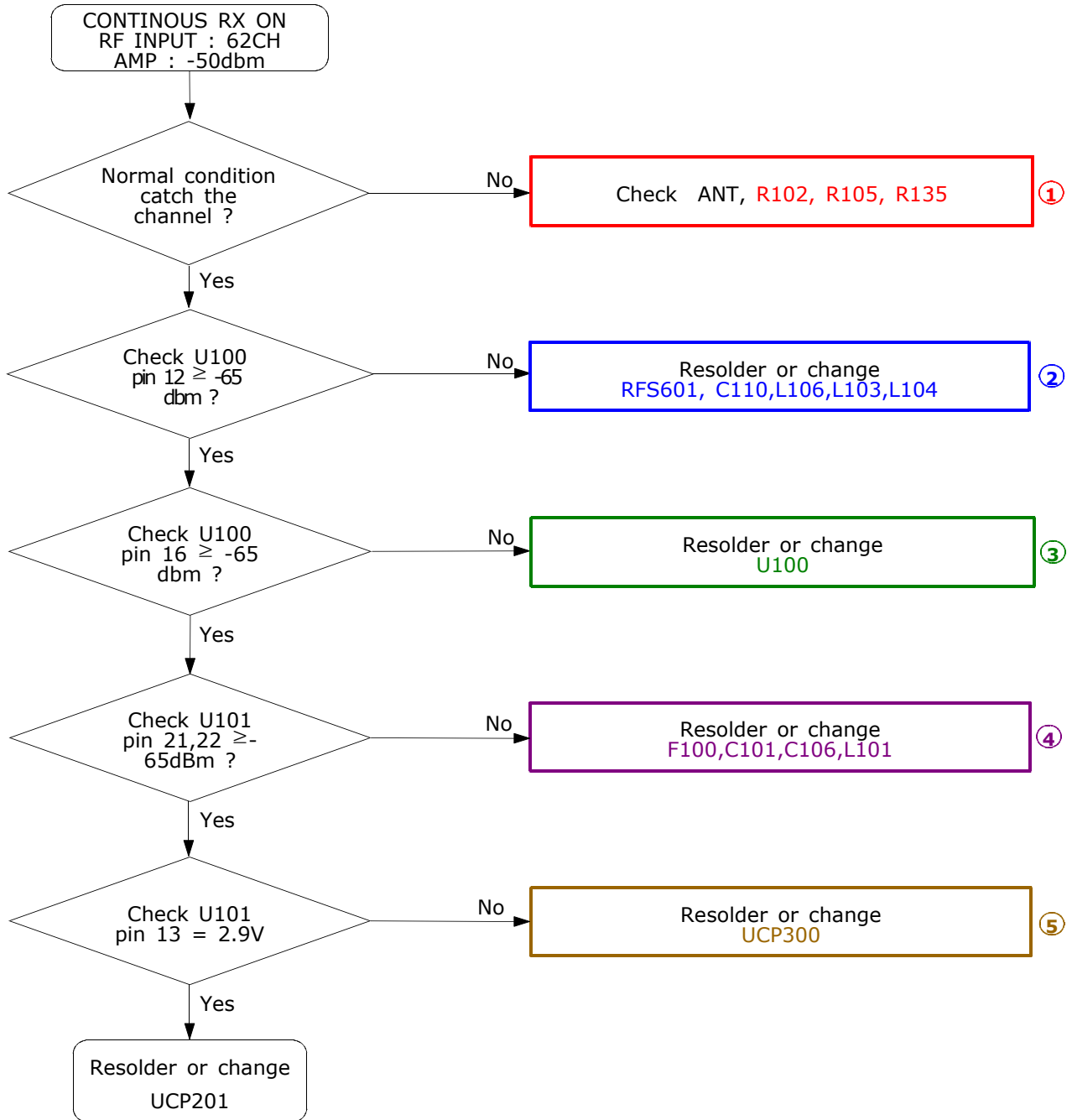

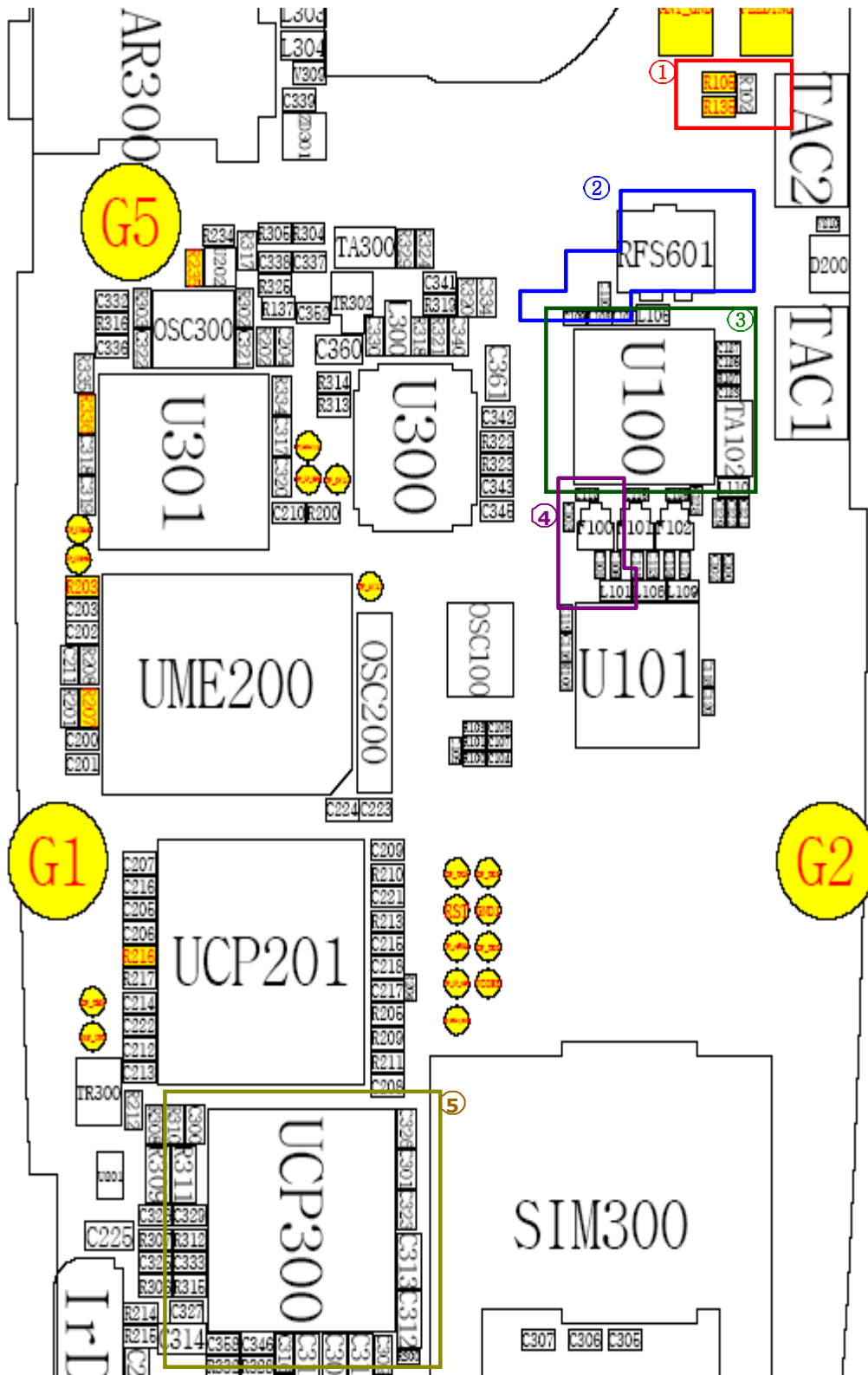

9-2-2. DCS Rx

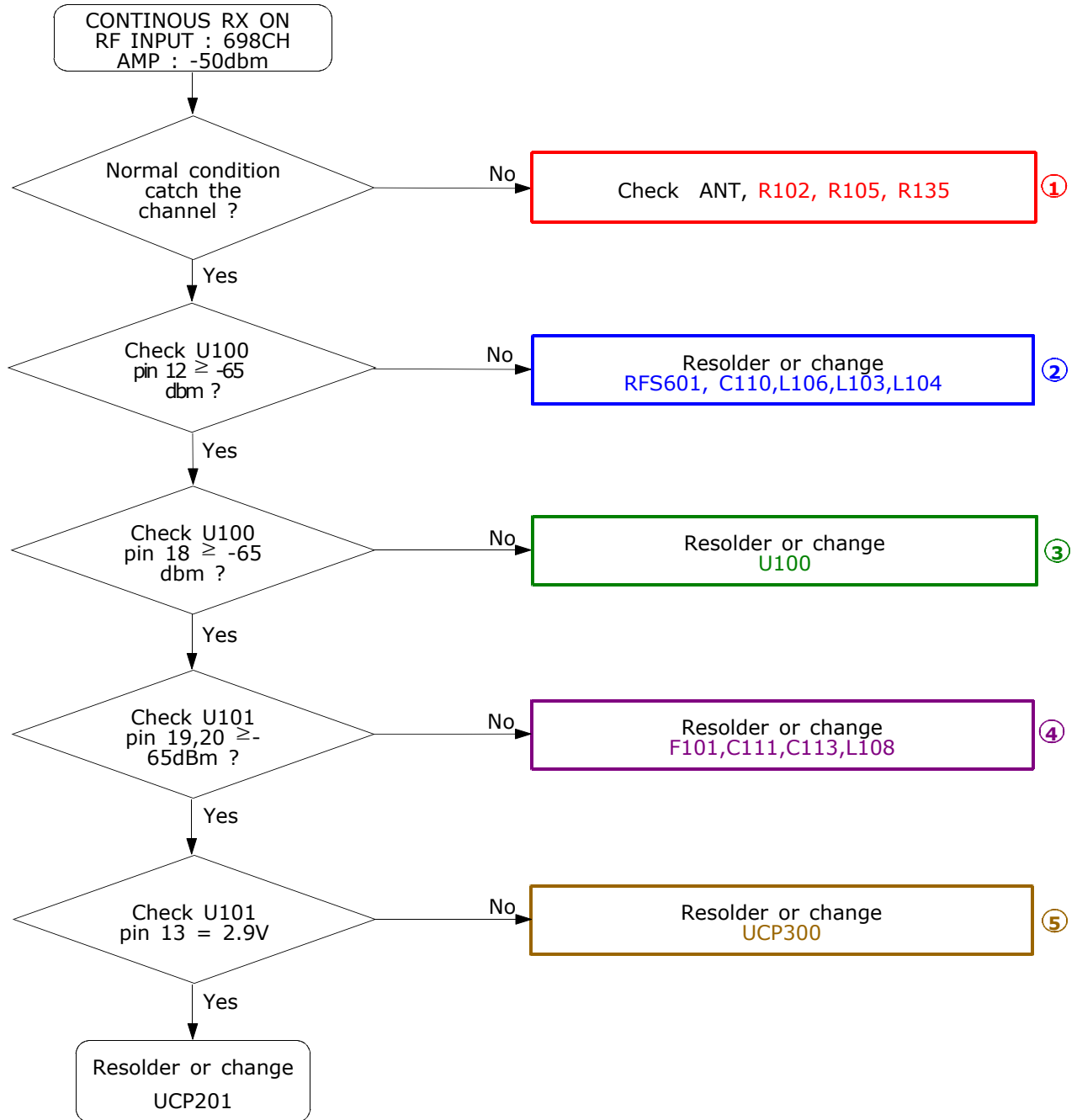

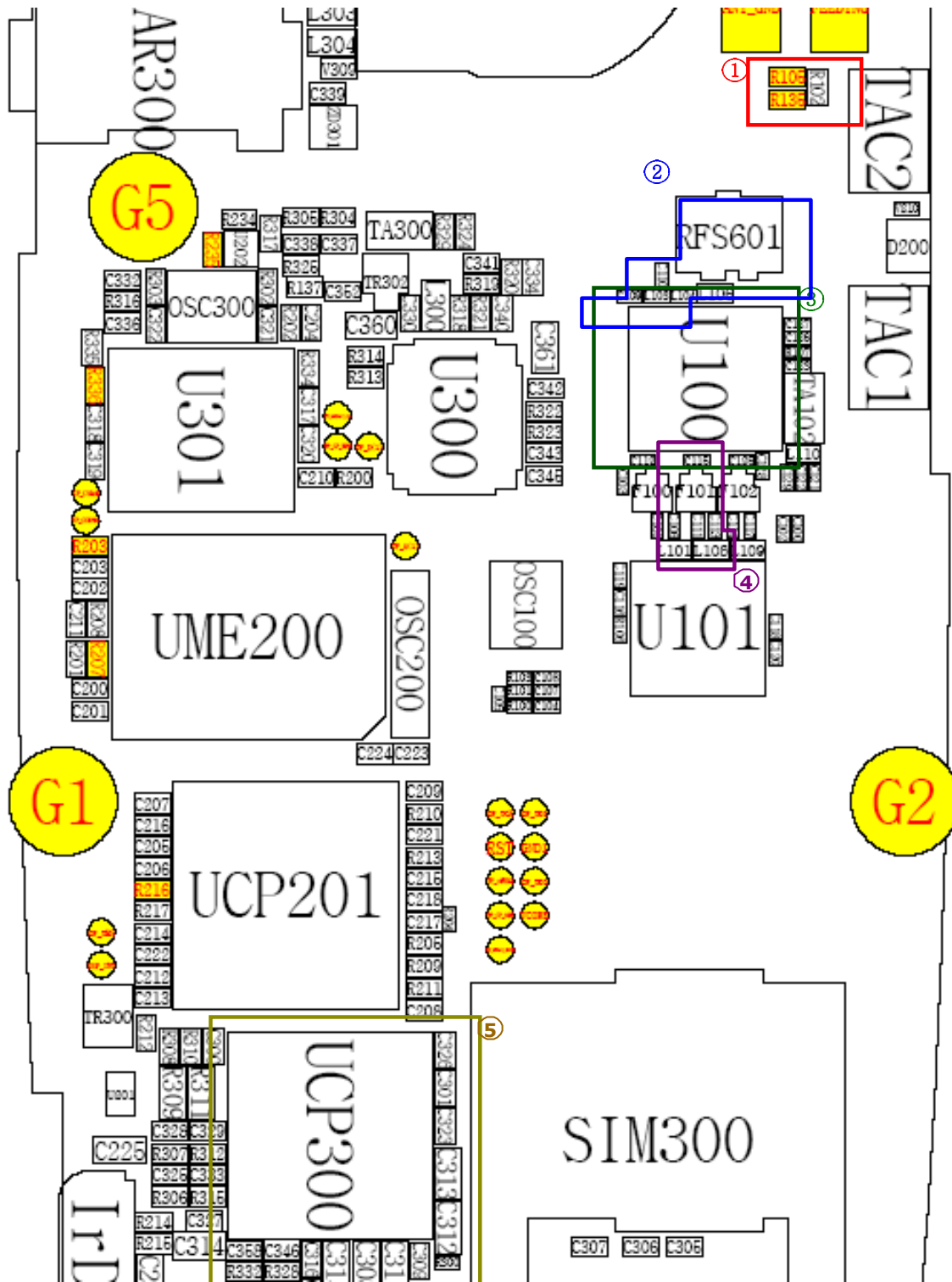

9-2-3. PCS Rx

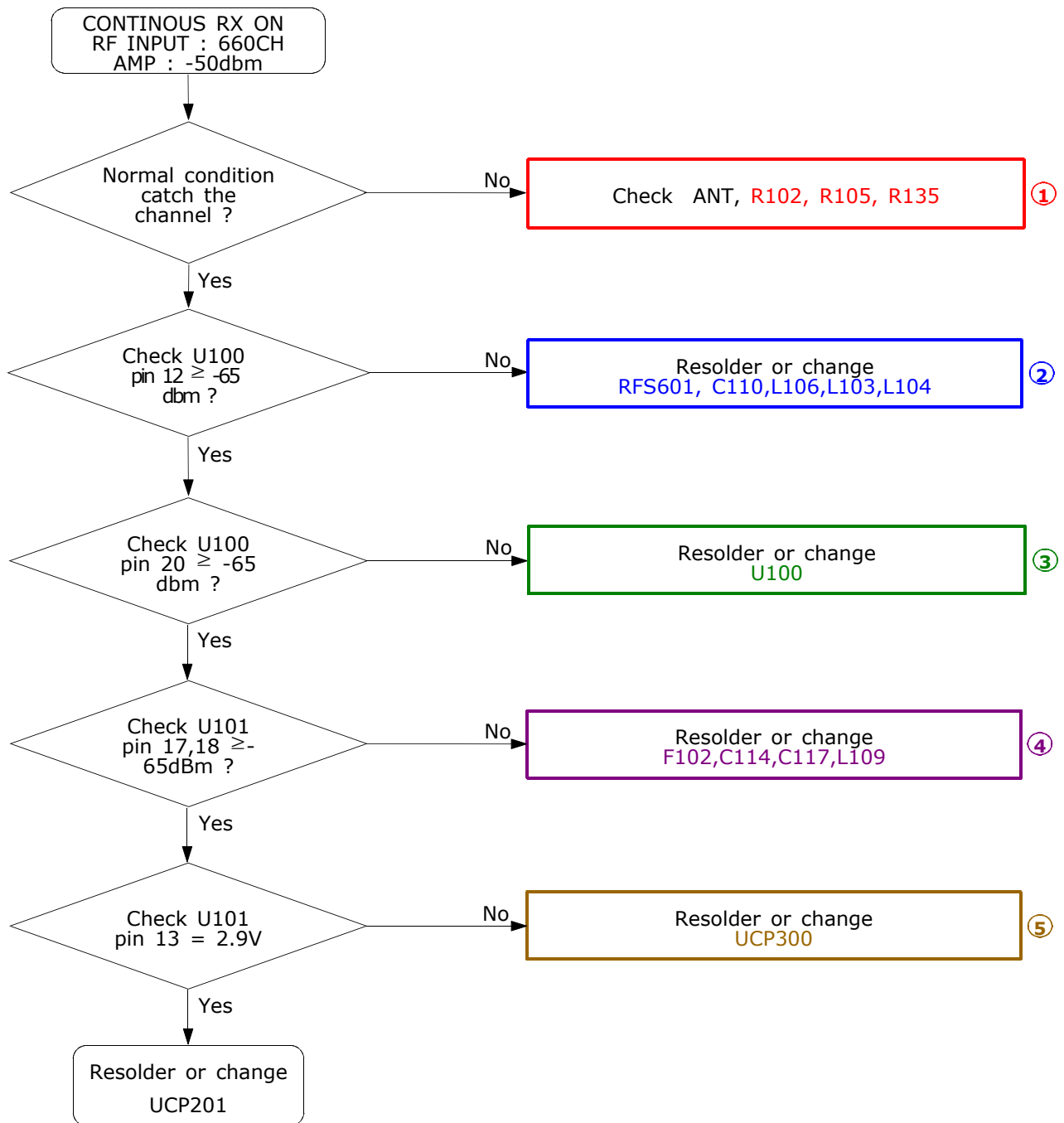

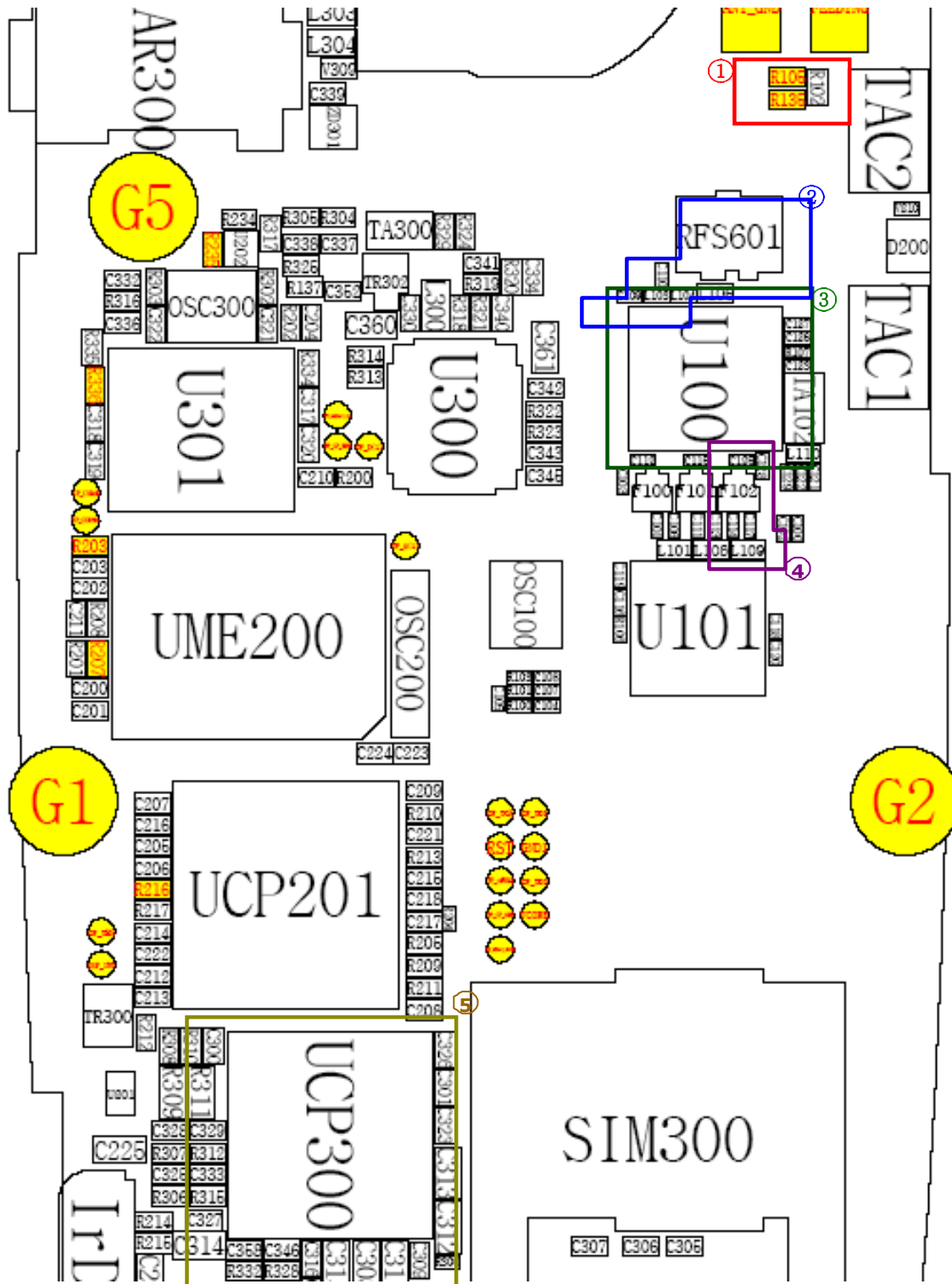

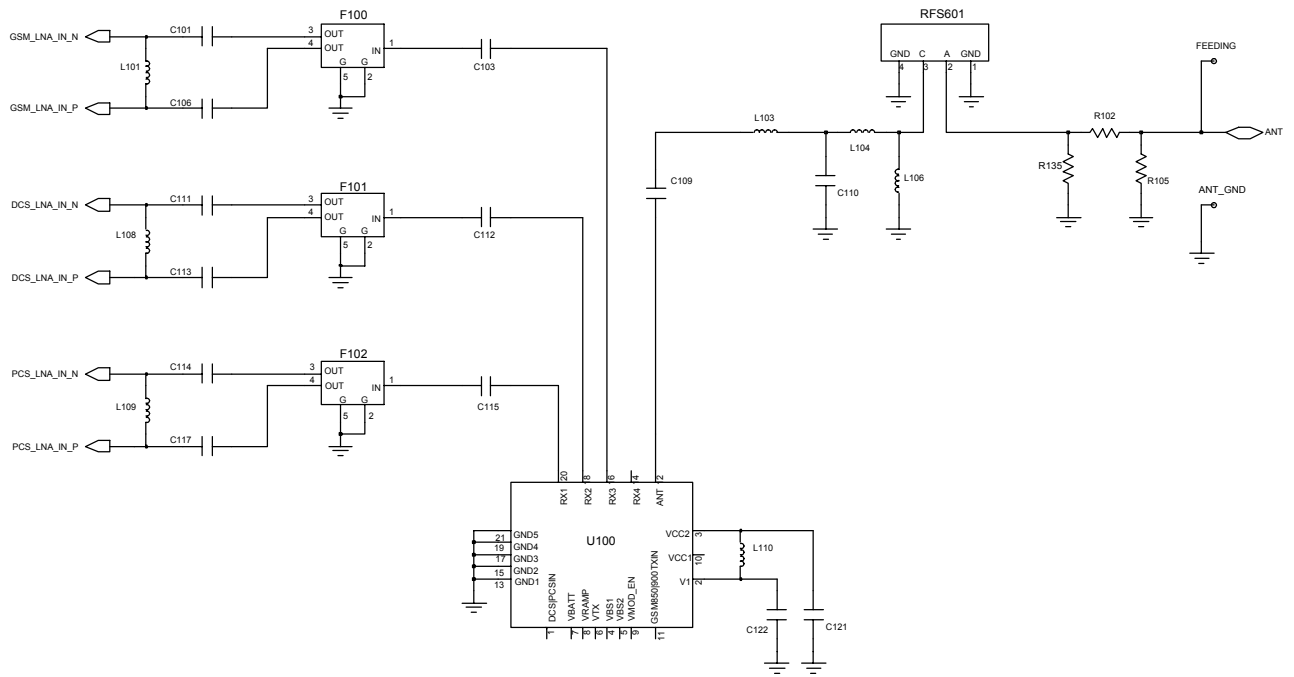

9-2-4. GSM Tx

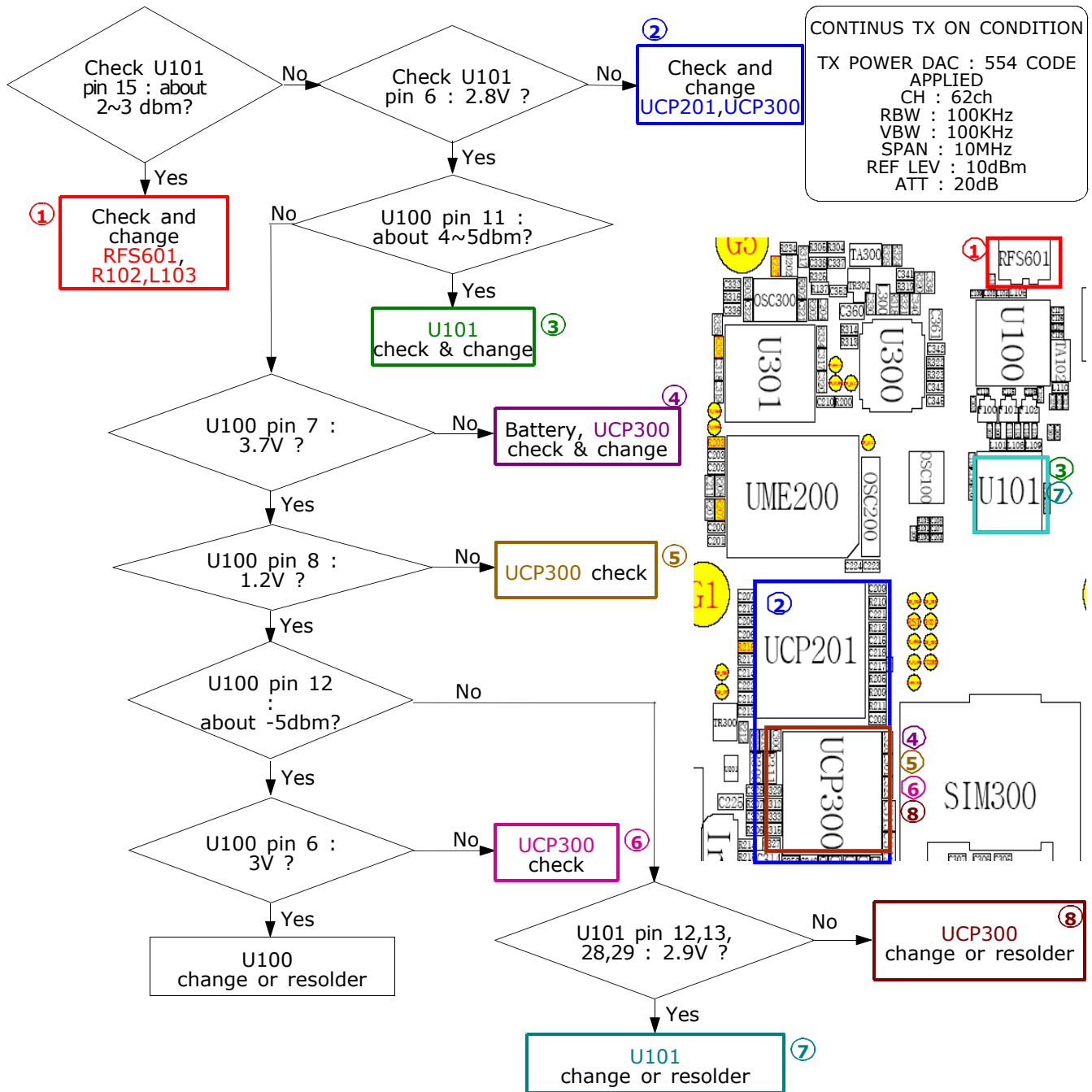

9-2-5. DCS/PCS Tx

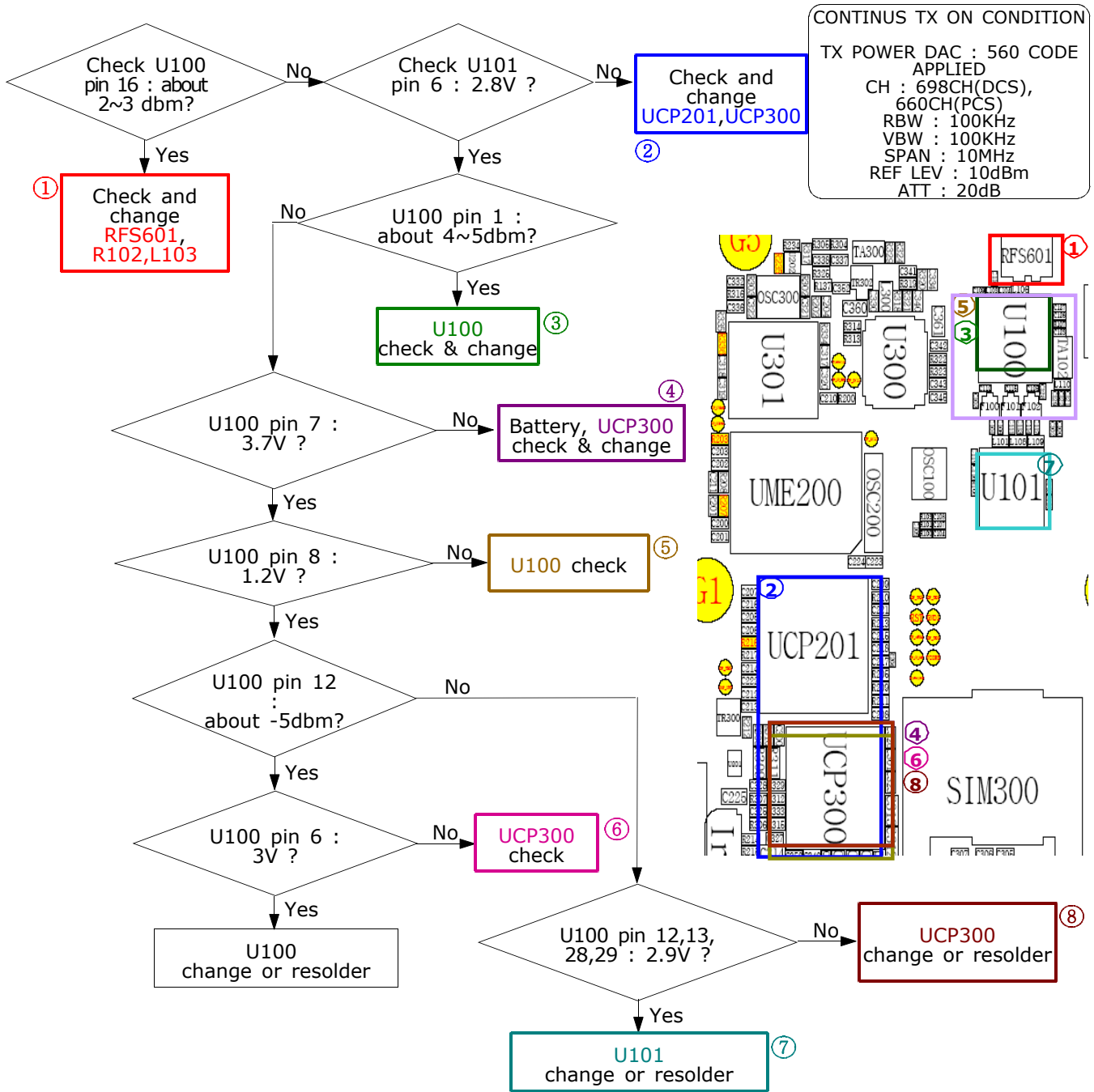

10. Reference data

10-1. Reference Abbreviate

AAC: Advanced Audio Coding.
AVC : Advanced Video Coding.
BER : Bit Error Rate
BPSK: Binary Phase Shift Keying
CA : Conditional Access
CDM : Code Division Multiplexing
C/I : Carrier to Interference
DMB : Digital Multimedia Broadcasting
EN : European Standard
ES : Elementary Stream
ETSI: European Telecommunications Standards Institute
MPEG: Moving Picture Experts Group
PN : Pseudo-random Noise
PS : Pilot Symbol
QPSK: Quadrature Phase Shift Keying
RS : Reed-Solomon
SI : Service Information
TDM : Time Division Multiplexing
TS : Transport Stream

**SAMSUNG
ELECTRONICS**



www.s-manuals.com