

E. PRODUCT GUIDE

<p>8265S Used with LF516 Copper washer</p>	<p>151920S Support element for use in fuel/water separator housing 256546S</p> 	<p>154272S Uses service part: 3302527S, 3318125S Used with AF250 Crankcase breather with steel stamped housing and cover with AF250 element.</p>
<p>101853S Replaces Luberfiner gasket #2788. This cover gasket is used on Luberfiner 500 and 750 series housings.</p> 	<p>151940S Used with FF108 Housing Assembly</p>	<p>154711S Used with FF105 Fuel Filter Head</p> 
<p>101853SB Bulk package (100) of 101853S.</p>	<p>153516S Used with LF516 Shell Assembly</p> 	<p>156171S Used with FF105D Fuel Filter Head</p>
<p>105208S Used with FF101 Gasket</p>	<p>153518S Used with LF516 Bolt Seal</p> 	<p>156779S Uses service part: 3318125S Used with AF250 Crankcase breather with steel stamped housing and cover, AF250 element, stopper fit, and chain on cover.</p> 
<p>116024S Used with LF502, LF516 O'ring</p> 	<p>153519S Support spring for 165286S shell assembly.</p>	<p>156780S Uses service part: 3318125S Same as 156779S without chain.</p>
<p>116029S O'ring used with Fleetguard 500 and 750 series bypass lube filter housings.</p> 	<p>153520S Used with LF516, LF509N Washer</p> 	<p>156810S Uses service part: 3302527S, 3318125S Crankcase breather.</p> 
<p>128801S Used with LF502 Flat gasket</p>	<p>153528S Used with LF516, LF502 Gasket used with Cummins head and shell combination: ENGINE HEAD SHELL REM NH 153516 Taper Stop Use with LF516 on the following Cummins head and shell combinations: ENGINE HEAD SHELL REM JC 169652 153516 Taper Stop JC 180066 184386 Positive Stop JC 185614 184386 Positive Stop JC 185616 184386 Positive Stop NH 153516 Taper Stop</p> 	<p>159667S Used with LF500, LF750A, LF750B Cover for by-pass housing assembly</p> 
<p>132484S Used with LF502 Flat gasket</p>	<p>153528SB Bulk package (100) of 153528S.</p> <p>Overall Height: 0.20 (5) Largest OD: 5.63 (143) Cross Section: Rectangular Largest ID: 5.23 (133)</p>	<p>161917S Element for 156810S crankcase breather.</p>
<p>132730SB Bulk package (100) of 132730S.</p>	<p>153717S Used with LF632B Turbo head</p> 	<p>161917SB Bulk package (100) of 161917S.</p>
<p>142784S Head used with FS1212, FF213, FF105C, FF105D, FF105, FF104, FS1000 Fuel filter head</p> 		<p>164159S Used with LF500, LF750A, LF750B Cover gasket</p> 
<p>145664SB Bulk package (500) of 3301385S.</p>		<p>164159SB Bulk package (100) of 164159S.</p>
<p>146990S Air compressor housing assembly.</p> 		<p>169802S Used with LF502 Cover gasket</p>
<p>147669S Housing used with AF251 Air compressor housing assembly. (Single cylinder)</p>		<p>171644S Cover gasket used with 176975 water filter housing.</p>
<p>150037S Hold-down spring for 500 and 750 housing assemblies.</p>		
<p>151884S Used with FF108, FF221, FF218 Gasket</p> 		

E. PRODUCT GUIDE

173368S

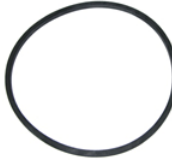

Used with LF516, LF613, LF509N Gasket used with the following head and shell combinations: ENGINE HEAD SHELL V6-140 252917 189977 V8-185 252917 189977 N & NH 177058 184386 V6-200 173285 184386 V8-185 173285 184386 V6-200 177058 173313 V8-185 177058 173313 V6-200 294353 184386 V8-185 294353 184386 V6-200 204354 184386 V8-185 204354 184386 V6-200 252990 173313 V8-185 252990 173313 V12 162671 184386 V12 180729 184386 V12 183771 184386 V12 195745 184386 V12 196079 184386 V12 199797 184386 J 199917 184386 J & C 177058 184386

173368SB

Bulk package (100) of 173368S.

181592S

Used with LF516 Shell and Bolt Assembly



183342S

Used with LF516 Element support in housing assembly



193302S

Used with LF613 O'ring used the following Cummins head shell combinations:
HEAD SHELL
166400 166422
167991 166422
168032 173178
175623 173178
175623 551680
175624 551680
181726 551681
551102 551681



Overall Height: 0.15 (4)
Largest OD: 5.66 (144)
Cross Section: Round
Largest ID: 5.36 (136)

202592S

Gasket

204163S

Water filter spin-on head.



212013S



Head used with FF104, FF105, FF213, FS1212 Dual fuel filter head

215617S



Dual water filter head, uses 256535S mounting bracket.

250024S

Used with AF250 Cover gasket

250301S

Gasket

250383S

Used with FF107 Gasket

250394S



Used with FF106, FF109, FF110, FF111, LF550, LF552 Rubber cover gasket

250439S

Used with LF509N, LF525, LF548, LF640

250457S

Gasket

250645S

LUBERFINER 1867 Cover gasket used on Luberfiner F-120 and F-155 housings before September, 1953.

250806S



One inch OD flat air filter bolt seal.

250843S

Used with FF108 Snap ring



250856S



Used with LF500, LF750A, LF750B Coupling assembly for use on LF500 and LF750 by-pass housing assemblies with the exception of 252281S. Also used on 10 quart power steering reservoir.

250879S



Cap Plug (Fuel inlet port protective plastic cap)

251081S



Used with FF108 Square washer for capscrew 1/2"

251091S

Used with FF108 Shell assembly

251129S



Used with FF108 Fuel filter head assembly

251139S

O'ring



251152S

Used with LF502, LF516 By-pass spring (relief valve located in bottom of shell)

251302S

CATERPILLAR 5M954 Gasket



251303S

CATERPILLAR 5H5601 Gasket



251390S

Used with FF108, FS1201 Rubber cover gasket



251390SB

Bulk package (100) of 251390S.

251919

Uses service part: 3902353S Coolant Immersion Heater 6' Replacement cord 120V



252011S

Spring for 2 & 4 quart power steering reservoirs.

252052S

Spring used in 10-quart power steering reservoirs.

252193S

Housing used with FF178



252274S

Used with LF500, LF750A, LF750B Mounting bracket also used on 10-quart power steering reservoir 251431S.



252598S

Used with FF178 Rubber cover gasket



E. PRODUCT GUIDE

<p>252916S Housing used with LF516 Housing assembly</p> 	<p>254511S Used with LF500, LF750B, LF750A Retaining ring</p>	<p>255816S Crankcase breather washer.</p> 
<p>252917S Used with LF516 Remote mount head for 252916 252916S</p> 	<p>254608S Gasket for 255180S and 257014S crankcase breathers.</p> 	<p>256172S Housing used with FS1201</p> 
<p>252943S LUBERFINER 2172 Cover seal for Luberfiner F-120 and F-155 housings made after September 1953.</p>	<p>254792 Coolant Immersion Heater 5' Replacement Cord 240V</p> 	<p>256421S Spring for 256546S fuel/ water separator housing.</p>
<p>253152S Bracket assembly for 254385S housing.</p> 	<p>255180S Uses service part: 255183S, 3302527S Crankcase breather for turbo applications</p> 	<p>256424S Shell assembly for fuel/ water separator housing assembly 256546S. (black)</p> 
<p>253200S THERMO-KING GASKETS 331044 Used with LF503 Gasket</p>	<p>255183S Used with 255180S Crankcase breather element used in 255180S assembly.</p> 	<p>256535S Mounting bracket for 204163S and 215617S water filter heads, 142784S, 3304315S and 212013S fuel filter heads.</p> 
<p>253312S Used with LF509N Head</p> 	<p>255357 Coolant Immersion Heater for Cummins 1500W/120VCSA</p> 	<p>256546S Housing used with FS1201 Fuel/water separator housing assembly (black cover and shell) (FS1201 element)</p> 
<p>253621S Housing used with LF509N</p> 	<p>255428S Chrome cover for use on 10-quart power steering reservoir 251431S.</p> 	<p>256555S Cover assembly for use on 4-quart power steering reservoir 254385S.</p>
<p>254005S Used with LF509N Cover gasket</p>	<p>255622S Used with FF105, FF105D, FS1212, 3837317S, FS1000, FS1001 Composition thread seal gasket</p> 	<p>257014S Uses service part: 3302527S Used with AF251 Crankcase breather with steel stamped housing and cover; two-stage filtration, Scott foam element (257419S)</p> 
<p>254028S Used with LF516 Snap ring</p>	<p>255721S Dipstick for use on 2-quart power steering reservoir 255730S.</p> 	<p>257203S Clamp for 257129S and 3300692S housings.</p>
<p>254064S Internal retaining screens for 156810S crankcase breather.</p> 	<p>255724S Cover assembly for use on 2-quart power steering reservoir 255730S.</p> 	<p>257419S Vapor element used with 255180S or 257014S crankcase breathers.</p>
<p>254098S Used with LF509N Bolt for LF509N housing.</p>	<p>255737S Vented dipstick for 10-quart power steering reservoir 251431S.</p> 	<p>257541S Vent valve for use on fuel/ water separator housing assembly.</p> 
<p>254176S Cover assembly for use on 10-quart power steering reservoir 251431S.</p>	<p>255815S Gasket for 255180S, 156810S, and 257014S crankcase breathers.</p> 	<p>257542S Valve assembly used in 256546S, consists of 257541S and 3302010S.</p> 
<p>254329S Gasket</p>	<p>254387S Dipstick for use on 4-quart power steering reservoir 254385S.</p> 	
<p>254387S Dipstick for use on 4-quart power steering reservoir 254385S.</p>	<p>254503S Gasket</p>	

E. PRODUCT GUIDE

<p>257715S Water filter head 204163S and bracket assembly.</p> 	<p>259223 Coolant Immersion Heater for Detroit Diesel 1500W/240V</p> 	<p>259305 Coolant Tank Replacement Heating Element **CSA Approved</p>
<p>258127S Housing cover (1 pack of 258092)</p>	<p>259225 Coolant Immersion Heater for Detroit Diesel 750W/120V</p> 	<p>259306 Replacement heating element for 259278 coolant tank heater. 2000W/120V</p> 
<p>258230S CATERPILLAR 5M5999 Gasket</p>	<p>259225C Coolant Immersion Heater for Detroit Diesel 750W/120V **CSA Approved</p> 	<p>259307 Replacement heating element for 259279 water-tight coolant tank heater. 2000W/120V</p> 
<p>258814S Used with LF750A, LF750B Reinforced mounting bracket</p>	<p>259229C Coolant Immersion Heater for Caterpillar 1000W/120V **CSA Approved</p> 	<p>259308 Replacement heating element for 259280 coolant tank heater. 2000W/240V</p> 
<p>258859S Used with WF2053 Head Assembly</p> 	<p>259231C Coolant Immersion Heater for Caterpillar 1500W/120V **CSA Approved</p> 	<p>259309 Replacement heating element for 259281 water-tight coolant tank heater. 2000W/240V</p> 
<p>259073S Used with LF750A, LF750B Chrome mounting bracket assembly for use on LF750 chrome by-pass housing assembly 252281S.</p> 	<p>259235 Coolant Immersion Heater for GMC & Caterpillar 1500W/120V</p> 	<p>259310 Replacement heating element for 259282 coolant tank heater. 2000W/480V **CSA Approved</p>
<p>259083S Capscrew used on 4-quart power steering reservoir with metal cover.</p>	<p>259246 Extension Cord 120V 15FT</p> 	<p>259311 Replacement heating element for 259283 coolant tank heater. 2250W/120V</p> 
<p>259204 Coolant Immersion Heater for Cummins 1000W/120V</p> 	<p>259247 Extension Cord 120V 25FT</p> 	<p>259313 Replacement heating element for 259285 coolant tank heater. 2500W/240V</p> 
<p>259205 Coolant Immersion Heater for Cummins 1000W/240V</p> 	<p>259248 Extension Cord 120V 50FT</p> 	<p>259316 Replacement heating element for 259288 coolant tank heater. 4000W/480V</p> 
<p>259211 Coolant Immersion Heater for Caterpillar, Detroit Diesel, and Fiat Allis 1000W/120V</p> 	<p>259250 Waterproof Remote Plug 240V CSA not required</p>	<p>259319 Universal replacement tank for coolant tank heaters. 3.5 X 17.5 inches</p> 
<p>259211C Coolant Immersion Heater for Caterpillar, Detroit Diesel, Fiat Allis 1000W/120V **CSA Approved</p>	<p>259296 Replacement heating element for 259268 coolant tank heater. 750W/120V **CSA Approved</p>	<p>259301 Replacement heating element for 259273 coolant tank heater. 1500W/120V</p> 
<p>259214 Coolant Immersion Heater for Detroit Diesel 1000W/120V</p>	<p>259301 Replacement heating element for 259273 coolant tank heater. 1500W/120V</p> 	<p>259317 Replacement heating element for 259289 coolant tank heater. 4000W/480V **CSA Approved</p> 
<p>259216 Coolant Immersion Heater for Detroit Diesel 1500W/120V</p> 	<p>259302 Replacement heating element for 259274 water-tight coolant tank heater. 1500W/120V</p> 	<p>259319 Universal replacement tank for coolant tank heaters. 3.5 X 17.5 inches</p> 
<p>259216C Coolant Immersion Heater for Detroit Diesel 1500W/120V **CSA Approved</p> 	<p>259218 Coolant Immersion Heater for Detroit Diesel 1000W/120V</p> 	

















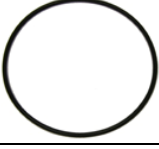





E. PRODUCT GUIDE

259325	Replacement cord for coolant tank heaters 2000W/120V. **CSA Approved		259386	Start Kit **CSA not required	
259326	Replacement cord for coolant tank heaters 4000W/240V**CSA Approved		259387	Start Kit **CSA not required	
259329	Coolant Tank Heater Replacement Thermostat Sensing Unit**CSA Approved		259389S	4-hole gasket for use with Cummins coolant heaters. **CSA not required	
259331	Coolant Tank Heater Replacement Thermostat Sensing Unit**CSA Approved		259390S	6-hole gasket for use with Cummins coolant heaters. **CSA not required	
259332	Coolant Tank Heater Replacement Thermostat Sensing Unit**CSA Approved		284094S	Plastic bag for maintenance kit builders, 284401S carton	
259334	Coolant Tank Heater Replacement Thermostat Sensing Unit**CSA Approved		284401S	Carton for customer maintenance kit containing a LF750 element.	
259346	Atomizer for some Cummins and Detroit Diesel engines. CSA not required		284407S	Carton for custom maintenance kit not containing a LF750 element.	
259349	Mack Atomizer CSA not required		285066S	Insert for custom maintenance kit not containing a LF750 element.	
259350	Atomizer for some Cummins and Perkins engines over 500 cid. CSA not required		285125S	Insert for custom maintenance kit containing a LF750 element.	
259352	Atomizer CSA not required		317237S	Used with HF6118, LF509N Cover gasket	
259354	Atomizer for some Cummins and International Harvester industrial engines.CSA not required		317506S	Gasket	
259365	Starting Fluid System 3cc Valve **CSA not required		323344S	Used with HF6054 Gasket	
259366	6cc valve for manual ether start kits. **CSA not required		333763S	Used with HF6184, HF6079, HF6165 Gasket	
259367	6cc valve for electric ether start kits. **CSA not required		394694S	Used with AK17 Hump Hose	
			2355280S	Cummins Power Care Head and Filter Assembly	
			3001483S	Used with LF670 Lock plate spin-on adaptor for Detroit Diesel engines 3301340S.	
			3040113S	Plastic crankcase breather for Cummins applications.	
			3300518S	Band wrench for 5 inch O.D. spin-ons.	
			3300903S	6 inch capscrew5/8 w/18 thds. - Grade 7	
259369	48" Nylon tubing for use with ether start kits. **CSA not required				
259370	Start Kit **CSA not required				
259371	Start Kit **CSA not required				
259372	Start Kit **CSA not required				
259373	Start Kit **CSA not required				
259374	C W Aids Start Kit **CSA not required				
259375	12CC Mechanical Start Kit **CSA not required				
259377	Thermal switch (100 degrees) 1/2" NPT for electric kits. **CSA not required				
259379C	Coolant Immersion Heater for some Caterpillar and Detroit Diesel engines. 1500W/120V. **CSA Approved				
259383	Atomizer for Cummins small vee engines. **CSA not required				
259384	Ether Start Kit **CSA not required				
259385	12CC/24V Electrical Starting Kit **CSA not required				



















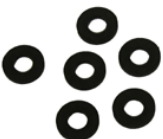

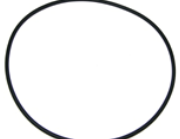

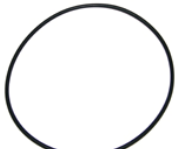
E. PRODUCT GUIDE

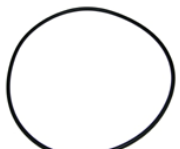
<p>3300904S 5-1/2 inch capscrew 5/8 w/18 thds. - Grade 7</p> 	<p>3301956S Used with LF516 Hitch pin clip</p> 	<p>3302696 84" Control Cable **CSA not required</p> 
<p>3300905S 5 inch capscrew 5/8 w/18 thds. - Grade 7</p>	<p>3302009S Used with FF108 Capscrew</p>	<p>3302698 Cylinder Clamp **CSA not required</p> 
<p>3300908SB Adaptor used with 3300922S conversion kit.</p>	<p>3302045S 4-1/2 inch capscrew 5/8 w/18 thds. - Grade 7</p> 	<p>3302699 Compression Sleeve **CSA not required</p> 
<p>3300922S Spin-on full flow adaptor for Cummins engines 1969 and after. (Uses LF670 element after conversion)</p> 	<p>3302058S Conversion adaptor for full flow lube filter (LF670) on Cummins Small Vee.</p> 	<p>3302700 90 degree Valve Fitting **CSA not required</p> 
<p>3300923S Spin-on full flow adaptor for Cummins engines 1968 and before.</p> 	<p>3302059S 5-1/2 inch capscrew 5/8 w/18 thds. - Grade 7</p>	<p>3303104 Coolant Immersion Heater for Mack 1500W/120V</p> 
<p>3301337S Inner gasket for 3301340S conversion kit.</p> 	<p>3302102S Used with FF178 Stat-o-seal</p> 	<p>3303104C Coolant Immersion Heater for Mack 1500W/120V **CSA Approved</p> 
<p>3301338S Outer gasket (flat type) for 3301340S conversion kit.</p> 	<p>3302134S Used with LF509N Stat-o-seal washer</p> 	<p>3303105 Coolant Immersion Heater for Mack 1500W/240V</p> 
<p>3301339S Outer gasket (narrow groove type) for 3301340S conversion kit.</p> 	<p>3302136S Used with LF509N Shell and bolt</p>	<p>3303225 Coolant Immersion Heater for Cummins 1500W/120V</p> 
<p>3301340S Adaptor kit for conversion of Detroit Diesel engines to LF3333 spin-on.</p>	<p>3302180S Gasket for use on Cummins crankcase breathers 257014S and 255180S.</p> 	<p>3303226 Coolant Immersion Heater for Cummins 1500W/240V</p> 
<p>3301385S Used with LF500, LF750B, LF750A Bracket For bulk see 145664SB.</p>	<p>3302367S Head used with FF202, FS1216, FS1006 Fuel filter head</p>	<p>3303311 Atomizer **CSA not required</p> 
<p>3301387S Used with LF500, LF750A, LF750B Strap. For bulk see 145665SB.</p>	<p>3302527S Used with 154272S, 156810S, 257014S, 255180S Wing nut for use with some crankcase breathers.</p> 	<p>3303326 Replacement Probe for Cummins Immersion Heaters 1500W/240V</p> 
<p>3301603S Copper seal used with 2-quart power steering reservoirs with metal covers</p> 	<p>3302630S Used with LF670 Adaptor gasket</p> <p>Overall Height: 0.20 (5) Largest OD: 6.28 (160) Cross Section: Rectangular Largest ID: 5.88 (149)</p> 	<p>3303424 Replacement probe for Cummins Immersion Heaters 1500W/120V **CSA Approved</p> 
<p>3301922S Vented dipstick 10-quart power steering reservoir.</p> 	<p>3302631S Used with LF670 Adaptor gasket</p> <p>Overall Height: 0.20 (5) Largest OD: 5.63 (143) Cross Section: Rectangular Largest ID: 5.23 (133)</p>	<p>3303424C Replacement probe for Cummins Immersion Heaters 1500W/120V **CSA Approved</p>
<p>3301949S Used with LF516 11.3 inch capscrew</p> 	<p>3302657 Low Pressure Ether Cyl. 90 psi. (Non-US) (For Canada use 259345 only)</p>	<p>3303424C Replacement probe for Cummins Immersion Heaters 1500W/120V **CSA Approved</p>
<p>3301950S Used with LF516 10.875 inch capscrew</p>		
<p>3301954S Used with LF516 14 inch capscrew</p>		

E. PRODUCT GUIDE

<p>3303427S Used with 3309188 O'ring used with some Cummins block heaters.</p> 	<p>3304173S Head used with LF777 Adaptor head, remote mount.</p> 	<p>3305996S Used with HF6054 Gasket</p>
<p>3303779 Uses service part: 3303899S 12-24V Electric Ether Starting Kit **CSA not required</p> 	<p>3304274S Used with FF202 Inlet and outlet fitting for use with Detroit Diesel; converts from 7/8"-14UNF to 3/8"NPT</p> 	<p>3305997S Used with HF6054 Gasket</p> 
<p>3303780 Uses service part: 3303899S Mechanical Starting Fluid Kit to 450 CID **CSA not required</p> 	<p>3304635S Used with LF750A, LF750B Cover assembly with drain</p>	<p>3306000S Used with HF6054 Gasket</p> 
<p>3303781 Uses service part: 3303899S Mechanical Starting Fluid Kit 450 to 900 CID **CSA not required</p>	<p>3304865 Ammeter **CSA not required</p>	<p>3306006 1000W/120V Block Heater for Detroit 8.2L, V-8, 501 CID and Cummins ISC, ISL engine</p>
<p>3303782S Uses service part: 3312054S Used with LF670 Low restriction spin-on head, remote mount.</p> 	<p>3304868 Generator Brushes (DC Starter) **CSA not required</p>	<p>3306006C Coolant Immersion Heater for Detroit 8.2L engine 1000W/120V **CSA Approved Navistar/International 444E and T444E 1994 models and newer</p> 
<p>3303897 Triplex Cord - 120V</p>	<p>3305004S Inner gasket for 3305000S adaptor.</p>	<p>3306007 Coolant Immersion Heater for Detroit 8.2L 1000W/240V</p> 
<p>3303897C Triplex Cord **CSA Approved</p>	<p>3305154S Used with LF750B, LF750A Inlet check valve</p>	<p>3307046 Economy Model Tank Heater 1500W/120V</p> 
<p>3303899S Used with 3310588, 3830394, 3303779, 3830396, 3303780, 3303781, 3313273, 3830397, 3316413, 3830395 Cork gasket for use with ether cylinder.</p>	<p>3305166S Gasket for 3301340S adaptor.</p>  <p>Overall Height: 0.07 (2) Largest OD: 3.16 (80) Cross Section: Rectangular Largest ID: 2.41 (61)</p>	<p>3307059 Economy Tank Heater 1000W/120V **CSA Approved</p> 
<p>3303975S Fuel System Service Part. Hex Nut Fam 9,13</p>	<p>3305315S Wing screw for 2-quart and 4-quart power steering reservoir.</p> 	<p>3307060 Economy Model Tank Heater 2000W/120V **CSA Approved</p> 
<p>3304015 12CC Manual Valve</p>	<p>3305536S Used with LF3000 Small gasket</p> 	<p>3307454S Housing used with FF246 Uses service part: 3307455S Bulk tank fuel filter (gasohol)</p> 
<p>3304016 12CC Electric Valve **CSA Approved</p> 	<p>3305647 Coolant Immersion Heater for Detroit Diesel 1500W/120V</p> 	<p>3307455S Used with 3307454S Replacement bowl</p> 
<p>3304017 C W Aids Union "T" **CSA Approved TE Connector for Ether Valve</p>	<p>3305647C Coolant Immersion Heater for Detroit Diesel 1500W/120V **CSA Approved</p> 	<p>3307532S Used with FF125 O-ring</p>
<p>3304018 Electric Starting Fluid System Switch **CSA Approved</p> 	<p>3305648 Coolant Immersion Heater for Detroit Diesel 1500W/240V</p> 	<p>3307647S Spring used in 250825S and 250826S; replaced 150037S in these applications.</p>
	<p>3305648C Coolant Immersion Heater for Detroit Diesel 1500W/240V</p>	
	<p>3305783 Thermostat for Circulation Fuel Warmer</p>	







E. PRODUCT GUIDE

<p>3307670 Coolant Immersion Heater for Caterpillar and Detroit Diesel 1000W/120V</p> 	<p>3308929S Cover assembly used on 4-quart power steering reservoir.</p> 	<p>3309196 Coolant Immersion Heater for Mack. 1500W/120V</p> 
<p>3307672 Coolant Immersion Heater for Caterpillar 1500W/120V</p> 	<p>3308958S Inner gasket used on 3300922S conversion kit.</p> <p>Overall Height: 0.20 (5) Largest OD: 2.23 (57) Cross Section: Irregular Largest ID: 1.70 (43)</p> 	<p>3309197 Coolant Immersion Heater for Mack. 1500W/240V</p>
<p>3307672C Coolant Immersion Heater for Caterpillar 1500W/120V **CSA Approved</p> 	<p>3308959S Inner gasket used on 3300923S conversion kit.</p> <p>Overall Height: 0.29 (7) Largest OD: 2.01 (51) Cross Section: Rectangular Largest ID: 1.48 (37)</p>	<p>3309198 Coolant Immersion Heater for IHC. 1500W/120V</p> 
<p>3307673 Coolant Immersion Heater for Caterpillar and Detroit Diesel 1500W/240V</p> 	<p>3308961S Gasket used with 3300923S adaptor package. Available in 100 quantity pack (3308961SB)</p>	<p>3309200 Coolant Immersion Heater for Volvo. 1000W/120V</p> 
<p>3308112S Used with FF191 Gasket</p>	<p>3309054S Seal assembly in 2-quart and 4-quart power steering reservoirs.</p> 	<p>3309438C Igniter Switch for 30,000 BTU Propane Tank Heater</p>
<p>3308690S CATERPILLAR 2H3928 Used with HF6097 Gasket</p>	<p>3309188 Uses service part: 3303427S, 3835426S Coolant Immersion Heater for Cummins L-10 and M-11. 1500W/120V</p> 	<p>3309490S Used with FS1242B Replacement O-ring gasket for use with self-venting drain valve screws used on all Superfilter Plus fuel/water separator assemblies.</p> 
<p>3308691S CATERPILLAR 2D8009 Used with HF6098 Gasket</p> 	<p>3309188C Coolant Immersion Heater for Cummins L10. 1500W/120V **CSA Approved</p> 	<p>3309738 Coolant Immersion Heater for Cummins. 1500W/120V</p> 
<p>3308692S CATERPILLAR 2H3935 Used with HF6098 Gasket</p> 	<p>3309189 Coolant Immersion Heater for Cummins L-10 and M-11. 1500W/240V</p> 	<p>3309738C Coolant Immersion Heater for Cummins. 1500W/120V **CSA Approved</p> 
<p>3308694S CATERPILLAR 5P3092 Used with HF6083 Gasket</p> 	<p>3309190 Coolant Immersion Heater for Mack. 1500W/120V</p> 	<p>3309739 Coolant Immersion Heater for Cummins. 1500W/240V</p> 
<p>3308695S Used with HF6098 Gasket</p>	<p>3309190C Coolant Immersion heater for Mack 1500W/120V **CSA Approved</p>	<p>3310049S Gasket for use with some block heaters.</p>
<p>3308720 Coolant Immersion Heater for IHC/Navistar Applications 600W/120V</p>	<p>3309194 Coolant Immersion Heater for Mack. 1000W/120V.</p> 	<p>3310063 Replacement Heater Element 1500W/120V</p> 
<p>3308844S Used with AF960M Gasket</p> 	<p>3308927S Dipstick used in 3308935S power steering reservoir.</p>	<p>3310063C Replacement Immersion Heater Element. 1500W/120V **CSA Approved</p> 
<p>3308928S Dipstick used in 2-quart power steering reservoir.</p> 		<p>3310064 Replacement Heater Element 1500W/240V</p> 

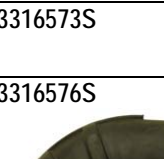
E. PRODUCT GUIDE

3310168	Replacement Heater Element for 3310400	3310859	Coolant Immersion Heater for Cummins. 1500W/240V 	3312554S	Used with AF852M, AF852 Cover gasket in Donaldson housing EBA-15-0005.(12 bolt holes) 
3310200	Thermo Blend Fuel Warmer **CSA not required 	3311273S	Used with HF6190 Gasket.	3312555S	Used with AF1600, AF1600M, AF1748, AF1748M, AF1781M, AF995M, AF997M, AF998M Cover gasket used in Donaldson 16" EBA housings. (12 bolt holes)
3310400C	Coolant Immersion Heater for Cummins V 1500W/120V	3311468S	Strap wrench. 	3312556S	Used with AF853, AF853M Cover gasket in Donaldson 13" EBA housings.(8 bolt holes) 
3310401C	Coolant Immersion Heater for Cummins V 1500W/240V	3311505S	Head used with FF5018, FF5052, FS1221, FS1251, FS1235 Remote mount head 	3312715S	Gasket
3310404	Coolant Immersion Heater for Agricultural Applications 600W/120V 	3311624S	1.25" inch O.D. plastic air filter bolt seal.	3312925	Replacement Element for 3312920 **CSA Approved
3310478C	10' Replacement Cord 120V **CSA Approved 	3311815	Remote Plug-In W/Cord	3312926	Replacement Element for 3312921 **CSA Approved
3310553	Oil Pressure Switch **CSA Approved	3312054S	Used with 3303782S, 3314849S Bracket 	3312927	Replacement Element for 3312922 **CSA Approved
3310587S	Cutter for spin-on filters. At this time, Fleetguard does not sell replacement blades. 	3312091S	Used with FF5036 Head to convert Detroit Diesel 12 and 16 cylinder engines 	3312928	Replacement Element for 3312923 **CSA Approved
3310588	Uses service part: 3303899S E-Z Mount Start Kit **CSA not required	3312092S	Used with FF5037 Head to convert Detroit Diesel 12 and 16 cylinder engines 	3312933	Replacement Element for 3312930.
3310591	E-Z Mount Valve **CSA not required 	3312097S	Used with HF6704 Gasket for use with some hydraulic filters.(Rectangular cross section) 	3312934	Replacement Element for 3312931.
3310593	Atomizer **CSA not required	3312307S	2-quart power steering reservoir gasket. Overall Height: 0.07 (2) Largest OD: 5.10 (130) Cross Section:Rectangular Largest ID: 4.38 (111)	3312941	Junction Box. 480V 
3310629S	Mounting bracket for 4-quart power steering reservoir.	3312308S	2-quart power steering reservoir cover. 	3312942	100-120 degree thermostat
3310750	Temperature Control	3312553S	Used with AF966, AF966M Cover gasket in Donaldson housing EBA-11-0009(8 bolt holes) 	3312943	120-140 degree thermostat
3310751C	Coolant Immersion Heater for IHC. 1250W/120V **CSA Approved			3313095S	Used with HF6505, HF6504 Gasket Overall Height: 0.27 (7) Largest OD: 2.83 (72) Cross Section:Rectangular Largest ID: 2.46 (63)
3310776S	Gasket			3313182	Coolant Immersion Heater for IHC 9L. 1000W/120V1993 and older 
3310777S	Gasket			3313182C	Coolant Immersion Heater for IHC 9L. 1000W/120V **CSA Approved 
3310858	Coolant Immersion Heater for Cummins. 1500W/120V (With Cord) See 3310839 for heater only. 				
3310858C	Coolant Immersion Heater for Cummins. 1500W/120V **CSA Approved 				

E. PRODUCT GUIDE

<p>3313268 Coolant Immersion Heater for Perkins. 600W/120V **CSA Approved</p> 	<p>3316406 10', 120V Weather Proof Plug and Cord</p> 	<p>3316569S 90 degree elbow for use with air cleaners.</p> 
<p>3313269 Coolant Immersion Heater for IHC 9L. 600W/120VCSA Approved</p> 	<p>3316408 Coolant Immersion Heater for Case. 1500W/120V</p> 	<p>3316570S 90 degree elbow for use with air cleaners.</p> 
<p>3313270 Coolant Immersion Heater for Agricultural Applications. 400W/120V</p> 	<p>3316409 Coolant Immersion Heater for John Deere. 1000W/120V</p> 	<p>3316571S 90 degree elbow for use with air cleaners.</p> 
<p>3313271 Coolant Immersion Heater for John Deere. 600W/120V</p> 	<p>3316410 Atomizer **CSA not required</p> 	<p>3316573S 90 degree elbow for use with air cleaners.</p> 
<p>3313272 Coolant Immersion Heater for Consolidated Dsl. 750W/120V</p> 	<p>3316413 Uses service part: 3303899S Electric Starting Kit 250-450 CID **CSA not required</p> 	<p>3316576S 90 degree elbow for use with air cleaners.</p> 
<p>3313272C Coolant Immersion Heater for Consolidated Dsl. 400W/120V **CSA Approved</p> 	<p>3316437S Gasket</p> 	<p>3316577S 90 degree elbow for use with air cleaners.</p> 
<p>3313273 Uses service part: 3303899S Ether Start Kit **CSA not required Includes atomizers 3303311, 259350, 259346</p> 	<p>3316438S Used with AK5, AK6, AK11 Gasket</p> 	<p>3316578S 90 degree elbow for use with air cleaners.</p> 
<p>3313274 All Purpose Magnetic Heater **CSA not required</p> 	<p>3316564S 90 degree elbow for use with air cleaners.</p> 	<p>3316579S 45 degree elbow for use with air cleaners.</p> 
<p>3313276 Battery Warmer Blanket **CSA Approved</p> 	<p>3316565S 90 degree elbow for use with air cleaners.</p> 	<p>3316580S 45 degree elbow for use with air cleaners</p> 
<p>3313277 Coolant Immersion Heater for Cummins 1000W/120V</p> 	<p>3316566S 90 degree elbow for use with air cleaners.</p> 	<p>3316581S 45 degree elbow for use with air cleaners.</p> 
<p>3313277C Coolant Immersion Heater for Cummins 1000W/120V **CSA Approved</p> 	<p>3316567S 90 degree elbow for use with air cleaners.</p> 	<p>3316582S 45 degree elbow for use with air cleaners.</p> 
<p>3314250S Used with HF6059, HF6720, HF6060 Gasket for use with some Gresen heads. ("L" Shape)</p> 	<p>3316568S 90 degree elbow for use with air cleaners.</p> 	<p>3316583S 45 degree elbow for use with air cleaners.</p> 
<p>3314849S Head used with HF6243, HF6318 Uses service part: 3312054S Remote mount head</p> 	<p>3316568S 90 degree elbow for use with air cleaners.</p> 	<p>3316583S 45 degree elbow for use with air cleaners.</p> 

















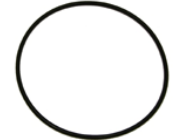

E. PRODUCT GUIDE

<p>3316584S 45 degree elbow for use with air cleaners.</p> 	<p>3316593S 90 degree reducing elbow for use with air cleaners.</p> 	<p>3316613S Hump hose for use with air cleaners.</p> 
<p>3316585S 45 degree elbow for use with air cleaners</p> 	<p>3316594S 45 degree reducing elbow for use with air cleaners.6" to 5"</p> 	<p>3316614S Hump hose for use with air cleaners.</p> 
<p>3316586S 45 degree elbow for use with air cleaners.</p> 	<p>3316595S 45 degree reducing elbow for use with air cleaners.</p> 	<p>3316615S Hump hose for use with air cleaners.</p> 
<p>3316587S 45 degree elbow for use with air cleaners.</p> 	<p>3316600S Special elbow for use with air cleaners.</p> 	<p>3316616S Hump hose reducer for use with air cleaners.</p> 
<p>3316588S 45 degree elbow for use with air cleaners.</p> 	<p>3316601S Special elbow for use with air cleaners.</p> 	<p>3316617S Hump hose reducer for use with air cleaners.</p> 
<p>3316589S 90 degree reducing elbow for use with air cleaners.</p> 	<p>3316606S Hump hose for use with air cleaners</p> 	<p>3316618S Hump hose reducer for use with air cleaners.</p> 
<p>3316590S 90 degree reducing elbow for use with air cleaners.</p> 	<p>3316607S Hump hose for use with air cleaners.</p> 	<p>3316619S Hump hose reducer for use with air cleaners.</p> 
<p>3316591S 90 degree reducing elbow for use with air cleaners.</p> 	<p>3316608S Hump hose for use with air cleaners.</p> 	<p>3316620S Hump hose reducer for use with air cleaners.</p> 
<p>3316592S 90 degree reducing elbow for use with air cleaners.</p> 	<p>3316609S Hump hose for use with air cleaners.</p> 	<p>3316621S Hump hose reducer for use with air cleaners.</p> 
	<p>3316610S Hump hose for use with air cleaners.</p> 	<p>3316622S Hump hose reducer for use with air cleaners.</p> 
	<p>3316611S Hump hose for use with air cleaners.</p> 	<p>3316623S Hump hose reducer for use with air cleaners.</p> 
	<p>3316612S Hump hose for use with air cleaners.</p> 	

E. PRODUCT GUIDE

<p>3316624S Hump hose reducer for use with air cleaners.</p> 	<p>3316653S "T" bar air inlet clamps for use with air cleaners.</p> 	<p>3316663S "T" bar air inlet clamps for use with air cleaners.</p> 
<p>3316625S Hump hose reducer for use with air cleaners.</p> 	<p>3316654S "T" bar air inlet clamps for use with air cleaners.</p> 	<p>3316664S "T" bar air inlet clamps for use with air cleaners.</p> 
<p>3316626S Hump hose reducer for use with air cleaners.</p> 	<p>3316656S "T" bar air inlet clamps for use with air cleaners.</p> 	<p>3316665S "T" bar air inlet clamps for use with air cleaners.</p> 
<p>3316627S Hump hose reducer for use with air cleaners.</p> 	<p>3316657S "T" bar air inlet clamps for use with air cleaners.</p> 	<p>3316666S "T" bar air inlet clamps for use with air cleaners.</p> 
<p>3316628S Hump hose reducer for use with air cleaners.</p> 	<p>3316657S "T" bar air inlet clamps for use with air cleaners.</p> 	<p>3316705S Used with FF125 Housing cover gasket</p> 
<p>3316629S Reducer insert sleeve for use with air cleaners.</p> 	<p>3316658S "T" bar air inlet clamps for use with air cleaners.</p> 	<p>3316953S Used with AF966, AF966M Cover gasket in Fram housing FA-1582-10E.(6 bolt holes)</p> 
<p>3316630S Reducer insert sleeve for use with air cleaners.</p> 	<p>3316659S "T" bar air inlet clamps for use with air cleaners.</p> 	<p>3317283 Coolant Immersion Heater for Cummins. 1500W/120V</p> 
<p>3316631S Reducer insert sleeve for use with air cleaners.</p> 	<p>3316659S "T" bar air inlet clamps for use with air cleaners.</p> 	<p>3317283C Bulk pack heater with cord. 1500W/120V **CSA Approved</p> 
<p>3316632S Reducer insert sleeve for use with air cleaners.</p> 	<p>3316660S "T" bar air inlet clamps for use with air cleaners.</p> 	<p>3317765S Used with AF852, AF852M Cover gasket used in Fram housing FA-595-10E(8 bolt holes)</p> 
<p>3316633S Reducer insert sleeve for use with air cleaners.</p> 	<p>3316661S "T" bar air inlet clamps for use with air cleaners.</p> 	<p>3318022S Band wrench for 4.2" and 4.6" O.D. spin-ons.</p> 
<p>3316635S Mounting band for use with air cleaners.</p> 	<p>3316662S "T" bar air inlet clamps for use with air cleaners.</p> 	<p>3318125S Used with 154272S, 156780S, 156779S, 156810S Gasket used in crankcase breather assemblies.</p> 
<p>3316636S Mounting band for use with air cleaners.</p> 	<p>3316662S "T" bar air inlet clamps for use with air cleaners.</p> 	<p>3318168S Probalyzer cap used with fluid analysis kits.</p> 
<p>3316639S Mounting band for use with air cleaners.</p> 		
<p>3316640S Mounting band for use with air cleaners.</p>		

E. PRODUCT GUIDE

3318169S	Mini gauge plug used with fluid analysis kits.	
3318213	3CC Replacement Valve **CSA not required	
3318304S	Used with HF6244 Gasket	
3318566S	Used with LF777 Cap with 3/8 NPT tap- LF3000 Retro Kit	
3318568S	Used with LF670 LF3000 Retro Kit	
3320223S	Used with FF5105 Gasket Overall Height: 0.14 (4) Cross Section:Rectangular Largest ID: 4.84 (123)	
3320513S	Removal tool	
3320515S	Removal tool	
3320571S	Used with HF6059, HF6060 Optional gasket Overall Height: 0.12 (3) Cross Section:Rectangular Largest ID: 1.83 (47)	
3320958S	Cable socket	
3320966S	Cable socket	
3320967S	Cable socket	
3321569S	Insulator	
3321577S	PTC Fuel Warmer **CSA not required	
3321578S	PTC Fuel Warmer **CSA not required	
3321579S	PTC Fuel Warmer **CSA not required	
3321580S	PTC Fuel Warmer **CSA not required	
3321592S	Fitting instructions for PTC Heater Kit	
3321608S	Fuel Heater Kit	
3321610S	Fuel Heater Kit	
3321967S	Single cable	
3321968S	Cable	
3321969S	Single cable	
3321970S	Twin cable	
3321978S	Fitting instructions for PTC Heater Kit	
3323007S	Gasket used with fuel filters Overall Height: 0.12 (3) Cross Section:Rectangular Largest ID: 2.89 (74)	
3323008S	Used with FF147, FF5054 Optional gasket. Enclosed with FF5228. Overall Height: 0.12 (3) Cross Section:Rectangular Largest ID: 3.72 (95)	
3323009S	Used with FF147, FF146 Optional Gasket Overall Height: 0.12 (3) Cross Section: Round Largest ID: 2.99 (76)	
3323010S	Used with FF146 Optional gasket Overall Height: 0.08 (2) Cross Section:Rectangular Largest ID: 2.99 (76)	
3320224S	Used with FF5105 Gasket	
3323483S	Replaced by 3923925S Nylon tubing, used for cold weather aids. Packaged 150 meters of tubing per carton.	
3324564S	Used with FF147 Optional gasket Overall Height: 0.12 (3) Cross Section: Round Largest ID: 3.86 (98)	
3328464S	Gasket	
3328567S	Gasket	
3328568S	Gasket	
3329059S	Electric cable for heater 2 conductors, no tape.	
3329992S	Used with LF3998, LF3999 Set of gaskets containing 3328578, 3329993, 3329994	
3625120S	Used with LF4072 Optional gasket. Only for RABA engine-Application IKARUS bus	
3825403	Tank Heater 1000W/240V	
3825405	Unfilled Ether Cyl. **CSA not required	
3825406C	5' Replacement Cord 120V **CSA Approved	
3825408	3CC Mechanical Ether Kit (B Series) **CSA not required	
3825409	6CC 12V Ether Kit (C Series) **CSA not required	
3825410	6CC Mech Ether Kit(C Series) **CSA not required	
3825411	Heater (C Series) 1000W/120VUses Cummins gasket 3910517	
3825414C	1/2" Oil Pan Heater **CSA Approved 150W/120V	
3825415C	1" Oil Pan Heater 150W/120V **CSA Approved	
3825416	22MM Oil Pan Heater 150W/120V	
3825417C	1/2" Oil Pan Heater **CSA Approved 300W/120V	
3825418C	1" Oil Pan Heater 300W/120V **CSA Approved	

E. PRODUCT GUIDE

3825419C 22MM Oil Pan Heater
300W/120V **CSA Approved



3825420 22MM Oil Pan Heater
150W/240V



3825421 22MM Oil Pan Heater
300W/240V

3825422 1/2" Oil Pan Heater
450W/120V



3825423 1/2" Oil Pan Heater
300W/240V



3825424 120V Y-Cord with Thermostat



3825425 240V Y-Cord With Thermostat
For Oil Pan Heaters



3825760 Coolant Immersion Heater for
Cummins C Series
1000W/240V



3826036S Dash mount filter minder
restriction gauge.



3826037 12cc 12-24 volt Ether Start Kit
for KV12 & KV16 engine
w/side mounted aftercooler
**CSA Approved



3826177S Used with HF6704 Service
pack for 332418 gasket.



3826255 Coolant Immersion Heater for
Cummins B Series
750W/240V



3826332S Used with LF3000 Retro Kit for
Cummins Big Cam III and IV

3826333S Used with LF3000 Retro Kit for
Cummins Big Cam III and IV
engines which use LF670 and
LF777 filters.



3826334S Used with LF3000 Retro Kit for
Detroit Diesel engines which
use LF3333 filter - less LF777
cap or hose.

3826335S Used with LF3000 Retro Kit for
Caterpillar engines which use
LF691 filter - less LF777 cap
or hose.

3826336S Used with LF3000 Retro Kit for
Cummins Big Cam I and II.



3826337S Mounting bracket for 2-quart
power steering reservoir.



3826359S Used with LF3000 Set screw

3826360S Used with LF3000 Capscrew

3826362S Used with LF3000 Small Oring



3826373 Thermal Switch w/45 degree
1/2" NPT, for electric start kits.
**CSA not required



3827107S Used with WF2076
Water Filter Head

3827195S Head used with LF3000
Remote mount head (1-1/4
inch inlet/outlet)

3830110S Used with HF6600 Optional
gasket (fluorocarbon
elastomer)

3830114S Used with HF6700, HF6703,
HF6704, HF6706, HF6707,
HF6712, HF6713, HF6725,
HF6726 Optional gasket
(fluorocarbon
elastomer)(Square cut gasket)

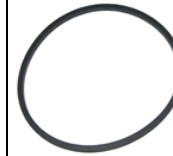

Overall Height: 0.19 (5)
Largest OD: 5.04 (128)
Cross Section: Rectangular
Largest ID: 4.71 (120)

3830325 Replacement Heating
Element for 3312936 Tank
Heater.



3830326 Replacement Heating
Element For 3312937



3830327 Replacement Heating
Element For 3896711



3830328 Replacement Heating
Element for 3312939 tank
heater.



3830329 2000W/240V Tank Heater
**CSA Approved



3830394 Uses service part: 3303899S
E-Z Mount 24V Start Kit
**CSA not required















3830395 Uses service part: 3303899S
24V Start Kit **CSA not
required



3830396 Uses service part: 3303899S
24V Start Kit **CSA not
required

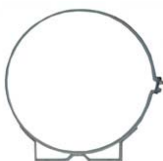

E. PRODUCT GUIDE

3830397  Uses service part: 3303899S 24V Start Kit **CSA not required Includes atomizers 3303311, 259350, 259346	3832165  240V Y-Cord w/Thermostat (55-75%)	3833593A Standard Replacement Ether (120 psi.)Purchase Quantity 1 To 96 Units
3830398  3CC Ether Valve for 24V Electric Kit **CSA not required	3832216  Coolant Immersion Heater	3833593B Standard Replacement Ether (120 psi.)Purchase Quantity 97 Or More Units **CSA Approved
3830399  6cc Valve for 24V Start Kit **CSA not required	3832218  Engine Heater	3833676S Mounting band for use with air cleaners.
3830400  6cc Valve for 24V E-Z Mount Start Kit **CSA not required	3832637S  CUMMINS 3284085 Insert	3833677S  Mounting band for use with air cleaners.
3830401  12cc Valve **CSA not required	3832879S  Used with FF127, HF6118, HF6270, HF6271, LF509N Gasket	3833678S Mounting band for use with air cleaners.
3830497S  1.5" O.D. flat filter bolt seal.	3833066  Coolant Immersion Heater for Nissan FE6. 1500W/120V	3833679S  Mounting band for use with air cleaners.
3831773S  Service gasket of LF3000 Large gasket used with LF3000 Retro Kit.	3833067  Coolant Immersion Heater for Nissan NE6. 1500W/120V	3833680S Mounting band for use with air cleaners.
3831852S  Used with FS1232V, FS1253V, FS1253, FS1232 Drain Valve Connector Assembly	3833068  Coolant Immersion Heater for Mitsubishi Fuso. 3/4" NPT **CSA Approved	3833681S  Mounting band for use with air cleaners.
3831871S  Used with FS1015, FS1242, FS1233, FS19511, FS1241, FS1240, FS1234B, FS1234 Replacement bowl	3833069  Coolant Immersion Heater for Cummins BC IV (Rear port). 1500W/120V	3833684S Brass wing nut 7/16" w/14 for use with air cleaners.
3832054S  Used with FS1232 Insert adaptor to extend threads when using 3832052S heater and FS1232.	3833198S  Remote mount head for Superfilter Plus filters. Head has removable threaded insert.	3833685S Lock nut for use on some air cleaners.
3832163  Cummins Side Plate Brazed Element W/Cord 1500W/120V	3833198S  Remote mount head for Superfilter Plus filters. Head has removable threaded insert.	3833685S Lock nut for use on some air cleaners.
3832164  120V Y-Cord w/Thermostat. (55-75 degrees)	3833199S  Used with FF5207 Fuel filter head for spin-on conversion of primary fuel for Detroit Diesel applications.	3833686S Lock nut for use on some air cleaners.
3832200S  Used with FF5206 Fuel filter head for spin-on conversion of secondary fuel FF5206 for Detroit Diesel applications.	3833200S  Used with FF5206 Fuel filter head for spin-on conversion of secondary fuel FF5206 for Detroit Diesel applications.	3833686S Lock nut for use on some air cleaners.
		3833687S Lock nut for use on some air cleaners.
		3833688S Lock nut for use on some air cleaners.
		3833689S Wing nut for use on some air cleaners.
		3833690S Lock nut for use on some air cleaners.
		3833691S  Dust valve for "2-stage plus safety" and "2-stage" air cleaners.
		3833692S Air inlet stack cap for use with air cleaners.
		3833693S Air inlet stack cap for use with air cleaners.

E. PRODUCT GUIDE

<p>3833694S Air inlet stack cap for use with air cleaners.</p>	<p>3834514 Coolant Immersion Heater for Cummins K-Series. 1500W/240V</p> 	<p>3836094S Remote mount multiport head for Cummins applied fuel filters (1/4 NPT inlet/ outlet)</p>
<p>3833696S Air inlet stack cap for use with air cleaners.</p> 	<p>3834558S Oil Analysis Kit</p>	<p>3836095S Remote mount multiport head for Cummins applied fuel filter (3/8 NPT inlet/ outlet)</p> 
<p>3833697S Air inlet stack cap for use with air cleaners.</p> 	<p>3834694 Replacement Heating Element for 3317938 Tank Heater</p>	<p>3836165S "L" shaped gasket for John Deere application RE41257.</p>
<p>3833698S Air inlet stack cap for use with air cleaners.</p>	<p>3835118S Used with 3837317S Cummins 3943780 Threaded insert to use heater with Superfilter Plus line with 3833198S and 3905661S heads.</p> 	<p>3836258 Starter Fluid</p>
<p>3833699S Air inlet stack cap for use with air cleaners.</p> 	<p>3835425 Atomizer **CSA not required</p>	<p>3836308S Hump hose for use with air cleaners.</p>
<p>3833700S Air inlet stack cap for use with air cleaners.</p>	<p>3835426S Used with 3309188 Hexagonal Nut Package **CSA not required</p> 	<p>3836931S Mounting clamps for ECO-SE air cleaners.</p>
<p>3834123S Head used with LF3000 Remote mount head (1-5/16 inch inlet/outlet)</p>	<p>3835603 Starting Fluid **CSA not required</p>	<p>3836932S Mounting clamps for ECO-SE air cleaners.</p> 
<p>3834172S Service gasket for AK00013.</p>	<p>3835604A Starting Fluid **CSA not required</p>	<p>3836933S Mounting clamps for ECO-SE air cleaners.</p>
<p>3834173S Support for use on 10-quart power steering reservoir.</p>	<p>3835841S Used with AF253, AF1650 Gasket (foam gasket with adhesive on one side)(5.416 ID/7.610 OD/.265 thick)</p> 	<p>3836943S Inlet adaptor for ECOII air cleaners.</p> 
<p>3834185S Used with 3837317S, 3847102S For Upgrade, use 3958485S Replacement gasket for PTC fuel heater kits.</p>  <p>Overall Height: 0.17 (4) Largest OD: 2.74 (70) Cross Section:Rectangular Largest ID: 2.46 (62)</p>	<p>3835842S Used with AF1650, AF253 Gasket (foam gasket with adhesive on one side)(7.716 ID/10.155 OD/.252 thick)</p> 	<p>3836945S Inlet adaptor for ECOII air cleaners.</p> 
<p>3834217S Uses service part: 3834335S Used with FS1242B Water in fuel indicator kit for Superfilter Plus product line. (For use on 12 volt DC systems only.)</p>	<p>3835862S Used with LF3000 Replacement hose for Retro Kits 3826332S and 3826333S.</p>	<p>3836946S Inlet adaptor for ECOII air cleaners.</p> 
<p>3834335S CUMMINS 3613643 Used with FS1242K, 3834217S Replacement WIF sensor for use with clear bowl used on the Superfilter Plus fuel filter/water separator assemblies.</p> 	<p>3836029S Used with FS1242K, FS1242B Complete fuel heater installation kit (300 watt/12 volt) **CSA Approved Gaskets Included: 3837316S & 3834185S</p> 	<p>3836947S Combination water separator and inlet adaptor for ECOII air cleaners.</p>
<p>3834340S Used with AF1872 Wing nut used in airkits for Caterpillar conversions.</p>	<p>3836032S Fuel heater element for 3836029S kit (300 watt) Includes 3834185 gasket</p> 	<p>3836948S Combination water separator and inlet adaptor for ECOII air cleaners.</p>
<p>3834513 Coolant Immersion Heater for Cummins K-Series 1500W/120V</p>	<p>3836091S Head used with LF3000 Remote mount head (1-5/8 straight threads inlet/outlet)</p> 	<p>3836950S Combination water separator and inlet adaptor for ECOII air cleaners.</p>
<p>3834513C Coolant Immersion Heater for Cummins K-Series. 1500W/120V **CSA not required</p> 		<p>3836951S Mounting clamp for ECOII air cleaners.</p> 















E. PRODUCT GUIDE

3836952S	Mounting clamp for ECOII air cleaners.
3836953S	Mounting clamp for ECOII air cleaners.
	
3836954S	Pressure tap sleeve with service indicator for ECOII air cleaners.
3836955S	Pressure tap sleeve with service indicator for ECOII air cleaners.
3836956S	Pressure tap sleeve with service indicator for ECOII air cleaners.
3836957S	Pressure tap sleeve with service indicator for ECOII air cleaners.
3837316S	Used with 3837317S Replacement gasket for the 3837317S adaptor kit.
	
3837317S	Uses service part: 255622S, 3834185S, 3835118S, 3837316S Retrofit adaptor kit for use of Superfilter Plus heater with existing Cummins fuel filter head. (Includes gaskets, adaptor disk, threaded insert, industrial loctite)
	
3838221S	CATERPILLAR 1H8128 Used with HF6098 Gasket
	Gasket: 3838221
3838222S	CATERPILLAR 2H9247 Used with HF6098 Gasket
	Gasket: 3838222
3838223S	CATERPILLAR 2S8439 Used with HF6097 Gasket
	Gasket: 3838223
3838224S	CATERPILLAR 3J1991 Used with HF6201 Gasket
	Gasket: 3838224

3838228S	CATERPILLAR 6D9157 Used with HF6202, HF6344 Gasket
	Gasket: 3838228
3838229S	CATERPILLAR 8F8882 Used with HF6097 Gasket
	Gasket: 3838229
3838230S	CATERPILLAR 8H2778 Used with FF234 Gasket
	Gasket: 3838230
3838290S	Used with LF691A Band wrench
	
3839974S	Cast iron wing nut for use with some air cleaners kits. 1/2 w/13 thds. used with AK kits
3839975S	Cast iron wing nut for use with some air cleaner kits. 1/2 w/20 thds. used with AK kits
3841697	Coolant Immersion Heater for Caterpillar 3176. 1500W/120V**CSA Approved
	
3841700	Coolant Immersion Heater for Caterpillar 3116. 1000W/240V
	
3841701	Coolant Immersion Heater for Caterpillar 3116. 1000W/120V**CSA Approved
	
3841702	Coolant Immersion Heater for Detroit 60 Series 1500W/120V**CSA Approved
	
3841703	Coolant Immersion Heater for Detroit 60 Series 1500W/240V
3841704	Weatherproof Receptacle Bracket (Square) **CSA not required
3841705	Weatherproof Receptacle Bracket (Round) **CSA not required

3841706	Coolant Immersion Heater for Ford 6.6 & 7.8L 1250W/240V
	
3841707	Coolant Immersion Heater for Ford 6.6 & 7.8L 1250W/120V
	
3841708	Coolant Immersion Heater for Mack E7 1500W/120V
	
3841709	Coolant Immersion Heater for Navistar DT360 1000W/240V
	
3841710	Heatsticker (Flexible Hot Pad Heater) **CSA not required 150W/120V
	
3841879S	Used with 3889182S, 3889181S Fuel Strainer used With FS1251
	
3843722S	Used with 3847102S, 3894689S Cord w/Thermostat used on 3847102S and 3894689S fuel system service parts
	
3845400S	Used with 3847102S, 3889181S, 3889182S Service Kit, Fuel Strainer Screen, Includes 3841883 Lock Nut and 3842021 Gasket.
	
3845969	12cc/24V valve starting Kit (12V version use 3826037) **CSA not required
	
3845970	12cc/24V valve starting kit (12V version use 259385) **CSA not required
	
3845971	24 volt valve starting kit (12V version use 259384) **CSA not required
	
3846568S	Remote mount lube filter head for Cummins C series. (LF3000 element used)
	



























E. PRODUCT GUIDE

3846751	Filter crusher for use on larger truck filters or multiple smaller filters.	3888726S	Washer seal for 2, 4 and 10 quart power steering reservoirs..	3890246C	Coolant Immersion Heater for Onan 1500W/240V **CSA Approved
3846752	Filter crusher for extremely high volume applications.			3890247C	Coolant Immersion Heater for Onan 1800W/120V **CSA Approved
3847102S	Uses service part: 3834185S, 3843722S, 3845400S, 3928013S Cummins Fuel Strainer for Mid-range engines. Complete assembly.	3889181S	FORD F4HZ9162B Uses service part: 3841879S, 3845400S Complete assembly.	3890248C	Coolant Immersion Heater for Onan 2000W/240V **CSA Approved
				3891506S	Insert, reducer
3847372S	Used with AF25005 Clamp Fastener Package	3889182S	Uses service part: 3841879S, 3845400S Fuel Strainer for Consolidated Diesel Co. Complete assembly.		
3847397S	Used with AF25005 Moisture Eliminator			3892256	Heat Transfer Fluid Additive
3847494S	ISB Fleetguard Fuel Filters. Self-Tapping Screw. Cummins # 3847494.	3889183S	Uses service part: 3928013S Cummins 3889183 Fuel Strainer	3892460	Oberg P100WM Fuel System Service Part
3847940S	CUMMINS 3932595 Cord, W/Thermostat	3889493S	Threaded Insert	3892646S	Uses service part: 3933978S Remote mount head w/metric threads M14 X 1.5 -6H for Superfilter Plus Filters
Height: 0.00 (0)		3889513S	CUMMINS 3889513 Hydraulic Filter Head		
Cross Section: 0.00 (0)		3889610	CUMMINS 196520 Die Cut Media Disk ValveQuantity 10,000	3892776S	Lid Assembly
End 1 OD: 0.00 (0)		3889610S	Die Cut Media Disk ValveQuantity 500		
End 2 OD: 0.00 (0)		3890011S	Fuel Filter Head	3892779S	Anti Drain Back Valve Assembly
End 1 ID: 0.00 (0)				3893030S	WIF Sensor Gasket
End 2 ID: 0.00 (0)		3890105S	CUMMINS 3681120 Gasket service pack		
3848716S	Head Assembly for Cummins Marine applications.	3890242C	Coolant Immersion Heater for Onan 500W/120V **CSA Approved	3893692S	Head used with NG5900 6B & L10 Engines Cummins 3606711 Head & O'ring Uses NG5900 element
3848717S	Head Assembly for Cummins Marine applications.				
3848869	Remote Mount Filter Minder Gauge (35" restriction)	3890243C	Coolant Immersion Heater for Onan 1000W/120V **CSA Approved	3893762C	Fleetcool Concentrate Additive
3888619	12V EZ Mount Start Kit **CSA not required			3893866S	O'ring Plug (2) Cummins 3943645
		3890244C	Coolant Immersion Heater for Onan 1000W/240V **CSA Approved	3894499	Immersion Heater 1250 Watt 120 Volt **CSA Approved
3888706	Contamination Monitor which includes printer, carrying case, batteries, trace heating element, lamp, printer paper and ribbon, DC adaptor and fuse.				
3888707	Industrial sensor with 5 - 26 GPM flow rate @ 6000 PSI	3890245C	Coolant Tank Heater for Onan 1500W/120V **CSA Approved(Thermostat 100 to 120 degrees)	3894689S	Uses service part: 3843722S, 3928013S
3888708	Industrial sensor rated at 21 - 100 GPM flow rate @ 6000 PSI			3894794S	Used with FS1007 Uses Service gasket: 3894794 Gasket
3888709	Single point sampler with carrying case and two hook-up hoses				



























E. PRODUCT GUIDE

3894901S	CUMMINS 3942357 Temperature Sensor for 12V heater used on Cummins ISB spin-on fuel filter	3896693	Coolant Tank Heater 1500W/240V **CSA Approved	3897183S	Gasket kit containing 1 carton gasket, 1 rubber gasket and washers. In Europe, use with HF6449.
3894967S	CASE 401849A1 Used with FS19519, FS19519V Valve and Sensor	3896694	Coolant Tank Heater 1500W/480V **CSA Approved	3897707	Replacement heating element for 389690 coolant tank heater. 1000W.120V
3894971S	Used with CH44105 Gasket	3896695	Coolant Tank Heater 2000W/120V **CSA Approved	3897709	Replacement heating element for 389692 coolant tank heater. 1500W/120V **CSA Approved
3894972S	Service gasket of CH44105, CH44110, CH44120	3896696	Coolant Tank Heater 2000W/240V **CSA Approved	3897710	Replacement heating element for 389693 coolant tank heater. 1500W/240V **CSA Approved
3894973S	Service gasket of CH44105, CH44110, CH44115, CH44120	3896697	Coolant Tank Heater 2000W/480V **CSA Approved	3897711	Replacement heating element for 389694 coolant tank heater. 1500W/480V **CSA Approved
3894975S	Overall Height: 0.21 (5) Largest OD: 6.02 (153) Cross Section: Round Largest ID: 5.60 (142)	3896698	Coolant Tank Heater 2250W/120V **CSA Approved	3897712	Replacement heating element for 389695 coolant tank heater. 2000W/120V **CSA Approved
3894975S	Used with CH44105, CH44110, CH44115, CH44120 Service Kit for Centrifuge. Includes (1) Rotor O-Ring, (1) Cone Stack Assembly, (1) Baffle Assembly, (1) CSA Turbine Can, (1) Can nut, (1) Jet Nut, and (1) FG Rotor shaft sub assembly.	3896699	Coolant Tank Heater 2500W/240V **CSA Approved	3897713	Replacement heating element for 389696 coolant tank heater. 2000W/240V **CSA Approved
3894976S	Used with CH44115, CH44105, CH44110 Shell Assembly	3896700	Coolant Tank Heater 2500W/480V **CSA Approved	3897714	Replacement heating element for 389697 coolant tank heater. 2000W/120V **CSA Approved
3894977S	Used with CH44120, CH44105 Clamp	3896701	Coolant Tank Heater 4000W/240V **CSA Approved	3897715	Replacement heating element for 389698 coolant tank heater. 2250W/120V **CSA Approved
3895084S	12V HEATER	3896702	Coolant Tank Heater 4000W/480V **CSA Approved	3897716	Replacement heating element for 389699 coolant tank heater. 2500W/240V **CSA Approved
3895540S	Replaces ST101106 Hydraulic Filter Head	3896704	Coolant Tank Heater 2500W/480V **CSA Approved	3897717	Replacement heating element for 389700 coolant tank heater. 2000W/480V **CSA Approved
3895546S	Replaces 6700FP17A00 Hydraulic Filter Head	3896705	Coolant Tank Heater 4000W/240V **CSA Approved	3897718	Replacement heating element for 389701 coolant tank heater. 2000W/120V **CSA Approved
3895593S	Replaces 6500BP05A25 Hydraulic Filter Head	3896706	Coolant Tank Heater 4000W/480V **CSA Approved	3897719	Replacement heating element for 389702 coolant tank heater. 2250W/120V **CSA Approved
3895630S	Head and Filter Assembly	3896707	Hazardous Location Heater 2500W/120V	3897720	Replacement heating element for 389703 coolant tank heater. 2500W/240V **CSA Approved
3896018	Universal Concentrate Additive	3896709	Uses service part: 3897724 Coolant Tank Heater 1500W/120V **CSA Approved	3897721	Replacement heating element for 389704 coolant tank heater. 2500W/240V **CSA Approved
3896692	Coolant Tank Heater 1500W/120V **CSA Approved	3896710	Uses service part: 3897725 Coolant Tank Heater 2500W/120V **CSA Approved	3897722	Replacement heating element for 389705 coolant tank heater. 2500W/240V **CSA Approved
		3896711	Uses service part: 3897726 Coolant Tank Heater 2500W/240V **CSA Approved	3897723	Replacement heating element for 389706 coolant tank heater. 2500W/240V **CSA Approved
		3896712	Uses service part: 3897727 Coolant Tank Heater 4000W/240V		
		3896722S	Threaded Adaptor		

E. PRODUCT GUIDE

<p>3897717 Replacement heating element for 3896700 coolant tank heater. 2500W/480V **CSA Approved</p> 	<p>3898281S CUMMINS 3931582, CHRYSLER 4883052 Used with FS19598 Head assembly for FS19528 assembly.</p>	<p>3903914 CUMMINS 3680963 Oil Pan Heater w/cord 450W/125V</p>
<p>3897718 Replacement heating element for 3896701 coolant tank heater. 4000W/240V</p> 	<p>3898282S CUMMINS 3931584, CHRYSLER 4882441 Used with FS19598 Housing Assembly</p> 	<p>3903916 CUMMINS 3688555 1500W/120V Engine Block Heater w/cord. Cummins Signature 600 & ISX</p> 
<p>3897719 Replacement heating element for 3896702 coolant tank heater. 4000W/480V</p>	<p>3898285S CUMMINS 3931489, CHRYSLER 4882437 Used with FS19598 FS Sensor</p> 	<p>3903938S CUMMINS 3943537 Adaptor</p> 
<p>3897720 Replacement heating element for 3896703 coolant tank heater. 2000W/480V **CSA Approved</p>	<p>3899371S CUMMINS 3942627 Head Casting</p> 	<p>3904378S Severe Duty Water Filter Head</p> 
<p>3897721 Replacement heating element for 3896704 coolant tank heater. 2500W/480V **CSA Approved</p>	<p>3899452S Used with CC2802 100ft. of 1/4 diameter polyethylene tubing</p>	<p>3904380 Head used with HF6177, HF7980 Head for HF6177 and HF7980 Bypass Settings : 1,75 bar Inlet/Outlet : 1"1/4 BSP</p> 
<p>3897722 Replacement heating element for 3896705 coolant tank heater. 4000W/240V **CSA Approved</p>	<p>3900349S CHRYSLER 5015586 Used with FS1258, FS1269, FS19586 Thermostat</p> 	<p>3904554S Gasket Package</p> 
<p>3897723 Replacement heating element for 3896706 coolant tank heater. 4000W/480V **CSA Approved</p>	<p>3900350S CUMMINS 3943648 Thermostat</p>	<p>3904837S SY-KLONE 901K1 Used with AP8403, AP8409 Kit to Install SY-KLONE Precleaner on equipment with 3"3.5"/3.75" Intake Size</p> 
<p>3897724 Used with 3896709 Replacement heating element for 3896709 coolant tank heater. 1500W/120V **CSA Approved</p> 	<p>3901159 Gasket #3901179, Adapter #3901180, thread insert #3901181, heater 3321569S are released in this package.</p> 	<p>3904838S SY-KLONE 901K2 Used with AP8403, AP8409 Kit to install SY-KLONE Precleaner on equipment with 4"4.5"/4.75"5" Intake Size</p> 
<p>3897725 Used with 3896710 Replacement heating element for 3896710 coolant tank heater. 2500W/120V **CSA Approved</p> 	<p>3901457S Fuel Filter Adapter To Convert FF167 C.A.V. Cartridge to use FS1235 spin-on</p> 	<p>3904839S SY-KLONE 901K3 Used with AP8403, AP8409 Kit to install SY-KLONE Precleaner on equipment with 5.25"/5.5"/6" Intake Size</p> 
<p>3897726 Used with 3896711 Replacement heating element for 3896711 coolant tank heater. 2500W/240V **CSA Approved</p> 	<p>3901608S Spring Assembly used in Optiguard Fuel Systems</p> 	<p>3904840S SY-KLONE 902K5 Used with AP8404, AP8410 Kit to install SY-KLONE Precleaner on equipment with 5"5.25"/5.5" Intake Size</p> 
<p>3897727 Used with 3896712 Replacement heating element for 3896712 coolant tank heater. 4000W/240V</p> 	<p>3901867S CUMMINS 3943649 Heater</p>	<p>3904841S SY-KLONE 902K6 Used with AP8404, AP8410 Kit to Install SY-KLONE Precleaner on equipment with 6.25"/6.5"/7" Intake Size</p> 
<p>3898280S CUMMINS 3931482 Used with FS19598 Valve shut-off for FWS assembly</p> 	<p>3901993S Used with FF5392 Service gasket for Federal Express fuel filter 3901342</p>	<p>3904842S SY-KLONE 903K9 Used with AP8410, AP8404 Kit to Install SY-KLONE Precleaner on equipment with 7"/9" Intake Size</p> 
<p>3902309 Uses service part: 3902309S Fuel filter head</p>	<p>3902309S Uses service part: 3933978S Used with 3902309, 3917480 Fuel filter head M16 x 1.5 for FF5074 type</p> 	<p>3905073S SY-KLONE 902K7 Used with AP8405, AP8406 Kit to Install SY-KLONE Precleaner on equipment with 9" Intake Size</p> 



E. PRODUCT GUIDE

3905074S  SY-KLONE 903K10 Used with AP8405, AP8406 Kit to Install SY-KLONE Precleaner on equipment with 10"/11" Intake Size	3910313 Thermostat for use with Coolant tank heaters Includes 4 ft. cord 100-120 degrees Fahrenheit 38 to 49 degrees Celsius Uses 3910317 Sensing Unit**CSA Approved	3911940S  Used with FS1040, FS1007 WIF Sensor
3905075S  SY-KLONE 903K11 Used with AP8405, AP8406 Kit to Install Sy-Klone Precleaner on equipment with 12"/13" Intake Size	3910314 Thermostat for use with coolant tank heaters. Includes 4 ft. cord 120-140 degrees Fahrenheit 49 to 60 degrees Celsius Uses 3910318 Sensing Unit**CSA Approved	3912214S Filter head for ISC engine
3905161S  Direct Mount Filter Minder Restriction Gauge	3910315  Thermostat for use with coolant tank heaters. Includes 4 ft. cord 140-160 degrees Fahrenheit 60 to 71 degrees Celsius (Uses 3910319 Sensing Unit)**CSA Approved	3912384S  Used with FS19536, FF5369W, FS1029W Gasket service pack Contains 1 small o'ring for fill cap and 1 large o'ring for bowl.
3905330S  CUMMINS 3284069 FS1242B plus 3833198S head assembly	3910316 Sensing unit for use with 3910312 Thermostat 80 to 100 degrees Fahrenheit 27 to 38 degrees Celsius **CSA Approved	3912703S Used with 3915556S, 3915420S O-Ring
3905498  CUMMINS 3393983 Fuel Filter Head	3910317 Sensing Unit for use with 3910313 Thermostat 100-120 degrees Fahrenheit 38 to 49 degrees Celsius **CSA Approved	3912717S  Head used with FS19512, FS19511, FS19511B
3905573S  Replacement hinged plastic Cover	3910318 Sensing unit for use with 3910314 Thermostat 120-140 degrees Fahrenheit 49 to 60 degrees Celsius **CSA Approved	3912899S  Bowl (with WIF sensor port)
3905594S Used with FS1269 24V Heater	3910438S  Thermostat 12V	3912970 NEW HOLLAND 86512435 Fuel Tank Filter
3905595S  Used with FS1269, FS1258 24V Connector w/2 Self Tapping Screws for use in Top Load FWS	3910450S  Used with AP4500 Replacement Bowl	3913044 Gasket Overall Height: 0.14 (4) Largest OD: 1.26 (32) Cross Section: Round Largest ID: 0.98 (25)
3905661S CUMMINS 3943443 Fuel Filter Head Assembly	3910500S  Used with AP5000 Replacement Bowl	3913068S Gasket
3905830S  Mounting Band w/ 10" bolt pattern.	3910776S Set of gaskets for LF3355 LF3573 and LF3605 containing 3320125, 3320129 & 3328578	3914240 CUMMINS 3681137 12V Ether Kit
3907161  1/2" Oil Pan Htr 150W/120V Oil Pan Heater 3825414C without heater cord	3911025S  Remote Mount Filter Minder Air Filter Restriction Gauge (25" Gauge)	3914241 CUMMINS 3681138 24V Ether Kit
3907721S  CUMMINS 3944897 Used with LF3970 HF Head	3911026S  Remote Mount Filter Minder Air Filter Restriction Gauge (35" Gauge)	3914692  Head and filter assembly
3909058S Mounting Band End 1 ID: 5.63 (143)	3911277S CUMMINS 3944685 Plate	3914693  Head and filter assembly
3910200S  Used with AP2000 Replacement Bowl	3911894S Head used with FF105 Head Assy.	3914848S  Head used with FS19511, FS19511B, FS19512
3910300S  Used with AP3000 Replacement Bowl		3914853  Used with 3928013S Head and Filter Assembly
3910312  Thermostat for use with coolant tank heaters. Includes 4 ft. cord 80 to 100 degrees Fahrenheit 27 to 38 degrees Celsius (Uses 3910316 Sensing Unit)**CSA Approved		





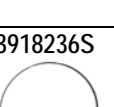















E. PRODUCT GUIDE

3914857S  CUMMINS 3944987 Head used with FS1022, FS1000 Filter head for ISC engine	3916018S Base, Bracket w/o Vent. 3916019S Fitting and O-ring (1/2 - 14 NPT thread adapter for fuel outlet port)	3917163S Bottom Drain 3917215 Gaskets package used with LF3607 and MK12059
3195264S Used with 3915423S Gasket	3916150S Used with HF28961 Gasket	3917215S Used with LF3607, MK12059 Gaskets package 
3915420S Uses service part: 3912703S Fuel Filter head cap for use with the FS1010.(To bypass the Secondary fuel filter head on Detroit Diesel engines to replace FF5206.)	3916708S DAF 1297620, M.A.N. 6569362632 Used with HF7999 Service gasket of 3916708 Overall Height: 0.12 (3) Largest OD: 2.96 (75) Cross Section: Round Largest ID: 2.72 (69)	3917443S CUMMINS 3303791 Used with 3917445S Spring, Valve. 
3915423S Uses service part: 3195264S Fuel Filter head cap for use with the FS1010.(To bypass the fuel filter head on Cummins engines to replace FF105/FS1212/FS1000 or Caterpillar engines to replace FF211/FF5264.) 	3916903S Drain Valve 	3917445S CUMMINS 3841590 Uses service part: 3917443S, 3917445S Used with 3917445S Disc, Valve. 
3915556S Uses service part: 3912703S Fuel Filter head cap for use with the FS1010.(To bypass the primary fuel filter head on Detroit Diesel engines to replace FF5207/FS19513.)	3916910S Used with CH44115, CH44120, CH44105, CH44110 Knob, Nut.	3917480 Uses service part: 3902309S Replaced by 3934467 Fuel heater kit
3915993S Used with CH44120, CH44115, CH44105, CH44110 Retainer Handle	3916911S Used with CH44120, CH44115, CH44105, CH44110 Gasket	3918034S Used with CC2858, CC2859, CC2861, CC2833, CC2834, CC2823, CC2838, CC2860 Valve/Cutter Kit 
3915994S Used with CH44120, CH44115, CH44105, CH44110 Orifice, Jet	3917063S Fitting (for drain valve installation to bowl - with O-ring)	3918190S Head used with FF5298 Uses service part: 3933978S
3915995S Used with CH44105, CH44120, CH44115, CH44110 Nut, Turbine	3917064S Used with CH44115, CH44110 Conversion PAC	3918193S OptiAir 5" Weatherhood
3915999S Assy., O/K19 Bell Housing.	3917065S Used with CH44110 Label	3918194S OptiAir 4" Weatherhood
3916002S Used with CH44115, CH44110 Plug, 9/16-18, Hollow Hex.	3917066S Used with CH44115 Label	3918195S 1.75" Plastic Air Inlet Stack Cap
3916003S Used with CH44115, CH44110 Plug, 3/4-16, Hollow Hex.	3917100S CUMMINS 3391524 Crankcase Breather Assembly for Cummins Natural Gas Engines	3918196S Used with AH19087, AH19088, AH19090 6.5" Steel Mounting Band 
3916004S Used with CH44115, CH44110 Gasket Overall Height: 0.21 (5) Largest OD: 7.15 (181) Cross Section: Round Largest ID: 6.73 (171)	3917101S CUMMINS 3395123 Crankcase Breather Assembly for Cummins Natural Gas Engines 	3918197S Used with AH19095, AH19096, AH19097, AH19098 8" Steel Mounting Band 
3916005S Used with CH44120, CH44115, CH44105, CH44110 Pin, Spring.	3917128S Used with CH44105 Label	3918198S Used with AH19085, AH19083, AH19084, AH19086 5.5" Steel Mounting Band
3916006S Used with CH44115, CH44110 Clamp	3917129S Used with CH44120 Label	3918199S Used with AH19081, AH19082 4" Steel Mounting Band
3916009S Used with CH44115, CH44110 Outside Chain	3917132S 120V Heater 	3918200S Used with AH19108 2" Air Inlet Stack Cap 
3916011S Used with CH44115, CH44110 Gasket, Hand Hole Cover.	3917160S Side Drain.	3918201S Used with AH19109, AH19061, AH19062 2.5" Air Inlet Stack Cap 
3916017S Base, Bracket - w/Vent.	3917161S Used with CH44105 Assy., Bell Housing	

E. PRODUCT GUIDE

3918202S  Used with AH19064, AH19110, AH19063 3" Air Inlet Stack Cap	3918220S  Used with AH19063, AH19109, AH19064 6.5" Mild Steel Mounting Band	3918234S  Used with AH19071, AH19072 14" Mild Steel Mounting Band
3918203S  Used with AH19065, AH19066 3.7" Air Inlet Stack Cap	3918221S  Used with AH19077 7.3" Mild Steel Mounting Band	3918235S  15" Mild Steel Mounting Band
3918204S  4" Air Inlet Stack Cap	3918222S  Used with AH19110, AH19065, AH19066 7.9" Mild Steel Mounting Band	3918236S  Used with AH19073, AH19074 16" Mild Steel Mounting Band
3918205S  Used with AH19067, AH19068, AH19069, AH19070 5" Air Inlet Stack Cap	3918223S  NELSON Q27178 8" Mild Steel Mounting Band	3918237S  Used with AH19075, AH19076 18.1" Mild Steel Mounting Band
3918206S  Used with AH19071, AH19072 6" Air Inlet Stack Cap	3918224S  Used with AH19078 8.5" Mild Steel Mounting Band	3918239S  Used with AP8407 Kit to Install SY-KLONE Precleaner on equipment with 1"1/5"1.75" Intake Size
3918207S  6" Plastic-Stainless Air Inlet Stack Cap	3918225S  9" Mild Steel Mounting Band	3918240S  SY-KLONE 90RK00 Used with AP8408 Kit to Install SY-KLONE Precleaner on equipment with 2"1/2.5"1.75" Intake Size
3918208S  7" Plastic-Stainless Air Inlet Stack Cap	3918226S  Used with AH19079 10.2" Mild Steel Mounting Band	3918242S  Used with AH19074 Adapter. To use Precleaner AP8410
3918209S  7" Air Inlet Stack Cap	3918227S  Used with AH19067, AH19068 10.3" Mild Steel Mounting Band	3918243S  Used with AP8406 8" to 7" reducer for AP8406
3918210S  5.5" Black Paint Air Inlet Stack Cap	3918228S  11" Mild Steel Mounting Band	3918244S  Used with AH19076 Adapter To use Precleaner AP8405/AP8406
3918211S  6" Black Paint Air Inlet Stack Cap	3918229S  11" Stainless Steel Mounting Band	3918245S  SY-KLONE 60R50 Sy-Klone pre-cleaner installation kit/reducer. To reduce from 6 inches to 5 inches.
3918212S  7" Black Paint Air Inlet Stack Cap	3918230S  Used with AH19080 11.8" Mild Steel Mounting Band	3918473S  Air Restriction Mini-Gauge (15" water) Overall Height: 1.66 (42)
3918213S  8" Black Paint Air Inlet Stack Cap	3918231S  Used with AH19069, AH19070 12.1" Mild Steel Mounting Band	3918474S  Air Restriction Mini-Gauge (20" water) Overall Height: 1.66 (42)
3918214S  5.5" Chrome Air Inlet Stack Cap	3918232S  13" Mild Steel Mounting Band	3918475S  Air Restriction Mini-Gauge (25" water) Overall Height: 1.66 (42)
3918215S  6" Chrome Air Inlet Stack Cap	3918233S  13" Stainless Steel Mounting Band	3918643  CUMMINS 3607923 Natural Gas
3918216S 7" Chrome Air Inlet Stack Cap		3918646S Heater Cord

















E. PRODUCT GUIDE

3918732S Elbow link for Air Filter restriction gauge	3922052 Fuel Strainer  Overall Height: 4.33 (110) Inlet Connection: .5 Outlet Connection: .5 Largest element OD: 1.91 (48)	3925469S CHRYSLER 5015584AB, CUMMINS 3945135 Used with FS1269, FS1258, FS19586, 3926758S For Upgrade, use 3959125S 
3918985S Used with FS19516, FS19517, FS19525, FS19526, FS19530, FS19531 Dust Cover Gasket for Stanadyne Fuel Managers Overall Height: 0.14 (4) Largest OD: 3.71 (94) Cross Section: Irregular Largest ID: 3.00 (76)	3922053 Fuel Strainer Overall Height: 3.70 (94) Inlet Connection: 7/8-14 Outlet Connection: 7/8-14 Largest element OD: 1.91 (48)	3926660S gasket 
3919025S CUMMINS 4920120 Gasket Overall Height: 0.24 (6) Largest OD: 2.76 (70) Cross Section: Rectangular Largest ID: 2.46 (63)	3923650S Anti Drainback Valve 	3926756S CHRYSLER 5015582AB, CUMMINS 3942468 Used with FS1258, FS1269, FS1259, FS19586 Water-In-Fuel Sensor 
3919147S RACOR 21620 Used with FS1281 Replacement bowl 	3923652S Housing 	3926757S CUMMINS 3942466, CHRYSLER 5015585AB Used with FS1258, FS1269, FS19586 12V Heater (300 Watt) 
3919181 Bilge Boy 7.5 gpm with 115 VAC / 1P / 60Hz	3923653S Fuel Filter Head 	3926758S CHRYSLER 5015578AC, CUMMINS 3937175, CUMMINS 3892545 Uses service part: 3925469S Used with FS1258, FS1269, FS1259, FS19586 Lid Assembly including gasket 
3919182 Bilge Boy 7.5 gpm with 220 VAC / 1P / 60Hz	3923820 Fuel Filter Head 	3926759S CUMMINS 3937225 Used with FS1258, FS1269, FS1259, FS19586 Valve, Shutoff Includes 2 O-rings & 4 Screws 
3919184 Bilge Boy 2.5 gpm with 115 VAC / 1P / 60Hz	3923831S Used with FS19586 Drain Valve	3926762S Cummins/Komatsu B 3.3L engine. Used for applications where the engine requires the lube filter to be remote mounted. 
3919185 Bilge Boy 2.5 gpm with 220 VAC / 1P / 60Hz	3923925S Replaces 3323483S Nylon tubing, used for cold weather aids. 150 meters of tubing per carton.	3926763S Cummins/Komatsu B 3.3L engine. Perma-Cool 111. Used for applications where the engine requires the lube filter to be remote mounted. Adapts the oil filter landing on the engine block to an oil passage for use with a remote mount lube filter. 
3919515 Fuel Coalescer 	3924027S Fitting and O-ring (7/8 - 14 UNF-2A thread adapter for fuel inlet port)	3926764 Cummins/Komatsu B 3.3L engine. 120V, 400W heater. 392676400. Package includes 5 Star #10443 for the frost plug and #11443 for the heater. 
3919562 Bilge Boy 7.5 GPM. Coalescer filter element	3924549S Fitting and O-ring (1/2 NPT thread adapter for fuel inlet port)	3927023S Uses service part: 3930973S 24 Volt, 300 Watts Heater
3920134 Head used with FS19511, FS19511B, FS19512	3924758S CUMMINS 3607921 Natural gas element and gasket. Service pack includes element 3924758 and gasket 3924757. 	3927719S Used with FS1291 Replacement Bowl 
3920138S Used with AP2000 Reducing Sleeve	3925199S Uses service part: 392776S Fuel Filter Restriction Gauge (Includes fitting for direct mount-1/8-27 NPT Thds) 	
3920175S Used with AP2000 Reducing Adaptor		
3920523S Used with AH19068 Adapter for use with AH19068 Air Hsg. to use Precleaner AP8403/AP8409 		
3920913 15.0 GPM Multiple Commercial Style KoalescerT Element Overall Height: 26.06 (662) End 1 OD: 4.50 (114) End 2 OD: 4.34 (110) End 1 ID: 3.47 (88) End 2 ID: 3.30 (84)		





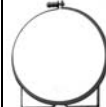









E. PRODUCT GUIDE

3927776S	ENGINEERING PRODUCTS CO. EW5650100410 Used with 3925199S Filter Minder fuel gauge with T fitting for #8 hose	3930200S	Reducer	3931663	100,000 service interval filter used in LF9001 applications Lube Filter
		3930225S	Reducer		Overall Height: 11.79 (299) Largest OD: 4.68 (119) Thread Size: M95 X 2.5-7H INT
3927812S	Includes head, housing, o-ring, and standpipe.	3930250S	Reducer	3931874S	Standpipe
		3930618S	Head used with FF105, FS1212, FS1000 Gasket: 255622 (1)		
3927871S	Filter Wrench for 4.2" OD size elements	3930708S	Used with CC2806 Daylight plate	3932494S	Used with AH19262, AH19263 Cover Assembly
		3930973S	CUMMINS 3954905 Used with 3927023S Wiring Connector		
3928013S	Uses service part: 3914853 Used with 3847102S, 3889183S, 3894689S Heater Kit	3931308S	Used with LF3730 Gaskets kit including 2 O'Ring gaskets 393131000 & 393131100, 1 gasket 393131300 and 1 washer 393131200 for SCANIA 4 series trucks. To be used with LF3730 Gasket: 3320128 (1), 3328464(1), 3931312 (1), 3931313(1)	3932495S	Used with AH19262, AH19263 Metal mounting bracket
		3928341	Cummins ISB & QSB (750 W/120V) Coolant Heater	3932866S	Bolt, Hex Head service kit
		3928342	Cummins ISX & Signature Series (1500W/120V) Coolant Heater	3932939	Kit containing Pre-filter FS19584 + head (incl. prime pump) + PTC + WIF (outlet connection at top of head is closed)
		3928350S	CUMMINS 3937720 Housing	3933037S	CHRYSLER 5093122AA FWS Housing
		3928544S	Used with FS19584 WIF Sensor	3933191	Fuel Filter Head
		3928814S	CHRYSLER 5015579AC, CUMMINS 3937754 Used with FS19586, FS1258, FS1269 Fuel Housing		
		3929113	Kit containing a Blind plate 3929124 + a gasket 3328464 for LF 777 Head	3933191S	Fuel Head for Fuel Island Filtration.
		3929251S	Used with HF6718, HF6733, HF6749, HH6951, HH6954, HH6955, HH6956, HH6959, HH6960, HH6961 Gasket Overall Height: 0.19 (5) Largest OD: 4.98 (126) Cross Section: Rectangular Largest ID: 4.42 (112)	3933344S	Gasket Overall Height: 0.14 (4) Largest OD: 1.64 (42) Cross Section: Round Largest ID: 1.36 (35)
		3929260	Kit containing an FS19584 + HEAD (incl. prime pump) + PTC+WIF (sidewise outlet connection on head is closed)	3933350	Clamp
		3929722S	Filter minder gauge	3933711S	25" Minder Gauge 1/8 male to male fitting
		3930200S	Reducer	3933746S	20" Minder Gauge 1/8 male to male fitting
		3930225S	Reducer	3933978S	Used with 3892646S, 3918190S, 3902309S, 3944660S Plug M14x1.5 and washer
		3930250S	Reducer		
		3930618S	Head used with FF105, FS1212, FS1000 Gasket: 255622 (1)		
		3930708S	Used with CC2806 Daylight plate		
		3930939	T-connector for ether valve & cylinder.		
		3930973S	CUMMINS 3954905 Used with 3927023S Wiring Connector		
		3931308S	Used with LF3730 Gaskets kit including 2 O'Ring gaskets 393131000 & 393131100, 1 gasket 393131300 and 1 washer 393131200 for SCANIA 4 series trucks. To be used with LF3730 Gasket: 3320128 (1), 3328464(1), 3931312 (1), 3931313(1)		
		3931657	Kit containing FS19584 + head (incl. prime pump) + WIF (with sidewise outlet connection closed).		
		3931658	100,000 service interval filter used in LF9009 applications Overall Height: 11.88 (302) Largest OD: 4.68 (119) Thread Size: 2 1/4-12 UNS-2B		
		3931659	100,000 service interval filter used in LF9667 applications Lube Filter Overall Height: 10.39 (264) Largest OD: 4.24 (108) Thread Size: 1 1/8-16 UN-2B		
		3931660	100,000 service interval filter used in LF9691A applications Lube Filter Overall Height: 12.20 (310) Largest OD: 5.38 (137) Thread Size: 1 1/2-16 UNS-2B		
		3931661	100,000 service interval filter used in LF9620 applications Lube Filter Overall Height: 10.32 (262) Largest OD: 4.74 (120) Thread Size: 1 5/8-12 UNS-2B		
		3931662	100,000 service interval filter used in LF9000 applications Lube Filter		

E. PRODUCT GUIDE

<p>3934206S Restriction Indicator</p> 	<p>3935421S Used with AH19257 Cover Assembly</p> 	<p>3936963 Oil Fill Cap for Centrifuge Products</p> 
<p>3934299 Uses service part: 3934304S PTC heater kit 24 volt</p>	<p>3935422S Cover Assembly used with AH19266</p>	<p>3937557S Power Steering Filter Nelson 879014F</p> <p>Overall Height: 2.73 (69) Overall OD: 3.38 (86) End 1 ID: 2.00 (51)</p>
<p>3934300S CUMMINS 4920119 Thread Adaptor Insert</p>	<p>3935621 Head and Filter Assembly</p> 	<p>3937616S Fuel/water separator housing assembly</p> <p>Width: 7.34 (186)</p>
<p>3934304S Used with 3934299, 3934467, 3934572, 3934573 Electrical cable for PTC heater kits : 3934299, 3934467, 3934572, 3934573</p>	<p>3935659 Tank Heater Heating Element</p>	<p>3937783S Fuel Filter Head</p> 
<p>3934467 Uses service part: 3934304S Replaces 3917480 PTC heater kit - 24 V - Replaces 3917480 & 3321732S</p> 	<p>3935660 Tank Heater Heating Element</p>	<p>3937860 CUMMINS 3966139 Head used with FS19608</p> 
<p>3934469S CUMMINS 4920118 Adapter for Cummins heater kit</p> 	<p>3935661 Tank Heater Heating Element</p>	<p>3937862 CUMMINS 3966140 (Uses FS19616 Element) Head and Filter Assembly</p> 
<p>3934572 Uses service part: 3934304S PTC heater kit - 24 volts - Replacing the 3923883</p>	<p>3935662 Tank Heater Heating Element</p> 	<p>3938140S Mounting Bracket</p>
<p>3934573 Uses service part: 3934304S Fuel Heater kit - 24 V</p>	<p>3935663 Tank Heater Heating Element</p>	<p>3938161S Thread Adapter Insert</p> 
<p>3934644S Head used with LF9009 For bulk filling of the oil filter prior to engine startup</p> 	<p>3935743S ENGINEERING PRODUCTS CO. EY5650301410 Fuel Minder Gauge and fitting #10 hose. Has a diaphragm with cloth backing that allows the gauge to operate under higher vacuum. This diaphragm will allow this gauge to be used on all Cummins, Caterpillar, and Detroit Diesel engines</p>	<p>3938173S Uses service part: 3940777S FS20000 Lubricity Enhancing Filter & Head assembly</p> 
<p>3934665 1500 Watt/120 Volt Caterpillar engines C10, C12, 3196, 3176, 1999 and newer. Replaces the 1" NPT plug in rear of oil coolerCaterpillar 3406 (with Brake Saver 1994 and newer) replaces 1" plug in oil cooler, front bonnet. This heater is not for use with 1998 3406E or 15.8L 600 HP models.</p>	<p>3936328 Urea Tote</p>	<p>3938495S Mounting</p>
<p>3934841S SCANIA 392654 Used with LF3895 Gasket</p>	<p>3936434 Head and filter assembly</p>	<p>3938835S WIF</p>
<p>3935185S For Upgrade, use 3958484S O-Ring</p>  <p>Overall Height: 0.14 (4) Largest OD: 2.76 (70) Cross Section: Round Largest ID: 2.48 (63)</p>	<p>3936434S FWS Housing</p>	<p>3938954 Strainer</p> <p>Overall Height: 4.34 (110) Inlet Connection: 0.500 Outlet Connection: 0.500 Largest element OD: 1.94 (49)</p>
<p>3935261S Used with CH41100 Housing Assembly</p>	<p>3936445S Used with AH19273, AH19274 Used on 13" plastic air cleaner</p> 	<p>3939391S Breather</p>
<p>3935262S Used with CH41100, CH41101, CH41102 Base and Shaft Assembly</p>	<p>3936509S CUMMINS 3321617 Fuel Heater Kit includes wiring harness</p> 	<p>3939392S Dip Stick Port Boss Adaptor for all Cummins M11 & ISM11 engines.</p>
<p>3935293S Used with CH41100 Housing Assembly</p>	<p>3936670 DCA4L 275 Gallon Tote</p>	
	<p>3936671 DCA4L 330 Gallon Tote</p>	

E. PRODUCT GUIDE

3939393S	O-ring Assembly	3939412S	A rubber adaptor for the installation of Sy-Klone precleaners.	3940108	FIVE STAR MFG. 36203 Diesel Fuel Warmer 
3939396S	A flanged insert for the installation of Sy-Klone precleaners.	3939413S	An expansion plug that permits the installation of Sy-Klone precleaners.	3940356S	10" Rain Cap 
3939397S	A flanged insert for the installation of Sy-Klone precleaners. 	3939414S	An expansion plug that permits the installation of Sy-Klone precleaners.	3940357S	8" Rain Cap 
3939398S	A flanged insert that permits the installation of Sy-Klone precleaners. 	3939415S	An expansion plug that permits the installation of Sy-Klone precleaners.	3940374S	Service element for the Davco Fuel Pro 382, DDC Series 60 Engine
3939399S	A flanged insert for the installation of Sy-Klone precleaners.	3939416S	An expansion plug that permits the installation of Sy-Klone precleaners.	3940750S	Used with CH41101, CH41102, CH41112 Base and Shaft
3939400S	A flanged insert for the installation of Sy-Klone precleaners.	3939417S	A screen that permits the installation of Sy-Klone precleaners.	3940756S	Used with CH41101, CH41102, CH41112 Housing Assembly
3939401S	A flanged insert for the installation of Sy-Klone precleaners.	3939418S	A screen that permits the installation of Sy-Klone precleaners. 	3940777S	CUMMINS 3954906 Head used with FF5421, FS20000 Used with 3944776, 3938173S 
3939402S	A flanged insert for the installation of Sy-Klone precleaners.	3939419S	A screen that permits the installation of Sy-Klone precleaners.	3941120	Switch Assembly
3939403S	A flanged insert for the installation of Sy-Klone precleaners.	3939421S	A screen that permits the installation of Sy-Klone precleaners.	3941157	Head used with AF26113 Cummins ISX & ISM Engines 
3939404S	A flanged insert for the installation of Sy-Klone precleaners.	3939441S	Breather	3941519S	Used with CH41114, CH41112, CH41101 Fitting
3939405S	A flanged insert for the installation of Sy-Klone precleaners.	3939442S	Breather Service Kit	3941717	HYUNDAI 11N84320616 24V heater kit 
3939406S	A flanged insert for the installation of Sy-Klone precleaners.	3939443S	Hose	3942821	Heater Kit
3939407S	A flanged insert for the installation of Sy-Klone precleaners.	3939461S	Fitting	3942834S	Insert
3939408S	A flanged insert for the installation of Sy-Klone precleaners.	3939604S	Used with CH41100 Consists of all components of the CH41100 except the casting.	3943071S	Used with CH41114, CH41112, CH41101 Plunger Assembly
3939409S	A rubber adaptor for the installation of Sy-Klone precleaners. 	3939702S	Threaded o-ring plug installed in one inlet port and one outlet port 	3943160S	For engine applications with dual breathers, both an Enviroguard System Kit and Dual Breather Kit are required for installation. 
3939410S	A rubber adaptor for the installation of Sy-Klone precleaners. 	3940065S	Element and head assembly. Has two ports with threaded pressure plugs. 	3943304S	FWS element
3939411S	A rubber adaptor for the installation of Sy-Klone precleaners.	3940104S	CATERPILLAR 4M0189 Used with FF5323, FF5337 O-ring gasket	3943736S	Head and filter pack
		3940105S	CATERPILLAR 6V3907 Used with LF3485 O-ring gasket	3943871S	Used with CH41111, CH41112, CH41113, CH41114 Top Shaft

E. PRODUCT GUIDE

3944223S	CUMMINS 4917446 Valve Piston Kit		3944451S	DAVCO 382002 Composite Collar Wrench for Diesel Pro and Fuel Pro		3944776	CUMMINS 3975125 Uses service part: 3940777S, FF5421 Applied on Cummins Tier 3 (OSB and QSL T3) Engine
3944287S	Head with Priming Pump		3944452S	DAVCO 93035 Check Valve for Diesel Pro and Fuel Pro		3944777	Head and Filter Assembly used on Cummins Tier 3 (OSB and QSL T3) Engine
3944440S	DAVCO 380043 Vent Cap & Assembly for Diesel Pro and Fuel Pro		3944453S	DAVCO 102008 Check Valve for Diesel Pro and Fuel Pro		3944793	CUMMINS 3972831 Fuel Filter Head
3944441S	DAVCO 380056 Holddown Spring for Diesel Pro and Fuel Pro		3944454S	DAVCO 90037 Fitting & O-ring for Diesel Pro and Fuel Pro		3944795S	Fuel Filter Head
3944442S	DAVCO 101994 O-ring Gasket for Diesel Pro and Fuel Pro		3944455S	DAVCO 102408 Harness Kit for Diesel Pro and Fuel Pro		3945058S	Used with FH23302, FH23303, FH23304, FH23200, FH23201, FH23202 Filter mount stud
3944443S	DAVCO 380040 Body Housing for Diesel Pro and Fuel Pro		3944456S	DAVCO 102176 Heater Kit for Diesel Pro and Fuel Pro		3945059S	Used with FH23302, FH23303, FH23304, FH23200, FH23201, FH23202 Collar
3944445S	DAVCO 380042 Collar for Diesel Pro and Fuel Pro		3944457S	DAVCO 382015SVC Heater Assembly Plate for Diesel Pro and Fuel Pro		3945060S	Used with FH23302, FH23303, FH23304 Cover Assembly
3944447S	DAVCO 101132 Check Valve Kit for Diesel Pro and Fuel Pro		3944458S	DAVCO 232007 Replaces 3945149S Wrench Collar for Diesel Pro and Fuel Pro		3945061S	Used with FH23302, FH23303, FH23304, FH23200, FH23201, FH23202 O-ring set - vent cap to cover and cover to body
3944448S	DAVCO 380134 Metal Collar Wrench for Diesel Pro and Fuel Pro		3944459S	DAVCO 232008 O-rings for Diesel Pro and Fuel Pro		3945062S	Used with FH23302, FH23303, FH23304, FH23200, FH23201, FH23202 Check valve service kit
3944449S	DAVCO 380072 O-rings for Diesel Pro and Fuel Pro		3944460S	DAVCO 232002 Wrench Collar for Diesel Pro and Fuel Pro		3945063S	Used with FH23302, FH23303, FH23304, FH23200, FH23201, FH23202 Drain valve
3944450S	DAVCO 102166 Fuel Heater Assembly for Diesel Pro and Fuel Pro		3944520S	Housing used with CH41102		3945064S	Thermostat Assembly
			3944660S	Uses service part: 3933978S Head		3945065S	Thermostat Assembly
			3944666S	DAVCO 333041 WIF Connector Module for Diesel Pro and Fuel Pro		3945120S	DAVCO 102455 Diesel Pro and Fuel Pro Unit Heater Wire Harness
			3944694	TENNANT 55850 Replaces 91645A, 91783A		3945121S	DAVCO 102145 Diesel Pro and Fuel Pro Unit Fuel Heater Assembly
			3944697	Head and Filter Assembly		3945122S	DAVCO 382006SVC Diesel Pro and Fuel Pro Unit Heater Assembly Plate
						3945123S	DAVCO 102220 Diesel Pro and Fuel Pro Unit Heater Wire Harness

E. PRODUCT GUIDE

3945124S	DAVCO 102412 Diesel Pro and Fuel Pro Unit Harness Kit	3945147S	DAVCO 101312 Maintenance Kit for Davco Fuel Pro and Diesel Pro Units	3945185S	DAVCO 101466 Diverter Cap for Davco Fuel Pro and Diesel Pro Units. 3/4"-16
3945125S	Diesel Pro and Fuel Pro Unit Service package				
3945126S	DAVCO 101868 Diesel Pro and Fuel Pro Unit Heater Cord	3945148S	DAVCO 232010, DAVCO 320620 Body Housing for Davco Fuel Pro and Diesel Pro Units	3945186S	DAVCO 101492 Diverter Cap for Davco Fuel Pro and Diesel Pro Units. 7/8"-14
					
3945127S	DAVCO 102456 Diesel Pro and Fuel Pro Unit Heater Wire Harness	3945153S	DAVCO 101814 Fuel Heater Assembly for Davco Fuel Pro and Diesel Pro Units	3945187S	DAVCO 101721 Diverter Cap for Davco Fuel Pro and Diesel Pro Units. M18-1.5
					
3945128S	DAVCO 101966 Diesel Pro and Fuel Pro Unit Service Package	3945154S	DAVCO 101439 WIF Wire Harness for Davco Fuel Pro and Diesel Pro Units	3945188S	DAVCO 101592 Diverter Cap for Davco Fuel Pro and Diesel Pro Units. 13/16"-12
					
3945129S	DAVCO 102359 Diesel Pro and Fuel Pro Unit Heater Wire Harness	3945155S	DAVCO 101815 WIF Wire Harness for Davco Fuel Pro and Diesel Pro Units	3945189S	DAVCO 101570 Diverter Cap for Davco Fuel Pro and Diesel Pro Units. M16 x 1.5 with 2 Studs
3945130S	DAVCO 101923 Diesel Pro and Fuel Pro Unit Stud	3945156S	DAVCO 100457 Heater Wire Harness for Davco Fuel Pro and Diesel Pro Units	3945190S	DAVCO 102436 Diesel Pro and Fuel Pro Unit Heater Wire Harness
					
3945131S	DAVCO 380638 Diesel Pro and Fuel Pro Unit Body Housing	3945157S	DAVCO 102445 WIF Wire Harness for Davco Fuel Pro and Diesel Pro Units	3945191S	DAVCO 102437 Diesel Pro and Fuel Pro Unit Heater Wire Harness
3945133S	DAVCO 102414 Diesel Pro and Fuel Pro Unit WIF Wire Harness	3945158S	DAVCO 100278 Heater Wire Harness for Davco Fuel Pro and Diesel Pro Units	3945207S	DAVCO 560016 Replacement Glass Window for REN Product
					
3945134S	DAVCO L4084 Diesel Pro and Fuel Pro Unit Decal Label	3945159S	DAVCO 230068 Heater Kit for Davco Fuel Pro and Diesel Pro Units	3945208S	DAVCO 560021 Inlet Sediment Bowl Screen for REN product
					
3945136S	DAVCO 102168 Diesel Pro and Fuel Pro Unit Fuel Heater Assembly	3945160S	DAVCO 101440 Heater Wire Harness for Davco Fuel Pro and Diesel Pro Units	3945209S	DAVCO 560028 Plexiglas Front Window Gasket (2 Required)-REN product
					
3945137S	DAVCO L4057 Diesel Pro and Fuel Pro Unit Decal Label	3945163S	DAVCO 102097 Heater Wire Harness for Davco Fuel Pro and Diesel Pro Units	3945210S	DAVCO 560030 Inlet Sediment Bowl Gasket-REN product
					
3945140S	DAVCO 382029SVCB Diesel Pro and Fuel Pro Unit Mounting Plate	3945164S	DAVCO 101707 O-ring for Davco Fuel Pro and Diesel Pro Units	3945211S	DAVCO 560340 REN product gasket
					
3945141S	Diesel Pro and Fuel Pro Unit Stud	3945182S	DAVCO 101480 Diverter Cap for Davco Fuel Pro and Diesel Pro Units. 1"-14		
					
3945144S	DAVCO 102271 Diesel Pro and Fuel Pro Unit Housing Bracket	3945183S	DAVCO 101589 Diverter Cap for Davco Fuel Pro and Diesel Pro Units. 1"-14 x4		
					
3945145S	DAVCO 102376 Diesel Pro and Fuel Pro Unit Heater Wire Harness	3945184S	DAVCO 102226 Diverter Cap for Davco Fuel Pro and Diesel Pro Units. M16 x 1.5		
					
3945146S	DAVCO 101017 Sensor for Davco Fuel Pro and Diesel Pro Units				

E. PRODUCT GUIDE

3945215S	REN gasket	3945563S	DAVCO 560026 Regulator to Mounting Plate Gasket- REN product	3945852S	DAVCO 560394 Counter Cover Gasket- REN Product
3945217S	DAVCO 57013343 REN Regulator Gasket				
		3945565S	DAVCO 57013370 1-Piece Isoplast Front Window Kit- REN product	3945960S	DAVCO 910016 REN Manifold Kit
3945218S	DAVCO 57013348 REN Valve Without Float				
		3945567S	DAVCO 560027 Valve Base Gasket- REN product	3946049S	Sy-Klone precleaner adaptor package
3945219S	DAVCO 57023342 REN Float Assembly				
		3945568S	DAVCO 560029 Glass Front Window Gasket (2 Required)- REN product	3946051S	Sy-Klone precleaner adaptor package
3945220S	DAVCO 57023343 REN Meter Gasket Kit				
		3945569S	DAVCO 560031 Screw- REN product	3946053S	Sy-Klone precleaner adaptor package
3945222S	DAVCO 5710032601 Conversion Kit MRA to MRA-E with Cover (remote applications)				
		3945570S	DAVCO 560032 Screw- REN product	3946055S	Sy-Klone precleaner adaptor package
3945300S	Reducer				
3945375S	Reducer	3945572S	DAVCO 560199 Fitting- REN Product	3946056S	Sy-Klone precleaner adaptor package
3945400S	Reducer				
3945425S	DAVCO 102517 Installation Kit for Davco Fuel Pro and Diesel Pro Units. LED Installation (WIF)	3945573S	DAVCO 560331 REN Product	3946057S	Sy-Klone precleaner adaptor package
					
3945426S	DAVCO 102491 Installation Kit for Davco Fuel Pro and Diesel Pro Units	3945581S	DAVCO 571303 Pressure Regulator Meter Kit- REN	3946058S	Sy-Klone precleaner adaptor package
3945427S	DAVCO 102492 Installation Kit for Davco Fuel Pro and Diesel Pro Units				
3945541S	Head and Insert Pack	3945630S	DAVCO 103033 Thermo Switch- REN	3946080S	Expansion Plug
					
3945560S	DAVCO 560100 Hose Nipples (4 required)- REN Product	3945780	CUMMINS 3976312 Contains Head and FF5580	3946084S	Dust seal
					
3945561S	DAVCO 57311606 Sight Gauge Install Kit (inserts & ferrules)- REN Product	3945821	INGERSOLL-RAND 57047300 Starter Kit, same as 259371 without Indicator Switch	3946085S	Dust seal
					
3945562S	DAVCO 57013334 Safety Cut-off Kit- REN Product			3946087S	Dust seal
					

E. PRODUCT GUIDE









3946097S	Flanged insert		3946322S	OptiAir 6" Weatherhood		3946456S	OptiAir 10" Metal Bracket Assembly	
3946098S	Flanged insert		3946323S	Restriction Indicator		3946457S	OptiAir Dust Ejection Valve	
3946099S	Flanged insert		3946324S	Restriction Indicator		3946458S	OptiAir 8" Weatherhood	
3946100S	Flanged insert		3946326S	Restriction Indicator		3946459S	Used with AH19474, AH19485, AH19496, AH19484 OptiAir 4" Cover Assembly Kit	
3946101S	Flanged insert		3946327S	Restriction Indicator		3946460S	Used with AH19483, AH19487, AH19482, AH19486 OptiAir 5" Cover Assembly Kit	
3946102S	Flanged insert		3946328S	Restriction Indicator		3946461S	Used with AH19476, AH19477, AH19489, AH19488 OptiAir 6" Cover Assembly Kit	
3946103S	Flanged insert		3946329S	Restriction Indicator		3946462S	Used with AH19261, AH19260, AH19491, AH19490 OptiAir 8" Cover Assembly Kit	
3946104S	Flanged insert		3946330S	Restriction Indicator		3946463S	Used with AH19478, AH19479 OptiAir 10" Cover Assembly Kit	
3946105S	Adaptor		3946331S	Restriction Indicator		3946464S	OptiAir 10" Weatherhood	
3946106S	Adaptor		3946332S	Restriction Indicator		3946465S	Used with AH19333, AH19334 OptiAir 11" Cover Assembly Kit	
3946107S	Adaptor		3946389S	DAVCO 570811 Used with RN24015 Universal Mounting Bracket for the 15 Gallon (56.8 liter) Oil Supply Reservoir and Stand.		3946466S	OptiAir 11" Weatherhood	
3946108S	Adaptor		3946390S	DAVCO 570812 Used with RN24017 Universal Mounting Bracket for the 30 Gallon (113.6 liter) Oil Supply Reservoir and Stand.		3946467S	Used with AH19480, AH19481 OptiAir 13" Cover Assembly Kit	
3946109S	Adaptor		3946411S	CUMMINS 4937489 Used with FS19511N Bowl Assembly		3946468S	OptiAir 13" Weatherhood	
3946110S	Adaptor							
3946111S	Adaptor Kit							
3946112S	Screen							
3946248S	Fuel Filter Head							
3946273S	Restriction Indicator							





E. PRODUCT GUIDE

3946497	Head and filter assembly		3946711S	DAVCO 910007 Fitting and O-ring for Diesel Pro and Fuel Pro		3946991S	CUMMINS 4924297 Vibration Isolator Kit	
3946512S	DAVCO 57020525 LCD Readout for Diesel Pro and Fuel Pro		3946712S	DAVCO 910009 Fitting for Diesel Pro and Fuel Pro		3946993S	CUMMINS 4924298 Drain Plug & Oring Kit	
3946662S	DAVCO 100311 Wiring Harness for Diesel Pro and Fuel Pro		3946714S	DAVCO 102493 Installation Kit for Diesel Pro and Fuel Pro		3946995S	CUMMINS 4924192 Electrical Fuel Pump Kit	
3946667S	DAVCO 102424 Conversion Kit for Diesel Pro and Fuel Pro		3946715S	DAVCO 101798 Heater Hose for Diesel Pro and Fuel Pro		3946996S	Electric Fuel Pump Kit	
3946668S	DAVCO 382023 Wire Display Rack for Diesel Pro and Fuel Pro		3946716S	DAVCO 102015 Electric Cord for Diesel Pro and Fuel Pro		3947034S	Fuel Filter Head	
3946670S	DAVCO 103041 LED WIF Assembly Light for Diesel Pro and Fuel Pro		3946905S	DAVCO 20909 Plug for REN Product		3947036	CUMMINS 3978466 Head and filter assembly	
3946673S	DAVCO 102454 Thermostat Switch for Diesel Pro and Fuel Pro		3946906S	DAVCO 57103352 Maintenance Kit for REN Product		3947114S	DAVCO 101935 Diesel Pro and Fuel Pro Unit Valve Assembly	
3946677S	DAVCO 382027SVCB Mounting Plate for Diesel Pro and Fuel Pro		3946907S	Plug for REN Product		3947136S	CUMMINS 4928763 Threaded Adaptor Insert	
3946703S	DAVCO 102453 Thermostat Switch for Diesel Pro and Fuel Pro		3946908S	DAVCO 560092 Mounting Plate for REN Product		3947315S	DAVCO 102536 Upgrade Kits for the Fuel Pro Units. Contains a 7 micron plus size filter, cover, and a collar to install a standard or plus size filter element.	
3946704S	DAVCO 102146 Hex Head Bolt for Diesel Pro and Fuel Pro		3946909S	DAVCO 560099 Regulator Bracket for REN Product		3947337S	DAVCO 102537 Upgrade Kits for the Fuel Pro Units. Contains a 25 micron plus size filter, cover, and a collar to install a standard or plus size filter element.	
3946705S	DAVCO 102420 Housing Cover for the Fuel Pro and Diesel Pro Units		3946910S	DAVCO 571302 Assembly Valve for REN Product		3947502S	DAVCO 920002 Mounting Plate for Davco Industrial Pro Units	
3946706S	DAVCO 102425 Collar for the Fuel Pro and Diesel Pro Units		3946911S	DAVCO 57013349 Screw for REN Product		3947503S	DAVCO 920003 Housing Bracket for Industrial Pro Unit	
3946707S	DAVCO 102463 Fuel Heater Assembly for Diesel Pro and Fuel Pro		3946951S	Used with FS19624 O-Ring		3947504S	DAVCO 101423 Fitting for Davco Industrial Pro Units	
3946708S	DAVCO 102464 Fuel Heater Assembly for Diesel Pro and Fuel Pro		3946989S	CUMMINS 4924295 Fuel Tube Kit		3947505S	DAVCO 101424 Fitting for Davco Industrial Pro Unit	
			3946990S	CUMMINS 4924296 Fuel Tube Kit		3947508S	CUMMINS 4924702 Kit containing one fuel tube (short, inlet)	

E. PRODUCT GUIDE

3947509S	CUMMINS 4924703 Kit containing one fuel tube (long,outlet)	
3947658S	Used with AK15 Hump Hose	
3947659S	Used with AK14 Hump Hose	
3947936	Head and filter assembly	
3948239S	Used with FF5421 Gasket is used as a thread seal Overall Height: 0.08 (2) Largest OD: 1.30 (33) Cross Section:Rectangular Largest ID: 0.78 (20)	
3948395S	RACOR RK211131311 Replacement Bowl Used with FS19532, FS19753, FS19736, FS19551, FS19687, FS1287, FS19734	
3948644S	DAVCO 560019 REN Flange Ring	
3948645S	DAVCO 560311 REN Gasket	
3948764S	DAVCO 57013564 REN Safety Cut-Off Switch	
3948978S	Service Kit for FH21010B4	
3949015S	Weatherhood for 6" ID Inlet OptiAir Systems	
3949066S	OptiAir 700 Series Bracket	
3949067S	Restriction Indicator	
3949163S	DAVCO 102005 Wire Rack which will hold Diesel Pro 232 and Diesel Pro 233.	
3949165S	Non-Operational Fuel Pro Unit	
3949166S	Non-Operational Diesel Pro Unit	
3950253	Filter Cart	

3950365S	Dual Fuel Head for Fuel Island Filtration.	
3950385S	DAVCO 57023549 REN Slow Flow Meter Screw	
3950386S	DAVCO 560017 REN Flange Ring	
3950387S	DAVCO 560020 REN Metal Bowl	
3950388S	DAVCO 560310 REN Endplate	
3950389S	DAVCO 560319 REN Spring	
3950390S	DAVCO 560324 REN Spring	
3950391S	DAVCO 560326 REN O-ring	
3950392S	DAVCO 560355 REN Gasket	
3950393S	DAVCO 560365 REN C Spring	
3950394S	DAVCO 560371 REN Ratchet Wheel	

3950395S	DAVCO 560389 REN Gasket	
3950396S	DAVCO 560393 REN Meter Counter Cover	
3950397S	DAVCO 57020326 REN LCD Meter Readout	
3950400S	Reducer	
3950444S	Used with FH23200, FH23201, FH23202, FH23209M, FH23210M, FH23211M, FH23302, FH23303, FH23304, FH23308, FH23315M, FH23316M, FH23317M, FH23321 Gasket package for Diesel Pro FH232 and FH233 Series. Consists of 3952163, 3952164, and 3952165.	
3950445S	Used with FH23027, FH23028, FH23029, FH23030, FH23031, FH23032, FH23038, FH23039, FH23040, FH23041, FH23042, FH23045, FH23049, FH23050, FH23054, FH23060, FH23061, FH23067M, FH23068M, FH23069M, FH23070, FH23400, FH23401, FH23402, FH23435, FH23438, FH23439, FH23440, FH23441, FH23453 Gasket package for Fuel Pro FH230 and Industrial Pro FH234 Series. Consists of 3952163, 3952164, and 3952207.	
3950450S	Reducer	
3950600S	Used with AP5000 Expansion Adaptor FOR AP0500	
3950622S	Threaded insert with loctite kit	
3950689S	Used with CH41111, CH41113 Base and Shaft	
3950690S	Used with CH41114, CH41112 Base and Shaft	
3950729S	DAVCO 102600 WIF Harness for Diesel Pro Fuel Housing	
3951006S	Head and Filter Assembly	
3951083S	Restriction Indicator	

E. PRODUCT GUIDE

3951084S	Remount Mounting Kit	3952332S	DAVCO 571003 REN Slow Flow Meter Piston Valve Kit 	3952363S	Metal Adapter used in Optimax Dual Stage and Series 9000 Ejective Air Precleaners
3951133	Cummins ISB Fuel Reservoir Overall Height: 5.58 (142) Largest OD: 3.02 (77) Thread Size: M16 X 1.5-6H INT	3952334S	Scavenger Adapter used in Optimax Dual Stage and Series 9000 Ejective Air Precleaners	3952436S	DAVCO 57023557 REN Slow Flow Meter Cycling Valve Kit 
3951210S	DAVCO 102599 WIF Harness/WIF LED Light Kit for Davco Bullet Style WIF. Contains 394662S & 3946670S. 	3952349S	Expansion Adapter used in Optimax Dual Stage and Series 9000 Ejective Air Precleaners	3953480S	DAVCO 560267 REN Slow Flow Meter Sensor 
3951359S	Heater with Thermostat and O-Ring Kit 	3952350S	Expansion Adapter used in Optimax Dual Stage and Series 9000 Ejective Air Precleaners 	3953507S	Pipe Extension used in Optimax Dual Stage and Series 9000 Ejective Air Precleaners
3951360S	CUMMINS 4934880 Heater Kit	3952351S	7"x7" Hump House used in Optimax Dual Stage and Series 9000 Ejective Air Precleaners	3953517S	CHRYSLER 5093128AA, CUMMINS 3949958 Used with FS1022, FS19616
3951366S	Housing used with CH41111	3952352S	Clamp used in Optimax Dual Stage and Series 9000 Ejective Air Precleaners	3953518S	Chamber used in Optimax Dual Stage and Series 9000 Ejective Air Precleaners
3951367S	Housing used with CH41112	3952353S	Clamp used in Optimax Dual Stage and Series 9000 Ejective Air Precleaners	3953519S	Chamber used in Optimax Dual Stage and Series 9000 Ejective Air Precleaners
3951438S	Service Kit for FH21010B4 	3952354S	Clamp used in Optimax Dual Stage and Series 9000 Ejective Air Precleaners	3953520S	Chamber used in Optimax Dual Stage and Series 9000 Ejective Air Precleaners
3951841S	DAVCO 101813 Used with FH23200, FH23201, FH23202, FH23302, FH23303, FH23304, FH23308 120 V AC / 37W Heater for the Diesel Pro FH232/FH233 Housings	3952355S	Clamp used in Optimax Dual Stage and Series 9000 Ejective Air Precleaners	3953521S	Chamber used in Optimax Dual Stage and Series 9000 Ejective Air Precleaners
3951929S	DONALDSON P603476 Mack Waste Control Equipment Overall Height: 8.08 (205) Overall OD: 5.09 (129)	3952356S	Clamp used in Optimax Dual Stage and Series 9000 Ejective Air Precleaners	3953522S	Chamber used in Optimax Dual Stage and Series 9000 Ejective Air Precleaners
3952025S	Housing used with LF500 Bypass housing vertical mount assembly	3952357S	Clamp used in Optimax Dual Stage and Series 9000 Ejective Air Precleaners 	3953523S	Chamber used in Optimax Dual Stage and Series 9000 Ejective Air Precleaners
3952026S	Housing used with LF500 Bypass Mounting- Vertical or horizontal mount.	3952358S	Clamp used in Optimax Dual Stage and Series 9000 Ejective Air Precleaners	3953524S	Chamber used in Optimax Dual Stage and Series 9000 Ejective Air Precleaners
3952027S	Uses service part: LF750A, LF750B, LF750D Inverted 750 housing assembly	3952359S	2"x10" Rubber Flex Hose used in Optimax Dual Stage and Series 9000 Ejective Air Precleaners 	3953525S	Chamber used in Optimax Dual Stage and Series 9000 Ejective Air Precleaners
3952028S	Used with LF750A, LF750B, LF750D Bypass housing vertical mount assembly 	3952360S	Elbow Hose used in Optimax Dual Stage and Series 9000 Ejective Air Precleaners	3953526S	Chamber used in Optimax Dual Stage and Series 9000 Ejective Air Precleaners
3952029S	Used with LF750A, LF750B, LF750D Vertical or Horizontal Mount	3952361S	Disposal Hose used in Optimax Dual Stage and Series 9000 Ejective Air Precleaners	3953527S	Chamber used in Optimax Dual Stage and Series 9000 Ejective Air Precleaners
		3952362S	Disposal Hose used in Optimax Dual Stage and Series 9000 Ejective Air Precleaners	3953528S	Chamber used in Optimax Dual Stage and Series 9000 Ejective Air Precleaners
				3953529S	Rubber Reducer used in Optimax Dual Stage and Series 9000 Ejective Air Precleaners

E. PRODUCT GUIDE

3953530S	Dust Boot used in Optimax Dual Stage and Series 9000 Ejective Air Precleaners	3956011S	Industrial Pro Bottom Plate 	3959125S	Upgrade of 3925469S High Performing Gasket for use in Bio-Diesel Applications Overall Height: 0.10 (3) Largest OD: 4.29 (109) Cross Section: Round Largest ID: 4.09 (104)
3953531S	Heat Shield used in Optimax Dual Stage and Series 9000 Ejective Air Precleaners	3956093S	24DVC, 250W high temperature heater for FH230 Series Applications	3959502S	CHRYSLER 3671076 PCV  Mexico only
3953532S	Mounting Bracket used in Optimax Dual Stage and Series 9000 Ejective Air Precleaners	3956191	CUMMINS 4939058 Head and Filter Assembly	3959505	CUMMINS 4945471 Head and Filter Assembly
3953533S	Mounting Bracket used in Optimax Dual Stage and Series 9000 Ejective Air Precleaners	3956192	CUMMINS 4939059 Head and Filter Assembly	3959506S	FORD D9ZZ6A666A PCV  Mexico only
3953534S	Mounting Bracket used in Optimax Dual Stage and Series 9000 Ejective Air Precleaners	3956193	CUMMINS 4939060 Head and Filter Assembly	3959507S	GMC 6487778 PCV  Mexico only
3953535S	Valve Check used in Optimax Dual Stage and Series 9000 Ejective Air Precleaners	3956196	CUMMINS 4934846 Cummins ISB07 Head and Filter Assembly	3959508S	FORD D90Z6A666A PCV  Mexico only
3953544S	Screen used in Optimax Dual Stage and Series 9000 Ejective Air Precleaners	3956561S	Metric Adaptor Kit for Industrial Pro Units 	3959509S	CHRYSLER 4777240 PCV  Mexico only
3953866S	Plastic Cover	3956562S	Heater Spacer for Industrial Pro Triple/Triplex 	3959510S	Safety Element used with 8995284 PCV  Mexico only
3954136S	DAVCO 910101 M26 Metric Adaptor Kit for Fuel Processors 	3957158S	WIF Sensor for use with Industrial Pros 	3959512S	GMC 6487936 PCV  Mexico only
3954138S	DAVCO 910102 M33 Metric Adaptor Kit for Fuel Processors	3957300	CUMMINS 4940648 Head and Filter Assembly	3959513S	FORD D9ZZ6A666A PCV  Mexico only
3954139S	DAVCO 102381 Check Valve for use with the Industrial Pro & Sea Pro Dual/Duplex/Triple/Triplex Assemblies	3957503S	CHRYSLER 680239774AB Fuel Line Kit	3959514S	FORD E5ZZ6A666A PCV  Mexico only
3954619	JOHN DEERE F0070016 Head used with FS19511N Uses service part: 3954620S, 3954621S 	3957737	Aluminum Head	3959515S	GMC 25097214 PCV  Mexico only
3954620S	Used with 3954619, FS19511N Insert	3957738	CUMMINS 4943201 Includes: FS19732 filter, 3944287 head with priming pump, 3951359 24V Heater		
3954621S	Head used with FS19511N Used with 3954619 Replacement Head Assembly	3957830	Pump Assembly used on Cummins ISB07		
3955168S	SCANIA 1475433 Gasket	3958392S	Used with WF2126, WF2127, LF3703, LF3941 Gasket service pack		
3955640S	Housing used with CH41113 Cover Housing	3958484S	CUMMINS 4898876 Upgrade of 3935185S High Performing Gasket for use in Bio-Diesel Applications Overall Height: 0.14 (4) Largest OD: 2.76 (70) Cross Section: Round Largest ID: 2.48 (63)		
3955641S	Housing used with CH41114 Cover Housing	3958485S	Upgrade of 3834185S High Performing Gasket for use in Bio-Diesel Applications Overall Height: 0.17 (4) Largest OD: 2.74 (70) Cross Section: Rectangular Largest ID: 2.46 (62)		

E. PRODUCT GUIDE

3959517S  FORD D90Z6A666A PCV Mexico only	3959751S DAVCO 102691 Fuel Heater Kit for use with Fuel Housings	AA2905  Kit Containing (1) AF1605M and (1) AF1604
3959518S  GMC 6487778 PCV Mexico only	3959752S DAVCO 102693 Fuel Heater Kit for use with Fuel Housings	AA2906  Kit Containing (1) AF879 and (1) AF857
3959519S  NISSAN 1181060U00 PCV Mexico only	3959753S DAVCO 102694 Fuel Heater Kit for use with Fuel Housings	AA2907  Kit Containing (1) AF899 and (1) AF880
3959520S  FORD E1DZ6A666A PCV Mexico only	3959755S DAVCO 102695 Fuel Heater Kit for use with Fuel Housings	AA2907M  Kit Containing (1) AF899M and (1) AF880
3959521S  CHRYSLER 5214088 PCV Mexico only	3960200S Replacement Lid & Wingnut for AP0200.	AA2908  Kit Containing (1) AF421 and (1) AF821M
3959522S  HONDA E63Z6A666A PCV Mexico only	3960300S Replacement Lid & Wingnut for AP0300.	AA2909  Ford (Outer Element) Ford (Inner Element) Elements Not Available Separately
3959524S  NISSAN 1181057Y00 PCV Mexico only	3960450S Replacement Lid & Wingnut for AP0450.	AA2910  Kit Containing (1) AF911 and (1) AF910 Overall Height: 24.00 (609) Overall OD: 12.77 (324) End 1 ID: 8.36 (212)
3959525S  CHRYSLER 53041134 PCV Mexico only	3960500S Replacement Lid & Wingnut for AP0500.	AA2912  Kit containing (1) AF1768M and (1) AF1767
3959527S  CHRYSLER 53030564 PCV Mexico only	Dual Pack Air Kits	AA2920  Kit containing (1) AF4504M and (1) AF1791
3959745S  DAVCO 102551 Metric Check Valve Fitting for Industrial Pro Series	AA2900  Kit Containing (1) AF851 and (1) AF883	AA2921  Kit containing (1) AF434KM and (1) AF804M
3959747S  NISSAN 11810F0500 PCV Mexico only	AA2901  Kit Containing (1) AF873M and (1) AF4516	Air Filters
3959748S  DAVCO 102688 Fuel Heater kit for use with Fuel Housings	AA2902  Kit Containing (1) AF424 and (1) AF820M	AF250  CUMMINS 255963 Uses service part: 154272S, 156779S, 250024S Breather For Naturally Aspirated Engines Only Overall Height: 2.73 (69) Overall OD: 2.99 (76) End 1 ID: 1.35 (34)
3959749S  DAVCO 102689 Fuel Heater Kit for use with Fuel Housings	AA2903  Kit Containing (1) AF4605M and (1) AF4603	
3959750S  DAVCO 102690 Fuel Heater Kit for use with Fuel Housings	AA2904  Kit Containing (1) AF875M and (1) AF4514	