

AutomationDirect Stellar SR22 Digital Soft Starters
Installation Instructions

These devices are suitable for use in industrial environments; EN 55011/22 Class A.

Mounting Clearances

45 mm [1.8 in]
143 mm [5.63 in]
117.8 mm [4.64 in]

Fan (optional) does not increase dimensions of size 45 soft starter
 Mounting Centers 30mm x 130mm

55 mm [2.2 in]
177.5 mm [6.99 in]
117.8 mm [4.64 in]

35mm DIN rail mounting
 Mounting Centers 40mm x 155mm

Size 45 mm: 5A to 16A *

SR22-05: 5A @ 208-460V
 SR22-07: 7A @ 208-460V
 SR22-09: 9A @ 208-460V
 SR22-12: 12A @ 208-460V
 SR22-16: 16A @ 208-460V

Size 55 mm: 22A to 40A *

SR22-22: 22A @ 208-460V
 SR22-30: 30A @ 208-460V
 SR22-36: 36A @ 208-460V
 SR22-40: 40A @ 208-460V

WARNING: These are Class 2 ratings!!
 These Amp ratings do not necessarily represent motor FLA.

* Soft Starter selection must be based on motor voltage & horsepower, load type, and O/L trip class.
 Please visit the AutomationDirect website for soft starter selection: <https://www.automationdirect.com/selectors/softstarters>

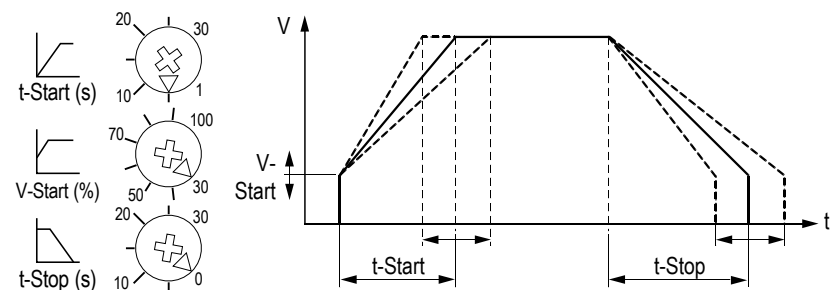

Function:
 SR22 soft starters are designed for reduced-voltage start/stop control of 3-phase AC induction motors. They use thyristors for controlled reduced-voltage starting and stopping, and then switch to internal contacts for efficient running at rated speed.

Overcurrent Protection:
 SR22 soft starters include internal overcurrent protection, which becomes active when the motor current exceeds 110% of the starter's rating. The RUN (green) LED flashes rapidly.

Trip Curves:
 Cold Curve (green) – ambient 20°C [68°F]; start frequency 1/hr
 Standard Curve (black) – ambient 40°C [104°F]; start frequency 10/hr
 Hot Curve (red) – ambient 40°C [104°F]; start frequency 20/hr (no derating)

Cooling Time:
 Cooling Time partially determined by severity of overcurrent.
 Max Cooling Time: 6 min without fan; 1 min with optional cooling fan.

Recommended General Purpose Settings			
Setting	Loaded Conveyor (O/L Class 20)	Centrifugal Pump (O/L Class 10)	Blower (O/L Class 2 or 10)
t-start (s)	approx 25s	approx 10s	approx 15s
V-start (%)	approx 30%	approx 30%	approx 50%
t-stop (s)	approx 30s	approx 20s	0s

NOTE: These settings are typical for general purpose applications. Appropriate settings for specific applications may vary.

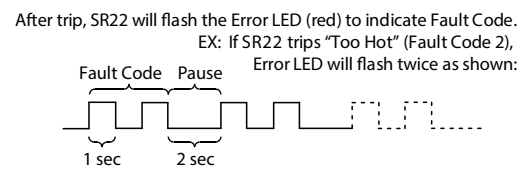

Stellar SR22 Soft Starter LED Indications			
LED	Color	Status	Flash Speed
RUN & Error	Green & Red	Initialization (not enabled)	approx 1/(2s)
RUN	Green	Ready for Operation	approx 1/(2s)
		Soft Starting or Soft Stopping	approx 1/ second
		Approaching O/L Trip	approx 1/(0.5s)
Error	Red	Running @ Full Voltage	constant
		Faults 1-6 (see Fault Table)	approx 1/s with approx 2s between errors

Stellar SR22 Soft Starter Fault Table			
#	Name	Description	Corrective Action
1	SCR or Supply	Missing phase on the input or output terminals, OR a fault with the internal switching device.	1. Verify 3-phase input voltage is present at L1, L2 & L3. 2. Verify the motor is properly connected to T1, T2 & T3. 3. Isolate the soft starter and measure resistance between L1-T1, and between L3-T3. If R < 10Ω, replace the starter.
2	Too Hot	Internal temperature of starter exceeded trip limit for 1 second (approx), OR surrounding air temperature is too high.	1. Increase the time between starts. 2. Install a cooling fan on the starter. (SR22-FAN-45 or -55) 3. Reduce the load on the motor. 4. Increase the size of the starter. 5. Check for sufficient cooling within the enclosure. 6. Replace the starter.
3	Control Supply Low Volts	Control supply voltage less than 19V (approx).	1. Verify that DC voltage > 19VDC. 2. If DC voltage > 19VDC & fault will not clear, replace starter.
4	Bypass Relay Fail	Internal bypass failed to close at the end of the start ramp time.	1. Replace the starter.
5	Shear Pin	Motor current exceeded 4.4 X rated current for 200 ms (approx).	1. Inspect the load for mechanical binding or jam condition. 2. Correct the source of mechanical binding or remove jam. 3. Uncouple the motor from the load and run the motor. 4. Verify motor current exceeds 4.4 X rated current. 5. If motor current is < 4.4 X rated current, replace starter.
6	Over-current	Motor current exceeded the overcurrent profile for the starter. (Refer to SR22 over current protection for addn'l info)	1. Inspect the load for mechanical binding or jam condition. 2. Correct the source of mechanical binding or remove jam. 3. Lengthen the start time 4. Verify motor current exceeds the profile for the starter. If motor current does not exceed the profile, replace starter.

NOTE: Reset faults by cycling the enable input.

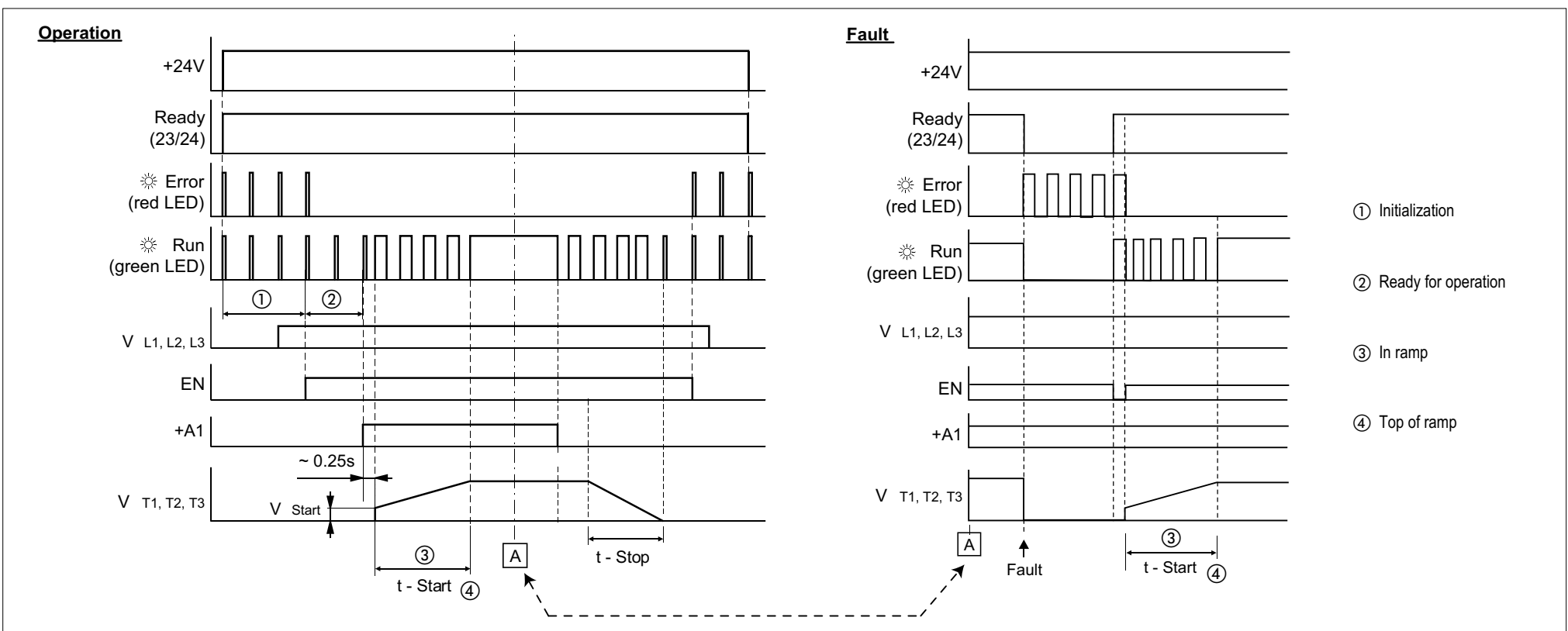
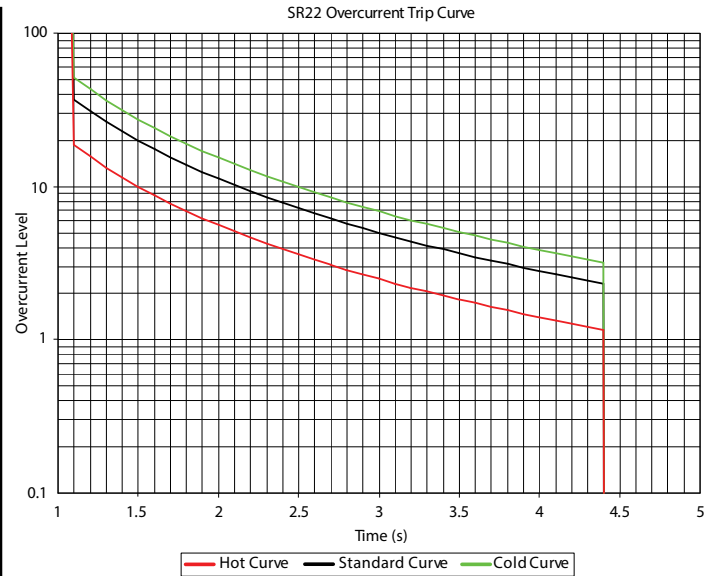

SR22 Control Terminals

+24, 0V
+A1, EN, -A2
23, 24

	mm ² / AWG	mm / inch	N·m / lb·in	mm
1 x	0.5 – 2.5 / 20 – 14	6 / ¼	0.4 / 3.5	0.6 x 3.5
2 x	0.5 – 1.5 / 20 – 16			

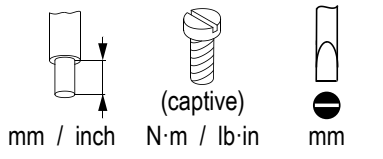

Signaling relay – (23, 24)

V	Inductive	Resistive	I _{min}	V _{min}
250 VAC	0.2A	2.5A	10 mA	100 VAC
30 VDC	0.7A	3.0A	100 mA	5VDC



DANGER! Hazardous Voltage. Will cause death or serious injury. Hazardous voltage is also present in the OFF/STOP status of the soft starter when the supply voltage is switched on (V_e).

DANGER! Tension dangereuse. Danger de mort ou risque de blessures graves. En cas de tension d'alimentation (U_e) enclenchée, la tension dangereuse existe aussi en position d'Arrêt à la sortie du démarreur progressif.

¡PELIGRO! Tensión peligrosa. Puede causar la muerte o lesiones graves. Si la tensión de alimentación está conectada (U_e), existe también en la salida tensión peligrosa con el arrancador suave en estado OFF/ON.

SR22-05 to SR22-16 (45 mm)

1 L1, 3 L2, 5 L3
2 T1, 4 T2, 6 T3

	mm ² / AWG	mm / inch	N·m / lb·in	mm
1 or 2 x	1 – 4 / 18 – 12	9 / 3/8"	1.3 / 12	1 x 6 PZ2

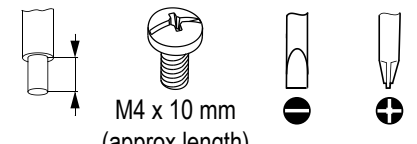

SR22-22 to SR22-40 (55 mm)

1 L1, 3 L2, 5 L3
2 T1, 4 T2, 6 T3

	mm ² / AWG	mm / inch	N·m / lb·in	mm
1 or 2 x	2.5 – 10 / 12 – 8	12 / ½"	2.5 / 22	1 x 6 PZ2



Where several conductors are to be connected, the difference between the wires/cables used must not exceed one DIN Standard size level.

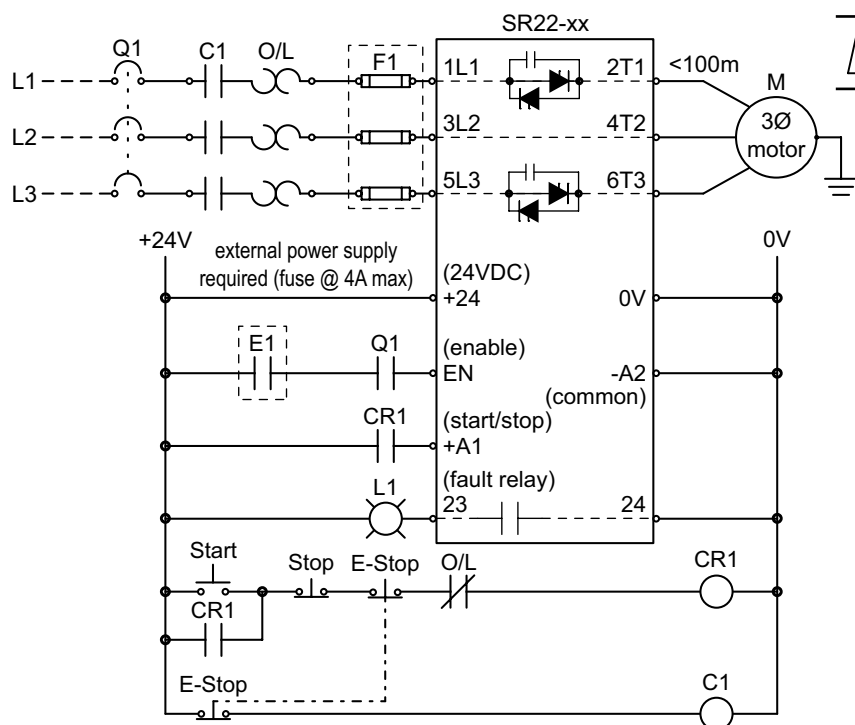

The soft starter must be connected to a 3-phase power supply and a 3-phase load for proper operation. Attempted starts will result in a starter fault if either the 3-phase power or the 3-phase load is not connected.



Electric shock risk. Danger!
Only skilled or instructed persons may carry out the following operations.
Tension électrique dangereuse !
Seules les personnes qualifiées et averties doivent exécuter les travaux ci-après.
¡Corriente eléctrica! ¡Peligro de muerte!
El trabajo descrito a continuación debe ser realizado por personas cualificadas.

UL Requirement

Short Circuit Rating 5kA @ 480V when protected by equivalent fuses or circuit breakers as indicated in the following table:

Soft Starter Model Number	Maximum Overcurrent Protection Devices * for 5kA @ 480V Short Circuit Rating	
	Max Non-Time-Delay Trip Rating * Fuse * – Class J or T (600V rated)	Circuit Breaker * (600V rated)
SR22-05	15A	N/A
SR22-07	15A	
SR22-09	30A	
SR22-12	40A	
SR22-16	50A	
SR22-22	80A	
SR22-30	100A	100A
SR22-36	125A	125A
SR22-40	150A	150A

* Maximum allowable trip ratings for non-time-delay overcurrent protection devices.
Maximum ratings for time-delay devices are 225% of Full Load Current.

5kA Coordination Type 1

Recommended equivalent semiconductor fuses (for optional Type 1 short-circuit coordination)

Soft Starter Model #	Recommended Semiconductor Fuses * for 5kA Short Circuit Coordination Type 1	
	Fuse – Class gRB-URB (690V rated)	Fuse Block
SR22-05	40A	6,9 URB 00 D08L 040
SR22-07		
SR22-09	50A	6,9 URB 00 D08L 050
SR22-12		
SR22-16		
SR22-22	125A	6,9 URB 00 D08L 125
SR22-30		
SR22-36		
SR22-40		

*NOTE: These fuses must be mounted in all three phases of the incoming power supply for optional Type-1 short circuit protection of the semiconductors.

Rated Impulse Withstand Voltage (V_{imp})	2.5 kV
Rated Insulation Voltage (V_i)	500V
Pollution Degree	2
Rated Short-Circuit Current (I_q)*	5kA
Short-Circuit Coordination *	Type 1
Surrounding Air Temperature	0°C to 40°C [32°F to 104°F] Above 40°C de-rate linearly by 2% of unit FLC per °C to a derate of 40% at 60°C (not UL)
Transport and Storage	-25°C to +60°C [-13°F to +140°F]
Altitude	1000m – 1000-2000m de-rate 1% of unit FLC per 100m to 2000m
Humidity	max 85% non-condensing, not exceeding 50% at 40°C
IP Rating	IP20
Design Standards	IEC 60947-4-2; EN60947-2 "AC Semiconductor Motor Controllers and Starters" United States Standard UL508

* When protected by recommended semiconductor fuse

Operational Voltage (V_e)	208–460 VAC rms 3-phase (-15% +10%)
Rated Frequency	50–60Hz ±2Hz Form Designation: Form 1
Index Rating	AC53b: 3–5: 355 Overcurrent (maximum) = 3 x I _{rated} for 5 seconds
Control Supply V_s	24VDC approx 4VA supplied to terminals 0V – +24V
Enable Control	24VDC galvanically isolated terminals -A2 – EN (opto-coupled sinking input; requires sourcing +24VDC)
Start/Stop Control	24VDC galvanically isolated terminals -A2 – +A1 (opto-coupled sinking input; requires sourcing +24VDC)
Auxiliary Circuits relay	Ready/Fault – 23/24: 250VAC 2.5A (resistive AC11)
Indication	LEDs: Green = Run Red = Error
t-Start	1 to 30 seconds
V-Start	30% to 100%
t-Stop	0 to 30 seconds
Power Terminals	IP20 Rated wire clamping terminals

EMC EMISSION AND IMMUNITY LEVELS		
ESD immunity	IEC 61000-4-2	4kV contact 8kV air discharge
R F immunity	IEC 61000-4-6	140 dBuV over 0.15–80 MHz
	IEC 61000-4-3	10V/m over 80–1000 MHz
Fast Transient immunity	IEC 61000-4-4	2kV/5kHz
Surge immunity	IEC 61000-4-5	2kV line to ground 1kV line to line
Conducted R F emissions	EN 55011	CLASS A
Radiated R F emissions		

Cooling Time

Cooling Time is partially determined by the severity of overcurrent.
• Max Cooling Time without fan: 6 minutes
• Max Cooling Time with optional cooling fan: 1 minute

Optional Cooling Fans

Cooling Fans do not run continuously.
Cooling Fans are temperature controlled.
• Fan turns on when soft starter reaches 45°C [113°F] or higher.

Optional cooling fans are available from AutomationDirect.com.
Listed Soft Starters can be used when fitted with fan part numbers as detailed in fan instruction document [SR22-FAN_DS](#).

Start Duty	3 x FLC for 5 seconds at standard rating
Starts/Hour* (Maximum)	standard (w/o fan) 10 starts per hour or 5 starts + 5 soft stops per hour with optional fan 60 starts per hour or 30 starts + 30 soft stops per hour
* Maximum starts per hour are required to be evenly spaced over one hour.	
WARNING: These are Class 2 ratings (for lightly-loaded motors)!! Please see our website for proper sizing information: https://www.automationdirect.com/selectors/softstarters	