

Service Manual

Air Conditioner

CS-TE9DKE CU-TE9DKE
CS-TE12DKE CU-TE12DKE

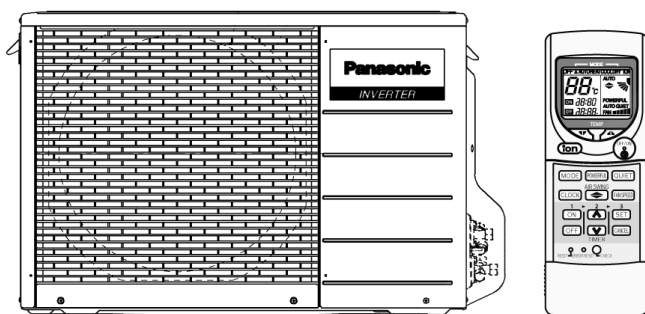
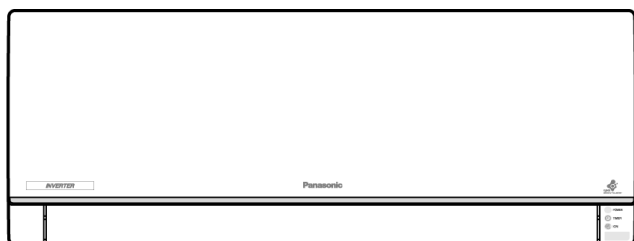

⚠ WARNING

This service information is designed for experienced repair technicians only and is not designed for use by the general public. It does not contain warnings or cautions to advise non-technical individuals of potential dangers in attempting to service a product. Products powered by electricity should be serviced or repaired only by experienced professional technicians. Any attempt to service or repair the product or products dealt with in this service information by anyone else could result in serious injury or death.

⚠ PRECAUTION OF LOW TEMPERATURE

In order to avoid frostbite, be assured of no refrigerant leakage during the installation or repairing of refrigeration circuit.

CONTENTS

	Page		Page
1 Features	2	7.2. CU-TE9DKE / CU-TE12DKE	15
2 Functions	3	8 Electronic Circuit Diagram	16
2.1. Remote Control	3	8.1. Indoor Unit / Remote Controller	16
2.2. Indoor Unit	4	8.2. Outdoor Unit	18
2.3. Outdoor unit	5	9 Operation Details	20
3 Product Specifications	6	9.1. BASIC FUNCTION	20
4 Dimensions	10	9.2. Indoor Power Relay Control	21
4.1. Indoor Unit	10	9.3. Room Air Temperature Control (Compressor Control)	21
4.2. Outdoor Unit	11	9.4. Airflow Direction Control	23
5 Refrigeration Cycle Diagram	12	9.5. Quiet operation (Cooling Mode / Cooling area of Dry Mode)	24
6 Block Diagram	13	9.6. Indoor Fan Control	26
7 Wiring Diagram	14	9.7. Powerful Operation	29
7.1. CS-TE9DTE / CS-TE12DKE	14		

Panasonic

© 2005 Matsushita Electric Industrial Co., Ltd. All rights reserved. Unauthorized copying and distribution is a violation of law.

9.8. Automatic Operation	30	12.4. INSTALLATION, TRANSFERRING, SERVICING	57
9.9. Timer Operation (24H Real Timer)	31	13 Servicing Information	61
9.10. Auto Restart Control	31	13.1. About Lead Solder (PbF)	61
9.11. Ionizer Operation	32	13.2. TROUBLESHOOTING	62
9.12. Protection Control	33	13.3. BREAKDOWN SELF DIAGNOSIS FUNCTION	64
10 Operating Instructions	34	13.4. DISASSEMBLY OF PARTS	66
11 Installation Instructions	40	14 Technical Data	74
11.1. SAFETY PRECAUTIONS	40	14.1. Operation Characteristics	74
11.2. INDOOR UNIT	43	14.2. Sensible Capacity Chart	76
11.3. OUTDOOR UNIT	46	15 Exploded View and Replacement Parts List	77
12 Installation and Servicing Air Conditioner Using R410A	49	15.1. Exploded View (Indoor Unit)	77
12.1. OUTLINE	49	15.2. Replacement Parts List (Indoor Unit)	78
12.2. TOOLS FOR INSTALLING/SERVICING REFRIGERANT PIPING	50	15.3. Exploded View (Outdoor Unit)	79
12.3. REFRIGERANT PIPING WORK	54	15.4. Replacement Parts List (Outdoor Unit)	80

1 Features

• Product

- Microcomputer-controlled compressor operating frequency.
- Vertical airflow direction.
- Four modes of operation selection.
- Air filter with function to reduce dust and smoke.
- SUPER Allergo-buster filter inactive various harmful airborne elements including allergens, viruses and bacteria.
- Ionizer control for generate negative ion in discharge air.
- Quiet mode to provide quiet operation.
- 24-hour timer setting.
- Long installation piping up to 15 meters.

• Quality Improvement

- Random auto restart after power failure for safety restart operation.
- Gas leakage detection.

• Serviceability

- Removable and washable front panel.
- Breakdown self diagnosis function.

• Environmental Protection

- Non-ozone depletion substances refrigerant (R410A).

2 Functions

2.1. Remote Control

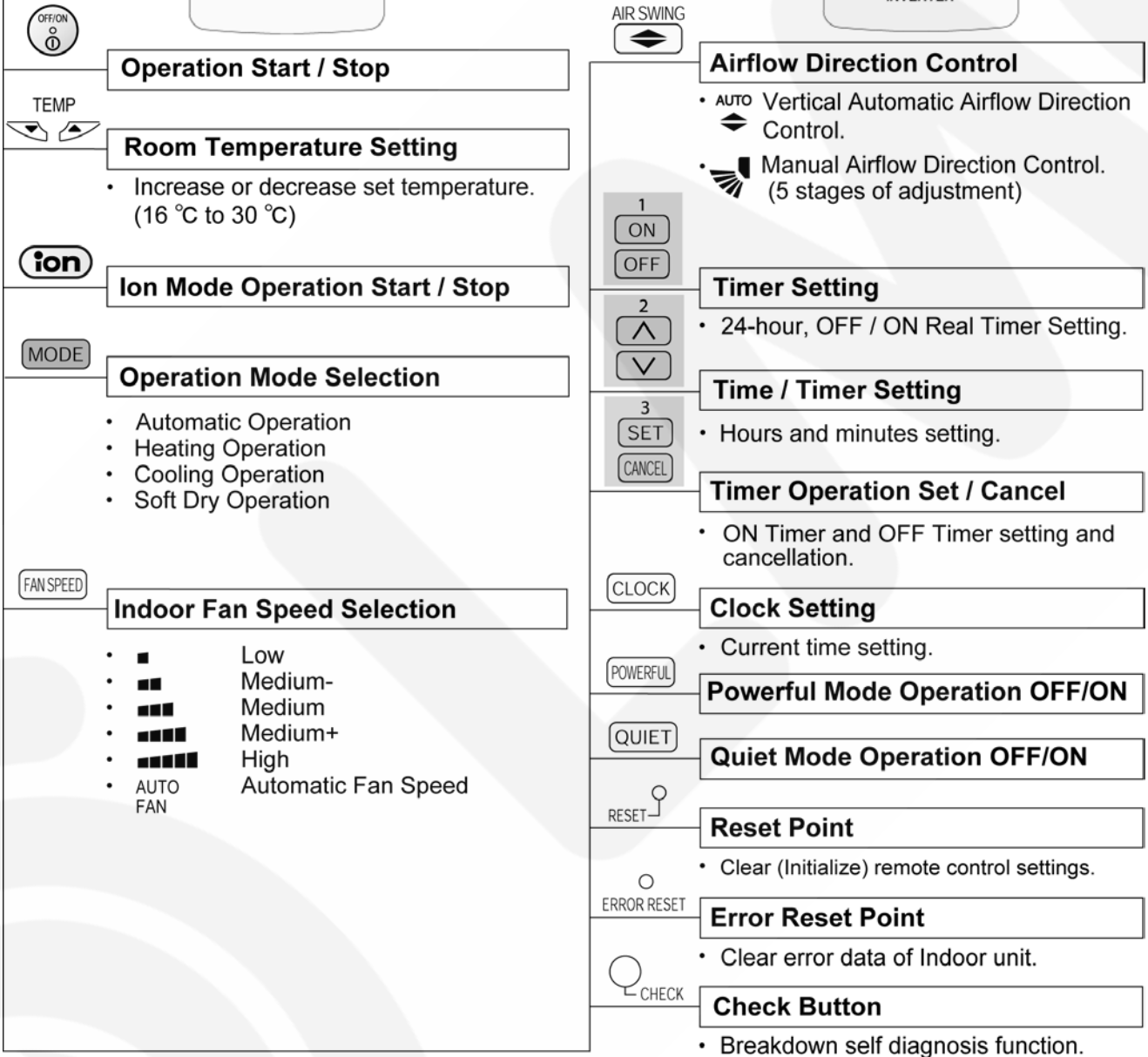
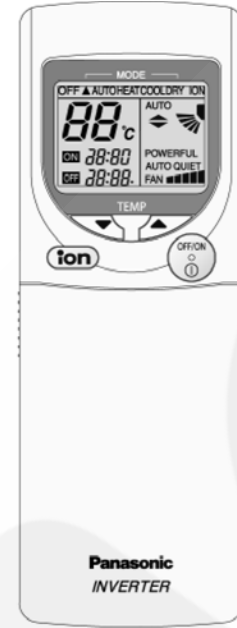
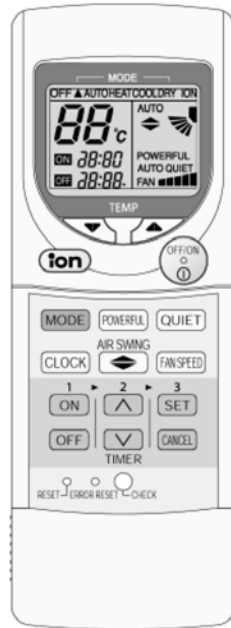

2.2. Indoor Unit

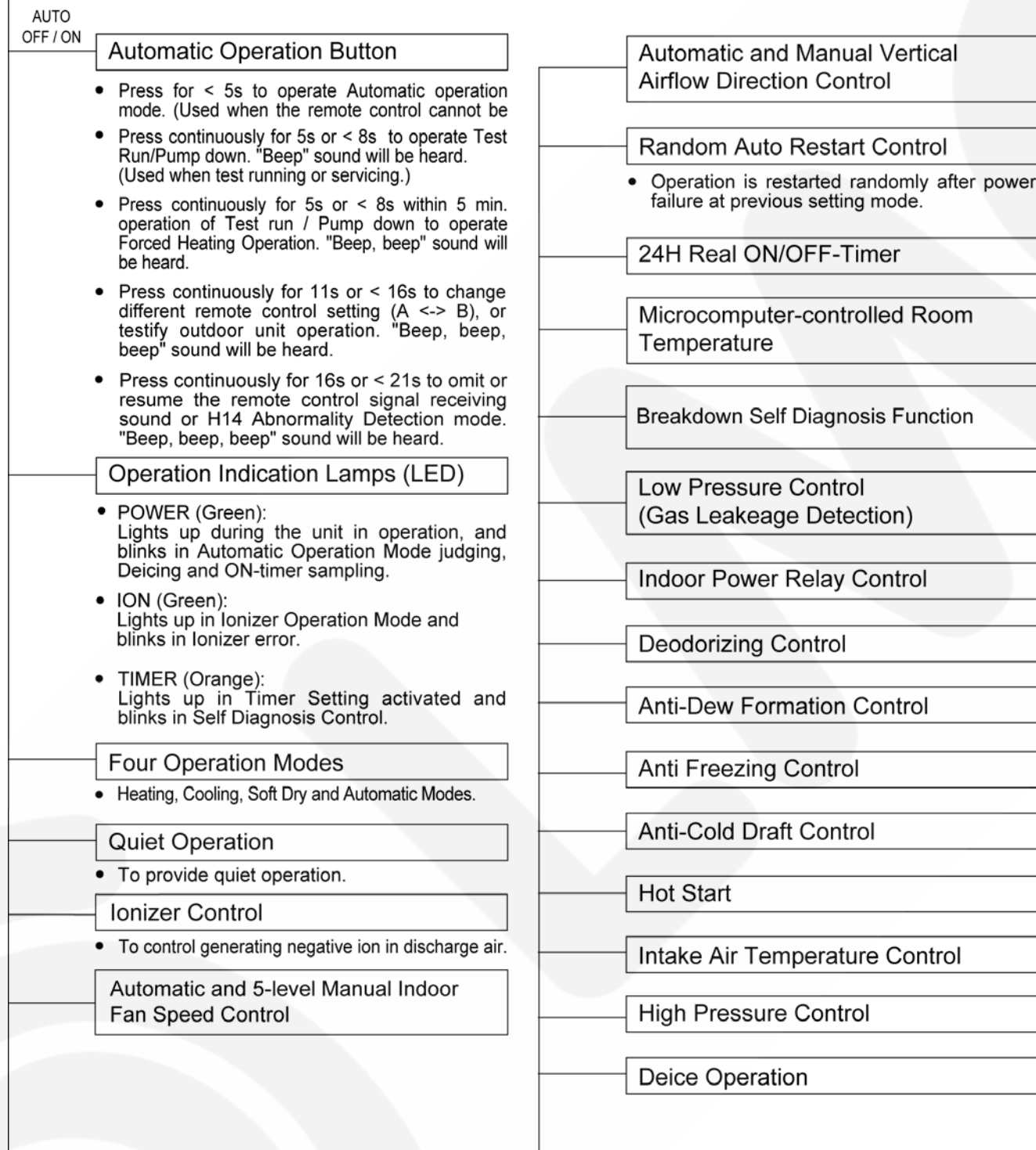
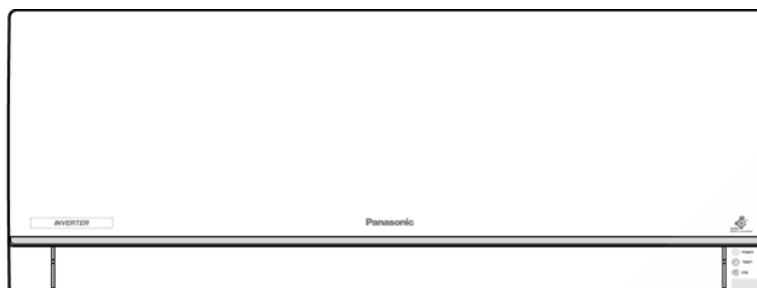

2.3. Outdoor unit

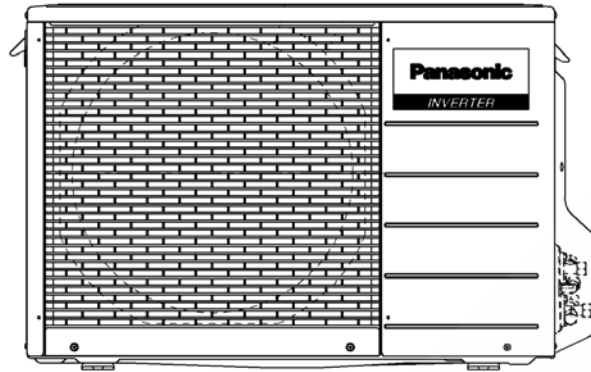

Deice Operation Control

Time Delay Safety Control

30 seconds Forced Operation

Total Running Current Control



Compressor Overheating Prevention Control

IPM (Power Transistor) Protection Control

Overloaded Protection

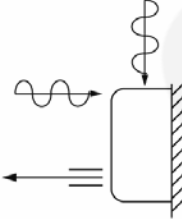
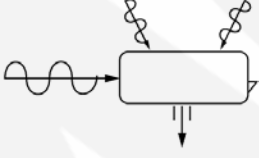

Outdoor Air Temperature Control

3 Product Specifications

		Unit	CS-TE9DKE	CU-TE9DKE
Cooling Capacity		kW kcal/h BTU/h	2.60 (0.60 - 3.00) 2,240 (520 - 2,580) 8,870 (2,050 - 10,200)	
Heating Capacity		kW kcal/h BTU/h	3.60 (0.60 - 5.30) 3,100 (520 - 4,560) 12,300 (2,050 - 18,100)	
Moisture Removal		l/h Pint/h	1.5 (3.2)	
Power Source		Phase V Cycle	Single 230/240 50	
Airflow Method		OUTLET  INTAKE 	SIDE VIEW 	TOP VIEW 
Air Volume	Indoor Air (Lo)	m ³ /min (cfm)	Cooling; 5.3 (190) Heating; 6.2 (220)	—
	Indoor Air (Me)	m ³ /min (cfm)	Cooling; 7.2 (250) Heating; 8.4 (290)	—
	Indoor Air (Hi)	m ³ /min (cfm)	Cooling; 9.2 (320) Heating; 10.5 (370)	—
Noise Level		dB (A)	Cooling; High 39, Low 26 Heating; High 40, Low 27	Cooling; 46 Heating; 47
		Power level dB	Cooling; High 50 Heating; High 51	Cooling; High 59 Heating; High 60
Electrical Data	Input	W	Cooling; 580 (120 - 720) Heating; 845 (115 - 1,360)	
	Running Current	A	Cooling; 2.7 Heating; 3.9	
	EER	W/W (kcal/hw), BTU/hw	Cooling; 4.48(3.86), 15.3	
	COP	W/W (kcal/hw), BTU/hw	Heating; 4.26 (3.67), 14.5	
	Starting Current	A	3.9	
Piping Connection Port (Flare piping)		inch inch	G ; Half Union 3/8" L ; Half Union 1/4"	G ; 3-way valve 3/8" L ; 2-way valve 1/4"
Pipe Size (Flare piping)		inch inch	G (gas side) ; 3/8" L (liquid side) ; 1/4"	G (gas side) ; 3/8" L (liquid side) ; 1/4"

		Unit	CS-TE9DKE	CU-TE9DKE	
Drain Hose	Inner diameter	mm	16	—	
	Length	m	0.65	—	
Power Cord Length			2.0 m	—	
Number of core-wire			3-core wires × 1.0 mm ²	—	
Dimensions	Height	inch (mm)	11 - 23/32 (298)	21 - 1/4 (540)	
	Width	inch (mm)	31 - 15/32 (799)	30 - 23/32 (780)	
	Depth	inch (mm)	5 - 15/32 (139)	11 - 3/8 (289)	
Net Weight		lb (kg)	18 (8)	73 (33)	
Compressor	Type		—	Involute scroll	
	Motor Type		—	Brushless (4-poles)	
	Rated Output	W	—	750	
Air Circulation	Type		Cross-flow Fan	Propeller Fan	
	Material		AS + Glass Fiber 30%	P.P	
	Motor Type		Transistor (8-poles)	Transistor (8-poles)	
	Input	W	—	—	
	Rate Output	W	30	40	
	Fan Speed	Lo (Cool/Heat)	rpm	800 / 840	—
		Me (Cool/Heat)	rpm	1,000 / 1,040	—
Hi (Cool/Heat)		rpm	1,200 / 1,270	790	
Heat Exchanger	Description		Evaporator	Condenser	
	Tube material		Copper	Copper	
	Fin material		Aluminium (Pre Coat)	Aluminium (Pre Coat)	
	Fin Type		Slit Fin	Corrugated Fin	
	Row / Stage		(Plate fin configuration, forced draft) 2 rows / 11 stages, 1 row / 4 stages		
	FPI		23	16.5	
	Size (W × H × L)	mm	640 × 304 × 25.4 + 12.7	725.8 × 504 × 36.4 694.6	
Refrigerant Control Device			—	Expansion valve	
Refrigeration Oil		(c.c)	—	RB68A (400)	
Refrigerant (R410A)		g (oz)	—	960 (33.9)	
Thermostat			Electronic Control	Electronic Control	
Protection Device			Electronic Control	Electronic Control	
Capillary Tube	Length	mm	—	—	
	Flow Rate	l/min	—	—	
	Inner Diameter	mm	—	—	
Air Filter	Material Style		P.P. Honeycomb	—	

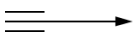
- Specifications are subject to change without notice for further improvement.

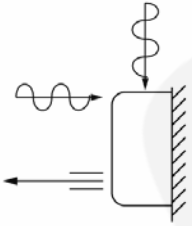
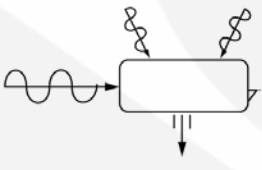
		Unit	CS-TE12DKE	CU-TE12DKE
Cooling Capacity		kW kcal/h BTU/h	3.50 (0.60 - 4.00) 3,010 (520 - 3,440) 11,950 (2,050 - 13,600)	
Heating Capacity		kW kcal/h BTU/h	4.80 (0.60 - 6.50) 4,130 (520 - 5,590) 16,400 (2,050 - 22,200)	
Moisture Removal		l/h Pint/h	2.0 (4.2)	
Power Source		Phase V Cycle	Single 230/240 50	
Airflow Method		<p>OUTLET</p>  <p>INTAKE</p> 	<p>SIDE VIEW</p> 	<p>TOP VIEW</p> 
Air Volume	Indoor Air (Lo)	m ³ /min (cfm)	Cooling; 6.1 (210) Heating; 8.2 (290)	—
	Indoor Air (Me)	m ³ /min (cfm)	Cooling; 7.9 (280) Heating; 9.5 (330)	—
	Indoor Air (Hi)	m ³ /min (cfm)	Cooling; 9.9 (350) Heating; 10.9 (380)	—
Noise Level		dB (A)	Cooling; High 42, Low 29 Heating; High 42, Low 33	Cooling; 48 Heating; 50
		Power level dB	Cooling; High 53 Heating; High 53	Cooling; High 61 Heating; High 63
Electrical Data	Input	W	Cooling; 900 (120 - 1,160) Heating; 1,320 (115 - 1,880)	
	Running Current	A	Cooling; 4.2 Heating; 6.2	
	EER	W/W (kcal/hw), BTU/hw	Cooling; 3.89 (3.34), 13.3	
	COP	W/W (kcal/hw), BTU/hw	Heating; 3.64 (3.13), 12.4	
	Starting Current	A	6.2	
Piping Connection Port (Flare piping)		inch inch	G ; Half Union 1/2" L ; Half Union 1/4"	G ; 3-way valve 1/2" L ; 2-way valve 1/4"
Pipe Size (Flare piping)		inch inch	G (gas side) ; 1/2" L (liquid side) ; 1/4"	G (gas side) ; 1/2" L (liquid side) ; 1/4"
Drain Hose	Inner diameter	mm	16	—
	Length	m	0.65	—
Power Cord Length			2.0 m	—
Number of core-wire			3-core wires × 1.0 mm ²	—

		Unit	CS-TE12DKE	CU-TE12DKE	
Dimensions	Height	inch (mm)	11 - 23/32 (298)	21 - 1/4 (540)	
	Width	inch (mm)	31 - 15/32 (799)	30 - 23/32 (780)	
	Depth	inch (mm)	5 - 15/32 (139)	11 - 3/8 (289)	
Net Weight		lb (kg)	18 (8)	75 (34)	
Compressor	Type		—	Involute scroll	
	Motor Type		—	Brushless (4-poles)	
	Rated Output	W	—	1100	
Air Circulation	Type		Cross-flow Fan	Propeller Fan	
	Material		AS + Glass Fiber 30%	P.P	
	Motor Type		Transistor (8-poles)	Transistor (8-poles)	
	Input	W	—	65.9	
	Rate Output	W	30	40	
	Fan Speed	Lo (Cool/Heat)	rpm	880 / 1,100	—
		Me (Cool/Heat)	rpm	1,100 / 1,230	—
Hi (Cool/Heat)		rpm	1,310 / 1,410	790	
Heat Exchanger	Description		Evaporator	Condenser	
	Tube material		Copper	Copper	
	Fin material		Aluminium (Pre Coat)	Aluminium (Pre Coat)	
	Fin Type		Slit Fin	Corrugated Fin	
	Row / Stage		(Plate fin configuration, forced draft) 2 rows / 11 stages, 1 row / 4 stages	2 rows / 24 stages	
	FPI		21	16.5	
	Size (W × H × L)	mm	640 × 304 × 25.4 + 12.7	725.8 × 504 × 36.4 694.6	
Refrigerant Control Device			—	Expansion valve	
Refrigeration Oil		(c.c)	—	RB68A (400)	
Refrigerant (R410A)		g (oz)	—	1,030 (36.3)	
Thermostat			Electronic Control	Electronic Control	
Protection Device			Electronic Control	Electronic Control	
Capillary Tube	Length	mm	—	—	
	Flow Rate	l/min	—	—	
	Inner Diameter	mm	—	—	
Air Filter	Material Style		P.P. Honeycomb	—	

- Specifications are subject to change without notice for further improvement.

4 Dimensions

4.1. Indoor Unit

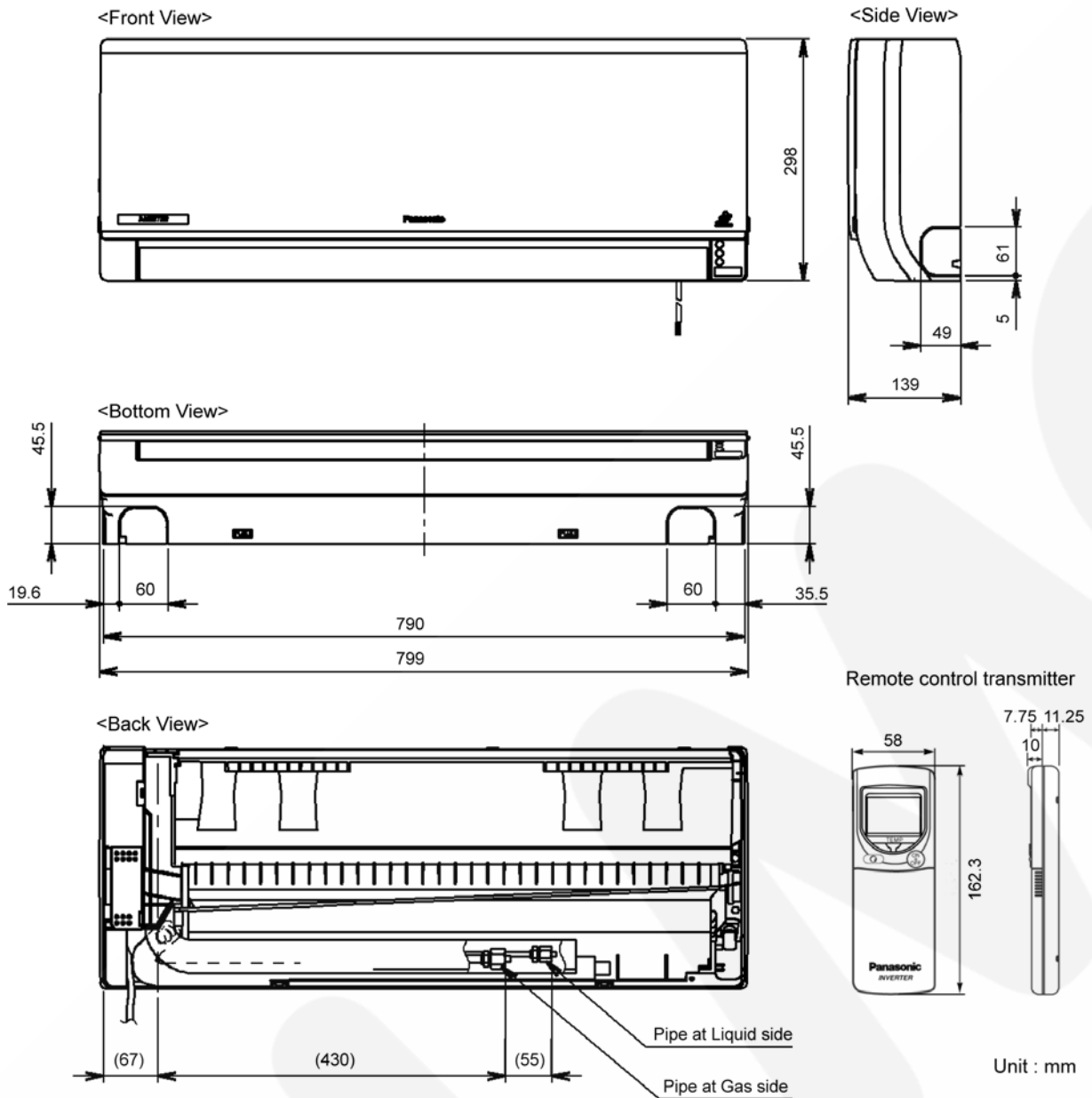

Relative position between the indoor unit and the installation plate <Front View>

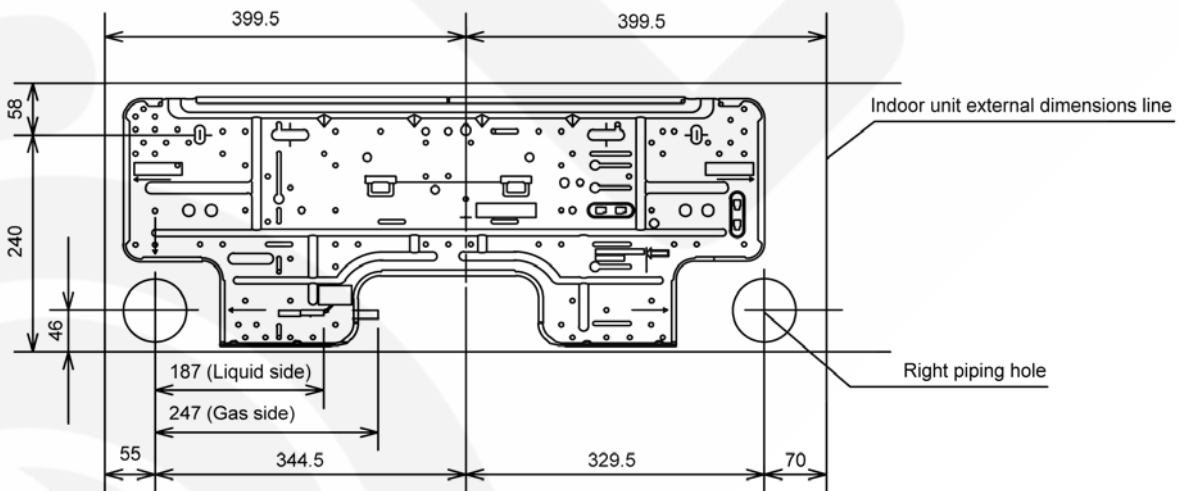

4.2. Outdoor Unit

Space necessary for installation

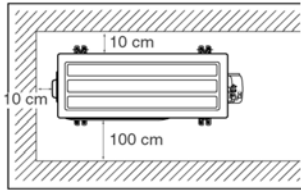

Anchor Bolt Pitch
320 X 570

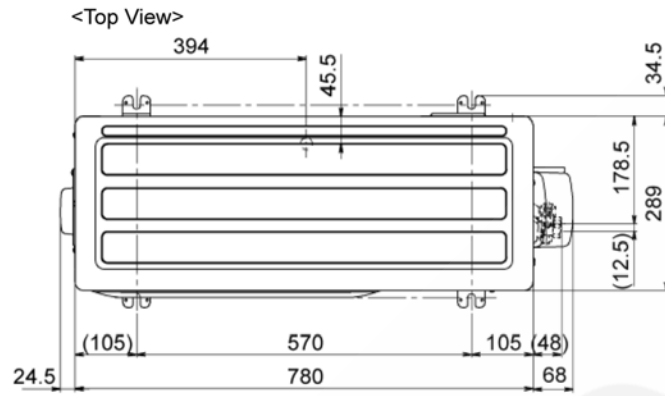

<Side View>

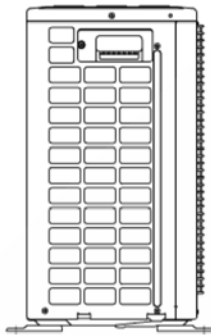

Unit : mm

<Front View>

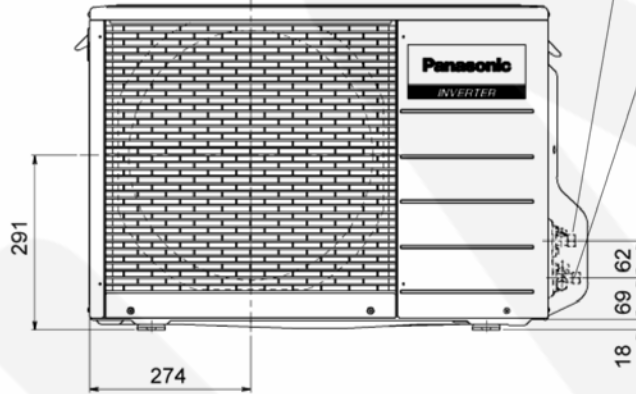

2-way valve at Liquid side
(High Pressure)

2-way valve at Gas side
(Low Pressure)

<Side View>

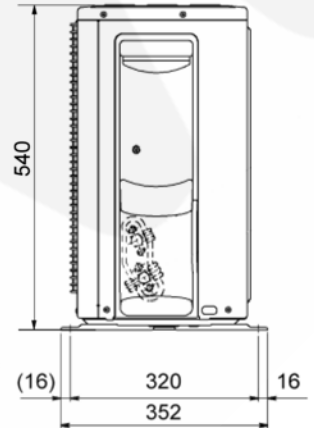

5 Refrigeration Cycle Diagram

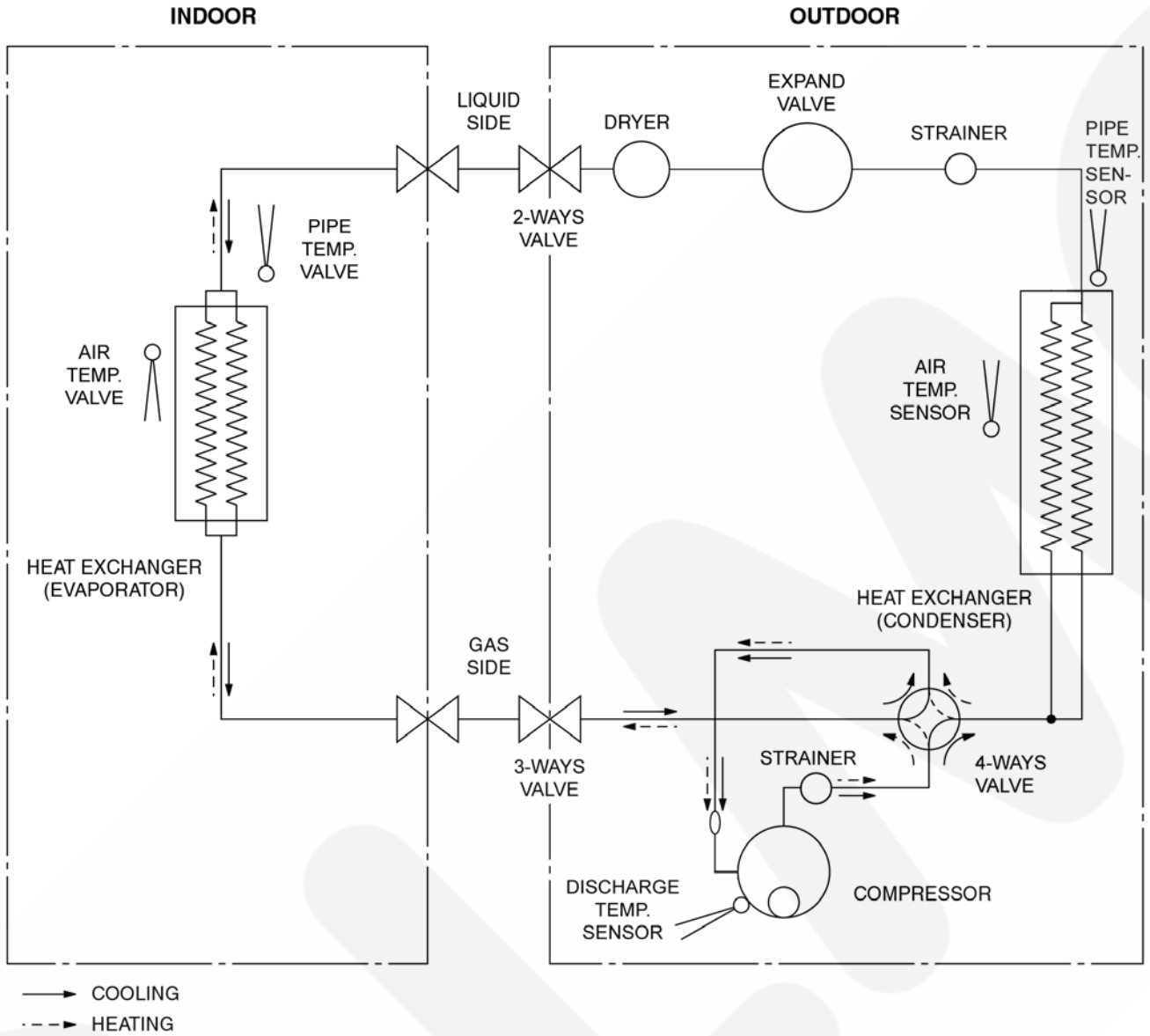

6 Block Diagram

CS-TE9DKE / CU-TE9DKE
 CS-TE12DKE / CU-TE12DKE

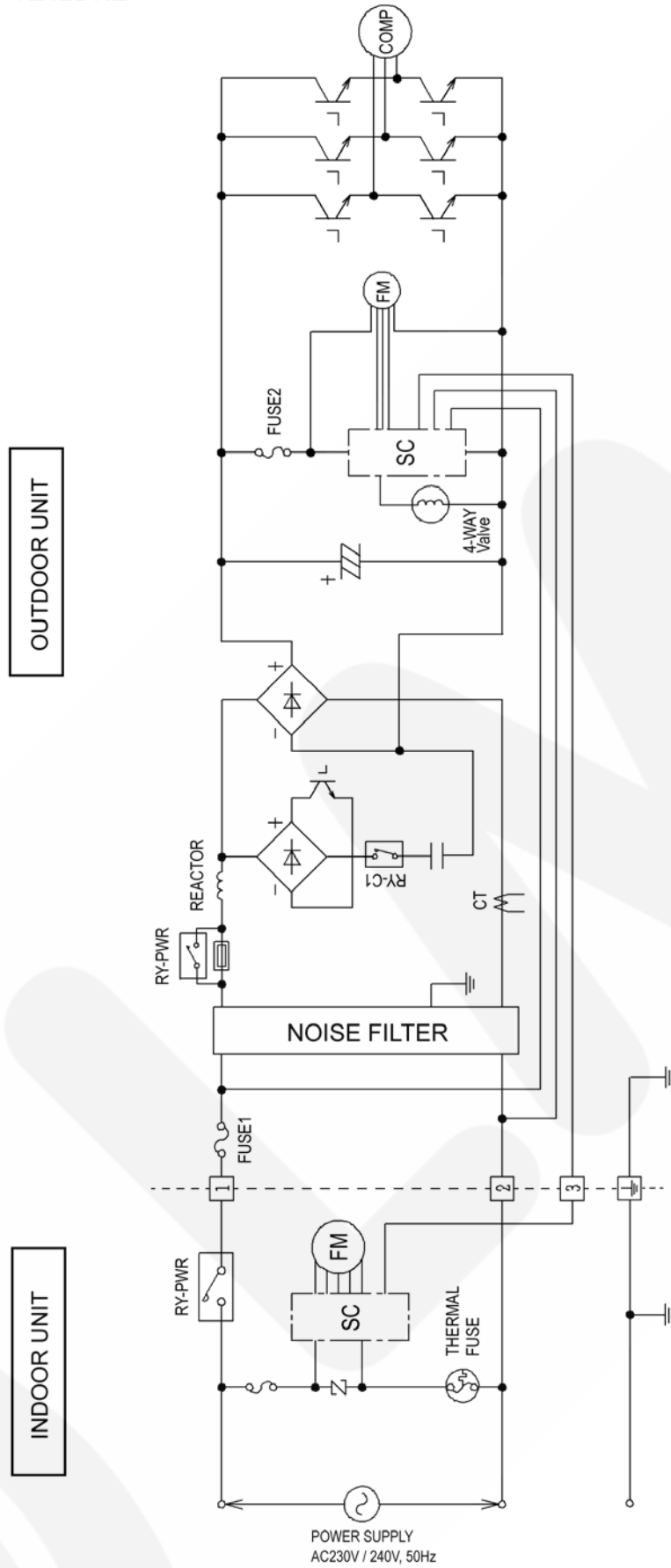

7 Wiring Diagram

7.1. CS-TE9DTE / CS-TE12DKE

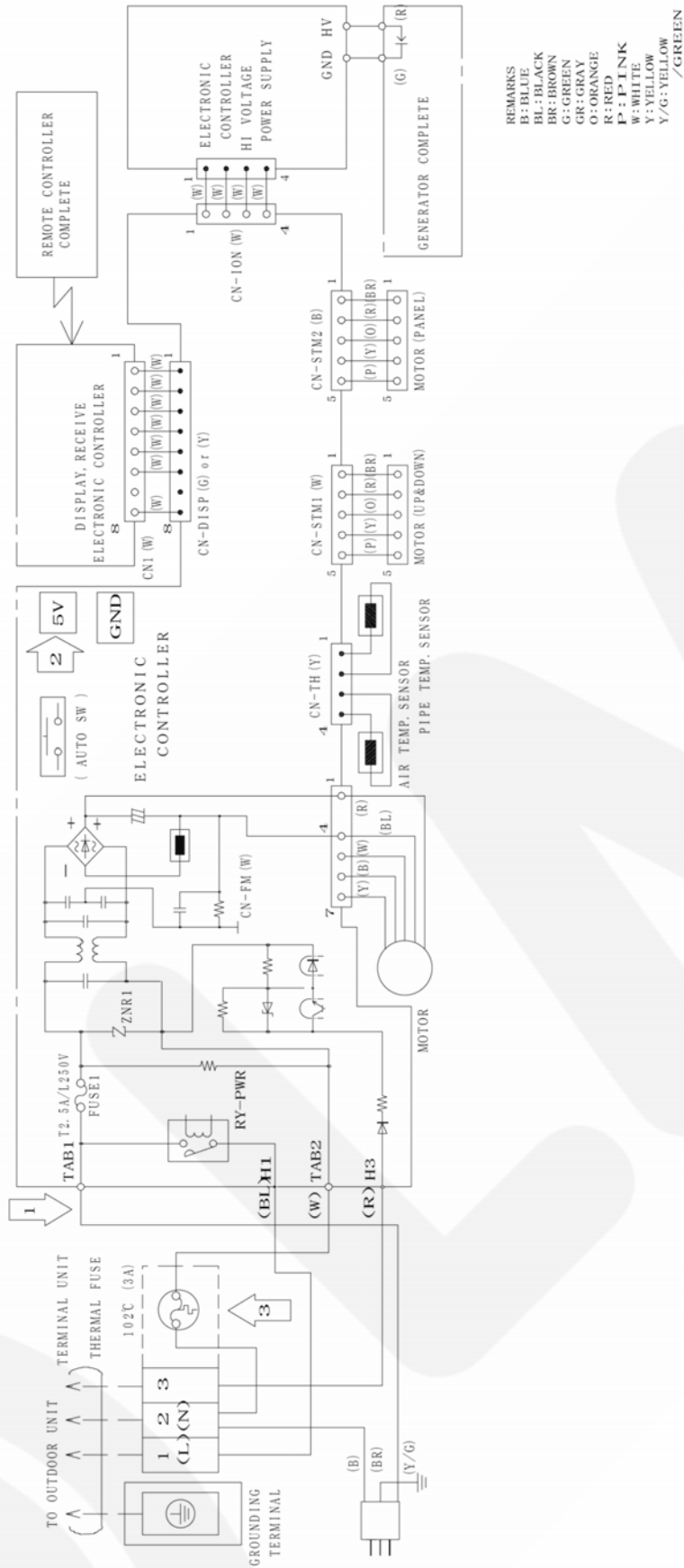

7.2. CU-TE9DKE / CU-TE12DKE

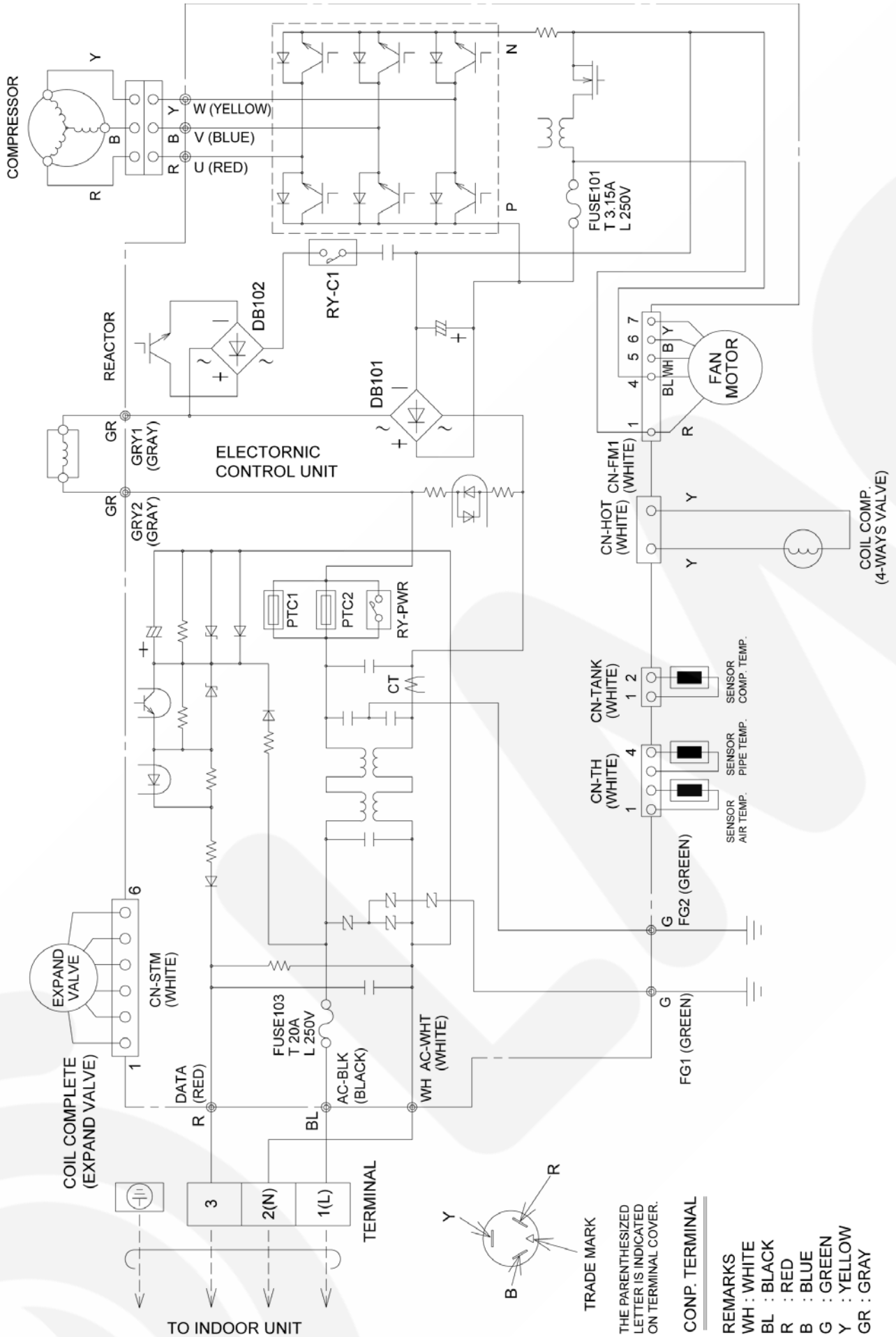

8 Electronic Circuit Diagram

8.1. Indoor Unit / Remote Controller

CS-TE9DKE, CS-TE12DKE

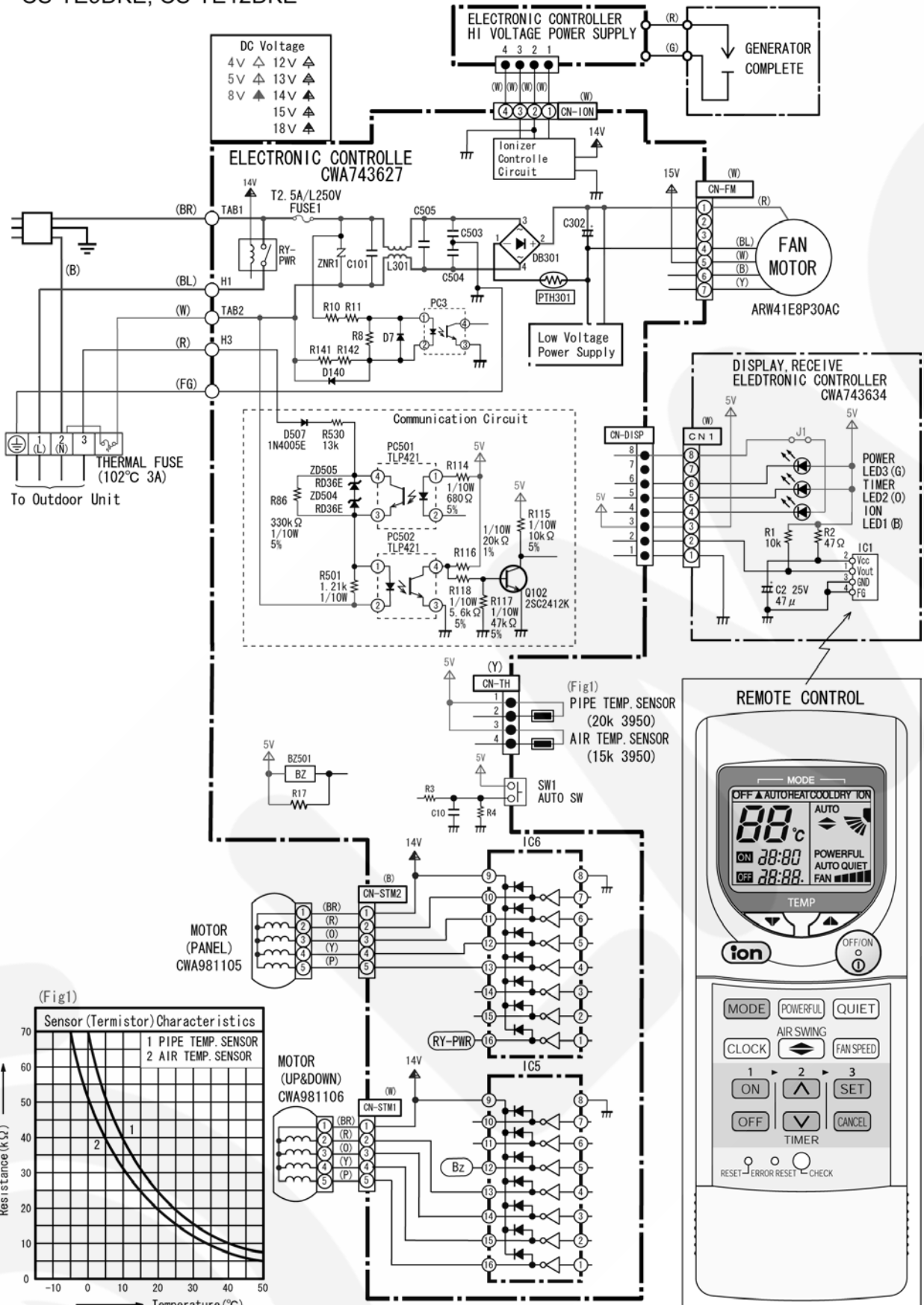

8.1.1. Printed Circuit Board

CS-TE9DKE / CS-TE12DKE

Control Board (Receiver & Display Unit)

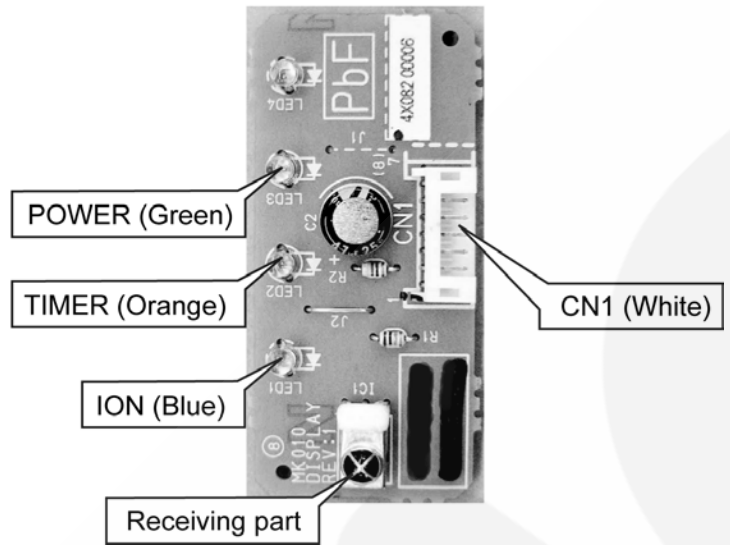

Control Board

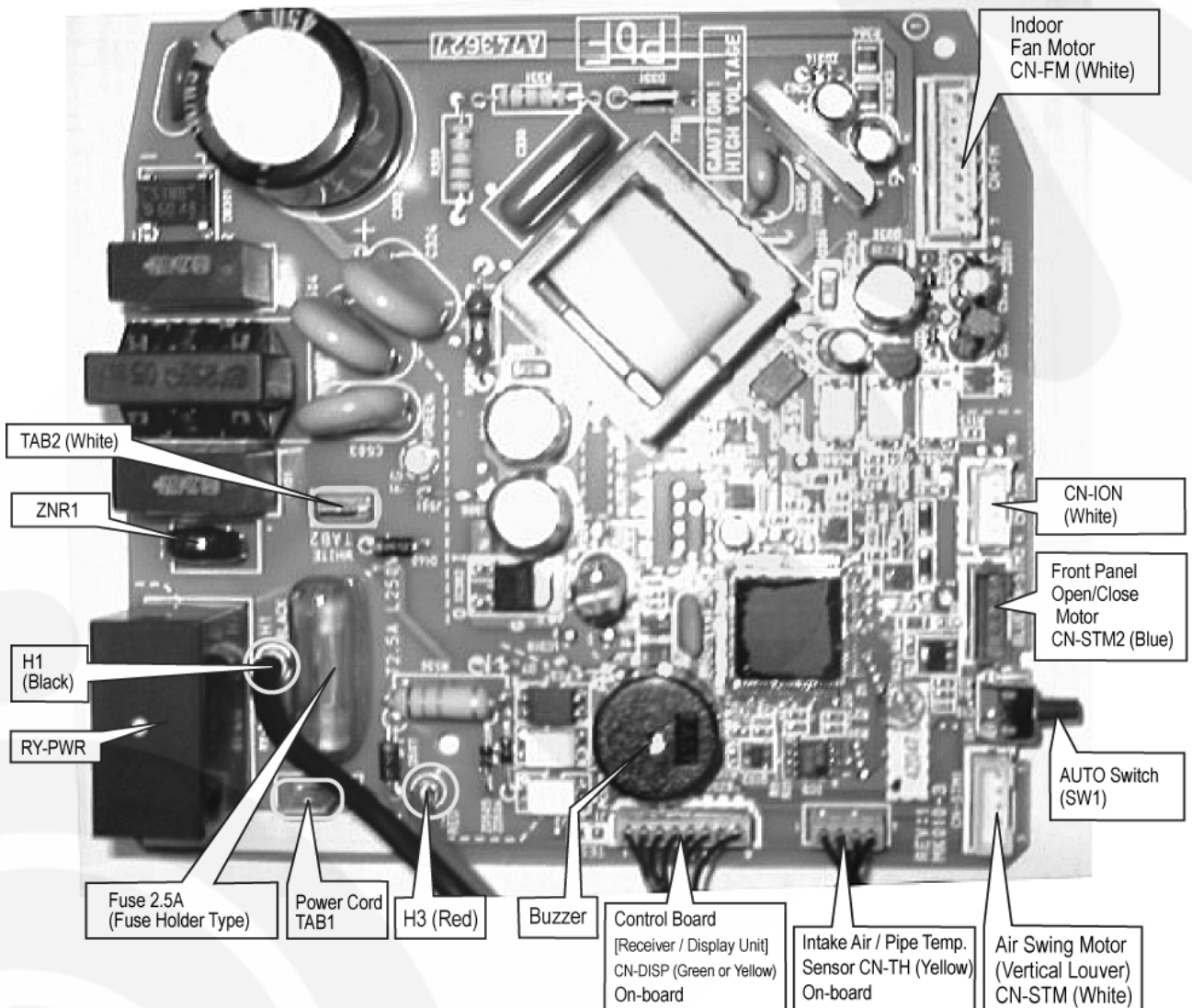

8.2. Outdoor Unit

CU-TE9DKE ,CU-TE12DKE

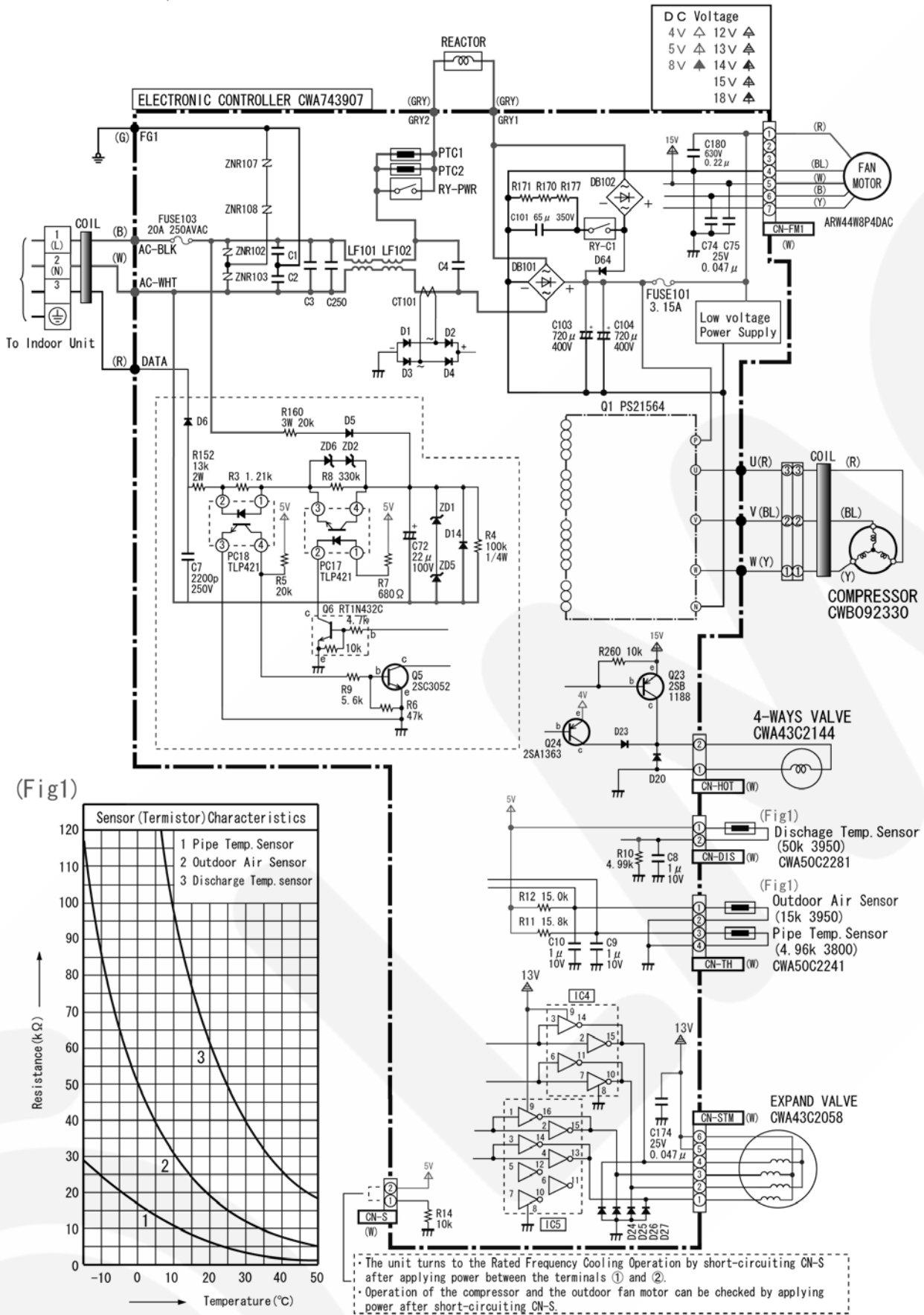

8.2.1. Printed Circuit Board CU-TE9DKE / CU-TE12DKE

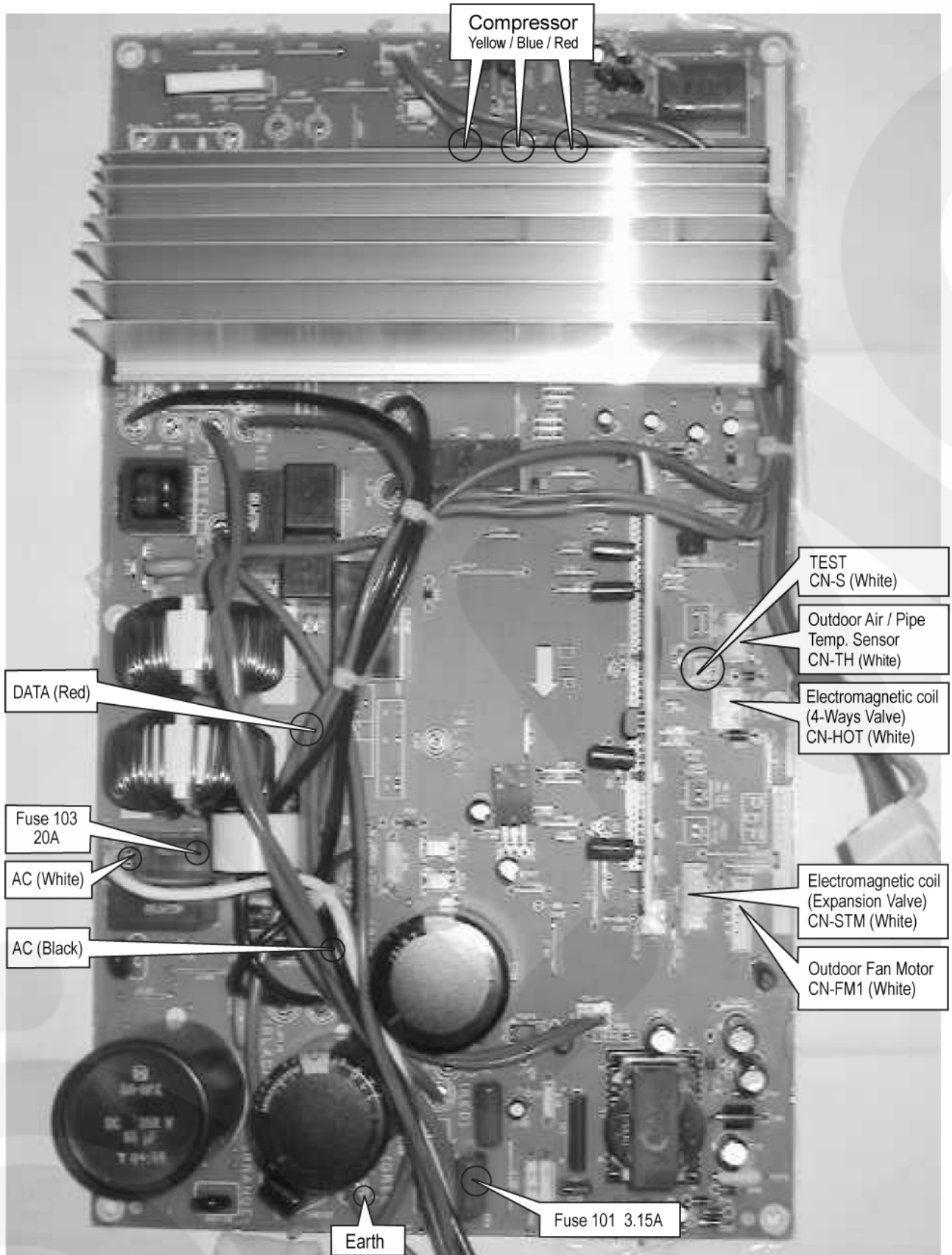

9 Operation Details

9.1. BASIC FUNCTION

Inverter control, which equipped with a microcomputer in determining the most suitable operating mode as time passes, automatically adjusts output power for maximum comfort always. In order to achieve the suitable operating mode, the microcomputer maintains the set temperature by measuring the temperature of the environment and performing temperature shifting. The compressor at outdoor unit is operating following the frequency instructed by the microcomputer at indoor unit that judging the condition according to internal setting temperature and intake air temperature.

9.1.1. Internal Setting Temperature

Once the operation starts, remote control setting temperature will be taken as base value for temperature shifting processes. These shifting processes are depending on the air conditioner settings and the operation environment. The final shifted value will be used as internal setting temperature and it is updated continuously whenever the electrical power is supplied to the unit.

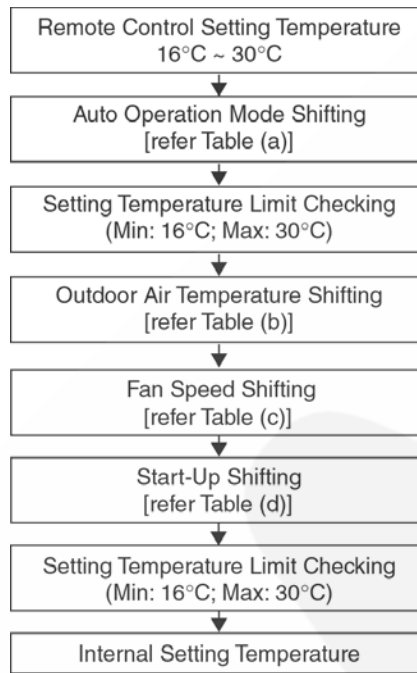

Table (a): Auto Operation Mode Setting

Mode Shift:	Temperature Shift (°C)
Cooling/Soft Dry → Heating	-2.0
Heating → Cooling/Soft Dry	+2.0

Table (b): Outdoor Air Temperature Shifting

Mode:	Outdoor Temperature, X (°C):	Temperature Shift (°C)	
		TE9DKE	TE12DKE
Cooling/Soft Dry	$38 \leq X$	0.00	0.00
	$30 \leq X < 38$	0.00	0.00
	$23 \leq X < 30$	0.00	0.00
	$X < 23$	0.00	0.00
Heating	$21 \leq X$	0.00	0.00
	$17 \leq X < 21$	0.00	0.00
	$9 \leq X < 17$	0.00	0.00
	$5 \leq X < 9$	+0.50	+1.00
	$1 \leq X < 5$	+1.00	+1.25
	$X < 1$	+1.50	+2.00

Table (c): Fan Speed Shifting

Mode:	Fan Speed:	Temperature Shift (°C)
Cooling	All	+1.25
Soft Dry	All	+1.0
Heating	Lo	+1.0
	Hi, Me-, Me, Me+, Auto	+0.25 (TE9DKE), +0.50 (TE12DKE)

Table (d): Start-Up Shifting

Mode within 60 Minutes from Start-up:	Temperature Shift (°C)
Cooling/Soft Dry	-1.0
Heating	+2.0

9.2. Indoor Power Relay Control

The Power Relay turns on under the following conditions.

1. For three minutes, when plugged in the A/C or the Error Reset button on remote controller is pressed.
2. During Installation Check Mode and following for three minutes after checking.
3. During On-timer sampling and during Preliminary operation.
4. During Operation and following for three minutes after the operation is stopped.
5. During Auto Operation, Test run, Forced Heating or Odour Removal Operation and following for three minutes after the operation is stopped.

9.3. Room Air Temperature Control (Compressor Control)

Operating frequency of a compressor is decided according to temperature differences between remote controller setting and room temperatures. A relative method which gives frequency changes, based on the decided frequency, will provide you with comfortable room environment that is not affected by operating conditions.

9.3.1. Cooling Operation

9.3.1.1. Thermostat Control

- [Intake Air Temp. - Remote Controller Setting Temp.] > [Thermostat-OFF Temp. +0.5 °C]
Operated in corresponding frequency.
- Frequency is decided after a completion of the starting control (in 60 seconds).
- When Room Temp. is below [Thermostat-OFF Temp.] continuously for 3 minutes or more, it turns to Thermostat-OFF operation.

Cooling	Power	TE9DKE	TE12DKE
Intake Air Temp. Difference (°C)	Maximum	2.7kW	4.0kW
	Rated	2.5kW	3.6kW
	Intermediate	~	~
	Minimum	0.8kW	0.8kW
(-1.00)	OFF	---	---

9.3.2. Dry Operation

9.3.2.1. Thermostat Control

- [Intake Air Temp. - Remote Controller Setting Temp.] > [Thermostat-OFF Temp. +0.5 °C]
Operated in corresponding frequency.
- Frequency is decided after a completion of the starting control (in 60 seconds).
- When Room Temp. is below [Thermostat-OFF Temp.] continuously for 3 minutes or more, it turns to Thermostat-OFF operation.
- When room temperature almost comes to Thermostat-OFF Temp., the operation turns to the Minimum power & fan speed: SSLo.

Dry	Power	TE9DKE	TE12DKE
Intake Air Temp. Difference (°C)	Maximum	2.7kW	4.0kW
	Rated	2.5kW	3.6kW
	Intermediate	~	~
	Minimum	0.8kW	0.8kW
(-2.50)	OFF	—	—

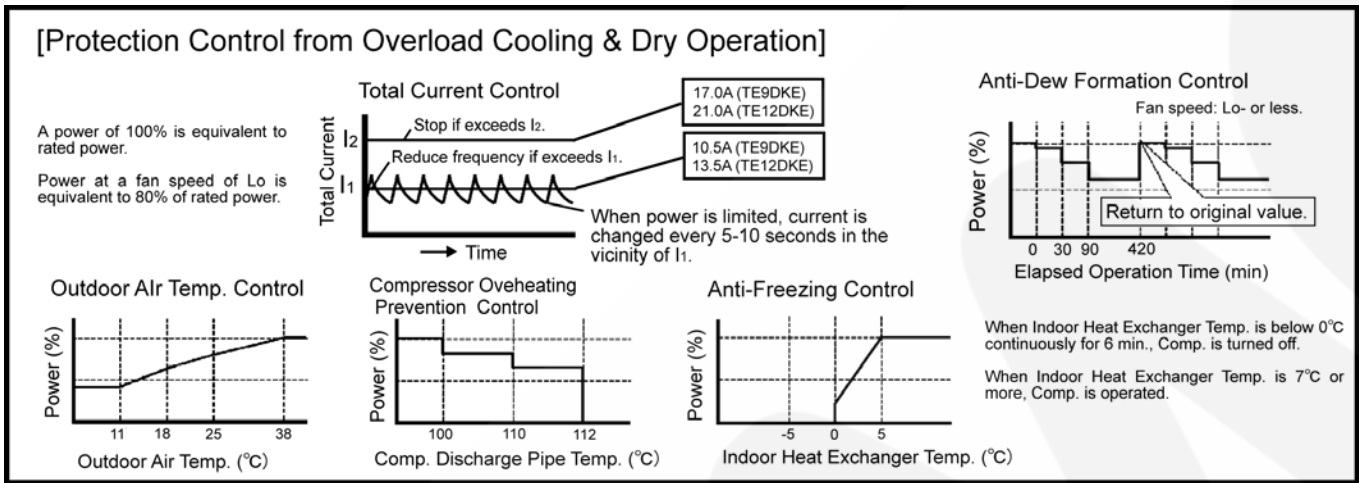

9.3.3. Heating Operation

9.3.3.1. Thermostat Control

- [Intake Air Temp. - Remote Controller Setting Temp.] > [Thermostat-OFF Temp. +0.5 °C]
Operated in corresponding frequency.
- Frequency is decided after a completion of starting control (in 60 seconds).
- When Room Temp. is below Thermostat-OFF Temp. continuously for 3 minutes or more, it turns to Thermostat-OFF operation.
- When room temperature almost comes to Thermostat-OFF Temp., the operation turns to the Maximum power.



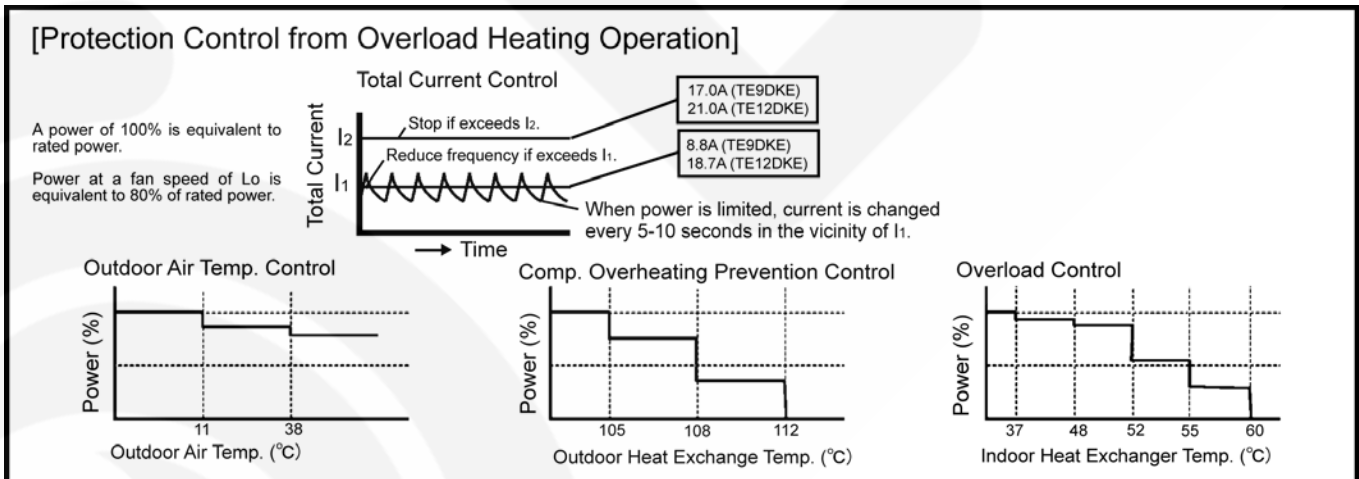



Heating	Power	TE9DKE	TE12DKE
Intake Air Temp. Difference (°C)	OFF	—	—
	Minimum	0.8kW	0.8kW
	Intermediate	~	~
	Rated	3.5kW	4.5kW
(+1.00)	Maximum	4.6kW	6.2kW

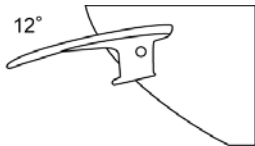
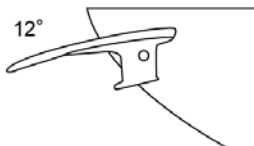

9.4. Airflow Direction Control

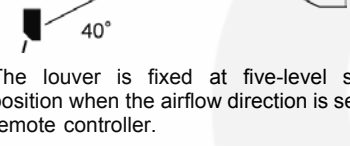
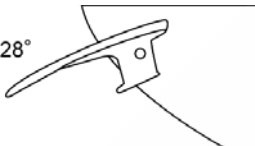
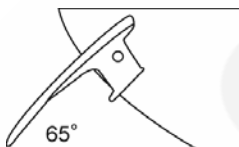
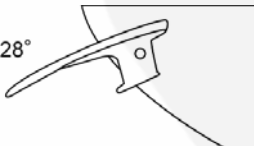
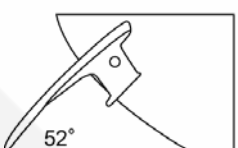
Vertical louver is controlled with Vertical Airflow Direction button on remote controller and by operation conditions, as shown in the table below.

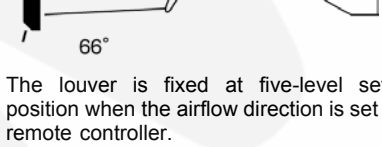
9.4.1. Vertical Airflow Louver Angle

Cooling and Dry Operations		
Airflow Direction Auto		Airflow Direction Setting
Manual Operation	Vertical Auto Operation	Powerful-ON
<p>Upper limit 12°</p>  <p>Lower limit 40°</p> <p>It vertically swings only in Cooling Operation.</p> <ul style="list-style-type: none"> It swings when airflow direction is set with remote controller. It does not swing while indoor fan is stopped. (It is fixed at the upper limit.) <p>12°</p>  <p>It is fixed at 20° in Dry Operation.</p>	<p>In Quick Cooling Operation</p> <p>12°</p>  <p>At least 5 min. after Powerful-on</p> <p>In Chilly Cooling & Dry Operations</p> <p>12°</p>  <p>After Quick Cooling-On.</p>	<p>12°</p>  <p>40°</p>  <ul style="list-style-type: none"> The louver is fixed at five-level setting position when the airflow direction is set with remote controller.
Heating Operation		
Airflow Direction Auto		Airflow Direction Setting
Fixed by Heat Exchanger Temperature	Powerful Operation	Remote Control
<ul style="list-style-type: none"> When Heat Exchanger Temperature is less than 33°C <p>28°</p>  <ul style="list-style-type: none"> When Heat Exchanger Temperature is between 33°C (, incl.) and 127°C <p>65°</p> 	<ul style="list-style-type: none"> When Heat Exchanger Temperature is less than 33°C <p>28°</p>  <ul style="list-style-type: none"> When Heat Exchanger Temperature is between 33°C (, incl.) and 127°C <p>In Quick Heating & Warm Heating Operations</p> <p>52°</p> 	<p>4°</p>  <p>66°</p>  <ul style="list-style-type: none"> The louver is fixed at five-level setting position when the airflow direction is set with remote controller.
Airflow Direction Auto		Airflow Direction Setting
Odour Removal Control		
<p>28°</p> 		

- The vertical louver is fully opened and move to the setting position when the unit is turned on with the remote controller.
- The vertical louver remains open position when the unit is turned off during operation.
- The horizontal louver is manually operated.

9.5. Quiet operation (Cooling Mode / Cooling area of Dry Mode)

A. Purpose

To provide quiet cooling operation compare to normal operation.

B. Control condition

a. Quiet operation start condition

- When "quiet" button at remote control is pressed.

Quiet LED illuminates.

b. Quiet operation stop condition

1. When one of the following conditions is satisfied, quiet operation stops:

- Powerful button is pressed.
- Stop by OFF/ON switch.
- Timer "off" activates.
- When change mode to ION only mode.

2. When quiet operation is stopped, operation is shifted to normal operation with previous setting.

3. When fan speed is changed, quiet operation is shifted to quiet operation of the new fan speed.

4. When operation mode is changed, quiet operation is shifted to quiet operation of the new mode, except ION only mode.

5. During quiet operation, if timer "on" activates, quiet operation maintains.

6. After off, when on back, quiet operation is not memorised.

C. Control contents

1. Fan speed is changed from normal setting to quiet setting of respective fan speed.

This is to reduce sound of Hi, Me, Lo for 3dB.

2. Fan speed for quiet operation is -100 rpm from setting fan speed.

9.5.1. Quiet operation under Soft Dry operation (Dry area at Dry Mode)

Automatic Fan Speed (Dry operation)

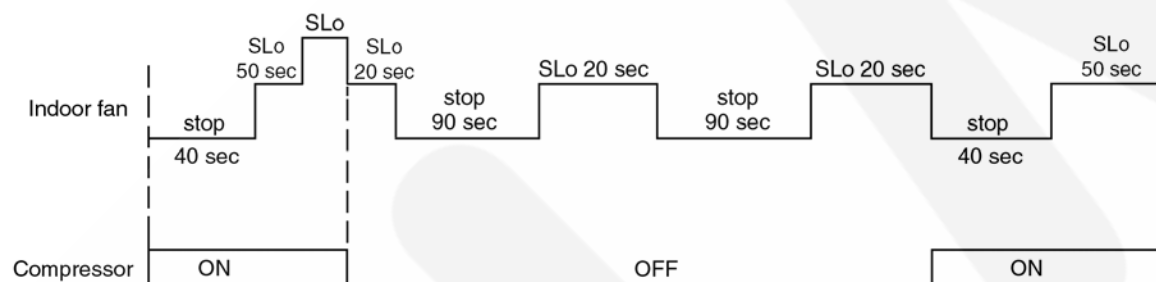

Manual Fan Speed (Dry operation)

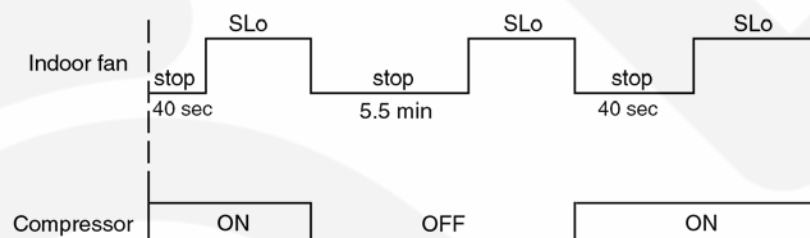

9.5.2. Quiet operation (Heating)

A. Purpose

To provide quiet heating operation compare to normal operation.

B. Control condition

a. Quiet operation start condition

- When “quiet” button at remote control is pressed.

Quiet LED illuminates.

b. Quiet operation stop condition

1. When one of the following conditions is satisfied, quiet operation stops:

- a. Powerful button is pressed.
- b. Stop by OFF/ON switch.
- c. Timer “off” activates.
- d. When change mode to ION only mode.

2. When quiet operation is stopped, operation is shifted to normal operation with previous setting.

3. When fan speed is changed, quiet operation is shifted to quiet operation of the new fan speed.

4. When operation mode is changed, quiet operation is shifted to quiet operation of the new mode, except ION only mode.

5. During quiet operation, if timer “on” activates, quiet operation maintains.

6. After off, when on back, quiet operation is not memorised.

C. Control contents

a. Fan Speed manual

1. Fan speed is changed from normal setting to quiet setting of respective fan speed.

This is to reduce sound of Hi, Me, Lo for 3dB.

2. Fan speed for quiet operation is -100 rpm from setting fan speed.

3. Fan Speed Auto

- If $FM \geq Lo$

-100 rpm reduce from normal Heating Auto Fan Speed

- If $FM < Lo$

maintain RPM

Indoor FM RPM depends on Piping temp sensor of indoor heat exchanger.

9.6. Indoor Fan Control

9.6.1. Fan Motor Control

- Fan speed is controlled according to operation conditions such as fan speed setting on the remote controller as shown in the table below.
- There is a different speed control from setting on the remote controller.
- When Dry operation is selected, in the Cooling area, fan speed will be switched to one at Cooling mode and in the Dry area, it will be switched to one at Dry mode.
- Indoor fan operates in Quiet and Quiet Control indicated in the table below by pressing the QUIET button on the remote controller.

CS-TE9DKE

Cooling and Dry Operations

Revolution(rpm)	Stop	~	770	~	840	~	850	~	910	~	1020	~	1130	~	1240	~	1370	~	1430	
Manual fan speed			SSLo		QUIET		Lo-		Lo		Me-		Me		Me+		Hi		SHi	
Cooling	Automatic fan speed	○		○							⊙	~	⊙							
		If "Room temp. - Remote controller setting temp. < 0°C" continues continuously for 3 min., fan speed is adjusted at steps of 60 rpm to be within the following range.																		
								⊙	~	⊙	~	⊙	~	⊙						
Powerful											⊙ Min 790	~	⊙ Max 1370						Quick Cooling	⊙
Manual fan speed			SSLo		QUIET		Lo-		Lo		Me-		Me		Me+		Hi		SHi	
Dry	Automatic fan speed	○																		
	Powerful																		Quick Cooling (Quick Dry)	⊙

(Notes) Conditions of "SHi" (At automatic fan speed): Room temp. is 24°C or more; Remote controller temp. is 16°C or more; Remote controller setting fan speed: "Hi"; Outdoor temp. is 30°C or more; Within 30 min. from starting operation.
 Quick Cooling: Unit forces to turn to Forced Cooling for 5 min. or more after POWERFUL-ON.
 The "⊙" indicates fan speed that is automatically set.
 In the Cooling condition marked with the "⊙", unit is controlled by using with Odour Cut Control and automatic fan speed.
 The items with indicates range that can be set with remote controller.

Heating Operation

Revolution(rpm)	Stop	~	440	~	580	~	860	~	930	~	980	~	1110	~	1340	~	1370	~	1490	
Manual fan speed			SSLo		SLo		Lo-		QUIET		Lo		Me-		Me		Me+		SHi	
Cooling	Automatic fan speed	○	○		⊙		⊙						⊙	~	⊙					
					*1		*2						1240	~	1490					
Powerful													⊙	~	⊙				Quick Heating	⊙

(Notes) *1: Indoor Heat Exchanger Temperature : 19-32°C
 *2: Indoor Heat Exchanger Temperature : 32-35°C
 Quick Heating: Unit turns to Quick Heating for 5 min. or more after the POWERFUL-ON.
 "⊙" indicates fan speed that is automatically set.
 In the Heating condition marked with the "⊙", unit is controlled by using with Hot Start Control and Cold Draft Control.
 The items with indicates range that can be set with remote controller.

CS-TE12DKE

Cooling and Dry Operations

Revolution(rpm)		Stop	~	880	~	970	~	990	~	1050	~	1160	~	1270	~	1380	~	1500	~	1560
Cooling	Manual fan speed			SSLo		QUIET		Lo-		Lo		Me-		Me		Me+		Hi		SHi
	Automatic fan speed	○			○							⊙	~	⊙						
	Powerful	Chilly Cooling										⊙ Min 990	~	⊙ Max 1500	Quick Cooling					⊙
Dry	Manual fan speed			SSLo		QUIET		Lo-		Lo		Me-		Me		Me+		Hi		SHi
	Automatic fan speed	○				QUIET Control														
	Powerful	Chilly Dry					⊙ Min 940	~	⊙ Max 1050	Quick Cooling (Quick Dry)										⊙

(Notes) Conditions of "SHi" (At automatic fan speed): Room temp. is 24°C or more; Remote controller temp. is 16°C or more; Remote controller setting fan speed: "Hi"; Outdoor temp. is 30°C or more; Within 30 min. from starting operation.
 Quick Cooling: Unit forces to turn to Forced Cooling for 5 min. or more after POWERFUL-ON.
 The "⊙" indicates fan speed that is automatically set.
 In the Cooling condition marked with the "⊙", unit is controlled by using with Odour Cut Control and automatic fan speed.
 The items with indicates range that can be set with remote controller.

Heating Operation

Revolution(rpm)		Stop	~	440	~	580	~	1000	~	1100	~	1200	~	1280	~	1360	~	1440	~	1520
Cooling	Manual fan speed			SSLo		SLo		Lo-		QUIET		Lo		Me-		Me		Me+		SHi
	Automatic fan speed	○		○		⊙ *1		⊙ *2						⊙	~	⊙				
	Powerful	Warm Heating										⊙	~	⊙	Quick Heating					⊙

(Notes) *1: Indoor Heat Exchanger Temperature : 19-32°C
 *2: Indoor Heat Exchanger Temperature : 32-35°C
 Quick Heating: Unit turns to Quick Heating for 5 min. or more after the POWERFUL-ON.
 "⊙" indicates fan speed that is automatically set.
 In the Heating condition marked with the "⊙", unit is controlled by using with Hot Start Control and Cold Draft Control.
 The items with indicates range that can be set with remote controller.

9.6.2. Cooling Operation

1. Automatic Fan Speed

Odour Cut Control is equipped with this model. Fan is temporarily stopped for 40 seconds at the beginning of unit operation or Thermostat-ON in order to wash away odour ingredients from heat exchanger with dehumidifying water.

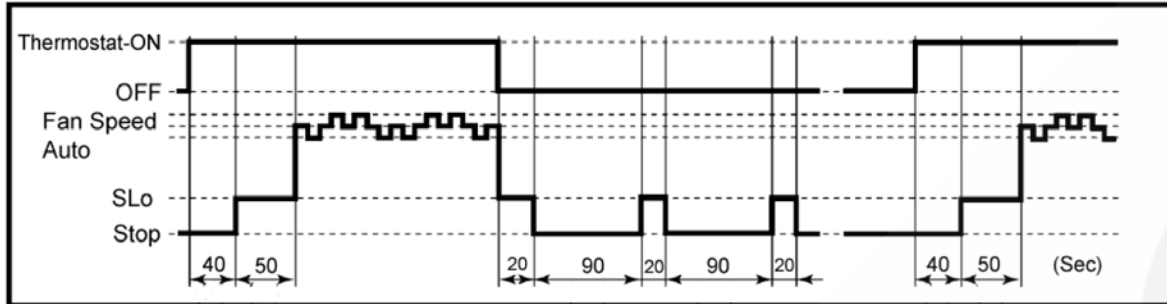

Conditions of Control Starting

- When Cooling fan speed is "Auto",
- When conditions other than Defrost control,
- When indoor Pipe temperature is in the area shown in the figure below,
- When operations other than Powerful operation,

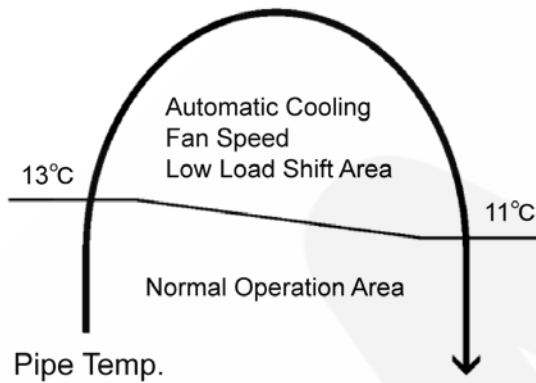

Items to be controlled

According to Intake air - Setting temperature differences, indoor fan speed is adjusted by revolution speed correction of automatic normal fan speed as shown in the graph below.

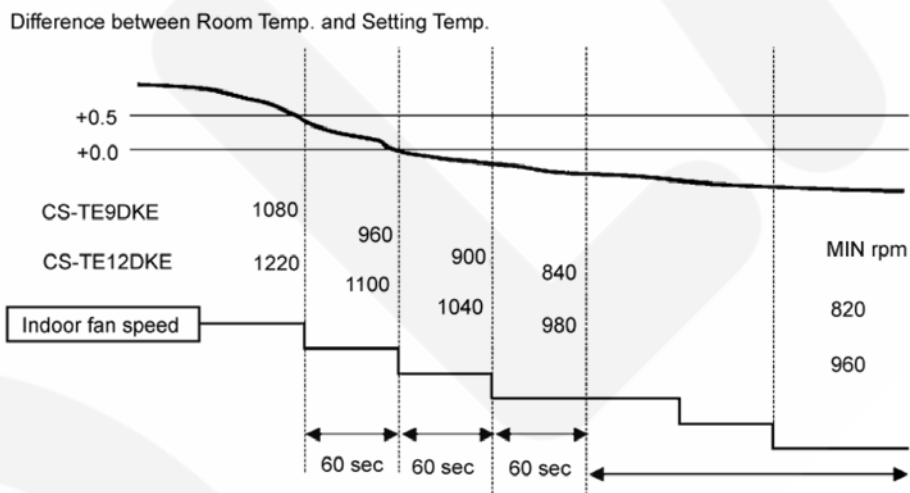

In addition, fan speed will be reduced to MIN rpm under the following conditions:

- Neural control stability
- [Intake air temp. - Indoor Pipe Temp.] < 13 °C
- Operating frequency < 25 Hz

2. Maximum Cooling Power

When cooling load is big, if fan speed: "SHi" and temp: 16 °C are set, fan speed will be increased for 30 minutes after operation starts in order to decrease room temperature quickly. (Refer to "Indoor fan speed control" for each model.)

3. Dew Condensation Prevention Control

Fan speed will be reduced if Dew Condensation Prevent Control is operated.

4. Forced Cooling Operation

Fan speed at Forced Cooling operation with the Emergency Operation button is "Hi". (Refer to "Indoor fan speed control" for each model.)

5. Emergency Operation

Fan speed when operation with the Emergency Operation button or Cooling operation with remote controller during performance of breakdown diagnosis (breakdown that emergency operation is possible) is "Me+". (Refer to "Indoor fan speed control" for each model.)

9.6.3. Dry Operation

1. Basic Fan Speed

In the cooling mode area, fan operates in the same speed as cooling operation mode. In the dry mode area, it is switched to "SLo". (Refer to "Indoor fan speed control" for each model.) In the Thermostat-OFF mode, fan stops for 5.5 minutes and after that, operates at a speed of level 3.

2. Automatic Fan Speed

Odour Cut Control functions and fan operates repeatedly between the 60-second stop and the 30-second "SLo" operations. In the beginning of unit operation and Thermostat-ON, fan stops for 40 seconds.

9.6.4. Heating Operation

1. Hot Start & Cold Draft

When Indoor Exchanger Temperature is low at the beginning of the operation, fan is stopped. Cold Draft is prevented by increased Exchanger temperature in proportion to fan speed.

2. Auto Fan Speed

In Auto Fan Speed, fan speed is controlled according to Exchanger temperature. (Refer to "Indoor fan speed control" for each model.)

3. Forced Heating Operation

Fan speed at Forced Heating operation with the Emergency Operation button is "Hi". (Refer to "Indoor fan speed control" for each model.)

4. Fan speed when operation with the Emergency Operation button or Heating operation with remote controller during performance of breakdown diagnosis (breakdown that emergency operation is possible) is "Me+". (Refer to "Indoor fan speed control" for each model.)

9.7. Powerful Operation

If the POWERFUL button is pressed during operating in Cooling, Heating, Dry or AUTO, unit always forces to operate respectively in Quick Cooling, Dry and Quick Heating for 5 minutes, which fan speed is "SHi" even though unit is in each stable area.

9.7.1. Cooling Operation

- Airflow direction, Fan speed and Setting temperature are optimized.
- "Intake Air temperature - Remote controller setting temperature" is detected every 20 seconds by indication from indoor unit and controlled to each area.

Quick Cooling → Unit forcibly turns to Quick Cooling operation for 5 minutes after POWERFUL ON even through it is in the stable area. If unit gets out of the Quick Cooling area, it turns to Chilly Cooling operation.

Chilly Cooling → Discharge Air temperature is kept low by changing fan speed according to room temperature and chilly feeling is produced.

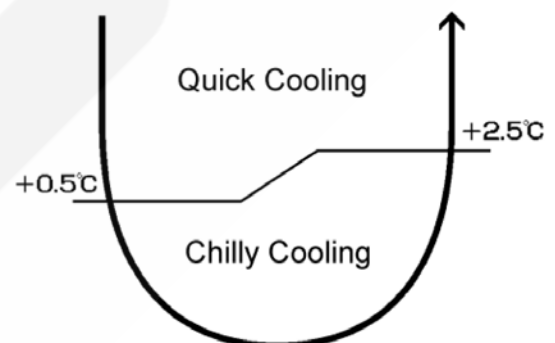

9.7.2. Dry Operation

- Airflow direction, Fan speed and Setting temperature are optimized.
- "Intake Air temperature - Remote controller setting temperature" is detected every 20 seconds by indication from indoor unit and controlled to each area.

Quick Dry → Unit forcibly turns to Quick Dry operation for 5 minutes after POWERFUL ON even through it is in the stable area. If unit gets out of the area, it turns to Chilly Dry operation.

Chilly Dry → Discharge Air temperature is kept low by changing fan speed according to room temperature and chilly feeling is produced.

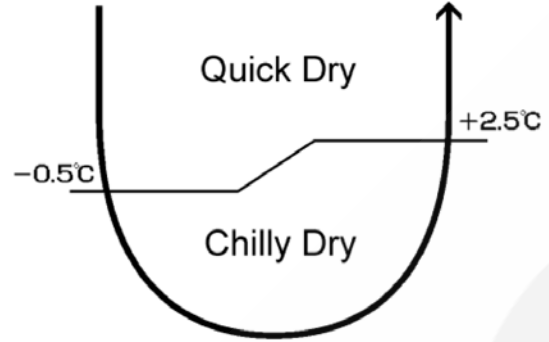

9.7.3. Heating Operation

- Airflow direction, Fan speed and Setting temperature are optimized.
- "Intake Air temperature - Remote controller setting temperature" is detected every 20 seconds by indication from indoor unit and controlled to each area.

Quick Heating → Unit forcibly turns to Quick Heating operation for 5 minutes after POWERFUL ON even through it is in the stable area. If unit gets out of the area, it turns to Warm Heating operation.

Warm Heating → Discharge Air temperature is kept high by changing fan speed according to room temperature and warm feeling is produced.

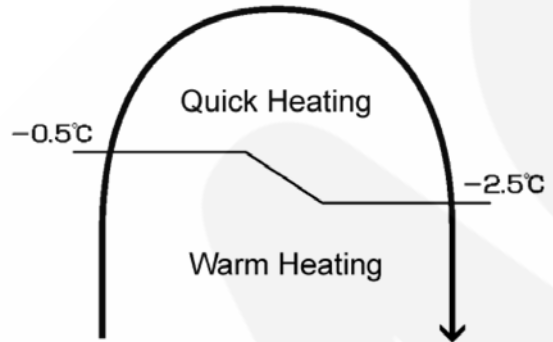

9.8. Automatic Operation

- Operation mode (Cooling, Dry and Heating) is automatically selected.
- Operation mode is selected at the beginning of unit operation and every 30 minutes. Temperature, Fan speed and Airflow directions are set with remote controller.

9.8.1. Operation Mode Selection

Operation mode is selected according to outdoor temperature, intake air temperature and setting temperature.

1. "Heating" is selected when intake air temperature is below 16 °C.
2. "Cooling" is selected when intake air temperature is 25 °C or more. (But, when intake air temperature is 16 °C or more.)
3. Selectable range of "Heating" and "Cooling" for setting temperature on the remote controller is increased when outside air temperature is below 25 °C.

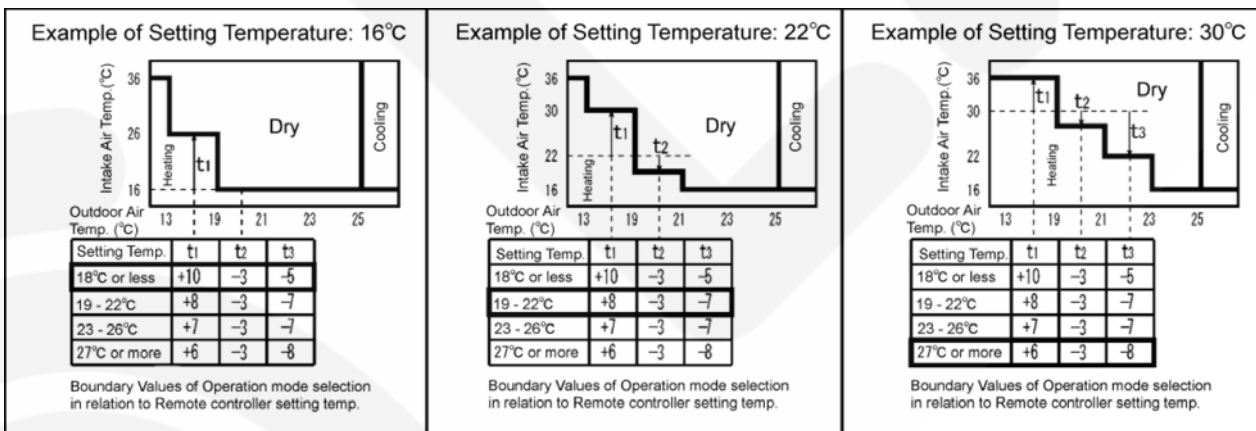

9.8.2. Setting Temperature Shift in Automatic Operation

- When Cooling mode is selected, setting temperature is shifted to +1 °C.
- When Heating mode is selected, setting temperature is shifted to -1 °C.

9.9. Timer Operation (24H Real Timer)

- On-timer and OFF-timer can be set simultaneously.
- Both On-timer and OFF-timer functions operate until they are canceled. (Excluding when power supplying condition is bad.)

An example of ON-timer operation

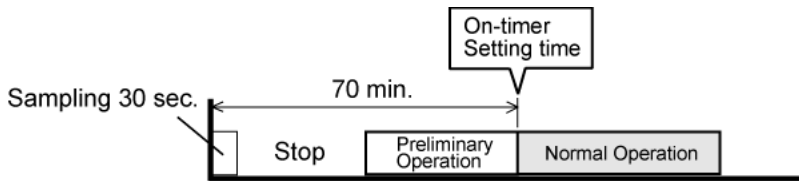

An example of OFF-timer operation

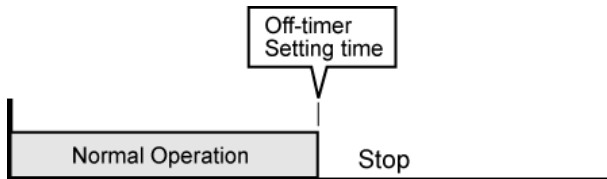

Preliminary operation

- Unit operates preliminarily until room temperature reaches setting temperature on ON-timer setting time. Preliminary operation times are as shown in the table below.
- Indoor and outdoor fans operate for 30 seconds in 70 minutes before setting time and sampling of outdoor air and intake air temperatures is performed.
- Fan speed and airflow directions in preliminary operation are based on remote controller setting. (Same condition as in normal operation.)
- In preliminary operation, deicing judgment is performed after heating operated for 15 minutes in 50 minutes before setting ON-time. This is because it makes start-up time short when outdoor air temperature is extremely low in midwinter.

Deicing Judgment: Deicing operation (Max. 12 minutes) will be performed when outdoor air temperature is below 0°C, if outdoor heat exchanger temperature of below 0°C continues for 14 minutes and below -8°C continues for 10 minutes or more.

Preliminary operation in Cooling or Dry mode

Outdoor Temperature	Air Intake Temperature	Air Warming-up Starting Time	Operation
35 °C or more	—	Before 15 min.	
—	30 °C or more	Before 15 min.	
30 - 35 °C	25 - 30 °C	Before 10 min.	
Below 30 °C	Below 25 °C	Before 5 min.	

Preliminary operation in Heating mode

Outdoor Temperature	Air Intake Temperature	Air Warming-up Starting Time	Operation
5 °C or more	—	Before 40 min.	
—	15 °C or more	Before 40 min.	
0 - 5 °C	5 - 15 °C	Before 45 min.	
Below 0 °C	Below 5 °C	Before 50 min.	

9.10. Auto Restart Control

1. When the power supply is cut off during the operation of air conditioner, the compressor will re-operate within three to four minutes (there are 10 patterns between 2 minutes 58 seconds and 3 minutes 52 seconds to be selected randomly) after power supply resumes.
2. This type of control is not applicable during ON/OFF Timer setting.

9.11. Ionizer Operation

9.11.1. Negative Ion Generator

Display and operation for the Negative Ion Generator remain unchanged for ION only operation and simultaneous ION operation.

Refer to the ION operation described below.

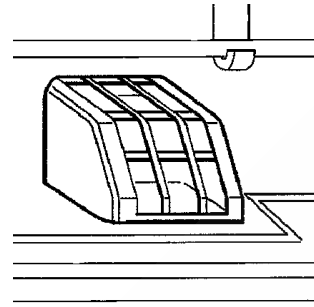

Single blinking of the ION LED does not indicate Breakdown.

- When unit was operated under the condition that a discharge insulation of the Ion Cleaning equipment is deteriorated (Dust, Attached water, etc.):

1. If the insulation deterioration of the unit discharge part is small;

When air cleaning abnormal status is detected in 1 minute or more from the unit starts operating, the unit is OFF for 10 minutes.

↑↓ (The ION LED and CLEAN monitor light up.)

The unit is ON in 5 minutes. (Repeating)

2. If the insulation deterioration of the unit discharge part is big;

When air cleaning abnormal status is detected within 1 minute from the unit starts operating, the unit is shut OFF immediately and the ION LED blinks.

3. If the insulation of the Ionizer is deteriorated;

When abnormal status is detected, the unit is OFF for 30 minutes. When abnormal status is detected 25 times, the operation stops and the ION LED blinks. (It will be reset if normal status continues for 10 minutes before reaching 25 times.)

To cancel it, stop the operation while the ION LED is blinking.

Note: Set ION Air Cleaning operation again because it is canceled when re-operated.

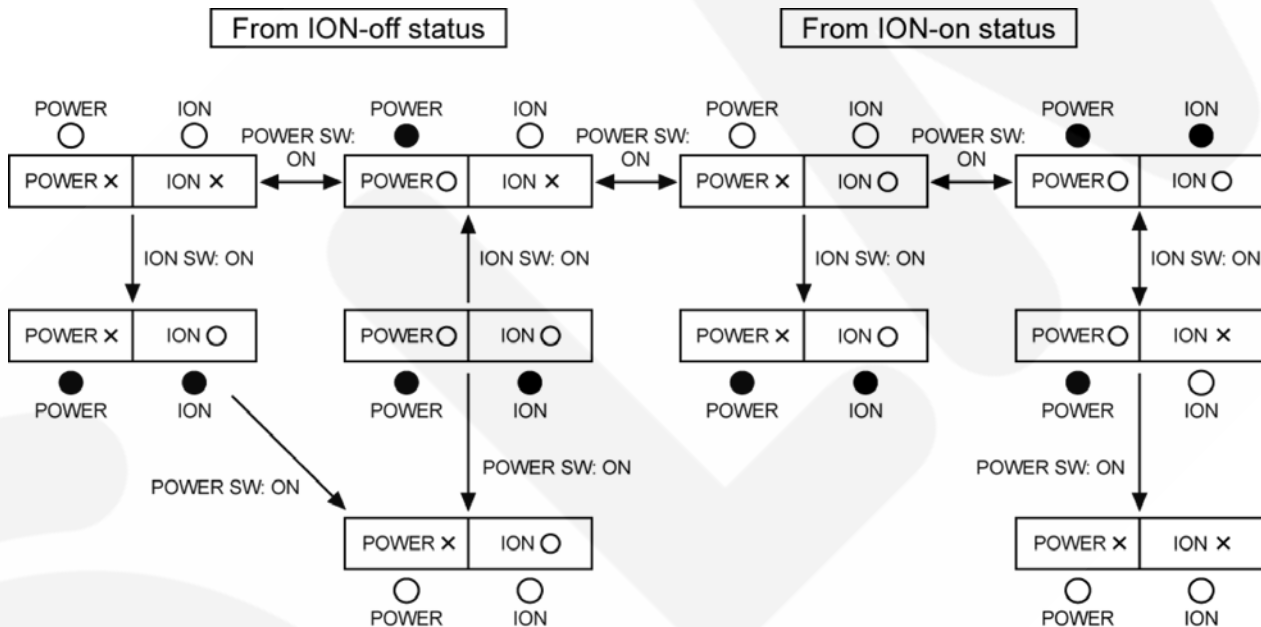

9.12. Protection Control

9.12.1. Time Delay Safety Control

1. The compressor will not start for two minutes after stop of operation.
2. This control is not applicable if the power supply is cut off and on again or after 4-way valve deices condition.

9.12.2. 30 Seconds Forced Operation

1. Once the compressor starts operation, it will not stop its operation for 30 minutes.
2. However, it can be stopped by using remote control or Auto Switch at indoor unit.

* The other Protection controls are shown in “9.3.2 Protection Control from Overload Cooling & Dry Operation” and “9.3.3 Protection Control from Overload Heating Operation“.

10 Operating Instructions

■ Definition

To prevent personal injury, injury to others and property damage, the following instructions must be followed.

Incorrect operation due to failure to follow instructions will cause harm or damage, the seriousness of which is classified as below:



Warning

This sign warns of death or serious injury.



Caution

This sign warns of injury or damage to property.

The instructions to be followed are classified by the following symbols:



This symbol denotes an action that is **PROHIBITED**.



These symbols denote actions that are **COMPULSORY**.

Thank you for purchasing Panasonic Air Conditioner

SAFETY PRECAUTIONS

Installation Precautions



Do not install, remove and reinstall the unit by yourself.

- Improper installation will cause leakage, electric shock or fire. Please consult an authorized dealer or specialist for the installation work.

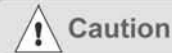

- This air conditioner must be earthed. Improper grounding will cause electric shock.
- Ensure that the drainage piping is connected properly. Otherwise, water will leak.
- Current leakage protection equipment must be installed. Otherwise, electric shock or fire may occur.
- Do not install the unit in a potentially explosive atmosphere.

Operation Precautions



- Do not share power outlet.
- Do not modify power cord.
- Do not use an extension cord.
- Do not operate with wet hands.
- Do not operate or stop the unit by inserting or pulling out the power plug.
- Do not insert finger or other objects into the indoor or outdoor unit.
- Do not attempt to repair the unit by yourself.
- Do not use rechargeable (Ni-Cd) batteries.
- Keep the remote control away from infants and small children to prevent them from accidentally swallowing the batteries.
- Insert the power plug properly.
- Use specified supply cord.
- If the supply cord is damaged or needed to be replaced, it must be replaced by the manufacturer or its service agent or a similarly qualified person in order to avoid a hazard.
- Remove the batteries if the unit is not going to be used for a long period of time.
- New batteries of the same type must be inserted following the polarity stated to prevent malfunction of the remote control.
- In case of emergency or abnormal condition (burnt smell, etc) occurs, turn off the power supply and unplug.



- Do not pull the cord to disconnect the plug.
- Do not wash the unit with water, benzene, thinner or scouring powder.
- Do not use for other purposes such as preservation of food.
- Do not use any combustible equipment at airflow direction.
- Do not sit or place anything on the indoor or outdoor unit.
- Do not expose directly to cold air for a long period.
- Ventilate the room regularly.
- Pay attention as to whether the installation rack is damaged after long period of usage.
- Switch off the power supply and unplug before cleaning or servicing.
- Turn off the power supply and unplug if the unit is not used for a long period of time.

Safety Regulation

The appliance is not intended for use by young children or infirm person without supervision. Young children should be supervised to ensure that they do not play with the appliance.

Replacement or installation of power plugs shall be performed by authorized/qualified personnel only. The wires in this mains lead are coloured in accordance with the following code:

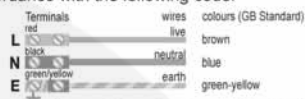

Different countries may have different colour coding for the wires.

Operation Condition (°C)

Use this air conditioner under the following temperature range.

DBT: Dry Bulb Temperature WBT: Wet Bulb Temperature	Indoor		Outdoor	
	DBT	WBT	DBT	WBT
Maximum Temperature (COOL)	32	23	43	26
Maximum Temperature (HEAT)	30	-	24	18
Minimum Temperature (COOL)	16	11	16	11
Minimum Temperature (HEAT)	16	-	-10	-11

Note: The illustrations in this manual are for explanation purposes only and may differ from the actual unit. It is subjected to change without notice for future improvement.

PRODUCT OVERVIEW

Indoor Unit

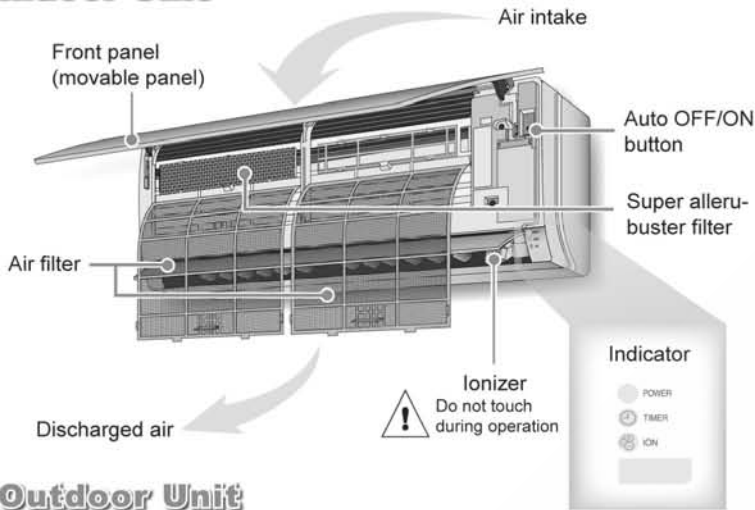

Outdoor Unit

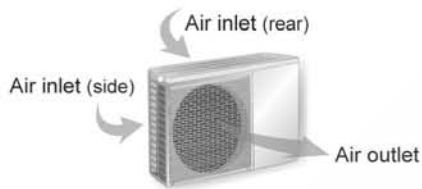

Remote Control



About

Remote Control Preparation

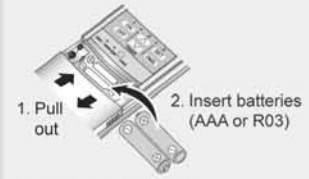

3. Press CLOCK button



5. Press again to confirm

- Timer operation will be based on current time set.
- The batteries can be used for approximately 1 year.
- The batteries must be recycled or disposed of properly.

Remote Control Signal

- Make sure it is not obstructed.
- Maximum distances : 10m.
- Certain fluorescent lights may interfere with signal transmission. Consult your dealer.

Auto OFF/ON Button

- To operate the unit if the remote control is misplaced or malfunctioning.

Action	Operation mode
Press once.	Automatic Operation
Press until "beep" sound and release.	Cooling Operation
Press until "beep" sound and release. Press again until "beep-beep" sound and release.	Heating Operation

- To OFF, press again the Auto OFF/ON button.
- The usage of this button is not recommended.

Troubleshooting

• Operation delayed for few minutes after restart.	➤ This is a normal self protection control.
• Sound like water flowing during operation.	➤ Caused by refrigerant flow inside.
• Mist emerges from indoor unit.	➤ Condensation effect due to cooling process.
• Noisy during operations.	➤ Installation work could be slanted or front panel didn't open properly.
• Remote control/display does not work.	➤ Check whether batteries are correctly inserted or need replacement.
• The unit cannot operate.	➤ Check either circuit breaker is tripped, power plug is inserted correctly or timer is used correctly.
	➤ Ensure "OFF" indicator does not shown on remote control.
• Outdoor unit emits water/steam.	➤ Condensation or evaporation happens at piping surface.

■ About

MOVABLE PANEL

- Opens for air intake when operation starts, and closes when operation stops. During this time, do not hold it as it may cause malfunction or breakdown.
- Movable panel does not open immediately.

■ Operation Details

AUTO - Automatic Operation

- The unit will automatically select the operation mode according to the setting, outdoor and room temperature. During operation mode selection, power indicator blinks. For every 30 minutes, the operation mode is reselected.

HEAT - Heating Operation

- Enables you to enjoy the warming effect at your preferred setting temperature.
- For cold air prevention, air might not blow out immediately and power indicator blinks when operation starts.
- Also operates in defrost mode (maximum 12 minutes) where by the power indicator blinks. The melted frost is drained at outdoor unit and indoor fan is stopped.

COOL - Cooling Operation

- Enables you to enjoy the cooling effect at your preferred setting temperature.

DRY - Soft Dry Operation

- Enables you to set the desired temperature at low fan speed which provides you with the dehumidifying surroundings.

HOW TO OPERATE

Auto, Heat, Cool, Dry

1
Start the operation.

2
Select the desired operation.

3
Set the temperature.
(16°C ~ 30°C)

- Powerful, Quiet and Ion operations can be activated in all operation modes.

- Press button again to stop the operation.



Hint

- To save electricity, close the curtains when using air conditioner to prevent sunlight and heat from coming in.



Troubleshooting

- The room has a peculiar odour.
 - This may be a damp smell emitted by the wall, carpet, furniture or clothing in the room.
- Air conditioner does not cool or heat efficiently.
 - Ensure the temperature has been set correctly.
 - Ensure windows and doors have been closed properly.
 - Ensure filters are cleaned or replaced when necessary.
 - Ensure inlet and outlet vents of outdoor unit have not been obstructed.

HOW TO OPERATE

Powerful, Quiet, Ion, Fan Speed, Air Swing

ION

Enables ion operation.

POWERFUL

Enables powerful operation.

QUIET

Enables quiet operation.

AIR SWING

Adjust the vertical airflow direction louver.

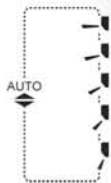

FAN SPEED

Select fan speed.



Operation Details

POWERFUL

- To achieve setting temperature quickly.

QUIET

- To provide a quiet environment.

ION

- To provide fresh air effect by producing negative ions.
- Ion operation could be activated independently. Press  button to stop the operation.
- During Ionizer only operation, Quiet and Powerful could not be activated.

FAN SPEED

- To provide you with the various fan speed selections.
- There are 5 levels of fan speed in addition to automatic fan speed.
- Automatic fan speed:

The speed of the indoor fan is automatically adjusted according to the operation.

AIR SWING

- To ventilate air in the room.
- There are 5 selections in addition to automatic vertical airflow direction.
- If automatic vertical airflow direction has been set, the louver swings up and down automatically.
- Please do not adjust the vertical airflow direction louver manually.
- Horizontal airflow direction louver could be adjusted manually.



- Powerful and Quiet operations could not be activated at the same time.
- Powerful, Quiet and Ion operations could be cancelled by pressing the respective button again.



Hints

- If you wish to have the cool air blowing directly on you, set the airflow direction downward but not for an excessive length of time, as it may harm your health.
- Approximately 10% of electricity can be saved if you set the temperature 1°C higher in cooling operation or 2°C lower in heating operation than the desired temperature.



Troubleshooting

- ION indicator on the indoor unit is blinking. > Press ION button twice. If the indicator is still blinking, please consult the dealer.
- Indoor fan stops occasionally during Automatic Fan Speed setting. > This is an advanced feature that helps to remove smell from the surrounding area during operation.
- Indoor fan stops occasionally during heating operation. > To avoid unintended cooling effect.

■ Operation Details

TIMER

- Use the ON timer to turn on the air conditioner at the desired time. This will give you a cooling or warming environment, e.g. when you return from work or wake up.
- When ON timer is set, operation will start up to 50 minutes before actual set time.
- Use the OFF timer to stop the air conditioner operation at the desired time. This can save electricity while you are going out or sleeping.
- The set timer will repeat daily once it is set.
- If there is a power failure, you can press SET button to restore the previous setting once the power is resumed.
- If the timer is cancelled, you can restore the previous setting by pressing SET button.

CHECK

- Where there is error, the unit stops its operation and timer indicator blinks.

1. Press for 5 seconds.



2. Browse for respective error code, where "beep" sounds are heard.

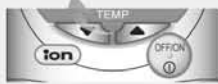

3. Turn off the power supply and call authorized distributor.

Note:

Press the "RESET" button to quit checking.
Unit might be operated with limited function depending on error found. (Operation starts, 4 "beep" sounds are heard.)

HOW TO OPERATE

Timer

1 Select ON or OFF timer.

2 Set the desired time.

3 Confirm the setting.

CANCEL Cancel the selected timer.

- Ensure the clock on the remote control has been set correctly.
- You could use the ON and OFF timers at the same time.
- To cancel either the ON or OFF timer, press **ON** or **OFF**, then press **CANCEL**.



Hint

- For your convenience, you could set the air conditioner to operate automatically by using both ON and OFF timer.



Troubleshooting

- **TIMER** indicator always on. > Timer is activated and the setting will repeat itself daily.
- **POWER** indicator is blinking up to 70 minutes before ON timer is activated. > The unit is determining the operation mode by sensing the room temperature.

CARE & CLEANING



Switch off the power supply before cleaning

FRONT PANEL

Raise and pull to remove.
Wash and dry.

INDOOR UNIT

Wipe gently.

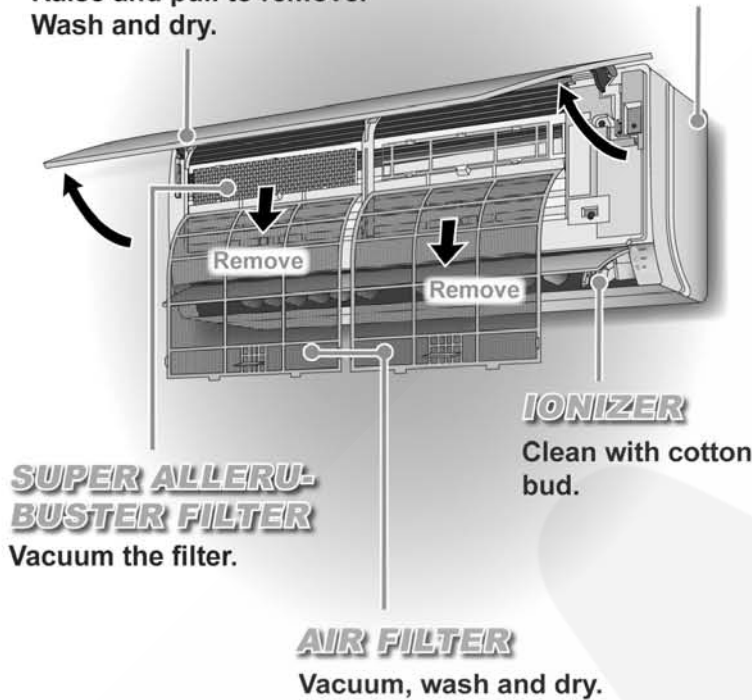

SUPER ALLERU-BUSTER FILTER

Vacuum the filter.

IONIZER

Clean with cotton bud.

AIR FILTER

Vacuum, wash and dry.

■ Cleaning Instructions

- Do not use benzene, thinner or scouring powder.
- Use soaps or neutral household detergent (≈pH7) only.
- Do not use water with temperature higher than 40°C.

INDOOR UNIT

- Wipe the unit gently with a soft, dry cloth.

AIR FILTER

- It is recommended to clean the air filters once every 2 weeks.
- Purchase the replacement filter if it is damaged.
Part no.: CWD001149

SUPER ALLERU-BUSTER

- It is recommended to clean the filter every 6 months.
- Replace the filter every 3 years or purchase the replacement filter if it is damaged.
Part no.: CWD00C1132

IONIZER

- It is recommended to clean the ionizer every 6 months.

■ Preparation for extended Non-operation

- Operate the unit for 2~3 hours using heating operation to dry the internal parts.
- Turn off the power supply and unplug.
- Remove the remote control batteries.

■ Pre-season Inspection

- This inspection is recommended before operating the air conditioner at every season.
- Check if the remote control batteries needed to be replaced.
- Ensure there is no obstruction at all air intake and outlet vents.
- After the start of operation for 15 minutes, it is normal if the temperature differences between air intake and outlet vents at indoor unit is:-

Operation	Temperature
Cooling	> 8°C
Heating	> 14°C

Hints



- Clean the filter regularly as dirty filters will cause unpurified air, low cooling or heating capacity, unpleasant smells and higher energy consumption.
- The unit will become dirty and the performance of the unit will decrease after used for several seasons. Please consult an authorized dealer to perform seasonal inspections in addition to regular cleaning.
- This air conditioner is equipped with a built-in surge protective device. However, in order to further protect your air conditioner from being damaged by abnormally strong lightning activity, you may switch off the power supply.

11 Installation Instructions

Required tools for Installation Works			
1. Philips screw driver	5. Spanner	9. Gas leak detector	13. Multimeter
2. Level gauge	6. Pipe cutter	10. Measuring tape	14. Torque wrench 18 N.m (1.8 kgf.m) 42 N.m (4.2 kgf.m) 55 N.m (5.5 kgf.m)
3. Electric drill, hole core drill ($\phi 70$ mm)	7. Reamer	11. Thermometer	15. Vacuum pump
4. Hexagonal wrench (4 mm)	8. Knife	12. Megameter	16. Gauge manifold

11.1. SAFETY PRECAUTIONS

- Read the following “SAFETY PRECAUTIONS” carefully before installation.
- Electrical work must be installed by a licensed electrician. Be sure to use the correct rating of the power plug and main circuit for the model to be installed.
- The caution items stated here must be followed because these important contents are related to safety. The meaning of each indication used is as below. Incorrect installation due to ignoring of the instruction will cause harm or damage, and the seriousness is classified by the following indications.



 WARNING	This indication shows the possibility of causing death or serious injury.
---	---

 CAUTION	This indication shows the possibility of causing injury or damage to properties only.
---	---

The items to be followed are classified by the symbols:

	Symbol with background white denotes item that is PROHIBITED from doing.
---	--

- Carry out test running to confirm that no abnormality occurs after the installation. Then, explain to user the operation, care and maintenance as stated in instructions. Please remind the customer to keep the operating instructions for future reference.

 WARNING	
1. Engage dealer or specialist for installation. If installation done by the user is defective, it will cause water leakage, electrical shock or fire.	
2. Install according to this installation instruction strictly. If installation is defective, it will cause water leakage, electrical shock or fire.	
3. Use the attached accessories parts and specified parts for installation. Otherwise, it will cause the set to fall, water leakage, fire or electrical shock.	
4. Install at a strong and firm location which is able to withstand the set's weight. If the strength is not enough or installation is not properly done, the set will drop and cause injury.	
5. For electrical work, follow the local national wiring standard, regulation and this installation instruction. An independent circuit and single outlet must be used. If electrical circuit capacity is not enough or defect found in electrical work, it will cause electrical shock or fire.	
6. Use the specified cable (1.5 mm ²) and connect tightly for indoor/outdoor connection. Connect tightly and clamp the cable so that no external force will be acted on the terminal. If connection or fixing is not perfect, it will cause heat-up or fire at the connection.	
7. Wire routing must be properly arranged so that control board cover is fixed properly. If control board cover is not fixed perfectly, it will cause heat-up at connection point of terminal, fire or electrical shock.	
8. When carrying out piping connection, take care not to let air substances other than the specified refrigerant go into refrigeration cycle. Otherwise, it will cause lower capacity, abnormal high pressure in the refrigeration cycle, explosion and injury.	
9. Do not damage or use unspecified power supply cord. Otherwise, it will cause fire or electrical shock.	
10. Do not modify the length of the power supply cord or use of the extension cord, and do not share the single outlet with other electrical appliances. Otherwise, it will cause fire or electrical shock.	

**CAUTION**

- | | |
|--|--|
| 1. The equipment must be earthed and installed with earth leakage breaker. It may cause electrical shock if grounding is not perfect. | |
| 2. Do not install the unit at place where leakage of flammable gas may occur. In case gas leaks and accumulates at surrounding of the unit, it may cause fire. | |
| 3. Carry out drainage piping as mentioned in installation instructions. If drainage is not perfect, water may enter the room and damage the furniture. | |

ATTENTION

- | |
|--|
| 1. Selection of the installation location.
Select an installation location which is rigid and strong enough to support or hold the unit, and select a location for easy maintenance. |
| 2. Power supply connection to the room air conditioner.
Connect the power supply cord of the room air conditioner to the mains using one of the following method.
Power supply point shall be the place where there is ease for access for the power disconnection in case of emergency.
In some countries, permanent connection of this room air conditioner to the power supply is prohibited. <ol style="list-style-type: none"> 1. Power supply connection to the receptacle using a power plug.
Use an approved 15A/16A power plug with earth pin for the connection to the socket. 2. Power supply connection to a circuit breaker for the permanent connection. Use an approved 15A circuit breaker for the permanent connection. It must be a double pole switch with a minimum 3 mm contact gap. |
| 3. Do not release refrigerant.
Do not release refrigerant during piping work for installation, reinstallation and during repairing a refrigeration parts. Take care of the liquid refrigerant, it may cause frostbite. |
| 4. Installation work.
It may need two people to carry out the installation work. |
| 5. Do not install this appliance in a laundry room or other location where water may drip from the ceiling, etc. |

Attached accessories

No.	Accessories part	Qty.	No.	Accessories part	Qty.
1	Installation plate	1	5	Super alleru - buster filter	1
2	Installation plate fixing screw	6	6	Remote control holder	1
3	Remote control	1	7	Remote control holder fixing screw	2
4	Battery	2	8	Drain elbow	1

Applicable piping kit
 CZ-3F5, 7BP (CS-TE9DKE)
 CZ-4F5, 7, 10BP (CS-TE12DKE)

SELECT THE BEST LOCATION

INDOOR UNIT

- There should not be any heat source or steam near the unit.
- There should not be any obstacles blocking the air circulation.
- A place where air circulation in the room is good.
- A place where drainage can be easily done.
- A place where noise prevention is taken into consideration.
- Do not install the unit near the door way.
- Ensure the spaces indicated by arrows from the wall, ceiling, fence or other obstacles.
- Recommended installation height for indoor unit shall be at least 2.5 m.

OUTDOOR UNIT

- If an awning is built over the unit to prevent direct sunlight or rain, be careful that heat radiation from the condenser is not obstructed.
- There should not be any animal or plant which could be affected by hot air discharged.
- Keep the spaces indicated by arrows from wall, ceiling, fence or other obstacles.
- Do not place any obstacles which may cause a short circuit of the discharged air.
- If piping length is over the common length, additional refrigerant should be added as shown in the table.

Model	Piping size (Torque)	
	Gas	Liquid
CS-TE9DKE	3/8" [42 N·m]	1/4" [18 N·m]
CS-TE12DKE	1/2" [55 N·m]	1/4" [18 N·m]

Indoor/Outdoor Unit Installation Diagram

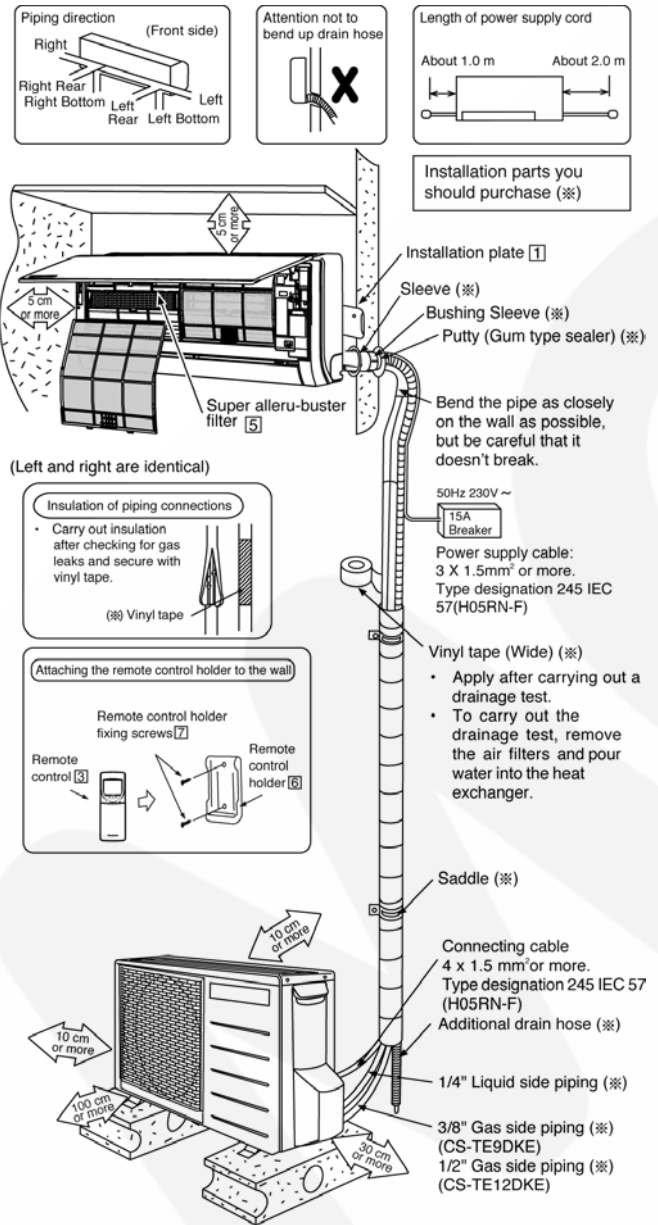

- This illustration is for explanation purposes only. The indoor unit will actually face a different way.

11.2. INDOOR UNIT

11.2.1. SELECT THE BEST LOCATION (Refer to “Select the best location” section)

11.2.2. HOW TO FIX INSTALLATION PLATE

The mounting wall is strong and solid enough to prevent it from the vibration.

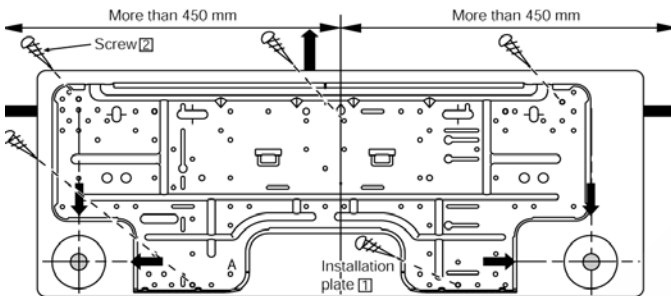

The centre of installation plate should be at more than 450 mm at right of the wall.

The centre of installation plate should be at more than 450 mm at left of the wall.

The distance from installation plate edge to ceiling should more than 66 mm.

From installation plate left edge to unit's left side is 20 mm.

From installation plate right edge to unit's right is 70 mm.

- Ⓐ : For left side piping, piping connection for liquid should be this line.
 : For left side piping, piping connection for gas should be about 50 mm from this line.
 : For left side piping, piping connecting cable should be about 750 mm from this line.

1. Mount the installation plate on the wall with 5 screws or more.

(If mounting the unit on the concrete wall, consider using anchor bolts.)

- Always mount the installation plate horizontally by aligning the marking-off line with the thread and using a level gauge.

2. Drill the piping plate hole with $\varnothing 70$ mm hole-core drill.

- The centre of the right piping hole is at the intersection of lines extending vertically from the edge of the installation plate and horizontally from the sideways arrow on the installation plate. (see figure above.)
- The centre of the left piping hole is at the intersection of lines extending vertically from the downward arrow on the installation plate and horizontally from the sideways arrow on the installation plate. (see figure above.)
- Drill the piping hole at either the right or the left and the hole should be slightly slanted to the outdoor side.

11.2.3. TO DRILL A HOLE IN THE WALL AND INSTALL A SLEEVE OF PIPING

1. Insert the piping sleeve to the hole.
2. Fix the bushing to the sleeve.
3. Cut the sleeve until it extrudes about 15 mm from the wall.

Caution

When the wall is hollow, please be sure to use the sleeve for tube ass'y to prevent dangers caused by mice biting the connecting cable.

4. Finish by sealing the sleeve with putty or caulking compound at the final stage.

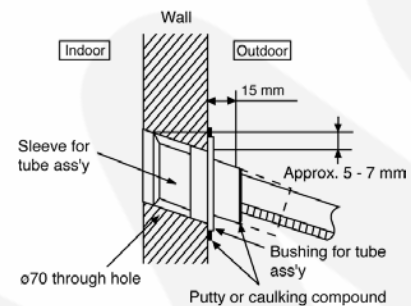

11.2.4. INDOOR UNIT INSTALLATION

1. For the right rear piping

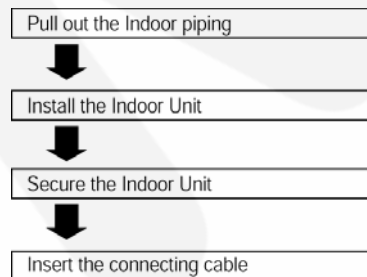

2. For the right and right bottom piping

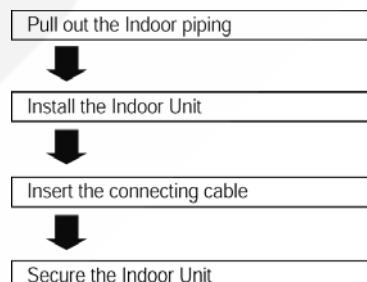

3. For the embedded piping

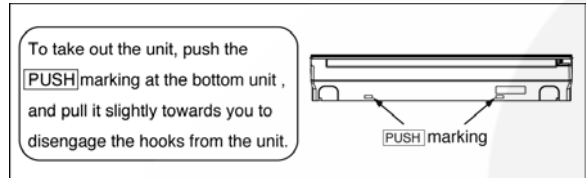
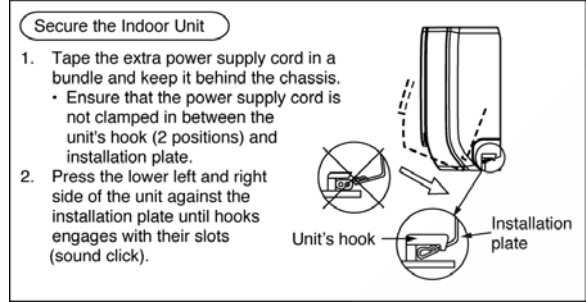
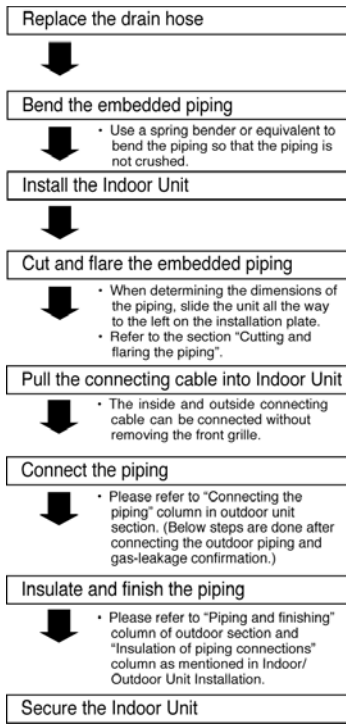

(This can be used for left rear piping & left bottom piping also.)

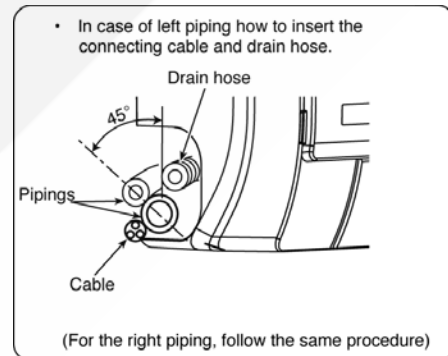
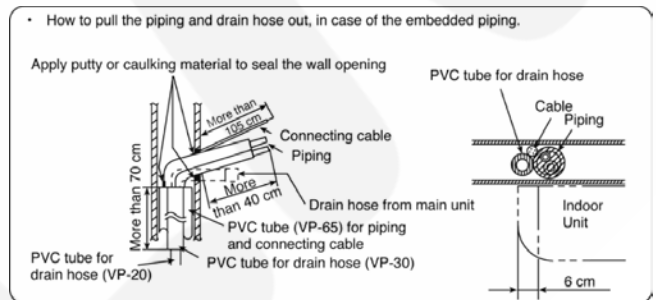
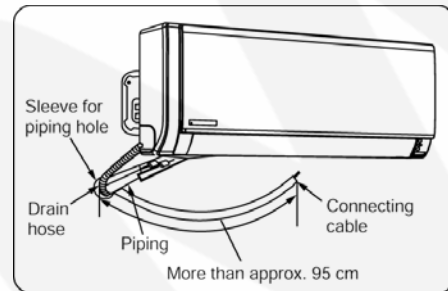
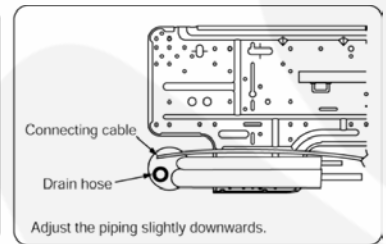
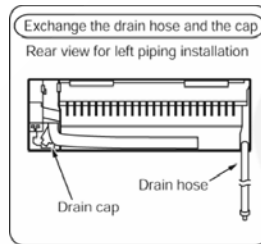
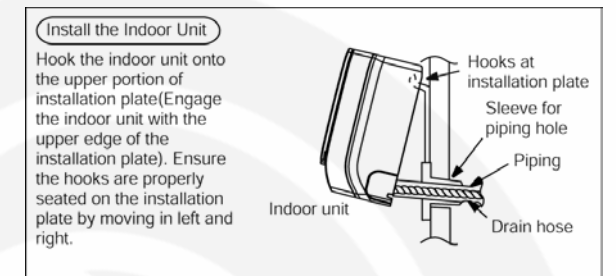
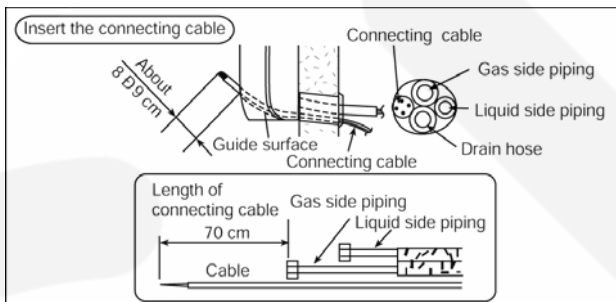
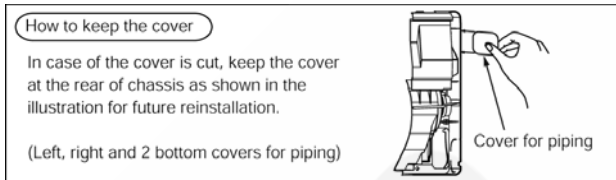
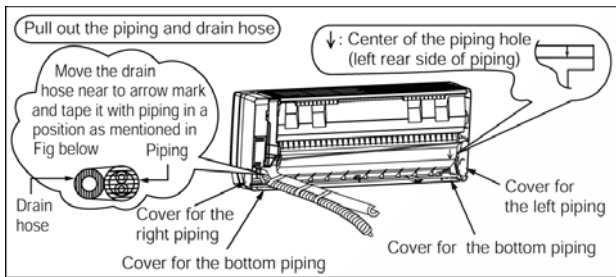

11.2.5. CONNECT THE CABLE TO THE INDOOR UNIT

- The inside and outside connecting cable can be connected without removing the front grille.
- Connecting cable between indoor unit and outdoor unit shall be approved polychloroprene sheathed $4 \times 1.5 \text{ mm}^2$ flexible cord, type designation 245 IEC 57 (H05RN-F) or heavier cord.
 - Ensure the color of wires of outdoor unit and the terminal Nos. are the same to the indoor's respectively.
 - Earth lead wire shall be longer than the other lead wires as shown in the figure for the electrical safety in case of the slipping out of the cord from the anchorage.

Terminals on the indoor unit	1	2	3	
Color of wires				
Terminals on the outdoor unit	1	2	3	

- Secure the cable onto the control board with the holder (clamper).

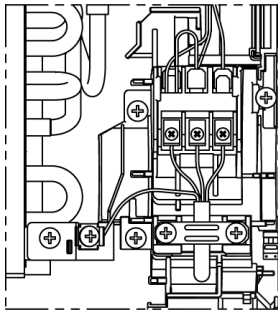

INSTALLATION OF SUPER ALLERU-BUSTER FILTER

- Open the front panel.
- Remove the air filters.
- Put Super Alleru-buster filter into place as shown in illustration below.

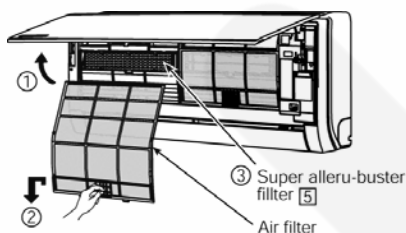

HOW TO TAKE OUT FRONT GRILLE

Please follow the steps below to take out front grille if necessary such as when servicing.

- Set the vertical airflow direction louver to the horizontal position.
- Slide down the two caps on the front grille as shown in the illustration below, and then remove the two mounting screws.
- Pull the lower section of the front grille towards you to remove the front grille.

Caution

When reinstalling the front grille, first set the vertical airflow direction louver to the horizontal position and then carry out above steps 2 - 3 in the reverse order.

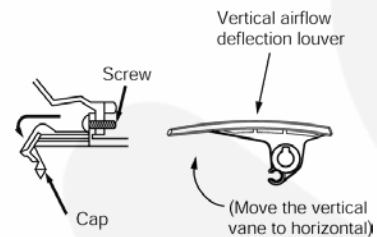

AUTO SWITCH OPERATION

The below operations will be performed by pressing the "AUTO" switch.

1. AUTO OPERATION MODE

The Auto operation will be activated immediately once the Auto Switch is pressed.

2. TEST RUN OPERATION (FOR PUMP DOWN/SERVICING PURPOSE)

The Test Run operation will be activated if the Auto Switch is pressed continuously for more than 5 sec. to below 8 sec. A "pep" sound will occur at the fifth sec., in order to identify the starting of Test Run operation.

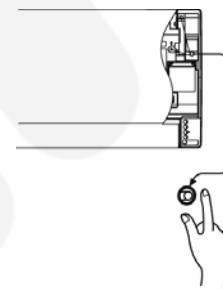

11.3. OUTDOOR UNIT

11.3.1. SELECT THE BEST LOCATION (Refer to “Select the best location” section)

11.3.2. INSTALL THE OUTDOOR UNIT

- After selecting the best location, start installation according to Indoor/Outdoor Unit Installation Diagram.
1. Fix the unit on concrete or rigid frame firmly and horizontally by bolt nut. (ø10 mm).
 2. When installing at roof, please consider strong wind and earthquake. Please fasten the installation stand firmly with bolt or nails.

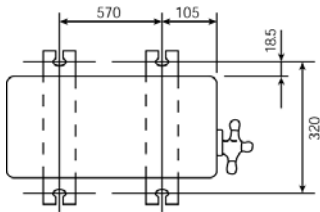

11.3.3. CONNECTING THE PIPING

Connecting The Piping To Indoor Unit

Please make flare after inserting flare nut (locate at joint portion of tube assembly) onto the copper pipe. (In case of using long piping)

Connect the piping

- Align the center of piping and sufficiently tighten the flare nut with fingers.
- Further tighten the flare nut with torque wrench in specified torque as stated in the table.

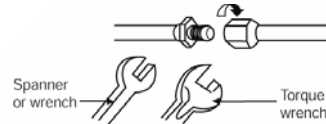

MODEL	Piping size (Torque)	
	Gas	Liquid
TE9CK	3/8" (42 N.m)	1/4" (18 N.m)
TE12CK	1/2" (55 N.m)	1/4" (18 N.m)

Connecting The Piping To Outdoor Unit

Decide piping length and then cut by using pipe cutter. Remove burrs from cut edge. Make flare after inserting the flare nut (located at valve) onto the copper pipe.

Align center of piping to valves and then tighten with torque wrench to the specified torque as stated in the table.

Cutting And Flaring The Piping

1. Please cut using pipe cutter and then remove the burrs.
2. Remove the burrs by using reamer. If burrs is not removed, gas leakage may be caused.
Turn the piping end down to avoid the metal powder entering the pipe.
3. Please make flare after inserting the flare nut onto the copper pipes.

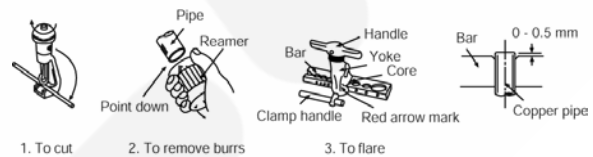

■ Improper flaring ■



When properly flared, the internal surface of the flare will evenly shine and be of even thickness. Since the flare part comes into contact with the connections, carefully check the flare finish.

11.3.4. EVACUATION OF THE EQUIPMENT (FOR EUROPE & OCEANIA DESTINATION)

WHEN INSTALLING AN AIR CONDITIONAL, BE SURE TO EVACUTE THE AIR INSIDE THE INDOOR UNIT AND PIPES in the following procedure.

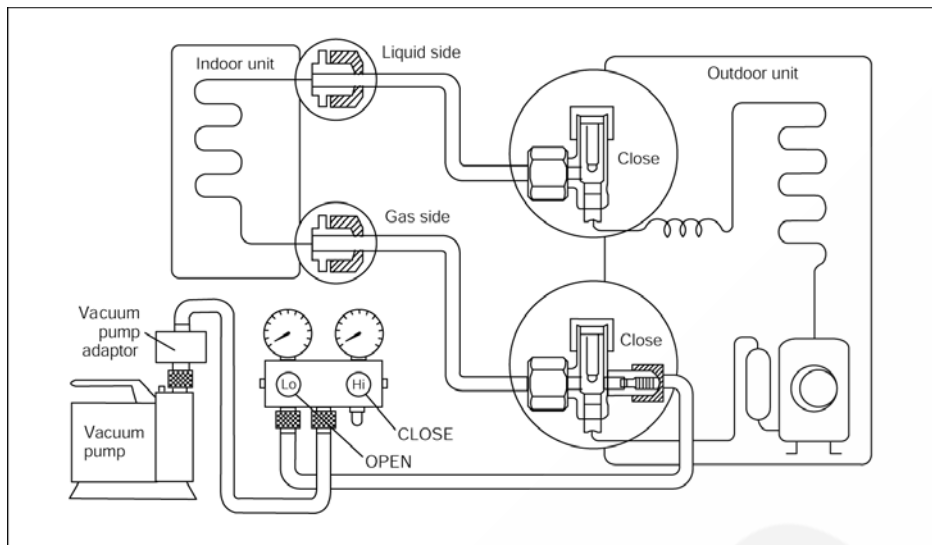

1. Connect a charging hose with a push pin to the Low and High side of a charging set and the service port of the 3-way valve.
 - Be sure to connect the end of the charging hose with the push pin to the service port.
2. Connect the center hose of the charging set to a vacuum pump with check valve, or vacuum pump and vacuum pump adaptor.
3. Turn on the power switch of the vacuum pump and make sure that the needle in the gauge moves from 0 cmHg (0 MPa) to -76cm Hg (-0.1 MPa). Then evacuate the air approximately 15 minutes.
4. Close the Low and High side valve of the charging set the turn off the vacuum pump. Make sure that the needle in the gauge does not move after approximately 5 minutes.

Note: BE SURE TO FOLLOW THIS PROCEDURE INORDER IN ORDER TO AVOID REFRIGERANT GAS LEAKAGE.
5. Disconnect the charging hose from vacuum pump and from the service port of the 3-way valve.
6. Tighten the service port caps of the 3-way valve at a torque of 18 N.m with a torque wrench.
7. Remove the valve caps of both of the 2-way valve and 3-way valve. Position both of the valves to "OPEN" using a hexagonal wrench (4 mm).
8. Mount valve caps onto the 2-way valve and the 3-way valve.
 - Be sure to check for gas leakage.

Caution

- If gauge needle does not move from 0 cmHg (0 MPa) to -76 cmHg (-0.1 MPa), in step 3 above take the following measure:
- If the leak stops when the piping connections are tightened further, continue working from step 3.
- If the leak does not stop when the connections are retightened, repair the location of leak.
- Do not release refrigerant during piping work for installation and reinstallation. Take care of the liquid refrigerant, it may cause frostbite.

11.3.5. CONNECT THE CABLE TO THE OUTDOOR UNIT

1. Remove the control board cover from the unit by loosening the screw.
2. Connecting cable between indoor unit and outdoor unit shall be approved polychloroprene sheathed $4 \times 1.5 \text{ mm}^2$ flexible cord, type designation 245 IEC 57 (H05RN-F) or heavier cord.

Terminals on the indoor unit	1	2	3	
Color of wires	Grey	Black	White	Green/Yellow
Terminals on the outdoor unit	1	2	3	

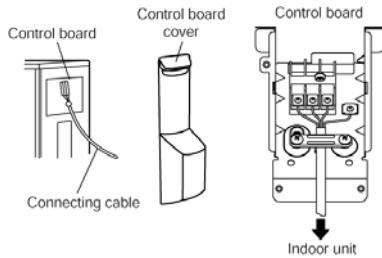

3. Secure the cable onto the control board with the holder (clammer).
4. Attach the control board cover back in its original position with the screw.

11.3.6. PIPE INSULATION

1. Please carry out insulation at pipe connection portion as mentioned in Indoor/Outdoor Unit Installation Diagram. Please wrap the insulated piping end to prevent water from going inside the piping.
2. If drain hose or connecting piping is in the room (where dew may form), please increase the insulation by using POLY-E FOAM with thickness 6 mm or above.

DISPOSAL OF OUTDOOR UNIT DRAIN WATER

- If a drain elbow is used, the unit should be placed on a stand which is taller than 3 cm.
- If the unit is used in an area where temperature falls below 0°C for 2 or 3 days in succession, it is recommended not to use a drain elbow, for the drain water freezes and the fan will not rotate.

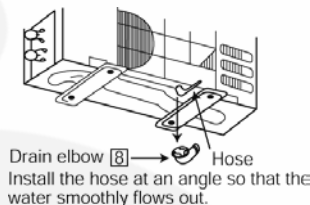

CHECK THE DRAINAGE

- Open front panel and remove air filters. (Drainage checking can be carried out without removing the front grille.)
- Pour a glass of water into the drain tray-styrofoam.
- Ensure that water flows out from drain hose of the indoor unit.

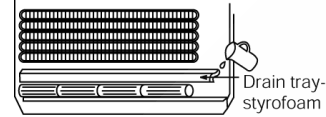

EVALUATION OF THE PERFORMANCE

- Operate the unit at cooling operation mode for fifteen minutes or more.
- Measure the temperature of the intake and discharge air.
- Ensure the difference between the intake temperature and the discharge is more than 8°C .

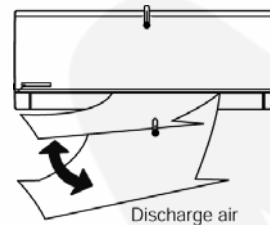

CHECK ITEMS

- Is there any gas leakage at flare nut connection?
- Has the heat insulation been carried out at flare nut connection?
- Is the connecting cable being fixed to terminal board firmly?
- Is the connecting cable being clamped firmly?
- Is the drainage OK?
(Refer to "Check the drainage" section)
- Is the earth wire connection properly done?
- Is the indoor unit properly hooked to the installation plate?
- Is the power supply voltage complied with rated value?
- Is there any abnormal sound?
- Is the cooling operation normal?
- Is the thermostat operation normal?
- Is the remote control's LCD operation normal?
- Is the air purifying filter installed?

12 Installation and Servicing Air Conditioner Using R410A

12.1. OUTLINE

12.1.1. About R410A Refrigerant

1. Converting air conditioners to R410A

Since it was declared in 1974 that chlorofluorocarbons (CFC), hydro chlorofluorocarbons (HCFC) and other substances pose a destructive danger to the ozone layer in the earth's upper stratosphere (20 to 40 km above the earth), measures have been taken around the world to prevent this destruction.

The R22 refrigerant which has conventionally been used in ACs is an HCFC refrigerant and, therefore, possesses this ozone-destroying potential. International regulations (the Montreal Protocol on Ozone-Damaging Substances) and the domestic laws of various countries call for the early substitution of R22 by a refrigerant which will not harm the ozone layer.

- In ACs, the HFC refrigerant which has become the mainstream alternative is called R410A. Compared with R22, the pressure of R410A is approximately 1.6 times as high at the same refrigerant temperature, but the energy efficiency is about the same. Consisting of hydrogen (H), fluorine (F) and carbon (C), R410A is an HFC refrigerant. Another typical HFC refrigerant is R407C. While the energy efficiency of R407C is somewhat inferior to that of R410A, it offers the advantage of having pressure characteristics which are about the same as those of R22, and is used mainly in packaged ACs.

2. The characteristics of HFC (R410A) refrigerants

a. Chemical characteristics

The chemical characteristics of R410A are similar to those of R22 in that both are chemically stable, non-flammable refrigerants with low toxicity.

However, just like R22, the specific gravity of R410A gas is heavier than that of air. Because of this, it can cause an oxygen deficiency if it leaks into a closed room since it collects in the lower area of the room. It also generates toxic gas when it is directly exposed to a flame, so it must be used in a well ventilated environment where it will not collect.

Table 1 Physical comparison of R410A and R22

	R410A	R22
Composition (wt%)	R32/R125 (50/50)	R22 (100)
Boiling point (°C)	-51.4	-40.8
Vaporizing pressure (25°C)	1.56 Mpa (15.9 kgf/cm ²)	0.94 Mpa (9.6 kgf/cm ²)
Saturated vapor density	64.0 kg/m ³	44.4 kg/m ³
Flammability	Non-flammable	Non-flammable
Ozone-destroying point (ODP)	0	0.055
Global-warming point (GWP)	1730	1700

b. Compositional change (pseudo-azeotropic characteristics)

R410A is a pseudo-azeotropic mixture comprising the two components R32 and R125. Multi-component refrigerants with these chemical characteristics exhibit little compositional change even from phase changes due to vaporization (or condensation), which means that there is little change in the circulating refrigerant composition even when the refrigerant leaks from the gaseous section of the piping.

Accordingly, R410A can be handled in almost the same manner as the single-component refrigerant R22. However, when charging, because there is a slight change in composition between the gas phase and the liquid phase inside a cylinder or other container, charging should basically begin with the liquid side.

c. Pressure characteristics

As seen in Table 2, the gas pressure of R410A is approximately 1.6 times as high as that of R22 at the same refrigerant temperature, which means that special R410A tools and materials with high-pressure specifications must be used for all refrigerant piping work and servicing.

Table 2 Comparison of R410A and R22 saturated vapor density

Refrigerant Temperature (°C)	Unit: MPa	
	R410A	R22
-20	0.30	0.14
0	0.70	0.40
20	1.35	0.81
40	2.32	1.43
60	3.73	2.33
65	4.15	2.60

d. R410A refrigerating machine oil

Conventionally, mineral oil or a synthetic oil such as alkylbenzene has been used for R22 refrigerating machine oil. Because of the poor compatibility between R410A and conventional oils like mineral oil, however, there is a tendency for the refrigerating machine oil to collect in the refrigerating cycle. For this reason, polyester and other synthetic oils which have a high compatibility with R410A are used as refrigerating machine oil.

Because of the high hygroscopic property of synthetic oil, more care must be taken in its handling than was necessary with conventional refrigerating machine oils. Also, these synthetic oils will degrade if mixed with mineral oil or alkylbenzene, causing clogging in capillary tubes or compressor malfunction. Do not mix them under any circumstances.

12.1.2. Safety Measures When Installing/Serviceing Refrigerant Piping

Cause the gas pressure of R410A is approximately 1.6 times as high as that of R22, a mistake in installation or servicing could result in a major accident. It is essential that you use R410A tools and materials, and that you observe the following precautions to ensure safety.

1. Do not use any refrigerant other than R410A in ACs that have been used with R410A.
2. If any refrigerant gas leaks while you are working, ventilate the room. Toxic gas may be generated if refrigerant gas is exposed to a direct flame.
3. When installing or transferring an AC, do not allow any air or substance other than R410A to mix into the refrigeration cycle. If it does, the pressure in the refrigeration cycle can become abnormally high, possibly causing an explosion and/or injury.
4. After finishing the installation, check to make sure there is no refrigerant gas leaking.
5. When installing or transferring an AC, follow the instructions in the installation instructions carefully. Incorrect installation can result in an abnormal refrigeration cycle or water leakage, electric shock, fire, etc.
6. Do not perform any alterations on the AC unit under any circumstances. Have all repair work done by a specialist. Incorrect repairs can result in a water leakage, electric shock, fire, etc.

12.2. TOOLS FOR INSTALLING/SERVICING REFRIGERANT PIPING

12.2.1. Necessary Tools

In order to prevent an R410A AC from mistakenly being charged with any other refrigerant, the diameter of the 3-way valve service port on the outdoor unit has been changed. Also, to increase its ability to withstand pressure, the opposing dimensions have been changed for the refrigerant pipe flaring size and flare nut. Accordingly, when installing or servicing refrigerant piping, you must have both the R410A and ordinary tools listed below.

Table 3 Tools for installation, transferring or replacement

Type of work	Ordinary tools	R410A tools
Flaring	Flaring tool (clutch type), pipe cutter, reamer	Copper pipe gauge for clearance Adjustment, flaring tool (clutch type)*1)
Bending, connecting pipes	Torque wrench (nominal diameter 1/4, 3/8, 1/2). Fixed spanner (opposing sides 12 mm, 17 mm, 19 mm). Adjustable wrench, Spring bender	
Air purging	Vacuum pump. Hexagonal wrench (opposing sides 4 mm)	Manifold gauge, charging hose, vacuum pump adaptor
Gas leak inspection	Gas leak inspection fluid or soapy water	Electric gas leak detector for HFC refrigerant*2)

*1) You can use the conventional (R22) flaring tool. If you need to buy a new tool, buy the R410A type.

*2) Use when it is necessary to detect small gas leaks.

For other installation work, you should have the usual tools, such as screwdrivers (+,-), a metal-cutting saw, an electrical drill, a hole core drill (65 or 70 dia.), a tape measure, a level, a thermometer, a clamp meter, an insulation tester, a voltmeter, etc.

Table 4 Tools for serving

Type of work	Ordinary tools	R410A tools
Refrigerant charging		Electronic scale for refrigerant charging. Refrigerant cylinder. Charging orifice and packing for refrigerant cylinder
Brazing (Replacing refrigerating cycle part*1)	Nitrogen blow set (be sure to use nitrogen blowing for all brazing), and brazing machine	

*1) Always replace the dryer of the outdoor unit at the same time. The replacement dryer is wrapped in a vacuum pack. Replace it last among the refrigerating cycle parts. Start brazing as soon as you have opened the vacuum pack, and begin the vacuuming operation within 2 hours.

12.2.2. R410A Tools

1. Copper tube gauge for clearance adjustment
(used when flaring with the conventional flaring tool (clutch type))

- This gauge makes it easy to set the clearance for the copper tube to 1.0-1.5 mm from the clamp bar of the flaring tool.

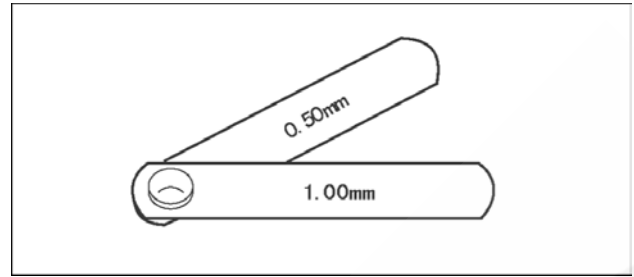

Fig. 1 Copper tube gauge for clearance adjustment

2. Flaring tool (clutch type)

- In the R410A flaring tool, the receiving hole for the clamp bar is enlarged so the clearance from the clamp bar can be set to 0-0.5 mm, and the spring inside the tool is strengthened to increase the strength of the pipe-expanding torque. This flaring tools can also be used with R22 piping, so we recommend that you select it if you are buying a new flaring tool.

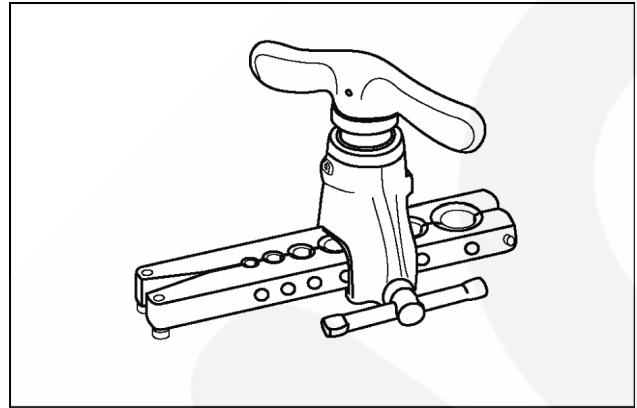

Fig. 2 Flaring tool (clutch type)

3. Torque wrenches

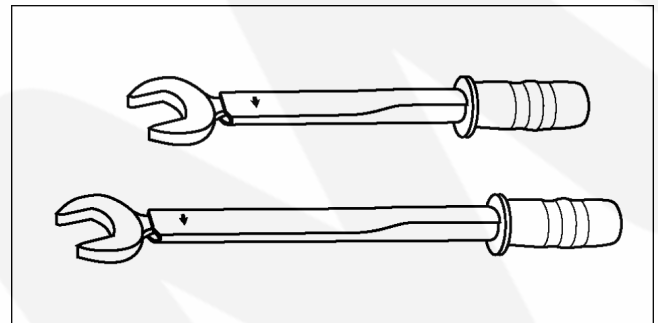

Fig. 3 Torque wrenches

Table 5

	Conventional wrenches	R410A wrenches
For 1/4 (opposite side x torque)	17 mm x 18 N.m (180 kgf.cm)	17 mm x 18 N.m (180 kgf.cm)
For 3/8 (opposite side x torque)	22 mm x 42 N.m (420 kgf.cm)	22 mm x 42 N.m (420 kgf.cm)
For 1/2 (opposite side x torque)	24 mm x 55 N.m (550 kgf.cm)	26 mm x 55 N.m (550 kgf.cm)

4. Manifold gauge

- Because the pressure is higher for the R410A type, the conventional type cannot be used.

Table 6 Difference between R410A and conventional high/low-pressure gauges

	Conventional gauges	R410A gauges
High-pressure gauge (red)	-76 cmHg - 35 kgf/cm ³	-0.1 - 5.3 Mpa -76 cmHg - 53 kgf/cm ³
Low-pressure gauge (blue)	-76 cmHg - 17 kgf/cm ³	-0.1 - 3.8 Mpa -76 cmHg - 38 kgf/cm ³

- The shape of the manifold ports has been changed to prevent the possibility of mistakenly charging with another type of refrigerant.

Table 7 Difference between R410A and conventional manifold port size

	Conventional gauges	R410A gauges
Port size	7/16 UNF 20 threads	1/2 UNF 20 threads

5. Charging hose

- The pressure resistance of the charging hose has been raised to match the higher pressure of R410A. The hose material has also been changed to suit HFC use, and the size of the fitting has been changed to match the manifold ports.

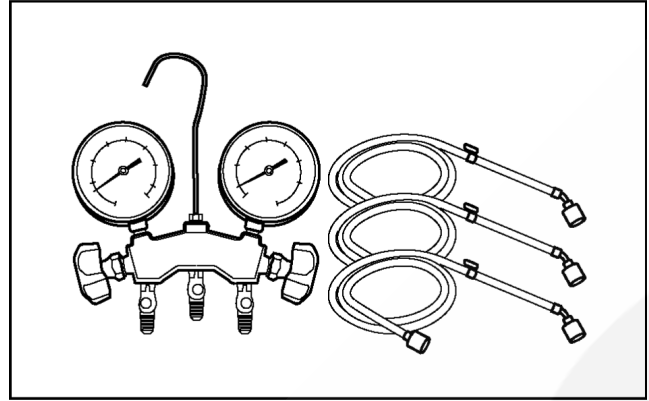

Fig. 4 Manifold gauge charging hose

Table 8 Difference between R410A and conventional charging hoses

		Conventional hoses	R410A hoses
Pressure resistance	Working pressure	3.4 MPa (35 kgf/cm ³)	5.1 MPa (52 kgf/cm ³)
	Bursting pressure	17.2 MPa (175 kgf/cm ³)	27.4 MPa (280 kgf/cm ³)
Material		NBR rubber	HNBR rubber Nylon coating inside

6. Vacuum pump adaptor

- When using a vacuum pump for R410A, it is necessary to install an electromagnetic valve to prevent the vacuum pump oil from flowing back into the charging hose. The vacuum pump adaptor is installed for that purpose. If the vacuum pump oil (mineral oil) becomes mixed with R410A, it will damage the unit.

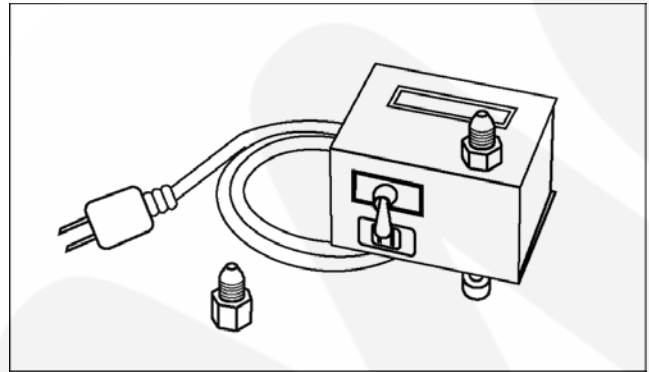

Fig. 5 Vacuum pump adaptor

7. Electric gas leak detector for HFC refrigerant

- The leak detector and halide torch that were used with CFC and HCFC cannot be used with R410A (because there is no chlorine in the refrigerant).
- The present R134a leak detector can be used, but the detection sensitivity will be lower (setting the sensitivity for R134a at 1, the level for R410A will drop to 0.6).
- For detecting small amounts of gas leakage, use the electric gas leak detector for HFC refrigerant. (Detection sensitivity with R410A is about 23 g/year).

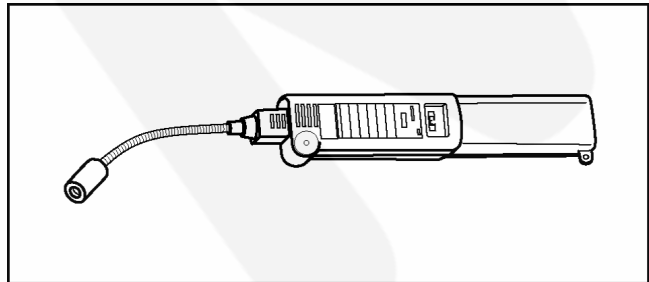

Fig. 6 Electric gas leak detector for HFC refrigerant

8. Electronic scale for refrigerant charging

- Because of the high pressure and fast vaporizing speed of R410A, the refrigerant cannot be held in a liquid phase inside the charging cylinder when charging is done using the charging cylinder method, causing bubbles to form in the measurement scale glass and making it difficult to see the reading. (Naturally, the conventional R22 charging cylinder cannot be used because of the differences in the pressure resistance, scale gradation, connecting port size, etc.)
- The electronic scale has been strengthened by using a structure in which the weight detector for the refrigerant cylinder is held by four supports. It is also equipped with two connection ports, one for R22 (7/16 UNF, 20 threads) and one for R410A (1/2 UNF, 20 threads), so it can also be used for conventional refrigerant charging.
- There are two types of electronic scales, one for 10-kg cylinders and one for 20-kg cylinders. (The 10-kg cylinder is recommended.)

Refrigerant charging is done manually by opening and closing the valve.

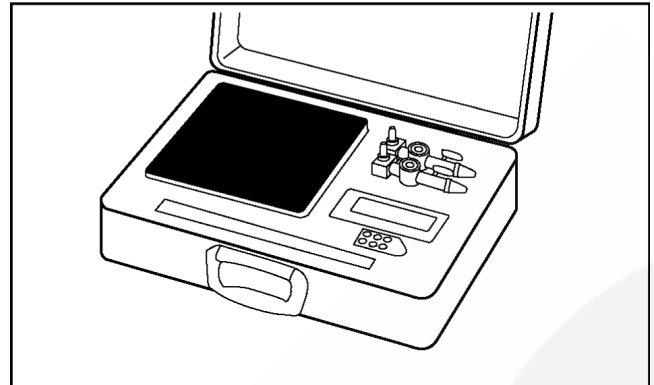

Fig. 7 Electronic scale for refrigerant charging

9. Refrigerant cylinders

- The R410A cylinders are labeled with the refrigerant name, and the coating color of the cylinder protector is pink, which is the color stipulated by ARI of the U.S.
- Cylinders equipped with a siphon tube are available to allow the cylinder to stand upright for liquid refrigerant charging.



Fig. 8 Refrigerant cylinders

10. Charging orifice and packing for refrigerant cylinders

- The charging orifice must match the size of the charging hose fitting (1/2 UNF, 20 threads).
- The packing must also be made of an HFC-resistant material.

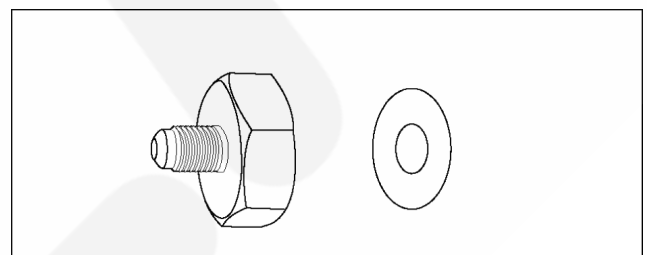

Fig. 9 Charging orifice and packing

12.2.3. R410A Tools Which Are Usable for R22 Models

Table 9 R410A tools which are usable for R22 models

	R410A tools	Usable for R22 models
(1)	Copper tube gauge for clearance adjustment	OK
(2)	Flaring tool (clutch type)	OK
(3)	Manifold gauge	NG
(4)	Charging hose	NG
(5)	Vacuum pump adaptor	OK
(6)	Electric gas leak detector for HFC refrigerant	NG
(7)	Electronic scale for refrigerant charging	OK
(8)	Refrigerant cylinder	NG
(9)	Charging orifice and packing for refrigerant cylinder	NG

12.3. REFRIGERANT PIPING WORK

12.3.1. Piping Materials

It is recommended that you use copper and copper alloy jointless pipes with a maximum oil adherence of 40 mg/10m. Do not use pipes that are crushed, deformed, or discolored (especially the inside surface). If these inferior pipes are used, impurities may clog the expansion valves or capillaries.

Because the pressure of ACs using R410A is higher than those using R22, it is essential that you select materials that are appropriate for these standards.

The thickness of the copper tubing used for R410A is shown in Table 10. Please be aware that tubing with a thickness of only 0.7 mm is also available on the market, but this should never be used.

Table 10 Copper tube thickness (mm)

Soft pipe		Thickness (mm)	
Nominal diameter	Outside diameter (mm)	R410A	(Reference) R22
1/4	6.35	0.80	0.80
3/8	9.52	0.80	0.80
1/2	12.7	0.80	0.80

12.3.2. Processing and Connecting Piping Materials

When working with refrigerant piping, the following points must be carefully observed: no moisture or dust must be allowed to enter the piping, and there must be no refrigerant leaks.

1. Procedure and precautions for flaring work

a. Cut the pipe

Use a pipe cutter, and cut slowly so the pipe will not be deformed.

b. Remove burrs and clean shavings from the cut surface

If the shape of the pipe end is poor after removing burrs, or if shavings adhere to the flared area, it may lead to refrigerant leaks.

To prevent this, turn the cut surface downward and remove burrs, then clean the surface, carefully.

c. Insert the flare nut (be sure to use the same nut that is used on the AC unit)

d. Flaring

Check the clamp bar and the cleanliness of the copper pipe.

Be sure to use the clamp bar to do the flaring with accuracy. Use either an R410A flaring tool, or a conventional flaring tool. Flaring tools come in different sizes, so be sure to check the size before using. When using a conventional flaring tool, use the copper pipe gauge for clearance adjustment, etc., to ensure the correct A dimension (see Fig. 10)

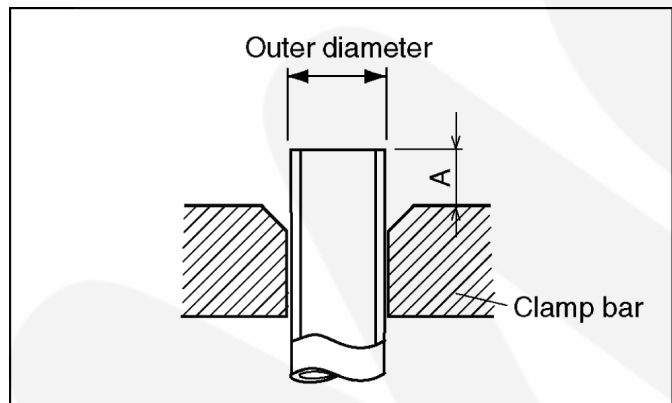

Fig. 10 Flaring dimensions

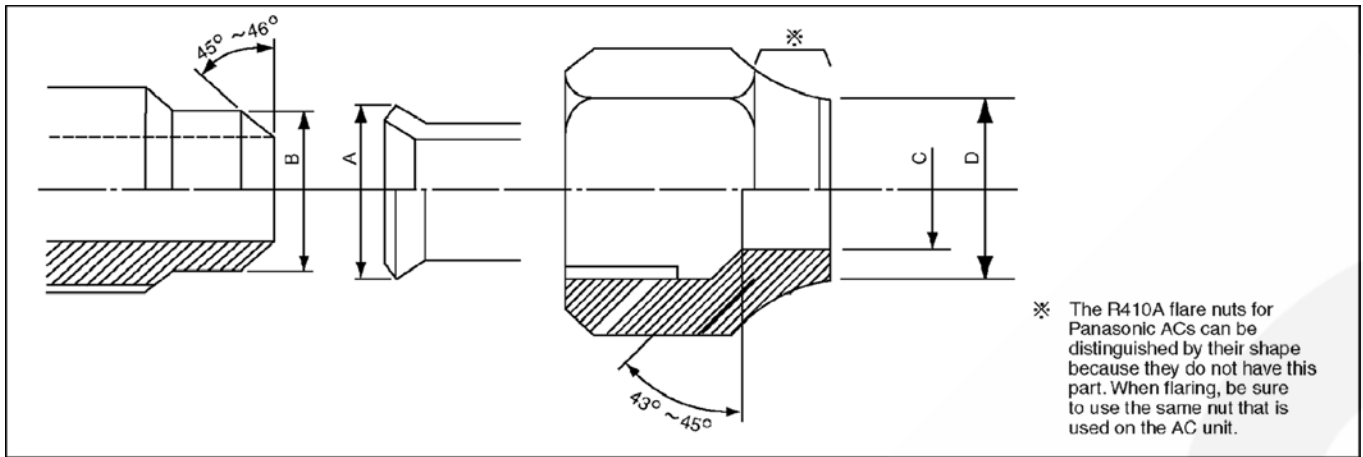

Fig. 11 Relation between the flare nut structure and flaring tool end

Table 11 R410A flaring dimensions

Nominal diameter	Outside diameter (mm)	Wall thickness (mm)	A (mm)		
			R410A flaring tool, clutch type	Conventional flaring tool	
				Clutch type	Wing-nut type
1/4	6.35	0.8	0 - 0.5	1.0 - 1.5	1.5 - 2.0
3/8	9.52	0.8	0 - 0.5	1.0 - 1.5	1.5 - 2.0
1/2	12.70	0.8	0 - 0.5	1.0 - 1.5	2.0 - 2.5

Table 12 R22 flaring dimensions

Nominal diameter	Outside diameter (mm)	Wall thickness (mm)	A (mm)		
			R410A flaring tool, clutch type	Conventional flaring tool	
				Clutch type	Wing-nut type
1/4	6.35	0.8	0 - 0.5	0.5 - 1.0	1.0 - 1.5
3/8	9.52	0.8	0 - 0.5	0.5 - 1.0	1.0 - 1.5
1/2	12.70	0.8	0 - 0.5	0.5 - 1.0	1.5 - 2.0

Table 13 R410A flare and flare nut dimensions Unit: mm

Nominal diameter	Outside diameter (mm)	Wall thickness (mm)	A +0, -0.4	B dimension	C dimension	D dimension	Flare nut width
1/4	6.35	0.8	9.1	9.2	6.5	13	17
3/8	9.52	0.8	13.2	13.5	9.7	20	22
1/2	12.70	0.8	16.6	16.0	12.9	23	26

Table 14 R22 flare and flare nut dimensions Unit: mm

Nominal diameter	Outside diameter (mm)	Wall thickness (mm)	A +0, -0.4	B dimension	C dimension	D dimension	Flare nut width
1/4	6.35	0.8	9.0	9.2	6.5	13	17
3/8	9.52	0.8	13.0	13.5	9.7	20	22
1/2	12.70	0.8	16.2	16.0	12.9	20	24

2. Procedure and precautions for flare connection

- Check to make sure there is no scratches, dust, etc., on the flare and union.
- Align the flared surface with the axial center of the union.
- Use a torque wrench, and tighten to the specified torque. The tightening torque for R410A is the same as the conventional torque value for R22. Be careful, because if the torque is too weak, it may lead to a gas leak. If it is too strong, it may split the flare nut or make it impossible to remove the flare nut.

Table 15 R410A tightening torque

Nominal diameter	Outside diameter (mm)	Tightening torque N.m (kgf.cm)	Torque wrench tightening torque N.m (kgf.cm)
1/4	6.35	14 - 18 (140 - 180)	18 (180)
3/8	9.52	33 - 42 (330 - 420)	42 (420)
1/2	12.70	55 (550)	55 (550)

12.3.3. Storing and Managing Piping Materials

1. Types of piping and their storage

The following is a general classification of the refrigerant pipe materials used for ACs.

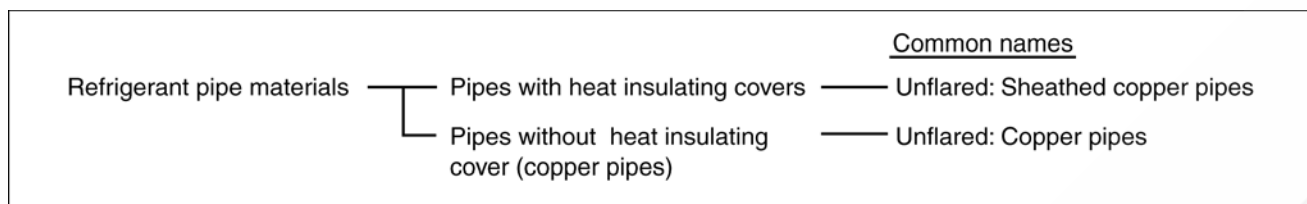

Because the gas pressure of R410A is approximately 1.6 times as high as that of R22, copper pipes with the thickness shown in Table 10, and with minimal impurities must be used. Care must also be taken during storage to ensure that pipes are not crushed, deformed, or scratched, and that no dust, moisture or other substance enters the pipe interior. When storing sheathed copper pipes or plain copper pipes, seal the openings by pinching or taping them securely.

2. Makings and management

a. Sheathed copper pipes and copper-element pipes

When using these pipes, check to make sure that they are the stipulated thickness. For flare nuts, be sure to use the same nut that is used on the AC unit.

b. Copper pipes

Use only copper pipes with the thickness given in table 10, and with minimal impurities. Because the surface of the pipe is exposed, you should take special care, and also take measures such as marking the pipes to make sure they are easily distinguished from other piping materials, to prevent mistaken use.

3. Precautions during refrigerant piping work

Take the following precautions on-site when connecting pipes. (Keep in mind that the need to control the entry of moisture and dust is even more important than in conventional piping).

a. Keep the open ends of all pipes sealed until connection with AC equipment is complete.

b. Take special care when doing piping work on rainy days. The entering of moisture will degrade the refrigerating machine oil, and lead to malfunctions in the equipment.

c. Complete all pipe connections in as short a time as possible. If the pipe must be left standing for a long time after removing the seal, it must be thoroughly purged with nitrogen, or dried with a vacuum pump.

12.4. INSTALLATION, TRANSFERRING, SERVICING

12.4.1. Inspecting Gas Leaks with a Vacuum Pump for New Installations (Using New Refrigerant Piping)

1. From the viewpoint of protecting the global environment, please do not release refrigerant into the atmosphere.
 - a. Connect the projecting side (pin-pushing side) of the charging hose for the manifold gauge to the service port of the 3-way valve. (1)
 - b. Fully open the handle Lo of the manifold gauge and run the vacuum pump. (2) (If the needle of the low-pressure gauge instantly reaches vacuum, re-check step a.)
 - c. Continue the vacuum process for at least 15 minutes, then check to make sure the low-pressure gauge has reached -0.1 MPa (-76 cmHg). Once the vacuum process has finished, fully close the handle Lo of the manifold gauge and stop the vacuum pump operation, then remove the charging hose that is connected to the vacuum pump adaptor. (Leave the unit in that condition for 1-2 minutes, and make sure that the needle of the manifold gauge does not return.) (2) and (3)
 - d. Turn the valve stem of the 2-way valve 90° counter-clockwise to open it, then, after 10 seconds, close it and inspect for a gas leak (4)
 - e. Remove the charging hose from the 3-way valve service port, then open both the 2-way valve and 3-way valve. (1) (4) (Turn the valve stem in the counter-clockwise direction until it gently makes contact. Do not turn it forcefully).
 - f. Tighten the service port cap with a torque wrench (18 N.m (1.8 kgf.m)). (5) Then tighten the 2-way valve and 3-way valve caps with a torque wrench (42 N.m (4.2 kgf.m)) or (55 N.m (5.5 kgf.m)). (6)
 - g. After attaching each of the caps, inspect for a gas leak around the cap area. (5) (6)

Precautions

- Be sure to read the instructions for the vacuum pump, vacuum pump adaptor and manifold gauge prior to use, and follow the instructions carefully.
- Make sure that the vacuum pump is filled with oil up to the designated line on the oil gauge.
- The gas pressure back flow prevention valve on the charging hose is generally open during use. When you are removing the charging hose from the service port, it will come off more easily if you close this valve.

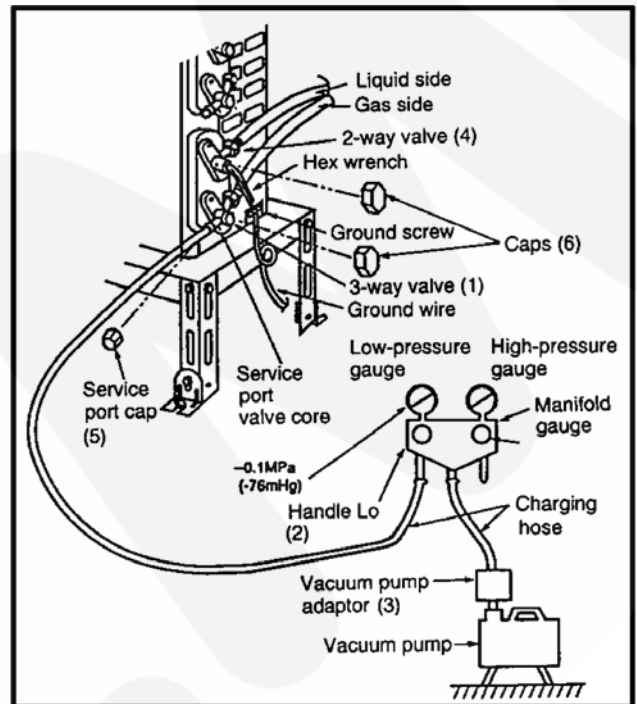

Fig. 12 Vacuum pump air purging configuration

12.4.2. Transferring (Using New Refrigerant Piping)

1. Removing the unit

a. Collecting the refrigerant into the outdoor unit by pumping down

The refrigerant can be collected into the outdoor unit (pumping down) by pressing the TEST RUN button, even when the temperature of the room is low.

- Check to make sure that the valve stems of the 2-way valve and 3-way valve have been opened by turning them counter-clockwise. (Remove the valve stem caps and check to see that the valve stems are fully opened position. Always use a hex wrench (with 4-mm opposing sides) to operate the valve stems.)
- Press the TEST RUN button on the indoor unit, and allow preliminary operation for 5-6 minutes. (TEST RUN mode)
- After stopping the operation, let the unit sit for about 3 minutes, then close the 2-way valve by turning the valve stem in the clockwise direction.
- Press the TEST RUN button on the indoor unit again, and after 2-3 minutes of operation, turn the valve stem of the 3-way valve quickly in the clockwise direction to close it, then stop the operation.
- Tighten the caps of the 2-way valve and 3-way valve to the stipulated torque.
- Remove the connection pipes (liquid side and gas side).

b. Removing the indoor and outdoor units

- Disconnect the pipes and connecting electric cables from between the indoor and outdoor units.
- Put capped flare nuts onto all of the pipe connections of the indoor and outdoor units, to make sure no dust or other foreign matter enters.
- Remove the indoor and outdoor units.

2. Installing the unit

Install the unit using new refrigerant piping. Follow the instructions in section 4.1 to evacuate the pipes connecting the indoor and outdoor units, and the pipes of the indoor unit, and check for gas leaks.

12.4.3. AC Units Replacement (Using Existing Refrigerant Piping)

When replacing an R410A AC unit with another R410A AC unit, you should re-flare the refrigerant piping. Even though the replacement AC unit uses the R410A, problems occur when, for example, either the AC unit maker or the refrigerating machine oil is different.

When replacing an R22 AC unit with an R410A AC unit, the following checks and cleaning procedures are necessary but are difficult to do because of the chemical characteristics of the refrigerating machine oil (as described in items c) and d) of section **About R410A Refrigerant**). In this case, you should use new refrigerant piping rather than the existing piping.

1. Piping check

Because of the different pressure characteristics of R22 and R410A, the design pressure for the equipment is 1.6 times different. The wall thickness of the piping must comply with that shown in Table 10, but this is not easy to check. Also, even if the thickness is correct, there may be flattened or bent portions midway through the piping due to sharp curves. Buried sections of the piping also cannot be checked.

2. Pipe cleaning

A large quantity of refrigerating machine oil (mineral oil) adheres to existing pipes due to the refrigeration cycle circulation. If the pipes are used just as they are for the R410A cycle, the capacity will be lowered due to the incompatibility of this oil with the R410A, or irregularities may occur in the refrigeration cycle. For this reason, the piping must be thoroughly cleaned, but this is difficult with the present technology.

12.4.4. Refrigerant Compatibility (Using R410A Refrigerant in R22 ACs and Vice Versa)

Do not operate an existing R22 AC with the new R410A refrigerant. Doing so would result in improper functioning of the equipment or malfunction, and might lead to a major accident such as an explosion in the refrigeration cycle. Similarly, do not operate an R410A AC with R22 refrigerant. The chemical reaction between the refrigerating machine oil used in R410A ACs and the chlorine that is contained in R22 would cause the refrigerating machine oil to degrade and lead to malfunction.

12.4.5. Recharging Refrigerant During Servicing

When recharging is necessary, insert the specified amount of new refrigerant in accordance with the following procedure.

1. Connect the charging hose to the service port of the outdoor unit.
2. Connect the charging hose to the vacuum pump adaptor. At this time, fully open the 2-way valve and 3-way valve.
3. Fully open the handle Lo of the manifold gauge, turn on the power of the vacuum pump and continue the vacuum process for at least one hour.
4. Confirm that the low pressure gauge shows a reading of -0.1 Mpa (-76 cmHg), then fully close the handle Lo, and turn off the

vacuum pump. Wait for 1-2 minutes, then check to make sure that the needle of the Low pressure gauge has not returned. See Fig. 13 for the remaining steps of this procedure.

- Set the refrigerant cylinder onto the electronic scale, then connect the hose the cylinder and to the connection port for the electronic scale. (1)(2)

Precaution:

Be sure to set up the cylinder for liquid charging. If you use a cylinder equipped with a siphon tube, you can charge the liquid without having to turn the cylinder around

- Remove the charging hose of the manifold gauge from the vacuum pump adaptor, and connect it to the connection port of the electronic scale. (2)(3)
- Open the valve of the refrigerant cylinder, then open the charging valve slightly and close it. Next, press the check valve of the manifold gauge and purge the air. (2)(4) (Watch the liquid refrigerant closely at this point.)
- After adjusting the electronic scale to zero, open the charging valve, then open the valve Lo of the manifold gauge and charge with the liquid refrigerant. (2)(5) (Be sure to read the operating instructions for the electronic scale.)
- If you cannot charge the stipulated amount, operate the unit in the cooling mode while charging a little of the liquid at a time (about 150 g/time as a guideline). If the charging amount is insufficient from one operation, wait about one minute, then use the same procedure to do the liquid charging again.

Precaution:

Never use the gas side to allow a larger amount of liquid refrigerant to be charged while operating the unit.

- Close the charging valve, and after charging the liquid refrigerant inside the charging hose, fully close the valve Lo of the manifold gauge, and stop the operation of the unit. (2)(5)
- Quickly remove the charging hose from the service port. (6) If you stop midway through, the refrigerant that is in the cycle will be discharged.
- After putting on the caps for the service port and operating valve, inspect around the caps for a gas leak. (6)(7)

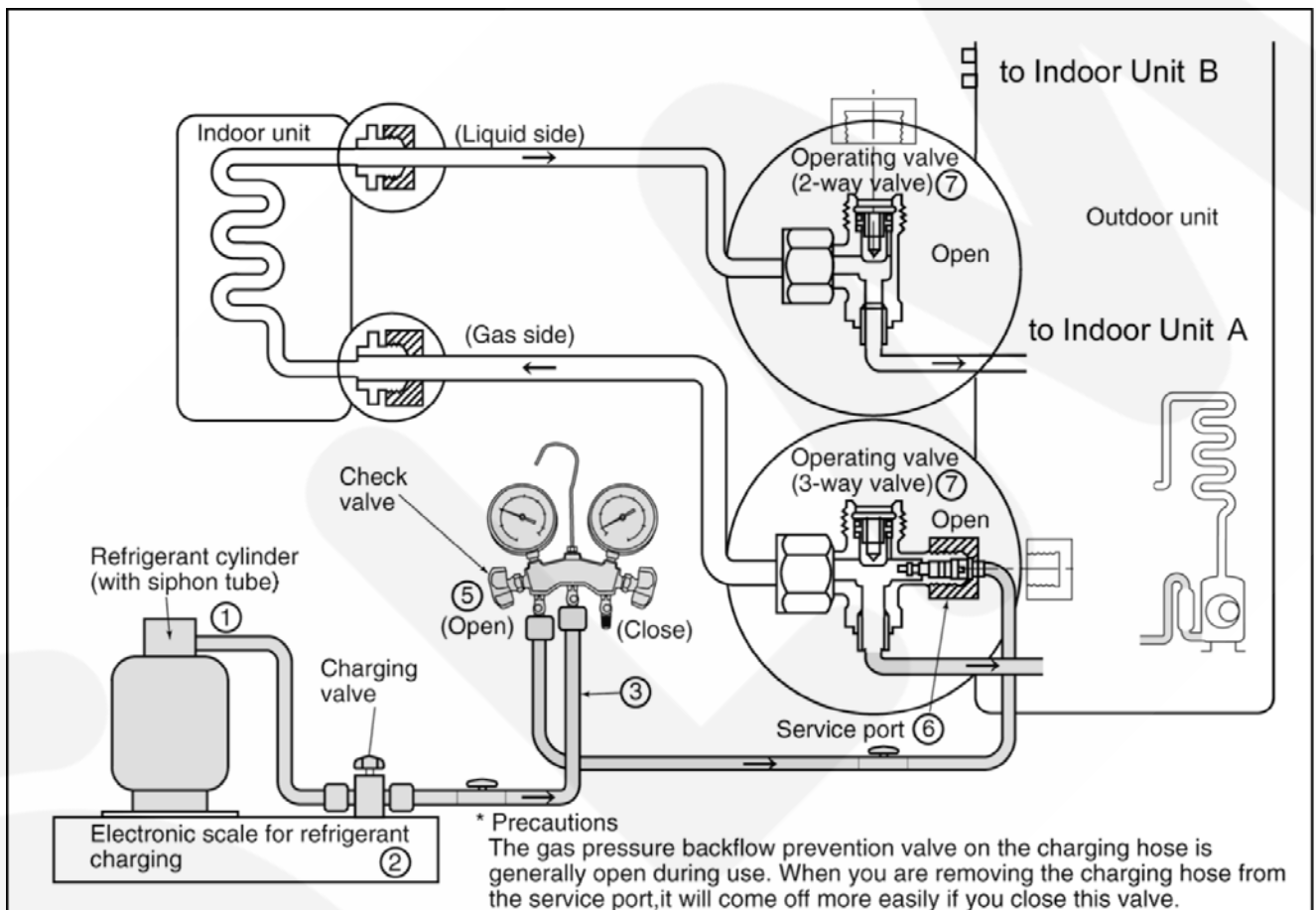

Fig. 13 Re-charging refrigerant

12.4.6. Brazing

As brazing requires sophisticated techniques and experiences, it must be performed by a qualified person.

In order to prevent the oxide film from occurring in the pipe interior during brazing, it is effective to proceed with brazing while letting dry nitrogen gas (N₂) flow.

<Brazing Method for Preventing Oxidation>

1. Attach a reducing valve to the nitrogen gas cylinder.
2. Apply a seal onto the clearance between the piping and inserted pipe for the nitrogen gas in order to prevent the nitrogen gas from flowing backward.
3. When the nitrogen gas is flowing, be sure to keep the piping end open.
4. Adjust the flow rate of nitrogen gas so that it is lower than 0.05 m³/h, or 0.02 MPa (0.2 kgf/cm²) by means of the reducing valve.
5. After taking the steps above, keep the nitrogen gas flowing until the piping cools down to a certain extent (i.e. temperature at which pipes are touchable with finger).
6. Completely remove the flux after brazing.

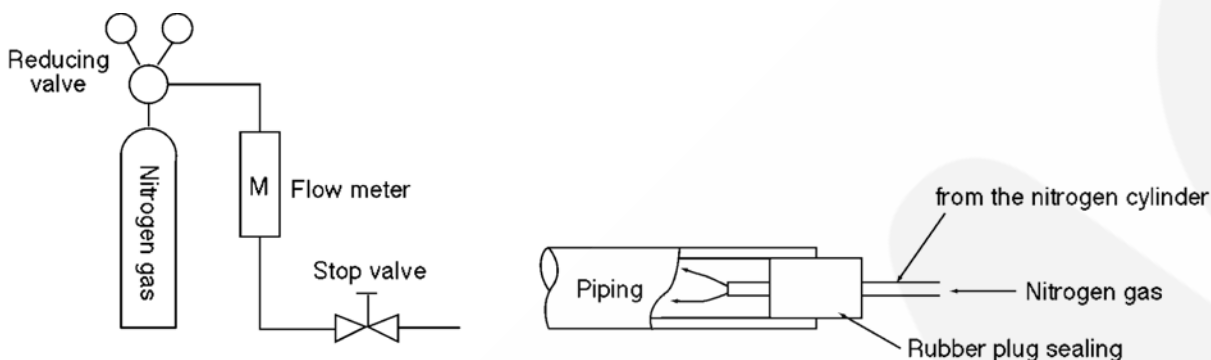

Fig. 14 Prevention of Oxidation during Brazing

Cautions during brazing

1. General Cautions

- a. The brazing strength should be high as required.
- b. After operation, airtightness should be kept under pressurized condition.
- c. During brazing do not allow component materials to become damaged due to overheating.
- d. The refrigerant pipe work should not become blocked with scale or flux.
- e. The brazed part should not restrict the flow in the refrigerant circuit.
- f. No corrosion should occur from the brazed part.

2. Prevention of Overheating

Due to heating, the interior and exterior surfaces of treated metal may oxidize. Especially, when the interior of the refrigerant circuit oxidizes due to overheating, scale occurs and stays in the circuit as dust, thus exerting a fatally adverse effect. So, make brazing at adequate brazing temperature and with minimum of heating area.

3. Overheating Protection

In order to prevent components near the brazed part from overheating damage or quality deterioration due to flame or heat, take adequate steps for protection such as (1) by shielding with a metal plate, (2) by using a wet cloth, and (3) by means of heat absorbent.

4. Movement during Brazing

Eliminate all vibration during brazing to protect brazed joints from cracking and breakage.

5. Oxidation Preventative

In order to improve the brazing efficiency, various types of antioxidant are available on the market. However, the constituents of these are widely varied, and some are anticipated to corrode the piping materials, or adversely affect HFC refrigerant, lubricating oil, etc. Exercise care when using an oxidation preventative.

12.4.7. Servicing Tips

The drier must also be replaced whenever replacing the refrigerant cycle parts. Replacing the refrigerant cycle parts first before replacing the drier. The drier is supplied in a vacuum pack. Perform brazing immediately after opening the vacuum pack, and then start the vacuum within two hours. In addition, the drier also needs to be replaced when the refrigerant has leaked completely. (Applicable for drier model only.)

13 Servicing Information

13.1. About Lead Solder (PbF)

DISTINCTION OF PbF P.C. BOARD

P.C. Boards (manufactured) using lead free solder will have a PbF stamp on the P.C. Board.

CAUTION

- Pb free solder has a higher melting point than standard solder; Typically the melting point is 50 - 70 °F (30 - 40 °C) higher. Please use a high temperature solder iron and set it to 700 ± 20 °F (370 ± 10 °C)
- Pb free solder will tend to splash when heated too high (about 1100 °F/ 600°C). If you must use Pb solder, please completely all of the Pb free solder on the pins or solder area before applying Pb solder. If this is not practical, be sure to heat the Pb free solder until it melts, before applying Pb solder.

13.2. TROUBLESHOOTING

Refrigeration cycle system

In order to diagnose malfunctions, make sure that there are no electrical problems before inspecting the refrigeration cycle. Such problems include insufficient insulation, problem with the power source, malfunction of a compressor and a fan.

The normal outlet air temperature and pressure of the refrigeration cycle depends on various conditions, the standard values for them are shown in the table to the right.

Normal Pressure and Outlet Air Temperature (Standard)

	Gas pressure MPa (kg/cm ² G)	Outlet air temperature (°C)
Cooling Mode	0.9 ~ 1.2 (9 ~ 12)	12 ~ 16
Heating Mode	2.3 ~ 2.9 (23 ~ 29)	36 ~ 45

- ★ Condition:
- Indoor fan speed; High
 - Outdoor temperature 35°C at cooling mode and 7°C at heating mode.
 - Compressor operates at rated frequency

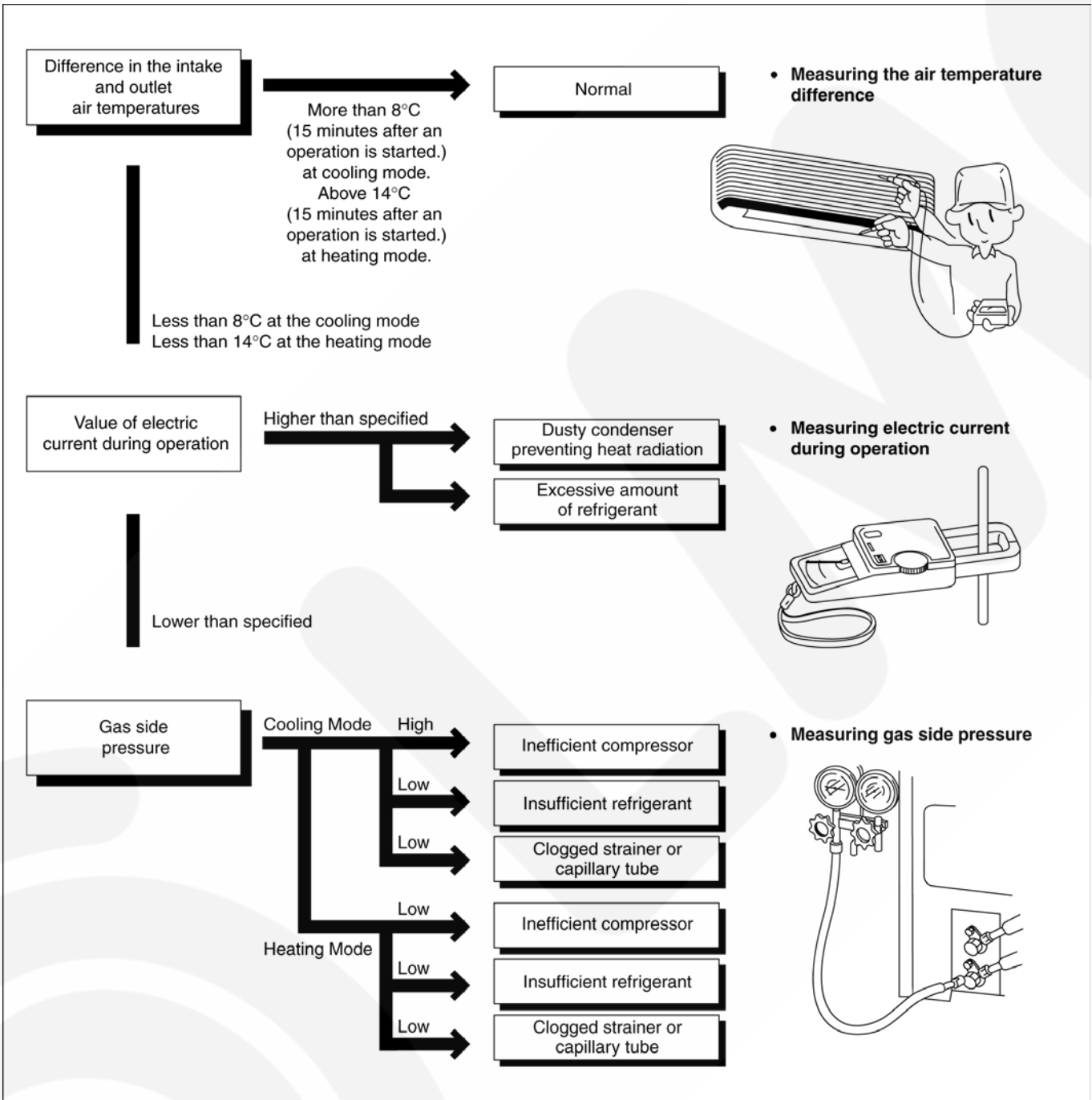

1. Relationship between the condition of the air conditioner and pressure and electric current

Condition of the air conditioner	Cooling Mode			Heating Mode		
	Low Pressure	High Pressure	Electric current during operation	Low Pressure	High Pressure	Electric current during operation
Insufficient refrigerant (gas leakage)	➔	➔	➔	➔	➔	➔
Clogged capillary tube or Strainer	➔	➔	➔	➔	➔	➔
Short circuit in the indoor unit	➔	➔	➔	➔	➔	➔
Heat radiation deficiency of the outdoor unit	➔	➔	➔	➔	➔	➔
Inefficient compression	➔	➔	➔	➔	➔	➔

- Carry on the measurements of pressure, electric current, and temperature fifteen minutes after an operation is started.

13.3. BREAKDOWN SELF DIAGNOSIS FUNCTION

13.3.1. Self Diagnosis Function (Three Digits Alphanumeric Code)

- Once abnormality has been detected during operation, the unit will immediately stop its operation. (Timer LED blinks.)
- Although timer LED goes off when power supply is turned off, if the unit is operated under a breakdown condition, the LED will light up again.
- In operation after breakdown repair, error code is not displayed. The last error code (abnormality) will be saved in IC memory.

- **Timer LED Blinking in Abnormal Operation:**

1. Automatically stops the operation.
2. Timer LED on display of the indoor unit blinks.
3. The LED will be off if the unit is turned off or the Error RESET button on the remote controller is pressed.

- **To display memorized error (Protective operation) status:**

1. Turn the unit on.
2. Slide the remote controller cover down to appear the operating buttons.
3. Press the CHECK button on the remote controller for continuously 5 seconds or more to appear "--" on the display.
4. Press the "TEMP" ▲ or ▼ button on the remote controller to appear "H00" on the display. Signal is transmitted to the main unit.
5. Press the "TEMP" ▲ button (When ▼ button is pressed, the display goes back.) repeatedly and slowly until Beep sound (about 5 seconds intermittently) is heard from main unit.
6. Then, displayed error code matches to the error code saved in unit memory. The power LED on the main unit also lights up.

Note: When the CHECK button is pressed continuously for 5 seconds again, or when no operation continues for 30 seconds, or when the RESET button on remote controller is pressed with a pointed object, the display is cancelled.

- **To clear memorized error (Protective operation) status after repair:**

1. Press the AUTO button in main unit continuously for 5 seconds or more and release it. (Test run / Pump down operation: Beep sound)
2. Press the CHECK button on remote controller for about 1 second to transmit signal to main unit. A beep sound is heard from main unit and the data is cleared.

- **Temporary Operation (Depending on breakdown status)**

1. Press the ON/OFF button after selecting Cooling or Heating operation. (Receiving Beep sound is heard and the TIMER LED blinks.)
2. The unit can temporarily be used until repaired.

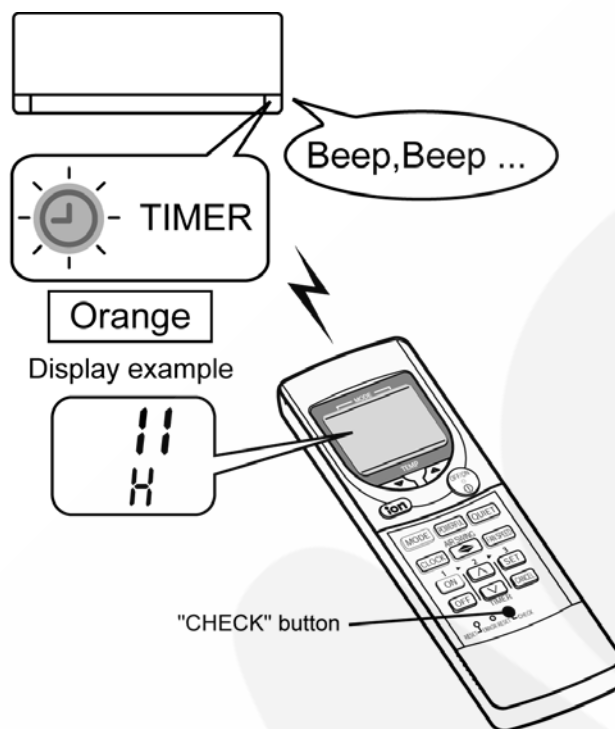

Error Code	Operation	Temporary items
H23	Cooling	Emergency Operation with limited power
H27, H28	Cooling, Heating	

13.3.2. Error Code Table

Diagnosis display	Abnormality / Protection control	Abnormality Judgement	Emergency operation	Primary location to verify
H11	Indoor / outdoor abnormal communication	> 1 min after starting operation	Indoor fan operation only	<ul style="list-style-type: none"> Internal / external cable connections Indoor / Outdoor PCB
H14	Indoor intake air temperature sensor abnormality	—	—	<ul style="list-style-type: none"> Intake air temperature sensor (defective or disconnected)
H15	Outdoor compressor temperature sensor abnormality	Continue for 5 sec.	—	<ul style="list-style-type: none"> Compressor temperature sensor (defective or disconnected)
H16	Outdoor Current Transformer open circuit	—	—	<ul style="list-style-type: none"> Outdoor PCB IPM (Power transistor) module
H19	Indoor fan motor mechanism lock	—	—	<ul style="list-style-type: none"> Indoor PCB Fan motor
H23	Indoor heat exchanger temperature sensor abnormality	Continue for 5 sec.	O (Cooling only)	<ul style="list-style-type: none"> Heat exchanger temperature sensor (defective or disconnected)
H26	Ionizer abnormality	—	—	<ul style="list-style-type: none"> Indoor PCB Ionizer
H27	Outdoor air temperature sensor abnormality	Continue for 5 sec.	O	<ul style="list-style-type: none"> Outdoor temperature sensor (defective or disconnected)
H28	Outdoor heat exchanger temperature sensor abnormality	Continue for 5 sec.	O	<ul style="list-style-type: none"> Outdoor heat exchanger temperature sensor (defective or disconnected)
H33	Indoor/Outdoor wrong connection	—	—	<ul style="list-style-type: none"> Indoor/Outdoor supply voltage
H97	Outdoor Fan Motor lock abnormality	—	—	<ul style="list-style-type: none"> Outdoor PCB Outdoor Fan Motor
H98	Indoor high pressure protection	—	—	<ul style="list-style-type: none"> Air filter dirty Air circulation short circuit
H99	Indoor heat exchanger anti-freezing protection	—	—	<ul style="list-style-type: none"> Insufficient refrigerant Air filter dirty
F11	Cooling / Heating cycle changeover abnormality	4 times occurrence within 30 minutes	—	<ul style="list-style-type: none"> 4-way valve V-coil
F91	Refrigeration cycle abnormality	2 times occurrence within 20 minutes	—	<ul style="list-style-type: none"> No refrigerant (3-way valve is closed)
F93	Outdoor compressor abnormal revolution	4 times occurrence within 20 minutes	—	<ul style="list-style-type: none"> Outdoor compressor
F95	Cool high pressure protection	4 times occurrence within 20 minutes	—	<ul style="list-style-type: none"> Outdoor refrigerant circuit
F96	IPM (power transistor) overheating protection	—	—	<ul style="list-style-type: none"> Excess refrigerant Improper heat radiation IPM (Power transistor)
F97	Outdoor compressor overheating protection	4 times occurrence within 10 minutes	—	<ul style="list-style-type: none"> Insufficient refrigerant Compressor
F98	Total running current protection	3 times occurrence within 20 minutes	—	<ul style="list-style-type: none"> Excess refrigerant Improper heat radiation
F99	Outdoor Direct Current (DC) peak detection	7 times occurrence continuously	—	<ul style="list-style-type: none"> Outdoor PCB IPM (Power transistor) Compressor

Note:

“O” - Frequency measured and fan speed fixed.

The memory data of error code is erased when the power supply is cut off, or press the Auto Switch until “beep” sound heard following by pressing the “RESET” button at remote controller.

Although operation forced to stop when abnormality detected, emergency operation is possible for certain errors (refer to Error Codes Table) by using remote controller or Auto Switch at indoor unit. However, the remote controller signal receiving sound is changed from one “beep” to four “beep” sounds.

13.4. DISASSEMBLY OF PARTS

13.4.1. Disassembly of Indoor Unit

13.4.1.1. Removal of the Front Panel

1. Push the Front Panel up toward upper side from the horizontal line a little by hand.



Fig. 1

2. Pull it out by pressing each arm located on left and right sides toward outside.

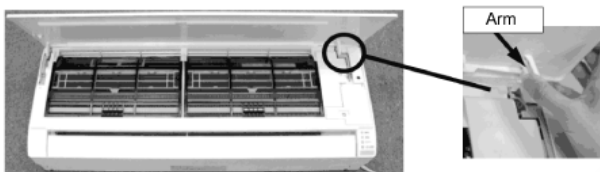

Fig. 2

Note for Reassembly:

Put each axis into Bearing Ass'y up to the bottom one side by one while keeping the Front Panel horizontal.

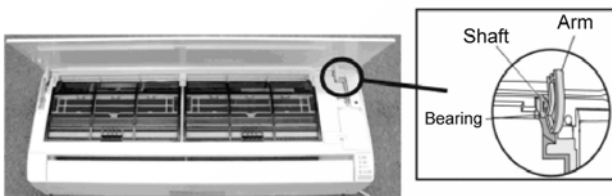

Fig. 3

Note for Reassembly:

Insert protruding parts on the reverse side of the panel (both left and right sides), for right side, between the PCB Control Box the Open/Close Motor, and for left side, into the left side of the Heat Exchanger respectively.



Fig. 4

13.4.1.2. Removal of Front Grille

1. Remove the Front Panel according to the item 13.5.1.1.
2. Keep the Vertical Louver horizontal.
3. Pull the Screw Caps (two in left and right sides) toward the front side and unscrew the screws inside (one each left and right), and finally unscrew the screw on the right side of the Front Grille (one).

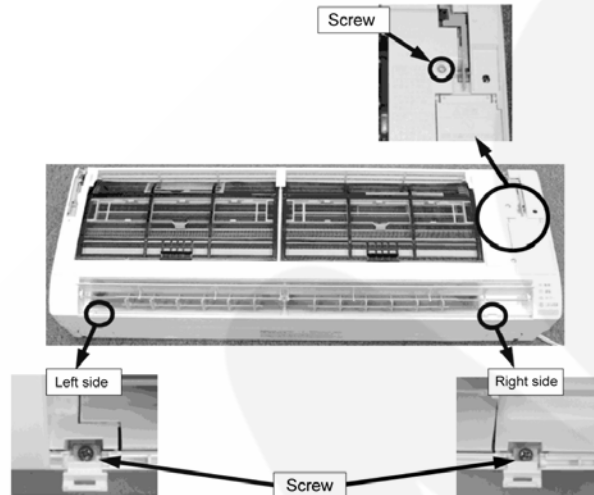

Fig. 5

Note for Disassembly:

Removing the Front Panel in advance before removal of Air Filters (two) can make reassembly of the Grille easy.

4. Remove the Front Grille to upside by holding the lower part up a little.

Note for Disassembly:

There are three hooks on the top. Holding the Grille up while holding these hooks down makes its removal easy. Be careful of the hooks that might be hard.

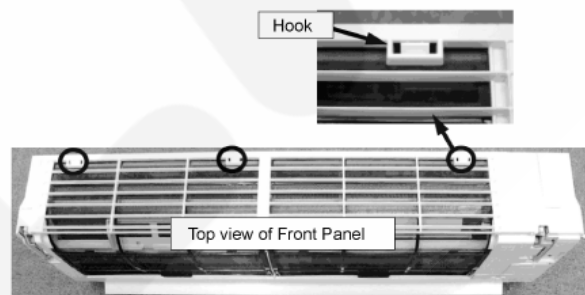

Fig. 6

Note for Reassembly:

Put the Grille back securely until you hear click sound of all the hooks (three) on the top. Or, it may cause breakdown such as "Front Panel does not open" due to out of gear of the Front Panel Open/Close Motor.

13.4.1.3. Removal of Control Board

1. Remove the Front Panel according to the item 13.5.1.1.
2. Remove the Front Grille according to the item 13.5.1.2.

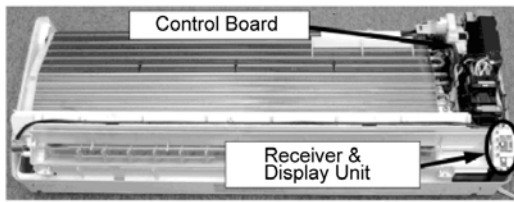

Fig. 7

3. Remove the Control Cover.

Note for Disassembly:

There are hooks on both sides (left and right).

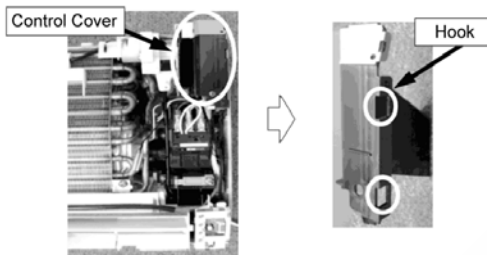

Fig. 8

4. Pull out the Control Board.

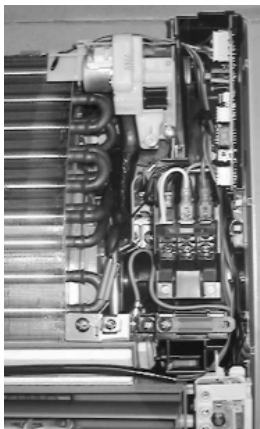

Fig. 9

5. Remove a variety of Connectors and Terminals.

Wiring parts from the upper side

- CN-STM2 (blue) Front Panel Open/Close Motor
- CN-TH (yellow) Intake Air / Pipe Temp. Sensor

Note for Disassembly:

The CN-TH (yellow) can not be disconnected. Disconnect thermosensitive part of the Pipe Temp. Sensor from the holder (Board-in). The Intake Air Temp. Sensor can be easily disconnected.

Wiring cables from lower side

- CN-STM1 (White) Air Swing Motor for Vertical Louver

- CN-FM (White) Indoor Fan Motor
- CN-ION (White) Ionizer
- CN-DISP (green or yellow) Control Board (Receiver & Display Unit)

Note for Disassembly:

The CN-TH (yellow) can not be disconnected from Control Board. Remove whole plastic part by releasing the hooks (two) for the Receiver & Display Unit (Board-in).

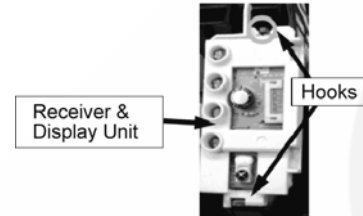

Fig. 10

Note for Disassembly:

Disconnect the connectors while holding the hooks down. Do not pull it out directly.

Wiring cables from the Terminal Board

- TAB1 terminal (brown) Disconnect the terminal.
- TAB2 terminal (white) Disconnect the terminal.

Note for Disassembly:

Disconnect the terminals while holding the convexity down in the center of each terminal.

- H1 (black), H3 (red) are soldered on PCB. Remove it from the PCB by desoldering.

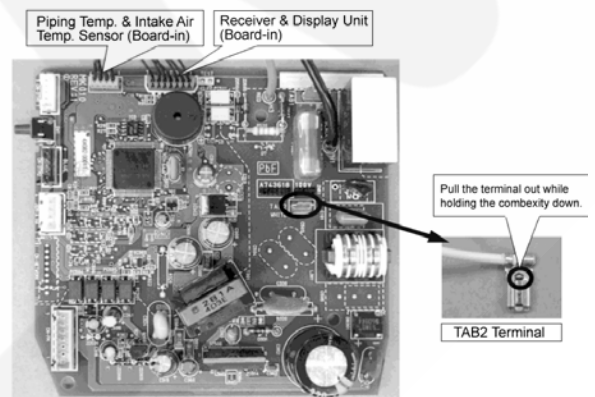

Fig. 11

13.4.1.4. Removal of Control Board Box

1. Remove the Front Panel according to the item 15.5.1.1.
2. Remove the Front Grille according to the item 15.5.1.2.
3. Remove the Control Board according to the item 15.5.1.3.

Note for Disassembly:

The Control Board Box can be removed without pulling out the Board. (Disconnect a variety of connectors and the Receiver & Display Unit first.)

4. Remove a fixing screw for interconnecting cables and a screw for earth wire.
5. Remove the screws (three) for Terminal Board and release the hook (one).

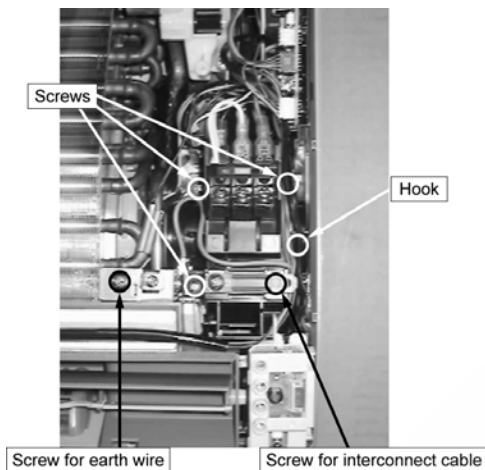

Fig. 12

6. Pull out the Control Board Box from the main unit.

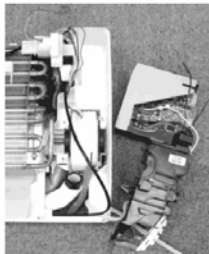

Fig. 13

13.4.1.5. Removal of Fan Motor and Cross-Flow Fan

1. Remove the Front Panel according to the item 13.5.1.1.
2. Remove the Front Grille according to the item 13.5.1.2.
3. Remove the Control Board Box according to the item 13.5.1.4.
4. Remove the Drain Hose and Discharge Grille.

Note for Disassembly:

Be careful of Drain Hose that will be hard to pulled out.

5. Unscrew the Screws (two) on the left side of the Heat Exchanger.

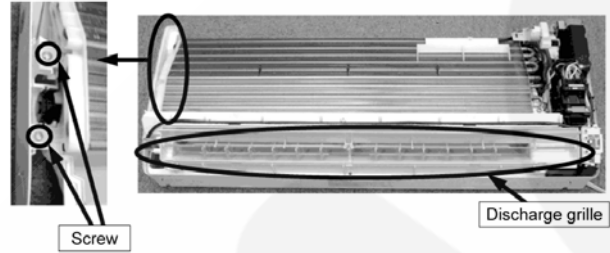

Fig. 14

6. Loosen the Screw (one) between the Cross-Flow Fan and Fan Motor.

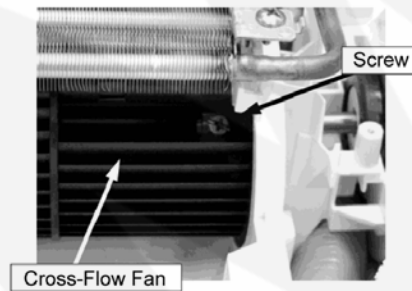

Fig. 15

7. Pull out the Cross-Flow Fan by holding up the left side of the Heat Exchanger.

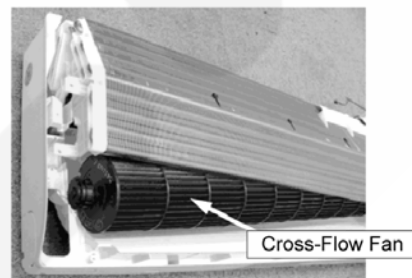

Fig. 16

8. Pull out the Indoor Fan Motor.

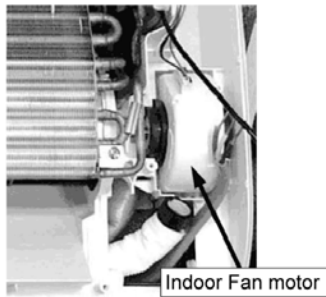

Fig. 17

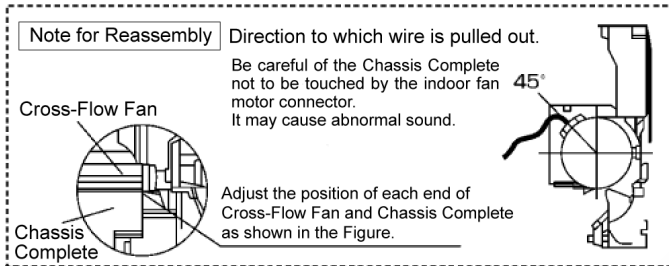

Fig. 18

13.4.1.6. Removal of Air Swing Motor for Vertical and Horizontal Louvers

1. Remove the Front Panel according to the item 13.5.1.1.
2. Remove the Front Grille according to the item 13.5.1.2.

Note for Disassembly:

The Air Swing Motor for Vertical Louver can be removed by only removal of the Front Grille.

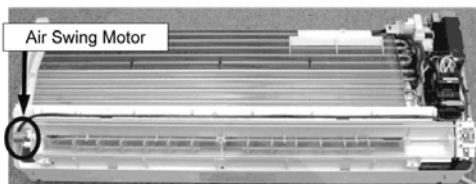

Fig. 19

3. Remove it by unscrewing screws (two).

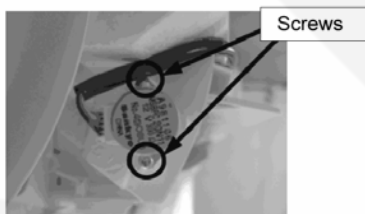

Fig. 20

13.4.1.7. Removal of Front Panel Open/Close Motor

1. Remove the Front Panel according to the item 13.5.1.1.
2. Remove the Front Grille according to the item 13.5.1.2.

Note for Disassembly:

The Front Panel Open/Close Motor for Vertical Louver can be removed by only removal of the Front Grille.

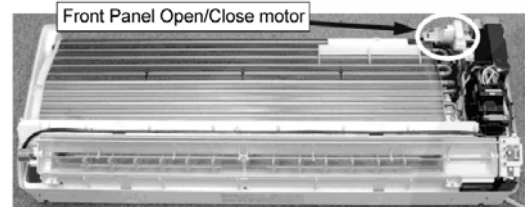

Fig. 21

3. Remove the Front Panel Open/Close Motor by unscrewing the screw and disconnecting the connector.

Note for Disassembly:

Replace the Motor together with the Gear (Plastic) when replacement. If further disassembly of the Gear is performed, the reassembly will become impossible due to out of gears inside.

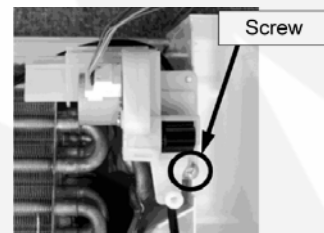

Fig. 22

13.4.2. Disassembly of Outdoor Unit

⚠ WARNING

Electric parts in Outdoor Unit (Control Cover inside) contain High Voltage by booster capacitor. Make sure to discharge it completely before servicing in order to prevent electric shock.

13.4.2.1. Removal of Cabinet Top Plate and Cabinet Front Plate

1. Unscrew the screws (three: two on the right side and one on the left side as you faces) and the Cabinet Top Plate.
2. Unscrew the screws (six: three on the upper side and another three on the lower side) on the Cabinet Top Plate.

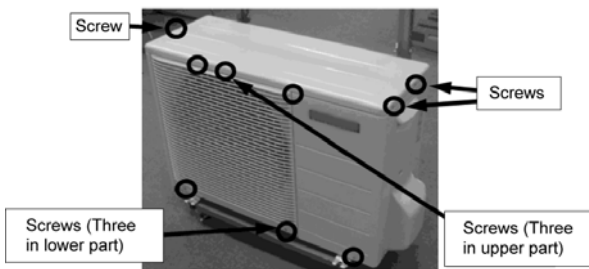

Fig. 1

3. Release the hooks (four: two on the right and another two on the left as you faces) for the Cabinet Front Plate and remove the Front Plate by holding it up a little.



Fig. 2

13.4.2.2. Removal of Control Cover (2- / 3-way valve Covers and Terminal Cover)

1. Remove the Front Grille according to the item 13.5.1.2.
2. Remove the screw (one) on the Control Cover and remove it by sliding it downward.

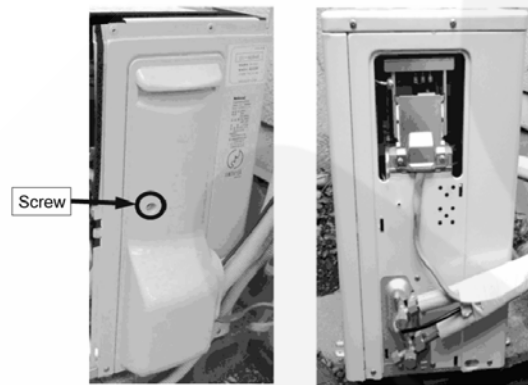

Fig. 3

3. Remove the Terminal Cover by removing the screws (two) and releasing the hooks (two).

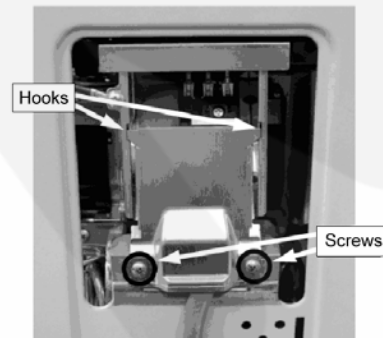

Fig. 4

13.4.2.3. Removal of Control Plate Casing

1. Remove the Cabinet Top Plate and Cabinet Front Plate according to the item 13.5.2.1.
2. Remove the Control Cover (2- / 3-way valve Covers and Terminal Cover) according to the item 13.5.2.2.
3. Remove the Control Plate Casing by releasing hooks (four: two each on the right and left).



Fig. 5

4. Remove the screw (one) fixing the Control Plate Casing.

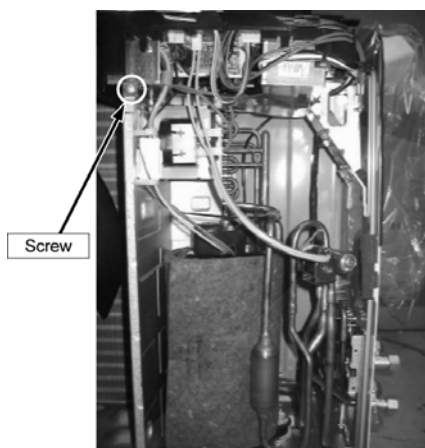

Fig. 6

5. Disconnect a variety of connectors and Terminals.

Wiring cables from lower side

- Compressor cables (red, blue and yellow) Disconnect the connector (white).
- CN-HOT (white) Electromagnetic Coil (4-way valve) Cable: Yellow
- Terminals connecting Reactor (two) Cable: Gray
- CN-TANK (white) Compressor Temp. Sensor

Wiring cables from left side

- CN-FM1 Outdoor Fan Motor

Wiring cables from right side

- CN-STM (white) Electromagnetic Coil (Expansion Valve)
- CN-TH (white) Outdoor Air Temp. / Pipe Temp. Sensor

6. Disconnect the interconnect cables and the Earth Wire (one screw).

- Remove the screws (two) fixing the Terminal part and the Cabinet Side Plate (right).

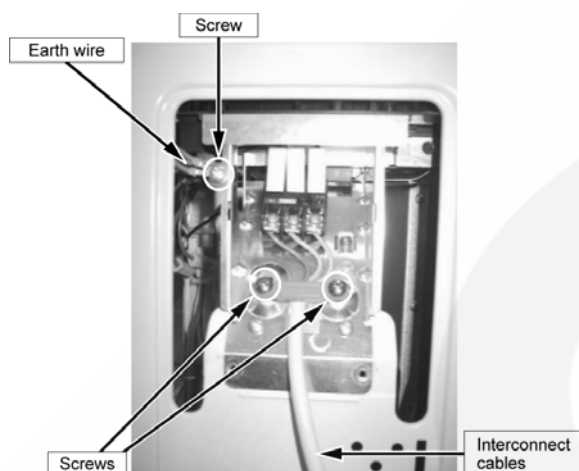

Fig. 7

7. Remove the Control Plate Casing from the main unit by holding it up.

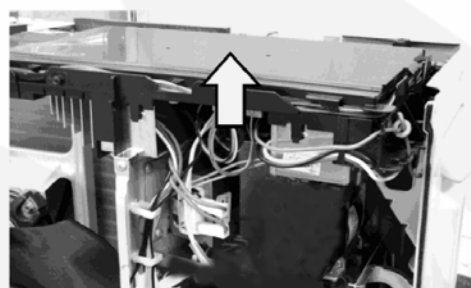

Fig. 8

13.4.2.4. Removal of Control Board

1. Remove the Cabinet Top Plate and Cabinet Front Plate according to the item 13.5.2.1.
2. Remove the Power Supply Cover (2- / 3-way valve Covers and Terminal Cover) according to the item 13.5.2.2.
3. Remove the Control Plate Casing according to 13.5.2.3.
4. Remove Outdoor Air Temp. Sensor and its fitting by releasing the hooks (two) the fitting.

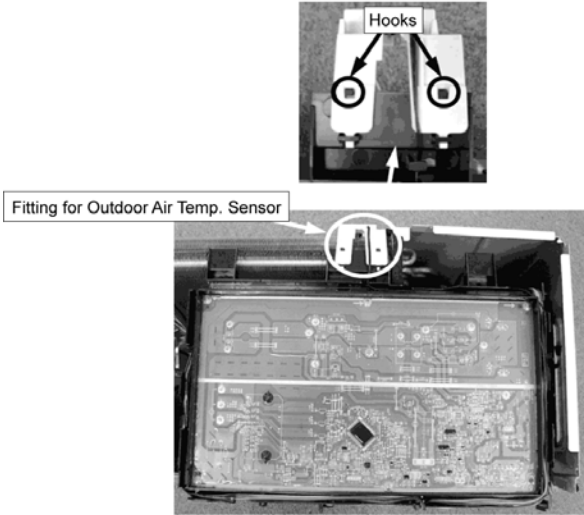

Fig. 9

5. Place the Control Box reversely and remove the Screws (Two) on the both sides of the Control Box (for Terminal Plate).

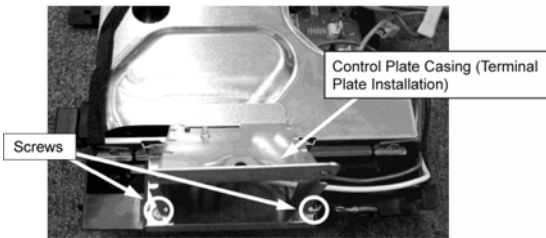

Fig. 10

6. Remove the Control Plate Casing (Terminal Plate) from the Control Plate Casing.

Note for Disassembly:

Remove Power supply terminal (red, white and black) from the Terminal Plate.

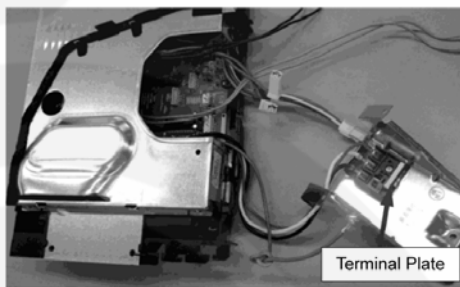

Fig. 11

7. Remove the Control Box by releasing the hooks (four) the Box (Control Board Lower Cover).

Note for Disassembly:

Be careful of hanging-up of connectors or wiring cables such as the earth wire when the Box (Control Board Lower Cover) is removed.

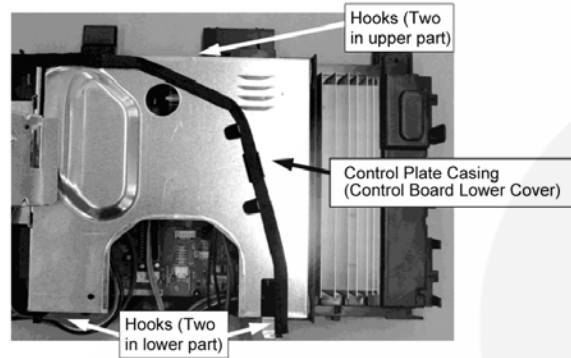

Fig. 12

8. Replace the Control Plate Casing (Black plastic part) together when the Control Board needs to be replaced.

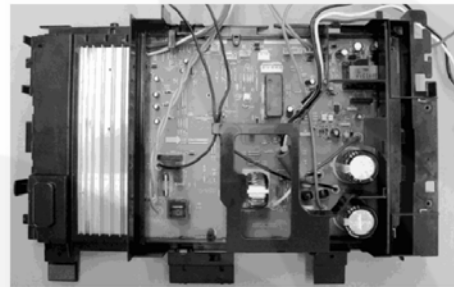

Fig. 13

Note for Disassembly:

Replacement of the Outdoor Control Board should be made as a whole unit due to silicon pasting, etc. although it can be separated PCB part from Control Box part by removing the screws (six) on the soldering side.

13.4.2.5. Removal of Propeller Fan and Fan Motor

1. Remove the Cabinet Top Plate and Cabinet Front Plate according to the item 13.5.2.1.
2. Remove the Control Cover (Control Board Upper Cover) by releasing the hooks (four: two each on the both sides).



Fig. 14

3. Remove only the Connector for the CN-MTR1 and CN-MTR2 (Outdoor Fan Motor).
4. Remove the Propeller Fan by turning the nut in the center of the fan clockwise.

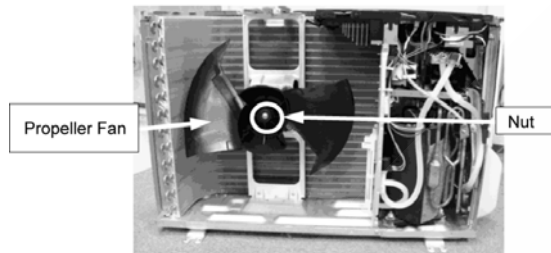

Fig. 15

5. Remove the Fan Motor by loosening the screws (four).

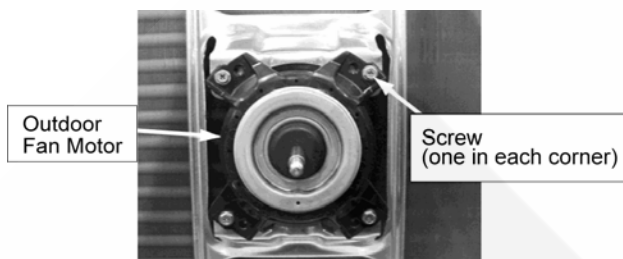

Fig. 16

Note for Reassembly:

Adjust each position of the Boss in the center of the Propeller and the groove on the shaft of the Motor when putting them together.

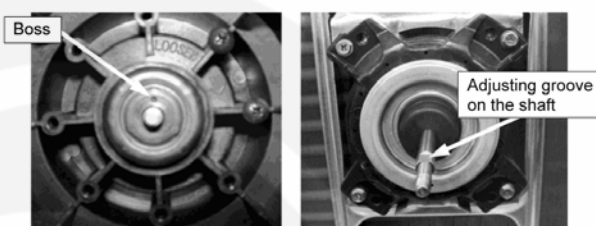

Fig. 17

14 Technical Data

14.1. Operation Characteristics

CS-TE9DKE / CU-TE9DKE

• Cooling Characteristic

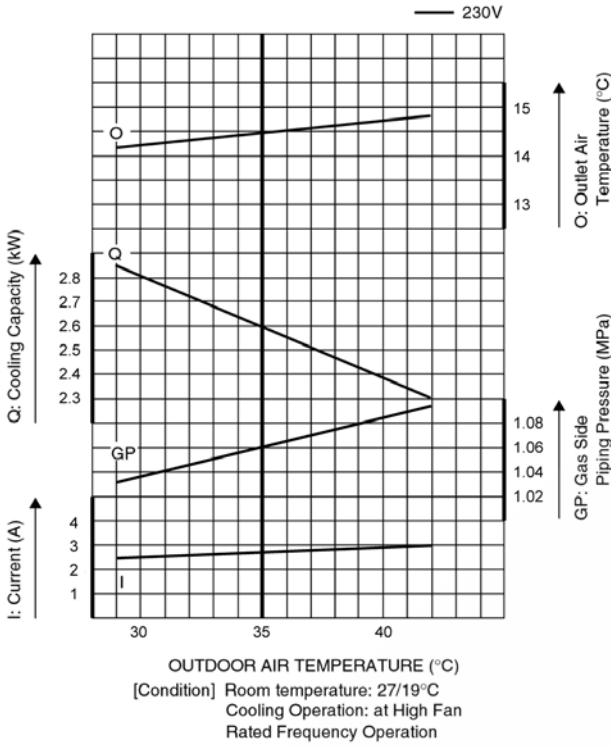

• Piping Length Characteristic (Cooling)

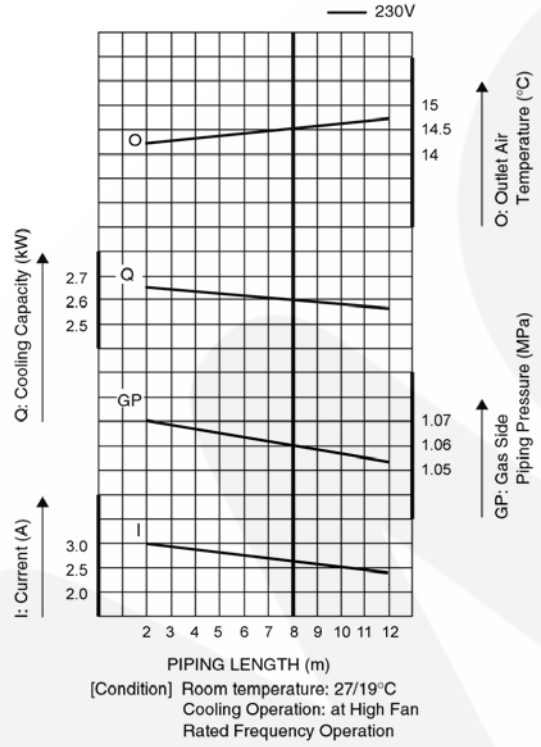

• Heating Characteristic

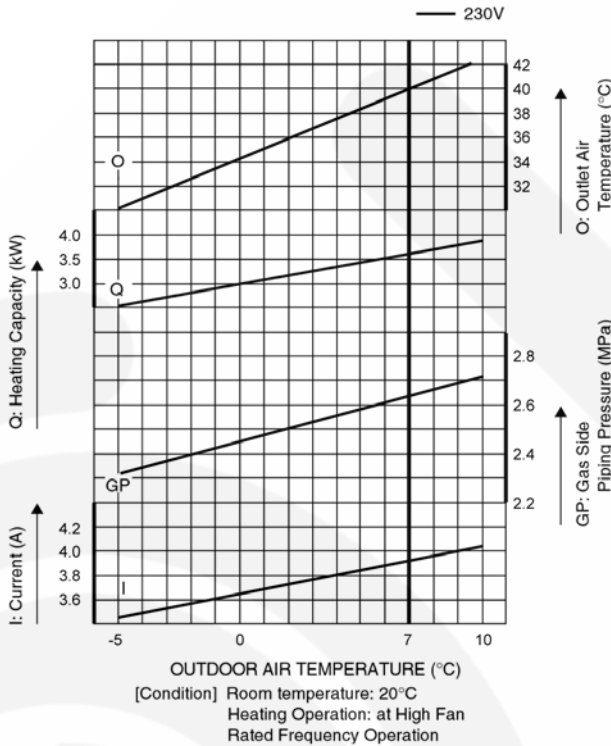

• Piping Length Characteristic (Heating)

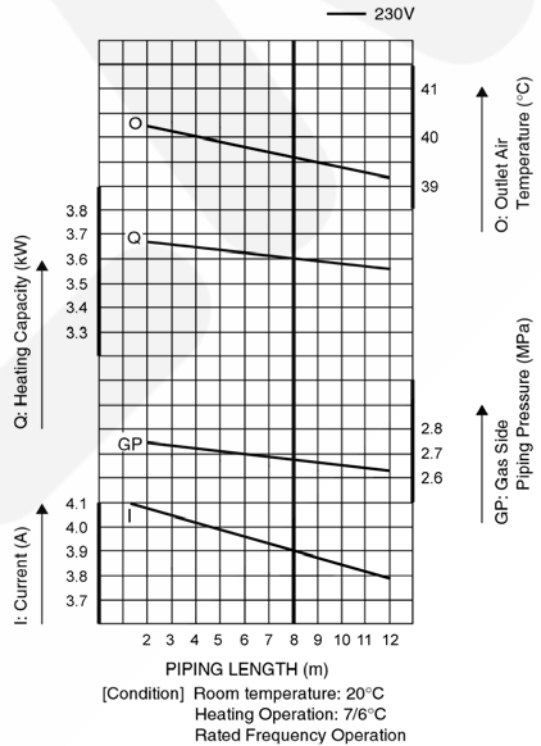

CS-TE12DKE / CU-TE12DKE

• Cooling Characteristic

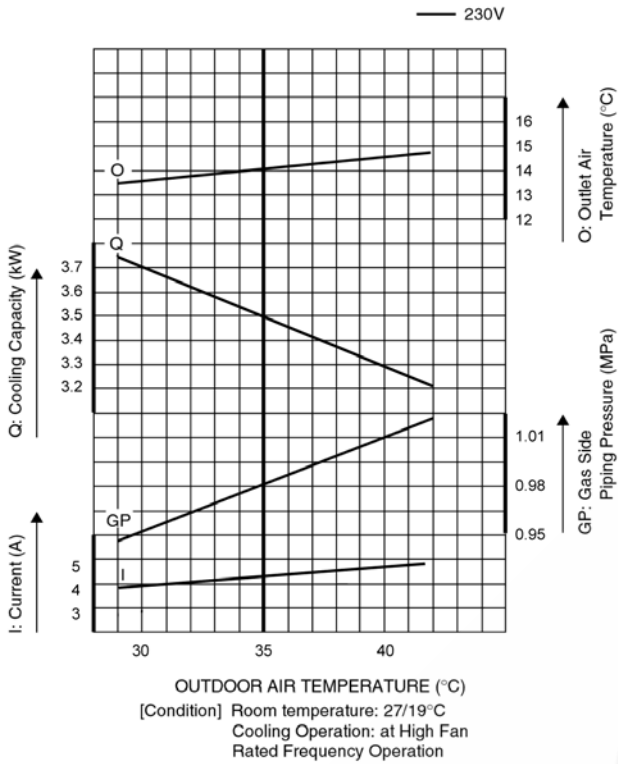

• Piping Length Characteristic (Cooling)

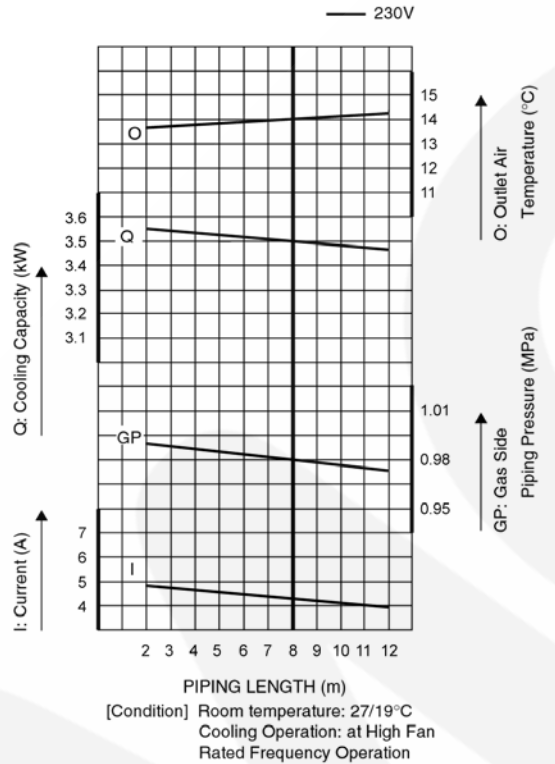

• Heating Characteristic

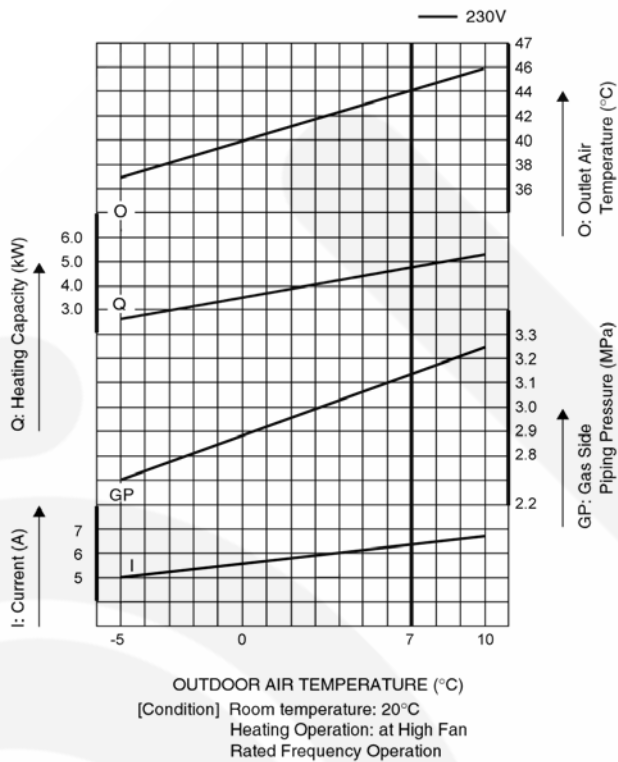

• Piping Length Characteristic (Heating)

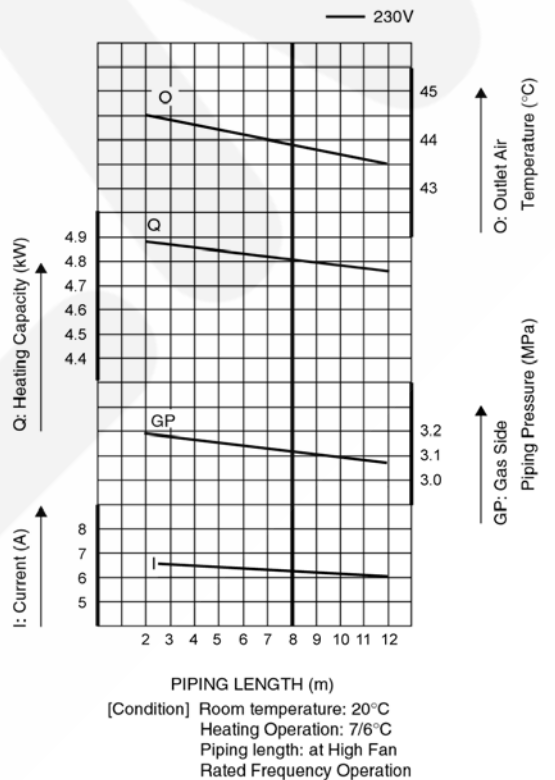

14.2. Sensible Capacity Chart

CS-TE9DKE / CU-TE9DKE

230V	Outdoor Temp. (°C)											
Indoor wet bulb temp.	30			35			40			46		
	TC	SHC	IP	TC	SHC	IP	TC	SHC	IP	TC	SHC	IP
17.0°C	2.58	2.33	0.53	2.41	2.24	0.57	2.24	2.14	0.61	2.04	2.03	0.66
19.0°C				2.60		0.58						
19.5°C	2.83	2.44	0.54	2.65	2.34	0.58	2.46	2.25	0.62	2.24	2.14	0.67
22.0°C	3.09	2.52	0.56	2.88	2.43	0.60	2.68	2.34	0.64	2.44	2.24	0.69

CS-TE12DKE / CU-TE12DKE

230V	Outdoor Temp. (°C)											
Indoor wet bulb temp.	30			35			40			46		
	TC	SHC	IP	TC	SHC	IP	TC	SHC	IP	TC	SHC	IP
17.0°C	3.42	2.86	0.82	3.20	2.75	0.89	2.97	2.64	0.95	2.70	2.51	1.02
19.0°C				3.45		0.95						
19.5°C	3.76	3.01	0.84	3.51	2.89	0.90	3.27	2.78	0.97	2.97	2.64	1.04
22.0°C	4.10	3.12	0.85	3.83	3.06	0.92	3.56	2.89	0.99	3.24	2.75	1.06

15 Exploded View and Replacement Parts List

15.1. Exploded View (Indoor Unit)

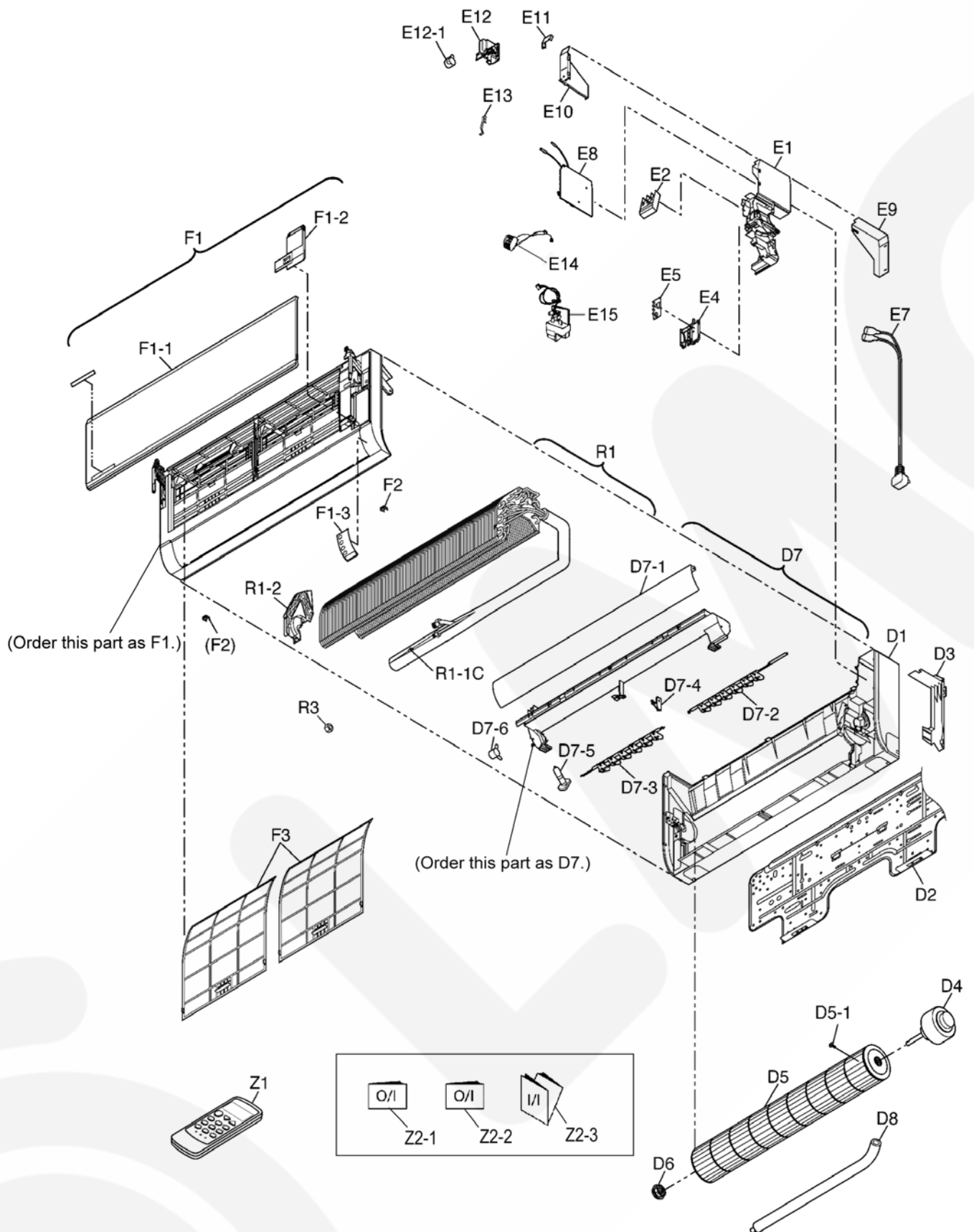

Note:

The above exploded view is for the purpose of parts disassembly and replacement.

The non-numbered parts are not kept as standard service parts.

15.2. Replacement Parts List (Indoor Unit)

<Models: CS-TE9DKE CS-TE12DKE>

REF. NO.	PART NAME & DESCRIPTION	QTY.	CS-TE9DKE	CS-TE12DKE	REMARKS
D1	CHASSY COMPLETE	1	CWD50C1418	←	
D2	INSTALLATION PLATE	1	CWH361074	←	
D3	PIPE HOLDING PLATE	1	CWD911465	←	
D4	FAN MOTOR	1	ARW41E8P30AC	←	0
D5	CROSS FLOW FAN COMPLETE	1	CWH02K1029	←	
D5-1	SCREW - CROSS FLOW FAN	1	CWH4580304	←	
D6	BEARING ASS'Y	1	CWH64K1005	←	
D7	DISCHARGE GRILLE COMPLETE	1	CWE20C2423	←	
D7-1	VERTICAL VANE	1	CWE24C1115	←	
D7-2	HORIZONTAL VANE COMPLETE (R)	1	CWE24C1106	←	
D7-3	HORIZONTAL VANE COMPLETE (L)	1	CWE24C1107	←	
D7-4	FULCRUM	1	CWH621050	←	
D7-5	CAP (DRAIN CAP)	1	CWH521091	←	
D7-6	AIR SWING MOTOR	1	CWA981106	←	0
D8	DRAIN HOSE	1	CWH851107	←	
E1	CONTROL BOARD CASING	1	CWH102280	←	
E2	TERMINAL BOARD COMPLETE	1	CWA28C2233	←	0
E4	DISPLAY PCB HOLDER	1	CWD932475	←	
E5	ELECTRONIC CONTROLLER - RECEIVER, INDICATOR	1	CWA743634	←	0
E7	POWER SUPPLY CORD	1	CWA20C2432	←	
E8	ELECTRONIC CONTROLLER - MAIN	1	CWA73C1810	←	0
E9	CONTROL COVER (LOWER)	1	CWH131229	←	
E10	CONTROL COVER (PLASTIC PLATE - UPPER)	1	CWH131232	←	
E11	CONTROL COVER (STEEL PLATE - UPPER)	1	CWH131230	←	
E12	GEAR (FRONT PANEL OPEN/CLOSE MOTOR)	1	CWH68C1022	←	
E12-1	FRONT PANEL OPEN/CLOSE MOTOR	1	CWA981126	←	
E13	SENSOR HOLDER (PIPE TEMP)	1	CWH32137	←	
E14	ELECTRONIC CONTROLLER - IONIZER	1	CWA73C1791	←	
E15	ION GENERATOR	1	CWH94C0005	←	
F1	FRONT GRILLE COMPLETE	1	CWE11C3206XA	←	
F1-1	FRONT PANEL (INTALE GRILLE)	1	CWE22C1184XA	←	
F1-2	DOOR (INTERCONNECT CABLE)	1	CWE141087A	←	
F1-3	INDICATOR	1	CWE312539	←	
F2	CAP	2	CWH521121	←	
F3	AIR FILTER	2	CWD001149	←	
R1	EVAPORATOR COMPLETE (WITH PIPE)	1	CWB30C1608X	CWB30C1706X	
R1-1C	FLARE NUT (1/4")	1	CWT25086	←	
R1-2	EVAPORATOR HOLDER	1	CWD61048	←	
R3	FLARE NUT (3/8")	1	CWT25087		
R3	FLARE NUT (1/2")	1		CWT25096	
Z1	REMOTE CONTROL COMPLETE	1	CWA75C2686X	←	
Z2-1	OPERATION INSTRUCTION	1	CWF564718	←	
Z2-2	OPERATION INSTRUCTION	1	CWF564719	←	
Z2-3	INSTALLATION INSTRUCTION	1	CWF612743	←	

(Note)

- All parts are supplied from ACD, Japan.
- "0" marked parts are recommended to be kept in stock.

15.3. Exploded View (Outdoor Unit)

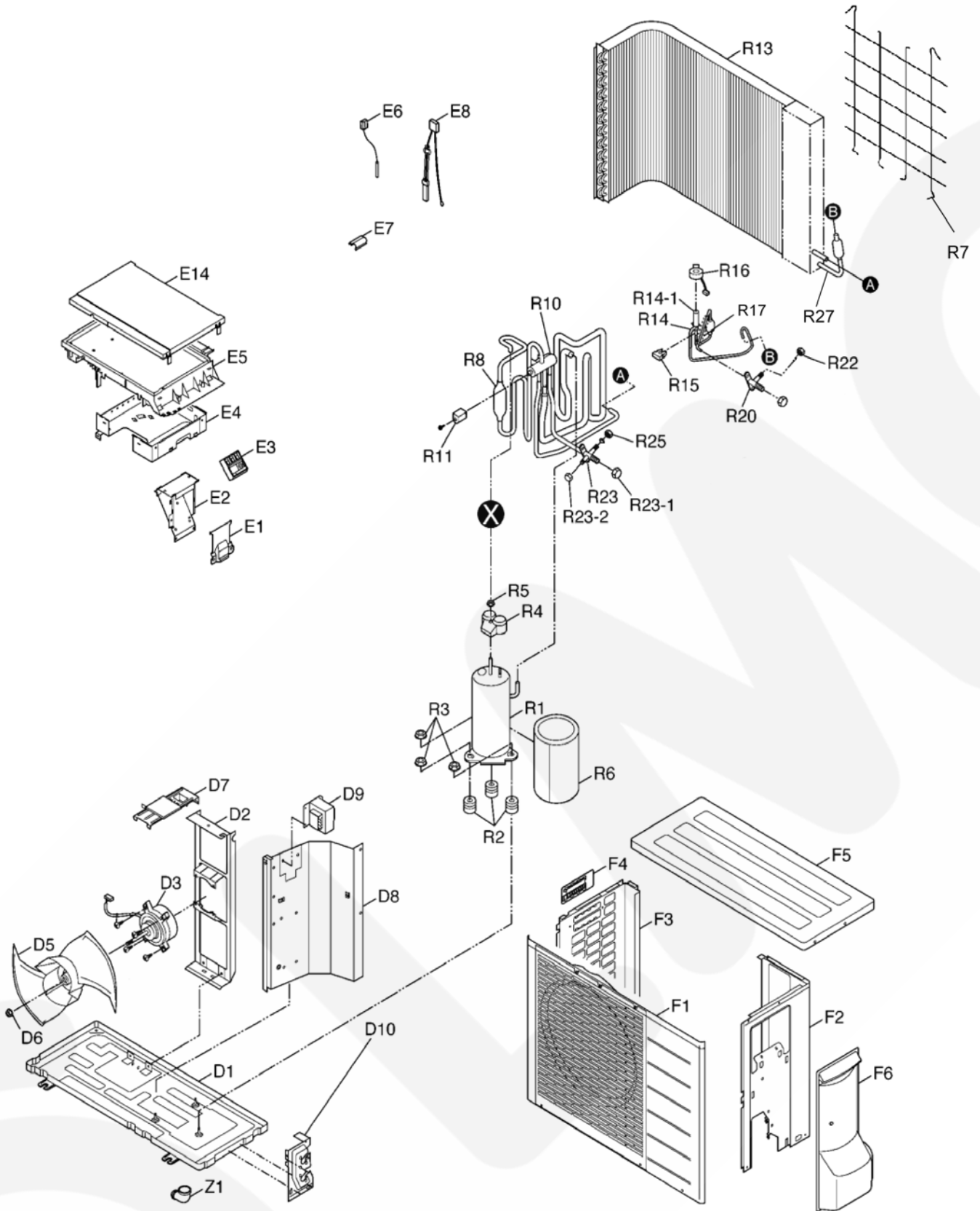

Note:

The above exploded view is for the purpose of parts disassembly and replacement.
The non-numbered parts are not kept as standard service parts.

15.4. Replacement Parts List (Outdoor Unit)

<Models: CU-TE9DKE CU-TE12DKE>

REF NO.	DESCRIPTION & NAME	QTY.	CU-TE9DKE	CU-TE12DKE	REMARKS
D1	CHASSY ASSY	1	CWD50K2126X	←	
D2	FAN MOTOR BRACKET	1	CWD541021	←	
D3	FAN MOTOR	1	ARW44W8P40AC	←	O
D5	PROPELLER FAN	1	CWH03K1014	←	
D6	NUT - PROPELLER FAN	1	CWH561034J	←	
D7	FAN MOTOR MOUNT PLATE (UPPER)	1	CWMD910001X2	←	
D8	SOUND PROOF BOARD	1	CWH151067RX	←	
D9	REACTOR	1	G0A193M00003	G0A193M00002	
D10	COUPLING MOUNT PLATE	1	CWMH350001	←	
E1	CONTROL COVER (TERMINAL PLATE COVER)	1	CWH131244X	←	
E2	CONTROL PLATE CASING (TERMINAL BOARD)	1	CWH102284	←	
E3	TERMINAL BOARD	1	CWA38K1121	←	
E4	CONTROL BOARD COVER (ELECTRONIC CONTROLLER - LOWER)	1	CWH102247	←	
E5	ELECTRONIC CONTROLLER - MAIN	1	CWA73C1821R	CWA73C1822R	O
E6	SENSOR COMPLETE	1	CWA50C2281	←	
E7	SENSOR HOLDER (OUTDOOR TEMP.)	1	CWH321046	←	
E8	SENSOR COMPLETE	1	CWA50C2241	←	
E14	CONTROL BOARD COVER (ELECTRONIC CONTROLLER - UPPER)	1	CWH131206XD	←	
F1	CABINET FRONT PLATE	1	CWE06C1115	←	
F2	CABINET SIDE PLATE (RIGHT)	1	CWE04C1052	←	
F3	CABINET SIDE PLATE (LEFT)	1	CWE041054	←	
F4	HANDLE	1	CWE161001	←	
F5	CABINET TOP PLATE	1	CWE031053	←	
F6	CONTROL BOARD COVER (2-, 3-WAY VALVE COVER)	1	CWMH13C0002	←	
R1	COMPRESSOR	1	CWB092330	←	O
R2	ANTI-VIBRATION BUSHING	3	CWH501022	←	
R3	NUT - COMPRESSOR MOUNT	3	CWH56000J	←	
R4	TERMINAL COVER	1	CWH17006	←	
R5	NUT - TERMINAL COVER	1	CWH7080300J	←	
R6	SOUND PROOF MATERIAL	1	CWMG300001	←	
R7	WIRE NET	1	CWD041046	←	
R8	LIQUID RECEIVER (MULTI BEND TUBE - MULTI BEND TUBE)	1	CWB14011	←	
R10	4-WAY VALVE	1	CWB001037J	←	
R11	V-COIL COMPLETE (4-WAY VALVE)	1	CWA43C2144J	←	
R13	CONDENSER	1	CWB32C1471XA	←	
R14	TUBE ASS'Y (WITH EXPANSION VALVE)	1	CWT01C3271	←	
R14-1	EXPANSION VALVE	1	CWB051016J	←	
R15	BUSHING (EXPANSION VALVE)	1	CWMH510005	←	
R16	V-COIL COMPLETE (EXPANSION VALVE)	1	CWA43C2058J	←	
R17	DRYER	1	CWB101016	←	
R20	2-WAY VALVE	1	CWB021180J	←	O
R22	FLARE NUT (1/4")	1	CWT25086	←	
R23	3-WAY VALVE COMPLETE (GAS)	1	CWB011165J	CWB011316J	O
R23-1	CAP (VALVE ROD)	1	CWH521098	←	
R23-2	CAP (SERVICE PORT)	1	CWH521099	←	
R25	FLARE NUT (3/8")	1	CWT25087	←	
R25	FLARE NUT (1/2")	1		CWY25096	
R27	STRAINER (MULTI BEND TUBE - U-TUBE)	1	CWB111004	←	
Z1	L-TUBE (DRAIN ELBOW)	1	CWT20C022	←	

(Note)

- All parts are supplied from ACD, Japan.
- "O" marked parts are recommended to be kept in stock.