

LS 3070

Product Reference Guide

Click on **red text** at any location in the manual to jump to the specified chapter, topic, or reference.

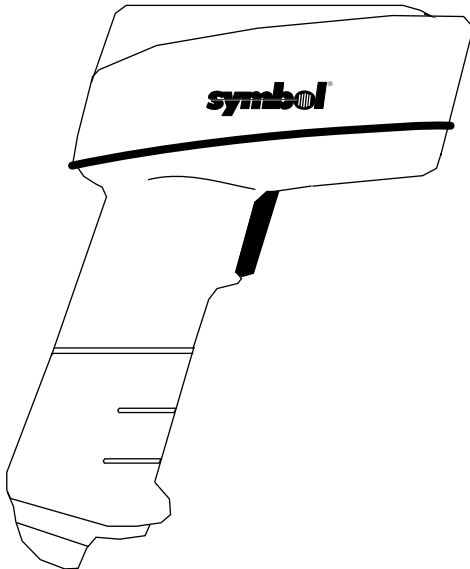

About This Manual
Table of Contents
Copyright
Feedback
Index

70-10294-02
Revision B
February 1998

symbol[®]



© 1997 **SYMBOL TECHNOLOGIES, INC.** All rights reserved.

No part of this publication may be reproduced or used in any form, or by any electrical or mechanical means, without permission in writing from the publisher. This includes electronic or mechanical means, such as photocopying, recording, or information storage and retrieval systems. The material in this manual is for informational purposes and is subject to change without notice.

Symbol reserves the right to make changes to any product to improve reliability, function, or design.

Symbol does not assume any product liability arising out of, or in connection with, the application or use of any product, circuit, or application described herein.

No license is granted, either expressly or by implication, estoppel, or otherwise under any patent right or patent, covering or relating to any combination, system, apparatus, machine, material, method, or process in which Symbol products might be used. An implied license only exists for equipment, circuits, and subsystems contained in Symbol products.

Symbol is a registered trademark of Symbol Technologies, Inc. Other product names mentioned in this manual may be trademarks or registered trademarks of their respective companies and are hereby acknowledged.

Symbol Technologies, Inc.
One Symbol Plaza
Holtsville, N.Y. 11742-1300

<http://www.symbol.com>

Contents

About This Manual

Notational Conventions	About-i
Related Publications	About-i
Service Information	About-i
Symbol Support Center	About-ii

Chapter 1. The LS 3070 Cordless Scanner

The Freedom of Cordless Scanning.....	1-1
The LS 3070 Scanner	1-2
Rechargeable Battery Pack	1-3
The Base/Charger Unit.....	1-4

Chapter 2. Setup

Unpacking	2-1
Connecting the Cable to the Base/Charger Unit.....	2-1
Installation Tip — Optimizing RF Performance	2-1
Inserting the Scanner Into and Removing Scanner from Base/Charger.....	2-2
Charging the Battery	2-3
Pairing the Scanner with the Base/Charger	2-3
Assigning Address to Base/Charger	2-3
Pairing Scanner with Base/Charger	2-5
Setting Transmission Frequency	2-6
Installing a Magstripe Reader	2-7

Chapter 3. Scanning with the LS 3070

1. Ready	3-1
2. Test	3-1
3. Scan	3-1
Hold at an Angle	3-2
Scan the Entire Symbol	3-2
Using a Long Range or High Visibility Scanner?	3-3
Scanning Transmission Range	3-4
RF Communication Errors	3-4
Restoring Normal RF Communications	3-4
What If	3-5
Decode Zones	3-6
LS 3070 Standard Range	3-6
LS 3070LR Long Range	3-7
LS 3070ALR Advanced Long Range	3-8

LS 3070XLR Extra Long Range	3-9
LS 3070HV High Visibility	3-10

Chapter 4. Maintenance and Specifications

Maintenance	4-1
Recharging the Battery	4-1
Changing Battery Packs	4-2
Charge Status LED Indications	4-4
Accessories	4-5
LS 3070 Standard Technical Specifications	4-6
LS 3070LR Technical Specifications	4-7
LS 3070ALR Technical Specifications	4-8
LS 3070XLR Technical Specifications	4-9
LS 3070HV Technical Specifications	4-10

Chapter 5. Interface Guide

Connecting to a Host Device	5-1
Connecting Base Station to a Host	5-2
OCIA and OCR Terminals	5-2
RS-232C Single Port	5-3
RS-232C Dual Port	5-3
IBM 4683/4684/4693/4694	5-4
Connecting Keyboard Wedges	5-5
PC Keyboards	5-5
Terminal Keyboards	5-5
IBM 3683/3684 Installation	5-6
IBM 3653 Installation	5-12
NCR 280 Installation	5-17
NCR 2151 Installation	5-18
NCR 2152 Installation	5-20
NCR 2154/2155 Installation	5-21
NCR 7052 Installation	5-21
Fujitsu 9000 Installation	5-22
Interfaces	5-23

Chapter 6. Programming

Programming Overview	6-1
Scanning Sequence Examples	6-2
Errors While Scanning	6-2
Parameter Descriptions	6-3
Set Parameter Defaults	6-3
Host Interface Code	6-3

Code Types	6-3
Code Lengths	6-3
Code 39 Full ASCII	6-4
Decode Options	6-5
UPC-A and -E Preamble	6-8
Pause Duration	6-8
Prefix/Suffix Values	6-8
Data Transmission Formats	6-9
Laser Control	6-10
RS-232C Options	6-11
Intercharacter Delay	6-16
Transmit Code ID Character	6-16
Transmit AIM ID Character	6-16
Ignore Unknown Characters	6-16
OCIA Clock Polarity	6-16
OCIA Transmit Timeout	6-17
NCR 2152 Fast Transmit	6-17
IBM 4683/93 Magstripe Communications	6-17
International Keypad Emulation	6-17
International Keypad Emulation Fast Transmit	6-17
National Keyboard Types	6-18
Set Transmission Frequency	6-20
Wait for Host Interface Response Time	6-20
Parameter Selections	6-21
Beeper Definitions	6-24
Standard Use	6-24
Parameter Menu Scanning	6-25
Code 39 Scan And Store	6-25
Code 39 Buffering	6-26
Buffer Data	6-26
Clear Transmission Buffer	6-26
Transmit Buffer	6-27
Overfilling Transmission Buffer	6-27
Attempt to Transmit an Empty Buffer	6-27
Default Table	6-28
Terminal Specific RS-232C Defaults	6-31

Chapter 7. Parameter Menus

Set Default Parameter	7-2
Host Interface	7-3
Code Type	7-17
Code Lengths	7-22
Decode Options	7-29

UPC-A Preamble	7-37
UPC-E Preamble.....	7-38
Pause Duration.....	7-39
Prefix/Suffix Values	7-42
Data Transmission Formats	7-46
Magstripe Options	7-48
Laser Control	7-53
Baud Rate	7-56
Parity	7-58
Check Parity	7-59
Hardware Handshaking	7-60
Software Handshaking	7-61
Serial Response Timeout.....	7-62
Stop Bit Select	7-65
ASCII Data Format.....	7-66
RTS Line State.....	7-67
Intercharacter Delay	7-68
Transmit Code ID Character	7-71
Transmit AIM Code ID	7-72
Ignore Unknown Characters	7-73
OCIA Clock Polarity	7-74
OCIA Transmit Timeout.....	7-75
NCR 2152 Fast Transmit	7-78
IBM 4683 Magstripe Communications	7-79
International Keypad Emulation	7-80
International Keypad Emulation Fast Transmit	7-81
National Keyboard Types.....	7-82
Set Transmission Frequency	7-84
All Countries Except France.....	7-84
France.....	7-84
Wait for Host Interface Response Time	7-87
Reserved For Future Use.....	7-90
Pairing	7-97

Chapter 8. Keyboard Maps

ASCII Table.....	8-1
Keyboard Identifier Maps.....	8-5

Index

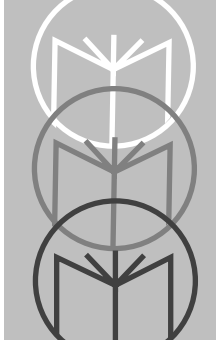

About This Manual

The *LS 3070 Product Reference Guide* provides general instructions for setup, operation, troubleshooting, maintenance, and programming.

Notational Conventions

The following conventions are used in this document:

- Bullets (•) indicate:
 - action items
 - lists of alternatives
 - lists of required steps that are not necessarily sequential
- Sequential lists (e.g., those that describe step-by-step procedures) appear as numbered lists.

Related Publications

- *LS 3070 Quick Reference Guide* 70-19993-0X

Service Information

If you have a problem with your equipment, contact the Symbol Support Center. Before calling, have the model number, serial number, and several of your bar code symbols at hand.

Call the Support Center from a phone near the scanning equipment so that the service person can try to talk you through your problem. If the equipment is found to be working properly and the problem is symbol readability, the Support Center will request samples of your bar codes for analysis at our plant.

If your problem cannot be solved over the phone, you may need to return your equipment for servicing. If that is necessary, you will be given specific directions.

***Note:** Symbol Technologies is not responsible for any damages incurred during shipment if the approved shipping container is not used. Shipping the units improperly can possibly void the warranty. If the original shipping container was not kept, contact Symbol to have another sent to you.*

Symbol Support Center

In the U.S.A, for service information, warranty information or technical assistance, call:

SYMBOL SUPPORT CENTER
1-800-653-5350

If you purchased your Symbol product from a Symbol Business Partner, contact that Business Partner for service.

Canada

Mississauga, Ontario
Canadian Headquarters
(905) 629-7226

Europe

Wokingham, England
European Headquarters
0734-771-222 (Inside UK)
+441-734-771222 (Outside UK)

Asia

Singapore
Symbol Technologies Asia, Inc.
337-6588 (Inside Singapore)
+65-337-6588 (Outside Singapore)

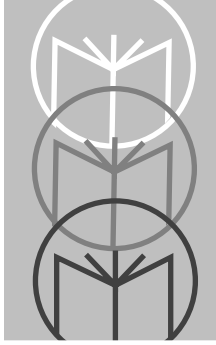

Chapter 1

The LS 3070 Cordless Scanner

The Freedom of Cordless Scanning

The LS 3070 is a revolutionary, cordless approach to capturing bar coded data. The scanner communicates with your host computer through a low-power radio transmission instead of through a cable. With the LS 3070, you are free to scan and transmit without a physical cable to limit your movement, from as far away as 30 - 50 feet (9 - 15 meters), depending on your environment. This lets you take the scanner to where the work is, whether on the loading dock, the plant floor, the warehouse, or the POS checkout area.

The scanning system has three main components: the cordless scanner, the base/charger interface unit, and a cable to interface with the host device.

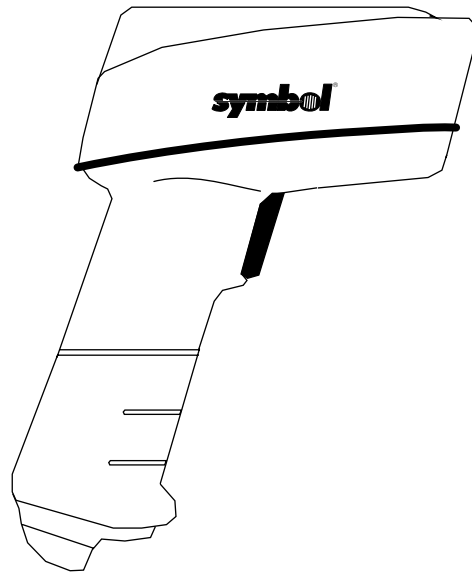

Figure 1-1. The LS 3070 Cordless Scanner

The LS 3070 Scanner

Housed in rugged, durable plastic, the LS 3070 scanner combines accurate, aggressive bar code scanning with solid state dependability. Its ergonomic design ensures comfortable use for extended periods of time.

This scanner combines premium visible laser diode (VLD) scanning performance, reading color bar codes and symbols printed on all substrates, with advanced decode and RF transceiver capabilities.

The scanning element can be any of a wide variety of configurations:

- Standard - for most Class II scanning applications, in which symbol density (5 to 55 mil) and range (0 - 35 in.) fall within relatively normal ranges.
- Long Range (LR) - for Class II applications with short range reading on medium density symbols and long range reading on low density symbols.
- Advanced Long Range (ALR) - for long range reading on medium and low-density symbols, optimized by the increased power of the Class IIIA laser.
- Extra Long Range (XLR) - for scanning ranges of up to 180 inches (457 cm) on 55 mil symbols, also using a Class IIIA laser.
- High Visibility (HV) - for scanning ranges up to 33 inches (86 cm) on 55 mil symbols, and ambient sunlight up to 10,000 ft. candles, using a Class IIIA laser.

Rechargeable Battery Pack

In the handle of the scanner, there is a rechargeable NiCad battery pack. This provides all power to the scanner during normal operation. It provides 360 mA hours, which is sufficient for normal operation during an 8-hour shift.

When fully depleted, the battery module can be recharged to full charge within two hours, with the LS 3070 inserted into the RL 470 base/charger unit. Alternatively, the battery module can be recharged in the Universal Four-Slot Charger/Recharger within 8 hours.

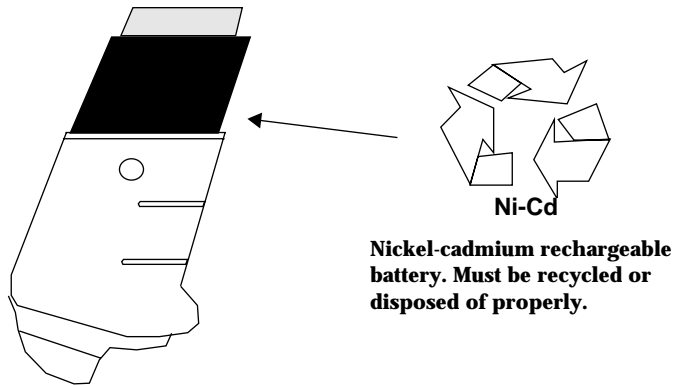

Figure 1-2. The LS 3070 Rechargeable Battery Pack

The Base/Charger Unit

The base/charger unit has two primary functions. First, it is the *base station* interface that manages the flow of information from the scanner to the host device. Second, it is a *charging stand* which charges the scanner's battery module (located in the handle) and also holds the scanner securely when it is not in use. An LED indicates the status of battery charging.

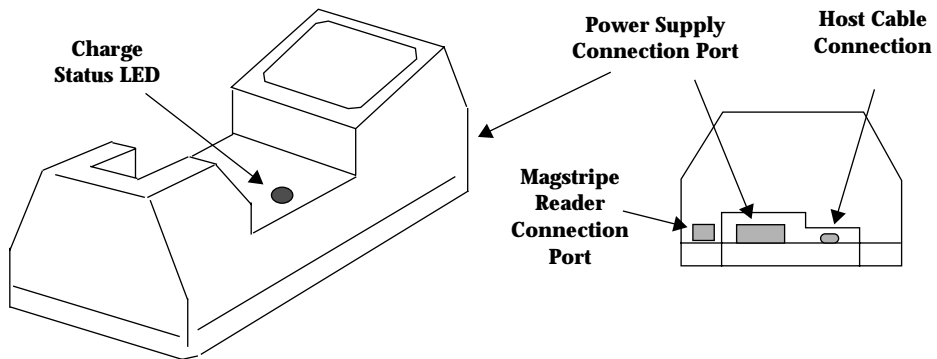
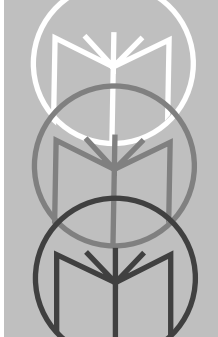

Figure 1-3. RL 470 Base/Charger Unit

The base/charger unit communicates via radio transmission with the scanner to receive bar code data from the scanner, confirm receipt of data back to the scanner, and exchange configuration information. The base/charger unit also formats the scanned bar code data as required and then transmits it to the host system through the attached cable.



Chapter 2 Setup

Unpacking

Remove the LS 3070, the RL 470 base/charger unit, and the host interface cable from its packing and inspect each for evidence of physical damage. If any equipment was damaged in transit, call the Symbol Support Center at the number in the front matter.

KEEP THE PACKING. It is the approved shipping container and should be used if you ever need to return your equipment for servicing.

Connecting the Cable to the Base/Charger Unit

The cable connects to the base/charger in the same way but to each host terminal differently. For complete details per terminal type, refer to the *RL 470 Base Station Interface Guide*.

Installation Tip — Optimizing RF Performance

The LS 3070 scanning system is equipped with a low power 2.4 Ghz radio. Depending on environmental conditions, the LS 3070 can have an RF transmission range of 30 - 50 feet (9 - 15 meters).

Where environmental objects affect RF range and performance, do the following when you install the LS 3070 scanning system. This will help assure peak performance.

The RL 470 base station is a charger, host interface, and — significantly — receiving station for RF transmission. Therefore, do not install the RL 470 inaccessibly under a table or buried in a desk drawer. At a minimum, mount the RL 470 on a table or desk top. For optimum RF performance, especially in difficult environments, mount the RL 470 on a wall as high as possible. But keep in mind the limits of interface cable length and charging accessibility.

Proper base positioning gives you the best possible range and coverage performance from the LS 3070 cordless scanning system.

Inserting the Scanner Into and Removing Scanner from Base/Charger

To insert the scanner into the base/charger:

1. First, place the nose to the scanner into the large rectangular receptacle of the base/charger.
2. Then place the scanner handle into the opening of the smaller, latched receptacle and press down firmly until the bottom of the handle seats snugly into the receptacle and engages the latch.

Caution

Use of excessive force in placing the scanner into the base can damage the charging contacts on the shoe of the scanner or in the receptacle of the base. Such damage can interfere with or prevent charging of the scanner's batteries by the base.

3. To remove the scanner from the base/charger, grasp the handle of the scanner and lift the bottom of the handle out of the latched receptacle, thereby freeing the scanner from the base.

Caution

*It is important to remove the scanner **handle-first**. Trying to remove the scanner nose-first can break latch in the base receptacle.*

Charging the Battery

Before its first use, the LS 3070 batteries must be charged. To do so:

- Connect the power supply to the power input port on the front panel of the RL 470 base/charger, shown in [Figure 1-3: RL 470 Base/Charger Unit on page 1-4](#).
- Connect the power supply to a receptacle supplying AC power of the proper voltage level.
- Then insert the scanner into the base/charger cradle, so that the nose of the scanner and tip of the handle fit snugly into the receptacles. Check the charge status indicator (blinking = fully charged) for full charge, which occurs within two hours. When fully charged, proceed with pairing.

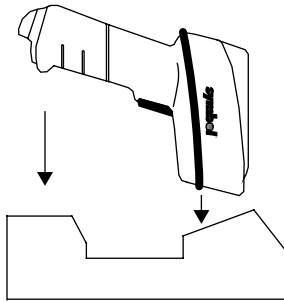

Pairing the Scanner with the Base/Charger

The wireless “connection” between the two is the low power radio transmission through RF transceivers in the both the scanner and base/charger. The actual communication consists of bidirectional message packets. However, ***the scanner and base/charger must be paired*** for this communication to work between the two devices.

Assigning Address to Base/Charger

First, the base/charger must be assigned an address, with a value between 01 and 7E. ***Each base station must have a unique address.***

Note: When setting the address of the base, you automatically set the initial frequency on which the base and the scanner communicate. In order to minimize possible interference between systems, bases which are close to each other should be assigned sequential addresses.

Set the address through setting two rotary dials, located by opening a panel on the base/charger's underside. Turn the base/charger upside down, open the panel, and notice two rotary dials.

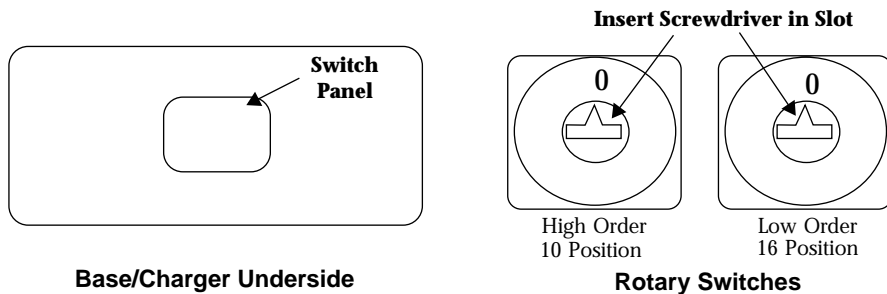

The first is a 10-position (0 to 9, high order address digit) and the second a 16-position (0 to F, low order address digit). Digits are printed sequentially around each circle. *Do not use positions 8 and 9. Setting the 10-position switch to 8 or 9 will result in an error beep (5 long low tones) during pairing.*

Set the desired address with a small screwdriver; possible addresses are listed on the next page. Note that too large a screwdriver can damage the dials. When the address is set, close the panel, turn the base/charger rightside up again.

Possible Base/Charger Addresses															
01	02	03	04	05	06	07	08	09	0A	0B	0C	0D	0E	0F	
10	11	12	13	14	15	16	17	18	19	1A	1B	1C	1D	1E	1F
20	21	22	23	24	25	26	27	28	29	2A	2B	2C	2D	2E	2F
30	31	32	33	34	35	36	37	38	39	3A	3B	3C	3D	3E	3F
40	41	42	43	44	45	46	47	48	49	4A	4B	4C	4D	4E	4F
50	51	52	53	54	55	56	57	58	59	5A	5B	5C	5D	5E	5F
60	61	62	63	64	65	66	67	68	69	6A	6B	6C	6D	6E	6F
70	71	72	73	74	75	76	77	78	79	7A	7B	7C	7D	7E	

Note: Each base station must have a unique address.

Pairing Scanner with Base/Charger

To pair the scanner with the base/charger:

- Scan the **PAIRING** bar code below or the bar code on the RL 470 base.



PAIRING

- Then insert the scanner into the base/charger's cradle. You have 15 seconds to do this, or there will be error beeps (4 beeps = unsuccessful pairing or base not powered). Note that you cannot scan data until this pairing is complete.

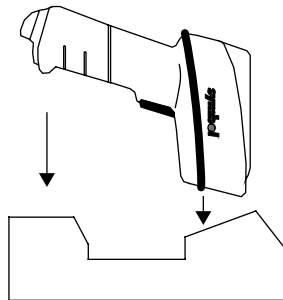

- At that time, through the scanner's contact shoe, there is an exchange of information (addressing, RF channels, etc.) between the scanner and the base/charger's cradle. This occurs in less than a second.
- After that exchange, the scanner and base/charger are paired. Successful pairing is indicated by a **warble** beep; failure, or unsuccessful link, is indicated by a **Lo Lo Lo Lo** beep.

Setting Transmission Frequency

Each scanner/base pair communicates on one of a number of channel frequencies, which varies by country. In most countries, there are 80 available channels (numbered 2 through 81); in France, there are only 9 channels (numbered 46 through 54).

The initial transmission frequency is determined by the base's unique address, so neighboring LS 3070 systems operate on different channels. This allows them to transmit simultaneously without interfering with each other. Channel separation is optimal between sequential base addresses, so base units closest to each other should be assigned sequential base addresses if possible. (Note that data is transmitted between a scanner and base so quickly that a number of different LS 3070 systems can normally operate on the same channel without noticeable interference.)

Occasionally, there can be excessive interference on a channel from some other source of radio transmissions. In this case, the default channel of a system can be changed using the parameter codes for *Set Transmission Frequency*. If you find a particular scanner/base pair has trouble communicating over a normal operating distance, try setting different transmission frequencies to see if performance improves. (The LS 3070 system changes channels automatically if it encounters interference as much as 80% of the time over a continuous 5-minute period.)

Note: To set transmission frequency correctly, be sure to use the correct *Select Channel Number* bar code for your country, and to set a channel within the allowable range.

Installing a Magstripe Reader

If desired, install a magstripe reader. This may be done before or after pairing.

1. Remove the blank plug in the magstripe connection port on the base/charger, and then plug the magstripe reader's cable into this port, as illustrated below.
2. The purpose of the blank plug is to protect the base/charger from accidental damage that can be caused by static electrical discharge into the magstripe connection port. *Keep this plug in the port whenever the magstripe reader is not connected.*

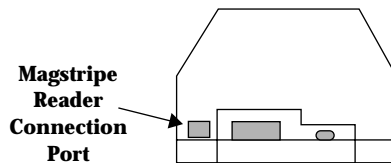

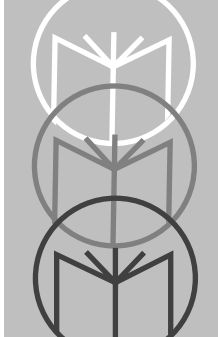

Chapter 3

Scanning with the LS 3070

1. Ready

Before starting to scan bar codes for data collection, make sure:

- The base station is connected to the host device.
- The battery has been charged.
- The scanner is paired with the base/charger.

2. Test

Aim the scanner toward a bar code and press the trigger. When you press the trigger, the scanning beam is energized.

3. Scan

Make sure the symbol you want to scan is within the proper scanning range. (See *Decode Zones beginning on page 3-6.*)

Aim and press the trigger.

- The scan beam and red **SCAN LED** will light for about 3 seconds, or until a successful decode.

The scanner has read the symbol when:

- You hear a beep.
- The green **DECODE LED** lights.

The **LED** stays green for up to one second if the trigger is down or disappears if you release the trigger. The scanner powers down after a successful decode.

If the scanning attempt ends in 4 error beeps, any of these may be true:

- Scanner is out of transmission range
- Scanner and base/charger are not paired
- Base/charger is not powered.

Hold at an Angle

Do not hold the scanner directly over the bar code. In this position, light can bounce back into the scanner's exit window and prevent a successful decode.

Scan the Entire Symbol

- Your scan beam must cross every bar and space on the symbol.
- The larger the symbol, the farther away you should hold the scanner.
- Hold the scanner closer for symbols with bars that are close together.
- A short high-tone beep indicates a good decode.



Using a Long Range or High Visibility Scanner?

These scanners have two-position triggers. Press the trigger to the first detent and center the “collapsed” aiming beam on the target bar code, as illustrated below. The collapsed beam helps to establish the correct scanning position. Press the trigger to the second detent, and a scan beam crosses all the bars and spaces on the bar code.

FIRST TRIGGER POSITION

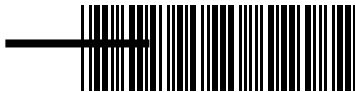

WRONG



RIGHT

SECOND TRIGGER POSITION



WRONG



RIGHT

Scanning Transmission Range

RF Communication Errors

RF communication errors occur when the scanner is out of range from the base during a scan data transmission attempt. An error is indicated by 6 beeps after a bar code is scanned, although the bar code data appears on the host display.

This happens when the base receives the bar code data but the scanner did NOT get the HIF response from the base, and therefore timed out.

The base reported an RF communication error because the NOMAD protocol was not completed before timeout, however, transmitted the bar code data to the host. Since the data has been sent, normal communications must be re-established.

Restoring Normal RF Communications

Move the scanner closer to the base station so the transceivers can communicate with each other better. Then re-scan the bar code. The scanner sounds a good decode beep but the base does not display the bar code data, because the data was already transmitted on the previous scan.

Resume normal scanning.

What If ...

Nothing happens when you follow the operating instructions?

You should

- Check that the power supply is attached to the base/charger.
- Check for loose cable connections at the base/charger and host device.
- Check the scanner's battery pack.
- Make sure the device is programmed to read the type of bar code you want to scan.
- Check the symbol to make sure it is not defaced.
- Try scanning similar symbols of the same code type.
- Check that the gas tank is not exhausted.*
- Make sure the scanner and base/charger have been successfully paired.
- Be sure you're within the proper scanning and transmission range.

If you get frequent Transmit Errors (error beeps after decode):

- Check that you are within scanning transmit range. (See *Scanning Transmission Range on page 3-4.*)
- Check that the scanner is successfully paired with the base/charger.
- Check that the base/charger is powered up and that its cable connections are secure.

Note: If after performing these checks the symbol still does not scan, contact your distributor or call the Symbol Support Center. See *Symbol Support Center on page About-ii* for the telephone number.

* The gas tank limits the amount of time the laser remains on within a given period to conform to the requirements of specific laser output classifications.

Decode Zones

LS 3070 Standard Range

NOTE: Typical performance at 23° C (75° F) on high quality symbols.

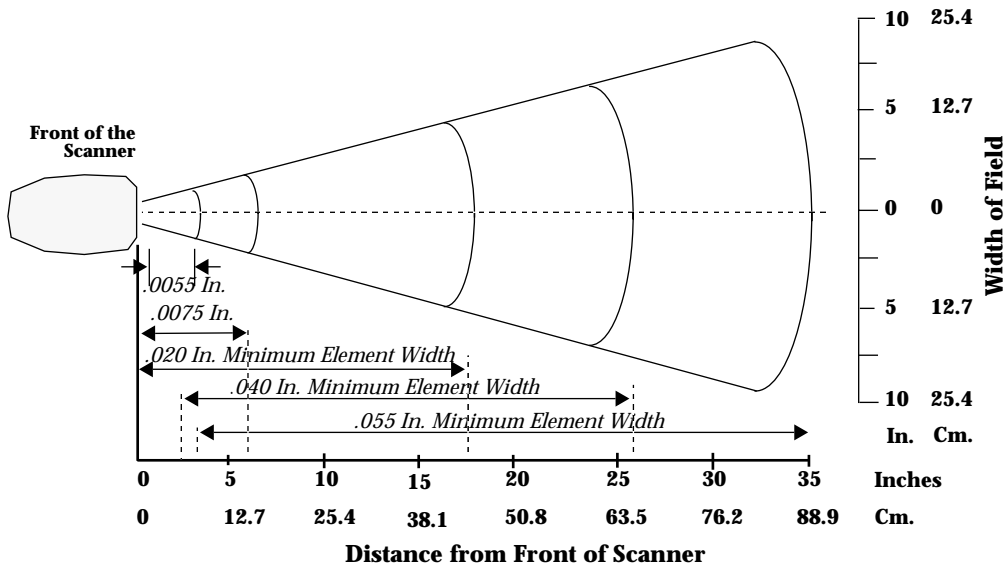

**Figure 3-1. LS 3070 Decode Zone:
Depth of field as a function of minimum element width.**

LS 3070LR Long Range

NOTE: Typical performance at 23° C (75° F) on high quality symbols.

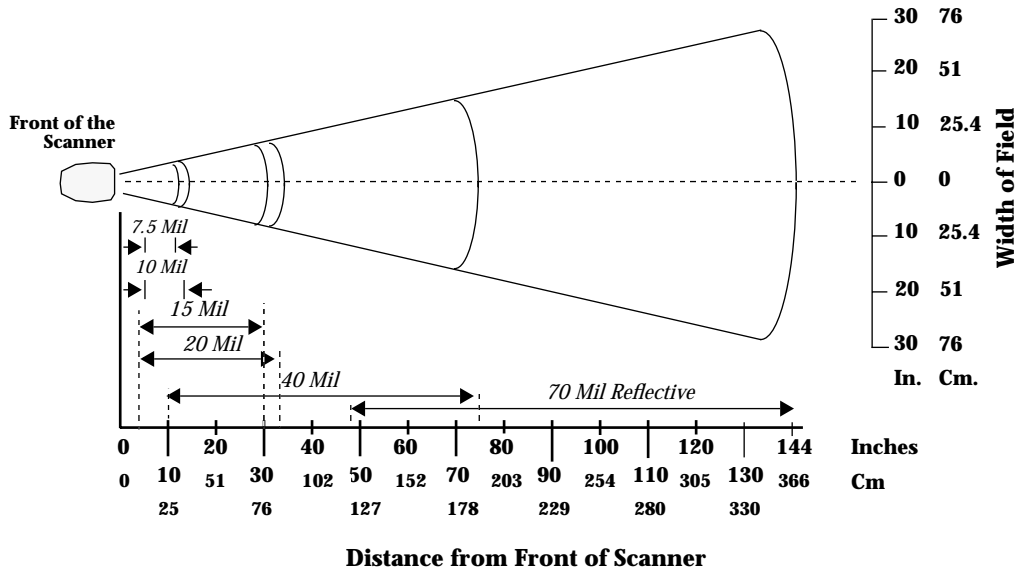

**Figure 3-2. LS 3070LR Decode Zone:
Depth of field as a function of minimum element width.**

LS 3070ALR Advanced Long Range

NOTE: Typical performance at 23° C (75° F) on high quality symbols.

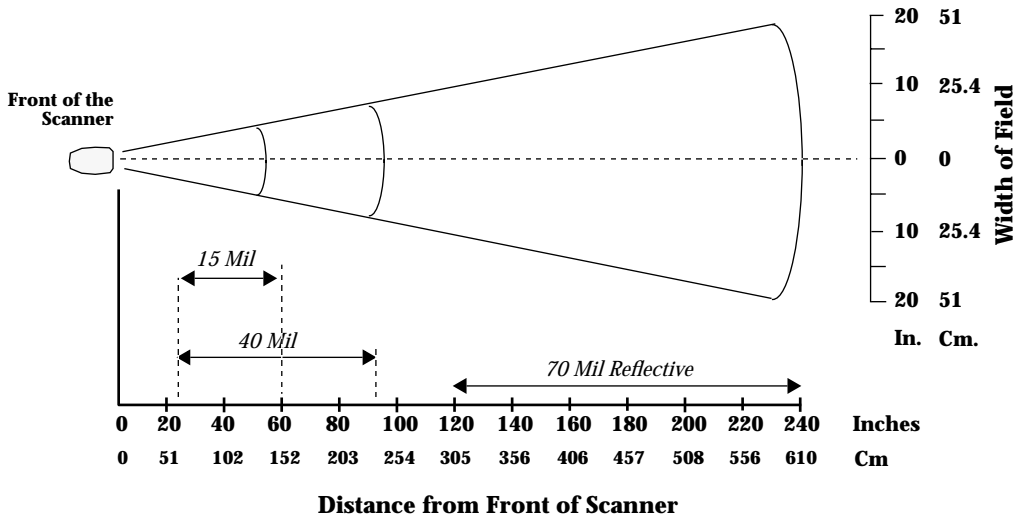

**Figure 3-3. LS 3070ALR Decode Zone:
Depth of field as a function of minimum element width.**

LS 3070XLR Extra Long Range

NOTE: Typical performance at 23° C (75° F) on high quality symbols.

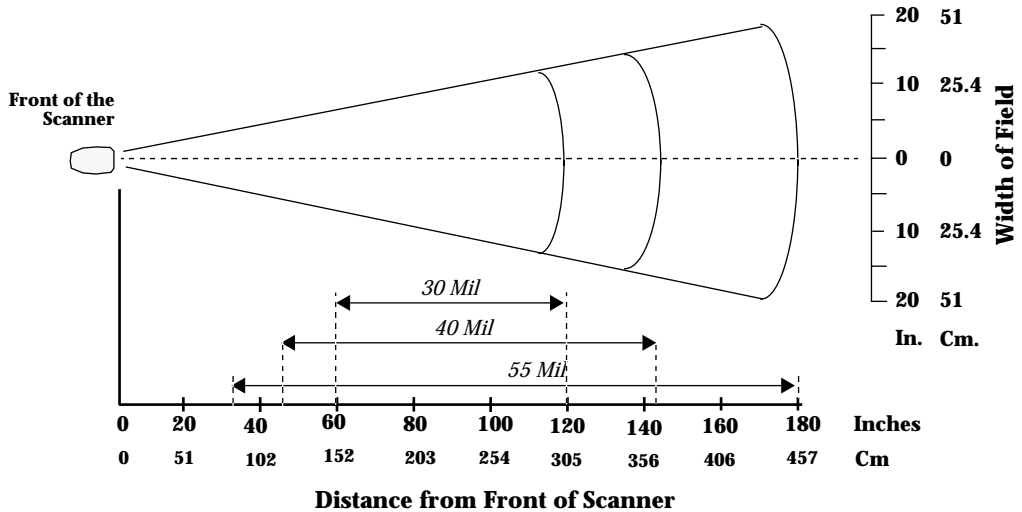

**Figure 3-4. LS 3070XLR Decode Zone:
Depth of field as a function of minimum element width.**

LS 3070HV High Visibility

NOTE: Typical performance at 23° C (75° F) on high quality symbols.

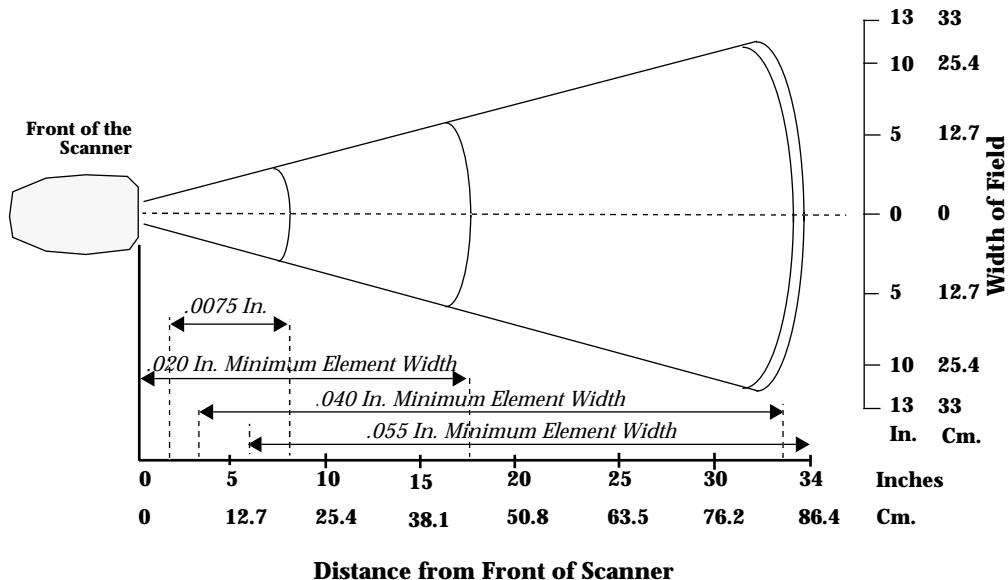

**Figure 3-5. LS 3070HV Decode Zone:
Depth of field as a function of minimum element width.**

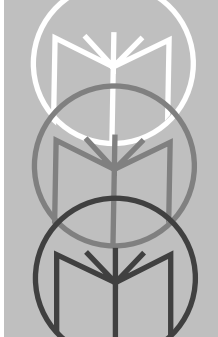

Chapter 4 Maintenance and Specifications

Maintenance

Cleaning the exit window is the only maintenance required. A dirty window may affect scanning accuracy.

- Do not allow any abrasive material to touch the window.
- Remove any dirt particles with a damp cloth.
- Wipe the window using a tissue moistened with ammonia/water.
- Do not spray water or other cleaning liquids directly into the window.

Recharging the Battery

As a charging stand, the base/charger recharges batteries in the scanner when the scanner is in the cradle. The status of the scanner battery module determines the charge rate. If the battery module is at full charge, the base/charger supplies a trickle charge. If the battery module is at less than full charge, there is a programmed charge. Note that the scanner can be removed from the base/charger at any time.

When necessary, recharge the batteries. To do so:

- Connect the power supply to the power input port on the front panel of the RL 470 base/charger, as illustrated below.
- Connect the power supply to a receptacle supplying AC power of the proper voltage level.
- Then place the scanner into the base/charger cradle, so that the nose of the scanner and tip of the handle fit snugly into the receptacles. Check the charge status indicator (blinking = fully charged) for full charge, which occurs within two hours. However, the scanner can be used on less than full charge.

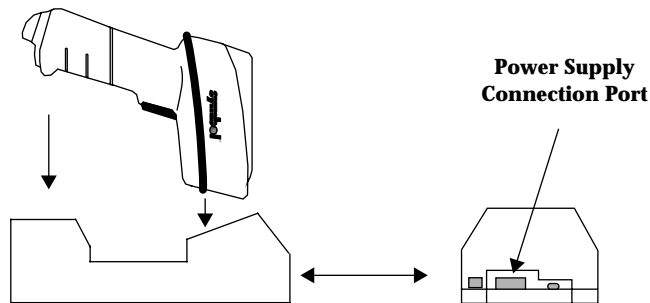

Figure 4-1. Recharging the LS 3070

Changing Battery Packs

You can charge battery packs on the Universal Four Slot Battery Charger so that a charged battery pack is available when needed. In this case, simply remove the depleted battery pack and replace it with a freshly charged one.

User instructions are in the *Universal Four-Slot Battery Charger Quick Reference Guide*.

1. Remove Lower Handle from Scanner.

Using a probe, press in the release button on the handle, as indicated at the right. With button pressed in below the outer housing, slide the battery pack out from the handle.

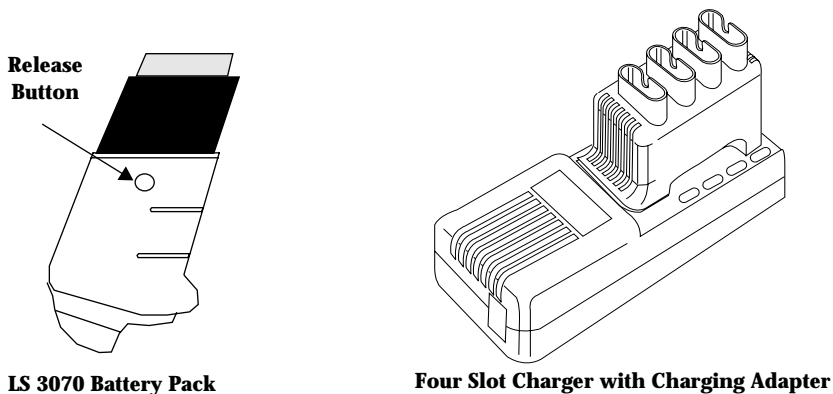

Figure 4-2. Changing LS 3070 Battery Packs

2. Insert Charged Battery Pack in Handle.

With release button down, slide charged battery pack up into handle until it locks into place and the release button pops up into place as well.

Charge Status LED Indications

On the base/charger, there is a red LED indicator which uses flashing patterns to indicate the current charger status. The red Charge Status LED indicates the following conditions:

- **RED LED OFF** — The scanner is not properly inserted or the battery is not functioning properly.
- **RED LED blinking slowly** (1/8 sec. ON, 3/8 sec. OFF) — Battery charge is pending. This can occur if the battery temperature is too high or low or if the battery is deeply discharged. After several minutes, normal charging should begin.
- **RED LED ON** — The battery is actively charging. Charging will complete in less than 2 hours.
- **RED LED blinking rapidly** (1/8 sec. ON, 1/8 sec. OFF) — Battery charging is complete.

Accessories

Standard Accessories

Part Number	Description
RL 470	Base/interface charger
Base/Charger Cable:	Cables are available for most applications. See the <i>Electronic Product Ordering Guide</i> for more information.
70-10294-01	LS 3070 Product Reference Guide
70-10538-01	LS 3070 Advanced Programmer's Guide
70-10294-01Q	LS 3070 Series Quick Reference Guide
50-04000-041	117 V Power Supply
50-04000-040	220 V Power Supply
50-04000-037	100 V Power Supply

Optional Accessories

Optional accessories, listed in the *Electronic Product Ordering Guide*, include various rechargers, magstripe readers, stands, and holders, which are supplied at extra cost. Additional units of standard accessories listed above may also be purchased at extra cost.

LS 3070 Standard Technical Specifications

ITEM	DESCRIPTION
Power Requirements:	
Scanner	4.75 to 14 VDC; 210 mA @ 5 VDC Typical.
Base/Charger	5 VDC \pm 10% @ 190 mA Typical. 12 VDC \pm 10% @ 400 mA Typical.
Scan Repetition Rate	Approximately 36 (\pm 3) scans/sec (bidirectional)
Start-up Time	<50 msec. from scan enable
Data Acquisition Time	<110 msec. from scan enable
Skew Tolerance	\pm 65° from normal
Pitch Angle	\pm 55° from normal
Decode Depth of Field	See <i>LS 3070 Standard Range on page 3-6</i>
Minimum Element Width	0.005 in. .127 mm
Maximum Element Width	0.2 in. 5.08 mm
Print Contrast Minimum	20% absolute dark/light reflectance differential, measured at 675 nm.
Ambient Light Immunity	
Artificial Lighting	450 ft. candles 4844 lux
Sunlight	8000 ft. candles 86112 lux (@8 in. on low density bar codes)
Durability	6-ft. drop to concrete
Operating Temperature	0° to 40°C 32° to 104°F
Storage Temperature	-40° to 60°C -40° to 140°F
Humidity	5% to 95% (non-condensing)
Height	6.3 in. 16 cm
Length	5 in. 12.7 cm
Width	2.8 in. 7.1 cm
CDRH Class	I, II

LS 3070LR Technical Specifications

ITEM	DESCRIPTION
Power Requirements:	
Scanner	4.75 to 14 VDC; 210 mA @ 5 VDC Typical.
Base/Charger	5 VDC \pm 10% @ 190 mA Typical. 12 VDC \pm 10% @ 400 mA Typical.
Scan Repetition Rate	Approximately 36 (\pm 3) scans/sec (bidirectional)
Start-up Time	<50 msec. from scan enable
Data Acquisition Time	<110 msec. from scan enable
Skew Tolerance	\pm 60° from normal
Pitch Angle	\pm 45° from normal
Decode Depth of Field	See <i>LS 3070LR Long Range on page 3-7</i>
Minimum Element Width	0.007 in. .178 mm
Maximum Element Width	0.2 in. 5.08 mm
Print Contrast Minimum	50% absolute dark/light reflectance differential, measured at 675 nm.
Ambient Light Immunity	
Incandescent	450 ft. candles 4844 lux
Fluorescent	450 ft. candles 4844 lux
Sodium Vapor	450 ft. candles 4844 lux
Mercury Vapor	450 ft. candles 4844 lux
Sunlight	8000 ft. candles 86112 lux
Durability	6-ft. drop to concrete
Operating Temperature	0° to 40°C 32° to 104°F
Storage Temperature	-40° to 60°C -40° to 140°F
Humidity	5% to 95% (non-condensing)
Height	6.3 in. 16 cm
Length	5 in. 12.7 cm
Width	2.8 in. 7.1 cm
CDRH Class	II

LS 3070ALR Technical Specifications

ITEM	DESCRIPTION	
Power Requirements:		
Scanner	4.75 to 14 VDC; 210 mA @ 5 VDC Typical.	
Base/Charger	5 VDC ± 10% @ 190 mA Typical. 12 VDC ± 10% @ 400 mA Typical.	
Scan Repetition Rate	Approximately 36 (± 3) scans/sec (bidirectional)	
Start-up Time	<50 msec. from scan enable	
Data Acquisition Time	<110 msec. from scan enable	
Skew Tolerance	± 60° from normal	
Pitch Angle	± 45° from normal	
Decode Depth of Field	See LS 3070ALR Advanced Long Range on page 3-8	
Minimum Element Width	0.015 in.	.380 mm
Maximum Element Width	0.1 in.	2.54 mm
Print Contrast Minimum	50% absolute dark/light reflectance differential, measured at 675 nm.	
Ambient Light Immunity		
Incandescent	450 ft. candles	4844 lux
Fluorescent	450 ft. candles	4844 lux
Sodium Vapor	450 ft. candles	4844 lux
Mercury Vapor	450 ft. candles	4844 lux
Sunlight	8000 ft. candles	86112 lux
Durability	6-ft. drop to concrete	
Operating Temperature	0° to 40°C	32° to 104°F
Storage Temperature	-40° to 60°C	-40° to 140°F
Humidity	5% to 95% (non-condensing)	
Height	6.3 in.	16 cm
Length	5 in.	12.7 cm
Width	2.8 in.	7.1 cm
CDRH Class	IIIA	

LS 3070XLR Technical Specifications

ITEM	DESCRIPTION	
Power Requirements:		
Scanner	4.75 to 14 VDC; 210 mA @ 5 VDC Typical.	
Base/Charger	5 VDC \pm 10% @ 190 mA Typical. 12 VDC \pm 10% @ 400 mA Typical.	
Scan Repetition Rate	Approximately 36 (\pm 3) scans/sec (bidirectional)	
Start-up Time	<50 msec. from scan enable	
Data Acquisition Time	<110 msec. from scan enable	
Skew Tolerance	\pm 60° from normal	
Pitch Angle	\pm 45° from normal	
Decode Depth of Field	See <i>LS 3070XLR Extra Long Range</i> on page 3-9	
Minimum Element Width	0.030 in.	.762 mm
Maximum Element Width	0.1 in.	2.54 mm
Print Contrast Minimum	50% absolute dark/light reflectance differential, measured at 675 nm.	
Ambient Light Immunity		
Incandescent	100 ft. candles	1076.4 lux
Fluorescent	450 ft. candles	4844 lux
Sodium Vapor	450 ft. candles	4844 lux
Mercury Vapor	450 ft. candles	4844 lux
Durability	6-ft. drop to concrete	
Operating Temperature	0° to 40°C	32° to 104°F
Storage Temperature	-40° to 60°C	-40° to 140°F
Humidity	5% to 95% (non-condensing)	
Height	6.3 in.	16 cm
Length	5 in.	12.7 cm
Width	2.8 in.	7.1 cm
CDRH Class	IIIA	

LS 3070HV Technical Specifications

ITEM	DESCRIPTION
Power Requirements:	
Scanner	4.75 to 14 VDC; 210 mA @ 5 VDC Typical.
Base/Charger	5 VDC \pm 10% @ 190 mA Typical. 12 VDC \pm 10% @ 400 mA Typical.
Scan Repetition Rate	Approximately 36 (\pm 3) scans/sec (bidirectional)
Start-up Time	<50 msec. from scan enable
Data Acquisition Time	<110 msec. from scan enable
Skew Tolerance	\pm 60° from normal
Pitch Angle	\pm 45° from normal
Decode Depth of Field	See <i>LS 3070HV High Visibility</i> on page 3-10
Minimum Element Width	0.0075 in. .190 mm
Maximum Element Width	0.1 in. 2.54 mm
Print Contrast Minimum	25% absolute dark/light reflectance differential, measured at 675 nm.
Ambient Light Immunity	
Incandescent	400 ft. candles 4305 lux
Fluorescent	450 ft. candles 4844 lux
Sodium Vapor	450 ft. candles 4844 lux
Mercury Vapor	450 ft. candles 4844 lux
Sunlight	10,000 ft. candles 107640 lux
Durability	6-ft. drop to concrete
Operating Temperature	0° to 40°C 32° to 104°F
Storage Temperature	-40° to 60°C -40° to 140°F
Humidity	5% to 95% (non-condensing)
Height	6.3 in. 16 cm
Length	5 in. 12.7 cm
Width	2.8 in. 7.1 cm
CDRH Class	IIIA

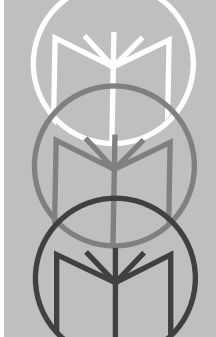

Chapter 5

Interface Guide

Connecting to a Host Device

In most cases, connecting your LS 3070's base station to your host terminal is a very simple operation. You need only plug the cable into your host. Typical configurations are shown on the following pages. Some POS keyboards require more intricate installation instructions. Those begin on [page 5-6](#).

We recommend that you disconnect the power supply from the base station prior to connecting or disconnecting cables.

Refer to [Interfaces](#) beginning on page 5-23 for the proper interface cable assembly.

After you've connected your base station to your host terminal, refer to [Chapter 6: Programming](#) for programming instructions.

Connecting Base Station to a Host

OCIA and OCR Terminals

The OCIA or OCR port must be activated and referenced by the POS system, or no communications will take place.

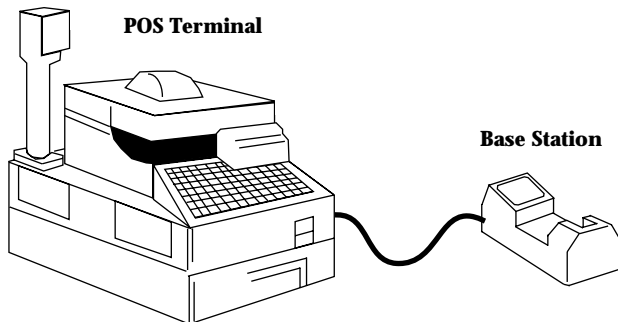

Figure 5-1. Connecting Base Station to OCIA/OCR Terminals

These include:

OCR

IBM 3653/3683/3684, Fujitsu 7770/7880/7990/8770/9000.

OCIA

NCR 2151/2152/2154/2155/2157/2126/2126-1120/2950/7050/7052,
Nixdorf 8812, ICL 9505/9507/9518.

The OCIA port on some terminals, specifically the NCR 2950, 2152 and 2257, may not be accessible from the exterior of the unit. These terminals must be opened and the base station cable connected to the OCIA port on the main processor board.

Note: Some of the above terminals may also be connected as POS keyboard wedges. See specific installation instructions beginning on [page 5-6](#).

RS-232C Single Port

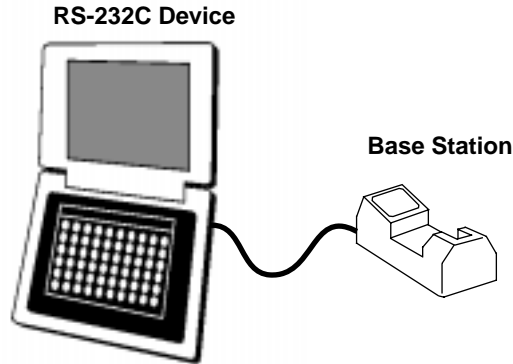

Figure 5-2. Connecting Base Station to RS-232C Single-Port Host

Any of the following RS-232C (DB 25) connectors are supported: Male, TxD on pin 2 or TxD on pin 3. Female, TxD on Pin 2 or Pin 3. For other pinouts and cable types, contact the Symbol Support Center at 1-800-653-5350.

RS-232C Dual Port

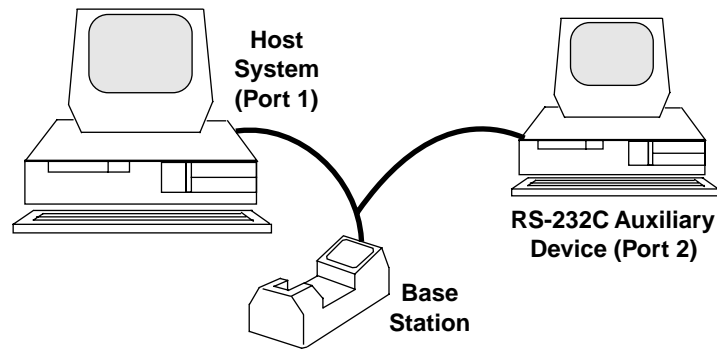

Figure 5-3. RS-232C Dual-Port Mode

This interface involves connecting a Y-cable, for which the male connector is Port 1 and the female connector is Port 2. For IK-1500, male = TxD on Pin 2 and female = TxD on Pin 3. For IK-1501, male = TxD on Pin 3 and female = TxD on Pin 2

IBM 4683/4684/4693/4694

IBM 4683/4	5B, 9B, 17
IBM 4693	5B, 9B, 9C«
IBM 4694	9E

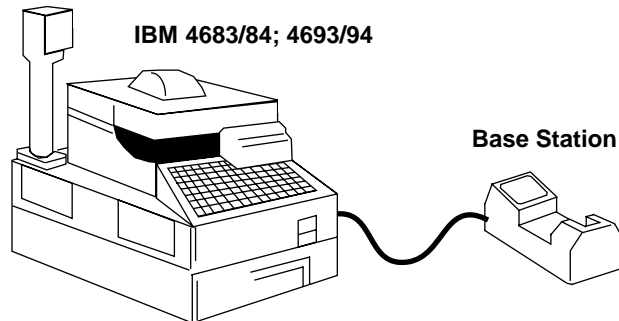

Figure 5-4. Connecting Base Station to IBM 4683/4684/4693/4694

To connect the base station, plug the cable into the appropriate port on the rear of the IBM 4683/84, 4693/94.

For the IBM 4693, port 9C (which replaces port 17 on the 4683/84) is the appropriate port for connecting the base station. Note that port 9C is compatible with ports 9A and 9B, which have identical assignments of connector pins.

For the IBM 4694, there is one single scanner attachment port, 9E, which is equivalent in pin assignments to ports 9A, 9B, and 9C on the IBM 4693.

Note that this variation of port assignments over this range of models represents electrical and mechanical changes only. For the IBM 4683/84 and 4693/94, communications between the attached scanning system and the terminal's operating system device driver programs remain the same.

Connecting Keyboard Wedges

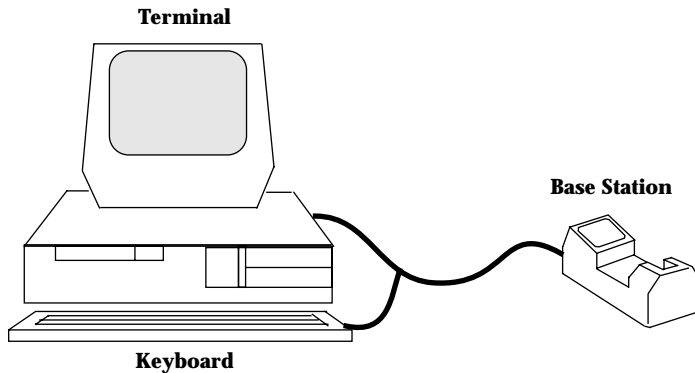

Figure 5-5. Connecting Base Station to Keyboard Wedge

These include:

PC Keyboards

IBM PC/AT/XT, PS2-30/50/55SX/60/70 and clones.

Terminal Keyboards

DEC VT2XX/VT3XX/4XX; HP 700/92, 2392; IBM 3178/3278/3151/316X/
3179/3180/319X, 3278, 347X; Telex-Memorex 88, 122; Wyse 50/60/85/185/
150.

To connect the base station as a keyboard wedge, disconnect the keyboard from the terminal, plug the keyboard connector into the base station cable, and plug the other end of the cable into the terminal.

IBM 3683/3684 Installation

Caution

Install cables as described below. Failure to do so may result in hardware damage.

There are four basic steps to this installation:

1. Remove the IBM 3683/84 top cover.
2. Remove the keyboard.
3. Install the cable internally or externally.
4. Replace the keyboard and top cover.

First: Remove the IBM 3683/84 Top Cover

1. Set ON/OFF switch to **OFF**.
2. If display is integrated, disconnect the display cable).
3. Release the front cover latches. See **Figure 5-6**.
 - Insert a spring hook through the gap between the top cover and base at the side of the cash register near ON/OFF switch.
 - Hook the spring latch and pull it outward to release.
 - Lift the cover slightly at this corner and maintain it in lifted position to prevent it from relatching.
 - Repeat this procedure and release spring latch at opposite side of the machine.
4. Holding the cover near the front on both sides, lift front, then push toward rear of the machine to release it from the retaining tabs.
5. Disconnect cable from connector on the right side. See **Figure 5-7**.
6. Remove by lifting the entire cover straight up.

Second: Remove the Keyboard

Remove the keyboard by lifting it straight up through the retaining guides.

Third: Install the Cable Internally

The base station cable is installed internal to the IBM 3683/84 with the cable exiting the rear of the terminal.

1. Remove the printer assembly as follows:
 - Disconnect the printer ground strap (slide on connector) from the right side of the printer, as shown in **Figure 5-7**).
 - Slide the two printer locking tabs (black plastic) toward the front of the register while pressing downward, as shown in **Figure 5-8**.
 - Lift the printer up and out.
2. The cable to be installed is illustrated in **Figure 5-9**.
3. Mark an X on the side of J16 that faces the front of the terminal. Remove the J16 connector from the keyboard connector bracket. Slide the J16 connector under the printer mounting plate. See **Figure 5-10**.
4. Using a small screwdriver, remove the cable access door from the rear of the register. Position the cable to connect J2 to J16 using the jumper PCB. Make sure J2 and J16 are positioned so that the X and • align. (Some cables are marked with TERM rather than •.) Use the tie wraps provided to secure the connection. See **Figure 5-11**.
5. Slide J1 under the printer mounting plate to the keyboard access opening. Pull it through the opening and secure it with the retaining clips (where J16 originally was). See **Figure 5-12**. (Some cables are marked with KBD or Keyboard rather than •.)
6. Push the J2/J16 connection under the printer mounting plate. Replace the cable access door at the rear of the register.
7. Replace the printer assembly as follows:
 - Attach the ground strap to the right side of the assembly.
 - Fasten the locking tabs by sliding them toward the rear of the register.

Fourth: Replace the Keyboard and Top Cover

1. Replace the keyboard down into the retaining glides.
2. Replace the top cover as follows:
 - Replace the display cable if display is integrated.
 - Hold the cover so that rear slots fit into retaining tabs.
 - Lower the cover at front to engage the front side latches.

You can now attach your scanner and peripheral devices.

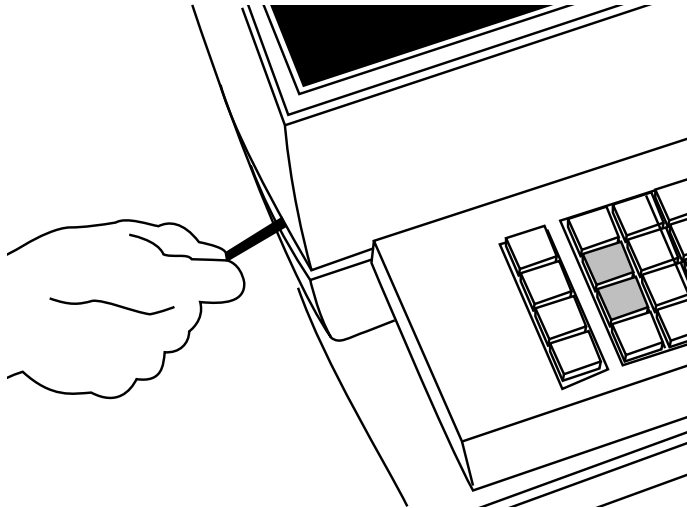

Figure 5-6. Releasing the Front Cover Latches

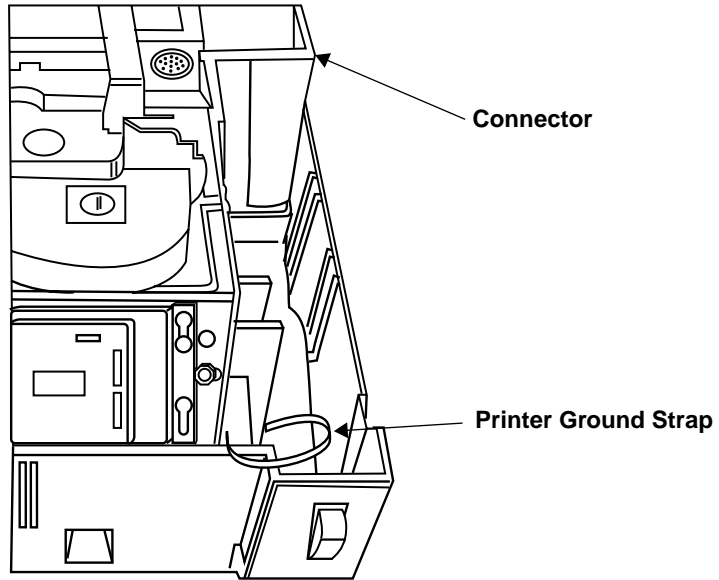

Figure 5-7. Disconnecting Cable from Connector

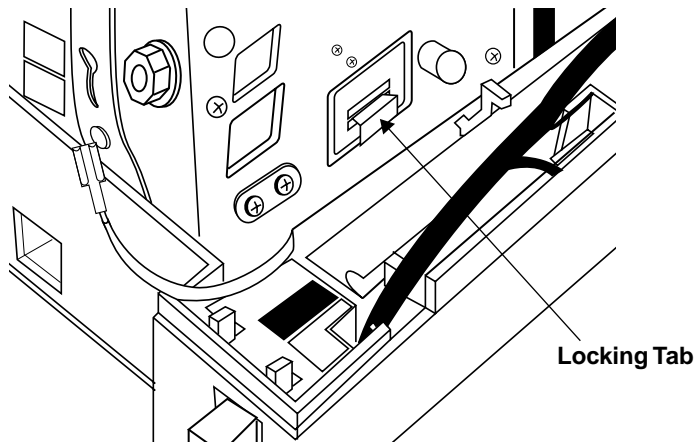

Figure 5-8. Sliding Printer Locking Tabs

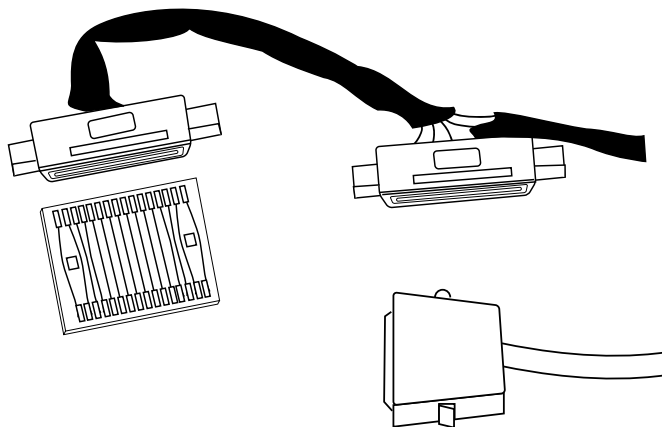

Figure 5-9. Cable

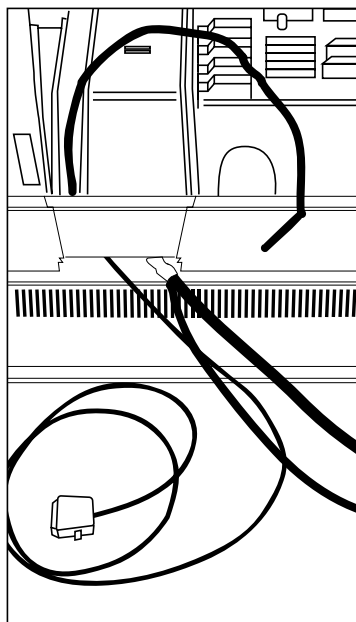

Figure 5-10. J16 Connector

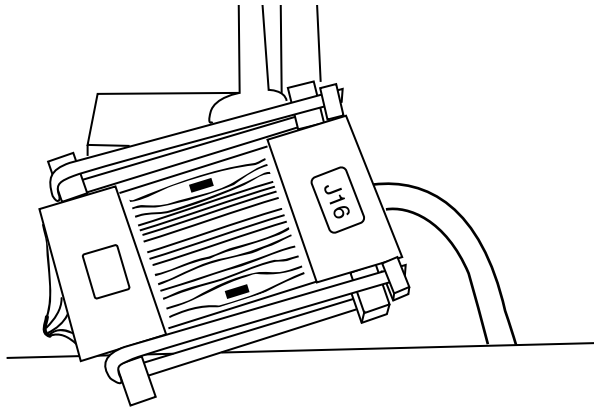

Figure 5-11. Connecting J2 to J16

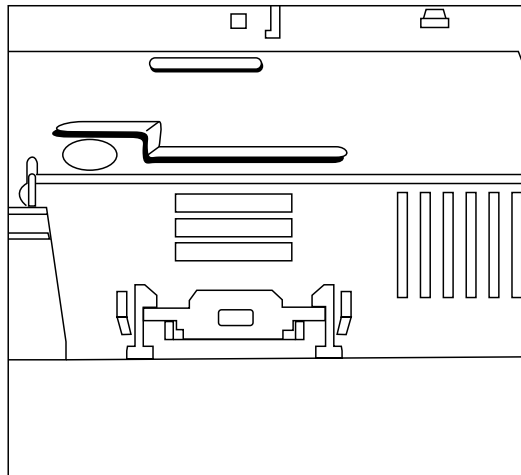

Figure 5-12. Securing J1

IBM 3653 Installation

1. Be sure the IBM 3653 terminal is powered-down. Open the door over the ribbon cartridge as shown in [Figure 5-13](#).
2. Loosen the right side panel screw (see [Figure 5-13](#)). Grasp the right panel at top of the rear corner; pull out to the side and push back to remove the panel.
3. Loosen the two screws behind the top of the keyboard cover. Lift and remove the keyboard cover. See [Figure 5-14](#).
4. From the bottom of the register, slide the cable retaining clips until the cables are free. From inside the register, pass the base station cable (single end) through the power cable hole. See [Figure 5-15](#).

Caution

Use extreme care to avoid damaging the connector pins.

5. Loosen the screw on the base of the cash register near the bottom left side of the card cage. Swing the card cage open by pulling on the left side. See [Figure 5-16](#).
6. Locate the keyboard connector to check for 5 volts DC. Using a DVM, connect the GND (-) probe to the screw that holds the keyboard to the chassis, and connect the POS (+) probe to the 5-volt lead on the TOP ROW of the keyboard connector, second from right (see [Figure 5-17](#)). Turn on the cash register. If the voltage is less than 5 volts, locate the voltage adjustment hole on the power supply case behind the card cage (see [Figure 5-18](#)). Using a flexible screw driver, adjust the potentiometer until the voltage is 5.0 to 5.1 volts. Turn off the register and remove the DVM.
7. Route cable under card cage to the front of the register.
8. Locate the keyboard connector on the keyboard and observe its orientation while removing the connector.
9. Place shrink sleeve over the cable assembly (heat with blow dryer or heat gun to shrink the sleeving if possible).
10. Insert the polarizing key into the top right corner socket. The polarizing key is found in the bag containing the tie wrap.

11. Remove the protective foam from the register end of the base station Y-cable, and insert into the cable assembly. Place the assembly near the bottom of the register behind the keyboard.
 12. Install the keyboard connector, as shown in **Figure 5-19**. Secure with the tie wrap that doesn't have a mounting hole.
 13. Locate the brass plate behind the card cage and remove the front left screw. Install tie wrap between the screw and plate. Replace the screw and tighten.
 14. Loop tie wrap around the cable. Insert in slot and pull tight.
 15. Close the card cage and tighten the screws.
 16. Replace the keyboard cover and side panel, then tighten the screws.
- You can now attach your scanner and peripheral devices.

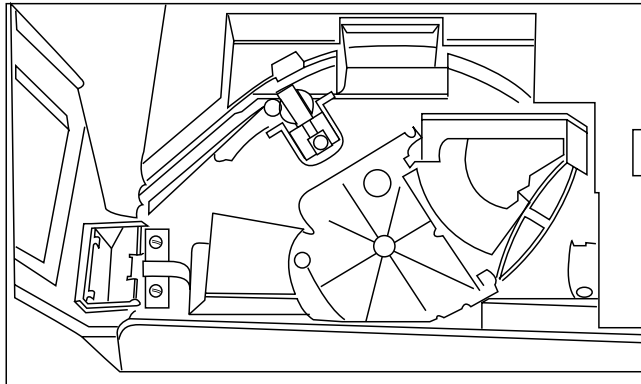

Figure 5-13. Removing Panel

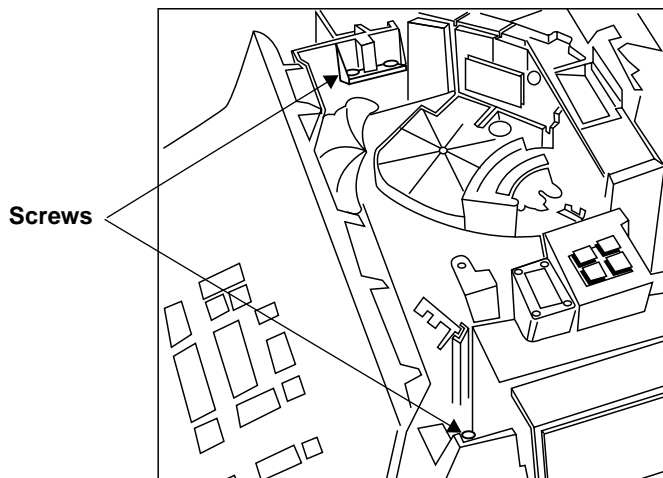

Figure 5-14. Removing Keyboard Cover

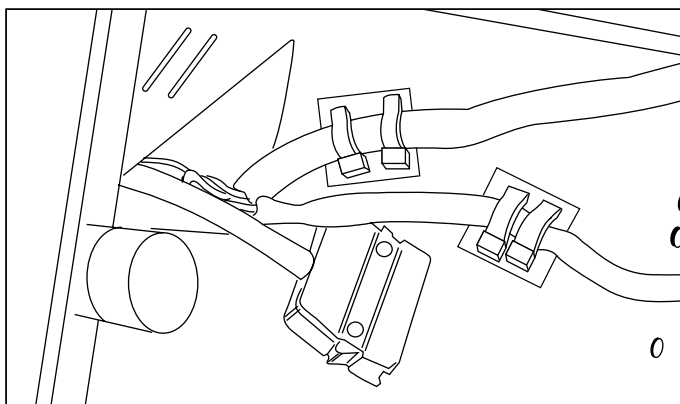

Figure 5-15. Sliding Base Station Cable Through Hole

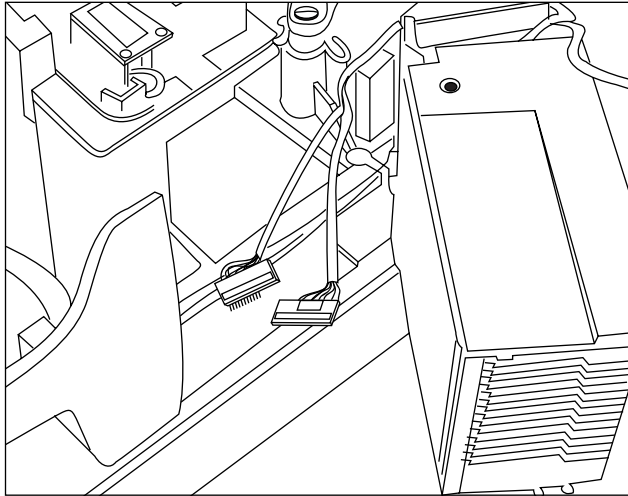

Figure 5-16. Opening Card Cage

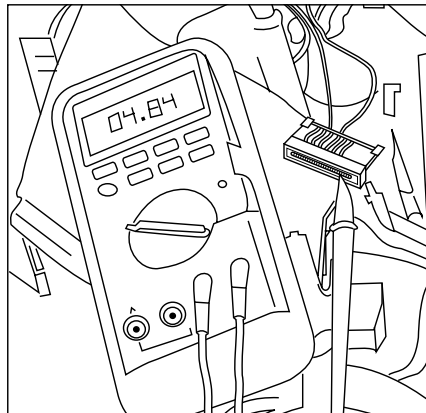

Figure 5-17. Connecting Probes

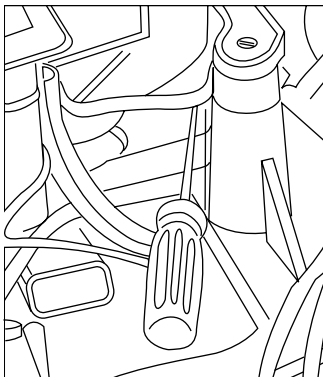

Figure 5-18. Voltage Adjustment Hole

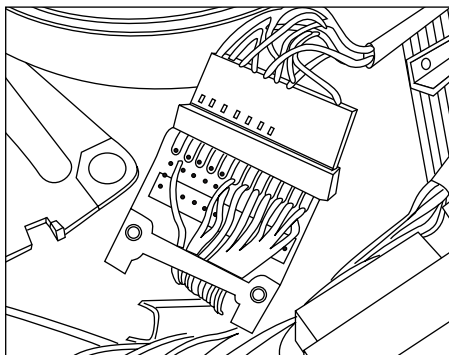

Figure 5-19. Installing Keyboard Connector

NCR 280 Installation

1. Ensure that the NCR 280 is powered down and unplugged. Open the door on the top, left-hand side and remove the two screws which fasten the steel plate to the terminal cover. Slide the steel plate to the left to remove.
2. Remove the two round head screws from the back of the terminal. Be sure the doors on the left and right side of the terminal are open and that there are no keys inserted in the locks on the front. Lift off the terminal cover.
3. Locate the card edge connector to the left of the keyboard. Mark the top side of the connector before removing it from the keyboard.
4. Remove the four “C” clips that hold the keyboard in place. Remove the keyboard.
5. Feed the end of the RL 470 base station cable with the 2x8 header connector under the large capacitor mounted horizontally in the terminal power supply. Next feed the cable between the two large vertically-mounted capacitors then through the hole in the plate adjacent to these two capacitors. Feed through enough cable so that the cable reaches the terminal keyboard.
6. Mate the 2x8 header connector to the connector on the interface board. Note that pin 10 is keyed.
7. With the component side up on the interface board, connect the card edge connector on the interface board to the card edge on the keyboard. The interface board will be mounted under the keyboard PC board.
8. Connect the card edge connector, removed earlier from the keyboard, to the interface board, with the marked side facing down.
9. Replace the keyboard with the interface board attached. Be sure the interface board is installed so that it doesn't interfere with any cable assemblies. Replace the “C” clips.
10. Remove any slack in the RL 470 base station cable by gently pulling it back through the terminal power supply.
11. Using the cable tie provided, secure the base station cable to the cable bundle near the capacitor, which is mounted horizontally approximately 6 1/2 in. from the rear of the terminal.

12. Cut a 1-in. diameter semicircle at the bottom left of the terminal cover, approximately 6 1/2 in. from the back of the unit, so that when the cover is replaced, this opening fits over the cable. Be sure to file down all sharp edges.
13. Replace the terminal cover making sure that cable fits into the opening; secure the two screws at the back of the terminal. Replace the steel plate to the terminal cover and secure.

You can now attach your scanner and peripheral devices.

NCR 2151 Installation

1. Be sure the NCR 2151 terminal is powered-down. Remove the terminal's front grille by loosening the two (2) screws (turn clockwise) that fasten the grille down to the front of the terminal. Fully extend the card slide assembly. Disengage the catches holding the board assemblies in place. Then gently pull out the processor board (top board) until the connectors at the rear of the board become visible. To prevent the board from falling through the card slide assembly, it may be necessary to support the board assembly during this phase.
2. Locate the integrated circuit designated U109 on the processor board. Note U109's orientation by locating its pin 1; this is crucial for the replacement that follows.

Note: U109 is socketed. Using a small screwdriver, remove U109 from its mating socket. Replace the part with the Terminal Retrofit Circuit provided with the installation kit. Be sure that the replacement part is oriented in the same direction as the part it replaces.

3. On the far left side of the processor board, carefully remove the connector marked I/O P7 from its mate (J7). Take the K8 T-board connector (p/n 21-02977-01) from the shipping container, and connect J1 to J7 on the processor board. This connection mates in one direction only. As the connectors are not keyed, be sure the connecting pair is properly aligned.
4. Locate the J3 connector on the rear right side of the processor board. If a cable mates to J3, remove it and note its orientation, as it must be returned to the same position later.

5. Locate the end of the RL 470 base station cable that branches into a “Y”. Slide that end under the board assembly inside the register. Leave enough slack to make the connection required in the next few steps.
6. Mate the RL 470 base station cable “Y” branch ending in a 2 x13 female box-type connector to P1 on the K8 T-board. Connector P1 is the middle connector on the T-Board.

Note: Connector position 1 of the mating pair is keyed.

7. Locate connector P2 on the K8 T-board; it is the top connector on the board. Mate P2 with the ribbon connector marked I/O P7. Be sure the ribbon connector label I/O P7 faces up. Also be sure the left and right edges of the two connectors line up. This check is very important, as the connectors are not keyed.
8. Mate the RL 470 base station cable “Y” branch ending in a 2X6 female box-type connector to P1 on the T-board (p/n 21-03428-01). Connector P1 is the middle connector on the T-board.

Note: The connector position 1 of the mating pair is keyed.

9. If J3 on the processor board had a cable mating to it, that cable must now mate with connector P2 on the T-board (p/n 21-03428-01).

Note: The cable must have the same orientation it had when removed from J3 on the processor board. If no cable was mating with J3, then P2 on the T-board (p/n 21-03428-01) is left unconnected.

10. Carefully slide the board assembly to its original position in the card slide. Then return the card slide to its retracted position. Check that all cables mating to the board assemblies are still firmly seated in position.
11. Locate the supplied cable fastener hardware. Using the hardware, secure the RL 470 base station cable to one of the cable fastening posts located at the bottom front edge of the terminal housing. Replace the grille removed at the beginning of this procedure. The RL 470 base station cable should be positioned so that it fits through a slot located at the bottom of the grille.

You can now attach your scanner and peripheral devices.

NCR 2152 Installation

1. Switch off the NCR 2152. Remove the two large, pan head screws from the front of the terminal to allow the top section to open up. Use the two hood support rods located to the sides of the housing to support the top section.
2. Locate the large steel plate covering the printed circuit board assembly. Remove the two screws on the right-hand side of the plate. Loosen, but do not remove, the two screws holding down the left side of the plate. Slide the plate to the left, lift up and remove to expose the component side of the processor board.
3. Locate the Keyboard Interface connector at the back left of the processor board. This connector will be designated either J12 or J8, depending on the processor board used. Mark the top of the connector with tape or a felt marker.
4. Feed the base station cable up through the opening at the back of the terminal. The opening is on the same side as the Keyboard Interface connector.
5. Connect J1 of the base station cable to the mating connector, P1, on the cable T-Connector provided (P1 is the middle connector).

Note: Position 16 for the connector pair is keyed.

6. Unplug the Keyboard Interface connector. Connect the Keyboard Interface ribbon cable (marked side up) to P2 of the T-Connector. P2 is the top connector on the T-Connector; position 2 of the connector pair is keyed.
7. Connect J1 of the T-Connector to J12/J8 on the terminal processor board. The T-Connector can mate with J12/J8 in one direction only.
8. Locate and remove the pan head cable mounting screw on a flat steel panel in the terminal housing. It is about 4 in. to one side of the T-Connector. Use the tie provided to secure the cable to the terminal housing; replace the pan head screw. The cable must be secured so that the T-Connector is seated vertically (i.e., at 90°) to the processor board.
9. Replace the metal plate that covers the processor board.
10. Remove the hood supports and lower the top of the terminal into position. Replace the two pan head screws to secure the top housing.

You can now attach your scanner and peripheral devices.

NCR 2154/2155 Installation

1. Power-down the NCR 2154/2155 POS terminal.
2. Remove the keyboard by grasping the keyboard cover at its corners and lifting upward.
3. Remove the cable connecting the keyboard to the terminal's main PC board.
4. Install the LL 500 cable in place of the keyboard cable just removed. The modular connector should be connected to J1 on the keyboard, and the 6-pin square connector should be connected to J4 on the terminal's main PC board.
5. Reinstall the keyboard by first placing the tabs, located on the back left and back right of the keyboard cover, behind the tabs located in a similar position on the terminal. The keyboard cable should be made to pass through the notch located at the rear left side of the keyboard cover.
6. Finally, making sure that the remaining tabs on the keyboard cover are positioned inside the terminal housing, press down on the keyboard cover until it snaps into place.

You can now attach your scanner and peripheral devices.

NCR 7052 Installation

1. Switch-off the NCR 7052 and remove the rear panel. If the terminal is not powered-down before the rear panel is removed, the unit will turn itself off. Note that the unit will turn on again when the rear panel is re-installed.
2. Unplug the keyboard connector. Run the keyboard-style connectors on the base station data output cable up the rear well of the terminal.
3. Plug the male keyboard connector into the female connector on the base station; plug the male connector from the base station into the NCR 7052 base.
4. Replace the rear panel of the terminal.

You can now attach your scanner and peripheral devices.

Fujitsu 9000 Installation

1. Switch-off the Fujitsu 9000, and disconnect the power. Push down on the keyboard release latch below the keyboard. Pull the keyboard forward, lift and remove
 2. Press down the printer release tab. Push the printer back and remove. Press down the display release tab. Push the display back and remove.
 3. Remove the four screws securing the top plate to the chassis. Carefully lift the top plate. Disconnect the 60-pin connector marked **KB-PR-DISP** from the motherboard.
 4. Remove one of the metal filler brackets at the left-rear corner of the chassis, and insert the base station cable ends with the two 15-pin connectors.
 5. By the connector marked **KB** on the top plate, remove the two phillips head screws holding the connector plate to the top plate.
 6. Remove the two screws holding the 15-pin D-type male connector to the plate. Push the connector through the top plate.
 7. Slide the insulating sleeve over the 15-pin D-type female connector on the base station cable.
 8. Attach the 15-pin D-type female connector on the base station cable to the 15-pin D-type male keyboard connector. Push the insulating sleeve down over the two connectors and secure both sides with tie wraps. **Connectors must be completely insulated to prevent any possibility of shorting to any component.**
 9. Push the 15-pin D-type male connector on the base station cable through the **KB** opening on the top plate. Attach this connector to the connector plate, making sure the small U-shaped spacer is between the connector and the plate.
 10. Attach the connector plate to the top plate with the small spacing washer closest to the top plate. Attach the top plate to the terminal, re-inserting the four screws.
 11. Replace the display and printer. Replace the keyboard
- You can now attach your scanner and peripheral devices.

Interfaces

Select the appropriate interface cable assembly for your host system.

Host	Type	Interface P/N
DEC VT 2XX/3XX/4XX	Wedge	IK-1400
Fujitsu 7770, 7880, 7990, 8770	OCR	IK-0901
Fujitsu 9000	OCR	IK-0900
Fujitsu 9000	Wedge	IK-0403
HP 700/XX, 239X	Wedge	IK-1301
RS-232C		
TxD on Pin 2, Male	RS-232C	IK-0801
TxD on Pin 3, Male	RS-232C	IK-0802
TxD on Pin 2, Female	RS-232C	IK-0803
TxD on Pin 3, Female	RS-232C	IK-0800
Dual, TxD on Pin 2, Male	RS-232C	IK-1500
Dual, TxD on Pin 3, Male	RS-232C	IK-1501
IBM 3151	Wedge	IK-0409
IBM 3161/319X	Wedge	IK-0406
IBM 3178	Wedge	IK-1200
IBM 3179, 3180	Wedge	IK-0405
IBM 3278	Wedge	IK-1201
IBM 347X	Wedge	IK-0409
IBM AT/XT*	Wedge	IK-0400
IBM PS/2* Model 30,50,55SX,60,70,80	Wedge	IK-0401
IBM 3653	Wedge	IK-0300
IBM 3653, 3683/3684	OCR	IK-0902
IBM 3683, 3684	Wedge	IK-0200
IBM 4683/4684	Port 5B	IK-0100
IBM 4683/4684	Port 9B	IK-1100
IBM 4683/4684	Port 17	IK-0101
ICL 9505, 9507, 9518	OCIA	IK-1005
ICL 9520	OCIA	IK-1006

*And clones

Host	Type	Interface P/N
NCR 280	Wedge	IK-0700
NCR 2126-1120	OCIA	IK-1004
NCR 2151	Wedge	IK-0600
NCR 2152	Wedge	IK-0500
NCR 2152/2257/2950	OCIA	IK-1001
NCR 2154/2155/2157/7050	OCIA	IK-1002
NCR 7052	OCIA	IK-1000
NCR 7052	Wedge	IK-0402
Nixdorf 8812	OCIA	IK-1003
Telex Memorex 88, 122	Wedge	IK-0400
Wyse 60, 85, 150, 150+, 185	Wedge	IK-1300

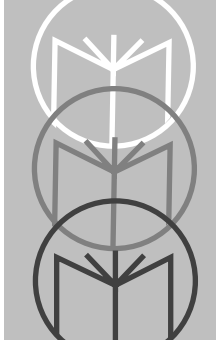

Chapter 6 Programming

Programming Overview

Before programming, follow the instructions in the *Chapter 2: Setup* and *Chapter 5: Interface Guide*.

Programming occurs through use of bar code menus. Not all parameters, however, apply to your specific host. For example, if you have an OCIA terminal, RS-232C parameters such as baud rate and parity will not apply. Simply ignore those parameters not designed for your application. If you're not sure which parameters apply, refer to the *Parameter Selections on page 6-21* for your specific terminal type.

The first section of this chapter, *Parameter Descriptions beginning on page 6-3*, defines parameters and the bar codes necessary to set those parameters.

To customize data for your specific needs, see the *Advanced Programmer's Guide*.

Consult the *Parameter Descriptions beginning on page 6-3* for explanations of parameter types; *Parameter Selections beginning on page 6-21* shows the available parameters for various terminal types.

If the default values suit your requirements, all you need to do is scan the **SET DEFAULT** bar code. Parameters other than default values can be set by scanning sequences of bar codes. *Chapter 7: Parameter Menus* contain all the bar codes necessary to program the scanner for each parameter selection.

Scanning Sequence Examples

In most cases you need only scan one bar code to set a specific parameter. For example, if you want to set the baud rate to 9600, simply scan the **9600** bar code listed under *Baud Rate*. The base station will issue a warble tone, signifying a successful parameter entry.

If you want to add or change prefixes and suffixes or customize the data transmission format, you will have to scan several bar codes. This procedure is described in *Parameter Descriptions* beginning on page 6-3.

Errors While Scanning

Don't worry if you make an error during a scanning sequence. Merely reenter the correct parameter.

Parameter Descriptions

Set Parameter Defaults

Scanning the **SET DEFAULT** bar code returns all parameters to the values listed in the *Default Table beginning on page 6-28*.

Host Interface Code

Each Interface Cable Assembly defaults to a given host. These assemblies, their corresponding defaults, and additional bar codes begin in *Chapter 7: Parameter Menus*. In some cases, two bar codes may correspond to one interface type; this happens when different software revisions exist for the same host type. If there are two bar codes for your host type, try the first bar code; if that does not work, then try the second one.

Code Types

The bar code menu selections enable the scanner to decode any or all of the following symbologies.

- UPC Versions A and E (EAN 8 and 13)
- Code 39
- Discrete 2 of 5
- Code 128
- EAN 128
- Codabar
- Code 39 Full ASCII
- Interleaved 2 of 5
- MSI Plessey

The scanner will autodiscriminate between all of the above symbologies, except for Code 39 and Code 39 Full ASCII.

Code Lengths

Code lengths for certain code type (i.e., Code 39, Codabar, etc.) may be set for any length, one or two discrete lengths, or lengths within a specific range. The length of a code refers to the number of characters (i.e., human readable characters) the code contains.

Length Within Range - This option allows you to decode a code type within a specified range. For example to decode Code 39 characters containing between 4 and 12 characters, first scan **Code 39 Length Within Range**. Then scan **0, 4, 1** and **2** (single digit numbers must always be preceded by a leading zero).

One Discrete Length - This option will allow you to decode only those codes containing a selected length. For example, if you select **D 2 of 5 One Discrete Length**, then scan **1, 4**, the only D 2 of 5 codes decoded will be those containing 14 characters

Two Discrete Lengths - This option will allow you to decode only those codes containing two selected lengths. For example, if you select **D 2 of 5 Two Discrete Lengths**, then scan **0, 2, 1, 4**, the only D 2 of 5 codes decoded will be those containing 2 or 14 characters.

Any Length - Scanning this option allows you to decode the selected code type containing any number of characters. For example, if you scan **Codabar Any Length**, you will be able to decode a Codabar symbol containing any number of characters.

Code 39 Full ASCII

The ASCII character set assigns a code for letters, punctuation marks, numerals, and most control keystrokes on the keyboard.

The first 32 codes are non-printable and are assigned to keyboard control characters such as **BACKSPACE** and **RETURN**. The other 96 are called printable codes because all but **SPACE** and **DELETE** produce visible characters.

Code 39 Full ASCII interprets the bar code control character (**\$ + % /**) preceding a Code 39 symbol and assigns an ASCII character value. For example, when Code 39 Full ASCII is enabled and a **+B** is scanned, it will be interpreted as **b**, **%J** as **?**, and **\$H** emulates the keystroke **BACKSPACE**. Scanning **ABC\$M** will output the keystroke equivalent of **ABC ENTER**.

The LS 3070 will not autodiscriminate between Code 39 and Code 39 Full ASCII.

Decode Options

Transmit UPC-E/UPC-A Check Digit

Select if decoded UPC symbols are transmitted with or without a check digit.

Convert UPC-E To UPC-A

Use this parameter to convert UPC-E (zero suppressed) decoded data to UPC-A format before transmission. After conversion, data will follow UPC format and be affected by UPC-A programming selections (e.g., Preamble, Check Digit).

Ean Zero Extend

This parameter adds five leading zeros to decoded EAN-8 symbols to make them compatible in format to EAN-13 symbols.

Xmit “No Decode” Message

This feature gives you the option to transmit “NR” when a symbol does not decode. Prefixes and suffixes enabled will be appended around this message.

Decode UPC/EAN Supplemental

Select whether UPC/EAN is decoded with or without supplemental characters. Supplementals are additionally appended characters (2 or 5) according to specific code format conventions (e.g., UPC A+2, UPC E+2, EAN 8+2).

If UPC/EAN with supplemental characters is selected, UPC/EAN symbols without supplemental characters won't be decoded. If UPC/EAN without supplemental characters is selected and the scanner is presented with a UPC/EAN plus supplemental symbol, the UPC/EAN will be decoded and the supplemental characters ignored.

If autodiscrimination is chosen, the LS 3070 will, after additional processing to ensure a good decode, transmit either. **(NOTE: To minimize the risk of invalid data transmission, it is recommended that you select whether to read or ignore supplemental characters.)**

Code 39 Check Digit

When enabled, this parameter checks the integrity of a Code 39 symbol to ensure it complies with a modulo 43 check digit algorithm.

ITF-14/EAN-13 Conversion

If your terminal supports EAN-13, this feature converts a 14 character I 2 of 5 code into EAN-13, and transmits to the host as EAN-13. In order to accomplish this, the I 2 of 5 code must be enabled, one length (either LENGTH 1 or LENGTH 2) must be set to 14, the code must have a leading zero and a valid EAN-13 check digit.

Bi-Directional Redundancy for Codabar

This parameter applies only to Codabar symbols. When enabled, the bar code must be decoded in both directions to be considered good.

MSI Plessey Check Digit

One or two digits at the end of the bar code that check the integrity of the data. At least one check digit (default) is always required. Check digits are not transmitted with the data.

Code 39 Buffering (Scan & Store)

When you select the scan and store option, all Code 39 symbols having a leading space as a first character are temporarily buffered in the unit to be transmitted later. The leading space is not buffered.

Decode of a valid Code 39 symbol with no leading space causes transmission in sequence of all buffered data in a first-in first-out format, plus transmission of the “triggering” symbol. See *Code 39 Buffering beginning on page 6-26* for further details.

When the scan and transmit option is selected, decoded Code 39 symbols without leading spaces are transmitted without being stored in the buffer.

Scan and Store affects Code 39 decodes only. If you select scan and store, it is recommended that you configure the scanner to decode Code 39 symbology only.

Beeper Volume

Select degree of volume — high or low.

Beep After Good Decode

Determine if the unit beeper will sound during normal scanning. Usually it is desirable to operate the unit with the beeper enabled. In all cases, the beeper operates during parameter menu scanning and indicates error conditions. See *Beeper Definitions* beginning on page 6-24.

UPC/EAN Security Level

The LS 3070 offers four levels of decode security for UPC/EAN bar codes. Increasing levels of security are provided for decreasing levels of bar code quality. There is an inverse relationship between security and scanner aggressiveness, so be sure to choose only that level of security necessary for any given application.

- **Security Level 0** - This is the default setting which allows the scanner to operate in its most aggressive state, while providing sufficient security in decoding “in spec” UPC/EAN bar codes.
- **Security Level 1** - As bar code quality levels diminish, certain characters become prone to mis-decodes before others (i.e., 1, 2, 7, 8). If you are experiencing mis-decodes of poorly printed bar codes, and the mis-decodes are limited to these characters, select this security level.
- **Security Level 2** - If you are experiencing mis-decodes of poorly printed bar codes, and the mis-decodes are not limited to characters 1, 2, 7 and 8, select this security level.
- **Security Level 3** - If you have tried Security Level 2, and are still experiencing mis-decodes, select this security level. Be advised, selecting this option is an extreme measure against mis-decoding severely out of spec bar codes. **Selection of this level will significantly impair the decoding ability of the scanner.**

Decode Redundancy

Use this parameter to indicate whether the scanner must read a bar code one time (**LEVEL 1**), two times (**LEVEL 2**), or three times (**LEVEL 3**) before decoding it. A higher level of redundancy ensures the accuracy of a decode in, for example, poor quality symbols.

UPC-A and -E Preamble

Three options are given for the lead-in characters of decoded UPC-A or UPC-E symbols transmitted to the host device. Select one preamble for UPC-A decodes and one for UPC-E decodes. These lead-in characters are considered part of the symbol itself. The three options are:

- a system character only
- the country code and system character
- no preamble

The system character is the digit printed to the extreme left of a UPC symbol. The country code for UPC is always zero, and it cannot be transmitted without the system character.

Pause Duration

This parameter, used in data editing, allows a pause to be inserted at any point in the data transmission. Pauses are set by scanning a two digit number (i.e., two bar codes), and are measured in 1/10 second intervals. For example, scanning bar codes “0” and “1” will insert a 1/10 second pause; “0” and “5” will give you a 1/2 second delay.

Prefix/Suffix Values

A prefix/suffix may be appended to scan and magstripe data, for use in data editing. These values are set by scanning a four digit number (i.e., four bar codes) that correspond to keycodes for various terminals. See the [ASCII Table beginning on page 8-1](#).

Data Transmission Formats

Magstripe Data Transmission Format

Magstripe data format options are open for user determination with the specific application. The following are standard selections:

- Standard: <data as on card>
- Option 1: <acct nr>
- Option 2: <acct nr> <SUFFIX>
- Option 3: <acct nr> <SUFFIX> <exp data (MMYY)> <SUFFIX>
- Option 4: <acct nr> <SUFFIX> <exp data (YYMM)> <SUFFIX>
- Option 5: <acct nr> <SUFFIX> <name> <SUFFIX>
- Option 6: <acct nr> <SUFFIX> <exp data (MMYY)> <SUFFIX>
<name> <SUFFIX>
- Option 7: <acct nr> <SUFFIX> <exp data (YYMM)> <SUFFIX>
<name> <SUFFIX>
- Option 8: <PREFIX> <acct nr>
- Option 9: <PREFIX> <acct nr> <SUFFIX>
- Option 10: <PREFIX> <acct nr> <SUFFIX> <exp data (MMYY)>
<SUFFIX>
- Option 11: <PREFIX> <acct nr> <SUFFIX> <exp data (YYMM)>
<SUFFIX>
- Option 12: <PREFIX> <acct nr> <SUFFIX> <name> <SUFFIX>
- Option 13: <PREFIX> <acct nr> <SUFFIX> <exp data (MMYY)>
<SUFFIX> <name> <SUFFIX>
- Option 14: <PREFIX> <acct nr> <SUFFIX> <exp data (YYMM)>
<SUFFIX><name> <SUFFIX>

<acct nr> = account number on card

<exp data> = expiration date (MMYY = month, year; YYMM = year, month)

<PREFIX> <SUFFIX> as selected by user

Scan Data Transmission Format

Scan data format options can be selected by the user. The following are standard selections:

- Standard: <data as is>
- Option 1: <data> <SUFFIX>
- Option 2: <PREFIX> <data> <SUFFIX>
- Option 3: <PREFIX> <data>

<data as is> = scanned bar code data

<PREFIX> and <SUFFIX> as selected by the user

Laser Control

Laser On Timeout

The maximum time the laser will remain on or decode processing will continue during a trigger pull. Programmable in .5 sec increments from 0.5 to 6.0 sec.

RS-232C Options

Baud Rate

Baud rate is the number of bits of data transmitted per second. The scanner's baud rate setting should match the data rate setting of the host device. If not, data may not reach the host device or may reach it in distorted form.

Parity

A parity check bit is the most significant bit of each ASCII coded character. If you select ODD parity, the parity bit will have a value 0 or 1, based on data, to ensure that an odd number of 1 bits are contained in the coded character.

If you select EVEN parity, the parity bit will have a value 0 or 1, to ensure that an even number of 1 bits are contained in the coded character. Select MARK parity and the parity bit will always be 1. Select SPACE parity and the parity bit is always 0. Select the parity type according to host device requirements.

Check Parity

Select whether or not the parity of received characters is checked. The type of parity can be selected with the **PARITY** parameter.

Hardware Handshaking

Hardware handshaking allows you to check the readiness of the receiving device before data is transmitted. If the receiving device is periodically occupied with other tasks, hardware handshaking is needed to prevent loss of transmitted data. Hardware handshaking may not be used in conjunction with software handshaking. Refer to the flowchart on the following page.

RS-232C communications are designed to operate either with or without hardware handshaking lines, RTS, *Request to Send*, and CTS, *Clear to Send*.

If RTS/CTS handshaking is selected, scan data is transmitted with the following sequence: (Note that the DTR signal is hardwired active.)

- The base station reads the CTS line for activity. If CTS is asserted, the base will wait up to one second for the host to negate the CTS line. If, after one second the CTS line is still asserted, the base will sound a transmit error and any scanned data will be lost.

- When the CTS line is negated, the base asserts the RTS line and waits for one second for the host to assert CTS. When the host asserts CTS, data is transmitted.
- When data transmission is complete, the base will negate RTS 10 msec after sending the last character.
- The host should respond by negating CTS. The base will check for a negated CTS upon the next transmission of data.

During the transmission of data, the CTS line should be asserted.

- If the above communications sequence should fail, the base station will issue a transmit error. In this case, the data is lost and must be rescanned.

Select whether the scan data is to be transmitted as soon as it is available or whether transmission follows the RTS/CTS procedure.

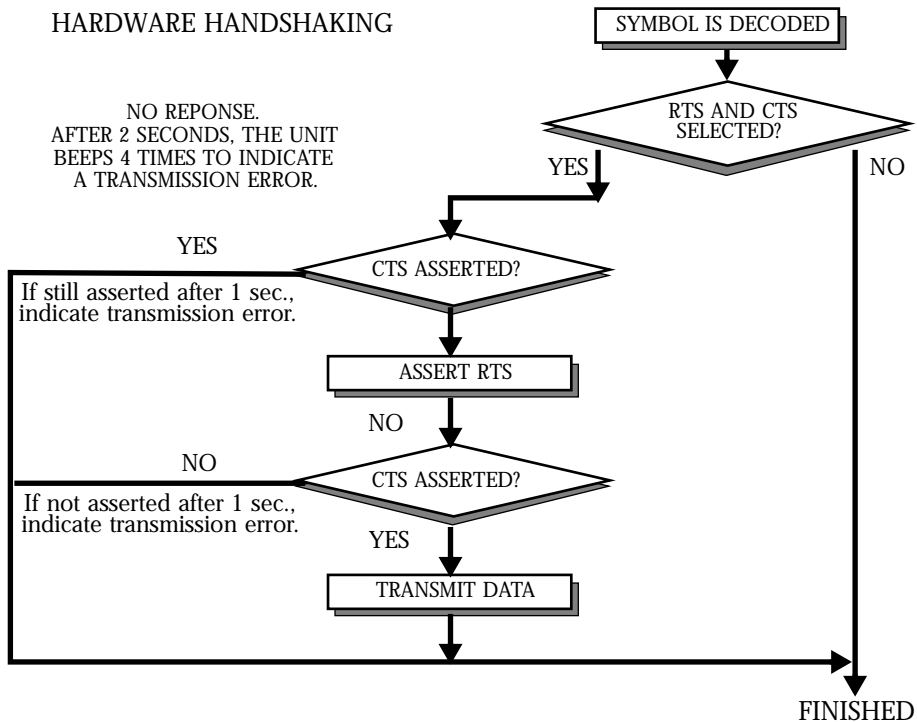

Software Handshaking

This parameter offers control of the data transmission process. It may be used instead of, but not in conjunction with, hardware handshaking. The base station also provides four software handshaking options: NONE, ENQ, ACK/NAK, and ACK/NAK with ENQ. These options may be combined, for example ACK/NAK with ENQ. Refer to the chart following the parameter description.

No Software Handshaking

ACK/NAK Only

The ACK/NAK option checks the success or failure of transmission. The base station expects one of the following host responses after a data transmission:

- <ACK> - Acknowledges a valid and successful transmission.
- <NAK> - Indicates a problem with the transmission.

Whenever a <NAK> is received, the unit retransmits the same data and awaits an ACK/NAK response. After three unsuccessful attempts to transmit the same data, the base aborts any further communication attempts on that message. Transmission error is indicated by the unit sounding 4 short beeps.

When no response for the duration of the serial response time-out parameter (default 2 seconds), or a NAK is received, the base station will retransmit the data until an ACK is received, or the third transmit failure. After three unsuccessful transmission attempts, the unit will abort any further communication attempts on the current message. It indicates this by sounding 4 long (1 second) beeps.

ENQ ONLY

The ENQ option needs the host to request data before it is transmitted to the host. This ensures that data transmission occurs only when the host is ready to receive.

When you select the wait for ENQ option, the base station waits for an ENQ, Enquire character, from the host before it transmits data; otherwise the unit transmits data without waiting for an ENQ character from the host. With ENQ enabled, the base station must receive an ENQ from the host within a 2 second period after the last activity or 4 short beeps are sounded to indicate a transmission error; the unit is now ready to scan again.

ACK/NAK with ENQ

This combines both handshaking options.

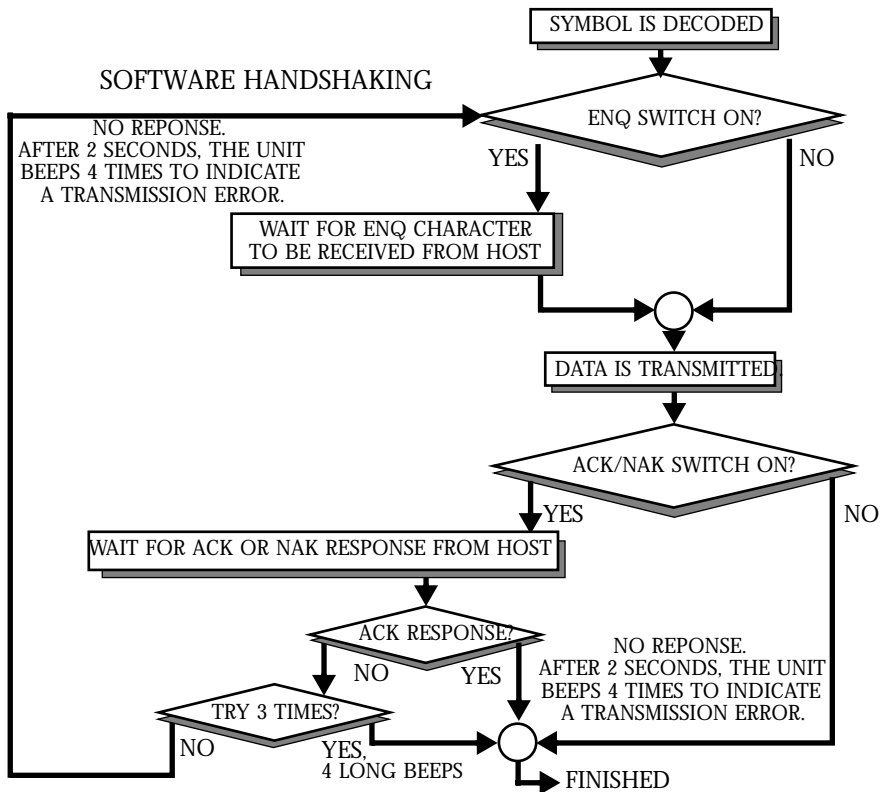

Serial Response Timeout

This parameter determines the maximum period allowed to elapse before the base station assumes end of transmission. The delay period can range from 0 to 9.9 seconds.

Stop Bit Select

The stop bit(s) at the end of each transmitted character marks the end of transmission of one character and prepares the receiving device for the next character in the serial data stream. The number of stop bits (one or two) selected depends on the number the receiving terminal is programmed to accommodate. Set the number of stop bits to match host device requirements.

ASCII Format

When enabled, this parameter transmits data in an 8-bit ASCII format. This allows the base station to interface with devices requiring that protocol. The default is 7-bit ASCII.

RTS Line State

In order to transmit, some hosts expect the RTS line to be in a certain state (High or Low) when there is no hardware handshaking. This parameter will adjust the RTS Line State.

Intercharacter Delay

Select the intercharacter delay option matching host device requirements. The intercharacter delay gives the host system time to service its receiver and perform other tasks between characters. Select from no delay to a 99 msec delay between the transmission of each character.

Transmit Code ID Character

A code ID character identifies the code type of a scanned bar code. This may be useful when the scanner is decoding more than one code type. If a prefix is selected, the code ID character is sent after the prefix. Code ID characters are: A = UPC-A, UPC-E, EAN-13, or EAN-8; B = Code 39; C = Codabar; D = Code 128; F = Interleaved 2 of 5; G = Discrete 2 of 5.

Transmit AIM ID Character

Enabling this parameter, with the Transmit Code ID Character parameter enabled allows you to send the AIM code identifier in lieu of the Symbol identifiers listed above. The identifier will be sent as a three character prefix, in accordance with AIM specifications for symbology identifiers. See AIM's *Guidelines on Symbology Identifiers* for full details.

Ignore Unknown Characters

When enabled, all data is sent except for unknown characters, and no error beeps are sounded. Unknown characters are those characters the selected terminal does not recognize.

When disabled, all data containing one or more unknown characters is discarded, and error beeps are sounded.

OCIA Clock Polarity

Selects the appropriate clock edge values so that a host terminal with non-standard OCIA format can recognize the clock signal phase synchronized with data.

OCIA Transmit Timeout

When connected to an OCIA terminal, the RL 470 base/interface will attempt to transmit the data to the host. If the host is not prepared to accept data at that time (i.e., the host data buffer may be full), the RL 470 will try to retransmit the data for up to 3 seconds. If transmission is not successful, the data will be discarded, and the RL 470 will issue a transmission error.

This parameter allows you to increase the time the RL 470 will attempt transmission before discarding the data. You can select up to a 30 second delay in one second increments. During the time the RL 470 is attempting to transmit data, no new data can be scanned.

NCR 2152 Fast Transmit

Selects the data transmission speed to the NCR 2152 POS terminal. Depending on the version of NCR 2152, selecting this option may increase the possibility of lost or mis-transmitted data.

IBM 4683/93 Magstripe Communications

The RL 470 base/interface communicates with the IBM 4683/84/4693/94 as a scanner device, and also as a magstripe reader device. The RL 470/IBM 4683/93 magstripe communications can be enabled and disabled via this parameter. If the RL 470 magstripe capability is needed, this parameter should be enabled. If not, it should be disabled to avoid contention with any other magstripe reader which may be connected to the host.

International Keypad Emulation

This parameter is supported by IBM AT/XT/PS2 terminals only. The layout of some international keyboards differ from that of American keyboards. To send a given character, regardless of its physical location on the keyboard, enable this parameter.

International Keypad Emulation Fast Transmit

This parameter is used when International Keypad Emulation is enabled. Some IBM AT/XT/PS2s allow for faster transmission. With this parameter enabled, the RL 470 transmits at a faster rate. Not all IBM AT/XT/PS2s support a faster transmission rate.

National Keyboard Types

Use this parameter to set the national character type for keyboard characters. Selections include U.S. English, French, German, French International, Spanish, Italian, Swedish, and U.K. English.

The following terminals do not support Italian or French International but do support the other six options: IBM 3680, 316X, 319X; HP 700/92, 2392; Telex 122; Wyse 50, 60, 160.

These terminals support all options but French International: VT 220, 320, 420.

These terminals support all eight options: IBM PC XT, PC AT, PS/2.

The table below indicates hosts supported by industrial versions of the scanner.

Table 6-1. Hosts Supported by Industrial Scanners

Host Interface	U.S.	U.K.	Fr.	Ger.	Spn.	Swe.	Ital.	Fr. In.
PC AT	Y	Y	Y	Y	Y	Y	Y	Y
PC XT	Y	Y	Y	Y	Y	Y	Y	Y
PS/2	Y	Y	Y	Y	Y	Y	Y	Y
Single RS-232	Y	N	N	N	N	N	N	N
Dual RS-232	Y	N	N	N	N	N	N	N
Dec VT 220	Y	Y	Y	Y	Y	Y	Y	N
Dec VT 320	Y	Y	Y	Y	Y	Y	Y	N
Dec VT 420	Y	Y	Y	Y	Y	Y	Y	N
HP 700/9XX	Y	Y	Y	Y	Y	Y	Y	N
HP 2392N	Y	Y	Y	Y	Y	Y	Y	N
IBM 3151	Y	N	N	N	N	N	N	N
IBM 347X	Y	N	N	N	N	N	N	N
IBM 3179	Y	N	N	N	N	N	N	N
IBM 3180	Y	N	N	N	N	N	N	N
IBM 3179	Y	N	N	N	N	N	N	N
IBM 3180	Y	N	N	N	N	N	N	N

Table 6-1. Hosts Supported by Industrial Scanners

Host Interface	U.S.	U.K.	Fr.	Ger.	Spn.	Swe.	Ital.	Fr. In.
PC AT	Y	Y	Y	Y	Y	Y	Y	Y
PC XT	Y	Y	Y	Y	Y	Y	Y	Y
PS/2	Y	Y	Y	Y	Y	Y	Y	Y
Single RS-232	Y	N	N	N	N	N	N	N
Dual RS-232	Y	N	N	N	N	N	N	N
Dec VT 220	Y	Y	Y	Y	Y	Y	Y	N
Dec VT 320	Y	Y	Y	Y	Y	Y	Y	N
Dec VT 420	Y	Y	Y	Y	Y	Y	Y	N
HP 700/9XX	Y	Y	Y	Y	Y	Y	Y	N
IBM 316X	Y	N	N	N	N	N	N	N
IBM 319X	Y	N	N	N	N	N	N	N
IBM 3178	Y	N	N	N	N	N	N	N
IBM 3278	Y	N	N	N	N	N	N	N
Telex - 88	Y	N	N	N	N	N	N	N
Telex - 122	Y	N	N	N	N	N	N	N
Wyse 60/PC	Y	Y	Y	Y	Y	Y	N	N
Wyse 60/ASCII	Y	Y	Y	Y	Y	Y	N	N
Wyse 60/ANSI	Y	Y	Y	Y	Y	Y	N	N
Wyse 85/ANSI	Y	Y	Y	Y	Y	N	Y	N
Wyse 150/ANSI	Y	N	N	N	N	N	N	N
Wyse 150+/PC	Y	N	N	N	N	N	N	N
Wyse 150+/ASCII	Y	N	N	Y	Y	N	N	N
Wyse 150+/ANSI	Y	N	N	Y	Y	N	N	N
Wyse 185/ANSI	Y	N	N	N	N	N	N	N

Set Transmission Frequency

Use this parameter to set an initial transmission frequency to avoid interference on the default channel (channel 50). During operation, the transmission channel changes automatically whenever interference is encountered 80% of the time or more over a continuous five-minute period. The selected frequency channel must be between 01 and 82.

Wait for Host Interface Response Time

The wait for host interface response timeout is the amount of time it takes for the base to communicate with the host interface and the base to send an acknowledgment back to the scanner. The amount of time required varies with the host device.

Based on the installed interface type, the scanning system automatically calculates a wait or timeout duration for host response. *Under normal operating conditions, there should be no need to program a wait for host response timeout value.*

However, use this parameter when the interface's data stream carries an additional ADF pause duration. The more pause duration added to the data stream, the longer the wait for host response timeout needs to be. Typically, most interfaces timeout in an average of three seconds. If a pause duration is added, this may cause RF communications errors (6 beeps); increase the host wait response timeout to eliminate RF communication errors. Just start by programming at least a 5-second timeout. If errors continue, increment the wait for host response timeout until the RF communications errors stop occurring.

Wait for host response timeout values vary from 1 second to 99 seconds. After scanning the **Wait for Host Interface Response Time** bar code, scan two number keypad bar codes for the two-digit response time (in seconds). If you program a value of zero, there will be an automatic calculation of the host wait response timeout value, based on the selected host interface type.

Parameter Selections

Supported features for each host type.

Table 6-2. Host Supported Parameters

Decode Parameters	RS-232C	IBM 4683*	OCIA	OCR	Keyboard Wedge
Add Codes to be Decoded	X	X	X	X	X
ASCII Format	X				
Baud Rate	X				
Beep After Good Decode	X	X	X	X	X
Beeper Volume	X	X	X	X	X
Check Parity	X				
Codabar Any Length	X	X	X		X
Codabar Length W/I Range	X	X	X		X
Codabar One Length	X	X	X		X
Codabar Two Lengths	X	X	X		X
Code 39 Buffering	X		X	X	X
Code 39 Check Digit	X	X	X	X	X
Code 39 Any Length	X	X	X	X	X
Code 39 Length W/I Range	X	X	X	X	X
Code 39 One Length	X	X	X	X	X
Code 39 Two Lengths	X	X	X	X	X
Code 128 Any Length	X	X	X	X	X
Convert UPC-E to A	X		X	X	X
Data Transmission Format	X	X	X	X	X
D 2 of 5 Any Length	X	X	X		X
D 2 of 5 Length W/I Range	X	X	X		X
D 2 of 5 One Length	X	X	X		X
D 2 of 5 Two Lengths	X	X	X		X

Table 6-2. Host Supported Parameters

Decode Parameters	RS-232C	IBM 4683*	OCIA	OCR	Keyboard Wedge
Decode Redundancy	X	X	X	X	X
EAN Zero Extend	X	X	X	X	X
Hardware Handshaking	X				
Host Interface Code	X	X	X	X	X
IBM 468X/9X Mgstripe Comm.		X			
Ignore Unknown Chars.	X	X	X	X	X
Intercharacter Delay	X				X
I 2 of 5 Any Length	X		X	X	X
I 2 of 5 Length Within Range	X		X	X	X
I 2 of 5 One Length	X		X	X	X
I 2 of 5 Two Lengths	X		X	X	X
ITF-14/EAN-13 Conversion	X	X	X	X	X
Int'l Keyboard Emulation					X
Int'l Keyboard Emul Fast Xmit					X
Laser Off Time-out	X	X	X	X	X
Laser On Time-out	X	X	X	X	X
Magstripe Prefix	X	X	X	X	X
Magstripe Suffix	X	X	X	X	X
NCR 2152 Fast Transmit				X	X
Number of Stop Bits	X				
OCIA Clock Polarity			X		
OCIA Transmit Time-out			X		
Parity	X				
Pause Duration	X				X
RTS Line State	X				
Scan Prefix	X	X	X	X	X

Table 6-2. Host Supported Parameters

Decode Parameters	RS-232C	IBM 4683*	OCIA	OCR	Keyboard Wedge
Scan Suffix	X	X	X	X	X
Serial Response Time-out	X				
Software Handshaking	X				
Transmit AIM Code ID	X	X	X	X	X
Transmit Code ID Chars.	X	X	X	X	X
Transmit MSI Check Digit	X	X	X	X	X
Transmit No Decode Message	X	X	X	X	X
Transmit UPC-A Check Digit	X	X	X	X	X
Transmit UPC-E Check Digit	X	X	X	X	X
UPC/EAN Security Level	X	X	X	X	X
UPC/EAN Supplemental	X	X	X	X	X
UPC-A Preamble	X	X	X	X	X
UPC-E Preamble	X	X	X	X	X

* Some parameters are programmed through host computer.

Beeper Definitions

Standard Use

Beeper Sequence	Indication
1 Beep - short high tone	A bar code symbol, or magstripe data was decoded (if decode beeper is enabled).
2 Beeps - long high tone	Mis-match between the selected host and the interface cable.
4 Beeps - long high tone	This signifies either a host interface error or a format or transmission error in the magnetic stripe card or in a scanned symbol. In that case, the data is ignored. This will occur if a unit is not properly configured. Check option settings.
5 Beeps - long high tone	Data conversion error. When Ignore Unknown Characters is disabled, any attempt to transmit data not supported by the selected host will produce these error beeps.
6 Beeps - short low tone	RF communication error.

Parameter Menu Scanning

Beeper Sequence	Indication
1 Beep - short high tone	Correct entry scanned or correct menu sequence performed.
1 Beep - lo/hi tone	Input error, incorrect bar code or CANCEL scanned, wrong entry, incorrect bar code programming sequence; remain in program mode.
1 Beep - hi/lo tone	Keyboard parameter selected. Enter value using bar code keypad.
1 Beep - hi/lo/hi/lo tone	Successful program exit with change in the parameter setting.

Code 39 Scan And Store

Beeper Sequence	Indication
1 Beep - hi/lo tone	New Code 39 data was entered into the buffer.
3 Beeps - long high tone	Code 39 buffer is full.
1 Beep - lo/hi/lo tone	The buffer was erased, or there was an attempt to transmit an empty buffer. When the Code 39 buffer was empty, the base station read a command to clear or to transmit a Code 39 buffer.
2 Beeps - long high tone	Error in data transmission.
1 Beep - lo/hi tone	A successful transmission of buffered data.

Code 39 Buffering

While there is data in the transmission buffer, deleting Code 39 buffering capability via the parameter menu is not allowed.

To allow disabling of Code 39 buffering, first force the buffer transmission (see [Transmit Buffer on page 6-27](#)) or clear the buffer.

Buffer Data

To buffer data, Code 39 buffering must be enabled, and a symbol must be read with a space immediately following the start pattern.

- Unless symbol overflows the transmission buffer, unit gives hi/lo beep to indicate successful decode and buffering. See [Overfilling Transmission Buffer on page 6-27](#).
- Unit adds the message, excluding the leading space to the transmission buffer.
- No transmission will occur.

Clear Transmission Buffer

To clear the transmission buffer, read a symbol which contains only a start character, a dash (minus), and a stop character.

- Unit issues a short hi/lo/hi beep to signal that the transmission buffer has been erased, and no transmission has occurred.
- Unit erases the transmission buffer.
- No transmission will occur.



Transmit Buffer

To transmit the buffer, read a symbol containing either the first or second condition:

1. Only a start character, a plus (+), and a stop character.
 - The unit signals that the transmission buffer has been sent (a hi/lo beep).
 - Unit sends the buffer.
 - Unit clears the buffer.

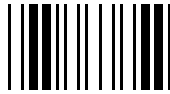

2. A Code 39 bar code with leading character other than a space.
 - The unit signals a good decode and buffering of that decode has occurred by giving a hi/lo beep.
 - Unit transmits the buffer.
 - Unit signals that the buffer has been transmitted with a lo/hi beep.

Overfilling Transmission Buffer

If the symbol just read will result in an overflow of the transmission buffer:

- Unit indicates that the symbol has been rejected by issuing three long, high beeps.
- No transmission will occur. Data in buffer is not affected.

Attempt to Transmit an Empty Buffer

If the symbol just read was the transmit buffer symbol and the Code 39 buffer is empty:

- A short lo/hi/lo beep signals that the buffer is empty.
- No transmission occurs.
- The buffer remains empty.

Default Table

Table 6-3. Defaults

Parameter	Default
Host Interface	See default table, page 6-31
Code Types	All
Code Lengths:	
Code 39	1 to 55
Code 128	3 to 55
Codabar	2 to 55
I 2 of 5	14
D 2 of 5	14
MSI Plessey	1 to 55
Decode Options	
Transmit UPC-A Check Digit	Enabled
Transmit UPC-E Check Digit	Enabled
Convert UPC-E to UPC-A	Disabled
EAN Zero Extend	Disabled
Transmit No Decode Message	Disabled
Decode UPC/EAN Supplemental	Disabled
ITF-14/EAN-13 Conversion	Enabled
Transmit Code 39 Check Digit	Disabled
MSI Plessey Check Digit	One
Buffer Code 39	Disabled
Beeper Volume	High
Beep After Good Decode	Enabled
UPC/EAN Security Level	0
Decode Redundancy	0
UPC-A Preamble	System Character
UPC-E Preamble	System Character
Pause Duration	0
Prefix/Suffix Values**	7013 (<Enter> for wedges, <CR/LF> for serial devices)
Magstripe Data Transmission Format	Data as is

Table 6-3. Defaults

Parameter	Default
Scan Data Transmission Format	Data as is
Laser Control: Laser On Time-out	3 Sec
RS-232C Options Baud Rate Parity Check Parity Hardware Handshaking Software Handshaking Serial Response Time-out Stop Bit Select ASCII Data Format RTS Line State	9600 Odd Enabled None None 2.0 Sec Two 7 Bit Low
Intercharacter Delay	0
Transmit Code ID Character	Disabled
Transmit AIM Code ID	Disabled
Ignore Unknown Characters	Enabled
OCIA Transmit Time-out	3 Sec
OCIA Clock Polarity	Falling
NCR 2152 Fast Transmit	Disabled
IBM 4683/4 Magstripe Communications	Enabled
International Keypad Emulation	Disabled
International Keypad Emulation Fast Xmit	Disabled
National Keyboard Type	U.S. English
Set Transmission Frequency (Channel)	50
Wait for Host Interface Response Time	00

**** Prefix/Suffix values only apply when the selected transmission format uses them. For example, if you select the default setting for Scan Data Transmission Format (Data As Is), any prefix or suffix selected is not recognized, since the format requires neither.**

Terminal Specific RS-232C Defaults

Two RS-232C hosts are set up with their own parameter default settings. Selecting the ICL or Nixdorf RS-232C terminal will set the defaults listed below. These defaults take precedence over standard defaults. So, if you've selected Nixdorf RS-232C, then select the standard defaults, the Nixdorf defaults will still take precedence.

Table 6-4. Terminal-Specific RS-232 Defaults

Parameter	Standard	ICL	NIXDORF
Fixed Host Select	No Host	RS-232C	RS-232C
Transmit Code ID	No	Yes	Yes
Data Transmission Format	Data as is	Data/Suffix	Data/Suffix
Suffix	CR/LF (7013)	CR (1013)	CR (1013)
Baud Rate	9600	9600	9600
Parity	Even	Even	Odd
Check Parity	Enabled	Enabled	Enabled
Hardware Handshaking	None	None	None
Software Handshaking	None	None	None
Serial Response Time-out	2 Sec.	2 Sec.	2 Sec.
Stop Bit Select	Two	One	One
ASCII Format	7-Bit	8-Bit	8-Bit
Beep On <BEL>	Disabled	Disabled	Disabled
RTS Line State	Low	High	Low
RS-232C UPC-A Code ID	"A"	"A"	"A"
RS-232C UPC-E Code ID	"A"	"E0"	"C0"
RS-232C EAN-8 Code ID	"A"	"FF"	"B"
RS-232C EAN-13 Code ID	"A"	"F"	"A"
RS-232C Code 39 Code ID	"B"	"C"	"M"
RS-232C Codabar Code ID	"C"	"N"	"N"

Table 6-4. Terminal-Specific RS-232 Defaults

Parameter	Standard	ICL	NIXDORF
RS-232C Code 128 Code ID	"D"	None	"K"
RS-232C I 2 of 5 Code ID	"F"	"I"	"I"
RS-232C MSI/Plessey Code ID	"J"	None	"O"

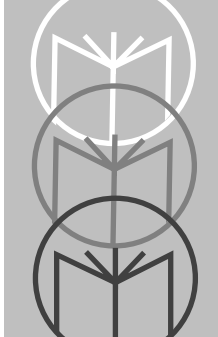

Chapter 7

Parameter Menus

While the last section provided descriptions of all parameter options and other programming information, this one provides the bar codes to do the actual programming.

Set Default Parameter

Defaults are those listed in the *Default Table* beginning on page 6-28.

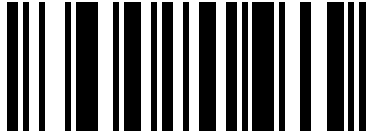

SET DEFAULTS



SET ICL RS-232C
DEFAULTS



SET NIXDORF RS-232C
DEFAULTS

Host Interface

To select a host interface:

1. Locate the type of interface from the list below.
2. Scan the corresponding bar code from those on the following pages.

Host Interface	Page	Host Interface	Page
RS-232C	7-4	Computer Terminal Wedges (Cont'd.)	
RS-232 Single Port	7-4	IBM 3180 (New SW)	7-14
RS-232 Dual Port	7-4	IBM 4683/4684 Port 5B	7-12
PC Keyboard		IBM 4683/4684 Port 9B	7-12
IBM PC/AT	7-6	IBM 4683/4684 Port 17	7-12
IBM PC/XT	7-6	Telex Memorex 88	7-15
IBM PS/2-30	7-6	Telex Memorex 122	7-14
IBM PS2/50/55SX/60/70/80	7-6	Telex 122	7-15
POS Keyboard		Wyse 60/80 (ASCII Kbd)	7-15
IBM 3653	7-6	Wyse 60/160 (PC Kbd)	7-16
IBM 3683/3684 Calc 35	7-7	Wyse 60/85/150/150+/185 (ANSI 105 Kbd)	7-16
IBM 3683/3684 Calc 48	7-7	OCR	
IBM 3683/3684 Calc 116	7-7	Fujitsu 7770/7880	7-13
IBM 3683/3684 Tel 35	7-8	Fujitsu 7990/8770/9000	7-13
IBM 3683/3684 Tel 48	7-8	IBM 3653/3683	7-12
IBM 3683/3684 Tel 116	7-8	IBM 3684	7-12
NCR 280	7-10	OCIA	
NCR 2151 (Tel)	7-9	NCR 255/2152	7-10
NCR 2151 (Calc)	7-9	NCR 2154/2155	7-10
NCR 2152 (Tel)	7-9	NCR 2126-1120	7-10
NCR 2152 (Calc)	7-9	NCR 2157	7-10
NCR 7052	7-10	NCR 2257	7-10
Computer Terminal Wedges		NCR "S" 2950	7-11
DEC VT 2XX, 3XX, 4XX	7-13	NCR 7050	7-10
DEC 420	7-13	NCR "S" 7052	7-10
HP 700-9X, 239X	7-13	NCR "F" 7052	7-10
HP 2392 (Later Version)	7-13	Nixdorf 8812	7-11
IBM 319X, 3178, 3278, 347X, 348X	7-14	ICL 9520	7-11
IBM 3151, 316X, 3179, 3180	7-14	ICL 9505/9507/9518	7-11
		Spectra Physics	7-11

Note: In some cases, two bar codes may correspond to one interface type; this happens when different software revisions exist for the same host type. If there are two bar codes for your host type, try the first bar code; if that does not work, then try the second one.



Single Port RS-232



Dual Port RS-232

Four Options for Dual Port RS-232:

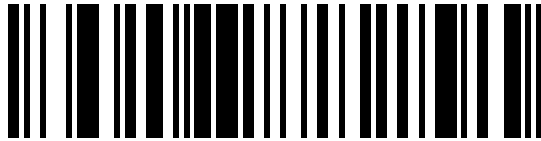

Dual Port RS-232: Transmit and Receive from Port 1.

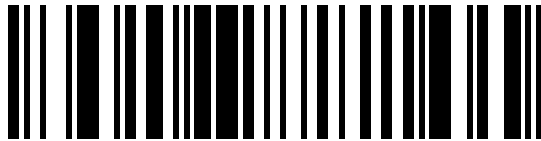

Dual Port RS-232: Transmit to Ports 1 and 2 — Receive from Port 1.

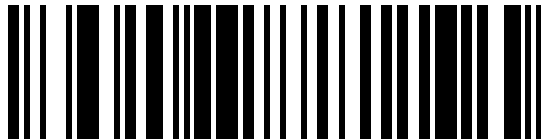

Dual Port RS-232: Transmit and Receive from Port 2.

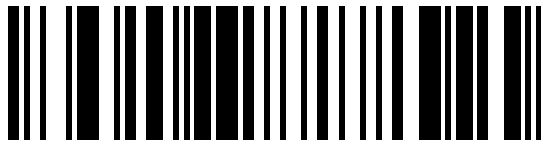

Dual Port RS-232: Transmit to Ports 1 and 2 — Receive from Port 2.



IBM PC/AT, IBM PS2-50/55SX/60/70/80 and Clones

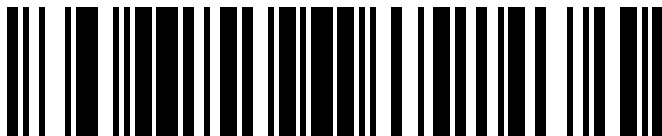

IBM PC/XT And Clones



IBM PS2-30 and Clones



IBM 3653 Keyboard Wedge



**IBM 3683/3684 Calc 35
Keyboard Wedge**



**IBM 3683/3684 Calc 48
Keyboard Wedge**



**IBM 3683/3684 Calc 116
Keyboard Wedge**

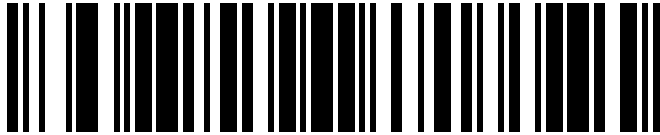

**IBM 3683/3684 Tel 35
Keyboard Wedge**



**IBM 3683/3684 Tel 48
Keyboard Wedge**



**IBM 3683/3684 Tel 116
Keyboard Wedge**



NCR 2151 (Tel) Keyboard Wedge

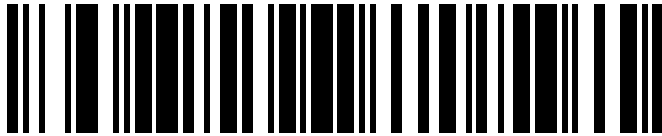

NCR 2151 (Calc) Keyboard Wedge



NCR 2152 (Tel) Keyboard Wedge

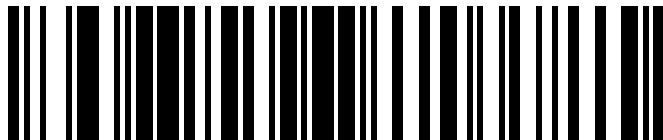

NCR 2152 (Calc) Keyboard Wedge

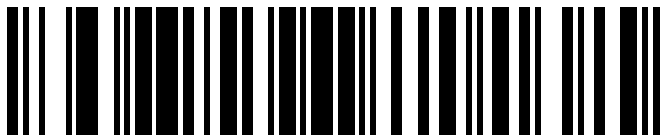

NCR 280 Keyboard Wedge



NCR 255/2152/2154/2155, NCR 2126-1120
NCR 2157/2257/7050, NCR "S" 7052 OCIA



NCR 7052 Keyboard Wedge

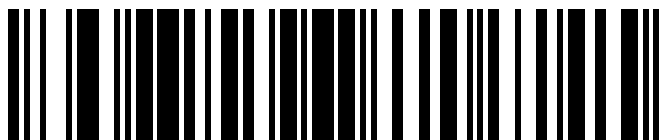

NCR "F" 7052 OCIA



NCR "S" 2950 OCIA

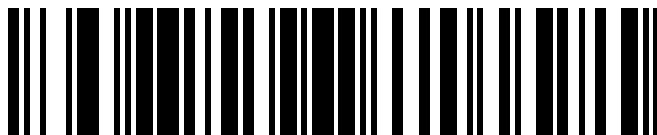

Nixdorf 8812 OCIA



**ICL 9505/9507/9518/9520
OCIA**

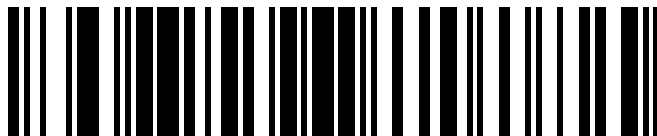

Spectra Physics OCIA



**IBM 4683/4684 Port 5B
4693**



**IBM 4683/4684 Port 9B
4693**



IBM 4683/4684 Port 17



IBM 3653/3683/3684 OCR

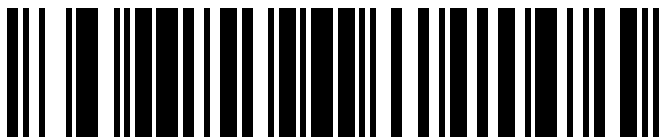

Fujitsu 7770/7880/7990/ 8770/9000 OCR

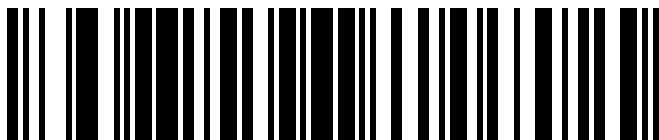

HP 239X

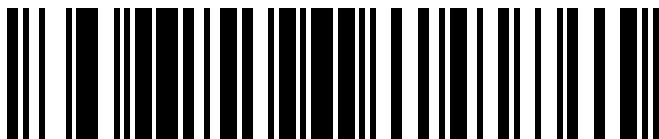

HP 700-9X

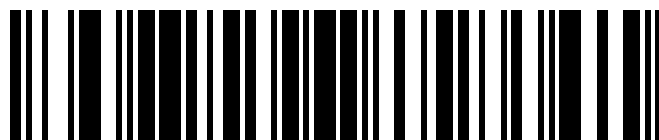

DEC VT 220/320

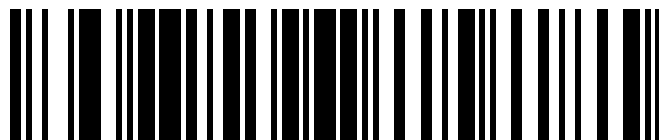

DEC VT 420

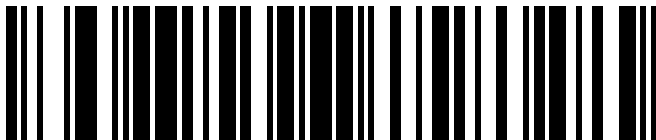

IBM 3178

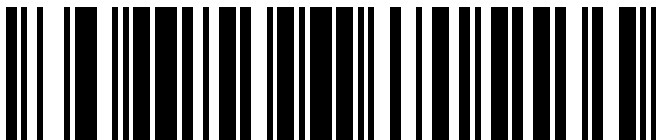

IBM 3278

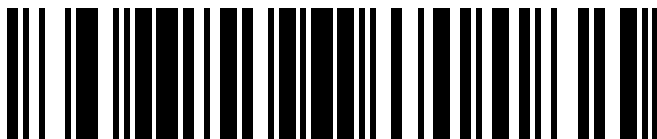

IBM 319X/347X/348X, Telex Memorex 122

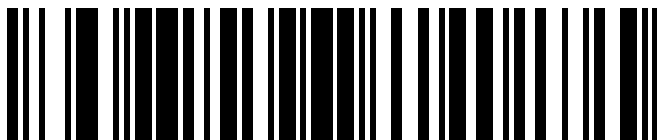

IBM 3151/316X

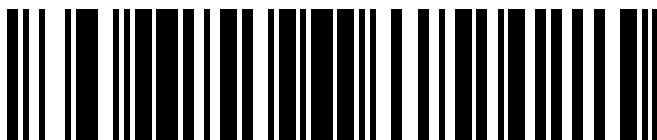

IBM 3179/3180

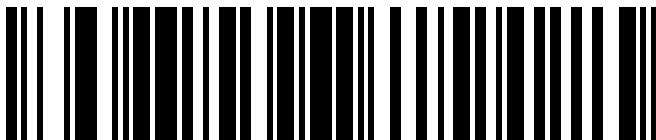

IBM 3180 (Later Software Revision) — See Note, p. 7-4.

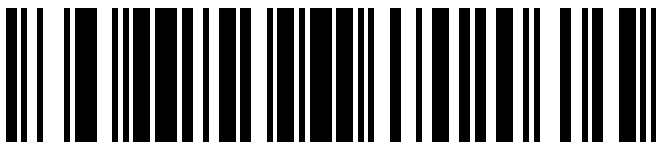

Telex Memorex 88

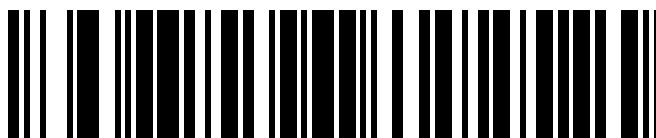

Telex 122 (Variant ENTER Key from that on Telex Memorex 122)

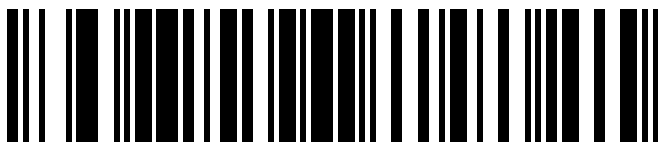

Wyse 50 (ASCII Keybd)

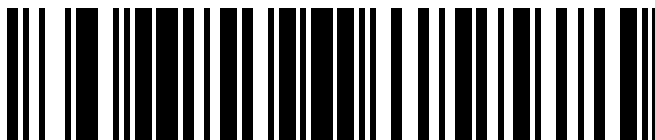

Wyse 60 (ASCII Keybd)
Wyse 150 / Wyse 150+



**Wyse 60 (PC Keybd)
Wyse 150 / Wyse 150+**



Wyse 60/150 (ANSI 101 Keybd)

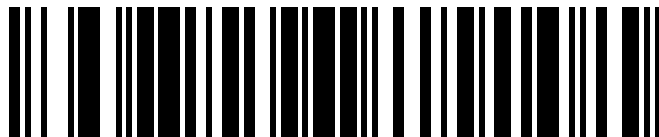

Wyse 85/150+/185 (ANSI 105 Keybd)



HP 2392 (Later Software Revision) — See Note, p. 7-4.

Code Type

Add or delete specific code types by scanning the appropriate bar code(s).

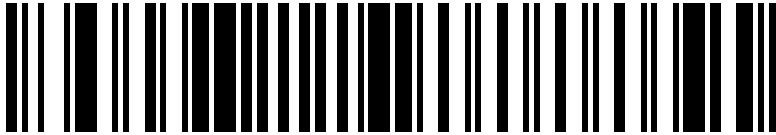

ENABLE ALL CODE TYPES

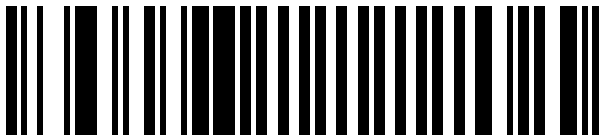

DISABLE ALL CODE TYPES

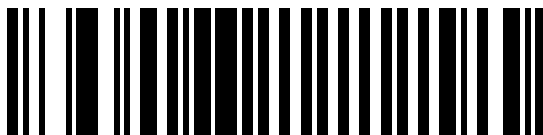

ADD CODE 39

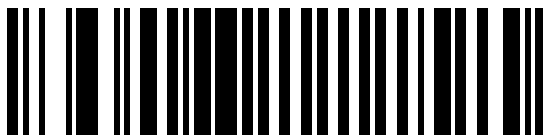

DELETE CODE 39

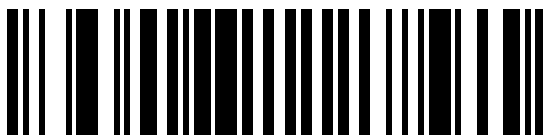

ADD CODE 39 FULL ASCII*

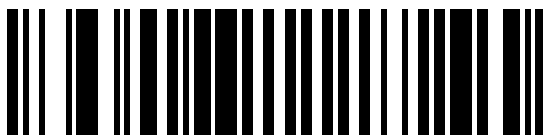

DELETE CODE 39 FULL ASCII*

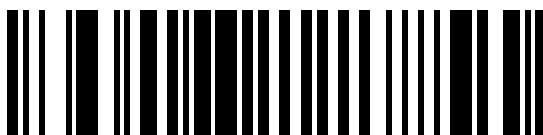

ADD UPC/EAN

*Adding or deleting Code 39 Full ASCII only has an effect when Code 39 has been selected.

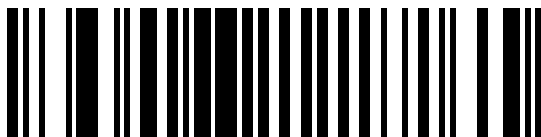

DELETE UPC/EAN

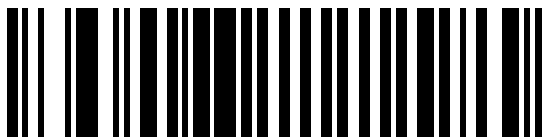

ADD CODE 128

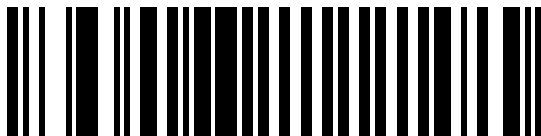

DELETE CODE 128

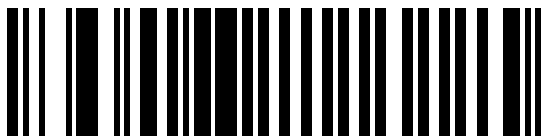

ADD EAN 128

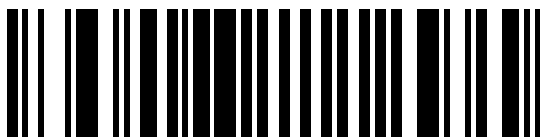

DELETE EAN 128

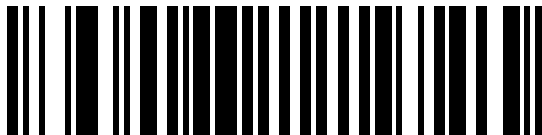

ADD D 2 of 5

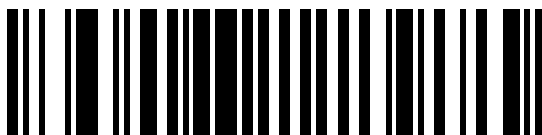

DELETE D 2 of 5

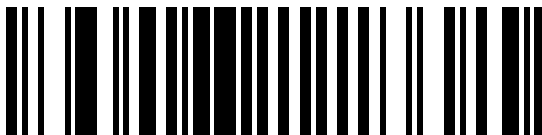

ADD I 2 of 5

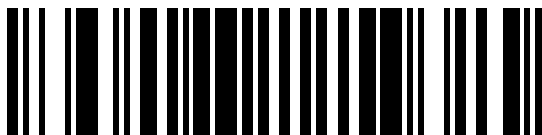

DELETE I 2 of 5

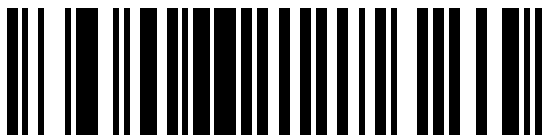

ADD CODABAR

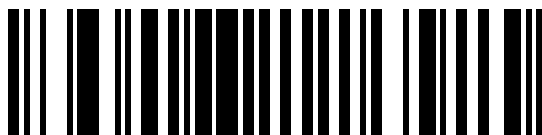

DELETE CODABAR

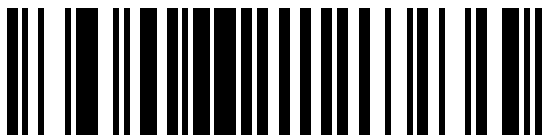

ADD MSI Plessey

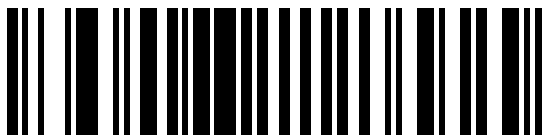

DELETE MSI Plessey

Code Lengths

To select two lengths for each code type:

1. Scan the desired option.
2. Scan two bar codes on [page 7-27](#) - [page 7-28](#) for each desired length. For example, for a length of “12”, scan “1” then “2”. For a length of “3”, scan “0”, then “3”. **You must always scan two bar codes for each length.**
3. If you make an error, or wish to change your selection, scan **CANCEL** on [page 7-28](#).

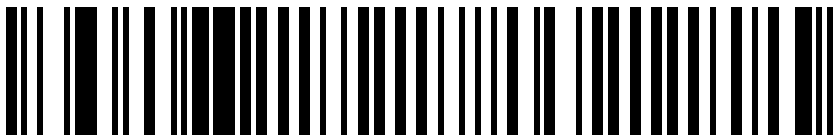

CODE 39 - ANY LENGTH

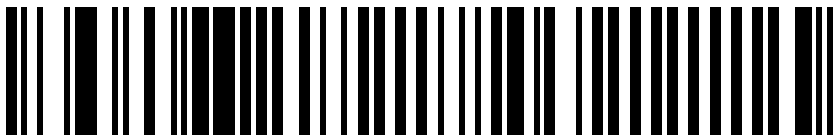

CODE 39 - LENGTH WITHIN RANGE

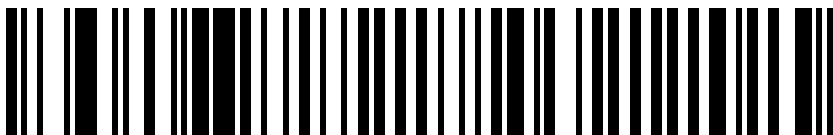

CODE 39 - 1 DISCRETE LENGTH

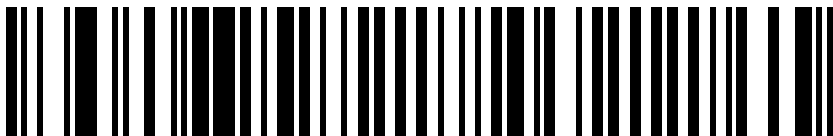

CODE 39 - 2 DISCRETE LENGTHS

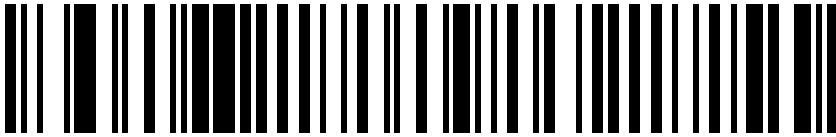

CODE 128 - ANY LENGTH

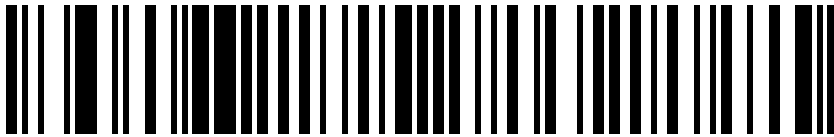

CODABAR - ANY LENGTH

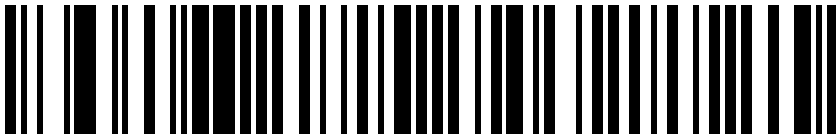

CODABAR - LENGTH WITHIN RANGE

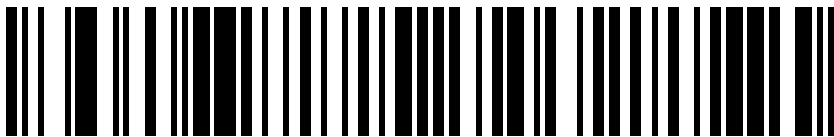

CODABAR 1 - DISCRETE LENGTH

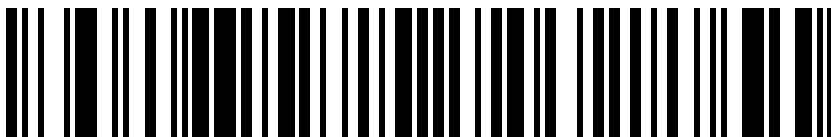

CODABAR - 2 DISCRETE LENGTHS

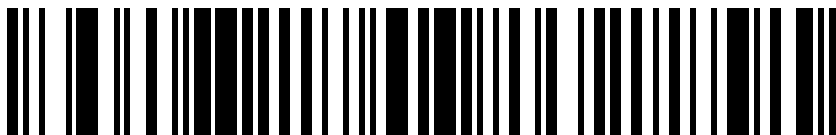

I 2 OF 5 - ANY LENGTH*

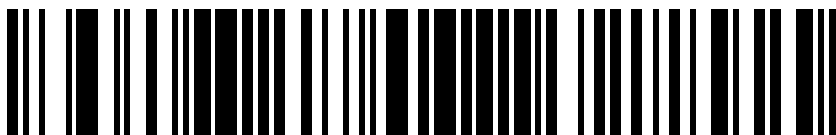

I 2 OF 5 - LENGTH WITHIN RANGE



I 2 OF 5 - 1 DISCRETE LENGTH

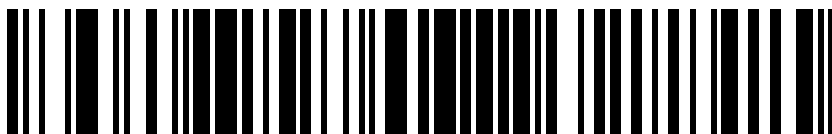

I 2 OF 5 - 2 DISCRETE LENGTHS

* Choosing I 2 of 5 Any Length may lead to misreads for I 2 of 5 and UPC codes.



D 2 OF 5 - ANY LENGTH



D 2 OF 5 - LENGTH WITHIN RANGE



D 2 OF 5 - 1 DISCRETE LENGTH



D 2 OF 5 - 2 DISCRETE LENGTHS

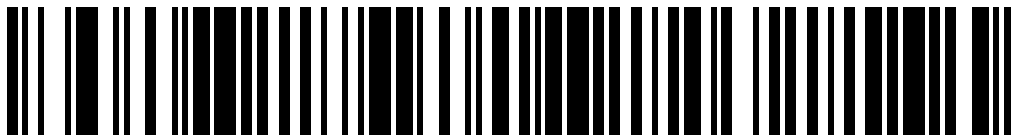

MSI Plessey - ANY LENGTH

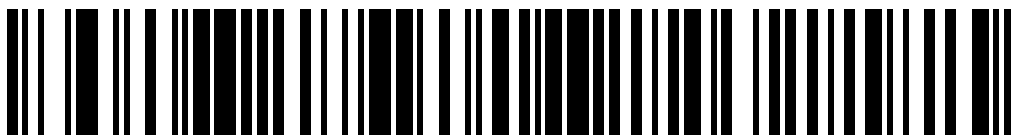

MSI Plessey - LENGTH WITHIN RANGE

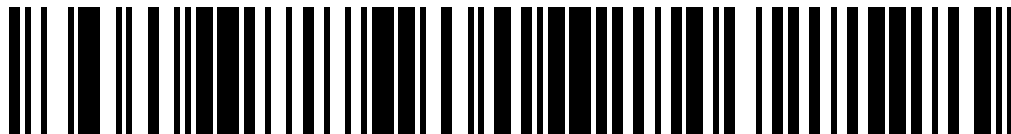

MSI Plessey - 1 DISCRETE LENGTH

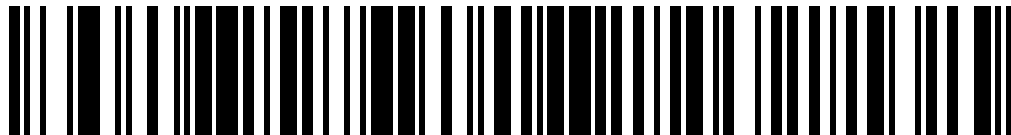

MSI Plessey - 2 DISCRETE LENGTHS

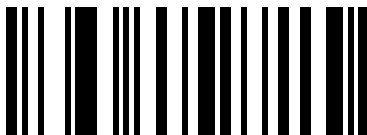

0

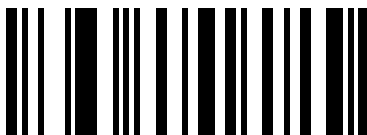

1



2

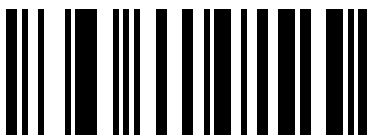

3

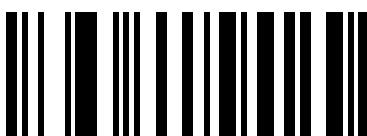

4

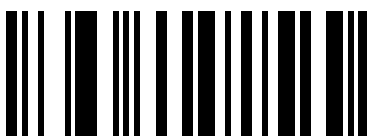

5

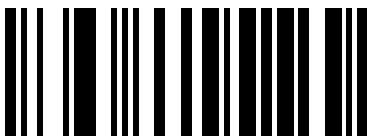

6



7



8

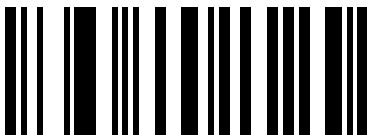

9

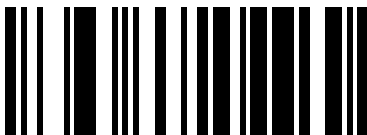

CANCEL

Decode Options

Enable or disable a specific decode option by scanning the appropriate bar code.

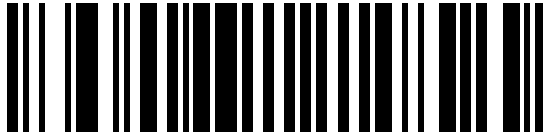

TRANSMIT UPC-A CHECK DIGIT

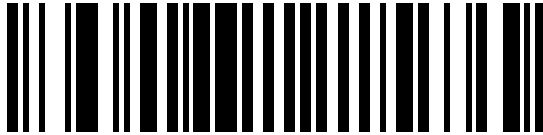

DO NOT TRANSMIT UPC-A CHECK DIGIT

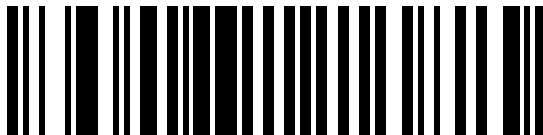

TRANSMIT UPC-E CHECK DIGIT

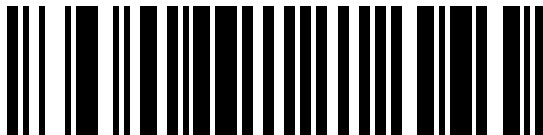

DO NOT TRANSMIT UPC-E CHECK DIGIT

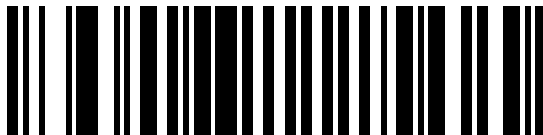

ENABLE 1 MSI Plessey CHECK DIGIT

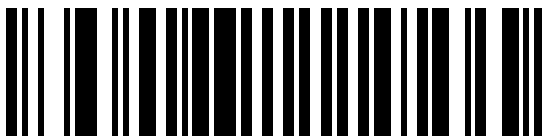

ENABLE 2 MSI Plessey CHECK DIGITS

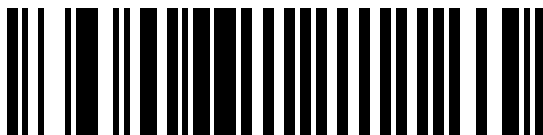

CONVERT UPC-E TO UPC-A

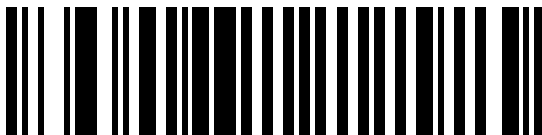

DO NOT CONVERT UPC-E TO UPC-A

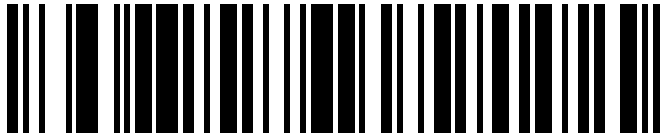

DECODE UPC/EAN SUPPLEMENTALS

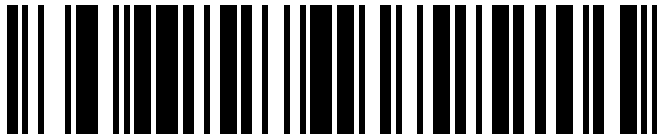

IGNORE UPC/EAN SUPPLEMENTALS

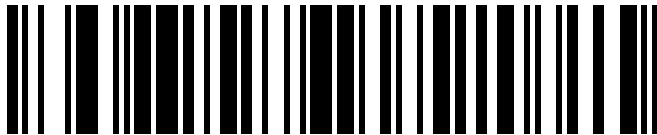

AUTODISCRIMINATE UPC/EAN SUPPLEMEN-

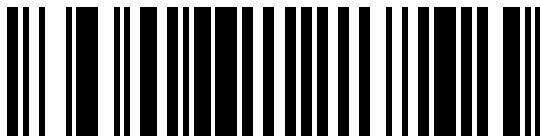

ENABLE EAN ZERO EXTEND

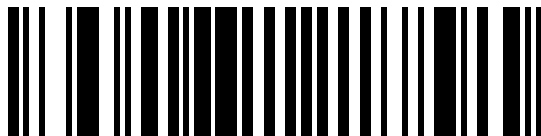

DISABLE EAN ZERO EXTEND

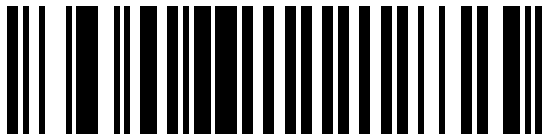

TRANSMIT "NO DECODED MESSAGE"

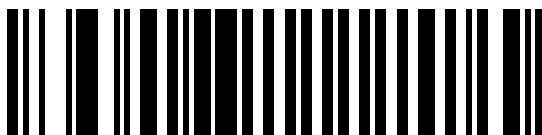

DO NOT TRANSMIT "NO DECODE" MESSAGE

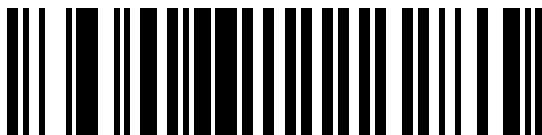

ITF14/EAN-13 CONVERSION ENABLED

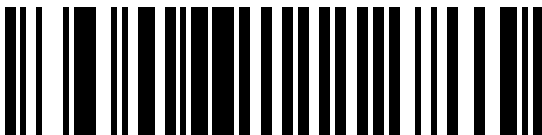

ITF14/EAN-13 CONVERSION DISABLED

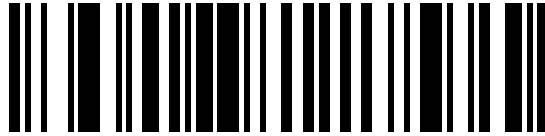

BUFFER CODE 39



DO NOT BUFFER CODE 39

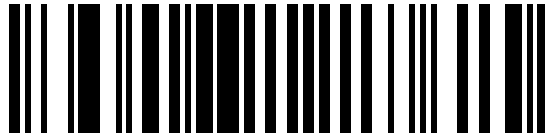

VERIFY CODE 39 CHECK DIGIT

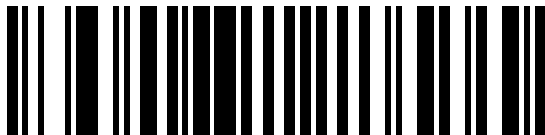

DO NOT VERIFY CODE 39 CHECK DIGIT

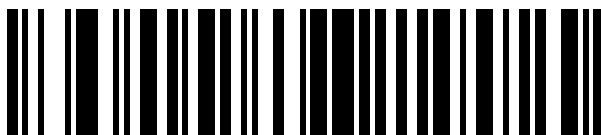

BI-DIRECTIONAL REDUNDANCY ENABLED

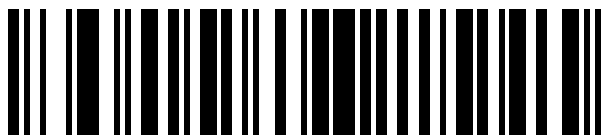

BI-DIRECTIONAL REDUNDANCY DISABLED



BEEP AFTER GOOD DECODE

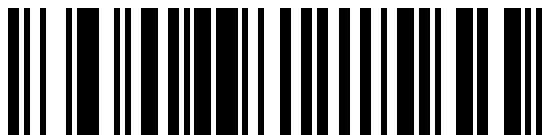

DO NOT BEEP AFTER GOOD DECODE

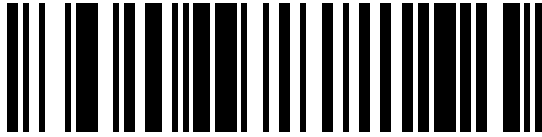

LOW BEEPER VOLUME

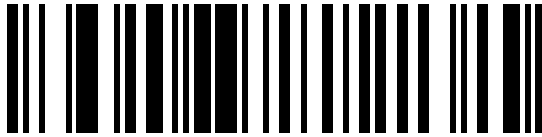

HIGH BEEPER VOLUME

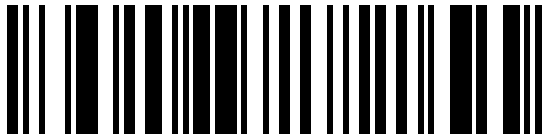

UPC/EAN SECURITY LEVEL 0

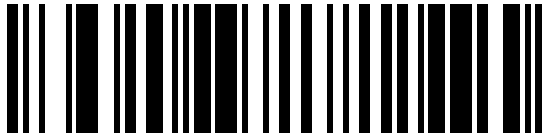

UPC/EAN SECURITY LEVEL 1

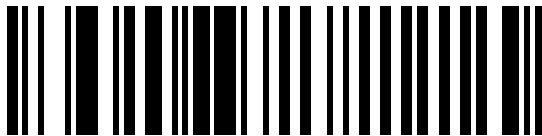

UPC/EAN SECURITY LEVEL 2

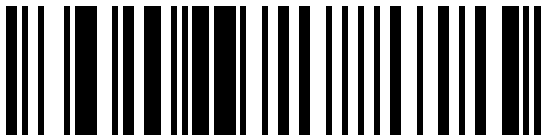

UPC/EAN SECURITY LEVEL 3

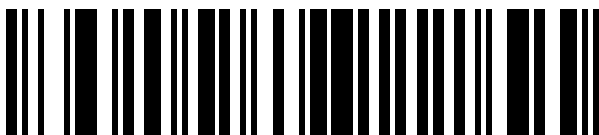

DECODE REDUNDANCY 1

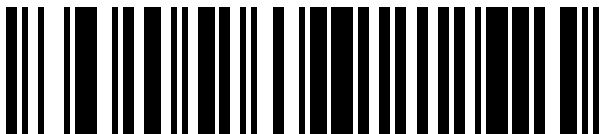

DECODE REDUNDANCY 2

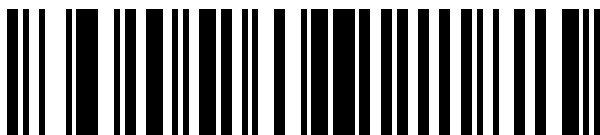

DECODE REDUNDANCY 3

UPC-A Preamble

Select one option for UPC-A preamble by scanning the appropriate bar code.

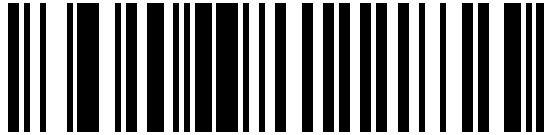

NONE

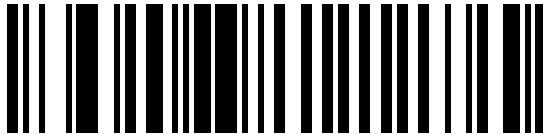

SYSTEM CHARACTER



SYSTEM CHARACTER & COUNTRY CODE

UPC-E Preamble

Select one option for UPC-E preamble by scanning the appropriate bar code.

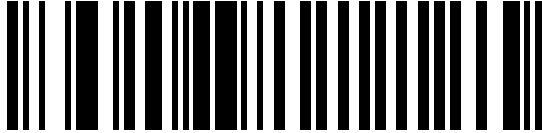

NONE



SYSTEM CHARACTER

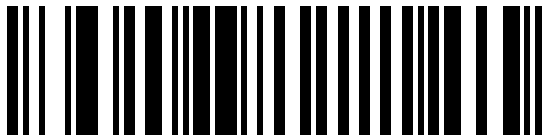

SYSTEM CHARACTER & COUNTRY CODE

Pause Duration

To set a pause duration:

1. Scan the **PAUSE DURATION** bar code below.
2. Scan two bar codes on the next two pages which represent the desired pause. You must always scan two bar codes.
3. If you make an error, or wish to change your selection, scan **CANCEL**.

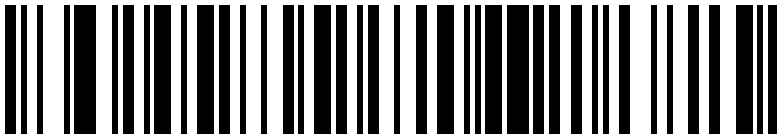

PAUSE DURATION

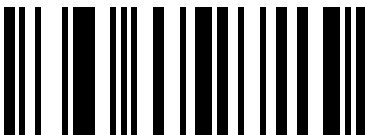

0

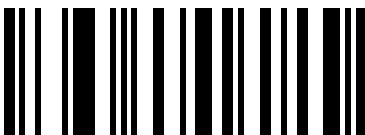

1

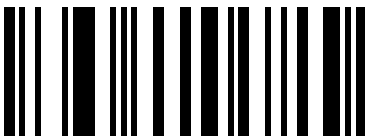

2

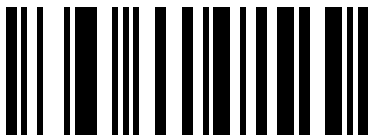

3

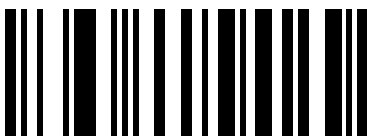

4

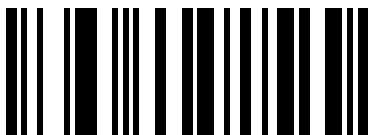

5

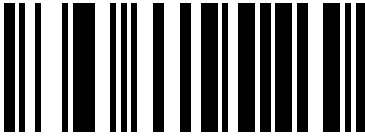

6

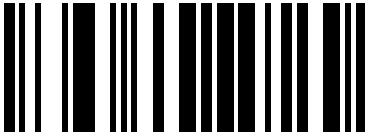

7



8

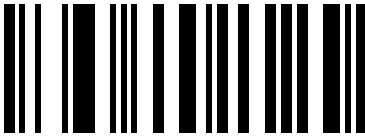

9

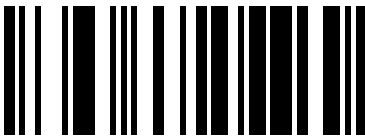

CANCEL

Prefix/Suffix Values

Note: These values will also be used for Advanced Data Formatting programming. See the Advanced Programmer's Guide for details.

To set a **PREFIX/SUFFIX** value:

1. Scan the option bar code you wish to set.
2. Scan four bar codes from **page 7-44** - **page 7-45** which correspond to the ASCII value or keystroke you wish to assign (see **ASCII Table beginning on page 8-1**). The **ENTER** key is the default for all options.
3. If you make an error, or wish to change your selection, scan **CANCEL**

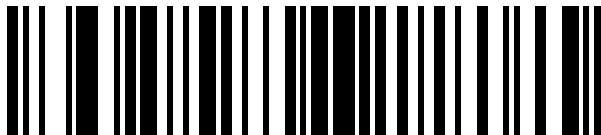

SCAN SUFFIX (VALUE 1)

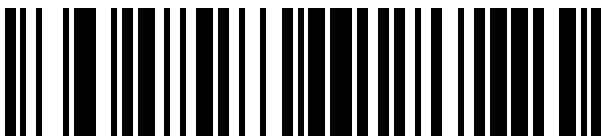

SCAN PREFIX (VALUE 2)

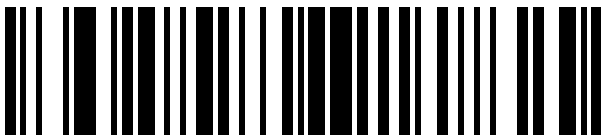

MAGSTRIPE SUFFIX (VALUE 3)

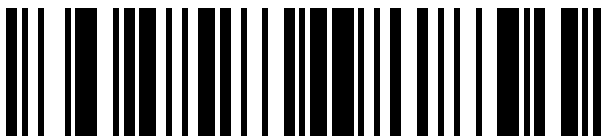

MAGSTRIPE PREFIX (VALUE 4)

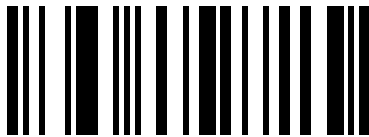

0

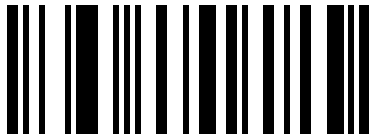

1

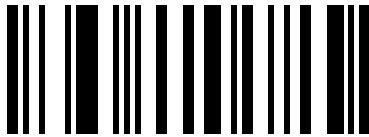

2

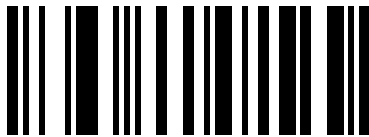

3

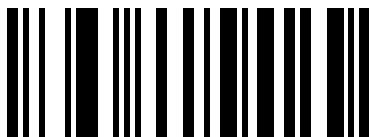

4



5



6

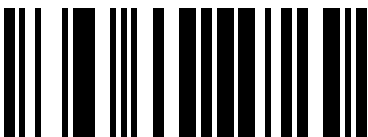

7

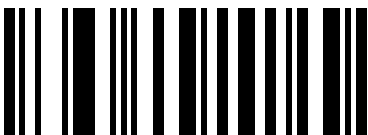

8

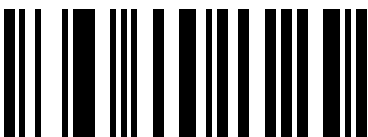

9

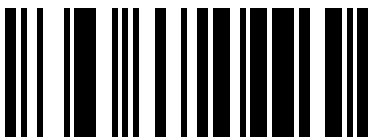

CANCEL

Data Transmission Formats

To select a data transmission format:

1. Scan the **SCAN OPTIONS** or **MAGSTRIPE OPTIONS** bar code.
2. Scan the bar code corresponding to the desired converted data format.
3. Scan **ENTER**.
4. If you make a mistake, scan **CANCEL**, or you wish to erase the last entered format, or all formats, scan the appropriate bar code from [page 7-52](#).

Note: RS-232C hosts will treat the extended keypad default suffix (7013) as Enter.



SCAN OPTIONS

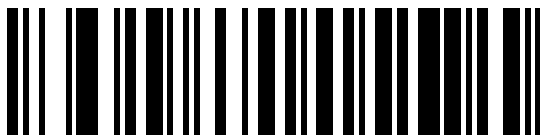

DATA AS IS

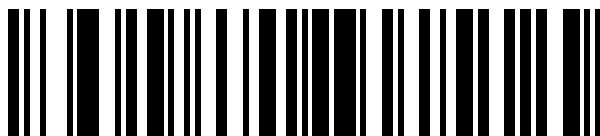

<PREFIX> <DATA>

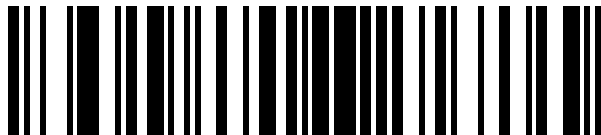

<DATA> <SUFFIX>

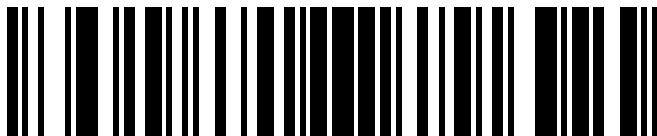

<PREFIX> <DATA> <SUFFIX>



ENTER

Magstripe Options



MAGSTRIPE OPTIONS

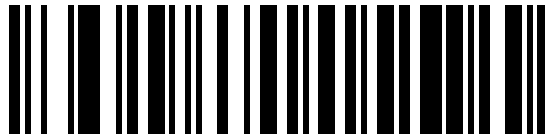

DATA AS ON CARD

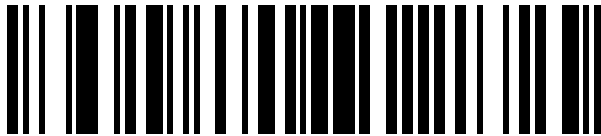

<ACCT NR>

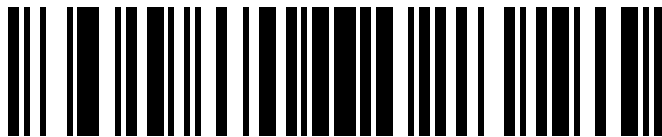

<ACCT NR> <SUFFIX>

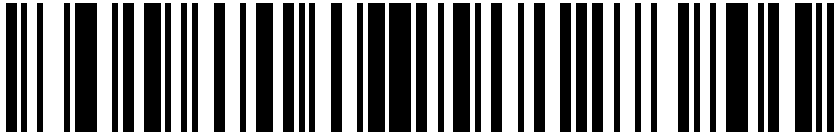

<ACCT NR> <SUFFIX> <EXP (MMYY)> <SUFFIX>

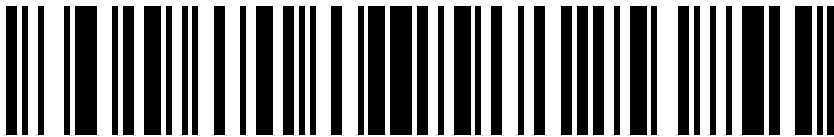

<ACCT NR> <SUFFIX> <EXP (YYMM)> <SUFFIX>

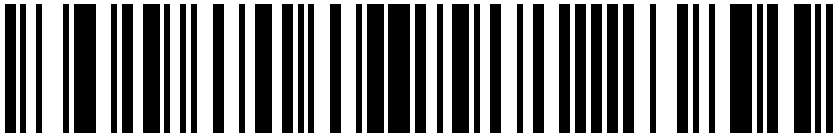

<ACCT NR> <SUFFIX> <NAME)> <SUFFIX>

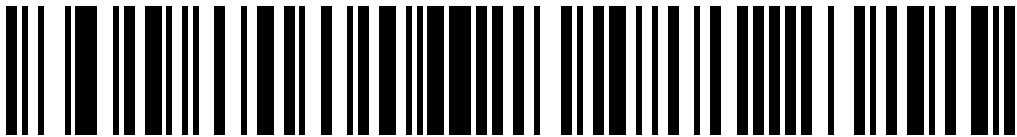

<ACCT NR> <SUFFIX> <EXP (MMYY)> <SUFFIX> <NAME)> <SUFFIX>

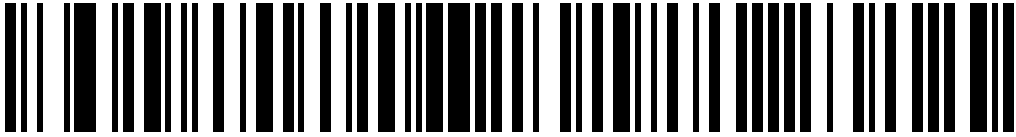

<ACCT NR> <SUFFIX> <EXP (YYMM)> <SUFFIX> <NAME> <SUFFIX>

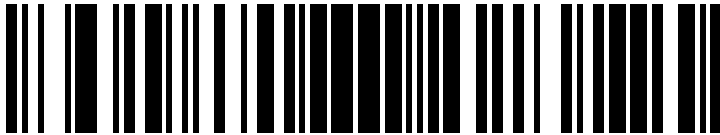

<PREFIX> <ACCT NR> <SUFFIX>

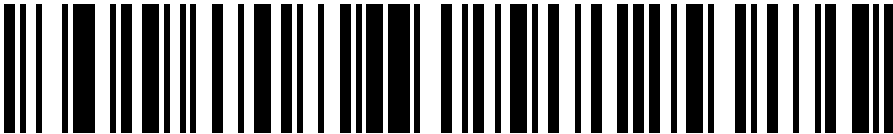

<PREFIX> <ACCT NR> <SUFFIX> <EXP (YYMM)> <SUFFIX>

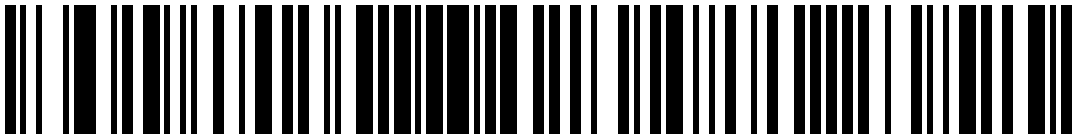

<PREFIX> <ACCT NR> <SUFFIX> <EXP (MMYY)> <SUFFIX> <NAME> <SUFFIX>

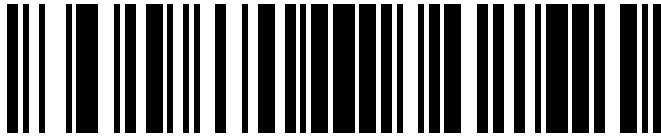

<PREFIX> <ACCT NR>

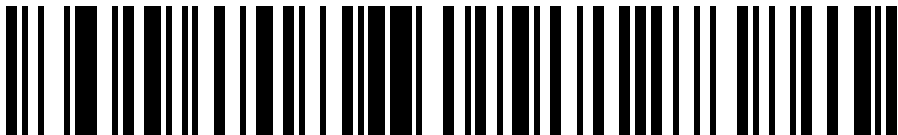

<PREFIX> <ACCT NR> <SUFFIX> <EXP (MMYY)> <SUFFIX>



<PREFIX> <ACCT NR> <SUFFIX> <NAME> <SUFFIX>

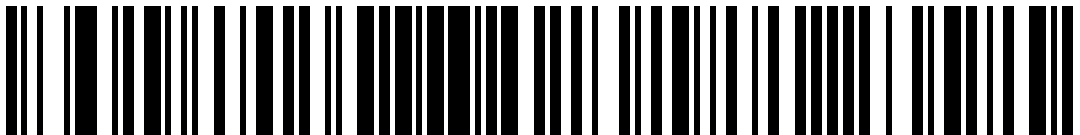

<PREFIX> <ACCT NR> <SUFFIX> <EXP (YYMM)> <SUFFIX> <NAME> <SUFFIX>

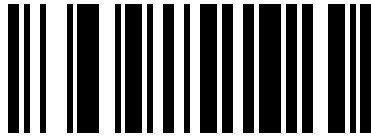

ERASE ALL FORMATS

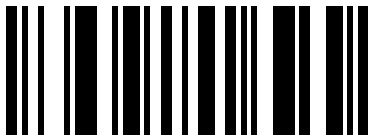

ERASE LAST ENTERED FORMAT

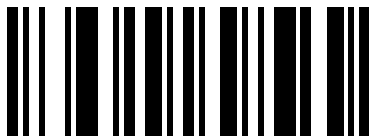

CANCEL

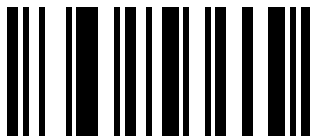

ENTER

Laser Control

To select a laser-on timeout:

1. Scan the **LASER ON TIMEOUT** bar code below.
2. Scan two bar codes from the next two pages which correspond to the desired time.
3. If you make an error, or wish to change your selection, scan **CANCEL**.

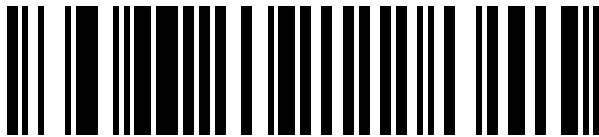

LASER ON TIMEOUT

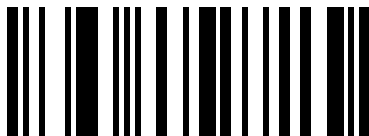

0

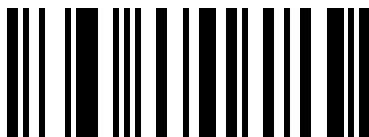

1



2

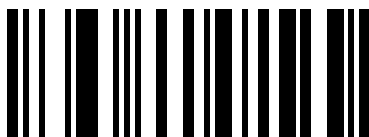

3

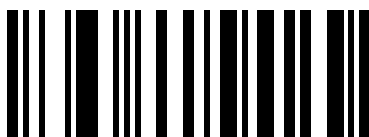

4

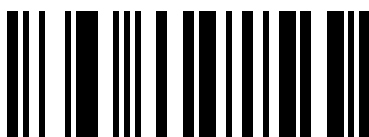

5



6



7

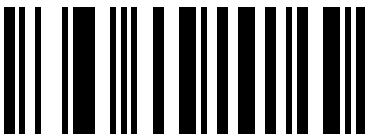

8



9

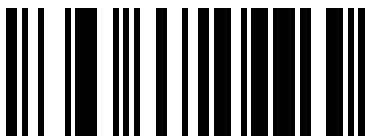

CANCEL

Baud Rate

Set the baud rate for RS-232C transmission.

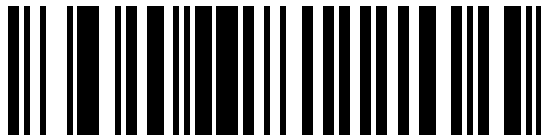

110

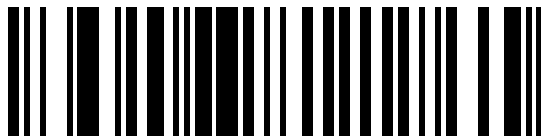

300

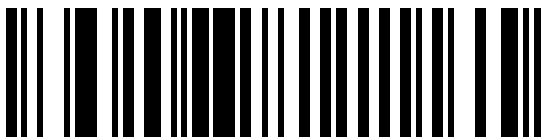

600

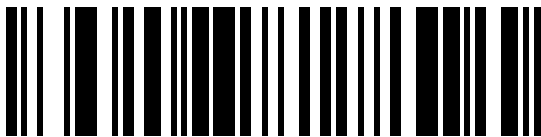

1200

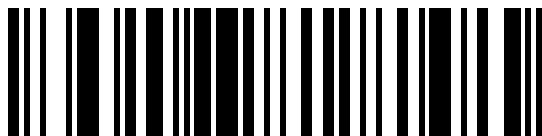

2400

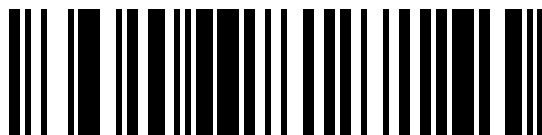

4800

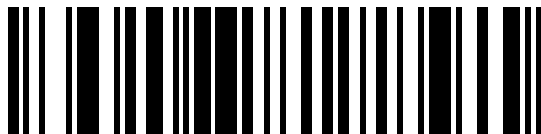

9600

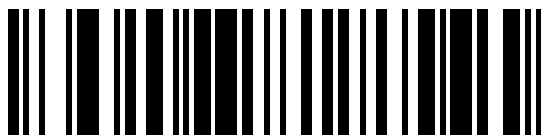

19200

Parity

Set the type of parity for RS-232C transmission.

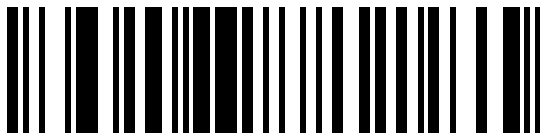

ODD

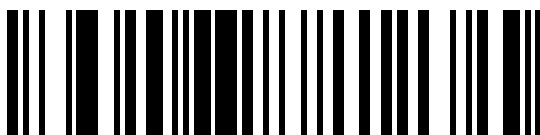

EVEN



MARK

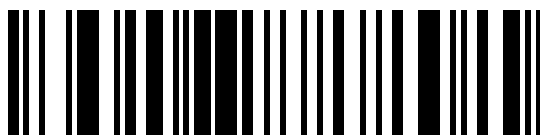

SPACE

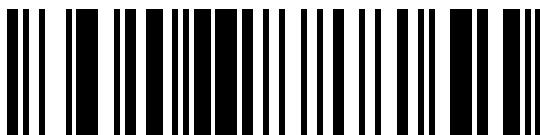

NONE

Check Parity

Select whether or not to check parity for RS-232C transmissions.

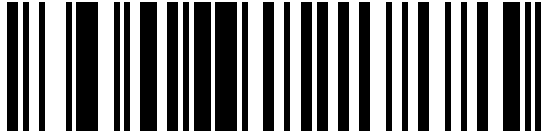

CHECK PARITY

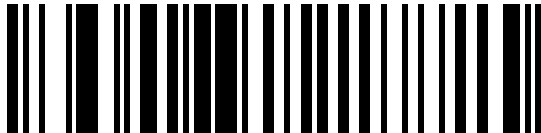

DO NOT CHECK PARITY

Hardware Handshaking

Select the type of RS-232C hardware handshaking protocol.

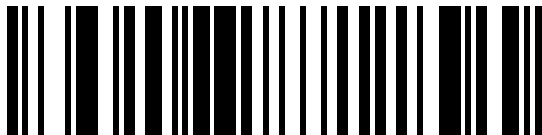

NONE

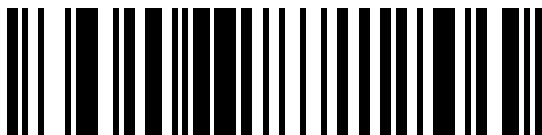

RTS/CTS

Software Handshaking

Select the type of RS-232C software handshaking protocol.

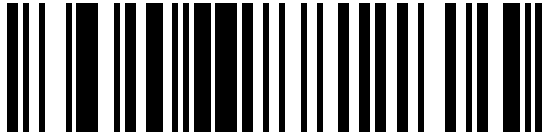

NONE

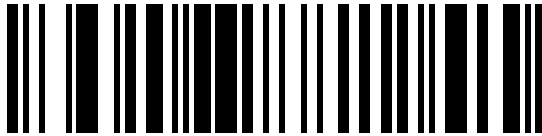

ACK/NAK

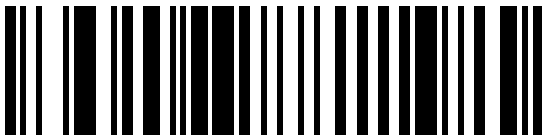

ACK/NAK with ENQ

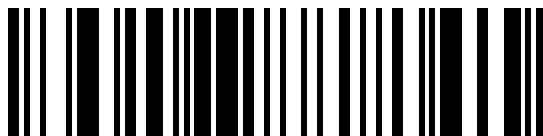

ENQ ONLY

Serial Response Timeout

To set a serial (RS-232C) response timeout:

1. Scan the **SERIAL RESPONSE TIMEOUT** bar code below.
2. Scan two bar codes from the next two pages which represent the desired timeout. You must always scan two bar codes.
3. If you make an error, or wish to change your selection, scan **CANCEL**.

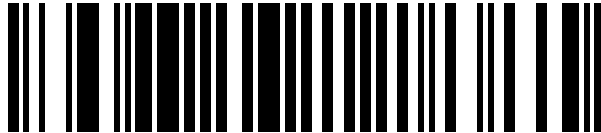

SERIAL RESPONSE TIMEOUT

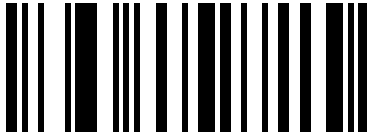

0

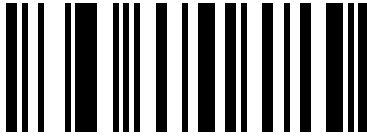

1

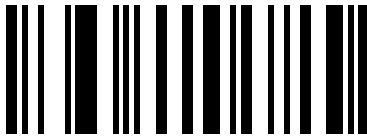

2

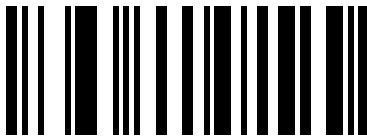

3

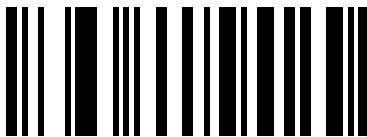

4

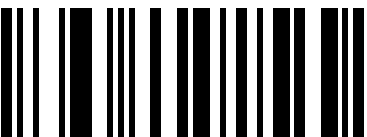

5

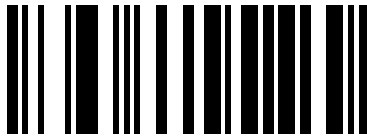

6

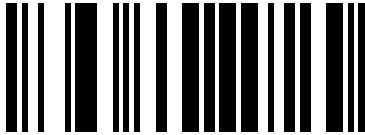

7



8



9

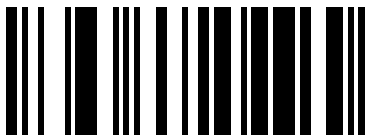

CANCEL

Stop Bit Select

Select the desired number of stop bits for RS-232C communications.

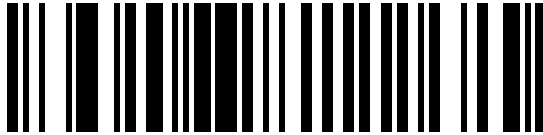

1 STOP BIT

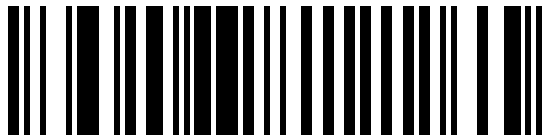

2 STOP BITS

ASCII Data Format

Select either 7-bit or 8-bit ASCII format for RS-232C communications.

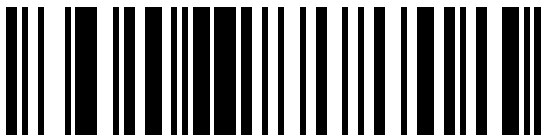

7-BIT

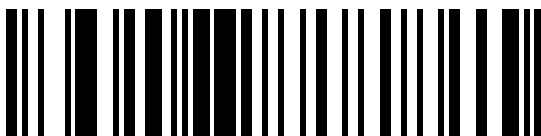

8-BIT

RTS Line State

Select the desired option.

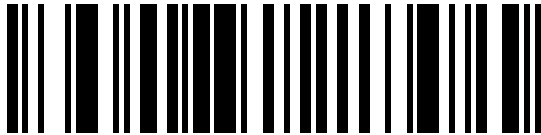

LINE HIGH



LINE LOW

Intercharacter Delay

To set a host communications intercharacter delay:

1. Scan the **INTERCHARACTER DELAY** bar code below.
2. Scan two bar codes from the next two pages which represent the desired delay. You must always scan two bar codes.
3. If you make an error, or wish to change your selection, scan **CANCEL**.



INTERCHARACTER DELAY

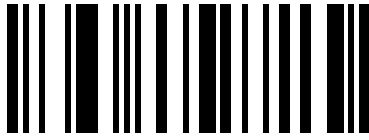

0

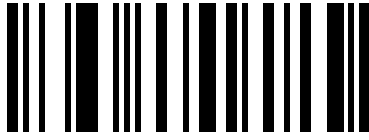

1



2

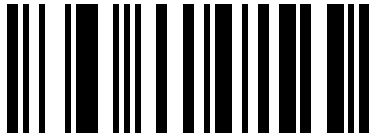

3



4

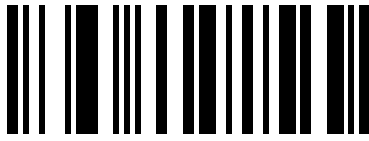

5

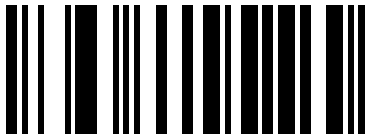

6

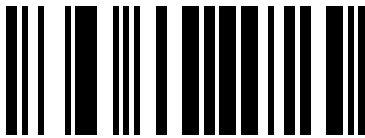

7

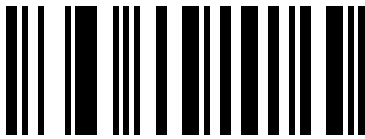

8

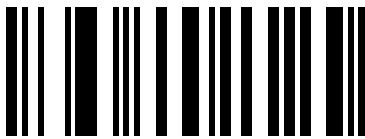

9

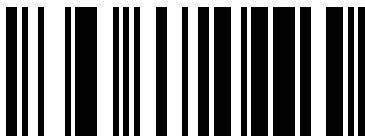

CANCEL

Transmit Code ID Character

Select whether to enable or disable this parameter.

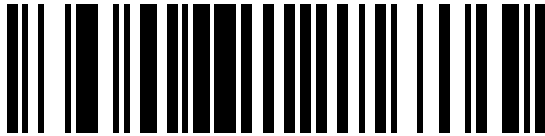

TRANSMIT CODE ID CHARACTER

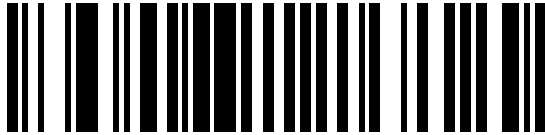

DO NOT TRANSMIT CODE ID CHARACTER

Transmit AIM Code ID

Select whether to enable or disable this parameter. This parameter is only valid when Transmit Code ID Character is enabled.

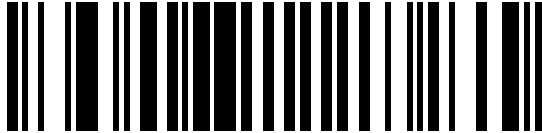

TRANSMIT AIM CODE ID

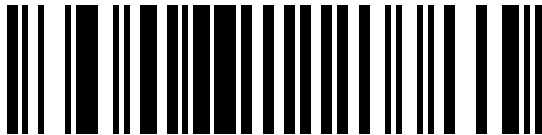

DO NOT TRANSMIT AIM CODE ID

Ignore Unknown Characters

Scan the appropriate bar code to enable or disable this parameter.

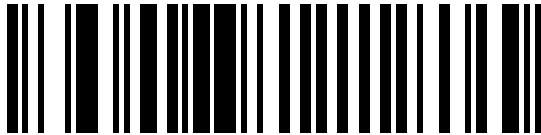

ENABLE



DISABLE

OCIA Clock Polarity

Select whether the OCIA clock pulse polarity will be rising or falling.



RISING

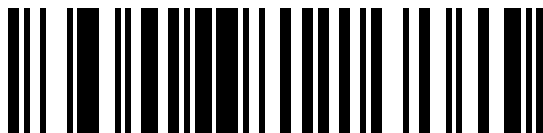

FALLING

OCIA Transmit Timeout

To set an OCIA Transmit Timeout

1. Scan the **OCIA TRANSMIT TIMEOUT** bar code below.
2. Scan two bar codes from the next two pages which represent the desired timeout - Between 3 and 30 seconds. **You must always scan two bar codes. For a timeout less than 10 seconds, scan a leading "0".**
3. If you make an error, or wish to change your selection, scan **CANCEL**.

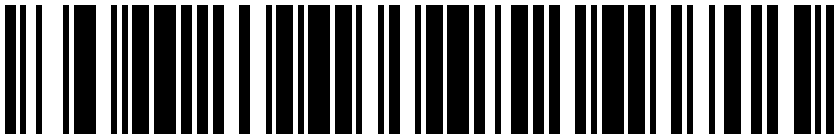

OCIA TRANSMIT TIMEOUT

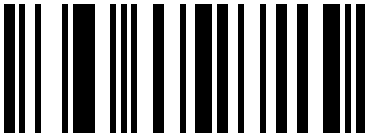

0

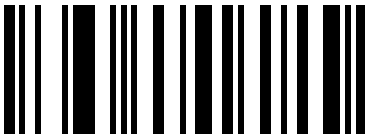

1

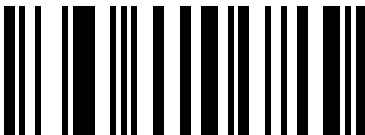

2

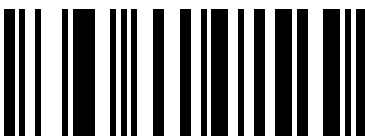

3

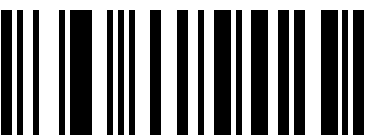

4

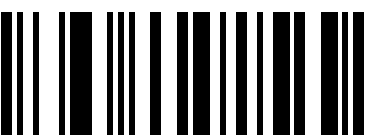

5

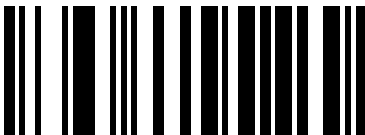

6

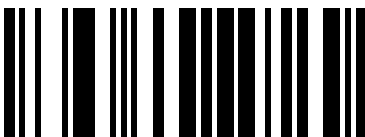

7

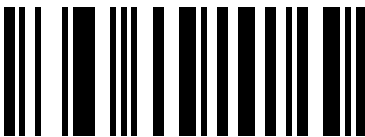

8

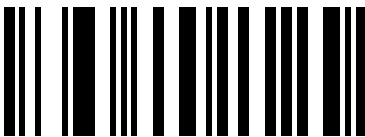

9

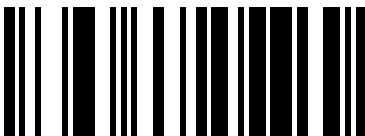

CANCEL

NCR 2152 Fast Transmit

This selects the data transmission speed of the NCR 2152 POS terminal. Depending on the version of NCR 2152, selecting this option may increase the possibility of lost or mis-transmitted data.

Scan the appropriate bar code to enable or disable this parameter.

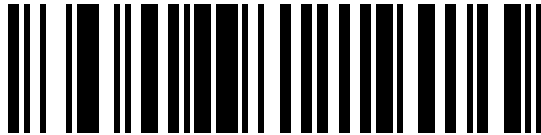

ENABLE

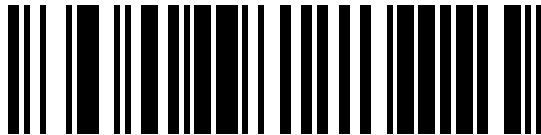

DISABLE

IBM 4683 Magstripe Communications

Select whether to enable or disable IBM 4683/84 magstripe communications.

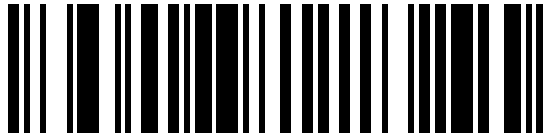

ENABLE



DISABLE

International Keypad Emulation

Select whether to enable or disable this parameter. Used only with IBM AT/XT/PS2.

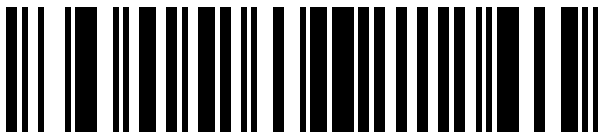

ENABLE

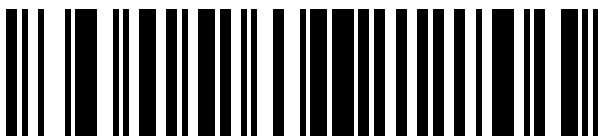

DISABLE

International Keypad Emulation Fast Transmit

Select whether to enable or disable this parameter. Used only with IBM AT/XT/PS2, and with International Keyboard Emulation enabled.

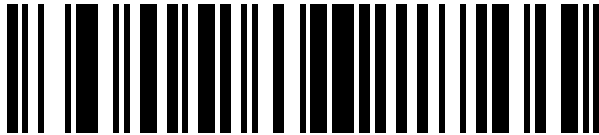

ENABLE

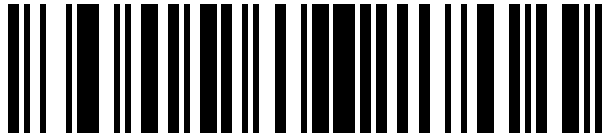

DISABLE

National Keyboard Types

Select National Type for the keyboard.



U.S. English



French



German



French International



Spanish



Italian



Swedish



U.K. English

Set Transmission Frequency

All Countries Except France

To set the initial channel in all countries except France:

1. Scan the **SELECT CHANNEL NUMBER** bar code below.
2. Scan two numeric keypad bar codes to set the two-digit channel number, which must be between 02 - 81.



SELECT CHANNEL NUMBER (02-81): ALL COUNTRIES EXCLUDING FRANCE

France

To set the initial channel in France:

1. Scan the **SELECT CHANNEL NUMBER** bar code below.
2. Scan two numeric keypad bar codes to set the two-digit channel number, which must be between 46 - 54.

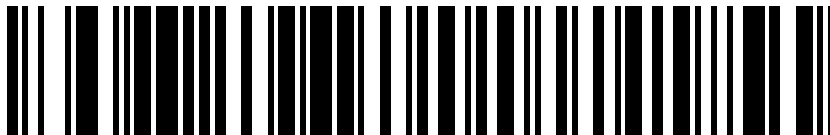

SELECT CHANNEL NUMBER (46-54): FRANCE

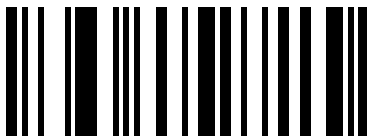

0

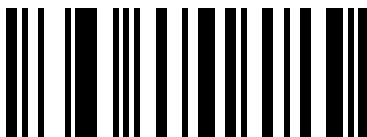

1



2

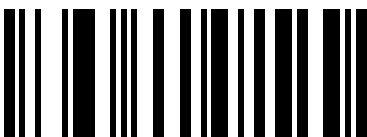

3

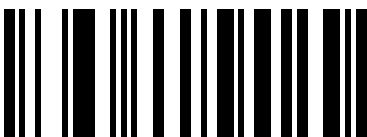

4

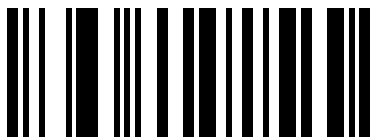

5

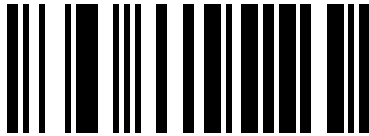

6

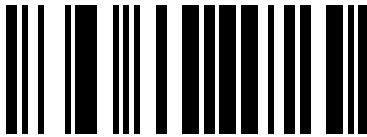

7

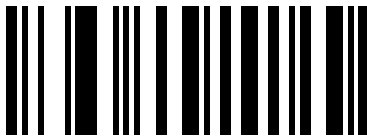

8

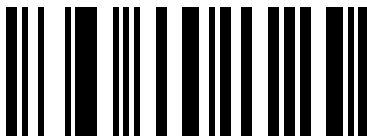

9

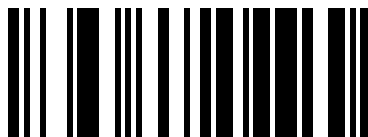

CANCEL

Wait for Host Interface Response Time

Programming this parameter overrides the automatically set wait for host timeout value. Conversely, programming a value of zero enables the automatic wait for host response timeout calculation feature.

To program the waiting period for the host's acknowledgement of data reception:

1. Scan the **WAIT FOR HOST INTERFACE RESPONSE TIME** bar code.
2. Scan two number keypad bar codes to set the two-digit response time (01 - 99, as measured in seconds).

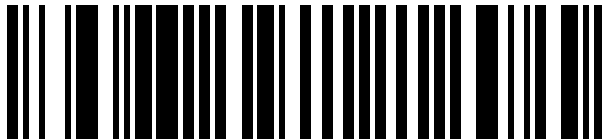

WAIT FOR HOST INTERFACE RESPONSE TIME

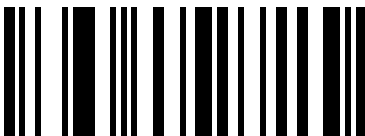

0

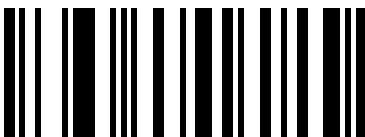

1

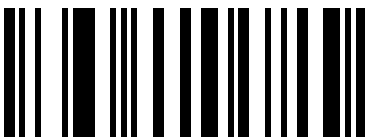

2

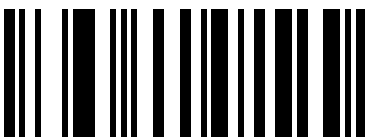

3

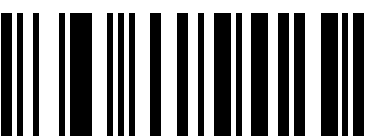

4

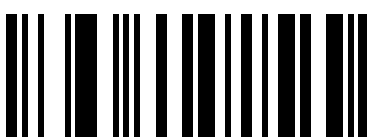

5

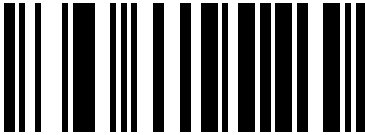

6

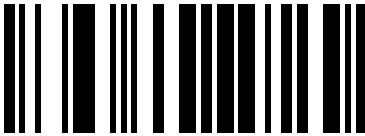

7

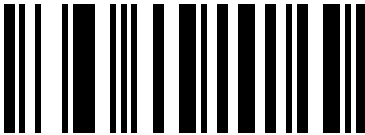

8



9

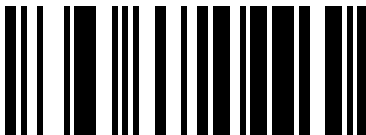

CANCEL

Reserved For Future Use

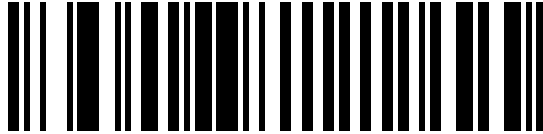

ITEM 1 ENABLE



ITEM 1 DISABLE



ITEM 2 ENABLE



ITEM 2 DISABLE

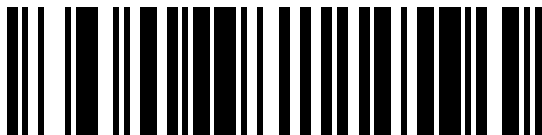

ITEM 3 ENABLE

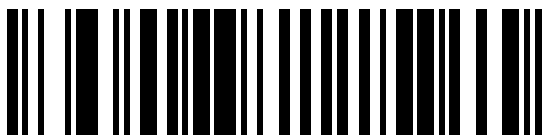

ITEM 3 DISABLE

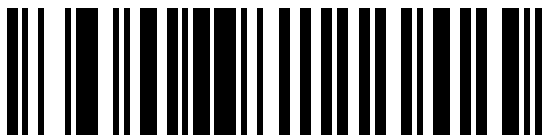

ITEM 4 ENABLE

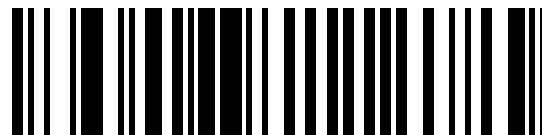

ITEM 4 DISABLE

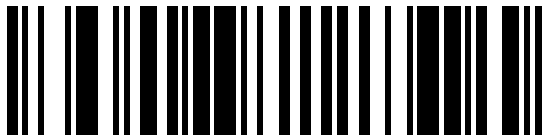

ITEM 5 ENABLE

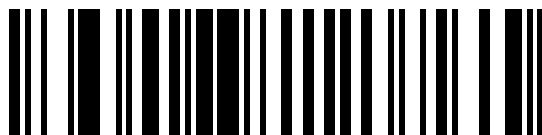

ITEM 5 DISABLE

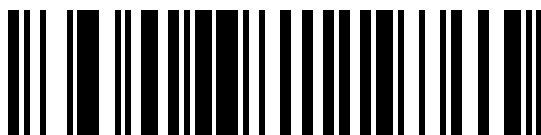

ITEM 6 ENABLE

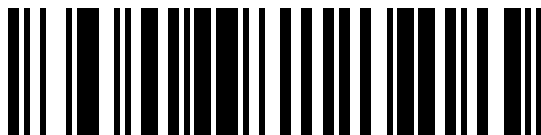

ITEM 6 DISABLE

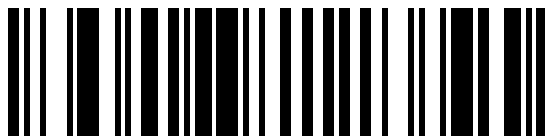

ITEM 7 ENABLE

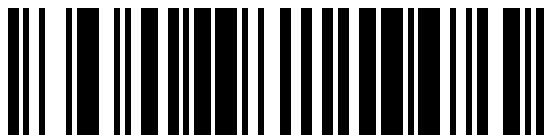

ITEM 7 DISABLE

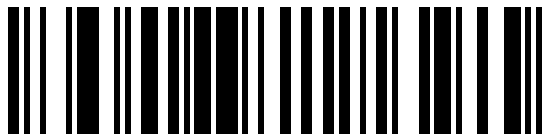

ITEM 8 ENABLE

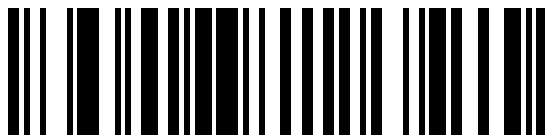

ITEM 8 DISABLE

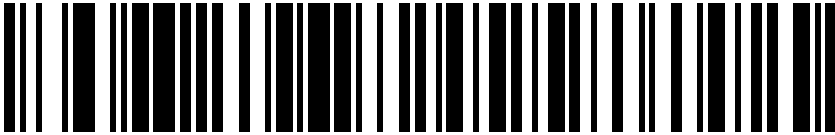

**APPLICATIONS VALUE 0 TO 255
ENTER 3-DIGIT NUMBER FROM NEXT 2 PAGES**

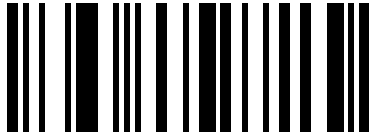

0

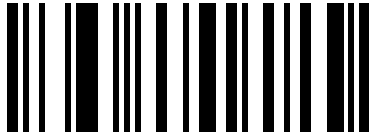

1



2

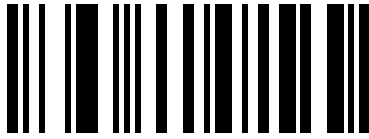

3

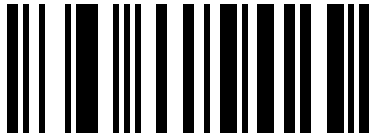

4

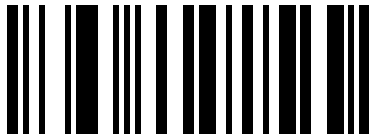

5



6

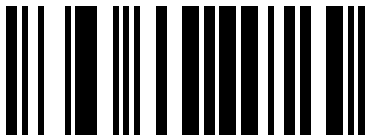

7

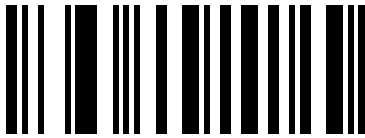

8

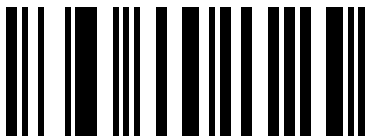

9

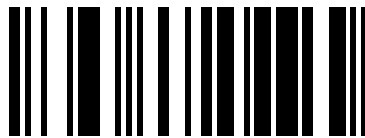

CANCEL

Pairing



PAIR

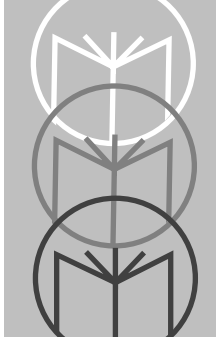

Chapter 8

Keyboard Maps

ASCII Table

The following values can be assigned as prefixes or suffixes for data transmission. **Not all options are available on every keyboard.** Refer to your own keyboard or *Keyboard Identifier Maps on page 8-5* for pertinent keystrokes.

ASCII Value	Full ASCII Code 39 Encode Char.	Key-stroke	ASCII Value	Full ASCII Code 39 Encode Char.	Key-stroke
1000	%U	CTRL 2	1027	%A	CTRL [
1001	SA	CTRL A	1028	%B	CTRL \
1002	SB	CTRL B	1029	%C	CTRL]
1003	SC	CTRL C	1030	%D	CTRL 6
1004	SD	CTRL D	1031	%E	CTRL -
1005	SE	CTRL E	1032	Space	Space
1006	SF	CTRL F	1033	/A	!
1007	SG	CTRL G	1034	/B	"
1008	SH	CTRL H	1035	/C	#
1009	SI	CTRL I	1036	/D	\$
1010	SJ	CTRL J	1037	/E	%
1011	SK	CTRL K	1038	/F	&
1012	SL	CTRL L	1039	/G	'
1013	SM	CTRL M	1040	/H	(
1014	SN	CTRL N	1041	/I)
1015	SO	CTRL O	1042	/J	*
1016	SP	CTRL P	1043	/K	+
1017	SQ	CTRL Q	1044	/L	,
1018	SR	CTRL R	1045	-	-
1019	SS	CTRL S	1046	.	.
1020	ST	CTRL T	1047	/	/
1021	SU	CTRL U	1047	/	/
1022	SV	CTRL V	1048	0	0
1023	SW	CTRL W	1049	1	1
1024	SX	CTRL X	1050	2	2
1025	SY	CTRL Y	1051	3	3
1026	SZ	CTRL Z	1052	4	4

ASCII Value	Full ASCII Code 39 Encode Char.	Key-stroke	ASCII Value	Full ASCII Code 39 Encode Char.	Key-stroke
11053	5	5	1091	%K	[
1054	6	6	1092	%L	\
1057	7	7	1093	%M]
1056	8	8	1094	%N	^
1057	9	9	1095	%O	_
1058	/Z	:	1096	%W	`
1059	%F	;	1097	+A	a
1060	%G	<	1098	+B	b
1061	%H	=	1099	+C	c
1062	%I	>	1100	+D	d
1063	%J	?	1101	+E	e
1064	%V	@	1102	+F	f
1065	A	A	1103	+G	g
1066	B	B	1104	+H	h
1067	C	C	1105	+I	i
1068	D	D	1106	+J	j
1069	E	E	1107	+K	k
1070	F	F	1108	+L	l
1071	G	G	1109	+M	m
1072	H	H	1110	+N	n
1073	I	I	1111	+O	o
1074	J	J	1112	+P	p
1075	K	K	1113	+Q	q
1076	L	L	1114	+R	r
1077	M	M	1115	+S	s
1078	N	N	1116	+T	t
1079	O	O	1117	+U	u
1080	P	P	1118	+V	v
1081	Q	Q	1119	+W	w
1082	R	R	1120	+X	x
1083	S	S	1121	+Y	y
1084	T	T	1122	+Z	z
1085	U	U	1123	%P	{
1086	V	V	1124	%Q	
1087	W	W	1125	%R	}
1088	X	X	1126	%S	~
1089	Y	Y			Undefined
1090	Z	Z	1127		

ALT Keys	Keystroke	Misc. Key	Keystroke	PF Keys	Keystroke
2064	ALT 2	3001	PA 1	4008	PF 8
2065	ALT A	3002	PA 2	4009	PF 9
2066	ALT B	3003	CMD 1	4010	PF 10
2067	ALT C	3004	CMD 2	4011	PF 11
2068	ALT D	3005	CMD 3	4012	PF 12
2069	ALT E	3006	CMD 4	4013	PF 13
2070	ALT F	3007	CMD 5	4014	PF 14
2071	ALT G	3008	CMD 6	4015	PF 15
2072	ALT H	3009	CMD 7	4016	PF 16
2073	ALT I	3010	CMD 8	4017	PF 17
2074	ALT J	3011	CMD 9	4018	PF 18
2075	ALT K	3012	CMD 10	4019	PF 19
2076	ALT L	3013	“¥	4020	PF 20
2077	ALT M	3014	£	4021	PF 21
2078	ALT N	3015	¤	4022	PF 22
2079	ALT O	3016	¬	4023	PF 23
2080	ALT P	3017	°	4024	PF 24
2081	ALT Q	3018	1/2		
2082	ALT R	3019	¶	F Keys	Keystroke
2083	ALT S	3020	§	5001	F 1
2084	ALT T	3021		5002	F 2
2085	ALT U	3022	0/00	5003	F 3
2086	ALT V			5004	F 4
2087	ALT W	PF Keys	Keystroke	5005	F 5
2088	ALT X	4001	PF 1	5006	F 6
2089	ALT Y	4002	PF 2	5007	F 7
2090	ALT Z	4003	PF 3	5008	F 8
2091	ALT [4004	PF 4	5009	F 9
2092	ALT \	4005	PF 5	5010	F 10
2093	ALT]	4006	PF 6	5011	F 11
2094	ALT 6	4007	PF 7		
2095	ALT -				

F Keys	Keystroke	Numeric Keypad	Keystroke	Extended Keypad	Keystroke
5012	F 12	6042	*	7001	Break
5013	F 13	6043	+	7002	Delete
5014	F 14	6044	Undefined	7003	Pg Up
5015	F 15	6045	-	7004	End
5016	F 16	6046	.	7005	Pg Dn
5017	F 17	6047	/	7006	Pause
5018	F 18	6048	0	7007	Scroll Lock
5019	F 19	6049	1	7008	Backspace
5020	F 20	6050	2	7009	Tab
5021	F 21	6051	3	7010	Prnt Screen
5022	F 22	6052	4	7011	Insert
5023	F 23	6053	5	7012	Home
5024	F 24	6054	6	7013	Enter
5025	F 25	6055	7	7014	Escape
5026	F 26	6056	8	7015	Up Arrow
5027	F 27	6057	9	7016	Dn Arrow
5028	F 28	6058	Enter	7017	Left Arrow
5029	F 29	6059	Num Lock	7018	Right Arrow
5030	F 30	6060	00	7019	Back Tab
5031	F 31				
5032	F 32				
5033	F 33				
5034	F 34				
5035	F 35				
5036	F 36				
5037	F 37				
5038	F 38				
5039	F 39				

Keyboard Identifier Maps

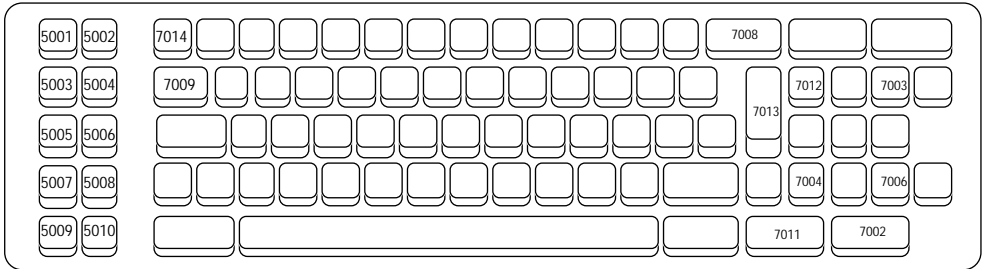

IBM PC/XT and Clones

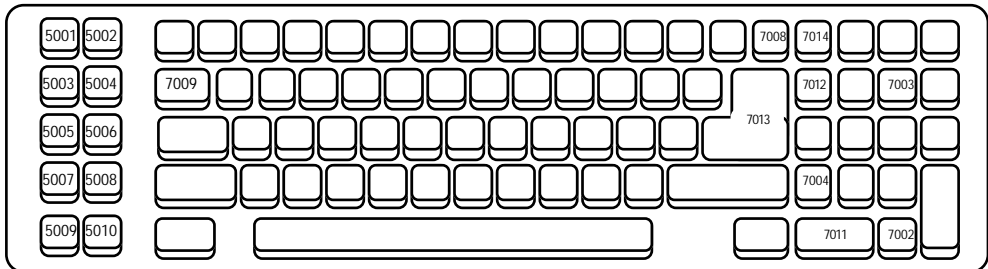

IBM PC/AT and Clones

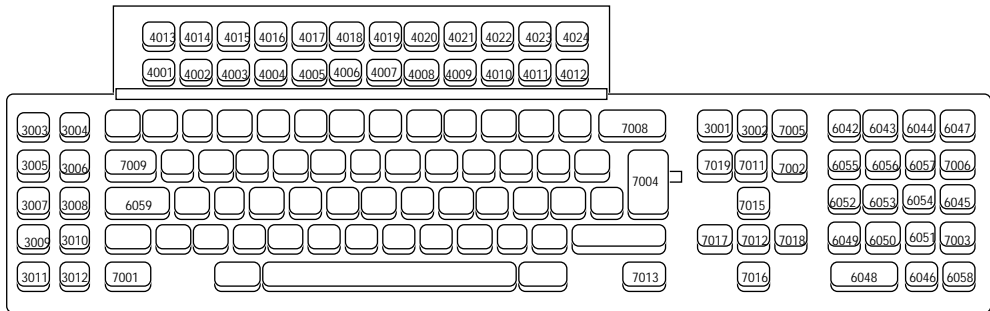

**IBM 3179
IBM 347X**

IBM 3180

**IBM 319X
Telex 122**

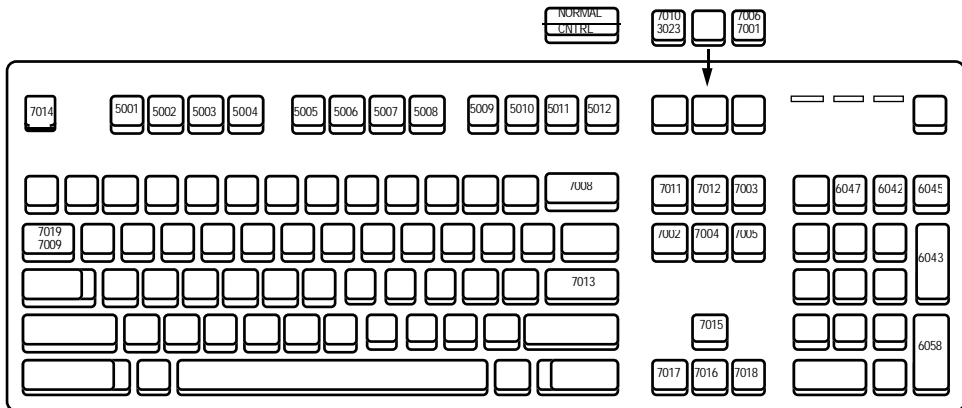

IBM PS2 and Clones

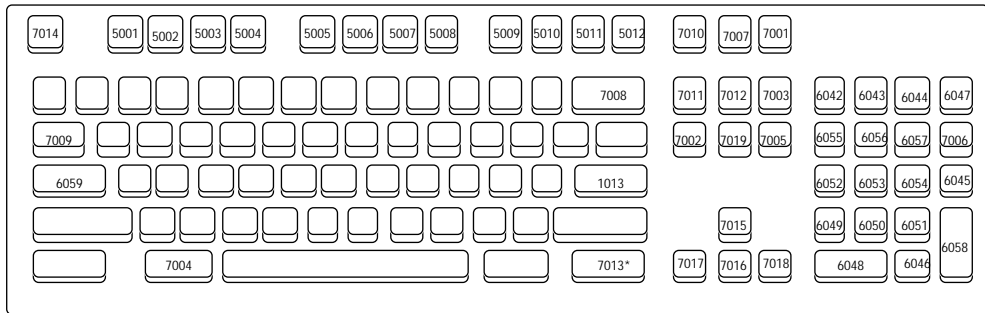

*3001 for IBM 3151

IBM 3151

DEC VT2XX/VT3XX/VT4XX

IBM 316X

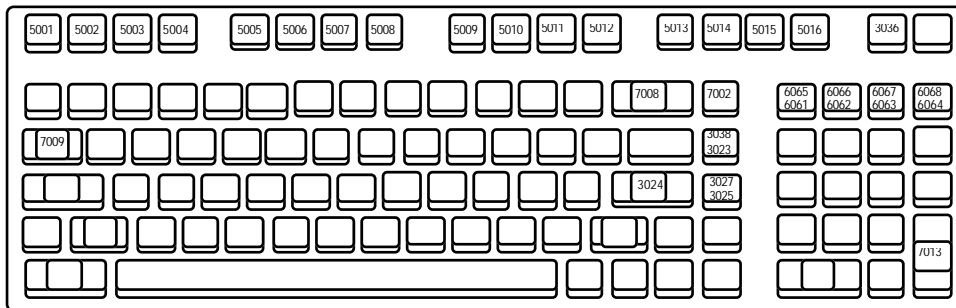

Wyse 50

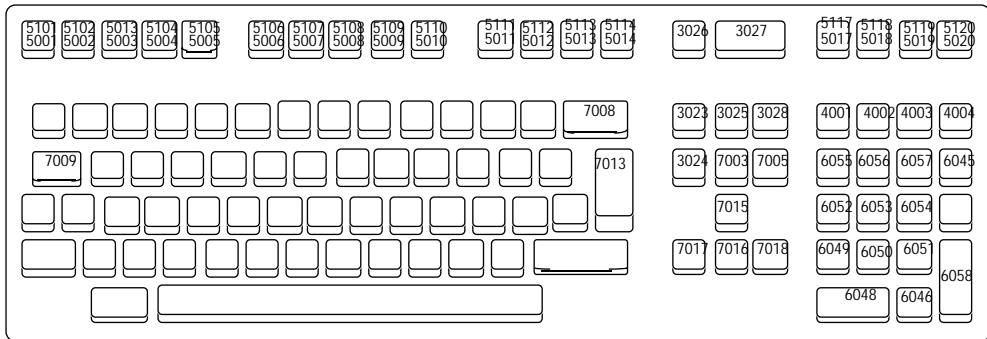

Wyse 60/85/150/185

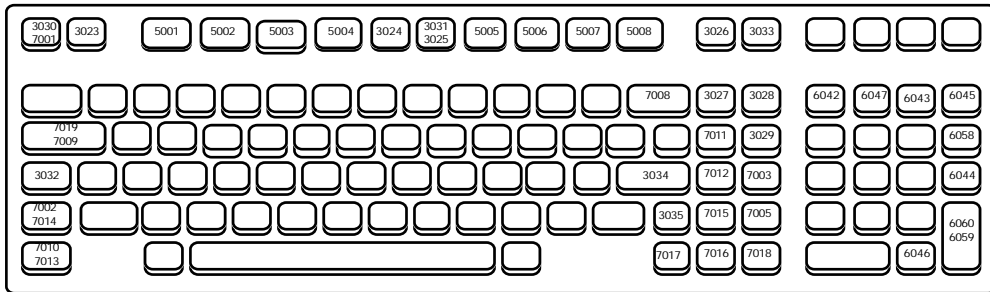

HP 239X

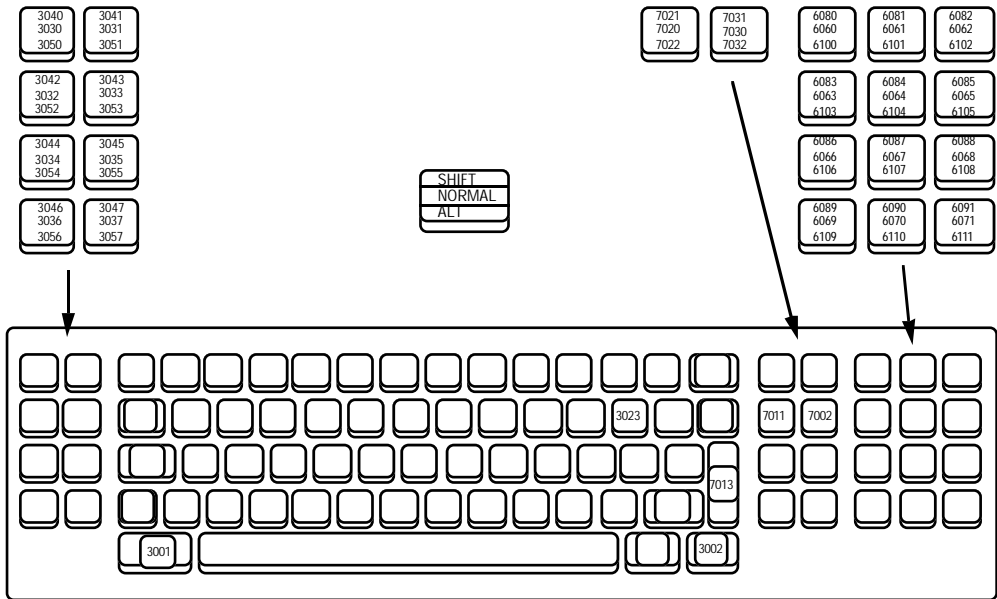

IBM 3178

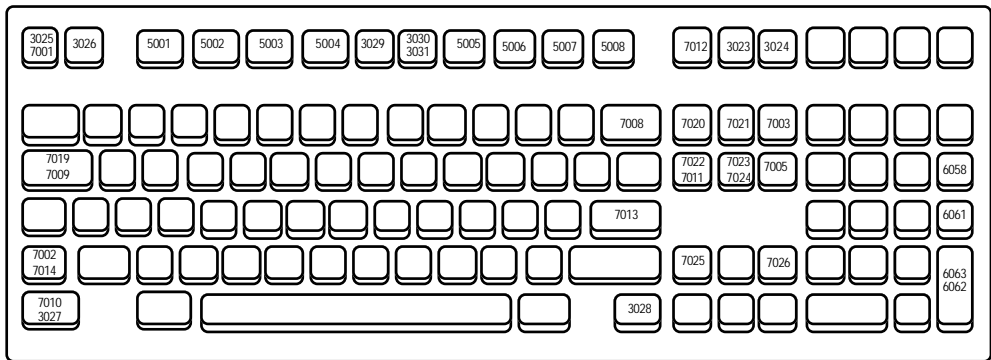

HP 700/9X

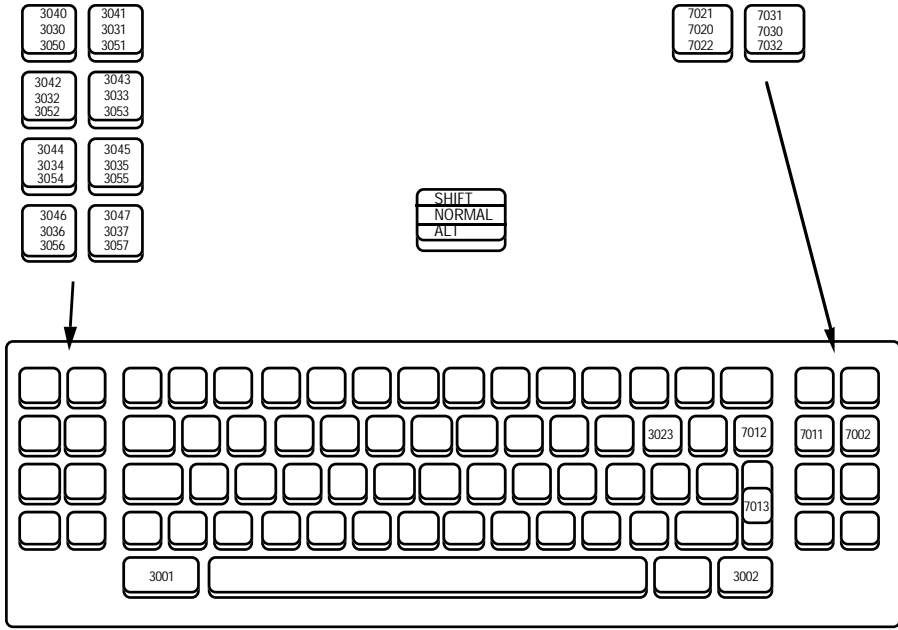

IBM 3278

5001	5006	5011		5012		5013	5016
5002	5007					5014	5017
5003	5008					5015	5018
5004	5009					7013	5019
5005	5010						5020

NCR 2151

5001	5006		5007		5008	5011
5002					5009	5012
5003					5010	5013
5004					7013	5014
5005						5015

NCR 2152 27-KEY

5001	5007	5013	5019	5021	5023	5028	5034
5002	5008	5014	5020	5022	5024	5029	5035
5003	5009	5015			5025	5030	5035
5004	5010	5016			5026	5031	5037
5005	5011	5017			5027	5032	5038
5006	5012	5018		1046	7013	5033	

NCR 2155

5001	5003	5005	5007	5009	5011	5013	5015	5017	5019	5021	5023	5025	5027	5029	5031	5032	5033
5002	5004	5006	5008	5010	5012	5014	5016	5018	5020	5022	5024	5026	5028	5030	5034	5035	5036
3022 3018														7008	5037	5038	5039
														1013			
		7009								7019	7013		6060				

NCR 2157

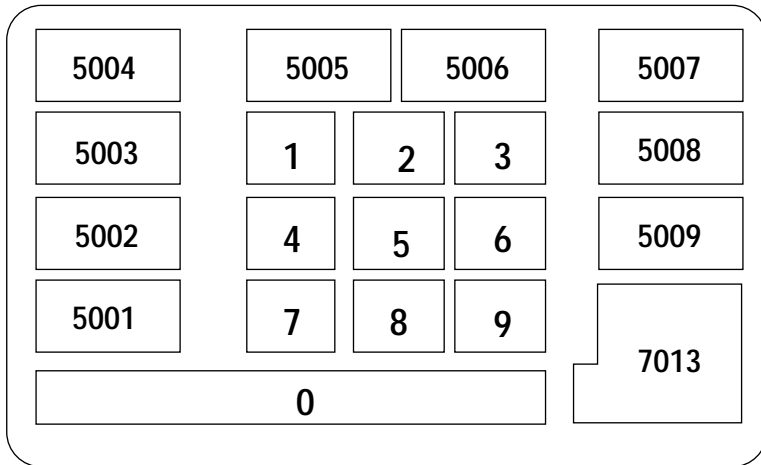

NCR 280

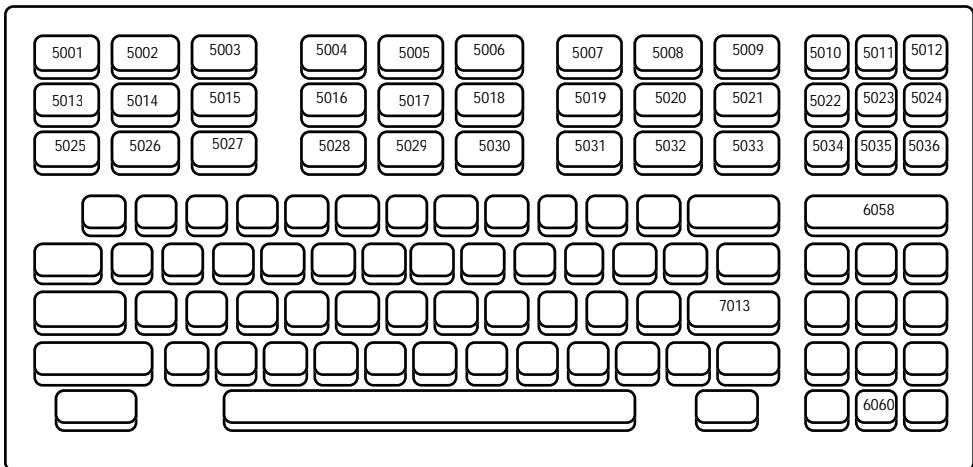

NCR 2950

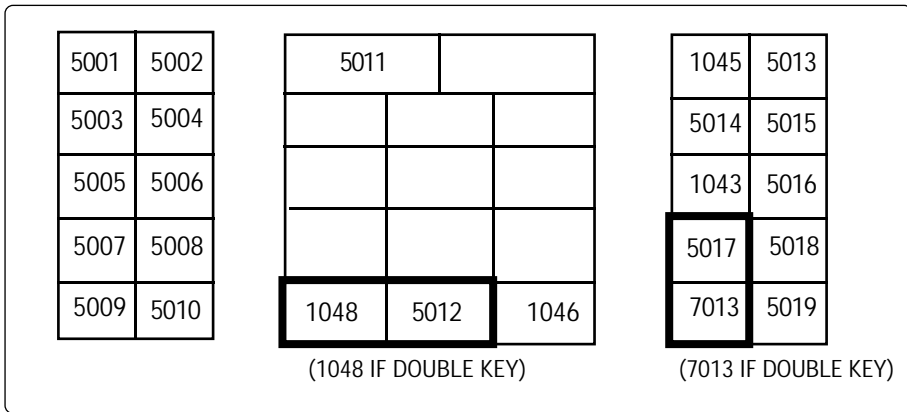

NCR 7052 32-KEY

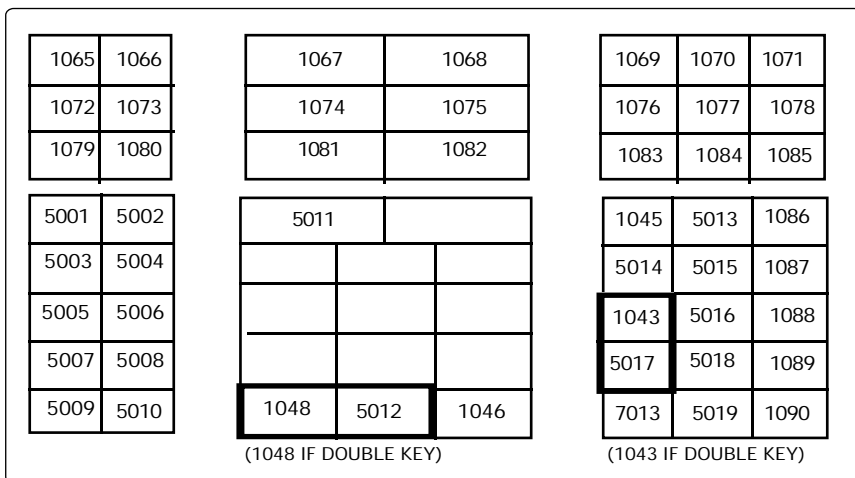

NCR 7052 58-KEY

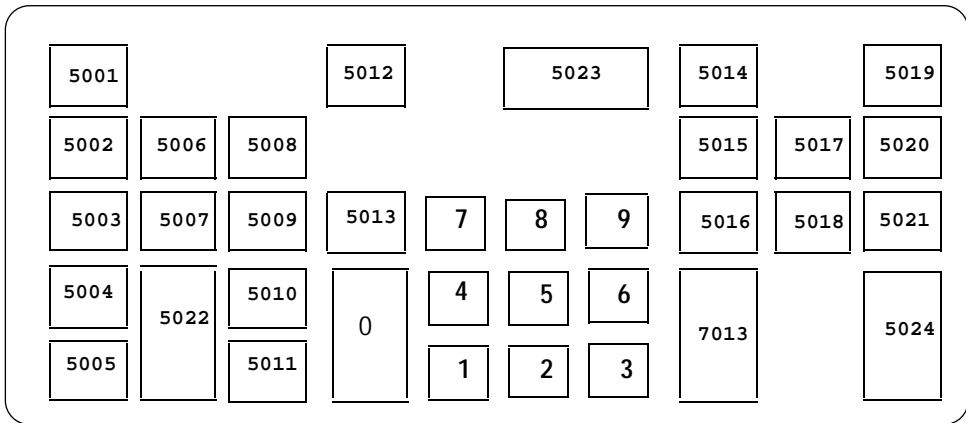

IBM 3683/3684 35-KEY Calculator Style

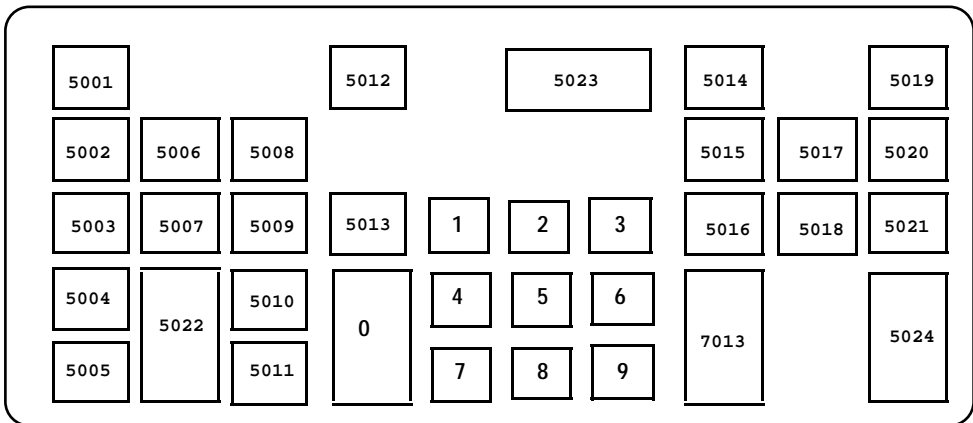

IBM 3683/3684 35-KEY Phone Style

5001	5029	5030	5031	5012	5035	5036	5014	5037	5019	
5002	5027	5006	5008	5032	7	8	9	5015	5017	5020
5003	5028	5007	5009	5013	4	5	6	5016	5018	5021
5004	5025	5022	5010	5033	1	2	3	7013	5026	5024
5005			5011	5034	0	.				

IBM 3683/3684 48-KEY Calculator Style

5001	5029	5030	5031	5012	5035	5036	5014	5037	5019	
5002	5027	5006	5008	5032	1	2	3	5015	5017	5020
5003	5028	5007	5009	5013	4	5	6	5016	5018	5021
5004	5025	5022	5010	5033	7	8	9	7013	5026	5024
5005			5011	5034	0	.				

IBM 3683/3684 48-KEY Phone Style

5001	5038	5009	5007	5054	5060	5066	5072	5078	5084	5090	5010	5000	5011	5102	5510	5014	5103	5019	5001
5002	5039	5044	5049	5055	5061	5067	5073	5079	5085	5091	5096	5006	5101	5103	5037	5015	5106	5020	5002
5018	5040	5045	5050	5056	5062	5068	5074	5080	5086	5092	5012	5036	1	2	3	5016	5107	5021	5018
5003	5041	5046	5051	5057	5063	5069	5075	5081	5087	5093	5030	5013	4	5	6	5027	5108	5109	5003
5004	5042	5047	5052	5058	5064	5070	5076	5082	5088	5094	5017	5033	7	8	9	7013	5110	5011	5004
5005	5043	5048	5053	5059	5065	5071	5077	5083	5089	5095	5097	5034	0	.					5005

IBM 3683 116-KEY

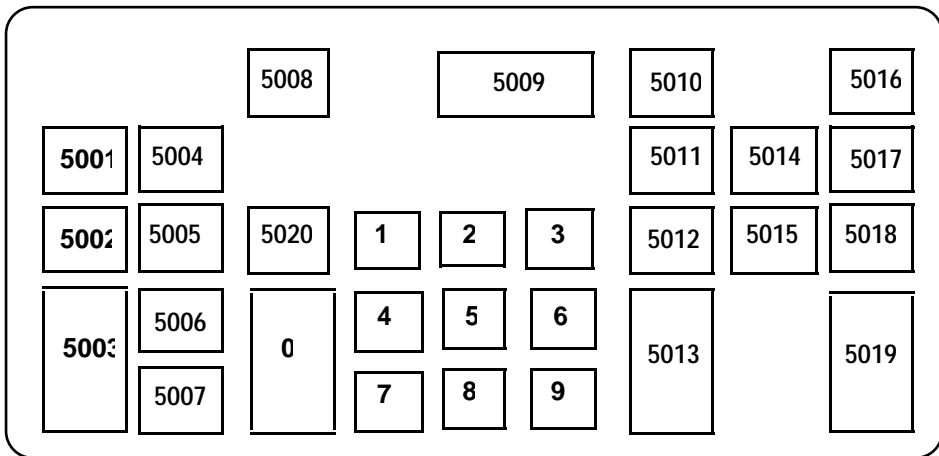

IBM 3653

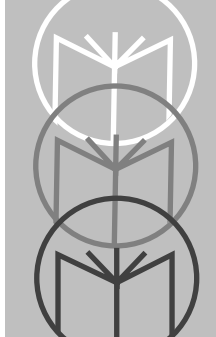

Index

A

Accessories	4-5
ASCII table	8-1

B

Base/charger unit	1-4
Battery	
Changing battery packs	4-2
Charging	2-3
LED indications	4-4
Recharging	4-1
Battery pack	1-3
Beeper definitions	6-24

C

Cable to base/charger unit	2-1
Cables,Interface	5-23
Charging the battery	2-3
Code 39 buffering	6-26
Connecting base station to host	5-2
Connecting cable to base/charger	2-1
Connecting keyboard wedges	5-5
Connecting to host	5-1

D

Decode zones	
Advanced long range	3-8
Extra long range	3-9
High visibility	3-10
Long range	3-7
Standard range	3-6
Default table	6-28

RS-232C defaults	6-31
------------------------	------

I

Installation

Assigning address to base/charger	2-3
Connecting base station to host	5-2
Connecting cable to base/charger ..	2-1
Connecting keyboard wedges	5-5
Connecting to host	5-1
Inserting scanner in base/charge ..	2-2
Installing a magstripe reader	2-7
Pairing scanner with base/ charger	2-3, 2-5
Interface cables	5-23

K

Keyboard identifier maps	8-5
Keyboard types	6-18

L

LED indications

Battery charge status	4-4
-----------------------------	-----

M

Magstripe reader	2-7
Maintenance	4-1

P

Pairing bar code	2-5, 7-97
Parameter bar codes	
ASCII data format	7-66

Baud rate	7-56
Check parity	7-59
Code lengths	7-22
Code type	7-17
Data transmission formats	7-46
Decode options	7-29
Hardware handshaking	7-60
Host interface	7-3
IBM 4683 magstripe	
communications	7-79
Ignore unknown characters	7-73
Intercharacter delay	7-68
International keypad emulation	7-80
International keypad emulation fast transmit	7-81
Laser control	7-53
National keyboard types	7-82
NCR 2152 fast transmit	7-78
OCIA clock polarity	7-74
OCIA transmit timeout	7-75
Pairing	7-97
Parity	7-58
Pause duration	7-39
Prefix/Suffix values	7-42
RTS line state	7-67
Serial response timeout	7-62
Set default	7-2
Set transmission frequency	7-84
Software handshaking	7-61
Stop bit select	7-65
Transmit AIM code ID	7-72
Transmit code ID character	7-71
UPC-A/E preamble	7-37
Wait for host interface response	
time	7-87
Parameter descriptions	6-3
Code 39 full ASCII	6-4
Code lengths	6-3
Code types	6-3
Data transmission formats	6-9
Decode options	6-5

Host interface code	6-3
IBM 4683/93 magstripe	
communications	6-17
Ignore unknown characters	6-16
Intercharacter delay	6-16
International keypad emulation	6-17
International keypad emulation	
fast transmit	6-17
Laser on timeout	6-10
National keyboard types	6-18
NCR 2152 fast transmit	6-17
OCIA clock polarity	6-16
OCIA transmit timeout	6-17
Pause duration	6-8
Prefix/Suffix values	6-8
RS-232C options	6-11
Set defaults	6-3
Set transmission frequency	6-20
Transmit AIM ID character	6-16
Transmit code ID character	6-16
UPC-A/-E preamble	6-8
Wait for host interface response	
time	6-20
Parameter selections	6-21
Programming	6-1

S

Scanning	3-1
Long range/high visibility scanner	3-3
Programming	6-1
Transmission range	3-4

T

Technical specifications

LS 3070ALR	4-8
LS 3070HV	4-10
LS 3070LR	4-7
LS 3070XLR	4-9
Standard LS 3070	4-6
Transmission frequency, setting	2-6

Transmission Range.3-4

U

Unpacking.2-1

Tell Us What You Think...

We'd like to know what you think about this Manual. Please take a moment to fill out this questionnaire and fax this form to: (516) 738-3318, or mail to:

Symbol Technologies, Inc.
One Symbol Plaza M/S B-4
Holtsville, NY 11742-1300
Attn: Technical Publications Manager

IMPORTANT: If you need product support, please call the appropriate customer support number provided. Unfortunately, we cannot provide customer support at the fax number above.

User's Manual Title: _____
(please include revision level)

How familiar were you with this product before using this manual?

- Very familiar Slightly familiar Not at all familiar

Did this manual meet your needs? If not, please explain. _____

What topics need to be added to the index?, if applicable _____

What topics do you feel need to be better discussed? Please be specific. _____

What can we do to further improve our manuals? _____

Thank you for your input—We value your comments.