

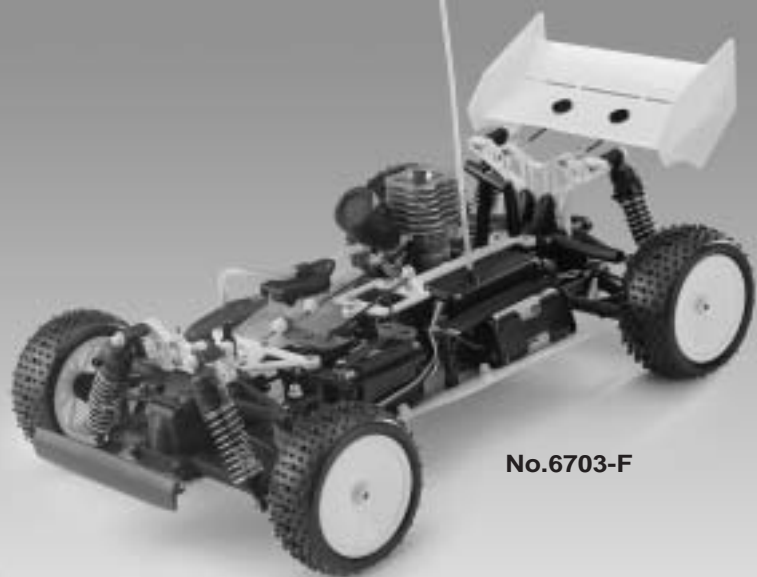

SSB

SSR

1/10 OFF-ROAD, 4WD CAR



No.6703-F



No.6704-F SUBARU IMPREZA

No.6705-F PEUGEOT 206

No.6706-F CITROEN SAXO



INSTRUCTION MANUAL

WARRANTY

JD6012

Thunder Tiger Corporation guarantees this model kit to be free from defects in both material and workmanship. The total monetary value under warranty will in no case exceed the cost of the original kit purchased. This warranty does not cover any components damaged by use or modification. Part or parts missing from this kit must be reported within 60 days of purchase. No part or parts will be sent under warranty without proof of purchase. To receive part or parts under warranty, the service center must receive a proof of purchase and/or the defective part or parts. Should you find a defective or missing part, contact the authorized Thunder Tiger Service/Distributor nearest you. Under no circumstances can a dealer or distributor accept return of a kit if assembly has started.

INTRODUCTION

Thank you for the purchase of this Thunder Tiger product. You should enjoy many hours of trouble free use from this advanced R/C product. Thunder Tiger strives to bring you the highest level of quality and service we can provide. We race and test our products around the world to bring you state-of-the-art items.

We offer on-line help 24-7 on our www.acehobby.com forum and our product specialists are ready to take your call if you have any technical questions. Please read all instructions and familiarize yourself with the systems and controls of this product before operating. Have fun and enjoy the exciting world of R/C.

ITEMS REQUIRED FOR OPERATION

PURCHASED SEPARATELY
WITH ARTR MODELS



2-Channel, surface radio
with 2 high torque servos (over 8kg/cm, 90oz/in)



Glow Fuel, Methanol
10% to 20% Nitro
5% to 18% Caster / Synthetic Oil



Fuel Bottle



Alkaline Batteries
(12), AA-size



Glow Starter w/ Charger



5-Way Wrench

TOOLS INCLUDED



Hex Wrench Set



4-Way Wrench



Screw Drivers, Lexan Body Reamer, Hobby Knife,
Lexan Scissors, Rubber Bands.

1 INSTALLING THE RADIO GEAR skip if already assembled

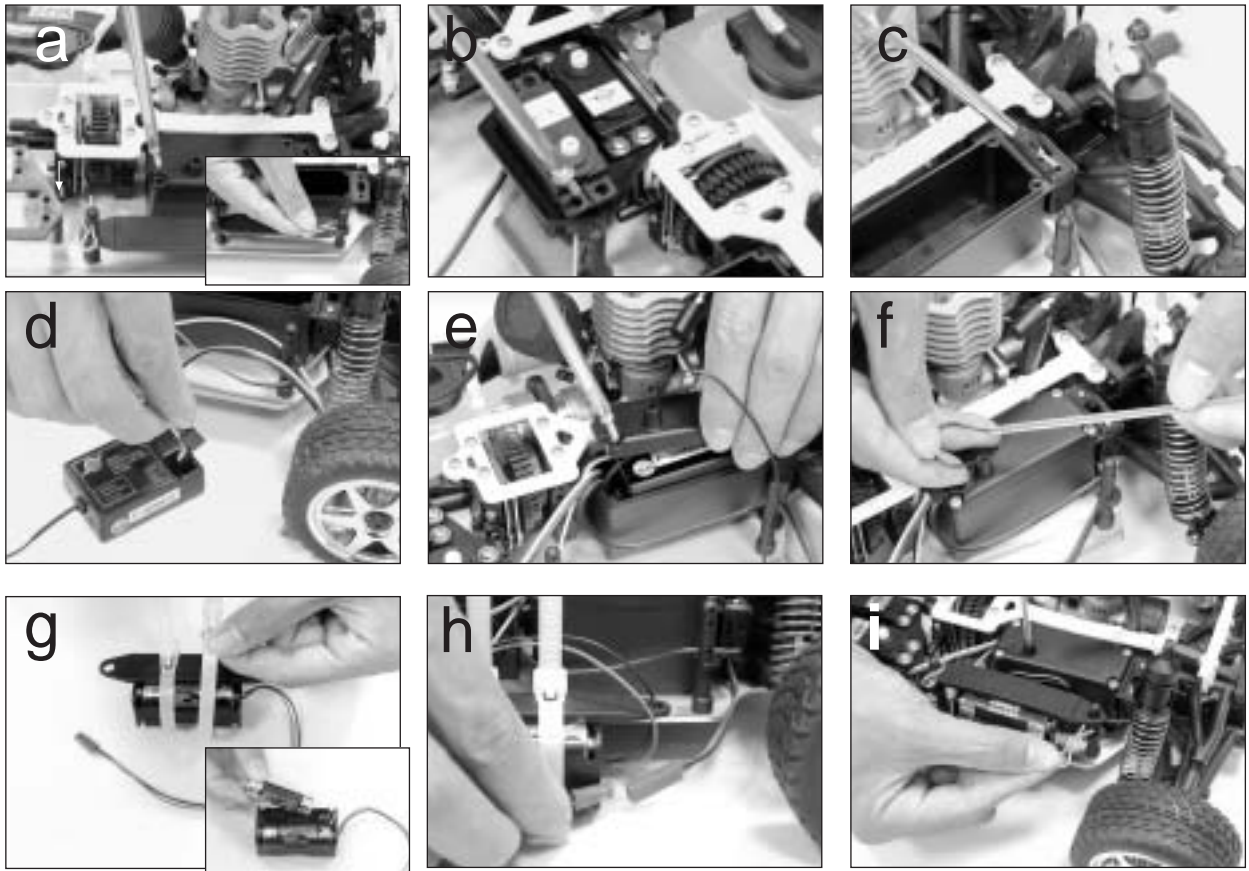

- a.** Take out the 4 screws on the receiver box to remove the box top.
- b.** Install the servos with tap screws. Notice the orientation of the steering and throttle servo output shafts.
- c.** Install the receiver switch onto the rear of the receiver box with its original screws.
- d.** Properly plug the connectors/wires into the receiver: steering servo connector/wire into channel 1 slot, throttle servo connector/wire into channel 2 slot, and battery switch connector/wire into battery slot.
- e.** Place the receiver and the wires inside the receiver box, thread the receiver antenna/wire through the box top hole, and reinstall the box top.
- f.** Thread the receiver antenna/wire through the antenna tube, then install the antenna tube onto the box top hole.
- g.** Install 4 AA size alkaline batteries in receiver battery box and strap the battery box onto the battery plate with two large nylon zip-ties.
- h.** Connect the receiver battery box wire/connector to the receiver switch wire/connector.
- i.** Install the battery box & plate onto the posts, then use the large body clips to secure the plate onto posts.

2 INSTALLING STEERING SERVO LINKAGE skip if already assembled



- a.** Install the threaded part of the linkage rod into the plastic tie-end. The linkage rod with tie-end should measure 55mm when finished.
- b.** Install the steering linkage rod with tie-end onto steering servo horn.
- c.** Pop the tie-end onto the standoff ball on the steering rack, and install the servo horn onto steering servo output shaft.

3 INSTALLING THROTTLE LINKAGE skip if already assembled

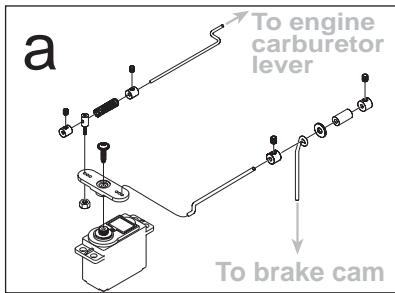

- a.** Build the throttle/brake linkages as shown on the diagram.
- b.** Secure the brake cam lever onto brake cam with set screw.
- c.** Install the servo horn onto throttle servo output shaft.

4 CHARGING THE GLOW PLUG IGNITER

Thunder Tiger Optional Part #2165, 1300MAH Glow Starter w/220V Charger.
 Thunder Tiger Optional Part #2166, 1300MAH Glow Starter w/110V Charger.



- a.** Plug the charger into an AC outlet.
- b.** Line up the charging adapter with the tip of the glow plug igniter.
- c.** Pull on the glow plug igniter lever to accept the charging adapter.
- d.** Plug the charging adapter into the glow plug igniter. At this point, the small red LED indicator on the charger should light up indicating the charging sequence is in progress.
- e.** Unplug the glow plug igniter from charger after charging is complete. Pull on the glow plug igniter lever.
- f.** Pull the charging adapter out of the glow plug igniter.

Charge the new glow plug igniter for 16 to 24 hours on the first charge. For subsequent charges, charge it about 12 hours before next use.

NOTE:

If the igniter gets warm or hot during the charge, unplug the igniter from charger immediately. A warm / hot igniter means the igniter is overcharged. Overcharging can damage the internal battery in the igniter; thus, shortening its life.

5 PREPARING THE RADIO

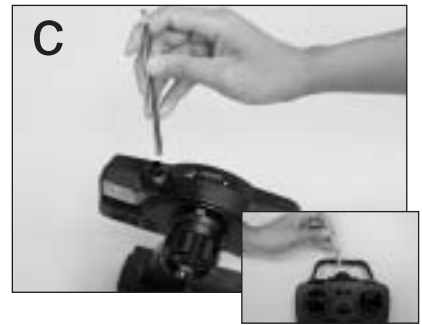

- a.** Check the frequency printed on the transmitter crystal.
- b.** Check the frequency printed on the receiver crystal, and make sure it matches with the transmitter crystal. Make sure no one will operate on the same frequency when you are. When there is a radio glitch, it will most likely be caused by improper crystal, damaged crystal, or people operating on the same frequency.
- c.** Install the antenna into transmitter.

6 RADIO BATTERY INSTALLATION

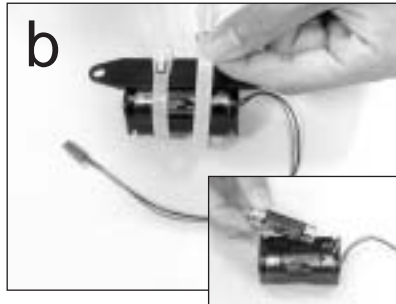
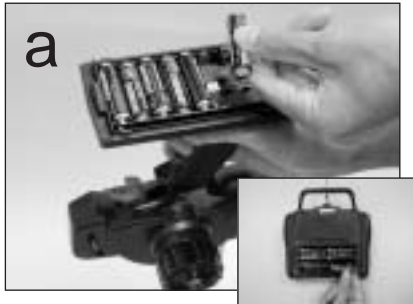

- a.** Install 8 AA-size alkaline batteries into transmitter.
- b.** Undo the large zip-tie, and remove the receiver battery box. Install 4 AA-size alkaline batteries into receiver battery box.
- c.** Secure the receiver battery box with batteries back onto the posts with large body clips.

7 RADIO OPERATION



- a.** When turning radio on, first turn on the transmitter.
- b.** Then, turn on the receiver. When turning off, first turn the receiver off, then the transmitter off.
- c.** To reverse the functions of servos, use the small, white servo reverse switches located on top of the pistol transmitter (or the inset servo reverse switches located at the center of the stick transmitter). To trim the servos on pistol transmitter, use the large, red trim levers on top and side of the steering wheel (the top trims steering, and the side trims throttle/brake). On a stick transmitter, the trim levers are located accordingly around the sticks.

8 OPERATING RADIO STEERING FUNCTION

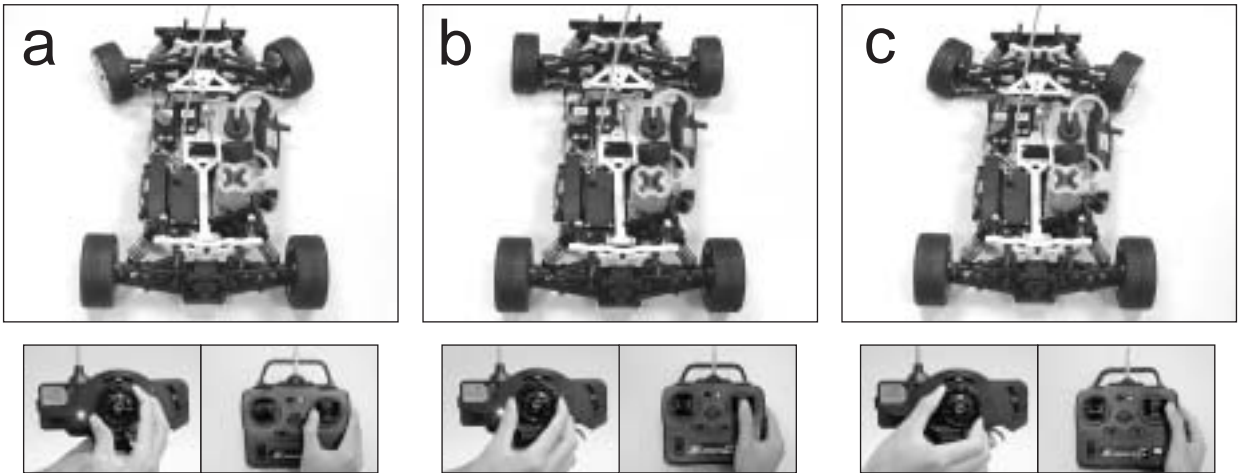

- a.** Check the radio steering functions. With the radio transmitter and receiver on, turn the steering wheel/stick to the left. The front tires/wheels should turn left accordingly. If not, flip the steering servo reverse switch.
- b.** Return the steering wheel/stick to neutral. The front tires/wheels should point straight forward. If not, use the steering trim lever to correct it.
- c.** Turn the steering wheel/stick to the right. The front tires/wheels should turn right accordingly.

9 OPERATING RADIO THROTTLE / BRAKE FUNCTION

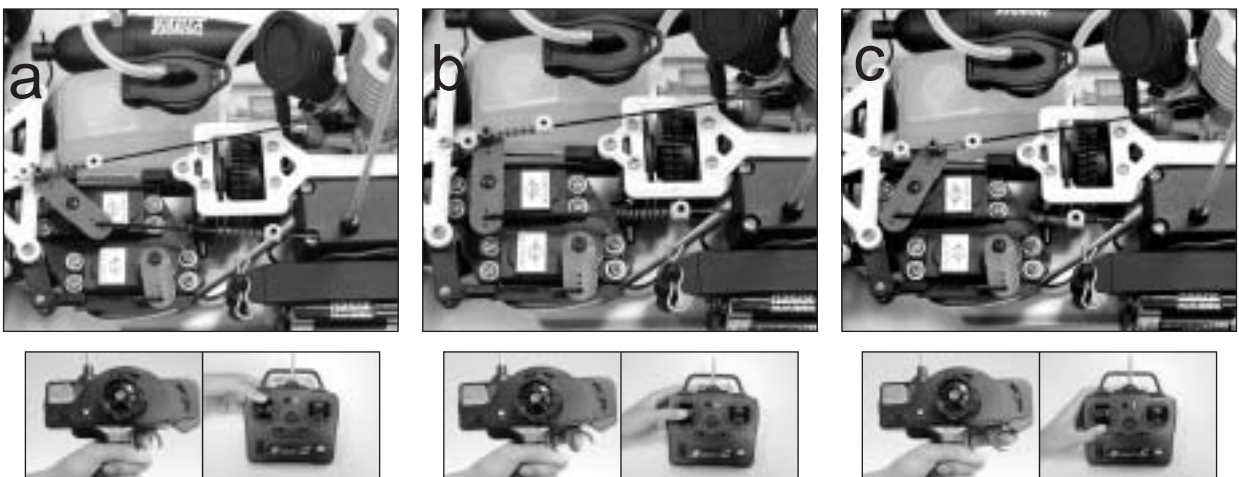

- a.** Check the radio throttle/brake functions. With the radio transmitter and receiver on, pull the trigger/push the stick forward. The carburetor should be fully opened and the brake disengaged. To reverse this function, flip the throttle/brake servo reverse switch.
- b.** Return the trigger/stick to neutral. The carburetor should be closed to a point where the idle has been set (see step for ADJUSTING THROTTLE/BRAKE LINKAGE), and the brake still disengaged. If not, use the throttle/brake trim lever to correct it.
- c.** Push the trigger/pull the stick backward. The carburetor opening should still be the same at neutral, throttle spring compressed slightly, and the brake engaged.

10 ADJUSTING THROTTLE / BRAKE LINKAGE

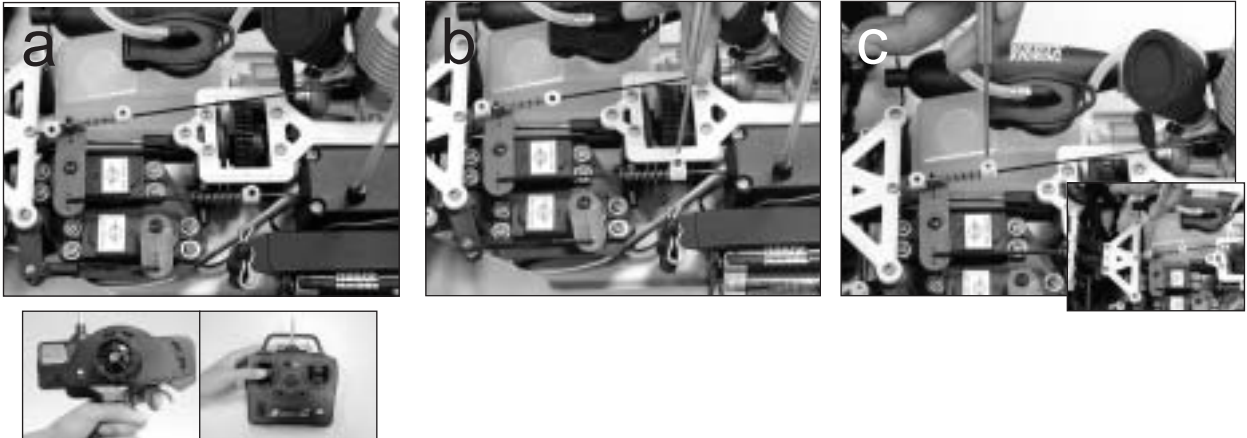

- a.** To set the throttle/brake linkage, first the radio should be on and neutral; thus, the servo is at neutral position.
- b.** With the servo at neutral, turn and adjust the brake collar to a point where the brake lever almost engages the brake system, but not yet.
- c.** With the servo at neutral, loosen the throttle collars. Then, manually close the carburetor, and set the collar (next to the spring) with the spring slightly compressed. Then, set the other collar next to the linkage pivot.

11 ADJUSTING CARBURETOR



- a.** To set the carburetor idle (small needle sticking out from the carburetor body), turn the screw as pictured. Initial idle setting should leave 1mm carburetor gap. Clockwise turn will provide higher idle (larger carburetor opening), and counterclockwise turn will provide lower idle (smaller carburetor opening).
- b.** To set the high speed needle (large needle sticking out from the carburetor body), turn the screw as pictured. Initial high speed needle setting should be 2.5 turns (close the needle completely, then back out 2.5 turns). Clockwise turn will provide leaner setting (lower fuel to air mixture), and counterclockwise turn will provide richer setting (higher fuel to air mixture). Please refer to ENGINE BREAK-IN/SETTING procedures to properly set the engine.
- c.** Remove the outer foam from filter and make it moist evenly with a few drops of fuel. If the vehicle will be operated in an area with fine dust, use filter oil or castor oil instead of fuel. It is important that the foam is only moist to trap dirt and allow air passage. With the foam too wet, limited air can pass through; therefore, limiting engine performance. Finally, make sure the air cleaner boot is securely fastened with a zip-tie.

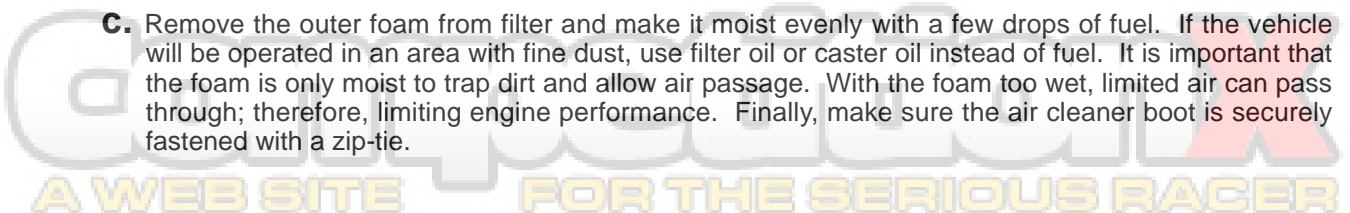

 A WEB SITE FOR THE SERIOUS RACER

12 FUELLING



- a.** Remove the cap from fuel bottle nozzle.
- b.** Squeeze the fuel bottle, insert into fuel, and draw fuel into the fuel bottle. The fuel used should be methanol based model engine glow fuel (available at hobby shops) with 10% to 20% nitro content and 5% to 18% castor/synthetic oil content for lubrication.
- c.** Fill car's fuel tank with glow fuel.

13 PREPARING THE ENGINE



- a.** To start an engine, first remove the glow plug.
- b.** Check the glow plug by plugging it into the glow plug igniter. The glow plug element should light up brightly. If it lights up dimly, then the glow plug igniter is low (and it needs recharging). If it does not light up or the plug element looks distorted, then the glow plug is bad (replace with new one). After checking, reinstall the glow plug.
The glow plug used for this engine can be: Thunder Tiger 9281, McCoy #9 / #59, Novarossi C4S / C5S / C6S, OS #8 / #A3 / #A5, and Picco P6S / P7S.
- c.** With the radio off, manually turn the servo to open the carburetor (open throttle).
- d.** Plug the tuned pipe exhaust tip.
- e.** Keeping the exhaust tip plugged, pull on the engine's starter. Keep doing it until fuel reaches engine's carburetor, then pull it 3 more times to prime the engine.
- f.** Manually return the servo back to neutral.

14 STARTING THE ENGINE



- a.** Turn on the radio (transmitter first, then receiver).
- b.** Clip the glow plug igniter onto engine's glow plug.
- c.** Pull on the engine starter, release, repeat until the engine starts. Throttle maybe required to be opened momentarily, but release throttle back to neutral immediately after the engine starts.

Remove the glow plug igniter from engine after engine has started and warmed up. If the engine stops right after the igniter is removed, the carburetor setting is too rich. Please refer to engine setting section.

If engine starter becomes hard to pull, the engine maybe flooded. To unflood an engine, remove the glow plug from engine, flip the car upside down, and pull on the starter to release excess fuel. Then, reinstall the glow plug and repeat the engine starting procedure.

15 ENGINE BREAK-IN

For a new engine (break-in setting), the high speed needle needs to be set as rich as possible. Turn the high speed needle 1/4 turn counterclockwise from initial setting (2.5 turns from fully closed). Repeat step 15b. Keep doing this until the engine stalls at full throttle, then turn the high speed needle 1/4 turn clockwise. Run the car in an open parking lot with this rich engine setting for at least 5 tanks of fuel to complete the break-in process. It is normal for a new engine to stall many times during this time due to the rich setting. When it does, just restart the engine. After break-in, follow the ENGINE SETTING procedure to set the carburetor for normal operations.

ENGINE SETTING

Due to different fuel formula, operating elevation, humidity . . . etc., the engine may/may not operate properly at initial setting. Please follow the following procedure to achieve proper carburetor setting. Do not perform this procedure until the engine has been properly broken in.

- a. Start the engine.
- b. With a running engine, run the car back and forth in a straight line (full throttle achieved during each passage) in an open parking lot. Repeat and note the sound of the exhaust. Do not hold the throttle open with car off the ground or the engine connecting rod may break.
- c. If the exhaust does not reach a high pitch note, turn the high speed needle (long needle, extending from carburetor body, pointing up) 1/4 turn clockwise, and repeat step 15b.
- d. Repeat step 15c until the engine reaches optimum setting (turning in the high speed needle will no longer have an effect at full throttle and turning out the needle will cause the engine's full throttle rpm to drop a little). For normal operations, turn the high speed needle 1/4 turn counterclockwise from the optimum setting.
- e. To set the idle, turn the idle screw in (higher rpm) or out (lower rpm). Basically, the idle needs to be set at the lowest possible point before the engine stalls.
- f. To set the low speed needle (inside the throttle lever), the engine needs to be broken in and high speed needle needs to be set first.
- g. Repeating step 15b every 10 seconds (1 second full throttle and 10 seconds idle). If the engine rpm at idle drops after a few seconds and stalls, then turn in the low speed needle (clockwise) 1/4 turn. If the engine rpm stays the same or goes up at idle, then turn out the low speed needle (counterclockwise) 1/4 turn.
- h. Keep repeating step 15g until the engine rpm drops (goes to idle rpm, then drops a few more rpm after a few seconds) but does not stall.

WARNING

Thank you for purchasing a Thunder Tiger Product. Please read all instructions thoroughly before operation.

1. This product is not a toy. It is a high performance model product. It is important to familiarize yourself with the model, its manual, and its construction before assembly or operation.
2. Do not operate model products in rain, on public roads, near crowds, near airport, or near areas with restricted radio operation.
3. Always keep fuel away from heat and open flame. Only operate in open, well-ventilated area. Store fuel in cool, dry area. Keep the fuel bottle cap tightly closed. Clean up any leak or excess fuel before starting the engine.
4. This product, its parts, and its construction tools can be harmful to your health. Always exercise extreme caution when assembling and/or operating this product. Do not touch any part of model which rotates.
5. Check your radio frequency with the proper operating frequency of the area or country. Always check to see if there are any modelers operating on the same frequency as your are. Also, check your radio for proper operation before operating a mode.
6. Improper operations may cause personal and/or property damage. Thunder Tiger and its distributor have no control over damage resulting from shipping, improper construction, or improper usage.
7. Thunder Tiger assumes and accepts no responsibility for personal and/or property damages resulting from the use of improper building materials, equipment and operations. By the act of assembling or operating this product, the user accepts all resulting liability. If the buyer is not prepared to accept this liability, then he/she should return this kit in new, unassembled, and unused condition to the place of purchase.

9414 PRO-15BXS(P) Shown

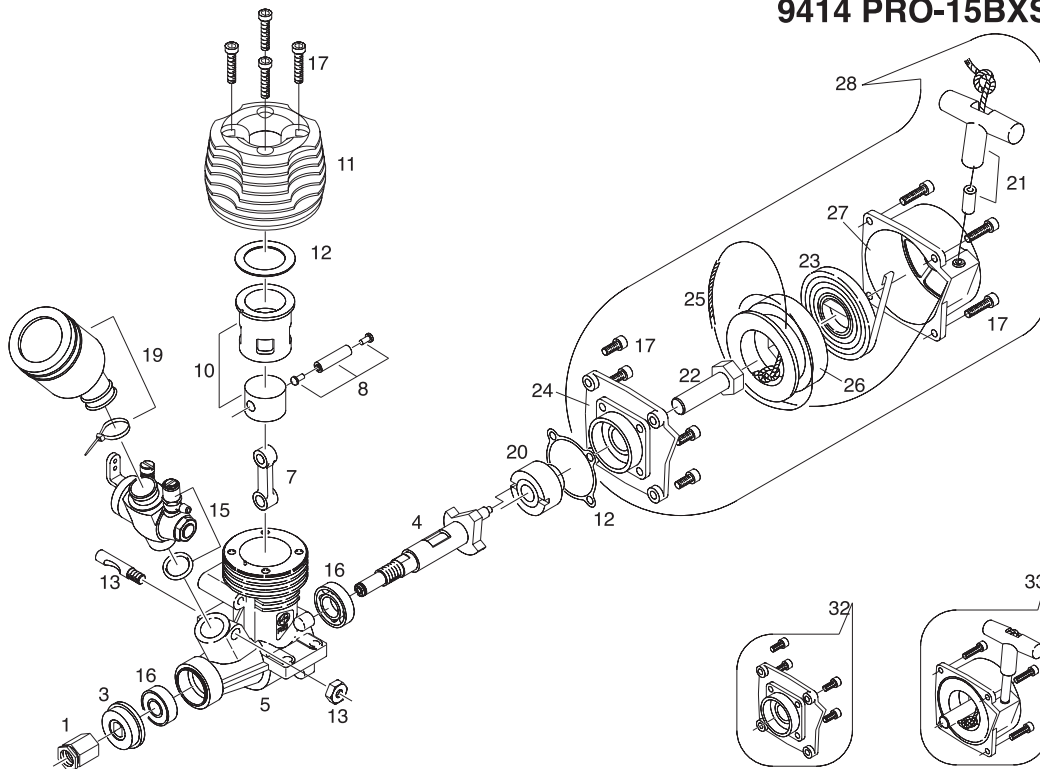

Car Engine PRO Series Parts Listing

No.	Description	9414 PRO-15BXS
1	PROP NUT	AA0199B
2	PROP WASHER	*****
3	DRIVE WASHER SET	AA0245
4	CRANKSHAFT	AA0244
5	CRANKCASE	AN0200
6	BACKPLATE	*****
7	CONNECTING ROD	AN0433
8	WRIST PIN ASSEMBLY	AN0148
9	CIRCLIP	*****
10	CYLINDER & PISTON	AN0202
11	CYLINDER HEAD	AA0694
12	GASKET SET	PN0013
13	CARB RETAINING BOLT	PN0011
14	MUFFLER ASSEMBLY	*****
15	CARBURETOR ASSEMBLY	9269
16	BEARINGS	PN0173
17	SCREW SET	PN0012
18	MUFFLER BOLT SET	*****
19	AIR CLEANER SET	9262
20	ONE WAY CLUTCH SET	AN0315
21	HANDLE SET	PN0050
22	STARTING AXLE	AA0313
23	STARTING SPRING	AA0316
24	BACKPLATE	AN0241
25	STARTING WHEEL WIRE	AA0155
26	STARTING WHEEL	AA0312
27	STARTING WHEEL COVER	AN0314
28	STARTING SET	PN0016
29	CLUTCH BAG	*****
30	CLUTCH BELL BAG	*****
31	E RING SET	*****
32	BACKPLATE & SCREW SET	PN0017
33	STARTING WHEEL COVER SET	PN0018
34	FLYWHEEL BAG	*****
35	EXHAUST HEADER PIPES	*****

PART LIST

PD6027 LEXAN BODY, SUBARU IMPREZA

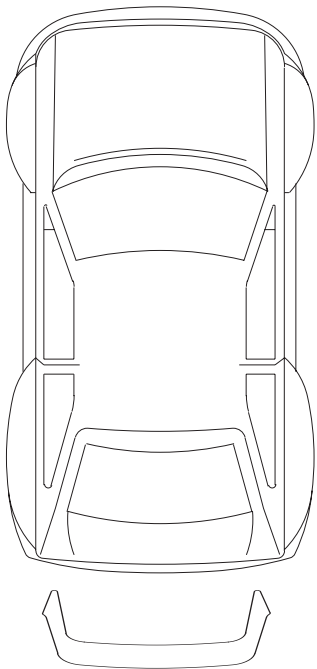

PD6028 DECAL, SUBARU IMPREZA

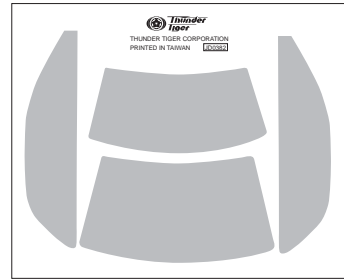

PD6029 LEXAN BODY & DECAL SET, SUBARU IMPREZA

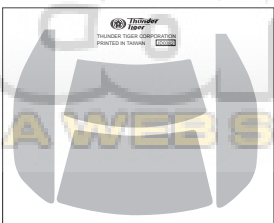
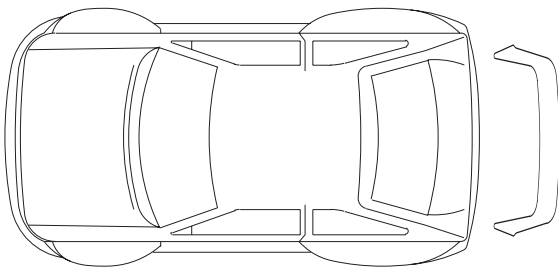

PD6030 PAINTED BODY SET, SUBARU IMPREZA



A WEB SITE FOR THE SERIOUS RACER

PART LIST

PD6031 LEXAN BODY, PEUGEOT 206

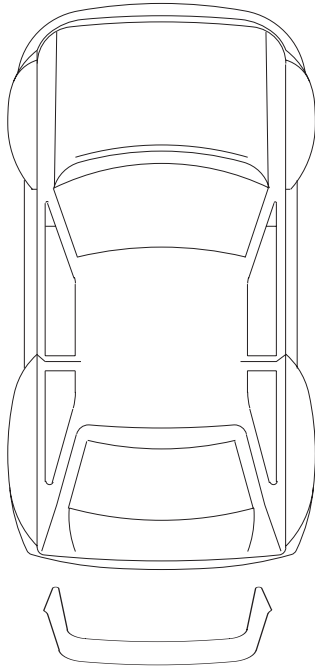

PD6032 DECAL, PEUGEOT 206

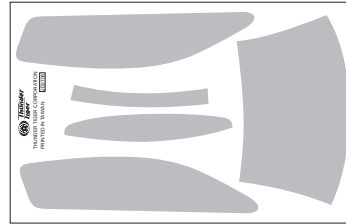

PD6033 LEXAN BODY & DECAL SET, PEUGEOT 206

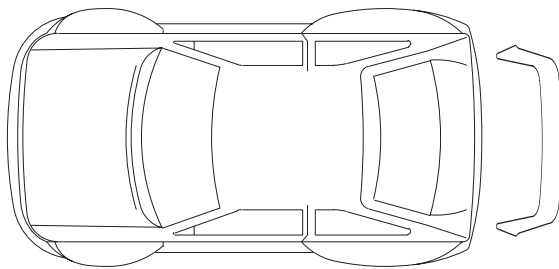

PD6034 PAINTED BODY SET, PEUGEOT 206



PART LIST

PD6035 LEXAN BODY, CITROEN SAXO

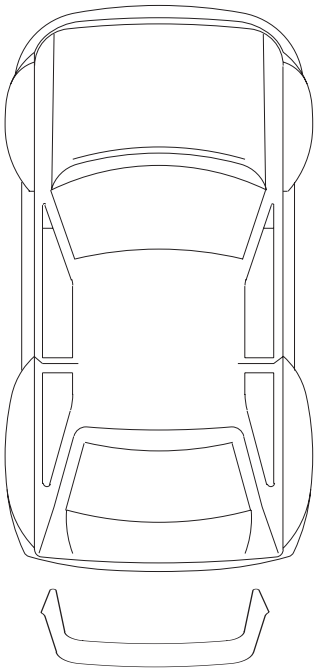

PD6036 DECAL, CITROEN SAXO



PD6037 LEXAN BODY & DECAL SET, CITROEN SAXO

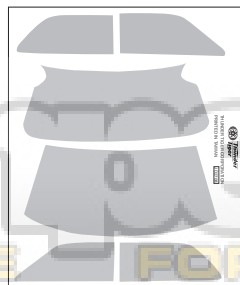
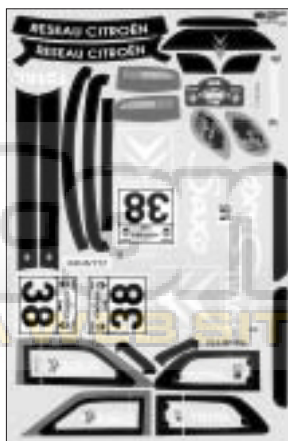
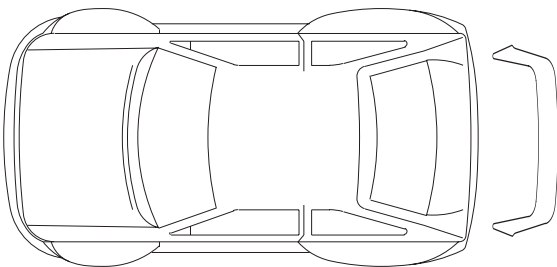

PD6038 PAINTED BODY SET, CITROEN SAXO





SSR

1/10 OFF-ROAD, 4WD RALLY CAR

- Factory assembled with painted body.
- Radio & servos included.
- Double wishbone suspension, front / rear.
- Oil filled composite shocks.
- Universal drive shaft, front.
- Dog bone and drive axle, center / rear.
- 2-speed transmission.
- Gear differential, front / rear.
- Single disc brake system.
- Sealed receiver box.
- PRO-15BX(P) pull-start engine.
- Performance manifold & tuned pipe.
- Rally tires and wheels.
- Three Lexan body styles:
 - Citroen Saxo
 - Peugeot 206
 - Subaru Impreza.

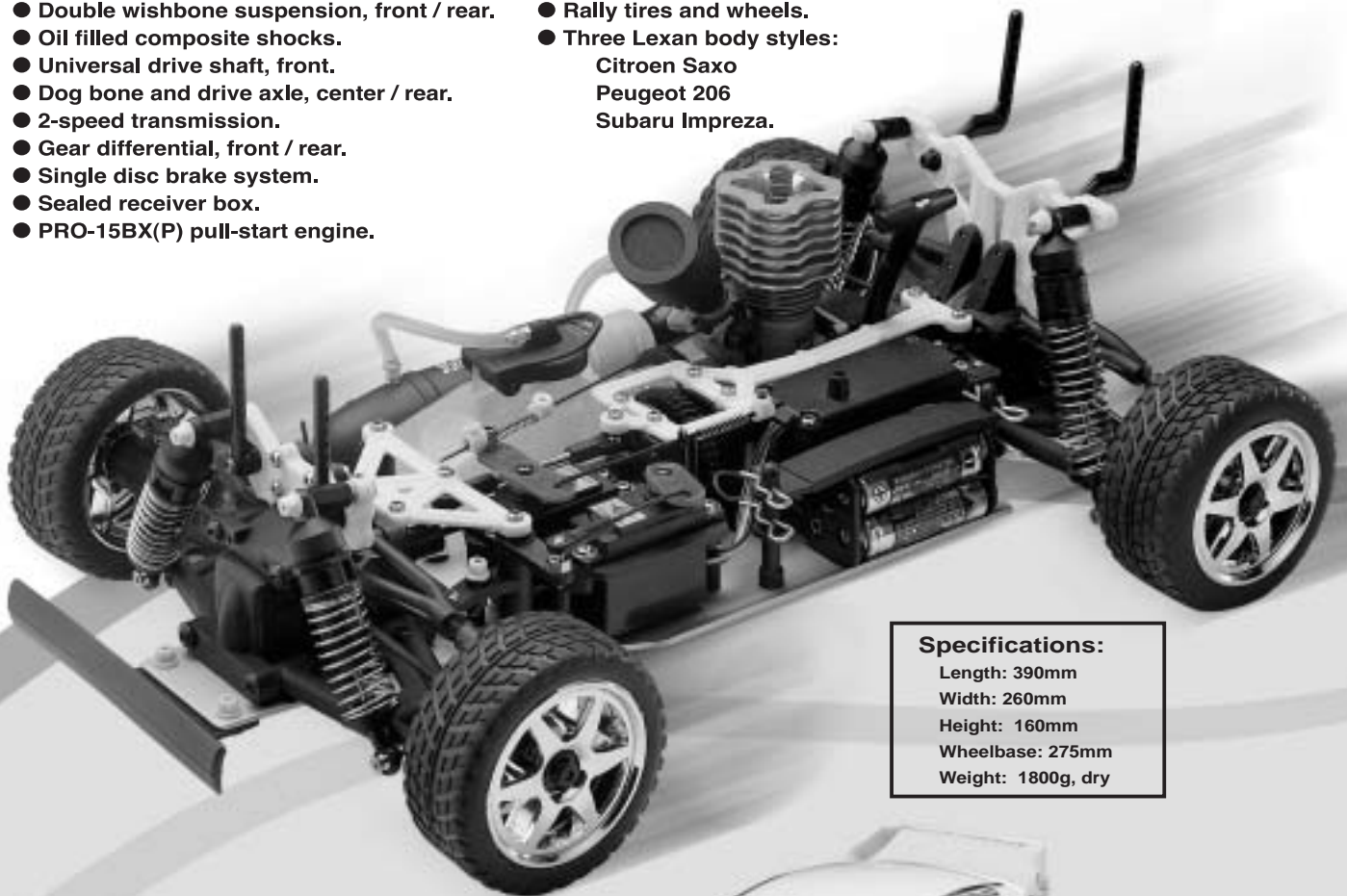

Specifications:

Length: 390mm
Width: 260mm
Height: 160mm
Wheelbase: 275mm
Weight: 1800g, dry

No.6705-F
PEUGEOT 206



No.6706-F
CITROEN SAXO



No.6704-F
SUBARU IMPREZA

