



User Guide

A downloadable, printable guide to your phone's features.

ZTE® PRESTIGE™

Table of Contents

Introduction	1
About the User Guide	1
Get Started	2
Parts and Functions	2
nano-SIM Card	3
SD Card	6
Insert SD Card	6
Unmount the SD Card	8
Remove SD Card	10
Format SD Card	12
Battery Use	15
Insert the Battery	15
Remove the Battery	16
Charge the Battery	17
Turn Your Phone On and Off	19
Use the Touchscreen	20
Activation and Service	23
Complete the Setup Screens	24
Basic Operations	27
Basics	27
Home Screen and Applications (Apps) List	27
Phone Settings Menu	29
Portrait and Landscape Screen Orientation	30
Capture Screenshots	31
Applications	31
Launch Applications	31
Apps List	33
Phone Number	35
Airplane Mode	36
Enter Text	36
Touchscreen Keyboards	36
Google Keyboard	37
Swype	38
TouchPal X	40
Tips for Editing Text	43

Google Account	43
Create a Google Account	44
Sign In to Your Google Account	46
Google Play Store	48
Find and Install an App	49
Request a Refund for a Paid App	50
Update an App	50
Uninstall an App	54
Get Help with Google Play	56
Lock and Unlock Your Screen	56
Update Your Phone	57
Update Your Phone Software	57
Update Your Profile	60
Update Your PRL	60
Your Phone Interface	61
Home Screen Basics	61
Home Screen Layout	61
Extended Home Screens	62
Status Bar and Notification Panel	63
Status Bar	63
Notification Panel	65
Customize the Home Screen	67
Change the Wallpaper	67
Add Shortcuts to the Home Screen	68
Add Widgets to the Home Screen	69
Add Folders to the Home Screen	69
Phone App	71
Place and Answer Calls	71
Call Using the Phone Dialer	71
Call Emergency Numbers	73
Answer Phone Calls	74
In-Call Screen Layout and Operations	78
Place a Call from Contacts	80
Call from Call Logs	81
Optional Services	82
Voicemail Setup	82
Visual Voicemail	83
Set Up Visual Voicemail	83

Review Visual Voicemail	84
Listen to Multiple Voicemail Messages	85
Visual Voicemail Options	86
Configure Visual Voicemail Settings	87
Caller ID Blocking	90
Call Waiting	91
Call Forwarding	92
Call Settings	92
Contacts	94
Add a Contact	94
View Contacts	96
Contacts Screen Layout	98
Edit a Contact	99
Delete a Contact	100
Share a Contact	101
Import Contacts	102
Back Up Contacts	103
Messaging and Internet	105
Text and Multimedia Messaging	105
Send a Text Message	105
Send a Multimedia Message (MMS)	106
Save and Resume a Draft Message	108
New Messages Notification	109
Manage Message Conversations	109
Text and MMS Options	111
Gmail	112
Create and Send a Gmail Message	113
Check Received Gmail Messages	114
Use Gmail Labels	115
Archive Gmail Threads	116
Mute Gmail Threads	117
Delete Gmail Threads	118
Search Gmail Messages	119
Report Spam or Phishing Gmail	121
Add Another Google (Gmail) Account	122
Switching between Gmail Accounts	125
Email	125
Set Up an Email Account	125

Add an Email Account	126
Add an Exchange ActiveSync Account	129
Compose and Send Email	130
Open Email Messages	130
Delete an Email Account	131
Manage Your Email Inbox	132
Exchange ActiveSync Email Features	133
Browser	134
Use the Browser	135
Add a Bookmark	136
View Browser History	138
Open New Browser Tabs	139
Browser Settings	140
Get Chrome Support	141
Camera and Video	143
Take Pictures and Record Videos	143
Take a Picture	143
Viewfinder Screen	144
Record Videos	145
View Pictures and Videos Using Gallery	146
Edit Pictures	147
Share Pictures and Videos	152
Send Pictures or Videos by Email	152
Send a Picture or Video by Multimedia Message	154
Send Pictures or Videos Using Bluetooth	156
Share Pictures or Videos via Additional Apps or Social Media	158
Share Videos on YouTube	160
Switch Cameras	162
Camera Modes	162
Camera Settings	163
Useful Apps and Features	165
Calculator	165
Calendar	165
Add an Event to the Calendar	165
View Calendar Events	167
Sync Calendars	167
Synchronize an Exchange ActiveSync Calendar	169
Clock	170

Set Alarms	171
Additional Clock Features	172
Facebook	173
Install the Facebook App on Your Phone	173
Use Facebook	174
File Manager	174
Google Search	174
Google Voice Search	175
Google+	176
Hangouts	177
Google Maps	179
Music Player	181
Listen to Music Using the Music Player	181
The Playback Screen	182
Create a Playlist	183
Manage Playlists	184
Manage Songs in a Playlist	185
Set a Song as Ringtone	186
Google Play Music App	187
Play Music with Google Play	187
Google Play Music Screen Layout	188
Create Playlists in Google Play Music	189
Sound Recorder	191
Voice Dialer	192
Twitter	192
Install the Twitter App on Your Phone	192
Tweet on Twitter	193
LinkedIn	193
Install the LinkedIn App on Your Phone	193
Sign In to Your LinkedIn Account	193
YouTube	194
View YouTube Videos	194
Post a Video to YouTube	194
Google Wallet	194
Connectivity	196
Transfer Files Between Your Phone and a Computer	196
Wi-Fi	197
Turn Wi-Fi On and Connect to a Wireless Network	197

Wi-Fi Settings	198
Disconnect Wi-Fi	199
Wi-Fi Direct	200
Mobile Hotspot	202
Tethering	202
Bluetooth	203
Bluetooth Information	203
Enable the Bluetooth Feature	203
Pair Bluetooth Devices	204
Connect to a Paired Bluetooth Device	205
Send Information Using Bluetooth	205
Receive Data via Bluetooth	206
Settings	208
Airplane Mode	208
Wi-Fi Settings Menu	209
Bluetooth Settings	210
Mobile Networks Settings	212
Data Usage Settings	212
Mobile Hotspot Settings	213
More Settings	214
Virtual Private Networks (VPN)	215
Prepare Your Phone for VPN Connection	215
Set Up Secure Credential Storage	215
Add a VPN Connection	215
Connect to or Disconnect from a VPN	216
Default SMS App Settings	218
Bluetooth Tethering Setting	218
Sound & Notifications Settings	218
Display Settings	219
Date & Time Settings	220
Language & Input Settings	221
Storage Settings	222
Battery Settings	222
App Settings	223
Connect to PC Settings	223
Navigation Key Setting	224
Location Access Settings	224
Security Settings	225

Backup & Reset	226
Accounts	228
Accessibility Settings	229
Printing	230
Connect Your Printer to Your Google Account	231
Use Cloud Print on Your Phone	231
Activate This Device	232
System Updates	233
About Phone	233
For Assistance	234
Troubleshooting	234
Specifications	235
Boost Account Information and Help	236
Manage Your Account	236
Re-Boost	237
Index	238

Introduction

The following topics describe the basics of using this guide and your new phone.

About the User Guide

Thank you for purchasing your new ZTE PRESTIGE. The following topics explain how best to use this guide to get the most out of your phone.

Before Using Your Phone

Read the Get Started guide and Important Information booklet that were packaged with your phone thoroughly for proper usage.

Accessible services may be limited by subscription contract conditions.

Descriptions in the User Guide

Note that most descriptions in this guide are based on your phone's setup at the time of purchase. Unless otherwise noted, instructions begin from the phone's home screen, which is displayed by tapping the **Home key** . Some operation descriptions may be simplified.

Screenshots and Key Labels

Screenshots and other illustrations in this user guide may appear differently on your phone. Key labels in the user guide are simplified for description purposes and differ from your phone's display.

Other Notations

In the user guide, the phone may be referred to either as "phone," "device," or "handset." A microSD™ or microSDHC™ card is referred to as an "SD Card" or a "memory card."

Get Started

The following topics give you all the information you need to set up your phone and wireless service the first time.

Parts and Functions

These topics illustrate your phone's primary parts and key functions.

Note: Your phone's screens and apps layouts are subject to change. This user guide uses sample images only.

Phone Layout

The following illustration outlines your phone's primary external features and keys.

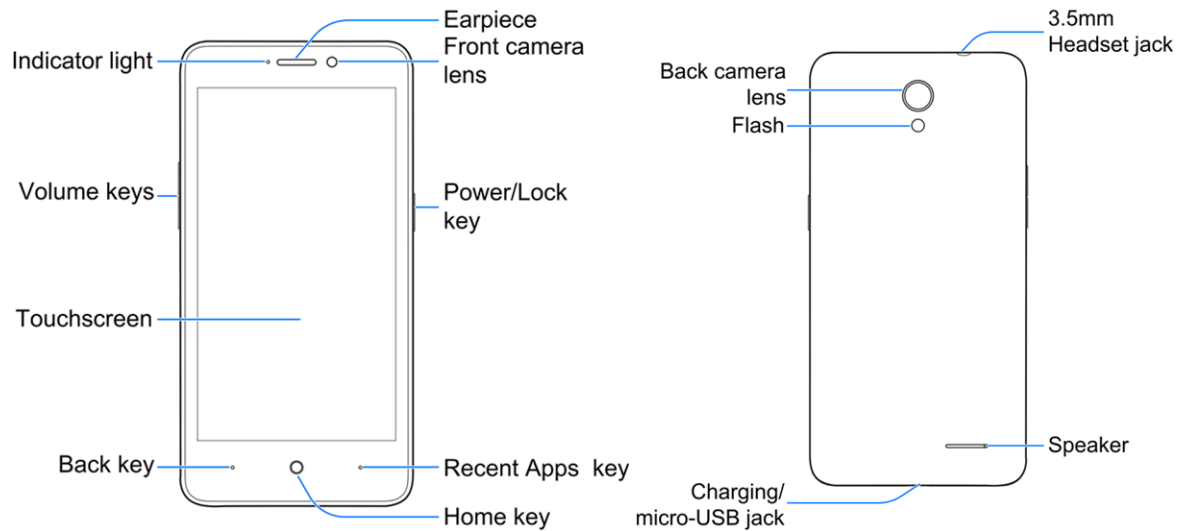

Part	Description
Indicator light	Displays a phone notification, charging status, or alert.
Volume keys	Allow you to adjust the ringtone or media volume or adjust the voice volume during a call.
Touchscreen	Displays all the information needed to operate your phone, such as the call status, the Contacts list, and the date and time. Also provides one-tap access to all of your features and applications.
Back key ◦	Lets you return to the previous screen, or close a dialog box, options menu, the notification panel, or onscreen keyboard.
Earpiece	Lets you hear the caller and automated prompts.
Front camera lens	Takes pictures and records videos while facing the screen, and allows you to video conference.

Part	Description
Power/Lock key	Lets you turn the phone on or off or turn the screen on or off, or switch your phone to silent mode, vibration mode, or airplane mode.
Recent Apps key ◦	Displays a list of recently used applications.
Home key ○	Returns you to the home screen.
Back camera lens	Lets you take pictures and videos.
Flash	Helps illuminate subjects in low-light environments when the camera is focusing and capturing a picture or video.
Charging/micro-USB jack	Allows you to connect the phone charger or the USB cable (included).
3.5 mm headset jack	Allows you to plug in either a stereo headset or an optional headset for convenient, hands-free conversations.
Speaker	Lets you hear the different ringtones and sounds. The speaker also lets you hear the caller's voice in speakerphone mode.

CAUTION! Inserting an accessory into the incorrect jack may damage the phone.

nano-SIM Card

The SIM card is an IC card containing phone number and other customer information.

Handling a nano-SIM Card

Keep the following in mind when handling a nano-SIM card.

- Customer is responsible for any damage caused by inserting nano-SIM card in another-brand IC card reader, etc. Boost Mobile is not responsible in such case.
- Always keep the IC chip clean.
- Wipe clean with a dry, soft cloth.
- Avoid applying labels. May damage nano-SIM card.
- See instructions included with nano-SIM card for handling.
- nano-SIM card is the property of Boost Mobile.
- nano-SIM card is replaceable (at cost) in case of loss/damage.
- Return nano-SIM card to Boost Mobile when canceling subscription.
- Returned nano-SIM cards are recycled for environmental purposes.
- Note that nano-SIM card specifications and performance may change without notice.
- It is recommended that you keep a separate copy of information that is stored on nano-SIM card. Boost Mobile is not responsible for damages from stored information that is lost.

- Always follow emergency procedures to suspend service if your nano-SIM card or phone (nano-SIM card inserted) is lost/stolen. For details, contact Customer Service.
- Always power off phone before inserting/removing nano-SIM card.

Insert nano-SIM Card

Follow these instructions to insert a nano-SIM card. Remember to power off your phone before inserting a nano-SIM card.

Note: Your phone's nano-SIM card is preinstalled. These instructions are for reference only.

1. Remove the battery cover.

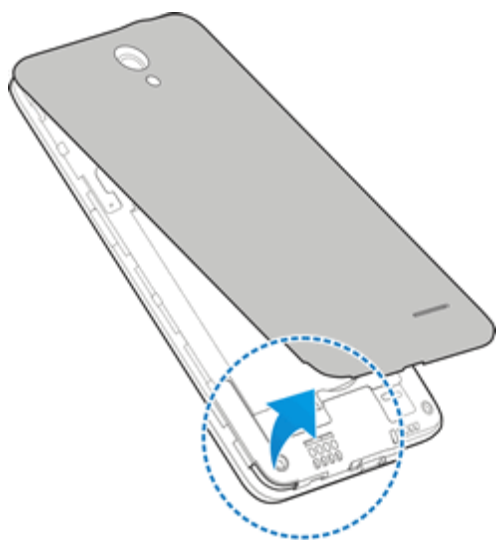

- Lift gently in the direction shown.

2. Remove the battery.

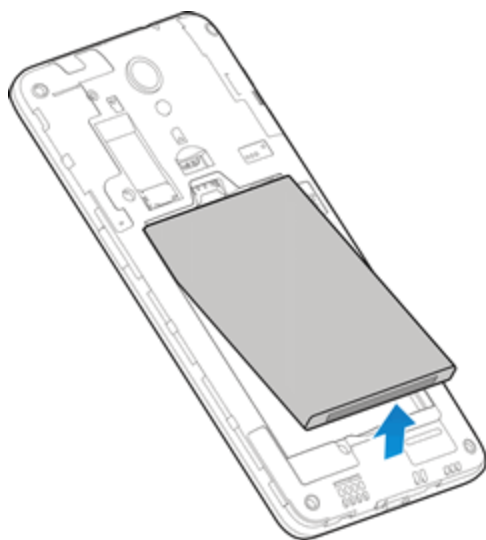

- Lift upward gently as shown.

3. Insert the nano-SIM card.

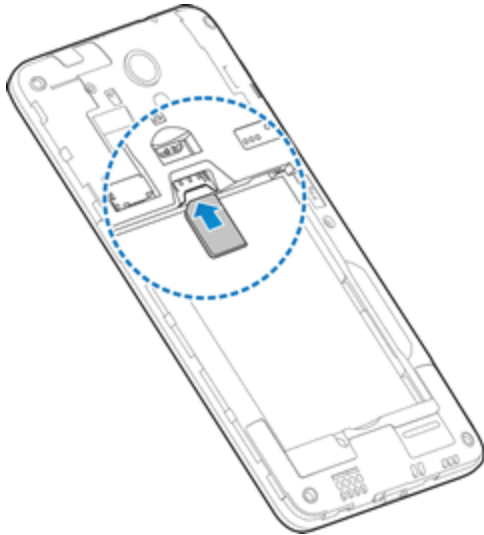

- Insert gently with gold IC chip facing downward.

4. Insert the battery.

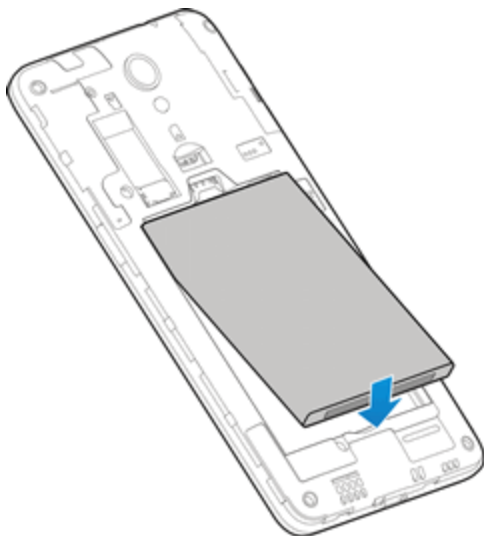

- Align the contacts of the battery with the contacts in the phone.

5. Attach the battery cover.

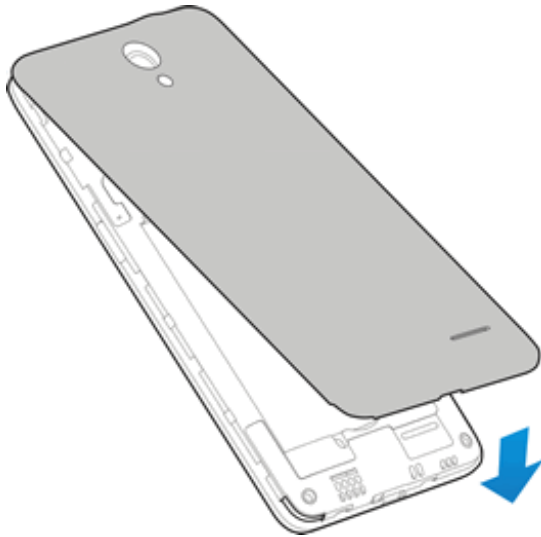

- Make sure all the tabs are secure and there are no gaps around the cover.

SD Card

Your phone supports the use of an optional SD card (not included) to expand its storage capacity. It supports cards up to 32 GB. Some cards may not operate properly with your phone.

! SD Card Cautions

Data: Information stored on SD Card can become lost or changed accidentally or as a result of damage. It is recommended that you keep a separate copy of important data. Boost Mobile is not responsible for damages from data that is lost or changed.

Reading/Writing Data: Never power off or remove Battery while reading or writing data.

Battery Level: A low battery charge may prevent reading/writing to SD Card.

Handling SD Card: Use/store SD Cards away from the reach of infants. May cause choking if swallowed.

Insert SD Card

Follow these steps to insert an optional SD card (not included). Make sure to power your phone off before inserting or removing an SD card.

1. Remove the battery cover.

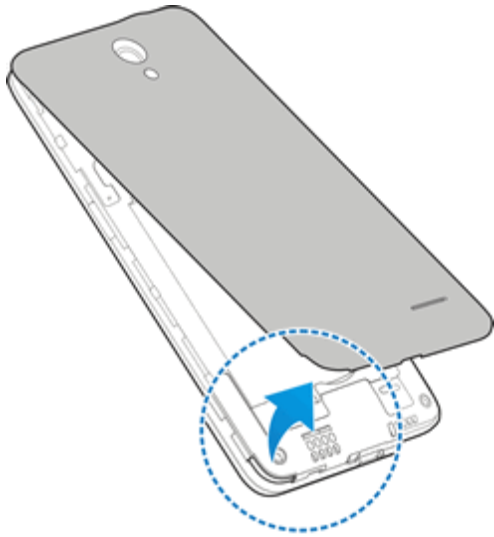

- Lift gently in the direction shown.

2. Remove the battery.

3. Insert SD card.

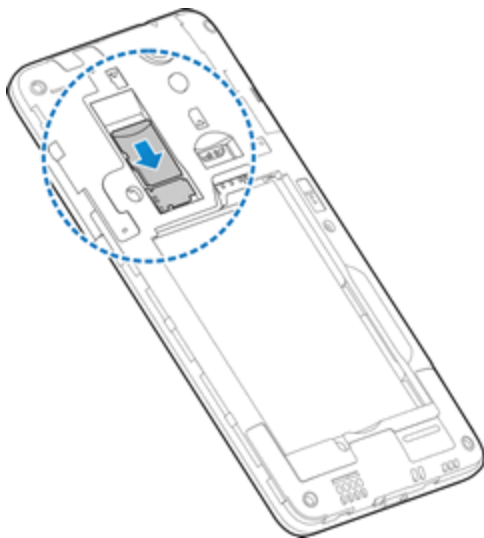

- Insert SD Card all the way gently without bending and with terminals facing down.
- Insert only SD Cards.

4. Insert the battery.

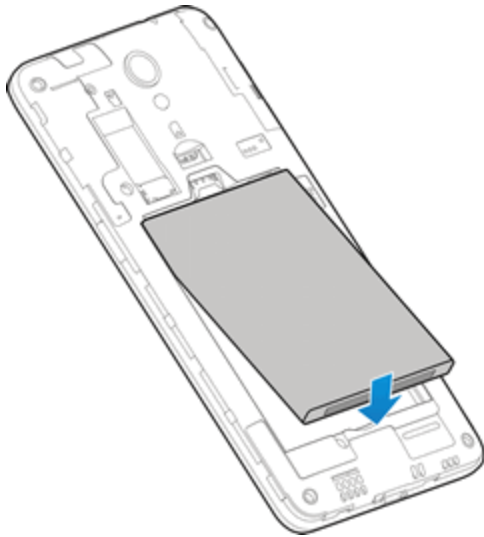

- Align the contacts of the battery with the contacts in the phone.

5. Attach the battery cover.

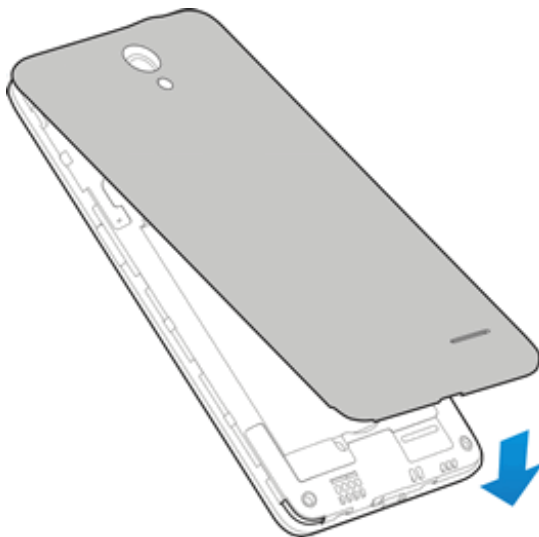

- Make sure all the tabs are secure and there are no gaps around the cover.

Unmount the SD Card

Always unmounts the SD card before removing it from your phone.

1. From home, tap **Apps**  > **Settings**  > **Storage**.

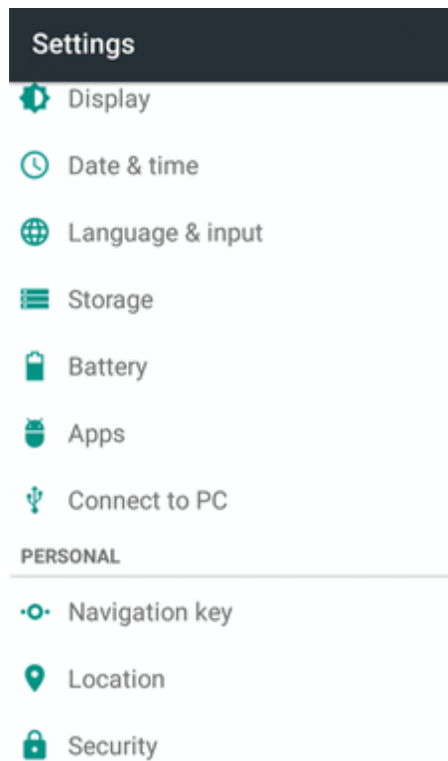

2. Tap **Unmount SD Card** > **OK**.

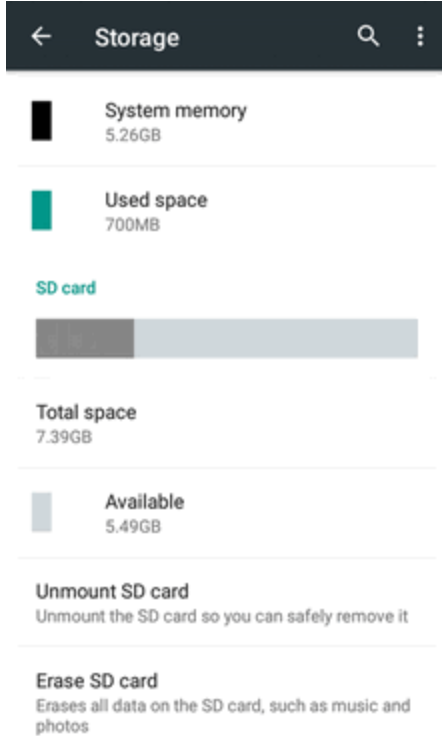

- ❖ The menu option name changes from **Unmount SD Card** to **Mount SD Card**. The card is now unmounted.

Remove SD Card

Follow these instructions to remove an SD card. Always power the phone off before inserting or removing an SD card.

1. Remove the battery cover.

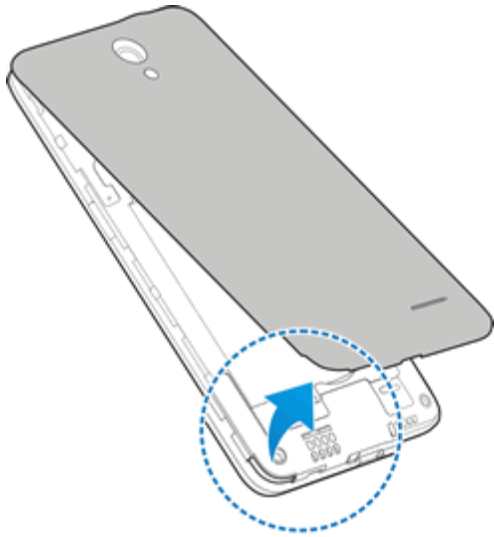

- Lift gently in the direction shown.

2. Remove the battery.
3. Remove SD card.
4. Insert the battery.

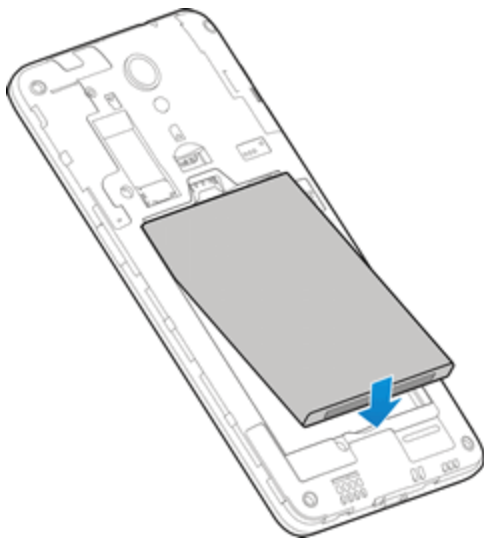

- Align the contacts of the battery with the contacts in the phone.

5. Attach the battery cover.

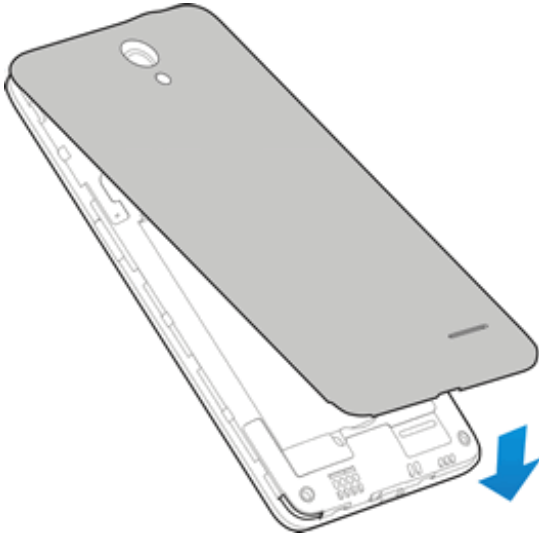

- Make sure all the tabs are secure and there are no gaps around the cover.

Format SD Card

When you insert an optional SD card for the first time, it is recommended that you format it on your phone.

1. From home, tap **Apps**  > **Settings**  > **Storage**.

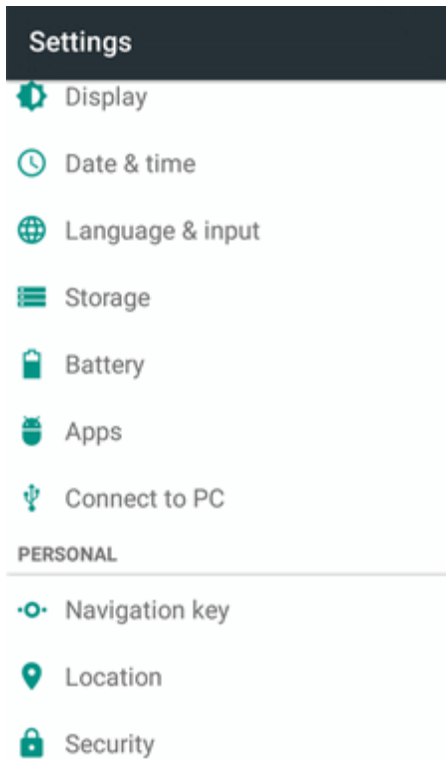

2. Tap **Erase SD Card**.

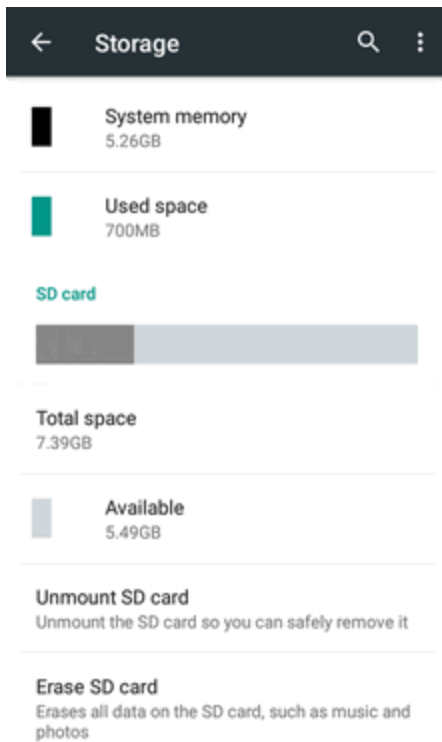

3. Tap **ERASE SD CARD**, and then tap **ERASE EVERYTHING** to confirm.

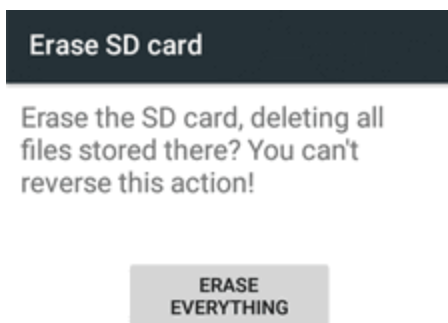

- ❖ All data on the SD card is erased, and the card is formatted for use on your phone.

Battery Use

The following topics explain how to insert and remove your phone's battery.

! Battery Cautions

Storage: Avoid storing or leaving battery with no charge remaining. Saved information and settings may become lost or changed, or battery may become unusable. Charge once every six months before storing or leaving unused for a long period.

Bulges: Depending on use, bulges may appear near end of battery life. This does not affect safety.

Replacing Battery: The battery is a consumable item. It needs to be replaced if operating time shortens noticeably. Purchase a new battery.

Cleaning: Clean soiled terminals between battery and phone with a clean, dry cotton swab. Soiled terminals can result in a poor connection and prevent charging, etc.

Insert the Battery

Follow these instructions to insert your phone's battery safely and properly.

1. Remove the battery cover.

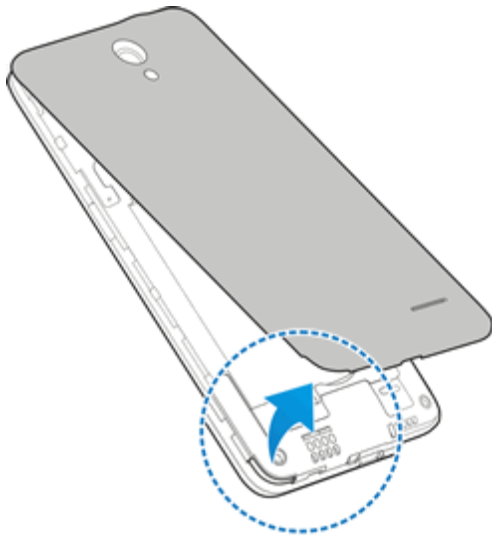

- Lift gently in the direction shown.

2. Insert the battery.

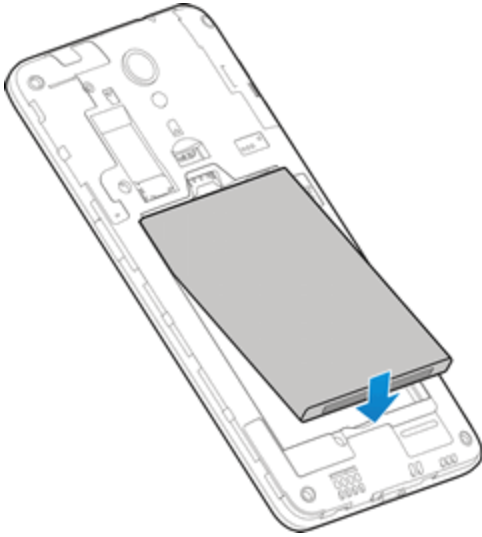

- Align the contacts of the battery with the contacts in the phone.

3. Attach the battery cover.

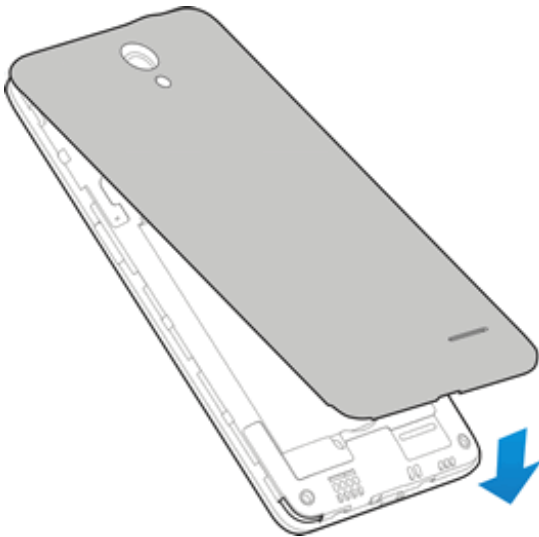

- Make sure all the tabs are secure and there are no gaps around the cover.

Remove the Battery

Follow these instructions to remove your phone's battery. Always power the phone off before removing the battery.

1. Remove the battery cover.

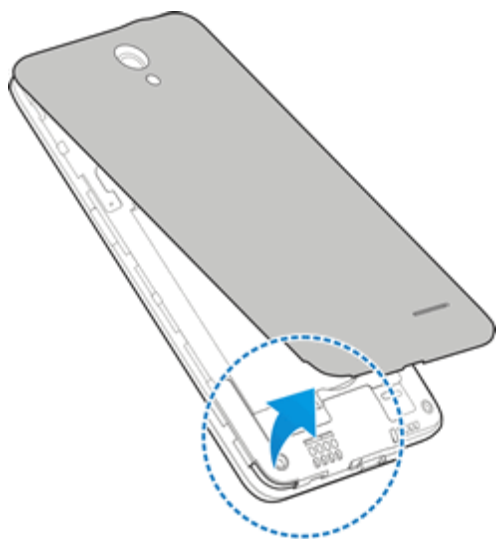

- Lift gently in the direction shown.

2. Remove the battery.

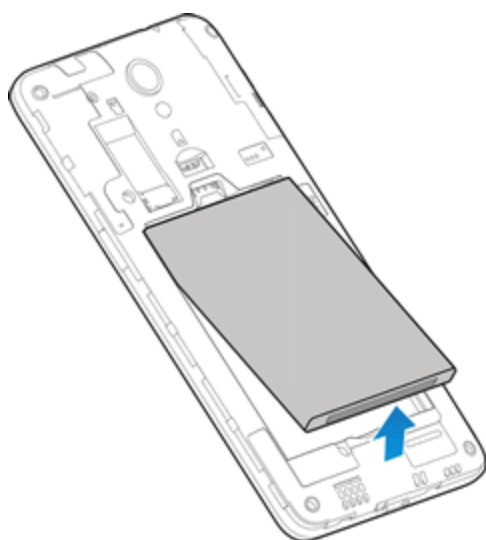

- Lift upward gently as shown.

Charge the Battery

Follow these instructions to charge your phone's battery using either the included AC adapter or via a USB connection on your computer.

Charge Using the AC Adapter

1. Plug the USB connector into the charging/micro-USB jack on the bottom of your phone.

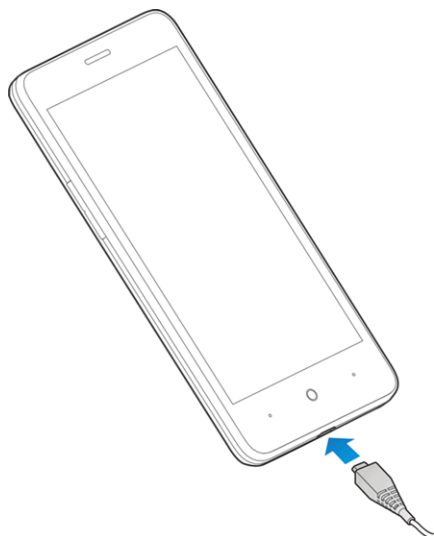

2. Plug the other end of the USB cable into the AC adapter.
3. Plug the AC adapter into an electrical outlet.
 - ❖ The indicator light illuminates when charging starts. The light goes off when the battery is fully charged. Fully charging a battery may take up to three hours.
4. After charging, disconnect the phone from the charger.
 - Unplug the AC adapter from the outlet, and remove the USB cable from the phone and the AC adapter.

Charge Using a PC Connection

Before using a PC connection to charge your phone, ensure that the computer is turned on. Depending on the type of connection, your phone's battery may not charge.

1. Insert the small end of the USB cord into the charger/accessory jack on the bottom of your phone.

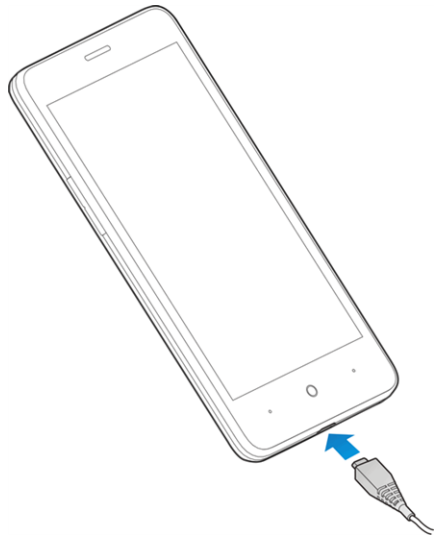

2. Insert the large end of the USB cord into an external USB port on your computer.
3. After charging, remove the USB cable from both the phone and the computer.

Turn Your Phone On and Off

The instructions below explain how to turn your phone on and off.

Turn Your Phone On

- Press and hold the **Power/Lock key**.
- ❖ Your phone will power on. Depending on the settings, you may see the lock screen.
 - The first time you turn the phone on, you will see the startup screens. See [Complete the Setup Screens](#) for details.
 - If your phone is not yet activated, see [Activation and Service](#) for more information.

Turn Your Phone Off

1. Press and hold the **Power/Lock key** to display the device options menu.

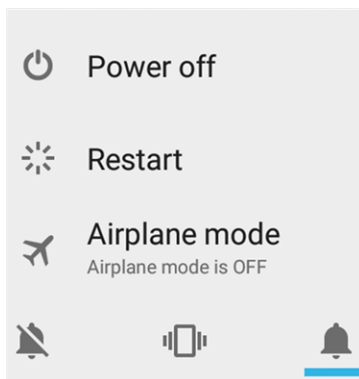

2. Tap **Power off** to turn the phone off.

❖ Your phone will power off.

Your screen remains blank while your phone is off (unless the battery is charging).

Use the Touchscreen

Your phone's touchscreen lets you control actions through a variety of touch gestures.

Tap

When you want to type using the onscreen keyboard, select items onscreen such as application and settings icons, or press onscreen buttons, simply tap or touch them with your finger.



Touch and Hold

To open the available options for an item (for example, a contact or link in a Web page), touch and hold the item.



Swipe or Slide

To swipe or slide means to quickly drag your finger vertically or horizontally across the screen.



Drag

To drag, press and hold your finger with some pressure before you start to move your finger. While dragging, do not release your finger until you have reached the target position.

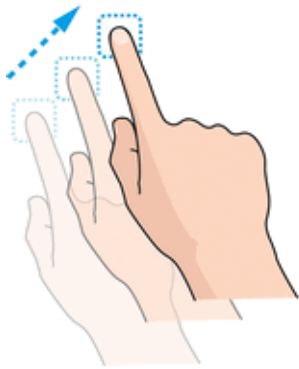

Flick

Flicking the screen is similar to swiping, except that you need to swipe your finger in light, quick strokes. This finger gesture is always in a vertical direction, such as when flicking the contacts or message list.



Rotate

For most screens, you can automatically change the screen orientation from portrait to landscape by turning the phone sideways. When entering text, you can turn the phone sideways to bring up a bigger keyboard. See [Touchscreen Keyboards](#) for more details.

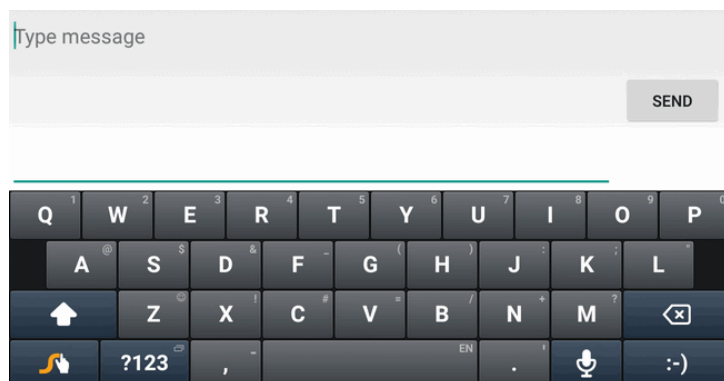

Note: The Auto-rotate check box needs to be selected for the screen orientation to automatically change. From home, tap **Apps**  > **Settings**  > **Display** > **Auto-rotate screen**.

Tip: You can also access the screen rotation setting from the notification panel. Pull down the status bar and tap **Screen rotation** to select or deselect the option.

Pinch and Spread

“Pinch” the screen using your thumb and forefinger to zoom out or “spread” the screen to zoom in when viewing a picture or a Web page. (Move fingers inward to zoom out and outward to zoom in.)

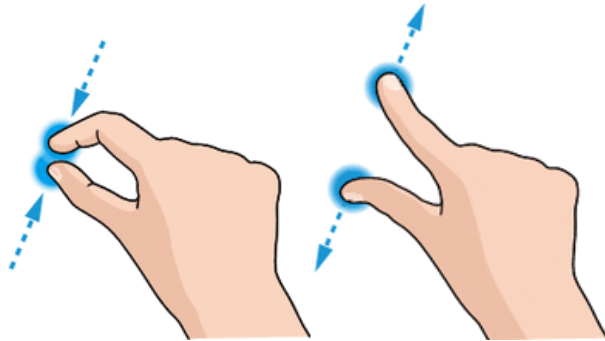

Activation and Service

Before using your phone, you must set up your service with Boost Mobile. You will need your phone’s serial number (MEID), printed on a sticker inside the battery compartment.

For more information about your Boost Mobile account, see [Boost Account Information and Help](#).

Create Your Account and Pick Your Plan

Set up your Boost Mobile account.

1. From your computer, visit boostmobile.com/activate.
2. Enter your phone’s MEID and click **start activation process**.
 - Your phone’s MEID (serial number) is printed on the sticker located on the back of your phone in the battery compartment. This number can also be found on the bottom panel of the phone’s package.
3. Follow the remaining instructions to choose your plan and select a payment method.
4. Follow the activation instructions below and you’ll be able to start using your phone.

Note: You can also activate by phone by calling **1-888-BOOST-4U** (1-888-266-7848) from any other phone.

Activate Your Phone

After setting up your account on boostmobile.com, simply turn your device on. Your device is designed to activate automatically. If you are swapping from another Boost Mobile device to a new one, be sure to turn off the old device before swapping the serial number (MEID). Once the MEID swap is complete, turn on the new device and the programming information will be pushed to your device automatically.

You can also start the activation process manually.

- From home, tap **Apps**  > **Settings**  > **Activate this device**.

Complete the Setup Screens

The setup screens help you set up certain features and preferences on your phone. Once your phone has been turned on, you can then complete the setup process.

Note: You may be able to complete the setup screens before your phone has been activated on your account.

1. On the Talkback screen, activate the Talkback feature by tapping the center of the screen if you have sight problems, or tap **Accessibility** to explore other accessibility features.

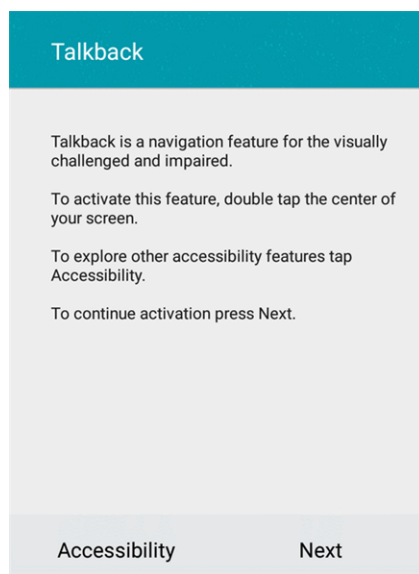

- If you have no accessibility problem with the phone, tap **Next**.

2. On the Language screen, select a language for your phone display and tap **Next**.

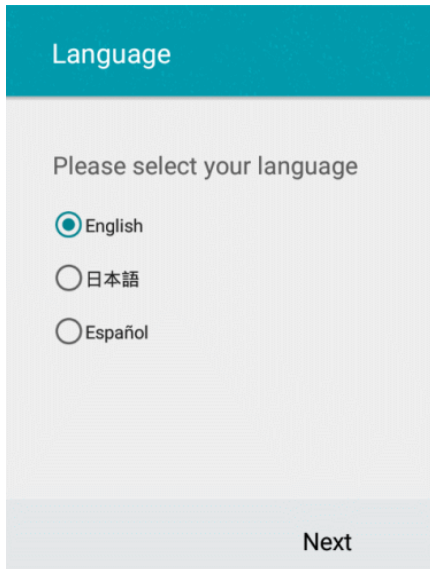

3. On the Why use Wi-Fi screen, tap **Next**.

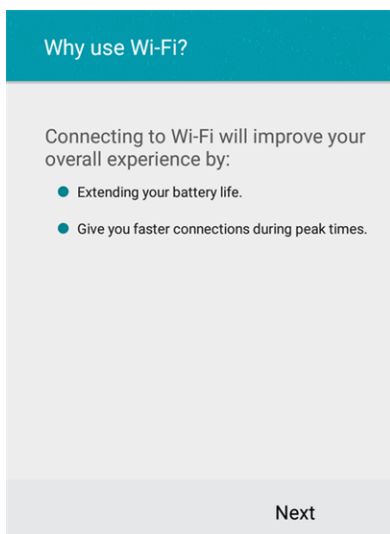

4. On the Select Wi-Fi screen, tap a Wi-Fi network to connect with it or tap **SKIP > SKIP ANYWAY** to finish the setup process.

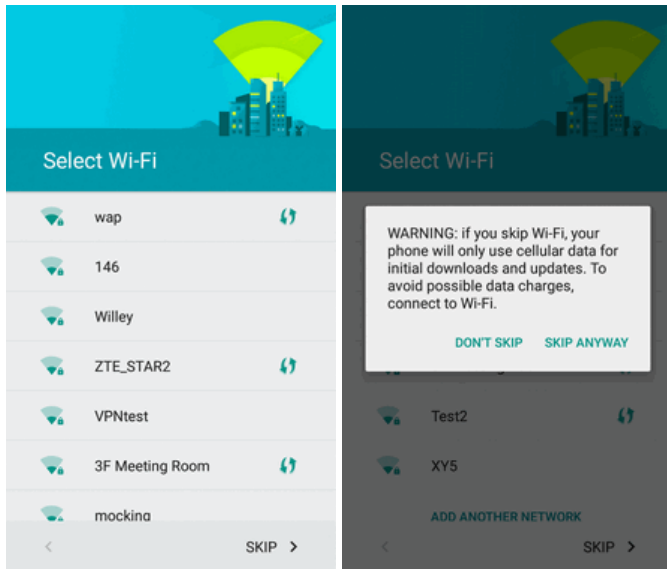

- ❖ Your phone is now set up for use. If you skipped any part of the setup, you can access additional options through the Apps screen or through Settings.

Basic Operations



The following topics outline basic features and operations of your phone.

Basics

The following topics offer an overview of your phone's basic operations.

Home Screen and Applications (Apps) List

Most of your phone's operations originate from the home screen or the apps list.

1. From any screen press the **Home key**  to display the home screen.
2. Tap **Apps**  to display the apps list.



For information about using the home screen, see [Home Screen Basics](#).

Select Options and Navigate Screens

Tap icons, onscreen keys, and other items to open or activate the assigned function. For example, to open Calculator, tap the **Home key** to get to the home screen and then tap **Apps**  >

Calculator



- Tap **Back**  to return to the previous screen.

Recent Applications

You can display a list of recently used applications using the **Recent Apps key**.

- Tap **Recent Apps**  to view a list of recently used applications.

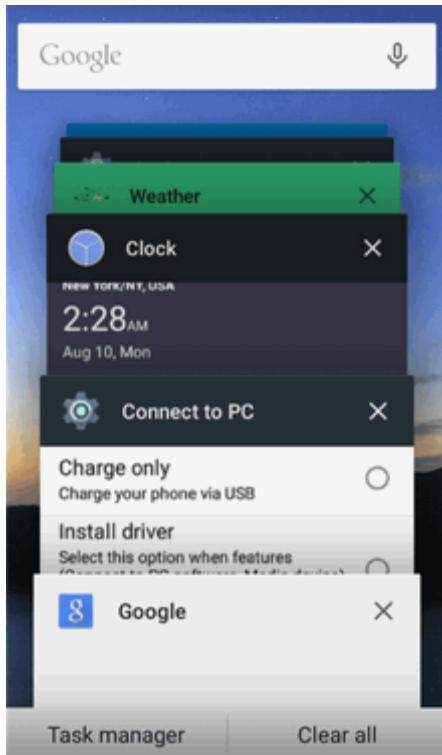

Phone Settings Menu

You can customize your phone's settings and options through the Settings menu.

- From home, tap **Apps**  > **Settings** .

– or –

Pull down the status bar and tap  > .

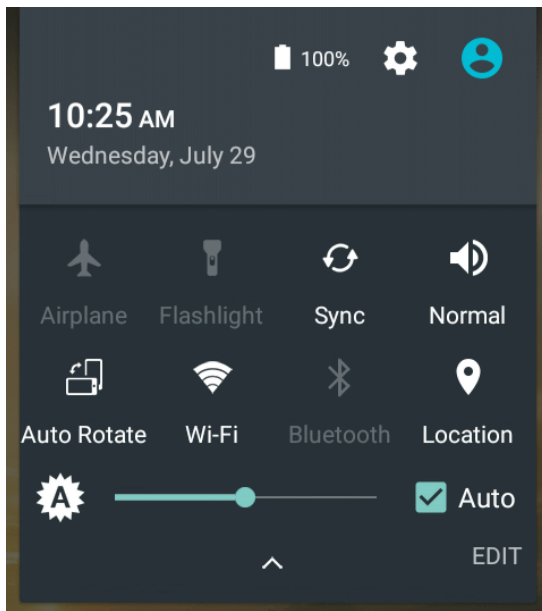

For more information, see [Settings](#).

Portrait and Landscape Screen Orientation

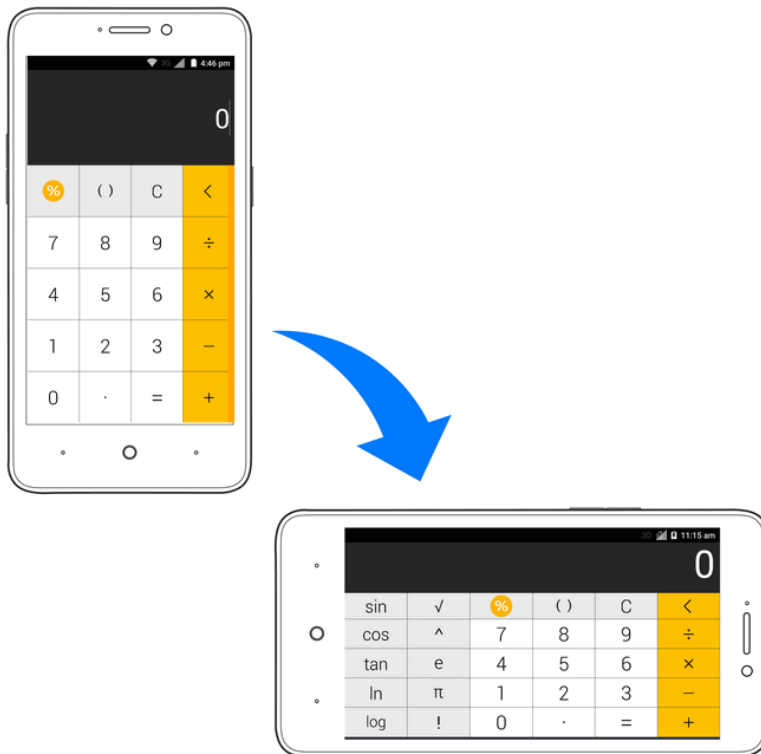

The default orientation for your phone's screen is portrait (vertical), but many apps will change to landscape orientation (widescreen) when you rotate the phone sideways.



Note: Not all screens will adjust for landscape orientation.



Turn Screen Rotation On or Off

1. Pull down the status bar to display the quick settings menu.
2. Tap **Auto Rotate**  to turn the option on or off.
 - You may need to scroll left or right to see the Screen rotation option.
 - If the Auto Rotate option is not available, tap **EDIT** to display the full options list.

Note: You can also set the rotation option from the main settings menu. From home, tap **Apps**  > **Settings**  > **Display** > **Auto-rotate screen**.

Capture Screenshots

You can use your phone's power and home keys to capture screenshots.

- Press and hold the **Power/Lock key** and **Volume Down key** at the same time to capture a screenshot of the current screen.
- ❖ The current screenshot will be captured and stored in the Screenshots album in the phone's Gallery. From home, tap **Apps**  > **Gallery** .

Applications

The following topics describe how to access the applications (apps) list and launch apps on your phone.

Launch Applications

All installed apps can be accessed and launched from the apps list.

1. From home, tap **Apps**  .









- ❖ The apps list opens.

2. Tap an app icon to launch the corresponding application.











Apps List

The apps list expands to include any apps you download and install on your phone. The following table outlines the primary apps that have been preinstalled on your phone.

App	Function/Service
 Boost Zone	Manage your Boost account and get support, news, apps, and more right from your phone.
 Browser	Browse the Internet and get your bookmarks, browsing history.
 Calculator	Perform basic and advanced mathematical equations and calculate tips.
 Calendar	Organize your time and reminds you of important events.
 Camera	Take and share pictures and videos.
 Chrome	Browse the Internet and get your bookmarks, browsing history, and more synced with your Google Account.
 Clock	Set alarms, view time in time zones around the world, use stopwatch, or set a time and count down to zero.

App	Function/Service
 Contacts	Store and manage contacts saved in your phone as well as contacts synchronized with your Web accounts and computer.
 Downloads	Check the record of files you have downloaded using apps such as Browser or Email.
 Drive	Store and share files on Google servers for free after you sign in to your Google Account.
 Email	Send and receive emails from your webmail accounts or your corporate email accounts.
 File Manager	View and manage files stored on your phone's internal storage and your SD card as well as a USB device when they are available.
 Gadget Guardian	Protect your phone from malware and spyware, back up your data, and locate your phone when it's missing.
 Gallery	View and manage pictures and videos on your phone.
 Gmail	Send and receive emails from your POP3 and IMAP email accounts as well as your Google Accounts.
 Google	Use Google search or get information when you need it with Google Now.
 Google Settings	Manage some settings related to Google applications.
 Google+	Socialize with friends on the Google+ online community.
 Hangouts	Chat with Google+ friends or send text or multimedia messages.
 Maps	Find your place on the map and find your way in the world.
 Messaging	Exchange text messages (SMS) and multimedia messages (MMS).
 Music	Play audio files stored on your phone.
 Phone	Place and receive calls and use voicemail.
 Photos	Manage photos on the phone and your Google Account.
 Play Books	Buy and read the electronic version of new bestsellers and classics.
 Play Games	Buy and play games from the Google Play Store. Share your gaming experience and progress with your friends.
 Play Movies & TV	Purchase, download and watch the latest and your favorite movies and TV shows.
 Play Music	Play music on the phone and on your Google Account.

App	Function/Service
 Play Newsstand	Purchase and read newspapers and magazines.
 Play Store	Buy and download apps, games, and other content from the Google Play Store.
 Settings	Customize and configure your phone.
 Sound Recorder	Record voice memos and listen to them whenever you like.
 Video Player	Play and management video files on your phone.
 Voice Dialer	Use speech recognition technologies to dial a phone number, open menus, or launch phone functions.
 Voice Search	Use Google search by voice.
 Voicemail	Use Visual Voicemail to check and manage your voicemail messages.
 YouTube	Watch video clips from YouTube.com, or upload your own and share with the world.

Phone Number

Follow the instructions below to display your phone's wireless phone number.

1. From home, tap **Apps**  > **Settings**  > **About phone**.
2. Tap **Status**.

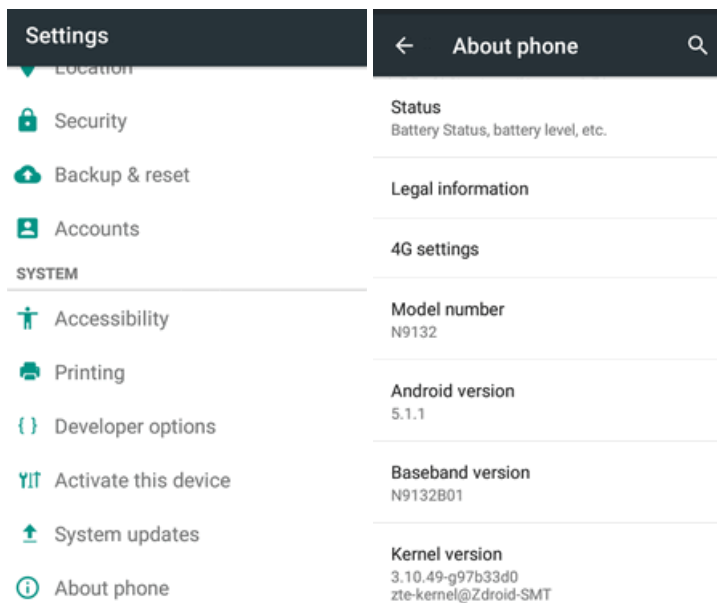

- ❖ You will see the number listed under **My phone number**.

Airplane Mode

Airplane mode turns off all functions that emit or receive signals, while leaving your phone on so you can use apps that don't require a signal or data.

To turn on airplane mode:

1. Press and hold the **Power/Lock key** to display the device options menu.
2. Tap **Airplane mode**.

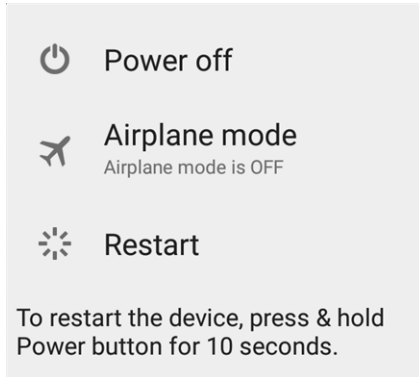

❖ Your phone is now in airplane mode. You will see the airplane mode icon  in the status bar.

Tip: You can also access airplane mode through the status bar menu. Pull down the status bar and tap . Tap **Airplane**.

To turn off airplane mode:

1. Press and hold the **Power/Lock key** to display the device options menu.
2. Tap **Airplane mode**.

❖ Your phone's wireless connection features are now restored.

Tip: You can also access airplane mode through the status bar menu. Pull down the status bar and tap . Tap **Airplane**.

Enter Text

You can type on your phone using one of the available touchscreen keyboards or Google voice typing.

Touchscreen Keyboards

Your phone offers you a choice of three touchscreen keyboards for entering text. The keyboard appear automatically onscreen when you tap a text entry field, and they can be used in either portrait or landscape mode.



The methods available include:

- **Google keyboard** lets you use a traditional QWERTY setup to enter text. Additional options expand your ability to enter text faster and more accurately. See [Google Keyboard](#) for details.
- **Swype** lets you enter letters and words in one continuous motion by swiping your finger across the letters. See [Swype](#) for details.
- **TouchPal X** lets you use Curve® to speed up text input by replacing key-tapping gesture with a tracing gesture where you move your finger from letter to letter without lifting the finger until you reach the end of each word. See [TouchPal X](#) for details.

Note: Keyboard layouts and options may change depending on where you're using them. For example, if you're entering text to do a Web search, a search icon may be available instead of an enter key.

To change the input method:

1. Tap a text entry field, so that a keyboard displays on the screen.
2. Slide the status bar down and tap **Change keyboard**.
3. Select an available input method.

Note: If you cannot find the input keyboard that has been installed, it may have been disabled. To enable it, from the home screen, tap **Apps**  > **Settings**  > **Language & input** > **Current Keyboard** > **CHOOSE KEYBOARDS** and tap the input keyboard that is disabled.







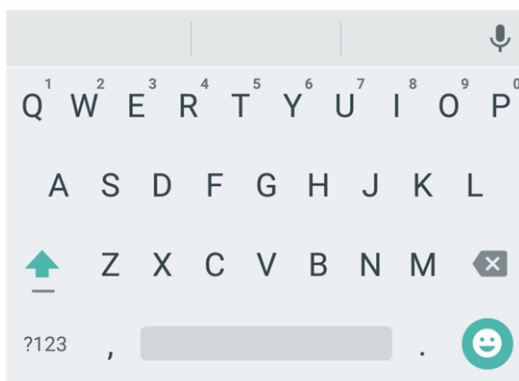



Google Keyboard

The Google keyboard offers a traditional QWERTY keyboard setup for entering text by tapping keys (like on a computer), along with enhancements and options that allow you to enter text faster and more accurately, such as continuous key input, personalized usage dictionaries, and more.

Use Android Keyboard



- Tap the alphabetic keys to enter letters. Touch and hold some specific keys to enter associated accented letters or numbers. For example, to enter È, touch and hold **E**³ and the available accented letters and number 3 appear. Then slide to choose È.

- As you enter a word, candidates appear above the keyboard. Tap to select the correct one; touch and hold to see more possible options.
- Tap  to use uppercase. Double-tap  to lock uppercase. This key also changes to indicate the current case you are using:  for lowercase,  for uppercase, and  when locked in uppercase.
- Tap  to delete the text before the cursor.
- Tap  to select numbers and symbols. You can then tap  to find more.
- Tap  to enter miniature icons, such as expressions, horoscopes, and animals.
- Tap  to use Google voice typing.
- Touch and hold  to change the input languages or set up the Google keyboard.

Use Gesture Typing

The Google keyboard supports the gesture typing feature. You use this feature to input a word by sliding through the letters.

To enable and use gesture typing:

1. Touch and hold  on the Google keyboard and then tap **Google Keyboard Settings**.
2. Tap **Gesture Typing** and then tap **Enable gesture typing** if this feature is turned off.
3. Move your finger from letter to letter on the keyboard to trace a word without lifting the finger until you reach the end of the word.

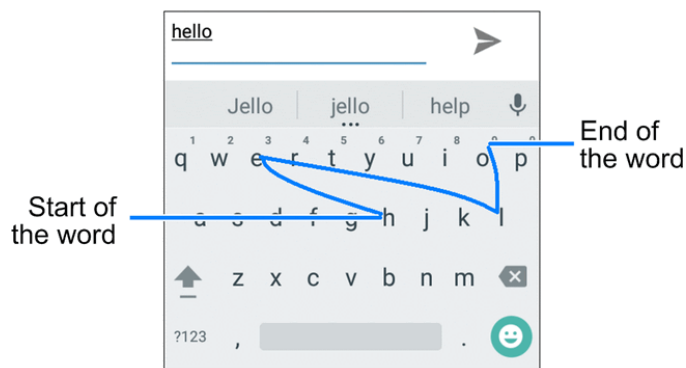

Swype

The Swype™ keyboard lets you enter words by drawing a path from letter to letter in one continuous motion. When you lift your finger after the last letter of a word, a space is automatically added.

Use Swype



- Tap the alphabetic keys to enter letters. Touch and hold specific keys to enter associated accented letters, symbols, or numbers. For example, to enter T^5 , touch and hold T^5 to open available characters and numbers. Slide to choose T^5 and release.
- Tap to use uppercase. Tap twice to lock uppercase. This key also indicates the current case: for lowercase, for uppercase, and when locked in uppercase.
- Tap to enter a space. Touch and hold this key to open a pop-up menu for language selection.
- Tap to select numbers and symbols. Tap to find more symbols. Tap to go back to enter letters.
- Touch and hold or and then slide to choose different keyboards. You can select keyboards layouts suitable for left hand, right hand or two hands, open a phone keypad to enter numbers and certain symbols, open a pop-up menu to choose emoticons, or open a text editing panel where you can select, copy, and paste text.
- Tap to enter a smile symbol. Hold or to open an emoticon list.
- Tap to delete a character before the cursor. Touch and hold to delete words one by one before the cursor.
- Tap to use Google voice typing.
- Touch and hold to open the Swype settings.

To enter text via Swype:

Move your finger from letter to letter to trace a word without lifting the finger until you reach the end of the word.

The following example shows how to enter the word "here". Put your finger on "h" and slide to "e", "r", and back to "e". When complete, lift your finger off the screen and the matched words are displayed.

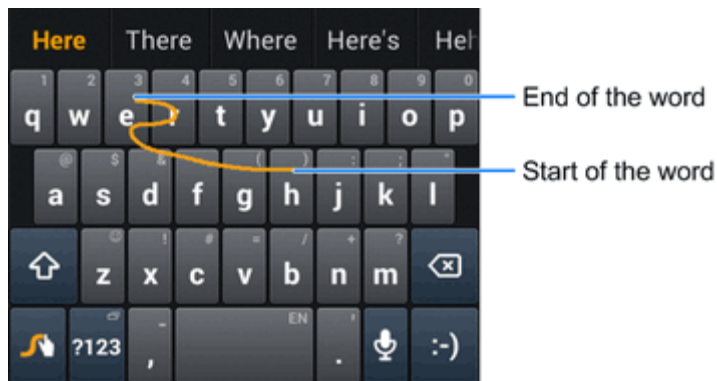

Tips for using Swype Text Input:

- To enter double letters, scribble slightly or make a loop on the letter. For example, to get the "ll" in "hello", scribble (or make a loop) on the "l" key.
- Lift your finger at the end of the word. A space is added automatically when you "Swype" the next word.

For more information about using Swype and its additional capabilities, including using voice entry and personalizing your Swype dictionary, touch and hold  from the Swype keyboard display and then tap **How to Swype**. You can also visit swype.com for more information.

TouchPal X







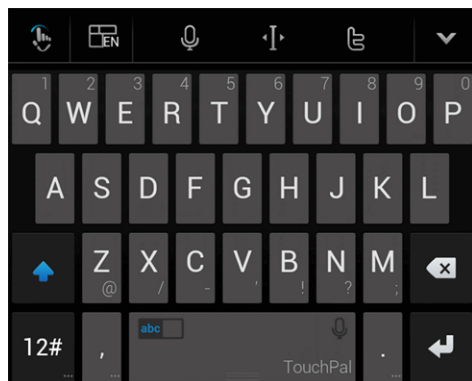









TouchPal X Keyboard offers three layouts including T26, T12 and T+. You can tap  to select a layout or an input language.

You can also use Curve[®] to speed up text input by replacing the key tapping operation with a tracing gesture where you move your finger from letter to letter without lifting the finger until you reach the end of the word.

The T26 Layout



The T26 layout offers an input experience similar to a computer keyboard.

- **The alphabetic keys:** Tap the keys to enter letters. Touch and hold a key and slide to choose more characters.
- **The capital key:** Tap  to use uppercase. Double-tap  to lock uppercase. This key also changes to indicate the current case you are using:  for lowercase,  for uppercase, and  when locked in uppercase.
- **Word prediction:** Slide left or right on the space key to turn on or off prediction, as indicated by  and .
- **Language and layout:** Tap  to select an input language or a keyboard layout.
- **Pre-defined texts:** Tap  to enter digits and symbols. You can tap the arrow keys to turn pages, or tap  to go back to the alphabetic keys. Touch and hold  or slide up on the space key to enter Emoji and emoticons.
- **The delete key:** Tap  to delete text before the cursor. You can also slide left on the key to delete a whole word.
- **Voice input:** Tap  and speak through the microphone.
- **Edit text:** Tap  to open text editing options. You can move the cursor, select, copy, cut, paste, or delete text.
- **More options:** Tap  to access the quick settings of TouchPal X keyboard, change the keyboard theme, and more.
- **Close the keyboard:** Tap . You can tap the text field again to show the keyboard.

The T12 Layout

The layout is similar to a phone pad in T12 mode.



Tap an alphabetic key repeatedly until the desired letter appears. You can also touch and hold the key and slide left or right to choose the letter or number you need.

If word prediction is enabled (), just tap the keys once and choose the right word.

The T+ Layout

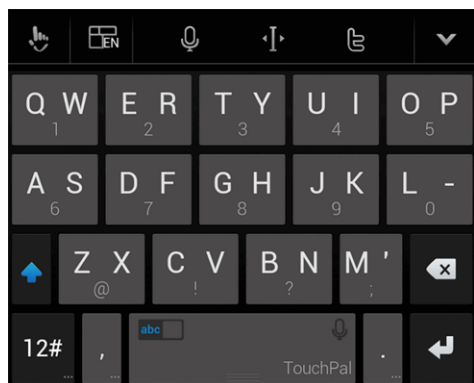

Tap to enter the left letter on the key. Double-tap or flick right to enter the right letter/symbol on the key. You can also touch and hold a key and slide left or right to choose more letters and symbols.

If word prediction is enabled (), just tap the keys and choose the right word.

Curve Word Gesture

Curve allows you to enter text by moving your finger on the screen from letter to letter to enter each word.

To enable and use Curve:

1. On the TouchPal X keyboard, tap  > **Settings** and check **Curve - Word gesture**.
2. If prompted, tap **OK** to switch to the T26 layout.
3. Move your finger from letter to letter on the keyboard to trace a word without lifting the finger until you reach the end of the word.

Note: Curve is only available in the T26 layout.

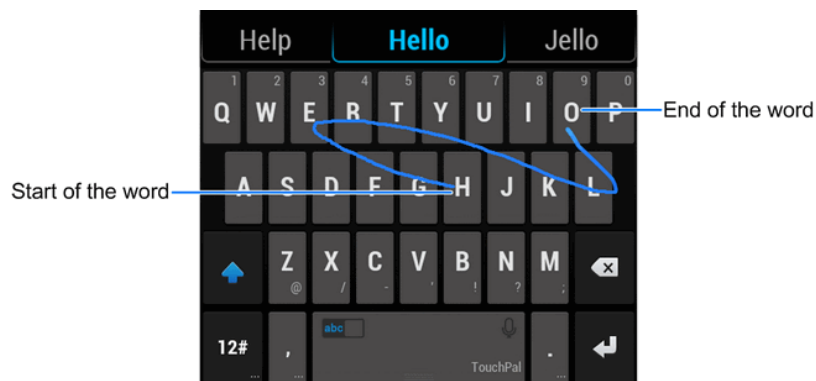



Tip: Tap when you want to. If you want to enter a single letter, go ahead and tap the key.





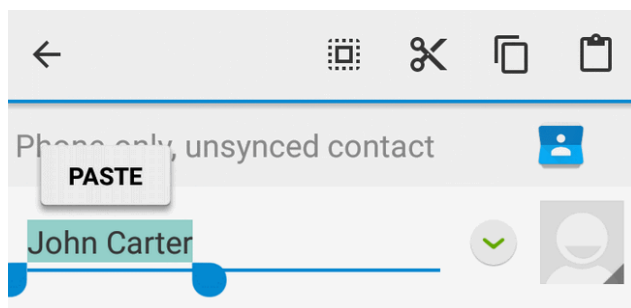

Tip: Lift your finger at the end of the word. A space is added automatically when you begin to trace the next word.

Tips for Editing Text

Your phone gives you many options to make entering text easier, including copying, cutting, and pasting text, customizing the user dictionary, using predictive text, and more.

- To move the insertion point, tap where you want to type. The cursor blinks in the new position, and a tab appears below it. Drag the tab to move the cursor.
- To select text, touch and hold or double-tap the text. The nearest word is selected, with a tab at both ends of the selection. Drag the tabs to change the selection. To cancel the selection, simply tap the text field.
- To cut or copy text, select the text you want to manipulate. Then tap  (cut) or  (copy) in portrait mode.
- To replace text with the clipboard text, select the text you want to replace. Then tap **PASTE** or .



- You can customize your personal dictionary for word suggestion and spell check. From home, tap **Apps**  > **Settings**  > **Language & input** > **Personal dictionary**. Then select a language and tap the Add (+) icon to add a new word.
- Many input methods have predictive text features of their own. You may need to configure them separately. For example, when using the TouchPal X keyboard, slide left or right on the space key to turn on or off prediction, as indicated by  and . For Swype, you can tap **Apps**  from home and select **Settings**  > **Language & input** > **Swype** > **Settings** and configure prediction options like **Auto-correction** and **Next word prediction**.

Google Account

You will need a Google Account to access several phone features such as Gmail, Google Maps, Hangouts, and the Google Play applications. Before you are able to access Google applications, you must enter your account information. These applications sync between your phone and your

online Google Account.

Google Account Cautions

Be sure not to forget your Google Account ID or password.

Create a Google Account

If you do not already have a Google Account, you can create one online or using your phone.

Note: You can also create and sign into your Google/Gmail account through your phone's Setup application.

Note: Although you need a Gmail account to use certain features of your phone, such as Google Play, you do not need to use Gmail as the default account for your phone.

Create a Google Account Online

1. From a computer, launch a Web browser and navigate to google.com.
2. On the main page, click **Sign-in > Create an account**.
3. Follow the onscreen prompts to create your free account.
4. Look for an email from Google in the email box you provided, and respond to the email to confirm and activate your new account.

Create a Google Account Using Your Phone

1. From home, tap **Apps**  > **Settings**  > **Accounts > Add account**.

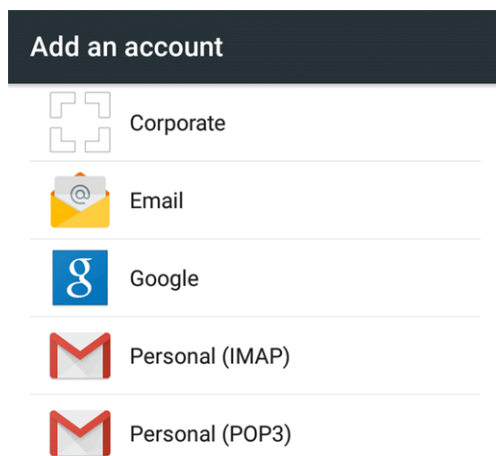

2. Tap **Google** and then tap **Or create a new account**.

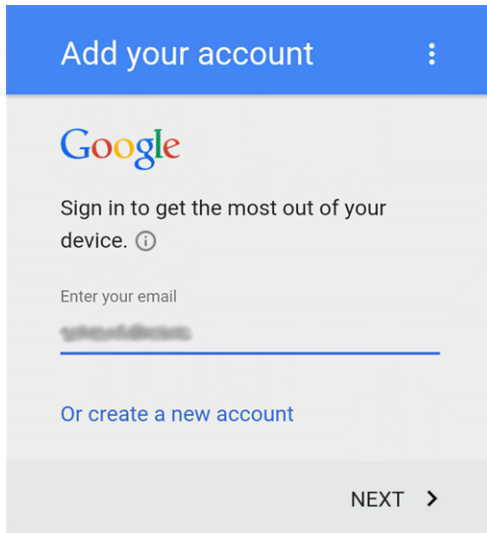

3. Follow the prompts to set up your account. Tap **Next** to proceed between steps, which may include:

- Enter your **First name** and **Last name**.
- Enter a desired **Username**.
- Enter and reenter a password.
- Create a security question and answer, enter a secondary email address to help you recover your password if you ever lose it.
- On the Finish account screen, select your Web history and additional Google Play options.
- Enter the letters from the Authenticating screen.
- After your phone connects with the Google servers, select the items you would like to sync with your phone and then tap **Sync now**.



4. Tap **Finish setup**.

- ❖ You are signed in to your Google Account, and your phone will synchronize the selected items.

Note: When setting up a new Google Account, either on your phone or online, you will be prompted to add a secondary email address. Enter a second Gmail address or any other email address from which you currently send and receive email. This address is used to authenticate your account should you ever encounter problems or forget your password. It is strongly encouraged for Android users so you can regain access to Google services and purchases on your phone.

Sign In to Your Google Account

If you have a Google Account but have not yet signed in with your phone, follow these instructions to sign in to your Google Account.

1. From home, tap **Apps**  > **Settings**  > **Accounts** > **Add account** > **Google**.
2. Enter your Gmail address and then tap **Next**.

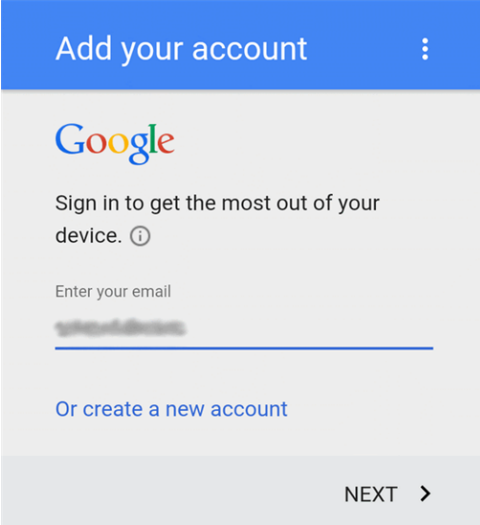

Add your account

Google

Sign in to get the most out of your device. ⓘ

Enter your email

Or create a new account

NEXT >

3. Enter your password and then tap **Next**.

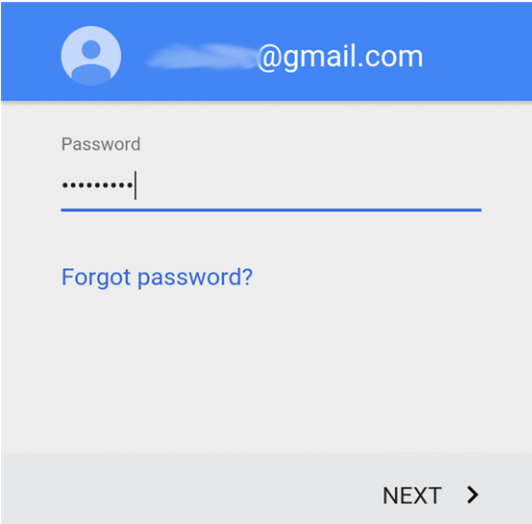

@gmail.com

Password

Forgot password?

NEXT >

4. After your phone connects with the Google servers, tap **ACCEPT >** to agree to Google privacy policy and terms of service.

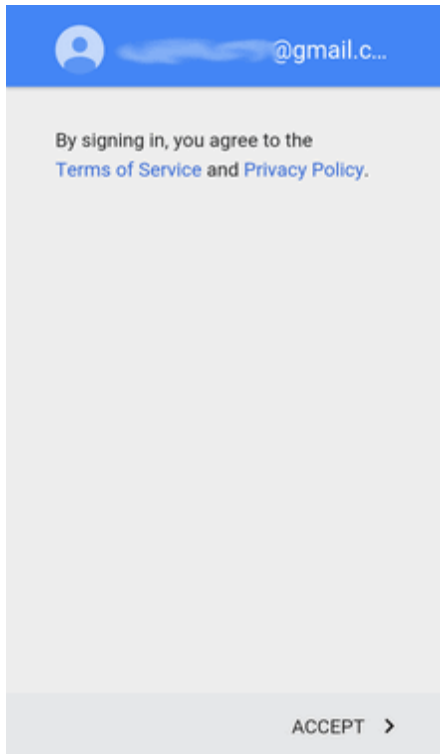

5. On the Google services screen, select your Google service options and tap **NEXT >**.

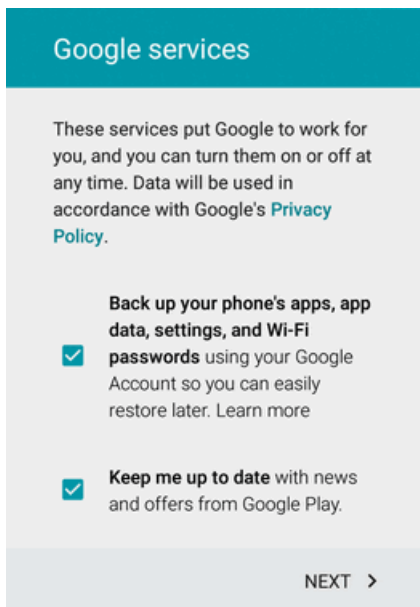

6. Select **Add credit or debit card** or **Redeem** and tap **NEXT >** to set up your billing or gift card information for purchasing apps, games, movies, and books in the Google Play Store app from your phone. You can also select **Remind me later** and tap **NEXT >**.

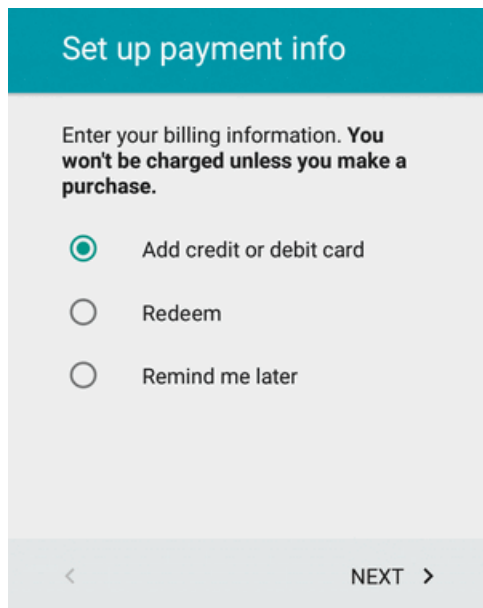

❖ You are signed in to your Google Account.

Google Play Store

Google Play™ is the place to go to find new Android apps, books, movies, and music for your phone. Choose from a wide variety of free and paid content ranging from productivity apps and games to bestselling books and blockbuster movies and music. When you find what you want, you can easily download and install it on your phone.

To access the Google Play store app, you must first connect to the Internet using your phone's Wi-Fi or mobile data connection and sign in to your Google Account. See [Browser](#) and [Sign In to Your Google Account](#) for details.



! Installing Applications

Many different kinds of applications can be installed on your phone from Google Play (provided by Google Inc.). Boost Mobile is not responsible in any way for user-installed applications (quality, reliability, legality, fitness for a purpose, credibility, accuracy, etc.) or resulting malfunctions (viruses, etc.).

Important: Our policies often do not apply to third-party applications. Third-party applications may access your personal information or require us to disclose your customer information to the third-party application provider. To find out how a third-party application will collect, access, use, or disclose your personal information, check the application provider's policies, which can usually be found on their website. If you aren't comfortable with the third-party application's policies, don't use the application.

Find and Install an App

When you install apps from Google Play app and use them on your phone, they may require access to your personal information (such as your location, contact data, and more) or access to certain functions or settings of your phone. Download and install only apps that you trust.

1. From home, tap **Apps**  > **Play Store** .
2. When you open the Google Play store app for the first time, the Terms of Service window will appear. Tap **ACCEPT** to continue.

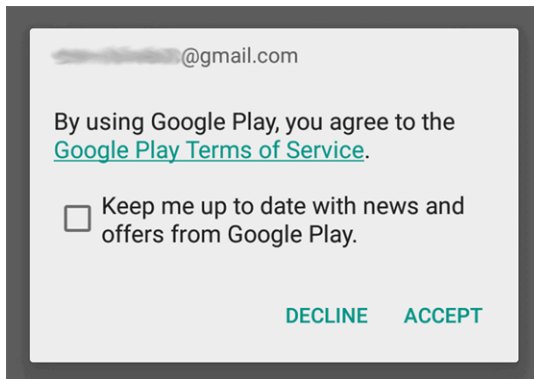

3. Browse through the categories (**Apps**, **Games**, **Movies & TV**, **Music**, **Books**, or **Newsstand**), find an item you're interested in, and tap the name.

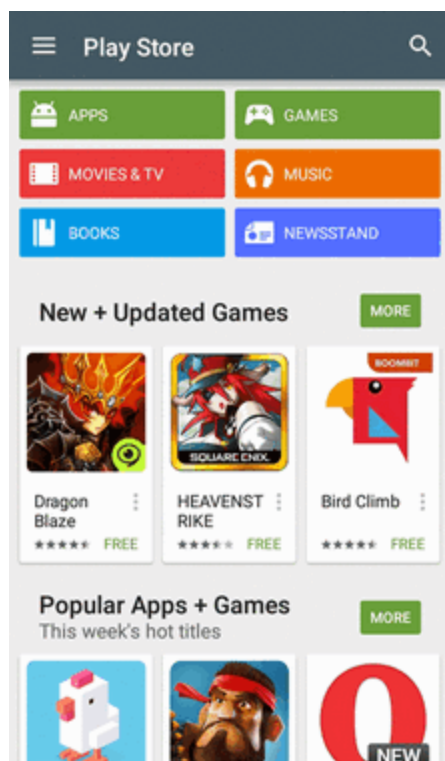

- Browse through featured apps. Scroll through the list of featured apps when you open Google Play.
 - Search for an app. Tap  on the Google Play home screen, enter the name or type of app you're looking for, and then tap the search key on the keyboard.
4. Tap an app to read a description about the app and user reviews.
 5. Tap **INSTALL** (for free applications) or the price (for paid applications).

Note: If you have not already done so, you will need to set up a payment method to purchase paid apps from Google Play.

6. The subsequent screen notifies you whether the app will require access to your personal information or access to certain functions or settings of your phone. If you agree to the conditions, tap **ACCEPT** (for free apps) or **ACCEPT** and then **BUY** (for paid apps) to begin downloading and installing the app.
 - If you have not already set up a payment method, tap **CONTINUE** and then follow the prompts to arrange payment and complete the purchase.
- ❖ The selected app is downloaded and installed on your phone.

Warning: Read the notification carefully! Be especially cautious with applications that have access to many functions or a significant amount of your data. Once you tap **OK** on this screen, you are responsible for the results of using this item on your phone.



Purchasing Applications

Purchase apps at your own risk. Boost Mobile is not responsible for any harm to you or third parties resulting from the use of purchased applications.

Request a Refund for a Paid App

If you are not satisfied with an app, you can ask for a refund within 15 minutes of the purchase. Your credit card is not charged and the app is uninstalled from your phone.



If you change your mind, you can install the app again, but you can't request a refund a second time.

1. From home, tap **Apps**  > **Play Store** .
2. Tap **Menu**  > **My Apps**.
3. Tap the app to uninstall for a refund. The details screen for the app opens.
4. Tap **REFUND**, and then tap **UNINSTALL**. Your app is uninstalled and the charge is canceled.

Update an App

Depending on your settings, many apps will update automatically, or you can update apps directly from the Play Store app.

Update an App Directly

1. From home, tap **Apps**  > **Play Store** .
2. Tap **Menu**  > **My Apps**.

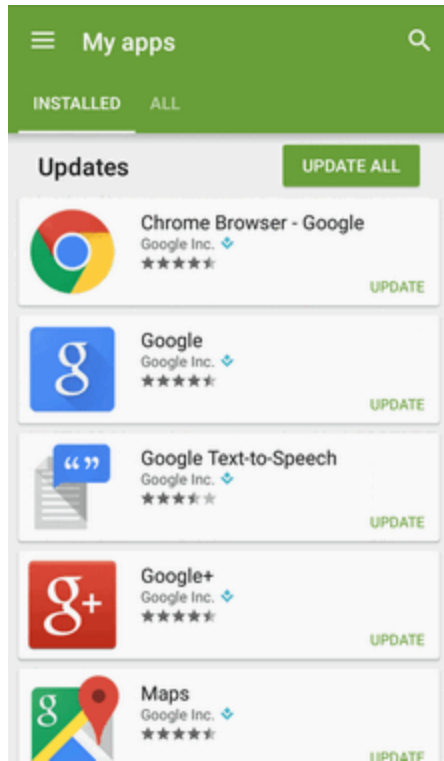



3. Tap the app you want to update, and then tap **UPDATE** > **ACCEPT**.



❖ The app update is downloaded and installed.

Set Automatic App Updates

1. From home, tap **Apps**  > **Play Store** .
2. Tap **Menu**  > **My Apps**.

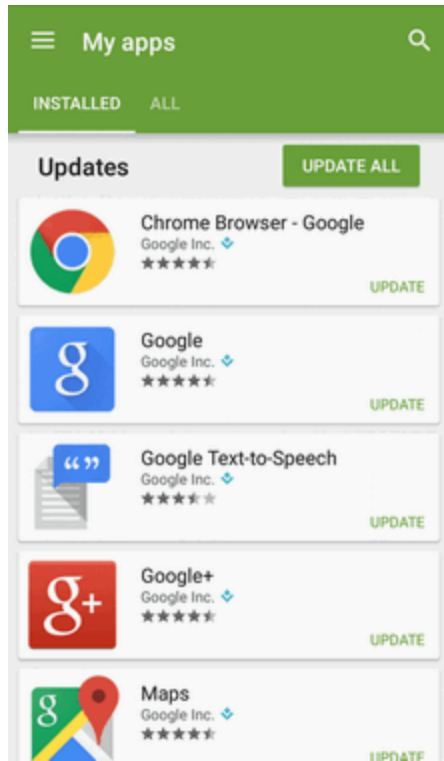

3. Tap the app you want to set for auto-update, and then tap  and check **Auto-update**.





-  The app is set to update automatically whenever an update becomes available.

Note: Automatic updates are unavailable for some apps.

Uninstall an App

You can uninstall any app that you have downloaded and installed from Google Play.

1. From home, tap **Apps**  > **Play Store** .
2. Tap **Menu**  > **My Apps**.

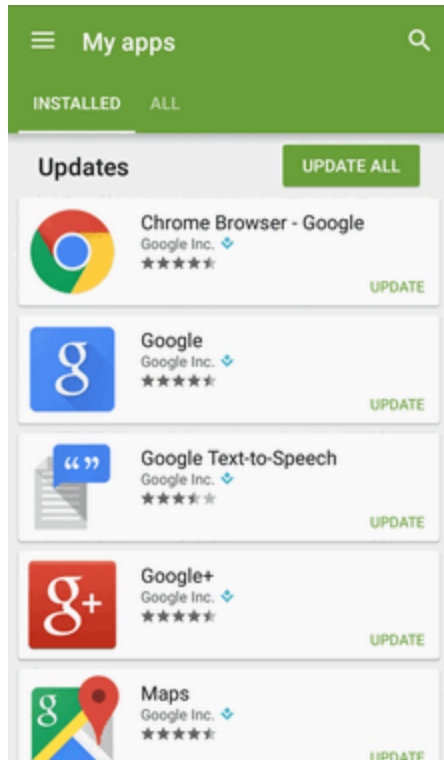

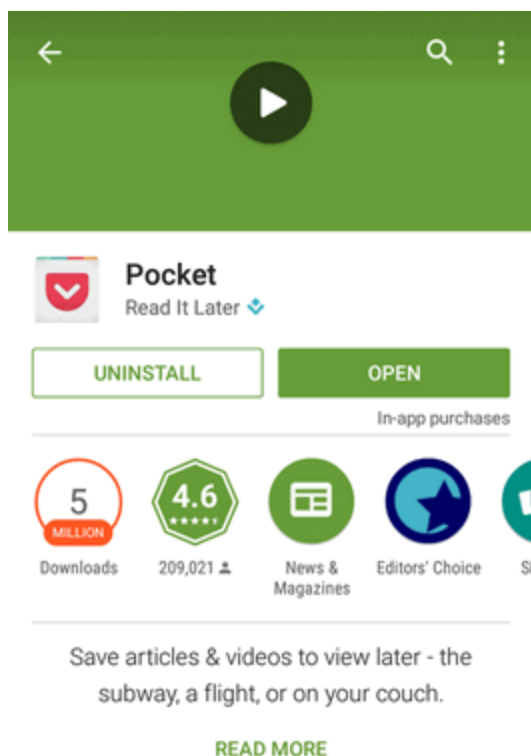

3. On the Installed screen, tap the app you want to uninstall, and then tap **UNINSTALL** > **OK**.



- ❖ The app is uninstalled and removed from your phone.

Get Help with Google Play

The Google Play store app offers an online help option if you have questions or want to know more about the app.

1. From home, tap **Apps**  > **Play Store** .
2. Tap **Menu**  > **Help & Feedback**.

- ❖ The Web browser will take you to the Google Play Help Web page, where you will find comprehensive, categorized information about Google Play.

Lock and Unlock Your Screen

Your phone allows you to quickly turn the screen off when not in use and to turn it back on and unlock it when you need it.

Turn the Screen Off When Not in Use

- To quickly turn the screen off, press the **Power/Lock key**. Pressing the **Power/Lock key** again or receiving an incoming call will turn on your phone screen and show the lock screen.

To save battery power, the phone automatically turns off the screen after a certain period of time when you leave it idle. You will still be able to receive messages and calls while the phone's screen is off.

Note: For information on how to adjust the time before the screen turns off, see [Display Settings](#).

Turn the Screen On and Unlock It

1. To turn the screen on, press the **Power/Lock key**.

❖ The lock screen appears.

2. Touch and hold an empty area of the screen to unlock it.

❖ The screen is unlocked.

- If you have set up a screen lock, you will be prompted to draw the pattern or enter the password or PIN. See [Security Settings](#).

Update Your Phone

From time to time, updates may become available for your phone. You can download and apply updates through the **Settings > System Update** menu.

! Software Update Cautions

During update: The phone cannot be used until the software update is complete. It may take time to update your phone's software.

Signal during update: Update your phone where signal reception is good, and do not change location during the update process. Make sure the battery is adequately charged before beginning an update. A weak signal or low battery during an update may cause the update to fail. An update failure may disable the phone.

Other functions during update: Other phone functions cannot be used during a software update.

Update Your Phone Software



You can update your phone's software using the System Update option.

Before Updating Your Phone



Updating your phone may result in a loss of saved data depending on the condition of your phone (malfunctioning, damaged, water seepage, etc.). You must back up all critical information before updating your phone firmware.

Back Up All Data Prior to Update



To back up your Gmail information:

1. From home, tap **Apps**  > **Settings**  > **Accounts** > **Google**.
2. Tap your Google Account to open the Sync screen.
 - If the Auto-sync data option is on, check the items you want to keep in sync.
 - If the Auto-sync data option is off, tap the items you want to synchronize to back up related data.



To back up your Exchange Mail information:

1. From home, tap **Apps**  > **Settings**  > **Accounts** > **Corporate**.
2. Tap your corporate account to open the Sync screen.
 - If the Auto-sync data option is on, check the items you want to keep in sync.
 - If the Auto-sync data option is off, tap the items you want to synchronize to back up related data.



To back up stored text messages:

1. From home, tap **Messaging** .
 2. Select the text message from the list to view the message thread.
 3. Tap a portion of the text message from the string. The Message options context menu appears.
- Note:** You can back up stored text messages by forwarding them to your own phone number. Open the messages after you have updated your firmware.
4. Tap **Forward**.
 5. Enter your phone number and tap .

To back up your Google apps:



1. From home, tap **Play Store** .
2. Tap **Menu**  > **My apps** > **ALL** tab.
3. Scroll through the list of previously downloaded Google apps and choose those you wish to reinstall.
4. Follow the onscreen instructions.

Note: Your Google app purchases are reloaded remotely and can be re-installed after the update is applied.

As an added precaution, to preserve any data on your SD card, please unmount it from your phone prior to starting the update process. From home, tap **Apps**  > **Settings**  > **Storage** > **Unmount SD card**.

Update Your Phone's Software

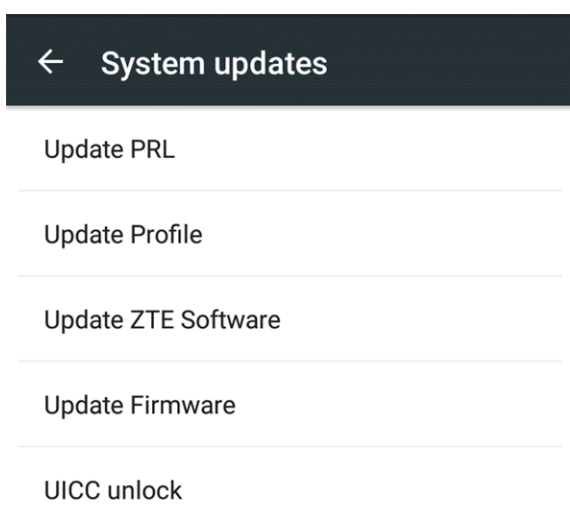

Once you have backed up all your data, use the **Update now** option to update your phone's software.

1. From home, tap **Apps**  > **Settings**  > **System updates**.
2. Tap **Update Firmware**.





- ❖ Your phone automatically downloads and installs any available updates. You may be required to power your phone off and back on to complete the software upgrade.

Alternatively, you can access system updates through the notification panel.



1. Locate the **System Update Available** icon () in notifications.
2. Pull down the status bar.
3. Tap  to open the System Updates screen.
4. Follow the onscreen instructions to restart and install the update.

Confirm Your Current Phone Software

1. From home, tap **Apps**  > **Settings**  > **About device**.
2. Locate the Software version read-only field.

Update Your Profile



This option allows you to automatically update your online user profile information. If you choose to change your user name and select a new one online, you must then update the user name on your phone.

1. From home, tap **Apps**  > **Settings**  > **System updates** > **Update Profile**.
2. Follow the onscreen instructions.
 - ❖ The phone will download and install the profile update and you will see a confirmation when complete.

Note: If your data services or account syncing ever seems to go out unexpectedly, use this feature to reconnect with the network.

Update Your PRL

This option allows you to download and update the PRL (preferred roaming list) automatically.

1. From home, tap **Apps**  > **Settings**  > **System updates** > **Update PRL**.
2. Follow the onscreen instructions.
 - ❖ The phone will download and install the PRL update and you will see a confirmation when complete.

Your Phone Interface

The following topics describe how to use and customize your phone's home screen, understand the status bar, and use the notification panel.

Home Screen Basics

The home screen is the starting point for your phone's applications, functions, and menus. You can customize your home screen by adding application icons, shortcuts, folders, widgets, and more.

Home Screen Layout

Your home screen extends beyond the initial screen. Swipe the screen left or right to display additional screens.

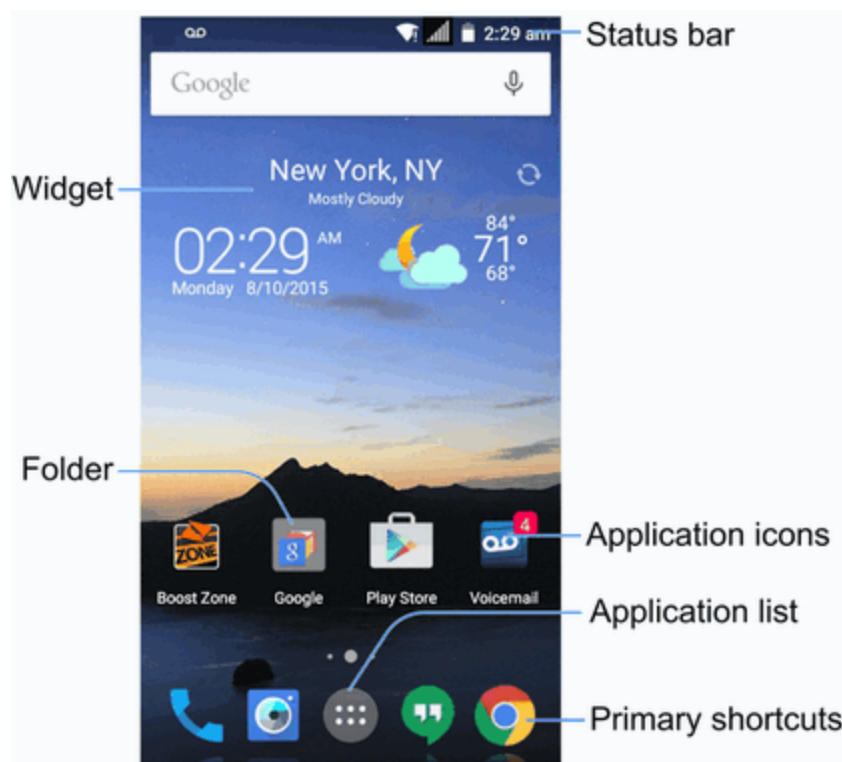

Item	Description
Status bar	The status bar displays icons to notify you of your phone's status (on the right side) and notifications (on the left side).
Widget	Widgets are self-contained onscreen apps that reside on your phone's home screen.
Application icons	Application icons are shortcuts to favorite applications. You can add and remove these shortcuts as you wish.
Folder	You can group shortcuts on the home screen into folders for convenient access.

Item	Description
Primary shortcuts	Primary shortcuts are application shortcuts that appear in the same location on all of your phone's home screens. These are customizable except for the Applications (Apps) shortcut, which remains static.
Applications (Apps) list key 	Tap to open the applications (apps) list. The apps list key is a primary shortcut available from all home screens.

Note: Your phone's home screens cycle through so that you can keep swiping in one direction and make it back to the main home screen. The small circles above the primary shortcuts let you know your current screen position.

Tip: Tap the **Home key**  to return to the main home screen from any other screen.

Extended Home Screens

In addition to the main home screen, your phone features extended home screens to provide more space for adding icons, widgets, and more. Tap the **Home key**  to display the main home screen and then slide the screen right or left to move from the main screen to an extended screen.



There are up to eight and at least two extended screens available in addition to the main home screen.

- If you are not already using the maximum number of screens for your phone, you can add more screens when adding a shortcut or widget to the home screen. See [Add Shortcuts to the Home Screen](#) and [Add Widgets to the Home Screen](#).
- If there are more than two extended screens and you remove all contents from one screen, the empty screen is deleted automatically.
- While on an extended screen, tap the **Home key**  to return to the main home screen.

To delete or set the home screens:

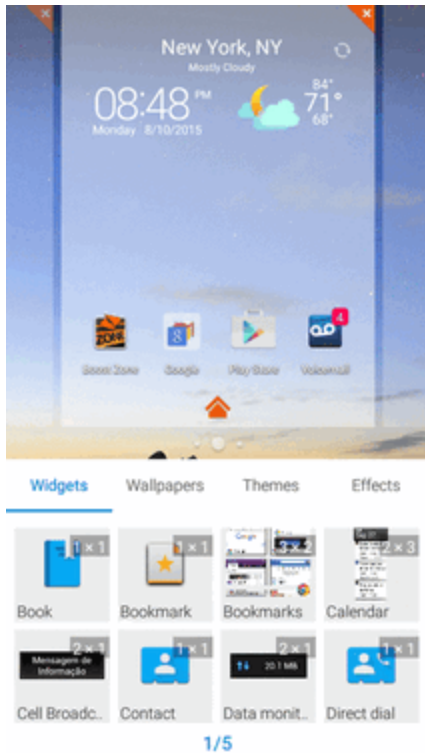
- From any home screen, touch and hold an empty area to display thumbnail images of all screens.



- To delete a home screen, tap  on the corner of its thumbnail and select **OK**.
- To set a home screen as the main home screen, tap  at the bottom of its thumbnail.
- To change the order of the screens, touch and hold a thumbnail and drag it left or right to a new position.

Status Bar and Notification Panel

Your phone's status and notifications are available at a glance at the top of the screen.







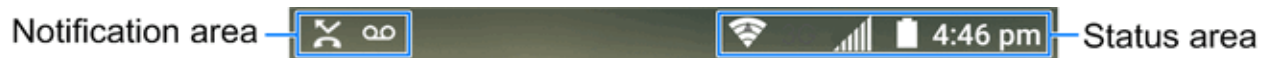









Status Bar

The status bar at the top of the home screen provides phone and service status information on the right side and notification alerts on the left. To view the notification panel or access the quick settings menu, pull down the status bar from the top of the screen.



Status Bar Layout















Main Notification Icons

Icon	Notification
	New text message
	New multimedia message
	New messages from the Email app
	New messages from the Gmail app
	Missed call
	New voicemail
	New Hangout message
	Upcoming event
	USB connection
	Call in progress
	Downloading or receiving data
	Uploading or sending data
	Open Wi-Fi network detected
	Wired headset connected
	Music playing
	Updates available from the Google Play Store
	SD card unmounted and safe to remove

Main Status Icons

Icon	Status
	Bluetooth® active
	GPS active

Icon	Status
	Wi-Fi® active
	Signal strength
3G	3G network available
LTE	Enhanced 4G LTE network available
	Airplane mode
	Alarm set
	Battery full
	Battery low
	Battery charging
	Priority mode
	Silent mode
	Vibration mode
	Speakerphone on
	Microphone off

Notification Panel

Your phone's notifications appear at the left side of the status bar, and you can access the full notification panel by pulling down the status bar. From there, you can check notifications, download updates, open messaging apps, use the quick settings menu, and more.

Open the Notification Panel

- Pull down the status bar. (Slide your finger down from the top of the screen.)



- ❖ The notification panel opens. To check notifications, tap an item in the list.

Close the Notification Panel

- Slide the notification panel up. (Slide your finger up from the bottom of the screen.)

– or –

Tap **Back**  to close the notification panel.

Notification Panel Layout

The notification panel gives you access both to notifications and the quick settings menu.

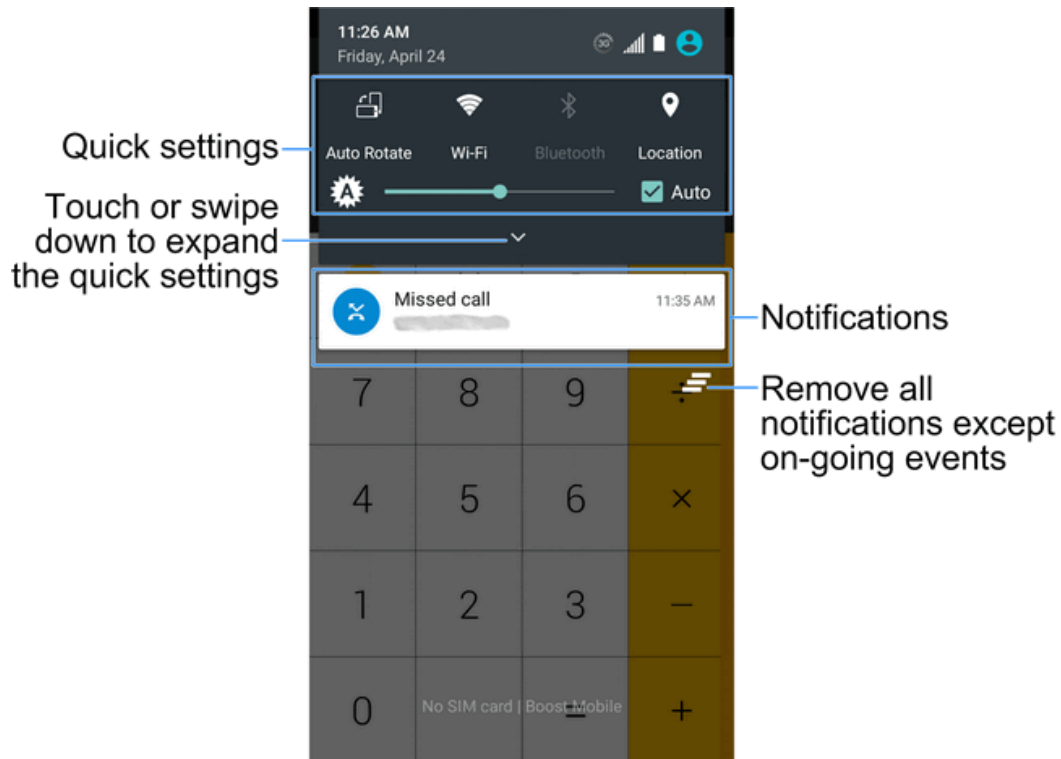

Customize the Home Screen

Learn how to set the wallpaper and add, move, or remove shortcuts, widgets, and folders from the home screen.

Operations for Rearranging the Home Screen



- **Moving Widgets and Icons:** From home, touch and hold an item and then drag it to the desired location.
- **Deleting Widgets and Icons:** From home, touch and hold an item and then drag it to **Delete** .
- **Displaying the Home Screen Menu:** From home, touch and hold an empty space to display the home screen menu. Menu options include Wallpapers, Widgets, and Home screen settings, and you also have the option to add or remove home screens.

Change the Wallpaper

Select and assign your phone's background wallpaper.

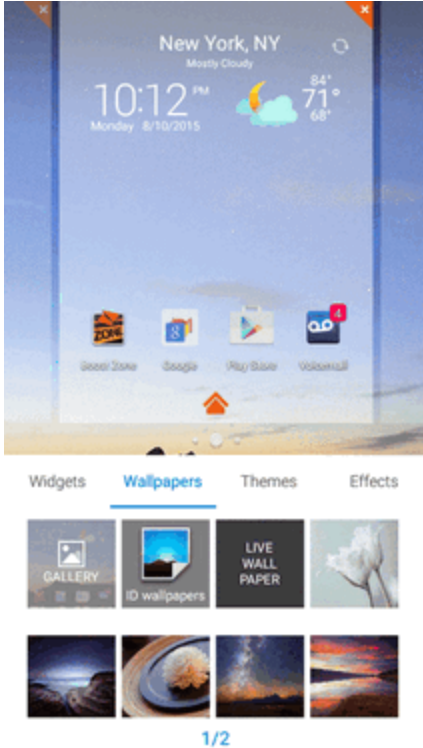
1. From home, touch and hold an empty space, and then tap **Wallpapers**.



- You can also access the wallpaper menu through settings. From home, tap **Apps**  > **Settings**  > **Display** > **Wallpaper**.

2. Tap an option to select the wallpaper.
3. If necessary, tap **Set wallpaper**.

❖ The wallpaper is set.

Note: If you select **Gallery**, you will need to select an album and a picture. Once selected, use the crop tool to resize and position the image and then tap .

Add Shortcuts to the Home Screen

You can add shortcuts for quick access to favorite apps from the home screen.

1. From home, tap **Apps** .
 - ❖ The Apps list opens.
2. Touch and hold an app icon.
 - ❖ The icon will disengage and you will see thumbnails of your home screens.
3. Drag the icon to an empty location on one of the home screens.

- ❖ The shortcut is added to the home screen.

Add Widgets to the Home Screen

You can add widgets to your phone's home screen. Widgets are self-contained apps that display on a home screen. Unlike a shortcut, the Widget works like as an onscreen application. There are all kinds of widgets, including links to a specific contact, Internet bookmarks, Facebook® status windows, Gmail and email accounts, and many others.

1. From home, touch and hold an empty space, and then tap **Widgets**.

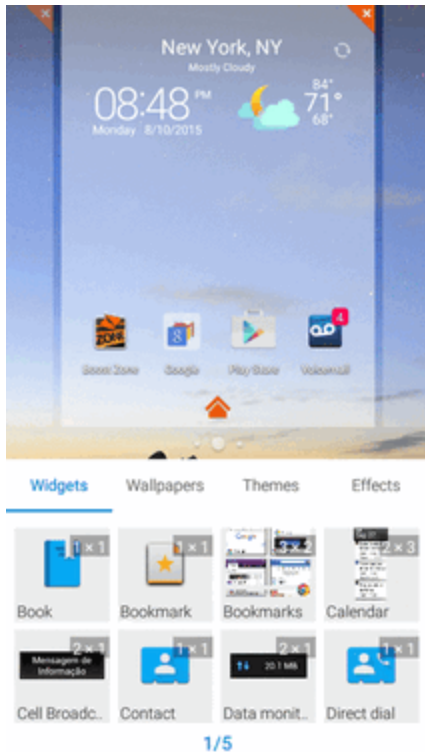

2. Touch and hold a widget icon.

- ❖ The icon will disengage and float with your finger.

3. Drag the icon to an empty location on one of the home screens.

Note: If there are less than eight extended home screens, you can add a new extended home screen while you add a widget. Just drag the widget icon to the right edge of the screen and drop it after you reach the right-most screen.

- ❖ The widget is added to the home screen.

Add Folders to the Home Screen

You can group home screen shortcuts into folders for convenient access.

1. From home, touch and hold a shortcut you want to place in a folder, and then drag it to **Folder**



2. Type a name for the folder and tap **OK**.
 - ❖ A new folder is created.
3. To add more app shortcuts to the folder, touch and hold a shortcut and drag it on top of the new folder.
 - ❖ The new shortcut is added to the folder.

Change Folder Names

Once you have added folders, you can change the name easily from the folder display.

1. From home, tap the folder to open it, and then tap the folder name.
2. Type a new name and then tap **Done**.

Phone App

The following topics outline the use of your device's phone app to place and receive calls, use voicemail, set up and manage contacts, and more.

Place and Answer Calls

The following topics describe how to directly dial calls, how to answer incoming calls, and how to use the in-call screen options.

Adjust In-Call Volume

- **Adjusting Call Volume:** Press the **Volume Up/Down keys** during the call.

Troubleshooting

Question: Difficulty during call.

Answer 1: It may not be possible to make a call properly in a noisy location.

Answer 2: When calling using Speaker, check the call volume. Raising the call volume may make calling difficult.

Question: Sound pops momentarily during a call.

Answer: Are you changing location while calling? Sound pops when signal is weak and the phone switches to a different area.

Emergency Call Cautions

Emergency calls are restricted in Airplane mode.

Call Using the Phone Dialer

The most “traditional” way to place a call is by using the phone's dialer screen.

1. From home, tap **Phone**  >  to display the dialer screen.

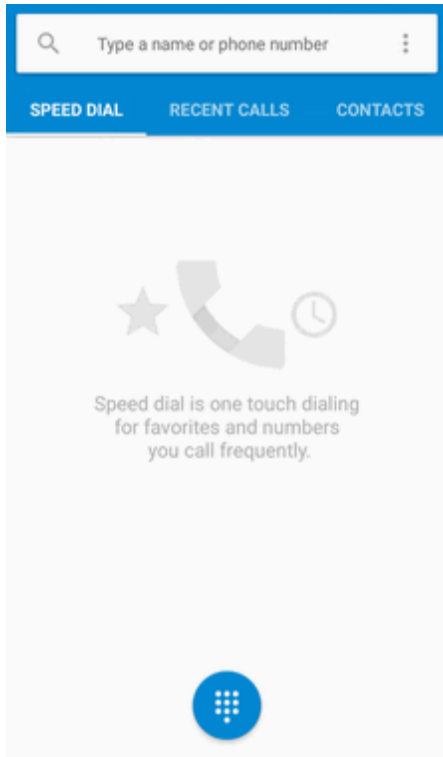

- ❖ The dialer screen opens.

2. Tap the number keys on the keypad to enter the phone number.

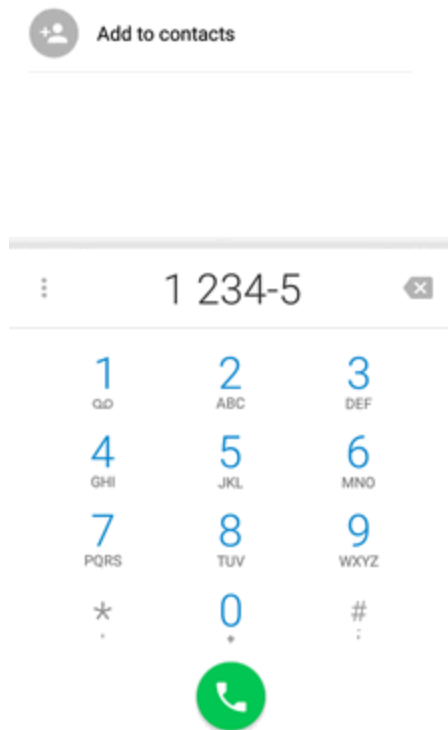

- As you enter digits, Smart Dial searches for contacts that match. If you see the number you want to dial, tap it to place the call immediately without entering the rest of the number.

3. Tap  to call the number.

- ❖ The phone dials the number. The call begins when the other party answers.

4. To end the call, tap .

- ❖ The call ends.

Troubleshooting

Question: Call does not connect.

Answer 1: Was the number dialed using the area code? If not, try dialing using the full 10-digit number including the area code.

Answer 2: Are you in an area with poor wireless coverage? Try calling again from another area.

Call Emergency Numbers

You can place calls to 9-1-1 even if the phone's screen is locked or your account is restricted.

To call the 9-1-1 emergency number when the phone's screen is locked with a screen lock:

1. From the lock screen, touch and hold **Emergency call (ICE)**.

2. Tap  next to 9-1-1.

❖ As long as you are in an area covered by wireless service, the emergency call is placed.

To call the 9-1-1 emergency number normally or when your account is restricted:

1. Unlock the screen. For more information, see [Lock and Unlock Your Screen](#).

2. From home, tap **Phone**  > .

3. Dial 9-1-1 and then tap .

❖ As long as you are in an area covered by wireless service, the emergency call is placed.

Enhanced 9-1-1 (E 9-1-1) Information

This phone features an embedded Global Positioning System (GPS) chip necessary for utilizing E 9-1-1 emergency location services where available.

When you place an emergency 9-1-1 call, the GPS feature of your phone seeks information to calculate your approximate location. Depending on several variables, including availability and access to satellite signals, it may take up to 30 seconds or more to determine and report your approximate location.

Important: Always report your location to the 9-1-1 operator when placing an emergency call. Some designated emergency call takers, known as Public Safety Answering Points (PSAPs), may not be equipped to receive GPS location information from your phone.

Answer Phone Calls

The following information lets you know how to answer incoming calls, mute the ringer on incoming calls, reject incoming calls, and more.

When you receive a phone call from a contact, the Incoming call screen appears and displays the caller ID icon, name, and phone number of the calling party. When you receive a phone call from someone who is not stored in People, only the default caller ID icon and phone number appear on the Incoming call screen.

Note: If your phone is turned off, all calls automatically go to voicemail.

Answer an Incoming Call

1. When a call arrives, drag  down to answer it.

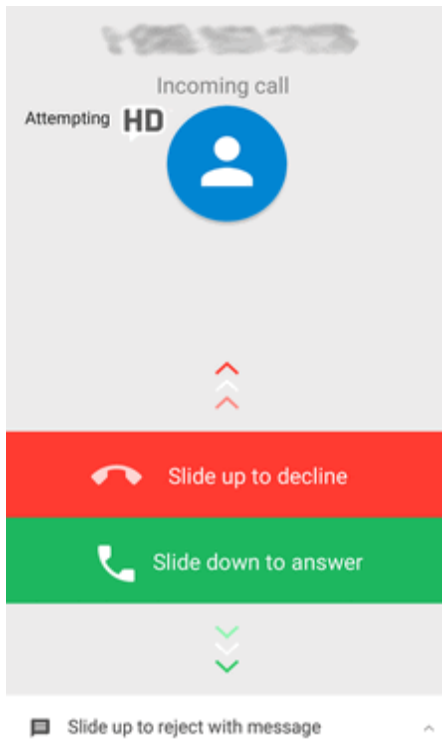

- ❖ The call begins.

2. To end the call, tap .

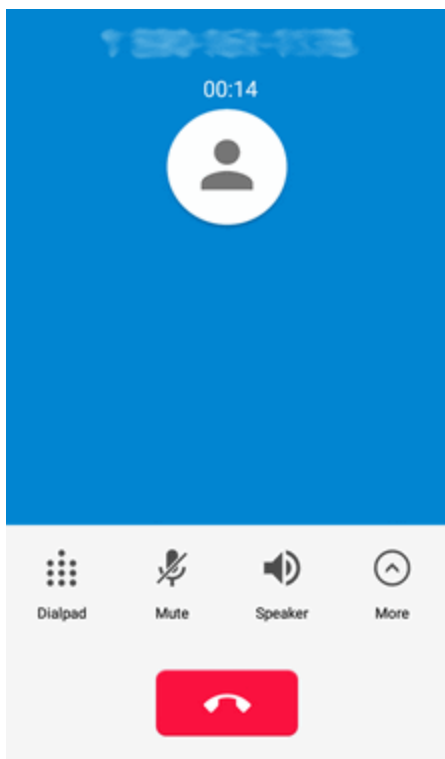

❖ The call ends.

Mute the Ringing Sound

To mute the ringer without rejecting the call, you can do any of the following:

- Press the **Volume keys**.
- Place the phone face down on a level surface.

Reject an Incoming Call

- When a call arrives, drag  up to reject it.

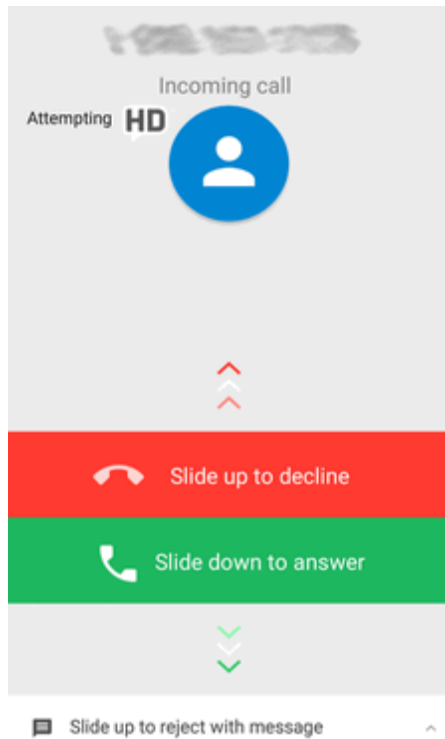

- ❖ The ringtone or vibration will stop and call will be sent directly to voicemail.

Reject a Call and Send a Text Message

You can reject an incoming call and automatically send a text message to the caller.

1. When a call arrives, drag  up from the bottom of the screen.

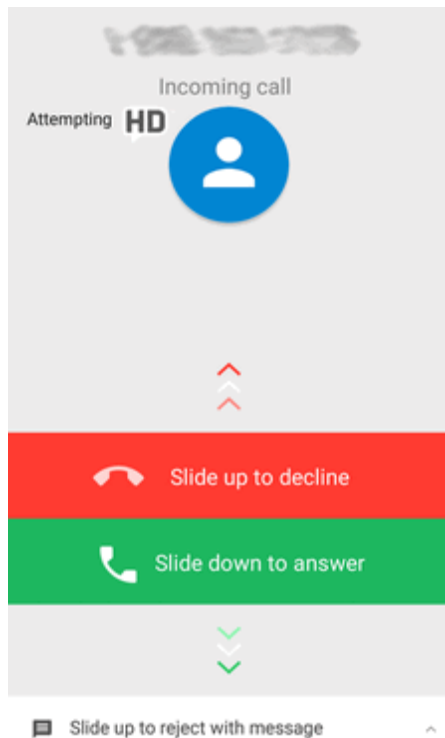

- ❖ The ringtone or vibration will stop and you will see a list of preset text messages.

2. Tap one of the messages to send it to the caller.



- ❖ The selected message will be delivered to the caller.
 - You can edit the reject messages through the Call settings menu. From the phone app, tap **Menu**  > **Settings** > **General settings** > **Quick responses** and tap a message to edit.

In-Call Screen Layout and Operations

While you're on a call, you will see a number of onscreen options.

In-Call Screen Layout

Tap **More** to display all available options. Tap options to activate them during a call.

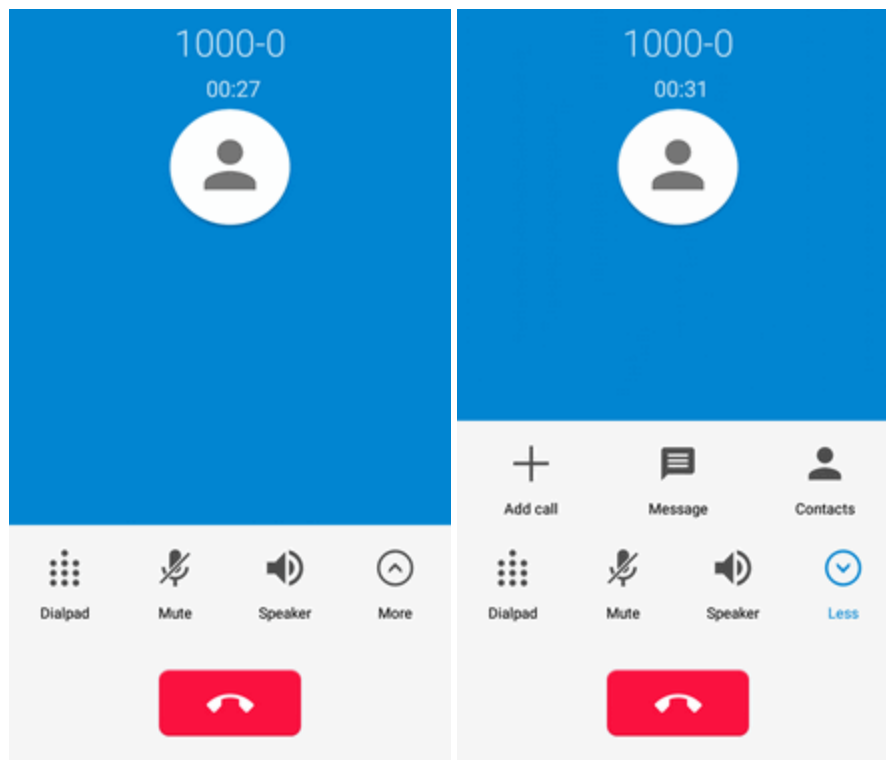

- **Add call:** Tap to make another call separately from the current call, which is put on hold. When both calls are connected, you can tap **Merge calls** to join the two calls into a conference call.
- **Message:** Open the Messaging app and view your text and multimedia messages.
- **Contacts:** Open the Contacts app and view your contacts list.
- **Dialpad:** Toggle the appearance of the onscreen keypad. You can use it during a call to enter additional numbers, such as an extension, account number or password.
- **Mute:** Mute the microphone during an active call. Tap again to unmute the microphone.
- **Speaker:** Route the phone's audio through the speaker (On) or through the earpiece (Off).
 - Activate **Speaker** to route the phone's audio through the speaker. (You can adjust the speaker volume using the **Volume Buttons**.)
 - Deactivate **Speaker** to use the phone's earpiece.

Warning: Because of higher volume levels, do not place the phone near your ear during speakerphone use.

- **End call:** Tap  to end the current call.

Place a Call from Contacts

You can place phone calls directly from entries in your Contacts list.

1. From home, tap **Phone**  to display the phone app.
2. Tap **CONTACTS** to display the Contacts list.

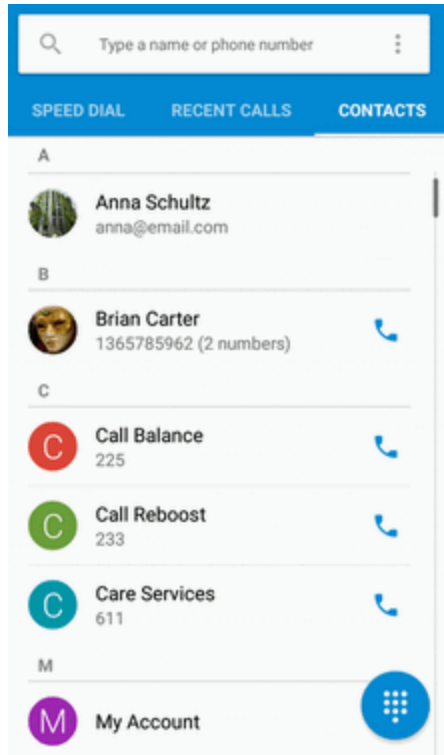

- ❖ The contacts list appears.

3. Tap a contact.

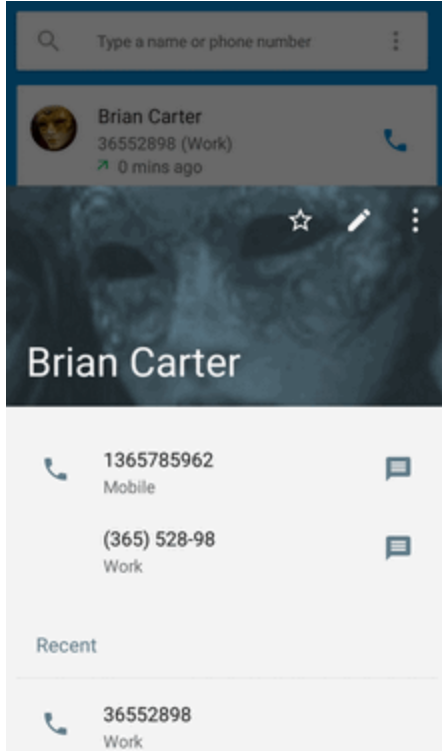

4. Tap the number you want to call.

❖ The phone dials the number. The call begins when the other party answers.

5. To end the call, tap .

❖ The call ends.

Tip: You can also place a call directly from the Contacts list. Tap  next to the entry you want to call to place a call to the entry's default number.

Call from Call Logs

The Call logs list lets you quickly place calls to recent incoming, outgoing, or missed numbers.

1. From home, tap **Phone**  to display the phone app.
2. Tap **RECENT CALLS** to display the recent call history.

Tip: To view the complete call history, scroll to the bottom of **RECENT CALLS** and tap **View full call history**.

3. Tap  next to an entry to call the number.

- ❖ The phone dials the number. The call begins when the other party answers.
 - For additional options, tap the name or number.

4. To end the call, tap .

- The call ends.

Optional Services

The following topics outline additional voice-related services available with your phone, including call services, voicemail, and more.

Voicemail Setup

You should set up your voicemail and personal greeting as soon as your phone is activated. Always use a password to protect against unauthorized access. Your phone automatically transfers all unanswered calls to your voicemail, even if your phone is in use or turned off.

1. From home, tap **Phone**  >  to display the dialer screen.

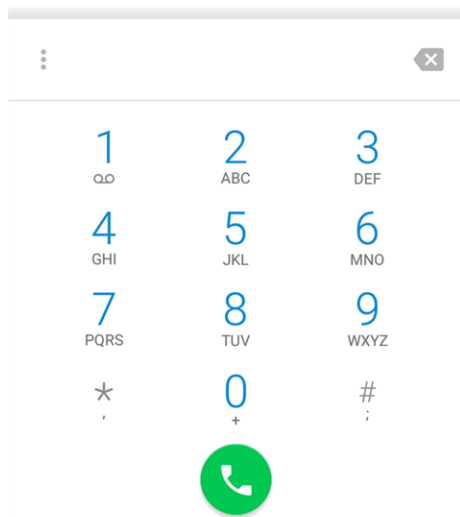

2. Touch and hold ¹_{no} to dial your voicemail number.

- ❖ Your phone dials the voicemail access number.

3. Follow the system prompts to:

- Create your password.
- Record your name announcement.
- Record your greeting.

Important: Voicemail Password – It is strongly recommended that you create a password when setting up your voicemail to protect against unauthorized access. Without a password, anyone who has access to your phone is able to access your voicemail messages.

Visual Voicemail

Visual Voicemail gives you a quick and easy way to access your voicemail. Now you can find exactly the message you are looking for without having to listen to every voicemail message first. This feature periodically goes out to your voicemail, and gathers the caller information from all of the current voicemails. It then populates a list with the caller name and number, along with the length of time and priority level of the voicemail message.

Set Up Visual Voicemail

Setting up Visual Voicemail follows many of the same procedures as setting up traditional voicemail. You should set up your voicemail and personal greeting as soon as your phone is activated. Your phone automatically transfers all unanswered calls to your voicemail, even if your phone is in use or turned off.

Note: To set up your traditional voicemail box, see [Voicemail Setup](#).

1. From home, tap **Apps**  > **Voicemail** .

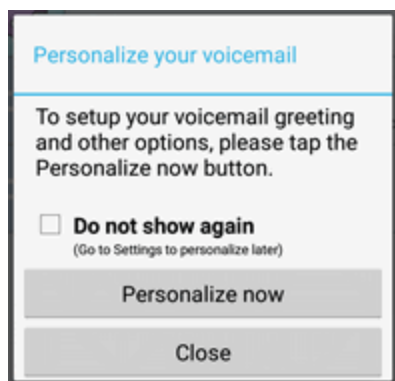

❖ You'll see a Personalize your voicemail prompt.

2. Tap **Personalize now** and follow the system prompts to:
 - Create a password (part of standard voicemail).
 - Record your name announcement.
 - Record your greeting.
3. Tap the Welcome to Voicemail message on the screen to play a brief explanation of the voicemail services.

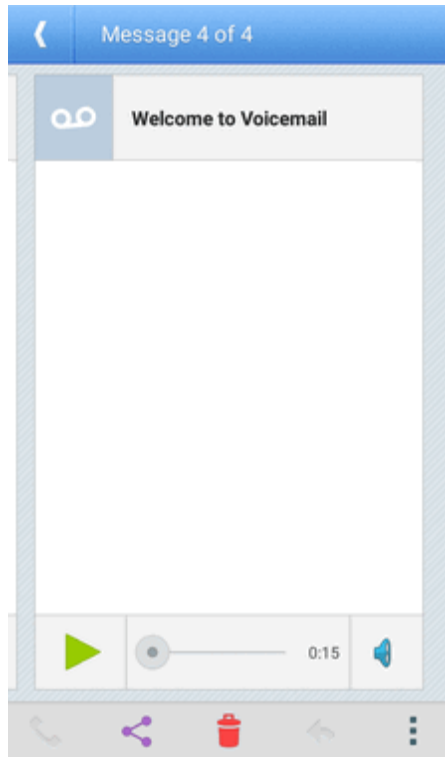

Important: Voicemail Password – It is strongly recommended that you create a password when setting up your voicemail to protect against unauthorized access. Without a password, anyone who has access to your phone is able to access your voicemail messages.

Review Visual Voicemail

Visual Voicemail lets you easily access and select which messages you want to review.

1. From home, tap **Apps**  > **Voicemail** .

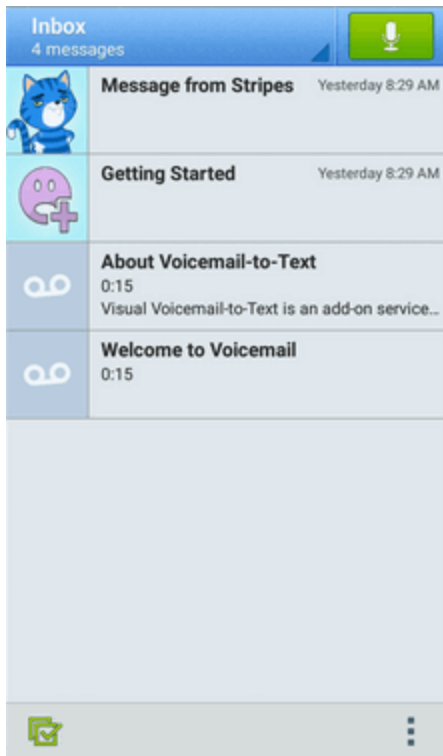

❖ You will see the voicemail inbox.

2. Tap a message to review it.

Tip: There are several icons at the bottom of the review screen for maintenance, storage, messaging, and other options. For an explanation of all your options, tap **Menu**  > **Help** > **Messaging** > **Receiving Messages** > **Message Playback**.

Listen to Multiple Voicemail Messages

When you are done listening to a voicemail message you can easily access other voicemail messages without returning to the main voicemail screen.

1. Listen to the current voicemail message.
2. Swipe your finger left or right to display the next or previous message.

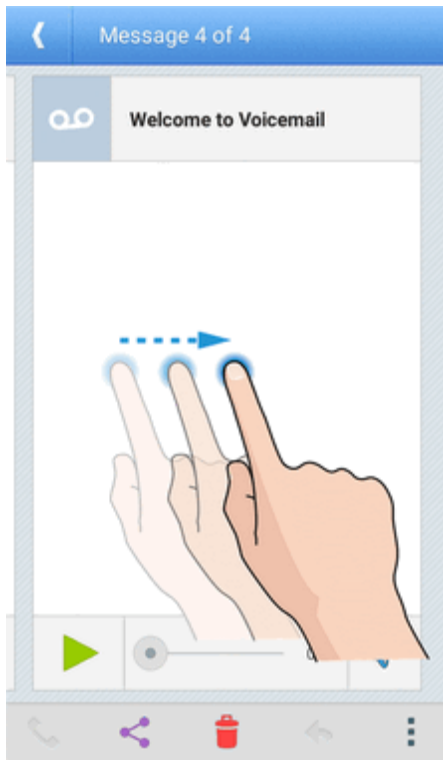

❖ The next or previous message is displayed. You can tap  to play it.





You can navigate through voicemail messages as frequently as you'd like. You can even move to the next or previous message before you're finished listening to the current one.

Visual Voicemail Options

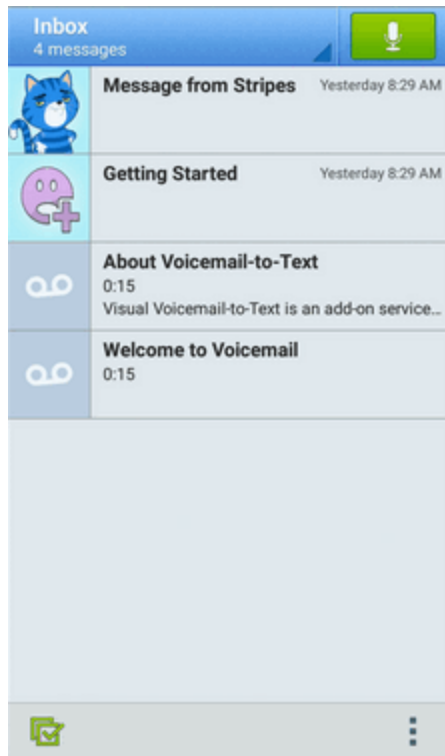
Your visual voicemail options appear as icons at the bottom of the voicemail review screen.

1. From home, tap **Apps**  > **Voicemail** .



2. Tap a message to review it. The following options are available while reviewing a voicemail message:
 -  **Call** to call the sender.
 -  **Share** to share the message. Options depend on the application installed.
 -  **Delete** to delete the voice message.
 -  **Reply** to reply to the message.
 - Tap  > **Archive** to archive the current message. You can find it in the Archive box.

Note: Not all options are available for all messages.

Configure Visual Voicemail Settings

The Visual Voicemail settings menu lets you access settings for notifications, pictures, greetings, and more.

1. From home, tap **Apps**  > **Voicemail** .

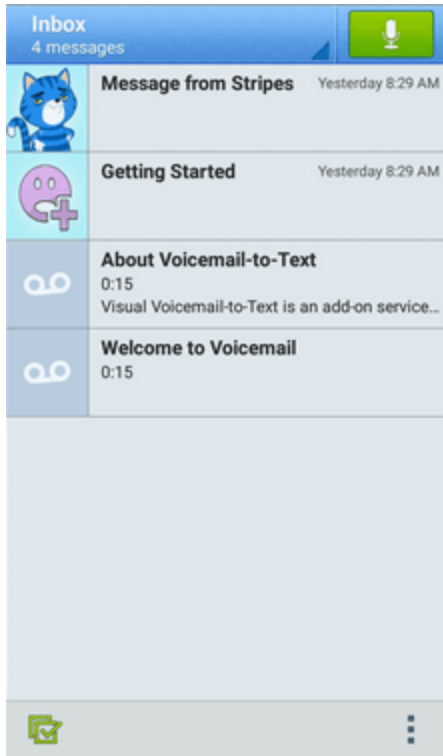

2. Tap **Menu** > **Settings**.

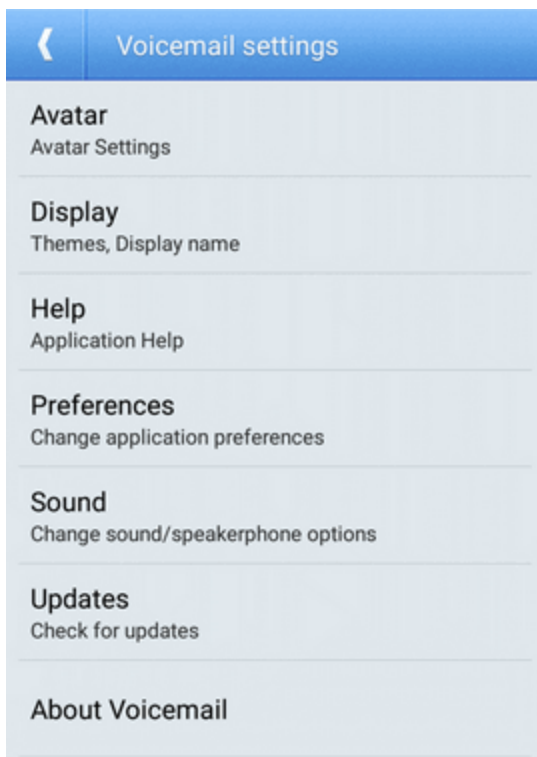

❖ You will see the voicemail settings menu.

3. Select an option to change its settings.

- Avatar
- Display
- Help
- Preferences
- Sound
- Updates
- About Voicemail

Change Your Main Greeting via the Voicemail Menu

Your main greeting can be changed directly via the Visual Voicemail system. This direct access saves you from having to navigate within the voicemail menu.

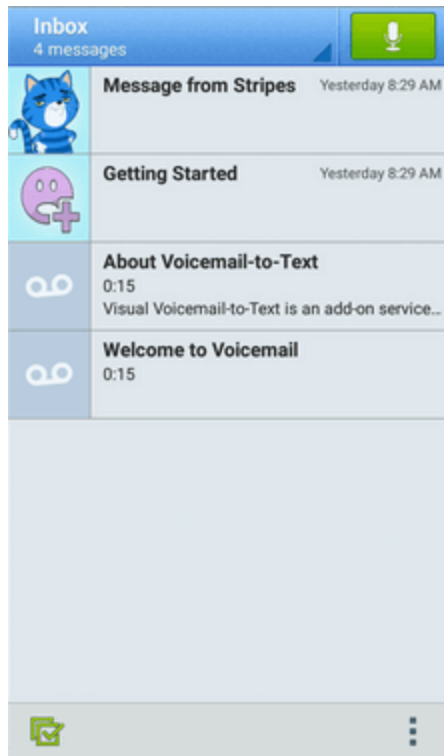

1. From home, tap **Apps**  > **Voicemail** .



2. Tap **Menu**  > **Settings** > **Preferences** > **Personalize voicemail**.
3. Tap **OK** to connect to the voicemail system. Follow the prompts to change your current greeting.





Edit the Display Name via the Voicemail Menu

From your Visual Voicemail menu, you can quickly change the name or number attached to your voice messages.

1. From home, tap **Apps**  > **Voicemail** .
2. Tap **Menu**  > **Settings** > **Display** > **Display name**.
3. Tap the existing identification field and enter a new identifying name or number (used to identify you to recipients of your voice messages).
4. Tap **OK** to save your information.

Caller ID Blocking

Caller ID identifies a caller before you answer the phone by displaying the number of the incoming call. If you do not want your number displayed when you make a call, follow these steps.

1. From home, tap **Phone**  > .
2. Tap  **6 7**
MNO PQRS.
3. Enter a phone number.
4. Tap .

❖ Your caller information will not appear on the recipient's phone.

To permanently block your number, call Boost Customer Service.

Call Waiting

When you're on a call, Call Waiting alerts you to incoming calls by sounding two beeps. Your phone's screen informs you that another call is coming in and displays the caller's phone number (if it is available).

To respond to an incoming call while you're on a call:

- Tap **Answer**. (This puts the first caller on hold and answers the second call.)

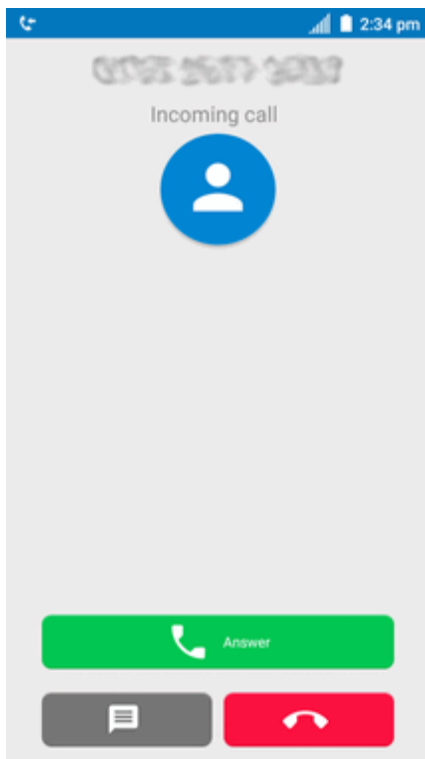

To switch back to the first caller:

- Tap **More** >  **Flash**.





Note: For those calls where you don't want to be interrupted, you can temporarily disable Call Waiting by pressing  * 7 0 before placing your call. Call Waiting is automatically reactivated once you end the call.

Call Forwarding

Call Forwarding lets you forward all your incoming calls to another phone number – even when your phone is turned off. You can continue to make calls from your phone when you have activated Call Forwarding.





Note: You are charged a higher rate for calls you have forwarded.

To activate Call Forwarding:

1. From home, tap **Phone**  > .
2. Tap  * 7 2
3. Enter the area code and phone number to which you want your calls forwarded.
4. Tap .

❖ You will hear a tone to confirm the activation of Call Forwarding. All calls to your wireless number will be forwarded to the designated phone number.

To deactivate Call Forwarding:

1. From home, tap **Phone**  > .
2. Tap  * 7 2 0
3. Tap .

❖ You will hear a tone to confirm the deactivation.

Call Settings

Your phone's Call Settings menu lets you configure your voicemail options and a number of other settings for the phone application.

Call Settings Options

Use the Call Settings menu to adjust the following settings:

Setting	Description
Contact display options	Set up the way contacts are displayed and sorted in the contacts list in the Phone app.

Setting	Description
Sounds and vibrate	Set up the default ringtone for incoming calls and enable/disable vibration or keypad tones.
Quick responses	Edit the text messages that you can quickly send to rejected callers.
Phone account settings	Manage Internet calling accounts and set Internet calling options.
Voicemail	Adjust your voicemail settings.
TTY mode	Select a TTY mode for your phone to work with a teletypewriter.
Hearing aids	Turn on or off hearing aids compatibility.
Noise reduction	Reduce background noise during calls.
Speed dial	Set speed dialing keys.
DTMF tones	Set the length of Dual-Tone Multi-Frequency signal tones.
Call ended operation tips	Get operation tips when you end a call.
Voice privacy	Use enhanced privacy mode.
Plus code dialing setting	Enable plus code dialing and set international dialing code.

Contacts







The Contacts application lets you store and manage contacts from a variety of sources, including contacts you enter and save directly in your phone as well as contacts synchronized with your Google Account, your PC, compatible email programs (including Exchange Server), and your Facebook friends.

Contacts Cautions

Information saved in Contacts may be lost or changed if the battery is removed for a long period or left uncharged. Accident or malfunction may also cause loss or change to information. It is recommended that you keep a separate copy of contacts and other important information. Boost Mobile is not responsible for any damages from lost or changed contacts.

Add a Contact

You can add contacts from your phone's Phone application. Enter details such as name, phone numbers, email addresses, mailing addresses, and more.

1. From home, tap **Apps**  > **Contacts** .
-  You will see the Contacts list.
2. Tap  to add a contact.
-  The Add Contact screen appears.
3. If you have multiple account types associated with your phone, select a contact type.
 - Select **Google** if you want to save contacts to your Google Account; these will be synced automatically with your Google Account online.
 - Select **Phone-only, unsynced contact** as the sync account if you want your contacts on your phone only; they will not be synced with your Google Account.
4. Use the keyboard to enter as much information as you want.
 - Contact photo: Tap  to assign a picture to the contact.
 - Name
 - Phone
 - Email
 - Address
 - Ringtone
 - Notification ringtone

- Special dates
- Groups
- Add another field: Tap **ADD ANOTHER FIELD** to include additional information such as IM address, Notes, Nickname, Website, etc.

Note: To select a type (label) for a phone number, email address, or postal address (such as Mobile, Home, Work, etc.), tap the type to the left of the field and select the appropriate type.



Note: To add more phone numbers, email addresses, etc., tap  on the right side of the entry field.

5. When you have finished adding information, tap  on the top left.

 The contact is added.



Save a Phone Number

You can save a phone number to Contacts directly from the phone keypad.

1. From home, tap **Phone**  > .
2. Enter a phone number and tap **Add to contacts**.

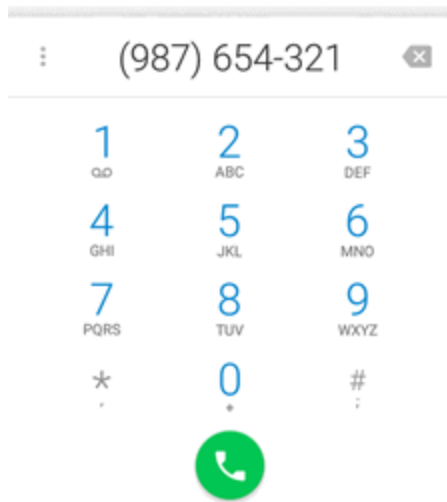
 Add to contacts



- To add the number to an existing contact, scroll the contact list and tap the contact. To add a new contact, tap  .
 - For an existing contact, tap the contact name and select a number type for the new number.
 - For a new contact, enter the name and any additional information.
- Tap  .
 -  The contact is added.

View Contacts

View a contact's details by displaying a contact entry.

1. From home, tap **Apps**  > **Contacts** .

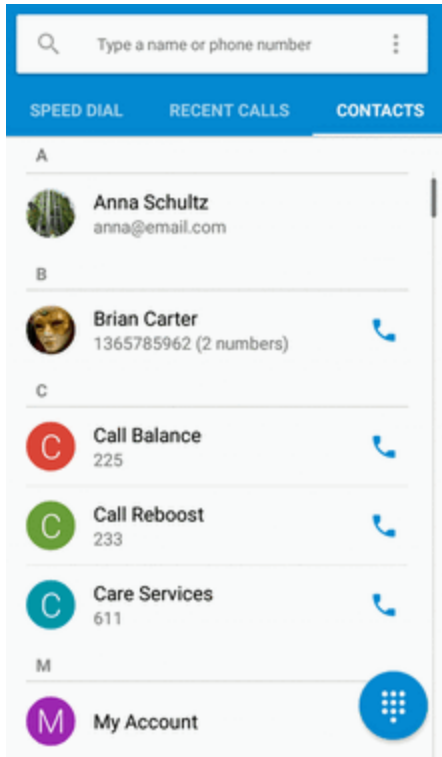

❖ You will see the Contacts list.

2. Tap a contact to view its details.

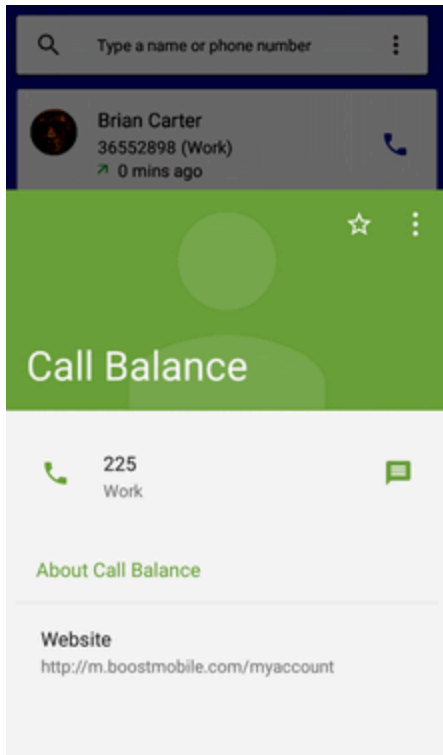

❖ The contact's detailed listing appears.

Contacts Screen Layout

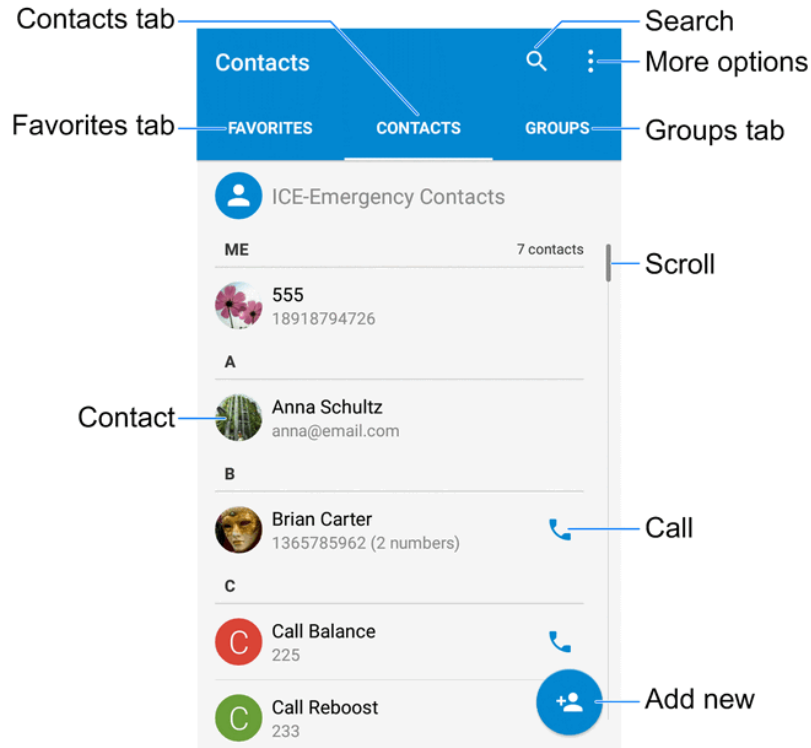

The following illustration show's your Contacts app layout and describes the various features.



Item	Description
Groups tab	Show contact groups.
Favorites tab	Show favorite contacts.
Contacts tab	Show all contacts.
Contact	Tap to show contact's details.
Scroll	Scroll the contacts list by letter.
Call	Place a call to the contact.
Add new	Add a new contact.
Search	Search contacts.
More options	Get more contacts options.

Edit a Contact



Once you've added a contact, you can add or edit any of the information in the entry, assign a caller ID picture, customize with a unique ringtone, and more.

1. From home, tap **Apps**  > **Contacts** .
- ❖ You will see the Contacts list.

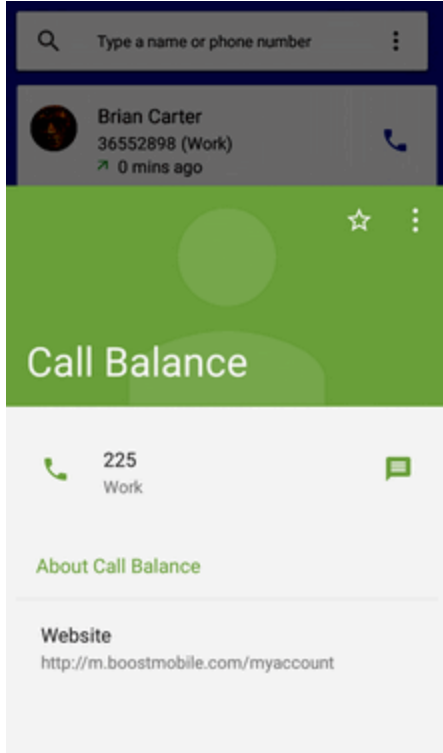
2. Tap a contact to view its details.



- ❖ The contact's detailed listing appears.

3. Tap **Edit** .
4. Tap any field you want to change or add. See [Add a Contact](#).
5. Add or edit the information, and then tap .

- ❖ Your changes are saved to the contact entry.

Note: To select a type (label) for a phone number, email address, or postal address (such as Mobile, Home, Work, etc.), tap the type to the left of the field.

Note: To add more phone numbers, email addresses, etc., tap **Add new** below the entry field.

Delete a Contact

You can delete a contact from the contacts details page.

1. From home, tap **Apps**  > **Contacts** .

- ❖ You will see the Contacts list.

2. Tap a contact to view its details.

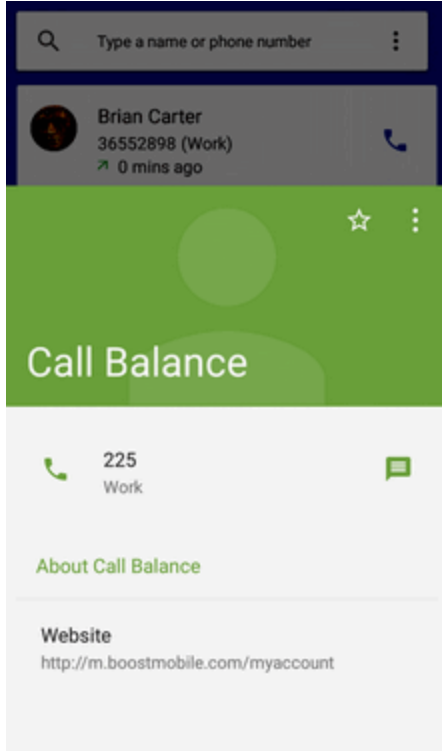

- ❖ The contact's detailed listing appears.

3. Tap **Menu**  > **Delete**.

4. Tap **OK**.

- ❖ The contact is deleted.

Tip: You can also touch and hold the contact from the contact list and then tap  > **OK**.

Share a Contact

You can quickly share contacts using Bluetooth, email, Gmail, or text messaging.

1. From home, tap **Apps**  > **Contacts** .

- ❖ You will see the Contacts list.





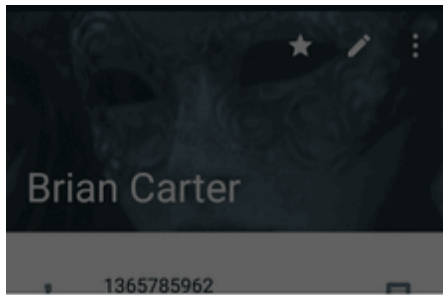

2. Tap a contact to display it, and then tap **Menu**  > **Share**.



- ❖ You will see the Share contact via menu. Scroll up to see all the options.

3. In the **Share contact via** menu, select a method:



Share contact via

-  Messaging
-  Bluetooth
-  Drive
-  Email
-  Gmail
-  WiFi Direct

- **Messaging** to send the information in a multimedia message. Select a contact or enter a wireless phone number or email address, enter any additional information, and then tap  or **SEND**. For more information on messaging, see [Send a Multimedia Message \(MMS\)](#).
- **Bluetooth** to send the information via Bluetooth. See [Bluetooth](#) for information on pairing and sending via Bluetooth.
- **Drive** to upload the information as vCard file to Google Drive.
- **Email/Gmail** to send the information as an attachment. Address the message, add a subject and a message, and then tap . See [Compose and Send Email](#) and [Create and Send a Gmail Message](#) for details.
- **WiFi Direct** to send the information via Wi-Fi Direct. See [Wi-Fi Direct](#) for information on pairing and sending via Wi-Fi Direct.

4. Complete the required steps as prompted for the selected method.

- ❖ The selected contact will be shared.

Import Contacts

Your phone offers a couple of options for importing contacts from installed SD memory cards or external devices via USB.

Before Importing Contacts from an SD Card

You will need to have installed an SD card with previously backed up contacts information into your phone before you can import contacts. See [SD Card](#) for SD card information.

Import Contacts from an SD Card or USB Storage

1. From home, tap **Apps**  > **Contacts** .

❖ You will see the Contacts list.

2. Tap **Menu**  > **Import/Export**.

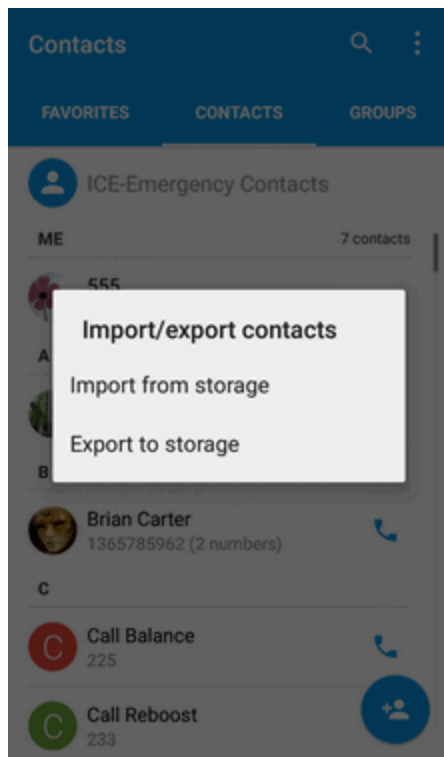

❖ You will see the Import/Export contacts menu.

3. Tap **Import from storage**.
4. Select an account for the imported contacts.
5. Follow the onscreen instructions to complete the import.

❖ The contacts are imported and stored in the selected account.



Back Up Contacts

If you are saving contacts to an account that does not automatically back them up via the Cloud, you can manually back them up to an optional installed SD Card for re-import if needed.

Before Backing Up Contacts to an SD Card

You will need to have installed an SD card with previously backed up contacts information into your phone before you can back up your contacts. See [SD Card](#) for SD card information.

Back Up Contacts to Your SD Card

1. From home, tap **Apps**  > **Contacts** .
- ❖ You will see the Contacts list.
2. Tap **Menu**  > **Import/Export**.

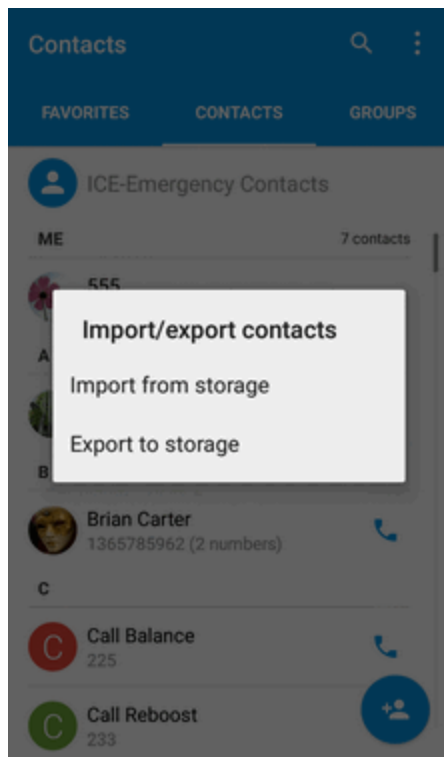

- ❖ You will see the Import/Export contacts menu.
3. Tap **Export to storage**.
4. The phone will prompt you with the name and the directory of the vCard file. Tap **OK** to create the file.
- ❖ The contacts are exported and saved to the installed SD card or the phone storage.

Messaging and Internet

With wireless service and your phone's messaging and data capabilities, you have the opportunity to share information through many different channels and accounts, including Gmail (Google), personal and corporate email, text and multimedia messaging, social networking accounts, and Hangouts.

Text and Multimedia Messaging





With text messaging (SMS), you can send and receive instant text messages between your wireless phone and another messaging-ready phone.

Multimedia messages, or MMS, can contain text and pictures, recorded voice, audio or video files, picture slideshows, contact cards (vCard), or appointments (vCalendar).

See your service plan for applicable charges for messaging.

Send a Text Message

Quickly compose and send text messages on your phone.

1. From home, tap **Apps**  > **Messages** .
2. On the Messaging screen, tap .
 - ❖ The New message screen opens.
3. Fill in one or more recipients. You can:
 - Enter phone numbers directly in the **To** field. If you're sending the message to several phone numbers, tap **Next** or the return key on the keyboard after entering each number. As you enter information, any matching phone numbers from your contacts list are displayed. Tap a match to enter that number or address directly.
 - Tap the  icon, and then select the contacts to whom you want to send the message. You can also select from call log, favorite contacts, or contact groups as recipients. When you have selected all the message recipients, tap **OK**.
 - Enter the first few letters of the recipient's name to display a matching list of names from your stored contacts. Tap a match to add the recipient.

4. Tap the “Type message” box and then start composing your message.

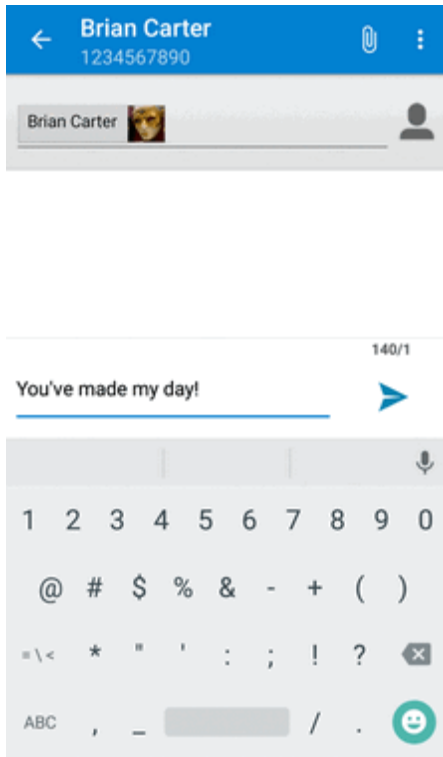





Note: A counter appears above the **Send** button (➤) to tell you how many characters you have entered and how many characters are left. Once you go over the 160-character limit, a new message is created but automatically joined into one when received.

5. When done, tap **Send** ➤ to send the text message.



Send a Multimedia Message (MMS)

When you need to add a little more to a text message, you can send a multimedia message (MMS) with pictures, voice recordings, audio or video files, contact cards (vCard), or appointments (vCalendar).

1. From home, tap  > **Messages** .
2. On the Messaging screen, tap . The New message screen opens.
 - Enter phone numbers directly in the To field. If you're sending the message to several phone numbers, tap **Next** or the return key on the keyboard after entering each number. As you enter information, any matching phone numbers from your contacts list are displayed. Tap a match to enter that number or address directly.

- Tap the  icon, and then select the contacts to whom you want to send the message. You can also select from call log, favorite contacts, or contact groups as recipients. When you have selected all the message recipients, tap **OK**.
- Enter the first few letters of the recipient's name to display a matching list of names from your stored contacts. Tap a match to add the recipient.

Note: You can add a subject line by tapping **Menu**  > **Add subject**.

3. Tap the "Type message" box, and then start composing your message.
4. Tap .
5. In the Attach window, select from the following file attachments:
 - **Picture:** Select a picture to attach to your MMS.
 - **Capture picture:** Open the camera and take a photo to attach to your MMS.
 - **Video:** Select a video clip to attach to your MMS.
 - **Capture video:** Open the camcorder and shoot a video clip to attach to your MMS.
 - **Audio:** Select an audio file to attach to your MMS.
 - **Record audio:** Open Sound Recorder and record an audio file to attach to your MMS.
 - **Slideshow:** See "Create a Slideshow" for details.
 - **Files:** Open File Manager and select a file to attach to your MMS.
 - **Insert contacts:** Select a contact entry and add it to your MMS as a vCard attachment.
6. To make changes to your attachment, tap **REPLACE** or **REMOVE**.
7. Tap **Send**  to send the MMS message.













Create a Slideshow

In a multimedia message, you can add slides, each containing a picture, video, or audio.

1. In the multimedia message you're composing, tap  > **Slideshow**.
2. On the Edit slideshow screen, tap **Slide 1**.

Note: You can tap **Add slide** to add more slides.

3. To compose your slideshow, do any of the following:

- **Add a picture:** Tap **ADD PICTURE**,  > **Add picture** or **Capture picture**.
- **Add a video:** Tap **Menu**  > **Add video** or **Capture video**. (You cannot add both a picture and a video on the same slide.)
- **Add music or a voice recording:** Tap **Menu**  > **Add music** and then tap **Audio** or **Record audio**.
- **Add a caption:** Tap the “Type message, or leave blank” box.
- **Add some preset text:** Tap **Menu**  > **Quick Text**.
- **Insert a smiley to the caption:** Tap **Menu**  > **Insert smiley**.
- **Set text layout:** Tap **Menu**  > **Layout**.
- **Preview your slide:** Tap **Menu**  > **Preview**.
- **Remove the caption on the slide:** Tap **Menu**  > **Remove text**.
- **Set duration for a slide:** Tap **Menu**  > **Duration**.
- **Add a new slide:** Tap **Menu**  > **Add slide**.
- **View the next or previous slide:** Tap  or .





4. When you have finished composing the multimedia message, tap **SEND**.

Tip: To compose a slideshow, you can also simply attach multiple items separately to the MMS message. Tap  and select a file type, location, and file and then repeat it for additional slides. Your phone will automatically compile a slideshow.

Save and Resume a Draft Message



While composing a text or multimedia message, tap **Back key**  to automatically save your message as a draft.

To resume composing the message:

1. From home, tap  > **Messages** .
2. On the Messaging screen, the draft messages are marked with a red word "Draft" next to them. You can also tap **Menu**  > **Drafts** to view them.
3. Tap the message to resume editing it.
4. When you finish editing the message, tap .

New Messages Notification

Depending on your notification settings, the phone will play a ringtone, vibrate, or display the message briefly in the status bar when you receive a new text or multimedia message. To change the notification for new text and multimedia messages, see [Text and MMS Options](#) for details.

A new message icon () also appears in the notifications area of the status bar to notify you of a new text or multimedia message. The Messages application icon (if shown on the home screen) also displays the number of new messages .

- To open the message, pull down the status bar to open the notification panel. Tap the new message to open and read it. For information on reading and replying to messages see [Manage Message Conversations](#).

Manage Message Conversations

Text and multimedia messages that are sent to and received from a contact (or a number) are grouped into conversations or message threads in the Messaging screen. Text or MMS conversations let you see exchanged messages (similar to a chat program) with a contact on the screen.

Read a Text Message

- Do one of the following:
 - On the Messaging screen, tap the text message or conversation to open and read it.
 - If you have a new message notification, pull down the status bar to open the notification panel. Tap the new message to open and read it.



To return to the Messaging screen from a conversation, tap the **Back key**.

Note: To view the details of a particular message, in the conversation, touch and hold the message to open the options menu, and then tap **View message details**.

Note: If a message contains a link to a Web page, tap the message and then tap the link to open it in the Web browser.

Note: If a message contains a phone number, tap the message and then tap the phone number to dial the number or add it to your contacts.

View a Multimedia Message (MMS)



1. From home, tap  > **Messages** .
2. On the Messaging screen, tap a multimedia message or conversation to open it.
3. Tap the attachment to open it.



- If the attachment is a vCard contact, it is imported to your phone's contacts list. For more information, see [Contacts](#).
 - If the attachment is a vCalendar file, you can choose the calendar where you want to save the event. For information on using Calendar, see [Calendar](#).
4. To save the attachment to device memory or an SD card, touch and hold the sender's name or number, and then tap **Save** on the options menu.

Note: When Auto-retrieve in MMS settings is disabled, only the message header is downloaded. To download the entire message, tap the **Download** button at the right side of the message. For details, see [Text and MMS Options](#).

Note: If you are concerned about the size of your data downloads, check the multimedia message size before you download it.



Reply to a Message

1. From home, tap  > **Messages** .
2. On the Messaging screen, tap a conversation to open it.
3. Tap the text box at the bottom of the screen, enter your reply message, and then tap .



Note: To reply to a text message with a multimedia message, open the text message, tap  or **Menu**  > **Add subject**. The text message is automatically converted into a multimedia message.

Protect (Lock) a Message

You can lock a message so that it will not be deleted even if you delete the other messages in the conversation.

1. From home, tap  > **Messages** .
2. On the Messaging screen, tap a conversation.
3. Touch and hold the message that you want to lock.
4. Tap **Lock** on the options menu. A lock icon is displayed at the right hand side of the message.

Delete Conversations

1. From home, tap  > **Messages** .
2. On the Messaging screen, tap the conversation that you want to delete.
3. Tap **Menu**  > **Delete thread**.

4. When prompted to confirm, tap **OK**. Any locked messages in the thread will not be deleted unless you select the **Delete locked messages** check box.

Delete a Single Message



1. While viewing a conversation, touch and hold the message that you want to delete.
 - If the message is locked, tap **Unlock** on the options menu and hold the message to display the options menu again.
2. Tap **Delete** on the options menu.
3. When prompted to confirm, tap **OK**.

View Contact Information from a Message

When you have received a message from someone in your stored contacts, you can tap the contact's picture or icon in the conversation to open a menu of options. Depending on the stored contact information, you can view the contact details, place a phone call or send an email message to the contact, and more.

Text and MMS Options

The messages settings menu lets you control options for your text and MMS messages including message limits, size settings, and notifications.

1. From home, tap  > **Messages** .
2. On the Messaging screen, tap **Menu**  > **Settings**. You can set the following:

SMS Enabled

- Change your default app for SMS and MMS. Tap **Default SMS app** and select **Hangouts** or **Messaging**.

Storage Settings

- **Delete old messages**: Automatically delete older messages, except for locked messages, when the set limits are reached.
- **Text message limit**: Choose the maximum number of text messages to store in each conversation.
- **Multimedia message limit**: Choose the maximum number of MMS messages to store in each conversation.

Text (SMS) Message Settings

- **SMS Reassembly**: Automatically reassemble segmented long SMS.

Multimedia (MMS) Message Settings

- **Auto-retrieve:** Select this option to automatically retrieve all your multimedia messages completely. When selected, the multimedia message header plus the message body and attachments will automatically download to your phone. If you clear this check box, only the multimedia message header will be retrieved and shown in your Messaging screen.
- **Group messaging:** Use MMS to send a single message when there are multiple recipients.
- **Roaming auto-retrieve:** Automatically retrieve messages while roaming.

Display Settings

- **Bubble and background:** Choose the pattern of the dialog balloons and background displayed in every conversation.

Notification Settings

- **Notifications:** Select this option if you want to receive a notification in the status bar when a new text or multimedia message arrives.
- **Select ringtone:** Select a ringtone that is specific to new text and multimedia messages. Note that the ringtone briefly plays when selected.
- **Vibrate:** Select this option if you want the phone to vibrate when a new text or multimedia message arrives.

Signature Settings

- **Edit signature:** Edit the signature for outgoing messages.
- **Add signature:** Select this option if you want to attach the signature to all outgoing messages.

WAP Push Switch

- **Enable wap push receiving:** Check this option if you want to receive WAP push messages.

Emergency Alerts

- **Receive emergency alerts:** Tap this option and check the threat levels that you want to receive alerts for.

Gmail

Use Google's Gmail service and your Google Account to send, receive, and manage your Gmail messages. Before using Gmail, you must register a Google (Gmail) Account on your phone. See [Google Account](#) for details.

Gmail Cautions

Gmail is handled as email from a PC. Restricting email from PCs on your phone prevents your phone from receiving Gmail.

Create and Send a Gmail Message

Use your phone to create and send Gmail messages.

1. From home, tap **Apps**  > **Gmail** . If prompted, tap **TAKE ME TO GMAIL**.

❖ The Gmail inbox opens.

2. In the inbox, tap **Compose** .

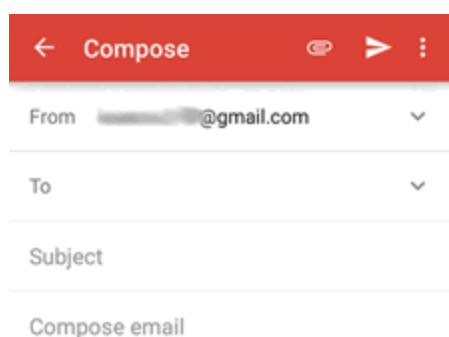

❖ The Gmail composition window opens.

3. Enter the message recipient(s), subject, and message, and then tap **Send** .



❖ The Gmail message is sent.

Gmail Composition Options

- **Adding Cc/Bcc:** In the mail composition window, tap  on the "To" line, and then add recipients.
- **Attaching Pictures or Videos:** In the mail composition window, tap  > **Attach file** or **Insert from Drive**. Locate and then tap the picture or video you want to attach.
- **Save as a Draft (Send Later):** While composing your message, tap **Menu**  > **Save draft**.

The message is saved as a draft for later.

- **Delete Mail Being Composed:** In the mail composition window, tap **Menu**  > **Discard** > **DISCARD**.



Note: To view your draft email messages, at the top left of the inbox, tap  > **Drafts**.

Note: To view your sent messages, at the top left of the inbox, tap  > **Sent**.

Check Received Gmail Messages

Your phone allows you to access, read, and reply to all your Gmail messages.



Open New Gmail Messages

When new Gmail arrives, you will see  /  in the status bar.





1. Pull down the status bar to display the notification panel.
2. Tap the new message from the notification panel.
 - ❖ The new Gmail message opens.
 - If you have two or more new Gmail messages, tapping the notification opens the Gmail inbox.

Open Gmail Messages

You can also read and reply to all your Gmail messages from the Gmail inbox.

1. From home, tap **Apps**  > **Gmail** .
- ❖ The Gmail inbox opens.
2. Tap the message thread you want to view.
 - ❖ The message thread opens, with the newest message displayed.

Options when Reviewing Gmail Messages

- **Replying to Gmail Messages:** With the Gmail message open, tap **Reply** , compose your reply message, and tap **Send** .
- To reply to all, tap **Options**  > **Reply all**.
- **Forwarding Gmail Messages:** With the Gmail message open, tap **Options**  > **Forward**, enter a recipient and an additional message, and tap **Send** .

Use Gmail Labels

Gmail saves all mail in one box, but you can add labels that allow you to sort your Gmail conversation threads. For example, when a new thread starts with a received mail, the label "Inbox" is automatically added to the thread. By then adding the label "travel," all threads with "travel" are shown in a list.

1. From home, tap **Apps**  > **Gmail** .

❖ The inbox opens.

2. Touch and hold a conversation thread to add a checkmark to it, and then tap **Options**  > **Move to**.

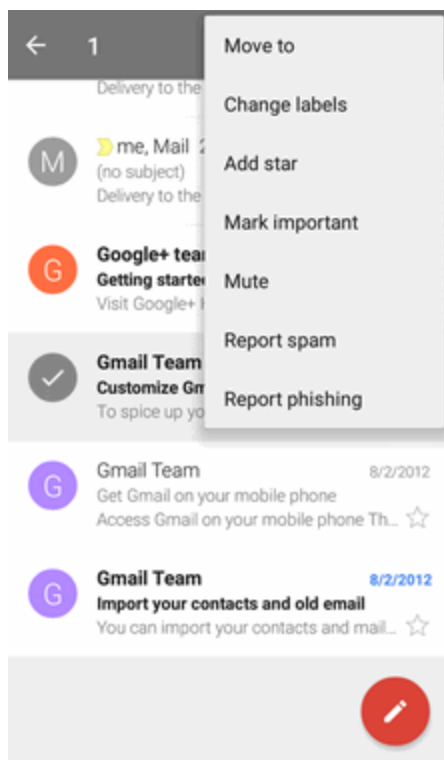

3. Tap a label for the thread.

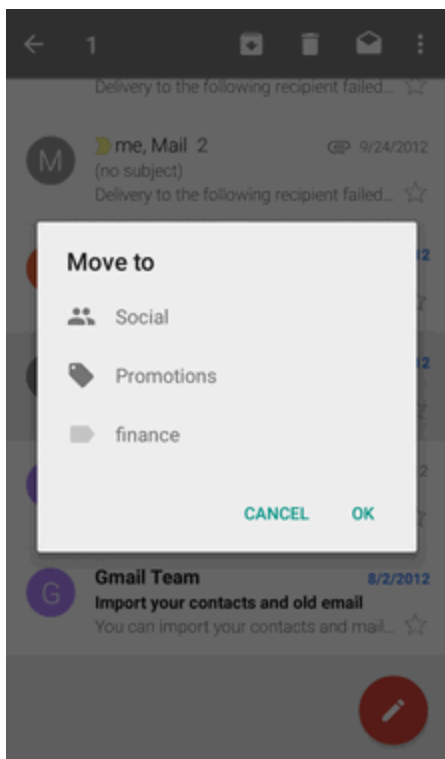

- ❖ The thread is added to the selected label.

Archive Gmail Threads

Remove sent and received Gmail threads so they do not appear in the inbox. When replies arrive for archived threads, they appear in the inbox again.

1. From home, tap **Apps**  > **Gmail** .

- ❖ The inbox opens.

2. Swipe a conversation thread from left to right or from right to left out of the list.

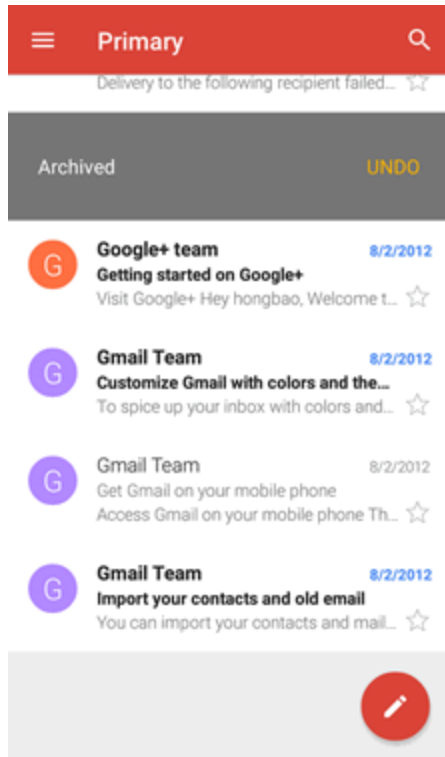

- ❖ The thread is now archived.

Mute Gmail Threads

If registered on a mailing list, there will be threads with always-continuing conversations. For long threads that are not important, mute the threads and they will no longer appear in the inbox. When mail arrives that includes user's address as a recipient or in Cc, mail will again appear in the inbox.

1. From home, tap **Apps**  > **Gmail** .

- ❖ The inbox opens.

2. Touch and hold a conversation thread to add a checkmark to it, and then tap **Options**  > **Mute**.

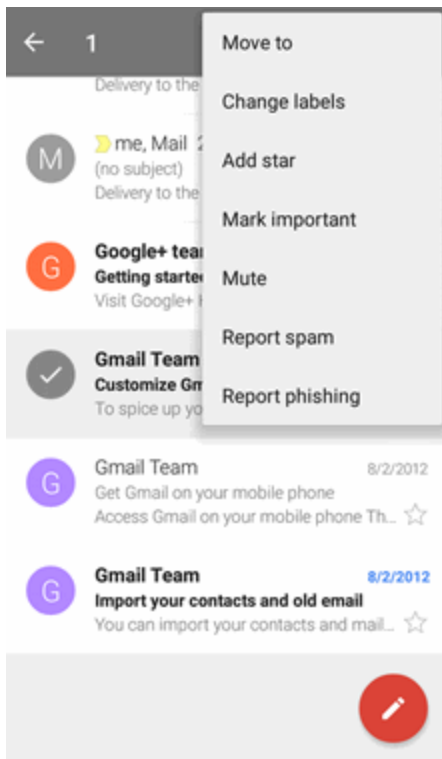

- ❖ The thread is now hidden.

Delete Gmail Threads

If you no longer wish to keep a Gmail conversation thread, you can simply delete it from the inbox.

1. From home, tap **Apps**  > **Gmail** .

- ❖ The inbox opens.

2. Touch and hold a conversation thread to add a checkmark to it, and then tap .

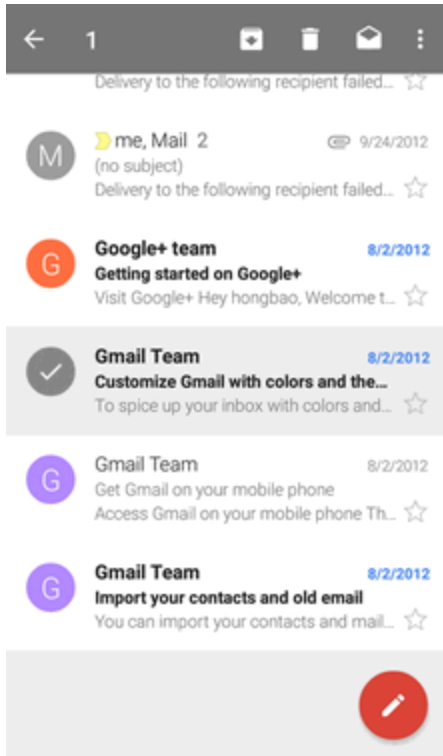

- ❖ The thread is deleted.

Search Gmail Messages

If you need to find a specific message or message thread, you can search Gmail from the inbox.

1. From home, tap **Apps**  > **Gmail** .

- ❖ The inbox opens.

2. Tap .

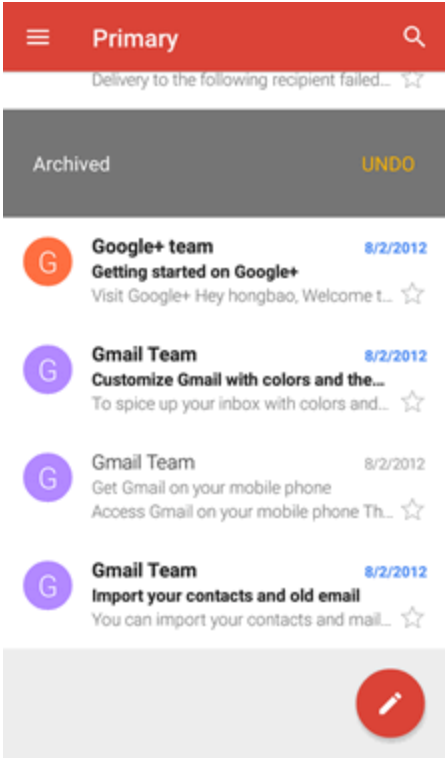

3. Enter your search text and tap the search key on the keyboard.

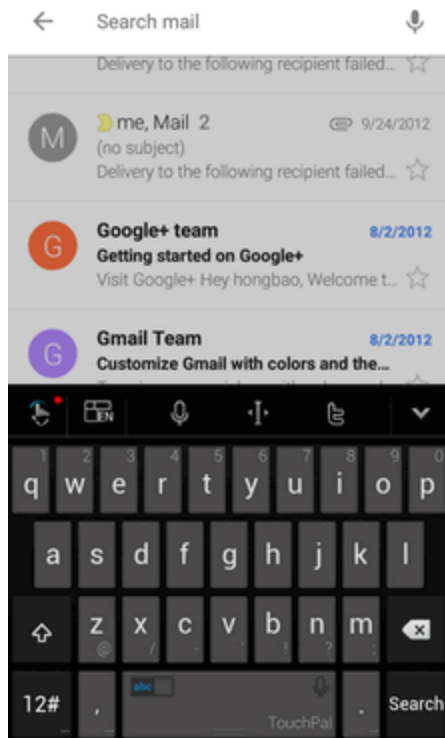

- ❖ The search results appear. Tap a message or thread from the list to display it.

Report Spam or Phishing Gmail

You can report spam or phishing Gmail messages from your phone's Gmail inbox.

1. From home, tap **Apps**  > **Gmail** .

- ❖ The inbox opens.

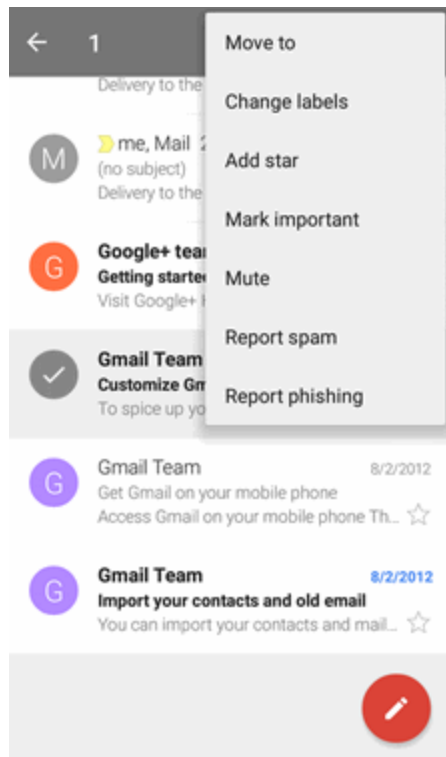

2. Touch and hold a conversation thread to add a checkmark to it, and then tap **Options**  > **Report spam** or **Report phishing**.



- ❖ The selected message is reported as spam or phishing Gmail.

Add Another Google (Gmail) Account

If you have multiple Gmail accounts you wish to view on your phone, you can add them from the **Settings > Accounts** menu.

1. From home, tap **Apps**  > **Settings**  > **Accounts > Add account**.
2. Enter your existing Google Account username or email, and then tap **NEXT**.

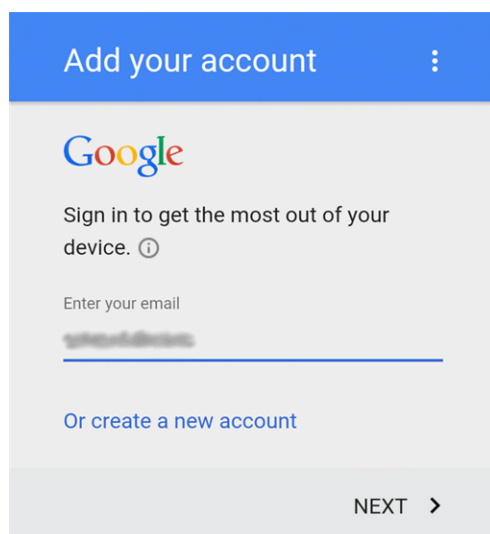

3. Enter your password, and then tap **NEXT >**.

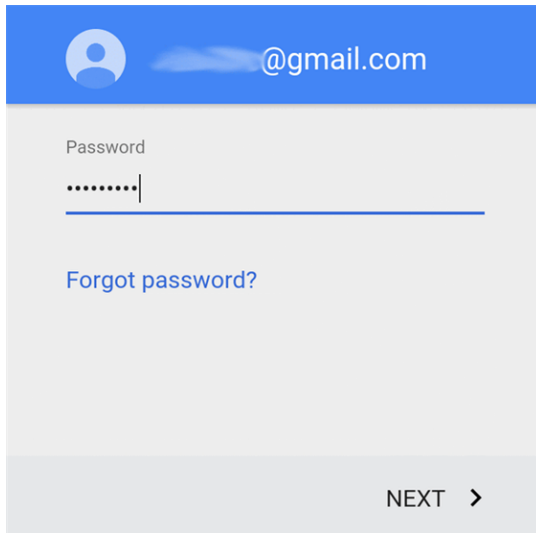

A screenshot of the Gmail sign-in interface. At the top, there is a blue header bar containing a profile icon and the text '@gmail.com'. Below the header, the word 'Password' is displayed above a text input field. The input field contains several dots and a vertical cursor. Below the input field is a blue link that says 'Forgot password?'. At the bottom of the screen, there is a light gray bar with the text 'NEXT >'.

4. After your phone connects with the Google servers, tap **ACCEPT** to agree to Google privacy policy and terms of service.

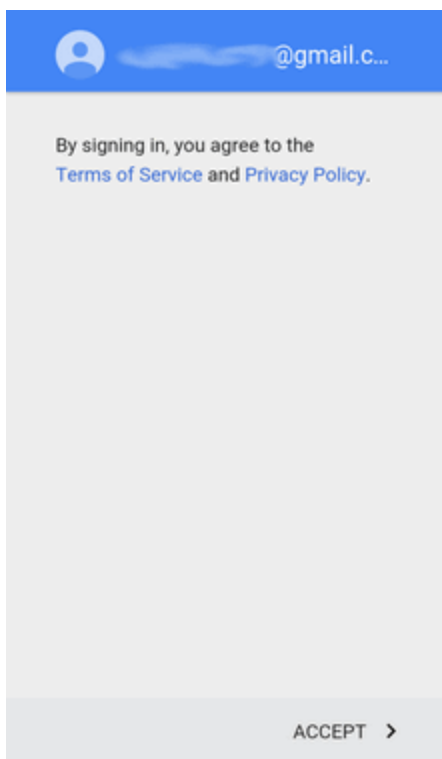

A screenshot of the Gmail sign-in interface showing a terms of service agreement. At the top, there is a blue header bar containing a profile icon and the text '@gmail.c...'. Below the header, the text 'By signing in, you agree to the Terms of Service and Privacy Policy.' is displayed. At the bottom of the screen, there is a light gray bar with the text 'ACCEPT >'.

5. On the Google services screen, select your Google service options and tap **NEXT**.

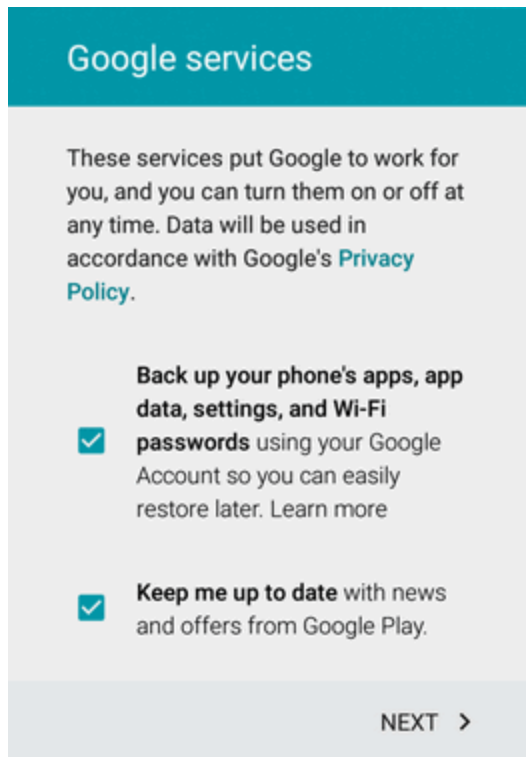

6. Select **Add credit or debit card** or **Redeem** and tap **NEXT >** to set up your billing or gift card information for purchasing apps, games, movies, and books in the Google Play Store app from your phone. You can also select **Remind me later** and tap **NEXT >**.

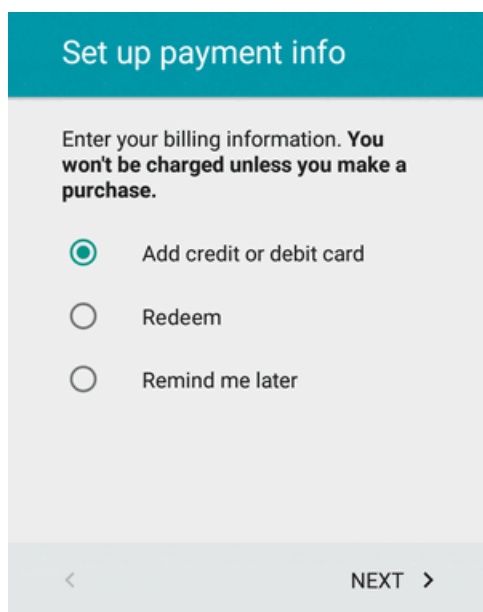

- ❖ You are signed in to your Google Account, and you can access both of your Gmail accounts from the Gmail app.

Switching between Gmail Accounts

If you have more than one Gmail account set up, you can switch between them in the Gmail app.

1. From home, tap **Apps**  > **Gmail** .

- ❖ The inbox opens.

2. Tap .

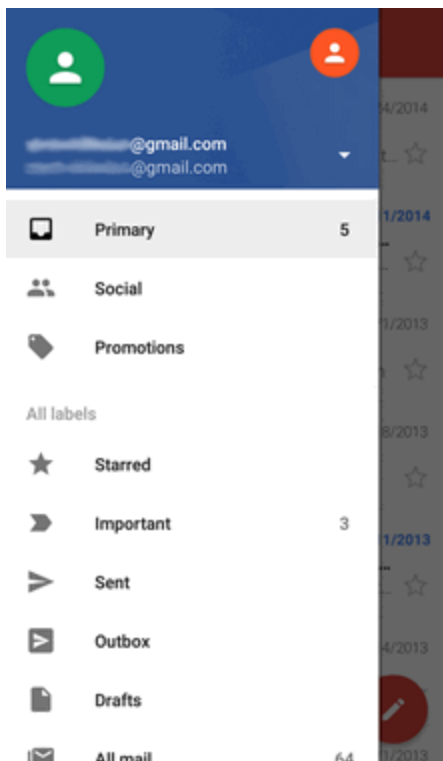

3. Tap the account you want to view from the list at the top of the menu.

- ❖ The selected account inbox is displayed.

Email

Use the Email application to send and receive email from your webmail or other accounts, using POP3 or IMAP, or access your Exchange ActiveSync account for your corporate email needs.

Set Up an Email Account

Your phone supports several types of email accounts and allows you to have multiple email accounts set up at one time.

Before setting up an email account, make sure you have the username (user ID), password, server name, etc., so you can get set up successfully.

1. From home, tap **Apps**  > **Email** .

- ❖ A popup window for adding an account appears if no email account has been previously set up.

2. Follow the onscreen instructions to set up your email account.

- ❖ The email account is set up and you will begin receiving email.

Add an Email Account

You can add several types of personal email accounts, such as POP3 and IMAP accounts, on your phone.

Add an Email Account from the Email App

You can add email accounts directly from the email app, even if you have another email account set up.

1. From home, tap **Apps**  > **Email** .

- ❖ The email inbox opens.

2. Tap **Menu**  > **Settings**.

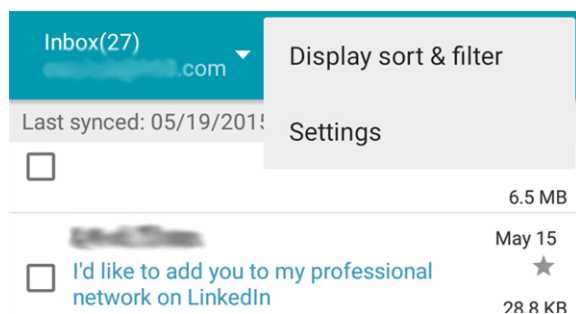

3. Tap **ADD ACCOUNT**.

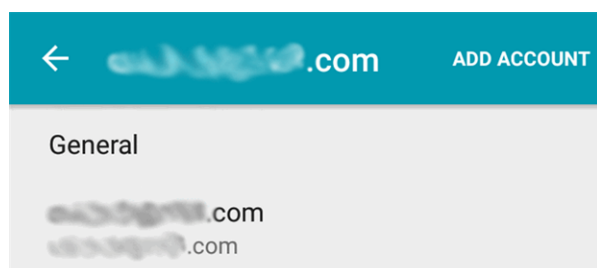



4. Follow the onscreen instructions to complete the account setup.

- ❖ The email account is added and you will begin receiving email for the account.

Add an Email Account from the Settings Menu

You can also set up email accounts from the **Settings > Accounts** menu.

1. From home, tap **Apps**  > **Settings**  > **Accounts > Add account > Email**.
2. Select an email server. Tap **Others** if the server you use is not listed.
3. Enter the **Email address** and **Password** for the email account and then tap **Next**.

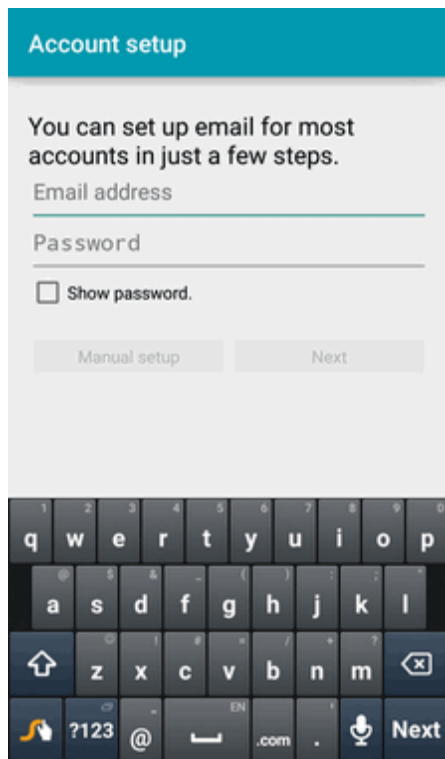

- ❖ Tapping **Next** prompts your phone to attempt a "regular" email setup and test the incoming and outgoing servers.
 - If you have custom settings you need to configure, tap **Manual setup** and enter your settings. These may include mail type, user name, password, server, security type, etc.

4. Select your sync settings and then tap **Next**.

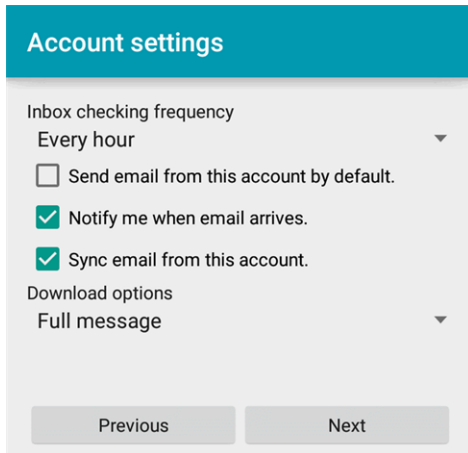

5. Enter an account name and a display name and tap **Next** to complete setup.

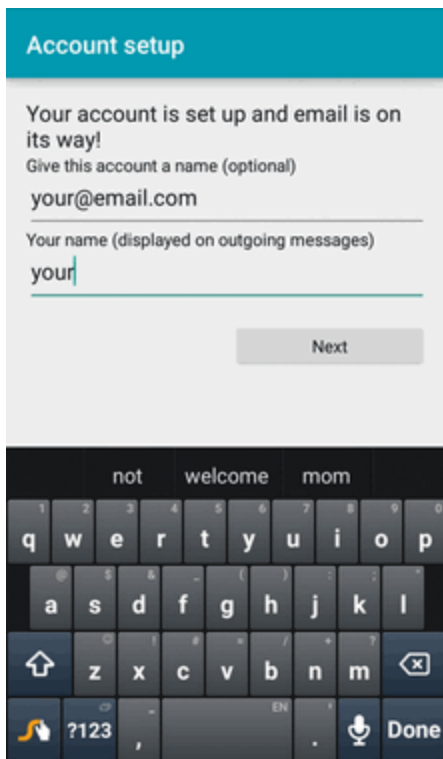



- ❖ The email account is set up and you will begin receiving email for the account.

Important: If the account type you want to set up is not in the phone database, you will be asked to enter more details. You should get all pertinent information for the email account, such as incoming and outgoing server settings, before you proceed.

Add an Exchange ActiveSync Account

If you synchronize your phone with your Exchange ActiveSync account, you can read, manage, and send email in the same easy way as with a POP3/IMAP account. However, you can also access some powerful Exchange features.

Important: Before setting up a Microsoft Exchange ActiveSync Account, contact your company's Exchange Server administrator for required account settings information.

1. From home, tap **Apps**  > **Settings**  > **Accounts** > **Add account** > **Corporate**.
2. Enter the **Email address** and **Password** for the email account and then tap **Manual setup**.

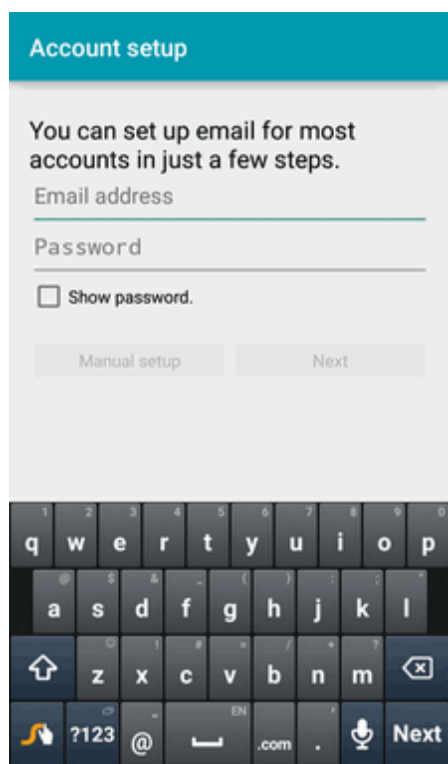

- ❖ Tapping **Next** prompts your phone to attempt an automatic setup and test the incoming and outgoing servers.
 - If the automatic setup fails, you need to enter your settings. These may include domain\username, password, server, security type, etc.
- 3. Follow the onscreen prompts to configure options for the account. Then tap **Next**.
- 4. Enter an account name and tap **Next** to complete setup.
 - ❖ Your corporate email account is set up and you will begin receiving email for the account.

Compose and Send Email

Compose and send email using any account you have set up on your phone. Increase your productivity by attaching files such as pictures, videos, or documents to your email messages.

1. From home, tap **Apps**  > **Email** .

❖ The email inbox opens.

- If you want to switch to a different email account, tap the account name at the top of the screen and select another account.

2. Tap **Compose** .

❖ The email composition window opens.

3. Enter the message recipient(s), subject and message.

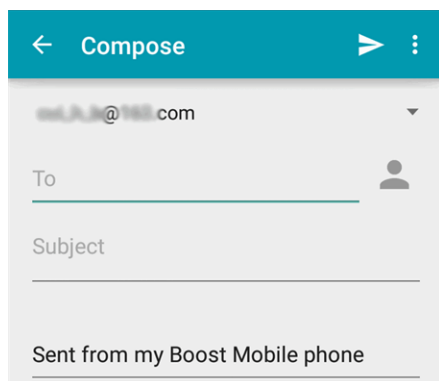

4. Tap .

❖ The email message is sent.

Open Email Messages

You can open and read email messages directly from the email inbox. Reading and replying to email on your phone is as simple as on your computer.

1. From home, tap **Apps**  > **Email** .

❖ The email inbox opens.







2. Tap the message you want to view.

❖ The email message opens.

Tip: Tap the account name at the top left of the screen to switch to a different email account.





3. Tap **Reply**  or **Reply all**  to reply to the message.

Options when Reviewing Email Messages

- **Resetting Message as Unread:** Tap the check box on the left side of a read message and then tap **Mark as unread** .
- **Deleting Email:** Tap the check box on the left side of a message or messages and then tap **Delete** .
- **Syncing Accounts Manually:** Sync sent and received email messages manually at any time regardless of the automatic sync settings. Switch to the account inbox you want to sync and then drag the message list downwards.
- **Replying to Email Messages:** With an email message open, tap **Reply**  or **Reply all** , compose your reply message, and tap **Send**.
- **Forwarding Email Messages:** With the email message open, tap **Forward** , enter a recipient and an additional message, and tap **Send** .

Delete an Email Account

You can delete an email account from your phone if you no longer wish to receive messages for the account on your phone.

1. From home, tap **Apps**  > **Email** .
 The email inbox opens.
2. Tap **Menu**  > **Settings**.

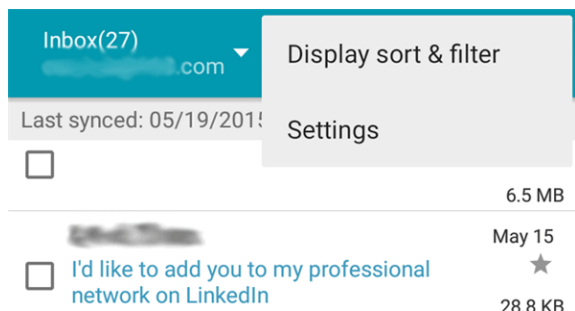

3. Tap the account you want to delete and scroll to the bottom of menu in the new screen.

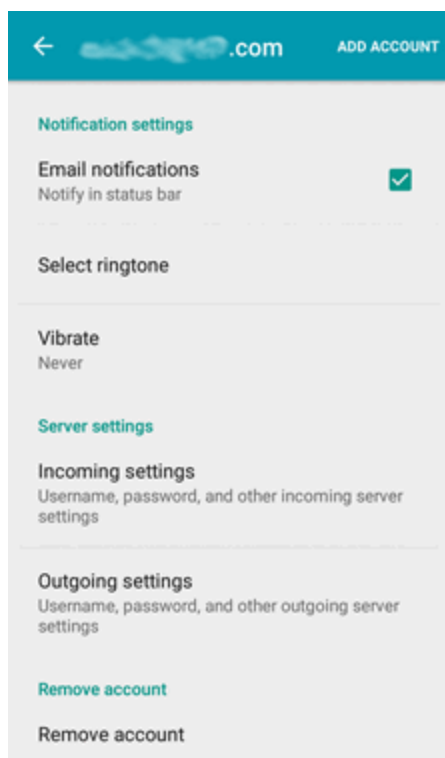

4. Tap **Remove account**.
5. Tap **OK** to confirm.

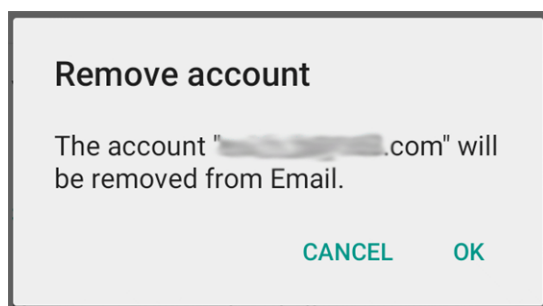

❖ The account is deleted from your phone

Manage Your Email Inbox

Your email inbox provides management options for viewing, sorting, and deleting your email messages.

View Your Email Inbox

1. From home, tap **Apps**  > **Email** .

❖ The email inbox opens.

2. Tap the email account at the top of the screen to select a different inbox, or tap **Combined view** to see all your email inboxes at once.

Refresh an Email Account

Whatever your automatic synchronization settings are, you can also synchronize your sent and received email messages manually at any time.

- While viewing the account you want to synchronize, drag the message list downwards.

Sort Email Messages

1. On the email account inbox, tap **Menu**  > **Display sort & filter**.
2. Tap the left drop-down menu at the top of the email list to sort email messages by date received, subject, sender, or size.

– or –

Tap the right drop-down menu to filter the inbox by priority, attachments, or read/unread status.

Delete an Email Message

1. On the email account inbox, touch and hold the message you want to delete.
2. At the bottom of the screen, tap **Delete**  > **OK**.

Delete Multiple Email Messages



1. On the email account inbox, tap the check box next to the messages you want to delete.
2. Tap **Delete**  > **OK**.

Exchange ActiveSync Email Features

Set options for your corporate Exchange ActiveSync email messages, including synchronization options, flagging messages, out-of-office messages, meeting requests, and message priority.

Synchronize Exchange ActiveSync Email



You can set Exchange ActiveSync to automatically check for new Exchange ActiveSync email messages.

1. From home, tap **Apps**  > **Email** .
2. Tap **Menu**  > **Settings**.
3. Tap the name of the Exchange ActiveSync account.

4. Tap **Inbox check frequency** and choose the option you want.

Flag Email Messages

For an Exchange ActiveSync account, you can flag email messages to help you keep track of them.



1. From home, tap **Apps**  > **Email** .
2. On the inbox screen, tap the message you want to view.

Tip: Tap your current email account at the top left to switch to a different email account.

3. Tap **Menu**  > **Toggle flag** and select a flag option (**Set flag**, **Complete flag**, or **Clear flag**).

Set Out of Office Status

You can set your Out of Office status and auto-reply message right from your phone.

1. From home, tap **Apps**  > **Email** .
2. Tap **Menu**  > **Settings** and tap the Exchange ActiveSync account name.
3. Tap **Out of Office**.
4. Check **Use out of office settings**.
5. Check **Send automatic replies during this time period** and set the time range when you will be out of the office.
6. Enter the auto-reply message for senders inside your organization. You can also choose to send a message to all senders outside your organization or senders in your contact list.
7. Tap **SAVE**.

Set Email Message Priority

You can set the priority for an email message you send with your Exchange ActiveSync account.

1. While composing the message, tap **Menu**  > **Show priority**.
 - ❖ A priority line appears below the email subject.
2. Select the priority for the message. You can select **High**, **Normal**, or **Low**.

Browser

Your phone's Chrome browser gives you full access to both mobile and traditional websites on the go, using 3G, 4G, or Wi-Fi data connections.

SSL/TLS

SSL (Secure Sockets Layer) and TLS (Transport Layer Security) are protocols for encrypting sent/received data. While in a screen connected by SSL/TLS, data is encrypted to safely send/receive private information, credit card numbers, corporate secrets, etc., and provide protection against online threats (eavesdropping, falsification, impersonation, etc.).

! SSL/TLS Cautions

When opening a secured page, users must decide as their responsibility whether or not to open the page with use of SSL/TLS. Boost Mobile and the applicable Certification Authorities make no guarantees whatsoever to users regarding security of SSL/TLS.

Use the Browser

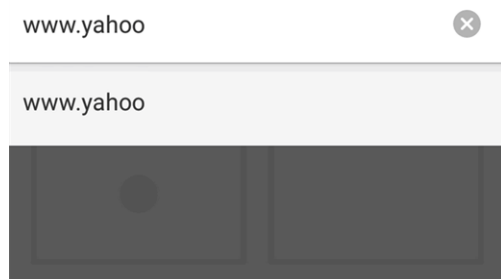

Launching the browser is as easy as tapping an icon.

1. From home, tap **Chrome**  .
 - ❖ The Chrome browser opens.
 - You can also launch the browser by tapping a URL in a text message, email message, or Gmail message.
2. Tap the address bar at the top and enter search words (for a Google search) or a Web address (URL).



- ❖ The search results appear or a Web page opens.

Browser Use Options

- **Refreshing the Web Page:** With the Web page displayed, tap **Menu** ⋮ > .
- **Going Forward to the Next Page:** Tap **Menu** ⋮ > .
- **Returning to the Last Page:** Tap the **Back key**.
- **Opening a New Browser Tab:** With at least one browser tab opened, tap **Menu** ⋮ > **New tab**.
- **Opening a New Incognito Browser Tab:** Tap **Menu** ⋮ > **New incognito tab**.

- **Switching Browser Tabs:** Tap the **Recent Apps key**. Opened browser tabs are displayed together with recently opened apps as a series of cards. Tap a card that corresponds to a browser tab to open the tab.
- **Viewing Recently Opened Tabs:** Tap **Menu** ⋮ > **Recent tabs**. Recently closed browser tabs are displayed. If you have signed in to your Google Account on the phone and other devices, you can also view Chrome browser tabs you have opened on those devices.
- **Viewing Browsing History:** Tap **Menu** ⋮ > **History**.
- **Sharing the Web Page URL:** Tap **Menu** ⋮ > **Share...** and select an app or service for sharing.
- **Printing the Web Page Wirelessly:** Tap **Menu** ⋮ > **Print....**
- **Searching within a Web Page:** With a Web page displayed, tap **Menu** ⋮ > **Find in page**, and enter your search text.
- **Adding a Shortcut of the Web Page to the home screen:** With the Web page displayed, tap **Menu** ⋮ > **Add to homescreen**. Edit the title of the shortcut and tap **ADD**.
- **Opening Desktop Sites:** If a mobile version of the Web site is loaded, you can tap **Menu** ⋮ and check **Request desktop site** to switch the desktop version of the Web site.

Add a Bookmark

Bookmark favorite sites using the browser menu options.

1. From home, tap **Chrome**  .
 - ❖ The browser opens.

2. Navigate to the Web page you want to bookmark, and tap **Menu** ⋮ > ☆.

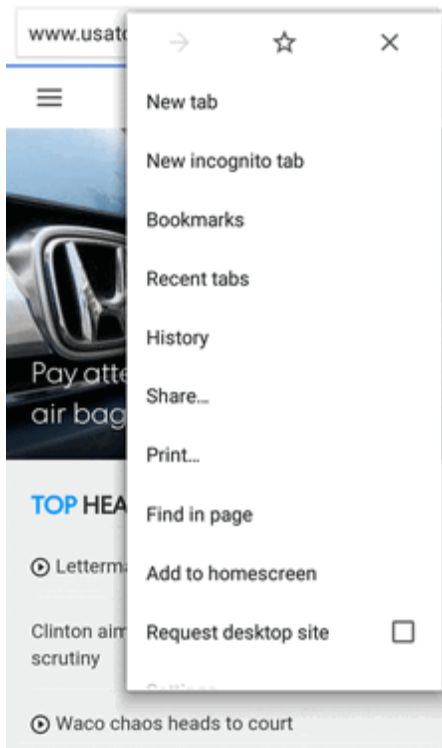

❖ The add bookmark window opens.

3. Check or change the bookmark name, URL, folder, and then tap **Save**.

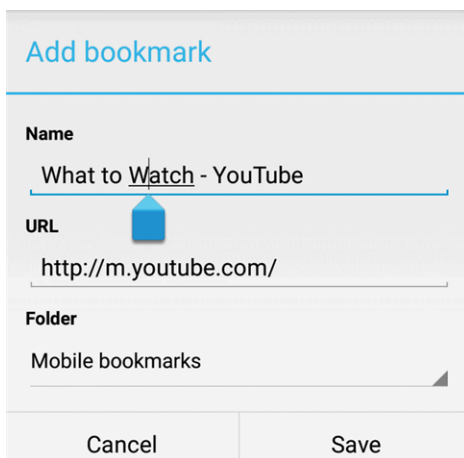

❖ The Web page is added to bookmarks.

Bookmark Options

- **Editing Bookmarks:** From the browser, tap **Menu** ⋮ > **Bookmarks**, touch and hold a bookmark, tap **Edit bookmark**, edit the bookmark, and then tap **Save**.
- **Deleting Bookmarks:** From the browser, tap **Menu** ⋮ > **Bookmarks**, touch and hold a bookmark, tap **Delete bookmark**.
- **Open the Bookmarked Web Page in a New Browser Tab:** From the browser, tap **Menu** ⋮ > **Bookmarks**, touch and hold a bookmark, tap **Open in new tab**.
- **Open the Bookmarked Web Page in an Incognito Browser Tab:** From the browser, tap **Menu** ⋮ > **Bookmarks**, touch and hold a bookmark, tap **Open in incognito tab**.

View Browser History

Use the browser menu options to view your browsing history.

1. From home, tap **Chrome** .
 - ❖ The browser opens.
2. Tap **Menu** ⋮ > **History**.

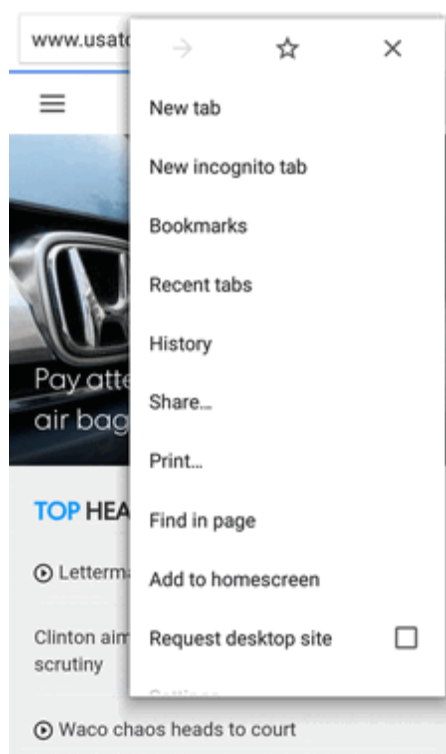

- ❖ The History window opens.

3. Tap the **History** tab and then tap an entry.

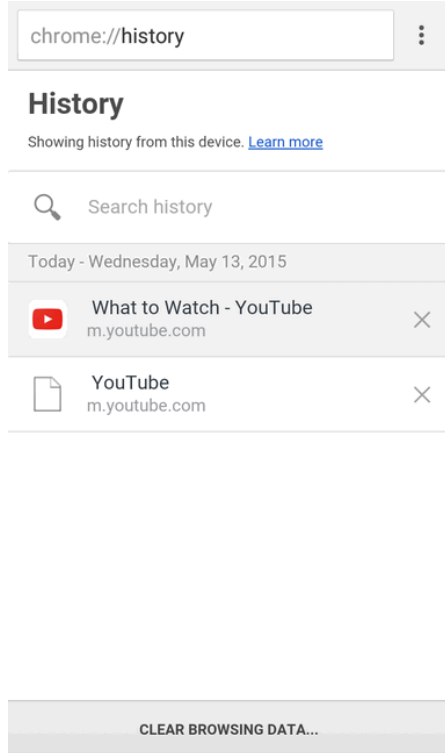

- ❖ The Web page opens.

Open New Browser Tabs

Use tabbed browsing to switch between websites quickly and easily.

1. From home, tap **Chrome** .

- ❖ The browser opens.

2. After you open a Web page, tap **Menu**  > **New tab**.

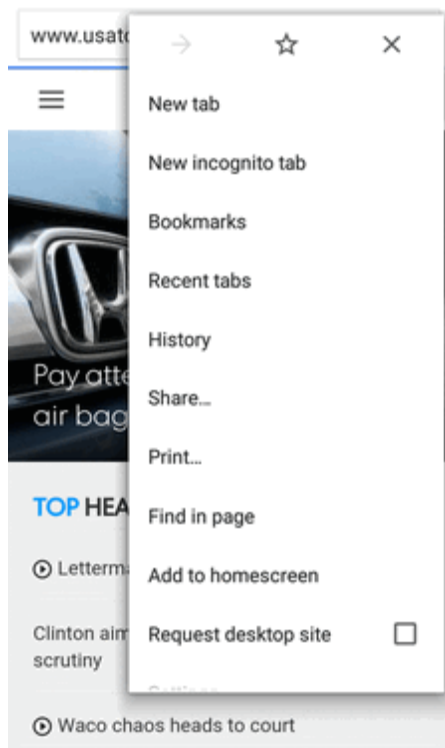

- ❖ A new tab appears.
 - To switch tabs, tap the **Recent Apps** key.

Browser Settings

Customize your experience with the Internet through the browser settings menu.

1. From home, tap **Chrome** .

- ❖ The browser opens.

2. Tap **Menu**  > **Settings**, and customize your Chrome browser settings.

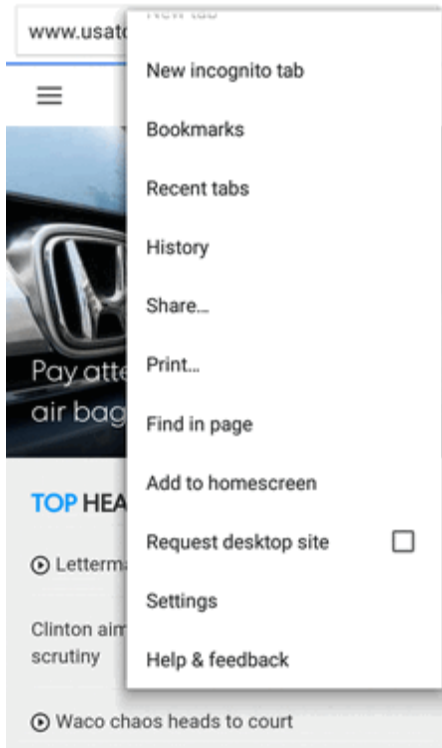

- ❖ Your browser settings are saved.

Get Chrome Support

Find on-phone help with Chrome if you want to learn more.

1. From home, tap **Chrome** .

- ❖ The browser opens.

2. Tap **Menu**  > **Help & feedback**.

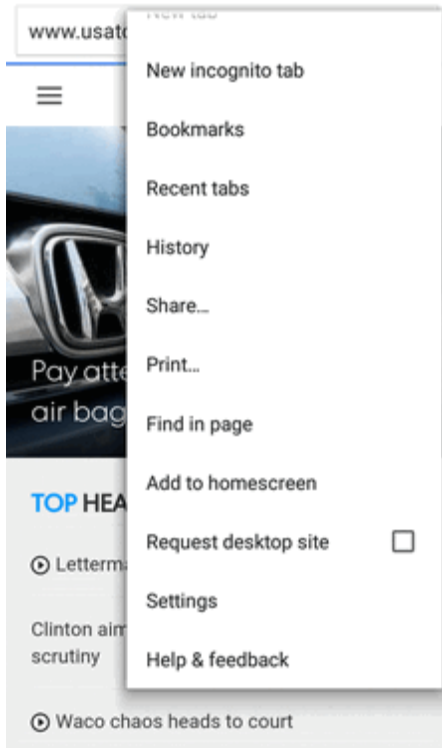

❖ A Web page will open displaying Google help for Chrome.

Tip: For more information, from your computer, visit: google.com/intl/en/chrome/browser/mobile/.

Camera and Video

You can use the camera or video camera to take and share pictures and videos. Your phone comes with a 13 megapixel back camera with an autofocus feature a front-facing camera that let you capture sharp pictures and videos.

Take Pictures and Record Videos

The following topics teach you how to take pictures and record videos with your phone's camera.

Capturing Pictures/Videos

- **File Format for Pictures:** File format for pictures is JPEG.
- **File Format for Videos:** File format for videos is MPEG4.

! Camera Cautions

If Lens Becomes Dirty: Fingerprints/smudges on lens prevent capturing of clear still images/videos. Wipe lens with a soft cloth beforehand.

Avoid Exposure to Direct Sunlight: Be careful not to expose lens to direct sunlight for long periods. May discolor color filter and affect color of images.



! Flash Warning

Do not shine the flash close to eyes. Do not look directly at the flash when shining. Do not shine the flash at other people's eyes. May affect eyesight, etc.

Take a Picture

You can take high-resolution pictures using your phone's camera.

Note: If you have an SD card installed, pictures and videos are stored to the SD card. If no card is installed, pictures and videos are saved to your phone's memory.

1. From home, tap **Apps**  > **Camera** .
- ❖ The camera viewfinder appears.
2. Before taking the picture, you can zoom in on your subject.
 - To zoom in, "spread" the screen with your thumb and finger or press the **Volume Up key**.
 - To zoom out, "pinch" the screen or press the **Volume Down key**.
3. Frame your subject on the screen and configure other necessary settings. See [Viewfinder Screen](#) for details.



Tip: Hold the phone vertically when taking portrait shots or hold the phone horizontally when taking landscape shots.

4. You can either let the camera autofocus on the center of the screen, or you can tap another area of the screen that you want to focus on.
5. Tap  to take the picture.
6. Tap the thumbnail at the corner of the screen and choose what you want to do with the picture you've just taken.

Viewfinder Screen

The Viewfinder screen lets you view your subject and access camera controls and options.



- **Switch view mode:** Switch between the back camera lens and the front-facing camera lens (for self-portraits, video chatting, etc.).
- **Self-timer:** Set a time delay before the camera takes a picture after you tap the shutter icon, or turn off this feature.
- **Flash:** Select a flash mode for the camera.

- **Settings:** Opens the camera and camcorder settings menu and lets you change additional camera and camcorder settings.
- **Captured picture/video:** View pictures and videos you have captured.
- **Capture picture:** Tap the icon to take a picture.
- **Capture video:** Tap the icon to start capturing a video.
- **Switch camera mode:** Select a camera mode for the back camera lens and the front-facing camera lens. When using the back camera, in addition to the default AUTO mode, you can tap **PRO** to adjust some advanced professional options, or tap **FUN** to use panorama, HDR, special effects, multi-exposure, macro subjects, or smile detection modes. When using the front camera, you can tap **BEAUTY** or **EFFECT** to capture beauty shots or apply various filters to your picture.

Record Videos

Record high-quality videos using your phone's video camera.

Note: If you have an SD card installed, pictures and videos are stored to the SD card. If no card is installed, pictures and videos are saved to your phone's memory.



1. From home, tap **Apps**  > **Camera** .

❖ The camera viewfinder appears.

2. Frame your subject on the screen. You can tap any area of the Viewfinder screen that you want the camera to focus on before and during recording.
3. Tap  to start recording video. The recording duration appears.

Tip: During recording, you can pinch or spread on the screen or press the **Volume Buttons** to zoom in or out. You can also tap  to take a picture.

❖ Video recording begins.

4. Tap  to pause recording. Tap  to continue recording.



5. Tap  to stop recording.

- ❖ The camera stops recording and the video is captured and saved to your phone or SD card.



View Pictures and Videos Using Gallery

Using the Gallery application, you can view pictures and watch videos that you've taken with your phone's camera, downloaded, or copied onto your storage card or phone memory. You can also take a look at your pictures and your friends' pictures that are on your social networks (Facebook and Flickr only).

For pictures that are on your storage card or phone memory, you can do basic editing such as rotating and cropping. You can also easily assign a picture as your contact picture or wallpaper and share pictures with your friends.

View Pictures and Videos

You can access and view all your stored pictures and videos from your phone's Gallery.

1. From home, tap **Apps**  > **Gallery** .
- ❖ The album list opens.
2. Tap an album (such as Camera).
- ❖ The list of pictures and videos for the album opens.
 - To select another album, tap **Back key** to return to the Albums view.
3. Tap an image to view the picture or video.

❖ The picture or video snapshot opens and displays in full screen.

- Tap  to play the video.
- When viewing pictures or videos in full screen, you can tap the screen to display a series of options and choose what to do with the picture or video.

Pictures and Videos: Review Screen

After capturing a picture or video, from the camera screen, tap the thumbnail image at the bottom right corner of the screen to see the item in the review screen. From there, you can access options such as save, view, send, or delete the picture or video.

Pictures and Videos: Options while Viewing

- **Zoom In or Out on a Picture or Video:** Tap the screen twice or pinch the screen to zoom in or out on a picture or video.
- **Viewing Videos:** Use the onscreen controls to play, pause, or stop the video playback.

After selecting an album from the Albums tab, you can browse through the pictures and videos of that album. Tap a picture or video to view it in full screen. By default, the pictures and videos in an album are displayed in grid view.

Note: When viewing pictures, you can touch and hold on a picture or video to open a selection menu and choose what to do with the picture or video.

Edit Pictures

Whether you're browsing pictures in filmstrip or grid view in the Gallery application, you can touch and hold on a picture to open a selection menu and choose to delete the picture, rotate or crop it, and more.

Rotate and Save a Picture



1. From home, tap **Apps**  > **Gallery** .

❖ The album list opens.

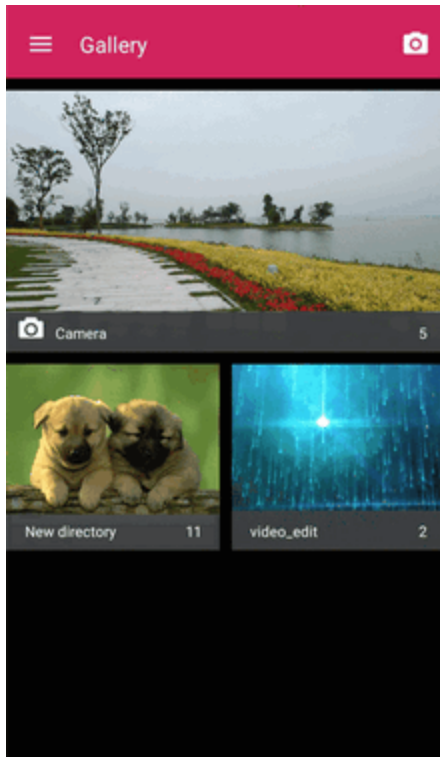
2. Tap an album (such as Camera).





- ❖ The list of pictures and videos for the album opens.

3. Tap the picture you want to rotate.
4. Tap  or  to rotate the picture counter-clockwise or clockwise.



- ❖ The picture is rotated and its file is updated.

Crop a Picture

1. From home, tap **Apps**  > **Gallery** .
- ❖ The album list opens.

2. Tap an album (such as Camera).

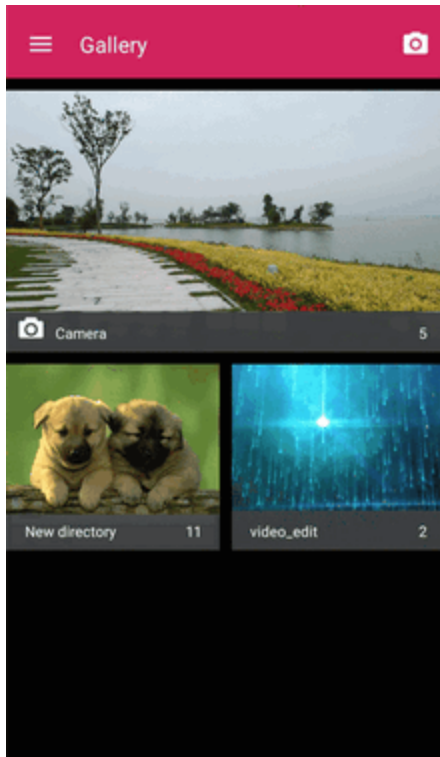

- ❖ The list of pictures and videos for the album opens.

3. Tap the picture you want to crop.
4. Tap **Menu**  > **Edit**.

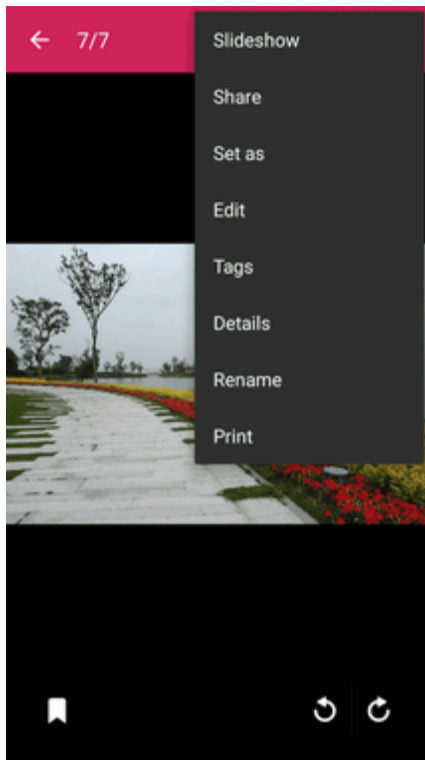



- ❖ The Photo Editor screen appears.

5. Tap an edit option along the bottom of the screen and edit the picture.



Tip: Slide the bottom options left or right to find all the options.

6. Tap  to keep the change or  to cancel it.
7. Tap  to save the new picture.

Note: Tap  in the Photo Editor screen to see the edits you have made and undo or redo them.

- ❖ The new picture is saved as a new file in the same album as the original picture. The original picture remains unedited.

Share Pictures and Videos

The Gallery application lets you send pictures and videos using email or multimedia messages. You can share pictures on your social networks (such as Facebook, Flickr, Picasa, and Twitter) and share videos on YouTube. You can also send them to another phone or your computer using Bluetooth.

Send Pictures or Videos by Email

You can send several pictures, videos, or both in an email or Gmail message. They are added as file attachments in your email. For more information about using email and Gmail, see [Compose and Send Email](#) or [Create and Send a Gmail Message](#).

1. From home, tap **Apps**  > **Gallery** .

❖ The album list opens.

2. Tap an album (such as Camera).

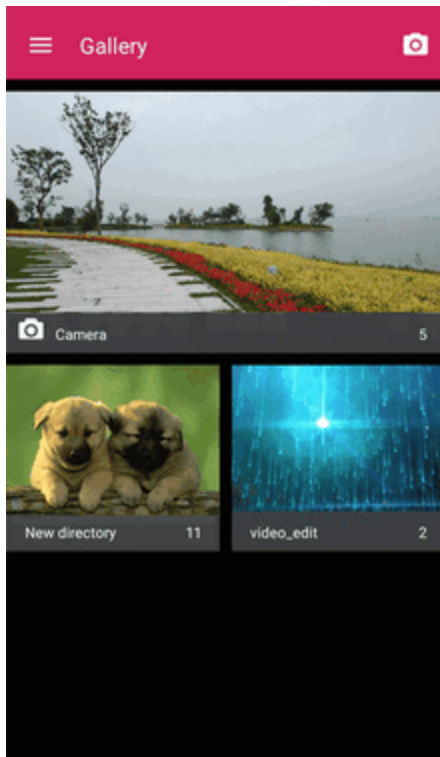

❖ The list of pictures and videos for the album opens.

3. Touch and hold a thumbnail of the picture or video you want to share.

- To select multiple items, tap all the items you want to include.

4. Tap **Menu**  > **Share** > **Email** or **Gmail**.

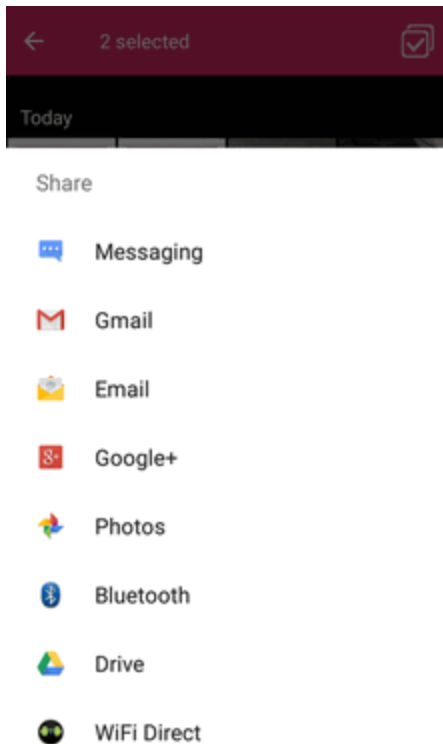

- ❖ Follow onscreen prompts to complete and send the message.

Note: If you have multiple email accounts, the default email account will be used. To change the account, tap the sender address displayed above the recipients' line and select the desired email account.

Send a Picture or Video by Multimedia Message

Multimedia Messaging (MMS) lets you send pictures and videos using your phone's messaging app. Although you can send several pictures or videos in a multimedia message, it may be better to just send one at a time, especially if the files are large in size.

1. From home, tap **Apps**  > **Gallery** .

- ❖ The album list opens.

2. Tap an album (such as Camera).

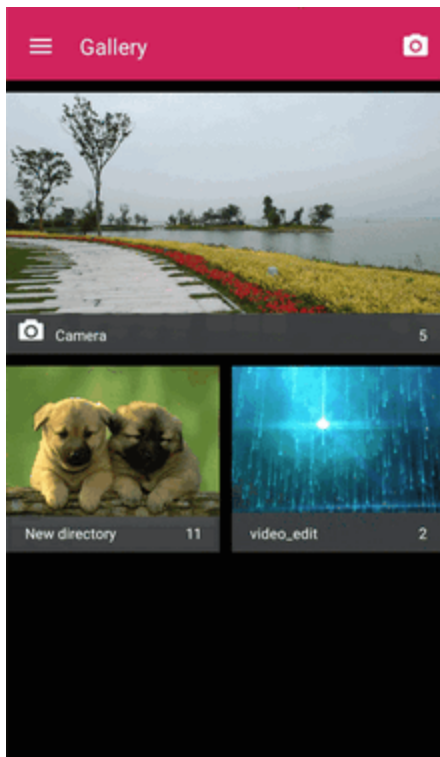

- ❖ The list of pictures and videos for the album opens.
3. Tap the album that contains the pictures or videos you want to share.
 4. Tap the pictures or videos you want to share.
 - To select multiple items, touch and hold an image to turn on multiple select. Tap all the items you want to include.

5. Tap **Menu**  > **Share** > **Messaging**.

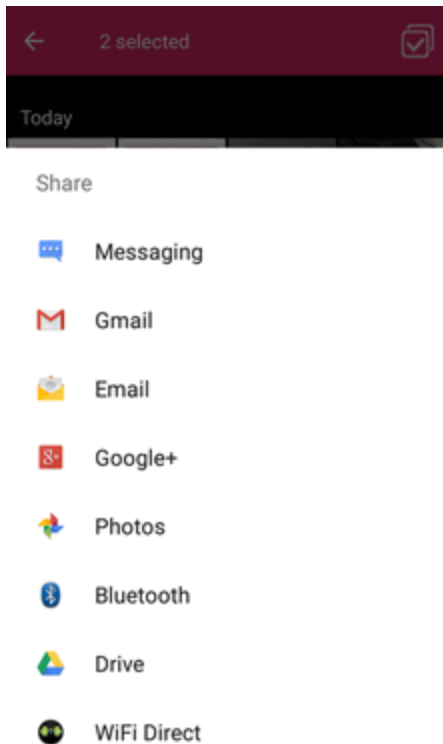

- ❖ Follow the onscreen prompts to complete and send the message.

For more information about sending multimedia messages, see [Send a Multimedia Message \(MMS\)](#).

Send Pictures or Videos Using Bluetooth

You can select several pictures, videos, or both and send them to someone's phone or your computer using Bluetooth.

1. From home, tap **Apps**  > **Gallery** .

- ❖ The album list opens.

2. Tap an album (such as Camera).

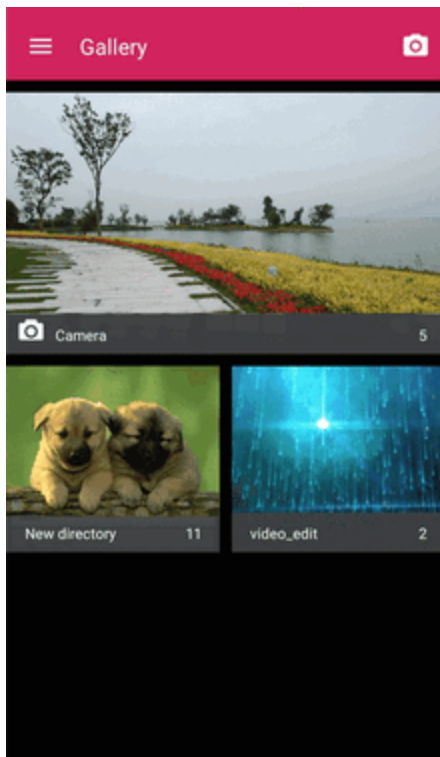

- ❖ The list of pictures and videos for the album opens.
3. Tap the album that contains the pictures or videos you want to share.
 4. Tap the pictures or videos you want to share.
 - To select multiple items, touch and hold an image to turn on multiple select. Tap all the items you want to include.

5. Tap **Menu**  > **Share** > **Bluetooth**.

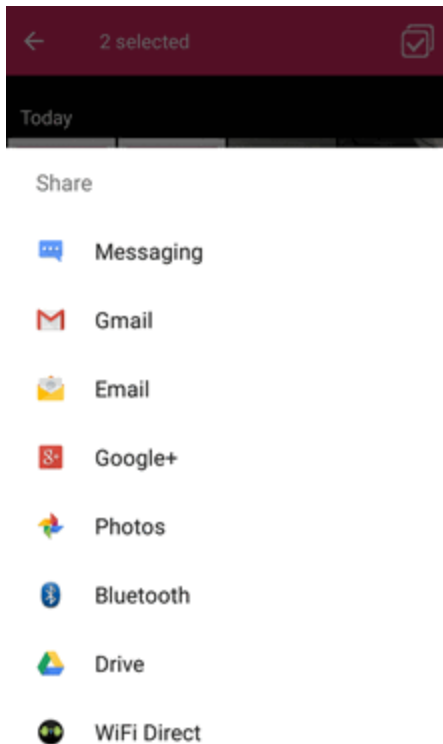

- ❖ Follow the onscreen prompts to complete and send the files.

For more information, see [Bluetooth](#).

Share Pictures or Videos via Additional Apps or Social Media

From Gallery, you can share your pictures and videos from a variety of apps and social media sites, such as Facebook, Google+, Hangouts, Instagram, Flickr, Picasa, and more. Available apps will vary depending on what you have installed on your phone.

1. From home, tap **Apps**  > **Gallery** .

- ❖ The album list opens.

2. Tap an album (such as Camera).

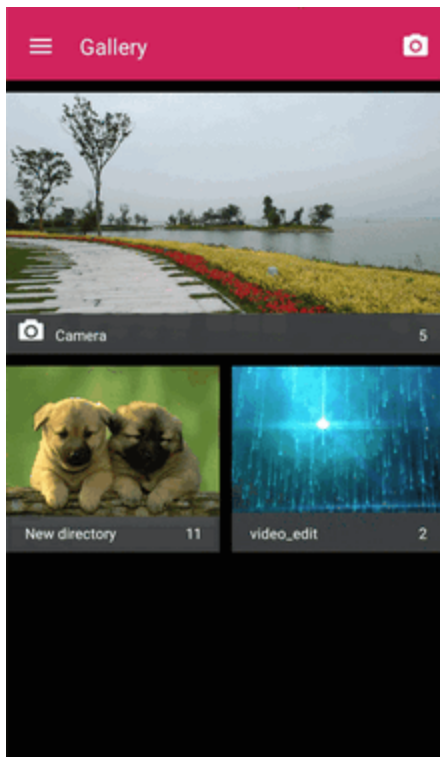

- ❖ The list of pictures and videos for the album opens.
3. Tap the album that contains the pictures or videos you want to share.
 4. Tap the pictures or videos you want to share.
 - To select multiple items, touch and hold an image to turn on multiple select. Tap all the items you want to include.

5. Tap **Menu**  > **Share** and then tap the app you want to use.

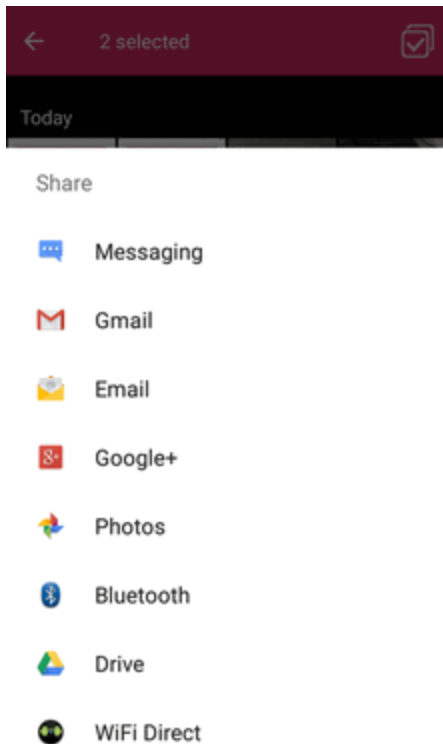

6. Follow the prompts to complete and post or share your pictures or videos.

- ❖ The upload is completed.
 - For confirmation, check the status bar for the upload information.

Share Videos on YouTube

You can share your videos by uploading them to YouTube™. Before you do this, you must create a YouTube account and sign in to that account on your phone.

1. From home, tap **Apps**  > **Gallery** .

- ❖ The album list opens.

2. Tap an album (such as Camera).

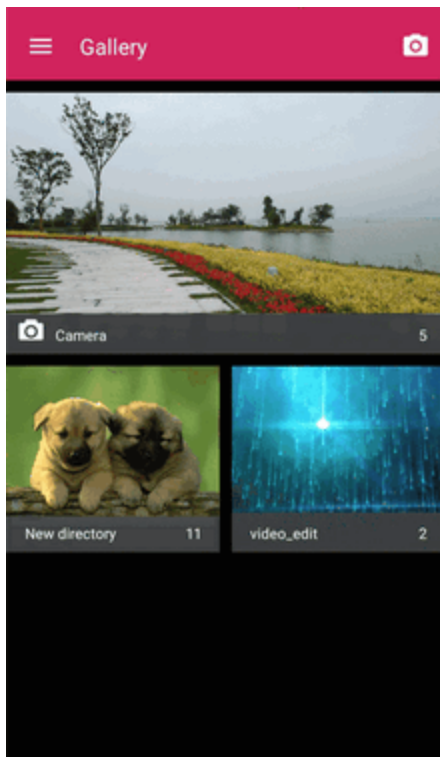

- ❖ The list of pictures and videos for the album opens.
3. Tap the album that contains the videos you want to share.
 4. Tap the videos you want to share.
 - To select multiple videos, touch and hold an image to turn on multiple select. Tap all the videos you want to include.

5. Tap **Menu**  > **Share** > **YouTube**.



6. Enter the prompted information, such as description and tags, and select a privacy option.
7. Tap **Upload**.

❖ The upload is completed.

Switch Cameras

You can switch between the front and back camera lenses.

1. From home, tap **Apps**  > **Camera** .

❖ The camera viewfinder appears.

2. Tap  to switch between the front and back camera lenses.

Camera Modes

Your phone lets you use different types of camera modes.

1. From home, tap **Apps**  > **Camera** .

❖ The camera viewfinder appears.

2. When the back camera lens is used, tap **PRO** to switch to professional mode where you can configure some advanced professional options, or tap **FUN** and select a mode. When the front-facing camera is used, tap **BEAUTY** to capture beauty shots or tap **EFFECT** to apply a filter to your picture.



- ❖ The camera switches mode.

Camera Settings

You can configure your camera's settings to fit any situation and event.

1. From home, tap **Apps**  > **Camera** .

- ❖ The camera viewfinder appears.

2. Tap **Settings** .



- ❖ The camera settings menu opens.

3. Select your desired settings.

- ❖ The settings are applied.
 - Settable items differ depending on the camera type in use.

Useful Apps and Features

The following topics detail many of your phone's tools and features such as news services, maps and navigation, calendar, clock, social networking apps, music, memos, and more.

Calculator

Your phone's convenient built-in calculator lets you perform basic mathematical equations.

1. From home, tap **Apps**  > **Calculator** .

❖ The calculator app launches.

2. Tap onscreen keys for calculations.

❖ Calculation results appear.

Calendar

Use Calendar to create and manage events, meetings, and appointments. Your Calendar helps organize your time and reminds you of important events. Depending on your synchronization settings, your phone's Calendar stays in sync with your Calendar on the Web, Exchange ActiveSync calendar, Google Calendar, and Outlook calendar.

In order to sync with your Google calendar, you must sign in to a Google account on your phone. See [Google Account](#).

Calendar Operations

- **View Today's Calendar:** From the Calendar, tap .
- **Change Calendar View:** From the Calendar, tap **Year**, **Month**, **Week**, **Day**, **List**, or **Task** to change the current view.
- **View Next/Previous Month (Month View):** From the Calendar, flick the screen up or down.
- **View Next/Previous Week (Week View):** From the Calendar, flick the screen left or right.
- **View Next/Previous Day (Day View):** From the Calendar, flick the screen left or right.
- **View the Next/Previous Time Period (Day/Week View):** From the Calendar, flick the screen up or down.

Add an Event to the Calendar

Add events to your calendar directly from the Calendar application.

1. From home, tap **Apps**  > **Calendar** .

❖ The Calendar app opens.

2. Tap **Add** .

❖ The add event window opens.

3. Enter an event title, start date/time, end date/time, etc., and then tap **SAVE**.

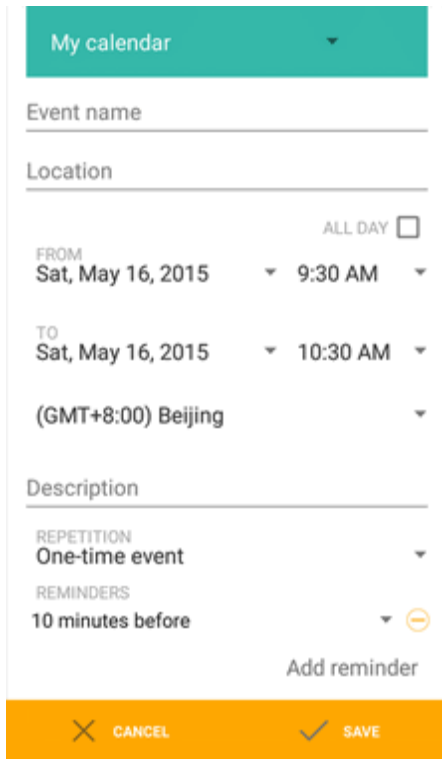

❖ The event is added to your calendar.

Selecting a Calendar

If you have more than one calendar, tap the field above the event name line to select a calendar in which to add events:



- Select **My calendar** to create an event that will appear only on your phone.
- Select your Google Account to create a Google Calendar event. If you have several Google Calendars on the Web, select one in which to add your event.
 - You can create multiple Google Calendars only in Google Calendar on the Web. After creating them in Google Calendar on the Web, you'll be able to see them in the Calendar application on your phone. For more information about creating and managing multiple Google Calendars, visit the Google website: calendar.google.com.
- If you have synchronized your phone with an Exchange ActiveSync account or Outlook on your

computer, you can also select these calendars.



- Select your Outlook Account to create an Outlook Calendar event to sync with your computer.
- Select your Exchange ActiveSync Account to create an Exchange ActiveSync calendar event.

View Calendar Events

You can display the Calendar in daily, weekly, monthly, or agenda view. To change the Calendar view, tap the **Year**, **Month**, **Week**, **Day**, **Agenda**, or **Task** tabs along the side.

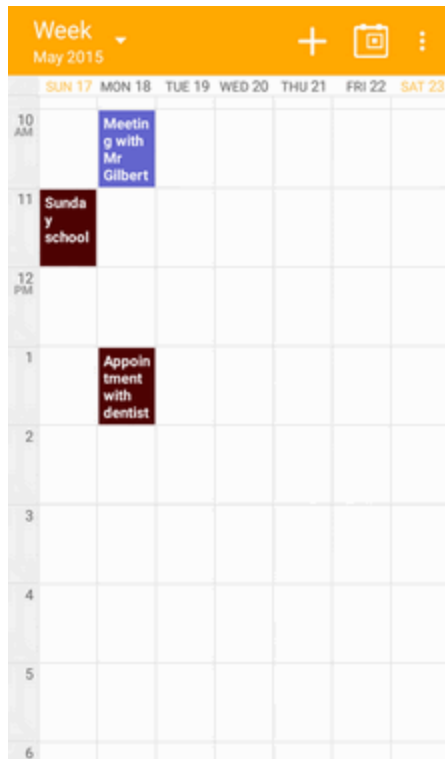

1. From home, tap **Apps**  > **Calendar** .
- ❖ The Calendar app opens.
2. Tap an event. If you are in month view, tap a date first.



- ❖ The event details appear.
 - In event details, tap  to edit the event.
 - In event details, tap **Delete**  to delete the event.

Sync Calendars

You can select which calendars you'd like to sync on your phone, along with what types of information you want to sync.

1. From home, tap **Apps**  > **Calendar** .
- ❖ The Calendar app opens.

2. Tap **Menu**  > **Calendars to display**.

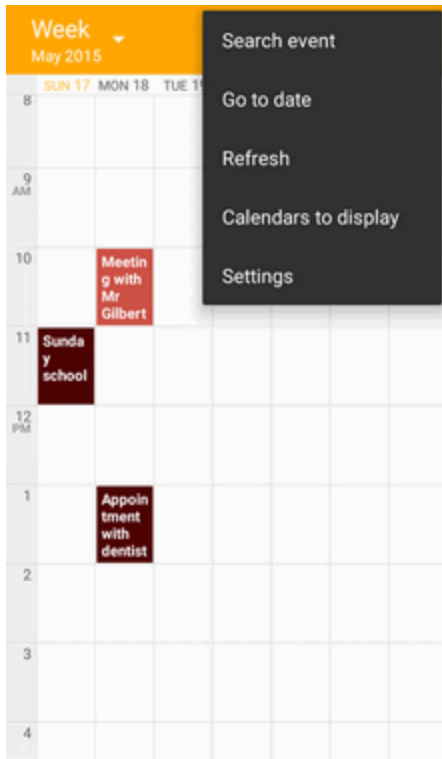

3. Tap **CALENDARS TO SYNC** at the bottom.

4. Select sync options by adding or removing check marks from the items.

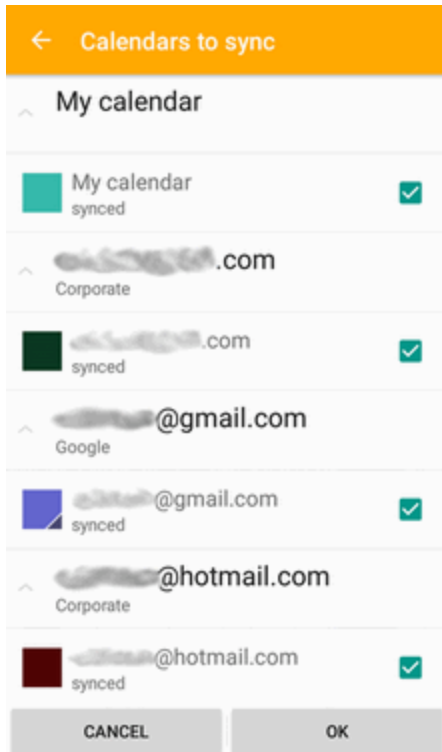

5. Tap **OK**.

❖ The sync settings have been updated.

Synchronize an Exchange ActiveSync Calendar

If you have set up a Microsoft Exchange ActiveSync account on your phone, you can also synchronize Exchange ActiveSync calendar events on your phone. Calendar events on your Exchange ActiveSync will also show in Calendar if you chose to synchronize with the Exchange ActiveSync Server.

1. From home, tap **Apps**  > **Settings**  > **Corporate**.

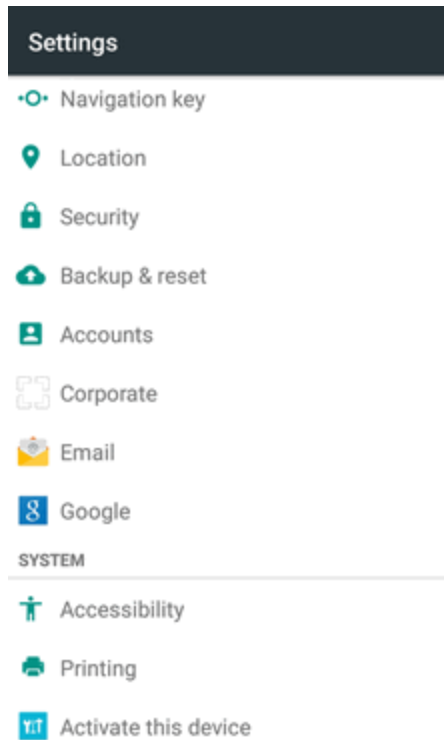

- If Corporate doesn't appear under Accounts in the Settings menu, you do not have an Exchange ActiveSync account configured on the phone. For information about adding an account, see [Add an Exchange ActiveSync Account](#).

2. If your Exchange ActiveSync account is set for synchronization, you will see a **Sync** icon .

Clock



Your phone has a clock app that lets you set alarms, view time in time zones around the world, use a stopwatch, set a timer, and use your phone as a desk clock.

Check the Time

You can check the phone any time on your phone. The current time displays in the upper right corner of the status bar. Many widgets and lock screens also display the time and provide options for how time is displayed.

Set the Date and Time

Your phone automatically receives the current date and time from the wireless network. You can set the date by hand by overriding the default setting.

1. From home, tap **Apps**  > **Settings**  > **Date & time**.
2. Clear the check mark next to **Automatic date & time** and **Automatic time zone**, and then set the date, time, and time zone as desired.

❖ The date, time, and time zone will reflect your new settings.

Set Alarms

Set multiple alarms using your phone's Clock app.

1. From home, tap **Apps**  > **Clock** .

❖ The Clock app appears.

2. Tap the **Alarm** tab  and then tap .

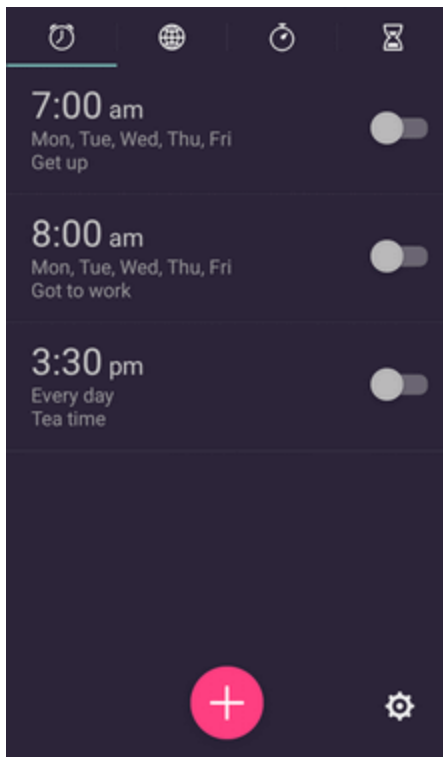

3. Set the alarm options, including time, days, repeat pattern, alarm type, alarm tone, and volume, and then tap **SAVE**.



❖ The alarm is set.

Phone at Alarm Time

- At the set alarm time, the phone sounds the alarm and/or vibrates.
- Stopping an alarm: When the alarm sounds, drag  to the right to dismiss it.



Additional Clock Features

Your phone's clock app provides additional useful features including world clock, stopwatch, and timer functions. All features are available from the clock app display.

- From home, tap **Apps**  > **Clock**  .
 - ❖ The Clock appears.



World Clock

The world clock lets you keep track of the current time in multiple cities around the globe.



1. From the clock app, tap **World Clock** .
2. Tap **Add City**  and select a city.
3. Repeat to add multiple cities.

Stopwatch

The stopwatch lets you time events down to the hundredth of a second.

1. From the clock app, tap **Stopwatch** .
2. Tap **Start**  to begin timing.
3. Tap **Record**  to record lap time and total time.

Note: The stopwatch can record 20 laps at a time.

4. Tap **Pause**  to pause timing. If you want to reset the stopwatch to zero, tap **Record** .

Timer

The timer provides a countdown timer for up to 99 hours, 59 minutes, and 59 seconds.





1. From the clock app, tap **Timer** .
2. Use the keypad to set the length of the timer.
3. Tap **START** to begin the timer.

Facebook



Post updates, read what your friends are up to, upload pictures and check-ins, and more with on-the-go Facebook access.

Install the Facebook App on Your Phone

Before you use Facebook on your phone, you must download and install the app.

1. From home, tap **Apps**  > **Facebook** .
2. Tap **DOWNLOAD**.
3. Tap **ACCEPT AND INSTALL**.
 - ❖ The app will be downloaded and installed on your phone.
 - To open the app from the home screen, tap **Apps**  > **Facebook** .

Sign in to Your Facebook Account from Account Settings

1. From home, tap **Apps**  > **Settings**  > **Accounts** > **Add account**.
2. Tap **Facebook**.

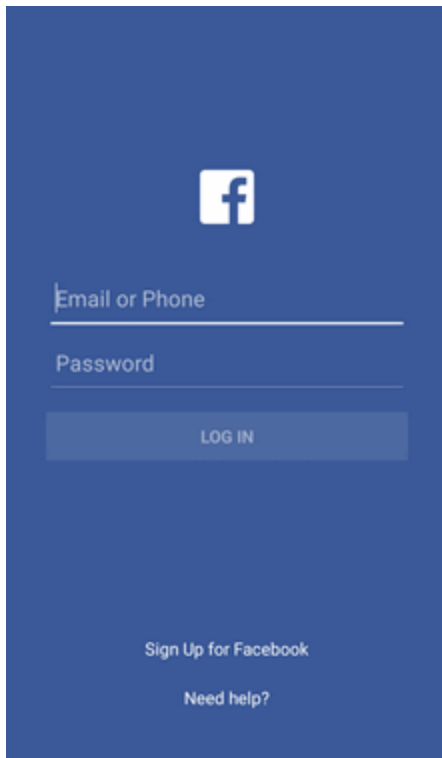

3. Enter your email/phone number and password and tap **LOG IN**.

- ❖ Your Facebook account is added to your phone.

Use Facebook

Once you've downloaded the app and signed in, you can post and read updates, upload pictures, tag locations, and more, all from your phone.







1. From home, tap **Apps**  > **Facebook** .

- ❖ The Facebook app launches.

- If this is the first time you've used Facebook on your phone, enter your Facebook ID and password and tap **LOG IN** to sign in to an existing account, or tap **Sign Up for Facebook** to set up a new Facebook account.
2. Tap **Status** and type an update, tap **Photo** and upload a picture from the gallery, tap **Check In** to share your location, "Like" and comment on friends' posts, and more.

File Manager

File Manager allows you to view and manage files stored on your phone's internal storage and your SD card as well as a USB device when they are available.

1. From home, tap **Apps**  > **File Manager** .
2. Find the file you need by category in the **Category**  tab, or tap **Phone** , **SD Card** , or **USB Device**  to browse folders and files on the phone's internal storage, the SD card or the USB device connected to the phone.
 - Tap folders and files to access stored items.
 - Touch and hold an item to access option icons such as Copy, Move, Share, Delete, and more.
 - To copy or move an item, navigate to a new location and tap **PASTE**.
 - Tap **+** to create a new folder in the current directory.

Google Search

Use the Google app to search and find information saved on your phone and the Internet.







1. From home, tap the Google search bar or tap **Apps**  > **Google** .

- ❖ The Search window opens.
 - If confirmation appears, follow onscreen instructions.
 - If a description for Google Now appears, tap **Next** and read information. Enable Google Now on the last page if you want to use the feature.

2. Type your search keywords and tap the search key on the keyboard.



- ❖ Search results appear.
 - To search by voice, tap  in the search bar and speak your search terms.

Google Search Operations

- **Changing Search Information:** From home, tap **Apps**  > **Google Settings**  > **Search & Now** > **Phone search** and select where to search.
- **Using or Canceling Google Now:** Google Now automatically searches for information based on search keywords used, your current location, etc., and presents search results in the search screen. Google Now also informs users of scheduled events.
 - To enable or disable Google Now, from home, tap **Apps**  > **Google Settings**  > **Search & Now** > **Now cards** and tap the **Show cards** slider.
 - To use all of Google Now's functions, ensure that Google Location History are turned on in your location settings. From home, tap **Apps**  > **Google Settings**  > **Location** > **Google Location History** and select your options.

Google Voice Search

Use your voice to search instead of typing, with Google Voice Search.

1. From home, tap **Apps**  > **Voice Search**  .
 - ❖ The Voice Search window opens.

2. Speak your search terms



Listening...



- ❖ Search results appear.

Google+





Google+ makes connecting on the Web more like connecting in the real world. Share your thoughts, links, and photos with the right circle. Get everyone on the same page with fast and simple group chat.

Note: For detailed information about Google+, open Google+ and tap  > **Help** to view the online instructions.

Sign In and Use Google+

1. From home, tap the Google search bar or tap **Apps**  > **Google+** .
2. If prompted, select your Google Account, or tap **Add account** to sign in to Google+ with another Google Account.
3. If prompted, set up your public Google Profile and then follow the onscreen prompts to continue.

Note: You won't see this step if you've already set up your profile on another device.

4. Get started with Google+. You can use the following features:
 - **Check out new posts:** Tap  near the top right corner and select **Home** to see posts people have shared with you, a circle or community you are in, or everyone. You can filter the posts displayed by tapping  and selecting a circle under **Circles**, a community under **Communities**, a hot topic below **Explore**, **What's Hot**, or **Nearby**.
 - **Write a post:** Tap  to write a post. You can select the people or circles you want to share the post with, and add pictures, your location, URLs, a survey, or your mood in the post.
 - **Manage your social calendar:** Tap  and select **Events** to add events, invite people, and then share photos in real time from the event by enabling Party Mode.

- **See friends' locations on a map:** Tap ▼ and select **Locations** at the bottom of the screen. You'll see a map that shows everyone who shares their location with you. Tap a photo of a person to display their location details.
- **Check out photos of you:** Tap ▼ and select **Photos** at the bottom of the screen to open the **Photos** app. Then tap ≡ at the top left and select **Photos of you**.
- **Manage your friends and circles:** Tap 👤 to find people and add them to your circles.
- **Search for people, pages, and photos:** Tap ▼ and then tap 🔍. Enter the information you want to search for.
- **Manage your own information:** Tap your photo avatar and name at the top left to view and edit your basic information, view your posts and photos.

Sign Out of Google+

If you are already signed in to the app, you can sign out by following these steps.

1. From home, tap the Google search bar or tap **Apps** ⋮ > **Google+** .
2. Tap ⋮ > **Settings** and then tap your account.
3. Tap **Sign out**.

Hangouts

Hangouts is Google's instant messaging service. Use to communicate with other Hangout users, and also use video calling. Log in to a Google Account beforehand (see [Google Account](#)).

Using Hangouts

1. From home, tap **Apps** ⋮ > **Hangouts** .
 - ❖ The Hangouts app will open.
2. Tap **Add** + to start a new Hangout.

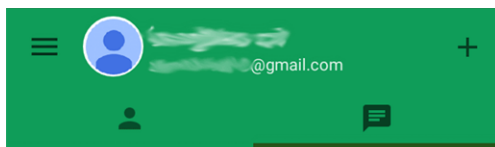



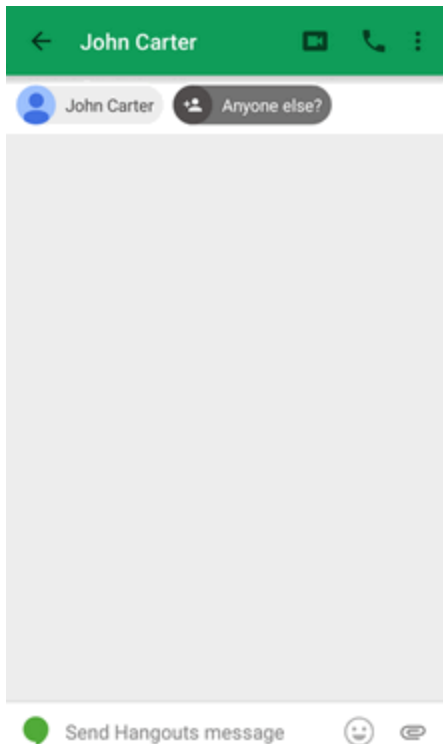

3. Type a name, email, number, or circle, or select a contact from the list.

4. Type a message and tap **Send** ➤, or tap  or  to make a voice call or start a video chat.



- If a friend is not in a Hangout, you will see a message. Tap **INVITE** to invite them to join the Hangout.

Hangouts Operations

- **Deleting a Chat:** In the chats tab  of the Hangouts window, touch and hold a chat and then tap **Delete**  > **DELETE**.
- **Ending a Video Chat:** In the video chat window, tap .
- **Disabling Chat History:** If you don't want to keep chat history, in the chat window, tap **Menu**  > **Turn history off**.
- **Delete Chat History:** To delete all your chat history, in the chat window, tap **Menu**  > **Delete** > **DELETE**.

Note: You can use Hangouts as your phone's default messaging app, or as a standalone IM app. If you set Hangouts as the default messaging app, the Messages app will be disabled. For more information, see [Default SMS App Settings](#).

Google Maps

Use the Google Maps app to determine your location, find directions, browse local businesses and attractions, rate and review places, and more.

Enable Location Services on Your Phone

Before using any location-based services, you must enable your phone's location feature. For information about setting your phone's location options, see [Location Access Settings](#).

View Maps of Specified Places

Use Google Maps to locate and map a specific address or destination.

1. From home, tap **Apps**  > **Maps** .

❖ Google Maps opens.

- If prompted, follow the onscreen instructions to accept terms of use.

2. Tap the search box at the top.

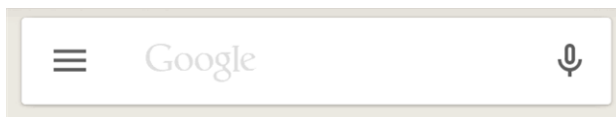



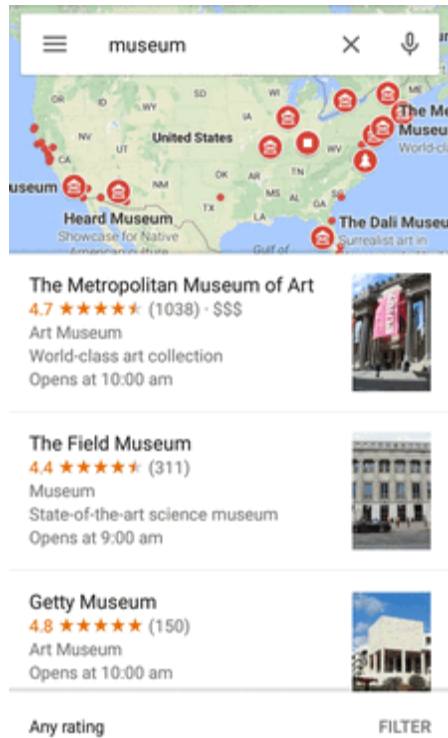

3. Enter an address, city, facility name, etc., and then tap a candidate in the results list.



Note: If your search term is specific enough, the map will automatically pan to that location.

- ❖ The information card for the specific location opens. You can find out its address, open hours, street view, people's review, how to get there, give the place a call, save it to your Google Account, and more.
 - Slide the card down to view the place on the map.

Google Maps Operations

- **Viewing Current Location:** From the Maps app, tap .
- **Obtain Useful Area Information for Current Location:** From the Maps app, tap . When your location is found, tap  at the bottom of the screen and, in the new screen, select a type of business or attraction to browse related locations. You can then tap a location to view detailed information and find out how to get there.
- **View Traffic Information, Aerial Photos, Etc., in Maps:** From the Maps app, tap **Menu**  and then tap **Traffic**, **Satellite**, **Google Earth**, etc.
- **Check Route to Destination:** From the Maps app, tap , select a method of transport (car,

public transit, or on foot), and then enter your current location and your destination.

- Route candidates appear in a list. Tap one to get more information.

- **Check Detailed Operation for Maps:** From the Maps app, tap **Menu**  > **Help**.

Music Player

Your phone's built-in music player app lets you listen to and organize music files you have loaded into your phone's memory or SD card.

Note: For information about loading music onto your phone, see [Transfer Files Between Your Phone and a Computer](#).

Listen to Music Using the Music Player

The Music app allows you to play music files in your phone's storages.

1. From home, tap **Apps**  > **Music** .

❖ The music library opens. Your music files are cataloged, according to the information stored in the files.

2. Tap **All Songs**, **Playlists**, **Favorites**, **Artists**, **Albums**, or **Folders** to browse your music. You can also tap a song in the **RECENT PLAY** list to select songs you recently played.

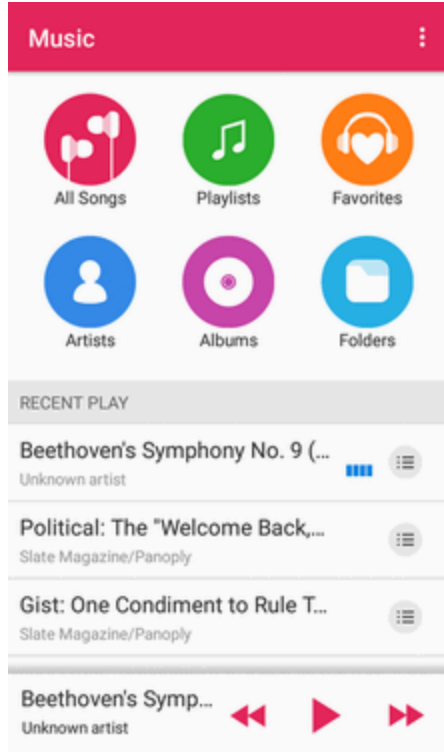

3. Tap a song to start playing in the music player.

Note: Adjust the volume with the **Volume keys**.

The Playback Screen

When you tap a song in the music library, the music player immediately starts to play it and its name and the player controls are displayed at the bottom of the screen. Tap the area to open the playback screen, where you can have more control over the player.

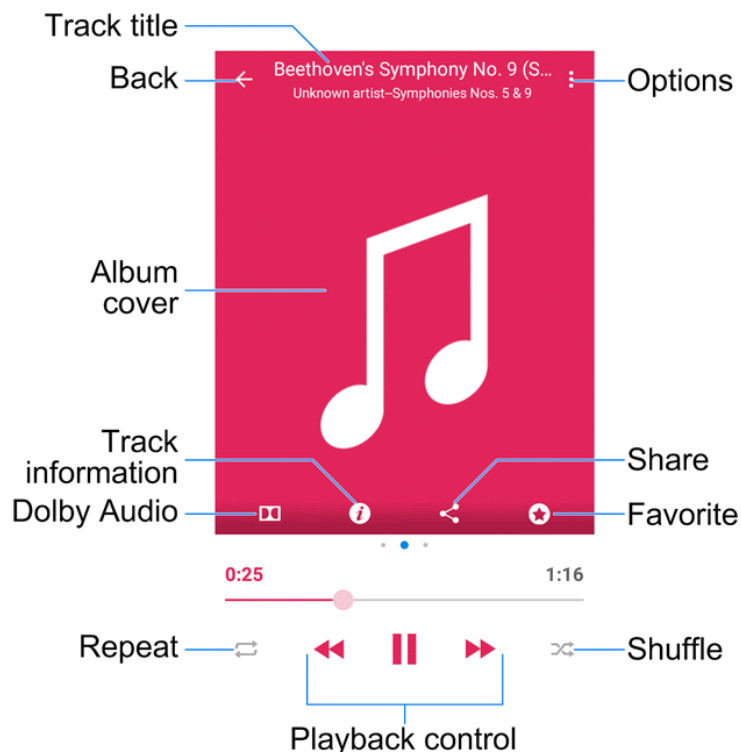



- **Track title:** Display track name, artist, and album information.
- **Back:** Return to the music library.
- **Album cover:** Display the cover art of the album when it is available. Swipe left to see lyrics (if available) and right the current playlist.
- **Track information:** Display the detailed information of the song and the file.
- **Dolby Audio:** Toggle Dolby Audio effects.
- **Repeat:** Toggle repeat mode (no repeat, repeat the current track, or repeat the current playlist).
- **Playback control:** Skip songs or pause and resume playback. Drag the progress bar to jump to any part of the track.
- **Shuffle:** Turn on or off shuffle.

- **Favorite:** Add the track to the Favorites playlist. Tap again to remove the track from the list.
- **Share:** Share the song.
- **Options:** Access additional options.

Create a Playlist

Music playlists help you organize your music files.

1. From home, tap **Apps**  > **Music**  .
 - ❖ The music library opens. Your music files are cataloged, according to the information stored in the files.
2. Find the music file you want to put in a playlist. Tap  next to the song to open a list of options.

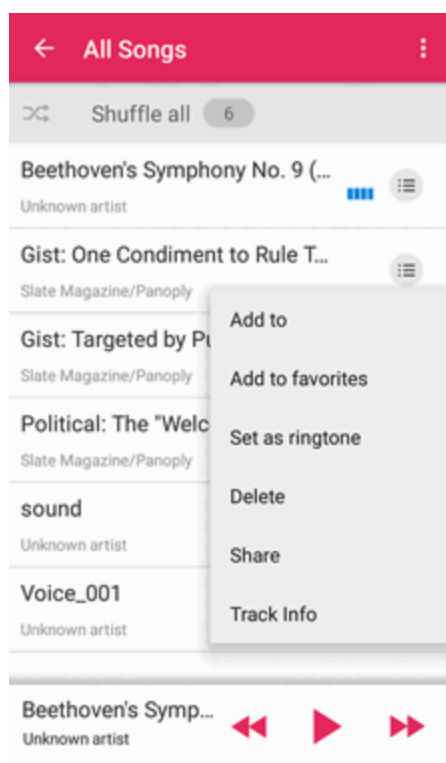

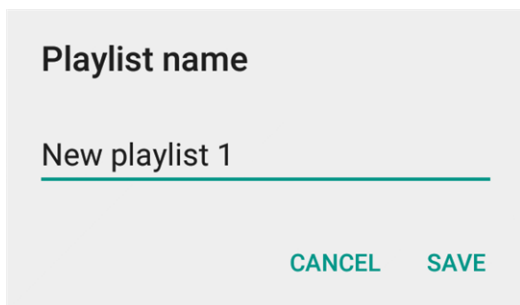

3. Tap **Add to** > **New playlist +**.

4. Enter the playlist name and tap **SAVE**.



Manage Playlists

You can rename or delete your music playlists.

1. From home, tap **Apps**  > **Music**  .
 - ❖ The music library opens. Your music files are cataloged, according to the information stored in the files.
2. Tap **Playlists** to view all music playlists.

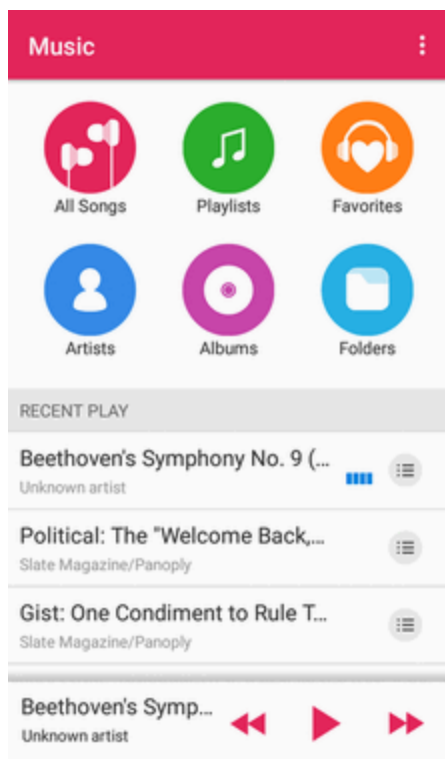

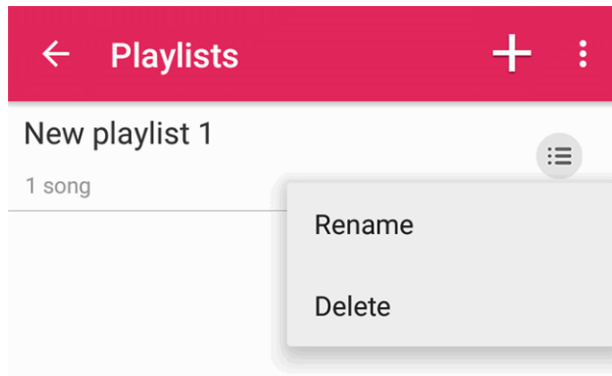

3. Tap  next to the playlist you want to manipulate to open the options menu.





4. Tap **Rename** or **Delete**.

Manage Songs in a Playlist

You can add more songs to a playlist or remove some tracks from a playlist.

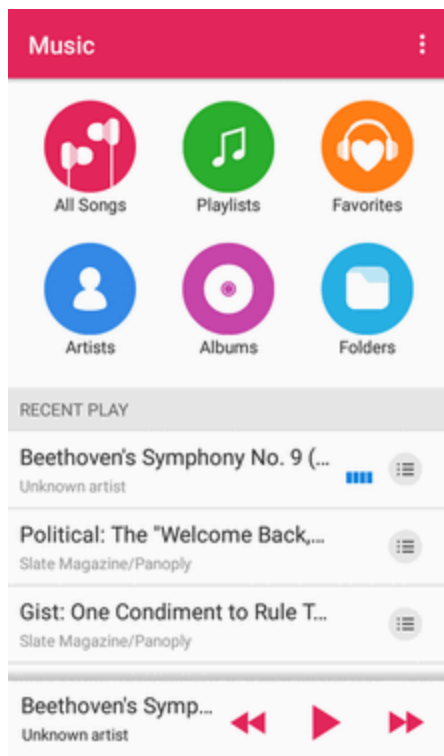
1. From home, tap **Apps**  > **Music**  .
 - ❖ The music library opens. Your music files are cataloged, according to the information stored in the files.
2. Tap **Playlists** to view all music playlists.





3. Tap a playlist to open its content.
4. Tap  > **Add Songs** and select the music you want to add before tapping .

– or –

Tap  next to the song you want to remove and select **Remove from playlist**.

Set a Song as Ringtone

You can set a song or audio file as your default ringtone. This will not change the ringtone you have assigned individually to specific contacts (see [Add a Contact](#) and [Edit a Contact](#)).

1. From home, tap **Apps**  > **Music** .
 - ❖ The music library opens. Your music files are cataloged, according to the information stored in the files.
2. Find the music file you want to use as the default ringtone. Tap  next to the song to open a list of options.

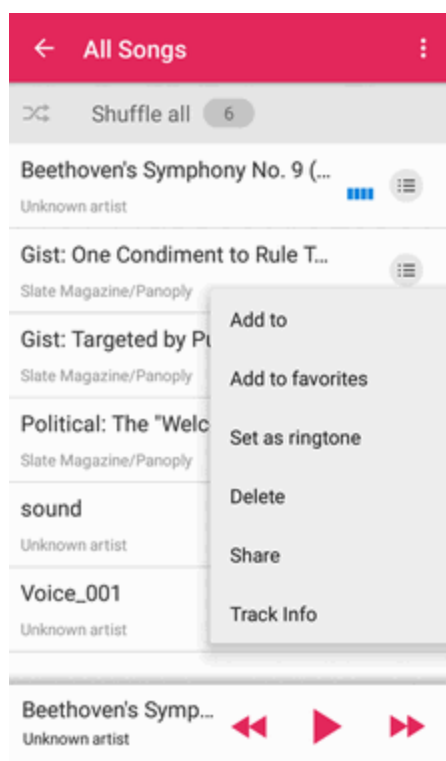

3. Tap **Set as ringtone**.

Tip: You can also set a song as the default ringtone in the playback screen. Just tap  > **Set as ringtone**.

Google Play Music App

The Google Play Music app lets you browse, shop, and play back songs purchased from Google Play as well as songs you have loaded from your own music library. The music you choose is automatically stored in your Google Play Music library and instantly ready to play via streaming or download.

For more information about Google Play Music, visit play.google.com/about/music.

Note: For information about loading music onto your phone, see [Transfer Files Between Your Phone and a Computer](#).

Play Music with Google Play

Use the Google Play Music app to listen to all your music on your phone.

1. From home, tap **Apps**  > **Play Music** .

❖ The Play Music app opens.

Note: If you have signed in to your Google Account, the first time Play Music launches, you may follow the prompts to get unlimited Play Music All Access service or opt for free standard service.

2. Tap a recommendation in the Listen Now screen, or tap  > **My Library** or **Playlists** to view all the music or playlists. To change views of your library, swipe left or right.

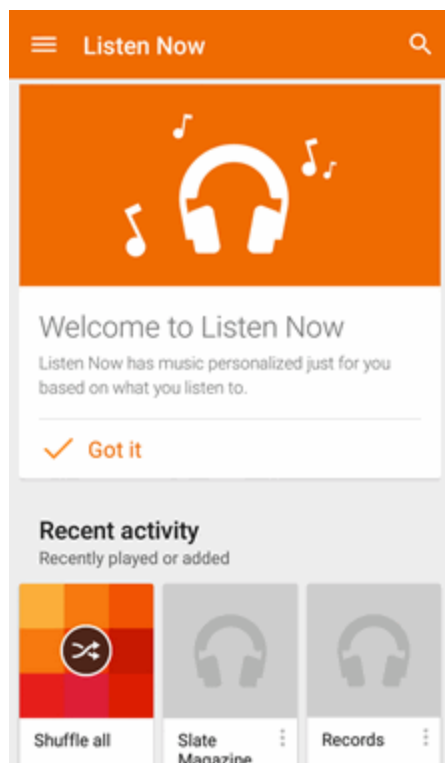

3. Tap a song to play it. The song title and player control appears at the bottom of the screen. You can touch it or drag it up to display the player screen.

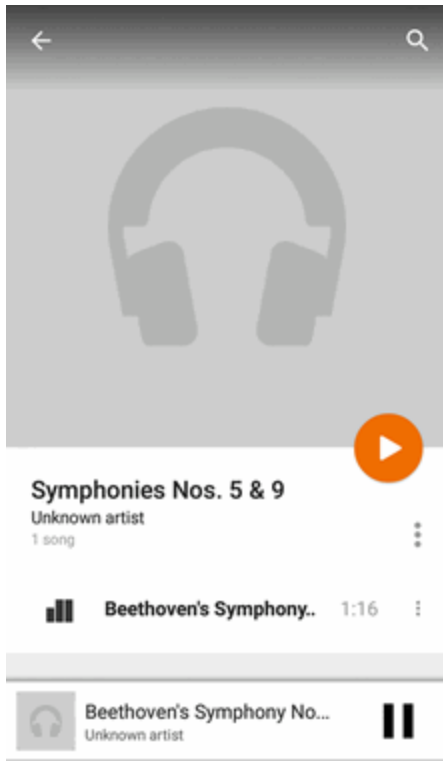

- ❖ The song begins playing.

Google Play Music Screen Layout

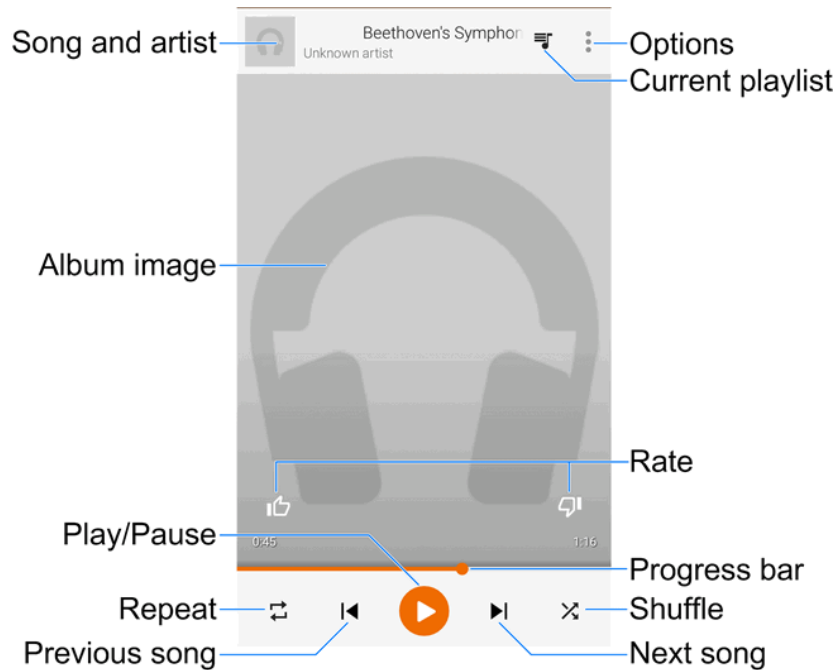

The following diagram outlines the main features of the Play Music app player screen.



Feature	Description
Song and artist	Shows the names of the song and the artist. Tap the area to close the player screen and return to the music library.
Album image	Displays the album artwork (if available). Swipe left or right to switch to the next or previous song in the current playlist.
Play/Pause	Tap to resume or pause the player.
Repeat	Tap to switch repeat modes. You can repeat the current song, the current playlist, or turn off repeat.
Previous song	Tap to restart the current song; tap twice to switch to the previous song in the playlist.
Next song	Tap to switch to the next song in the playlist.
Shuffle	Tap to turn on or off shuffle.
Progress bar	Shows the progress of the current song. Drag or tap it to jump to any part of song.
Rate	Give the song a thumbs-up or thumbs-down.
Current playlist	Tap to display the current music list (queue).
Options	Tap to access more player options.

Create Playlists in Google Play Music

Organize music into playlists to fit every occasion.

- From home, tap **Apps**  > **Play Music**  .
 The Play Music app opens.

2. Tap **☰** > **My Library** to view all the music files.
3. Tap **⋮** next to a song and select **Add to playlist**.

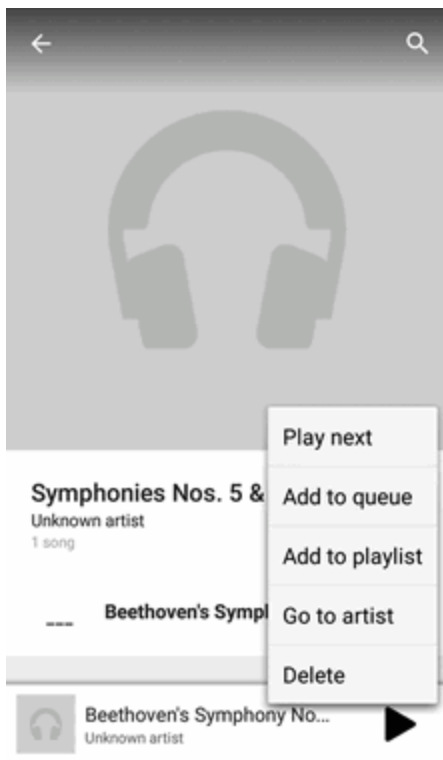

4. Tap **New playlist**. Enter a playlist name and description and tap **CREATE PLAYLIST**.

A screenshot of a "New playlist" form. The form has a light grey background. At the top, the title "New playlist" is displayed in bold. Below the title are two input fields: "Name" and "Description". Each field has a horizontal line underneath it. At the bottom of the form, there are two buttons: "CANCEL" and "CREATE PLAYLIST", both in teal text.

- ❖ The playlist is created.
5. Tap the **Back Key** to return to the library view and select another song or album.
 6. Tap **⋮** next to the song or album and then tap **Add to playlist** > **<playlist name>**.
 - ❖ The song or album is added to the playlist. Repeat to add more items to the playlist.



Adding Currently Playing Music to a Playlist

- From the player view, tap  > **Add to playlist** > <playlist name>.
- ❖ The music is added to the playlist.







Sound Recorder

You can use Sound Recorder to record voice memos.

Record and Play a Voice Memo

1. From home, tap **Apps**  > **Sound Recorder** .
2. Tap  to start recording.





- During recording, you can do the following:
 - Tap  /  to pause or continue the recording.
 - Tap  to cancel the recording.
- 3. Tap  to stop the recording. The memo is automatically saved.
- 4. Tap  to play the voice recording. If you are not satisfied with it, tap  to delete.

Note: To find all your voice memos, tap  at the top right of the screen.

Voice Dialer

Voice Dialer is speech recognition software. You can use it to dial a phone number in your contacts, open menus or launch phone functions.

1. From home, tap **Apps**  > **Voice Dialer** .
2. When you see "listening", follow the onscreen examples to speak "Call...", "Dial...", or "Open..." to make phone calls or open phone menus and applications.

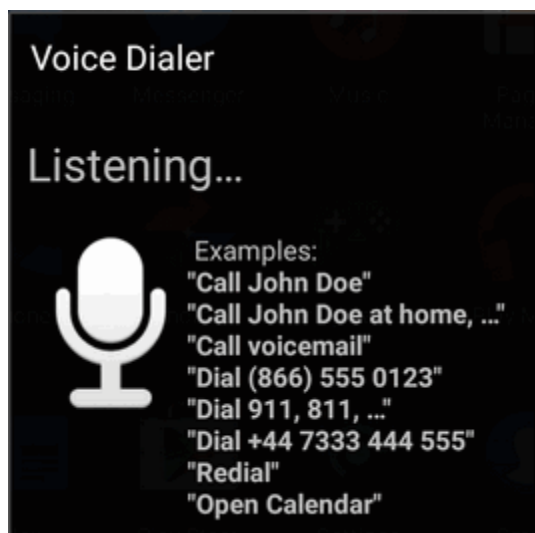





Twitter

Tweet (post messages) and view other people's tweets on Twitter. Login may be required to use Twitter. For details on Twitter, visit twitter.com.

Install the Twitter App on Your Phone

Before you can use Twitter on your phone, you have to download and install the app from Google Play.

1. From home, tap **Apps**  > **Play Store** .
2. Tap  and search for "twitter".
3. Tap **Twitter** from the results list.
4. Tap **INSTALL**, and then tap **ACCEPT**.
 - ❖ The app will be downloaded and installed on your phone.
5. When the download has completed, tap **OPEN**.

- To open the app from the home screen, tap **Apps**  > **Twitter** .

Tweet on Twitter

Read Twitter feeds, follow your friends, and tweet your own updates right from your phone.

1. From home, tap **Apps**  > **Twitter** .

❖ The Twitter app launches.

- If this is the first time you've used Twitter on your phone, tap **Log in** to sign in to an existing account, or tap **Sign up** to set up a new Twitter account.

2. Tap the "What's happening?" text box, type a tweet, and tap **TWEET**.

❖ The tweet is sent and appears on your Twitter feed.

LinkedIn

Find and connect with members worldwide, read the latest industry news, keep up-to-date you're your groups, and more with on-the-go LinkedIn access.

Install the LinkedIn App on Your Phone

Before you use LinkedIn on your phone, you must download and install the app from the Google Play Store app.

1. From home, tap **Apps**  > **Play Store** .



2. Tap  and search for "linkedin".

3. Tap **LinkedIn** from the results list.

4. Tap **INSTALL**, and then tap **ACCEPT**.

❖ The app will be downloaded and installed on your phone.

5. When the download has completed, tap **OPEN**.

- To open the app from the home screen, tap **Apps**  > **LinkedIn** .

Sign In to Your LinkedIn Account

Once you've downloaded and installed the LinkedIn app, sign in to your account.

1. From home, tap **Apps**  > **LinkedIn** .



2. Follow the onscreen prompts to enter your LinkedIn username and password to sign in. You can also create a new LinkedIn account.

YouTube

View videos uploaded to YouTube and upload your own videos to your YouTube account.





View YouTube Videos

You can use the YouTube app to view videos on YouTube even if you aren't signed in to a YouTube account.

1. From home, tap **Apps**  > **YouTube** .
- ❖ The YouTube app launches.
 - If you're prompted to provide confirmation to use the site, follow the onscreen instructions to continue.
2. Search through the YouTube channels and tap a video you want to see.
 - ❖ The video plays on your phone screen.
 - Tap the screen to pause or resume play while watching.

Post a Video to YouTube

You can post videos to your YouTube account from your phone. Before posting, you must set up a YouTube account and sign in to it on your phone.

1. From home, tap **Apps**  > **YouTube** .
- ❖ The YouTube app launches.
2. Tap **Options**  > **Uploads** > .
- ❖ The Open from menu appears.
3. Select a video to upload.
 - Enter a title, description, and tags, and select a privacy setting.
4. Tap .
- ❖ The video is uploaded to your YouTube channel.

Google Wallet

You must have a Google Wallet account associated with your Google Account to purchase items from the Google Play Store app.

To create a Google Wallet account, do one of the following:

- On your computer, go to google.com/wallet to create a Google Wallet account.

– or –

- The first time you use your phone to buy an item from Google Play, you're prompted to enter your billing information to set up a Google Wallet account.

Warning: When you've used Google Wallet once to purchase an application from the Google Play Store app, the phone remembers your password, so you don't need to enter it the next time. For this reason, you should secure your phone to prevent others from using it without your permission. (For more information, see [Security Settings](#).)

Connectivity

The following topics address your phone’s connectivity options, including USB file transfer and tethering, Wi-Fi, Bluetooth, IR connectivity, and more.

Transfer Files Between Your Phone and a Computer

You can use the supplied USB cable to connect your phone directly to your computer and transfer music, pictures, and other content files.

For example, if you have a music album stored on your computer that you want to listen to on your phone with any of the music apps, just attach your phone to the computer and copy the files to the music folder.

File Transfer Tips

- If you want to save data to an SD card on your phone, make sure the SD card is installed and active. See [SD Card](#).
- Avoid removing the battery or SD card while transferring data.
- Data exchange may use the methods outlined in the following table:

Method	Description
Media Device (MTP)	Connect your phone as a media device and transfer between your phone and PC files such as pictures, videos, and music.
Camera (PTP)	Connect your phone as a camera and use camera software on your PC to transfer picture and video files from phone to PC.

Transfer Files between the Phone and a Computer

1. Connect your phone to your computer using the supplied USB/charging cable.
 - Insert the smaller end of the cable to the charger/accessory jack at the bottom of the phone.
 - Insert the USB end of the cable into an available USB port on your computer. You may need to remove the USB cable from the charging head to access it.
2. When  appears in the notifications area, drag the status bar down to display the notifications panel.
3. Select either **Media device (MTP)** or **Camera (PTP)**.

- ❖ The files on your phone can now be accessed via your computer.
 - For most transfers, you'll want to use **Media device (MTP)**.
 - To change the option, tap  in the notifications panel to open the **Connect to PC** window, and then tap the desired option.
- 4. On your computer, navigate to the detected device (such as through the My Computer menu) and open it.
- 5. If available, select a drive (**SD Card** for SD card, **Phone** for internal phone storage).
- 6. Select a folder (for example, **Music** for songs and albums) and copy files to it from your computer.
- 7. When you are done, disconnect your phone from your computer.
 - ❖ The transferred files are now saved to your phone or SD card.

Wi-Fi

Wi-Fi provides wireless Internet access over distances of up to 300 feet. To use your phone's Wi-Fi, you need access to a wireless access point or "hotspot."

The availability and range of the Wi-Fi signal depends on a number of factors, including infrastructure and other objects through which the signal passes.

Turn Wi-Fi On and Connect to a Wireless Network

Use the wireless and networks setting menu to enable your phone's Wi-Fi radio and connect to an available Wi-Fi network.

1. From home, tap **Apps**  > **Settings**  > **Wi-Fi**.

- ❖ The Wi-Fi settings menu appears.

2. Tap the Wi-Fi slider to turn Wi-Fi on.



- ❖ Wi-Fi is enabled. You will see the names and security settings of in-range Wi-Fi networks.
 - To disable Wi-Fi, tap the slider again.
- 3. Tap a Wi-Fi network to connect, enter the password (if it's not an open network), and then tap **CONNECT**.

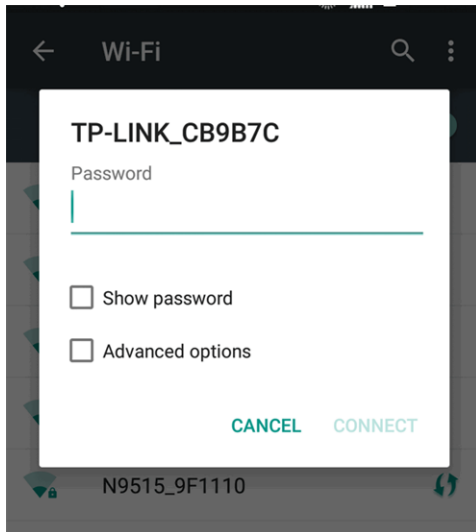

❖ Your phone is connected to the Wi-Fi network. You will see () in the status bar.

- The password, for a household wireless LAN router, is sometimes found on a sticker on the router (WEP, WPA, KEY, etc.). Contact the router manufacturer for information. For password for a public wireless LAN, check with user's service provider.
- Entering a password is not required if an access point is not security protected.

Note: The next time your phone connects to a previously accessed secured wireless network, you will not be prompted to enter the password again, unless you reset your phone to its factory default settings or you instruct the phone to forget the network.

Note: Wi-Fi networks are self-discoverable, which means no additional steps are required for your phone to connect to a Wi-Fi network. It may be necessary to provide a user name and password for certain closed wireless networks.

Wi-Fi Settings

Use the Wi-Fi settings menu to manually set your Wi-Fi connection options.

1. From home, tap **Apps**  > **Settings**  > **Wi-Fi**.

❖ The Wi-Fi settings menu appears.

2. Tap the Wi-Fi slider to turn Wi-Fi on.



- ❖ Wi-Fi is enabled. You will see the names and security settings of in-range Wi-Fi networks.
 - To disable Wi-Fi, tap the slider again.

3. Tap **Menu**  > **Advanced**.

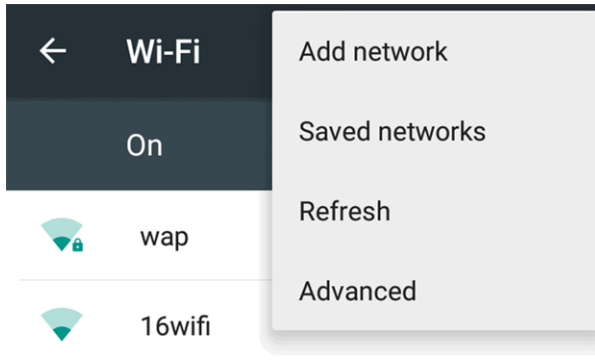

- ❖ The advanced Wi-Fi settings menu appears.

4. Configure your Wi-Fi settings.

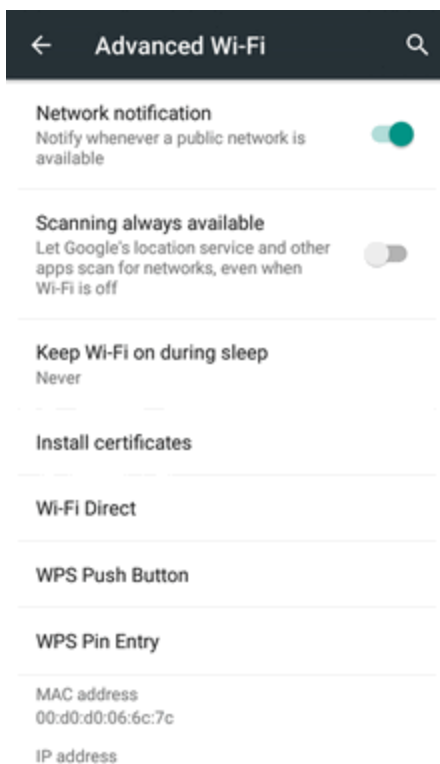

- ❖ Your Wi-Fi settings changes are saved.

Disconnect Wi-Fi

You may wish to disconnect from a connected Wi-Fi network without turning Wi-Fi off.

1. From home, tap **Apps**  > **Settings**  > **Wi-Fi**.

❖ The Wi-Fi settings menu appears.

2. Tap the name of the connected access point and then tap **FORGET**.

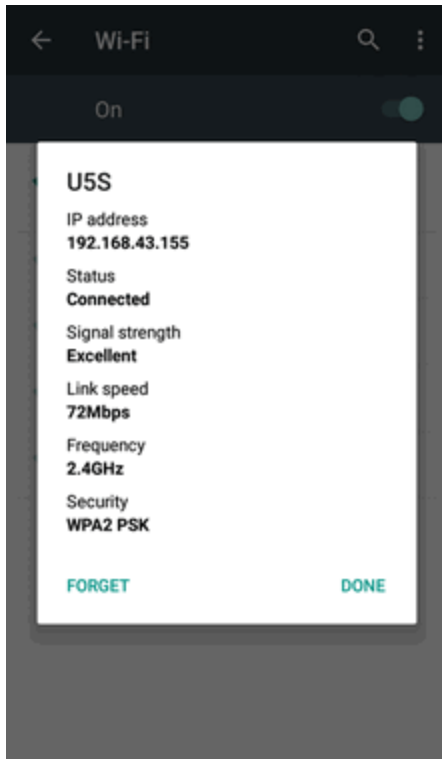

❖ Wi-Fi is disconnected.

- After disconnecting from an access point, you may need to re-enter the password to reconnect.

Wi-Fi Direct

Use Wi-Fi Direct to connect directly to other Wi-Fi Direct devices simply via Wi-Fi, without an access point or via the Internet.

1. From home, tap **Apps**  > **Settings**  > **Wi-Fi**.

❖ The Wi-Fi settings menu appears.

2. Tap the Wi-Fi slider to turn Wi-Fi on.

❖ Wi-Fi is enabled. You will see the names and security settings of in-range Wi-Fi networks.

3. Tap **Menu**  > **Advanced** > **Wi-Fi Direct**.

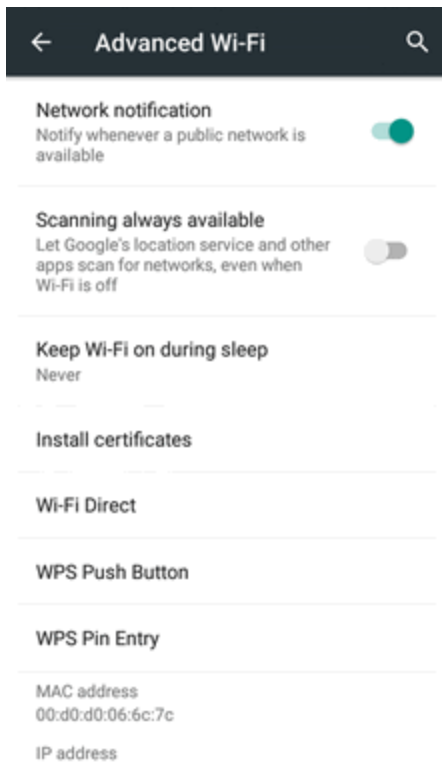

- ❖ The Wi-Fi Direct settings menu appears.
 - Wi-Fi Direct and Wi-Fi are unavailable at the same time.

4. Tap a device with which to connect below **Peer devices** and tap **CONNECT**.

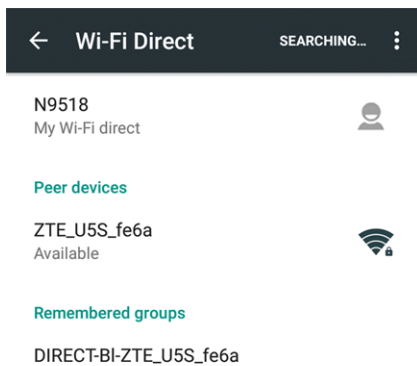



5. Accept the connection on the other device.

- ❖ The phone is connected via Wi-Fi Direct.
 - If a connection is not accepted after a certain period, the connection request is cancelled.
 - To stop a connection, tap the connected device and tap **DISCONNECT**.



Mobile Hotspot

Hotspot allows you to turn your phone into a Wi-Fi hotspot. When this feature is turned on, you can share your phone's mobile data services via Wi-Fi with other Wi-Fi enabled devices. The feature works best when used in conjunction with 4G data services (although 3G service can also be used).

Important: Use of the Hotspot feature requires an additional subscription. Sign on to your account at boostmobile.com or access your account via Boost Zone (tap **Apps**  > **Boost Zone** ) to learn more.

Note: Turning on Hotspot on will disable your phone's connection to other Wi-Fi networks.

Set Up Mobile Hotspot

1. From home, tap **Apps**  > **Settings** .
2. Tap **Mobile Hotspot**.
 - ❖ The Hotspot window opens.
3. Tap the slider to turn Hotspot on.
 - ❖ Hotspot is enabled.
 - To disable Hotspot, tap the slider again.

Note: The best way to keep using the phone as a hotspot is to have it connected to a power supply.

Important: Write down the passkey (password) for this communication (shown onscreen).

Connect to Mobile Hotspot

1. Enable Wi-Fi (wireless) functionality on your target device (laptop, media device, etc.).
2. Scan for Wi-Fi networks from the device and select your phone hotspot from the network list.
 - The default name for your phone hotspot is **N9132_XXXXXX**. You can change the name by tapping  > **Configuration** from the Mobile Hotspot screen.
3. Select this phone and follow your onscreen instructions to enter the passkey (provided on the Hotspot page).
 - ❖ The device is connected via your phone's Hotspot.
4. Launch your Web browser to confirm you have an Internet connection.

Tethering

Use Tethering to share your device's Internet connection with a computer that connects to your device via USB cable, or by Bluetooth.

1. From home, tap **Apps**  > **Settings** .

2. Tap **More** > **Bluetooth tethering**.

❖ Bluetooth tethering is turned on, and your phone's Internet connection can be shared with a connected Bluetooth device.

- For information on pairing and connecting with Bluetooth devices, see [Pair Bluetooth Devices](#) and [Connect to a Paired Bluetooth Device](#).

Bluetooth

Bluetooth® is a short-range communications technology that allows you to connect wirelessly to a number of Bluetooth devices, such as headsets and hands-free car kits, and Bluetooth-enabled handhelds, computers, printers, and wireless phones. The Bluetooth communication range is usually approximately 30 feet.

Bluetooth Hints

Question: Can't use Bluetooth?

Answer: Is your phone in airplane mode? Bluetooth is unavailable in airplane mode.

Bluetooth Function Cautions

Information may not appear correctly on connected devices depending on the transferred data.

Bluetooth Information

Bluetooth is a technology that enables wireless connection with PCs, Bluetooth devices with hands-free features, etc.

Function	Description
Audio output	Listen to music, etc., wirelessly.
Hands-free calls	Call hands-free, using Bluetooth-capable hands-free devices and headsets.
Data exchange	Exchange data with Bluetooth devices.

Enable the Bluetooth Feature

Use the settings menu to enable or disable your phone's Bluetooth capabilities.

- Wireless connection to all Bluetooth® functions is not guaranteed for the phone.
- The phone may not connect properly depending on the other device.
- Noise may be experienced with wireless calls and hands-free calls depending on the conditions.

To enable Bluetooth:

1. From home, tap **Apps**  > **Settings** .

2. Tap **Bluetooth**.

❖ The Bluetooth settings open.

3. Tap the slider to turn Bluetooth on.

❖ Bluetooth is enabled.

- To disable Bluetooth, tap the slider again.

Tip: You can also turn Bluetooth on or off with the toggle menu in the notification panel. Pull down the status bar to display the notification panel and then tap **Bluetooth** to turn Bluetooth on or off.

Note: Turn off Bluetooth when not in use to conserve battery power, or in places where using a wireless phone is prohibited, such as aboard an aircraft and in hospitals.

Pair Bluetooth Devices

Search for and pair nearby Bluetooth devices. Registered Bluetooth® devices can be connected simply.

- Enable the Bluetooth function on the Bluetooth devices being paired beforehand.

To pair Bluetooth devices:

1. From home, tap **Apps**  > **Settings** .

2. Tap **Bluetooth**.

❖ The Bluetooth settings open.

- Nearby devices appear in the “Available devices” list.
- If a target device is not detected, tap **Scan** to search again.

3. Tap a device from the “Available devices” list, and follow the onscreen instructions to pair with the device.

❖ The Bluetooth device is paired to your phone.

- Methods to accept a Bluetooth connection differ depending on the devices used.

Unpairing from a Paired Device

1. From the Bluetooth settings menu, tap **Settings**  next to the paired device you wish to unpair.

2. Tap **Unpair**.

- ❖ The device is unpaired from your phone. To make another connection with the device, you will need to pair again.

Connect to a Paired Bluetooth Device

You can listen to music over a Bluetooth stereo headset, or have hands-free conversations using a compatible Bluetooth headset or car kit. It's the same procedure to set up stereo audio and hands-free devices.

1. From home, tap **Apps**  > **Settings** .

2. Tap **Bluetooth**.

- ❖ The Bluetooth settings open.

- Paired Bluetooth devices appear in the “Paired devices” list.

3. Tap a device from the “Paired devices” list.

- ❖ Your phone connects to the paired device.

The pairing and connection status is displayed below the device's name in the Bluetooth devices section. When the device is connected to your phone, the Bluetooth paired icon  is displayed in the status bar. Depending on the type of device you have connected, you can then start using the headset or car kit to listen to music or make and receive phone calls.

Note: Due to different specifications and features of other Bluetooth-compatible devices, display and operations may be different, and functions such as transfer or exchange may not be possible with all Bluetooth-compatible devices.

Send Information Using Bluetooth

You can use Bluetooth to transfer information between your phone and another Bluetooth-enabled device such as a phone or notebook computer.

Types of Data You Can Send via Bluetooth

You can send the following types of information, depending on the device you are sending to:

- Images and videos
- Calendar events
- Contacts
- Audio files

In the instructions below, Contacts data is being used as an example.

Sending Contacts Data via Bluetooth

1. From home, tap **Contacts** .

❖ You will see the Contacts list.

2. Tap a contact to send.
3. Tap **Menu** ⋮ > **Share** > **Bluetooth**.
4. Tap a paired device to receive the data.

❖ The contact information is sent.

- If you see a message to confirm, follow the onscreen instructions.

Receive Data via Bluetooth

Your phone is capable of receiving a wide variety of file types with Bluetooth, including pictures, music tracks, and documents such as PDFs.

1. When another device attempts to send a file to your phone via Bluetooth, you will see a request to accept the file.
2. When another device attempts to send a file to your phone via Bluetooth, you will see a request to accept the file in the status bar.

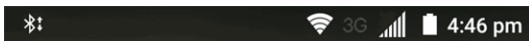

3. Drag the status bar down to display the notifications panel and then tap the **Bluetooth share** notification.
4. Tap **ACCEPT**.

Accept incoming file?

From

ZTE U5S

Filename

4e9b5a14-7866-458e-
b98d-9950100f65e1_5.jpg

Size

1.30MB

DECLINE ACCEPT

❖ The file is sent to your phone.

- When your phone receives a file, you will see a notification. To open the file immediately, drag the status bar down to display the notifications panel, and then tap the notification.
- When you open a received file, what happens next depends on the file type:
 - Media files and documents are usually opened directly in a compatible application. For example, if you open a music track, it starts playing in a music app you choose.

- For a vCalendar file, tap **OK** and the vCalendar event is imported to your local calendar account. (For more information on using the Calendar, see [Calendar](#).)
- For a vCard contact file, all contacts in the file will be imported to your phone contacts automatically.

Settings

The following topics provide an overview of items you can change using your phone's **Settings** menus. The settings menu is grouped into the following categories, all of which are available through the main settings screen.

- **WIRELESS & NETWORKS** menu options include Airplane mode, Wi-Fi, Bluetooth, Mobile networks, Data usage, Mobile hotspot and More.
- **DEVICE** menu options comprise Sound & notifications, Display, Date & time, Language & input, Storage, Battery, Apps, Users, and Connect to PC.
- **PERSONAL** settings include Navigation key, Location, Security, Backup & reset, and Accounts.
- **SYSTEM** menu options include Accessibility, Printing, Activate this device, System updates, and About phone.

Airplane Mode

Airplane mode allows you to use many of your phone's features, such as Gallery, Camera, and Music, when you are on an airplane or in any other area where making or receiving calls or data is prohibited. When you set your phone to Airplane mode, it cannot send or receive any calls or access online information.

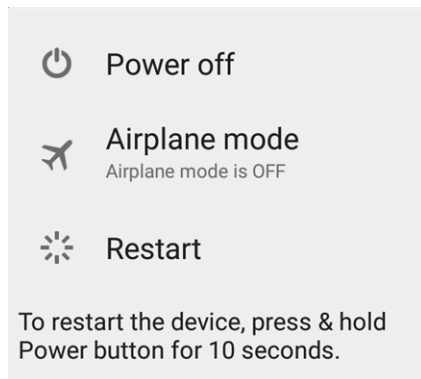

To quickly turn Airplane mode on or off:

- Press and hold the **Power Button**, and then tap **Airplane mode**.



- When in airplane mode, the status bar will display .



To turn Airplane mode on or off in Settings:

1. From home, tap **Apps**  > **Settings** .
2. Tap the Airplane mode slider. When in airplane mode, the status bar will display .

Wi-Fi Settings Menu

The Wi-Fi settings menu lets you turn Wi-Fi on or off, set up and connect to available Wi-Fi networks, and configure advanced Wi-Fi options.

For more information about Wi-Fi settings, see [Wi-Fi](#).

1. From home, tap **Apps**  > **Settings** .
2. Tap **Wi-Fi**.
 - ❖ The Wi-Fi settings menu appears.
3. Tap the Wi-Fi slider to turn Wi-Fi on.
 - ❖ Wi-Fi is enabled. You will see the names and security settings of in-range Wi-Fi networks.
 - To disable Wi-Fi, tap the slider again.
4. Tap a Wi-Fi network, enter the password, and tap **CONNECT**.

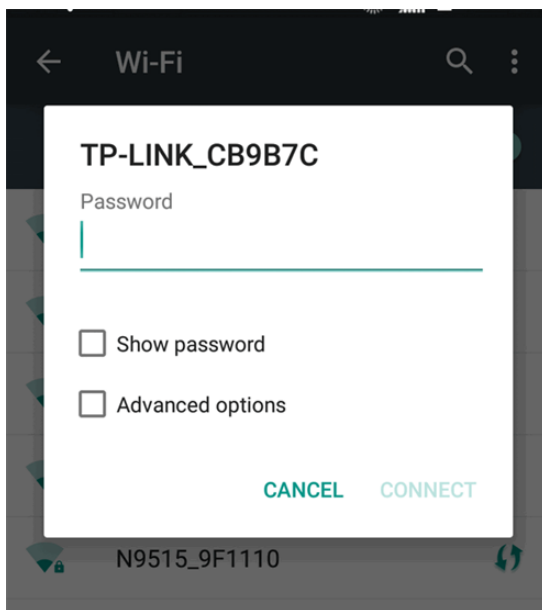

- ❖ Your phone is connected to the selected Wi-Fi network.
 - The password, for a household wireless LAN router, is sometimes found on a sticker on the router (WEP, WPA, KEY, etc.). Contact the router manufacturer for information. For password for a public wireless LAN, check with user's service provider.
 - Entering a password is not required if an access point is not security protected.

Advanced Wi-Fi Settings

The advanced Wi-Fi settings menu lets you set up and manage wireless access points.



- **Enable Notification when Open Networks Are Available:** From Wi-Fi settings, tap **Menu** ⋮ > **Advanced** and tap the **Network notification** slider.
 - The setting is available when Wi-Fi is turned on.
 - Tap **Network notification** to turn the option on or off.
- **Allow Some Services to Scan for Networks even when Wi-Fi is Off:** From Wi-Fi settings, tap **Menu** ⋮ > **Advanced** and tap the **Scanning always available** slider.
 - Tap **Scanning always available** to turn the option on or off.
- **Set Timing for Pausing a Connection:** From Wi-Fi settings, tap **Menu** ⋮ > **Advanced** > **Keep Wi-Fi on during sleep** and then select a setting.
- **Install Certificates for Secured Wi-Fi Networks** From Wi-Fi settings, tap **Menu** ⋮ > **Advanced** > **Install certificates** and then select the file to install.
- **Use Wi-Fi Direct:** From Wi-Fi settings, tap **Menu** ⋮ > **Advanced** > **Wi-Fi Direct**.
 - The setting is available when Wi-Fi is turned on.
 - For more information, see [Wi-Fi Direct](#).
- **Use WPS to Connect to a Wi-Fi Network:** From Wi-Fi settings, tap **Menu** ⋮ > **Advanced** > **WPS Push Button** or **WPS Pin Entry**.
 - The settings are available when Wi-Fi is turned on.
 - If you tap **WPS Push Button**, press the WPS button on the access point and the access point will recognize your phone and add it to the network.
 - If you tap **WPS Pin Entry**, enter the PIN number displayed on the phone into the access point's setup page. Your phone automatically finds the access point and configures the connection.

Note: For detailed information about the WPS feature of the access point, please refer to its user documents.

- **Check MAC Address:** From Wi-Fi settings, tap **Menu** ⋮ > **Advanced**.
 - MAC Address appears below “MAC address.”
- **Check IP Address:** From Wi-Fi settings, tap **Menu** ⋮ > **Advanced**.
 - IP Address appears below “IP address.”







Bluetooth Settings

Your phone's Bluetooth® capabilities let you use wireless headsets, send and receive pictures and files, and more. For details on your phone's Bluetooth usage, see [Bluetooth](#).

1. From home, tap **Apps**  > **Settings** .
2. Tap **Bluetooth**.

❖ The Bluetooth settings open.



Bluetooth Settings Operations

- **Enable Bluetooth:** In Bluetooth settings, tap the slider at the top of the menu.
 - Alternately, drag the status bar down to display the notifications panel and then tap **Bluetooth** to turn Bluetooth on or off.
- **Pairing Bluetooth Devices:** Make sure the other devices are set to be discovered. From Bluetooth settings, tap the device name in “Available devices” and follow the onscreen instructions.
 - Depending on the device, you may be required to enter or accept a passkey.
 - If the target device does not appear, tap **Menu**  > **Refresh** to search again.
 - This setting is available when Bluetooth is enabled.
- **Change the Name of a Paired Device:** From Bluetooth settings, tap **Settings**  next to a paired device name, tap **the current name**, enter a new name, and tap **OK**.
 - Emoji cannot be used in a device name.
 - This setting is available when Bluetooth is enabled.
- **Cancelling Pairing:** From Bluetooth settings, tap **Settings**  next to a paired device name, and then tap **FORGET**.
 - This setting is available when Bluetooth is enabled.
- **Enable Service from Paired Device:** From Bluetooth settings, tap **Settings**  next to a paired device name, and then tap the listing under **Use for**.
 - If a confirmation prompt appears, follow the onscreen instructions.
 - This setting is available when Bluetooth is enabled.
 - This setting is available when the paired device is providing a service.
- **Search for Other Devices:** From Bluetooth settings, tap **Menu**  > **Refresh**.
 - This setting is available when Bluetooth is enabled.
- **Check Files Received via Bluetooth Transfer:** From Bluetooth settings, tap **Menu**  > **Show received files**, and follow the onscreen instructions.

Mobile Networks Settings

The Mobile networks options let you enable your phone's mobile data access and set your preferred network mode.

Enable Data Services

1. From home, tap **Apps**  > **Settings**  > **Mobile networks**.
2. Tap **Data Enabled** to enable or disable data services over the mobile network.



Note: Certain data service request may require additional time to process. While your phone is loading the requested service, the touchscreen may appear unresponsive when in fact it is functioning properly. Allow your phone some time to process your data usage request.

Switch Network Mode

1. From home, tap **Apps**  > **Settings**  > **Mobile networks** > **Preferred network type**.
2. Tap **LTE/CDMA** or **CDMA**.

Data Usage Settings

The data usage menu lets you view your phone's mobile and Wi-Fi data usage, set data limits, restrict hotspot usage, and more.

1. From home, tap **Apps**  > **Settings** .
2. Tap **Data usage**.

 The data usage window opens.



Data Usage Settings Operations

- **Enable Mobile Data:** In Data usage window, tap the Mobile data slider to enable or disable the service.
 - If a confirmation appears, follow the onscreen instructions.
- **Enable Restrictions on Mobile Data Usage:** From the Data usage window, tap **Set mobile data limit** to enable restriction and tap **OK** to confirm.
 - With restriction turned on, drag the horizontal Limit slider up or down to set the data usage limit and data warning amount.
 - This setting is available when Mobile data is enabled.
- **Set Date for Resetting Data Usage:** To set the data usage measuring cycle, from the Data usage window, tap the box above the data usage graph, tap **Change cycle**, set a reset date, and tap **SET**.

- This setting is available when Mobile data is enabled.
- **Check Data Usage for Each Application:** To see how your data is being used, slide the vertical white bars in the graph to set a usage period, and then tap an app name to see its usage for the period.
- **Enable Restriction on Mobile Data in Background:** From the Data usage window, tap **Menu** ⋮ > **Restrict background data**.
 - This setting stops some apps and services from working unless your phone is connected to a Wi-Fi network.
 - If a confirmation appears, tap **OK**.
- **View Both Mobile Data and Wi-Fi Usage:** From the Data usage window, tap **Menu** ⋮ > **Show Wi-Fi**.
 - Tap **Menu** ⋮ > **Hide Wi-Fi** to disable the feature.
 - When the feature is on, you will see a CELLULAR tab and a WI-FI tab at the top of the Data usage window. Tap **WI-FI** to view your phone's Wi-Fi data usage.

Mobile Hotspot Settings

Use the settings menu to configure your hotspot settings, which allow you to share your phone's data service with multiple Wi-Fi capable devices.

1. From home, tap **Apps**  > **Settings**  > **Mobile Hotspot**.
 - ❖ The Mobile hotspot window opens.
2. Tap the slider to turn Mobile hotspot on.
 - ❖ Mobile Hotspot is enabled.
 - To disable Mobile Hotspot, tap the slider again.

Advanced Mobile Hotspot Settings

The Mobile hotspot settings menu lets you configure advanced options.

- **Set Network SSID:** From the Mobile hotspot window, tap **Menu** ⋮ > **Configuration**, tap the **Network name** field to edit the name for your hotspot, and then tap **SAVE**.
- **Set Hotspot Security:** From the Mobile hotspot window, tap **Menu** ⋮ > **Configuration**, tap the **Security** line and select a security settings option, and then tap **SAVE**.
 - If you select WPA2 PSK, tap the **Password** field to edit the password.
- **Set Hotspot Password:** From the Mobile hotspot window, tap **Menu** ⋮ > **Configuration**, tap the **Password** field and enter a password, and then tap **SAVE**.

- **Set Hotspot Visibility:** From the Mobile hotspot window, tap **Menu** ⋮ > **Configuration**, tap the **Broadcast SSID** line. Select **Enable** if you want the hotspot to be searchable, or select **Disable** if you want the hotspot to be undetectable. Then tap **SAVE**.
- **Set Hotspot Channel:** From the Mobile hotspot window, tap **Menu** ⋮ > **Configuration**, tap the **Channel** line, select a channel, and then tap **SAVE**.
 - Use a different channel may help you avoid interference with other Wi-Fi networks.
- **Set Allowed Devices:** To select which devices are allowed to connect to mobile hotspot, In Mobile hotspot window, tap **Menu** ⋮ > **Manage Users** > **Allowed Devices** > **ADD NEW**, enter a device name and MAC address, and then tap **SAVE**.
 - To remove allowed devices, tap **DELETE**, select the devices and then tap **REMOVE**.
 - In the Allowed Devices screen, uncheck **Allow all devices if you want only devices in the list to connect to the hotspot**.
- **Set Maximum Connections:** To set the maximum number of devices that can connect to the hotspot simultaneously, in Mobile hotspot window, tap **Menu** ⋮ > **Manage Users** > **Max connection** and tap a number.
- **Set Hotspot Sleep Settings:** From the Mobile hotspot window, tap **Menu** ⋮ > **Advanced**, and configure the following options.
 - **Hotspot sleep policy:** Set the wait time before Mobile hotspot turns off when there is no connected device.
 - **Hotspot notification:** Check this option to display a notification in the status bar when the sleep policy turns off the hotspot.
 - **Data service dependency:** Check this option to turn off Mobile hotspot when mobile data service is unavailable.
- **Set Local Area Network (LAN) Settings:** From the Mobile hotspot window, tap **Menu** ⋮ > **Advanced**, configure your options in the LAN settings section.



More Settings

The more settings menu provides access to additional wireless and network options, such as default messaging app, mobile networks, VPN, roaming, NFC, and more.

More Settings Options

Setting	Description
VPN	Manage Virtual Private Network (VPN).
Default SMS app	Set the default app for SMS/MMS.
Bluetooth tethering	Turn on or off the Bluetooth tethering feature.

Access More Settings Options

1. From home, tap **Apps**  > **Settings** .
2. Tap **More settings**.
3. Set items.

❖ Your settings are saved and implemented.

Virtual Private Networks (VPN)

From your phone, you can add, set up, and manage virtual private networks (VPNs) that allow you to connect and access resources inside a secured local network, such as your corporate network.



Prepare Your Phone for VPN Connection

Depending on the type of VPN you are using at work, you may be required to enter your login credentials or install security certificates before you can connect to your company's local network. You can get this information from your network administrator.

Before you can initiate a VPN connection, your phone must first establish a Wi-Fi or data connection. For information about setting up and using these connections on your phone, see [Browser](#) and [Turn Wi-Fi On and Connect to a Wireless Network](#).

Set Up Secure Credential Storage



If your network administrator instructs you to download and install security certificates, you must first set up the phone's secure credential storage.

1. From home, tap **Apps**  > **Settings**  > **Security** > **Install from SD card**.
2. Select the certificate file you need to install. Only certificates that you have not installed are displayed.
3. If prompted, enter the certificate password and tap **OK**.
4. Enter a name for the certificate and tap **OK**.

Note: If you have not set a PIN or password for your phone, you are prompted to set one up.

Add a VPN Connection

Use the Wireless & networks settings menu to add a VPN connection to your phone.

1. From home, tap **Apps**  > **Settings**  > **More** > **VPN**.
❖ The VPN settings window appears.

2. Tap , and then enter the information for the VPN you want to add.

Edit VPN profile

Name

Type
PPTP ▼

Server address

PPP encryption (MPPE)

Show advanced options

CANCEL **SAVE**

- Information may include Name, Type, Server address, PPP encryption (MPPE), and advanced options.
- Set up all options according to the security details you have obtained from your network administrator.



3. Tap **SAVE**.

❖ Your VPN is added to the VPNs section of the VPN settings window.

Connect to or Disconnect from a VPN

Once you have set up a VPN connection, connecting and disconnecting from the VPN is easy.

Access the VPN Settings Window

- From home, tap **Apps**  > **Settings**  > **More** > **VPN**.
- ❖ The VPN settings window appears.

Connect to a VPN

1. From the VPNs section of the VPN setting window, tap the VPN that you want to connect to.



2. When prompted, enter your login credentials, and then tap **CONNECT**.

Connect to Company

Username

Password

Save account information

CANCEL **CONNECT**

- ❖ You will connect to the selected VPN.
 - When you are connected, a VPN connected icon appears in the notification area.

3. Open the Web browser to access resources such as intranet sites on your corporate network.



Disconnect from a VPN

1. Drag the status bar down to open the notifications panel.
2. Tap the VPN connection to return to the VPN settings window.
3. Tap the VPN connection to disconnect from it.

- ❖ Your phone disconnects from the VPN.
 - When your phone has disconnected from the VPN, you will see a VPN disconnected icon in the notification area of the status bar.

Default SMS App Settings

If you have multiple messaging apps installed on your phone, you can choose the app your phone uses for messaging. The app you select here will be used when you choose Messaging in other apps, such as when sharing items like pictures or video.

1. From home, tap **Apps**  > **Settings**  > **More** > **Default SMS app**.
2. Choose a messaging app.

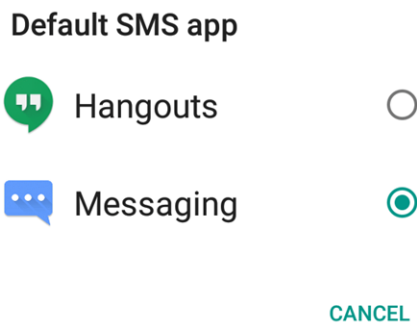



 The default SMS app is set.

Note: If you choose a default SMS app other than Messaging (for example, Google Hangouts), you will not be able to use the **Messaging** app unless you restore it as the default SMS app.

Bluetooth Tethering Setting

Bluetooth tethering allows you to share your phone's mobile data connection with other devices via Bluetooth.

From home, tap **Apps**  > **Settings**  > **More** and then tap **Bluetooth tethering** to turn the feature on or off.

Sound & Notifications Settings

The Sound & notifications settings menu lets you control your phone's audio, from ringtones and alerts to tap tones and notifications.



Sound and Notifications Settings Overview

The sound & notifications settings menu allows you to configure the following options:

Sound Setting	Description
Volume	Set volume for media, alarm, ringtone, and notification.
Interruptions	Set interruption mode for calls and notifications.

Sound Setting	Description
Phone ringtone	Set your phone's default ringtone.
Default notification ringtone	Set the default tone for phone notifications.
Vibrate pattern	Set the pattern of vibration when vibration is enabled for notifications.
Other sounds	Manage system sounds including dial pad tones, screen lock sounds, touch sounds, vibration on touch, and emergency tone.
Notification mode	Select the sound mode of notification.
When device is locked	Set the appearance of notification content on the lock screen.
App notifications	Set the priority and sensitivity of your apps. Notifications from priority apps are allowed in priority interruptions mode; while you can hide notifications from sensitive apps on the lock screen. Some apps also allow you to block all of their notifications.
Notification access	Manage the authority of individual apps to access notifications.

Access Sound Settings

1. From home, tap **Apps**  > **Settings**  > **Sound & notification**.
2. Set your sound & notifications options.
 - ❖ Your settings are saved and applied.





Display Settings

Use the phone's display settings menu to adjust items such as wallpaper, brightness, screen timeout, and more.



Display Settings Overview

The display settings menu allows you to configure the following options:

Display Setting	Description
Brightness level	Set the screen brightness.
Adaptive brightness	Set whether to automatically adjust the screen brightness for available light.
Wallpaper	Set a wallpaper.
Auto-rotate screen	Set whether to allow the screen to rotate the display with the phone orientation, where applicable.
Sleep	Set a screen timeout duration before it automatically turns off. Note: Longer durations discharge the battery more quickly.
Daydream	Manage the Daydream function. When Daydream is enabled, photos or animations will be displayed as a screensaver.

Display Setting	Description
Font size	Set font size for display.
Pulse notification light	Set whether to flash the light beneath the Home Key  to notify you of missed calls, new messages, and other events.
Accelerometer Calibration	Calibrate the phone's accelerometer when you detect any error during use.
Navigation key light duration	Control the back light duration of the Home Key  , the Back Key  , and the Recent Apps Key  .

Access Display Settings

1. From home, tap **Apps**  > **Settings**  .
 2. Tap **Display**.
 3. Set your display options.
- ❖ Your display settings are saved and applied.

Date & Time Settings



Use the Date & Time settings menu either to automatically use the network-provided date and time or manually set these values, as well as select time and date format options.

Date and Time Overview

The following Date and time options may be configured:

Date and Time Option	Description
Automatic date & time	Set the date and time automatically via the connected mobile network.
Automatic time zone	Set the time zone automatically via the connected mobile network.
Set date	Set the date manually (only available when Automatic date & time option is disabled).
Set time	Set the time manually (only available when Automatic date & time option is disabled).
Select time zone	Set the time zone manually (only when Automatic time zone is disabled).
Use 24-hour format	Enable or disable 24-hour format.
Choose date format	Set the date display format.

Access Date and Time Options

1. From home, tap **Apps**  > **Settings**  > **Date & time**.
 2. Set available date and time options.
- ❖ Your date and time settings are applied and saved.

Language & Input Settings

Your phone's language & input settings let you select a language for the phone's menus and keyboards, select and configure keyboard settings, configure speech input settings, and set your phone's mouse/trackpad options.

Language and Input Settings Overview

You can set the following options in the Language and input settings menu:

Language and Input Setting	Description
Language	Set the language for your display and menus.
Spell checker	Turn on or off the feature and configure Google Spell Checker options to check for spelling errors when entering text.
Personal dictionary	Add words to a personal phone dictionary to improve word suggestion and spell check when entering text.
Current Keyboard	Set the default method for entering text and enable/disable installed input methods.
Google Keyboard	Set Google Keyboard options.
Swype	Set Swype keyboard options.
TouchPal X	Set TouchPal X keyboard options.
Voice input	Select and configure voice input services.
Text-to-speech output	Set text-to-speech options.
Pointer speed	Set the speed of the pointer for a mouse/trackpad.

Access Language and Input Setting Options

1. From home, tap **Apps**  > **Settings**  > **Language & input**.

❖ The Language and input settings menu opens.

2. Set options.

❖ The language and input settings are applied and saved.

Language and Input Options

Some of the language and input options are detailed below.

- **Set the Display Language:** From the Language & input settings menu, tap **Language** and then tap a language to assign it.
- **Set Input Method:** From the Language & input setting menu, tap **Current Keyboard** and then tap an input method.

- **Set Google Keyboard Options:** From the Language & input settings menu, tap **Google Keyboard** and configure your keyboard options.
- **Set Output for Text-to-Speech Output:** From the Language & input settings menu, tap **Text-to-speech output**, tap a settings option, and follow the onscreen instructions.
- **Set Speed of Pointer for Mouse/Trackpad:** From the Language & input settings menu, tap **Pointer speed**, drag the bar to adjust the speed, and tap **OK**.

Storage Settings



The storage settings menu lets you manage internal storage on your phone and provides menu choices for an optional SD card (not included).

Storage Settings Overview

The storage settings menu allows you to configure the following options:



Storage Setting	Description
Save location	Set the default location for new data, such as files downloaded, photos captured, and voice recorded.
Total space	View the total space/free space in your phone memory and in an optional installed SD card.
Unmount SD card	If an optional SD card is installed, tap to unmount the card to allow for safe removal.
Mount SD card	If an optional SD card is installed, tap to mount the card and make it available for use.
Erase SD card	If an optional SD card is installed, tap to erase all data stored on the card and prepare it for use by your phone.

Access Storage Settings

1. From home, tap **Apps**  > **Settings** .
2. Tap **Storage**.
3. Check or tap items.
 - ❖ Review your storage settings.

Battery Settings

Monitor your phone's battery usage through this settings menu. View which functions are consuming your battery's charge and at what percentage.

1. From home, tap **Apps**  > **Settings** .
2. Tap **Battery**.
3. Tap items to view details.
 - ❖ Check your battery condition and access additional options.

App Settings



Check installed applications and running applications.

Apps Settings Overview

Items that can be checked in the Apps settings menu are the following.

Apps Setting	Description
Downloaded	Check downloaded apps.
Running	Check running apps.
All	Check all apps.



Access Apps Settings

1. From home, tap **Apps**  > **Settings**  > **Apps**.
2. Tap items to view details.
 - ❖ Check your application settings condition and access additional options.
 - Depending on the app and its location, you may be able to force the app closed, uninstall or disable the app, clear cache and data, move the app between phone and SD card, and more.

Connect to PC Settings

The Connect to PC settings menu lets you select the USB connection type between your phone and PC. For more information, see [Transfer Files Between Your Phone and a Computer](#).

Access Connect to PC Settings

1. From home, tap **Apps**  > **Settings**  > **Connect to PC**.
2. Tap one USB connection type.

Note: Uncheck **Don't ask me again** to be prompted to select a connection type each time you connect the phone to a PC.

Navigation Key Setting

The Navigation key setting menu allows you to exchange the positions of the **Back Key** ^o and the **Recent Apps Key** ^o.

To swap the positions of the two keys:

1. From home, tap **Apps**  > **Settings**  > **Navigation key**.
2. Tap an option.

Location Access Settings

Your Location Services settings menu lets you select how your phone determines its location (using the wireless networks, GPS satellites, both, or neither).



Location Settings Overview

Your Location settings menu allows you to configure the following options.



Location Setting	Description
Mode	Select a locating method: High accuracy, Power saving, or GPS only
Place	Add favorite locations for use with location-enabled features
Location tagging	Allow specific apps to tag your location automatically

Enable Location Services

Before using any features that require location assistance, you must enable your phone's location services.

1. From home, tap **Apps**  > **Settings** .
2. Tap **Location**.
3. Tap the setting to toggle Location on.
 - ❖ Your phone's location services are enabled.
 - If you see a confirmation, follow the onscreen instructions to connect.

Access Location Settings

1. From home, tap **Apps**  > **Settings** .
2. Tap **Location**.
3. Configure the desired settings.
 - ❖ Your location settings are applied and saved.

Security Settings

The Security settings menus let you set encryption options, password visibility, administrator settings, and credential storage options.



Security Settings Overview

Many security settings are dependent on Screen lock settings, SIM lock settings, etc. The following table outlines the settings available through the Security settings menu:

Security Setting	Description
Screen lock	Protect your phone with a screen lock that you must enter to use the phone.
Owner info	Set the text that you may display on the lock screen.
Smart Lock	Keep the phone unlocked when connected to trusted devices, in trusted places, unlocked by trusted faces or voices, or as long as you keep holding or carrying the device. Note: You need to sign in to your Google Account on the phone to use this feature.
Encrypt phone	Encrypt all data on your phone.
Encrypt SD card	Encrypt the data on an optional installed SD card.
Make passwords visible	Toggle to show or hide passwords when entering form data.
Device administrators	View or turn off device administrators.
Unknown sources	Allow or deny installation of apps from sources other than the Google Play Store app.
Storage type	Check the credential storage type.
Trusted credentials	Display trusted CA certificates.
Install from SD card	Install certificates from the phone storage or an optional installed SD card.
Clear credentials	Clear the credential storage and delete all certificates.
Trust agents	View or deactivate trust agents.
Screen pinning	Keep a screen of your choice in view, so that others cannot switch to other apps and access your personal information.
Apps with usage access	Turn on or off some apps' access to your phone usage information.

Access Security Settings

Before using any features that require location assistance, you must enable your phone's location services.

1. From home, tap **Apps**  > **Settings**  > **Security**.
 The Security settings menu opens.
2. Set your security options.

- ❖ Your security settings are applied and saved.

Backup & Reset

Your phone's **Backup & reset** menu lets you back up your phone's data and settings to Google servers before resetting your phone to the original factory settings. The Factory data reset erases all data from the phone's application storage, including:

- Your Google Account
- All other email and social networking accounts
- System and application data and settings
- Downloaded applications

Backup and Reset Overview

The following options are available in the Backup and reset menu:

Backup and Reset Option	Description
Back up my data	Enable backup for application data, Wi-Fi passwords, and other settings to Google servers.
Backup account	Select the account used to back up data.
Automatic restore	When reinstalling an application, backed up settings and data will be restored.
Factory data reset	Reset all settings and delete all data on phone.

- Performing a factory data reset erases all data on the phone. It is recommended that you back up important data before performing a factory data reset.
- Erased information cannot be restored. Only erase data after you are sure you have saved everything you need.

Access Backup and Reset Options

1. From home, tap **Apps**  > **Settings**  > **Backup & reset**.



- ❖ The Backup and reset menu opens.

2. Set options.

- ❖ The backup and reset settings are applied and saved.

- If you're performing a Factory Data Reset, follow the prompts to confirm the data removal. The phone will erase all data and reboot.

Factory Data Reset

Tip: Before performing a factory data reset on your phone, you may want to unmount the SD card to avoid losing any data you may have stored on it. From home, tap **Apps**  > **Settings**  > **Storage** > **Unmount SD card** to unmount the storage card.

1. From the Backup and reset menu, tap **Factory data reset**.

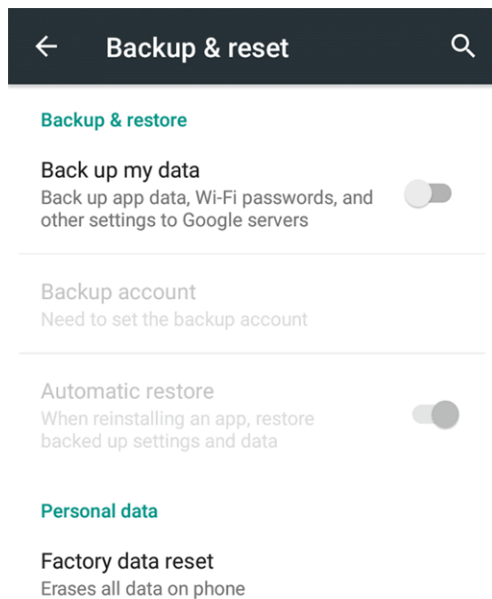

2. Read the factory data reset information page and tap **RESET PHONE**.

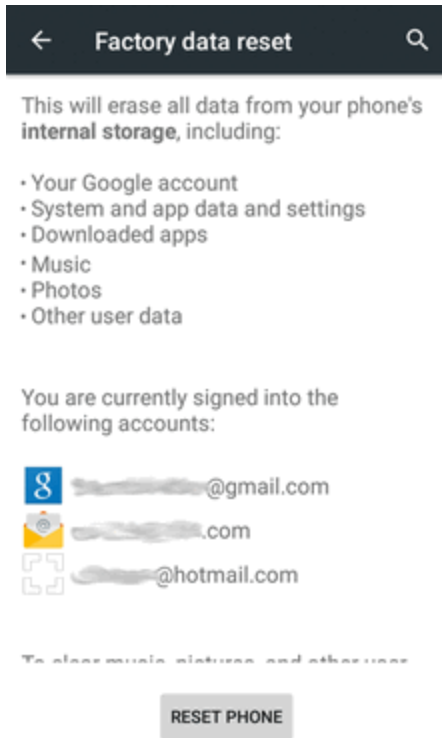

3. Tap **ERASE EVERYTHING**.

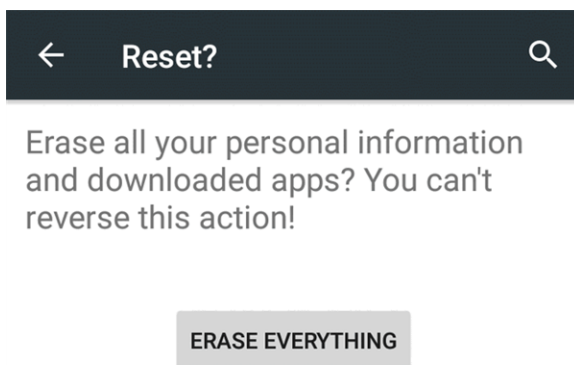



- ❖ Your phone will power down and reset itself, which may take up to 10 minutes.
 - Once the phone has reset, it will run through the Setup Screens again. See [Complete the Setup Screens](#) to start over.



Accounts

The Accounts settings menu lets you add and manage all your email, social networking, and picture and video sharing accounts.

Set Up a New Account

1. From home, tap **Apps**  > **Settings** .
2. Tap **Accounts** > **Add account**.
 - ❖ An Add account window appears.
3. Tap an account type and then follow the onscreen instructions to add the required account information, and then tap **Done**.
 - ❖ The account is added to the accounts list.

Manage Existing Accounts

1. From home, tap **Apps**  > **Settings** .
2. Tap an account type displayed below **Accounts**.
3. Tap an account in the category.

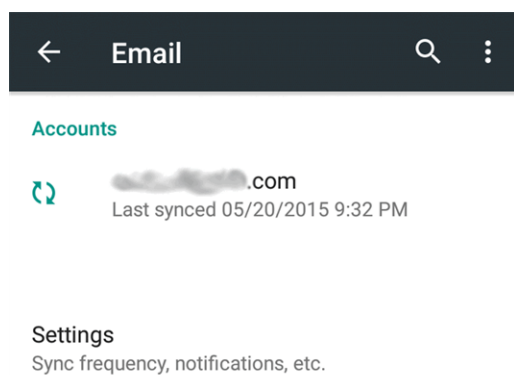

- ❖ The account settings menu appears.
4. Select your account settings.
 - ❖ The account options are updated.

Accessibility Settings



The accessibility menu lets you enable and manage accessibility-related applications.

Accessibility Settings Overview

The following accessibility options may be configured:

Accessibility Option	Description
TalkBack	Set the TalkBack service to help blind or low-vision users access the phone.
Switch Access	Set Switch Access to allow you to control the phone using configurable key combinations.
Magnification gestures	Set whether to allow zooming in and out the screen content by triple-tapping the screen.
Large text	Set whether to enlarge the text on the screen.
High contrast text	Set whether to display onscreen text with higher contrast.
Color correction	Set whether to correct color on the screen for color-blind users.
Text-to-speech output	Set text-to-speech options.
Notification reminder	Set whether to remind you of notifications.
Captions	Set the language, text size, and style for the captions.
Audio Type	Set the type of the phone's audio output.
Sound Balance	Set the sound volume balance.
Physical key vibrating	Set whether to let the phone vibrate when you press the physical buttons (the Power Button and the Volume Buttons).
Touch & hold delay	Adjust the delay required for the phone to notice your "touch & hold" gesture (for example, when you want to move an app to the home screen).
Power button ends call	When enabled, you can press the Power Button to end phone calls without turning the screen off.
Auto-rotate screen	Set whether to allow the screen to rotate the display with the phone orientation, where applicable.
Speak passwords	Get spoken feedback while typing passwords.
Accessibility shortcut	When this feature is enabled, you can quickly enable accessibility features following the steps prompted on the Accessibility shortcut screen.

Access Accessibility Options

1. From home, tap **Apps**  > **Settings** .
2. Tap **Accessibility**.
3. Set available accessibility options.
 - ❖ Your accessibility settings are applied and saved.

Printing

The Printing menu lets you configure Google's Cloud Print service. You can connect your printer to your Google Account and then add the printer on your phone in the Printing menu. After that, you can send documents, pictures, emails, or Web pages from your phone to the printer wirelessly and have them printed out.

Connect Your Printer to Your Google Account

How you connect your printer to your Google Account depends on the type of your printer.

For traditional printers, follow the steps below.



1. Connect the printer to your computer and install necessary software so that the printer is ready for printing.
2. Open the Chrome Web browser on the computer and go to the Settings page.
3. Click **Add printers** and follow the prompts to add the printer to your Google Account. You need to sign in to your Google Account in Chrome.

For Cloud Ready Printers, you can connect it to the Internet and register it to your Google Account directly without using a computer.

Use Cloud Print on Your Phone

To use Google Cloud Print on your phone, you must sign in to your Google Account.

If you haven't added a printer on the phone or haven't turned on the Cloud Print feature, tap **Apps**

 > **Settings**  > **Printing** > **Cloud Print** from home to enable this function or add a printer registered to your Google Account.

1. Open a file on the phone and select the option for print. For example, open a Web page with the Chrome app and tap **Menu**  > **Print....**

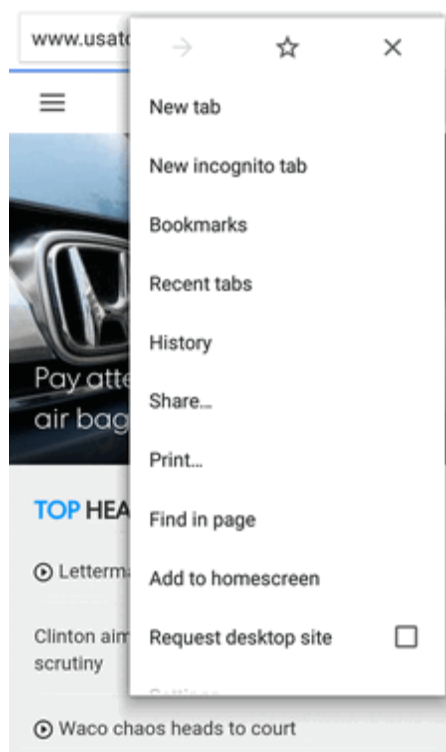

2. Select a printer you have added to the phone or tap ▼ > **All printers...** to add a printer right away.

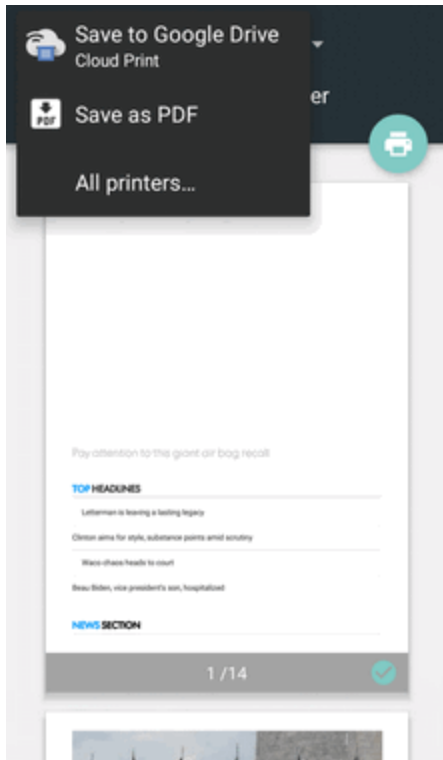



3. Configure other print job options, such as number of copies, color, and paper size.
4. Tap **Print**  to send the print job wireless to your printer through Google Servers.

Note: Instead of selecting a printer, you can also choose to save the file to Google Drive or as a PDF file.



Activate This Device

The activate this device menu lets you activate a new phone or use additional self-service options such as checking the status of an in-service phone.

1. From home, tap **Apps**  > **Settings** .
2. Tap **Activate this device**.
 - ❖ The Device Self Service menu appears.
3. Follow the onscreen prompts to activate your phone or review your summary.
 - ❖ Your phone activates. If already activated on an account, you will see a usage and plan summary.

System Updates

The System updates menu lets you update your PRL (preferred roaming list), your user profile, your Android software, and your phone firmware.

1. From home, tap **Apps**  > **Settings**  .
2. Tap **System updates** and select an option and follow the prompts to complete the update.
 - For complete system update information, see [Update Your Phone](#).

About Phone



The about phone menu lets you access important phone information, search for and apply updates, and view legal and safety information.

About Phone Overview

The following About Phone items may be reviewed or set:

About Phone Item	Description
Status	Check your phone's status.
Legal information	Check open source license information, Google legal document, etc.
4G settings	Check the 4G LTE network provider and your IP address.
Model number	Check the phone's model number.
Android version	Check the Android version number.
Baseband version	Check the phone's baseband version.
Kernel version	Check the phone's kernel version.
SW Version	Check the current phone software version.
HW Version	Check the current phone hardware version.

Access About Phone Options

1. From home, tap **Apps**  > **Settings**  .
2. Tap **About Phone**.
3. Select or view available options.
 - ❖ Your phone information is displayed.

For Assistance

The following topics address areas of support for your phone, including troubleshooting, specifications, account information, warranty information, and customer service contact information.

Troubleshooting

Check the questions and answers below for troubleshooting solutions for common phone issues.

Check Here First

Question: Phone freezes/operation is unstable.

Answer: Turn the phone on again. If you are unable to turn the phone off, remove and replace the Battery, and then turn the phone on again. Data that was being edited is erased after your phone is powered on again.

Question: Operation is unstable after a new application was installed.

Answer: The newly installed application may be the cause. Uninstall the application in Safe mode. See [Uninstall an App](#). To turn the phone on in Safe mode:

- Press and hold the **Power/Lock key** > touch and hold **Power off**, read the disclaimer for safe mode, and then tap **OK**.
 - After turning the phone on in Safe mode, "Safe Mode" appears at lower left.
 - After restarting in Safe mode, your phone can be powered on as usual.
 - Before turning the phone on in Safe mode, it is recommended that you back up important data.
 - By powering the phone on in Safe mode, added widgets may be deleted.

Question: Cannot use phone, mail, or Internet.

Answer 1: Check whether you are where signal is weak or out of service area.

Answer 2: Power the phone on again.

Answer 3: Is the phone in Airplane mode? To check that Airplane mode is canceled:

- From home, tap **Apps**  > **Settings**  > **Airplane mode**.

Answer 4: Is data communication disabled? To check that data communication is enabled:

- From home, tap **Apps**  > **Settings**  > **Data usage** > **Mobile data**.

Answer 5: Is a disabled access point set? To reset to initial settings:

- From home, tap **Apps**  > **Settings**  > **Mobile networks** > **Access Point Names** > **More** > **Reset to default**.

Question: Battery level goes down quickly.

Answer: Are you where signal is weak or have been out of service area for a long period? Calling where signal is weak or being out of service area uses a lot of Battery.

Question: Cannot install applications.

Answer: Applications cannot be installed with only a little free space on the phone or SD card. To check free space, see [Storage Settings](#). Applications not supported by your phone cannot be installed.

Question: Cannot unlock screen.

Answer: Power the phone on again. If you are unable to turn the phone off, remove and replace the Battery, and then power the phone on again. Data that was being edited is erased after the phone is powered on again.

Specifications

The following tables list your phone's and battery's specifications.

Phone Specifications

Item	Description
Weight	Handset alone: Approx. 119g Battery installed: Approx. 163.5g
Continuous Talk Time	3G: Approx. 870 minutes GSM: Approx. 810 minutes
Continuous Standby Time	3G: Approx. 3120 minutes GSM: Approx. 3000 minutes
Charging Time	Approx. 240 minutes
Dimensions	Approx. 145.5 x 72.9 x 10.3 mm
Maximum Output	3G: 0.25W GSM: 2W
Communication Speed	CDMA: Up to 3.1 Mbps downlink/up to 1.8 Mbps uplink WCDMA: Up to 21 Mbps downlink/up to 5.7 Mbps uplink LTE: Up to 100 Mbps downlink/up to 50 Mbps uplink

Battery Specifications

Item	Description
Voltage	3.8V
Type	Lithium-ion
Capacity	2300mAh
Dimensions (W x H x D)	Approx. 5.0 x 53.8 x 73 mm

Boost Account Information and Help

Find out about managing your account online and on your phone, buying additional minutes for your plan, and getting help.

For more information about your Boost Mobile account, as well as other Boost Mobile services, visit us at: boostmobile.com.

Manage Your Account

Access information about your account. You can:

- Check your minutes.
- Re-Boost® (add money to your account).
- Change plans.
- And more.

From Your Phone

Access account information and other self-service tools from Boost Zone.

- From home, tap **Apps**  > **Boost Zone** .

You can also dial directly for access to certain information:

- Dial # **2 2 5** (ABC ABC JKL) (**#BAL**) to check account balance.
- Dial # **2 3 3** (ABC DEF DEF) (**#ADD**) to make a payment.
- Dial # **6 1 1** (MNO QP QP) to launch BoostZone or call Boost Customer Care (depending on your Settings) to get answers to other questions.

From Your Computer

- Visit boostmobile.com, click **My Account**, and log in with your wireless phone number and account PIN.

From Any Other Phone

- Boost Customer Care: **1-888-BOOST-4U** (1-888-266-7848).

Re-Boost

Boost Mobile makes it easy to add money to your account. You decide exactly how and where you want to pay. Keep your account active by using your phone and adding money to your account.

Pay with Cash

Find an Authorized Re-Boost Retailer near you. Pick up a Re-Boost Card or recharge for as low as \$10 at the register, where available.

Pay Anytime with a Credit/Debit Card

Dial # **2 3 3** (**#ADD**) to add money from your phone or visit **My Account** at boostmobile.com to do it online. Securely register your credit/debit card with Boost for more convenient one-time payments or to set up easy Auto Re-Boost payments.

Set Up Worry-Free Payments with Auto Re-BoostSM

It's the easiest way to make sure your account stays on and active. Use a credit card, debit card or bank account—whatever's best for you.

Visit boostmobile.com/reboost to get the details on all your Re-Boost options.

Index

A

- Accessibility 229
- Accessory Port 3
- Accounts
 - Add new 229
 - Manage 229
 - Settings 228
- Activation 23, 232
- Airplane Mode 36, 208
- Alarm 171
- Android Keyboard 37
- Answer a Call 75
- Apps 33
 - Find and install 49
 - Request refunds 50
 - Uninstall 54
 - Update 50
- Apps List 27
- Apps Settings 223

B

- Back Key 2
- Back Up Phone 226
- Battery
 - Charge 17
 - Insert 15
 - Remove 16
 - Settings 222
- Bluetooth
 - Connect 205
 - Receive information 206
 - Send information 205
 - Settings 210
 - Share pictures and videos 156
 - Turn on or off 203
- Bookmark 136
- Browser
 - Bookmark 136
 - History 138
 - Launch connection 135
 - Settings 140
 - Tabs 139

C

- Calculator 165

- Calendar 165
 - Add event 165
 - Sync 167
 - Sync Exchange ActiveSync calendar 169
 - View events 167
- Call Forwarding 92
- Call Logs
 - Make call from 81
- Call Waiting 91
- Caller ID 90
- Camera 143
 - Settings 162
 - Take a picture 143
 - Viewfinder 144
- Car Kit
 - Connect 205
- Charger Port 3
- Chrome Support 141
- Clock
 - Alarm 171
 - Stopwatch 172
 - Timer 172
 - World Clock 172
- Contacts 94
 - Add contact 94
 - Delete 100
 - Edit 99
 - Import 102
 - Make call from 80
 - Save a phone number 95
 - Share 101
 - View 96
- Credentials 225

D

- Data Usage Settings 212
- Date & Time 220
- Device Administrators 225
- Display Settings 219
- Drag 21

E

- Editing Text 43
- Email
 - Add account 126
 - Add Exchange ActiveSync account 129
 - Compose and send 130

- Delete account 131
- Manage inbox 132
- Send Gmail 113
- Setup 125
- Share pictures 152
- View and reply 130
- Emergency Numbers 73
- Encrypt phone 225
- Encrypt SD Card 225
- Enhanced 9-1-1 (E 9-1-1) 74
- Enter Text 36
- Exchange ActiveSync
 - Add account 129
 - Features 133
- Extended Home Screen 62

F

- Facebook 173
 - Share pictures and videos 158
- Factory Data Reset 227
- File Manager 174
- Files
 - Transfer between phone and computer 196
- Flash 3
- Flick 22
- Flickr
 - Share pictures 158
- Folders 69
- Font
 - Size 220

G

- Gallery 146
 - View pictures and videos 146
- Gmail
 - Archive threads 116
 - Create account 44
 - Delete threads 117-118
 - Labels 115
 - Mute threads 117
 - New messages 114
 - Read and reply 114
 - Read messages 114
 - Report phishing 121
 - Report spam 121
 - Search 119
 - Send message 113
 - Share pictures 152
 - Switch accounts 125
- Google
 - Create account 44

- Hangouts 177
 - Sign in 46
 - Voice search 175
- Google Keyboard 221
- Google Maps 179
- Google Play
 - Find and install apps 49
 - Help 56
 - Store 48
- Google Play Music 187
- Google Wallet 194
- Google+ 176
- GPS Satellites 224

H

- Hangouts 177
- Headset
 - Connect 205
- Headset Jack 3
- Home Screen 61
 - Add Folders 69
 - Add Shortcuts 68
 - Add Widgets 69
 - Customize 67
 - Extended 62
- Hotspot 202
 - Settings 213

I

- Import Contacts 102
- Incoming Call
 - Answer 75
 - Reject 77
- Input Settings 221
- Internet 105

K

- Keyboard
 - Android keyboard 37
 - Default settings 221
 - Swype 38
 - TouchPal X 40
 - Touchscreen 36

L

- Language 221
- Language Settings 221
- LinkedIn 193
- Location
 - GPS satellites 224

Wireless networks 224
Location Services 224
Lock Key 3

M

Maps 179
Memory 222
Messaging 105
microSD Card
 Encrypt 225
 Format 222
 Mount 222
 Unmount 222
MMS
 Options 111
 Send messages 106
Mobile Hotspot 202
Multimedia Messaging
 Share pictures and videos 154
Music
 Google Play Music 187
Music Player 181

N

nano-SIM Card 3
Navigation Key Setting 224
Notification Icons 64
Notification Panel 65
Notifications 64

P

Phone
 Dialer 71
Phone Calls 71
 Answer 74
 Emergency numbers 73
 Using Call Logs 81
 Using contacts 80
 Using phone keypad 71
Phone Layout (illustration) 2
Phone Number
 Save to contacts 95
Phone Status 233
Phone Update
 PRL 60
 Profile 60
 Software 57
Picasa
 Share pictures 158
Pictures
 Crop 149

Rotate 147
Share via Bluetooth 156
Share via email 152
Share via Facebook 158
Share via Flickr 158
Share via messaging 154
Take with camera 143
View 146

Pictures
 Share via Picasa 158
Pinch 23
Play Music 187
Play Store 48
 Find and install apps 49
Pointer Speed 221
Power Key 3
Power Off 19
Power On 19
Printing 230
PRL Update 60

R

Re-Boost 237
Recent Applications 28
Reject Incoming Call 77
Ringtone 219
Rotate 22

S

Save a Phone Number 95
Screen Orientation 30
Screenshots 31
SD card
 Format 222
SD Card
 Encrypt 225
 Format 12
 Insert 6
 Mount 222
 Remove 10
 Unmount 8, 222
Secure Credential Storage 215
Security Settings 225
Settings 208
Setup Screens 24
Share
 Contacts 101
Sleep 219
Slide 21
Sound Recorder 191
Sound Settings 218

- Speaker 3
- Specifications 235
- Spread 23
- Status Bar 63
- Status Icons 64
- Stopwatch 172
- Storage
 - Settings 222
- Swipe 21
- Swype 38
 - Settings 221
- Synchronize
 - Exchange ActiveSync 133
- System Updates 233

T

- Tap 20
- Tethering 202
- Text-to-Speech 221
- Text Editing 43
- Text Entry 36
- Text Messaging
 - Conversations 109
 - Draft messages 108
 - Notifications 109
 - Options 111
 - Send messages 105
- Timer 172
- Touch 20
- Touch and Hold 20
- TouchPal X 40
- Touchscreen
 - Keyboard 36
 - Turn off 56
 - Turn on 57
- Troubleshooting 73
- Turn Device Off 19
- Turn Device On 19
- Twitter 192
- Typing 36

V

- Video Camera
 - Record video 145
- Videos
 - Record 145
 - Share via Bluetooth 156
 - Share via Facebook 158
 - Share via messaging 154
 - Share via YouTube 160
 - View 146

- Visual Voicemail 83
 - Listen to multiple messages 85
 - Options 86
 - Review 84
 - Set up 83
 - Settings 87
- Voice Dialer 192
- Voice Search 175
- Voicemail
 - Display name 90
 - Greeting 89
 - Setup 82
- Volume 218
 - Key 2
- VPN 215
 - Add connection 215
 - Connect or disconnect 216
 - Prepare for connection 215
 - Secure credential storage 215

W

- Wallpaper 67, 219
- Web
 - Launch connection 135
- Wi-Fi 197
 - Disconnect 199
 - Settings 209
 - Turn on and connect 197
- Wi-Fi Direct 200
- Widgets 69
- World Clock 172

Y

- YouTube 194
 - Share videos 160

Z

- Zoom 23