

Register online to extend your warranty an additional 12 months and to receive one free calibration after your 1st year of use. (freight excluded)



Registration Web Page :  
[www.uprtek.com/english/Register\\_00.asp](http://www.uprtek.com/english/Register_00.asp)

\* To ensure your warranty validation, please place your agent's stamp in the box and fill in the purchase date. If the agent stamp and purchase date cannot be supplied, the warranty period will be based on the manufacturing date of the product.

Original / Authorized Agent Stamp

Product Serial Number : \_\_\_\_\_

Purchase Date : \_\_\_\_\_

v 2.1 © Copyright 2014 UPRtek All rights reserved.

**UPRtek** 群耀科技股份有限公司  
United Power Research Technology Corporation

TEL : +886-37-580-885  
FAX : +886-37-580-398

Website : [www.uprtek.com](http://www.uprtek.com)  
Address : No.38, Keyi St., Zhunan Township, Miaoli County 35059, Taiwan, R.O.C.



## MK350N LED METER

User Manual and Warranty

# Contents

<b>1</b>	<b>MK350N Introduction</b> .....	1
1.1	Packing Contents .....	2
1.2	Appearance Introduction .....	3
1.3	Product Features .....	4
1.4	Annual Product Calibration .....	5
1.5	Product Notes and Precautions .....	6
<b>2</b>	<b>Preparing Before Use</b> .....	7
2.1	Battery Installation and Charging .....	8
2.2	Memory Card Installation .....	10
2.3	Strap and Neck Strap Installation .....	11
2.4	Screen Wiper Usage Method .....	12
2.5	Power On / Off .....	13
2.6	Dark Calibration .....	14
2.7	Option Function Setting .....	16
2.8	System Reset .....	18
<b>3</b>	<b>System Overview</b> .....	19
3.1	Measurement Modes Introduction .....	20
3.2	Measurement Introduction .....	22
3.3	Measurement Setting Introduction .....	24
3.4	Continuous Measurement Introduction .....	25
3.5	Transferring Data with PC Connection .....	26
<b>4</b>	<b>Specification</b> .....	27
4.1	Product Specification .....	28
<b>5</b>	<b>Troubleshooting Guide</b> .....	30
5.1	FAQ .....	31
<b>6</b>	<b>Appendix Warranty</b>	
6.1	Product Warranty	

## MK350N Introduction

1.1	Packing Contents
1.2	Appearance Introduction
1.3	Product Features
1.4	Annual Product Calibration
1.5	Product Notes and Precautions

## 1.3 Product Features

---

1. 250g Only, Light and Easy to Carry
2. Measure at Any Time, High Mobility
3. 3.5" Color Touch Screen
4. Simple Interface, Easy to Use
5. SD Card Storage, Easy to Transfer Data

## 1.4 Annual Product Calibration

---

This product is a high-precision measurement device with sensitive components—handle with care. To ensure the accuracy of measurements, it is recommended to have the unit calibrated once a year. Please contact your agent or our customer service department for calibration service.

## 1.1 Packing Contents

Please check MK350N packing before use, contact your agent if there are missing items.



Case



MK350N LED Meter



Protection Bag



Battery



USB Cable

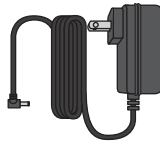

Power Adaptor

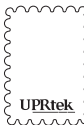

Screen Wiper



Strap



Neck Strap



User Manual and Warranty

## 1.2 Appearance Introduction

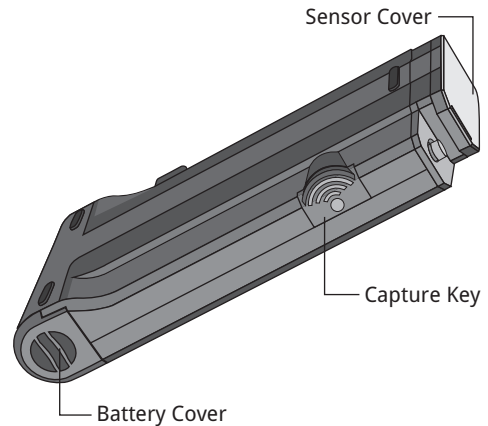
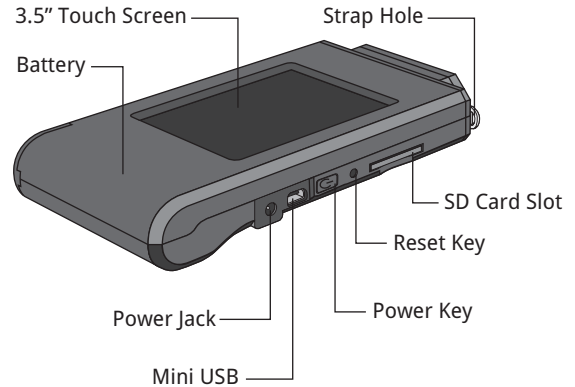

## 1.5 Product Notes and Precautions

---

1. The MK350N LED Meter contains sensitive components. Please unpack with care, as any trauma to the unit may damage the equipment. Contact your agent if the unit appears not to be operating normally. Do not attempt any repairs – all repairs must be performed by qualified service agents.
2. Most LCD screens have a very small and inconsequential defective pixel rate (usually less than 0.1%). This results in occasional pinpoints of white or other colors but will not affect the accuracy of measurements.



### Precautions / Warnings

Please read the following precautions to avoid fire, excessive heat, chemical leakage and explosion.

- Do not disassemble or modify the battery.
- Do not expose the battery to heat (fire) or water/moisture.
- When disposing used/old batteries, wrap with insulation tape to shield the battery from electrical contact with metallic objects, which might ignite a fire or explosion.
- If the unit is plugged into the power adapter and the battery seems to be overheating, or if there is smoke or peculiar odors emanating from the unit, unplug immediately to avoid the possibility of fire.
- However, do not touch the cables if there is heat emanating from near the cables as melted or deformed cables could expose wiring and result in burns or electric shock.
- Do not use cloth or anything to wrap or cover the equipment while charging – this could cause the unit to overheat, melting the casing or causing fire.
- If the unit is accidentally immersed in water, or if moisture has seeped inside, or metal objects have dropped into the casing, immediately remove the battery to avoid fire or electric shock.
- Do not operate or store the battery in high-temperature environments - it will cause battery leakage and/or shorten the life of the battery .
- Do not use paint thinner, benzene or other organic solvents to clean the equipment – this may damage the exterior finish or touch screen, and may even ignite fire.

# 2

## Preparing Before Use

- 2.1 Battery Installation and Charging
- 2.2 Memory Card Installation
- 2.3 Strap and Neck Strap Installation
- 2.4 Screen Wiper Usage Method
- 2.5 Power On / Off
- 2.6 Dark Calibration
- 2.7 Option Function Setting
- 2.8 System Reset

## 2.1 Battery Installation and Charging

Battery installation :

- Step1. Hold MK350N then press the battery cover.
- Step2. Press the battery cover down to remove it.
- Step3. Install the battery after remove battery cover.

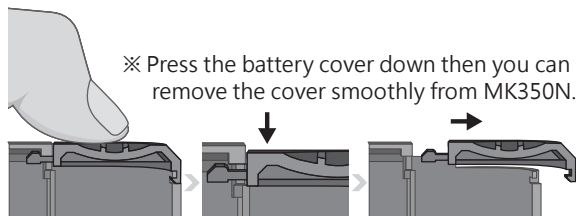
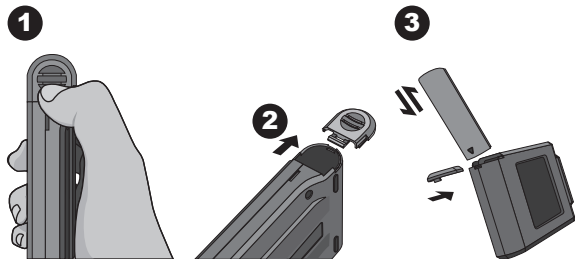

1. Please charge the battery for 6 hours at first time usage.
2. To avoid any interruption while measuring, please check battery status before use.
3. Please purchase a new battery if battery low easily after fully charged, it means battery life end.



## 2.1 Battery Installation and Charging

Battery charging :

1. Plug power charging cable into power jack to start charging.
2. Power Off Status: Users can check power key, it will light in red while charging and light off after fully charged.
3. Power On Status: Users can check MK350N screen, it will appear a lightning symbol to indicate charging, and lightning symbol will disappear after fully charged.

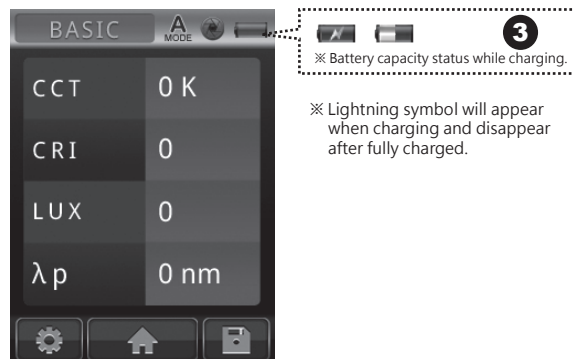
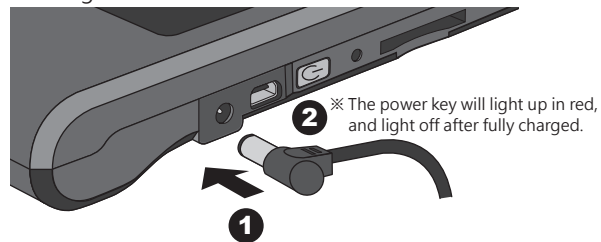

## 2.2 Memory Card Installation

Installing the SD Card :

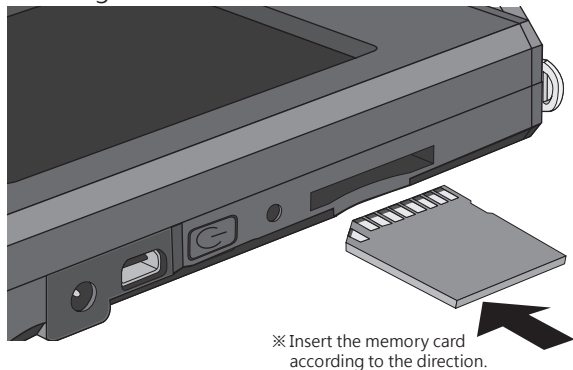

Remove the SD Card :

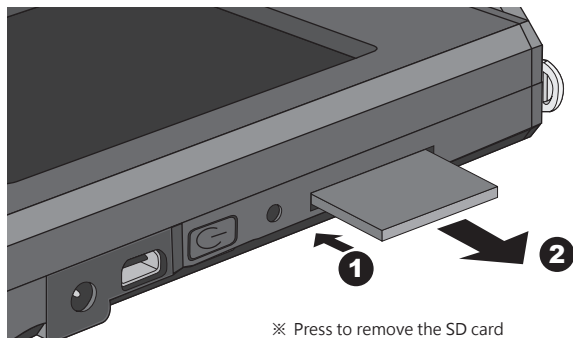

1. Check SD card status, refer 2.7 Storage
2. Check SD card storage method, refer 3.2 Save Measured Data

## 2.3 Strap and Neck Strap Installation

Strap installation :

Step1. Unscrew the strap

Step2. Tie the strap to the strap hole of MK350N

Step3. Tie the strap to the sensor cover

Step4. Screw the strap

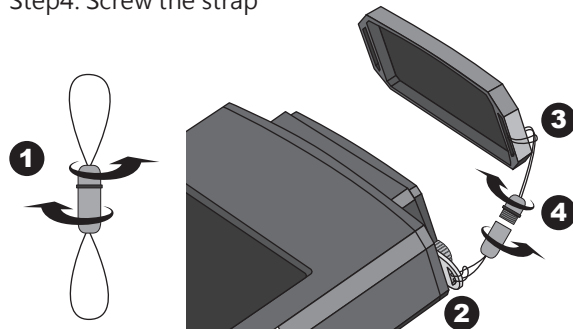

Neck strap installation :

Tie on the strap hole of MK350N put on your neck so you can use it at any time.

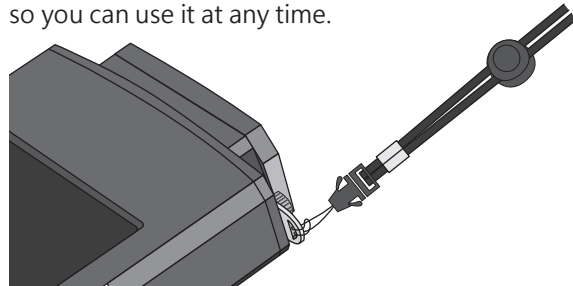

## 2.4 Screen Wiper Usage Method

---

1. The wiper can remove the dirt easily.
2. Strong absorbent and no effect after repeated washing.
3. Can use bleach for wash but do not iron the wiper.

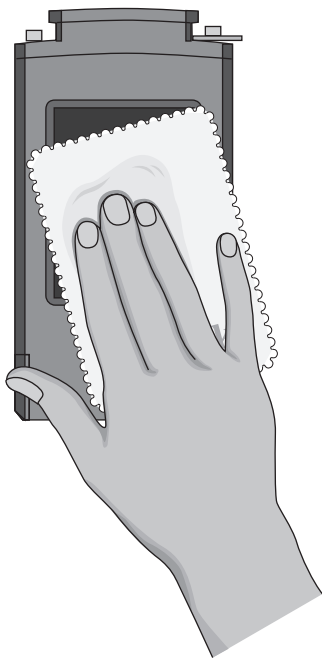

## 2.5 Power On / Off

---

- Turn on the power : Press the power key for 1 second.  
Turn off the power : Press the power key for 5 seconds.

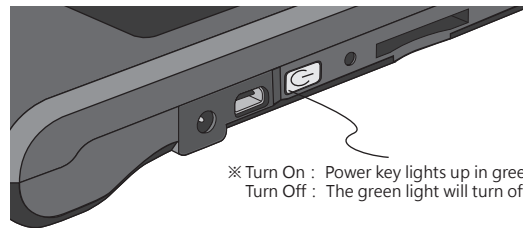

- ※ Turn On : Power key lights up in green light.  
Turn Off : The green light will turn off.

## 2.6 Dark Calibration

1. After turn on MK350N, system will process dark calibration automatically.

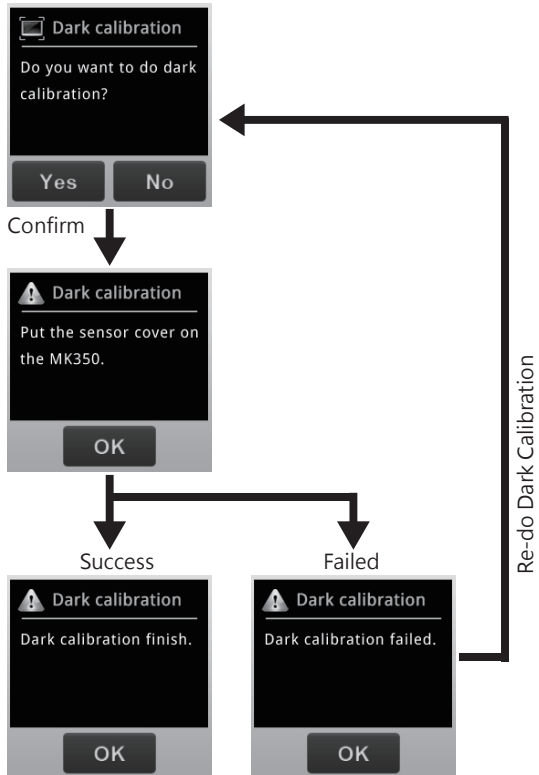

1. Suggest to execute dark calibration when every time turn on MK350N.

## 2.6 Dark Calibration

2. When using MK350N, users can execute dark calibration manually.

Users can go to measurement page then select MEASUREMENT SETTING --> DARK CALIBRATION to execute dark calibration manually.



## 2.7 Option Function Setting

Go to main menu and select OPTION to start system setting.

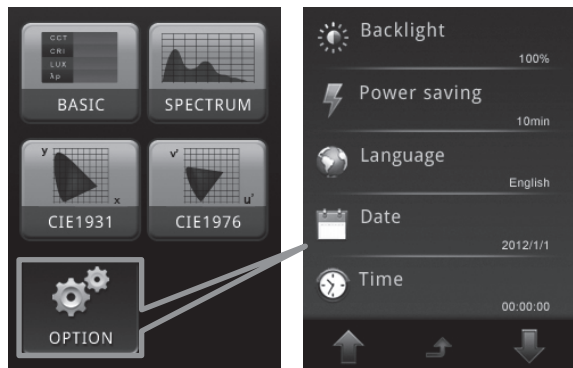

Main Menu

Previous page

Back to main menu

Next page

Backlight Setting :

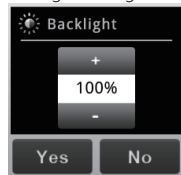

Power Saving Setting :



Language Setting :



Date Setting :



Time Setting :



+ / - : Adjust key  
Yes / No : End of the setting

## 2.7 Option Function Setting



Check Storage Device :

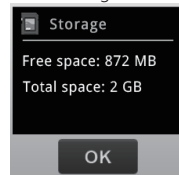

Check Version :

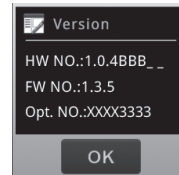

USB Mode Setting :



1. Please setup date and time before save the files.
2. Users can setup auto power-off time to save battery power. Default auto power-off setting is 10 minutes.
3. Users will need to fill up optical serial number when on line regist, meantime, please go to version to check optical serial number.



## 2.8 System Reset

Users can press the reset key to turn off the system if system crashed.

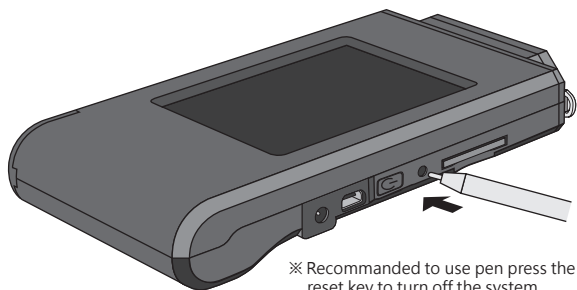
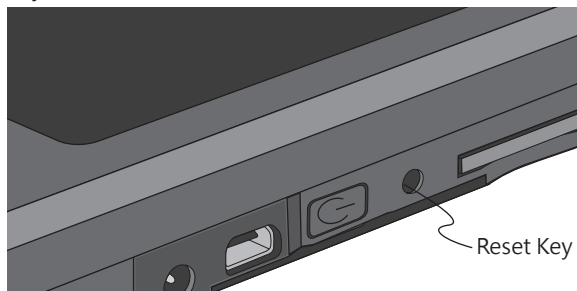

※ Recommended to use pen press the reset key to turn off the system.

# 3

## System Overview

- 3.1 Measurement Modes Introduction
- 3.2 Measurement Introduction
- 3.3 Measurement Setting Introduction
- 3.4 Continuous Measurement Introduction
- 3.5 Transferring Data with PC Connection

## 3.1 Measurement Modes Introduction

4 kinds of measurement modes :

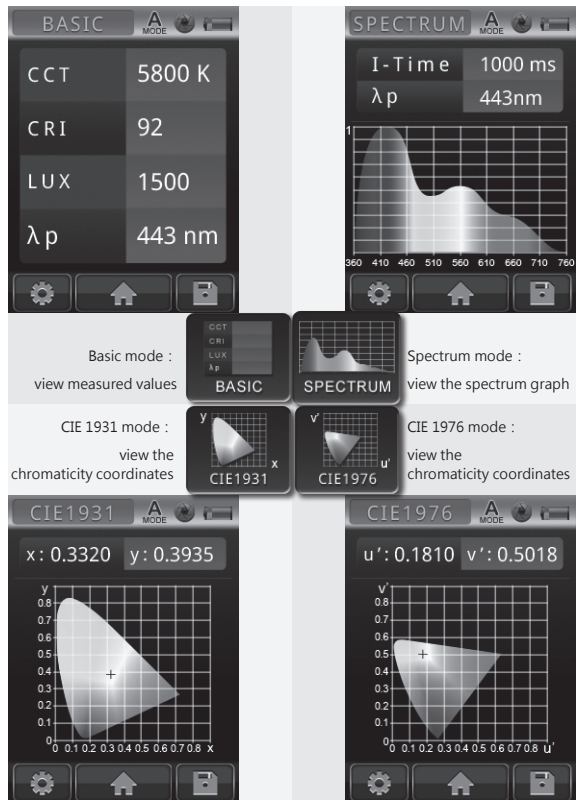

## 3.1 Measurement Modes Introduction

Interface introduction :

 Means button



1. Measurement mode - BASIC / SPECTRUM / CIE1931 / CIE1976
2. Integration mode - Auto **A** / Manual **M**
3. Capture function - One time / Continuous
4. Battery capacity
5. Measurement result
6. Measurement setting
7. Back to main menu
8. Save data

## 3.2 Measurement Introduction

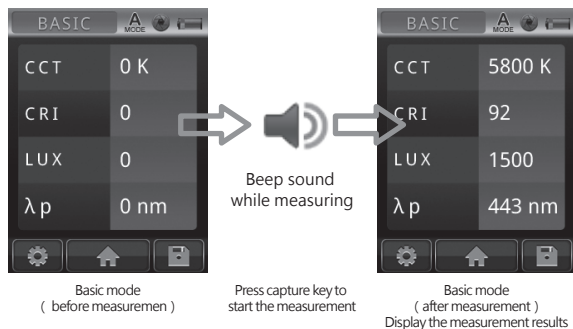
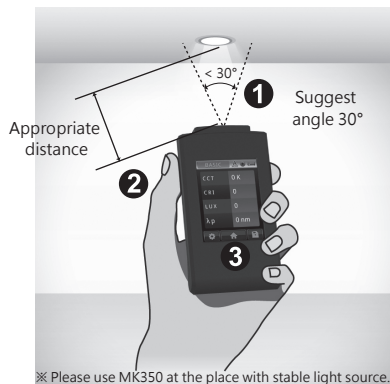

- Step1. Point sensor head at light source with suggest angle 30°.
- Step2. At appropriate distance then press capture key.
- Step3. After beep sound, measured data will display on the screen.



1. Operation sound setting, refer 3.3 Operation sound

## 3.2 Measurement Introduction

Save measured data :

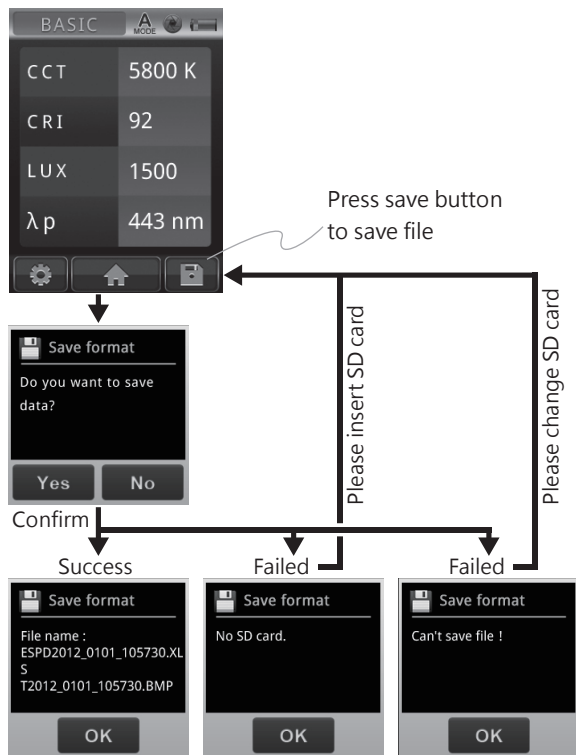

1. Save format setting, refer 3.3 Save format
2. Available capacity of SD card, refer 2.7 Storage

## 3.3 Measurement Setting Introduction

Please go to measurement page to do measurement settings.

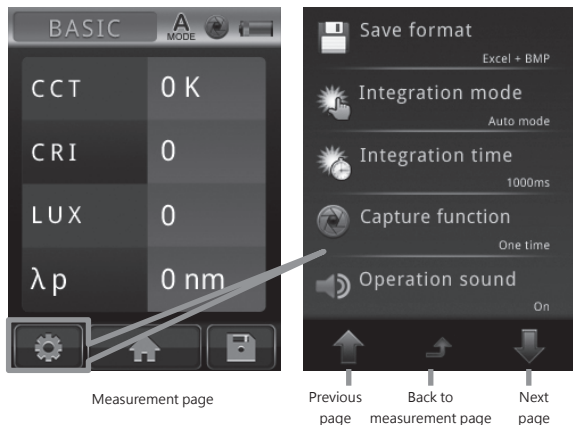

Save Format Setting :

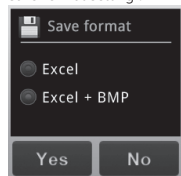

Integration Mode Setting :

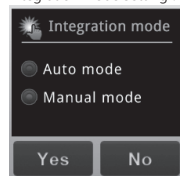

Integration Time Setting :

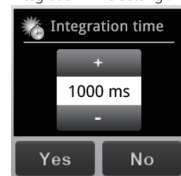

Capture Function Setting :

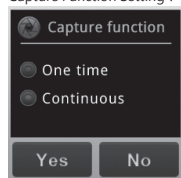

Operation Sound Setting :

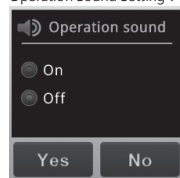

+ / - : Adjust key  
Yes / No : End of the setting

## 3.4 Continuous Measurement Introduction

1

※ View capture function setting, refer 3.3

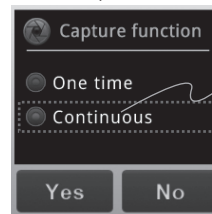

Select Continuous

2



3



※ The capture symbol is rotating when MK350N is processing continuous measurement.

Basic mode  
( start measurement )  
press capture key

MK350N will process  
measurement with  
interval of 3 seconds.

4

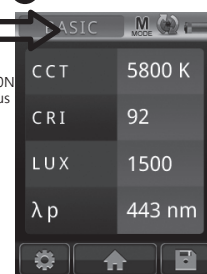

Basic mode  
( after measurement )  
Press the capture key again to  
see the measurement results.

Step1. Select the continuous capture

Step2. Press the capture key

Step3. Processing the continuous measurement

Step4. Press capture key again to stop continuous measurement



1. Continuous measurement has no beep sound after press capture key.
2. Users cannot save the measurement data while processing continuous measurement.
3. Adjust the integration time only can work in the manual mode.

## 3.5 Transferring Data with PC Connection

Storage the measurement data :

Inside the package has a USB cable, connect the mini USB to MK350N and plug the USB to your PC then you can read the data saved in SD card.

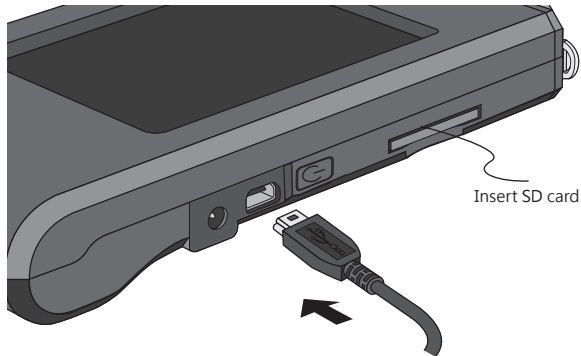

After connected USB cable, MK350N will display as below.

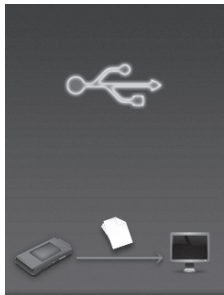

# 4

## Specification

### 4.1 Product Specification

## 4.1 Product Specification

Sensor	CMOS linear image sensor
Spectral Bandwidth	Approximately 12 nm (half bandwidth)
Receptor Size	Ø 6.6 ± 0.1 mm
Cosine Correction	refer Figure 1.
Measurement Range	70 ~ 70000 Lux
Wavelength Range	360 ~ 750 nm
Integration Time Range	8 ~ 1000 ms
Capture Function	One time / Continuous
Integration Mode	Auto / Manual
Measuring Modes	<ol style="list-style-type: none"> <li>1. Basic Value Mode</li> <li>2. Spectrum Graph Mode</li> <li>3. CIE 1931 Chromaticity Coordinates</li> <li>4. CIE 1976 U.C.S Chromaticity Coordinates</li> </ol>
Measuring Capabilities	<ol style="list-style-type: none"> <li>1. Illuminance / Lux</li> <li>2. Spectral Irradiance</li> <li>3. C.I.E. Chromaticity Coordinates               <ol style="list-style-type: none"> <li>(1) CIE 1931 x,y Coordinates</li> <li>(2) CIE 1976 U.C.S u',v' Coordinates</li> </ol> </li> <li>4. Peak Wavelength</li> <li>5. Correlated Color Temperature; CCT ( in Kelvins )</li> <li>6. Color Rendering Index; Ra ( Rendering Average )</li> </ol>
Digital Resolution	16 bits
Dark Calibration	Yes
Stray Light	-25 dB max. *1
Wavelength Data Increment	1 nm
Wavelength Reproducibility	± 1 nm *2

## 4.1 Product Specification

Illuminance Accuracy	Illuminant A @ 2856K at 20000 Lux	± 5%
Color Accuracy		± 0.0025 in CIE 1931 x,y
Color Repeatability		± 0.0005 in CIE 1931 x,y
CCT Accuracy		± 2%
CRI Accuracy @ Ra		± 1.5%
Display	3.5" LCD 320X240 Touch Panel	
Max. Files	≈ 2000 Files @ 2GB SD Card	
Battery Operation Time	≤ 5 hours / Fully Charged	
Battery	2500 mAh / Rechargeable Li-ion Battery	
Data Output Interface	SD Card / USB 2.0	
Data Format	Compatible Excel / BMP Data Format	
Dimensions	144.2 x 78 x 24 mm ( H x W x D )	
Weight(with Battery)	250 g ± 20 g	
Operating Temperature	0 ~ 35 °C	
Storage Temperature	-10 ~ 40 °C	
Language Selection	English / Traditional Chinese / Simplified Chinese / Japanese / German / French / Russian	
<p>*1 : Use the input of 550nm single-frequency and measurement the range of optical ± 40nm. *2 : Input source must be a stable light source. The company reserves the right to change product specifications, if it has any changes will not give any notice.</p>		

Figure 1 : Cosine Correction

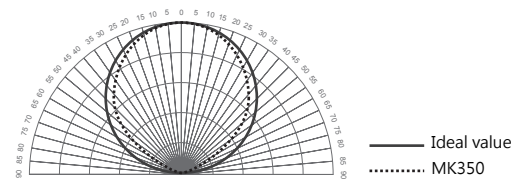

## 5.1 FAQ

---

Q 1 : How long can I use after MK350N battery had fully charged ?

A : Usage time will depends on battery life, MK350N battery can operate 5 hours after fully charged.

Q 2 : Why the SD card always stuck on the slot while in / out the slot ?

A : This special designed is called "anti-fly card" functions, which can prevent SD card write error if SD card was hit accidentally.

Q 3 : Could MK350N measure the UV or IR Spectrum ?

A : No, MK350N measurement range is 360 ~ 750nm. You will need to buy the equipment that compatible with UV and IR spectrum.

Q 4 : Could MK350N measure the light that except LED light? Such as: fluorescent lamps ( fluorescent lamps ) ?

A : MK350N is the measurement equipment for LED lamps, it will not guarantee the results accuracy on other kind of lamps.

Q 5 : Do I need to execute dark calibration at every time power on the machine ?

A : The environment temperature changes will affect the measurement results, it is recommended to execute dark calibration when power on or execute the dark calibration after a period time of use.

If you still have other problems that is not in the FAQ,  
please visit [WWW.UPRTEK.COM](http://WWW.UPRTEK.COM)

## 6.1 Product Warranty

---

### Warranty Policy

UPRtek provides replacement or repair services to our customers for defective products within the applicable warranty period.

#### 1. DOA (Dead on Arrival) Returns :

- In the event that you receive a product that is not working properly or is defective, you should notify our service staff upon receipt of the products. If defects in the product are discovered within 7 days after receiving the product (except those due to willful damage or customer misuse), you should notify us by email, facsimile, or phone immediately upon noticing the defect, so we can process the return as a DOA product. You will be issued a DOA number accordingly.
- DOA products must be returned within 30 days of purchase and in original condition. For products considered as “Dead on Arrival” , we will replace it with a new product (in whole package) at no charge and pay return and re-delivery shipping costs. International customers should allow for additional transit time due to international customs clearance.

#### 2. RMA (Return Merchandise Authorization) :

- For merchandise sent for repair or replacement with or without warranty, you must first obtain an RMA number by contacting our service staff by mail. The following information is required in order to complete your RMA request: company name, contact person, phone number and e-mail, customer ship-to address, product model number, serial number, and a brief description of the problem you are experiencing with the product you wish to return.
- All returned products will be tested by our professional technicians to verify the complaint / defect in question. However, if the defect in question cannot be found by our technicians, you are responsible for paying a testing fee plus shipping fee for NDF (No-Defect Found) products.
- Claims for loss or damage during shipment must be made to the courier by the customer. For your protection, we strongly recommend that you fully insure your return shipment for damages. Please use a courier that is able to provide you with proof of delivery.

### Limitation of Warranty

Please note that UPRtek is not responsible for providing repairs under warranty if the product defect is caused by any of the following factors :

1. Damage caused by natural calamity or any inappropriate usage.
2. Product has been repaired or taken apart by unauthorized

## 6.1 Product Warranty

---

technicians.

- The warranty label is altered, damaged or missing.
- Product serial number does not conform to our original system or the label has been damaged.

### Disclaimer

- UPRtek shall in no event be liable for any defect, damage or data loss that has occurred during the delivery of in-warranty products. Prior to claiming warranty service, UPRtek recommends that you make a backup of your data and remove your data from in-warranty products.
- Under the maximum allowable range of applicable laws and regulations, any business loss, expected cost loss, data disappearance, or any other indirect, accidental, or derived loss or damages due to the utilization of or related to the company product, shall not be the responsibility of UPRtek for any compensation.

### Customers Eligible for Warranty Service

UPRtek warranty policy applies to all customers who purchased from either UPRtek or through authorized agents of UPRtek.

### Duration of Warranty

#### 1. MK350 HOST :

The MK350 LED METER series all come with a 1-year product warranty. We also provide an extended warranty service when customers visit our official website and register their product within 120 days after receiving the goods. This extended warranty also includes one free calibration service by UPRtek after the product has been in use for 1 year (shipping costs will be incurred by the consumer).

#### 2. Accessories :

UPRtek RMA policy is only for LED Meter repair and does not cover maintenance or calibration services (aside from one time free calibration on extended warranty). The policy also does not cover accessories like tripods and straps, nor does it cover consumable items like batteries.

### Authorized Distributor/Dealer Services

- Product-based functional testing** - Performed by distributors and dealers to determine whether the product needs to be returned to the factory for further calibration services or technical repairs (All UPRtek authorized distributors/dealers have a right to perform "Product-based functional testing" for a reasonable charge).

## 6.1 Product Warranty

---

- RMA product delivery to and from factory** - Distributors/dealers can assist customers in sending/receiving RMA products to/from the UPRtek factory.
- Authorized distributors/dealers are listed on our website : [www.uprtek.com](http://www.uprtek.com)

### Additional Remarks

Product parts and components are not always manufactured by UPRtek. On occasion, these 3rd party components may need to be replaced but are already discontinued by the supplier. In this case, UPRtek assures customers that it will fulfill its repair and replacement responsibilities by using substitute parts or components of equal level and quality.

### Delivery Methods

Consumers can choose either of the two methods indicated below to return the product to the factory for RMA Service :

- Customers can send the products through UPRtek global distribution channels that will send and return the products to and from the factory for repair and warranty service.
- Customers can return the product directly to the UPRtek factory for servicing.

### Rules on Product Repairs After The Warranty Period

UPRtek provides product services after warranty expiration at reasonable charges. In case of product defects, the customers are still able to send products back to the UPRtek factory for service. The repair charges will be based on the type of defect, and in some cases, maintenance fees will be charged.

However, purchasing a new product is advised under these conditions:

- If the MK350 series or its accessories are no longer available.
- If the product functionality is almost certain to be impossible to recover from (e.g. total immersion in water, undergoing extreme electrical shock, severe contamination or corrosion damage).
- If the product was dropped or sustained such a traumatic impact causing major structural damage, or if our technicians determine that normal functionality cannot be recovered even after major component replacement.
- If multiple parts simultaneously fail due to normal wear and tear, or poor handling.
- Even if the product is within the service period of the warranty, yet parts are no longer available.