



*Gold Ring™ Two-Way,
Three-Way and Four-Way
Solenoid Valves*

Catalog 7300A

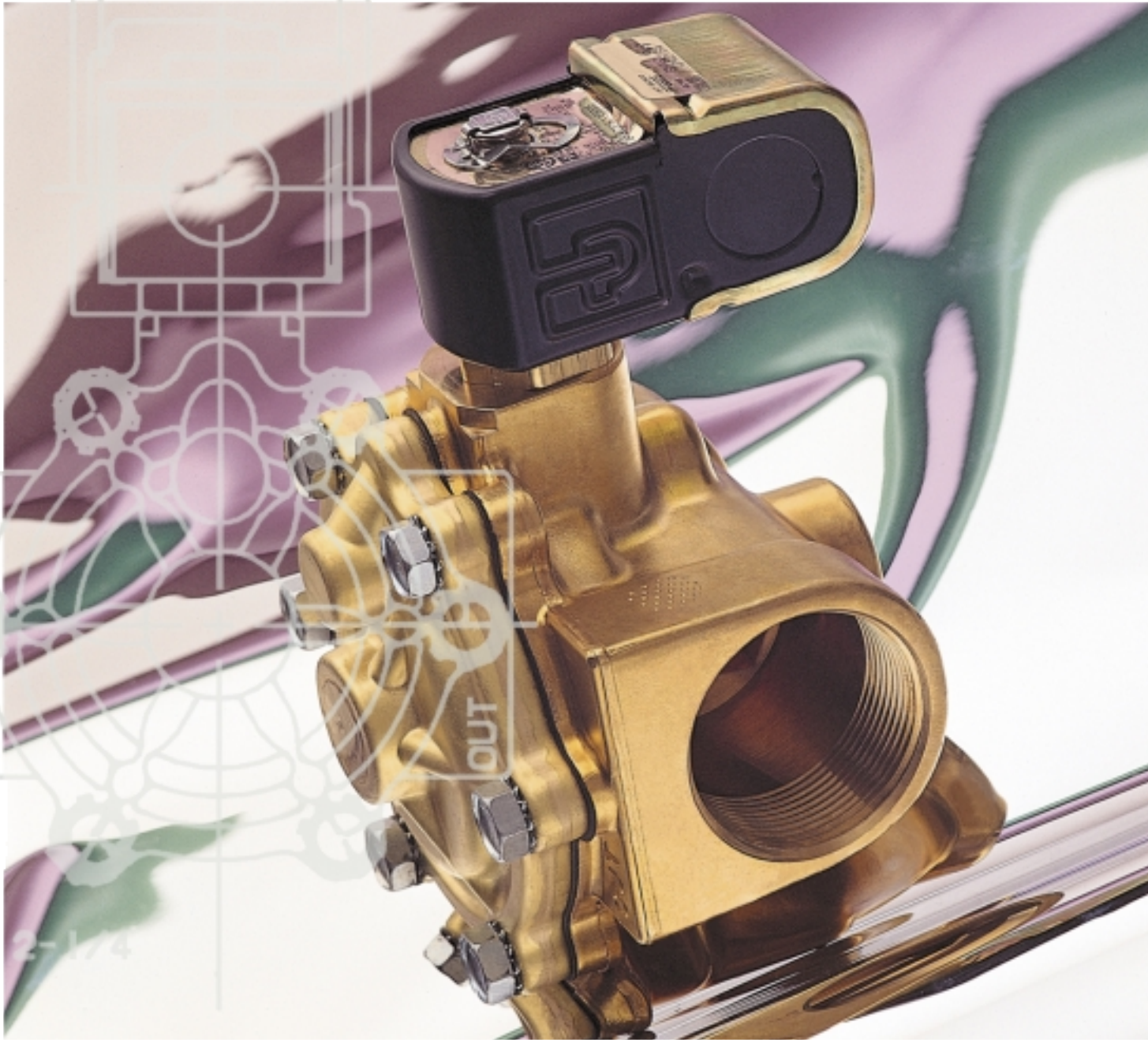

Table of Contents

Product Overview	1
Condensed Valve Listing	2-9
Valve Ordering Information	10-12
Gold Ring Ordering	10
Coil Information	11-12
Gold Ring Two-Way Specifications	13-32
Series 20, Direct Acting	14-18
Series 20, Low Pressure.....	19-20
Series 22, 23, 24, 26, Pilot Operated.....	21-24
Series 25, H5 Pivoted Edge.....	25-27
Hot Water and Steam	28-30
Series 28, High Pressure.....	31-32
Gold Ring Three-Way Specifications	33-42
Series 30, Direct Acting	34-37
Series 34, Pilot Operated	38-39
Series 35, 38, Quick Exhaust	40-42
Gold Ring Four-Way Specifications	43-45
Series 48	44-45
Gold Ring Specialty Specifications	46-51
Cryogenic Two-Way Specifications.....	47-48
Vacuum Service Two-Way Specifications.....	49
Long Life, Quiet Operating Specifications.....	50-51
Technical Information	52-66

WARNING

FAILURE OR IMPROPER SELECTION OR IMPROPER USE OF THE PRODUCTS AND/OR SYSTEMS DESCRIBED HEREIN OR RELATED ITEMS CAN CAUSE DEATH, PERSONAL INJURY AND PROPERTY DAMAGE.

This document and other information from Parker Hannifin Corporation, its subsidiaries and authorized distributors provide product and/or system options for further investigation by users having technical expertise. It is important that you analyze all aspects of your application and review the information concerning the product or system in the current product catalog. Due to the variety of operating conditions and applications for these products or systems, the user, through its own analysis and testing, is solely responsible for making the final selection of the products and systems and assuring that all performance, safety and warning requirements of the application are met.

The product described herein, including without limitation, product features, specifications, designs, availability and pricing, are subject to change by Parker Hannifin Corporation and its subsidiaries at any time without notice.

Offer of Sale

The items described in this document are hereby offered for sale by Parker Hannifin Corporation, its subsidiaries or its authorized distributors. This offer and its acceptance are governed by the provisions stated on the separate page of this document entitled "Terms and Conditions of Sale" (See page 67.)

Introduction

Gold Ring™ products are produced by the Skinner Valve Division of Parker Hannifin Corporation, the leading supplier of products controlling motion, flow and pressure. Since 1949, when Skinner first started manufacturing solenoid valves, we have been recognized as a leader in solenoid valve technology.

With vertically integrated manufacturing facilities in Madison, Mississippi, and New Britain, Connecticut, we produce a large percentage of our parts from the raw material level. This permits a high degree of control over the quality and availability of all Gold Ring products.

In addition to our full line of Gold Ring solenoid valves, our experienced design engineers—among the best in the business—allow rapid completion of customized valves for specific applications. Our well equipped manufacturing facilities and evaluation and testing laboratories ensure proper valve operation, long cycle life, and optimum reliability.

With many affiliates worldwide, an extensive Gold Ring distribution network, and a broad product line, Parker's Skinner Valve Division is in a unique position to serve the world's requirements for solenoid valves.

We have people in place to help you with almost any application you can imagine. Our technical sales personnel can be reached at 1-800-VALVE05, or by fax at 860-827-2384.

For information on additional products from Parker, call toll-free at 1-800-C-Parker (1-800-272-7537).

Gold Ring Product Line

A wide range of two-way, three-way, and four-way Gold Ring solenoid valves in brass or stainless steel, along with a wide variety of seal and disc materials, ensures that we have a standard valve to fit most applications. Special purpose solenoid valves for long life-quiet operation, cryogenic or vacuum service applications are also available.

If a unique application requires a unique product, our technical and manufacturing experience allows us to develop and supply the right valve for that application.

Unit valves and unit solenoids enable us to offer versatility in stocking and manufacturing requirements. With the introduction of Parker's optional Gold Ring II™ completely encapsulated solenoid, Type 4X requirements can also be met with unit valves and unit solenoids. Of course, completely assembled valves can be supplied at no extra cost. In either case, applicable agency approvals prevail.

Gold Ring Condensed Valve Listing

NPT Pipe Size	Valve Part Number	Operating Pressure Differential								Body Material
		Min.		Max. (MOPD)						
				Air, Inert Gas		Water		Light Oil 300SSU		
		PSI	Bar	PSI	Bar	PSI	Bar	PSI	Bar	
Two-Way Normally Closed Valves										
AC Specifications										
1/8	02F20C1103AAF	0	0	750	51.72	750	51.72	530	36.55	BR
1/8	02F20C1106AAF	0	0	275	18.97	290	20.00	130	8.97	BR
1/8	02F20C1108AAF	0	0	155	10.69	180	12.41	140	9.66	BR
1/8	02F20C3103AAF	0	0	750	51.72	750	51.72	530	36.55	SS
1/8	02F20C3106AAF	0	0	275	18.97	290	20.00	130	8.97	SS
1/8	02F20C3108AAF	0	0	155	10.69	180	12.41	140	9.66	SS
1/4	04F20C1103AAF	0	0	750	51.72	750	51.72	500	34.48	BR
1/4	04F20C1106AAF	0	0	360	24.83	340	23.45	160	11.03	BR
1/4	04F20C1108AAF	0	0	140	9.66	165	11.38	90	6.21	BR
1/4	04F20C1108ACF	0	0	300	20.69	300	20.69	200	13.79	BR
1/4	04F20C1503ACF	0	0	1500	103.45	1500	103.45	1100	75.86	BR
1/4	04F20C2100ACF	0	0	150	10.34	150	10.34	145	10.00	BR
1/4	04F20C2114AAF	0	0	40	2.76	50	3.45	40	2.76	BR
1/4	04F20C2114BDF	0	0	100	6.90	100	6.90	100	6.90	BR
1/4	04F20C2118AAF	0	0	27	1.86	36	2.48	28	1.93	BR
1/4	04F20C2118BCF	0	0	60	4.14	60	4.14	50	3.45	BR
1/4	04F20C2118BDF	0	0	90	6.21	80	5.52	80	5.52	BR
1/4	04F20C3103AAF	0	0	750	51.72	750	51.72	500	34.48	SS
1/4	04F20C3106AAF	0	0	360	24.83	340	23.45	160	11.03	SS
1/4	04F20C3108AAF	0	0	140	9.66	165	11.38	90	6.21	SS
1/4	04F20C3110ACF	0	0	150	10.34	150	10.34	145	10.00	SS
1/4	04F20C3114AAF	0	0	40	2.76	50	3.45	40	2.76	SS
1/4	04F20C3114BDF	0	0	100	6.90	100	6.90	100	6.90	SS
1/4	04F20C3118AAF	0	0	27	1.86	36	2.48	28	1.93	SS
1/4	04F20C3118BDF	0	0	90	6.21	80	5.52	80	5.52	SS
1/4	04F20C3503ACF	0	0	2200	151.72	2000	137.93	1100	75.86	SS
3/8	06F20C2108AAF	0	0	160	11.03	150	10.34	90	6.21	BR
3/8	06F20C2110ACF	0	0	150	10.34	150	10.34	145	10.00	BR
3/8	06F20C2114BDF	0	0	100	6.90	100	6.90	100	6.90	BR
3/8	06F20C2118BDF	0	0	90	6.21	80	5.52	80	5.52	BR
3/8	06F20C6108AAF	0	0	160	11.03	150	10.34	90	6.21	SS
3/8	06F20C6110ACF	0	0	150	10.34	150	10.34	145	10.00	SS
3/8	06F20C6114BDF	0	0	100	6.90	100	6.90	100	6.90	SS
3/8	06F20C6118BDF	0	0	90	6.21	80	5.52	80	5.52	SS
3/8	06F20C2120AAF	0	0	15	1.03	12	0.83	-	-	BR
3/8	06F20C2120ACF	0	0	20	1.38	20	1.38	-	-	BR
1/2	08F20C2128AAF	0	0	4	0.28	6	0.41	-	-	BR
1/2	08F20C2128ADF	0	0	15	1.03	15	1.03	-	-	BR
3/4	12F20C2148ADF	0	0	4	0.28	4	0.28	-	-	BR
3/8	06F20C6120ACF	0	0	20	1.38	20	1.38	-	-	SS
1/2	08F20C6128ADF	0	0	15	1.03	15	1.03	-	-	SS
3/4	12F20C6148ADF	0	0	4	0.28	4	0.28	-	-	SS
3/8	06F23C2140ACF	0	0	150	10.34	150	10.34	150	10.34	BR
3/8	06F22C2140AAF	5	0.34	200	13.79	135	9.31	135	9.31	BR
3/8	06F22C2140ADF	5	0.34	300	20.69	300	20.69	300	20.69	BR
1/2	08F23C2140ACF	0	0	150	10.34	150	10.34	150	10.34	BR
1/2	08F22C2140AAF	5	0.34	200	13.79	135	9.31	135	9.31	BR
1/2	08F22C2140ADF	5	0.34	300	20.69	300	20.69	300	20.69	BR
3/4	12F23C2148ACF	0	0	150	10.34	150	10.34	150	10.34	BR
3/4	12F22C2148AAF	5	0.34	200	13.79	135	9.31	135	9.31	BR
3/4	12F24C2148AAF	5	0.34	250	17.24	150	10.34	100	6.90	BR
1	16F24C2164AAF	5	0.34	150	10.34	125	8.62	100	6.90	BR
1 1/4	20F24C2172AAF	5	0.34	150	10.34	125	8.62	100	6.90	BR
1 1/2	24F24C2180AAF	5	0.34	150	10.34	125	8.62	100	6.90	BR
2	32F24C2199ACF	2	0.14	150	10.34	150	10.34	150	10.34	BR
3	48F28C9699ACF	2	0.14	150	10.34	150	10.34	150	10.34	BR
3/8	06F23C6140ACF	0	0	150	10.34	150	10.34	150	10.34	SS
3/8	06F22C6140ADF	5	0.34	300	20.69	300	20.69	300	20.69	SS
1/2	08F23C6140ACF	0	0	150	10.34	150	10.34	150	10.34	SS
1/2	08F22C6140ADF	5	0.34	300	20.69	300	20.69	300	20.69	SS
3/4	12F23C6148ACF	0	0	150	10.34	150	10.34	150	10.34	SS
3/4	12F22C6148ADF	5	0.34	300	20.69	300	20.69	300	20.69	SS
1	16F24C6164AAF	5	0.34	150	10.34	125	8.62	100	6.90	SS
1 1/2	24F24C6180AAF	5	0.34	150	10.34	125	8.62	100	6.90	SS
1/4	04F25C2122CAF	5	0.34	300	20.69	300	20.69	300	20.69	BR
3/8	06F25C2122CAF	5	0.34	300	20.69	300	20.69	300	20.69	BR
3/8	06FH5C2132ACF	0	0	200	13.79	200	13.79	200	13.79	BR

NPT Pipe Size	Valve Part Number	Operating Pressure Differential								Body Material		
		Max. (MOPD)										
		Min.		Air, Inert Gas		Water		Light Oil 300SSU				
		PSI	Bar	PSI	Bar	PSI	Bar	PSI	Bar			
3/8	06F25C2132ACF	1	0.07	300	20.69	235	16.21	235	16.21	BR		
1/2	08FH5C2132ACF	0	0	200	13.79	200	13.79	200	13.79	BR		
1/2	08F25C2132ACF	1	0.07	300	20.69	235	16.21	235	16.21	BR		
3/4	12FH5C2148ACF	0	0	200	13.79	200	13.79	200	13.79	BR		
3/4	12F25C2148ACF	1	0.07	300	20.69	235	16.21	235	16.21	BR		
1	16F25C2164ACF	1	0.07	300	20.69	300	20.69	300	20.69	BR		
1	16FH5C2164ADF	0	0	150	10.34	125	8.62	125	8.62	BR		
1/4	04F25C6122CAF	5	0.34	300	20.69	300	20.69	300	20.69	SS		
3/8	06F25C6122CAF	5	0.34	300	20.69	300	20.69	300	20.69	SS		
1/4	04F28C1D20ACF	15	1.03	1500	103.45	1500	103.45	1500	103.45	BR		
3/8	06F28C1D20ACF	15	1.03	1500	103.45	1500	103.45	1500	103.45	BR		
1/2	08F28C1D24ACF	25	1.72	1500	103.45	1500	103.45	1500	103.45	BR		
3/4	12F28C1D48BCF	25	1.72	1000	68.97	1000	68.97	1000	68.97	BR		

Two-Way Normally Open Valves

AC Specifications

1/8	02F20O1104ABF	0	0	500	34.48	300	20.69	225	15.52	BR
1/8	02F20O1106AAF	0	0	275	18.97	200	13.79	150	10.34	BR
1/8	02F20O1108AAF	0	0	125	8.62	100	6.90	85	5.86	BR
1/4	04F20O1103ACF	0	0	750	51.72	700	48.28	700	48.28	BR
1/4	04F20O1106ACF	0	0	300	20.69	250	17.24	230	15.86	BR
1/4	04F20O1108ACF	0	0	130	8.97	110	7.59	100	6.90	BR
1/4	04F20O2110ACF	0	0	85	5.86	75	5.17	60	4.14	BR
1/4	04F20O2114ACF	0	0	45	3.10	45	3.10	40	2.76	BR
1/4	04F20O2118ACF	0	0	30	2.07	25	1.72	20	1.38	BR
1/8	02F20O3104ABF	0	0	500	34.48	300	20.69	225	15.52	SS
1/8	02F20O3106AAF	0	0	275	18.97	200	13.79	150	10.34	SS
1/8	02F20O3108AAF	0	0	125	8.62	100	6.90	85	5.86	SS
1/4	04F20O3103ACF	0	0	750	51.72	700	48.28	700	48.28	SS
1/4	04F20O3106ACF	0	0	300	20.69	250	17.24	230	15.86	SS
1/4	04F20O3108ACF	0	0	130	8.97	110	7.59	100	6.90	SS
1/4	04F20O3110ACF	0	0	85	5.86	75	5.17	60	4.14	SS
1/4	04F20O3114ADF	0	0	65	4.48	65	4.48	60	4.14	SS
1/4	04F20O3118ADF	0	0	45	3.10	40	2.76	35	2.41	SS
3/8	06F20O2120ADF	0	0	15	1.03	15	1.03	-	-	BR
1/2	08F20O2128ADF	0	0	15	1.03	15	1.03	-	-	BR
3/4	12F20O2148ACF	0	0	2	0.14	2	0.14	-	-	BR
3/8	06F23O2140ACF	0	0	150	10.34	150	10.34	150	10.34	BR
1/2	08F23O2140ACF	0	0	150	10.34	150	10.34	150	10.34	BR
3/4	12F23O2148ACF	0	0	150	10.34	150	10.34	150	10.34	BR
3/4	12F24O2148ACF	5	0.34	250	17.24	200	13.79	200	13.79	BR
1	16F24O2164ACF	5	0.34	125	8.62	125	8.62	125	8.62	BR
1 1/4	20F24O2172ACF	5	0.34	125	8.62	125	8.62	125	8.62	BR
1 1/2	24F24O2180ACF	5	0.34	125	8.62	125	8.62	125	8.62	BR
2	32F24O2199ACF	2	0.14	125	8.62	125	8.62	125	8.62	BR
3	48F28O9199ACF	2	0.14	125	8.62	125	8.62	125	8.62	BR
3/8	06F23O6140ACF	0	0	150	10.34	150	10.34	150	10.34	SS
1/2	08F23O6140ACF	0	0	150	10.34	150	10.34	150	10.34	SS
3/4	12F23O6148ACF	0	0	150	10.34	150	10.34	150	10.34	SS
1	16F24O6164ACF	5	0.34	125	8.62	125	8.62	125	8.62	SS
1 1/2	24F24O6180ACF	5	0.34	125	8.62	125	8.62	125	8.62	SS
1/4	04F25O2122CCF	5	0.34	300	20.69	300	20.69	300	20.69	BR
3/8	06F25O2122CCF	5	0.34	300	20.69	300	20.69	300	20.69	BR
3/8	06F25O2132ACF	1	0.07	200	13.79	175	12.07	175	12.07	BR
1/2	08F25O2132ACF	1	0.07	200	13.79	175	12.07	175	12.07	BR
3/4	12F25O2148ACF	1	0.07	275	18.97	275	18.97	275	18.97	BR
1	16F25O2164ACF	1	0.07	300	20.69	250	17.24	230	15.86	BR
1/4	04F25O6122CCF	5	0.34	300	20.69	300	20.69	300	20.69	SS
3/8	06F25O6122CCF	5	0.34	300	20.69	300	20.69	300	20.69	SS
1/2	08F28O1D28ACF	25	1.72	1000	68.97	1000	68.97	1000	68.97	BR
3/4	12F28O1D48BCF	25	1.72	500	34.48	500	34.48	500	34.48	BR

Two-Way Normally Closed Valves

DC Specifications

1/8	02F20C1103A1F	0	0	500	34.48	500	34.48	500	34.48	BR
1/8	02F20C1106A1F	0	0	150	10.34	140	9.66	145	10.00	BR
1/8	02F20C1108A1F	0	0	80	5.52	80	5.52	80	5.52	BR
1/4	04F20C1103A1F	0	0	500	34.48	500	34.48	500	34.48	BR
1/4	04F20C1106A1F	0	0	150	10.34	125	8.62	125	8.62	BR
1/4	04F20C1108A1F	0	0	65	4.48	60	4.14	60	4.14	BR

Gold Ring Condensed Valve Listing continued

NPT Pipe Size	Valve Part Number	Operating Pressure Differential								Body Material		
		Max. (MOPD)										
		Min.		Air, Inert Gas		Water		Light Oil 300SSU				
		PSI	Bar	PSI	Bar	PSI	Bar	PSI	Bar			
1/4	04F20C1108A3F	0	0	75	5.17	70	4.83	70	4.83	BR		
1/4	04F20C2110A3F	0	0	40	2.76	40	2.76	45	3.10	BR		
1/4	04F20C2114A1F	0	0	17	1.17	20	1.38	21	1.45	BR		
1/4	04F20C2114A3F	0	0	25	1.72	25	1.72	25	1.72	BR		
1/4	04F20C2118A1F	0	0	15	1.03	16	1.10	16	1.10	BR		
3/8	06F20C2108A3F	0	0	75	5.17	70	4.83	70	4.83	BR		
3/8	06F20C2110A3F	0	0	35	2.41	35	2.41	35	2.41	BR		
3/8	06F20C2114A3F	0	0	25	1.72	25	1.72	25	1.72	BR		
3/8	06F20C2118A1F	0	0	14	0.97	14	0.97	14	0.97	BR		
1/8	02F20C3103A1F	0	0	500	34.48	500	34.48	500	34.48	SS		
1/8	02F20C3106A1F	0	0	150	10.34	140	9.66	145	10.00	SS		
1/8	02F20C3108A1F	0	0	80	5.52	80	5.52	80	5.52	SS		
1/4	04F20C3103A1F	0	0	500	34.48	500	34.48	500	34.48	SS		
1/4	04F20C3106A1F	0	0	150	10.34	125	8.62	125	8.62	SS		
1/4	04F20C3108A1F	0	0	65	4.48	60	4.14	60	4.14	SS		
1/4	04F20C3110A3F	0	0	40	2.76	40	2.76	45	3.10	SS		
1/4	04F20C3114A1F	0	0	17	1.17	20	1.38	21	1.45	SS		
1/4	04F20C3114A3F	0	0	25	1.72	25	1.72	25	1.72	SS		
1/4	04F20C3118A1F	0	0	15	1.03	16	1.10	16	1.10	SS		
3/8	06F20C6108A1F	0	0	65	4.48	60	4.14	60	4.14	SS		
3/8	06F20C6110A3F	0	0	35	2.41	35	2.41	35	2.41	SS		
3/8	06F20C6114A3F	0	0	25	1.72	25	1.72	25	1.72	SS		
3/8	06F20C6118A3F	0	0	18	1.24	15	1.03	18	1.24	SS		
3/8	06F20C2120A1F	0	0	3	0.21	3	0.21	-	-	BR		
3/8	06F20C2120A3F	0	0	9	0.62	9	0.62	-	-	BR		
1/2	08F20C2128A3F	0	0	3	0.21	3	0.21	-	-	BR		
3/8	06F20C6120A3F	0	0	3	0.21	3	0.21	-	-	SS		
1/2	08F20C6128A3F	0	0	3	0.21	3	0.21	-	-	SS		
3/8	06F23C2140A3F	0	0	40	2.76	40	2.76	-	-	BR		
3/8	06F22C2140A3F	5	0.34	125	8.62	100	6.90	100	6.90	BR		
1/2	08F22C2140A3F	5	0.34	125	8.62	100	6.90	100	6.90	BR		
1/2	08F23C2140A3F	0	0	40	2.76	40	2.76	-	-	BR		
3/4	12F23C2148A3F	0	0	40	2.76	40	2.76	-	-	BR		
3/4	12F24C2148A3F	5	0.34	100	6.90	90	6.21	75	5.17	BR		
3/4	12F24C2148A3F	5	0.34	125	8.62	125	8.62	125	8.62	BR		
1	16F24C2164A3F	5	0.34	125	8.62	125	8.62	125	8.62	BR		
1 1/4	20F24C2172A3F	5	0.34	125	8.62	125	8.62	125	8.62	BR		
1 1/2	24F24C2180A3F	5	0.34	125	8.62	125	8.62	125	8.62	BR		
2	32F24C2199A3F	2	0.14	150	10.34	150	10.34	150	10.34	BR		
3	48F28C9199A3F	2	0.14	150	10.34	150	10.34	150	10.34	BR		
3/8	06F23C6140A3F	0	0	40	2.76	40	2.76	-	-	SS		
3/8	06F22C6140A3F	5	0.34	125	8.62	100	6.90	100	6.90	SS		
1/2	08F23C6140A3F	0	0	40	2.76	40	2.76	-	-	SS		
1/2	08F22C6140A3F	5	0.34	125	8.62	100	6.90	100	6.90	SS		
3/4	12F23C6148A3F	0	0	40	2.76	40	2.76	-	-	SS		
3/4	12F22C6148A3F	5	0.34	125	8.62	100	6.90	100	6.90	SS		
1	16F24C6164A3F	5	0.34	125	8.62	125	8.62	125	8.62	SS		
1 1/2	24F24C6180A3F	5	0.34	125	8.62	125	8.62	125	8.62	SS		
1/4	04F25C2122C3F	5	0.34	275	18.97	275	18.97	275	18.97	BR		
3/8	06F25C2122C3F	5	0.34	275	18.97	275	18.97	275	18.97	BR		
3/8	06F25C2132A3F	1	0.07	130	8.97	130	8.97	130	8.97	BR		
1/2	08F25C2132A3F	1	0.07	130	8.97	130	8.97	130	8.97	BR		
3/4	12F25C2148A3F	1	0.07	70	4.83	70	4.83	70	4.83	BR		
1	16F25C2164A3F	1	0.07	275	18.97	275	18.97	275	18.97	BR		
1/2	08F28C1D24A3F	25	1.72	500	34.48	500	34.48	500	34.48	BR		
3/4	12F28C1D48A3F	25	1.72	450	31.03	450	31.03	450	31.03	BR		

Two-Way Normally Open Valves

DC Specifications

1/4	04F25O2122C3F	5	0.34	160	11.03	160	11.03	160	11.03	BR
3/8	06F25O2122A3F	1	0.07	200	13.79	175	12.07	175	12.07	BR
3/8	06F25O2132A3F	1	0.07	200	13.79	175	12.07	175	12.07	BR
1/2	08F25O2132A3F	1	0.07	200	13.79	175	12.07	175	12.07	BR
3/4	12F25O2148A3F	1	0.07	230	15.86	200	13.79	200	13.79	BR
1	16F25O2164A3F	1	0.07	200	13.79	150	10.34	125	8.62	BR
3/8	06F23O6140A3F	0	0	125	8.62	125	8.62	80	5.52	SS
1/2	08F23O6140A3F	0	0	125	8.62	125	8.62	80	5.52	SS
3/4	12F23O6148A3F	0	0	125	8.62	125	8.62	80	5.52	SS
1	16F24O6164A3F	5	0.34	125	8.62	125	8.62	125	8.62	SS
1 1/2	24F24O6180A3F	5	0.34	125	8.62	125	8.62	125	8.62	SS

NPT Pipe Size	Valve Part Number	Operating Pressure Differential								Body Material
		Max. (MOPD)								
		Min.		Air, Inert Gas		Water		Light Oil 300SSU		
PSI	Bar	PSI	Bar	PSI	Bar	PSI	Bar			
1/2	08F23O2140A3F	0	0	125	8.62	125	8.62	80	5.52	BR
3/4	12F23O2148A3F	0	0	125	8.62	125	8.62	80	5.52	BR
3/4	12F24O2148A3F	5	0.34	125	8.62	125	8.62	125	8.62	BR
1	16F24O2164A3F	5	0.34	125	8.62	125	8.62	125	8.62	BR
1 1/4	20F24O2172A3F	5	0.34	125	8.62	125	8.62	125	8.62	BR
1 1/2	24F24O2180A3F	5	0.34	125	8.62	125	8.62	125	8.62	BR
2	32F24O2199A3F	2	0.14	125	8.62	125	8.62	125	8.62	BR
3	48F28O9199A3F	2	0.14	125	8.62	125	8.62	125	8.62	BR
3/8	06F20O2120A3F	0	0	5	0.34	3	0.21	-	-	BR
1/2	08F20O2128A3F	0	0	1	0.07	1	0.07	-	-	BR
1/8	02F20O3104A1F	0	0	400	27.59	250	17.24	150	10.34	SS
1/8	02F20O3106A1F	0	0	190	13.10	110	7.59	110	7.59	SS
1/8	02F20O3108A1F	0	0	80	5.52	60	4.14	50	3.45	SS
1/4	04F20O3103A3F	0	0	500	34.48	500	34.48	500	34.48	SS
1/4	04F20O3106A3F	0	0	200	13.79	150	10.34	125	8.62	SS
1/4	04F20O3108A3F	0	0	80	5.52	60	4.14	60	4.14	SS
1/4	04F20O3110A3F	0	0	45	3.10	30	2.07	30	2.07	SS
1/8	02F20O1104A1F	0	0	400	27.59	250	17.24	150	10.34	BR
1/8	02F20O1106A1F	0	0	190	13.10	110	7.59	110	7.59	BR
1/8	02F20O1108A1F	0	0	80	5.52	60	4.14	50	3.45	BR
1/4	04F20O1103A3F	0	0	500	34.48	500	34.48	500	34.48	BR
1/4	04F20O1106A3F	0	0	200	13.79	150	10.34	125	8.62	BR
1/4	04F20O1108A3F	0	0	80	5.52	60	4.14	60	4.14	BR
1/4	04F20O2110A3F	0	0	45	3.10	30	2.07	30	2.07	BR
1/4	04F20O2114A3F	0	0	25	1.72	20	1.38	20	1.38	BR
1/4	04F20O2118A3F	0	0	15	1.03	15	1.03	15	1.03	BR

Hot Water and Steam Valves

NPT Pipe Size	Valve Part Number	Operating Pressure Differential						Body Material
		Max. (MOPD)						
		Min.		Steam		Hot Water		
PSI	Bar	PSI	Bar	PSI	Bar			

Two-Way Normally Closed Valves

AC Specifications

1/4	04FS0C3410ACH	0	0	110	7.59	-	-	BR
3/8	06FS5C2332ACF	1	0.07	50	3.45	-	-	BR
3/8	06FS5C2432ACF	1	0.07	80	5.52	-	-	BR
3/8	06FS5C2432ACH	1	0.07	125	8.62	-	-	BR
3/8	06FS3C2340ACF	0	0	50	3.45	150	10.34	BR
1/2	08FS5C2332ACF	1	0.07	50	3.45	-	-	BR
1/2	08FS5C2432ACF	1	0.07	80	5.52	-	-	BR
1/2	08FS5C2432ACH	1	0.07	125	8.62	-	-	BR
1/2	08FS3C2340ACF	0	0	50	3.45	150	10.34	BR
3/4	12FS5C2348ACF	1	0.07	50	3.45	-	-	BR
3/4	12FS5C2448ACF	1	0.07	80	5.52	-	-	BR
3/4	12FS5C2448ACH	1	0.07	125	8.62	-	-	BR
3/4	12FS3C2348ACF	0	0	50	3.45	150	10.34	BR
1	16FS5C2364ACF	1	0.07	50	3.45	150	10.34	BR
1	16FS5C2464ACF	1	0.07	80	5.52	-	-	BR
1	16FS5C2464ACH	1	0.07	125	8.62	-	-	BR
1 1/4	20FS4C2372AAF	5	0.34	50	3.45	150	10.34	BR
1 1/2	24FS4C2380AAF	5	0.34	50	3.45	150	10.34	BR

DC Specifications

3/8	06F22C2340A3F	5	0.34	-	-	100	6.90	BR
3/8	06F23C2340A3F	0	0	-	-	40	2.76	BR
1/2	08F22C2340A3F	5	0.34	-	-	100	6.90	BR
1/2	08F23C2340A3F	0	0	-	-	40	2.76	BR
3/4	12F22C2348A3F	5	0.34	-	-	100	6.90	BR
3/4	12F23C2348A3F	0	0	-	-	40	2.76	BR

Two-Way Normally Open

AC Specifications

3/8	06FS5O2432ACH	1	0.07	125	8.62	-	-	BR
1/2	08FS5O2432ACH	1	0.07	125	8.62	-	-	BR
3/4	12FS5O2448ACH	1	0.07	125	8.62	-	-	BR
1	16FS5O2464ACH	1	0.07	125	8.62	-	-	BR
1 1/2	24FS4O2380ACF	5	0.34	50	3.45	-	-	BR

Gold Ring Condensed Valve Listing continued

NPT Pipe Size	Valve Part Number	Operating Pressure Differential								Body Material
		Min.		Max. (MOPD)						
		PSI	Bar	Air, Inert Gas		Water		Light Oil 300SSU		
		PSI	Bar	PSI	Bar	PSI	Bar	PSI	Bar	
Three-Way Normally Closed Valves										
AC Specifications										
1/8	02F30C1103AAF	0	0	200	13.79	200	13.79	200	13.79	BR
1/8	02F30C1104AAF	0	0	125	8.62	125	8.62	125	8.62	BR
1/8	02F30C1106AAF	0	0	100	6.90	100	6.90	100	6.90	BR
1/8	02F30C1108AAF	0	0	40	2.76	40	2.76	40	2.76	BR
1/4	04F30C2104AAF	0	0	125	8.62	125	8.62	125	8.62	BR
1/4	04F30C2106ABF	0	0	110	7.59	110	7.59	110	7.59	BR
1/4	04F30C2106ACF	0	0	150	10.34	150	10.34	150	10.34	BR
1/4	04F30C2108AAF	0	0	40	2.76	40	2.76	40	2.76	BR
1/4	04F30C2111ABF	0	0	30	2.07	30	2.07	30	2.07	BR
1/8	02F30C3103AAF	0	0	200	13.79	200	13.79	200	13.79	SS
1/8	02F30C3104AAF	0	0	125	8.62	125	8.62	125	8.62	SS
1/8	02F30C3106AAF	0	0	100	6.90	100	6.90	100	6.90	SS
1/8	02F30C3108AAF	0	0	40	2.76	40	2.76	40	2.76	SS
1/4	04F30C3104AAF	0	0	125	8.62	125	8.62	125	8.62	SS
1/4	04F30C3106ACF	0	0	150	10.34	150	10.34	150	10.34	SS
1/4	04F30C3108ACF	0	0	85	5.86	85	5.86	85	5.86	SS
3/8	06F34C2140AAF	10	0.69	125	8.62	125	8.62	125	8.62	BR
3/8	06F34C2140ADF	10	0.69	250	17.24	250	17.24	250	17.24	BR
1/2	08F34C2140ADF	10	0.69	125	8.62	125	8.62	125	8.62	BR
1/2	08F34C2140AAF	10	0.69	250	17.24	250	17.24	250	17.24	BR
3/4	12F34C2140ADF	10	0.69	125	8.62	125	8.62	125	8.62	BR
3/4	12F34C2140AAF	10	0.69	250	17.24	250	17.24	250	17.24	BR
1/4	04F35C1116ACF	5	0.34	150	10.34	150	10.34	95	6.55	BR
1/4	04F38C1122AAF	10	0.69	200	13.79	200	13.79	200	13.79	BR
3/8	06F38C1122AAF	10	0.69	200	13.79	200	13.79	200	13.79	BR
1/4	04F35C3116ACF	5	0.34	150	10.34	150	10.34	95	6.55	SS
Three-Way Normally Open Valves										
AC Specifications										
1/8	02F30O1103AAF	0	0	200	13.79	200	13.79	200	13.79	BR
1/8	02F30O1104AAF	0	0	125	8.62	125	8.62	125	8.62	BR
1/8	02F30O1106AAF	0	0	100	6.90	100	6.90	100	6.90	BR
1/8	02F30O1108AAF	0	0	40	2.76	40	2.76	40	2.76	BR
1/4	04F30O2104ADF	0	0	235	16.21	250	17.24	250	17.24	BR
1/4	04F30O2106ACF	0	0	140	9.66	140	9.66	140	9.66	BR
1/4	04F30O2108AAF	0	0	40	2.76	40	2.76	40	2.76	BR
1/4	04F30O2108ACF	0	0	70	4.83	70	4.83	70	4.83	BR
1/4	04F30O2111ACF	0	0	40	2.76	40	2.76	40	2.76	BR
3/8	06F34O2140ACF	10	0.69	225	15.52	225	15.52	225	15.52	BR
1/2	08F34O2140ACF	10	0.69	225	15.52	225	15.52	225	15.52	BR
3/4	12F34O2140ACF	10	0.69	225	15.52	225	15.52	225	15.52	BR
1/4	04F35O3116ACF	5	0.34	160	11.03	160	11.03	95	6.55	SS
1/4	04F35O1116ACF	5	0.34	160	11.03	160	11.03	95	6.55	BR
1/4	04F38O1122ACF	10	0.69	200	13.79	200	13.79	200	13.79	BR
3/8	06F38O1122ACF	10	0.69	200	13.79	200	13.79	200	13.79	BR
1/8	02F30O3103AAF	0	0	200	13.79	200	13.79	200	13.79	SS
1/8	02F30O3104AAF	0	0	125	8.62	125	8.62	125	8.62	SS
1/8	02F30O3106AAF	0	0	100	6.90	100	6.90	100	6.90	SS
1/8	02F30O3108AAF	0	0	40	2.76	40	2.76	40	2.76	SS
1/4	04F30O3104AAF	0	0	125	8.62	125	8.62	125	8.62	SS
1/4	04F30O3106ACF	0	0	150	10.34	140	9.66	140	9.66	SS
1/4	04F30O3108ACF	0	0	70	4.83	70	4.83	70	4.83	SS
Three-Way Universal Valves										
AC Specifications										
1/8	02F30U1103ABF	0	0	175	12.07	175	12.07	175	12.07	BR
1/8	02F30U1104ABF	0	0	100	6.90	100	6.90	100	6.90	BR
1/8	02F30U1106AAF	0	0	50	3.45	50	3.45	50	3.45	BR
1/8	02F30U1108ABF	0	0	30	2.07	30	2.07	30	2.07	BR
1/4	04F30U2104ACF	0	0	125	8.62	130	8.97	130	8.97	BR
1/4	04F30U2106ADF	0	0	100	6.90	100	6.90	100	6.90	BR
1/4	04F30U2108ACF	0	0	50	3.45	50	3.45	50	3.45	BR
1/4	04F30U2111ACF	0	0	20	1.38	20	1.38	20	1.38	BR
1/8	02F30U3103ABF	0	0	175	12.07	175	12.07	175	12.07	SS
1/8	02F30U3104ABF	0	0	100	6.90	100	6.90	100	6.90	SS
1/8	02F30U3106AAF	0	0	50	3.45	50	3.45	50	3.45	SS
1/8	02F30U3108ABF	0	0	30	2.07	30	2.07	30	2.07	SS
1/4	04F30U3104ABF	0	0	100	6.90	100	6.90	100	6.90	SS

NPT Pipe Size	Valve Part Number	Operating Pressure Differential								Body Material
		Max. (MOPD)								
		Min.		Air, Inert Gas		Water		Light Oil 300SSU		
PSI	Bar	PSI	Bar	PSI	Bar	PSI	Bar			
1/4	04F30U3106ADF	0	0	100	6.90	100	6.90	100	6.90	SS
1/4	04F30U3108ABF	0	0	50	3.45	50	3.45	50	3.45	SS
1/4	04F35U1116ACF	5	0.34	80	5.52	80	5.52	50	3.45	BR
1/4	04F35U1116ACF	5	0.34	80	5.52	80	5.52	50	3.45	SS

Three-Way Normally Closed

DC Specifications

1/8	02F30C1103A1F	0	0	200	13.79	200	13.79	200	13.79	BR
1/8	02F30C1104A1F	0	0	125	8.62	125	8.62	125	8.62	BR
1/8	02F30C1106A1F	0	0	100	6.90	100	6.90	100	6.90	BR
1/8	02F30C1108A1F	0	0	40	2.76	40	2.76	40	2.76	BR
1/4	04F30C2104A1F	0	0	125	8.62	125	8.62	125	8.62	BR
1/4	04F30C2104A3F	0	0	160	11.03	160	11.03	160	11.03	BR
1/4	04F30C2106A3F	0	0	115	7.93	115	7.93	115	7.93	BR
1/4	04F30C2108A3F	0	0	60	4.14	60	4.14	60	4.14	BR
1/4	04F30C2111A3F	0	0	25	1.72	25	1.72	25	1.72	BR
1/8	02F30C3103A1F	0	0	200	13.79	200	13.79	200	13.79	SS
1/8	02F30C3104A1F	0	0	125	8.62	125	8.62	125	8.62	SS
1/8	02F30C3106A1F	0	0	100	6.90	100	6.90	100	6.90	SS
1/8	02F30C3108A1F	0	0	40	2.76	40	2.76	40	2.76	SS
1/4	04F30C3104A1F	0	0	125	8.62	125	8.62	125	8.62	SS
1/4	04F30C3106A3F	0	0	115	7.93	115	7.93	115	7.93	SS
1/4	04F30C3108A3F	0	0	60	4.14	60	4.14	60	4.14	SS
3/8	06F34C2140A1F	10	0.69	125	8.62	125	8.62	125	8.62	BR
3/8	06F34C2140A3F	10	0.69	250	17.24	250	17.24	250	17.24	BR
1/2	08F34C2140A1F	10	0.69	125	8.62	125	8.62	125	8.62	BR
1/2	08F34C2140A3F	10	0.69	250	17.24	250	17.24	250	17.24	BR
3/4	12F34C2140A1F	10	0.69	125	8.62	125	8.62	125	8.62	BR
3/4	12F34C2140A3F	10	0.69	250	17.24	250	17.24	250	17.24	BR
1/4	04F35C1116A3F	5	0.34	115	7.93	115	7.93	60	4.14	BR
1/4	04F38C1122A3F	10	0.69	200	13.79	200	13.79	200	13.79	BR
3/8	06F38C1122A1F	10	0.69	200	13.79	200	13.79	200	13.79	BR
1/4	04F35C3116A3F	5	0.34	115	7.93	115	7.93	60	4.14	SS

Three-Way Normally Open Valves

DC Specifications

1/8	02F30O1103A1F	0	0	200	13.79	200	13.79	200	13.79	BR
1/8	02F30O1104A1F	0	0	200	13.79	200	13.79	200	13.79	BR
1/8	02F30O1106A1F	0	0	100	6.90	100	6.90	100	6.90	BR
1/8	02F30O1108A1F	0	0	40	2.76	40	2.76	40	2.76	BR
1/4	04F30O2140A3F	0	0	160	11.03	160	11.03	160	11.03	BR
1/4	04F30O2106A3F	0	0	100	6.90	100	6.90	100	6.90	BR
1/4	04F30O2108A3F	0	0	55	3.79	55	3.79	55	3.79	BR
1/4	04F30O2111A3F	0	0	30	2.07	30	2.07	30	2.07	BR
1/8	02F30O3103A1F	0	0	200	13.79	200	13.79	200	13.79	SS
1/8	02F30O3104A1F	0	0	125	8.62	125	8.62	125	8.62	SS
1/8	02F30O3106A1F	0	0	100	6.90	100	6.90	100	6.90	SS
1/8	02F30O3108A1F	0	0	40	2.76	40	2.76	40	2.76	SS
1/4	04F30O3104A1F	0	0	125	8.62	125	8.62	125	8.62	SS
1/4	04F30O3106A3F	0	0	100	6.90	100	6.90	100	6.90	SS
1/4	04F30O3108A3F	0	0	55	3.79	55	3.79	55	3.79	SS
3/8	06F34O2140A3F	10	0.69	225	15.52	225	15.52	225	15.52	BR
1/2	08F34O2140A3F	10	0.69	225	15.52	225	15.52	225	15.52	BR
3/4	12F34O2140A3F	10	0.69	225	15.52	225	15.52	225	15.52	BR
1/4	04F35O1116A3F	5	0.34	100	6.90	100	6.90	50	3.45	BR
1/4	04F38O1122A3F	10	0.69	200	13.79	200	13.79	200	13.79	BR
3/8	06F38O1122A3F	10	0.69	200	13.79	200	13.79	200	13.79	BR
1/4	04F35O3116A3F	5	0.34	100	6.90	100	6.90	50	3.45	SS

Three-Way Universal Valves

DC Specifications

1/8	02F30U1103A1F	0	0	125	8.62	125	8.62	125	8.62	BR
1/8	02F30U1104A1F	0	0	65	4.48	65	4.48	65	4.48	BR
1/8	02F30U1106A1F	0	0	50	3.45	50	3.45	50	3.45	BR
1/8	02F30U1108A1F	0	0	20	1.38	20	1.38	20	1.38	BR
1/4	04F30U2104A3F	0	0	75	5.17	75	5.17	75	5.17	BR
1/4	04F30U2106A3F	0	0	60	4.14	60	4.14	60	4.14	BR
1/4	04F30U2108A3F	0	0	25	1.72	25	1.72	25	1.72	BR
1/4	04F30U2111A3F	0	0	12	0.83	12	0.83	12	0.83	BR
1/8	02F30U3103A1F	0	0	125	8.62	125	8.62	125	8.62	SS

Gold Ring Condensed Valve Listing continued

NPT Pipe Size	Valve Part Number	Operating Pressure Differential Max. (MOPD)								Body Material
		Min.		Air, Inert Gas		Water		Light Oil 300SSU		
		PSI	Bar	PSI	Bar	PSI	Bar	PSI	Bar	
1/8	02F30U3104A1F	0	0	65	4.48	65	4.48	65	4.48	SS
1/8	02F30U3106A1F	0	0	50	3.45	50	3.45	50	3.45	SS
1/8	02F30U3108A1F	0	0	20	1.38	20	1.38	20	1.38	SS
1/4	04F30U3104A1F	0	0	65	4.48	65	4.48	65	4.48	SS
1/4	04F30U3106A3F	0	0	60	4.14	60	4.14	60	4.14	SS
1/4	04F30U3108A3F	0	0	25	1.72	25	1.72	25	1.72	SS
1/4	04F35U1116A3F	5	0.34	60	4.14	60	4.14	30	2.07	BR
1/4	04F35U3116A3F	5	0.34	60	4.14	60	4.14	30	2.07	SS

Four-Way Universal Valves

AC Specifications

1/4	04F48S2106ACF	10	0.69	150	10.34	150	10.34	150	10.34	BR
-----	---------------	----	------	-----	-------	-----	-------	-----	-------	----

Four-Way Universal Valves

DC Specifications

1/4	04F48S2106A3F	10	0.69	100	6.90	100	6.90	100	6.90	BR
-----	---------------	----	------	-----	------	-----	------	-----	------	----

NPT Pipe Size	Valve Part Number	Operating Pressure Differential Max. (MOPD)						Body Material
		Min.		Cryogenic Fluids				
		PSI	Bar	PSI		Bar		

Cryogenic Two-Way Normally Closed Valves

AC Specifications

1/8	02F20C1408BDF-L	0	0	200	13.79	BR
1/4	04F20C2414BDF-L	0	0	70	4.83	BR
1/4	04F20C2418BDF-L	0	0	35	2.41	BR
3/8	06F20C2414BDF-L	0	0	70	4.83	BR
3/8	06F20C2418BCF-L	0	0	35	2.41	BR
1/2	08FH6C2440CCF-L	10	0.69	200	13.79	BR
1	16F26C2464BCF-L	10	0.69	200	13.79	BR
1/4	04F20C2K06ADF-L	0	0	500	34.48	BR
1/4	04F20C2K18ADF-L	0	0	80	5.52	BR
1/8	02F20C3503ABF-43	0	0	1000	68.97	SS
1/8	02F20C3506ABF-43	0	0	300	20.69	SS

Cryogenic Two-Way Normally Open Valves

AC Specifications

1/4	04F20O2K18ADF-L	0	0	40	2.76	BR
-----	-----------------	---	---	----	------	----

NPT Pipe Size	Valve Part Number	Operating Pressure Differential Max. (MOPD)				Body Material
		Min.		Max.		
		PSI	Bar	PSI	Bar	

Two-Way Normally Closed Low Vacuum Valves

AC Specifications

1/4	04F20C2118AAF	0	0	15	1.03	BR
3/8	06F20C2120AAF	0	0	15	1.03	BR
1/2	08F20C2128ADF	0	0	15	1.03	BR
3/4	12F20C2148ADF	0	0	4	0.28	BR
3/4	12F23C2140ACF	0	0	15	1.03	BR
1	16FH5C2164ADF	0	0	15	1.03	BR

Two-Way Normally Open Low Vacuum Valves

AC Specifications

3/8	06F23O2140ACF	0	0	15	1.03	BR
1/2	08F23O2140ACF	0	0	15	1.03	BR
3/4	12F23O2148ACF	0	0	15	1.03	BR

Two-Way Normally Closed Medium Vacuum Valves

AC Specifications

1/4	04F20C2118AAF-S	0	0	15	1.03	BR
3/8	06F20C2120AAF-S	0	0	15	1.03	BR
1/2	08F20C2128ADF-S	0	0	15	1.03	BR
3/4	12F20C2148ADF-S	0	0	4	0.28	BR
3/4	12F23C2140ACF-S	0	0	15	1.03	BR
1	16FH5C2164ADF-S	0	0	15	1.03	BR

NPT Pipe Size	Valve Part Number	Operating Pressure Differential Max. (MOPD)				Max. Body Material
		Min.		Min.		
		PSI	Bar	PSI	Bar	

Two-Way Normally Open Medium Vacuum Valves

AC Specifications

3/8	06F23O2140ACF-S	0	0	15	1.03	BR
1/2	08F23O2140ACF-S	0	0	15	1.03	BR
3/4	12F23O2148ACF-S	0	0	15	1.03	BR

Two-Way Normally Closed High Vacuum Valves

AC Specifications

1/4	04F20C2218AAF-V	0	0	15	1.03	BR
3/8	06F20C2220AAF-V	0	0	15	1.03	BR
1/2	08F20C2228ADF-V	0	0	15	1.03	BR
3/4	12F20C2248ADF-V	0	0	4	0.28	BR
3/4	12F23C2248ACF-V	0	0	15	1.03	BR
1	16FH5C2264ADF-V	0	0	15	1.03	BR

Two-Way Normally Open High Vacuum Valves

AC Specifications

3/8	06F23O2240ACF-V	0	0	15	1.03	BR
1/2	08F23O2240ACF-V	0	0	15	1.03	BR
3/4	12F23O2248ACF-V	0	0	15	1.03	BR

NPT Pipe Size	Valve Part Number	Operating Pressure Differential Max. (MOPD)						Body Material		
		Min.		Air, Inert Gas		Water			Light Oil 300SSU	
		PSI	Bar	PSI	Bar	PSI	Bar		PSI	Bar

Two, Three, Four-Way Normally Closed Long Life, Quiet Operating Valves

AC Specifications

3/8	06F22C2140ACF-08	5	0.35	125	8.62	100	6.90	100	6.90	BR
1/2	08F22C2140ACF-08	5	0.35	125	8.62	100	6.90	100	6.90	BR
3/4	12F22C2148ACF-08	5	0.35	125	8.62	100	6.90	100	6.90	BR
1	16F24C2164ACF-08	5	0.35	125	8.62	125	8.62	125	8.62	BR
1 1/4	20F24C2172ACF-08	5	0.35	125	8.62	125	8.62	125	8.62	BR
1 1/2	24F24C2180ACF-08	5	0.35	125	8.62	125	8.62	125	8.62	BR
3/8	06F34C2140ACF-08	10	0.69	125	8.62	100	6.90	100	6.90	BR
1/2	08F34C2140ACF-08	10	0.69	125	8.62	100	6.90	100	6.90	BR
1/4	04F20C1108ACF-08	0	0	175	12.07	175	12.07	175	12.07	BR
1/4	04F20C2114ACF-08	0	0	50	3.45	40	2.76	40	2.76	BR
1/4	04F30C2104ACF-08	0	0	125	8.62	125	8.62	125	8.62	BR
1/4	04F30C2108ACF-08	0	0	35	2.41	35	2.41	35	2.41	BR

Two, Three, Four-Way Normally Open Long Life, Quiet Operating Valves

AC Specifications

3/8	06F34O2140ACF-08	10	0.69	125	8.62	100	6.90	100	6.90	BR
1/2	08F34O2140ACF-08	10	0.69	125	8.62	100	6.90	100	6.90	BR
1/4	04F30O2140ACF-08	0	0	125	8.62	125	8.62	125	8.62	BR
1/4	04F30O2108ACF-08	0	0	35	2.41	35	2.41	35	2.41	BR

Two, Three, Four-Way Universal Long Life, Quiet Operating Valves

AC Specifications

1/4	04F30U2104ACF-08	0	0	70	4.83	70	4.83	70	4.83	BR
1/4	04F30U2106ACF-08	0	0	40	2.76	40	2.76	40	2.76	BR

Two Position Four-Way Valve

AC Specifications

1/4	04F48S2106ACF-08	10	0.69	100	6.90	100	6.90	100	6.90	BR
-----	------------------	----	------	-----	------	-----	------	-----	------	----

Ordering Information

Gold Ring Type I General Purpose, Splice Box, Conduit Hub and Type 4X, Gold Ring II unit solenoids and unit valves can be ordered separately for maximum inventory flexibility. No prefix or suffix required to order standard features.

To Order

Step 1: Select the Gold Ring valve required by using the appropriate valve specification table.

Step 2: Select one enclosure code, one coil termination code and one voltage code. Standard leads are 18-inches long with all enclosures, except splice box where 6-inch leads are standard.

Step 3: When separate valve and solenoid, the last two digits of the valve must match the first two digits of the solenoid.

Example: Valve: 04F20C1103AAF
Solenoid: AF GC05

Step 4: Open frame and Types 6, 7 and 9 must be ordered factory assembled.

Solenoid Enclosure and Coil Information

Surrounding the coil is the metal solenoid enclosure and frame. Together with the plunger and pole piece, it forms the magnetic circuit that operates the valve. Without the enclosure, the magnetic circuit is not complete. Without a complete magnetic circuit, the magnetic field is reduced and valve performance suffers.

The enclosure also protects the coil from the environment. Solenoid enclosures come in a range of constructions offering varying levels of protection against the elements and other forces. NEMA identifies the different enclosures as "Types" and sets standards for their safety and performance. Following is a description of Gold Ring solenoid valve enclosures.

The National Electrical Manufacturers Association (NEMA) recommends suitable materials and components to meet each enclosure type. The enclosures listed here will only meet the applicable NEMA recommendations when properly installed and operated to NEMA specifications and in accordance with the NEC.

Condensed Listing of NEMA Enclosures

NEMA Type	Gold Ring Enclosure Code
1	G,P,S
2	4
3	4
3R	4
3S	4
4	P*,4
4X	4
6	W
7	E,M,Y,Z
9	E,M,Y,Z

* With suitable connector

Enclosure/Coil Termination Combinations

	Coil Termination						
	Screw (K)	Spade (S)	DIN (H)	6" Leads	18" Leads	24" Leads	36" Leads
Enclosures							
Explosion-Proof (E)					X	X	X
General Purpose (G)					X	X	X
316 SS Explosion-Proof (M)					X	X	X
Open Frame (O)	X	X			X	X	X
Encapsulated DIN (P)			X				
Splice Box (S)				X			
316 SS Submersible (U)					X	X	X
Submersible Splice Box (W)	X	X	X				
Explosion-Proof W/Ground Lead (Y)					X	X	X
316 SS Explosion-Proof W/Ground Wire (Z)					X	X	X
Gold Ring II (4)					X		

Solenoid Enclosures

Open Frame

Open Frame enclosures are unclassified by NEMA. The solenoid is open on two or more sides. They are used where space is limited and protection is afforded by mounting the solenoid in an approved panel box or other protective enclosure. Available with panel mount construction.

- Material Specifications:**
- Formed Sheet Carbon Steel: SAE 1008-1010
 - Zinc Plated Gold Color: Federal Specification QQ-Z-325

Spade/Screw

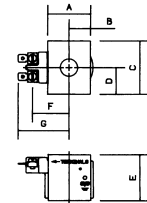

A, B, & 1 WATTAGES	C, D & 3 WATTAGES
A 1-3/8	1-3/8
B 11/16	11/16
C 1-9/16	1-3/4
D 25/32	7/8
E 1-1/4	1-1/2
F 1-1/8	1-3/16
G 1-5/8	1-21/32

Type 1: General Purpose

Type 1 General Purpose enclosures are designed for indoor use to provide moderate protection against contact with other equipment. **General Purpose** enclosures completely enclose the coil and have a standard conduit hole or hub for electrical connections. **Splice Box** enclosures provide an integral splice box to accommodate the coil leads and incoming wires. The splice box has two standard knock-outs, one on each side.

- Material Specifications:**
- Formed Sheet Carbon Steel: SAE 1008-1010
 - Zinc Plated Gold Color: Federal Specification QQ-Z-325
 - Black Epoxy Coating on Galvanization

General Purpose, Type

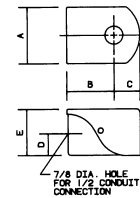

A, B, & 1 WATTAGES	C, D & 3 WATTAGES
A 1-9/16	1-13/16
B 1-5/16	1-9/16
C 25/32	27/32
D 5/8	23/32
E 1-9/32	1-1/2

General Purpose, Type 1 Splice Box

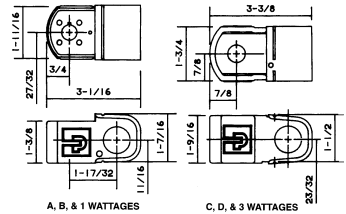

Type 1, 2, 3, 3R, 3S, 4 and 4X: Gold Ring II

These completely encapsulated solenoids are suitable for **Type 1**; **Type 2**—indoor installations to provide protection against splashing; **Type 3**—outdoor installations for protection against rain, snow, sleet and dust; **Type 3R**; **Type 3S**; **Type 4**, watertight and dusttight; and **Type 4X**, corrosion resistant.

Gold Ring II, Types 1, 2, 3, 3R, 3S, 4, 4X

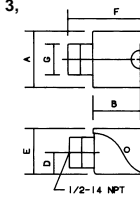

CONDUIT HUB		GOLD RING II™
A, B, & 1 WATTAGES	C, D & 3 WATTAGES	C, D & 3 WATTAGES
A 1-9/16	1-13/16	1-13/16
B 1-5/16	1-9/16	1/2
C 25/32	27/32	2-1/8
D 5/8	23/32	23/32
E 1-9/32	1-1/2	1-1/2
F 2-13/16	3-7/32	3-7/32
G 1 DIA	1 DIA	1 DIA

Type 6: Submersible, Watertight, Dusttight and Sleet-Resistant

Indoor and Outdoor, **Type 6** enclosures protect the coil against occasional submersion (6 ft. for 30 minutes, longer duration or depth consult factory); dust; splashing, seeping, falling or hose-directed water; external condensation; and lint.

NEMA 6 Splice Box

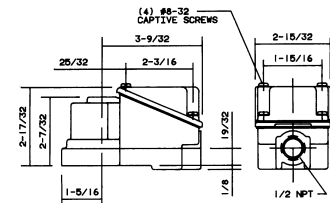

Solenoid Enclosures continued

DIN Connector

DIN Connector coils meet ISO4400/DIN 43650 requirements. With optional connector kits, these coils will meet Type 1 and 4 enclosure requirements.

Connector Kits For DIN Coils	Part No.
1/2" conduit connector	SA06-005
6-10mm cable gland connector	SA06-004

Each kit contains a gasket and attaching screw.
Contact factory for timer information.

DIN Connector

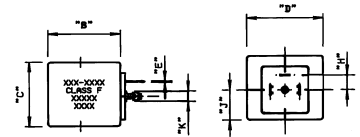
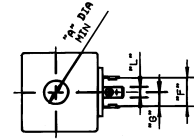

Type 7: Explosion-Proof for Indoor Hazardous Locations

Type 9: Dust-Ignition Proof

Type 7 Explosion-Proof enclosures are designed for use in gas or vapor atmospheres. **Type 9** enclosures prevent explosive amounts of dust from metal, coal, coke, flour, starch or grain from entering the enclosure.

Material Specifications:
Splice Box or Explosion-Proof
 Aluminum Cast: ASTM SC84A
 Black Epoxy Coating
Explosion-Proof: 316 Stainless Steel
 Investment Cast: ACI CF-8M
NEMA Classifications: Type 7
 Class 1 Division 1 Group C and D
 Type 9 Class 2 Division 1
 Group E,F,G

Type 7, 9



Type 7, 9 Stainless Steel

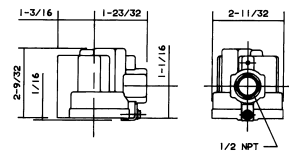

Two-Way Valve Contents

Gold Ring Two-Way Valve Specifications	13-32
Series 20, Direct Acting	14-18
Series 20, Low Pressure	19-20
Series 22, 23, 24, 26 Pilot Operated	21-24
Series 25, H5 Pivoted Edge	25-27
Hot Water and Steam.....	28-30
Series 28, High Pressure	31-32



GOLD RING Series 20 Small Two-Way Direct Acting Valves

SPECIFICATIONS

Mechanical Characteristics

Standard Materials of Construction

- Body-Brass, 303 Stainless Steel, 316 Stainless Steel as listed
- Seals-NBR or Urethane as listed
- Plunger and Pole Piece-430FR Stainless Steel
- Plunger Tube-305 Stainless Steel
- Springs-302 Stainless Steel
- Shading Coil-Copper(Brass Bodies), Silver(Stainless Steel Bodies)
- Disc Holder-1/8-inch NPT Celcon, 1/4-inch Ryton

Compatible Fluids

- Gases, Fluid, Light Oils, or Vacuum from 760-23 Torr (29" Mercury) and other clean flowing media compatible with brass or stainless steel

Electrical Characteristics

Voltages

- DC-6, 12, 24, 120, 125 (other voltages available upon request)
- AC-24/60, 110/120-50/60, 220/240-50/60, 440/480-50/60

Coil

- Class F Standard, Class H Available

Agency Approvals

- Standard valves with general purpose or explosion proof solenoid enclosures are UL Listed and CSA Certified. For details, consult factory.

Miscellaneous

Temperature Ratings (media as listed)

- AC Voltages: 200°F max.
- DC Voltages: 150°F max.
- Ambient: 32-77°F (standard)
- For temperature variations, consult the factory.

Installation

- Series 20 valves may be mounted in any position. Product and mounting dimensions shown are nominal. For certified dimensions, consult factory.

Applications

- Used in a variety of applications including: Material Transfer, Molding, Vending Machines, Instrumentation, Welding Equipment, Water Treatment Systems, Spray Equipment, Dental Equipment, Laundry Equipment, Food Processing Machinery.

DIRECT ACTING BRASS VALVES – NORMALLY CLOSED (ENERGIZE TO OPEN), NBR SEALS

AC VALVE SPECIFICATIONS

NPT Pipe Size	Orifice Diameter		Flow Factor		Operating Pressure Differential							Max. Temp.		AC Watt	Const. Ref.	Valve Part Number
	inch	mm	Cv	Kv	Min. (PSI/Bar)	Max. (MOPD)			°F	°C						
						Air, Inert Gas (PSI/BAR)	Water (PSI/Bar)	Light Oil 300SSU (PSI/BAR)								
1/8	3/64	1.19	.06	0.05	0	750	51.72	750	51.72	530	36.55	180	82	6.0	1	02F20C1103AAF
1/8	3/32	2.38	.20	0.17	0	275	18.97	290	20.00	130	8.97	180	82	6.0	1	02F20C1106AAF
1/8	1/8	3.18	.34	0.29	0	155	10.69	180	12.41	140	9.66	180	82	6.0	1	02F20C1108AAF
1/4	3/64	1.19	.06	0.05	0	750	51.72	750	51.72	500	34.48	180	82	6.0	2	04F20C1103AAF
1/4	3/64	1.19	.06	0.05	0	1500	103.45	1500	103.45	1100	75.86	140	60	11.0	3	04F20C1503ACF*
1/4	3/32	2.38	.17	0.15	0	360	24.83	340	23.45	160	11.03	180	82	6.0	2	04F20C1106AAF
1/4	1/8	3.18	.35	0.30	0	140	9.66	165	11.38	90	6.21	180	82	6.0	2	04F20C1108AAF
1/4	1/8	3.18	.35	0.30	0	300	20.69	300	20.69	200	13.79	180	82	11.0	3	04F20C1108ACF
1/4	5/32	3.97	.50	0.43	0	150	10.34	150	10.34	145	10.00	180	82	11.0	5	04F20C2110ACF
1/4	7/32	5.56	.85	0.73	0	40	2.76	50	3.45	40	2.76	180	82	6.0	4	04F20C2114AAF
1/4	7/32	5.56	.72	0.62	0	100	6.90	100	6.90	100	6.90	180	82	16.0	5	04F20C2114BDF
1/4	9/32	7.14	.96	0.83	0	27	1.86	36	2.48	28	1.93	180	82	6.0	4	04F20C2118AAF
1/4	9/32	7.14	.88	0.76	0	60	4.14	50	3.45	50	3.45	180	82	11.0	5	04F20C2118BCF
1/4	9/32	7.14	.88	0.76	0	90	6.21	80	5.52	80	5.52	200	93	16.0	5	04F20C2118BDF
3/8	1/8	3.18	.35	0.30	0	160	11.03	150	10.34	90	6.21	180	82	6.0	6	06F20C2108AAF
3/8	5/32	3.97	.52	0.45	0	150	10.34	150	10.34	145	10.00	180	82	11.0	7	06F20C2110ACF
3/8	7/32	5.56	.72	0.62	0	100	6.90	100	6.90	100	6.90	200	93	16.0	7	06F20C2114BDF
3/8	9/32	7.14	.85	0.73	0	90	6.21	80	5.52	80	5.52	200	93	16.0	7	06F20C2118BDF

* Valve is standard with urethane disc.

DIRECT ACTING BRASS VALVES – NORMALLY OPEN (ENERGIZE TO CLOSE), NBR SEALS

AC VALVE SPECIFICATIONS

NPT Pipe Size	Orifice Diameter		Flow Factor		Operating Pressure Differential						Max. Temp.		AC Watt	Const. Ref.	Valve Part Number	
	inch	mm	Cv	Kv	Min. (PSI/Bar)	Max. (MOPD)			°F	°C						
						Air, Inert Gas (PSI/Bar)	Water (PSI/Bar)	Light Oil 300SSU (PSI/Bar)								
1/8	1/16	1.59	.09	0.08	0	500	34.48	300	20.69	225	15.52	180	82	10.2	8	02F2001104ABF
1/8	3/32	2.38	.15	0.13	0	275	18.97	200	13.79	150	10.34	180	82	6.0	8	02F2001106AAF
1/8	1/8	3.18	.21	0.18	0	125	8.62	100	6.90	85	5.86	180	82	6.0	8	02F2001108AAF
1/4	3/64	1.19	.06	0.05	0	750	51.72	700	48.28	700	48.28	180	82	11.0	9	04F2001103ACF
1/4	3/32	2.38	.17	0.15	0	300	20.69	250	17.24	230	15.86	180	82	11.0	9	04F2001106ACF
1/4	1/8	3.18	.35	0.30	0	130	8.97	110	7.59	100	6.90	180	82	11.0	9	04F2001108ACF
1/4	5/32	3.97	.49	0.42	0	85	5.86	75	5.17	60	4.14	180	82	11.0	10	04F2002110ACF
1/4	7/32	5.56	.83	0.72	0	45	3.10	45	3.10	40	2.76	180	82	11.0	10	04F2002114ACF
1/4	9/32	7.14	.96	0.83	0	30	2.07	25	1.72	20	1.38	180	82	11.0	10	04F2002118ACF

DIRECT ACTING BRASS VALVES – NORMALLY CLOSED (ENERGIZE TO OPEN), NBR SEALS

DC VALVE SPECIFICATIONS

NPT Pipe Size	Orifice Diameter		Flow Factor		Operating Pressure Differential						Max. Temp.		AC Watt	Const. Ref.	Valve Part Number	
	inch	mm	Cv	Kv	Min. (PSI/Bar)	Max. (MOPD)			°F	°C						
						Air, Inert Gas (PSI/Bar)	Water (PSI/Bar)	Light Oil 300SSU (PSI/Bar)								
1/8	3/64	1.19	.06	0.05	0	500	34.48	500	34.48	500	34.48	120	49	9.5	1	02F20C1103A1F
1/8	3/32	2.38	.20	0.17	0	150	10.34	140	9.66	145	10.00	120	49	9.5	1	02F20C1106A1F
1/8	1/8	3.18	.34	0.29	0	80	5.52	80	5.52	80	5.52	120	49	9.5	1	02F20C1108A1F
1/4	3/64	1.19	.06	0.05	0	500	34.48	500	34.48	500	34.48	120	49	9.5	2	04F20C1103A1F
1/4	3/32	2.38	.17	0.15	0	150	10.34	125	8.62	125	8.62	120	49	9.5	2	04F20C1106A1F
1/4	1/8	3.18	.35	0.30	0	65	4.48	60	4.14	60	4.14	120	49	9.5	2	04F20C1108A1F
1/4	1/8	3.18	.35	0.30	0	75	5.17	70	4.83	70	4.83	150	66	11.5	3	04F20C1108A3F
1/4	5/32	3.97	.50	0.43	0	40	2.76	40	2.76	45	3.10	150	66	11.5	5	04F20C2110A3F
1/4	7/32	5.56	.85	0.73	0	17	1.17	20	1.38	21	1.45	120	49	9.5	4	04F20C2114A1F
1/4	7/32	5.56	.72	0.62	0	25	1.72	25	1.72	25	1.72	150	66	11.5	5	04F20C2114A3F
1/4	9/32	7.14	.96	0.83	0	15	1.03	16	1.10	16	1.10	120	49	9.5	4	04F20C2118A1F
3/8	1/8	3.18	.35	0.30	0	75	5.17	70	4.83	70	4.83	150	66	11.5	7	06F20C2108A3F
3/8	5/32	3.97	.52	0.45	0	35	2.41	35	2.41	35	2.41	150	66	11.5	7	06F20C2110A3F
3/8	7/32	5.56	.72	0.62	0	25	1.72	25	1.72	25	1.72	150	66	11.5	7	06F20C2114A3F
3/8	9/32	7.14	.85	0.73	0	14	0.97	14	0.97	14	0.97	120	49	9.5	6	06F20C2118A1F

DIRECT ACTING BRASS VALVES – NORMALLY CLOSED (ENERGIZE TO OPEN), NBR SEALS

DC VALVE SPECIFICATIONS

NPT Pipe Size	Orifice Diameter		Flow Factor		Operating Pressure Differential						Max. Temp.		AC Watt	Const. Ref.	Valve Part Number	
	inch	mm	Cv	Kv	Min. (PSI/Bar)	Max. (MOPD)			°F	°C						
						Air, Inert Gas (PSI/Bar)	Water (PSI/Bar)	Light Oil 300SSU (PSI/Bar)								
1/8	1/16	1.59	.09	0.08	0	400	27.59	250	17.24	150	10.34	120	49	9.5	8	02F2001104A1F
1/8	3/32	2.38	.15	0.13	0	190	13.10	110	7.59	110	7.59	120	49	9.5	8	02F2001106A1F
1/8	1/8	3.18	.21	0.18	0	80	5.52	60	4.14	50	3.45	120	49	9.5	8	02F2001108A1F
1/4	3/64	1.19	.06	0.05	0	500	34.48	500	34.48	500	34.48	140	60	11.5	9	04F2001103A3F
1/4	3/32	2.38	.17	0.15	0	200	13.79	150	10.34	125	8.62	140	60	11.5	9	04F2001106A3F
1/4	1/8	3.18	.35	0.30	0	80	5.52	60	4.14	60	4.14	150	66	11.5	9	04F2001108A3F
1/4	5/32	3.97	.49	0.42	0	45	3.10	30	2.07	30	2.07	150	66	11.5	10	04F2002110A3F
1/4	7/32	5.56	.83	0.72	0	25	1.72	20	1.38	20	1.38	150	66	11.5	10	04F2002114A3F
1/4	9/32	7.14	.96	0.83	0	15	1.03	15	1.03	15	1.03	150	66	11.5	10	04F2002118A3F

To choose a solenoid for your valve, refer to the AC or DC chart found on the flap attached to the back cover of this catalog.

Series 20 Small Two-Way Direct Acting Valves

DIRECT ACTING BRASS VALVES – NORMALLY OPEN (ENERGIZE TO CLOSE), NBR SEALS

AC VALVE SPECIFICATIONS

NPT Pipe Size	Orifice Diameter		Flow Factor		Operating Pressure Differential						Max. Temp.		AC Watt	Const. Ref.	Valve Part Number	
	inch	mm	Cv	Kv	Min. (PSI/Bar)	Max. (MOPD)			°F	°C						
						Air, Inert Gas (PSI/Bar)	Water (PSI/Bar)	Light Oil 300SSU (PSI/Bar)								
1/8	3/64	1.19	.06	0.05	0	750	51.72	750	51.72	530	36.55	180	82	6.0	1	02F20C3103AAF
1/8	3/32	2.38	.20	0.17	0	275	18.97	290	20.00	130	8.97	180	82	6.0	1	02F20C3106AAF
1/8	1/8	3.18	.34	0.29	0	155	10.69	180	12.41	140	9.66	180	82	6.0	1	02F20C3108AAF
1/4	3/64	1.19	.06	0.05	0	750	51.72	750	51.72	500	34.48	180	82	6.0	11	04F20C3103AAF
1/4	3/64	1.19	.06	0.05	0	2200	151.72	2000	137.93	1100	75.86	140	60	11.0	12	04F20C3503ACF*
1/4	3/32	2.38	.17	0.15	0	360	24.83	340	23.45	160	11.03	180	82	6.0	11	04F20C3106AAF
1/4	1/8	3.18	.35	0.30	0	140	9.66	165	11.38	90	6.21	180	82	6.0	11	04F20C3108AAF
1/4	1/8	3.18	.35	0.30	0	215	14.83	245	16.90	160	11.03	180	82	10.2	11	04F20C3108ABF
1/4	5/32	3.97	.50	0.43	0	150	10.34	150	10.34	145	10.00	180	82	11.0	12	04F20C3110ACF
1/4	7/32	5.56	.85	0.73	0	40	2.76	50	3.45	40	2.76	180	82	6.0	11	04F20C3114AAF
1/4	7/32	5.56	.72	0.62	0	100	6.90	100	6.90	100	6.90	180	82	11.0	12	04F20C3114BDF
1/4	9/32	7.14	.96	0.83	0	27	1.86	36	2.48	28	1.93	180	82	6.0	11	04F20C3118AAF
1/4	9/32	7.14	.88	0.76	0	90	6.21	80	5.52	80	5.52	200	93	16.0	12	04F20C3118BDF
3/8	1/8	3.18	.35	0.30	0	160	11.03	150	10.34	90	6.21	180	82	6.0	6	06F20C6108AAF
3/8	1/8	3.18	.35	0.30	0	310	21.38	310	21.38	260	17.93	200	93	16.0	7	06F20C6108ADF

* Valve is standard with urethane disc.

DIRECT ACTING STAINLESS STEEL VALVES – NORMALLY CLOSED (ENERGIZE TO OPEN), NBR SEALS

AC VALVE SPECIFICATIONS

NPT Pipe Size	Orifice Diameter		Flow Factor		Operating Pressure Differential						Max. Temp.		AC Watt	Const. Ref.	Valve Part Number	
	inch	mm	Cv	Kv	Min. (PSI/Bar)	Max. (MOPD)			°F	°C						
						Air, Inert Gas (PSI/Bar)	Water (PSI/Bar)	Light Oil 300SSU (PSI/Bar)								
1/8	3/64	1.19	.06	0.05	0	750	51.72	750	51.72	530	36.55	180	82	6.0	1	02F20C3103AAF
1/8	3/32	2.38	.20	0.17	0	275	18.97	290	20.00	130	8.97	180	82	6.0	1	02F20C3106AAF
1/8	1/8	3.18	.34	0.29	0	155	10.69	180	12.41	140	9.66	180	82	6.0	1	02F20C3108AAF
1/4	3/64	1.19	.06	0.05	0	750	51.72	750	51.72	500	34.48	180	82	6.0	11	04F20C3103AAF
1/4	3/64	1.19	.06	0.05	0	2200	151.72	2000	137.93	1100	75.86	140	60	11.0	12	04F20C3503ACF*
1/4	3/32	2.38	.17	0.15	0	360	24.83	340	23.45	160	11.03	180	82	6.0	11	04F20C3106AAF
1/4	1/8	3.18	.35	0.30	0	140	9.66	165	11.38	90	6.21	180	82	6.0	11	04F20C3108AAF
1/4	1/8	3.18	.35	0.30	0	215	14.83	245	16.90	160	11.03	180	82	10.2	11	04F20C3108ABF
1/4	5/32	3.97	.50	0.43	0	150	10.34	150	10.34	145	10.00	180	82	11.0	12	04F20C3110ACF
1/4	7/32	5.56	.85	0.73	0	40	2.76	50	3.45	40	2.76	180	82	6.0	11	04F20C3114AAF
1/4	7/32	5.56	.72	0.62	0	100	6.90	100	6.90	100	6.90	180	82	11.0	12	04F20C3114BDF
1/4	9/32	7.14	.96	0.83	0	27	1.86	36	2.48	28	1.93	180	82	6.0	11	04F20C3118AAF
1/4	9/32	7.14	.88	0.76	0	90	6.21	80	5.52	80	5.52	200	93	16.0	12	04F20C3118BDF
3/8	1/8	3.18	.35	0.30	0	160	11.03	150	10.34	90	6.21	180	82	6.0	6	06F20C6108AAF
3/8	5/32	3.97	.52	0.45	0	150	10.34	150	10.34	145	10.00	180	82	11.0	7	06F20C6110ACF
3/8	7/32	5.56	.72	0.62	0	100	6.90	100	6.90	100	6.90	200	93	16.0	7	06F20C6114BDF
3/8	9/32	7.14	.85	0.73	0	90	6.21	80	5.52	80	5.52	200	93	16.0	7	06F20C6118BDF

* Valve is standard with urethane disc.

DIRECT ACTING STAINLESS STEEL VALVES – NORMALLY OPEN (ENERGIZE TO CLOSE), NBR SEALS

AC VALVE SPECIFICATIONS

NPT Pipe Size	Orifice Diameter		Flow Factor		Operating Pressure Differential						Max. Temp.		AC Watt	Const. Ref.	Valve Part Number	
	inch	mm	Cv	Kv	Min. (PSI/Bar)	Max. (MOPD)			°F	°C						
						Air, Inert Gas (PSI/Bar)	Water (PSI/Bar)	Light Oil 300SSU (PSI/Bar)								
1/8	1/16	1.59	.09	0.08	0	500	34.48	300	20.69	225	15.52	180	82	10.2	8	02F20O3104ABF
1/8	3/32	2.38	.15	0.13	0	275	18.97	200	13.79	150	10.34	180	82	6.0	8	02F20O3106AAF
1/8	1/8	3.18	.21	0.18	0	125	8.62	100	6.90	85	5.86	180	82	6.0	8	02F20O3108AAF
1/4	3/64	1.19	.06	0.05	0	750	51.72	700	48.28	700	48.28	200	93	11.0	13	04F20O3103ACF
1/4	3/32	2.38	.17	0.15	0	300	20.69	250	17.24	230	15.86	200	93	11.0	13	04F20O3106ACF
1/4	1/8	3.18	.35	0.30	0	130	8.97	110	7.59	100	6.90	200	93	11.0	13	04F20O3108ACF
1/4	5/32	3.97	.50	0.43	0	85	5.86	75	5.17	60	4.14	200	93	11.0	13	04F20O3110ACF
1/4	7/32	5.56	.83	0.72	0	65	4.48	65	4.48	60	4.14	200	93	16.0	13	04F20O3114ADF
1/4	9/32	7.14	.96	0.83	0	45	3.10	40	2.76	35	2.41	200	93	16.0	13	04F20O3118ADF

DIRECT ACTING STAINLESS STEEL VALVES – NORMALLY CLOSED (ENERGIZE TO OPEN), NBR SEALS

DC VALVE SPECIFICATIONS

NPT Pipe Size	Orifice Diameter		Flow Factor		Operating Pressure Differential						Max. Temp.		AC Watt	Const. Ref.	Valve Part Number	
	inch	mm	Cv	Kv	Min. (PSI/Bar)	Max. (MOPD)			°F	°C						
						Air, Inert Gas (PSI/Bar)	Water (PSI/Bar)	Light Oil 300SSU (PSI/Bar)								
1/8	3/64	1.19	.06	0.05	0	500	34.48	500	34.48	500	34.48	120	49	9.5	1	02F20C3103A1F
1/8	3/32	2.38	.20	0.17	0	150	10.34	140	9.66	145	10.00	120	49	9.5	1	02F20C3106A1F
1/8	1/8	3.18	.34	0.29	0	80	5.52	80	5.52	80	5.52	120	49	9.5	1	02F20C3108A1F
1/4	3/64	1.19	.06	0.05	0	500	34.48	500	34.48	500	34.48	120	49	9.5	11	04F20C3103A1F
1/4	3/32	2.38	.17	0.15	0	150	10.34	125	8.62	125	8.62	120	49	9.5	11	04F20C3106A1F
1/4	1/8	3.18	.35	0.30	0	65	4.48	60	4.14	60	4.14	120	49	9.5	11	04F20C3108A1F
1/4	5/32	3.97	.50	0.43	0	40	2.76	40	2.76	45	3.10	120	49	11.5	12	04F20C3110A3F
1/4	7/32	5.56	.85	0.73	0	17	1.17	20	1.38	21	1.45	120	49	9.5	11	04F20C3114A1F
1/4	7/32	5.56	.72	0.62	0	25	1.72	25	1.72	25	1.72	150	66	11.5	12	04F20C3114A3F
1/4	9/32	7.14	.96	0.83	0	15	1.03	16	1.10	16	1.10	120	49	9.5	11	04F20C3118A1F
3/8	1/8	3.18	.35	0.30	0	65	4.48	60	4.14	60	4.14	120	49	9.5	6	06F20C6108A1F
3/8	5/32	3.97	.52	0.45	0	35	2.41	35	2.41	35	2.41	150	66	11.5	7	06F20C6110A3F
3/8	7/32	5.56	.72	0.62	0	25	1.72	25	1.72	25	1.72	150	66	11.5	7	06F20C6114A3F
3/8	9/32	7.14	.85	0.73	0	18	1.24	15	1.03	18	1.24	150	66	11.5	7	06F20C6118A3F

DIRECT ACTING STAINLESS STEEL VALVES – NORMALLY OPEN (ENERGIZE TO CLOSE), NBR SEALS

DC VALVE SPECIFICATIONS

NPT Pipe Size	Orifice Diameter		Flow Factor		Operating Pressure Differential						Max. Temp.		AC Watt	Const. Ref.	Valve Part Number	
	inch	mm	Cv	Kv	Min. (PSI/Bar)	Max. (MOPD)			°F	°C						
						Air, Inert Gas (PSI/Bar)	Water (PSI/Bar)	Light Oil 300SSU (PSI/Bar)								
1/8	1/16	1.59	.09	0.08	0	400	27.59	250	17.24	150	10.34	120	49	9.5	8	02F20C3104A1F
1/8	3/32	2.38	.15	0.13	0	190	13.10	110	7.59	110	7.59	120	49	9.5	8	02F20C3106A1F
1/8	1/8	3.18	.21	0.18	0	80	5.52	60	4.14	50	3.45	120	49	9.5	8	02F20C3108A1F
1/4	3/64	1.19	.06	0.05	0	500	34.48	500	34.48	500	34.48	150	66	11.5	13	04F20C3103A3F
1/4	3/32	2.38	.17	0.15	0	200	13.79	150	10.34	125	8.62	150	66	11.5	13	04F20C3106A3F
1/4	1/8	3.18	.35	0.30	0	80	5.52	60	4.14	60	4.14	150	66	11.5	13	04F20C3108A3F
1/4	5/32	3.97	.50	0.43	0	45	3.10	30	2.07	30	2.07	150	66	11.5	13	04F20C3110A3F

DRAWINGS

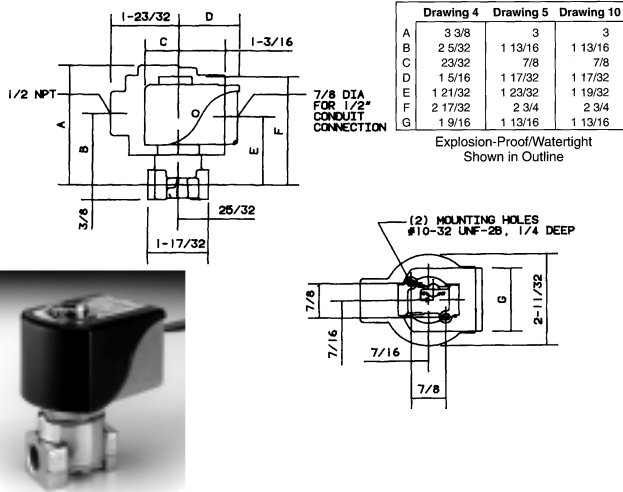

#4, 5, 10

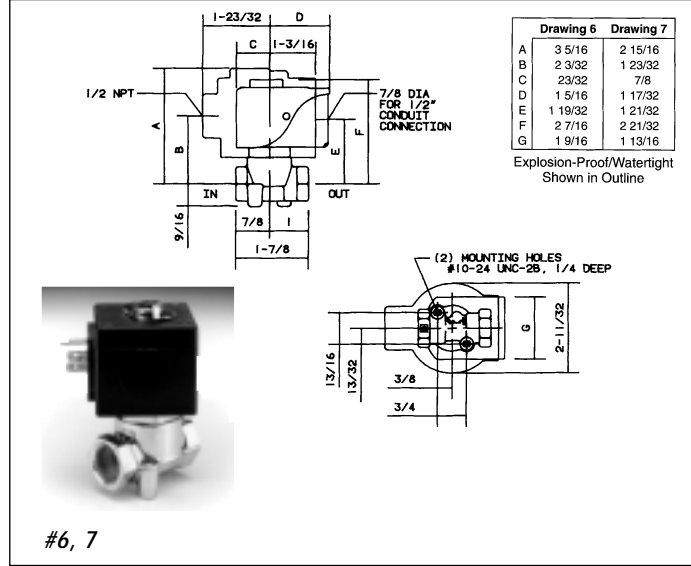

#6, 7

To choose a solenoid for your valve, refer to the AC or DC chart found on the flap attached to the back cover of this catalog.

Series 20 Small Two-Way

	Drawing 1	Drawing 2	Drawing 3	Drawing 9	Drawing 11	Drawing 12	Drawing 13
A	11/32	13/32	13/32	13/32	3/8	3/8	3/8
B	2 29/32	3 13/32	3 1/32	3 1/32	3 3/8	3	3
C	1 11/16	2 3/16	1 13/16	1 13/16	2 5/32	1 13/16	1 13/16
D	23/32	23/32	7/8	7/8	23/32	7/8	7/8
E	1 5/16	1 5/16	1 17/32	1 17/32	1 5/16	1 17/32	1 17/32
F	1 3/16	1 1/4	1 1/4	1 1/4	1 9/16	1 9/16	1 9/16
G	19/32	5/8	5/8	5/8	19/32	19/32	19/32
H	1 9/32	1 11/16	1 3/4	1 19/32	1 11/16	1 3/4	1 19/32
J	2 1/8	2 17/32	2 3/4	2 3/4	2 17/32	2 3/4	2 3/4
K	1 9/16	1 9/16	1 13/16	1 13/16	1 9/16	1 13/16	1 13/16

Explosion-Proof/
Watertight
Shown in Outline

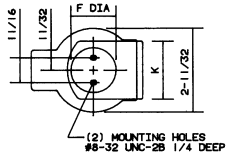
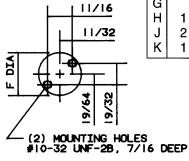

#2, 3, 9 Bottom

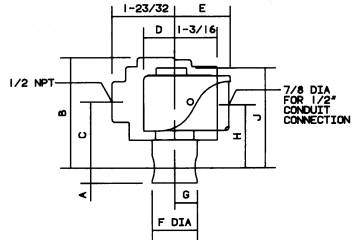

#1, 2, 3, 9, 11, 12, 13

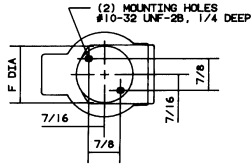

#11, 12, 13 Bottom

1-23/32 | 1-5/16
23/32 | 1-3/16
1/2 NPT
2-7/8
1-11/16
1-9/32
2-1/8
2
OUT
IN
19/32
1-3/16 DIA
7/8 DIA FOR 1/2" CONDUIT CONNECTION
2-11/32
1-9/16
1-5/16
7/32
17/64
17/32
2 MOUNTING HOLES FOR #8 THREAD CUTTING SCREW
2 SLOTS .275 X .187
7/16
7/32
7/16
7/16

#8

GOLD RING Series 20 Low Pressure Two-Way Direct Acting Valves

SPECIFICATIONS

Mechanical Characteristics

Standard Materials of Construction

- Body-Brass, 303 Stainless Steel, 316 Stainless Steel as listed
- Seals-NBR
- Plunger and Pole Piece-430FR Stainless Steel
- Plunger Tube-305 Stainless Steel
- Springs-302 Stainless Steel
- Shading Coil-Copper (Brass Bodies), Silver (Stainless Steel Bodies)
- Plunger Rod & Plate-303 Stainless Steel

Compatible Fluids

- Gases, Fluid, Light Oils and other clean flowing media compatible with brass or stainless steel

Electrical Characteristics

Voltages

- DC-6, 12, 24, 120, 125 (other voltages available upon request)
- AC-24/60, 110/120-50/60, 220/240-50/60, 440/480-50/60

Coil

- Class F Standard, Class H Available

Agency Approvals

- Standard valves with general purpose or explosion proof solenoid enclosures are UL Listed and CSA Certified. For details, consult factory.

Miscellaneous

Temperature Ratings (media as listed)

- AC Voltages: 200°F max.
- DC Voltages: 180°F max.
- Ambient: 32-77°F (standard)
- For temperature variations, consult the factory.

Installation

- Low Pressure Series 20 should be mounted vertical and upright. See mounting dimensions (nominal) shown here. For certified dimensions, consult factory.

Applications

- Used in a variety of applications including: Low Pressure Systems (gases, fluids, light oils), Vacuum Systems 760-25 Torr (29" Mercury) - (molding, collating, material transfer).

DIRECT ACTING BRASS VALVES – NORMALLY CLOSED (ENERGIZE TO OPEN), NBR SEALS

AC VALVE SPECIFICATIONS

NPT Pipe Size	Orifice Diameter		Flow Factor		Operating Pressure Differential						Max. Temp.		AC Watt	Const. Ref.	Valve Part Number	
	inch	mm	Cv	Kv	Min. (PSI/Bar)	Max. (MOPD)						°F				°C
						Air, Inert Gas (PSI/Bar)		Water (PSI/Bar)		Light Oil 300SSU (PSI/Bar)						
3/8	5/16	7.94	1.10	0.95	0	15	1.03	12	0.83	-	-	180	82	6.0	14	06F20C2120AAF
3/8	5/16	7.94	1.10	0.95	0	20	1.38	20	1.38	-	-	180	82	11.0	15	06F20C2120ACF
1/2	7/16	11.11	2.80	2.41	0	4	0.28	6	0.41	-	-	180	82	6.0	16	08F20C2128AAF
1/2	7/16	11.11	2.80	2.41	0	15	1.03	15	1.03	-	-	200	93	16.0	17	08F20C2128ADF
3/4	3/4	19.05	5.00	4.31	0	4	0.28	4	0.28	-	-	180	82	16.0	18	12F20C2148ADF

These are high flow, direct acting, low pressure valves. Please verify system pressure before installing.

DIRECT ACTING BRASS VALVES – NORMALLY OPEN (ENERGIZE TO CLOSE), NBR SEALS

AC VALVE SPECIFICATIONS

NPT Pipe Size	Orifice Diameter		Flow Factor		Operating Pressure Differential						Max. Temp.		AC Watt	Const. Ref.	Valve Part Number	
	inch	mm	Cv	Kv	Min. (PSI/Bar)	Max. (MOPD)						°F				°C
						Air, Inert Gas (PSI/Bar)		Water (PSI/Bar)		Light Oil 300SSU (PSI/Bar)						
3/8	5/16	7.94	1.10	0.95	0	15	1.03	15	1.03	-	-	200	93	16.0	19	06F20C2120ADF
1/2	7/16	11.11	2.20	1.90	0	15	1.03	15	1.03	-	-	200	93	16.0	20	08F20C2128ADF
3/4	3/4	19.05	5.50	4.74	0	2	0.14	2	0.14	-	-	180	82	11.0	21	12F20C2148ACF

DIRECT ACTING STAINLESS STEEL VALVES – NORMALLY CLOSED (ENERGIZE TO OPEN), NBR SEALS

AC VALVE SPECIFICATIONS

NPT Pipe Size	Orifice Diameter		Flow Factor		Operating Pressure Differential						Max. Temp.		AC Watt	Const. Ref.	Valve Part Number	
	inch	mm	Cv	Kv	Min. (PSI/Bar)	Max. (MOPD)						°F				°C
						Air, Inert Gas (PSI/Bar)		Water (PSI/Bar)		Light Oil 300SSU (PSI/Bar)						
3/8	5/16	7.94	1.10	0.95	0	20	1.38	20	1.38	-	-	180	82	11.0	15	06F20C6120ACF
1/2	7/16	11.11	2.80	2.41	0	15	1.03	15	1.03	-	-	200	93	16.0	17	08F20C6128ADF
3/4	3/4	19.05	6.00	5.17	0	4	0.28	4	0.28	-	-	180	82	16.0	18	12F20C6148ADF

Important: For proper operation, do not exceed maximum rated pressure.

To choose a solenoid for your valve, refer to the AC or DC chart found on the flap attached to the back cover of this catalog.

Series 20 Low Pressure Two-Way Direct Acting Valves

DIRECT ACTING BRASS VALVES – NORMALLY CLOSED (ENERGIZE TO OPEN), NBR SEALS

DC VALVE SPECIFICATIONS

NPT Pipe Size	Orifice Diameter		Flow Factor		Operating Pressure Differential						Max. Temp.		AC Watt	Const. Ref.	Valve Part Number	
	inch	mm	Cv	Kv	Min. (PSI/Bar)	Max. (MOPD)				°F	°C					
						Air, Inert Gas (PSI/Bar)	Water (PSI/Bar)	Light Oil 300SSU (PSI/Bar)								
3/8	5/16	7.94	1.10	0.95	0	3	0.21	3	0.21	-	-	120	49	9.5	14	06F20C2120A1F
3/8	5/16	7.94	1.10	0.95	0	9	0.62	9	0.62	-	-	120	49	11.5	15	06F20C2120A3F
1/2	7/16	11.11	2.80	2.41	0	3	0.21	3	0.21	-	-	180	82	11.5	17	08F20C2128A3F

DIRECT ACTING BRASS VALVES – NORMALLY OPEN (ENERGIZE TO CLOSE), NBR SEALS

DC VALVE SPECIFICATIONS

NPT Pipe Size	Orifice Diameter		Flow Factor		Operating Pressure Differential						Max. Temp.		AC Watt	Const. Ref.	Valve Part Number	
	inch	mm	Cv	Kv	Min. (PSI/Bar)	Max. (MOPD)				°F	°C					
						Air, Inert Gas (PSI/Bar)	Water (PSI/Bar)	Light Oil 300SSU (PSI/Bar)								
3/8	5/16	7.94	1.10	0.95	0	5	0.34	3	0.21	-	-	180	82	11.5	19	06F20C2120A3F
1/2	7/16	11.11	2.20	1.90	0	1.5	0.10	1	0.07	-	-	180	82	11.5	20	08F20C2128A3F

DIRECT ACTING STAINLESS STEEL VALVES – NORMALLY CLOSED (ENERGIZE TO OPEN), NBR SEALS

DC VALVE SPECIFICATIONS

NPT Pipe Size	Orifice Diameter		Flow Factor		Operating Pressure Differential						Max. Temp.		AC Watt	Const. Ref.	Valve Part Number	
	inch	mm	Cv	Kv	Min. (PSI/Bar)	Max. (MOPD)				°F	°C					
						Air, Inert Gas (PSI/Bar)	Water (PSI/Bar)	Light Oil 300SSU (PSI/Bar)								
3/8	5/16	7.94	1.10	0.95	0	3.0	0.21	3.0	0.21	-	-	150	66	11.5	15	06F20C6120A3F
1/2	7/16	11.11	2.8	2.41	0	3	0.21	3	0.21	-	-	180	82	11.5	17	08F20C6128A3F

DRAWINGS

Drawing 14 Drawing 15 Drawing 19

A	3 5/16	2 15/16	2 15/16
B	2 3/32	1 23/32	1 23/32
C	23/32	7/8	7/8
D	1 5/16	1 17/32	1 17/32
E	1 19/32	1 21/32	1 1/2
F	2 7/16	2 21/32	2 21/32
G	1 9/16	1 13/16	1 13/16

Explosion-Proof/
Watertight
Shown in Outline

(2) MOUNTING HOLES
#10-24 UNC-2B, 1/4 DEEP

#14, 15, 19

Drawing 16 Drawing 17 Drawing 18 Drawing 20 Drawing 21

A	9/16	9/16	11/16	9/16	11/16
B	3 9/16	3 9/16	3 21/32	3 9/16	3 21/32
C	2 11/32	2 11/32	2 7/16	2 11/32	2 7/16
D	23/32	7/8	7/8	7/8	7/8
E	1 5/16	1 17/32	1 17/32	1 17/32	1 17/32
F	2 13/16	2 13/16	2 29/32	2 13/16	2 29/32
G	1 13/32	1 13/32	1 15/32	1 13/32	1 15/32
H	1 15/16	2 1/4	2 11/32	2 1/8	2 7/32
J	2 25/32	3 9/32	3 3/8	3 9/32	3 3/8
K	1 9/16	1 13/16	1 13/16	1 13/16	1 13/16

Explosion-Proof/
Watertight
Shown in Outline

#16, 17, 18, 20, 21

GOLD RING Series 22, 23, 24, 26 Two-Way Pilot-Operated Valves

SPECIFICATIONS

Mechanical Characteristics

Standard Materials of Construction

- Body-Brass, Bronze, 316 Stainless Steel as listed
- Seals-NBR
- Plunger and Pole Piece-430FR Stainless Steel
- Plunger Tube-305 Stainless Steel
- Springs-302 Stainless Steel
- Shading Coil-Copper(Brass Bodies), Silver(Stainless Steel Bodies)
- Disc Holder (Normally Open Valves)-Ryton
- Retaining Ring (Series 26)-PH15-7 Stainless Steel
- Seals (Series 26)-Fluorelastomer and TFE

Compatible Fluids

- Gases, Fluid, Light Oils and other clean flowing media compatible with brass or stainless steel

Electrical Characteristics

Voltages

- DC-6, 12, 24, 120, 125 (other voltages available upon request)
- AC-24/60, 110/120-50/60, 220/240-50/60, 440/480-50/60

Coil

- Class F Standard, Class H Available

Agency Approvals

- Standard valves with general purpose or explosion proof solenoid enclosures are UL Listed and CSA Certified. For details, consult factory.

Miscellaneous

Temperature Ratings (media as listed)

- AC Voltages: 180°F max.
- DC Voltages: 180°F max.
- Ambient: 32-77°F (standard)
- For temperature variations, consult the factory.

Installation

- Valves should be mounted vertical and upright. See mounting dimensions (nominal) shown here. For certified dimensions, consult factory.

Applications

- Used in a variety of applications including: Automated Systems, Dispensing Systems, Instrumentation, Welding Equipment, Restaurant Equipment, Food Processing Machinery, Water Treatment Systems and Laundry Equipment.

PILOTED BRASS VALVES-NORMALLY CLOSED (ENERGIZE TO OPEN), NBR SEALS

AC VALVE SPECIFICATIONS

NPT Pipe Size	Orifice Diameter		Flow Factor		Operating Pressure Differential						Max. Temp.		AC Watt	Const. Ref.	Valve Part Number		
	inch	mm	Cv	Kv	Min. (PSI/Bar)	Max. (MOPD)			°F	°C							
						Air, Inert Gas (PSI/Bar)	Water (PSI/Bar)	Light Oil 300SSU (PSI/Bar)									
3/8	5/8	15.88	3.00	2.59	0	0.00	150	10.34	150	10.34	150	10.34	180	82	11.0	23	06F23C2140ACF
3/8	5/8	15.88	3.00	2.59	5	0.34	200	13.79	135	9.31	135	9.31	180	82	6.0	22	06F22C2140AAF
3/8	5/8	15.88	3.00	2.59	5	0.34	300	20.69	300	20.69	300	20.69	175	79	16.0	23	06F22C2140ADF
1/2	5/8	15.88	4.00	3.45	0	0.00	150	10.34	150	10.34	150	10.34	180	82	11.0	23	08F23C2140ACF
1/2	5/8	15.88	4.00	3.45	5	0.34	200	13.79	135	9.31	135	9.31	180	82	6.0	22	08F22C2140AAF
1/2	5/8	15.88	4.00	3.45	5	0.34	300	20.69	300	20.69	300	20.69	175	79	16.0	23	08F22C2140ADF
3/4	3/4	19.05	5.00	4.31	0	0.00	150	10.34	150	10.34	150	10.34	180	82	11.0	25	12F23C2148ACF
3/4	3/4	19.05	5.00	4.31	5	0.34	200	13.79	135	9.31	135	9.31	180	82	6.0	24	12F22C2148AAF
3/4	3/4	19.05	6.50	5.60	5	0.34	250	17.24	150	10.34	100	6.90	180	82	6.0	26	12F24C2148AAF
1	1	25.40	13.00	11.21	5	0.34	150	10.34	125	8.62	100	6.90	180	82	6.0	28	16F24C2164AAF
1 1/4	1 1/8	28.58	15.00	12.93	5	0.34	150	10.34	125	8.62	100	6.90	180	82	6.0	30	20F24C2172AAF
1 1/2	1 1/4	31.75	22.5	19.40	5	0.34	150	10.34	125	8.62	100	6.90	180	82	6.0	32	24F24C2180AAF
2	2	50.80	56.00	48.27	2	0.14	150	10.34	150	10.34	150	10.34	180	82	11.0	1A	32F24C2199ACF
3	3	76.20	125.00	107.75	2	0.14	150	10.34	150	10.34	150	10.34	180	82	11.0	2A	48F28C9199ACF

PILOTED BRASS VALVES-NORMALLY OPEN (ENERGIZE TO CLOSE), NBR SEALS

AC VALVE SPECIFICATIONS

NPT Pipe Size	Orifice Diameter		Flow Factor		Operating Pressure Differential						Max. Temp.		AC Watt	Const. Ref.	Valve Part Number		
	inch	mm	Cv	Kv	Min. (PSI/Bar)	Max. (MOPD)			°F	°C							
						Air, Inert Gas (PSI/Bar)	Water (PSI/Bar)	Light Oil 300SSU (PSI/Bar)									
3/8	5/8		3.00	2.59	0	0.00	150	10.34	150	10.34	150	10.34	180	82	11.0	34	06F23O2140ACF
1/2	5/8		4.00	3.45	0	0.00	150	10.34	150	10.34	150	10.34	180	82	11.0	34	08F23O2140ACF
3/4	3/4		5.50	4.74	0	0.00	150	10.34	150	10.34	150	10.34	180	82	11.0	35	12F23O2148ACF
3/4	3/4		6.50	5.60	5	0.34	250	17.24	200	13.79	200	13.79	180	82	11.0	36	12F24O2148ACF
1	1		13.00	11.21	5	0.34	125	8.62	125	8.62	125	8.62	180	82	11.0	37	16F24O2164ACF
1 1/4	1 1/8		15.00	12.93	5	0.34	125	8.62	125	8.62	125	8.62	180	82	11.0	38	20F24O2172ACF
1 1/2	1 1/4		22.50	19.40	5	0.34	125	8.62	125	8.62	125	8.62	180	82	11.0	39	24F24O2180ACF
2	2		56.00	48.27	2	0.14	125	8.62	125	8.62	125	8.62	180	82	11.0	1A	32F24O2199ACF
3	3		125.00	107.75	2	0.14	125	8.62	125	8.62	125	8.62	180	82	11.0	2A	48F28O9199ACF

To choose a solenoid for your valve, refer to the AC or DC chart found on the flap attached to the back cover of this catalog.

Series 20, 23, 24, 26 Two-Way Pilot-Operated Valves

PILOTED BRASS VALVES—NORMALLY CLOSED (ENERGIZE TO OPEN), NBR SEALS

DC VALVE SPECIFICATIONS

NPT Pipe Size	Orifice Diameter		Flow Factor		Operating Pressure Differential						Max. Temp.		AC Watt	Const. Ref.	Valve Part Number		
	inch	mm	Cv	Kv	Min. (PSI/Bar)	Max. (MOPD)			°F	°C							
						Air, Inert Gas (PSI/Bar)	Water (PSI/Bar)	Light Oil 300SSU (PSI/Bar)									
3/8	5/8	15.88	3.00	2.59	0	0.00	40	2.76	40	2.76	-	150	66	11.5	23	06F23C2140A3F	
3/8	5/8	15.88	3.00	2.59	5	0.34	125	8.62	100	6.90	100	6.90	150	66	11.5	23	06F22C2140A3F
1/2	5/8	15.88	4.00	3.45	5	0.34	125	8.62	100	6.90	100	6.90	150	66	11.5	23	08F22C2140A3F
1/2	5/8	15.88	4.00	3.45	0	0.00	40	2.76	40	2.76	-	150	66	11.5	23	08F23C2140A3F	
3/4	3/4	19.05	5.00	4.31	0	0.00	40	2.76	40	2.76	-	150	66	11.5	25	12F23C2148A3F	
3/4	3/4	19.05	5.00	4.31	5	0.34	100	6.90	90	6.21	75	5.17	150	66	11.5	27	12F24C2148A3F
3/4	3/4	19.05	6.50	5.60	5	0.34	125	8.62	125	8.62	125	8.62	150	66	11.5	27	12F24C2148A3F
1	1	25.40	13.00	11.21	5	0.34	125	8.62	125	8.62	125	8.62	150	66	11.5	29	16F24C2164A3F
1 1/4	1 1/8	28.58	15.00	12.93	5	0.34	125	8.62	125	8.62	125	8.62	150	66	11.5	31	20F24C2172A3F
1 1/2	1 1/4	31.75	22.50	19.40	5	0.34	125	8.62	125	8.62	125	8.62	150	66	11.5	33	24F24C2180A3F
2	2	50.80	56.00	48.27	2	0.14	150	10.34	150	10.34	150	10.34	150	66	11.5	40	32F24C2199A3F
3	3	76.20	125.00	107.75	2	0.14	150	10.34	150	10.34	150	10.34	150	66	11.5	42	48F28C9199A3F

PILOTED BRASS VALVES—NORMALLY OPEN (ENERGIZE TO CLOSE), NBR SEALS

DC VALVE SPECIFICATIONS

NPT Pipe Size	Orifice Diameter		Flow Factor		Operating Pressure Differential						Max. Temp.		AC Watt	Const. Ref.	Valve Part Number		
	inch	mm	Cv	Kv	Min. (PSI/Bar)	Max. (MOPD)			°F	°C							
						Air, Inert Gas (PSI/Bar)	Water (PSI/Bar)	Light Oil 300SSU (PSI/Bar)									
1/2	5/8	15.88	4.00	3.45	0	0.00	125	8.62	125	8.62	80	5.52	150	66	11.5	34	08F23O2140A3F
3/4	3/4	19.05	5.50	4.74	0	0.00	125	8.62	125	8.62	80	5.52	150	66	11.5	35	12F23O2148A3F
3/4	3/4	19.05	6.5	5.60	5	0.34	125	8.62	125	8.62	125	8.62	180	82	11.5	36	12F24O2148A3F
1	1	25.40	13.00	11.21	5	0.34	125	8.62	125	8.62	125	8.62	180	82	11.5	37	16F24O2164A3F
1 1/4	1/8	28.58	15.00	12.93	5	0.34	125	8.62	125	8.62	125	8.62	180	82	11.5	38	20F24O2172A3F
1 1/2	1 1/4	31.75	22.5	19.40	5	0.34	125	8.62	125	8.62	125	8.62	180	82	11.5	39	24F24O2180A3F
2	2	50.80	56.00	48.27	2	0.14	125	8.62	125	8.62	125	8.62	150	66	11.5	43	32F24O2199A3F
3	3	76.20	125	107.75	2	0.14	125	8.62	125	8.62	125	8.62	150	66	11.0	45	48F28O09199A3F

PILOTED STAINLESS STEEL VALVES—NORMALLY CLOSED (ENERGIZE TO OPEN), NBR SEALS

AC VALVE SPECIFICATIONS

NPT Pipe Size	Orifice Diameter		Flow Factor		Operating Pressure Differential						Max. Temp.		AC Watt	Const. Ref.	Valve Part Number		
	inch	mm	Cv	Kv	Min. (PSI/Bar)	Max. (MOPD)			°F	°C							
						Air, Inert Gas (PSI/Bar)	Water (PSI/Bar)	Light Oil 300SSU (PSI/Bar)									
3/8	5/8	15.88	3.00	2.59	0	0.00	150	10.34	150	10.34	150	10.34	180	82	11.0	23	06F23C6140ACF
3/8	5/8	15.88	3.00	2.59	5	0.34	300	20.69	300	20.69	300	20.69	175	79	16.0	23	06F22C6140ADF
1/2	5/8	15.88	4.00	3.45	0	0.00	150	10.34	150	10.34	150	10.34	180	82	11.0	23	08F23C6140ACF
1/2	5/8	15.88	4.00	3.45	5	0.34	300	20.69	300	20.69	300	20.69	175	79	16.0	23	08F22C6140ADF
3/4	3/4	19.05	5.00	4.31	0	0.00	150	10.34	150	10.34	150	10.34	180	82	11.0	25	12F23C6148ACF
3/4	3/4	19.05	5.00	4.31	5	0.34	300	20.69	300	20.69	300	20.69	175	79	16	25	12F22C6148ADF
1	1	25.40	13.00	11.21	5	0.34	150	10.34	125	8.62	100	6.90	180	82	6.0	28	16F24C6164AAF
1 1/2	1 1/4	31.75	22.50	19.40	5	0.34	150	10.34	125	8.62	100	6.90	180	82	6.0	32	24F24C6180AAF

PILOTED STAINLESS STEEL VALVES—NORMALLY OPEN (ENERGIZE TO CLOSE), NBR SEALS

AC VALVE SPECIFICATIONS

NPT Pipe Size	Orifice Diameter		Flow Factor		Operating Pressure Differential						Max. Temp.		AC Watt	Const. Ref.	Valve Part Number		
	inch	mm	Cv	Kv	Min. (PSI/Bar)	Max. (MOPD)			°F	°C							
						Air, Inert Gas (PSI/Bar)	Water (PSI/Bar)	Light Oil 300SSU (PSI/Bar)									
3/8	5/8	15.88	3.00	2.59	0	0.00	150	10.34	150	10.34	150	10.34	180	82	11.0	34	06F23O6140ACF
1/2	1/2	12.70	4.00	3.45	0	0.00	150	10.34	150	10.34	150	10.34	180	82	11.0	34	08F23O6140ACF
3/4	3/4	19.05	5.00	4.31	0	0.00	150	10.34	150	10.34	150	10.34	180	82	11.0	35	12F23O6148ACF
1	1	25.40	13.00	11.21	5	0.34	125	8.62	125	8.62	125	8.62	180	82	11.0	37	16F24O6164ACF
1 1/2	1 1/4	31.75	22.50	19.40	5	0.34	125	8.62	125	8.62	125	8.62	180	82	11.0	39	24F24O6180ACF

PILOTED STAINLESS STEEL VALVES – NORMALLY CLOSED (ENERGIZE TO OPEN), NBR SEALS

DC VALVE SPECIFICATIONS

NPT Pipe Size	Orifice Diameter		Flow Factor		Operating Pressure Differential						Max. Temp.		AC Watt	Const. Ref.	Valve Part Number		
	inch	mm	Cv	Kv	Min. (PSI/Bar)	Max. (MOPD)			°F	°C							
						Air, Inert Gas (PSI/Bar)	Water (PSI/Bar)	Light Oil 300SSU (PSI/Bar)									
3/8	5/8	15.88	3.00	2.59	0	0.00	40	2.76	40	2.76	-	-	150	66	11.5	23	06F23C6140A3F
3/8	5/8	15.88	3.00	2.59	5	0.34	125	8.62	100	6.90	100	6.90	150	66	11.5	23	06F22C6140A3F
1/2	5/8	15.88	4.00	3.45	0	0.00	40	2.76	40	2.76	-	-	150	66	11.5	23	08F23C6140A3F
1/2	5/8	15.88	4.00	3.45	5	0.34	125	8.62	100	6.90	100	6.90	150	66	11.5	23	08F22C6140A3F
3/4	3/4	19.05	5.00	4.31	0	0.00	40	2.76	40	2.76	-	-	150	66	11.5	25	12F23C6148A3F
3/4	3/4	19.05	5.00	4.31	5	0.34	125	8.62	100	6.90	100	6.90	150	66	11.5	25	12F22C6148A3F
1	1	25.40	13.00	11.21	5	0.34	125	8.62	125	8.62	125	8.62	150	66	11.5	29	16F24C6164A3F
1 1/2	1 1/4	31.75	22.50	19.40	5	0.34	125	8.62	125	8.62	125	8.62	150	66	11.5	33	24F24C6180A3F

PILOTED STAINLESS STEEL VALVES – NORMALLY OPEN (ENERGIZE TO CLOSE), NBR SEALS

DC VALVE SPECIFICATIONS

NPT Pipe Size	Orifice Diameter		Flow Factor		Operating Pressure Differential						Max. Temp.		AC Watt	Const. Ref.	Valve Part Number		
	inch	mm	Cv	Kv	Min. (PSI/Bar)	Max. (MOPD)			°F	°C							
						Air, Inert Gas (PSI/Bar)	Water (PSI/Bar)	Light Oil 300SSU (PSI/Bar)									
3/8	5/8	15.88	3.00	2.59	0	0.00	125	8.62	125	8.62	80	5.52	150	66	11.5	34	06F23O6140A3F
1/2	5/8	15.88	4.00	3.45	0	0.00	125	8.62	125	8.62	80	5.52	150	66	11.5	34	08F23O6140A3F
3/4	3/4	19.05	5.00	4.31	0	0.00	125	8.62	125	8.62	80	5.52	150	66	11.5	35	12F23O6148A3F
1	1	25.40	13.00	11.21	5	0.34	125	8.62	125	8.62	125	8.62	180	82	11.5	37	16F24O6164A3F
1 1/2	1 1/4	31.75	22.5	19.40	5	0.34	125	8.62	125	8.62	125	8.62	180	82	11.5	39	24F24O6180A3F

DRAWINGS

	Drawing 22	Drawing 23	Drawing 24	Drawing 25	Drawing 34	Drawing 35
A	9/16	9/16	11/16	11/16	9/16	11/16
B	3 9/16	3 9/16	3 21/32	3 21/32	3 9/16	3 21/32
C	2 11/32	2 11/32	2 7/16	2 7/16	2 11/32	2 7/16
D	23/32	7/8	23/32	7/8	7/8	7/8
E	1 5/16	1 17/32	1 5/16	1 17/32	1 17/32	1 17/32
F	2 13/16	2 29/32	2 29/32	2 13/16	2 29/32	2 29/32
G	1 13/32	1 13/32	1 15/32	1 15/32	1 13/32	1 15/32
H	1 15/16	2 1/4	2	2 11/32	2 1/8	2 7/32
J	2 25/32	3 9/32	2 7/8	3 3/8	3 9/32	3 3/8
K	1 9/16	1 13/16	1 9/16	1 13/16	1 13/16	1 13/16

Explosion-Proof/Watertight Shown in Outline

#22, 23, 24, 25, 34, 35

	Drawing 28	Drawing 29	Drawing 30	Drawing 31	Drawing 37	Drawing 38
A	4 3/4	4 15/32	4 3/4	4 15/32	4 31/32	4 21/32
B	3 17/32	3 1/4	3 17/32	3 1/4	3 23/32	3 7/16
C	23/32	7/8	23/32	7/8	23/32	7/8
D	1 5/16	1 17/32	1 5/16	1 17/32	1 5/16	1 17/32
E	15/32	15/32	17/32	17/32	3 5/16	3 17/32
F	3 1/8	3 9/32	3 1/8	3 9/32	4 5/32	4 3/8
G	3 31/32	4 3/16	3 31/32	4 3/16	1 9/16	1 13/16
H	1 9/16	1 13/16	1 9/16	1 13/16		

Explosion-Proof/Watertight Shown in Outline

#28, 29, 30, 31, 37, 38

To choose a solenoid for your valve, refer to the AC or DC chart found on the flap attached to the back cover of this catalog.

Series 22, 23, 24, 26 Two-Way Pilot-Operated Valves

DRAWINGS

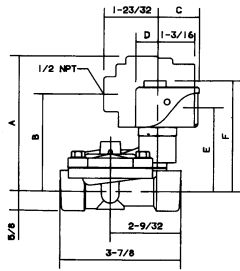

	Drawing 26	Drawing 27	Drawing 36
A	4 11/32	4 1/32	4 1/32
B	3 1/8	2 13/16	2 13/16
C	1 5/16	1 17/32	1 17/32
D	23/32	7/8	7/8
E	2 11/16	2 29/32	2 3/4
F	3 17/32	3 3/4	3 3/4
G	1 9/16	1 13/16	1 13/16

Explosion-Proof/Watertight
Shown in Outline

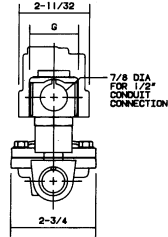

#26, 27, 28

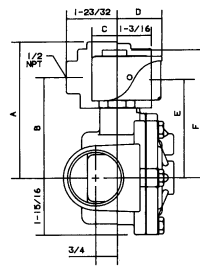

	Drawing 32	Drawing 33	Drawing 39
A	4 31/32	4 21/32	4 21/32
B	3 23/32	3 7/16	3 7/16
C	23/32	7/8	7/8
D	1 5/16	1 17/32	1 17/32
E	3 5/16	3 17/32	3 3/8
F	4 5/32	4 3/8	4 3/8
G	1 9/16	1 13/16	1 13/16

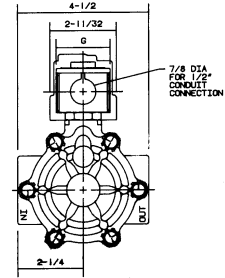

#32, 33, 39

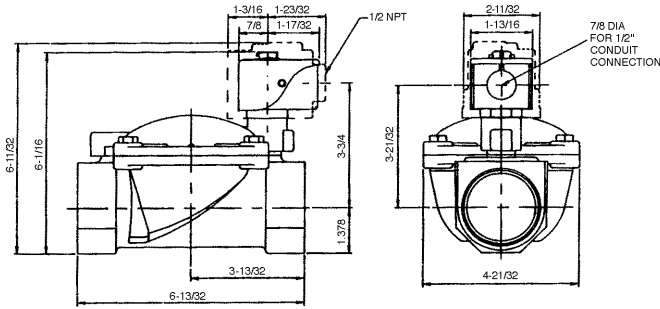

#1A

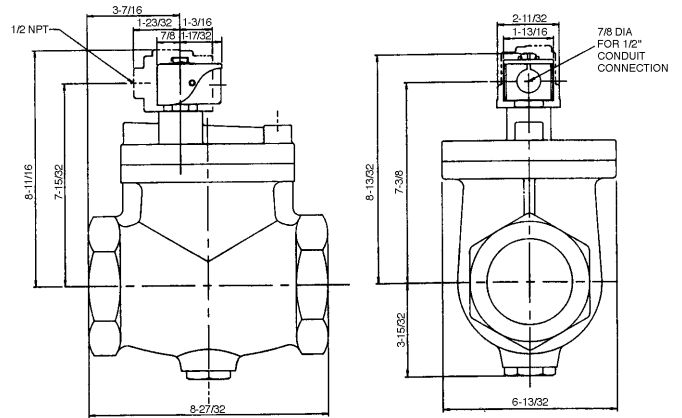

#2A

GOLD RING Series 25, H5 Two-Way Pilot-Operated Valves

SPECIFICATIONS

Mechanical Characteristics

Standard Materials of Construction

- Body-Brass, 316 Stainless Steel as listed
- Seals-NBR
- Plunger and Pole Piece-430FR Stainless Steel
- Plunger Tube-305 Stainless Steel
- Springs-302 Stainless Steel
- Shading Coil-Copper (Brass Bodies), Silver (Stainless Steel Bodies)
- Disc Holder (Normally Open Valves)-Ryton
- Pilot Seats-Nickel Plated Brass
- Wire Screen-Brass or Stainless Steel

Compatible Fluids

- Gases, Fluid, Light Oils and other clean flowing media compatible with brass or stainless steel

Electrical Characteristics

Voltagess

- DC-6, 12, 24, 120, 125 (other voltages available upon request)
- AC-24/60, 110/120-50/60, 220/240-50/60, 440/480-50/60

Coil

- Class F Standard, Class H Available

Agency Approvals

- Standard valves with general purpose or explosion proof solenoid enclosures are UL Listed and CSA Certified. For details, consult factory.

Miscellaneous

Temperature Ratings (media as listed)

- AC Voltages: 180°F max.
- DC Voltages: 180°F max.
- Ambient: 32-77°F (standard)
- For temperature variations, consult the factory.

Installation

- Valves should be mounted vertical and upright. See mounting dimensions (nominal) shown here. For certified dimensions, consult factory.

Applications

- Used in a variety of applications including: Automated Systems, Dispensing Systems, Instrumentation, Welding Equipment, Food Processing Machinery, Water Treatment Systems and Laundry Equipment.

PILOTED BRASS VALVES-NORMALLY CLOSED (ENERGIZE TO OPEN), NBR SEALS

AC VALVE SPECIFICATIONS

NPT Pipe Size	Orifice Diameter		Flow Factor		Operating Pressure Differential								Max. Temp.		AC Watt	Const. Ref.	Valve Part Number
	inch	mm	Cv	Kv	Min. (PSI/Bar)	Max. (MOPD)						°F	°C				
						Air, Inert Gas (PSI/BAR)		Water (PSI/Bar)		Light Oil 300SSU (PSI/BAR)							
1/4	11/32	8.73	1.20	1.03	5	0.34	300	20.69	300	20.69	300	20.69	180	82	6.0	46	04F25C2122CAF
3/8	11/32	8.73	1.20	1.03	5	0.34	300	20.69	300	20.69	300	20.69	180	82	6.0	47	06F25C2122CAF
3/8	1/2	12.70	3.00	2.59	0	0.00	200	13.79	200	13.79	200	13.79	180	82	11.0	48	06FH5C2132ACF
3/8	1/2	12.70	3.00	2.59	1	0.07	300	20.69	235	16.21	235	16.21	180	82	11.0	48	06F25C2132ACF
1/2	1/2	12.70	3.60	3.10	0	0.00	200	13.79	200	13.79	200	13.79	180	82	11.0	48	08FH5C2132ACF
1/2	1/2	12.70	3.60	3.10	1	0.07	300	20.69	235	16.21	235	16.21	180	82	11.0	48	08F25C2132ACF
3/4	3/4	19.05	7.40	6.38	0	0.00	200	13.79	200	13.79	200	13.79	180	82	11.0	49	12FH5C2148ACF
3/4	3/4	19.05	7.40	6.38	1	0.07	300	20.69	235	16.21	235	16.21	180	82	11.0	49	12F25C2148ACF
1	1	25.40	12.2	10.52	1	0.07	300	20.69	300	20.69	300	20.69	180	82	11.0	50	16F25C2164ACF
1	1	25.40	12.2	10.52	0	0.00	150	10.34	125	8.62	125	8.62	174	79	16.0	50	16FH5C2164ADF

PILOTED BRASS VALVES-NORMALLY OPEN (ENERGIZE TO CLOSE), NBR SEALS

AC VALVE SPECIFICATIONS

NPT Pipe Size	Orifice Diameter		Flow Factor		Operating Pressure Differential								Max. Temp.		AC Watt	Const. Ref.	Valve Part Number
	inch	mm	Cv	Kv	Min. (PSI/Bar)	Max. (MOPD)						°F	°C				
						Air, Inert Gas (PSI/BAR)		Water (PSI/Bar)		Light Oil 300SSU (PSI/BAR)							
1/4	11/32	8.73	1.20	1.03	5	0.34	300	20.69	300	20.69	300	20.69	180	82	11.0	51	04F25O2122CCF
3/8	11/32	8.73	1.20	1.03	5	0.34	300	20.69	300	20.69	300	20.69	180	82	11.0	52	06F25O2122CCF
3/8	1/2	12.70	3.0	2.59	1	0.07	200	13.79	175	12.07	175	12.07	180	82	11.0	53	06F25O2132ACF
1/2	1/2	12.70	3.60	3.10	1	0.07	200	13.79	175	12.07	175	12.07	180	82	11.0	53	08F25O2132ACF
3/4	3/4	19.05	7.40	6.38	1	0.07	275	18.97	275	18.97	275	18.97	180	82	11.0	54	12F25O2148ACF
1	1	25.40	12.2	10.52	1	0.07	300	20.69	250	17.24	230	15.86	180	82	11.0	55	16F25O2164ACF

To choose a solenoid for your valve, refer to the AC or DC chart found on the flap attached to the back cover of this catalog.

Series 25 H5 Two-Way Pilot-Operated Valves

PILOTED BRASS VALVES – NORMALLY CLOSED (ENERGIZE TO OPEN), NBR SEALS

DC VALVE SPECIFICATIONS

NPT Pipe Size	Orifice Diameter		Flow Factor		Operating Pressure Differential								Max. Temp.		AC Watt	Const. Ref.	Valve Part Number
	inch	mm	Cv	Kv	Min. (PSI/Bar)	Max. (MOPD)						°F	°C				
						Air, Inert Gas (PSI/BAR)		Water (PSI/Bar)		Light Oil 300SSU (PSI/BAR)							
1/4	11/32	8.73	1.20	1.03	5	0.34	300	20.69	300	20.69	300	20.69	180	82	11.0	51	04F25O2122CCF
1/4	11/32	8.73	1.20	1.03	5	0.34	275	18.97	275	18.97	275	18.97	150	66	11.5	56	04F25C2122C3F
3/8	11/32	8.73	1.20	1.03	5	0.34	275	18.97	275	18.97	275	18.97	150	66	11.5	57	06F25C2122C3F
3/8	1/2	12.70	3.00	2.59	1	0.07	130	8.97	130	8.97	130	8.97	180	82	11.5	48	06F25C2132A3F
1/2	1/2	12.70	3.60	3.10	1	0.07	130	8.97	130	8.97	130	8.97	180	82	11.5	48	08F25C2132A3F
3/4	3/4	19.05	7.40	6.38	1	0.07	70	4.83	70	4.83	70	4.83	150	66	11.5	49	12F25C2148A3F
1	1	25.40	12.20	10.52	1	0.07	275	18.97	275	18.97	275	18.97	180	82	11.5	50	16F25C2164A3F

PILOTED BRASS VALVES – NORMALLY OPEN (ENERGIZE TO CLOSE), NBR SEALS

DC VALVE SPECIFICATIONS

NPT Pipe Size	Orifice Diameter		Flow Factor		Operating Pressure Differential								Max. Temp.		AC Watt	Const. Ref.	Valve Part Number
	inch	mm	Cv	Kv	Min. (PSI/Bar)	Max. (MOPD)						°F	°C				
						Air, Inert Gas (PSI/BAR)		Water (PSI/Bar)		Light Oil 300SSU (PSI/BAR)							
1/4	11/32	8.73	1.20	1.03	5	0.34	160	11.03	160	11.03	160	11.03	150	66	11.5	51	04F25O2122C3F
3/8	1/2	12.70	3.00	2.59	1	0.07	200	13.79	175	12.07	175	12.07	180	82	11.5	53	06F25O2122A3F
3/8	1/2	12.70	3.00	2.59	1	0.07	200	13.79	175	12.07	175	12.07	180	82	11.5	53	06F25O2132A3F
1/2	1/2	12.70	3.60	3.10	1	0.07	200	13.79	175	12.07	175	12.07	180	82	11.5	53	08F25O2132A3F
3/4	3/4	19.05	7.40	6.38	1	0.07	230	15.86	200	13.79	200	13.79	150	66	11.5	54	12F25O2148A3F
1	1	25.40	12.20	10.52	1	0.07	200	13.79	150	10.34	125	8.62	180	82	11.5	55	16F25O2164A3F

PILOTED STAINLESS STEEL VALVES – NORMALLY CLOSED (ENERGIZE TO OPEN), NBR SEALS

AC VALVE SPECIFICATIONS

NPT Pipe Size	Orifice Diameter		Flow Factor		Operating Pressure Differential								Max. Temp.		AC Watt	Const. Ref.	Valve Part Number
	inch	mm	Cv	Kv	Min. (PSI/Bar)	Max. (MOPD)						°F	°C				
						Air, Inert Gas (PSI/BAR)		Water (PSI/Bar)		Light Oil 300SSU (PSI/BAR)							
1/4	11/32	8.73	1.20	1.03	5	0.34	300	20.69	300	20.69	300	20.69	180	82	6.0	46A	04F25C6122CAF
3/8	11/32	8.73	1.20	1.03	5	0.34	300	20.69	300	20.69	300	20.69	180	82	6.0	47A	06F25C6122CAF

PILOTED STAINLESS STEEL VALVES – NORMALLY OPEN (ENERGIZE TO CLOSE), NBR SEALS

AC VALVE SPECIFICATIONS

NPT Pipe Size	Orifice Diameter		Flow Factor		Operating Pressure Differential								Max. Temp.		AC Watt	Const. Ref.	Valve Part Number
	inch	mm	Cv	Kv	Min. (PSI/Bar)	Max. (MOPD)						°F	°C				
						Air, Inert Gas (PSI/BAR)		Water (PSI/Bar)		Light Oil 300SSU (PSI/BAR)							
1/4	11/32	8.73	1.20	1.03	5	0.34	300	20.69	300	20.69	300	20.69	180	82	11.0	51A	04F25O6122CCF
3/8	11/32	8.73	1.20	1.03	5	0.34	300	20.69	300	20.69	300	20.69	180	82	11.0	52A	06F25O6122CCF

DRAWINGS

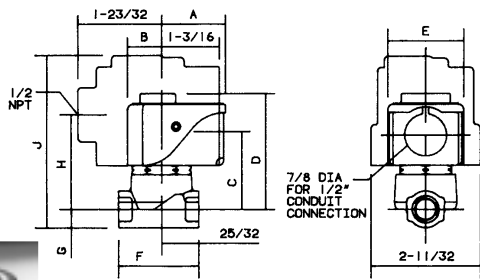

#46, 46A, 47, 47A,
51, 51A, 52, 52A, 56, 57

	46	46A	47	47A	51	51A	52	52A	56	57
A	1 5/16	1 5/16	1 5/16	1 5/16	1 17/32	1 17/32	1 17/32	1 17/32	1 17/32	1 17/32
B	23/32	23/32	23/32	23/32	7/8	7/8	7/8	7/8	7/8	7/8
C	1 9/16	1 17/32	1 5/8	1 5/8	1 25/32	1 3/4	1 27/32	1 27/32	1 15/16	2
D	2 7/16	2 13/32	2 1/2	2 1/2	2 7/8	2 27/32	2 15/16	2 15/16	2 7/8	2 15/16
E	1 9/16	1 9/16	1 9/16	1 9/16	1 13/16	1 13/16	1 13/16	1 13/16	1 13/16	1 13/16
F	1 3/4	1 7/8	1 3/4	1 7/8	1 3/4	1 7/8	1 3/4	1 7/8	1 3/4	1 3/4
G	3/8	9/16	7/16	9/16	3/8	9/16	7/16	9/16	3/8	7/16
H	1 31/32	1 15/16	2 1/32	2 1/32	1 31/32	1 15/16	2 1/32	2 1/32	1 31/32	2 1/32
J	3 9/16	3 17/32	3 5/8	3 5/8	3 9/16	3 17/32	3 5/8	3 5/8	3 9/16	3 5/8
K	1 3/16	1			13/16	1	13/16	1	13/16	13/16

Explosion-Proof/Watertight Shown in Outline

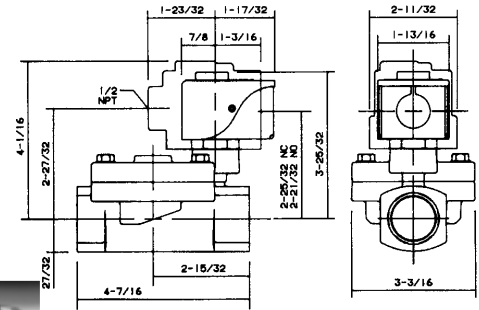

#50, 55

	Drawing 48	Drawing 49	Drawing 53	Drawing 54
A	3 5/8	3 21/32	3 5/8	3 21/32
B	1/2	5/8	1/2	5/8
C	1 5/16	1 5/8	1 5/16	1 5/8
D	1 1/8	1 1/2	1 1/8	1 1/2
E	2 7/16	3 1/8	2 7/16	3 1/8
F	2 5/16	2 11/32	2 7/32	2 1/4
G	3 5/16	3 15/32	3 5/16	3 15/32
H	2 1/4	3 1/2	2 1/4	2 29/32

Explosion-Proof/Watertight
Shown in Outline

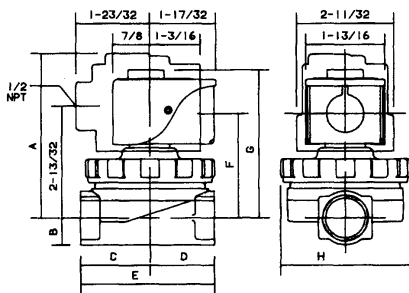

#48, 49, 53, 54

To choose a solenoid for your valve, refer to the AC or DC chart found on the flap attached to the back cover of this catalog.

GOLD RING Series S, 22, 23 Two-Way Hot Water and Steam Valves

SPECIFICATIONS

Mechanical Characteristics

Standard Materials of Construction

- Body-Brass, 303 Stainless Steel as listed
- Seals-Ethylene Propylene or PTFE and FKM
- Plunger and Pole Piece- 430FR Stainless Steel
- Plunger Tube - 305 Stainless Steel
- Springs-302 Stainless Steel
- Shading Coil-Copper (Brass Bodies), Silver (Stainless Steel Bodies)
- Disc Holder (Normally Open Valves)- 50 psi Steam: Ryton, 125 psi Steam: 303 Stainless Steel
- Pilot Seats-Nickel Plated Brass

Compatible Fluids

- Ideal for the control of hot water and steam

Electrical Characteristics

Voltages

- DC-6, 12, 24, 120, 125 (other voltages available upon request)
- AC-24/60, 110/120-50/60, 220/240-50/60, 440/480-50/60

Coil

- Class F Standard, Class H Available

Agency Approvals

- Standard valves with general purpose or explosion proof solenoid enclosures are UL Listed and CSA Certified. For details, consult factory.

Miscellaneous

Temperature Ratings (media as listed)

- AC Voltages: 353°F max.
- DC Voltages: 150°F max.
- Ambient: 32-77°F (standard)
- For temperature variations consult the factory.

Installation

- Valves should be mounted vertical and upright. See mounting dimensions (nominal) shown here. For certified dimensions, consult factory.

Applications

- Used in a variety of applications including: Dry Cleaning, Steam Irons, Steam Baths, Autoclaves, Molding, Steam Atomization, Sterilizers and Laundry Equipment.
- Series S0 Valves are direct acting valves; Series S4 and Series S5 are offset or center pilot valves; Series S3 valves are hung diaphragm with integral seats.

BRASS HOT WATER AND STEAM VALVES – NORMALLY CLOSED (ENERGIZE TO OPEN), ETHYLENE PROPYLENE OR PTFE SEALS

AC VALVE SPECIFICATIONS

NPT Pipe Size	Orifice Diameter		Flow Factor		Operating Pressure Differential						Max. Temp.		AC Watt	Const. Ref.	Valve Part Number	
	inch	mm	Cv	Kv	Max. (MOPD)				Notes	°F	°C					
					Min. (PSI/Bar)	Steam (PSI/Bar)	Hot Water (PSI/Bar)									
1/4	5/32	3.97	.52	0.45	0	0.00	11	0.76	-	-	1	344	173	11.0	56	04FS0C3410ACH
3/8	1/2	12.70	3.00	2.59	1	0.07	50	3.45	-	-	2,4	300	149	11.0	57	06FS5C2332ACF
3/8	1/2	12.70	3.00	2.59	1	0.07	80	5.52	-	-	3	320	160	11.0	57	06FS5C2432ACF
3/8	1/2	12.70	3.00	2.59	1	0.07	125	8.62	-	-	3	353	178	11.0	57	06FS5C2432ACH
3/8	5/8	15.88	3.00	2.59	0	0.00	50	3.45	150	10.34	4	300	149	11.0	58	06FS3C2340ACF
1/2	1/2	12.70	3.60	3.10	1	0.07	50	3.45	-	-	2,4	300	149	11.0	57	08FS5C2332ACF
1/2	1/2	12.70	3.60	3.10	1	0.07	80	5.52	-	-	3	320	160	11.0	57	08FS5C2432ACF
1/2	1/2	12.70	3.60	3.10	1	0.07	125	8.62	-	-	3	353	178	11.0	57	08FS5C2432ACH
1/2	5/8	15.88	4.00	3.45	0	0.00	50	3.45	150	10.34	4	300	149	11.0	58	08FS3C2340ACF
3/4	3/4	19.05	7.40	6.38	1	0.07	50	3.45	-	-	2,4	300	149	11.0	59	12FS5C2348ACF
3/4	3/4	19.05	7.40	6.38	1	0.07	80	5.52	-	-	3	320	160	11.0	59	12FS5C2448ACF
3/4	3/4	19.05	7.40	6.38	1	0.07	125	8.62	-	-	3	353	178	11.0	59	12FS5C2448ACH
3/4	3/4	19.05	5.00	4.31	0	0.00	50	3.45	150	10.34	4	300	149	11.0	60	12FS3C2348ACF
1	1	25.40	12.20	10.52	1	0.07	50	3.45	150	10.34	4	300	149	11.0	61	16FS5C2364ACF
1	1	25.40	12.20	10.52	1	0.07	80	5.52	-	-	3	320	160	11.0	61	16FS5C2464ACF
1	1	25.40	12.20	10.52	1	0.07	125	8.62	-	-	3	353	178	11.0	61	16FS5C2464ACH
1 1/4	1 1/8	28.58	15.00	12.93	5	0.34	50	3.45	150	10.34	4	300	149	6.0	62	20FS4C2372AAF
1 1/2	1 1/2	38.10	22.50	19.40	5	0.34	50	3.45	150	10.34	4	300	149	6.0	63	24FS4C2380AAF

BRASS HOT WATER AND STEAM VALVES— NORMALLY OPEN (ENERGIZE TO CLOSE), ETHYLENE PROPYLENE OR PTFE SEALS

AC VALVE SPECIFICATIONS

NPT Pipe Size	Orifice Diameter		Flow Factor		Operating Pressure Differential				Notes	Max. Temp.		AC Watt	Const. Ref.	Valve Part Number		
	inch	mm	Cv	Kv	Min. (PSI/Bar)	Max. (MOPD)		°F		°C						
						Steam (PSI/Bar)	Hot Water (PSI/Bar)									
3/8	1/2	12.70	3.00	2.59	1	0.07	125	8.62	-	-	3	353	178	11.0	64	06FS5O2432ACH
1/2	1/2	12.70	3.60	3.10	1	0.07	125	8.62	-	-	3	353	178	11.0	64	08FS5O2432ACH
3/4	3/4	19.05	7.40	6.38	1	0.07	125	8.62	-	-	3	353	178	11.0	65	12FS5O2448ACH
1	1	25.40	12.20	10.52	1	0.07	125	8.62	-	-	3	353	178	11.0	66	16FS5O2464ACH
1 1/2	1 1/2	38.10	22.50	19.40	5	0.34	50	3.45	-	-	4	300	149	11.0	67	24FS4O2380ACF

1. Valve contains stainless steel valve body.
2. Valve contains stainless steel seat and ethylene propylene elastomers.
3. Valve contains stainless steel seat and PTFE elastomers.
4. Valves with ethylene propylene elastomers are limited to 50 psi and 300°F (149°C). Do not use on higher pressure steam with pressure reducing valve, since this may result in super heated steam.

BRASS HOT WATER AND STEAM VALVES— NORMALLY CLOSED (FOR NORMALLY OPEN CONSULT FACTORY), ETHYLENE PROPYLENE OR PTFE SEALS

DC VALVE SPECIFICATIONS

NPT Pipe Size	Orifice Diameter		Flow Factor		Operating Pressure Differential				Notes	Max. Temp.		AC Watt	Const. Ref.	Valve Part Number		
	inch	mm	Cv	Kv	Min. (PSI/Bar)	Max. (MOPD)		°F		°C						
						Steam (PSI/Bar)	Hot Water (PSI/Bar)									
3/8	5/8	15.88	3.00	2.59	5	0.34	-	-	100	6.90	-	150	66	11.5	58	06F22C2340A3F
3/8	5/8	15.88	3.00	2.59	0	0.00	-	-	40	2.76	-	150	66	11.5	58	06F23C2340A3F
1/2	5/8	15.88	4.00	3.45	5	0.34	-	-	100	6.90	-	150	66	11.5	58	08F22C2340A3F
1/2	5/8	15.88	4.00	3.45	0	0.00	-	-	40	2.76	-	150	66	11.5	58	08F23C2340A3F
3/4	3/4	19.05	5.00	4.31	5	0.34	-	-	100	6.90	-	150	66	11.5	60	12F22C2348A3F
3/4	3/4	19.05	5.00	4.31	0	0.00	-	-	40	2.76	-	150	66	11.5	60	12F23C2348A3F

DRAWINGS



#61, 66

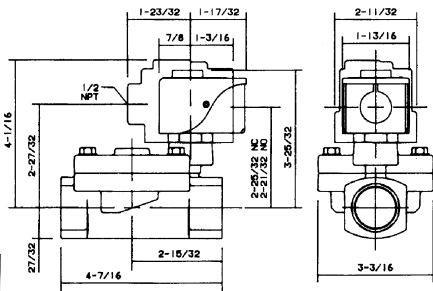

#57, 59, 64, 65

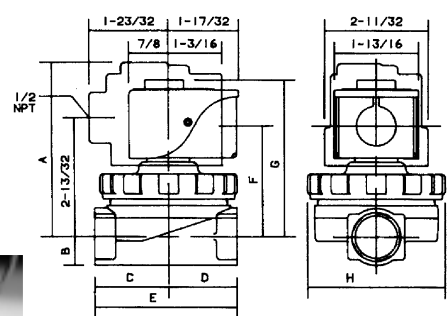

To choose a solenoid for your valve, refer to the AC or DC chart found on the flap attached to the back cover of this catalog.

Series S, 22, 23 Two-Way

DRAWINGS

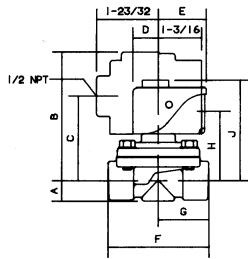

Drawing 58 Drawing 60

A	9/16	11/16
B	3 9/16	3 21/32
C	2 11/32	2 7/16
D	7/8	7/8
E	1 17/32	1 17/32
F	2 13/16	2 29/32
G	1 13/32	1 15/32
H	2	2 1/4
J	3 9/32	3 3/8
K	1 13/16	1 13/16

Explosion-Proof/Watertight Shown in Outline

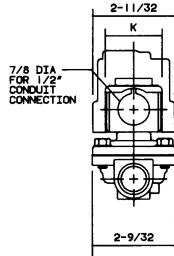

#58, 60

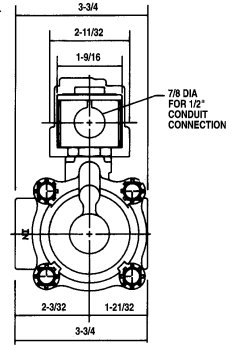
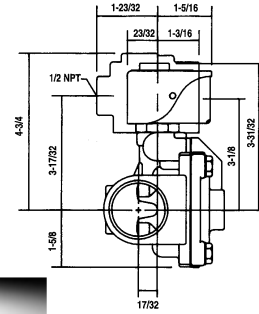

#62

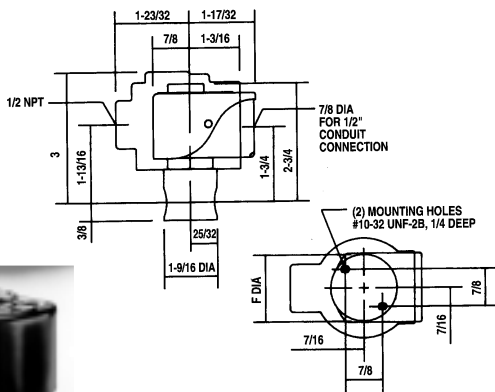

#56

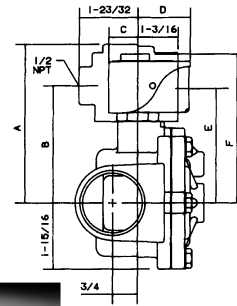

#63, 67

Drawing 63 Drawing 67

A	4 31/32	4 21/32
B	3 23/32	3 7/16
C	23/32	7/8
D	1 5/16	1 17/32
E	3 5/16	3 3/8
F	4 5/32	4 3/8
G	1 9/16	1 13/16

Explosion-Proof/ Watertight Shown in Outline

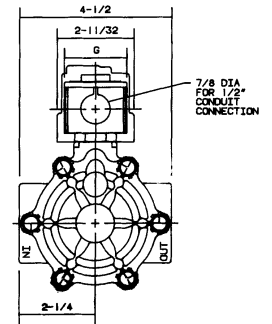

GOLD RING Series 28 Two-Way Pilot-Operated High Pressure Valves

SPECIFICATIONS

Mechanical Characteristics

Standard Materials of Construction

- Body-Brass
- Seals-NBR and Urethane
- Plunger and Pole Piece-430FR Stainless Steel
- Plunger Tube-305 Stainless Steel
- Springs-302 Stainless Steel
- Shading Coil-Copper (Brass Bodies)
- Piston-Delrin
- Piston Rings-PTFE

Compatible Fluids

- Generally installed where high pressure and large flow requirements dictate the use of piston valves

Electrical Characteristics

Voltages

- DC-6, 12, 24, 120, 125 (other voltages available upon request)
- AC-24/60, 110/120-50/60, 220/240-50/60, 440/480-50/60

Coil

- Class F Standard, Class H Available

Miscellaneous

Temperature Ratings (media as listed)

- AC Voltages: 200°F max.
- DC Voltages: 150°F max.
- Ambient: 32-77°F (standard)
- For temperature variations, consult the factory.

Installation

- Valves should be mounted vertical and upright. See mounting dimensions (nominal) shown here. For certified dimensions, consult factory.

Applications

- Used in a variety of applications including: Blow Molding, Compressors, Car Washer Equipment, and Pumps.

PILOTED PISTON HIGH PRESSURE BRASS VALVES– NORMALLY CLOSED (ENERGIZE TO OPEN), NBR SEALS

AC VALVE SPECIFICATIONS

NPT Pipe Size	Orifice Diameter		Flow Factor		Operating Pressure Differential								Max. Temp.		AC Watt	Const. Ref.	Valve Part Number
	inch	mm	Cv	Kv	Min. (PSI/Bar)	Max. (MOPD)						°F	°C				
						Air, Inert Gas (PSI/Bar)		Water (PSI/Bar)		Light Oil 300SSU (PSI/Bar)							
1/4	5/16	7.94	1.5	1.29	15	1.03	1500	103.45	1500	103.45	1500	103.45	200	93	11.0	69A	04F28C1D20ACF
3/8	5/16	7.94	1.5	1.29	15	1.03	1500	103.45	1500	103.45	1500	103.45	200	93	11.0	69B	06F28C1D20ACF
1/2	3/8	9.53	3.2	2.76	25	1.72	1500	103.45	1500	103.45	1500	103.45	200	93	11.0	69	08F28C1D24ACF
3/4	3/4	19.05	7.8	6.72	25	1.72	1000	68.97	1000	68.97	1000	68.97	200	93	11.0	70	12F28C1D48BCF

PILOTED PISTON HIGH PRESSURE BRASS VALVES– NORMALLY OPEN (ENERGIZE TO CLOSE), NBR SEALS

AC VALVE SPECIFICATIONS

NPT Pipe Size	Orifice Diameter		Flow Factor		Operating Pressure Differential								Max. Temp.		AC Watt	Const. Ref.	Valve Part Number
	inch	mm	Cv	Kv	Min. (PSI/Bar)	Max. (MOPD)						°F	°C				
						Air, Inert Gas (PSI/Bar)		Water (PSI/Bar)		Light Oil 300SSU (PSI/Bar)							
1/2	3/8	9.53	3.2	2.76	25	1.72	1000	68.97	1000	68.97	1000	68.97	200	93	11.0	71	08F28C1D28ACF
3/4	3/4	19.05	7.8	6.72	25	1.72	500	34.48	500	34.48	500	34.48	200	93	11.0	72	12F28C1D48BCF

PILOTED PISTON HIGH PRESSURE BRASS VALVES– NORMALLY CLOSED (ENERGIZE TO OPEN), NBR SEALS

DC VALVE SPECIFICATIONS

NPT Pipe Size	Orifice Diameter		Flow Factor		Operating Pressure Differential								Max. Temp.		AC Watt	Const. Ref.	Valve Part Number
	inch	mm	Cv	Kv	Min. (PSI/Bar)	Max. (MOPD)						°F	°C				
						Air, Inert Gas (PSI/Bar)		Water (PSI/Bar)		Light Oil 300SSU (PSI/Bar)							
1/2	3/8	9.53	3.2	2.76	25	1.72	500	34.48	500	34.48	500	34.48	150	66	11.5	69	08F28C1D24A3F
3/4	3/4	19.05	7.8	6.72	25	1.72	450	31.03	450	31.03	450	31.03	150	66	11.5	70	12F28C1D48A3F

To choose a solenoid for your valve, refer to the AC or DC chart found on the flap attached to the back cover of this catalog.

Series 28 Two-Way Pilot-Operated

DRAWINGS

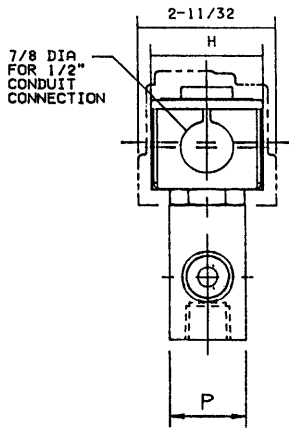

#69, 69A, 69B, 70, 71, 72

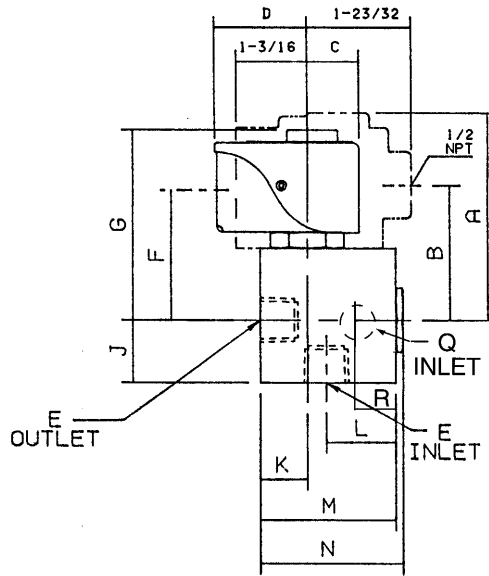

	Drawing 69	Drawing 69A	Drawing 69B	Drawing 70	Drawing 71	Drawing 72
A	3 29/64	3 1/32	3 1/32	3 27/32	3 29/64	3 27/32
B	2 1/4	1 57/64	1 57/64	2 41/64	2 1/4	2 41/64
C	7/8	7/8	7/8	7/8	7/8	7/8
D	1 17/32	1 17/32	1 17/32	1 17/32	1 17/32	1 17/32
E	1 1/2 NPT	---	---	3/4" NPT	1/2" NPT	3/4" NPT
F	2 11/64	1 13/16	1 13/16	2 9/16	2 1/32	2 13/32
G	3 3/16	2 3/4	2 3/4	3 37/64	3 3/16	3 37/64
H	1 13/16	1 13/16	1 13/16	1 13/16	1 13/16	1 13/16
I	1 3/64	11/16	11/16	1 13/32	1 3/64	1 13/32
J	25/32	13/16	13/16	29/32	25/32	29/32
K	63/64	---	---	2 11/32	63/64	2 11/32
L	---	---	---	---	---	---
M	2 1/4	2 1/4	2 1/4	3 35/64	2 1/4	3 35/64
N	2 3/8	2 13/32	2 13/32	3 47/64	2 3/8	3 47/64
P	1 1/4	1 1/2	1 1/2	2	1 1/4	2
Q	---	1/4" NPT	3/8" NPT	---	---	---
R	---	15/16	15/16	---	---	---

Explosion-Proof/Watertight
Shown in Outline

To choose a solenoid for your valve, refer to the AC or DC chart found on the flap attached to the back cover of this catalog.

Three-Way Valve Contents



Gold Ring Three-Way Valve Specifications 33-42

Series 30, Direct Acting 34-37

Series 34, Pilot Operated 38-39

Series 35, 38 Quick Exhaust 40-42

GOLD RING Series 30 Small Three-Way Direct Acting Valves

SPECIFICATIONS

Mechanical Characteristics

Standard Materials of Construction

- Body-Brass or 303 Stainless Steel as listed
- Seals-NBR
- Plunger and Pole Piece-430FR Stainless Steel
- Plunger Tube-305 Stainless Steel
- Springs-302 Stainless Steel
- Shading Coil-Copper (Brass Bodies), Silver (Stainless Steel Bodies)
- Disc Holder-Celcon

Electrical Characteristics

Voltages

- DC-6, 12, 24, 120, 125 (other voltages available upon request)
- AC-24/60, 110/120-50/60, 220/240-50/60, 440/480-50/60

Coil

- Class F Standard, Class H Available

Agency Approvals

- Standard valves with general purpose or explosion proof solenoid enclosures are UL Listed and CSA Certified. For details, consult factory.

Miscellaneous

Temperature Ratings (media as listed)

- AC Voltages: 200°F max.
- DC Voltages: 150°F max.
- Ambient: 32-77°F (standard)
- For temperature variations, consult the factory.

Installation

- Series 30 valves may be mounted in any position. Product and mounting dimensions shown are nominal. For certified dimensions, consult factory.

Applications

- Used in a variety of applications including: Automated Systems, Dispensing Systems, Instrumentation, Pilot Operators, Laundry Equipment, Sampling Systems, Compressors, Water Treatment, and Air Dryers.

Operating Specifications

- Normally Closed-energize to pressurize operating device. De-energized, operating device is exhausted.
- Normally Open-energize to exhaust operating device. De-energized, operating device is pressurized.
- Universal-Can be installed for either normally closed, or normally open operation. Universal mode of operation is also suitable for flow selection (pressure at port 2 and 3) or diversion (pressure at port 1).

DIRECT ACTING BRASS VALVES—NORMALLY CLOSED (PRESSURE AT 2, ENERGIZE TO OPEN), NBR SEALS

AC VALVE SPECIFICATIONS

NPT Pipe Size	Orifice Diameter		Flow Factor		Min. (PSI/Bar)	Operating Pressure Differential						Max. Temp.		AC Watt	Const. Ref.	Valve Part Number
	inch	mm	Cv	Kv		Max. (MOPD)						°F	°C			
						Air, Inert Gas (PSI/BAR)		Water (PSI/Bar)		Light Oil 300SSU (PSI/BAR)						
1/8	3/64	1.19	.06	0.05	0	200	13.79	200	13.79	200	13.79	180	82	6.0	73	02F30C1103AAF
1/8	1/16	1.59	.09	0.08	0	125	8.62	125	8.62	125	8.62	180	82	6.0	73	02F30C1104AAF
1/8	3/32	2.38	.12	0.10	0	100	6.90	100	6.90	100	6.90	180	82	6.0	73	02F30C1106AAF
1/8	1/8	3.18	.21	0.18	0	40	2.76	40	2.76	40	2.76	180	82	6.0	73	02F30C1108AAF
1/4	1/16	1.59	.09	0.08	0	125	8.62	125	8.62	125	8.62	180	82	6.0	74	04F30C2104AAF
1/4	3/32	2.38	.12	0.10	0	110	7.59	110	7.59	110	7.59	180	82	10.2	74	04F30C2106ABF
1/4	3/32	2.38	.12	0.10	0	150	10.34	150	10.34	150	10.34	200	93	11.0	75	04F30C2106ACF
1/4	1/8	3.18	.25	0.22	0	40	2.76	40	2.76	40	2.76	180	82	6.0	74	04F30C2108AAF
1/4	11/64	4.37	.35	0.30	0	30	2.07	30	2.07	30	2.07	180	82	10.2	74	04F30C2111ABF

DIRECT ACTING BRASS VALVES—NORMALLY OPEN (PRESSURE AT 3, ENERGIZE TO CLOSE), NBR SEALS

AC VALVE SPECIFICATIONS

NPT Pipe Size	Orifice Diameter		Flow Factor		Min. (PSI/Bar)	Operating Pressure Differential						Max. Temp.		AC Watt	Const. Ref.	Valve Part Number
	inch	mm	Cv	Kv		Max. (MOPD)						°F	°C			
						Air, Inert Gas (PSI/BAR)		Water (PSI/Bar)		Light Oil 300SSU (PSI/BAR)						
1/8	3/64	1.19	.06	0.05	0	200	13.79	200	13.79	200	13.79	180	82	6.0	73	02F30O1103AAF
1/8	1/16	1.59	.09	0.08	0	125	8.62	125	8.62	125	8.62	180	82	6.0	73	02F30O1104AAF
1/8	3/32	2.38	.12	0.10	0	100	6.90	100	6.90	100	6.90	180	82	6.0	73	02F30O1106AAF
1/8	1/8	3.18	.21	0.18	0	40	2.76	40	2.76	40	2.76	180	82	6.0	73	02F30O1108AAF
1/4	1/16	1.59	.09	0.08	0	235	16.21	250	17.24	250	17.24	200	93	16.0	75	04F30O2104ADF
1/4	3/32	2.38	.12	0.10	0	140	9.66	140	9.66	140	9.66	200	93	11.0	75	04F30O2106ACF
1/4	1/18	1.41	.25	0.22	0	40	2.76	40	2.76	40	2.76	180	82	6.0	74	04F30O2108AAF
1/4	1/8	3.18	.25	0.22	0	70	4.83	70	4.83	70	4.83	200	93	11.0	75	04F30O2108ACF
1/4	11/64	4.37	.35	0.30	0	40	2.76	40	2.76	40	2.76	200	93	11.0	75	04F30O2111ACF

DIRECT ACTING BRASS VALVES – UNIVERSAL (PRESSURE AT ANY PORT), NBR SEALS

AC VALVE SPECIFICATIONS

NPT Pipe Size	Orifice Diameter		Flow Factor		Operating Pressure Differential						Max. Temp.		AC Watt	Const. Ref.	Valve Part Number	
	inch	mm	Cv	Kv	Min. (PSI/Bar)	Max. (MOPD)			°F	°C						
						Air, Inert Gas (PSI/Bar)	Water (PSI/Bar)	Light Oil 300SSU (PSI/Bar)								
1/8	3/64	1.19	.06	0.05	0	175	12.07	175	12.07	175	12.07	140	60	10.2	73	02F30U1103ABF
1/8	1/16	1.59	.09	0.08	0	100	6.90	100	6.90	100	6.90	180	82	10.2	73	02F30U1104ABF
1/8	3/32	2.38	.12	0.10	0	50	3.45	50	3.45	50	3.45	180	82	6.0	73	02F30U1106AAF
1/8	1/8	3.18	.21	0.18	0	30	2.07	30	2.07	30	2.07	180	82	10.2	73	02F30U1108ABF
1/4	1/16	1.59	.09	0.08	0	125	8.62	130	8.97	130	8.97	200	93	11.0	75	04F30U2104ACF
1/4	3/32	2.38	.12	0.10	0	100	6.90	100	6.90	100	6.90	200	93	16.0	75	04F30U2106ADF
1/4	1/8	3.18	.25	0.22	0	50	3.45	50	3.45	50	3.45	200	93	16.0	75	04F30U2108ADF
1/4	11/64	4.37	.35	0.30	0	20	1.38	20	1.38	20	1.38	200	93	11.0	75	04F30U2111ACF

DIRECT ACTING BRASS VALVES – NORMALLY CLOSED (PRESSURE AT 2, ENERGIZE TO OPEN), NBR SEALS

DC VALVE SPECIFICATIONS

NPT Pipe Size	Orifice Diameter		Flow Factor		Operating Pressure Differential						Max. Temp.		AC Watt	Const. Ref.	Valve Part Number	
	inch	mm	Cv	Kv	Min. (PSI/Bar)	Max. (MOPD)			°F	°C						
						Air, Inert Gas (PSI/Bar)	Water (PSI/Bar)	Light Oil 300SSU (PSI/Bar)								
1/8	3/64	1.19	.06	0.05	0	200	13.79	200	13.79	200	13.79	120	49	9.5	73	02F30C1103A1F
1/8	1/16	1.59	.09	0.08	0	125	8.62	125	8.62	125	8.62	120	49	9.5	73	02F30C1104A1F
1/8	3/32	2.38	.12	0.10	0	100	6.90	100	6.90	100	6.90	120	49	9.5	73	02F30C1106A1F
1/8	1/8	3.18	.21	0.18	0	40	2.76	40	2.76	40	2.76	120	49	9.5	73	02F30C1108A1F
1/4	1/16	1.59	.09	0.08	0	125	8.62	125	8.62	125	8.62	120	49	9.5	74	04F30C2104A1F
1/4	1/16	1.59	.09	0.08	0	160	11.03	160	11.03	160	11.03	150	66	11.5	75	04F30C2104A3F
1/4	3/32	2.38	.12	0.10	0	115	7.93	115	7.93	115	7.93	150	66	11.5	75	04F30C2106A3F
1/4	1/8	3.18	.25	0.22	0	60	4.14	60	4.14	60	4.14	150	66	11.5	75	04F30C2108A3F
1/4	11/64	4.37	.35	0.30	0	25	1.72	25	1.72	25	1.72	150	66	11.5	75	04F30C2111A3F

DIRECT ACTING BRASS VALVES – NORMALLY OPEN (PRESSURE AT 3, ENERGIZE TO CLOSE), NBR SEALS

DC VALVE SPECIFICATIONS

NPT Pipe Size	Orifice Diameter		Flow Factor		Operating Pressure Differential						Max. Temp.		AC Watt	Const. Ref.	Valve Part Number	
	inch	mm	Cv	Kv	Min. (PSI/Bar)	Max. (MOPD)			°F	°C						
						Air, Inert Gas (PSI/Bar)	Water (PSI/Bar)	Light Oil 300SSU (PSI/Bar)								
1/8	3/64	1.19	.06	0.05	0	200	13.79	200	13.79	200	13.79	120	49	9.5	73	02F30O1103A1F
1/8	1/16	1.59	.09	0.08	0	200	13.79	200	13.79	200	13.79	120	49	9.5	73	02F30O1104A1F
1/8	3/32	2.38	.12	0.10	0	100	6.90	100	6.90	100	6.90	120	49	9.5	73	02F30O1106A1F
1/8	1/8	3.18	.21	0.18	0	40	2.76	40	2.76	40	2.76	120	49	9.5	73	02F30O1108A1F
1/4	1/16	1.59	.09	0.08	0	160	11.03	160	11.03	160	11.03	150	66	11.5	75	04F30O2140A3F
1/4	3/32	2.38	.12	0.10	0	100	6.90	100	6.90	100	6.90	150	66	11.5	75	04F30O2106A3F
1/4	1/8	3.18	.12	0.10	0	55	3.79	55	3.79	55	3.79	150	66	11.5	75	04F30O2108A3F
1/4	11/64	4.37	.35	0.30	0	30	2.07	30	2.07	30	2.07	150	66	11.5	75	04F30O2111A3F

DIRECT ACTING BRASS VALVES – UNIVERSAL (PRESSURE AT ANY PORT), NBR SEALS

DC VALVE SPECIFICATIONS

NPT Pipe Size	Orifice Diameter		Flow Factor		Operating Pressure Differential						Max. Temp.		AC Watt	Const. Ref.	Valve Part Number	
	inch	mm	Cv	Kv	Min. (PSI/Bar)	Max. (MOPD)			°F	°C						
						Air, Inert Gas (PSI/Bar)	Water (PSI/Bar)	Light Oil 300SSU (PSI/Bar)								
1/8	3/64	1.19	.06	0.05	0	125	8.62	125	8.62	125	8.62	120	49	9.5	73	02F30U1103A1F
1/8	1/16	1.59	.09	0.08	0	65	4.48	65	4.48	65	4.48	120	49	9.5	73	02F30U1104A1F
1/8	3/32	2.38	.12	0.10	0	50	3.45	50	3.45	50	3.45	120	49	9.5	73	02F30U1106A1F
1/8	1/8	3.18	.21	0.18	0	20	1.38	20	1.38	20	1.38	120	49	9.5	73	02F30U1108A1F
1/4	1/16	1.59	.09	0.08	0	75	5.17	75	5.17	75	5.17	150	66	11.5	75	04F30U2104A3F
1/4	3/32	2.38	.12	0.10	0	60	4.14	60	4.14	60	4.14	150	66	11.5	75	04F30U2106A3F
1/4	1/8	3.18	.25	0.22	0	25	1.72	25	1.72	25	1.72	150	66	11.5	75	04F30U2108A3F
1/4	11/64	4.37	.35	0.30	0	12	0.83	12	0.83	12	0.83	150	66	11.5	75	04F30U2111A3F

To choose a solenoid for your valve, refer to the AC or DC chart found on the flap attached to the back cover of this catalog.

Series 30 Small Three-Way Direct Acting Valves

DIRECT ACTING STAINLESS STEEL VALVES— NORMALLY CLOSED (PRESSURE AT 2, ENERGIZE TO OPEN), NBR SEALS

AC VALVE SPECIFICATIONS

NPT Pipe Size	Orifice Diameter		Flow Factor		Operating Pressure Differential						Max. Temp.		AC Watt	Const. Ref.	Valve Part Number	
	inch	mm	Cv	Kv	Min. (PSI/Bar)	Max. (MOPD)			°F	°C						
						Air, Inert Gas (PSI/Bar)	Water (PSI/Bar)	Light Oil 300SSU (PSI/Bar)								
1/8	3/64	1.19	.06	0.05	0	200	13.79	200	13.79	200	13.79	180	82	6.0	73	02F30C3103AAF
1/8	1/16	1.59	.09	0.08	0	125	8.62	125	8.62	125	8.62	180	82	6.0	73	02F30C3104AAF
1/8	3/32	2.38	.12	0.10	0	100	6.90	100	6.90	100	6.90	180	82	6.0	73	02F30C3106AAF
1/8	1/8	3.18	.21	0.18	0	40	2.76	40	2.76	40	2.76	180	82	6.0	73	02F30C3108AAF
1/4	1/16	1.59	.09	0.08	0	125	8.62	125	8.62	125	8.62	180	82	6.0	76	04F30C3104AAF
1/4	3/32	2.38	.12	0.10	0	150	10.34	150	10.34	150	10.34	200	93	11.0	76	04F30C3106ACF
1/4	1/8	3.18	.31	0.27	0	85	5.86	85	5.86	85	5.86	200	93	11.0	76	04F30C3108ACF

DIRECT ACTING STAINLESS STEEL VALVES— NORMALLY OPEN (PRESSURE AT 3, ENERGIZE TO CLOSE), NBR SEALS

DC VALVE SPECIFICATIONS

NPT Pipe Size	Orifice Diameter		Flow Factor		Operating Pressure Differential						Max. Temp.		AC Watt	Const. Ref.	Valve Part Number	
	inch	mm	Cv	Kv	Min. (PSI/Bar)	Max. (MOPD)			°F	°C						
						Air, Inert Gas (PSI/Bar)	Water (PSI/Bar)	Light Oil 300SSU (PSI/Bar)								
1/8	3/64	1.19	.06	0.05	0	200	13.79	200	13.79	200	13.79	180	82	6.0	73	02F30C3103AAF
1/8	1/16	1.59	.09	0.08	0	125	8.62	125	8.62	125	8.62	180	82	6.0	73	02F30C3104AAF
1/8	3/32	2.38	.12	0.10	0	100	6.90	100	6.90	100	6.90	180	82	6.0	73	02F30C3106AAF
1/8	1/8	3.18	.21	0.18	0	40	2.76	40	2.76	40	2.76	180	82	6.0	73	02F30C3108AAF
1/4	1/16	1.59	.09	0.08	0	125	8.62	125	8.62	125	8.62	180	82	6.0	76	04F30C3104AAF
1/4	3/32	2.38	.12	0.10	0	150	10.34	140	9.66	140	9.66	200	93	11.0	76A	04F30C3106ACF
1/4	1/8	3.18	.31	0.27	0	70	4.83	70	4.83	70	4.83	200	93	11.0	76A	04F30C3108ACF

DIRECT ACTING STAINLESS STEEL VALVES— UNIVERSAL (PRESSURE AT ANY PORT), NBR SEALS

AC VALVE SPECIFICATIONS

NPT Pipe Size	Orifice Diameter		Flow Factor		Operating Pressure Differential						Max. Temp.		AC Watt	Const. Ref.	Valve Part Number	
	inch	mm	Cv	Kv	Min. (PSI/Bar)	Max. (MOPD)			°F	°C						
						Air, Inert Gas (PSI/Bar)	Water (PSI/Bar)	Light Oil 300SSU (PSI/Bar)								
1/8	3/64	1.19	.06	0.05	0	175	12.07	175	12.07	175	12.07	140	60	10.2	73	02F30U3103ABF
1/8	1/16	1.59	.09	0.08	0	100	6.90	100	6.90	100	6.90	180	82	10.2	73	02F30U3104ABF
1/8	3/32	2.38	.12	0.10	0	50	3.45	50	3.45	50	3.45	180	82	6.0	73	02F30U3106AAF
1/8	1/8	3.18	.21	0.18	0	30	2.07	30	2.07	30	2.07	180	82	10.2	73	02F30U3108ABF
1/4	1/16	1.59	.09	0.08	0	100	6.90	100	6.90	100	6.90	180	82	10.2	76	04F30U3104ABF
1/4	3/32	2.38	.12	0.10	0	100	6.90	100	6.90	100	6.90	200	93	16.0	76A	04F30U3106ADF
1/4	1/8	3.18	.31	0.27	0	50	3.45	50	3.45	50	3.45	200	93	16.0	76A	04F30U3108ADF

DIRECT ACTING STAINLESS STEEL VALVES— NORMALLY CLOSED (PRESSURE AT 2, ENERGIZE TO OPEN), NBR SEALS

DC VALVE SPECIFICATIONS

NPT Pipe Size	Orifice Diameter		Flow Factor		Operating Pressure Differential						Max. Temp.		AC Watt	Const. Ref.	Valve Part Number	
	inch	mm	Cv	Kv	Min. (PSI/Bar)	Max. (MOPD)			°F	°C						
						Air, Inert Gas (PSI/Bar)	Water (PSI/Bar)	Light Oil 300SSU (PSI/Bar)								
1/8	3/64	1.19	.06	0.05	0	200	13.79	200	13.79	200	13.79	120	49	9.5	73	02F30C3103A1F
1/8	1/16	1.59	.09	0.08	0	125	8.62	125	8.62	125	8.62	120	49	9.5	73	02F30C3104A1F
1/8	3/32	2.38	.12	0.10	0	100	6.90	100	6.90	100	6.90	120	49	9.5	73	02F30C3106A1F
1/8	1/8	3.18	.21	0.18	0	40	2.76	40	2.76	40	2.76	120	49	9.5	73	02F30C3108A1F
1/4	1/16	1.59	.09	0.08	0	125	8.62	125	8.62	125	8.62	1120	604	9.5	76	04F30C3104A1F
1/4	3/32	2.38	.12	0.10	0	115	7.93	115	7.93	115	7.93	150	66	11.5	76A	04F30C3106A3F
1/4	1/8	3.18	.31	0.27	0	60	4.14	60	4.14	60	4.14	150	66	11.5	76A	04F30C3108A3F

DIRECT ACTING STAINLESS STEEL VALVES— NORMALLY OPEN (PRESSURE AT 3, ENERGIZE TO CLOSE), NBR SEALS

DC VALVE SPECIFICATIONS

NPT Pipe Size	Orifice Diameter		Flow Factor		Min. (PSI/Bar)	Operating Pressure Differential						Max. Temp.		AC Watt	Const. Ref.	Valve Part Number
	inch	mm	Cv	Kv		Max. (MOPD)						°F	°C			
						Air, Inert Gas (PSI/Bar)		Water (PSI/Bar)		Light Oil 300SSU (PSI/Bar)						
1/8	3/64	1.19	.06	0.05	0	200	13.79	200	13.79	200	13.79	120	49	9.5	73	02F3003103A1F
1/8	1/16	1.59	.09	0.08	0	125	8.62	125	8.62	125	8.62	120	49	9.5	73	02F3003104A1F
1/8	3/32	2.38	.12	0.10	0	100	6.90	100	6.90	100	6.90	120	49	9.5	73	02F3003106A1F
1/8	1/8	3.18	.21	0.18	0	40	2.76	40	2.76	40	2.76	120	49	9.5	73	02F3003108A1F
1/4	1/16	1.59	.09	0.08	0	125	8.62	125	8.62	125	8.62	120	49	9.5	76	04F3003104A1F
1/4	3/32	2.38	.12	0.10	0	100	6.90	100	6.90	100	6.90	150	66	11.5	76A	04F3003106A3F
1/4	1/8	3.18	.31	0.27	0	55	3.79	55	3.79	55	3.79	150	66	11.5	76A	04F3003108A3F

DIRECT ACTING STAINLESS STEEL VALVES—UNIVERSAL (PRESSURE AT ANY PORT), NBR SEALS

DC VALVE SPECIFICATIONS

NPT Pipe Size	Orifice Diameter		Flow Factor		Min. (PSI/Bar)	Operating Pressure Differential						Max. Temp.		AC Watt	Const. Ref.	Valve Part Number
	inch	mm	Cv	Kv		Max. (MOPD)						°F	°C			
						Air, Inert Gas (PSI/Bar)		Water (PSI/Bar)		Light Oil 300SSU (PSI/Bar)						
1/8	3/64	1.19	.06	0.05	0	125	8.62	125	8.62	125	8.62	120	49	9.5	73	02F30U3103A1F
1/8	1/16	1.59	.09	0.08	0	65	4.48	65	4.48	65	4.48	120	49	9.5	73	02F30U3104A1F
1/8	3/32	2.38	.12	0.10	0	50	3.45	50	3.45	50	3.45	120	49	9.5	73	02F30U3106A1F
1/8	1/8	3.18	.21	0.18	0	20	1.38	20	1.38	20	1.38	120	49	9.5	73	02F30U3108A1F
1/4	1/16	1.59	.09	0.08	0	65	4.48	65	4.48	65	4.48	120	49	9.5	76	04F30U3104A1F
1/4	3/32	2.38	.12	0.10	0	60	4.14	60	4.14	60	4.14	150	66	11.5	76A	04F30U3106A3F
1/4	1/8	3.18	.31	0.27	0	25	1.72	25	1.72	25	1.72	150	66	11.5	76A	04F30U3108A3F

DRAWINGS

Drawing 73 Drawing 76 Drawing 76A			
A	1	1	23/32
B	2 7/8	2 7/8	3
C	1 11/16	1 11/16	125/32
D	23/32	23/32	7/8
E	1 5/16	1 5/16	1 17/32
F	1 3/16	1 1/2	1 1/2
G	1 9/32	23/32	3/4
H	1 9/32	1 9/32	1 11/16
J	2 1/8	2 1/8	2 23/32
K	1 9/16	1 9/16	1 13/16

#73, 76, 76A

Drawing 74 Drawing 75		
A	3 9/32	3
B	2 1/16	125/32
C	23/32	7/8
D	1 5/16	1 17/32
E	1 21/32	1 11/16
F	2 1/2	2 23/32
G	1 9/16	1 13/16

#74, 75

To choose a solenoid for your valve, refer to the AC or DC chart found on the flap attached to the back cover of this catalog.

GOLD RING Series 34 High Flow Three-Way Internally Piloted Diaphragm Valves

SPECIFICATIONS

Mechanical Characteristics

Standard Materials of Construction

- Body-Brass
- Seals-NBR
- Plunger and Pole Piece-430FR Stainless Steel
- Plunger Tube-305 Stainless Steel
- Springs-302 Stainless Steel
- Shading Coil-Copper (Brass Bodies)
- Disc Holder-Celcon

Compatible Fluids

- Series 34 valves are ideal for control of a variety of media including gases and water

Electrical Characteristics

Voltages

- DC-6, 12, 24, 120, 125 (other voltages available upon request)
- AC-24/60, 110/120-50/60, 220/240-50/60, 440/480-50/60

Coil

- Class F Standard, Class H Available

Miscellaneous

Temperature Ratings (media as listed)

- AC Voltages: 180°F max.
- DC Voltages: 180°F max.
- Ambient: 32-77°F (standard)
- For temperature variations, consult the factory.

Installation

- For proper operation, valves should be mounted vertical and upright. Product and mounting dimensions shown are nominal. For certified dimensions, consult factory.

Applications

- Used in a variety of applications including: Pilots, Cylinders, Compressor Unloaders and Turbines.

Operating Specifications

- Normally Closed-energize to pressurize operating device. De-energized to exhaust operating device.
- Normally Open-energize to exhaust operating device. De-energized to pressurize operating device.

PILOTED DIAPHRAGM BRASS VALVES-NORMALLY CLOSED (ENERGIZE TO OPEN), NBR SEALS

AC VALVE SPECIFICATIONS

NPT Pipe Size	Orifice Diameter		Flow Factor		Operating Pressure Differential						Max. Temp.		AC Watt	Const. Ref.	Valve Part Number		
	inch	mm	Cv	Kv	Min. (PSI/Bar)	Max. (MOPD)			°F	°C							
						Air, Inert Gas (PSI/Bar)	Water (PSI/Bar)	Light Oil 300SSU (PSI/Bar)									
3/8	5/8	15.88	3.00	2.59	10	0.69	125	8.62	125	8.62	125	8.62	180	82	6.0	77	06F34C2140AAF
3/8	5/8	15.88	3.00	2.59	10	0.69	250	17.24	250	17.24	250	17.24	180	82	16.7	78	06F34C2140ADF
1/2	5/8	15.88	4.00	3.45	10	0.69	125	8.62	125	8.62	125	8.62	180	82	6.0	77	08F34C2140AAF
1/2	5/8	15.88	4.00	3.45	10	0.69	250	17.24	250	17.24	250	17.24	180	82	16.7	78	08F34C2140ADF
3/4	5/8	15.88	5.00	4.31	10	0.69	125	8.62	125	8.62	125	8.62	180	82	6.0	79	12F34C2140AAF
3/4	5/8	15.88	5.00	4.31	10	0.69	250	17.24	250	17.24	250	17.24	180	82	16.7	80	12F34C2140ADF

PILOTED DIAPHRAGM BRASS VALVES-NORMALLY OPEN (ENERGIZE TO CLOSE), NBR SEALS

AC VALVE SPECIFICATIONS

NPT Pipe Size	Orifice Diameter		Flow Factor		Operating Pressure Differential						Max. Temp.		AC Watt	Const. Ref.	Valve Part Number		
	inch	mm	Cv	Kv	Min. (PSI/Bar)	Max. (MOPD)			°F	°C							
						Air, Inert Gas (PSI/Bar)	Water (PSI/Bar)	Light Oil 300SSU (PSI/Bar)									
3/8	5/8	15.88	3.00	2.59	10	0.69	225	15.52	225	15.52	225	15.52	180	82	11.0	81	06F34O2140ACF
1/2	5/8	15.88	4.00	3.45	10	0.69	225	15.52	225	15.52	225	15.52	180	82	11.0	81	08F34O2140ACF
3/4	5/8	15.88	5.00	4.31	10	0.69	225	15.52	225	15.52	225	15.52	180	82	11.0	82	12F34O2140ACF

PILOTED DIAPHRAGM BRASS VALVES-NORMALLY CLOSED (ENERGIZE TO OPEN), NBR SEALS

DC VALVE SPECIFICATIONS

NPT Pipe Size	Orifice Diameter		Flow Factor		Operating Pressure Differential						Max. Temp.		AC Watt	Const. Ref.	Valve Part Number		
	inch	mm	Cv	Kv	Min. (PSI/Bar)	Max. (MOPD)			°F	°C							
						Air, Inert Gas (PSI/Bar)	Water (PSI/Bar)	Light Oil 300SSU (PSI/Bar)									
3/8	5/8	15.88	3.00	2.59	10	0.69	125	8.62	125	8.62	125	8.62	120	49	9.5	77	06F34C2140A1F
3/8	5/8	15.88	3.00	2.59	10	0.69	250	17.24	250	17.24	250	17.24	180	82	11.5	78	06F34C2140A3F
1/2	5/8	15.88	4.00	3.45	10	0.69	125	8.62	125	8.62	125	8.62	120	49	9.5	77	08F34C2140A1F
1/2	5/8	15.88	4.00	3.45	10	0.69	250	17.24	250	17.24	250	17.24	180	82	11.5	78	08F34C2140A3F
3/4	5/8	15.88	5.00	4.31	10	0.69	125	8.62	125	8.62	125	8.62	120	49	9.5	79	12F34C2140A1F
3/4	5/8	15.88	5.00	4.31	10	0.69	250	17.24	250	17.24	250	17.24	180	82	11.5	80	12F34C2140A3F

PILOTED DIAPHRAGM BRASS VALVES – NORMALLY OPEN (ENERGIZE TO CLOSE), NBR SEALS

DC VALVE SPECIFICATIONS

NPT Pipe Size	Orifice Diameter		Flow Factor		Operating Pressure Differential								Max. Temp.		AC Watt	Const. Ref.	Valve Part Number
	inch	mm	Cv	Kv	Min. (PSI/Bar)	Max. (MOPD)			°F	°C							
						Air, Inert Gas (PSI/Bar)	Water (PSI/Bar)	Light Oil 300SSU (PSI/Bar)									
3/8	5/8	15.88	3.00	2.59	10	0.69	225	15.52	225	15.52	225	15.52	180	82	11.5	81	06F34O2140A3F
1/2	5/8	15.88	4.00	3.45	10	0.69	225	15.52	225	15.52	225	15.52	180	82	11.5	81	08F34O2140A3F
3/4	5/8	15.88	5.00	4.31	10	0.69	225	15.52	225	15.52	225	15.52	180	82	11.5	82	12F34O2140A3F

DRAWINGS

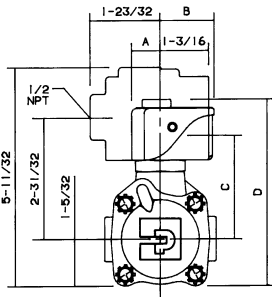

	Drawing 77	Drawing 78	Drawing 81
A	23/32	7/8	7/8
B	1 5/16	1 17/32	1 17/32
C	2 17/32	2 19/32	2 7/16
D	4 9/16	4 25/32	4 25/32
E	1 9/16	1 13/16	1 13/16

Explosion-Proof/Watertight
Shown in Outline

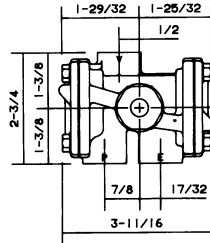
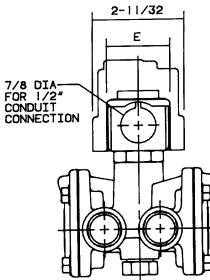

#77, 78, 81

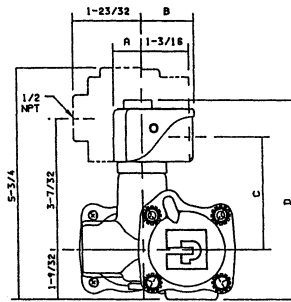

	Drawing 79	Drawing 80	Drawing 82
A	23/32	7/8	7/8
B	1 5/16	1 17/32	1 17/32
C	2 25/32	2 7/8	2 3/4
D	4 15/16	5 5/32	5 5/32
E	1 9/16	1 13/16	1 13/16

Explosion-Proof/Watertight
Shown in Outline

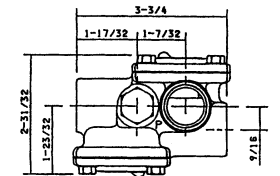
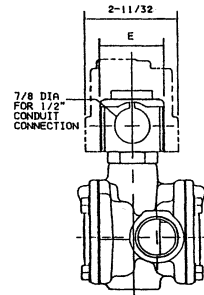

#79, 80, 82

To choose a solenoid for your valve, refer to the AC or DC chart on the flap attached to the back cover of this catalog.

GOLD RING Series 35, 38 Quick Exhaust Three-Way Valves

SPECIFICATIONS

Mechanical Characteristics

Standard Materials of Construction

- Body-Series 35: Brass, 303 Stainless Steel; Series 38: Brass
- Seals-NBR or FKM as listed
- Plunger and Pole Piece-430FR Stainless Steel
- Plunger Tube-305 Stainless Steel
- Springs-302 Stainless Steel
- Shading Coil-Copper (Brass Bodies), Silver (Stainless Steel Bodies)
- Disc Holder-Cellon

Electrical Characteristics

Voltages

- DC-6, 12, 24, 120, 125 (other voltages available upon request)
- AC-24/60, 110/120-50/60, 220/240-50/60, 440/480-50/60

Coil

- Class F Standard, Class H Available

Agency Approvals

- Standard valves with general purpose or explosion proof solenoid enclosures are UL Listed and CSA Certified. For details, consult factory.

Miscellaneous

Temperature Ratings (media as listed)

- AC Voltages: 180°F max.
- DC Voltages: 120°F max.
- Ambient: 32-77°F (standard)
- For temperature variations, consult the factory.

Applications

- Designed to provide large exhaust orifice for quick exhaust. Increased exhaust capacity significantly reduces cycle time for single acting spring return actuators.

QUICK EXHAUST BRASS VALVES-NORMALLY CLOSED (PRESSURE AT 2, ENERGIZE TO OPEN), NBR SEALS

AC VALVE SPECIFICATIONS

NPT	Orifice Pressure		Orifice Exhaust		Pressure		Exhaust		Operating Pressure Differential				Max. Temp.		AC Watt	Const. Ref.	Valve Part Number				
	inch	mm	inch	mm	Cv	Kv	Cv	Kv	Max. (MOPD)				°F	°C							
									Min. (PSI/Bar)	Air, Inert Gas (PSI/Bar)	Water (PSI/Bar)	Light Oil 300SSU (PSI/Bar)									
1/4	3/32	2.38	1/4	6.35	.20	0.17	.73	0.15	5	0.34	150	10.34	150	10.34	95	6.55	180	82	11.0	84	04F35C1116ACF
1/4	9/32	7.14	11/32	8.73	.80	0.69	1.20	0.59	10	0.69	200	13.79	200	13.79	200	13.79	180	82	6.0	85	04F38C1122AAF
3/8	9/32	7.14	11/32	8.73	.80	0.69	1.20	0.59	10	0.69	200	13.79	200	13.79	200	13.79	180	82	6.0	85	06F38C1122AAF

QUICK EXHAUST BRASS VALVES-NORMALLY OPEN (PRESSURE AT 3, ENERGIZE TO CLOSE), NBR SEALS

AC VALVE SPECIFICATIONS

NPT	Orifice Pressure		Orifice Exhaust		Pressure		Exhaust		Operating Pressure Differential				Max. Temp.		AC Watt	Const. Ref.	Valve Part Number				
	inch	mm	inch	mm	Cv	Kv	Cv	Kv	Max. (MOPD)				°F	°C							
									Min. (PSI/Bar)	Air, Inert Gas (PSI/Bar)	Water (PSI/Bar)	Light Oil 300SSU (PSI/Bar)									
1/4	3/32	2.38	1/4	6.35	.20	0.17	.73	0.63	5	0.34	160	11.03	160	11.03	95	6.55	180	82	11.0	84	04F35O1116ACF
1/4	9/32	7.14	11/32	8.73	.80	0.69	1.20	1.03	10	0.69	200	13.79	200	13.79	200	13.79	180	82	6.0	85	04F38O1122ACF
3/8	9/32	7.14	11/32	8.73	.80	0.69	1.20	1.03	10	0.69	200	13.79	200	13.79	200	13.79	180	82	6.0	85	06F38O1122ACF

QUICK EXHAUST BRASS VALVES-UNIVERSAL (PRESSURE AT 2 OR 3), NBR SEALS

AC VALVE SPECIFICATIONS

NPT	Orifice Pressure		Orifice Exhaust		Pressure		Exhaust		Operating Pressure Differential				Max. Temp.		AC Watt	Const. Ref.	Valve Part Number				
	inch	mm	inch	mm	Cv	Kv	Cv	Kv	Max. (MOPD)				°F	°C							
									Min. (PSI/Bar)	Air, Inert Gas (PSI/Bar)	Water (PSI/Bar)	Light Oil 300SSU (PSI/Bar)									
1/4	3/32	2.38	1/4	6.35	.20	0.17	.73	0.63	5	0.34	80	5.52	80	5.52	50	3.45	180	82	11.0	84	04F35U1116ACF

QUICK EXHAUST STAINLESS STEEL VALVES-NORMALLY CLOSED (PRESSURE AT 2, ENERGIZE TO OPEN), NBR SEALS

AC VALVE SPECIFICATIONS

NPT	Orifice Pressure		Orifice Exhaust		Pressure		Exhaust		Operating Pressure Differential				Max. Temp.		AC Watt	Const. Ref.	Valve Part Number				
	inch	mm	inch	mm	Cv	Kv	Cv	Kv	Max. (MOPD)				°F	°C							
									Min. (PSI/Bar)	Air, Inert Gas (PSI/Bar)	Water (PSI/Bar)	Light Oil 300SSU (PSI/Bar)									
1/4	3/32	2.38	1/4	6.35	.20	0.17	.73	0.63	5	0.34	150	10.34	150	10.34	95	6.55	180	82	11.0	84	04F35C3116ACF

QUICK EXHAUST STAINLESS STEEL VALVES– NORMALLY OPEN (PRESSURE AT 3, ENERGIZE TO CLOSE), NBR SEALS

AC VALVE SPECIFICATIONS

NPT	Orifice Pressure		Orifice Exhaust		Pressure		Exhaust		Operating Pressure Differential				Max. Temp.		AC Watt	Const. Ref.	Valve Part Number				
	inch	mm	inch	mm	Cv	Kv	Cv	Kv	Max. (MOPD)				°F	°C							
									Min. (PSI/Bar)	Air, Inert Gas (PSI/Bar)	Water (PSI/Bar)	Light Oil 300SSU (PSI/Bar)									
1/4	3/32	2.38	1/4	6.35	.20	0.17	.73	0.63	5	0.34	160	11.03	160	11.03	95	6.55	180	82	11.0	84	04F35O3116ACF

QUICK EXHAUST STAINLESS STEEL VALVES– UNIVERSAL (PRESSURE AT 2 OR 3), NBR SEALS

AC VALVE SPECIFICATIONS

NPT	Orifice Pressure		Orifice Exhaust		Pressure		Exhaust		Operating Pressure Differential				Max. Temp.		AC Watt	Const. Ref.	Valve Part Number				
	inch	mm	inch	mm	Cv	Kv	Cv	Kv	Max. (MOPD)				°F	°C							
									Min. (PSI/Bar)	Air, Inert Gas (PSI/Bar)	Water (PSI/Bar)	Light Oil 300SSU (PSI/Bar)									
1/4	3/32	2.38	1/4	6.35	.20	0.17	.73	0.63	5	0.34	80	5.52	80	5.52	50	3.45	180	82	11.0	84	04F35U3116ACF

QUICK EXHAUST BRASS VALVES–NORMALLY CLOSED (PRESSURE AT 2, ENERGIZE TO OPEN), NBR SEALS

DC VALVE SPECIFICATIONS

NPT	Orifice Pressure		Orifice Exhaust		Pressure		Exhaust		Operating Pressure Differential				Max. Temp.		AC Watt	Const. Ref.	Valve Part Number				
	inch	mm	inch	mm	Cv	Kv	Cv	Kv	Max. (MOPD)				°F	°C							
									Min. (PSI/Bar)	Air, Inert Gas (PSI/Bar)	Water (PSI/Bar)	Light Oil 300SSU (PSI/Bar)									
1/4	3/32	2.38	1/4	6.35	.20	0.17	.73	0.63	5	0.34	115	7.93	115	7.93	60	4.14	104	40	11.5	84	04F35C1116A3F
1/4	9/32	7.14	11/32	8.73	.80	0.69	1.20	1.03	10	0.69	200	13.79	200	13.79	200	13.79	120	49	11.5	85	04F38C1122A3F
3/8	9/32	7.14	11/32	8.73	.80	0.69	1.20	1.03	10	0.69	200	13.79	200	13.79	200	13.79	120	49	11.5	85	06F38C1122A1F

QUICK EXHAUST BRASS VALVES–NORMALLY OPEN (PRESSURE AT 3, ENERGIZE TO CLOSE), NBR SEALS

DC VALVE SPECIFICATIONS

NPT	Orifice Pressure		Orifice Exhaust		Pressure		Exhaust		Operating Pressure Differential				Max. Temp.		AC Watt	Const. Ref.	Valve Part Number				
	inch	mm	inch	mm	Cv	Kv	Cv	Kv	Max. (MOPD)				°F	°C							
									Min. (PSI/Bar)	Air, Inert Gas (PSI/Bar)	Water (PSI/Bar)	Light Oil 300SSU (PSI/Bar)									
1/4	3/32	2.38	1/4	6.35	.20	0.17	.73	0.63	5	0.34	100	6.90	100	6.90	50	3.45	104	40	11.5	84	04F35O1116A3F
1/4	9/32	7.14	11/32	8.73	.80	0.69	1.20	1.03	10	0.69	200	13.79	200	13.79	200	13.79	120	49	11.5	85	04F38O1122A3F
3/8	9/32	7.14	11/32	8.73	.80	0.69	1.20	1.03	10	0.69	200	13.79	200	13.79	200	13.79	120	49	11.5	85	06F38O1122A3F

QUICK EXHAUST BRASS VALVES– UNIVERSAL (PRESSURE AT 2 OR 3), NBR SEALS

DC VALVE SPECIFICATIONS

NPT	Orifice Pressure		Orifice Exhaust		Pressure		Exhaust		Operating Pressure Differential				Max. Temp.		AC Watt	Const. Ref.	Valve Part Number				
	inch	mm	inch	mm	Cv	Kv	Cv	Kv	Max. (MOPD)				°F	°C							
									Min. (PSI/Bar)	Air, Inert Gas (PSI/Bar)	Water (PSI/Bar)	Light Oil 300SSU (PSI/Bar)									
1/4	3/32	2.38	1/4	6.35	.20	0.17	.73	0.63	5	0.34	60	4.14	60	4.14	30	2.07	104	40	11.5	84	04F35U1116A3F

QUICK EXHAUST STAINLESS STEEL VALVES– NORMALLY CLOSED (PRESSURE AT 2, ENERGIZE TO OPEN), NBR SEALS

DC VALVE SPECIFICATIONS

NPT	Orifice Pressure		Orifice Exhaust		Pressure		Exhaust		Operating Pressure Differential				Max. Temp.		AC Watt	Const. Ref.	Valve Part Number				
	inch	mm	inch	mm	Cv	Kv	Cv	Kv	Max. (MOPD)				°F	°C							
									Min. (PSI/Bar)	Air, Inert Gas (PSI/Bar)	Water (PSI/Bar)	Light Oil 300SSU (PSI/Bar)									
1/4	3/32	2.38	1/4	6.35	.20	0.17	.73	0.63	5	0.34	115	7.93	115	7.93	60	4.14	104	40	11.5	84	04F35C3116A3F

To choose a solenoid for your valve, refer to the AC or DC chart found on the flap attached to the back cover of this catalog.

Series 35, 38 Quick Exhaust Three-Way Valves

QUICK EXHAUST STAINLESS STEEL VALVES— NORMALLY OPEN (PRESSURE AT 3, ENERGIZE TO CLOSE), NBR SEALS

DC VALVE SPECIFICATIONS

NPT	Orifice Pressure		Orifice Exhaust		Pressure		Exhaust		Operating Pressure Differential				Max. Temp.		AC Watt	Const. Ref.	Valve Part Number				
	inch	mm	inch	mm	Cv	Kv	Cv	Kv	Max. (MOPD)				°F	°C							
									Min. (PSI/Bar)	Air, Inert Gas (PSI/Bar)	Water (PSI/Bar)	Light Oil 300SSU (PSI/Bar)									
1/4	3/32	2.38	1/4	6.35	.20	0.17	.73	0.63	5	0.34	100	6.90	100	6.90	50	3.45	104	40	11.5	84	04F35O3116A3F

QUICK EXHAUST STAINLESS STEEL VALVES—UNIVERSAL (PRESSURE AT 2 OR 3), NBR SEALS

AC VALVE SPECIFICATIONS

NPT	Orifice Pressure		Orifice Exhaust		Pressure		Exhaust		Operating Pressure Differential				Max. Temp.		AC Watt	Const. Ref.	Valve Part Number				
	inch	mm	inch	mm	Cv	Kv	Cv	Kv	Max. (MOPD)				°F	°C							
									Min. (PSI/Bar)	Air, Inert Gas (PSI/Bar)	Water (PSI/Bar)	Light Oil 300SSU (PSI/Bar)									
1/4	3/32	2.38	1/4	6.35	.20	0.17	.73	0.63	5	0.34	80	5.52	80	5.52	50	3.45	180	82	11.0	84	04F35U1116ACF

DRAWINGS

	NORMALLY CLOSED	NORMALLY OPEN
A	1-21/32	1-23/32
B	3-33/64	3-37/64
C	23/32	7/8
D	1-5/16	1-17/32
E	1-9/16	1-13/16

#84

#85

Three-Way Solenoid Valves

To choose a solenoid for your valve, refer to the AC or DC chart on the flap found on the back cover of this catalog.

Four-Way Valve Contents

Gold Ring Four-Way Valve Specifications.....	43-45
Series 48	44-45



GOLD RING Series 48 Two Position Four-Way Valves

SPECIFICATIONS

Mechanical Characteristics

Standard Materials of Construction

- Body-Brass
- Seals-NBR
- Plunger and Pole Piece-430FR Stainless Steel
- Plunger Tube-305 Stainless Steel
- Springs-302 Stainless Steel
- Shading Coil-Copper (Brass Bodies)
- Disc Holder-Celcon

Compatible Fluids

- Series 48 valves are ideal for control of a variety of media including gases, fluid, light oils and other clean flowing media compatible with brass.

Electrical Characteristics

Voltages

- DC-6, 12, 24, 120, 125 (other voltages available upon request)

- AC-24/60, 110/120-50/60, 220/240-50/60, 440/480-50/60

Coil

- Class F Standard, Class H Available

Agency Approvals

- Standard valves with general purpose or explosion proof solenoid enclosures are UL Listed and CSA Certified. For details, consult factory.

Miscellaneous

Temperature Ratings (media as listed)

- AC Voltages: 180°F max.
- DC Voltages: 104°F max.
- Ambient: 32-77°F (standard)
- For temperature variations, consult the factory.

Installation

- For proper operation, valves should be mounted vertical and upright. Product and mounting dimensions shown are nominal. For certified dimensions, consult factory.

Applications

- Used in a variety of applications including: Pilots, Air Vises, Air Motors and Dampers.

Operating Specifications

- De-energized-Pressure to "A"; "B" to exhaust.
- Energized-Pressure to "B"; "A" to exhaust.
- Avoid exhaust flow restriction.

BRASS VALVES – UNIVERSAL (PRESSURE AT P), NBR SEALS

AC VALVE SPECIFICATIONS

NPT Pipe Size	Orifice Diameter		Flow Factor		Operating Pressure Differential						Max. Temp.		AC Watt	Const. Ref.	Valve Part Number		
	inch	mm	Cv	Kv	Min. (PSI/Bar)	Max. (MOPD)						°F				°C	
						Air, Inert Gas (PSI/BAR)		Water (PSI/Bar)		Light Oil 300SSU (PSI/BAR)							
1/4	1/16	1.59	.09	0.08	10	0.69	150	10.34	150	10.34	150	10.34	180	82.22	11.0	83	04F48S2106ACF
	3/32	2.38	.09	0.08													

BRASS VALVES – UNIVERSAL (PRESSURE AT P), NBR SEALS

DC VALVE SPECIFICATIONS

NPT Pipe Size	Orifice Diameter		Flow Factor		Operating Pressure Differential						Max. Temp.		AC Watt	Const. Ref.	Valve Part Number		
	inch	mm	Cv	Kv	Min. (PSI/Bar)	Max. (MOPD)						°F				°C	
						Air, Inert Gas (PSI/BAR)		Water (PSI/Bar)		Light Oil 300SSU (PSI/BAR)							
1/4	1/16	1.59	.09	0.08	10	0.69	100	6.90	100	6.90	100	6.90	104	40	11.2	83	04F48S2106A3F
	3/32	2.38	.09	0.08													

DRAWINGS

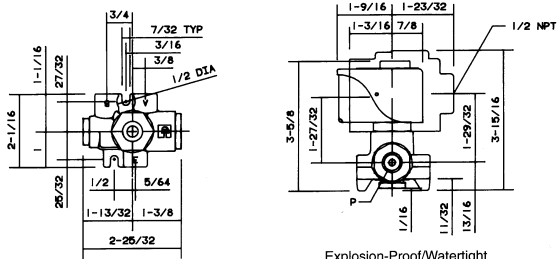

Explosion-Proof/Watertight
Shown in Outline

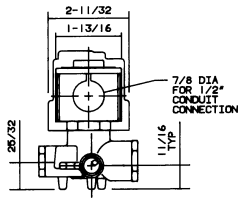

#83

To choose a solenoid for your valve, refer to the AC or DC chart found on the flap attached to the back cover of this catalog.

Specialty Valve Contents



Gold Ring Specialty Specifications	46-51
Cryogenic Two-Way Specifications	47-48
Vacuum Service Two-Way Specifications.....	49
Long Life, Quiet Operating Specifications	50-51

GOLD RING Two-Way Cryogenic Service and Liquid CO₂ Valves

SPECIFICATIONS

Mechanical Characteristics

Standard Materials of Construction

- Body-Brass or 303 Stainless Steel as listed
- Seals-PTFE, Urethane or PCTFE, Lead-Clad Copper in 1/8-3/8-inch NPT Valves
- Plunger and Pole Piece-430FR or 49FM Stainless Steel
- Plunger Tube-305 Stainless Steel
- Springs-302 Stainless Steel
- Shading Coil-Copper (Brass Bodies), Silver (Stainless Steel Bodies)
- Disc Holder (Normally Open Valves)-303 Stainless Steel

Compatible Fluids

- Cryogenic Service solenoid valves are designed to withstand the severe temperatures associated with controlling cryogenic fluids at temperatures to -320°F(-196°C). Due to the sealing materials available for use at extremely low temperatures, slight leakage can be expected. Specially designed valves for bubble-tight shut-off are also available.

Electrical Characteristics

Voltages

- AC-24/60, 110/120-50/60, 220/240-50/60, 440/480-50/60 (other voltages available upon request)

Coil

- Class F Standard, Class H Available

Miscellaneous

Temperature Ratings (media as listed)

- AC Voltages: 150°F max.
- DC Voltages: -320°F max.
- Ambient: 32-77°F (standard)
- For temperature variations, consult the factory.

Installation

- Important: Use downstream piping with an inside diameter no larger than the valve orifice to prevent expanding CO₂ from freezing the valve. Consult factory for dimensional information.
- Valves are supplied with a mounting bracket for direct mounting. A 1/8-inch NPT port is supplied for remote mounting.

BRASS VALVES—NORMALLY CLOSED PTFE SEALS

AC VALVE SPECIFICATIONS

NPT Pipe Size	Orifice Diameter		Flow Factor		Operating Pressure Differential				Min. Temp.		Max. Temp.		AC Watt	Valve Part Number	
	inch	mm	Cv	Kv	Min. (PSI/Bar)	Max. (MOPD)		°F	°C	°F	°C				
						Cryogenic Fluids (PSI/Bar)	Liquid CO ₂								
1/8	1/8	3.18	.35	0.30	0	0.00	200	13.79	-	-320	-196	150	66	16.0	02F20C1408BDF-L
1/4	7/32	5.56	.56	0.48	0	0.00	70	4.83	-	-320	-196	150	66	16.0	04F20C2414BDF-L
1/4	9/32	7.14	.70	0.60	0	0.00	35	2.41	-	-320	-196	150	66	16.0	04F20C2418BDF-L
3/8	7/32	5.56	.56	0.48	0	0.00	70	4.83	-	-320	-196	150	66	16.0	06F20C2414BDF-L
3/8	9/32	7.14	.70	0.60	0	0.00	35	2.41	-	-320	-196	150	66	11.0	06F20C2418BDF-L
1/2	5/8	15.88	3.8	3.28	0	0.00	150	13.79	-	-320	-196	150	66	11.0	08FH6C2440CCF-L
1	1	25.40	13.5	11.64	10	0.69	200	13.79	-	-320	-196	150	66	11.0	16F26C2464BCF-L

BRASS VALVES—NORMALLY CLOSED, STAINLESS STEEL SEAT AND PCTFE DISC FOR BUBBLE-TIGHT SHUT-OFF

AC VALVE SPECIFICATIONS

NPT Pipe Size	Orifice Diameter		Flow Factor		Operating Pressure Differential				Min. Temp.		Max. Temp.		AC Watt	Valve Part Number
	inch	mm	Cv	Kv	Min. (PSI/Bar)	Max. (MOPD)		°F	°C	°F	°C			
						Cryogenic Fluids (PSI/Bar)	Liquid CO ₂							
1/4	3/32	2.38	.17	0.15	0	500	34.48	-	-320	-196	150	66	16.0	04F20C2K06ADF-L
1/4	9/32	7.14	.70	0.60	0	80	5.52	-	-320	-196	150	66	16.0	04F20C2K18ADF-L

BRASS VALVES—NORMALLY OPEN, STAINLESS STEEL SEAT AND PCTFE DISC FOR BUBBLE-TIGHT SHUT-OFF

AC VALVE SPECIFICATIONS

NPT Pipe Size	Orifice Diameter		Flow Factor		Operating Pressure Differential				Min. Temp.		Max. Temp.		AC Watt	Valve Part Number
	inch	mm	Cv	Kv	Min. (PSI/Bar)	Max. (MOPD)		°F	°C	°F	°C			
						Cryogenic Fluids (PSI/Bar)	Liquid CO ₂							
1/4	9/32	7.14	.70	0.60	0	40	2.76	-	-320	-195.5555556	150	65.56	16.0	04F20O2K18ADF-L

To choose a solenoid for your valve, refer to the AC or DC chart found on the flap attached to the back cover of this catalog.

**Two-Way Cryogenic Service
and Liquid CO₂ Valves**

LIQUID CO₂ SERVICE STAINLESS STEEL VALVES – NORMALLY CLOSED, URETHANE SEALS

AC VALVE SPECIFICATIONS

NPT Pipe Size	Orifice Diameter		Flow Factor		Operating Pressure Differential			Min. Temp.		Max. Temp.		AC Watt	Valve Part Number	
	inch	mm	Cv	Kv	Min. (PSI/Bar)	Max. (MOPD)		°F	°C	°F	°C			
						Cryogenic Fluids (PSI/BAR)	Liquid CO ₂							
1/8	3/64	1.19	.06	0.05	0	-	1000	68.97	-75	59	120	49	10.2	02F20C3503ABF-43
1/8	3/32	2.38	.20	0.17	0	-	300	20.69	-75	59	120	49	10.2	02F20C3506ABF-43

For DC applications, consult factory.

Typical Cryogenic Temperatures

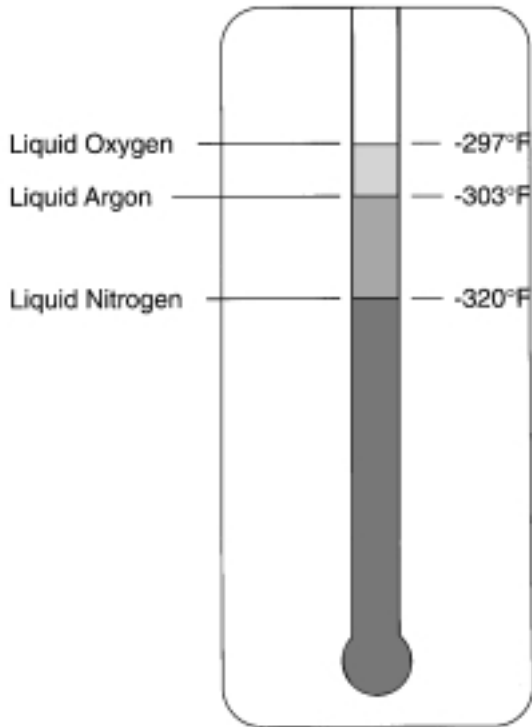

Ordering Information

Parker Gold Ring solenoid valves for cryogenic or liquid CO₂ service are available as complete valves only.

- 1.) Select the valve required by pipe size, C_v and pressure and temperature requirements.
- 2.) Select one enclosure, one coil termination and one voltage code from each column. Note: 18" leads are standard. 6" leads are standard with splice box enclosures. Screw and spade terminals are only available with open frame or submersible splice box enclosures.
- 3.) Complete the part number with suffix L or 43 as indicated in the table.
Example: 04F20C2418BDFGC05L.

GOLD RING Two-Way Low, Medium and High Vacuum Service Valves

SPECIFICATIONS

Mechanical Characteristics

Standard Materials of Construction

- Body-Brass
- Seals-Low and Medium Vacuum : NBR, High Vacuum: FKM
- Plunger and Pole Piece- 430FR Stainless Steel
- Plunger Tube-305 Stainless Steel
- Springs-302 Stainless Steel
- Shading Coil-Copper
- Disc Coil (Normally Open Valves)-Ryton

Compatibility

- Vacuum service solenoid valves are suitable for use with the following vacuum ranges as indicated in the specification table. Operating pressure differentials on some valves may render the valve unsuitable for certain vacuum applications. Verify pressure differential requirements before installing.

Low Vacuum

760 to 25 Torr (0 psi to 29 in. Hg)

Medium Vacuum

25 to 10⁻³ Torr (29 in. Hg to 1 micron)

High Vacuum

10⁻³ to 10⁻⁶ Torr (1 to 10-3 microns)

Electrical Characteristics

Voltages

- AC-24/60, 110/120-50/60, 220/240-50/60, 440/480-50/60 (other voltages available upon request)

Coil

- Class F Standard, Class H Available

Miscellaneous

Temperature Ratings (media as listed)

- AC Voltages: 180°F max.
- Ambient: 32-77°F (standard)
- For temperature variations, consult the factory.

Installation

- For proper operation, solenoid valves should be mounted vertical and upright. Dimensions are shown in the standard series section. Refer to the appropriate sections for nominal dimensions. For certified drawings, consult factory.

BRASS VALVES—NORMALLY CLOSED, NBR OR FKM SEALS

AC VALVE SPECIFICATIONS

NPT	Orifice Diameter		Flow Factor		Operating Pressure Differential			AC Watt	Low Vacuum to 29" Hg Valve Part No.	Med. Vac. to 10 ⁻³ Torr Add Suffix	High Vacuum to 10 ⁻⁶ Torr Valve Part No.
	inch	mm	Cv	Kv	Minimum (PSI/Bar)	Maximum (PSI/Bar)	Minimum (PSI/Bar)				
1/4	9/32	7.14	.96	0.83	0	15	1.03	6.0	04F20C2118AAF	S	04F20C2218AAF-V
3/8	5/16	7.94	1.40	1.21	0	15	1.03	6.0	06F20C2120AAF	S	06F20C2220AAF-V
1/2	7/16	11.11	2.80	2.41	0	15	1.03	16.0	08F20C2128ADF	S	08F20C2228ADF-V
3/4	3/4	19.05	5.00	4.31	0	4	0.28	16.0	12F20C2148ADF	S	12F20C2248ADF-V
3/4	3/4	19.05	5.00	4.31	0	15	1.03	11.0	12F23C2140ACF	S	12F23C2248ACF-V
1	1	25.40	12.2	10.52	0	15	1.03	16.0	16FH5C2164ADF	S	16FH5C2264ADF-V

BRASS VALVES—NORMALLY OPEN NBR OR FKM SEALS

AC VALVE SPECIFICATIONS

NPT	Orifice Diameter		Flow Factor		Operating Pressure Differential			AC Watt	Low Vacuum to 29" Hg Valve Part No.	Med. Vac. to 10 ⁻³ Torr Add Suffix	High Vacuum to 10 ⁻⁶ Torr Valve Part No.
	inch	mm	Cv	Kv	Minimum (PSI/Bar)	Maximum (PSI/Bar)	Minimum (PSI/Bar)				
3/8	5/8	15.88	3.00	2.59	0	15	1.03	11.0	06F23O2140ACF	S	06F23O2240ACF-V
1/2	5/8	15.88	4.00	3.45	0	15	1.03	11.0	08F23O2140ACF	S	08F23O2240ACF-V
3/4	3/4	19.05	5.00	4.31	0	15	1.03	11.0	12F23O2148ACF	S	12F23O2248ACF-V

For DC applications and stainless steel bodied valves, consult factory.

To choose a solenoid for your valve, refer to the AC or DC chart found on the flap attached to the back cover of this catalog.

GOLD RING

Long Life-Quiet Operating Two-Way, Three-Way and Four-Way Valves

SPECIFICATIONS

Mechanical Characteristics

Standard Materials of Construction

- Body-Brass
- Seals-NBR
- Plunger and Pole Piece-430FR Stainless Steel
- Plunger Tube-305 Stainless Steel
- Springs-302 Stainless Steel
- Shading Coil-Copper (Brass Bodies)
- Rider Rings-PTFE

Electrical Characteristics

Voltages

- AC-24/60, 110/120-50/60, 220/240-50/60, 440/480-50/60 (other voltages available upon request)

Coil

- Class F Standard

Miscellaneous

Temperature Ratings (media as listed)

- AC Voltages: 140°F max.
- Ambient: 32-77°F (standard)
- For temperature variations, consult the factory.

Installation

- Dimensions are shown in the standard series sections. Refer to the appropriate sections for nominal dimensions.

Applications

- The valves are ideal for applications where rapid cycling dictates the need for extended cycle life. Installations requiring quiet valves, such as office buildings, schools or hospitals, will also benefit from the valves. By eliminating metal to metal contact, wear is greatly reduced. AC hum and the typical opening impact click are also eliminated.

20 Million Cycle Life

TWO-WAY BRASS VALVES—NORMALLY CLOSED (ENERGIZE TO OPEN), NBR SEALS

AC VALVE SPECIFICATIONS

NPT Pipe Size	Orifice Diameter		Flow Factor		Operating Pressure Differential						Max. Temp.		AC Watt	Valve Part Number	
	inch	mm	Cv	Kv	Min. (PSI/Bar)	Max. (MOPD)			°F	°C					
						Air, Inert Gas (PSI/Bar)	Water (PSI/Bar)	Light Oil 300SSU (PSI/Bar)							
1/4	1/8	3.18	.35	0.30	0	175	12.07	175	12.07	175	12.07	140	60	11.2	04F20C1108ACF-08
1/4	7/32	5.56	.96	0.83	0	50	3.45	40	2.76	40	2.76	140	60	11.2	04F20C2114ACF-08

THREE-WAY BRASS VALVES—NORMALLY CLOSED (PRESSURE AT PORT 2), NBR SEALS

AC VALVE SPECIFICATIONS

NPT Pipe Size	Orifice Diameter		Flow Factor		Operating Pressure Differential						Max. Temp.		AC Watt	Valve Part Number	
	inch	mm	Cv	Kv	Min. (PSI/Bar)	Max. (MOPD)			°F	°C					
						Air, Inert Gas (PSI/Bar)	Water (PSI/Bar)	Light Oil 300SSU (PSI/Bar)							
1/4	1/16	1.59	.09	0.08	0	125	8.62	125	8.62	125	8.62	140	60	11.2	04F30C2104ACF-08
1/4	1/8	3.18	.25	0.22	0	35	2.41	35	2.41	35	2.41	140	60	11.2	04F30C2108ACF-08

THREE-WAY BRASS VALVES—NORMALLY OPEN (PRESSURE AT PORT 3), NBR SEALS

AC VALVE SPECIFICATIONS

NPT Pipe Size	Orifice Diameter		Flow Factor		Operating Pressure Differential						Max. Temp.		AC Watt	Valve Part Number	
	inch	mm	Cv	Kv	Min. (PSI/Bar)	Max. (MOPD)			°F	°C					
						Air, Inert Gas (PSI/Bar)	Water (PSI/Bar)	Light Oil 300SSU (PSI/Bar)							
1/4	1/16	1.59	.09	0.08	0	125	8.62	125	8.62	125	8.62	140	60	11.2	04F30U2140ACF-08
1/4	1/8	3.18	.25	0.22	0	35	2.41	35	2.41	35	2.41	140	60	11.2	04F30U2108ACF-08

THREE-WAY BRASS VALVES—UNIVERSAL (PRESSURE AT ANY PORT), NBR SEALS

AC VALVE SPECIFICATIONS

NPT Pipe Size	Orifice Diameter		Flow Factor		Operating Pressure Differential						Max. Temp.		AC Watt	Valve Part Number	
	inch	mm	Cv	Kv	Min. (PSI/Bar)	Max. (MOPD)			°F	°C					
						Air, Inert Gas (PSI/Bar)	Water (PSI/Bar)	Light Oil 300SSU (PSI/Bar)							
1/4	1/16	1.59	.09	0.08	0	70	4.83	70	4.83	70	4.83	140	60	11.2	04F30U2104ACF-08
1/4	3/32	2.38	.12	0.10	0	40	2.76	40	2.76	40	2.76	140	60	11.2	04F30U2106ACF-08

FOUR-WAY TWO POSITION BRASS VALVES, NBR SEALS

AC VALVE SPECIFICATIONS

NPT Pipe Size	Orifice Diameter		Flow Factor		Operating Pressure Differential						Max. Temp.		AC Watt	Valve Part Number		
	inch	mm	Cv	Kv	Min. (PSI/Bar)	Max. (MOPD)						°F			°C	
						Air, Inert Gas (PSI/Bar)	Water (PSI/Bar)	Light Oil 300SSU (PSI/Bar)								
1/4	3/32	1.59	.09	0.08	10	0.69	100	6.90	100	6.90	100	6.90	140	60	11.2	04F48S2106ACF-08

5 Million Cycle Life

TWO-WAY BRASS VALVES – NORMALLY CLOSED (ENERGIZE TO OPEN), NBR SEALS

AC VALVE SPECIFICATIONS

NPT Pipe Size	Orifice Diameter		Flow Factor		Operating Pressure Differential						Max. Temp.		AC Watt	Valve Part Number		
	inch	mm	Cv	Kv	Min. (PSI/Bar)	Max. (MOPD)						°F			°C	
						Air, Inert Gas (PSI/Bar)	Water (PSI/Bar)	Light Oil 300SSU (PSI/Bar)								
3/8	5/8	15.88	3.0	2.59	5	0.34	125	1.09	100	6.90	100	6.90	140	60	11.2	06F22C2140ACF-08
1/2	5/8	15.88	4.0	3.45	5	0.34	125	1.09	100	6.90	100	6.90	140	60	11.2	08F22C2140ACF-08
3/4	3/4	19.05	5.0	4.31	5	0.34	125	1.09	100	6.90	100	6.90	140	60	11.2	12F22C2148ACF-08
1	1	25.40	13.0	11.21	5	0.34	125	1.09	125	8.62	125	8.62	140	60	11.2	16F24C2164ACF-08
1 1/4	1 1/8	28.58	15.00	12.93	5	0.34	125	1.09	125	8.62	125	8.62	140	60	11.2	20F24C2172ACF-08
1 1/2	1 1/4	31.75	22.50	19.40	5	0.34	125	1.09	125	8.62	125	8.62	140	60	11.2	24F24C2180ACF-08

THREE-WAY BRASS VALVES – NORMALLY CLOSED (ENERGIZE TO OPEN), NBR SEALS

AC VALVE SPECIFICATIONS

NPT Pipe Size	Orifice Diameter		Flow Factor		Operating Pressure Differential						Max. Temp.		AC Watt	Valve Part Number		
	inch	mm	Cv	Kv	Min. (PSI/Bar)	Max. (MOPD)						°F			°C	
						Air, Inert Gas (PSI/Bar)	Water (PSI/Bar)	Light Oil 300SSU (PSI/Bar)								
3/8	5/8	15.88	3.00	2.59	10	0.69	125	8.62	100	6.90	100	6.90	140	60	11.2	06F34C2140ACF-08
1/2	5/8	15.88	4.00	3.45	10	0.69	125	8.62	100	6.90	100	6.90	140	60	11.2	08F34C2140ACF-08

THREE-WAY BRASS VALVES – NORMALLY OPEN (ENERGIZE TO CLOSE), NBR SEALS

AC VALVE SPECIFICATIONS

NPT Pipe Size	Orifice Diameter		Flow Factor		Operating Pressure Differential						Max. Temp.		AC Watt	Valve Part Number		
	inch	mm	Cv	Kv	Min. (PSI/Bar)	Max. (MOPD)						°F			°C	
						Air, Inert Gas (PSI/Bar)	Water (PSI/Bar)	Light Oil 300SSU (PSI/Bar)								
3/8	5/8	15.88	3.00	2.59	10	0.69	125	8.62	100	6.90	100	6.90	140	60	11.2	06F34O2140ACF-08
1/2	5/8	15.88	4.00	3.45	10	0.69	125	8.62	100	6.90	100	6.90	140	60	11.2	08F34O2140ACF-08

For DC applications, consult factory.

Long life construction requires the use of rectified voltage coils.

Note: Cycle life longevity is based on using clean, lubricated media and may not be typical of all applications.

To choose a solenoid for your valve, refer to the AC or DC chart found on the flap attached to the back cover of this catalog.

Technical Information

Introduction

Solenoid valves are highly engineered products that can be utilized in many diverse and unique applications. In addition to operational functionality, it is important to consider safety, reliability, media compatibility and suitability for the operating environment when selecting the best product for a given application. This section provides a brief overview of the components and functional varieties of Gold Ring solenoid valves available from Parker.

General Information

Operation

Solenoid valves are electrically operated devices used to control flow. They are used for the remote on/off or directional control of liquids, gases and steam. They do not regulate flow.

Solenoid valves consist of two main elements: 1.) An electrical coil in the solenoid, and 2.) A valve body or pressure vessel. The solenoid is the electromagnetic unit that powers (acts to open or close) the valve. The valve is the pressure containing unit that acts to shut off or open media flow.

When the solenoid is energized by an electrical signal, current flow results in the build up of a magnetic field. The field attracts a moveable plunger in the valve. Physical movement of the plunger opens or closes a valve orifice which gives the valve on/off or directional control of media.

In general, solenoid valves are constructed to be: 1.) Normally-Open, or 2.) Normally-Closed. Both designations refer to action of the valve on flow when the solenoid is not energized. There would be, for example, no media flow through a normally-closed valve until the solenoid is energized.

The most common types of solenoid actuated valves are: 1.) Direct-Acting, and 2.) Pilot-Operated. In a direct-acting valve, the plunger is in direct contact with the body main orifice, and opens or closes the orifice. In a pilot-operated valve, the main orifice is not directly controlled by the plunger, but by a diaphragm, piston or spool. Pilot operated valves contain both a pilot and a bleed orifice.

Operational Specifications

All solenoid valves are individually rated for **Maximum Operating Pressure Differential (MOPD)**. This is the maximum differential pressure between the inlet and outlet sides of the valve against which the solenoid can safely operate the valve.

Pilot-operated solenoid valves may also have an additional specification, **Minimum Operating Pressure Differential (MOP)**. This is the minimum system pressure differential required to operate the valve and maintain it in the open position. MOP applies only to pilot-operated solenoid valves where system pressure is used to lift the diaphragm off the seat (normally-closed) when the solenoid is energized. Direct-acting or hung-diaphragm valves do not require a minimum operating pressure.

There will be a pressure differential ΔP before the solenoid of a normally-closed valve is energized. Just after flow begins moving through the valve, the pressure differential may decrease. When sizing any normally-closed, normally-open, or universal solenoid valve, pressure differential before and after flow begins must be considered.

Solenoid valves are also rated for **Maximum Fluid (media) Temperature** due to temperature limitations of the various disc or diaphragm materials used in their construction.

Response Time, the time necessary for a fully open valve to fully close, or the time necessary for a fully closed valve to fully open, is affected by several factors including: electrical service, media, valve, size, system pressure, pressure drop, and operating mode.

The following general response times (nominal) apply for air service using alternating current.

- Small direct-acting valves (1/8 to 1/4-inch) .5 to 10 milliseconds
- Large direct-acting valves (3/8 to 3/4-inch) 20 to 40 milliseconds
- Small pilot (diaphragm) valves (3/8 to 3/4-inch) 15 to 50 milliseconds
- Large pilot (diaphragm) valves (1 to 3-inch) 50 to 75 milliseconds

Viscous liquids have very little effect on response time on small direct-acting valves. However, on all other valves, viscous liquids may increase response time by 50 to 100 percent.

DC operated solenoid valves will generally increase response time (relative to AC operated solenoids) by as much as 50 percent. Where response time is critical, consult your authorized local Gold Ring distributor.

Two-Way Solenoid Valve Operation

Two-way solenoid valves have one inlet and one outlet connection with one main orifice and flow path. A normally closed valve is closed when the solenoid is de-energized, open when the solenoid is energized. A normally open valve is open when the solenoid is de-energized, closed when the solenoid is energized. Consideration should be given to the desired fail-safe condition of the valve when selecting the type of operation.

Operational Sequence:
Direct-Acting Normally Closed



To Open: When the solenoid receives an electrical signal, a magnetic field is formed which attracts the plunger. The plunger lifts off the main orifice allowing flow through the valve.

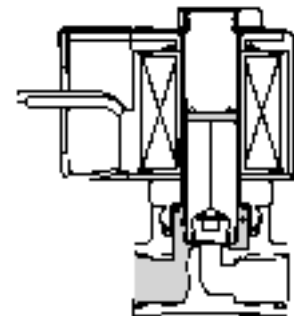

Normally Closed, De-Energized

To Close: When the solenoid is de-energized, it releases its hold on the plunger. The plunger drops and covers the main orifice.

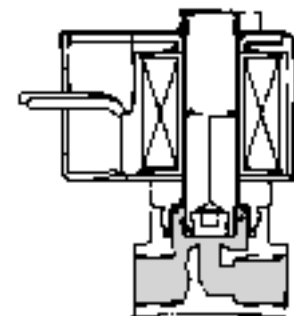

Normally Closed, Energized

*Operational Sequence:
Direct-Acting Normally Open*



In a normally open valve, the sequence of operation is reversed from that of a normally closed valve. The main orifice is open when the solenoid is de-energized.

To Close: When the solenoid is energized, it attracts the plunger. The plunger covers the main orifice stopping media flow through the valve.

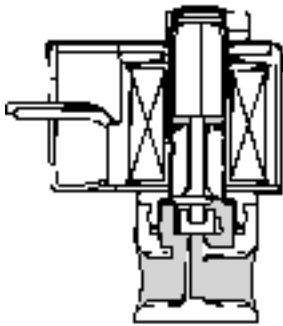

Normally Open, De-energized

To Open: When the solenoid is de-energized, it releases its hold on the plunger. The plunger uncovers the main orifice allowing flow through the valve.

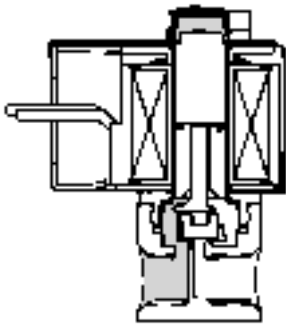

Normally Open, Energized

*Operational Sequence:
Pilot-Operated Normally Closed*



To Open: When the solenoid receives an electrical signal, a magnetic field is formed which attracts the plunger. The plunger covering the pilot orifice lifts off, causing system pressure (holding the diaphragm closed) to drop.

As system pressure on top of the diaphragm is reduced, full system pressure on the opposite side of the diaphragm acts to lift the diaphragm away from the main orifice, thus allowing full media flow through the valve. Since the bleed orifice is dimensionally smaller than the pilot orifice, system pressure cannot rebuild on top of the diaphragm as long as the pilot orifice remains open.

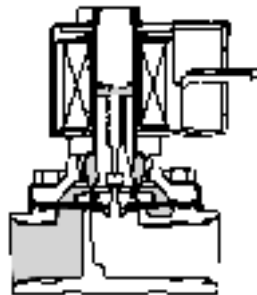

Normally Closed, De-Energized

To Close: When the solenoid is de-energized, it releases its hold on the plunger. The plunger drops and covers the main orifice. System pressure then builds up on top of the diaphragm through the bleed orifice, forcing the diaphragm down until it covers the main orifice and stops media flow through the valve.

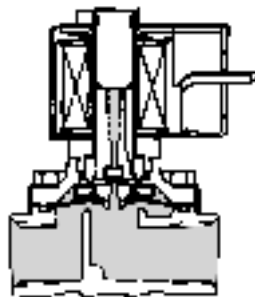

Normally Closed, Energized

*Operational Sequence: Pilot-Operated
Normally Open*



In a normally open valve, the sequence of operation is reversed from that of a normally closed valve. The main orifice is open when the solenoid is de-energized. All other relationships (e.g., the size relationship between the pilot and bleed orifice) still apply.

To Close: When the solenoid is energized, it attracts the plunger. The plunger covers the pilot orifice. System pressure then builds up on top of the diaphragm through the bleed orifice, forcing the diaphragm down until it covers the main orifice and stops media flow through the valve.

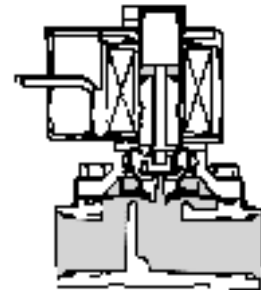

Normally Open, De-Energized

To Open: When the solenoid is de-energized, it releases its hold on the plunger. The plunger uncovers the pilot orifice causing system pressure holding the diaphragm closed to drop. As system pressure on top of the diaphragm is reduced, full system pressure on the opposite side of the diaphragm acts to lift the diaphragm away from the main orifice, thus allowing full media flow through the valve.

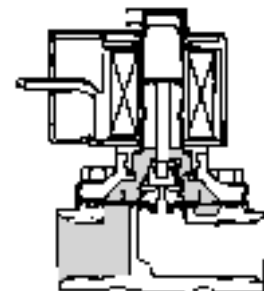

Normally Open, Energized

Three-Way Solenoid Valve Operation

The difference between two-, three- and four-way solenoid valves lies in the construction of the valve body. Three-way valves have three connections and two main orifices. One orifice is always closed, the other always open. Which orifice is open, and which is closed, determines whether the valve is operationally normally open or normally closed.

Operational Sequence:

Direct-Acting Normally Closed

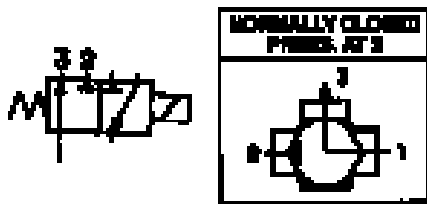

As with a normally closed, two-way valve, the system pressure orifice is closed when the solenoid is de-energized. The second orifice is open to whatever device it is connected to. When energized, the system pressure orifice is opened and the second orifice is closed. This allows system pressure to be applied to the device that was previously being exhausted through the second orifice (now closed).

Normally Open

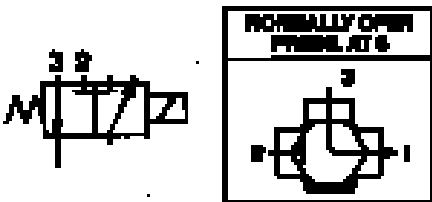

As with a normally open, two-way valve, the system pressure orifice is open when de-energized. The second orifice is closed to whatever device it is connected to. With the solenoid energized, the system pressure orifice is closed, the second orifice opened and the device exhausted.

Universal Construction

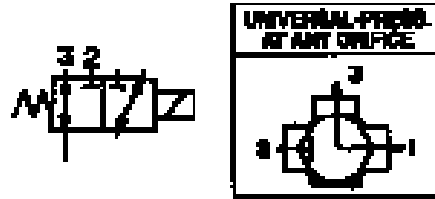

This type of three-way valve may be used in either the normally closed or normally open mode. It can be piped either way. The valve can be used to divert media flow from one outlet connection to the other, or to select one or two inlet flows.

Operational Sequence:

Pilot-Operated Normally Closed

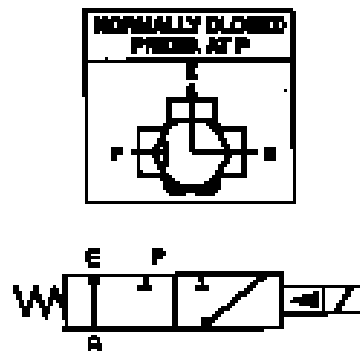

As with pilot-operated two-way valves, the plunger movement controls the pilot orifice which controls the pressure holding one of the diaphragms closed against the main orifice. As with direct-acting three-way valves, one orifice is closed when the other is open. When de-energized, flow is from the pressurized device to exhaust and the system pressure port is closed. When energized, flow is from the pressure port to the controlled device and the exhaust port is closed.

Normally Open

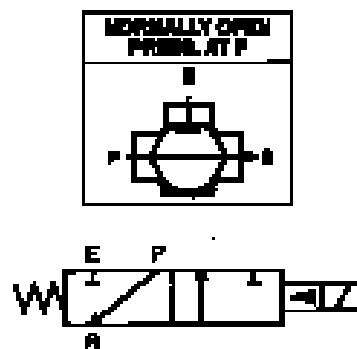

The normally open piloted three-way valve operates similarly to the normally closed valve, except that when de-energized, flow is from the pressure port to the controlled device and the exhaust port is closed. When energized, flow is from the controlled device to exhaust and the pressure port is closed.

These pilot-operated double diaphragm valves control the flow to a device and are not intended to be used as a selector or diverter valve. Universal construction is not available.

A minimum pressure drop is required for proper operation. Care should be taken not to restrict the exhaust port.

Four-Way Solenoid Valve Operation

A four-way valve is generally used to operate double-acting cylinders vs. a three-way for single-acting cylinders.

A double-acting cylinder has a port at either end of the cylinder body by which fluid can enter and exit. This allows the piston to be moved (propelled) in either direction (double-acting). To distinguish the ports on a double-acting cylinder, one is usually marked "A" and the other "B". A four-way solenoid valve acts to change the direction of fluid flow from the "A" port to the "B" port and, therefore, change direction of the cylinder.

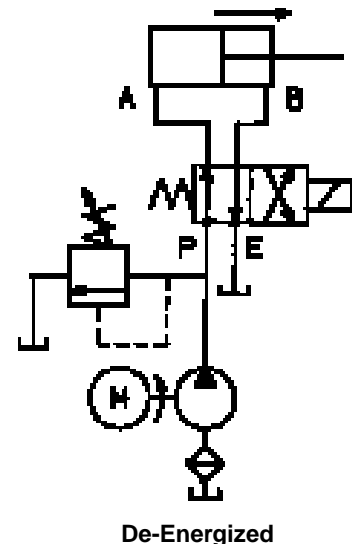

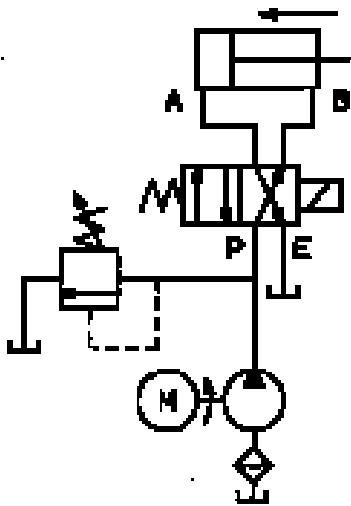

Energized

In addition to the "A" and "B" cylinder ports, the four-way valve has a pressure and exhaust port. When de-energized, the pressure port is internally connected to the "A" cylinder port, and the "B" cylinder port is internally connected to the valve's exhaust port. Energizing the four-way valve reverses the system, routing the "A" port to exhaust and the "B" port to pressure. A minimum pressure drop is required for proper operation. Care should be taken not to restrict the exhaust port.

General Data-Solenoid Coils

Power and Voltage

All coils used in Gold Ring solenoid valves are designed for continuous duty except where noted. On AC, inrush current occurs at the moment the solenoid is energized. The continuous current after inrush is holding current. Typical AC current values are shown below. DC solenoids have no inrush. Typical amp ratings for DC are determined by dividing DC watts by DC voltage.

All Gold Ring solenoid valves are tested to operate at 15% undervoltage and full pressure ratings. AC and DC voltage ratings (nominal) and normal operating ranges, as shown in the following table, are standard. For special voltages, consult the factory.

Holding and Inrush Current

Small, Direct-Acting 2-Way, 3-Way and 4-Way Series 20, 30, and 48 (1/8 to 3/8")

WATT RATING AND VOLT AMPERAGE			
Standard Coil Insulation Class	AC		
	Watts	VA Holding	VA Inrush
F	6	16	26
F	10.2	23	37
F	11	20	34
F	16	31	50

2-Way, Direct-Acting Series 20 (3/8 to 3/4")

WATT RATING AND VOLT AMPERAGE			
Standard Coil Insulation Class	AC		
	Watts	VA Holding	VA Inrush
F	6	16	36
F	11	20	61
F	16	31	88

Pilot 2-Way Series 22, 23, 24, 25, 26, 28, 34 (3/8 to 1-1/2")

WATT RATING AND VOLT AMPERAGE			
Standard Coil Insulation Class	AC		
	Watts	VA Holding	VA Inrush
F (Offset Pilot)	6	16	26
F (Center Pilot)	6	16	34
F	11	20	53
F	16	31	76

AC/DC Voltage Range

All coils used in Gold Ring valves are designed for continuous duty except where noted. They can remain energized continuously without damage from overheating or mechanical failure. AC and DC voltage ratings (nominal) and normal operating ranges, as shown in the following table, are standard.

AC		DC	
Nominal Voltage Rating	Normal Operating Range	Nominal Voltage Rating	Normal Operating Range
24	20-24	12	10.2-12.6
120	102-120	24	20-25
240	204-240	120	102-126
480	408-480		

All coils used in Gold Ring solenoid valves are either Class "F" or Class "H" molded epoxy, and are constructed in accordance with UL, IEEE, NEMA and other accepted standards.

Testing

All Gold Ring solenoid valves are 100% tested. Coil insulation systems must satisfy performance standards set by the National Electrical Manufacturers Association (NEMA) and tested by Underwriter's Laboratories.

Electrical components of AC and DC coils are tested in accordance with ASTM D2307-78 and become a recognized component under U.L.1446. The procedure produces data for an evaluation which concludes, a coil with 20,000 hours continuous operation will perform within the same specifications of a zero time coil (new coil).

Temperature

Just as fluid (media) temperatures affect valve body trim; ambient, fluid and power input temperatures affect solenoid coils. The following table with ambient temperature at 77°F (25°C) shows temperature limitations of Gold Ring solenoids.

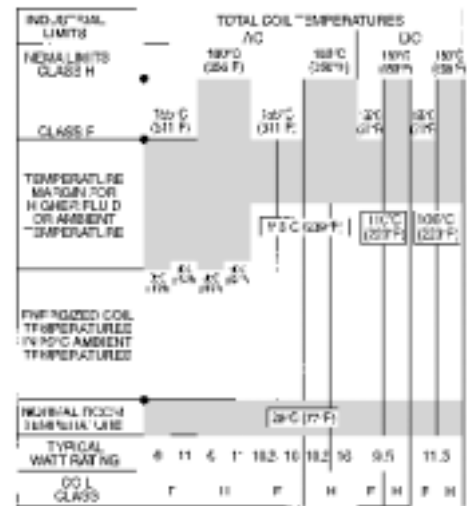

Temperature rise due to power input varies with coil design. Temperature rise due to power input and ambient temperature is directly additive and helps determine the class of coil required for specific valve applications.

When ambient temperature is greater than 25°C (77°F), add the difference of ambient and 25°C (77°F) to the energized coil temperature shown in the table.

The effect of higher fluid temperatures needs to be considered only when fluid temperature is greater than 180°F. Do not exceed the catalog maximum temperature limitation for the valve. Add the difference of your fluid temperature and 180°F to the energized coil temperature shown in the table.

Use the "Saturated Steam Temperature Table" when working with saturated steam. Do not exceed the catalog maximum temperature limitation for the valve. Add the difference of steam temperature and 180°F to the energized coil temperature shown in the table.

Total of additional ambient and fluid or steam temperature to the energized coil temperature shown must not exceed the industrial limit of the coil class selected.

Class "H" coil is required if total temperature exceeds "F" Class coil limits. Consult your Gold Ring authorized distributor if total temperature exceeds the "H" Class coil limit.

Coil Construction

All Gold Ring coils are epoxy encapsulated. This compound is waterproof and impervious to oil, dust, moisture and most corrosive fumes and vapors.

All coils used in Gold Ring valves are molded and constructed in accordance with UL, IEEE, NEMA and other accepted standards, and are 100% tested.

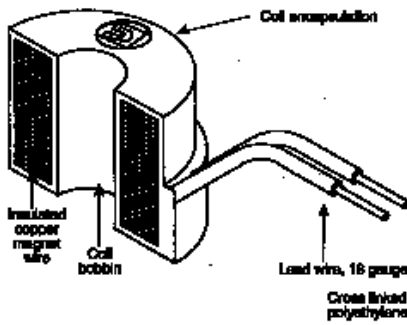

All coils are 100% tested.

Valve Sizing

Any given application requires proper sizing of the Gold Ring solenoid valve. If the valve selected is too small, flow conditions will not be met. If too large, system cost will be excessive. Gold Ring solenoid valves are tested and rated using the industry accepted C_v method. This method, used in both the U.S. and Europe, is both simple and accurate.

The correct size valve for an application can be determined by either using the engineered formulae shown below, or by using the curves and simplified formulae on the following pages.

Using Flow Formulae

Gases

If $P_2 > P$ critical

$$Q_m = C_v \sqrt{\frac{P_1 \Delta P}{SG}} \times \sqrt{\frac{520^*}{T}}$$

If $P_2 \leq P$ critical

$$Q_m = C_v \sqrt{\frac{P_1}{2SG}} \times \sqrt{\frac{520^*}{T}}$$

Q_m = Rate of flow SCFM (Standard Cubic Feet per Minute) at 14.7 psia and 60 degrees F (standard conditions)

C_v = Flow rating of the valve

P_1 = Upstream pressure, psia

P_2 = Downstream pressure, psia

P critical is approximate 53% P_1

ΔP = Pressure drop across the valve (open position), psi

SG = Specific gravity of gas, relative to air at 14.7 psi and 60 degrees F (standard conditions)

T = Absolute (degrees Rankine) temperature in degrees F. ($460 + \text{degrees F}$)

Note*: 520 is $460^\circ\text{F} + 60^\circ\text{F}$

Liquids

$$Q = C_v \sqrt{\frac{\Delta P}{SG}}$$

Q = Rate of flow, in gallons per minute

C_v = Flow rating of the valve

ΔP = Pressure drop across the valve (open position), psi

SG = Specific gravity relative to water at 60 degrees F

Steam

If $P_2 > P$ critical

$$W = 3C_v \sqrt{\frac{P_1 \Delta P}{X}}$$

If $P_2 \leq P$ critical

$$W = 3C_v \sqrt{\frac{P_1}{2X}}$$

W = Rate of flow in pounds per hour

C_v = Flow rating of valve

P_1 = Upstream pressure, psia

P_2 = Downstream pressure, psia

P critical is approximate 57% P_1

ΔP = Pressure drop across the valve (open position), psi

X = Quality of steam (Fraction Dry Steam)

Critical pressure has the following significance in the flow of compressible fluids (gases and steam) through valves. Assuming a fixed upstream pressure of P_1 , an increase in flow is obtained as the downstream pressure P_2 is reduced below P_1 . Continuing increases in flow are experienced until P_2 is reduced to a critical value (P critical). When P_2 is reduced below P critical, no further increase in flow results. P critical can be expressed as a percentage of P_1 with approximate values (53% to 57%) given above.

Note: PSIA is absolute pressure which is gauge pressure plus atmospheric pressure (14.7 psi at sea level).

Definition of Symbols

- C_V = Flow coefficient
- Q_L = Liquid flow (GPM)
- Q_g = Gas flow, standard cu-ft-hr (SCFH)
- Q_s = Steam flow (lb./hr.)
- P_1 = Inlet pressure (PSI)
- P_2 = Outlet pressure (PSI)
- ΔP = Pressure differential (PSI) ($P_1 - P_2$)
- K_L = Liquid flow curve factor
- K_g = Gas flow curve factor
- K_s = Steam flow curve factor
- K_{sg} = Specific gravity factor
- K_t = Temperature factor

There will be a pressure differential ΔP before the solenoid of a normally closed valve is energized. Just after flow begins moving through the valve, the pressure differential may decrease.

When sizing any normally closed, normally open, or universal solenoid valve, pressure differential before and after flow begins must be considered.

Curves to correct for specific gravity (K_{sg}) and temperature (K_t) are included. These curves apply to liquids and gases only, not saturated steam.

For liquids with viscosity in excess of 300 SSU, consult your Gold Ring authorized distributor or contact the factory.

The simple and easy to read flow curves for liquids, gases and steam will help in properly sizing valves.

There is a constant relationship between gas and saturated steam flow curves. The flow curve for gases can be used for steam by reading the K_s steam scale.

Specific gravity for various compounds are also included.

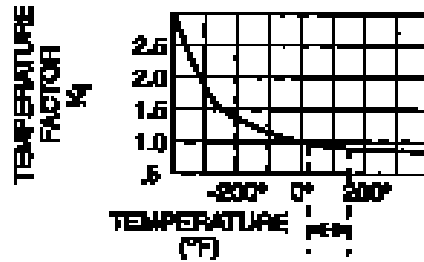
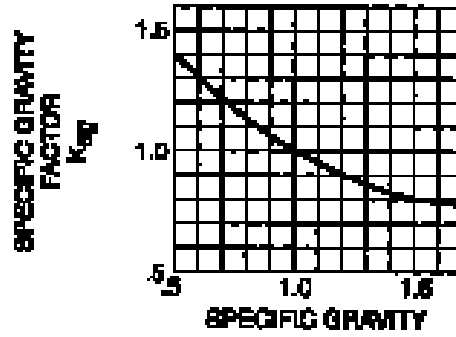

The correction for temperature in the range of 20°F to 150°F is very small, and, therefore, can be ignored in ordinary applications.

Basic Formulae Using Graphs

Liquid

$$C_V = \frac{Q_L}{K_L \times K_{sg}}$$

Steam

$$C_V = \frac{Q_s}{K_s}$$

Gas

$$C_V = \frac{Q_L}{K_g \times K_{sg} \times K_t}$$

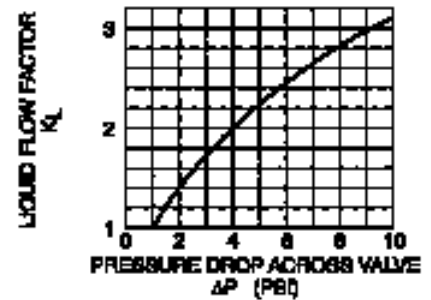
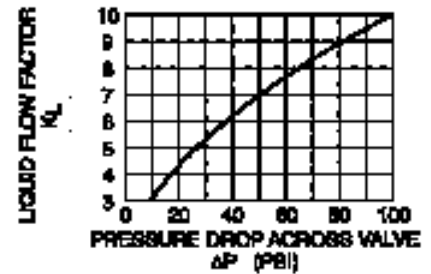
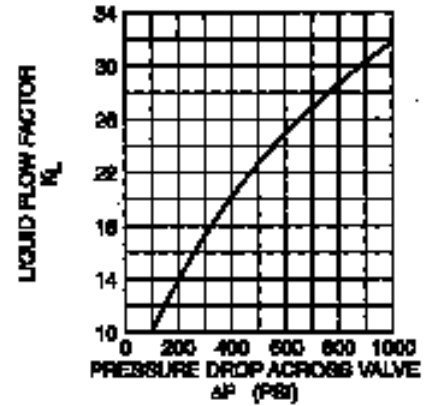

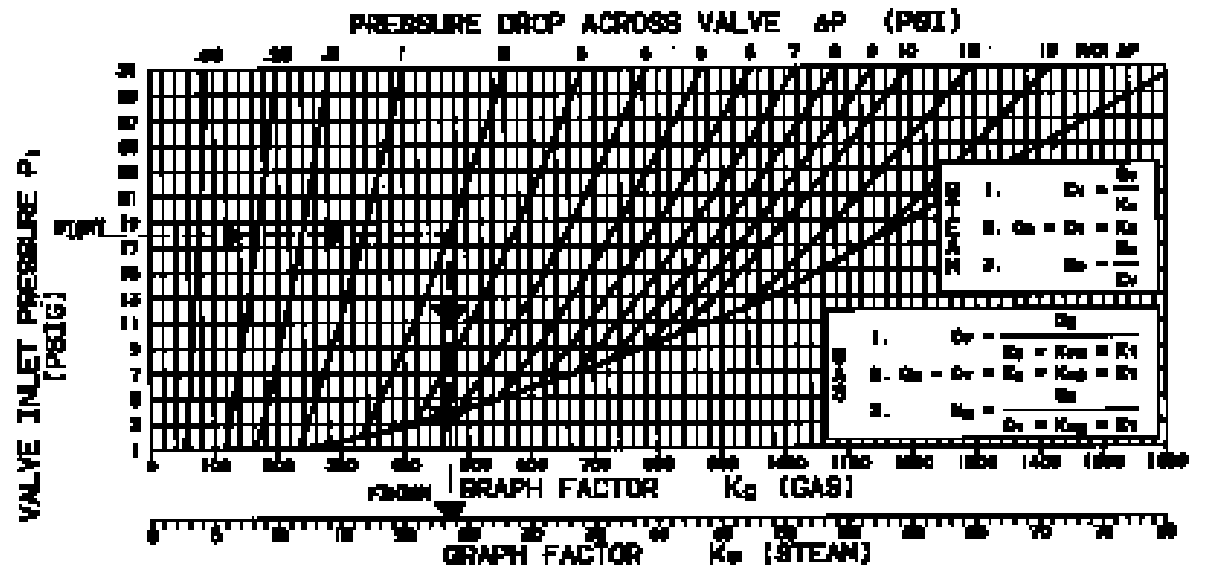
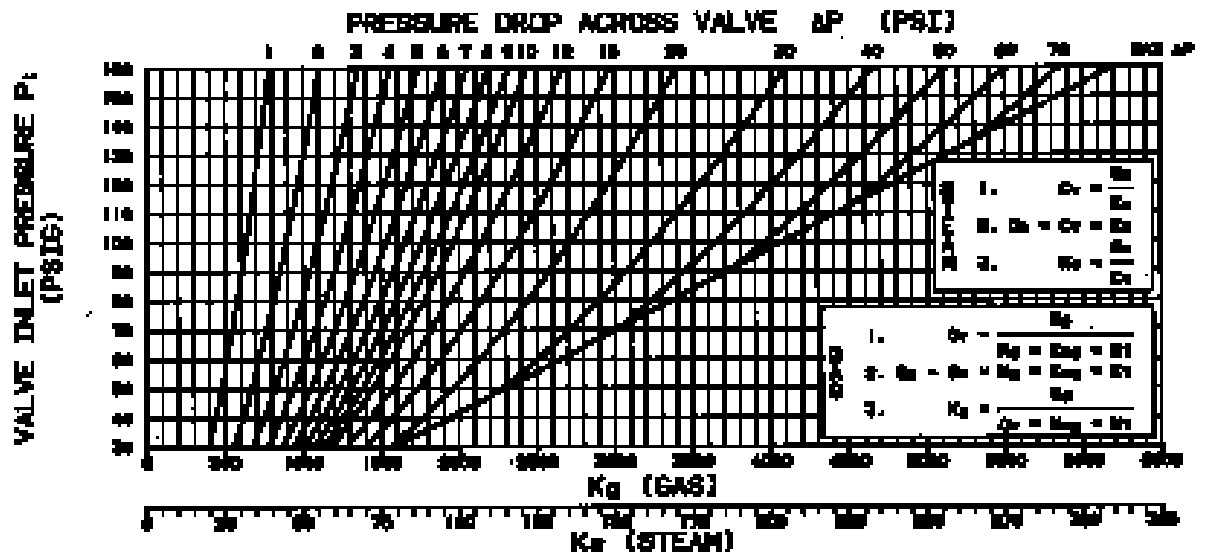
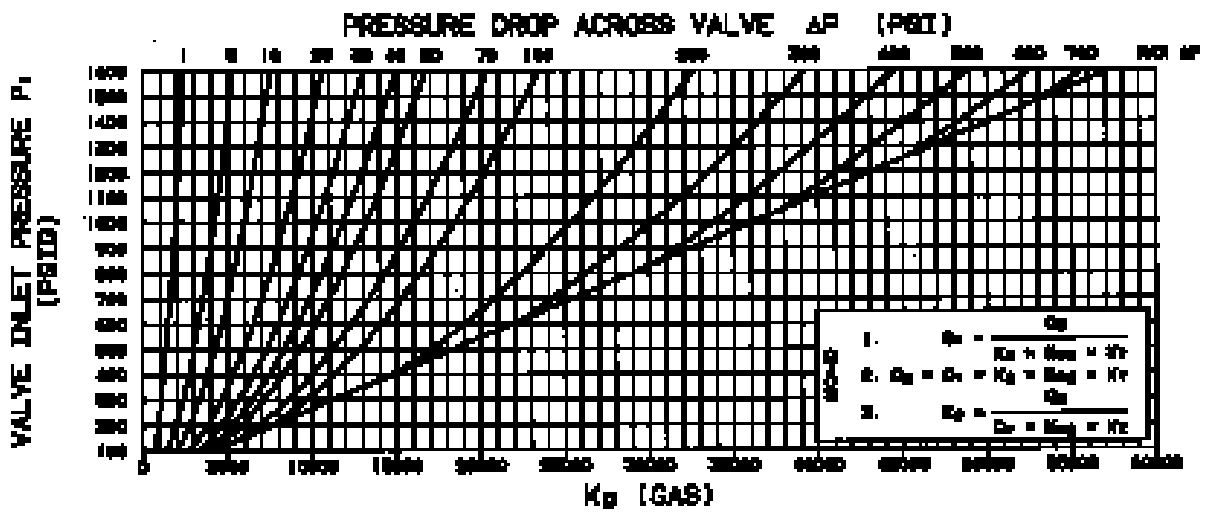

Sample Problems

Problem: Liquids

Determine C_V when the required flow is 30 GPM, media is light oil with a specific gravity of 0.82, inlet pressure (P_1) is 36 PSI and outlet pressure (P_2) is 0 ($\Delta P = 36$ PSI).

Solution

Use the formula:

$$C_V = \frac{Q_L}{K_L \times K_{sg}}$$

From the liquid flow curve using the pressure drop (36 PSI), read vertically up to the curve. Read horizontally to $K_L = 6$.

From the specific gravity curve using the specific gravity value (0.82), read vertically to the curve. Read horizontally to $K_{sg} = 1.1$.

From the formula:

$$C_V = \frac{30 \text{ (GPM)}}{6 \times 1.1}$$

$$C_V = \frac{30}{6.6}$$

$$C_V = 4.5$$

Problem: Air and Gases

Determine C_V when the required flow is 700 SCFH, media is air ($sg=1.0$), inlet pressure (P_1) is 70 PSI, outlet pressure (P_2) is 55 PSI, ΔP ($P_1 - P_2$) = 15 PSI, and air is at 50°F.

Solution

Use the formula:

$$C_V = \frac{Q_g}{K_g \times K_{sg} \times K_t}$$

From the gas and steam flow curve using the inlet pressure (70 PSI), read horizontally to the curve for pressure drop ($\Delta P=15$ PSI). Read vertically down to $K_g = 2025$.

Air at (50°F) falls into an area of the temperature correction curve where K_t is approximately 1 and can be ignored.

$$C_V = \frac{700}{2025 \times 1.0}$$

$$C_V = \frac{700}{2025}$$

$$C_V = 0.35$$

Steam

Determine C_V when the required flow is 30 lb./hr., media is saturated steam, inlet pressure (P_1) is 80 PSI, outlet pressure (P_2) is 60 PSI and ΔP ($P_1 - P_2$) is 20 PSI.

Solution

Use the formula:

$$C_V = \frac{Q_s}{K_s}$$

Remembering that the gas and steam flow curves have been combined, from the gas and steam flow curve using the inlet pressure value (80 PSI) read horizontally to the curve for the pressure drop ($\Delta P=20$ PSI). Read vertically down to $K_s = 121$.

From the formula:

$$C_V = \frac{30}{121}$$

$$C_V = 0.25$$

Formula Variations

The examples used here for liquids, gases, and steam show how to determine C_V . These same formulae can be transposed to determine other useful data once a specific value has been selected to meet the desired C_V (see formula variations table on page 59).

MEDIA	KNOWN	FIND	FORMULA	CURVE
Liquids	$C_V, \Delta P, K_{sg}$	Q_L	$Q_L = C_V \times K_L \times K_{sg}$	Liquids
	P_1, C_V, Q_g, K_{sg}	ΔP	$K_L = \frac{Q_L}{C_V \times K_{sg}}$	Liquids
Apply K_L to the liquid factor curve with P_1 to find ΔP .				
Gases	C_V, K_g, K_{sg}, K_t	Q_g	$Q_g = C_V \times K_g \times K_{sg} \times K_t$	Gases
	$P_1, C_V, Q_g, K_{sg}, K_t$	ΔP	$K_g = \frac{Q_g}{C_V \times K_{sg} \times K_t}$	Gases
Apply K_g to the liquid factor curve with P_1 to find ΔP . After solving for P (pressure differential), a general rule of $2(\Delta P)$ will equal the minimum pressure for a required flow.				
Steam*	$C_V, \Delta P$	Q_s	$Q_s = C_V \times K_s$	Gases Steam Scale
	P_1, C_V, Q_s	ΔP	$K_s = \frac{Q_s}{C_V}$	Gases Steam Scale
Apply K_s to the liquid factor curve with P_1 to find ΔP .				
<small>* In all cases, steam is considered saturated.</small>				

Specific Gravity For Liquids And Gases

	Liquid	Gas		Liquid	Gas
Acetic Acid, 10%	1.01	-	Liquid petroleum	0.06	2.067
Acetic Acid, Pure	1.06	-	Gas (LPG)		
Acetone	0.79	-	Mercury	13.6	-
Acetylene	0.60	0.91	Methane	0.50	0.554
Alcohol Amyl	0.81	-	Mineral Oil, USP	0.89	-
Alcohol Ethyl (Ethanol)	0.79	-	Motor Oil-SAE #10, etc.	0.89	-
Alcohol Methyl (Methanol)	0.81	-	Naptha	0.76	-
Ammonia	0.93	0.596	Natural Gas	0.55	0.554
Ammonium Nitrate	1.72	-	Oxygen	1.15	1.105
Ammonium Phosphate	1.69	-	Perchloroethylene	1.50	-
Argon Gas	1.40	1.379	Petroleum Oils	0.89	-
Beer	1.01	-	Potassium Sulfate	1.05	-
Benzene Benzol	0.88	-	Prestone Anti-Freeze	1.03	-
(Benzene)			Propane	1.10	1.56
Butadiene (Gas)	0.65	2.00	Pydraul (Mansanto)	1.28	-
Butane (L.P. Gas)	0.60	2.067	Sodium Hydroxide (100%)	2.13	-
Carbon Dioxide Dry	-	1.53	Sodium Hydroxide (50%) (Caustic Soda)	1.45	-
Carbon Disulfide	1.26	-	Steam Condensate	1.00	0.62
Carbon Tetrachloride	1.59	-	Stoddards Solvent	0.80	-
Cellulube	0.91	-	Sulfuric Acid (10%)	1.08	-
Coffee	1.05	-	Toluene (Toluol)	0.87	-
Corn Oil	0.92	-	Transmission Fluid (Type A)	0.90	-
Cottonseed Oil	0.90	-	Trichloroethylene	1.36	-
Diesel Fuel	0.88	-	Turpentine	0.87	-
Distilled Water	1.00	0.62	Vegetable oils	0.92	-
Ethylene Glycol	1.11	-	Vinegar	1.01	-
Fatty Acids	0.92	-	Water		
Formaldehyde	0.82	-			
Freon BF (Solvent)	1.57	-	Carbonated	1.00	0.62
Freon MF (Solvent)	1.48	-	Distilled	1.00	0.62
Freon TF (Solvent)	1.57	-	Fresh	1.01	0.65
Fuel Oils	0.88	-	Boiler Feed	1.00	0.62
Gasoline	0.68	-	Return Condensate	1.00	0.62
Heptane (Liquid)	0.68	-	Brackish	1.02	0.67
Hydraulic Oil	0.91	-	Sea	1.03	0.68
Hydrogen	0.07	0.0696			
JP4-5 Fuel	0.79	-			
Kerosene	0.81	-			
Linseed Oil	0.94	-			

PSIA	PSIG	Temp. °F	Heat of Sat. Liquid (BTU/lb)	Latent Heat of Evap. (BTU/lb)	Total Heat of Steam (BTU/lb)
15	1	213	181.2	969.7	1150.9
20	5	227	196.2	960.1	1156.3
30	15	250	218.9	945.2	1164.1
40	25	267	236.1	933.6	1169.7
50	35	281	250.2	923.9	1174.1
60	45	292	262.2	915.4	1177.6
70	55	302	272.7	907.8	1180.5
80	65	312	282.1	900.9	1183.0
90	75	320	290.7	894.6	1185.3
100	85	327	298.5	888.6	1187.1
110	95	334	305.8	883.1	1188.9
120	105	341	312.6	877.8	1190.4
130	115	347	319.0	872.8	1191.8
140	125	353	325.0	868.0	1193.0
150	135	358	330.6	863.5	1194.1

Fluid Compatibility

General Information

The following table lists many of the liquids and gases commonly considered for handling with solenoid valves. In some cases, specific limitations are listed, and in other cases, Gold Ring solenoid valves are not recommended. For media not listed in the tables, consult the factory for specific recommendations.

Trim Materials

Buna "N" (Nitrile) Symbol NBR

A soft synthetic compound, Buna "N" is the most widely used elastomer in industry today. Buna "N" is standard disc and diaphragm material in Gold Ring solenoid valves. It has excellent service characteristics for use with water, light oil and gas in a temperature range of (-10°F) to 180°F.

Ethylene Propylene Symbol EP

Introduced to the rubber industry in 1961, Ethylene

Propylene is used primarily for applications involving hot water or steam service. It has excellent service characteristics for many liquids in a temperature range from (-10°F) to 300°F.

Viton* Symbol V

A soft fluoroelastomer, Viton was originally developed to handle hydrocarbons including gasoline, jet engine fuels and various solvents. It handles media in a broader temperature range than Ethylene Propylene. Its temperature range extends from (-10°F) PTFE. Viton is also an ideal material for handling a wide range of chemical media.

PTFE* Symbol T

Another fluorocarbon, PTFE is available as a solid material or combined with fillers. PTFE will withstand chemical attack from almost any fluid. Its temperature range extends from (-320°F) to 350°F. Because it is not easily fabricated and known to have cold flow characteristics, its applications are limited.

* DuPont Co. Trademark

Neoprene Symbol CR

Most elastomers are resistant to either petroleum lubricants or oxygen. Neoprene has limited resistance to both. Combining wide spectrum of resistance with a temperature range of (-10°F) to 180°F account for its use in many applications.

Urethane Symbol U

A synthetic compound, Urethane is widely used where high strength and abrasive resistance are required. Its temperature range is similar to Buna "N" (-10°F) to 160°F.

Guide to Media and Material Compatibility for Gold Ring Solenoid Valves

Key:

- A = Aluminum¹
- AT = Acetal
- BR = Brass
- C = Copper
- CE = Celcon
- CR = Neoprene
- EP = Ethylene Propylene
- NBR = Buna "N"
- S = Silver
- SS = Stainless Steel²
- T = PTFE
- U = Urethane
- V = Viton

¹ Available by special order only.

² Stainless Steel 302, 303, 305, 316

Applications shown on the next page are based on known usage or authoritative sources. Factors of temperature, pressure and concentration may render material compatibility unacceptable.

Trim Material Availability by Valve Series

Pipe Size Series	Orifice NPT	Size	Food Grade EP	EP	T	V	CR	NBR
20	1/8 - 3/8	3/64 - 9/32	X	X	X*	X	X	X
20	3/8 - 3/4	5/16 - 3/4	X			X		X
22, 23, 24	3/8 - 1-1/2	5/8 - 1-1/2	X	X		X	X	X
25	1/4 - 3/8	11/32	X			X		X
25	3/8 - 1	1/2 - 1	X		X*			X
26	2 - 3	2 - 3				X		X
28	1/4 - 3/4	5/16 - 3/4						
30	1/8 - 1/4	All	X	X	X*	X	X	X
34	3/8 - 3/4	All	X			X		X
48	1/4	All						X

Note: Use of PTFE materials reduces catalog pressure ratings by 25%.
For alternate trim materials, consult factory.

SEAL MATERIAL DESIGNATIONS

ASTM Designation	Commercial Designations and/or Trade Names
NBR	Buna-N, Nitrile
EPDM	Ethylene Propylene
FKM	Fluorinated Hydrocarbon, Viton®
PCTFE	Kel-F
PTFE	PTFE, Rulon®
PFPM	Kalrez
CR	Neoprene

Viton® is a Dupont Co. trademark. Rulon® AR is a Furon-Advanced Polymers Division trademark.

Materials of Construction

Liquid or Gas	Body	Trim	Shading Coil	Wetted Non-Metal	Limitations
Acetic Acid, 10%	SS	EP	S	CE	
Acetic Acid, Pure	SS	EP, T	S		Less corrosive than 10%
Acetone	SS, BR	EP, T	S, C	CE, AT	
Acetylene	SS	NBR, V	A	AT	
Alcohol Amyl	SS, BR	EP, V, T	S, C	AT	
Alcohol Ethyl (Ethanol)	SS, BR	NBR, EP, V, T	S, C	CE, AT	
Alcohol Methyl (Methanol)	SS, BR	NBR, EP, T	S, C	CE, AT	For high purity, use SS
Ammonia	SS, A	CR, T	A	CE	
Ammonium Nitrate	SS	NBR, EP, T	S	CE, AT	
Ammonium Phosphate	SS	NBR, EP, T	S	CE, AT	
Argon Gas	SS	NBR, CR	S	CE	For welding, standard brass construction acceptable.
Beer	SS, BR	NBR, T, V	C, A	CE, AT	
Benzene Benzol (Benzene)	SS, BR	V, T	S, C	CE	
Butadiene (Gas)	SS, BR	NBR, V	C	C	
Butane (L.P. Gas)	SS, BR	V, T	C, A	CE, AT	
Carbon Dioxide Dry	SS, BR	NBR, U, T	S, C	CE	
Carbon Disulfide	SS	U, V, T	A	CE, AT	
Carbon Tetrachloride	SS	V, T	S	CE, AT	
Carbonated Water	SS, BR	NBR, V, T	A		
Cellulube	SS, BR	EP, T	S, C		
Coffee	SS, BR	NBR, CR, V, T	S, C	CE	
Coke Oven Gas	SS	NBR, T, V	S	AT	
Corn Oil	SS, BR	NBR, V, T	S, C	CE, AT	
Cottonseed Oil	SS, BR	NBR, T	A	CE, AT	
Diesel Fuel	SS, BR	V, T	S, C	CE	
Distilled Water	SS	NBR, CR, T	S	CE	
Ethylene Glycol	SS, BR	NBR, EP, V, T	S, C	CE, AT	
Fatty Acids	SS	NBR, V, T	S	CE	
Formaldehyde	SS, BR	NBR, EP, U, T	S, C	CE	
Freon BF (Solvent)	SS, BR	V	S, C		
Freon MF (Solvent)	SS, BR	V	S, C		
Freon TF (Solvent)	SS, BR	NBR, V	S, C		
Fuel Oils	SS, BR	V, T	S, C	CE, AT	
Gasoline	SS, BR	V, T	S, C	CE, AT	
Grease	SS, BR	NBR, U, V, T	S	CE	
Heptane (Liquid)	SS, BR	NBR, V, T	S, C	CE	
Hydraulic Oil	SS, BR	NBR, U, V, T	S, C	CE, AT	
Hydrogen	SS, BR	NBR, V	S, C	CE, AT	Soft durameter seating
JP4-5 Fuel	SS, BR	V, T	S, C	CE, AT	
Kerosene	SS, BR	NBR, V, T	S, C	CE, AT	
Linseed Oil	SS, BR	NBR, T	S, C	CE, AT	
Liquid Petroleum Gas (LPG)	SS, BR	NBR, V	S, C		
Mercury	SS	NBR, T		CE, AT	Special construction-consult factory
Methane	SS, BR	NBR, V	S, C	CE	
Mineral Oil, USP	SS	NBR, V, T	S, C	CE	
Motor Oil-SAE #10, etc.	SS, BR	NBR, V	S, C	CE	
Naptha	SS, BR	V, T	S, C	CE	
Natural Gas	SS, BR	NBR	S, C	CE	Special construction
Oxygen	SS, BR	CR, V	S, C	CE, AT	Special cleaning
Perchloroethylene	SS, BR	V, T	S, C	CE, AT	No diaphragm valves
Petroleum Oils	SS, BR	NBR	S, C	CE	
Potassium Sulfate	SS	NBR, V, T	S, C	CE, AT	Non-compatible
Propane	SS, BR	NBR, V	C	CE, AT	Special construction
Pydraul (Mansanto)	SS, BR	V, T	S, C		
Silicone Oil	SS, BR	NBR, V	S, C	CE, AT	
Skydrol	SS, BR	EP	S, C		
Soap (Molten)	SS, BR	NBR, V, T	C	CE, AT	
Sodium Hydroxide (Caustic Soda)	SS	EP, T	S	CE	
Steam Condensate	BR	EP	C		
Stoddards Solvent	SS, BR	NBR, V			
Sulfuric Acid	A	V, T	A		Non-compatible
Toluene (Toluol)	SS, BR	V, T	S, C	CE, AT	
Transmission Fluid (Type A)	SS, BR	NBR	S, C	CE	
Trichloroethylene	SS	V, T	A	CE, AT	
Turpentine	SS, BR	NBR, T	S, C	CE	
Vegetable Oils	SS	EP, V, T	A	CE, AT	
Vinegar	SS	EP, T	S, C	AT	
Water					
Carbonated	SS, BR	NBR, V, T	C		
Distilled, Demineralized, Deionized	SS	EP, V, T	S	CE, AT	
Fresh	SS, BR	NBR, EP, V, T	S, C	CE, AT	
Boiler Feed	SS	NBR, T	S	CE	
Return Condensate	SS	NBR, EP, T	S	CE	
Brackish		T	S, C		Non-compatible
Sea		NBR, EP, V, T	S, C	CE, AT	Non-compatible

Consult factory for media not listed.

Part Number Information

1 & 2		3		4		5		6		7		8		9 & 10		11		
Connection Size		Connection Type		Construction		Operation		Body Material		Trim		Orifice Size		Current Design Series Designation				
02	1/8"	F	Female Pipe Thread NPT	2	2-way	0	Direct Acting	C	Normally Closed	1	Brass (Bar Stock)	1	NBR	Valve orifice diameter in 1/64-inch increments. Example: a 1/2-inch orifice diameter has an orifice size designation of 32.				
04	1/4"			3	3-way	2	Diaphragm Center pilot	O	Normally Open	2	Brass (Forging)	2	FKM					
06	3/8"			4	4-way	3	Diaphragm Hung	U	Universal	3	303 Stainless Steel (Bar)	3	EPDM					
08	1/2"			H	Diaphragm, Hung	4	Diaphragm Offset pilot	S	4-Way Single Solenoid	5	Brass Nickel Plate	4	TFE					
12	3/4"			5	Diaphragm, Pivoted Edge	5	Diaphragm Pivoted Edge			6	316 Stainless Steel (Cast)	5	Urethane					
16	1"			S	Steam	6	Piston			7	Aluminum (Bar Stock)	6	CR					
20	1 1/4"					8	Piston piloted			8	316 Stainless Steel (Bar)	8	FDA EPR					
24	1 1/2"									9	Bronze (Cast)	9	Kalrez					
32	2"												D	Delrin				
48	3"												K	KEL F				

12		13		14		15		16 & 17			
Coil Wattage AC (nominal)	Coil Wattage DC (nominal)	Coil Class		Solenoid Enclosure		Coil Termination		Coil Voltage AC	Coil Voltage DC		
A 6 Watts	1 9.5 Watts	F	Standard (Class 155)	E	Explosion-Proof/Watertight	B	6" Leads	01	24/60	70	6
B 10.2 Watts	3 11.5 Watts	H	High Temperature (Class 180)	G	Type 1 Gen. Purpose	C	18" Leads (Standard)	02	24/50	75	12
C 11 Watts				M	316 SS Explosion-Proof/Watertight	D	24" Leads	05	110/50 120/60	80	24
D 16 Watts				O	Open Frame	E	36" Leads	10	208/60	90	120
				P	Epoxy Encapsulated	H	DIN	15	220/50 240/60	95	125
				S	Type 1 Splice Box	K	Screw	20	440/50 480/60		
				U	316 SS Explosion-Proof/Watertight	S	Spade	41	24/60 rectified		
				W	Submersible Splice Box			42	120/60 rectified		
				Y	Explosion-Proof/Watertight with Ground Lead			44	240/60 rectified		
				Z	Grounded M			51	120-240/60		
				4	Type 4, 4X			53	240-480/60		

Options

Mounting Brackets

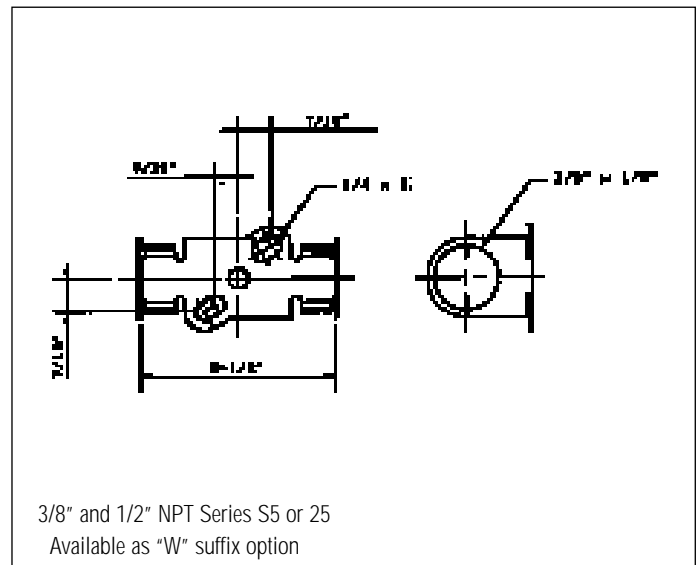
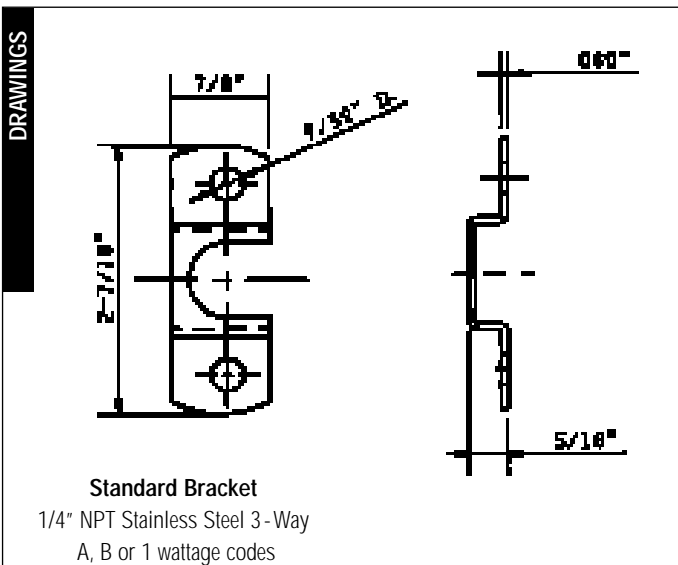

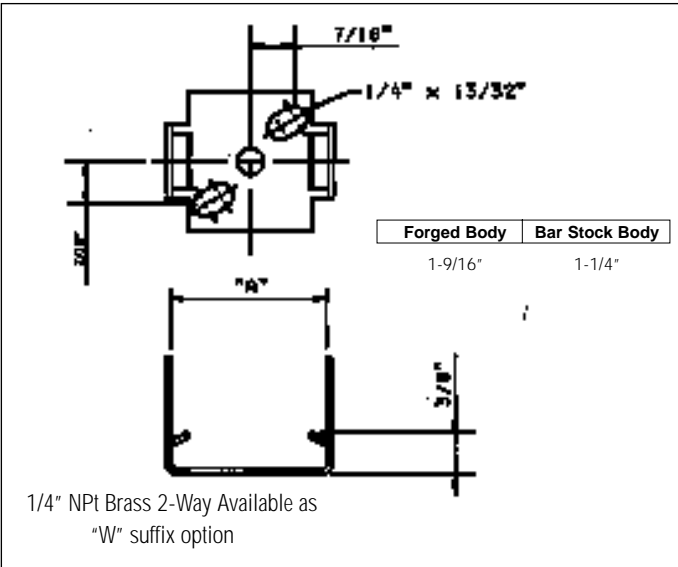
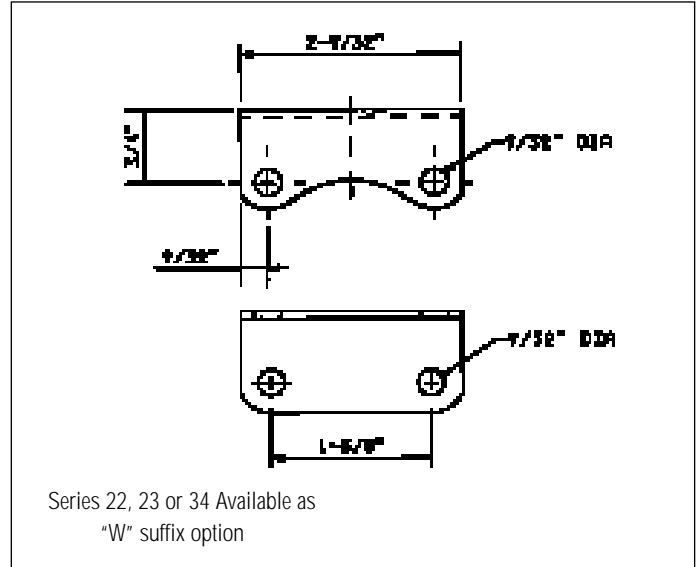
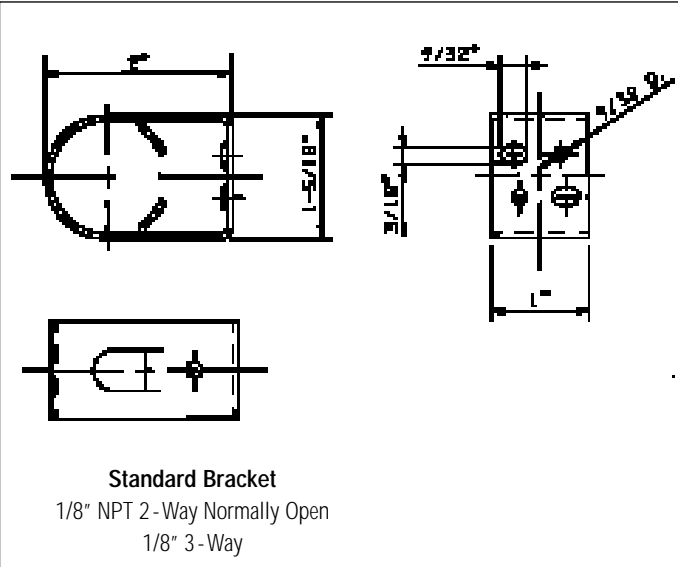

Measures

1 inch = 25.4mm
 1 inch = 2.54cm
 1 U.S. gal = 3.785 liters
 1 Imperial gallon = 4.546 liters

Pressure

1 psi = 0.0703 Kg/square cm
 1 psi = 27.73 inches water (@60/F)
 1 psi = 2.036 inches of mercury (@32/F)
 1 psi = 51.7 mm of mercury (@32/F)
 1 psi = 0.0689 bar

Vacuum

1 torr = 1 mm mercury
 1 micron = 0.001 torr

Volumetric Flow Rate

1 Cv = 14.28 Kv
 1 gpm = 3.785 liters/min (U.S. gallon)
 1 cfm = 28.317 liters/min
 1 liter/min = 0.0353 cfm

Temperature

Degrees C = (Degrees F - 32) (5/9)
 Degrees F = (Degrees C) (9/5) + 32

Torque

1 in lb. = 0.113 Nm
 1 in lb. = 1.15 cm Kg

Unit Conversion Charts

Fractional Conversions		
mm	inches	decimal inches
0.79	1/32	0.031
1.59	1/16	0.063
2.38	3/32	0.094
3.18	1/8	0.125
3.97	5/32	0.156
4.76	3/16	0.188
5.56	7/32	0.219
6.35	1/4	.0250
7.14	9/32	0.281
7.94	5/16	0.313
8.73	11/32	0.344
9.53	3/8	0.375
10.3	13/32	0.406
11.1	7/16	0.438
11.9	15/32	0.469
12.7	1/2	0.500
13.5	17/32	0.531
14.3	9/16	0.563
15.1	19/32	0.594
15.9	5/8	0.625
16.7	21/32	0.656
17.5	11/16	0.688
18.3	23/32	0.719
19.1	3/4	0.750
19.8	25/32	0.781
20.6	13/16	0.813
21.4	27/32	0.844
22.2	7/8	0.875
23.0	29/32	0.906
23.8	15/16	0.938
24.6	31/32	0.969
25.4	1	1.000

Special Handling & Cleaning

Service	Description	Order By Specifying Suffix
Clean Systems	Valve components are degreased to eliminate hydrocarbons and foreign particles and are blacklight inspected. Valves are tested with clean nitrogen and are shipped in sealed bags.	H
Oxygen	Valve components are degreased to eliminate oils and foreign particles and are blacklight inspected. An oxygen compatible lubricant is used for assembly. Valves are tested with clean nitrogen, certified for oxygen service and shipped in sealed bags.	O
Degreasers	Valve components are degreased to eliminate hydrocarbons and foreign particles. They are assembled using a non-silicone base lubricant and tested with clean nitrogen. Shipped in a sealed bag.	Consult Factory

All series of valves can be ordered with special cleaning or handling. Valves for vacuum or cryogenic applications are supplied using appropriate cleaning and handling techniques.

Manual Operators

Manual operators are available for normally closed valves in the following series.

Series	Pipe Size	Screw Type (Suffix M)	Momentary to 100 psi (Suffix U)
20	1/8"	X	X
20	1/4"	X	
20	3/8"	X	
22,23,24	3/8 - 1-1/2"	X	
30	1/8"	X	X
30	1/4"	X	
34	3/8-3/4"	X	
48	1/4"	X	

Series 30 Manual Operators for Normally Closed, Normally Open or Universal Operation.
Series 20 Momentary Manual operators are available for Normally Open or Normally Closed operation (1.8" NPT)

Metering Suffix N

Metering stems can be supplied on 1/8"-1/4" NPT Series 20 brass or stainless steel bodied valves. This device is designed to meter the flow through the valve. Shutoff of flow is provided by the normal valve operation.

Metal Clamp Solenoid Retainer-Suffix J

Metal solenoid retainers are available for high temperature applications or applications subject to vibration.

Troubleshooting Guide

Gold Ring solenoid valves are manufactured using the highest quality materials under close quality control. All Gold Ring valves are 100% tested prior to shipment. There are only two to four moving parts. The simplicity of operation makes Gold Ring valves reliable electro-mechanical devices. Failures, however, can occur. Experience has shown failure is usually the result of either improper

installation or neglected maintenance.

This guide will assist you in properly diagnosing a failure and provide a proper solution to correct the failure.

The following general procedures must be followed whether the valve in question is direct-acting or pilot-operated.

General Troubleshooting Discussion

Note 1) If the valve fails to operate because of a burn-out or shorted coil, the cause of the burn-out must be determined before the new unit solenoid, or coil for explosion-proof valves, is installed. Usually the cause is in the mechanical portion of the unit body, therefore, the entire solenoid valve must be inspected.

Note 2) If the coil has failed, a complete Gold Ring unit solenoid, or coil for explosion-proof valves, should be installed. Be sure to turn off all electrical power in the valve circuit prior to any disassembly.

Note 3) If the solution requires the replacement of a defective part or parts, a complete Gold Ring rebuild kit should be used. Be sure all parts in the rebuild kit are installed in the valve, not only the part or parts deemed defective. As this procedure requires opening the valve body (pressure vessel), be sure to bleed all system pressure to zero. If either the plunger tube assembly or the bonnet screws are loosened to relieve trapped valve pressure, do so carefully. Do not completely remove the plunger tube assembly or the bonnet screws until the bleeding is complete. Refer to the appropriate I & M Sheet for instructions.

Note 4) In most installations, after a solenoid valve has been energized for a short time, the solenoid housing will be hot to the touch. This is not an indication of a failure or possible failure. It is perfectly normal.

Note 5) Regardless of system size, water hammer must be considered and controlled to protect piping systems and solenoid valves from its effects. Water hammer occurs when the flow of a non-compressible fluid in a pipe is abruptly stopped. Water hammer is not always identified by noise and vibration. Examine diaphragms, plunger discs and other internal parts for tears, distortion and other damage. Replace internal parts with a rebuild kit and modify the piping system. Commercially available water hammer arresters range from flexible rubber hose, a simple extension pipe to a type of permanently sealed chamber.

Hints

- 1.) Never replace a burned-out coil or unit solenoid until the cause of the burn-out has been determined, ie: missing parts, plugged plunger tube, worn plunger, over voltage, etc.
- 2.) Before reassembly of valve body, if possible, flush out inlet to valve.
- 3.) Use a flat screwdriver placed on top of plunger tube to test magnetic circuit.
- 4.) If the cause of failure is the presence of foreign matter, install a strainer or filter in the upstream (inlet) side of the valve.

Symptoms

Five basic symptoms indicate a solenoid valve is not operating properly to specifications:

- 1.) Failure to operate (shift position) when energized.
- 2.) Failure to operate (shift position) when de-energized.
- 3.) Internal or external leakage.
- 4.) Erratic flow.
- 5.) Excessive solenoid noise when energized even though any of the above symptoms does not exist. (In some AC installations, a very slight hum may be noticeable and is normal.)

Possible Failure Cause*

	Improper / No Voltage	Open / Shorted Coil	Faulty Electrical Circuit	Excessive Ambient / Media Temperature	Non-Compatible Media	Over-Pressurization	Missing / Loose Solenoid Retainer	Loose Body Assembly	Dirt In Valve / Media	Seat Erosion	Worn Disc	Worn Plunger / Tube / Pole Piece	Blocked Pilot Hole	Blocked Bleed Hole	Torn / Hole In Diaphragm	Inadequate Flow	Restricted Outlet	Restricted Inlet	
Fails to Close/Shift	X	X	X		X	X													
Fails to Open/Shift	X	X	X		X	X													
Internal Leakage					X														
External Leakage					X	X			X	X									
Excessive Noise/Hum	X		X					X											
Short Coil Life	X		X	X															
Failure Symptom*	Series																		
	All											22,23,24,25,S3,S5,26,28				34 & 48			

* Partial list

Note: This check list is intended to serve as a preliminary guide to common valve failure troubleshooting, and is not intended to contain recommendations for proper solenoid valve or systems operation or design. For proper solenoid valve usage, follow manufacturer's recommendations. Improper system design may result in ineffective valve operation.

Glossary of Terms

Bleed Orifice: An internal orifice which controls the closing rate of a pilot operated solenoid valve. Also called the equalizer hole.

Bonnet: The upper half of a diaphragm type solenoid valve.

Cv: See flow coefficient.

Diaphragm: An elastomeric or other material seal which covers the main orifice.

Elastomer: Material having elastic properties. These materials are generally used for sealing purposes.

Enclosure Tube Assembly: The portion of a solenoid valve which houses the plunger.

Flow Coefficient: Abbreviated Cv. The amount of flow in gpm of water that will flow through an orifice with a pressure differential of 1 psi.

Flux Frame: The magnetic steel frame surrounding the coil which provides for efficient travel of magnetic flux. Also called magnetic frame assembly.

Holding Current: The current required to hold the plunger in the energized position. Value is normally about one half of inrush current.

Inrush Current: The current at the moment of energization of AC voltage coils. This current is of greater value than holding current due to low inductance at the moment of energization. Supply transformers should be sized using this value.

Media: The fluid flowing through the valve.

MOP: Minimum operating pressure. The minimum pressure a pilot operated valve requires for proper operation.

MOPD: Maximum operating pressure differential. The maximum pressure differential between inlet and outlet that a valve is designed to operate against.

NEMA: National Electrical Manufacturers Association - Recommends suitable materials and constructions to meet coil enclosure installation types.

Pilot Orifice: An internal orifice which controls opening characteristics of a pilot operated solenoid valve. In a pilot operated solenoid, the plunger covers the pilot orifice.

Plunger: Moveable portion of a solenoid valve operator which controls media flow.

Pole Piece: The stationary half of the magnetic attractor inside the plunger tube.

Pressure Differential: The difference between inlet and outlet pressures.

Safe Working Pressure: Twenty percent of the pressure which causes external leakage. The valve is not expected to operate at this pressure unless the MOPD is a value less than the SWP.

Shading Ring: A single coil located in the pole piece in which a secondary flux wave is induced during AC current operation.

Solenoid: The electrical portion containing the coil and magnetic frame and/or enclosure.

Specific Gravity: The ratio of the mass of an equal volume of distilled water at 4°C or of a gas to an equal volume of air or hydrogen under prescribed conditions of temperature and pressure.

Viscosity: The amount of resistance to flow.

TERMS AND CONDITIONS OF SALE

- 1. TERMS AND CONDITIONS OF SALE** The order shall be subject to the terms and conditions set forth herein, notwithstanding any terms and conditions that may be contained in any order, acknowledgment or other form of Buyer. Such terms and conditions of Buyer shall not bind Seller unless accepted by it in writing, whether or not they manually alter this order. This order shall be governed in all respects by the law of the State of Ohio.
- 2.** Stenographical and clerical errors are subject to correction. Until order is accepted, prices are subject to change without notice. All quotations, unless otherwise stated, are for immediate acceptance. All orders and contracts subject to approval if accepted by a salesman or selling agent. Prices do not include special taxes now in effect or later put in effect.
- 3. PAYMENT** Payment shall not prejudice claims on account of omissions or shortages but no such claim will be allowed unless made within 30 days after receipt by Buyer.
- 4.** Accounts are opened only with firms or individuals on approved credit. The Seller reserves the privilege of declining to make deliveries except for cash whenever, for any reason, doubt as to the Buyer's financial responsibility develops and shall not, in such event, be held liable for non-performance of contract in whole or in part.
- 5.** Terms are Net 30 days. F.O.B. New Britain, Connecticut, where credit rating has been established. In all other cases C.O.D. or cash with order.
- 6.** There is a minimum order of \$100.00 net for manufacturer's terms unless specific minimum quantities are noted on the quotation.
- 7.** All Shipments are made F.O.B. point of shipment. After delivery to the carrier, the risk of loss shall be on the Buyer and any claims for loss or damage in transit must be filed by the Buyer.
- 8. DELIVERY** Seller shall not be liable for any delays in or failure of delivery due to acts of God or public authority, labor disturbances, accidents, fires, floods, extreme weather conditions, failure of and delays by carriers, shortages of material, delays of a supplier or any other cause beyond Seller's control. Buyer's requested delivery date or schedule shall be approximate and subject to Seller's acceptance.
- 9. PREMIUM FREIGHT** Shipments are made via common carrier. Any premium freight must be requested and paid for by the Buyer.
- 10.** In making of materials to customer specifications, it is impossible to produce exactly the quantity ordered and it is, therefore, agreed all orders are subject to over or under shipment of 5% on orders over 500 pieces, 10% on orders less than 500 pieces.
- 11. WARRANTIES** Seller warrants the goods sold hereunder to be free from defects in material and workmanship under normal use and service for a period of two (2) years from date of shipment from Skinner Valve's facility. THE ABOVE WARRANTIES COMPRISE SELLER'S SOLE AND ENTIRE WARRANTY OBLIGATIONS AND LIABILITY TO BUYER, ITS CUSTOMERS OR ASSIGNS IN CONNECTION WITH GOODS SOLD HEREUNDER SELLER EXTENDS NO WARRANTY TO THE ULTIMATE CONSUMERS OR USERS. ALL OTHER WARRANTIES, EXPRESS OR IMPLIED, INCLUDING BUT NOT LIMITED TO, WARRANTIES OF MERCHANTABILITY AND FITNESS, ARE EXPRESSLY EXCLUDED. Seller's sole obligation under these warranties shall be to repair or replace any item or part thereof which is proved to be other than as warranted. When claiming a breach of the above warranties, Buyer must notify Seller promptly whereupon Seller will either examine the goods at their site or issue shipping instructions for return to Seller (transportation cost prepaid by Buyer). The above warranties shall terminate unless Buyer in writing claims for breach thereof within 90 days from Seller's plant where damage is not directly due to a defect in material or workmanship, nor do they apply to goods altered or repaired except when performed under Seller's specific authority, nor to articles furnished by Buyer or acquired at Buyer's request and or to Buyer's specifications.
- 12. CONSEQUENTIAL DAMAGES** In no event shall Seller be liable for consequential or special damages arising out of a delay in or failure of delivery, defects in material or workmanship, or arising out of breach by Seller of any other term or obligation of Seller under this contract.
- 13. CHANGES IN SPECIFICATIONS OR DESIGN** If Buyer requests changes in specifications or designs related to any goods, delivery schedules shall be revised, if necessary, and an equitable adjustment, upward or downward, shall be made in price if warranted.
- 14. CANCELLATIONS AND RESCHEDULES** Cancellations and reschedules are subject to acceptance by Seller, and are also subject to cancellation charges and price increases.
- 15. RETURNED GOODS** No material shall be returned without our consent. When material is returned, with our consent, credit will be allowed only for that which is in good condition and can be resold. Freight must be prepaid on such shipments. The amount of freight paid by us on the original shipment to consignee is not subject to credit. Credit for approved returns is provided at a discount of 58% off list price at the time of purchase.
- 16. SPECIAL TOOLS** Any special tools, jigs, patterns, etc. which Seller makes or acquires for Buyer, notwithstanding any change therefore, shall be and remain Seller's property subject to its possession and control: In no event shall Buyer have any tooling belonging to Seller which is utilized in the production of goods for Buyer, or which has been converted or adapted by Seller for such use, notwithstanding any charge for any such utilization, conversion or adaptation Seller shall have the right to alter discard or otherwise dispose of any tooling without liability to Buyer when for two (2) consecutive years no orders have been received from Buyer requiring the use of such tooling.
- 17. BUYER'S PROPERTY** Any design, tools, patterns, drawings, information or equipment furnished by Buyer, or any special tools made or acquired for the Buyer by the Seller which becomes Buyer's property, shall be used only in the production of goods ordered by Buyer and not otherwise, unless by Buyer's written consent, provided that such property may be considered obsolete and destroyed by Seller when for two (2) consecutive years no orders are received from Buyer for products to be made with such property. Seller agrees to exercise reasonable care with respect to such property and equipment while in its possession and control, but shall not be responsible for loss or damage occurring without its fault or negligence or for ordinary wear and tear.
- 18. PATENT INDEMNITY** Seller shall have no liability for patent infringement unless the goods furnished hereunder in and of themselves constitute the infringement. If they do, and Seller is notified of the claim of infringement within ten days after such claim is made by the Buyer and is permitted to settle or defend such claim. Seller will indemnify the Buyer against the reasonable expense of defending suit and against any judgment or settlement to which Seller agrees. However, such indemnity will be limited to an amount not exceeding the price paid by Buyer to Seller for infringing goods. If an injunction is issued against the further use of the goods, Seller will have the option of either procuring for the Buyer the right to use the goods, replacing them with non-infringing goods, modifying them so that they become non-infringing, or refunding the purchase price. The forgoing constitutes Seller's entire warranty and liability as to patents. If the goods furnished hereunder are in accordance with a design furnished by the Buyer, the Buyer will defend and save harmless Seller from all costs, expenses and judgments on account of any claim of infringement of any patent.
- 19. TAXES** Any sales, use, excise or similar tax payable by Seller which is or may be imposed by any taxing authority upon the manufacture, sale or delivery of goods covered by this order, or any increase in rate of any such tax now in force, shall be added to the sales price, if not collected at the time of payment of sales price, Buyer will hold Seller harmless.
- 20. ADDITIONAL CONDITIONS APPLICABLE TO ORDERS PLACED UNDER GOVERNMENT CONTRACTS OR SUBCONTRACTS THEREUNDER** If Buyer notifies Seller that goods ordered hereunder are for use under a prime contract with an agency of the United States Government, the following terms and conditions of the Armed Services Procurement Regulations shall be incorporated into Seller's terms of sale insofar as Buyer may be required to incorporate such provision in its subcontracts or insofar as applicable to the goods hereunder. WALSH-HEALEY PUBLIC CONTRACTS ACT (12-605), RENEGOTIATION (7-103-13), BUY AMERICAN ACT (6-104,5), EXAMINATION OF RECORDS (7-104 15), AUDIT AND RECORDS (7-104,41), PRICE REDUCTION FOR DEFECTIVE COST OR PRICING DATA (7-104,29), CONVICT LABOR (12-203), NOTICE OF THE GOVERNMENT OF LABOR DISPUTES (7-104,4), WORK HOURS ACT (12-303,1), EXCESS PROFITS (7-104,11) MILITARY SECURITY REQUIREMENT (7-104,12), TERMINATION (8-706), EQUAL OPPORTUNITY (12-802).
- 21. PRICES SHOWN HEREON ARE STATED AT CURRENT RAW MATERIAL COSTS AND ARE SUBJECT TO CHANGE AS FLUCTUATIONS IN THE MARKET SO DICTATES.**
- 22. OTHER SERVICES** The prices issued in this schedule are for standard packaged products only. Any additional or supplemental services, material, or product marking or identification are subject to additional charges at the discretion of Parker.
- 23.** Where the Buyer requires tests for inspection not regularly provided, Parker reserves the right to charge an additional reasonable amount.
- 24. COMPLIANCE WITH LAW** Seller warrants that products sold or services furnished will be produced or furnished in full and complete compliance with all applicable federal, state, or local statutes, rules, regulations and orders, including those pertaining to labor, hours and conditions of employment, and in particular the Fair Labor Standards Act, as amended, and Executive Order No. 11248 (Equal Employment Opportunity) effective October 24, 1965, with all amendments thereto or as it may be superseded. Seller agrees that all the provisions of said Executive Order, as it may be amended or superseded, are hereby made a part hereof by reference and are binding upon Seller. Seller further agrees and confirms that Seller as a subcontractor or vendor has complied with and will comply with the provisions of said Executive Order and the rules and regulations promulgated under the authority thereof, including among others, reporting requirements.

AC Solenoid Specifications

Select One Code From Each Column			
Enclosure	Coil Termination	Voltage	
E Explosion Proof Watertight	K Screw	01 24/60	
G General Purpose	S Spade	02 24/50	
M 316 SS Explosion Proof Watertight	H D.I.N.	05 120/60 110/50	
O Open Frame	Leads:	10 208/60	
P D.I.N.	B* 6"	15 240/60 220/50	
S Splice Box	C* 18"	20 480/60 440/50	
U 316 SS Submersible	D 24"	51 120 - 240/60	
W Submersible Splice Box	E 36"	53 240 - 480/60	
Y Explosion Proof Watertight With Ground Lead	<i>* Only coil terminations available for Long Life-Quiet Operating valves.</i>	Voltages for Long Life-Quiet Operating Valves	
Z M, With Ground Lead		41 24/60	42 120/60
4 Gold Ring II Totally Encapsulated		44 240/60	

This chart prints on both sides of fold-out from back cover.

DC Solenoid Specifications

Select One Code From Each Column		
Enclosure	Coil Termination	Voltage
E Explosion Proof Watertight	K Screw	6 70
G General Purpose	S Spade	12 75
M 316 SS Explosion Proof Watertight	H D.I.N.	24 80
O Open Frame	Leads:	120 90
P D.I.N.	B 6"	125 95
S Splice Box	C 18"	
U 316 SS Submersible	D 24"	
W Submersible Splice Box	E 36"	
Y Explosion Proof Watertight With Ground Lead		
Z M, With Ground Lead		
4 Gold Ring II Totally Encapsulated		



Climate & Industrial Controls

UNITED STATES

Skinner Valve Division

Parker Hannifin Corporation
Climate & Industrial Controls Group
147 W. Hoy Road
Madison, MS 39110 USA
Tel: (601) 856-4123
Fax: (601) 853-7250
Email: skinnervalue@parker.com
Internet: <http://www.parker.com/skinner>



EUROPE, MIDDLE EAST AND AFRICA

Parker Lucifer SA

P.O. Box 1456
CH-1227 Carouge/Geneva
Switzerland
Tel: 41 22 3077 111
Fax: 41 22 3077 110

Republic of South Africa

Parker Hannifin (Africa) (Pty) Ltd.

Parker Place
10 Berne Avenue
Aeroporto, Kempton Park
P.O. Box 1153
Kempton Park 1620
Republic of South Africa
Tel: (27) (11) 392-7280
Fax: (27) (11) 392-7213

CANADA

Parker Hannifin (Canada) Inc.

Skinner Valve Division
530 Kipling Avenue
Toronto, Canada
M8Z 5E6
Tel: 416 255-1585
1-888-249-4806
Fax: 416-255-2107

MEXICO

Schrader Bellows – Parker, S.A. de C.V.

Division Mexico
Calle 9 no. 6, Franc. Alce Blanco 053370
Naucalpan Edo. de Mexico
Tel: (52-5) 358-5477
Fax: (52-5) 358-1823

SOUTH AMERICA AND CARRIBBEAN

Caribbean, Central America
Columbia, Equador, Peru
Bolivia, Chile, Guyana
Suriname, French Guiana

Parker Hannifin Corporation

Pan American Division
7400 N.W. 19th St. Suite A
Miami, FL 33126 USA
Tel: (305) 470-8800
Fax: (305) 470-8808

Argentina

Parker Hannifin Argentina

Av. Av. P. Illia 2064
Villa Maipu
1650 - San Martin
Buenos Aires
Argentina
Tel: 54 1 752 6008/4129
Fax: 54 1 752 3704

Venezuela

Parker Hannifin de Venezuela S.A.

Av. Ppal. De Boleita Norte con
Calle Miraima
Edificio DRAZA, PB
Caracas 1070, Venezuela
Tel: (58)-2-2385422
Fax: (58)-2-2392272

ASIA PACIFIC

Australia

Parker Hannifin (Australia) Pty. Ltd

9 Carrington Road
Castle Hill NSW 2154
Australia
Tel: (61) 2 9 634 7777
Fax: (61) 2 9 842 5111

New Zealand

Parker Hannifin (N.Z.) Limited

103 Harris Road, East Tamaki
Private Bag 94420, Greenmount
Auckland, New Zealand
Tel: (64 9) 273 8944
Fax: (64 9) 273 8943

India

Parker Hannifin India Pvt. Ltd.

701, Gateway Plaza
Hiranandani Gardens
Powai,
Mumbai 400 076, India
Tel: 91-570 5671
Fax: 91-22 570 5880

Japan

Yamatake-Corporation

1-12-2, Kawana, Fujisawa
Kanagawa, 251
Tel: (81) 466 20 2232
Fax: (81) 466 20 2193

Korea

LG-Honeywell Co Ltd

17F, Hanil Group Building
191 Hangangro-2 ga, Yongsan-gu
Seoul 140-702, Korea
Tel: (822) 799 6011
Fax: (822) 792 9013

Parker Hannifin Korea Ltd

902 Dae Heung Bldg
648-23 Yeoksam-Dong
Kangnam-Ku, Seoul, Korea 135-080
Tel: 82 2 561 0414
Fax: 82 2 556 8187

Singapore

Parker Hannifin Singapore Pte Ltd.

No. 11 4th Chin Bee Road
Jurong Town, Singapore 619702
Republic of Singapore
Tel: (65) 261-5233
Fax: (65) 265-5125, 261-4929

Taiwan

Parker Hannifin Taiwan Co., Ltd.

8F-1, No. 102 Sung Lung Rd.
Taipei, Taiwan, ROC
Tel: 886 2 8787 3780
Fax: 886 2 8787 3782

Thailand

Parker Hannifin (Thailand) Co. Ltd

252/96, 18th Floor
Muang Thai Phatra II
Rachadaphisek Rd., Huaykwang,
Bangkok 10320, Thailand
Tel: (662) 693 3304
Fax: (662) 693 3307

CHINA REGION

Parker Hannifin Hong Kong Ltd.

8/F, Kin Yip Plaza
9 Cheung Street
Cheung Sha Wan
Kowloon, Hong Kong
Tel: (852) 2428-8008
Fax: (852) 2480-4256

Parker Hannifin Beijing Office

Suite B9-B11, 21st Floor Hanwei Plaza
No. 7 Guanghua Road, Chaoyang District
Beijing 100004, P.R. China
Tel: 8610 65610520-5
Fax: 86 10 65610527

Parker Hannifin Shanghai Office

Rm 1101, Peregrine Plaza
1325 Huai Hai Road (M)
Shanghai 200031, China
Tel: 86 21 6445 9339
Fax: 86 21 6445 9717



Form No. 7300A (1198)

Online: www.parker.com/skinner