

# Ready, steady, mow!

Walk Behind Mower & Lawn Tractor Range



**JOHN DEERE**



# Experience the difference

## Welcome to the world of John Deere

The home of innovation, quality and reliability for over 170 years. Our long history and our experience shine through in our lawn mowers and tractors – and it's all for your benefit. You'll find John Deere whenever and wherever that extra bit of quality and professionalism is called for – in agriculture, golf courses, sports facilities and parks. So why not experience it for yourself?

This brochure will introduce you to our lawn mowers and tractors for residential groundscape. No matter which model catches your eye, you'll soon see that a John Deere mower is exactly what your garden needs. Even our basic designs boast numerous extra features, sophisticated technology and all the comfort and convenience you could hope for. And with other innovative features including the Edge Xtra mower deck, 4-Wheel Steer and even more powerful engines, our Select Series really will change your life – and the way you work. Only John Deere can do all that.



### **We don't leave anything to chance**

All our machines are put through strict quality checks and tough tests. As a result, there's one thing you can be sure of – if it says John Deere on the outside, it's John Deere quality through and through.

### **You'll never walk alone**

It's not just a product with John Deere, it's also the full support, back up and specialist advice available to you from dealers that have the experience.

**The customer is king**

Superior products deserve unique customer service! We're here whenever you need us. We have a wide network of sales partners, plus a parts service that can supply you within just 24 hours.

**The quality factory**

John Deere delivers quality. Always has, always will. We stand by that – with every single walk behind mower and every one of our lawn tractors produced both in Germany and in the USA respectively.

# What a great act to follow



24 models



## Walk Behind Mower & Scarifier

### Standard Series

3-in-1 Mower.....	8
Mulch Mower .....	9

### Select Series

Electric.....	10
Push.....	12
Single Speed.....	14
Key start / Variable speed .....	16
Rear Roller .....	18
Scarifier.....	20

## Ride-on Mowers & Lawn Tractors

### Standard Series

CR and LR Series .....	26
X100 Series .....	30

### Select Series

X300 Series .....	38
X500 Series .....	44
X700 Series .....	50
EZtrak .....	54
Attachments.....	58



17 models

# Finding your perfect fit

Whether it measures 50 or 2500 m<sup>2</sup>, your garden is your own little kingdom. It's where you come to relax, meet friends and simply enjoy nature. John Deere is here to help you give it the care and attention it deserves. We provide all the products and quality you could ever wish for. And good ideas and advice that you know you can rely on. Make sure your garden stays just as it should be – the most beautiful place in the world!



## Standard Series

The range of Standard Walk Behind Lawn mowers offer great features.

\*Only available in selected markets.

## Select Series

**Electric**  
– A silent solution



- 40 cm | R40EL
- 43 cm | R43EL, R43ELV

**Push**  
– Even with a push you shouldn't miss selected features



- 40 cm | R40
- 43 cm | R43
- 47 cm | R47\*

# Standing out from the crowd



## Select Series

- 1 Ready, steady, go!**  
The ReadyStart engine means your mower is always ready when you are, due to the Automatic Choke System.
- 2 For a truly flawless cut**  
An ingenious system consisting of mower deck, blades, collector and fan ensures an unparalleled cut and collecting performance. We know it, quite simply, as the TurboStar Mowing System.
- 3 Durability – guaranteed**  
The lightweight, rust-proof diecast aluminium mower deck comes with a 15-year guarantee (residential use).
- 4 No time to waste.**  
Get your work done in record time. Our mowers are both nimble and extraordinarily manoeuvrable. The wheels with ball-bearing mounts deliver excellent drive – even on wet grass.
- 5 Why make things complicated?**  
The textile grass collector bag is a real lightweight. In fact, you can even carry it in just one hand – even when it's filled up. The signal indicator tells you when it's time to empty.

**Single speed**  
– Single speed for easy drive support

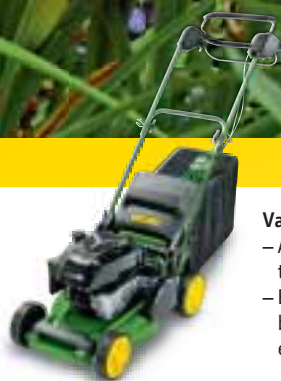

43 cm | R43S  
47 cm | R47S  
54 cm | R54S

**Variable speed**  
– Adjust the mowing speed to your needs  
– Blade brake clutch stops blade – no restarting when emptying the bagger

47 cm | R47KB  
54 cm | JX90



**Key start**  
– As simple as a car – just turn the key  
– Variable speed

43 cm | R43VE  
47 cm | R47VE  
54 cm | R54VE



# Standard Series

## 3-in-1 Mower

### Much more than “just” standard

Try one of the mowers in our Standard Series and discover just how easy and efficient mowing can be. With a whole lot of power, easy operation and typical John Deere quality, these mowers are – quite literally – a cut above the rest.

The 3-in-1 Mower deck lets you switch between mulching, collecting and side discharge in seconds.



Specifications	JM36	JM46
Recommended Mowing Area, m <sup>2</sup>	2500	2500
Cutting Width, cm	56	56
Cutting Height Adjustment, mm	30 – 107	30 – 107
Bag Capacity, litre	88	88
Weight, kg	43	45

#### MowMentum Drive

This John Deere exclusive drive system lets you control the speed of your mower. Speed is dictated by how far you pivot the handle.

#### Key Start

The JM46 Mower comes complete with an electric starter – key in, one twist and away you go!



## Mulch Mower

### Reduce mowing time

Imagine cutting the time it takes to tend your garden by as much as one third. Not having to empty the grass collector and saving money while doing something positive for the environment.

Sounds impossible? Then you've never experienced our mulching mowers! Discover the benefits of mowing and mulching in one easy step. If you want to save time and money without compromising on cutting quality, then look no further than a John Deere mulching mower!



Specifications	JS63V	JS63VC
Recommended Mowing Area, m <sup>2</sup>	2000	2000
Cutting Width, cm	53	53
Cutting Height Adjustment, mm	20 – 97	20 – 97
Caster Wheels	No	Yes
Weight, kg	40	43

#### Natural goodness.

During mulching, nitrogen-rich clippings are returned to the grass as a natural fertiliser. This prevents nutrients being lost and retains moisture. But want to know the best thing? You'll be able to cut right back on artificial fertilisers!

#### A tight fit?

Find trees, shrubs, flowers and beds a bit tricky? Not any more! Thanks to the 360 degree manoeuvrability of its front caster wheels, the JS63VC mulching mower takes all obstacles in its stride.

# Select Series

## Electric

### The sound of silence

John Deere is also the right choice for anyone who prefers the quiet life. With our electric models you and your neighbours can revel in the blissful peace of your garden.

And the relaxed approach doesn't end there. The simple operation, robust mower deck and TurboStar Mower System deliver an outstanding cut and make the whole process absolutely worry-free! You'll save time, too, putting the finishing touches to your lawn while others are still refuelling!

Specifications	R40EL	R43EL	R43ELV*
Recommended Mowing Area, m <sup>2</sup>	600	700	700
Cutting Width, cm	40	43	43
Cutting Height Adjustment, mm	25 – 75	22 – 80	15 – 80
Bag Capacity, litre	44	55	55
Weight, kg	22	26	35

\*Available Spring 2011



#### Power and comfort in one

Our self-propelled, variable speed model combines ease of operation with the quietness of electric power – enjoy your garden whilst you mow!

#### Take the weight off

Our electric models really do take the weight of work off your shoulders. And to save the best for last: Our polypropylene deck includes a 10 year guarantee for residential applications!



**Still waters run deep**

Don't be fooled by the quiet exterior of these models. The high-torque motor packs a whole lot of punch.



	Extremely quiet operation
	Very robust
	Very easy to use
	High-torque motor
	Variable speed (R43ELV)

# Select Series

Push

## A mower of many talents

Our Select Series Petrol Push models are the perfect complement to any lawn – from the smallest garden to the grandest of grounds.

Enjoy absolute mowing freedom and transform your garden into the most beautiful place on the planet! Our all-rounders are durable, reliable and extremely easy to work with – and you'll never fail to be amazed by the sheer power of their performance!

Specifications	R40	R43	R47*
Recommended Mowing Area, m <sup>2</sup>	700	800	1200
Cutting Width, cm	40	43	47
Cutting Height Adjustment, mm	25 – 75	22 – 80	20 – 80
Bag Capacity, litre	44	55	65
Weight, kg	24	30	31

\*Only available in selected markets.



### Height adjustment

Personalise the cutting height to your needs – simply by choosing one of 6 – 9 cutting steps

### Ready to go with ReadyStart!

The powerful 4-stroke ReadyStart petrol engines are ready to go when you are – because of their Automatic Choke System.



**Small and nippy**

The R40, R43 and R47 compact mowers will take you wherever you need to go. And these little powerhouses won't leave you wanting when it comes to performance and reliability, either!



	ReadyStart engine
	Central cutting height adjustment
	Folding handlebars
	TurboStar mowing system
	Optional mulching equipment

# Select Series

## Single Speed

### Power at your fingertips

Shift things up a gear with our self-propelled mowers from the Select Series Single Speed range. With these models, you can be putting the finishing touches to larger areas and even hilly ground. What's more, you'll barely even have to break into a sweat – the drive system does all the hard work for you!

The TurboStar Mowing System ensures a flawlessly accurate cut, while the collector holds up to an impressive 75 litres. Put the fun factor into your mowing!

Specifications	R43S	R47S	R54S
Recommended Mowing Area, m <sup>2</sup>	1000	1400	2500
Cutting Width, cm	43	47	54
Cutting Height Adjustment, mm	15 – 80	20 – 80	17 – 104
Bag Capacity, litre	65	65	75
Weight, kg	35	33	45



Empty



Full

#### The time is right

The practical indicator shows when the grass collector is ready to be emptied.

**No more uphill struggles**

This nimble, single-speed model doesn't let even hilly ground get in its way.



	Suitable for hilly ground
	ReadyStart engine
	Up to 75 litre grass collector
	Folding handlebars
	TurboStar mowing system
	Fill indicator
	Optional mulching equipment

# Select Series

Key Start | Variable Speed | BBC

## Isn't it nice to have a choice?

If you're all for keeping things simple, then choose either an electric (key) start model or a Blade Brake Clutch (BBC) version. Simply turn the key on the electric start models and watch the engine spring into life or if you prefer – choose the BBC version which means you no longer have to keep re-starting as the engine stays running when you empty

the bagger. What's more, these nimble little movers boast a durable aluminium mower deck, wheels with ball-bearings for easy operation and variable speed control to set your pace. And that means the whole mowing experience stays nice and simple, too.

Specifications	R47KB	JX90	R43VE	R47VE	R54VE
Recommended Mowing Area, m <sup>2</sup>	1500	2500	1000	1500	2500
Cutting Width, cm	47	54	43	47	54
Cutting Height Adjustment, mm	20 – 80	17 – 104	15 – 80	20 – 80	17 – 104
Bag Capacity, litre	65	75	65	65	75
Weight, kg	42	54	38	38	49



### Ultra-convenient

As soon as you release the grip, the Blade Brake Clutch (BBC) stops the blades – but leaves the engine running. With no need to restart the mower, you can just keep on enjoying mowing. Experience this new dimension in safety and convenience.

### Got big plans?

Good, so do we! That's why the XXL-size grass bagger can hold an impressive 75 litres.

### Choose the natural option

Natural fertilisers like clippings are a contemporary and extremely intelligent way to keep your lawn lush and healthy. That's why optional mulching equipment is available for virtually all our walk-behind mowers.



**Just a flick of the wrist**

All it takes to start the mower is a simple turn of the ignition key. It couldn't be easier!



	Electric Start (R43VE, R47VE, R54VE)
	Variable speeds
	ReadyStart engine
	TurboStar mowing system
	Optional mulching equipment
	Blade Brake Clutch (R47KB, JX90)
	75 litre grass bagger (R54VE, JX90)

# Select Series

## Rear Roller

### For the classic stripe

Dreaming of perfect stripes on your own lawn? John Deere is here to make that dream a reality. Our mowers with robust, integrated rear rollers create a stunning effect as you mow.

You'll also enjoy a range of cutting widths, an electric or recoil starter, single or variable speeds, and much, much more. As ever, your wish is our command! Our broad product portfolio is specially designed with your needs in mind.



Specifications	R43RS	R43RVE	R47RKB	R54RKB
Recommended Mowing Area, m <sup>2</sup>	1000	1000	1500	2500
Cutting Width, cm	43	43	47	54
Cutting Height Adjustment, mm	15 – 70	15 – 70	15 – 70	15 – 80
Bag Capacity, litre	65	65	65	75
Weight, kg	35	40	47	55



#### Because you love your lawn

Our rear roller mower range together with TurboStar fan assisted collection help create that perfect stripe for your lawn.

#### No scalping

The durable rear roller keeps the machine balanced and helps protect your lawn when operating along edges.

**The stripe of perfection**

Be the envy of all your neighbours. Create a perfectly finished lawn with truly eye-catching features!



	Improves the look of your lawn
	ReadyStart (R43RS, R43RVE)
	TurboStar mowing system
	Available in various designs and widths

# Select Series

## Scarifier

### Give moss the heave-ho!

A healthier lawn doesn't just happen by accident, but with the correct lawn care including scarifying, the work pretty much does itself.

Regular scarifying is essential to nip lawn thatch and moss in the bud and ensure the ground receives enough nutrients. With our scarifiers, you can get this work done easily. These models glide along effortlessly, breathing new life into your lawn.

Specifications	D31RE	D35RE	D38R
Recommended Mowing Area, m <sup>2</sup>	500	700	1500
Cutting Width, cm	31	35	38
Power	Electric	Electric	Electric
Bag Capacity, litre	Option – 50	Option – 50	Option – 55
Weight, kg	17.5	18.5	33



Don't let thatch build-up stand in your way of a healthier, thicker lawn. Give your grassroots the water, air and nutrients they need. Break up thatch (that dead layer of grass and moss build-up) every spring and autumn with a scarifier.

**Keep everything nice and tidy**  
An optional bagger is available to make sure no thatch or moss is left lying around.

**Neighbours take note!**

Whether you have a small garden or more extensive grounds, our electric and petrol scarifiers will revitalise your lawn and transform it into a picture of health!



	Create a healthy lawn
	Powerful engines
	Steel scarifier blades
	Optional bagger
	Light weight



Specifications	Description	JM36	JM46	JS63V	JS63VC	R40EL	R43EL	R43ELV*
<b>Recommended Mowing Area, up to, m<sup>2</sup></b>		2500	2500	2000	2000	600	700	700
<b>Engine</b>	Type	Petrol, 4 Stroke, Ready Start	Petrol, 4 Stroke, Ready Start	Petrol, 4 Stroke	Petrol, 4 Stroke	Electric	Electric	Electric
	Nominal Power*, kW	2.3	3.3	3.2	3.2	1.3	1.5	1.7
	RPM	2800	2900	2800	2800	–	–	–
	Displacement	190	190	190	190	–	–	–
<b>Guaranteed Sound Power Level, dB(A)</b>		98	98	98	98	96	96	96
<b>Cutting Width, cm</b>		56	56	53	53	40	43	43
<b>Cutting Height Adjustment</b>	Cutting Height, mm	30 – 107	30 – 107	20 – 97	20 – 97	25 – 75	22 – 80	15 – 80
	Adjustment	Central	Central	Front 1/Rear 1	Front 2/Rear 1	Central	Central	Central
	Positions	9	9	7	7	6	7	9
<b>Discharge</b>		3-in-1 Mulch, Rear, Side	3-in-1 Mulch, Rear, Side	Mulch Side	Mulch Side	Rear	Rear	Rear
<b>Collection</b>		Rear	Rear	Optional: Bagger Rear		Rear	Rear	Rear
<b>Bag Capacity, litre</b>		88	88	–	–	44	55	55
<b>Drive</b>	System	Variable MowMentum Drive System™		Variable Speed	Variable Speed	Push	Push	Variable Speed
	Speed, km/h	0 – 6.5	0 – 6.5	2.5 – 5.2	2.5 – 5.2	–	–	2.5 – 3.6
<b>Start / Stop</b>		Recoil	Electric	Recoil	Recoil	–	–	–
<b>Handlebar</b>	Adjustable	Standard (3 Positions)	Standard (3 Positions)	Standard	Standard	Standard	Standard	Standard
	Foldable	Standard	Standard	Standard	Standard	Standard	Standard	Standard
	Vibration ahw, m/s <sup>2</sup>	NA	NA	2.5	2.5	1.5	1	1
<b>Deck</b>	Material	Steel	Steel	Steel	Steel	Polypropylene	Aluminium	Aluminium
<b>Wheels</b>	Diameter front/rear, mm	203	229	210/210	210/210	150/180	180/180	180/200
	Bearings	Friction	Friction	Ball/Needle	Ball/Needle	Ball	Ball	Ball
<b>Weight, kg</b>		43	45	40	43	22	26	35

\*Available Spring 2011



Specifications	Description	R40	R43	R47**	R43S	R47S	R54S
<b>Recommended Mowing Area, up to, m<sup>2</sup></b>		700	800	1200	1000	1400	2500
<b>Engine</b>	Type	Petrol, 4 Stroke	Petrol, 4 Stroke Ready Start	Petrol, 4 Stroke	Petrol, 4 Stroke Ready Start	Petrol, 4 Stroke Ready Start	Petrol, 4 Stroke Ready Start
	Nominal Power*, kW	2.1	2.4	2.4	2.4	2.4	2.4
	RPM	2900	2800	2800	2800	2800	2800
	Displacement	158	190	190	190	190	190
<b>Guaranteed Sound Power Level, dB(A)</b>		96	96	96	96	96	98
<b>Cutting Width, cm</b>		40	43	47	43	47	54
<b>Cutting Height Adjustment</b>	Cutting Height, mm	25 – 75	22 – 80	20 – 80	15 – 80	20 – 80	17 – 104
	Adjustment	Central	Central	Central	Central	Central	Central
	Positions	6	7	9	9	9	7
<b>Discharge</b>		Rear, Mulch Kit Option	Rear, Mulch Kit Option	Rear, Mulch Kit Option	Rear, Mulch Kit Option	Rear, Mulch Kit Option	Rear, Mulch Kit Option
<b>Collection</b>		Rear	Rear	Rear	Rear	Rear	Rear
<b>Bag Capacity, litre</b>		44	55	65	65	65	75
<b>Drive</b>	System	Push	Push	Push	Single Speed	Single Speed	Single Speed
	Speed, km/h	–	–	–	3.6	3.6	3.6
<b>Start / Stop</b>		Recoil	Recoil	Recoil	Recoil	Recoil	Recoil
<b>Handlebar</b>	Adjustable	Standard	Standard	Standard	Standard	Standard	Standard
	Foldable	Standard	Standard	Standard	Standard	Standard	Standard
	Vibration ahw, m/s <sup>2</sup>	8	7.7	5	4	5	4.4
<b>Deck</b>	Material	Polypropylene	Aluminium	Aluminium	Aluminium	Aluminium	Aluminium
<b>Wheels</b>	Diameter front/rear, mm	150/180	180/180	180/180	180/200	180/180	210/210
	Bearings	Ball	Ball	Ball	Ball/Needle	Ball/Needle	Ball/Needle
<b>Weight, kg</b>		24	30	31	35	33	45

\* The engine horsepower information is provided by the engine manufacturer to be used for comparison purposes only.

\*\*Available in selected markets only.



Specifications	Description	R47KB	JX90	R43VE	R47VE	R54VE
<b>Recommended Mowing Area up to, m<sup>2</sup></b>		1500	2500	1000	1500	2500
<b>Engine</b>	Type	Petrol, OHV, 4 Stroke	Petrol, OHV, 4 Stroke	Petrol, 4 Stroke, Ready Start	Petrol, 4 Stroke, Ready Start	Petrol, 4 Stroke, Ready Start
	Nominal Power*, kW	2.8	2.8	2.4	2.4	2.4
	RPM	2800	2800	2800	2800	2800
	Displacement	179	179	190	190	190
<b>Guaranteed Sound Power Level, dB(A)</b>		96	98	96	96	98
<b>Cutting Width, cm</b>		47	54	43	47	54
<b>Cutting Height Adjustment</b>	Cutting Height, mm	20 – 80	17 – 104	15 – 80	20 – 80	17 – 104
	Adjustment	Central	Central	Central	Central	Central
	Positions	9	7	9	9	7
<b>Discharge</b>		Rear, Mulch Kit Option	Rear, Mulch Kit Option	Rear, Mulch Kit Option	Rear, Mulch Kit Option	Rear, Mulch Kit Option
<b>Collection</b>		Rear	Rear	Rear	Rear	Rear
<b>Bag Capacity, litre</b>		65	75	65	65	75
<b>Drive</b>	System	Variable Speed	Variable Speed	Variable Speed	Variable Speed	Variable Speed
	Speed, km/h	2.7 – 4.3	2.7 – 5	2.5 – 4.3	2.7 – 4.3	2.7 – 5
<b>Start/Stop</b>		Recoil BBC	Recoil – BBC	Electric	Electric	Electric
<b>Handlebar</b>	Adjustable	Standard	Standard	Standard	Standard	Standard
	Foldable	Standard	Standard	Standard	Standard	Standard
	Vibration ahw, m/s <sup>2</sup>	39	5	4	5	4.6
<b>Deck</b>	Material	Aluminium	Aluminium	Aluminium	Aluminium	Aluminium
<b>Wheels</b>	Diameter front/rear, mm	180/180	210/210	180/200	180/180	210/210
	Bearings	Ball/Needle	Ball/Needle	Ball/Needle	Ball/Needle	Ball/Needle
<b>Weight, kg</b>		42	54	38	38	49



Specifications	Description	R43RS	R43RVE	R47RKB	R54RKB	D31RE	D35RE	D38R
<b>Recommended Mowing Area up to, m<sup>2</sup></b>		1000	1000	1500	2500	500	700	1500
<b>Engine</b>	Type	Petrol, 4 Stroke Ready Start	Petrol, 4 Stroke Ready Start	Petrol, OHV 4 Stroke	Petrol, OHV 4 Stroke	Electric	Electric	Petrol 4 Stroke
	Nominal Power*, kW	2.4	2.4	2.8	2.8	1.4	1.6	2.3
	RPM	2800	2800	2800	2800	–	–	3400
	Displacement	190	190	179	179	–	–	127
<b>Guaranteed Sound Power Level, dB(A)</b>		96	96	96	98	92	92	98
<b>Cutting Width, cm</b>		43	43	47	54	31	35	38
<b>Cutting Height Adjustment / Working Depth Adjustment</b>	Cutting Height, mm	15 – 70	15 – 70	15 – 70	15 – 80	–	–	–
	Adjustment	Central	Central	Central	Front 2/Rear 1	Central	Central	Central
	Positions	9	9	9	Front 7/Rear 11	–	–	Stepless
<b>Blades</b>		–	–	–	–	13	15	15
<b>Discharge</b>		Rear	Rear	Rear	Rear	Rear	Rear	Rear
<b>Collection</b>		Rear	Rear	Rear	Rear	Optional	Optional	Optional
<b>Bag Capacity, litre</b>		65	65	65	75	Option – 50	Option – 50	Option – 55
<b>Drive</b>	System	Single Speed	Variable Speed	Variable Speed	Variable Speed	Push	Push	Push
	Speed, km/h	4.1	3.3 – 5	3.3 – 5	3.3 – 5	–	–	–
<b>Start / Stop</b>		Recoil	Electric	Recoil BBC	Recoil – BBC	–	–	Recoil
<b>Handlebar</b>	Adjustable	Standard	Standard	Standard	Standard	Standard	Standard	–
	Foldable	Standard	Standard	Standard	Standard	Standard	Standard	Standard
	Vibration ahw, m/s <sup>2</sup>	4	4	3.8	3.6	–	–	–
<b>Deck</b>	Material	Aluminium	Aluminium	Aluminium	Aluminium	ABS	ABS	Aluminium
<b>Wheels</b>	Diameter front/rear, mm	180/100	180/100	180/100	180/100	180/180	180/180	180/180
	Bearings	Ball	Ball	Ball	Ball	Friction	Friction	Cone
<b>Weight, kg</b>		35	40	47	55	17.5	18.5	33
<b>Extras</b>		–	–	–	–	Working depth with memory function		

\* The engine horsepower information is provided by the engine manufacturer to be used for comparison purposes only.

# Mow your lawn to perfection

Perhaps it's what you don't notice on a John Deere that really makes the difference

You'll love the exceptionally smooth ride but you may not see the transmission and the heavy-duty fully welded frame that make your ride so comfortable. You might even notice the legendary green bonnet remains dent-free and rust-free but maybe not realise it's the UV-resistant John Deere engineered plastic material that keeps it away. So what do all of these little differences mean? The true reason that a John Deere lawn tractor stands apart and is more than just the sum of its parts.



**Standard Series**

**Select Series**

**CR/LR Series**  
**Reliable lawnmower for smaller lawn size**

- Compact design



**X100 Series**  
**The start to a great lawn begins here**

- Ergonomic design
- Simple and intuitive to use



**X300 Series**  
**Perfection taken to new heights**

- John Deere iTorque power system by Kawasaki
- CruiseControl
- TwinTouch Foot Control System







### Rear Collection

For the cleanest looking lawns. Choose the custom engineered, rear-collection lawn tractors or a collection attachment. Great collection performance for a lawn free of clippings.



### Edge Xtra Cutting System

Solid stamped steel decks designed with superior airflow for unmatched cut quality and uniform discharge even in the most difficult mowing conditions.



### Mulching

Trim on both sides, eliminate collecting and enjoy all the lawn health benefits of mulching with the Edge Mulch deck.



#### X500 Series A powerful cut on all terrains

- Commercial grade engines
- Premium high back seat
- Hydraulic Power Steering
- Heavy duty steel frame



#### X700 Series The ultimate Lawn Tractor

- 4-Wheel Drive and 4-Wheel Steer options
- Broad choice of front and rear attachments
- Road homologation available
- Commercial grade steel frame
- Diesel Engine



#### EZtrak Sets the bar for productivity

- Zero turning radius
- Intuitive two stick steering
- Mowing speed of up to 8.5 mph



# CR | LR Series

## Standard Series Lawn Mower

Reliable lawn mower  
for smaller lawn size

Outstanding manoeuvrability, even in confined areas.





## CR | LR Series

Relax while looking after your garden



Comfort, power and a whole lot of fun. With the CR riders and LR lawn tractors, gardening is an enjoyment in itself. Which of these versatile models best fits your requirements?



Model	CR125 5-Speed	CR125 Automatic	LR135
<b>Recommended Mowing Area, m<sup>2</sup></b>	up to 2000	up to 2000	up to 3000
<b>Engine</b>	Briggs&Stratton	Briggs&Stratton	Briggs&Stratton
Nominal Power*, kW/min <sup>-1</sup>	6.8/2800	6.8/2800	6.8/2800
Displacement, cm <sup>3</sup>	344	344	344
<b>Turning radius, cm</b>	35	35	40
<b>Mower Deck Options (Cutting Height), mm</b>	30 – 80	30 – 80	30 – 80
28RD (72 cm/28 in)	●	●	–
36RD (92 cm/36 in)	–	–	●
<b>Attachments</b>	–	–	Frontblade 125 cm Rotary Broom 120 cm

Standard ● Optional ○

\* The engine horsepower information is provided by the engine manufacturer to be used for comparison purposes only.

### Rear discharge rider.

Your benefits: excellent visibility up-front and outstanding manoeuvrability – even in confined areas.

1

**High performance engines.**

Your benefits: best performance even under the most demanding conditions, e.g. cutting long grass.

2

**Automatic foot control to easily change from forward to reverse.**

Your benefits: easy to manoeuvre and perfect trimming.

3

**Comfort seat with adjustable lumbar support and high back.**

Your benefits: comfortable, ergonomic seating.

4

**Large grass bagger makes your job quicker and easier.**

Your benefits: fewer stops for emptying.



# X100 Series

Standard Series Lawn Tractors

The start to a great lawn  
begins here

Perfect for keeping your lawn in order.





## X100 Series

If you want durability, look no further.



Fully welded frame, cast-iron front axle and fully enclosed UV resistant bonnet – these are just some of the many benefits of these lawn tractors. That's why you'll have many years of fun on them.

Model	X125	X145	X155R	X165
<b>Recommended Mowing Area, m<sup>2</sup></b>	up to 5000	up to 5000	up to 6000	up to 6000
<b>Engine</b>	Briggs&Stratton	Briggs&Stratton	Briggs&Stratton	Briggs&Stratton
Nominal Power*, kW/min <sup>-1</sup>	9.8/3150	10.3/3250	12.5/3150	13.3/3350
Displacement, cm <sup>3</sup>	500	500	656	656
<b>Turning radius, cm</b>	45.7	45.7	50.8	45.7
<b>Uncut Circle Radius, mm</b>	63.5	63.5	N/A	50.8
<b>Mower Deck Options (Cutting Height), mm</b>	25 – 101	25 – 101	25 – 101,6	25 – 101
42C (107 cm/42 in)	●	●	–	–
42RD (107 cm/42 in)	–	–	●	–
48C (122 cm/48 in)	–	–	–	●
<b>Collector, ltr</b>	○ 230	○ 230	● 300	○ 230
<b>Attachments</b>	Front Bumper (Standard), Front blade, Rotary Broom, Tyre Chains	Front Bumper (Standard), Front blade, Rotary Broom, Tyre Chains	Front Bumper (Standard), Front blade, Rotary Broom, Tyre Chains	Front Bumper (Standard), Front blade, Rotary Broom, Tyre Chains

Standard ● Optional ○

\* The engine horsepower information is provided by the engine manufacturer to be used for comparison purposes only.



### Versatile

If you need the occasional ability to collect your clippings or free your lawn from leaves then the optional high capacity 230 ltr collection system is available.

**Your benefits:** Pick up clippings and leaves.



1

X145 and X165 come standard with a high back seat. The X165 also has adjustable lumbar support on top.

2

The V-Twin engine will get your heart racing: high performance with low fuel consumption (X155R, X165). Your benefits: more power at a lower cost.

3

It's just a small step from mowing to mulching (recycling). Your benefits: fast tool-free conversion.

4

On demand you can equip your tractor with a 230 litre rear collector to pick up clippings and several other attachments. Your benefits: great versatility.

5

Integrated convenient mower deck wash port easily removes grass build-up underneath the deck. Your benefits: a perfect cut every time.



Compliance covering for mower decks shown in this picture may vary by country

## X155R

It's quite a collection

Are you looking for robustness, efficiency and professionalism? John Deere developed the X155R to meet these very requirements. This lawn tractor has all the best qualities of the X100 Series machines with a large capacity collector to boot. For a perfect looking lawn – free of grass clippings.

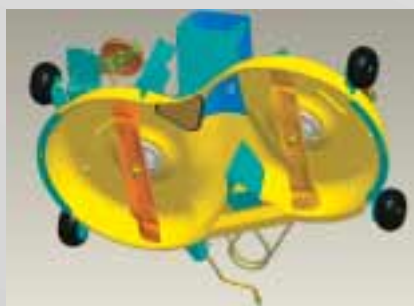

High quality deck designed specifically for optimised grass collection.  
**Your benefits:** perfect collection and a great looking lawn.



Deflector as an option for the grass collector.  
**Your benefits:** excess clippings are evenly distributed over the lawn in areas you don't want to collect.

**1** 300 litre grass collector as standard.  
Your benefits: worry-free mowing.

**2** Edge Xtra deck propels the grass clippings efficiently into the collector.  
Your benefits: a perfect clean cut.

**3** Briggs & Stratton V-Twin engine.  
Your benefits: extremely powerful and fuel-efficient.

**4** Premium high back seat.  
Your benefits: relaxing work and optimum comfort.

**5** Integrated front bumper as standard.  
Your benefits: additional protection perfectly integrated into the tractor design.



# Select Series

These are the lawn tractors we're proudest of.

We gave our engineers a simple charge: Build the best lawn tractors on the market. Do whatever it takes.

The result is The Select Series. The finest John Deere has to offer.

Strong, versatile and agile, they represent everything we've learned in over 175 years in the business.

**We're proud you're considering one.**



Heavy-duty robotically welded frame is the bedrock of these machines. So solid, it can stand up to the toughest of demands.



Rigorous quality control audits ensure your tractor is built to the same exact tolerances as our engineers demand!

Whether it's The Edge Xtra Cutting System or the 7-Iron, all of our mowing decks are formed from a single sheet of heavy-gauge steel for superior strength. Not cobbled together using fabricated sections or welding extra steel on.

# X300 Series

Select Series Tractors

Perfection taken to new heights

Easily handle intricate landscaping and garden maintenance.





## X300 Series

An accurate cut down to the smallest blade of grass



Manoeuvrable even in the most confined areas. Extremely powerful engines with outstanding fuel efficiency. What about the cut? Pure precision. Every single blade of grass is perfectly cut leaving an immaculate finish.

Model	X300	X304	X300R	X320
<b>Recommended Mowing Area, m<sup>2</sup></b>	up to 8000	up to 8000	up to 8000	over 8000
<b>Engine</b>	John Deere iTorque by Kawasaki			
Nominal Power*, kW/min <sup>-1</sup>	11.0/3100	11.0/3100	13.8/3350	16.1/3350
Displacement, cm <sup>3</sup>	603	603	726	726
<b>Turning radius, cm</b>	40.6	38.1	48.2	40.6
<b>Uncut Circle Radius, cm</b>	68.6 (42M)	40.6	73.7	53.3 (48C)
<b>Mower Deck Options (Cutting Height), mm</b>	25 – 102	25 – 102	25 – 102	25 – 102
42M (107 cm/42 in)	○	●	–	○
42C (107 cm/42 in)	○	○	–	○
42TS (107 cm/42 in)	–	–	●	–
48C (122 cm/48 in)	–	–	–	○
<b>Collector, ltr</b>	○ 250 only with 42C deck	○ 250 only with 42C deck	● 300	○ 250 only with 42C/48C deck
<b>Attachments</b>	Front Bumper, Front Brush Guard, Tyre chains, Front blade 125 cm, Rotary Broom, Utility Carts	Front Bumper, Front Brush Guard, Tyre chains, Front blade 125 cm, Rotary Broom, Utility Carts	Front Bumper, Front Brush Guard, Tyre chains, Front blade 125 cm, Rotary Broom, Utility Carts	Front Bumper, Front Brush Guard, Tyre chains, Front blade 125 cm, Rotary Broom, Utility Carts

Standard ● Optional ○

\* The engine horsepower information is provided by the engine manufacturer to be used for comparison purposes only.



1

**With the deluxe seat, gardening becomes an enjoyable pastime.**

Your benefits: the ultimate in driving pleasure – on all terrains!

2

**The electric PTO clutch is standard.**

Your benefits: Easy and smooth engagement of the mower deck.

3

**Automatic transmission with TwinTouch foot pedals and standard cruise control.**

Your benefits: easy operation and operator comfort.

4

**Extremely small turning radius thanks to the four wheel steering facility (X304).**

Your benefits: effortless trimming around the tightest of obstacles.

5

**More power, durability and higher fuel efficiency thanks to the V-Twin Kawasaki engine.**

Your benefits: exceptional traction and lower fuel consumption.



# X300R

Summer is too short to make compromises.

The deck of the X300R is the perfect answer for precision lawn mowing on formal lawns, all thanks to the TurboStar System. The integrated fan lifts the grass and blows the clippings into the collector. When the collector is full the deck switches off automatically so there is no chance of the deck becoming congested with clippings.

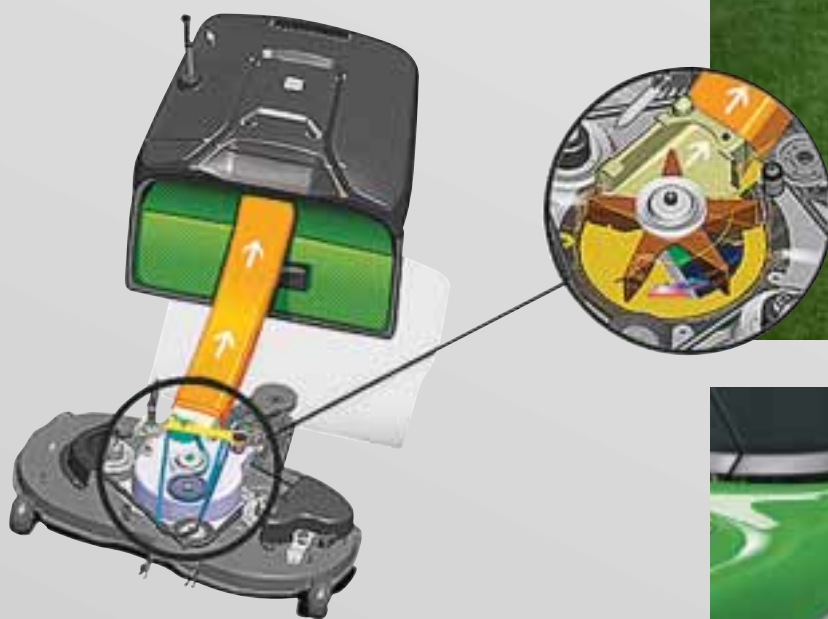

The superior TurboStar Mower System lifts the grass, cuts it and piles it up in the grass collector.

**Your benefits:** a clipping-free lawn and fewer stops needed to empty the collector.

TwinTouch pedal control ensures smooth, effortless speed and direction changes.

**Your benefits:** really intuitive to use and steer.



When the grass collector is full, the deck switches off automatically and the orange LED lights up.  
**Your benefits:** the deck and the collector never get blocked up from over-filling.



Exact adjust ports and on-board deck levelling gauge make precise deck adjustment easy.  
**Your benefits:** get the perfect cut with ease.



Adjust the height of cut at 6 mm intervals with the integrated levelling dial.  
**Your benefits:** everything can be set from the operator's seat for optimum operating comfort.

# X500 Series

## Select Series Tractors

A powerful cut on all terrain

Ideal for homeowners with many landscape features, challenging terrain and a variety of tasks to accomplish.





## X500 Series

### All-terrain mowing



With their low centre of gravity, long wheel base and differential lock, there is almost no terrain where X500 Series smooth-running machines won't go. And there is lots of room for grass clippings in the 250 or 500 litre grass collector. You'll be leaps ahead of other lawn tractors on the market.

Model	X534	X540
<b>Recommended Mowing Area, m<sup>2</sup></b>	over 8000	over 8000
<b>Engine</b>	John Deere iTorque by Kawasaki	John Deere iTorque by Kawasaki
Nominal Power*, kW/min <sup>-1</sup>	16.1/3350	16.4/3350
Displacement, cm <sup>3</sup>	726	675
<b>Turning radius, cm</b>	55.9	68.6
<b>Uncut Circle Radius, cm</b>	35.6 (48C)	68.6 (48C)
<b>Mower Deck Options (Cutting Height), mm</b>	25 – 102	25 – 102
42M (107 cm/42 in)	○	○
42C (107 cm/42 in)	○	○
48C (122 cm/48 in)	○	○
54C (137 cm/54 in)	○	○
<b>Collector, ltr</b>	○ 250 or 500	○ 250 or 500
<b>Attachments</b>	Front Brush Guard, Tyre Chains Front blade, Rotary Broom, Utility Carts	Front Brush Guard, Tyre Chains Front blade, Rotary Broom, Utility Carts

Standard ● Optional ○

\* The engine horsepower information is provided by the engine manufacturer to be used for comparison purposes only.

1

**Fully welded 3 mm steel frame and cast-iron front axle for optimum driving conditions.**

Your benefits: extreme robustness and durability.

2

**The Edge Xtra Cutting System will ensure a perfectly clean and accurate cut.**

Your benefits: optimum quality of cut regardless of terrain/conditions.

3

**The V-Twin air-cooled (X534) and the liquid-cooled engine (X540) enhance the durability of these exclusive lawn tractors.**

Your benefits: unequalled power combined with smooth operation.

4

**High back seat provides great lumbar support together with suspension mountings for optimal ride quality.**

Your benefits: unrivalled user comfort.

5

**Power steering and power lift for smooth operation.**

Your benefits: provides effortless automotive-like control.

6

**4 wheel steering makes trimming around obstacles considerably easier (X534).**

Your benefits: outstanding manoeuvrability and efficient trimming.

7

**Easy access to level the mower deck, the handy tool to do so comes as standard.**

Your benefits: ensures evenly cut grass, every time.



## X534

Obstacles are no challenge!

Thanks to the superior four wheel steering, the X534 is highly manoeuvrable and can manage an extremely narrow, uncut circle of just 33 cm with a 1.37 m wide deck. Power steering and power lift are also a standard feature for easy operation.





## X500 Series / More than “just” mowers

Your lawn tractor has a multitude of talents:



**Broom**  
At 1.20 metres wide, it is ideal for sweeping paths clear of debris.



**Front blade**  
At 1.37 metres wide, it clears paths and drives with maximum ease.



**Utility cart**  
Transfer heavy loads safely and reliably.



**2 and 3-Bag Baggers**  
An efficient way to collect leaves and grass clippings.



# X700 Series

## Select Series – Ultimate Tractors

### Perfection without limits

For the ultimate in mowing, these tractors can also tackle a wide variety of lawn chores, including loader and landscaping work, all backed by a powerful diesel engine.





## X700 Series

### The ultimate lawn tractor



A lawn and utility tractor rolled into one. X700 Series machines benefit from the extensive experience and qualities of John Deere agricultural technology: large and robust, reliable, powerful diesel engines and differential lock – plus a tried and tested design. First class lawn care for first class requirements.

Model		X740	X748	X749
<b>Recommended Mowing Area, m<sup>2</sup></b>		over 8.000	over 8.000	over 8.000
<b>Engine</b>		Yanmar	Yanmar	Yanmar
	Nominal Power*, kW (hp)	17.9 (24)	17.9 (24)	17.9 (24)
	Displacement, cm <sup>3</sup>	1116	1116	1116
<b>Turning radius, cm</b>		63.5	63.5	53.3
<b>Mower Deck Options</b>				
<b>Side discharge with Mulch Option</b>	122 cm/48 in	○	○	○
	137 cm/54 in	○	○	○
	157 cm/62 in	○	○	○
<b>Heavy duty rear discharge</b>	152 cm/60 in	○	○	○
<b>Attachments</b>		3-bag power flow 500 l MCS, 580 MCS 600 l, Rear/front hitch, Rear PTO, Front hitch, Front blade (137 cm), Rotary Broom (132 cm), Front loader, Utility Carts, Tyre Chains		3-bag power flow 500 l MCS, Rear/front hitch, Rear PTO, Front hitch, Front blade (137 cm), Rotary Broom (132 cm), Utility Carts, Tyre Chains

Standard ● Optional ○

\* The engine horsepower information is provided by the engine manufacturer to be used for comparison purposes only.



#### Front loader

Transfer heavy loads with ease. The front loader can be mounted and removed in just a few minutes – all without tools.

#### MCS collection system

Maximise your grass collection capacity by up to 600 litres.

#### Front blade

Clears paths and drives with maximum ease.

**1** The front axle is made of strong, shock-resistant nodular cast iron and the full length welded steel frame is 4.6 mm thick.  
Your benefits: uncompromising durability for use with heavy implements.

**2** With the Edge Xtra Cutting System, you'll always be a cut ahead – regardless of how long the grass is.  
Your benefits: your lawn is a picture.

**3** The high torque diesel engine will impress you with its low fuel consumption and durability.  
Your benefits: you'll save money but won't lose out on performance.

**4** Exclusive to the X700-Series, impressive grass collection capacity of up to 600 litres.  
Your benefits: greater efficiency thanks to fewer stops.

**5** 4 wheel steering makes trimming around obstacles far easier (X748, X749).  
Your benefits: maximum manoeuvrability and efficient trimming.

**6** Dual function hydraulic implement control levers.  
Your benefits: optimal ease of use



For further information on the X700 Series, see the dedicated brochure.



1

5

3

6

4

2

# EZtrak

## Zero-Turn Riding Mowers

### Cut your mowing time

Efficient mowing machines with exceptional manoeuvrability and trimming capability.





## EZtrak

### The manoeuvrable mowing machines



While high mowing speeds were once the preserve of the professionals, with the EZtrak, high mowing speeds are now within anybody's reach. This means that your work will not only become easier, it will also be a lot faster and smoother. You'll almost regret it's over so fast.

<b>Model</b>	<b>Z425</b>
<b>Recommended Mowing Area, m<sup>2</sup></b>	over 8000
<b>Engine</b>	Briggs & Stratton
Nominal Power*, kW/min <sup>-1</sup>	14.9/3350
Displacement, cm <sup>3</sup>	724
<b>Turning radius, cm</b>	Zero Turn Radius
<b>Mower Deck Options (Cutting Height), mm</b>	25 – 102
48C (122 cm/48 in)	●
<b>Collector, ltr</b>	○ 250
<b>Attachments</b>	Mulch Kit

Standard ● Optional ○

\* The engine horsepower information is provided by the engine manufacturer to be used for comparison purposes only.



- 1** The generously sized seating platform features plenty of leg room.  
Your benefits: optimum seating comfort. Easy to get on and off.
- 5** The mower switches off automatically as soon as you get off the seat.  
Your benefits: optimum safety guaranteed.
- 2** EZtrak has no bonnet.  
Your benefits: everything is in view!
- 6** At fast mowing speeds, you work more quickly but without compromising on cut quality.  
Your benefits: save time without forfeiting quality.
- 3** A suspended seat with adjustable arm rests.  
Your benefits: Operate the machine in comfort and enjoy gardening.
- 7** On-the-spot turning manoeuvres to drive around obstacles in no time.  
Your benefits: fun, fun and more fun with excellent mowing results.
- 4** The deep Edge Xtra Mower deck ensures an accurate cut: the grass is perfectly lifted and cleanly cut.  
Your benefits: accurate trimming and the best mowing results right up to the lawn edges.
- 8** Truly intuitive operation and control thanks to the dual lever system.  
Your benefits: simplified handling.



## Unlock your machine's full potential!

Your John Deere has many hidden talents

The extremely strong and solid metal frame gives your John Deere the strength to do much more than "just" mow the lawn with the addition of several implements. Make your choice and enjoy your John Deere all year round.



**Utility cart**  
Transfer heavy loads safely and reliably.



**Broom**  
Make light work of leaves, dirt and even snow!

**Front blade**  
Clears paths and drives with maximum ease!

# Attachments

	Front Blade			Rotary Broom	Tyre Chains	Front Bumper	Front Brush Guard	Utility Cart	Rear Collector		Mulch Option
	112 cm	122 cm	125 cm						120 cm	500 kg	
CR125											<input type="radio"/>
LR135			<input type="radio"/>	<input type="radio"/>							<input type="radio"/>
X125			<input type="radio"/>	<input type="radio"/>	<input type="radio"/>				<input type="radio"/>		<input checked="" type="radio"/>
X145			<input type="radio"/>	<input type="radio"/>	<input type="radio"/>				<input type="radio"/>		<input checked="" type="radio"/>
X155R			<input type="radio"/>	<input type="radio"/>	<input type="radio"/>						<input type="radio"/>
X165			<input type="radio"/>	<input type="radio"/>	<input type="radio"/>				<input type="radio"/>		<input checked="" type="radio"/>
X300	<input type="radio"/>		<input type="radio"/>	<input type="radio"/>	<input type="radio"/>	<input type="radio"/>	<input type="radio"/>	<input type="radio"/>	<input type="radio"/>	<input type="radio"/>	<input type="radio"/>
X304	<input type="radio"/>		<input type="radio"/>	<input type="radio"/>	<input type="radio"/>	<input type="radio"/>	<input type="radio"/>	<input type="radio"/>	<input type="radio"/>	<input type="radio"/>	<input type="radio"/>
X300R	<input type="radio"/>		<input type="radio"/>	<input type="radio"/>	<input type="radio"/>	<input type="radio"/>	<input type="radio"/>				<input type="radio"/>
X320	<input type="radio"/>		<input type="radio"/>	<input type="radio"/>	<input type="radio"/>	<input type="radio"/>	<input type="radio"/>	<input type="radio"/>	<input type="radio"/>		<input type="radio"/>
X534		<input type="radio"/>	<input type="radio"/>	<input type="radio"/>	<input type="radio"/>		<input type="radio"/>	<input type="radio"/>	<input type="radio"/>	<input type="radio"/>	<input type="radio"/>
X540		<input type="radio"/>	<input type="radio"/>	<input type="radio"/>	<input type="radio"/>		<input type="radio"/>	<input type="radio"/>	<input type="radio"/>	<input type="radio"/>	<input type="radio"/>
Z425									<input type="radio"/>		<input type="radio"/>

Optional  Standard



**Material collection system**  
Collect your leaves and clippings with maximum ease!



**Front loader**  
Give yourself a helping hand with heavy loads. The front loader can be mounted and removed in just a few minutes – all without tools via the Quick-Attach System.



**Front bumper**  
Give your tractor a tougher image and protect it from damage.

Standard Series	
CR/LR Series	X100 Series



Model	CR125 5-Speed / CR125 Automatic	LR135	X125	X145	X155R	X165
<b>Recommended Mowing Area, m<sup>2</sup></b>	up to 2000	up to 3000	up to 5000	up to 5000	up to 6000	up to 6000
<b>Engine</b>	Briggs&Stratton	Briggs&Stratton	Briggs&Stratton	Briggs&Stratton	Briggs&Stratton	Briggs&Stratton
Nominal Power*, kW/min <sup>-1</sup>	6.8/2800	6.8/2800	9.8/3150	10.3/3250	12.5/3150	13.3/3350
Displacement, cm <sup>3</sup>	344	344	500	500	656	656
Cylinder	1 cyl, OHV	1 cyl, OHV	1 cyl, OHV	1 cyl, OHV	V-twin, OHV	V-twin, OHV
<b>Fuel Capacity, ltr</b>	4	6	15.1	15.1	7.5	15.1
Fuel type	Petrol	Petrol	Petrol	Petrol	Petrol	Petrol
<b>Transmission</b>	Gear / Hydrostatic	Hydrostatic	Hydrostatic	Hydrostatic	Hydrostatic	Hydrostatic
Drive system	2 wheel drive	2 wheel drive	2 wheel drive	2 wheel drive	2 wheel drive	2 wheel drive
Cruise Control	no	no	no	Standard	no	Standard
Forward, mph	0.9 – 4.2 / 0 – 5.3	0 – 5.2	0 – 5.6	0 – 5.6	0 – 5.2	0 – 5.6
Reverse, mph	1.2 / 0 – 2	0 – 1.9	0 – 3.2	0 – 3.2	0 – 3.1	0 – 3.2
<b>Steering</b>	2-Wheel Steer	2-Wheel Steer	2-Wheel Steer	2-Wheel Steer	2-Wheel Steer	2-Wheel Steer
Steering Wheel						
Turning Radius, cm	35	40	45.7	45.7	50.8	45.7
Uncut Circle Radius, cm	N/A	N/A	63.5	63.5	N/A	50.8
<b>Deck Lift System</b>	Manual	Manual	Manual	Manual	Manual	Manual
<b>Deck Engagement</b>	Manual	Electric	Manual	Manual	Electric	Electric
<b>Mower Deck Options (Cutting Height), mm</b>	30 – 80	30 – 80	25 – 101	25 – 101	25 – 101.6	25 – 101
28RD (72 cm/28 in)	●					
36RD (92 cm/36 in)		●				
42M (107 cm/42 in)						
42C (107 cm/42 in)			●			
42RD (107 cm/42 in)					●	
42TS (107 cm/42 in)						
48C (122 cm/48 in)						●
54C (137 cm/54 in)						
<b>Collector, ltr</b>	● 170	● 250	○ 230	○ 230	● 300	○ 230
<b>Seat</b>	medium	high, 2 position lumbar	medium	high	high	high, 2 position lumbar
<b>Tyres</b>						
Front	11x4.00-4	15x5.00-6	15x6.00-6	15x6.00-6	15x6.00-6	16x6.50-8
Rear	15x6.00-6	18x8.50-8	20x8.00-8	20x10.00-8 Wide	18x8.5-8	22x9.50-12
<b>Dimensions</b>						
Height (Seat Height), mm	1010	1070	1040	1140	1165	1170
Length, overall, mm	1863	2190	1752	1752	2430	1752
Min. Storage Width overall, mm	760	960	1320	1320	1165	1450
Wheelbase, mm	1130	1125	1242	1242	1277	1242
Weight, approx., kg	161/167	193	210	210	230	241

Standard ● Optional ○

\*The engine power information is provided by the engine manufacturer to be used for comparison purposes only.

## Select Series

## X300 Series

## X500 Series

## EZtrak



Model	X300 / X304	X300R	X320	X534	X540	Z425
<b>Recommended Mowing Area, m<sup>2</sup></b>	up to 8000	up to 8000	up to 8000	over 8000	over 8000	over 8000
<b>Engine</b>	John Deere iTorque by Kawasaki	John Deere iTorque by Kawasaki	John Deere iTorque by Kawasaki	John Deere iTorque by Kawasaki	John Deere iTorque by Kawasaki	Briggs&Stratton
Nominal Power*, kW/min <sup>-1</sup>	11.0/3100	11.0/3100	13.8/3350	16.1/3350	16.4/3350	14.9/3350
Displacement, cm <sup>3</sup>	603	603	726	726	675	724
Cylinder	V-twin, OHV	V-twin, OHV	V-twin, OHV	V-twin, OHV	V-twin, OHV	V-twin, OHV
<b>Fuel Capacity, ltr</b>	13.2	7.6	13.2	18.9	18.9	13.2
Fuel type	Petrol	Petrol	Petrol	Petrol	Petrol	Petrol
<b>Transmission</b>	Hydrostatic	Hydrostatic	Hydrostatic	Hydrostatic	Hydrostatic	Hydrostatic
Drive system	TwinTouch Foot 2 wheel drive	TwinTouch Foot 2 wheel drive	TwinTouch Foot 2 wheel drive	TwinTouch Foot 2 wheel drive	TwinTouch Foot 2 wheel drive	Twin stick speed & direction control levers 2 wheel drive
Cruise Control	Standard	Standard	Standard	Standard	Standard	
Forward, mph	0 – 5.5	0 – 5.5	0 – 6.2	0 – 7	0 – 7	0 – 8.5
Reverse, mph	0 – 3.5	0 – 3.5	0 – 3.5	0 – 4	0 – 4	0 – 3.5
<b>Steering</b>	2-Wheel Steer/ 4-Wheel Steer	2-Wheel Steer	2-Wheel Steer	Power Steering, 4-Wheel Steer	Power Steering, 2-Wheel Steer	2-Wheel Steer
Steering Wheel						
Turning Radius, cm	40.6/38.1	48.2	40.6	55.9	68.6	zero turn radius
Uncut Circle Radius, cm	68.6 (42M) 71.1 (42C)	73.7	53.3 (48C)	35.6 (48C) 33 (54C)	68.6 (48C) 61 (54C)	zero turn radius
<b>Deck Lift System</b>	Foot pedal	Foot pedal	Foot pedal	Hydraulic	Hydraulic	Manual
<b>Deck Engagement</b>	Electric	Electric	Electric	Electric	Electric	Electric
<b>Mower Deck Options (Cutting Height), mm</b>	25 – 102	25 – 102	25 – 102	25 – 102	25 – 102	25 – 102
42M (107 cm/42 in)	○ / ●		○	○	○	
42C (107 cm/42 in)	○		○	○	○	
42RD (107 cm/42 in)						
42TS (107 cm/42 in)		●				
48C (122 cm/48 in)			○	○	○	●
54C (137 cm/54 in)				○	○	
<b>Bagger, ltr</b>	○ 250 only with 42C deck	● 300	○ 250 only with 42C/48C deck	○ 250 or 500	○ 250 or 500	○ 250
<b>Seat</b>	open back	open back	open back	high deluxe	high deluxe	high back w/armrests
<b>Tyres</b>	Front	15x6-6	15x6-6	15x6.5-8	16x6.5-9	16x6.5-8
Rear	20x10-8	20x10-8	22x11-10	23x9.5-12	24x12-12	22x9.50-10
<b>Dimensions</b>	Height (Seat Height), mm	1092	1092	1092	1219	1219
Length, overall, mm	1830	2520	1830	2007	2007	1900
Min. Storage Width overall, mm	970	970	970	1041	1041	N/A
Wheelbase, mm	1260	1260	1260	1300	1300	1220
Weight, approx., kg	225	302	225	341	327	299

Standard ● Optional ○

\*The engine power information is provided by the engine manufacturer to be used for comparison purposes only.

# Gator CX

## Set your plans in motion

Make every path a shortcut with the versatile, nimble CX. Whether you're overhauling your back yard or just carrying out your normal duties.

- 182 kg (400 lb) capacity cargo box – handles almost any load
- Fold down tailgate and integrated handles – for virtually effortless lowering and lifting
- Handy tie downs and divider slots in the cargo box – organise and secure your load

You will enjoy its comfortable ride provided by its superior rear suspension. Discover well thought through details such as the glove box, hour metre and a fuel sight gauge.



Specifications		Gator CX
<b>Engine</b>		1-cylinder, 4-cycle OHV petrol
	Nominal Power*, kW/min <sup>-1</sup>	6.0/3850
	Displacement, cm <sup>3</sup>	286
<b>Transmission Type</b>		Continuously variable transmission (CVT)
<b>Ground Speed, mph</b>		0 – 15
<b>Width, mm</b>		1245
<b>Payload Capacity, kg</b>		363
<b>Cargobox – Volume, m<sup>3</sup></b>		0.15
<b>Weight Capacity (On Level Terrain), kg</b>		182



## Enjoy the ride!

Operator comfort comes in the shape of two bucket seats that allow plenty of leg room for two people.

## The right tools for the job

The generous cargo box means transporting loads couldn't be easier. An optional electric lift is also available.



\*The engine horsepower information is provided by the engine manufacturer to be used for comparison purposes only.

# Home Maintenance Kit

Do it yourself made easy

Protect your investment. A few minutes simple maintenance once a year is all it takes. The Home Maintenance Kit contains practically everything you need to keep your John Deere lawn mower or tractor running smoothly for years to come. Filters, plugs and oil are packaged in a convenient box. It is available at your local John Deere Dealer.



# The John Deere Collection

The perfect choice for real John Deere fans

Something special for your needs. John Deere gifts and merchandise items offer something for everyone.

At [www.JohnDeereShop.com](http://www.JohnDeereShop.com) you can download our catalogue and shop online. Or call your local John Deere Dealer – if the item you want is not in stock, the staff are happy to order it for you.



# 5 good reasons for choosing John Deere

John Deere lawn tractors and walk behinds are definitely the right choice. Here is a brief summary of the many advantages our machines have to offer.

- High product quality
- Superb cut quality
- Great resale value
- Worldwide parts distribution system
- Ultimate service from your local John Deere dealer

Contact your John Deere dealer for further information and advice. And why not arrange a test drive?



**JOHN DEERE**

[JohnDeere.com](http://JohnDeere.com)