



OWNER'S MANUAL & INSTALLATION GUIDE

Serenity DriftBath™

INSTALLER: This booklet must be given to the product owner.

Read all instructions before proceeding. All specifications are $\pm 3/8''$ and are subject to change without notice. Dimensions listed in inches.

Model # _____

Purchase Date _____

Serial # _____

Distributor _____



TABLE OF CONTENTS

PRODUCT WARRANTY REGISTRATION INFORMATION	3
IMPORTANT SAFETY INSTRUCTIONS	4 – 5
DRIFTBATH USER INFORMATION	6
FCC CONSUMER INFORMATION	6
INSTALLATION INSTRUCTIONS	
Pre-Installation Instructions	7 – 8
Structural Preparation	9
Framing Diagrams	10
Deck Cutouts	11
Plumbing	12
Electrical Installation	12
DriftBath with Chromatherapy LED Lights	13
OPERATION INSTRUCTIONS	
Bath-side On/Off Controls	14
TUB CARE	
Maintenance	15
Repair	15
WATER QUALITY	
Chemical & Water Quality	16 – 17
TROUBLESHOOTING GUIDE	18
REPLACEMENT PARTS MAP	19
REPLACEMENT PARTS LIST	20
AQUATIC LIMITED WARRANTY	21

AQUATIC Product Warranty Registration Information

Thank you for choosing an Aquatic bath. You have chosen one of the finest bath products in the industry. Aquatic supports your purchase with strong commitments to quality and customer satisfaction.

IMPORTANT!

To activate Product Warranty please register with Aquatic. Your product warranty must be registered and confirmed with Aquatic through the Serial Number on your unit. To register, please contact Aquatic.

800.945.2726 • www.aquaticbath.com/register

Please read and follow all of the instructions contained in this Owner's Manual before installing, operating or maintaining your DriftBath. In addition, you should continually refer to these instructions during the life of your tub. Failure to comply with these instructions may invalidate your warranty. If you have any questions concerning installation, operation, maintenance or any other aspect of your tub, please contact **CUSTOMER SERVICE: 800.945.2726** (The Troubleshooting Guide on page 18 may be helpful in answering some of your questions.)

NOTE: The installation and service of your Tub should be performed **ONLY** by a licensed electrician and plumber.

IMPORTANT!

This product **MUST BE WATER-TESTED** and inspected prior to installation or warranty will be voided. [See **TO INSPECT** on page 7.] Neither Aquatic nor the distributor will be responsible for removal or reinstallation costs should replacement of the bath be necessary.

PLEASE CHECK ENTIRE UNIT FOR ANY DAMAGE.

If it appears damaged, do not install. Contact your Aquatic Distributor immediately. Aquatic warranty does not cover damage that occurs in transit.

Serial Number Location

The tub model and serial number is attached to the shell located above the pump area on the backside of the bathtub. Your installer should have a service access panel in this location.

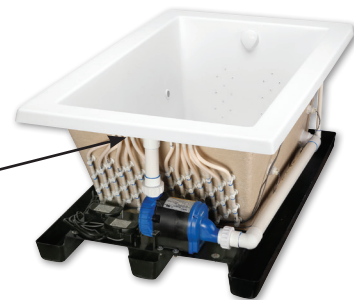

AQUATIC

The bath people

Customer Service: 800.945.2726 • aquaticbath.com



IMPORTANT SAFETY INSTRUCTIONS

WARNING: When using this unit, basic precautions should always be followed. Failure to follow these instructions could result in personal injury, electric shock, or fire.

READ AND FOLLOW ALL INSTRUCTIONS:

- **WARNING:** Risk of lethal electric shock. To reduce risk of electric shock, connect only to circuits protected by a Ground-Fault Circuit-Interrupter (GFCI) or Residual Current Device (RCD).
- **DANGER:** To reduce the risk of injury, do not permit children to use this unit unless they are closely supervised at all times.
- Use this unit only for its intended use as described in this manual. Do not use attachments not recommended by the manufacturer.
- Never drop or insert any object into any opening.
- Do not operate this unit without the guard over the suction fitting.
- The unit must be connected only to a supply circuit that is protected by a ground-fault circuit-interrupter (GFCI). Such a GFCI should be provided by the installer and should be tested on a routine basis. To test the GFCI, push the test button. The GFCI should interrupt power. Push the reset button. Power should be restored. If the GFCI fails to operate in this manner, there is a ground current flowing, indicating the possibility of an electric shock. Do not use this unit. Disconnect the unit and have the problem corrected by a qualified service representative before using.
- This product is intended for indoor use only. Installing this unit outdoors could cause personal injury and will void your warranty.

SAVE THESE INSTRUCTIONS.

 WARNING

Electrical Shock Hazard
Plug into a grounded 3-prong outlet.
Do not remove ground prong.
Do not use an adapter.
Do not use an extension cord.
Failure to follow these instructions can result in death, fire, or electrical shock.

Your safety and the safety of others are very important.

We have provided many important safety messages in this manual and on your appliance. Always read and obey all safety messages.



This is the safety alert symbol. This symbol alerts you to potential hazards that can kill or hurt you and others.

All safety messages will follow the safety alert symbol and either the word "DANGER" or "WARNING." These words mean:

 **DANGER**

You can be killed or seriously injured if you don't immediately follow instructions.

 **WARNING**

All safety messages will tell you what the potential hazard is, tell you how to reduce the chance of injury, and tell you what can happen if the instructions are not followed.

IMPORTANT SAFETY INSTRUCTIONS

DANGER! TO REDUCE THE RISK OF INJURY:

1. Do not permit children to use this unit unless they are closely supervised by an adult at all times. Supervision is also required when whirlpool bath is used by an elderly or handicapped individual.
2. The water in a whirlpool should never exceed 40°C (104°F). Water temperatures between 38°C (100°F) and 40°C (104°F) are considered safe for a healthy adult. Use time should be limited to approximately 30 minutes, followed by a shower to cool down. Longer exposures may result in hyperthermia. The symptoms of this condition are nausea, dizziness and fainting, which can be fatal. Lower water temperatures are recommended for extended use (exceeding 10-15 minutes) and for young children.
3. Since excessive water temperatures have a high potential for causing fetal damage during the early months of pregnancy, pregnant or possibly pregnant women should limit whirlpool water temperatures to 38°C (100°F).
4. The use of drugs or alcoholic beverages before or during whirlpool use may lead to unconsciousness with the possibility of drowning. Never use the whirlpool while under the influence of alcohol, anticoagulants, stimulants, antihistamines, vasoconstrictors, vasodilators, hypnotics, narcotics or tranquilizers.
5. Persons with a medical history of heart disease, low or high blood pressure, circulatory system problems, or diabetes should consult a physician before using a whirlpool.
6. Persons using medication should consult a physician before using a whirlpool since medication may induce drowsiness while other medication may affect heart rate, blood pressure and circulation.

DANGER: To reduce the risk of injury, enter and exit the bath slowly.

WARNING: Never operate electrically connected devices in or near the bath. Never drop or insert any object into any opening within the whirlpool.

To avoid the possibility of personal injury and discoloration of the acrylic surface, the inlet water temperature should not exceed 60°C (140°F). The bath should be drained after each use. Each bather should start their bath with fresh water.

CAUTION: DO NOT USE HARSH ABRASIVES OR SOLVENTS FOR CLEANING THIS UNIT. SEE PAGE 15, TUB CARE.

INSTALLER/OWNER BEARS ALL RESPONSIBILITY TO COMPLY WITH ALL NATIONAL, STATE AND LOCAL CODES WHEN INSTALLING THIS PRODUCT.

SAVE THESE INSTRUCTIONS

DRIFTBATH USER INFORMATION

PLEASE NOTE:

No servicing of this product should be done by the user. There are no user serviceable parts. All controls are located in the control recesses on the lip of the tub. These are the only controls that should be used by the consumer. Do not change or alter any of these controls under any circumstances.

Motors are self-lubricating – No lubrication required.

FCC CONSUMER INFORMATION

This equipment generates and uses radio frequency energy and if not installed and used properly, that is, in strict accordance with the manufacturers instruction, may cause interference to radio and television reception. It has been type tested and found to comply with the limits for a class B computing device in accordance with the specifications in subpart J of part 15 of the FCC rules, which are designed to provide reasonable protection against such interference in a residential installation. However, there is no guarantee that interference will not occur in a particular installation. If this equipment does cause interference, which can be determined by turning the equipment on and off, the user is encouraged to try to correct the interference by one or more of the following measures:

- Reorient the receiving antenna.
- Relocate the receiver with respect to the bath tub.
- Move the receiver away from the bath.
- Plug the receiver into a different outlet so that the receiver and bath are on different branch circuits.
- If necessary, the user should consult the dealer or an experienced radio/television technician for additional suggestions.
- The user may find the following booklet prepared by the FCC helpful: "How To Identify and Resolve Radio-TV Interference Problems." It is available from the U.S. Government Printing Office, Washington, DC 20402, Stock No., 004-000-00345-4.

INSTALLATION INSTRUCTIONS

READ ALL INSTRUCTIONS CAREFULLY BEFORE INSTALLATION

PRE-INSTALLATION PROCEDURES

PLEASE NOTE: THE MANUFACTURER ACCEPTS A $\pm\frac{3}{8}$ " VARIANCE. THERE ARE VARIATIONS ON EACH TUB AND SPECIFICATIONS ARE SUBJECT TO CHANGE AS WE IMPROVE UPON OUR PRODUCT AS REQUIRED.

THE DIMENSIONS NEEDED FOR SITE PREPARATION AND STRUCTURE BUILDINGS SHOULD BE MEASURED FROM THE TUB; AQUATIC ASSUMES NO RESPONSIBILITY FOR PREPARATORY WORK.

Note: A good knowledge of construction techniques, plumbing and electrical installation according to codes are required for proper installation. We recommend that a qualified licensed contractor perform the installation of all Aquatic products. Our warranty does not cover improper installation related problems.

1. Immediately upon receiving your Aquatic bath inspect it thoroughly for freight damage. If necessary, contact your dealer/distributor immediately (your dealer/distributor must contact Aquatic, Inc. within 24 hours of receiving unit to file a claim.) Should inspection indicate any damage, do not install the bath.
2. All baths are filled with water and operated in our manufacturing facility prior to shipment. Inspectors ensure watertight operation, however, rough handling may cause leaks which may be detected prior to installation.

Damage or defect to the finish claimed after the bath is installed is not covered under the warranty.

To Inspect:

1. Place the tub in an area where it may be drained after testing.
2. Fill the tub with clean water to the overflow and allow to stand for a few minutes. Carefully inspect all fittings and connections for leaks.
3. Plug in pump control box cord and run pump for 10 minutes.
4. Inspect the tub completely. Any defect must be reported to Aquatic prior to installation in order to have it covered by warranty. **Should inspection indicate any damage, do not install the bath.**
5. Check to ensure that your installation will conform to all applicable codes and secure necessary permits. All electrical and plumbing connections should be made by qualified electricians and plumbers.

Damage or leaks claimed after the bath is installed are not covered under the warranty.

WARNING: FAILURE TO FOLLOW THESE INSTRUCTIONS DURING INSTALLATION WILL RESULT IN TERMINATION OF THE WARRANTY: DO NOT LIFT THE TUB BY ANY PORTION OF THE PLUMBING OR PUMP. DO NOT STAND IN THE TUB DURING INSTALLATION/CONSTRUCTION.

DO NOT MAKE ANY ALTERATIONS, ADDITIONS, OR DELETIONS TO THE SYSTEM PUMP OR BATH.

WARNING: Pump and piping are factory assembled. Relocation of pump or other modifications could adversely affect the performance and safe operation of this tub. Aquatic shall not be liable under its warranty or otherwise for personal injury or damage caused by any such unauthorized modification.

INSTALLATION INSTRUCTIONS

QUIETNESS OF OPERATION: Aquatic has engineered their baths from base to lip to ensure quality, value, functional design, and maximum bathing comfort. However, installation is accountable for as much as 50% of a tub's operating quietness. Please ensure the following:

- The floor structure is adequate to support the installation.
- For quieter operation and heat retention conservation, the walls surrounding the tub may be insulated.
- Insulate the tub surround. Do not allow any insulation to come within 3 feet of the pump. The area around the pump must be clean and free of any foreign matter.
- Leave $\frac{1}{8}$ " to $\frac{3}{16}$ " gap between tub lip and surround.
- Spread a bed of cement mortar on the floor or subfloor under the tub to reduce vibration and noise.

INSTALLATION INSTRUCTIONS

STRUCTURAL PREPARATION

Note: The bath should remain in its shipping carton until time of installation.

1. Literature dimensions are for reference only. Installation dimensions should be taken directly from the tub. An unobstructed access panel of 16" x 16" minimum must be provided at the pump end of the tub allowing sufficient clearance to make final connections and for servicing the pump and power panel. Access may be through the wall or platform apron at the end of the unit. In the case of sunken installations, access should be made through the ceiling below.

IMPORTANT: IT IS THE INSTALLER'S RESPONSIBILITY TO PROVIDE SUFFICIENT SERVICE ACCESS. MAKE ABSOLUTELY CERTAIN THAT ACCESS PANELS AND/OR SERVICE OPENINGS ARE PROPERLY PLACED AND THAT ALL POSSIBLE AREAS WHERE SERVICE MAY BE REQUIRED ARE ACCESSIBLE.

2. Install the drain fitting to the bath. **THE DRAIN FITTING WILL PROTRUDE BELOW THE BASE OF THE TUB APPROXIMATELY 1 1/2".** Clearance must be provided for the drain by cutting away the subfloor (where possible) or by blocking below the tub as may be required. **NOTE:** Watertight installation of the drain and overflow is the installer's responsibility. Drain and/or overflow leakage is not included in the warranty of this product. **WARNING:** Factory skirts do not allow for blocking up of the tub base. All blocking must be solid and provide uniform support to the tub base.
3. Tub must rest entirely on the base. **DO NOT SUPPORT THE WEIGHT OF THE TUB BY THE RIM.** Where leveling is required, and to reduce vibration noise, prepare a bed of wet mortar in area where tub is to be installed. Carefully level unit, ensuring that uniform support is given to all areas of the base and no portion of the lip is bearing weight.
4. Frame out under the tub rim as shown in the framing diagrams on page 10. **NOTE:** Due to the variety of installations possible, framing procedures other than those described may be required. Plumb in selected location using a level. Level front to back and across both sides. A ledge under the rim, or an apron without a ledge, may be constructed as required, with blocking below rim to prevent deflection or movement of tub. To prevent a rocking movement of tub after installation, it is important to have rim in contact, but not supported by blocking material.
5. When placing the tub on a platform or cut out extreme care must be taken in this type of installation to ensure the tub will come to rest entirely on the base.
6. Another installation option is that of a tile flange. Aquatic offers a factory installed tile flange for all rectangular and corner-unit tubs.
7. Install the bath unit per the instructions provided in this manual. **CAUTION: THE TILE FLANGE DOES NOT SUPPORT THE TUB!** A ledger board must be provided under the bath rim as indicated in the installation instructions. Take care to ensure tub is not hanging from the ledger boards, as this will void your warranty.
8. Pre-drill pilot holes. Use nails or screws to secure the flange into the studs around the bath.

NOTE: Before tub is used, the DriftBath system should be cleaned in accordance with the procedures on page 15 of this manual.

9. Install water resistant drywall against the tile flange and flush to the top of the tub deck. Install the tile or other finishing materials. Apply a second bead of silicone between the first course of tile and the bath deck.

INSTALLATION INSTRUCTIONS

FRAMING DIAGRAMS

1. Protect interior of tub throughout installation process.
2. Framing and supports will vary according to the model and type of installation selected.
3. Please refer back to the unit's Technical Data sheet for specific dimensions located at www.aquaticbath.com.

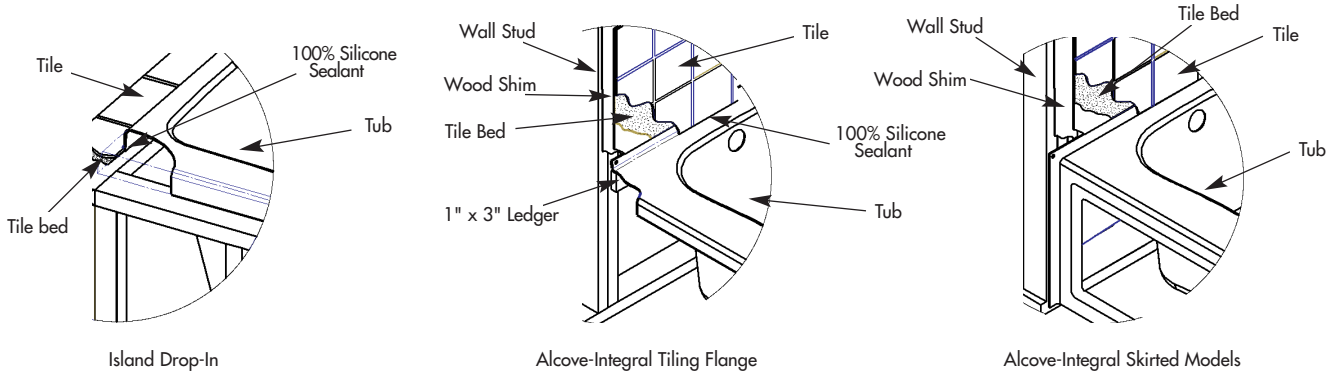

RECTANGULAR MODELS CORNER MODELS OVAL MODELS

ALCOVES			
		<p>LEGEND</p> <ul style="list-style-type: none"> AW Overall Width DH Deck Height ID Inner Depth IW Inner Width LH Ledger Height LD Ledger Depth 	

A - 6" x 12" Box-outs
 B - Levelled Supports
 1" x 3" Ledgers
 C - 16" x 16" minimum access on pump end

INSTALLATION INSTRUCTIONS

DECK CUTOUTS

A paper template will be enclosed with all rounded-edged models. Use the directions on the paper template for cutout dimensions. **If the paper template has been lost or needs replacement, please contact Customer Service at: 800.945.2726.**

USING THE CUTOUT TEMPLATE

Draw a center line horizontally and vertically on a 1" thick plywood deck. Place the template in the upper left hand quadrant, noted as Quadrant 1 on the diagram below. Trace template to outline Quadrant 1. Flip the paper cutout horizontally, making sure to match the dotted center line on the template with the center line on the plywood. Trace again to outline Quadrant 2. Repeat until the remaining quadrants of the cutout have been traced.

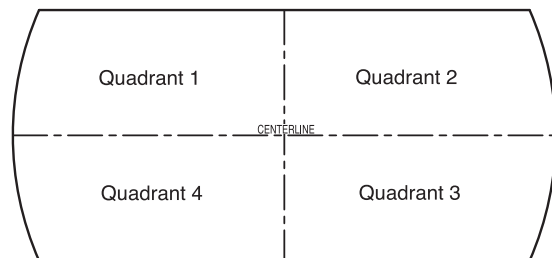
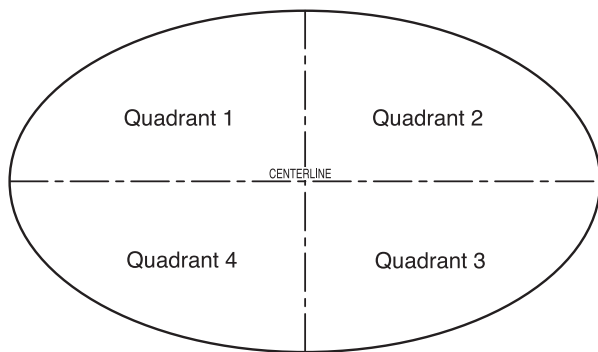

CORNER MODELS

On a 1" thick plywood deck, place the template in the upper section noted as Section 1 in the diagram. Trace Section 1 to establish the centerline and front edge of the cutout. Flip the template along the centerline and trace to complete the other half of the unit noted as Section 2 in the diagram below.

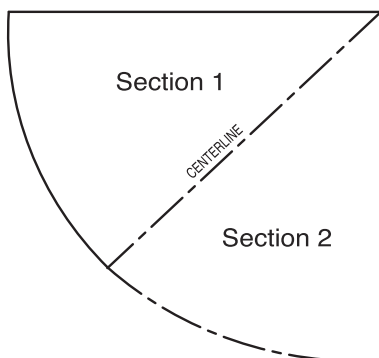

RECTANGLE MODELS

Using a 1" thick plywood deck, the cutout should be 2" smaller than the overall tub dimensions (length & width), for 1" overhangs on all sides. For example, a 72" x 42" unit should have a deck cutout of 70" x 40". Additional dimensions can be found in the technical data sheets at www.aquaticbath.com.

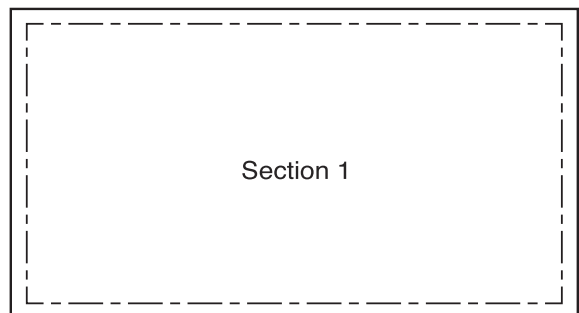

INSTALLATION INSTRUCTIONS

PLUMBING

1. After securing tub in place, normal waste and overflow, water spout and valves are installed per normal plumbing procedures, in accordance with all national, state and local standards.
2. Install standard 1½" trap to drain and overflow. Before proceeding, make final operational check by filling tub with water to overflow and operate pump for 5 minutes. Check for leaks carefully both while pump is running and has been turned off. Allow water to stand in tub for at least 30 minutes before draining. **AQUATIC WILL NOT BE RESPONSIBLE FOR WATER DAMAGE OF ANY KIND IN CONNECTION WITH ONE OF OUR BATHS.**
3. When selecting fill spout location, check to ensure that spout is long enough to clear the tub rim from its desired location. If installation is to be on the tub deck, check the back side of tub for adequate space for connection to water lines before drilling or cutting tub.

NOTE: For rough-in measurements, please refer to your tub's technical data sheet found at www.aquaticbath.com.

ELECTRICAL INSTALLATION

WARNING: ALL ELECTRICAL CONNECTIONS SHOULD BE MADE BY A LICENSED, LOCALLY CERTIFIED ELECTRICIAN, IN ACCORDANCE WITH THE REQUIREMENTS OF THE NATIONAL ELECTRICAL CODES AND PROCEDURES.

WARNING: WHEN USING ELECTRICAL PRODUCTS, PRECAUTIONS SHOULD ALWAYS BE FOLLOWED, INCLUDING THE FOLLOWING:

DANGER: RISK OF ELECTRIC SHOCK! This unit requires two dedicated circuits, protected by a Ground Fault Circuit Interrupter (GFCI). Rough in wiring to control boxes on dedicated 120V, 15 amp, GFCI protected circuits.

GFCI's are not supplied; however we do specify their use.
All known code authorities require GFCI's.

ELECTRICAL: Two GFCI protected, 120 Volt, 15 Amp, 60 Hz, circuits with a service ground is required, "dedicated" only to powering the bath.

PLEASE NOTE: Because the pump is housed in a plastic non-conductive housing, the pump does not need to be grounded.

DANGER: Risk of electric shock. Do not alter the factory installed wiring. A licensed electrician must provide the "dedicated" electrical services protected by the GFCI's. The location of the GFCI's must be accessible for regular testing. **USE COPPER CONDUCTORS ONLY.**

CAUTION: Before use of the pump. test the GFCI's for proper operation. The pump should turn off when the GFCI "test" button is pushed.

INSTALLATION INSTRUCTIONS

DRIFTBATH WITH CHROMATHERAPY LED LIGHTS

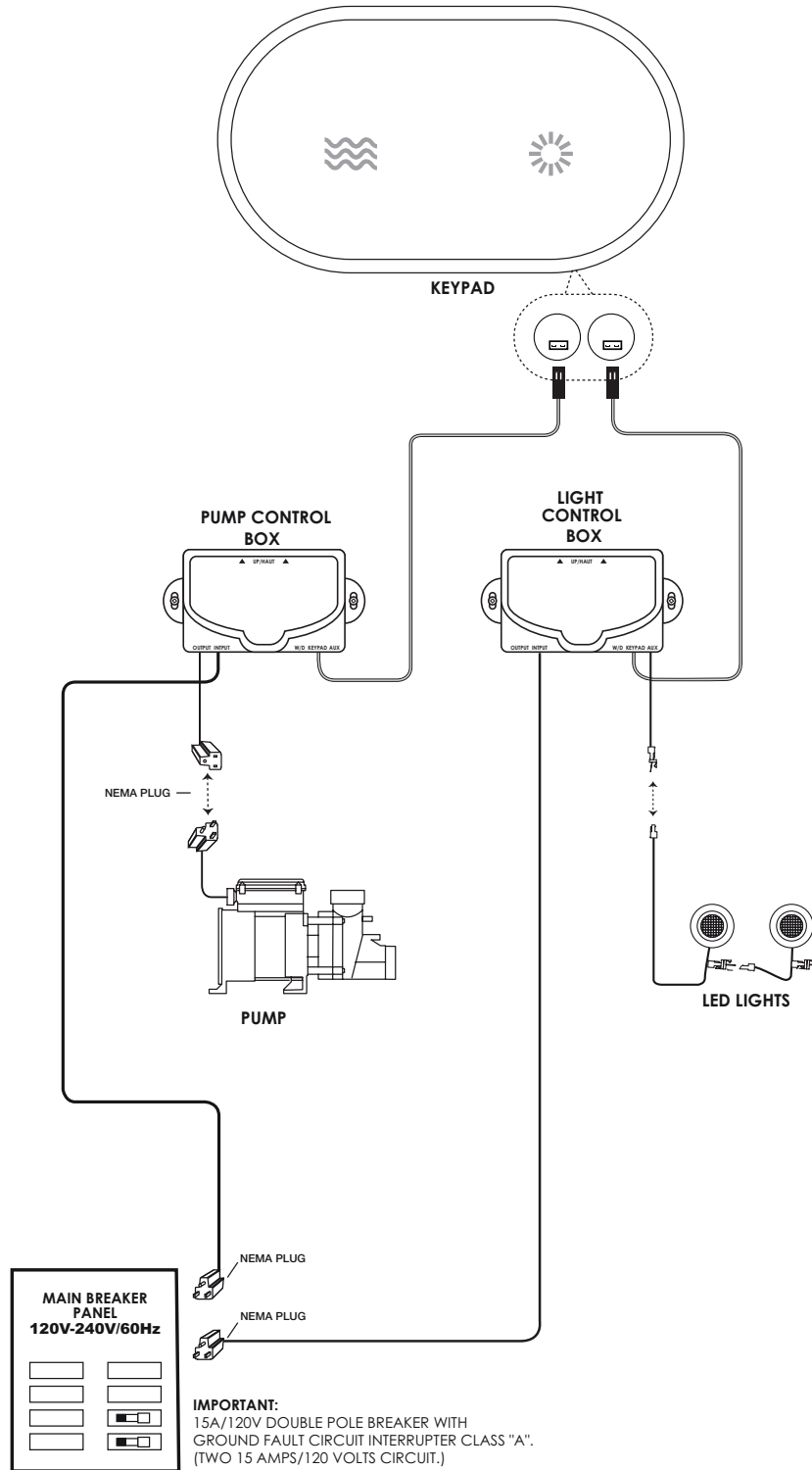

WARNING: All electrical connections should be made by a locally licensed electrician/technician.

OPERATION INSTRUCTIONS

BATH-SIDE ON/OFF CONTROLS



Keypad Functions	
1:	On/Off Pump
1st Press:	The pump starts
2nd Press:	The pump stops
2:	Chromatherapy
1st Press:	Turn on the light in white
2nd Press:	Rainbow cycle – Low speed
3rd Press:	Rainbow cycle – High speed
4th Press:	Turquoise
5th Press:	Blue
6th Press:	Magenta
7th Press:	Red
8th Press:	Orange
9th Press:	Yellow
10th Press:	Green
11th Press:	Back to Rainbow cycle – Low speed
	<i>(Press and hold 2 seconds at any time to turn off the light.)</i>
ADVANCED PROGRAMMING	
	Integrated 20 minutes pump shut-off automatic timer



Electronic Keypad

CAUTION: BEFORE USE OF THE PUMP, TEST THE GFCI FOR PROPER OPERATION. THE PUMP SHOULD TURN OFF WHEN THE GFCI "TEST" BUTTON IS PUSHED.

Warning - Prolonged Immersions in Hot Water May Induce Hyperthermia
 Hyperthermia occurs when the internal temperature of the body reaches a level several degrees above the normal body temperature of 98.6°F. The symptoms of hyperthermia include an increase in the internal temperature of the body, dizziness, lethargy, drowsiness, and fainting. The effects of hyperthermia include (1) failure to perceive heat, (2) failure to recognize the need to exit the tub, (3) unawareness of impending hazard, (4) fetal damage in pregnant women, (5) physical inability to exit the tub, (6) unconsciousness resulting in the danger of drowning.

WARNING - THE USE OF ALCOHOL, DRUGS, OR MEDICATION CAN GREATLY INCREASE THE RISK OF FATAL HYPERTHERMIA.

TUB CARE

MAINTENANCE

DriftBath Cleaning

Before tub is used, remove all debris and clean tub. **DO NOT USE ABRASIVE CLEANERS ON THE ACRYLIC FINISH.** Use a non-abrasive detergent and rinse well after cleaning.

- Fill the tub with HOT water to a level 2" above the highest water port.
- Add 4-6 tablespoons of low-sudsing automatic liquid dishwashing detergent and no more than 24-48 ounces of regular household bleach to the water (do not use splashless bleach).
- Operate tub for 10 minutes. Drain.
- Refill with cold water and operate tub for 5 minutes. Drain.

NOTE: DO NOT USE OIL OR OIL BASED BATH ADDITIVES. If you want to use any kind of bath additive, use only a small amount of low-foaming powder or crystal substance; the DriftBath action may intensify the foaming properties of soaps. The use of certain bubble baths and bath additives may increase the level of accumulations of bath residue in the DriftBath system. If excess accumulations persist, you should discontinue use of these products. Bath salts and Epsom salts are ok.

If you have followed the monthly purging instructions and still have an excess accumulation of bath residue and desire an alternative cleaning mechanism, we recommend SUPER SYSTEMS CLEAN PLUS manufactured by Stearns Packaging Corporation to rectify this condition. This may be obtained by calling Aquatic, at (800) 945-2726. It is recommended that you follow the instructions provided by the manufacturer with the product. Repeated use may be necessary. SUPER SYSTEMS CLEAN PLUS does not replace the necessity to purge your DriftBath system at least once a month with a low foaming detergent and bleach.

Surface Cleaning

Use common household, non-abrasive cleaners for most cleaning jobs. Rinse well and dry with a clean cloth. Never use abrasive cleaners. Do not allow your Lucite® acrylic surface to come into contact with products such as acetone (nail polish remover), nail polish, dry cleaning solution, lacquer thinners, gasoline, pine oil, etc. Remove dust with a soft, dry cloth. Clean grease, oil, paint, and ink stains with isopropyl (rubbing) alcohol.

Surface Scratch Removal

Minor scratches may be removed by polishing your tub with a non-abrasive car polish, followed by buffing. Deeper scratches can be removed by:

- Sanding with wet 400 grit sandpaper.
- Sanding with wet 600 grit sandpaper.
- Sanding with wet micro-grit sandpaper.
- Buffing out using car polish.

CAUTION: Do not wax/polish the bottom interior of the tub, as it can become slippery.

REPAIR

The installation and service of your bath should be performed only by a qualified service technician. Remember when contacting your dealer always have your serial number, proof of purchase and model number available. This will ensure a quick response on warranty items. The model and serial numbers are located above the pump on the backside of the tub.

NOTE: ALL WARRANTY REPAIRS MUST BE AUTHORIZED BY AQUATIC BEFORE WORK IS STARTED. FOR SERVICE, ALWAYS CONTACT YOUR DEALER.

CAUTION: Care should be taken to prevent inappropriate chemicals coming in contact with the Lucite® acrylic surface. Please read and observe all instructions and/or warnings on containers containing substances you contemplate applying to your tub. Any failure to comply may void your warranty.

WATER QUALITY

CHEMICAL & WATER QUALITY

Owners of fill and drain whirlpool bathtubs need to know basic information concerning water quality, how it affects the performance and enjoyment of the operation of their tubs, and steps that can be taken by the owner to correct related problems. Important issues are the microbiological and chemical quality of the water.

1. Microbiological Quality

Microbes are present in water supplied by individual wells or water systems and even in the air around us. These microbes are usually in amounts below what is noticeable. Microbes from the water or air or from a bather's body may settle on wet surfaces such as bathtub surface or piping system where they can grow in numbers. With regards to whirlpool bathtubs, brown/black fungi/mold or pigmented (colored) bacteria can be noted.

Fungi/Mold - Fungi and mold are always present. Usually the levels are such that we don't notice them. When moisture and temperature are sufficient, the organisms will grow to levels that we may smell and/or see. The best examples of such growth is the very common black growth on the bottom of shower curtains. The best solution to keep these surfaces free from fungi/mold growth is frequent cleaning.

Pigmented Bacteria - A pinkish substance may appear on bathroom fixtures that is very persistent, appearing in the shower, sink and along the water line of toilet bowls. The residue is less likely a problem associated with water quality than with naturally occurring airborne bacteria. The bacteria may produce a pinkish film, and sometimes a dark gray film, on surfaces that are regularly moist, including toilet bowls, shower heads, sink drains, and tiles. The problem is more common in humid areas of the country. In any particular case, the determination of the exact species of bacteria causing the problem would require lengthy and costly laboratory testing; however, most experts believe the bacteria responsible is *Serratia Marcescens*. These bacteria thrive on moisture, dust and phosphates, and are widely distributed in soil, food and also in animals. The best solution to keep these surfaces free from the bacterial film is continual cleaning. A chlorine containing compound is the best cleaner. Avoid abrasives to limit scratching fixtures, which will make them even more susceptible to bacteria.

2. Chemical Quality

The water supplied by individual wells or water systems always contains chemicals, usually in amounts below those which the consumer would notice. Examples of such chemicals, which are of potential concern for the owners of whirlpool bathtubs, are calcium and magnesium salts, copper, iron, manganese and sulfates. When these chemicals are present in sufficient amounts, they may cause problems in whirlpool bathtubs. You should contact your water supply or treatment company and follow their suggestions for treatment.

Calcium and Magnesium Salts - Collectively, the various compounds of calcium and/or magnesium are referred to as salts. Calcium and magnesium salts are often found in ground water supplies and cause "hardness" in water. Hard and soft water are relative terms. Hard water retards the cleaning action of soaps and detergents, causing expense in the form of extra work and cleaning agents. When hard water is heated, it will deposit a hard scale. With regard to whirlpool bathtubs, high calcium and/or magnesium levels may result in the formation of white stains and scale formation on the inside of the tubs, especially noticeable with colored tubs. If this occurs, you need to contact the water supplier to determine the calcium and/or magnesium content and/or corrosion potential of the water and follow their suggestions for treatment. If your water supply is generated from a well, you need to contact a water treatment company to test your water and suggest solutions if a problem is present.

WATER QUALITY

Iron - Iron is found in many natural waters especially from wells. Iron in water can also result from the corrosion of piping in the water supply system, such as cast iron mains or galvanized steel service lines, or galvanized piping in the home water system. High iron levels may result in the formation of brown stains in the vicinity of the faucet outlets of various fixtures in the home. With whirlpool bathtubs, the staining may be particularly pronounced because the aeration action can oxidize iron to a form that settles out on the inside of the tubs, especially noticeable with white tubs. If high iron in the water is present, you can also notice rust colored deposits inside your toilet tank or dishwasher. If this occurs, you need to contact the water supplier to determine the iron content and/or corrosion potential of the water and follow their suggestions for treatment. If your water supply is generated from a well you need to contact the water treatment company to test your water and suggest solutions if a problem is present.

Manganese - Manganese is found in many natural waters especially from wells. High manganese levels may result in the formation of small black particles that can stain laundry, especially noticeable with whites such as sheets or towels. With whirlpool bathtubs, the formation of small black particles may be particularly pronounced because the aeration action in the tub can oxidize manganese to an insoluble form that is especially noticeable with white tubs. If high manganese in the water is present, you may also notice black stains on white laundry. If this occurs, you need to contact the water supplier to determine the manganese content of the water and follow their suggestions for treatment. If your water supply is generated from a well, you need to contact a water treatment company to test your water and suggest solutions if a problem is present.

3. Treatment

If you have contacted your water supplier and followed their instructions and you are still having problems, you need to increase the frequency of cleaning with low-foaming detergent/bleach starting from monthly purging down to using it every other day as required to eliminate your particular problem. The use of certain bath oils, bubble bath soaps and bath additives may increase the level of accumulations of bath residue in the whirlpool system. More frequent cleaning may be necessary if these products are used in the whirlpool tub. If excess accumulations persist, you should discontinue the use of these products. If you have followed the monthly purging instructions and still have an excess accumulation of bath residue and desire an alternative cleaning mechanism, we recommend **SUPER SYSTEMS CLEAN PLUS** (Aquatic Part #ST1010) manufactured by Stearns Packaging Corporation to rectify this condition. This may be obtained by contacting Aquatic at (800) 945-2726. It is recommended that you follow the instructions provided by the manufacturer with the product. Repeated use may be necessary. **SUPER SYSTEMS CLEAN PLUS** does not replace the necessity to purge your whirlpool system at least once a month with a low foaming detergent and bleach.

TROUBLESHOOTING GUIDE

WARNING: Always turn off power at the main electrical service panel when servicing your tub.

SYMPTOMS	POSSIBLE PROBLEMS	SUGGESTED SOLUTIONS
Motor does not start	<ol style="list-style-type: none"> 1) GFCI or circuit breaker in OFF position. 2) Fuses blown or thermal overload open. 3) Locked motor shaft. 4) Motor windings burned out. 5) Defective starting switch inside single-phase motor. 6) Disconnected or defective wiring. 7) Low voltage. 	<ol style="list-style-type: none"> 1) Reset GFCI (if optional heater is installed, be sure there are two GFCI circuits.) 2) Contact your electrician. 3) Contact Aquatic. 4) Contact Aquatic. 5) Contact Aquatic. 6) Check and reconnect if needed. 7) Contact your electrician.
Motor does not reach full speed:	<ol style="list-style-type: none"> 1) Low voltage. 2) Wiring too small. 	<ol style="list-style-type: none"> 1) Contact your electrician. 2) Contact your electrician.
Motor overheats (protector trips):	<ol style="list-style-type: none"> 1) Low voltage. 2) Inadequate ventilation. 3) Wiring too small. 	<ol style="list-style-type: none"> 1) Contact your electrician. 2) Refer to installer/dealer. 3) Contact your electrician.
Pump delivers no water	<ol style="list-style-type: none"> 1) Leakage of air into suction system. 2) Impeller clogged. 	<ol style="list-style-type: none"> 1) Check suction screen for clogs. 2) Clean and unlog.
Low pump capacity	<ol style="list-style-type: none"> 1) Suction or discharge line partly plugged. 2) Pump running at reduced speed. 3) Impeller clogged. 	<ol style="list-style-type: none"> 1) Clean and unlog. 2) See "Motor does not reach full speed." 3) Clean and unlog.
Noisy pump and motor	<ol style="list-style-type: none"> 1) Worn motor bearings. 2) Pumps touching a stationary object. 3) Suction line partly plugged. 4) Pump not supported properly. 5) Low voltage 	<ol style="list-style-type: none"> 1) Contact Aquatic. 2) Refer to installer/dealer. 3) Clean and unlog. 4) Contact Aquatic. 5) Contact electrician.
Lights do not turn on	<ol style="list-style-type: none"> 1) GFCI or circuit breaker in OFF position 2) Fuses blown or thermal overload open 3) Disconnected or defective wiring 4) Low voltage 	<ol style="list-style-type: none"> 1) Reset GFCI. 2) Contact your electrician. 3) Check and reconnect if needed. 4) Contact your electrician.
Leakage of water at shaft	<ol style="list-style-type: none"> 1) Shaft seal requires replacement. 	<ol style="list-style-type: none"> 1) Contact Aquatic
Leaking unions	<ol style="list-style-type: none"> 1) O-ring missing or damaged. 2) Plumbing in a bind. 3) Loose unions. 	<ol style="list-style-type: none"> 1) Contact Aquatic 2) Contact Aquatic 3) Tighten unions.
Vibration noise	<ol style="list-style-type: none"> 1) Tub or tub plumbing is touching tile/wall. 2) Pump is touching framing. 	<ol style="list-style-type: none"> 1) Refer to installer/dealer. 2) Refer to installer/dealer.

REPLACEMENT PARTS MAP

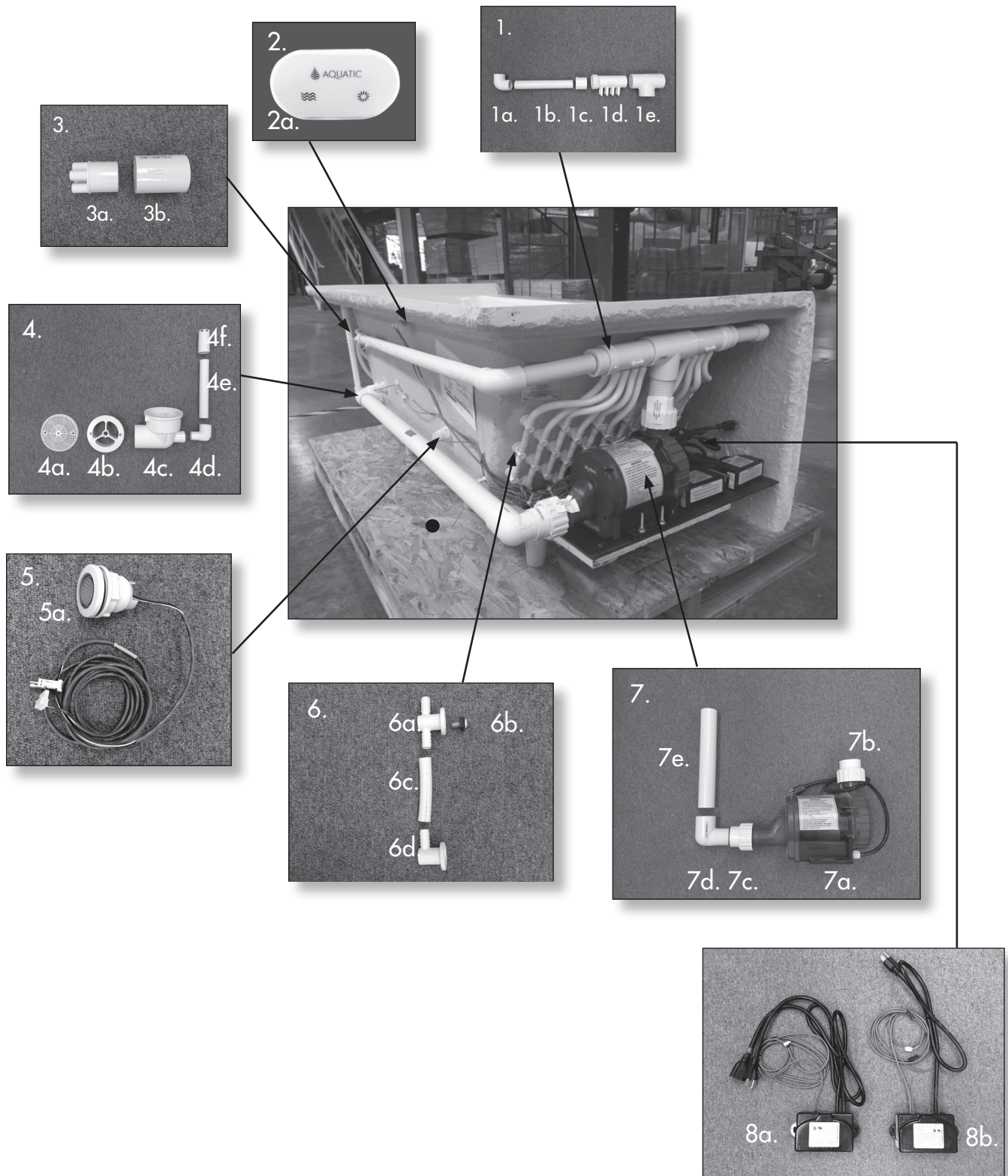

REPLACEMENT PARTS LIST

ILLUSTRATION NO.	PART #	DESCRIPTION
1A.	8406010FTG	1" 90 DEG SLIP ELBOW
1B.	8100PIPE	1" PVC PIPE
1C.	8437211FTG	1.5" X 1" REDUCER FITTING
1D.	8500MANIFOLD	DRIFTBATH MANIFOLD; 8 PORT
1E.	8401015FTG	TEE FITTING; 1.5"S X 1.5"S X 1.5"S
2A.	8500PADCL	KEYPAD KIT;TMS TIMER/LIGHT; CL
3A.	5982MANIFOLD	MANIFOLD; 4 PORT
3B.	8429010FTG	1" COUPLING FITTING
4A.	1127WH / BI	120GPM SUCTION ASSEMBLY; LO-PRO;WH or BI
4B.	(PACKAGED WITH 4A.)	SUCTION WALL FITTING (DRIFTBATH)
4C.		1.5" SUCTION ELBOW (DRIFTBATH)
4D.	8409005FTG	0.5" 90 DEG ST ELBOW
4E.	8050PIPE	0.5" PVC PIPE
4F.	1119SLIP	1.5" POP CHECK VALVE
5A.	8112LIGHTWH / BI	9 LED HIGH BRIGHT LIGHT;WH or BI
6A.	1106TFIT	T FITTING W/ WASHER"
6B.	1100WH / BI	DRIFTBATH INJECTOR;WH or BI
6C.	8500HOSE	HOSE; 3/8" X 9/16" WHITE VINYL
6D.	1105LFIT	L FITTING W/ WASHER
7A.	8500MOTOR	0.75HP 115V/60HZ DRIFTBATH PUMP
7B.	(PACKAGED WITH 7A.)	1.5" PUMP UNION W/ 40MM ADAPTER
7C.		1.5" PUMP UNION W/ 50MM ADAPTER"
7D.	8409015FTG	1.5" 90 DEG ST ELBOW
"7E.	8150PIPE	1.5" PVC PIPE"
"8A.	8501CONTROL	CONTROL BOX;TMS;W/P ON/OFF"
"8B.	8500CONTROL	CONTROL BOX; CHROMATHERAPY 120V"
10D. (OPTION)	8020LIGHTS	20LEDS CHROMATHERAPY BULB
11	8160BOX	CONTROL BOX;TMS;W/P ON/OFF CNFG;120V



Aquatic Limited Warranty Serenity DriftBath™

Limited Warranty For Original Consumer For Household Usage

WHAT PRODUCTS ARE COVERED

Structures and surface finishes on the tub and their support systems including equipment, components, attachments and plumbing equipment. Different warranty periods apply to specific components.

Warranty Periods for Specific Components

10 YEAR STRUCTURAL WARRANTY FOR TUB SHELL

Aquatic extends to the original consumer purchaser (the "Purchaser") of the acrylic, fiberglass reinforced shell of tubs a limited warranty that the shell will retain its structural integrity and configuration and be free of water loss due to a defect in the tub shell for a period of 10 years from the date of purchase or 11 years from date of manufacture. This limited structural warranty does not apply to attachments to the acrylic, fiberglass reinforced shell, such as plumbing, fittings and other apparatus; this support equipment pieces is covered below.

10 YEAR SURFACE WARRANTY FOR FACE OF TUB

The interior surface/face of a tub is warranted against fading, blistering, cracking and delamination due to defects in the surface materials for a period of 10 years from the date of purchase or 11 years from date of manufacture. This surface warranty extends to defects due to surface material mixing or molding. This surface warranty does not apply to fading, cracking, delamination or blistering due to excessive wear, sun fading or scouring due to cleaning.

2 YEAR EQUIPMENT WARRANTY FOR SUPPORT EQUIPMENT, COMPONENTS, CONTROLS & PLUMBING EQUIPMENT

All support equipment, components, controls and plumbing equipment on tubs are warranted for 2 years from date of purchase or 3 years from date of manufacture, against defects in workmanship and materials. Fuses and pillows are not included in this limited warranty.

EXCLUSIVE REMEDY

Aquatic shall, as its sole obligation, and Purchaser's sole and exclusive remedy for any breach of the limited warranty set forth herein, repair or replace the affected components of any defective tub. If Aquatic determines that repair or replacement of the entire defective tub is not commercially practicable, Aquatic may accept return of the tub and refund the then-current list price of the tub (or, if the tub has been discontinued, of the most nearly comparable current product) to Purchaser for the defect. Any repair, replacement or warranty service by Aquatic hereunder will not extend the applicable warranty periods set forth herein. Unless otherwise agreed upon by Aquatic in writing, Purchaser will bear the costs of access, de-installation, re-installation and transportation of the tub to Aquatic and back to Purchaser.

WHAT YOU MUST DO

To obtain warranty service under these warranties:

1. You must be the Purchaser of the tub.
2. You must give prompt notice to Aquatic of any defect claim within the warranty period and provide us with any substantiation that we may reasonably request.
Contact: Warranty Service 800.945.2726 • aquaticbath.com.
3. Tubs must have been installed and maintained in accordance with standard industry practice and with Aquatic's instructions contained in the Owner's Manual and Installation Guide. Please contact Aquatic at the address stated above to obtain a copy of Aquatic's Owner's Manual and Installation Guide.

EXCLUSIONS

These limited warranties are null and void if:

1. The tub is subject to damage during shipping by carriers, faulty installation, maintenance, abuse, accident or other damages.
2. The tub is installed outdoors.
3. The tub is not installed in accordance with standard industry practice and Aquatic's instructions contained in the Owner's Manual and Installation Guide.
Please contact Aquatic at the address stated above to obtain a copy of Aquatic's Owner's Manual and Installation Guide.
4. Unreasonable use of the tub occurs (including any use for non-bathing purposes or failure to provide reasonable and necessary maintenance as specified in Aquatic Owner's Manual and Installation Guide supplied with the tub).
5. The tub is altered, customized, or modified without Aquatic's prior written approval.

LIMITATIONS

1. Aquatic tubs sold to Purchasers for industrial, commercial or hotel use are warranted for two years from the original date of purchase or 3 years from date of manufacture, with a limited warranty that the shell will retain its structural integrity and configuration and be free of water loss due to a defect in the tub. The interior surface/face of the tub is warranted against fading, blistering, cracking and delamination due to defects in the surface materials. All support equipment, components, controls and plumbing equipment sold to Purchasers for industrial, commercial or hotel uses on the support equipment, controls, or plumbing is warranted for 1 year from date of purchase or 2 years from date of manufacture. Fuses and pillows are not included in this limited warranty. Aquatic reserves the right to furnish a substitute or replacement tub component in the event the tub component is discontinued or otherwise unavailable.
2. THESE WARRANTIES ARE NON-TRANSFERABLE TO ANY OTHER PURCHASER OR PARTY OTHER THAN THE PURCHASER. NO OTHER AGENT OR PARTY CAN GIVE ANY OTHER WARRANTY OR PROMISE. THIS IS THE SOLE WARRANTY FOR YOUR AQUATIC TUB.
3. Building Code Compliance is not covered by this limited warranty. Local building codes vary considerably, the Purchaser of the tub is responsible for checking with local building or plumbing contracts to insure local code compliance before installation.
4. Your warranty period starts (begins to run) at the earlier of 1) the beginning of installation of your tub in a home, or 2) the purchase of your tub, and shall never exceed 11 years from the date the tub is manufactured for its shell or finish, or 3 years from the manufacture of plumbing supplies and accessories.

GENERAL

EXCEPT FOR THE LIMITED WARRANTIES SET FORTH ABOVE, THE TUBS ARE PROVIDED "AS IS" WITHOUT ANY REPRESENTATIONS OR WARRANTIES OF ANY KIND. AQUATIC EXPRESSLY DISCLAIMS ALL OTHER WARRANTIES, EXPRESS, IMPLIED, INCLUDING BUT NOT LIMITED TO ANY WARRANTIES OF MERCHANTABILITY, FITNESS FOR A PARTICULAR PURPOSE, TITLE, AND NON-INFRINGEMENT OF THIRD PARTY RIGHTS. AQUATIC DOES NOT WARRANT THAT THE TUBS FURNISHED HEREUNDER WILL MEET PURCHASER'S REQUIREMENTS OR THAT THE OPERATION OF THE PRODUCT WILL BE UNINTERRUPTED OR DEFECT-FREE OR THAT ALL DEFECTS WILL BE CORRECTED. PURCHASER ACKNOWLEDGES THAT IT HAS RELIED ON NO WARRANTIES OTHER THAN THE EXPRESS WARRANTIES PROVIDED HEREIN.

IN NO EVENT WILL AQUATIC BE LIABLE FOR ANY INDIRECT, SPECIAL, INCIDENTAL, EXEMPLARY OR CONSEQUENTIAL DAMAGES; INCLUDING WITHOUT LIMITATION ANY LOST PROFITS AND COSTS OF PROCUREMENT OF SUBSTITUTE PRODUCT, ARISING OUT OF OR RELATED TO A BREACH OF THIS LIMITED WARRANTY.

Some states do not allow exclusions or limitations on implied warranties. Thus, the above exclusions or limitations may not apply. This warranty gives you specific legal rights. Purchaser may also have other rights which may vary from state to state.



AQUATIC

The bath people

Customer Service: 800.945.2726 • aquaticbath.com