

INSTRUCTION MANUAL FOR WIRELESS PAIN RELIEF DEVICE



Document No.: DDX-LT5011C-CE-09
Version: 1.0

TABLE OF CONTENTS

INTRODUCTION.....	5
IMPORTANT SAFETY PRECAUTIONS AND WARNINGS.....	6
HOW TENS WORK FOR PAIN RELIEF.....	11
PACKAGE CONTENTS.....	12
KNOW YOURS DEVICE.....	13
INSERT BATTERIES.....	15
CHARGING.....	16
EASY STEPS TO GET STARTED WITH YOUR THERAPY WITH ELECTRODE PADS.....	17
SPECIFICATIONS.....	23
HOW TO CONTROL AND REDUCE YOUR PAIN.....	24
CLEANING AND STORAGE.....	26
TROUBLESHOOTING.....	28
DISPOSAL.....	29
GLOSSARY OF SYMBOLS.....	29
WARRANTY.....	30
IMPORTANT INFORMATION REGARDING ELECTRO MAGNETIC COMPATIBILITY (EMC).....	31
FCC COMPLIANCE INFORMATION.....	36

INTRODUCTION

Thank you for purchasing Wireless Pain Relief Device LT5011C for your pain relief solution.

In order to use the stimulator safely, read the complete manual carefully before using the device for the first time.

Keep this instruction manual in a convenient place or store with the device for future reference.

The Essential Performance of the device is free from the production of unwanted or excessive stimulation output.

The Wireless Pain Relief Device LT5011C is designed to be used for temporary relief of pain associated with sore and aching muscles in the shoulder, joint, back, upper extremities(arm),and lower extremities(leg), due to strain from exercise or normal household work activities.And to be used for the symptomatic relief and management of chronic, intractable pain and relief of pain associated with arthritis. It should be applied to normal, healthy, dry and clean skin of adult patients.

Standard Parts:





The giftbox contains the following components:

NO.	DESCRIPTION	QUANTITY
A	TheraRelief Unit	1PC
B	Electrode pad	3PCS
C	Remote control	1PC
D	Battery	2PCS
E	Adapter and Micro-USB cable	1PC
F	Instruction manual	1PC
G	Quick Start Guide	1PC
H	Electrode Placement Guide	1PC

IMPORTANT SAFETY PRECAUTIONS AND WARNINGS



It is important that you read all the warning and precautions included in this manual because they are intended to keep you safe, prevent injury and avoid a situation that could result in damage to the device.

SAFETY SYMBOLS USED IN THIS MANUAL	
 DANGER	Indicates a potentially hazardous situation which, if not avoided, could result in death or serious injury.
 WARNING	Indicates a potentially hazardous situation which, if not avoided, could result in serious injury and equipment damage.
 CAUTION	Indicates a potentially hazardous situation which, if not avoided, may result in minor or moderate injury to the user or patient or damage to the device or other property.
 DANGER	
<p>This stimulator must not be used in combination with the following medical devices:</p> <ul style="list-style-type: none"> ■ Internally transplanted electronic medical devices, such as Cardiac pacemaker, implanted defibrillator, or other implanted metallic, rods or electronic device. ■ Electronic life support equipment, such as respirators. ■ Electronic medical devices attached to the body, such as electrocardiographs. Using this stimulator with other electronic medical devices may cause erroneous operation of those devices. 	

 WARNING
<p>DO NOT USE THIS DEVICE UNDER THESE CONDITIONS:</p> <ul style="list-style-type: none"> ■ Consult with your physician before using this device, because the device may cause lethal rhythm disturbances in certain susceptible individuals. ■ On open wounds or rashes, or over swollen, red, infected, or inflamed areas or skin eruptions (e.g., phlebitis, thrombophlebitis, varicose veins); or on top of, or in proximity to, cancerous lesions. ■ Over areas of skin that lack normal sensation. ■ On the opposite sides of your head since the effects of stimulation of the brain are unknown. ■ Do not apply stimulation in the presence of electronic monitoring equipment (e.g., cardiac monitors, ECG alarms), which may not operate properly when the electrical stimulation device is in use.

- Stimulation should not take place while the user is connected to high-frequency surgical equipment, it may cause burn injuries on the skin under the electrodes, as well as problems with the stimulator.
- Do not use the stimulator in the vicinity of shortwave or microwave therapy equipment, since this may affect the output power of the stimulator.
- The specific recommendations for separation distances from other wireless products please refer to the table 4 (pg.34) of the user manual.

DO NOT USE ON THESE INDIVIDUALS

- Pregnant women, because the safety of electrical stimulation during pregnancy has not been established.
- Children or infants, because the device has not been evaluated for pediatric use.
- Persons incapable of expressing their thoughts or intentions.

DO NOT USE THIS DEVICE DURING THESE ACTIVITIES

- When in the bath or shower;
- While sleeping;
- While driving, operating machinery, or during any activity in which electrical stimulation can put you at risk for injury.

PAIN MANAGEMENT WARNINGS

- If you have had medical or physical treatment for your pain, consult with your physician before using this device.
- If your pain does not improve, becomes seriously chronic or severe, or continues for more than five days, stop using the device and consult with your physician.
- The mere existence of pain functions as a very important warning telling us that something is wrong. Therefore, if you suffer from any serious illness, consult your physician in order to confirm that it is advisable for you to use this TENS Stimulator.

WARNINGS AND PRECAUTIONS REGARDING THE PADS

- Apply pads to normal, healthy, dry, clean skin (of adult patients) because it may otherwise disrupt the healing process.
- If you experience any skin irritation or redness after a session, do not continue stimulation in that area of the skin.



NEVER APPLY THE PADS TO:

- The head or any area of the face.
- Never apply the pads to the side of the neck (on the carotid sinus) or any area of the throat (front of the neck) because this could cause severe muscle spasms resulting in closure of the airway, difficulty in breathing, or adverse effects on heart rhythm or blood pressure.



- Both sides of the thorax simultaneously (lateral or front and back), or across your chest because the introduction of electrical current may cause rhythm disturbances which could be lethal.



 **CAUTION**

CAUTION AND PRECAUTIONS REGARDING THE PADS

- Do not bend or fold because the pad may not function properly. Place the pads onto the plastic film and then store into the sealed package when not in use.
- Do not apply ointment or any solvent to the pads or to your skin because it will disrupt the pads from functioning properly.
- The pads are already pre-gelled and will adhere to your skin.
- To avoid damage to the adhesive surface of the pads, put the pads only on the skin or on the plastic film provided.
- Place the pads at least 1 inch apart on your skin. The pads should never touch each other.
- Always place clean pads in accordance with illustrations provided (Refer the electrode placement guide).
- Make sure the components are connected well and the pads are fixed on the part of the body you wish to treat or the therapy may not be effective.

DO NOT USE YOUR PADS THIS WAY

- Pads should not touch each other when placed onto your skin.
- Do not place on your spine or backbone.
- Pad should not touch any metal object, such as a belt buckle or necklace.
- Pads should not be placed simultaneously on the soles of both feet.
- Pads should not be placed simultaneously on the calves of both legs.
- Do not share pads with another person. This may cause a skin irritation or infection. Pads are intended for use by one person.
- Always turn the power off before removing or changing the pad location.
- Do not leave pads attached to the skin after treatment.

CAUTION WHILE USING THE STIMULATOR

- If the stimulator is not functioning properly or you feel discomfort, immediately stop using the device.
- Do not use for any other purpose except for what it is intended for.

- Do not use the device while wearing electronic devices such as watches as this may damage the device.
- Do not throw the batteries into a fire. The batteries may explode.
- Dispose of the device, batteries, and components according to applicable legal regulations. Unlawful disposal may cause environmental pollution.
- The size, shape and type of pads may affect the safety and effectiveness of electrical stimulation.
- The electrical performance characteristics of pads may affect the safety and effectiveness of electrical stimulation.
- Using pads that are too small or incorrectly applied, could result in discomfort or skin burns.

GENERAL PRECAUTIONS

- The patient is the intended operator.
- The long-term effects of electrical stimulation are unknown.
- Apply stimulation to only normal, intact, clean, dry, and healthy skin.
- TENS is not effective in treating the original source or cause of the pain, including headache.
- TENS is not a substitute for pain medications and other pain management therapies.
- TENS devices do not cure disease or injuries.
- TENS is a symptomatic treatment and, as such, suppresses the sensation of pain that would otherwise serve as a protective mechanism.
- Effectiveness is highly dependent upon patient selection by a practitioner qualified in the management of pain patients.
- You may experience skin irritation or hypersensitivity due to the electrical stimulation or electrical conductive medium (gel).
- If you have suspected or diagnosed heart disease, you should follow precautions recommended by your physician.
- If you have suspected or diagnosed epilepsy, you should follow precautions recommended by your physician.

- Use caution if you have a tendency to bleed internally, such as following an injury or fracture.
- Consult with your physician prior to using the device after a recent surgical procedure, because stimulation may disrupt the healing process.
- This stimulation should not be applied over the menstruating or pregnant uterus.
- This stimulation should not be applied over areas of skin that lack normal sensation.
- Keep unit away from young children. The unit contains small pieces that may be swallowed. Contact your physician immediately if ingested.
- Keep unit away from young children. The unit contains a Micro-USB cable that may cause strangulation.
- Do not modify this equipment without authorization of the manufacturer.
- Do not use the device or an electrode if it is damaged. The continuous use of a damaged unit may cause injury, improper results, or serious danger.
- Please report to your manufacturer or dealer if any unexpected operation or events occur.
- If you have any problems with this device, such as setting up, maintaining or using, please contact manufacturer or dealer.

Possible Adverse Reactions

- Do not use to treat one region for extended periods of time (more than 30 minutes a session, up to 3 times/day) or muscles in that region may become exhausted and sore.
- You may experience skin irritation and allergic beneath the stimulation electrodes applied to your skin.
- You may experience headache and other painful sensations during or following the application of electrical stimulation near your eyes and to your head and face.
- You should stop using the device and consult with your physician if you experience adverse reactions from the device.

HOW TENS WORK FOR PAIN RELIEF

What is it?

The Wireless Pain Relief Device LT5011C is a three output channels TENS machine and highly effective in relieving pain.

Transcutaneous Electrical Nerve Stimulation (TENS) is a noninvasive, drug free method of controlling pain. TENS uses tiny electrical impulses sent through the skin to nerves to modify your pain perception. TENS does not cure any physiological problem; it only helps control the pain. TENS does not work for everyone; however, in most patients it is effective in reducing or eliminating the pain, allowing for a return to normal activity.

How TENS works?

Scientific theory suggests that electrical stimulation therapy may work in several ways:

- 1) The gentle electrical pulses move through the skin to nearby nerves to block or shut out the pain message from ever reaching the brain from the source of the pain.
- 2) The gentle electrical pulses increase the production of the body's natural pain killer, such as endorphins.

KNOW YOUR DEVICE

Features

- Channels: Three channels
- Treatment modes TENS: 20 programs
- Output Amplitude: 0-60mA (1000 Ω Load)
- Waveform type: Symmetrical Biphasic square pulse
- Control platform APP control (ios or Android) and Remote control

Front and Rear Panel

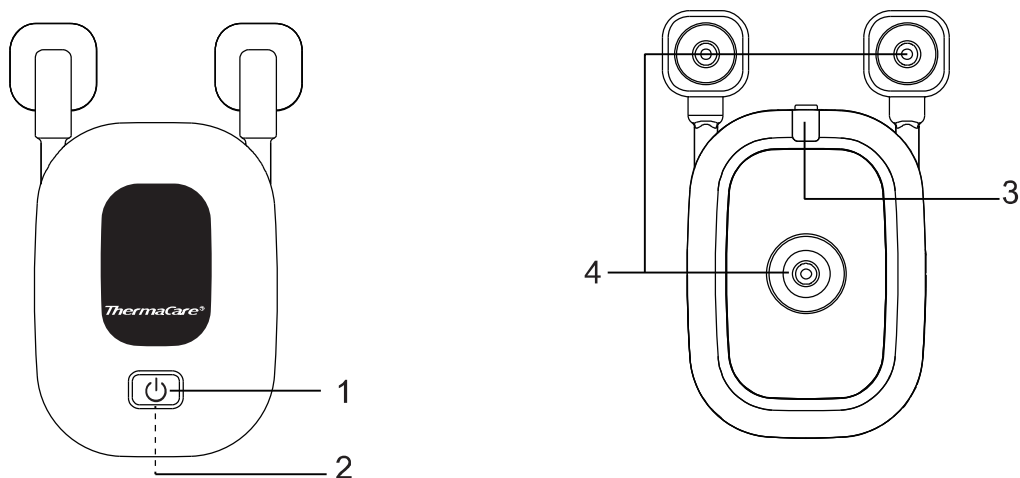

1. On/off button []: Press this button to turn on the device or turn off the device.
 - Green Flashing indicator light: The device hasn't connected with APP or the Remote control;
 - Continuous green: The device is in standby mode;
 - Continuous Orange: The device is in treatment mode;
 - Orange flashing: The device is in paused mode;
2. Indicator light when charging:
 - Continuous orange: The battery is charging;
 - Continuous green: The battery is fully charged.
3. Device charging port:
 - Connect the Micro-USB cable and the adaptor to the device port to charge;
4. Output port:
 - Connect the electrode pads

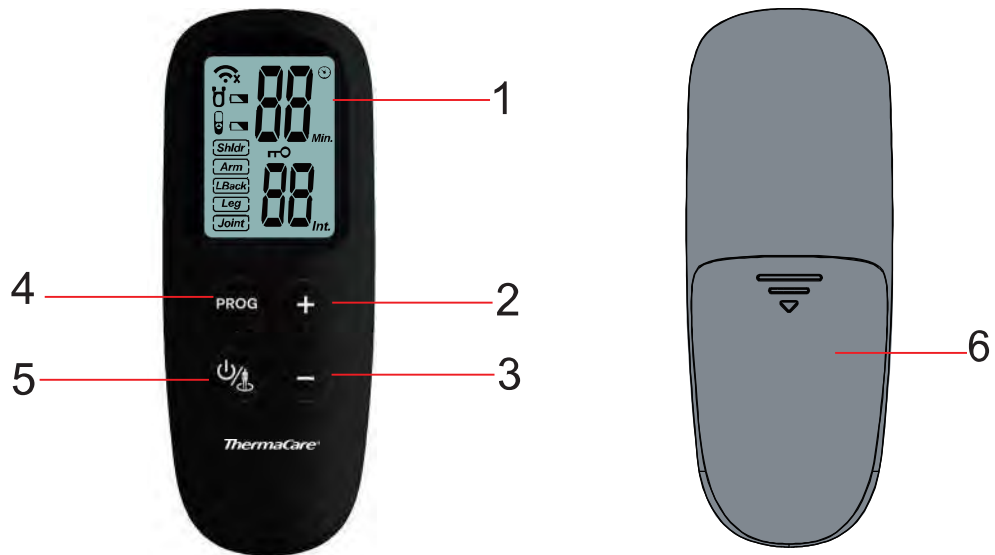

- 1.LCD display
- 2.Increase intensity button
- 3.Decrease intensity button
- 4.Program adjusting button
- 5.Power on and off/Body parts adjusting button
- 6.Battery cover

LCD display :

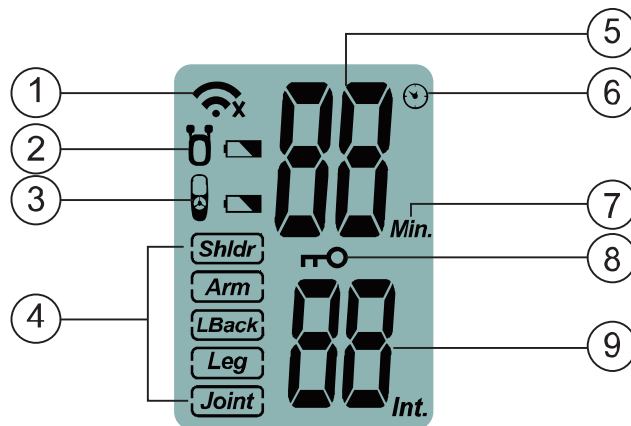

- | | |
|-----------------------------|------------------------|
| 1. Wireless Connection Hint | 7. Treatment Time Unit |
| 2. Control Low Voltage | 8. Lock |
| 3. Remote Low Voltage | 9. Treatment Intensity |
| 4. Treatment Body Part | |
| 5. Program and Time | |
| 6. Treatment Time Icon | |

INSERT BATTERIES

1) Remove the battery cover on the back.

2) Insert AAA batteries. Make sure the positive “+” and negative “-” signs correspond when inserting batteries.

3) Reinstall the battery cover

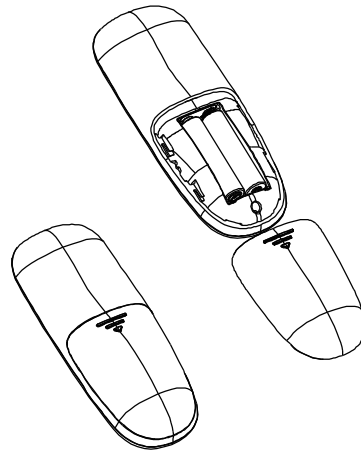

NOTES:

- 1) Please use 2*AAA batteries in this stimulator.
- 2) Remove the batteries if the device is not in use for long periods of time.
- 3) Warning: If batteries leak and come into contact with the skin or eyes, wash immediately with copious amounts of water.
- 4) Batteries must be handled by an adult. Keep batteries out of the reach of children.
- 5) Remove exhausted batteries from the unit.
- 6) Dispose the used batteries safely according to the local regulations.

CHARGING

Insert the Micro-USB plug of the cable into the charging port of the LT5011C device, and then connect to the Standard USB plug of the cable to the appropriate power supply device which could output 5V d.c. ,300mA. When the battery light goes from continuous orange (which means that the battery is being charged) to a continuous green (the battery is full), remove the plug from the socket of the device.

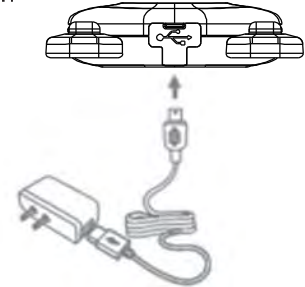

NOTES:

- Only use the Micro-USB cable which is provided by the manufacturer.
- Device must be charged prior to first use. Typically it takes 2 hours to charge the device. A full charge allows a battery life of about 2 hours continuously when functioning in normal (ambient temperature) conditions.
- Please charge the device fully before beginning each session. If the charge is not complete at the beginning of a program, the battery may become depleted before the end of the session. You cannot use the device while it is charging.



WARNING

- If batteries leak and come into contact with the skin or eyes, wash immediately with copious amounts of water.
- Dispose of the used batteries safely according to the local regulations.
- The life of a rechargeable battery depends on the number of recharging/rundown cycles it undergoes and how these cycles are performed.
- The service life of rechargeable battery is more than 300 recharging/rundown cycles.
- We provide the following suggestions to extend the life of the battery:
Whenever the device is not used frequently, we recommend recharging the battery once a month.

EASY STEPS TO GET STARTED WITH YOUR THERAPY WITH ELECTRODE PADS

Using the Remote control to control the main device:

Clip excess hair from the treatment area and remove any jewelry that may come in contact with the stimulation of the device. Wash area with soap and water, and dry completely.

Step 1 – Connect electrode pad

Take off the electrode pad and connect it on the device by attaching the snap button.

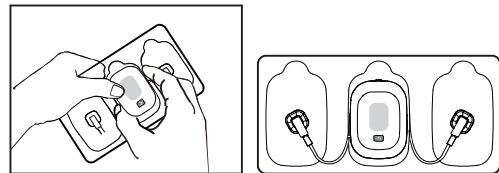

Step 1

Step 2 – electrode pad placement

Remove the protective Film layer and apply the electrode pad to the skin. Press Firmly to ensure adhesion .

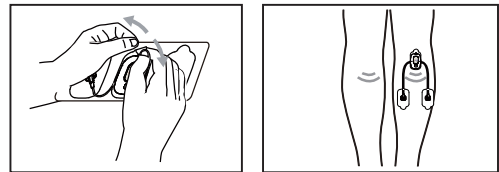

Step2

NOTE: See the Electrode Placement Guide for more information.

Step 3 – Turn on the device and remote control

Press [Power] on the remote control, LCD will display for a moment to standby mode.

Press [Power] on the TheraRelief Unit ,viridity LED indicator of TheraRelief Unit will light.

Attention:  icon will blink if remote control has poor wireless connection with TheraRelief Unit.

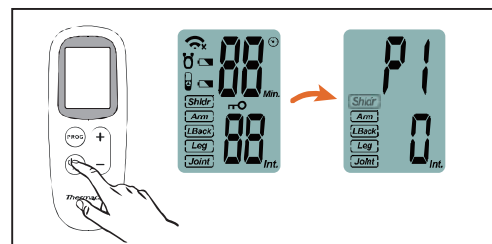

Step3

Step 4 –Choose Treatment Body parts

Press and release [Power] each time to select treatment body parts (Shoulder-Arm-Lback -Leg-Jiont).

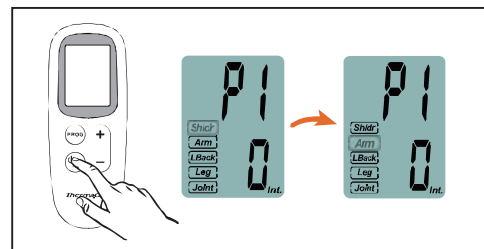

Step4

Step 5 – Selecting treatment program

Press and release [PROG] each time to select treatment program from P1-P4

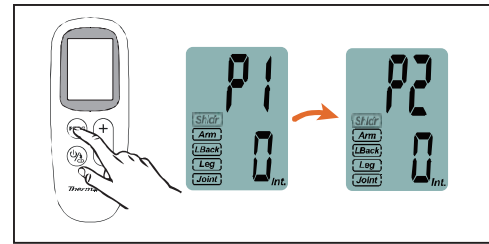

Step5

Step 6 –Start treatment and adjust intensity

Adjust electrical stimulation intensity by pressing [+] or [-] button.

NOTE: If there is any emergency happen, press [⏏] button on remote control or press [⏏] button on unit to stop treatment, the device will back to standby status.

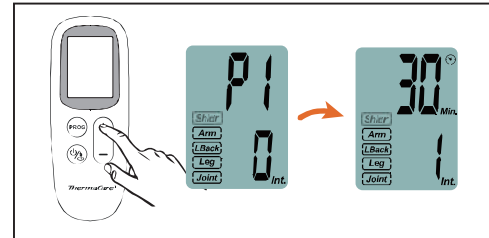

Step6

⚠ CAUTION:

- 1) If the electrodes are not placed firmly on skin or the TheraRelief Unit has not connected with the electrodes and the output intensity level over 5, the intensity will stop automatically.
- 2) If the stimulation levels make you feel uncomfortable, reduce the stimulation intensity to a comfortable level and contact your medical practitioner if problems persist.
- 3) If your pain does not improve and become sore from over-use, refrain from treating those areas for 2 days. If this issue reoccurs, reduce the treatment time and intensity settings for future treatment.
- 4) If you feel pain, dizziness, discomfort or nausea, call your physician or medical practitioner.
- 5) You should therefore take care to work with maximum intensities, i.e., always at the limit of what you can support. Do not exceed your comfort level.

Step 7 – Turn off the device

The device will turn off automatically after 30 minutes treatment time.

Press and hold [⏏] button for 3 seconds to turn off the TheraRelief Unit.

Press and hold [⏏] button for 3 seconds to turn off remote control.

Also both remote control and TheraRelief unit can be turned off together by pressing and holding [⏏] button on remote control for 3 seconds.

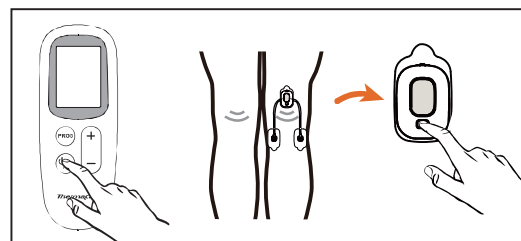

Step7

 **CAUTION:**

If there is no operation in the panel for 5 minutes in the standby status, the device will be off automatically and you can hear beep sounds.

Other important functions

- The lock function automatically activates after there is no operation in the panel for 20 seconds in treatment status, the indicator "🔒" display on LCD . This is a safety feature to prevent accidental increases the output intensity level.Press - button to unlock.
- When the low power indicator "🔋" display on LCD,the battery of the remote control need to be replaced as soon as possible.
- When the low power indicator "🔋" display on LCD,the battery of the TheraRelief Unit need to be charged as soon as possible

Using the APP to control main device:

Step 1- Downloading the APP

Download the application to your smart phone :

- By the Appstore or Google Play
- Then search 'LT5011C', and click the Smart Pain Reliever LT5011C icon.
- The app operates on ios and Android platforms(At least ios 8.0, Android 5.0)

Clip excess hair from the treatment area and remove any jewelry that may come in contact with the stimulation of the device.Wash area with soap and water,and dry completely.

Step 2 – Connect electrode pad

Please refer to pg.16

Step 3 – Electrode pad placement

Please refer to pg.16

NOTE: See the Electrode Placement Guide for more information.

 **WARNING:**

NOTE: DO NOT place the electrodes on top of each other or so close to each other that they touch each other.

It is possible that you may need external assistance for placing the electrodes in certain areas.

Always replace the electrodes with electrodes recommended for this device by the manufacturer.

Make sure the device is turned off before applying electrodes.

Replace the electrodes if:

- They are damaged or torn.
- They are past the use-by date indicated on the re-sealable bag.
- They have lost their adhesive power. Never use plaster or tape to attach them to your skin.
- Stimulation feels less strong.
- When stimulation is uncomfortable, i.e. when you experience an unpleasant stinging or biting sensation.

Step 4—Starting a session through the use of the device application

- Ensure that the Bluetooth (4.0) connection is activated on your smartphone or tablet. Turn on the APP.
- Press the [⏻] button on the device so that the device is in standby mode (Continuous green light : Standby mode, ready for the session). The App detects the device which is switched on. In case of inactivity for more than 5 min, the device switches off. Press the [⏻] button again to begin a session.
- Once the device is paired with the app, the screen will indicate that the devices are now connected and you may click on the "Press to continue" text.

Step 5—Select the area to be treated

In the case of a new session, it is essential to select a treatment area.

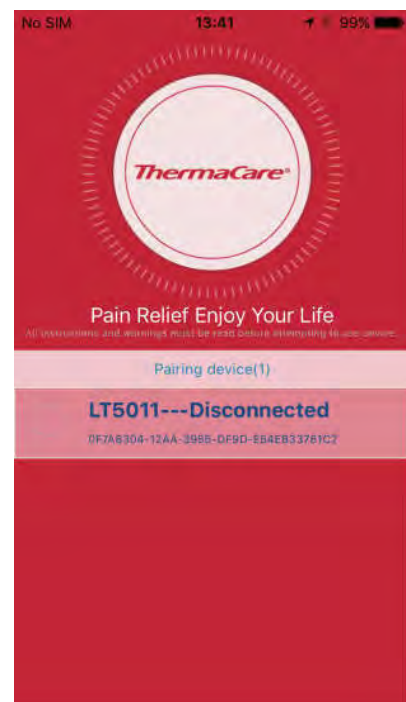

Step 6—Select the model and estimate your pain level

- 4 models(Single/Dual/Triple/Set)
- On a scale of 1 to 10, evaluate the intensity of the pain.For no pain press 0, for extremely intense pain press 10

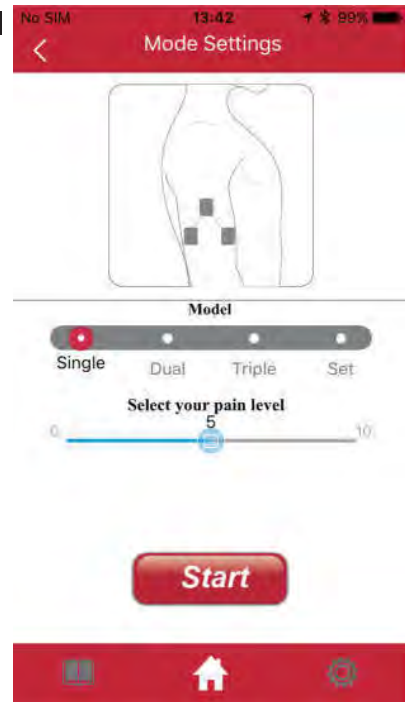

Step 7—Select and start a session

- Starting a session : Click [+] button to begin treatment.
- After session is complete,estimate your satisfaction level, the session is then recorded in the history.

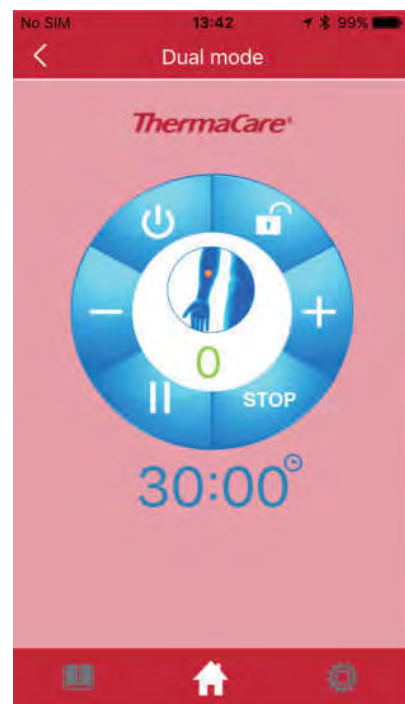

[⏻] Power button shuts down both the app and the device.

[🔒] Unlocked, you may increase and decrease intensity.

When locked, intensity controls are locked for safety.

[-] Decrease intensity

[+] Increase intensity

[||] Pause treatment

[Stop] Stop treatment and back out to main menu

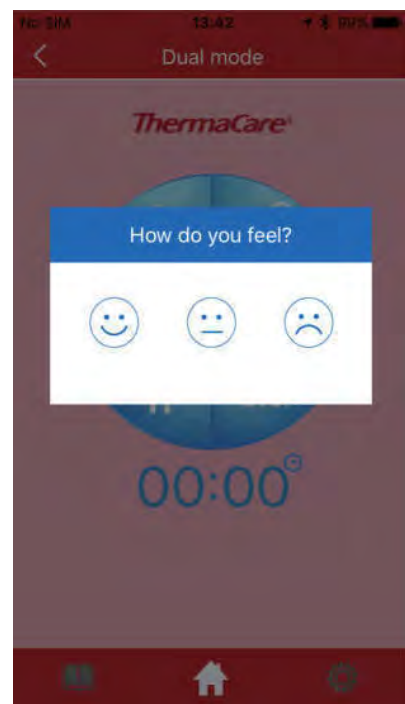
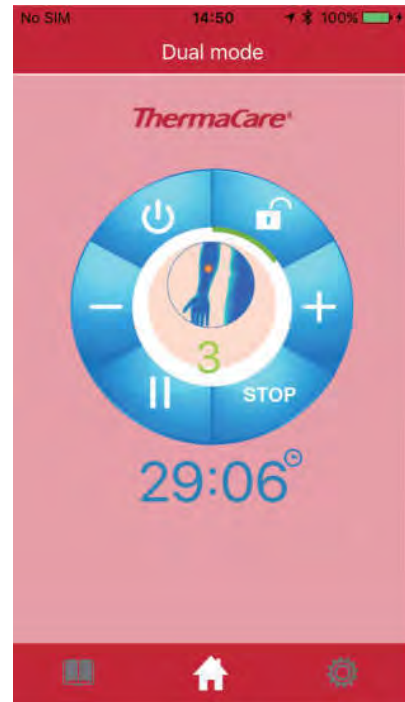

Step8 - Following completion of session

- To turn off the device, press the [⏻] button.
- Remove the electrodes from the skin.
- Detach from the edges.
- Remove the device from the electrodes. If you forget the device for more than 5 minutes, it turns off. If the device is frequently used during the day, it is advisable to charge it before starting a new session.

SPECIFICATIONS

- Power Sources:
 - Adaptor: I/P: 100-240V~, 50/60Hz, 0.2A. O/P: 5V $\overline{\text{---}}$, 300mA.
 - Remote control: I/P: 2*1.5V AAA batteries.
 - TheraRelief Unit: Lithium Ion Battery: 3.7V $\overline{\text{---}}$, 250mAh
 - Charging: 5V $\overline{\text{---}}$, 300mA
- Frequency: 2Hz~100Hz
- Pulse Width: 100us~300us
- Output Voltage: 0~60mA (1000 ohm load)
- Output Intensity Level: 0~20 levels
- Treatment Time: 5 - 90 minutes
- Operating Conditions: 5 °C~40 °C; 30%RH~75%RH;700hpa-1060hpa
- Storage and transport Conditions: -10 °C~55 °C; 10%RH~90%RH;700hpa-1060hpa
- Remote control Size: 127mm (L) x 48.7mm (W) x 24.2mm (H)
- TheraRelief Unit Size: 80.5mm (L) x 45mm (W) x 13.5mm (H)
- Remote control Weight: about 65g(without batteries)
- TheraRelief Unit Weight: about 33g
- The service life of device: 3 years
- Service life of electrode pads: 10 times
- Electrode impedance: $\leq 500\Omega$
- Applied part: Electrode
- Size of electrode: 84.4x49mm
- IP classification system: IP22
- Maximum separation distance: 10m (In the opened environment)
- The recommended separation distance: 3m

Description of the Wireless Functions and Technology:

■ RF Frequency	2.4GHZ-2.48GHZ
■ Channel Bandwidth	2 M H z (-20db)
■ Operation Voltage	3.7 V
■ Modulation type	GFSK
■ Number of channel	40
■ Chanel spacing	2 MHz
■ Channel frequency	0-39 Channel 2.402-2.480GHZ
■ Dwell time (if FHSS)	400ms
■ Hopping rate (if FHSS)	1600HZ
■ Antenna gain	0dBi
■ Bluetooth version	V1.0

The LT5011C device uses the one-on-one connection of BLE4.0, and our device as a peripheral, responds to the APP's connection request passively, establishing a one-on-one connection with the APP. After the LT5011C device connects to the APP, the device will not be connected to other wireless devices or controlled.

After the APP connects to the peripheral device, the APP will send the command, and when the LT5011C device ensures this command is right, it will open the control command, then you can control the LT5011C device. Otherwise, the APP can't control the LT5011C device.

HOW TO CONTROL AND REDUCE YOUR PAIN

When should the device be used?

Use as soon as your pain begins. Start with one session (unit automatically turns off at 30 minutes). If you get to your pain early, it may prevent the pain from becoming worse, or even chronic. It's better for you to get it under control sooner so that it does not reach a high pain threshold where it limits your daily activities.

Setting the intensity

Intensity is based upon your level of comfort. Begin the first session with a low intensity and a short duration while learning how to operate. You should therefore take care to work with maximum intensities, i.e., always at the limit of what you can support. Do not exceed your comfort level.

How long should you use the device?

Start with one 30 minute session. Always turn unit off before remove the pads from you skin . Rate your pain to check your progress, 1 low to 20 high. Intensity is based upon your level of comfort. Begin the first session with a low intensity and a short duration while learning how to operate.

Stop therapy session if pain has reduced or stopped. If your pain does not improve and become sore from over-use, refrain from treating those areas for 2 days. If this issue reoccurs, reduce the treatment time and intensity settings for future treatment.

Recommended treatment session as following:

1 session	Max session	Max times/day
30 minute section shut-off	2 Sections	3 Sections per day

When to stop using the device?

- 1) If you experienced an adverse reaction (skin irritation/ redness/burns, headache or other painful sensation, or if you feel any unusual discomfort).
- 2) If your pain does not improve, becomes seriously chronic and severe, or continues for more than five days.

NOTE:

If you feel pain, dizziness, discomfort or nausea, call your physician or medical practitioner.

CLEANING AND STORAGE

Cleaning the unit and the remote control

- 1) Turn unit off .
- 2) Clean the device after use with a soft, slightly moistened cloth and wipe gently.
 - Do not use chemicals (like thinner, benzene).
 - Do not let water get into the internal area.

Note:

- This device and accessories does not require sterilization.

Cleaning the electrode pads

- 1) Turn the power off and remove the pads from the unit.
- 2) Wash the pads when the adhesive surface becomes dirty and/or the pads are difficult to attach.
 - Wash the pad softly with your fingertips under slow running cold water for several seconds (do not use a sponge/cloth/sharp object like a nail on adhesive side, do not use detergents, chemicals or soap).
- 3) Dry the pads and let the adhesive surface air-dry completely (do not wipe with a tissue paper or cloth).



CAUTION:

- 1) The life of pads may vary by the frequency of washing, skin condition, and storage state.
- 2) If the pad no longer sticks to your skin or the pad is broken, you should replace new pads.
- 3) Before applying the self-adhesive electrodes, it is recommended to wash and degrease the skin, and then dry it.
- 4) Do not turn on the device when the electrodes are not positioned on the body.
- 5) Never remove the self-adhesive electrodes from the skin while the device is still turned on.
- 6) If replacement electrodes are necessary, use only electrodes that are the same size as the electrodes provided with the TheraRelief.

7) Use of electrodes that are larger may reduce the effect of the stimulation. Use of electrodes that are much smaller than the electrodes provided with the TheraRelief may increase the chance of skin irritation or electrode burns occurring under the electrodes.

8) Always use electrodes that have been cleared for marketing in the US by the FDA.

Storing the electrode pads

- 1) Turn the device off .
- 2) Remove the pad from your body.
- 3) Place the pads onto the plastic film and then store into the sealed package.

Storing the unit

- Place the unit, electrodes, and manual back to gift box. Store the box in a cool, dry place, -10°C~55°C; 10% ~90% relative humidity. Do not expose the product to any chemical solvent, water lint, dust, direct sunshine or high temperature.
- Do not keep at places that can be easily reached by children. Keep the device away from pet and pests.
- When not in use for a long period, remove the batteries before storage, to avoid liquid discharge from batteries.

TROUBLESHOOTING

Problem	Possible causes	Possible solution
The unit can not power on	Are the batteries exhausted?	Charging
Stimulation weak or cannot feel any stimulation	Electrodes dried out or dirty	Replace new electrodes
	Electrodes cannot stick skin well	Reconnect the electrodes
Stimulation is uncomfortable	Intensity is too high	Decrease intensity.
	Electrodes are too close together	Reposition the electrodes.
	Electrode active area size is too small	Use the electrode of TheraRelief
	Is the device being operated according to the manual	Please check the manual before use
Stimulation is ineffective	Improper electrode placement	Reposition electrode
	Unknown	Contact clinician
The skin becomes red and/or you feel a stabbing pain	Use the electrodes on the same site every time	Re-position the electrodes. If at any time you feel pain or discomfort stop use immediately
	The electrodes are not adhered to the skin properly	Ensure the electrodes are securely adhered to the skin
	The electrodes are dirty	Clean the electrodes according to description in this manual or replace new electrodes.
	The surface of the electrode is scratched.	Replace new electrode.

Output current stops during therapy	The electrodes come off the skin.	Turn off the device and place the electrodes again.
	The power of the batteries has been exhausted.	Charging
The Remote control can not power on	Are the batteries installed correctly?	Insert the batteries observing polarity.
The APP or Remote control can't connect to the LT5011C device	The Bluetooth connection failure.	Restart the LT5011C and the APP or Remote control.
The APP or Remote control can't control the LT5011C device, but the APP or Remote control can connect the LT5011C device.	The Bluetooth communication failure.	Restart the APP or Remote control, and then connect the device again.

DISPOSAL

Used fully discharged batteries must be disposed of in a specially labeled collection container, at toxic waste collection points or through an electrical retailer. You are under legal obligation to dispose of batteries correctly. Please dispose of the device in accordance with the legal obligation.



GLOSSARY OF SYMBOLS



Electrical devices are recyclable material and should not be disposed of with household waste after their useful life! Help us to protect the environment and save resources and take this device to the appropriate collection points. Please contact the organization which is responsible for waste disposal in your area if you have any questions.





Type BF Applied Part (The applied part is electrode pads).



Refer to instruction manual.

IP22 The first number 2: Protected against solid foreign objects of 12.5 mm and greater. The second number: Protected against vertically falling water drops when enclosure tilted up to 15°. Vertically falling drops shall have no harmful effects when the enclosure is tilted at any angle up to 15° on either side of the vertical.

 55°C
-10°C Transportation and storage temperature from -10 °C to 55 °C

 90%
10% Transportation and storage humidity limits from 10% to 90%

 106.0kPa
70.0kPa Transportation and storage atmospheric pressure limits from 700 hPa to 1060 hPa

WARRANTY

Please contact your dealer or the device center in case of a claim under the warranty. If you have to send in the unit, enclose a copy of your receipt and state what the defect is. The following warranty terms apply:

1) The warranty period for device is one year from date of purchase. In case of a warranty claim, the date of purchase has to be proven by means of the sales receipt or invoice.

2) Repairs under warranty do not extend the warranty period either for the device or for the replacement parts.

3) The following is excluded under the warranty:

- All damage which has arisen due to improper treatment, e.g. nonobservance of the user instruction.
- All damage which is due to repairs or tampering by the customer or unauthorized third parties.
- Damage which has arisen during transport from the manufacturer to the consumer or during transport to the service center.
- Accessories which are subject to normal wear and tear.

4) Liability for direct or indirect consequential losses caused by the unit is excluded even if the damage to the unit is accepted as a warranty claim.

ELECTROMAGNETIC COMPATIBILITY (EMC)

- Use of accessories other than those specified or provided by the manufacturer of this equipment could result in increased electromagnetic emissions or decreased electromagnetic immunity of this equipment and result in improper operation..
- Use of this equipment adjacent to or stacked with other equipment should be avoided because it could result in improper operation. If such use is necessary, this equipment and the other equipment should be observed to verify that they are operating normally.
- Portable RF communications equipment (including peripherals such as antenna cables and external antennas) should be used no closer than 30 cm (12 inches) to any part of the device, including cables specified by the manufacturer. Otherwise, degradation of the performance of this equipment could result.

Table 1

declaration - electromagnetic emission		
The device is intended for use in the electromagnetic environment specified below. The customer or the user of device should assure that it is used in such an environment.		
Emissions test	Compliance	Electromagnetic environment - guidance
RF emissions CISPR 11	Group 1	The device uses RF energy only for its internal function. Therefore, its RF emissions are very low and are not likely to cause any interference in nearby electronic equipment.
RF emissions CISPR 11	Class B	The device is suitable for use in all establishments, including domestic establishments and those directly connected to the public low-voltage power supply network that supplies buildings used for domestic purposes.
Harmonic emissions IEC 61000-3-2	Class A	
Voltage fluctuations/ flicker emissions IEC 61000-3-3	Complies	

Table 2

declaration - electromagnetic immunity			
The device is intended for use in the electromagnetic environment specified below. The customer or the user of device should assure that it is used in such an environment.			
Immunity test	IEC 60601 test level	Compliance level	Electromagnetic environment - guidance
Electrostatic discharge (ESD) IEC 61000-4-2	±8 kV contact ±2 kV, ±4 kV, ±8 kV, ±15 kV air	±8 kV contact ±2 kV, ±4 kV, ±8 kV, ±15 kV air	Floors should be wood, concrete or ceramic tile. If floors are covered with synthetic material, the relative humidity should be at least 30 %.
Electrical fast transient/burst IEC 61000-4-4	± 2 kV for power supply lines ± 1 kV for input/output lines	± 2 kV for power supply lines ± 1 kV for input/output lines	Mains power quality should be that of a typical commercial or hospital environment.
Surge IEC 61000-4-5	± 0.5kV, ± 1 kV line(s) to lines ± 0.5kV, ± 1 kV, ± 2 kV line(s) to earth	± 0.5kV, ± 1 kV line(s) to lines ± 0.5kV, ± 1 kV, ± 2 kV line(s) to earth	Mains power quality should be that of a typical commercial or hospital environment.
Voltage dips, short interruptions and voltage variations on power supply input lines IEC 61000-4-11	0 % UT; 0.5 cycle At 0°, 45°, 90°, 135°, 180°, 225°, 270°and 315° 0 % UT; 1 cycle and 70 % UT; 25/30 cycles Single phase: at 0° 0 % UT; 250/300 cycles	0 % UT; 0.5 cycle At 0°, 45°, 90°, 135°, 180°, 225°, 270°and 315° 0 % UT; 1 cycle and 70 % UT; 25/30 cycles Single phase: at 0° 0 % UT; 250/300 cycles	Mains power quality should be that of a typical commercial or hospital environment. If the user of the device requires continued operation during power mains interruptions, it is recommended that the device be powered from an uninterruptible power supply or a battery.
Power frequency (50/60 Hz) magnetic field IEC 61000-4-8	30 A/m	30 A/m	Power frequency magnetic fields should be at levels characteristic of a typical location in a typical commercial or hospital environment.
NOTE: UT is the a.c. mains voltage prior to application of the test level.			

Table 3

declaration - electromagnetic immunity			
The device is intended for use in the electromagnetic environment specified below. The customer or the user of device should assure that it is used in such an environment.			
Immunity test	IEC 60601 test level	Compliance level	Electromagnetic environment - guidance
Conducted RF IEC 61000-4-6	3 V 0.15 MHz to 80 MHz 6 V in ISM and amateur radio bands between 0.15 MHz and 80 MHz	3 V 0.15 MHz to 80 MHz 6 V in ISM and amateur radio bands between 0.15 MHz and 80 MHz	Portable and mobile RF communications equipment should be used no closer to any part of device, than the recommended separation distance calculated from the equation applicable to the frequency of the transmitter. Recommended separation distance $d = 1.2\sqrt{P}$ 150 KHz to 80 MHz $d = 1.2\sqrt{P}$ 80 MHz to 800 MHz $d = 2.3\sqrt{P}$ 80 MHz to 2.7 GHz where P is the maximum output power rating of the transmitter in watts (W) according to the transmitter manufacturer and d is the recommended separation distance in meters (m). Field strengths from fixed RF transmitters, as determined by an electromagnetic site survey, ^a should be less than the compliance level in each frequency range. Interference may occur in the vicinity of equipment marked with the following symbol: 
Radiated RF IEC 61000-4-3	10V/m 80 MHz to 2.7 GHz	10V/m	
NOTE 1 At 80 MHz and 800 MHz, the higher frequency range applies.			
NOTE 2 These guidelines may not apply in all situations. Electromagnetic propagation is affected by absorption and reflection from structures, objects and people.			
a Field strengths from fixed RF transmitters, such as base stations for radio (cellular/cordless) telephones and land mobile radios, amateur radio, AM and FM radio broadcast and TV broadcast cannot be predicted theoretically with accuracy. To assess the electromagnetic environment due to fixed RF transmitters, an electromagnetic site survey should be considered. If the measured field strength in the location in which device is used exceeds the applicable RF compliance level above, device should be observed to verify normal operation. If abnormal performance is observed, additional measures may be necessary, such as re-orienting or relocating device.			
b Over the frequency range 0.15 MHz to 80 MHz, field strengths should be less than 3 V/m.			

Table 4

Recommended separation distances between portable and mobile RF communications equipment and device			
The device is intended for use in an electromagnetic environment in which radiated RF disturbances are controlled. The customer or the user of device can help prevent electromagnetic interference by maintaining a minimum distance between portable and mobile RF communications equipment (transmitters) and device, as recommended below, according to the maximum output power of the communications equipment.			
Rated maximum output power of transmitter W	Separation distance according to frequency of transmitter m		
	0.15 MHz to 80 MHz $d = 1.2\sqrt{P}$	80 MHz to 800 MHz $d = 1.2\sqrt{P}$	80 MHz to 2.7 GHz $d = 2.3\sqrt{P}$
0.01	0.12	0.12	0.23
0.1	0.38	0.38	0.73
1	1.2	1.2	2.3
10	3.8	3.8	7.3
100	12	12	23
For transmitters rated at a maximum output power not listed above, the recommended separation distance d in meters (m) can be estimated using the equation applicable to the frequency of the transmitter, where P is the maximum output power rating of the transmitter in watts (W) according to the transmitter manufacturer			
NOTE 1 At 80 MHz and 800 MHz, the higher frequency range applies.			
NOTE 2 These guidelines may not apply in all situations. Electromagnetic propagation is affected by absorption and reflection from structures, objects and people.			

FCC COMPLIANCE INFORMATION

changes or modifications not expressly approved by the party responsible for compliance could void the user's authority to operate the equipment.

This equipment has been tested and found to comply with the limits for a Class B digital device, pursuant to Part 15 of the FCC Rules. These limits are designed to provide reasonable protection against harmful interference in a residential installation. This equipment generates, uses and can radiate radio frequency energy and, if not installed and used in accordance with the instructions, may cause harmful interference to radio communications. However, there is no guarantee that interference will not occur in a particular installation.

If this equipment does cause harmful interference to radio or television reception, which can be determined by turning the equipment off and on, the user is encouraged to try to correct the interference by one or more of the following measures:

- Reorient or relocate the receiving antenna.
- Increase the separation between the equipment and receiver.
- Connect the equipment into an outlet on a circuit different from that to which the receiver is connected.
- Consult the dealer or an experienced radio/TV technician for help.

This device complies with Part 15 of the FCC Rules. Operation is subject to the following two conditions:

- (1) this device may not cause harmful interference, and
- (2) this device must accept any interference received, including interference that may cause undesired operation.

FCC Radiation Exposure Statement:

This equipment complies with FCC radiation exposure limits set forth for an uncontrolled environment. This transmitter must not be colocated or operating in conjunction with any other antenna or transmitter.



Name: Shenzhen Dongdixin Technology Co., LTD.

Add: No.3 Building XiliBaimang Xusheng Industrial
Estate 518108,Nanshan Shenzhen, China.

Tel: 0086-755-27652316

E-mail: service@e-caretalk.com

www.e-caretalk.com