



DA304  
DA602  
DA604  
DA904  
DA4001  
DA6001  
DA8001

# PERFORMANCE SERIES

---

INSTALLATION / OWNER'S MANUAL

**Mobile Power Amplifiers**



# INSTALLATION

---

## Preparation

Please read entire manual before installation. Due to the technical nature of amplifiers, it is highly recommended that your Dual amplifier is installed by a professional installer or an authorized dealer.

### Before You Start

- Disconnect negative battery terminal. (consult a qualified technician for instructions)
- Avoid installing the amplifier where it would be subject to high temperatures, such as from direct sunlight, or where it would be subject to dust, dirt or excessive vibration.
- Use extreme caution when drilling holes to avoid damaging fuel lines or existing vehicle wiring.
- All amplifier installations require power, signal and speaker wires (not included).
- An amplifier installation kit (sold separately) is highly recommended to facilitate the installation. Consult your dealer for recommendations.

### Mounting Location

- Choose a mounting location for the amplifier. Suggested locations include under a seat or in the trunk.
- The amplifier can be mounted horizontal (recommended) or vertical. For optimum performance, make sure to provide at least 1" of space around all sides. Do not mount the amplifier under carpets or where airflow is restricted.
- Do not install the amplifier where it may be exposed to moisture.
- The optimum mounting location varies between vehicles. Remember to test all amplifier functions before completing the final mounting procedure.



TYPICAL MOUNTING METHOD

# INSTALLATION

---

## Connection Descriptions

### NOTE:

Be sure to follow specific instructions included with your amplifier installation kit (not included with this amplifier). The information below should be used as a general guideline only.

### Power Wire (+12V)

- Disconnect negative battery terminal before proceeding. Consult a qualified technician for instructions if you are unsure.
- Plan wire routing before cutting any wires to length. Begin by routing the power +12V wire from the battery to the amplifier location. Use a grommet when running wires through the firewall or metal openings. Avoid running the power wire near existing vehicle wiring to prevent induced noise from entering the audio system.
- Use extreme caution when drilling holes to avoid damaging fuel lines or existing vehicle wiring.
- The +12V wire **MUST** be fused within 18" of the battery for protection of the vehicle's electrical system.

### Ground Wire (GND)

- The amplifier ground wire should be as short as possible (no more than 36" or 1 meter). Choose a clean unpainted section of metal or the vehicle chassis when attaching the ground connection. Be sure to clean the area of any dirt or grease.

### Remote Turn-on Wire (REM)

- The remote turn-on wire connects to the head unit's amplifier turn-on lead or power antenna output.

### Speaker Wires

- Choose adequate gauge speaker wire depending on your exact amplifier/speaker combination. Be sure to observe polarity when connecting.
- Do not ground any speaker wires or connect any speaker wires together.

### Input Signal

- The amplifier's input signal connects to the head unit's low level (RCA) or high level (speaker wire) outputs.
- Low level input signals deliver the best performance. If unavailable, use the high level inputs - when interfacing with factory head unit for instance.

### CAUTION

- Do not use both low and high level inputs at the same time. Connect only one or the other.
- Keep low level inputs away from any power wires to avoid engine noise.
- Never run any wires underneath or outside the vehicle.

# INSTALLATION

## Audio Inputs and Controls

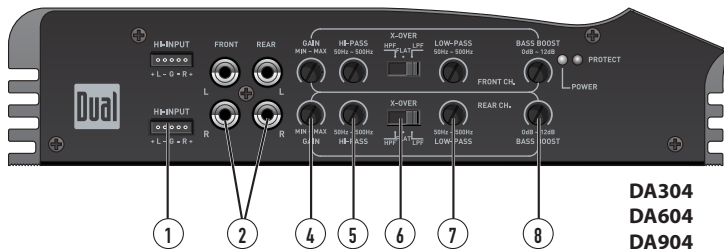
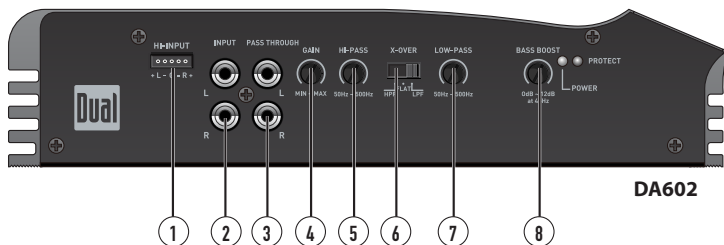

- |   |                   |   |                 |
|---|-------------------|---|-----------------|
| 1 | High Level Inputs | 5 | Hi-Pass Filter  |
| 2 | RCA Line Inputs   | 6 | Crossover Mode  |
| 3 | Pass Through      | 7 | Low-Pass Filter |
| 4 | Gain              | 8 | Bass Boost      |

# INSTALLATION

## Power and Speaker Connections

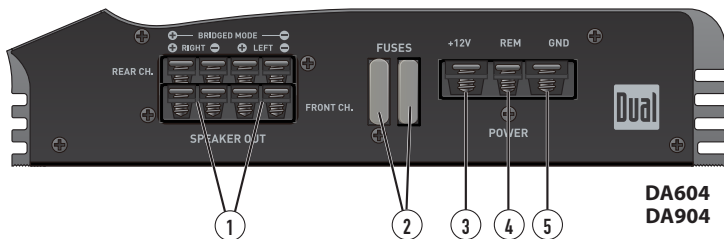
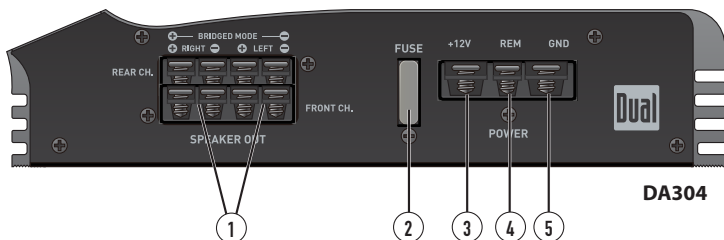
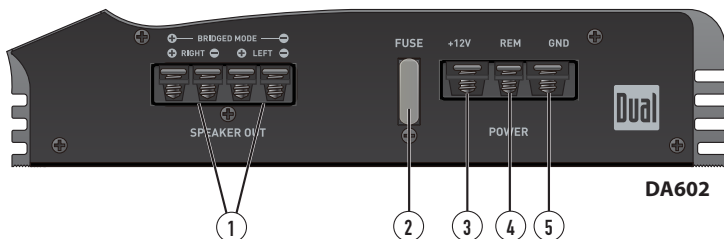

- 1 Speaker Connections
- 2 Fuse(s)
- 3 +12VDC Battery Connection

- 4 Remote Turn On
- 5 Ground Connection

# INSTALLATION

## Audio Inputs and Controls

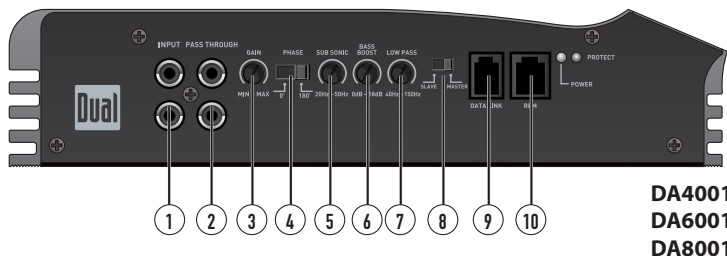

- |   |                 |   |                       |
|---|-----------------|---|-----------------------|
| ① | RCA Line Inputs | ⑥ | Bass Boost            |
| ② | Pass Through    | ⑦ | Low Pass Filter       |
| ③ | Gain            | ⑧ | Slave/Master Controls |
| ④ | Phase Control   | ⑨ | Data Link             |
| ⑤ | Subsonic Filter | ⑩ | Remote                |

# INSTALLATION

## Power and Speaker Connections

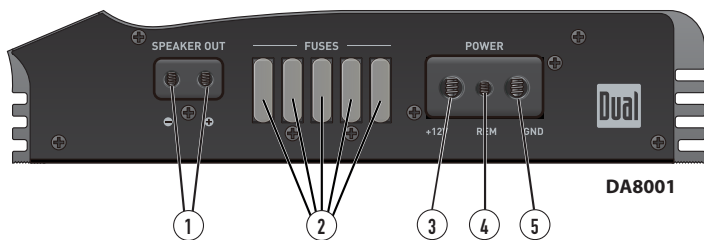
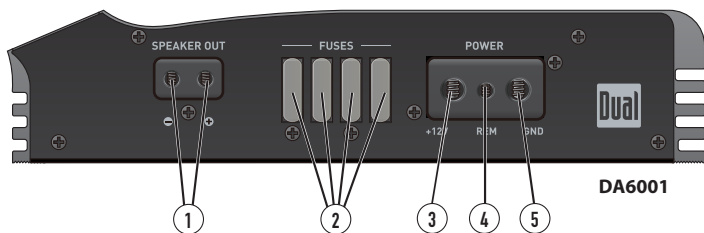
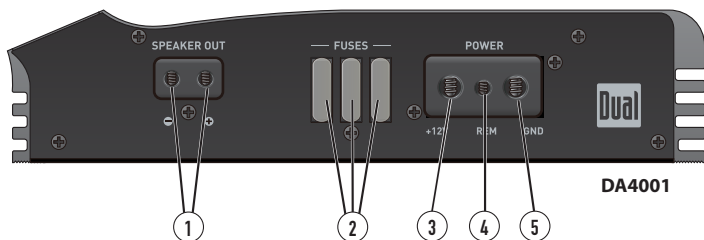

- 1 Speaker Connections
- 2 Fuse(s)
- 3 +12VDC Battery Connection

- 4 Remote Turn On
- 5 Ground Connection

# INSTALLATION

## Typical Wire Routing

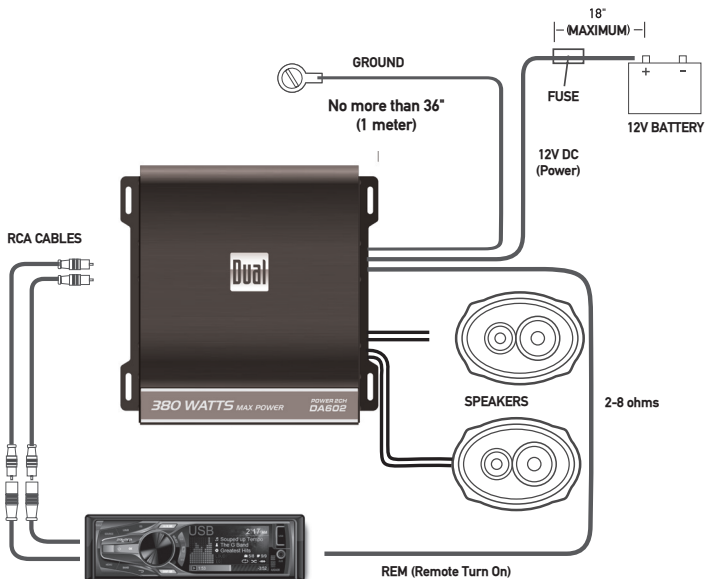

### Main Power Connections

Connect +12V, GND and REM wires accordingly. A suitable fuse **MUST** be installed on the +12V lead within 18" of the battery for protection of the vehicle's electrical system.

#### Fuse Rating

When replacing fuses, make sure new fuse is the correct type and amperage. Using an incorrect fuse could damage the amplifier.

DA602 20A x 1  
DA304 30A x 1  
DA604 20A x 2  
DA904 30A x 2  
DA4001 30A x 3  
DA6001 30A x 4  
DA8001 30A x 5

#### Power/Ground Wire Size

For optimum performance, use only the wire size listed below or larger. Make sure to use the same size power and ground wire.

DA304 4 Ga.  
DA602 4 Ga.  
DA604 4 Ga.  
DA904 4 Ga.  
DA4001 2 Ga.  
DA6001 2 Ga.  
DA8001 2 Ga.



# INSTALLATION

## Amplifier Connections

### Speaker Connections

Connect speaker wires observing polarity. The minimum impedance load for the DA304, DA602, DA604 and DA904 is 2 ohms stereo and 4 ohms bridged. Use of loads lower than these is not recommended and may cause amplifier damage. The DA304, DA602, DA604 and DA904 can be wired for stereo, bridged or stereo/bridged simultaneous operation.

### 2 Speakers (stereo)

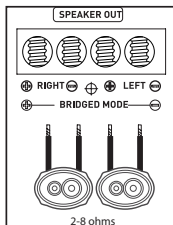

Typical Stereo Wiring  
(2 ohms minimum)

### Subwoofer (mono)

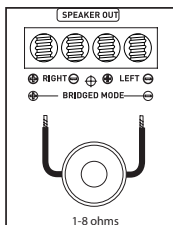

Typical Bridged Wiring  
(4 ohms minimum)

DA602 speaker connections shown

### Input Signal Connections

#### Low Level Input (RCA)

Low level (RCA) input signal is preferred for best performance. Typical trunk-mount amplifier installations require a 17-20 foot RCA cable. Most trucks and under-seat applications require a 6-9 foot RCA cable. Using twisted pair construction RCA cables will minimize noise.

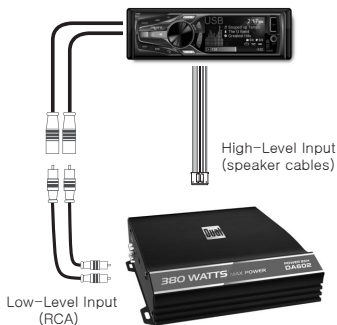

#### High Level Input (Speaker Wire)

High level inputs should only be used when RCA outputs are not available from the head unit. Connect the head unit speaker outputs to the high level input connector as shown below. The black wire (signal reference ground) may or may not require a connection to chassis ground - depending on your particular installation.

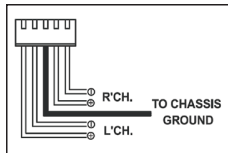

**Note:** Do not use both low and high level inputs at the same time - connect only one or the other. High level inputs not available on DA4001, DA6001 and DA8001.

# INSTALLATION

## Master/Slave Mode

The Dual mono amplifiers feature a Master/Slave mode, where two amplifiers can be connected together. When two mono amplifiers are connected together, the power from both amplifiers is combined.

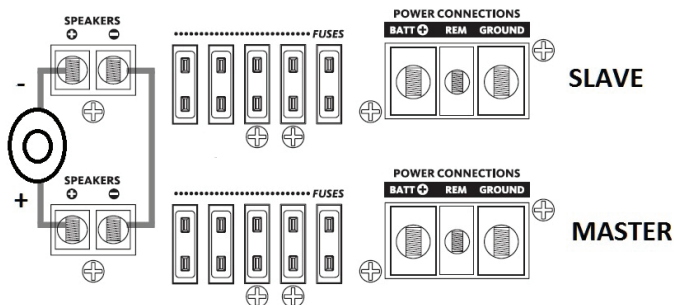
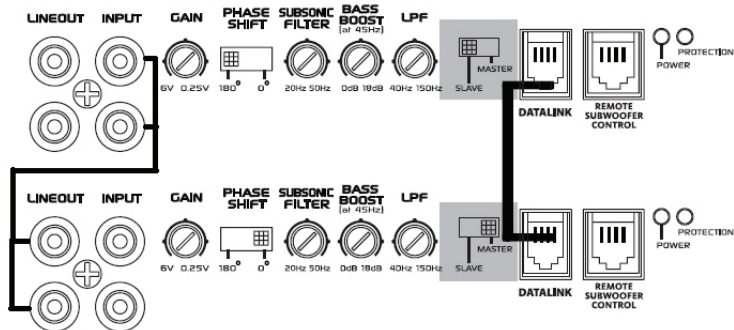

## INSTALLATION

---

### Master/Slave Mode (cont.)

**\*MASTER**

For master amplifier, set the switch to master. This will route the signal through Line-out to the slave amplifier. Set the phase to 0, all adjustments for gain and sound are done on this amplifier. The remote subwoofer control should be connected to master amplifier as well.

**\*SLAVE**

For slave amplifier, set the switch to slave and phase to 180. Connect the Line-out of master amplifier to input on this amplifier. All adjustments should be set to minimum.

Connect Data-Link plug from master to slave amplifier. For speaker connection, the positive (+) of the speaker connects to positive (+) of master and negative (-) of the speaker connects to positive (+) of slave amplifier. Connect both negatives (-) of master and slave each other.

**NOTE: FOR BEST PERFORMANCE, USE WIRE 12 AWG OR THICKER FOR THE NEGATIVE TO NEGATIVE CONNECTION.**

**\*MINIMUM IMPEDANCE MUST NOT BE LOWER THAN 2 OHMS**

# INSTALLATION

---

## Configuration/Setup

|   |   |
|---|---|
| <b>Input level Control</b>                          | The input level control (gain) is used to obtain the best possible match between the head unit audio output and the amplifier input. Begin by turning the input level control fully counterclockwise. Next, turn up the head unit volume control around 3/4 of the way up. Adjust the input level control clockwise until audible distortion is heard, then slightly counterclockwise to provide the best match. Repeat for all input level controls.   |
| <b>Crossover Mode</b>                               | The crossover is used to filter out frequencies above or below a certain point. Choose <b>LPF</b> when using the amplifier with subwoofers, <b>HPF</b> when using with midrange/tweeter combinations and <b>FLAT</b> when using with coaxial-type speakers.<br><br><b>Note:</b> Choose <b>FLAT</b> when using the amplifier in stereo/bridged simultaneous mode. In this mode, passive crossovers are required. Failure to use the correct passive components may damage the amplifier and/or speakers. Consult a qualified professional for recommendations. |
| <b>Crossover Frequency Control</b>                  | This control allows precise adjustment of the crossover frequency.  |
| <b>Bass Boost</b>                                   | This control provides additional boost @ 45Hz when used with subwoofers. Adjust this control with caution - as improper use can damage speakers!  |
| <b>Subsonic Filter</b><br>(DA4001, DA6001 & DA8001) | Setting this control to the desired frequency will limit harmful frequencies below the setting from going to the subwoofer(s), preventing possible damage from frequencies that subwoofers are not designed to handle.  |
| <b>LED Indicators</b>                               | The green LED indicator illuminates during normal operation ( <b>POWER</b> ) and the red LED indicator is visible when the amplifier detects a fault ( <b>PROTECT</b> ).  |

# INSTALLATION

## Troubleshooting

| Problem   | Cause   | Action  |
|---|---|---|
| Unit will not turn on<br>(no power LED indicator) | +12V wire not connected or incorrect voltage. REM wire not connected or incorrect voltage | Check connections for proper voltage (11~16VDC)                                   |
|   | GND wire not connected  | Check connection to ground  |
|   | Fuse(s) blown   | Replace fuse(s)   |
| Unit has power - LED is green (but no sound)      | Speaker wires not connected   | Check connections at speakers   |
|   | Volume turned all the way down  | Increase volume level at head unit  |
|   | One or more speaker wires touching each other or touching chassis ground                  | Insulate all bare speaker wires from each other and chassis ground                |
|   | Speaker(s) defective or damaged   | Check/replace speaker(s)  |
|   | Input signal not connected  | Check high or low level inputs for proper connection                              |
| Unit blows fuse(s)                                | Incorrect fuse rating   | Use fuse(s) with correct rating   |
|   | +12V wire touching chassis ground   | Check for pinched wire  |
|   | Speaker(s) defective or damaged   | Check/replace speaker(s)  |
| Engine noise                                      | Bad ground connection   | Make sure amplifier is grounded to clean bare metal                               |
|   | Signal ground loop or RFI (radio frequency interference)                                  | Re-route RCA cables from existing high current wiring                             |
| LED illuminates red (protect mode)                | One or more speaker wires touching each other or touching chassis ground                  | Insulate all bare speaker wires from each other and chassis ground                |
|   | Speaker(s) defective or damaged internally (shorted)                                      | Check/replace speaker(s)  |
|   | Speaker load less than 2 ohms (stereo). Speaker load less than 4 ohms (bridged)           | Adjust speaker load - amplifier will not operate at less than 4 ohms when bridged |
| Distorted audio output                            | Incorrect input signal type or input level too high                                       | Check connections and reduce/adjust input level                                   |
| Low audio output                                  | Incorrect input signal type or input level too low  | Check connections and increase/adjust input level                                 |
| Weak bass   | Speaker(s) are wired out of phase   | Check (+) and (-) speaker connections<br>(Observe correct polarity)               |

# INSTALLATION

---

## Specifications

### DA602

**Power Output (14.4VDC, 20Hz ~ 20kHz):**

- **60 Watts RMS x 2 channels @ 4ohms**
- **100 Watts RMS x 2 channels @ 2ohms**
- **215 Watts RMS x 1 channel @ 4ohms (bridged)**

**Peak Music Power Output: 380 Watts**

**Signal to noise ratio: 90dB (THD < 0.05% @ 4Ω, 14.4V)**

**Frequency response: 10Hz– 35kHz (-3dB)**

**Amplifier dimensions: 2" x 9.3" x 7.9" (51 x 236 x 201 mm)**

---

### DA304

**Power Output (14.4VDC, 20Hz ~ 20kHz):**

- **40 Watts RMS x 4 channels @ 4ohms**
- **65 Watts RMS x 4 channels @ 2ohms**
- **160 Watts RMS x 2 channels @ 4ohms (bridged)**

**Peak Music Power Output: 500 Watts**

**Signal to noise ratio: > 90dB (THD < 0.05% @ 4Ω, 14.4V)**

**Frequency response: 10Hz– 35kHz (-3dB)**

**Amplifier dimensions: 2" x 9.3" x 13.8" (51 x 236 x 351 mm)**

---

### DA604

**Power Output (14.4VDC, 20Hz ~ 20kHz):**

- **60 Watts RMS x 4 channels @ 4ohms**
- **100 Watts RMS x 4 channels @ 2ohms**
- **215 Watts RMS x 2 channels @ 4ohms (bridged)**

**Peak Music Power Output: 650 Watts**

**Signal to noise ratio: > 90dB (THD < 0.05% @ 4Ω, 14.4V)**

**Frequency response: 10Hz– 35kHz (-3dB)**

**Amplifier dimensions: 2" x 9.3" x 15.7" (51 x 236 x 399 mm)**

---

### DA904

**Power Output (14.4VDC, 20Hz ~ 20kHz):**

- **90 Watts RMS x 4 channels @ 4ohms**
- **140 Watts RMS x 4 channels @ 2ohms**
- **360 Watts RMS x 2 channels @ 4ohms (bridged)**

**Peak Music Power Output: 110 Watts**

**Signal to noise ratio: > 90dB (THD < 0.05% @ 4Ω, 14.4V)**

**Frequency response: 10Hz– 35kHz (-3dB)**

**Amplifier dimensions: 2" x 9.3" x 11.4" (51 x 236 x 290 mm)**

---

# INSTALLATION

---

## Specifications

### DA4001

**Power Output (14.4VDC, 20Hz ~ 250Hz):**

- **850 Watts RMS x 1 channel @ 2ohms**
- **1200 Watts RMS x 1 channel @ 1ohm**

**Peak Music Power Output: 3200 Watts**

**Signal to noise ratio: > 80dB (THD < 0.5% @ 4Ω, 14.4V)**

**Frequency response: 20Hz -150Hz (-3dB)**

**Amplifier dimensions: 2" x 9.3" x 11.8" (51 x 236 x 300 mm)**

---

### DA6001

**Power Output (14.4VDC, 20Hz ~ 250Hz):**

- **1200 Watts RMS x 1 channel @ 2ohms**
- **1800 Watts RMS x 1 channel @ 1ohm**

**Peak Music Power Output: 4200 Watts**

**Signal to noise ratio: > 80dB (THD < 0.5% @ 4Ω, 14.4V)**

**Frequency response: 20Hz -150Hz (-3dB)**

**Amplifier dimensions: 2" x 9.3" x 14.5" (51 x 236 x 368 mm)**

---

### DA8001

**Power Output (14.4VDC, 20Hz ~ 250Hz):**

- **1500 Watts RMS x 1 channel @ 2ohms**
- **2500 Watts RMS x 1 channel @ 1ohm**

**Peak Music Power Output: 5200 Watts**

**Signal to noise ratio: > 80dB (THD < 0.5% @ 4Ω, 14.4V)**

**Frequency response: 20Hz -150Hz (-3dB)**

**Amplifier dimensions: 2" x 9.3" x 17.3" (51 x 236 x 439 mm)**

---

# One Year Limited Warranty

This warranty gives you specific legal rights. You may also have other rights which vary from state to state.

Dual Electronics Corp. warrants this product to the original purchaser to be free from defects in material and workmanship for a period of one year from the date of the original purchase.

Dual Electronics Corp. agrees, at our option, during the warranty period, to repair any defect in material or workmanship or to furnish an equal new, renewed or comparable product (whichever is deemed necessary) in exchange without charges, subject to verification of the defect or malfunction and proof of the date of purchase. Subsequent replacement products are warranted for the balance of the original warranty period.

**Who is covered?** This warranty is extended to the original retail purchaser for products purchased from an authorized Dual dealer and used in the U.S.A.

**What is covered?** This warranty covers all defects in material and workmanship in this product. The following are not covered: software, installation/removal costs, damage resulting from accident, misuse, abuse, neglect, product modification, improper installation, incorrect line voltage, unauthorized repair or failure to follow instructions supplied with the product, or damage occurring during return shipment of the product. Specific license conditions and copyright notices for the software can be found via [www.dualav.com](http://www.dualav.com).

## What to do?

1. Before you call for service, check the troubleshooting guide in your owner's manual. A slight adjustment of any custom controls may save you a service call.
2. If you require service during the warranty period, you must carefully pack the product (preferably in the original package) and ship it by prepaid transportation with a copy of the original receipt from the retailer to an authorized service center.
3. Please describe your problem in writing and include your name, a return UPS shipping address (P.O. Box not acceptable), and a daytime phone number with your shipment.
4. For more information and for the location of the nearest authorized service center please contact us by one of the following methods:

- Call us toll-free at 1-866-382-5476
- E-mail us at [cs@dualav.com](mailto:cs@dualav.com)

**Exclusion of Certain Damages:** This warranty is exclusive and in lieu of any and all other warranties, expressed or implied, including without limitation the implied warranties of merchantability and fitness for a particular purpose and any obligation, liability, right, claim or remedy in contract or tort, whether or not arising from the company's negligence, actual or imputed. No person or representative is authorized to assume for the company any other liability in connection with the sale of this product. In no event shall the company be liable for indirect, incidental or consequential damages.



Dual Electronics Corp.  
Toll Free: 1-866-382-5476  
9AM-5PM, EST

[www.dualav.com](http://www.dualav.com)  
©2014 Dual Electronics Corp.  
NSA1113-V01