

Quick Start

Make sure you have all the items shown in Figure 1. (Labels included in the package may vary.)

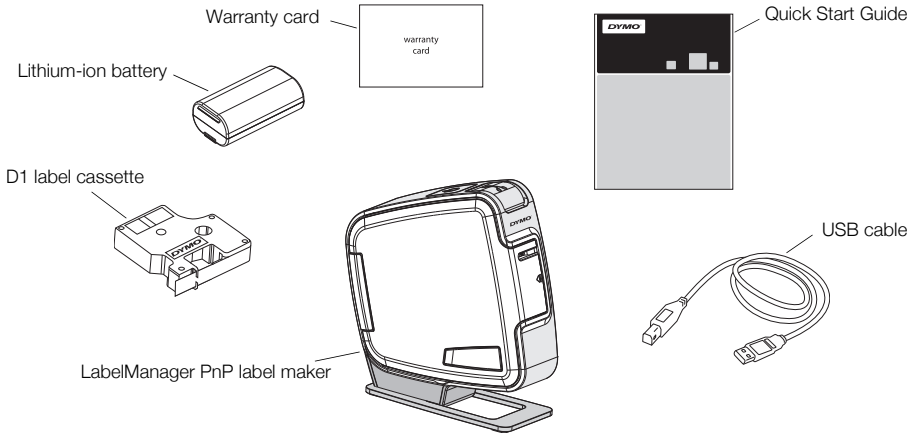

Figure 1

Become familiar with the features shown in Figure 2.

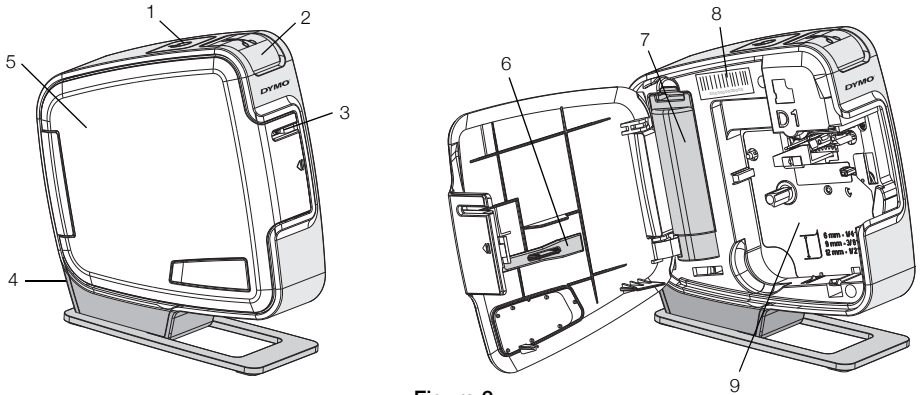

Figure 2

- | | | |
|-----------------------------|-----------------|-----------------------|
| 1 Power button/Status light | 4 USB port | 7 Battery compartment |
| 2 Cutter button | 5 Side cover | 8 Serial Number label |
| 3 Label exit slot | 6 Cleaning tool | 9 Label compartment |

Inserting the Battery

The label maker is powered using a rechargeable lithium-ion battery.

To insert the battery

- 1 Open the side cover of the label maker.
- 2 Remove the battery compartment cover. See Figure 3.
- 3 Insert the battery into the battery compartment as shown.
- 4 Replace the battery compartment cover.
- 5 Close the side cover of the label maker.

NOTE Remove the battery if the label maker will not be used for a long period of time.

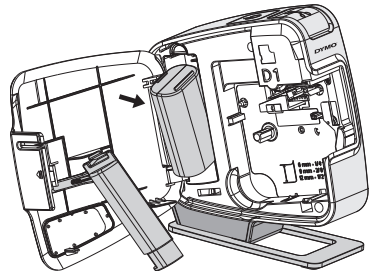

Figure 3

Inserting the Label Cassette

Your label maker uses DYMO D1 label cassettes.

To insert the label cassette

- 1 Open the side cover of the label maker.
- 2 Make sure the tape and ribbon are taut across the mouth of the cassette and that the tape passes between the label guides.

If necessary, turn the ribbon rewind spool clockwise to tighten the ribbon.

- 3 Insert the cassette and press firmly until the cassette clicks into place. See Figure 5.
- 4 Close the side cover of the label maker.

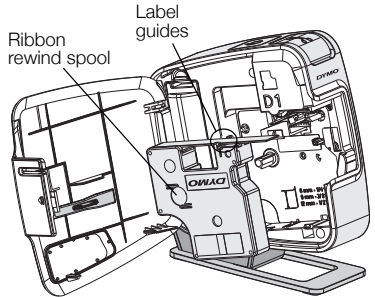

Figure 4

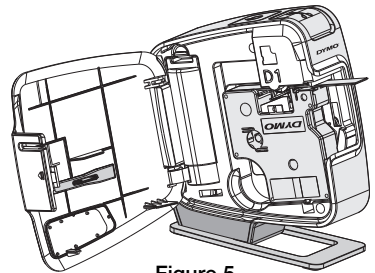

Figure 5

Connecting the Label Maker to your Computer

The label maker connects to your computer using the USB connection located on the back of the label maker. You do not need to install additional software or drivers to use the label maker with your computer.

To connect the label maker to your computer

- 1 Plug the USB cable into the USB port on the back of the label maker. See Figure 6.
- 2 Plug the other end of the USB cable into an available USB port on your computer.

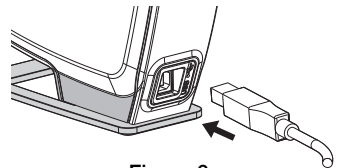



Figure 6

NOTE The label maker must be connected to a powered USB port. The label maker may not charge or function properly when connected to a non-powered USB port, such as those on some Mac keyboards, or a non-powered USB hub.

Starting the Built-In Software

The built-in software resides on the label maker; no installation is required.

To start the software for Windows®

- 1 If necessary, press the power button to turn on the label maker.
Depending on Windows AutoRun settings, the software may start automatically.
- 2 If the software does not start automatically, do one of the following:
 - If the AutoRun or AutoPlay dialog box appears, follow the on-screen instructions to start the  DYMO Label Light software.
 - If the AutoRun dialog box does not appear, navigate to **My Computer**→**DYMO PnP**, and then click  **DYMO Label Light.exe**.

To start the software for Mac OS®

- 1 If necessary, press the power button to turn on the label maker.
The DYMO PnP volume appears on your desktop.
- 2 Double-click **DYMO PnP** to open the volume.
- 3 Double-click  to start the software.

Disconnecting the Label Maker from Your Computer

To disconnect the label maker from your computer

- 1 (Mac Only) Drag the **DYMO PnP** volume to the trash.
- 2 Press the power button to turn off the label maker.
- 3 Unplug the USB cable from your computer.

Printing Labels with the Built-In Software

The following figure shows some of the features available in the software.

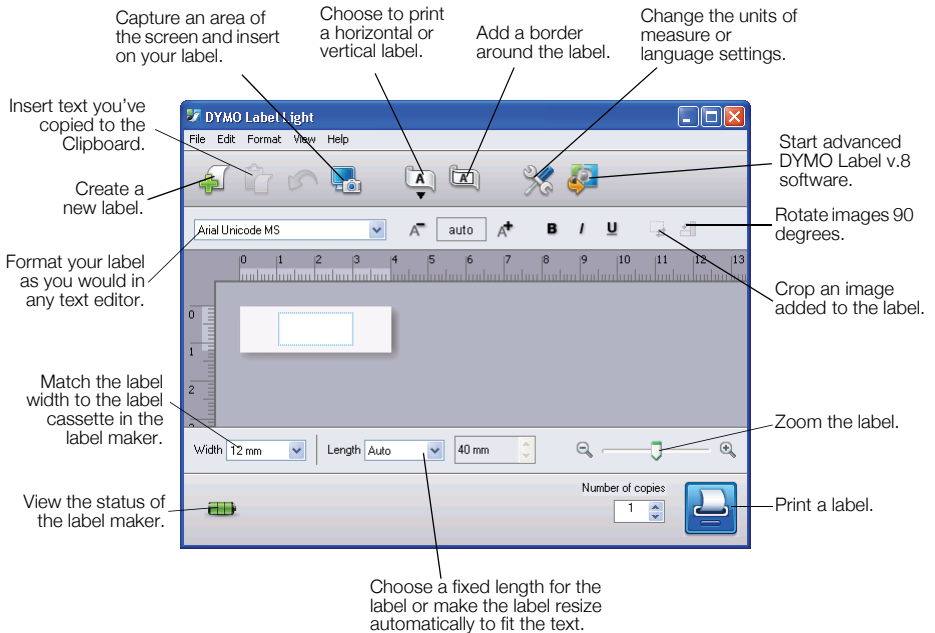

To print your first label

- 1 Click once on the label in the Edit area and type some text.
- 2 Click  to print the label.
- 3 Press the cutter button on the label maker to cut the label.

To capture and insert an image from your desktop

- 1 Click  on the toolbar.
- 2 Drag the cursor to draw a selection box around the area to capture.

The selected area is inserted into your label.

To take advantage of more advanced formatting features, click  in the built-in software to download and install DYMO Label™ v.8 software from the DYMO Web site.





Maintaining Your Label Maker

Recharging the Battery

The label maker is shipped with the lithium-ion battery partially charged. The battery is recharged through the USB connection to your computer.

NOTE The label maker must be connected to a powered USB port. The label maker may not charge or function properly when connected to a non-powered USB port, such as those on some Mac keyboards, or a non-powered USB hub.

The label maker status is displayed in the lower-left corner of the software window. The following table describes the possible states of the label maker.

	Label maker is connected and battery is charging
	Label maker is connected and battery is not charging
	Label maker is not connected
	Label maker is connected and there is a problem with the battery

To charge the battery

- 1 Make sure the USB cable is connected to both the label maker and the computer.
- 2 If necessary, press the power button to turn on the label maker and begin charging the battery.

Cleaning the Label Maker

Your label maker is designed to give you long and trouble-free service, while requiring very little maintenance. Clean your label maker from time to time to keep it working properly. Clean the cutter blade each time you replace the label cassette.

To clean the tape print head

- 1 Open the side cover of the label maker.
- 2 Remove the label cassette.
- 3 Use a small, soft brush or cotton swab to wipe away paper dust and other stray particles from the inside of the label compartment.
- 4 Remove the cleaning tool from the inside of the cover. See Figure 7.
- 5 Gently wipe the print head with the tool.
The print head is very delicate, so use care when cleaning.
- 6 Replace the cleaning tool, insert the label cassette, and close the side cover.

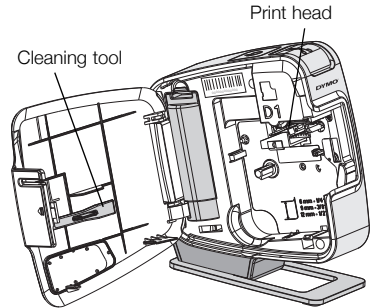

Figure 7

To clean the cutter blade

- 1 Open the side cover of the label maker.
- 2 Remove the label cassette.
- 3 Press the cutter button. See Figure 8.
The cutter blade will move into view.
- 4 Use a cotton swab and alcohol to clean both sides of the cutter blade.
CAUTION The cutter blade is extremely sharp. Use caution when cleaning.
- 5 After cleaning the blade, release the cutter button to return the blade to its home position.

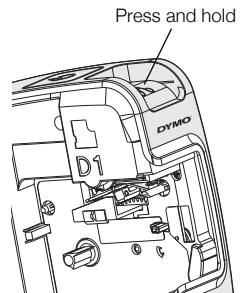

Figure 8

Troubleshooting

Review the following possible solutions if you encounter a problem while using your label maker.

Problem/Error Message	Solution
Poor Print Quality	Ensure label cassette is installed properly. Clean the print head. See <i>Cleaning the Label Maker</i> . Replace the label cassette.
Poor Cutter Performance	Clean the cutter blade. See <i>Cleaning the Label Maker</i> .
Printer is disconnected or turned off	The label maker is disconnected or turned off. Make sure the USB cable is connected and the printer is turned on.
Printer error	Make sure the label cassette is inserted properly and is not jammed or empty.
Battery level is too low to print	Battery charge level is too low to print. Charge the battery and reprint the label.
Battery is not functioning properly	Verify the battery is inserted properly. Otherwise, contact Customer Support.
Battery is not charging	Make sure the label maker is connected to a powered USB port.
Battery level is getting low or too low	Connect the label maker to a powered USB port to begin charging.

If you still need assistance, visit the support section of the DYMO Web site at www.dymo.com.